

Programming Guide

EZ-MAX PLUS™ RELAY PRODUCTS

Covering EZ-Maz Plus Relay Panels
Software Revision 1.0 and above.

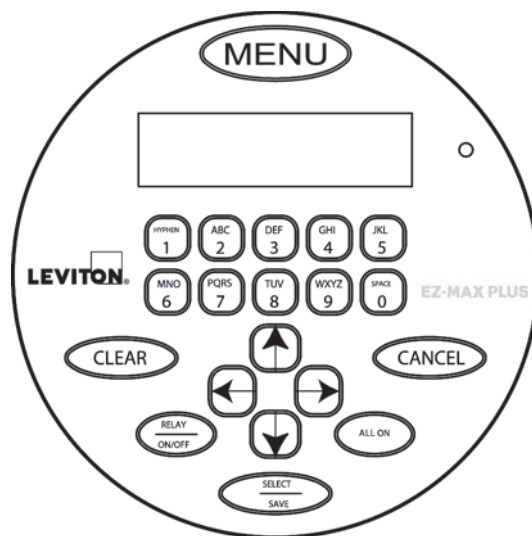

Table of Contents

Overview

Introduction	1
Product Specifications and Capabilities	1
EZ-Max Plus—Stand Alone Panels	1
Product Specifications and Capabilities Chart	2

EZ-MAX Plus User Interface

Front Panel Display	3
Programming/Function Buttons	4
Menu Structure	4
Deciphering the LCD Display Elements	4
Navigation Buttons	6
Auto-Repeat	6
LED's	6
System Status LED's	6
Relay Status LED's	8
Internal Relay Cabinet Controls	8
Master Override	9
Individual Relay Overrides	10
Temporarily Overriding a Relay	11
Locking out a Relay using its Override Button	11
Unlocking a Relay Using its Override Button:	12

Setting the Time, Date, and Astronomical Time Clock

Menu Overview	13
Setting the Time	13
Setting the Date	15
Setting the Astronomical Time Clock	15
Setting the Astro Clock by City	16
Setting the Astro Clock by Longitude and Latitude	16

Configuring System Settings

Menu Overview	19
Relays	19
Supported Relay Types	20
Basic Relay Configuration	20
Relay Response to a Blink Warn Message	20
Relay Response to an Emergency Signal	20
Set All Relays	21
Configuring Individual Relays	22

Global Timers.....	23
Blink Warn Parameters	23
Example Blink Warn Scenario	23
Momentary Timed interval	23
Configuring Global Timers Settings	24
Security.....	25
Disabling the Passcode	25
Changing your Passcode	25
Factory Default Settings.....	26
Saving and Restoring Configuration	26

The Scheduler

Basic Concepts.....	27
Days of the Week.....	27
Event Times.....	28
Holiday Mode.....	28
Common North American Holidays.....	28
Creating a New Event	29
Changing an Event Time.....	31
Deleting an Event.....	31
Editing an Event.....	32

Configuring Low Voltage Inputs

Low Voltage Inputs	35
Low Voltage Switches	35
Low Voltage Switch Inputs.....	35
Configuring a Low Voltage Switch.....	36
Occupancy Sensors	37
Configuring Occupancy Sensors.....	37
Photocells.....	39
Daylight Harvesting	39
Configuring Photocells	40

Digital Switches

Configuring A Digital Switch	43
Manual and Auto-Assign	43
Determining the State of a Digital Switch	44
Unconfiguring a Digital Switch Button	45
Table of Binary Addresses.....	46

Updating Firmware

Installing Updates	49
Terminal Settings	49
Configuring the Terminal Program	50
Upgrading your EZ-Max Plus Cabinet Firmware.....	51
Viewing All Tera Term Commands	56
Verifying your Upgrade	56

Appendix A: Longitude/Latitude and City Code Reference

Quick-Codes for 101 Major Cities	A-1
Longitude and Latitude of Major Cities	A-2

Appendix B: Menus

Set Time/Date, Astro Clock	B-1
Scheduler	B-2
System Settings	B-3
Configuring Inputs.....	B-4

Introduction

The EZ-MAX Plus product line offers a scalable time-clock solution of relay and relay controls that can fit any application.

This manual is designed to assist you in the programming of your relay cabinet. It assumes you have already installed the relay cabinet. See the EZ-MAX Plus Installation Guide for detailed installation instructions.

The following resources are also available to you:

- Quick Start Programming Guide (included with every panel).
- Programming Guide (included with every panel).
- Additional resources located at our website at <http://www.leviton.com/lms>. The Quick Picks drop down menu near the bottom of the page contains links to documentation and software updates.

A hard copy of the Programmer's Guide is included with your system purchase. Please contact Leviton Technical Support at (800)959-6004 to request additional copies.

NOTE

Leviton recommends that you check our website regularly for important product updates.

<http://www.leviton.com/lms>

Product Specifications and Capabilities

The specifications and capabilities for each product are shown in the "EZ-MAX Plus Product Capabilities Chart" on page 2.

EZ-Max Plus—Stand Alone Panels

EZ-Max Plus relay panels offer the most commonly used feature set of the Z-MAX Plus product line family, including networking functionality and modular relays. Relay panel sizes range from 8 to 24 relays per panel.

Product Specifications and Capabilities Chart

The table below gives a general overview of the specifications of all EZ-Max Plus relay products. The table uses the following abbreviations:

Y = Yes

N = No

O = Optional

* = A single asterisk in any column indicates that there is support for this feature, however, there are conditions that you should be aware of. Consult the specific sections of the manual dealing with this feature for additional information and requirements.

EZ-Max Plus Product Type	Min-Max Relays	Relay Types	Weight (lbs (Kg))	Size W", H", D" (Wcm,Hcm,Dcm)	Flush Mount Option	# Discreet Inputs	Sw. Input Board Avai	Luma-Net Network	DMX Network	Master/Slave Net	Emergency Input	Emergency Output	Touch-Tone Phone	Data Modem	Ethernet Network	Front Panel Program	Event Scheduler
Master Panel, 8 relays*	0-8	**	16 (7.26)	13" x 13" x 4-9/32" (33 x 33 x 10.9)	Y	8	N	Y	N	N	Y	Y	O*	O*	N	Y	Y
Master Panel, 16 relays*	0-24	**	44 (19.96)	20-1/4"x34"x4-9/32" (54.4 x 86.4 x 10.9)	Y	12	Y	Y	N	N	Y	Y	O*	O*	N	Y	Y
Master Panel, 24 relays*	0-24	**	44 (19.96)	20-1/4"x34"x4-9/32" (54.4 x 86.4 x 10.9)	Y	12	Y	Y	N	N	Y	Y	O*	O*	N	Y	Y
Note: Voltage:120v/277v/347 @20A, 240v @20/30A																	
** Relay Types: 30A Latching, 2-Pole, 1-Pole (optional)																	

Figure 1: EZ-MAX Plus Product Capabilities Chart

EZ-MAX Plus User Interface

Your relay panel has many unique operational features which can be accessed directly from the front panel, including relay control, relay overrides, and basic status information. You will also find several "status" indicators (LED's) inside the relay panel as well as on the outside of the panel. These LED's indicate how your panel is operating and whether or not it is operating properly.

Front Panel Display

This section covers the basic functions of the front panel display. The following sections cover specifics on how to use the front panel to program and configure your relay cabinet.

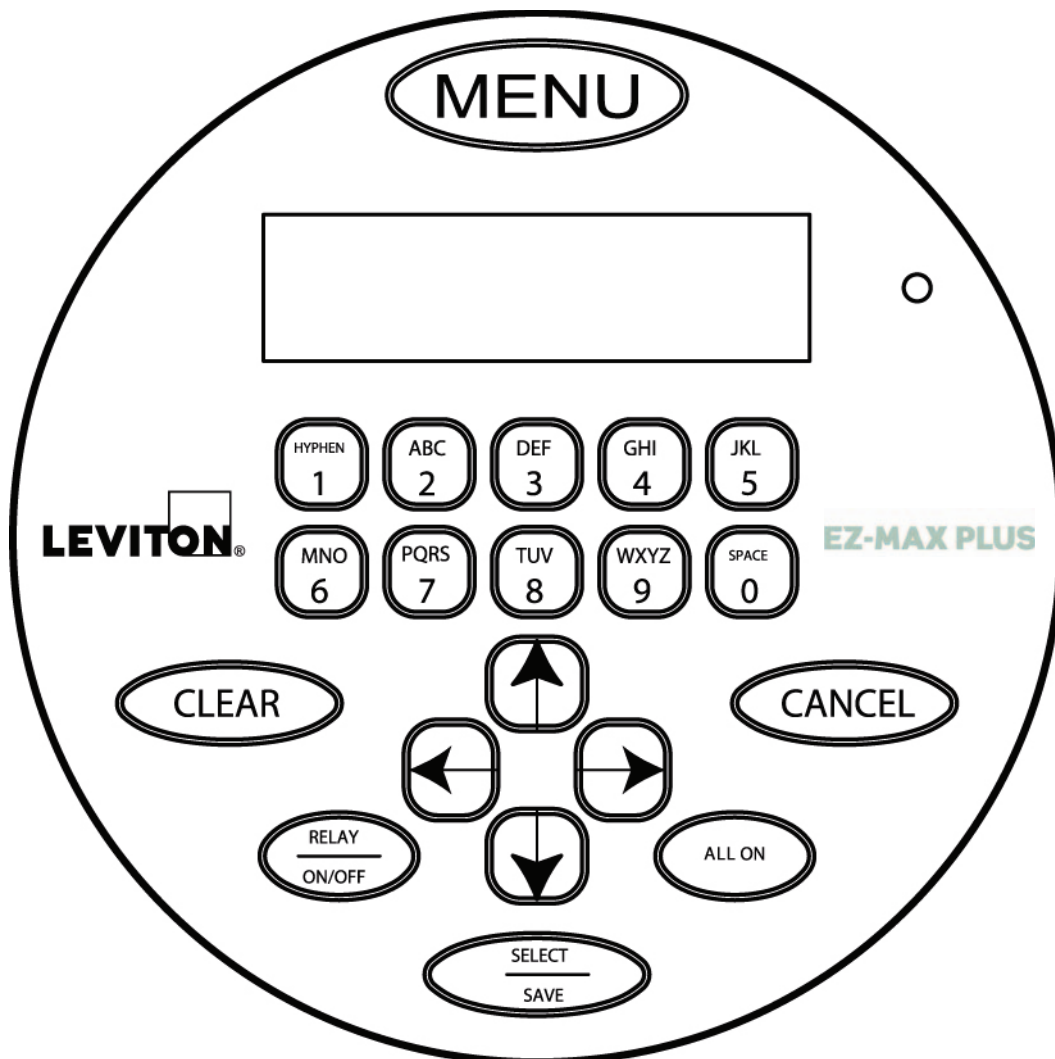

Figure 2: EZ-MAX Plus LCD Display

Programming/Function Buttons

The main buttons you will use to program the functionality of your cabinet are listed below.

- **MENU**—displays the main menu.
- **SELECT/SAVE**—moves you through the menu tree, and saves any changes.
- **CANCEL**—returns to the previous menu.
- **CLEAR**—clears the text or value that was just entered.
- **RELAY ON/OFF**—button that allows a user to turn a relay ON or OFF, or execute a permanent relay override.
- **ALL ON/ALL OFF**—forces all relays to ON or OFF state. When in the ON state inputs are temporarily disabled.

NOTE

If you exit from any menu via the MENU or CANCEL button, and have not pressed Select/Save, **all changes will be lost.**

NOTE

Many parameters can be modified using the LCD screen and a password (setup code), however these modifications should be made by a qualified factory technician.

Menu Structure

The top level menu structure for the programming functions is outlined below. Each of the menu items shown below is covered in detail in separate sections of the documentation. See Appendix B for a complete view of all top level menu items and their submenus.

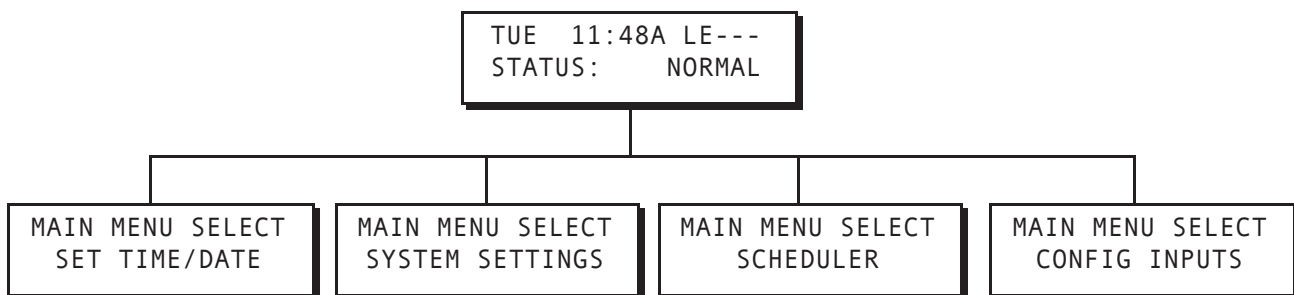

Deciphering the LCD Display Elements

The LCD display shows information on the current state of your relay panel, and provides an easy and intuitive means of programming the panel.

When the system is operating normally the top line of the LCD display shows the current day, time and the status of the event scheduler. The second line shows the status of your relay cabinet.

The example below shows the following:



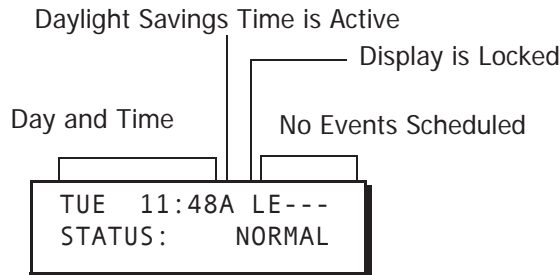

- Daylight Savings Time is active.
- The display is locked.
- The Event Scheduler is active ("E"), but there are no events scheduled (the dashes after the "E"). If there was an event currently running the display would also show the event number (i.e.: LE003).



The table below explains what each of the elements in the display means. Notice that uppercase and lowercase alpha characters have different meanings.

Display	Description
Day and Time—12 or 24-Hour Mode	
"a" or "p"	Lower case "a" or "p" indicates that daylight savings is inactive.
"A" or "P"	Uppercase "A" or "P" indicates that daylight savings is active.
Daylight Savings for 24-Hour Clock	
"s"	Lower case "s" indicates that daylight savings is inactive.
"d"	Lower case "d" indicates that daylight savings is active.
Panel Lock Status	
"L"	"L" indicates that the panel is in a locked state.
"u"	"u" indicates that the panel is in a temporary un-locked state and will automatically lock after three minutes of inactivity.
"U"	"U" indicates that the panel is in an un-locked state and will not automatically enabled the lock.
Event Scheduler	
"E OFF"	Event Scheduler is off.
"E---"	Event Scheduler is active but no events have executed since the last system reset/power cycle.
"E1"	Any number displayed indicates the number of the last event executed.

Navigation Buttons

Use the arrow buttons to navigate the menu structure. Press the **LEFT**  and **RIGHT**  buttons to navigate between “fields” on the screen. Press the **UP**  and **DOWN**  buttons to change values in the fields.

You can use either the arrow keys or the keypad to change or enter data in many cases.

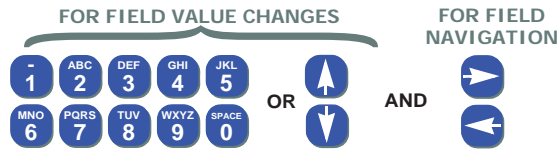

Figure 3: Arrow Key & Alpha-Numeric Key Functions

NOTE

After approximately three minutes of inactivity on any menu screen, the LCD will revert back to the status screen.

Auto-Repeat

In some screens where you are adjusting values, you may find it helpful to press and hold an arrow key. After a brief moment, the key will repeatedly issue its command giving you a quick way to scroll through a broad range of values.

LED's

Your EZ-MAX Plus relay cabinet has a variety of feedback mechanisms that are designed to alert you as to how your panel is operating and the current status of each relay.

The LED's inside the panel can be broken up into two categories, “System Status” and “Relay Status” LED's.

System Status LED's

System Status LED's are designed to tell you at a quick glance the operational characteristics of your system. For example, whether or not your system is receiving data on one of the communication lines! This will assist you and our technical support team should any diagnostics be necessary.

Generally, the following conventions apply:

- Green – All Systems Go! No alerts detected.
- Flashing Green – All Systems Go! Receiving or transmitting data.
- Solid Red – Alert Condition. Specific alert depends on LED.
- Slow Flashing Red – Systems operating Normally, usually a heartbeat.
- Quick Flashing Red – Alert Condition or Override Condition, specific alert depends on LED.

The specific functions and states of each System Status LED are listed in the table below.

LED Label	LED State	Indication
EMERGENCY	Solid Red	Indicates system is in emergency state
	Off	System is in Normal State
HEARTBEAT-C	Slow Blinking Amber (~1 bps)	Control Module Microprocessor is operating properly
	Fast Blinking Amber (~2 bps)	Control module microprocessor is in boot mode
	Off	Control Module Microprocessor off line - usually indicates system failure
Digital Station (Luma-Net protocol)	Solid Green	Configured (Negotiating a connection)
	Off	Disabled
	Fast Flash	Negotiating connections/initialization
	Slow Flash	Connected, TX/RX data
MODEM	Solid Green	Indicates modem is installed, enabled, and link is established
5V POWER	Solid Amber	+5V power supply working normally
HEARTBEAT-R	Slow Blinking Amber	Relay Communications Microprocessor operating properly
	Fast Blinking Amber	Relay Communications Microprocessor detects a hardware alert
	Off	Relay Communications Microprocessor Off Line

Figure 4: System Status LED Functions and States

Relay Status LED's

Adjacent to each relay button you will find an LED that indicates the current status of that particular relay card.

The possible states for the Relay Status LED's are as follows:

LED Label	LED State	Indication
RELAY X	Solid Green	Relay On
	Off	Relay Off
	Blinking Green	Relay Override On, could be either local relay override, or if all relay LED's are blinking slowly more likely the master override is On
All RELAYS	All Relay LED's Short Off Long On	Master Override/Bypass On
	All Relay LED's, Long Off, Short On	Master Override/Bypass Off

Figure 5: Relay Status LED's

Internal Relay Cabinet Controls

In addition to front panel controls, your EZ-MAX Plus cabinets have two different types of internal override switches for the relays:

- Master Override Switch
- Relay Override Button

NOTE The inside of a relay cabinet, when energized, can be DANGEROUS as HIGH VOLTAGES are present. Fatal accidents are possible. Only trained authorized personnel should have and gain access to the internal workings of your relay panel, access is not required for any normal configuration or operational purpose.

Master Override

See the figure below for the location of the master override. The master override has three modes of operation:

- **Normal**—allows the Control Module and inputs to control the state of the relays.
- **All ON**—forces all of the relays to the ON state and the Control Module and inputs can not turn the relays Off.
- **All OFF**—forces all of the relays to the OFF state and the Control Module and inputs can not turn the relays On.

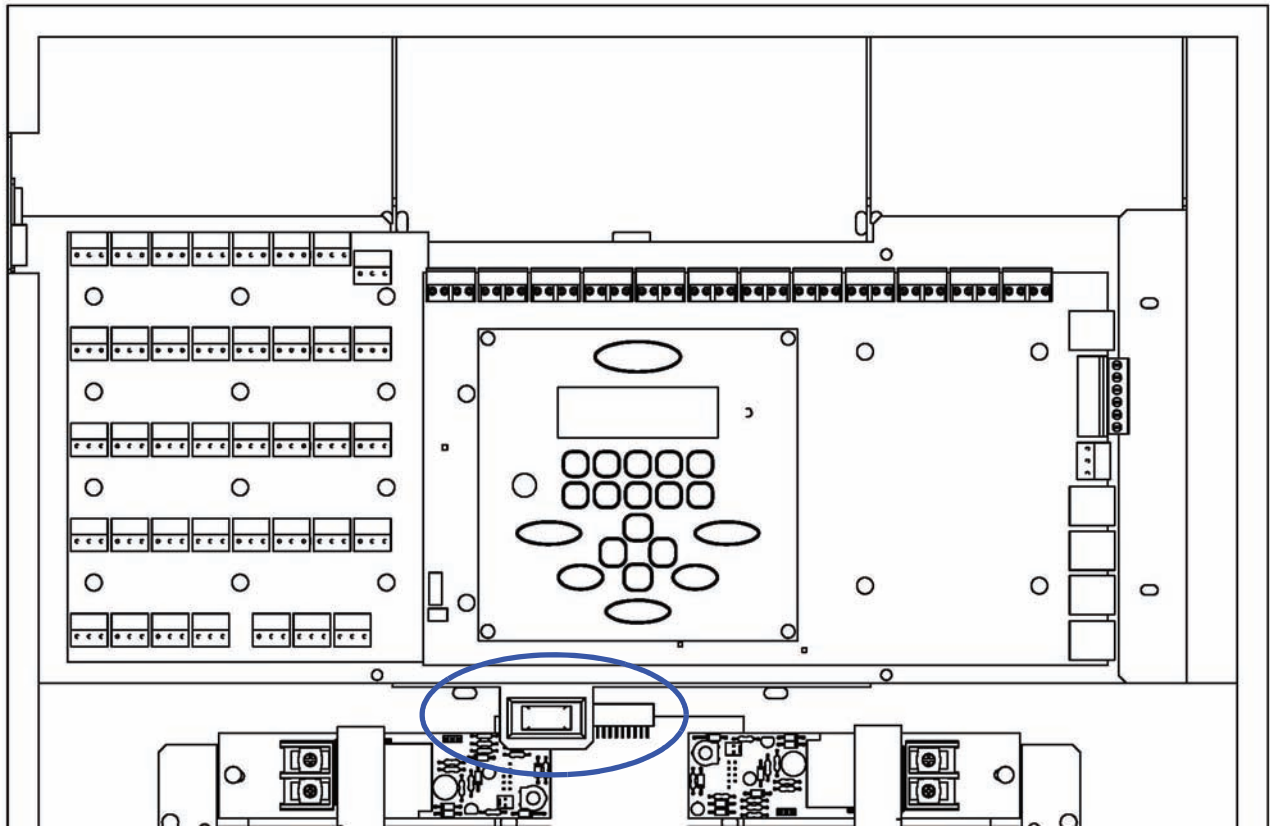

Figure 6: Location of Master Override Switch

Individual Relay Overrides

Each relay has an individual override button. See the Figures below for the location of these buttons in each cabinet.

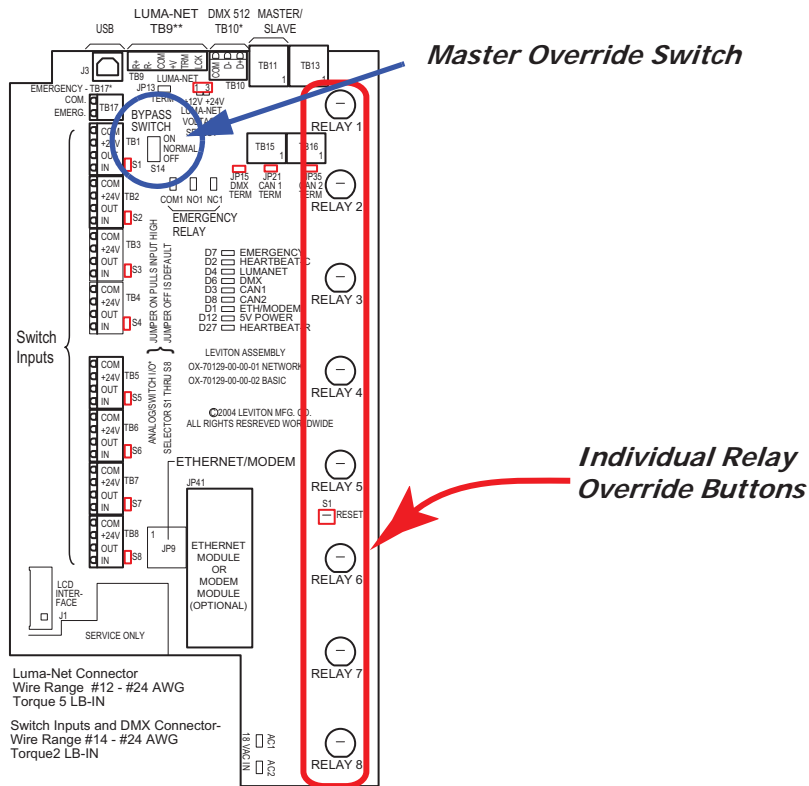

Figure 7: Location of Individual Relay Override Buttons in the 8 Cabinet

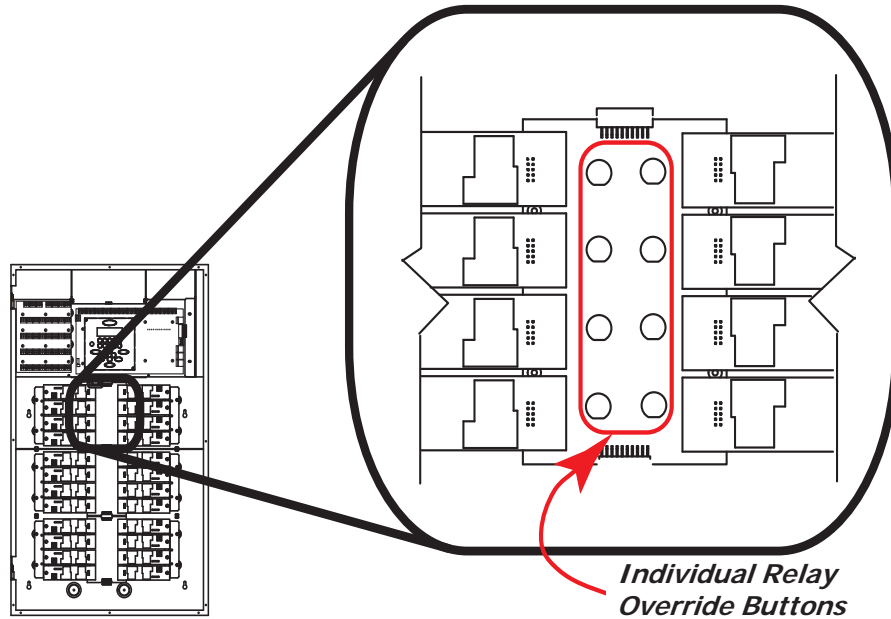

Figure 8: Location of Individual Relay Override Buttons in 16 and 24 cabinets

These buttons have one primary use with two modes of operation:

- Local override of individual relay without having to go through the Control Module.
 - Temporary - Any control input with a higher priority can change its state.
 - Locked Out - Event scheduler and control inputs, regardless of Priority will not be able to alter its state.

Temporarily Overriding a Relay

Step 1: Open the cabinet door using the supplied key

Step 2: Press the button next to the relay you wish to change

The relay will audibly click when it changes states (ON to OFF and vice versa)

NOTE

There is a green LED above each relay override button. If the LED is on, the relay is ON. If the LED is OFF, the relay is OFF.

Step 3: Press the button again to turn the relay on and off.

NOTE

Pressing the individual relay override button will always clear higher priority overrides for the relay. This allows manual control of the relay even when Emergency or Master Override is active.

Locking out a Relay using its Override Button

Step 1: Open the cabinet door using the supplied key

Step 2: Get the relay to the state that you want to Lock it in. For example, if you wish to lock the relay in the On state and it is Off, press the button one time to toggle the relay to the On state.

Step 3: Press and hold the button for approximately 5 seconds until the LED beneath the button begins to blink.
The relay will audibly click when it changes states (ON to OFF and vice versa)

NOTE There is a green LED above each relay override button. If the LED is mostly on when it blinks, the relay is locked ON. If the LED is mostly OFF when it blinks, the relay is locked OFF.

Unlocking a Relay Using its Override Button:

Step 1: Open the cabinet door using the supplied key

Step 2: Press and release the button of the relay that is locked out
The relay will change its state from On to Off or vice versa

Setting the Time, Date, and Astronomical Time Clock

Menu Overview

The top-level menu structure for date and time settings is below:

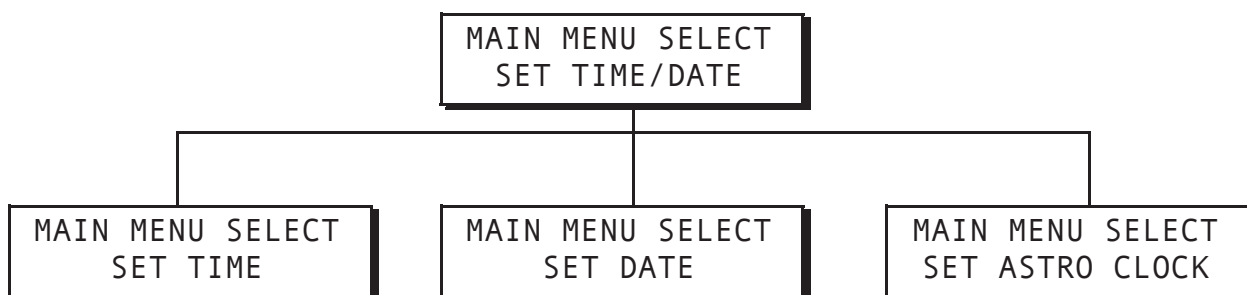

In addition to the three menu choices above, there is also a choice to VIEW ASTRO CLOCK. This display screen cannot be edited.

Setting the Time

You can change the following fields in the Time display:



- 12 or 24-hour clock
- Hours
- Minutes
- AM or PM
- Daylight Savings Time Mode:
 - **OFF**: Daylight savings time is disabled.
 - **US**: Daylight savings time is set to “United States” daylight savings mode, with one-hour adjustments in the fall and spring.
 - **EU**: Daylight savings time is set to “European” daylight savings mode with 1 hour adjustments in the fall and spring, yet different dates than the US.
 - **US7**: Daylight savings time is set to “United State” daylight savings mode which became active in 2007 per the new Energy Conservation act.

NOTE

If Daylight Savings Time is active, the field will display in upper case characters.

If Daylight Savings Time is inactive, the field will display in lower case characters.

Step 1: Press the **MENU** button.

Step 2: Press   until the display reads as shown below, then press **SELECT/SAVE**.





```
MAIN MENU SELECT
SET TIME/DATE
```

Step 3: Press **SELECT/SAVE**.

```
MAIN MENU SELECT
SET TIME
```

The display will show the current setting for the time.

```
SET TIME    12 HOUR
4:46PM     D: OFF
```

Step 4: Use   to navigate through the fields. Use   to change the settings for each field. For example, use  to change the clock from a 12-hour clock to a 24-hour clock:

```
SET TIME    24 HOUR
16:46S     D: US
```

Step 5: Press **SELECT/SAVE** when you have finished editing the fields.

NOTE

The AM/PM field is only active for editing when 12-hour mode is active.

If 24-hour mode is active, the AM/PM field is replaced with an "s" or a "d" and is not editable. Instead, the value is determined by the Daylight Savings Time setting. The "s" indicates standard time (Daylight Savings Time inactive); the "d" indicates that Daylight Savings Time is active.

Setting the Date

Step 1: Press the **MENU** button.

Step 2: Press  until the display reads as below, then press **SELECT/SAVE**.



```
MAIN MENU SELECT
SET TIME/DATE
```

Step 3: Press  until the display reads SET DATE, then press **SELECT/SAVE**

```
MAIN MENU SELECT
SET DATE
```

The display will show the current setting for the date, and the active field will blink.

```
SET DATE      MON
12/22/2008
```

Step 4: Use   to navigate through the fields. Use the numeric keypad to change the settings for each field.

Step 5: Press **SELECT/SAVE** when you have finished editing the fields.

Setting the Astronomical Time Clock

The EZ-MAX Plus Scheduler allows you to turn lights on or off in relation to sunrise and sunset. For example, yard lights can be set to turn on an hour before sunset, and turn off an hour after sunrise, according to the time of year.

The astronomical time clock (Astro Time) calculates the time of sunrise and sunset for every week of the year depending on the location of the installation. To use Astro Time you must know the approximate latitude (in degrees) (See Appendix A for various cities in North America) of the controller's location, as well as the present time of sunrise and sunset (often found in the daily newspaper).

There are two ways to set the astronomical clock:

- **By City**—the latitudes and longitudes of 101 major cities are pre-programmed into the EZ-MAX Plus relay cabinet.
- **By Longitude and Latitude**—you can manually enter the longitude and latitude of your location if your city is not pre-programmed in. See "Appendix A: Longitude/Latitude and City Code Reference" for longitude and latitude values of major US cities, or visit www.srrb.noaa.gov/highlights/sunrise/sunrise.html for a complete listing of Latitude, Longitude, Sunrise and Sunset information.

Setting the Astro Clock by City

Follow the steps below to set the Astro Clock by using a quick city code. See “Quick-Codes for 101 Major Cities” on page A-1 to see if your city or a city near you is listed.

Step 1: Press the **MENU** button.

Step 2: Press  until the display reads as below, then press **SELECT/SAVE**.

```
MAIN MENU SELECT
SET TIME/DATE
```

Step 3: Press  until the display reads as below, then press **SELECT/SAVE**.

```
MAIN MENU SELECT
SET ASTRO CLOCK
```

Step 4: The display should now read as below. Press **SELECT/SAVE**.

```
SET ASTRO CLOCK
CITY
```

Step 5: Use the numeric keypad to enter the number that is listed next to your city name (i.e. 55 for Las Vegas, NV), and then press **SELECT/SAVE**.

```
LAS VEGAS
NV
```

See “Quick-Codes for 101 Major Cities” on page A-1 for a complete list of pre-programmed city codes.

Setting the Astro Clock by Longitude and Latitude

The example below walks you through how to set the astronomical clock if your city is not listed in Appendix A. Make sure you have the following information for your city before you begin: current sunrise time, current sunset time, latitude. This information can be found at www.srrb.noaa.gov/highlights/sunrise/sunrise.html.

Step 1: Press the **MENU** button.

Step 2: Press  until the display reads as shown below

```
MAIN MENU SELECT
SET TIME/DATE
```

Step 3: Press  until the display reads as shown below, then press **SELECT/SAVE**.

```
MAIN MENU SELECT
SET ASTRO CLOCK
```

The display should now read:

```
SET ASTRO CLOCK  
CITY
```

Step 4: Press  until the display reads SUN/LAT, then press **SELECT/SAVE**.

```
SET ASTRO CLOCK  
SUN/LAT
```

Step 5: You will now be prompted to set the Sunrise (SR), Sunset (SS) and Latitude (LAT) for your location. The active field will flash. Use the  key to navigate between fields. Use the numeric keypad to enter in the values.

```
SR=07:01A  
SS=08:25P LAT=45
```

See "Appendix A: Longitude/Latitude and City Code Reference" for a listing of longitude and latitude values for many major cities in North America.

NOTE

Latitude should be rounded to the nearest multiple of "5" to your location. This is normal.

Sunrise and sunset times can be found in your local newspaper, by calling our technical services department, or at <http://www.sunrisesunset.com>.

Step 6: Press the **SELECT/SAVE** button when you have finished editing the fields.

Configuring System Settings

Menu Overview

The System Settings menus give you access to many configuration parameters and options that “globally” affect your relay panel.

The top-level menu structure for SYSTEM SETTINGS is below:

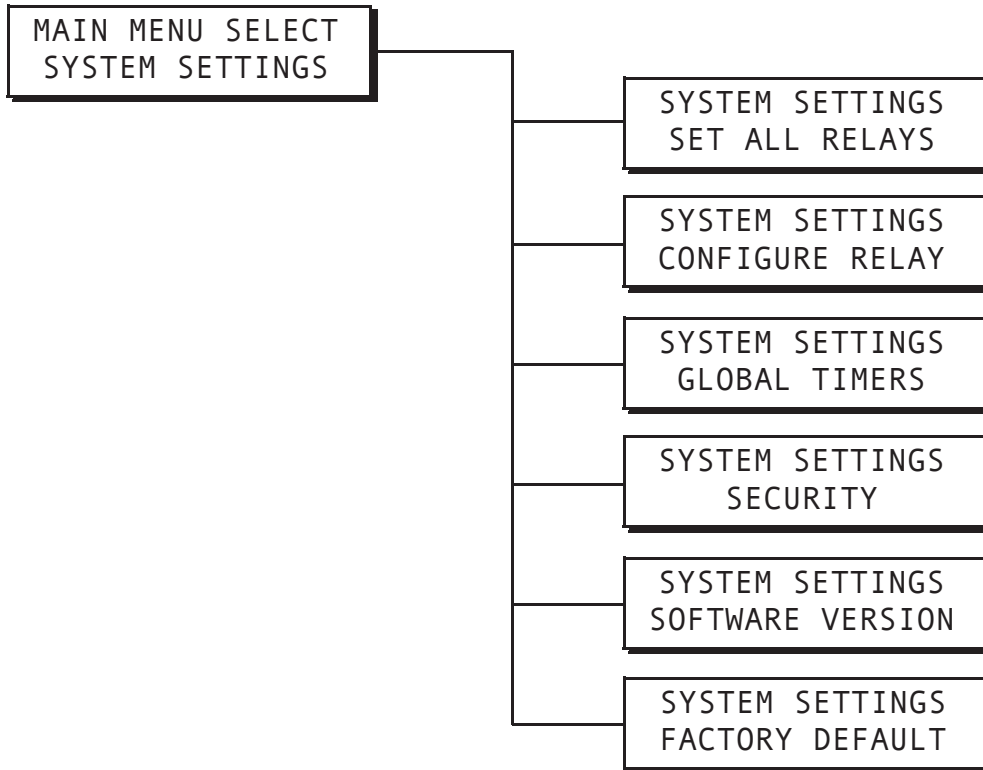

Relays

There are two menu options under the SYSTEM SETTINGS menu for configuring your relays:

- **SET ALL RELAYS**—allows you to globally configure all relays.
- **CONFIGURE RELAY**—allows you to configure individual relays.

Each of these options will be explained in detail on the following pages. See “Individual Relay Overrides” on page 10 for more information on manually overriding relays.

Supported Relay Types

The table below shows the types of relays that are supported in the EZ-MAX Plus relay cabinet.

Relay Type	Description
Normally Open	A Normally Open electrically held relay requires electricity to keep it closed. In the event of a power failure this relay will open.
Normally Closed	A Normally Closed electrically held relay requires electricity to keep it open. In the event of a power failure this relay will close.
Latched	<p>Leviton's latching relay module which is mechanically held in the last position indicated by the relay cabinet.</p> <p>Additional Drivers Available:</p> <p>Sentry Switch—for use only with Leviton relay module Latching ST2. This unique relay type can be used in conjunction with sentry switches. When an Off command is issued, the relay will shut off for a brief time period and then turn back on. This signals the downstream Sentry Switch to turn off the lights, however, the circuit remains energized.</p> <p>AS100—for use only with Leviton relay module Latching ST2 and is designed to be used with WattStopper AS-100 style switches which require a short pulse to signal the lights turning off yet the relay must remain on.</p>

Basic Relay Configuration

There are three settings you can configure for your relays in the SYSTEM SETTINGS menu. You can configure these settings globally or for each individual relay. The settings are:

- Relay Type—Normally Open, Normally Closed, Latched
- Blink Warn—Y, N
- Emergency—ON, OFF, NC

Relay Response to a Blink Warn Message

Sometimes it is necessary to override the relay so it will not respond to a blink warn command. This is especially true of HID fixtures. This feature can be used to turn the blink warn on or off for a particular relay. When blink warn is turned off for a relay, the relay will not blink before turning off.

Relay Response to an Emergency Signal

Each relay can be programmed to respond differently to the Emergency Input Signal (assuming the cabinet is connected in this fashion - Refer to the Installation manual for wiring configurations). The valid values for this setting are:



- **ON**—This relay will turn on when the emergency input is connected to common.
- **OFF**—This relay will turn off when the emergency input is connected to common.
- **NC** —This relay will not change state when the emergency input is connected to common.

Set All Relays

Use the SET ALL RELAYS menu item to configure all of your relays at once. Changing settings in this menu will change the relay type for ALL relays in the cabinet, even if you have already specified a different relay type to an individual relay.

Follow the steps below to configure the three global settings for your relays.



Step 1: Press the **MENU** button.

Step 2: If you aren't at the default screen, press  or  until the display reads as shown below, then press **SELECT/SAVE**.

```
MAIN MENU SELECT
SYSTEM SETTINGS
```

Step 3: Press  until the display reads SET ALL RELAYS, then press **SELECT/SAVE**.

```
SYSTEM SETTINGS
SET ALL RELAYS
```



Step 4: Press  or  to toggle through the relay type choices. Set your global relay type and press **SELECT/SAVE**.

```
ALL RELAY TYPE
LATCH (DEFAULT)
```

The system automatically saves the configuration change you just made and displays the next menu item.

Step 5: Press  or  to toggle BLINK WARN to **Y** or **N**. Press **SELECT/SAVE**.

```
ALL RELAYS
BLINK WARN?    Y
```

Step 6: Press  or  to toggle EMERGENCY to **OFF**, **ON** or **NC**. Press **SELECT/SAVE**.

```
ALL RELAYS
EMERGENCY?    OFF
```

Your global relay configuration settings have now been saved.

Configuring Individual Relays

Use CONFIGURE RELAY to override the global relay settings for individual relays.



Step 1: Press the **MENU** button.

Step 2: If you aren't at the default screen, press  or  until the display reads as shown below, then press **SELECT/SAVE**.



```
MAIN MENU SELECT
SYSTEM SETTINGS
```

Step 3: Press  until the display reads CONFIGURE RELAY, then press **SELECT/SAVE**.



```
SYSTEM SETTINGS
CONFIGURE RELAY
```

Step 4: Press  or  to select the relay number you want to configure or use the keypad to enter a relay number, then press **SELECT/SAVE**.

```
SELECT RELAY
RELAY #1
```

Step 5: Press  or  to toggle through the relay type choices. Press **SELECT/SAVE**.

```
RELAY # 1 TYPE
LATCH (DEFAULT)
```

Step 6: Press  or  to toggle through the driver choices. Press **SELECT/SAVE**.

```
RELAY # 1 DRVR
NORMAL (DEFAULT)
```

The system automatically saves the configuration changes you just made and displays the next menu item.

Step 7: Press  or  to toggle BLINK WARN to **Y** or **N**. Press **SELECT/SAVE**.

RELAY # 1
BLINK WARN- Y

Step 8: Press  or  to toggle EMERGENCY to **ON**, **OFF** or **CN**. Press **SELECT/SAVE**.

RELAY # 1
EMERGENCY- OFF

Repeat steps 4-8 until you have configured all relays.

Global Timers

Use the Global Timers menu to set your global Blink Warn Parameters and the Timer setting for your Momentary Timed switches.

Blink Warn Parameters

The blink warn feature is used to issue a warning just before the relay cabinet turns off the lights. The warning is issued in the form of a “blink” of the lights. Hence the term “Blink Warn.” The Blink Warn feature has several configurable parameters to determine the actions of your cabinet.

- **OVRD TIME**—sets the amount of time that the lights will remain on when a user cancels a blink warn for their particular zone. The setting defaults to 120 minutes.
- **TIME OUT**—sets the amount of time between when the blink warn is issued and the lights turn off (go black.) The setting defaults to 5 minutes.
- **FLASH TIME**—sets the length of the flash. The setting defaults to 0.5 seconds.

Example Blink Warn Scenario

- Assume that an over-zealous worker is working in their office late on a Saturday afternoon. The lights in the facility are scheduled to be turned off at 5:00pm.
- At 5:00pm, the event triggers to turn off all of the lights. As such, all relays which are enabled for blink warn, turn off for 1/2 second (*Flash Time value*) and then immediately turn back on.
- Since the worker isn't done yet for the day and noticing both blink warn and the fact that his wall switch is flashing, the blink warn for their office can be delayed for the OvrD Time value, two hours in this instance, by pressing their wall switch.
- Now, at 5:05pm, (*Event time plus Time Out value*) all lights in the facility will be turned off except for the worker's office.
- 120 minutes later (*OvrD Time value*.) at 7:00pm, a blink warn is issued again this time only for David's office. Again, if the worker is still in his office, he has five minutes to delay the blink warn or the lights will turn off.

Momentary Timed interval

When using the “momentary timed” switch input type, a switch input will trigger the lights on for the timer period specified in this setting.

Configuring Global Timers Settings

Follow the steps below to configure your global Blink Warn settings, and the global setting for any switch set to "Momentary Timed."

Step 1: Press the **MENU** button.

Step 2: If you aren't at the default screen, press  or  until the display reads as shown below, then press **SELECT/SAVE**.



```
MAIN MENU SELECT
SYSTEM SETTINGS
```

Step 3: Press  until the display reads GLOBAL TIMERS, then press **SELECT/SAVE**.



```
SYSTEM SETTINGS
GLOBAL TIMERS
```

Step 4: Press  or  to adjust the FLASH TIME. or use the keypad to enter a specific time. Press **SELECT/SAVE**.



```
BLINK WARN
FLASH TIME: 0.3 S
```

Step 5: Press  or  to adjust the TIME OUT setting for Blink Warn, or use the keypad to enter a specific time. Press **SELECT/SAVE**.

```
BLINK WARN
TIME OUT: 5M
```

Step 6: Press  or  to adjust the Override Time (OVRD TIME). or use the keypad to enter a specific time. Press **SELECT/SAVE**.

```
BLINK WARN
OVRD TIME: 120M
```

Step 7: Press  or  to adjust the TIMER setting for Momentary Timed switches, or use the keypad to enter a specific time. Press **SELECT/SAVE**.

```
TIME SWITCH
TIMER: 30M
```

All other programming functions will now use the above global settings when setting a Blink Warn or a Momentary Timed switch.

Security

Your EZ-Max Plus cabinet can be passcode protected to prevent unauthorized access. There are two security modes: Locked and Unlocked. Your cabinet is shipped with a default passcode of "1234," but you can change or disable your passcode by following the steps below.

Disabling the Passcode

It is helpful to actually disable the passcode and leave the user interface unlocked while you program your EZ-MAX Plus settings. You should change the security setting to locked mode when you are done programming the settings.

Step 1: Press the **MENU** button

Step 2: If you aren't at the default screen, press  until the display reads as shown below, then press **SELECT/SAVE**.



MAIN MENU SELECT
SYSTEM SETTINGS

Step 3: Press  until the display reads SECURITY, then press **SELECT/SAVE**.



SYSTEM SETTINGS
SECURITY

Step 4: Press **SELECT/SAVE** to toggle between LOCK and UNLOCK.



SECURITY
LOCK/UNLOCK

When your display reads UNLOCKED you have disabled the passcode.



SECURITY
UNLOCKED

Changing your Passcode

It is a good idea to change the default passcode as soon as possible in order to prevent unauthorized access to your system.

Step 1: Press the **MENU** button

Step 2: If you aren't at the default screen, press  or  until the display reads as shown below, then press **SELECT/SAVE**.



MAIN MENU SELECT
SYSTEM SETTINGS

Step 3: Press  until the display reads SECURITY, then press **SELECT/SAVE**.

```
SYSTEM SETTINGS
SECURITY
```

Step 4: Press  to display the passcode screen.

```
SECURITY
PASSCODE: 1234
```

Step 5: Use the numeric keypad to type in a new 4-digit passcode and press **SELECT/SAVE**.

Factory Default Settings

If it ever becomes necessary to restore the factory defaults and begin the programming from a clean slate, simply follow the steps below.

Step 1: Press the **MENU** button.

Step 2: If you aren't at the default screen, press  or  until the display reads as shown below, then press **SELECT/SAVE**.

```
MAIN MENU SELECT
SYSTEM SETTINGS
```

Step 3: Press  until the display reads FACTORY DEFAULT, then press **SELECT/SAVE**.

```
SYSTEM SETTINGS
FACTORY DEFAULT
```

Step 4: Press  or  to toggle from N to Y and press **SELECT/SAVE**.

```
FACTORY DEFAULT
RESTORE?      N
```

NOTE

Resetting to factory defaults will erase any programming or configuration you've completed. Any parts of this programming you desire to use after the rest will have to be recreated from scratch programming in your system.

Saving and Restoring Configuration

Your configuration data can be saved and restored to/from a connected PC using our Visual Programmer 4.0 software. This program can be downloaded from our website. Leviton recommends that a backup of all cabinet configuration files be made so that in the unfortunate event of product failure, you can quickly restore your configuration.

The Scheduler

Use the SCHEDULER menu to create, edit, or delete an event. An “event” is defined as any action that occurs at a specific time.

The top level of the SCHEDULER menu structure is shown below. See Appendix B for the complete menu structure.

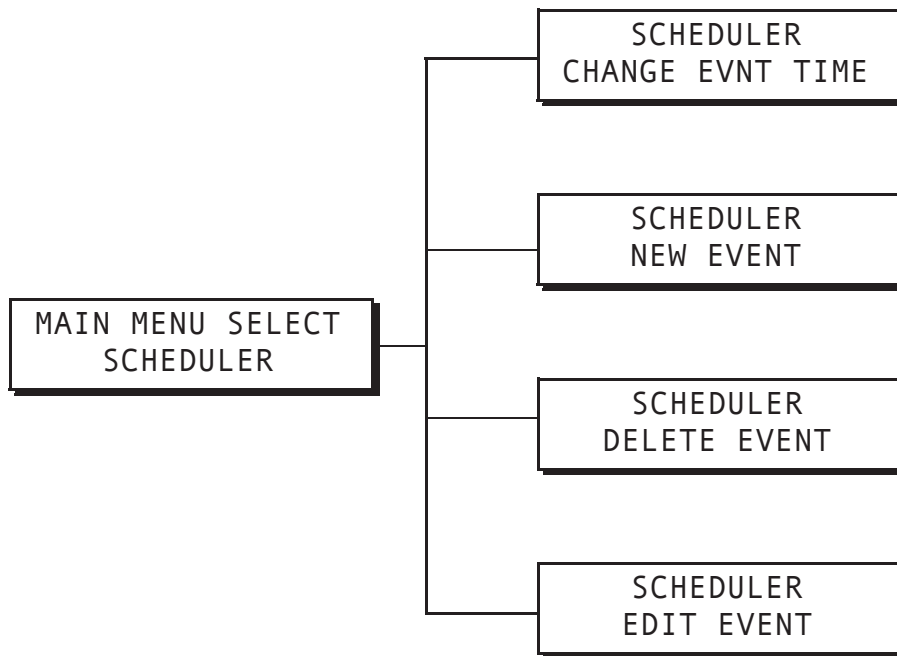

Basic Concepts

Before you start programming events, you should become familiar with the different types of events you can define. You can define events based on a specific time of day, an offset from sunrise or sunset, or a certain day (or days) of the week.

Days of the Week

Events are based on a weekly schedule. You can define your events to take place on certain days of the week. Things you need to remember when programming your events:

- The days of the week are represented by single alpha characters (MTWTFSS).
- The week starts on Monday.
- Dashes represent days when the event does NOT run.
- Pressing the zero (0) key in an active day-of-the-week field will change it to a dash (the event will not run that day).
- Pressing any alpha key in an active field with a dash will activate that day of the week.

Event Times

Schedule your event times based on one of the following:

- An absolute time of day (i.e. 7:00am).
- Sunrise, or an offset of Sunrise (i.e.: SR-0:05). Offsets for Sunrise are calculated as times before (-), after (+) or at Sunrise.
- Sunset, or an offset of Sunset (i.e.: SS+0:00). Offsets for Sunset are calculated as times before (-), after (+) or at Sunset.

Some example events you could define:

- Event 001: turn the lights on in the lobby at 7am, Monday through Friday (MTWTHF--).
- Event 002: turn the lights off in the lobby at 6:30pm, Monday through Friday (MTWTHF--).
- Event 003: turn a specific Photocell on at sunset every day of the week.

Holiday Mode

Holidays are events that occur on a specific day of year as opposed to those events that recur on a weekly schedule. Part of programming your events is choosing whether or not you want them to run on what the system defines as a “holiday.”

Holiday Modes are defined as:

- **Always Run**—run the event whether it’s scheduled on a holiday or not.
- **Holiday Enable**—don’t run the event if it falls on a holiday.
- **Holidays Only**—only run the event on holidays (defined by the list of holidays in the system).

NOTE

You can edit the list of holidays, and define additional holidays using the EZ-MAX Plus software on a PC.

Common North American Holidays

Your EZ-MAX Plus relay cabinet is pre-programmed with the most common North American holidays.



- New Years Eve
- New Years Day
- Martin Luther King Day
- Abraham Lincoln’s B-Day
- President’s Day
- George Washington’s B-Day
- Mothers Day
- Memorial Day
- Fathers Day
- Independence Day
- Labor Day
- Columbus Day

- Veteran's Day
- Thanksgiving Day
- Christmas Eve
- Christmas Day
- Good Friday
- Easter
- St. Patrick's Day
- Cinco De Mayo - May 5
- Ground Hog day
- Halloween
- Mexico Independence Day
- Thanksgiving Day - Canada

Creating a New Event

You can control your lighting based on an event schedule that you create. For example, you may want to create an event that turns all lobby lights on at 7am Monday thru Friday, and another event that turns all lobby lights off at 7pm Monday thru Friday.

Step 1: Press the **MENU** button.

Step 2: Press  or  until the display reads as below, then press **SELECT/SAVE**.

MAIN MENU SELECT
SCHEDULER



Step 3: Press  until the display reads NEW EVENT, then press **SELECT/SAVE**.

SCHEDULER
NEW EVENT



Step 4: Use the numeric keypad to enter an event number (001-999) and press **SELECT/SAVE**.

ENTER EVENT #
E022 :

The display will then prompt you to enter a "Time Type." You can set your event for a specific time of day, or according to sunrise and sunset. The example below shows how to set an event time based on the time of five minutes before sunrise.

Step 5: Press  or  to toggle between TIME OF DAY and SUNRISE/SUNSET, then press **SELECT/SAVE**.



ENTER TIME TYPE
SUNRISE/SUNSET

Step 6: Press  or  to toggle between SR+ and SS-. Use the numeric keypad to enter the time of the event, and press **SELECT/SAVE** when you have finished editing the fields.

```
ENTER SR/SS TIME
SR-0:05
```

Step 7: Press  to move through the days of the week. The active field (day of the week) will flash. Press zero (0) to disable a day of the week (displays as a slash), or press an alpha key to enable a day of the week. Press **SELECT/SAVE** when you have finished editing the fields.



```
ENTER DAYS OF WK
MTWTF--
```

Step 8: Define whether or not this event will run on holidays. Press  or  to toggle between the three Holiday Mode choices. Press **SELECT/SAVE**.

```
HOLIDAY MODE
HOLIDAY ENABLED
```



Now define the Event Type and behavior. The event types and available behaviors are as follows:

- Relay—RELAY ON, RELAY BW OFF, RELAY OFF
- LV Input
 - Photocell—DISABLE, ENABLE
 - Occ Sensor—DISABLE, ENABLE
 - Switch—DISABLE, ENABLE
- Digital Switch—DISABLE, ENABLE (per button if multi-button switch)

Step 9: The example below is for a relay. Press  or  to toggle between the three choices until you get to RELAY, and press **SELECT/SAVE**.

```
SELECT RLY MODE
RELAY ON
```



Assign the relays that will be associated with this event. If there are 16 relays in your cabinet you will have to set each one to YES or IGNORE, depending on whether or not you want the relay to respond.

Step 10: Use the alphanumeric keys to input the relay number. Press  to navigate to the IGNORE/YES field. Press  or  to toggle between YES and IGNORE and set any relays you want to be affected by this event to YES. Press **SELECT/SAVE** when you have finished setting all relays.

```
ASSIGN RELAYS
RELAY #01 YES
```

Changing an Event Time

Step 1: Press the **MENU** button.

Step 2: Press  or  until the display reads as below, then press **SELECT/SAVE**.



MAIN MENU SELECT
SCHEDULER

Step 3: Press  until the display reads CHANGE EVNT TIME, then press **SELECT/SAVE**.

SCHEDULER
CHANGE EVNT TIME

Step 4: Use the numeric keypad to enter the event number you want to modify. Once you actually enter the event number the event time will display. Press **SELECT/SAVE**.

SELECT EVENT #
E022: 7:00AM

Step 5: You will then be prompted to choose a Time Type. Press  or  to toggle between the two time types (TIME OF DAY and SUNRISE/SUNSET). Press **SELECT/SAVE**.

EDIT TIME TYPE
TIME OF DAY

Step 6: Use the numeric keypad to enter a new time. Press  to navigate the fields. Press **SELECT/SAVE**.



EDIT TIME
7:00AM

Step 7: Press **SELECT/SAVE** when you have finished editing the fields.

Deleting an Event

You might find out down the line that you don't need all of the events that you originally programmed into your EZ-MAX Plus system. It's a very simple process to delete an event.

Step 1: Press the **MENU** button.

Step 2: Press  or  until the display reads as below, then press **SELECT/SAVE**.

MAIN MENU SELECT
SCHEDULER

Step 3: Press  until the display reads DELETE EVENT, then press **SELECT/SAVE**.

```
SCHEDULER
DELETE EVENT
```

Step 4: Use the numeric keypad to enter the event number you want to delete. Once you actually enter the event number the event time will display. Press **SELECT/SAVE**.

```
SELECT EVENT
E022:    7:00AM
```



Step 5: Press  or  to toggle to "Y," and press **SELECT/SAVE**.

```
DELETE EVENT:  Y
E022:    7:00AM
```

Your event has been deleted.

Editing an Event

Step 1: Press the **MENU** button

Step 2: Press  or  until the display reads as below, then press **SELECT/SAVE**.

```
MAIN MENU SELECT
SCHEDULER
```

Step 3: Press  until the display reads EDIT EVENT, then press **SELECT/SAVE**.



```
SCHEDULER
EDIT EVENT
```

Step 4: Use the numeric keypad to enter the event number you want to modify. Once you actually enter the event number the event time will display. Press **SELECT/SAVE**.

```
SELECT EVENT #
E022:    7:00AM
```

Step 5: Press  or  to toggle between the three choices until you get to RELAY, and press **SELECT/SAVE**.

```
SELECT RLY MODE
RELAY ON
```

Step 6: Use the alphanumeric keys to input the relay number. Press  to navigate to the IGNORE/YES field. Press  or  to toggle between YES and IGNORE and set any relays you want to be affected by this event to YES. Press **SELECT/SAVE** when you have finished setting all relays.

```
ASSIGN RELAYS  
RELAY #01 YES
```

Configuring Low Voltage Inputs

This section of the manual focuses on configuring low voltage inputs. See “Digital Switches” on page 43 for details on configuring digital switches.

The top level of the CONFIG INPUTS menu structure is shown below. See Appendix B for the complete menu structure.

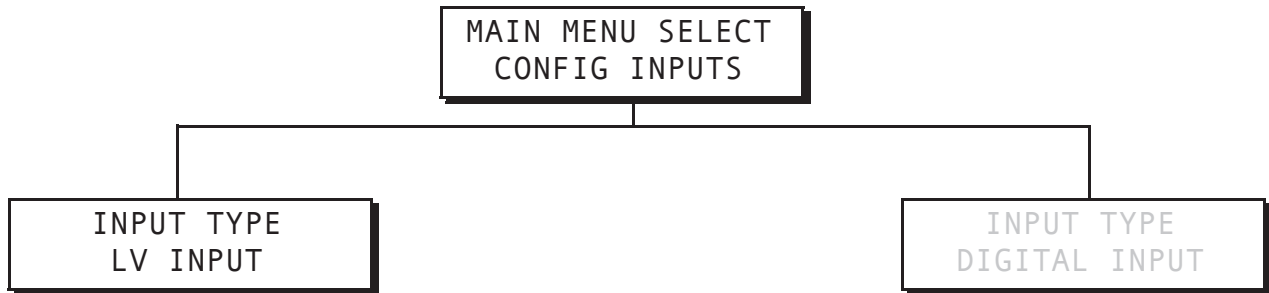

Low Voltage Inputs

There are a number of devices that can be configured as low voltage inputs:

- Low Voltage Switches
 - Momentary
 - Maintained
 - Momentary Timed
- Occupancy Sensors
- Photocells

Low Voltage Switches

Low Voltage Switch Inputs

There are three behaviors that can be assigned to a switch input. Your selection for the behavior of your switch will be determined by the type of switch you have and how you want it to operate. The available behaviors are as follows:



Momentary—the first press turns on the assigned relays, the second press turns off the assigned relays.

Momentary Timed—the first press turns on the assigned relays for the specified amount of time. When the time elapses, control of the relays is relinquished to other controls, which generally results in the relays turning off. If the switch is pressed a second time, the timer is reset. The timing mechanism for this mode is controlled by the Timer setting in the Global Timers menu. See “Global Timers” on page 23.



Maintained—the assigned relays will be on whenever the input detects an active (on) state. The assigned relays will be off whenever the input detects an inactive (off) state.

Configuring a Low Voltage Switch

Step 1: Press the **MENU** button.

Step 2: Press  or  until the display reads as below, then press **SELECT/SAVE**.

```
MAIN MENU SELECT
CONFIG INPUTS
```

Step 3: Press  or  to navigate to **LV INPUT**, and press **Select/Save**.



```
INPUT TYPE
LV INPUT
```

Step 4: Set the low voltage input for the switch.



```
SELECT INPUT
1: SWITCH
```

NOTE



If you are configuring a multi-button switch, the number you enter in the SWITCH field corresponds to a specific button on the switch. The top button on the switch would be #1 in the SWITCH field. The second button down would be #2 in the SWITCH field, and so on.

Step 5: Press  or  to choose a behavior for this particular button. Press **Select/Save**.

```
LV SWITCH TYPE
MOMENTARY
```

Step 6: Assign a relay (or multiple relays) to the switch. Press  or  to cycle through the relay numbers, or use the numeric keypad to enter a relay number. Press  to navigate to the next field and toggle **IGNORE** to **YES** if you want to assign the relay.

```
ASSIGN RELAYS
RELAY# 3: YES
```

Step 7: Continue to use the   to move between the relay field and the behavior field, and cycle through all relays until you have set all of them to **YES** or **IGNORE**. Press **Select/Save** when you have finished assigning all relays.

If you are configuring a multi-button switch, continue to repeat the above steps until you've configured all buttons on the switch.

Occupancy Sensors

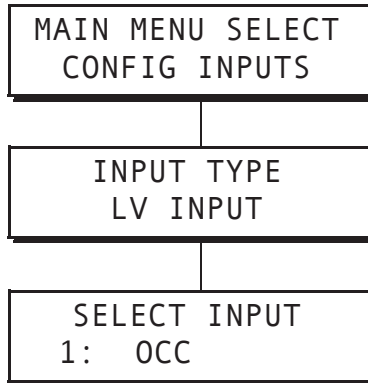

Occupancy sensors are devices that sense when a person enters a particular room or area. Leviton's Occupancy Sensors are designed for a variety of applications, using a variety of technologies, which can be applied to your specific need. The Occupancy sensors that this relay panel is designed to work with are those that are powered by +24Vdc and provide a ~+24Vdc output when the covered area is occupied.





Configuring Occupancy Sensors

These instructions assume that your Occupancy Sensor is already connected to one of the low voltage inputs.



Step 1: Press the **MENU** button.

Step 2: Press  or  until the display reads as below, then press **SELECT/SAVE**.



Step 3: Press  or  to navigate to LV INPUT, and press **Select/Save**.





Step 4: Use the numeric keypad to enter the input number for the occupancy sensor. Press  to navigate to the next field, and press  or  to change the field to OCC. Press **Select/Save**.





The next step is to choose the behavior of your occupancy sensor.

- **Manual (Manual On-Auto Off)**—The occupancy sensor will turn off the assigned relays when the occupancy sensor indicates an unoccupied state. When the room becomes occupied, the relays will not be automatically turned on, instead, the user will have to manually turn on the lights from a wall switch or other input.



- **Auto (Always On/Auto Off)**—In this mode, the Occupancy Sensor will turn the assigned relays both on and off based on either an occupied or unoccupied state indicated by the occupancy sensor.

Step 5: Press  or  to select the behavior **INTERIOR** or **EXTERIOR**, and press **Select/Save**.

```
OCC SENSOR MODE
INTERIOR
```

Step 6: Assign the relay (or relays) to this occupancy sensor. Press  or  to cycle through the relay numbers, or use the numeric keypad to enter a relay number. Press  to navigate to the next field and toggle **IGNORE** to **YES** if you want to assign the relay.

```
ASSIGN RELAYS
RELAY# 3:  YES
```

Step 7: Continue to use the   to move between the RELAY field and the behavior field, and cycle through all relays until you have set all of them to YES or IGNORE. Press **Select/Save** when you have finished assigning all relays.

NOTE

Occupancy sensor Delay times and Retrigger times must be set on the occupancy sensor itself.

Photocells

Photocells are used with relay panels to control the switching on and off of relays relative to the amount of light received by the relay panel. Two types of photocells are supported by your relay panel, called switching and 0-10V. Switching photocells interact with your relay panel just like a switch. They output a low voltage signal to the relay panel when the amount of light received by the photocell crosses a pre-set threshold. 0-10V photocells output 0-10V, proportional to the amount of light received. Switching photocells must be configured to trip at a specific level which is also appropriate for your project. 0-10V photocells must be optimized for the range of lighting levels to which the photocell is intended.

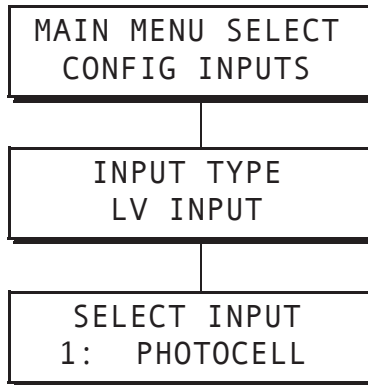

Photocells have a variety of uses and applications but most can be broken down into two categories: simple on/off control and the more complex daylight harvesting. Your EZ-MAX Plus cabinet is capable of doing both.

Daylight Harvesting

In a daylight harvesting application, the goal is to maintain a consistent lighting level within the space, regardless of the source of light which could be either daylight or dimmable artificial light. If this lighting level can be maintained completely with daylight, no artificial light is necessary. However, if the day lighting is not sufficient to meet the desired level, it can be boosted by the artificial light connected to your relay cabinets.

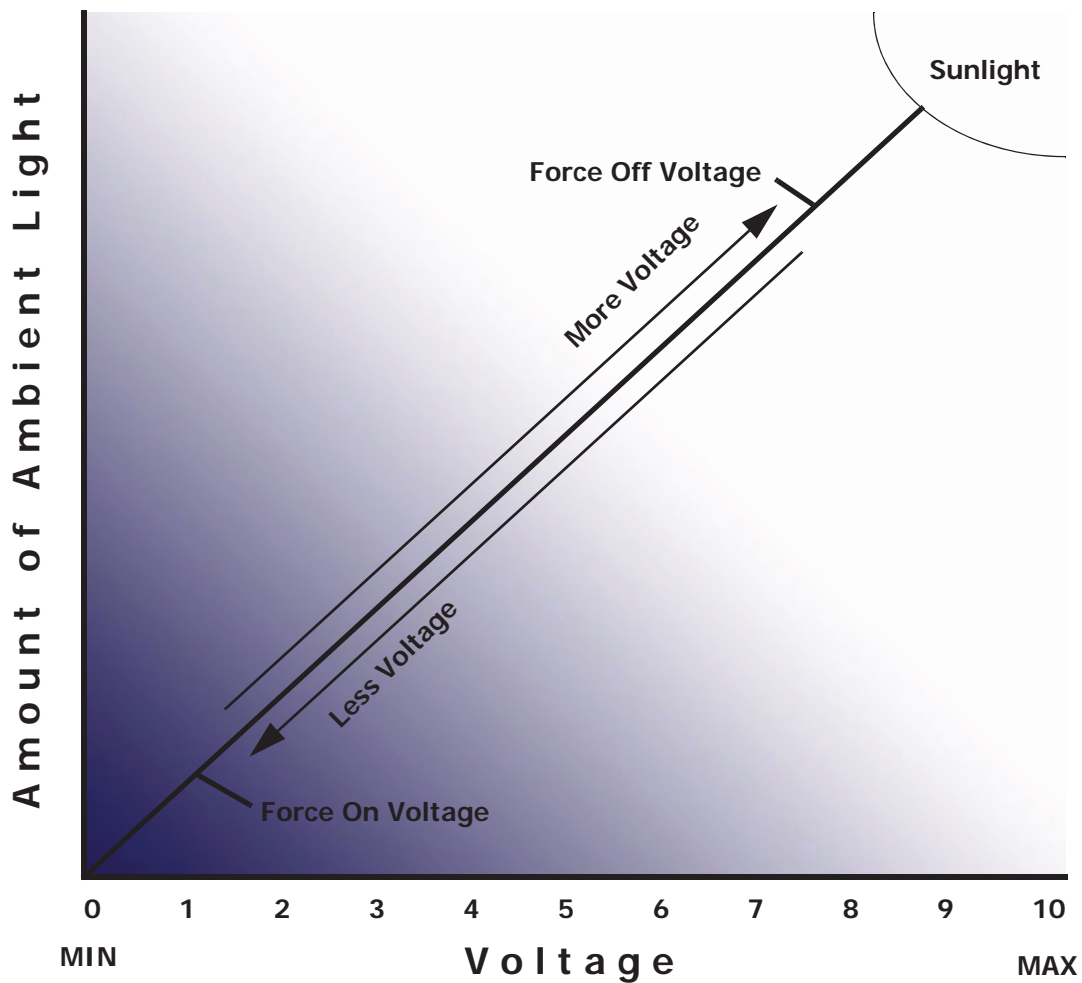



Figure 8: Photocell Levels—Force On/Force Off

Configuring Photocells

Follow the steps below to configure your photocells.

Step 1: Press the **MENU** button.

Step 2: Press  or  until the display reads as below, then press **SELECT/SAVE**.



```

MAIN MENU SELECT
CONFIG INPUTS
    
```

Step 3: Press  or  to navigate to LV INPUT, and press **Select/Save**.

```



INPUT TYPE
LV INPUT
    
```

Step 4: Use the numeric keypad to enter the input number for the photocell. Press  to navigate to the next field, and press  or  to change the field to PHOTOCELL. Press **Select/Save**.

```
SELECT INPUT
2: PHOTOCELL
```

The next step is to choose the behavior of your photocell.

- **Interior (Manual On)**—is useful for applications where you want to turn relays on manually and off automatically when it gets bright. This mode also allows manual control to turn relays off and on. This is the typical Daylight Harvesting application. For example, think about a classroom where there is only an on/off switch for use by the occupants. The teacher comes in the morning, when it's dark outside, and turns on the switch. All of the lights come on. When the sun comes up and natural light fills the space, the photocell would detect lights which would pass the trigger point and then turn off some or all of the lights in the room. When the sun goes down or prolonged cloud cover exists making the room dark again, the photocell would detect the darkness and then turn the associated relays on and then relinquish control back to the manual switch which if in the on position would turn the lights on.
- **Exterior (Force On/Force Off)**—is useful for applications where you do not want to allow manual control of the lights at all. The relays come on when it's dark, and go off when it's bright. Think about parking lot lighting, when it's dark the lights go on, when it's light the lights go off and you don't ever want anything else to override it.

Step 5: Press  or  to select the behavior **INTERIOR** or **EXTERIOR**, and press **Select/Save**.



```
PHOTOCELL
INTERIOR
```

The next step is to define a Delay Time.

- **Delay Time**—used to prevent rapid changes to lighting based on changing conditions in the environment. For example, clouds passing the sun which temporarily darkens the space. It is expressed in minutes and represents the length of contiguous time between trigger points in order for the relays to be turned on or off.

Step 6: Use the numeric keypad to enter a delay time, and press **Select/Save**.

```
PHOTOCELL
DELAY TIME: 5 M
```

Step 7: Press  or  to select the type of photocell (either 0-10 Volt or Switched), and press **Select/Save**.

```
PHOTOCELL TYPE
0-10 VOLT
```

If you choose 0-10 VOLT you will be prompted to provide a minimum activation (ON) voltage and a minimum OFF voltage setting.



- On Voltage must be a voltage between 1-10 VDC, AND must be less than the OFF voltage.
- OFF Voltage must be a voltage between 1-10 VDC, AND must be greater than the ON voltage.

Step 8: Enter the level, in volts, for which you desire these relays to be activated when the light levels are FALLING (ON). Press **Select/Save**.



```
PHOTOCELL
ON VOLTS: 4.0
```

Step 9: Enter the level, in volts, for which you desire these relays to be deactivated when the light levels are RISING (OFF). Press **Select/Save**

```
PHOTOCELL
OFF VOLTS: 6.0
```

Step 10: Assign the relay (or relays) to this occupancy sensor. Press  or  to cycle through the relay numbers, or use the numeric keypad to enter a relay number. Press  to navigate to the next field and toggle IGNORE to **YES** if you want to assign the relay.

```
ASSIGN RELAYS
RELAY# 3: YES
```

Step 11: Continue to use the   to move between the RELAY field and the behavior field, and cycle through all relays until you have set all of them to YES or IGNORE. Press **Select/Save** when you have finished assigning all relays.

Digital Switches

Digital Switches are an extension of low voltage switches in that a digital switch is assigned to a “virtual” discrete input which is then programmed identically to a local discrete input. Low voltage switches are hard wired to low voltage inputs in the EZ-MAX Plus relay cabinet, and digital switches are connected to the cabinet via a Phoenix Connector, and are networked over LumaNet, Leviton’s proprietary communications protocol.

The EZ-MAX Plus uses LumaNet to communicate with remote digital switches. Other Leviton architectural products such as the D8000 or D4000 series digital stations will also work on this panel, but this manual refers to the Digital Station series designed specifically for the EZ MAX Plus product line.

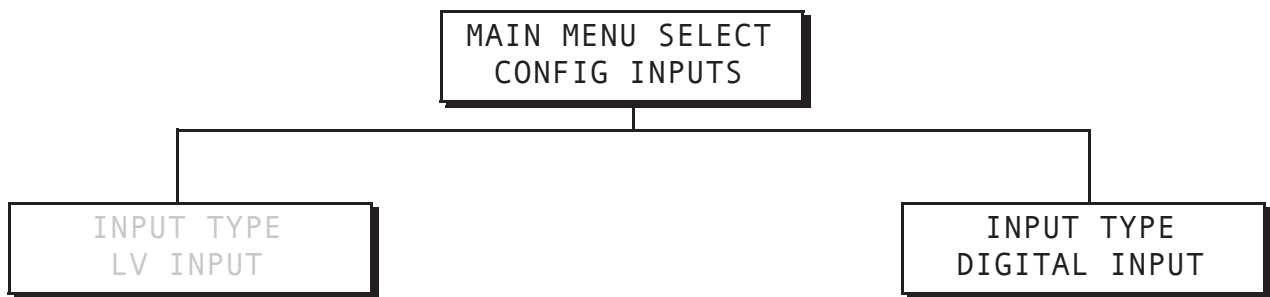

Configuring A Digital Switch

There are a maximum of 255 addresses for digital switches, as defined by the binary dip switches on the switch itself. See the table at the end of this section for a complete list of binary addresses from 1-255.

Manual and Auto-Assign

There are two ways to program digital switch addresses into the EZ-MAX Plus relay cabinet. You can manually assign each digital switch address as you program the behaviors into the relay cabinet, or you can just plug the Phoenix Connector cable into the EZ-MAX Plus relay cabinet and all of the switch addresses will be input to the system automatically.

Determining the State of a Digital Switch

You can see the configuration state of a digital switch in the display when you enter the switch number you want to unconfigure.

The examples below will help you see the three states:

- **74 (switch address only)**—the digital switch with the address of 74 has been manually assigned or auto assigned, but hasn't been installed or configured yet.

```
SELECT SWITCH
ADDRESS: 74
```

- **74CFG**—the digital switch with the address of 74 is configured (CFG), but hasn't been installed yet.



```
SELECT SWITCH
ADDRESS: 74CFG
```

- **74CFG***—the digital switch with the address of 74 is configured AND installed (CFG*).



```
SELECT SWITCH
ADDRESS: 74CFG*
```

The steps below show you how to manually input a digital switch into the system. If you install your digital switches first, and then use the auto-assign feature, your digital switch addresses will be displayed automatically when you get to the SELECT SWITCH step.

Step 1: Press the **MENU** button.

Step 2: Press  or  until the display reads as below, then press **SELECT/SAVE**.

```
MAIN MENU SELECT
CONFIG INPUTS
```

Step 3: Press  or  to navigate to **DIGITAL INPUT**, and press **Select/Save**.

```
INPUT TYPE
DIGITAL INPUT
```



Step 4: Use the numeric keypad to enter the address for the digital switch. Press **Select/Save**.

```
SELECT SWITCH
ADDRESS: 74
```

Program the behavior for all buttons on your switch. If you have a 4-button switch you will go through the steps below four times.

Step 5: Use the numeric keypad to enter the button number you want to program. Press **Select/Save**.

```
ADDRESS: 74
BUTTON: 4
```

Step 6: Press  or  to choose a behavior for this particular button. Press **Select/Save**.

```
ADDR: 74 BTN: 4
MOMENTARY TIMED
```

Step 7: Assign the switch to a particular relay. Use the numeric keypad to enter a relay number. Press  to navigate to the next field and toggle IGNORE to **YES** if you want to assign the relay. Cycle through all relays until you have set all of them to YES or IGNORE. Press **Select/Save**.

```
ASSIGN RELAYS
RELAY# 3: YES
```



Unconfiguring a Digital Switch Button

You can unconfigure and disable an entire digital switch (or individual buttons) without actually physically uninstalling it. Follow the steps below to unconfigure a digital switch.



NOTE You must unconfigure each button on your digital switch individually in order for the entire switch to be unconfigured.

Follow the steps below to unconfigure a digital switch.

Step 1: Press the **MENU** button.

Step 2: Press  or  until the display reads as below, then press **SELECT/SAVE**.

```
MAIN MENU SELECT
CONFIG INPUTS
```

Step 3: Press  or  to navigate to **DIGITAL INPUT**, and press **Select/Save**.

```
INPUT TYPE
DIGITAL INPUT
```

Step 4: Use the numeric keypad to enter the address for the digital switch you want to unconfigure. Press **Select/Save**.



```

SELECT SWITCH
ADDRESS:    74CFG
    
```

Step 5: Use the numeric keypad to enter the first button on the switch (1). Press **Select/Save**.



```

ADDRESS:    74
BUTTON:     1CFG
    
```

Step 6: Press  or  to toggle the behavior to **UNCONFIGURED**. Press **Select/Save**

```

ADDR: 74 BTN: 1
UNCONFIGURED
    
```

Step 7: You will then be prompted to confirm the deletion of the switch. Press  or  to toggle the choice to **YES**, and press **Select/Save**

```

DELETE SWITCH?
YES
    
```

Repeat Steps 5, 6 and 7 until you have unconfigured all buttons on your digital switch. Your digital switch will be disabled once you have unconfigured all buttons.

Table of Binary Addresses

The table below shows the binary representation of decimal numbers. Use it as a reference when setting the addresses (dip switches) on your digital switches.

Dec	Bin		Dec	Bin		Dec	Bin		Dec	Bin
0	00000000		64	01000000		128	10000000		192	11000000
1	00000001		65	01000001		129	10000001		193	11000001
2	00000010		66	01000010		130	10000010		194	11000010
3	00000011		67	01000011		131	10000011		195	11000011
4	00000100		68	01000100		132	10000100		196	11000100
5	00000101		69	01000101		133	10000101		197	11000101
6	00000110		70	01000110		134	10000110		198	11000110
7	00000111		71	01000111		135	10000111		199	11000111
8	00001000		72	01001000		136	10001000		200	11001000
9	00001001		73	01001001		137	10001001		201	11001001

Dec	Bin		Dec	Bin		Dec	Bin		Dec	Bin
10	00001010		74	01001010		138	10001010		202	11001010
11	00001011		75	01001011		139	10001011		203	11001011
12	00001100		76	01001100		140	10001100		204	11001100
13	00001101		77	01001101		141	10001101		205	11001101
14	00001110		78	01001110		142	10001110		206	11001110
15	00001111		79	01001111		143	10001111		207	11001111
16	00010000		80	01010000		144	10010000		208	11010000
17	00010001		81	01010001		145	10010001		209	11010001
18	00010010		82	01010010		146	10010010		210	11010010
19	00010011		83	01010011		147	10010011		211	11010011
20	00010100		84	01010100		148	10010100		212	11010100
21	00010101		85	01010101		149	10010101		213	11010101
22	00010110		86	01010110		150	10010110		214	11010110
23	00010111		87	01010111		151	10010111		215	11010111
24	00011000		88	01011000		152	10011000		216	11011000
25	00011001		89	01011001		153	10011001		217	11011001
26	00011010		90	01011010		154	10011010		218	11011010
27	00011011		91	01011011		155	10011011		219	11011011
28	00011100		92	01011100		156	10011100		220	11011100
29	00011101		93	01011101		157	10011101		221	11011101
30	00011110		94	01011110		158	10011110		222	11011110
31	00011111		95	01011111		159	10011111		223	11011111
32	00100000		96	01100000		160	10100000		224	11100000
33	00100001		97	01100001		161	10100001		225	11100001
34	00100010		98	01100010		162	10100010		226	11100010
35	00100011		99	01100011		163	10100011		227	11100011
36	00100100		100	01100100		164	10100100		228	11100100
37	00100101		101	01100101		165	10100101		229	11100101
38	00100110		102	01100110		166	10100110		230	11100110
39	00100111		103	01100111		167	10100111		231	11100111
40	00101000		104	01101000		168	10101000		232	11101000
41	00101001		105	01101001		169	10101001		233	11101001
42	00101010		106	01101010		170	10101010		234	11101010

Dec	Bin		Dec	Bin		Dec	Bin		Dec	Bin
43	00101011		107	01101011		171	10101011		235	11101011
44	00101100		108	01101100		172	10101100		236	11101100
45	00101101		109	01101101		173	10101101		237	11101101
46	00101110		110	01101110		174	10101110		238	11101110
47	00101111		111	01101111		175	10101111		239	11101111
48	00110000		112	01110000		176	10110000		240	11110000
49	00110001		113	01110001		177	10110001		241	11110001
50	00110010		114	01110010		178	10110010		242	11110010
51	00110011		115	01110011		179	10110011		243	11110011
52	00110100		116	01110100		180	10110100		244	11110100
53	00110101		117	01110101		181	10110101		245	11110101
54	00110110		118	01110110		182	10110110		246	11110110
55	00110111		119	01110111		183	10110111		247	11110111
56	00111000		120	01111000		184	10111000		248	11111000
57	00111001		121	01111001		185	10111001		249	11111001
58	00111010		122	01111010		186	10111010		250	11111010
59	00111011		123	01111011		187	10111011		251	11111011
60	00111100		124	01111100		188	10111100		252	11111100
61	00111101		125	01111101		189	10111101		253	11111101
62	00111110		126	01111110		190	10111110		254	11111110
63	00111111		127	01111111		191	10111111		255	11111111

Updating Firmware

Leviton may occasionally release an update to the EZ-MAX Plus's operating system. You can install the updates by connecting a personal computer to the controller board inside the cabinet via a USB cable.

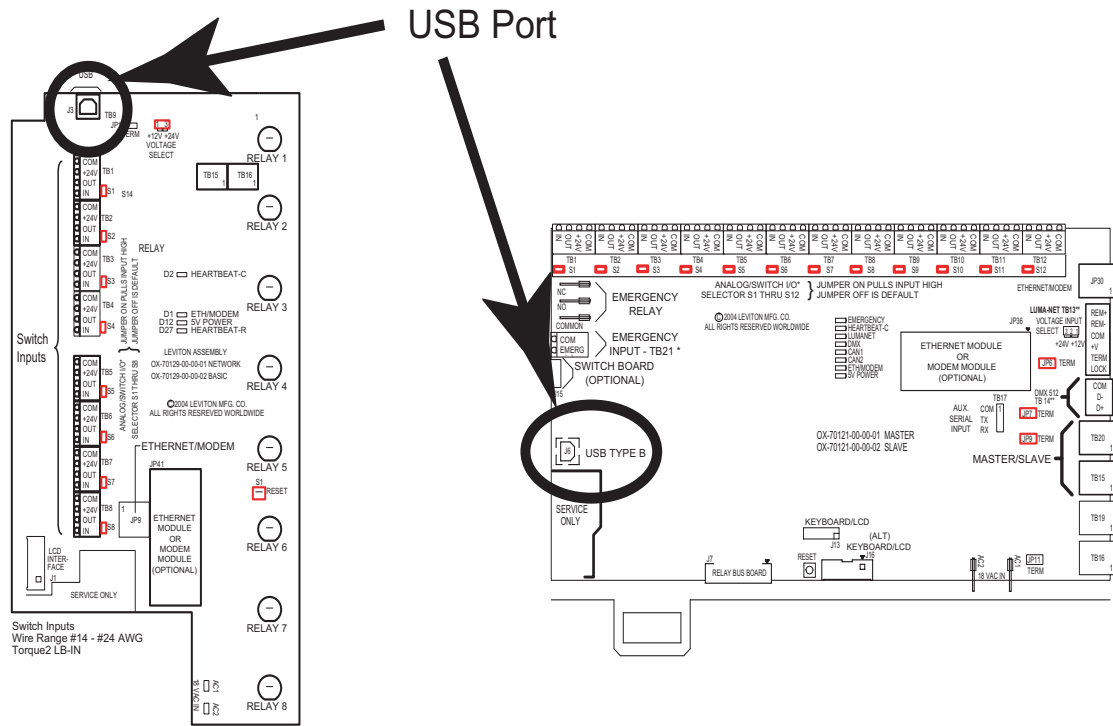

EZ-MAX Plus 8 Relay Cabinet

EZ-MAX Plus 16/24 Relay Cabinet

Installing Updates

New operating system files can be found on Leviton's web site under Product Information and then Lighting Controls. A USB driver for the EZ-MAX Plus cabinet can also be found on Leviton's web site.

The software has a command-line interface that can be accessed via a terminal window on your computer. Leviton recommends a freeware program called Tera Term, <http://hp.vector.co.jp/authors/VA002416/teraterm.html>, because of its superior efficiency. You can find the Tera Term program on Leviton's web site.

Terminal Settings

The terminal program settings are as follows:

- COM Port - set to port number of the USB port.
- Baud Rate - 115200
- Data - 8 Bit

- Parity - None
- Stop Bits - 1
- Flow Control - Hardware

Configuring the Terminal Program

Follow the instructions below to configure the settings in your terminal program. The examples below show the Tera Term program, but the settings are the same for all terminal programs.

Step 1: Launch the Tera Term program, and change the following settings: select **Serial** along with the **COM** port assigned to USB port and click **OK**.

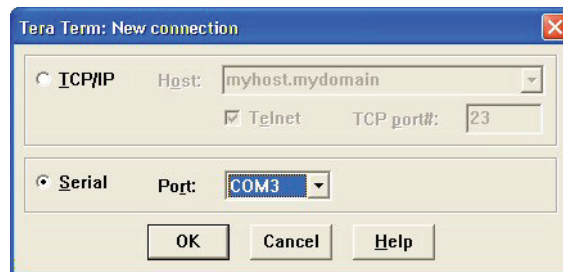

Step 2: Select the **Setup>Serial Port**.

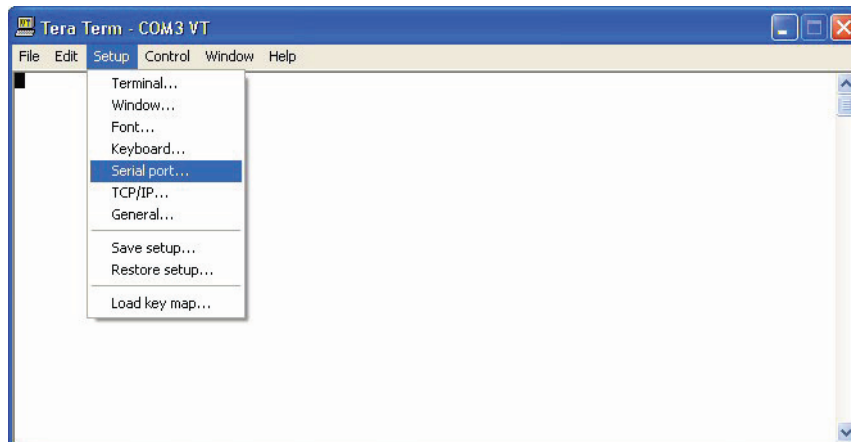

Step 3: Set the parameters as shown below, and click **OK**.

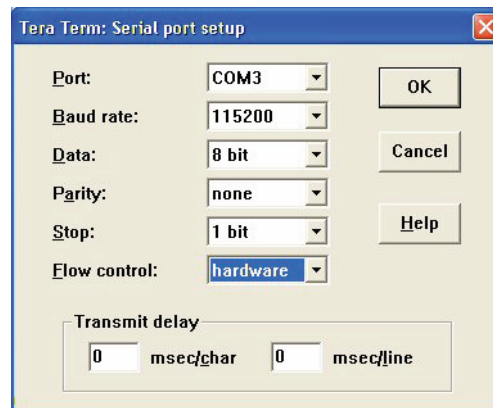

Upgrading your EZ-Max Plus Cabinet Firmware

Once you have the terminal program configured correctly you can communicate with the EZ-MAX Plus relay cabinet.

Step 1: Press **Enter** on the computer keyboard and you should see one of the two prompts below

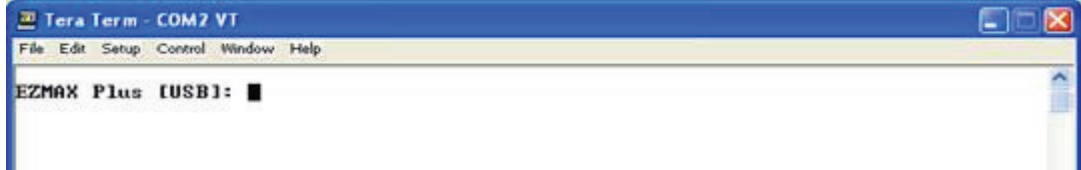

OR



Step 2: Enter the password **1234** at the prompt and press Return.

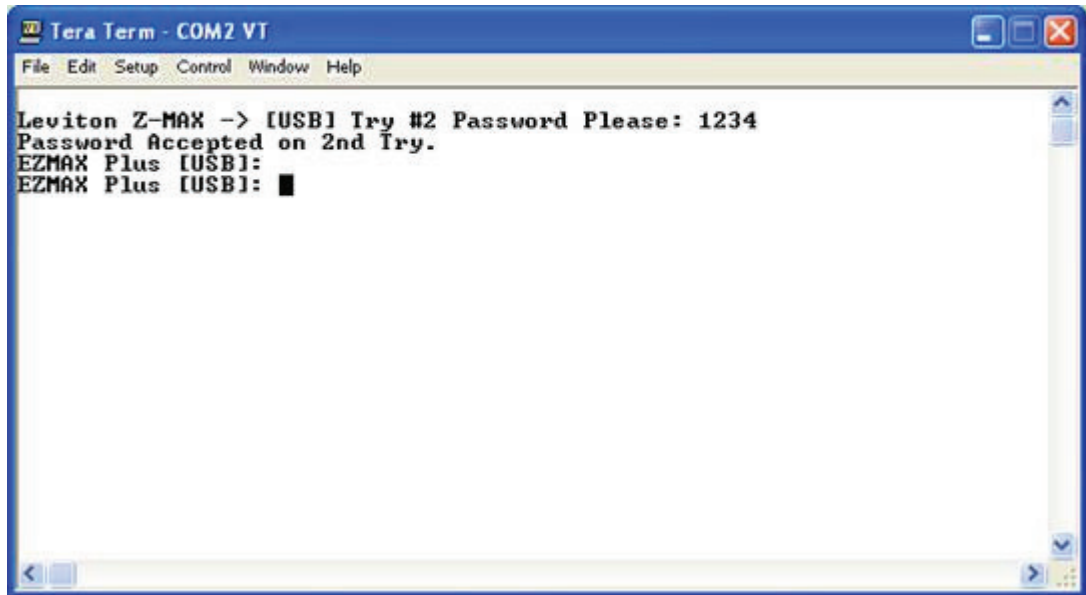

You must be at the boot prompt to perform the file transfer of the new operating system software. The step below will get you to the boot prompt.

Step 3: Type **EXIT** at the prompt and press the **Enter** key.

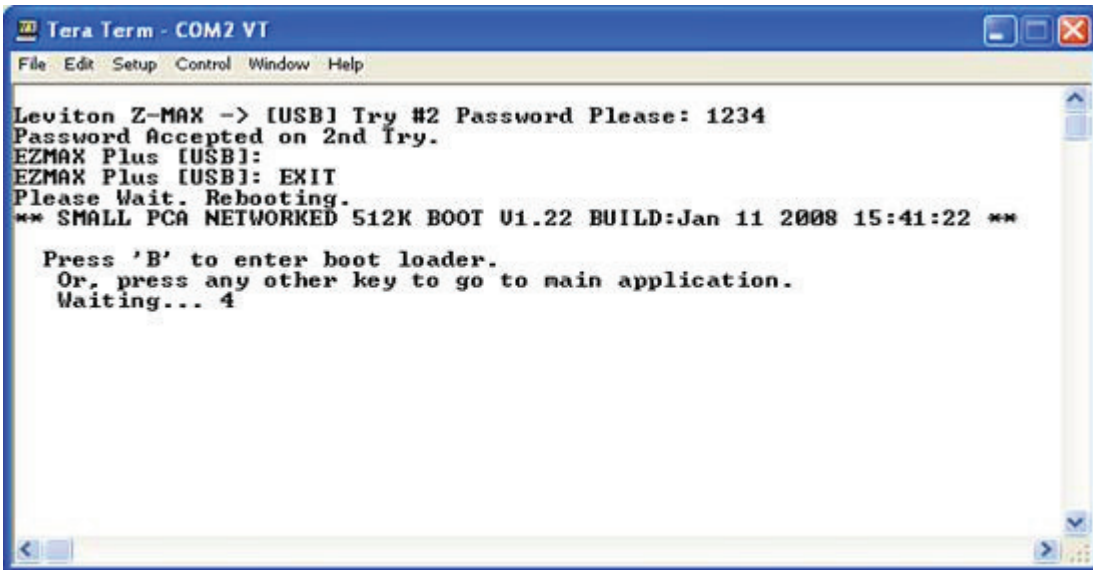

```
Tera Term - COM2 VT
File Edit Setup Control Window Help

Leviton Z-MAX -> [USB] Try #2 Password Please: 1234
Password Accepted on 2nd Try.
EZMAX Plus [USB]:
EZMAX Plus [USB]: EXIT
Please Wait. Rebooting.
** SMALL PCA NETWORKED 512K BOOT U1.22 BUILD:Jan 11 2008 15:41:22 **

Press 'B' to enter boot loader.
Or, press any other key to go to main application.
Waiting... 4
```

Step 4: Press **"b"** or **"B"** to enter boot mode. **Note:** once you press Enter you will have five seconds to confirm that you want to enter boot mode. If you don't press **"b"** or **"B"** within five seconds you will return to the main application."

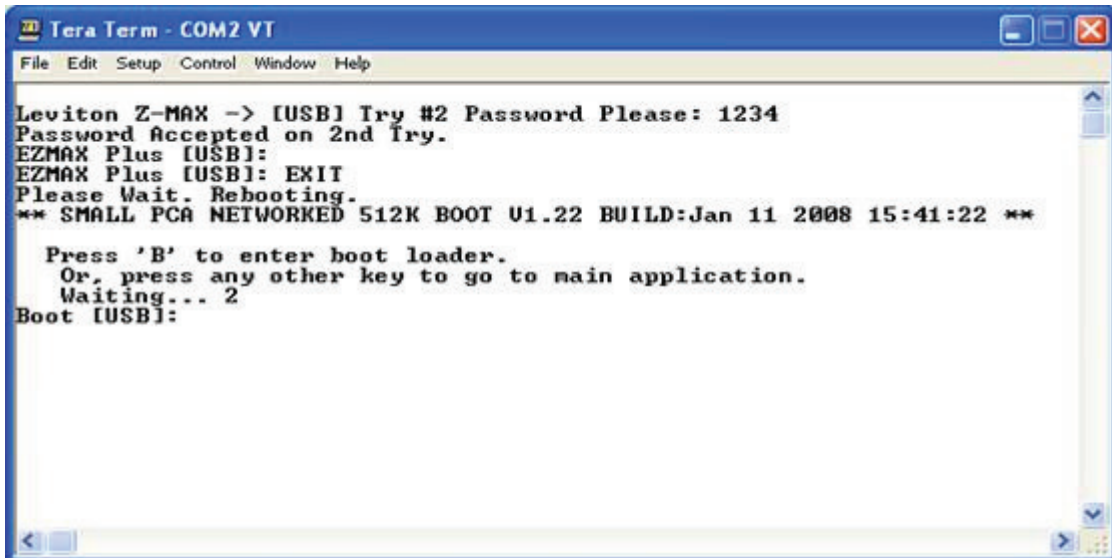

```
Tera Term - COM2 VT
File Edit Setup Control Window Help

Leviton Z-MAX -> [USB] Try #2 Password Please: 1234
Password Accepted on 2nd Try.
EZMAX Plus [USB]:
EZMAX Plus [USB]: EXIT
Please Wait. Rebooting.
** SMALL PCA NETWORKED 512K BOOT U1.22 BUILD:Jan 11 2008 15:41:22 **

Press 'B' to enter boot loader.
Or, press any other key to go to main application.
Waiting... 2
Boot [USB]:
```

The prompt will now be "Boot" instead of "EZ-MAX Plus."

Step 5: Type Put A 0 at the prompt and press Return.

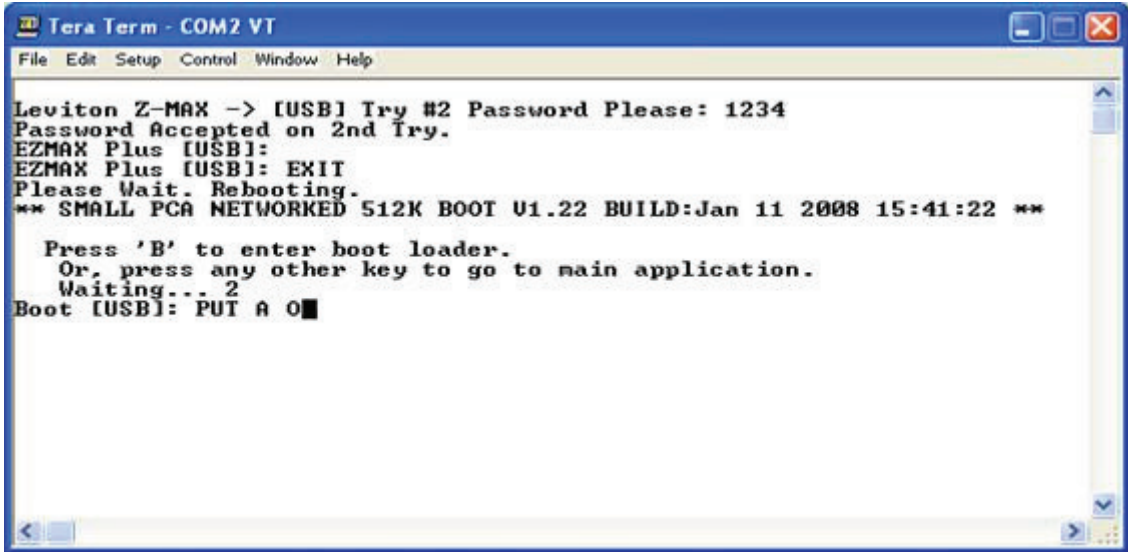

The screenshot shows a terminal window titled "Tera Term - COM2 VT" with a menu bar (File, Edit, Setup, Control, Window, Help). The text in the terminal is as follows:

```
Leviton Z-MAX -> [USB] Try #2 Password Please: 1234
Password Accepted on 2nd Try.
EZMAX Plus [USB]:
EZMAX Plus [USB]: EXIT
Please Wait. Rebooting.
** SMALL PCA NETWORKED 512K BOOT U1.22 BUILD:Jan 11 2008 15:41:22 **

  Press 'B' to enter boot loader.
  Or, press any other key to go to main application.
  Waiting... 2
Boot [USB]: PUT A 0
```

The progress of the file transfer will display in the terminal window.

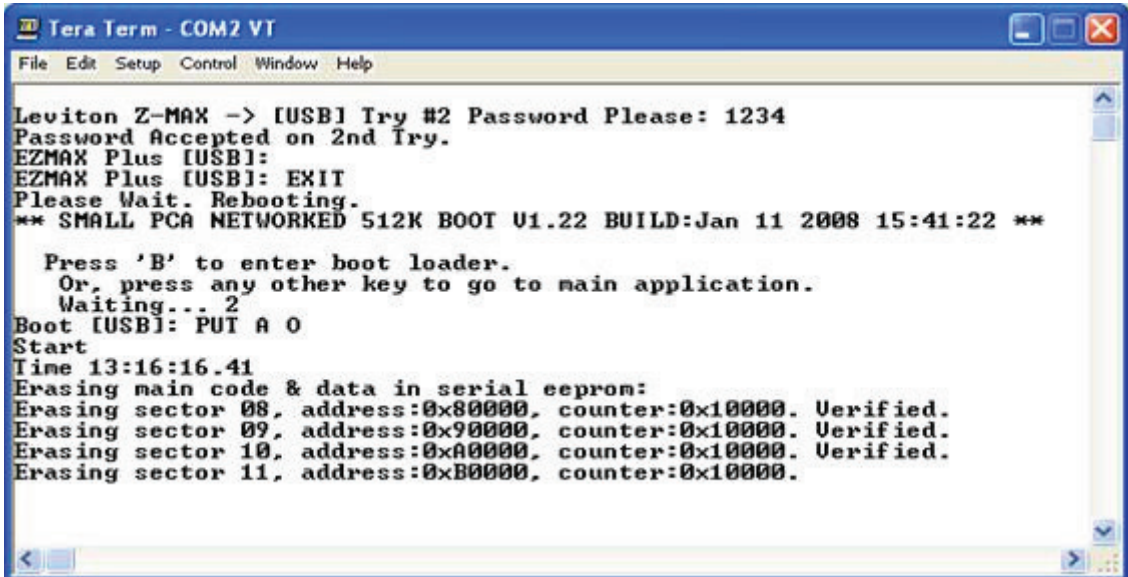

The screenshot shows the same terminal window as above, but with additional text indicating the progress of the file transfer:

```
Leviton Z-MAX -> [USB] Try #2 Password Please: 1234
Password Accepted on 2nd Try.
EZMAX Plus [USB]:
EZMAX Plus [USB]: EXIT
Please Wait. Rebooting.
** SMALL PCA NETWORKED 512K BOOT U1.22 BUILD:Jan 11 2008 15:41:22 **

  Press 'B' to enter boot loader.
  Or, press any other key to go to main application.
  Waiting... 2
Boot [USB]: PUT A 0
Start
Time 13:16:16.41
Erasing main code & data in serial eeprom:
Erasing sector 08, address:0x80000, counter:0x10000. Verified.
Erasing sector 09, address:0x90000, counter:0x10000. Verified.
Erasing sector 10, address:0xA0000, counter:0x10000. Verified.
Erasing sector 11, address:0xB0000, counter:0x10000.
```

Step 6: Select **File>Send File...** to transfer the file using Tera Term.

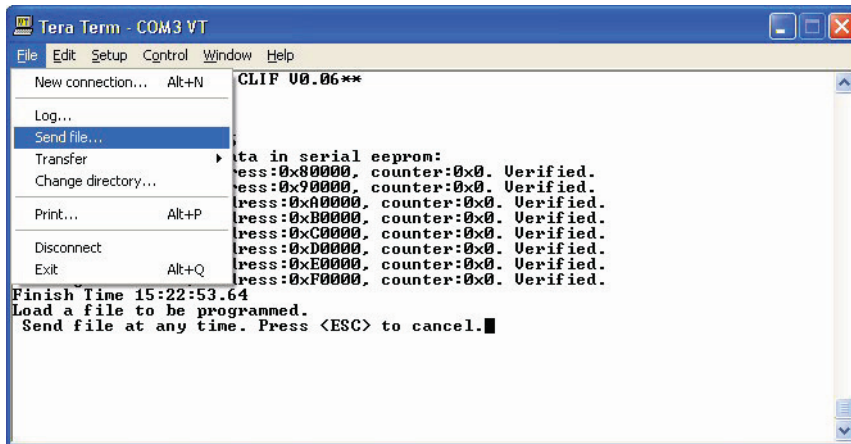

You will then be prompted to begin the file transfer from your terminal program. Select the upgrade file from the dialog box, and click Open.

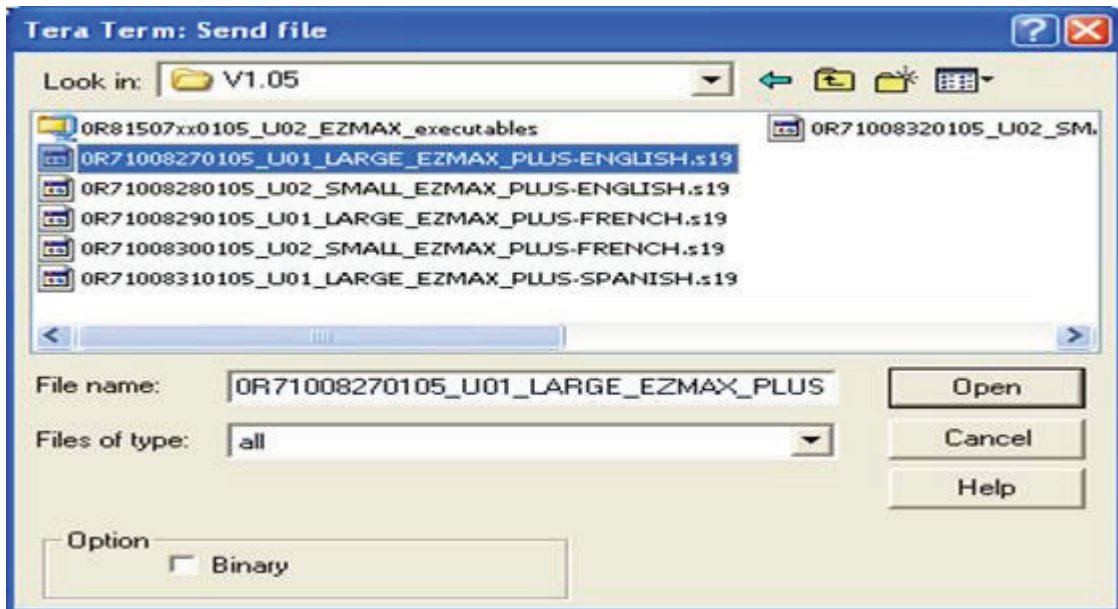

The dialog box below appears when the file transfer is complete.

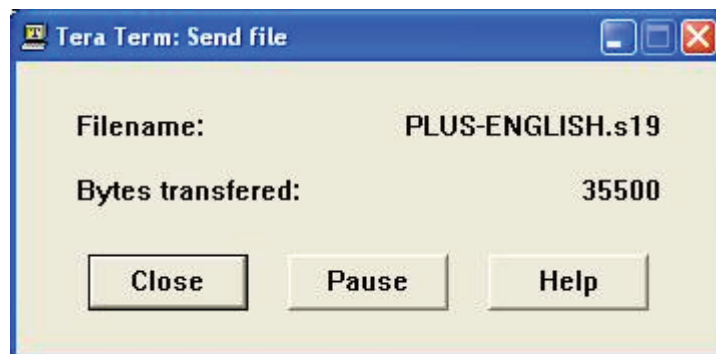

Step 7: When the transfer is complete, you will again be prompted to select between boot mode or the main application. This time, enter the main application by pressing any key other than “B” or “B”, or let the five second timer expire.

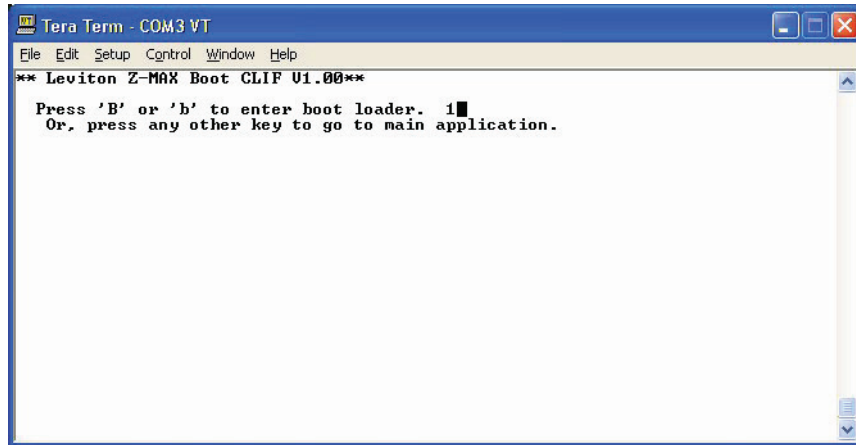

The new software will boot up automatically.

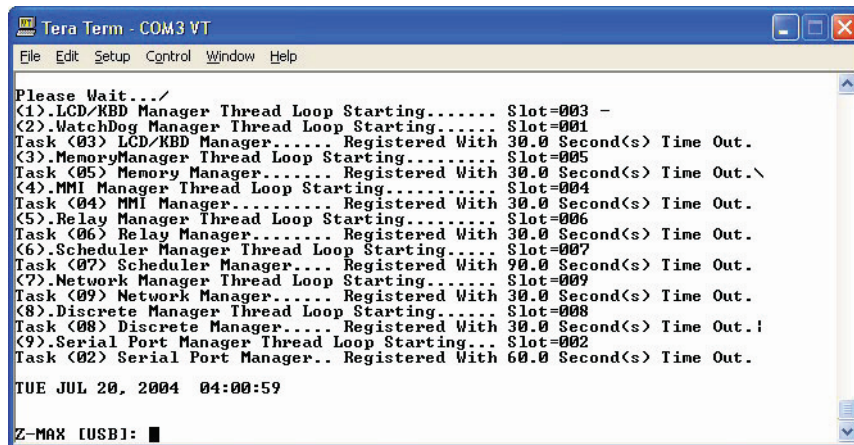

Viewing All Tera Term Commands

There are many Tera Term commands that are not used when upgrading the EZ-MAX Plus firmware. You can see all of the available commands by typing **HELP** at the boot prompt.

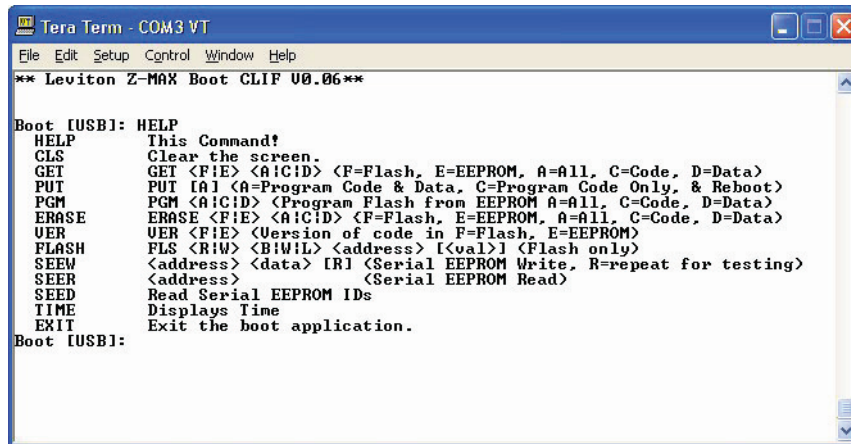

NOTE

Many of the commands listed are for trained personnel and used improperly could render the EZ-MAX Plus cabinet inoperable. Therefore, only use those commands listed below as described.

Verifying your Upgrade

You can verify that new upgrade was installed successfully by checking the firmware release number from the EZ-MAX Plus display.

Step 1: Press the **MENU** button

Step 2: Press  until the display reads, and press **SELECT/SAVE**.



Step 3: Use the  to navigate to SOFTWARE VERSION, and press **SELECT/SAVE**.



Step 4: Your display will show the version of the software and the date and time that software build was created.

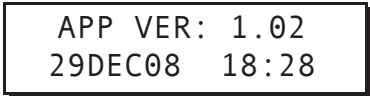

Appendix A: Longitude/Latitude and City Code Reference

There are two ways to program the location for the Astronomical Clock. You can use a quick-key shortcut if your city is on the list of the 100 major cities below, or you can key in the latitude and longitude of your city.

Quick-Codes for 101 Major Cities

1 Albany, NY	26 Chattanooga, TN	51 Iowa City, IA	76 Pittsburgh, PA
2 Albuquerque, NM	27 Cheyenne, WY	52 Jackson, MS	77 Portland, ME
3 Allentown, PA	28 Chicago, IL	53 Jacksonville, FL	78 Portland, OR
4 Anchorage, AK	29 Cincinnati, OH	54 Kansas City, MO	79 Providence, RI
5 Atlanta, GA	30 Cleveland, OH	55 Las Vegas, NV	80 Reno, NV
6 Atlantic City, NJ	31 Columbus, OH	56 Little Rock, AR	81 Rochester, NY
7 Augusta, GA	32 Dallas, TX	57 Los Angeles, CA	82 Sacramento, CA
8 Austin, TX	33 Daytona Beach, FL	58 Louisville, KY	83 Salt Lake City, UT
9 Bakersfield, CA	34 Denver, CO	59 Memphis, TN	84 San Diego, CA
10 Baltimore, MD	35 Des Moines, IA	60 Mexico City, MX	85 San Francisco, CA
11 Bangor, ME	36 Detroit, MI	61 Miami, FL	86 Scranton, PA
12 Baton Rouge, LA	37 El Paso, TX	62 Milwaukee, WI	87 Seattle, WA
13 Beijing, China	38 Edmonton, AB	63 Minneapolis, MN	88 Springfield, MA
14 Biloxi, MS	39 Erie, PA	64 Mobile, AL	89 St. Louis, MO
15 Birmingham, AL	40 Evansville, IN	65 Montreal QC	90 Sudbury, ON
16 Bismarck, ND	41 Fairbanks, AK	66 Nashville, TN	91 Syracuse, NY
17 Boise, ID	42 Fort Wayne, IN	67 New Orleans, LA	92 Tampa, FL
18 Boston, MA	43 Fort Worth, TX	68 New York City, NY	93 Toronto, ON
19 Bridgeport, CT	44 Fresno, CA	69 Norfolk, VA	94 Trenton, NJ
20 Buffalo, NY	45 Grand Rapids, MI	70 Oklahoma City, OK	95 Tucson, AZ
21 Burlington, VT	46 Hartford, CT	71 Omaha, NE	96 Tulsa, OK
22 Calgary, AB	47 Hong Kong, China	72 Orlando, FL	97 Vancouver BC
23 Cambridge, MA	48 Honolulu, HI	73 Ottawa, ON	98 Virginia Beach, VA
24 Charleston, SC	49 Houston, TX	74 Philadelphia, PA	99 Washington, D.C.
25 Charlotte, NC	50 Indianapolis, IN	75 Phoenix, AZ	100 Wichita, KS
			101 Winnipeg, MN

Longitude and Latitude of Major Cities

STATE/CITY	Lat	Long
ALABAMA		
Alexander City	33° N	86° W
Anniston AP	34° N	86° W
Auburn	33° N	85° W
Birmingham AP	34° N	87° W
Decatur	35° N	87° W
Dothan AP	31° N	85° W
Florence AP	35° N	88° W
Gadsden	34° N	86° W
Huntsville AP	35° N	87° W
Mobile AP	31° N	88° W
Mobile Co	31° N	88° W
Montgomery AP	32° N	86° W
Selma-Craig AFB	02° N	88° W
Talladega	33° N	86° W
Tuscaloosa AP	33° N	88° W
ALASKA		
Anchorage AP	61° N	150° W
Barrow (S)	71° N	157° W
Fairbanks AP(S)	65° N	148° W
Juneau AP	58° N	135° W
Kodiak	58° N	152° W
Nome AP	64° N	165° W

STATE/CITY	Lat	Long
ARIZONA		
Douglas AP	31° N	110° W
Flagstaff AP	35° N	112° W
Fort Huachuca AP (S)	32° N	110° W
Kingman AP	35° N	114° W
Nogales	31° N	111° W
Phoenix AP (S)	33° N	112° W
Prescott AP	35° N	112° W
Tucson AP (S)	32° N	111° W
Winslow AP	35° N	111° W
Yuma AP	33° N	115° W
ARKANSAS		
Blytheville AFB	36° N	90° W
Camden	34° N	93° W
El Dorado AP	33° N	93° W
Fayetteville AP	36° N	94° W
Fort Smith AP	35° N	94° W
Hot Springs	34° N	93° W
Jonesboro	36° N	91° W
Little Rock AP (S)	5° N	92° W
Pine Bluff AP	34° N	92° W
Texarkana AP	33° N	94° W

STATE/CITY	Lat	Long
CALIFORNIA		
Bakersfield AP	35° N	119° W
Barstow AP	35° N	117° W
Blythe AP	34° N	115° W
Burbank AP	34° N	118° W
Chico	40° N	122° W
Concord	38° N	122° W
Covina	34° N	118° W
Crescent City AP	42° N	125° W
Downey	34° N	118° W
El Cajon	33° N	117° W
El Cerrito AP (S)	33° N	116° W
Escondido	33° N	117° W
Eureka/Arcata AP	41° N	124° W
Fairfield-Travis AFB	38° N	122° W
Fresno AP (S)	37° N	120° W
Hamilton AFB	38° N	122° W
Laguna Beach	34° N	118° W
Livermore	38° N	122° W
Lompoc, Vandenberg AFB	35° N	121° W
Long Beach AP	34° N	118° W
Los Angeles AP (S)	34° N	118° W
Los Angeles CO (S)	34° N	118° W
Merced-Castle AFB	37° N	121° W
Modesto	38° N	121° W
Monterey	37° N	122° W
Napa	38° N	122° W
Needles AP	35° N	115° W
Oakland AP	38° N	122° W

STATE/CITY	Lat	Long
Oceanside	33° N	117° W
Ontario	34° N	118° W
Oxnard	34° N	119° W
Palmdale AP	35° N	118° W
Palm Springs	34° N	117° W
Pasadena	34° N	118° W
Petaluma	38° N	123° W
Pomona Co	34° N	118° W
Redding AP	41° N	122° W
Redlands	34° N	117° W
Richmond	38° N	122° W
Riverside-March AFB (S)	34° N	117° W
Sacramento AP	39° N	121° W
Salinas AP	37° N	122° W
San Bernadino, Norton AFB	34° N	117° W
San Diego AP	33° N	117° W
San Fernando	34° N	118° W
San Francisco AP	38° N	122° W
San Francisco Co	38° N	122° W
San Jose AP	37° N	122° W
San Louis Obispo	35° N	121° W
Santa Ana AP	34° N	118° W
Santa Barbara MAP	34° N	120° W
Santa Cruz	37° N	122° W
Santa Maria AP (S)	35° N	120° W
Santa Monica CIC	34° N	118° W
Santa Paula	34° N	119° W
Santa Rosa	39° N	123° W
Stockton AP	38° N	121° W

STATE/CITY	Lat	Long
Ukiah	39° N	123° W
Visalia	36° N	119° W
Yreka	42° N	123° W
Yuba City	39° N	122° W
COLORADO		
Alamosa AP	37° N	106° W
Boulder	40° N	105° W
Colorado Springs AP	39° N	105° W
Denver AP	40° N	105° W
Durango	37° N	108° W
Fort Collins	41° N	105° W
Grand Junction AP (S)	39° N	109° W
Greeley	40° N	105° W
Lajunta AP	38° N	103° W
Leadville	39° N	106° W
Pueblo AP	38° N	104° W
Sterling	48° N	103° W
Trinidad	37° N	104° W
CONNECTICUT		
Bridgeport AP	41° N	73° W
Hartford, Brainard Field	42° N	73° W
New Haven AP	41° N	74° W
New London	41° N	72° W
Norwalk	41° N	73° W
Norwick	42° N	72° W
Waterbury	42° N	73° W
Windsor Locks, Bradley FI	42° N	73° W

STATE/CITY	Lat	Long
DELAWARE		
Dover AFB	39° N	75° W
Wilmington AP	40° N	76° W
DISTRICT OF COLUMBIA		
Andrews AFB	38° N	76° W
Washington, National AP	39° N	77° W
FLORIDA		
Belle Glade	27° N	81° W
Cape Kennedy AP	28° N	81° W
Daytona Beach AP	29° N	81° W
E Fort Lauderdale	26° N	80° W
Fort Myers AP	27° N	82° W
Fort Pierce	27° N	80° W
Gainesville AP (S)	30° N	82° W
Jacksonville AP	30° N	82° W
Key West AP	25° N	82° W
Lakeland Co (S)	28° N	82° W
Miami AP (S)	26° N	80° W
Miami Beach Co	26° N	80° W
Ocala	29° N	82° W
Orlando AP	29° N	81° W
Panama City, Tyndall AFB	30° N	86° W
Pensacola Co	30° N	87° W
St. Augustine	30° N	81° W
St. Petersburg	28° N	83° W
Stanford	29° N	81° W

STATE/CITY	Lat	Long
Sarasota	27° N	83° W
Tallahassee AP (S)	30° N	84° W
Tampa AP (S)	28° N	83° W
West Palm Beach AP	27° N	80° W
GEORGIA		
Albany, Turner AFB	32° N	84° W
Americus	32° N	84° W
Athens	33° N	83° W
Atlanta AP (S)	34° N	84° W
Augusta AP	33° N	82° W
Brunswick	31° N	81° W
Columbus, Lawson AFB	33° N	85° W
Dalton	35° N	85° W
Dublin	32° N	83° W
Gainesville	34° N	84° W
Griffin	33° N	84° W
LaGrange	33° N	85° W
Macon AP	33° N	84° W
Marietta, Dobbins AFB	34° N	85° W
Savannah	32° N	81° W
Valdosta-Moody AFB	31° N	83° W
Waycross	31° N	82° W
HAWAII		
Hilo AP (S)	20° N	155° W
Honolulu AP	21° N	158° W
Kaneohe Bay MCAS	21° N	158° W
Wahiawa	21° N	158° W

STATE/CITY	Lat	Long
IDAHO		
Boise AP (S)	44° N	116° W
Burley	43° N	114° W
Coeur D'Alene AP	48° N	117° W
Idaho Falls AP	44° N	112° W
Lewiston AP	46° N	117° W
Moscow	47° N	117° W
Mountain Home AFB	43° N	116° W
Pocatello AP	43° N	113° W
Twin Falls AP (S)	42° N	114° W
ILLINOIS		
Aurora	42° N	88° W
Belleville, Scott AFB	39° N	90° W
Bloomington	40° N	89° W
Carbondale	38° N	89° W
Champaign/Urbana	40° N	88° W
Chicago, Midway AP	42° N	88° W
Chicago, O'Hare AP	42° N	88° W
Chicago Co	42° N	88° W
Danville	40° N	88° W
Decatur	40° N	89° W
Dixon	42° N	89° W
Elgin	42° N	88° W
Freeport	42° N	90° W
Galesburg	41° N	90° W
Greenville	39° N	89° W
Joliet	42° N	88° W
Kankakee	41° N	88° W

STATE/CITY	Lat	Long
La Salle/Peru	41° N	89° W
Macomb	40° N	91° W
Moline AP	41° N	91° W
Mt Vernon	38° N	89° W
Peoria AP	41° N	90° W
Quincy AP	40° N	91° W
Rantoul, Chanute AFB	40° N	88° W
Rockford	42° N	89° W
Springfield AP	40° N	90° W
Waukegan	42° N	88° W
INDIANA		
Anderson	40° N	86° W
Bedford	39° N	86° W
Bloomington	39° N	87° W
Columbus, Bakalar AFB	39° N	86° W
Crawfordsville	40° N	87° W
Evansville AP	38° N	88° W
Fort Wayne AP	41° N	85° W
Goshen AP	42° N	86° W
Hobar	42° N	87° W
Huntington	41° N	85° W
Indianapolis AP	40° N	86° W
Jeffersonville	38° N	86° W
Kokomo	40° N	86° W
Lafayette	40° N	86° W
La Porte	42° N	87° W
Marion	40° N	86° W
Muncie	40° N	85° W

STATE/CITY	Lat	Long
Peru, Grissom AFB	41° N	86° W
Richmond AP	40° N	85° W
Shelbyville	40° N	86° W
South Bend AP	42° N	86° W
Terre Haute AP	39° N	87° W
Valparaiso	42° N	87° W
Vincennes	39° N	88° W
IOWA		
Ames (S)	42° N	94° W
Burlington AP	41° N	91° W
Cedar Rapids AP	42° N	92° W
Clinton	42° N	90° W
Council Bluffs	41° N	96° W
Des Moines AP	42° N	94° W
Dubuque	42° N	91° W
Fort Dodge	43° N	95° W
Iowa City	42° N	92° W
Keokuk	40° N	91° W
Marshalltown	42° N	93° W
Mason City AP	43° N	93° W
Newton	42° N	93° W
Ottumwa AP	41° N	92° W
Sioux City AP	42° N	96° W
Waterloo	43° N	92° W
KANSAS		
Atchison	40° N	95° W
Chanute AP	38° N	95° W

STATE/CITY	Lat	Long
Dodge City AP (S)	38° N	100° W
El Dorado	38° N	97° W
Emporia	38° N	96° W
Garden City AP	38° N	101° W
Goodland AP	39° N	102° W
Great Bend	38° N	99° W
Hutchinson AP	38° N	98° W
Libera	37° N	101° W
Manhattan, Ft Riley (S)	39° N	97° W
Parsons	37° N	96° W
Russell AP	39° N	99° W
Salina	39° N	98° W
Topeka AP	39° N	96° W
Wichita AP	38° N	97° W
KENTUCKY		
Ashland	39° N	83° W
Bowling Green AP	36° N	86° W
Corbin AP	37° N	84° W
Covington AP	39° N	85° W
Hopkinsville, Ft Campbell	37° N	88° W
Lexington AP (S)	38° N	85° W
Louisville AP	38° N	86° W
Madisonville	37° N	87° W
Owensboro	38° N	87° W
Paducah AP	37° N	89° W
LOUISIANA		
Alexandria AP	31° N	92° W

STATE/CITY	Lat	Long
Baton Rouge AP	31° N	91° W
Bogalusa	31° N	90° W
Houma	30° N	91° W
Lafayette AP	30° N	92° W
Lake Charles AP (S)	30° N	93° W
Minden	33° N	93° W
Monroe AP	33° N	92° W
Natchitoches	32° N	93° W
New Orleans AP	30° N	90° W
Shreveport AP (S)	32° N	94° W
MAINE		
Augusta AP	44° N	70° W
Bangor, Dow AFB	45° N	69° W
Caribou AP (S)	47° N	68° W
Lewiston	44° N	70° W
Millinocket AP	46° N	69° W
Portland (S)	44° N	70° W
Waterville	45° N	70° W
MARYLAND		
Baltimore AP	39° N	77° W
Baltimore Co	39° N	76° W
Cumberland	40° N	79° W
Frederick AP	40° N	78° W
Hagerstown	40° N	78° W
Salisbury (S)	38° N	75° W
MASSACHUSETTS		
Boston AP	42° N	71° W
Clinton	42° N	72° W

STATE/CITY	Lat	Long
Fall River	42° N	71° W
Framingham	42° N	71° W
Gloucester	43° N	71° W
Greenfield	42° N	72° W
Lawrence	43° N	71° W
Lowell	43° N	71° W
New Bedford	42° N	71° W
Pittsfield AP	42° N	73° W
Springfield, Westover AFB	42° N	73° W
Taunton	42° N	71° W
Worcester AP	42° N	72° W
MICHIGAN		
Adrian	42° N	84° W
Alpena AP	45° N	83° W
Battle Creek AP	42° N	85° W
Benton Harbor AP	42° N	86° W
Detroit	42° N	83° W
Escanaba	46° N	87° W
Flint AP	43° N	84° W
Grand Rapids AP	43° N	86° W
Holland	43° N	86° W
Jackson AP	42° N	84° W
Kalamazoo	42° N	86° W
Lansing AP	43° N	85° W
Marquette Co	47° N	87° W
Mt Pleasant	44° N	85° W
Muskegon AP	43° N	86° W
Pontiac	43° N	83° W

STATE/CITY	Lat	Long
Port Huron	43° N	82° W
Saginaw AP	44° N	84° W
Sault Ste. Marie AP (S)	46° N	84° W
Traverse City AP	45° N	86° W
Ypsilanti	42° N	84° W
MINNESOTA		
Albert Lea	44° N	93° W
Alexandria AP	46° N	95° W
Bemidji AP	48° N	95° W
Brainerd	47° N	94° W
Duluth AP	47° N	92° W
Faribault	44° N	93° W
Fergus Falls	46° N	96° W
International Falls AP	49° N	93° W
Mankato	44° N	93° W
Minneapolis/St. Paul AP	45° N	94° W
Rochester AP	44° N	92° W
St. Cloud AP (S)	46° N	94° W
Virginia	47° N	92° W
Willmar	45° N	93° W
Winona	44° N	92° W

STATE/CITY	Lat	Long
MISSISSIPPI		
Biloxi—Keesler AFB	30° N	89° W
Clarksdale	34° N	91° W
Columbus AFB	33° N	88° W
Greenville AFB	34° N	91° W
Greenwood	33° N	90° W
Hattiesburg	31° N	89° W
Jackson AP	32° N	90° W
Laurel	31° N	89° W
Mccomb AP	32° N	90° W
Meridian AP	32° N	89° W
Natchez	32° N	91° W
Tupelo	34° N	89° W
Vicksburg Co	32° N	91° W
MISSOURI		
Cape Girardeau	37° N	90° W
Columbia AP (S)	39° N	92° W
Farmington AP	38° N	90° W
Hannibal	40° N	91° W
Jefferson City	39° N	92° W
Joplin AP	37° N	94° W
Kansas City AP	39° N	95° W
Kirksville AP	40° N	93° W
Mexico	39° N	92° W
Moberly	39° N	92° W
Poplar Bluff	37° N	90° W
Rolla	38° N	92° W
St. Joseph AP	40° N	95° W

STATE/CITY	Lat	Long
St. Louis AP	39° N	90° W
St. Louis CO	39° N	91° W
Sikeston	37° N	90° W
Sedalia—Whiteman AFB	39° N	94° W
Sikeston	37° N	90° W
Springfield AP	37° N	93° W
MONTANA		
Billings AP	46° N	109° W
Bozeman	46° N	111° W
Butte AP	46° N	112° W
Cut Bank AP	49° N	112° W
Glasgow AP (S)	48° N	107° W
Glendive	47° N	105° W
Great Falls AP (S)	47° N	111° W
Havre	49° N	110° W
Helena AP	47° N	112° W
Kalispell AP	48° N	114° W
Lewiston AP	47° N	109° W
Livingstown AP	46° N	110° W
Miles City AP	46° N	106° W
Missoula AP	47° N	114° W
NEBRASKA		
Beatrice	40° N	97° W
Chadron AP	43° N	103° W
Columbus	41° N	97° W
Fremont	41° N	96° W
Grand Island AP	41° N	98° W

STATE/CITY	Lat	Long
Hastings	41° N	98° W
Kearney	41° N	99° W
Lincoln Co (S)	41° N	97° W
McCook	40° N	101° W
Norfolk	42° N	97° W
North Platte AP (S)	41° N	101° W
Omaha AP	41° N	96° W
Scottsbluff AP	42° N	104° W
Sidney AP	41° N	103° W
NEVADA		
Carson City	39° N	120° W
Elko AP	41° N	116° W
Ely AP (S)	39° N	115° W
Las Vegas AP (S)	36° N	115° W
Lovelock AP	40° N	119° W
Reno AP (S)	39° N	120° W
Reno Co	39° N	120° W
Tonopah AP	38° N	117° W
Winnemucca AP	41° N	118° W
NEW HAMPSHIRE		
Berlin	44° N	71° W
Claremont	43° N	72° W
Concord AP	43° N	71° W
Keene	43° N	72° W
Laconia	43° N	71° W
Manchester, Grenier AFB	43° N	71° W
Portsmouth, Pease AFB	43° N	71° W

STATE/CITY	Lat	Long
NEW JERSEY		
Atlantic City CO	39° N	74° W
Long Branch	40° N	74° W
Newark AP	41° N	74° W
New Brunswick	40° N	74° W
Paterson	41° N	74° W
Phillipsburg	41° N	75° W
Trenton Co	40° N	75° W
Vineland	39° N	75° W
NEW MEXICO		
Holloman AFB	33° N	106° W
Albuquerque AP (S)	35° N	107° W
Artesia	33° N	104° W
Carlsbad AP	32° N	104° W
Clovis AP	34° N	103° W
Farmington AP	37° N	108° W
Gallup	36° N	109° W
Grants	35° N	108° W
Hobbs AP	33° N	103° W
Las Cruces	32° N	107° W
Los Alamos	36° N	106° W
Raton AP	37° N	104° W
Roswell, Walker AFB	33° N	105° W
Santa Fe CO	36° N	106° W
Silver City AP	33° N	108° W
Socorro AP	34° N	107° W
Tucumcari AP	35° N	104° W

STATE/CITY	Lat	Long
NEW YORK		
Albany AP (S)	43° N	74° W
Albany Co	43° N	74° W
Auburn	43° N	77° W
Batavia	43° N	78° W
Binghamton AP	42° N	76° W
Buffalo AP	43° N	79° W
Cortland	43° N	76° W
Dunkirk	42° N	79° W
Elmira AP	42° N	77° W
Geneva (S)	43° N	77° W
Glens Falls	43° N	74° W
Gloversville	43° N	74° W
Hornell	42° N	78° W
Ithaca (S)	42° N	76° W
Jamestown	42° N	79° W
Kingston	42° N	74° W
Lockport	43° N	79° W
Massena AP	45° N	75° W
Newburgh, Stewart AFB	41° N	74° W
NYC-Central Park (S)	41° N	74° W
NYC-Kennedy AP	41° N	74° W
NYC-La Guardia AP	41° N	74° W
Niagara Falls AP	43° N	80° W
Olean	42° N	79° W
Oneonta	43° N	75° W
Oswego Co	43° N	77° W
Plattsburg AFB	45° N	73° W
Poughkeepsie	42° N	74° W

STATE/CITY	Lat	Long
Rochester AP	43° N	78° W
Rome, Griffiss AFB	43° N	75° W
Schenectady (S)	43° N	74° W
Suffolk County AFB	41° N	73° W
Syracuse AP	43° N	76° W
Utica	43° N	75° W
Watertown	44° N	76° W
NORTH CAROLINA		
Asheville AP	35° N	83° W
Charlotte AP	35° N	81° W
Durham	36° N	79° W
Elizabeth City AP	36° N	76° W
Fayetteville, Pope AFB	35° N	79° W
Goldsboro, Seymour-Johnson	35° N	78° W
Greensboro AP (S)	36° N	80° W
Greenville	36° N	77° W
Henderson	36° N	78° W
Hickory	06° N	81° W
Jacksonville	35° N	78° W
Lumberton	35° N	79° W
New Bern AP	35° N	77° W
Raleigh/Durham AP (S)	36° N	79° W
Rocky Mount	36° N	78° W
Wilmington AP	34° N	78° W
Winston-Salem AP	36° N	80° W

STATE/CITY	Lat	Long
NORTH DAKOTA		
Bismarck AP (S)	47° N	101° W
Devils Lake	48° N	99° W
Dickinson AP	47° N	103° W
Fargo AP	47° N	97° W
Grand Forks AP	48° N	97° W
Jamestown AP	47° N	99° W
Minot AP	48° N	101° W
Williston	48° N	104° W
OHIO		
Akron-Canton AP	41° N	81° W
Ashtabula	42° N	81° W
Athens	39° N	82° W
Bowling Green	41° N	84° W
Cambridge	40° N	82° W
Chillicothe	39° N	83° W
Cincinnati Co	39° N	85° W
Cleveland AP (S)	41° N	82° W
Columbus AP (S)	40° N	83° W
Dayton AP	40° N	84° W
Defiance	41° N	84° W
Findlay AP	41° N	84° W
Fremont	41° N	83° W
Hamilton	39° N	85° W
Lancaster	40° N	83° W
Lima	41° N	84° W
Mansfield AP	41° N	83° W
Marion	41° N	83° W

STATE/CITY	Lat	Long
Middletown	40° N	84° W
Newark	40° N	82° W
Norwalk	41° N	83° W
Portsmouth	39° N	83° W
Sandusky Co	41° N	83° W
Springfield	40° N	84° W
Steubenville	40° N	81° W
Toledo AP	42° N	84° W
Warren	41° N	81° W
Wooster	41° N	82° W
Youngstown AP	41° N	81° W
Zanesville AP	40° N	82° W
OKLAHOMA		
Ada	35° N	97° W
Altus AFB	35° N	99° W
Ardmore	34° N	97° W
Bartlesville	37° N	96° W
Chickasha	35° N	98° W
Enid, Vance AFB	36° N	98° W
Lawton AP	35° N	98° W
McAlester	35° N	96° W
Muskogee AP	36° N	95° W
Norman	35° N	97° W
Oklahoma City AP (S)	35° N	98° W
Ponca City	37° N	97° W
Seminole	35° N	97° W
Stillwater (S)	36° N	97° W
Tulsa AP	36° N	96° W

STATE/CITY	Lat	Long
Woodward	37° N	100° W
OREGON		
Albany	45° N	123° W
Astoria AP (S)	46° N	124° W
Baker AP	45° N	118° W
Bend	44° N	121° W
Corvallis (S)	44° N	123° W
Eugene AP	44° N	123° W
Grants Pass	42° N	123° W
Klamath Falls AP	42° N	122° W
Medford AP (S)	42° N	123° W
Pendleton AP	46° N	119° W
Portland AP	46° N	123° W
Portland Co	46° N	123° W
Roseburg AP	43° N	123° W
Salem AP	45° N	123° W
The Dalles	46° N	121° W
PENNSYLVANIA		
Allentown AP	41° N	75° W
Altoona Co	40° N	78° W
Butler	41° N	80° W
Chambersburg	40° N	78° W
Erie AP	42° N	80° W
Harrisburg AP	40° N	77° W
Johnstown	40° N	79° W
Lancaster	40° N	76° W
Meadville	42° N	80° W

STATE/CITY	Lat	Long
New Castle	41° N	80° W
Philadelphia AP	40° N	75° W
Pittsburgh AP	40° N	80° W
Pittsburgh Co	40° N	80° W
Reading Co	40° N	76° W
Scranton/Wilkes-Barre	41° N	76° W
State College (S)	41° N	78° W
Sunbury	41° N	77° W
Uniontown	40° N	80° W
Warren	42° N	79° W
West Chester	40° N	76° W
Williamsport AP	41° N	77° W
York	40° N	77° W
RHODE ISLAND		
Newport (S)	41° N	71° W
Providence AP	42° N	71° W
SOUTH CAROLINA		
Anderson	34° N	83° W
Charleston AFB (S)	33° N	80° W
Charleston Co	33° N	80° W
Columbia AP	34° N	81° W
Florence AP	35° N	80° W
Georgetown	33° N	79° W
Greenville AP	35° N	82° W
Greenwood	35° N	82° W
Orangeburg	33° N	81° W
Rock Hill	35° N	81° W

STATE/CITY	Lat	Long
Spartanburg AP	35° N	82° W
Sumter, Shaw AFB	34° N	80° W
SOUTH DAKOTA		
Aberdeen AP	45° N	98° W
Brookings	44° N	97° W
Huron AP	44° N	98° W
Mitchell	44° N	98° W
Pierre AP	44° N	100° W
Rapid City AP (S)	44° N	103° W
Sioux Falls AP	44° N	97° W
Watertown AP	45° N	97° W
Yankton	43° N	97° W
TENNESSEE		
Athens	35° N	85° W
Bristol-Tri City AP	36° N	82° W
Chattanooga AP	35° N	85° W
Clarksville	37° N	87° W
Columbia	36° N	87° W
Dyersburg	36° N	89° W
Greenville	36° N	83° W
Jackson AP	36° N	89° W
Knoxville AP	36° N	84° W
Memphis AP	35° N	90° W
Murfreesboro	35° N	86° W
Nashville AP (S)	36° N	87° W
Tulahoma	35° N	86° W

STATE/CITY	Lat	Long
TEXAS		
Abilene AP	32° N	100° W
Alice AP	28° N	98° W
Amarillo AP	35° N	101° W
Austin AP	30° N	98° W
Bay City	29° N	96° W
Beaumont	30° N	94° W
Beeville	28° N	98° W
Big Spring AP (S)	32° N	101° W
Brownsville AP (S)	26° N	97° W
Brownwood	32° N	99° W
Bryan AP	31° N	97° W
Corpus Christi AP	28° N	97° W
Corsicana	32° N	96° W
Dallas AP	33° N	97° W
Del Rio, Laughlin AFB	29° N	101° W
Denton	33° N	97° W
Eagle Pass	29° N	101° W
El Paso AP (S)	32° N	106° W
Fort Worth AP (S)	33° N	97° W
Galveston AP	29° N	95° W
Greenville	33° N	96° W
Harlingen	26° N	98° W
Houston AP	30° N	95° W
Houston Co	30° N	95° W
Huntsville	31° N	96° W
Killeen, Robert Gray AAF	31° N	98° W
Lamesa	33° N	102° W
Laredo AFB	28° N	99° W

STATE/CITY	Lat	Long
Longview	32° N	95° W
Lubbock AP	34° N	102° W
Lufkin AP	31° N	95° W
McAllen	26° N	98° W
Midland AP (S)	32° N	102° W
Mineral Wells AP	33° N	98° W
Palestine Co	32° N	96° W
Pampa	36° N	101° W
Pecos	31° N	103° W
Plainview	30° N	94° W
Goodfellow AFB	31° N	100° W
San Antonio AP (S)	30° N	98° W
Sherman, Perrin AFB	34° N	97° W
Snyder	33° N	101° W
Temple	31° N	97° W
Tyler AP	32° N	95° W
Vernon	34° N	99° W
Victoria AP	29° N	97° W
Waco AP	32° N	97° W
Wichita Falls AP	34° N	98° W
UTAH		
Cedar City AP	38° N	113° W
Logan	42° N	112° W
Moab	39° N	110° W
Ogden AP	41° N	112° W
Price	40° N	111° W
Provo	40° N	112° W
Richfield	39° N	112° W

STATE/CITY	Lat	Long
St George Co	37° N	114° W
Salt Lake City AP (S)	41° N	112° W
Vernal AP	40° N	110° W
VERMONT		
Barre	44° N	73° W
Burlington AP (S)	44° N	73° W
Rutland	44° N	73° W
VIRGINIA		
Charlottesville	38° N	79° W
Danville AP	37° N	79° W
Fredericksburg	38° N	77° W
Harrisonburg	38° N	79° W
Lynchburg AP	37° N	79° W
Norfolk AP	37° N	76° W
Petersburg	37° N	78° W
Richmond AP	37° N	77° W
Roanoke AP	37° N	80° W
Staunton	38° N	79° W
Winchester	39° N	78° W
WASHINGTON		
Aberdeen	47° N	124° W
Bellingham AP	49° N	123° W
Bremerton	48° N	123° W
Ellensburg AP	47° N	121° W
Everett, Paine AFB	48° N	122° W
Kennewick	46° N	119° W

STATE/CITY	Lat	Long
Longview	46° N	123° W
Moses Lake, Larson AFB	47° N	119° W
Olympia AP	47° N	123° W
Port Angeles	48° N	123° W
Seattle-Boeing Field	48° N	122° W
Seattle Co (S)	48° N	122° W
Seattle-Tacoma AP (S)	47° N	122° W
Spokane AP (S)	48° N	118° W
Tacoma, McChord AFB	47° N	122° W
Walla Walla AP	46° N	118° W
Wenatchee	47° N	120° W
Yakima AP	47° N	121° W
WEST VIRGINIA		
Beckley	38° N	81° W
Bluefield AP	37° N	81° W
Charleston AP	38° N	82° W
Clarksburg	39° N	80° W
Elkins AP	39° N	80° W
Huntington Co	38° N	82° W
Martinsburg AP	39° N	78° W
Morgantown AP	40° N	80° W
Parkersburg Co	39° N	82° W
Wheeling	40° N	81° W
WISCONSIN		
Appleton	44° N	88° W
Ashland	47° N	91° W
Beloit	42° N	89° W

STATE/CITY	Lat	Long
Eau Claire AP	45° N	91° W
Fond Du Lac	44° N	88° W
Green Bay AP	44° N	88° W
La Crosse AP	44° N	91° W
Madison AP (S)	43° N	89° W
Manitowoc	44° N	87° W
Marinette	45° N	88° W
Milwaukee AP	43° N	88° W
Racine	43° N	88° W
Sheboygan	44° N	88° W
Stevens Point	44° N	90° W
Waukesha	43° N	88° W
Wausau AP	45° N	90° W
WYOMING		
Casper AP	43° N	106° W
Cheyenne	41° N	105° W
Cody AP	45° N	109° W
Evanston	41° N	111° W
Lander AP (S)	43° N	109° W
Laramie AP (S)	41° N	106° W
Newcastle	44° N	104° W
Rawlins	42° N	107° W
Rock Springs AP	42° N	109° W
Sheridan AP	45° N	107° W
Torrington	42° N	104° W

Appendix B: Menus

Set Time/Date, Astro Clock

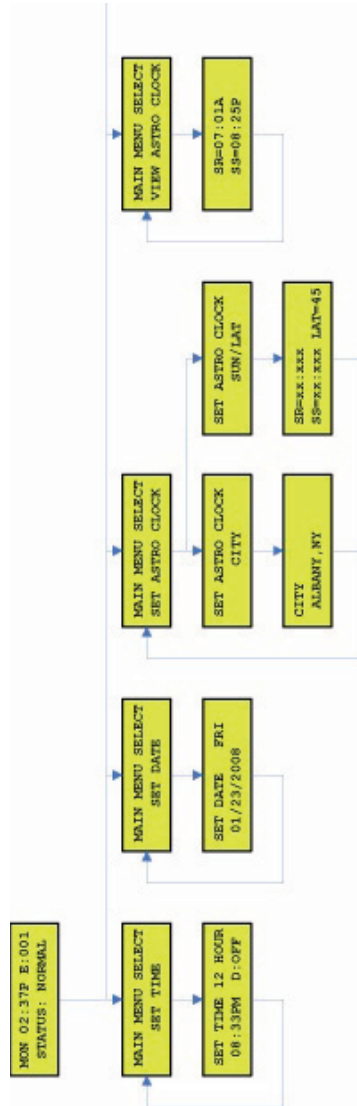

Scheduler

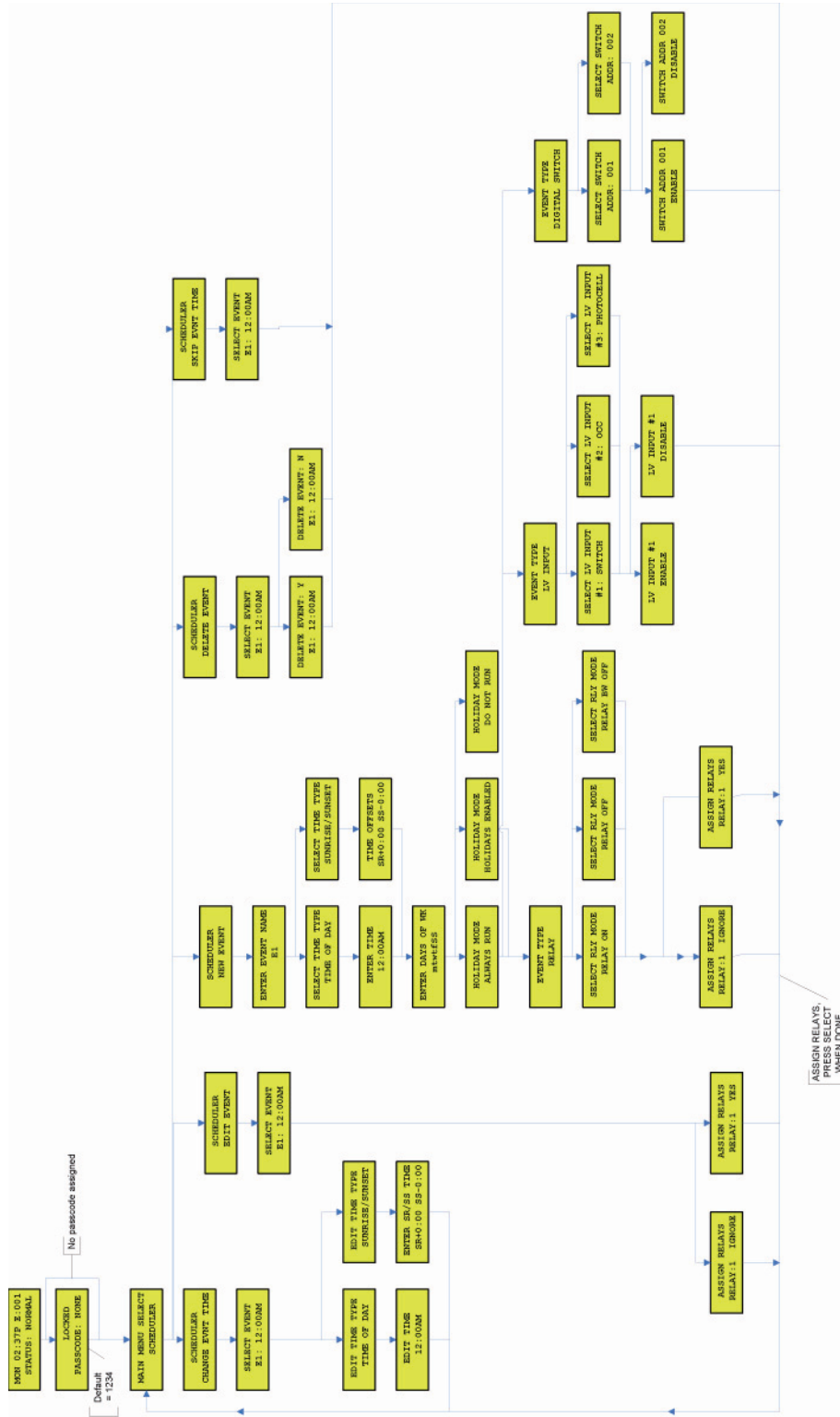

System Settings

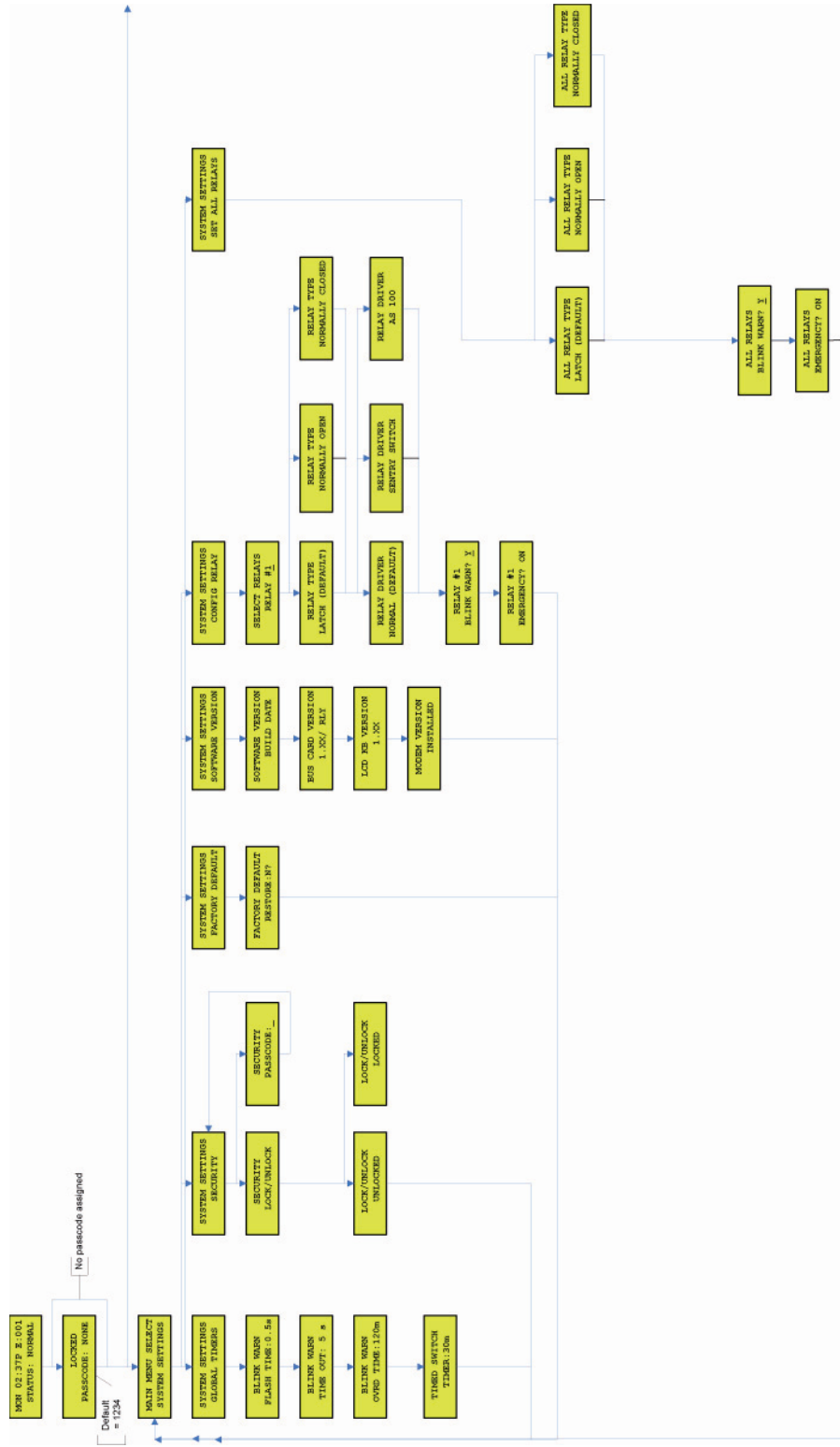

Configuring Inputs

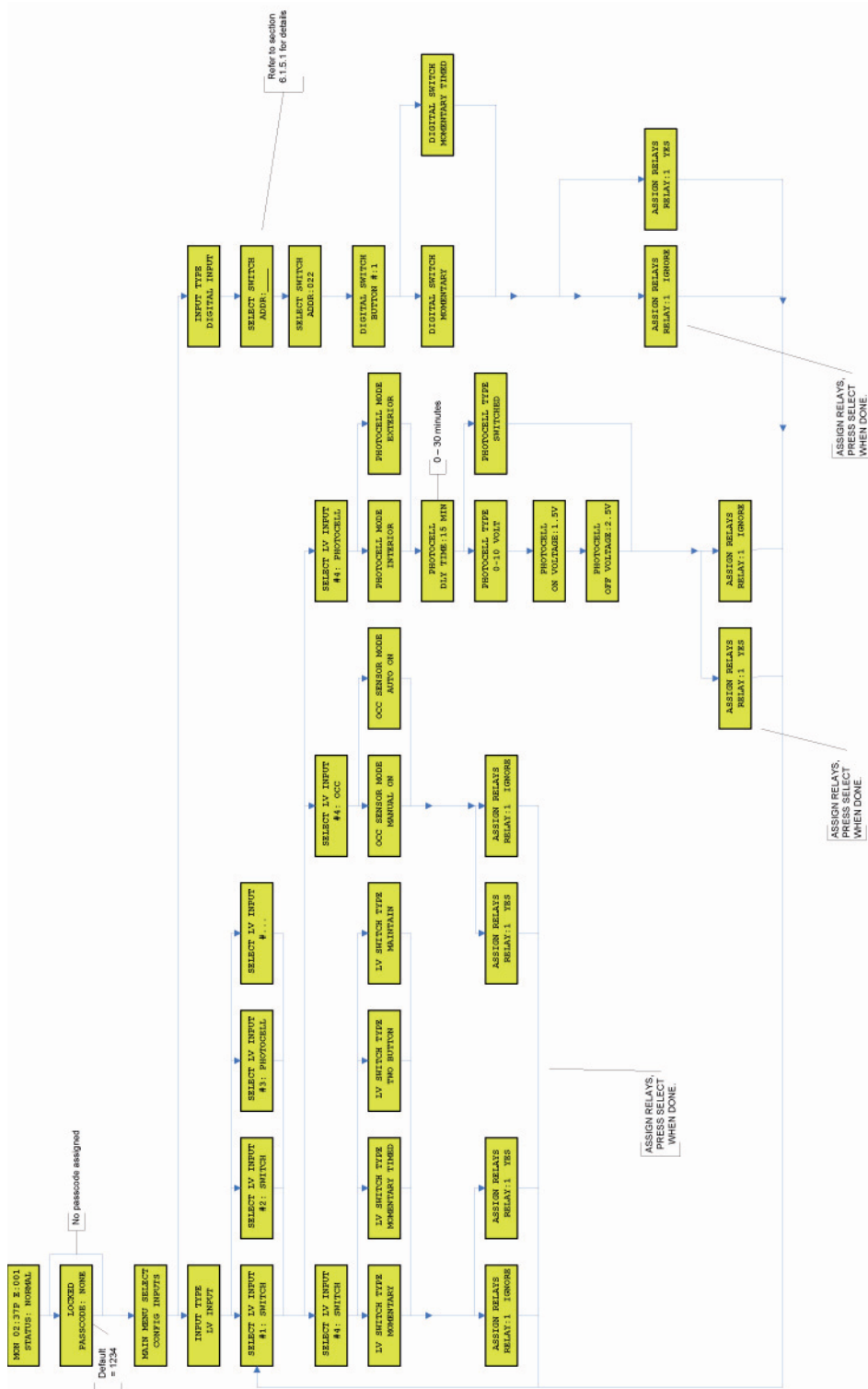

Warranty Information

Limited Warranty

Leviton Manufacturing Co Inc. warrants the products represented in this manual to be free of material and workmanship defects for a period of two years after system acceptance or 26 months after shipment from Leviton, whichever comes first. The EZ-MAX Plus relay cards are covered for a period of ten (10) years. Lighting fixtures manufactured by Leviton are covered for a period of one year.

This Warranty is limited to repair or replacement of defective equipment returned Freight Pre-Paid to Leviton Manufacturing at 20497 SW Teton Ave., Tualatin, Oregon 97062, USA. User shall call 1-800-959-6004 and request a return authorization number to mark on the outside of the returning carton, to assure that the returned material will be properly received at Leviton.

All equipment shipped back to Leviton must be carefully and properly packed to avoid shipping damage. Replacements or repaired equipment will be returned to sender freight prepaid, F.O.B. factory. Leviton is not responsible for removing or replacing equipment on the job site, and will not honor charges for such work. Leviton will not be responsible for any loss of use time or subsequent damages should any of the equipment fail during the warranty period, but agrees only to repair or replace defective equipment returned to its plant in Tualatin, Oregon.

This Warranty is void on any product that has been improperly installed, overloaded, short circuited, abused, or altered in any manner. Neither the seller nor Leviton shall be liable for any injury, loss or damage, direct or consequential arising out of the use of or inability to use the equipment. This Warranty does not cover lamps, ballasts, and other equipment which is supplied or warranted directly to the user by their manufacturer. Leviton makes no warranty as to the Fitness for Purpose or other implied Warranties.

NOTES

Lined area for taking notes, consisting of multiple horizontal lines.



Leviton Lighting Management Systems Division Headquarters
20497 SW Teton Avenue, Tualatin, OR 97062
Customer Service Telephone: 1-800-736-6682 • FAX: 1-503-404-5600
Tech Line: 1-800-959-6004

Leviton Manufacturing Co., Inc.
201 North Service Road, Melville, N.Y. 11747
Telephone: 1-800-323-8920 • FAX: 1-800-832-9538

Visit Leviton's Web site at <http://www.leviton.com>
© 2010 Leviton Manufacturing Co., Inc. All Rights Reserved
Specifications and Pricing Subject to Change at any time without notice