

software age

November 1969

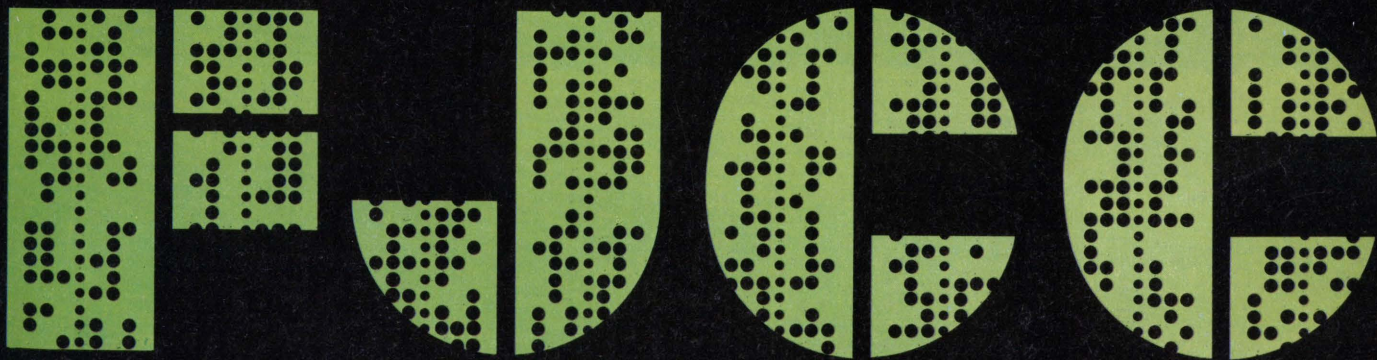
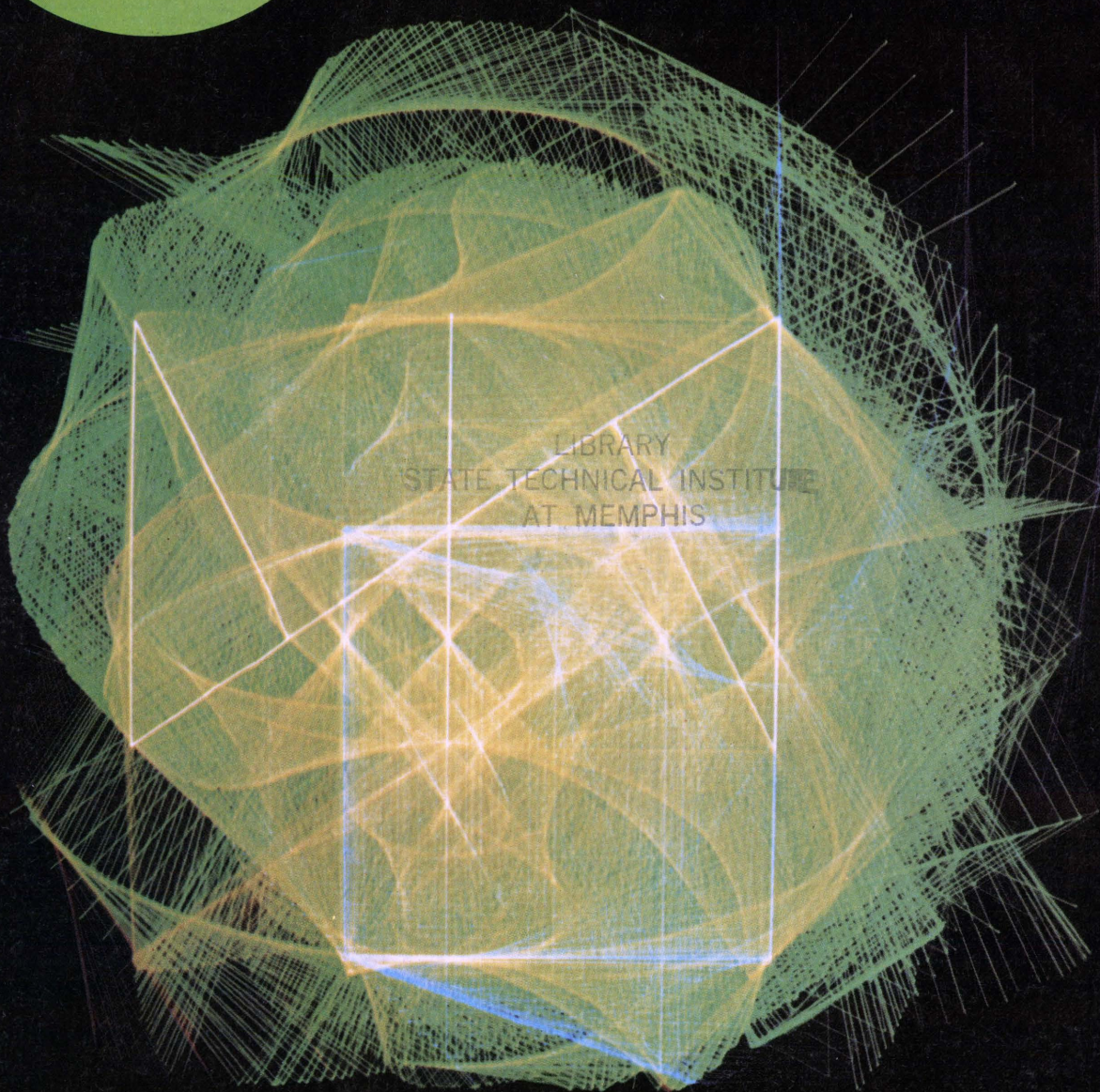

see page 9

PROGRAMMERS

There's no better
time to
expand your horizons

JOIN THE
CREATIVE
WORLD OF

XDS
Xerox Data Systems

701 South Aviation Blvd., El Segundo, California 90245

An Equal Opportunity Employer

Xerox Data Systems, formerly Scientific Data Systems, has expanded from serving only the scientific community to now include the fields of education, medicine, government, and general business. Our rapid growth, enlarged interests, and proud new name create exciting and challenging opportunities for those professionals interested in accelerating their own personal careers. Seize your creative opportunity NOW!

If your skills match any of those listed below . . . don't delay . . . contact us today!

- Business Software Development
- Systems Programmers
 - Compilers/Assemblers
 - Time Sharing
 - Real Time
 - Operating Systems Specialists
- Utility Programmers
- Linear Programmers
- Application Software Product Managers
- Business Applications Programmers
- Programming Instructors
- Diagnostic Programming
- Computer Analysts (to support sales)

Call collect or send resume to:

Mr. Carl Kundman (213) 679-4511

OR BETTER YET

ASK TO SEE US AT THE BIG XDS DISPLAY AT THE FJCC

- 5 Conference Countdown
- 7 Personal Lines
- 8 FJCC Preview
- 18 New Product Preview
- 28 A General Logic Simulation Program
Robert Marsh
- 37 Use of Mathematics to Perform Bit Manipulation
Lt. Colonel Edwin Hudspeth
- 41 Financial Currents
- 45 Trouble Tran's Adventures in Fortran
- 47 From Better to Best Tips for Good Programming
Marilyn Bohl and Arline Bohl Walter
- 51 Better Books
- 59 Marketplace
- 61 S/A's Confidential Inquiry Form
- 62 Index of Advertisers

Publisher David W. French
Editor John F. Sikora
Managing Editor Elspeth Taylor
Editorial Assistant Laura Brandt
Traffic Manager Betsy Pavkovich
Circulation Ann Vickers
Business Stephenie Jensen
Resume Control Sue Bullington

CIRCULATION OF THIS ISSUE
MORE THAN 130,000
BPA Audit Applied For

SOFTWARE AGE

2211 FORDEM AVENUE, MADISON, WISCONSIN 53701
PHONE: (608) 249-0128 OR (800) 356-8141

R. John Antil

Los Angeles, Calif.: Richard Faust, 9800 S. Sepulveda Blvd.
(213) 776-0100

San Francisco, Calif.: Ernesto Montano, 595 Buckingham Way,
Suite 226 (415) 731-8240

Philadelphia, Pa.: Richard D. Clemmer, 27 Acoma Lane,
Collegeville, Pa. (215) 489-9141

Houston, Texas: W. Royce House, 4040 Southwest Freeway,
Houston, Texas (713) 622-2868

SOFTWARE AGE is published monthly by

press tech inc.

2211 Fordem Avenue, Madison, Wisconsin 53701

Subscription free to qualified readers. Others, 10/yr. Individual copies, \$1. Foreign subscriptions, \$15/yr.

For change of address please return your address label from the magazine.

Controlled circulation postage paid at Madison, Wisconsin.

THE
**POWER
SYSTEMS
DIVISIONS**
OF
**NORTH AMERICAN
ROCKWELL**

has a Range of Openings
within Computing & Data Processing

FOR
PROGRAMMERS
(Business Appl. & Software)

AND
SYSTEM ANALYSTS
(Business Systems)

- **HARDWARE — IBM S/360**
Models 50 & 65
- **SOFTWARE**
Cobol, BAL, QTAM, ASP, OS-MFT II, MVT
- **APPLICATIONS ORIENTATION**
On Line T/P
Large Random Access Data Bases

*Personnel capable and interested
in complex computer systems and
concepts are invited for an
interview and discussion.*

- For Prompt, Confidential Attention,
Send Your Inquiry and Resume to:
S. C. Mayborn,
c/o Professional Placement
POWER SYSTEMS DIVISIONS
6633 Canoga Avenue
Canoga Park, California 91304



Power Systems Divisions
North American Rockwell

An Equal Opportunity Employer

Programmers and systems analysts . . .

Univac: Where you can help make the world a little bit better

America's Apollo 11 space shot, with the help of UNIVAC® Computers, has successfully landed on the moon. And made it possible for two American astronauts to explore the lunar surface.

The people who are proudest of this Apollo flight aren't just NASA people. They are also the Univac programmers and systems analysts who spent months writing the programs that made the use of telemetering of this flight possible.

You see, we understand that nothing bothers a programmer or systems analyst more than doing busy work. So we keep our people busy with meaningful work like the Apollo program.

What's more, we feel that the important problem is a problem that still hasn't been solved: the problem of keeping America strong. Because when America is strong she can better fulfill her obligations to underprivileged countries looking to her for help and direction. This is where you come in.

Univac needs people who are old-fashioned enough to care about making the world a little better. Who are interested in making a real contribution, not just marking time. And who want to be rewarded on the basis of the excellence of their service, instead of just on the length of their service.

If you're this kind of person, we here at Univac can't offer you a job. But we can offer you a fine career. Think it over and then check the facing page for a complete list of current Univac job opportunities.

An Equal Opportunity Employer M/F

UNIVAC

 **SPEERY RAND**

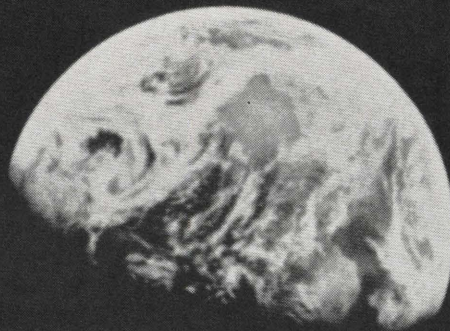

conference

countdown

NOVEMBER

- 17-18** Digital Equipment Computer Users Society Meeting, Las Vegas, Nevada. Contact: Angela Cossette, Digital Equipment Computer Users Society, Maynard, Massachusetts 01754.
- 17-19** 1969 IEEE Symposium on Adaptive Processes (8th), Penn. State University, State College, Penn. Contact: Prof. G. J. McMurtry, Electrical Engineering Dept., Penn State University, University Park, Penn. 16802.
- 18-20** Fall Joint Computer Conference, Las Vegas, Nevada. Contact: AFIPS, 245 E. 47th St., New York, New York 10017.
- 19-20** ACUTE (Accountants Computer Users Technical Exchange) Conference, Atlanta, Georgia. Contact: ACUTE, 947 Old York Rd., Abington, Pa., 19001.
- 20-21** IEEE Computer Group Data Acquisition & Control Workshop Meeting, Las Vegas, Nevada. Contact: Dr. Albert Hopkins, MIT Instrument Lab., Station #35, 75 Cambridge Pkwy., Cambridge, Mass. 02142.
- 20-21** 1969 Data Processing Conference, Empire Division (13), New York, N. Y. Contact: Registrar, Conference '69, P.O. Box 1926, Grand Central Station, New York, N. Y.

DECEMBER

- 1- 3** Second International Forum on "Data Entry", Hollywood, Florida. Contact: Robin B. Connors, International Business Forms Industries, 5223 River Road, Washington, D. C. 20016.
- 8-10** Third Conference on Applications of Simulation, Los Angeles, Calif. Contact: Mr. Arnold Ockene, Simulation Associates, Inc., 600 North Broadway, White Plains, N. Y. 10601.
- 8-10** IFIP Conference on Computer Management, Manchester, England. Contact: Malcolm Gotterer, Computer Science Dept., Penn. State University, 426 McAllister Building, University Park, Penn. 16802.
- 18-20** Third International Symposium on Computer and Information Science, Bal Harbour, Miami Beach, Fla. Contact: Dr. Julius Tou, Dept. of Electrical Engineering, University of Florida, Gainesville, Fla. 32601.
- 27-28** Annual Meeting of the Association for Symbolic Logic, New York, N. Y. Contact: Dr. Barwise, Dept. of Mathematics, Yale University, New Haven, Conn. 06520.

JANUARY, 1970

- 14-16** 1970 International Conference on System Sciences (IEEE), Honolulu, Hawaii. Contact: Dr. Richard Jones, 2565 The Mall, University of Hawaii, Honolulu, Hawaii 96822.
- 20-22** Computer Software and Peripherals Show and Conference, Eastern Region, New York, N.Y. Contact: Show World, Inc., 37 West 39th St., New York, N.Y. 10018.

FEBRUARY

- 17-19** Computer Software and Peripherals Show and Conference, Mid-western Region, Chicago, Ill. Contact: Show World, Inc. 37 West 39th St., New York, N. Y. 10018.

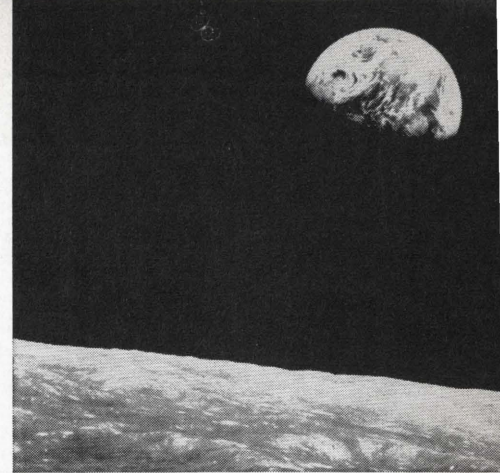

Programmers and systems analysts . . .

Join the winning team in computer technology

Major computer systems development in St. Paul, Minnesota.

Mr. W. R. Short
Univac Employment Manager, Dept. SA119
Data Processing Division
2276 Highcrest Drive
Roseville, Minnesota 55113

Openings in all levels of programming for Navy ASW programs.

Mr. John Spearing
Univac Site Manager, Dept. SA119
P.O. Box 147
Warminster, Pa. 18974

Advanced software development on commercial systems and technical marketing support at Univac world headquarters.

Mr. L. G. Holliday
Univac Employment Manager
Data Processing Division, Dept. SA119
P.O. Box 8100
Philadelphia, Pa. 19101

Sophisticated defense and aero space assignments in the Midwest and Far West.

Mr. Charles Kay
Univac Employment Manager
Federal Systems Division, Dept. SA119
2750 West 7th Blvd.
St. Paul, Minnesota 55116

Programmers and systems analysts for home office and overseas assignments.

Mr. Donald Uppman
Univac Employment Manager
International Division, Dept. SA119
P.O. Box 8100
Philadelphia, Pa. 19101

Systems analysts for developing applications using communication and terminal devices.

Mr. Brent Redd
Univac Employment Supervisor, Dept. SA119
322 North 21st West
Salt Lake City, Utah 84116

An Equal Opportunity Employer M/F

UNIVAC

SPERRY RAND

personal lines

William H. Hamilton has joined the International Reservations Corporation, a subsidiary of the Planning Research Corporation, as Manager of its recently announced American Automobile Association (AAA) reservation system program.

The program, one of the largest-scale reservation system projects ever undertaken, is designed to enable AAA clubs anywhere in the United States to place instant free reservations for AAA members with up to 10,000 AAA-approved hotels and motor hotels nationwide.

Hamilton and his program staff, working with a counterpart AAA group, will be responsible for the implementation of a system that is projected to place 48 million reservations for the accommodations industry over the five year term of the contract—a number which represents approximately \$1 billion of revenue to the accommodations industry.

Dr. Edward M. Davis, Jr., has been promoted to Division Director of Development, Components Division, International Business Machines Corporation. He will be responsible for all development and product engineering within the Components Division, which produces microelectronic component products used in the company's data processing systems . . . **Arthur Rubin** has rejoined Electronic Associates, Inc., as Senior Technical Staff Consultant on the Scientific Advisor's Staff, Computer Division. He will engage in studies and development work leading to new analog/hybrid computer systems . . . **Harold Sanders** has joined Applied Logic Corporation as Senior Quality Assurance Engineer, with major responsibility for AL/COM Time-Sharing Network and Equipment reliability and standards.

David H. Axner has joined the staff of Datapro Research, a division of Computer Conversions, Inc., as Editor of DATAPRO 70, an encyclopedic looseleaf guide to EDP hardware and software. . . . **Alan Taylor** has been named Research Consultant to DATAPRO 70 . . . Commed, subsidiary of Compress, Inc., has named **Keith W. Sehnert, M. D.**, Vice President and Director of Research and Development. Commed is developing automated medical information systems and providing service to hospitals, medical

clinics, individual physicians and pharmaceutical firms . . . **Ronald G. Donoghue** has been appointed Manager of Management Information Systems of National-Standard Company, to supervise the overall activities of a third generation computer being acquired by the company.

Kenneth J. Thomas has been named senior systems analyst of Computer Response Corporation's Boston area office, and **Charles F. Mather** has been named a Consultant in Systems Management in the same office . . . **James R. Thompson** has joined Tel-Tech Corporation as a Senior Engineer responsible for the design, development and production of data communications equipment . . . **Stanley P. Eikoos** has been named Manager of Career Development and Education, and **Stephen J. McGrath** has been appointed Manager of Personnel Policy and Planning by Computer Technology Inc.

Data Management Services, Inc., has appointed **Robert J. MacBain** to the new post of Manager, Research and Planning, for the firm's Implementation Division headquartered in Philadelphia. Its Implementation Division provides proprietary software packages, systems analysis, and contract programming . . . **Allen J. Berg**, assistant data processing supervisor at Maynard Electric Steel Casting Co., Milwaukee, has been named operations manager of the firm's data processing service bureau division, Maynard Data Processing, which features total data processing service coupled with OCR, Optical Character Recognition, inputs . . . **Edwin H. Bowers** will direct computer-based consulting services offered to bank trust departments by Scientific Resources Corporation, Philadelphia . . . **Richard J. Petschauer**, Vice President—Research and Engineering for Fabri-Tek, Inc., has been named President and General Manager of the firm's newly-formed Memory Products Division.

John E. Parady has been named Systems Manager for Marketing Systems Incorporated (MSI) where his chief responsibilities will include the continuing development and coordination of a national field force of professional Systems Engineers to support MSI customers in systems planning, programming, training, and implementation. In addition, he will be involved in new product and software development.

COMPUTER PROFESSIONALS:

"HOWARD LEVIN IS PROBABLY THE WORLD'S BEST QUALIFIED* EDP EMPLOYMENT AGENT"



*MBA, Personnel management; 5 years industrial personnel experience for a major electronics and computer firm; 5 years hands-on computer programming and systems analysis experience; Director and placement counsellor for RSVP SERVICES since 1966.

His personal services are free and convenient. Why settle for less?

SERVING PHILADELPHIA, NEW JERSEY, NEW YORK
CALL COLLECT: N.J. (609) 667-4488
PHILA. (215) 922-3993

(24 HOUR LIVE ANSWERING SERVICE)

or send resume or rough notes of objective, salary, education, and experience to:



HOWARD LEVIN
Director, Dept. S
RSVP SERVICES
ONE CHERRY HILL MALL (Suite 714)
CHERRY HILL, N.J., 08034

Recruitment, Selection, Vocational Training, Placement for Computer Oriented Companies

ADVANCEMENT MINDED?

The Metropolitan New York area offers outstanding opportunities in the field of Data Processing.

WELLS RECRUITING SYSTEMS, INC.

one of the nation's leading EDP groups, is now placing qualified Programmers and Analysts in exceptionally rewarding positions with over 1500 client firms in such industries as Petrochemical, Financial, Transportation, Manufacturing, and Consulting.

Applications include:

COMMERCIAL, COMMUNICATIONS, SCIENTIFIC, and HARDWARE SOFTWARE DESIGN.

For an accurate and prompt evaluation of the opportunities that exist for you, call or send a resume to:

WELLS RECRUITING SYSTEMS, INC.

170 Broadway, New York, N.Y. 10038
212-964-5566

For more information, circle No. 2 on the Reader Service Card

1969 fall joint computer conference

	location 9	10	11	12	1	2	3	4	
Tues Nov 18	AUD	1 operating systems				5 programming languages and language processors			
	GOLD	2 array logic—logic design for the 70's				6 new computer architectures		9 architecture long term r	
	1-2-3	3 computers for congress (panel)				7 digital simulation of continuous systems			
	15-16	4 the computer security and privacy controversy				8 problems in medical data processing		10 publishing v computing (p	
Wed Nov 19	AUD	11 information management systems for the 70's (panel)		conference luncheon international hotel	15 data base and file management strategies				
	GOLD	12 what happened to lsi promises?			16 circuit/memory innovations				
	1-2-3	13 graphics processing			17 the impact of standardization for the 70's (panel)				
	15-16	14 managing money with computers (panel)			18 using computers in education				
Thur Nov 20	AUD	21 proprietary software products (panel)			25 computer output microfilm systems				
	GOLD	22 peripherals and displays			26 communications: its future in data processing				
	1-2-3	23 computer aided design of computers			27 topical papers				
	15-16	24 management problems in hybrid computer facilities			28 hybrid computer applications		29 real-time hybrid computational		

Wed Nov 19 Evening Schedule

	7	8	9	10
AUD		19 computer related social problems: effective action alternatives (panel)		
GOLD		20 developing a software engineering discipline (panel)		
15-16		education meeting		

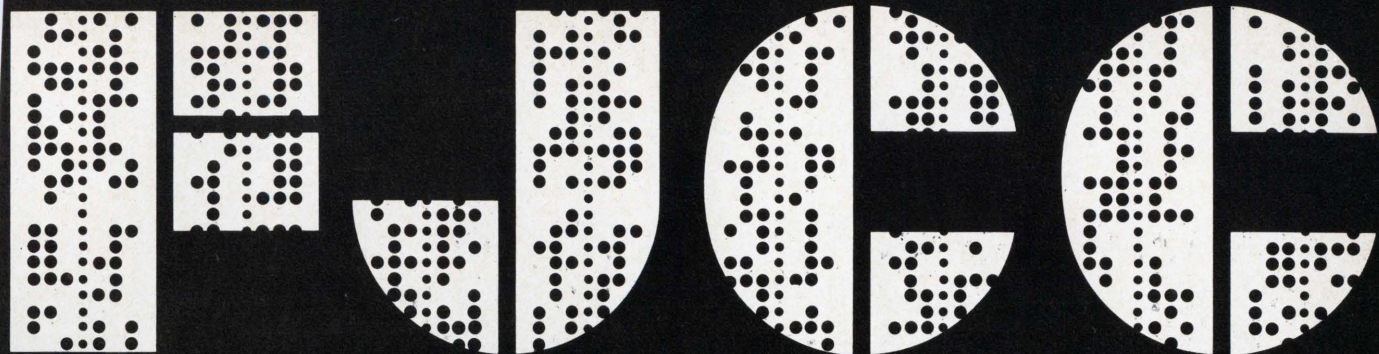

PREVIEW



This year the Fall Joint Computer Conference will take place in Las Vegas, Nevada. Headquarters for the conference will be the Las Vegas Convention Center, which is located about 1 block from the famous Las Vegas "strip". The exhibition will be the "biggest ever" for a computer conference. Almost 350 companies will display their products and services in 988 exhibit booths in the Exhibit Halls of the Convention Center and in the nearby Sahara Hotel.

Registration for the Conference will start Monday, November 17 at 6:00 p.m., although it is not required for the Tuesday morning technical sessions. Following the first day's sessions there will be an All Conference Reception at the

Stardust Hotel (6-8 p.m.). On Wednesday, November 19, there will be an All Conference Luncheon at the International Hotel. During the luncheon the 1969 Harry Goode Memorial Award and the Best Paper Award will be presented. The Recipient of a third award, to be given in conjunction with the Fall Joint Computer Conference, will be announced following the conference and a plaque will be presented at the Spring Joint Computer Conference in Atlantic City, New Jersey.

Numerous exciting and different activities will be taking place concurrently with the 29 technical sessions.

The Computer Science and Art Theater will be active Tuesday,

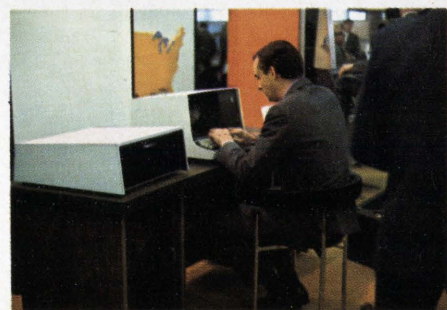

These two color photos and the black and white shots on the next page were taken in Boston at the Spring Joint Computer Conference. These photos show one or two of the hundreds of equipment displays that were part of the exhibit at SJCC. A similar, but larger, Exhibit will be held at the Fall Joint Computer Conference for all the FJCC conferees at the Las Vegas Convention Center (left).

In addition to the activities that are related to the Fall Joint Computer Conference there will be a wide choice of Las Vegas entertainment on the "Las Vegas Strip" and in the Downtown Casino Center, including the following:

Buddy Hackett	Hotel Sahara, Congo Room
Filles de Soulskin	Hotel Sahara, Casbar Theatre
Phil Harris and Harry James	Frontier Hotel, Music Hall through Wednesday
Bob Newhart	Frontier Hotel, Music Hall starting Thursday
Frank Sinatra, Jr. and the Doodletown Pipers	Frontier Hotel, Circle F Theatre
Dinah Shore	The Sands, Copa Room through Tuesday
Righteous Brothers with Bobby Hatfield	The Sands, Celebrity Theatre
John Davidson	The Riviera Hotel, Versailles Room
Shecky Greene and Sonny King	The Riviera Hotel, Starlight Theatre
Jimmie Rogers	Caesars Palace, Circus Maximus
Gaylord and Holiday	Caesars Palace, Roman Theatre
Flower Drum Song	Thunderbird Hotel, Continental Theatre
Sandler and Young with Corbett Monica	Flamingo Hotel, Flamingo Room through Wednesday
Al Martino—Dick Shawn	Flamingo Hotel, Flamingo Room starting Thursday
Rosemary Clooney	Tropicana Hotel, Blue Room
1969 Folies Bergere	Tropicana Hotel, Theatre Restaurant
Rusty Warren with Wayne Cochran	Flamingo Hotel, Casino Theatre through Wednesday

Wednesday and Thursday from 9:00–11:30 a.m. and from 1:30–5:00 p.m. The films that will be presented include the best available films on computer science as well as films in which an artistic presentation is made with the computer.

The Computer Art Exhibit will also feature the art that computers can produce. The AFIPS sponsored an art contest which received entries from many parts of this country as well as from other countries. Prizes were awarded to the first three place winners in two categories: "The Artist Looks at Computing", in which scenes or abstractions must relate to computing or its implications; and "Computer-produced Art". All of the entries of the contest will be on exhibit for FJCC attendants to enjoy.

The best available music composed with computer assistance or played on a computer will be presented at the conference music exhibit at the International Hotel. The exhibit will be open from 9:00 a.m. to 5:00 p.m. Tuesday–Thursday.

Tours of the Sheriff's Computer Operation for Protection and Enforcement will be offered during FJCC at nine different times. Tickets will be available at no charge during registration.

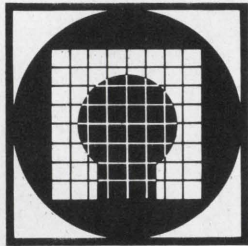

Man-Computer Interactive Systems

Airlift Center of the World
LOCKHEED-GEORGIA
A Division of Lockheed Aircraft Corporation

Lockheed is continuing to expand its efforts in interactive systems and has immediate openings in its research laboratory.

The company is a leader in research, development and implementation of computer-aided design, computer graphics and man-computer interactive systems.

Positions are available in design and research in interactive computer and data management systems. Six years programming experience with a bachelor's degree or three years' programming experience with an advanced degree is required. Knowledge of digital computer executive systems and interactive computing is desirable.

If you are interested in expanding your career in this field and would like to join in some very interesting work, write U. D. McDonald, Employment Manager, Lockheed-Georgia Company, Dept. 6611, 2363 Kingston Court S.E., Marietta, Georgia 30060. Lockheed is an equal opportunity employer.



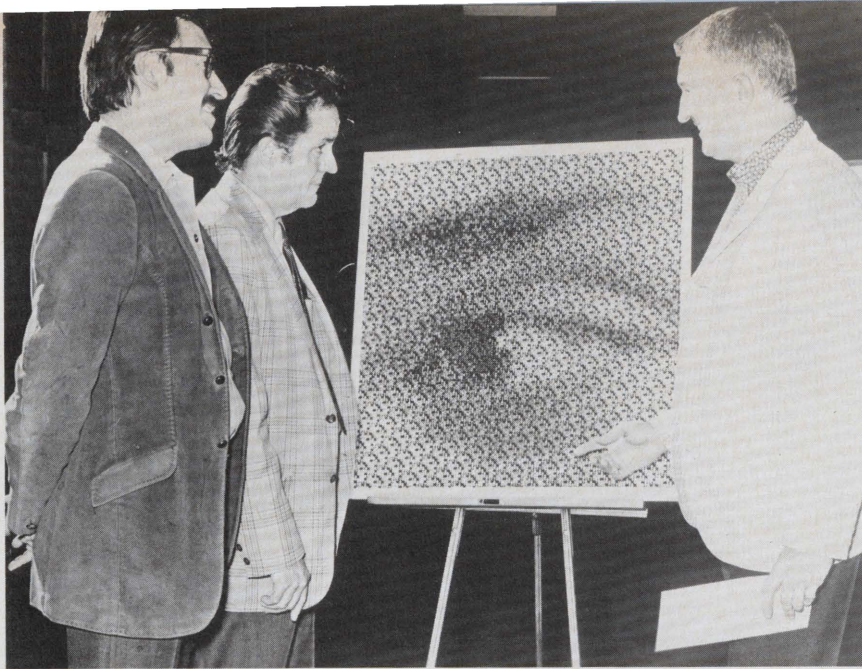

The cover of November SOFTWARE AGE was the second place winner in the computer generated art category of the AFIPS sponsored art contest. The entry is entitled Solar Maelstrom and it was produced by Malcolm T. Malm, a Univac photographer. The forms distinguishable on the photographs—triangles, lines and points—were programmed randomly into a Univac Computer. The rotating, tumbling figures were projected or played on several random sequences—onto an accompanying graphics display console. (The computer and Graphics Display console used, comprise the Univac 1557/58 Graphics Display Subsystem.) Malm draped the area around the console shutting out all light except that produced by images on the tube. Using a 4-by-5 inch view camera with color negative film, he took a time exposure of each moving object, passing red, blue and green filters over the lens at random intervals.

"We were photographing something a machine was doing, but we injected the elements of time and color", said Malm.

Since no record of elapsed time for each exposure, the time each filter was used or the sequences in which various shapes appeared, "It would be almost humanly impossible to produce the same identical pattern in a photograph."

The first prize entry, shown above with the 3 judges of the computer art contest, was done by Manfred Schroeder, Professor of

Physics at Germany's University of Goettingen. From left to right the judges are Maurice Tuchman, Senior Curator of Modern Art at the Los Angeles Museum of Art, Robert Mallary, Associate Professor of Art at the University of Massachusetts, and Paul Thomas, Member of the Technical Staff, Autometics Division of North American Rockwell Corp.



SEARCHING ???

Systems Design	18-22K
Financial/Acting. exp.	
Project Leaders	16-19K
Commercial applics.	
Systems Analysts	13-17K
Acting/Mfg. applics.	
Systems Analysts	To 20K
Plan, create, design, new applics.	
Programmer Analysts	13-16K
Cobol/Bal for Software	
Marketing Mgrs.	18-30K
Sales exp. Hardware or Software	

We continue to have an unusually heavy inflow of requisitions from Client companies throughout the Midwest and West Coast.

These positions are in a wide range of specialties: Commercial as well as Scientific.

Your Confidential inquiry will be personally handled by a professional E.D.P. specialist. He can, and will, locate that Prime Position you seek—promptly, ethically, and intelligently. Please contact Bob Swanson.

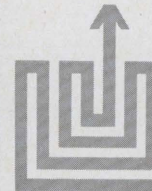

SEARCH INCORPORATED
Suite 600
20 East Jackson Blvd.
Chicago, Illinois 60604
(312) 922-6066

Client Companies pay all fees, including interview/relocation expense.

TECHNICAL SESSIONS

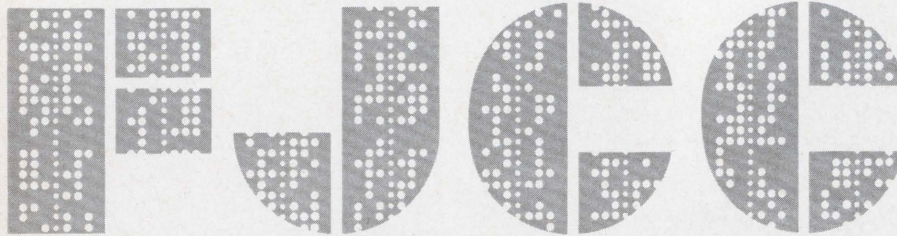

1. Tuesday, 9:00–11:45 a.m.
Auditorium

Operating Systems

Joseph W. Smith, *Chairman*

Each of the papers to be presented in this session will offer a distinct approach to the problem of handling complex computational paths that arise in multi-task environments.

M. Gonzalez and C. Ramamoorthy will present a survey of some of the techniques available for detection, recognition and execution of parallel processable streams of a computer program. Then they will develop two techniques, one for implicit recognition and representation, and the other for parallel processing of substructures within a task.

Jack Shemer and Douglas Heying have developed a mathematical model of a computational system which they use to analyze and compare a system's performance and the model's estimates.

Butler Lampson will discuss some of the problems for controlling the behavior of the various parts of a complex computation.

Richard Linde, Clark Weissman and Clayton Fox will describe a time sharing system that was primarily designed to support large programs and data files without the benefit of mapping or segmentation hardware.

In the last presentation in the first session J. Braun and A. Gartenhaus will describe a system that was designed to permit background programs to get a fair share of resources in an on-line real-time environment.

2. Tuesday, 9:00–11:45 a.m.
Gold Room

Array Logic—Logic Design of the 70's

Donald Meier, *Chairman*

This session will be devoted to the treatment of system design with LSI. The emphasis will be divided between new system organization and the development of LSI technology. The aim of the session is to speed the progress toward the day

when LSI can be applied to general logic.

R. Henle, I. Ho, G. Maley and R. Waxman will discuss read-only store, read-only associative memory and Solid Logic Technology arrays. Besides discussing each type of array, the authors will also describe and compare the various arrays' applications to logic design.

F. Erwin and James McKeivitt will discuss a universal architecture for designing digital systems with specified, functionally oriented building blocks—characters. The emphasis of the paper will be the elimination of logic design and the universal application of the few LSI characters to a very broad range of digital requirements.

Kenneth Thurber will describe a solution to fault testing in cellular arrays. First he will derive a necessary and sufficient condition for the location of a single error and obtain an algorithm to locate the error in a number of tests. Second, a criterion will be given which allows the detection of an error in an arbitrary cell in only two tests.

C. Ramamoorthy and S. Economides will continue this session with the discussion of cellular array implementation of a complete binary multiplication unit primarily for LSI realization.

Don Calhoun will conclude with a description of a Pad Relocation technique that is an efficient means of LSI yield enhancement.

3. Tuesday, 9:00–11:45 a.m.
Rooms 1–2–3

Computers for Congress (panel)

Martin Greenberger, *Chairman*

This session will engage in a discussion of the various possibilities of extending computer application to include congressional problems and needs. The panel consists of a Congressman, John Tunney; a political scientist, John Saloma III; a businessman, John Horty; and Robert L. Chartrand, Library of Congress, who has been working on the interface between computers and Congress. Chartrand will present a position paper in which he will discuss several systems that have been developed to enhance chamber, committee and member efficiency. He will also

explore the potential of the systems approach by the Legislative Branch to improve the functioning of Congress.

4. Tuesday, 9:00–11:45 a.m.
Rooms 15–16

The Computer Security and Privacy Controversy

Jerome Lobel, *Chairman*

This session will focus on the fundamental issues and problems of the controversial subject of computer and communications security and privacy.

In the first presentation, R. Skatrud will describe two digital cryptographic techniques which may have potential applications in Data Processing Systems. He will also touch on some possible ways of achieving key leverage in each ciphering process.

The second paper, to be presented by Clark Weissman, will give a formal set theoretic model that defines time-sharing in security control of user terminal, job and file security objects, based upon their security profiles. The presentation will conclude with a recapitulation of the goals of ADEPT security control, approximate costs of implementation and operation of security controls, and suggested extensions and improvements.

Edward Comber will present the third paper of the session. He contends that an adequately designed computer-controlled data management system has a greater potential to protect "privacy" than any manual or mechanical system and will discuss this point.

Following these presentations, William DeLair, Phillip Scheidermayer, and Willis Ware will discuss some of the controversial questions related to and brought out by the three papers.

5. Tuesday, 1:30–5:30 p.m.
Auditorium

Programming Languages and Language Processors

Robert McClure, *Chairman*

The first two papers of this session will concern themselves with syntax directed language processors. Victor Schneider will present a new syntax for EULER (a generalization of ALGOL with many features of LISP) as well as specifications on how EULER is translated; and James Vander Mey, Robert Varney and Robert Patchen will describe a general syntax directed macro pre-processor system.

In the third paper Prentiss Knowlton will describe an algebraic extension to LISP, the reverse of the usual process of embedding list processing facilities into an algebraic language.

William Josephs will then turn the discussion to an interesting technique for debugging on-line for the IBM System 360 operating under OS/360. The method should prove very useful to assembly language programmers who would like to reduce debugging time. Robert Freiburghouse will present the final paper of the session, describing the organization of a

machine independent PL/I compiler and the implementation of that compiler on the Multics Operating System.

The Panel: **W. M. McKeeman, Richard Wexelblat, Roy Davis and C. W. Medlock** will discuss the papers and the current trends in programming systems.

6. Tuesday, 1:15-3-15 p.m.

Gold Room

Forthcoming Computer Architectures

James Burrows, Chairman

This session will review some of the implications in user interface, software design, programming and hardware design, that must be faced in the development of new systems.

The first paper, by **P. M. Melliar-Smith**, will propose a technique whereby a programmer is provided with complex instructions capable of controlling the operation of the whole machine during one logic cycle.

R. Watson, T. Myer, I. Sutherland and M. Vosbury will describe, in the second paper, a general purpose display system for a time-shared computer. The design includes a push-down stack system in which saved information is marked with the register of its origin. The authors view the display processor more as a computer than as an I/O device.

R. Murphy will describe a System Logic in the third presentation. It is intended for application in exploring and developing new concepts of computer organization and programming.

J. Pariser and H. Maurer will conclude this session with a description of the system design and analysis of a modular computer using prespecified, functionally organized building blocks (called functional characters).

As you can see from the above brief descriptions, the emphasis of the presentations will be on overall design as related to the use, and measurement where available, rather than implementation design embodied in the hardware.

7. Tuesday, 1:30-4:00 p.m.

Rooms 1-2-3

Digital Simulation of Continuous Systems

David Brandin, Chairman

The seventh session will address itself to the problem of digital and hybrid software for simulation of continuous systems, to the evolution of the technology from digital to hybrid simulation languages, and to the corresponding executive software systems.

The first paper, Project Dare, by **Grano Korn**, will demonstrate economical and convenient all-digital on-line simulation of dynamical systems. The capabilities of each of the four DARE systems will be described as they relate to the topic of the session.

Donald Miller and Michael Merritt will talk along the same lines as Korn, but they will concern themselves with the

MOBSSL-UAF, a block structured continuous system simulation language derived from MIDAS and PACTOLUS. The hybrid interface elements of this system permit on-line parameter changes to be made and also permit the observation of the affects on analog plotting devices.

The third paper will present a comprehensive approach for the design of a complete hybrid programming system in terms of four distinct language levels and the processing between these levels. In conclusion a paper will be presented by **Walter Graves and R. MacDonald** that will describe the philosophy used in designing and developing the hybrid executive which was employed in a large hybrid simulation in support of the Apollo Program.

8. Tuesday, 1:00-3:15 p.m.

Rooms 15-16

Problems in Medical Data Processing

Richard Johns, Chairman

The problem of computer data processing, as applied to Medical Science, will be explored in this session. The various areas of application include hospital information, patients' medical diagnoses, medical image processing and pattern recognition, and many other topics.

In the first paper **Robert Greenes, A. Neil Pappalardo, Curtis Marble and G. Octo Barnett** will discuss the hospital data Management as it has been applied at Massachusetts General Hospital.

The second paper will focus on the educational possibilities of the computer in medical science. The authors, **John Weber and Wilbur Hagamen**, will describe the current system, using tutorial discussions and programmed instruction, at Cornell Medical School.

The overview of these problems and the many others in the area will be discussed by **L. Weed, M. Mendelsohn and J. Mayne**.

9. Tuesday, 3:30-5:30 p.m.

Gold Room

Architectures for Long Term Reliability

William L. Martin, Chairman

This session will direct itself to the problem of achieving reliable computer systems, even in the presence of hardware failure. Each of the papers in the session will present an aspect of the goal of achieving high reliability.

H. Chang and J. Scanlon will describe several design principles including: planning a processor organization, designing logic circuits, and diagnostic and fault detection tests. They will also touch upon the significance of modularization accessibility and observability, system recovery and unwinding mechanisms, and interfacing techniques for fault isolation in planning a processor organization.

M. Ball and F. Hardie will focus on the problem of evaluating the detectability of different classes of intermittent faults.

F. Erwin and E. Bersoff will continue the session by discussing the reliability of modular computer organization on unattended long-term missions.

The final paper of the session will be presented by **E. Dieterich and L. C. Kaye**. They will describe an airborne computer intended for large-scale command and control applications. High reliability is projected through the use of two Central Processing Units and two Input/Output Units by which maximum throughput is obtained with all the processing units operating simultaneously and independently.

10. Tuesday, 3:30-6:00 p.m.

Rooms 15-16

Publishing Versus Computing (Panel)

Bret Nebel, Chairman

The panel for Session 10 will direct itself to the discussion of special considerations that must be made for the computer systems that will provide technological support for scientific and commercial information management, and for publishing systems that are being developed today. The panel is made up of members of the publishing and computing fields and includes: **Lynn Abbott** of the Los Angeles Times; **Kenneth Schurr** of the Miami Herald Publishing Co.; **Aaron Coleman, RCA**; **Robert Jefferson, IBM Corp.**; **Lawrence Urdang, Publishing Consultant**; and **Robert S. Cope** of AutoGraphics, Inc.

11. Wednesday, 9:00-11:45 a.m.

Auditorium

Information Management Systems for the 70's (Panel)

Paul S. Collins, Chairman

This panel is going to review the national, industrial, governmental and higher education business organizations' experience in applying advanced computer software and hardware technology of the 60's. It will assess these efforts in the business information systems applications and will establish factors that should be considered for more effective utilization of existing and anticipated computer hardware capabilities. The panelists will include: **Ben Erdman and Robert Sanders, USAF Defense Communications Agency**; **S. K. Chooljian, Hughes Aircraft**; **Jack Myers, Butler Data Systems**; **John P. Singleton, Federal Reserve Board**; and **Eric Wolf, Naval Command Systems**.

12. Wednesday, 9:00-11:45 a.m.

Gold Room

What Happened to LSI Promises?

Arthur Lipton, Chairman

This session will be devoted to the appraisal of the promises of LSI. The participants will try to ascertain whether LSI's present failings are due to an irrevocable or temporary delay.

PROGRAMMERS

BOLD CHALLENGES IN DATA PROCESSING

The name of the game is "Do a better job—faster!" We play it all the time. We're the civilian organization which serves Armed Forces personnel through worldwide "PX" and "BX" outlets. We're seeking more and better EDP information to improve our performance in retailing!

If you enjoy a challenge, and the opportunity to show what you can do with excellent equipment and professional associates, **your route to success may be with us!** We need:

COMPUTER PROGRAM- MERS

\$9,300 - \$11,200

You'd be writing specific programs to organize and process our management information by the most rapid and meaningful methods. Our EDP division is fully equipped with 360 MOD 30/40 Disk/Tape/Card systems using ALC or COBOL, and is staffed with real professionals who know how to use them! To qualify for one of these challenging opportunities, you'll need at least one year of programming experience on third generation equipment using COBOL or assembly language. In addition to a good starting salary, you'll have outstanding fringe benefits, including life insurance, family coverage in our hospital-medical-surgical plan, liberal vacations, sick leave, retirement plan, and opportunity for personal and professional advancement throughout our worldwide organization, since we promote from within! You must be willing to relocate, and accept occasional transfers throughout our worldwide network. Relocation expenses will be paid. If you qualify, RUSH your resume, which must include your salary history to:

Mr. Chris Ciampaglia
DEPT. SA-11

You will be contacted within two weeks!

ARMY & AIR FORCE EXCHANGE SERVICE

THE **PX-BX** SYSTEM

3911 WALTON WALKER BLVD. DALLAS, TEXAS 75222
Equal Opportunity Employer

In the first paper of the session, **H. Rudenberg** will appraise the past promises and the present accomplishments of LSI. Some of the broken promises and dilemmas of the component makers are also to be discussed along with the reasons for the misunderstanding about the meaning of state-of-the-art as applied to devices and computers.

In the second paper **Clarence Thornton** attributes the delays in implementing LSI to three major factors:

1. Specific limitations that existed in the IC state-of-the-art at the time of the original LSI announcements were unknown or uncontrolled until recently.
2. Gross underestimates were made of the amount of engineering required to upgrade untegrated circuit manufacturing and user capabilities.
3. The belief that the integrated circuit designers would be able to do the majority of the required subsystems design and the custom chip design.

The two panelists for this sessions are: **Howard Steenbergen**, Air Force Avionics Lab; and **John Willner**, Hughes Aircraft Corp.

13. Wednesday, 9:00-11:30 a.m.
Rooms 1-2-3

Topics in On-Line Techniques
Morton Bernstein, Chairman

Each of the papers in this session will deal with some combination of graphics, man-machine interaction, time-sharing, on-line computation and real-time processing. The first paper, by **Jerrold Grochow**, will investigate the problem of dynamic observation of the state of a time-shared computer system. To do this he has developed the Graphical Display Monitoring System (GDM) and he will explain the advantages and disadvantages of GDM and other types of monitoring.

Hugo DiGiulio and **Paul Tuan** will concern themselves with the use of interactive computer graphics for processing systems analysis network pictures. The purpose of the interactive graphics system is to provide a way to generate, manipulate, decompose, partition, simplify and display network pictures as a means of achieving rapid convergence in man-machine experiments.

George Miller will present the final paper of this session. He will describe a system for real-time recognition of hand-written symbols using an electronic graphic tablet, a CRT display, and a time-share computer.

14. Wednesday, 9:00-11:30 a.m.
Rooms 15-16

Managing Money with Computers (Panel)

Robert Thaler, Chairman

This panel will discuss personal and business money management. **Tony Lumpkin**, of **William O'Neil and Company**, will

briefly comment on the use of the computer in brokerage firms. **Les Goldberg**, of the Valley National Bank, will mention the areas in personal money management that can be affected by the computer. **B. C. Hogan**, Corporation S, will mention the computer techniques that can be applied to accelerate the corporate cash flow; and **Stanley Halper**, of S. D. Leidesdorf and Co., will discuss the aspects of auditing a computer system responsible for financial management. Following these brief discussions by the panel members, a general discussion of money management and computers will take place.

15. Wednesday, 2:00-5:00 p.m.
Auditorium

Data Base and File Management Strategies

Robert Brown, Chairman

The first paper in this session, by **Ned Chapin**, will compare the available techniques for file organization in terms of the usual range of characteristics. Some of the techniques that Chapin will mention seem to offer a more attractive balance of characteristics than some of the better-known techniques.

John Files and **Harry Huskey** will discuss a method of coding a large file for information retrieval. The simplicity of the search facilitates implementation of the system on a small computer with access to a large bulk storage device.

For the third paper, **James Considine** and **Allan Weis** will present the results of the establishment and maintenance of a storage hierarchy for an on-line data base. They will discuss a system designed to control the growth of the data base and also they will report on the results of operation with the system. **Ho-Nien Liu**, **William Peck** and **Paul Pollard** will deal with the design of software for a large on-line data processing system and, in particular, with the resource management part of that system.

The final paper of session 15, by **Stephen Kidd**, will delve into the problem of incorporating a complex data structure for representing certain social science data. The scope of the language Kidd develops is extended to include statistics on data embedded in a hierarchial structure.

16. Wednesday, 2:00-5:00 p.m.
Gold Room

Circuit/Memory Innovations

Walter Kosonocky, Chairman

The 16th session will focus on an examination of new and significant developments in the area of implementation of logic and memory devices for applications in digital computer systems of the next decade. Papers will be presented by: **Lutz Micheel**, **J. R. Burns** and **J. H. Scott**; **Thomas W. Hart, Jr.**, **Durrell Hillis**, **John Marley**, **Robert C. Lutz** and **Charles Hoffman**; **A. H. Bobeck**, **R. F. Fischer** and **A. J. Perneski**; **M. Blanchon** and **M. Carbonel**; and **L. A. Prohofsky** and **D. W. Morgan**.

17. Wednesday, 2:00-5:00 p.m.
Rooms 1-2-3

The Impact of Standardization for the 70's (Panel)

Louis Robinson, *Chairman*

The effort to produce both national and international standards for the data processing industry got started in the 1960's; more data processing standards are likely to be produced each year in the 1970's. This panel will discuss these standards as well as addressing itself to the questions below:

- What will be the ultimate usefulness and impact of these standards to the user?
- Will standards produce a convergence to a "single" style in data processing systems design?
- Will users benefit or pay a penalty as a price of the standardization effort?
- What effect will standardization have upon stifling innovation in data processing systems design?
- How representative of user interests of the standardization effort?
- How can awareness of the existing standards catalog affect one's planning for future data processing systems?

Panel: **Thomas Steel, Jr., Joseph Harrison, L. Avanzino, Robert Bemer and Al Knipe.**

18. Wednesday, 2:00-5:00 p.m.
Rooms 15-16

Using Computers in Education

Malcolm Golterer, *Chairman*

The application of computer technology to education has been met by several problems. For one thing, the computer is very expensive and, for another, one must be a highly skilled computer operator or programmer to utilize the computer effectively. Different areas in which these problems have or have not been overcome will be discussed in this session.

David Robinson, in the first paper, will talk about a small computing system designed for use in undergraduate labs to instruct in the problem areas created by the realization of computers or computer-like systems.

Paul Oliver and **Fred Brooks, Jr.** will describe an interactive display system designed to be used as an aid in teaching selected topics in elementary numerical analysis.

In the third paper **P. Lorton, Jr.** and **John Slimick** will present a description of the software package used to teach the fundamentals of computer programming for business applications to *inner city* high school juniors and seniors.

Following the presentation of the papers, the panel will reveal the current status of computers in education and they will discuss the role of computers

in education in the future. The panelists include: **John Hamblen**, Southern Regional Education Board; **Roger Levien**, The Rand Corp.; **Thomas McConnell, Jr.**, Atlanta Public Schools; and **Robert Seidel**, Human Resources Research Office.

19. Wednesday, 7:30-10:00 p.m.
Auditorium

Computer Related Social Problems: Effective Action Alternatives (Panel)

Don Lebell, *Chairman*

This panel will attempt to answer some of the questions listed below that have been brought up by the increasing concern over the social problems that are directly aggravated or ameliorated by the current growth of information systems and technology. These questions will be discussed from all perspectives by the panel and then further discussion will be encouraged from the audience. A follow-up session is scheduled for Thursday, Nov. 20 in anticipation of the wide concern for the social issues caused by computer and automation technology.

Some of the questions that will be brought up include:

- What are the computer-related social problems?
- What are their solutions?
- What action alternatives have we individually and collectively?
- What are the costs, risks and consequences of these actions?

The panel members will be: **Paul Armer**, Stanford University; **Alan Butcher**, Parsons and Williams (Denmark); **H. R. J. Grosch**, National Bureau of Standards; **George Lehner**, University of California; **K. Stephen Menger**, Sperry Rand Corp.; **Max Palevsky**, Xerox Data Systems; and **Thomas Rees**, Congressman, 26th District of California.

20. Wednesday, 7:30-10:00 p.m.
Gold Room

Developing a Software Engineering Discipline (Panel)

Kenneth Kolence, *Chairman*

This panel will consider the criteria which should be met by methodology claiming to be a part of a software engineering discipline. They will focus on three areas of consideration:

1. Hierarch design concepts and notation
2. Physics of program structure
3. Related Management techniques.

The panel hopes to achieve some sort of definition of Software Engineering and it invites the conferees who attend the session to participate and contribute to the discussion. The panelists will include: **Alex D'Agapeyett**, **Ken Charshaf**, **Paul Metzelaar**, **K. Okashima** and **Julius Tou.**

"Gee, Thanks. Great Selling Job."

Sweet words. Trouble is, too often that's all we hear. Compliments won't pay the rent. The right job will. That's why Electronic Systems Personnel of Philadelphia has become a leader in the selection and placement of data processing sales people. We represent a select group of firms actively interested in competent, eager sales and sales support personnel, with openings throughout the U.S. and Canada and earnings potential as high as \$25,000 to start.

Candidates should be experienced in EDP or systems sales; business machine sales; programming; or systems analysis. If your involvement in sales has been limited, you should feel strongly about your ability to develop into a successful sales representative.

Send us your resume, or write, telling about your background, capabilities and career goals. You'll receive careful and prompt consideration. And your inquiry will be acknowledged.

Write: **Gary S. Kaplan**
Electronic Systems Personnel
Suite 427, 1819 J.F. Kennedy Blvd.
Philadelphia, Pa. 19103
esp
We Represent Equal Opportunity Employers, And You.

PERT-PROGRAMMING

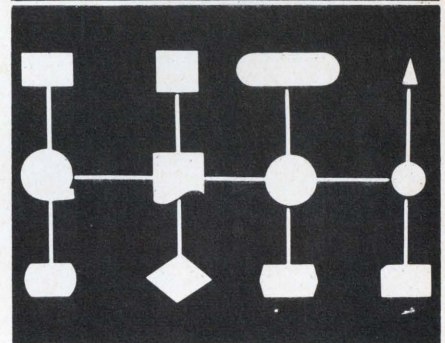

MAGNETIC SYMBOLS

Reduce Work and Speed Operations for

- SYSTEMS ANALYSTS
- PROGRAMMERS
- METHODS SPECIALISTS

MINUTEMAN Magnetic Symbols provide fast, simple and highly visual means of handling PERT, flow charts, diagramming and scheduling problems. Made of sturdy Vinyl "write-on" plastic, in colors. Symbols are easily marked with grease pencil and wiped off. Last indefinitely. The ultimate in convenience, efficiency and economy.

Write for FREE catalog on the most modern and flexible visual programming and scheduling systems.

 **MAGNETIC AIDS, INC.**
11 WEST 42nd STREET, NEW YORK 36, N. Y.

For more information, circle No. 1
on the Reader Service Card

Callahan Goes West

Yes, the Callahan Center for Computer Professionals is opening a California office on November 1st to service our clients west of the Mississippi.

Callahan-West will continue the same high standards which so many Computer Professionals on the East Coast have come to depend on when in need of career placement service.

You, the applicant, pay no fees whatsoever with Callahan. There's no contract to sign. You may call and discuss your background. A resume is **not** required. You benefit from the close rapport which we have built over the past four years with hundreds of client companies all over the world. Our dealings are in strict confidence.

Your Man For All Reasons

Meet Wally Peterson. Wally is Director of our Western operations. Here is a man of action who is already well known and respected for his expertise and insight regarding computer professionals. Wally is no newcomer to California. He's been a resident for the past 19 years. Wally's experience as Employment Supervisor of the California Institute of Technology's Jet Propulsion Laboratory will help you to look at yourself from the other side of the table. Wally has been hiring key personnel for major employers for 16 years. He can help you to present yourself in the best possible light. Furthermore, Wally's associations with the other employers in conjunction with a thorough knowledge of their requirements means he can save you considerable time in your efforts to locate and secure the right position. Call today or send your resume c/o Mr. Wallace Peterson, Director Western Operations



Wally Peterson

CALLAHAN CENTER FOR COMPUTER PROFESSIONALS

Suite 400-20 Union Bank Tower
Del Almo Financial Center
(Wall Street West)
Torrance, California 90503

Phone: (Area Code 213) 371-4659

Corporate Offices: 1819 JFK Blvd., Philadelphia, Pa. 19103
(215) 561-1950

If it is more convenient, you may deposit your resume in the Callahan Lock Box at the SOFTWARE AGE Resume Center in the Frontier Hotel—November 18th to 20th.

Visit us at the Hacienda Hotel during FJCC. Speak with a technical manager, who will be with us to discuss excellent opportunities including overseas openings.

21. Thursday, 9:00-11:45 a.m.

Auditorium

Proprietary Software Products (Panel)

Robert Head, *Chairman*

Session 21 will be a discussion of "proprietary software products", which have been defined to include systems software, accounting systems, management aids, and scientific packages. The major emphasis of the discussion will be speculative, in that the panelists will attempt to anticipate what major developments will occur in the 70's.

The panel will include: Peter Harris, David McElroy, Joseph Hootman and William Woolley.

22. Thursday, 9:00-11:45 a.m.

Gold Room

Hardware Techniques for In- terfacing Man with the Com- puter

Robert Stuckelman, *Chairman*

This session will treat the fields of hardware displays and peripherals for real-time man/machine interface. It will cover the widely divergent topics of: a graphic input device, an analytic approach to display output queueing, an output display circuit technique, and a unique display implementation.

The contributors to this session: A. M. Hlady, T. W. Gay, Jr., Michael Dertouzos, Koji Nezu and Sachio Natio, have done their work in various parts of the United States, Canada and Japan.

23. Thursday, 9:00-11:45 a.m.

Rooms 1-2-3

Computer Aided Design of Computers

A. H. Halpin, *Chairman*

The essential questions to be answered by the authors and panelists of session 23 are:

- How much of the design process should be automated? and
- What is the function of the designer in such a system?

To bring out the points relevant to these problems, each of the papers will focus itself on a specialized problem dealing with computer aided design of computers:

- The design of computer instruction sets;
- The selection of components and
- The design of LSI devices.

Following the presentations are participants will try and work out how these particular pieces fit into a total system of semi-automated design and what the role of user interaction is, in such a system.

The authors of the papers to be presented are Fred Haney, Bruce Chubb and William Orr; and the panelists are to be Sergio Bernstein, Melvin Breuer and Alan Hecht.

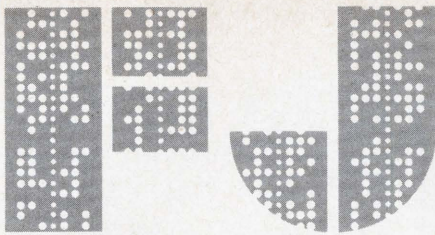

24. Thursday, 9:00-11:45 a.m.
Rooms 15-16

Management Problems in Hybrid Computer Facilities (Panel)

Ray Lawrence, *Chairman*

Hybrid facilities are now found in all areas of computer application—industry, government, service bureaus, and universities. The panelists for this session, representing all these areas, will discuss problems of the operation of hybrid computers on almost all levels, with special emphasis on the special problems of the individual facility.

The panelists include **Robert Barnett**, Ames Research Center; **Paul Berthiaume**, Electronic Associates, Inc.; **Stephen Kahne**, University of Minn.; **Carl Malstrom**, Martin-Marietta Corp.; **John Seilly**, Computer Sciences Corp.; and **Milton Warshawsky**, Wright-Patterson Air Force Base.

25. Thursday, 1:00-3:00 p.m.
Auditorium

Computer Output Microfilm Systems

Francis Goff, *Chairman*

The 25th session will concern itself with the growth and development of computer output microfilm (COM). The first presentation, by **Donald Avedon**, will introduce the subject by giving an overview of: COM technology, the various types of COM recorders, a comparison of the units, and microfilm origination, dissemination and retrieval systems.

Steven Brown will then follow with a discussion of the software problems encountered by those responsible for the design of computer microfilm applications. The third paper, by **John Koeneman** and **John Schwanbeck** will show how microfilm can solve the computer output problem. The panelists: **Carl Nelson**, **R. C. Leader** and **K. Otten**, will continue to discuss the issues brought up by the three paper presentations.

26. Thursday, 1:00-4:00 p.m.
Gold Room

The Future in Data Processing with Communications

Merlin G. Smith, *Chairman*

In this session three presentations and a panel of four will address the issue of communications-oriented data processing systems. The first paper, by **Norman Nisenoff** will describe the on-line, quasi real-time data processing system of the U. S. Army civilian personnel system.

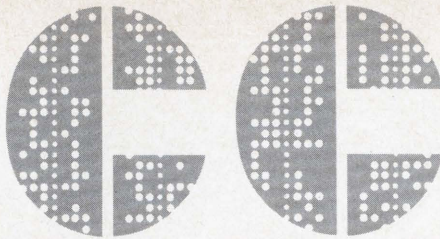

The evaluation on which the system was based supports the theory that total hardware and communications costs favor a single processor site configuration. **J. Sykes** will investigate, for the second presentation, Inquiry-Response systems, as typified by reservation systems.

For the third paper, **Wesley Chu** will tell about a study of asynchronous time division multiplexing for time-sharing computer systems. The panel will include **Joseph Wimbrow**, **James Castle**, **Robert Lucky** and **J. Kassar**.

27. Thursday, 1:00-3:00 p.m.
Rooms 1-2-3

Topical Papers

Leon Blitzer, *Chairman*

Session 27 will offer five general interest papers in diverse areas. In the first paper **David B. Mayer** will discuss the attempts of computer professionals to train disadvantaged people for positions in the data processing industry. The second paper will present a new and convenient method for computation of partial derivatives frequently encountered in engineering applications (**J. D. McCully**).

In the third paper, **Nancy Clark** and **W. Cody** will present a new approach to exponentiation. This approach is supposed to limit errors to the least significant one or two bits rather than the former process which only "limited" errors to some 14 significant bits.

The fourth paper, by **H. Potash**, **A. Tyrrell**, **D. Allen**, **S. Joseph** and **G. Estrin** will present a pseudo-machine for the simulation of new design digital systems to eliminate the need for hardware prototypes. For the final paper, **S. K. Das** and **W. S. Mohn** will discuss the interesting computer application of identifying speakers from high quality utterances. An average misclassification rate of only 1% was obtained although there was a "no decision" rate of 10%.

28. Thursday, 1:00-3:30 p.m.
Rooms 15-16

Hybrid Techniques and Applications

Walter Brunner, *Chairman*

The first and last papers of the 28th session will direct themselves to the problem of simplifying the software for engineers so they can use the computer for solving their problems. **Alan Carlson** will discuss the use of a hybrid/digital computer for the solution of chemical kinetic parameter identification problems while **Philip Balaban** will describe a hybrid computer program to aid in circuit analyses.

In the second paper **D. J. Newman** and **J. C. Strauss** will present a method for solving partial differential equations by model techniques on the hybrid computer. For the third paper **Nelson Kemp** will analyze the use of derivatives to compensate for time delay and D-to-A hold errors during hybrid solution to linear differential equations.

The panelists will be **Edward Mitchell**, **L. Fogarty**, **A. Clymer** and **Elias Hochman**.

29. Thursday, 3:45-5:30 p.m.
Rooms 15-16

Real-Time Hybrid Computations Systems

Michael Burwen, *Chairman*

In the last session of the Fall Joint Computer Conference three papers will be presented on the real-time hybrid computing systems and the search of more cost-effective operating environments that will appeal to the user.

T. Strollo, **R. Tomlinson**, and **E. Fiala** will describe a new operating system permitting hybrid operations to occur in a time-sharing computer. **Witzel** and **Hughes** will explain, for the second presentation, how they have used a digital computer, display terminal and space vehicle flight computer to enable programmers to check out flight programs in a simulated space flight environment. In the final paper, **J. Simmons**, **W. Benson**, and **J. P. Fiedler** will show how utilization can be improved by adapting the hybrid system to handle a new application.



EDP-SYSTEMS

WE SPECIALIZE IN CAREER CORRECTION

ARE YOU 'UNDERED'?

UNDER . . . PAID or UNDER THE WRONG BOSS . . . UNDER THE
WRONG CLIMATE or UNDER PROMOTED

UNDER UTILIZED or UNDER THE WRONG HOURS . . . UNDER THE
WRONG POLICIES . . . or just "UNDERED"?

FOR "OVERING" . . . CALL (215) 839-1500

LAWRENCE PERSONNEL

29 Bala Avenue, Bala Cynwyd, Penna. 19004
(Philadelphia's Main Line Suburb)

FEE PAID BY CLIENT COMPANIES • NO CONTRACTS • ALWAYS CONFIDENTIAL

NEW PRODUCT

PREVIEW

A New Series of Encoders

Keymatic Data Systems Corp. of Bay Shore, New York, will be introducing the keymatic Series 1000 Encoders. The Series 1000 Encoders were designed primarily for the keyboarding of textually oriented data or information (both alpha and numeric) directly onto standard ½ inch computer-compatible magnetic tape. The Keymatic features record lengths which are both (1) virtually indefinite and (2) completely variable between consecutive records.

Distinct UPPER and lower case characters are encoded on the magnetic tape with the same simplicity as a standard typewriter. The expanded character set (256 8-bit plus parity codes) permits reduction to single keystrokes of most data (instructions, identifiers, etc.) which would require combinations of multiple keystrokes on conventional keyboards.

Keymatic is said to be ideal for the keyboarding of :

- Computer programs or instructions (multi-punching is eliminated because anyone of the 256 EBCDIC codes can be recorded with one key depression).
- Jobs of multiple fields and variable length, where start and/or end points of fields had to be identified by keyboarding certain predetermined multiple character combinations.
- Where a data base for a retrieval system is being created, retrieval or extraction becomes simpler as the computer search becomes a search for single identifier codes keyboarded on the keymatic, rather than for combination of multiple characters keyboarded on devices with 64-code character sets.

For more information, circle No. 10
on the Reader Service Card

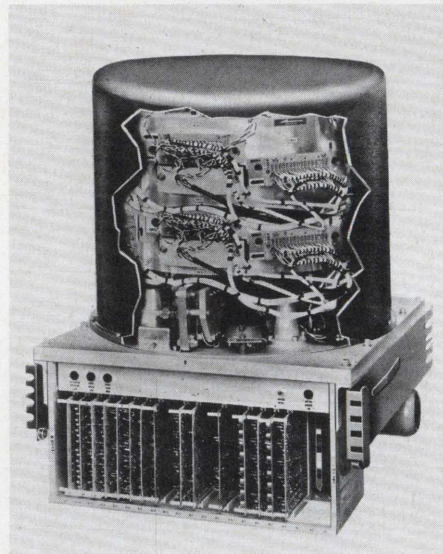

A New Rotating Digital Memory Unit

A. W. O'Sullivan, President of Digital Development Corp. of San Diego, Calif., has announced that the DDC 73-03, the newest member of the DDC 73 family of Rotating Digital Memory units will be on display at the Fall Joint Computer Conference. The 73-03 provides up to eight dual disks and 1024 data tracks, with bit-packing densities up to 35,000 B.P.T. at 3600 R.P.M. nominal rotational speed. The 73-03 can be mounted in a 19" rack, as can the 73-01 and 73-02 units, and it retains the same non-contact flying head mechanization, disk configuration, and inert-gas sealed closure.

Mr. O'Sullivan stressed that retention of design characteristics so thoroughly substantiated by operational experience makes utilization of the DDC 73-03 possible at minimal risk and maximum cost effectiveness in new system generations and expansions.

For more information, circle No. 11
on the Reader Service Card

* * *

MINITS II Time-sharing System

Jacobi Systems Corp. will unveil for the first time, a small time-sharing computer system MINITS II which will permit up to 24 simultaneous remote users to com-



municate with the UNIVAC 1108 on a time-sharing and remote-entry basis. The addition of MINITS 11 makes it possible for the 1108 user to do program compiling and debugging on the small computer at a cost of approximately \$2 per terminal hour instead of having to use the 1108, to do these routine tasks. The 1108 can continue to operate in its normal modes under EXEC II and EXEC 8. With the addition of the Jacobi MINITS II computer, 24 simultaneous remote uses can make use of the speed and mass storage of the 1108. Engineers and programmers can enter problems from Teletype terminals at their desks.

MINITS II has a core storage of 32,768 (8-bit) bytes plus a 512,000 head per track disk memory. In addition, the huge mass storage of the UNIVAC 1108 is accessible to all MINITS II time-sharers. MINITS files can be extracted from 1108 storage, updated using the MINITS EDITOR, returned to storage, or submitted to the 1108 job-stream for execution.

For more information, circle No. 12
on the Reader Service Card

* * *

New Data Base Package From ITS

A conversational system for data base manipulation is scheduled to be announced by International Timesharing Corp. Dubbed "Q-PAK", the product is said to offer a high degree of flexibility to users

in such applications as Survey and Questionnaire Analysis, Market and Sales Analysis, and a number of generalized information retrieval uses. Q-PAK will allow complete cross tabulation of data with data identification by either alphabetic or numeric labels. An asset of the Q-PAK is that many different users, such as departments or divisions within a company, can use the same data base and extract different reports.

Q-PAK was designed to appeal to managers who are dependent on computerized data who are now being made to wait for specialized reports. With Q-PAK the report request is submitted at the terminal in terms which are defined by the user and the report is then printed out within minutes.

Q-PAK actually combines the functions of tabulation and statistical analysis into one package. The result is a much more efficient way of handling large data files in a meaningful and rapid manner. This is made possible by the large storage capacity and the fully randomized file handling capability of the ITS computer system.

For more information, circle No. 13
on the Reader Service Card

* * *

New Tape Drive Technique

A new digital tape drive technique, designed for remote area digital recording, will be introduced by Wang Computer Products, Inc., of Los Angeles, Calif. The new Mod 8 Data Logger uses a direct reel-to-reel drive to reduce the number of mechanical and electronic parts. The Mod 8 is also said to simplify threading and improve tape life.

The Mod 8 provides tape speeds of 50 to 100 inches per second; it uses 8½-inch reels of ½-inch tape, and writes 7 and 9 track IBM compatible formats. The Data Densities are 200, 556 and 800 bpi. The dimensions of the tape deck and data electronics are 14" high, 19" wide, and 7½" deep.

Wang will also show the Mod 7 and Mod 10 systems, intended for computers, data terminals and other data handling applications.

For more information, circle No. 14
on the Reader Service Card



Motorola's Data Terminals

Data communications terminals will be the featured equipment at the exhibit of Motorola Instrumentation and Control Inc. The terminal configuration shown will be designed to fill the need for low cost, versatile subsystems that concentrate and communicate data via high- and low-speed modems to large centralized processing systems, or which can function independently as self-contained information processors.

The data communications terminals will be comprised of several modules. Each can function independently and is available for users of OEM application. The modules include the MTP-6000 silent, high-speed teleprinter, the Motorola MDP-1000 stored program computer, the Motorola Data Recorder, and the MDR Optical mark reader.

The capability of each unit contributes uniquely to the objective of accurate and rapid results by entering data as close to the source as possible. As an example, the MDR document reader provides rapid, accurate source data input. The unit is an optical mark reader that translates data to USASCII language or to other binary decimal codes from punched or pencil-marked forms for near-real-time entry in bit-serial or bit-parallel form. It drives telephone data sets, acoustic couplers, and common carrier circuits. It also communicates with the Motorola data recorder to record data on magnetic tape for processing by large computers.

For more information, circle No. 15
on the Reader Service Card

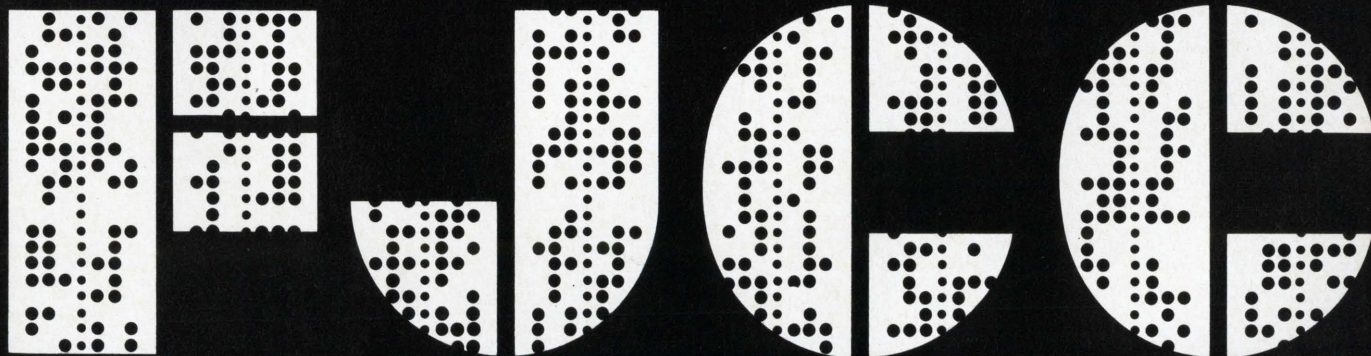

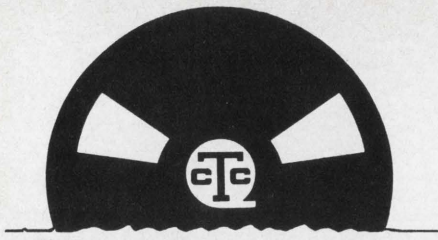

WHERE TOTAL SYSTEMS BEGIN A WIDE WORLD OF GROWTH OPPORTUNITY FOR QUALIFIED DATA PROCESSING PERSONNEL

CTC Computer Corporation is a young, dynamic organization committed to the belief that computer industry success will belong to the company offering full services and products to meet every data processing need.

CTC offers its customers everything from data processing equipment, through programming, to the final furnishing of information in useable form.

Your opportunities for growth are greater with a company dedicated to total systems capabilities.

- DATA SYSTEMS
- ENGINEERING SYSTEMS
- SOFTWARE SYSTEMS
- FINANCIAL SYSTEMS
- HOSPITAL SYSTEMS
- PROPRIETARY SYSTEMS

If your background and experience covers programming or marketing of any of the above, call or write today. Resumes treated in strict confidence;

Richard Denzler, Personnel Manager



**COMPUTER CORPORATION
1018 Palo Alto Office Center
Palo Alto, California 94301**

An Equal Opportunity Employer

Mini-line Printer

A new mini-line printer has been developed by Nortec Computer Devices, Inc. of Ashland, Mass., to complement the recent accent on the development of mini-computers. The Nortec 200 is a medium-speed, 132 column, fully buffered impact-type line printer. The unit can be interfaced on-line with digital computers, or data transmission facilities or off-line with data storage devices. The Nortec-200 accepts ASCII coded alphanumeric 6-bit data at rates up to 500K HZ, and produces hard copy printout at 200 lines per minute for a 64-character font.

Printing is accomplished on edge-punched, fan-fold paper forms of from one to six parts. These forms are carried through the printer by pin-feed tractors actuated by a clutch/brake. Fine positioning of the paper-feed tractors is provided in both the horizontal and vertical planes to permit accurate registration of pre-printed forms. The forms are stored below the printer, fed through the printing station, and exit at the top of the printer.

For more information, circle No. 16 on the Reader Service Card

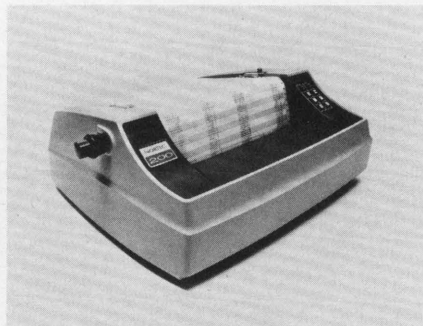

A New Datacraft Computer

Datacraft Corp of Ft. Lauderdale, Fla., will be exhibiting their DC 6024 Digital Computer. The Computer features a full cycle time of 600 nano seconds and a fixed word length of 24 bits. These features provide rapid memory access, ease of programming and a real-time capability approaching that of a multiprocessor or large-scale system.

The basic system includes five 24-bit general-purpose registers, three of which may be used for indexing, an 8,192 word memory (with parity) which is expandable to 65,536 words in increments of 8,192 words, hardware multiply/divide/square root, four levels of priority interrupt and a standard software package. The basic Input/Output structure includes a console ASR-33 typewriter.

The DC 6024 instruction set includes in excess of 500 discrete operations, providing the programmer with considerable convenience and flexibility. Besides the DC 6024, Datacraft also manufactures six different types of magnetic core memory systems widely used in data terminal equipment and small computer systems.

For more information, circle No. 17 on the Reader Service Card

Utility Terminal

Computer Terminals, Inc. of Minneapolis, Minn. will show a new utility terminal which is a programmable control unit. The Terminal is compatible with computers that have either Remote Batch or Conversational Capabilities. The flexibility to configure the terminal with a Card Reader, Printer, Multiple CET Displays, and Special Input/Output Devices, provides for a wide range of data communications applications. The software supplied with the Utility Terminal will provide communication software compatibility with the major large computer systems.

For more information, circle No. 18 on the Reader Service Card

* * *

New Business Data Communication Terminal

Novar Corporation, Mountain View, Calif., will demonstrate its new Model 5-50 business data communications terminal at the FJCC. Described as the first fourth generation, total capability, hard copy impact printer and electronic data communications terminal, the 5-50 has many features not found in competitive systems. The 5-50 is designed with a proprietary, Novar-developed magnetic tape cartridge with record and playback capability of 240 characters per second. The high-speed capability makes possible the transmission of a 43,200-character message within the basic three-minute telephone company time period. Teletype transmission of the same message would require 72 minutes and Novar claims that the best competitive system would need 49 minutes for the same message. The 5-50 is the latest in what Novar expects to be a continuing series of new concepts in electronic data processing.

For more information, circle No. 19 on the Reader Service Card

* * *

A New Computer

Call-A-Computer, Inc. of Los Angeles, Chicago, and Atlanta, will give the first public demonstration of their new computer, the Innovator 7000. The Innovator 7000 allows customers to utilize a broad range of terminal devices; and to devise powerful information retrieval systems which can have mixed languages within a single program. The Innovator 7000 is actually made up of three computers: one computer handles communications and overhead tasks; a second supervisory unit schedules the central processor tasks; and a third actually performs the arithmetic computations. Each of the last two units can access the Innovator's 64K memory concurrently. The System's memory will be expanded to 256K to meet later demands.

For more information, circle No. 20 on the Reader Service Card



A New Plotter

The Computer Graphics Division of Milgo Electronic Corp. announces the introduction of a new general purpose X-Y plotter. The DPS-7 Digital Plotting System provides a practical plotter for a broad range of applications, including engineering drawings, contour mapping, machine tool verification, highway and waterway design, pipeline layouts, financial data and data reduction. The DPS-7 uses hybrid design techniques to produce smooth fast plots from digital data.

Two models of DPS-7 Plotters are available, with plot surfaces of 30" x 30" and 45" x 60". The plotters accommodate paper up to the full size of the plot surface as well as smaller sizes. A vacuum system holds paper firmly to the plot surface. The DPS-7 operates on-line or off-line with 7 or 9 track magnetic tape input.

Full software support is offered with the DPS-7, including a standard basic software package, and specialized software provided by Milgo's applications and programming group.

For more information, circle No. 21
on the Reader Service Card

• • •

Man/Machine Readable Media

Interface Mechanisms Sons, Inc., of Seattle, Wash., will display Dual Image, a unique modular data recording and retrieval system which provides both a human readable character and a machine readable code on 11/16" wide paper tape. This new concept in man/machine readable media is suited for remote data entry. Information can be entered either at typing speeds via the keyboard or from a variety of digital devices at rates up to 75

cps. Then the information is transmitted to computers, or other standard business machines, over data links at speeds up to 1000 characters per second. Up to 128 characters can be printed and, because the last character keyed is visible to the operator, data can be immediately confirmed and errors instantly corrected.

Other Dual Image features include:

- Asynchronous reading rate of 120 characters per second.
- Unlimited use of white space within the record for punctuating sentences, separating messages, permitting computer fill-in writing instructions by hand, signing off records or adding data at a later date to update or correct the record.
- Complete modular construction making Dual Image ideal for OEM applications.



• Simultaneous printing of the human readable symbol and the standard machine readable code.

For more information, circle No. 22
on the Reader Service Card

• • •

A Microfilm Printer

Memorex Corporation of San Francisco will introduce an on-line computer output microfilm (COM) device that operates as a standard peripheral with IBM System/360 (Model 25 and above). Designated the Memorex 1603 Microfilm Printer, the new device is hardware and software compatible with IBM 1403 and 1443 line printers. Thus, its use requires no hardware modifications or changes in software systems, and in conjunction with his 1403, gives the user a choice of either paper or microfilm direct computer printouts. The 1603's printout rate is ten thousand 132 character lines per minute.

The 1603 will cost substantially less than other microfilm printers, according to Laurence L. Spitters, Memorex president and chairman of the board. A prime reason for the low cost is said to be the fact that the 1603, through its own, built-in control unit, provides direct interface with the IBM data channel. This eliminates the need for duplicate equipment functions.

The basis of the 1603, is its application of fiber optics for converting digital signals to alphanumeric characters. The 1603 forms its characters with three major components: a translation matrix, a bank of light-emitting diodes, and a fiber optics bundle. Digital signals are directed to the diodes by the translation matrix. Light from pulsed diodes is transmitted in turn through fiber optic strands to form a display of alphanumeric characters on the face of the fiber optics assembly. The entire fiber optics assembly is aligned and sealed at the factory and it "never" needs adjustment.

For more information, circle No. 23
on the Reader Service Card

programmers • analysts

GROW

NATIONWIDE POSITIONS
FROM \$7,000 TO \$25,000

ALL FEE PAID

- SOFTWARE DEVELOPMENT
- SCIENTIFIC PROGRAMMING
- REAL TIME SYSTEMS
- BUSINESS SYSTEMS
- COMMERCIAL PROGRAMMING
- MANAGEMENT INFO SYSTEMS

Send resume, in confidence, with present salary and geographic preference.

FREE: CAREER OPPORTUNITIES BULLETIN

For a complete listing of outstanding positions with national companies circle subscriber reader card using home address only. No obligation.

La Salle Associates

DEPT. A

719 N. 25th STREET, PHILA., PA. 19130

For more information, circle No. 4
on the Reader Service Card

Make Profits for Your Company
and **MORE MONEY FOR YOURSELF!**

... ENROLL in North American's New
HOME STUDY COURSE in
Systems & Procedures

Sponsored by the
ASSOCIATION FOR
SYSTEMS MANAGEMENT

We'll Send You This Fact-Filled
CAREER OPPORTUNITY BOOKLET **FREE!**

North American Correspondence Schools has guided thousands of ambitious men and women to success through its accredited Home-Study Courses in many fields.



NOW NORTH AMERICAN ANNOUNCES its new 50-lesson Course in Systems & Procedures. Written and edited with the help of acknowledged leaders in the systems and procedures field and sponsored by the Association for Systems Management, this is a complete, comprehensive, authentic and up-to-date correspondence course on systems and procedures. The cost is less than \$400.00 cash. Low monthly tuition payment plans available. If you are seriously interested in investigating this Course, write for FREE fact-filled CAREER OPPORTUNITY BOOKLET, plus full details on North American School of Systems & Procedures. There's no cost or obligation, now or ever. No salesman will call. Write today!

Accredited Member, National Home Study Council.

SPECIAL DISCOUNTS AVAILABLE for

Multiple Enrollments from the same Company

NORTH AMERICAN SCHOOL OF SYSTEMS & PROCEDURES
Dept. 363B, 4401 Birch Street, Newport, California 92660

For more information, circle No. 5
on the Reader Service Card



New Software Product

Boole & Babbage will introduce a new software product, the DPPE-DOS Problem Program Efficiency. It is an expansion of their Systems Measurement Software, SMS/360, to cover IBM System 360 users who operate in a DOS environment.

The DOS Problem Program Efficiency is said to be much like the OS product in that it runs in production with the problem program and allows the user to pinpoint high time usage areas. From this data the user is able to realize maximum optimization of the system. SMS/360 is said to be the first software program which measures true systems performance. Boole & Babbage are also in the process of developing SMS for use on other computer manufacturers' hardware.

For more information, circle No. 24
on the Reader Service Card

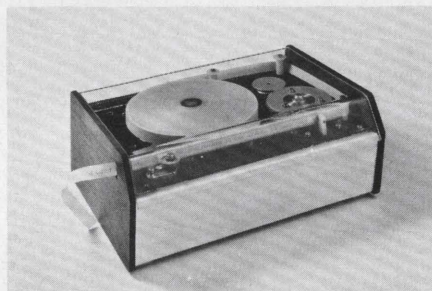

A Strip Printer

Di/An Controls, Inc. of Boston, Massachusetts, will feature the new Series S Strip Printers at the FJCC. The Series S will be shown in three OEM configurations in complete, attractively packaged, units designed for use as desk-top models.

The Series S Printer will accept either ASCII or Teletype Baudot codes and it will print a full complement of 63 characters at up to 20 characters/second. The output of the unit was designed to be highly legible since each character is 1/8-inch high.

It would appear that Di/An's terminal would be a good product to investigate if you have a communications problem that could be solved by a receive only terminal.

For more information, circle No. 25
on the Reader Service Card

Data Modem

Codex Corp. of Watertown, Massachusetts, will show its new AE-96 High Speed Data Modem. Codex Corp. will demonstrate the capability of the AE-96 to quadruple the capacity of a 2400 bps voice grade line at the Convention. Moreover, the demonstration will include the use of Codex's new TM-4 Time Division Multiplexer, which combines four 2400 bps data streams into one 9600 bps data stream. The AE-96's capacities in data communications are said to be the result of a specially developed digital adaptive equalizer. This allows the AE-96 to automatically measure and compensate for the intersymbol interferences caused by cir-

cuit amplitude and delay distortion which had previously limited high speed data transmission on telephone circuits to a maximum of 4800 bps.

For more information, circle No. 26
on the Reader Service Card

A New Video Terminal

Alphameric will display their first product, the Model 33 Video Terminal. The terminal consists of a television-type display unit and a keyboard-logic unit. Although the two units are physically separate they can be conveniently stacked. The Model 33 was designed for time-share users and small computer users and its features include:

- Character inset and delete
- Automatic line-by-line call-up in conversational mode
- Audible bell and data line signal monitor

All solid-state (except CRT & H.V. rectifier).

Three basic modes of operation may be selected by the user: compose, conversational and batch, and three optional operating modes are available: format, print and error correction. The Model 33 is said to be fully compatible with the teletype ASR-33.

For more information, circle No. 27
on the Reader Service Card

A Disk Drive

Century Data Systems, Inc. of Anaheim, California, will show their Model 114 Disk Drive at their booth at the FJCC. The Model 114 was designed to operate with the Century Data Model 1014 Disk Drive Controller. When operated together, the system is plug interchangeable with the IBM Model 2314-A1 or 2314-A2 Direct Access Storage facility, depending on the number of Model 114 Disk Drives attached.

The Model 114 incorporates an Electro-mechanical Positioner and an Electronic Track Detent System which eliminates moving mechanical components from the positioning system and which is said to provide ease of maintenance and high reliability. The storage capacity of each Model 114 is 29,176,000 and the transfer rate is 312,000 bytes per second. Another impressive statistic is the average access time which is 40 milliseconds.

For more information, circle No. 28
on the Reader Service Card

A Computer

Xerox Data Systems, formerly Scientific Data Systems, of El Segundo, California, will exhibit, for the first time, their new Sigma 3 Computer. Field tested software available for use with the Sigma 3 Computer includes two multi-use operating systems, Real-Time Batch Monitor and Basic Control Monitor, each of which provides concurrent real-time foreground and batch background data processing capabilities. A third operating system that

is provided with the computer is Stand-Alone which is primarily batch-oriented.

In addition to the three operating systems, two FORTRAN compilers, Symbol and Extended Symbol assemblers, and more than 100 numerical subroutines for scientific and engineering applications will be supplied with the computer.

The primary hardware features of Sigma 3 include a multiport core memory expandable from 8,192 to 65,536 words, 975 nanosecond memory cycle time, a separate input/output processor for concurrent compute and input/output operations, 28 input/output channels and 100 levels of priority interrupt.

For more information, circle No. 29
on the Reader Service Card

* * *

A New Multiplexor And a New Terminal

Computer Communications, Inc. will be introducing the CC-70 programmed Buffered Multiplexor. Controlled by the CC-701 Communications/Control Processor, the CC-70 can handle up to 128 communication lines, and multiprocessor configurations can handle an almost unlimited number of lines. The CC-70, with CCI-supplied multiplexing software, was designed to handle multiple communications stations for a wide variety of computers, including the IBM System/360 and 1130, computers, the XDS Sigma Series, and the CDC 3000 and 6000 Series.

Wescal Industries, a division of Computer Communications, Inc., will be introducing the CAL 30/30 Data Terminal. The CAL 30/30 accepts operator input or standard typewriter and adder keyboards, records data on magnetic tape cartridge, and transmits to a computer via phone line.

The CAL 30/30 offers the advantages of data protection, elimination of key-punch errors and efficient use of phone lines and computers. The operator input can be recorded on-line during daytime hours and then transmit and receive at machine speeds to central EDP during economical, low-traffic hours.

For more information, circle No. 30
on the Reader Service Card

* * *

A Terminal

Information International of Los Angeles and Boston will introduce a new time-shared graphic display system, the TSD 1060. The TSD 1060 was designed for application in areas such as information inquiry, management analysis, engineering design, scientific computation, process control and test monitoring.

It consists of a display controller interfaced to the appropriate computer and up to six display consoles operating independently of one another. The user interacts with the computer system via an alphanumeric or function keyboard with function overlays, a 13 by 14 inch display, a light pen, and rotatable knobs.

The character generator is said to be very fast, with an average writing time of less than 4 microseconds per character.



Moreover, the generator is a stroke-type with 62 strokes per character maximum and a capacity of 128 characters.

For more information, circle No. 31
on the Reader Service Card

* * *

Multi-Terminal System

Mini-Comp, Inc. of Natick, Massachusetts, will unveil a new multi-terminal system designed to operate up to 48 terminals simultaneously, including teletypes, auto-

matic I/O typewriters, keyboards, graphic displays, printers and plotters. The new system can be expanded from one central processor to two or more; the core memory is expandable from 12K to 32K 16-bit words; and high speed mass storage is available from 262K words on up.

The systems include software packages designed to meet the needs of users in engineering, science, education, industry and general business.

For more information, circle No. 32
on the Reader Service Card

Professional PROGRAMMERS — ENGINEERS — SENIOR SCIENTISTS Nationwide • International

Computer Careers Incorporated offers a truly unique service on a nationwide basis to the professional programmer, engineer, or senior scientist seeking personal advancement and career growth. Our professional staff is qualified by reason of actual working experience in your field to know and understand your background and to best serve your personal and career interests. Our carefully selected clients are outstanding leaders in the computer industry and directly related fields of industrial activity. Current openings include a wide range of assignments in the fields of digital hardware design, systems analysis and programming on a variety of software, management systems, scientific and commercial applications. May we suggest that you forward a confidential summary of your background and career objectives today, or contact Mr. Edward McLaren at 301-654-9225 for additional information. Client organizations assume payment of all fees.

COMPUTER CAREERS INCORPORATED

Suite 503—4720 Montgomery Lane—Bethesda, Maryland 20014
(A suburb of Washington, D. C.)

CONSULTANTS TO THE COMPUTER INDUSTRY

A nationwide computer services group providing both business and scientific data processing services at every level. We are not an employment agency.

COMPDATA

Services
Corporation

An
Auerbach/CDI
Organization

SYSTEMS ANALYSTS PROGRAMMERS COMPUTER OPERATORS

Investigate the challenges and financial rewards that COMPDATA can offer you. Our opportunities are nationwide and offer extremely attractive compensation. Your resume is invited or call collect.

R. N. Cherwinski
(215) 569-2200
for further details.

COMPDATA Services Corporation

Dept. SA-5
Executive Offices
4 Penn Center Plaza
Philadelphia, Pennsylvania 19103
An Equal Opportunity Employer



Once upon a time there was a service specializing in the placement of experienced computer professionals in California.

Then it acquired nationwide clients and joined over 130 affiliates in National Personnel Associates, a cooperative effort to match people to positions linked by an IBM 360 computer system.

Now this service can communicate with numerous firms across the nation. If you are a computer pro (especially an experienced third generation Analyst or Programmer) and would like to utilize our services -- confidentially and at no cost to you -- send us your resume, with current salary and geographic selection, or complete the Software application. We will do the rest.

Inquiries from personnel and technical Management seeking to fill current openings are, of course, always invited.

This may be the end of our tale, but it is just the beginning of our service to you.

contact: lorne evje

computer personnel agency INC.

12 geary street suite 805
san francisco, california 94108
telephone 415/982-0840

Concentrator

A new Data Concentrator System will be introduced by Varian Data Machines of Irvine, California. The new Varian 520/DC System was designed to be a concentrator for interactive timesharing networks. The function of the system in such applications is to gather data from a number of local, low-speed terminals and to concentrate it for economical transmission over one or more high-speed lines to a distant computer center. The system can also serve as a communications preprocessor, organizing incoming data for direct entry into a large computer or dispatching data from the computer over a number of communication lines. The software supplied with the Varian 520/DC System includes a setup program for establishing the controls for each communication line, an operating program for transferring input/output data between the communications controller and buffer areas in core memory, and a diagnostic program for checking the controller.

For more information, circle No. 33
on the Reader Service Card



Computer

Wilkinson Computer Sciences will introduce a new high speed general purpose digital computer at FJCC. The display will include the WCS-881 Computer and

some of the peripheral devices to be available with it, including a disk memory, an XY plotter, a teletype printer and an optical character reader, for business applications. The WCS-881 Computer will be available in memory sizes from 4K to 65K and will feature a true 16/8 word length. Some of the computer's features include: 1 microsecond memory cycle time, eight programmable hardware registers including a 17-bit accumulator and a 16-bit index register; hardware multiply, divide, normalize, compare and shift/rotate; 78 basic machine instructions; variable word length instructions; direct addressing up to 65,536 bytes and four level priority interrupts.

For more information, circle No. 34
on the Reader Service Card

* * *

A Data Coupler

A new Acoustical Coupler, the Model 3040, will be introduced by Beckman Instruments, Inc. of Fullerton, California. It was designed to provide a communications link between various sources (keyboard devices, tape units, teletype paper punch paper, or a distant terminal) over public telephone networks through the use of a conventional telephone handset.

The coupler has the capability of dual interface which allows ease in adapting its interchangeability with teletype Models 33, 35, 37 or various other printing mechanisms that require EIA specifications RS-232B. The Beckman Model 3040 also offers a self-contained, closed loop circuit assurance check as an instantaneous troubleshooting aid.

For more information, circle No. 35
on the Reader Service Card

* * *

A Data Coupler

Scientific Resources Corporation of Houston, Texas, Paragon Systems, Inc., a subsidiary of Scientific Resources Corporation, will be participating in the FJCC with the introduction of their IBM 1130 computer expander, Comp-Ex and their new acoustical telephone data coupler. Comp-Ex is a new hardware-software interface system that extends the IBM 1130's capabilities to on-line, real-time scientific, industrial, business and educational applications.

Modular construction permits Comp-Ex to multiplex from two to thirty-two devices, including teletypes, data phones, CRT and digital displays, A/D converters, transducers, analog computers, and a variety of analytical instruments. It can output information to operate relays, close contacts and start or stop experiments and processes.

For more information, circle No. 36
on the Reader Service Card

Small Computer and Terminal

Spiras Systems, Inc., of Waltham, Massachusetts, an affiliate of USM Corporation, plans to exhibit two products for the first time at FJCC.

The Spiras-65 is a general purpose computer, expandable to 65K memory, which is said to represent core and speed economy as a direct result of its power, instruction set, addressing and indexing modes, and input/output versatility.

The IRASCOPE is a stand alone, alphanumeric CRT editing display terminal. Its primary features are: optimized human interface and a high degree of versatility as a system component, based on the fact that every performance characteristic predictable is being made available as an option including a wide variety of interfaces in either serial or parallel, synchronous or a synchronous, at speeds of up to 72,000 characters per second.

For more information, circle No. 37
on the Reader Service Card



Data Entry

Inforex, Inc. of Burlington, Massachusetts, will display their Intelligent Key Entry System. The system was designed to cut data entry costs for all but the smallest information processing systems. The basic concept of the system is a central intelligent control unit linking as many as eight key entry stations to a buffer. Programs and entry forms, stored in memory, can be made available on demand to any of the keyboards. The control unit provides each station with additional data entry functions, such as balancing, skipping, and duplicating.

The systems' features include: the ability to handle a full range of input and verification functions; the ability to transfer the input to 7 or 9 track compatible tape within the system; and also the ability to pool from up to eight keyboards into one buffer.

The Inforex Intelligent Key Entry can be adapted to operate directly on-line with a central processor. Input data is held in disk memory until data entry has been completed. Then it is released in a batch as called by central processor programming.

For more information, circle No. 38
on the Reader Service Card

Business Programmers/Systems Analysts

WE HAVE COME AS FAR AS ANY

WE WILL GO FURTHER THAN MOST!

At Pratt & Whitney Aircraft, world's leading producer of dependable jet engines, you will find everything your analytical mind desires. Myriad business applications probing ever deeper into every facet of this vast aerospace organization. Manufacturing • Product Support • Engineering • Finance • Purchasing • Advanced Planning • Operations Research . . . and much more.

Ours is one of the most advanced and sophisticated business information computer complexes in the country. We have come as far as any. We will go further than most. Projects vary from simple card systems to complex on-line systems involving, for example, a Full Production Information System, Automated Financial Analysis and Reporting, and an Integrated Material Control System which includes procurement, forecasting and scheduling. Tools include 360 models 20, 30, 40 and 50; tapes and random devices; data collection equipment; on-line facilities; DOS and OS.

The total commitment of Information Systems to serving the needs of management at P&WA means real-time opportunity for EDP pro-

fessionals with promise. Our Systems-Programming Analysts are exposed to virtually every phase of the business. They get to move around, and they get to move up . . . just as fast as their talents will take them. Isn't it time you talked to P&WA?

If this sounds like your kind of action, why not send your resume with salary requirement to Mr. H. M. Heldmann, Professional Placement, Office A-43, Pratt & Whitney Aircraft, East Hartford, Connecticut 06108. An equal opportunity employer.

Pratt & Whitney Aircraft

U
A
DIVISION OF UNITED AIRCRAFT CORP.

Now...

DIGICOMP II - the "second generation" of the famous DigiComp,

enormously more "sophisticated" as additional "switches" and "core positions" permit many more decisions and "branching" possibilities.

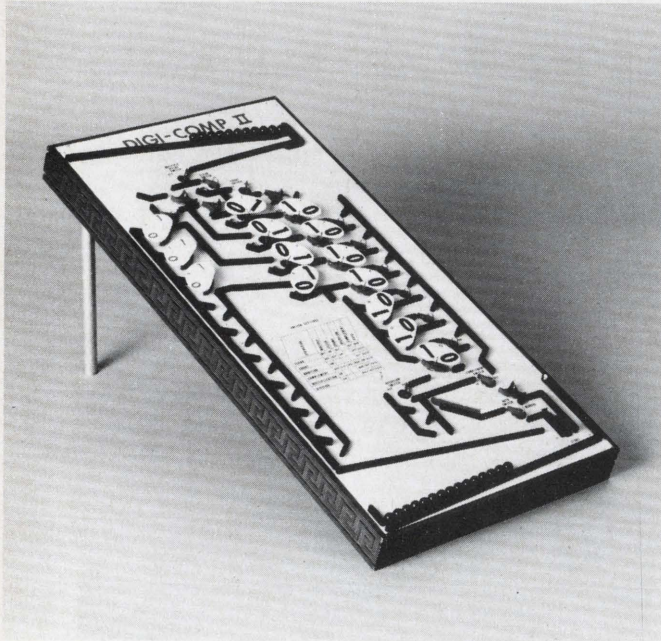

Like its predecessor the DigiComp-I is entirely mechanical in operation but affords the functions common to electronic computers in a form far more comprehensible. The best way ever to learn (or to teach) the principles of modern data processing.

\$16.95 Postpaid

WFF 'N PROOF

Developed in the course of the ALL Project (Accelerated Learning of Logic) Wff'nProof incorporates 21 games of progressive difficulty; has been used to teach propositional calculus to elementary school children but challenges the intellect of professional logicians. Complete with 224-page manual which is an introduction to the world of modern logic; filled with valuable tips to clear thinking.

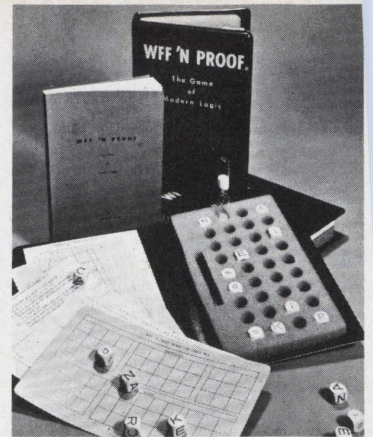

\$6.75 Postpaid

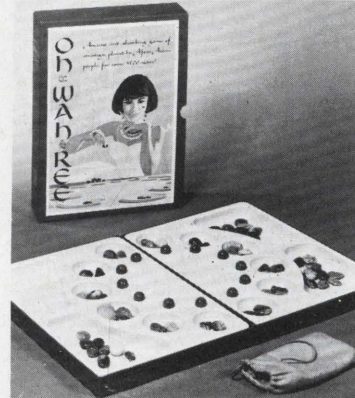

OH WAH REE

The ancient game of mathematical strategy which has intrigued millions for more than 30 centuries. A game at once so simple in its basics that a pre-schooler can enjoy it yet so complex in its possibilities that its fascination multiplies with the mathematical grasp of the player.

\$8.50 Postpaid

TWIXT

Another famous "bookshelf" game, package matches that of Oh-Wah-Ree. A stimulating game with a fascinating chess-like strategy of move and countermove. Two or four players.

\$8.50 Postpaid

CONFIGURATIONS

Based on concepts from the geometry of incidence, CONFIGURATIONS is a series of intriguing mathematical and geometric puzzles that will challenge and delight those who enjoy careful reasoning. It is authored by Professor Harold L. Dorwart, Chairman of the Mathematics Department, Trinity College, Hartford.

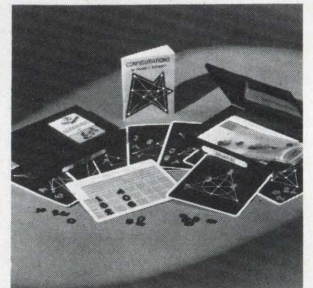

\$4.95 Postpaid

PRESS TECH, INC.

SALES DIVISION

P. O. Box 2076

Madison, Wis. 53701

S/A-11

Please send me at the address below:

.....

Foreign please write us for postage quote.
 Cash, check or money order with order.
 (Games are shipped from separate warehouses)

_____ (name)

_____ (address)

_____ (city) _____ (state) _____ (zip code)

Wisconsin residents add 4% sales tax

Programmers/Analysts:

Give IBM a hand and we'll try to make it a free one

If predictable thinking were what we wanted, we'd just program it. But what we're looking for are imagination and ingenuity.

If you have these qualities, and you qualify for a job with IBM, you can be sure you'll get to use them.

Immediate openings

There are openings for Programmers/Analysts and Systems Programmers at IBM Endicott, N.Y.

You'd design, program, test, and install software and application programs for our new Information



IBM programmers and systems analysts work in small teams on an IBM System/360.

Systems. These systems will aid manufacturing and production planning functions at all IBM facilities.

You will be involved with real-time and on-line processing applications, using IBM System/360 programming.

A Bachelor's degree and at least a year's experience are required. You should have a knowledge of basic assembler language and large-scale computer concepts.

Grow with IBM

Today's major growth industry is information handling and control.

And IBM is a leader in that field. Our job is to help IBM improve its manufacturing and production planning functions by applying information handling and control techniques.

If you're a problem-solver who wants a personal sense of achievement for your hard work in a growth company, consider IBM.

Call or write

Call Dom Santoni collect at (607) 755-2855. Or write him at IBM Corp., Dept. CL1015, 1701 North St., Endicott, N.Y. 13760.

An Equal Opportunity Employer

IBM®



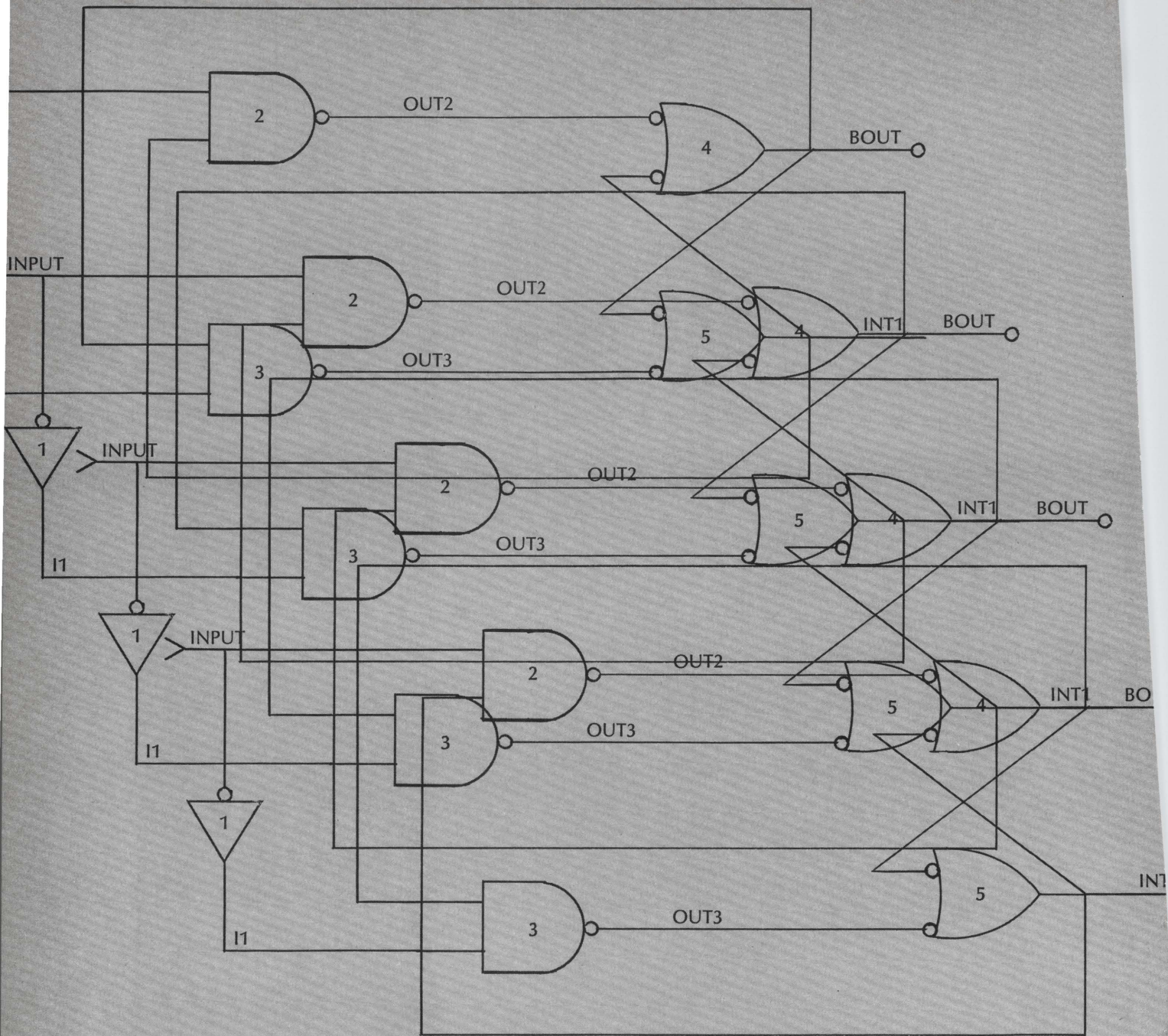

Robert E. Marsh received a BSEE in 1965 and a MSEE in 1967 from Michigan State University. Before he received his Master's degree he worked for Whirlpool Corporation in St. Joseph, Michigan. During that time he became experienced in math modeling, simulation, and data reduction in engineering applications with an IBM 1620 and a Univac 1107. While working on his Master's degree he added to his experience by studying pattern recognition simulation and numerical methods techniques. From September 1967 until July 1969, Mr. Marsh has been employed by Radiation Inc., of Melbourne, Florida. At Radiation he has been working on linear and non-linear circuit modeling and analysis, worst case analysis and optimization logic simulation with an IBM 360/50, IBM 1130 and a GE Terminal. Marsh is presently teaching in the Engineering Department of Andrews University, Berrien Springs, Michigan.

This program was developed by Mr. Marsh at Radiation, Inc.

Introduction

A computer program has been developed and is operational on the IBM 360/50 which can simulate general logic systems.

Implementing a logic system is made simple through the input language. Most of the common logic functions such as flip-flops, latches, gating, shift registers, one-shots, etc. are available to be used in *building* a system model. Models of special logic devices can easily be included in the complete system.

Most of the input data is accepted in *free* format. For example, the preparation of data cards to realize the gating shown below could be coded as follows:

LOGSIM

A

GENERAL

LOGIC

SIMULATION

PROGRAM

by

Robert Marsh
Engineering Department
Andrews University
Berrien Springs, Michigan

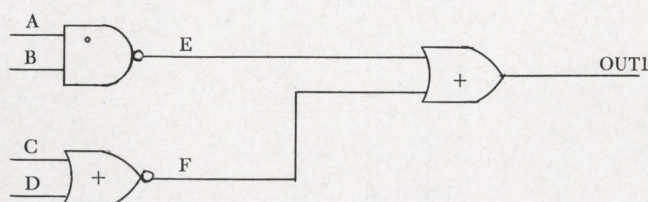

$$1 \text{ OUT1} = A(\text{BAR}(A * B) + \text{BAR}(C + D))$$

An alternate description could be

- 1 $E = \text{NAND}(A, B)$
- 2 $F = \text{NOR}(C, D)$
- 3 $\text{OUT1} = \text{OR}(E, F)$

Note the input data is *not* column oriented. The above coding would be accepted independent of its location within the first 70 columns of the data card.

The topology of a system is of little importance to the program. It is described implicitly to the computer by the *outputs* and *inputs* to the logical boxes which make up the system.

Most reasonably sized logic systems can be simulated with this program. The primary limitation depends on the number of logical variables in the system. A 110K byte partition will accommodate over 200 variables in a system.

There are quite a few special features of LOGSIM including the following:

- Medium to large logic systems can be simulated by LOGSIM.
- Easy to model a system via the input language.
- Special logic functions can easily be included in the system simulation.
- Oscillating signals are detected and displayed by the program.
- Any output variable of the system can be defined to fail either High or Low so that effects of failure modes can be simulated.
- Various signals are internally generated to aid in realizing a system model. For example, a pulse generator option is available which can be used to sequence the logic system as desired.
- The options on simulation control include:
 - i. Step by step printer output showing output variables or all variables of the system.
 - ii. The printer can be turned ON or OFF at will during the simulation so a system can be run through several stages and just the final stage is printed out.
 - iii. Title or heading changes can be made easily.
 - iv. The system can be initialized to any arbitrary state at any point in the simulation.
 - v. The pulse generator can be turned ON or OFF as desired.
 - vi. Failure modes can be changed or eliminated as desired.
- Edge sensitive inputs are easily included in a system.
- By adding certain control cards one can save a system on disk for future simulations. This eliminates the computer time required to regenerate the system model and compile the generated routines.
- Illegal signal conditions to the various flip-flops or other logic elements can be flagged if desired.
- Logic functions such as counters, shift registers, one-shots, etc., are available to use as needed in system description.
- The user can partition his output as desired with asterisks; e.g., one could separate a truth table into two blocks, one for inputs and the other for outputs.

Describing A System to LOGSIM

Pictorially a logic system can be represented as follows:

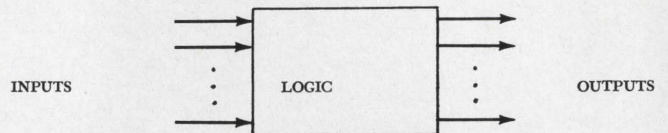

Thus there are three sets of data necessary to define a system: INPUTS, OUTPUTS, and LOGIC. This constitutes the system description data for LOGSIM. To define the set of inputs to a system LOGSIM accepts the key word "INPUTS" followed by the list of input variable names separated by commas. A typical card would be:

INPUTS ALPHA, BETA , BETA , A, B, OP

Similarly, to define the set of outputs of a system the key word "OUTPUTS" is used followed by the set of output variable names (108 or less) separated by commas to be displayed during the simulation. If more than the first 70 columns are needed to list the names, one simply continues with additional "INPUTS" (or "OUTPUTS") cards by putting an "x" in column 73 and continuing the list on additional cards as needed.

The last set of data describes the logic of the system using the various logic functions NAND, NOR, and JKFLIP, etc. Each logic function has some *box* number associated with it. (This number is a convenient reference identifier which can be used during the simulation phase.) This set of data has one of two forms as follows:

Form 1

N VARIABLE NAME = GATE (INPUT)

where:

N = a "Box" number

VARIABLE NAME = the name of a signal
(6 or less characters starting with an alpha character)

GATE = one of the LOGSIM supplied gating functions. (AND, OR, NAND, etc.)

INPUT = Some variable name or some logical expression involving several system variables.

Example:

131 OPFI = NAND (A, APB, OUT1 12)

Form 2

N FNAME (M, O₁, . . . O_M, I₁, . . . I_L)

<h1 style="margin: 0;">U.S.</h1>	<h1 style="margin: 0;">CAREER RECRUITERS</h1>
LAFAYETTE BLDG. SUITE 427 55 SOUTH FIFTH STREET PHILADELPHIA, PENNA. 19106 PHONE (215) MA 7-8414	
WE AT U. S. CAREER RECRUITERS ARE EXTREMELY PROUD TO ANNOUNCE THE ADDITION OF OUR NEW COMPUTERIZED RETRIEVAL SYSTEM. IT IS OUR PLEASURE TO EXTEND TO OUR TWENTY-THOUSAND ACCOUNTS FROM COAST TO COAST A BETTER SERVICE. DUE TO THE GREAT MANY JOB OPENINGS THAT WE HAVE LISTED IN THE AREAS OF DATA PROCESSING, ENGINEERING AND DRAFTING, IT BECAME NECESSARY TO UTILIZE A MORE EFFICIENT SYSTEM. WHETHER YOU, THE READER, REPRESENT A FIRM SEEKING NEW EMPLOYEES, OR YOU ARE AN INDIVIDUAL SEEKING A BETTER WORKING OPPORTUNITY, THEN YOU CANNOT AFFORD NOT TO INQUIRE ABOUT OUR SERVICE. LET OUR KNOWLEDGE AND OUR MANY AVAILABLE CONTACTS DO THE SEARCHING FOR YOU.	

where:

N = box number

FNAME = Is the name of a LOGSIM supplied logical function (SHIFTR, JKFLIP, MS, etc.) or the name of a user supplied special logic function.

M = An integer number (10 or less) equal to the number of output variables of this "box".

O₁, ... O_M = The "M" variable names for the outputs of this "Box"

I₁, ... I_L = the inputs to this "Box". (They may be logical expressions).

Example:

6 JFKLIP (2,A,ABAR, IN1*IN2, A*IN4, PULSE, DCSET, DCRSET)

Efficiency Hints

- Use the Re-run feature. This saves reprocessing the system description data every time another run of the same system is made.
- Wherever applicable use the LOGSIM provided routines to realize special functions such as latches, shifting, counting, etc. rather than using gating to implement these functions.
- Especially in the first passes of a simulation insert UPDATE commands at key points in the command sequence. If LOGSIM detects an oscillating system, it searches out an UPDATE or INITIALIZATION command to set the logic into some valid state before it continues the simulation. Thus the simulation will not end after the first oscillation condition is found if the UPDATE command is used.
- Before starting the simulation, initialize the logic system into some valid state. If this is not done LOGSIM will use whatever happens to reside in core for each variable. Thus the system could have inconsistent values for the variables, e.g., both outputs of flip-flops could be high, etc. In some systems this can cause a chain reaction which never settles out so the system would be declared to be oscillating.
- Variable names must not be used which:
 - i. Are identical to any of the LOGSIM provided routines—AND, NAND, JK, FLIP, OR, NOR, etc.
 - ii. Begin with the letter z.
 - iii. Contain imbedded blanks or more than 6 characters.

Requirements of LOGSIM

Machine Requirements

LOGSIM is executed in two steps. The first step processes the system description data and generates Fortran sub-routines, and a set of data on peripheral storage. This step requires about 90K bytes of core storage.

The second step compiles the generated sub-routines, links them with the necessary LOGSIM routines, reads the generated set of data, and executes the Simulation Control data. Core storage for this step depends on the number of variables in the sys-

EAST MEETS WEST WITHOUT A COMPUTER

Sorry we've no computer to process you. Only a personal approach, human to human. Let us discuss together your experience and career interests with our extensive intimate and personal contacts with companies of all sizes throughout the United States. We've divided up the country, better to work with you, by your present location.

If you're living West of Mississippi, write or call (collect) R. Tanen 505/982-4436.
If you are East of Mississippi,
D. Jaffe 212/679-5688.

The people in our Western and Eastern offices are constantly in direct communication on nationwide opportunities in such areas as:

- Sales and/or Technical Software Support
- Software Development (4th Generation)
- Interactive Systems
- Data Communications/On-Line Systems
- Hospital-Medical Systems
- Social Systems (Urban Dvmt, Educational)
- Commercial Programming and Systems
- MIS
- Scientific Applications

SALARIES \$8,000-\$30,000

ALBERT ASSOCIATES

210 Fifth Ave., New York, N.Y. 10010
Route 4 Box 36, Santa Fe, N.M. 87501

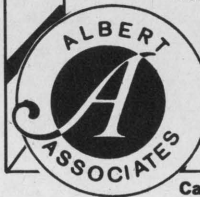

Career Consultants in the Data Processing Field

OCR Opportunity

The challenge is OCR . . .

The opportunity is NOW!

We are one of the leaders in the rapidly expanding business forms industry. Our OCR activities have grown to the point where we require an Optical Scanning System Coordinator.

To the person who fills this position, the career broadening advantages of working with advanced Optical Scanning and other new technologies in data processing are obvious.

You'll investigate new OCR units in terms of forms, design and printing requirements. You won't be tied to a desk, you will work directly with machine company people as well as our customers, salesmen, engineers and manufacturing supervisors.

Ideal qualifications would include a working knowledge of optical scanners, 3 or more years data processing experience and a college degree.

Salary, benefits and advancement opportunities are excellent. Please send resume and salary history in confidence to:

SOFTWARE AGE, Box SA-110
2211 Fordem Ave., Madison, Wis. 53701

An Equal Opportunity Employer

respect

they're synonomous

Respect. Remember when respect for the wishes, the goals, and the personal feelings of customers was a rigid business policy. It still is at Electronic Systems Personnel. We insist on it! So, if you're an EDP professional in search of an opportunity or an EDP opportunity in search of a professional, you can count on respect from ESP. You can also count on results!

Respect. Maybe that's what made ESP the leader in EDP personnel placements.

OFFICES IN U.S.A.: Chicago, Cleveland, Denver, Detroit, Kansas City, Los Angeles, Minneapolis, New Orleans, Orange, Philadelphia, Phoenix, Pittsburgh, Portland, San Diego, Seattle, Sherman Oaks, Washington D.C.
OFFICES IN CANADA: Hamilton, Montreal, Toronto



Electronic Systems Personnel

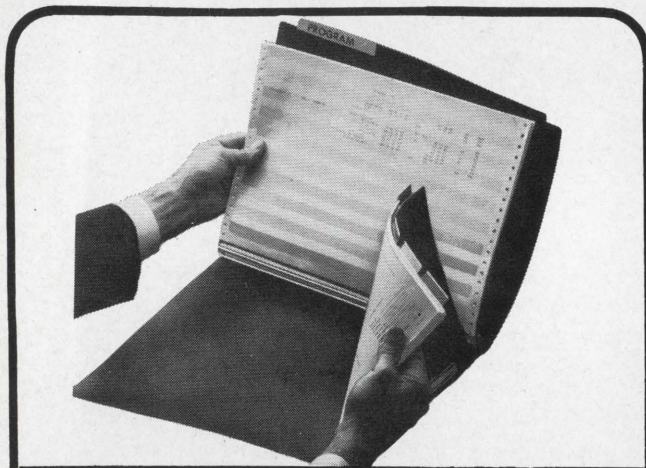

DOK'UMENTATION BINDERS

A PROGRAM BINDER
THAT CAN BE
STUFFED, STACKED
AND FILLED
WITH INFORMATION
ABOUT A
COMPUTER PROGRAM

A totally new concept developed and tested to fill a vital need of virtually every computer programmer in the country. This is one of numerous Data Processing items for information storage and retrieval we've been doing something about since 1842.

Standard

**BOORUM
& PEASE**

84 Hudson Ave., Brooklyn, N.Y. 11201

For more information, circle No. 6 on the Reader Service Card

tem being simulated and the number of different sub-routines used in the system description. In most cases step two will require over 50,000 bytes. An estimate can be made as follows:

Step 2 total storage = $55K + 100 * N$ (Bytes)
where N = the number of variables in the system being simulated.

The output from LOGSIM must be processed on a line printer with 132 or more characters per line.

User Generated Routines

For each routine $N + M$ must be 10 or less.

where N = number of outputs of logic function being modeled.

M = number of inputs to logic function being modeled.

User generated routines are modified slightly by LOGSIM to make them compatible with the other routines. The program executes sub-routines through the use of the Fortran EXTERNAL specification statement. Thus the name of the sub-routine is passed along with its several arguments to a LOGSIM sub-routine which executes the user generated routine. Since Fortran does not allow a variable number of arguments in an argument list, LOGSIM has the upper limit of 10 arguments in any sub-routine. LOGSIM automatically inserts dummy arguments to make up the difference for those cases involving less than 10 arguments.

How LOGSIM Works

LOGSIM has two basic execution phases:

- 1) Processing system description data and creating sub-routines.
- 2) Compiling the created sub-routines and including the several LOGSIM sub-routines to control the simulation.

The first phase creates Fortran card images which define the mathematical relationships between the system variables, allocates necessary storage, initializes various variables for the simulation and provides for output and output identification.

The second phase compiles the created sub-routines and joins them with the several LOGSIM routines and starts the execution of the simulation commands.

LOGSIM uses the fact that the *truth* of any Boolean function can be determined using ordinary arithmetic if TRUE is assigned value 1 and FALSE is assigned value 0 (zero). Then if a Boolean expression* has a non-zero value, the result is assigned a value of 1 (or i.e., TRUE). The expression will only have value 0 (zero) when the corresponding logical expression is FALSE. The solution to the set of logic equations is obtained by evaluating all the equations using present values for these variables and then updating

* The Boolean operators "OR" and "AND" are replaced with the arithmetic operators "+" and "*" respectively. Hence "OR" is equivalent to "adding" and "AND" is equivalent to multiplication.

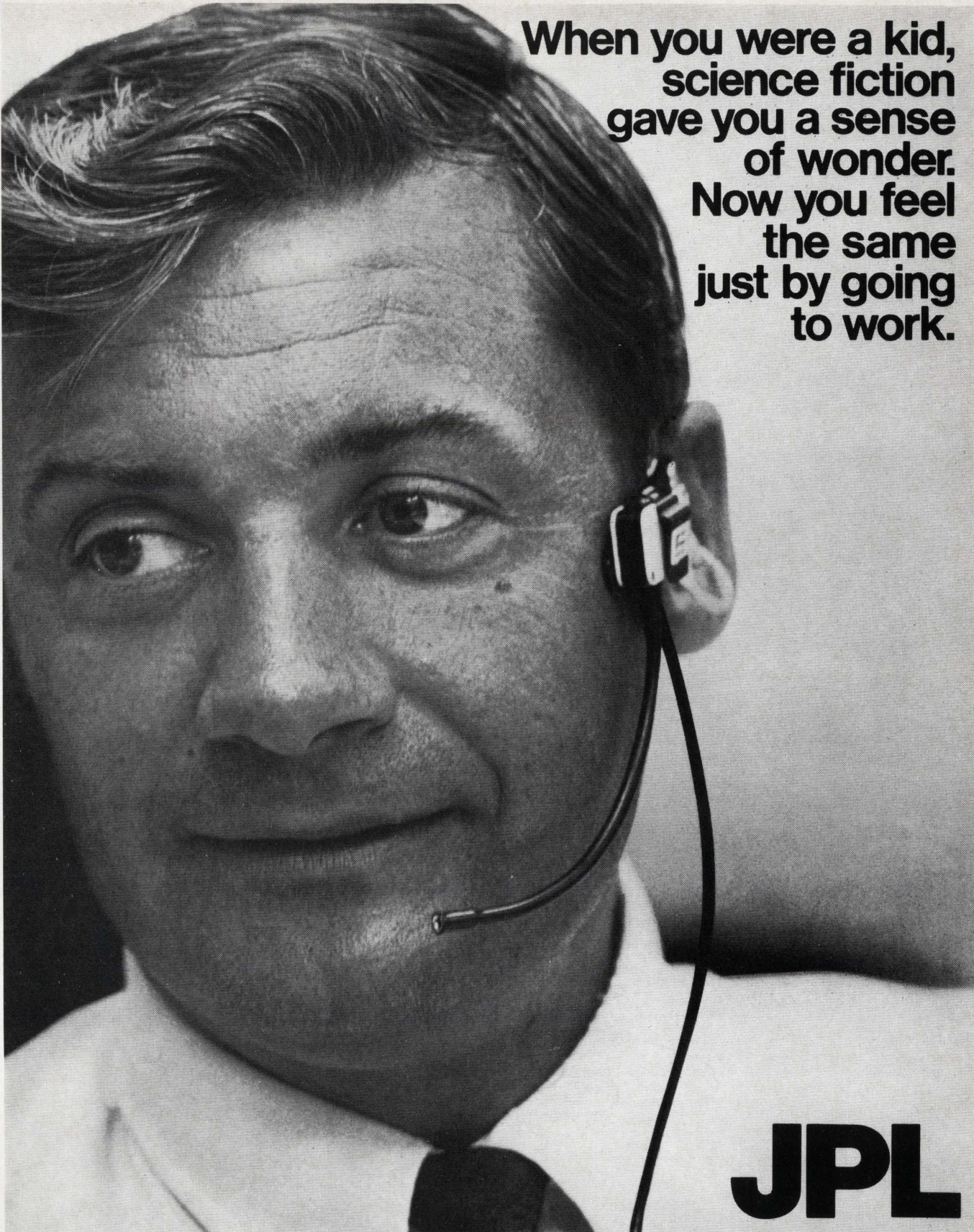

When you were a kid,
science fiction
gave you a sense
of wonder.
Now you feel
the same
just by going
to work.

JPL

In fact, you've got what the great science-fiction heroes never had so good: the excitement of discovery. If you want to be part of the action, we can help.

Right now openings exist in: Spacecraft Structural Design • Temperature Control Materials & Processing • Ap-

plication of Microelectronics & Transistors • Guidance & Control Systems • Electro Optics • Propulsion Systems Analysis • Space Vehicles Design • Trajectory Design & System Analysis • Systems Design & Integration • Deep Space Support Systems • Electromechanical Spacecraft Instrumentation •

Scientific Programming • TV Image Processing and Electronic Packaging.

Send your resume to:
JET PROPULSION LABORATORY
California Institute of Technology
4806 Oak Grove Drive,
Pasadena, California 91103
Attn: Professional Staffing Dept. 11

"An equal opportunity employer." Jet Propulsion Laboratory is operated by the California Institute of Technology for the National Aeronautics and Space Administration.

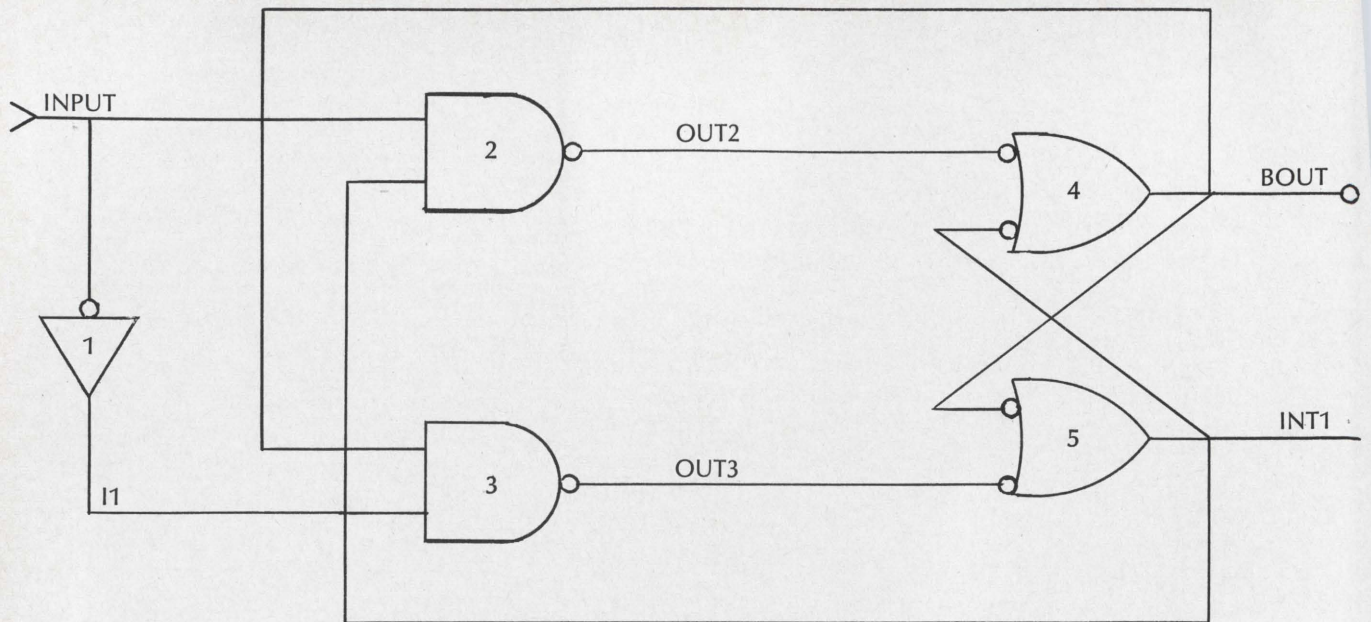

Logic diagram for sample problem

all the present values to their corresponding evaluated values. This is repeated until no changes have occurred in the logic and hence the solution is determined.

In some systems oscillations are found so there is no solution. This is detected VIA the user supplied "RACE" parameter which defines the maximum number of evaluations to be made before the system is to be declared oscillating.

Thus the method of solution is identical with the way the physical system *solves* the logic if each logic element or *box* has equal time delays. Since this is not the case in physical systems LOGSIM may detect oscillating signals which would not necessarily be a problem in the actual system. Hence LOGSIM does not address itself to the time delay problem in logic design, rather it will verify the correctness of the basic logic which constitutes a system.

LOGIC DESCRIPTION DATA

```

INPUTS  INPUT
1  I1 = INVERT (INPUT)
2  OUT2 = NAND(INPUT, INT1)
3  OUT3 = NAND(BOUT, I1)
4  BOUT = OR(BAR(OUT2), BAR(INT1))
5  INT1 = OR(BAR(OUT3), BAR(BOUT))
OUTPUTS INPUT, AST, I1, OUT2, OUT3, BOUT, INT1
END

```

CORRESPONDING COMPUTER OUTPUT

***** SYSTEM DESCRIPTION DATA *****

```

INPUTS  INPUT
2  OUT2 = NAND(INT1, INPUT)
4  BOUT = OR(BAR(OUT2), BAR(INT1))
1  I1 = INVERT(INPUT)
3  OUT3 = NAND(BOUT, I1)
5  INT1 = OR(BAR(OUT3), BAR(BOUT))
OUTPUTS INPUT,AST, I1, OUT2,OUT3,BOUT,INT1
END DESCRIPTION

```

SIMULATION COMMAND DATA
 INITIALIZE BOTH BOX 1,1,0 2,1,1 3,1,1 4,1,1 5,1,0
 T1 TEST CASE DEMONSTRATING
 T2 EFFECTS OF A FAILURE
 T3 ON THE INVERTER OUTPUT I1.
 * TEST INPUT = 1 1
 * TEST INPUT = 0
 FAIL 1,1,1
 * TEST INPUT = 0
 * TEST INPUT = 1 1
 UPDATE PRESENT
 FAILURES
 DEBUG ALL
 * TEST INPUT = 1 1
 END TESTS

TEST CASE DEMONSTRATING
 EFFECTS OF A FAILURE
 ON THE INVERTER OUTPUT I1.

			I	I	O	O	B	I
			N	1	U	U	O	N
			P		T	T	U	T
			U		2	3	T	1
			T					
<u>TEST</u>	<u>INPUT</u>	<u>ID</u>						
1	TEST INPUT = 1		1	*	0	1	1	1
2	TEST INPUT = 0		0	*	1	1	1	0

<u>BOX NUMBER</u>	<u>OUTPUT NAME</u>	<u>FAILURE MODE</u>
1	I1	HIGH

TEST CASE DEMONSTRATING
 EFFECTS OF A FAILURE
 ON THE INVERTER OUTPUT I1.

			I	1	O	O	B	I
			N	1	U	U	O	N
			P		T	T	U	T
			U		2	3	T	1
			T					
<u>TEST</u>	<u>INPUT</u>	<u>ID</u>						
3	TEST INPUT = 0		0	*	1	1	1	0

SYSTEM IS OSCILLATING.

			O	B	I	O	I	I
			U	O		U	N	N
			T	U		T	T	P
			2	T		3	1	U
			T					
<u>STEP NUMBER</u>								
1			1	0	1	1	1	1
2			0	0	1	1	1	1
3			0	1	1	1	1	1
4			0	1	1	0	0	1
5			1	1	1	0	1	1
6			0	0	1	0	1	1
7			0	1	1	1	1	1
8			0	1	1	0	0	1
9			1	1	1	0	1	1
10			0	0	1	0	1	1
11			0	1	1	1	1	1
12			0	1	1	0	0	1

"More than half the computer professionals and corporate executives who come to Source Edp do so because someone recommended us."

(Ed Golden, Source Edp-New York)



"The reason is simple. Source Edp has experienced its dynamic growth and success over the past seven years because of its ability to meet the objective of both groups.

The satisfaction of organizations seeking outstanding computer people stems from the fact that we only recommend a candidate when we are convinced that he is suited for the available position. That's why many companies utilize Source Edp exclusively in their recruiting.

Computer professionals seeking to enhance their careers also find results through Source Edp. They know we're vitally interested in associating them in positions that are suited to their needs and, of equal importance, suited to their objectives for professional growth. They appreciate the fact that our initial interviews go far beyond the bare facts of a resume. They

gain the benefit of our own extensive computing experience in evaluating available career alternatives in light of their specific career goals."

Check Ed Golden's statements. Ask those of your professional associates whom you respect the most. Chances are one or more of them has benefited directly from the services of Source Edp.

And send today for your FREE copy of the Source Edp Computer Salary Survey and Career Planning Guide.

This authoritative report and analysis is a product of Source Edp's knowledge and experience in the computing field. It contains a wealth of information regarding career paths in computing, studies of information processing development by industry classification, strategies in career planning and up-to-date computer salary information. To receive your free copy circle the reader service card or, for faster service, write directly to the Source Edp office nearest you.

source  **edp**

Atlanta—William S. Barnett, 11 Corporate Square (404) 634-5127

Chicago—David B. Grimes, 100 S. Wacker Drive (312) 782-0857

Dallas—Paul K. Dittmer, 7701 Stemmons Freeway (214) 638-4080

Detroit—Robert C. Stevens, 24500 Northwestern Hwy.,

Southfield, Mich. (313) 352-6520

Houston—George P. Dyer, 2300 W. Loop S. (713) 621-6070

Los Angeles—Wayne G. Emigh, 3470 Wilshire Blvd.

(213) 386-5500

Minneapolis—Fred L. Anderson, 801 Nicollet Mall (612) 332-8735

New York—Edward R. Golden, 1414 Ave. of the Americas

(212) 752-8260

Palo Alto—Gordon M. Best, 525 University Ave. (415) 328-7155

Philadelphia—George D. Ramming, 1700 Market Street

(215) 665-1717

St. Louis—Robert T. Trumbull, 130 S. Bemiston, Clayton

(314) 862-3800

San Francisco—Richard O. Clark, 111 Pine Street (415) 434-2410

Union—Dan C. Mickel, 2204 Morris Ave. (201) 687-8700

Use of Mathematics to Preform Bit Manipulation and Reduce Storage Requirements in Remote Terminal Operations

EDWIN G. HUDSPETH
Lt. Colonel, USAF

The views expressed herein are those of the author and do not necessarily reflect the views of Air University, the United States Air Force, or the Department of Defense.

With the development of time-shared systems, there has been a rapid growth of computer users. Remote terminals are found in many places and many of their users must rely solely on the time-shared service without any access to the central computer complex.

This time-shared service has its advantages, but it also has some drawbacks. Among these are the lack of a bit manipulation capability and a limited amount of storage space. Space is limited oftentimes due to the number of users, the cost, or the type of programming language used. For example, in some systems using the BASIC language, the data must be included in the program, and the size of the program is limited.

The Rome Air Development Cen-

ter at Griffiss AFB, New York furnishes time-shared services using a GE-645 through remote terminals to the Air University, the parent organization of the Aerospace Studies Institute (ASI) located at Maxwell AFB, Alabama. The terminals used are the ASR-33 and ASR-35 teletype machines.

The ASI desired to be able to rapidly search a number of documents to select those that pertained to a specified group of subjects. To do this they have developed a form of binary expansion to, in effect, do bit manipulation and to save space for doing document sorting operations on a time-shared system.

The index system developed by ASI consists of a series of keywords, each pertaining to a subject area or time period, and for each of which

there is a unique number. Typical subject areas include terms such as: F-4 aircraft, F-105 aircraft, interdiction, reconnaissance, operations, South Vietnam, psychological warfare, etc. All the documents are screened and a Document Review Questionnaire is prepared for each, listing the numbers of all the keywords covered by the document.

The basic data base for this index system is made up of the identification number of each document followed by a list of the numbers of the keywords that pertain to the document. For example, if document #1256 covered keywords F-4, F-105, interdiction, operations, North Vietnam, reconnaissance, and rescue, the data would be 1256, 11, 18, 22, 29, 32, 38 and 59. The idea is that if a user wants all the docu-



CAREER MEMO

To the Computer Professional

Does your present position lack pride of accomplishment? . . . If so, it is time for a change. Professional Opportunities presently exist in:

- SOFTWARE DEVELOPMENT
- SYSTEMS DESIGN
- PROGRAMMING
- REAL TIME SYSTEMS
- TIME SHARING
- MANA. INFO SYSTEMS
- ENGINEERING
- MATHEMATICS
- OPERATIONS RESEARCH

Your confidential inquiry is welcome. Call or write, Robert L. Keilholtz or Donald Wayne,

EVERETT KELLEY ASSOCIATES, INC.
Suite 1300—121 S. Broad St.
Philadelphia, Pa. 19107
215—KI 6-5240

Placement of Computer Professionals
since BINAC.



VISU-TROL SOLVES SCHEDULING PROBLEMS

- Permits Easy Schedule Changes
- Shows Available Open Time Slots
- Expands Horizontally and/or Vertically with Additional Units

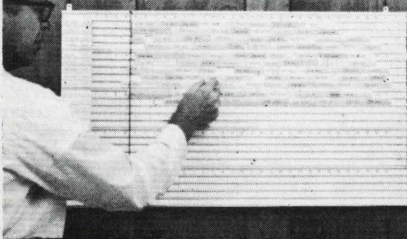

SEE AT-A-GLANCE

VISU-TROL™ SHOWS SCHEDULE OF:

- COMPUTER TIME • MANPOWER
- MACHINE LOAD • BUDGETS
- TRAINING SCHEDULES
- JOB ORDERS
- MATERIALS



\$4949

COMPLETE

including basic supplies

FREE: Complete System Brochure—Write Dept.SA-11

W

(203) - 227-4111

WASSELL ORGANIZATION, INC.

25 Sylvan Road South, Westport, Conn. 06880

Wassell Systems Canada Ltd., Toronto

For more information, circle No. 8
on the Reader Service Card

ments pertaining to F-4 operations in North Vietnam, he could search for all documents whose data contained the numbers 11, 29 and 32.

At first an attempt was made to put a matrix of document numbers and keyword numbers into the storage of the computer and just look for the numbers. However, because each document had an average of about seven keywords, with some having over twenty, it was soon found that there wasn't enough storage space.

It was then reasoned that since the computer stored information in 36 bit binary words, if the position of each bit represented a keyword they could save storage space. To do this ASI resorted to some basic number theory. The fact that a number in binary form like 10101101 can be represented as $1x2^0 + 0x2^1 + 1x2^2 + 1x2^3 + 0x2^4 + 1x2^5 + 0x2^6 + 1x2^7$, equal to 173 in decimal notation, is known to most high school students today. It was therefore decided to use a form of binary expansion, based on this type of representation, to store data. By omitting the zero power from the representation it was guaranteed that all terms and sums would be even.

Here's how it works. The keyword numbers were used as powers of 2 and the various terms were summed. Thus, if a document covered keywords 2, 3, 9, 11 and 15 the sum: $2^2 + 2^3 + 2^9 + 2^{11} + 2^{15}$ (35,340), and the document ID number, were stored.

In mathematical terms, where k is the number of keywords pertaining to a particular document,

$$\sum_{i=1}^k 2^{a_i}$$

is the sum.

In analyzing this sum note that 2 is an even number and that each term is an integral power of 2 and therefore an even number. Thus, the sum is even in all cases.

One could then tell if a particular document covered a certain keyword by dividing the sum by 2 raised to the power denoting the keyword of interest. If the quotient was even the keyword was not covered, if it was odd, the keyword was covered by the document. The reason behind this is seen by an analysis of the division process.

When dividing numbers composed of the same base raised to different powers, you subtract expo-

nents. Thus, dividing $\sum_{i=1}^k 2^{a_i}$ by 2^n

the result is

$$\frac{2^{a_1} + 2^{a_2} + 2^{a_3} + \dots + 2^{a_k}}{2^n}$$

which is the same as $2^{a_1-n} + 2^{a_2-n} + 2^{a_3-n} + \dots + 2^{a_k-n}$.

Now, in the above expression, for each $a_i - n$ if $a_i > n$, $a_i - n$ is an integral exponent and 2^{a_i-n} is even; if $a_i < n$, $a_i - n$ is a negative exponent and the term is dropped; if $a_i = n$, $a_i - n = 0$ and $2^{a_i-n} = 1$. Since the sum is made up of even terms except where $2^{a_i-n} = 1$ the quotient of the division is odd only when $a_i = n$ for some i .

So when a search is desired to find all documents covering a group of subjects, the data for each document is divided by 2 raised to the power that corresponds to the number of the desired keywords. If the result of the division by 2 raised to the number of the first subject is even, that subject is not covered and the next document's data is considered. If the results of the division is odd, then that subject is covered and division is performed on the same sum by 2 raised to the next number and so on. When a document is found to cover all the desired subjects, its ID number is printed.

Since the number of keywords in the ASI system exceeds the number of bits available per word, the data for each document was stored in three words. Thus the data file consists of a series of four numbers for each document, the first being the ID number and the next 3 the data (sums of powers of two).

In the ASI program about 2700 documents have been indexed and reviewed for coverage of a list of 59 keywords. This uses 25 links (512 words to a link) of disk storage. This same amount of storage will handle up to 100 keywords. An average search through the 2700 documents takes just over a minute.

The technique used in the ASI program can be used by anyone using BASIC or FORTRAN and does allow the user to do bit manipulation through remote terminals.

**S
O
F
T
W
A
R
E
A
G
E**

**R
E
A
D
E
R
S
H
I
P
S
U
R
V
E
Y**

READERS:

Help us bring you editorial material that is in your specialty.

Just fill out the coupon below and return it to us.

I already receive SOFTWARE AGE Yes No

Enter my subscription. Yes No

The information below gives my professional status.

Name

Company

Title

Home Address

City State Zip

Signature

Circle the most appropriate items below to describe your present position and experience.

MY SPECIALTY:

- 1—Systems Analysis
- 2—Math/Math Analysis
- 3—Operations Research
- 4—Scientific Programmer
- 5—Business Programmer
- 6—EDP Management
- 7—EDP Instructor
- 8—EDP Consultant
- 9—.....
other, incl. EDP student,
operator, technician, etc.

PRIME EXPERIENCE IN:

- 1—Aerospace/Defense Industry
- 2—Non-Defense Industry
- 3—Commercial/Finance
- 4—Research Organization
- 5—Govt./Military
- 6—EDP Consulting
- 7—Transportation/Utilities
- 8—Education/Library
- 9—.....
other, specify

I WAS BORN:

- A—1920 or before
- B—1921-25
- C—1926-30
- D—1931-35
- E—1936-40
- F—1941-45
- G—1946-50
- H—1951-55

I HAVE:

- Technical Degree
- Non-Technical Degree
- No Degree

RENTAL CHARGE ON THE EQUIPMENT I WORK WITH:

- \$1,500 or less, monthly
- \$1,500-2,500
- \$2,500-5,000
- \$5,000-10,000
- \$10,000-20,000
- over \$20,000 monthly

Suggestions for SOFTWARE AGE

.....

.....

.....

.....

Are you a creative software designer?

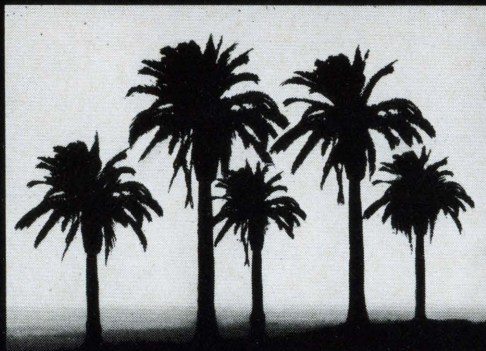

Like to join Hughes in California?

You'll be doing conceptual design of new-generation aerospace software systems. For an advanced, real-time computer system.

You'll be part of a small team of exceptional software/hardware specialists. But also part of a growing, highly diversified company where good work and creative thinking are recognized and rewarded.

It's a great spot to grow professionally. And Southern California isn't such a bad spot for your family to grow up, either.

Requirements: Degree (MS preferred) in engineering, mathematics, or physics. At least three years' experience with software systems, assembler and compiler languages, simulation systems, and use of large-scale computers.

Please airmail resume today to:

Mr. Robert A. Martin
Head of Employment
Hughes Aerospace Divisions
Dept. 27
11940 W. Jefferson Blvd.
Culver City, Calif. 90230

An equal-opportunity employer—
M & F. U.S. citizenship is required



financial currents

EDP Supply Growth Forecast by Brandon

A minimum six-fold growth of the data-processing support services market, by 1980 has been predicted by Dick H. Brandon, President of Brandon Applied Systems, Inc., before the Chicago Science Analysts. Brandon said the present \$2.8 billion market would grow to between \$16 and \$20 billion by 1980—a potential, he stated, which may have been the determining factor in IBM's recent unbundling decision. Intense competition will eventually cause a major shake-out among the 2,500 companies in the market, he added.

At present, he said, approximately 70 support service companies had annual revenues of more than \$1 million each. This could shrink to fewer than 40 by 1975, including some four to eight companies with annual revenues of \$250 million plus, and 10 to 20 with revenues of over \$50 million.

Describing his own company—founded in 1964, and now the eleventh largest independent service firm—Brandon said revenues for the current fiscal year are projected at approximately \$7 million, with plans calling for revenues of \$50 to \$60 million in fiscal 1974.

Government Buying Ways Scored by Company Head

A call for major changes in the federal government's procurement practices on computer software was sounded by Dr. Walter F. Bauer, chairman of the board and president of Informatics, Inc., in a critical speech at a conference sponsored by the Bureau of the Budget.

Dr. Bauer noted a recent "significant increase in the frequency of purchasing software services on a 'body shop' basis." He said that body shop software companies were quoting rates which were too low to enable them to survive as viable, professional organizations.

He also said that the practice denigrated the professionalism and contributed to the general instability of the industry.

"Therefore, this type of procurement is not in the best interests of the gov-

ernment since it adversely effects its set of software suppliers as a group."

Dr. Bauer offered government agencies two choices: "They should either give a contractor major pieces of responsibility to produce software or some desired data processing end objective and procure those pieces at reasonable rates, or they should fight for an increase in their budgets and hire personnel for their own staff as civil servants—in other words, contract nothing to software companies."

Another trend in government procurement of software services that Dr. Bauer objected to was "the increased emphasis on fixed price programming." He said that while fixed price programming may look highly attractive from the government and the contractor's standpoint, it all too frequently worked to their mutual disadvantage.

Dr. Bauer gave two reasons why fixed price contracts cause trouble:

1. Software technology lacks the maturity to bid with accuracy on a fixed price basis on a sizable software program, particularly on any program costing more than \$100,000.

2. The specifications are almost never developed in sufficient detail or comprehensiveness to warrant a dependable fixed price quotation.

Dr. Bauer recommended, where appropriate, that the government "engage a contractor on a time and materials basis to develop a set of program specifications upon which a fixed price basis can be obtained. If need be, competitive quotations can be developed on the basis of the specifications."

Dr. Bauer also criticized the government for not availing itself of separately priced and procured software packages to the extent that commercial organizations have.

SALES and MARKETING

Although the Compumeter I, an IBM/360 system compatible software package, was made available only four months ago, more than 130 commitments to use the package have been made, it was reported by Donald E. Lees, President of Computing Efficiency, Inc.

"We believe, it is the first time in the history of the electronic data proc-

essing industry that so many purchases of a single software package have been made in such a short time," Lees said. The number of orders also places the package third as far as total sales of any single software program are concerned.

"It appears that Computer I sales will exceed \$1,000,000 in a single year," Lees added. "By March 1971 we believe that the compumeter will be the most widely used software package in the world."

* * *

MAI Equipment Corporation, a wholly owned subsidiary of Management Assistance Inc., has launched an aggressive marketing program to capture an even larger share of the unit record market through new low-cost, long-term lease plans and outright sales.

"IBM accounts for some 30,000 out of an estimated 45,000 unit record installation sites, taking in an estimated \$500 million each year in rentals and sales," explained Luther A. Schwalm, MAI president and chief executive officer.

"We are going after that huge market: MAI has equipment available to supply these users and an extensive service force to provide maintenance."

To date, MAI has supplied some 6,000 installation sites, either all or in part, with leased or purchased equipment, producing revenues of over \$50 million in 1968.

* * *

"It" . . . has "everything your company needs for a high-performance, time-sharing computer operation. Hardware. Software. Programs. Installation. Operation. Up-keep. Trouble-shooting. Staffing. Training. Even housing."

So reads the first advertisement in a campaign by Time Share Corporation for its new computer service-product package. The ad appeared in *Time*, *Newsweek* and *Sports Illustrated*.

"The evolution of 'It' has been a natural one," said Richard T. Bueschel, president of Time Share. "We have added software programs to our catalogue, while expanding the scope and range of our hardware facilities. All the working experience we have accumulated over the past five years has helped shape and is available in our newest customer package."

Mr. Bueschel also said "It" will cost about \$5,000 a month to lease, and that permanent total service was included in the price of the package, based on the Hewlett-Packard 2116 computer hardware.

Job Gripes

(If any apply to you, apply to us.)

- The seniority gripe
- Didn't-get-the-raise gripe
- Slow-promotion gripe
- No-promotion gripe
- Boss-doesn't-like-me gripe
- Lousy-transportation gripe
- Shot-down-again gripe
- No-bonus gripe
- Too-many-gripes gripe

If you're an engineer, accountant, computer professional or scientist our computerized nationwide job file has a sure cure for the gripes. Over 16,000 jobs. Individually developed by our 56 nationwide affiliated placement agencies. Naturally there's never any fee with NMR. And we only release your identity if we have your OK. So go ahead and mail this form along with your latest resume. But be prepared to have nothing to gripe about.

NMR Computer Input Form
Return this with a copy of your resume if you have one.

For Office Use Only
[] [] [] [] [] []
Software 11/69 Job Gripes

Name _____ Date _____

Address _____ City _____ State _____ Zip _____

Home Phone _____ Business Phone _____
(include area code) (if ok to use)

Position Desired: _____

Geographical Preference: I will consider opportunities in the: Northeast Mid Atlantic I will NOT relocate
 Midwest South Southwest Calif. Northwest Any location Metropolitan area
 Medium town Rural area

Availability: Actively seeking Date available _____ **Identity Release:** My identity may be released to:
 (check one) Just shopping (check one) All but present employer No employer

Education Degrees _____ Major field _____ Year Earned _____ College or University _____

Present or Most Recent Position Employer _____ City/State _____
From _____ Title _____ Duties & Accomplishments _____
To _____

Previous Position Employer _____ City/State _____
From _____ Title _____ Duties & Accomplishments _____
To _____

Previous Position Employer _____ City/State _____
From _____ Title _____ Duties & Accomplishments _____
To _____

General Information (Summarize your overall qualifications and experience in your field. List any pertinent information not included above.)

Principal Industry Background (Glass, Textiles, etc.)

Current Annual Base Salary _____ Total Years of Experience _____ U.S. Citizen Yes No Level of Security Clearance: _____ Presently Employed Yes No

National Manpower Register, 635 Madison Avenue, New York, N.Y. 10022

NMR

PRICING and POLICIES

Xerox Data Systems—formerly Scientific Data Systems—announced that it is selectively adjusting prices and lowering rental rates “to improve its competitive position in the business data processing marketplace.” The company also announced a clarification and expansion of its previous policy of charging separately for programs and equipment.

Specifically, XDS will significantly broaden the range of Program Products available to customers; furnish and maintain these Program Products on a fee basis; continue to provide and maintain Control Programs (monitor and utility programs) at no extra charge to customers; offer significantly expanded systems analyst support on a fee basis; and institute purchase and short-term lease price adjustments which will establish a more competitive structure for commercial configurations.

* * *

The National Cash Register Company announced a new U. S. pricing structure for NCR computer systems under which the company will supply certain essential and predetermined systems support, educational assistance and software without extra charge but will price separately additional services required above that basic level.

* * *

Delta Data Systems has entered a new segment of the proprietary computer software market, by announcing a low-payment, three-year licensing arrangement for its commercial applications software. The new rental plan includes purchase options.

Under the new arrangement, a client pays an initial \$2,500 implementation fee, and \$400 per month for three years. During the period of the license, the client will receive regular announcements on all updates or modifications made to the system. Source program decks for the modifications will be sent to the client on his request, at no additional charge.

* * *

Bolstered by \$10 million in new contracts and passing the 1,000 mark in sales of its 620/i computer, Varian Data Machines announced an 18 percent price reduction for the mini-computer, equipped with 4096 16-bit words of storage—from \$12,100 to \$9,950.

* * *

An effective 8 percent increase in prices for its Mark II time-sharing computer service in the United States has been announced by General Electric.

The new rates, to be effective December 1, “reflect the significant financial and technical resources (GE is) investing to increase the value of Mark II service and the need to adjust prices as a result of rising operating costs.”

* * *

A 38 percent price reduction on Computer Automation Corporation's Model 216 general purpose mini-computer—from \$12,890 to \$7,990—was announced by CAI President Dave Methvin, who said:

“A new price of \$7,990 opens a much larger market for this class of computer so that potential volume warrants the lower cost.”

* * *

A 10 percent discount has been announced by Interdata, Inc. on all com-

puters sold by the firm to recognized educational institutions. Interdata's President, Daniel Sinnott, in announcing the discount said:

“We recognize the value of computers to colleges and universities. They serve not only to educate students in computer technology but support research programs on all levels of learning. By offering a discount we hope a greater number of institutions will be able to purchase computers.”

* * *

Applied Data Research, Inc. will raise the lease price 10 percent on Autoflow, a proprietary software program.

The across-the-board increase, the first since the computer documentation system was initially introduced commercially in late 1966, would apply to all new Autoflow leases after January 1, 1970. Available on a three-year lease, the system is used by more than 800 computer installations.

We're hiring systems engineers like there's no tomorrow!

The truth is we need you to work on some very important tomorrows. Like the Navy's Poseidon Submarines . . . control and navigation systems. Like the Coast Guard's National Data Buoy System . . . for the electronic reporting of world-wide oceanographic and weather information. Like the automated answers to one of America's most critical civilian problems . . . urban and highway traffic controls. Here at Sperry Systems Management Division, we've created the ideal environment for building tomorrows. For our customers. For America. For you, too, Mr. Engineer. Why not call us *today!*

Engineering Programming Analysts

Systems design, planning and generation of digital computer programs for real-time control systems, including analysis and programming of one or more phases of a project involving solution of complex system engineering problems, and generation of test plans. B.S. degree in Engineering, Physics or Math, with 2 to 8 years' programming experience required.

Send resume including salary requirements, or call collect:
Mr. J. KELLY (516) 938-9300

An Equal Opportunity Employer

SPERRY RAND

SPERRY

SYSTEMS MANAGEMENT DIVISION
SYOSSET, NEW YORK 11791

ANALYSTS • PROGRAMMERS:

YOU CAN HELP DEVELOP A

total manufacturing control system

WANT A
PIECE OF
THE ACTION?



Sooner or later, you'll want to do better. And doing better is what to expect at Sikorsky. The chance to use your abilities in depth. To go and grow—from one absorbing assignment to another.

Consider the intriguing possibilities inherent in 33 sub-systems. A great breadth of action which includes *order entry . . . inventory . . . shop scheduling*—just to start your thinking.

Obviously, we want people who need involvement. People who can kick the bread and butter routine and get

excited with us. And who want the personal and professional rewards associated with new dimensions.

The tasks and environment are here to support your creativity. Our inventory includes IBM 360's with graphics, tele-processing and time-sharing.

So, if you possess a degree—or a comparable background—get in touch *now*. *We have exceptional positions at all levels of experience.* (Plus a corporation-financed Study Program to help keep you moving up.)

For prompt consideration, please airmail your resume in confidence, stating salary requirements, to:

MR. L. S. SHALVOY,
PROFESSIONAL EMPLOYMENT



You'll like Connecticut living.

Sikorsky
Aircraft

STRATFORD, CONNECTICUT

DIVISION OF UNITED AIRCRAFT CORPORATION

U
A

An Equal Opportunity Employer

TROUBLE-TRAN PRESENTS XTRAN'S ADVENTURES IN FORTRAN



By GEORGE N. VASSILAKIS

Send your ANSWER to the problems posed here in each issue to:

TROUBLE-TRAN EDITOR

software age

P. O. Box 2076

2211 Fordem Ave., Madison, Wis. 53701

You can also profit by submitting PROBLEMS for this feature. If your problem in FORTRAN programming is selected for use in this feature, you will receive \$50.00

TROUBLE-TRAN'S Objectives:

1. To have fun.
2. To promote USA Standard FORTRAN by pointing out differences and inconsistencies of existing FORTRAN Compilers.
3. To alert programmers to the physical limitations of hardware.

PROBLEM OF THE MONTH

Here is a problem you will enjoy and it will give you the opportunity to win ten dollars.

Problem 19: THE SELF-REPRODUCING PROGRAM

Write a program to print an exact duplicate of itself.

Rules:

1. No input statements are allowed.
2. The output is an exact, line by line, duplicate of the source statement cards.
3. Non-standard FORTRAN is allowed.
4. Any programming language may be used, as long as the first two rules are observed.
5. Five \$10 prizes will be awarded at random by a program that will use your last name in a random number generator algorithm.
6. To become eligible, your entry must be postmarked prior to December 5, 1969, and must include computer output.

Answer to Problem 17:

The outstanding response to "The One Instruction Computer" problem indicates that many TROUBLE-TRAN readers like to see something more than just a few lines of machine dependent FORTRAN coding. However, a large number of readers still enjoy the machine dependent FORTRAN problems. In order to satisfy both groups, I have decided to alternate the two types of problems.

A minority group has expressed a desire to see problems in COBOL, Assembly Language and O/S 360. At this point I don't know what I can do to please these readers. However, if I have more similar requests, I may consider the possibility of expanding this column to include more than one problem per month.

Problem 17 was enjoyed by many as indicated by the following comments:

"I found this to be a most enjoyable exercise. . . . I am pleased to see an assembly/machine language problem in your column. . . . Thank you for an enjoyable feature. . . . I enjoy seeing problems of this sort. . . . I have been using your 'Problem of the Month' as classwork. . . . I think it's a good idea to include some problems of this sort, but I hope that the column remains devoted primarily to FORTRAN. . . . There are many programmers working only in assembly language who would appreciate some more problems in that area. . . . Congratulations for including a problem aimed at those who enjoy problem solving at the machine-language level. . . . Say, what does Problem 17 have to do with FORTRAN?"

The solution of this problem required a minimum number of nine instructions. In the mail that I have received so far the solutions have between nine and twenty-five instructions.

Here are two of the best solutions:

1. Submitted by: **Stan Kurtz, Columbus, Ohio**

			Comments
A0	SJ	Y,Y,A1	Zero Y
A1	SJ	Y,X,END	-X to Y, Jump End If X is 0
A2	SJ	Z,Z,A3	Zero Z
A3	SJ	Z,X,A4	-X to Z
A4	SJ	Z,I,END	Z-1 to Z, Jump End If 0, Y is -X
	SJ	X,I,A6	X-1 to X, Jump A6 If 0, X Is Pos.
A5	SJ	W,W,A4	Loop
A6	SJ	Y,Z,A7	Y=-X,Z=-2X,Y-Z=X
A7	SJ	W,W,END	Required Jump to End

2. Submitted by: **T. F. Coleman, Cleveland, Ohio**

			Comments
START	SJ	MINUSX,MINUSX,NS11	Clear MINUS-X to Zero
NS11	SJ	Y,Y,NS12	Clear Absolute X to Zero
NS12	SJ	MINUSX,X,END	Setup MINUS-X and Exit If Zero
	SJ	MINUS1,MINUS1,NS13	Setup a Constant
			of Minus One
NS13	SJ	MINUS1,I,Any	
LOOP	SJ	Y,MINUS1,Any	Increment Absolute X
	SJ	X,I,END	Decrement and Test Positive X
	SJ	MINUSX,I,END	Decrement and Test Positive X
	SJ	JUMP,JUMP,LOOP	Return to Loop

P.S. It is interesting to note that the best solutions come from Ohio!

XTRAN

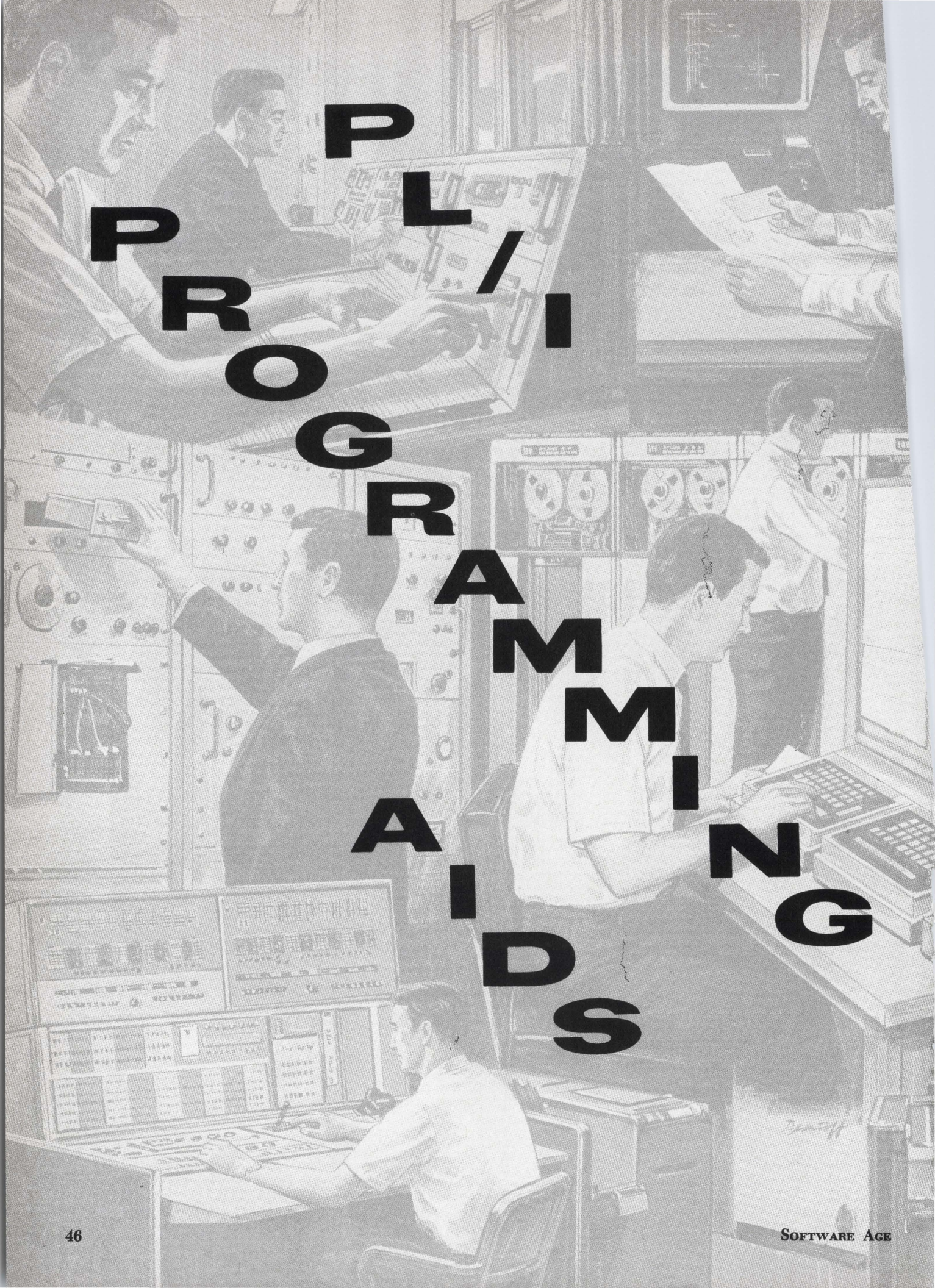

PROGRAMMING AID S

FROM

BETTER

TO

BEST

tips for good programming

Arline Bohl Walter

*Senior Computing Engineer
Autonetics Division
North American Rockwell
Anaheim, California*

and

Marilyn Bohl

*Author, Curriculum Dev't.
Science Research Associates
Palo Alto, California*

Most of us learned to communicate at a very early age. We have gained the use of a language (which, for many of us, was English). First, we spoke it; then, we wrote it. The skills that we developed enabled us to convey our ideas, wants, and needs to others.

Now, as electronic data processing becomes vitally important in our world, many of us are learning new communication techniques. Our newly acquired skills enable us to communicate with machines essential for electronic data processing—namely, computers.

Historically, programmers first learned to communicate with computers via machine language. That is, we attempted to talk with computers in *their* language. But speaking or writing with 1 bits and 0 bits proved to be a tedious job. A search for better means of communication led to the development of assembler languages. High-level languages such as FORTRAN and COBOL soon followed. Continued efforts to provide the means for easy communication with computers has led to the development of Programming Language I (PL/I).

Now programmers are no longer forced to use 1's and 0's, or even to use highly structured phrases or strange terminology. PL/I offers programming flexibility and capabilities in communications hitherto unheralded. The opportunity available to each of us is to learn to use PL/I effectively. Techniques enumerated below will provide significant assistance in this effort.

DOCUMENTATION/MAINTENANCE

A good programmer realizes that the programs which he creates provide the basis for communication with other persons as well as with the computer. Programs that are written and entered in system libraries must be maintained. Maintenance personnel usually refer to source program listings when program modifications are required. Sometimes (and perhaps with increasing frequency as the scope of EDP widens) auditing personnel also examine computer programs. Concise, accurate documentation is essential and helps the reader to understand the processing steps within a program in these and many similar situations. The items listed below suggest standards or guides which can be established.

1. Write all source statements within columns 2 through 72 of the coding form; avoid writing more than one statement per line.
2. Abbreviate key words (DCL for DECLARE, CHAR for CHARACTER, and so on).
3. Align the assignment symbols in successive assignment statements.

```
L_VAL    = L_NET
L_GROSS1 = L_VAL + L_EXPI
```

4. Use blanks to improve clarity.
 $xx = yy$ is preferable to $xx=yy$
 (TAG) (A) is preferable to (TAG)(A)
5. Use break characters for ease of readability where blanks are not permitted. For example, labels and variables can be written as RATE_OF_PAY, OLD_MAS, and so on.
6. Observe the following conventions with respect to margins and alignment of IF statements and DO groups.

```
Column 2    10  13    18
      label IF
                THEN DO;
                    statements
                    of
                    DO-group
                    .
                    .
                    .
                END;
      ELSE DO;
```

7. Identify structure levels by assigning the integers 1, 05, 10, 15, . . . to succeeding levels within a program. Omission of numbers when assigning structure levels will readily permit establishment of minor structures within an existing structure if program modification is required. Observe alignment as given below. Also consider the use of a prefix within each programmer-supplied name as indicated, thus

causing structure elements to appear as consecutive entries in the compiler-generated attribute list. Duplicate names are less apt to occur.

```
DCL 1 P_COST_OF_LIVING,
      05 P_RENT      FIXED BIN (31),
      05 P_FOOD,
          10 (P_MEAT,
              P_FRUIT)
          FIXED BIN (31),
      05 P_TRANSPORTATION
          FIXED BIN (31);
```

8. Place all DECLARE (DCL) statements for a PROCEDURE immediately after the PROCEDURE statement.
9. Declare all variables except those for which the attributes and the function served by the variable within the program are obvious. Indices, subscripts, and statement labels usually need not be declared explicitly.
10. Comment a program liberally. Use columns 50 through 72 of coding lines for comments if this space is available. Otherwise, place the comment on succeeding lines, indented four columns from the leftmost character of the preceding source statement.
11. Avoid separating portions of a GET or PUT statement format-list. Rather, indent the succeeding line of coding four columns and place the entire format-list on that line, if possible.
12. Specify COLUMN(nn) rather than x(nn) in a format-list to achieve desired spacing. Required modification will be obvious, and careless errors will be avoided.
13. Do not include a data file description in a file declaration statement. Should modification of the file be necessary or desirable, information within the program cannot be overridden by entries in job control cards.
14. Identify work areas by names which clearly indicate the utility purpose of the work area and the attributes of the area. This will prevent redundant specification of utility areas and careless use of work areas, requiring unnecessary conversion of data because of work area attributes.

```
DCL  DEC60  FIXED  DEC (06,0),
      CHAR5  CHAR   (05);
```

EFFICIENCY IN COMPILATION/EXECUTION

One group of programming techniques within PL/I is important primarily because the techniques lead toward efficient program compilation and/or execution. Some of these follow.

- A. Avoid the inclusion of unused labels or variables.
- B. Use multiple assignment statements when possible.

```
A, B = C; is preferable to A = C;
                                B = C;
```

C. Use factoring in DCL statements when possible.

```
DCL 1 P_WORK,  
    05 P_HOUR,  
    10 (P_REG, P_OVER)  
    FIXED DEC (5,2);
```

D. With edit-directed data transmission, use iteration factors in format-lists.

3 F(5) is preferable to F(5), F(5), F(5)

E. Avoid unnecessary entries in a format-list. For example, incorporate blanks in character-string data; to describe the character-string QUANTITY SOLD, followed by two blanks,

```
PUT FILE (EDIT) ('QUANTITY  
    SOLD  ') (A);  
    is preferable to
```

```
PUT FILE (EDIT) ('QUANTITY  
    SOLD') (A(13),X(2));
```

F. Use remote format if the same format-list is applicable to numerous GET and PUT statements. Note, however, that these statements should be related so that a change in the format of one statement implies changes in the formats of other statements as well.

G. The number of compiler-generated dictionary entries as well as the need for internal procedures can be minimized through the use of label arrays.

```
    I = 2;  
    GO TO L(3);  
L(2):  
    .  
    .  
    .  
    I = 4;  
L(3):  
    .  
    .  
    .  
    GO TO L(1);  
L(4):  
    .  
    .  
    .
```

H. Based storage can be used to provide multiple area descriptions and thus permits character assignments rather than structure assignments to be made.

```
DCL 1 S_SAV,  
    05 S_INT,  
    .  
    .  
    .  
    CHAR120  
    CHAR (120) BASED (PS)  
    CHAROUT  
    CHAR (120) BASED (POUT);  
    .
```

The data in the structure s_sav can be written on the output file OUTPUT by the following statements.

```
PS = ADDR(S_SAV);  
LOCATE CHAROUT FILE (OUTPUT);  
CHAROUT = CHAR120;
```



It's never too early to start saving their hearts

Help your children form good health habits now to reduce risk of heart attack later:

- Encourage normal weight; obesity in youth may persist throughout life;
- Build body health through regular physical activity;
- Serve them foods low in saturated fats;
- Teach them that cigarette smoking is hazardous to health;
- Make medical check-ups a family routine.

Set a good example. Follow the rules yourself and guard *your* heart, too.

GIVE...
so more will live
HEART FUND

Contributed by the Publisher



DEBUGGING

Even a skilled programmer faces the task of program debugging. However, he can apply several techniques during original program coding that will make this task easier. Some of the techniques mentioned under the previous subheadings also apply as debugging aids. Others are listed below.

- If possible, place coding inserted for temporary purposes on lines that do not contain permanent coding. For example, prefix lists can be inserted on the line immediately preceding the appropriate source statement.
- Identify temporary coding inserted for debugging purposes by comments such as `/*DEBUG*/` or `/*TEMP*/`. These comments should begin in column 2 or column 50 of coding lines.
- Declare attributes that could be assigned by default when the explicit declaration serves as valuable program documentation or when a change in the default assumption could significantly effect program execution. Explicit declaration also requires cognizance on the part of the programmer of just what attributes variables do have. By scanning the compiler-generated attribute list, errors in spelling or keypunching can be detected after program compilation (rather than during program execution).
- Declare all entry points and their associated parameter lists and any return values in programmer-defined functions.

- Use `INITIAL` in `DECLARE` statements as often as possible. This avoids careless mistakes due to failure to initialize variables, eliminates the need to use separate assignment statements, and exhibits initial values.
- Use repetition factors in `GET` and `PUT` numeric picture specifications.

`'(07)9'` is preferable to `'9999999'`
`'(06)9V(03)9'` is preferable to `'9999999V999'`

- The length of a character string need not be specified for output described by format code `A`.
`DCL CARD CHAR (80);`
`PUT FILE EDIT (CARD) (A);`
 is preferable to
`PUT FILE EDIT (CARD) (A(80));`
- Align labels to internal procedures with the statement margin of the containing procedure. Align the `PROCEDURE` and `END` statements as shown below.

```
PIFST: PROCEDURE;
.
.
CALL P2SCD;
P2SCD: PROCEDURE;
.
.
P2GO: other statements of
      this procedure
.
.
PIADD: other statements of PIFST
.
.
END;
```

- Improper boundary alignment may occur after execution of a `READ` statement in locate mode I/O. Before comparing a fixed binary field in a based structure, the fixed binary element should be assigned to a non-based fixed binary variable.
- Do not close files immediately after executing a `READ` statement in locate mode I/O. Closing a file permits reuse of the storage addressed by the pointer.
- Assign a 1- or 2-character prefix for use in the first entry-name of a procedure and all statement labels and entry-names internal to the procedure which are not entry-names of a contained procedure or internal to a contained procedure. These labels will then appear as consecutive entries in the compiler-generated attribute list. Errors arising from branches to labels which are unknown to the procedure and use of duplicate labels are thus avoided. Examples are `L_LREAD:` and `L_LOOP:`.
- An imbalance in `END` statements created by omission of one or more `END` statements can be determined after compilation rather than at execution time (where it is evidenced by abnormal program termination). Omitted statements are indicated by labels having smaller numeric values than those of consecutive instructions near the end of the object program listing.



What is
the best way
to cope with
an OCTOPUS ?

Surround it?
Hardly.

With 50,000 computers installed and 400,000 data processing professionals working in the field already, finding the right job is like battling an army of octopi.

Don't let every recruiting company get his tentacles around your resume. You only need ONE job and your time and energy for interviews are limited. What you need is personalized job selection, not mass resume processing.

When your target is an octopus, zero in. Contact us EXCLUSIVELY for the best data processing positions coast to coast.

Management
Scientists, Inc.

101 Park Avenue, New York, N. Y. 10017—Dept. 5A-11-69
(212) 532-7710

Career Planners: DATA PROCESSING & MANAGEMENT SCIENCES

better books

by *Dennie Van Tassel*

THE TECHNOLOGY OF COMPUTER MUSIC. By M. V. Mathews. Cambridge: M. I. T. Press. 188 pages. 1969. \$12.00.

Since very little has been published on computer music this book is quite welcome. In the past, several types of computer novelty music have been developed but very little serious computer music has been done. Computers have been programmed so card readers, line printers, and tape vacuum tubes produce music. Others have programmed computers so that once a portable radio is placed on top of a computer and tuned to the correct frequency music will emit from the radio.

This book is by M. V. Mathews, a pioneer and authority in the increasingly important field of generating and processing speech and music through computers. And even though *THE TECHNOLOGY OF COMPUTER MUSIC* is intended for people with a serious interest in computer sound generation, such as engineers, scientists, musicians, and audiologists, one may understand it and appreciate Mathews' concern for contemporary sound generation through computers without having a thorough knowledge of sound generating programs.

The first section of this book covers the representation of sounds as numbers, the underlying processes of sampling and quantizing a sound wave; the approximations and errors which are inherent in sampling and quantizing; the operation of digital-to-analog and analog-to-digital converters; the construction of smoothing filters; the storage and manipulation of sound waves in numerical form.

A perusal of the book shows that it is primarily for the serious student of computer music and that some understanding of the physical nature of music would be a prerequisite to a better understanding of the text.

The second section is titled "A Sequence of Tutorial Examples of Sound Generation" and it discusses a series of examples ranging from simple to complex sound synthesis. This part is meant to provide training in the use of a particular sound generating program—Music V.

The final chapter of the book gives a detailed description of the operation and structure of the program, Music V. Since Music V is written in Fortran it is easily adaptable to many computers. Also, researchers attempting to write their own music generating program will find the information on Music V helpful. And Mathews has provided many annotated references for further research.

One of the interesting appendixes discusses the relations of psychoacoustics to the composition of music by computers. Although the technology of electronic and computer sound generation has given us new tools of almost unlimited power for making new sounds, it has also created a new problem—the need to understand the psychoacoustics of musical perception. Sounds produced by conventional instruments are so well known that composers can proceed with the intuition they have developed from long experience. However, no such intuition exists for sounds such as computer produced music. Composers must understand the relation between the physical sound wave and how it is perceived by a hearer. Possibly in the future a composer will be able to look at a computer printout and perceive how it would sound as he can perceive regular music.

RUN, COMPUTER, RUN: The Mythology of Educational Innovation. By Anthony G. Oettinger. Cambridge, Massachusetts: Harvard University Press. 302 pages. 1969. \$5.95.

Advocates of computer in education will be hard-pressed to find one overall successful system, even in an experimental environment, let alone a regular school classroom situation. This is not to say there are no computer educational systems around

... that's the 3-part program that spells success in data processing. New York and Chicago offer rapid advancement because there's a critical shortage of EDP professionals with salaries from \$8,000 to \$25,000. YOUR skills are needed and wanted.

DREW, the largest EDP personnel placement organization in New York and Chicago, is in constant touch with hundreds of nationally known corporations.

Here's how we tell you about them: When your resume is on file with us we call you wherever you are in the U.S. and give you full information on jobs suited to your abilities and background. Opportunity doesn't knock—it rings!

Scores of major companies look to Drew to provide EDP personnel in the areas of applications programming, systems programming, systems design, software systems and management information systems.

TO START DREW WORKING FOR YOU

Simply send us your resume. We'll take it from there—start immediately to match your skills with job openings on file and coming in every day, call you on the phone to discuss salaries offered, responsibilities and everything you need to know to grow in EDP. Drew will arrange for a client company to fly you in for a personal interview at no cost to you. Everything will be handled in confidence, of course. Let's get started—send your resume or call today.

DREW

Personnel Placement Center
160 Broadway, New York, New York 10038
(212) 964-8150

333 North Michigan Ave.
Chicago, Illinois 60601
(312) 641-2580

For more information, circle No. 8 on the Reader Service Card

EDP SEARCH

WHY DO MOST DATA PROCESSING
PROFESSIONALS PREFER
FOX-MORRIS ASSOCIATES . . .

- A recognized staff of professional experts offering LOCAL, REGIONAL and NATIONAL COVERAGE through our direct branches (Philadelphia, New York City and Wilmington) as well as coast to coast coverage throughout the U.S.A.
- Completely confidential service including private offices for the data processing department.
- Unparalleled contacts with industry based on years of successful results.
- Professional resume evaluation and career guidance.
- Client companies assume all employment costs—including interview expense relocation (if necessary) and search fee.



J. J. SHIELDS
Nat'l EDP Mgr.
Phila. Office

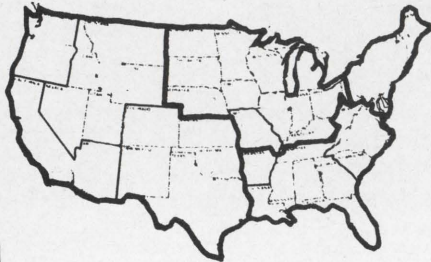

FOX-MORRIS ASSOCIATES
Personnel Consultants

All replies to J. J. Shields:

1500 Chestnut Street, Philadelphia, Pa. 19102
NEW YORK: Pan Am Building, 200 Park Avenue, New York, N. Y.
WILMINGTON: 2115 Concord Pike, Wilmington, Del.

PROGRAMMERS SYSTEMS ANALYSTS earn \$10M to \$25M

IN THE SOUTH! (And Anywhere in the U. S.)

Are you looking for a new challenge? . . . A greater opportunity for advancement? . . . A change of climate? We have clients throughout the U. S. (heavy concentration in S.E. & S.W.) who are seeking Programmers, analysts and Systems Engineers with 3rd generation experience. Real-Time, Telecommunications and other advanced applications are urgently needed. Telephone or send resume' in confidence to the South's leading EDP placement specialists.

SPEER PERSONNEL CONSULTANTS

(EDP DIV.) 1115 HEALEY BUILDING
ATLANTA, GA. 30303 (404) 523-2961

OUR FEES PAID BY EMPLOYERS

PROGRAMMERS—ENGINEERS

Washington, D. C. • New York • New Jersey • New England • Philadelphia • Chicago • Minnesota • Texas • Ohio • Florida • Arizona • California • Southeast Asia

If you have a B.S., M.S. or Ph.D. and you are experienced or interested in any of the following, contact us immediately for free career counseling and an objective analysis of your position in today's market.

- | | | |
|---------------------------|----------------------------|--------------------------|
| PROGRAMMERS | • Systems Simulation | • Digital Logic Design |
| • Management Info Systems | • Software Development | • Digital Circuit Design |
| • Information Retrieval | • Communications | • Digital Communications |
| • Command & Control | SYSTEMS ENGINEERS | • Systems Integration |
| • Aerospace Applications | • Reliability Analysis | • Soft Ware Analysis |
| • Real Time/On Line | • Digital Computer Systems | • Oceanography |

Salaries range from \$8,200 to \$25,000. Our client companies assume all fees. Forward resume in confidence, or call (collect): Mr. Martin E. Sheridan (Area Code 703) 524-7660.

SHERIDAN ASSOCIATES INC.

1901 North Fort Myer Dr., Suite 1010, Arlington, Virginia 22209

(Just over the Potomac from Washington, D. C.)

Personnel Consultants to the Computer Industry

Write for application and wage/salary survey.

—sure there are, but they are in places like Pittsburgh, Stanford, Purdue, and Harvard and that about exhausts the list. Even these systems which are in very favorable financial, political, and intellectual environments, are limited in scope.

The above environments stand in sharp relief to other situations where embattled school boards are anxious only to keep both the budgets and kids in line. This contrast makes one aware of the problems any CAI system will have trying to obtain approval at the local level.

Anyone familiar with school politics in New York or innovative textbook acceptance in California will not be surprised to hear that one funded CAI system resulted in a school board recall election with the proposed computer system cancelled.

As one can determine from the subtitle (perhaps the author intended it to refer to *RUN, RABBIT, RUN*) this book suggests that computer age of education is not just around the corner—at least not without a lot of effort. When local school boards spend an average of only \$4.00 per year per student on books, surely they cannot be expected to come forth with the required \$50.00 per student per year for a CAI system. One must also remember that even an additional cost of \$1.00 per student would result in a 50 million dollar expenditure in one year for education in the U. S.

In spite of all this Anthony Oettinger is not just a prophet of doom for all educational computer systems because he does mention that there are conditions necessary for successful CAI systems. One of the most important of these is that both long term commitments and the willingness to risk failures are necessary to spark successful CAI systems. Short term commitments have produced little except automatic page turners and prestigious expensive toys.

Another suggestion which is very interesting because it has been suggested several times by radicals of many contrasting hues is that students should be issued coupons for education which they can spend anywhere they wish. Thus the theory goes, lousy schools would have no pupils and be forced to upgrade or close, bad teachers would be shunned and competition would be brought into the schools.

Ideally this would result in the educational field being invaded by private, parochial, and public schools competing for the educational dollar and thus the best methods of education, including computers, would be employed, experimental successes would be rewarded, and a high degree of originality and diversity would be available.

For those interested in the educational computer field this book will provide both provocative and interesting reading and will probably shatter a few dreams.

For more information, circle No. 9 on the Reader Service Card

Are you keeping pace with the giant strides in computer technology?

It isn't easy. But The Library of Computer and Information Sciences helps you tune in with what's happening. By providing you with the most advanced, most essential, most significant books in the exploding world of computer science.

Each month, the Library carefully screens hundreds of manuscripts, and chooses only the most informative and most important. Books on programming. Software. Hardware. Theory. Management uses of the computer. Books that help thousands of executives, EDP managers, programmers and technicians keep up-to-date. And move ahead in their careers.

All books are yours at discounts of up to 30% (sometimes more). And for each four books you buy, you get your choice of a fifth—a free bonus book.

The strides computer technology is taking daily are boundless. No matter how alert you are, it's tough to keep in step. Unless you take advantage of this special introductory offer—now.

Special Introductory Offer:
Take any 3 (values to \$46.40)
for only \$1.00 each
 with a short trial membership in
The Library of Computer and Information Sciences

(Retail prices shown)

56300. INTRODUCTION TO COMPUTING. *T. E. Hull.* Highly useful new guide to algorithms, stored-program computers and programming techniques. Focuses on FORTRAN IV. **\$10.60**

42060. DEVELOPING COMPUTER-BASED INFORMATION SYSTEMS. *Perry E. Rosove.* Comprehensive study of the new information technology. Examines development of systems. **\$14.95**

42170. DIGITAL COMPUTER SYSTEM PRINCIPLES. *Herbert Hellerman.* A unified and authoritative overview of digital computer systems, many of which are common to programming, machine design, and problem description. **\$13.50**

42370. DISPLAY SYSTEMS ENGINEERING. *Edited by H. R. Luxenberg and R. L. Kuehn.* Thorough exploration of the devices and systems of recording and displaying computer based information. Develops theoretical foundations and discusses their technological applications. Many illustrations and diagrams. **\$16.50**

70790. PROGRAMMING SYSTEMS AND LANGUAGES. *Edited by Saul Rosen.* Outstanding review of computer software. Brings together the most authoritative articles on history of programming systems. **\$12.50**

56490. INTRODUCTION TO COMPUTATIONAL LINGUISTICS. *David G. Hays.* An ideal volume for self-tuition. Book covers three levels—computational, linguistic and the level of the myriad of applications now or soon-to-be available. **\$9.75**

41660. ELEMENTS OF DATA PROCESSING MATHEMATICS. *Wilson T. Price and Merlin Miller.* Enables readers with minimal math background to become proficient in math needed for understanding automatic data processing and computer programming. **\$10.50**

44100. ELECTRONIC INFORMATION HANDLING. *Edited by Allen Kent and Orrin E. Taulbee.* Comprehensive overview of total information handling and retrieval. Includes interpreting signals and numerical information. **\$11.00**

56410. INTRODUCTORY COMPUTER METHODS AND NUMERICAL ANALYSIS. *Ralph H. Pennington.* Covers most commonly used methods of modern analysis, stressing those of proven value in computer solution of science and engineering problems. **\$9.25**

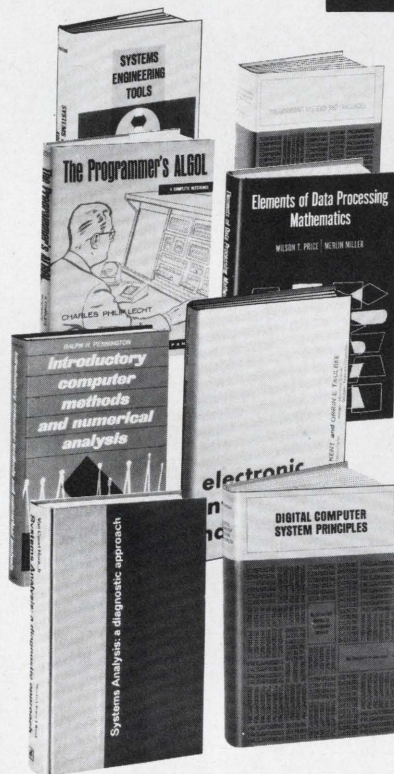

70720. THE PROGRAMMER'S ALGOL. *Charles Philip Lecht.* Complete guide to ALGOL. Bridges gap between too-theoretical presentations and the needs of the practicing programmer. **\$8.95**

56140. INTRODUCTION TO OPERATIONS RESEARCH. *Frederick S. Hillier and Gerald J. Lieberman.* Comprehensive survey of the basic technology and techniques of operations research, with emphasis on motivation and simplicity of explanation. **\$14.75**

81870. SYSTEMS ANALYSIS: A DIAGNOSTIC APPROACH. *Van Court Hare, Jr.* A major work on a new discipline. Contains progressively more difficult examples and problems. Ideal for self-instruction. **\$12.50**

42190. DIGITAL COMPUTER PROGRAMMING. *Peter A. Stark.* Uniquely practical introduction to the programmer's art, with step-by-step solutions to hundreds of typical computer problems. Covers computer characteristics, applications, techniques, and languages. **\$9.95**

82100. SYSTEMS ENGINEERING TOOLS. *Harold Chestnut.* Drawing on practical situations, the author explains nature of systems, engineering problems and the tools used in solving them. Over 300 diagrams. **\$14.95**

TRIAL MEMBERSHIP APPLICATION

The Library of Computer and Information Sciences
 Front and Brown Streets, Riverside, N.J. 08075

7-688

Please enroll me as a trial member, and send the three books whose numbers I've indicated on this coupon. Bill me only \$1.00 each, plus a small shipping charge. If I am not delighted, I will return the books within 10 days, and my membership will be cancelled. As a trial member, I need accept as few as 3 more selections during the next 12 months, *always* at reduced member's prices, plus shipping. I understand that savings range up to 30%, and occasionally even more. Each month I will receive advance reviews describing forthcoming selections, along with a convenient form for requesting alternate selections or no book at all. For every 4 selections purchased, I may choose a *free* bonus book. (This introductory offer counts as the first selection.)

Three Books for only \$1.00 each

(write in numbers)

NAME.....
 ADDRESS.....
 CITY..... STATE..... ZIP CODE.....

Offer good in Continental U.S. and Canada only.

Can an EDP man attending FJCC find that better job without letting the world know he's looking? **SURE HE CAN!**

SOFTWARE AGE Magazine's FREE Resume Center protects your privacy . . . speeds your search . . . costs you nothing!



1. Fill out the special resume form from magazine or at Center.



2. Our Remington operator will photocopy the resume free and return all copies to you.



3. You place your resume in the company lock boxes of your choice.

Your job is simple. You follow the same procedure at the center that you do in S/A—but on a highly accelerated basis. Fill out the special resume form at the S/A RESUME CENTER. Our Remington operators will provide you with as many *free* photo copies of your resume as you require.

You personally deposit them in the lock boxes of those companies which interest you. The resume form includes blanks where you can enter your hotel, telephone number and room number. Only the participating company representative has access to the lockbox. At his convenience, he can contact you at your hotel to arrange an interview.

The entire operation of the S/A RESUME CENTER is designed to provide speed, convenience, simplicity and maximum confidence with no middlemen involved. You determine exactly the companies you want—no others will see your resume or know of your interests.

The S/A RESUME CENTER is FREE. There is no charge to you or the company for this valuable service. The resume center is sponsored solely by the advertisers in SOFTWARE AGE magazine.

software age resume center

El Dorado Room of the Frontier Hotel
Las Vegas, Nevada

9 A.M. to 7 P.M., Wednesday, November 19th.

9 A.M. to 7 P.M., Thursday, November 20th.

SOFTWARE AGE Magazine, 2211 Fordem Ave., Madison, Wis. 53701 David W. French, Publisher

S/A RESUME CENTER

Special Resume Form

For Use at
The Frontier Hotel, Las Vegas, Nov. 19-20, 1969

Do not use this form to answer advertisements in this issue. See page 61

BE SURE TO CHECK YOUR HOTEL FOR MESSAGES

NAME
HOTEL
TELEPHONE NUMBER
ROOM NUMBER
BEST TIME TO CALL

JOB DESIRED: _____

List computer hardware knowledge (names of systems, tape, disk, terminals, etc.): _____

Programming specialties and years of experience (commercial, scientific, theoretical, experimental, analog, etc.): _____

Systems programming on which you have had development experience (compilers, assemblers, executives, monitors, O.S., etc. Indicate for what computer): _____

Programming languages used and extent of experience (COBOL, FORTRAN, etc.): _____

Applications programmed (aerospace, banking, insurance, math subroutines, compilers, etc.): _____

Systems analysis experience (card design, flow charting, operation analysis, etc.): _____

EDP management experience (include years and number of people reporting to you): _____

SALARY: _____ **DATE OF AVAILABILITY:** _____
(current) (desired)

EDUCATION: Indicate major as well as degree unless self-explanatory.

Degrees	_____	_____	_____
Years	_____	_____	_____
Schools	_____	_____	_____

EMPLOYMENT: Indicate present employment and previous jobs below.

Employer	_____	_____	_____
City	_____	_____	_____
Years	_____ to _____	_____ to _____	_____ to _____
Title or Function	_____	_____	_____

Name _____ Age _____

Home Address _____ Home Phone _____

(city) (state) (ZIP code) U.S. Citizen? _____

Security Clearance _____ Location Preference _____

Marital Status _____

Military Status _____

BE SURE YOU HAVE NOTED YOUR HOTEL, ROOM AND TELEPHONE NUMBER IN THE BOX—UPPER RIGHT CORNER OF THIS PAGE

software age

MAGAZINE

2211 FORDEM AVE., MADISON, WIS. 53701

TEAR OUT THIS RESUME PAGE AND BRING IT TO THE S/A RESUME CENTER
The Frontier Hotel—Las Vegas

This is a special resume form to be used only if you plan on being in Boston during the FJCC Show. Fill out the reverse side and bring it with you to the S/A RESUME CENTER, November 19-20, The Frontier Hotel, Las Vegas, Nevada.

COMPANIES PARTICIPATING IN THE S/A RESUME CENTER

	Page
<input type="checkbox"/> Burroughs Corporation (Paoli, Pennsylvania; Pasadena, California)	3rd Cover
<input type="checkbox"/> Callahan Center for Computer Personnel (Torrance, California; Philadelphia, Pennsylvania)	16
<input type="checkbox"/> Foxboro Company (Foxboro, Massachusetts)	58
<input type="checkbox"/> Hughes Aircraft Co., Aerospace Div. (Culver City, California)	40
<input type="checkbox"/> IBM Corporation (Endicott, New York)	27
<input type="checkbox"/> Jet Propulsion Laboratory (Pasadena, California)	33
<input type="checkbox"/> Lockheed Missiles & Space Company (Sunnyvale, California)	6
<input type="checkbox"/> National Cash Register Co., Electronics Div. (Hawthorne, California)	57
<input type="checkbox"/> National Manpower Register (New York, New York)	42
<input type="checkbox"/> RCA, Information Systems Div. (Camden, New Jersey)	60
<input type="checkbox"/> Sikorsky Aircraft (Stratford, Connecticut)	44
<input type="checkbox"/> SINGER Friden Div. (Leandro, California)	4th Cover
<input type="checkbox"/> Source EDP (Atlanta, Georgia; Chicago, Illinois; Dallas, Texas; Detroit Michigan; Houston, Texas; Los Angeles, California; Minneapolis, Minnesota; New York, New York; Palo Alto, California; Philadelphia, Pennsylvania; St. Louis, Missouri; San Francisco, California; Union, New Jersey)	36
<input type="checkbox"/> Univac (Roseville, Minnesota; Warminster, Pennsylvania; Philadelphia, Pennsylvania; St. Paul, Minnesota; Salt Lake City, Utah)	4-5
<input type="checkbox"/> Xerox Data Systems (El Segundo, California)	2nd Cover

TOTAL for duplicating -----

NCR *Programmers/Engineers* **Los Angeles** **offers you** **fourth-** **generation** **opportunity** **today**

BUSINESS SYSTEMS ANALYSTS AND PROGRAMMERS

Junior and senior level positions available for systems analysts and programmers who have several years' experience in any of the following areas: engineering specifications, bills of material, engineering change control, inventory control, production planning, quality control, cost determination, cost control, payroll, accounting. Prefer degree in business or related disciplines and experience in multi-programming, direct-access storage, disc files or large-storage media and thorough knowledge of COBOL.

SYSTEMS ANALYST ENGINEERS

Junior and senior level positions available for ENGINEERS, ANALYSTS and PROGRAMMERS who have several years' experience in any of the following areas:

Systems analysis and evaluation of business systems. Selected applicants will determine and participate in the establishment of either small processor systems or a large multi-processing system.

Study and development of on-line systems in business data communication environment.

Evaluation of multi-programming, multi-processor time sharing systems using simulation techniques.

ADVANCED DEVELOPMENT ENGINEERS

Positions available for senior MECHANICAL and ELECTRONIC engineers with strong experience in high-speed mechanisms and mechanical, hydraulic, and electro-mechanical mechanisms.

Also senior level positions in logic and circuit design for engineers with knowledge in MSI and LSI circuitry for fourth-generation computer systems.

These positions require BSME/BSEE and five years' related experience.

SOFTWARE PROGRAMMERS

To design, code, de-bug and document operating systems software or on-line executive software modules. Prefer degree in business or a science discipline and/or experience in systems programming.

DIAGNOSTIC PROGRAMMERS

Positions involve the writing of diagnostic programs for checkout, acceptance test, file maintenance of EDP systems. Requires previous programming experience.

NOW INTERVIEWING

Interviews are now being held for these positions, all of which are currently open. To schedule an appointment in your area or at the Fall Joint Computer Conference in Las Vegas, Nevada, Nov. 18-20, send resume, including salary history, to Steve Williams at the Electronics Division.



The National Cash Register Company
ELECTRONICS DIVISION
2873 West El Segundo Boulevard,
Hawthorne, California 90250
An equal opportunity employer

Software designers and programmers: develop Foxboro systems that can talk to cement



(and chemicals and textiles and
electricity and paper and...)

Today Foxboro's computer controlled processing systems are performing monitoring and direct digital control of kiln and wet blending operations for cement production. They're also controlling processing functions around the world in power plants, refineries, for the chemical industry, pulp and paper, textiles and food.

That's today. Tomorrow's programs are even more challenging, and they're underway now.

The complexity, size and world-wide diversity of existing projects and development programs now underway at Foxboro are greater than at any other time in our 60-year history. Our modern, multimillion dollar facility, located between Boston and Cape Cod, is staffed by one of the world's most experienced teams of computer professionals. We invite you to join them.

APPLICATIONS PROGRAMMERS. Opportunities exist at varying levels of experience, requiring creative individuals who can take complete responsibility for bringing a system's software from its introductory stage of design through to full real time simulation testing and installation. Experience is required in one or more of the following: Real Time Executives and/or Real Time Input-Output, Time Sharing, Batch Control, DDC, Setpoint Control and Multilevel Programming.

SOFTWARE SYSTEMS DESIGNERS AND PROGRAMMERS. You will work on developing a new generation of digital technology. Present programs encompass advanced Real Time Systems, Computer-based CRT Display Systems, and Man-Machine Communications. At least 3 years' programming experience is required, related to leading development efforts in operating systems, languages and communication, and control software development. You will be responsible for all phases of program designing, coding, checkout and documentation.

FJCC INTERVIEWS may be arranged by contacting Jay D. Hobson at Caesar's Palace in Las Vegas during FJCC. If you prefer, forward your resume to his attention at The Foxboro Company, Dept. SA, Neponset Avenue, Foxboro, Mass. 02035. Foxboro is an equal opportunity employer.

FOXBORO

S/A market place

where you can reach ^{130,000} programmers, mathematicians, analysts and EDP managers

RATES

Classified—75¢ per word, minimum order \$7.50. Blind ads are an additional \$10.00. Payment must accompany copy.

Display Classified—One inch by one column, \$75.00. Column width is 2 1/4". Help wanted and employment services ads will be accepted in the classified section. Ads of 1/8 page or more will be listed in the Advertisers' Index, and will qualify for the free resume service.

Closing Date—the 10th of the month preceding (i.e. May issue closes April 10th). Send order and remittance to:

software age

Classified Department

P. O. Box 2076, Madison, Wisconsin 53701

EMPLOYMENT AND SEARCH COMPANIES

PROGRAMMERS (3)

Large financial firm needs (1) Senior, salary to \$28,000; (2) Intermediates, salaries \$16,000 to \$23,000 to help open new company locations. Entire fee, traveling, if necessary—moving expenses are all paid by your new employer.

ERIN EXECUTIVE AGENCY
132 W. 34 St., New York, N. Y. 10001
Phone: (212) 594-8296

DATA PROCESSING POSITIONS IN THE SOUTHWEST

Contact:

DATA PROCESSING CAREERS

Richard Kemmerly, Suite 1109, Stemmons Towers West, Dallas, Texas 75207. 214/637-6360.

TOP OPPORTUNITIES FOR COBOL/BAL Programmers. N. Y., N. J., Conn. No degree necessary. **RUSSO ASSOCIATES**, 756 7th Ave., New York, N. Y. 10019.

PROFESSIONAL SERVICES

CONTRACT PROGRAMMING SERVICES: Systems Analysis and Design; Applications and Software Programming (by mail, if you wish). **COMPUTER APPLICATIONS & SYSTEMS TECHNIQUES**, LaRocca Center #3 2nd Floor, Easton & County Line Roads, Horsham, Pa. 19044; tel. 215-343-2260.

ALP AND COBOL Programming and Systems. All applications. Complete documentation. **TASET SOFTWARE SERVICES INC.**, 1 East 42nd St., New York, N.Y. 10017; (212) 867-1230.

PRODUCTS

ADD/SUBTRACT 6-DIGIT HEXADECIMALS in seconds with 100% accuracy. The pocket **HEXADDER**, \$15. Free brochure from **HEXCO**, Dept. SA, P. O. Box 55588, Houston, Texas 77055.

A COMPREHENSIVE MANUAL on how to write an effective EDP resume, plus 6 successful samples. Send \$4.25 to **K & H ASSOCIATES**, Resume Specialists, P. O. Box 265, Horseheads, N. Y. 14845.

CLASSIFIED ADVERTISING ORDER FORM

1	2	3	4	5
6	7	8	9	10
11	12	13	14	15
16	17	18	19	20
21	22	23	24	25
26	27	28	29	30
31	32	33	34	35

_____ Words = \$ _____

Blind Ad \$10.00 Insert _____ time(s) Total Enclosed \$ _____

NAME _____

ADDRESS _____

CITY _____ STATE _____ ZIP _____

Signature _____

WORD COUNT: Includes name and address (unless blind ad). The name of the city (Des Moines), state (New York) and zip code are counted as a total of two (2) words. Each abbreviation, initial, single figure or group of figures or letters count as a word. Symbols such as 35mm, COD, AC, etc. count as a single word. Hyphenated words count as two (2) words.

Don't miss:

Executive's Guide to Systems Analysis and Design

An Information System for Vehicle Scheduling

An Experimental Approach to Recursive FORTRAN Subroutine Programming Under Operating System 360

Coming—
in December

software age

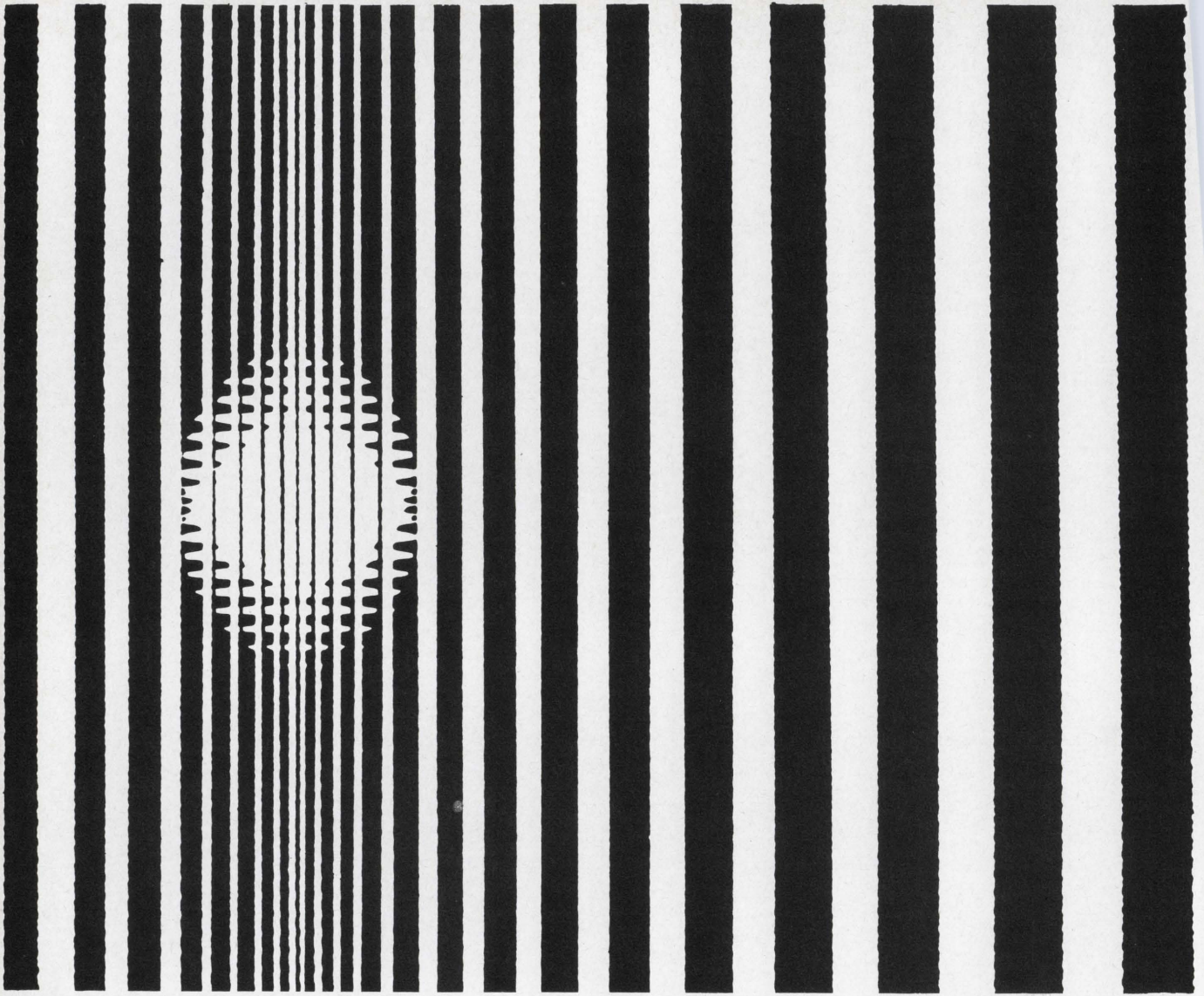

Your ideas about EDP leadership may be 18 months behind the times.

But here's a chance to catch up.

RCA is committed to being on the frontier of EDP technology.

That includes hardware and software — interface and interaction.

For instance, right now, we are eighteen months ahead in large multi-user, multi-application, time sharing systems.

We consider that as just the beginning. We want to talk

to every EDP professional qualified to join us in exploring this frontier. Those who want a choice ranging over almost every conceivable application — commercial, military, peripheral equipment, memory systems, programming, research, graphic composition systems, education, sales and systems support, new product development — you name it. We're involved.

The openings are throughout

the United States and overseas.

Your best bet during the FJCC is to see RCA.

To arrange an interview in Las Vegas, during the conference, please call Mr. A. C. Bennett at 702-734-8085.

If you can't see us during the conference, write to him at RCA, Dept. FJ-1B, Building 2-2, Camden, New Jersey 08102. We are an equal opportunity employer.

RCA

software age

CONFIDENTIAL INQUIRY

Your original copy of this form will be retained at the offices of SOFTWARE AGE and will be used for no other purpose than to notify the specific firms which you have checked (on the reverse side) of your interest.

TYPE OR PRINT CLEARLY FOR PHOTO REPRODUCTION

JOB DESIRED: _____

List computer hardware knowledge (names of systems, tape, disk, terminals, etc.): _____

Programming specialties and years of experience (commercial, scientific, theoretical, experimental, analog, etc.): _____

Systems programming on which you have had development experience (compilers, assemblers, executives, monitors, O.S., etc. Indicate for what computer): _____

Programming languages used and extent of experience (COBOL, FORTRAN, etc.): _____

Applications programmed (aerospace, banking, insurance, math subroutines, compilers, etc.): _____

Systems analysis experience (card design, flow charting, operation analysis, etc.): _____

EDP management experience (include years and number of people reporting to you): _____

SALARY: _____ DATE OF AVAILABILITY: _____
(current) (desired)

EDUCATION: Indicate major as well as degree unless self-explanatory.

Degrees _____	_____	_____
Years _____	_____	_____
Schools _____	_____	_____

EMPLOYMENT: Indicate present employment and previous jobs below.

Employer _____	_____	_____
City _____	_____	_____
Years _____ to _____	_____ to _____	_____ to _____
Title or Function _____	_____	_____

Name _____ Signature _____

Home Address _____ (city) _____ Home Phone _____

(state) _____ (ZIP code) _____ Age _____ U. S. Citizen? _____

Security Clearance _____ Location Preference _____

Marital Status _____

Military Status _____

BE SURE YOU HAVE CHECKED ON REVERSE SIDE
THE COMPANIES YOU WANT TO SEE THIS INQUIRY.
PUT FORM IN STAMPED ENVELOPE AND MAIL TO:

software age

MAGAZINE

P. O. BOX 2076

2211 FORDEM AVE., MADISON, WIS. 53701

check your interests here

Fill in the confidential inquiry form on the other side of this sheet. This form provides all the information advertisers require to screen applicants. If further information is desired, you will hear from the advertiser direct. Then, check below the boxes of those companies to which you want copies of your

form sent. Mail to SOFTWARE AGE, P.O. Box 2076, 2211 Fordem Avenue, Madison, Wisconsin 53701. (Please do not send us your own resume. We will only process this form. A new form must be filled out for each issue in which you are answering ads.)

	Page
<input type="checkbox"/> 1. Army & Air Force Exchange Service	14
<input type="checkbox"/> 2. Burroughs Corporation	3rd Cover
<input type="checkbox"/> 3. COMPDATA Services Corporation	24
<input type="checkbox"/> 4. CTC Computer Corporation	20
<input type="checkbox"/> 5. Foxboro Company	58
<input type="checkbox"/> 6. Hughes Aircraft Company, Aerospace Div.	40
<input type="checkbox"/> 7. IBM Corporation	27
<input type="checkbox"/> 8. Jet Propulsion Laboratory	33
<input type="checkbox"/> 9. Lockheed-Georgia Company	10
<input type="checkbox"/> 10. Lockheed Missiles & Space Company	6
<input type="checkbox"/> 11. National Cash Register Company, Electronics Div. .	57
<input type="checkbox"/> 12. North American Rockwell, Power Systems Div.	3
<input type="checkbox"/> 13. Pratt & Whitney Aircraft	25
<input type="checkbox"/> 14. RCA, Information Systems Div.	60
<input type="checkbox"/> 15. SA-110	31
<input type="checkbox"/> 16. Sikorsky Aircraft	44
<input type="checkbox"/> 17. Singer-Friden Div.	4th Cover
<input type="checkbox"/> 18. Sperry Systems Management Div.	43
<input type="checkbox"/> 19. Univac	4-5
<input type="checkbox"/> 20. Xerox Data Systems	2nd Cover

EMPLOYMENT AND SEARCH AGENCIES

<input type="checkbox"/> 21. Albert Associates	31
<input type="checkbox"/> 22. Callahan Center for Computer Personnel	16
<input type="checkbox"/> 23. Computer Careers, Inc.	26

	Page
<input type="checkbox"/> 24. Computer Personnel Agency, Inc.	24
<input type="checkbox"/> 25. Drew Personnel Placement Center	51
<input type="checkbox"/> 26. Electronic Systems Personnel (Philadelphia)	15
<input type="checkbox"/> 27. Electronic Systems Personnel	32
<input type="checkbox"/> 28. Fox-Morris Associates	52
<input type="checkbox"/> 29. Everett Kelley Associates, Inc.	38
<input type="checkbox"/> 30. LaSalle Associates	22
<input type="checkbox"/> 31. Lawrence Personnel	17
<input type="checkbox"/> 32. Management Scientists, Inc.	50
<input type="checkbox"/> 33. National Manpower Register	42
<input type="checkbox"/> 34. RSVP Services	7
<input type="checkbox"/> 35. Search, Inc.	11
<input type="checkbox"/> 36. Sheridan Associates, Inc.	52
<input type="checkbox"/> 37. Source EDP	36
<input type="checkbox"/> 38. Speer Personnel Consultants	52
<input type="checkbox"/> 39. U. S. Career Recruiters	30
<input type="checkbox"/> 40. Wells Recruiting Systems, Inc.	7

PRODUCTS AND SERVICES

(use reader service card)

Boorum & Pease	32
Library of Computer and Information Sciences	53
Magnetic Aids, Inc.	15
North American Institute of Systems & Procedures	22
Wassell Organization, Inc.	38

I do not now receive S/A. Please send me information on how I may receive a FREE subscription.

.....
Name

.....
Street Address

.....
City

.....
State

.....
Zip Code



P. O. Box 2076
2211 Fordem Avenue
Madison, Wisconsin 53701