

Operating Instructions

Smartec CLD134

Conductivity measuring system

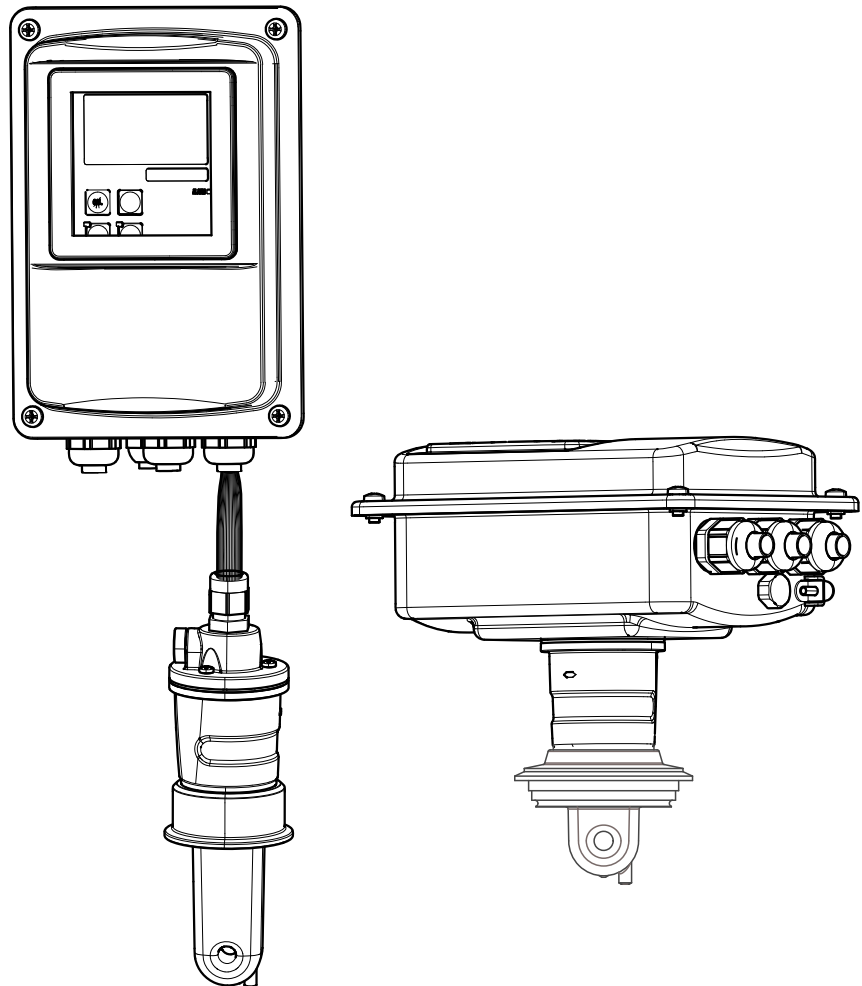





Table of contents

1	Document information	5	6	Operation options	34
1.1	Warnings	5	6.1	Operation and commissioning	34
1.2	Symbols used	5	6.2	Display and operating elements	34
1.3	Symbols at the device	5	6.2.1	Display	34
2	Basic safety instructions	6	6.2.2	LC display	35
2.1	Requirements for personnel	6	6.2.3	Operating elements	36
2.2	Designated use	6	6.3	Local operation	37
2.3	Occupational safety	6	6.3.1	Operating concept	37
2.4	Operational safety	6	7	Commissioning	39
2.5	Product safety	7	7.1	Function check	39
3	Incoming acceptance and product identification	8	7.2	Switching on	39
3.1	Incoming acceptance	8	7.3	Quick Setup	41
3.2	Product identification	8	7.4	Device configuration	44
3.2.1	Nameplate	8	7.4.1	SETUP 1 (conductivity / concentration)	44
3.2.2	Product identification	9	7.4.2	Setup 2 (temperature)	45
3.2.3	Basic version and function upgrade ...	9	7.4.3	Current outputs	48
3.3	Scope of delivery	10	7.4.4	Alarm	49
3.4	Certificates and approvals	11	7.4.5	Check	51
3.4.1	Declaration of conformity	11	7.4.6	Relay configuration	52
3.4.2	Hygiene	11	7.4.7	Temperature compensation with table	54
3.4.3	Pressure approval	11	7.4.8	Concentration measurement	56
4	Installation	12	7.4.9	Service	60
4.1	Quick installation guide	12	7.4.10	E+H Service	61
4.2	Measuring system	13	7.4.11	Interfaces	62
4.3	Installation conditions	14	7.4.12	Determination of the temperature coefficient	63
4.3.1	Installation instructions	14	7.4.13	Remote parameter set configuration (measuring range switching, MRS) ...	64
4.3.2	Remote version	16	7.4.14	Calibration	67
4.3.3	Compact version	20	7.4.15	Communication interfaces	70
4.4	Installation instructions	23	8	Diagnostics and troubleshooting ...	71
4.4.1	Installation of CLD134, remote version	23	8.1	Trouble shooting instructions	71
4.4.2	Installing the CLD134 compact version or the CLS54 sensor for the remote version	25	8.2	System error messages	71
4.5	Post-installation check	26	8.3	Process-specific errors	74
5	Electrical connection	27	8.4	Device-specific errors	78
5.1	Electrical connection of the transmitter	27	9	Maintenance	80
5.1.1	Wiring	27	9.1	Maintenance of the entire measuring point ..	80
5.1.2	Wiring diagram	30	9.1.1	Cleaning the conductivity sensors ...	80
5.1.3	Connecting the binary inputs	31	9.1.2	Testing inductive conductivity sensors	81
5.1.4	Connection compartment sticker ...	31	9.1.3	Device check by medium simulation ..	81
5.1.5	Structure and termination of the measuring cable	32	10	Repair	83
5.2	Alarm contact	33	10.1	Spare parts	83
5.3	Post-connection check	33	10.2	Disassembling the transmitter	83
			10.3	Replacing the central module	84
			10.4	Exploded drawing	85
			10.5	Spare part kits	86







10.6	Return	87
10.7	Disposal	87
11	Accessories	88
11.1	Cable extension	88
11.2	Post mounting kit	88
11.3	Software upgrade	89
11.4	Calibration solutions	89
11.5	Optoscope	89
12	Technical data	90
12.1	Input	90
12.2	Output	90
12.3	Power supply	91
12.4	Performance characteristics	92
12.5	Environment	93
12.6	Process	94
12.7	Flow velocity	95
12.8	Mechanical construction	95
13	Appendix	97
Index	102

1 Document information

1.1 Warnings

Structure of information	Meaning
<p> DANGER</p> <p>Causes (/consequences) Consequences of non-compliance (if applicable)</p> <ul style="list-style-type: none"> ▶ Corrective action 	<p>This symbol alerts you to a dangerous situation. Failure to avoid the dangerous situation will result in a fatal or serious injury.</p>
<p> WARNING</p> <p>Causes (/consequences) Consequences of non-compliance (if applicable)</p> <ul style="list-style-type: none"> ▶ Corrective action 	<p>This symbol alerts you to a dangerous situation. Failure to avoid the dangerous situation can result in a fatal or serious injury.</p>
<p> CAUTION</p> <p>Causes (/consequences) Consequences of non-compliance (if applicable)</p> <ul style="list-style-type: none"> ▶ Corrective action 	<p>This symbol alerts you to a dangerous situation. Failure to avoid this situation can result in minor or more serious injuries.</p>
<p>NOTICE</p> <p>Cause/situation Consequences of non-compliance (if applicable)</p> <ul style="list-style-type: none"> ▶ Action/note 	<p>This symbol alerts you to situations which may result in damage to property.</p>

1.2 Symbols used

Symbol	Meaning
	Additional information, tips
	Permitted or recommended
	Not permitted or not recommended
	Reference to device documentation
	Reference to page
	Reference to graphic
	Result of a step

1.3 Symbols at the device

Symbol	Meaning
	Reference to device documentation

2 Basic safety instructions

2.1 Requirements for personnel

- Installation, commissioning, operation and maintenance of the measuring system may be carried out only by specially trained technical personnel.
- The technical personnel must be authorized by the plant operator to carry out the specified activities.
- The electrical connection may be performed only by an electrical technician.
- The technical personnel must have read and understood these Operating Instructions and must follow the instructions contained therein.
- Measuring point faults may be repaired only by authorized and specially trained personnel.

 Repairs not described in the Operating Instructions provided may only be carried out directly by the manufacturer or by the service organization.

2.2 Designated use

Smartec is a practical and reliable measuring system designed to determine the conductivity of liquid media.

It is particularly suitable for use in the food industry.

Use of the device for any purpose other than that described, poses a threat to the safety of people and of the entire measuring system and is therefore not permitted.

The manufacturer is not liable for damage caused by improper or non-designated use.

2.3 Occupational safety

As the user, you are responsible for complying with the following safety conditions:

- Installation guidelines
- Local standards and regulations

Electromagnetic compatibility

- The product has been tested for electromagnetic compatibility in accordance with the applicable European standards for industrial applications.
- The electromagnetic compatibility indicated applies only to a product that has been connected in accordance with these Operating Instructions.

2.4 Operational safety

1. Before commissioning the entire measuring point, verify that all connections are correct. Ensure that electrical cables and hose connections are undamaged.
2. Do not operate damaged products, and safeguard them to ensure that they are not operated inadvertently. Label the damaged product as defective.
3. If faults cannot be rectified:
Take the products out of operation and safeguard them to ensure that they are not operated inadvertently.

2.5 Product safety

The product is designed to meet state-of-the-art safety requirements, has been tested, and left the factory in a condition in which it is safe to operate. The relevant regulations and European standards have been observed.

We only provide a warranty if the device is installed and used as described in the Operating Instructions. The device is equipped with security mechanisms to protect it against any inadvertent changes to the device settings.

IT security measures in line with operators' security standards and designed to provide additional protection for the device and device data transfer must be implemented by the operators themselves.

3 Incoming acceptance and product identification

3.1 Incoming acceptance

1. Verify that the packaging is undamaged.
 - ↳ Notify your supplier of any damage to the packaging.
Keep the damaged packaging until the matter has been settled.
2. Verify that the contents are undamaged.
 - ↳ Notify your supplier of any damage to the delivery contents.
Keep the damaged products until the matter has been settled.
3. Check the delivery for completeness.
 - ↳ Check it against the delivery papers and your order.
4. Pack the product for storage and transportation in such a way that it is protected against impact and moisture.
 - ↳ The original packaging offers the best protection.
The permitted ambient conditions must be observed (see "Technical data").

If you have any questions, please contact your supplier or your local sales center.

3.2 Product identification

3.2.1 Nameplate

The nameplate provides you with the following information on your device:

- Manufacturer identification
- Order code
- Serial number
- Ambient and process conditions
- Input and output values
- Activation codes
- Safety information and warnings
- Protection class

 Compare the data on the nameplate with your order.

3.2.2 Product identification

Product page

www.endress.com/CLD134

Interpreting the order code

The order code and serial number of your product can be found in the following locations:

- On the nameplate
- In the delivery papers

Obtaining information on the product

1. Go to the product page for your product on the Internet.
2. At the bottom of the page, select the "Online Tools" link followed by "Check your device features".
 - ↳ An additional window opens.
3. Enter the order code from the nameplate into the search field, and then select "Show details".
 - ↳ You will receive information on each feature (selected option) of the order code.

3.2.3 Basic version and function upgrade

Functions of the basic version	Additional options and associated functions
<ul style="list-style-type: none"> ▪ Measurement ▪ Calibration of cell constant ▪ Calibration of residual coupling ▪ Entry of installation factor ▪ Device parameter read-out ▪ Linear current output for measured value ▪ Current output simulation for measured value ▪ Service functions ▪ Choice of temperature compensation (including a user-configurable coefficient table) ▪ Choice of concentration measurement (4 fixed curves, 1 user-configurable table) ▪ Relay as a fault-signaling contact 	<ul style="list-style-type: none"> ▪ Second current output for temperature (additional hardware option) ▪ HART communication ▪ PROFIBUS communication <p>Remote parameter set configuration (additional software option):</p> <ul style="list-style-type: none"> ▪ Remote switching of max. 4 parameter sets (measuring ranges) ▪ Temperature coefficients can be determined ▪ Temperature compensation can be selected (including 4 user-configurable coefficient tables) ▪ Choice of concentration measurement (4 fixed curves, 4 user-configurable tables) ▪ Measuring system checked with PCS alarm (live check) ▪ Relay can be configured as limit contactor or fault-signaling contact <p>Biological reactivity test in accordance with USP <87>, <88> class VI</p>

3.3 Scope of delivery

The scope of delivery of the "compact version" comprises:

- 1 compact Smartec CLD134 measuring system with an integrated sensor
- 1 terminal strip set
- 1 set of Operating Instructions BA00401C/07/EN
- 1 set of Brief Operating Instructions KA00401C/07/EN
- For versions with HART communication:
 - 1 set of Operating Instructions: Field communication with HART BA00212C/07/EN
- For versions with PROFIBUS interface:
 - 1 set of Operating Instructions: Field communication with PROFIBUS BA00213C/07/EN
 - 1 M12 connector (for device version -*****PF*)

The scope of delivery of the "remote version" comprises:

- 1 Smartec CLD134 transmitter
- 1 CLS54 inductive sensor with fixed cable
- 1 terminal strip set
- 1 set of Operating Instructions BA00401C/07/EN
- 1 set of Brief Operating Instructions KA00401C/07/EN
- For versions with HART communication:
 - 1 set of Operating Instructions: Field communication with HART BA00212C/07/EN
- For versions with PROFIBUS interface:
 - 1 set of Operating Instructions: Field communication with PROFIBUS BA00213C/07/EN
 - 1 M12 connector (for device version -*****PF*)

The scope of delivery of the "transmitter excluding sensor" version comprises:

- 1 Smartec CLD134 transmitter
- 1 terminal strip set
- 1 set of Operating Instructions BA00401C/07/EN
- 1 set of Brief Operating Instructions KA00401C/07/EN
- For versions with HART communication:
 - 1 set of Operating Instructions: Field communication with HART BA00212C/07/EN
- For versions with PROFIBUS interface:
 - 1 set of Operating Instructions: Field communication with PROFIBUS BA00213C/07/EN
 - 1 M12 connector (for device version -*****PF*)

3.4 Certificates and approvals

3.4.1 Declaration of conformity

The product meets the requirements of the harmonized European standards. As such, it complies with the legal specifications of the EU directives. The manufacturer confirms successful testing of the product by affixing to it the **CE** mark.

3.4.2 Hygiene

FDA

All materials in contact with the product are listed by the FDA.

EHEDG

The cleanability of the CLS54 sensor is certified to EHEDG Type EL - Class I.

 When using the sensor in hygienic applications, please note that the cleanability of the sensor also depends on the way the sensor is installed. To install the sensor in a pipe, use the appropriate and EHEDG-certified flow vessels for the particular process connection.

3-A

Certified according to 3-A Standard 74- ("3-A Sanitary Standards for Sensor and Sensor Fittings and Connections Used on Milk and Milk Products Equipment").

Biological reactivity (USP class VI) (option)

Biological reactivity test certificate according to USP (United States Pharmacopoeia) part <87> and part <88> class VI with lot number traceability of materials in contact with the medium.

EC Regulation No. 1935/2004

The sensor meets the requirements of EC Regulation No. 1935/2004 on materials and articles intended to come into contact with food.

3.4.3 Pressure approval

Canadian pressure approval for pipes according to ASME B31.3

4 Installation

4.1 Quick installation guide

Proceed as follows for complete measuring point installation:

Compact version:

1. Perform an air set.
2. Install the compact version in the measuring point (see the "Installing the CLD134 compact version" section).
3. Connect the device as illustrated in the "Electrical connection" section.
4. Commission the device as explained in the "Commissioning" section.

Remote version:

1. Mount the transmitter (see the "Installing the CLD134 remote version" section).
2. If the sensor is not yet installed in the measuring point, perform an air set and install the sensor (see the Technical Information of the sensor).
3. Connect the sensor to the Smartec CLD134 as illustrated in the "Electrical connection" section.
4. Connect the transmitter as illustrated in the "Electrical connection" section.
5. Commission the Smartec CLD134 as explained in the "Commissioning" section.

4.2 Measuring system

A complete measuring system comprises:

- The remote version of the Smartec CLD134 transmitter
- The CLS54 conductivity sensor with an integrated temperature sensor and fixed cable
or
- The compact version with the integrated CLS54 conductivity sensor

Optionally for the remote version: CLK6 extension cable, VBM junction box, mounting kit for post mounting

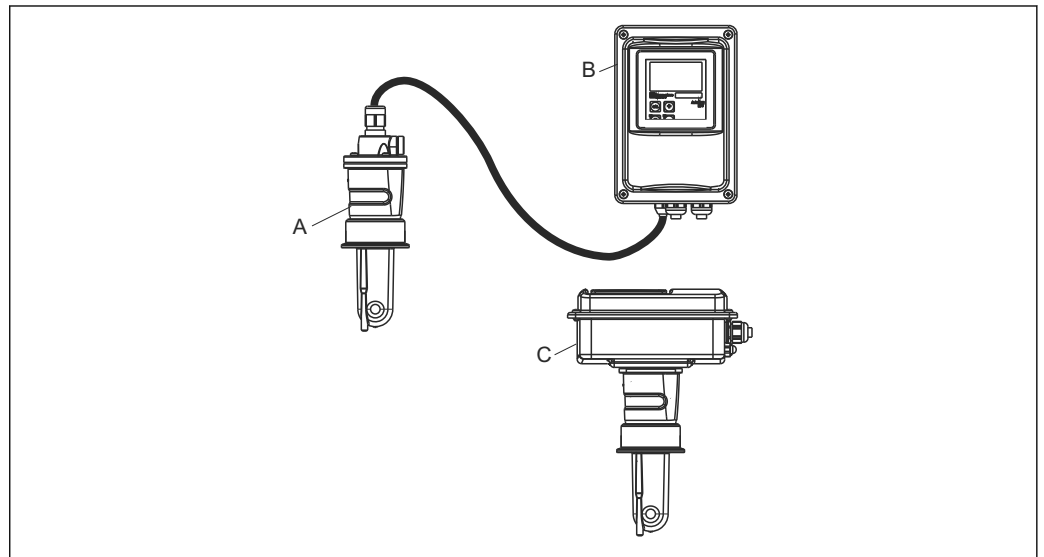

A0005438

1 Example of a measuring system with CLD134

A CLS54 conductivity sensor

B Smartec CLD134 transmitter

C Smartec CLD134 compact version with integrated CLS54 conductivity sensor

4.3 Installation conditions

4.3.1 Installation instructions

i For a 3-A compliant installation, the following must be noted:

After the instrument is installed its hygienic integrity shall be maintained. All process connections must be 3-A compliant.

Orientations

The sensor must be completely immersed in the medium. Avoid air bubbles in the area of the sensor.

i For hygienic applications, only use materials that comply with the 3-A standard 74- and the FDA requirements. The cleanability of a sensor also depends on how the sensor is installed. To install the sensor in a pipe, use the appropriate and EHEDG-certified flow vessels for the particular process connection.

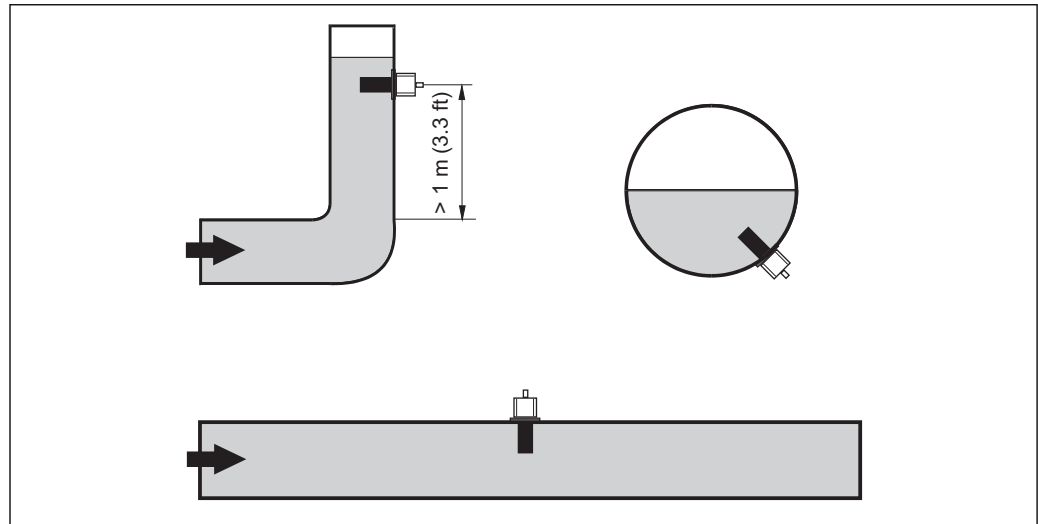

2 Orientation of conductivity sensors

i If the flow direction changes (after pipe bends), turbulence in the medium can result. Install the sensor at a distance of at least 1 m (3.3 ft) downstream from a pipe bend.

Air set

Before installing the sensor, you must carry out an air set (see "Calibration" section). The device must be operational for this purpose, i.e. the power supply and the sensor must be connected.

Wall distance

The sensor's distance from the pipe inner wall affects the measuring accuracy →  3 .

The ionic current in the liquid is affected by the walls in confined installation conditions. This effect is compensated by what is referred to as the installation factor.

The installation factor can be disregarded ($f = 1.00$) if the distance to the wall is sufficient ($a > 15$ mm, from DN 65). If the distance to the wall is smaller, the installation factor increases for electrically insulating pipes ($f > 1$) and decreases for electrically conductive pipes ($f < 1$). The procedure for determining the installation factor is described in the "Calibration" section.

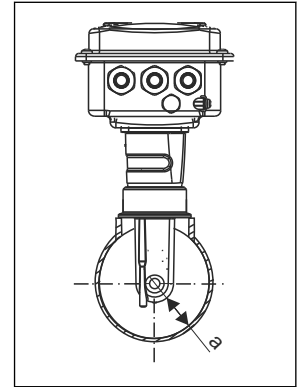

A0005440

 3 Installation of CLD134

a Wall distance

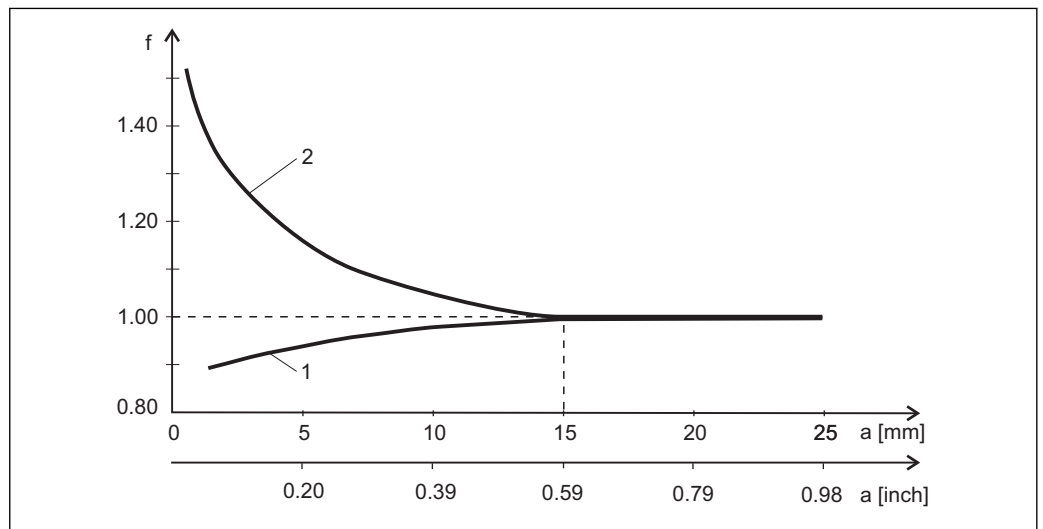

A0005441

 4 Relationship between installation factor f and wall distance a

- 1 Electrically conductive pipe wall
- 2 Electrically insulating pipe wall

4.3.2 Remote version

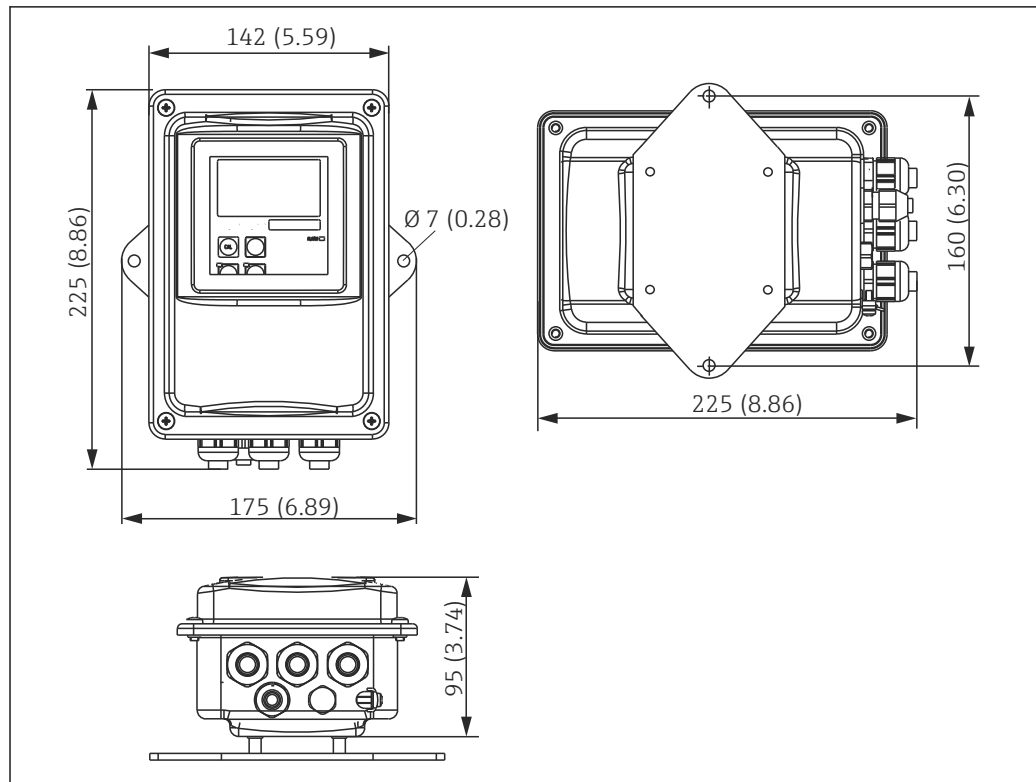

A0005632

5 CLD134 wall mounting, remote version

i Wall mounting is not recommended in areas with strict hygiene requirements!

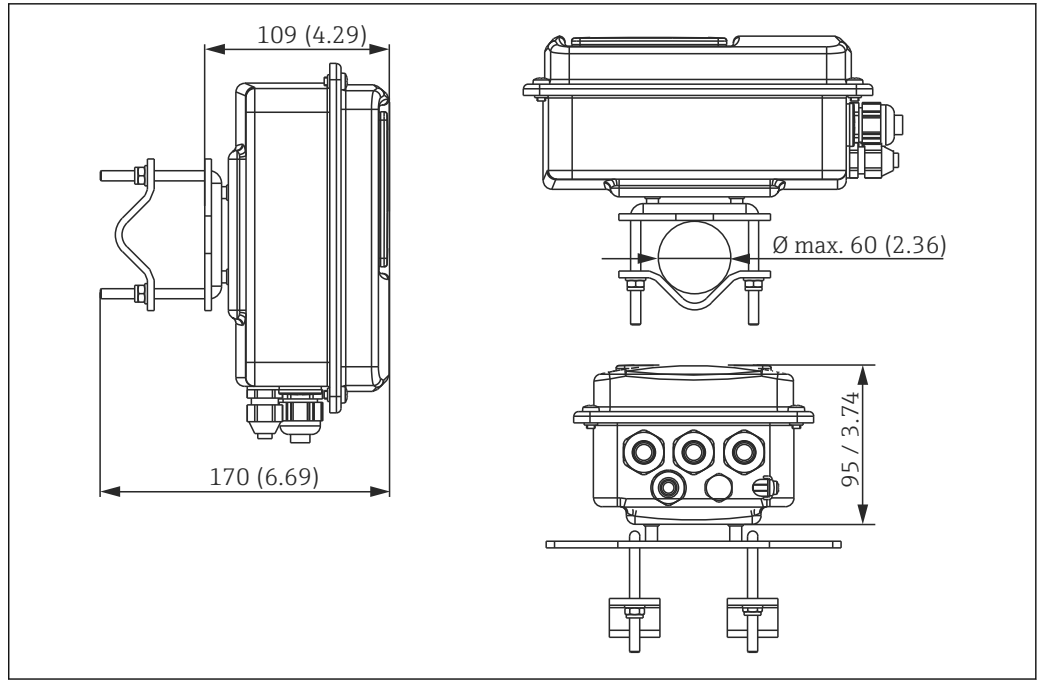

A0005633

6 CLD134 remote version for post mounting on pipes Ø 60 mm (2.36") with a post mounting kit (see "Accessories")

i Shorten the thread as much as possible if you are using the transmitter in areas with strict hygiene requirements!

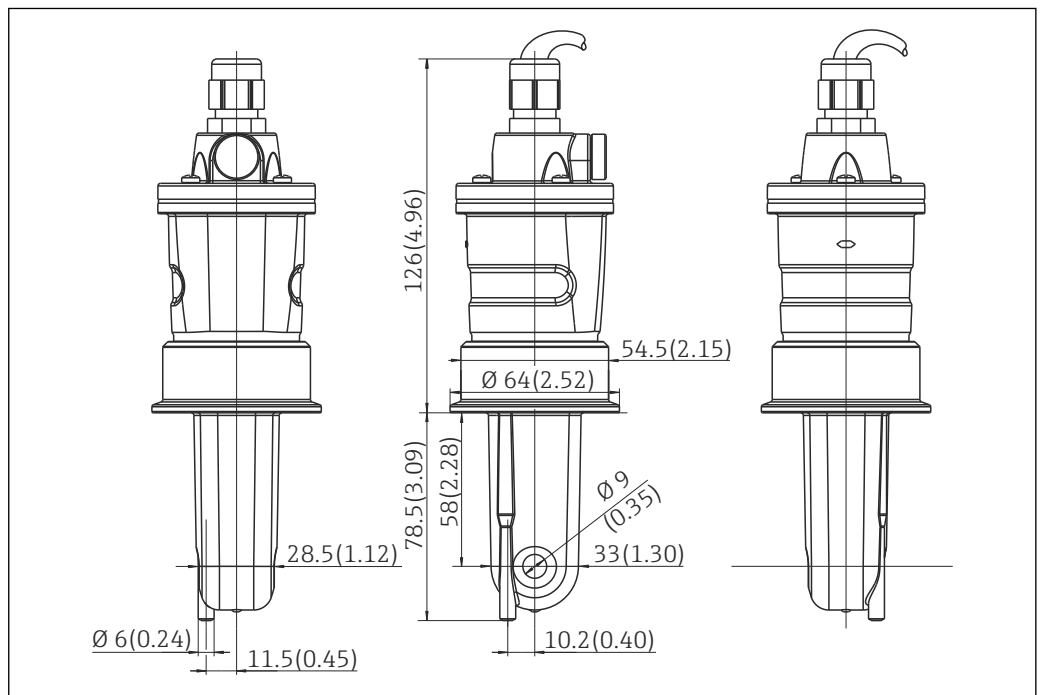

A0005429

7 Long version of CLS54, dimensions in mm (inch)

Conductivity sensors for CLD134, remote version

CLS54 conductivity sensors with a variety of process connections covering all common installation positions are available for the remote version.

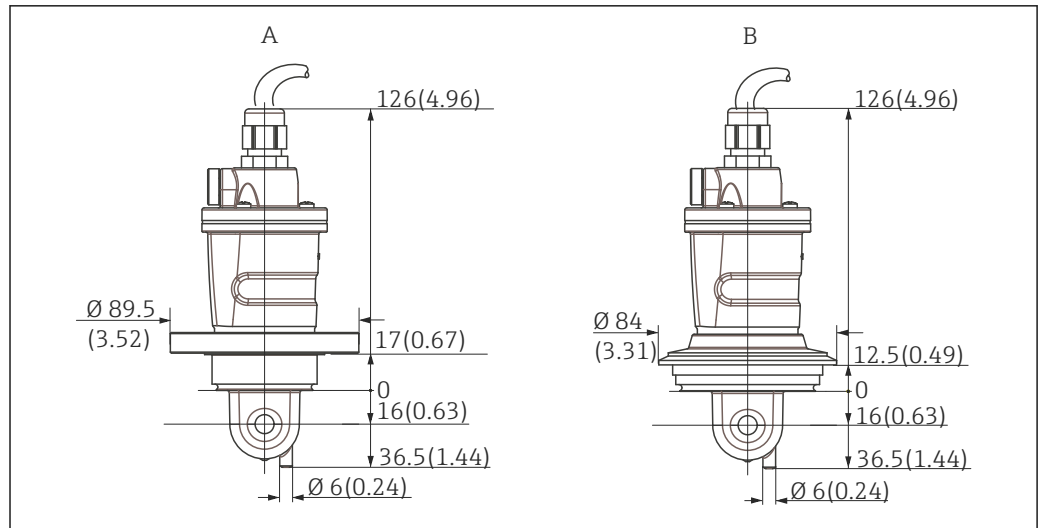

A0004949

8 Process connections for CLS54 (short version), dimensions in mm (inch)

A NEUMO BioControl D50

For pipe connection:

DN 40 (DIN 11866 series A, DIN 11850)

DN 42.4 (DIN 11866 series B, DIN EN ISO 1127)

2" (DIN 11866 series C, ASME-BPE)

B Varivent N DN 40 to 125

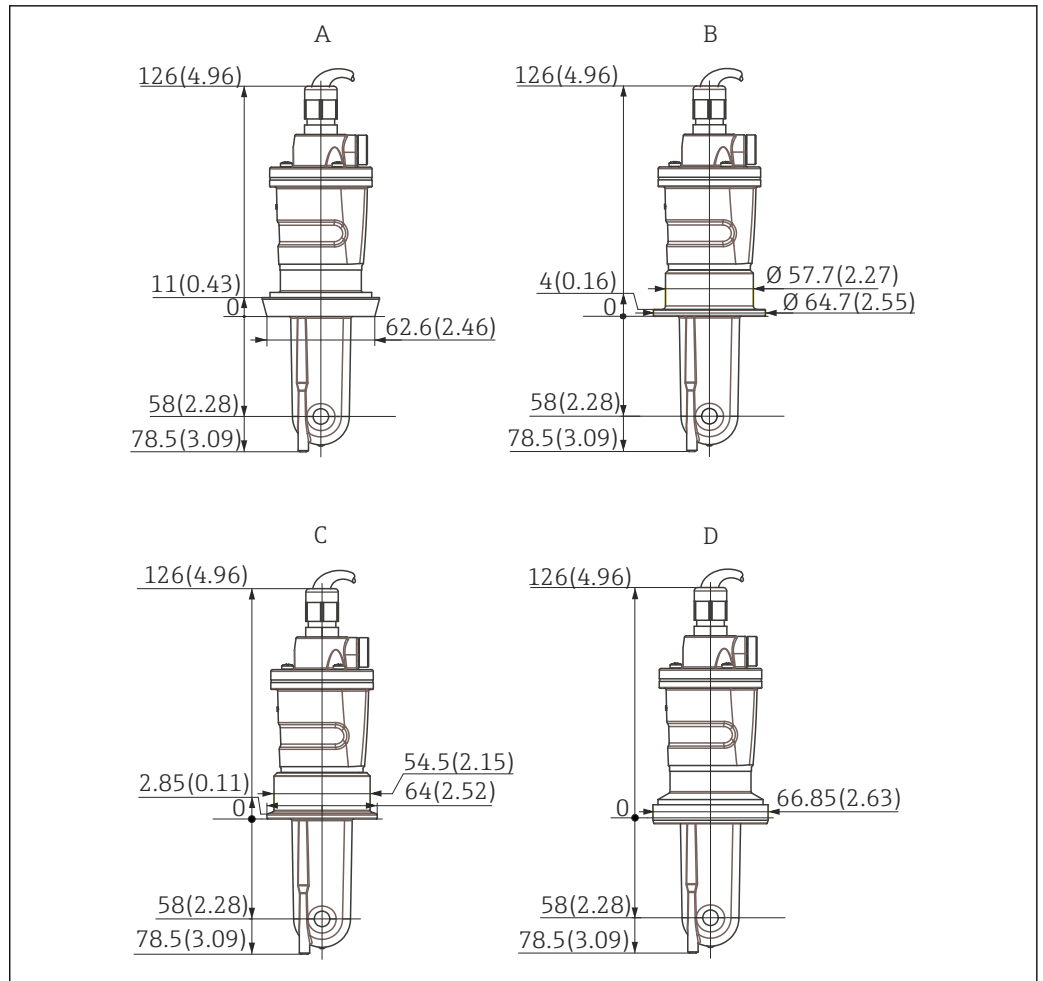

A0005436

9 Process connections for CLS54 (long version), dimensions in mm (inch)

A Sanitary connection DIN 11851, DN 50

B SMS coupling 2"

C Clamp ISO 2852, 2"

D Aseptic coupling DIN 11864-1 form A, for pipe according to DIN 11850, DN 50

4.3.3 Compact version

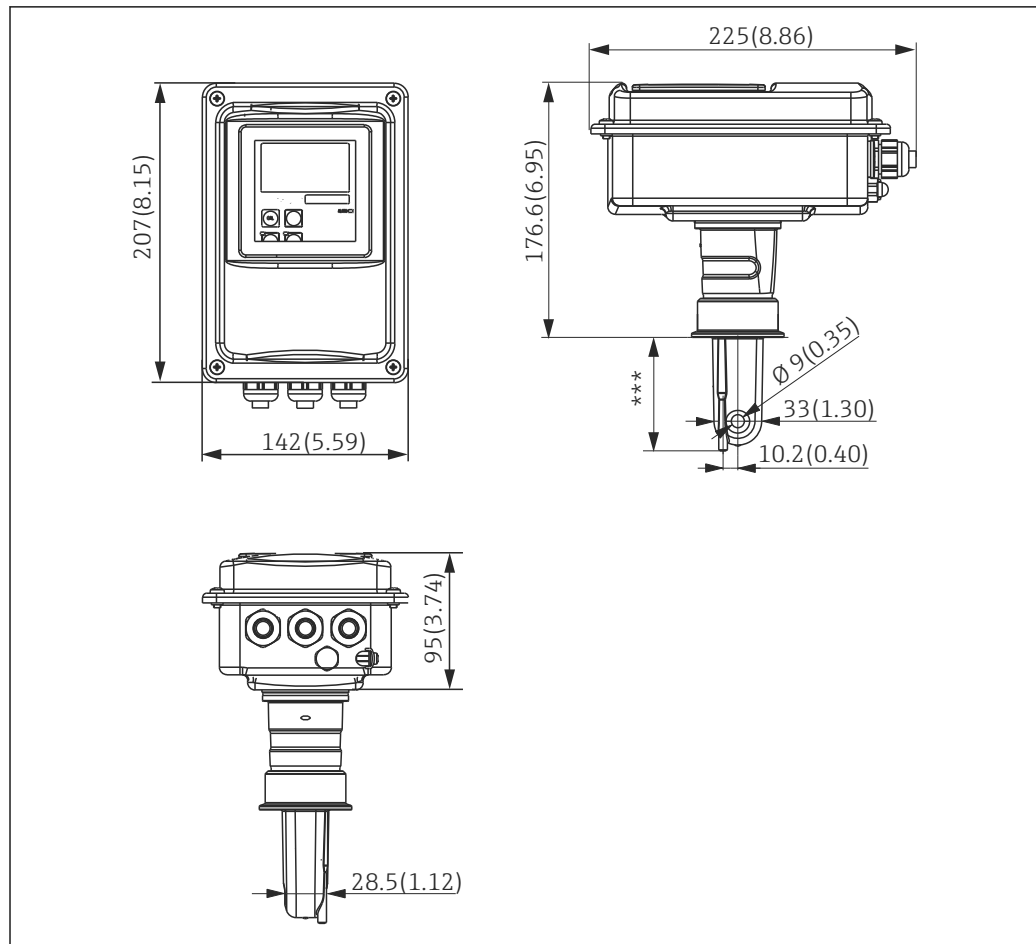

10 CLD134 compact version, dimensions in mm (inch)

*** Depends on the process connection selected

Connection versions

Various process connections covering all common installation positions are available for the compact version.

The device is installed at the measuring point with the appropriate process connection.

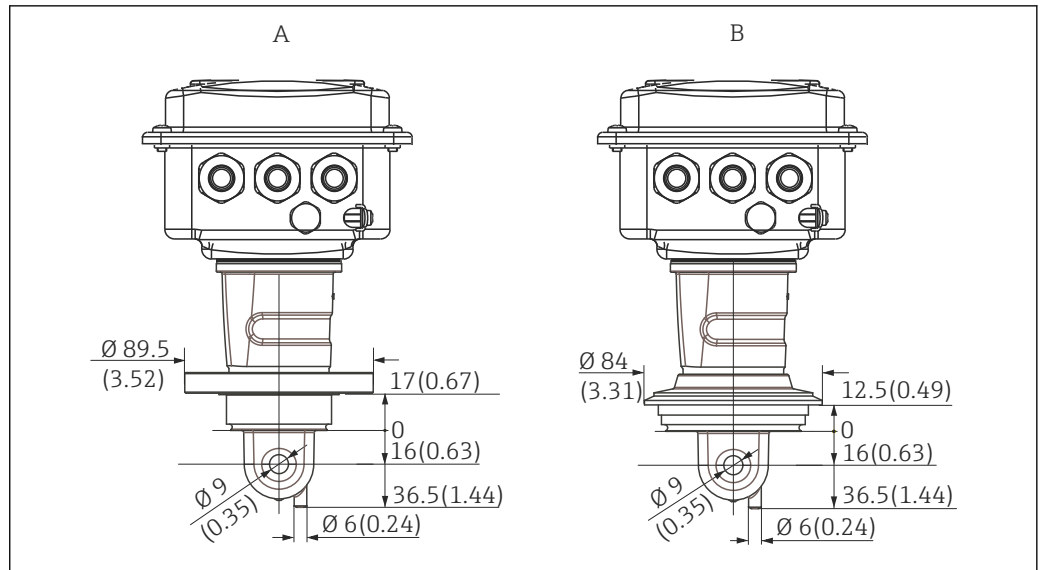

A0005501

11 Process connections for compact version (short), dimensions in mm (inch)

- | | | |
|---|--|---|
| A | NEUMO BioControl D50
For pipe connection: | DN 40 (DIN 11866 series A, DIN 11850)
DN 42.4 (DIN 11866 series B, DIN EN ISO 1127)
2" (DIN 11866 series C, ASME-BPE) |
| B | Varivent N DN 40 to 125 | |

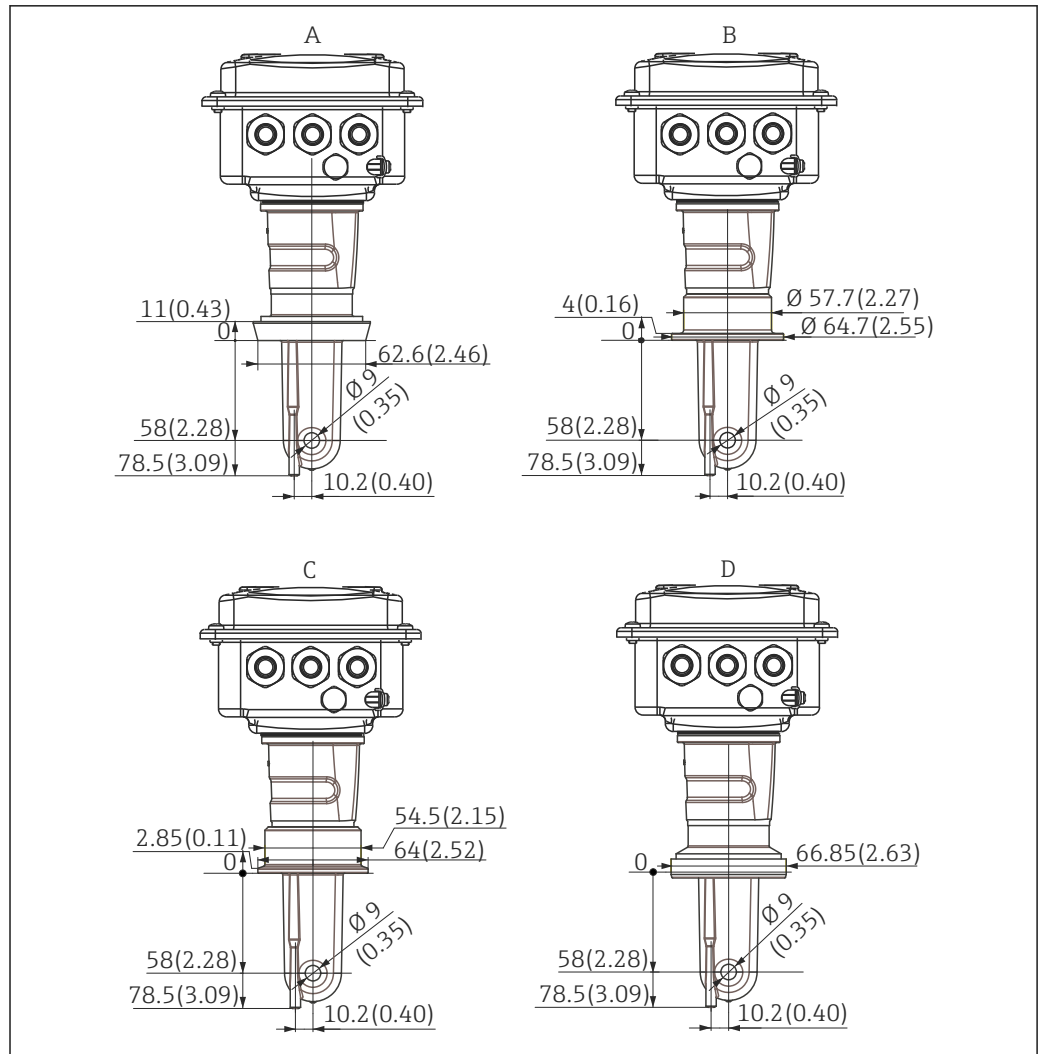

A0005502

12 Process connections for compact version (long), dimensions in mm (inch)

- A Sanitary connection DIN 11851 DN 50
- B SMS coupling 2"
- C Clamp ISO 2852, 2"
- D Aseptic coupling DIN 11864-1 form A, for pipe according to DIN 11850, DN 50

4.4 Installation instructions

4.4.1 Installation of CLD134, remote version

Transmitter wall mounting

Secure the mounting plate to the wall by drilling holes as required. Wall plugs and screws must be provided by the customer.

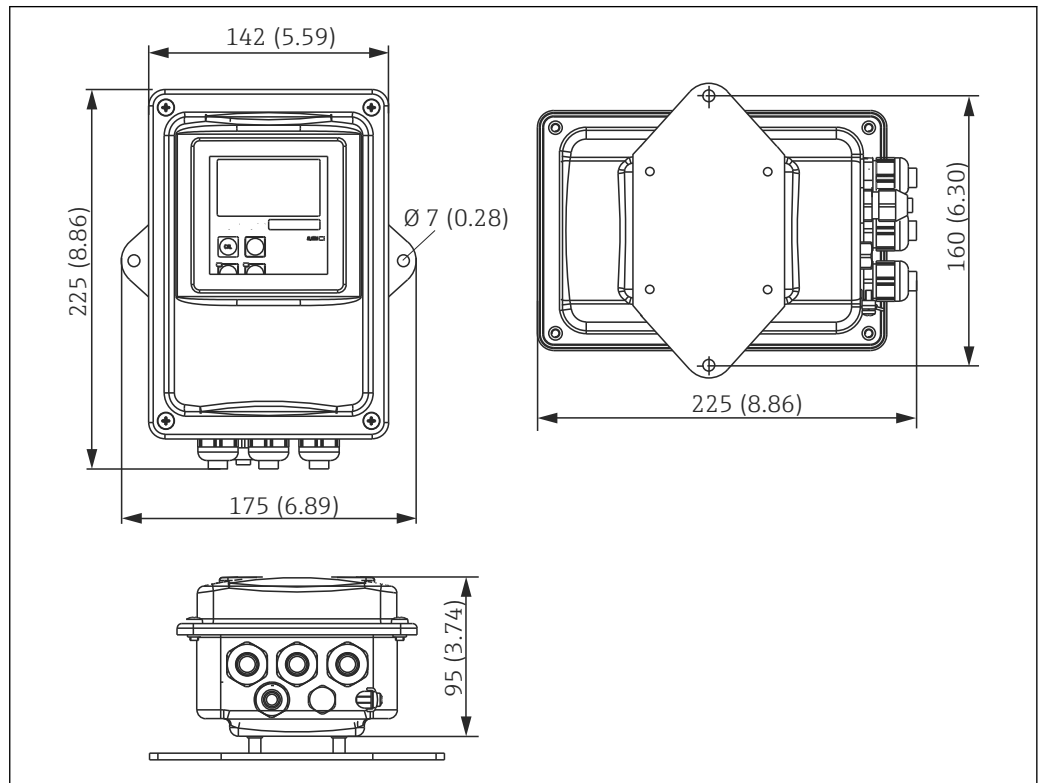

13 CLD134 wall mounting, remote version

i Wall mounting is not recommended in areas with strict hygiene requirements!

Transmitter post mounting

You require a post mounting kit to secure the CLD134 on horizontal and vertical posts or pipes (max. \varnothing 60 mm (2.36")). This can be acquired as an accessory (see the "Accessories" section).

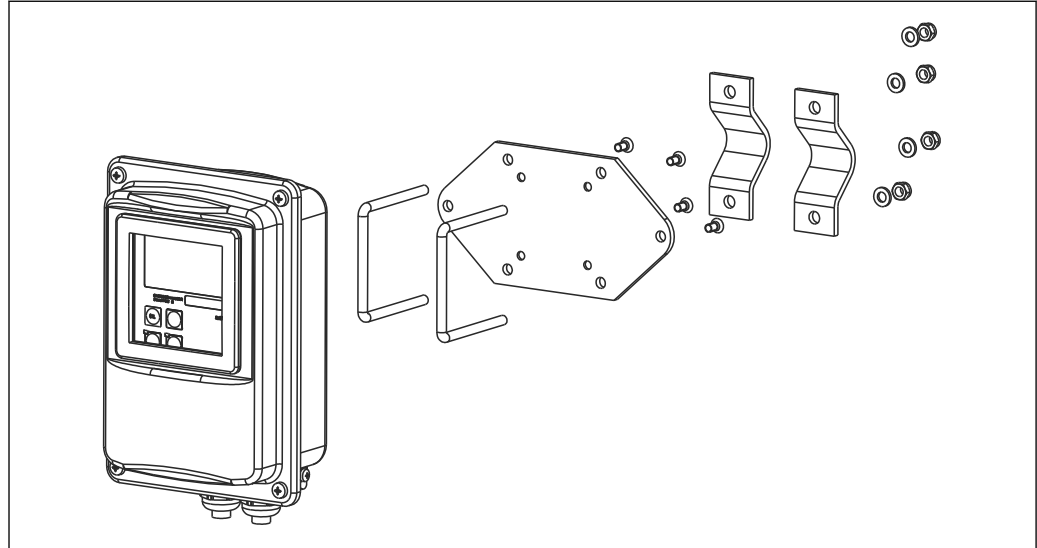

A0004902

 14 Mounting kit for post mounting, CLD134 remote version

 Shorten the thread as much as possible if you are using the transmitter in areas with strict hygiene requirements!

1. Unscrew the pre-assembled mounting plate.
2. Insert the holding bars of the mounting kit through the pre-drilled holes of the mounting plate and screw the mounting plate back onto the transmitter.
3. Secure the bracket with the Smartec on the post or pipe using the clamp (\rightarrow  24).

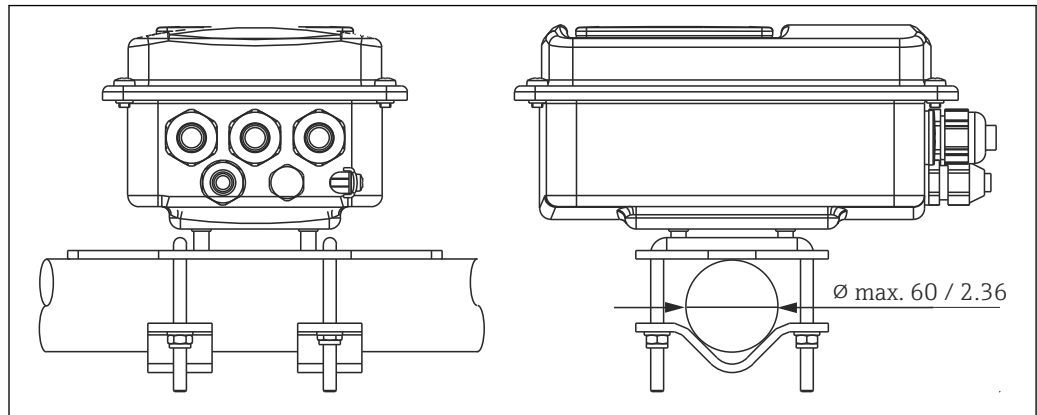

A0005634

 15 Post mounting of CLD134, remote version

4.4.2 Installing the CLD134 compact version or the CLS54 sensor for the remote version

- i** Perform an air set and calibrate the sensor before installing the compact version or the sensor.

Install the compact version or the CLS54 sensor directly on a pipe or vessel socket via the process connection (depending on ordered version).

1. When installing, align the Smartec CLD134 or the sensor in such a way that the medium flows through the flow opening of the sensor in the direction of medium flow. The orientation arrow on the adapter piece facilitates the alignment.
 2. Tighten the flange.
- i**
 - Choose the installation depth of the sensor in the medium such that the coil body is completely immersed in the medium.
 - Pay attention to the information on wall clearance in the "Installation conditions" section.
 - Observe the limits for the medium and ambient temperature when using the compact version (see the "Technical data" section).

Sensor orientation in the compact version

The sensor in the compact device version must be aligned with the flow direction.

Proceed as follows if you wish to change the orientation of the sensor in the compact version in relation to the transmitter housing:

1. Unscrew the housing cover.
2. Loosen the screws of the electronics box and carefully remove the box from the housing.
3. Loosen the three sensor securing screws until the sensor can be turned.
4. Align the sensor and tighten the screws again. Make sure you do not exceed the maximum torque of 1.5 Nm!
5. Reassemble the transmitter housing in the reverse order.

- i** For the exact positions of the electronics box and the sensor screws, see the exploded drawing in the "Troubleshooting" section.

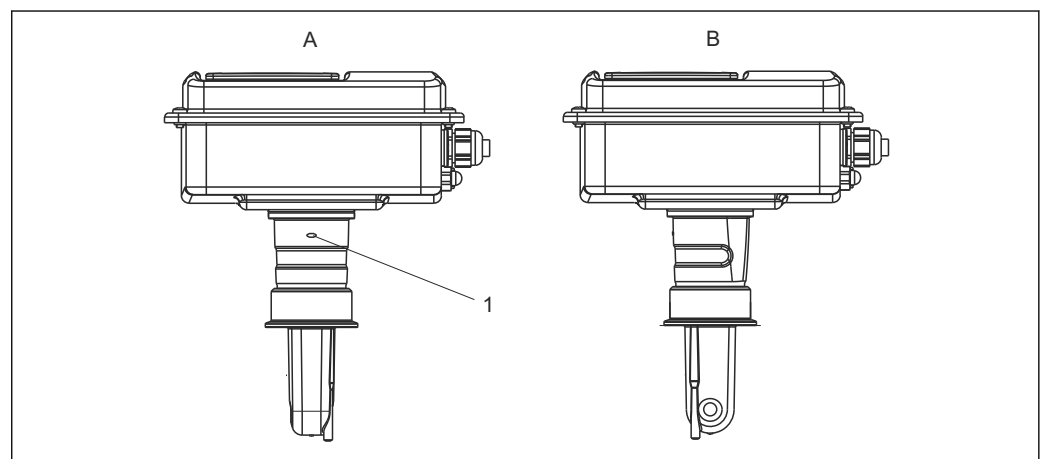

16 Sensor orientation in the transmitter housing

- A Standard orientation
- B Sensor turned by 90°
- 1 Orientation arrow on adapter piece

A0005635

4.5 Post-installation check

- After installation, check the measuring system for damage.
- Ensure that the sensor is aligned with the direction of medium flow.
- Ensure that the coil body of the sensor is completely immersed in the medium.

5 Electrical connection

⚠ WARNING

Device is live

Incorrect connection may result in injury or death

- ▶ The electrical connection may be performed only by an electrical technician.
- ▶ The electrical technician must have read and understood these Operating Instructions and must follow the instructions contained therein.
- ▶ **Prior** to commencing connection work, ensure that no voltage is present on any cable.

5.1 Electrical connection of the transmitter

⚠ WARNING

Risk of electric shock!

- ▶ At the supply point, the power supply must be isolated from dangerous live cables by double or reinforced insulation in the case of devices with a 24 V power supply.

NOTICE

The device does not have a power switch





- ▶ The customer must provide a protected circuit breaker in the vicinity of the device.
- ▶ The circuit breaker must be a switch or power switch, and you must label it as the circuit breaker for the device.

5.1.1 Wiring

Risk of electric shock!

- ▶ Ensure that the device is de-energized.

Proceed as follows to connect the transmitter:

1. Loosen the 4 Phillips screws on the housing cover and remove the cover.
2. Remove the cover frame from the terminal blocks. To do so, insert a screwdriver into the recess (A) as shown in →  17 and push the tab inwards (B).
3. Insert the cables through the open cable glands into the housing according to the terminal assignment in →  18.
4. Connect the power supply according to the terminal assignment in →  19.
5. Connect the fault-signaling contact according to the terminal assignment in →  19.
6. Connect the housing ground.
7. For the separate version: connect the sensor according to the terminal assignment in →  19. In the case of the separate version, the CLS54 conductivity sensor is connected via the multi-core, shielded sensor cable. Termination instructions are supplied with the cable. A junction box VBM (see the "Accessories" section) must be used to extend the measuring cable. The maximum total cable length if extended using a junction box is 55 m (180 ft.).
8. Firmly tighten the cable glands.

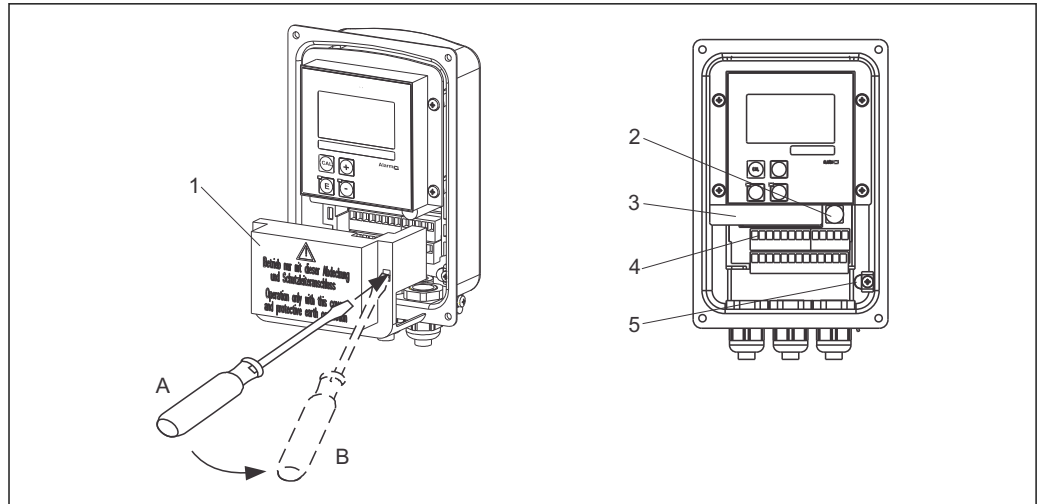

A0005636

17 View of open housing

- 1 Cover frame
- 2 Fuse
- 3 Removable electronics box
- 4 Terminals
- 5 Housing ground

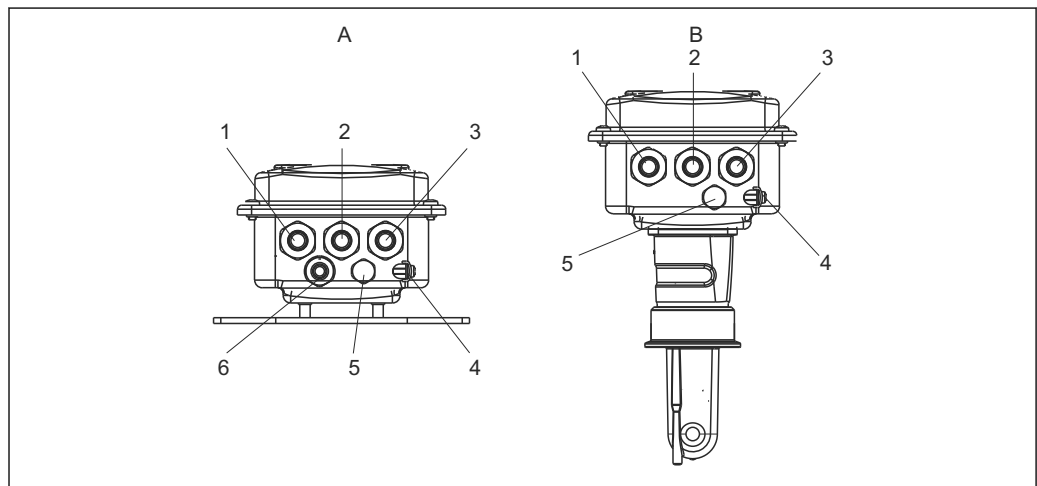

A0005439

18 Arrangement of cable entries

- | | |
|---|---|
| <p><i>A Separate version</i></p> <ul style="list-style-type: none"> 1 Dummy plug, analog output, binary input 2 Cable entry for fault-signaling contact 3 Cable entry for power supply 4 Housing ground 5 Pressure compensation element PCE (Goretex® filter) 6 Cable entry for sensor connection, Pg 9 | <p><i>B Compact version</i></p> <ul style="list-style-type: none"> 1 Dummy plug, analog output, binary input 2 Cable entry for fault-signaling contact 3 Cable entry for power supply 4 Housing ground 5 Pressure compensation element PCE (Goretex® filter) |
|---|---|

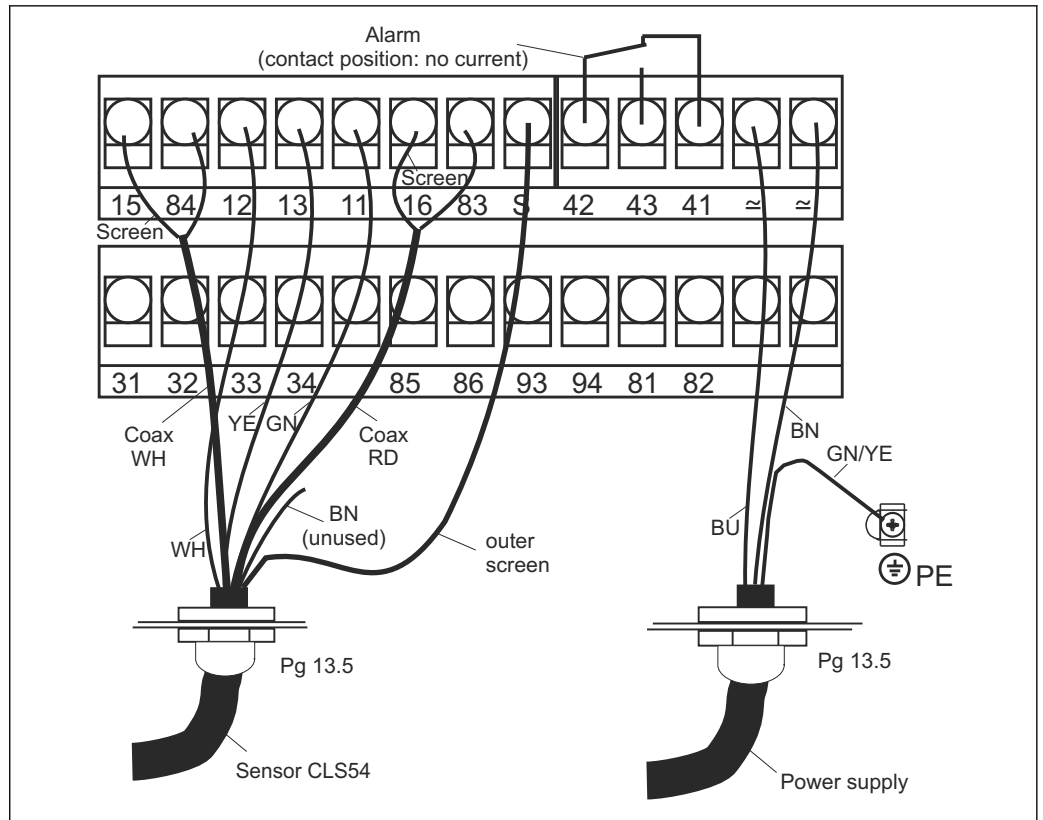

A0005637-EN

19 Electrical connection of the Smartec

5.1.2 Wiring diagram

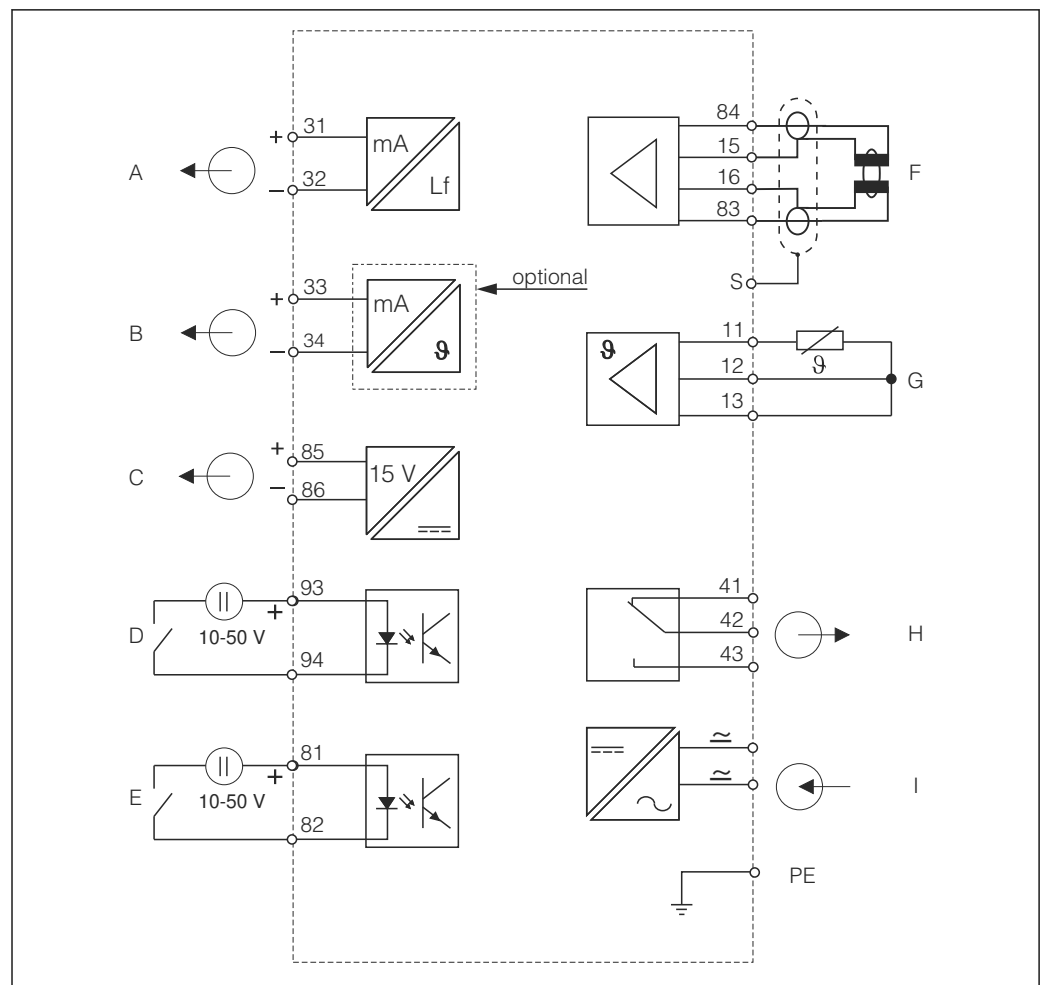

A0004895

20 Electrical connection CLD134

- | | | | |
|---|---------------------------------|---|---------------------------------------|
| A | Signal output 1, conductivity | F | Conductivity sensor |
| B | Signal output 2, temperature | G | Temperature sensor |
| C | Auxiliary voltage output | H | Alarm (current-free contact position) |
| D | Binary input 2 (MRS 1+2) | I | Power supply |
| E | Binary input 1 (hold / MRS 3+4) | | |
- MRS: remote parameter set configuration (measuring range switching)

5.1.3 Connecting the binary inputs

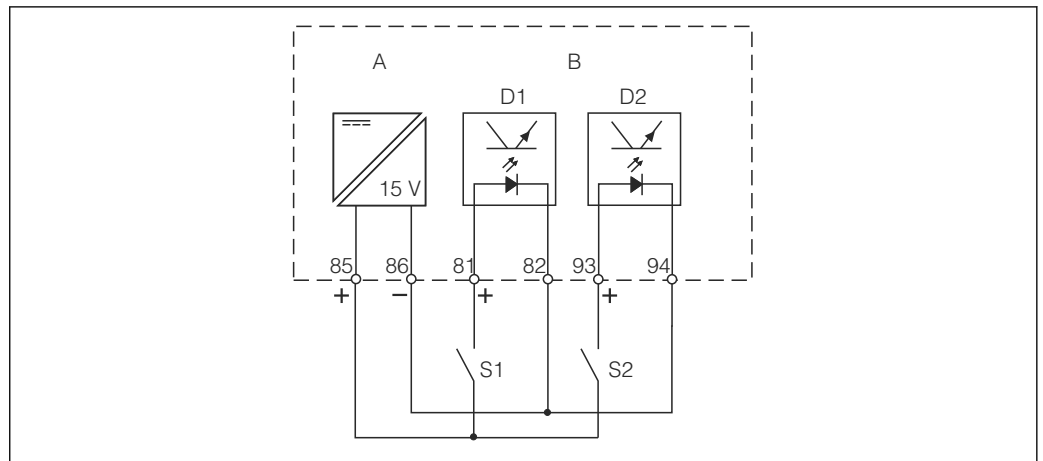

A0005639

21 Connection of the binary inputs when using external contacts

- A Auxiliary voltage output
- B Contact inputs D1 and D2
- S1 External current-free contact
- S2 External current-free contact

5.1.4 Connection compartment sticker

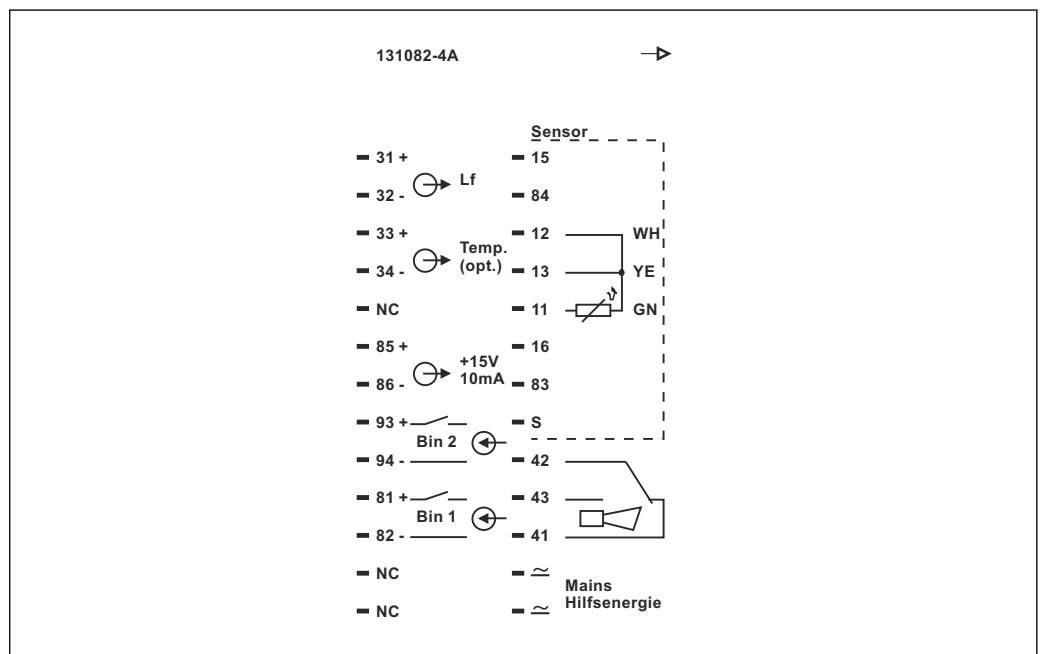

A0005644

22 Connection compartment sticker for Smartec

- i** The device has Class I equipment protection. The metal housing must be connected to PE.
- Terminals marked NC may not be connected.
- Unmarked terminals may not be connected.

5.1.5 Structure and termination of the measuring cable

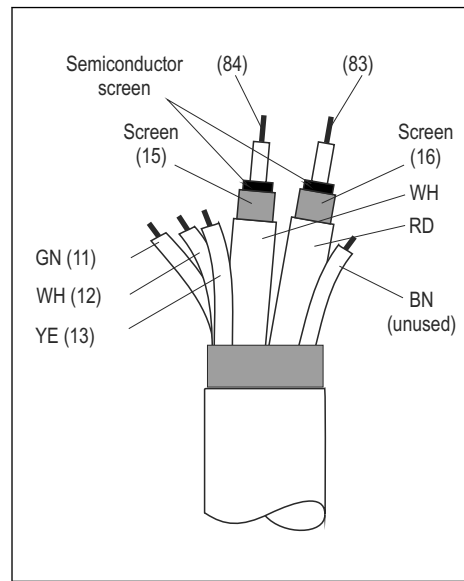

23 Structure of the sensor cable

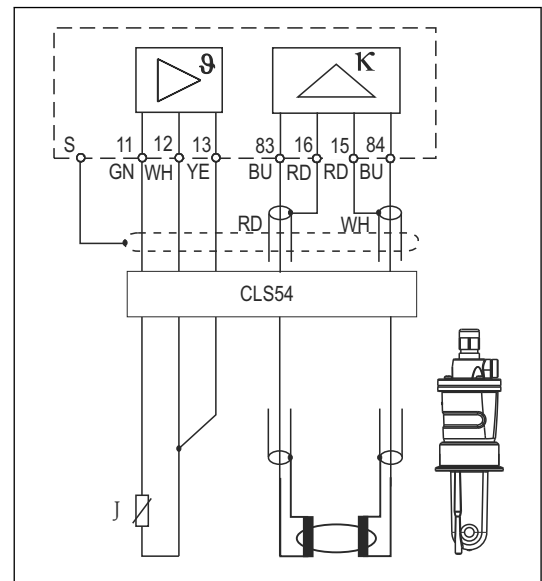

24 Electrical connection of the CLS54 sensor in the remote version

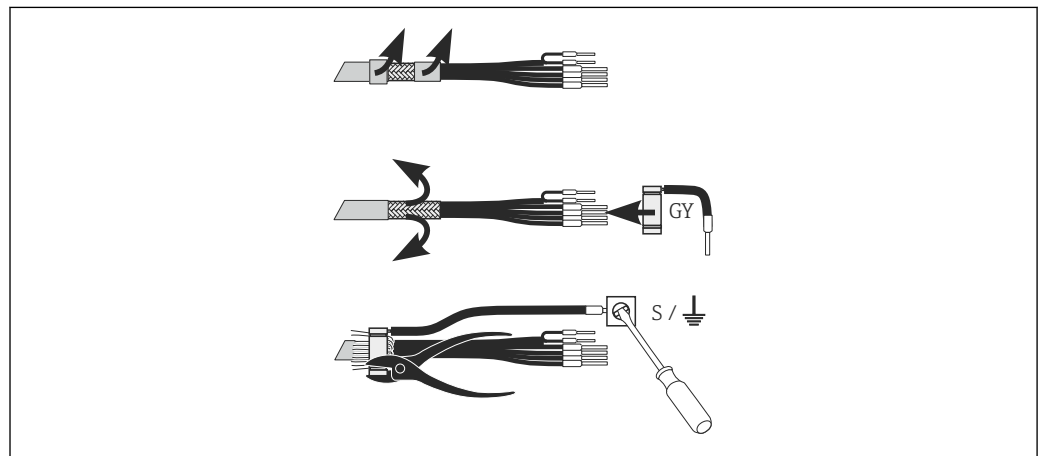

25 CLK6 screen connection

Install the terminated special measuring cable as illustrated:

1. Guide the cable through a cable gland into the wiring compartment.
2. Strip approx. 3 cm of the shielding braid and fold it back over the cable insulation.
3. Guide the crimping ring of the screen connection supplied over the prepared shielding braid and close the ring tight with a pair of pliers.
4. Connect the strand of the screen connection to the terminal bearing the grounding symbol.
5. Connect the remaining wires according to the wiring diagram. Then tighten the cable gland.

5.2 Alarm contact

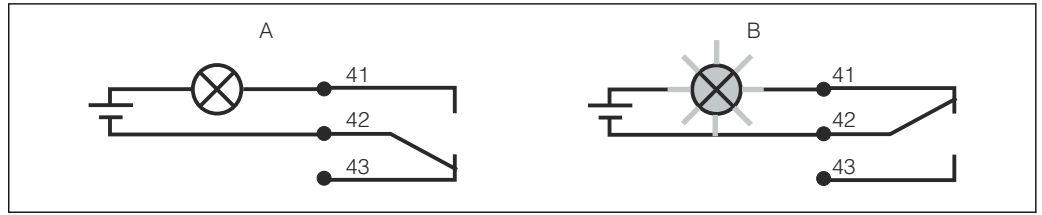

A0006415

26 Recommended fail-safe switching for the alarm contact

A Normal operating status
 B Alarm condition

Normal operating status

Device in operation and no error message present (alarm LED off):

- Relay energized
- Contact 42/43 closed

Alarm condition

Error message present (alarm LED red) or device defective or de-energized (alarm LED off):

- Relay de-energized
- Contact 41/42 closed

5.3 Post-connection check

Carry out the following checks once you have made the electrical connection:

Instrument status and specifications	Comments
Are the devices and cables free from damage on the outside?	Visual inspection

Electrical connection	Comments
Does the supply voltage correspond to that specified on the nameplate?	
Are the connected cables provided with strain relief?	
Is the cable run correct, without loops and cross-overs?	
Are the power cable and signal cables connected correctly and in accordance with the wiring diagram?	
Are all the screw terminals tightened?	
Are all the cable entries fitted, tightened and leak-proof?	
Are the PE distributor blocks grounded (if present)?	Grounding is carried out at the point of installation.

6 Operation options

6.1 Operation and commissioning

You have the following ways of operating the transmitter:

- On site via the key field
- Via the HART interface (optional, with corresponding order version) with:
 - HART handheld terminal
 - PC with HART modem and the Fieldcare software package
- Via PROFIBUS PA/DP (optional, with corresponding order version) by PC with a corresponding interface and the Fieldcare software package or via a programmable logic controller (PLC).

 For operation via HART or PROFIBUS PA/DP, please read the relevant sections in the additional Operating Instructions:

- PROFIBUS PA/DP, field communication for Smartec CLD134, BA00213C/07/EN
- HART, field communication for Smartec CLD134, BA00212C/07/EN

The following section only explains operation via the keys.

6.2 Display and operating elements

6.2.1 Display

ALARM  <small>A0027809</small>	Alarm indication, e.g. for continuous limit violation. Temperature sensor failure or system error (see error list).
--	---

6.2.2 LC display

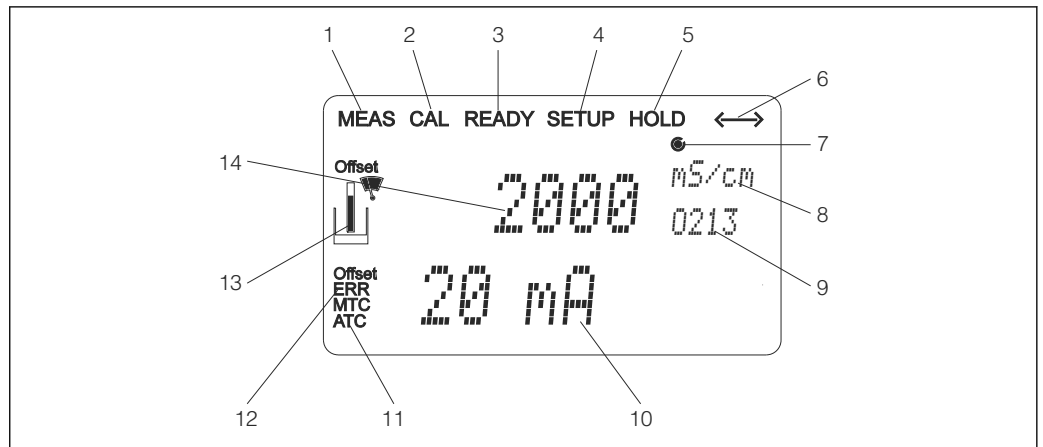

A0005645

27 LC display of Smartec CLD134

- 1 Indicator for measuring mode (normal operation)
- 2 Indicator for calibration mode
- 3 Indicator for calibration completed
- 4 Indicator for setup mode (configuration)
- 5 Indicator for "Hold" mode (current outputs remain in defined state)
- 6 Signal reception indicator for devices with communication
- 7 Indicator of relay operating state: ○ inactive, ● active
- 8 In measuring mode: measured variable - in setup mode: configured variable
- 9 Function code
- 10 In measuring mode: secondary measured value - in setup/calibr. mode: e.g. set value
- 11 Indicator for manual/automat. temperature compensation
- 12 "Error" indicator
- 13 Sensor symbol flashes during calibration
- 14 In measuring mode: main measured value - in Setup/calibr. mode: e.g. parameter

6.2.3 Operating elements

The operating elements are covered by the housing cover. The display and the alarm LEDs are visible through the viewing window. To operate the Smartec, loosen the four screws and open the housing cover.

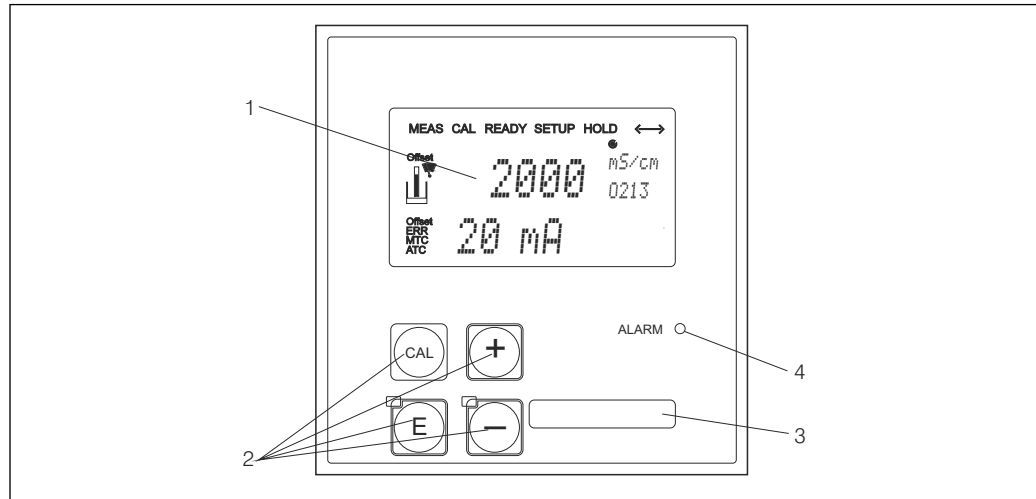

28 Display and keys of the CLD134

- 1 LC display for displaying the measured values and configuration data
- 2 Four operating keys for calibration and device configuration
- 3 Field for user-defined information
- 4 Light emitting diode for alarm function

6.3 Local operation

6.3.1 Operating concept

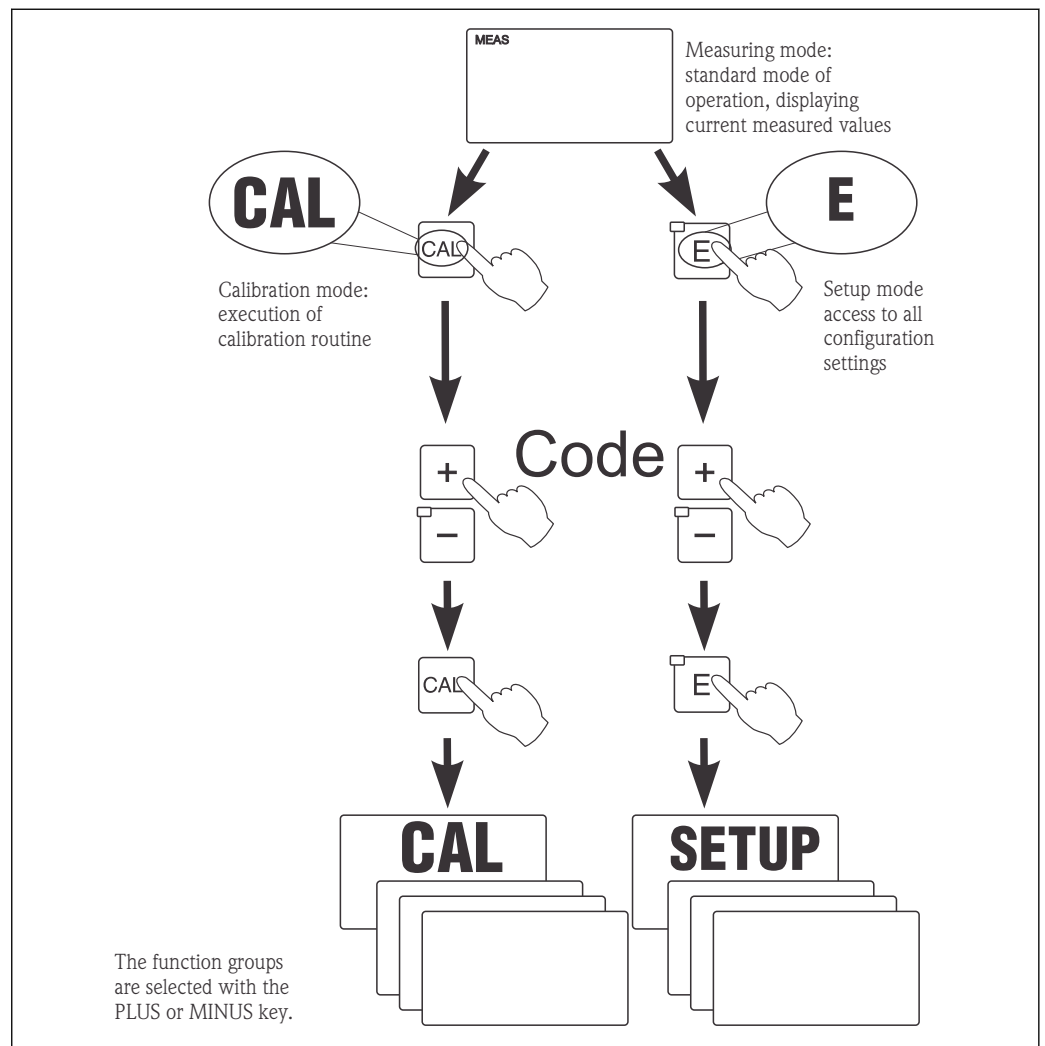

29 Description of the possible operating modes

i If no key is pressed in the setup mode for approx. 15 min, the device automatically returns to the measuring mode. Any active hold (hold during setup) is canceled.

Access codes

All device access codes are fixed and cannot be altered. When the device requests the access code, it distinguishes between different codes.

- **CAL key + code 22**: access to Calibration and Offset menu
- **ENTER key + code 22**: access to the menus for the parameters which make configuration and user-specific settings possible
- **PLUS + ENTER keys** simultaneously (min. 3 s): lock the keyboard
- **CAL + MINUS keys** simultaneously (min. 3 s): unlock the keyboard
- **CAL or ENTER key + any code**: access to read mode, i.e. all the settings can be read but not modified.

Menu structure

The configuration and calibration functions are arranged in function groups.

- In the setup mode, select a function group with the PLUS and MINUS keys.
- In the function group itself, switch from function to function with the ENTER key.
- Within the function, select the desired option with the PLUS and MINUS keys or edit the settings with these keys. Then confirm with the ENTER key and continue.
- Press the PLUS and MINUS keys simultaneously (Escape function) to exit programming (return to the main menu).
- Press the PLUS and MINUS keys simultaneously again to switch to the measuring mode.

 If a modified setting is not confirmed by pressing ENTER, the old setting is retained.

An overview of the menu structure is provided in the Appendix to these Operating Instructions.

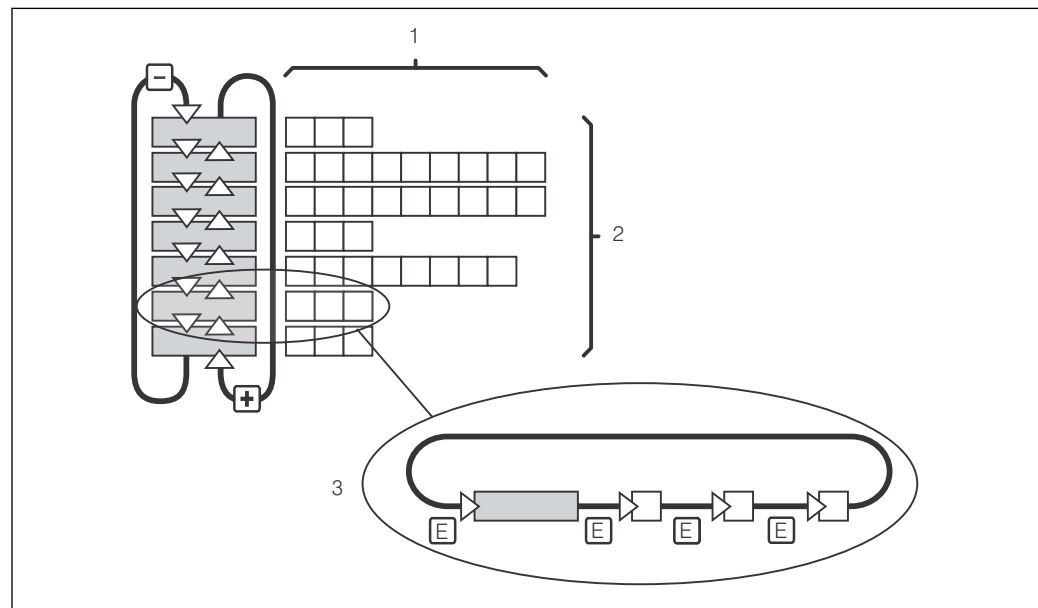

 30 Menu structure

- 1 Functions (selection of parameters, entry of numbers)
- 2 Function groups, scroll backwards and forwards with the PLUS and MINUS keys
- 3 Switch from function to function with the ENTER key

Hold function: "freeze" the outputs

In both the setup mode and during calibration, the current output can be "frozen" (factory setting), i.e. it constantly retains its current status. "HOLD" appears on the display.

- Hold settings can be found in the "Service" function group.
- During a hold, all contacts assume a quiescent state.
- An active hold has priority over all other automatic functions.
- With every hold, the I-component of the controller is set to "0".
- Any alarm delay is reset to "0".
- This function can also be activated externally via the hold input (see Wiring diagram; binary input 1).
- A manual hold (field S3) remains active even after a power failure.

7 Commissioning

7.1 Function check

⚠ WARNING

Incorrect connection, incorrect supply voltage

Safety risks for staff and device malfunctions

- ▶ Check that all connections have been established correctly in accordance with the wiring diagram.
- ▶ Ensure that the supply voltage matches the voltage indicated on the nameplate.

7.2 Switching on

Familiarize yourself with the operation of the transmitter before it is first switched on. In particular please read the "Basic safety instructions" and "Operation options" sections. After power-up, the device performs a self-test and then goes to the measuring mode.

Then perform the first configuration in accordance with the instructions in the "Quick setup" section. The values set by the user are kept even in the event of a power failure.

The following function groups are available in the transmitter (the function groups that are only available with a function upgrade are marked accordingly):

Setup mode

- SETUP 1 (A)
- SETUP 2 (B)
- CURRENT OUTPUT (O)
- ALARM (F)
- CHECK (P)
- RELAY (R)
- ALPHA TABLE (T)
- CONCENTRATION MEASUREMENT (K)
- SERVICE (S)
- E+H SERVICE (E)
- INTERFACE (I)
- TEMPERATURE COEFFICIENT (D)
- MRS (M)

Calibration mode

CALIBRATION (C)

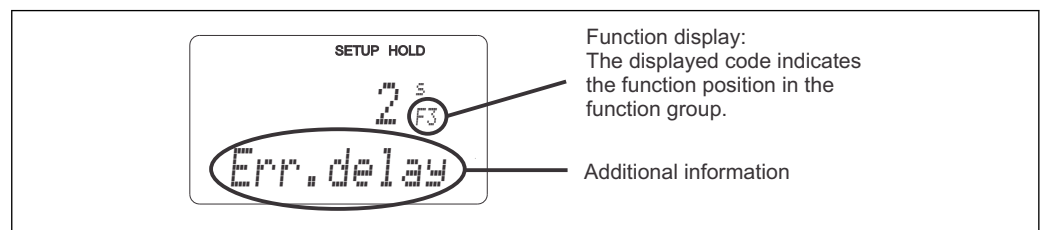

A0025560-EN

31 Information for the user on the display

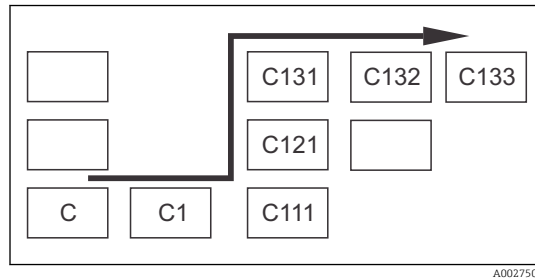

To make it easier for you to select and find function groups and functions, a code for the corresponding field is displayed for each function → 31

The structure of this code is illustrated in → 32. The function groups are indicated as letters in the first column (see the names of the function groups). The functions of the individual groups are displayed incrementally by row and by column.

32 Function code

A detailed explanation of the function groups available in the transmitter can be found in the "Device configuration" section.

Factory settings

The first time the device is switched on, the factory setting is set for all the functions. The table below provides an overview of the most important settings.

All other factory settings can be found in the description of the individual function groups in the "System configuration" section (the factory setting is highlighted in **bold**).



Function	Factory setting
Type of measurement	Inductive measurement of conductivity, Temperature measurement in °C
Type of temperature compensation	Linear with reference temperature 25 °C (77 °F)
Temperature compensation	Automatic (ATC on)
Relay function	Alarm
Hold	Active during configuration and calibration
Measuring range	100 µS/cm to 2000 mS/cm (measuring range selected automatically)
Current outputs 1* and 2*	4 to 20 mA
Current output 1: measured value for 4 mA signal current	0 µS/cm
Current output 1: measured value for 20 mA signal current	2000 mS/cm
Current output 2: temperature value for 4 mA signal current*	0 °C (32 °F)
Current output 2: temperature value for 20 mA signal current*	150 °C (302 °F)

* with appropriate version

7.3 Quick Setup

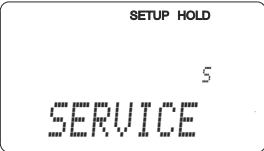
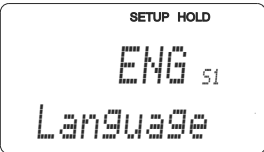
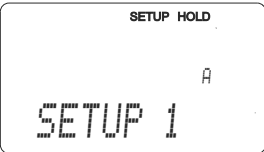
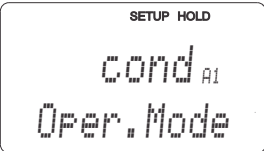
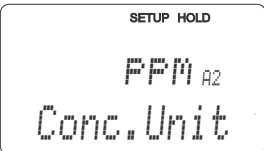
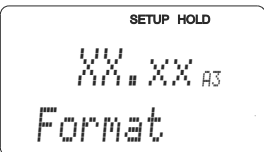
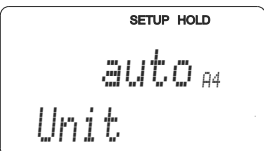
After power-up, you must make some settings to configure the most important functions of the transmitter which are required for correct measurement. The following section gives an example of this.

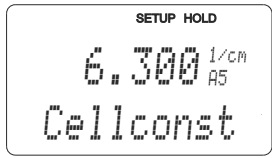
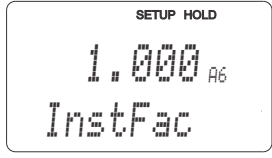
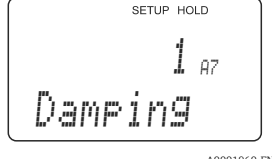
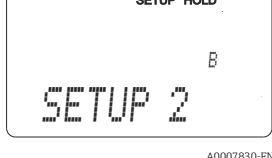
User entry		Range of adjustment (factory settings in bold)	Display
1.	Press the ENTER key		
2.	Enter the code 22 to open access to the menus. Press the ENTER key.		
3.	Press the MINUS key until you get to the "Service" function group.		 <p style="text-align: right; font-size: small;">A0008408-EN</p>
4.	Press ENTER to be able to make your settings.		
5.	Select your language in S1, e.g. "ENG" for English. Press ENTER to confirm your entry.	ENG = English GER = German FRA = French ITA = Italian NEL = Dutch ESP = Spanish	 <p style="text-align: right; font-size: small;">A0008409-EN</p>
6.	Press the PLUS and MINUS key simultaneously to exit the "Service" function group.		
7.	Press the MINUS key until you get to the "Setup 1" function group.		 <p style="text-align: right; font-size: small;">A0007824-EN</p>
8.	Press ENTER to be able to make your settings for "Setup 1".		
9.	In A1, select the desired mode of operation, e.g. "cond" = conductivity. Press ENTER to confirm your entry.	Cond = conductivity Conc = concentration	 <p style="text-align: right; font-size: small;">A0028187-EN</p>
10.	In A2, press ENTER to accept the factory setting.	% ppm mg/l TDS = total dissolved solids None	 <p style="text-align: right; font-size: small;">A0028188-EN</p>
11.	In A3, press ENTER to accept the standard setting.	XX.xx X.xxx XXX.x XXXX	 <p style="text-align: right; font-size: small;">A0009004-EN</p>
12.	In A4, press ENTER to accept the standard setting.	auto , μ S/cm, mS/cm, S/cm, μ S/m, mS/m, S/ m	 <p style="text-align: right; font-size: small;">A0009005-EN</p>

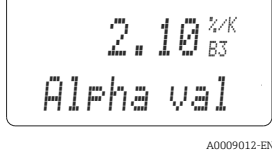
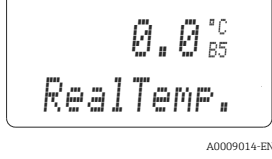
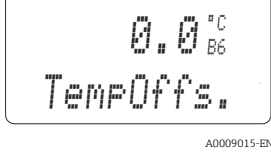
User entry		Range of adjustment (factory settings in bold)	Display
13.	In A5, enter the exact cell constant of the sensor. The cell constant is provided on the sensor quality certificate.	0.10 to 6.3 to 99.99	 <p>SETUP HOLD 6.300 ^{1/CP}_{A5} Cellconst</p> <p>A0005688-EN</p>
14.	In A6, press ENTER to accept the standard setting. If your wall clearance is less than 15 mm, information on how to calculate the installation factor is provided in the "Installation conditions" and "Calibration" sections.	0.10 to 1 to 5.00	 <p>SETUP HOLD 1.000 _{A6} InstFac</p> <p>A0028195-EN</p>
15.	If measuring conditions are unstable and you need to stabilize the display, enter the appropriate damping factor in A7. Press ENTER to confirm your entry. The display returns to the initial display of the "Setup 1" function group.	1 1 to 60	 <p>SETUP HOLD 1 _{A7} DampIn9</p> <p>A0001960-EN</p>
16.	Press the MINUS key to get to the "Setup 2" function group. Press ENTER to make your settings for "Setup 2".		 <p>SETUP HOLD B SETUP 2</p> <p>A0007830-EN</p>
17.	In B1, select the temperature sensor. By default, your measuring system is supplied with the CLS54 sensor with a Pt 1000 temperature sensor. Press ENTER to confirm your entry.	Pt100 Pt1k = Pt 1000 NTC30 Fixed	 <p>SETUP HOLD Pt1k _{B1} ProcTemp.</p> <p>A0005689-EN</p>
18.	In B2, select the appropriate type of temperature compensation for your process, e.g. "lin" = linear. Press ENTER to confirm your entry. Detailed information is provided in the "Temperature compensation with table" section	None Lin = linear NaCl = table salt (IEC 60746) Tab 1 to 4	 <p>SETUP HOLD lin _{B2} TempComp.</p> <p>A0009011-EN</p>
19.	In B3, enter the temperature coefficient α . Press ENTER to confirm your entry. Detailed information on determining the temperature coefficient is provided in the "Temperature compensation with table" and "Determining the temperature coefficient" sections.	2.1 %/K 0.0 to 20.0 %/K	 <p>SETUP HOLD 2.10 ^{%/K}_{B3} Alpha val</p> <p>A0009012-EN</p>
20.	The current temperature is displayed in B5. If necessary, adjust the temperature sensor to an external measurement. Press ENTER to confirm your entry.	Actual value displayed and entered -35.0 to 250.0 °C	 <p>SETUP HOLD 0.0 ^{°C}_{B5} RealTemp.</p> <p>A0009014-EN</p>
21.	The difference between the measured and entered temperature is displayed. Press the ENTER key. The display returns to the initial display of the "Setup 2" function group.	0.0 °C -5.0 to 5.0 °C	 <p>SETUP HOLD 0.0 ^{°C}_{B6} TempOffs.</p> <p>A0009015-EN</p>

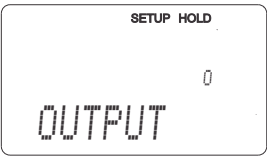
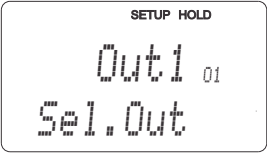
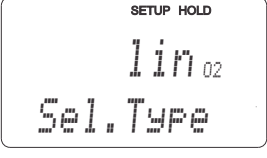
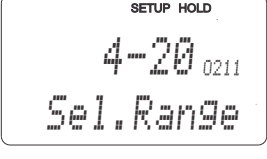
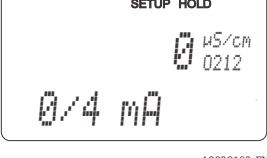
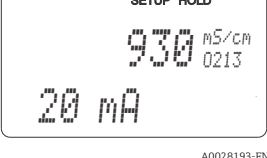
User entry		Range of adjustment (factory settings in bold)	Display
22.	Press the MINUS key to get to the "Current output" function group. Press ENTER to make your settings for the current outputs.		 <small>A0025026-EN</small>
23.	In O1, select your current output, e.g. "Out 1" = output 1. Press ENTER to confirm your entry.	Out 1 Out 2	 <small>A0025027-EN</small>
24.	In O2, select the linear characteristic. Press ENTER to confirm your entry.	Lin = linear (1) Sim = simulation (2)	 <small>A0028189-EN</small>
25.	In O211, select the current range for your current output, e.g. 4 to 20 mA. Press ENTER to confirm your entry.	4 to 20mA 0 to 20 mA	 <small>A0028190-EN</small>
26.	In O212, specify the conductivity at which the minimum current value is applied at the transmitter output, e.g. 0 µS/cm. Press ENTER to confirm your entry.	0.00 µS/cm 0.00 µS/cm to 2000 mS/cm	 <small>A0028192-EN</small>
27.	In O213, specify the conductivity at which the maximum current value is applied at the transmitter output, e.g. 930 mS/cm. Press ENTER to confirm your entry. The display returns to the initial display of the "Current output" function group.	2000 mS/cm 0.00 µS/cm to 2000 mS/cm	 <small>A0028193-EN</small>
28.	Press PLUS and MINUS simultaneously to switch to the measurement mode.		

 You must perform an air set before installing the inductive sensor. See the "Calibration" section for more information.



7.4 Device configuration

The following sections describe all the functions of the Smartec CLD134.

7.4.1 SETUP 1 (conductivity / concentration)

In the SETUP 1 function group, you can change the settings for the measuring mode and the sensor.

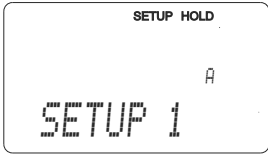
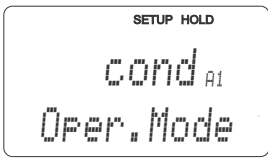
You will have already made all the settings in this menu during initial commissioning. However, you can change the settings at any time.

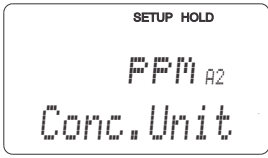
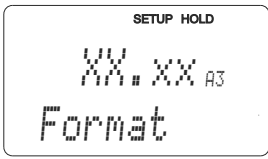
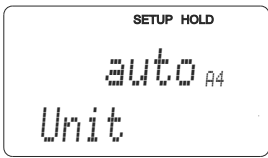
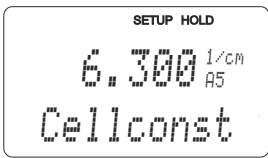
Coding	Field	Range of adjustment (factory settings in bold)	Display	Info
A	SETUP 1 function group		 A0007824-EN	Configuration of basic functions
A1	Select the operating mode	cond = conductivity <i>conc</i> = concentration	 A0028187-EN	Display varies depending on the device: <ul style="list-style-type: none"> ▪ cond ▪ conc  When the operating mode is changed, all user settings are automatically reset.
A2	Select the concentration unit to be displayed	% ppm mg/l TDS = total dissolved solids None	 A0028188-EN	
A3	Select the display format for the concentration unit	XX.xx X.xxx XXX.x XXXX	 A0009004-EN	
A4	Select the unit to be displayed	auto , µS/cm, mS/cm, S/cm, µS/ m, mS/m, S/m	 A0009005-EN	If "auto" is selected, the highest possible resolution is automatically selected.
A5	Enter the cell constant for the connected sensor	0.10 to 6.3 to 99.99	 A0005688-EN	The exact cell constant is provided on the sensor quality certificate.

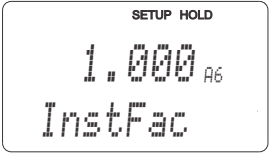
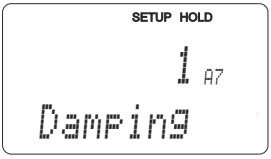
Coding	Field	Range of adjustment (factory settings in bold)	Display	Info
A6	Installation factor	0.10 to 1 to 5.00	 <small>A0028195-EN</small>	The installation factor can be edited here. The correct factor is determined in the C1(3) function group, see the "Calibration" section, or use the installation factor chart.
A7	Enter the value for measured value damping	1 1 to 60	 <small>A0009008-EN</small>	Measured value damping causes averaging over the specified number of individual measured values. This is used, for example, to stabilize the display if the measurement is unstable. There is no damping if "1" is entered.

7.4.2 Setup 2 (temperature)

Temperature compensation only needs to be performed in the conductivity mode (select in field A1).

The temperature coefficient specifies the change in the conductivity per degree of temperature change. It depends both on the chemical composition of the solution and the temperature itself.

To determine the level of dependency, four different types of compensation can be selected in the transmitter:

Linear temperature compensation

The change between two temperature points is taken to be constant, i.e. $\alpha = \text{const}$. The α value can be edited for linear compensation. The reference temperature can be edited in the B7 field. The default setting is 25 °C.

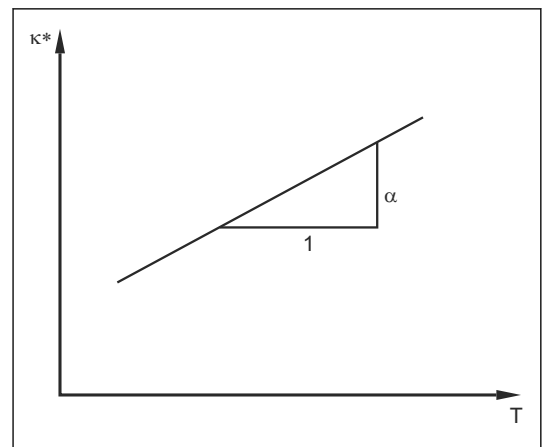

33 Linear temperature compensation

* Uncompensated conductivity

NaCl compensation

In the case of NaCl compensation (as per IEC 60746), a fixed non-linear curve specifying the relationship between the temperature coefficient and temperature is saved in the device. This curve applies to low concentrations of up to approx. 5 % NaCl.

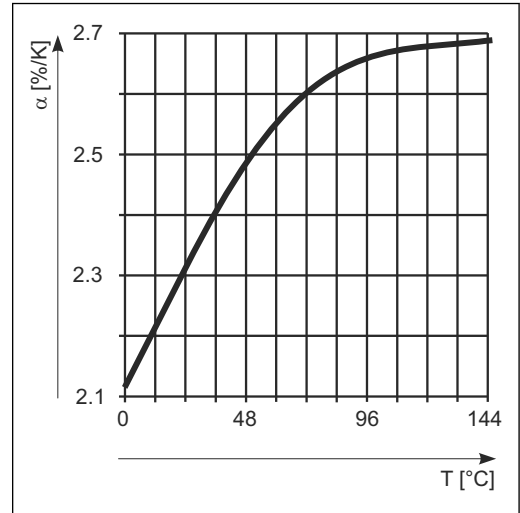

34 NaCl compensation

Temperature compensation with table

For devices with the Plus Package, it is possible to enter a table with temperature coefficients α as a function of the temperature. The following conductivity data of the medium under measurement are required to use the alpha table function for temperature compensation:

Value pairs comprising the temperature T and conductivity κ with:

- κ(T₀) for the reference temperature T₀
- κ(T) for the temperatures that occur in the process

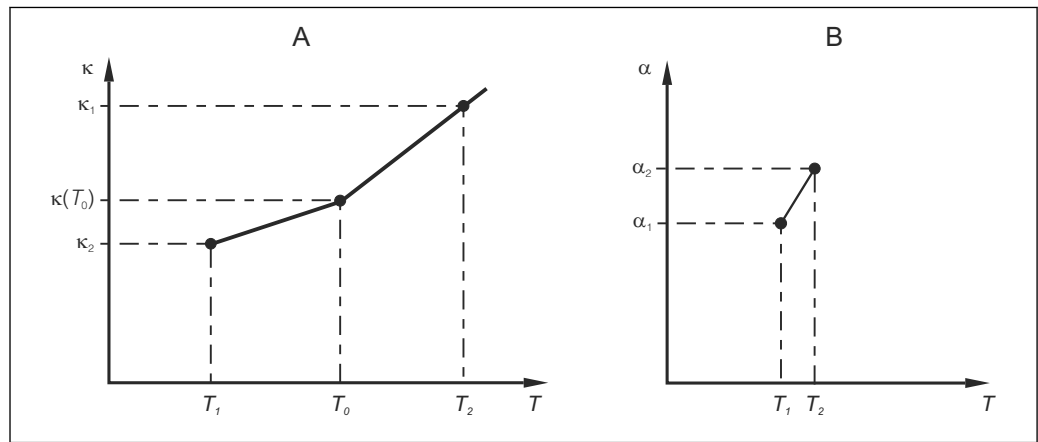

35 Determination of the temperature coefficient

- A Required data
- B Calculated α values

Use the following formula to calculate the α values for the temperatures that are relevant in your process:

$$\alpha = \frac{100\%}{\kappa(T_0)} \cdot \frac{\kappa(T) - \kappa(T_0)}{T - T_0}; T \neq T_0$$



A0009162

Enter the α-T value pairs obtained in this way in the T4 and T5 fields of the ALPHA TABLE function group.

SETUP 2 function group

Use this function group to change the settings for temperature measurement.

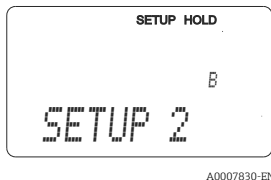
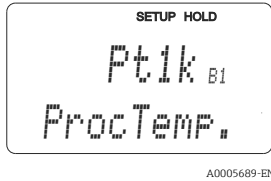
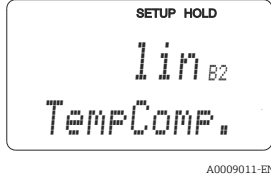
You already made all the settings for this function group during initial commissioning. However, you can change the values chosen at any time.

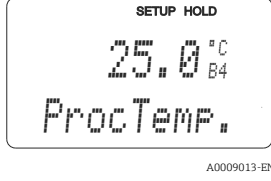
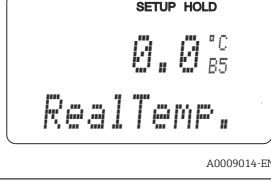
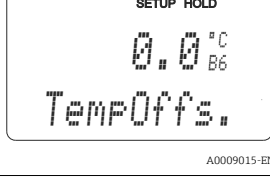
Coding	Field	Range of adjustment (factory settings in bold)	Display	Info
B	SETUP 2 function group		 A0007830-EN	Settings for temperature measurement
B1	Select the temperature sensor	Pt100 Pt1k = Pt 1000 NTC30 Fixed	 A0005689-EN	"fixed": No temperature measurement; a fixed temperature value is specified instead.
B2	Select the type of temperature compensation	None Lin = linear NaCl = table salt (IEC 60746) Tab 1 to 4	 A0009011-EN	This option does not appear for concentration measurement. The Tab 2 to 4 option is only available on devices with the additional function "Remote parameter set configuration".
B3	Enter temperature coefficient α	2.10 %/K 0.00 to 20.00 %/K	 A0009012-EN	Only if B2 = lin. Any table entered is also not active in this case.
B4	Enter the process temperature	25.0 °C -10.0 to 150.0 °C	 A0009013-EN	Only if B1 = fixed. The value entered can only be in °C.
B5	Display the temperature and adjust the temperature sensor	Actual value displayed and entered -35.0 to 250.0 °C	 A0009014-EN	With the value entered here, the temperature sensor can be adjusted to an external measurement. Omitted if B1 = fixed.
B6	Enter the temperature difference	0.0 °C -5.0 to 5.0 °C	 A0009015-EN	The difference between the actual value entered and the measured temperature is displayed. Omitted if B1 = fixed.

7.4.3 Current outputs

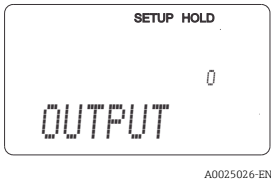
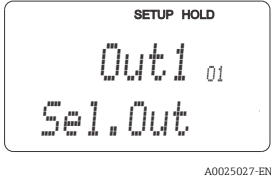
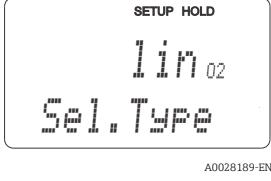
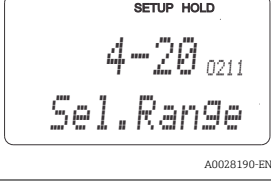
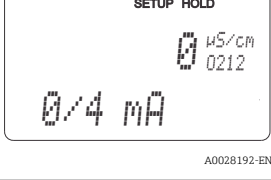
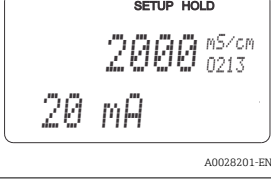
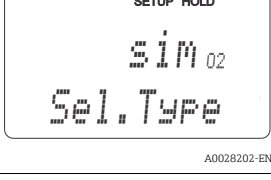
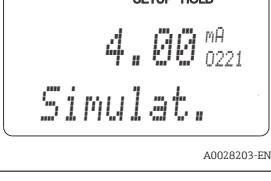

The individual outputs are configured in the CURRENT OUTPUT function group. In addition, you can also simulate a current output value (O2 (2)) to check the current outputs.

Coding	Field	Range of adjustment (factory settings in bold)	Display	Info
0	CURRENT OUTPUT function group			Configuration of the current output (does not apply for PROFIBUS).
O1	Select current output	Out 1 Out 2		A characteristic can be selected for every output.
O2 (1)	Enter the linear characteristic	Lin = linear (1) Sim = simulation (2)		The slope of the characteristic can be positive or negative.
O211	Enter the current range	4 to 20mA 0 to 20 mA		
O212	0/4 mA value: Enter the associated measured value	Cond: 0.00 $\mu\text{S/cm}$ Conc: 0.00 % Temp: -10.0 °C Entire measuring range		Here you can enter the measured value at which the min. current value (0/4 mA) is applied at the transmitter output. Display format from A3. (Spread see Technical data.)
O213	20 mA value: Enter the associated measured value	Cond: 2000 $\mu\text{S/cm}$ Conc: 99.99 % Temp: 60 °C Entire measuring range		Enter the measured value corresponding to the max. current value (20 mA) at the transmitter output. Display format from A3. (Spread see Technical data.)
	Simulate current output	Lin = linear (1) Sim = simulation (2)		The option (1) must be selected to quit the simulation.
O221	Enter simulation value	Current value 0.00 to 22.00 mA		Entering a current value results in this value being directly output at the current output.

7.4.4 Alarm

You can use the "Alarm" function group to define various alarms and configure output contacts.

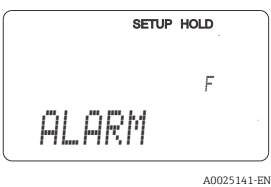
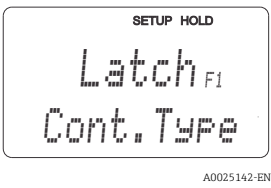
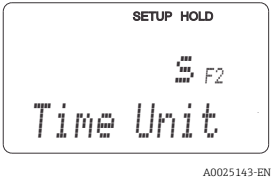
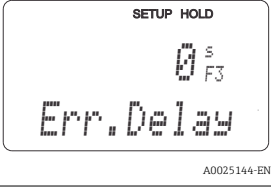
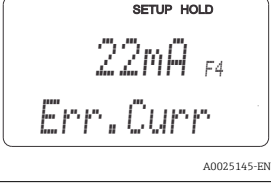
Each individual error can be defined to be effective or not (at the contact or as an error current).

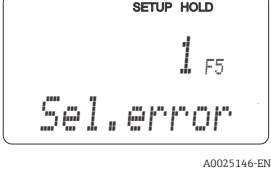
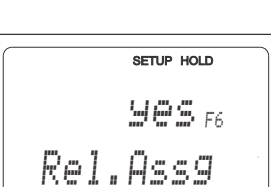
Coding	Field	Range of adjustment (factory settings in bold)	Display	Info
F	ALARM function group			Alarm function settings.
F1	Select contact type	Latch = latching contact Momen = momentary contact		The option selected here only applies to the fault-signaling contact.
F2	Select the time unit for the alarm delay	s min		
F3	Enter alarm delay	0 s (min) 0 to 2000 s (min)		Depending on the option selected in F2, the alarm delay can be entered in s or min. The alarm delay does not affect the LED; it indicates the alarm immediately.
F4	Select error current	22 mA 2.4 mA		This selection must be made even if all error messages are suppressed in F5.  If "0-20 mA" was selected in O311, "2.4 mA" may not be used.
F5	Select the error number	1 1 to 255		Here you can select all the errors which should trigger an alarm. The errors are selected by the error numbers. Please refer to the table in the "System error messages" section for the meaning of the individual error numbers. The factory settings remain in effect for all errors that are not edited.
F6	Set alarm contact to be effective for the selected error	Yes No		If "no" is selected, all the other alarm settings are deactivated (e.g. alarm delay). The settings themselves are retained. This setting only applies to the error currently selected in F5. The factory setting is No from E080 onwards!

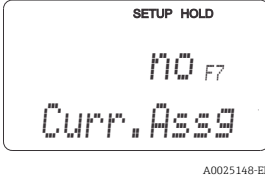
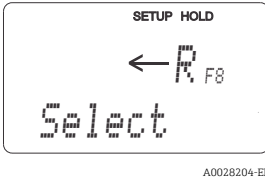
Coding	Field	Range of adjustment (factory settings in bold)	Display	Info
F7	Set error current to be effective for the selected error	No Yes	 <p>The display shows 'SETUP HOLD' at the top, 'NO F7' in the middle, and 'Curr. Assg' at the bottom. The reference code 'A0025148-EN' is at the very bottom.</p>	The option selected in F4 becomes effective or is suppressed when an error occurs. This setting only applies to the error currently selected in F5.
F8	Select return to menu or next error	Next = next error number <R	 <p>The display shows 'SETUP HOLD' at the top, '<R F8' in the middle, and 'Select' at the bottom. The reference code 'A0028204-EN' is at the very bottom.</p>	If <R is selected, you return to F. If Next is selected, you go to F5.

7.4.5 Check

PCS alarm (process check system)

The PCS alarm is only available for devices with remote parameter set configuration. This function is used to check the measuring signal for deviations. An alarm is triggered if the measuring signal remains constant for a specific period of time (several measured values). This type of sensor behavior can be caused by contamination, a cable open circuit or similar.

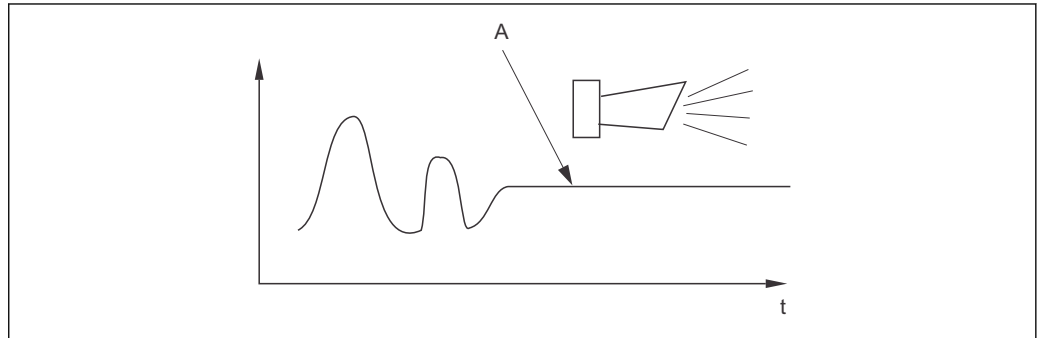

A0006744

36 PCS alarm (live check)

A Constant measuring signal = alarm triggered after PCS alarm time has elapsed

i An active PCS alarm is automatically cleared as soon as the measuring signal changes.

Coding	Field	Range of adjustment (factory settings in bold)	Display	Info
P	CHECK function group		<p>A0009045-EN</p>	Settings for sensor and process monitoring
P1	Set PCS alarm (live check)	Off 1 h 2 h 4 h	<p>A0028207-EN</p>	This function is used to monitor the measuring signal. If the measuring signal does not change in the period of time set here, an alarm is triggered. Monitoring limit: 0.3 % of mean value over selected period of time. (Error no.: E152.)

7.4.6 Relay configuration

There are three ways to configure the relay (selection in field R1) on devices with remote parameter set configuration:

- **Alarm**

The relay closes the contact 41/42 (current-free, safe state) as soon as an alarm occurs and the setting in the "Fault-signaling contact" column is "Yes". These settings can be changed as required (field F5 ff).

- **Limit value**

The relay only closes the contact 42/43 if one of the defined limits is exceeded or undershot (\rightarrow  37), but not when an alarm occurs.

- **Alarm + limit value**

The relay closes the contact 41/42 if an alarm occurs. When a limit value is exceeded, the relay only closes this contact if error E067 is set to "Yes" during relay assignment (field F6).

Please refer to the switch states in \rightarrow  37 for a graphic representation of the relay contact states.

- When measured values increase (maximum function), the relay goes into alarm state (limit exceeded) at time t_2 after the switch-on point (t_1) has been exceeded and the pickup delay ($t_2 - t_1$) has elapsed.
- When measured values decrease, the relay returns to the normal state when the measured value drops below the switch-off point and once the dropout delay ($t_4 - t_3$) has elapsed.
- If the pickup and dropout delays are set to 0 s, the switch-on and switch-off points are also switch points of the contacts. Settings for a minimum function can be made in the same way as for a maximum function.

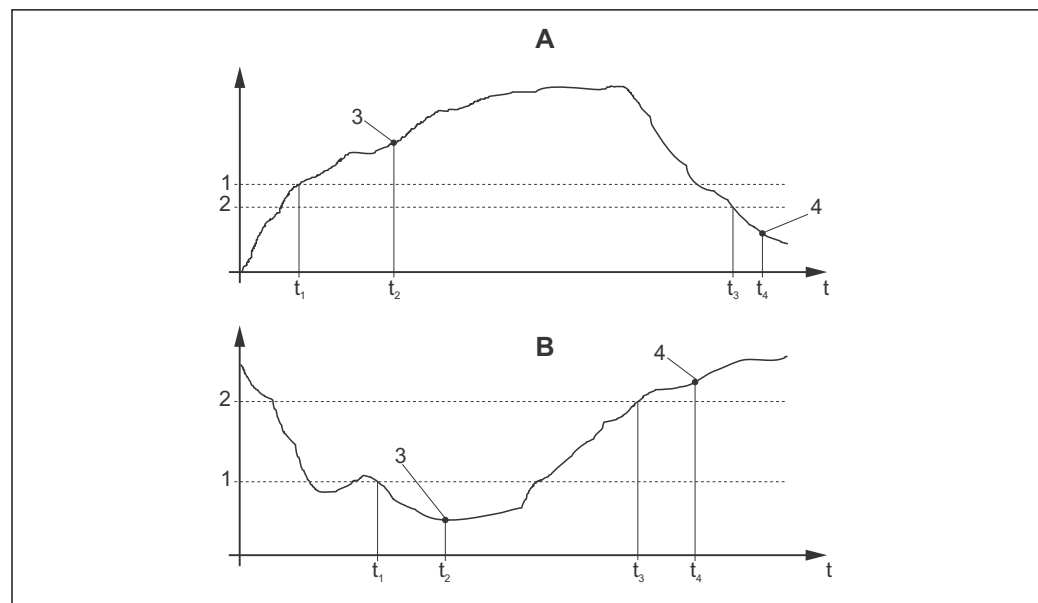



 37 Relation between switch-on and switch-off points and pickup and dropout delays

- A Switch-on point > switch-off point: Max. function
- B Switch-on point < switch-off point: Min. function
- 1 Switch-on point
- 2 Switch-off value
- 3 Contact ON
- 4 Contact OFF

Relay function group

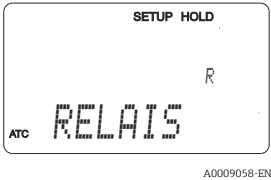
Functions marked in italics are not supported by the basic device version.

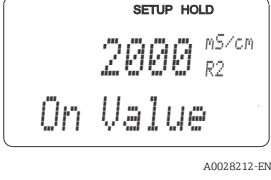
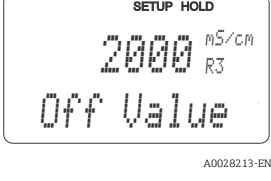
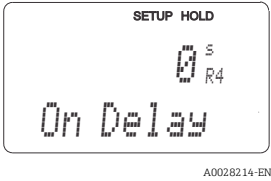
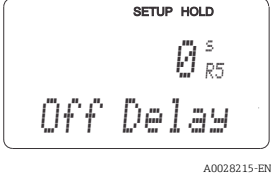
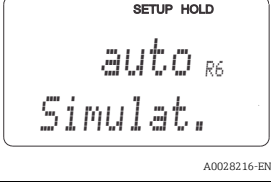
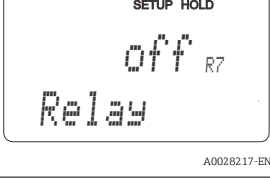
Coding	Field	Range of adjustment (factory settings in bold)	Display	Info
R	RELAY			Relay contact settings
R1	Select the function	Alarm LV alarm limit (al+li)		If "Alarm" is selected, fields R2 to R5 are not relevant. LV = limit value
R2	Enter the switch-on point of the contact	Cond: 2000 mS/cm Conc: 99.99 % Entire measuring range		Only the operating mode selected in A1 is displayed. i Never set the switch-on point and the switch-off point to the same value!
R3	Enter the switch-off point of the contact	Cond: 2000 mS/cm Conc: 99.99 % Entire measuring range		By entering the switch-off point, either a max. contact (switch-off point < switch-on point) or a min. contact (switch-off point > switch-on point) is selected and a hysteresis function which is always required is implemented.
R4	Enter pickup delay	0 s 0 to 2000 s		
R5	Enter dropout delay	0 s 0 to 2000 s		
R6	Select simulation	Auto Manual		A selection can only be made if limit value has been selected in R1.
R7	Switch relay on or off	Off On		A selection can only be made if manual has been selected in R6. The relay can be switched on and off.

7.4.7 Temperature compensation with table

With this function group, you can perform temperature compensation with a table (field B2 in the SETUP 2 function group).

Enter the α -T value pairs in the T5 and T6 fields.

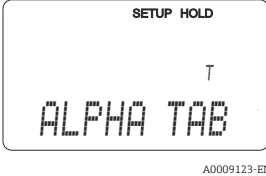
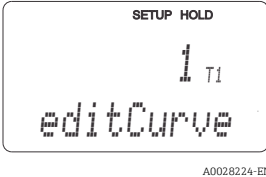
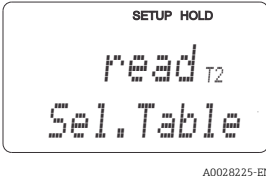
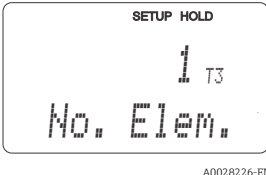
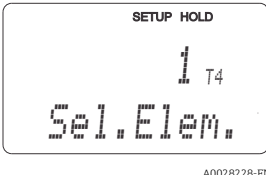
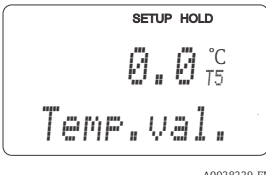
Coding	Field	Range of adjustment (factory settings in bold)	Display	Info
T	ALPHA TABLE function group		 A0009123-EN	Settings for temperature compensation.
T1	Select the table	1 1 to 4	 A0028224-EN	Select the table to be edited. Options 1 to 4 are only available if the device is equipped with the additional "remote parameter set configuration" function.
T2	Select table option	Read Edit	 A0028225-EN	
T3	Enter number of table value pairs	1 1 to 10	 A0028226-EN	Up to 10 value pairs can be entered in the α table. These pairs are numbered from 1 to 10 and can be edited individually or consecutively.
T4	Select table value pair	1 1 to number of table value pairs Assign	 A0028228-EN	"Assign" takes the user to T8.
T5	Enter temperature value	0.0 °C -10.0 to 150.0 °C	 A0028229-EN	The temperature values must be at least 1 K apart. Factory setting for the temperature value in the table value pairs: 0.0 °C; 10.0 °C; 20.0 °C; 30.0 °C ...

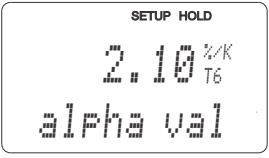
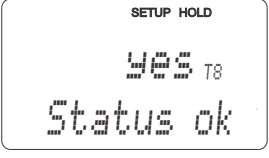
Coding	Field	Range of adjustment (factory settings in bold)	Display	Info
T6	Enter temperature coefficient α	2.10 %/K 0.00 to 20.00 %/K	 <p>SETUP HOLD 2.10 ^{%/K} T6 alpha val <small>A0028230-EN</small></p>	
T8	Message as to whether table status is OK	Yes No	 <p>SETUP HOLD YES T8 Status ok <small>A0028231-EN</small></p>	"Yes" takes the user back to T. "No" takes the user back to T3.

7.4.8 Concentration measurement

The transmitter can convert from conductivity values to concentration values. For this purpose, the operating mode is first set to concentration measurement (see field A1).

In the measuring device you must enter the basic data on the basis of which the concentration is to be calculated. For the most common substances, the required data are already saved in your device. You can select one of these substances in field K1.

If you want to determine the concentration of a sample that is not saved in the device, you need the conductivity characteristics of the medium. You can either refer to your data sheets for these characteristic curves or determine the characteristic curves yourself.

1. Create samples of the medium in the concentrations that occur in the process.
2. Then measure the uncompensated conductivity of these samples at temperatures that also occur in the process. To get the uncompensated conductivity, press the PLUS key several times in measuring mode (see the "Function of the keys" section) or deactivate temperature compensation (Setup 2, field B 2).

- For variable process temperatures:

If variable process temperatures should be taken into consideration, you must measure the conductivity of each sample created at two temperatures at least (ideally the minimum and maximum process temperature). The temperature values of the various samples must be identical in each case. The temperatures must be at least 0.5 °C apart.

At least two samples of different concentrations, taken at two different temperatures in each case, are required as the transmitter needs at least four points in the table (this must include the minimum and maximum concentration values).

- For constant process temperatures:

Measure the differently concentrated samples at this temperature. At least two samples are required.

At the end you should have measuring data which resemble those shown in the following figures.

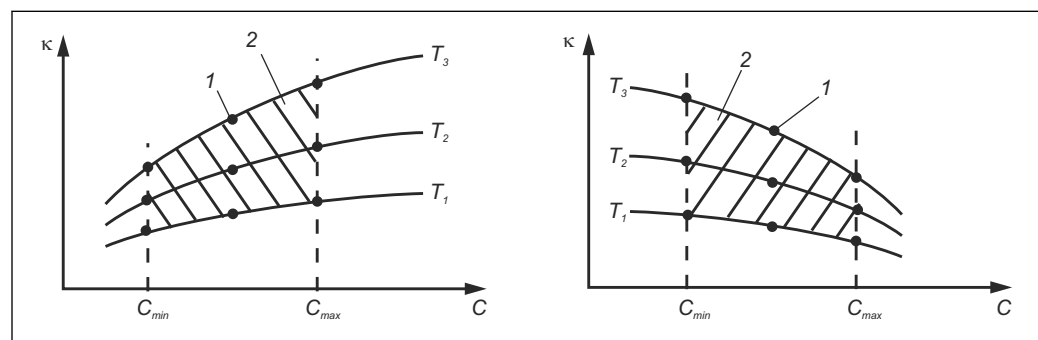

38 Example of measured data for variable temperatures

- κ Conductivity
- C Concentration
- T Temperature
- 1 Measuring point
- 2 Measuring range

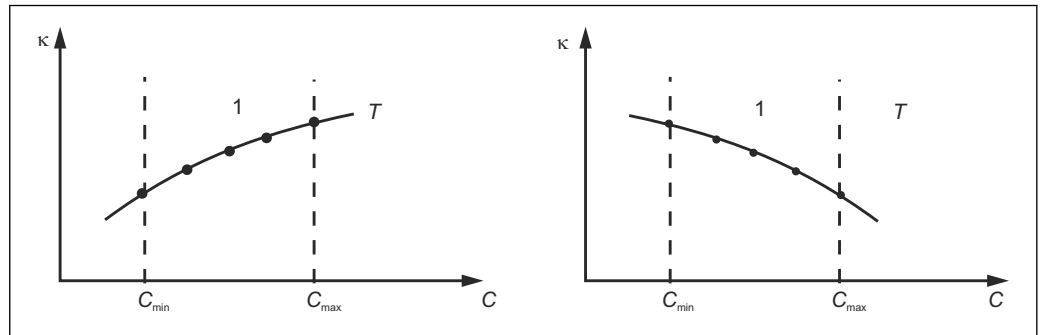

39 Example of measured data for constant temperatures

- κ Conductivity
- C Concentration
- T Constant temperature
- 1 Measuring range

The characteristic curves received from the measuring points must increase or decrease very monotonically in the range of the process conditions, i.e. neither maximum points, nor minimum points, nor ranges with a constant behavior can occur. The curve profiles opposite are therefore not permitted.

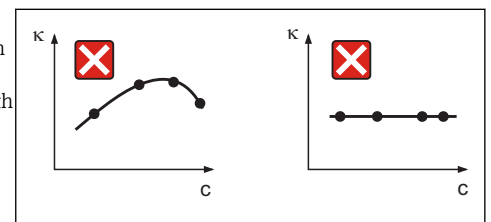

40 Impermissible curve profiles

- κ Conductivity
- C Concentration

Value entry



Enter the three characteristic values for each measured sample in the fields K6 to K8 (value triplets of uncompensated conductivity, temperature and concentration).

- Variable process temperature:
Enter at least the four value triplets needed.
- Constant process temperature:
Enter at least the two value triplets needed.

- If the measured values for conductivity and temperature in measuring operation are outside the values entered in the concentration table, the accuracy of the concentration measurement deteriorates considerably and error message E078 or E079 is displayed. Therefore, take the limit values of your process into consideration when determining the characteristic curves.
If you enter an additional value triplet of 0 μS/cm and 0% for every temperature used when the characteristic curve is increasing, you can work from the start of the measuring range with sufficient accuracy and without an error message.
- Temperature compensation of the concentration measurement is performed automatically with the tables entered. Therefore, the temperature coefficient entered in "Setup 2" is not active here.

mS/cm	%	°C (°F)
240	96	60 (140)
380	96	90 (194)
220	97	60 (140)
340	97	90 (194)
120	99	60 (140)
200	99	90 (194)

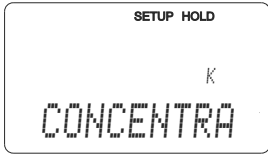
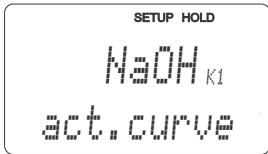
Concentration function group

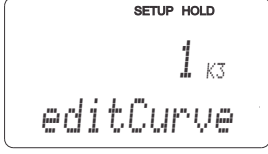
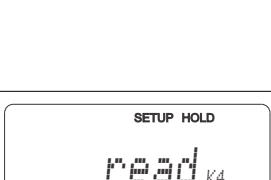
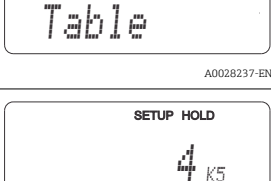
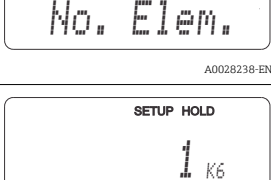
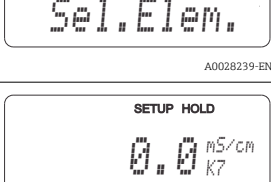
Coding	Field	Range of adjustment (factory settings in bold)	Display	Info
K	CONCENTRATION function group		 A0009113-EN	Settings for concentration measurement. Four fixed and four editable concentration fields are stored in this function group.
K1	Select the concentration curve on which the calculation of the display value is based	NaOH 0 to 15 % H ₂ SO ₄ 0 to 30 % H ₃ PO ₄ 0 to 15 % HNO ₃ 0 to 25 % Tab 1 to 4	 A0028234-EN	The User Tables 2 to 4 option is only available if the device is equipped with the additional "remote parameter set configuration" function.
K2	Select the correction factor	1 0.5 to 1.5	 A0028235-EN	Select a correction factor if necessary (only possible for a user table).
K3	Select the table to be edited	1 1 to 4	 A0028236-EN	If a curve is being edited, another curve should be used to calculate the current display values (see K1). Options 1 to 4 can only be selected if the device is equipped with the additional "remote parameter set configuration" function.
K4	Select table option	Read Edit	 A0028237-EN	This option is valid for all concentration curves.
K5	Enter number of reference triplets	4 1 ... 16	 A0028238-EN	Each triplet consists of three numeric values.
K6	Select triplet	1 1 to number of triplets in K4 Assign	 A0028239-EN	Any triplet can be edited. "Assign" takes the user to K10
K7	Enter uncompensated conductivity value	0.0 mS/cm 0.0 to 9999 mS/cm	 A0028240-EN	

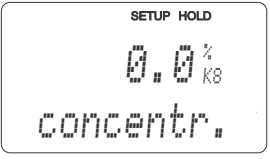
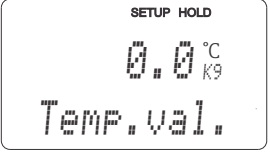
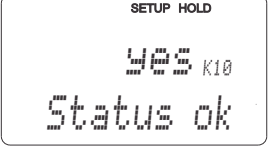
Coding	Field	Range of adjustment (factory settings in bold)	Display	Info
K8	Enter concentration value for K6	0.00 % 0.00 to 99.99 %	 <p>SETUP HOLD 0.00% K8 concentr.</p> <p><small>A0028241-EN</small></p>	
K9	Enter temperature value for K6	0.0 °C -35.0 to 250.0 °C	 <p>SETUP HOLD 0.0°C K9 Temp. val.</p> <p><small>A0028242-EN</small></p>	
K10	Message as to whether table status is OK	Yes No	 <p>SETUP HOLD YES K10 Status ok</p> <p><small>A0028243-EN</small></p>	Back to K.

7.4.9 Service

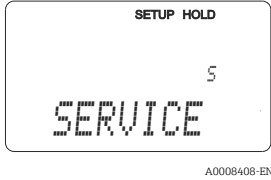
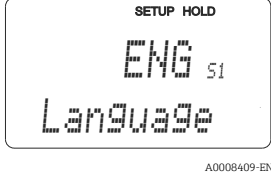
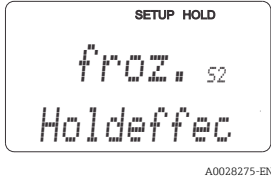
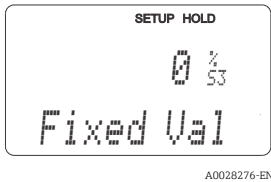
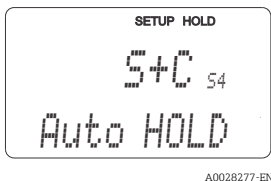
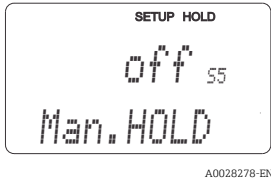
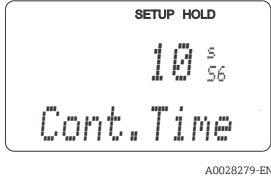
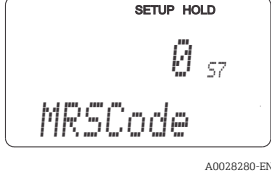
Coding	Field	Range of adjustment (factory settings in bold)	Display	Info
S	SERVICE function group		 The display shows 'SETUP HOLD' at the top, the number '5' in the middle, and 'SERVICE' at the bottom. A small reference code 'A0008408-EN' is at the bottom right.	Service function settings.
S1	Select language	ENG = English GER = German FRA = French ITA = Italian NL = Dutch ESP = Spanish	 The display shows 'SETUP HOLD' at the top, 'ENG 51' in the middle, and 'Language' at the bottom. A small reference code 'A0008409-EN' is at the bottom right.	This field must be configured once during device configuration. Then you can exit S1 and continue.
S2	HOLD effect	froz. = last value fix = fixed value	 The display shows 'SETUP HOLD' at the top, 'froz. 52' in the middle, and 'Holdeffec' at the bottom. A small reference code 'A0028275-EN' is at the bottom right.	Last: display shows the last value before the device switched to hold. Fixed: when a hold is active, a fixed value specified in S3 is displayed.
S3	Enter the fixed value	0 0 to 100 % (of the current output value)	 The display shows 'SETUP HOLD' at the top, '0 53' in the middle, and 'Fixed Val' at the bottom. A small reference code 'A0028276-EN' is at the bottom right.	Only if S2 = fixed value
S4	Configure a hold	S+C = setup and calibrate CAL = calibrate Setup = configure None = no hold	 The display shows 'SETUP HOLD' at the top, 'S+C 54' in the middle, and 'Auto HOLD' at the bottom. A small reference code 'A0028277-EN' is at the bottom right.	S = setup C = calibration
S5	Manual hold	Off On	 The display shows 'SETUP HOLD' at the top, 'off 55' in the middle, and 'Man.HOLD' at the bottom. A small reference code 'A0028278-EN' is at the bottom right.	
S6	Enter hold dwell period	10 s 0 to 999 s	 The display shows 'SETUP HOLD' at the top, '10 56' in the middle, and 'Cont. Time' at the bottom. A small reference code 'A0028279-EN' is at the bottom right.	
S7	SW upgrade Enter the release code for remote parameter set configuration	0 0 ... 9999	 The display shows 'SETUP HOLD' at the top, '0 57' in the middle, and 'MRSCode' at the bottom. A small reference code 'A0028280-EN' is at the bottom right.	If an incorrect code is entered, you are taken back to the measurement menu. The number is edited with the PLUS or MINUS key and confirmed with the ENTER key.

Coding	Field	Range of adjustment (factory settings in bold)	Display	Info
S8	Order number is displayed		<p>SETUP HOLD order 58 CLD134-xx A0005842-EN</p>	If the device is upgraded, the order code is not changed automatically.
S9	Serial number is displayed		<p>SETUP HOLD SerNo 59 XXXXXXXX A0028281-EN</p>	
S10	Reset the device to the basic settings	No Sens = sensor data Facy = factory settings	<p>SETUP HOLD NO 510 S.Default A0028282-EN</p>	<p>Sens = sensor data are cleared (temperature offset, air set value, cell constant, installation factor) Facy = all the data are cleared and reset to the factory setting!</p> <p>i Following a reset, set the cell constant (field A5) to 6.3 and the temperature sensor (field B1) to Pt1k.</p>
S11	Perform device test	No Displ = display test	<p>SETUP HOLD NO 511 Test A0028283-EN</p>	

7.4.10 E+H Service

Coding	Field	Range of adjustment (factory settings in bold)	Display	Info
E	E+H SERVICE function group		<p>SETUP HOLD E E+H SERV A0007857-EN</p>	Settings for E+H Service
E1	Select module	Contr = controller (1) Trans = transmitter (2) MainB = mainboard (3) Sens = sensor (4)	<p>SETUP HOLD Contr E1 Select A0007858-EN</p>	
E111 E121 E131 E141	The software version is displayed		<p>SETUP HOLD XX.XX E111 SW-Vers. A0007859-EN</p>	E111: device software version E121-141: module firmware version (if available)

Coding	Field	Range of adjustment (factory settings in bold)	Display	Info
E112 E122 E132 E142	Hardware version is displayed		<p>A0007861-EN</p>	Cannot be edited
E113 E123 E133 E143	Serial number is displayed		<p>A0007860-EN</p>	Cannot be edited
E145 E146 E147 E148	Enter and accept the serial number		<p>A0028284-EN</p>	

7.4.11 Interfaces

Coding	Field	Range of adjustment (factory settings in bold)	Display	Info
I	INTERFACE function group		<p>A0007863-EN</p>	Communication settings (only for HART or PROFIBUS device version).
I1	Enter bus address	Address HART: 0 to 15 or PROFIBUS: 0 to 126	<p>A0007864-EN</p>	Each address may only be assigned once in a network. If a device address ≠ 0 is selected for a HART device, the current output is automatically set to 4 mA and the device prepares for multi-drop operation.
I2	The tag name is displayed		<p>A0007865-EN</p>	

7.4.12 Determination of the temperature coefficient

The temperature coefficient can only be determined using the method below on devices equipped with the remote parameter set configuration function (measuring range switching, MRS), (see "Product structure"). Standard device versions can be upgraded to include the remote parameter set configuration function (see the "Accessories" section).

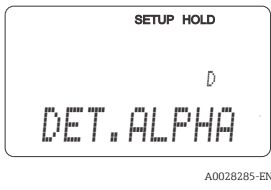
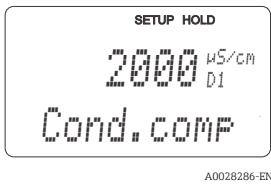
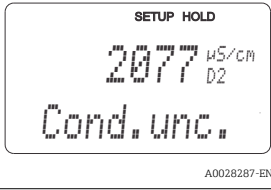
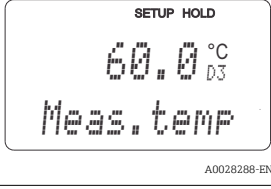
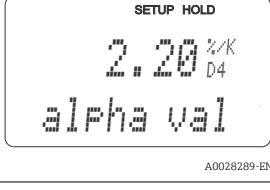
Coding	Field	Range of adjustment (factory settings in bold)	Display	Info
D	TEMPERATURE COEFFICIENT			Settings for the temperature coefficient. Calculator function: the α -value is calculated from the compensated value + uncompensated value + temperature value.
D1	Enter the compensated conductivity	Current value 0 to 9999		Displays the current compensated conductivity. Edit the value to the target value (e.g. from a comparison measurement).
D2	The uncompensated conductivity is displayed	Current value 0 to 9999		The current value for uncompensated conductivity cannot be edited.
D3	Enter the current temperature	Current value -35.0 to 250.0 °C		
D4	The determined α -value is displayed			Used in B3, for example. The value must be entered manually.

7.4.13 Remote parameter set configuration (measuring range switching, MRS)

You can order remote parameter set configuration via binary inputs either directly when ordering the device (see "Product structure") or subsequently after purchasing the device (see the "Accessories" section).

Complete parameter sets for up to 4 substances can be entered with the remote parameter set configuration function.

The following can be set individually for each parameter set:

- Operating mode (conductivity or concentration)
- Temperature compensation
- Current output (main parameter and temperature)
- Concentration table
- Limit relay

Assignment of binary inputs

The transmitter has two binary inputs. They can be defined in field M1 as follows:



Assignment of field M1	Assignment of binary inputs
M1 = 0	No MRS active. Binary input 1 can be used for an external hold.
M1 = 1	Binary input 2 can be used to switch between 2 parameter sets (measuring ranges). Binary input 1 can be used for an external hold.
M1 = 2	Binary inputs 1 and 2 can be used to switch between 4 parameter sets (measuring ranges). This is the setting used in the following example.



Setting of 4 parameter sets

Example: CIP cleaning

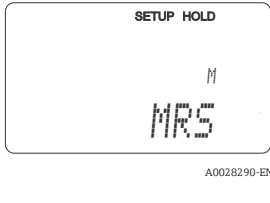
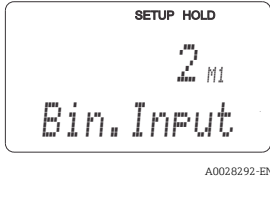
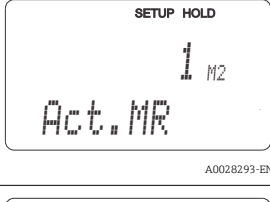
Binary input 1		0	0	1	1
Binary input 2		0	1	0	1
	Parameter set	1	2	3	4
Coding / software field	Medium	Beer	Water	Alkali	Acid
M4	Mode of operation	Conductivity	Conductivity	Concentration	Concentration
M8, M9	Current output	1 to 3 mS/cm	0.1 to 0.8 mS/cm	0.5 to 5%	0.5 to 1.5 %
M6	Temp.comp.	User tab. 1	Linear	-	-
M5	Conc.tab.	-	-	NaOH	User tab.
M10, M11	Limit values	On: 2.3 mS/cm Off: 2.5 mS/cm	On: 0.7 µS/cm Off: 0.8 µS/cm	On: 2 % Off: 2.1 %	On: 1.3 % Off: 1.4 %

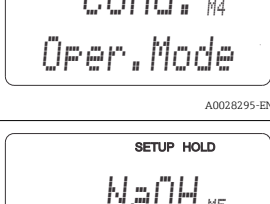
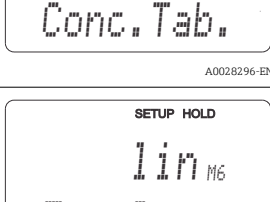
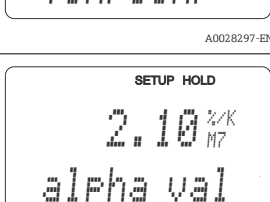
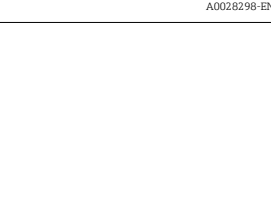
MRS function group (remote parameter set configuration)

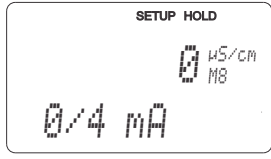
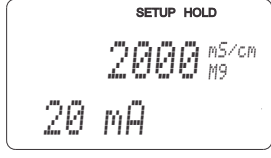
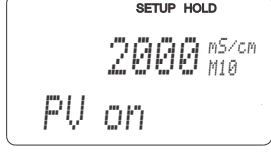
Coding	Field	Range of adjustment (factory settings in bold)	Display	Info
M	MRS (remote parameter set configuration)		 <p>A0028290-EN</p>	Settings for remote parameter set configuration. M1 + M2: apply to the measuring mode M3 to M11: apply to the configuration of the parameter sets
M1	Select the binary inputs	1 0, 1, 2	 <p>A0028292-EN</p>	0 = no MRS 1 = 2 parameter sets can be selected via binary input 2. Binary input 1 for hold. 2 = 4 parameter sets can be selected via binary inputs 1+2.
M2	Display active parameter set or if M1 = 0 select the active parameter set	1 1 to 4 if M1 = 0	 <p>A0028293-EN</p>	Select if M1 = 0. Display depends on binary inputs if M1 = 1 or 2
M3	Select parameter set to be configured in M4 to M8	1 1 to 4 if M1=0 1 to 2 if M1=1 1 to 4 if M1=2	 <p>A0028294-EN</p>	Selection of the parameter set to be defined (the active parameter set is selected in M2 or with the binary inputs).
M4	Select operating mode	Cond = conductivity Conc = concentration	 <p>A0028295-EN</p>	The operating mode can be defined individually for each parameter set.
M5	Select medium	NaOH , H2SO4, H3PO4, HNO3 Tab 1 to 4	 <p>A0028296-EN</p>	Can only be selected if M4 = conc
M6	Select temperature compensation	None, lin , NaCl, Tab 1 to 4 if M4 = cond	 <p>A0028297-EN</p>	Can only be selected if M4 = cond
M7	Enter α-value	2.10 %/K 0 to 20 %/K	 <p>A0028298-EN</p>	Can only be entered if M6 = lin

Coding	Field	Range of adjustment (factory settings in bold)	Display	Info
M8	Enter the measured value for the 0/4 mA value	Cond.: 0 to 2000 mS/cm Conc.: unit: A2, format: A3	 A0028299-EN	
M9	Enter the measured value for the 20 mA value	Cond.: 0 to 2000 mS/cm Conc.: unit: A2, format: A3	 A0028300-EN	
M10	Enter the switch-on point for the limit value	Cond.: 0 to 2000 mS/cm Conc.: unit: A2, format: A3	 A0028301-EN	
M11	Enter the switch-off point for the limit value	Cond.: 0 to 2000 mS/cm Conc.: unit: A2, format: A3	 A0028302-EN	By entering the switch-off point, either a max. contact (switch-off point < switch-on point) or a min. contact (switch-off point > switch-on point) is selected and a hysteresis function is implemented. It is not permitted to set the switch-off point to equal the switch-on point.

 If remote parameter set configuration is selected, the parameter sets that are entered are processed internally but the values of the first measuring range are displayed in the fields A1, B1, B3, R2, K1, O212, O213.

7.4.14 Calibration



Use the CAL key to access the calibration function group.



Use this function group to calibrate and adjust the transmitter. The calibration can be performed in two different ways:

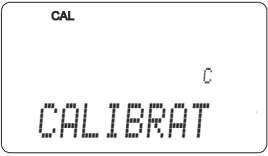

- By measuring in a calibration solution of known conductivity.
- By entering the exact cell constant of the conductivity sensor.

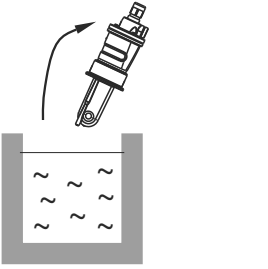
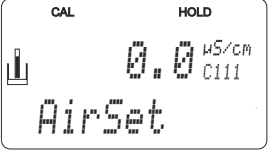
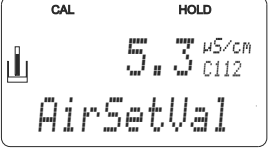
Please note the following:

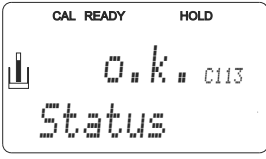
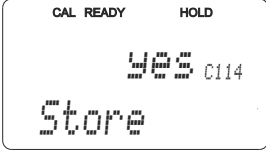
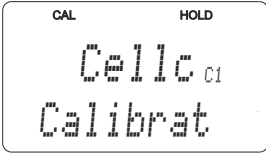
- During initial commissioning of inductive sensors, an air set is absolutely essential for residual coupling compensation (from field C111) so that the measuring system can return precise measurement data.
- If the calibration is aborted by simultaneously pressing the PLUS and MINUS keys (return to C114, C126 or C136), or if the calibration is incorrect, the original calibration data are used again. A calibration error is indicated by “ERR” and the sensor symbol flashes on the display. Repeat calibration!
- For each calibration, the device automatically switches to hold (factory setting).

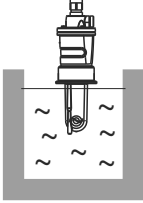
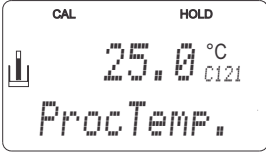
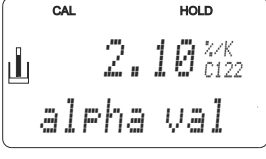
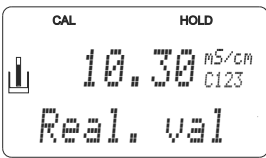
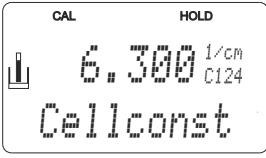
Coding	Field	Range of adjustment (factory settings in bold)	Display	Info
C	CALIBRATION function group:		 <small>A0009141-EN</small>	Settings for calibration.
C1(1)	Compensation of residual coupling	Airs = air set (1) Cellc = cell constant (2) InstF = installation factor (3)	 <small>A0009142-EN</small>	When commissioning inductive sensors, an air set is mandatory . The sensor air set must be performed in air. The sensor must be dry.
Remove the sensor from the liquid and dry it completely.			 <small>A0005690</small>	
C111	Residual coupling start calibration (air set)	Current measured value	 <small>A0009145-EN</small>	Press CAL to start the calibration.
C112	The residual coupling is displayed (air set)	-80.0 to 80.0 µS/cm	 <small>A0009146-EN</small>	Residual coupling of measuring system (sensor and transmitter).

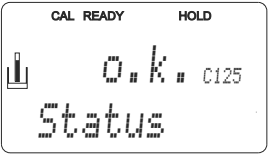
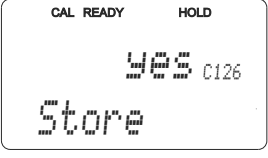
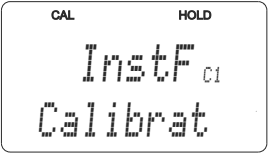
Coding	Field	Range of adjustment (factory settings in bold)	Display	Info
C113	Calibration status is displayed	o.k. E xxx	 <small>A0009147-EN</small>	If the calibration status is not o.k., a reason for the error is provided on the second line of the display.
C114	Store calibration result?	Yes No New	 <small>A0009148-EN</small>	If C113 = E xxx, then only No or New . If New, return to C. If Yes/No, return to "Measurement".
C1(2)	Cell constant calibration	Airs = air set (1) Cellc = cell constant (2) InstF = installation factor (3)	 <small>A0009143-EN</small>	The sensor should be immersed in such a way that there is sufficient distance to the vessel wall (the installation factor has no influence if a > 15 mm).
	Immerse the sensor in the calibration solution.  The following section describes calibration with the temperature-compensated conductivity value of the reference solution. If calibration is to be performed with the uncompensated conductivity value, you must set the temperature coefficient α to zero.		 <small>A0005691</small>	
C121	Enter calibration temperature (MTC)	25 °C -35.0 to 250.0 °C	 <small>A0028303-EN</small>	Only available if B1 = fixed.
C122	Enter the α value of the calibration solution	2.10 %/K 0.00 to 20.00 %/K	 <small>A0009150-EN</small>	The value is given in the Technical Information for all E+H calibration solutions. You can also use the printed-on table to calculate the value. Set α to 0 for calibration with uncompensated values.
C123	Enter the correct conductivity value of the calibration solution	Current measured value 0.0 μ S/cm to 9999 mS/cm	 <small>A0009151-EN</small>	The value is always displayed in mS/cm.
C124	The calculated cell constant is displayed	0.1 ... 6.3 ... 99.99 cm^{-1}	 <small>A0005846-EN</small>	The calculated cell constant is displayed and accepted in A5.

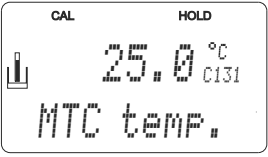
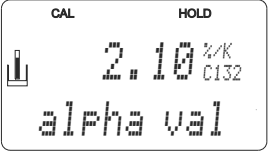
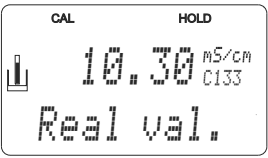
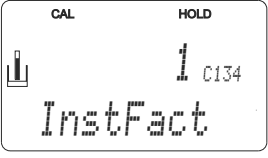
Coding	Field	Range of adjustment (factory settings in bold)	Display	Info
C125	Calibration status is displayed	o.k. E xxx	 <p style="text-align: right; font-size: small;">A0009153-EN</p>	If the calibration status is not o.k., a reason for the error is provided on the second line of the display.
C126	Store calibration result?	Yes No New	 <p style="text-align: right; font-size: small;">A0009154-EN</p>	If C125 = E xxx, then only No or New . If New, return to C. If Yes/No, return to "Measurement".
C1(3)	Calibration with sensor matching for inductive sensors	Airs = air set (1) Cellc = cell constant (2) InstF = installation factor (3)	 <p style="text-align: right; font-size: small;">A0009144-EN</p>	Sensor adjustment with compensation for wall effects. The measured value is influenced by the distance between the sensor and the pipe wall and by the material of the pipe (conductive or insulating). The installation factor indicates these dependencies. See the "Installation instructions" section.
The sensor is installed at the place of operation.			 <p style="text-align: right; font-size: small;">A0005693</p>	
C131	Enter the process temperature (MTC)	25 °C -35.0 to 250.0 °C	 <p style="text-align: right; font-size: small;">A0009155-EN</p>	Only available if B1 = fixed.
C132	Enter the α value of the calibration solution	2.10 %/K 0.00 to 20.00 %/K	 <p style="text-align: right; font-size: small;">A0009156-EN</p>	The value is given in the TI for all E+H calibration solutions. You can also use the printed-on table to calculate the value. Set α to 0 for calibration with uncompensated values.
C133	Enter the correct conductivity value of the calibration solution	Current measured value 0.0 μS/cm to 9999 mS/cm	 <p style="text-align: right; font-size: small;">A0009157-EN</p>	Determine the correct conductivity value of the medium by performing a reference measurement.
C134	Calculated installation factor is displayed	1 0.10 to 5.00	 <p style="text-align: right; font-size: small;">A0009158-EN</p>	

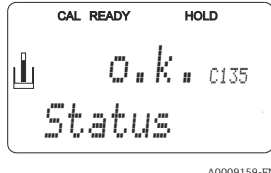
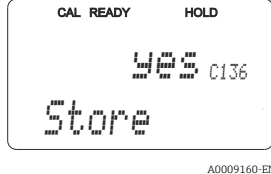
Coding	Field	Range of adjustment (factory settings in bold)	Display	Info
C135	Calibration status is displayed	o.k. E xxx		If the calibration status is not o.k., a reason for the error is provided on the second line of the display.
C136	Store calibration result?	Yes No New		If C135 = E xxx, then only No or New . If New, return to C. If Yes/No, return to "Measurement".

7.4.15 Communication interfaces

For devices with a communication interface, please also refer to the separate Operating Instructions BA00212C/07/EN (HART) or BA00213C/07/EN (PROFIBUS).

8 Diagnostics and troubleshooting

8.1 Trouble shooting instructions

The transmitter continuously monitors its functions itself. If an error occurs which the device recognizes, this is indicated on the display. The error number is shown below the display of the main measured value. If more than one error occurs, you can call these up with the MINUS key.

Refer to the "System error messages" table for the possible error numbers and remedial measures.

Should a malfunction occur without any transmitter error message, please refer to the "Process-specific errors" or the "Device-specific errors" tables to localize and rectify the error. These tables provide you with additional information on any spare parts required.

8.2 System error messages

You can display and select the error messages with the MINUS key.

Error No.	User interface	Tests/remedial action	Alarm contact		Error current	
			Facty	User	Facty	User
E001	EEPROM memory error	<ul style="list-style-type: none"> ▪ Switch off device and switch it on again. 	Yes		No	
E002	Device not calibrated, calibration data invalid, no user data or user data invalid (EEPROM error), device software not suitable for hardware (controller)	<ul style="list-style-type: none"> ▪ Load software compatible with hardware. ▪ Load measurement-parameter specific device software. ▪ If the error persists, send in the device for repair to your local sales center or replace the device. 	Yes		No	
E003	Download error	The download file may not access locked functions (e.g. temperature table in basic version)	Yes		No	
E007	Transmitter malfunction, device software not compatible with transmitter version		Yes		No	
E008	Sensor or sensor connection faulty	Check sensor and sensor connection (see the "Device check by medium simulation" section or contact E+H Service).	Yes		No	
E010	No temperature sensor connected or temperature sensor short-circuited (temperature sensor faulty)	Check temperature sensor and connections; where necessary check the measuring device with a temperature simulator.	Yes		No	
E025	Limit value for air set offset exceeded	Repeat air set (in air) or replace sensor. Clean and dry the cell before the air set.	Yes		No	

Error No.	User interface	Tests/remedial action	Alarm contact		Error current	
			Facty	User	Facty	User
E036	Calibration range of sensor exceeded	Clean sensor and recalibrate; if necessary, check the sensor, cable and connections.	Yes		No	
E037	Below calibration range of sensor		Yes		No	
E045	Calibration aborted	Repeat the calibration.	Yes		No	
E049	Calibration range of installation factor exceeded	Check pipe diameter, clean sensor and perform calibration again.	Yes		No	
E050	Below calibration range of installation factor		Yes		No	
E055	Below main parameter measuring range	Immerse the sensor in conductive medium or perform an air set.	Yes		No	
E057	Main parameter measuring range exceeded	Check measurement, control and connections (for simulation, see the "Device check by medium simulation" section).	Yes		No	
E059	Below temperature measuring range		Yes		No	
E061	Temperature measuring range exceeded		Yes		No	
E063	Below current output range 1	Check measured value and current output assignment (function group O).	Yes		No	
E064	Current output range 1 exceeded		Yes		No	
E065	Below current output range 2	Check measured value and current output assignment.	Yes		No	
E066	Current output range 2 exceeded		Yes		No	
E067	Limit contactor set value exceeded	Check measured value, limit setting and metering devices. Only active if R1 = alarm +LV or LV.	Yes		No	
E077	Temperature outside a value table range	Check measurement and tables.	Yes		No	
E078	Temperature outside concentration table		Yes		No	
E079	Conductivity outside concentration table		Yes		No	
E080	Parameter range of current output 1 too small	Spread current output.	No		No	
E081	Parameter range of current output 2 too small	Spread current output.	No		No	
E100	Current simulation active		No		No	
E101	Service function yes	Switch off service function or switch device off and then on again.	No		No	
E102	Manual mode active		No		No	

Error No.	User interface	Tests/remedial action	Alarm contact		Error current	
			Facty	User	Facty	User
E106	Download yes	Wait for download to finish.	No		No	
E116	Download error	Repeat download.	No		No	
E150	Distance between temperature values in α value table too small	Enter correct α value table (temperatures must be entered at intervals of at least 1K).	No		No	
E152	Live check alarm	Check sensor and connection.	No		No	

8.3 Process-specific errors

Use the following table to localize and rectify any errors occurring.

Problem	Possible cause	Tests/remedial action	Tools, spare parts
Incorrect reading compared to comparison measurement	Device calibrated incorrectly	Calibrate the device according to the "Calibration" section	Calibration solution or cell certificate
	Sensor fouled	Clean sensor	See the "Cleaning of conductivity sensors" section
	Incorrect temperature measurement	Check temperature measured value in measuring device and reference device	Temperature measuring device, precision thermometer
	Temperature compensation incorrect	Check compensation method (none / ATC / MTC) and compensation type (linear/substance/user table)	Please note: the transmitter has separate calibration and operating temperature coefficients
	Reference device is calibrated incorrectly	Calibrate reference device or use verified device	Calibration solution, Operating Instructions of reference device
	Incorrect ATC setting in reference device	Compensation method and compensation type must be identical on both devices.	Operating Instructions of reference device
Implausible measured values in general: <ul style="list-style-type: none"> ■ Continuous measured value overflow ■ Measured value constantly 000 ■ Measured value too low ■ Measured value too high ■ Measured value frozen ■ Current output value not as expected 	Short-circuit/moisture in sensor	Check sensor	See the "Checking inductive conductivity sensors" section.
	Short-circuit in cable or socket	Check cable and socket	
	Disconnection in sensor	Check sensor	See the "Checking inductive conductivity sensors" section.
	Disconnection in cable or socket	Check cable and socket	
	Incorrect cell constant setting	Check cell constant	Sensor nameplate or certificate
	Incorrect output assignment	Check assignment of measured value to current signal	
	Incorrect output function	Check preset value (0-20 / 4 -20 mA) and curve shape (linear / table)	
	Air pockets in assembly	Check assembly and installation position	
	Incorrect temperature measurement/ temperature sensor defective	Check the device with an equivalent resistor / check Pt 1000 in the sensor.	
	Transmitter module defective	Check with new module	See the "Device-specific errors" and "Spare parts" sections.
Device in impermissible operating condition (does not respond when key pressed)	Switch off device and switch it on again	EMC problem: if this persists, check the grounding, shields and line routing or have checked by E+H Service.	
Incorrect conductivity	No/incorrect temperature compensation	ATC: select type of compensation; if linear, set suitable coefficients. MTC: set process temperature.	

Problem	Possible cause	Tests/remedial action	Tools, spare parts
measured value in the process	Incorrect temperature measurement	Check temperature measured value.	Reference device, thermometer
	Bubbles in medium	Suppress formation of bubbles by: <ul style="list-style-type: none"> ▪ Gas bubble trap ▪ Creating counterpressure (orifice plate) ▪ Measurement in bypass 	
	Incorrect sensor alignment	The central bore of the sensor must point in the flow direction of the medium.	Compact version: remove the electronics box to turn the sensor. Remote version: turn the sensor in the flange.
	Flow rate too high (can lead to bubble formation)	Reduce flow rate or select less turbulent mounting location.	
	Interference current in medium	Ground medium close to sensor; remove/repair source of interference.	Most frequent cause of currents in medium: defective submersible motors
	Sensor fouling or buildup on sensor	Clean sensor (see the "Cleaning the conductivity sensors" section).	For heavily contaminated media: Use spray cleaning
Incorrect temperature value	Incorrect sensor connection	Check connections using wiring diagram. Three-wire connection always required.	Wiring diagram, "Electrical connection" section
	Measuring cable defective	Check cable for interruptions/short-circuit/shunt.	Ohmmeter
	Incorrect sensor type	Set type of temperature sensor at the device (field B1).	
Fluctuations in measured value	Interference on measuring cable	Connect cable shield as per wiring diagram	See the "Electrical connection" section
	Interference on signal output cable	Check cable routing, possibly route cable separately	Route signal output and measuring input lines separately
	Interference current in medium	Eliminate source of interference or ground medium as close as possible to sensor.	
Limit contact not working	Relay configured for alarm	Activate limit value switch.	See field R1.
	Pickup delay setting too long	Shorten pickup delay time	See field R4.
	"Hold" function active	"Auto hold" for calibration, "Hold" input activated; "Hold" active via keyboard	See fields S2 to S5
Limit contact working constantly	Dropout delay setting too long	Shorten dropout delay time	See field R5.
	Control loop interruption	Check measured value, current output value, actuators, chemical supply	
No conductivity current output signal	Cable disconnected or short-circuited	Disconnect cable and measure directly at device	mA meter 0–20 mA
	Output defective	See the "Device-specific errors" section	
Fixed conductivity current output signal	Current simulation active	Switch off simulation.	See field O22

Problem	Possible cause	Tests/remedial action	Tools, spare parts
	Impermissible operating state of processor system	Switch off device and switch it on again.	EMC problem: if problem persists, check the installation, shielding and grounding or have checked by Endress +Hauser Service.
Incorrect current output signal	Incorrect current assignment	Check current assignment: 0–20 mA or 4–20 mA?	Field O211
	Total load in the current loop too high (> 500 Ω)	Disconnect output and measure directly at device	mA meter for 0–20 mA DC
	EMC (interference coupling)	Disconnect both output cables and measure directly at device	Use shielded cables, ground shields at both ends, where necessary route cable in another cable duct
No temperature output signal	Device does not have a second current output	Check version using nameplate, if necessary replace the LSCH-x1 module	LSCH-x2 module, see "Spare parts" section
	Device with PROFIBUS-PA	PA device has no current output!	
Extension package functions not available (Live check, current curve 2-4, alpha value curve 2-4, user concentration curve 1-4)	Extension package not enabled (enable by entering a code which depends on the serial number and which is supplied by Endress +Hauser when an extension package is ordered)	<ul style="list-style-type: none"> ▪ If retrofitting the E-Package: code is supplied by E+H → enter this code. ▪ After replacing a defective LSCH/ LSCP module: first enter device serial number manually (see nameplate), then enter the existing code number. 	For a detailed description, see the "Replacing the central module" section.
No HART communication	No HART central module	Verify using nameplate: HART = -xxx5xx and -xxx6xx	Upgrade to LSCH-H1 / -H2
	No or incorrect DD (device description)	For more information, see BA00212C/07/EN, "HART field communication with Smartec S CLD132".	
	HART interface missing		
	Current output < 4 mA		
	Load too small (must be > 230 Ω)		
	HART receiver (e.g. FXA 191) not connected via load but via power supply		
	Incorrect device address (addr. = 0 for single operation, addr. > 0 for multidrop operation)		
	Line capacitance too high		
	Interference on line		
	Several devices set to same address		
No PROFIBUS communication	No PA/DP central module	Check using the nameplate: PA = -xxx3xx /DP = xxx4xx	Upgrade to LSCP module, see the "Spare parts" section
	Incorrect device software version (without PROFIBUS)	For more information, see BA00213C/07/EN "PROFIBUS PA/DP - Field communication for Smartec S CLD132".	

Problem	Possible cause	Tests/remedial action	Tools, spare parts
	With Commuwin (CW) II: CW II version and device software version incompatible		
	No or incorrect DD/DLL		
	Incorrect baud rate setting for segment coupler in DPV-1 server		
	Bus user (master) has wrong address or address assigned twice		
	Bus user (slave) has wrong address		
	Bus line not terminated		
	Line problems (too long, cross-section too small, not shielded, shield not grounded, wires not twisted)		
	Bus voltage too low (Bus voltage typ. 24 V DC for non-Ex)	The voltage at the device's PA/DP connector must be at least 9 V	

8.4 Device-specific errors

The following table helps you during the diagnosis and points to any spare parts required.

Depending on the degree of difficulty and the measuring equipment present, diagnosis is carried out by:

- Trained operator personnel
- The user's trained electrical technicians
- Company responsible for system installation/operation
- Endress+Hauser Service

Information on the exact spare part designations and on how to install these parts can be found in the "Spare parts" section.

Problem	Possible cause	Tests/remedial action	Execution, tools, spare parts
Display dark, no light-emitting diode active	No line voltage	Check whether line voltage is present	Electrical technician / e.g. multimeter
	Supply voltage wrong/too low	Compare actual line voltage and nameplate data	User (data for energy supply company or multimeter)
	Connection faulty	<ul style="list-style-type: none"> ▪ Terminal not tightened ▪ Insulation jammed ▪ Wrong terminals used 	Electrical technician
	Device fuse defective	Compare line voltage and the nameplate data and replace fuse	Electrical technician/suitable fuse; see exploded drawing in the "Spare parts" section
	Power unit defective	Replace power unit, note version	Onsite diagnosis by Endress+Hauser Service, test module necessary
	Central module defective	Replace central module, note version	Onsite diagnosis by Endress+Hauser Service, replacement module necessary
	Ribbon cable between the central module and power supply unit loose or defective	Check ribbon cable, replace if necessary	See the "Spare parts" section
Display dark, light-emitting diode active	Central module defective (module: LSCH/LSCP)	Replace central module, note version	Onsite diagnosis by Endress+Hauser Service, test module necessary
Values appear on display but: <ul style="list-style-type: none"> ▪ Display does not change and / or ▪ Device cannot be operated 	Ribbon cable or transmitter module not mounted correctly	Reinsert the transmitter module, use additional fastening screw M3 if necessary. Check if ribbon cable is inserted correctly.	Perform using the installation drawings in the "Spare parts" section.
	Impermissible operating system condition	Switch off device and switch it on again.	Possible EMC problem: if this persists, check the installation or have checked by Endress+Hauser Service.
Device gets hot	Voltage wrong/too high	Compare line voltage and nameplate data	User, electrical technician
	Heating from process or solar radiation	Improve positioning or use the remote version. Use a sun guard outdoors.	
	Power unit defective	Replace power unit.	Diagnosis only by Endress+Hauser Service

Problem	Possible cause	Tests/remedial action	Execution, tools, spare parts
Incorrect conductivity measured value and/or temperature measured value	Transmitter module defective (module: MKIC), please first carry out tests and take measures as described in the "Process-specific errors" section.	Measuring input test: <ul style="list-style-type: none"> ■ Simulation with resistor, see table in the "Device check by medium simulation" section ■ 1000 Ω resistance at terminals 11/ 12 + 13 = display 0 °C 	If the test is negative: replace module (note version). Perform using the exploded drawings in the "Spare parts" section.
Incorrect current output signal	Incorrect adjustment	Test with built-in current simulation (field O221). For this, disconnect the two lines and connect the mA meter directly to the current output.	If simulation value incorrect: adjustment in factory or new LSCH/LSCP module required. If simulation value correct: check current loop for load and shunts.
	Load too large		
	Shunt / short to ground in current loop	Check whether 0–20 mA or 4–20 mA is selected.	
Incorrect mode of operation			
No current output signal	Current output stage defective (LSCH/LSCP module)	Test with built-in current simulation, connect the mA meter directly to the current output	If test negative: Replace central module (note version)
Additional functions missing (extended functions or measuring range switching)	No or incorrect release code used	If retrofitting: check whether the correct serial number was used when ordering the extended functions or the MRS.	Handled by Endress +Hauser Sales
	Incorrect device serial number saved in LSCH/LSCP module	Check whether serial number on the nameplate matches SNR in LSCH/ LSCP (field S 10).	The device serial number in the LSCH/LSCP module is required for the extended functions.
Additional functions (extended functions or measuring range switching) missing after replacement of LSCH/LSCP module	LSCH or LSCP replacement modules have the device serial number 0000 when they leave the factory. The Plus Package or Chemoclean are not enabled on leaving the factory.	For LSCH/LSCP with SNR 0000, a device serial number can be entered once in fields E115 to E118. Then enter the release code for the extension package.	For a detailed description, see the "Replacing the central module" section.
No HART or PROFIBUS PA/DP interface function	Incorrect central module	HART: LSCH-H1 or H2 module, PROFIBUS-PA: LSCP-PA module, PROFIBUS-DP: LSCP-DP module, See field E111 to 113.	Replace central module; User or Endress+Hauser Service.
	Incorrect device software	SW version, see field E111.	
	Incorrect configuration	See the troubleshooting list in the "Process-specific errors" section.	

9 Maintenance

⚠ WARNING

Process pressure and temperature, contamination, electrical voltage

Risk of serious or fatal injury

- ▶ If the sensor has to be removed during maintenance work, avoid hazards posed by pressure, temperature and contamination.
- ▶ Make sure the device is de-energized before you open it.
- ▶ Power can be supplied to switching contacts from separate circuits. De-energize these circuits before working on the terminals.

Take all the necessary precautions in time to ensure the operational safety and reliability of the entire measuring point.

The maintenance of the measuring point comprises:

- Calibration
- Cleaning the controller, assembly and sensor
- Checking the cables and connections

When performing any work on the device, bear in mind any potential impact this may have on the process control system or on the process itself.

NOTICE

Electrostatic discharge (ESD)

Risk of damaging the electronic components

- ▶ Take personal protective measures to avoid ESD, such as discharging beforehand at PE or permanent grounding with a wrist strap.
- ▶ For your own safety, only use genuine spare parts. With genuine parts, the function, accuracy and reliability are also ensured after maintenance work.

9.1 Maintenance of the entire measuring point

9.1.1 Cleaning the conductivity sensors

⚠ CAUTION

Risk of injury from cleaning agents, damage to clothing and equipment

- ▶ Wear protective goggles and safety gloves.
- ▶ Clean away splashes on clothes and other objects.
- ▶ Pay particular attention to the information provided in the safety data sheets for the chemicals used.

As there is no galvanic contact with the medium, inductive sensors are considerably less sensitive to dirt and fouling than conventional conductive sensors.

However, dirt can clog the measuring channel which, in turn, can alter the cell constant. In such cases, an inductive sensor also needs to be cleaned.

Clean away fouling on the sensor as follows depending on the type of fouling:

- Oily and greasy films:
Clean with grease remover, e.g. alcohol, acetone, possibly hot water and dishwashing detergent.
- Lime and metal hydroxide buildup:
Dissolve buildup with diluted hydrochloric acid (3 %) and then rinse thoroughly with plenty of clear water.
- Sulfidic buildup (from flue gas desulfurization or sewage treatment plants):
Use a mixture of hydrochloric acid (3 %) and thiocarbamide (commercially available) and then rinse thoroughly with plenty of clear water.
- Buildup containing proteins (e.g. food industry):
Use a mixture of hydrochloric acid (0.5 %) and pepsin (commercially available) and then rinse thoroughly with plenty of clear water.

9.1.2 Testing inductive conductivity sensors

The following applies for the CLS54 sensor.

The sensor cables must be disconnected at the device or junction box for all tests described here!

- Testing the transmitting and receiving coils:
 Measure between the inner connector and the shield at the white and red coaxial cables in the case of the remote version, and at the white and brown coaxial cables in the case of the compact version.

 - Ohmic resistance approx. 1 to 3 Ω.
 - Inductance approx. 180 to 500 mH (for 2 kHz, series circuit as equivalent circuit diagram)
- Testing the coil shunt:
 A shunt between the two sensor coils is not allowed. The resistance measured must be > 20 MΩ.
 Test with the ohmmeter from the brown or red coaxial cable to the white coaxial cable.
- Temperature sensor test:
 To test the Pt 1000 in the sensor, you can use the table in the "Device check by medium simulation" section.
 In the case of the remote sensor version, measure between the green and white wires and between the green and yellow wires. The resistance values must be identical.
 In the case of the compact version, measure between the two red strands.
- Temperature sensor shunt test:
 Shunts are not permitted between the temperature sensor and the coils. Check with ohmmeter for > 20 MΩ
 Measure between the temperature sensor wires (green + white + yellow or red + red) and the coils (red and white coaxial cable or brown and white coaxial cable).

9.1.3 Device check by medium simulation

The inductive sensor cannot be simulated.

However, the entire CLD134 measuring system including the inductive sensor can be tested using equivalent resistors. Note the cell constant $k_{\text{nominal}} = 6.3 \text{ cm}^{-1}$ for CLS54.

For accurate simulation, the actual cell constant used (visible in field C124) must be used to calculate the display value.

$$\text{Conductivity [mS/cm]} = k[\text{cm}^{-1}] \cdot 1/(\text{R[k}\Omega]) \cdot 1.21$$

Values for simulation with CLS54 at 25 °C (77 °F):

Simulation resistance R	Default cell constant k	Conductivity reading
10 Ω	6.3 cm ⁻¹	520 mS/cm
26 Ω	6.3 cm ⁻¹	200 mS/cm
100 Ω	6.3 cm ⁻¹	52 mS/cm
260 Ω	6.3 cm ⁻¹	20 mS/cm
2.6 kΩ	6.3 cm ⁻¹	2 mS/cm
26 kΩ	6.3 cm ⁻¹	200 μS/cm
52 kΩ	6.3 cm ⁻¹	100 μS/cm

Conductivity simulation:

Pull a cable through the sensor opening and then connect it to a decade resistor, for instance.

Temperature sensor simulation

The temperature sensor of the inductive sensor is connected to terminals 11, 12 and 13 on the device irrespective of whether this is a compact device or a remote device version.

For the simulation, the temperature sensor is disconnected from the sensor and an equivalent resistor is connected instead. This resistor must also be connected using a three-wire arrangement, i.e. connection to terminals 11 and 12 and a jumper between terminal 12 and 13.

The table shows some resistance values for temperature simulation:

Temperature	Resistance value
- 20 °C (-4 °F)	921.3 Ω
-10 °C (14 °F)	960.7 Ω
0 °C (32 °F)	1,000.0 Ω
10 °C (50 °F)	1,039.0 Ω
20 °C (68 °F)	1,077.9 Ω
25 °C (77 °F)	1,097.3 Ω
50 °C (122 °F)	1,194.0 Ω
80 °C (176 °F)	1,308.9 Ω
100 °C (212 °F)	1,385.0 Ω
150 °C (302 °F)	1,573.2 Ω
200 °C (392 °F)	1,758.4 Ω

10 Repair

10.1 Spare parts

Please order spare parts from your local Sales Office. For this purpose, use the order numbers listed in the "Spare part kits" section.

For safety, you should always provide the following additional data when ordering spare parts:

- Device order code
- Serial number
- Software version, if possible

You can take the order code and serial number from the nameplate.

The software version is provided in the device software provided that the device processor system is still working.

For more detailed information on spare parts kits, please refer to the "Spare Part Finding Tool" on the Internet:

www.endress.com/spareparts_consumables

10.2 Disassembling the transmitter

 Please note the effects on the process if the device is taken out of service!

See the exploded drawing for the item numbers.

Proceed as follows to disassemble the field device:

1. Remove the cover (item 40).
2. Remove the inner protective cover (item 140). Release the side clips with a screwdriver.
3. Disconnect the five-pin terminal block so that the device is voltage-free.
4. Then disconnect the remaining terminal blocks. Now you can continue to disassemble the device.
5. Once you have loosened the 4 screws, you can remove the entire electronics box from the steel housing.
6. The power unit assembly is only clipped into place and can be released and removed by gently bending open the walls of the electronic box. Start with the clips at the back!
7. Disconnect the plug of the ribbon cable (item 110). The power unit is free.
8. If the central module is secured with a central screw, remove the screw. Otherwise the central module is just clipped into place and can be easily removed.

10.3 Replacing the central module

i On leaving the factory, a LSCx-x replacement module has the device serial number that identifies the module as a new module. As the serial number and release number are linked to enable extended functions and measuring range switching, any existing extension/MRS cannot be active. Generally, when a central module has been replaced, all data which can be changed are set to the factory setting.

If possible, note the customized settings of the device, such as:

- Calibration data
- Current assignment, main parameter and temperature
- Relay function selections
- Limit value settings
- Alarm setting, alarm current assignment
- Monitoring functions
- Interface parameters

Proceed as described below if a central module is replaced:

1. Disassemble the device as described in the "Disassembling the transmitter" section.
2. Use the part number on the central module to check whether the new module has the same part number as the previous module.
3. Reassemble the device with the new module.
4. Put the device back into operation and check the basic functions (e.g. measured value and temperature display, operation via keyboard).
5. Read the serial number ("ser-no.") off the nameplate of the device and enter this number into the fields E115 (1st digit = year, single-digit), E116 (2nd digit: month, single-digit), E117 (cons. number, four-digit).
 - ↳ In the field E118, the complete number is displayed again so you can check it is correct.

i You can only enter the serial number for new modules with the serial number 0000. This can only be done once! For this reason, make sure the number entered is correct before you press ENTER to confirm!

If an incorrect code is entered, the additional functions are not enabled. An incorrect serial number can only be corrected at the factory!

1. Press ENTER to confirm the serial number or cancel the entry to enter the number again.
2. In the field S7, enter the release code again (see nameplate "/Codes:").
3. Make sure the functions are enabled: extended functions must be available, e.g. when you call up the CHECK / Code P function group, the PCS function must be visible; measuring range switching must be visible when you open the alpha tables (T function group / it must be possible to select 1 to 4 in T1).
4. Set the default value to 6.3 cm^{-1} for the cell constant (field A5) and to Pt1k for the temperature sensor (field B1).
5. Make the customized device settings again.

10.4 Exploded drawing

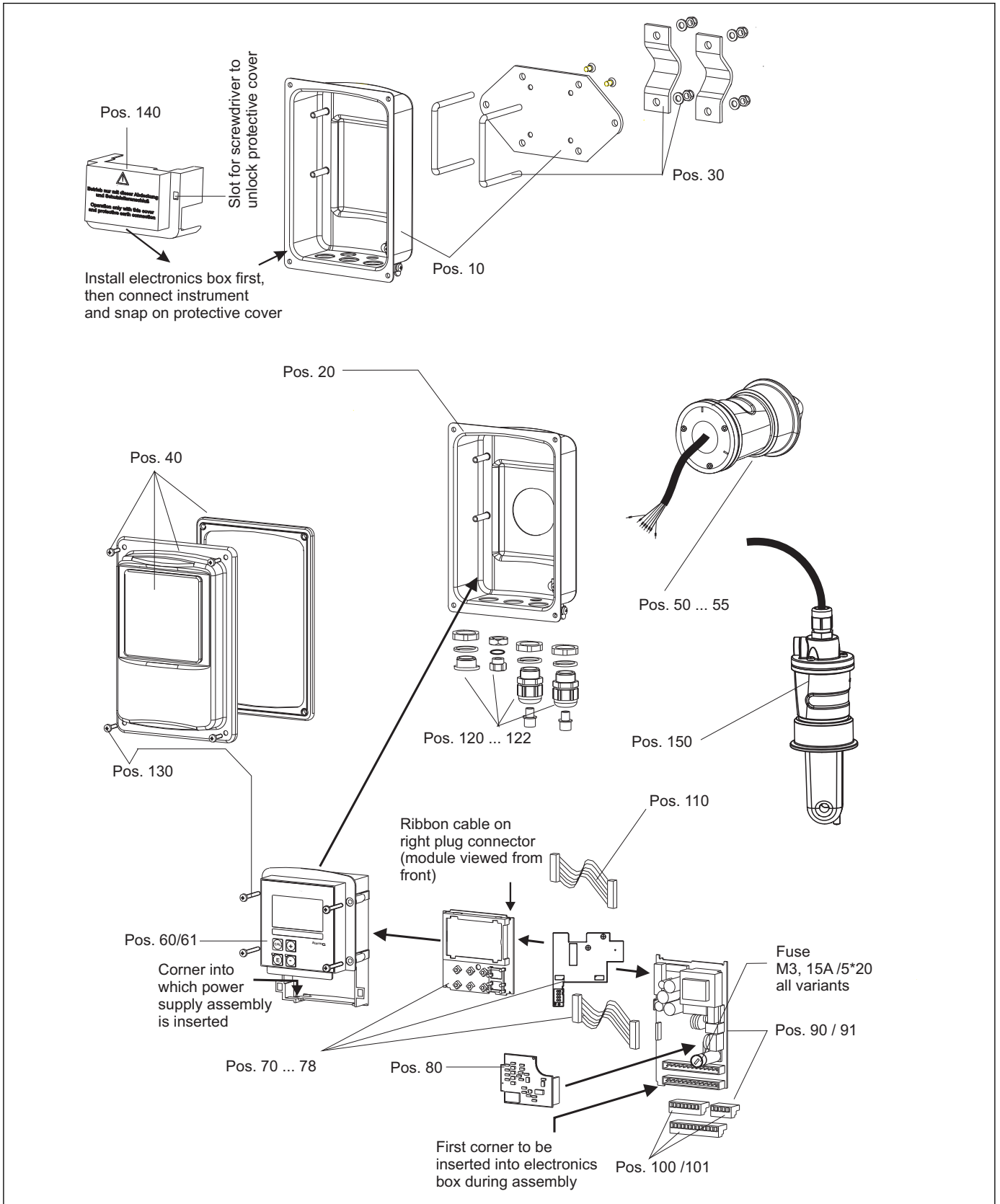

A0017383-EN

10.5 Spare part kits

Item	Kit description	Name	Function/contents	Order no.
10	Housing bottom, remote		Complete bottom assembly	51501574
20	Housing bottom, compact		Complete bottom assembly	51501576
30	Post mounting kit		1 pair of post mounting parts	50062121
40	Housing cover		Cover with accessories	51501577
50	Sensor module MV5, sanitary connection		Replacement sensor	71020487
51	Sensor module AA5, aseptic coupling		Replacement sensor	71020488
	Sensor module AA5, aseptic coupling, USP 87		Replacement sensor	71020493
52	Sensor assembly CS1, Clamp ISO 2852 2"		Replacement sensor	71020489
	Sensor assembly CS1, Clamp ISO 2852 2" USP 87		Replacement sensor	71020495
53	Sensor assembly SMS, SMS coupling 2"		Replacement sensor	71020490
54	Sensor assembly VA4, Varivent N DN 40 to 125		Replacement sensor	71020491
	Sensor assembly VA4, Varivent N DN 40 to 125 USP 87		Replacement sensor	71020496
55	Sensor assembly BC5, Neumo BioControl® D50		Replacement sensor	71020492
	Sensor assembly BC5, Neumo BioControl® D50 USP 87		Replacement sensor	71020497
60	Electronics box		Box with front membrane, sensory tappets	51501584
61	Electronics box PA/DP		Box with front membrane, sensory tappets, protective cover	51502280
70	Central module (controller)	LSCH-S1	1 current output	51502376
71	Central module (controller)	LSCH-S2	2 current outputs	51502377
72	Central module (controller)	LSCH-H1	1 current output + HART	51502378
73	Central module (controller)	LSCH-H2	2 current outputs + HART	51502379
74	Central module (controller)	LSCP-PA	PROFIBUS-PA	51502380
75	Central module (controller)	LSCP-DP	PROFIBUS-DP	51502381
	Central module (controller)	LSCP-DP	PROFIBUS-DP PROFIBUS-DP connection module LSK-B from version 2.10	71134734
78	PROFIBUS-DP connection module	LSK-B	from version 2.10	71134735
80	Conductivity transmitter	MKIC	Conductivity + temperature input	71161133
90	Power unit (main module)	LTGA	100/115/230 V AC	51501585
91	Power unit (main module)	LTGD	24 V AC + DC	51501586
100	Terminal strip kit		Terminal strips 5/8/13-pin	51501587
101	Terminal strip kit PA/DP		Terminal strips 5/8/13-pin	51502281

Item	Kit description	Name	Function/contents	Order no.
110	Ribbon cable		20-pin cable with connector	51501588
121	Cable entry kit, M20		Cable glands, dummy plugs, Goretex filter	51502282
122	Cable entry kit, conduit		Cable glands, dummy plugs, Goretex filter	51502283
130	Screws + seals kit		All screws and seals	51501596
140	Protective cover kit		Connection compartment protective cover	51502382
150	Sensor, remote		CLS54 standard	See TI00400C

10.6 Return

The product must be returned if repairs or a factory calibration are required, or if the wrong product was ordered or delivered. As an ISO-certified company and also due to legal regulations, Endress+Hauser is obliged to follow certain procedures when handling any returned products that have been in contact with medium.

To ensure swift, safe and professional device returns, please read the return procedures and conditions at www.endress.com/support/return-material.

10.7 Disposal

The device contains electronic components and must therefore be disposed of in accordance with regulations on the disposal of electronic waste.

Observe the local regulations.

11 Accessories

11.1 Cable extension

Measuring cable CLK6

- Extension cable for inductive conductivity sensors, for extension via VBM junction box
- Sold by the meter, order number: 71183688

VBM

- Junction box for cable extension
- 10 terminal strips
- Cable entries: 2 x Pg 13.5 or 2 x NPT ½"
- Material: aluminum
- Degree of protection: IP 65
- Order numbers
 - Cable entries Pg 13.5 : 50003987
 - Cable entries NPT ½": 51500177

i Depending on the ambient conditions, the inserted desiccant pouch must be checked and replaced at regular intervals to prevent incorrect measurements resulting from moisture bridges in the measuring line.

Desiccant pouch

- Desiccant pouch with color indicator for VBM junction box
- Order No. 50000671

11.2 Post mounting kit

Post mounting kit

- Mounting kit for securing the Smartec CLD132/CLD134 on horizontal and vertical pipes (max. Ø 60 mm (2.36"))
- Material: stainless steel 1.4301 (AISI 304)
- Order No. 50062121

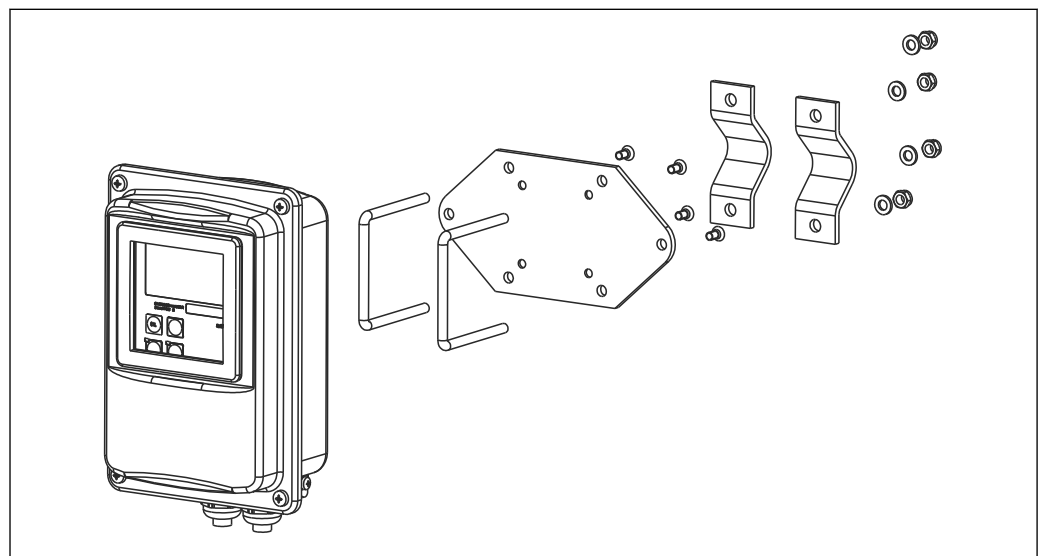

41 *Mounting kit for mounting the CLD132/CLD134 remote version on a post (base plate is included in the scope of delivery for the transmitter)*

11.3 Software upgrade

Function upgrade

- Remote parameter set configuration (measuring range switching, MRS) and determination of temperature coefficient;
- Order No. 51501643
- The serial number of the device must be specified when ordering.

11.4 Calibration solutions

Conductivity calibration solutions CLY11

Precision solutions referenced to SRM (Standard Reference Material) by NIST for qualified calibration of conductivity measuring systems in accordance with ISO 9000

- CLY11-B, 149.6 $\mu\text{S}/\text{cm}$ (reference temperature 25 °C (77 °F)), 500 ml (16.9 fl.oz)
Order No. 50081903
- CLY11-C, 1.406 mS/cm (reference temperature 25 °C (77 °F)), 500 ml (16.9 fl.oz)
Order No. 50081904
- CLY11-D, 12.64 mS/cm (reference temperature 25 °C (77 °F)), 500 ml (16.9 fl.oz)
Order No. 50081905
- CLY11-E, 107.00 mS/cm (reference temperature 25 °C (77 °F)), 500 ml (16.9 fl.oz)
Order No. 50081906



Technical Information TI00162C

11.5 Optoscope

Optoscope

- Interface between the transmitter and PC/laptop for service purposes.
- The necessary Windows software "Scopeware" is supplied with the optoscope.
- The optoscope is supplied in a sturdy case along with all the necessary accessories.
- Order No.: 51500650

12 Technical data

12.1 Input

Measured variable	Conductivity Concentration Temperature	
Measuring range	Conductivity:	Recommended range: 100 μ S/cm to 2000 mS/cm (uncompensated)
	Concentration:	
	NaOH:	0 to 15 %
	HNO ₃ :	0 to 25 %
	H ₂ SO ₄ :	0 to 30 %
	H ₃ PO ₄ :	0 to 15 %
	User 1 (to 4):	(4 tables available in versions with additional "remote parameter set configuration" function)
	Temperature:	-35 to +250 °C (-31 to +482 °F)
Temperature measurement	Pt 1000	
Sensor cable	Max. cable length of 55 m (180 ft.) with CLK6 cable (remote version)	
Binary inputs 1 and 2	Voltage	10 to 50 V
	Current consumption	Max. 10 mA at 50 V

12.2 Output

Output signal	Conductivity, concentration: Temperature (optional second current output)	0 / 4 to 20 mA, galvanically isolated
Signal on alarm	2.4 or 22 mA in the event of an error	
Load	Max. 500 Ω	
Transmission range	Conductivity Temperature	Configurable Configurable
Signal resolution	Max. 700 digits/mA	
Separation voltage	Max. 350 V _{RMS} / 500 V DC	

Minimum spread of output signal	Conductivity	
	Measured value 200 to 1999 $\mu\text{S}/\text{cm}$	200 $\mu\text{S}/\text{cm}$
	Measured value 0 to 19.99 mS/cm	2 mS/cm
	Measured value 20 to 200 mS/cm	20 mS/cm
	Measured value 200 to 2000 mS/cm	200 mS/cm
	Concentration	No minimum spread
	Temperature	15 °C or 27 °F
Overvoltage protection	According to EN 61000-4-5:1995	
Auxiliary voltage output	Output voltage	15 V \pm 0.6 V
	Output current	Max. 10 mA
Contact outputs	Switching current with ohmic load ($\cos \varphi = 1$)	Max. 2 A
	Switching current with inductive load ($\cos \varphi = 0.4$)	Max. 2 A
	Switching voltage	Max. 250 V AC, 30 V DC
	Switching power with ohmic load ($\cos \varphi = 1$)	Max. 500 VA AC, 60 W DC
	Switching power with inductive load ($\cos \varphi = 0.4$)	Max. 500 VA AC
Limit contactors	Pickup/dropout delay	0 to 2000 s
	(for versions with remote parameter set configuration)	
Alarm	Function (switchable):	Latching/momentary contact
	Alarm delay:	0 to 2000 s (min)

12.3 Power supply

Supply voltage	Depending on order version: <ul style="list-style-type: none"> ■ 100/115/230 V AC +10/-15 %, 48 to 62 Hz ■ 24 V AC/DC +20/-15 %
Power consumption	Max. 7.5 VA
Mains fuse	Fine-wire fuse, semi-delay 250 V/3.15 A

12.4 Performance characteristics

Measured value resolution	Temperature:	0.1 °C
Response time	Conductivity:	t95 < 1.5 s
	Temperature:	t90 < 26 s
Measured error of sensor ¹⁾	Conductivity:	± (0.5 % of reading + 10 µS/cm) after calibration (plus uncertainty of the conductivity of the calibration solution)
	Temperature:	Pt 1000 Class A according to IEC 60751
Measured error of transmitter ²⁾	Conductivity:	
	- Display:	Max. 0.5 % of measured value ± 4 digits
	- Conductivity signal output:	Max. 0.75 % of current output range
	Temperature:	
	- Display:	Max. 0.6 % of measuring range
	- Temperature signal output:	Max. 0.75 % of current output range
Repeatability ³⁾	Conductivity:	Max. 0.2 % of measured value ± 2 digits
Cell constant		6.3 cm ⁻¹
Measuring frequency (oscillator)		2 kHz
Temperature compensation	Range	-10 to +150 °C (+14 to +302 °F)
	Types of compensation	<ul style="list-style-type: none"> ■ None ■ Linear with user-configurable temperature coefficient ■ A user-programmable coefficient table (four tables in versions with remote parameter set configuration) ■ NaCl in accordance with IEC 60746-3
	Minimum distance for table:	1 K
Reference temperature		25 °C (77 °F)
Temperature offset		Adjustable, ± 5 °C, for adjusting the temperature display

1) In accordance with DIN IEC 746 Part 1, at rated operating conditions

2) In accordance with DIN IEC 746 Part 1, at rated operating conditions

3) In accordance with DIN IEC 746 Part 1, at rated operating conditions

12.5 Environment

Ambient temperature range	Compact version or electronics housing: Sensor (remote version):	0 to +55 °C (32 to +131 °F) -20 to +60 °C (-4 to +140 °F)
Ambient temperature limits	-10 to +70 °C (14 to +158 °F) (remote version) and separate transmitter -10 to +55 °C (14 to +131 °F) (compact version) See also graphic for "Permitted temperature ranges of Smartec CLD134".	
Storage temperature	-25 to +70 °C (-13 to +158 °F)	
Electromagnetic compatibility	Interference emission and interference immunity as per EN 61326-1:2006, EN 61326-2-3:2006	
Degree of protection	IP 67	
Relative humidity	10 to 95%, not condensing	
Vibration resistance as per IEC 60770-1 and IEC 61298-3	Oscillation frequency: Deflection (peak value): Acceleration (peak value):	10 to 500 Hz 0.15 mm 19.6 m/s ² (64.3 ft/s ²)
Display window shock resistance	9 J	

12.6 Process

Process temperature	CLS54 sensor with: Remote version: max. 125 °C (257 °F) at 70 °C (158 °F) ambient temperature Compact version: max. 125 °C (257 °F) at 35 °C (95 °F) ambient temperature max. 55 °C (131 °F) at 55 °C ambient temperature
Sterilization	CLS54 sensor with: Remote version: 150 °C (302 °F) at 60 °C (140 °F) ambient temperature, 6 bar (87 psi), abs, max. 60 min Compact version: 150 °C (302 °F) at 35 °C (95 °F) ambient temperature, 6 bar (87 psi), abs, max. 60 min
Absolute process pressure	13 bar (188.5 psi), abs to up to 90 °C (194 °F) 9 bar (130.5 psi), abs at 125 °C (257 °F) 1 to 6 bar (14.5 to 87 psi), abs in CRN environment (tested with 51 bar (739.5 psi), abs) Negative pressure to 0.1 bar (1.45 psi) absolute

Permitted temperature ranges of the Smartec CLD134

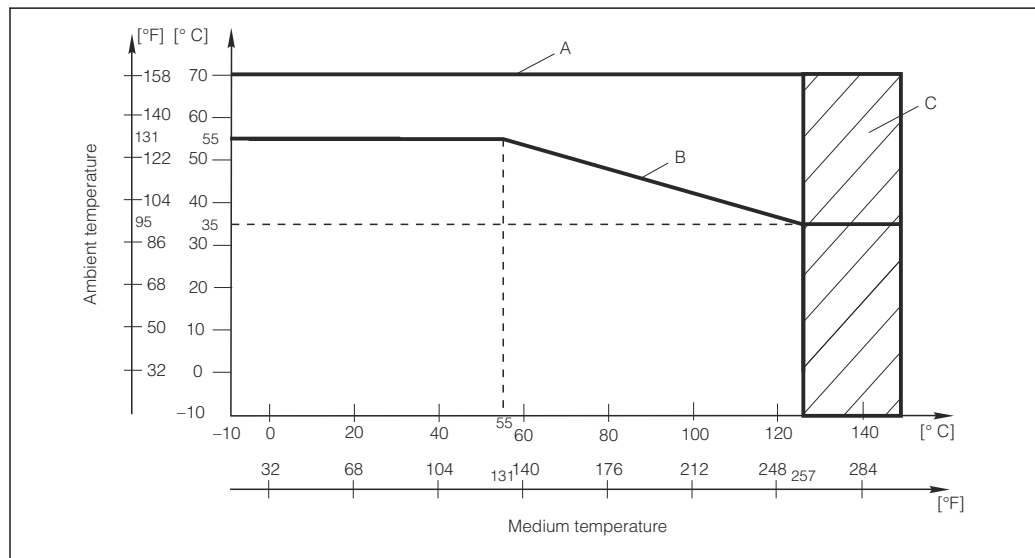

42 Permitted temperature ranges of Smartec CLD134

- A CLS54 sensor with remote version
- B Compact version
- C Temporarily for sterilization (< 60 min)

Pressure-temperature ratings of CLS54 sensor

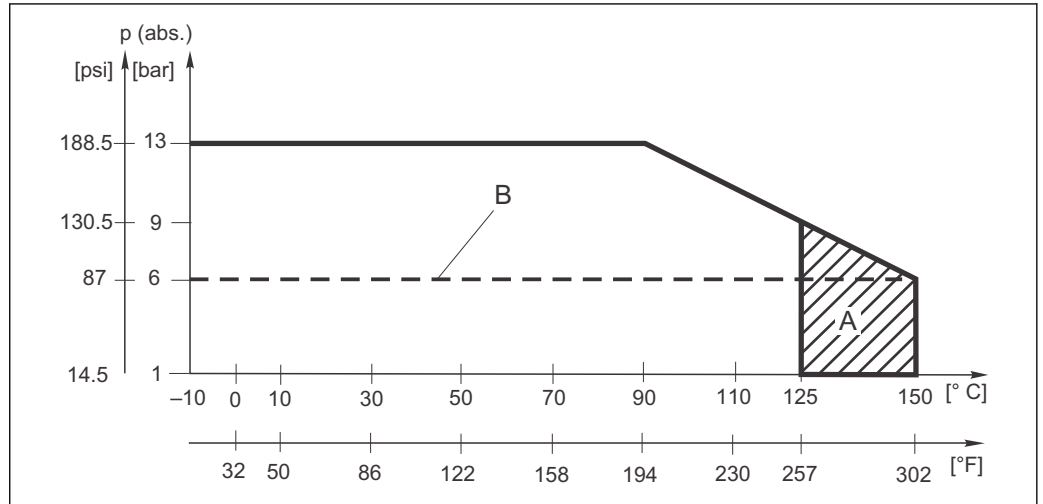

43 Pressure temperature ratings

A Temporarily for sterilization (max. < 60 minutes)

B MAWP (maximum allowable working pressure) according to ASME-BPVC Sec. VIII, Div 1, UG101 for CRN registration

12.7 Flow velocity

Max. 5 m/s (16.4 ft/s) for low-viscosity media in DN65 pipes

12.8 Mechanical construction

Dimensions	Remote version with mounting plate:	L x B x D: 225 x 142 x 109 mm (8.86 x 5.59 x 4.29 ")
	Compact version:	
	Version MV5, CS1, AA5, SMS:	L x B x D: 225 x 142 x 255 mm (8.86 x 5.59 x 10.04 ")
	Version VA4, BC5:	L x B x D: 225 x 142 x 213 mm (8.86 x 5.59 x 8.39 ")
Weight	Remote version:	
	Transmitter:	Approx. 2.5 kg (5.5 lb.)
	CLS54 sensor:	Depending on version 0.3 to 0.5 kg (0.66 to 1.1 lb.)
	Compact version with CLS54 sensor:	Approx. 3 kg (6.6 lb.)
Materials of CLS54 sensor (in contact with medium)	In contact with medium:	Virgin PEEK
	Not in contact with medium:	PPS-GF40 Stainless steel 1.4404 (AISI 316L) Screws: 1.4301 (AISI 304) FKM, EPDM (seals) PVDF (cable glands - remote version only) TPE (cable - remote version only)
Materials of transmitter	Housing:	Stainless steel 1.4301 (AISI 304)
	Front window:	Polycarbonate

Chemical resistance of
CLS54 sensor

Medium	Concentration	PEEK
Caustic soda NaOH	0 to 15 %	20 to 90 °C (68 to 194 °F)
Nitric acid HNO ₃	0 to 10 %	20 to 90 °C (68 to 194 °F)
Phosphoric acid H ₃ PO ₄	0 to 15 %	20 to 80 °C (68 to 176 °F)
Sulfuric acid H ₂ SO ₄	0 to 30 %	20 °C (68 °F)
Peracetic acid H ₃ C-CO-OOH	0.2 %	20 °C (68 °F)

Errors and omissions excepted

13 Appendix

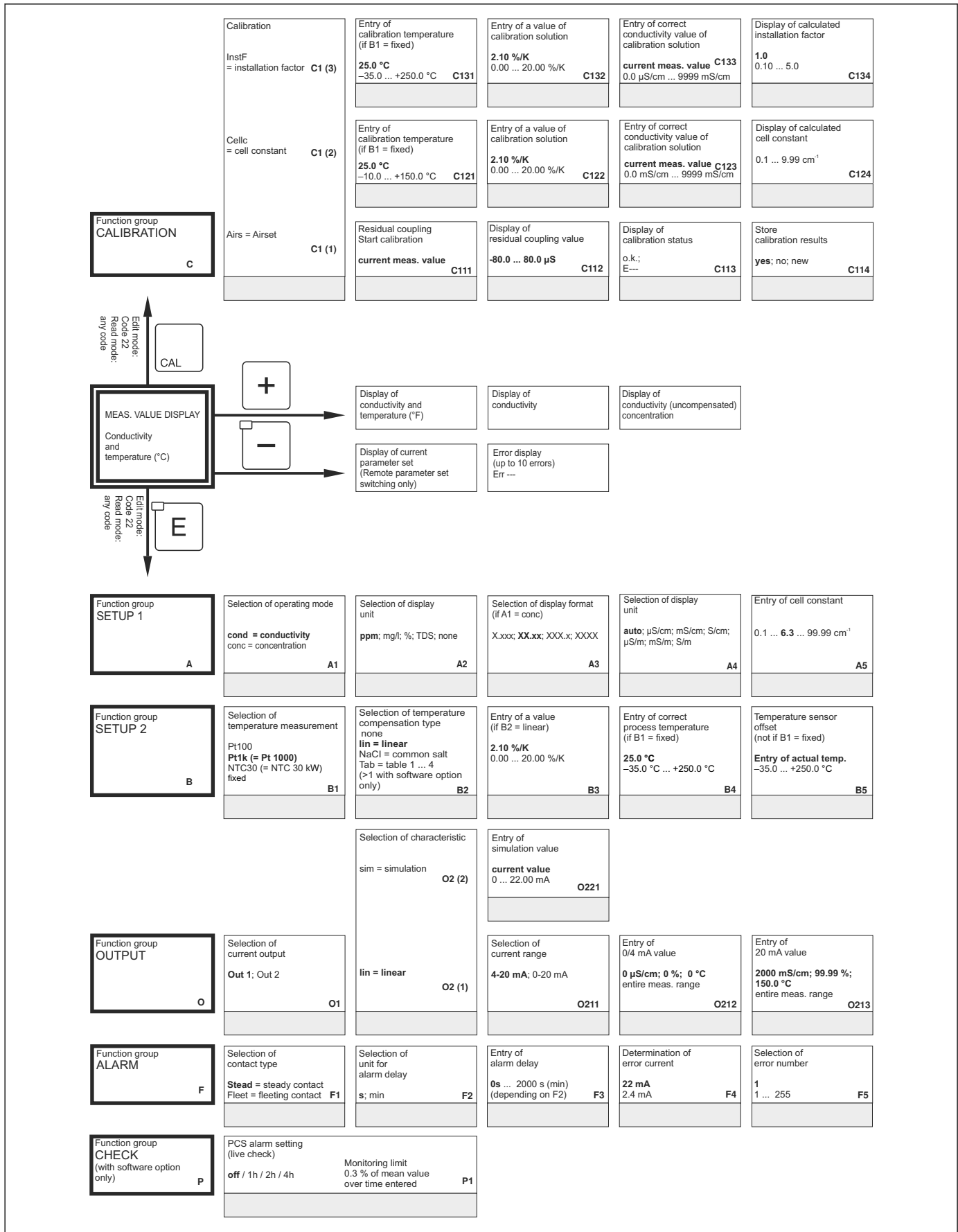

A0005699-EN

Display of calibration status o.k.; E--- C135	Store calibration results yes; no; new C136
--	---

Display of calibration status o.k.; E--- C125	Store calibration results yes; no; new C126
--	---

Entry of installation factor 01 ... 1.00 ... 5.00 A6	Entry of measured value damping 1 (no damping) 1 ... 60 A7
--	---

Display of temperature difference (not if B1 = fixed) 0.0 °C -5.0 ... 5.0 °C B6	
---	--

Field for entry of user setting

Set alarm contact to be effective yes; no F6	Set error current to be effective no; yes F7	Select "next error" or return to menu next = next error ~R F8
--	--	--

<p>Function group RELAY (with software option only)</p> <p>R</p>	<p>Selection of function</p> <p>Alarm; Limit; Alarm+limit</p> <p>R1</p>	<p>Selection of contact switch-on point</p> <p>2000 mS/cm; 99.99 % entire meas. range</p> <p>R2</p>	<p>Selection of contact switch-off point</p> <p>2000 mS/cm; 99.99 % entire meas. range</p> <p>R3</p>	<p>Pickup delay setting</p> <p>0 s 0 ... 2000 s</p> <p>R4</p>	<p>Dropout delay setting</p> <p>0 s 0 ... 2000 s</p> <p>R5</p>
<p>Function group ALPHA TABLE</p> <p>T</p>	<p>Selection of tables 1 1 ... 4 (>1 with software option only)</p> <p>T1</p>	<p>Selection of table option</p> <p>read edit</p> <p>T2</p>	<p>Entry of number of value pairs in table</p> <p>1 1 ... 10</p> <p>T3</p>	<p>Selection of table value pair</p> <p>1 1 ... number of T3 assign</p> <p>T4</p>	<p>Entry of temperature value (x value)</p> <p>0.0 °C -35.0 ... 250.0 °C</p> <p>T5</p>
<p>Function group CONCENTRATION</p> <p>K</p>	<p>Selection of active concentration table</p> <p>NaOH; H₂SO₄; H₃PO₄; HNO₃ User 1 ... 4</p> <p>K1</p>	<p>Multiplication factor for concentration value of a user table (with user tables only)</p> <p>1 0.5 ... 1.5</p> <p>K2</p>	<p>Selection of tables 1 1 ... 4 (>1 with software option only)</p> <p>K3</p>	<p>Selection of table option</p> <p>read edit</p> <p>K4</p>	<p>Entry of number of value pairs in table</p> <p>4 1 ... 16</p> <p>K5</p>
<p>Function group SERVICE</p> <p>S</p>	<p>Selection of language</p> <p>ENG; GER ITA; FRA ESP; NEL</p> <p>S1</p>	<p>Selection of HOLD effect</p> <p>froz = last value fixed = fixed value</p> <p>S2</p>	<p>Entry of fixed value (only if S2 = fixed)</p> <p>0 0 ... 100 % of 20 or 16 mA</p> <p>S3</p>	<p>HOLD configuration none = no HOLD S+C = during setup and calibration Setup = during setup CAL = dur. calibration</p> <p>S4</p>	<p>Manual HOLD</p> <p>off on</p> <p>S5</p>
	<p>Module selection</p> <p>Sens = sensor E1(4)</p>	<p>Software version</p> <p>SW version E141</p>	<p>Hardware version</p> <p>HW version E142</p>	<p>Display of serial number</p> <p>E143</p>	<p>Entry of serial number</p> <p>yes no E144</p>
	<p>MainB = Mainboard E1(3)</p>	<p>Software version</p> <p>SW version E131</p>	<p>Hardware version</p> <p>HW version E132</p>	<p>Display of serial number</p> <p>E133</p>	
	<p>Trans = Transmitter E1(2)</p>	<p>Software version</p> <p>SW version E121</p>	<p>Hardware version</p> <p>HW version E122</p>	<p>Display of serial number</p> <p>E123</p>	
<p>Function group E+H SERVICE</p> <p>E</p>	<p>Contr = Controller E1(1)</p>	<p>Software version</p> <p>SW version E111</p>	<p>Hardware version</p> <p>HW version E112</p>	<p>Display of serial number</p> <p>E113</p>	
<p>Function group INTERFACE</p> <p>I</p>	<p>Entry of address HART: 0 ... 15 PROFIBUS: 1 ... 126</p> <p>I1</p>	<p>Tag description</p> <p>@@@@@ I2</p>			
<p>Function group DETERMIN. OF TEMPERATURE COEFFICIENT (with software option only)</p> <p>D</p>	<p>Entry of compensated conductivity</p> <p>current value 0 ... 9999</p> <p>D1</p>	<p>Display of uncompensated conductivity</p> <p>current value 0 ... 9999</p> <p>D2</p>	<p>Entry of current temperature</p> <p>current value -35 ... +250 °C</p> <p>D3</p>	<p>Display of determined Alpha value</p> <p>2.10 %/K</p> <p>D4</p>	
<p>Function group REMOTE PARAMETER SET SWITCHING (MRS)</p> <p>M</p>	<p>Selection of binary inputs for MRS</p> <p>2 0 ... 2</p> <p>M1</p>	<p>Display of current parameter set</p> <p>1 1 ... 4 if M1=0</p> <p>M2</p>	<p>Selection of parameter set</p> <p>1 1 ... 4 if M1=0 1 ... 2 if M1=1</p> <p>M3</p>	<p>Selection of oper. mode</p> <p>cond = conductivity conc = concentration</p> <p>M4</p>	<p>Selection of medium</p> <p>NaOH; H₂SO₄; H₃PO₄; HNO₃; User 1 ... 4 (if M4=conc)</p> <p>M5</p>

Selection of simulation (only if R1 = limit) auto manual R6	Switch simulation on or off (only if R6 = manual) off on R7				
Entry of temperature coefficient a (y value) 2.10 %/K 0.00 ... 20.00 %/K T6	Output table status o.k. yes; no T7				
Selection of table value pair 1 1 ... number from K5 K6	Entry of uncompensated conductivity value 0.0 $\mu\text{S/cm}$ 0.0 ... 9999 mS/cm K7	Entry of associated concentration value 0.00 % 0 ... 99.99 % K8	Entry of associated temperature value 0.0 °C -35.0 ... +250.0 °C K9	Output table status o.k. yes; no K10	
Entry of HOLD dwell period 10 0 ... 999 s S6	Entry of release code for SW upgrade MRS 0000 0000 ... 9999 S7	Display of order number S8	Display of serial number S9	Instrument reset no; Sens = sensor data; Factly = factory settings S10	Start instrument test no; Display S11
Entry of serial number 1st digit 0 0 ... 9 E145	Entry of serial number 2nd digit 1 1 ... 9, A, B, C E146	Entry of serial number 3rd - 6th digit 1 1 ... FFF E147	Confirm serial number yes no E148		
Selection of temperature compensation none; lin; NaCl; Tab 1 ... 4 if M4=cond M6	Entry of alpha value 2.1 0 ... 20 %/K if M6=lin M7	Entry of measured value for 0/4 mA value cond.: 0 ... 2000 mS/cm conc.: 0 ... 99.99 % Unit: A2 Format: A3 M8	Entry of measured value for 20 mA value cond.: 0 ... 2000 mS/cm conc.: 0 ... 99.99 % Unit: A2 Format: A3 M9	Entry of limit switch-on point cond.: 0 ... 2000 mS/cm conc.: 0 ... 99.99 % Unit: A2 Format: A3 M10	Entry of limit switch-off point cond.: 0 ... 2000 mS/cm conc.: 0 ... 99.99 % Unit: A2 Format: A3 M11

Index

A

Access codes	37
Accessories	88
Alarm	49
Alarm contact	33

B

Basic version	9
-------------------------	---

C

Calibration	67
Certificates and approvals	11
Check	51
Cleaning	80
Commissioning	39
Communication interfaces	70
Concentration measurement	56
Connection compartment sticker	31
Current outputs	48

D

Declaration of conformity	11
Designated use	6
Device configuration	44
Device-specific errors	78
Diagnostics	71
Disassembling	83
Display	35
Display elements	34
Disposal	87

E

E+H Service function group	61
Electrical connection	27
Exploded drawing	85

F

Function check	39
Function group	
Alarm	49
Alpha table	54
Calibration	67
Check	51
Concentration	58
Current outputs	48
E+H Service	61
Interface	62
MRS	65
Service	60
SETUP 1 function group	44
SETUP 2 function group	47
Temperature coefficient	63
Function upgrade	9

H

Hold function	38
-------------------------	----

I

Incoming acceptance	8
Installation	12
Installation conditions	14
Installation instructions	23
Interfaces	62
Interpreting the order code	9
IT security measures	7

L

Local operation	37
---------------------------	----

M

Maintenance	80
Measuring cable	32
Measuring range switching	64
Measuring system	13
Menu structure	38

N

Nameplate	8
---------------------	---

O

Occupational safety	6
Operating concept	37
Operating elements	34, 36
Operation	34
Operational safety	6
Orientations	14

P

Post-connection check	33
Post-installation check	26, 39
Pressure approval	11
Problem	
Device-specific	78
Process-specific	74
System error messages	71
Process-specific errors	74
Product identification	8
Product page	9
Product safety	7

Q

Quick Setup	41
-----------------------	----

R

Relay configuration	52
Remote parameter set configuration	64
Repair	83
Replacing the central module	84
Return	87

S

Safety instructions	6
Scope of delivery	10
Sensor cleaning	80

Service function group	60
Setup 1	44
Setup 2	45
Spare part kits	86
Spare parts	83
Switching on	39
Symbols	5
System error messages	71

T

Technical data	90
Temperature coefficient	63
Temperature compensation	54
Test	
Conductivity sensors	81
Device	81
Trouble shooting instructions	71
Troubleshooting	71

W

Wall distance	15
Warnings	5
Wiring	27
Wiring diagram	30



www.addresses.endress.com
