

# Residential Recessed Lighting

Brilliant lighting for every room of the home



**JUNO**<sup>®</sup>





## Table of Contents

Juno Residential Lighting Introduction	2-5
Lighting Essentials	6-29
LED Downlights	30-93
Incandescent Downlights	94-123
Slope Ceiling LED Downlights	124-131
Slope Ceiling Incandescent Downlights	132-135
LED Step Lights	136-147
Incandescent Step Lights	148-149
Linear and Undercabinet LED	150-168
Index	170





# Juno Recessed Lighting

## Advanced illumination for the discerning homeowner

Welcome to the world of Juno Recessed Lighting. A brilliant world where lighting is effective and efficient ... blending seamlessly with every décor ... perfectly illuminating every room of the house. Juno offers the largest selection of high-quality recessed fixtures, incorporating industry leading performance, features and efficiency. Standard or sloped ceilings; ambient, task or accent lighting; niches or open spaces; Juno has a solution for every conceivable application.

Juno recessed fixtures are the favorite of contractors, architects, and lighting designers because they offer feature-rich installation, integrate quietly into ceilings, and present artwork, textures and architectural features at their dramatic best. They set the mood, expand space, and create stunning effects ... all the while allowing you to navigate easily throughout the interior of your home.

So whether you want your lighting to make a bold statement, provide practical illumination, or both, you need to look no further than Juno's superb line of recessed lighting products.





# The best and the brightest

Every Juno® recessed fixture is designed and engineered to exacting quality standards, employing only the finest materials and manufacturing processes. A full range of trims, optics, and light sources ensures that you will be able to create the exact lighting effect you desire with the economy and efficiency you demand.

In addition to its exceptional recessed fixtures, Juno offers an extensive range of track systems, decorative pendants, and linear lighting solutions. Other complementary brands for residential lighting include

Lithonia Lighting® and Aculux®. By taking advantage of this diverse fixture collection, you can employ layers of light to create any mood or suit any illumination requirement throughout your home.

Since 1976, Juno has been providing the lighting industry with innovative products and unsurpassed service and support. When you choose Juno fixtures for your home, rest assured you are choosing the best and brightest.



## Housing Offering

Juno Downlights are a complete line of LED, low-voltage, and incandescent recessed luminaires for both standard and sloped ceilings. They provide high-quality illumination for all your applications, including general, task, accent, wall-wash, and step lighting. New construction and remodel housings are available in 1", 2", 3", 4", 5", and 6" sizes for insulated and non-insulated ceilings.

### **AIR-LOC** Air-Loc®

Juno IC housings are Air-Loc rated and designed to minimize air leak paths. Air-Loc rated housings are tested in accordance with ASTM E283 and certified by an independent laboratory to be in compliance with the minimum air-leakage standards as set in the International Energy Conservation Code, as well as several state energy codes, including Washington State. Significant cost savings are realized as summarized in the chart below:



	Standard IC	Juno Air-Loc IC	Juno Air-Loc IC w/Air-Loc Trim or Gasket
Areas of Leak Path	2.8 sq. inches	2.46 sq. inches	< .1 sq. inch
Air Leakage	5 cu. ft./min. 2.6 million cu. ft./year	2.6 cu. ft./min. 1.4 million cu. ft./year	0
Energy Loss	.86 million BTUs/year	.45 million BTUs/year	0
Annual Energy Savings (VS. STANDARD IC)		\$3.53 per fixture	\$7.34 per fixture

\* Based on 10 cents per KWH



### Real Nail 3® Bar Hanger

The Juno originated, Real Nail bar hanger has set the industry standard for ease of installation for over 40 years. This 3rd generation design features an improved range of benefits:

- Proprietary bugle-head, ring shank nail for positive installation and simple claw hammer removal when repositioning housings
- Integral T-bar notch for secure installation in suspended ceilings
- Patented break-away bars for tight joist spacings
- Curved foot facilitates alignment with joist bottom

### Regulatory Listings & Standards - Catalog Icons



ENERGY STAR® Qualified products



Juno's sealed recessed IC housings meet IECC Air-Loc® Code requirements per ASTM E283 for minimum leakage with IC housing



Juno Downlights meet the high efficacy requirements of California Title 24 (JA8-2016)



UL and C-UL Listed for Wet Location when used with outdoor rated lamps or when used with lensed trims



Many Juno Step Lights are ADA Compliant



WarmDim® technology brings the warmth and atmosphere of incandescent dimming to LED.

LED fixtures are RoHS Compliant



## Aesthetically Superior Trims

Juno downlight trim offering is unparalleled in the industry; choose from traditional 4", 5" and 6" baffle, cone, wall wash, and lensed trims in an array of finishes and styles.



### Clear Cone

Specular finish produces a neutral appearance with exceptionally low brightness.



### Haze Cone

Uniform satin finish has a soft luminous appearance and hides dust and fingerprints. Blends with white ceilings and coordinates well with cooler interior finishes, light hardwoods and metallic accents such as satin nickel and stainless steel.



### Wheat Haze Cone

Offers a rich trim appearance, and adds subtle warmth to an interior. Coordinates well with warmer tone interior finishes, hardwoods and metallic accents such as satin brass and oil-rubbed bronze.



### Gold Cone

Specular finish with a pale gold tint slightly warms lamp color temperature and provides decorative aperture appearance.



### Black Cone

Specular black finish produces lowest possible brightness and maximum source concealment.



### Black Baffle

Sharply defined concentric ridges reduce trim brightness and create a pleasing architectural appearance.



### White Baffle

Brighter appearance when illuminated, but blends with white ceiling when off.

## Styles

### Baffle



### Cone



### Adjustable



### Wall Wash



### Decorative



### Lensed



### Trim Ring Finishes

- ABZ** Classic Aged Bronze
- BL** Black
- PW:** Plastic (Polycarbonate material shower trim)
- SC** Satin Chrome
- WH** White

## Small Aperture Trims

Perfect for today's upscale interiors, Juno Mini and 2" round and square downlight and adjustables are offered with a wide selection of trim styles and finishes.



Mini Downlight



Mini Adjustable



2" Adjustable



2" Downlight



## Hyperbolic Trims – A Breakthrough in the Art and Science of LED Recessed Lighting

In 2012 we pioneered the hyperbolic trim with the introduction of Indy™-brand hyperbolic trims for use in commercial interiors. Never before had the industry been able to enjoy high luminaire efficiencies and extremely low aperture brightness! Hyperbolic trims are available for Juno-brand 4-, 5- and 6-inch 600, 900 and 1400 lumen residential/light commercial IC and TC rated LED downlights. Easy to install – they are as simple as installing a standard trim.



### Juno® Hyperbolic Trims compared to standard cone trims



Juno hyperbolic trims provide a Silent Ceiling™ effect.



Standard cone trims in the ceiling.

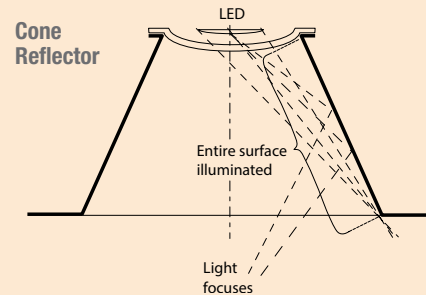
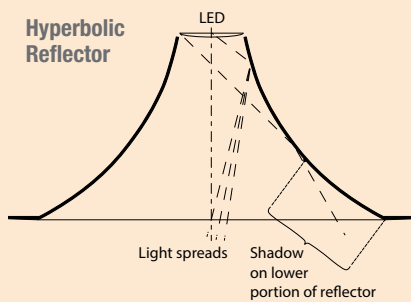



# Energy efficiency ... it just makes \$ense

Today, we live in an environment where the specter of global warming threatens our eco-system and our very way of life. That's why Juno recessed fixtures are designed first-and-foremost for optimal energy efficiency. Efficient lighting requires less electrical power, which in turn, contributes to a cleaner, more sustainable habitat for all living things.



Juno leads the way in efficiency with ENERGY STAR®

Qualified LED fixtures that consume as little as 15% of the energy of conventional lighting.

Even our halogen units provide substantial energy savings compared to standard incandescent lamps. Energy efficiency ... it just makes sense. Our most efficient fixtures can help reduce your electric bill thanks to energy-saving light sources and unique construction features such as our Air-loc® housings. And when you install energy efficient lighting products, you may find that you qualify for valuable rebates from your local utility company.

Saving energy. It makes sense for our planet ... and your pocketbook.

See pages 31-93, 125-131, 137-147, 151-168 for the latest energy efficient LED fixtures.





Juno leads the way in efficiency with ENERGY STAR® Qualified LED fixtures that consume as little as 15% of the energy of conventional lighting.





# Lighting your home like a pro

Light is an invisible element that has a tremendous influence on your quality of life. Nowhere is this influence greater than in the interior of your home. How you illuminate it has everything to do with the look, feel and quality of your environment. Lighting professionals understand this and deftly use lighting to create mood and ambiance in addition to general illumination. For the homeowner, knowledge of a few lighting basics can go a long way toward achieving professional results.

## Know your space

Before selecting your lighting, you need a clear idea about what you want the lighting to do. Think about how you use each room, its architectural features, and the furniture layout. Consider the carpeting, fabrics, and colors; paintings, collectibles, and other forms of art. There are lighting techniques tailored to every situation, and the first step is to understand your needs.

## What you can control

There are three major aspects of lighting that you can control. First, there's the amount of light produced by your fixtures, measured in lumen output and footcandles. Next is the distribution of light, i.e. where the light is going. Finally, there's the quality of light, which refers to whether the light is warm, cool, or somewhere in between. By taking control of these elements, you can create the ideal lighting scheme or every interior space.



## Perfect Marriage of Light and Sound

The recessed Lithonia Lighting® 6SL Wireless LED Speaker Downlight module provides an easy and efficient way to light up a room and enjoy music for the entire family. It's perfect to retrofit into existing 6" downlight cans or new construction and remodel applications. Wirelessly stream audio from your mobile device via Bluetooth®. Easily pair wirelessly up to 8 units for a more enhanced and balanced sound experience.

The Bluetooth® word mark and logos are registered trademarks owned by Bluetooth SIG, Inc. and any use of such marks by Acuity Brands Lighting is under license.



## Lighting in layers

Layering is the concept of incorporating different types of lighting into a specific space to satisfy multiple illumination requirements. For instance, a dining room can have linear fixtures in coves to expand space or establish a mood, or fixtures can be incorporated into casework to add sparkle to glassware. Recessed downlights positioned above tables and serving areas can be dimmed for a romantic dinner or used at full intensity when doing homework or paying the bills. Chandeliers, pendants, and sconces can provide general illumination or produce a lateral lighting element that fills in shadows on walls and on people's faces.

With multiple lighting layers, you will always have just the right light for your specific purpose. And by balancing all the layers at your disposal, you can create just the right atmosphere for any occasion.





# Kitchen

## Downlighting (General)

Fills the room with light, allowing you to move through your space. Downlights can also be centered over islands and leading edges of countertops for task illumination.

## Undercabinet (Task)

Illuminate countertops, backsplashes and other work surfaces with undercabinet fixtures. Cool, bright-white light is ideal for cooking chores such as cutting, slicing, and dicing. Modular, linear fixtures are ideal for long surface lengths, while “solo” fixtures put light exactly where needed.

## Accent/Mood Lighting

Highlight decorative cabinet detail, artwork or architectural features with adjustable downlights or mini-downlights. Set the mood by lighting cabinet interiors with linear lighting or mini-downlights, and the space between cabinets and ceiling with linear lighting. Lighting controls can provide selective dimming to create the perfect effect.

## Pendants/Decorative

Add a decorative touch and general illumination over islands and tabletops. Translucent pendant shades also provide a lateral lighting element that fills shadows and contributes to the overall mood.

### Tip

The complete line of Juno fixtures are ideal for task, cove, up-lighting and undercabinet lighting. All offer a comprehensive selection of finishes, lengths and lamp options, including the latest energy efficient LED technology.

For comprehensive lighting techniques, see pages 22-29.





# Dining Room



## Downlighting (General)

Provide general illumination with downlighting; position fixtures in the general navigating area to fill the room with light. Light vertical surfaces such as walls, draperies, or screens with recessed adjustables or wall washers to add visual interest and showcase artwork or architectural details.



## Accent/Mood Lighting

Supplement the light from pendants and chandeliers while enhancing the richness of natural woods and highlighting centerpieces and place settings. Lighting wall-mounted artwork with recessed adjustable fixtures also adds to the dramatic appeal of the room. Incorporate linear lighting in coves, mini-downlights or solo undercabinet lighting into china cabinets to produce sparkle and spaciousness.



## Pendants/Decorative

Make a bold statement with decorative pendants that set the tone for your dining room. Position pendants above tables or serving areas, and arrange them in clusters for a creative splash. Pendants with translucent shades give off a soft, warm glow that also provides a lateral lighting component to fill distracting shadows.

### Tip

To create an inviting environment for your guests, consider exclusive Juno WarmDim® LED fixtures along with Aculux® precision luminaires to highlight place settings and create sparkle.

For comprehensive lighting techniques, see pages 22-29.





# Hallway & Step Lights



## Downlighting (General)

Provide general and navigational lighting with recessed downlights. Combine fixture placement with the appropriate lamp output to create uniform lighting or pools of light that add visual interest and make the hallway appear larger.



## Step Lights, Night Lights

Illuminate hallways, pathways, or stairs to provide safe navigation and add a sense of visual direction and destination.



## Accent

Highlight artwork with adjustable accent lighting. Create a dramatic focal point with brightly lit objects at the end of hallways. Use mini recessed fixtures to illuminate niches and nooks.

## Grazing

Introduces shadow and contrast to lend a dimensional appearance to brick, stone, stucco or textured material.



## Wall Washing

Uniform illumination on walls makes hallways feel wider and brighter. Recessed wall wash fixtures provide ceiling to floor lighting, eliminating scallop patterns that can cause a cave-like effect.

### Tip

Evenly spaced hallway downlights and step lights provide a sense of visual direction and destination.

For comprehensive lighting techniques, see pages 22-29.





# Bathroom



## Downlighting (General)

For a large bathroom, use multiple downlight fixtures spaced throughout the room for general lighting. Downlights mounted over the sink or vanity brighten horizontal surfaces and provide illumination for grooming or applying makeup. Soft, flat light from wall-mounted fixtures fills-in facial shadows when using mirrors.



## Accent

Selectively illuminating artwork and architectural elements can make the bathroom environment more interesting and intimate.



## Shower Light

Lensed downlight fixtures approved for wet locations may be mounted in showers and above baths and whirlpools.

## Tip

Proper downlight placement combined with soft, flat light from wall-mounted fixtures fills in facial shadows when using mirrors.

For comprehensive lighting techniques, see pages 22-29.





# Living Room



## Downlighting (General)

Provide illumination for the most dramatic room of the home. In addition to general lighting, downlights can be used to wash the walls with light, creating a brighter, more spacious environment. And downlights can be positioned to graze the surfaces of brick, stone, or stucco to accentuate textures and add contrast. Juno Slope and Super-Slope LED housings cover pitch ranges of 2/12 to 12/12 (9° to 45°) and deliver up to 1400 high-performance lumens with efficiency and style.

## Accent, Cove

Emphasizing focal points adds visual interest. Use narrow-beam downlights with higher light-output and adjustable trim to dramatize artwork, end tables and collectibles. Establish a mood with downlighting or linear lighting by illuminating architectural features such as columns, niches, and coves. Add miniature fixtures to built-in casework to add sparkle and further expand interior spaces.

## Tip

Downlights can provide general lighting or create dramatic effects whether ceilings are standard or sloped.

For comprehensive lighting techniques, see pages 22-29.





# Precision Lighting

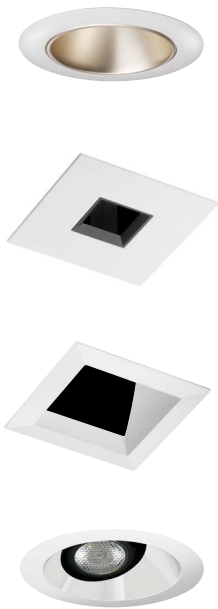

## **Aculux® ... the ultimate expression of recessed lighting perfection**

The Aculux line of precision recessed luminaires offers elegance, style, and performance. These superb fixtures are designed to provide highly efficient illumination while producing dramatic, space-enhancing lighting effects.

Featuring precision gearing and adjustments, Aculux can put light precisely where you want it, whether you are highlighting a painting, sculpture, or tabletop ... or illuminating an entire room. And Aculux incorporates a unique adjustable platform that permits perfect fixture-to-fixture alignment. No other downlights can match the degree of precision adjustments offered by Aculux.

Aculux apertures may be either round or square and are available in sizes from 2" to 4" all the way down to stylish pinholes. Trim options range from nearly invisible tapered flanges to flush-mount designs that literally disappear into the ceiling. A spectacular collection of reflectors includes colors and finishes to complement any décor. Whether your look is contemporary or traditional, Aculux delivers stunning results quite distinct from standard recessed fixtures.

Aculux luminaires are designed for a wide range of light sources including ultra-efficient LEDs that offer unprecedented energy savings and service life. These supremely versatile fixtures excel at general, task, accent and wall wash lighting for today's leading homes and are an ideal complement to the comprehensive Juno recessed lighting collection.

### **Tip**

Aculux adjustable luminaires complement Juno downlights adding dramatic visual appeal to any room. To learn more about precision Aculux fixtures, visit [www.acuitybrands.com/aculux](http://www.acuitybrands.com/aculux)



# Lighting Techniques & Planning Tips

## General Lighting

General lighting sets the basic ambient illumination level of a space. It is important for circulation and functionality.

## Uniform Downlighting

Uniform illumination provides a layer of ambient light typically used to provide general lighting on horizontal surfaces. It is important to note that, while useful, uniform illumination typically has the least visual impact on a space. Uniform illumination can be accomplished using the following techniques.

## 8' - 10' Ceilings

Use wide distribution LED or frosted PAR lamp downlights with a baffle or a cone, spaced approximately the same distance on center as the ceiling height. Use Juno 600 lumen LED downlights for the ultimate energy efficient option.

## 10' and Higher Ceilings

Medium and narrow spread LEDs or PAR lamps in downlights using a baffle or a cone provide more concentrated light beams and are effective for uniform illumination from higher ceilings. For higher ceilings, narrower beam spreads are required. Use Juno 900 lumen LED downlights with a medium or narrow optic for the ultimate energy efficient option.

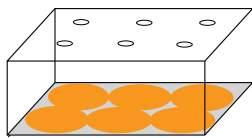

## Non-Uniform Downlighting

Non-uniform downlighting provides the appearance of pools of light and can provide a more interesting visual appearance. Non-uniform illumination is generally accomplished with narrow PAR or MR16 lamps, or Juno LED downlights with the narrow optic spaced far enough apart so their beams do not overlap. Spacing is a function of the chosen lamp's beam spread and desired effect.

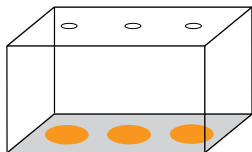

## Task Lighting - Ceiling Techniques

Supplemental illumination is essential for performing tasks accurately, efficiently, and safely.

## Task Lighting

Placement of recessed downlights to facilitate tasks is critical. For counter or work surface tasks, recessed fixtures should be placed between the cabinet face and the front edge of the counter. This position avoids casting of shadows and minimizes veiling reflections. Medium beam lamps will light inside of cabinets and also highlight cabinet detail, providing light on the vertical surface.

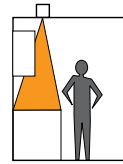

Correct

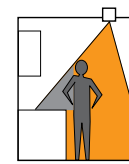

Incorrect

When lighting paper-handling tasks, adjustable downlights should be placed on each side of the task to minimize glare and veiling reflections.

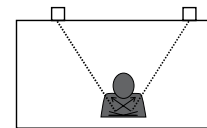

Correct

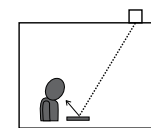

Incorrect

When lighting tasks in front of people, such as on a tabletop, it is important to locate downlights in front of the person so as not to cast unnatural/unpleasant shadows. For grooming at a vanity or mirror, provide fill lighting from a diffuse source, such as a wall sconce. Accent hardware and countertops with recessed narrow beams.

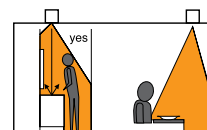

Correct

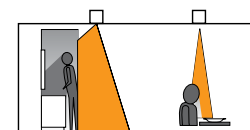

Incorrect

## Application Tips

Downlight fixtures are assigned a value called spacing criteria (SC). The SC is typically a number from .5 to 1.5 and can be found on Juno product specification sheets. It indicates how close together fixtures need to be spaced in relation to the mounting height from the ceiling to the workplane or floor to achieve overlapping beams for uniform illumination. For example, if the SC of a fixture is equal to 1, you would space the fixtures a maximum of 1x mounting height for even illumination. (The mounting height can be the floor or table top 2'-6" above the floor.) For higher levels of illumination, fixtures can be spaced closer together.

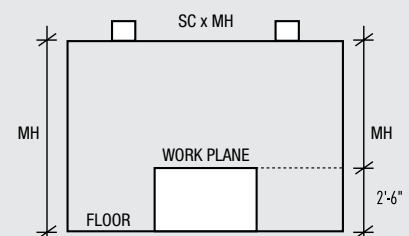

## Task Lighting - Undercabinet and Indirect Linear Techniques

Juno® Undercabinet luminaires place bright lighting on work surfaces by utilizing a light source located close to the task. This placement is ideal since general lighting is often blocked by a person's shadow or a shadow from upper cabinets. Undercabinet lighting provides the increased light levels required to accurately, quickly, and safely perform tasks.

### Recommended Illuminance Levels

Twenty to fifty footcandles are generally adequate to perform kitchen undercabinet tasks such as food preparation or paying bills. More detailed tasks such as sewing or craftwork require 50-150 footcandles. Tasks that are very small, have intricate detail, or involve very dark surfaces may require even higher illumination levels. With the advent of dimmable halogen, xenon and LED undercabinet lighting, what was once strictly task lighting is now also used as accent lighting for granite, hardware, tile, backsplashes, and other fine finishes to provide an element of sparkle and vitality.

### Accent Lighting

Cabinets and shelves create dark cavities that can detract from the aesthetics of a room. By illuminating these cavities, Juno Undercabinet fixtures create visual interest and a sense of spaciousness and, in addition, can highlight objects of interest. Juno Mini Downlights, Juno 2" Downlights and Adjustables, Solo-Task and Trac 12™ linear fixtures are ideal for accent lighting applications.

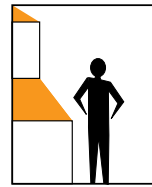

Correct

### Recommended Illuminance Levels:

Accent lighting usually requires 20 footcandles or less.

### Indirect Cove Lighting

Indirect lighting above cabinets or in architectural coves can increase the sense of spaciousness and add drama and pleasing warmth to an interior. Juno Trac 12™ or Juno FlexConnect™ linear lighting is ideal for cove lighting applications.

### Recommended Illuminance Levels:

Cove lighting usually requires 20 footcandles or less.

## Special Design Considerations

### Dark Interior Finishes

The amount of perceived light from undercabinet, accent, and cove lighting will vary greatly depending on the reflectance of surrounding surfaces. A dark countertop and backsplash will absorb light from undercabinet fixtures and diminish its apparent brightness. Likewise, indirectly illuminating a dark wood-paneled ceiling from an architectural cove will be much less dramatic than illuminating a white ceiling. Providing increased levels of illumination can partially offset light absorption by dark surfaces.

### High Ambient Light Levels

The apparent brightness of a lighted countertop, cabinet interior, or cove will also vary depending on the amount of general room illumination. If the general ambient lighting is 30 footcandles, then a cabinet interior illuminated to only 20 footcandles will not appear illuminated. Conversely, in a darkened room, 20 footcandles will appear brilliant. A minimum 3:1 ratio between the focus area and background is recommended to have visual impact. A 5:1 ratio makes the focus area appear twice as bright.

### Age

As age increases, so does our need for light. A typical 65-year-old needs five times more light than a teenager to experience equal visual acuity.

### Shiny Work Surfaces

For high-gloss countertops and backsplashes, place the fixture at the front edge of the cabinet to minimize glare reflecting into the eyes of someone working at the counter. Keep in mind that shiny dark surfaces act like a mirror and will reflect any source of light that is placed above them. How the reflected image of one fixture appears vs. another is subjective.

Cove Lighting

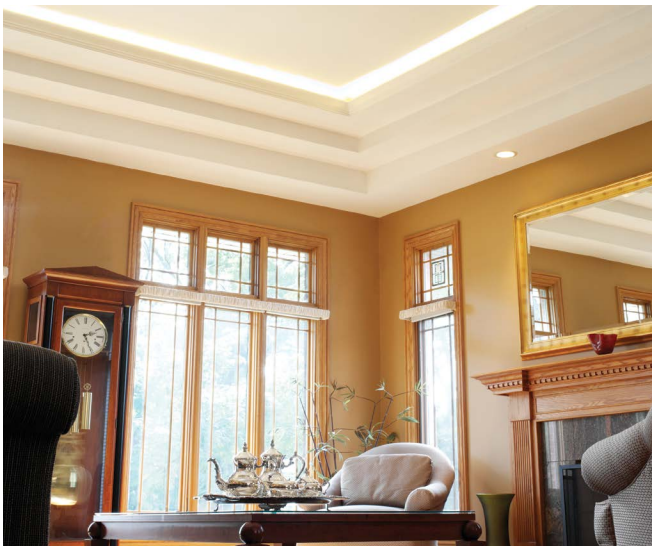

Undercabinet Lighting





## Accent Lighting

Accent lighting creates high contrast on objects of interest such as sculptures, paintings, collectibles and architectural details. For noticeable visual impact, accent lighting should be at least three times as bright as the surrounding area. More dramatic accent lighting requires contrast ratios of 5:1 or greater. Smaller objects such as figurines or gem stones will benefit from even higher ratios of up to 20:1.

### Accent lighting of flat artwork

Flat art is ideally illuminated by a light source striking its surface at a 30° angle. This eliminates reflected glare from vertical glass and prevents casting a shadow of the viewer onto the artwork. To determine the correct distance from wall to fixture you can use the formula listed below or the quick reference chart on the right.

Formula to calculate luminaire distance from the wall for a 30° aiming angle where H = Distance from the ceiling to the aiming point and D = Distance from the wall to the center of the luminaire. (The aiming point is generally located at 1/3 down from the top of the picture or object.)

$$D = H \times .6$$

Example:  $D = 4.5' \times .6 = 2.7'$  or approximately 2'-8"

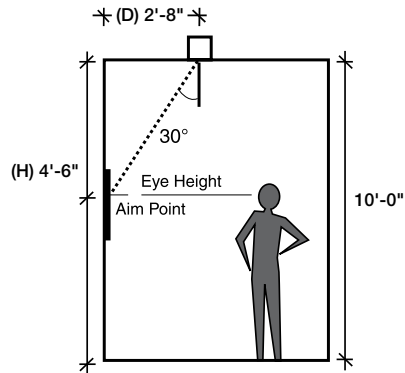

If the formula places the fixture on a beam or mechanical obstruction, move the fixture closer, **not** farther back.

### Accent lighting of three dimensional objects

"Key and fill" is an effective technique for accentuating the three-dimensional character of an object. This technique uses key and fill lighting from two sides of the object. Key lighting is a "hard" accent light used to create shadows and highlight an object's form and texture. Fill lighting is a softer light directed from the opposite side of the object to soften the shadows, making the object appear more natural. Other techniques can also be applied to further accentuate unique features, such as silhouetting an object from behind with a wall wash.

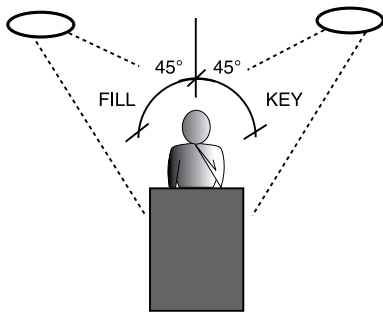

BACK

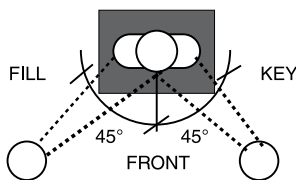

PLAN VIEW

### Accent Lighting Fixture/Lamp Choices

**12-volt MR16 Adjustables** are the fixture of choice for accent lighting due to their small aperture; intense beam spreads; and available range of light control and color correction accessories – see pages 98-100.

**PAR36** adjustables are ideal for longer throw distances up to 30', where tightly controlled pinspots of light are required. They are well suited for illuminating larger objects or areas such as fireplaces, coffee tables, large art or murals, potted trees, etc – see the TC46 housing on page 101.

**4" Internally Adjustable LED** These fixtures offer internal adjustability of up to 35° vertical and 360° rotation so that light can be directed where needed – see pages 43-45.

**Mini and 2" LED** Ideal for niches, bookcases, soffits, cabinetry and more, these luminaires open-up a multitude of task and accent lighting possibilities – see pages 34-41.

## Wall Lighting

The illumination of vertical surfaces can impact the perception of a space more than any other type of lighting. Light reflecting off of walls creates a bright, spacious feel and adds visual interest.

### Wall Washing

Wall washing provides even, diffuse illumination of vertical surfaces such as walls, large paintings, wall hangings, bookcases and shelving, cabinet fronts (glass not recommended), or stairwells. The desired effect is that of an even blanket or "wash" of light without hot spots or scallops. The diffuse nature of wall wash illumination has the effect of flattening out textured surfaces.

Wall wash luminaires are usually spaced equal to the set back distance from the wall. Closer spacing leads to higher light levels with better uniformity. There are three fixture types that are most commonly used to achieve uniform wall washing:

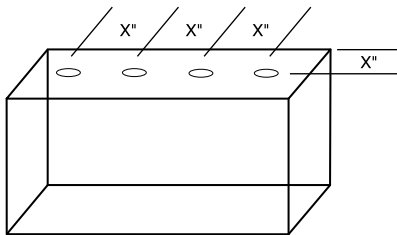

### Scoop Wall Wash Trims

These are the most economical type of wall washer. The combination of a directional reflector and a light "scoop" direct light toward the wall. Most residential scoop wall washers utilize A-lamps or LEDs. Scoop wall wash trims are generally spaced 20" - 30" from the wall and 20" - 30" apart.



### Lensed PAR/MR Wall Washers (Aculux® only)

These utilize an internal kicker reflector and a special spread lens to more efficiently put light on the wall. Lensed wall washers produce a soft, slightly vertical pattern that can be used singularly or in multiples. MR16 lensed wall washers are generally spaced 12" - 18" from the wall and 12" - 18" apart. PAR lamp, lensed wall washers are generally spaced 2' from the wall and 2' apart. Consult specification sheets for specific information on spacing and light levels.

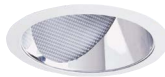

### LED Wall Wash

LED Wall Wash reflectors are truly innovative. By leveraging the properties of the directional LED light source, the unique reflector system has been optimized to direct the light with such precision as to essentially "paint" the light on the wall horizontally from floor to ceiling with unsurpassed uniformity. This LED wall wash system eliminates scallops and projects light close to the ceiling line. These luminaires are almost always used in multiples, and are generally spaced 24"-36" from the wall and 24"-36" apart.

### Grazing

By placing downlights 6" - 12" on center from a wall, a grazing effect can be achieved on textured surfaces such as brick, stone or stucco. PAR or narrow flood LEDs are a good source to use for grazing. (**Note:** Grazing on smooth surfaces is not recommended as it will magnify any surface imperfections).

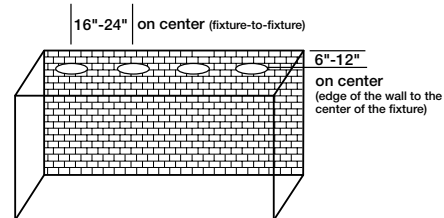

### Light Scallops

Light scallops can be an intentional or unintentional effect of a downlighting plan. A row of downlights close to the wall will cause light scallops, which can add visual interest to a space. The more diffuse the light source and trim, the softer the scallop. For example an R/BR-lamp mounted in a white baffle trim will barely create any scallop; a PAR lamp in a deep-black baffle trim will cause a crisp scallop. You should also be mindful of the vertical location of the center of scallops relative to architectural features such as cabinet frames, doorways, windows, etc. The best scallop effect should be symmetrical and requires careful measurement and planning.

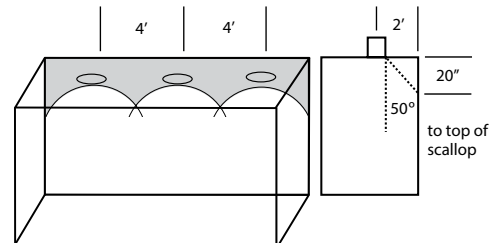

Well placed Light Scallops using 6" downlights

Scallop height will vary with setback, trim, and lamp combination. The lower the ceiling, the higher the scallop tips should be, e.g. on an 8' ceiling, the scallop peaks should be approximately 9" - 15" from the ceiling.

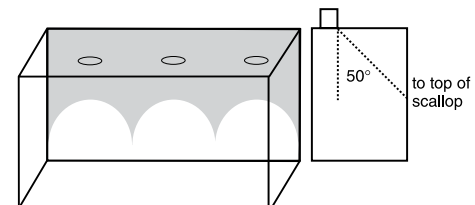

Scallops placed too low on wall will cause a "cave effect"



# Pendant Lighting (Kitchen Island)

Hanging pendants with glass or fabric shades are functional, beautiful pieces of art that provide surface mood lighting. An odd number of pendants is usually desirable for symmetrical spacing. The “middle” pendant should be placed in the center of the kitchen island, and each subsequent pendant should be spaced 18" to 24" on center for smaller sizes or up to 30" on center for larger sizes. The recommended mounting height, measured from the bottom of the pendant shade to the top of the surface (countertop/tabletop), is typically 29" to 33". Avoid placing the pendants directly over the edge of the counter; 12" to 14" from each edge is recommended.

Note: The greater the bottom diameter (aperture) of the pendant, the lower it should be mounted to avoid glare and visual exposure to the lamp. Pendant height also will vary depending on the height of the individuals living in the space.

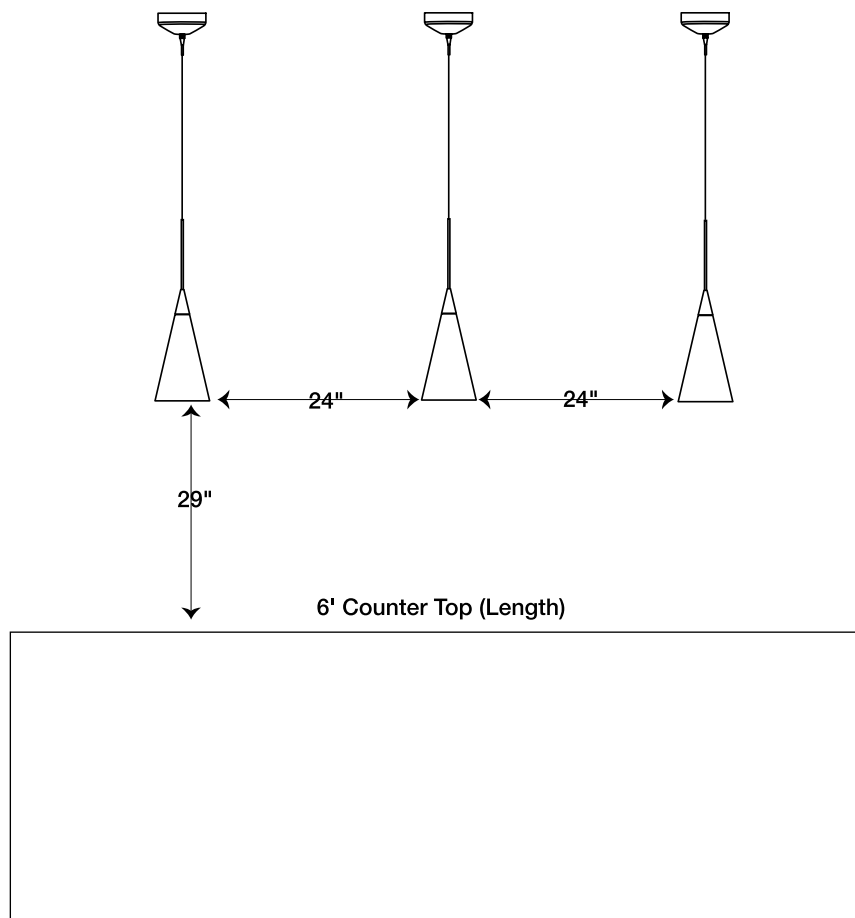





# Lamp and Trim Selection

Juno recessed housings are designed to accept a variety of different lamp types and trims. Each lamp type has unique performance characteristics and each trim has a different function and/or appearance. The following information will help you select the best lamp type and trim for your application.

## Lamp Types

Lamps for recessed lighting can be categorized into directional and diffuse. Directional lamps contain integral reflectors to direct and control the light. Diffuse lamps produce omni-directional light and are used in conjunction with trims that have reflectors to control their distribution.

### Directional Lamps

#### LED (Dedicated)

LED light sources can be integral to the fixture or a screw-in retrofit. Light output and color consistency have improved dramatically since LEDs were first introduced, and today they represent the state of the art in residential lighting. LEDs are more easily dimmed than CFLs, have a 50,000-hour rated life, and produce minimal UV with virtually no projected heat. Although more expensive than conventional light sources, LEDs are very energy efficient and especially useful for inaccessible locations or where long lamp-life lighting applications are desirable, such as kitchens, tall ceilings, etc. Optimal performance results from integrating the LED package into the housing design so that internal heat is well dissipated and the optics are customized for the LED light engine. This approach is superior to the "one size fits all" nature of screw-in retrofit LEDs. Juno dedicated LED housings typically offer 50,000-hour rated service life.

#### Incandescent R and BR lamps

R (reflector) and BR (bulge reflector) lamps are made of "soft glass" with an integral funnel shaped reflector. These lamps are available in several sizes and wattages in both spot and flood patterns and are the most economical type of directional lamp. R/BR Flood lamps produce a pleasant, warm, diffuse light well suited for general ambient illumination and subtle directional lighting. Like the incandescent A-lamp, R and BR lamps are subject to increasing legislative regulations on energy consumption. Typical rated life: 2,000 hours.

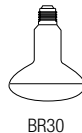

#### Halogen PAR lamps

Parabolic Aluminized Reflector (PAR) lamps are similar to R lamps, but have a more controlled lens/reflector optical system. Clearly recognizable by their thicker pressed glass construction, these halogen sources produce whiter, more concentrated beams of light. Available in a wide variety of sizes, wattages, and beam spreads, PAR lamps are well suited for higher-level ambient lighting, task lighting, and accent lighting. Typical rated life: 2,000 hours.

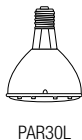

#### MR16 & PAR36 low-voltage lamps

These halogen sources have smaller "point-source" filaments that are accurately aligned in integral computer designed reflectors. This combination produces precisely controlled beams of light in a tremendous variety of beam patterns and intensities. Low-voltage lamps are used in special fixtures that contain a step-down 12-volt transformer. They are best used to precisely highlight artwork, sculpture, and architectural details and to create other dramatic effects. Typical rated life: MR16-5,000 hours, PAR36-2,000 hours.



### Diffuse Lamps

#### Incandescent A-Lamps

Also known as general service lamps, A-lamps provide a soft, warm, uniform ambient illumination. They are ideally suited for use in downlight and wall wash trims that contain integral reflectors. Incandescent A-lamps are the most economical, often costing less than a dollar each. White coated A-lamps are preferable to the generic inside frost types. Typical rated life: 750 hours.

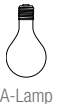

#### Halogen A-line Lamps

Similar in appearance to incandescent A lamps, halogen A-line lamps incorporate a halogen capsule inside as opposed to a standard bare filament. Like all halogen sources, they are typically whiter, brighter, and last longer than standard incandescent lamps. As energy regulations become more restrictive, these could replace standard incandescent A lamps, since they are about one third more energy efficient.



#### Compact Fluorescent Lamps (Dedicated)

Compact Fluorescent Lamps (CFL) are similar in size and light output to A-lamps, but produce 3-5 times more light per watt consumed. This energy savings, combined with a significantly longer rated life, makes them ideal for ambient lighting in rooms such as kitchens which experience long burning hours. CFLs are used in special recessed housings with integral ballasts that regulate the starting and operating current. CFLs are more difficult and costly to dim and do not create the characteristic intimate feeling associated with dimmed incandescent or halogen lamps. Typical rated life: 10,000 hours.



## Color Temperature

Lamps have different color characteristics that can affect the appearance and feel of a space. The color that a lamp produces is expressed as its Color Temperature, in degrees Kelvin (K). Like an iron in a fire, the higher the temperature, the cooler the color of the light. Standard incandescent lamps have a 2700° K color that is warm and familiar... something you might associate with a table lamp or chandelier. Halogen lamps have a whiter, crisper 3000° K color. Halogen lamps are also more efficient than standard incandescent lamps, producing up to 50% more light per watt of energy consumed. Both standard incandescent and halogen lamps can be dimmed to create a warmer, more intimate atmosphere. (Placing incandescent or halogen lamps on dimmers also will considerably extend their service life.)

## Lamp Styles

Recessed trims are available in a variety of basic aperture styles described below. The correct aperture style for a given application is partially dependent on personal preference.

### Baffles

Baffles are the most popular of all residential recessed trims. They are deeply grooved to absorb extraneous light and create a crisp architectural appearance. They are economical, easy to maintain, and available in black or white. Black baffles have low aperture brightness. White baffles blend with the ceiling to eliminate the appearance of dark holes and serve to soften light scallops on adjacent walls.

### Cones

Cones produce a low brightness aperture with a choice of polished clear, gold, black, haze, wheat haze or pewter. Clear and gloss white cones are the least conspicuous, gold provides a warm accent to a room, and black serves to more fully obscure the lamp and lamp image. Haze has a softer, cool appearance, depending on the light source, that blends with white ceilings. Wheat haze has a soft, warm appearance that coordinates with warmer-tone interior finishes.

### Multipliers

Multipliers are similar in appearance to cones but are designed to control the omni-directional light from diffuse A-lamps and CFLs. They are available in white, clear, gold, haze and wheat haze finishes.

### Lensed

Lensed apertures are designed to provide a very diffuse light quality and to protect the lamp. They are particularly useful in wet locations such as bathrooms and eave lighting, as well as closets and pantries.

### Luminous

Luminous trims combine the diffuse quality of a lensed trim but with an open downlight component. Luminous trims provide efficient downlighting while producing a pleasing, soft glow of light on the ceiling and upper part of walls.

### Adjustables

Several types of adjustable trims are available for accent and perimeter lighting. Eyeball style trims are the most economical. Gimbal rings and recessed adjustables provide excellent adjustability while concealing the light source.

### Wall Washers

A variety of wall wash trims are designed to provide even ceiling to floor illumination of vertical surfaces without light scallops. The scoop wall wash is the most economical. Specular clear kicker reflectors direct light toward wall surface and provide a combination of efficient downlighting and wall wash illumination.



### What trim size is right for the application?

This is a commonly asked question that does not have a single answer. Generally, smaller aperture trims are less conspicuous and therefore considered more architecturally desirable. Six-inch trims are still the mainstay for general residential downlight and wall wash illumination, due to their ability to accommodate a wide range of lamps, wattages, and efficient optics. Five-inch trims have become popular for task lighting, and even general lighting in smaller scale settings. Four-inch trims are useful for task and accent lighting with short throw distances and/or lower light level requirements, such as over a bar or counter. They have also become the choice for inconspicuous yet powerful precision accent lighting. Juno unique three-inch trims find use in close proximity downlighting in niches and casework. Juno one-inch and two-inch LED downlights and gimbals are also ideal for these types of applications. With the advent of LEDs, smaller apertures can now provide lumen output previously achieved in only larger sizes.



1" LED Mini Downlights and Gimbals



2"



3"



4"



5"



6"





The new standard in  
efficiency, performance  
and application diversity

# LED Downlights

Juno LED downlights are setting new standards for efficiency, performance and application diversity.

Since their inception, Juno LED Downlights have been an unqualified success, offering unprecedented energy savings, superior quality, brilliant white light, and exceptional service life. The Juno LED product family has taken another step forward with a host of LED fixtures; Generation 4 downlights, slope and super-slope downlights, mini downlights, 2" downlights and adjustables as well as Retrofit LED modules available in a downlight and gimbal version.

No matter what your application, you'll find that Juno LED Downlights have advanced the art and science of illumination to the next plateau, with a range of fixtures that are engineered in the USA by our highly regarded design team.

## **Juno LED Advantages**

- LEDs use as little as 15% of the energy of conventional lighting
- Expected service life of 50,000 hours (typically 11-years or more of maintenance-free operation)
- 25-times the life expectancy of incandescent
- LEDs contain no toxic lead, mercury, or PCBs
- Available with exclusive WarmDim® technology
- 1", 2", 4", 5" and 6" aperture options
- 600, 900 or 1400 lumen can be used in IC or TC applications
- 2700K, 3000K, 3500K, or 4000K color temperature options
- Available with standard Juno trims





## LED housings ... the energy-efficient advantage



### ENERGY STAR®

Most Juno LED Downlights are listed as ENERGY STAR Qualified to luminaire V2.0 requirements. ENERGY STAR is a government sponsored program that establishes criteria and testing requirements to ensure energy efficient luminaires meet consistent performance standards. Many local utilities offer builder and homeowner rebates for installing ENERGY STAR Qualified products.



### T24

Juno LED Downlights are certified to meet the high efficacy requirements of California Title 24 (JA8-2016).



### Air-Loc®

Juno IC LED housings are Air-Loc rated and designed to minimize air leak paths. Air-Loc rated housings are tested in accordance with ASTM E283 and certified by an independent laboratory to be in compliance with the minimum air-leakage standards as set in the International Energy Conservation Code, as well as several state energy codes, including Washington State.

# The industry's most comprehensive LED downlight offering

## Housings

Juno offers the most comprehensive LED lineup in the industry, including downlights for standard and slope ceilings; new construction, remodel, and retrofit; plus adjustable eyeballs, minis, and gimbals. Generation 4 LED downlights are available with IC or TC rated housings with light output up to 1400 lumens. And they are all designed and engineered in the USA to the very highest standards.

## Color Temperature Offering







Select from a large range of color temperatures to suit any application: 2700K, 3000K, 3500K and 4000K.

## Trims

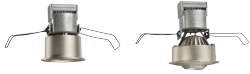
Juno LED downlights are as beautiful as they are efficient. The extensive trim options include baffle, cone, hyperbolic, decorative, lensed, and wall wash in a wide variety of handsome colors and finishes. The trim collection is compatible with both 600-, 900- and 1400-lumen housings.



## Juno LED Downlight Index

<p>Mini Downlight and Gimbal   34-35</p> 	<p>6" Retrofit Downlight Trim Module   68-71</p> 
<p>2" LED Downlights &amp; Adjustables   36-41</p> 	<p>6" Retrofit Downlight Eyeball Trim Module   72-73</p> 
<p>4" Internally Adjustable   42-45</p> 	<p>4", 5" &amp; 6" Basics Series™ Retrofit LED Downlight Trims   74-79</p> 
<p>4" Gimbal   46-49</p> 	<p>4", 5" &amp; 6" Basics Series™ Retrofit LED Adjustable Gimbal Ring   80-85</p> 
<p>4", 5" and 6" WarmDim® Downlights   50-57</p> 	<p>4" &amp; 6" Basics Series™ Surface Mount LED   86-87</p> 
<p>4" IC Rated New Construction &amp; Remodel Downlights   58-61</p> 	<p>Round &amp; Square, SlimForm™ LED Surface Mount Downlights   88-93</p> 
<p>5" &amp; 6" IC Rated New Construction &amp; Remodel Downlights   62-67</p> 	

Slope Ceiling LED Downlights are also available. See page 125 for more information.



# Mini LED Downlight/Gimbal

## Big-time illumination for small spaces

Ideal for niches, bookcases, soffits, cabinetry and so much more, Juno Mini LED Downlights and Gimbals open-up a multitude of task and accent lighting possibilities, especially when installation space is at a premium. Using less than 5-watts input, these versatile little recessed luminaires are the most energy-efficient solution for providing the desired look and just the right amount of light in confined areas.

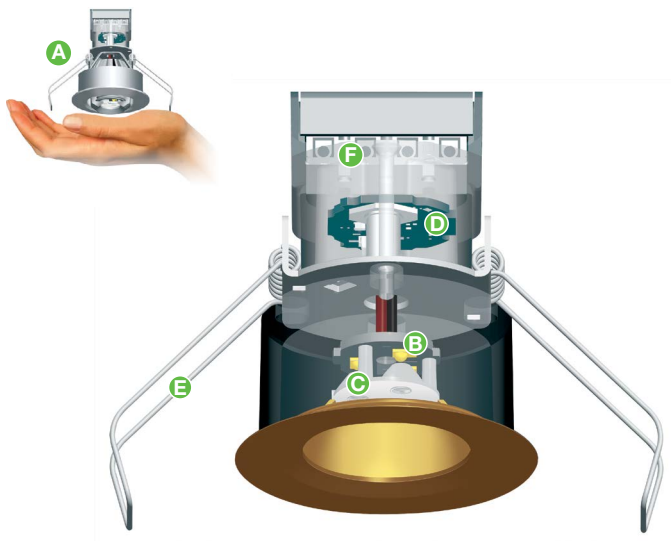

### A. Ultra-compact design

Able to fit in the palm of your hand, these versatile, miniature fixtures easily integrate into the smallest of spaces. From kitchen soffits to cabinetry and architectural niches... even a wet location version that is perfect for outdoor applications such as under eaves.

### B. Super-efficient LED light engine

The latest generation of high performance LEDs produce over 300 lumens in 2700K, 3000K, 3500K or 4000K; exceeding the performance of 20W halogen MR11 lamps while consuming less than 5-watts of power. 80+CRI color rendering out of an inconspicuous 1" aperture with a 50,000 L70 service life... truly remarkable! Optional 90 CRI minimum also available.

### C. Versatile Optics

Precision injection molded spot, narrow flood and flood optics provide maximum versatility for task, accent and even ambient/ circulation lighting in low ambient lighting applications such as home theatres.

### D. Familiar, easily dimmable 12V AC operation

An onboard 12-volt LED driver allows the mini-downlight and gimbal to be operated off of Class 2 Juno 12-volt electronic or magnetic transformers, eliminating concerns over voltage drop while providing reliable, fool proof dimming using commercially available low voltage style halogen dimmers.

### E. Easy installation

Fixtures and the TL602E transformer install from below the ceiling through miniature holes that can be cut using standard 2" or 2-3/8" hole saws. Fixtures grip securely in place on material thicknesses from 1/8" to 1" using easy to use "mouse-trap" springs. And both the fixtures and the TL602E transformer are rated for direct contact with insulation.

### F. Simplified daisy-chain wiring

Unlike most low voltage systems which require a home run back to the transformer from each fixture, Juno Mini-Downlights and Gimbals have an integral 4-port terminal block that facilitates fixture to fixture wiring using commonly available type CL2 or NEC equivalent 18-12 AWG wire.

## IC-Rated Mini LED Downlight and Mini LED Gimbal

Ideal for niches, bookcases, soffits, displays, elevators and so much more, Juno Mini LED Downlights and Gimbals open-up a multitude of task and accent lighting possibilities.

### Finishes



## Mini LED Downlights

Example: MD1LG2 SQ 03LM 27K 80CRI FL WL WH

Housing	Fixture Form	Lumens	Color Temperature	CRI	Distribution	Environment	Trim Finish
<b>MD1LG2</b>	<b>RD</b> Round	<b>03LM</b> 300 Nominal Lumens	<b>27K</b> 2700K	<b>80CRI</b> 80+ CRI	<b>FL</b> Flood <b>NFL</b> Narrow Flood <b>SP</b> Spot	<b>Blank</b> Damp Location  <b>WL</b> Wet Location	<b>BL</b> Black
	<b>SQ</b> Square		<b>30K</b> 3000K <b>35K</b> 3500K <b>40K</b> 4000K				<b>90CRI</b> 90+ CRI

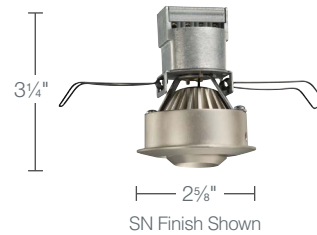

## Mini LED Gimbals

Example: MG1LG2 SQ 03LM 27K 80CRI FL WL WH

Housing	Fixture Form	Lumens	Color Temperature	CRI	Distribution	Trim Finish
<b>MG1LG2</b>	<b>RD</b> Round	<b>03LM</b> 300 Nominal Lumens	<b>27K</b> 2700K	<b>80CRI</b> 80+ CRI	<b>FL</b> Flood <b>NFL</b> Narrow Flood <b>SP</b> Spot	<b>BL</b> Black
	<b>SQ</b> Square		<b>30K</b> 3000K <b>35K</b> 3500K <b>40K</b> 4000K			<b>90CRI</b> 90+ CRI

## Transformers

### Ordering Options

**Electronic:** 10W, 25W AND 60W 12V AC Electronic Transformer. Available with optional factory installed 6ft. cord & plug.



**Magnetic:** 10W, 25W and 60W 12V AC Magnetic Transformer



Catalog Number	Finish	Description
<b>TL602E 10W 120 12AC WH</b>	White	10W 12V AC Electronic Driver/Transformer
<b>TL602E 25W 120 12AC WH</b>	White	25W 12V AC Electronic Driver/Transformer
<b>TL602E 60W 120 12AC WH</b>	White	60W 12V AC Electronic Driver/Transformer

Catalog Number	Finish	Description
<b>MAGXFMR 1C 10W 120 12AC BL</b>	Black	10W 12V AC Magnetic Transformer
<b>MAGXFMR 1C 25W 120 12AC BL</b>	Black	25W 12V AC Magnetic Transformer
<b>MAGXFMR 1C 60W 120 12AC BL</b>	Black	60W 12V AC Magnetic Transformer

Suffix No.	Description
<b>6CP</b>	6 ft. Cord & Plug, Factory Installed

(Add as suffix to catalog number). Example: TL602 10W 120 12AC 6CP WH



## 2" LED Downlights & Adjustables

Energy-efficient, discreet aperture, high performance LED lighting



The second generation of Juno 2" LED downlights and adjustables feature the latest high lumen output LED array, binned to within 3-step MacAdam Ellipse, exceeding ENERGY STAR® requirements. They provide superior fixture-to-fixture color consistency and are available in color temperatures of 2700K, 3000K, 3500K, and 4000K with 80 CRI or 90 CRI minimum. Dimmable LED drivers now come in a choice of 600 or 1000 lumen outputs. Both driver options are offered with 120-volt only operation (compatible with most incandescent dimmers) or universal 120-277V operation (compatible with most 0-10V protocol dimmers). Additionally, field-interchangeable optics are available to provide distributions ranging from 18° to 40°. Energy-efficient, stylish Juno 2" LED downlights and adjustables are the little something extra for today's residential and commercial lighting applications.



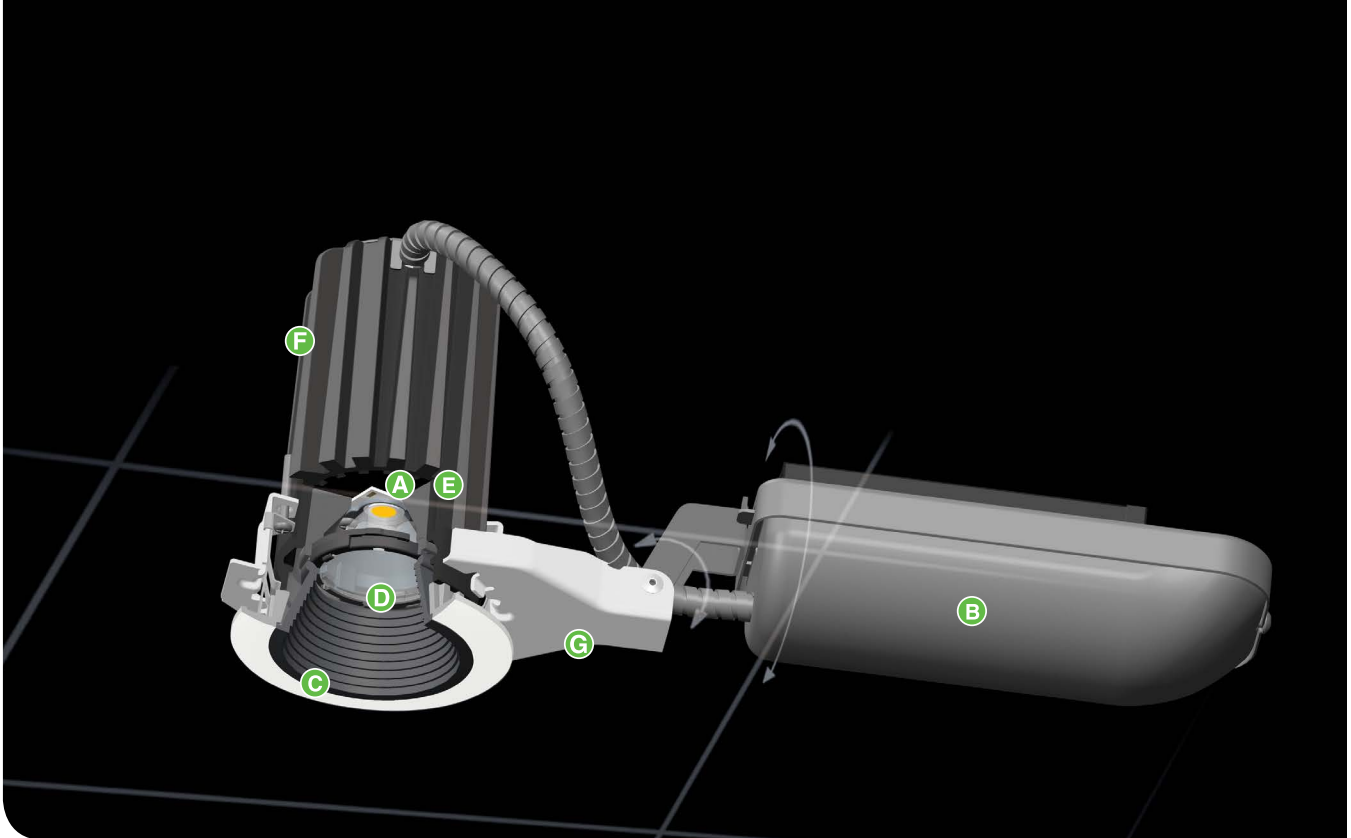

**A. Advanced Light Engine:** Advanced LED technology produces up to 1,000 lumens from as little as 11 watts or 600 lumens from as little as 7 watts input. LEDs are binned to within a 3-step MacAdam Ellipse for superior fixture to fixture color consistency. Color temperatures of 2700K, 3000K, 3500K and 4000K with 80 CRI or 90 CRI minimum.

**B. LED Driver:** Specify either 600 or 1,000 lumen output; for both versions, choose either the dedicated 120-volt driver compatible with incandescent, magnetic low voltage and ELV dimming or the universal 120V-277V driver with 0-10V dimming.

**C. Downlight Trim:** All metal trim is offered in cone and baffle styles. Round aperture downlight features shadow free knife edge trim ring to blend seamlessly into the ceiling. **Adjustable Trim** (not shown): Die cast gimbal trim features 35° tilt adjustment. Round aperture adjustable features shadow free knife edge trim ring to blend seamlessly into the ceiling.

**D. High Efficiency Optics:** Three field interchangeable TIR optics available in 18°, 24° and 40° beam angles.

**E. Superior Thermal Management:** LED array is attached to die cast trim with integral heat sink to provide excellent heat transfer and ensure long life. At the end of their rated life, LEDs can be expected to produce 70% of their initial light output with no perceptible changes in color.

**F. Low Profile Housing:** Permits easy installation in a wide variety of applications and fits nicely within 2 x 6 ceiling joists for shallow applications.

**G. Easy Installation:** Fixture easily installs from below the ceiling through a small 2-5/8" ceiling cut out. Galvanized steel plaster frame accommodates ceiling thicknesses from 1/2" to 1". New construction mounting frame with Real Nail® 3 telescoping bar hangers to position fixture and locate wiring prior to ceiling installation is also available.

# 2" LED Round Downlights & Adjustables

## Two Part Ordering System

### Order Driver and LED Trim Module separately

The Juno 2" LED Gen 2 system allows you to create a modular assembly by selecting your desired driver output and pairing it with the Gen 2 trim module of your choice.



## Trims

Juno 2" LED round downlights and adjustables are offered in an extensive selection of trims. Downlights are available in cone and baffle styles, and downlights and adjustables are offered in white, black, satin nickel and brushed bronze with various combinations. You are certain to find the perfect fixture for any room in the home or office.

### Downlight Baffle



**BBL**  
Black Baffle/  
Black Trim

**BZBZ**  
Brushed Bronze Baffle/  
Brushed Bronze Trim

**SNSN**  
Satin Nickel Baffle/  
Satin Nickel Trim

**WWH**  
White Baffle/  
White Trim

**BWH**  
Black Baffle/  
White Trim

### Downlight Cone



**BBL**  
Black Cone/  
Black Trim

**WHZBZ**  
Wheat Haze Cone/  
Brushed Bronze Trim

**HZSN**  
Haze Cone/  
Satin Nickel Trim

**CWH**  
Clear Cone/  
White Trim



**WWH**  
White Cone/  
White Trim

**HZWH**  
Haze Cone/  
White Trim

**BWH**  
Black Cone/  
White Trim

### Adjustable



**BL**  
Black

**BZ**  
Brushed Bronze

**SN**  
Satin Nickel

**WH**  
White

## 2" LED Driver Assembly



Driver options include assemblies that produce up to 600 or 1000 lumens. Both are available with dedicated 120V or universal 120-277 VAC.

### Example: 2LEDDRIVER G2 10LM 120 FRPC

Series	Gen	Lumens	Voltage/Driver
2LEDDRIVER 2" LED Driver	G2	<b>06LM</b> 600 Lumens	<b>120 FRPC</b> Dedicated 120V Only; Forward Phase/ ELV Dimmable
		<b>10LM</b> 1000 Lumens	<b>MVOLT ZT</b> Universal 120-277V; 0-10V Dimming

Note: Driver assembly only intended for use with Gen 2 LED trim modules. Not backward compatible with previous generation.

## Downlight

## 2" LED Round Downlight Trim Module



Baffle



Cone

Combined with the driver assembly, the 2 inch aperture recessed downlight is IC rated for insulated or non-insulated applications. Luminaire produces up to 1,000 lumens and is available with optical distributions ranging from 18°- 40°. Low profile form factor allows luminaire to fit in 2 x 6 construction. LED Light Engine provides exceptional fixture to fixture color consistency within a 3-step MacAdam ellipse. Air-Loc rated LED housings and UL Listed for wet location.

### Example: 2LEDTRIM G2 DB 27K 80CRI SP WH

Series	Gen	Trim Type	CCT	CRI	Beam Optics	Downlights/Reflector Finish
2LEDTRIM	G2	DB Downlight Baffle	<b>27K</b> 2700K	<b>80CRI</b> 80 CRI	<b>SP</b> 18° Spot	<b>Downlight Baffle</b> <b>WWH</b> White Baffle/ White Trim Ring
			<b>3K</b> 3000K	<b>90CRI</b> 90 CRI	<b>NFL</b> 24° Narrow Flood	<b>BBL</b> Black Baffle/ Black Trim Ring
		DC Downlight Cone	<b>35K</b> 3500K		<b>FL</b> 40° Flood	<b>BWH</b> Black Baffle/ White Trim Ring
			<b>40K</b> 4000K			<b>BZBZ</b> Bronze Baffle/ Bronze Trim Ring
						<b>SNSN</b> Satin Nickel Baffle/Satin Nickel Trim Ring
						<b>Downlight Cone</b> <b>WWH</b> White Cone/ White Trim Ring
						<b>BBL</b> Black Cone/ Black Trim Ring
						<b>CWH</b> Clear Cone/ White Trim Ring
						<b>BWH</b> Black Cone/ White Trim Ring
						<b>HZWH</b> Haze Cone/ White Trim Ring
						<b>WHZBZ</b> Wheat Haze Cone/ Bronze Trim Ring
						<b>HZSN</b> Haze Cone/ Satin Nickel Trim Ring

## Adjustable

## 2" LED Round Adjustable Trim Module



Combined with the driver assembly, the 2 inch aperture recessed adjustable is IC rated for insulated or non-insulated applications. Luminaire produces up to 1,000 lumens and is available with optical distributions ranging from 18°- 40°. Low profile form factor allows luminaire to fit in 2 x 6 construction. LED Light Engine provides exceptional fixture to fixture color consistency within a 3-step MacAdam ellipse. Air-Loc rated LED housings and UL Listed for damp location.

### Example: 2LEDTRIM G2 ADJ 27K 80CRI SP WH

Series	Gen	Trim Type	CCT	CRI	Beam Optics	Finish
2LEDTRIM	G2	ADJ Adjustable Gimbal	<b>27K</b> 2700K	<b>80CRI</b> 80 CRI	<b>SP</b> 18° Spot	<b>WH</b> White
			<b>3K</b> 3000K	<b>90CRI</b> 90 CRI	<b>NFL</b> 24° Narrow Flood	<b>BL</b> Black
			<b>35K</b> 3500K		<b>FL</b> 40° Flood	<b>BZ</b> Bronze
			<b>40K</b> 4000K			<b>SN</b> Satin Nickel



### Accessories

Catalog Number	Description
2NCMF	New Construction Mounting Frame with Real Nail® 3 bar hangers
2JCTA150	Thick Ceiling adapter for 1" - 1-1/2" thick ceiling
LEDOPTIC2 SP	Spot Optic (18° beam)
LEDOPTIC2 NFL	Narrow Flood Optic (24° beam)
LEDOPTIC2 FL	Flood Optic (40° beam)

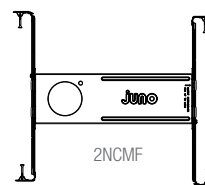

2JCTA150



### Regulatory Listings and Standards

- UL and C-UL Listed
- Listed for Direct Contact with Insulation
- ENERGY STAR® Certified
- RoHS Compliant
- Juno LED Downlights are certified to meet the high efficacy requirements of California Title 24 (JA8 2016).
- Air-Loc® rated to minimize air leakage and promote building energy efficiency.
- Downlights are UL and cUL listed for Wet Locations.

### Qualified Dimmers

Choice of dimmable drivers includes dedicated 120 volt driver compatible with the use of most incandescent, magnetic low voltage and electronic low voltage dimmers, or universal voltage driver, dimmable with the use of most 0-10V protocol dimmers. Refer to the spec sheet for a list of compatible dimmers.



# 2" LED Square Downlights & Adjustables

## Two Part Ordering System

### Order Driver and LED Trim Module separately

The Juno 2" LED Gen 2 system allows you to create a modular assembly by selecting your desired driver output and pairing it with the Gen 2 trim module of your choice.



## Trims

Perfect for today's upscale interiors, Juno 2" LED square downlights and adjustables are offered with a wide selection of trim finishes. Downlights and adjustables are offered in white, black, satin nickel, and brushed bronze with various combinations.

### Downlight Reflectors

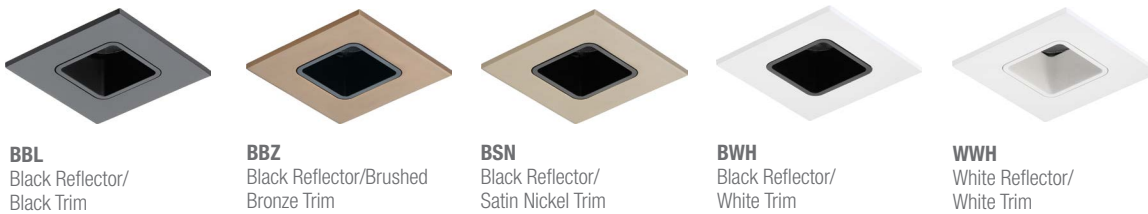

### Adjustable



## 2" LED Driver Assembly



Driver options include assemblies that produce up to 600 or 1000 lumens. Both are available with dedicated 120V or universal 120-277 VAC.

### Example: 2LEDDRIVER G2 10LM 120 FRPC

Series	Gen	Lumens	Voltage/Driver
2LEDDRIVER 2" LED Driver	G2	<b>06LM</b> 600 Lumens	<b>120 FRPC</b>
		<b>10LM</b> 1000 Lumens	<b>MVOLT ZT</b>

Dedicated 120V Only; Forward Phase/ELV Dimmable  
Universal 120-277V; 0-10V Dimming

## Downlight

Note: Driver assembly only intended for use with Gen 2 LED trim modules. Not backward compatible with previous generation.

## 2" LED Square Downlight Trim Module



Combined with the driver assembly, the 2 inch aperture recessed downlight is IC rated for insulated or non-insulated applications. Luminaire produces up to 1,000 lumens and is available with optical distributions ranging from 18°-40°. Low profile form factor allows luminaire to fit in 2 x 6 construction. LED Light Engine provides exceptional fixture to fixture color consistency within a 3-step MacAdam ellipse. Air-Loc rated LED housings and UL Listed for wet location.

### Example: 2LEDTRIM G2 SQ 27K 80CRI SP WH

Series	Gen	Trim Type	CCT	CRI	Beam Optics	Finish
2LEDTRIM	G2	SQ Square Downlight	<b>27K</b> 2700K	<b>80CRI</b> 80 CRI	SP 18° Spot NFL 24° Narrow Flood FL 40° Flood	<b>WWH</b> White/White Trim Ring
			<b>3K</b> 3000K	<b>90CRI</b> 90 CRI		<b>BBL</b> Black/Black Trim Ring
			<b>35K</b> 3500K			<b>BWH</b> Black/White Trim Ring
			<b>40K</b> 4000K			<b>BBZ</b> Black/Bronze Trim Ring
						<b>BSN</b> Black/Satin Nickel Trim Ring

## Adjustable

## 2" LED Square Adjustable Trim Module



Combined with the driver assembly, the 2 inch aperture recessed adjustable is IC rated for insulated or non-insulated applications. Luminaire produces up to 1,000 lumens and is available with optical distributions ranging from 18°-40°. Low profile form factor allows luminaire to fit in 2 x 6 construction. LED Light Engine provides exceptional fixture to fixture color consistency within a 3-step MacAdam ellipse. Air-Loc rated LED housings and UL Listed for damp location.

### Example: 2LEDTRIM G2 SQADJ 27K 80CRI SP WH

Series	Gen	Trim Type	CCT	CRI	Beam Optics	Finish
2LEDTRIM	G2	SQADJ Adjustable Gimbal	<b>27K</b> 2700K	<b>80CRI</b> 80 CRI	SP 18° Spot NFL 24° Narrow Flood FL 40° Flood	<b>WH</b> White
			<b>3K</b> 3000K	<b>90CRI</b> 90 CRI		<b>BL</b> Black
			<b>35K</b> 3500K			<b>BZ</b> Bronze
			<b>40K</b> 4000K			<b>SN</b> Satin Nickel

### Accessories

Catalog Number	Description
<b>2NCMF</b>	New Construction Mounting Frame with Real Nail® 3 bar hangers
<b>2JCTA150</b>	Thick Ceiling adapter for 1" - 1-1/2" thick ceiling
<b>LEDOPTIC2 SP</b>	Spot Optic (18° beam)
<b>LEDOPTIC2 NFL</b>	Narrow Flood Optic (24° beam)
<b>LEDOPTIC2 FL</b>	Flood Optic (40° beam)

### Qualified Dimmers

Choice of dimmable drivers includes dedicated 120 volt driver compatible with the use of most incandescent, magnetic low voltage and electronic low voltage dimmers, or universal voltage driver, dimmable with the use of most 0-10V protocol dimmers. Refer to the spec sheet for a list of compatible dimmers.

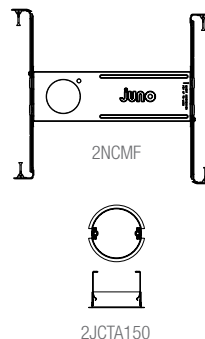

### Regulatory Listings and Standards

- UL and C-UL Listed
- Listed for Direct Contact with Insulation
- ENERGY STAR® Certified
- RoHS Compliant
- Juno LED Downlights are certified to meet the high efficacy requirements of California Title 24 (JA8 2016).
- Air-Loc® rated to minimize air leakage and promote building energy efficiency.
- Downlights are UL and cUL listed for Wet Locations.







## 4" Internally Adjustable LED Fixture

Adjustable, beautifully made fixtures that blend seamlessly into the ceiling

Downlighting, accent lighting, sloped ceiling or wet location, round or square aperture, it's the one fixture for all your needs – now and in years to come.

Juno 4-inch internally adjustable LED fixtures are agents of change. Imagine just about any change in room décor or interior design you might desire, and these fixtures are ready to respond.

### **Let's say you would like to change the trim.**

Instead of having the trim integrated with the light source, trims for these fixtures are sold separately. You can change color or style anytime you want without needing to replace the entire luminaire. And there are a bevy of trims to choose from.

### **Want to adjust the light beam?**

These fixtures offer internal adjustability of up to 35-degrees vertical and 360 degrees rotation so that light can be directed where needed. There are no mechanical parts below the ceiling plane ... just a beautifully made fixture that blends seamlessly into the ceiling. Redirect the light pattern anytime a change is desired.

### **Changing the beam spread is easy, too.**

High-precision TIR optics are field interchangeable. The fixture series offers a 40-degree flood, a 30-degree narrow flood or 18-degree spot – all easy to switch out when your lighting design needs change. The fact is, these fixtures are all about change and adaptability. The dimmable drivers enable change to lumen output to alter light intensity and mood. The media holder accepts a wide variety of lenses, films, and filters, permitting unlimited changes to lighting effects.

# 4" Internally Adjustable LED Fixtures

## 700 and 1000 Lumen

Two lumen packages, choices in LED color temperature, multiple driver options and extensive trim selection...if you want stylish, efficient fixtures that offer a magnitude of options for customizing your fixture to your needs now or in the future, you won't find a better solution than Juno 4" internally adjustable LED fixtures.



**New Construction**  
11 7/8" L X 6 3/4" W X 6" H  
Ceiling Cutout: 4 1/2"



**Remodel**  
12 1/2" L X 4 1/4" W X 6" H  
Ceiling Cutout: 4 3/8"

### New Construction and Remodel, IC Housings

Example: **IC4AL 10LM 30K 90CRI FL 120 FRPC**

Series	Lumens	CCT	CRI	Beam Optics	Voltage/Driver
<b>IC4AL†</b> 4" IC New Construction Housing	<b>07LM</b> 700 Lumens	<b>27K</b> 2700K <b>30K</b> 3000K	<b>90 CRI</b>	<b>SP</b> 18° Spot <b>NFL</b> 30° Narrow Flood <b>FL</b> 40° Flood	<b>120 FRPC</b> 120V Only; Forward Phase/ELV Dimming <b>MVOLT ZT</b> Universal 120-277V; 0-10V Dimming <b>MVOLT ECOS3</b> Lutron Hi Lume® 3-Wire Dimming EcoSystem Compatible
	<b>10LM</b> 1000 Lumens	<b>35K</b> 3500K <b>40K</b> 4000K			
<b>IC4RAL*</b> 4" IC Remodel Housing					

† IC4AL 1000 lumen not available with MVOLT ECOS3.

\* IC4RAL available in 700 lumen only. Not available with MVOLT ECOS3.

### New Construction and Remodel, TC Housings

Example: **TC4AL 10LM 30K 90CRI FL MVOLT ECOS3**

Series	Lumens	CCT	CRI	Beam Optics	Voltage/Driver
<b>TC4AL††</b> 4" TC New Construction Housing	<b>07LM</b> 700 Lumens	<b>27K</b> 2700K <b>30K</b> 3000K	<b>90 CRI</b>	<b>SP</b> 18° Spot <b>NFL</b> 30° Narrow Flood <b>FL</b> 40° Flood	<b>120 FRPC</b> 120V Only; Forward Phase/ELV Dimming <b>MVOLT ZT</b> Universal 120-277V; 0-10V Dimming <b>MVOLT ECOS3</b> Lutron Hi Lume® 3-Wire Dimming EcoSystem Compatible
	<b>10LM</b> 1000 Lumens	<b>35K</b> 3500K <b>40K</b> 4000K			
<b>TC4RAL**</b> 4" TC Remodel Housing					

†† TC4AL available in 1000 lumen only. Not available with 120 FRPC or MVOLT ZT.

\*\* TC4RAL 700 lumen not available with 120 FRPC or MVOLT ZT.

### Accessories

Catalog Number	Description	Catalog Number	Description
<b>CGF 200 MPINK</b>	Medium Pink Color Filter	<b>DGF 200 CYAN</b>	Blue Green Dichroic Lens
<b>CGF 200 WRED</b>	Warm Red Color Filter	<b>DCCF 200 HL4250</b>	Daylight Blue Correction Lens
<b>CGF 200 DLTBLUE</b>	Daylight Blue Color Filter	<b>DIFF 200</b>	Diffuse Spread Lens
<b>CGF 200 MBLU</b>	Medium Blue Color Filter	<b>UVF 200</b>	UV Filter Lens
<b>CGF 200 MAMB</b>	Medium Amber Color Filter	<b>HCLBL 200</b>	Hexcell Louver
<b>CGF 200 MGRN</b>	Medium Green Color Filter	<b>LSPREAD 200</b>	Linear Spread Lens
<b>DGF 200 DRED</b>	Red Dichroic Lens	<b>PRISM 200</b>	Prismatic Lens
<b>DGF 200 MGRN</b>	Medium Green Dichroic Lens	<b>TIR2 SPT</b>	18° Spot Optic
<b>DGF 200 MBLU</b>	Medium Blue Dichroic Lens	<b>TIR2 NFLD</b>	30° Narrow Flood Optic
<b>DGF 200 DYEL</b>	Yellow Dichroic Lens	<b>TIR2 FLD</b>	40° Flood Optic
<b>DGF 200 MAGEN</b>	Magenta Dichroic Lens		

## Trims

All trims for Juno 4-inch internally adjustable LED fixtures are sold separately and easily changed to adapt to future needs. The available styles and finishes are extensive.

This stunning trim collection is an expansion of the popular Juno 4-inch LED fixture family and offers perfectly matched finishes. Round trims feature a beveled edge design that blends cleanly with the ceiling.

Now you can change trims whenever lighting requirements dictate or whenever the mood strikes you. It's all part of the visionary philosophy behind the design of these extraordinary fixtures.

### Round Trims

 <p>47L Series Adjustable Cone</p>	47L BWH	Black Alzak®, White Trim
	47L CWH	Clear Alzak®, White Trim
	47L WWH	Gloss White, White Trim
	47L HZWH	Haze, White Trim
	47L PTSC	Pewter Alzak®, Satin Chrome Trim
	47L WHZABZ	Wheat Haze, Classic Aged Bronze Trim
	47L WHZWH	Wheat Haze, White Trim

 <p>42L Series Downlight Cone</p>	42L BWH	Black Alzak®, White Trim
	42L CWH	Clear Alzak®, White Trim
	42L WWH	Gloss White, White Trim
	42L HZWH	Haze, White Trim
	42L PTSC	Pewter Alzak®, Satin Chrome Trim
	42L WHZABZ	Wheat Haze, Classic Aged Bronze Trim
	42L WHZWH	Wheat Haze, White Trim

 <p>45L Adjustable Slot Aperture</p>	45L WH	White
---	--------	-------

 <p>41L Series Adjustable Shower</p>	41L ABZ	Perimeter Frosted Lens, Classic Aged Bronze Trim
	41L SC	Perimeter Frosted Lens, Satin Chrome Trim
	41L WH	Perimeter Frosted Lens, White Trim

 <p>39 Series Lensed Wall Wash</p>	39 CWH	Clear Alzak®, White Trim
	39 HZWH	Haze, White Trim
	39 WHZWH	Wheat Haze, White Trim
	39 WWH	White, White Trim

### Round Trims

 <p>46L Series Slope (9°-24° Ceiling Slope)</p>	46L BWH	Black Alzak®, White Trim
	46L CWH	Clear Alzak®, White Trim
	46L WWH	Gloss White, White Trim
	46L HZWH	Haze, White Trim
	46L PTSC	Pewter Alzak®, Satin Chrome Trim
	46L WHZABZ	Wheat Haze, Classic Aged Bronze Trim
	46L WHZWH	Wheat Haze, White Trim

 <p>48L Series Super Slope (20°-35° Ceiling Slope)</p>	48L BWH	Black Alzak®, White Trim
	48L CWH	Clear Alzak®, White Trim
	48L WWH	Gloss White, White Trim
	48L HZWH	Haze, White Trim
	48L PTSC	Pewter Alzak®, Satin Chrome Trim
	48L WHZABZ	Wheat Haze, Classic Aged Bronze Trim
	48L WHZWH	Wheat Haze, White Trim

### Square Trims

 <p>47LSQ Series Adjustable</p>	47LSQ BWH	Black Alzak®, White Trim
	47LSQ WWH	Gloss White, White Trim
	47LSQ HZWH	Haze, White Trim
	47LSQ WHZWH	Wheat Haze, White Trim

 <p>42LSQ Series Downlight</p>	42LSQ BWH	Black Alzak®, White Trim
	42LSQ WWH	Gloss White, White Trim
	42LSQ HZWH	Haze, White Trim
	42LSQ WHZWH	Wheat Haze, White Trim

 <p>41LSQ Adjustable Lensed</p>	41LSQ WH	Perimeter Frosted Lens, White Trim
--	----------	------------------------------------



ENERGY STAR® and T24 certification dependent on trim finish and LED color temperature. See housing spec sheet for specific information on each trim.





## 4" LED Recessed Gimbals

Energy-efficient, stylish downlighting for residential applications



These 4" gimbals are the latest development in the exceptional Generation 4 LED Downlight family. In addition to being a step forward in energy efficiency, they also offer:

- Designer-grade quality with gimbal adjustability
- Exceptional color accuracy with 90+ CRI
- Dedicated, new construction or remodel, Air-Loc® LED housings
- Accent-lighting trim modules with plug-in LED light engines
- ENERGY STAR® certified and certified to meet the height efficacy requirements of California Title 24 (JA8-2016)
- A+ Capable configurations, compatible with A+ Certified solutions
- Designed and engineered in the USA

# 4" LED Recessed Gimbals...the next in line

4" LED recessed gimbal for new construction, shown with white trim

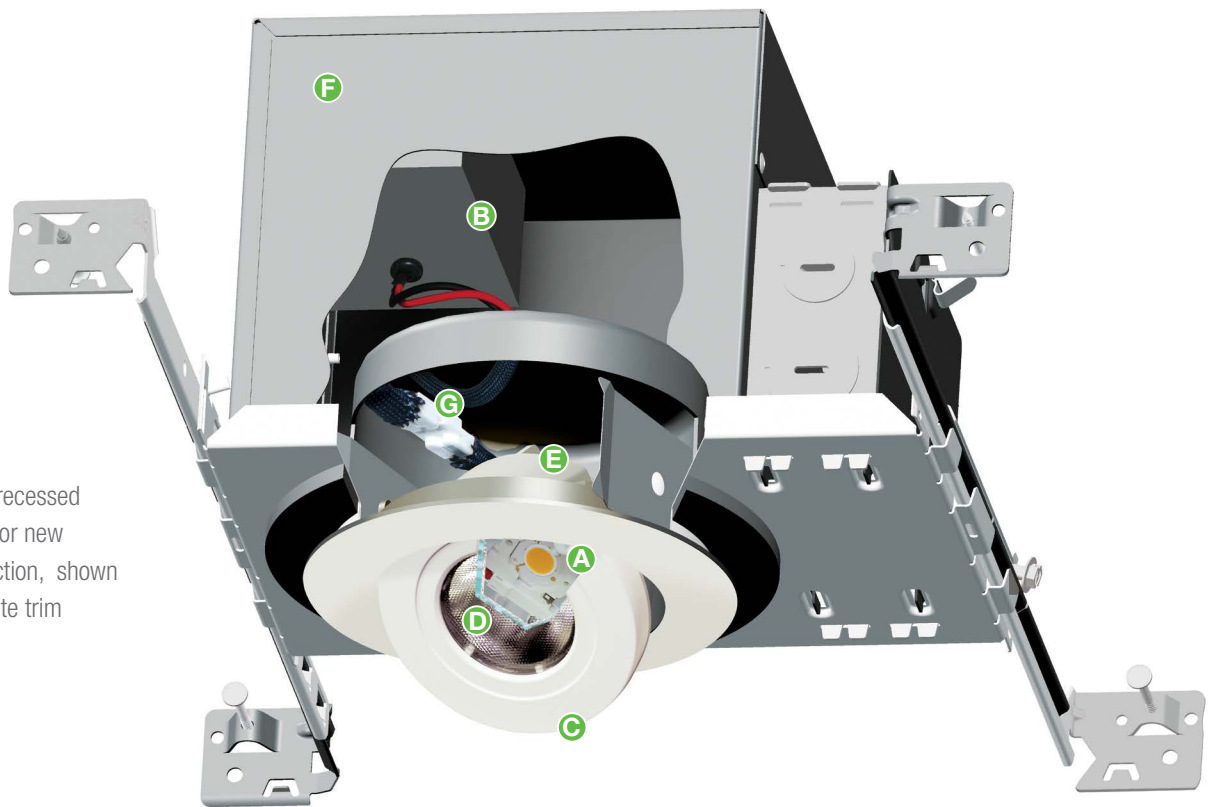

- A. Generation 4 LED Light Engine** Advanced LED technology produces more than 600 lumens from just 8-watts input. LEDs are binned to within 3-step MacAdam Ellipse for superior fixture to fixture color consistency. Color temperatures of 2700K, 3000K, 3500K and 4000K with 90+ CRI minimum.
- B. LED Driver** Specify either a dedicated 120 volt driver compatible with incandescent, magnetic low voltage and ELV dimming or universal 120V-277V driver with 0-10V dimming.
- C. Adjustable Gimbal Trim** Die cast gimbal trim features shadow free knife edge to blend seamlessly into the ceiling. Available finishes: white, black, satin chrome and aged bronze.
- D. High Efficiency Optics** Three field interchangeable TIR optics available in 18°, 30° and 40° beam angles. The light engine trim module is supplied with 30° optic installed.
- E. Superior Thermal Management LED array** is attached to die cast trim with integral heat sink to provide excellent heat transfer and ensure long life. At the end of their rated life, LEDs can be expected to produce 70% of their initial light output with no perceptible changes in color.
- F. Low Profile Housing Permits** easy installation in a wide variety of applications and fits nicely within 2 x 6 ceiling joists for shallow applications. New construction housings are supplied with Juno Real Nail 3® bar hanger system. For suspended ceilings the integral T-bar notch can be used to secure the housing into the ceiling grid – no accessory clips required.
- G. Easy Installation:** LED light engine trim module features a plug-in connector for easy installation with the housing.

# Juno® 4" LED Recessed Gimbals

## Simple, Two-Part Ordering System

Order your housing and LED Trim Modules separately to complete your fixture assembly. Installation is literally "a snap" with our quick connect system.



## Adjustable Accent LED Trim Modules

The die-cast gimbal-ring trim provides 35° tilt adjustment and features a shadow-free, knife-edge design that blends seamlessly into ceilings. It's stylishly finished in white, black, satin chrome, or aged bronze.



**WH** White



**BL** Black



**SC** Satin Chrome



**ABZ** Aged Bronze



LED light engine trim module features field interchangeable TIR optics. Trim module ships with the Narrow Flood optic installed. Spot (TIR1 SPT) and Flood (TIR2 FLD) optics are also available.

Trim module can accommodate one 2-inch diameter beam control accessory. See specification sheet for available media accessories.

### Regulatory Listings and Standards

- UL and C-UL Listed for Damp Location
- Listed for Direct Contact with Insulation
- UL Listed for through-branch wiring
- ENERGY STAR® Certified
- RoHS Compliant
- Juno LED Downlights are certified to meet the high efficacy requirements of California Title 24 (JA8-2016)





# Juno® 4" LED Recessed Gimbals

## 4" LED Recessed New Construction Housing



### IC1ALED G4N-440LED G4N

Dedicated LED, Air-Loc® sealed new construction housing with a choice of dimmable drivers. LED light engine trim module (order separately) features a plug-in connector for easy installation with IC1ALED G4N housing. Double wall, shallow housing allows for fit in 2 x 6 construction with a 4-1/2" ceiling cutout. IC housing designed for uses in IC or non-IC construction.

Series	Gen	Lumens	Voltage/Driver*	Trim	Gen	Lumens	CCT	CRI	Trim Style
IC1ALED	G4N	06LM 600 LM	120 FRPC 120V Forward/ Reverse Cut, 5% dim	440LED	G4N	06LM 600 LM	27K 2700K 30K 3000K 35K 3500K 40K 4000K	90 CRI	WH White BL Black SC Satin Chrome ABZ Aged Bronze

## 4" LED Recessed Remodel Housing



### IC1RALED G4N-440LED G4N

Dedicated LED, Air-Loc® remodel housing with a choice of dimmable drivers. LED light engine trim module (order separately) features a plug-in connector for easy installation with IC1RALED G4N housing. Shallow housing allows for fit in 2 x 6 construction with a 4-3/8" ceiling cutout. IC housing designed for uses in IC or non-IC construction.

Series	Gen	Lumens	Voltage/Driver*	Trim	Gen	Lumens	CCT	CRI	Trim Style
IC1RALED	G4N	06LM 600 LM	120 FRPC 120V Forward/ Reverse Cut, 5% dim	440LED	G4N	06LM 600 LM	27K 2700K 30K 3000K 35K 3500K 40K 4000K	90 CRI	WH White BL Black SC Satin Chrome ABZ Aged Bronze

\* Consult factory for voltage/dimming options.

## Accessories

Catalog Number	Description	Catalog Number	Description
CGF 200 MPINK	Medium Pink Color Filter	DGF 200 CYAN	Blue Green Dichroic Lens
CGF 200 WRED	Warm Red Color Filter	DCCF 200 HL4250	Daylight Blue Correction Lens
CGF 200 DLTBLUE	Daylight Blue Color Filter	DIFF 200	Diffuse Spread Lens
CGF 200 MBLU	Medium Blue Color Filter	UVF 200	UV Filter Lens
CGF 200 MAMB	Medium Amber Color Filter	HCLBL 200	Hexcell Louver
CGF 200 MGRN	Medium Green Color Filter	LSPREAD 200	Linear Spread Lens
DGF 200 DRED	Red Dichroic Lens	PRISM 200	Prismatic Lens
DGF 200 MGRN	Medium Green Dichroic Lens	TIR2 SPT	18° Spot Optic
DGF 200 MBLU	Medium Blue Dichroic Lens	TIR2 NFLD	30° Narrow Flood Optic
DGF 200 DYEL	Yellow Dichroic Lens	TIR2 FLD	40° Flood Optic
DGF 200 MAGEN	Magenta Dichroic Lens		



Standard LED dimming

Juno WarmDim dimming

## WarmDim® LED Dimming 4", 5" and 6", 600 & 900 Lumen LED Downlights



WarmDim®



### Juno® technology breakthrough brings warmth to LED dimming

Juno Generation 4 LED Downlights with the exclusive patented WarmDim feature bring atmosphere and romance to LED lighting. Juno WarmDim downlights incorporate a proprietary, micro-processor controlled light engine that warms the LED color temperature while dimming to capture all the warmth and ambience previously achieved only with incandescent dimming. Now you can match the mood to every occasion while still experiencing the operating efficiencies of LED lighting. It's a Juno first ... a Juno exclusive or recessed downlights.

Like all the downlights in the Juno Generation 4 family, the WarmDim version raises the bar for LED efficiency, producing over 600 lumens of high-quality light while using just 10 watts. They are offered in new construction and remodel housing styles and are approved for use in both insulated and non-insulated ceilings. They include push-in electrical connectors and all the easy-installation features you have come to expect from Juno.

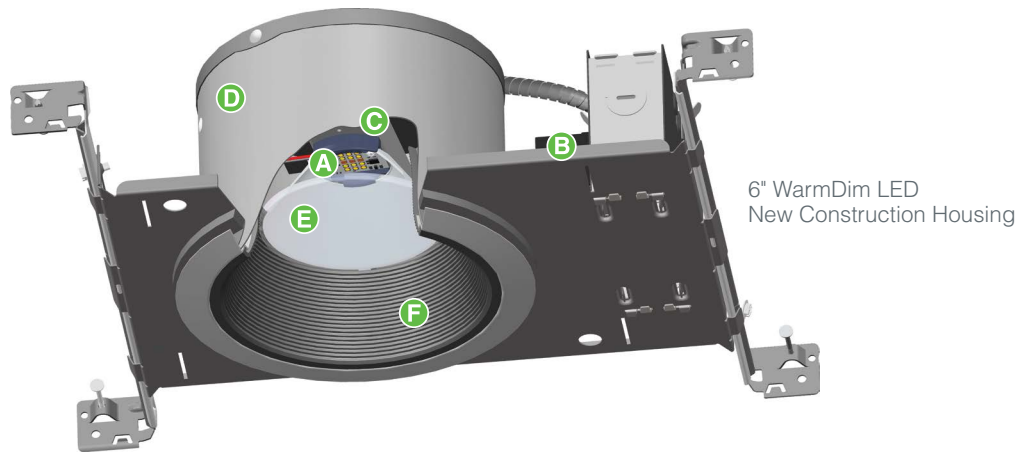

**A. WarmDim® LED light engine:** Proprietary patented WarmDim LED light engine features micro-processor controlled dimming that replicates the warmth of incandescent dimming. Dims from 3000K CCT at full lumen output to a warm 2000K while maintaining 90 minimum CRI throughout the dimming range (Patent US 8,710,754).

**B. LED driver:** Dedicated 120V LED driver supports WarmDim forward phase dimming using readily available incandescent, magnetic low-voltage, and electronic low-voltage dimmers.

**C. Effective thermal management:** This is achieved by integrating the light engine into a thermally conductive housing that provides uninterrupted heat transfer for remarkable LED longevity. Service life is rated at 50,000 hours with 70% lumen maintenance and no perceptible color shifts.

**D. Versatile installation:** Low-profile housings fit easily within 2 x 6 joists to accommodate shallow installations. New construction housings are supplied with Juno Real Nail 3® bar hangers; an integral T-bar notch secures housings to suspended ceiling grids without the need for clips. Remodel housings also available. See page 59 for a full description on the Real Nail® 3 bar hangers.

**E. Efficient, low-glare optics:** High-performance optic system produces uniform light distribution and reduces glare. The reflector and high-transmission diffusing lens are computer optimized for each aperture size, and the lens conceals the LED array, providing the aesthetic of a deeply regressed PAR lamp.

**F. Extensive trim collection:** WarmDim LED recessed housings are compatible with a broad selection of existing Juno 4", 5" and 6" open, lensed, wall wash, and decorative trims.

Unlike traditional LED dimming, Juno WarmDim® warms as it dims, emulating incandescent dimming.

**Traditional LED Dimming**

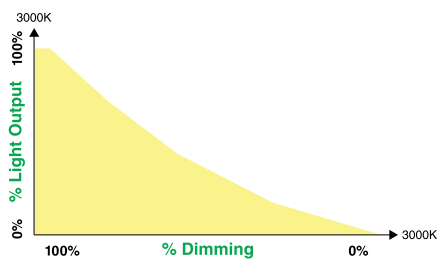

**Juno WarmDim® Dimming**

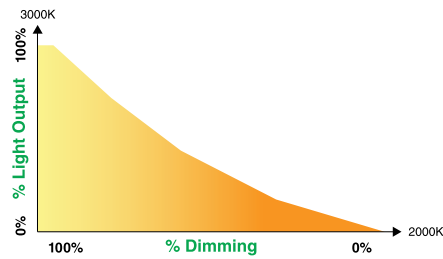



# 4" IC-Rated 600 & 900 Lumen WarmDim® LED Downlights



WarmDim®

Juno's exclusive WarmDim technology brings the warmth and atmosphere of incandescent dimming to the world of LED downlighting. The smaller 4" aperture size blends inconspicuously into the ceiling.



## 4" WarmDim® IC1LED Series



(New Construction Shown)



Dedicated 4" WarmDim LED new construction or remodel housings with integral light engine and dimmable driver. Dedicated 120V driver with forward phase and ELV dimming. Shallow housing allows for fit into a 2x6 construction. IC housing is designed for use with IC or Non-IC construction. Wide flood optic provided as standard.

### New Construction

12¼" L x 6¾" W x 6" H  
Ceiling cutout: 4½"

### Remodel

14⅞" L x 4¾" W x 4⅝" H  
Ceiling cutout: 4⅝"

### Qualified Dimmers

Compatible with incandescent, magnetic low voltage or electronic low voltage wall box dimmers.

































Refer to catalog # on [www.acuitybrands.com](http://www.acuitybrands.com) for the specific list of Acuity Brands qualified dimmer model numbers on the specification sheet.

### Example: IC1LED WD G4 09LM 30K 90CRI 120 FRPC

Series	Dynamic Features	Gen	Lumens	CCT	CRI	Voltage/Driver
<b>IC1LED</b> 4" New Construction Housing	<b>WD</b> WarmDim®	<b>G4N</b>	<b>06LM</b> 600 Lumens	<b>30K</b> 3000K	<b>90CRI</b>	<b>120 FRPC</b> 120V Only; Forward Phase/ELV Dimming
<b>IC1RLED</b> 4" Remodel Housing		<b>G4</b>	<b>09LM</b> 900 Lumens			

## 4" LED Downlight Trims

The trims shown here may be used with any 4" IC-Rated 600 & 900 Lumen WarmDim® LED housings shown on page 36.

Downlights	Lensed	Square Trims
		
<p><b>Pinhole with Integral Shield</b> 13 WH White 2" Aperture</p>	<p><b>Beveled Cylinder</b> 4103 FROSTWH 4103 FROSTSC 3" Aperture</p> 	<p><b>Square Trim</b> 13SQ WH White Trim</p>
		
<p><b>Baffle</b> 14 BWH Black 14 BSC Black 14 BABZ Black 14 BBL Black 14 WWH White 3 3/8" Aperture</p>  	<p><b>Beveled Cone</b> 4104 HZSC Haze 4104 WHZABZ Wheat Haze 3 3/8" Aperture</p> 	<p><b>Square Trim</b> 17SQ HZWH Haze, White Trim 17SQ WWH White, White Trim 17SQ BWH Black, White Trim 17SQ WHZWH Wheat Haze</p>
		
<p><b>Cone</b> 17 CWH Clear Alzak® 17 GWH Gold Alzak® 17 BWH Black Alzak® 17 PTSC Pewter Alzak® 17 WWH Gloss White 17 HZWH Haze 17 WHWH Wheat Haze 17 WHZABZ Wheat Haze 3 3/8" Aperture</p>  	<p><b>Cylinder</b> 4150 MESHSC 2 5/8" Aperture</p>	<p><b>Frosted Lens with Clear Center</b> 12SQ WWH White Trim</p> 
<p><b>Trim Ring Finishes</b></p>		
<p><b>ABZ</b> Classic Aged Bronze <b>SC</b> Satin Chrome <b>WH</b> White <b>BL</b> Black</p>	<p><b>Drop Opal</b> 11 WH</p> 	
		
	<p><b>Frosted Lens with Clear Center</b> 12 WWH 12 WSC 12 WABZ</p>  	
		
	<p><b>Beveled Dome - Lensed</b> 4101 ABZ 4101 SC 4101 WH</p>  	
		
	<p><b>Beveled Lens</b> 4102 ABZ 4102 SC 4102 WH</p> 	
		
	<p><b>Wall Wash</b> 39 CWH Clear Alzak® 39 HZWH Haze 39 WWH Gloss White 39 WHZWH Wheat Haze</p>	
	<p>ENERGY STAR® Qualification and T24 certification is dependent on trim finish. Refer to specification sheet.</p>	



# 5" IC-Rated 600 & 900 WarmDim® LED Downlights



WarmDim®

Juno 5" WarmDim LED downlights warm as they dim, emulating the romantic mood of incandescent dimming. Ultra-efficient LED illumination saves energy and offers a remarkable rated service life of 50,000 hours.



## 5" WarmDim® IC20LED Series



(New Construction Shown)



Dedicated 5" WarmDim LED new construction or remodel housings with integral light engine and dimmable driver. Dedicated 120V driver with forward phase and ELV dimming. Shallow housing allows for fit into a 2x6 construction. IC housing is designed for use with IC or Non-IC construction. Wide flood optic provided as standard.

### New Construction

15¼" L x 9¼" W x 4⅞" H  
Ceiling cutout: 5½"

### Remodel

13½" L x 5⅞" W x 4⅞" H  
Ceiling cutout: 5½"

### Qualified Dimmers

Compatible with incandescent, magnetic low voltage or electronic low voltage wall box dimmers.

Refer to catalog # on [www.acuitybrands.com](http://www.acuitybrands.com) for the specific list of Acuity Brands qualified dimmer model numbers on the specification sheet.













### Example: IC20LED WD G4 09LM 30K 90CRI 120 FRPC

Series	Dynamic Features	Gen	Lumens	CCT	CRI	Voltage/Driver
<b>IC20LED</b> 5" New Construction Housing	<b>WD</b> WarmDim®	<b>G4N</b>	<b>06LM</b> 600 Lumens	<b>30K</b> 3000K	<b>90CRI</b>	<b>120 FRPC</b> 120V Only; Forward Phase/ELV Dimming
<b>IC20RLED</b> 5" Remodel Housing		<b>G4</b>	<b>09LM</b> 900 Lumens			



## 5" LED Downlight Trims

The trims shown here may be used with any 5" IC-Rated 600 & 900 Lumen LED WarmDim® housings shown on page 54.

Downlights	Wall Wash	Lensed	
 <p><b>Downlight Baffle</b> 205 WWH White 205 BWH Black 205 BSC Black 205 BABZ Black 4 7/8" Aperture</p> 	 <p><b>Wall Wash</b> 213G3 WWH White 213G3 BWH Black</p>	 <p><b>Flat Glass Shower Trim*</b> 210N ABZ 210N SC 210N WH</p> 	 <p><b>White Baffle, Regressed Frosted Dome Lens*</b> 2130 WWH 2130 BWH</p> 
 <p><b>Downlight Cone</b> 204 CWH Clear Alzak® 204 GWH Gold Alzak® 204 BWH Black Alzak® 204 PTSC Pewter Alzak® 204 WWH Gloss White 204 HZWH Haze 204 WHZWH Wheat Haze 204 WHZABZ Wheat Haze 4 7/8" Aperture</p> 		 <p><b>Frosted Lens with Clear Center*</b> 212N ABZ 212N SC 212N WH</p> 	 <p><b>Beveled Frame, Frosted Dome Lens*</b> 5101 ABZ 5101 SC 5101 WH</p> 

Trim Ring Finishes	Accessories	
<b>ABZ</b> Classic Aged Bronze	Catalog Number	Description
<b>SC</b> Satin Chrome	<b>LEDOPTICG3 MFL</b>	Medium Flood Optic (50° beam)
<b>WH</b> White	<b>TR5 ABZ, TR5 SC, TR5 WH, TR5 BL</b>	5" Trim Ring compatible with 204 and 205 trims
<b>BL</b> Black		

ENERGY STAR® Qualification and T24 certification is dependent on trim finish.  
See housing spec sheet on [www.acuitybrands.com](http://www.acuitybrands.com) for specific information for each trim.

\* Do not use reflector shipped with trim for LED housing. Discard or recycle reflector.

# 6" IC-Rated 600 & 900 Lumen WarmDim® LED Downlights



WarmDim®

Juno's exclusive WarmDim LED downlights replicate the effect of incandescent dimming, offering a warm, natural glow as light levels are reduced. The 6" housings feature the largest selection of trims and accessories.



## 6" WarmDim® IC22LED Series



(New Construction Shown)



Dedicated 6" WarmDim LED new construction or remodel housings with integral light engine and dimmable driver. Dedicated 120V driver with forward phase and ELV dimming. Shallow housing allows for fit into a 2x6 construction. IC housing is designed for use with IC or Non-IC construction. Wide flood optic provided as standard.

### New Construction

15¼" L x 9⅞" W x 5⅞" H  
Ceiling cutout: 6⅞"

### Remodel

14½" L x 7¼" W x 5⅞" H  
Ceiling cutout: 6¾"

### Qualified Dimmers

Compatible with incandescent, magnetic low voltage or electronic low voltage wall box dimmers.

Refer to catalog # on [www.acuitybrands.com](http://www.acuitybrands.com) for the specific list of Acuity Brands qualified dimmer model numbers on the specification sheet.

### Example: IC22LED WD G4 09LM 30K 90CRI 120 FRPC

Series	Dynamic Features	Gen	Lumens	CCT	CRI	Voltage/Driver
<b>IC22LED</b> 6" New Construction Housing	<b>WD</b> WarmDim®	<b>G4N</b>	<b>06LM</b> 600 Lumens	<b>30K</b> 3000K	<b>90CRI</b>	<b>120 FRPC</b> 120V Only; Forward Phase/ ELV Dimming
<b>IC22RLED</b> 6" Remodel Housing		<b>G4</b>	<b>09LM</b> 900 Lumens			

Also see WarmDim® Retrofit LED Downlight and Gimbal Trim Modules on pages 82-84.

## 6" LED Downlight Trims

The trims shown here may be used with any 6" IC-Rated 600 & 900 Lumen LED WarmDim® housings shown on page 56.

Downlights		Lensed	
 <b>Downlight Baffle</b> 24 WWH White 24 BWH Black 24 BSC Black 24 BABZ Black 24 BBL Black 5¼" Aperture	 <b>Luminous Disc (Frosted)</b> 9324 SC 3¼" Aperture	 <b>Albalite</b> 20 PW Shower/ Closet Light 20 WH	 <b>Frosted Lens with Clear Center</b> 242 ABZ 242 SC 242 WH
 <b>Downlight Cone</b> 27 CWH Clear Alzak® 27 GWH Gold Alzak® 27 BWH Black Alzak® 27 PTSC Pewter Alzak® 27 WWH Gloss White 27 HZWH Haze 27 WHZWH Wheat Haze 27 WHZABZ Wheat Haze 5¼" Aperture	 <b>Metal Band</b> 9524 SC 5½" Aperture	 <b>Drop Opal</b> 21 PW Shower/ Closet Light 21 WH	 <b>Decorative Swirled Etched Opal Glass*</b> 243 WH
 <b>Octagonal</b> 9024 WWH 5¼" Aperture	 <b>Luminous Collar (Frosted)</b> 9702 6¾" Aperture	 <b>Fresnel</b> 22 WH	 <b>White Baffle, Regressed Frosted Dome Lens*</b> 2330 WWH 2330 BWH
	 <b>Wall Wash</b> 262G3 WWH White 262G3 BWH Black	 <b>Frosted Lens*</b> 239 WH	 <b>Beveled Frame, Frosted Dome Lens*</b> 6101 ABZ 6101 SC 6101 WH

Trim Ring Finishes		Accessories	
<b>ABZ</b>	Classic Aged Bronze	Catalog Number	Description
<b>SC</b>	Satin Chrome	<b>LEDOPTICG3 MFL</b>	Medium Flood Optic (50° beam)
<b>WH</b>	White		
<b>BL</b>	Black	<b>TR6 ABZ, TR6 SC, TR6 WH, TR6 BL</b>	6" Trim Ring compatible with 24 and 27 trims.
<b>PW</b>	Plastic White (Polycarbonate material shower trim)		

ENERGY STAR® Qualification and T24 certification is dependent on trim finish.  
 See housing spec sheet on [www.acuitybrands.com](http://www.acuitybrands.com) for specific information for each trim.  
 \* Do not use reflector shipped with trim for LED housing. Discard or recycle reflector.





## Generation 4

# 4" IC-Rated 600 & 900 Lumen LED Downlights

### Ultra-efficient LED lighting with extra style and flair

The smaller aperture of the 4-inch, Juno Generation 4 LED downlight offers the “designer-look” that perfectly complements many of today’s upscale residential interiors. These ultra-efficient fixtures produce up to 900 lumens of brilliant white light, while requiring just 11-watts input to deliver over 85 lumens per watt. Offered in new construction or remodel housing styles, they are approved for use in both insulated and non-insulated ceilings. They include push-in electrical connectors and all the easy-installation features Juno is famous for.



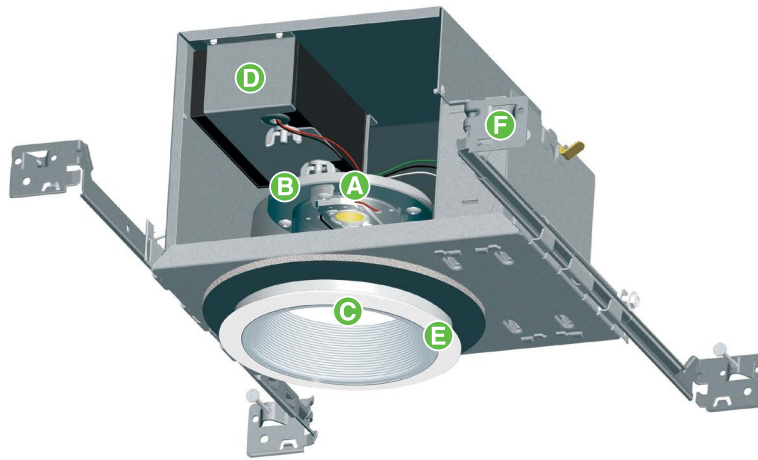

**A. Generation 4 LED light engine:** Advanced

LED technology produces up to 900 lumens from just 11-watts input. LEDs are binned to exceed ENERGY STAR® requirements and provide superior fixture-to-fixture color uniformity. Color temperatures of 2700K, 3000K, 3500K, and 4000K are available; 90 CRI minimum.

**B. Superior thermal management:** Double wall, shallow construction. LED array is attached to high-purity aluminum, thermally conductive inner housing and heat sink, which provides superior heat transfer to ensure long life of LEDs. At the end of their 50,000 hour rated life, the LEDs can be expected to produce 70% of their initial light output with no perceptible changes in color.

**C. Low-glare, high-efficiency optics:** The reflector and high-transmission diffusing lens are optimized for the smaller 4" aperture, resulting in an optic system that provides uniform light distribution and reduced glare. The lens also serves to conceal the LED light source, producing an aesthetic similar to a deeply regressed PAR20 lamp.

**D. LED driver options:** Specify either dedicated 120-volt driver with forward and reverse phase dimming or Multi-Volt (120-277V) eldoLED driver with 0-10V dimming.

**E. Extensive trim selection:** The 4", Generation 4 LED recessed housing is compatible with a wide range of existing Juno open and lensed trims.

**F. Real Nail® 3 Bar Hangers**

The industry's best engineered mounting system ... Juno housings originated the Real Nail bar hanger system that set the standard for quality and ease of installation.

- **Patented Real Nail® 3 Hangers**  
Permit quick housing placement anywhere within 24" O.C. joists or suspended ceilings.
- **Captive Bugle Head Nail**  
Quickly secures housing in place. The nail is easily removable for quick housing repositioning/relocation without changing the bar hanger or nail.
- **Bar Hanger Locking**  
Secures bar hanger adjustments with the oversized locking screw or the quick-lock screwdriver slot feature.
- **Patented Break-Away Design**  
Score lines on the bar hangers provide a clean and fast break to fit the housing in tight applications.
- **T-Bar Mounting**  
Integral T-bar mounting feature secures the housing to suspended ceilings; no additional parts required.
- **Locking System**  
Quick-Loc slot and oversized set screw lock fixture in position.

# 4" IC-Rated 600 & 900 Lumen Generation 4 LED Downlights

The smaller aperture of the 4", Generation 4 downlight offers the “designer look,” while advanced LED technology from Juno maximizes energy savings. The extensive trim offering complements a wide range of interior styles.

## 4" New Construction



### IC1LED G4 Series

Dedicated 4" LED new construction housing with integral light engine and choice of dimmable drivers: nominal dedicated 120 volt driver with forward phase and ELV dimming. Shallow housing construction allows for fit in 2 x 6 construction. IC housing designed for use with IC or non-IC construction. Wide flood optic provided as standard.

12¼" L x 6¾" W x 6" H  
Ceiling cutout: 4½"

Example: IC1LED G4 06LM 27K 90 CRI 120 FRPC

Housing	Gen	Lumens	CCT	CRI	Voltage/Driver*
<b>IC1LED G4</b> 4" New Construction Housing	<b>G4</b>	<b>06LM</b>	<b>27K</b> 2700K	<b>90CRI</b> 90 CRI	<b>120 FRPC</b> 120V Only; Forward Phase/ELV Dimming
		600 Lumens	<b>30K</b> 3000K		
		<b>09LM</b>	<b>35K</b> 3500K		
		900 Lumens	<b>40K</b> 4000K		

## 4" Remodel



Shown with dedicated 120 volt driver.



### IC1RLED G4 Series

Dedicated 4" LED remodel housing with integral light engine and choice of dimmable drivers: nominal dedicated 120 volt driver with forward phase and ELV dimming. Shallow housing construction allows for fit in 2 x 6 construction. Air-Loc® gasket kit supplied with housing. IC housing designed for use with IC or non-IC construction. Wide flood optic provided as standard.

14⅞" L x 4¾" W x 4⅝" H  
Ceiling cutout: 4⅞"

Example: IC1RLED G4 06LM 27K 90 CRI 120 FRPC

Housing	Gen	Lumens	CCT	CRI	Voltage/Driver*
<b>IC1RLED G4</b> 4" Remodel Housing	<b>G4</b>	<b>06LM</b>	<b>27K</b> 2700K	<b>90CRI</b> 90 CRI	<b>120 FRPC</b> 120V Only; Forward Phase/ELV Dimming
		600 Lumens	<b>30K</b> 3000K		
		<b>09LM</b>	<b>35K</b> 3500K		
		900 Lumens	<b>40K</b> 4000K		

### Qualified Dimmers

#### Dedicated 120-volt fixtures:

Compatible with incandescent, magnetic low voltage or electronic low voltage wall box dimmers.





















Refer to catalog # on [www.acuitybrands.com](http://www.acuitybrands.com) for the specific list of Acuity Brands qualified dimmer model numbers on the specification sheet.

\* Consult factory for voltage/dimming options.



## 4" LED Downlight Trims

The trims shown here may be used with any 4" IC-Rated 600 and 900 Lumen Generation 4 LED housings shown on page 60.

Downlights	Lensed	Square Trims
 <p><b>Pinhole with Integral Shield</b> 13 WH 2" Aperture</p>	 <p><b>Beveled Cylinder</b> 4103FROST WH 4103FROST SC 3" Aperture</p> 	 <p><b>Beveled Dome - Lensed</b> 4101 ABZ 4101 SC 4101 WH</p> 
 <p><b>Baffle</b> 14 BWH Black 14 BSC Black 14 BABZ Black 14 BBL Black 14 WWH White 3 3/8" Aperture</p> 	 <p><b>Beveled Cone</b> 4104 HZSC Haze 4104 WHZABZ Wheat Haze 3 3/8" Aperture</p> 	 <p><b>Beveled Lens</b> 4102 ABZ 4102 SC 4102 WH</p> 
 <p><b>Cone</b> 17 CWH Clear Alzak® 17 GWH Gold Alzak® 17 BWH Black Alzak® 17 PTSC Pewter Alzak® 17 WWH Gloss White 17 HZWH Haze 17 WHZWH Wheat Haze 17 WHZABZ Wheat Haze 3 3/8" Aperture</p> 	 <p><b>Cylinder</b> 4150 MESHSC 2 1/2" Aperture</p>  <p><b>Hyperbolic</b> 17HYP2 CWH Clear Alzak®, White Trim Ring 17HYP2 BWH Black Alzak®, White Trim Ring 17HYP2 WWH White Cone, White Trim Ring 17HYP2 HZWH Haze Cone, White Trim Ring 17HYP2 WHZWH Wheat Haze Cone, White Trim Ring 17HYP2 WHZABZ Wheat Haze Cone, Aged Bronze Trim Ring 3 3/8" Aperture</p>	 <p><b>Square Trim</b> 13SQ WH White Trim</p>  <p><b>Square Trim</b> 17SQ HZWH Haze, White Trim 17SQ WWH White, White Trim 17SQ BWH Black, White Trim 17SQ WHZWH Wheat Haze, White Trim</p>
	 <p><b>Wall Wash</b> 39 CWH Clear Alzak® 39 HZWH Haze 39 WWH White 39 WHZWH Wheat Haze</p>	
	<p><b>Trim Ring Finishes</b></p> <p><b>ABZ</b> Classic Aged Bronze <b>SC</b> Satin Chrome <b>WH</b> White <b>BL</b> Black</p>	 <p><b>Frosted Lens with Clear Center</b> 12SQ WWH White Trim</p> 



Generation 4

## 5" and 6" IC-Rated 600, 900 & 1400 Lumen LED Downlights



### Offering ultra-efficient, high-performance illumination for residential interiors

With the latest generation of LED downlights, Juno offers greater efficiency, higher performance, and more sophisticated optics than ever before. For the Generation 4 LED line, Juno has reduced the energy consumption of its IC-Rated downlight by over 25%.

Juno Generation 4, IC-Rated, 600-, 900- and 1400-lumens LED downlights provide superior illumination for both standard and high ceiling applications. Designed for either new construction or remodel applications, they are approved for use in both insulated and non-insulated ceilings. They include push-in electrical connectors and all the easy-installation features Juno is famous for.

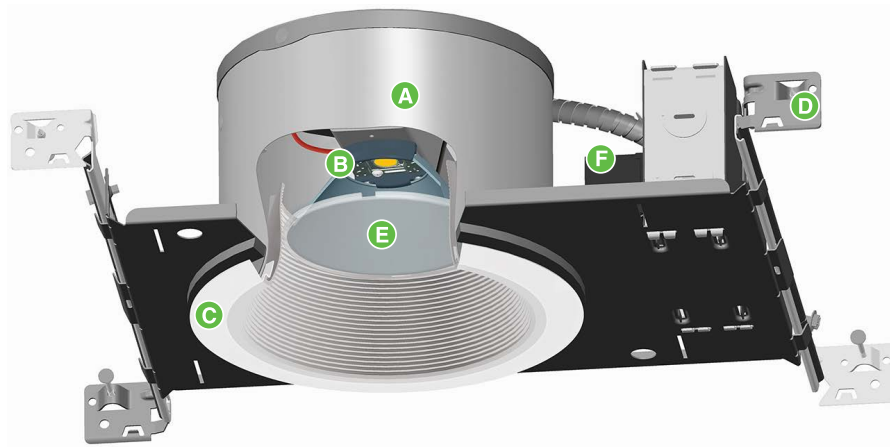

**A. Advanced thermal management:** Thermally conductive aluminum housing is secured to the plaster frame and draws heat away from the LEDs through the continuous metal construction to ensure long life of the LEDs. At the end of their 50,000 hour rated life, the LEDs can be expected to produce 70% of their initial light output with no perceptible changes in color.

**B. Generation 4 LED light engine:** The light engine features the latest in high-performance LED arrays. The 600-lumen fixture uses just 10.5 watts input; the 900-lumen fixture just 14.6 watts and 1400-lumen fixture just 16 watts. LEDs are binned to exceed ENERGY STAR® requirements and provide superior fixture-to-fixture color uniformity. Available color temperatures are 2700K, 3000K, 3500K, and 4000K with 90 CRI minimum.

**C. Extensive trim options:** Generation 4 LED recessed housings are compatible with a broad selection of existing Juno 5" and 6" open and lensed trims. A dedicated LED scoop trim is also available for wall wash applications.

**D. Easy installation:** Lower-profile housing permits easy installation in a wide range of applications and fits nicely within shallow, 2 x 6 ceiling joist. New-construction housings are supplied with the Juno Real Nail 3® bar hanger system. For suspended ceilings, the integral T-bar notch can be used to secure the housing onto the ceiling grid – no accessory clips required. See page 59 for a full description of the Real Nail® 3 bar hangers.

**E. High-efficiency, low-brightness optics:** The computer-optimized reflector features a high-reflectance white finish that together with a high-transmission diffusing lens produces uniform aperture luminance while concealing the LED light source. From below, it looks like an incandescent fixture with a deeply regressed PAR30 lamp. Alternate optics are available for all 5" and 6" Generation 4 fixtures. Wide-flood beam pattern is standard; medium-flood, narrow-flood and spot are also available. Reflector styles can be changed easily via the convenient twist and lock accessory feature.

**F. LED driver:** Dedicated 120-volt driver with forward and reverse phase dimming.

### Beam Patterns

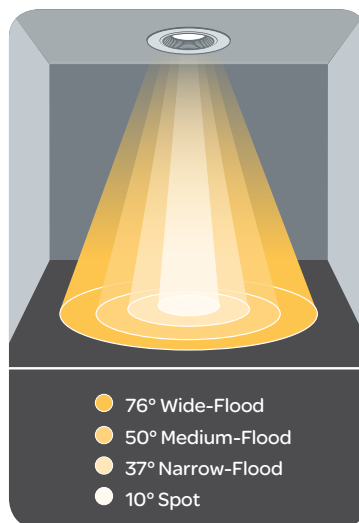

Juno Generation 4, 5" and 6", IC-Rated, 600, 900 & 1400 Lumen LED Downlights are available in four optics. Wide-flood beam pattern is standard; medium-flood, narrow-flood and spot are also available. Reflector styles can be changed easily via the convenient twist and lock accessory feature.





# 5" IC-Rated 600, 900 & 1400 Lumen Generation 4 LED Downlights

This 5", Generation 4 LED downlight is over 25% more energy efficient than its predecessor, requiring just 16 watts to produce up to 1400 brilliant lumens. Available for both new construction and remodel applications.

## 5" New Construction



600-900 lm  
Shown with universal  
voltage driver.



1400 lm  
Shown with universal  
voltage driver.



### IC20LED G4 Series

Dedicated 5" LED new construction housing with integral light engine and choice of dimmable drivers: nominal dedicated 120 volt driver with forward phase and ELV dimming. Shallow housing allows for fit in 2 x 6 construction (600 & 900lm) or 2x8 construction (1400lm) Air-Loc® fully sealed housing does not require separate gasket. IC housing designed for use in IC or non-IC construction. Wide flood optic provided as standard.

15¼" L x 9½" W x 4⅞" H  
Ceiling cutout: 5⅝"

### Example: IC20LED G4 06LM 27K 90 CRI 120 FRPC

Housing	Gen	Lumens	CCT	CRI	Voltage/Driver*
IC20LED G4 5" New Construction Housing	G4	<b>06LM</b>	<b>27K</b> 2700K	<b>90CRI</b> 90 CRI	<b>120 FRPC</b> 120V Only; Forward Phase/ELV Dimming
		600 Lumens	<b>30K</b> 3000K		
		<b>09LM</b>	<b>35K</b> 3500K		
		900 Lumens	<b>40K</b> 4000K		
		<b>14LM</b>			
		1400 Lumens			

## 5" Remodel



Shown with dedicated  
120 volt driver.



### IC20RLED G4 Series

Dedicated 5" LED remodel housing with integral light engine and choice of dimmable drivers: nominal dedicated 120 volt driver with forward phase and ELV dimming. Shallow housing construction allows for fit in 2 x 6 construction. Air-Loc gasket kit supplied with housing. IC housing designed for use with IC or non-IC construction. Wide flood optic provided as standard.

13½" L x 5⅞" W x 4⅞" H  
Ceiling cutout: 5½"

### Example: IC20RLED G4 06LM 27K 90 CRI 120 FRPC

Housing	Gen	Lumens	CCT	CRI	Voltage/Driver*
IC20RLED G4 5" Remodel Housing	G4	<b>06LM</b>	<b>27K</b> 2700K	<b>90CRI</b> 90 CRI	<b>120 FRPC</b> 120V Only; Forward Phase/ELV Dimming
		600 Lumens	<b>30K</b> 3000K		
		<b>09LM</b>	<b>35K</b> 3500K		
		900 Lumens	<b>40K</b> 4000K		

### Qualified Dimmers

#### Dedicated 120-volt fixtures:















Compatible with incandescent, magnetic low voltage or electronic low voltage wall box dimmers.

Refer to catalog # on [www.acuitybrands.com](http://www.acuitybrands.com) for the specific list of Acuity Brands qualified dimmer model numbers on the specification sheet.

\* Consult factory for voltage/dimming options.

## 5" LED Downlight Trims

The trims shown here may be used with any 5" IC-Rated 600, 900 and 1400 Lumen LED housings shown on page 64.

Downlights	Hyperbolic	Lensed	
 <p><b>Downlight Baffle</b> 205 WWH White 205 BWH Black 205 BSC Black 205 BABZ Black 4 7/8" Aperture</p> 	 <p><b>Hyperbolic (600 lumen only)</b> 204HYP2 CWH Clear Alzak® 204HYP2 BWH Black Alzak® 204HYP2 WWH White 204HYP2 HZWH Haze 204HYP2 WHZWH Wheat Haze 204HYP2 WHZABZ Wheat Haze 4 1/2" Aperture</p>	 <p><b>Flat Glass Shower Trim*</b> 210N ABZ 210N SC 210N WH</p> 	 <p><b>White Baffle, Regressed Frosted Dome Lens*</b> 2130 WWH White 2130 BWH Black</p> 
 <p><b>Downlight Cone</b> 204 CWH Clear Alzak® 204 GWH Gold Alzak® 204 BWH Black Alzak® 204 PTSC Pewter Alzak® 204 WWH Gloss White 204 HZWH Haze 204 WHZWH Wheat Haze 204 WHZABZ Wheat Haze 4 7/8" Aperture</p> 	 <p><b>Hyperbolic (900 &amp; 1400 lumen only)</b> 204HYP3 CWH Clear 204HYP3 BWH Black 204HYP3 WWH White 204HYP3 HZWH Haze 204HYP3 WHZWH Wheat Haze 204HYP3 WHZABZ Wheat Haze 4 1/2" Aperture</p>	 <p><b>Frosted Lens with Clear Center*</b> 212N ABZ 212N SC 212N WH</p> 	 <p><b>Beveled Frame, Frosted Dome Lens*</b> 5101 ABZ 5101 SC 5101 WH</p> 
	<p><b>Wall Wash</b></p>  <p><b>Wall Wash</b> 213G3 WWH White 213G3 BWH Black</p>		

Trim Ring Finishes	Accessories										
<p><b>ABZ</b> Classic Aged Bronze <b>SC</b> Satin Chrome <b>WH</b> White <b>BL</b> Black</p>	<table border="1"> <thead> <tr> <th>Catalog Number</th> <th>Description</th> </tr> </thead> <tbody> <tr> <td><b>LEDOPTICG3 MFL</b></td> <td>Medium Flood Optic (50° beam)</td> </tr> <tr> <td><b>LEDOPTICG3 NFL</b></td> <td>Narrow Flood Optic (37° beam)</td> </tr> <tr> <td><b>LEDOPTICG3 SP</b></td> <td>Spot Optic (10° beam)</td> </tr> <tr> <td><b>TR5 ABZ, TR5 SC, TR5 WH, TR5 BL</b></td> <td>5" Trim Ring compatible with 204, 205, 204HYP2 and 204HYP3 trims</td> </tr> </tbody> </table>	Catalog Number	Description	<b>LEDOPTICG3 MFL</b>	Medium Flood Optic (50° beam)	<b>LEDOPTICG3 NFL</b>	Narrow Flood Optic (37° beam)	<b>LEDOPTICG3 SP</b>	Spot Optic (10° beam)	<b>TR5 ABZ, TR5 SC, TR5 WH, TR5 BL</b>	5" Trim Ring compatible with 204, 205, 204HYP2 and 204HYP3 trims
Catalog Number	Description										
<b>LEDOPTICG3 MFL</b>	Medium Flood Optic (50° beam)										
<b>LEDOPTICG3 NFL</b>	Narrow Flood Optic (37° beam)										
<b>LEDOPTICG3 SP</b>	Spot Optic (10° beam)										
<b>TR5 ABZ, TR5 SC, TR5 WH, TR5 BL</b>	5" Trim Ring compatible with 204, 205, 204HYP2 and 204HYP3 trims										

ENERGY STAR® Qualification and T24 certification is dependent on trim finish and LED color temperature. See housing spec sheet on [www.acuitybrands.com](http://www.acuitybrands.com) for specific information for each trim.

\* Do not use reflector shipped with trim for LED housing. Discard or recycle reflector.

# 6" IC-Rated 600, 900 and 1400 Lumen Generation 4 LED Downlights

The 6", Generation 4 LED downlights feature the most extensive collection of trims and accessories.

## 6" New Construction



### IC22LED G4 Series

Dedicated 6" LED new construction housing with integral light engine and choice of dimmable drivers: nominal dedicated 120 volt driver with forward phase and ELV dimming. Shallow housing allows for fit in 2 x 6 construction (600 & 900 only) or 2x8 construction (1400). Air-Loc® fully sealed housing does not require separate gasket. IC housing designed for use in IC or non-IC construction. Wide flood optic provided as standard.

15¼" L x 9⅞" W x 5⅞" H  
Ceiling cutout: 6⅞"

### Example: IC22LED G4 06LM 27K 90 CRI 120 FRPC

Housing	Gen	Lumens	CCT	CRI	Voltage/Driver*
IC22LED G4 6" New Construction Housing	G4	<b>06LM</b>	<b>27K</b> 2700K	<b>90CRI</b> 90 CRI	<b>120 FRPC</b> 120V Only; Forward Phase/ELV Dimming
		600 Lumens	<b>30K</b> 3000K		
		<b>09LM</b>	<b>35K</b> 3500K		
		900 Lumens	<b>40K</b> 4000K		
		<b>14LM</b>			
		1400 Lumens			

## 6" Remodel



### IC22RLED G4 Series

Dedicated 6" LED remodel housing with integral light engine and choice of nominal dedicated 120 volt driver with forward phase and ELV dimming. Shallow housing construction allows for fit in 2 x 6 construction. Air-Loc® gasket kit supplied with housing. IC housing designed for use with IC or non-IC construction. Wide flood optic provided as standard.

14½" L x 7¼" W x 5⅞" H  
Ceiling cutout: 6⅞"

### Example: IC22RLED G4 06LM 27K 90 CRI 120 FRPC

Housing	Gen	Lumens	CCT	CRI	Voltage/Driver*
IC22RLED G4 6" Remodel Housing	G4	<b>06LM</b>	<b>27K</b> 2700K	<b>90CRI</b> 90 CRI	<b>120 FRPC</b> 120V Only; Forward Phase/ELV Dimming
		600 Lumens	<b>30K</b> 3000K		
		<b>09LM</b>	<b>35K</b> 3500K		
		900 Lumens	<b>40K</b> 4000K		

### Qualified Dimmers

#### Dedicated 120-volt fixtures:

Compatible with incandescent, magnetic low voltage or electronic low voltage wall box dimmers.

Refer to catalog # on [www.acuitybrands.com](http://www.acuitybrands.com) for the specific list of Acuity Brands qualified dimmer model numbers on the specification sheet.

\* Consult factory for voltage/dimming options.



## 6" LED Downlight Trims

The trims shown here may be used with any 6" IC-Rated 600, 900 and 1400 Lumen LED housings shown on page 66.

### Downlights



**Downlight Baffle**  
24 WWH White  
24 BWH Black  
24 BSC Black  
24 BABZ Black  
24 BBL Black  
5 3/4" Aperture



**Downlight Cone**  
27 CWH Clear Alzak®  
27 GWH Gold Alzak®  
27 BWH Black Alzak®  
27 PTSC Pewter Alzak®  
27 WWH Gloss White  
27 HZWH Haze  
27 WHZWH Wheat Haze  
27 WHZABZ Wheat Haze  
5 3/4" Aperture



**Octagonal**  
9024 WH  
5 3/4" Aperture



**Luminous Disc (Frosted)**  
9324 SC  
3 1/4" Aperture



**Metal Band**  
9524 SC  
5 7/8" Aperture



**Luminous Collar (Frosted)**  
9702  
6 3/8" Aperture



**Hyperbolic (600 lumen only)**  
27HYP2 CWH Clear Alzak®  
27HYP2 BWH Black Alzak®  
27HYP2 WWH White  
27HYP2 HZWH Haze  
27HYP2 WHZWH Wheat Haze  
27HYP2 WHZABZ Wheat Haze  
5 3/4" Aperture



**Hyperbolic (900 & 1400 lumen only)**  
27HYP3 CWH Clear Alzak®  
27HYP3 BWH Black Alzak®  
27HYP3 WWH White  
27HYP3 HZWH Haze  
27HYP3 WHZWH Wheat Haze  
27HYP3 WHZABZ Wheat Haze  
5 3/4" Aperture

### Wall Wash



**Wall Wash**  
262G3 WWH White  
262G3 BWH Black

### Lensed



**Albalite**  
20 PW Shower/  
Closet Light  
20 WH



**Drop Opal**  
21 PW Shower/  
Closet Light  
21 WH



**Fresnel**  
22 WH



**Frosted Lens\***  
239 WH



**Frosted Lens with Clear Center**  
242 ABZ  
242 SC  
242 WH



**Decorative Swirled Etched Opal Glass\***  
243 WH



**White Baffle, Regressed Frosted Dome Lens\***  
2330 WWH White  
2330 BWH Black



**Beveled Frame, Frosted Dome Lens\***  
6101 ABZ  
6101 SC  
6101 WH



### Trim Ring Finishes

**ABZ** Classic Aged Bronze  
**SC** Satin Chrome  
**WH** White  
**PW** Plastic White (Polycarbonate material shower trim)  
**BL** Black

### Accessories

	Description
<b>LEDOPTICG3 MFL</b>	Medium Flood Optic (50° beam)
<b>LEDOPTICG3 NFL</b>	Narrow Flood Optic (37° beam)
<b>LEDOPTICG3 SP</b>	Spot Optic (10° beam)
<b>TR6 ABZ, TR6 WH, TR6 SC, TR6 BL</b>	6" Trim Ring compatible with 24, 27, 27HYP2 and 27HYP3 trims

ENERGY STAR® Qualification and T24 certification is dependent on trim finish and LED color temperature.

See housing spec sheet on [www.acuitybrands.com](http://www.acuitybrands.com) for specific information for each trim.

\* Do not use reflector shipped with trim for LED housing. Discard or recycle reflector.

# Retrofit LED Trim Modules



## Ultra-efficient, super-easy, very affordable

With Juno Retrofit LED Trim Modules, standard 6" recessed housings can be quickly and conveniently upgraded to efficient LED illumination. These economical LED trims are available in 600 or 900 lumen modules and the patent pending WarmDim® technology is offered with the 600 lumen LED trim modules. The J6RL series provides up to 900 lumens of brilliant illumination that is equivalent to the output of a 75W PAR30 ... but requiring just 14.5 watts input. ENERGY STAR® Qualified. Dimmable with most incandescent, magnetic low-voltage, and electronic low-voltage dimmers.

### A. All-In-One Design:

#### Downlight:

LEDs, driver and trim are contained in a single unit. Includes a whip adapter with screw base and quick-connect plug for easy retrofit in 6" housings equipped with a medium-base socket. Or the unit can be installed directly into a dedicated Juno quick-connect housing. Retrofit compatible with Juno 6" standard and shallow housings as well as with other manufacturers' housings\*. Module is wet location listed and designed for use in IC or non-IC, new-construction or remodel housings\*.

#### Eyeball:

All-in-one trim, driver, and adjustable eyeball are designed as a single unit for installation into retrofit, new construction, or remodel applications. Rotates 358 degrees with vertical adjustment of 30 degrees. For use with IC or non-IC, 6" housings. Compatible with Juno 6" standard and shallow housings as well as those of other manufacturers\*.

### B. LED Light Engine:

The LED array is integrated with a one-piece, high-purity aluminum, thermally conductive trim to provide uninterrupted heat transfer. Ensures long life of the LEDs even when used in housings covered with insulation. At the end of their 50,000 hour rated life, the LEDs can be expected to produce 70% of their initial light output with no perceptible changes in color.

### C. Efficient Thermal Management:

The LED array is integrated with a one-piece, high-purity aluminum, thermally conductive trim to provide uninterrupted heat transfer. Ensures long life of the LEDs even when used in housings covered with insulation. At the end of their 50,000 hour rated life, the LEDs can be expected to produce 70% of their initial light output with no perceptible changes in color.

### D. Easy Installation:

Whip adapter with screw base and quick-connect plug screws into 6" housings equipped with medium-base sockets. It's nearly as easy as installing a conventional lamp. Or for California Title 24 compliance, Retrofit LED Modules can be installed into dedicated Juno new-construction or remodel housings with hard-wired quick connects. Torsion springs secure trim into housing.

### E. High-Efficiency, Low-Glare Optics:

#### Downlight:

A computer-optimized reflector and deeply regressed high-transmission diffusing lens provide uniform light distribution and effective glare control, while concealing the LED light source from view.

#### Eyeball:

A computer-optimized reflector and high-transmission diffusing lens create an efficient, aesthetically pleasing optic system that provides uniform light distribution while reducing glare and masking the LED source. Wide-flood beam pattern is standard; medium-flood, narrow-flood, and spot also available. Reflector styles can be changed easily via the convenient twist-and-lock accessory feature. See page 84 for optic options.

### F. Aesthetic Trim:

#### Downlight:

The Retrofit LED Downlight Trim Module ships complete with either a baffle or cone insert that mimics the aesthetics of Juno's most popular trims. These interchangeable trim inserts can be easily changed in the field to customize the look of the product.

#### Eyeball:

An attractive addition to any décor, the aluminum, adjustable eyeball trim module follows traditional Juno styling and is finished in lustrous white.

### G. Dimmable LED Driver:

State of the art 120V LED forward phase driver is dimmable using most incandescent, magnetic low-voltage, and electronic low-voltage dimmers.

### H. Juno Retrofit LED Trim Modules with quick-connect housings comply with Title 24 requirements

Juno Retrofit LED Trim Modules can be installed in dedicated, 6" Juno new-construction or remodel housings via hard-wired quick connects. When installed in this configuration, these units offer full California Title 24 compliance.



Supplied whip adapter with screw base and quick-connect plug permits quick installation in 6" housings equipped with medium-base sockets.

\* See spec sheet for housing compatibility.

## Retrofit LED Downlight Trim Module



WarmDim®

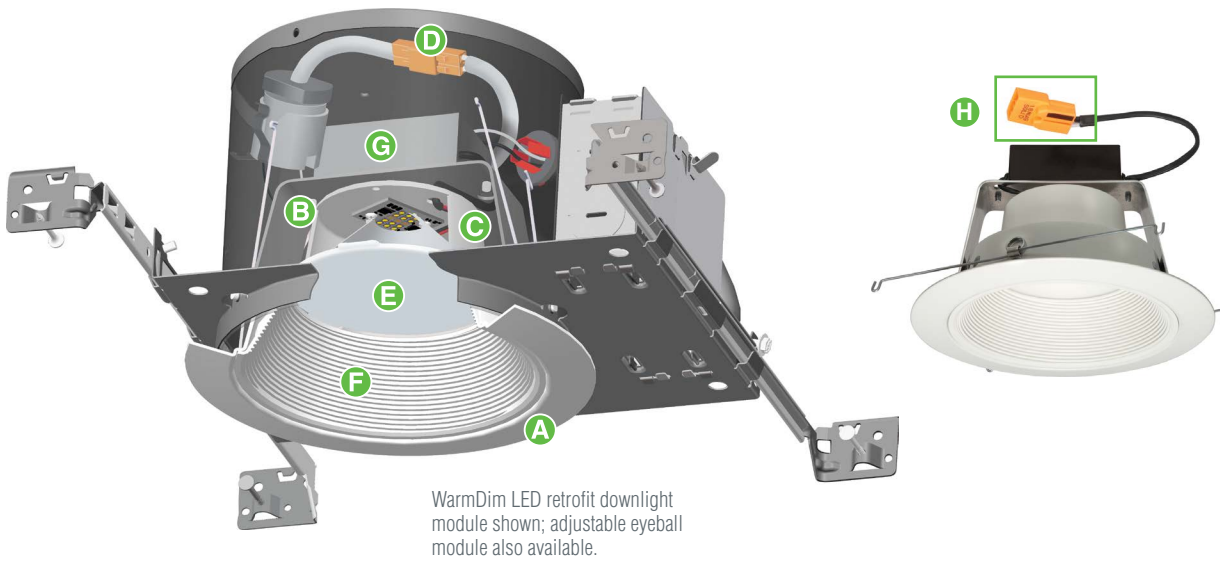

WarmDim LED retrofit downlight module shown; adjustable eyeball module also available.

Juno Retrofit LED Downlight Trim Modules are available in a selection of finishes designed to complement a wide range of décors.



**J6RLTRIM DB WWH**  
White Baffle



**J6RLTRIM DB BWH**  
Black Baffle



**J6RLTRIM DC CWH**  
Clear Cone



**J6RLTRIM DC WWH**  
White Cone



**J6RLTRIM DC HZWH**  
Haze Cone



**J6RLTRIM DC WHZWH**  
Wheat Haze Cone

## Retrofit LED Eyeball Trim Module

### Available in four optics:

Wide-flood beam pattern is standard; medium-flood, narrow-flood and spot optics are also available. Reflector styles can be changed easily via the convenient twist-and-lock accessory feature.





# Retrofit LED Downlight Trim Module

Quick, easy, and affordable ... these retrofit LED modules upgrade standard 6" recessed housings to energy-efficient LED illumination. Medium-base socket, screw-in whip adapter included.

## 6" Retrofit 600 and 900 Lumen Downlight Trim Module



### J6RL

All-in-one 6" LED Retrofit Downlight Trim available with choice of integral 600 Lumen 11.4W or 900 Lumen 14.5W nominal light engine, dimmable with use of most incandescent, magnetic and electronic low voltage wall box dimmers. 6" WarmDim® LED Retrofit Downlight trim with integral 600 lumen 12W nominal light engine and dedicated 120V driver Designed for use in IC or non-IC construction. White trim flange is standard.



Medium-based socket whip adapter included with trim.

Example: J6RL G4 DC 06LM 27K 90CRI 120 FRPC CWH

Series	Gen	Trim Style	Lumens	CCT	CRI	Voltage/Driver	Trim Finish
J6RL	G4	DC*	06LM	27K 2700K	90CRI	120 FRPC 120V Only; Forward Phase/ELV Dimming	WWH White
		Downlight Cone	600 Lumens	30K 3000K			BWH <sup>1</sup> Black
		DB**	09LM	35K 3500K			CWH Clear Alzak®
		Downlight Baffle	900 Lumens	40K 4000K			HZWH Haze
							WHZWH Wheat Haze

\* DC not available with BWH trim finish. \*\* DB available with WWH and BWH trim finish only.

## 6" Retrofit 600 Lumen WarmDim® LED Downlight Trim Module



WarmDim®



### J6RL WD

All-in-one 6" WarmDim® LED Retrofit Downlight trim with integral 600 lumen 12W nominal light engine and dedicated 120V driver, dimmable with use of most incandescent, magnetic and electronic low voltage wall box dimmers. Designed for use in IC or non-IC construction. White trim flange is standard.



Medium-based socket whip adapter included with trim.

Example: J6RL WD G4 DC 06LM 30K 90CRI 120 FRPC CWH

Series	Dynamic Feature	Gen	Trim Style	Lumens	CCT	CRI	Voltage/Driver	Trim Finish
J6RL	WD WarmDim®	G4N	DC*	06LM	30K 3000K	90CRI	120 FRPC 120V Only; Forward Phase/ELV Dimming	CWH Clear
			Downlight Cone	600 Lumens				WWH White
			DB**					HZWH Haze
			Downlight Baffle					WHZWH Wheat Haze
							BWH <sup>1</sup> Black	

\* DC not available with BWH trim finish. \*\* DB available with WWH and BWH trim finish only.

## Trim Inserts

### Downlights



J6RLTRIM DB WWH  
White Baffle



J6RLTRIM DB BWH  
Black Baffle



J6RLTRIM DC CWH  
Clear Cone



J6RLTRIM DC WWH  
White Cone



J6RLTRIM DC HZWH  
Haze Cone



J6RLTRIM DC WHZWH  
Wheat Haze Cone

5-3/8" Aperture – Interchangeable trim inserts can be easily changed in the field to customize the look of the trim module.

ENERGY STAR® Qualification and T24 certification is dependent on trim finish and LED color temperature.

See specifications for a list of factory qualified dimmers.



### Juno Dedicated LED Housings

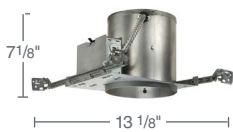

Fixture Style	Description
IC23 LEDT24	6" IC New Construction



Fixture Style	Description
IC23R LEDT24	6" IC Remodel



### Compatible Housings

The J6RL Series Retrofit LED Downlight Trim Modules are compatible with most 6" recessed housings measuring at least 5-1/4" high with an inside diameter between 6" and 6-3/4". Removal of the housing socket plate or socket mounting bracket may be required in order for the trim to fit properly. Compatible housings include, but not limited to:

**Juno® Housings:** IC2, IC21, IC22, IC23 and TC2 Series

**Juno Quick-Connect LED Housings:** IC23 LEDT24 and IC23R LEDT24

**Lithonia Lighting® Housings:** L7X and LC6 Series

**VuLite® Housings:** V6IC and V6TC Series

**Halo® Housings:** H7 Series and J25 Series

**Thomas® Lighting Housings:** PS1 and PS3 Series

**Capri Housings:** CR1, PR1, QL6 Series and P9ASIC Series

### Accessories

Catalog Number	Description
V6RLTRB	Torsion receiver bracket kit to install Juno Retrofit LED Trim Module into housings that do not have torsion receiver brackets



### Qualified Dimmers - 120V

Compatible with incandescent, magnetic low voltage or electronic low voltage wall box dimmer.

See specifications for a list of factory qualified dimmers.

# Retrofit LED Eyeball Trim Module

This retrofit LED eyeball installs easily into existing 6" recessed housings and provides 358-degrees rotation and up to 30-degrees vertical adjustment. Medium-base socket, screw-in whip adapter included.

## 6" Retrofit 600 and 900 Lumen Eyeball Trim Module



### J6RLE

All-in-one 6" LED Retrofit Eyeball Trim available with choice of integral 600 lumen 11.14W or 900 Lumen 15.8W nominal light engine and dedicated 120V driver, dimmable with use of most incandescent, magnetic and electronic low voltage wall box dimmers. 6" WarmDim® LED Retrofit Eyeball trim with integral 600 Lumen 12W nominal light engine and dedicated 120V driver. Designed for use in IC or non-IC construction. Wide flood optic provided as standard.



Medium-based socket whip adapter included with trim.

Example: J6RLE G4 06LM 30K 90CRI 120 FRPC WH

Series	Gen	Lumens	CCT	CRI	Voltage/Driver	Trim Finish
J6RLE	G4	<b>06LM</b>	<b>27K</b> 2700K	<b>90CRI</b>	<b>120 FRPC</b> 120V Only; Forward Phase/ELV Dimming	<b>WH</b> White
		600 Lumens	<b>30K</b> 3000K			
		<b>09LM</b>	<b>35K</b> 3500K			
		900 Lumens	<b>40K</b> 4000K			

## 6" Retrofit 600 Lumen WarmDim® LED Eyeball Trim Module



WarmDim®



### J6RLE WD

All-in-one 6" WarmDim® LED Retrofit Eyeball trim with integral 600 lumen 14W nominal light engine and dedicated 120V driver, dimmable with use of most incandescent, magnetic and electronic low voltage wall box dimmers. Designed for use in IC or non-IC construction. Wide flood optic is standard.





Medium-based socket whip adapter included with trim.

Example: J6RLE WD G4N 06LM 30K 90CRI 120 FRPC WH

Series	Dynamic Feature	Gen	Lumens	CCT	CRI	Voltage/Driver	Trim Finish
J6RLE	<b>WD</b> WarmDim®	<b>G4N</b>	<b>06LM</b> 600 Lumens	<b>30K</b> 3000K	<b>90CRI</b>	<b>120 FRPC</b> 120V Only; Forward Phase/ELV Dimming	<b>WH</b> White

### Accessories

Catalog Number	Description
 <b>LEDOPTICG3 MFL</b>	Medium Flood Optic (50° beam)
<b>LEDOPTICG3 NFL</b>	Narrow Flood Optic (37° beam)
<b>LEDOPTICG3 SP</b>	Spot Optic (10° beam)
 <b>V6RLTRB</b>	Torsion receiver bracket kit to install Juno Retrofit LED Trim Module into housings that do not have torsion receiver brackets

**Note:** For best performance use LEDOPTICG3 MFL with WarmDim® Eyeball Trim Module.

**Note:** ENERGY STAR® Qualification and T24 certification is dependent on LED color temperature. See housing specification sheet on [www.acuitybrands.com](http://www.acuitybrands.com) for specific information.



### Compatible Housings

The J6RLE Series Retrofit LED Eyeball Trim Modules are compatible with most 6" recessed housings measuring at least 5-1/4" high with an inside diameter between 6" and 6-3/4". Removal of the housing socket plate or socket mounting bracket may be required in order for the trim to fit properly. Compatible housings include, but not limited to:

#### Juno® Housings:

IC2, IC21, IC22, IC23 and TC2 Series

#### Juno Quick-Connect LED Housings:

IC23 LEDT24 and IC23R LEDT24

#### Lithonia Lighting® Housings:

L7X and LC6 Series

#### VuLite® Housings:

V6IC and V6TC Series

#### Halo® Housings:

H7 Series and J25 Series

#### Thomas® Lighting Housings:

PS1 and PS3 Series

#### Capri Housings:

CR1, PR1, QL6 Series and P9ASIC Series

### Juno Dedicated LED Housings

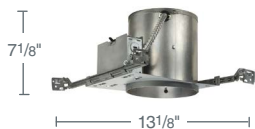

Fixture Style	Description
IC23 LEDT24	6" IC New Construction



Fixture Style	Description
IC23R LEDT24	6" IC Remodel



### Qualified Dimmers - 120V

Compatible with incandescent, magnetic low voltage or electronic low voltage wall box dimmer.

See specifications for a list of factory qualified dimmers.





## Basics Series™ Retrofit LED Downlight Trims



### Economical 4", 5" and 6" LED Trim Modules

You no longer need to pay a premium to experience all the benefits of LED lighting. With Juno Basics Series Retrofit LED trim modules, upgrading your existing 4", 5", or 6" recessed fixtures is inexpensive and nearly as simple as replacing an incandescent lamp.



# It's the affordable way to upgrade to LED lighting

Ultra-efficient Basics Series Retrofit LED Trims are offered in two lumen packages. The 13.5-watt RLD Series provides up to 1000 lumens, while the 10-watt RLD Series offers up to 700 lumens. Both lumen packages offer energy savings of up to 85%. Plus, with a rated service life of 44,000 hours, Basics Series LED retrofits last about 18-times longer than incandescents, providing many years of maintenance-free operation. Additionally, they are ENERGY STAR® Certified and can be used to comply with Title 24, Part 6, JA8 high efficacy LED light source requirements.

Juno Retrofit LED Basics Series trim modules don't scrimp on aesthetics. The aluminum housings feature a white baffle with a built-in flange. A deeply regressed diffusing lens conceals the LEDs from direct view and provides uniform aperture luminance. With color temperatures of 2700K, 3000K or 3500K and 90+ CRI, the trims offer superb light quality and superior color rendering and consistency. These handsome modules blend nicely with the ceiling and enhance the appearance of any room in the house, including kitchens, living rooms, and bathrooms. Basics Series LED retrofits operate on 120VAC and are dimmable to 5% with many incandescent, magnetic low-voltage, or electronic low-voltage wall box dimmers.

Installing Juno Retrofit LED Basics Series trims could not be easier. They can be quickly installed into Juno 4", 5", or 6" housings or virtually any other manufacturers' standard or shallow, new-construction or remodel, IC or Non-IC housing equipped with a medium-base socket. Basics Series LED retrofit modules are provided with a medium-base socket adapter with quick-connect that screws into the existing housing. After making the plug-in connection, the module is inserted into the housing and is held securely in place with the attached springs ... simple as that. And Basics Series LED retrofits are backed with a five-year warranty.



4"

4RLD Series



5"

5RLD Series



6"

6RLD Series

Juno® Basics Series™  
Retrofit LED Downlight Trims  
lasts 18-times longer than  
incandescent with up to  
85% energy savings.



4RLD

Saves up to **80%** in energy costs when compared to equivalent incandescent light source

## Juno® 4" Retrofit LED Basics Series Trim Modules

These LED retrofit trim modules are the easy, economical way to upgrade existing 4" recessed downlight housings to ultra-efficient LED illumination. Available in two lumen packages, they produce 650 lumens from just 10-watts or up to over 900 lumens from only 13.5 watts, offering energy cost savings of up to 80% compared to equivalent incandescent fixtures. With a rated service life of 44,000 hours, they provide many years of maintenance-free operation while delivering exceptionally accurate color rendering of 90+ CRI.

### Product Specifications

4RLD



Medium-base socket whip adapter included with trims



- Delivers 650 lumens at 10-watts input, or up to over 900 lumens from 13.5-watts with 90+ CRI
- 2700K, 3000K or 3500K color temperatures
- Fast, easy, retrofit installation in almost any medium-base 4" housing using included socket adapter and quick connect
- Very affordable with no compromise in Juno quality
- Durable die-cast aluminum construction
- Knife-edge, white baffle trim with regressed lens
- Dimmable to 5% with many incandescent, magnetic low-voltage, or electronic low-voltage wall box dimmers
- Rated for use in IC (insulated ceiling) or non-IC housings
- 5-year limited warranty

### Compatible Housings

Compatible with many 4" standard or shallow Juno-brand and alternative housings:

- Juno housings: IC1 and TC1 Series
- VuLite® housings: V4IC and V4TC Series
- Juno Quick-Connect LED housings: IC1 LEDT24 and IC1R LEDT24
- Lithonia® housings: L3 Series

Other housings include, but are not limited to:

- Halo® housings: H99 Series
- Thomas® housings: PS4 Series
- Capri® housings: P4 Series, R4 Series

### Juno Dedicated LED T24 Housings

**Catalog #:** IC1 LEDT24

**Description:** 4" IC New Construction



12¼" L x 6¾" W x 6" H  
Ceiling cutout: 4½" diameter

**Catalog #:** IC1R LEDT24

**Description:** 4" IC Remodel



12" L x 4¼" W x 5½" H  
Ceiling cutout: 4¾" diameter

### Regulatory Listings & Standards



Approved for use in Wet Locations (indoor covered ceilings only)



ENERGY STAR® Certified



Meets IECC air leakage requirements per ASTM E283

UL and C-UL Classified

RoHS Compliant



Can be used to comply with Title 24, Part 6, (JA8-2016) high efficacy LED light source requirements.

Catalog #	CI Code	Description
4RLD G3 06LM 27K 90CRI 120 FRPC WWH	*251P4C	4" LED retrofit baffle trim, 650 Lumens, 2700K
4RLD G3 06LM 30K 90CRI 120 FRPC WWH	*251P4L	4" LED retrofit baffle trim, 650 Lumens, 3000K
4RLD G3 06LM 35K 90CRI 120 FRPC WWH	*251P4T	4" LED retrofit baffle trim, 650 Lumens, 3500K
4RLD G3 09LM 27K 90CRI 120 FRPC WWH	*251P4J	4" LED retrofit baffle trim, 900 Lumens, 2700K
4RLD G3 09LM 30K 90CRI 120 FRPC WWH	*251P4P	4" LED retrofit baffle trim, 900 Lumens, 3000K
4RLD G3 09LM 35K 90CRI 120 FRPC WWH	*251P4U	4" LED retrofit baffle trim, 900 Lumens, 3500K

### Qualified Dimmers

Compatible with incandescent, magnetic low voltage or electronic low voltage wall box dimmers. See specifications for a list of factory recommended dimmer models.

5RLD

Saves up to **85%** in energy costs when compared to equivalent incandescent light source

## Juno® 5" Retrofit LED Basics Series Trim Modules

These LED retrofit trim modules are the easy, economical way to upgrade existing 5" recessed downlight housings to ultra-efficient LED illumination. Available in two lumen packages, they produce 700 lumens from just 10-watts or up to over 950 lumens from 13.5-watts, offering energy cost savings of up to 85% compared to equivalent incandescent fixtures. With a rated service life of 44,000 hours, they provide many years of maintenance-free operation while delivering exceptionally accurate color rendering of 90+ CRI.

### Product Specifications

5RLD



Medium-base socket whip adapter included with trims

- Delivers 700 lumens at 10-watts input, or up to over 950 lumens from 13.5-watts with 90+ CRI
- 2700K, 3000K or 3500K color temperatures
- Fast, easy, retrofit installation in almost any medium-base 5" housing using included socket adapter and quick connect
- Very affordable with no compromise in Juno quality
- Durable die-cast aluminum construction
- Knife-edge, white baffle trim with regressed lens
- Dimmable to 5% with many incandescent, magnetic low-voltage, or electronic low-voltage wall box dimmers
- Rated for use in IC (insulated ceiling) or non-IC housings
- 5-year limited warranty



### Compatible Housings

Compatible with many 5" standard or shallow Juno-brand and alternative housings:

- Juno housings: IC20, IC25, and TC20 Series
- VuLite® housings: V5IC and V5TC Series
- Juno Quick-Connect LED housings: IC20 LEDT24 and IC20R LEDT24
- Lithonia® housings: L5 Series

Other housings include, but are not limited to:

- Halo® housings: H5 and H25 Series
- Thomas® housings: PS5 Series
- Capri® housings: R5, CR5, and QL5 Series

### Juno Dedicated LED T24 Housings

**Catalog #:** IC20 LEDT24

**Description:** 5" IC New Construction



11 7/8" L x 6 3/4" W x 7 1/2" H  
Ceiling cutout: 5 5/8" diameter

**Catalog #:** IC20R LEDT24

**Description:** 5" IC Remodel



12 1/2" L x 5 5/8" W x 7 1/2" H  
Ceiling cutout: 5 1/2" Diameter

### Regulatory Listings & Standards



Approved for use in Wet Locations (indoor covered ceilings only)



ENERGY STAR® Certified



Meets IECC air leakage requirements per ASTM E283

UL and C-UL Classified

RoHS Compliant



Can be used to comply with Title 24, Part 6, (JA8-2016) high efficacy LED light source requirements.

Catalog #	CI Code	Description
5RLD G3 07LM 27K 90CRI 120 FRPC WWH	*251P4W	5" LED retrofit baffle trim, 700 Lumens, 2700K
5RLD G3 07LM 30K 90CRI 120 FRPC WWH	*251P51	5" LED retrofit baffle trim, 700 Lumens, 3000K
5RLD G3 07LM 35K 90CRI 120 FRPC WWH	*251P58	5" LED retrofit baffle trim, 700 Lumens, 3500K
5RLD G3 09LM 27K 90CRI 120 FRPC WWH	*251P4Y	5" LED retrofit baffle trim, 900 Lumens, 2700K
5RLD G3 09LM 30K 90CRI 120 FRPC WWH	*251P55	5" LED retrofit baffle trim, 900 Lumens, 3000K
5RLD G3 09LM 35K 90CRI 120 FRPC WWH	*251P5A	5" LED retrofit baffle trim, 900 Lumens, 3500K

### Qualified Dimmers

Compatible with incandescent, magnetic low voltage or electronic low voltage wall box dimmers. See specifications for a list of factory recommended dimmer models.

6RLD

Saves up to **85%** in energy costs when compared to equivalent incandescent light source

## Juno® 6" Retrofit LED Basics Series Trim Modules

These LED retrofit trim modules are the easy, economical way to upgrade existing 6" recessed downlight housings to ultra-efficient LED illumination. Available in two lumen packages, they produce 700 lumens from just 10-watts, or up to 1,000 lumens from just 13.5-watts, offering energy cost savings of up to 85% compared to equivalent incandescent fixtures. With a rated service life of 44,000 hours, they provide many years of maintenance-free operation while delivering exceptionally accurate color rendering of 90+ CRI.

### Product Specifications

6RLD



Medium-base socket whip adapter included with trims

- Delivers 700 lumens at 10-watts input, or up to 1,000 lumens from 13.5 watts with 90+ CRI
- 2700K, 3000K or 3500K color temperatures
- Fast, easy, retrofit installation in almost any medium-base 6" housing using included socket adapter and quick connect
- Very affordable with no compromise in Juno quality
- Durable die-cast aluminum construction
- Knife-edge, white baffle trim with regressed lens
- Dimmable to 5% with many incandescent, magnetic low-voltage, or electronic low-voltage wall box dimmers
- Rated for use in IC (insulated ceiling) or non-IC housings
- 5-year limited warranty

### Compatible Housings

Compatible with many 6" standard or shallow Juno-brand and alternative housings:

- Juno housings: IC2, IC21, IC22, IC23, and TC2 Series
- VuLite® housings: V6IC and V6TC Series
- Juno Quick-Connect LED housings: IC23 LEDT24 and IC23R LEDT24
- Lithonia® housings: L7X and LC6 Series
- Halo® housings: H7 and H25 Series
- Thomas® housings: PS1 and PS3 Series
- Capri® housings: CR1, PR1, QL6, and R9ASIC Series

### Juno Dedicated LED T24 Housings

**Catalog #:** IC23 LEDT24

**Description:** 6" IC New Construction



13½" L x 7½" W x 7½" H  
Ceiling cutout: 6⅞" diameter

**Catalog #:** IC23R LEDT24

**Description:** 6" IC Remodel



13¼" L x 7⅞" W x 7⅞" H  
Ceiling cutout: 6¾" diameter

### Regulatory Listings & Standards



Approved for use in Wet Locations (indoor covered ceilings only)



ENERGY STAR® Certified



Meets IECC air leakage requirements per ASTM E283  
UL and C-UL Classified  
RoHS Compliant



Can be used to comply with Title 24, Part 6, (JA8-2016) high efficacy LED light source requirements.

Catalog #	CI Code	Description
6RLD G3 07LM 27K 90CRI 120 FRPC WWH	*251P5G	6" LED retrofit baffle trim, 700 Lumens, 2700K
6RLD G3 07LM 30K 90CRI 120 FRPC WWH	*251P5N	6" LED retrofit baffle trim, 700 Lumens, 3000K
6RLD G3 07LM 35K 90CRI 120 FRPC WWH	*251P60	6" LED retrofit baffle trim, 700 Lumens, 3500K
6RLD G3 10LM 27K 90CRI 120 FRPC WWH	*251P5K	6" LED retrofit baffle trim, 1000 Lumens, 2700K
6RLD G3 10LM 30K 90CRI 120 FRPC WWH	*251P5R	6" LED retrofit baffle trim, 1000 Lumens, 3000K
6RLD G3 10LM 35K 90CRI 120 FRPC WWH	*251P63	6" LED retrofit baffle trim, 1000 Lumens, 3500K

### Qualified Dimmers

Compatible with incandescent, magnetic low voltage or electronic low voltage wall box dimmers. See specifications for a list of factory recommended dimmer models.

### Accessories

Catalog #	Description
V6RLTRB	 Torsion receiver bracket kit to install 6RLD into housings that do not have torsion receivers.









## Basics Series™ Retrofit LED Adjustable Gimbal Ring

### Economical 4", 5" and 6" Adjustable Trims

Juno Basics Series Retrofit LED trim modules make it easy and inexpensive to upgrade your existing recessed fixtures to energy-efficient LED illumination. Adjustable-gimbal trims enable you to achieve superb accent lighting throughout your home. These economical retrofits offer Juno-brand quality in a basic design that's as simple to install as replacing an incandescent lamp.



## It's the affordable way to upgrade to LED accent lighting

Basics Series LED retrofit adjustables are available for 4", 5", or 6" housings and require just 10.5-watts input to deliver up to over 650 brilliant lumens. Compared to 65-watt incandescent fixtures, they provide superior quality light while offering energy savings of as much as 85%. Plus, with a rated service life of 44,000 hours, they last about 18-times longer than incandescent, providing many years of maintenance-free operation. These ultra-efficient LED retrofits are ENERGY STAR® Certified and certified to meet the high efficacy requirements of California T24 (JA8-2016).

The adjustable gimbal is designed for vertical aiming up to 35° and is offered in a choice of optics: narrow flood or wide flood. In this all-in-one design, the LED light engine is mounted directly to the housing for superior thermal management, and the gimbal trim with built-in flange is made of durable die-cast aluminum. With color temperatures of 2700K or 3000K and CRI of 90 minimum, the modules offer high-quality white light and outstanding color rendering and consistency.

These handsome trims are available in a white finish and feature a diffusing lens for LED concealment and uniform aperture luminance. They blend easily with any decor and provide beautiful accent lighting for every room of the home. Juno Basics Series Retrofit LED Adjustables are dimmable to 5% with many incandescent, magnetic low-voltage, or electronic low-voltage wall box dimmers

Installing Juno Basics Series Retrofit LED adjustable trims couldn't be easier. They are designed to quickly replace the lamps and trim in virtually any manufacturers' standard or shallow, new construction or remodel, IC or Non-IC housing equipped with a medium base socket. They also can be easily installed directly into Juno dedicated LED housings, using only the supplied plug-in quick connect.



4"



5"



6"

Juno® Basics Series™ LED retrofit adjustable trim modules offer economical, energy-efficient accent lighting throughout the house. Saves up to 85% in energy costs.



# 4RLA

## Juno® Basics Series™ 4" Retrofit LED Adjustable Trim

These all-in-one, LED retrofit trim modules are the easy, economical way to upgrade existing 4" recessed downlight housings to ultra-efficient, fully adjustable LED accent lighting. They produce over 600 brilliant lumens from just 10.5 watts, offering energy cost savings of up to 85% compared to equivalent incandescent fixtures. With a rated service life of 44,000 hours, they provide many years of maintenance-free operation while delivering exceptionally accurate color rendering of 90+ CRI.

### Product Specifications:



Medium-base socket whip adapter included with trims

- Adjustable gimbal design provides up to 35° vertical aiming
- Delivers over 600 lumens at 10.5-watts input with 90+ CRI
- 2700K or 3000K color temperatures
- Available with 25° narrow flood or 65° wide flood optic; diffusing lens conceals LEDs
- Fast, easy retrofit installation in almost any medium-base 4" housing using included socket adapter and quick connect
- Also installs directly into dedicated Juno LED T24 housings
- Very affordable with no compromise in Juno quality
- Durable die-cast aluminum construction finished in white
- Dimmable to 5% with many incandescent, magnetic low-voltage, or electronic low-voltage wall box dimmers
- Rated for use in IC (insulated ceiling) or non-IC housings
- ENERGY STAR® Certified and certified to meet the high efficacy requirements of California T24
- 5-year limited warranty

### Compatible Housings

Compatible with many 4" standard or shallow housings by Acuity Brands or other manufacturers:

- Juno housings: IC1 and TC1 Series
- VuLite® housings: V4IC and V4TC Series
- Juno Quick-Connect LED housings: IC1 LEDT24 and IC1R LEDT24
- Lithonia® housings: L3 Series

Other housings include but are not limited to:

- Halo® housings: H99 Series
- Thomas® housings: PS4 Series
- Capri® housings: P4 Series, R4 Series

### Juno Dedicated LED T24 Housings

**Catalog #:** IC1 LEDT24

**Description:** 4" IC New Construction



12¼" L x 6¾" W x 6" H  
Ceiling cutout: 4½" diameter

**Catalog #:** IC1R LEDT24

**Description:** 4" IC Remodel



12" L x 4¼" W x 5½" H  
Ceiling cutout: 4¾" diameter

### Regulatory Listings & Standards



ENERGY STAR®  
Certified

UL and C-UL Classified



Certified to meet the high efficacy requirements of California Title 24 (JA8-2016)

RoHS Compliant

### Qualified Dimmers

Compatible with incandescent, magnetic low voltage or electronic low voltage wall box dimmers. See specifications for a list of factory recommended dimmer models.

Catalog #	CI Codes	Description
4RLA G2 06LM 27K 90CRI NFL 120 FRPC WH	*257KHN	4" LED retrofit adjustable trim, 2700K, Narrow Flood
4RLA G2 06LM 27K 90CRI WFL 120 FRPC WH	*257KHP	4" LED retrofit adjustable trim, 2700K, Wide Flood
4RLA G2 06LM 30K 90CRI NFL 120 FRPC WH	*257U25	4" LED retrofit adjustable trim, 3000K, Narrow Flood
4RLA G2 06LM 30K 90CRI WFL 120 FRPC WH	*257JL6	4" LED retrofit adjustable trim, 3000K, Wide Flood

# 5RLA

## Juno® Basics Series™ 5" Retrofit LED Adjustable Trim

These all-in-one, LED retrofit trim modules are the easy, economical way to upgrade existing 5" recessed downlight housings to ultra-efficient, fully adjustable LED accent lighting. They produce over 650 brilliant lumens from just 10.5 watts, offering energy cost savings of up to 85% compared to equivalent incandescent fixtures. With a rated service life of 44,000 hours, they provide many years of maintenance-free operation while delivering exceptionally accurate color rendering of 90+ CRI.

### Product Specifications:



Medium-base socket whip adapter included with trims



- Adjustable gimbal design provides up to 35° vertical aiming, 359° rotation
- Delivers over 650 lumens at 10.5-watts input with 90+ CRI
- 2700K or 3000K color temperatures
- Available with 25° narrow flood or 70° wide flood optic; diffusing lens conceals LEDs
- Fast, easy retrofit installation in almost any medium-base 5" housing using included socket adapter and quick connect
- Also installs directly into dedicated Juno LED T24 housings
- Very affordable with no compromise in Juno quality
- Durable die-cast aluminum construction finished in white
- Dimmable to 5% with many incandescent, magnetic low-voltage, or electronic low-voltage wall box dimmers
- Rated for use in IC (insulated ceiling) or non-IC housings
- ENERGY STAR® Certified and certified to meet the high efficacy requirements of California T24
- 5-year limited warranty

### Compatible Housings

Compatible with many 5" standard or shallow housings by Acuity Brands or other manufacturers:

- Juno housings: IC20, IC25, and TC20 Series
- VuLite® housings: V5IC and V5TC Series
- Juno Quick-Connect LED housings: IC20 LEDT24 and IC20R LEDT24
- Lithonia® housings: L5 Series

Other housings include but are not limited to:

- Halo® housings: H5 Series
- Thomas® housings: PS5 Series
- Capri® housings: QL5 Series

### Juno Dedicated LED T24 Housings

**Catalog #:** IC20 LEDT24

**Description:** 5" IC New Construction



11½" L x 6¼" W x 7½" H  
Ceiling cutout: 5½" diameter

**Catalog #:** IC20R LEDT24

**Description:** 5" IC Remodel



12½" L x 5½" W x 7½" H  
Ceiling cutout: 5½" Diameter

### Regulatory Listings & Standards



ENERGY STAR®  
Certified

UL and C-UL Classified



Certified to meet the high efficacy requirements of California Title 24 (JA8-2016)

RoHS Compliant

### Qualified Dimmers

Compatible with incandescent, magnetic low voltage or electronic low voltage wall box dimmers. See specifications for a list of factory recommended dimmer models.

Catalog #	CI Codes	Description
5RLA G2 06LM 27K 90CRI NFL 120 FRPC WH	*257KHR	5" LED retrofit adjustable trim, 2700K, Narrow Flood
5RLA G2 06LM 27K 90CRI WFL 120 FRPC WH	*257U27	5" LED retrofit adjustable trim, 2700K, Wide Flood
5RLA G2 06LM 30K 90CRI NFL 120 FRPC WH	*257U28	5" LED retrofit adjustable trim, 3000K, Narrow Flood
5RLA G2 06LM 30K 90CRI WFL 120 FRPC WH	*257KHT	5" LED retrofit adjustable trim, 3000K, Wide Flood









## Basics Series™ Surface Mount LED Fixtures



### Affordable and easy-to-install, 4" and 6" fixtures

There's never been an easier to install LED fixture than this one. The Juno® Basics Series™ Surface Mount LED fixture attaches directly to any standard junction box in two simple steps. No recessed housing required. Take it out of the box, and you're almost done. Use it as a downlight or wall sconce. This super-thin fixture fits flush with any flat surface, mimicking the appearance of a recessed fixture. But without the need for a housing, installation time and fixture cost are kept to the bare minimum. This attractive, all-in-one design includes LED light engine, lens, and trim.

The Juno surface-mount design offers performance and efficiency similar to typical LED recessed fixtures. The 4" 10-watt 4RLS Series is available in a 700 lumen version, while the 6" 6RLS is available in two lumen packages. The 14.5-watt 6RLS Series provides an impressive 1000 lumens, while the 10-watt 6RLS Series offers 750 lumens. These ultra-efficient fixtures provide energy savings of up to 85% compared to equivalent incandescent light sources. They are available in 2700K or 3000K CCTs with excellent 90 CRI minimum color rendering. Dimmable to 5%, they are compatible with many incandescent, magnetic low-voltage or electronic low-voltage dimmers.



4RLS

6RLS

## Juno® 4" and 6" Basics Series Surface Mount Fixtures

### Product Specifications:



- 4RLS Delivers 700 lumens at 10-watts with 90 CRI minimum
- Two 6RLS light engines available. 750 lumens from only 10-watts and 1000 lumens from only 14.5 watts, both with 90 CRI minimum
- 2700K or 3000K color temperature
- Easy installation directly to junction box or existing 4" recessed housing via 4RLSRETROKIT or existing 5" and 6" recessed housings via 56RLSRETROKIT accessory
- Can be used as a downlight or a sconce
- Very low 1-1/8" profile (4RLS) and 1-1/4" profile (6RLS)
- Beveled aluminum frame with white finish
- Dimmable with most standard incandescent, magnetic low voltage and electronic low voltage dimmers
- Five year limited warranty

### Qualified Dimmers

Compatible with incandescent, magnetic low voltage or electronic low voltage wall box dimmers. See specifications for a list of factory recommended dimmer models.

### Accessories

Catalog #	Description
56RLSRETROKIT	Allows 6RLS to retrofit in 5" or 6" recessed housings. Kit contains: medium base adapter, mounting springs, and electrical connectors.

**Saves up to 85% in energy costs when compared to 65W incandescent light source**

### Installation

#### Junction Box Mounting

- Installs directly into industry standard junction boxes
- Compatible boxes include 3-1/2" and 4" octagon junction boxes (1-1/2" minimum depth), round mud rings with 2-3/4" mounting centers and 3" and 4" diameter non-metallic boxes
- Quick-mount strap and spring securement system provides fast installation of fully assembled fixture to junction box
- Suitable for ceiling or wall mount
- Suitable for use within closet storage spaces when installed per NEC requirements

#### Recessed Housing Mounting - 4RLS

- Must use 4RLSRETROKIT accessory
- 4RLS is compatible with most 4" recessed incandescent housings with an inside diameter between 4" and 4-1/2" and a minimum height of 4"

#### Compatible Juno Housings - 4RLS

- Juno IC1 and TC1 Series
- VuLite® V4IC and V4TC Series

#### Recessed Housing Mounting - 6RLS

- Must use 56RLSRETROKIT accessory
- 6RLS is compatible with most 5" and 6" recessed incandescent housings with an inside diameter between 5" and 7" and a minimum height of 4"

#### Compatible Juno Housings - 6RLS

- Juno IC20, IC25, IC2, IC21, IC22, IC23, TC20 and TC2 Series
- VuLite V5IC, V6IC, V5TC, V6TC Series

### Regulatory Listings & Standards



Approved for use in Wet Locations (indoor covered ceilings only)



Meets IECC air leakage requirements per ASTM E283



ENERGY STAR® Certified



Certified to meet the high efficacy requirements of California Title 24 (JA8-2016)

UL and C-UL Classified

RoHS Compliant

Catalog #	CI Codes	Description
4RLS G2 07LM 27K 90CRI 120 FRPC WH	*251P66	4" Surface Mount Fixture, 700 lumens, 2700K
4RLS G2 07LM 30K 90CRI 120 FRPC WH	*251P68	4" Surface Mount Fixture, 700 lumens, 3000K
4RLSRETROKIT	*243V4V	Accessory kit for use when installing in existing 4" recessed housings
6RLS G2 07LM 27K 90CRI 120 FRPC WH	*251P6A	6" Surface Mount Fixture, 750 lumens, 2700K
6RLS G2 07LM 30K 90CRI 120 FRPC WH	*251P6F	6" Surface Mount Fixture, 750 lumens, 3000K
6RLS G2 10LM 27K 90CRI 120 FRPC WH	*251P6J	6" Surface Mount Fixture, 1000 lumens, 2700K
6RLS G2 10LM 30K 90CRI 120 FRPC WH	*251P6K	6" Surface Mount Fixture, 1000 lumens, 3000K
56RLSRETROKIT	*243V66	Accessory kit for use when installing in existing 5" or 6" recessed housings

\*See installation guidelines provided with fixture for information on installing in wet location environments.





## Juno SlimForm™ LED Surface Mount Downlights

**Sleek in form, when space is slim**

Juno SlimForm downlights are economical and easy-to-install, surface mounted LED fixtures with an unobtrusive - less than 1" deep - profile that cleanly integrates and complements any décor.



# Juno SlimForm™ LED Surface Mount Downlights

The low cost, low maintenance, low plenum, low-profile fixture ... high in performance and style!



JSF Series



JSFSQ Series

## Features include:

- Standard white finish for round or square fixtures in multiple sizes; outputs up to 1800 lumens
- Mounts directly to a standard junction box – see specifications
- Multi-volt 120-277V (0-10V dimmable) or dedicated 120V (forward phase/ELV dimmable) drivers
- 2700K, 3000K, 3500K or 4000K color temperature with 90+ CRI
- ENERGY STAR® certified
- Can be used to comply with Title 24, Part 6, JA8 high efficiency LED light source requirements
- Wet Location listed with standard non-metallic housing



## Quick and Simple Installation

Juno SlimForm Surface Mount Downlights are easily installed over a junction box. These fixtures are ideal for use in areas with limited plenum space or when recessed downlights are impractical.

# Juno SlimForm™ LED Surface Mount Downlights

## JSF Series - Rounds

Juno SlimForm JSF Series round-shaped fixtures come standard in white. Available in four sizes, four color temperatures and outputs up to 1800 lumens, they can be utilized across many applications including bathrooms, closets, hallways/common area, corridors, outdoor canopies and more.



5" Fixture



7" Fixture



11" Fixture



13" Fixture



**JSF Series** - Classic, round surface-mounted fixtures with slim-profiles that are cost-effective and easy to install in a variety of applications.

**Ordering Information** – Example: JSF 5IN 07LM 27K 90CRI 120 FRPC WH

Series	Size/Lumens	CCT	CRI	Voltage/Driver	Finish	Options
<b>JSF</b> Juno SlimForm™ LED Series, Round	<b>5IN 07LM</b> 5" Diameter, 700 Lumens	<b>27K</b> 2700K	<b>90CRI</b> 90 CRI	<b>120 FRPC</b> 120V (Forward phase/ ELV Dimmable)	<b>WH</b> White	<b>EL<sup>1,2</sup></b> Integral Battery Backup  <b>EBX<sup>1</sup></b> Empty Back Box
	<b>7IN 10LM</b> 7" Diameter, 1000 Lumens	<b>30K</b> 3000K				
	<b>11IN 13LM</b> 11" Diameter, 1300 Lumens	<b>35K</b> 3500K				
	<b>13IN 18LM</b> 13" Diameter, 1800 Lumens	<b>40K</b> 4000K				
				<b>MVOLT ZT</b> Universal 120-277V (0-10V Dimmable)		

<sup>1</sup> Available with 11IN and 13IN models only

<sup>2</sup> Available with MVOLT ZT option only



# Juno SlimForm™ LED Surface Mount Downlights

## JSFSQ Series - Squares

The JSFSQ Series of Juno SlimForm fixtures offer a modern square-shaped design in a standard white finish. Offered in a choice of size/lumen package, color temperature and driver, these surface mounted fixtures are suitable in a range of different residential and commercial applications.

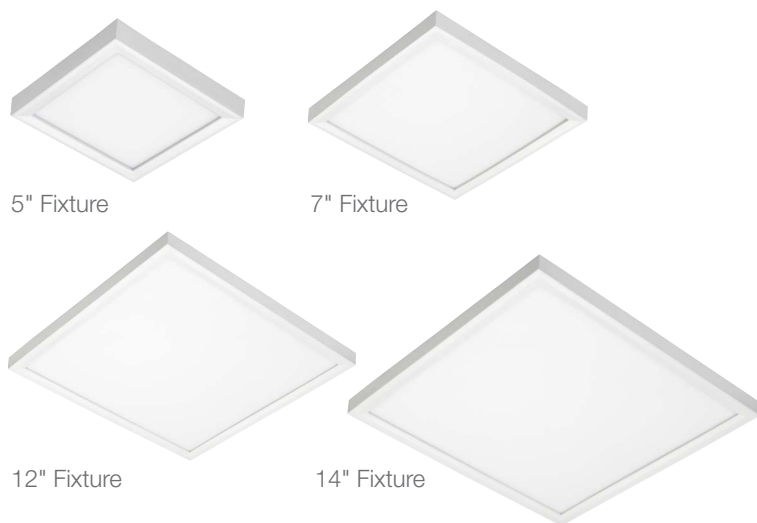

**JSFSQ Series** - Architecturally-pleasing, square-shaped fixtures with a low-profile design that is virtually maintenance-free.

**Ordering Information** – Example: JSFSQ 12IN 13LM 30K 90CRI MVOLT ZT WH

Series	Size/Lumens	CCT	CRI	Voltage/Driver	Finish	Options
<b>JSFSQ</b> Juno SlimForm™ LED Series, Square	<b>5IN 07LM</b> 5" Diameter, 700 Lumens	<b>27K</b> 2700K	<b>90CRI</b> 90 CRI	<b>120 FRPC</b> 120V (Forward phase/ ELV Dimmable)	<b>WH</b> White	<b>EL<sup>1,2</sup></b> Integral Battery Backup
	<b>7IN 10LM</b> 7" Diameter, 1000 Lumens	<b>30K</b> 3000K				
	<b>12IN 13LM</b> 12" Diameter, 1300 Lumens	<b>35K</b> 3500K				
	<b>14IN 18LM</b> 14" Diameter, 1800 Lumens	<b>40K</b> 4000K				
				<b>MVOLT ZT</b> Universal 120-277V (0-10V Dimmable)		<b>EBX<sup>1</sup></b> Empty Back Box

<sup>1</sup> Available with 12IN and 14IN models only

<sup>2</sup> Available with MVOLT ZT option only

## Juno SlimForm™ Accessories

Juno SlimForm fixtures can be accessorized by adding an optional trim or shroud. These accessories include field-bendable tabs that easily secure to the fixture without the need for tools!



Optional trims and shrouds provide a decorative look and feel like a recessed downlight for multi-family residential, hospitality and other commercial environments.

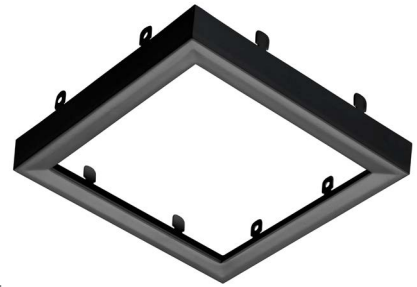

### Trims

Field-installable trims 'wrap' around the exterior of the fixture to provide a decorative finish.



### Shrouds

Optional field-installable shrouds offer a source shield and aesthetic similar to a recessed downlight with a baffle or cone trim finish.



Trims and shrouds are as easy to install as changing a picture frame. Simply bend the tabs over the fixture to hold it in place.

# Juno SlimForm™ Field-Installable Accessories

Decorative trims and shrouds are available for use on Juno SlimForm 5" and 7" fixtures.

## Options Include:

### Round Trim (JSFTRIM)



**BZ:** Bronze Finish



**SN:** Satin Nickel Finish



**BL:** Black Finish

### Square Trims (JSFSQTRIM)



**BZ:** Bronze Finish



**SN:** Satin Nickel Finish



**BL:** Black Finish

### Round Shroud (JSFSHROUD)



**DB BWH:** Black Baffle,  
White Shroud



**DB WWH:** White Baffle,  
White Shroud



**DC HZWH:** Haze Cone,  
White Shroud



**DC WHZWH:** Wheat Haze  
Cone, White Shroud



**DC WWH:** White Cone,  
White Shroud

### Square Shroud (JSFSQSHROUD)

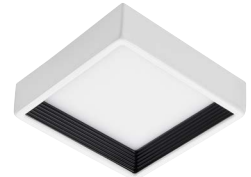

**DB BWH:** Black Baffle,  
White Shroud



**DB WWH:** White Baffle,  
White Shroud

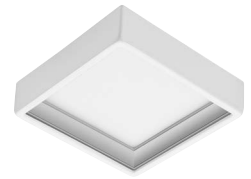

**DC HZWH:** Haze Cone,  
White Shroud

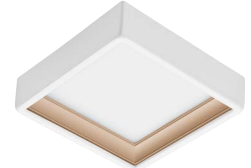

**DC WHZWH:** Wheat Haze  
Cone, White Shroud



**DC WWH:** White Cone,  
White Shroud

**Note:** Accessories are shown installed on fixtures. Fixtures and accessories must be ordered separately.





Versatile, efficient, and economical

# Incandescent Downlights

Juno's incandescent downlights are the industry's most comprehensive and versatile line. No matter what your application, you are certain to find the perfect solution... from new construction to remodel housings... from 3" miniature downlights to 6" downlights for general illumination... from white baffle trims to stunning satin-chrome trims. Whether it's general downlighting, task, wall washing, or accent lighting, Juno recessed incandescent fixtures will meet your every illumination need.

Juno incandescent downlights are designed and engineered in the USA for economy, efficiency, and ease of installation. Juno innovations such as IC housings that can be directly covered with insulation and sealed Air-Loc® housings offer substantial gains in energy efficiency. And Juno Real Nail® 3 bar hanger system leads the way in installation simplicity.

## **Juno Incandescent Downlight Advantages**

- The industry's most comprehensive downlight line
- Aperture sizes of 3", 4", 5", and 6"
- Housings for either insulated or non-insulated ceilings
- Large selection of efficient, long-life halogen fixtures
- Extensive selection of high-quality reflector and trim finishes
- Easy installation with the Real Nail® 3 bar hanger system







# Juno Incandescent Downlights

Versatile, practical, and economical accurately describes the lineup of Juno incandescent downlights. They're versatile in the wide selection of housing and trim styles and sizes ... practical in the design and installation features such as the patented Real Nail® 3 bar hanger system ... and economical in initial installed costs and energy efficiency.

Juno incandescent downlights are available in a wide variety of low-voltage and line-voltage models, new construction and remodel housings, and four aperture sizes for insulated or non-insulated installations.

## Juno Incandescent Downlight Index

<p>4" MR16 and 6" MR16/PAR36 Universals   98-101</p> 	<p>6" Standard Universals   116-117</p> 
<p>3" Mini and 4" R/PAR20 Universals   102-106</p> 	<p>6" Standard Universals with Floating Sockets   118-119</p> 
<p>5" Universals   108-109</p> 	<p>6" Shallow Universals   120-121</p> 
<p>5" Shallow Universals   110-111</p> 	<p>8" and 10" Squares   122-123</p> 
<p>6" Deluxe Universals, High Wattage   112-115</p> 	

# 4" MR16 Universals

Juno 4" low-voltage series offers a wide variety of housings and trims utilizing 12-volt, MR16 lamps. These lamps provide excellent beam control and superior color rendering for accent, task, wall washing, or downlight applications.

## 4" MR16 Universals



### IC Housing

50 Watt Energy-efficient, Air-Loc® double wall housing. May be covered with insulation. Housing includes 50VA 12V, thermally protected magnetic transformer. Includes Real Nail® 3 bar hangers (unless otherwise stated).

**IC44N** New construction IC housing

**IC44N G** New construction IC housing with pre-installed Air-Loc® gasket

**IC44N S** with deep plaster lip. Smaller footprint bar hangers (Real Nail® 2)

**IC44N S G** with deep plaster lip and pre-installed Air-Loc® gasket. Smaller footprint bar hangers (Real Nail® 2)

**IC44N W** with push-in electrical connectors

**IC44N W G** with push-in electrical connectors and pre-installed Air-Loc® gasket

50W MR16

18½" L x 9⅞" W x 7⅝" H\*  
Ceiling cutout: 4½"



### TC Housing

50 Watt housing includes 50VA 12V, thermally protected magnetic transformer. Requires 3" spacing from insulation. Includes Real Nail® 3 bar hangers (unless otherwise stated).

**TC44** New construction non-IC housing

**TC44 V** with 277V magnetic transformer

**TC44 S** with smaller footprint bar hangers (Real Nail® 2)

**TC44 E1** with electronic transformer

50W MR16

12⅞" L x 6¼" W x 5⅝" H  
Ceiling cutout: 4½"



### TC Remodel Housing

50 Watt housing includes 50VA 12V, thermally protected magnetic transformer and mounting tray. Requires 3" spacing from insulation. Transformer tray and housing may be installed from below through a 4-3/8" hole.

**TC44R** Remodel non-IC housing

**TC44R E1** with electronic transformer

50W MR16

10½" L x 4¾" W x 5¼" H  
Ceiling cutout: 4⅞"

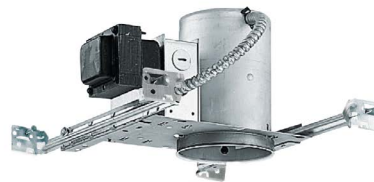

### TC Housing

75 Watt housing includes 75VA 12V, thermally protected magnetic transformer. Requires 3" spacing from insulation. Includes Real Nail® 3 bar hangers.

**TC47** New Construction non-IC housing

**TC47 V** with 277V magnetic transformer

75W MR16

12¾" L x 6¼" W x 6" H  
Ceiling cutout: 4½"

**Note:** In Canada when insulation is present, Type IC fixtures must be used.  
Use dimmers specifically designed for low voltage magnetic transformers.

## 4" MR16 Universal Trims

The trims shown here may be used with any 4" MR16 Universal housing on page 98.

### Downlight Trims



**Deep Cone**  
 442 BWH Black Alzak® Cone  
 442 CWH Clear Alzak® Cone  
 442 GWH Gold Alzak® Cone  
 442 HZWH Haze  
 442 WHZWH Wheat  
 Haze Cone  
 50W MR16  
 3 3/8" Aperture



**Pinhole with Baffle**  
 443 BWH Pinhole,  
 White with Black Baffle  
 IC/TC44: 50W MR16;  
 TC47: 75W MR16  
 1 1/4" Aperture

### Adjustables



**Baffle - Downlight/  
 Adjustable**  
 444 WWH White Baffle  
 444 BWH Black Baffle  
 444 BABZ Black Baffle  
 444 BSC Black Baffle,  
 444 BBL Black Baffle  
 30° vertical adjustment  
 IC/TC44: 50W MR16;  
 TC47: 75W MR16  
 3 3/8" Aperture



**Cone - Downlight/Adjustable**  
 447 BWH Black Alzak®  
 447 CWH Clear Alzak®  
 447 GWH Gold Alzak®  
 447 HZWH Haze  
 447 PTSC Pewter  
 447 WHZABZ Wheat Haze  
 447 WHZWH Wheat Haze  
 35° vertical adjustment  
 IC/TC44: 50W MR16;  
 TC47: 75W MR16  
 3 3/8" Aperture



**Flush Gimbal Ring**  
 440 ABZ  
 440 BL  
 440 SC  
 440 WH  
 40° vertical adjustment  
 50W MR16  
 Uses 2" light control  
 lenses-consult factory.



**Adjustable Slot Aperture**  
 445 WH  
 45° vertical adjustment  
 IC/TC44: 50W MR16;  
 TC47: 75W MR16  
 1 1/2" x 2 1/8" Slot Aperture



**Eyeball w/Black Baffle**  
 448 WH  
 35° vertical adjustment  
 IC/TC44: 50W MR16;  
 TC47: 75W MR16



**Aiming Elbow**  
 449 ABZ  
 449 BL  
 449 SC  
 449 WH  
 75° vertical adjustment  
 50W MR16

### Lensed



**Downlight/Adjustable  
 Shower Trim**  
 441 WABZ  
 441 WSC  
 441 WWH  
 35° vertical adjustment  
 50W MR16



### Wall Wash



**Adjustable Scoop**  
 446 WH  
 45° vertical adjustment  
 IC/TC44: 50W MR16;  
 TC47: 75W MR16

### Squares



**Square Pinhole Trim**  
 443SQ WH White  
 IC/TC44: 50W MR16



**Downlight Adjustable Trim**  
 447SQ HZWH Haze  
 447SQ BWH Black  
 447SQ WHZWH Wheat Haze  
 IC/TC44: 50W MR16  
 35° Vertical Adjustment



**Square Flush Gimbal Trim**  
 440SQ WH  
 440SQ BL  
 IC/TC44: 50W MR16  
 35° Vertical Adjustment

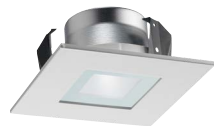

**Downlight Adjustable  
 Square Lensed Trim**  
 441SQ WWH White,  
 35° Vertical Adjustment



Trim Ring Finishes	Housing Accessories	
<b>ABZ</b> Classic Aged Bronze	Catalog Number	Description
<b>SC</b> Satin Chrome	<b>4TSA</b>	Torsion Spring Adapter use in TC44, IC44N and TC47
<b>WH</b> White	<b>SMPLT4</b>	4" Smash Plate for TC44R
<b>BL</b> Black	<b>G2405</b>	T-Bar Clips (Set of 4) for TC44 S, IC44N S

For light control accessories, see page 101.



# 4" Deco Trims Series

For MR16 Housing IC44N/TC44/TC47 (See housings on page 98).

The trims shown here may be used with any 4" MR16 Universal housing on page 98.



## Downlight Decorative Trims

### Decorative Downlights



**Beveled Lensed**  
4402 ABZ  
4402 SC  
4402 WH  
30° vertical adjustment  
50W MR16



**Beveled Dome Lensed**  
4401 ABZ  
4401 SC  
4401 WH  
50W MR16



**Frosted Glass**  
4481 CLEAR  
50W MR16



**Solid Glass Collar**  
4480 FROST  
50W MR16  
2 5/8" Aperture



**Beveled Cone**  
4404 HZSC Haze/Satin  
Chrome Trim Ring  
4404 WHZABZ Wheat Haze/  
Bronze Trim Ring 30° vertical  
adjustment  
30° vertical adjustment  
50W MR16  
3 3/8" Aperture



**Beveled Cylinder  
with Frost Glass**  
4403 FROSTSC Satin Chrome  
4403 FROSTWH White  
30° vertical adjustment  
50W MR16  
3" Aperture



**Mesh Glass Cylinder**  
4450 MESHSC  
50W MR16  
2 5/8" Aperture

### Trim Ring Finishes

- ABZ** Classic Aged Bronze
- SC** Satin Chrome
- WH** White
- BL** Black

For light control accessories, see page 101.

# 6" MR16 / PAR36 Universals

Juno offers 6" low-voltage housings and trims to coordinate with the popular Juno 6" line-voltage downlights. Choose from MR16 or PAR36 light sources.

## 6" Low Voltage Universal Housings



### MR16 TC Housing

Housing includes 75VA 12V, thermal protected magnetic transformer and adjustable bar hangers. Requires 3" spacing from insulation.

**TC45** with Real Nail® 3 bar hangers

50W or 75W MR16  
13 1/8" L x 7 1/2" W x 7 1/4" H  
Ceiling cutout: 6 3/4"



### PAR36 TC Housing

Housing includes 50VA 12V, thermally protected magnetic transformer and adjustable bar hangers. Requires 3" spacing from insulation.

**TC46** with Real Nail® 3 bar hangers

50W PAR36  
13 1/8" L x 7 1/2" W x 7 1/4" H  
Ceiling cutout: 6 1/2"

**Note:** In Canada when insulation is present, Type IC fixtures must be used.

## 6" MR16 Trims / 6" PAR36 Trims

### Adjustables – 6" MR16 Trims



#### Adjustable Downlight Baffle

454 BWH Black Baffle  
35° vertical adjustment  
75W MR16  
3 1/2" Aperture



#### Cylinder Spotlight in Baffle

458 WWH White  
50° vertical adjustment  
50W MR16  
5 3/4" Aperture



#### Adjustable Downlight Cone

457 CWH Clear Alzak® Cone  
35° vertical adjustment  
75W MR16  
3 1/2" Aperture

### Adjustables – 6" PAR36 Trims\*



#### Adjustable Downlight Baffle

464 WWH White Baffle  
464 BWH Black Baffle  
35° vertical adjustment,  
358° rotation  
50W PAR36  
5 3/4" Aperture



#### Adjustable Downlight Cone

467 CWH Clear Alzak®  
35° vertical adjustment,  
358° rotation  
50W PAR36  
5 3/4" Aperture

### Trim Ring Finishes

**WH** White

\* Can not be used with light control accessories.

## Accessories

Catalog Number	Description	Catalog Number	Description
<b>CGF 175 MPINK</b>	Medium Pink Color Filter	<b>DGF 175 MAGEN</b>	Magenta Dichroic Lens
<b>CGF 175 WRED</b>	Warm Red Color Filter	<b>DGF 175 CYAN</b>	Blue Green Dichroic Lens
<b>CGF 175 DLTBLUE</b>	Daylight Blue Color Filter	<b>DCCF 175 HL4250</b>	Daylight Blue Correction Lens
<b>CGF 175 MBLU</b>	Medium Blue Color Filter	<b>DIFF 175</b>	Diffuse Spread Lens
<b>CGF 175 MAMB</b>	Medium Amber Color Filter	<b>UVF 175</b>	UV Filter Lens
<b>CGF 175 MGRN</b>	Medium Green Color Filter	<b>HCLBL 175</b>	Hexcell Louver
<b>DGF 175 DRED</b>	Red Dichroic Lens	<b>LSPREAD 175</b>	Linear Spread Lens
<b>DGF 175 MGRN</b>	Medium Green Dichroic Lens	<b>PRISM 175</b>	Prismatic Lens
<b>DGF 175 MBLU</b>	Medium Blue Dichroic Lens	<b>SOLITE 175</b>	Uniformity Lens
<b>DGF 175 DYEL</b>	Yellow Dichroic Lens	<b>DCCF 175 HIDINC</b>	HID to Incandescent Lens

# 3" Mini Universals

Mini halogen downlights are ideal for illuminating small niches and casework.





## 3" Mini-Downlight Housings with Trims



### 3" Mini-round TC Housing and Trim

Shipped complete with trims as listed.  
Requires 3" spacing from insulation.  
Includes Real Nail® 3 bar hangers.

**TC18 184 WWH** White Baffle  
**TC18 184 BWH** Black Baffle

60W PAR16  
7<sup>7</sup>/<sub>8</sub>" L x 3<sup>1</sup>/<sub>8</sub>" W x 6<sup>1</sup>/<sub>4</sub>" H  
Ceiling cutout: 3<sup>1</sup>/<sub>4</sub>"  
2<sup>1</sup>/<sub>2</sub>" Aperture

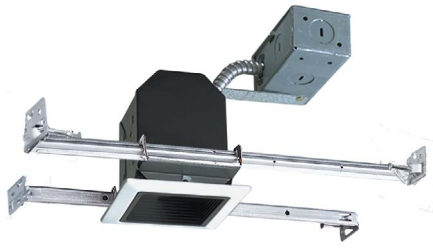

### 3" Mini-square TC Housing and Trim

Shipped complete with trims as listed.  
Requires 3" spacing from insulation.  
Includes Real Nail® 3 bar hangers.

**TC19 194 BWH** Black Baffle

60W PAR16  
7<sup>7</sup>/<sub>8</sub>" L x 3<sup>1</sup>/<sub>8</sub>" W x 6<sup>1</sup>/<sub>4</sub>" H  
Ceiling cutout: 3<sup>1</sup>/<sub>4</sub>" sq.  
2<sup>1</sup>/<sub>2</sub>" Aperture

**Note:** In Canada when insulation is present, Type IC fixtures must be used.

## Features

- Shallow housing easily fits into casework and other tight spaces
- PAR16 halogen lamp produces focused accent lighting from a miniature 2-1/2" aperture
- Easy to use Real Nail® 3 bar hangers are pre-installed
- Unique plaster frame design facilitates new construction or remodel installation
- TC18 and TC19 series fixtures are shipped complete with housing, trim, and bar hangers

For an even smaller downlight with an energy-efficient LED light source, see page 35 for Juno Mini LED Downlights and Gimbals.

# 4" R/PAR20 Universals

These small aperture downlights utilize the popular PAR20 and R20 light sources. They are an excellent choice for lower installation-height applications such as soffits, casework and niches, as well as in settings with shorter beam-throw distances or lower light-level requirements.

## 4" R/PAR Housings



### IC Housing

Energy-efficient, Air-Loc® housing can be covered with insulation. Air-Loc rated in combination with all trims. Includes Real Nail® 3 bar hangers (unless otherwise noted).

- IC1** 4" IC New Construction Housing
- IC1 G** with pre-installed Air-Loc gasket
- IC1 S** with smaller footprint bar hangers (Real Nail® 2)
- IC1 S G** with smaller footprint bar hangers (Real Nail® 2) and pre-installed Air-Loc gasket
- IC1 W** with push-in electrical connectors
- IC1 W G** with push-in electrical connectors and pre-installed Air-Loc gasket
- 12-1/4" L x 6-3/4" W x 6" H

- IC1P** Slightly larger IC housing for use with model 10 trim and GU10WHIP.
- IC1P G** with pre-installed Air-Loc gasket
- 16 1/8" L x 9 1/8" W x 7 1/2" H

Ceiling cutout: 4 1/2"



### TC Housing

Requires 3" spacing from insulation.

- TC1** 4" Non-IC New Construction Housing with Real Nail® 3 bar hangers
- TC1S** with smaller footprint bar hanger (Real Nail® 2)

12 1/8" L x 6 3/4" W x 5 5/8" H  
Ceiling cutout: 4 1/2"



### TC Remodel Housing

Requires 3" spacing from insulation. Installs from below ceiling.

- TC1R** Remodel Housing
- 11 1/2" L x 4 3/4" W x 5 1/4" H

Ceiling cutout: 4 3/8"

- TC1RC W N**
- Non-IC Remodel Housing
- 11 1/2" L x 5 1/4" W x 5 5/8" H

Ceiling cutout: 4 3/8"



## Housing Accessories

Catalog Number	Description
<b>4TSA</b>	Torsion Spring Adapter for use in IC1, TC1.
<b>T599</b>	1" socket extension.
<b>GU10WHIP</b>	For use in IC1P, TC1, and TC1R housings with trims 10 (page 105) and 440, 445, 446, and 448 (page 99, 50W 120V MR16). For use in IC1 housing with trims 440 & 448 only.
<b>SMP4</b>	4" Smash Plate for TC44R
<b>G2405</b>	T-Bar Clips (Set of 4) for IC1 S, TC1 S

**Note:** In Canada when insulation is present, Type IC fixtures must be used. 4" R/PAR20 Universals.

## 4" Line Voltage Trims

The trims shown here may be used with 4" R/PAR20 Universal housing on page 104.

### Downlights



**Pinhole with Integral Shield**  
**13 WH**  
 IC1: 30W R20, 35W PAR20  
 IC1P/TC: 50W PAR/R20  
 IC1P: 40W K19  
 2" Aperture



**Baffle**  
**14 WWH** White  
**14 BBL** Black  
**14 BWH** Black  
**14 BABZ** Black  
**14 BSC** Black  
 IC1: 50W PAR20  
 (Requires T599  
 Socket Extender),  
 50W R20  
 IC1P/TC1/TC1R: 50W  
 PAR/R20  
 3 3/8" Aperture



**PAR20/R20 Cone**  
**17 BWH** Black Alzak®  
**17 CWH** Clear Alzak®  
**17 GWH** Gold Alzak®  
**17 HZWH** Haze  
**17 PTSC** Pewter Alzak®  
**17 WWH** Gloss White  
**17 WHZABZ** Wheat Haze  
**17 WHZWH** Wheat Haze  
 IC1/IC1P/TC1/TC1R:  
 50W PAR/R20  
 IC1P: 60W K19  
 3 3/8" Aperture

### Adjustables



**Gimbal Ring**  
**10 ABZ**  
**10 BL**  
**10 SC**  
**10 WH**  
 IC1P/TC: 50W PAR20;  
 75W ES20 (120V GU10)  
 Adjustment: PAR20=25°,  
 ES20=35°



**Mini Eyeball PAR16**  
**18 SC**  
**18 WH**  
 40W R16  
 60W PAR16  
 Adjustment: 35° vertical



**Mini Eyeball**  
**19 WH**  
 IC-25W R14; TC-40W R14,  
 40W R16  
 (Intermediate screw base lamp)  
 Adjustment: 35° vertical



**Flush Gimbal Ring**  
**440 WH**  
**440 BL**  
**440 SC**  
**440 ABZ**  
 35W MR16/ES16 GU10 base  
 (Requires GU10WHIP)



**Slot**  
**445 WH**  
 50W MR16/ES16 120V GU10  
 base (Not used with IC1).  
 (Requires GU10WHIP)  
 Adjustment: 40° vertical



**Eyeball with Black Baffle**  
**448 WH**  
**448 SC**  
 35W MR16/ES16 GU10 base  
 (Requires GU10WHIP)

### Wall Wash



**Scoop**  
**16 WH**  
 IC-25W R14; TC-40W R14,  
 40W R16  
 (Intermediate screw base  
 lamp) Adjustment: 50° vertical

**Scoop**  
**446W**  
 50W MR16/ES16 120V GU10  
 base (Not used with IC1)  
 (Requires GU10WHIP)  
 Adjustment: 40° vertical

### Lensed



**Frosted Lens with Clear Center**  
**12 WABZ**  
**12 WSC**  
**12 WWH**  
 IC1: 30W R20,  
 50W PAR20 with 1"  
 socket extender #T599  
 IC1P/TC: 50W PAR/R20  
 IC1P: 40W K19



**Drop Opal**  
**11 WH**  
 IC1: 30W R20,  
 35W PAR20  
 IC1P: 30W R20,  
 50W PAR20, 40W K19  
 TC: 50W PAR/R20

### Squares

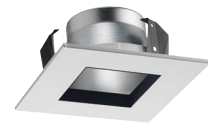

**Downlight**  
**17SQ HZWH** Haze  
**17SQ WWH** White  
**17SQ BWH** Black  
**17SQ WHZWH** Wheat Haze  
 50W PAR20 (Requires T599  
 socket extender), 39W  
 PAR20, 30W R20



**Flush Gimbal**  
**440SQ WH**  
**440SQ BL**  
 35W MR16 120V  
 (Requires GU10WHIP).  
 Adjustment: 35° vertical



**Pinhole**  
**13SQ WH** White  
 50W PAR20 (Requires T599  
 socket extender), 35W PAR20,  
 30W E20

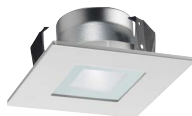

**Frosted Lens with Clear Center**  
**12SQ WWH** White  
 50W PAR20  
 (Requires T599 socket  
 extender), 30W R20



### Trim Ring Finishes

**ABZ** Classic Aged Bronze  
**SC** Satin Chrome  
**WH** White  
**BL** Black



## 4" Line Voltage Deco Trims

The trims shown here may be used with any 4" R/PAR20 Universal housing on page 104.

### Deco Trims



**Beveled Lensed**  
 4102 ABZ  
 4102 SC  
 4102 WH  
 IC1: 50W PAR20, 30W R20  
 IC1P/TC: 50W PAR/R20



**Beveled Dome Lensed**  
 4101 ABZ  
 4101 SC  
 4101 WH  
 IC1: 50W PAR20, 30W R20  
 IC1P/TC: 50W PAR/R20



**Frosted Glass**  
 4181 CLEAR  
 IC1: 50W PAR20,  
 30W R20  
 IC1P/TC: 50W PAR/R20



**Solid Glass Collar**  
 4180 FROST  
 IC1: 50W PAR20, 30W R20  
 w/ 1" socket extender #T599  
 IC1P/TC: 50W PAR/R20  
 2 5/8" Aperture



**Beveled Cone**  
 4104 HZSC Haze  
 4104 WHZABZ Wheat Haze  
 50W MR16  
 3 5/8" Aperture



**Beveled Cylinder**  
 4103 FROSTSC Frost Glass  
 4103 FROSTWH Frost Glass  
 50W MR16  
 3" Aperture



**Mesh Glass Cylinder**  
 4150 MESHSC  
 IC1: 50W PAR20, 30W R20  
 IC1P/TC: 50W PAR/R20  
 2 5/8" Aperture

### Trim Ring Finishes

**ABZ** Classic Aged Bronze

**SC** Satin Chrome

**WH** White



# 5" Universals

Juno offers a wide selection of 5" housings and trims that accommodates many of the same lamps and wattage ratings as the popular 6" series. The reduced size aperture provides a pleasing, smaller scale that compliments many settings.

## 5" Universal Housings



**IC Housing**  
Energy-efficient, Air-Loc® housing can be covered with insulation. Includes Real Nail® 3 bar hangers (unless otherwise noted).

- IC20** 5" IC New Construction Housing
- IC20 G** with pre-installed Air-Loc gasket
- IC20 S** with smaller footprint bar hangers (Real Nail® 2)
- IC20 S G** with smaller footprint bar hangers (Real Nail® 2) and pre-installed Air-Loc gasket
- IC20 W** with push-in electrical connectors
- IC20 W G** with push-in electrical connectors and pre-installed Air-Loc gasket
- IC20N** No socket plate
- IC20N G** No socket plate with pre-installed Air-Loc gasket
- IC20N W** No socket plate with push-in electrical connectors
- IC20N W G** No socket plate with push-in electrical connectors and pre-installed Air-Loc gasket

11<sup>7</sup>/<sub>8</sub>" L x 6<sup>3</sup>/<sub>4</sub>" W x 7<sup>1</sup>/<sub>2</sub>" H  
Ceiling cutout: 5<sup>5</sup>/<sub>8</sub>"



**IC Remodel Housing**  
Energy-efficient, Air-Loc® housing can be covered with insulation. Installs from below ceiling.

**IC20R Remodel Housing**  
12<sup>1</sup>/<sub>2</sub>" L x 5<sup>7</sup>/<sub>8</sub>" W x 7<sup>1</sup>/<sub>2</sub>" H  
Ceiling cutout: 5<sup>1</sup>/<sub>2</sub>"



**TC Housing**  
Requires 3" spacing from insulation.

- TC20** 5" Non-IC New Construction Housing with Real Nail® 3 bar hangers
- TC20 S** with smaller footprint bar hanger (Real Nail® 2)

11<sup>7</sup>/<sub>8</sub>" L x 6<sup>3</sup>/<sub>4</sub>" W x 7<sup>1</sup>/<sub>2</sub>" H  
Ceiling cutout: 5<sup>5</sup>/<sub>8</sub>"



**TC Remodel Housing**  
Requires 3" spacing from insulation. Installs from below ceiling.

**TC20R 5" Non-IC Remodel Housing**  
12<sup>1</sup>/<sub>2</sub>" L x 5<sup>7</sup>/<sub>8</sub>" W x 7<sup>1</sup>/<sub>2</sub>" H  
Ceiling cutout: 5<sup>1</sup>/<sub>2</sub>"

**Note:** In Canada when insulation is present, Type IC fixtures must be used.



# 5" Universal Trims

## Downlights



**BR30/PAR30 Baffle**  
 205 WWH White  
 205 BWH Black  
 205 BABZ Black  
 205 BSC Black  
 IC: 50W PAR30  
 TC: 75W PAR30,  
 65W BR30  
 4 1/2" Aperture



**Deep Baffle**  
 For TC Housings Only  
 203 WWH White  
 203 BWH Black  
 TC: 75W PAR30,  
 65W BR30  
 4 1/2" Aperture



**BR30/PAR30 Cone**  
 204 BWH Black Alzak®  
 204 CWH Clear Alzak®  
 204 GWH Gold Alzak®  
 204 HZWH Haze  
 204 PTSC Pewter Alzak®  
 204 WWH White  
 204 WHZABZ Wheat Haze  
 204 WHZWH Wheat Haze  
 IC20: 50W PAR30  
 TC20: 75W PAR30,  
 75W PAR30L,  
 65W BR30  
 4 1/2" Aperture



**Open Frame**  
 201N WH  
 65W BR30  
 4" Aperture



**PAR/R20 Cone**  
 207 BWH Black Alzak®  
 207 CWH Clear Alzak®  
 207 GWH Gold Alzak®  
 207 HZWH Haze  
 207 WWH Gloss White  
 207 WHZWH Wheat Haze  
 50W PAR/R20  
 4 1/2" Aperture



**Deep Cone**  
 206 BWH Black Alzak®  
 206 CWH Clear Alzak®  
 206 GWH Gold Alzak®  
 206 HZWH Haze  
 206 PTSC Pewter Alzak®  
 206 WHZABZ Wheat Haze  
 206 WHZWH Wheat Haze  
 IC: 50W PAR30  
 TC: 75W PAR30,  
 65W BR30  
 4 1/2" Aperture



**BR30/PAR30 Enclosed Baffle\***  
 (Wet Location)  
 215 WWH White  
 215 BWH Black  
 IC20: 65W BR30, 75W PAR30L,  
 75W PAR30, w/Socket  
 Extender  
 IC20N: 65W BR30  
 TC: 75W PAR30L, 75W PAR30, w/Socket  
 Extender, 85W BR30,  
 60W A19  
 4 1/2" Aperture



**BR30/PAR30 Enclosed Cone\***  
 (Wet Location)  
 w/Outdoor Lamps)  
 216 CWH Clear Alzak®  
 216 GWH Gold Alzak®  
 216 HZWH Haze  
 216 WWH Gloss White  
 216 WHZWH Wheat Haze  
 IC20: 65W BR30,  
 75W PAR30L,  
 75W PAR30, w/Socket  
 Extender  
 IC20N: 65W BR30  
 TC: 75W PAR30L,  
 75W PAR30, w/Socket  
 Extender, 85W BR30,  
 60W A19 (Clear and  
 Gold Cone), 40W A19  
 (White Cone)  
 4 1/2" Aperture



\* Wet location approved when used with outdoor rated lamps.

## Adjustables



**Eyeball with Baffle**  
 208N WWH White  
 208N BWH Black  
 35° vertical  
 adjustment,  
 358° rotation  
 50W PAR/R20



**Gimbal Ring in Baffle**  
 688 WWH White  
 688 BWH Black  
 30° vertical adjustment,  
 358° rotation  
 IC: 50W PAR30  
 TC: 75W PAR30



**PAR30 Eyeball**  
 529 ABZ  
 529 SC  
 529 WH  
 30° vertical adjustment,  
 358° rotation  
 75W PAR30



**Flat Glass Shower Trim**  
 210N ABZ  
 210N SC  
 210N WH  
 IC20: 40W A19,  
 IC20N: 35W PAR30L  
 TC20: 90W A19



**Frosted Lens with Clear Center**  
 212N ABZ  
 212N SC  
 212N WH  
 IC: 50W PAR30,  
 40W A15  
 TC: 75W PAR30, 60W A15



**Gimbal Ring with Flat Trim**  
 209N WH  
 30° vertical  
 adjustment, 358°  
 rotation  
 75W PAR30



**Gimbal Ring in Cone**  
 689 CWH Clear Alzak®  
 689 GWH Gold Alzak®  
 689 HZWH Haze  
 689 WHZWH Wheat Haze  
 689 WHZABZ Wheat Haze  
 30° vertical adjustment,  
 358° rotation  
 IC: 50W PAR30  
 TC: 75W PAR30

## Lensed



**Dome Shower Trim**  
 211 PW  
 40W A19



## Housing Accessories

Catalog Number	Description
ALG5	Energy Conserving Gasket for 5" New Construction Air-Loc® IC Housings
ALG5R	Energy Conserving Gasket Kit for 5" Air-Loc® IC Remodel Housings
SMPLT5	Galvanized steel plate for locating remodel style housings in new construction. Screw/nail holes for full coverage between 16" & 24".
TR5 ABZ TR5 SC TR5 WH TR5 BL	5" Trim Ring compatible with 204, 206 & 207 trims

## Trim Ring Finishes

**ABZ** Classic Aged Bronze    **PW** Plastic White  
**SC** Satin Chrome                      (Polycarbonate material  
**WH** White                                      shower trim)

# 5" Shallow Universals

These downlights are designed for applications where vertical installation space is limited and are offered with a selection of popular downlight, adjustable, or lensed trims. Both new construction and remodel housings fit comfortably within 2 x 6 ceiling joists, and IC-rated housings can be covered with insulation.



## 5" Shallow Universal Housings



### IC Housing

5" IC Shallow New Construction Housing. Includes Real Nail® 3 bar hangers (unless otherwise noted).

- IC25** 5" IC Shallow New Construction Housing
- IC25 G** with pre-installed Air-Loc gasket
- IC25 S** with smaller footprint bar hangers (Real Nail® 2)
- IC25 S G** with smaller footprint bar hangers (Real Nail® 2) and pre-installed Air-Loc gasket
- IC25 W** with push-in electrical connectors
- IC25 W G** with push-in electrical connectors and pre-installed

11 7/8" L x 6 3/4" W x 5 3/4" H  
Ceiling cutout: 5 5/8"



### IC Remodel Housing

5" IC Shallow Remodel Housing

### IC25R Remodel Housing

12 1/2" L x 5 7/8" W x 5 3/4" H  
Ceiling cutout: 5 1/2"

## 5" Shallow Universal Trims

### Downlights



#### Shallow Baffle

(Wet Location w/  
outdoor lamps)  
**275S WWH** White  
**275S BWH** Black  
50W BR30,  
50W PAR30, 50W PAR30L  
4 3/8" Aperture



#### Shallow Cone

**276S BWH** Black Alzak®  
**276S WWH** Gloss White  
**276S CWH** Clear Alzak®  
**276S HZWH** Haze  
**276S WHZWH** Wheat Haze  
50W BR30,  
50W PAR30, 50W PAR30L  
4 3/8" Aperture



### Lensed



#### Frosted Lens with Clear Center

**212N ABZ**  
**212N SC**  
**212N WH**  
35W PAR30



### Adjustable



#### Eyeball with Baffle

**208N WWH** White  
**208N BWH** Black  
50W PAR20, R20  
35° vertical adjustment,  
358° rotation



#### PAR30 Eyeball

**529 ABZ**  
**529 SC**  
**529 WH**  
50W PAR30  
30° vertical adjustment,  
358° rotation



#### Gimbal Ring with Flat Trim

**209N WH**  
35W PAR30  
30° vertical adjustment,  
358° rotation



#### Gimbal Ring in Baffle

**688 WWH** White  
**688 BWH** Black  
35W PAR30  
30° vertical adjustment,  
358° rotation



#### Gimbal Ring in Cone

**689 CWH** Clear Alzak®  
**689 GWH** Gold Alzak®  
**689 HZWH** Haze  
**689 WHZWH** Wheat Haze  
**689 WHZABZ** Wheat Haze  
35W PAR30  
30° vertical adjustment,  
358° rotation

### Housing Accessories

Catalog Number	Description
<b>ALG5</b>	Energy Conserving Gasket for 5" New Construction Air-Loc® IC Housings
<b>ALG5R</b>	Energy Conserving Gasket Kit for 5" Air-Loc® IC Remodel Housings
<b>SMPLT5</b>	Galvanized steel plate for locating remodel style housings in new construction. Screw/nail holes for full coverage between 16" & 24".
<b>TR5 ABZ, TR5 SC</b> <b>TR5 WH, TR5 BL</b>	5" Trim Ring compatible with 204, 206 & 207 trims

### Trim Ring Finishes

**ABZ** Classic Aged Bronze  
**SC** Satin Chrome  
**WH** White



# 6" Deluxe Universal Line-Voltage Series

Juno 6" Universal downlights support the use of higher wattage lamps and the widest selection of trims. They feature deep lamp shielding for maximum brightness control. The IC2 model has a deluxe double-wall housing that provides optimal performance when covered with insulation.



## 6" Deluxe Universal Housings



### IC Housing

Energy-efficient, Air-Loc® double wall housing can be covered with insulation. Includes Real Nail® 3 bar hangers.

**IC2** 6" IC new Construction Housing  
**IC2 G** with pre-installed Air-Loc gasket  
**IC2 W** with push-in electrical connectors  
**IC2 W G** with push-in electrical connectors and pre-installed Air-Loc gasket

17 $\frac{3}{8}$ " L x 9 $\frac{5}{8}$ " W x 7 $\frac{1}{2}$ " H  
 Ceiling cutout: 6 $\frac{1}{8}$ "



### TC Housing

Requires 3" spacing from insulation. Includes Real Nail® 3 bar hangers (unless otherwise noted).

**TC2** 6" Non-IC New Construction Housing  
**TC2 S** with smaller footprint bar hangers  
 Real Nail® 2)  
**TC2 W** with push-in electrical connectors

13 $\frac{1}{8}$ " L x 7 $\frac{1}{2}$ " W x 7 $\frac{1}{2}$ " H  
 Ceiling cutout: 6 $\frac{3}{8}$ "



### TC Remodel Housing

Requires 3" spacing from insulation. Installs from below ceiling.

### TC2R Remodel Housing

13 $\frac{3}{4}$ " L x 7 $\frac{5}{16}$ " W x 5 $\frac{1}{4}$ " min H;  
 7 $\frac{1}{4}$ " max H  
 Ceiling cutout: 6 $\frac{3}{4}$ "

**Note:** In Canada when insulation is present, Type IC fixtures must be used.

## 6" Deluxe Universal Trims

### Downlights



#### Tapered Baffle\*

24 WWH White  
 24 BBL Black  
 24 BWH Black  
 24 BABZ Black  
 24 BSC Black  
 75W PAR30L,  
 65W BR30  
 5 $\frac{1}{4}$ " Aperture



#### Pinhole with Baffle

23 BWH Black  
 50W R/PAR20  
 3 $\frac{3}{8}$ " Aperture



#### Straight Cone

26 BWH Black Alzak®  
 26 CWH Clear Alzak®  
 26 GWH Gold Alzak®  
 26 HZWH Haze  
 26 PTSC Pewter Alzak®  
 26 WWH Gloss White  
 26 WHZWH Wheat Haze  
 IC: 90W PAR38, 85W BR40  
 TC: 150W PAR38,  
 120W BR40  
 5 $\frac{1}{4}$ " Aperture



#### Straight Baffle

25 WWH White  
 25 BWH Black  
 25 BBL Black  
 25 BSC Black  
 IC: 85W BR40, 90W PAR38  
 TC: 150W PAR38, 120W  
 BR40  
 5 $\frac{1}{4}$ " Aperture



#### PAR30 Deep Baffle

254 WWH White  
 254 BWH Black  
 75W PAR30, 100W PAR38  
 5 $\frac{1}{8}$ " Aperture



#### Tapered Cone\*

27 BWH Black Alzak®  
 27 CWH Clear Alzak®  
 27 GWH Gold Alzak®  
 27 HZWH Haze  
 27 PTSC Pewter Alzak®  
 27 WWH Gloss White  
 27 WHZABZ Wheat Haze  
 27 WHZWH Wheat Haze  
 75W PAR30L, 65W BR30  
 5 $\frac{1}{8}$ " Aperture



#### PAR30 Deep Cone

257 BWH Black Alzak®  
 257 CWH Clear Alzak®  
 257 GWH Gold Alzak®  
 257 HZWH Haze  
 257 WHZWH Wheat Haze  
 75W PAR30, 100W PAR38  
 5 $\frac{1}{8}$ " Aperture



#### BR40/R40 Open Frame

251 WH  
 IC: 100W BR40  
 TC: 120W BR40, 250W R40  
 Heat Lamp  
 5 $\frac{1}{8}$ " Aperture



#### BR30 Open Frame

250 ABZ  
 250 SC  
 250 WH  
 65W BR30  
 4" Aperture

### Trim Ring Finishes

**ABZ** Classic Aged Bronze

**SC** Satin Chrome

**WH** White

**BL** Black

### Housing Accessories

Catalog Number	Description
<b>ALG6</b>	Energy Conserving Gasket for 6" New Construction Air-Loc® IC Housings
<b>G2405</b>	T-Bar Clips (Set of 4) for TC2 S
<b>TR6 ABZ</b> <b>TR6 SC</b> <b>TR6 WH</b> <b>TR6 BL</b>	6" Trim Ring compatible with 24, 25, 26, 27, 254 and 257 trims

\* Trim may be used with TC2R housing adjusted in lowest (5-1/4") height position.



# 6" Deluxe Universal Line-Voltage Series, continued.

## 6" Deluxe Universal Trims

Trims listed below are for use with housings located on the preceding page 113.

### Downlights



#### Ultra-Trim Baffle

(Wet Location w/ Outdoor Lamps)  
**28 WWH** White  
**28 BWH** Black  
 IC: 75W A19, 100W PAR38, 75W PAR30/30L, 85W BR30, 120W BR40  
 TC: 100W A19, 150W A21, 150W PAR38, 75W PAR30/30L, 85W BR30, 120W BR40  
 5 7/8" Aperture



#### Ultra-Trim Cone

(Wet Location w/ Outdoor Lamps)  
**29 CWH** Deep - Clear  
**29 WWH** Deep - White  
 IC: 100W A19, 100W PAR38, 75W PAR30/30L, 85W BR30, 120W BR40  
 TC: 100W A19, 150W A21, 150W PAR38, 75W PAR30/30L, 85W BR30, 120W BR40  
 5 7/8" Aperture



#### A-Lamp Reflector

**232 CWH** Clear Alzak®  
**232 HZWH** Haze  
**232 GWH** Gold Alzak®  
**232 WWH** Gloss White  
**232 WHZWH** Wheat Haze  
 IC2/TC2: 150W A21, 100W A19  
 IC2: 75W A19 (White Finish Only)  
 TC2: 100W A19 (White Finish Only)  
 5 7/8" Aperture



#### Economy A-Lamp Reflector with Baffle

**230 CWWH** Clear w/ White Baffle  
**230 CBWH** Clear w/ Black Baffle  
 100W A19  
 5 1/2" Aperture



#### A-Lamp Reflector with Black Baffle

**233 CWH** Clear Alzak®  
 IC: 75W A19  
 TC: 100W A19, 50W A21  
 5 7/8" Aperture



#### Shallow Baffle\*

**244S WWH** White  
**244S BWH** Black  
 75W PAR30/30L, 65W BR30  
 5 3/4" Aperture



#### Shallow Cone

**247S CWH** Clear Alzak®  
**247S GWH** Gold Alzak®  
**247S BWH** Black Alzak®  
**247S HZWH** Haze  
**247S WHZWH** Wheat Haze  
 75W PAR30/30L, 65W BR30  
 5 3/4" Aperture



### Adjustables



#### Low Voltage Cylinder Spotlight in Baffle\*\*\*

**427 WWH** White Cylinder with White Baffle  
 45° vertical adjustment, 358° rotation  
 50W MR16



#### R/PAR20 Regressed Eyeball\*

**228 WH** White  
 50W R/PAR20

#### R/PAR20 Regressed Eyeball in Baffle\*

**248 WWH** White  
 50W R/PAR20



#### PAR/BR30 Regressed Eyeball\*

**229 ABZ**  
**229 BL**  
**229 SC**  
**229 WH**  
 75W PAR30L, 65W BR30

#### PAR/BR30 Regressed Eyeball in Baffle\*

**249 WWH** White  
**249 BWH** Black  
 75W BR30



#### Cylinder Spotlight in Baffle\*

**226 BWH** Black Cylinder in Black Baffle  
**226 WWH** White Cylinder in White Baffle  
 60W PAR16



#### PAR30 Adjustable Tapered Baffle\*

**264 WWH** White  
**264 BWH** Black  
 75W PAR30  
 5 3/4" Aperture



#### Low Voltage Pinhole with Baffle\*\*

**424 BWH** Black  
 30° vertical adjustment, 358° rotation  
 IC: 35W MR16;  
 TC: 50W MR16  
 3 1/2" Aperture



#### PAR30 Adjustable Tapered Cone\*

**267 BWH** Black Alzak®  
**267 CWH** Clear Alzak®  
**267 GWH** Gold Alzak®  
**267 HZWH** Haze  
**267 WHZWH** Wheat Haze  
 75W PAR30  
 5 3/4" Aperture



#### Gimbal Ring in Baffle

**224 WWH** White  
**224 BWH** Black  
 IC: 75W PAR38/Medium Side Prong  
 TC: 150W PAR38/Medium Side Prong  
 5 3/4" Aperture

### Wall Wash



#### Scoop

**261 WWH** White Baffle  
**261 BWH** Black Baffle  
 IC: 40W A19  
 TC: 75W A19

### Lensed



#### Albalite

**20 PW** Shower/Closet Light  
**20 WH**  
 IC: 40W A19  
 TC: 75W A19



#### Albalite with Reflector

**240 PW** Shower/Closet Light  
**240 WH**  
 IC: 60W A19; TC: 100W A19







**Drop Opal\***  
21 PW Shower/  
Closet Light  
21 WH  
IC: 40W A19  
TC: 75W A19



**Drop Opal with Reflector\***  
241 PW Shower/  
Closet Light  
241 WH  
IC: 60W A19  
TC: 100W A19



**Frosted Lens with Clear Center Shower Trim**  
242 ABZ  
242 SC  
242 WH  
IC: 75W PAR38,  
60W PAR38 IR  
TC: 120W PAR38



**Fresnel**  
22 WH  
IC: 40W A19  
TC: 75W A19



**Frosted Lens with Reflector**  
239 WH  
IC2: 40W A19,  
35W PAR30L  
TC2: 100W A19  
TC2R: 75W A19



### Decorative



**Metal Band\***  
9524 SC  
65W BR30  
6½" Ring  
5½" Aperture



**Luminous Disc (Frosted)\***  
9324 SC  
65W BR30  
3¼" Aperture



**Fluted Drop Opal\***  
9900 WH  
IC: 60W A19  
TC: 75W A19



**Octagonal\***  
9024 WWH White  
65W BR30  
5¼" Aperture



**Luminous Collar (Frosted)\***  
9702  
65W BR30  
6¾" Aperture



**Decorative Swirled Etched Opal Glass**  
243 WH  
IC: 60W A19;  
TC: 100W A19



### Housing Accessories

Catalog Number	Description
TR6 ABZ	6" Trim Ring compatible with 244, 247, 264, 267 and 9900 trims
TR6 SC	
TR6 WH	
TR6 BL	

### Trim Ring Finishes

<b>ABZ</b>	Classic Aged Bronze
<b>SC</b>	Satin Chrome
<b>PW</b>	Plastic White (Polycarbonate material shower trim)
<b>WH</b>	White
<b>BL</b>	Black

\* Trim may be used with TC2R housing adjusted in lowest (5¼") height position.  
\*\* Supplied with magnetic transformer.  
\*\*\* Use dimmers specifically designed for low voltage magnetic transformers.

# 6" Standard Universals

Standard Universal downlights are offered with basic trim options but include all the installation and performance features Juno is known for.

## 6" Standard Universal Housings



### IC Housing

Energy-efficient, Air-Loc® housing can be covered with insulation. Includes Real Nail® 3 bar hangers (unless otherwise stated).

- IC22** 6" IC New Construction Housing
- IC22 G** with pre-installed Air-Loc gasket
- IC22 S** with smaller footprint bar hangers (Real Nail® 2)
- IC22 S G** with smaller footprint bar hangers (Real Nail® 2) and pre-installed Air-Loc gasket
- IC22 W** with push-in electrical connectors
- IC22 W G** with push-in electrical connectors and pre-installed Air-Loc gasket

13 1/8" L x 7 1/2" W x 7 1/8" H  
Ceiling cutout: 6 7/8"



### IC Remodel Housing

Energy-efficient, Air-Loc® housing can be covered with insulation. Installs from below ceiling with clips provided.

### IC22R 6" IC Remodel Housing

13 3/4" L x 7 5/16" W x 7 1/8" H  
Ceiling cutout: 6 3/4"

## 6" Standard Universal Trims

### BR/PAR Downlights



#### Tapered Cone

- 27 BWH Black Alzak®
- 27 CWH Clear Alzak®
- 27 GWH Gold Alzak®
- 27 HZWH Haze
- 27 PTSC Pewter Alzak®
- 27 WWH Gloss White
- 27 WHZABZ Wheat Haze
- 27 WHZWH Wheat Haze
- 50W PAR30, 65W BR30, 75W PAR30L
- 5 1/4" Aperture



#### Tapered Baffle

- 24 WWH White
- 24 BWH Black
- 24 BABZ Black
- 24 BBL Black
- 24 BSC Black
- 75W PAR30L, 50W PAR30, 65W BR30
- 5 1/4" Aperture



#### Shallow Baffle

- 244S WWH White
- 244S BWH Black
- 60W PAR30, 65W BR30, 75W PAR30L
- 5 3/4" Aperture



#### Straight Baffle

- 25 WWH White
- 25 BBL Black
- 25 BABZ Black
- 25 BWH Black
- 25 BSC Black
- 50W PAR30, 65W BR30
- 5 3/4" Aperture



#### Ultra-Trim Cone - Fully Enclosed\*

- (Wet Location w/ Outdoor Lamps)
- 29 CWH Clear Cone
- 29 WWH White Cone
- 60W A19, 65W BR30, 75W PAR30/30L, 90W PAR38/BR40
- 5 1/8" Aperture



#### BR30 Open Frame

- 250 ABZ
- 250 SC
- 250 WH
- 65W BR30
- 4" Aperture



#### Shallow Cone

- 247S BWH Black Alzak®
- 247S CWH Clear Alzak®
- 247S GWH Gold Alzak®
- 247S HZWH Haze
- 247S WHZWH Wheat Haze
- 75W PAR30L, 65W BR30, 75W PAR30
- 5 3/4" Aperture



#### BR30 Regressed Open Frame

- 252 WH
- 65W BR30
- 4" Aperture



#### Ultra-Trim Baffle - Fully Enclosed\*

- (Wet Location w/ Outdoor Lamps)
- 28 WWH White
- 28 BWH Black
- 60W A19, 65W BR30, 75W PAR30/30L, 90W PAR38/BR40
- 5 1/8" Aperture

#### Adjustables



#### Cylinder Spotlight in Baffle

- 226 WWH White
- Cylinder in White Baffle
- 226 BWH Black
- Cylinder in Black Baffle
- 60W PAR16



#### R/PAR20 Regressed Eyeball

- 228 WH
- 50W R/PAR20

#### R/PAR20 Regressed Eyeball in Baffle

- 248 WWH White
- 50W R/PAR20



#### PAR/BR30 Regressed Eyeball

- 229 ABZ
- 229 BL
- 229 SC
- 229 WH
- 75W PAR30L, 65W BR30

#### PAR/BR30 Regressed Eyeball in Baffle

- 249 WWH White
- 249 BWH Black
- 75W PAR30L, 65W BR30



### A-Lamp Downlights



**PAR30 Adjustable Tapered Baffle**  
 264 WWH White  
 264 BWH Black  
 50W PAR30  
 5 1/4" Aperture



**A-Lamp Reflector**  
 231 CWH Clear Alzak®  
 231 GWH Gold Alzak®  
 231 WWH Gloss White  
 60W A19  
 5 1/8" Aperture



**Metal Band**  
 9524 SC  
 65W BR30, 50W PAR30,  
 75W PAR30L  
 6 1/2" Ring  
 5 1/8" Aperture



**Frosted Lens with Clear Center**  
 242 ABZ  
 242 SC  
 242 WH  
 45W PAR38



**Drop Opal with Reflector Shower Trim**  
 241 PW Shower/  
 Closet Light  
 241 WH  
 40W A19



**PAR30 Adjustable Tapered Cone**  
 267 BWH Black Alzak®  
 267 CWH Clear Alzak®  
 267 GWH Gold Alzak®  
 267 HZWH Haze  
 267 WHZWH  
 Wheat Haze  
 50W PAR30  
 5 1/4" Aperture

### BR/PAR Decorative



**Luminous Disc (Frosted)**  
 9324 SC  
 65W BR30, 50W  
 PAR30  
 3 1/4" Aperture



**Octagonal**  
 9024 WWH  
 65W BR30, 50W PAR30  
 5 1/4" Aperture

### Lensed



**Frosted Lens with Reflector**  
 239 WH  
 40W A19,  
 35W PAR30L



**Luminous Collar (Frosted)\***  
 9702  
 65W BR30, 50W  
 PAR30, 75W PAR30L  
 6 3/8" Aperture

### Housing Accessories

Catalog Number	Description
<b>ALG6</b>	Energy Conserving Gasket for 6" New Construction Air-Loc® IC Housings
<b>ALG6R</b>	Energy Conserving Gasket for 6" Remodel Air-Loc® IC Housings
<b>TR6 ABZ, TR6 SC, TR6 WH, TR6 BL</b>	6" Trim Ring compatible with 24, 25, 27, 244 and 247 trims

### Trim Ring Finishes

**ABZ** Classic Aged Bronze    **WH** White  
**SC** Satin Chrome    **BL** Black  
**PW** Plastic White (Polycarbonate material shower trim)

\* Trim may be used with TC2R housing adjusted in lowest (5 1/4") height position.



# 6" Standard Universals with Floating Socket

Standard Universal downlights with floating sockets are optimized for the quickest possible attachment to enclosed and adjustable style trims.

## 6" Standard Universal Housings (Floating Socket)



### Economy IC Housing

Energy-efficient, Air-Loc® housing with floating socket. Includes Real Nail® 3 bar hangers.

- IC23** 6" IC No Plate New Construction Housing
- IC23 G** with pre-installed Air-Loc gasket
- IC23 W** with push-in electrical connectors
- IC23 W G** with push-in electrical connectors and pre-installed Air-Loc gasket

13<sup>1</sup>/<sub>8</sub>" L x 7<sup>1</sup>/<sub>2</sub>" W x 7<sup>1</sup>/<sub>8</sub>" H  
Ceiling cutout: 6<sup>5</sup>/<sub>8</sub>"

## 6" Standard Universal Trims

### BR/PAR Downlights



#### Ultra-Trim Baffle - Fully Enclosed\*

(Wet Location w/ Outdoor Lamps)  
28 WWH White  
28 BWH Black  
60W A19, 65W BR30,  
75W PAR30/30L,  
90W PAR38/BR40  
5<sup>1</sup>/<sub>8</sub>" Aperture



#### Shallow Baffle

244S WWH White  
244S BWH Black  
60W PAR30, 65W BR30,  
75W PAR30L  
5<sup>3</sup>/<sub>4</sub>" Aperture



#### Shallow Cone

247S BWH Black Alzak®  
247S CWH Clear Alzak®  
247S GWH Gold Alzak®  
247S HZWH Haze  
247S WHZWH Wheat Haze  
75W PAR30L, 65W BR30,  
75W PAR30  
5<sup>3</sup>/<sub>4</sub>" Aperture



#### PAR30 Adjustable Tapered Cone

267 BWH Black Alzak®  
267 CWH Clear Alzak®  
267 GWH Gold Alzak®  
267 HZWH Haze  
267 WHZWH Wheat Haze  
50W PAR30  
4" Aperture



#### PAR/BR30 Regressed Eyeball

229 ABZ  
229 BL  
229 SC  
229 WH  
75W PAR30L,  
65W BR30



#### Ultra-Trim Cone - Fully Enclosed\*

(Wet Location w/ Outdoor Lamps)  
29 CWH Clear  
29 WWH White  
60W A19, 65W BR30,  
75W PAR30/30L,  
90W PAR38/BR40  
5<sup>1</sup>/<sub>8</sub>" Aperture



#### BR30 Open Frame

250 ABZ  
250 SC  
250 WH  
65W BR30  
4" Aperture

### BR/PAR Adjustables



#### Cylinder Spotlight in Baffle

226 WWH White  
Cylinder in White Baffle  
226 BWH Black  
Cylinder in Black Baffle  
60W PAR16



#### PAR30 Adjustable Tapered Baffle

264 WH White  
264 BWH Black  
50W PAR30  
5<sup>3</sup>/<sub>4</sub>" Aperture



#### R/PAR20 Regressed Eyeball

228 WH  
50W R20/PAR20

#### R/PAR20 Regressed Eyeball in Baffle

248 WWH White  
50W R20/PAR20



### A-Lamp Downlights



**A-Lamp Reflector**  
 232 CWH Clear Alzak®  
 232 GWH Gold Alzak®  
 232 HZWH Haze  
 232 WWH Gloss White  
 232 WHZWH Wheat  
 Haze  
 60W A19  
 5½" Aperture



**A-Lamp Reflector with Black Baffle**  
 233 CWH Clear Alzak®  
 40W A19  
 5½" Aperture



**Economy A-Lamp Reflector with Black Baffle (IC23 Series only)**  
 230C WWH Clear w/ White Baffle  
 230 CBWH Clear w/ Black Baffle  
 40W A19  
 5½" Aperture

### Wall Wash



**Scoop**  
 261 WWH White Baffle  
 261 BWH Black Baffle  
 40W A19

### Lensed



**Drop Opal with Reflector Shower Trim**  
 241 PW Shower/Closet Light  
 241 WH  
 40W A19



**Frosted Lens with Reflector**  
 239 WH  
 40W A19,  
 35W PAR30L



### Housing Accessories

Catalog Number	Description
<b>ALG6</b>	Energy Conserving Gasket for 6" New Construction Air-Loc® IC Housings
<b>TR6 ABZ, TR6 SC, TR6 WH, TR6 BL</b>	6" Trim Ring compatible with 244 and 247 trims

### Trim Ring Finishes

**ABZ** Classic Aged Bronze  
**SC** Satin Chrome  
**PW** Plastic White (Polycarbonate material shower trim)

**WH** White  
**BL** Black

\* Wet location approved when used with outdoor rated lamps.



## 6" Shallow Universals

Shallow universal housings are the ideal solution where vertical installation space is limited. The overall housing height is only 5-3/4", permitting these fixtures to fit comfortably within 2 x 6 ceiling joists. Housings are available for new construction or remodeling, can be completely covered with insulation, and used with a variety of downlight, adjustable, or lensed trims.





## 6" Shallow Universal Housings



AIR-LOC

### IC Housing

Energy-efficient, Air-Loc® housing can be covered with insulation. Includes Real Nail® 3 bar hangers.

**IC21** 6" IC Shallow New Construction Housing  
**IC21 G** with pre-installed Air-Loc gasket

13 1/8" L x 7 1/2" W x 5 3/4" H  
 Ceiling cutout: 6 3/8"



AIR-LOC

### IC Remodel Housing

Energy-efficient, Air-Loc® housing can be covered with insulation. Installs from below ceiling.

**IC21R** 6" IC Shallow Remodel Housing

13 3/4" L x 7 5/16" W x 5 3/4" H  
 Ceiling cutout: 6 3/4"

## 6" Shallow Universal Trims

### Downlights



**Shallow Baffle**  
 244S WWH White  
 244S BWH Black  
 50W PAR30, 75W PAR30L  
 65W BR30  
 5 3/4" Aperture

AIR-LOC



**Shallow Cone**  
 247S BWH Black Alzak®  
 247S CWH Clear Alzak®  
 247S GWH Gold Alzak®  
 247S HZWH Haze  
 247S WHZWH Wheat Haze  
 75W PAR30, 75W PAR30L,  
 65W BR30  
 5 3/4" Aperture

AIR-LOC



**BR30 Open Frame**  
 250 ABZ  
 250 SC  
 250 WH  
 65W BR30  
 4" Aperture

### Adjustables



**R/PAR20 Regressed Eyeball**  
 228 WH  
 50W R/PAR20

**R/PAR20 Eyeball in Baffle**  
 248 WWH White  
 50W R/PAR20



**PAR/BR30 Regressed Eyeball**  
 229 ABZ  
 229 BL  
 229 SC  
 229 WH  
 75W PAR30L, 65W BR30

**PAR/BR30 Regressed Eyeball in Baffle**  
 249 WWH White  
 249 BWH Black  
 75W PAR30L, 65W BR30

### Lensed



**Drop Opal with Reflector**  
 241 PW Shower/  
 Closet Light  
 241 WH  
 40W A19



### Housing Accessories

Catalog Number	Description
<b>ALG6</b>	Energy Conserving Gasket for 6" New Construction Air-Loc® IC Housings
<b>TR6 ABZ, TR6 SC, TR6 WH, TR6 BL</b>	6" Trim Ring compatible with 244 and 247 trims

### Trim Ring Finishes

**ABZ** Classic Aged Bronze  
**SC** Satin Chrome  
**PW** Plastic White (Polycarbonate material shower trim)  
**WH** White  
**BL** Black

# Squares

These downlights feature square apertures with large opal or prismatic lenses. They use higher-wattage lamps to produce bright, diffuse and shadow-free illumination.



## Square Housings

### 8" Square

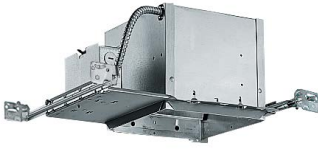

#### IC Housing

Energy-efficient, double wall housing.  
Can be covered with insulation.

**IC6** with Real Nail® 3 bar hangers

17 $\frac{5}{8}$ " L x 9 $\frac{5}{8}$ " W x 7" H  
Ceiling cutout: 8 $\frac{5}{8}$ " sq.



#### TC Housing

Requires 3" spacing from insulation.

**TC6** with Real Nail® 3 bar hangers

17 $\frac{5}{8}$ " L x 9 $\frac{5}{8}$ " W x 5" H  
Ceiling cutout: 8 $\frac{5}{8}$ " sq.

### 8" Square Trims



#### Crystal Diffuser

**60 WH**  
IC: 60W A19  
TC: 100W A19  
Trim O.D.: 9 $\frac{5}{8}$ " sq.

### 10" Square



#### IC Housing

Energy-efficient, double wall housing.  
Can be covered with insulation.

**IC7** with Real Nail® 3 bar hangers

20 $\frac{3}{8}$ " L x 11 $\frac{1}{16}$ " W x 7" H  
Ceiling cutout: 10 $\frac{3}{8}$ " sq.



#### TC Housing

Requires 3" spacing from insulation.

**TC7** with Real Nail® 3 bar hangers

20 $\frac{3}{8}$ " L x 11 $\frac{1}{16}$ " W x 5 $\frac{1}{2}$ " H  
Ceiling cutout: 10 $\frac{3}{8}$ " sq.

### 10" Square Trims



#### Crystal Diffuser

**70 WH**  
IC: 100W A19  
TC: 150W A21/100W A19  
Trim O.D.: 11 $\frac{1}{8}$ " sq.



#### Drop Opal

**71 WH**  
IC: 100W A19  
TC: 150W A21/100W A19  
Trim O.D.: 11 $\frac{1}{8}$ " sq.

**Note:** In Canada when insulation is present, Type IC fixtures must be used.





High-performance lighting  
with efficiency and style

# Slope Ceiling LED Downlights

With an established legacy of leading the industry in slope ceiling applications, Juno Slope and Super-Slope LED downlights offer innovative solutions and energy-efficiency. These downlights provide the performance, efficiency and longevity of illumination in today's most avant-garde interiors.

Juno Slope LED recessed downlights are available in 4" and 6" apertures specifically engineered to install and blend seamlessly into sloped ceiling architecture while delivering the right amount of light for the application. Juno sloped ceiling LED housings are IC rated and can be installed in either insulated or non-insulated applications to cover pitch ranges of 2/12 to 12/12 with efficiency and style.

## **Juno Slope Ceiling LED Downlight Advantages**

- Provides industry's smallest 4" slope ceiling downlight delivering over 1000 lumens
- 6" slope ceiling downlights deliver over 1400 brilliant lumens; also available with WarmDim® technology up to 1000 lumens
- Covers standard and super-slope applications ranging from pitch of 2/12 to 12/12
- Available with color temperatures of 2700K, 3000K, 3500K and 4000K
- Excellent color rendering of 90+ CRI
- Dimmable driver options include forward and reverse phase dimming and multi-volt driver (120-277V) with 0-10V dimming
- Extensive selection of trim styles that blend seamlessly with sloped ceilings
- Service life is rated at a remarkable 50,000 hours
- Patented 6" design (US patent # 8550669) and patent pending designs for 4"





## 4" IC-Rated LED Downlights for Slope and Super Slope Ceilings

Delivering 1000 high-performance lumens with efficiency and style

Offering internal adjustability of up to 35° vertical and 360° rotation using the patent pending adjustable light engine module, light can be directed where needed for downlighting or accent lighting applications. Adaptable for slope and super slope applications using the 46L and 48L series trims.





# Juno® 4" Internally Adjustable LED Fixtures



11 7/8" L X 6 3/4" W X 6" H  
Ceiling Cutout: 4 1/2"

## IC 1000 Lumen Housing - Utilizes as little as 16-watts output

Example: **IC4AL 10LM 27K 90CRI SP 120 FRPC**

Series	Lumens	CCT	CRI	Beam Optics	Voltage/Driver
<b>IC4AL</b> 4" New Construction Housing	<b>10LM</b> 1000 Lumens	<b>27K</b> 2700K <b>30K</b> 3000K <b>35K</b> 3500K <b>40K</b> 4000K	<b>90CRI</b>	<b>SP</b> 18° Spot <b>NFL</b> 30° Narrow Flood <b>FL</b> 40° Flood	<b>120 FRPC</b> 120V Only; Forward Phase/ELV Dimming <b>MVOLT ZT</b> Universal 120-277V; 0-10V Dimming

## IC 700 Lumen Housing - Utilizes as little as 10-watts output

Example: **IC4AL 07LM 30K 90CRI SP 120 FRPC**

Series	Lumens	CCT	CRI	Beam Optics	Voltage/Driver
<b>IC4AL</b> 4" New Construction Housing	<b>07LM</b> 700 Lumens	<b>27K</b> 2700K <b>30K</b> 3000K <b>35K</b> 3500K <b>40K</b> 4000K	<b>90CRI</b>	<b>SP</b> 18° Spot <b>NFL</b> 30° Narrow Flood <b>FL</b> 40° Flood	<b>120 FRPC</b> 120V Only; Forward Phase/ ELV Dimming <b>MVOLT ZT</b> Universal 120-277V; 0-10V Dimming <b>MVOLT ECOS3</b> Lutron Hi Lume® 3-Wire Dimming EcoSystem Compatible



12 1/2" L X 4 1/4" W X 6" H  
Ceiling Cutout: 4 3/8"

## Remodel

Example: **IC4RAL 07LM 30K 90CRI FL 120 FRPC**

Series	Lumens	CCT	CRI	Beam Optics	Voltage/Driver
<b>IC4RAL</b> 4" IC Remodel Housing	<b>07LM</b> 700 Lumens	<b>27K</b> 2700K <b>30K</b> 3000K <b>35K</b> 3500K <b>40K</b> 4000K	<b>90CRI</b>	<b>SP</b> 18° Spot <b>NFL</b> 30° Narrow Flood <b>FL</b> 40° Flood	<b>120 FRPC</b> 120V Only; Forward Phase/ ELV Dimming <b>MVOLT ZT</b> Universal 120-277V; 0-10V Dimming

## Round Trims



46L Series  
Slope  
(9°-24°  
Ceiling Slope)

46L BWH	Black Alzak®, White Trim
46L CWH	Clear Alzak®, White Trim
46L WWH	Gloss White, White Trim
46L HZWH	Haze, White Trim
46L PTSC	Pewter Alzak®, Satin Chrome Trim
46L WHZABZ	Wheat Haze, Classic Aged Bronze Trim
46L WHZWH	Wheat Haze, White Trim



48L Series  
Super Slope  
(20°-35°  
Ceiling Slope)

48L BWH	Black Alzak®, White Trim
48L CWH	Clear Alzak®, White Trim
48L WWH	Gloss White, White Trim
48L HZWH	Haze, White Trim
48L PTSC	Pewter Alzak®, Satin Chrome Trim
48L WHZABZ	Wheat Haze, Classic Aged Bronze Trim
48L WHZWH	Wheat Haze, White Trim

For additional trim options, see page 45.



## 6" IC-Rated LED Downlights for Slope and Super Slope Ceilings

Delivering up to 1400 high-performance lumens with efficiency and style

Juno Slope and Super Slope LED housings are the industry's first recessed LED luminaires designed specifically for slope ceiling applications. The Juno Slope ceiling LED offering includes 6" new construction housings for both standard and super slope applications covering a pitch range of 2/12 to 6/12. Juno Slope and Super Slope LED housings can be used in insulated and non-insulated ceilings, and are engineered to the highest quality standards.



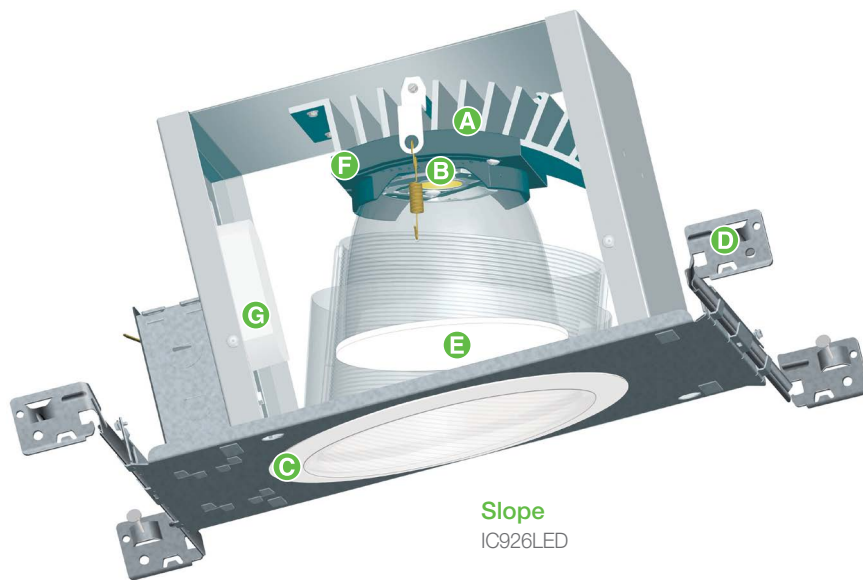

**Slope**  
IC926LED



**Super Slope**  
IC928LED

Both the Juno Slope and Super Slope LED Downlights are a perfect complement to existing Juno downlights, offering a similar below-the-ceiling aesthetic.

- A. Advanced thermal management:** Juno Slope and Super Slope LED Downlights achieve superior thermal management by integrating an extruded aluminum heat sink and a cast aluminum slider plate directly with the fixture housing. Advanced thermal-management technology permits the LEDs to easily attain their remarkable rated service life of 50,000 hours at 70% lumen maintenance ... even when covered with insulation.
- B. High-output LED light engine:** The light engine features the latest in high-performance LED arrays. Fixture output of up to 1400 lumens requires just 17.4 watts nominal – a mere fraction of the energy needed by conventional light sources. LEDs are binned to exceed ENERGY STAR® requirements and provide superior fixture-to-fixture color uniformity. With available color temperatures of 2700K, 3000K, 3500K and 4000K, and 90+ CRI.
- C. Aesthetic trim options:** Juno LED slope ceiling housings are compatible with a selection of existing Juno 6" slope ceiling cone, baffle and lensed trims. Juno downlight trims feature shadow-free, knife edge trim rings that blend unobtrusively with sloped ceilings and are removable for painting if desired.
- D. Easy installation:** Installs easily in either insulated or non-insulated, new-construction applications. Standard Slope fixtures accommodate ceilings with 2/12 to 6/12 pitch (9° to 27°). Super-Slope fixtures are designed for 7/12 to 12/12 pitch (30° to 45°). The housings are supplied with the Juno Real Nail® 3 bar hanger system, which includes captive bugle-headed nails to secure the fixture in wood joist construction or integral T-bar clips for suspended ceiling installation.
- E. High-efficiency optics:** A computer-optimized reflector combined with a high-transmission diffusing lens conceals the LEDs and produces uniform aperture luminance. The PAR38 size reflector developed specifically for the slope LED provides optimum performance and obscures view into the housing through all pitch ranges.
- F. Adjustable Slider Plate:** The adjustable slider plate allows the LEDs and reflector to be positioned perpendicular to the floor through the entire pitch range and includes 1/4" adjustment indicators for consistent fixture-to-fixture alignment.
- G. Dimmable LED driver:** Specify either dedicated 120-volt driver with forward and reverse phase dimming or universal voltage driver (120-277V) with 0-10V dimming.



# 6" IC-Rated 900 and 1400 Lumen Slope Ceiling LED Downlights

6" new construction housings for use in standard slope applications with 2/12 to 6/12 pitch (9° to 27°).

## 6" Slope New Construction



Dedicated 6" Slope Ceiling LED new construction housing with integral light engine and choice of dimmable drivers: 17.4W nominal dedicated 120-volt driver with forward phase and ELV dimming. Air-Loc fully sealed housing does not require separate gasket. IC housing designed for use in IC or non-IC construction.

16 $\frac{1}{8}$ " L x 9 $\frac{1}{8}$ " W x 7 $\frac{5}{8}$ " H  
Ceiling cutout: 7 $\frac{1}{32}$ " x 6 $\frac{1}{16}$ "

**Example: IC926LED G4 09LM 27K 90CRI 120 FRPC**

Housing and trim can be ordered together or separately, but will always ship separately.

Series	Generation	Lumens	Color Temperature	CRI	Voltage/Driver*
IC926LED 6" LED Slope Ceiling New Construction IC Housing	G4 Generation 4	<b>09LM</b> 900 Nominal Lumens	<b>27K</b> 2700K <b>30K</b> 3000K <b>35K</b> 3500K <b>40K</b> 4000K	<b>90CRI</b> 90+ CRI	<b>120 FRPC</b> 120V Forward/Reverse Cut, 5% Dim.
		<b>14LM</b> 1400 Nominal Lumens			
					* Consult factory for voltage/ dimming options.

## 6" Slope LED with WarmDim® Technology



Dedicated LED, Air-Loc® sealed slope ceiling new construction housing with our patented WarmDim® technology. The LED color temperature warms while dimming to emulate the dimming performance of traditional incandescent light source.

16 $\frac{1}{8}$ " L x 9 $\frac{1}{8}$ " W x 7 $\frac{5}{8}$ " H  
Ceiling cutout: 7 $\frac{1}{32}$ " x 6 $\frac{1}{16}$ "

**Example: IC926LED WD G4 09LM 30K 90CRI 120 FRPC**

Housing and trim can be ordered together or separately, but will always ship separately.

Series	Dynamic Feature	Generation	Lumens	Color Temperature	CRI	Voltage/Driver
IC926LED 6" LED Slope Ceiling New Construction IC Housing	WD WarmDim®	G4 Generation 4	<b>09LM</b> 900 Nominal Lumens	<b>30K</b> 3000K	<b>90CRI</b> 90+ CRI	<b>120 FRPC</b> 120V Forward/ Reverse Phase Cut

For a list of compatible dimmers, see specifications sheet at [www.acuitybrands.com](http://www.acuitybrands.com)

## 6" Slope LED Trims

### Downlights



**Downlight Baffle\***  
614 BWH Black  
614 BSC Black  
614 BABZ Black  
614 BBL Black  
614 WWH White



**Downlight Cone**  
620 CWH Clear Alzak®  
620 BWH Black Alzak®  
620 GWH Gold  
620 HZWH Haze  
620 HZSC Haze  
620 WWH White  
620 WHZWH Wheat Haze  
620 WHZABZ Wheat Haze



### Lensed



**Baffle, Regressed  
Frosted Dome  
Lens**  
6330 WWH White  
6330 BWH White



### Trim Ring Finishes

**ABZ** Classic Aged Bronze  
**SC** Satin Chrome  
**WH** White  
**BL** Black

\* Patent pending one piece design eliminates the unsightly seam on the long side of the baffle.

# 6" IC-Rated 900 and 1400 Lumen Super Slope Ceiling LED Downlights

6" new construction housings for use in super slope applications with 7/12 to 12/12 pitch (30° to 45°).

## 6" Super Slope New Construction



Dedicated 6" Super Slope Ceiling LED new construction housing with integral light engine and choice of dimmable drivers: 17.4W nominal dedicated 120 volt driver with forward phase and ELV dimming. Air-Loc fully sealed housing does not require separate gasket. IC housing designed for use in IC or non-IC construction.

18½" L x 9¼" W x 7⅞" H  
Ceiling cutout: 8⅞" x 6⅞"

### Example: IC928LED G4 09LM 27K 90CRI 120 FRPC

Housing and trim can be ordered together or separately, but will always ship separately.

Series	Generation	Lumens	Color Temperature	CRI	Voltage/Driver*
IC928LED 6" LED Super Slope New Construction IC Housing	G4 Generation 4	<b>09LM</b> 900 Nominal Lumens	<b>27K</b> 2700K	<b>90CRI</b> 90+ CRI	<b>120 FRPC</b> 120V Forward/Reverse Cut, 5% Dim.
		<b>14LM</b> 1400 Nominal Lumens	<b>30K</b> 3000K		
			<b>35K</b> 3500K		
			<b>40K</b> 4000K		

\* Consult factory for voltage/dimming options.

## 6" Super Slope LED with WarmDim® Technology



Dedicated LED, Air-Loc® sealed slope ceiling new construction housing with our patented WarmDim® technology. The LED color temperature warms while dimming to emulate the dimming performance of traditional incandescent light source.

18½" L x 9¼" W x 7⅞" H  
Ceiling cutout: 8⅞" x 6⅞"

### Example: IC928LED WD G4 09LM 30K 90CRI 120 FRPC

Housing and trim can be ordered together or separately, but will always ship separately.

Series	Dynamic Feature	Generation	Lumens	Color Temperature	CRI	Voltage/Driver
IC928LED 6" LED Super Slope Ceiling New Construction IC Housing	WD WarmDim®	G4 Generation 4	<b>09LM</b> 900 Nominal Lumens	<b>30K</b> 3000K	<b>90CRI</b> 90+ CRI	<b>120 FRPC</b> 120V Forward/Reverse Phase Cut
			<b>14LM</b> 1400 Nominal Lumens			

## 6" Super Slope LED Trims

### Downlights



**Downlight Baffle**  
604 BWH Black  
604 BSC Black  
604 BABZ Black  
604 BBL Black  
604 WWH White



**Downlight Cone**  
602 CWH Clear Alzak®  
602 BWH Black Alzak®  
602 GWH Gold  
602 HZWH Haze  
602 HZSC Haze  
602 WWH White  
602 WHZWH Wheat Haze  
602 WHZABZ Wheat Haze



### Lensed



**Baffle, Regressed Frosted Dome Lens**  
6033 WWH White



### Trim Ring Finishes

**ABZ** Classic Aged Bronze  
**SC** Satin Chrome  
**WH** White  
**BL** Black



An economical solution  
offering warm, natural light



# Slope Ceiling Incandescent Downlights

Patented, Juno incandescent downlight housings for sloped ceiling applications cover the full pitch range from 2/12 for standard slopes up to 12/12 for super slopes. The housings are available in new construction or remodel versions for both insulated and non-insulated ceilings. The lamp socket is adjustable, enabling the light beam to be kept perpendicular to the floor. Downlight, adjustable, and lensed trims are available with a wide variety of baffles and reflector cones.

Economical incandescent lamps produce warm, natural illumination. Housings that accept a broad selection of lamp types and wattages are available, assuring that you'll have just the right amount of light for your interior space.

## **Juno Slope Ceiling Incandescent Downlight Advantages**

- Covers standard and super slope applications ranging from pitch of 2/12 to 12/12
- Adjustable socket enables light beam to be aimed perpendicular to the floor
- Angle-cut baffle assures that grooves remain parallel to the floor for proper optic performance
- Oblique angle of shovel-cut housing holds the trim flush with the ceiling

# 6" Incandescent Sloped Ceiling Downlights

Patented Juno Slope Ceiling Downlights direct light straight down, providing proper light distribution from a sloped surface.

## 6" Standard Slope Housings – 2/12 to 6/12 Pitch (9° to 27°)



### IC Housing

Energy-efficient, Air-Loc® double wall housing can be covered with insulation. Fits 2 x 8 construction.

**IC926** with Real Nail® 3 bar hangers  
**IC926 W** with push-in electrical connectors and Real Nail® 3 bar hangers

16 1/8" L x 9 1/8" W x 7 5/8" H  
 Ceiling opening: 7 1/2" x 6 1/16" oval



### TC Housing

Requires 3" spacing from insulation. For 2 x 8 or 2 x 10 construction.

**TC926** with Real Nail® 3 bar hangers

16 1/8" L x 9 1/8" W  
 Adjustable fixture height: 7 1/2" to 9"  
 Ceiling opening: 7 1/2" x 6 1/16" oval



### TC Remodel Housing

Requires 3" spacing from insulation. For 2 x 8 or 2 x 10 construction.

**TC926R** Remodel Housing

14" L x 6 7/8" W  
 Adjustable fixture height: 7 1/2" to 9"  
 Ceiling opening: 6 1/2" x 6 7/8" oval

**Note:** In Canada when insulation is present, Type IC fixtures must be used.

## 6" Standard Slope Trims

### Downlights



#### Downlight Baffle\*

**614 WWH** White  
**614 BWH** Black  
**614 BABZ** Black  
**614 BBL** Black  
**614 BSC** Black  
 IC: 90W PAR38  
 TC: 150W PAR38



#### Reflector Cone

**612 BWH** Black Alzak®  
**612 CWH** Clear Alzak®  
**612 GWH** Gold Alzak®  
**612 HZSC** Haze  
**612 HZWH** Haze  
**612 WWH** White  
**612 WHZABZ** Wheat Haze  
**612 WHZWH** Wheat Haze  
 IC: 75W PAR30, 90W PAR38, 65W BR30  
 TC: 75W PAR30, 150W PAR38, 85W BR30

### Adjustables



#### Cylinder Spotlight in Baffle

**616 WWH** White  
**616 BWH** Black  
 60W PAR16  
 45° vertical adjustment,  
 358° rotation



#### Low Voltage Cylinder Spotlight in Baffle

**617 WWH** White  
 45° vertical adjustment,  
 358° rotation  
 IC: 35W MR16  
 TC: 50W MR16  
 Supplied with magnetic transformer. Use dimmers specifically designed for low voltage magnetic transformers.



#### Eyeball in Baffle

**619 WWH** White  
**619 BWH** Black  
 35° vertical adjustment,  
 358° rotation  
 IC/TC: 85W BR30

### Lensed



#### Lensed Shower Trim

Flat Diffuser  
**610 WWH** White  
**610 BWH** Black  
 IC: 50W PAR30  
 TC: 75W A19,  
 75W PAR30



### Accessories

Catalog Number	Description
<b>ALG926</b>	Energy Conserving Gasket for Air-Loc® IC926 Housings

### Trim Ring Finishes

<b>ABZ</b> Classic Aged Bronze	<b>WH</b> White
<b>SC</b> Satin Chrome	<b>BL</b> Black

\* Patent pending one piece design eliminates the unsightly seam on the long side of the baffle.

U.S. Patent No. 4,729,08. Canadian Patent No. 1264158.

# 6" Incandescent Super Sloped Ceiling Downlights

Juno's patented Super Slope Ceiling Downlights are available in new construction or remodel versions for both insulated and non-insulated ceilings.

## 6" Super Slope Housings – 7/12 to 12/12 Pitch (30° to 45°)



### IC Housing

Energy-efficient, Air-Loc® double wall housing can be covered with insulation. Fits 2 x 8 construction.

**IC928** with Real Nail® 3 bar hangers  
**IC928 W** with push-in electrical connectors and Real Nail® 3 bar hangers

18½" L x 9½" W x 7⅞" H  
 Ceiling opening: 6⅞" x 8⅞" oval



### TC Housing

Requires 3" spacing from insulation. For 2 x 8 or 2 x 10 construction.

**TC928** with Real Nail® 3 bar hangers

18½" L x 9½" W  
 Adjustable fixture height: 7½" to 9⅞"  
 Ceiling opening: 6⅞" x 8⅞" oval



### TC Remodel Housing

Requires 3" spacing from insulation. For 2 x 8 or 2 x 10 construction.

**TC928R** Remodel Housing

14" L x 7⅞" W  
 Adjustable fixture height: 7⅞" to 9"  
 Ceiling opening: 6⅞" x 8¼" oval

**Note:** In Canada when insulation is present, Type IC fixtures must be used.

## 6" Standard Super Slope Trims

### Downlights



#### Downlight Baffle

**604 WWH** White  
**604 BWH** Black  
**604 BABZ** Black  
**604 BBL** Black  
**604 BSC** Black  
 IC: 90W PAR38  
 TC: 150W PAR38  
 For superior baffling, use 75W PAR30



#### Reflector Cone

**602 BWH** Black Alzak®  
**602 CWH** Clear Alzak®  
**602 GWH** Gold Alzak®  
**602 HZSC** Haze  
**602 HZWH** Haze  
**602 WWH** White  
**602 WHZABZ** Wheat Haze  
**602 WHZWH** Wheat Haze  
 IC: 75W PAR30, 90W PAR38, 85W BR30  
 TC: 75W PAR30, 150W PAR38, 85W BR30

### Adjustables



#### Cylinder Spotlight in Baffle

**606 WWH** White  
**606 BWH** Black  
 60W PAR16  
 45° vertical adjustment, 358° rotation

### Lensed



#### Lensed Shower Trim

Flat Diffuser  
**603 WWH** White  
**603 BWH** Black  
 IC: 50W PAR30  
 TC: 75W A19, 75W PAR30



### Accessories

Catalog Number	Description
<b>ALG928</b>	Energy Conserving Gasket for Air-Loc® IC928 Housings

### Trim Ring Finishes

<b>ABZ</b> Classic Aged Bronze	<b>WH</b> White
<b>SC</b> Satin Chrome	<b>BL</b> Black





Energy efficient and  
virtually maintenance-free

# LED Step Lights . . .

## the all around performers

Juno LED Step Lights are an energy efficient, virtually maintenance-free solution for indoor and outdoor, low-level lighting. They produce high-quality light with minimal power consumption, are rated to last a remarkable 50,000 hours, and are backed by a limited 5-year warranty. LEDs contain no toxic lead or mercury and produce no harmful ultraviolet or infrared wavelengths, making them the ideal eco-friendly solution.

Up to 85% more energy  
efficient than incandescent;  
50,000-hour rated service life



## Mini LED Step Lights

### Low-level lighting ... high style

For such a small fixture, Juno Mini LED Step Lights make a major statement. These architectural grade fixtures are about the size of a standard switch plate. With an approximate aperture size of one-inch square, they offer a unique, high-style appearance that blends seamlessly into its environment. An array of beautiful finishes completes the package. With their trendsetting design, extraordinary energy efficiency and long service life, Juno Mini LED Step Lights represent the new standard in upscale low-level lighting.



## The supremely versatile step light

This little light goes a long way. The unique, compact, modular construction of the Mini LED Step Light provides solutions for a diverse number of applications. The IC-Rated, all-in-one design includes the 3-watt LED light engine, 120-volt dimmable driver, optic, and decorative face plate that all mount directly to a standard 2" x 4" junction box. Choose from four distinct optic designs and a selection of high-quality finishes.

Shown in actual size

## Delivering modular flexibility for vertical and horizontal installations

Juno Mini LED Step Lights can be mounted in the wall either vertically or horizontally (shipped from the factory in the vertical position). Fixture orientation can be easily changed by simply removing the optic, rotating the mounting plate and re-installing in the horizontal orientation. The face plate easily attaches to the back plate with a single set screw. Juno Mini LED Step Lights provide unsurpassed flexibility for virtually any installation.



Cutoff -  
Vertical Orientation

Cutoff -  
Horizontal Orientation

# Optic Options

## Adaptable to your specific needs

Four striking optic designs satisfy a variety of illumination and aesthetic requirements. Each optic creates a one-of-a-kind lighting effect, ranging from a subtle pool of accent lighting to a wide distribution ideally suited for steps and pathways. Juno Mini LED Step Lights are adaptable to a wide variety of low-level lighting applications.



### Marker

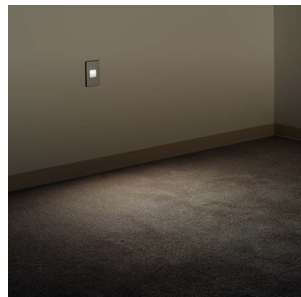

The opal lens produces an attractive glow ideal for marking corridors or pathways.

### Hood



Casts a pleasant pool of light at floor level while eliminating glare - ideal for theatre or auditorium lighting.

### Cutoff



Balances low glare with a wide light pattern for steps and pathway lighting.

### Louver



Integral louver provides superior shielding, making it an excellent choice for step lighting and other low level applications.



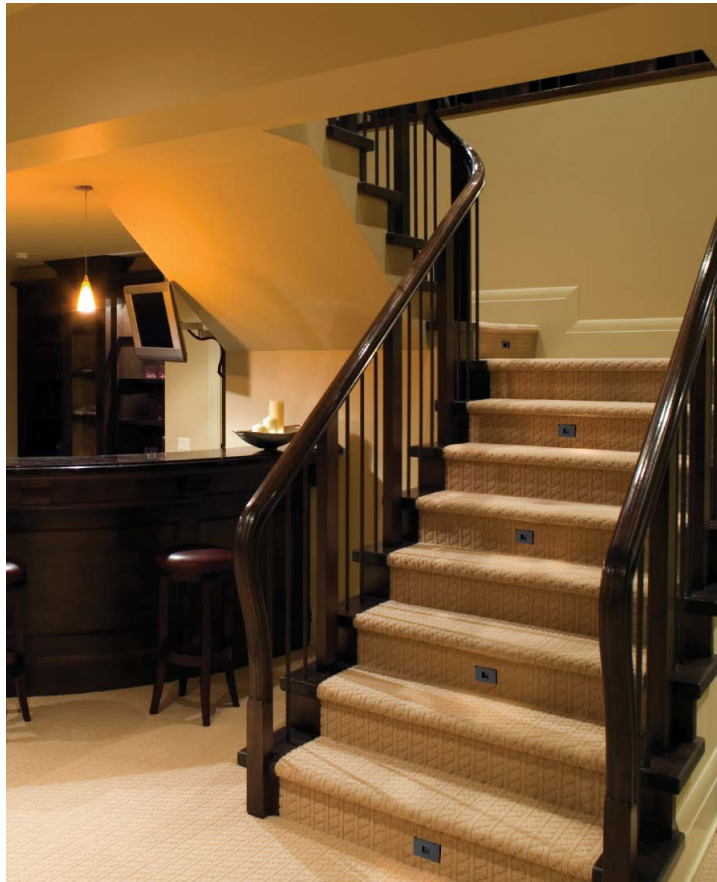
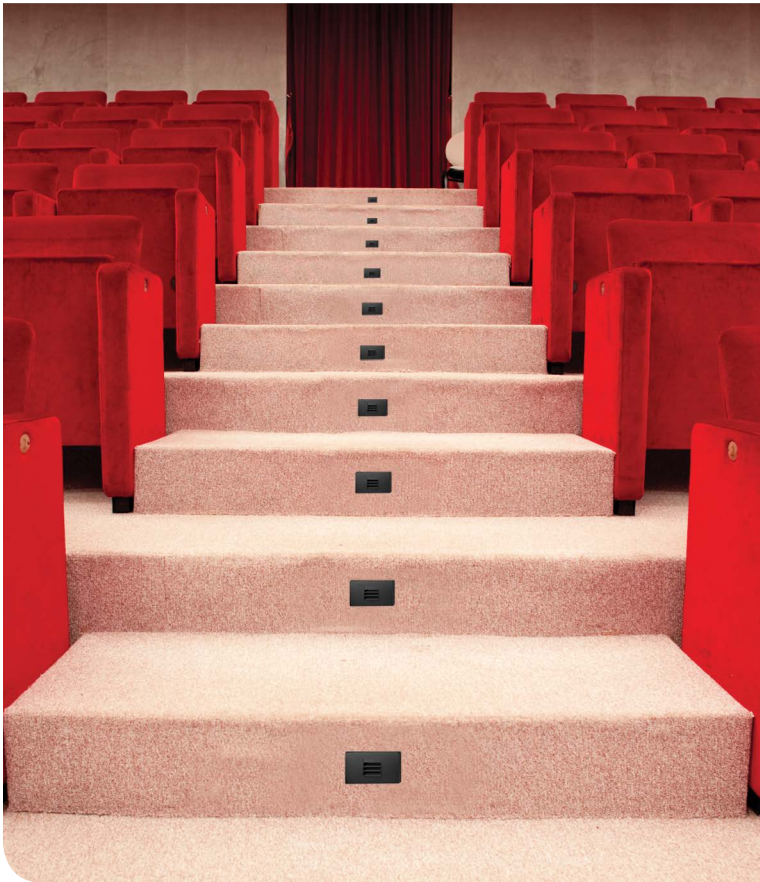





## Outdoor/Wet Location Mini LED Step Lights

IP65



### Specially designed to resist the elements

Constructed of high-quality, die-cast aluminum, the LMS (WL) Series of Outdoor/Wet Location Mini IC-Rated LED Step Lights provides long lasting performance in virtually any wet location. Designed to mount directly in standard 2"x4" (2-1/8" minimum depth) or 4"x4" (1-1/2" minimum depth) junction boxes.

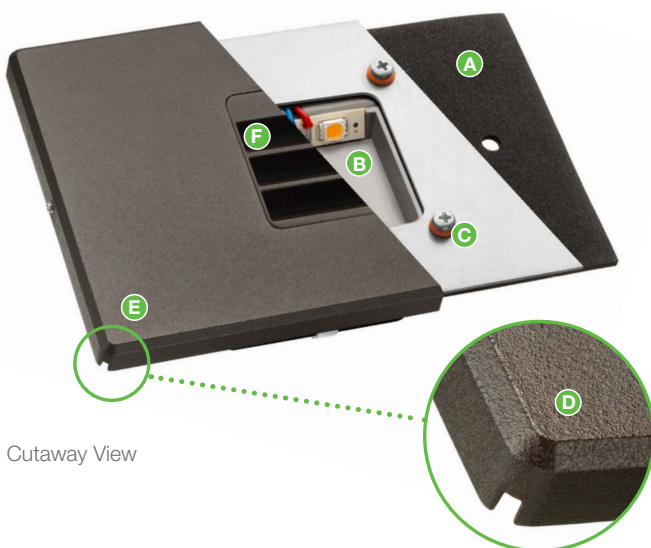

Cutaway View

- A. Gasket** protects the junction box from intrusion of water and contaminants.
- B. Light Engine Driver** features a diffused lens (not shown) that protects the LED against water infiltration. Accepts 120V input and is dimmable with reverse phase electronic low-voltage dimmers.
- C. O-rings** prevent water seepage around the screws.
- D. Drain Slot** guides water away from the fixture without compromising aesthetics.
- E. Decorative Faceplate with Corrosion-Resistant Finish** preserves the appearance for years of use. Field adjustable in horizontal or vertical orientation.
- F. Four optic choices** are available.

## Finishes

Juno IC-Rated Mini LED Step Lights are available for both indoor and outdoor applications. High-quality indoor finishes include plated bronze and satin nickel; outdoor/wet location units are finished with corrosion-resistant textured bronze or silver for superior durability. All fixtures are also available in white or black.

### Indoor Finishes - LMS

Shown in vertical orientation



Black, Textured

White, Textured

Satin Nickel, Plated

Bronze, Plated

### Dimensions:

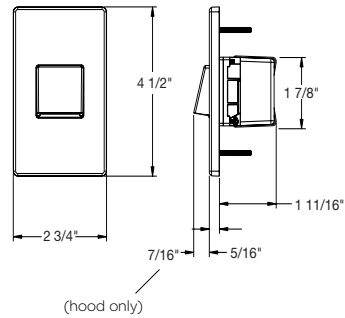

**LMS – Indoor**  
(Shown in vertical orientation)

### Outdoor/Wet Location Finishes - LMS (WL)

Shown in horizontal orientation



Black, Textured

White, Textured

Silver, Textured

Bronze, Textured

### Dimensions:

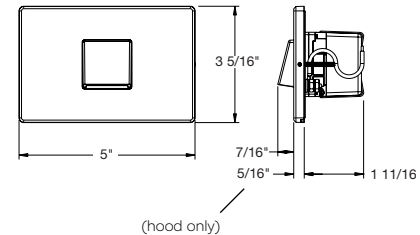

**LMS (WL) – Wet Location**  
(Shown in horizontal orientation)

**IP65**



## Ordering Information

Example: LMS 30K CTO 120 RPC BL, LMS 30K LVR 120 RPC WL WH

Housing	Color Temperature	Optic	Voltage	Driver	Environment	Finishes
<b>LMS</b> LED Mini Step Light	<b>30K</b> 3000K <b>40K</b> 4000K	<b>CTO</b> Cutoff 	<b>120</b> 120V	<b>RPC</b> Reverse Phase Cut	(Blank) Indoor	<b>BL</b> Black <b>BZ</b> Bronze, Plated <b>WH</b> White <b>SN</b> Satin Nickel, Plated
	<b>LVR</b> Louver 	<b>WL</b> Outdoor/Wet Location			<b>BL</b> Black <b>BZ</b> Bronze, Textured <b>WH</b> White <b>SR</b> Silver, Textured	
		<b>HD</b> Hood 				
		<b>MKR</b> Marker 				







## Step-up to Juno Performance LED Step Lights

The outdoor-rated Juno Performance LED Step Lights are the perfect combination of aesthetic fixture design and optimum illumination performance. These architectural-grade fixtures feature sleek, low-profile trims, attractively finished in corrosion-resistant, textured paint. Trims and matching hardware are available in black, white, silver, and bronze.



**IP65**





## Features

- Unique all-in-one power module mounts directly to the cast aluminum trim and includes the LED light engine and 120-volt, non-dimming driver.
- Low-profile trim and baffle-steps produce wide illumination patterns and minimize glare.
- 3000K or 4000K color temperature available
- Fixture produces up to 300 lumens with nominal 13-watt power consumption.
- May be used as a retrofit for existing Juno PL115 outdoor-rated step light installations.

## Finishes



Black



White



Silver





Bronze

## Ordering Information

Housing and power module trim each ordered separately. For use as a retrofit, order power module trim only.

**Example: IC115LEDHSG**

**Example: 838LED 13W 40K 120 BL**

Back Housing	Power Module Trim	Wattage	Color Temperature	Voltage	Trim Finish
<b>IC115LEDHSG</b> 	<b>838LED</b> 	<b>13W</b> 13 Watts	<b>30K</b> 3000K <b>40K</b> 4000K	<b>120</b> 120V	<b>BL</b> Black, Textured <b>BZ</b> Bronze, Textured <b>SR</b> Silver, Textured <b>WH</b> White, Textured

**Trim Size:** 9<sup>3</sup>/<sub>4</sub>" L x 3<sup>5</sup>/<sub>8</sub>" H

**Dimensions:**

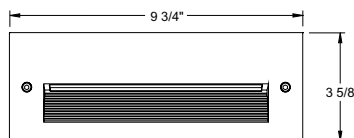
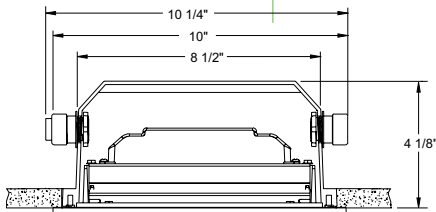

Wall Cutout: 9" x 3"

# Indoor and Outdoor Rated LED Step Lights

Juno LED step lights provide an energy-efficient solution for low-level lighting in indoor or outdoor applications. Consuming just 6-watts of power, these LED step lights use far less energy than the comparable incandescent and fluorescent versions and are compatible with standard trims.





## Indoor-Rated LED Step/Night Light

The indoor LED Step/Night Light is rated for use in wall- or ceiling-mount, indoor drywall applications. Two trims are available: one featuring a diffuse-glass lens for even light distribution; the other with louvers that reduce glare and provide a softer lighting effect.

- Dedicated LED housing ships complete with LED light engine and 120-volt, non-dimming driver
- Recessed housing is IC-Rated and can be completely covered with insulation
- Real Nail® 3 bar hanger system provides quick and easy installation
- 3000K or 4000K color temperature available

## Ordering Information

Housing and trim can be ordered together or separate, but will always ship separate.

Series	Color Temperature	Voltage	Trims	Trim Finish
<b>IC113LED</b>	<b>30K</b> 3000K <b>40K</b> 4000K	<b>120</b> 120V	<b>104</b> Diffuse Glass Lens Step Light Trim	<b>WH</b> White
				
			<b>840</b> Angled Louvers Step Light Trim	
				

## Dimensions:

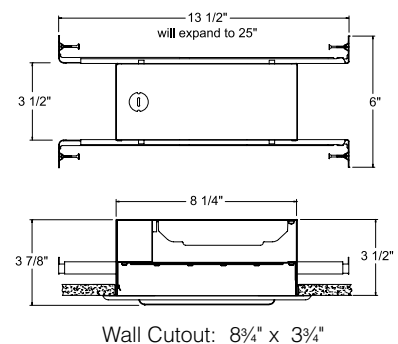

**Trim Size:** 9 9/16" L x 4 7/8" H







## Outdoor Rated LED Step Light

The Outdoor LED Step Light is rated for use in outdoor and indoor wall-mount applications, including concrete pour, brick masonry, or drywall. Trims are cast aluminum and are offered in opal lens, grill and louver designs.

- Die-cast aluminum housing is IC rated and gasketed for wet locations
- Back housing ships separately from power module for rough-in purposes
- Power module assembly with LED light engine and 120-volt, non-dimming driver is mounted directly to metal tray for ease of installation into housing
- 3000K or 4000K color temperature available

## Ordering Information

Order housing, and power module and trim separately.

Example: IC115LEDHSG		Example: IC115LEDPM 30K 120		Example: 835 WH		
Back Housing	Power Module	Color Temperature	Voltage	Trims		Trim Finish
<b>IC115LEDHSG</b>	<b>IC115LEDPM</b>	<b>30K</b> 3000K <b>40K</b> 4000K	<b>120</b> 120V	<b>835</b> Full Opal Lens Step Light Trim		<b>BL</b> Black <b>WH</b> White
				<b>836</b> Opal Lens with Grill Step Light Trim		
				<b>837</b> Opal Lens with Angled Louvers Step Light Trim		

## Dimensions:

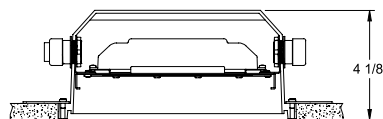
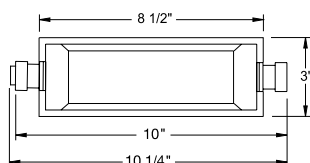

Wall Cutout: 9" x 3"





# Incandescent Step Lights

Juno incandescent step lights are a cost-effective option for low-level, indoor lighting applications. With two trims available — one featuring a diffuse lens for even light distribution and another with louvers to provide a softer effect with reduced glare — these step lights suit a variety of needs. These fixtures can be used in either insulated or non-insulated areas and incorporate the Real Nail® 3 bar hanger system for fast, easy installation.

# Night Lights/Step Lights

The Indoor Incandescent Step/Night Light is rated for use in indoor wall- or ceiling-mount drywall applications. Trim offering includes diffuse glass lens and louver designs.

- Provided with medium base porcelain socket
- Recessed housing is IC rated and can be completely covered with insulation
- Rated for 25W A19 lamp in insulated IC applications, or 40W A19 lamp in Non-IC applications
- Real Nail® 3 Bar Hangers for quick housing placement

## Ordering Information

Housing and trim can be ordered together or separately, but will always ship separately.

Example: ICTC113	Example (Trim): 104 WH	Example (Together): ICTC113 104 WH
Series	Trims	Trim Finish
<b>ICTC113</b>	<b>104</b> Diffuse Glass Lens Step Light Trim	<b>WH</b> White
	<b>840</b> Angled Louvers Step Light Trim	

**Trim Size:** 9<sup>9</sup>/<sub>16</sub>" L x 4<sup>7</sup>/<sub>8</sub>" H

## Dimensions:

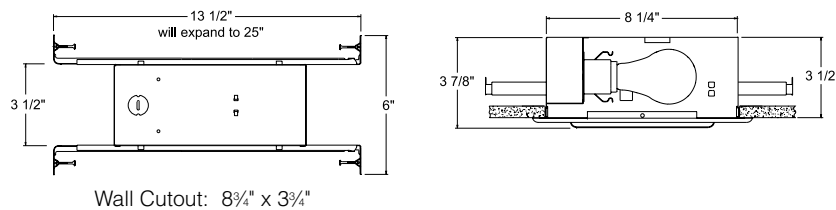

**Trim Finishes:** WH: White







# Linear & Undercabinet LED

Juno LED linear and undercabinet luminaires are setting new standards for performance, efficiency and application versatility.

The Juno FlexConnect™ is a versatile, architectural linear lighting system that allows you to cut LED strips in sections as small as 6", and reconnect them in the field. These luminaires can be shaped around curved surfaces or mounted with linear channels, and provide exceptional performance and quality of light. Systems are fully customizable to meet the needs of virtually any residential space.

Juno® Solo-Task™ LED luminaires offer the ultimate in flexibility and efficiency. Their small size allows them to be used easily and unobtrusively in myriad applications including cabinetry, shelving, bookcases, and wall niches. The LEDs approximate the light levels of 25-watt halogen and xenon while consuming less than 1/5 of the energy and generating significantly less heat. The luminaires can be connected using the daisy-chain method, making installation simple. A convenient all-in-one recessed mount kit is also available.

Juno® Pro-Series LED and Pro-Series SoftTask™ LED fixtures provide quality, energy-efficient undercabinet lighting with an easy to conceal 1" profile. They feature integral drivers, fast and easy installation, warm 3000K CCT with identical wiring, control and finish options. Traditional Pro-Series LED fixtures mimic the light levels and color of halogen, while Pro-Series SoftTask features illumination more comparable to fluorescent. These fixtures are also available with Passive Infrared (PIR) Occupancy Sensor, field set for 30 seconds to 30 minutes.



**SL Series – Juno FlexConnect™**  
**Indoor Luminaires** Damp Location Rated

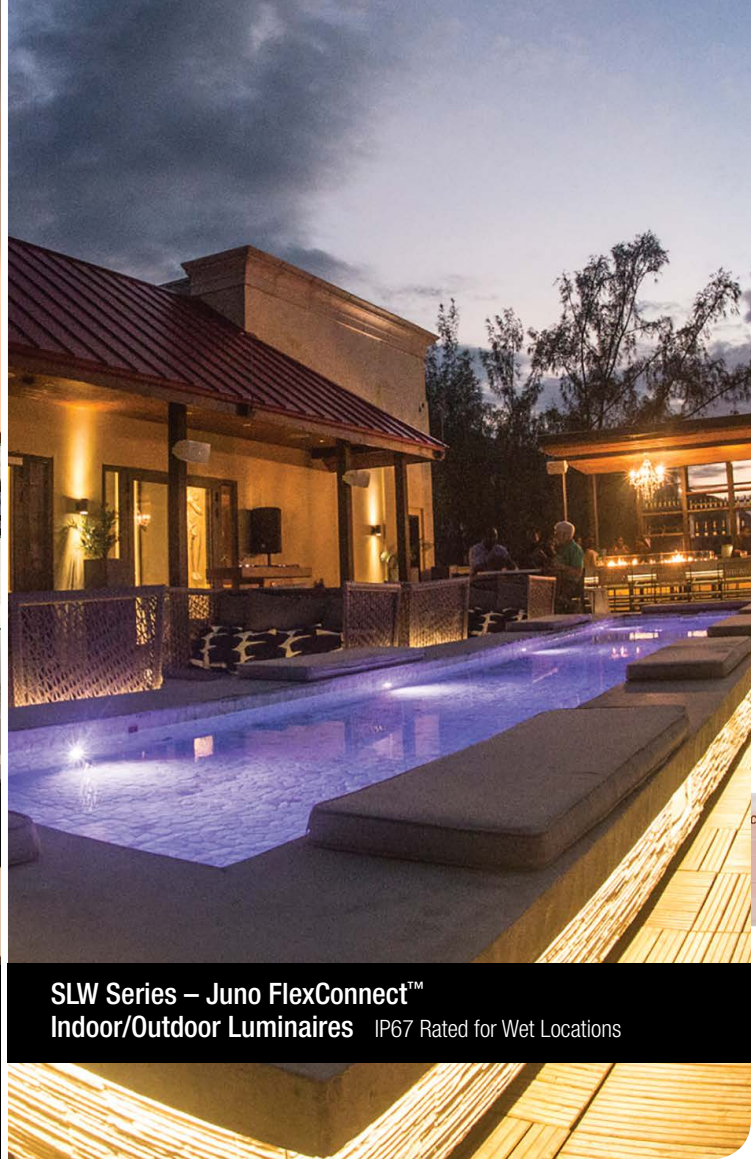

**SLW Series – Juno FlexConnect™**  
**Indoor/Outdoor Luminaires** IP67 Rated for Wet Locations



## Juno FlexConnect™ Architectural Linear Lighting System

Flexible LED lighting that can be shaped and reconnected in the field

Juno FlexConnect™ is the industry's most versatile LED linear lighting system. Shape it around curved surfaces, cut it in the field, reconnect individual segments ... no other linear lighting product gives you so many installation options.

The Juno FlexConnect™ system includes indoor damp-location luminaires and indoor/outdoor IP67-rated luminaires. They offer a host of connector accessories that provide unsurpassed application versatility. The flexible luminaire comes in 20-foot spools that can be field-cut and customized in 6-inch increments, reconnected using the integral connectors, then attached in a variety of configurations including linear channels and curved surfaces.



# Superior Performance and Quality of Light

Juno FlexConnect™ LED luminaires offer superb lighting performance, producing up to 450 lumens per foot of brilliant white light in CCTs of 2200K, 2700K, 3000K, 3500K, and 4000K. This UV-stable pigment maintains color throughout the life of the product and corrects color shift that regularly occurs with other encapsulated strips. Linear runs from 1-foot to 40-feet in length are possible with no voltage drop, ensuring even illumination throughout.

**Onboard Current Regulation** – Consistent light output is maintained across the length of the run utilizing current regulators every 6-inches; unlike traditional LED tape that uses resistors which results in voltage drop and light degradation.

**Brilliant LED Performance** – Available with 12 LEDs per foot or 24 LEDs per foot, for supremely uniform linear illumination.

**Embedded Connectors** – Patent pending, embedded connectors allow Juno FlexConnect to be field-cut in 6-inch increments and reconnected in the field to another strip, electrical feed or connector.

**Durable Silicone Encapsulation** – UV stable silicon protects the luminaire, providing extended reliability and long life.

Up to  
**95 CRI**

**Proprietary Optical Pigment** – Patent pending optical pigment corrects color shift that results from LED encapsulation. Color point is spot-on as the pigment provides industry leading color rendering and color consistency.



**24VDC power supply** – ELV/forward phase and 0-10V dimming; Compatible with nLight® nPP16d. Lutron driver options available.



# Juno FlexConnect™

## Easy to configure ... easy to install

Supplied in 20-foot spools, Juno FlexConnect™ is the only encapsulated flexible linear luminaire on the market that features unique, integral connectors. Each connector is spaced 6-inches apart, enabling the luminaires to be cut to any length and reconnected in the field. This helps eliminate waste and makes it easy to configure. Linear runs from 1-foot to 40-feet in length are possible with no voltage drop, ensuring even illumination throughout.

## Installation couldn't be easier. Simply ... Flex it, Cut it, Reconnect it!



**SL/S LW Series Cutting Tool** – Make quick, fool-proof cuts through the center of embedded connectors placed every 6-inches along the strip.



Luminaire strips must be cut using the custom cutting tool (ordered separately).

## Electrical Feeds

A variety of cables and modular connectors are available to customize each SL and SLW Series installation.



**Starter Cables**  
CL2 rated for in-wall use.

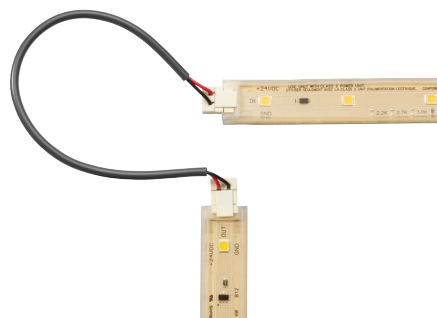

**Joiner Cables**  
Provides a flexible connection for two luminaire strips.

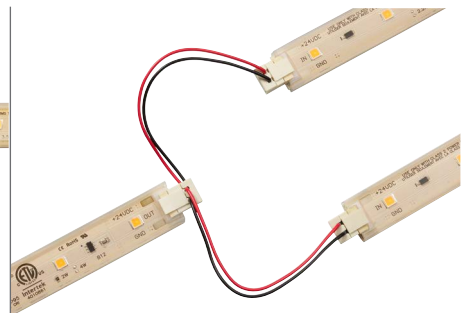

**3-Way Connector**  
Provides a flexible connection for three luminaire strips.

## Modular Connectors

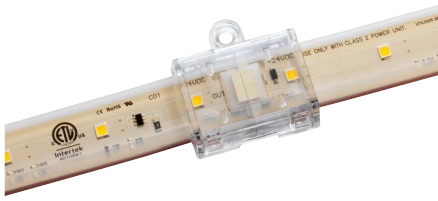

**End-to-End Connector** – SLW Series connector seals two cut luminaire strips.



**End Cap** – Seals cut end of luminaire strip.

## IP67 Rated Connectors (SLW Series)



A translucent silicone gel is included inside SLW Series clear acrylic enclosures that repels moisture – without inhibiting the light. These easy to install connectors allow the IP67 rating to be maintained when Juno FlexConnect™ strips are cut in the field.

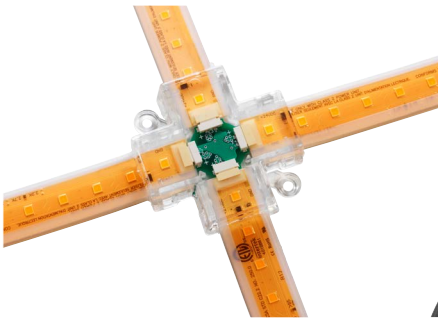

**4-Way Connector** – Accepts four luminaire strips or three strips and one power feed. Available in SL Series for indoor use or SLW Series for outdoor wet locations.

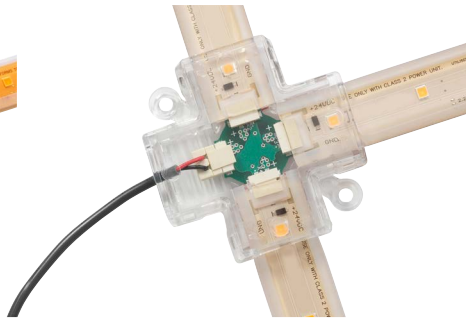

**Terminal Block** – Accepts 14-22 AWG wire, allowing power supply to be remotely mounted up to 100 feet away.



## Mounting Options

### Aluminum Channel and Lens Options

Channels are available in satin aluminum, white or black finishes. They can be ordered with clear or frosted lens, or be specified without a lens.



**Low Profile Surface Mount**



**Deep Surface Mount**



**45° Low Profile**



**Mounting Clips** – Provide secure attachment to a variety of surfaces when placed at 1-foot intervals. The back of luminaires features 3M adhesive strips to maintain positioning while installing clips.



**45° Square**



**45° Round**

**Note:** Except as indicated, all optional accessories are ordered separately.

# SL Series – Indoor, Damp Location System



SL212/SL412

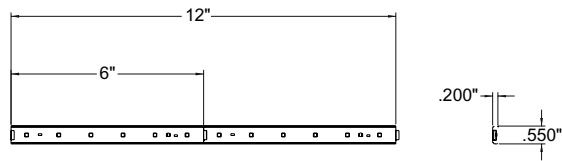

## Product Codes

### 24V Standard Output Flexible LED Strips (12 LEDs per ft) - Damp Location

Series	CCT	CRI Min.	R9	Watts per Foot	Lumens per Foot
SL212	2200K	80	35	2.2	140
	2700K	80	35	2.2	180
	3000K	80	34	2.2	190
	3500K	80	20	2.2	205
	4000K	80	21	2.2	225

### 24V High Output Flexible LED Strips (12 LEDs per ft) - Damp Location

Series	CCT	CRI Min.	R9	Watts per Foot	Lumens per Foot
SL412	2700K	80	33	4.4	315
	3000K	80	34	4.4	360
	3500K	80	19	4.4	400
	4000K	80	19	4.4	425
	2700K	95	74	4.4	265
3000K	95	74	4.4	275	

Order in 20' spools.



Remote 24VDC Power Supply



Lutron® Hi-Lume, A-Series, 3-Wire



Lutron® Hi-Lume, A-Series, 2-Wire

Power Supplies	Catalog #	Input Voltage	Output Voltage	Max. Wattage	Min. Wattage	Dimming	Min. Dimming %
24VDC Power Supply	<b>DLDP5 60W FPCZT</b> <b>DLDP5 96W FPCZT</b>	120-277 VAC	24VDC	60W 96W	2W 36W	0-10V, ELV, Trac	5%
Lutron® Hi-Lume, A-Series, 3-Wire	<b>DLDP5 40W ECOS3</b> <b>DLDP5 96W ECOS3</b>	120-277 VAC	24VDC	40W 96W	5W 25W	3-wire & EcoSystem	1% 0.1%
Lutron® Hi-Lume, A-Series, 2-Wire	<b>DLDP5 40W ECOS2</b>	120 VAC	24VDC	40W	5W	2-wire & EcoSystem	1%



Starter Cable



Terminal Block



Joiner Cable



3 Way Connector



4 Way Connector

Electronic Feeds	Series	Description	Length
Starter Cable	<b>SL101P</b>	22 AWG, CL2 rated starter cable, rated for in-wall use	36", 144"
Terminal Block, Indoor	<b>SL101TB</b>	One end connects to strip. Accepts 14-22 AWG solid/stranded wire, including non-metallic sheathed cable.	
Straight Joiner Cables	<b>SL102FLX</b>	22 AWG, CL2 rated cable, rated for in-wall use	2", 6", 12" 36" & 72"
3-Way Connector	<b>SL102Y</b>	3-Way, 22 AWG	3"
4-Way Connector	<b>SL102X</b>	4-Way Connector, accepts up to 4 strips for 1 feed and 3 strips	





System Accessories	Series	Description
Cutting Tool	<b>SLCUTTER</b>	SL Series Cutting Tool - REQUIRED TO FIELD CUT LUMINAIRE
Mounting Clips	<b>SLCLIP</b>	SL Series Mounting Clips, Qty: 20

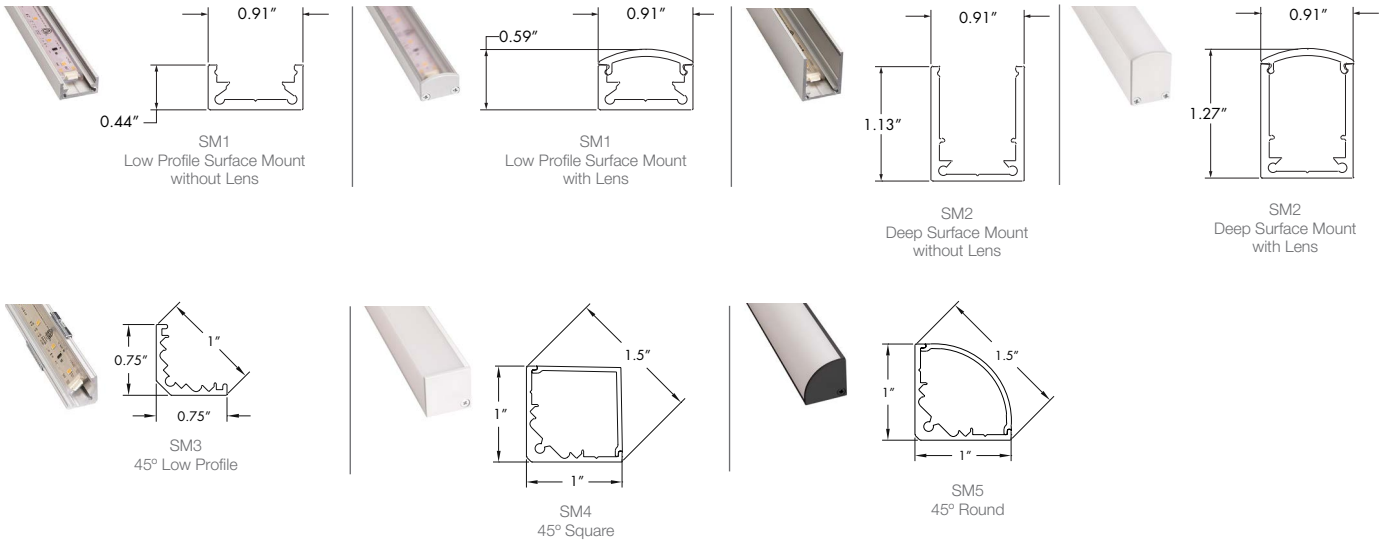

### Aluminum Channels

Channel Type	Nominal Length	Lens	Finish
<b>SM1</b> Low Profile Surface Mount	<b>48IN**</b>	<b>NL</b> No Lens	<b>SA</b> Satin Aluminum
<b>SM2</b> Deep Surface Mount		<b>CL</b> Clear Lens	<b>BL</b> Black
<b>SM3*</b> 45 Degree Low Profile		<b>FR</b> Frosted Lens	<b>WH</b> White
<b>SM4</b> 45 Degree Square			
<b>SM5</b> 45 Degree Round			

\*Only available with 'NL' lens option

\*\*Actual length is 49 inches long to accommodate luminaire connectors and power feed

Endcaps included with lensed options



# SLW Series – Indoor/Outdoor, IP67 Rated Wet Location System



SLW212/SLW412

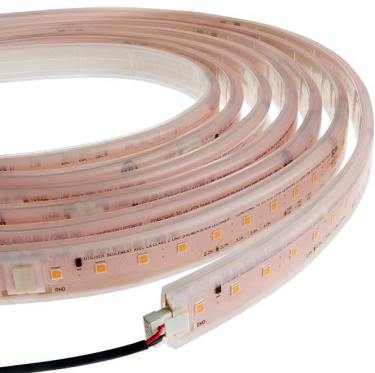

SLW424

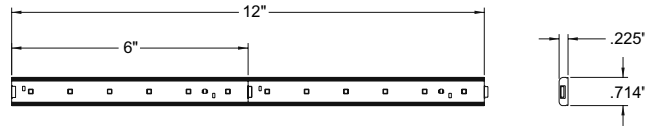

## Product Codes

### 24V Standard Output Flexible LED Strips (12 LEDs per ft) - IP67 Wet Location

Series	CCT	CRI Min.	R9	Watts per Foot	Lumens per Foot
SLW212	2700K	80	35	2.2	175
	3000K	80	34	2.2	200
	3500K	80	20	2.2	215
SLW412	4000K	80	20	2.2	220
	2700K	95	95	2.2	140
	3000K	95	95	2.2	155

### 24V Standard Output Flexible LED Strips (12 LEDs per ft) - IP67 Wet Location

Series	CCT	CRI Min.	R9	Watts per Foot	Lumens per Foot
SLW412	2700K	80	32	4.4	340
	3000K	80	28	4.4	370
	3500K	80	18	4.4	415
SLW424	4000K	80	16	4.4	425
	2700K	95	77	4.4	270
	3000K	95	74	4.4	300

### 24V Standard Output Flexible LED Strips (12 LEDs per ft) - IP67 Wet Location

Series	CCT	CRI Min.	R9	Watts per Foot	Lumens per Foot
SLW424	2700K	80	40	4.8	350
	3000K	80	20	4.8	385
	3500K	80	17	4.8	425
SLW424	4000K	80	20	4.8	450
	2700K	95	80	4.8	280
	3000K	95	75	4.8	310

Order in 20' spools.



Remote 24VDC Power Supply



Lutron® Hi-Lume, A-Series, 3-Wire



Lutron® Hi-Lume, A-Series, 2-Wire

Power Supplies	Catalog #	Input Voltage	Output Voltage	Max. Wattage	Min. Wattage	Dimming	Min. Dimming %
24VDC Power Supply	<b>DLDP5 60W FPCZT</b> <b>DLDP5 96W FPCZT</b>	120-277 VAC	24VDC	60W 96W	2W 36W	0-10V, ELV, Trac	5%
Lutron® Hi-Lume, A-Series, 3-Wire	<b>DLDP5 40W ECOS3</b> <b>DLDP5 96W ECOS3</b>	120-277 VAC	24VDC	40W 96W	5W 25W	3-wire & EcoSystem	1% 0.1%
Lutron® Hi-Lume, A-Series, 2-Wire	<b>DLDP5 40W ECOS2</b>	120 VAC	24VDC	40W	5W	2-wire & EcoSystem	1%



Electronic Feeds	Series	Description	Length
Starter Cable	<b>SL101P</b>	22 AWG, CL2 rated starter cable, rated for in-wall use	36", 144"
Terminal Block, IP67	<b>SLW101TB</b>	One end connects to strip. Accepts 14-22 AWG solid/stranded wire, including non-metallic sheathed cable. IP67 Rated.	
Joiner Cables	<b>SL102FLX</b>	22 AWG, CL2 rated cable, rated for in-wall use	2", 6", 12" 36 & 72"
End-to-End Connector, IP67	<b>SLW102EE</b>	End-to-End Connector for continuous lit run, IP67	
4-Way Connector, IP67	<b>SLW102X</b>	4-Way Connector, accepts up to 4 strips for 1 feed and 3 strips, IP67	
End Cap, IP67	<b>SLW101EC</b>	End Cap for sealing field cut end of luminaires. IP67.	

System Accessories	Series	Description
Cutting Tool	<b>SLWCUTTER</b>	SLW Series Cutting Tool - REQUIRED TO FIELD CUT LUMINAIRE
Mounting Clips	<b>SLWCLIP</b>	SLW Series Mounting Clips, Qty: 20

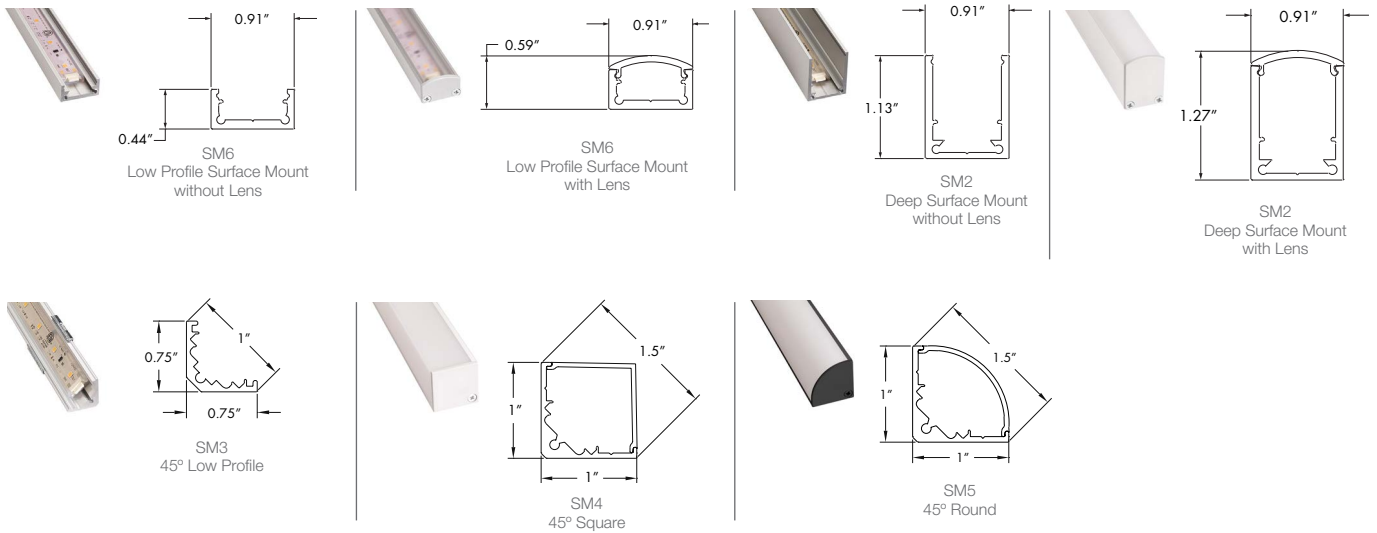

### Aluminum Channels

Channel Type	Nominal Length	Lens	Finish
<b>SM6</b> Low Profile Surface Mount	<b>48IN**</b>	<b>NL</b> No Lens	<b>SA</b> Satin Aluminum
<b>SM2</b> Deep Surface Mount		<b>CL</b> Clear Lens	<b>BL</b> Black
<b>SM3*</b> 45 Degree Low Profile		<b>FR</b> Frosted Lens	<b>WH</b> White
<b>SM4</b> 45 Degree Square			
<b>SM5</b> 45 Degree Round			

\*Only available with 'NL' lens option

\*\*Actual length is 49 inches long to accommodate luminaire connectors and power feed

Endcaps included with lensed options





## Undercabinet Solo-Task™ LED Lighting

Ultra-compact, super-efficient luminaires for task and accent lighting

Juno Solo-Task LED luminaires are the mighty-mite of undercabinet lighting. At less than 3" in diameter and a low 9/16" profile, they fit unobtrusively under cabinets and shelves, yet can produce over 280 lumens of brilliant white light for task and accent illumination. At just 3.8-watts, they consume less than one-fifth the energy of equivalent halogen or xenon light sources and generate significantly less heat.

Kitchen counters, work surfaces, retail displays ... all are ideal applications for this unique little light. Solo-Task LED luminaires feature quick and easy surface or recessed mounting and create high-quality, even, color-consistent illumination, with light levels comparable to 25-watt halogen or xenon. Solo-Task LED produces a wide, even light pattern with a color temperature of 3000K and CRI of 85. The luminaires are fully dimmable using factory qualified dimmers. They can be installed wherever light is needed and easily connected in daisy-chain fashion to provide uniform illumination.

It's almost a shame to hide these attractive little lights. Solo-Task LED luminaires are stylish and contemporary, and the die-cast aluminum housings are available in four beautiful finishes ... designer white, satin nickel, brushed bronze and black. They are the perfect enhancement to a wide variety of residential and commercial decors.

# The LED Advantage

Juno® Solo-Task™ LED luminaires are more than space savers; they're energy savers, too. At just 3.8-watts, they consume less than one-fifth the energy of equivalent halogen or xenon light sources and generate significantly less heat. With no IR emissions in the beam, LEDs are far cooler in operation, and with no UV rays, they are ideal for fade-free illumination of light-sensitive materials. An exceptionally long service life of 50,000 hours assures many years of maintenance-free use.



Remarkably small and thin, Juno Solo-Task LED luminaires can produce over 280 lumens

2-1/2" x 9/16"



Surface Mount



Recessed Mount



# Juno® Undercabinet Solo-Task LED Lighting

## Finishes

Juno® Solo-Task LEDs can be surface (shown) or recessed mounted and come in your choice of four stylish finishes.



White



Brushed Bronze



Satin Nickel



Black

## Ordering Information

### Juno Undercabinet Solo-Task LED Fixtures

Model	Color Temperature	CRI	Shade Finish
<b>USTL1</b> Surface Mount	<b>30K</b> 3000K	<b>80CRI</b>	<b>BL</b> Black
<b>USTLR1</b> Recessed Mount			<b>BZ</b> Brushed Bronze
			<b>SN</b> Satin Nickel
			<b>WH</b> White

### Electrical Data

#### USTL1 30K/USTLR1 30K

Total input power (watts)*	3.8
Lumens	286
Efficacy (lumens/watt)	74.5

\* Solo-Task LED input power – additional losses vary depending upon transformer and system loading.

### Juno Undercabinet Solo-Task LED Kits

Each Kit includes:

3 Surface Mount Luminaires, 1 Plug-in Driver/Transformer with field installed switch, 10-feet of wire, and 5-adhesive backed wire clips

<b>UK3STL 30K 80CRI BL</b>	Black Face/Black Base	3000K
<b>UK3STL 30K 80CRI BZ</b>	Brushed Bronze Face/Black Base	3000K
<b>UK3STL 30K 80CRI SN</b>	Satin Nickel Face/Black Base	3000K
<b>UK3STL 30K 80CRI WH</b>	White Face/White Base	3000K

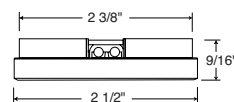
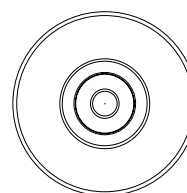

Surface Mount (USTL1)

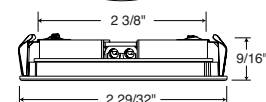
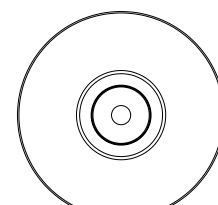

Recessed Mount (USTLR1)  
2-3/4" cutout

## Drivers/Transformers



Catalog #	Finish	Description
<b>TL602E 10W 120 12AC WH</b>	White	10W 12V AC (Class-2) Electronic Driver/Transformer
<b>TL602E 25W 120 12AC WH</b>	White	25W 12V AC (Class-2) Electronic Driver/Transformer
<b>TL602E 60W 120 12AC WH</b>	White	60W 12V AC (Class-2) Electronic Driver/Transformer

Ordering Options (Add to catalog number prior to finish)



Catalog #	Finish	Description
<b>6CP</b>	White	6ft. Cord & Plug, factory installed.
<b>TL548 LED 60W 120 12AC WH</b>	White	60W 12V AC (Class-2) Plug-in Electronic Driver/Transformer
<b>TL548 LED 60W 120 12AC BL</b>	Black	60W 12V AC (Class-2) Plug-in Electronic Driver/Transformer



Catalog #	Finish	Description
<b>MAGXFMR 1C 10W 120 12AC BL</b>	Black	10W 12V AC (Class-2) Magnetic Driver/Transformer
<b>MAGXFMR 1C 25W 120 12AC BL</b>	Black	25W 12V AC (Class-2) Magnetic Driver/Transformer
<b>MAGXFMR 1C 60W 120 12AC BL</b>	Black	60W 12V AC (Class-2) Magnetic Driver/Transformer

The Solo-Task LED luminaire offering is a low voltage system. As such, voltage drop is an inherent characteristic. Refer to the Solo-Task LED specification sheet or installation instructions for system run lengths utilizing the above driver/transformers to ensure optimal system performance.



## Ordering Information

### Accessories

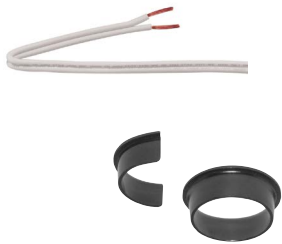

Catalog #	Description
<b>UST18G 10FT WH</b>	18AWG 2-Conductor Parallel Bonded Wire, 10-Feet, White
<b>UST18G 25FT WH</b>	18AWG 2-Conductor Parallel Bonded Wire, 25-Feet, White
<b>UST18G 10FT BL</b>	18AWG 2-Conductor Parallel Bonded Wire, 10-Feet, Black
<b>UST18G 25FT BL</b>	18AWG 2-Conductor Parallel Bonded Wire, 25-Feet, Black
<b>USTREC BL</b>	Kit to convert USTL1 Surface Mount to USTLR1 Recessed Mount, Black
<b>USTREC BZ</b>	Kit to convert USTL1 Surface Mount to USTLR1 Recessed Mount, Brushed Bronze
<b>USTREC SN</b>	Kit to convert USTL1 Surface Mount to USTLR1 Recessed Mount, Satin Nickel
<b>USTREC WH</b>	Kit to convert USTL1 Surface Mount to USTLR1 Recessed Mount, White
<b>USTSHIELD WH</b>	Solo-Task Shield, White
<b>USTSHIELD BL</b>	Solo-Task Shield, Black
<b>USTSNOOT WH</b>	Solo-Task Snoot, White
<b>USTSNOOT BL</b>	Solo-Task Snoot, Black



## Convenient Kits

Kits include three surface mount luminaires, plug-in driver/transformer, switch, wire and clips.

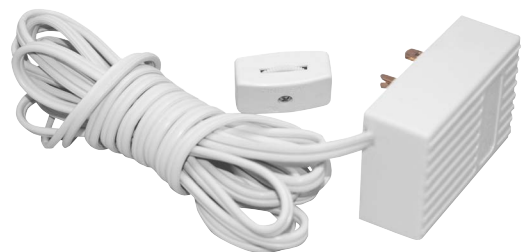



## Juno® Pro-Series Undercabinet Lighting

### LED Undercabinet Linear Solutions for Residential Use

High-quality design and performance, along with fast, trouble-free installation are the essence of our Pro-Series flagship modular system. Pro-Series LED models provide cool-to-touch, energy efficient operation, making them ideal for residential settings. The Pro-Series LED produces high quality illumination with unprecedented energy savings and a 50,000 hour service life. They are now available with an optional occupancy sensor.

All Pro-Series fixtures maintain a slim 1" extruded aluminum profile available in a variety of lengths and four designer finishes to complement any décor. The extrusion is optimally designed to dissipate heat, to both maximize life and minimize the cabinet contact temperature. A reverse-angled tempered glass prism lens\* hinges down for relamping and cleaning to provide the optimum mix of safety, simple maintenance, high light transmission and glare control. All these features and more are integrated into an attractive package that will provide years of high-quality, problem-free task lighting.

\*Except SoftTask™ models which utilize a polycarbonate diffuser.



# Installation

Pro-Series fixtures install in less than five minutes owing to their unique rear-wire access door and captive mounting screws that allow installation without having to open up the wireway or remove the lens. These fixtures include an integral driver that allows direct connection to 120-volt supply wires. Additional fixtures in a run simply plug into the first. The Pro-Series installation innovations turn one of the contractor's least favorite fixtures to install into a pleasure.



## Pro-Series 5-Minute Direct-Wire Installation



**Step 1** Attach supply wires to rear access cover.



**Step 2** Connect supply wires to fixture leads using push-in connectors.



**Step 3** Mount fixture to cabinet bottom using captive mounting screws



# Pro-Series LED vs. Pro-Series SoftTask™ LED

Pro-Series LED and Pro-Series SoftTask LED fixtures both provide quality, energy-efficient undercabinet lighting with an easy to conceal 1" profile. They also feature integral drivers, fast and easy installation, warm 3000K CCT with identical wiring, control and finish options. Traditional Pro-Series LED fixtures mimic the light levels and color of halogen, producing multiple points of light on the working plane. For those that prefer more uniform illumination, Pro-Series SoftTask fixtures produce an effect more comparable to fluorescent, free of multiple hot spots and shadows.

**Pro-Series SoftTask LED**



**Pro-Series Fluorescent**



# Juno® Pro-Series SoftTask™ LED



Juno Pro-Series SoftTask LED duplicates the light level of Fluorescent undercabinet lighting while consuming up to 45% of the energy. And by virtue of its amazing 50,000 hour life, lamp replacement is a thing of the past...at 4 hours/day you can expect over 34 years of maintenance-free operation!

## Accessories



### JC3 8IN, JC3 17IN, JC3 26IN – Jumper Cords

3-wire Jumper Cord to electrically join fixtures when spaced apart, turning corners, or spanning cabinet frames.

**Finish:** BL-Black, WH-Designer White



### UG6P – 6' Cord and Plug

3-wire grounded cord and plug accessory for portable plug-in installation.

**Finish:** BL-Black, WH-Designer White



### UDWMO – Occupancy Sensor Module

Direct wire Passive Infrared (PIR) Occupancy Sensor without on/off rocker switch. 6" L 4-1/2" D x 1" H

**Finish:** BL-Black, WH-Designer White



### UDWMO (WH, BL) RS – Occupancy Sensor Module

Direct wire Passive Infrared (PIR) Occupancy Sensor with on/off rocker switch. 6" L 4-1/2" D x 1" H

**Finish:** BL-Black, WH-Designer White



### UDWM – Direct Wire Module

Facilitates code-compliant installation of fixture at front edge of cabinet. Includes wiring enclosure and 36" field-shortenable jumper cord that plugs into the right or left side of the fixture. 3" L x 3" D x 1" H

**Finish:** BL-Black, WH-Designer White



### UGONN – 3/8" Miniature Die-Cast Electrical Connector

Accessory for use when loop wiring with non-metallic sheathed cable or BX.

## Ordering Information

Example: UPS22 30K 90CRI SL NS

Pro-Series SoftTask LED Fixture	CCT	CRI	Finish	Direct Wire/Portable	Control Options
<b>UPS09</b> 9" (9-1/2"L x 3-1/2"D x 1"H)	<b>30K</b> 3000K	<b>90 CRI</b> 90CRI	<b>WH</b> Designer White	<b>Blank</b> Direct Wire <b>6CP<sup>2</sup></b> Portable with 6' Cord & Plug	<b>Blank</b> Includes On/Off Rocker Switch <b>NS</b> No Rocker Switch <b>OC<sup>1</sup></b> Occupancy Sensor with Switch <b>OCN<sup>1</sup></b> Occupancy Sensor without Switch
<b>UPS14</b> 14" (14"L x 3-1/2"D x 1"H)			<b>BL</b> Black		
<b>UPS22</b> 22" (22"L x 3-1/2"D x 1"H)			<b>BZ</b> Brushed Bronze		
<b>UPS30</b> 30" (29-1/4"L x 3-1/2"D x 1"H)			<b>SL</b> Brushed Silver		
<b>UPS40</b> 40" (40"L x 3-1/2"D x 1"H)					

<sup>1</sup> Occupancy Sensor is available on UPS22, UPS30 and UPS40 only.

<sup>2</sup> UL Listed as portable when supplied from factory with cord & plug. UPS09 not available as portable.

## Finishes



Black



Brushed Bronze



Brushed Silver



Designer White

**Listings** UL/C-UL for damp locations

## Performance Features

- Utilizes warm-white 3000K LEDs tightly binned to within a 3-step MacAdam Ellipse for industry-leading color consistency, 90CRI minimum
- Approximates the color temperature and illumination levels of Fluorescent using up to 45% less energy
- 22", 30" and 40" fixtures are available with Passive Infrared (PIR) Occupancy Sensor. The PIR sensor can be field adjustable time delay that can be set from 30 seconds to 30 minutes. All additional fixtures connected to the fixture with occupancy sensor will be controlled by the single sensor
- Dimmable with the use of most forward and reverse phase dimmer – see specification sheet.
- No UV or forward projected heat

## Construction Features

- Slim 1" extruded aluminum profile
- Polycarbonate diffusing lens provides uniform illumination without hotspots
- Integral state of the art 120-volt constant current electronic driver
- Integral on/off rocker switch standard, available without switch as well
- Choice of Designer White, Brushed Silver, Brushed Bronze or Black finish

## Installation Features

- Modular design for maximum flexibility and quick installation allows up to 40 fixtures to plug together using the supplied internal straight connector or optional jumper cords
- Captive external mounting screws
- Rear wireway access cover with flush non-metallic cable clamp and push-in electrical connectors facilitate fast wiring without having to open fixture (14", 22", 30" and 40" only)
- Miniature die-cast fitting for flexible metal conduit, off-center knock-outs and extra mounting plate for feed-through fixture-to-fixture loop wiring increase installation versatility (14", 22", 30" and 40" only)

## Dimensions

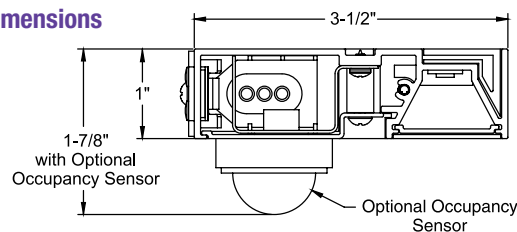







# Juno® Pro-Series LED



Juno Pro-Series LED duplicates the light level and color of Halogen undercabinet lighting using just 1/6 of the energy and virtually no heat. And by virtue of its amazing 50,000 hour life, lamp replacement is a thing of the past...at 4 hours/day you can expect over 34 years of maintenance-free operation!

## Accessories

- 
**JC3 8IN, JC3 17IN, JC3 26IN – Jumper Cords**  
 3-wire Jumper Cord to electrically join fixtures when spaced apart, turning corners, or spanning cabinet frames.  
**Finish:** BL-Black, WH-Designer White
- 
**U6CP – 6' Cord and Plug**  
 3-wire grounded cord and plug accessory for portable plug-in installation.  
**Finish:** BL-Black, WH-Designer White
- 
**UDWMOC – Occupancy Sensor Module**  
 Direct wire Passive Infrared (PIR) Occupancy Sensor without on/off rocker switch. 6"L 4-1/2"D x 1"H  
**Finish:** BL-Black, WH-Designer White
- 
**UDWMOC (WH, BL) RS – Occupancy Sensor Module**  
 Direct wire Passive Infrared (PIR) Occupancy Sensor with on/off rocker switch. 6"L 4-1/2"D x 1"H  
**Finish:** BL-Black, WH-Designer White
- 
**UDWM – Direct Wire Module**  
 Facilitates code-compliant installation of fixture at front edge of cabinet. Includes wiring enclosure and 36" field-shortenable jumper cord that plugs into the right or left side of the fixture. 3"L x 3"D x 1"H  
**Finish:** BL-Black, WH-Designer White
- 
**UCONN – 3/8" Miniature Die-Cast Electrical Connector**  
 Accessory for use when loop wiring with non-metallic sheathed cable or BX.

## Performance Features

- Utilizes warm-white 3000K LEDs tightly binned to within a 2-step MacAdam Ellipse for industry-leading color consistency, 80CRI minimum
- Approximates the color temperature and illumination levels of halogen using 1/6 of the energy
- 22" and 30" fixtures are available with Passive Infrared (PIR) Occupancy Sensor. The PIR sensor can be field adjustable time delay that can be set from 30 seconds to 30 minutes. All additional fixtures connected to the fixture with occupancy sensor will be controlled by the single sensor
- Dimmable with most incandescent, magnetic low voltage or electronic low voltage wall box dimmers
- No UV or forward projected heat

## Construction Features

- Slim 1" extruded aluminum profile
- Premium clear prismatic tempered glass lens for maximum light transmission and wipe down cleaning. Reversed angled to minimize perceived fixture brightness
- Hinged lens captured by spring loaded retention bar, lens cannot fall out
- Integral state of the art 120-volt constant current electronic driver
- Integral on/off rocker switch standard, available without switch as well
- Choice of Designer White, Brushed Silver, Brushed Bronze or Black finish

## Installation Features

- Modular design for maximum flexibility and quick installation allows up to 40 fixtures to plug together using the supplied internal straight connector or optional jumper cords
- Captive external mounting screws
- Rear wireway access cover with flush non-metallic cable clamp and push-in electrical connectors facilitate fast wiring without having to open fixture (14", 22", and 30" only)
- Miniature die-cast fitting for flexible metal conduit, off-center knock-outs and extra mounting plate for feed-through fixture-to-fixture loop wiring increase installation versatility (14", 22", and 30" only)

## Ordering Information

Example: UPLED22 30K 80CRI BL OCN

Pro-Series LED Fixture	CCT	CRI	Finish	Direct Wire/Portable	Control Options
<b>UPLED09</b> 9" (9-1/2"L x 4-1/2"D x 1"H)	<b>30K</b> 3000K	<b>80 CRI</b> 80CRI	<b>WH</b> Designer White	<b>Blank</b> Direct Wire	<b>Blank</b> Includes On/Off Rocker Switch
<b>UPLED14</b> 14" (14"L x 4-1/2"D x 1"H)			<b>BL</b> Black	<b>6CP</b> <sup>2</sup> Portable with 6' Cord & Plug	<b>NS</b> No Rocker Switch
<b>UPLED22</b> 22" (22"L x 4-1/2"D x 1"H)			<b>BZ</b> Brushed Bronze		<b>OC'</b> Occupancy Sensor with Switch
<b>UPLED30</b> 30" (29.25"L x 4-1/2"D x 1"H)			<b>SL</b> Brushed Silver		<b>OCN'</b> Occupancy Sensor without Switch

<sup>1</sup> Occupancy Sensor is available on UPLED22 and UPLED30 only.  
<sup>2</sup> UL Listed as portable when supplied from factory with cord & plug.

## Finishes



Listings UL/C-UL

## Dimensions

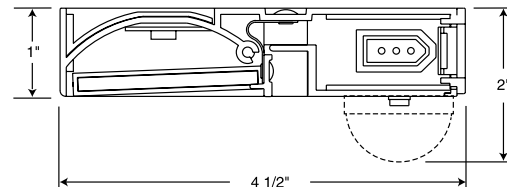





# Index

Catalog Number	Page	Catalog Number	Page	Catalog Number	Page	Catalog Number	Page
<b>Housings</b>		JSF.....	90	28.....	114, 116, 118	602.....	131, 135
2LEDDRIVER.....	39, 41	JSFSQ.....	91	29.....	114, 116, 118	603.....	135
2LEDTRIM.....	39, 41	LMS.....	143	39.....	45, 53, 61	604.....	131, 135
4RLS.....	87	MD1LG2.....	35	60.....	123	606.....	135
6RLS.....	87	MG1LG2.....	35	70.....	123	610.....	134
IC1.....	104	TC1.....	104	71.....	123	612.....	134
IC1 LEDT24.....	76, 82	TC18.....	103	104.....	147, 149	614.....	130, 134
IC113LED.....	146	TC19.....	103	203.....	109	616.....	134
IC115LEDHSG.....	145, 147	TC1R.....	104	204.....	55, 65, 109	617.....	134
IC115LEDPM.....	147	TC1RC.....	104	205.....	55, 65, 109	619.....	134
IC1ALED.....	49	TC2.....	113	206.....	109	620.....	130
IC1LED G4.....	60	TC20.....	108	207.....	109	688.....	109, 111
IC1LED WD G4N.....	52	TC20R.....	108	211.....	109	689.....	109, 111
IC1R LEDT24.....	76, 82	TC2R.....	113	215.....	109	835.....	147
IC1RALED.....	49	TC44.....	98	216.....	109	836.....	147
IC1RLED G4.....	60	TC44R.....	98	224.....	114	837.....	147
IC1RLED WD G4.....	52	TC47.....	98	226.....	114, 116, 118	838LED.....	145
IC2.....	113	TC4AL.....	44	228.....	114, 116, 118, 121	840.....	147, 149
IC20.....	108	TC4RAL.....	44	229.....	114, 116, 118, 121	2130.....	55, 65
IC20 LEDT24.....	77, 83	TC6.....	123	230.....	114, 119	2330.....	57, 67
IC20LED G4.....	64	TC7.....	123	231.....	117	4101.....	53, 61, 105
IC20LED WD G4N.....	54	TC926.....	134	232.....	114, 119	4102.....	53, 61, 105
IC20R.....	108	TC926R.....	134	233.....	114, 119	4103.....	53, 61, 105
IC20R LEDT24.....	77, 83	TC928.....	135	239.....	57, 67, 115, 117, 119	4104.....	53, 61, 105
IC20RLED G4.....	64	TC928R.....	135	240.....	114	4150.....	53, 61, 105
IC20RLED WD G4.....	54			241.....	117, 119, 121	4180.....	105
IC21.....	121	<b>Luminaires</b>		242.....	57, 67, 115, 117	4181.....	105
IC21R.....	121	SL212.....	156	243.....	57, 67, 115	4401.....	100
IC22.....	116	SL412.....	156	248.....	114, 116, 118, 121	4402.....	100
IC22LED G4.....	66	SLW212.....	158	249.....	114, 116, 118	4403.....	100
IC22LED WD G4N.....	56	SLW412.....	158	250.....	113, 116, 118, 121	4404.....	100
IC22RLED G4.....	66	SLW424.....	158	251.....	113	4450.....	100
IC22RLED WD G4.....	56	UK3STL.....	162	252.....	116	4480.....	100
IC23 LEDT24.....	71, 73	UPS.....	167	254.....	113	4481.....	100
IC23 LEDT24.....	78, 84	UPLED.....	168	257.....	113	5101.....	55, 65
IC23R LEDT24.....	71, 73	USTL1.....	162	261.....	114, 119	6033.....	131
IC23R LEDT24.....	78, 84	USTLR1.....	162	264.....	114, 117, 118	6101.....	57, 67
IC25.....	111			267.....	114, 117, 118	6330.....	130
IC25R.....	111	<b>Trims</b>		424.....	114	9024.....	57, 67, 115, 117
IC25R.....	116	10.....	105	427.....	114	9324.....	57, 67, 115, 117
IC44N.....	98	11.....	53, 61, 105	440.....	99, 105	9524.....	57, 67, 115, 117
IC4AL.....	44, 127	12.....	53, 61, 105	441.....	99	9702.....	57, 67, 115, 117
IC4RAL.....	44, 127	13.....	53, 61, 105	442.....	99	9900.....	115
IC6.....	123	14.....	53, 61, 105	443.....	99	12SQ.....	53, 61, 105
IC7.....	123	16.....	105	444.....	99	13SQ.....	53, 61, 105
IC926.....	134	17.....	53, 61, 105	445.....	99, 105	17HYP2.....	61
IC926LED.....	130	18.....	105	446.....	99, 105	17SQ.....	53, 61, 105
IC926LED WD.....	130	19.....	105	447.....	99	201N.....	109
IC928.....	135	20.....	57, 67	448.....	99, 105	204HYP2.....	65
IC928LED.....	131	21.....	57, 67, 115	449.....	99	204HYP3.....	65
IC928LED WD.....	131	22.....	57, 67, 115	454.....	101	208N.....	109, 111
ICTC113.....	149	23.....	113	457.....	101	209N.....	109, 111
J6RL.....	70	24.....	57, 67, 113, 116	458.....	101	210N.....	55, 65, 109
J6RL WD.....	70	25.....	113, 116	464.....	101	212N.....	55, 65, 109, 111
J6RLE.....	72	26.....	113	467.....	101	213G3.....	55, 65
J6RLE WD.....	72	27.....	57, 67, 113, 116	529.....	109, 111	244S.....	114, 116, 118, 121



Catalog Number	Page
247S	114, 116, 118, 121
262G3	57, 67
275S	111
276S	111
27HYP2	67
27HYP3	67
41L	45
41LSQ	45
42L	45
42LSQ	45
440SQ	99, 105
441SQ	99
443SQ	99
447SQ	99
45L	45
46L	45, 127
47L	45
47LSQ	45
48L	45, 127
4RLA	82
4RLD	76
5RLA	83
5RLD	77
6RLA	84
6RLD	78
J6RLTRIM DB	70
J6RLTRIM DC	70
JSFSHROUD	93
JSFSQSHROUD	93
JSFSQTRIM	93
JSFTRIM	93

**Accessories**

2JCTA150	39, 41
2NCMF	39, 41
4TSA	99, 104
56RLSRETROKIT	87
6CP	35, 162
ALG5	109, 111
ALG5R	109, 111
ALG6	113, 117, 119, 121
ALG6R	117
ALG926	134
ALG928	135
CGF 175 DLTBLUE	101
CGF 175 MAMB	101
CGF 175 MBLU	101
CGF 175 MGRN	101
CGF 175 MPINK	101
CGF 175 WRED	101
CGF 200 DLTBLUE	44, 49
CGF 200 MAMB	44, 49
CGF 200 MBLU	44, 49
CGF 200 MGRN	44, 49
CGF 200 MPINK	44, 49
CGF 200 WRED	44, 49

Catalog Number	Page
DCCF 175 HIDINC	101
DCCF 175 HL4250	101
DCCF 200 HL4250	44, 49
DGF 175 MBLU	101
DGF 175 CYAN	101
DGF 175 DRED	101
DGF 175 DYEL	101
DGF 175 MAGEN	101
DGF 175 MGRN	101
DGF 200 CYAN	44, 49
DGF 200 DRED	44, 49
DGF 200 DYEL	44, 49
DGF 200 MAGEN	44, 49
DGF 200 MBLU	44, 49
DGF 200 MGRN	44, 49
DIFF 175	101
DIFF 200	44, 49
DLDPS	156, 158
G2405	99, 104, 113
GU10WHIP	104
HCLBL 175	101
HCLBL 200	44, 49
LEDOPTIC2 FL	39, 41
LEDOPTIC2 NFL	39, 41
LEDOPTIC2 SP	39, 41
LEDOPTICG3 MFL	55, 57, 65, 67, 72
LEDOPTICG3 NFL	65, 67, 72
LEDOPTICG3 SP	65, 67, 72
LSPREAD 175	101
LSPREAD 200	44, 49
MAGXFMR	35, 162
PRISM 175	101
PRISM 200	44, 49
SL101P	156, 159
SL101TB	156
SL102FLX	156, 159
SL102X	156
SL102Y	156
SLCLIP	157
SLCUTTER	157
SLW101EC	159
SLW101TB	159
SLW102EE	159
SLW102X	159
SLWCLIP	159
SLWCUTTER	159
SM1	157
SM2	157, 159
SM3	157, 159
SM4	157, 159
SM5	157, 159
SM6	159
SMPLT4	99, 104, 109, 111
SOLITE 175	101
T599	104
TIR2 FLD	44, 49

Catalog Number	Page
TIR2 NFLD	44, 49
TIR2 SPT	44, 49
TL548	162
TL602E	35, 162
TR5	55, 65, 109, 111
TR6	57, 67, 113, 115, 117, 119, 121
UST18G	163
USTREC	163
USTSHIELD	163
USTSNOOT	163
UVF 175	101
UVF 200	44, 49
V6RLTRB	71, 72, 78, 84





**Juno**