

No Frost

For household use only

## Model



R-M700AGPRU4X

Thank you very much for purchasing the HITACHI refrigerator.  
Before using this please read the instruction manual carefully for the correct usage.

Maintenance work must only be carried out at workshop  
by well-trained maintenance worker

## Contents

Page

Preparation for Use	
Warnings and Cautions for Safety ..	2
Preparations before Use .....	5
■ Installation .....	5
■ Before Use .....	6
■ Optimal Food Storage .....	6
Operation	
Location of Food Storage .....	7
How to Use Glass Touch Panel and ECO Monitoring Sensor .....	7
■ Name and Functions of Display, Buttons, Each Component .....	7
■ ECO Monitoring Sensor .....	8
■ Temperature Control .....	8
■ Others function .....	9
· Quick Freezing .....	9
· Quick Cooling .....	9
· Child Lock .....	10
· Energy Saving .....	10
· Door Alarm ECO Alarm Functions .....	10
■ Auto Door .....	11
Freezer Compartment .....	12
Refrigerator Compartment .....	13
Vegetable Compartment .....	14
How to use the Ice Dispenser and Water Dispenser .....	15
■ Filling the Water Tank .....	16
■ How to use the Ice Dispenser .....	17
■ When using the Automatic Ice Maker..	17
■ How to use the Water Dispenser .....	18
■ Maintenance .....	19
Maintenance (General Matters) ....	21
■ How to Maintain Your Refrigerator ....	21
Part Removal .....	22
■ How to remove parts .....	22
■ Replacing Lamps inside the Refrigerator .....	23
■ Take urgent action when ice jams ....	23
Troubleshooting .....	24
■ First Check the Following .....	24
- General Problems .....	24
- Ice Dispenser and Water Dispenser .....	25
- Auto Door .....	27
■ What to do in these situation .....	27

R600a

Refrigerant

# Warnings and Cautions for Safety

To avoid harm to the user, other persons or damage to property, please read and follow the warnings and cautions below and those given throughout this manual.

The following warnings and cautions are categorized by the level of possible harm or damage that may occur from ignoring directions.

The symbols are shown as below clearly showing the significance of directions.



**Warning**

This pictograph indicates "There is high possibility of serious injury or death, if ignored".



**Caution**

This pictograph indicates "There is a high possibility of injury or damage to property if ignored".

The symbols below are examples.



This symbol is an alert mark.



This symbol indicates "prohibited".



This symbol indicates "necessary".

■ This refrigerator uses flammable refrigerants. The symbol column below states the precautions on flammable refrigerants.



This symbol denotes the precautions on flammable refrigerants.

## Warning

**When you install ... To avoid fire, electric shock, and injury.**

- Do not install the refrigerator in a place where it may come in contact with water.
  - Do not install the refrigerator in a place exposed to rain.
  - This may impair electricity insulation and cause electric shock or fire.
- 
- 
- Ground this refrigerator to prevent electric shock and noise interference. Always ground this refrigerator and install earth leakage circuit breaker when using it in places with high humidity or moisture. (Please consult with a retailer or HITACHI service center.)
- 

**Power Cord and Power Plug ... To avoid fire, electric shock.**

- Do not connect the refrigerator plug to any wall outlet whose power capacity is less than the refrigerator's. Also, do not use power sources that are not a rated voltage.
  - If a power source is shared with other appliances using double or multipoint adapters, the adapter may heat up beyond the normal level and cause fire.
- 
- 
- Connect the power plug firmly to a power outlet with the cord running down.
  - Connection of the power plug with the cord running up could apply stress on the cord and cause electrical short or overheat, which could result in electrical shock or fire.
  - Incomplete connection of the power plug could result in electrical shock or fire due to heat.
- 
- Do not use a damaged or loose power plug or power outlet. This may cause fire or electric shock.
  - If the supply cord is damaged, it must be replaced by the manufacturer, its service agent or similarly qualified persons in order to avoid a hazard.
- 
- 
- Do not cut, bend, fold the power cord to avoid fire and electric shock.
  - Clean the dust on the power plug frequently with a dry cloth.
  - Unplug the power plug and wipe it with a dry cloth.
  - An insulation failure due to moisture, when dust collects on the power plug, may cause fire.
- 
- Do not insert or remove the power plug with wet hands.
  - Be sure to unplug the power plug before maintaining the refrigerator. (P.21)
  - Be sure to hold the power plug to unplug.
- 
- 

**During daily use ... To avoid fire, electric shock.**

- Do not splash water on or inside the refrigerator.
  - This may impair electricity insulation causing electric shock or fire.
  - This may also cause the gas leakage because of pipe rust.
- 
- Do not put water containers or foreign articles on the top of the refrigerator.
  - Opening and closing doors etc. may cause the articles on the top of the refrigerator may fall down, resulting in injury.
- 
- Do not disassemble, repair, or modify your refrigerator by yourselves.
  - Please consult with a retailer if any repair is required.
  - Do not use the refrigerator in the atmosphere of flammable gas.
  - Sparks from points of electrical contacts such as door switches may ignite a fire.
- 
-

# ⚠ Warning

## During daily use ...To avoid fire, electric shock. (Continuance)

- |   |  |
|---|--|
| <p> Do not use other electrical appliances in the food storage compartment, unless it is the type recommended by the manufacturer.</p>  | <p> Do not use mechanical devices or other means to accelerate the defrosting process, other than those recommended by the manufacturer.</p>   |
| <p> Do not damage the refrigerant circuit.</p>  | <p> Keep ventilation openings in the appliance enclosure or in the built-in structure, clear of obstruction.</p>   |
| <p> This appliance is not intended for use by persons (including children) with reduced physical, sensory or mental capabilities, lack of experience and knowledge, unless they have been given supervision or instructions concerning use of the appliance by a person responsible for their safety.</p>         | <p> Children should be supervised to ensure that they do not play with the appliance.</p> <ul style="list-style-type: none"> <li>● Children getting inside may not be able to get out.</li> </ul>  |
| <p> Do not hang on the doors or step up on the various compartments.</p> <ul style="list-style-type: none"> <li>● Injury may be caused by the refrigerator tipping over or hands getting caught in door.</li> </ul>   | <p> Medicines, chemicals, research and experimental substances should not be stored in the refrigerator.</p> <ul style="list-style-type: none"> <li>● Substances that require precise conditions for storage cannot be stored in a domestic refrigerator.</li> </ul> |
| <p> Ether, liquid propane gas, solvent, etc. which volatile cannot be stored in this refrigerator.</p> <ul style="list-style-type: none"> <li>● Do not store explosive substances such as aerosol cans with a flammable propellant in this appliance.</li> </ul>  | <p> If you find something wrong with the refrigerator, immediately unplug and consult with the retailers.</p>  |
| <p> In the event of a flammable gas leak, do not touch the refrigerator and open windows to ventilation.</p>  | <p> When replacing the refrigerator interior lamp, unplug the power cord. Use the specified lamp and fix it firmly when replacing. (P.23)</p>  |
| <p> Do not make an impact on the glass-made doors or shelves.</p> <ul style="list-style-type: none"> <li>● They are made of tempered glass; however, an excess impact may result in breakage, and is dangerous.</li> </ul>  | <p> Do not put your hands into the Ice Bank of the Ice Dispenser.</p> <ul style="list-style-type: none"> <li>● The Ice Dispenser mechanism revolves and may result in injury.</li> </ul>   |
| <p> Do not continue using the refrigerator with the Ice Bank being detached.</p> <ul style="list-style-type: none"> <li>● The Ice Dispenser mechanism revolves and may result in injury.</li> </ul>   | <p> Do not touch the mechanism of the automatic ice maker.</p> <ul style="list-style-type: none"> <li>● There is a danger of injury when the mechanism is working.</li> </ul>  |
| <p> Do not damage the refrigerant circuit.</p> <ul style="list-style-type: none"> <li>● If you happen to damage the refrigerant tube, stay away from the refrigerator and avoid using fire and electrical appliances.</li> <li>● Open the window to ventilate and contact retailers or service center.</li> </ul> |  |

- When an infant child may use the Auto Door to make mischief, please stop the Auto Door function.
- 

## When discarding the refrigerator.





- |   |  |
|---|--|
| <p> Follow the instructions of your region when discarding.</p> <ul style="list-style-type: none"> <li>● This refrigerator uses R-600a for the refrigerant and cyclopentane for the blowing agent of the urethane heat insulation.</li> </ul> | <p> When discarding the refrigerator, remove the door gaskets.</p> <ul style="list-style-type: none"> <li>● To avoid a risk of an infant or child to be entrapped inside.</li> </ul> |
|---|--|

# Warnings and Cautions for Safety



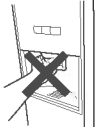

To avoid harm to the user, other persons or damage to property, please read and follow the warnings and cautions below and those given throughout this manual.

## ⚠ Caution

During daily use ...To avoid illness and injury.

- 
  - Do not put bottles, etc. forcibly in the door pockets.
  - This may cause bottles dropping down or door pockets coming off.
- 
  - Do not have food items protruding over the front edge of each shelf.
  - Doors may not be closed properly or the door pockets may drop down. Injury may be caused from items like bottles falling and knocking over your feet.
- 
  - Do not store food which smells or food whose color is changed abnormal.
  - Such an action may cause diseases.
- 
  - Do not store glass bottles in the freezer compartment.
  - Bottles may break by the contents freezing and cause injury.
- 
  - Food and containers inside the freezer compartment should not be touched with wet hands.
  - This may cause frost injury. (Especially in case of metal items.)
- 
  - Do not put your hands into the bottom surface of the refrigerator cabinet.
  - When cleaning, putting your hands near the bottom surface of the refrigerator may result in injury by thin metal sheets.
- 
  - Do not hold the top, bottom and side of the doors when closing them.
  - This may result in your fingers caught by the door edge.
- 
  - Be sure to hold the handle firmly to open and close the door.
- 
  - If someone else is using the refrigerator, do not open or operate the control panel.
  - Fingers may get caught in the spaces between the doors and may cause injury.
- 
  - Do not have your feet too close when opening the door of the refrigerator.
  - When opening the door, your feet may be hit, resulting in injury.
- 
  - Do not store food or foreign articles in the Ice Bank of the Ice Dispenser. Also, be careful not to let them go in.
- 
  - Do not put your fingers into the ice outlet, or do not touch the components around the opening.
- 
  - Be careful not to operate the Auto Door when another person is in front of the refrigerator, which may lead to personal injury unexpectedly caused by the opening door.

When moving or carrying ...To avoid damaging, wetting, soiling the floor, or to avoid injury.

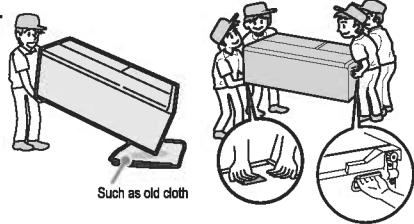
- 
  - Do not use door handles when carrying the refrigerator.
  - Never use the carrying handles to hang up with a chain hoist or similar machines.
- 
  - On a floor that is easily scratched do move the refrigerator using the wheels at its base.
  - For a floor that may be easily scratched, lay a protective mat, etc. .
- 
  - Use the carrying handle when carrying the refrigerator.
  - Hold the carrying handles only. If you hold door handles, your hands may slip and may cause injury.
  - More than 4 persons should carry the refrigerator for safety reasons.
  - Carry it with the doors facing upward.
  - Before carrying the refrigerator:
    1. Take out the food items and ice cubes.
    2. Dispose of the water in the evaporating tray located in the bottom of the refrigerator.
    3. Place the protective mat or cloth on the floor on which you move.
    4. Finally carry the refrigerator with the doors facing upward.
  - Secure the doors well with adhesive tapes so they do not open.
  - If transporting in a vehicle, do not load the refrigerator on its side. This could damage the compressor.

Such as old cloth

# Preparations before Use

## Installation

### 1. Check the width of the doors of the house.

- Following shows the installation dimensions for this refrigerator. Be sure to check if you with refrigerator can pass the house doors.
- The refrigerator doors may have to be removed if the width or depth of the refrigerator are more than the width of the house doors.
- To remove the refrigerator door, please consult with the retailer.

### 2. Install the refrigerator in the following place.

- Install on a rigid and level floor.
    - If you install on a such a floor, place a wood board (1 cm thick) and place the refrigerator on the board.
    - In case that the floor may be deformed or floor color may be changed due to a heat from the refrigerator.
    - In case of soft or fragile floors on which the refrigerator might incline.
  - Do not install where the refrigerator is exposed on a direct sunlight or other heat sources.
    - Such circumstances may result in poor cooling performance or electricity costs increase.
    - Direct sunlight will cause discoloration of the plastic parts of the refrigerator.
  - Install in a atmosphere which is dry or has air ventilation.
    - This helps to avoid rusting and keeps electricity costs down.
- \* If you wish to install the refrigerator in a hot spring area exposed to sulfide gas, you may need to apply anti-rust treatment to the piping. Contact your dealer in advance. A failure caused by that gas damage will not be covered under guarantee.

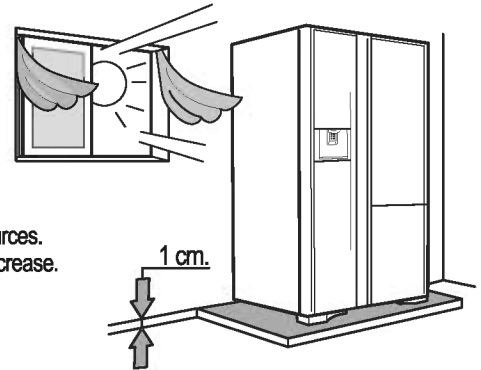

### 3. Allow enough space to release heat.

- The refrigerator requires enough air ventilation space around the cabinet to have efficient cooling performance.
  - At least 5 cm space must be secured for the left/right, top and back side of the refrigerator to the wall.
- To ensure that the doors can open properly and fully, make sure that the following space is available. Check the available space before installation.

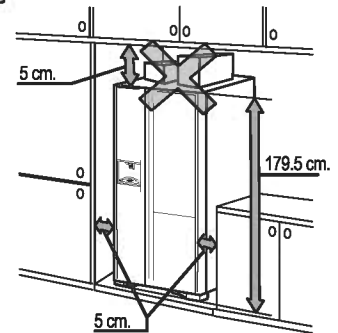
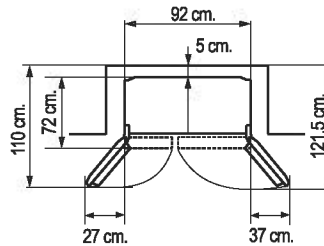

### 4. Earthing wiring.

- Ground this refrigerator to prevent electric shock and noise interference. Always ground this refrigerator when using it in places with high humidity or moisture. (Please consult with retailers.)

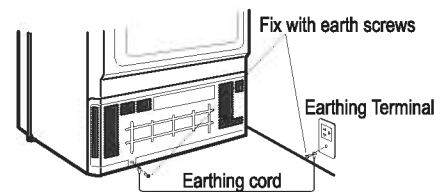

## Warning

Do not connect the ground line to a gas pipe, telephone line or lightning rod.

### 5. Adjusting the adjustable legs to keep the left/right refrigerator door level.

- Without adjusting the legs, door height may not be level, or there may be abnormal vibration or noises depending on floor conditions. Follow the instructions below.

- ① Turn the adjustable legs to lower the adjustable legs until they touch the floor firmly.
  - ② Compare the height of left and right doors and lower adjustable leg whose door height is lower than the other until the both door height become level.
    - Turn the adjustable leg for 1 turn makes approx. 1 mm door height change.
    - It will take several days until the legs fits the floor and the door height becomes stable.
- In case that the adjustable legs are difficult to turn:
    - Remove 2 screws and then remove the adjuster cover.
    - Insert a screw driver to a groove of the adjustable leg and turn.

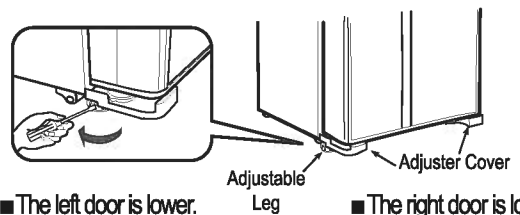

■ The left door is lower.

■ The right door is lower

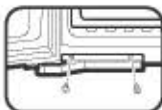
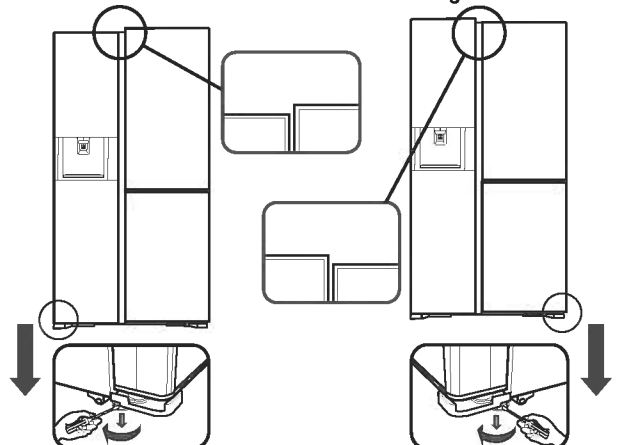

Remove 2 screws (both sides)

Lower the left adjustable leg

Lower the right adjustable leg

# Preparation before Use (Continued)

## Before Use

A refrigerator is not an appliance that increases the freshness of food but an appliance to brake the food being spoiled to some extent. Please follow the User's Guide carefully and take proper actions to keep food fresh.

### 1. Cleaning inside the refrigerator.

- Wipe the surface gently with wet soft cloth.

### 2. Connect the refrigerator to an exclusive wall power outlet.

- The refrigerator can be connected to an outlet soon after it is installed.
- Surely use with the rated voltage and exclusive power outlet.



### Notice

- 30 seconds after the power is connected, the compressor will start.

### 3. Allow enough duration for sufficient cooling before storing food.

- It may take about 4 hours to fully cool down and could even take about 24 hours when the ambient temperature is high.

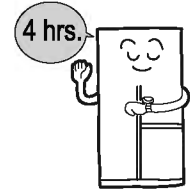

## Optimal Food Storage

### Keep enough space between food.

- Several food placed too close together may obstruct the flow of cold air. Keep enough space.



### Make food cool enough before putting it in the refrigerator.

- Putting warm food in the refrigerator raises the inside temperature and wastes electricity.



### Do not block the Cold Air Vent.

- This will adversely affect the cool air flow and may not keep the temperature inside even. Moreover, it could result in food near the vent freezing.



### Keep the food wrapped or sealed and store.

- Using food wrap or sealed containers prevents the food from drying or transition of smells.



### Keep food hygienic.

- A surprising amount of unhygienic substances can be found on food.

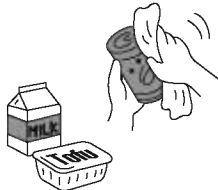

### Do not place warm food on the already chilled food.

- This will warm up the already chilled food.



# Location of Food Storage

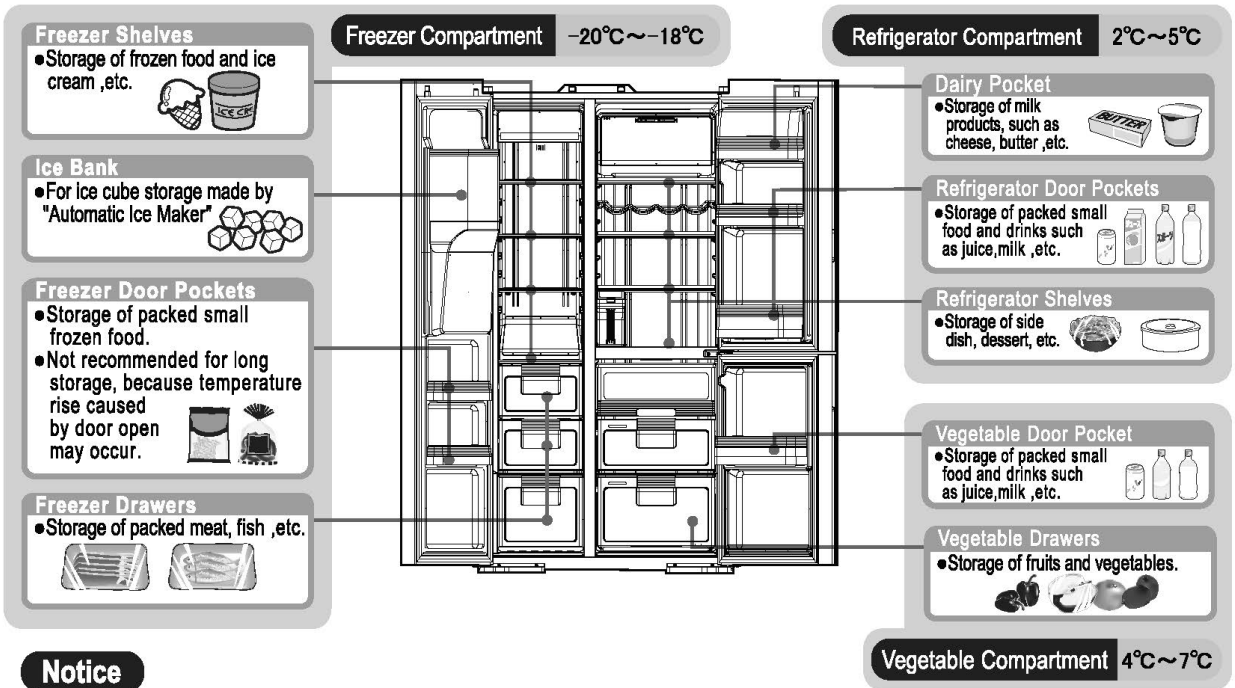

## Notice

- Above temperatures are the approximate values in the conditions of outside temperature  $32^{\circ}\text{C}$ , the setting of the refrigerator compartment, freezer compartment while doors being closed and without food storage is shown in the table.
- Door pocket temperatures may be little higher than above temperatures.

# How to Use Glass Touch Panel and ECO Monitoring Sensor

## Names and Function of Display, Button, Each Component.

The Control Panel is a touch panel made of glass. To change a setting, Just touch and switch the setting.

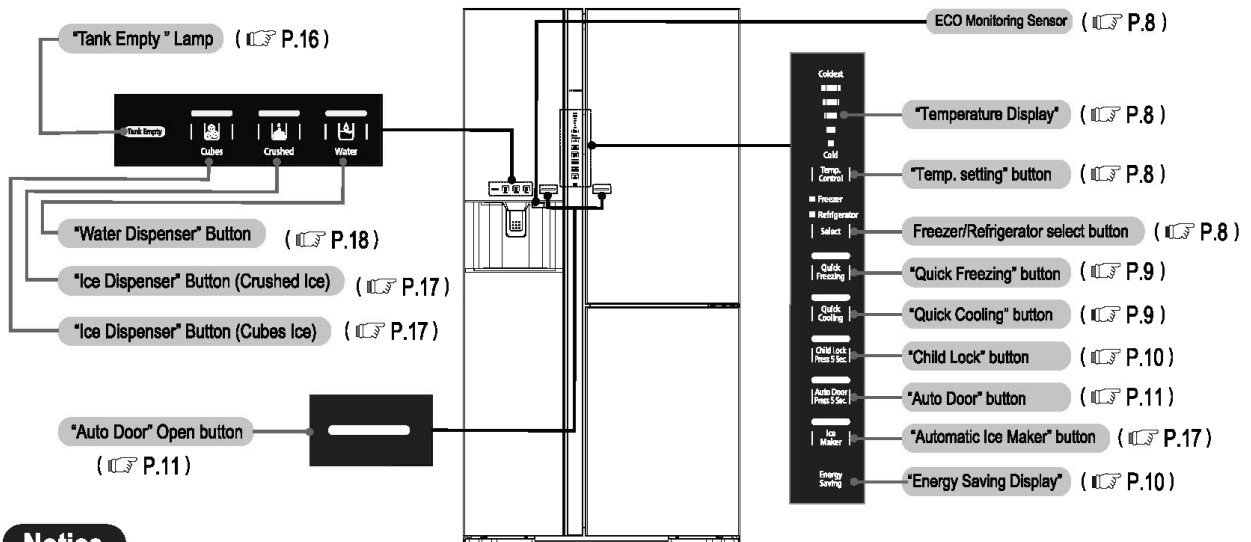

## Notice

- If you unplug the power plug or a power failure occurs and then the refrigerator restarts, the temperature display and each setting will be automatically resumed.
- Approximately 10 sec. after the end of operation, indicator LED become unlit.
- Responses of the touch panel may change depending on the surrounding temperature, humidity, physical condition of the user or operation status of the adjoining electric product.
- The panel may not respond if it is wet or dirty.

# How to Use Glass Touch Panel and ECO Monitoring Sensor (Continued)

## ECO Monitoring Sensor

- The controller section is displayed automatically only when the refrigerator is used and provides guidance in a user-friendly manner.

ECO Monitoring Sensor

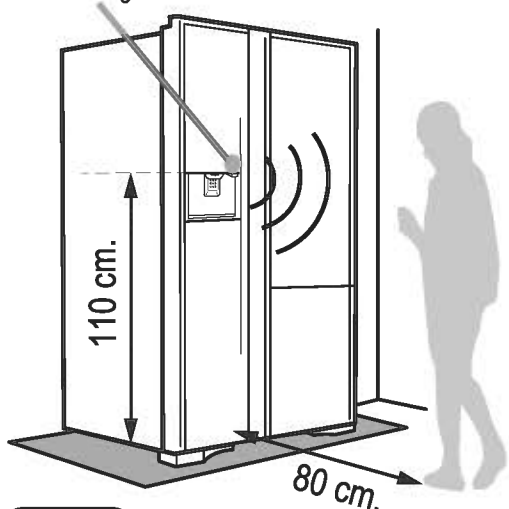

### Nobody else

when nobody is near the refrigerator, control panel is not displaying

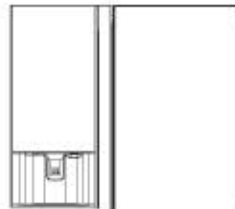

Lamp lights off.

### When somebody approach

When somebody comes to the front of refrigerator in ECO monitoring zone (about 80 cm.), control panel is displaying automatically.

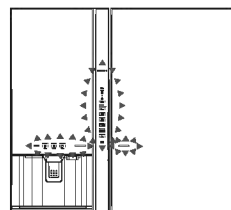

Lamp lights on.

### Caution

- Avoid placing the refrigerator in the hallway or areas where the most people walk through it.
- ECO Monitoring Sensor can detect people near refrigerator only.
- If the sensor cover is dirty, it may cause sensor error. Always clean it with a dry cloth.
- Do not put anything in the detecting area.

### Notice

When the ECO Monitoring Sensor does not work, you can light up the touch screen button as follows

- Touch any on button area (water ice dispenser or control area)
- Push the water / ice dispenser
- Open any door.

## Temperature Control

- The initial temperature setting of the refrigerator compartment is level 3, and one of the freezer compartment is level 3.
- The temperatures displayed on the control panel are targeted temperatures, and may not be actual. The actual temperature is subject to food and ambient conditions.

### Freezer Compartment



Refrigerator



Press "Select" button  
"Freezer" lamp light is on.

Press "Temp." button  
to setting a temperature

When storing neither frozen food nor ice cream.	For normal use.	When making ice quickly or making frozen food quickly. Or, a surrounding temperature is high and the Freezer compartment is not cold enough.
<p><b>Cold</b></p> <p>( Sound " Pi " )</p>	<p><b>Normal</b></p> <p>( Sound " Pi Pi " )</p>	<p><b>Coldest</b></p> <p>( Sound " Pi " )</p>

The display is indicating the status of temperature setting.

### Refrigerator Compartment

Freezer

Refrigerator



Press "Select" button  
"Refrigerator" lamp light is on.

Press "Temp." button  
to setting a temperature

When the food is too cold	For normal use.	When cooling food more coldly or quickly
<p><b>Cold</b></p> <p>( Sound " Pi " )</p>	<p><b>Normal</b></p> <p>( Sound " Pi Pi " )</p>	<p><b>Coldest</b></p> <p>( Sound " Pi " )</p>

The display is indicating the status of temperature setting.



## Other Functions

### "Quick Freezing"

■ When you wish to store frozen food at a lower temperature than usual, use this button.

1. Put food on the quick Freezing corner.

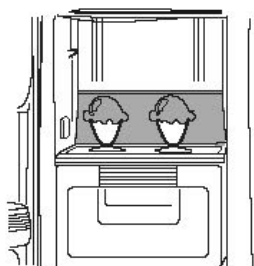

"Quick Freezing" corner is located on the carter shelf in front of freezer fan.

2. Press "Quick Freezing" button, and start operation of "Quick Freezing".

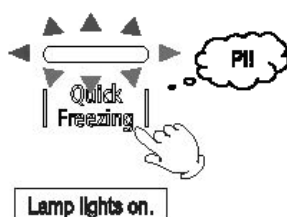

3. Press again "Quick Freezing", and stop the operation.

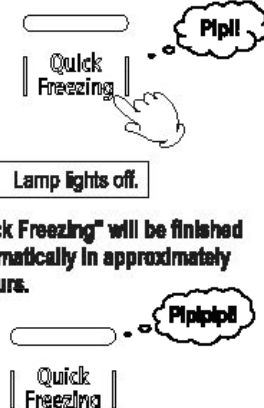

#### Notice

- During "Quick Freezing", priority cooling of the freezer compartment will be done. Thus, try to avoid unnecessary opening and closing the doors not to have a temperature rise of the refrigerator compartment.
- After "Quick Freezing" is automatically finished, if the button is pressed again, the lamp will turn on, however, the next "Quick Freezing" operation will not start. After 60 minutes, the operation will be started again.
- During defrost periods, even if "Quick Freezing" lamp is on, no operation will be made. After finishing the defrost operation, "Quick Freezing" will be automatically started.
- Normally, Lamp is off when no operation approximately 10sec. after the end of operation. Indicator LED become unit.

### "Quick Cooling"

■ When you want to cool food or drinks quickly, use this function.

1. Put food on the quick cooling corner.

"Quick Cooling" corner is located on the upper part of the refrigerator compartment.

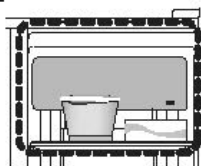

"Quick Cooling" is more effective if food is placed near the back wall of the refrigerator compartment.

2. Touch "Quick Cooling" button to start operation.

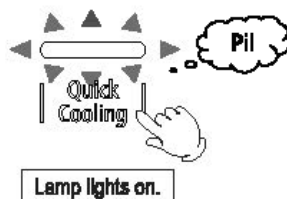

3. To stop this function before it is completed, touch "Quick Cooling" again.



"Quick Cooling" will be finished automatically in approximately 90 minutes.



#### Notice

- During defrost period, "Quick Cooling" operation will stop even when the lamp lights on. After finishing its period, the operation will restart automatically.
- Please note "Quick Cooling" mode will be released after power cut off or unplug.
- Normally, Lamp is off when no operation approximately 10sec. after the end of operation. Indicator LED become unit.

## Other Functions (Continued)

### “Child Lock”

■ You can prevent mischief of all the buttons on the control panel by children.

1. Press “Child Lock” button for 5 seconds(to lock).

2. To stop this function , press 5 seconds “Child Lock” again.

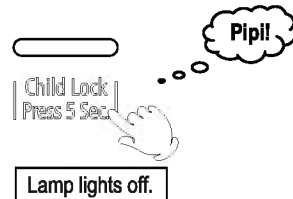
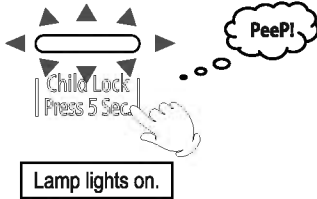

#### Notice

- When “Child Lock” is activated, other buttons will not be accepted even if you press, but Auto Door of the touch operation is possible.

### “Energy Saving”

■ Energy saving function will operate automatically as below conditions.

1. Mode “Energy Saving” ON



- No ECO Monitoring sensor detection.
- No door open
- No control panel operation.
- No Water/Ice Dispenser operation.

2. Mode “Energy Saving” OFF



- Door open.
- Control panel operation
- Water/Ice Dispenser operation.

#### Notice

- Mode “Energy Saving” ON will operate automatically as below conditions finished in approximately 24 hours.
- After a long time operation of “Energy Saving” ON, in some cases, fatty ice cream ,etc., may become soft.
- In case the compartment temperature rises up, the operation will be back to a normal setting temporarily.

#### Caution

- If “Energy Saving” operation is working in high humidity environment, dew may appear on refrigerator surface.

## Door Alarm and ECO Alarm Functions

■ If the door is left open for more than 1 minute, the alarm system will inform the user by the sound and digital display.

- Door Alarm: Informs by Peeppeeppeep sound.
- Eco Alarm Display: Indicates the door opening state on the control panel.

Duration of Door Opening	Door Alarm Sound	ECO Alarm Display
After 1 minute	PeepPeepPeep	All LED on display - are Flashing
After 2 minute	PeepPeepPeepPeepPeep	
After 3 minute	Peeps continuously.	

#### To Disactivate Alarm and Sound

1. Keep pressing “Quick Freezing” button for approximately 5 seconds until the sound of “Peep!” is heard.

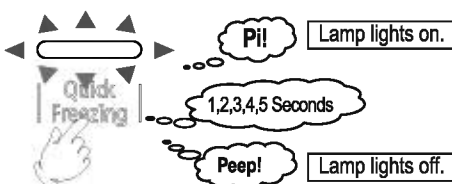

#### Notice

- Upon shipment, the alarm and sound are set “ON”.
- In case of Door Alarm, Eco Alarm Display and each button operation sound was deactivated. If we unplugging and inserting the power plug or in the event of a power failure the refrigerator will still set the alarm and sound to “OFF”.

#### To re-activate Alarm and Sound

1. Keep pressing “Quick Freezing” button for approximately 5 seconds until the sound of “Pipi!” is heard.

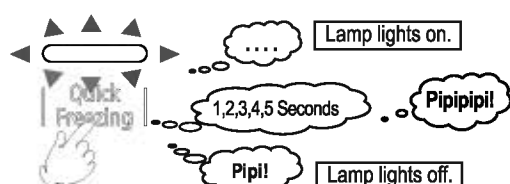

## Auto Door

You can open the door easily by touching the door lightly with your fingers thanks to the Auto Door function.

Control Panel for the Auto Door (Automated).

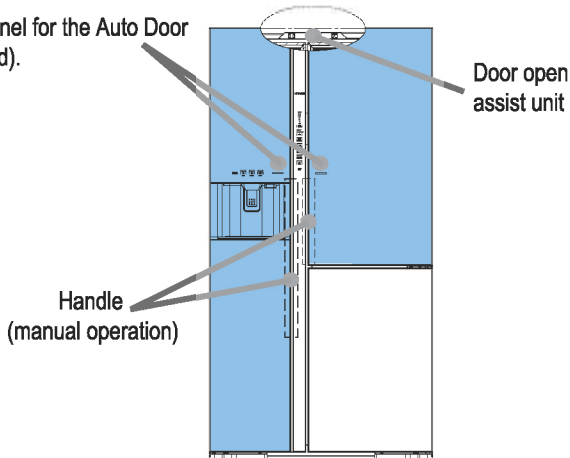

### Caution

- When an infant child may use the Auto Door to make mischief, please stop the Auto Door function.
- Use fingers to operate the control panel.
- Do not operate the Auto Door when another person is in front of the refrigerator or opening door (which may lead to personal injury unexpectedly by the opening door.)
- Be sure to unplug the power before cleaning the Auto Door.
- Do not put any item on the refrigerator.

## Setting the "Auto Door"

You can prevent mischief of all the buttons on the control panel by children.

1. To activate this function, press 5 seconds "Auto Door"

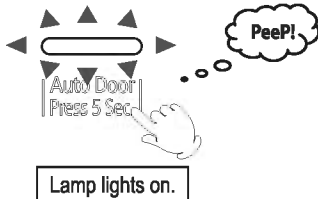

2. To stop this function, press 5 seconds "Auto Door" again.

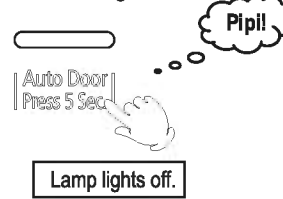

### Notice

- When an infant child may use the Auto Door to make mischief please stop the Auto Door function.

## Using the "Auto Door"

When touching the open button for the Auto Door, the operation sound is heard, and then it will open automatically. When closing it, use the handle with your hand to do so (not electrically operate).

1. Opening one door on either side.

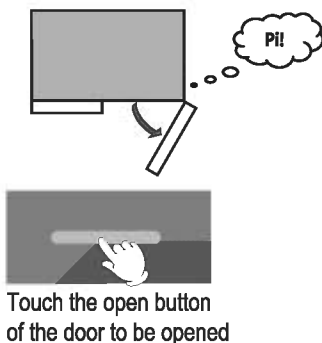

2. Opening both doors at a time.

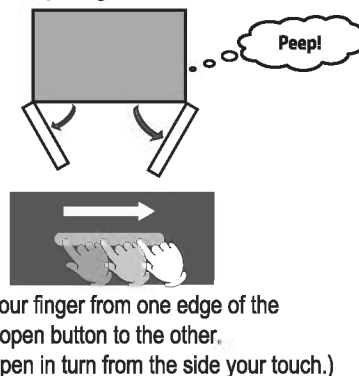

### Notice

- Auto door is the function to reduce the load at the opening operation when opening the refrigerator door. Opening angle of the door may vary or the door may go back a little after it is opened automatically depending on installation conditions of the refrigerator how beverages or foods are stored in the door pocket, but this is not malfunction.
- Auto Door of the Refrigerator Compartment will not be open, When door of vegetable compartment opened.
- After touching the open button for the Auto Door, the operation sound may be heard when opening the door, but this is not malfunction.
- If open button for the Auto door is wet or dirty, it may not respond. Use wet cloth to wipe off dirt, and then wipe it with a dry cloth.
- If you touch the open button for the Auto Door and its neighbouring part at the same time, or you touch it for about one second or more, the Auto Door may not be opened automatically.

# Freezer Compartment

■ The 4 shelves in the upper part and the 3 drawers in the lower part of the freezer compartment allow you to organize your food by size and intended use.

■ Please read ( P.8 ) for information on temperature control.

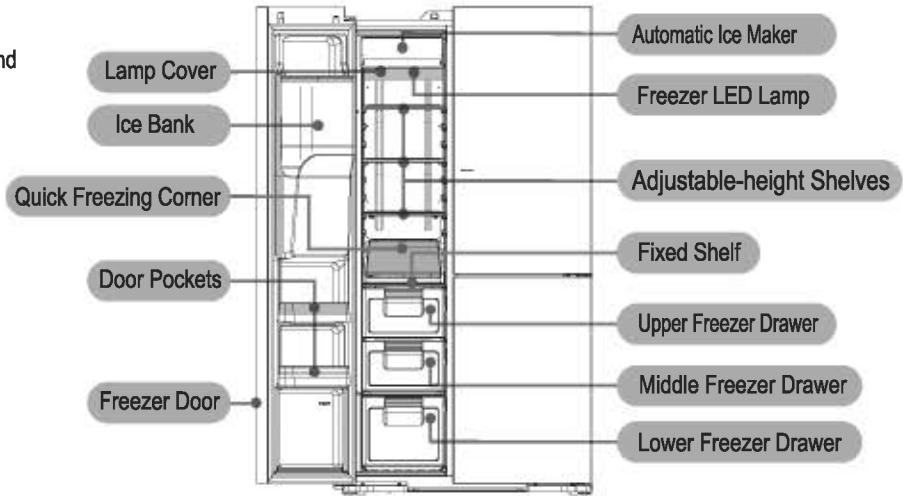

## Quick Freezing

- Use this function to freeze your home food or to make ice quickly.
  1. Place food in the "Quick Freezing Corner" on the center shelf. ( P.9 )
  2. Touch the "Quick Freezing" button.



## Adjustable-height Shelves

- These shelves can be adjusted to match the height of your frozen food and the way in which they are to be used.
  1. Remove the frozen food stored on the shelf.
  2. Lift the front of the shelf upward slightly, then pull the shelf out towards you.
  3. Adjust the shelf to the desired height, then push the shelf in until it reaches the back of the slot.

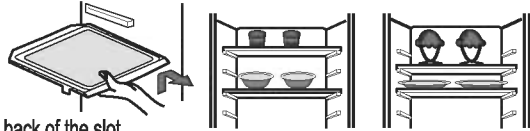

## Freezer Drawers

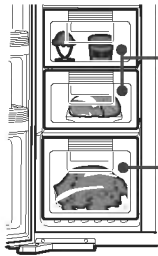

- The freezer drawers can store food separately according to size or way in which they are to be used.
  1. Upper / Middle Freezer Drawer for storing ice cream or freezer bags.
  2. Lower Freezer Drawer for storing large frozen food items.

### Caution

- When closing the freezer door, be sure that each freezer drawer is pushed all the way in. If the freezer door is closed while a drawer is still out, the freezer drawers might be damaged.

### Caution

- To avoid smell transition of food, always either wrap meat or fish, or store it inside a freezer bag. Also, note that there are cases where fat in meat or fish causes the plastic refrigerator components to split.
- When putting food into the freezer compartment, try not to strike the lamp cover with the food. The lamp cover might break.

# Refrigerator Compartment

- The upper part of this compartment has 4 shelves, and the lower part has 3 drawers. You can separate food by size and the way in which it is to be used.

- For information on temperature control read. ( P.8 )

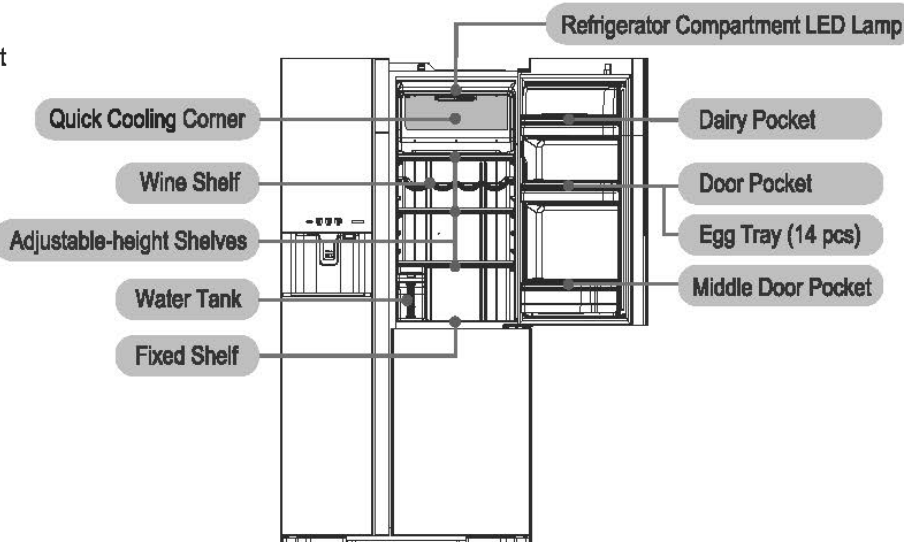

## Adjustable-height Shelves

- The height of these shelves can be adjusted to match the height of your food and the way in which they are to be used.
  1. Remove all food stored on the shelf to be.
  2. Lift the front of the shelf upward slightly, then pull the shelf out towards you.
  3. Adjust the shelf to the desired height, then push the shelf in until it reaches the back of the slot.

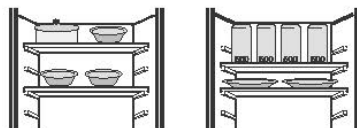
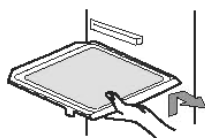

## Quick Cooling

- Use this function to cool the food or drinks stored inside rapidly.
  - 1 Place the food in the "Quick Cooling Corner" on the top.
  - 2 Press the "Quick Cooling" button. ( P.9 )

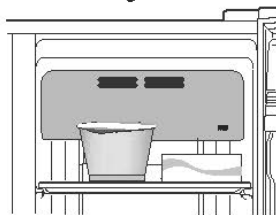

## Dairy Pocket

- Can be use to store butter, cheese or milk products.

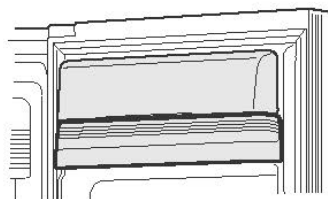

## Egg Tray

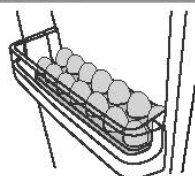

Egg Tray (Placed normally)

- Store eggs in the egg tray. (This tray holds up to 14 eggs.)

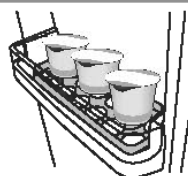

Egg Tray (Placed upside down)

- When turned over, the egg tray can be used as a pocket for small items.

## Caution

- Do not place moist food in front of the cold air outlet, as this may cause food to freeze. Moist food stored such that it comes into contact with the back left wall of the refrigerator might also freeze. Keep food slightly separated from the left side wall of the refrigerator.
- When putting food into the refrigerator, try not to strike the lamp cover with the food. The lamp cover might break.
- Let hot cooked food cool down before placing it into the refrigerator. The plastic components inside the refrigerator might be deformed.

# Vegetable Compartment

- Store vegetables efficiently according to their size and shape.

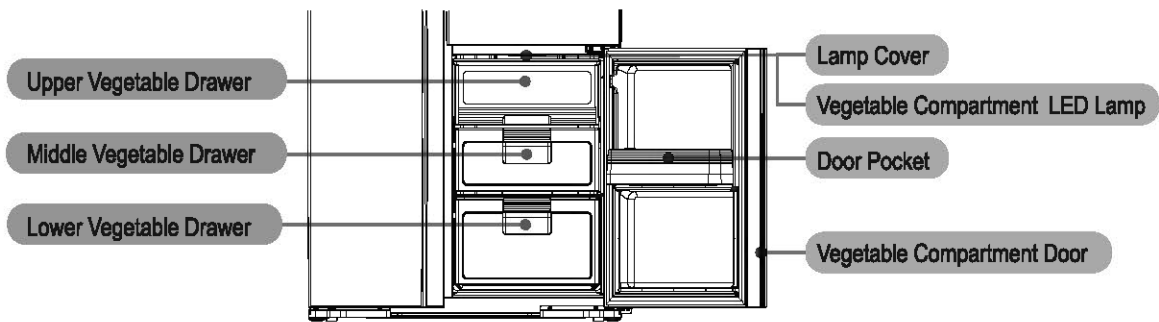

## Vegetable Drawers

### ■ Upper Vegetable Drawers

- Store partially used vegetables or small vegetables such as tomatoes or lemons. This drawer has a door, so it can be opened and closed easily.

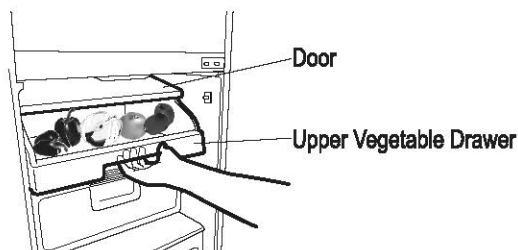

### ■ Middle and Lower Vegetable Drawers

- Store medium and large-sized vegetables such as cabbage and lettuce.

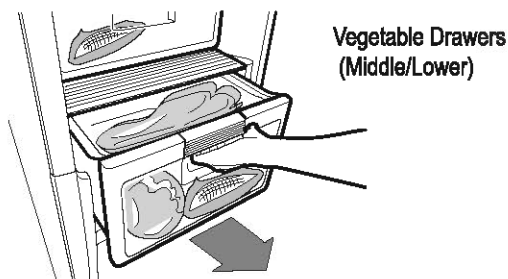

### Wrap vegetables in the following situations.

- When storing strong-smelling vegetables or when you are worried that odors might spread to other food
- When storing partially used vegetables or fruits
- When you are concerned about condensation inside the drawer
- When there are few vegetables or many packaged vegetables

### Notice

- Depending on the amount and type of vegetables stored, condensation might form inside or on the ceiling of the vegetable drawers. Wipe off any condensation with a dry cloth if this becomes a concern.

### Caution

- When closing the vegetable compartment door, be sure that all vegetable drawers are pushed all the way in. If the vegetable compartment door is closed when a drawer is pulled out, it might be damaged.

## Door Pocket (Vegetable Compartment)

- This pocket is convenient for plastic bottles or temporarily stocking beer.

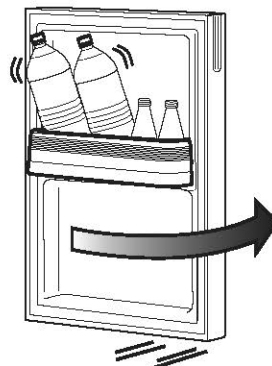
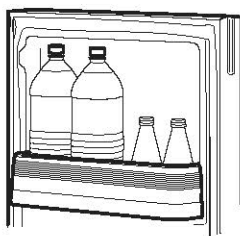

### Caution

- Open and close the vegetable compartment door slowly. If you open or close this door with too much force, the plastic bottles or glass bottles in the door pocket might fall out.

# How to use the Ice Dispenser and Water Dispenser

You can pour yourself a cold glass of water without having to open your refrigerator by simply filling the Water Tank with water and pushing the button. Furthermore, ice is automatically made in the Ice Bank, allowing you to dispense either cubed or crushed ice at the touch of a button. (  P.7 )

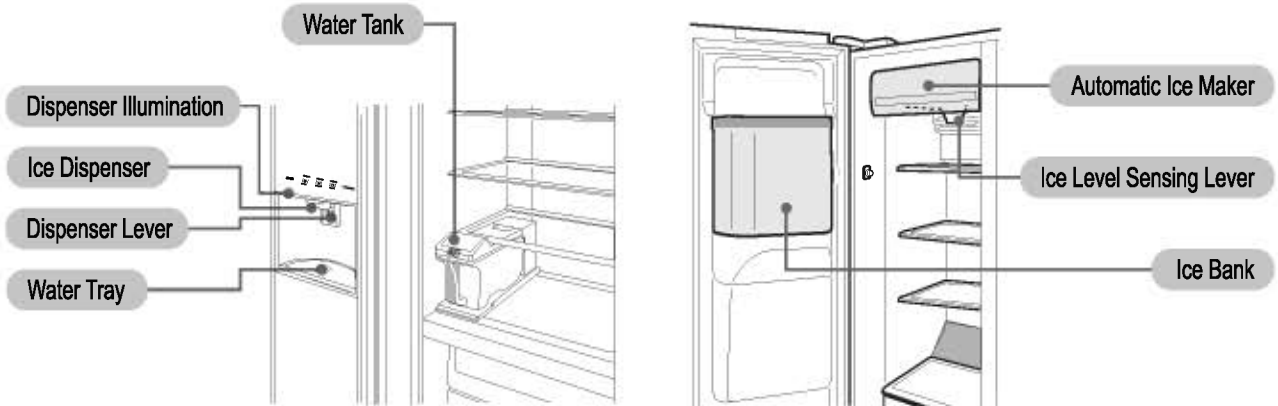

## Notice

- If the power cord is unplugged while the refrigerator is in use, or if there is a power failure, each component's functions will automatically be restored to the settings previously in place when the power is turned back on.
- All the display lights turn on for approx. 5 seconds after the power cord is plugged in.
- The Automatic Ice Maker is set to operate when installed. And, the Ice Dispenser is set to make "Crushed Ice".

## Warning

**Be careful, as the Ice Dispenser rotates and may cause injury to the fingers, etc.**



- Do not insert hands into the bottom of the Ice Bank in the Ice Dispenser.
- Do not use the Ice Dispenser with the Ice Bank detached.
- When someone else is using the refrigerator, refrain from opening the door or using the control panel.
- Do not touch any of the mechanical parts of the Automatic Ice Maker. Since the Automatic Ice Maker rotates, there is a risk of injury to the fingers, etc.
- Do not let small children operate the dispenser, as this may result in injury.
- Do not hang on the Ice Bank.
- Do not disassembly, repair, or modify your refrigerator by yourselves. Please consult with a retailer if any repair or is required.

## Caution



- Do not store food or other objects other than ice made by the Automatic Ice Maker in the Ice Bank (located in the Ice Dispenser). Also, be sure not to place food or other articles into the ice tray, as doing so can cause a malfunction of the Ice Dispenser.
- Do not touch the Ice Level Sensing Lever in the Automatic Ice Maker, as doing so may cause an accident to occur.
- Do not insert fingers into the ice outlet or touch any parts nearby. Your fingers may be pinched or otherwise injured.
- Do not use fragile glassware with the Automatic Ice Maker, as doing so could cause the glass to shatter, resulting in injury.

## Filling the Water Tank

Fill the Water Tank (located in the Refrigerator Compartment) as follows.

Note: Be sure to thoroughly wash the Water Tank before use for the first time.

### Filling the Water Tank

#### Instructions for Normal Filling

1. Push the button on the Water Tank to open the water tank lid and fill the tank with water.

Close the lid to complete the filling process.

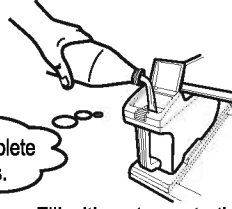

- Fill with water up to the "Full" line.

#### Instructions for Removing the Water Tank and Filling

1. Remove the Water Tank.

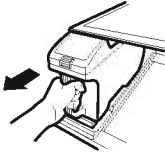

- Hold the handle and pull the Water Tank towards yourself.

3. Carry the Water Tank by the handle with care.

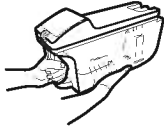

- When carrying the Water Tank, place one hand below the tank for horizontal stability.

2. Push the button on the Water Tank, open the lid and fill the tank with water.

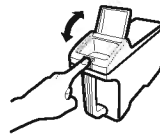

- Fill with water up to the "Full" line.

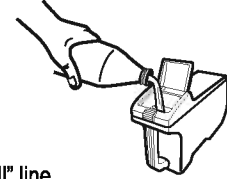

4. Insert the Water Tank until it passes the "Tank Position" line.

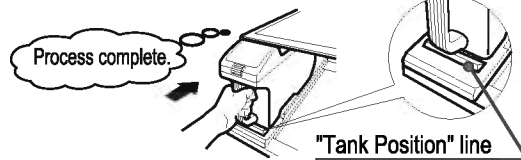

- If the Water Tank is not inserted all the way, water will not be supplied to the Water Dispenser or Automatic Ice Maker. This will prevent these features from functioning properly.

### Caution

- Do not fill the Water Tank with anything other than water. (Filling the Water Tank with fluids such as juice, sports drinks, tea, or hot water can damage your refrigerator. The Water Tank can withstand temperatures up to 50 °C)



Mineral water



Filtered water



Juice



Isotonic drink



Carbonated drink



Tea

### Notice

- Germs can multiply quickly when filtered water, dechlorinated water, mineral water, or boiled water is used in the Water Tank. Be sure to thoroughly clean the Water Tank regularly.
- Change the water in the Water Tank once a week.
- When not using the Water Tank for extended periods of time, thoroughly clean and dry the water tank and reinstall it to its place in the refrigerator.
- The capacity of the Water Tank is approx. 4 liters.

### "Tank Empty" lamp

When the Water Tank becomes empty, the "Tank Empty" lamp automatically turns on. Refill the Water Tank when this happens.

#### Notice

- If the Water Tank is not placed into its proper position, the "Tank Empty" lamp will turn on even if the Water Tank is not empty. When this happens, adjust the position of the Water Tank and make sure that it is pushed all the way in.
- The lamp will temporarily turn off when the refrigerator compartment door is opened and closed, but will turn back on if the Water Tank is still empty.



Lamp lights on.



# How to use the Ice Dispenser

## Ice Dispenser

### Cubed Ice

For large pieces of ice.  
(Dispense ice the way the Automatic Ice Maker makes it.)

1. Touch the "CUBES" button.

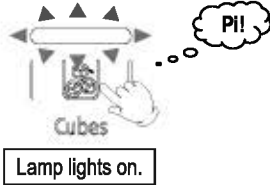

2. Press a cup against the Dispenser Lever to dispense ice cubes.



### Crushed Ice

For finely crushed ice.  
(Crush the ice made by the Automatic Ice Maker and dispense it.)

1. Touch the "CRUSHED" button.

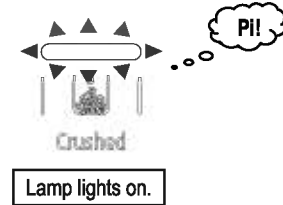

2. Press a cup against the Dispenser Lever to dispense crushed ice.



### Notice

- When using the "Ice Dispenser" for the first time, discard the first 2 glasses of ice cubes for cleaning.
- Hold your cup high with respect to the Dispenser Lever so as to prevent ice from scattering.
- The Dispenser may be used even when the Automatic Ice Maker is not in operation.
- To prevent misuse of the buttons and of the Dispenser lever, and to prevent children from playing with the refrigerator, utilizing the "Child Lock" feature is recommended. ( P.10 )
- If the ice cubes in the Ice Bank are left unused for a long time, ice cubes may stick together and may form a big block of ice. Therefore, it is recommended to use the Ice Dispenser as often as possible.
- Ice in the Ice Bank may freeze together after a power failure due to a temporary increase in temperature within the refrigerator. If this happens, remove the Ice Bank, discard any remaining ice and thoroughly dry the Ice Bank. After it has dried, return it to its place in the refrigerator and make a new batch of ice. ( P.17 )
- The Ice Dispenser will turn off temporarily if it is use continuously for more than approx. 16 seconds . In this case, the Dispenser Illumination will flash, indicating that the Ice Dispenser stops operating. Remove your glass from the Dispenser Lever in order to let the system reset. After resetting, the Ice Dispenser shall be used again.
- The regular condition is recommended to use -18°C or -19°C. The freezer temperature is adjusted at -15°C is inappropriate to put warm or too much food. Ice cube may stick together and may form a mass of ice. It is recommended to remove the mass of ice from the Ice Bank and Ice Dispenser Duct. ( P.20 )

## When using the Automatic Ice Maker

### Turning on/off the Automatic Ice Maker Function

First, check whether the Automatic Ice Maker is in operation.

1. When in operation.

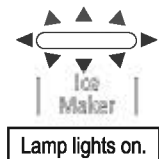

2. To stop the operation, Touch the "Ice Maker" button.

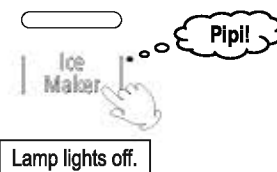

3. When restarting operation.

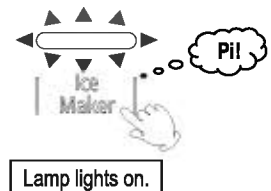

### Notice

- If you do not intend to use the Automatic Ice Maker, manually cancel its operation.

## ■ When using the Automatic Ice Maker (Continued)

### Ice Making Time

When you wish to make ice especially quickly, use the "Quick Freezing" function. ( P.9 )

Ice Preparation Time ( 8 (eight) cubes / ice making cycle)		Ice Storage Capacity
Normal Operation	Approx. 90 to 110 minutes	Approx. 160 cubes (maximum)
Quick Freezing	Approx. 70 to 90 minutes	

- The Ice Preparation Time shown is the average time to make ice when the ambient temperature is 32°C and the door is not opened and closed.

### Notice

- Ice cannot be made until the interior of the refrigerator is sufficiently cool. It may take 24 hours or longer to make ice for the first time after installation. Normally, however, it only takes 2 to 3 hours to make 8(eight) ice cubes.
- The Ice Making Time will be longer in the following situations.
  - When the door is frequently opened and closed
  - When there is a power outage
  - When a large amount of food is placed inside the refrigerator at the same time
  - During winter, or when the surrounding temperature is low

## ■ How use the Water Dispenser

### Water Dispenser

1. Touch the "WATER" button.



Lamp lights on.

2. To dispense water, simply press a cup against the "Dispenser Lever".



- Hold the cup up when pressing it against the "Dispenser Lever".

If "Tank Empty" lamp is turned on.



- If the lamp is on, fill water.

### Notice

- Discard the first cup of water that is dispensed just after installation, as the system needs to rinse itself out.
- It may take 24 hours or longer for the water in the Water Tank to cool sufficiently when the ambient temperature is high, such as during summer. Normally, the water (4L in volume) can be chilled in 8 to 9 hours.
- When you wish to have cold water quickly, use the Ice Dispenser to put ice in your cup, then dispense water using the Water Dispenser.
- The Water Dispenser will turn off temporarily if used continuously for more than approx. 60 seconds. In this case, the Dispenser Illumination will flash, indicating that the Water Dispenser has been stopped. Remove your glass from the Dispenser Lever in order to let the system reset. After the reset, the Water Dispenser can be used again.

### Caution

- Wait for 2 to 3 seconds before removing your cup from the dispensing area after dispensing water or ice. If you remove your cup without waiting, water or ice may fall into the Water Tray or on the floor.
- Dry any water that accumulates in the Water Tray with a dry cloth or remove the Water Tray and dispose of the water. Also, wipe up any water droplets on the surface of the door of the refrigerator with a dry cloth.

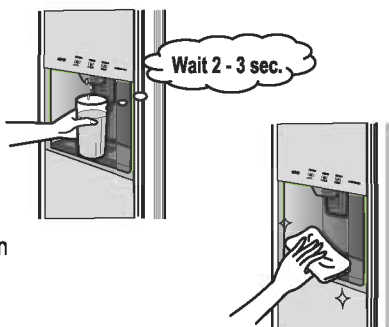

# Maintenance

## Water Tank

In order to prevent grime and hard water stains from building up, make sure to rinse the Water Tank once a week.

### 1. How to open the Lid.

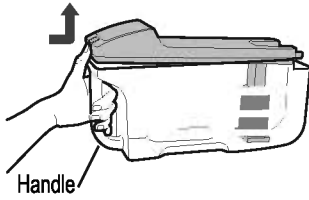

- Grasp the handle. To remove the lid, use your thumb to push the lid up.

### 2. How to Close the Lid.

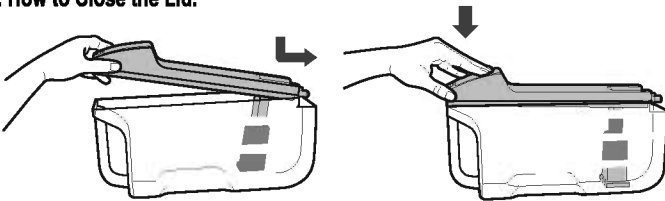

- Slide the lid in back-end first in the direction of the arrows to close the lid.

### Notice

- If the Automatic Ice Maker is not set to "Stop," the water pump may make sounds occasionally. This is not a malfunction.

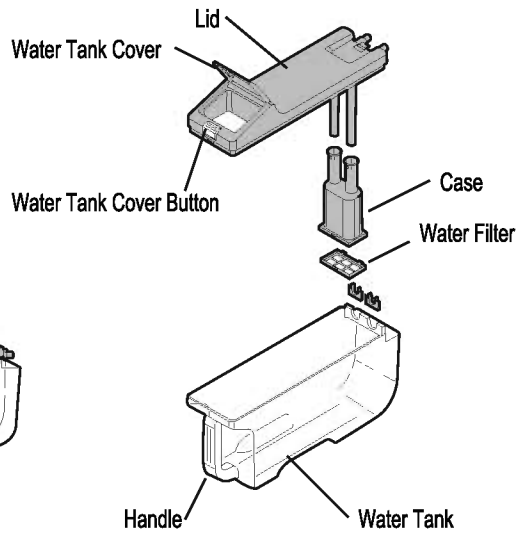

## Water Filter

In order to prevent grime and hard water stains from building up, make sure to rinse the Water Filter once per week.

### 1. Pull the Case to remove it from the lid.

### 2. Pull the tab to remove the Water Filter from the case.

### 3. Use a soft sponge to clean the Water Filter.

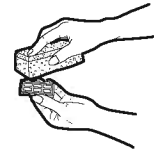
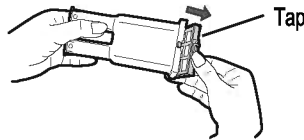
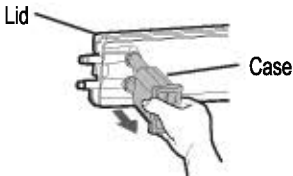

- Do not use cleansers as this may damage the filter.

### Notice

- Replace the Water Filter when it wears out. Water Filters need replacing every 3 to 4 years.

## Ice Bank

### Notice

- When not using the Ice Dispenser for a long time, thoroughly clean and dry the Ice Bank and reinstall it to its place in the refrigerator.

### 1. To stop the operation, press the "Ice Maker" button.

### 2. Remove ice in the Ice Bank, clean and dry the ice Bank and reinstall it to its place in the refrigerator. ( P.20 )

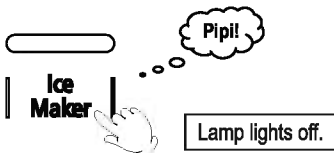

- If there are still ice cubes remaining in the Crusher Case in the reverse side of the Ice Bank, remove them using with a spoon, etc..( P. 20 )

### Notice

- In this case, if ice is not removed from the Ice Bank, Ice cube may stick together causing the Ice Dispenser cannot operate.

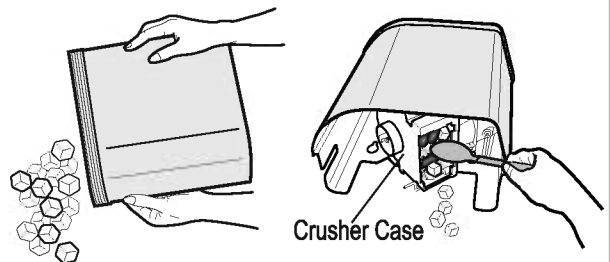

## Maintenance (Continued)

### Ice Bank

Before performing maintenance, make sure that the refrigerator is unplugged.

#### Instructions for Regular Cleaning

1. Wipe the Ice Bank dry with a soft cloth.

#### Instructions for Removing and Cleaning the Ice Bank

1. Grasp the top of the Ice Bank with both hands. Then, lift it up and pull it towards yourself.
2. After removing the ice, wipe the Ice Bank with a soft cloth, being careful to remove any water in or on the Ice Bank.

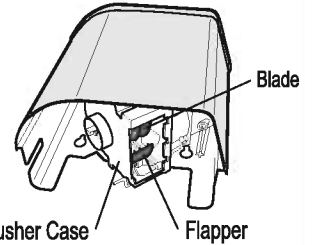
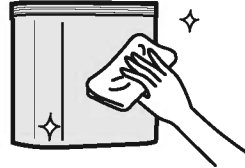
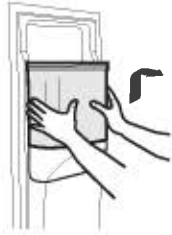

- If there are still ice cubes remaining in the Crusher Case in the reverse side of the Ice Bank, remove them using a spoon, etc..

3. When installing the Ice Bank, be sure that there is no gap at the bottom of the Ice Bank.

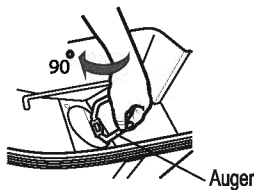
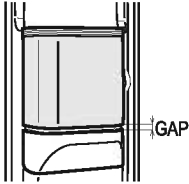

- If there is a gap, rotate the Auger 90 degrees and then install the Ice Bank.

### Warning

- Be careful, as the Ice Dispenser rotates and may cause injury.
  - Before performing maintenance, make sure that the refrigerator is unplugged.
  - Do not put your hands inside the Ice Bank.
  - Do not use the Ice Dispenser when the Ice Bank is removed from the refrigerator.
  - Do not disassemble, repair, or modify this equipment.
- When repairs are necessary, contact retailers or service center.

### Caution

- Do not touch the blades of the Ice Bank when it is removed. There is a risk of injury.

### Water Tray

If the Water Tray becomes soiled, remove it and rinse it off.

1. To remove the Water Tray, pull it forward.



2. To install the Water Tray, insert the tabs (2 tabs) on the back side first, then insert the tabs on the front side (3 tabs) securely.

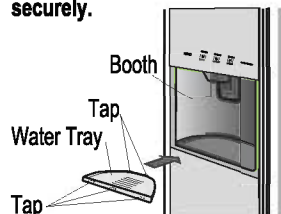

- Wipe up any water or debris in the dispenser pit (especially the bottom) with a soft cloth.

# Maintenance (General Matters)

## How to Maintain Your Refrigerator

1 Unplug the power cord.

2 Remove the food.

3 Wipe the refrigerator clean.

- It is the best if smudges are wiped off immediately. It is also recommended to clean the areas of the refrigerator not clearly in view once a year.
- Use a soft cloth moistened with lukewarm water to wipe off smudges. For difficult to remove smudges, use a diluted, neutral kitchen detergent, and then wipe off the smudges using a cloth moistened with lukewarm water.
  - The following parts can be cleaned with water:

Freezer Compartment	Refrigerator Compartment	Vegetable Compartment
<ul style="list-style-type: none"><li>● Adjustable-height Shelves</li><li>● Fixed Shelf</li><li>● Freezer Drawers</li><li>● Door Pockets</li><li>● Water Tray (Dispenser)</li></ul>	<ul style="list-style-type: none"><li>● Adjustable-height Shelves</li><li>● Dairy Pocket<ul style="list-style-type: none"><li>● Dairy Pocket Cover</li></ul></li><li>● Door Pockets</li><li>● Egg Tray</li></ul>	<ul style="list-style-type: none"><li>● Vegetable Drawers<ul style="list-style-type: none"><li>● Vegetable Drawer Door</li><li>● Vegetable Drawers Cover</li></ul></li><li>● Door Pocket</li></ul>

### Control Panel

- Wipe with a soft, dry cloth. Be sure not to get water on the control panel, as it could become damaged.



### Door Surface

- To clean the door surface, wipe with a soft cloth wetted with lukewarm water.



### Door Gasket

- This area is prone to smudges, so be sure to wipe it thoroughly.

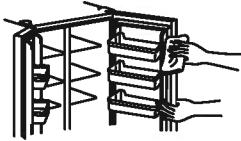

### Drip Catcher

- Liquid that has accumulated here should be wiped away.

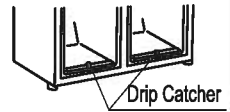

### Back Panel, Floor of Refrigerator

1. Turn the leg adjuster to raise the refrigerator up off the floor.

- If the adjuster does not turn easily, use a screwdriver to turn it. If it still will not turn, then remove the leg cover and try again.

( P. 5 )

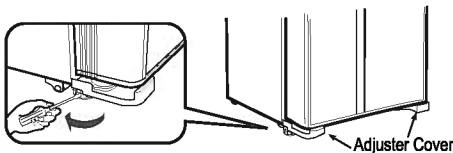

2. Pull the refrigerator straight out toward you.

- For floors that are easily damaged, lay out a protective mat, or other protective material.



3. Wipe off the smudges on the back panel, walls, and floor of the refrigerator.

- Due to the convection of air, this is a place where fine dust is likely to adhere.

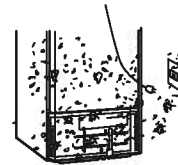

4 If any droplets remain on the surface of the parts that have been washed, wipe them .

5 Return all parts to their original locations.

6 Inspect and clean the power plug, cord and outlet.

### Inspection

- Are there any cuts in the cord?
- Is the plug damaged or is the outlet loose and heating up excessively?
- When there is a problem with the power cord, plug, or outlet, please consult the retailer or the service center.



### Refrigerator Care

- If the power plug is plugged in with dust on the power cord, it can result in fire.
- Remove all dust once a year and wipe with a dry cloth.



## How to Maintain Your Refrigerator (Continued)

### 7 Plug the power cord into the outlet.

- Insert the power plug into the outlet securely, all the way to the end with the power cord facing downward.

#### Notice

- Even if the power plug is plugged in immediately after being unplugged, the compressor will not run for 5 minutes. However, if the inside is not cold, it will start running in approximately 30 seconds.

#### Caution

- Do not use the following : An alkaline or weak alkaline kitchen detergent, scouring powder, soap, petroleum, boiling water, scouring pads, acid, benzine, alcohol, or bleach (for details, see the Caution on the detergent package).
- When any cooking oil, citrus fruit juice, or juice from any food pours on this refrigerator, wipe it off.
- When using a chemical rag, be sure to heed the warnings for rag use.
- The doors, painted surfaces, and plastic parts may be scratched, or discolored by the chemical rag.

#### Notice

- The evaporating tray for defrosting of this refrigerator does not need to be cleaned.

## Part Removal

### How to remove parts

#### Upper Vegetable Drawer Door

- Push the lower right shaft backward, then push the entire right side to the back. Next, pull the left side forward towards yourself.

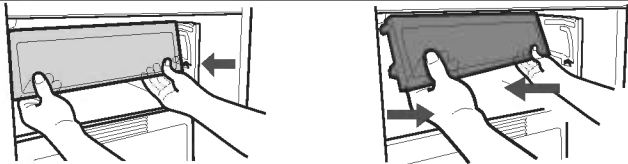

#### Drawers

- To remove drawers, pull them all the way out, then lift them upward.

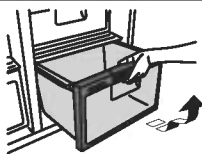

#### Door Pocket

- Gently tap the left and right of the bottom surface while pulling a pocket up to remove it. When installing the pockets, push it all the way down in a smooth, controlled manner.



#### Dairy Pocket Cover

- Lift the cover up, and pull the left and right shaft inward to remove it.

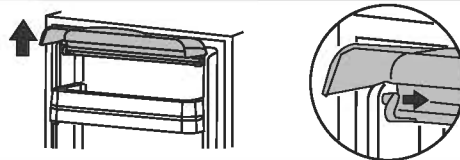

#### Adjustable-height Shelves/Fixed Shelf (Freezer)

- To remove a shelf, lift it up slightly, then pull it towards you. To install a shelf, push it in until it comes into contact with the end of the slot.

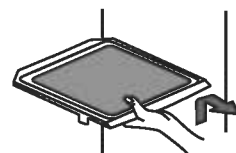

## ■ Replacing Lamp inside Refrigerator



**Warning**

■ Do not remove the cover of interior lamp

- When the interior lamp is damaged, please contact the Hitachi service centre or retailers for replacing the lamp to avoid injury

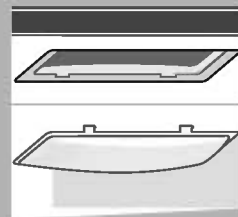

## ■ Take urgent action when ice jams



**Warning**

- Be sure to unplug the power cord before carrying out any maintenance. Failure to unplug the power cord can result in electric shock or injury.

### How to remove a mass of ice from the Ice bank and Ice Dispenser Duct

1. Remove the ice bank from the freezer door. If you cannot remove it, take the following steps.
  - 1.1 Remove all ice cubes from the ice bank until only the ice mass remains.
  - 1.2 Place a glass at the ice outlet of the ice dispenser booth.
  - 1.3 Gently pour warm water into the ice bank, continuing to do so until the tank can be removed.
2. Check the duct portion and the crusher case to be sure that there is no further icing or ice mass. If any should remain, remove it and clean the duct portion. Again if it is difficult to remove, pour warm water until the ice has melted enough to remove it, or in the case it is too hard to remove ice, dip the ice bank into water to melt the ice mass.
3. Check the crusher axle (Part of the motor box), make sure it is still correctly in place and not loose. If it is loose it is possible that a hole at the centre of the axle is deformed. In this case please contact your retailer or authorised service centre for assistance.
4. Re-assemble the ice bank. ( P. 23 )
5. Restart the refrigerator operation, and wait for a while until the freezer temperature reaches your desired setting. (The crusher must not be operated at temperatures above 0°C)
6. Check the crusher operation, motor movement and lid on/off.



Fig. of 1.1

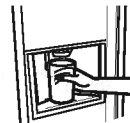

Fig. of 1.2



Fig. of 1.3

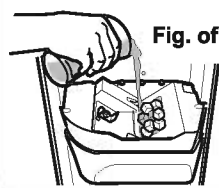
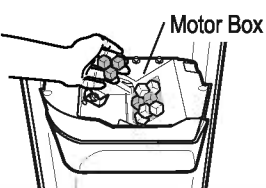
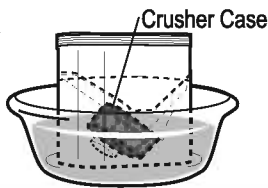

Fig. of 2



Motor Box



Crusher Case

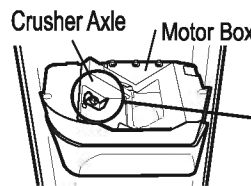

Crusher Axle

Motor Box

a hole at center of Crusher Axle

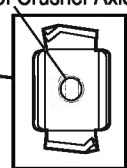

## Check the Following First

- If the refrigerator still does not operate properly, contact the retailer from where it was purchased.

### General Problems

Problems	Point to be checked	Detailed Check Points and Countermeasures
Does not cool at all.	<ul style="list-style-type: none"> <li>● Is the power plug supplied ?</li> </ul>	<ul style="list-style-type: none"> <li>● Check the power supply at the wall outlet.</li> <li>● Make sure the power supply cord is plugged firmly.</li> <li>● Check the fuse box for blown fuse or tripped circuit breaker.</li> </ul>
Does not cool properly.	<ul style="list-style-type: none"> <li>● Was the refrigerator just installed ?</li> </ul>	<ul style="list-style-type: none"> <li>● Up to approximately 4 hours is required until your refrigerator cools properly. In the summer, up to 24 hours may be required. ( P.6 )</li> </ul>
	<ul style="list-style-type: none"> <li>● Confirm that the refrigerator was installed properly.</li> </ul>	<ul style="list-style-type: none"> <li>● Is your refrigerator in contact with direct sunlight ?</li> <li>● Is there a heat producing device such as a gas stove nearby ?</li> <li>● Is there sufficient open space around your refrigerator ? ( P.5 )</li> </ul>
	<ul style="list-style-type: none"> <li>● Is the freezer compartment temperature set to level 1 or 2, and is the refrigerator compartment temperature set to level 1 or 2 ?</li> </ul>	<ul style="list-style-type: none"> <li>● Set the freezer compartment temperature to level 3, and set the refrigerator compartment to level 3. ( P.8 )</li> </ul>
	<ul style="list-style-type: none"> <li>● Check the inside of the refrigerator.</li> </ul>	<ul style="list-style-type: none"> <li>● Is there too much food in the refrigerator ?</li> <li>● Are there any hot items inside ?</li> <li>● Is the cold air outlet blocked by any food items ? ( P.6 )</li> </ul>
	<ul style="list-style-type: none"> <li>● Is the door being opened frequently ?</li> <li>● Is the door touching food and not completely closing ?</li> <li>● Is there anything such as a plastic bag caught between the door gasket and the refrigerator main body, or are there any gaps ?</li> </ul>	<ul style="list-style-type: none"> <li>● We recommend that you open and close the door quickly, and open and close it as little as possible.</li> <li>● Confirm that there are no gaps when the door is closed.</li> <li>● When the door is closed, be sure that no food or plastic bags are caught between the door and the refrigerator main body.</li> </ul>
	<ul style="list-style-type: none"> <li>● Is it a hot summer day ?</li> </ul>	<ul style="list-style-type: none"> <li>● Set the temperature inside the freezer compartment to level 4 or 5 and inside the refrigerator compartment to level 4 or 5.</li> <li>● On very hot days, the cooling capacity could decrease, ice cream could become soft, and the temperature in the door pockets could increase. ( P.8 )</li> </ul>
	<ul style="list-style-type: none"> <li>● Because the freezer compartment has priority to be cooled during "Quick Freezing" operation, the temperature inside the refrigerator compartment could increase.</li> </ul>	<ul style="list-style-type: none"> <li>● Avoid opening and closing the door as much as possible. ( P.9 )</li> </ul>
Food in the refrigerator compartment and vegetable compartment freezes.	<ul style="list-style-type: none"> <li>● Is the temperature for the refrigerator compartment set to level 4 or 5 ?</li> <li>● Is the ambient temperature 5 °C or less ?</li> </ul>	<ul style="list-style-type: none"> <li>● Change the temperature setting for the refrigerator compartment to level 3 or 2. When set to level 5, food might freeze.</li> <li>● If the temperature in the refrigerator compartment is set to level 1, food is less likely to freeze. ( P.8 )</li> </ul>
	<ul style="list-style-type: none"> <li>● Has any moist food been placed in front of the cold air outlet or at the back of a refrigerator shelf ?</li> </ul>	<ul style="list-style-type: none"> <li>● Moist food might freeze, so do not place it in front of the cold air outlet or at the back of a refrigerator compartment shelf.</li> </ul>
	<ul style="list-style-type: none"> <li>● Is any moist food being stored such that it is touching the back left wall of the refrigerator compartment ?</li> </ul>	<ul style="list-style-type: none"> <li>● Because the food is touching the freezer compartment partition whose temperature is comparatively low, the food might freeze. Either increase the temperature setting or move the food away from the compartment partition a little. ( P.6 )</li> </ul>
Condensation (or frost) is forming.	<ul style="list-style-type: none"> <li>● When the humidity is so high, condensation might form on the outside of the unit, on the door gasket, or on the door. Also, after the door is opened and closed, the cold air might make the door surface fog up. This is not unusual.</li> </ul>	<ul style="list-style-type: none"> <li>● Wipe it off with a dry cloth.</li> <li>● Condensation is less likely to form if the temperature setting for the freezer compartment is changed to level 3 or 2. ( P.8 )</li> </ul>
	<ul style="list-style-type: none"> <li>● Is condensation forming on the vegetable compartment drawer ?</li> </ul>	<ul style="list-style-type: none"> <li>● This is because high humidity is maintained inside the drawer to prevent vegetables from drying out and to increase their life. Wipe with a dry cloth.</li> </ul>
	<ul style="list-style-type: none"> <li>● Is the door securely closed ?</li> </ul>	<ul style="list-style-type: none"> <li>● If there are any gaps between the door and the refrigerator main body, not only will the temperature inside increase, but condensation or frost could also form. Please close the door securely.</li> </ul>
	<ul style="list-style-type: none"> <li>● Is the door opened for a long time or opened and closed frequently ?</li> </ul>	<ul style="list-style-type: none"> <li>● Decrease the number of times the door is opened and closed, and open and close the door quickly.</li> </ul>
Water is collecting either inside the refrigerator or on the floor.	<ul style="list-style-type: none"> <li>● Is the door touching food, etc., and not closing completely ?</li> </ul>	<ul style="list-style-type: none"> <li>● If the door is not closed completely, condensation drips onto the inside of the refrigerator or on the floor. Please close the door completely.</li> </ul>
	<ul style="list-style-type: none"> <li>● Did any water in a plastic bottle spill ?</li> </ul>	<ul style="list-style-type: none"> <li>● Store bottled water so it does not spill.</li> </ul>



## ■ Check the Following First (Continued)

### General Problems (Continued)

Problem	Point to be checked	Detailed Check Points and Countermeasures
The refrigerator is noisy.	• Is the floor stable ?	• Install the refrigerator on a stable, level floor, or in a place with a stable board under it. ( P.5 )
	• Is there any object between the refrigerator leg and the floor where it is installed ?	
	• Is the rear face touching a wall, etc. ?	• Install the refrigerator in a location with enough space around it. ( P.5 )
	• Did the leg adjuster cover come off ?	• Securely attach the leg adjuster cover. ( P.5 )
The refrigerator is noisy. Some kind of sound is being made. (These sounds are not a sign of malfunction.)	• Sometimes the normal operating sound of the refrigerator gets louder.	• After installation, the refrigerator operates at full power to cool its interior, so it will make a louder sound.
	• A sound like running water is emitted.	• This is the sound of the cooling fluid (refrigerant) flowing through the cooling device. This sound might also be heard when the compressor has stopped.
	• A knocking sound.	
	• A sound like something is boiling (a bubbling sound).	
	• A sizzling sound like when meat is being cooked.	• This is the sound of parts, such as the motor, which control the temperature inside the refrigerator running.
	• A sound like something stuck in a machine.	
• A whirring sound.		
• A cracking sound. (This is heard inside the refrigerator when the door is opened).	• This is the sound of the plastic creaking due to a change in temperature (when the door is opened).	
• A hissing sound right after the door is closed.	• This is the sound of a temporary drop in air pressure when the air that entered into the refrigerator is suddenly cooled.	
Unpleasant odor inside the refrigerator.	• Has strong-smelling food been put inside without being wrapped ?	• The deodorizing function will not remove all odor. ( P.6 )
	• Food smells like plastic.	• This is because many plastic parts are used inside the refrigerator. As your food cools, the odor will gradually go away.
The front and back of the refrigerator is warm. Warm wind blows out from the bottom.	• The heat exhaust pipe and fan release the heat inside the refrigerator, so they might become hot.	• The temperature in these locations might reach 50 °C to 60 °C immediately after your refrigerator is installed. This is not abnormal. ( P.3 )
Very weak electrical shock is felt when touching the main body.	• The refrigerator occasionally accumulates static electricity, but this is not a safety concern.	• If this becomes an annoyance, earthing the refrigerator main body is recommended. ( P.5 )
The door feels heavy when trying to open it right after being closed.	• This is caused by a temporary drop in air pressure due to the suddenly cooling of the air entering inside the refrigerator.	• The door might feel heavy for a moment, but it will soon feel normal again.
When one door is closed, the other door opens.	• The compartments are connected by a cold air pathway, so the air pressure from the closing of one door might cause the other door to open temporarily.	• Closing the doors slowly will eliminate this problem.

## Ice Dispenser and Water Dispenser

Problems	Point to be checked	Detailed Check Points and Countermeasures
Ice is not dispensed.	• Are there ice cubes in the Ice Bank ?	• Wait until ice cubes are made and try again.
	• Is the "WATER" lamp is on to select water dispensing ?	• Touch "CUBES" or "CRUSHED" button to select ice dispensing. ( P.17 )
	• Is the "Child Lock" lamp on ? ( P.10 )	• Reset the "Child Lock" function. ( P.10 )
	• Is the "Tank Empty" lamp on ? ( P.16 )	• Fill up the Water Tank with water to the "Full" line.
	• Is the "Ice Maker" lamp off ? ( P.17 )	• If there is enough water, Push the Water Tank into the "Tank Position".
	• Is the water in the Water Tank frozen ?	• Activate the Automatic Ice Maker and use this function. Check the "Ice Maker" lamp is on to make sure that the Automatic Ice Maker is activated.
	• Is the ice dispensing duct is stopped up with food or fine crushed ice ?	• If frozen, set the temperature of the refrigerator compartment to level 1 or 2. ( P.8 )
	• Are any other articles such as food, etc. than ice stored in the Ice Bank ?	• Get rid of the food or crushed ice by using a spoon, etc.. Do not use your fingers, since the Ice Dispenser may revolve and result in injury.
	• Is the Ice Bank placed correctly ? Is there any gap between the bottom of the Ice Bank and the dispenser mechanism ?	• Take away these articles and store in other locations in the refrigerator.
	• Have you been using the Ice Dispenser for more than 1.5 minutes ?	• If there is a gap at the bottom of the Ice Bank, remove the Ice Bank, rotate the "Auger" of the Ice bank for approx. 90 degrees and place the Ice Bank again. ( P.20 )
		• To protect the electrical components, the system stops the operation for 20 minutes for cooling down. If the Ice Dispenser is used during this period, the "Dispenser Illumination" flashes to inform you of this temporary stop.

# Troubleshooting (Continued)

## Check the Following First (Continued) Ice Dispenser and Water Dispenser (Continued)



Problems	Point to be checked	Detailed Check Points and Countermeasures
Ice is not dispensed.	● Do ice cubes stick together in the Ice Bank ?	● Remove the Ice Bank, discard the ice cubes ,and make new ones.
	● Is the Ice Dispenser outlet stopped up with ice ?	● If the outlet is stopped up with ice, get rid of ice.
Ice is not made quickly.	● Have the doors opened so often, or so much food have been stored a the same time ?	● Do not open the doors so often. ● Keep the distance between one food item to another as much as possible.
	● Have the refrigerator just been started up ? ● Was there any power failure ?	● Ice cannot be made if the interior of the refrigerator is not cooled down. It may take 24 hours to complete the first ice.
	● Is the freezer compartment temperature adjusted to the higher temperature(level 2 or 1) than the standard position ?	● Set the freezer temperature to the lower position(level 3 or 4).  ( P.8 )
	● Is the ambient temperature low ? Is it a winter time ?	● If the ambient temperature is low just like winter, the ice making time can be longer.
	● Is there any gap between the door gasket and refrigerator body ?	● Close the door completely , if there is a gap.
The ice cubes have projecting sections.		● The ice tray is grooved to have even water flow for all areas. Therefore this groove may make projecting sections.
Ice cubes stick together in the Ice Bank.	● Was there any power failure ? ● Have the doors been opened so often?	● Since the temperature of the freezer compartment rose, thus the ice cubes melted and stick together. Remove the Ice Bank ,discard ice cubes ,and make new ice cubes again. And, make the door opening/closing frequency as little as possible.
	● Has the Ice Dispenser not been used for a long time ?	● If the Ice Dispenser is not used for a long time, the ice cubes may stick together. Therefore, it is recommended to use the Ice Dispenser as often as possible.
	● Is there any gap between the door gasket and refrigerator body ?	● If there is a gap, the freezer compartment temperature may rise and the ice cubes may stick together. Close the door completely.
Even when "CRUSHED" is selected, not only crushed ice but also ice cubes (uncrushed ice) is dispensed.		● Due to unevenness of ice cubes, some small ice cubes will not be crushed and will be dispensed, however, this not an abnormal situation.
	● Is the water in the Water Tank enough ? If the water is not sufficient, the ice cubes may be smaller than usual and thus may not be crushed.	● If the water is not much, fill up the Water Tank with water upto the "Full" line.  ( P.19 )
	● If the Ice Dispenser has not been used for a long time, the ice cubes may become smaller and thus may not be crushed.	● Remove the Ice Bank ,discard old ice cubes ,and make new ice cubes again.
	● "CUBES" were selected just before dispensing "CRUSHED" ice ?	● When switching from "CUBES" to "CRUSHED", ice cubes instead of crushed ice may be dispensed for the first moment. On the other hand, when switching from "CRUSHED" to "CUBES", crushed ice instead of ice cubes may be dispensed for the first moment. They are not abnormal.
	● Is there stopped-up ice cubes in the ice crusher section (at the reverse bottom side of the Ice Bank) of the Ice dispenser and the flapper to feed ice to be crushed kept opened ?	● Remove the Ice Bank to get rid of the ice in the ice crusher.
Ice or water smells.	● Is the Water Tank or water purification Water Filter dirty ?	● In order to prevent grime and hard water stains from building up, make sure to rinse the Water Tank once a week. ( P.19 )
	● Is not the water or ice fresh ?	● Replace the water in the Water Tank once a week. And, first, discard the existing ice cubes , then make new ice cubes. ( P.19 )
	● Has strong-smelling food been put inside without being wrapped ?	● When food with strong smell is stored, such food should be wrapped and sealed for storage.
Water is not dispensed.	● Is the "CUBES" or "CRUSHED" lamp is on ?	● Touch the "WATER" button to select dispensing water. ( P.18 )
	● Is the "Child Lock" lamp on ?	● Reset the "Child Lock" function. ( P.10 )
	● Is the "Tank Empty" lamp on ?	● Fill up the Water Tank with water to the "Full" line. ● If there is water in the Water Tank, surely push the Water Tank into the "Tank Position". ( P.16 )
	● Is the water in the Water Tank frozen ?	● If frozen, set the temperature of the refrigerator compartment to level 1 or 2. ( P.8 )
	● Has the Water Dispenser been used for more than 1 minute continuously ?	● If the Water Dispenser is used for approx. 1 minute, the system temporarily stop dispensing for the sake of safety in case of a malfunction of dispenserswitch. The "Dispenser Illumination" flashes to inform you of this case. To use again, release the glass from the Dispenser Lever.

## ■ Check the Following First (Continued)

### Ice Dispenser and Water Dispenser (Continued)

Problems	Point to be checked	Detailed Check Points and Countermeasures
Water from the Water Dispenser is not chilled.	● Has the water just been put into the Water Tank ?	● It may take 24 hours or even more to chill the water in the Water Tank completely, if the ambient temperature is high in the summer seasons, etc.. However, it will just take 8 to 9 hours to chill the tank-full of water. ● If you need chilled water immediately, it is effective to put ice cubes into the glass by using the Ice Dispenser and then to use the Water Dispenser.
	● When using the Water Dispenser, the water dispensed in the beginning is not chilled enough.	● Chilled water is supplied from the WaterTank in the refrigerator compartment through the tubes which is placed in the compressor compartment, the bottom of the cabinet, and the door. Therefore, the water in the beginning may not be chilled, because that water was not in the cold sections, however, after dispensing half of glass of water, chilled water will be dispensed.

## Auto Door

Problems	Point to be checked	Detailed Check Points and Countermeasures
Noise loud. There is an abnormal noise.	● Hitting sound (thumping sound).	● This is operating sound of the Auto Door ● This is not malfunction.
	● Buzzing sound (whir) (whir).	● This is operating sound of Electric Refrigerator Unit. ● This is not malfunction.
	● The operation sound of the Auto Door differs depending on door (left or right).	● This may vary depending on installation conditions of the refrigerator or volume of foods stored in the door pocket. ● This is not malfunction.
— Lamp of open button is off or Auto Door won't open even if touching.	● Is  lamp not lit? ● Auto Door of the Refrigerator Compartment can not open.	● Touch  button for 5 second or more until lamp on. ● Auto Door of the Refrigerator Compartment will not be open, When door of vegetable compartment opened. ( P.11)
The Auto Door dose not close.	● Is any food or food bag caught on the compartment?	● Remove food and others that are caught in.
	● Did a power failure occur or did the compartment knock against any obstacle during electrical operation?	● Auto Door function stops on the way, so push in the door with hand.
Auto Door dose not open widely.	● Don't stored foods and others make contact with the wall in the Refrigerator Compartment.	● Remove food and others make contact with the wall.
	● Installation site may not be levelled out.	● Opening angle of the Auto Door may vary or the door may go back a little after it is opened automatically depending on installation conditions of the refrigerator, but this is not malfunction.
Auto Door moves even though "Child Lock" is activated.	● Auto Door function can not be locked even though "Child Lock" is activated.	● In order to stop Auto Door function, unlock "Child Lock" first on the Control Panel first, and then touch  button for 5 seconds or more until lamp off. ( P.11)

## ■ What to do in these situations

This is not a malfunction of the refrigerator.

The surface of the refrigerator is hot.	● The refrigerator is equipped with the dew prevention and heat radiation tubes. The back and side plates may be heated especially when starting up or if the door is frequently opened and closed.
If a door is shut, other doors may open.	● The two compartments are connected with an air duct. When closing one of the doors, the door may be opened by the air pressure through the duct. This is a normal phenomenon.
Does the refrigerator make any abnormal noises (sound)?	● The sound like water flowing and boiling water is the sound of the cooling liquid (refrigerant). ● A creaking sound comes from the storage compartment. It is the sound caused by friction of the parts due to temperature change.
Annoying sound is generated by the refrigerator.	● You may feel that the operation sound is larger because the compressor operates in high-speed under the following conditions: the refrigerator does not cool fully on the occasion such as using it for th The sound becomes more quiet after cooling fully. The compressor operates at low speed at night, for long vacations or absences, potentially creating large vibrations.
Operation sound lasts long.	● It is because the compressor operates in low-speed for conserving energy.
Operation sound sometimes becomes louder.	● It is because the system changes the operating power of the refrigerator according to the temperature change.

## About Non-fluorocarbon refrigerator.

- This refrigerator, including refrigerant and the heat insulator, is using hydrocarbon (non-fluorocarbon). The hydrocarbon is a material that does not rip up the ozone and have very little influence on global warming. It is the global environment concern material).
- R600a refrigerant is flammable. But the refrigerant is sealed up by the refrigerate circuit, and never leaks by usual use. In case of the refrigerant circuit being damaged by any chance, please avoid the use of fire and electric product, open the window and ventilate. Afterwards, please contact Hitachi Service Center.

## Severe warning signs for Disposal

Cyclopentane is used as in the insulation. The gases in insulation material require a special disposal procedure.

Please contact your local authorities in regard to the environmentally safe disposal of this product.



This symbol mark means that used electrical and electronic products shall not be mixed with general household waste. Do not try to dismantle the system and unit by yourself as this could have harmful effects on your health and the environment. Refrigerators must be treated at a specialized treatment facility for recycling and recovery and shall not be disposed of in the municipal waste stream. Please contact the installer, dealer or local authority for more information.

## Warning

- Children should be supervised to ensure that they do not play with the appliance or get in.
  - Children getting inside may not be able to get out.
- This appearance can be used by children aged from 8 years and above and persons with reduced physical, sensory or mental capabilities or lack of experience and knowledge if they have been given supervision or instruction concerning use of the appliance in a safe way and understand the hazards involved.
- Children shall not play with the appliance.
- Cleaning and user maintenance shall not be made by children without supervision.