

# FS-*i* Series

## INSTRUCTION MANUAL

---



### Check Weighing Scales

FS-6*Ki*  
FS-15*Ki*  
FS-30*Ki*

**AND**  
A&D Company, Limited

## This Manual and Marks

All safety messages are identified by the following, "WARNING" or "CAUTION", of ANSI Z535.4 (American National Standard Institute: Product Safety Signs and Labels). The meanings are as follows:

 WARNING	A potentially hazardous situation which, if not avoided, could result in death or serious injury.
 CAUTION	A potentially hazardous situation which, if not avoided, may result in minor or moderate injury.



This is a hazard alert mark.

Note This manual is subject to change without notice at any time to improve the product. No part of this manual may be photocopied, reproduced, or translated into another language without the prior written consent of the A&D Company.

Product specifications are subject to change without any obligation on the part of the manufacture.

Copyright©2018 A&D Company, Limited

# Contents

<b>1. COMPLIANCE</b> .....	3
<b>2. INTRODUCTION</b> .....	4
<b>3. UNPACKING</b> .....	4
<b>4. CAUTION</b> .....	5
4-1. Precautions for Installing the Scale .....	5
4-2. Precautions for Operating the Scale.....	5
4-3. Precautions for Storing the Scale .....	5
<b>5. SETTING UP</b> .....	6
5-1. Attaching a display pod to the display support column.....	6
5-2. Installing the scale.....	6
<b>6. NAMES AND FUNCTIONS</b> .....	7
<b>7. BASIC OPERATION</b> .....	11
7-1. Turning the power ON and OFF .....	11
7-2. Selecting a weighing unit.....	11
7-3. Basic operation .....	11
7-4. Weighing with Preset Tare.....	12
7-5. To Clear a Tare Weight.....	12
7-6. Weight display resolution .....	13
7-7. Simplified operation mode.....	13
7-8. LCD backlight.....	13
<b>8. CHECK WEIGHING</b> .....	14
8-1. Target weight setting mode .....	14
8-2. Upper & Lower limits weight setting mode .....	17
8-3. The comparator memory .....	18
8-4. AUTO-TARE FUNCTION.....	20
<b>9. ANALOG SWEEP DISPLAY</b> .....	21
9-1. Selecting a display mode .....	21
9-2. Example of the analog sweep display .....	22
<b>10. CALIBRATION</b> .....	24
10-1. Calibration using a weight .....	24
10-2. Gravity acceleration correction.....	25
<b>11. FUNCTIONS</b> .....	26
11-1. The procedure for setting parameters.....	26
11-2. Function list .....	27

- 12. HC-02i BATTERY** ..... 30
  - 12-1. Using the HC-02i SLA Battery ..... 30
- 13. FS-03i RS-232C / RELAY OUTPUT** ..... 32
  - 13-1. Installation ..... 32
  - 13-2. FS-03i Specifications..... 33
  - 13-3. Command Mode..... 36
  - 13-4. Using UFC (Universal Flex Coms) function..... 40
- 14. FS-04i RS-422 / 485 / RELAY OUTPUT** ..... 43
  - 14-1. Installation ..... 43
  - 14-2. FS-04i Specifications..... 44
  - 14-3. Data output..... 45
- 15. SPECIFICATIONS** ..... 47
  - 15-1. Specifications ..... 47
  - 15-2. Dimensions ..... 48
- 16. GRAVITY ACCELERATION MAP** ..... 49

---

# 1. COMPLIANCE

---

## Compliance with FCC rules

- Please note that this equipment generates, uses and can radiate radio frequency energy. This equipment has been tested and has been found to comply with the limits of a Class A computing device pursuant to Subpart J of Part 15 of FCC rules. These rules are designed to provide reasonable protection against interference when equipment is operated in a commercial environment. If this unit is operated in a residential area it might cause some interference and under these circumstances the user would be required to take, at his own expense, whatever measures are necessary to eliminate the interference.  
(FCC = Federal Communications Commission in the U.S.A.)

## Classification of protection provided by enclosures

- The equipment is designed to comply with the IP Code of IEC 60529. The "IP65" is explained as follows:
  - "IP" International Protection.
  - "6" Against ingress of solid foreign objects.  
Dust-tight. No ingress of dust.
  - "5" Against ingress of water with harmful effects.  
Protected against water jets (no power full jets). Water projected in jets against the enclosure from any direction shall have no harmful effects.

## NSF listed

- The equipment is certified and listed to NSF/ANSI Standard 169 by NSF International. NSF International evaluated the equipment and certified that it is compliant with food protection and sanitation requirements for the design, construction and materials.

---

## 2. INTRODUCTION

---

This manual describes how this scale works and how to get the most out of it in terms of performance.

FS-*i* series check weighing scales have the following features:

- The FS-*i* series has three kinds of weight display resolution, 1/3,000, 1/6,000 (~1/7,500) and 1/12,000 (~1/15,000) to cover various applications.
- There are 2 sizes of weighing pan. The FS-30Ki has a larger pan and the FS-6Ki / FS-15Ki has a smaller pan.
- Weighing units are **kg** kilogram, **g** gram, **lb** pound; **oz** ounce; and **lb-oz** pound and ounce.
- Waterproof to IP-65 specifications.
- Constructed from stainless steel for harsh working environment.
- Large liquid crystal display with back lighting and analog sweep display of 60 segments with back lighting.
- Scale may be operated by AC power source or an optional SLA (sealed lead acid) battery.
- Built in comparator with large and bright LED display of results.
- Three colors of comparator results for better visibility.
- Two modes of comparator operation, Target weight setting and Upper/Lower limits setting.
- Optional serial data and comparator relay interface.

---

## 3. UNPACKING

---

*Unpack the scale carefully and keep the packing material if you are likely to transport the scale again in the future.*

When unpacking, check whether all of the following items are included:

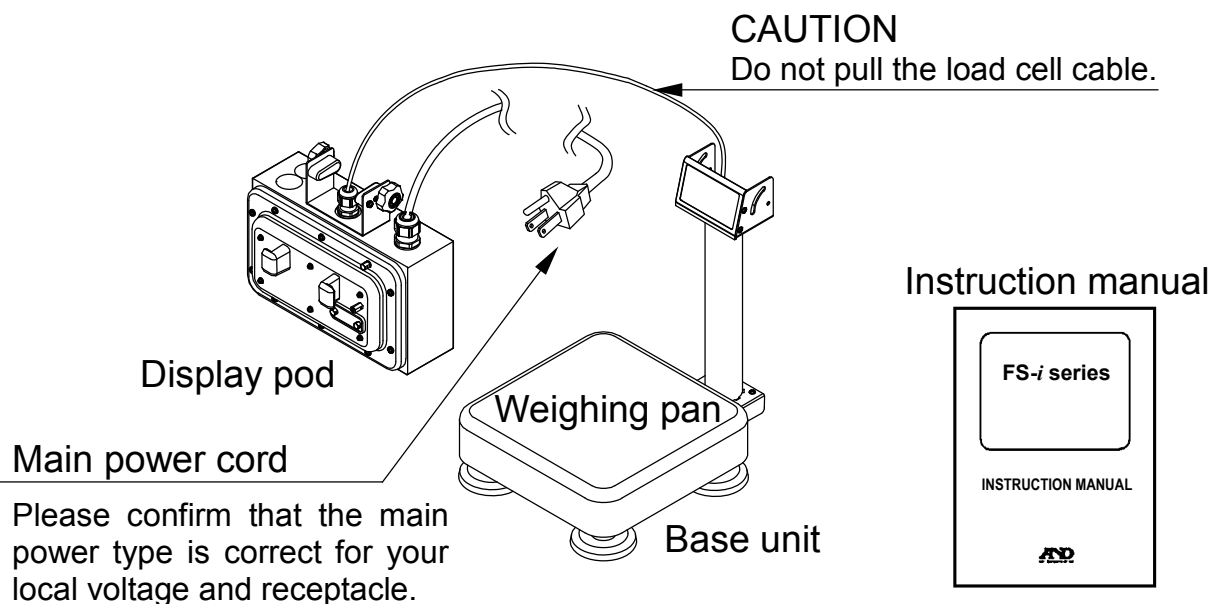





Please confirm that the main power type is correct for your local voltage and receptacle.

---

## 4. CAUTION

---

### 4-1. Precautions for Installing the Scale

-   Ground the scale so that the user will not be subjected an electric shock.
-   Do not handle the main power cord with wet hands.
-   The AC plug is not water-resistant. Install it in an area where it does not get wet.
-   Do not install the scale where there is flammable or corrosive gas present.
- Do not install the scale under water.
- Do not pull, fold or arrange cables forcibly.

Consider following conditions to get the most from your scale.

- Install the scale where the temperature and relative humidity is stable. There is no draft and a stable power source is available.
- Install the scale on a solid and level surface.
- Do not install the scale in direct sunlight.
- Do not install the scale near heaters or air conditioners.
- Do not install the scale where there is flammable or corrosive gas present.
- Do not install the scale near equipment which produces magnetic fields.
- Do not install the scale in a place where it is apt to be charged with static electricity, or where the relative humidity is lower than 45% RH. Plastic and isolators are apt to be charged with static electricity.
- Do not use an unstable power source.

### 4-2. Precautions for Operating the Scale

- Periodically ensure that the weighing value is correct.
- Calibrate the scale periodically to keep weighing accuracy (See “10. CALIBRATION”).
- Calibrate the scale when you move it to another location.
- Do not place anything on the pan that is heavier than the weighing capacity.
- Do not apply a shock load to the scale.
- Do not use a sharp instrument such as a pencil or ball-point pen to press the keys.
- Make sure that the STABLE annunciator is ON whenever reading or storing a value.
- We recommend you to press the  or  key before each weighing to prevent possible error.

### 4-3. Precautions for Storing the Scale

- Do not disassemble the scale.
- Do not use solvents to clean the scale.
- For best cleaning of the display pod, wipe with a lint free cloth that is dry or moistened with warm water and mild detergent.
- The base unit is can be cleaned with gentle water jet and brushing. Dry the unit well before use.
- Do not use a powerful water jet.

---

## 5. SETTING UP

---

### 5-1. Attaching a display pod to the display support column

1. Take out whole of the scale from the box taking care not to pull the load cell cable.
  2. Remove 2 clamps and 2 M4x12 screws.
  3. Attach the display pod to the display support column and tighten the M4x12 screws removed at step 2.
  4. Attach the clamps and tighten them after tilting the display pod where you like to use.
- Put the excess part of the load cell cable into the display support column

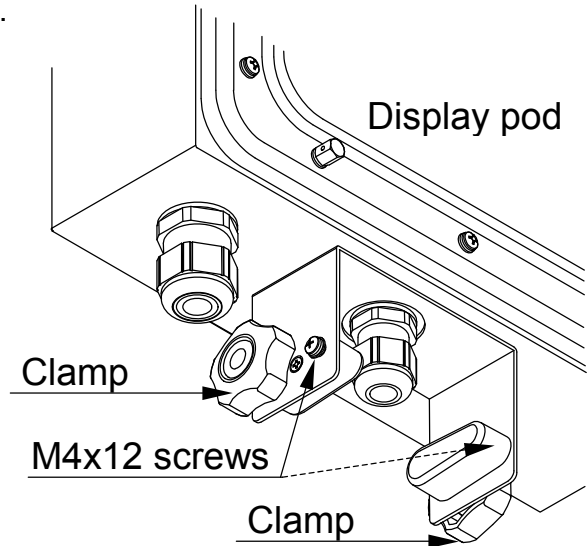

### 5-2. Installing the scale

1. Select the place for installing the scale. Refer to "Cautions for installing the scale" below.
2. Adjust the level of the base, using the spirit level and leveling feet. There is an extra foot under the display support column. Adjust this foot to reach floor after adjusting the level of the base.

 3. Connect the main power cord to the outlet that has the earth wiring.

4. If necessary, adjust the viewing angle of the display by loosening the 2 clamps, changing the angle and re-tightening the clamps.

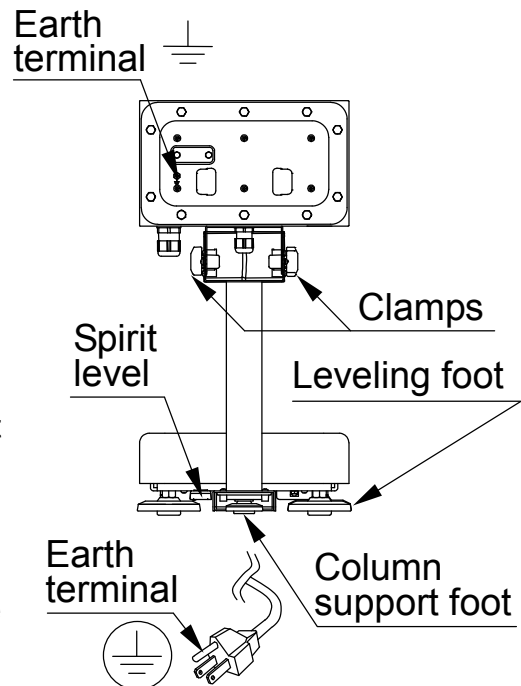



# 6. NAMES AND FUNCTIONS

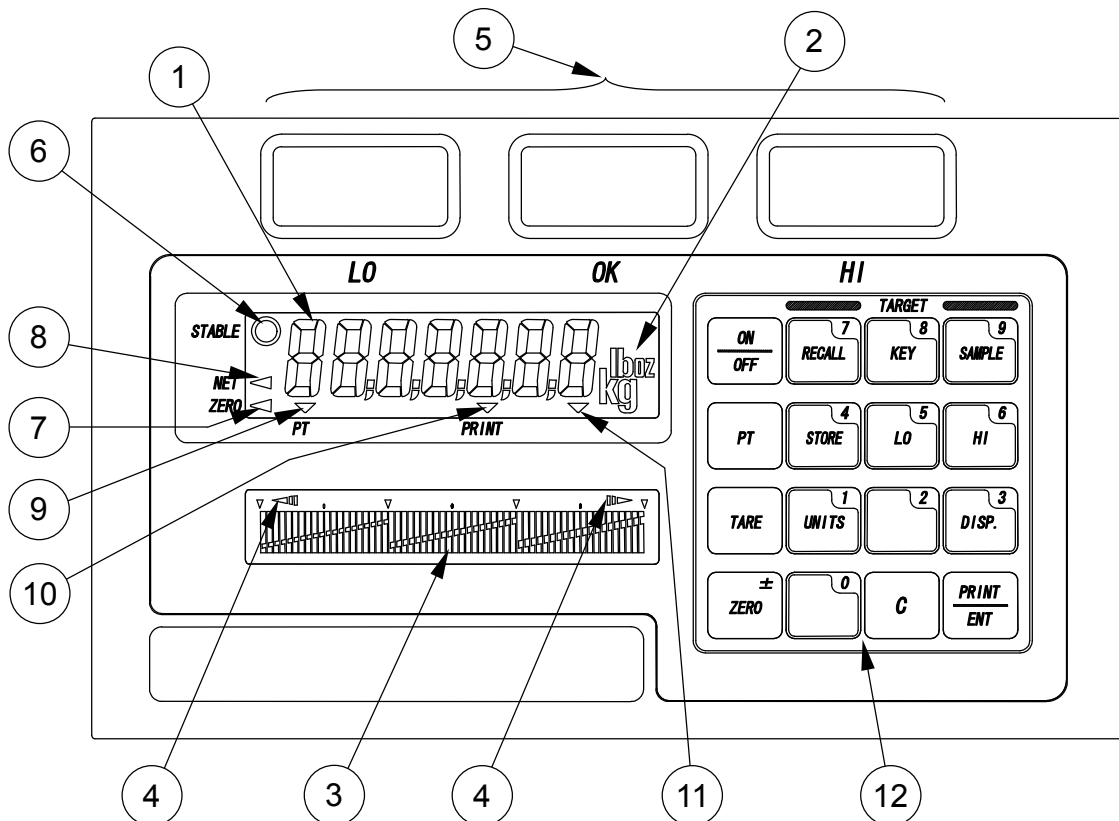
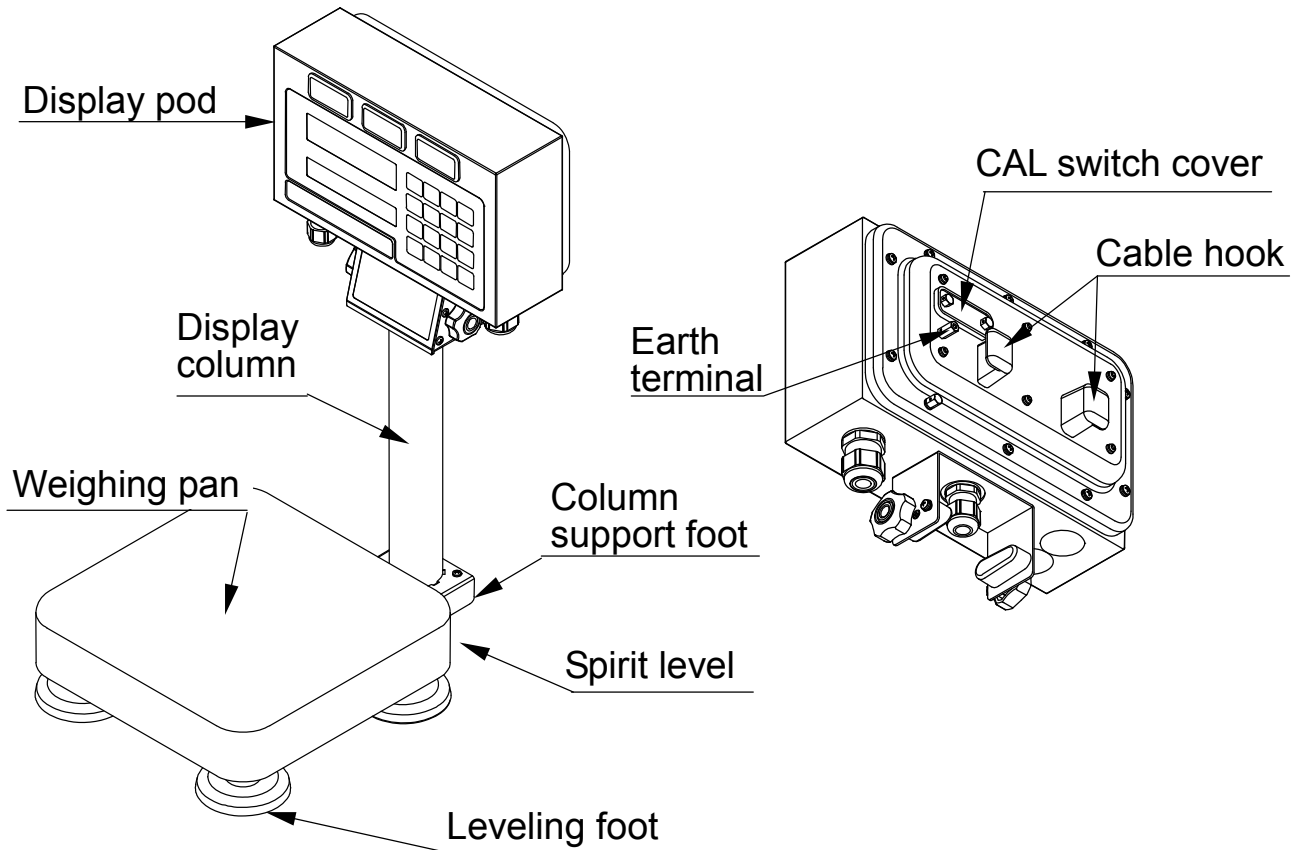

- ① **WEIGHT DATA DISPLAY.**  
This display shows the weight on the weighing pan.
- ② **WEIGHING UNIT INDICATOR.**  
This display area shows the weighing unit in use.
- ③ **ANALOG WEIGHT DISPLAY.**  
This scale has a 60 segments analog sweep display representing zero to full scale when the simple weighing mode display is selected. In the limit check weighing display mode, this display shows comparison limits and results.
- ④ **OVER RANGE INDICATORS.**  
This mark comes ON when the weight is outside the range of analog sweep display..
- ⑤ **COMPARISON INDICATORS.**  
The indicators LO (RED), OK (GREEN) and HI (YELLOW) show the results of the weight comparison.
- ⑥ **STABLE ANNUNCIATOR.**  
This annunciator will come ON when the weight reading is STABLE.
- ⑦ **ZERO ANNUNCIATOR.**  
This annunciator will come ON when the scale is showing the center of ZERO.
- ⑧ **NET ANNUNCIATOR.**  
This annunciator will come ON when the scale is displaying the NET weight on the weighing pan.
- ⑨ **PT ANNUNCIATOR.**  
This annunciator will come ON when the scale is displaying the preset tare weight.
- ⑩ **PRINT ANNUNCIATOR.**  
This annunciator will come ON for a moment when the scale sends out the weight data by pressing the PRINT key or auto-printing.
- ⑪ **PRECAUTION AGAINST LOW BATTERY.**  
This annunciator will come ON when the optional battery is getting close to low battery.
- ⑫ **KEYPAD.**  
A 13 key pad provides control and number keys.

## Description of Key Operations

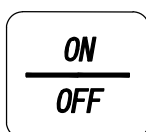

### ON/OFF Key

The **ON/OFF** key turn the power on or off. When turned on, the scale will be automatically set to zero (power-on zero).

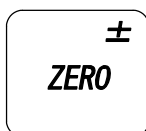

### ZERO / ± Key

The **ZERO** key zeros the scale when the weight is stable (STABLE annunciator ON). In the data entry sequence this key switches the sign “+” and “-”.



### TARE Key

The **TARE** key switches the scale to net weight mode and zeros the weight display when the weight is plus and stable. The ZERO and NET annunciators will come ON.



### PT Key

The **PT** key is used to enter a tare weight via the 10-key pad.



### SAMPLE / 9 Key

The **SAMPLE** key will register the sample weight as the target. In the data entry sequence this key displays the number 9.

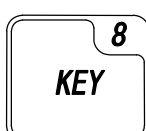

### KEY / 8 Key

The **KEY** key allows you to enter a target weight using the keypad. In the data entry sequence this key displays the number 8.



### RECALL / 7 Key

The **RECALL** key is used to recall target weight and/or HI/LO limits. In the data entry sequence this key displays the number 7.



### HI / 6 Key

The **HI** key allows you to enter the comparator HI limit using the numeric keypad. In the data entry sequence this key displays the number 6.

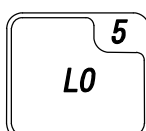

### LO / 5 Key

The **LO** key allows you to enter the comparator LO limit using the numeric keypad. In the data entry sequence this key displays the number 5.



### STORE / 4 Key

The **STORE** key is used to store target weight and/or HI/LO limits. In the data entry sequence this key displays the number 4.



### DISP. / 3 Key

When the **DISP.** key is pressed the analog weight display steps through the 4 available modes of simple weighing, target weighing, limit check weighing and display off. In the data entry sequence this key displays the number 3.



### UNITS / 1 Key

The **UNITS** key is used to select the desired weighing unit. In the data entry sequence this key displays the number 1.

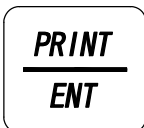

### PRINT / ENT Key

The **PRINT** key is used when the serial data option FS-03*i* or FS-04*i* is installed and sends one data string. In the data entry sequence this key is used to ENTER the numeric data into the scale memory.

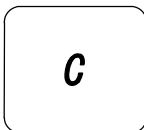

### C Key

The **C** key is used to clear an incorrect data entry from the numeric keys.

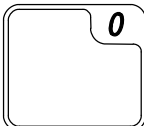

### 0 and 2 Keys

These keys are used to display the number 0 or 2 during a data entry sequence.

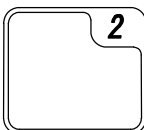

---

# 7. BASIC OPERATION

---

## 7-1. Turning the power ON and OFF

1. Press the **ON/OFF** key to turn the power ON.

All the display symbols are displayed and the scale waits for the weighing data to become stable.

After the weighing value internally becomes stable, the display turns off for a moment and zero is shown with the ZERO annunciator (power-on zero).

If the weighing value is unstable, the display will continue to "88888888". Check if anything touches the weighing pan, or check if there is strong wind or vibration.

The range for power-on zero is within  $\pm 50\%$  of the weighing capacity (kg) around the calibrated zero point.

If the power is switched ON while there is a load beyond this range, the scale shows "-----". Remove the load on the weighing pan.

2. Pressing the **ON/OFF** key again, and the power will be switched OFF.

- Auto power-off function

It is possible to have the power automatically switched OFF, if zero is displayed for approximately 5 minutes. See "11-2. Function list" and set the function "F1-1".

## 7-2. Selecting a weighing unit

Press the **UNITS** key to select the weighing unit if necessary.

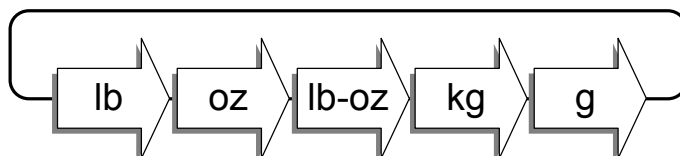

- It is possible to specify the display unit that will be shown first when the power is switched on. See the Function "F3".
- In some countries or areas "kg" or "g" only is available and the **UNITS** key does not work.

## 7-3. Basic operation

1. Press the **ON/OFF** key to switch on the scale.
2. Select a weighing unit using the **UNITS** key if necessary.
3. When the display doesn't show zero, press the **ZERO** key to set the display to zero.
4. When using a tare (container), place the container on the weighing pan, and press the **TARE** key to set the display to zero (net weight display).
5. Place the item to be weighed on the pan or in the container, and wait for the STABLE annunciator to come on and read the value.
6. Remove the item from the weighing pan.

## Note for the Legal for Trade Models

- The range for power-on zero is within  $\pm 10\%$  of the weighing capacity around the calibrated zero point.
- The  key will zero the scale if the weight is within  $\pm 2\%$  of the weighing capacity around the power-on zero point. The ZERO annunciator turns on. When the weight exceeds  $\pm 2\%$  of the weighing capacity, the key does not work.

## 7-4. Weighing with Preset Tare

Using  key, known tare weight can be entered via the 10-key pad.

1. Remove everything on weighing pan.
2. Press the  key. The display will blink with the preset tare weight previously entered, or will show blank if there is no preset tare entered.
3. Use the 10-key pad to display the known tare weight.
- If you hit the wrong key, press the  key to return to the display at step 2 and try again.
4. Press the  key. The weight display changes to net weight mode and the NET annunciator comes on.
5. Place the item together with the tare (container) to display the net weight.

## 7-5. To Clear a Tare Weight

Either:

1. Remove all items from the weighing pan.
2. Press the  key. Then the display will go to zero and tare will be cleared.
- The NET annunciator goes off.
- In some countries or areas, the  key does not clear the tare weight. Press the  key after zeroing at step 2. Then the tare weight will be cleared.

Or:

1. Press the  key. The display will blink with the preset tare weight previously entered, or will show blank if there is no preset tare entered.
2. Press the  key and .press the  key.
3. The tare weight is cleared and the NET annunciator goes off.

## 7-6. Weight display resolution

The FS-*i* series has three kinds of weight display resolution, NORMAL, HIGH and HIGHER. The following is about “kg” and “lb” display for reference. See the “12. SPECIFICATIONS” in detail.

NORMAL:	1/3,000
HIGH:	1/6,000 ~ 1/7,500 (depending on capacity)
HIGHER:	1/12,000 ~ 1/15,000 (depending on capacity)

The factory setting is the NORMAL resolution, but it is possible to change by Function “F2”. Set this function according to the application.

- ❑ **The resolution of the Legal for Trade Models is fixed to NORMAL, and the setting F2 cannot be changed.**

## 7-7. Simplified operation mode

If desired, the FS-*i* scale can be set in a Simplified Operation Mode. There are two kinds of mode according to the Function F14-1 and F14-2. In this mode, the following keys are active.

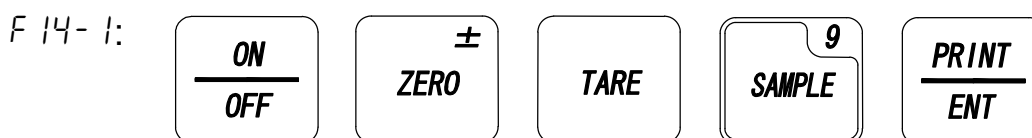

Set the upper/lower limits in the setting F14-0 first and change it to F14-1. Then, the target weight only can be set using the SAMPLE key. This setting will be used with Function F7-1 or F7-2.

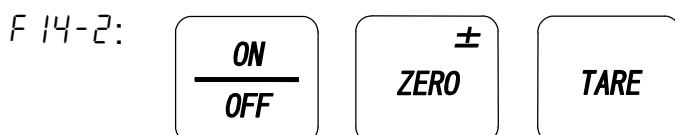

Set the target weight and upper/lower limits in the setting F14-0, and change it to F14-2. Then, The settings can not be changed accidentally.

- ❑ **Be sure to set the Function F3 (weighing unit to be used) and F16 (analog sweep display mode) together with the setting above. Because the weighing unit and analog display cannot be changed in the simplified operation mode.**

## 7-8. LCD backlight

The Function F17 controls how the LCD backlight turns off. If F17-2 or F17-3 is selected, the backlight will automatically turn off after the weight display continues to be stable for 30 or 60 seconds. It will turn on when the weight changes more than 4d (d= minimum display division) or any key operation is pressed.

---

## 8. CHECK WEIGHING

---

The FS-*i* series provides for easy check weighing of products. There are two comparison modes according to number of parameters to set, "Target weight setting mode" and "Upper & lower limits weight setting mode". The comparator results are indicated by HI (yellow), OK (green) or LO (red) lights on the display. The results are also audible by the buzzer inside the scale.

The analog sweep display will help to see where the weight is in the OK range or how far from the OK range. See "9. ANALOG SWEEP DISPLAY" in detail.

If the optional FS-03*i* or FS-04*i* is installed, comparator relay output is also available.

- It is necessary to set the "comparator function (F8-0 ~ F8-6)" parameters, upper limit (HI), lower limit (LO) and target weight (Target weight setting mode only) in advance to use comparator function.
- Select the operating conditions to compare (see the Function F8).
  - F8-0: Comparator OFF.
  - F8-1: Compare when weight is stable or moving.
  - F8-2: Compare when weight is stable. (STABLE annunciator lit.)
  - F8-3: Compare when weight is stable or moving and more than +4d or less than -4d.
  - F8-4: Compare when weight is stable and more than +4d or less than -4d.
  - F8-5: Compare when weight is stable or moving and more than +4d above zero.
  - F8-6: Compare when weight is stable and more than +4d above zero.
- d = minimum weight display in "kg". (see "15-1 Specifications")
- If necessary, use the buzzer sound for comparator results. The Function set the buzzer to sound with which result (see the Function F9).
- The brightness of comparator lights is adjustable. See the Function F15 to adjust.

### 8-1. Target weight setting mode

The TARGET WEIGHT SETTING MODE uses a target weight and +/- deviation from the target. The target weight is entered via the 10-key pad or a sample product to be weighed. The upper (HI) and lower (LO) limits are entered via the 10-key pad. Those will be deviation weight or % of the target weight.

- Set the Function setting "F7-1 Target weight setting mode with HI/LO limit weight" or "F7-2 Target weight setting mode with HI/LO limit % of the target weight".
- The formula to compare is as follows:
  - LO < Lower limit value ≤ OK ≤ Upper limit value < HI
  - Lower limit value = Target weight – LO limit
  - Upper limit value = Target weight + HI limit



## Setting the target weight by sample

1. Press the **ZERO** key to zero the weight display if necessary.
2. Place the sample on the weighing pan. The display shows the sample item's weight.
3. Press the **SAMPLE** key. The sample weight flashes and the central part of analog display turns on.
  - Press the **ON/OFF** key or **SAMPLE** key to exit without anything changed.
4. Wait for the STABLE annunciator to come on and press the **ENT** key to store the sample weight in memory.
5. The display shows **StorEd** for a few seconds and returns to weighing mode.

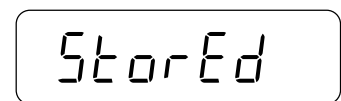

## Setting the target weight by key

1. Press the **KEY** key and the last target weight entered will flash and the central part of analog display turns on.
2. Enter the target weight via the 10-key pad.
  - If you hit the wrong key, press the **C** key and the old target weight is re-displayed. Continue data entry again.
  - You can place minus value using the **±** key. This key toggles the sign.
3. Press the **ENT** key to store the target weight in memory.
4. The display shows **StorEd** for a few seconds and returns to weighing mode.

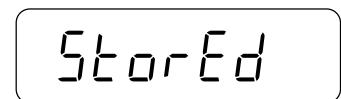
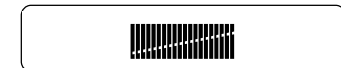
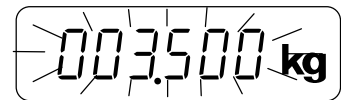

## Setting the HI limit weight and LO limit weight

- Set the Function setting "F7-1 Target weight setting mode with HI/LO limit weight".
1. Press the **HI** key. Then, the last HI limit weight entered will flash and the right part of analog display turns on.
  2. Enter the HI limit weight via the 10-key pad.
    - If you hit the wrong key, press the **C** key and the old HI limit weight is re-displayed. Continue data entry again.
    - You cannot enter the "+" or "-" sign for the LO limit.

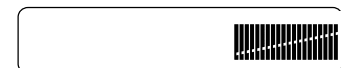

3. Press the **ENT** key to store the HI limit weight in memory.

4. The display shows **StorEd** for a few seconds and returns to weighing mode.

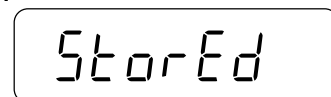

5. Press the **LO** key. Then, the last LO limit weight entered will flash and the left part of analog display turns on.



6. Enter the LO limit weight via the 10-key pad.

If you hit the wrong key, press the **C** key and the LO limit weight is re-displayed. Continue data entry again.



You cannot enter the "+" or "-" sign for the LO limit.



7. Press the **ENT** key to store the LO limit weight in memory.

8. The display shows **StorEd** for a few seconds and returns to weighing mode.

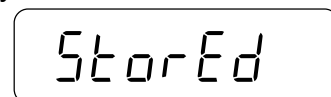

Example:

Target weight: 3.000 kg, HI limit weight: 0.050 kg, LO limit weight: 0.030 kg

Then,

Upper limit = 3.000 kg + 0.050 kg = 3.050 kg

Lower limit = 3.000 kg - 0.030 kg = 2.970 kg

LO: weight < 2.970 kg

OK: 2.970 kg ≤ weight ≤ 3.050 kg

HI: 3.050 kg < weight

## Setting the HI limit % and LO limit %

Set the Function setting "F7-2 Target weight setting mode with HI/LO limit %".

1. Press the **HI** key. Then, the last HI limit % entered will flash and the right part of analog display turns on.

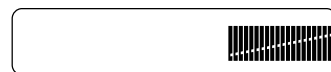
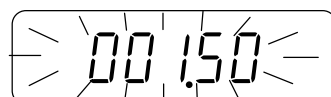

2. Enter the HI limit % via the 10-key pad.

If you hit the wrong key, press the **C** key and the old HI limit % is re-displayed. Continue data entry again.

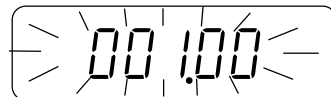

You cannot enter the "+" or "-" sign for the HI limit.

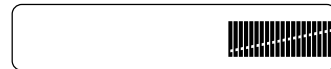

3. Press the **ENT** key to store the HI limit % in memory.

4. The display shows **StorEd** for a few seconds and returns to weighing mode.

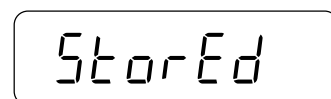

5. Press the **LO** key. Then, the last LO % weight entered will flash and the left part of analog display turns on.



6. Enter the LO limit weight via the 10-key pad.

If you hit the wrong key, press the **C** key and the LO limit % is re-displayed. Continue data entry again.



You can not enter the “+” or “-” sign for the LO limit.



7. Press the **ENT** key to store the LO limit % in memory.

8. The display shows **StorEd** for a few seconds and returns to weighing mode.

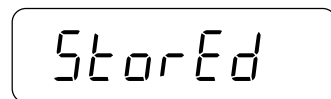

The HI/LO limit % has 2 decimal places fixed in the setting mode above.

The HI/LO limit weight entered in the previous section will not be converted to %, and vice versa.

Example:

Target weight: 3.000 kg, HI limit weight: 1.00 %, LO limit weight: 0.50 %

Then,

Upper limit = 3.000 kg + 3.000kg x 1.00 % = 3.030 kg

Lower limit = 3.000 kg - 3.000kg x 0.50 % = 2.985 kg

## 8-2. Upper & Lower limits weight setting mode

The UPPER & LOWER LIMITS WEIGHT SETTING MODE uses an upper limit weight and a lower limit weight. The target weight is not used. These upper (HI) and lower (LO) limits are entered via the 10-key pad directly.

Set the Function “F7-0 Upper & Lower limit weight setting”.

The formula to compare is as follows:

$LO < Lower\ limit\ value \leq OK \leq Upper\ limit\ value < HI$

### Setting the upper (HI) limit weight and lower (LO) limit weight

Set the Function “F7-0 Upper & Lower limit weight setting”.

1. Press the **HI** key and the last HI limit weight entered will flash and the right part of analog display turns on.

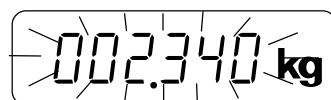

2. Enter the HI limit weight via the 10-key pad.

If you hit the wrong key, press the **C** key and the old HI limit weight is re-displayed. Continue data entry again.



You can enter minus value using the **±** key. This key toggles the sign.



3. Press the **ENT** key to store the HI limit weight in memory.

4. The display shows **StorEd** for a few seconds and returns to weighing mode.

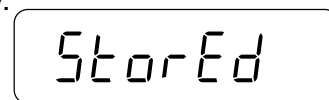

5. Press the **LO** key and the last LO limit weight entered will flash.

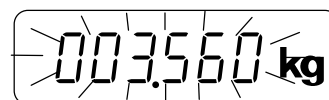

6. Enter the LO limit weight via the 10-key pad.

If you hit the wrong key, press the **C** key and the LO limit weight is re-displayed. Continue data entry again.

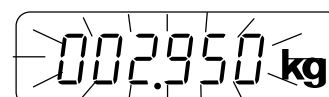

You can enter minus value using the **±** key. This key toggles the sign.



7. Press the **ENT** key to set the LO limit weight in memory.

8. The display shows **StorEd** for a few seconds and returns to weighing mode.

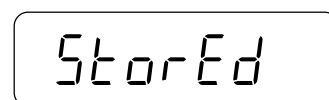

Example:

Upper (HI) limit weight: 3.050 kg, Lower (LO) limit weight: 2.950 kg

Then,

LO: weight < 2.950 kg

OK: 2.950 kg ≤ weight ≤ 3.050 kg

HI: 3.050 kg < weight

### 8-3. The comparator memory

The FS-*i* scale can store up to 100 comparator limits by 2 digit numbers, form 00 to 99.

To use this function, the scale must not be set to the simplified operation mode.

#### Storing a set of limits in memory

1. Set the comparator data according to the previous sections “8-1. Target weight setting mode” (target weight, HI limit and LO limit) or “8-2. Upper & Lower limits weight setting mode” (HI limit and LO limit).

2. Press the **STORE** key. Then the display will show **5d 00**.

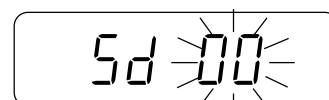

3. Press the memory number, for example 6.

If you stop to store, press the **C** key, the scale returns to the weighing mode.

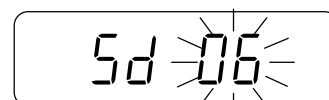

4. Press the **ENT** key to store the data to into the memory. The display shows **StorEd** for a few seconds and returns to weighing mode.

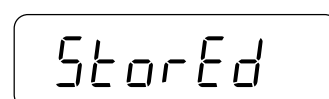

## Recalling a set of limits from memory

1. Press the **RECALL** key. Then the display will show **rd 00**.
2. Press the memory number, for example 3.  
 If you stop to recall, press the **C** key, the scale returns to the weighing mode.
3. Press the **ENT** key to recall the data from the memory.
4. The display shows a set of data for a few seconds one by one and returns to weighing mode.

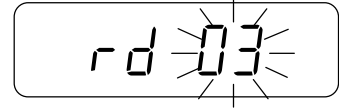
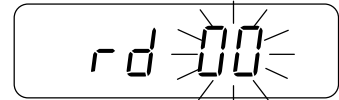

TARGET WEIGHT  
(Target weight setting mode only)



HI LIMIT

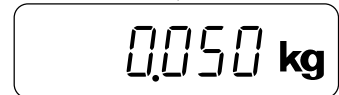

LO LIMIT

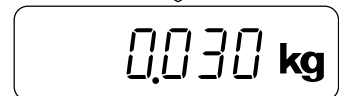

WEIGHING MODE

## 8-4. AUTO-TARE FUNCTION

The auto-tare function will be used with comparator function enabled. If the weight value is within the OK range and stable for seconds of time, then the scale will automatically tare the weight and show zero. The Function “F22” designates the timing to tare automatically.

- ❑ To use the auto-tare function, set the function settings below.

F08-1: Compare all weighing data (the other setting may be used depending on the application).

F21-1: Auto-tare function enabled.

F22-0~9: Select the timing to tare automatically to avoid the wrong tare operation.

- ❑ Take-away check weighing “F24-1”

To use the scale with take-away check weighing (negative comparison), set the Function “F24-1” together with the auto-tare function enabled “F21-1”. The scale operates as “take-away the stuff” → “OK and stable” → “auto-tare” → “take-away the stuff” → …….

In this mode, the comparator results are shown as below.

F07-1:  $-(|Target|+HI\ limit)$        $-(|Target|-LO\ limit)$

F07-0:  $-|Upper\ limit|$        $-|Lower\ limit|$

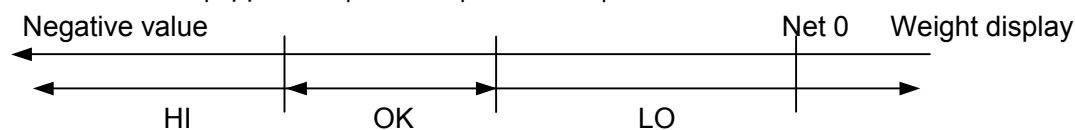

- ❑ When the Function “F23-1 Tares the initial (container) weight.” is set:

To start the auto-tare function application, usually the weight of container (filled with stuff) must be tared using the **TATE** key. When the Function “F23-1” is set, the scale will tare the initial (container weight) weight automatically.

Remove all load on the weighing pan to return to zero point, the tare weight will be automatically cleared. If the scale could not return to zero point because of the zero shift, press the **ZERO** key to clear the tare weight.

- ❑ If the scale is equipped with the optional RS-232C interface, the OK weighing data only can be sent out automatically. Set the Function setting “F06-7 Auto-print mode +/- data & OK”.

---

# 9. ANALOG SWEEP DISPLAY

---

The FS-*i* series has a 60 segments analog sweep display. The DISP. key switches its display mode.

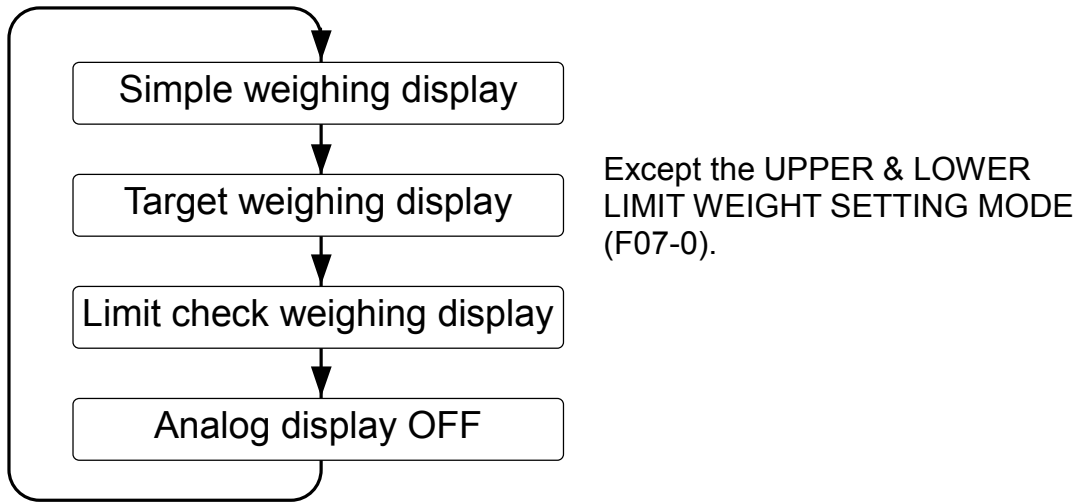

- It is possible to specify the display mode that will be shown first when the power is switched on. See the Function F16.
- Use the analog sweep display with positive target and limit weights.

## 9-1. Selecting a display mode

### Simple weighing display mode

The 60 segments represent zero to full scale. When the scale is in the net mode, the analog sweep display shows net weight.

In the TARGET WEIGHT SETTING MODE (F07-1 or F07-2), the target weight will be shown on the display as a flashing segment.

- The UPPER & LOWER LIMIT WEIGHT SETTING MODE (F07-0) does not show the target weight segment.

### Target weighing display mode

The 60 segments represent zero to full scale. When the scale is in the net mode, the analog sweep display shows net weight.

In the TARGET WEIGHT SETTING MODE, the 40th segment will flash as the target weight. Thus the 60 segments represent the relative weight that the target weight is scaled to the 40 segments.

As the weight increases, the analog segments approach the flashing segment. This will provide a simple way of filling the container to the target weight.

- The UPPER & LOWER LIMIT WEIGHT SETTING MODE (F07-0) does not have this display.

### Limit check weighing display mode

The display shows comparison limits and results. The lower limit is shown at the 21st segment flashing and the upper limit is shown at the 40th segment flashing. The results will be known by the segments turned on.

## 9-2. Example of the analog sweep display

### Simple weighing display mode

FS-30Ki / d=0.01 kg

TARGET WEIGHT SETTING MODE  
(F07-1 or F07-2)

Target weight = 15.00 kg.

Net weight display (tare entered)

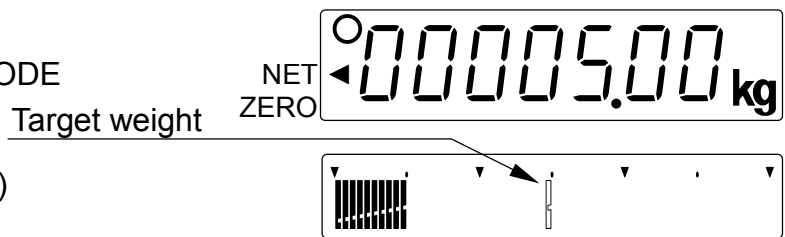

FS-30Ki / d=0.01 kg

UPPER & LOWER LIMIT WEIGHT SETTING MODE  
(F07-0)

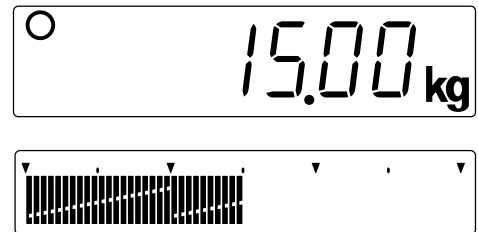

### Target weighing display mode

FS-30Ki / d=0.01 kg

TARGET WEIGHT SETTING MODE  
(F07-1 or F07-2)

Target weight = 15.00 kg.

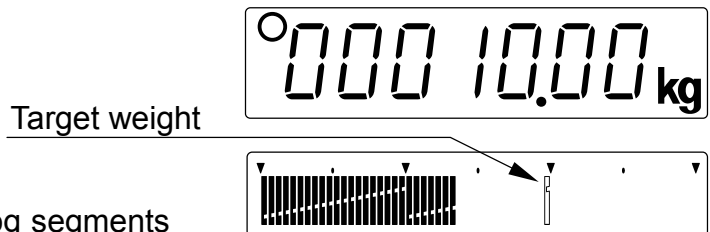

❑ As the weight increases, the analog segments approach the flashing segment. This will provide a simple way of filling a container to a target weight.

❑ The UPPER & LOWER LIMIT WEIGHT SETTING MODE (F07-0) does not have this display mode.

### Limit check weighing display mode

FS-30Ki / d=0.01 kg

TARGET WEIGHT SETTING MODE  
(F07-1 or F07-2)

Target weight = 5.00 kg.

HI = 0.10 kg, LO = 0.09 kg

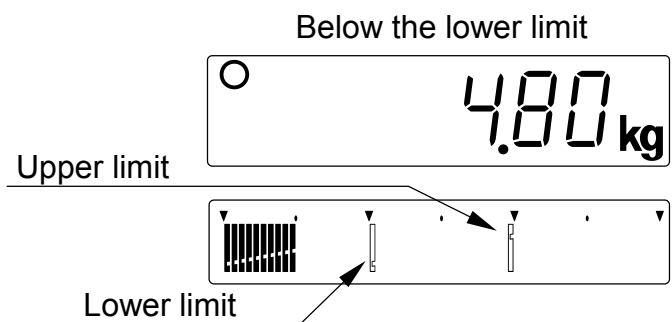

Within the limits

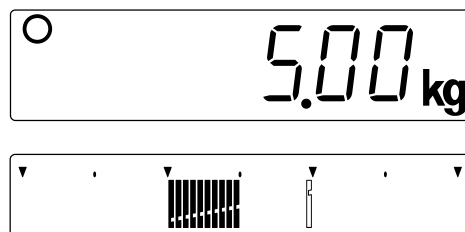

Above the upper limit

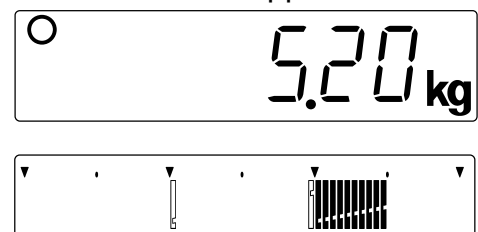



FS-30Ki / d=0.01 kg

UPPER & LOWER LIMIT WEIGHT SETTING MODE  
(F07-0)

Target weight = 5.00 kg.

HI = 10.10 kg, LO = 9.91 kg

Below the lower limit

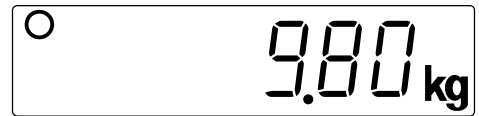

Upper limit

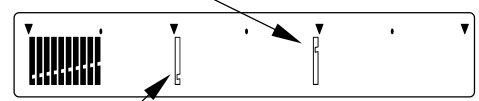

Lower limit

Within the limits

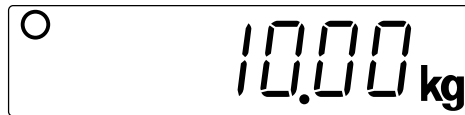

Above the upper limit

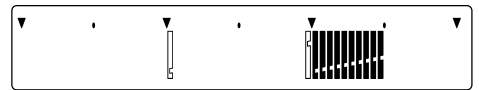
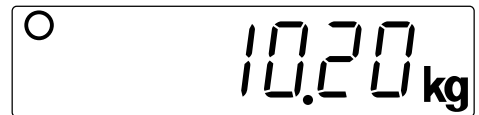

Outside the range of the analog sweep display

FS-30Ki / d=0.01 kg

TARGET WEIGHT SETTING MODE  
(F07-1 or F07-2)

Target weight = 5.00 kg.

HI = 0.10 kg, LO = 0.09 kg

Below the lower limit

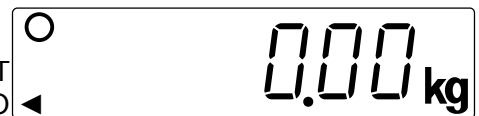

NET  
ZERO

Lower than range

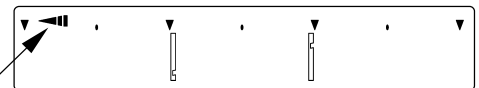

Above the upper limit

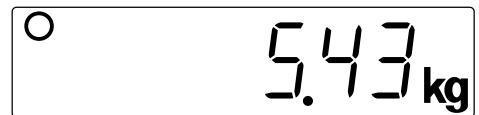

Higher than range

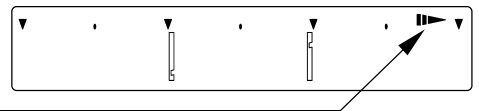

# 10. CALIBRATION

This function adjusts the scale for accurate weighing.  
Calibrate the scale in the following cases.

- When the scale is first used.
- When the scale has been moved.
- When the ambient environment has changed.
- For regular calibration.

Loosen the lock screws on the rear side of the display pod, and remove the CAL switch cover. Then, there is a calibration switch inside.

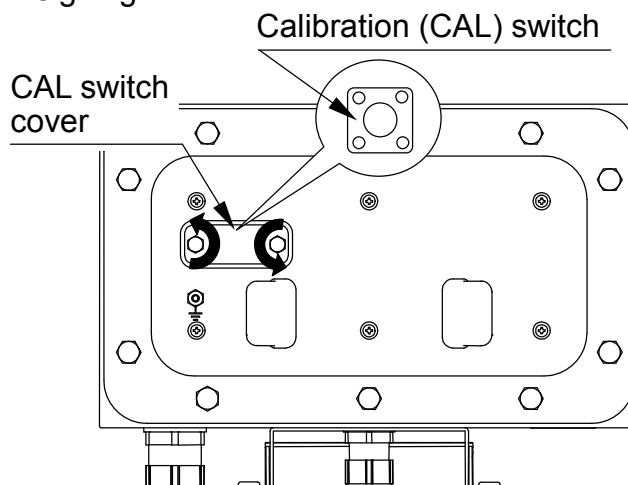

## 10-1. Calibration using a weight

1. Warm up the scale for at least half an hour with nothing on the weighing pan.
  - Change Function setting "F1" or place something on the pan to disable the auto power-off function.

2. Press and hold the calibration (CAL) switch until  appears, and release the switch.

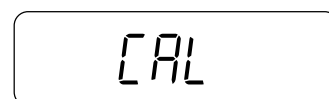

- Press and hold the  key for about 5 seconds, then you can also enter the calibration mode.**

- Press the  key or CAL switch to exit without calibration.

3. Press the  key, then the gravity acceleration value will be displayed.

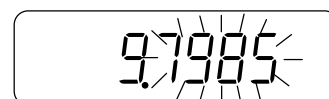

- It is not necessary to set the gravity acceleration value when calibrating the scale with a calibration weight at the place where it is to be used. (See the next section about the gravity acceleration correction.)**

4. Press the  key, then the  will be displayed.

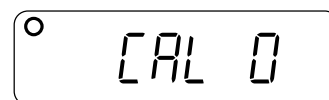

5. Make sure that there is nothing on the weighing pan, and wait until the STABLE annunciator turns on.

6. Press the  key. The scale calibrates the zero point, and the display shows "SPn 1" and the weight value to calibrate (SPAN calibration).

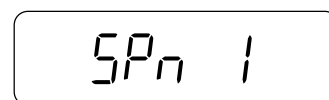

- The weight value is equal to the capacity. When you enter with "kg" or "g" mode, then the value is "kg". Entering with "lb" or "oz", then "lb".**

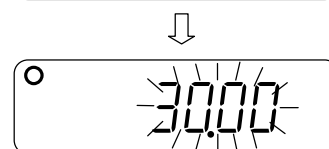

- If you do not need SPAN calibration, turn the power off to exit from the calibration procedure.

7. To calibrate with the different weight, change the displayed value using the 10-key pad.

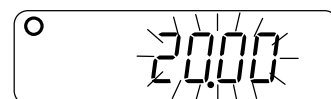

If you hit the wrong number, press the  key. The value returns to the capacity and enter again.

8. Place the calibration weight on the pan with the same value as displayed, and wait until the STABLE annunciator turns on.

9. Press the  key. The scale calibrate SPAN and  will appear. Remove the weight from the pan, and turns the power off.

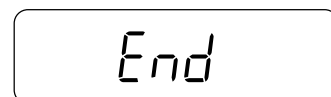

**Note**

*The value set in step 7 will be cleared after the power is switched off.*

*If the scale will suppose to move to another location, set the gravity acceleration value for the current location and calibrate the scale according to the procedure above. See the next section to set the value.*

## 10-2. Gravity acceleration correction

When the scale is first used or has been moved to different place, it should be calibrated using a calibration weight.

But if a calibration weight is not available, the gravity acceleration correction will compensate the scale. Change the gravity acceleration value of the scale to the value of area where the scale will be used. Refer to the gravity acceleration map appended to the end of this manual.

**Note**

*It is not necessary to set the gravity acceleration correction when calibrating the scale with a calibration weight at the place where it is to be used.*

1. At step 3. of the previous section “10-1. Calibration using a weight”, enter a new value using 10-key pad.



The integral part “9” is fixed and enter the value after the decimal point.

If you hit the wrong number, press the  key. The value returns to the original number. Enter again.

2. Press the  key, then the  will be displayed.

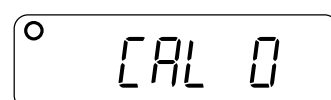

3. If necessary to calibrate the scale using a calibration weight, go to step 5 of “10-1. Calibration using a weight”. To finish the setting, turn the power off.

---

# 11. FUNCTIONS

---

The scale has Function settings to expand your applications. The parameters set in the Function settings are maintained even if the power switched off.

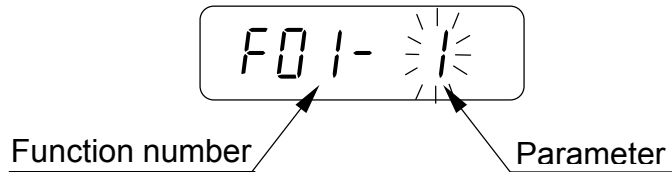

## 11-1. The procedure for setting parameters

1. Turn the power off.
2. Press and hold the **ZERO** key and turn the power on via the **ON/OFF** key. Then the first function number is displayed.
3. Enter the Function number using the 10-ley pad.
4. Press the **ENT** key. Then the parameter stored is appears.
3. Enter the parameter value using the 10-ley pad.
  - If you do not need to change the parameter, turn the power off without pressing **ENT** key.
  - If you like to go to the next function number, press the **ZERO** key and set the new parameter if necessary.
4. Press the **ENT** key. The display shows **End** for a few seconds and returns to weighing mode.
  - Be sure to press the **ENT** key because all of the new parameters are not stored until **End** is displayed.

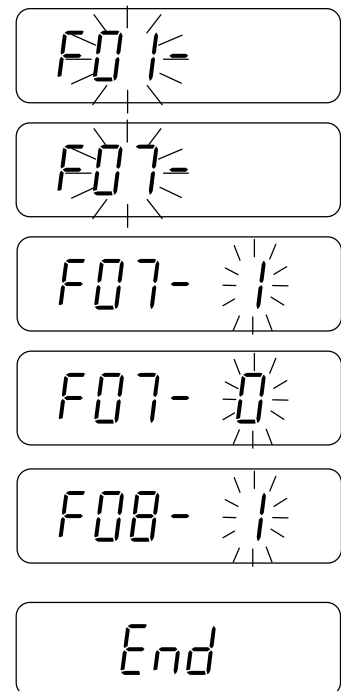

## 11-2. Function list

Item	Function number	Description	
Auto power-off function	◆ F 1- 0	Auto power-off disabled	Automatically power off
	F 1- 1	Auto power-off enabled	
Display resolution	◆ F 2- 0	Normal (1/3,000 class)	Legal for trade is Normal only.
	F 2- 1	High (1/6,000~1/7,500 class)	
	F 2- 2	Higher (1/12,000~1/15,000 class)	
Weighing unit when powered on	F 3- 0	kg	Factory setting may be different depending on the area to be shipped.
	F 3- 1	g	
	◆ F 3- 2	lb	
	F 3- 3	oz	
	F 3- 4	lb-oz	
Serial interface Baud rate	◆ F 4- 0	2400 bps	Optional RS-232C/422/485
	F 4- 1	4800 bps	
	F 4- 2	9600 bps	
Serial interface Data bit / Parity	◆ F 5- 0	7 bit / Even parity	Optional RS-232C/422/485
	F 5- 1	7 bit / Odd parity	
	F 5- 2	8 bit / Non parity	
Serial interface Data output mode	F 6- 0	Stream mode	Optional RS-232C/422/485. The UFC format is applicable to f6-2 to 4.
	F 6- 1	Command mode	
	◆ F 6- 2	Print key mode	
	F 6- 3	Auto-print mode + data	
	F 6- 4	Auto-print mode +/- data	
	F 6- 5	Multi-connection with Print key mode (RS-422/485)	
	F 6- 6	Auto-print mode + data & OK	
F 6- 7	Auto-print mode +/- data & OK		
Comparison mode	F 7- 0	Upper & Lower limits weight setting mode	Way to set parameters.
	◆ F 7- 1	Target weight setting mode with HI/LO limit weight	
	F 7- 2	Target weight setting mode with HI/LO limit % of the target weight	
Comparator operating condition	F 8- 0	Comparator disabled	Conditions to compare. d = minimum display division
	◆ F 8- 1	Compares all data	
	F 8- 2	Compares all stable data	
	F 8- 3	Compares data > +4d or < -4d	
	F 8- 4	Compares stable data > +4d or < -4d	
	F 8- 5	Compares data > +4d	
Comparator buzzer	◆ F 9- 0	Buzzer does not sound.	Buzzer sounds according to the comparator results
	F 9- 1	Buzzer sounds at LO	
	F 9- 2	Buzzer sounds at OK	
	F 9- 3	Buzzer sounds at LO and OK	
	F 9- 4	Buzzer sounds at HI	
	F 9- 5	Buzzer sounds at LO and HI	
	F 9- 6	Buzzer sounds at OK and HI	
	F 9- 7	Buzzer sounds at LO, OK and HI	
Response / Filtering	F 10- 0	Fast / Weak (sensitive)	Software filtering
	◆ F 10- 1		
	F 10- 2		
	F 10- 3		
	F 10- 4		

◆ Factory setting

Item	Function number	Description	
Stability detection width	<i>F 11- 0</i>	Narrow	Condition to detect stability
	◆ <i>F 11- 1</i>	Wide	
	<i>F 11- 2</i>		
Stability detection time	<i>F 12- 0</i>	Short	
	◆ <i>F 12- 1</i>	Long	
	<i>F 12- 2</i>		
Zero tracking	<i>F 13- 0</i>	Zero tracking OFF	Legal for trade models cannot set F13-2 and 3.
	◆ <i>F 13- 1</i>	Zero tracking ON, 0.5d/sec	
	<i>F 13- 2</i>	Zero tracking ON, 1.0d/sec	
	<i>F 13- 3</i>	Zero tracking ON, 2.0d/sec	
Key operation	◆ <i>F 14- 0</i>	All keys enabled	Simplified operation available
	<i>F 14- 1</i>	ON/OFF, ZERO, TARE, SAMPLE & PRINT/ENT only enabled.	
	<i>F 14- 2</i>	ON/OFF, ZERO & TARE only enabled	
Comparator light brightness	<i>F 15- 0</i>	Dark	Brightness control
	<i>F 15- 1</i>		
	<i>F 15- 2</i>		
	<i>F 15- 3</i>		
	<i>F 15- 4</i>		
	<i>F 15- 5</i>		
	◆ <i>F 15- 6</i>		
	<i>F 15- 7</i>		
<i>F 15- 8</i>	Bright		
Analog sweep display when powered on	◆ <i>F 16- 0</i>	Simple weighing display mode	
	<i>F 16- 1</i>	Target weighing display mode	
	<i>F 16- 2</i>	Limit check weighing display mode	
	<i>F 16- 3</i>	Display off	
LCD backlight	<i>F 17- 0</i>	Always OFF	Weight change or key operation turns on.
	◆ <i>F 17- 1</i>	Always ON	
	<i>F 17- 2</i>	Turns off after 30 sec. weight stability	
	<i>F 17- 3</i>	Turns off after 60 sec. weight stability	
Serial interface Address	◆ <i>F 18- 00</i>	00 RS-232C must be set to this.	Optional RS-232C/422/485
	<i>F 18- ##</i>	## = 01~99 RS-422/485	
Serial interface	◆ <i>F 19- 0</i>	RS-232C	
	<i>F 19- 1</i>	RS-422	
	<i>F 19- 2</i>	RS-485	
Serial interface operation mode	<i>F 20- 0</i>	Reply to the command is sent.	F6-1
	◆ <i>F 20- 1</i>	No reply to the command.	F6-2, 3 or 4
	<i>F 20- 2</i>	UFC format	
Auto-tare function	◆ <i>F 21- 0</i>	Auto-tare function disabled.	
	<i>F 21- 1</i>	Auto-tare function enabled.	

◆ Factory setting

Item	Function number	Description	
Auto-tare timing	<i>F22- 0</i>	Immediately after OK and stable	Timing to tare automatically after the comp. OK and weight stable. To be used with <i>F21- 1</i> .
	<i>F22- 1</i>	0.5 sec. after OK and stable	
	◆ <i>F22- 2</i>	1.0 sec. after OK and stable	
	<i>F22- 3</i>	1.5 sec. after OK and stable	
	<i>F22- 4</i>	2.0 sec. after OK and stable	
	<i>F22- 5</i>	2.5 sec. after OK and stable	
	<i>F22- 6</i>	3.0 sec. after OK and stable	
	<i>F22- 7</i>	4.0 sec. after OK and stable	
	<i>F22- 8</i>	5.0 sec. after OK and stable	
	<i>F22- 9</i>	6.0 sec. after OK and stable	
Auto-tare for the initial weight	◆ <i>F23- 0</i>	Function disabled	Automatic operation.
	<i>F23- 1</i>	Tares the initial (container) weight.	
Normal/Negative comparison	◆ <i>F24- 0</i>	Normal comparison	
	<i>F24- 1</i>	Negative comparison for take-away	

◆ Factory setting

---

## 12. HC-02*i* BATTERY

---

### 12-1. Using the HC-02*i* SLA Battery

- ❑ The scale can be operated with an SLA (Sealed Lead Acid) battery that will be commercially available.
- ❑ The scale (with no other options) can be operated with a fully charged battery for;
  - LCD backlight OFF and Comparator light OFF: approximately 80 hours
  - LCD backlight OFF and Comparator light ON: approximately 55 hours
  - LCD backlight ON and Comparator light ON: approximately 25 hours
- ❑ The battery will take about 15 hours to be fully charged.
- ❑ The battery life will vary depending on how the scale is used, the ambient temperature and so on.



- ❑ Use a GS Yuasa Battery NP4-6 (6V, 4Ah).
- ❑ There will be risk of explosion if the battery is connected improperly or replaced with the incorrect type.
- ❑ Dispose of a used battery according to the local laws and regulations.

### Installing the battery

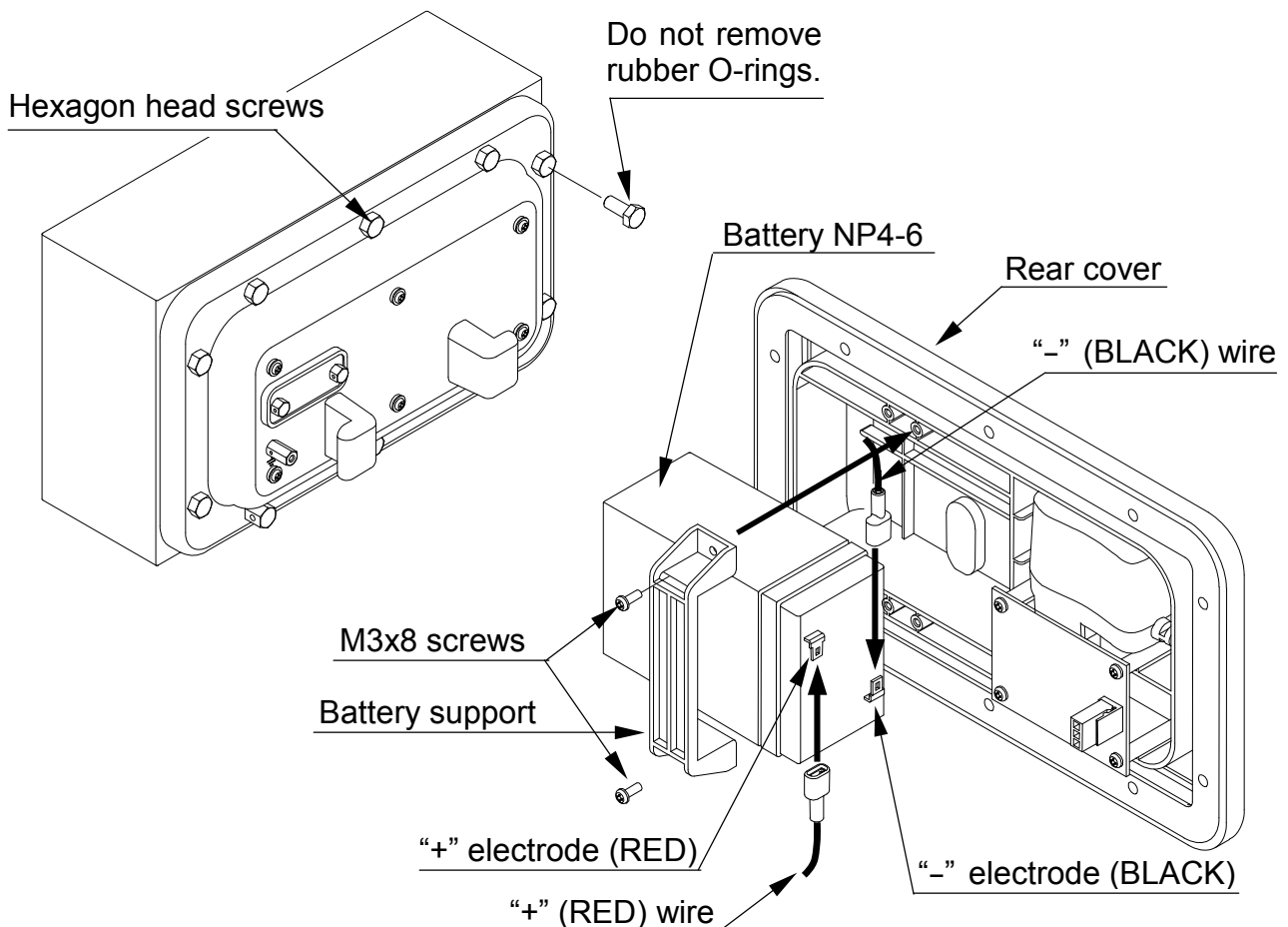



1. Disconnect the main power cord from the outlet.
2. Remove the ten hexagon head screws and open the rear cover.
- ⚠ **Take care not to drop the rear cover or the wires connecting between front display and rear cover will be damaged.**
3. Loosen the screws fixing the battery support and remove it.
4. Connect the wires inside the display pod to the battery.
- ⚠ **Be sure to connect RED wire to positive (+ / RED) terminal and BLACK wire to negative (- / BLACK) terminal. Or there is a risk of explosion.**
5. Place the battery into the rear cover and fix with screws and battery support that removed at step 3 above.
6. Attach the rear cover to the front display firmly using the ten hexagon head bolts.
7. Connect the main power cord to the outlet.
8. Press the ON/OFF key and check that the scale works normally.
9. Disconnect the main power cord again and check that the scale still works.

## Charging the battery

- When the weight display shows “L b I”, the battery voltage is low in voltage and should be recharged. Connect the main power cord to the outlet. The charging process will start while the scale is powered on or not.
- When the battery is getting close to the low battery, the annunciator (PRECAUTION AGAINST LOW BATTERY) will come on. Prepare to charge the battery.
- The scale can be used while the battery is charging. After fully charged, the scale will change the charging process to trickle charge automatically.
- The battery cannot be charged with the OP-04 in operation. Turn the power off to charge.
- Charge the battery at a temperature between 0°C (32°F) and 40°C (104°F). Preferably 5°C (41°F) ~ 35°C (95°F) is recommended.**
- Charge the battery when using for the first time.**
- The battery must be recharged regularly if the scale is not used for a long period of time. Every 3 months in a warmer area and every 6 months in a cooler area will be needed.**

# 13. FS-03i RS-232C / RELAY OUTPUT

This interface allows the FS-*i* series to be connected with a multifunction printer or a personal computer, and the relay outputs for comparator result are obtained.

- The FS-03*i* unit includes an interface board, a connector cable, a cable gland and two screws (M3x6).

## 13-1. Installation

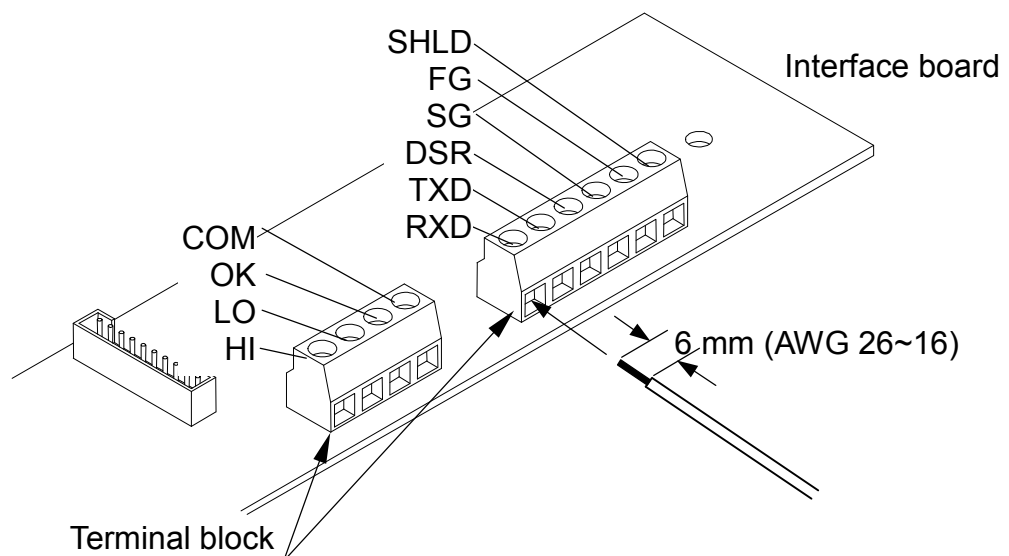
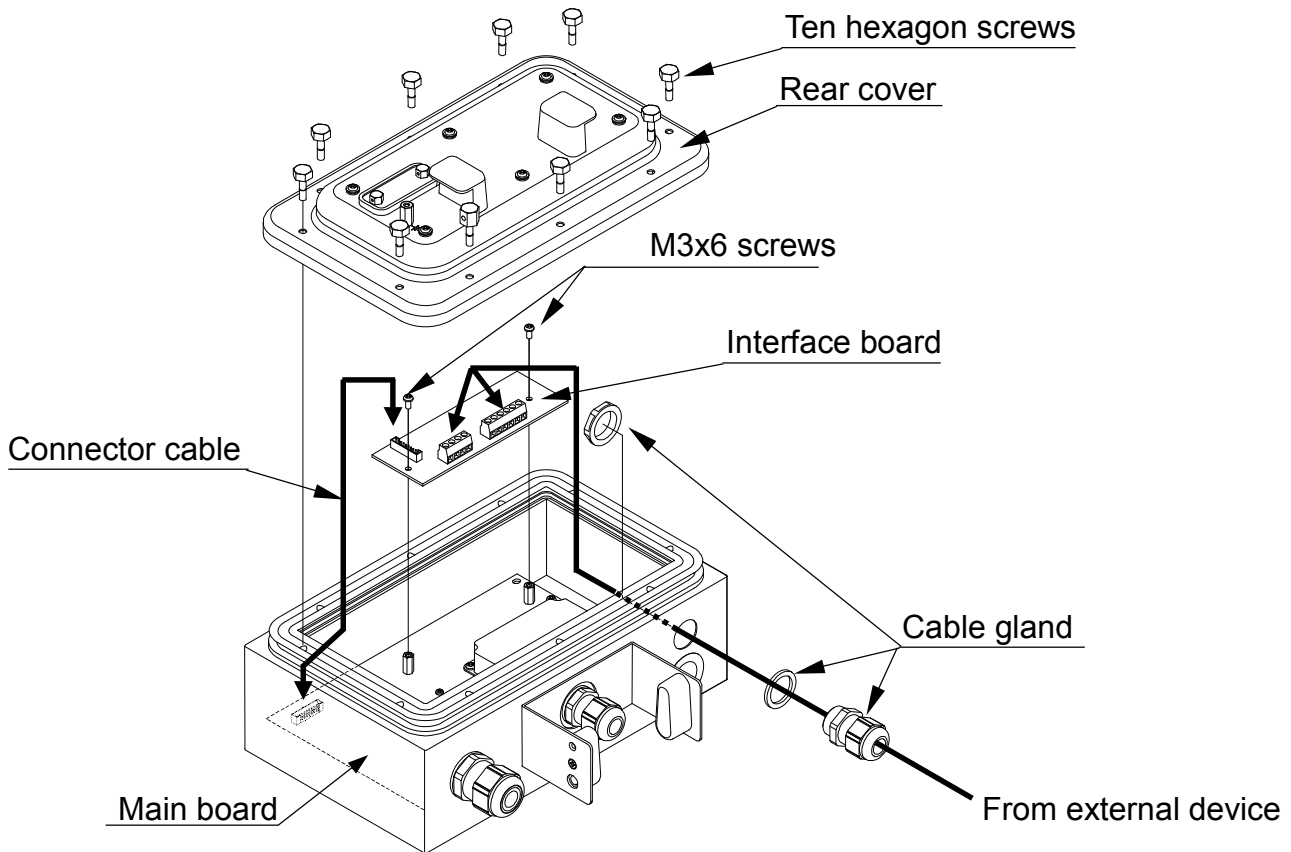

1. Disconnect the main power cord from the outlet.
2. Remove the ten hexagon screws and open the rear cover.
3. Connect the cable from external device through the cable gland to the terminal blocks on the interface board. Also connect a yellow/green wire inside the display pod directly to "FG" on the terminal block.

**⚠ Take care not to drop the rear cover or the wires connecting between front display and rear cover will be damaged.**

4. Connect the connector cable included in the FS-03i to the connectors on the interface board and the main board inside the display pod.
5. Fix the interface board with 2 M3 x 6 screws included in the FS-03i.
6. Tighten the cable gland and attach the rear cover to the front display firmly using the ten hexagon bolts.
7. Connect the main power cord to the outlet.
8. Set the function parameters F04, F05, F06, F18, F19 and F20 according your application.

The FS-03i RS-232C must have settings F18-00 and F19-0.

## 13-2. FS-03i Specifications

### RS-232C Specification

Transmission form	Asynchronous, bi-directional, half-duplex
Data format	Baud rate: 2400, 4800, 9600 bps
	Data: 7 bits + parity 1bit (even / odd) or 8 bits (non-parity)
	Start bit: 1 bit
	Stop bit: 1 bit
	Code: ASCII
	Terminator: C <sub>R</sub> L <sub>F</sub>

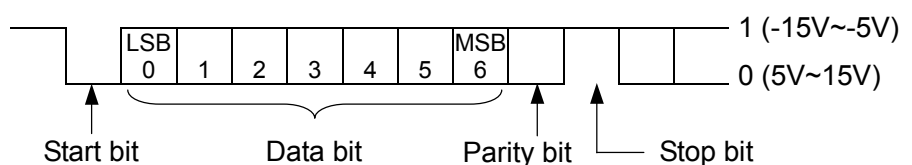

### Maximum rating of the Relau Outoput

The maximum rating of the replay output is as follows.

- Maximum voltage: 50V DC
- Maximum current: 100 mA DC
- Maximum ON resistance: 8 Ω

## Circuit diagram

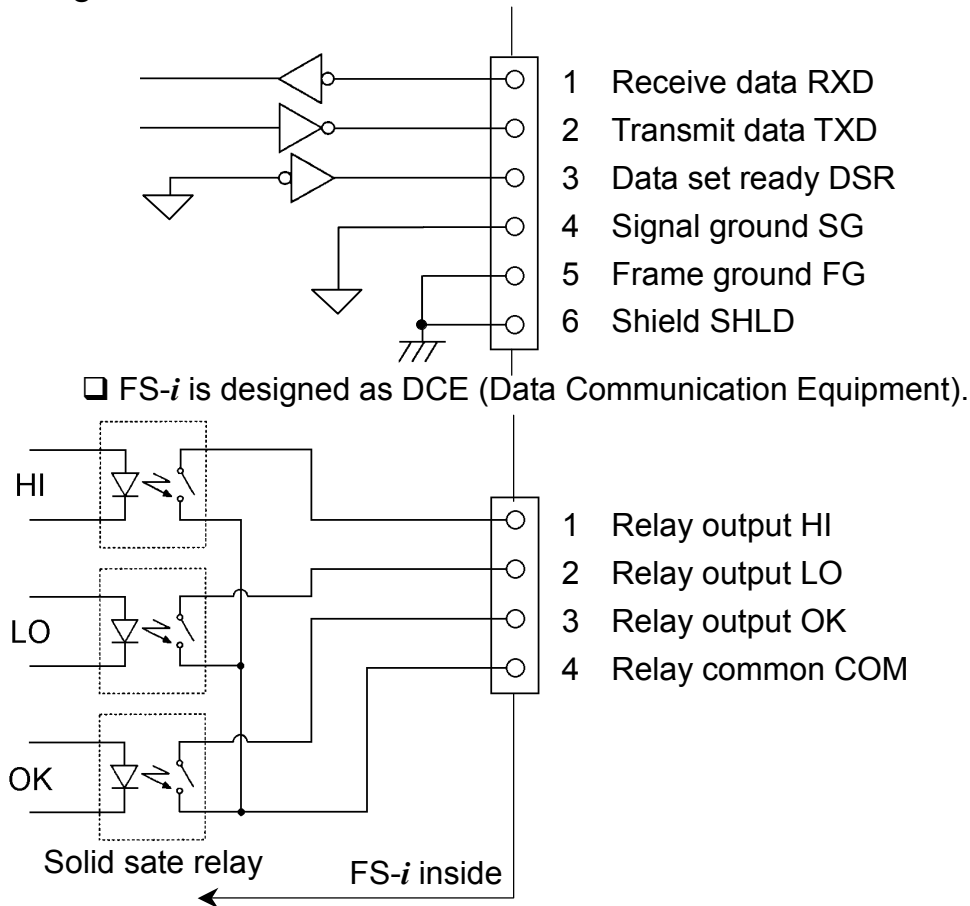

## Data format

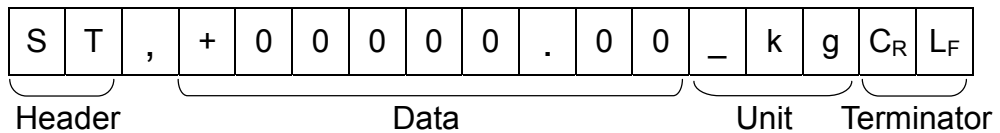

□ There are 3 headers for the weighing data.

- ST: Stable weighing data
- US: Unstable weighing data
- OL: Out of weighing range

□ The data consists of 9 characters including polarity and decimal point.

□ There are 5 units.

- \_ k g: Weighing unit "kg"
- \_ \_ g: Weighing unit "g"
- \_ l b: Weighing unit "lb"
- \_ o z: Weighing unit "oz"
- \_ \_ %: HI/LO limit % (F07-2)

□ Example of data

Weighing data "kg" (+)

S	T	,	+	0	0	1	2	.	3	4	5	_	k	g	C <sub>R</sub>	L <sub>F</sub>
---	---	---	---	---	---	---	---	---	---	---	---	---	---	---	----------------	----------------

Weighing data "g" (-)

S	T	,	-	0	0	0	0	1	2	3	4	_	_	g	C <sub>R</sub>	L <sub>F</sub>
---	---	---	---	---	---	---	---	---	---	---	---	---	---	---	----------------	----------------

Out of range (+)

O	L	,	+	9	9	9	9	9	9	9	9	_	k	g	C <sub>R</sub>	L <sub>F</sub>
---	---	---	---	---	---	---	---	---	---	---	---	---	---	---	----------------	----------------

## Data output mode (F06)

### Stream Mode (F06-0)

Data is sent continuously. The data-update rate is approximately 20 times per second. But for 2400 bps, it is too slow to send 20 times. If necessary, set the baud rate 4800 bps or more.

### Command Mode (F06-1)

The scale is controlled by commands that come from an external device, computer etc. See “2-3. Command mode” in detail.

### Print Key Mode (F06-2)

When the weight display is stable, data is sent by pressing the PRINT key. The PRINT annunciator will turn on for a short while when the data has been sent.

### Auto-print Mode + data (F06-3)

Data is sent if the weight display is stable at +5d (d = weighing display division) and above. The next transmission can not occur until after the weight display falls below +5d.

### Auto-print Mode +/- data (F06-4)

Data is sent if the weight display is stable at  $\pm 5d$  (d = weighing display division) and above/below. The next transmission can not occur until after the weight display falls between  $-5d$  and  $+5d$ .

The commands can be used in all data output mode (F06-1 is command mode only).

As the new modes, the F06-5, F06-6 and F06-7 are added to the Function “F06”.

### Auto-print Mode + data and OK (F06-6)

Data is sent if the weight display is stable at +5d (d = weighing display division) and above, and the comparator result OK in addition. The next transmission cannot occur until after the weight display falls below +5d.

### Auto-print Mode +/- data and OK (F06-7)

Data is sent if the weight display is stable at  $\pm 5d$  (d = weighing display division) and above/below, and the comparator result OK in addition. The next transmission cannot occur until after the weight display falls between  $-5d$  and  $+5d$ .

### Multi-connection with Print key mode (RS-422/485) (F06-5)

This is one of applications when a PC and more than one FS-*i* (RS-422/485 installed) connected. Refer to “Multi-connection with Print key mode” in detail.

## Baud Rate (F04)

Select the baud rate according to the device to be connected.

2400 bps (F04-0)            Select 2400 bps to connect with an AD-8127.

4800 bps (F04-1)

9600 bps (F04-2)

### 13-3. Command Mode

- ❑ In the command mode, the scale is controlled by commands that come from an external device, computer etc.

#### Command List

Command	Definition	Notes
Q	Send data immediately.	
Z	Zero the scale when the weight is stable.	Same as the <b>ZERO</b> key.
T	Tare the scale when the data is stable.	Same as the <b>TARE</b> key.
U	Switch the weighing unit.	Same as the <b>UNITS</b> key.
D	Switch the analog sweep display mode.	Same as the <b>DISP.</b> key.
PT	Set a known (preset) tare weight.	Set "+" and 6 digit number without decimal point.
CT	Clear tare weight.	Including preset tare.
?PT	Send a preset tare weight in-use.	
?TR	Send a tare weight in-use.	
?OK	Send a target weight in-use.	
?HI	Send a HI limit value or upper limit weight in-use.	Send a set value.
?LO	Send a LO limit value or lower limit weight in-use.	
OK	Set a target weight.	Set "+" and 6 digit (5 digit for %) number without decimal point.
HI	Set a HI limit value or upper limit weight.	
LO	Set a LO limit value or lower limit weight.	
ML	Store the comparator limits into the specified memory number.	
CM	Clear the contents of specified memory number.	

#### Examples of command and reply ("\_" shows "Space" (20H).)

Examples below are for F20-0 (Reply to command is sent.)

- ❑ Request a weight data.

Command 

Q	C <sub>R</sub>	L <sub>F</sub>
---	----------------	----------------

Reply

S	T	,	+	0	0	1	2	.	3	4	5	_	k	g	C <sub>R</sub>	L <sub>F</sub>	Stable Positive Data	
U	S	,	+	0	0	0	7	.	8	9	0	_	k	g	C <sub>R</sub>	L <sub>F</sub>		Unstable Positive Data
O	L	,	+	9	9	9	9	.	9	9	9	_	k	g	C <sub>R</sub>	L <sub>F</sub>		

- ❑ Zero the scale. (No reply for F20-1.)

Command 

Z	C <sub>R</sub>	L <sub>F</sub>
---	----------------	----------------

Reply 

Z	C <sub>R</sub>	L <sub>F</sub>
---	----------------	----------------

 The scale is within the zero range and stable.

- Tare the scale. (No reply for F20-1.)

Command 

T	C <sub>R</sub>	L <sub>F</sub>
---	----------------	----------------

Reply 

T	C <sub>R</sub>	L <sub>F</sub>
---	----------------	----------------

 The scale shows positive and stable data.

- Switch the weighing unit. (No reply for F20-1.)

Command 

U	C <sub>R</sub>	L <sub>F</sub>
---	----------------	----------------

Reply 

U	C <sub>R</sub>	L <sub>F</sub>
---	----------------	----------------

 Switch the weighing unit to the next weighing unit.

- Switch the analog sweep display mode. (No reply for F20-1.)

Command 

D	C <sub>R</sub>	L <sub>F</sub>
---	----------------	----------------

Reply 

D	C <sub>R</sub>	L <sub>F</sub>
---	----------------	----------------

 Switch the display mode to the next display mode.

- Set a preset tare weight. (No reply for F20-1.)

Command 

P	T	,	+	0	0	1	2	0	0	C <sub>R</sub>	L <sub>F</sub>
---	---	---	---	---	---	---	---	---	---	----------------	----------------

 Decimal point follows the weight display.

Reply 

P	T	,	+	0	0	1	2	0	0	C <sub>R</sub>	L <sub>F</sub>
---	---	---	---	---	---	---	---	---	---	----------------	----------------

FS-15Ki : The preset tare weight 1.200 kg is subtracted and the display shows net weight.

- Clear tare weight. (No reply for F20-1.)

Command 

C	T	C <sub>R</sub>	L <sub>F</sub>
---	---	----------------	----------------

Reply 

C	T	C <sub>R</sub>	L <sub>F</sub>
---	---	----------------	----------------

- Send a preset tare weight in-use.

Command 

?	P	T	C <sub>R</sub>	L <sub>F</sub>
---	---	---	----------------	----------------

Reply 

P	T	,	+	0	0	0	1	2	.	0	0	_	k	g	C <sub>R</sub>	L <sub>F</sub>
---	---	---	---	---	---	---	---	---	---	---	---	---	---	---	----------------	----------------

- Send a tare weight in-use.

Command 

?	T	R	C <sub>R</sub>	L <sub>F</sub>
---	---	---	----------------	----------------

Reply 

T	R	,	+	0	0	0	1	2	.	0	0	_	k	g	C <sub>R</sub>	L <sub>F</sub>
---	---	---	---	---	---	---	---	---	---	---	---	---	---	---	----------------	----------------

- Send a target weight in-use.

Command 

?	O	K	C <sub>R</sub>	L <sub>F</sub>
---	---	---	----------------	----------------

Reply 

O	K	,	+	0	0	0	1	0	.	0	0	_	k	g	C <sub>R</sub>	L <sub>F</sub>
---	---	---	---	---	---	---	---	---	---	---	---	---	---	---	----------------	----------------

- ❑ Send a HI limit value or upper limit weight in-use.

Command 

?	H	I	C <sub>R</sub>	L <sub>F</sub>
---	---	---	----------------	----------------

Reply 

H	I	,	+	0	0	0	3	.	0	5	0	_	k	g	C <sub>R</sub>	L <sub>F</sub>
H	I	,	+	0	0	0	0	.	0	5	0	_	k	g	C <sub>R</sub>	L <sub>F</sub>
H	I	,	+	0	0	0	0	1	.	0	0	_	_	%	C <sub>R</sub>	L <sub>F</sub>

 Upper limit weight (F07-0)  
 HI limit weight (F07-1)  
 HI limit % (F07-2)

- ❑ Send a LO limit value or lower limit weight in-use.

Command 

?	L	O	C <sub>R</sub>	L <sub>F</sub>
---	---	---	----------------	----------------

Reply 

L	O	,	+	0	0	0	2	.	9	5	0	_	k	g	C <sub>R</sub>	L <sub>F</sub>
L	O	,	+	0	0	0	0	.	0	3	0	_	k	g	C <sub>R</sub>	L <sub>F</sub>
L	O	,	+	0	0	0	0	0	.	5	0	_	_	%	C <sub>R</sub>	L <sub>F</sub>

 Lower limit weight (F07-0)  
 LO limit weight (F07-1)  
 LO limit % (F07-2)

- ❑ Set a target weight. (Use with F07-1 or F07-2. No reply for F20-1.)

Command 

O	K	,	+	0	0	1	0	0	0	C <sub>R</sub>	L <sub>F</sub>
---	---	---	---	---	---	---	---	---	---	----------------	----------------

 Decimal point follows the weight display.

Reply 

O	K	,	+	0	0	1	0	0	0	C <sub>R</sub>	L <sub>F</sub>
---	---	---	---	---	---	---	---	---	---	----------------	----------------

FS-15Ki : Target weight 1.000 kg will be set.

- ❑ Set a HI limit value or upper limit weight. (No reply for F20-1.)

F07-0 or F07-1 is set, the command should have “+/-” (“+/-” only for F07-1) and 6 digit number without decimal point.

Command 

H	I	,	+	0	0	0	2	0	0	C <sub>R</sub>	L <sub>F</sub>
---	---	---	---	---	---	---	---	---	---	----------------	----------------

 Decimal point follows the weight display.

Reply 

H	I	,	+	0	0	0	2	0	0	C <sub>R</sub>	L <sub>F</sub>
---	---	---	---	---	---	---	---	---	---	----------------	----------------

FS-15Ki :

F07-0: 0.200 kg will be set as an upper limit weight.

F07-1: 0.200 kg will be set as a HI limit weight.

F07-2 is set, the command should have “+” and 5 digit number without decimal point.

Command 

H	I	,	+	0	0	2	0	0	C <sub>R</sub>	L <sub>F</sub>
---	---	---	---	---	---	---	---	---	----------------	----------------

 Assume 2 decimal place number.

Reply 

H	I	,	+	0	0	2	0	0	C <sub>R</sub>	L <sub>F</sub>
---	---	---	---	---	---	---	---	---	----------------	----------------

 2.00% will be set as HI limit %.

- ❑ Set a LO limit value or lower limit weight. (No reply for F20-1.)

F07-0 or F07-1 is set, the command should have “+/-” (“+/-” only for F07-1.) and 6 digit number without decimal point.

Command 

L	O	,	+	0	0	0	1	0	0	C <sub>R</sub>	L <sub>F</sub>
---	---	---	---	---	---	---	---	---	---	----------------	----------------

 Decimal point follows the weight display.

Reply 

L	O	,	+	0	0	0	1	0	0	C <sub>R</sub>	L <sub>F</sub>
---	---	---	---	---	---	---	---	---	---	----------------	----------------

FS-15Ki :

F07-0: 0.100 kg will be set as a lower limit weight.

F07-1: 0.100 kg will be set as a LO limit weight.



F07-2 is set, the command should have “+” and 5 digit number without decimal point.

Command 

L	O	,	+	0	0	1	0	0	C <sub>R</sub>	L <sub>F</sub>
---	---	---	---	---	---	---	---	---	----------------	----------------

 Assume 2 decimal place number.

Reply 

L	O	,	+	0	0	1	0	0	C <sub>R</sub>	L <sub>F</sub>
---	---	---	---	---	---	---	---	---	----------------	----------------

 1.00% will be set as LO limit %.

- Store the comparator limits into the specified memory number. (No reply for F20-1.)

F07-0 is set, the command should have 2 digit memory number and 2 setting values that have a polarity and 6 digit number without decimal point.

Command 

M	L	,	0	1	,	+	0	0	1	2	0	0	,	+	0	0	0	9	0	0	C <sub>R</sub>	L <sub>F</sub>
---	---	---	---	---	---	---	---	---	---	---	---	---	---	---	---	---	---	---	---	---	----------------	----------------

Reply 

M	L	,	0	1	,	+	0	0	1	2	0	0	,	+	0	0	0	9	0	0	C <sub>R</sub>	L <sub>F</sub>
---	---	---	---	---	---	---	---	---	---	---	---	---	---	---	---	---	---	---	---	---	----------------	----------------

FS-15Ki : Store upper limit weight +1.200 kg and lower limit weight +0.900 kg into the memory number “01”.

F07-1 is set, the command should have 2 digit memory number, target weight that has a polarity and 6 digit number without decimal point, and HI/LO limit weight that has “+” and 6 digit number without decimal point.

Command 

M	L	,	0	1	,	+	0	0	1	0	0	0	,	+	0	0	0	2	0	0	,
+	0	0	0	1	0	0	C <sub>R</sub>	L <sub>F</sub>													

Reply 

M	L	,	0	1	,	+	0	0	1	0	0	0	,	+	0	0	0	2	0	0	,
+	0	0	0	1	0	0	C <sub>R</sub>	L <sub>F</sub>													

FS-15Ki : Store target weight 1.000 kg, upper limit weight +0.200 kg and lower limit weight +0.100 kg into the memory number “01”.

F07-2 is set, the command should have 2 digit memory number, target weight that has a polarity and 6 digit number without decimal point, and HI/LO limit % that has “+” and 5 digit number without decimal point.

Command 

M	L	,	0	1	,	+	0	0	1	0	0	0	,	+	0	0	0	2	0	,
+	0	0	0	1	0	C <sub>R</sub>	L <sub>F</sub>													

Reply 

M	L	,	0	1	,	+	0	0	1	0	0	0	,	+	0	0	0	2	0	,
+	0	0	0	1	0	C <sub>R</sub>	L <sub>F</sub>													

FS-15Ki : Store target weight 1.000 kg, upper limit +0.2 % and lower limit +0.1 % into the memory number “01”.

- Clear the contents of specified memory number. (No reply for F20-1.)

Command 

C	M	,	0	1	C <sub>R</sub>	L <sub>F</sub>
---	---	---	---	---	----------------	----------------

 Clear the contents of memory number “01”.

Reply 

C	M	,	0	1	C <sub>R</sub>	L <sub>F</sub>
---	---	---	---	---	----------------	----------------

### Reply in case of the function setting F20-0

There are other replies to the commands other than examples above, when the function setting F20-0 is selected.

- The scale is not in a state where a command could be executed. Then, the scale will reply “1”.

Command 

Z	C <sub>R</sub>	L <sub>F</sub>
---	----------------	----------------

Reply 

I	C <sub>R</sub>	L <sub>F</sub>
---	----------------	----------------

 The scale is not within the zero range or unstable.

- Command does not exist for the scale. Then, the scale will reply “?”.

Command 

B	C <sub>R</sub>	L <sub>F</sub>
---	----------------	----------------

 Undefined command for the scale.

Reply 

?	C <sub>R</sub>	L <sub>F</sub>
---	----------------	----------------

- When the function setting F20-1 is selected, there is no reply to those commands.

### 13-4. Using UFC (Universal Flex Coms) function

- The UFC function allows you to format the print out (UFC format).
- The scale can store the UFC format as text data. It will include parameters to replace with the weight data, tare data and so on.
- The maximum number of text data is 300 characters.
- To use the UFC function, the text data has to be sent to the scale from the computer using “PF” command in the command mode (F06-1) in advance. Then, connect the scale with the printer and set the F06-2, F06-3 or F06-4.**
- When the 

PRINT
-------

 key is pressed or by auto-print mode (F06-2, F06-3 or F06-4), the scale will send the stored text data with the parameters replaced by the original data.

### Store Text Data into the Scale Memory

Command 

P	F	,	'	T	E	X	T	'	,	#	2	0	,	\$	S	P	*	2	,	&
\$	C	R	,	\$	L	F	,	\$	W	T	,	\$	C	R	,	\$	L	F	C <sub>R</sub>	L <sub>F</sub>

Reply 

P	F	C <sub>R</sub>	L <sub>F</sub>
---	---	----------------	----------------

The “PF” command sends text data that will include:

- Parameters for the scale data and control codes.

Parameter	Data & Code
\$WT	Weight
\$TR	Tare weight in use
\$CP	Comparator result
\$OK	Target weight
\$HI	HI limit value or upper limit weight

Parameter	Data & Code
\$CM	Comma (2CH)
\$SP	Space (20H)
\$CR	C <sub>R</sub> (0DH)
\$LF	L <sub>F</sub> (0AH)
\$LO	LO limit value or lower limit weight

- These parameters must be used in capital letters.

❑ ASCII text string

A text string is described in single quote marks as 'Data'. The single quote itself is written as '' (2 single quotes).

Example:           Text ABC is described as 'ABC'.  
                       Text 'ABC' is described as "'ABC'".

❑ The ASCII hexadecimal code

The ASCII hexadecimal codes are written in the form "#" + 2 hexadecimal digits. This will mainly be used to send control codes that can't be described as a text string.

Example:           #04           "EOT" of ASCII code

❑ Repeat data

The control codes \$SP, \$CR and \$LF can be used with "\*" plus a 1 or 2 digit number". That code will be repeated the number of times designated.

Example:           \$LF\*9       Repeat "\$LF" 9 times.  
                       \$SP\*12    Use 12 "Spaces".

❑ Link mark "&"

If you will send more than 2 lines of data, attach "&" to the end of the first line. Then, the scale considers the data to be continued.

**❑ A "Space" or "," will be used to separate these data. You can skip them to reduce the number of characters, but you cannot skip "," after "PF". You must start with "PF,".**

Data Format for the Scale Data ("\_" shows "Space" (20H).)

Parameters for the scale data will be replaced by the format below when the scale sends them out.

❑ Data has a fixed number of digits including a sign and a decimal point. The insignificant zeros are replaced by "Space (20H)".

\$WT	<table border="1" style="display: inline-table; border-collapse: collapse;"><tr><td>_</td><td>_</td><td>_</td><td>+</td><td>1</td><td>.</td><td>2</td><td>3</td><td>4</td><td>_</td><td>k</td><td>g</td></tr></table>	_	_	_	+	1	.	2	3	4	_	k	g	1.234 kg / 9 digit weight data + 3 digit unit
_	_	_	+	1	.	2	3	4	_	k	g			
\$TR	<table border="1" style="display: inline-table; border-collapse: collapse;"><tr><td>_</td><td>_</td><td>_</td><td>+</td><td>1</td><td>.</td><td>2</td><td>3</td><td>4</td><td>_</td><td>k</td><td>g</td></tr></table>	_	_	_	+	1	.	2	3	4	_	k	g	1.234 kg / 9 digit tare data + 3 digit unit
_	_	_	+	1	.	2	3	4	_	k	g			
\$CP	<table border="1" style="display: inline-table; border-collapse: collapse;"><tr><td>O</td><td>K</td></tr><tr><td>H</td><td>I</td></tr><tr><td>L</td><td>O</td></tr><tr><td>_</td><td>_</td></tr></table>	O	K	H	I	L	O	_	_	Comparator result "OK" / 2 characters Comparator result "HI" / 2 characters Comparator result "LO" / 2 characters No Comparator result / 2 spaces				
O	K													
H	I													
L	O													
_	_													
\$OK	<table border="1" style="display: inline-table; border-collapse: collapse;"><tr><td>_</td><td>_</td><td>_</td><td>+</td><td>1</td><td>.</td><td>0</td><td>0</td><td>0</td><td>_</td><td>k</td><td>g</td></tr></table>	_	_	_	+	1	.	0	0	0	_	k	g	1.000 kg / 9 digit target data + 3 digit unit
_	_	_	+	1	.	0	0	0	_	k	g			
\$HI	<table border="1" style="display: inline-table; border-collapse: collapse;"><tr><td>_</td><td>_</td><td>_</td><td>+</td><td>0</td><td>.</td><td>2</td><td>0</td><td>0</td><td>_</td><td>k</td><td>g</td></tr></table>	_	_	_	+	0	.	2	0	0	_	k	g	0.200 kg / 9 digit HI data + 3 digit unit
_	_	_	+	0	.	2	0	0	_	k	g			
\$LO	<table border="1" style="display: inline-table; border-collapse: collapse;"><tr><td>_</td><td>_</td><td>_</td><td>+</td><td>0</td><td>1</td><td>.</td><td>0</td><td>0</td><td>_</td><td>_</td><td>%</td></tr></table>	_	_	_	+	0	1	.	0	0	_	_	%	1.00 % / 9 digit LO data + 3 digit unit
_	_	_	+	0	1	.	0	0	_	_	%			

## Examples of PF command and AD-8127 Printout Sample

AD-8127  
(FS-i → AD-8127)

```
Weight
      +1.234 kg
CHECK
      OK

DATE 09/18/2006
TIME 12:34:56

A&D FS-15Ki
```

"PF" Command  
(Computer → FS-i)

```
PF, 'Weight', $CR, $LF, &
$SP*4, $WT, $CR, $LF, &
'CHECK', $CR, $LF, &
$SP*7, $CP, $CR, $LF, &
$CR, $LF, &
#1B, #44, $CR, $LF, &
#1B, #54, $CR, $LF, &
$CR, $LF, &
'_A&D_FS-15Ki', $CR, $LF
```

Terminator code ↑

"\_" shows "Space".

- ❑ Normally the printer needs to receive the terminator, and do not forget to add the terminator code to the end of text data.

# 14. FS-04*i* RS-422 / 485 / RELAY OUTPUT

This interface allows a personal computer to connect and control up to 16 FS-*i* scales, and the relay outputs for comparator result are obtained.

- ❑ The FS-04*i* unit includes an interface board, a connector cable, two cable glands and two screws (M3x6).
- ❑ The relay output specifications are same as the FS-03*i*. See "13-2. FS-03*i* Specifications".

## 14-1. Installation

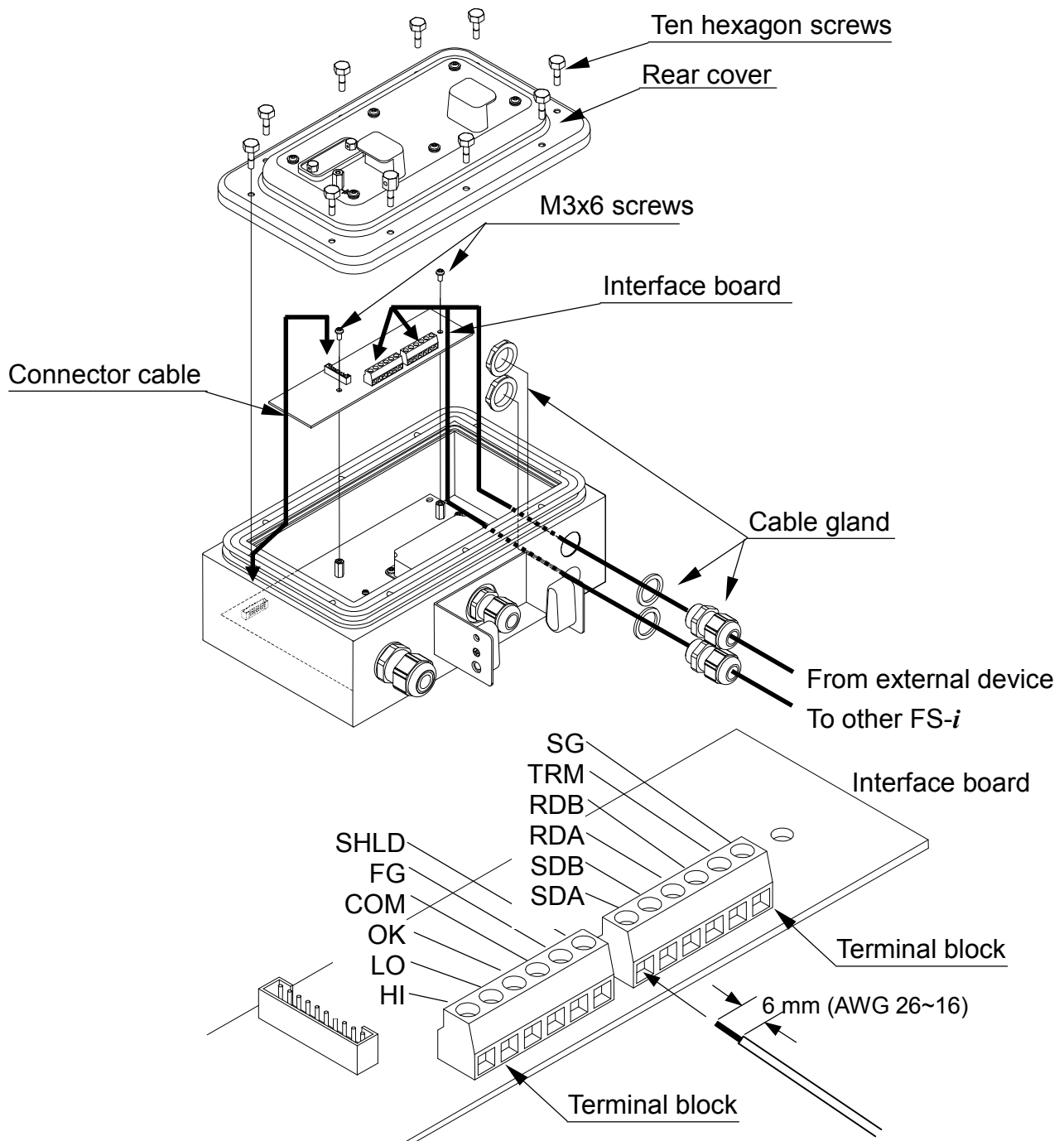

- ❑ Installation is similar to the FS-03*i*. See “13-1. Installation”.
- ❑ Set the function parameters F04, F05, F06, F18, F19 and F20 according your application.
- ❑ *The function setting F19-1 must be set for RS-422 and F19-2 must be RS-485. To connect more than one scale with a computer, set a different address to each scale by F18-##.*

## 14-2. FS-04*i* Specifications

### RS-422/485 Specifications

Transmission form	Asynchronous, bi-directional, half-duplex
Data format	Baud rate: 2400, 4800, 9600 bps
	Data: 7 bits + parity 1bit (even / odd) or 8 bits (non-parity)
	Start bit: 1 bit
	Stop bit: 1 bit
	Code: ASCII
	Terminator: C <sub>RLF</sub>

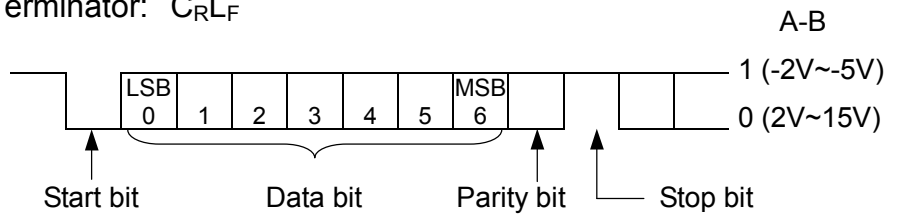

### Circuit diagram

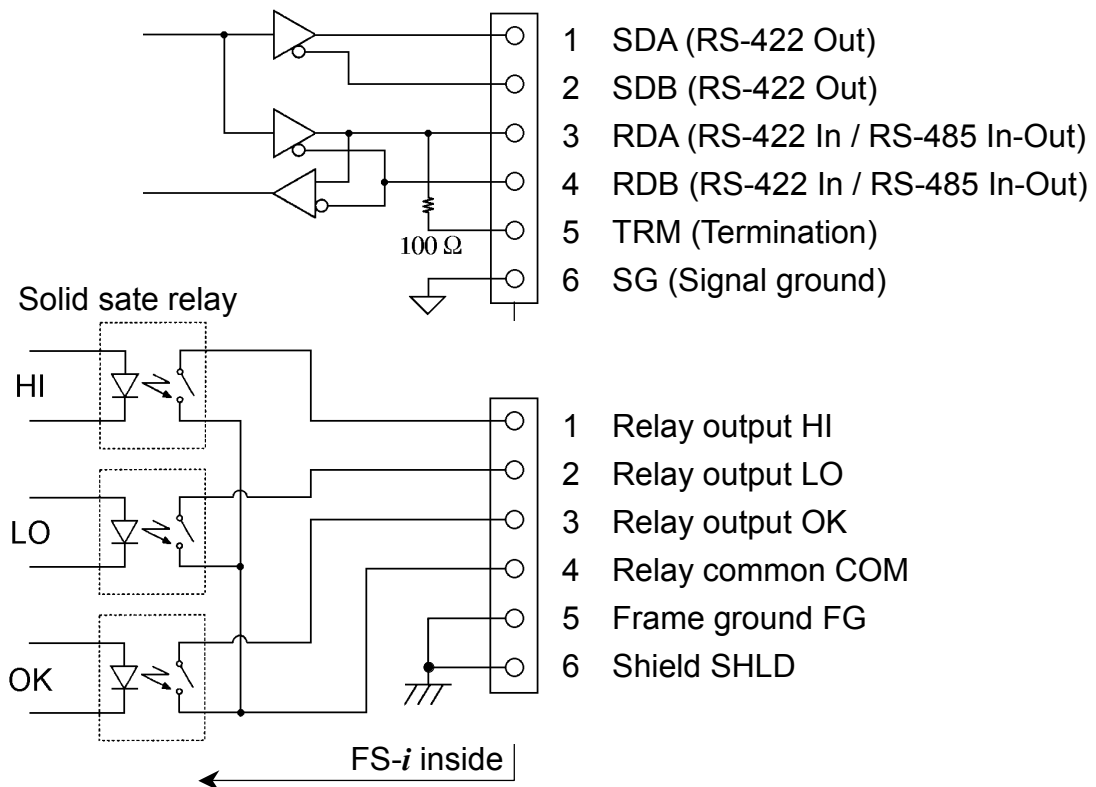

## Example of connection

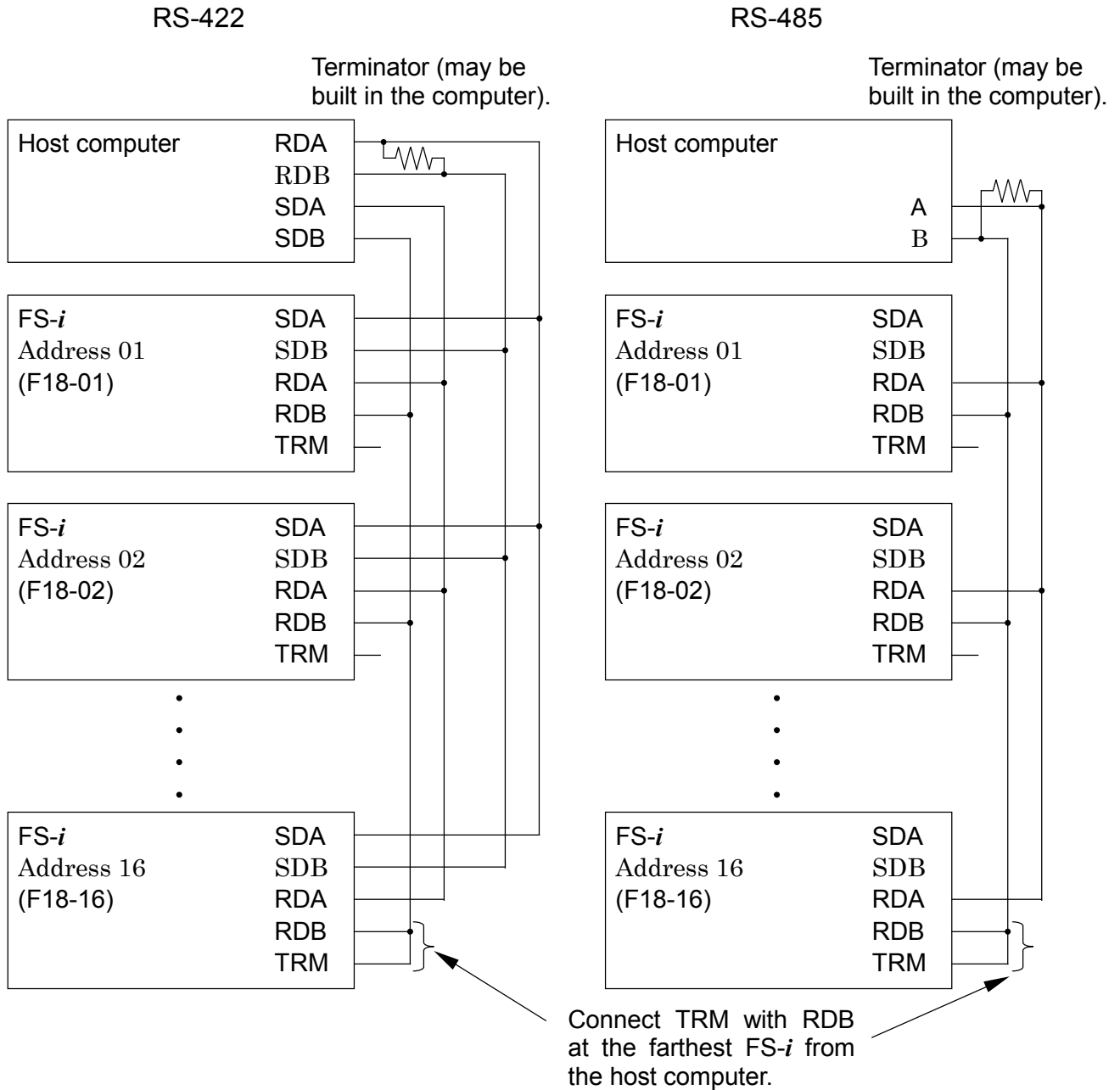

- ❑ The polarity (A, B) of the host computer signal depends on model. Check the technical manual of the computer.

### 14-3. Data output

Data and commands for the RS-422/485 are same as the RS-232C except following.

- ❑ When used with the setting F19-1 (RS-422) or F1-2 (RS-485), set a different address F18-## (## = 01 ~ 99) to each scale.
- ❑ Add "@##" (## is the address of the scale to send a command) at the head of command of the RS-232C. All of data or reply from the scale have "@##" at the head.

## Examples of command and reply (“\_” shows “Space” (20H).)

Following examples are for F20-0 (Reply to command is sent.)

The address ## = 23 (F18-23).

- Request a weight data.

Command 

@	2	3	Q	C <sub>R</sub>	L <sub>F</sub>
---	---	---	---	----------------	----------------

Reply 

@	2	3	S	T	,	+	0	0	1	2	.	3	4	5	_	k	g	C <sub>R</sub>	L <sub>F</sub>
@	2	3	U	S	,	+	0	0	0	7	.	8	9	0	_	k	g	C <sub>R</sub>	L <sub>F</sub>
@	2	3	O	L	,	+	9	9	9	9	.	9	9	9	_	k	g	C <sub>R</sub>	L <sub>F</sub>

 Stable data  
Unstable data  
“E” display

- Zero the scale. (No reply for F20-1.)

Command 

@	2	3	Z	C <sub>R</sub>	L <sub>F</sub>
---	---	---	---	----------------	----------------

Reply 

@	2	3	Z	C <sub>R</sub>	L <sub>F</sub>
---	---	---	---	----------------	----------------

 The scale is within the zero range and stable.

- Send a target weight in-use.

Command 

@	2	3	?	O	K	C <sub>R</sub>	L <sub>F</sub>
---	---	---	---	---	---	----------------	----------------

Reply 

@	2	3	O	K	,	+	0	0	0	1	0	.	0	0	_	k	g	C <sub>R</sub>	L <sub>F</sub>
---	---	---	---	---	---	---	---	---	---	---	---	---	---	---	---	---	---	----------------	----------------

## Multi-connection with Print key mode (new function)

This is one of applications when a PC and more than one FS-*i* are connected. The scale will prepare the weighing data by pressing the 

PRINT
-------

 key first and will send out the prepared data after receiving a command from the PC.

- Set the Function “F06-5” for all of the scales.
- Weigh something and wait for the stable annunciator to turn on (the scale having F18-##).
- Press the 

PRINT
-------

 key, the scale will temporarily store the weight data and turn the PRINT annunciator on.

- The scale does not accept the 

PRINT
-------

 key while the PRINT annunciator on.

- Send the “@##S” command to the scales from the PC.
- The scale (F18-##) will respond the command to send the weight data memorized and turn the PRINT annunciator off.

The address ## = 23 (F18-23).

- Request a weight data.

Command 

@	2	3	S	C <sub>R</sub>	L <sub>F</sub>
---	---	---	---	----------------	----------------

Reply 

@	2	3	S	T	,	+	0	0	1	2	.	3	4	5	_	k	g	C <sub>R</sub>	L <sub>F</sub>
---	---	---	---	---	---	---	---	---	---	---	---	---	---	---	---	---	---	----------------	----------------

Reply 

@	2	3	I	C <sub>R</sub>	L <sub>F</sub>
---	---	---	---	----------------	----------------

 The scale does not have a stored data to send.

- While the PRINT annunciator is on, the scale will send back “@##I” to the commands other than “@##S” command.



# 15. SPECIFICATIONS

## 15-1. Specifications

MODEL		FS-6Ki	FS-15Ki	FS-30Ki
kg	Capacity	6	15	30
	Min. display	0.002 *	0.005 *	0.01 *
		0.001	0.002	0.005
		0.0005	0.001	0.002
g	Capacity	6000	15000	30000
	Min. display	2 *	5 *	10 *
		1	2	5
		0.5	1	2
lb	Capacity	15	35	70
	Min. display	0.005 *	0.01 *	0.02 *
		0.002	0.005	0.01
		0.001	0.002	0.005
oz	Capacity	240	560	1120
	Min. display	0.1 *	0.2 *	0.5 *
		0.05	0.1	0.2
		0.02	0.05	0.1
lb-oz	Capacity	15	35	70
	Min. display	0.1	0.1	0.1
Repeatability (Std. deviation)		0.001 kg	0.002 kg	0.005 kg
Linearity error		±0.002 kg	±0.005 kg	±0.01 kg
Span drift		±20 ppm / °C (5°C~35°C / 41°F~95°F)		
Display		7 segment LCD display (Character height 18.6 mm) with backlight 60 segment analog sweep display with backlight		
Display update		Approximately 20 times per second		
Operating temp.		-10°C~40°C / 14°F~104°F, less than 85% R.H.		
Power supply		AC main (100V~240V) or SLA Battery (option)		
Weighing pan size		250 x 250 mm / 9.8 x 9.8 in.		380 x 300 mm 15.0 x 11.8 in.
Dimension		250(W) x 414(D) x 496(H) mm 9.8(W) x 16.3(D) x 19.5(H) in.		380(W) x 464(D) x 496(H) mm 15.0(W) x 18.3(D) x 19.5(H) in.
Weight (approximately)		8.1 kg / 17.9 lb		14.9 kg / 32.8 lb
Calibration weight		6 kg 15 lb	15 kg 30 lb	30 kg 60 lb

\*) Factory setting

## 15-2. Dimensions

FS-6Ki  
FS-15Ki

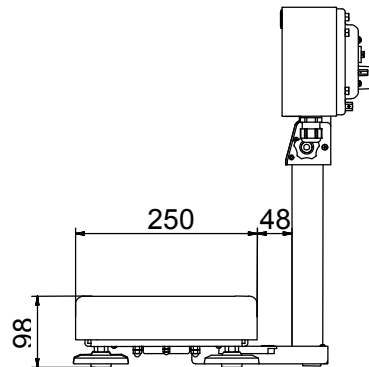
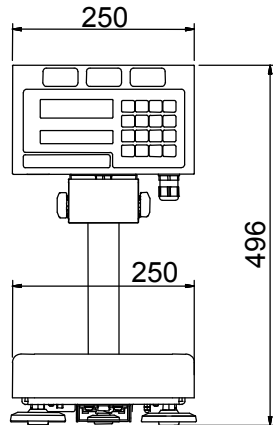
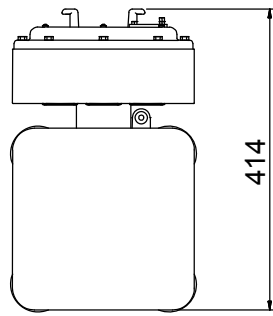

FS-30Ki

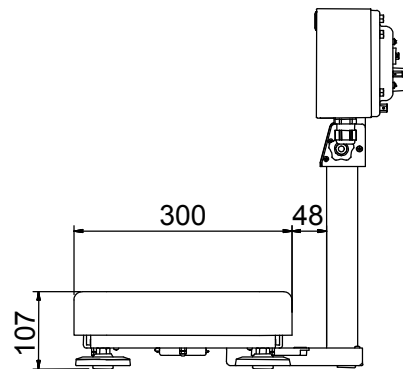
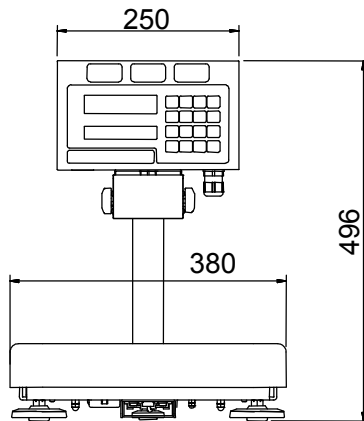
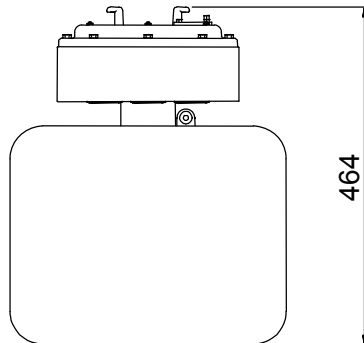

Unit: mm

# 16. GRAVITY ACCELERATION MAP

Values of gravity at various locations

Amsterdam	9.813 m/s <sup>2</sup>	Manila	9.784 m/s <sup>2</sup>
Athens	9.807 m/s <sup>2</sup>	Melbourne	9.800 m/s <sup>2</sup>
Auckland NZ	9.799 m/s <sup>2</sup>	Mexico City	9.779 m/s <sup>2</sup>
Bangkok	9.783 m/s <sup>2</sup>	Milan	9.806 m/s <sup>2</sup>
Birmingham	9.813 m/s <sup>2</sup>	New York	9.802 m/s <sup>2</sup>
Brussels	9.811 m/s <sup>2</sup>	Oslo	9.819 m/s <sup>2</sup>
Buenos Aires	9.797 m/s <sup>2</sup>	Ottawa	9.806 m/s <sup>2</sup>
Calcutta	9.788 m/s <sup>2</sup>	Paris	9.809 m/s <sup>2</sup>
Cape Town	9.796 m/s <sup>2</sup>	Rio de Janeiro	9.788 m/s <sup>2</sup>
Chicago	9.803 m/s <sup>2</sup>	Rome	9.803 m/s <sup>2</sup>
Copenhagen	9.815 m/s <sup>2</sup>	San Francisco	9.800 m/s <sup>2</sup>
Cyprus	9.797 m/s <sup>2</sup>	Singapore	9.781 m/s <sup>2</sup>
Djakarta	9.781 m/s <sup>2</sup>	Stockholm	9.818 m/s <sup>2</sup>
Frankfurt	9.810 m/s <sup>2</sup>	Sydney	9.797 m/s <sup>2</sup>
Glasgow	9.816 m/s <sup>2</sup>	Taichung	9.789 m/s <sup>2</sup>
Havana	9.788 m/s <sup>2</sup>	Taiwan	9.788 m/s <sup>2</sup>
Helsinki	9.819 m/s <sup>2</sup>	Taipei	9.790 m/s <sup>2</sup>
Kuwait	9.793 m/s <sup>2</sup>	Tokyo	9.798 m/s <sup>2</sup>
Lisbon	9.801 m/s <sup>2</sup>	Vancouver, BC	9.809 m/s <sup>2</sup>
London (Greenwich)	9.812 m/s <sup>2</sup>	Washington DC	9.801 m/s <sup>2</sup>
Los Angeles	9.796 m/s <sup>2</sup>	Wellington NZ	9.803 m/s <sup>2</sup>
Madrid	9.800 m/s <sup>2</sup>	Zurich	9.807 m/s <sup>2</sup>

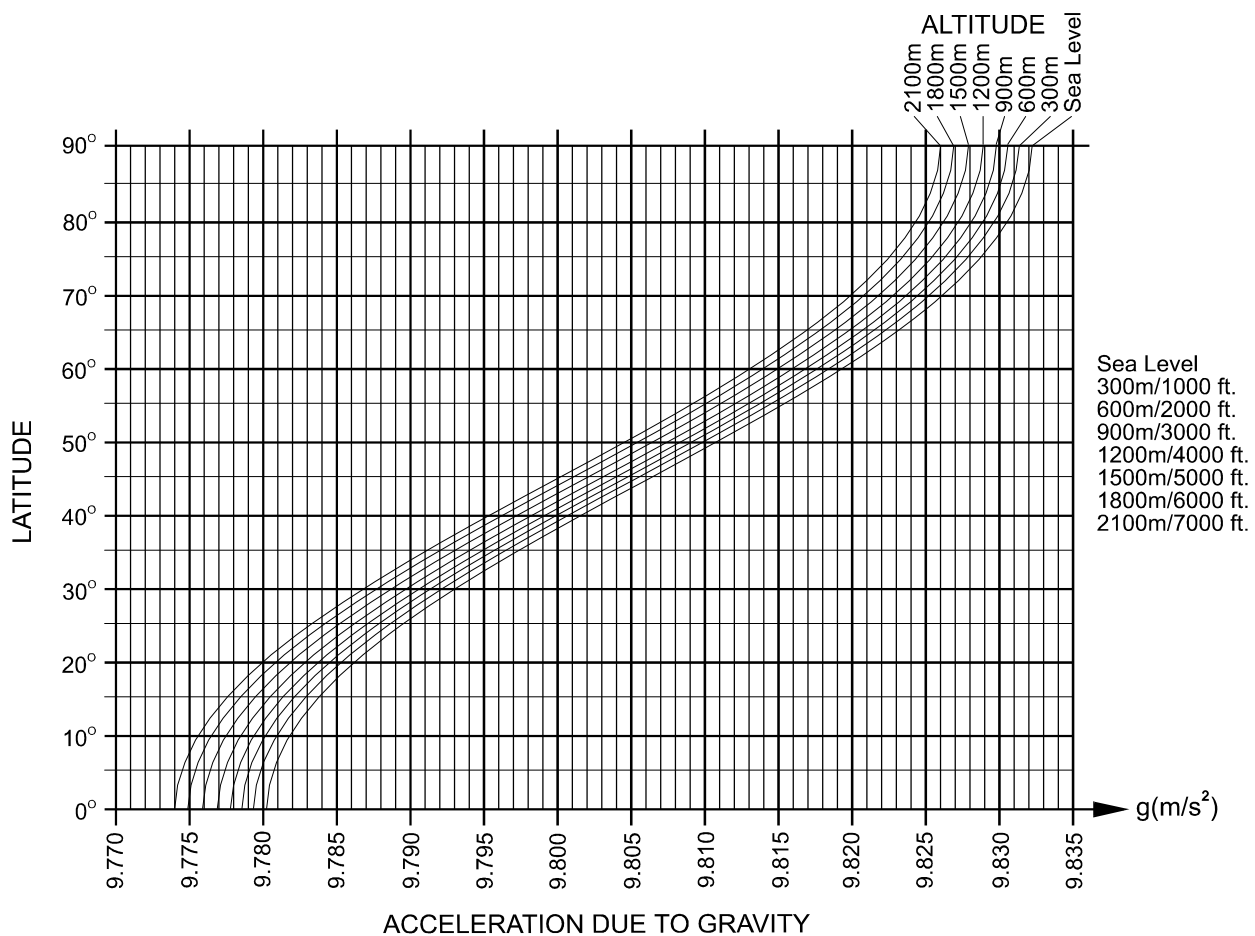

# World map

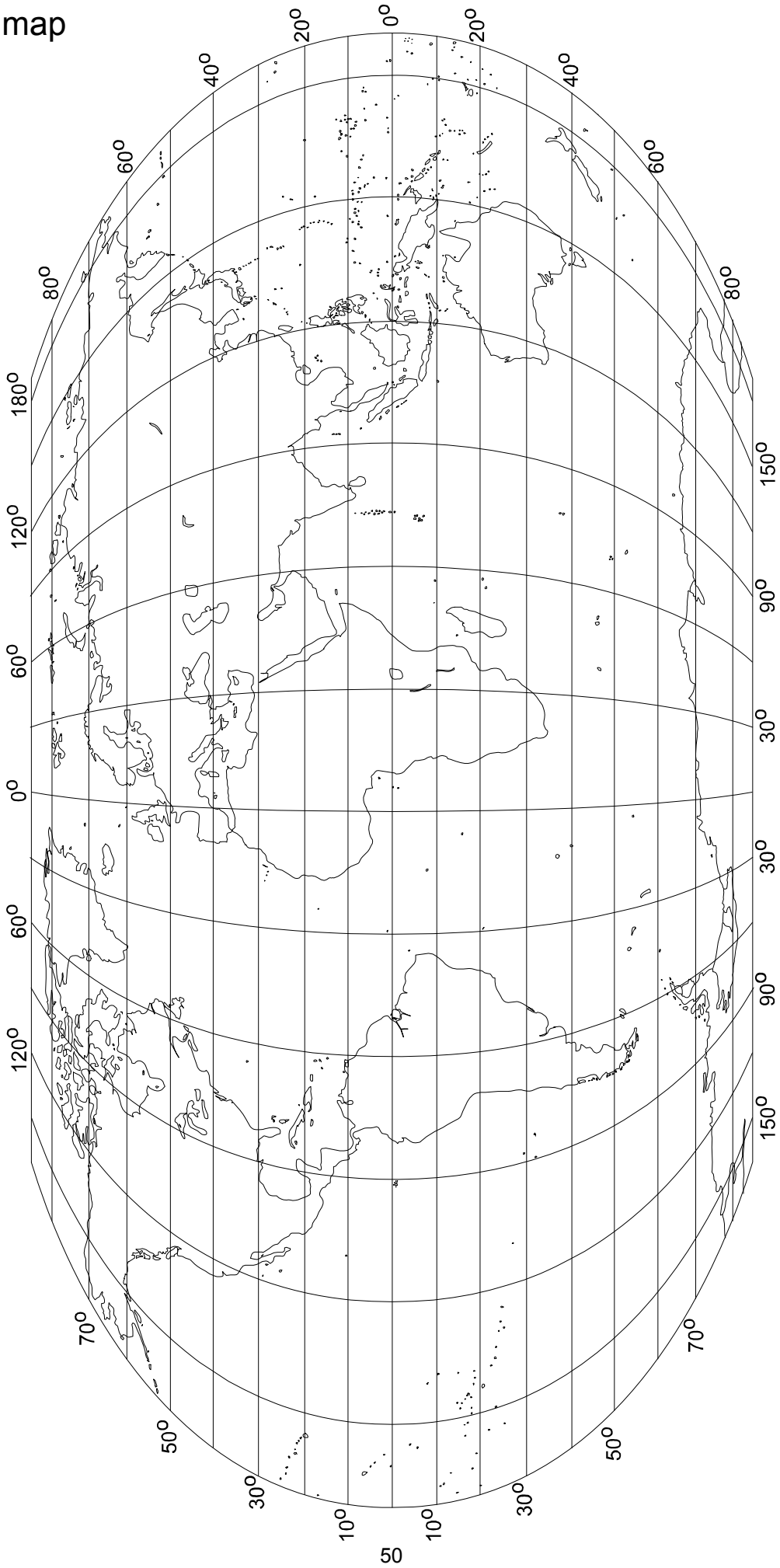









### **A&D Company, Limited**

3-23-14 Higashi-Ikebukuro, Toshima-ku, Tokyo 170-0013, JAPAN  
Telephone: [81] (3) 5391-6132 Fax: [81] (3) 5391-6148

### **A&D ENGINEERING, INC.**

1756 Automation Parkway, San Jose, California 95131, U.S.A.  
Telephone: [1] (408) 263-5333 Fax: [1] (408)263-0119

### **A&D INSTRUMENTS LIMITED**

Unit 24/26 Blacklands Way, Abingdon Business Park, Abingdon, Oxfordshire OX14 1DY United Kingdom  
Telephone: [44] (1235) 550420 Fax: [44] (1235) 550485

### **A&D AUSTRALASIA PTY LTD**

32 Dew Street, Thebarton, South Australia 5031, AUSTRALIA  
Telephone: [61] (8) 8301-8100 Fax: [61] (8) 8352-7409

### **A&D KOREA Limited**

한국에이.엔.디(주)  
서울특별시 영등포구 국제금융로6길33 (여의도동) 맨하탄빌딩 817 우편 번호 150-749  
( 817, Manhattan Bldg., 33. Gukjegeumyung-ro 6-gil, Yeongdeungpo-gu, Seoul, 150-749 Korea )  
전화: [82] (2) 780-4101 팩스: [82] (2) 782-4280

### **ООО A&D RUS**

ООО "ЭЙ энд ДИ РУС"  
121357, Российская Федерация, г.Москва, ул. Вереysкая, дом 17  
( Business-Center "Vereyskaya Plaza-2" 121357, Russian Federation, Moscow, Vereyskaya Street 17 )  
тел.: [7] (495) 937-33-44 факс: [7] (495) 937-55-66

### **A&D INSTRUMENTS INDIA PRIVATE LIMITED**

ऐ&डी इन्स्ट्रुमेन्ट्स इण्डिया प्रा० लिमिटेड  
509, उद्योग विहार, फेस -5, गुडगांव - 122016, हरियाणा, भारत  
( 509, Udyog Vihar, Phase-V, Gurgaon - 122 016, Haryana, India )  
फोन : 91-124-4715555 फैक्स : 91-124-4715599