



Pure Data for a Healthy Planet.®



YSI 5200
Recirculating System Monitor

Operations
Manual

Table of Contents

SECTION 1. SAFETY	3
1.1 GENERAL SAFETY INFORMATION	3
SECTION 2. INTRODUCTION	5
SECTION 3. INSTALLATION	9
3.1 UNPACKING AND INSPECTION	9
3.2 SELECTING AN INSTALLATION LOCATION.....	10
3.3 INSTALLING THE COMPONENTS	12
3.4 MOUNT THE YSI 5200 RECIRCULATING SYSTEM MONITOR.....	13
3.5 INSTALLING THE 5562 OR 5561 PROBE ASSEMBLIES	17
3.6 WIRING THE SYSTEM	20
3.7 COMMUNICATIONS METHOD	23
3.8 GROUNDING INFORMATION	26
3.9 SAFETY ISSUES	26
3.10 LIGHTNING AND SURGE PROTECTION	26
SECTION 4. PROBE MODULE	27
4.1 UNPACKING THE PROBE MODULE	27
4.2 FEATURES OF THE YSI 5561 PROBE MODULE	27
4.3 FEATURES OF THE YSI 5562 PROBE MODULE	28
4.4 PREPARING THE YSI 5561 PROBE MODULE	28
4.5 PREPARING THE YSI 5562 PROBE MODULE	28
4.6 MEMBRANE CAP INSTALLATION	30
4.7 CALIBRATION/STORAGE CUP (5562 ONLY).....	31
4.8 INSTRUMENT/CABLE CONNECTION	31
SECTION 5. OPERATION.....	33
5.1 RUN SCREEN	33
5.2 MAIN MENU.....	34
5.3 PARAMETERS MENU	35
5.4 DAILY CHECKS	57
5.5 CONDUCTING A SYSTEM TEST.....	58
SECTION 6. CALIBRATION	60
6.1 GETTING READY TO CALIBRATE	60
6.2 CALIBRATION PROCEDURES	62
SECTION 7. ALARM/PAGER.....	73

7.1	ALARM LOGIC FLOW CHARTS	73
7.2	GENERAL ALARM	77
SECTION 8.	NETWORK.....	78
8.1	RS485 NETWORK.....	78
8.2	AUXILIARY INPUTS WIRING	79
SECTION 9.	ADVANCED SETUP	82
9.1	SYSTEM MENU.....	82
9.2	TIMERS MENU.....	93
9.3	RELAY OUTPUT WIRING.....	100
9.4	AUXILIARY SYSTEM	102
SECTION 10.	AQUAMANAGER SOFTWARE	106
SECTION 11.	MAINTENANCE	107
11.1	PROBE MAINTENANCE AT THE DEPLOYMENT SITE.....	107
11.2	CALIBRATION CHECKS	108
11.3	RECOMMENDED QUALITY ASSURANCE PROTOCOL	108
11.4	SENSOR CARE AND MAINTENANCE.....	110
11.5	RECOMMENDED CLEANING OF THE 5200 MONITOR AND ACCESSORIES	114
SECTION 12.	STORAGE.....	115
12.1	SHORT TERM STORAGE	115
12.2	LONG TERM STORAGE.....	115
SECTION 13.	TROUBLESHOOTING.....	117
SECTION 14.	WARRANTY AND SERVICE INFORMATION	120
SECTION 15.	SYSTEM SPECIFICATIONS.....	123
SECTION 16.	FACTORY DEFAULT SETTINGS	125
SECTION 17.	INTERNATIONAL MODEM SUPPORT	133
SECTION 18.	HEALTH AND SAFETY.....	134
SECTION 19.	REQUIRED NOTICE.....	138
SECTION 20.	ACCESSORIES.....	139
SECTION 21.	SOLUBILITY AND PRESSURE/ALTITUDE TABLES	140
SECTION 22.	YSI CONDUCTIVITY CALIBRATION SOLUTION VALUES.....	144
SECTION 23.	DECLARATION OF CONFORMITY	145

Section 1. Safety

1.1 General Safety Information

Read all safety information in this manual carefully before using the YSI 5200 Recirculating System Monitor. Reagents that are used to calibrate and check this instrument may be hazardous to your health. Take a moment to review *Section 18 Health and Safety*.

WARNING

Warnings are used in this manual when misuse of the instrument could result in death or serious injury to a person.

CAUTION

Cautions are used in this manual when misuse of the instrument could result in mild or serious injury to a person and/or damage to equipment.

IMPORTANT SAFETY INSTRUCTIONS!

Save these instructions for future reference!

 The most important safety rule for use of the YSI 5200 is to utilize the instrument **ONLY** for purposes documented in this manual. The user should be certain to read all of the safety precautions outlined below before using the instrument.

 **WARNING:** To avoid severe personal injury or damage to the equipment, installation, operation and service should be performed by qualified personnel who are thoroughly familiar with the entire contents of this manual.

 **WARNING:** All wiring involving connections to mains power must be performed by a qualified licensed electrician, and must conform to all locally applicable electrical codes. Any mains power circuit connected within the 5200 enclosure must be protected by a Ground Fault Circuit Interrupt device. Do not make connections while power is applied. Disconnect power before proceeding. See Section 3.6 *Wiring the System*.

 **WARNING:** The 5200 utilizes sensitive solid state devices that can be damaged by static shock. Installers must observe accepted ESD, Electro-Static Discharge, procedures while connecting cabling to the 5200 I/O plate or damage may result. See Section 3.6 *Wiring the System*.

 **CAUTION:** It is essential that all sensor wiring be run in a separate cable or conduit from power wiring. See Section 3.6 *Wiring the System*.

 **CAUTION:** The YSI 5579 power supply accessory is for indoor use only, and must be connected to the 5200 Monitor with a suitable waterproof extension cable if the 5200 Monitor is installed in a damp location. See Section 3.6.1 *DC Power Input Wiring*.

 **WARNING:** A UL Listed DC power supply is required for any installation which is connected to “mains supply” or other power source which is “hazardous live” per UL 3101-1 section 3.5.2. See Section 3.6.1 *DC Power Input Wiring*.

 **WARNING:** A UL Listed slow-blow fuse with a maximum current rating of 1A must be connected in series with the positive terminal of any power supply not provided by YSI. See Section 3.6.1 *DC Power Input Wiring*.

 **CAUTION:** Power supply voltage above 16.5VDC may permanently damage the 5200 Monitor. See Section 3.6.1 *DC Power Input Wiring*.

 **CAUTION:** The sensitivity and stability of the monitor will be impaired if the monitor is not grounded. Do not apply power to the Monitor until all electrical connections are verified and secure. See Section 3.8 *Grounding Information*.

 **CAUTION:** Do not ground the probe body. See Section 3.6 *Wiring the System*.

 **WARNING:** Turn off all power and assure power “lockout” before servicing to avoid contact with electrically powered circuits. See Section 3.6 *Wiring the System*.

 **CAUTION:** Section 3.10 *Lightning and Surge Protection* or any other installation procedure cannot protect against a direct lightning strike. YSI Incorporated cannot accept liability for damage due to lightning or secondary surges.

Section 2. Introduction

Congratulations on your purchase of a sophisticated, yet easy-to-use aquatic environment controller. Designed with a powerful INTEL™ microprocessor, your YSI 5200 Recirculating System Monitor/Controller includes the following features:

- Continuous monitoring of Dissolved Oxygen (DO), conductivity, salinity, temperature, pH and Oxidation Reduction Potential (ORP).
- Menu-driven programming environment.
- 4 Relay outputs
- Aux. I/O system supporting 2 Inputs (1 Digital, 1 Analog/Digital)
- FLASH memory that makes upgrading your YSI 5200 Recirculating Monitor with new software a simple task.
- Local audible alarm or optional remote dialup pager alarm capability.
- Parameter control capability for controlling peripheral equipment such as pumps, and lighting.
- Powerful data logging capability that stores up to 30-days of data.
- Communications ports supporting both direct and modem connectivity. RS232, TCP/IP connectivity and a network communications port allowing multiple YSI 5200 Recirculating Monitors to be connected via an RS485 network.
- Wide operating power range (7–16VDC) along with 12VDC battery backup capability.
- AquaManager™—Software that allows you to communicate with your YSI 5200 Recirculating Monitor, perform advanced graphical analysis of current and historical data—from any Windows 2000/XP PC.

The YSI 5200 is constructed with only the highest quality components. All information gathered by the controller is processed digitally. The YSI 5200 architecture includes Digital Signal Processing (DSP) hardware and software that guarantees accurate and repeatable readings over the life of the YSI 5200.

Monitoring Capability

The YSI 5200 software provides for monitoring, control, and alarm capabilities. The five water quality parameters monitored and controlled are:

- Dissolved Oxygen
- Conductivity
- Temperature
- pH
- ORP

In addition to the five parameters the YSI 5200 also provides two auxiliary inputs that can be configured to provide 2 digital inputs or 1 digital input and 1 analog input for sampling a recorder output from another instrument.

The probe is connected to the YSI 5200 through a waterproof connector (see Figure 4-10 Bottom Connectors).

Ports for up to three non-metallic watertight compression or conduit fittings are located on the 5200 bottom panel and provide the means for connecting power, relay outputs and communications via the I/O plate located within the 5200 Monitor. The 5200 Monitor is supplied with compression fittings; conduit fittings are available as an accessory.

Front Panel

The front panel of the 5200 contains the display and keypad as shown in Figure 2-1 Front Panel.

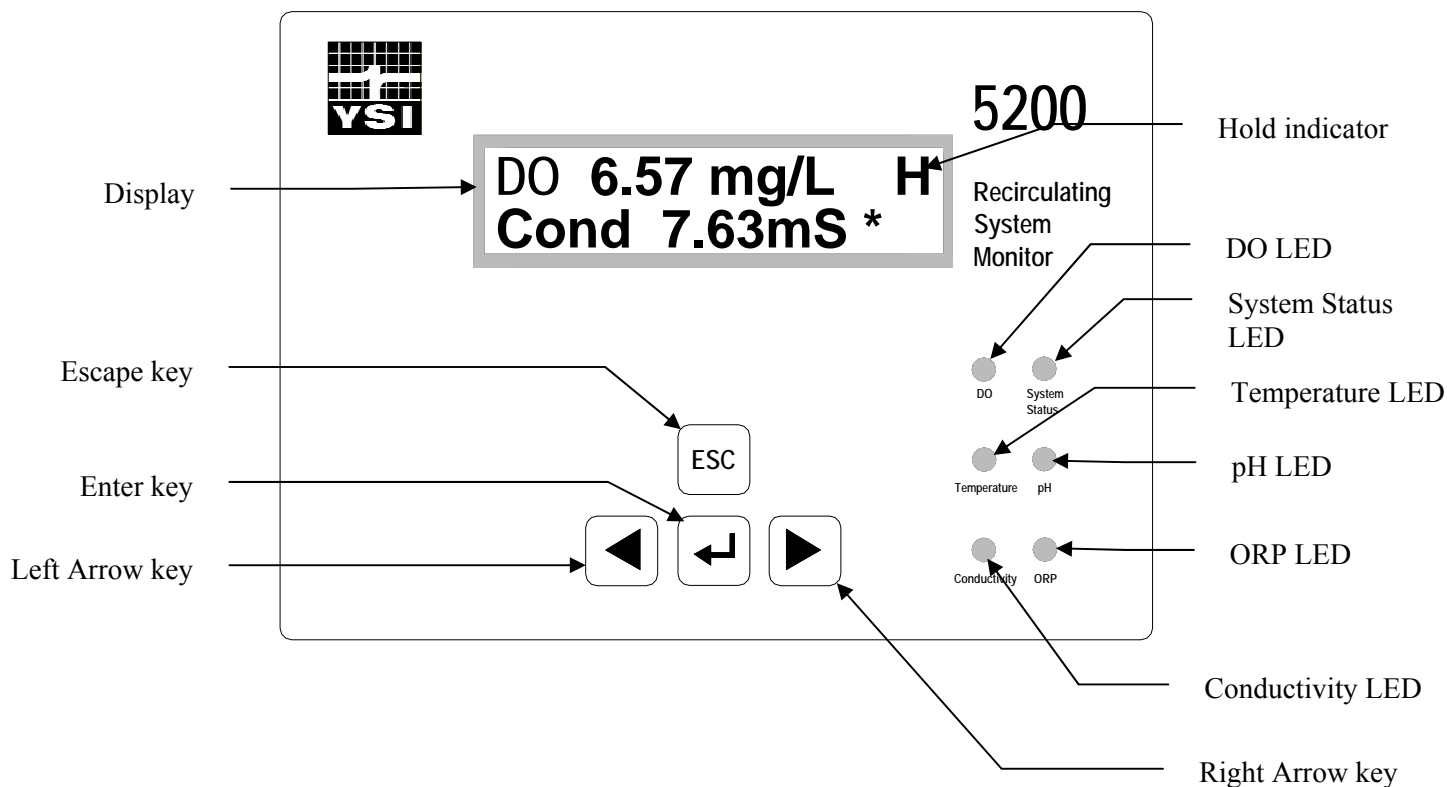

Figure 2-1 Front Panel

The YSI 5200 is operated using tactile switches mounted behind the front overlay.

Key	Name	Main Display Function	Menu Function
[↵]	Enter	Enter main menu	Pressing the Enter key confirms a selection and advances the menu.
[ESC]	Escape	Hold display line	Pressing the Escape key cancels a selection and backs the system one menu level.
[▶]	Right Arrow	Scroll display parameters forward	Scrolls right to the next selection.
[◀]	Left Arrow	Scroll display parameters backwards	Scrolls left to the next selection.

Status Lights

The 6 status lights located on the front panel of the 5200 (see Figure 2-1 Front Panel) indicate whether a system is operating within its preset limits or a control system has been activated.

Parameter Status Lights for Temperature, DO, pH, Conductivity and ORP are configured as follows:

OFF – parameter not enabled

GREEN – normal range

FLASHING GREEN – control mode (turns off when it crosses the original set point)

RED – alarm (turned off by pressing any key, except escape, and resolving the alarm condition)

The System Status LED is configured:

GREEN – normal operation

RED – battery back-up

Flash Memory Architecture

A key feature of the YSI 5200 is that it is designed using FLASH memory allowing software updates to be easily accomplished. Refer to Section 9.1.5 *Downloader (Upgrading Software)* for instructions on upgrading the software in the YSI 5200.

Powering the YSI 5200

Primary power for the YSI 5200 is either a wall mount power transformer providing 8.5 to 16 VDC at 700 mA or any power source providing voltage and current in the stated operating range. The YSI 5200 comes standard with a 12VDC 700 mA wall mount power supply. In addition, an optional 12VDC battery backup input is available for powering the YSI 5200 should the primary power fail.

The YSI 5200 design incorporates FLASH Memory, RAM, and a battery backed-up real-time clock. Should power be lost, none of the parameter setpoints or configuration data will be lost. **However, during a power failure, data in the data-log will be erased if no backup power is provided to the unit.**

Control Capability

The YSI 5200's software gives it the capability for parameter control as well as monitoring. Using the 4 built in control relays, a wide variety of monitoring and control features can be automatically activated.

The sensors gather information and relay it to the YSI 5200 controller. The 5200 can directly control devices through the four built-in relay outputs. Each device that the YSI 5200 controls, such as a heater or chiller, can be programmed

Timing System

The timing control feature allows the YSI 5200 to control external devices such as a lighting system. The timing system will support up to 4 independent control times per 24 hours. Each channel has one ON and OFF time per 24-hour period.

Alarm System

The alarm system provides visual and audible notification in the event that a monitored parameter exceeds the user defined range. Used in conjunction with the YSI 5201 modem (or a computer running AquaManager software and equipped with a compatible modem), it provides remote alarm notification

via a digital pager. Used in conjunction with a computer running AquaManager Software, it provides email alarm notification.

Feed Timer System

The Feed Timer System allows control and monitoring of feedings made by the 5200. Optional Parameter control reduces the amount of food dispensed if the DO, temp or pH values are “out of range.” The optional *FCR (feed conversion ratio)* feature automatically increases the daily amount of food dispensed.

Section 3. Installation

Installation includes the following sections:

- Unpacking and Inspection
- Selecting an Installation Location
- Installing the Components
- Mount the YSI 5200 Recirculating System Monitor
- Installing the 5562 or 5561 Probe Assemblies
- Wiring the System
- Communications Method
- Grounding Information
- Safety Issues
- Lightning and Surge Protection

3.1 Unpacking and Inspection

Inspect the outside of the shipping carton for damage. If damage is detected, contact the carrier immediately. Remove the instrument from the shipping container. Be careful not to discard any parts or supplies. Confirm that all items on the packing list are present. Inspect all assemblies and components for damage.

Save the original packing carton. Carriers typically require proof of damage due to mishandling. Also, if it becomes necessary to return the monitor, you should pack the equipment in the same manner it was received.

The following components are included with the purchase of the 5200 Monitor:

- 5200 Monitor
- 006515 Flange Mounting Kit
- 6506 Desiccant Kit
- 605226 Instruction Manual
- 605230 Compression Plugs, 2 each
- 605229 Compression Plugs, 2 each
- 655384 Dual Male RJ-45 Cable Assembly
- 655383 Adapter, DB-9 to RJ-45
- 655385 Inline Power Ferrite Assembly
- 655361 Ferrite Bead for Communication Port .390, .870, 1.272, 2 each
- 655365 Ferrite Bead for Relays, .500, 1.142, 1.280
- 605227UL 5579 (or 655478UL 5578) 12-Volt Power Supply
- 605223UL Pluggable Socket Connector for 12 VDC Power
- 605223UL Pluggable Socket Connector for RS-485, 4 Pole, with 120Ω termination resistor
- 065944UL Pluggable Socket Connector for Relays, 12 Pole
- 065942UL Pluggable Socket Connector for Auxiliary Inputs, 3 Pole

If any parts are damaged or missing, contact your factory representative or YSI immediately.

⚠ WARNING: To avoid severe personal injury or damage to the equipment, installation, operation and service should be performed by qualified personnel who are thoroughly familiar with the entire contents of this manual.

3.2 Selecting an Installation Location

The 5200 monitor is an on-line continuous measurement tool that can be used to control various operations and provide valuable insight into the facility's operation. As with any instrument of this type, proper installation is the first important step to ensure you are provided with reliable performance and accurate data. Installation of the monitor and probe should be carefully planned in advance to obtain the most effective and accurate utilization of the equipment.

3.2.1 Choosing a Probe Location

Probe location is determined by the necessity to obtain water quality readings which are representative of the bulk flow stream. A suitable location should take a number of physical and chemical factors into consideration. See Section 3.5 *Installing the 5562 or 5561 Probe Assemblies*.

- Standard probe cable lengths for the 5200 are 4, 10 and 20 meters. Consider the entire distance required for cable routing when determining cable length requirements and mounting locations.
- The probe must be located in the flow stream where the sensors will remain submersed at all times and level fluctuations will not expose them to the atmosphere.
- The probe must be placed in a well mixed, free-flowing area of the process stream. The flow stream should be representative of the process being monitored/controlled. Placing the probe midstream and mid-depth typically gives the most reliable results.
- Ideally, the probe should be placed at an angle within 45° of vertical and directed with the flow direction (see Figure 3-1). This location will provide for the least stress on the support arm holding the probe while minimizing the opportunity to collect debris. Placement against the flow stream or perpendicular to the flow stream also provides accurate monitoring, but inspection and cleaning may be required more frequently due to increased collection of debris.

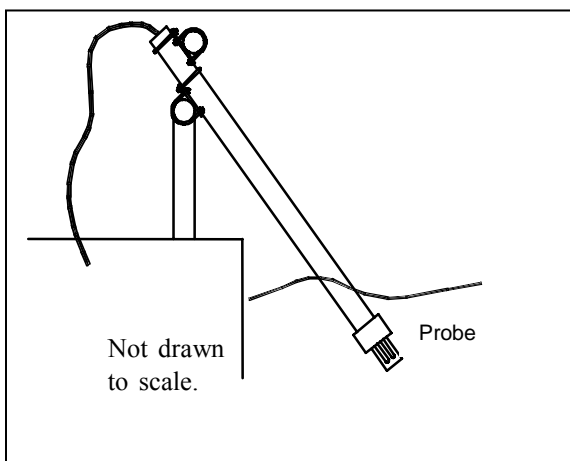

Figure 3-1 Probe orientation (using rail mount kit)

The flow stream should be as free as possible of debris (e.g., algae) which could collect on the probe and cause erroneous readings. See 3.5 *Installing the 5562 or 5561 Probe Assemblies* for flow requirements.

Note that this is an on-line device that is measuring actual conditions in real time. Composite sampling for pH, for example, will not match on-line monitoring. Therefore, pH values recorded by the chart recorder and/or plant control system connected to the 5200 Monitor cannot be averaged to equal the pH of a composite sample.

3.2.2 Choosing a Monitor Location

The probe measures conditions in the flow stream and transmits a low voltage signal to the 5200 Monitor. The probe is attached to a cable that is equipped with a “military grade” watertight connection to the monitor.

Several options are available for mounting the 5200 Monitor. Easy to use, wall mount brackets (006515 Flange Mounting Kit) are provided with the 5200. If rail or panel mounting is desired, the 6509 Rail Mount Kit and 6510 Panel Mount Kits are available as accessories.

NOTE: The 5200 Monitor is provided with a weatherproof enclosure that will withstand most environmental conditions with no compromise to system performance. An optional Weather Shield (YSI #6505) is available for added protection from the elements. When mounting the 5200 outdoors the 6505 Weather Shield should be used.

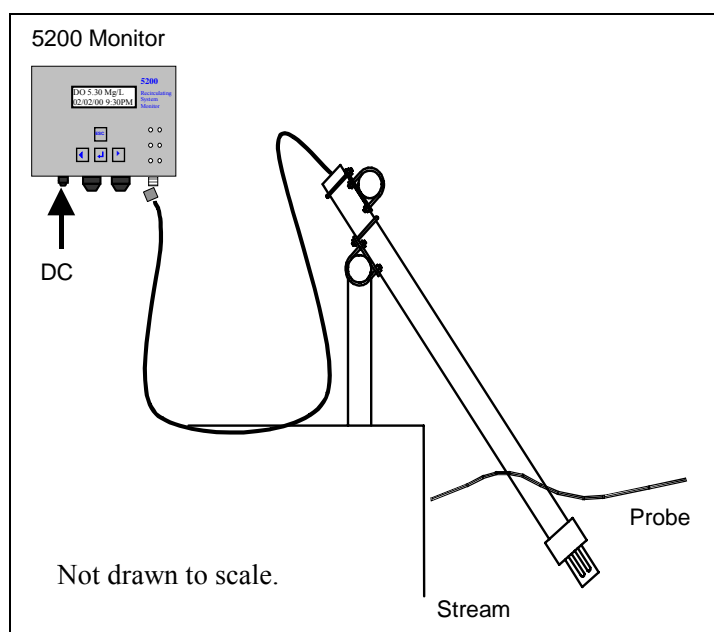

Figure 3-2 Monitor and probe installed using 6511 probe rail mount kit

Locating the monitor close to the sample location has advantages since accuracy checks and calibration can be more easily facilitated under this arrangement. For example, a recently calibrated, hand-held dissolved oxygen meter can be placed next to the 5200's probe and readings can be compared.

Probe cables for the 5200 Monitor are available in 4 (13.1 ft), 10 (32.8 ft) and 20 (65.6 ft) meter lengths. The probe cable length determines the maximum distance the monitor can be mounted from the sample being measured.

Location of the 5200 Monitor should be elevated and in a dry place above the potential flood level. The unit should be easily accessible for an operator or technician.

Although the monitor is suitable for outdoor use, it should be located in an area where temperature extremes, vibrations, electromagnetic and radio frequency interference are minimal. Select an installation location that is at least two (2) feet from any high voltage conduit. Avoid mounting on severely vibrating

structures or near a high heat source, AC motor or transformer, radio transmitter or antenna. Be sure the monitor can be fully opened and serviced at its installed location by maintenance personnel.

3.3 Installing the Components

There are three basic parts to installing the YSI 5200 Monitor, which are covered in the following sections:

- Installing the YSI 5200 Monitor hardware and additional components
- Installing the probe assembly
- Wiring the 5200 Monitor

3.3.1 Sealants, Desiccants and Securing the Monitor

Since the 5200 Monitor will likely be subjected to environmental conditions that promote formation of condensation, it is very important to follow the instructions below before securing the cover to your unit(s). This will prevent damage to the electronic components within the Monitor and extend the life of the monitoring system.

The 5200 Monitor is shipped with three compression fittings. The small compression fitting on the left side of the bottom panel is to be used for the power supply wire. The two larger compression fitting are supplied with solid plugs installed. These solid plugs should be left in place if no other electrical connections are to be made to the 5200.

If electrical connections are required for control relays, PC connections or other devices, there are a number of options to ensure a watertight installation to the 5200's case.

1. Solid plugs, located in the 2 larger compression fitting, can be frozen (put in a freezer for 1 hour) and then easily drilled to the required diameter. The drill bit diameter should be slightly smaller than the wire diameter so that a watertight seal can be made.
2. Compression plugs with two different pre-sized holes are supplied with the 5200 Monitor. The hole size in the plugs varies with the amount of torque applied to the compression nut. To install a pre-drilled plug, the solid plug can be "pushed out" of the compression fitting housing and the pre-drilled plug installed.
3. Optional conduit fittings (YSI #065926) can be installed in place of the compression fittings. When using conduit fittings, industrial encapsulant (YSI #065921 conduit sealer) must be used to prevent moisture from entering the 5200 monitor. After all wiring and connections are complete, apply the sealant to the conduit openings from the inside of the 5200 Monitor. Failure to use industrial encapsulant may result in damage to the 5200 Monitor.

Also included with the 5200 Monitor is a desiccant pack, YSI #6506. Desiccant absorbs moisture captured within the enclosure. After all wiring and connections are complete (just before the cover is to be installed), place the desiccant pack inside the 5200 enclosure near the bottom right corner. Remove the desiccant from its protective packet prior to installation.

Secure the monitor's cover using four mounting screws. Note that the cover contains a captured rubber gasket that provides weatherproofing. Make certain that the gasket is in place and not twisted or damaged. Make certain that the large blue ribbon cable is not trapped in the gasket channel before inserting the screws. When securing the screws, take care not to cross thread. The screws are stainless steel, and the receiving threads are brass. Do not over-tighten!

 **CAUTION:** Anytime the 5200 cover is removed, replace the desiccant pack with a new pack. Anytime the 5200 front panel is removed, place it on top of the 5200 Monitor or secure it so that the blue ribbon cable does not bear the weight of the cover.

3.3.2 Installation Check List

- ✓ Determine optimum mounting location for the probe based on the parameters being measured and/or controlled
- ✓ Determine optimum mounting location for 5200 Monitor
- ✓ Fabricate probe mounting plate if necessary
- ✓ Mount the probe
- ✓ Connect the probe to the monitor
- ✓ Make wiring connections for relays
- ✓ Make wiring connections for communication ports
- ✓ Make wiring connections for DC power
- ✓ Make ground wiring connections
- ✓ Verify that all wiring connections are secure
- ✓ Apply industrial encapsulant to conduit fittings-if applicable
- ✓ Insert desiccant pack(s) into 5200 Monitor
- ✓ Reinstall front cover to 5200
- ✓ Recheck grounding and surge protection installations
- ✓ Allow probe circuitry and sensors to warm up for several minutes
- ✓ Calibrate the probes and program the monitor's software
- ✓ Place calibrated probe in mounting fixture

3.4 Mount the YSI 5200 Recirculating System Monitor

Several options are available for mounting the 5200 Monitor. Easy to use, wall mount brackets (6515 Flange Mounting Kit) are provided. If rail or panel mounting is desired, the 6509 Rail Mount Kit and 6510 Panel Mount Kits are available as accessories.

3.4.1 Wall Mounting Option

Although the monitor is designed for outdoor deployment, some operators may prefer the convenience of reading the monitor under shelter, for example, inside a nearby building. Figure 3-4 shows this indoor type of installation. Wall-mounting the 5200 Monitor is a simple process using the enclosed 006515 mounting hardware.

The following steps should be followed when wall mounting the 5200 Monitor.

1. Loosely fasten the mounting brackets (included) to the back of the 5200 Monitor with the mounting screws provided as shown in Figure 3-3.
2. Tighten the screws, securing the brackets to the Monitor.
3. Loosely fasten the 5200 Monitor to the mounting surface with the mounting screws provided as shown in Figure 3-4.
4. Tighten the screws, securing the Monitor to the surface.

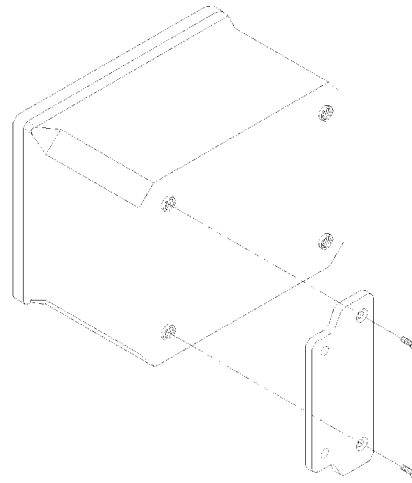

Figure 3-3 Attaching the Mounting Brackets

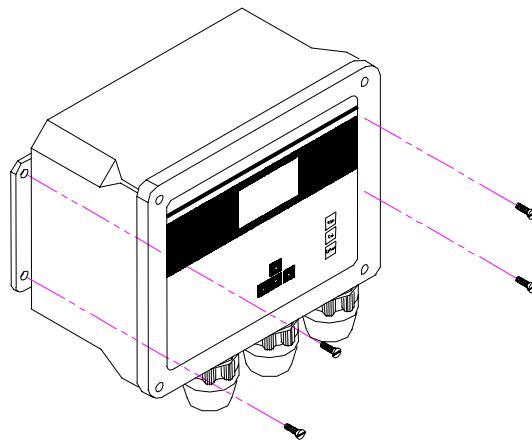
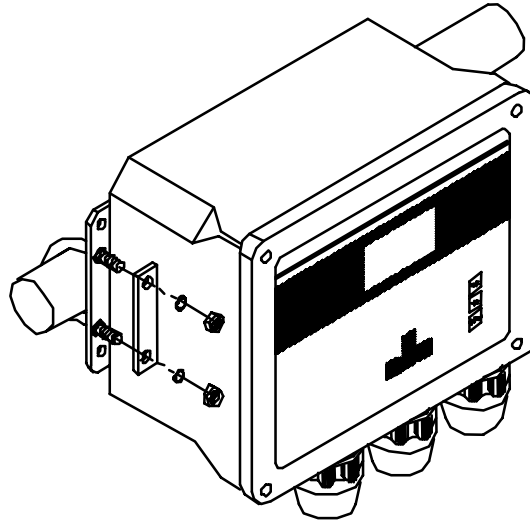

Figure 3-4 Securing the screws to the mounting surface

3.4.2 Optional 6509 – Rail Mount Kit

The 5200 Monitor can be easily mounted to pipe or handrail (1 to 1½ inch diameter) using the optional 6509 Rail Mount Kit. When using the 6509 Rail Mount Kit, the 006515 mounting flanges will have to be modified by drilling two holes to accept the u-bolts. The predrilled metal plates can be used as a template.

⚠ CAUTION: The monitor should not be mounted on electrical conduit, a hot or vibrating pipe or structure, or near a high heat source, an AC motor, transformer, radio transmitter or antenna.



3.4.3 Optional 6505 – Weather shield

The Weather Shield provides wall or optional rail mounting capability for the 5200 Monitor.

⚠ CAUTION: The monitor should not be mounted on electrical conduit, a hot or vibrating pipe or structure, or near a high heat source, an AC motor, transformer, radio transmitter or antenna.

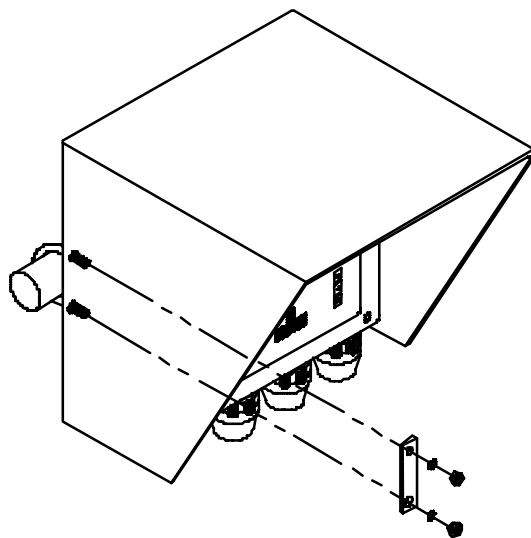

3.4.4 Optional 6510 – Panel Mount Kit

Panel mounting the 5200 Monitor is a simple process using the 6510 Panel Mount hardware and the following tools; 5/32" Allen wrench, Philips screwdriver, and the necessary tools for cutting the mounting hole in the control panel. The 5200 Monitor may be mounted in any panel with 9.5"L x 7.5"W space available, and behind the panel depth of 5.5".

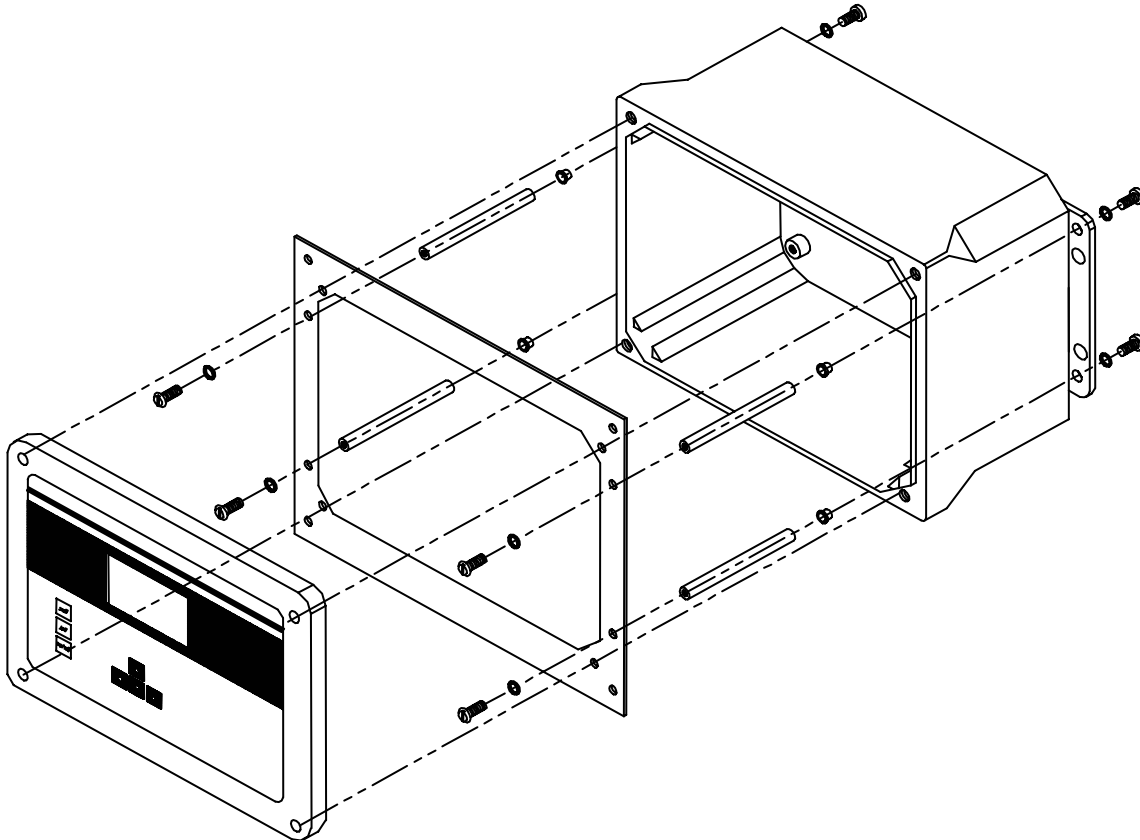

3.5 Installing the 5562 or 5561 Probe Assemblies

 **CAUTION:** Keep pH and ORP probe tips IN A MOIST ENVIRONMENT at all times.

After you have chosen suitable sites for the monitor and probe, proceed with the probe installation as described below.

Avoid routing probe cabling near wiring associated with rotating machinery and/or equipment involving electrical switching or regulation. In all cases, it is desirable to locate the probes away from sources of electrical interference such as UV sterilizers, florescent lighting, ballasts, pumps, etc. Consider placing probe cabling in grounded metallic conduit if unstable readings appear due to electromagnetic interference.

The 5200 can be configured with either a 5562 multiprobe assembly (DO, Conductivity, Temperature, and optional pH or pH/ORP sensors) or a 5561 DO/Temp probe assembly.

NOTES: When the 5200's *control* functions are to be used, probe placement will be critical to the operation of the system. Consequently, a professional should be consulted when designing the system.

Water flow is important to the operation of the DO sensor. In addition, the mixing action provided by water flow ensures that the area of sampled water is representative of the entire body of water.

Probe installation steps:

1. Select a suitable location for the probe assembly that allows for adequate water flow across the DO sensor (approximately 0.5 ft/sec).
2. Select a method of securing the probe assembly.
3. Determine a method of routing and securing the cable.

In-Filter Location—A common place for probe location is in the filter. Installing probes in a filter or sump requires that the probe be secured or hung in an area that will allow for adequate water flow across the DO sensor (approximately .5 ft/sec).

In-Filter Location Using a Float—A float installation keeps probes at a constant depth, and is economical to purchase or construct.

To construct a probe float, cut a hole (slightly smaller than the probe diameter) through a small piece of Styrofoam. Insert the probe into the float so that the entire sensor guard protrudes through the Styrofoam and the sensors are completely submerged.

In-Tank Location—Installing the probe assembly in a tank requires that the assembly be secured or hung in an area that will allow for adequate water flow across the DO sensor (approximately 0.5 ft/sec). It is preferred that the probe be secured so that the cable is not constantly flexed.

If using the 5562, the probe assembly can be secured using the 5205 Probe Mounting Kit or 6511 Probe Rail Mount Kit. See Section 3.5.2 *5205 and 6511 – Optional Probe Mount Kits for 5562 Probes*. A mounting kit is not available for the 5561 probe.

In-Line Location Using a Tee-Fitting—Although in-line probe placement is more time consuming and requires some extra plumbing, it has been found to be a very effective and safe way to place probes. In-line placement gives accurate readings because water is moving across the probe tips at all times. It also minimizes biological growth on the sensors.

IMPORTANT NOTE: When maintenance and/or calibration of the sensors is required, the probe assembly will have to be removed from the in-line fitting. Take this into account when designing the system. If water flow must be maintained during maintenance, by-pass plumbing will be required.

For this type of installation, the probe guard is removed and the probe is threaded into a tee-fitting using the probe guard's threads. All probes need to be placed into the flow stream. YSI does not provide tee fittings for this type of installation.

Thread size for 5562 multiparameter probe assembly: 1.50-12 UNF 2A

Thread size for 5561 DO/Temp probe assembly: 3/4-27 Class 2 thread

In-Line Location Using A Flow Cell (5562 Probe only) – The 5083 Flow Cell can be connected anywhere in the pumping system where a water flow rate of 2–3 L/minute can be obtained. Maximum pressure rating for the 5083 is 25 psi. A portion of water from a pump discharge line can be diverted through the 5083 Flow Cell, or a method with a designated pump can be utilized.

3.5.2 5205 and 6511 – Optional Probe Mount Kits for 5562 Probes

NOTE: The 6511 kit includes Clamps for Rail Mounting. The 5205 Kit does not include mounting hardware.

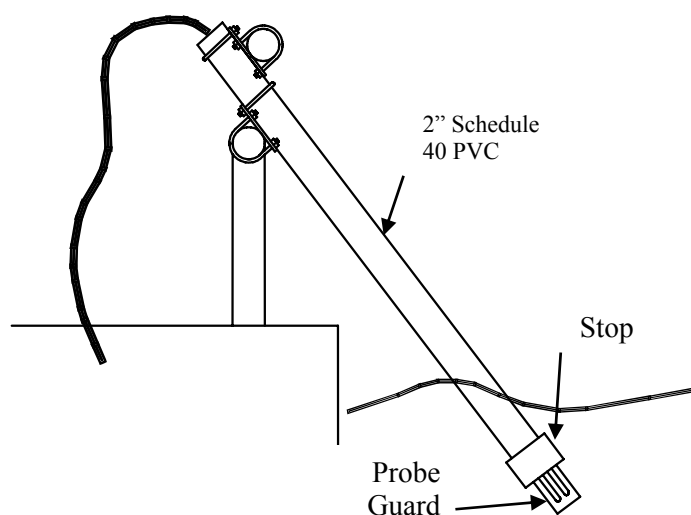



Figure 3-5 Probe Mounting Kit

5205 and 6511 Probe Mount Kits allow a 5562 Probe to be deployed in a permanently mounted two-inch schedule 40 PVC tube. The schedule 40 PVC is **not included** in the kit. Once installed, the probe is deployed by **gently** sliding it down the tube, where it will rest on a stop cap at the end of the tube. The sensors and probe guard will protrude through a hole in the stop cap at the end of the tube. See Figure 3-5.

When mounting to a 1–1½" railing, the 6511 kit should be used. It includes **brackets and u-bolts** for rail mounting and a **stop cap and adaptor**. See Figure 3-5.

When mounting to structures **other than** 1–1½" railing, a 5205 kit should be used. When using the 5205 kit, the installer must develop a method of mounting the 2" PVC tube to a permanent structure. The 5205 kit consists of a **stop cap and adaptor** and does not include mounting hardware.

The 5205 and 6511 Kits should **not** be mounted on hot or vibrating pipes or structures, or near high heat sources, AC motors or transformers, radio transmitters or antennas.

 **CAUTION:** Do not mount on electrical conduit.

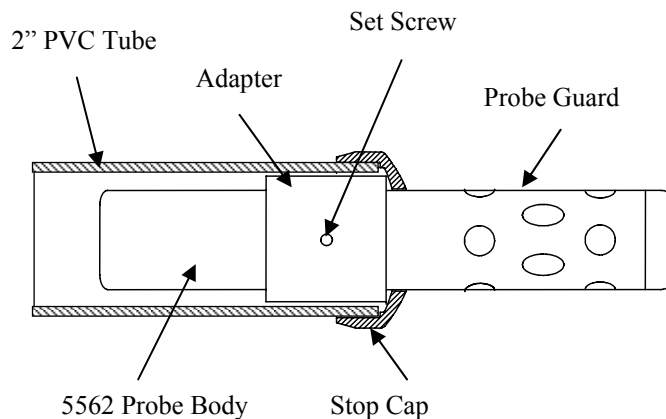

Figure 3-6 Adapter Position

The following steps should be followed when mounting the 5205 or 6511 Probe Mount Kit.

1. With the 3 setscrews removed from the adapter, slide the adapter over the 5562 Probe. Align the open screw holes directly over the 3 hex bolts located on the side of the 5562 Probe.
2. Insert the setscrews so that they seat into the head of the probe's hex bolts.

⚠ CAUTION: Do not over-tighten the setscrews or damage to the probe body or adapter may occur.

NOTE: The 5562 Probe Assembly can be deployed without the probe guard attached. When doing so, application related precautions must be considered or system performance can be compromised. Deployment without the guard is preferred as the effects of low water flow and fouling are reduced, but exposed sensors or the DO membrane, can be damaged if not properly protected.

3. Attach the stop cap to the end of a PVC pipe using PVC cement, as per instructions on the cement can label, ensuring that the stop cap is positioned straight and the pipe is fully inserted.
4. **5205 Only:** Firmly mount PVC pipe to permanent structure. Skip to Step 9.
5. Loosely fasten two 1½" u-bolts on each mounting plate to the railing, orientated as shown in Figure 3-7.

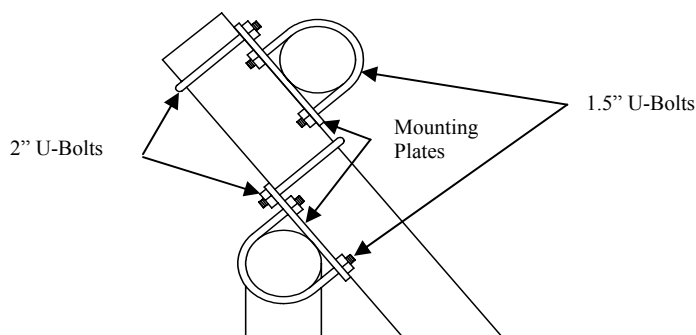

Figure 3-7 6511 U-Bolt Mounting

6. Loosely attach the 2" u-bolts to the mounting plates, orientated as shown in Figure 3-7.

7. Slide the uncapped end of the PVC pipe up through the 2" u-bolts until there is approximately 1" of the PVC pipe above the upper mounting plate, and tighten 2" u-bolts. **Note: Do not over tighten u-bolts or deformation of the PVC pipe may occur.**
8. Tighten all remaining u-bolts to secure pipe.
9. **Slowly** slide the 5562 Probe/Adapter Assembly down the PVC pipe until it rests on the Stop Cap.
10. Connect the cable to the 5200 Monitor.

3.6 Wiring the System

WARNING: All wiring involving connections to mains power must be performed by a qualified licensed electrician, and must conform to all locally applicable electrical codes. Any mains power circuit connected within the YSI 5200 enclosure must be protected by a Ground Fault Circuit Interrupt device. Do not make connections while power is applied. Disconnect power before proceeding.

WARNING: The 5200 utilizes sensitive solid-state devices that can be damaged by static shock. Installers must observe accepted ESD (Electro-Static Discharge) procedures while connecting cabling to the 5200 I/O plate or damage may result.

The 5200 Monitor has one MS-19 connector and three compression fittings in the bottom of the monitor housing. The two larger compression fittings can be replaced with 3/4 inch conduit fittings. From a front view, the smaller compression fitting on the left is for 12-volt power. The opening on the right is for communications and I/O wiring and the center opening is for relay wiring.

NOTE: The 5200 Monitor is supplied with components necessary to make reliable electrical connections. When received, pluggable sockets are installed in the power, relay, RS485 and auxiliary ports. These sockets are to be unplugged prior to making electrical connections and reinstalled after connections are made.

CAUTION: It is essential that all sensor wiring be run in a separate cable or conduit from power wiring.

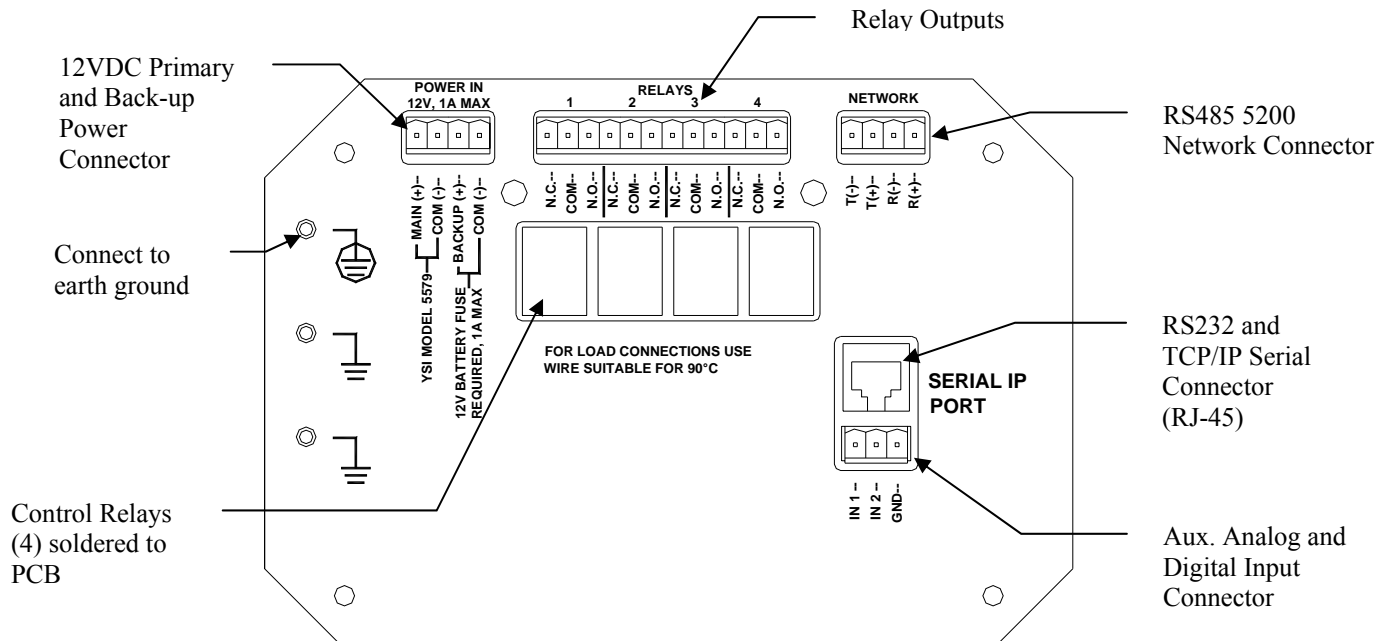

Figure 3-8 I/O Plate

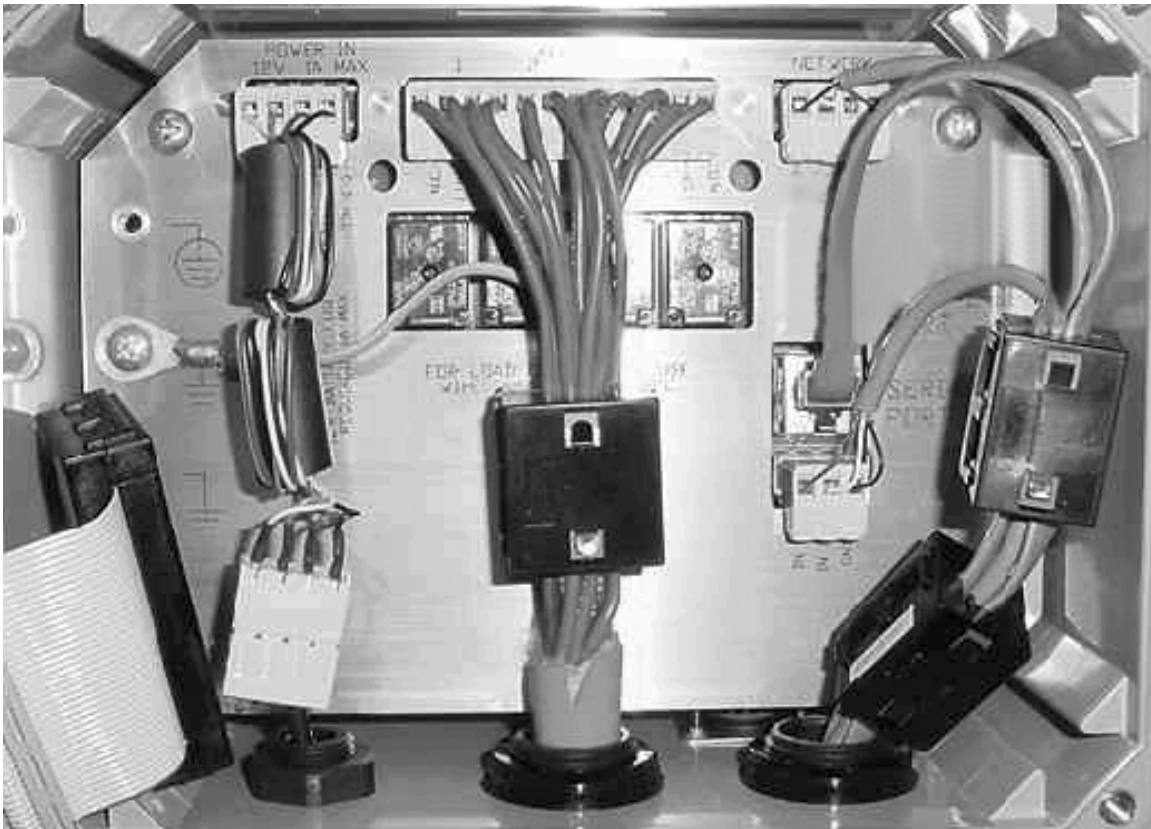

Figure 3-9 Placement of Ferrites and Pluggable Sockets

3.6.1 DC Power Input Wiring

12VDC power for the 5200 Monitor may be supplied by the YSI 5578/5579 power supply accessory provided with the unit, or by a 12VDC source supplied by the user.

CAUTION: The YSI 5578/5579 power supply accessory is for indoor use only, and must be connected to the 5200 Monitor with a suitable waterproof extension cable if the 5200 Monitor is installed in a damp location.

For outdoor or damp locations, the YSI 5578/5579 power supply may also be installed in a NEMA 4X enclosure adjacent to the 5200.

3.6.2 Installing the 5578/5579 Power Supply

When using the 5579 power supply it should be wired as follows: (see Figure 3-9)

- Connect the Inline Power Ferrite Assembly, YSI# 655385, to the I/O plate power connector. Failure to do so could cause catastrophic monitor failure.
- Route the 5578/5579 power supply wire through the small compression fitting and into the case.
- Connect the 5578/5579 wires to the 4-pole 605223UL Pluggable Socket Connector so that the white wire goes to Main (+) and black wire to Common (-).
- Connect the 4-pole 605223UL Pluggable Socket Connector to Inline Power Ferrite Assembly.
- Tighten compression fitting. See Section 3.3.1 *Sealants, Desiccants and Securing the Monitor*.

WARNING: A UL Listed DC power supply is required for any installation which is connected to “mains

supply” or other power source which is “hazardous live” per UL 3101-1 Section 3.5.2.

The 5200 Monitor may be powered by any regulated 8.5–16.5 VDC source that can provide approximately 800mA of current and is isolated from mains supply by double or reinforced insulation. (An unregulated supply may also be acceptable if the peak output voltage does not exceed 16.5VDC.)

 **WARNING:** A UL Listed slow-blow fuse with a maximum current rating of 1A must be connected in series with the positive terminal of any power supply not provided by YSI.

 **CAUTION:** Power supply voltage above 16.5VDC may permanently damage the 5200 Monitor.

When the front panel of the 5200 Monitor is removed, take care not to drop the cover since it is not hinged to the Monitor.

 **CAUTION:** The sensitivity and stability of the monitor will be impaired if the monitor is not grounded. **Do not** apply power to the Monitor until all electrical connections are verified and secure. Connect earth ground to the 5200 I/O plate (see Figure 3-8 I/O Plate).

3.6.3 Back-up Power

 **WARNING:** A UL Listed slow-blow fuse with a maximum current rating of 1A must be connected in series with the positive terminal of the back-up supply.

The 5200 Monitor will automatically switch to auxiliary battery back-up operation if primary voltage drops below 8.5 VDC, providing back-up power is connected. For proper back-up power operation, use the YSI 5578/5579 Power Supply as the primary power source. Use of a different primary power supply may prevent proper switching to back-up power.

 **WARNING:** A UL Listed DC power supply is required for any installation which is connected to “mains supply” or other power source which is “hazardous live” per UL 3101-1 Section 3.5.2.

The auxiliary power source is user supplied and can come from a variety of choices including lead acid or gel cell external batteries. The 5200 will not charge batteries, so quality assurance maintenance procedures must be established if batteries are used as the back-up power source.

Input power requirements for back-up operation are the same as primary power, 8.5–16.5 VDC at approximately 800mA. With no primary power, when the back-up voltage falls below 7.0 volts the 5200 will cease to operate properly.

Connecting back-up power to the 5200 Monitor

Refer to Figure 3-9.

- If necessary, disconnect power to the 5200 Monitor
- Route the back-up supply wire through the compression fitting and into the case. See Section 3.3.1 *Sealants, Desiccants and Securing the Monitor*.
- Connect the back-up wires to the 4-pole 605223UL Pluggable Socket Connector so that the positive wire goes to the Back-up (+) terminal and the negative wire goes to the Common (-) terminal.
- Connect the 4-pole 605223UL Pluggable Socket Connector to Inline Power Ferrite Assembly. Failure to do so could cause catastrophic monitor failure.
- Connect the Inline Power Ferrite Assembly to the I/O plate power connector.

IMPORTANT: After completing system installation, test back-up power by removing main power while **all** control/alarm relays are energized. At cold temperatures, logged data may be lost due to temporary power loss when switching to battery backup power.

⚠ CAUTION: The sensitivity and stability of the monitor will be impaired if the monitor is not grounded. **Do not** apply power to the Monitor until all electrical connections are verified and secure.

3.7 Communications Method

The 5200 has three methods of communication:

- RS232 TCP/IP Serial Port—to directly connect with a computer or network
- Modem—to communicate with a computer or pager via phone line
- RS485 Network—to directly connect with other 5200s

3.7.1 RS232 and TCP/IP Port

RS232 serial and TCP/IP communications are made through the TCP/IP port. This port can be permanently connected to a PC or network for continuous monitoring applications, or to the 5201 Modem sending alarm messages via phone. The RS232/TCP/IP port uses a standard RJ-45 connector.

Two snap on ferrite assemblies, YSI# 655361, are included with the 5200 Monitor. Wires being connected to the communication port need to be routed through the ferrites as shown in Figure 3-9. Failure to do so could cause catastrophic monitor failure.

RS232 PC Connection

When connecting the 5200 via the serial port to a PC for continuous operation, use an inline RS232 Opto-Isolator device (YSI# 5285 or equivalent) to prevent ground loops. Failure to use this device may cause incorrect DO, pH, ORP and conductivity data to be displayed and logged. Mount the isolator as close to the PC as possible or in an area where it is protected from moisture.

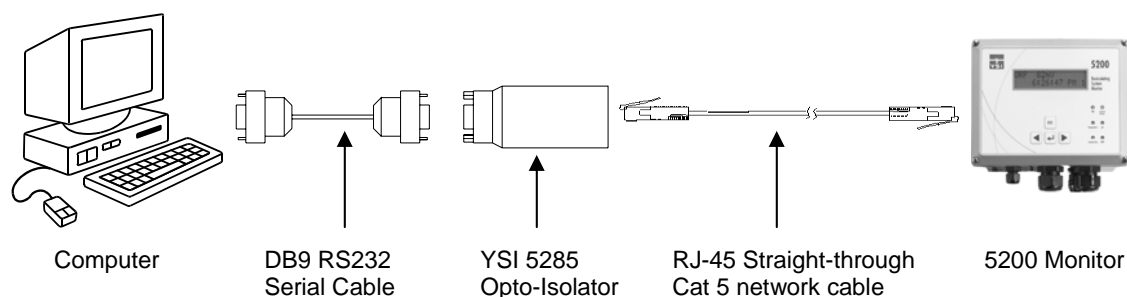

RS232 Serial Connection to a PC

When making RS232 cable runs greater than 100 feet (30.5 meters), use an RS232 Line Extender/Booster. Not using this device may cause communication failures. Mount the booster in an area where it is protected from moisture.

When temporarily connecting the 5200 to a PC, a “Straight-Pinned” Dual Male RJ-45 cable and a DB-9 to RJ-45 Adapter (YSI# 655383) wired as in the chart below are required.

Wiring Diagram for DB-9 to RJ-45 Adapter

Signal name (from 5200)	RJ-45 pin #	Wire color internal to adapter (may change based on supplier)	DB-9 pin #
TX (232TXD)	4	Red	3
RX (232RXD)	5	Green	2
Common (DGND)	6	Yellow	5
CTS (232CTS)	7	Brown	8
DTR (232DTR)	8	Gray	4

Supplied with the 5200 are a YSI# 655384 Straight-pinned Cat 5 EIA568 compliant network patch cable and pre-wired YSI# 655383 RJ-45 to DB-9 Adapter. The supplied cable and adapter are only intended to be used for software upgrades or downloading data. Do **not** use this cable for long-term installation as the compression fitting cannot form a proper seal. See Section 3.3.1 *Sealants, Desiccants and Securing the Monitor*.

Bulk cable for permanent installations must be round (to allow the compression fitting to seal) and should be purchased locally. A crimping tool will be required to install RJ-45 connectors to each end of the cable.

IMPORTANT: 1. The connector that is to connect inside the case should be crimped after the cable is run through the compression fitting.

2. Round cable must be used so a watertight seal at the compression can be achieved.

TCP/IP LAN Connection

An Ethernet serial server is required to connect the 5200 to a LAN. The serial server must be assigned a static IP address.

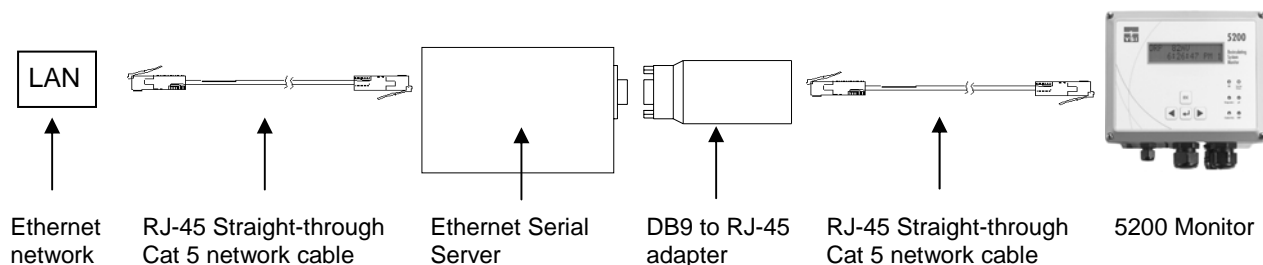

TCP/IP Connection to a LAN

Additional RS232 TCP/IP Wiring Information

The 5200 uses a symmetrical EIA-232 data terminal equipment (DTE) pinout on the RJ-45 serial port. Table 3-1 lists the pinouts of the RJ-45 ports used for EIA-232 serial communications.

RJ-45 Pin Number	RS232 Name	Direction	RS232	TCP/IP	Signal Function
1	DCD	I	NC	P	Signals module that remote device is attached and powered on
2	RTS	O	NC	P	Flow control, to enable remote device to send data
3	SG		P	P	Signal return (NOT chassis ground)
4	TXD	O	P	P	Serial data out, from YSI-5200 to remote device
5	RXD	I	P	P	Serial data in, from remote device to YSI-5200
6	SG		P	P	Signal return (NOT chassis ground)
7	CTS	I	NC	P	Flow control, to enable YSI-5200 to send data on TXD
8	DTR	O	NC	P	Signals remote device that YSI-5200 is attached and powered on

Table 3-1

To connect the 5200 to an EIA-232 device, it needs to be determined if the device connector wiring follows the standard for data terminal equipment (DTE) or for data communication equipment (DCE). In general, modems are wired as DCE devices and all other devices are wired as DTE; however, some equipment manufacturers may deviate from the standard. In most cases, you use "straight through" RJ-45 cable. If you use "crossover" RJ-45 cable, the RJ-45 pins will be reversed.

3.7.2 5201 Modem

The YSI 5201 Modem is available only for use within the United States. For modem support outside the US, an external modem registered for use within the local country is required. See Section 17 *International Modem Support*.

The YSI 5201 Modem mounts inside the 5200 case and connects to the RS232/TCP/IP Port. Refer to the *5201 Modem Installation Instructions*, included with the modem, for details.

 **CAUTION:** The phone line entering the 5200 case must be #26 AWG wire and must be sealed where it enters the case or the instrument may be seriously damaged.

 **CAUTION:** The ground wire from the 5201 Modem must be connected to the ground screw on the 5200 I/O plate.

3.7.3 RS485 Network

Connecting 5200s via the RS485 network is described in *8.1 RS485 Network*.

3.8 Grounding Information

This section contains important installation information regarding grounding of the 5200 Monitor. Connect earth ground to the 5200 I/O panel as described below in *3.9 Safety ISSUES*.

The probe is powered by the 5200 Monitor and will be operated with a “floating” ground reference. This requires that the probe **not** be individually grounded. Grounding the probe individually will cause a “ground loop”; i.e. one conductor of the probe output grounded common to both the probe and the monitor. Grounding the probe will cause significant performance problems with the sensors and likely result in erroneous readings.

 **CAUTION:** Do not ground the probe body.

All tanks should be electrically grounded via a ground probe.

3.9 Safety Issues

The electrical system must be grounded via the I/O plate to avoid possible electrical shock or damage to the equipment (see Figure 3-8 I/O Plate).

 **WARNING:** Turn off all power and assure power “lockout” before servicing to avoid contact with electrically powered circuits.

To avoid possible electrical shock, do not touch other circuit components when making adjustments to the 5200 Monitor circuit board. Disconnect external power to the unit before connecting or disconnecting wiring.

3.10 Lightning and Surge Protection

Surge protectors are strongly recommended to protect from secondary surges and lightning on outdoor installations.

Surge suppression devices should be located on the AC line supplying power to the 5200 Monitor and any signal lines connecting the 5200 Monitor.

AC line voltage surge suppressors protect field equipment on any AC line to ground from damage due to electrical transients induced in the interconnecting power lines from lightning discharges and other high voltage surges. The unit should include noise filtering, common mode and normal mode suppression and nanosecond reaction time. Surge suppressors should be internally fused to remove the load if the unit is overloaded or the internal protection fails.

Signal line suppressors protect low voltage signals and relay outputs from damage due to electrical transients induced in the signal lines from lightning discharges or nearby electrical devices. Signal line suppressors should be installed at each end of an analog loop. Relay outputs should be protected at the receiver end. Signal line suppressors should consist of a three-element gas tube followed by metal oxide varistors and suppressor diodes. The protective elements should be matched such that high-energy surge voltages trigger the gas surge arrester, while low energy or surge voltages affect the MOV's and suppressor diodes.

Lightning protection devices should be located as close to the monitor as possible and wired in accordance with the National Electric Code in approved watertight enclosures.

 **CAUTION:** This or any other installation procedure cannot protect against a direct lightning strike. YSI Incorporated cannot accept liability for damage due to lightning or secondary surges.

Section 4. Probe Module

Probe Module covers the following:

- Unpacking the Probe Module
- Features of the YSI 5561 Probe Module
- Features of the YSI 5562 Probe Module
- Preparing the YSI 5561 Probe Module
- Preparing the YSI 5562 Probe Module
- Membrane Cap Installation
- Calibration/Storage Cup (5562 only)
- Instrument/Cable Connection

Two different probe modules are available for the YSI 5200 Recirculating Monitor. The YSI 5561 Probe module is used for measuring dissolved oxygen and temperature only, while the YSI 5562 Probe module is used for measuring dissolved oxygen, temperature, conductivity, and optional pH or pH/ORP. A 4, 10 or 20 meter cable is directly connected to the probe module body making it waterproof.

4.1 Unpacking the Probe Module

1. Remove the Probe module from the shipping box(es).
2. Use the packing list to ensure all items are present.
3. Visually inspect all components for damage.

NOTE: If any parts are missing or damaged, contact your YSI Service Center immediately. Refer to *Section 14 WARRANTY AND SERVICE INFORMATION* or www.yisi.com/environmental.

4.2 Features of the YSI 5561 Probe Module

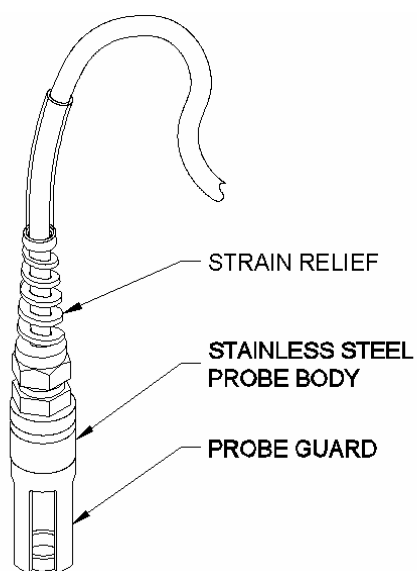

Figure 4-1 5561 Probe Module

4.3 Features of the YSI 5562 Probe Module

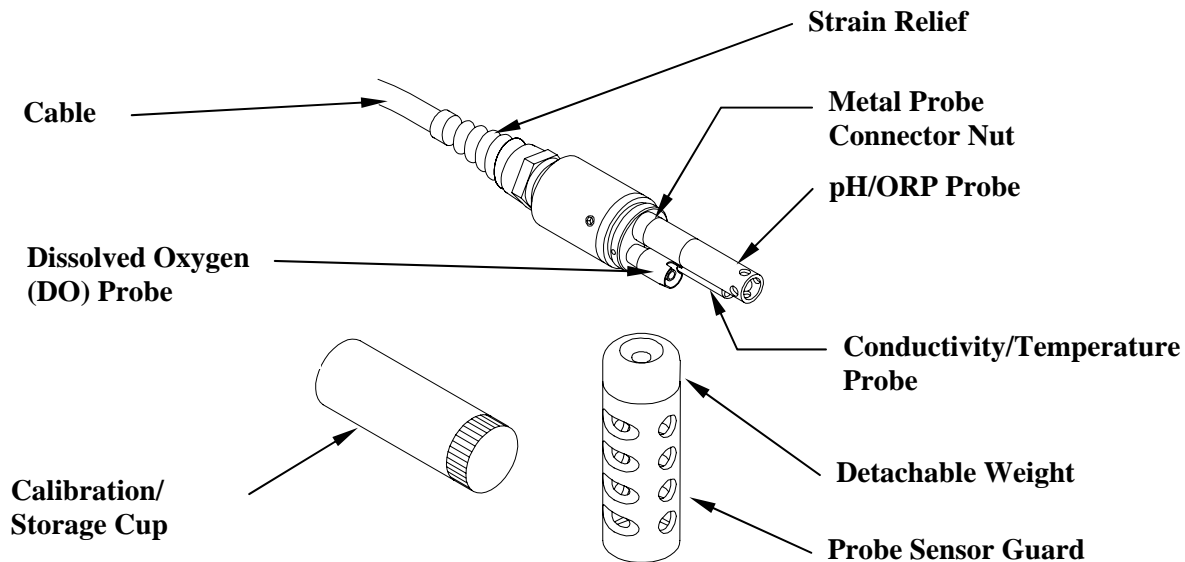

Figure 4-2 5562 Probe Module

4.4 Preparing the YSI 5561 Probe Module

To prepare the YSI 5561 Probe Module for calibration and operation, you need to install a new DO membrane cap. Refer to Section 4.6 *Membrane Cap Installation* for details.

4.5 Preparing the YSI 5562 Probe Module

To prepare the YSI 5562 Probe Module for calibration and operation, you need to install the sensors into the connectors on the probe module bulkhead. In addition to sensor installation, you need to install a new DO membrane cap.

4.5.1 Sensor Installation

Whenever you install, remove or replace a sensor, it is extremely important that the entire probe module and all sensors be thoroughly dried prior to the removal of a sensor or a sensor port plug. This will prevent water from entering the port. Once you remove a sensor or plug, examine the connector inside the probe module sensor port. If any moisture is present, use compressed air to completely dry the connector. If the connector is corroded, return the probe module to your dealer or directly to YSI Customer Service. Refer to *Section 14 Warranty and Service Information*.

Conductivity/Temperature and pH, pH/ORP Sensor Installation

1. Unscrew and remove the probe sensor guard.
2. Using the sensor installation tool supplied in the YSI 5511 maintenance kit, unscrew and remove the sensor port plugs.

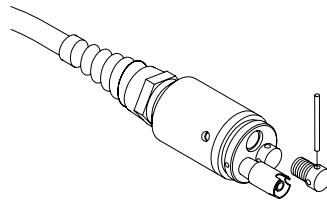

Figure 4-3 Port Plug Removal

3. Locate the port with the connector that corresponds to the sensor that is to be installed. The number of pins is specific for each probe type.

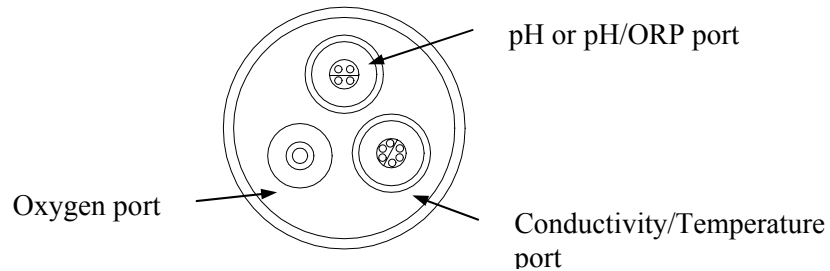

Figure 4-4 Sensor Port Identification

4. Apply a thin coat of o-ring lubricant (supplied in the YSI 5511 maintenance kit) to the o-rings on the connector side of the sensor (see Figure 4-5 O-Ring Lubrication).

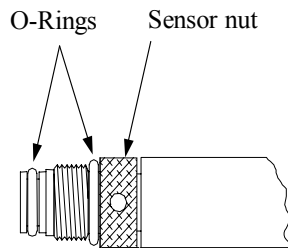

Figure 4-5 O-Ring Lubrication

⚠ CAUTION: Make sure that there are NO contaminants between the O-ring and the sensor. Contaminants that are present under the O-ring may cause the O-ring to leak.

5. Be sure the probe module sensor port is free of moisture and then insert the sensor into the correct port. Gently rotate the sensor until the two connectors align.
6. With connectors aligned, screw down the sensor nut by hand, and then tighten using the sensor installation tool.

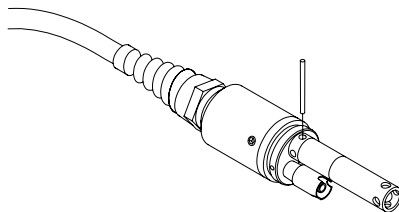

Figure 4-6 Sensor Installation

⚠ CAUTION: Do not cross thread the sensor nut. Tighten the nut until it is flush with the face of the probe module bulkhead. Do not over tighten.

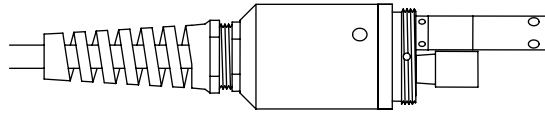

Figure 4-7 Bulkhead Seating

7. Repeat steps 3-6 for any other sensors.
8. Replace the probe sensor guard.

Dissolved Oxygen Sensor Installation

The YSI 5562 comes with the DO sensor already installed. Refer to Section 11.4.2 *DO Sensor Replacement* for instructions on installing the YSI 558 Replaceable DO Module Kit.

4.6 Membrane Cap Installation

NOTE: The DO sensor was shipped dry. A shipping membrane cap was installed to protect the electrode. **A new membrane cap must be installed before the first use.**

1. Unscrew and remove the probe sensor guard.
2. Unscrew, remove, and discard the old membrane cap.
3. Thoroughly rinse the sensor tip with distilled water.
4. Install a gasket from the 5204 Teflon or 5909 PE Membrane Kit onto the DO sensor.

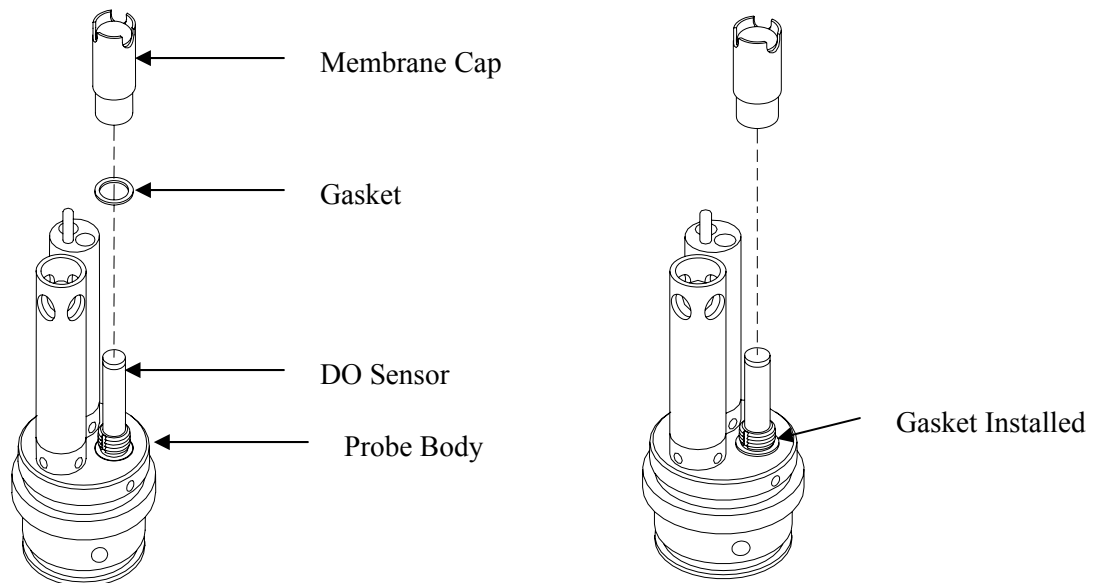

Figure 4-8 Gasket Installation

5. Seat the gasket all the way down against the probe body. A small pair of tweezers may aid in the installation.
6. Prepare the electrolyte according to the directions on the electrolyte solution bottle.
7. Hold the new membrane cap and fill it at least 1/2 full with the electrolyte solution.

⚠ CAUTION: Do not touch the membrane surface.

8. Screw the membrane cap onto the sensor moderately tight. A small amount of electrolyte should overflow.
9. **IMPORTANT:** To prevent the formation of a bulge in the membrane (which can slow sensor response), partially unscrew the membrane cap then retighten.
10. Screw the probe sensor guard on moderately tight.

4.7 Calibration/Storage Cup (5562 only)

The YSI 5562 Probe module is supplied with a convenient calibration/storage cup. This cup is an ideal container for calibration of the different sensors, minimizing the amount of solution needed. Refer to *Section 6 Calibration*.

4.7.1 Calibration/Storage Cup Installation

1. Remove probe sensor guard, if already installed.
2. Ensure that an o-ring is installed in the o-ring groove on the threaded end of the probe module body.
3. Screw the calibration/storage cup on the threaded end of the probe module and securely tighten.

NOTE: Do not over tighten as this could cause damage to the threaded portions.

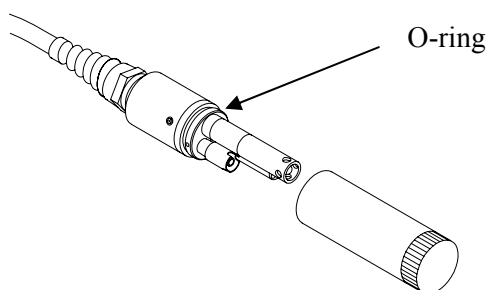

Figure 4-9 Calibration/Storage Cup Installation

4.8 Instrument/Cable Connection

Attach the probe cable to the instrument as follows:

1. Line up the pins and guides on the cable with the holes and indentations on the cable connector at the bottom of the YSI 5200 instrument.

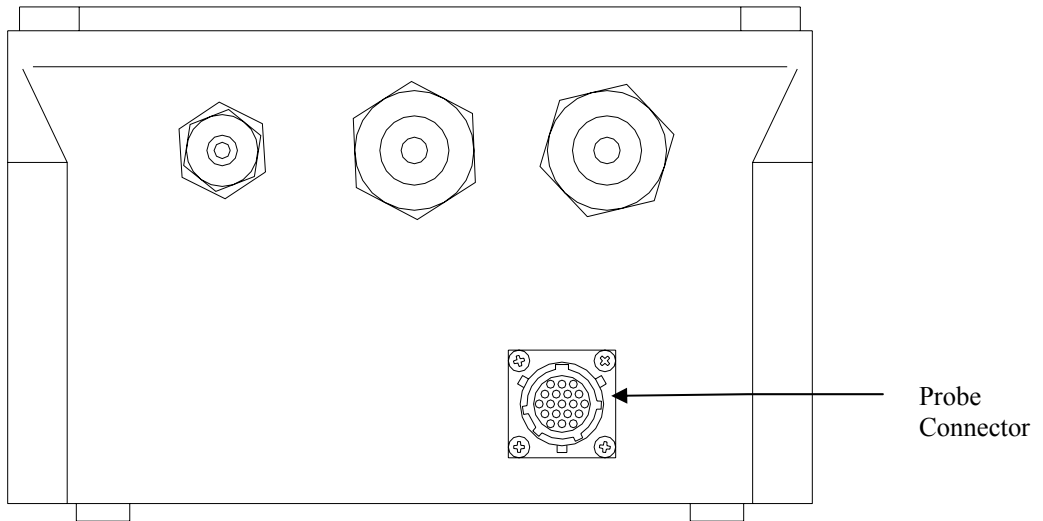

Figure 4-10 Bottom Connectors

2. Holding the cable firmly against the cable connector, turn the locking mechanism clockwise until it snaps into place.
3. Remove the cable from the instrument by turning the cable connector counterclockwise until the cable disengages from the instrument.

Section 5. Operation

Operation covers the basic set up and operation of the 5200 Recirculating Monitor including:

- Run Screen
- Main Menu
- Parameters Menu
- Daily Checks
- System Test

See *Section 9 Advanced Setup* for more advanced set up options.

In the Parameters menu section, Temperature is explained in step-by-step detail as an example. Once familiar with the temperature set up procedure, other parameters can be set up in a similar manner.

5.1 Run Screen

The initial 5200 display is the Run screen.

DO 8.31 mg/L Temp 18.5 °C

The current values of enabled parameters are displayed (two at a time in a rotating fashion) on the Run Screen. The speed with which the display automatically rotates through these values can be changed (see *Section 9.1.4 Display, Display Speed*). The parameters may also be manually rotated by pressing the [◀] or [▶] arrow key. Press the [ESC] key to hold the currently shown parameter on the top line of the display. An **H** will appear to the right of the parameter indicating Hold mode. Press the [ESC] key again to hold the 2nd displayed parameter. Press the [ESC] key again to return to the normal display that rotates through all parameters.

DO 7.15 mg/L H	← Hold indicator
Temp 18.5 °C	

Any messages will also appear on the Run Screen. As systems are activated or alarms are triggered the display provides up to date status on the system being managed. Up to 16 events are saved and displayed in sequence. Figure 3.2 shows the Run screen.

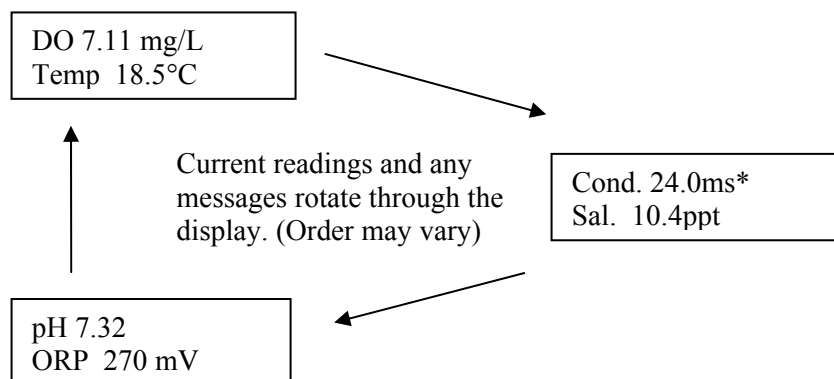

Cond 24.0mS *
Sal. 10.4ppt

Indicates temperature compensation

The status LEDs show the current status of each parameter as follows:

- OFF – parameter not enabled
- GREEN – normal range
- FLASHING GREEN – control mode (turns off when it crosses the original set point)
- RED – alarm (turned off by pressing any key, except escape, and resolving the alarm condition)

5.2 Main Menu

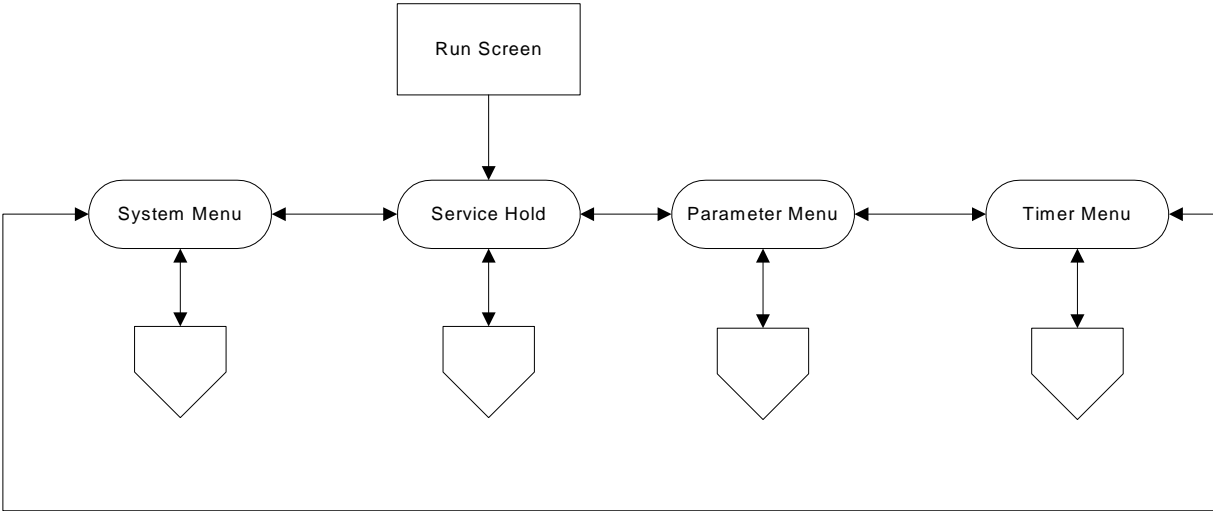

Figure 5-1 Main Menu

From the Run screen, press the **Enter** [↵] key to enter the Main menu.

Service Hold
Enter to Select

NOTE: Service Hold is the first selection in the Main menu. It allows you to perform service operations (clean probes, provide tank maintenance etc.) without breaching any alarms or set points. See Section 9.2.2 *Service Hold*.

Press the [◀] or [▶] key to rotate through the Main menu selections.

Parameters
Enter to Select

The menus are displayed in the order indicated in Figure 5-1, starting with Service Hold. You can cycle through the menus as many times as you desire in either direction using the arrow keys.

NOTE: Entering the menus automatically turns off all 4 internal control relays.

5.3 Parameters Menu

The **Parameters Menu** allows you to enter the menu for specific measurement parameters. In addition to establishing Set Points, Control Points and Alarms, the Parameters menu also enables the user to perform calibrations (refer to *Section 6 Calibration* for calibration routines). The majority of the day-to-day operations of the YSI 5200 will be accessed through this menu.

The options in this menu include:

- DO System
- pH System
- ORP System
- Temperature System
- Conductivity System
- Salinity System
- Auxiliary System

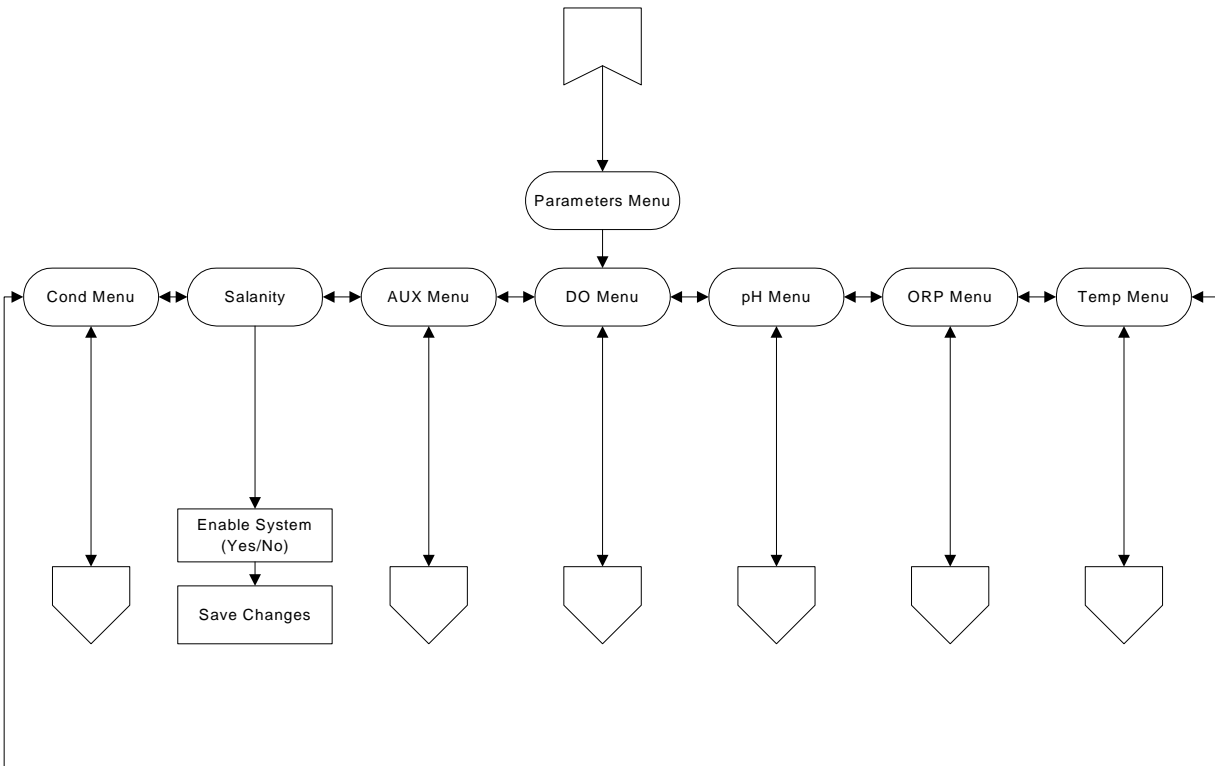

Figure 5-2 Parameters Menu

5.3.1 Entering Setpoint and Range Values

Various Set Points and ranges must be established for each of the five monitoring parameters that are enabled: conductivity, temperature, pH, ORP and DO.

- The optimal Set Point value.
- The control range, or High and Low Set Points.
- The alarm range.

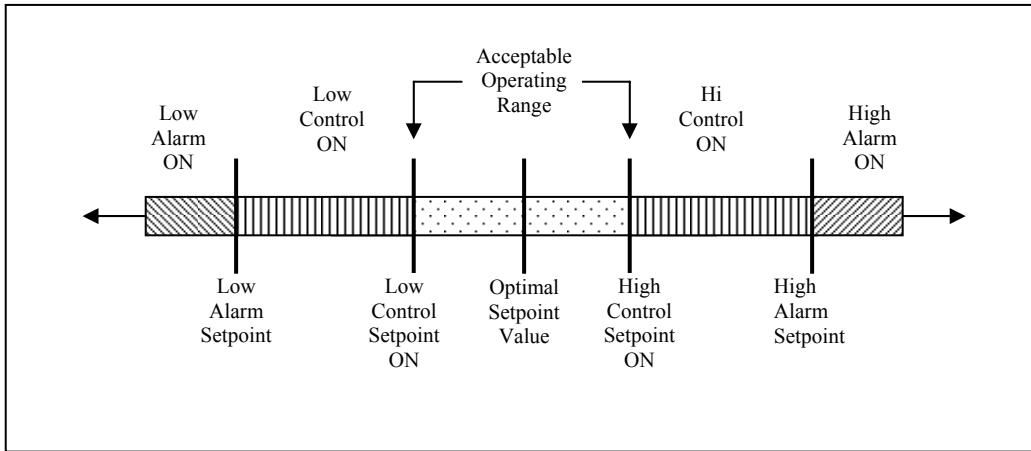

Figure 5-3 Setpoints and Ranges

When these values are entered, the system will operate as illustrated in Figure 5-3. As long as the water quality parameters remain within the acceptable operating range, no control or alarm will be activated. If, however, a parameter rises above or falls below the acceptable operating range, the YSI 5200 will activate the appropriate control device. The control device remains in operation until the parameter returns to the Set Point value.

As you enter a Set Point value, the YSI 5200 may prompt you if there are problems with the set up. If the High or Low value breaches the optimal Set Point, you will see an Autofix question displayed that will automatically adjust your High or Low value to a value ± 0.1 or ± 0.01 to the high or low side of your optimal Set Point depending on the parameter of interest. For example, pH will be adjusted to the hundredths place while DO will be adjusted to the tenths place.

If you had your optimal Set Point at 8.0 mg/L for DO and the Low range at 7.8 and the High range at 8.2 and you changed your optimal Set Point to 7.7 then attempted to escape without resetting the High and Low ranges, you would see the following displayed:

Setpoint Errors.
Auto Fix? YES

If you choose YES, the Low range Set Point would automatically be adjusted to 7.6, but the High range Set Point would remain 8.2 because it did not get breached.

IMPORTANT: For Controlling Applications, it is highly recommended that you use Alarms and verify all Set Point, Alarm and Control Range settings.

This product has been designed and tested to provide trouble free service. However, as with all microprocessor based products, there is potential for failure which could cause loss of control functions. Proper QC procedures can reduce the potential for failure. See *11.3 Recommended Quality Assurance Protocol*.

The default set point and alarm values loaded during factory configuration are shown below.

Parameter	Set Point	High Set Point #1	High Set Point #2	Low Set Point #1	Low Set Point #2	High Alarm	Low Alarm
ORP	+400 mV	+425 mV	---	+375 mV	---	+435 mV	+300 mV
Temperature	25°C or 77°F	26°C or 78.8°F	---	24°C or 75.2°F	---	26.5°C or 79.7°F	23.5°C or 74.3°F
pH	7.00	7.50	---	6.50	---	8.00	6.00
Specific Conductance (range dependent; 0-200 us, 0-2000 us, 0-20 ms, 0-200 ms)	(0-200 us) 160.0 us	(0-200 us) 180.0 us	---	(0-200 us) 140.0 us	---	(0-200 us) 190.0 us	(0-200 us) 130.0 us
	(0-2000 us) 1600 us	(0-2000 us) 1800 us		(0-2000 us) 1400 us		(0-2000 us) 1900 us	(0-2000 us) 1300 us
	(0-20 ms) 16.00 ms	(0-20 ms) 18.00 ms		(0-20 ms) 14.00 ms		(0-20 ms) 19.00 ms	(0-20 ms) 13.00 ms
	(0-200 ms) 160.0 ms	(0-200 ms) 130.0 ms		(0-200 ms) 140.0 ms		(0-200 ms) 190.0 ms	(0-200 ms) 130.0 ms
Dissolved Oxygen	8.3 mg/L	8.5 mg/L	8.7 mg/L	8.1 mg/L	7.9 mg/L	8.9 mg/L	7.7 mg/L

5.3.2 Temperature System

Temperature is explained in step-by-step detail as an example. Once you are familiar with the temperature set up procedure, other parameters can be set up in a similar manner.

From the Parameters menu, press the [◀] or [▶] key until the **Temp System** option appears.

Temp System
Enter to Select

Press the **Enter** [↵] key to enter the Temp System menu.

Temp System
ENABLED? Yes

If the Temperature System is disabled (as indicated by **No** appearing on the display), press the [◀] or [▶] key to select **Yes**.

Temp System
ENABLED? Yes

Press the **Enter** [↵] key to confirm that the option is Enabled and enter the Temp System menu.

Set Point Menu
Enter to Select

Temperature System menu selections are shown below.

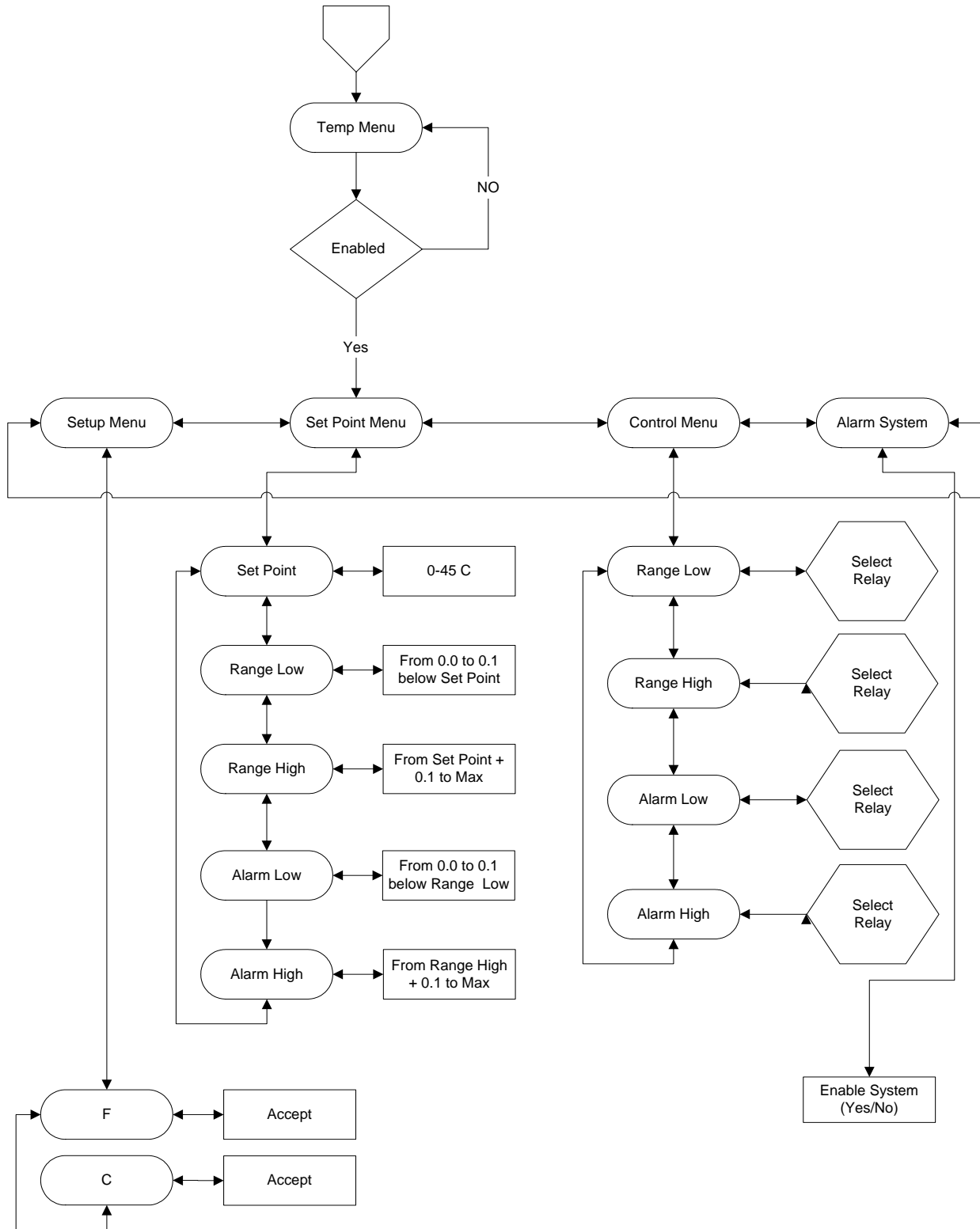

Figure 5-4 Temperature Menu

Set Point Menu

From the Temp System menu, press the [◀] or [▶] key until the **Set Point Menu** option appears.

Set Point Menu
Enter to Select

Press the **Enter** [↵] key.

Enter to Select
SetPoint

Set Point Menu selections for Temperature are SetPoint, Range Low, Range High, Alarm Low and Alarm High.

SetPoint

The Temperature Set Point defines the optimum Temperature that you wish the YSI 5200 to maintain in the aquatic environment. This determines the control range for heating and chilling devices. See Section 5.3.1 *Entering Setpoint and Range Values* for an overview of control functions.

From the Set Point menu (with the SetPoint option displayed), press the **Enter** [↵] key.

SetPoint
077.0°F

Using the [◀], [▶] and **Enter** [↵] keys, enter the Temp Set Point value.

NOTE: The previous value entered will be displayed.

SetPoint
069.0°F

Press the **Enter** [↵] key. The display returns to the Set Point Menu.

Enter to Select
SetPoint

Press the [▶] key for the next Set Point selection, Range Low.

Range Low

From the Set Point menu (with the Range Low option displayed), press the **Enter** [↵] key.

Range Low
068.9°F

Using the [◀], [▶] and **Enter** [↵] keys, enter the Temperature Range Low value.

NOTE: The Range Low value must be lower than the Set Point.

Range Low
065.0°F

Press the **Enter** [↵] key. The display returns to the Set Point Menu.

Enter to Select
Range Low

Press the [▶] key for the next Set Point selection, Range High.

Range High

From the Set Point menu (with the Range High option displayed), press the **Enter** [↵] key.

Range High
078.8°F

Using the [◀], [▶] and **Enter** [↵] keys, enter the Range High value.

NOTE: The Range High value must be higher than the Set Point.

Range High
074.0°F

Press the **Enter** [↵] key. The display returns to the Set Point Menu.

Enter to Select
Range High

Press the [▶] key for the next Set Point selection, Alarm Low.

Alarm Low

From the Set Point menu (with the Alarm Low option displayed), press the **Enter** [↵] key.

Alarm Low
068.8°F

Using the [◀], [▶] and **Enter** [↵] keys, enter the Alarm Low value.

NOTE: The Alarm Low value must be lower than the Range Low.

Alarm Low
062.0°F

Press the **Enter** [↵] key. The display returns to the Set Point Menu.

Enter to Select
Alarm Low

Press the [▶] key for the next Set Point selection, Alarm High.

Alarm High

From the Set Point menu (with the Alarm High option displayed), press the **Enter** [↵] key.

Alarm High
079.7°F

Using the [◀], [▶] and **Enter** [↵] keys, enter the Alarm High value.

NOTE: The Alarm High value must be higher than the Range High.

Alarm High
085.0°F

Press the **Enter** [↵] key. The display returns to the Temp System Menu.

Enter to Select
Alarm High

NOTE: You may enter the other Temperature System menu options (Control Menu, Alarms System and Calibration), but your changes are not saved until you exit the Temp System menu as described below.

Press the [ESC] key two times to exit the Temp System menu. You will be prompted to save your changes.

Set Point Menu
Save? Yes

Press the **Enter** [↵] key to save the changes, or press the [◀] or [▶] key to select No, then press the **Enter** [↵] key to exit without saving any changes.

Control Menu

After entering the Temperature set point and ranges, use the Control Menu to select which relay each range or alarm will activate. At the beginning of the control range, the YSI 5200 will turn on the chiller or heater, as required. These peripheral devices will remain activated to drive the temperature value back to the optimal Set Point value, and once achieved, the peripheral device will be turned off. Since most heaters and chillers have their own thermostat, these thermostats can be used as a backup temperature control system. The heater thermostat should be set several degrees above your desired temperature and the chiller several degrees below. If your desired temperature is 78°F then set your heater thermostat at 81°F and your chiller thermostat at 75°F.

The YSI 5200 has a chiller hold off feature. When you are cooling (running a compressor using a relay) the relay will turn on immediately but if cycled off and back on it will not allow the relay to come back on for about 8 minutes. This keeps compressors from burning up.

From the Temp System menu, press the [◀] or [▶] key until the **Control Menu** option appears.

Control Menu
Enter to Select

Press the **Enter** [↵] key.

Enter to Select
Range Low

Control Menu selections for Temp are Range Low, Range High, Alarm Low and Alarm High.

Relay Setup

From the Control Menu, press the [◀] or [▶] key until the **Range Low** option appears.

Enter to Select
Range Low

Press the **Enter** [↵] key to select Range Low.

Range Low
Relay Disabled

Range Low menu selections are Relay Disabled, Relay Internal and Relay SubNet.

NOTE: Range High, Alarm Low and Alarm High menus have these same selections.

Relay Disabled

Relay Disabled is the default setting. It prevents the Range Low control point from triggering any relays (Internal or SubNet). To select this option, press the [ESC] key to return to the Control Menu.

```
Enter to Select
Range Low
```

NOTE: You may enter another of the other Control Menu options (Range High, Alarm Low and Alarm High), but your changes are not saved until you exit the Control Menu as described below.

Press the [ESC] key two times to exit the Control Menu. You will be prompted to save your changes.

```
Control Menu
Save? Yes
```

Press the **Enter** [↵] key to save the changes, or press the [◀] or [▶] key to select No, then press the **Enter** [↵] key to exit without saving any changes.

Relay Internal

Set the Range Low control to trigger one of the four internal relays in **this** 5200 as follows:

From the Range Low menu, press the [◀] or [▶] key until the **Relay Internal** option appears.

```
Range Low
Relay Internal
```

Press the **Enter** [↵] key to select Relay Internal.

```
Range Low
Relay R:1
```

Use the [◀] or [▶] key to select the desired Internal Relay number (1–4).

```
Range Low
Relay R:4
```

Press the **Enter** [↵] key.

NOTE: If the relay address is already in use, an error message will appear. See *Section 13 Troubleshooting, Relay In Use Error Codes*.

```
Enter to Select
Range Low
```

NOTE: You may enter another of the other Control Menu options (Range High, Alarm Low and Alarm High), but your changes are not saved until you exit the Control Menu as described below.

Press the [ESC] key two times to exit the Control Menu. You will be prompted to save your changes.

```
Control Menu
Save? Yes
```

Press the **Enter** [↵] key to save the changes, or press the [◀] or [▶] key to select No, then press the **Enter** [↵] key to exit without saving any changes.

NOTE: Use the same procedure as described above to set up a relay to be triggered by Range High, Alarm Low or Alarm High.

Relay SubNet

This function is for future expansion and is not yet available. Set the Range Low control to trigger an external subnet relay (connected to this 5200 via the RS485 network).

Alarm System

The alarm system for each measurement parameter can be turned on or off. When on, an audible alarm will sound on the YSI 5200 and an alarm page will be sent (if a modem is installed and paging is enabled). The alarm will remain on until a key is pressed. See *7.1 Alarm Logic Flow Charts* for details.

From the Temp System menu, press the [◀] or [▶] key until the **Alarm System** option appears.

```
Alarm System
Enter to Select
```

Press the **Enter** [↵] key.

```
Alarm System
Alarms? No
```

If the Temperature Alarm System is disabled (as indicated by **No** appearing on the display), press the [◀] or [▶] key to select **Yes**.

```
Alarm System
Alarms? Yes
```

Press the **Enter** [↵] key. The display returns to the Temp System menu.

```
Alarm System
Enter to Select
```

NOTE: You may enter another of the Temp System menu options (Calibration, Set Point Menu or Control Menu), but your changes are not saved until you exit the Temp System menu as described below.

Press the [ESC] key to exit the Temp System Menu. You will be prompted to save your changes.

```
Alarm System
Save? Yes
```

Press the **Enter** [↵] key to save the changes, or press the [◀] or [▶] key to select No, then press the **Enter** [↵] key to exit without saving any changes.

Setup Menu

The Setup Menu allows you to select the scale you wish to use for temperature measurement—Celsius or Fahrenheit. The YSI 5200 controller is set to Celsius at the factory.

Changing the temperature scale automatically recomputes your Set Points. For example, if your Set Points were entered in Fahrenheit and you change the temperature scale to Celsius, all of your Set Points will be automatically converted to their Celsius equivalents. Select the temperature scale as follows:

From the Temp System menu, press the [◀] or [▶] key until the **Setup Menu** option appears.

```
Setup Menu
Enter to Select
```

Press the **Enter** [↵] key.

```
Temp Scale
Enter to Select
```

Press the **Enter** [↵] key.

```
Temp Scale
Temp Scale? °C
```

Use the [◀] or [▶] key to select either °F or °C.

```
Temp Scale
Temp Scale? °F
```

Press the **Enter** [↵] key.

```
Temp Scale
Enter to Select
```

NOTE: You may enter another of the Temp System Menu options (Set Point Menu, Control Menu or Alarm System), but your changes are not saved until you exit the Temp Setup Menu as described below.

Press the [ESC] key two times to exit the Temp Setup Menu. You will be prompted to save your changes.

```
Setup Menu
Save? Yes
```

Press the **Enter** [↵] key to save the changes, or press the [◀] or [▶] key to select No, then press the **Enter** [↵] key to exit without saving any changes.

5.3.3 DO System

DO System menu selections are shown below.

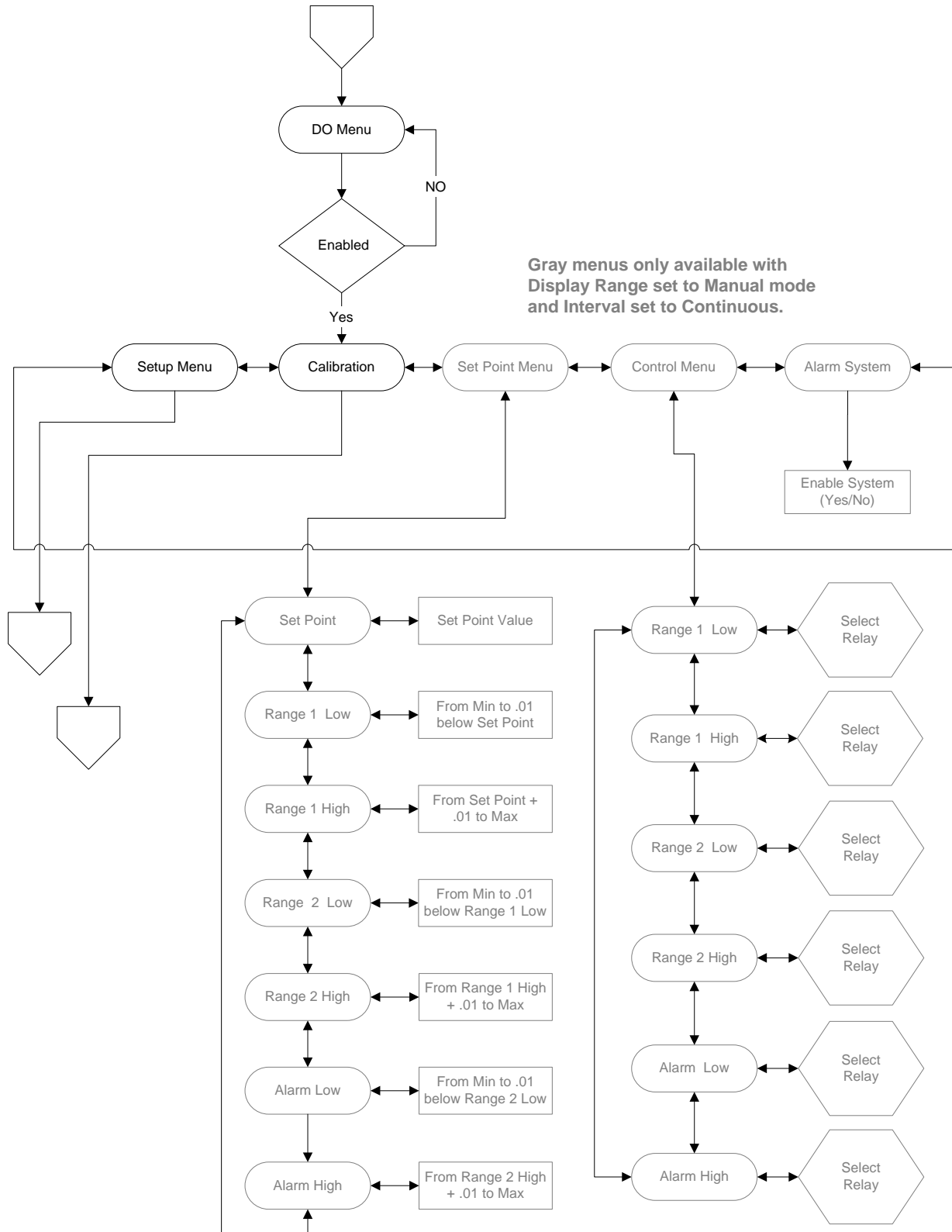

Figure 5-5 DO Menu

NOTE: Set Point, Control and Alarm System Menus are only available when a Manual Display Range is selected (see Section 5.3.3 *DO System, Setup Menu, Display Range*) and the DO Interval is set to Off (DO is on continuously). See Section 5.3.3 *DO System, Setup Menu, Interval*.

NOTE: DO readings are still compensated for salinity changes even if conductivity is disabled.

Calibration

Calibration is covered in Section 6 *Calibration*. DO can be calibrated in either % saturation (recommended) or mg/L. See Section 6.2.2 *Dissolved Oxygen Calibration* for details.

Set Point Menu

Set Point Menu selections for DO are SetPoint, Range1 Low, Range1 High, Range2 Low, Range2 High, Alarm Low and Alarm High.

SetPoint

The DO Set Point defines the optimum DO level that you wish the YSI 5200 to maintain in the aquatic environment.

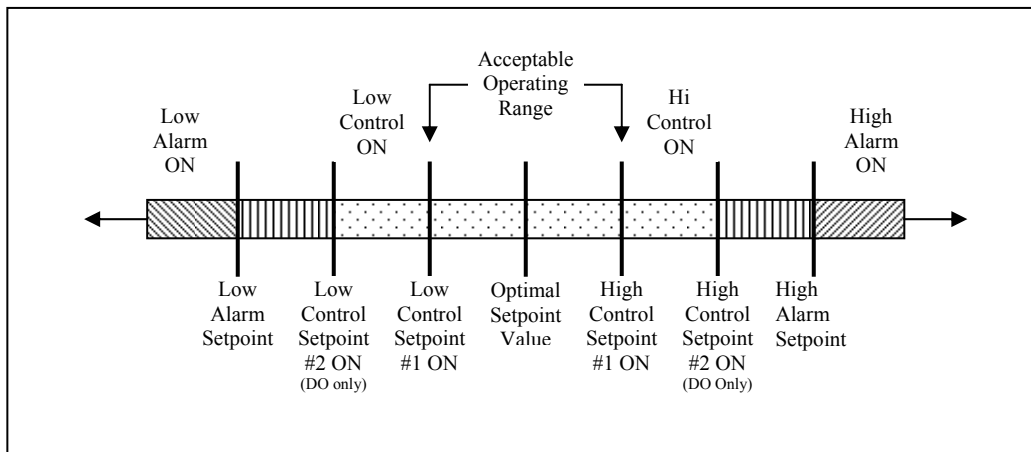

Figure 5-6 DO Setpoints

The DO system uses a more advanced control system employing two control ranges instead of just one as in the other parameters (See Figure 5-6). The dual range design allows you to change the way oxygen levels are managed in the system if the DO level moves out of the first range and into the second. This provides the ability, for example, to use an air injection system (controlled by range 1) to maintain DO levels for the first range and a pure oxygen injection system (controlled by range 2) as a backup should the DO level continue to fall.

If the YSI 5200 senses that the DO level is outside of the operating Range #1 it will turn on the Range #1 control system. If the DO level continues to move outside of operating Range #2 then Range #2 control system will activate.

NOTE: To allow for DO probe stabilization, the 5200 waits for two minutes after being powered up before activating DO alarms or control.

Control Menu

After entering the DO set point and ranges, use the Control Menu to select which relay each range or alarm will activate.

Alarm System

The alarm system for each measurement parameter can be turned on or off. When on, an audible alarm will sound on the YSI 5200 and an alarm page will be sent (if a modem is installed and paging is enabled). The alarm will remain on until a key is pressed. See *7.1 Alarm Logic Flow Charts* for details.

Setup Menu

DO Setup Menu selections are shown below.

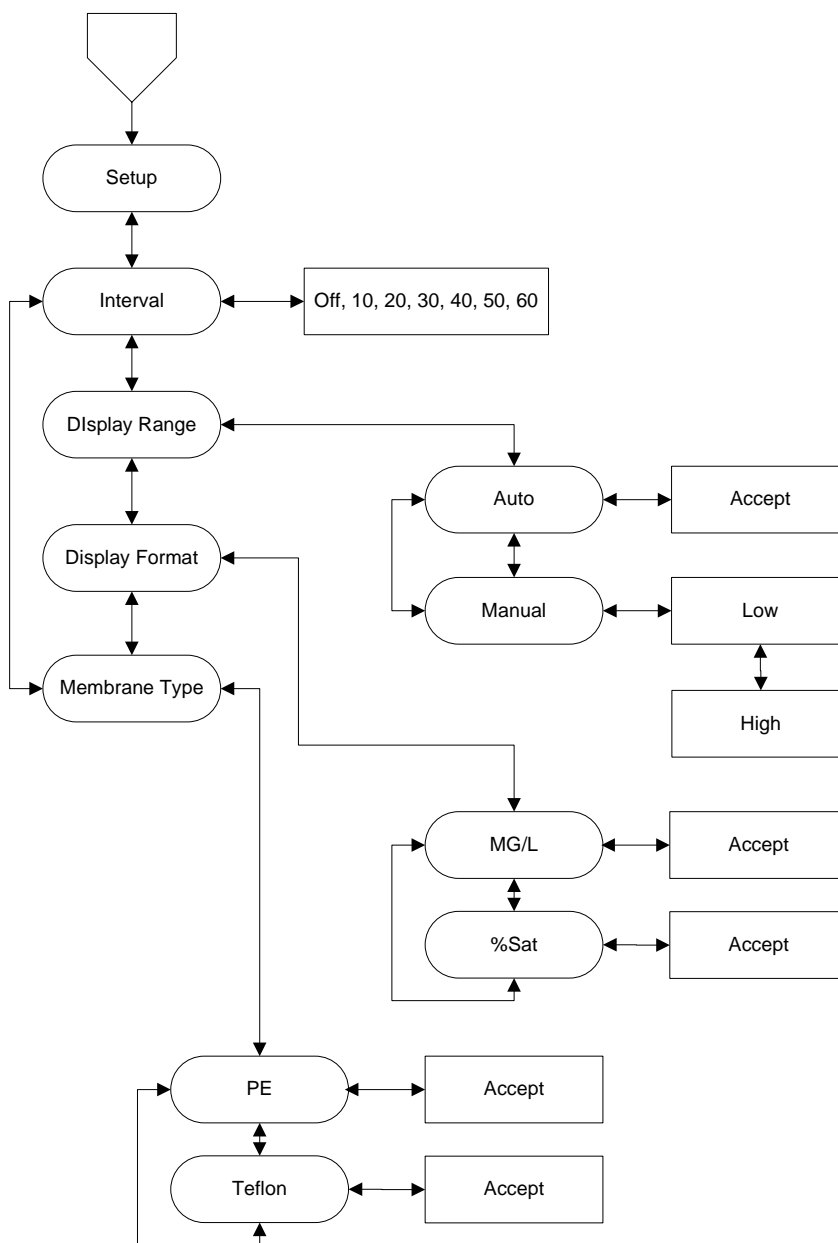

Figure 5-7 DO Setup Menu

Interval

The 5200's DO system operates in either continuous or interval mode. In continuous mode, the DO probe is on all the time. In interval mode, the DO system is powered down for a selected interval (10, 20, 30, 40, 50 or 60 minutes), then powered back up for 75 seconds. The DO level is measured during the last 15

seconds of the powered cycle. The entire cycle is then repeated. Interval mode extends the time between probe servicing and calibration, but **disables DO control and alarm functions**.

Display Range

The 5200's DO system operates in either an Auto or Manual Range. Use Manual to enable the 5200's control and alarm functions. **If you select Auto, the control/alarm options are NOT available.**



CAUTION: Changing the display range will cause the DO alarm and control set points to change. After changing the display range, confirm all set point values.

Display Format

The **Display Format** refers to the option between displaying your DO values in % saturation or mg/L.

Membrane Type

The 5200's DO system can use either polyethylene or Teflon membrane caps. Teflon membranes offer traditional, reliable performance for most applications; while polyethylene provide a significantly faster response time and less flow dependence.

NOTE: After changing the membrane type, the DO probe must be calibrated. See 6.2.2 *Dissolved Oxygen Calibration*.

5.3.4 pH System

pH System menu selections are shown below.

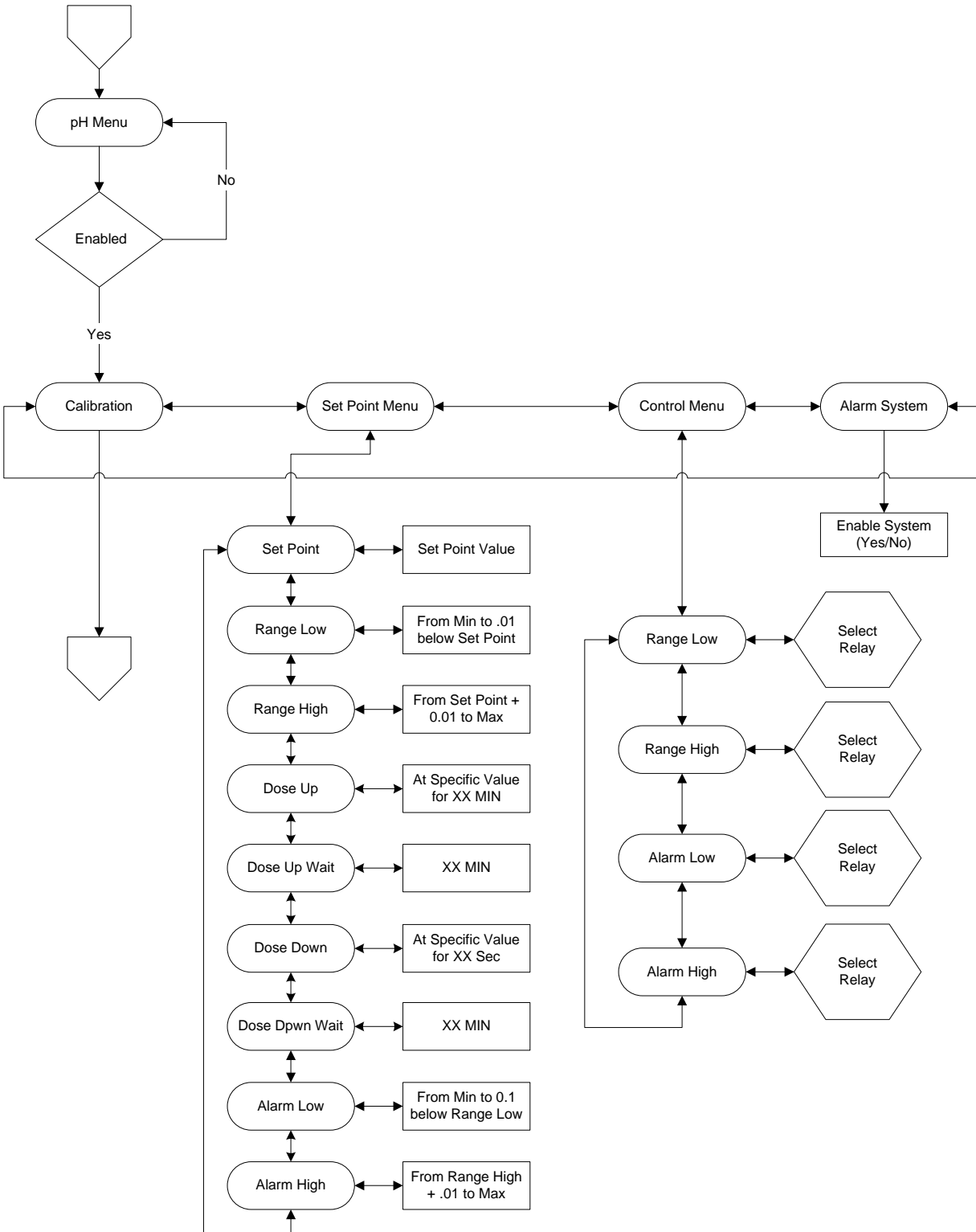

Figure 5-8 pH Menu

Calibration

Calibration is covered in *Section 6 Calibration*. pH can be calibrated at either one point or two points. See *Section 6.2.4 pH Calibration* for details.

Set Point Menu

The YSI 5200 can control pH by dosing a buffer solution, injecting CO₂ gas or both. pH control can operate in two different ways. It can operate the same as most other 5200 control systems—when the parameter value reaches the low or high range setpoint, control is activated until the value returns to the optimal setpoint. Or, it can operate in a timed mode—when the value reaches the low or high range setpoint, control is activated for a fixed length of time (Dose Time) regardless of whether or not the value returns to the optimal setpoint. The 5200 then waits for a fixed length of time (Dose Wait) before checking the value of the parameter and applying additional control. The default method of pH control is the timed mode. To select the normal mode, set the Dose Time to 0.

When using timed mode, additional values must be entered on the Set Points Menu, including the dose and dwell (Dose Wait) values. The dose time allows you to establish the length of time a dose is administered and the dwell time allows for a period between doses to prevent over-applying a dose.

SetPoint

The pH Set Point defines the optimum pH level that you wish the YSI 5200 to maintain in the aquatic environment. See *Section 5.3.1 Entering Setpoint and Range Values* for an overview of control functions.

Dose Up

Dose Up in **minutes** (time per dose of buffer solution) is the amount of time that the YSI 5200 will dose buffer to bring the pH level back up into the target operating range to the optimal Set Point. The acceptable values for buffer solution dosing are from 1 to 999 minutes. Set to 0 to select normal pH control (see *Section 5.3.4 pH System, Set Point Menu*).

Dose Up Wait

Dose Up Wait (dwell time) is the length of time that the YSI 5200 will wait until dosing can occur again. This feature prevents overdosing a system with buffer.

Dose Down

Dose Down (in **seconds**) controls how long the CO₂ gas valve will remain open. The possible values range from 0 to 999 seconds. For example, if you enter 10 seconds, when the upper end of the target operating range for pH is reached, the YSI 5200 will turn on the CO₂ gas for 10 seconds to reduce the pH to a lower value. A CO₂ Dose Down Wait time will force the YSI 5200 to wait to allow the gas to be absorbed into the water. This will prevent the pH value from dropping too fast.

Set the Dose Down to 0 to select normal pH control (see *Section 5.3.4, pH System, Set Point Menu*) where the YSI 5200 will turn the gas valve on when the pH level reaches the high end of the target operating range and will keep the valve open until the pH drops below the optimal pH level. The 0 seconds option is for systems with pressurized CO₂ injection.

 **WARNING:** If the 5200 is instructed (by AquaManager) to transmit logged data during the Dose Down cycle, dose time will be extended until data transmission is complete (up to 3½ minutes maximum with a full data log).

Dose Down Wait

Dose Down Wait time is the time that the YSI 5200 waits before allowing another CO₂ gas injection to occur. This time is selectable from 0-999 minutes. If the YSI 5200 senses that the pH is outside of the

target operating range, it will turn on the pH doser or CO₂ injector until the pH returns to the optimal Set Point value.

Control Menu

After entering the pH set point and ranges, use the Control Menu to select which relay each range or alarm will activate.

Alarm System

The alarm system for each measurement parameter can be turned on or off. When on, an audible alarm will sound on the YSI 5200 and an alarm page will be sent (if a modem is installed and paging is enabled). The alarm will remain on until a key is pressed. See *7.1 Alarm Logic Flow Charts* for details.

5.3.5 ORP System

ORP System menu selections are shown below.

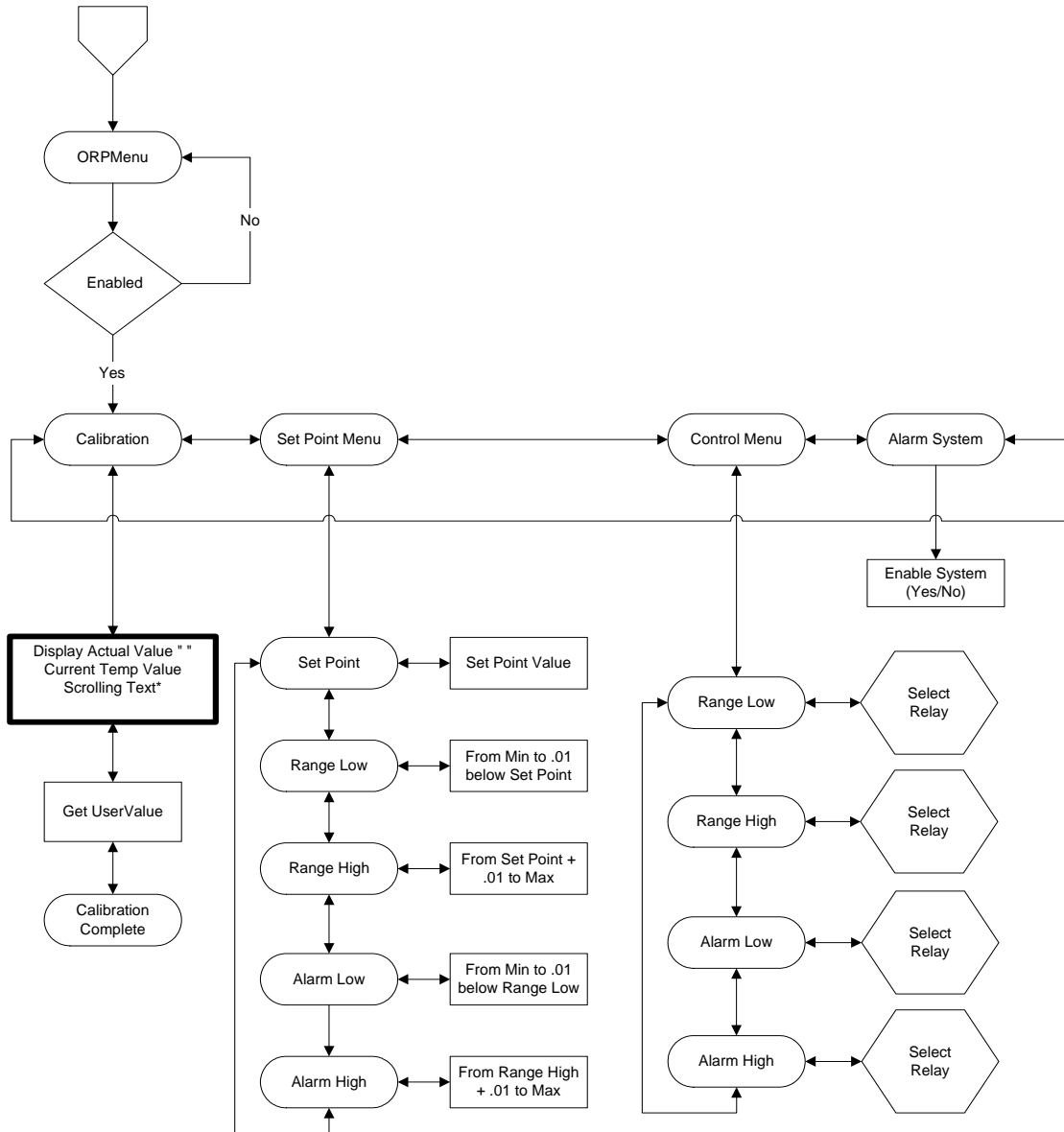

Figure 5-9 ORP Menu

Calibration

Calibration is covered in *Section 6 Calibration*. See *Section 6.2.5 ORP Calibration* for details.

Set Point Menu

The ORP level can be used as an indicator of ozone. Acceptable levels are between 0 and 450 mV. The ORP Set Point can be maintained through the use of an ozonizer in a monitoring and control system. The Set Point can be established anywhere from -999 to +999 mV. For controlling applications you will also need to establish the Low and High control values and alarm values.

SetPoint

The ORP Set Point defines the optimum ORP level that you wish the YSI 5200 to maintain in the aquatic environment. See *Section 5.3.1 Entering Setpoint and Range Values* for an overview of control functions.

Control Menu

After entering the ORP set point and ranges, use the Control Menu to select which relay each range or alarm will activate.

Alarm System

The alarm system for each measurement parameter can be turned on or off. When on, an audible alarm will sound on the YSI 5200 and an alarm page will be sent (if a modem is installed and paging is enabled). The alarm will remain on until a key is pressed. See *7.1 Alarm Logic Flow Charts* for details.

5.3.6 Conductivity System

Conductivity System menu selections are shown below.

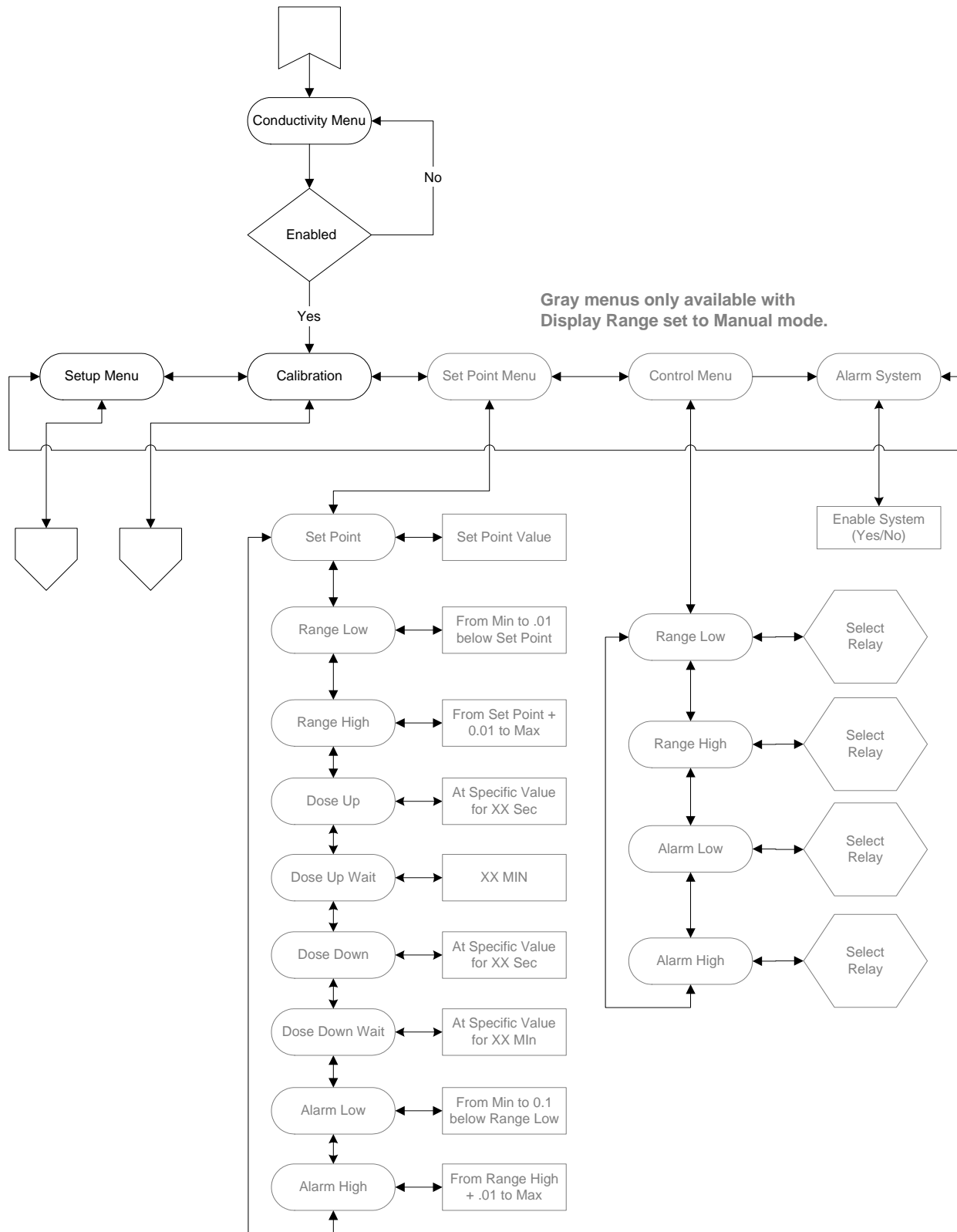

Figure 5-10 Conductivity Menu

NOTE: Set Point, Control and Alarm System Menus are only available when a Manual Display Range is selected. See Section 5.3.6 *Conductivity System, Setup Menu, Display Range*.

Calibration

Calibration is covered in *Section 6 Calibration*. See Section 6.2.3 *Conductivity Calibration* for details.

Set Point Menu

Conductivity control, like pH, can operate in two different ways. It can operate the same as most other 5200 control systems—when the parameter value reaches the low or high range setpoint, control is activated until the value returns to the optimal setpoint. Or, it can operate in a timed mode—when the value reaches the low or high range setpoint, control is activated for a fixed length of time (Dose Time) regardless of whether or not the value returns to the optimal set point. The 5200 then waits for a fixed length of time (Dose Wait) before checking the value of the parameter and applying additional control. The default method of Conductivity control is the timed mode. To select the normal mode, set the Dose Time to 0.

When using timed mode, additional values must be entered on the Set Points Menu, including the dose and dwell (Dose Wait) values. The dose time allows you to establish the length of time a dose is administered and the dwell time allows for a period between doses to prevent over-applying a dose.

SetPoint

The Conductivity Set Point defines the optimum Conductivity level that you wish the YSI 5200 to maintain in the aquatic environment. See Section 5.3.1 *Entering Setpoint and Range Values* for an overview of control functions.

Dose Up

Dose Up in **seconds** (time per dose) is the amount of time that the YSI 5200 will dose to bring the conductivity level back up into the target operating range to the optimal Set Point. The acceptable values for dosing are from 1 to 999 seconds. A Dose Up Wait time forces the YSI 5200 to wait before applying another dose. This will prevent the value from rising too fast. Set to 0 to select normal conductivity control (see Section 5.3.6 *Conductivity System, Set Point Menu*).

 **WARNING:** If the 5200 is instructed (by AquaManager) to transmit logged data during the Dose Up cycle, dose time will be extended until data transmission is complete (up to 3½ minutes maximum with a full data log).

Dose Up Wait

Dose Up Wait (in minutes), or dwell time, is the length of time that the YSI 5200 will wait until dosing can occur again. This feature prevents overdosing a system with a dosing solution and protects against “short cycling” of equipment.

Dose Down

Dose Down (in **seconds**) controls the length of time the 5200 will dose. The range is from 0 to 999 seconds. A Dose Down Wait time forces the YSI 5200 to wait before applying another dose. This will prevent the value from dropping too fast.

 **WARNING:** If the 5200 is instructed (by AquaManager) to transmit logged data during the Dose Down cycle, dose time will be extended until data transmission is complete (up to 3½ minutes maximum with a full data log).

Set the Dose Down to 0 to select normal conductivity control (see Section 5.3.6 *Conductivity System, Set Point Menu*) where the YSI 5200 will start dosing when the conductivity level reaches the high end of the target operating range and will keep dosing until it reaches the optimal set point.

Dose Down Wait

Dose Down Wait (in minutes), or dwell time, is the length of time that the YSI 5200 will wait until dosing can occur again. This feature prevents overdosing a system with a dosing solution and protects against “short cycling” of equipment.

Control Menu

After entering the Conductivity set point and ranges, use the Control Menu to select which relay each range or alarm will activate.

Alarm System

The alarm system for each measurement parameter can be turned on or off. When on, an audible alarm will sound on the YSI 5200 and an alarm page will be sent (if a modem is installed and paging is enabled). The alarm will remain on until a key is pressed. See 7.1 *Alarm Logic Flow Charts* for details.

Setup Menu

Conductivity Setup Menu selections are Display Range and Temperature Compensation.

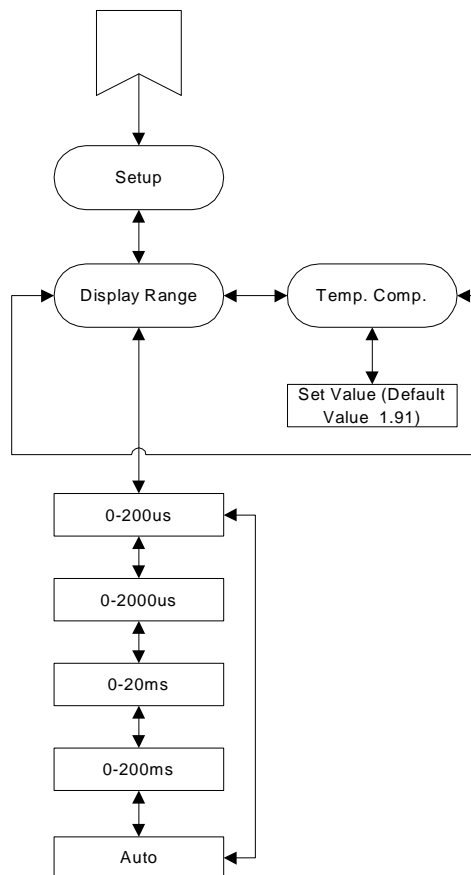

Figure 5-11 Conductivity Setup Menu

Display Range

The 5200's Conductivity system operates in either Auto ranging or 1 of 4 manual ranges. Use a manual range to enable the 5200's control and alarm functions. **If you select Auto, the control/alarm options are NOT available.**



CAUTION: Changing the display range will cause the Conductivity alarm and control set points to change. After changing the display range, confirm all set point values.

Temperature Compensation

The conductivity of a sample varies with temperature, therefore, conductivity readings are normally compensated to 25°C. An adjustment of approximately 1.91% per °C is common for the water environment. The YSI 5200 has a default value of 1.91% and a range of 0–4%.

An asterisk next to the conductivity value on the 5200 display indicates that the reading is temperature compensated. If the temperature compensation value is set to 0%, temperature compensation is disabled and no asterisk is displayed.

5.3.7 Salinity System

The only Salinity Menu option is Enable/Disable.

5.4 Daily Checks

The YSI 5200 is designed to run 24 hours a day, 365 days a year. The only time it is not running is during maintenance. Under normal operation the system requires virtually no interaction with the user. However, below are some hints for keeping your YSI 5200 in good operating condition.

Daily Check List

By checking your YSI 5200 daily, you can identify a potential problem early.

1. Check the Status lights. Respond to any alarms. Refer to Section 2 *Introduction, Status Lights* for details.

Should an alarm condition occur, pressing Enter key will reset the alarm - terminating further audible and pager alarms for that event. However, as long as the parameter value stays within the alarm range, an alarm message will be displayed in the status line. Once the parameter value returns to acceptable Operating Range, the alarm will be turned off and the status message will be removed.
2. Check your conductivity, temperature, pH, DO, and ORP values and compare them to the optimal levels for your environment.
3. Check all of your peripheral devices to ensure proper operation (i.e. heater, chiller, ozonizer, pH doser).
4. Conduct an alarm test, including paging or email if enabled.
5. Look for signs of stress on all aquatic inhabitants, if any.

Weekly/Monthly Checks

6. Check sensor calibration weekly, recalibrate if necessary.
7. Clean the probe module monthly, or as needed.

- Clean the sensors every 30–90 days, or as needed. A screen prompt on the YSI 5200 display will remind you to do so. See 9.1.1 Service, Clean Probes.

5.5 Conducting a System Test

When you conduct a System Test, all built-in relays automatically go to an "off" condition. Once in the System Test mode, you can select any relay and manually turn it on or off. The purpose of this test is to make sure each relay is working correctly.

When you exit System Test, each relay will revert to the ON or OFF state that it was in prior to System Test.

Conduct a System Test as follows:

- From the Run screen, press the **Enter** [↵] key, then the [◀] or [▶] key until the **System** option appears.

```

System
Enter to Select
  
```

- Press the **Enter** [↵] key to select System.

```

Service
Enter to Select
  
```

- Press the **Enter** [↵] key to select Service.

```

Clean Probes
Enter to Select
  
```

- Press the [◀] or [▶] key until **System Test** appears.

```

System Test
Enter to Select
  
```

- Press the **Enter** [↵] key to display the System Test screen.

```

■R1■ R2 R3 R4
Off Off Off Off
  
```

- Press the [◀] or [▶] key to select the relay you want to test (indicated by two black cursors surrounding it).

```

R1 ■R2■ R3 R4
Off Off Off Off
  
```

- Press the **Enter** [↵] key to select the relay. The state of the relay will flash.

```

R1 ■R2■ R3 R4
Off Off Off Off
  
```

- Press the [◀] or [▶] key to select **On**.

```

R1 ■R2■ R3 R4
Off On Off Off
  
```

9. Press the **Enter** [↵] key to change the state of the relay to On.

R 1	■	R 2	■	R 3	R 4
Off	On	Off	Off		

10. After you have finished testing this relay system, press the **Enter** [↵] key. The state of the relay will flash.

R 1	■	R 2	■	R 3	R 4
Off	On	Off	Off		

11. Press the [◀] or [▶] key to select **Off**.

R 1	■	R 2	■	R 3	R 4
Off	Off	Off	Off		

12. Press the **Enter** [↵] key to turn the relay Off.

R 1	■	R 2	■	R 3	R 4
Off	Off	Off	Off		

13. Repeat Steps 6–12 for any other relays you would like to test.

14. After you have tested all relays, press the [ESC] key to exit the System Test menu. All relays will return to their previous state.

Section 6. Calibration

All of the sensors, except temperature, require periodic calibration to assure high performance. You will find specific calibration procedures for all sensors that require calibration in the following sections. If a sensor listed is not installed in your probe module, skip that section and proceed to the next sensor until the calibration is complete.

 **CAUTION:** Reagents that are used to calibrate and check this instrument may be hazardous to your health. Take a moment to review *Section 18 Health and Safety*. Some calibration standard solutions may require special handling.

6.1 Getting Ready to Calibrate

6.1.1 Containers Needed to Calibrate the Probe Module

The calibration/storage cup that comes with the YSI 5562 Probe Module serves as a calibration chamber for all calibrations and minimizes the volume of calibration reagents required.

Instead of the calibration/storage cup, you may use laboratory glassware to perform calibrations. If you do not use the calibration/storage cup that is designed for the probe module, you are cautioned to do the following:

- Perform all calibrations with the Probe Sensor Guard installed. This protects the sensors from possible physical damage.
- Use a ring stand and clamp to secure the probe module body to prevent the module from falling over. Most laboratory glassware has convex bottoms.
- Ensure that all sensors are immersed in calibration solutions. Many of the calibrations factor in readings from other sensors (e.g., temperature sensor). The top vent hole of the conductivity sensor must also be immersed during some calibrations.

6.1.2 Calibration Tips

- If you use the Calibration/Storage Cup for dissolved oxygen (DO) calibration, make certain to loosen the seal to allow pressure equilibration before calibration. The DO calibration is a water-saturated air calibration.
- The key to successful calibration is to ensure that the sensors (except DO) are completely submersed when calibration values are entered. Use recommended volumes when performing calibrations.
- For maximum accuracy, use a small amount of previously used calibration solution to pre-rinse the probe module. You may wish to save old calibration standards for this purpose.
- Fill a bucket with ambient temperature water to rinse the probe module between calibration solutions.
- Have several clean, absorbent paper towels or cotton cloths available to dry the probe module between rinses and calibration solutions. Shake the excess rinse water off of the probe module, especially when the probe sensor guard is installed. Dry off the outside of the probe module and probe sensor guard. Making sure that the probe module is dry reduces carry-over contamination of calibrator solutions and increases the accuracy of the calibration.

- If you are using laboratory glassware for calibration, you do not need to remove the probe sensor guard to rinse and dry the sensors between calibration solutions. The inaccuracy resulting from simply rinsing the sensor compartment and drying the outside of the guard is minimal.
- If you are using laboratory glassware, remove the stainless steel weight from the bottom of the YSI 5562 Probe Module sensor guard by turning the weight counterclockwise. When the weight is removed, the calibration solutions have access to the sensors without displacing a lot of fluid. This also reduces the amount of liquid that is carried between calibrations.
- Make certain that port plugs are installed in all ports where sensors are not installed. It is extremely important to keep these electrical connectors dry.

6.1.3 Recommended Volumes

Follow these instructions to use the calibration/storage cup for calibration procedures.

- Ensure that an o-ring is installed in the o-ring groove of the calibration/storage cup bottom cap, and that the bottom cap is securely tightened.
NOTE: Do not over-tighten as this could cause damage to the threaded portions.
- Remove the probe sensor guard, if it is installed.
- Remove the o-ring, if installed, from the probe module and inspect the installed o-ring on the probe module for obvious defects and, if necessary, replace it with the extra o-ring supplied.
- Some calibrations can be accomplished with the probe module upright or upside down. A separate clamp and stand, such as a ring stand, is required to support the probe module in the inverted position.
- To calibrate, follow the procedures in the next section, *6.2 Calibration Procedures*. The approximate volumes of the reagents are specified below for both the upright and upside down orientations.
- When using the Calibration/Storage Cup for dissolved oxygen % saturation calibration, make certain that the vessel is vented to the atmosphere (by loosening the bottom cap or cup assembly) and contains approximately 1/8" of water.

Sensor to Calibrate	Upright	Upside Down
Conductivity	55ml	55ml
pH, pH/ORP	30ml	60ml

Table 6-1 Calibration Volumes

6.2 Calibration Procedures

6.2.1 Accessing the Calibrate Screen

1. From the Run screen, press the **Enter** [↵] key, then the [◀] or [▶] key until the **Parameters** option appears.

Parameters
Enter to Select

2. Press the **Enter** [↵] key to select Parameters.

DO System
Enter to Select

3. Press the [◀] or [▶] key until the parameter you want to calibrate appears. Conductivity is used as an example below.

Cond System
Enter to Select

4. Press the **Enter** [↵] key to display the Enabled screen.

Cond System
ENABLED? No

5. If the parameter is disabled (as indicated by **No** appearing on the display), press the [◀] or [▶] key to select **Yes**.

Cond System
ENABLED? Yes

6. Press the **Enter** [↵] key.

Calibration
Enter to Select

7. Press the **Enter** [↵] key to select Calibration.
8. Follow the instructions in the following sections for the specific parameter that you are calibrating.

6.2.2 Dissolved Oxygen Calibration

This procedure calibrates dissolved oxygen. Calibrating any one option (% or mg/L) automatically calibrates the other.

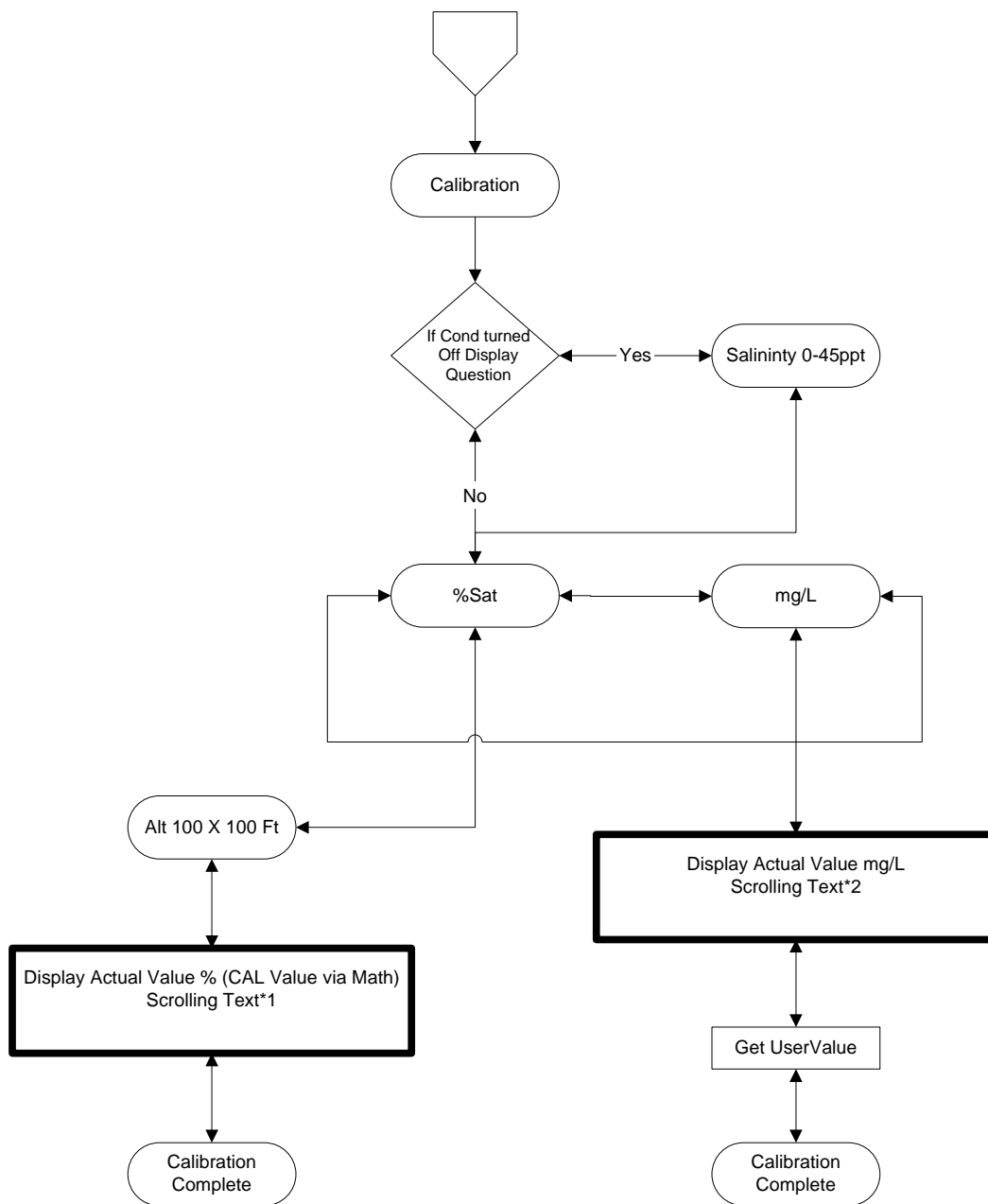

Figure 6-1 DO Calibration Menu

DO Calibration in % Saturation

1. Go to the DO calibrate screen as described in Section 6.2.1 *Accessing the Calibrate Screen*.
2. If your probe module contains a conductivity probe and it is Enabled, skip to Step 3. If your probe module does **not** contain a conductivity probe (or the conductivity probe is **not** Enabled), enter the salinity of the sample stream.

NOTE: The salinity compensation range for DO is 0–45 ppt.

Salinity
30 ppt

NOTE: The instrument must be on for at least 20 minutes to polarize the DO sensor before calibrating.

% SAT
Enter to Select

3. Select % Saturation.
4. Place approximately 3 mm (1/8 inch) of water in the bottom of the calibration/storage cup.
5. Place the probe module into the calibration/storage cup.
NOTE: Make sure that the DO and temperature sensors are **not** immersed in the water.
6. Engage only 1 or 2 threads of the calibration/storage cup to ensure the DO sensor is vented to the atmosphere.
7. Enter the current altitude in feet (rounded to the nearest 100 feet).

Alt (X 100 feet)
008

The current DO reading and calibration setting are displayed, along with a message on the bottom line of the screen.

DO 87.2% Cal=97.4
Wait til Stable

8. Allow approximately ten minutes for the air in the calibration/storage cup to become water saturated and for the temperature to equilibrate before proceeding.
9. Observe the DO reading. When the reading shows no significant change for approximately 30 seconds, press the **Enter** [↵] key. After a short pause, the display will return to the DO System menu.
NOTE: You may enter one of the other DO System menus (Set Point, Control, Alarm or Setup menu), but your calibration changes are not saved until you exit the DO System menu as described below.
10. Press the [ESC] key to exit the DO System menu. You will be prompted to save your changes.

Calibration
Save? Yes

11. Press the **Enter** [↵] key to save the new calibration value, or press the [◀] or [▶] key to select No, then press the **Enter** [↵] key to exit without saving any changes.
12. Rinse the probe module and sensors in tap or purified water and dry.

DO Calibration in mg/L

DO calibration in mg/L is carried out in a water sample which has a known concentration of dissolved oxygen (usually determined by a reading from a recently calibrated handheld DO probe in the immediate vicinity of the 5200 probe module or from a Winkler titration).

1. Go to the DO calibrate screen as described in Section 6.2.1 *Accessing the Calibrate Screen*.

2. If your probe module contains a conductivity probe and it is Enabled, skip to Step 3. If your probe module does **not** contain a conductivity probe (or the conductivity probe is **not** Enabled), enter the salinity of the sample stream.

Salinity
30 ppt

NOTE: The instrument must be on for at least 20 minutes to polarize the DO sensor before calibrating.

% Sat
Enter to Select

3. Press the [◀] or [▶] key to select mg/L.

mg/L
Enter to Select

4. Press the **Enter** [↵] key. The current DO reading is displayed, along with a message on the bottom line of the screen.

DO 9.52
Wait til Stable

5. Place the probe module in water with a known DO concentration. Be sure to completely immerse all the sensors.

NOTE: The DO sensor requires a sample flow rate of at least 1 foot per second. If the sample is not flowing, stir the water with a stir bar or by rapidly moving the probe module through the sample.

6. Allow at least one minute for temperature equilibration before proceeding.
7. Observe the DO reading. When the reading shows no significant change for approximately 30 seconds, press the **Enter** [↵] key.

User Val
09.47

8. Enter the current DO value in mg/L. The display will return to the DO Calibration menu.

Calibration
Enter to Select

NOTE: You may enter one of the other DO System menus (Set Point, Control, Alarm or Setup menu), but your calibration changes are not saved until you exit the DO System menu as described below.

9. Press the [ESC] key to exit the DO System menu. You will be prompted to save your changes.

Calibration
Save? Yes

10. Press the **Enter** [↵] key to save the new calibration value, or press the [◀] or [▶] key to select No, then press the **Enter** [↵] key to exit without saving any changes.
11. Rinse the probe module and sensors in tap or purified water and dry.

6.2.3 Conductivity Calibration

This procedure calibrates conductivity and salinity. Note that the 5200 is calibrated at the factory and, with proper sensor maintenance, calibration is rarely required. However, from time to time it is wise to check the conductivity calibration and recalibrate when necessary.

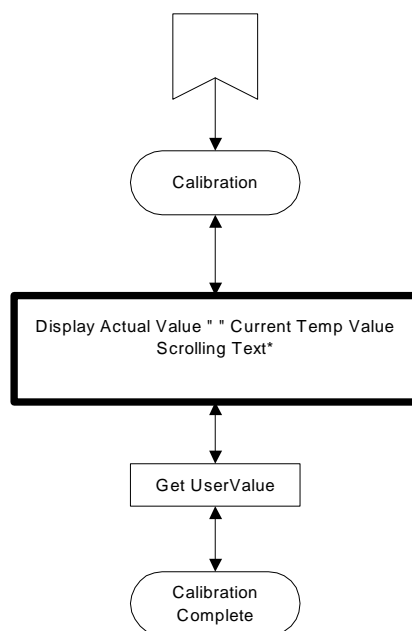

Figure 6-2 Conductivity Calibration Menu

1. Go to the Conductivity calibrate screen as described in Section 6.2.1 *Accessing the Calibrate Screen*. The current conductivity and temperature are displayed, along with a message on the bottom line of the screen.

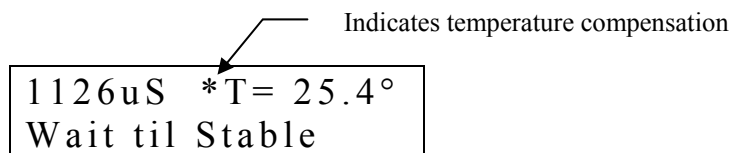

Figure 6-3 Conductivity Calibration Screen

NOTE: An asterisk next to the conductivity value indicates temperature compensation.

2. Place the correct amount of conductivity standard (see Table 6-1 Calibration Volumes) into a clean, dry or pre-rinsed calibration/storage cup.

⚠ WARNING: Calibration reagents may be hazardous to your health. See *Section 18 Health and Safety* for more information.

NOTE: Before proceeding, ensure that the sensor is as dry as possible. Ideally, rinse the conductivity sensor with a small amount of standard that can be discarded. Be certain that you avoid cross-contamination of solutions. Make certain that there are no salt deposits around the oxygen or pH/ORP sensors, particularly if you are employing standards of low conductivity.

3. Carefully immerse the sensor end of the probe module into the solution.
4. Gently rotate and/or move the probe module up and down to remove any bubbles from the conductivity cell.

NOTE: The sensor must be completely immersed past its vent hole. Using the recommended volumes from Table 6-1 Calibration Volumes, should ensure that the vent hole is covered.

5. Screw the calibration/storage cup on the threaded end of the probe module and securely tighten.

NOTE: Do not over tighten as this could cause damage to the threaded portions.

6. Allow at least one minute for temperature equilibration before proceeding.
7. Observe the Conductivity and Temperature readings. When the readings show no significant change for approximately 30 seconds, press the **Enter** [↵] key.

1126uS *T= 25.4° User Val 1126uS

8. If conductivity temperature compensation is enabled (as indicated by an asterisk next to the value, see Figure 6-3), enter the value of the conductivity standard **at 25°C**.

or

If conductivity temperature compensation is disabled, enter the value of the conductivity standard **at the current temperature** (see *Section 22 YSI Conductivity Calibration Solution Values*).

9. After a brief message is displayed, the display will return to the Conductivity Calibration menu.

NOTE: You may enter one of the other Conductivity System menus (Set Point, Control, Alarm or Setup menu), but your calibration changes are not saved until you exit the Conductivity System menu as described below.

10. Press the [ESC] key to exit the Conductivity System menu. You will be prompted to save your changes.

Calibration Save? Yes

11. Press the **Enter** [↵] key to save the new calibration value, or press the [◀] or [▶] key to select No, then press the **Enter** [↵] key to exit without saving any changes.

Cond System Enter to Select

12. Rinse the probe module and sensors in tap or purified water and dry.

6.2.4 pH Calibration

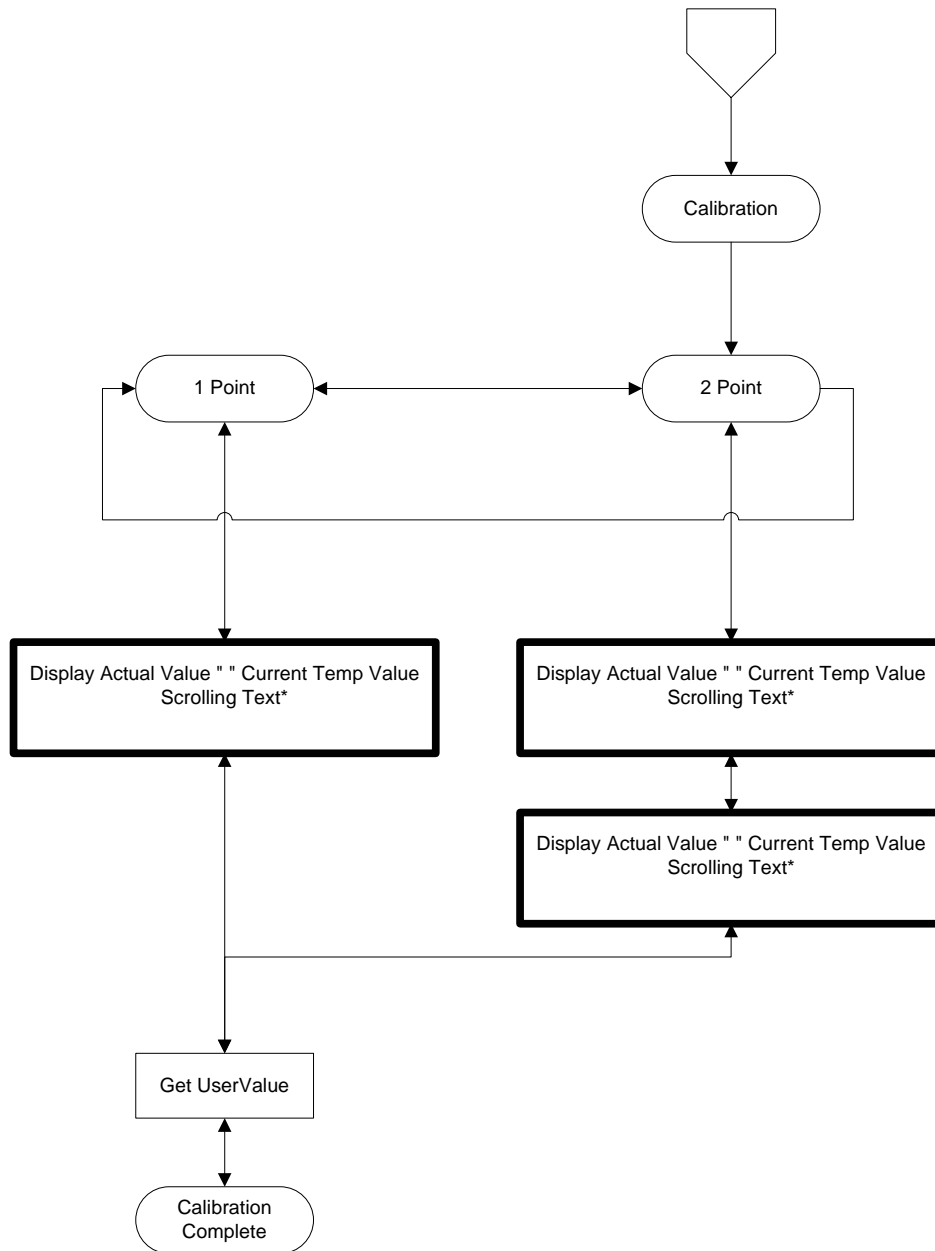

Figure 6-4 pH Calibration Menu

1. Go to the pH calibrate screen as described in Section 6.2.1 *Accessing the Calibrate Screen*.

Enter to Select
1-Point

2. Select either One-Point or Two-Point calibration.

Enter to Select
2-Point

- ➔ Select the **1-point** option only if you are adjusting a previous calibration. If a 2-point calibration has been performed previously, you can adjust the calibration by carrying out a

one-point calibration. The procedure for this calibration is the same as for a 2-point calibration, but the software will prompt you to select only one pH buffer.

- ➔ Select the **2-point** option to calibrate the pH sensor using two calibration standards. Use two standards that cover the pH range of your samples. For example, if the pH of a pond is known to vary between 5.5 and 7, perform a two-point calibration with pH 7 and pH 4 buffers.
3. The pH Entry screen is displayed, along with a message on the bottom line of the screen.

Calibration Pass(1)

NOTE: For 2-Point calibration, the display will notify you that this is Pass(1).

pH 7.34 T=25.5°C Wait til Stable

4. Place the correct amount (see Table 6-1 Calibration Volumes) of pH buffer into a clean, dry or pre-rinsed calibration/storage cup.

⚠ WARNING: Calibration reagents may be hazardous to your health. See *Section 18 Health and Safety* for more information.

NOTE: For maximum accuracy, the pH buffers you choose should be within the same pH range as the water you are preparing to sample.

NOTE: Before proceeding, ensure that the sensor is as dry as possible. Ideally, rinse the pH sensor with a small amount of buffer that can be discarded. Be certain that you avoid cross-contamination of buffers with other solutions.

5. Carefully immerse the sensor end of the probe module into the solution.
6. Gently rotate and/or move the probe module up and down to remove any bubbles from the outside of the pH sensor.

NOTE: The sensors must be completely immersed. Using the recommended volumes from Table 6-1 Calibration Volumes, should ensure that the sensors are covered.

7. Screw the calibration/storage cup on the threaded end of the probe module and securely tighten.

NOTE: Do not over tighten as this could cause damage to the threaded portions.

8. Allow at least one minute for temperature equilibration before proceeding.
9. Observe the pH and Temperature readings. When the readings show no significant change for approximately 30 seconds, press the **Enter** [↵] key.

pH 7.34 T=25.5°C User Val 08.26

10. Enter the value of the pH standard **at the current temperature**.

NOTE: pH vs. temperature values are printed on the labels of all YSI pH buffers.

pH 7.34 T=25.5°C User Val 07.04

11. Skip to step 14 if you are performing a One-Point calibration.

12. Press the **Enter** [↵] key to enter the value. The display will notify you that this is Pass(2), then the pH Entry screen is displayed.

Pass 2

pH= 7.04 T= 73.5°
Wait til Stable

13. Repeat steps 4 through 10 above (pass 2) using a second pH buffer.
14. Press the **Enter** [↵] key to enter the value. After displaying a brief message, the display will return to the pH Calibration menu.

Calibration
Complete

Calibration
Two-Point

15. Press the [ESC] key to exit the pH Calibration menu. You will be prompted to save your changes.

Calibration
Save? Yes

16. Press the **Enter** [↵] key to save the new calibration value, or press the [◀] or [▶] key to select No, then press the **Enter** [↵] key to exit without saving any changes.
17. Rinse the probe module, calibration/storage cup and sensors in tap or purified water and dry.

6.2.5 ORP Calibration

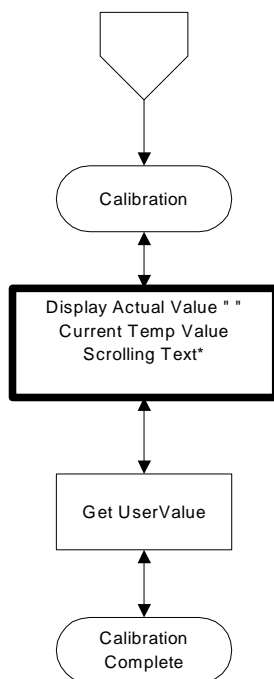

1. Go to the ORP calibrate screen as described in Section 6.2.1 *Accessing the Calibrate Screen*.

-703 mV T=72.5 °C Wait til Stable

2. Place the correct amount (see Table 6-1 Calibration Volumes) of a known ORP solution (we recommend Zobell solution) into a clean, dry or pre-rinsed calibration/storage cup.

⚠ WARNING: Calibration reagents may be hazardous to your health. See *Section 18 Health and Safety* for more information.

NOTE: Before proceeding, ensure that the sensor is as dry as possible. Ideally, rinse the ORP sensor with a small amount of solution that can be discarded. Be certain that you avoid cross-contamination with other solutions.

3. Carefully immerse the sensor end of the probe module into the solution.
4. Gently rotate and/or move the probe module up and down to remove any bubbles from the outside of the pH/ORP sensor.

NOTE: The sensor must be completely immersed. Using the recommended volumes from Table 6-1 Calibration Volumes should ensure that the sensor is covered.

5. Screw the calibration/storage cup on the threaded end of the probe module and securely tighten.

NOTE: Do not over tighten as this could cause damage to the threaded portions.

6. Allow at least one minute for temperature equilibration before proceeding.
7. Observe the ORP reading, when the reading shows no significant change for approximately 30 seconds, press the **Enter** [↵] key.

-703 mV	T=72.5 °C
User Val	+307

8. Enter the correct value of the calibration solution you are using at the current temperature. Refer to Table 6-2 Zobell Solution Values.

Temperature °C	Zobell Solution Value, mV
-5	270.0
0	263.5
5	257.0
10	250.5
15	244.0
20	237.5
25	231.0
30	224.5
35	218.0
40	211.5
45	205.0
50	198.5

Table 6-2 Zobell Solution Values

9. After displaying a brief message, the display will return to the ORP Calibration menu.
- NOTE:** You may enter one of the other ORP System menus (Set Point, Control or Alarm menu), but your calibration changes are not saved until you exit the ORP System menu as described below.
10. Press the [ESC] key to exit the ORP Calibration menu. You will be prompted to save your changes.

Calibration Save? Yes

11. Press the **Enter** [↵] key to save the new calibration value, or select No, then press the **Enter** [↵] key to exit without saving any changes.
12. Rinse the probe module and sensors in tap or purified water and dry.

Section 7. Alarm/Pager

7.1 Alarm Logic Flow Charts

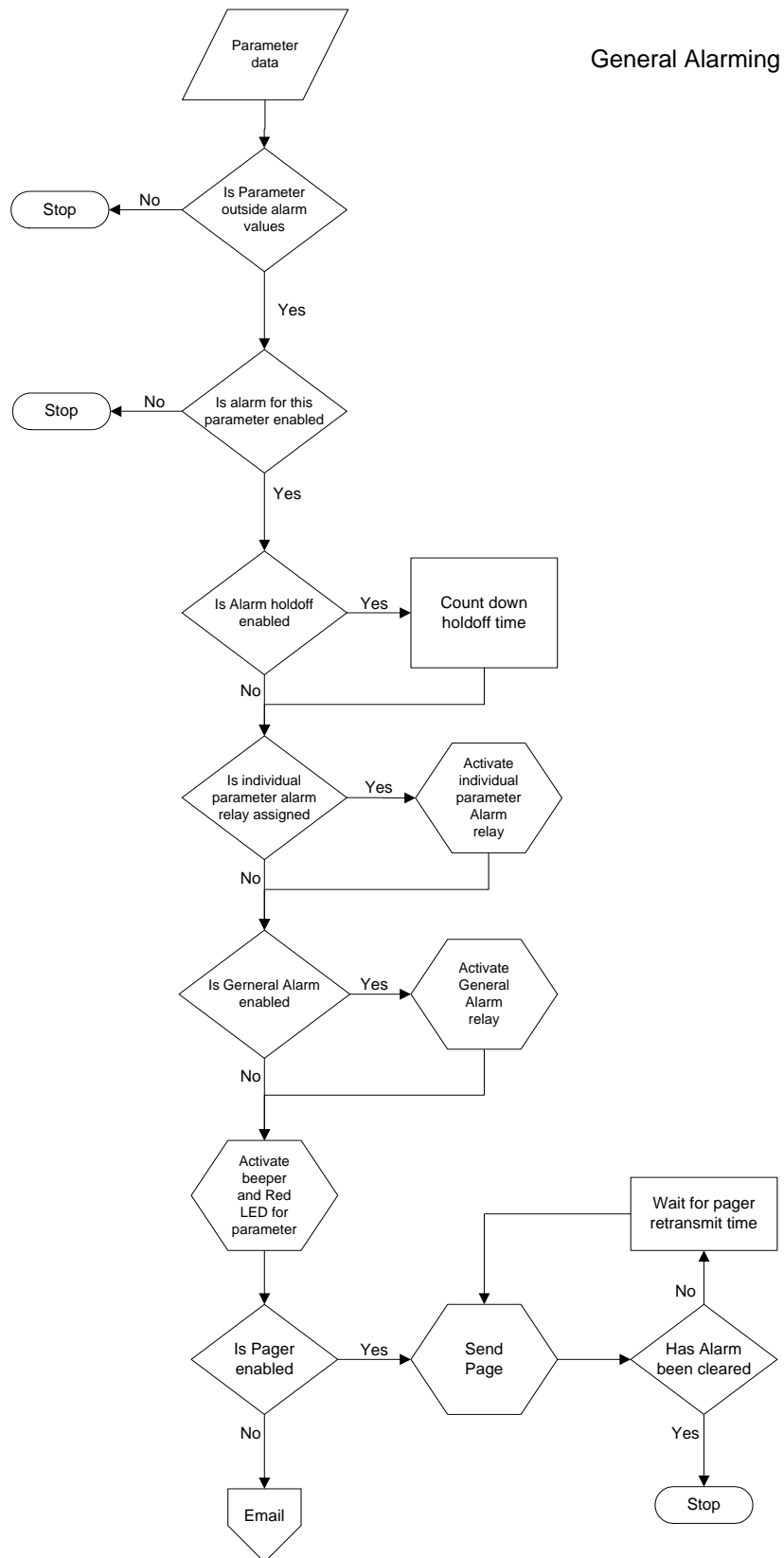

Email Paging

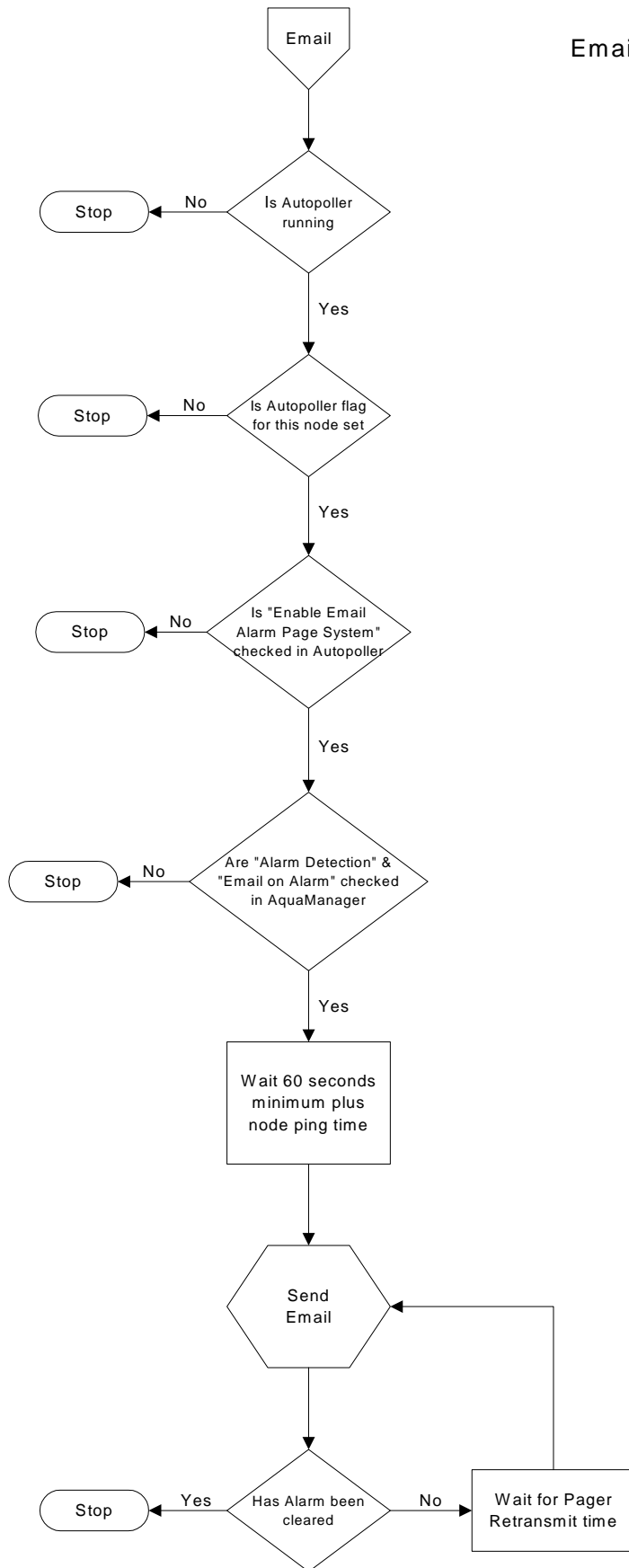

Power Alarm

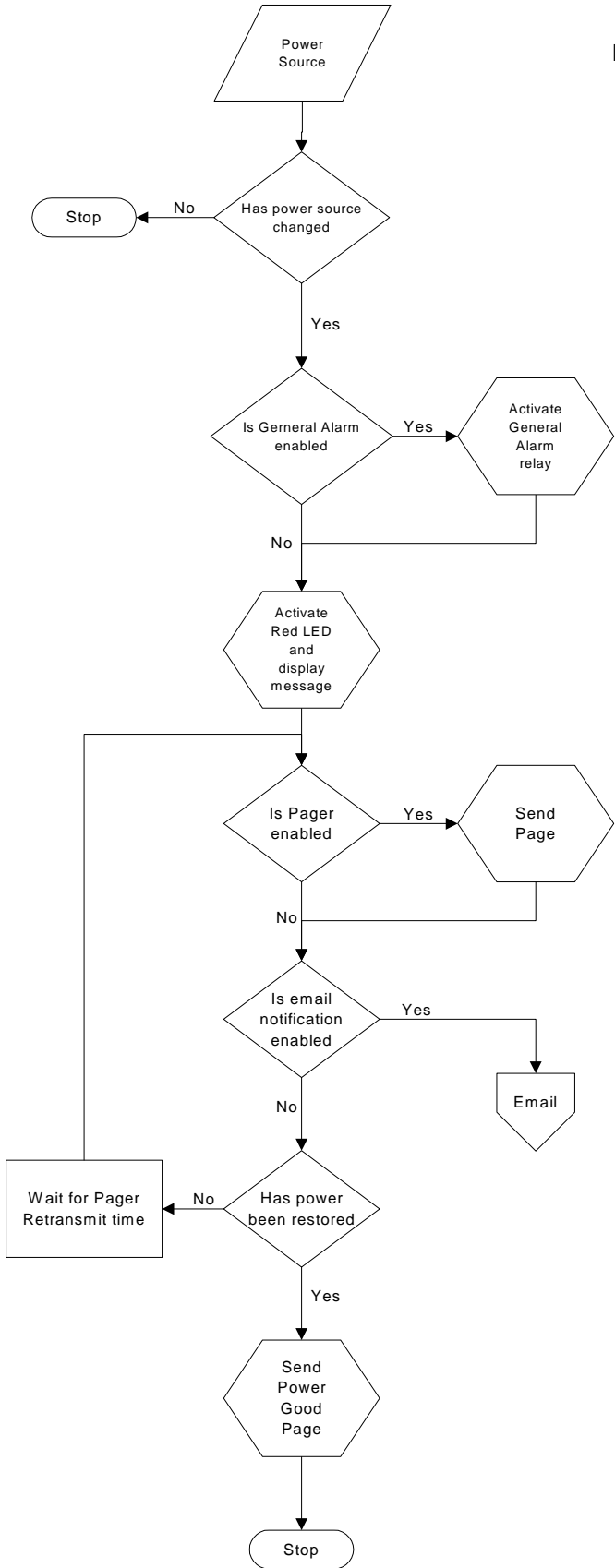

Auxiliary Alarming (digital mode only)

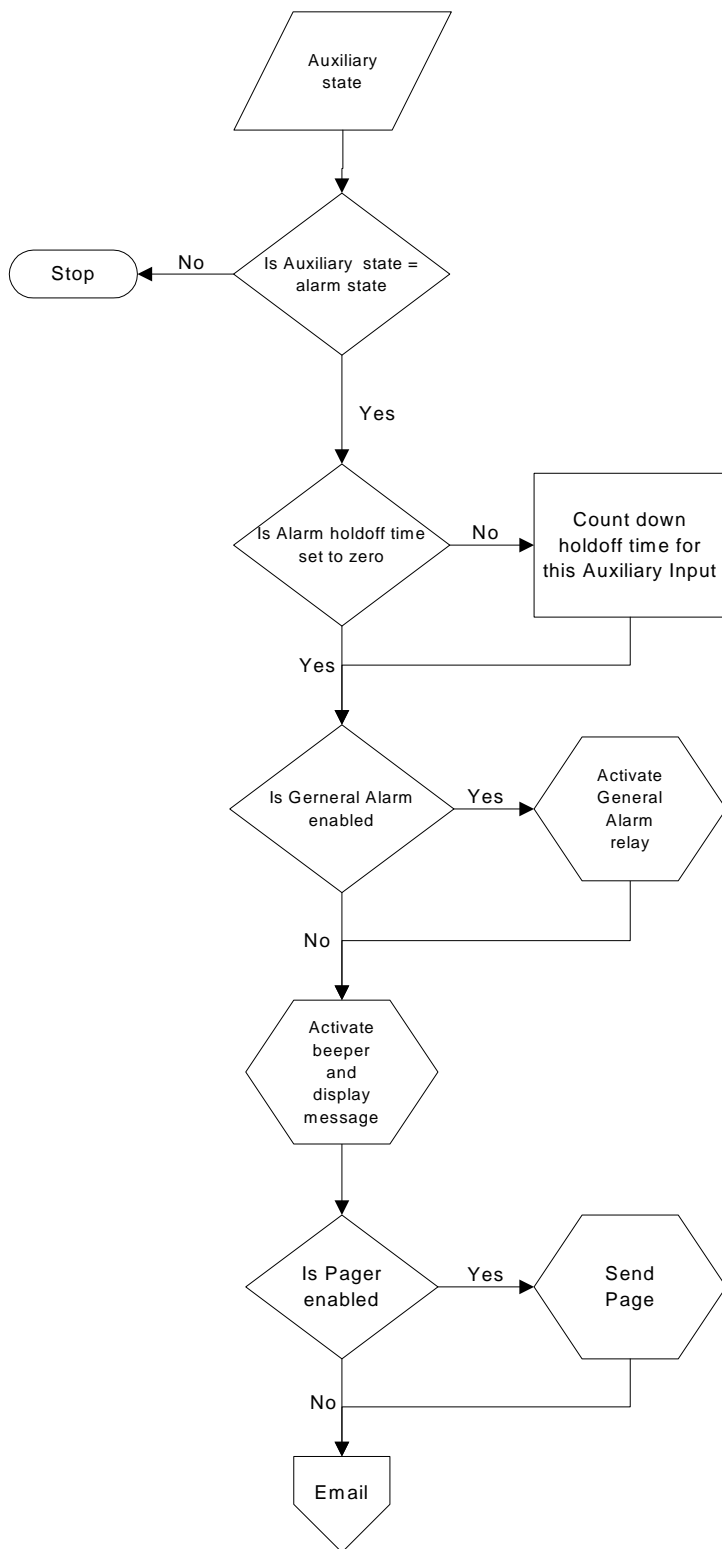

7.2 General Alarm

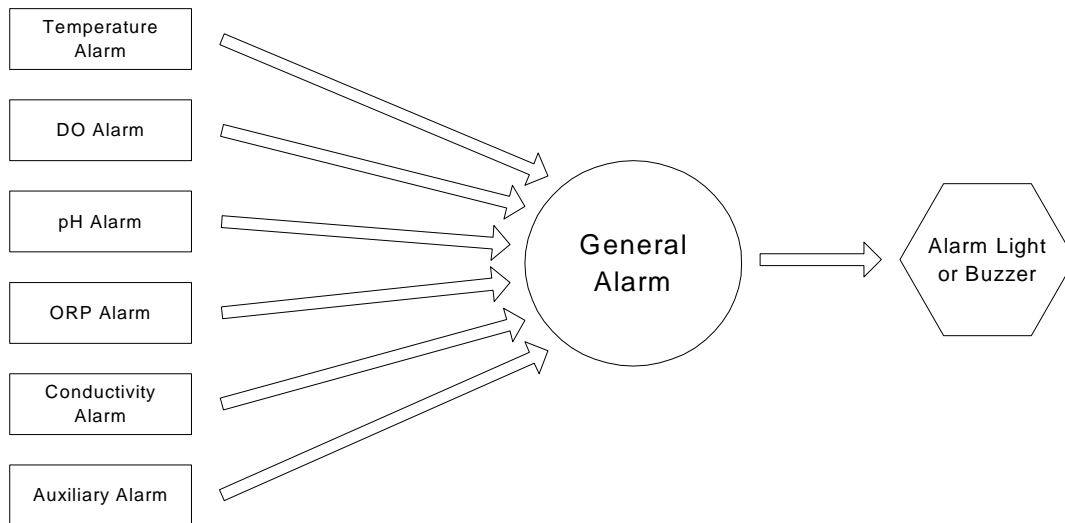

The General Alarm is a Summary alarm that activates a single device, such as a light or buzzer, whenever any one of the individual parameter alarms is triggered. If the value of a parameter reaches the alarm low or high point and the Alarm Hold Off time (See Section 9.2.3 *Alarm Hold Off*) has expired, an alarm occurs. The status LED turns red showing which system(s) triggered the alarm (see 7.1 *Alarm Logic Flow Charts*). The individual parameter alarm relay is activated (if a relay is assigned) and the General Alarm is activated (if enabled). If the individual parameter alarm is enabled, the buzzer sounds and an alarm page is sent (if the pager is enabled).

Reset the alarm by pressing the Enter key on the front of the 5200. Pressing the Enter key stops the audible alarm and cancels any pending pages, but alarm status messages will NOT be cleared until the 5200 no longer senses the alarm condition.

Relay Disabled

Relay Disabled is the default setting for the General Alarm. It prevents the General Alarm from triggering any relays (Internal or SubNet).

Relay Internal

Select Relay internal to trigger one of the four internal relays in **this** 5200.

Relay SubNet

Set the General Alarm to trigger an external subnet relay (connected to this 5200 via the RS485 network).

Section 8. Network

Multiple 5200 Recirculating Monitors can be connected together via their RS485 network ports (see 8.1 *RS485 Network*). Each network (group of connected 5200s) consists of 1 Master unit and up to 31 Slave units. The default network Mode setting is Master.

NOTE: Each Slave in the network must have a unique Sub Address.

8.1 RS485 Network

The 5200's optically isolated RS485 interface is located on the upper right hand corner of the I/O plate. Up to 32 YSI 5200 Monitors can be connected per network (1 master, 31 slaves). Each network requires a PC COM port, so conceivably a PC could support multiple 32-instrument networks. This provides significant flexibility in regard to alarming, monitoring and control.

The RS485 network wiring can span distances up to 4000 feet. If additional length is required, use an RS485 Line Extender/Booster. Not using this device may cause communication failures. Mount the booster in an area where it is protected from moisture.

NOTE: The 5200's RS485 port is optically isolated. No further isolation is required.

Two snap-on ferrite assemblies, YSI# 655361, are included with the 5200 Monitor. Wires being connected to the RS485 port need to be routed through the ferrites as shown in Figure 3-9. Failure to do so could cause catastrophic monitor failure.

Terminal Connection Description (From left to right on I/O plate RS485 network connector)

1. T (-) Transmit to Network
2. T (+) Transmit to Network
3. R (-) Receive from Network
4. R (+) Receive from Network

8.1.1 Network Wiring

The network consists of 2 pair of twisted pair cable. Although, Category 3 and 4 cables can be used, Category 5 Ethernet cable is recommended. Strip the wires about 2 times longer than necessary so that they can be folded over and twisted to make a thicker connection. Below is an example with Ethernet Category 5 cable. Note that this example color scheme is only applicable with category 5 wire:

Pair #1: Solid blue wire and white wire with blue stripe

Pair #2: Solid orange wire and white wire with orange stripe

The Master 5200 is wired as follows:

Wire	Terminal	Connection
Solid Orange Wire	1	T (-)
White w/Orange Stripe	2	T (+)
Solid Blue Wire	3	R (-)
White w/Blue Stripe	4	R (+)

NOTE: Install one 120Ω (ohm) resistor between T(+) and T(-) and one 120Ω (ohm) resistor between R(+) and R(-) on the master 5200. Resistors are included with each 5200.

All 5200 slaves are wired as follows:

Wire	Terminal	Connection
Solid Blue Wire	1	T (-)
White w/Blue Stripe	2	T (+)
Solid Orange Wire	3	R (-)
White w/Orange Stripe	4	R (+)

NOTE: On the final slave in a string, install one 120Ω (ohm) resistor between T(+) and T(-) and one 120Ω (ohm) resistor between R(+) and R(-). Resistors are included with each 5200.

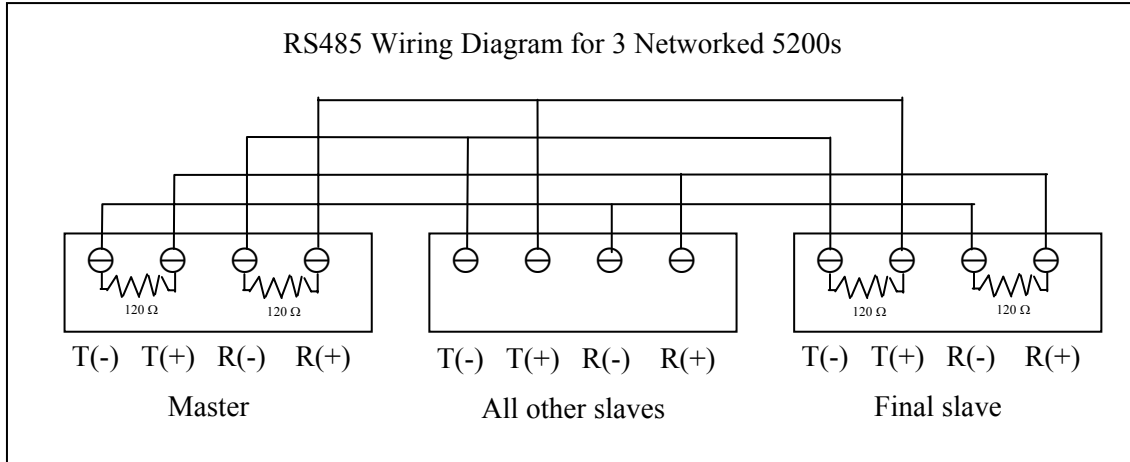

8.2 Auxiliary Inputs Wiring

The auxiliary inputs are configurable for a number of applications including monitoring level and/or pressure switches. Both inputs have input protection, but the maximum input voltage should be no more than 6 VDC. YSI recommends that twisted pair wire be used for these connections.

CAUTION: The auxiliary inputs are not isolated. Devices connected must be electrically isolated from ground and the water.

CAUTION: Observe correct polarity on analog input. Do not apply negative voltage to analog input.

Two snap-on ferrite assemblies, YSI# 655361, are included with the 5200 Monitor. Wires being connected to the Auxiliary ports need to be routed through the ferrites as shown in Figure 3-9. Failure to do so could cause catastrophic monitor failure.

Auxiliary inputs can be configured as follows:

Input #1 – Digital (contact open/close w/current source) **CAUTION:** Do **not** input external voltage.

Input #2 – User Defined (0 to 1.0 VDC, 0 to 5.0 VDC, or 4 to 20 mA selectable; max. 6.0 VDC) 10K impedance

or

Digital (contact open/close w/current source) **CAUTION:** Do **not** input external voltage.

NOTE: For proper digital input operation, use low impedance switches and wiring. The total resistance should not exceed 200 ohms.

8.2.1 Example (Digital)—Installing a Float Switch

1. Install the float switch at the desired water level according to the manufacturer's instructions.

2. Connect the switch to Auxiliary Input #1 or Auxiliary Input #2 using the 3-pole YSI 065942UL Pluggable Socket Connector. See Figure 8-1.

Connect one wire to the ground (GND) terminal and the other to the In 1 or In 2 terminal.

NOTE: When connecting a switch to Auxiliary Input #2, set the input to Digital mode. See Section 9.4.2 *Input #2*.

3. Set the 5200 to either Alarm on Open or Alarm on Closed, depending on the type of switch used. See Section 9.4.1 *Input #1, Control*.

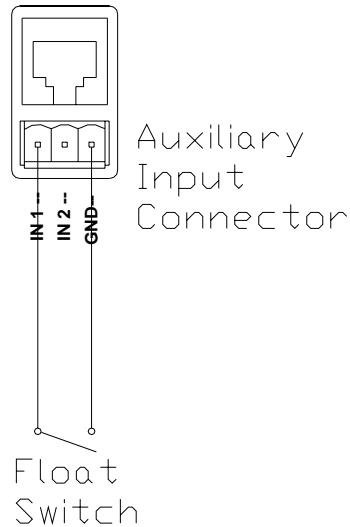

Figure 8-1 Float Switch Wiring

8.2.2 Example (User Defined)—Connecting an Instrument

1. Connect the instrument to Auxiliary Input #2 using the 3-pole YSI 065942UL Pluggable Socket Connector. See Figure 8-2.
2. Connect the negative wire to the ground (GND) terminal and the positive wire to the In 2 terminal.
3. For a 4–20mA input, connect a 250 Ω resistor between the ground (GND) and positive In 2 terminals. See Figure 8-2.
4. Set Auxiliary Input #2 to User Defined mode and select the correct scale (0–1 VDC, 0–5VDC, or 4–20mA). See Section, 9.4.2 *Input #2*.

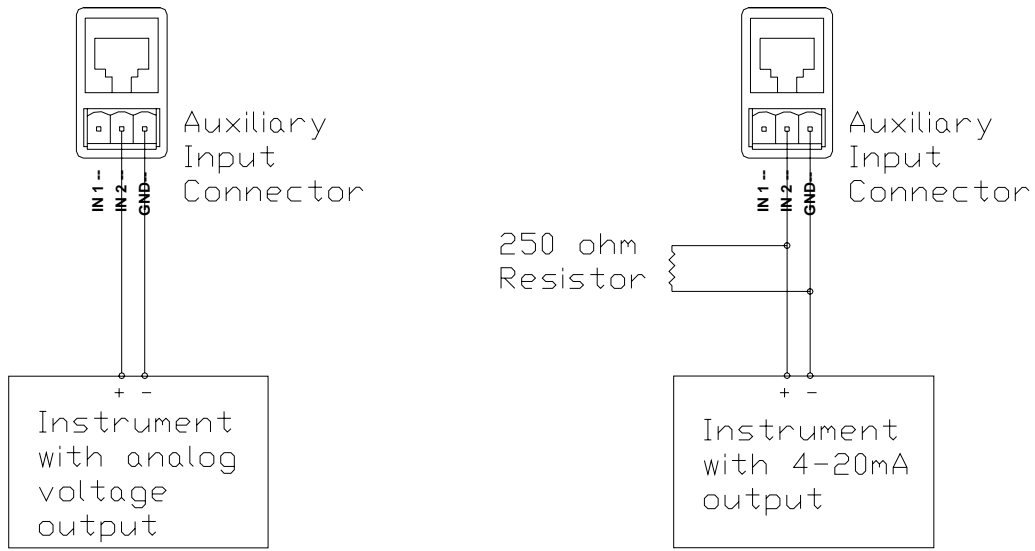

Figure 8-2 Analog Instrument Connection

Section 9. Advanced Setup

Advanced Setup includes:

- System Menu
- Timers Menu
- Relay Output Wiring

9.1 System Menu

The System menu is used primarily during initial setup of the YSI 5200 Recirculating Monitor and includes the following:

- Service
- Communications
- Password
- Display
- Downloader
- General Alarm
- Display Address
- Data
- Locale

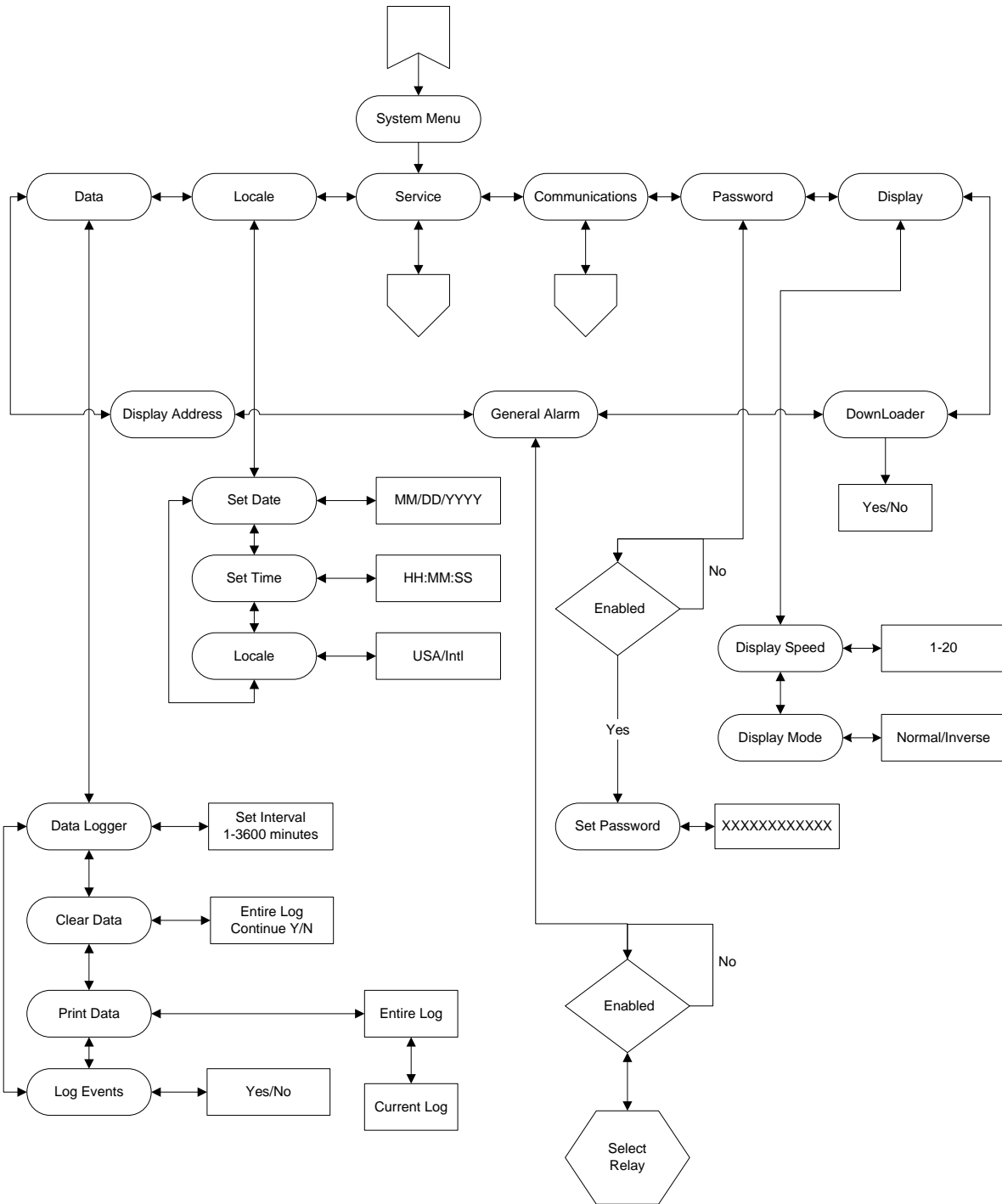

Figure 9-1 Systems Menu

9.1.1 Service

Service menu selections are shown below.

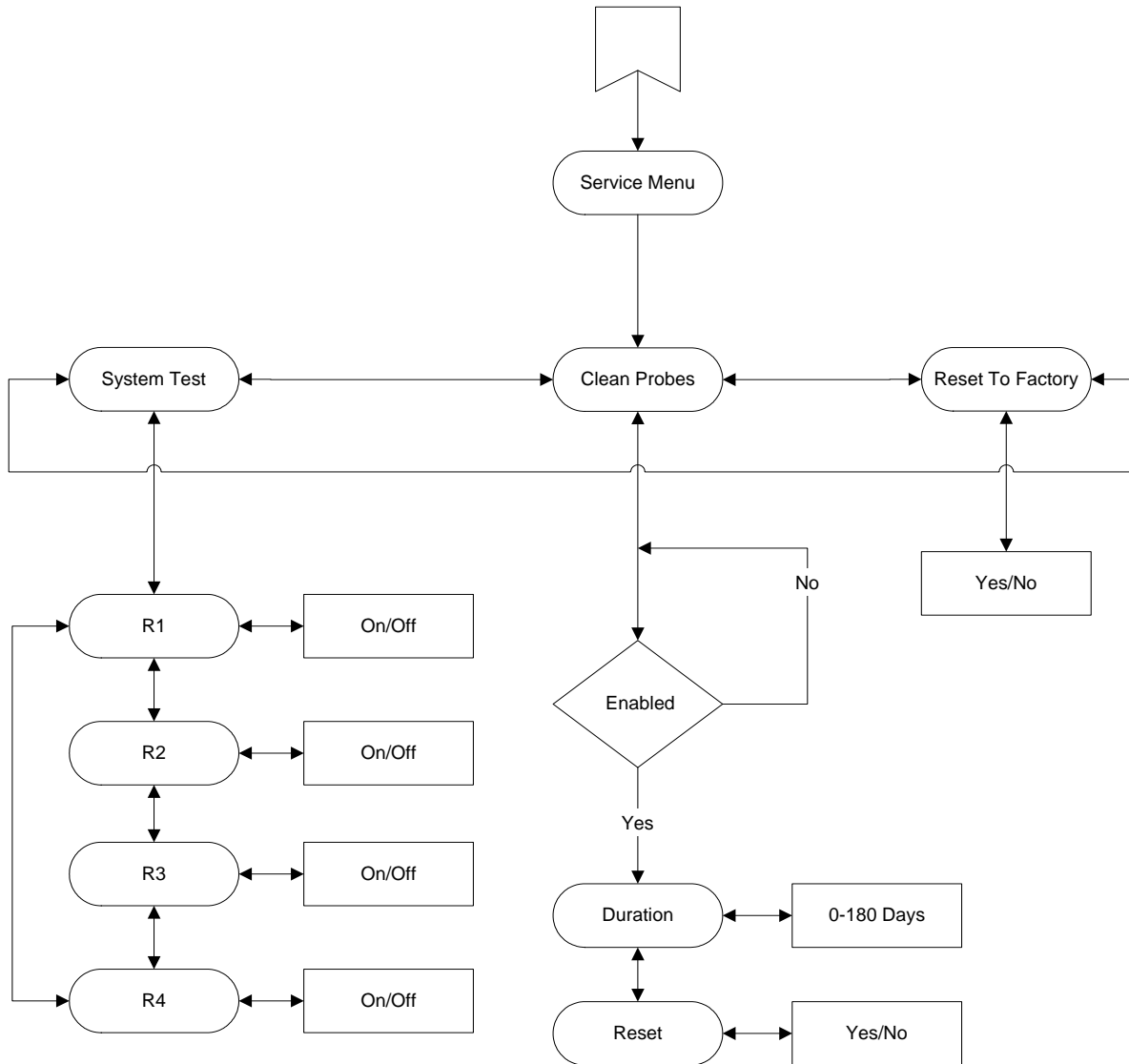

Figure 9-2 Service Menu

Clean Probes

This feature reminds the user when it is time to clean the probes by scrolling a text message across the display.

Duration

In the example above, a message will scroll across the bottom of the display after 45 days indicating it is time to clean the probes.

Reset

After the set number of days has passed and the Clean Probes message appears on the display, it must be reset.

Reset to Factory

 **CAUTION:** Reset to Factory returns all the settings to the factory default values (see *Section 16 Factory Default Settings*). **All calibration values, alarms, set point values and control functions will be lost.** If you are sure you want to return to the factory settings, proceed as follows:

System Test

Use System Test to verify that each control system is working correctly. See *Section 5.5 Conducting a System Test* for details.

9.1.2 Communications

Communications menu selections are shown below.

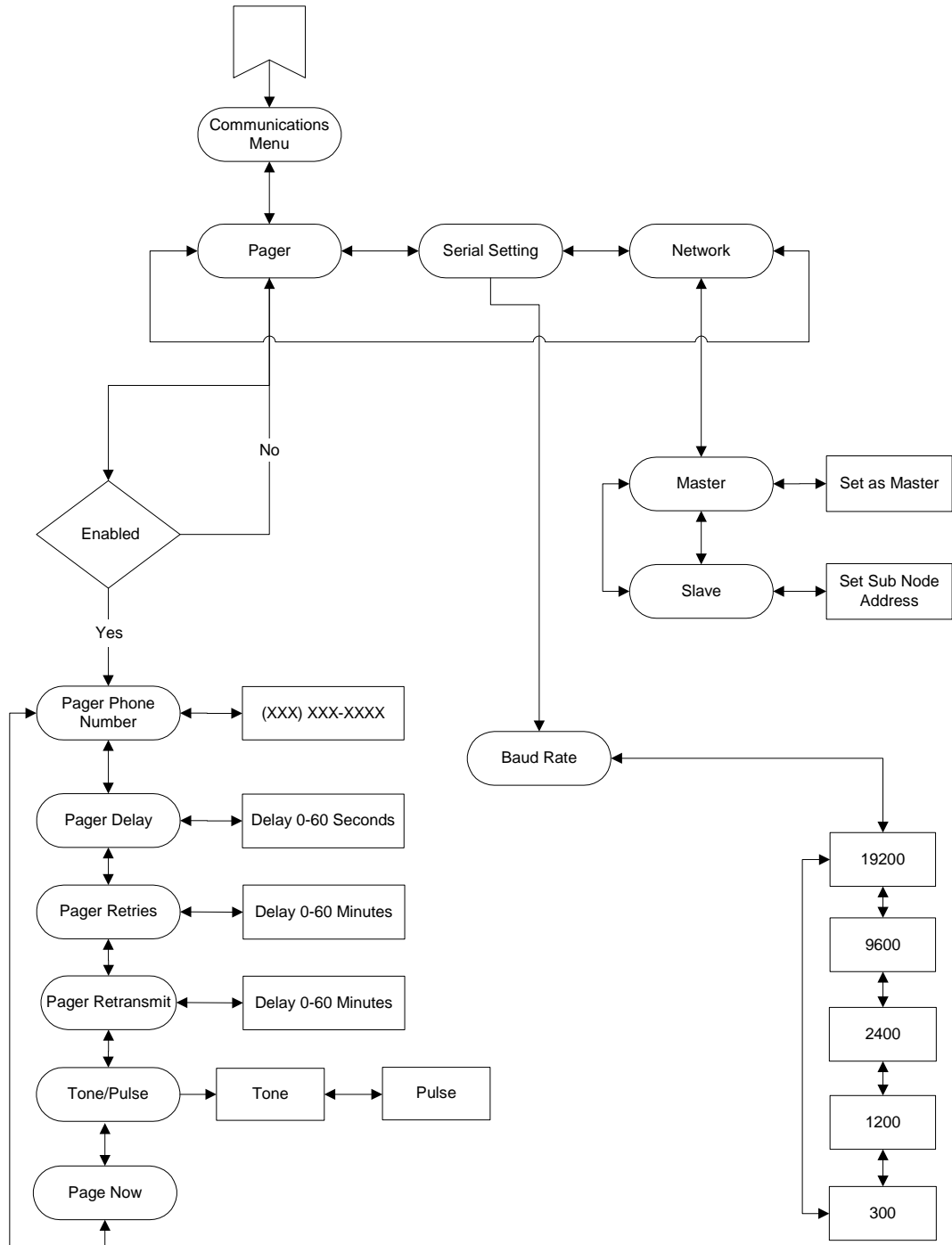

Figure 9-3 Communications Menu

Pager

The Pager feature allows you to receive 5200 alarm messages on your **numeric** pager. If a parameter enters the alarm range, its status indicator (on the front of the 5200) will change to solid red (see 7.1

Alarm Logic Flow Charts). After the Alarm Hold Off period expires, the audible alarm (a standard feature) will activate. If the 5200 is configured and enabled for alarm pager support, an alarm page will be sent indicating which parameter is in alarm state (pH, ORP, Temperature, etc.) and the type of alarm it is (high alarm, low alarm, etc.). This information is transmitted via modem (the 5200's modem or a computer running AquaManager software and equipped with a compatible modem) to your pager. The page consists of the last three digits of the serial number of the YSI 5200, followed by a seven digit alarm code as indicated below.

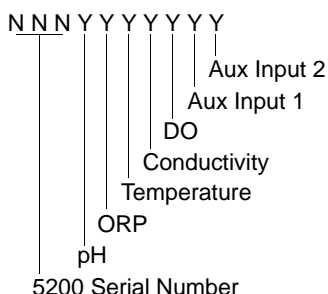

Figure 9-4 Pager Alarm Parameter Identification

After the serial number of the unit, the first digit always refers to pH status, the second digit indicates ORP status, the third digit indicates temperature status, the fourth digit is conductivity status, the fifth is DO status and the last two digits are Aux Input #1 and Aux Input #2. Table 9-1 shows the possible alarm conditions and the codes that are displayed. Note that a “0” in any digit location indicates that no alarm condition occurred for that parameter.

	pH	ORP	Temperature	Conductivity	DO	Aux Input 1	Aux Input 2
Low Alarm	1	1	1	1	1	1	1
High Alarm	2	2	2	2	2	1	1
Both High & Low Alarms	3	3	3	3	3	n/a	n/a
Main Power Restored	0	0	0	0	0	0	0
On Battery Power	8	8	8	8	8	8	8

Table 9-1 Pager Alarm Codes

NOTE: The 5200 also sends code 8888888 if back-up power is lost, but primary power is still present.

As an example, an alarm for a YSI 5200 unit with serial number 52-003598 was activated, indicating a high pH and low ORP condition, the page would appear as follows:

“598 2100000”

If your system has backup power, you will receive pages through the power fail detect feature. If power fails on a unit that has no backup battery, when the power comes back on, the unit will dial the phone pager and send a power out message. (All zeros mean the unit has powered back up after a power outage.)

Pager Phone Number

The first step in programming the YSI 5200 for pager support is the entry of the phone number you want the 5200 to dial in the event of an alarm condition.

Dial Modifiers

Depending on your situation, you may need to use the dial modifiers listed below. These are special parameters that tell the modem what, when and how to dial the telephone number.

Dial Modifier	Description
,	Delay for approx. 1 second
W	Wait for dial tone

The ‘W’ dial modifier is particularly important to make sure that there is a “dial tone” before initiating a page.

Pager Phone Number Example

The following is an example of one scenario where the pager number requires a bit more than the phone number:

To reach the pager, it is necessary to:

- Dial 9 for an outside line.
- Wait for the dial tone.
- Dial the paging company.
- Wait a few seconds for the paging company to answer the phone and accept a pager input.

The pager number to be used in this example would be:

9W16195551212

NOTE: To perform the last step (Wait a few seconds...), see the *Pager Delay* Section below.

Pager Delay

Every pager service company processes pager calls differently. It is important that the YSI 5200 does not start sending information before the pager company is ready to receive it.

The pager delay time is the number of seconds that the YSI 5200 waits after it has dialed the phone number before it sends the serial number and alarm values. For example, if your pager service has a message that precedes the transmission of a page, you will need to time the message period and program this time period into the Pager Delay. If the interval is set for too short a period, the serial number and alarm code will not be properly processed by the paging system. If the time period is set for too long a period, then the pager service company may terminate the call before the alarm code information is sent. A good starting value is 5-10 seconds.

Pager Retries (Redial)

The pager retry timer is activated if the YSI 5200 is unable to send a page due to a busy phone line. The controller will wait the number of minutes specified by this command and attempt to send another page. The default value is 3 minutes. Valid times are from 0 to 120 minutes.

Pager Retransmit (Until Reset)

When an alarm condition is detected (and after the hold-off period has expired), the 5200 will send a pager alarm. The YSI 5200 is programmed to continue paging until the alarm is reset (someone physically pushes a key on the front of the YSI 5200).

The pager retransmit value sets the length of time that the controller waits before it pages again—assuming that the alarm has not been reset.

Pager Tone/Pulse

The Tone/Pulse setting controls whether the modem uses tone or pulse dialing. If you have a rotary phone, select pulse as shown below; otherwise, use the default setting, tone.

Page Now

Page Now sends a test page consisting of the last 3 digits of the serial number of the 5200 followed by 999. As an example, for a YSI 5200 with serial number 52-003598, the page would appear as follows:

“598 999”

Serial Setting

The only Serial Setting selection is Baud Rate.

Baud Rate

The baud rate is the speed that the YSI 5200 transmits data via the serial IP port. It can be set at 300, 1200, 2400, 9600 or 19,200 baud. The default value (19,200 baud) will work with 90% of the modems in use today. If you are using AquaManager software, the baud rate must be set to 19,200.

Network

Multiple 5200s can be connected together via their RS485 network ports (see *8.1 RS485 Network*).

9.1.3 Password

Use the password feature to protect your 5200 from unauthorized use. Anyone attempting to use the 5200 will not be able to enter the menus unless they enter the correct password.

NOTE: If you choose not to use the password protection, do not enter any password. Move to the next setup procedure, Section *9.1.4 Display*.

Once you have **enabled** and **entered** a password, you will be prompted to enter it when attempting to access any menus from the Run screen. In order to disable it in the future, you will have to know the Password, enter the **System Menu**, select **Password** and select **No** for **Enabled?**

Do not forget your password!

9.1.4 Display

The only Display selection is Display Speed.

Display Speed

Display Speed controls how quickly the Run screen scrolls through the parameter readings. The higher the value entered, the longer the display will remain on each parameter. The allowable range is 1–20, corresponding to an actual display time of 1–6 seconds per parameter.

9.1.5 Downloader (Upgrading Software)

Use Downloader to upgrade the 5200 software.

1. Access the YSI Environmental web site **Downloads** page at <http://www.ysi.com/edownloads> to download the latest version of the 5200 Code Updater software.
2. Click on the **YSI Instruments Software Updates** link (or scroll down until you see YSI 5200).
3. Click on the file icon to the right of the **YSI 5200** listing and save the file to a temporary directory on your computer.
4. Uninstall any previously installed versions of the YSI 5200 Code Updater from your computer.

- After the download is complete, run the file (that you just downloaded) and follow the on screen instructions to install the YSI 5200 Code Updater on your computer. If you encounter difficulties, contact YSI customer service for advice. Refer to *Section 14* Warranty and Service Information.
- Connect the YSI 5200 to a serial port of your computer using the YSI 655384 Network Cable and YSI 655383 RJ-45 to DB-9 Adapter (or YSI 5285 Opto-isolator).

NOTE: The 5200 must be on and displaying the Run screen. It must also be in Master mode (see *9.1.2 Communications*) and have 120Ω resistors installed on the RS485 connection as described in *8.1.1 Network Wiring*. Paging must be disabled (see *9.1.2 Communications, Pager*).

- Run the **YSI 5200 Updater** software that you previously installed on your computer. The following window will be displayed:

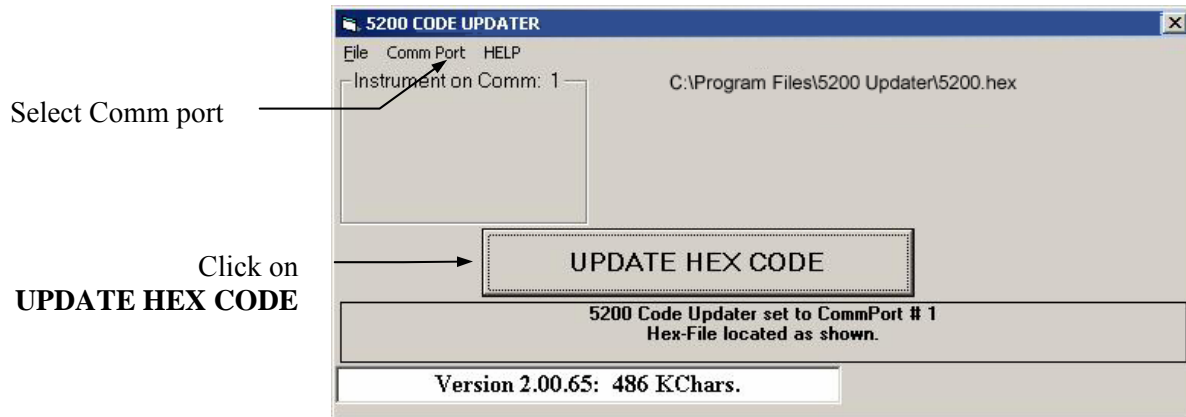

- Set the Comm Port number to match the port that you connected the 5200 to.
- Click on the [UPDATE HEX CODE] button.

The YSI 5200 screen will count up as the code is updated.

DOWNLOADER V2.9f
Writing 294C6

A progress indicator will be displayed on the PC as shown below.

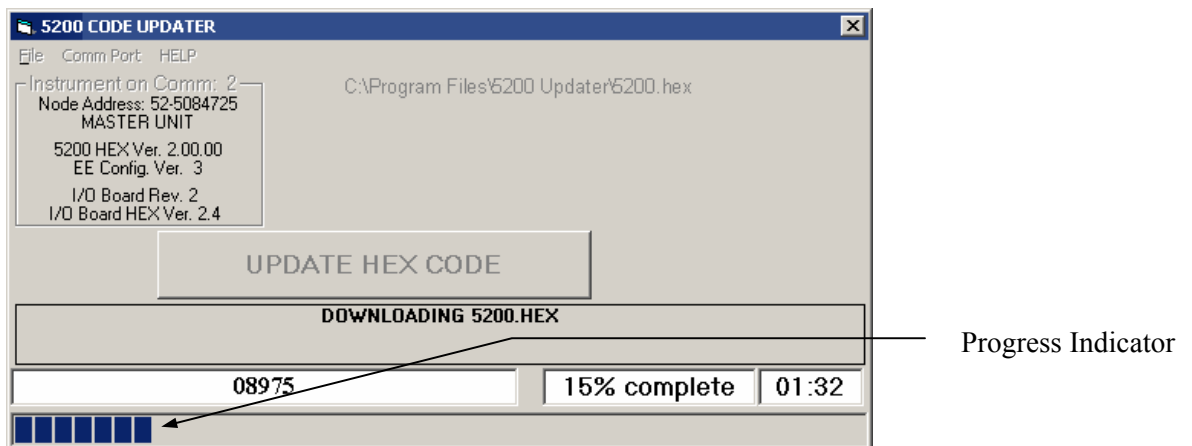

When the update is finished, the YSI 5200 will return to the Run screen.

- Close the YSI 5200 Code Updater window (on the PC) by clicking on the "X" in the upper right corner of the window.
- Disconnect the YSI 5200 from the computer.

12. Disconnect power from the 5200.
13. Reapply power to the 5200.

9.1.6 General Alarm

See Section 7.2 *General Alarm* for a detailed description.

9.1.7 Display Address (Serial Number)

Displays the Address (serial number) of the 5200 on the screen. The Address and software version are also displayed whenever the 5200 is powered on.

9.1.8 Data

The 5200 has a 32K volatile memory, allowing it to log 750 sample data sets. The logging rate is user selectable. Data menu selections are Data Logger, Clear Data, Print Data and Log Events.

Data Logger

Select **Data Logger** to enter the desired Data Logging time interval.

Clear Data

Clear Data erases all logged data stored in the 5200's memory.

Print Data

Use Print Data to send logged sample data via the 5200's RS232 serial port to a computer equipped with any standard communications software. See Section 3.7.1 *RS232 and TCP/IP Port* for wiring connections.

Entire Log

Sends the **Entire Log** to a computer via the 5200's RS232 port. The output is tab delimited ASCII text that can be imported into a spreadsheet. The format is shown below. Headings are not included in the output.

Date	Time	pH	ORP	Temp	Cond	DO	DO%	A1A2	AC	CS
05/17/2001	09:32:29AM	6.97	209mV	76.6F	187uS	17.22	207	0 0	0	136
05/17/2001	09:38:04AM	6.97	209mV	76.8F	221uS	13.04	157	0 0	0	146
05/17/2001	09:43:04AM	6.97	209mV	76.8F	227uS	12.80	154	0 0	0	144
05/17/2001	09:48:04AM	6.98	209mV	76.8F	249uS	12.70	153	0 0	0	136

A1—Auxiliary Input #1. 0 or 1

A2—Auxiliary Input #2. Digital mode, 0 or 1

AC—Auxiliary Input #2. Analog mode, Analog Counts (4096 counts = full scale)

CS—Check Sum

Current Log

Sends the **Current Log** (current readings) to a computer via the 5200's RS232 port. The format is identical to the Entire Log format shown above. Note that the data sent is the current reading from the sensors not the last logged data point.

Log Events

The 5200 can Log Events performed, such as a control system, alarm, or timer turning on or off. YSI AquaManager software is required to display logged events.

9.1.9 Locale

The YSI 5200 is equipped with an internal clock/calendar with its own backup battery. The clock/calendar is set from the factory, but you may need to adjust it to your time zone. Selections are:

- Set Date
- Set Time
- Set Locale—**USA** or **International**

9.2 Timers Menu

The Timers Menu includes options for the YSI 5200 to control various timers including:

- Feed Timer
- Service Hold
- Alarm Hold Off
- Timer 1
- Timer 2
- Timer 3
- Timer 4

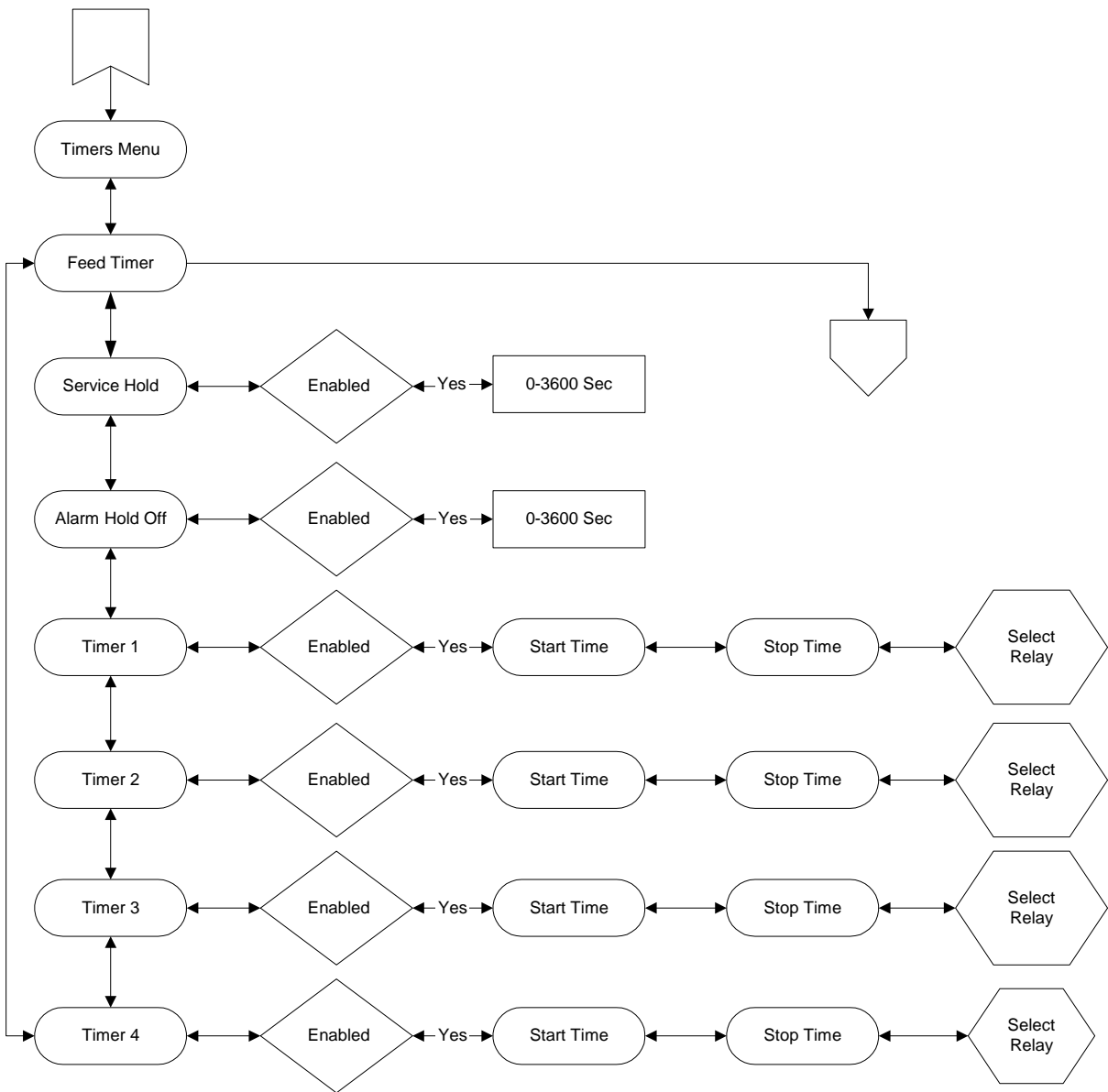

Figure 9-5 Timers Menu

9.2.1 Feed Timer

The Feed Timer System allows control and monitoring of feedings made by the 5200. Optional Parameter control reduces the amount of food dispensed if the DO, temp or pH values are “out of range.” Feed Timer parameter controls work independently of the 5200 parameter setpoint menus and operation. The optional FCR (feed conversion ratio) feature automatically increases the daily amount of food dispensed.

For proper operation, the Feed Timer System requires the user to enter the total **amount of food** to be dispensed, **number of feedings** that total amount of food will be dispensed in, and a defined **time period** within which the feedings will occur.

It is also important that the 5200 be configured with valid data. The feeder system will not operate properly, if, for example, the daily weight of food is greater than can be dispensed in the defined time period.

Feed Timer menu selections are shown below.

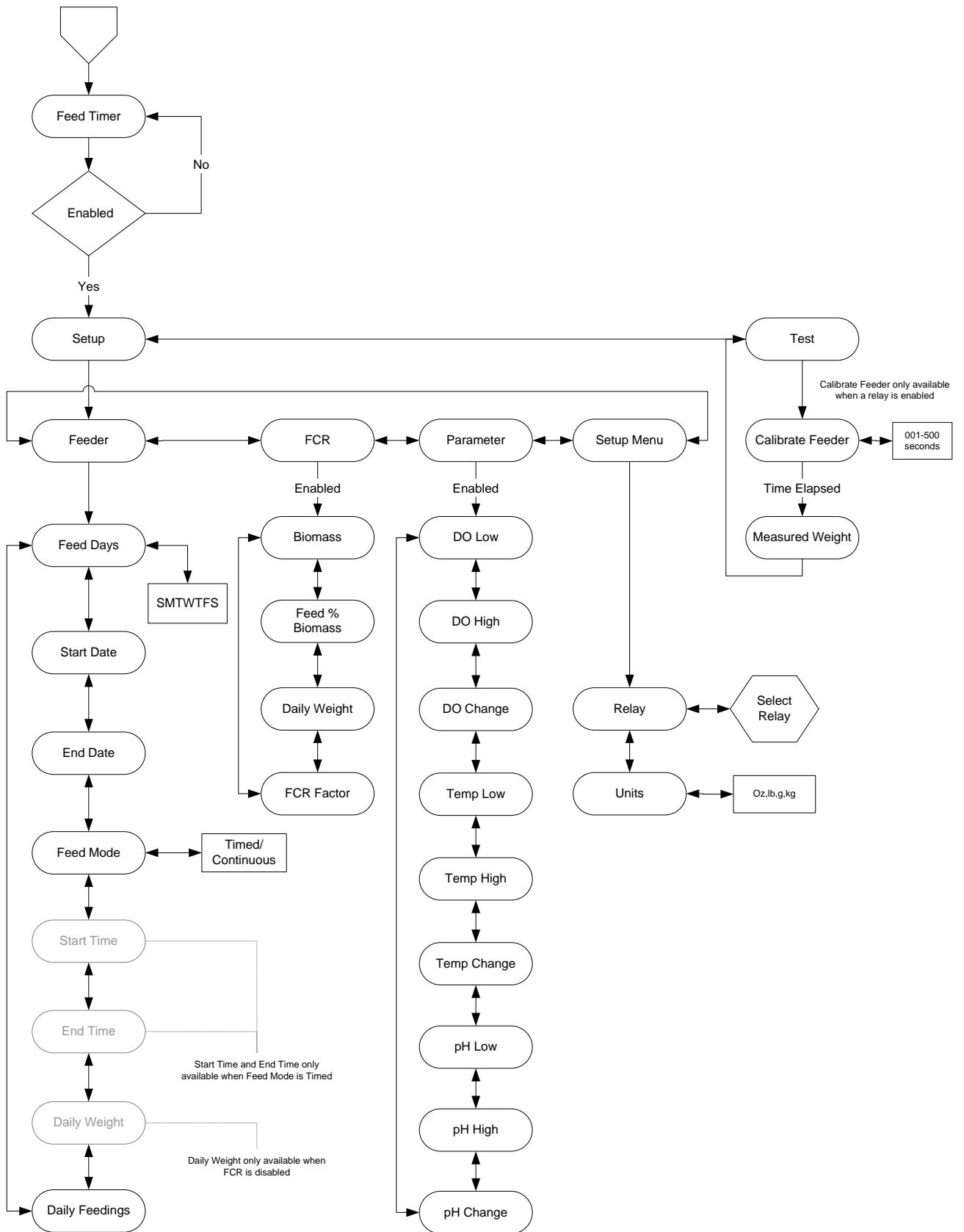

Figure 9-6 Feed Timer Menu

Feeder

Prior to operating the feed timer system, the following fields must be configured:

- Feed Days—days of the week feedings will occur
- Start and End Dates—dates within which the feed timer system will operate
- Feed Mode—feed cycle type (timed or continuous)
- Daily Feed Amount—daily weight of food to be dispensed
- Daily Feedings—number of feedings to occur per feeding cycle

Feed Days

Select the days of the week that feeding(s) should occur. Enter “Y” (yes, feed cycle(s) to occur on selected day) or “N” (no, feed cycle(s) not to occur on selected day).

Continuous feed mode

In continuous feed mode, feeding(s) will end after the last completed feeding that ends prior to 11:59 pm (23:59) of the day before an “N” day. Feeding(s) will resume at 12:00 am (00:00) for the next feeding day that is tagged “Y”.

Timed feed mode

If a timed feed cycle includes feed times that cross midnight, the feed cycle will complete regardless of operating (finishing the feed cycle) on an “N” day.

Example—with the following days selected

S	M	T	W	T	F	S
N	N	Y	Y	Y	Y	Y

and start time set to 10:00 pm (23:00) and end time set to 01:00, a Saturday feeding would complete any feedings on Sunday (even though it's tagged N, because the timed feed cycle began on a “Y” tagged day). The feed cycle will not start again until 10:00 pm on Tuesday. No feeding would occur Monday, because Monday is an “N” day even though the feed cycle crosses midnight and Tuesday is “Y” day.

Start Date

Enter the date the feed cycle(s) will begin.

End Date

Enter the date the feed cycle(s) will end. Note that no feed cycles will occur if this date is not set.

Continuous feed mode

In continuous feed mode, feeding(s) will cease after the last completed feeding that occurs with an end time prior to 11:59 pm (23:59) of end date.

Timed feed mode

If a timed feed cycle crosses midnight, the feed cycle will complete regardless of operating during the day beyond end date.

Feed Mode

Select Timed feed mode if feedings are to occur only during certain times of the day. If Timed feed mode is selected, the user will need to enter Start and End Times.

Select Cont. (Continuous) if feedings are to occur over the entire day. Once a Continuous feed configuration has been configured, the 5200 determines any remaining feeds for the 24 hour period, ending at 23:59. In continuous feed mode the feed cycle always begins at 00:00 (midnight). Start and End time fields are not available options for Continuous feed mode.

Start Time

Select the time the 1st feeding should occur (in 24 hour format). If configuration of timed feed mode is done during a feed cycle, the 5200 calculates the number of feeds and their intervals for the remainder of the time period.

In timed mode, the 1st feeding will always occur at the start time of the feed cycle.

End Time

Select the time the last feeding should be completed by. Because of the way the 5200 determines feed cycle durations and intervals, the end time will occur during the last feed cycle interval, not at the end time of the last feed cycle feed duration.

Daily Feed Amount

This is the total weight of food that will be dispensed over the feeding time period. The value is user selectable from 000.1–999.9. The Feed Timer system divides the total daily feed amount by the number of daily feedings and uses the calibration/test data to determine feed cycle duration times.

Daily Feedings

Enter the number of feedings per feed cycle time period; 1–99.

Note: Any change to feed timer configuration resets the feed timer system.

FCR

The optional FCR (feed conversion ratio) feature automatically increases the amount of food dispensed over a feed cycle. The increase in the amount of food is based on the user selected increase in biomass over a 24 hour period. Biomass and daily (feed) weight amounts are adjusted by the 5200 prior to the 1st feed “on” time of a scheduled feed cycle occurring after midnight.

NOTE: If changes are made to the FCR settings during a feed cycle, they do not take effect until the following feed cycle.

Biomass

Enter the total weight of all fish being fed at the time FCR is enabled; 1–32767.

Feed % (of) Biomass

Enter the percentage of the total fish weight (biomass) that will be used to determine the daily feed weight; 0.1–9.9%.

Daily (Feed) Weight

Input the initial daily feed weight by multiplying the biomass amount by the Feed % Biomass percentage (the 5200 will not calculate the initial amount). For example—if the biomass is 1000 and the feed % biomass is 3%, the initial daily feed weight amount is 30. On each following day, the 5200 will use the biomass value along with the feed % biomass to automatically calculate this value.

FCR Factor

Enter the ratio of the amount of food required vs. the corresponding increase in fish weight (biomass). This value is used to automatically increase the biomass amount—as shown in the example below.

	Day1	Day 2	Day 3	Day 4	Day 5	Day 6	Day 7
Biomass	1000	1020	1040	1061	1082	1104	1126
Feed % (of) Biomass	3%	3%	3%	3%	3%	3%	3%
Daily Feed Amount	30	30.6	31.2	31.8	32.5	33.1	33.8
FCR Factor	1.5	1.5	1.5	1.5	1.5	1.5	1.5
1/FCR x Feed Amount	20	20.4	20.8	21.2	21.6	22.1	22.5
New Biomass	1020	1040	1061	1082	1104	1126	1149

Parameter

Changes in water parameter conditions will affect the amount of food fish eat and thus will affect fish growth. With the parameter feature enabled, the feed timer system will verify that pH, temperature and DO values are within user selected ranges. This verification is done immediately prior to starting each feed cycle duration. If the values are outside these ranges, food weight amount is reduced by a user selected percentage.

DO/Temp/pH Low

Enter the lower limit of the parameter range where no feed compensation will take place.

DO/Temp/pH High

Enter the high limit of the parameter range where no feed compensation will take place.

DO/Temp/pH Change

Enter the percent reduction in feed weight that will occur for each 1/10 unit of measure the parameter is out of range. Results from all out of range parameters are added.

Setup Menu

Relay

Assign a relay address to the feeder.

NOTE: Feed calibration cannot be performed if the Relay is disabled.

Units

Select lb (pound), g (gram), kg (kilogram), or oz (ounce) as the unit of weight the Feed Timer System uses for the calibration/test sample amount and to the total daily feed amount.

NOTE: If the units are changed, the feeder must be recalibrated.

Test

Calibrating (Testing) the feeder is essential for proper operation of the Feed Timer System. Calibration will determine the rate at which food is dispensed from a feeder. This information is used to determine feed cycle duration(s).

NOTE: A relay must be assigned in order to enter the Calibrate Feeder menu.

Calibrate Feeder

Enter the amount of time the feeder relay will be energized for testing; 001–500 seconds. The relay will energize after the last digit is entered. After the timer counts down to zero, the feed relay deenergizes and the Measured Weight screen is displayed.

Measured Weight

Weigh the amount of food dispensed and enter the value at the Measured Weight screen. Digits to the left of the blinking cursor cannot be changed. If an incorrect value is entered, another test will have to be performed.

NOTE: Since feeders and food size vary, run several tests and enter the average weight. If food lot or size is changed, be sure to recalibrate the feeder.

Press Esc and enter “Yes” to save the value, or “No” to cancel and perform another calibration/test. The 5200 will base feed cycle duration times on the last saved test/calibration value.

NOTE: If no test/calibration has been performed, or the results have not been saved, the 5200 will be unable to perform any feeding(s) because there will be no reference to determine the rate at which feeding(s) will occur. Stored calibration data is available from the AquaManager program.

NOTE: Any change to feed timer configuration resets the feed timer system.

9.2.2 Service Hold

Use the Service Hold timer to perform service operations (clean probes, provide tank maintenance etc.) without breaching any alarms or set points. It overrides alarms and controlling operations until it has completed its countdown.

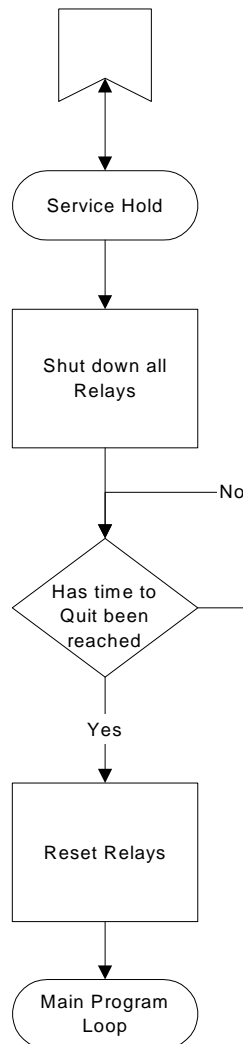

Figure 9-7 Service Hold Menu

NOTE: Allow enough time to clean the probes or provide tank maintenance without breaching any control or alarm conditions.

9.2.3 Alarm Hold Off

The Alarm Hold Off timer prevents any system parameter (DO, pH, etc.) from generating an alarm or page until the hold off time has expired.

NOTE: The Auxiliary Inputs each have separate Hold Off timers. See Section 9.4.1 *Input #1, Hold Off*.

9.2.4 Timers 1–4

Use Timers 1–4 to control external devices, such as a lighting system. Each timer has one ON and one OFF time per 24-hour period.

For example, in your application you may wish to use a combination of metal halide, fluorescent, and incandescent lighting. Each lighting system may require a dedicated ON and OFF time. The YSI 5200 lighting system can manage these and other various timing needs.

Example Lighting Scheme

Timer 1 is for the fluorescent lamps. These lamps are the first lights to come on in the morning and the last to go off late at night.

Timer 2 is for the metal halide lamps. To approximate the sun rising, these lamps come on in the late morning and go off in the late afternoon.

Timer 3 is for an additional halide lamp. This lamp will come on for about one to two hours at noon to simulate the midday sun.

Timer 4 is for a red bulb during the night to allow observation of nocturnal creatures that come out when the lights are out, and or moonlight simulation.

9.3 Relay Output Wiring

The four (4) output relay connections are made (using YSI 065944UL Pluggable Socket Connector) through terminals 1 through 12 of the 12-pin connector located at the top of the I/O plate. See Figure 3-8 I/O Plate. Relays may be wired normally open (N.O.) or normally closed (N.C.). Use appropriate wire in terms of gauge and insulation to adequately handle the voltage and current being switched by the relays. See *Section 15 System Specifications* for relay specifications. Do not use the primary 12 volt power source as a source for any of the relays in the 5200 system. Remember that relays are intended to activate alarms, lights, pumps and similar devices. The relays are **not** intended to switch heavy loads above the current rating of the relay.

 **WARNING:** If any of the relay contacts are connected to a "hazardous-live" circuit, ALL contacts on ALL relays must be considered "hazardous live" and appropriately protected from user contact outside the 5200 enclosure.

A snap on ferrite assembly, YSI# 655365, is included with the 5200 Monitor. Wires being connected to relay terminals need to be routed through this ferrite as shown in Figure 3-9. Failure to do so could cause catastrophic monitor failure.

9.3.1 Example—Wiring a Contactor

The 5200's internal relays are **not** intended to switch heavy loads above the current rating of the relay (see *Section 15 System Specifications* for relay specifications). Heavy loads require installing a separate external relay (contactor) between the 5200 and the load. Figure 9-8 shows a typical connection of the 5200 and a load using a contactor.

NOTE: Make sure that the contactor meets the electrical requirements of the load.

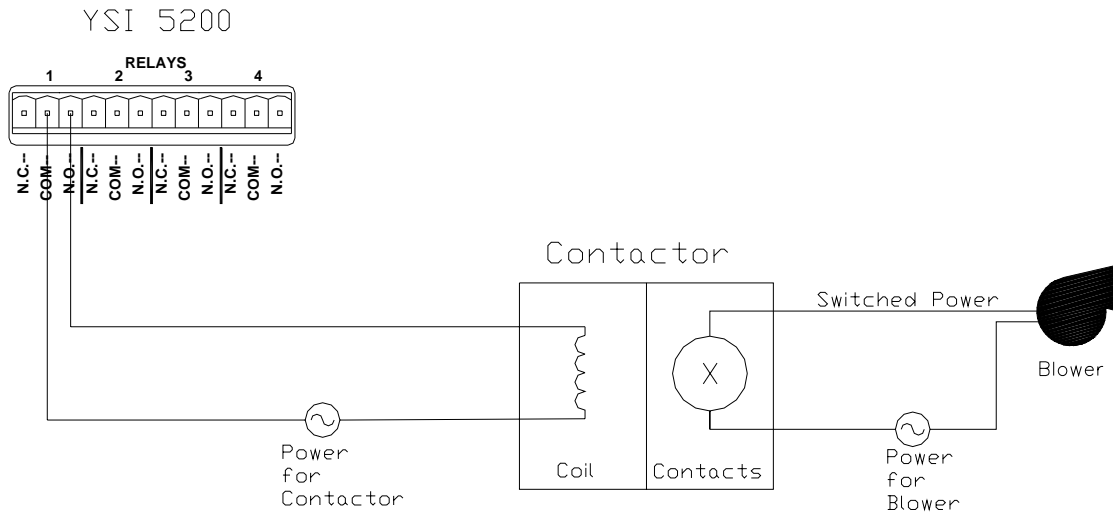

Figure 9-8 Wiring a Contactor

9.4 Auxiliary System

The YSI 5200 has two auxiliary inputs. Use digital inputs for control, and to trigger alarms and paging (see 7.1 Alarm Logic Flow Charts). A selectable wait period (Hold Off) prevents false control or alarms.

Auxiliary System Menu selections are shown below.

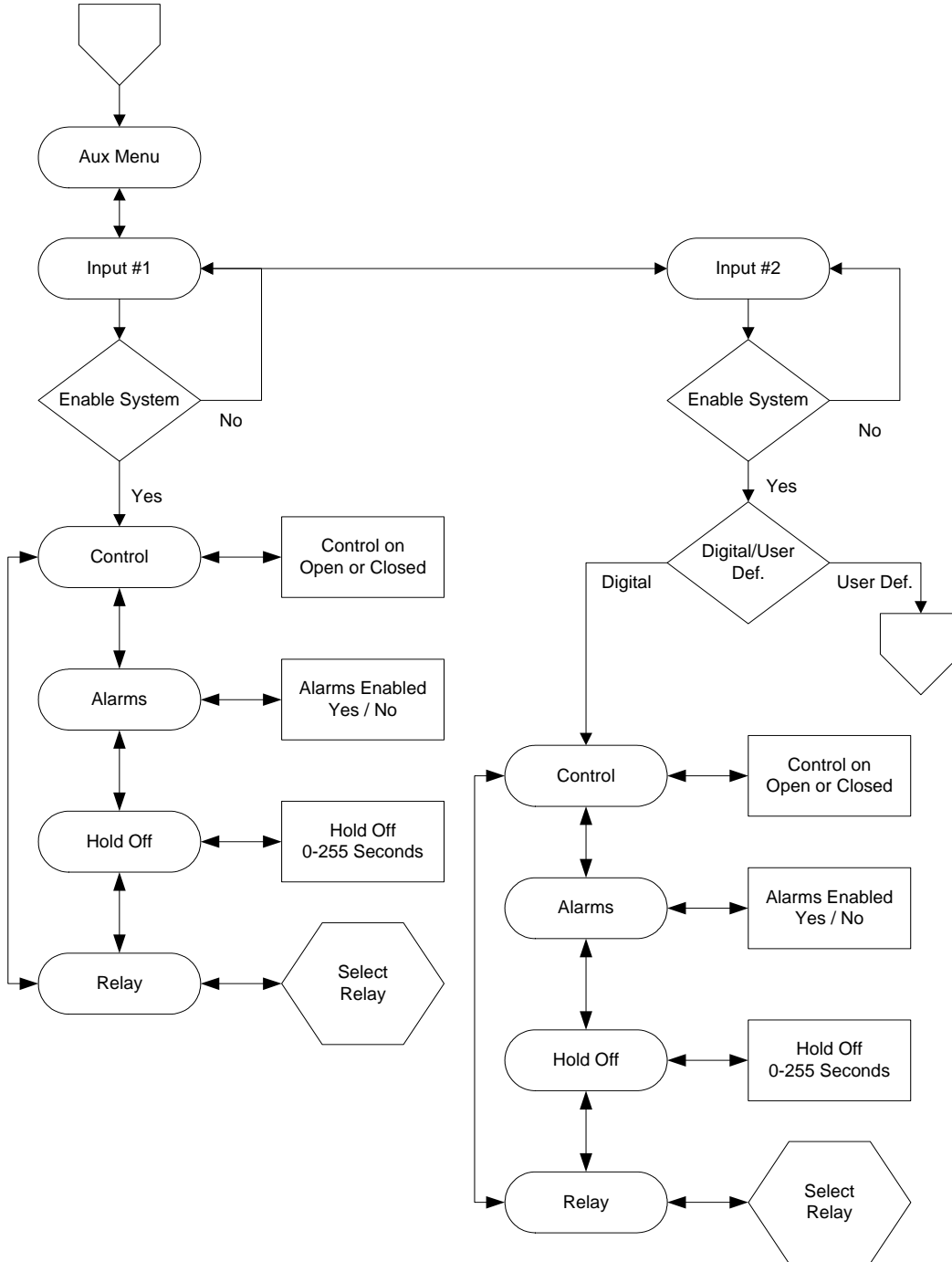

Figure 9-9 Auxiliary Menu

9.4.1 Input #1

Input #1 is a digital only input, triggered by either a switch open or a switch closed condition.

Control

Select **Close** to trigger the input when the contacts of an external switch close. Select **Open** to trigger the input when the contacts of an external switch open.

Hold Off

Hold Off is the number of seconds that the 5200 will wait before activating a control relay or generating an alarm. The hold off time is selectable from 0 to 255 seconds.

If the hold off time is set to “0”, the YSI 5200 will activate a control relay or generate an alarm and a page (if enabled) as soon as the switch opens or closes. The most common application this is used for is to detect high or low water levels using a float switch.

Alarms

The alarm system can be turned on or off. When on, an audible alarm will sound on the YSI 5200 and an alarm page will be sent (if paging is enabled). The alarm will remain on until a key is pressed. See *7.1 Alarm Logic Flow Charts* for details.

Relay

Relay Disabled

Relay Disabled is the default setting. It prevents Input #1 from triggering any relays (Internal or SubNet).

Relay Internal

Select Relay internal to trigger one of the four internal relays in **this** 5200.

Relay SubNet

See *7.2 General Alarm, Relay SubNet*.

9.4.2 Input #2

Input #2 can be set to either digital or a user defined mode. Use user defined mode to connect an external instrument or sensor, such as the YSI 5566 TGP (Total dissolved Gas Pressure) Sensor, with an analog recorder output to the 5200 and log the voltage or current.

Digital

Input #2 Digital selections are the same as Input #1 selections.

User Defined

User Defined mode gives you the choice of 2 Voltage ranges, 0–1VDC or 0–5VDC, or a current range of 4–20mA. The user defined menu is shown below.

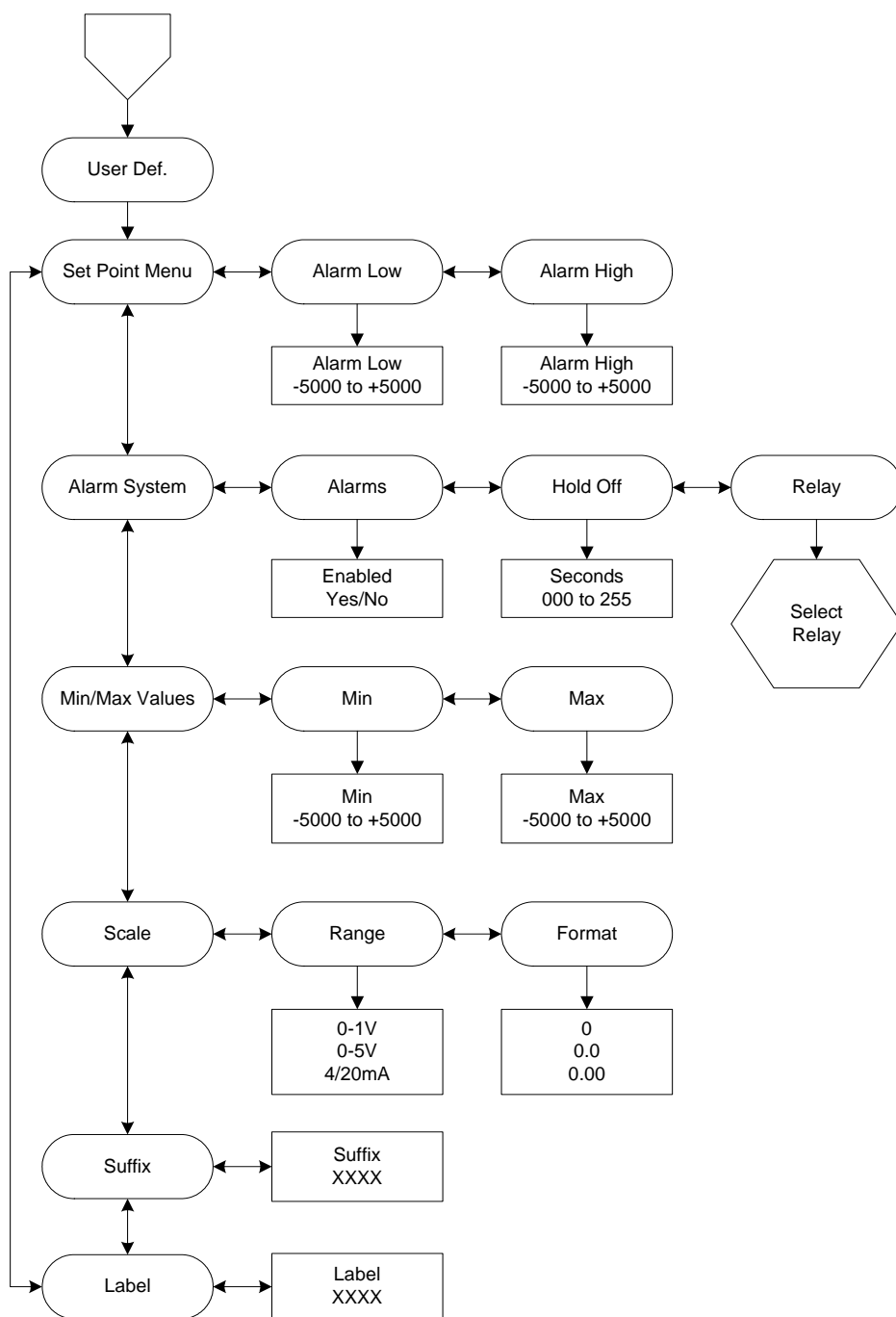

Figure 9-10 Auxiliary Input 2 User Defined Menu

Set Point Menu

Alarm Low

Enter the displayed parameter value that will trigger the low alarm (must be \geq the Min value). The allowed range is -5000 to +5000.

Alarm High

Enter the displayed parameter value that will trigger the high alarm (must be \leq the Max value). The allowed range is -5000 to +5000.

Alarm System

The alarm system can be turned on or off. When on, an audible alarm will sound on the YSI 5200 and an alarm page will be sent (if paging is enabled). The alarm will remain on until a key is pressed. See 7.1 *Alarm Logic Flow Charts* for details.

Hold Off

Hold Off is the number of seconds that the 5200 will wait before activating a control relay or generating an alarm. The hold off time is selectable from 0 to 255 seconds

Relay

Relay Disabled

Relay Disabled is the default setting. It prevents Input #2 from triggering any relays (Internal or SubNet).

Relay Internal

Select Relay internal to trigger one of the four internal relays in **this** 5200.

Relay SubNet

See 7.2 *General Alarm, Relay SubNet*.

Min/Max Values

Min

Enter the parameter value that corresponds to the minimum input level (0V or 4mA). Example—when using the YSI 5566 to measure TGP (Total dissolved Gas Pressure), enter “-400” as the Min value.

Max

Enter the parameter value that corresponds to the maximum input level (1V, 5V or 20mA). Example—when using the YSI 5566 to measure TGP, enter “+400” as the Max value.

Scale

Range

Select the input type and range, 0–1VDC, 0–5VDC, or 4–20mA. Example—when using the YSI 5566 to measure TGP, select 0–5VDC.

Format

Select the resolution (number of decimal places displayed) for the input parameter:

0
0.0
0.00

Example—when using the YSI 5566 to measure TGP, select “0.0” as the format.

Suffix

Enter up to 4 characters to be displayed as the suffix (units) for the input parameter. Example—when using the YSI 5566 to measure TGP, enter “mmHg” as the suffix.

Label

Enter up to 4 characters to be displayed as the label (name) for the input parameter. Example—when using the YSI 5566 to measure TGP, enter “TGP” as the label.

Section 10. AquaManager Software

AquaManager is a 32-bit Windows® application that provides remote access and network management services between a PC and the YSI 5200 Recirculating Monitor. The function of the software is to assist users with the complex task of monitoring local or remotely-connected YSI 5200 Recirculating Monitor units.

AquaManager has three methods of communicating with YSI 5200s.

Direct Connection—A direct serial connection between a dedicated RS232 serial port on a computer and the serial port of a 5200.

Modem Connection—A dial up telephone line connection between a computer equipped with a modem and a 5200 equipped with a 5201 Modem.

IP Connection—A TCP/IP network connection between a computer with access to a TCP/IP network (either through an Ethernet connection or via a dialup access connection such as AOL) and a 5200 connected to a Serial to Ethernet Converter.

AquaManager works very much like an e-mail system. Periodically, it initiates a direct or modem-to-modem dial-up connection with a YSI 5200. Once connected, many actions can then be accomplished, including downloading of the datalog, viewing current conditions, reviewing configuration setpoints, uptime, and graphing data.

Your YSI 5200 is ready to communicate with any AquaManager-enabled Windows PC. YSI's security system allows only authorized users to access your systems and data.

For further information about AquaManager, consult the AquaManager On-Line Help, or visit our web site at www.YSI.com/environmental.

Section 11. Maintenance

It is important to remember that the quality of data obtained will be heavily dependent on three factors directly related to the probe:

- Proper attention to detail of and general maintenance at the physical deployment site of your probe.
- A well-defined quality assurance program that is carried out on a regular basis to assure that the sensors are performing properly.
- Proper periodic calibration and maintenance of the specific sensors.

The following sections are designed to help you in these important areas by providing maintenance tips for the overall probe deployment, help in implementing a quality assurance protocol, and suggested service methods and intervals for the sensors.

11.1 Probe Maintenance at the Deployment Site

11.1.1 Algae and Debris

The problem most likely to be encountered with regard to the overall probe deployment is fouling from algae (and occasionally other debris). Algae will inevitably collect on any object immersed in the sample stream, and, unless periodically removed, can seal off the sensor compartment of the probe. Once algal build-up occurs, it isolates the sensor environment from the sample stream. Thus, even though the sensors themselves may be relatively free of fouling and performing correctly, the readings may be non-representative with regard to the sample stream.

To avoid, or at least minimize, this problem, it is necessary to periodically remove the algae from the probe. This may require the complete removal of the unit from the sample stream and “hands on” removal of the fouling. Removal of the probe is easier if it has been installed using an optional probe mounting kit. See *Section 20 Accessories*, for more information.

Minimizing the Effect of Algae and Debris

The collection of algae on your probe and the frequency of cleaning can be minimized by the overall deployment configuration and the way in which the probe is mounted. As outlined in *Section 3.2.1 Choosing a Probe Location*, it is preferable to angle the probe with (rather than against) the current of the stream. This configuration will maximize the chances that much of the algae will be swept free of the probe rather than collecting.

Remember that no matter what precautions you take, debris will still collect on the probe and the fouling will have to be removed by periodic cleaning. Cleaning will be easier if the method of mounting allows for easy removal and replacement of the probe. A little extra time spent on implementing a good mounting arrangement using the optional probe mounting kits will save a lot of time in subsequent cleaning operations. See *Section 20 Accessories* for more information.

The frequency with which you will have to remove fouling from your probe varies with the water being monitored and with the physical arrangement of the probe, but the need for cleaning can usually be ascertained by visual inspection. You can do no harm by excess cleaning, so it is best to err on the side of caution, removing and cleaning the probe if any significant fouling is even suspected.

11.2 Calibration Checks

The sensors are of high quality and should exhibit excellent performance in your application in excess of the warranty period. However, the dissolved oxygen, pH, ORP and conductivity sensors will inevitably show some drift during deployment due to natural chemical changes to the reagents in the probes, physical changes of the electrodes, minor fouling of the sensor surfaces, or all of these factors. Noisy sensor readings (especially for the conductivity and dissolved oxygen sensors) signal the need for specific maintenance procedures. With these factors in mind, it is imperative for you to establish and carry out regular checks of the quality of your sensor readings in order to assure that they are performing within their specifications.

11.3 Recommended Quality Assurance Protocol

This product has been designed and tested to provide trouble free service. However, as with all microprocessor based products, there is potential for failure which could cause loss of control functions. Proper QC procedures can reduce the potential for failure.

We recommend that you carry out the following quality assurance program **weekly** during the initial use of your 5200 system. After several weeks of this program, you should be able to ascertain if this frequency is appropriate for your application. If only minimal drift is observed, then the frequency of implementing the protocol can be decreased. The procedure is relatively simple and should take only about 20 minutes to complete.

1. Take the following items to the deployment site:
 - Bucket of clean water
 - The small brush supplied with the conductivity sensor
 - The calibration/storage cap supplied with the Probe
 - pH 7 buffer and another pH buffer (usually pH 4 or pH 10) of your choice
 - Latex gloves
2. Press the **Enter** [↵] key two times to place the 5200 in Service Hold mode. Remember that **all relays will return to their default state**.
3. Remove the probe from the sample stream.

 **WARNING:** The pH sensor should never be exposed for more than a few minutes to subfreezing air temperatures.

4. Remove the probe guard from the probe.
5. Manually remove any gross debris from the sensors and then rinse carefully in a bucket of clean water, being very careful not to damage the sensors.
6. (5562 Probe only) Using the small brush provided with the sensor, repeatedly scrub the two conductivity channels. After brushing is complete, rinse the sensor with clean water.
7. While the probe guard is removed, inspect the dissolved oxygen membrane for obvious holes or tears. Do not remove the membrane cap at this time.
8. Replace the probe guard.
9. (5562 Probe only) Place the probe in enough pH 7 buffer to immerse the pH probes. Wait about 3 minutes for the sensor to stabilize in the new medium and record the reading shown on the 5200 Monitor display. The deviation from pH 7 will reflect the sensor drift during the deployment period.

10. (5562 Probe only) Activate the 2-point pH calibration protocol from the 5200 display and recalibrate the instrument using the two buffers as described in Section 6.2.4 *pH Calibration*.
11. Rinse the probe with water and place in the calibration/storage cap containing about 1/8 inch (3 mm) of water. Make sure that the dissolved oxygen sensor is not immersed in the water.
12. Wait about 5 minutes for temperature equilibration and then record the dissolved oxygen reading in percent air saturation as shown on the 5200 display.
13. If the dissolved oxygen readings show minimal drift (within about 5 % of the correct value) and are stable, proceed with Step #13. If excessive drift is noted or the readings are jumpy, replace the membrane cap as described in Section 4.6 *Membrane Cap Installation*, then proceed with Step #13 after allowing a 10-15 minute break-in period before calibrating.
14. Activate the DO % calibration protocol from the 5200 display and recalibrate the instrument to the current altitude. See Section 6.2.2 *Dissolved Oxygen Calibration*.
15. Replace the probe in the sample stream and continue monitoring.

NOTE: The procedure does not include quantitative data taken with regard to either the temperature or conductivity sensors. The temperature sensor only fails in very rare circumstances and, when it does, the temperature readings will seem unreasonable for the current conditions. In the unlikely event that the temperature sensor shows unusual and/or jumpy readings, it will need to be checked by authorized service personnel. No user service is possible. For the conductivity sensor, drift is usually minimal except as caused by build-up of debris in the cell. Once this is cleaned out as described in Step 5 above, the sensor almost always yields accurate readings again with no recalibration needed. However, if you wish to check your conductivity calibration, place the probe in a known standard being sure that the top vent hole is completely covered. If significant drift has occurred, recalibrate the sensor as described in Section 6.2.3 *Conductivity Calibration*.

16. Test all control and alarm relays for proper operation.

11.3.1 Alternative Quality Assurance Protocol (quick check and adjustment)

An alternative, complementary type of quality assurance program to that described above for the sensors can be carried out by comparing the current dissolved oxygen and pH readings shown on the 5200 display with those taken by recently-calibrated hand held instruments. For dissolved oxygen, the probe of a handheld DO instrument similar to the YSI 550 can be placed in the stream near the 5200 Probe and the reading recorded. If a comparison of the readings from the recently-calibrated DO meter and the 5200 indicates a drift, the 5200 system can be recalibrated to reflect the DO meter reading. Note, however, that this comparison should only be used in a reset of the calibration if the 5200 Probe has been cleaned of all algae and other debris prior to the determination. If a gross variation is observed between the two instruments (> 1 mg/L), it is usually a sign that maintenance is required on the 5200 DO sensor.

For pH, a similar field calibration adjustment can be made using a YSI 60 or 63 field pH meter. Alternatively, a sample of the stream can be taken to the laboratory for evaluation of the true pH. After this value is determined, you should immediately return to the deployment site and, leaving the 5200 probe in the water, perform a single point pH calibration inputting the laboratory pH as the calibration value.

It is important to remember, however, that this “adjustment” of DO and pH values to those determined by recently calibrated single parameter instruments should only be used to compensate for minor drifts. It is **not** a substitute for the detailed quality assurance procedure outlined above which confirms proper sensor function and which should always be performed on a regular basis.

11.4 Sensor Care and Maintenance

Once the sensors have been properly installed, remember that periodic cleaning and DO membrane changes are required.

11.4.1 DO Sensor

The YSI polarographic dissolved oxygen probe is a Clark-type sensor in which the reduction of oxygen at the gold cathode is accompanied by a corresponding oxidation of a silver anode to silver chloride (AgCl). This natural deposition of AgCl will be seen initially as a slight darkening of the silver surfaces of the probe with no compromise in sensor accuracy. Eventually, however, the AgCl coating will become so thick that it will affect the function of the sensor, usually resulting in erroneously low and noisy DO readings.

Our experience in water quality monitoring suggests that DO readings will begin to deteriorate from this electrochemical action after about 30–90 days under the continuous operation associated with the 5200 system.

For best results, we recommend that the KCl solution and the membrane cap be changed at least once every 30–90 days.

1. It is important to recognize that oxygen dissolved in the sample is consumed during sensor operation. It is therefore essential that the sample continuously flow pass the sensor at a rate of at least 0.5 feet per second. If stagnation occurs, your readings will be artificially low.
2. Membrane life depends on usage. Membranes will last a long time if installed properly and treated with care. Erratic readings are a result of loose, wrinkled, damaged, or fouled membranes, or from large (more than 1/8" diameter) bubbles in the electrolyte reservoir. If erratic readings or evidence of membrane damage occurs, you should replace the membrane and the electrolyte solution.
3. If the membrane is coated with oxygen consuming (e.g. bacteria) or oxygen producing organisms (e.g. algae), erroneous readings may occur.
4. Chlorine, sulfur dioxide, nitric oxide, and nitrous oxide can affect readings by behaving like oxygen at the sensor. If you suspect erroneous readings, it may be necessary to determine if these gases are the cause.
5. Avoid any environment that contains substances that may attack the probe module and sensor materials. Some of these substances are concentrated acids, caustics, and strong solvents. The sensor materials that come in contact with the sample include FEP Teflon, acrylic plastic, EPR rubber, stainless steel, epoxy, polyetherimide and the PVC cable covering.
6. It is possible for the silver anode, which is the entire silver body of the sensor, to become contaminated. This will prevent successful calibration. To restore the anode, refer to Section *11.4.1 DO Sensor, Silver Anode Cleaning*.
7. For correct sensor operation, the gold cathode must always be bright. If it is tarnished (which can result from contact with certain gases), or plated with silver (which can result from extended use with a loose or wrinkled membrane), the gold surface must be restored. To restore the cathode, refer to Section *11.4.1 DO Sensor, Gold Cathode Cleaning*.

Silver Anode Cleaning

After extended use, a thick layer of AgCl builds up on the silver anode reducing the sensitivity of the sensor. The anode must be cleaned to remove this layer and restore proper performance. The cleaning can be chemical or mechanical:

Chemical Cleaning: Remove the membrane cap and soak the entire anode section in a 14% ammonium hydroxide solution for 2 to 3 minutes, followed by a thorough rinsing with clean water. The anode should then be thoroughly wiped with a wet paper towel to remove the residual layer from the anode.

Mechanical Cleaning: Sand off the dark layer from the silver anode with 400 grit wet/dry sandpaper. Wrap the sandpaper around the anode and twist the sensor. Rinse the anode with clean water after sanding, followed by wiping thoroughly with a wet paper towel.

NOTE: After cleaning, a new membrane cap must be installed. Refer to Section 4.6 *Membrane Cap Installation*.

Turn the instrument on and allow the system to stabilize for at least 30 minutes. If, after several hours, you are still unable to calibrate, contact your dealer or YSI Customer Service. Refer to *Section 14 WARRANTY AND SERVICE INFORMATION*.

Gold Cathode Cleaning

For correct sensor operation, the gold cathode must be textured properly. It can become tarnished or plated with silver after extended use. The gold cathode can be cleaned by using the adhesive backed sanding disc and tool provided in the YSI 5238 Probe Reconditioning Kit.

Using the sanding paper provided in the YSI 5238 Probe Reconditioning Kit, wet sand the gold with a twisting motion about 3 times or until all silver deposits are removed and the gold appears to have a matte finish. Rinse the cathode with clean water after sanding, followed by wiping thoroughly with a wet paper towel. If the cathode remains tarnished, contact your dealer or YSI Customer Service. Refer to *Section 14 WARRANTY AND SERVICE INFORMATION*.

NOTE: After cleaning, a new membrane cap must be installed. Refer to Section 4.6 *Membrane Cap Installation*.

11.4.2 DO Sensor Replacement

1. Remove the probe sensor guard.

⚠ CAUTION: Thoroughly dry the sensor so that no water enters the probe module sensor port when the sensor is removed.

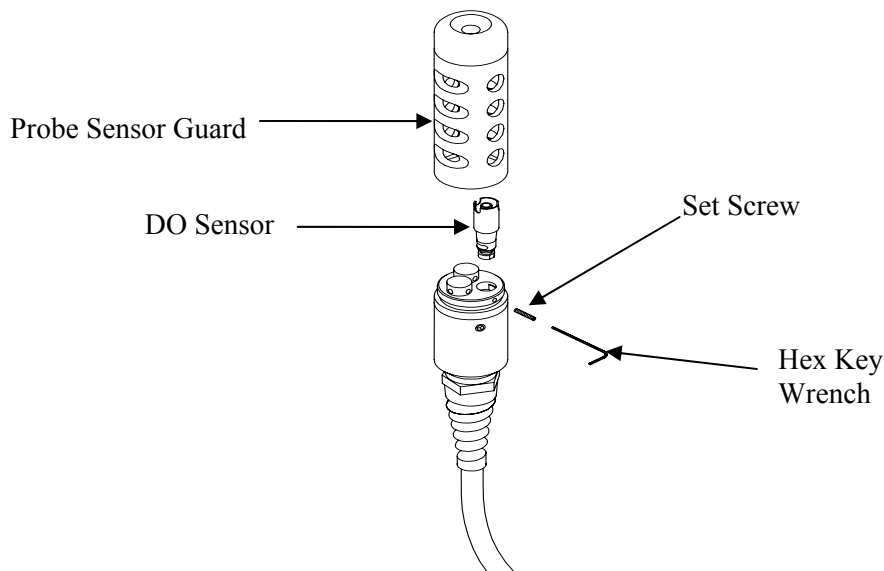

Figure 11-1 5562 Probe Module - DO Sensor Replacement

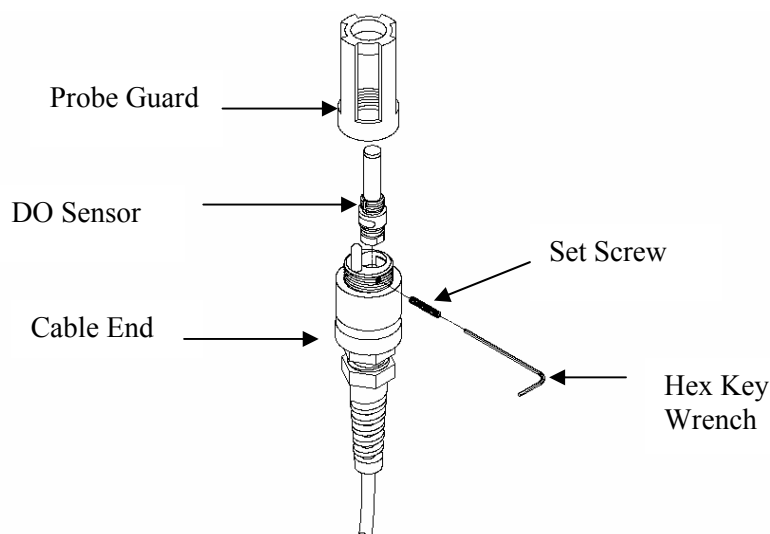

Figure 11-2 5561 Probe Module - DO Sensor Replacement

2. Insert the long end of the hex key wrench into the small hole in the side of the probe module bulkhead. Turn the wrench counterclockwise and remove the screw. (You do not have to remove the screw all the way to release the sensor.)
3. Pull the old DO sensor module straight out of the probe module body.

NOTE: The DO sensor is not threaded, it is keyed, so it cannot be removed by twisting.

4. Insert the new DO sensor module. Make sure that the inside of the probe module sensor port and the o-ring on the sensor are clean, with no contaminants, such as grease, dirt, or hair. The DO sensor is keyed, or has a flat side, so that it cannot be aligned improperly.

NOTE: Make sure the DO sensor bottoms out before the set screw is inserted.

5. Insert the set screw into the small hole in the side of the probe module bulkhead, and turn clockwise to rethread.

⚠ CAUTION: Make sure that you do not cross-thread the set screw. Use the hex key wrench to tighten the screw in properly, making sure that the screw does not stick out of the side of the probe module bulkhead. The probe sensor guard will not thread on properly and damage may result if the screw is allowed to stick out.

NOTE: The DO sensor is shipped dry. A shipping membrane was installed to protect the electrode. A new membrane cap must be installed before the first use. Refer to Section 4.5.1 *Sensor Installation*.

11.4.3 YSI 5564 pH and 5565 Combination pH/ORP Sensor Cleaning

Cleaning is required whenever deposits or contaminants appear on the glass and/or platinum surfaces of these sensors or when the response of the sensor becomes slow.

1. Remove the sensor from the probe module.
2. Initially, simply use clean water and a soft clean cloth, lens cleaning tissue, or cotton swab to remove all foreign material from the glass bulb (YSI 5564 and YSI 5565) and platinum button (YSI 5565). Then use a moistened cotton swab to carefully remove any material that may be blocking the reference electrode junction of the sensor.

 **CAUTION:** When using a cotton swab with the YSI 5564 or YSI 5565, be careful NOT to wedge the swab tip between the guard and the glass sensor. If necessary, remove cotton from the swab tip, so that the cotton can reach all parts of the sensor tip without stress.

NOTE: If good pH and/or ORP response is not restored by the above procedure, perform the following additional procedure:

1. Soak the sensor for 10-15 minutes in clean water containing a few drops of commercial dishwashing liquid.
2. GENTLY clean the glass bulb and platinum button by rubbing with a cotton swab soaked in the cleaning solution.
3. Rinse the sensor in clean water, wipe with a cotton swab saturated with clean water, and then re-rinse with clean water.

NOTE: If good pH and/or ORP response is still not restored by the above procedure, perform the following additional procedure:

1. Soak the sensor for 30-60 minutes in one molar (1 M) hydrochloric acid (HCl). This reagent can be purchased from most distributors. Be sure to follow the safety instructions included with the acid.
2. GENTLY clean the glass bulb and platinum button by rubbing with a cotton swab soaked in the acid.
3. Rinse the sensor in clean water, wipe with a cotton swab saturated with clean water, and then re-rinse with clean water. To be certain that all traces of the acid are removed from the sensor crevices, soak the sensor in clean water for about an hour with occasional stirring.

NOTE: If biological contamination of the reference junction is suspected or if good response is not restored by the above procedures, perform the following additional cleaning step:

1. Soak the sensor for approximately 1 hour in a 1 to 1 dilution of commercially available chlorine bleach.
2. Rinse the sensor with clean water and then soak for at least 1 hour in clean water with occasional stirring to remove residual bleach from the junction. (If possible, soak the sensor for period of time longer than 1 hour in order to be certain that all traces of chlorine bleach are removed.) Then re-rinse the sensor with clean water and retest.

11.4.4 Temperature/Conductivity Sensor Cleaning

The single most important requirement for accurate and reproducible results in conductivity measurement is a clean cell. A dirty cell will change the conductivity of a solution by contaminating it. The small cleaning brush included in the YSI 5511 Maintenance Kit is ideal for this purpose.

To clean the conductivity cell:

1. Dip the brush in clean water and insert it into each hole 15-20 times.
2. Rinse the cell thoroughly in deionized or clean tap water.

NOTE: In the event that deposits have formed on the electrodes, perform the following additional procedure:

1. Use a mild detergent solution in combination with the brush. Dip the brush in the solution and insert it into each hole 15-20 times.
2. Rinse the cell thoroughly in deionized or clean tap water.

3. After cleaning, check the response and accuracy of the conductivity cell with a calibration standard.

NOTE: If this procedure is unsuccessful, or if sensor performance is impaired, it may be necessary to return the sensor to a YSI authorized service center for service, Refer to *Section 14 WARRANTY AND SERVICE INFORMATION*.

The temperature portion of the sensor requires no maintenance.

11.5 Recommended cleaning of the 5200 Monitor and Accessories

Clean the 5200 Monitor and accessories as needed. Dampen a cloth with warm water and wipe the outside of the unit. You may use mild detergent with water, if necessary. Do **not** use acid-based, alkali-based or organic solvent-based solvents (e.g., acetone, alcohol, etc.).

Section 12. Storage

Proper storage between periods of usage will not only extend the life of the sensors, but will also ensure that the unit will be ready to use as quickly as possible in your next application.

12.1 Short Term Storage

No matter what sensors are installed in the instrument, it is important to keep them moist without actually immersing them in liquid. Immersing them could cause some of them to drift or result in a shorter lifetime.

YSI recommends that short term storage of all multi-parameter instruments be done by placing approximately ½ inch of tap water in the calibration/storage cup that was supplied with the instrument, and by placing the probe module with all of the sensors installed into the cup. The use of a moist sponge instead of a ½ inch of tap water is also acceptable, as long as its presence does not compromise the attachment of the cup to the probe module. The calibration/storage cup should be sealed to prevent evaporation.

NOTE: Ensure that an o-ring is installed in the o-ring groove on the threaded end of the probe module body. See Figure 4-9 Calibration/Storage Cup Installation.

 **CAUTION:** The water level has to be low enough so that none of the sensors are actually under water. Check the calibration/storage cup periodically to make certain that the water is still present or the sponge is still moist.

NOTE: If the storage water (tap water) is accidentally lost during field use, environmental water can be used.

12.2 Long Term Storage

12.2.1 Probe Module Storage

1. Remove the pH or pH/ORP sensor from the probe module and store according to the individual sensor storage instructions found in Section 12.2.2 *Sensor Storage*.
2. Seal the empty pH/ORP port with the provided port plug.

NOTE: Leave the conductivity/temperature sensor and dissolved oxygen sensor in the probe module.

3. Follow the individual sensor storage instructions below in Section 12.2.2 *Sensor Storage*.

12.2.2 Sensor Storage

Temperature/Conductivity Sensor

No special precautions are required. Sensor can be stored dry or wet, as long as solutions in contact with the thermistor and conductivity electrodes are not corrosive (for example, chlorine bleach). However, it is recommended that the sensor be cleaned with the provided brush prior to long term storage. Refer to Section 11.4.4 *Temperature/Conductivity Sensor Cleaning*.

pH and Combination pH/ORP Sensor

The key to sensor storage is to make certain that the reference electrode junction does not dry out. Junctions which have been allowed to dry out due to improper storage procedures can usually be

rehydrated by soaking the sensor for several hours (overnight is recommended) in a solution which is 2 molar potassium chloride. If potassium chloride solution is not available, soaking the sensor in tap water or commercial pH buffers may restore sensor function. However in some cases the sensor may have been irreparably damaged by the dehydration and will require replacement.

 **CAUTION:** Do not store the sensor in distilled or deionized water as the glass sensor may be damaged by exposure to this medium.

1. Remove the pH or pH/ORP sensor from the probe module.
2. Seal the empty port with the provided port plug.
3. Place the sensor in the storage vessel (plastic boot or bottle) which was on the sensor at delivery. The vessel should contain a solution which is 2 molar potassium chloride.

NOTE: Make certain that the vessel is sealed to prevent evaporation of the storage solution.

DO Sensor

The DO sensor should be stored dry with a membrane cap installed to protect it.

1. Rinse the DO sensor with distilled or deionized water.
2. Dry the DO sensor and install a membrane cap.
3. Insert the probe module into the calibration/storage cup.

NOTE: Ensure that an o-ring is installed in the o-ring groove on the threaded end of the probe module body. See Figure 4-9 Calibration/Storage Cup Installation.

Section 13. Troubleshooting

The following table describes problems you may encounter when using the YSI 5200 Recirculating Monitor and provides suggestions to overcome the symptom.

Problem	Possible Solution
Display Problems	
No display	Check power supply.
	Remove power (primary and back-up) for 30 seconds then reapply power.
Instrument software appears to be locked up as evidenced by no response to keypad entries or the display not changing.	Wait at least 3½ minutes for the 5200 to finish transmitting any logged data via the RS232 port. Remove power (primary and back-up) for 30 seconds then reapply power.
Instrument will not respond even after removing and reapplying power	Remove power (primary and back-up) for 30 seconds. Hold down the Right Arrow and Enter keys while reapplying power. This will reset the 5200 to factory default values. It will then be necessary to reprogram all your settings.
RS485 Network Problems	
5200 does not respond after it is wired to RS485 network	More than one 5200 is configured as a Master. Make sure only one 5200 is set to Master mode and all other units are in Slave mode.
	Termination resistors missing/improperly installed. Install termination resistors on Master unit and last Slave unit only.
Sensor Problems	
Dissolved Oxygen reading unstable or inaccurate. Out of Range message appears during calibration.	Sensor not properly calibrated. Follow DO cal procedures.
	Membrane cap not properly installed or may be punctured. Replace membrane cap.
	DO sensor electrodes require cleaning. Follow DO cleaning procedure. Use 5511 Maintenance kit.
	Water in sensor connector. Dry connector; reinstall sensor.
	Algae or other contaminant clinging to DO sensor. Rinse DO sensor with clean water.
	Altitude entry is incorrect. Repeat DO cal procedure.
	Calibrated at extreme temperature. Recalibrate at (or near) sample temperature.
	DO sensor has been damaged. Replace sensor.
Internal failure. Return probe module for service.	

Problem	Possible Solution
Sensor Problems	
pH or ORP readings are unstable or inaccurate. Out of Range message appears during calibration.	Sensor requires cleaning. Follow sensor cleaning procedure.
	Sensor requires calibration. Follow cal procedures.
	pH sensor reference junction has dried out from improper storage. Soak sensor overnight in 2 molar potassium chloride. If not available, tap water or pH buffer may be substituted.
	Water in sensor connector. Dry connector; reinstall sensor.
	Calibration solutions out of spec or contaminated with other solution. Use new calibration solutions.
	ORP fails Zobell check. Take into account temperature dependence of Zobell solution readings.
	Sensor has been damaged. Replace sensor.
Conductivity unstable or inaccurate. Out of Range message appears during calibration.	Internal failure. Return probe module for service.
	Conductivity improperly calibrated. Follow calibration procedure.
	Conductivity sensor requires cleaning. Follow cleaning procedure.
	Calibration solution out of spec or contaminated. Use new calibration solution.
	Internal failure. Return probe module for service.
	Calibration solution or sample does not cover entire sensor. Immerse sensor fully.
Temperature, unstable or inaccurate	Conductivity sensor damaged. Replace sensor.
	Water in connector. Dry connector; reinstall sensor.
Installed sensor has no reading	Sensor has been damaged. Replace the sensor.
	The sensor has been disabled. Enable sensor.
	Water in sensor connector. Dry connector; reinstall sensor.
	Sensor has been damaged. Replace the sensor.
	Internal failure. Return probe module for service.

If these guidelines and tips fail to correct your problem or if any other symptoms occur, contact YSI Customer Service for Advice. Refer to *Section 14*.

13.1.1 Relay In Use Error Codes

<p>Range Low Relay R1</p>

When selecting an internal control relay, an error message will appear when you press the **Enter** [↵] key if the relay address is already in use. In the example below, the relay is already in use by the General Alarm.

Range Low In Use (120)

Only one parameter can control each relay. In order to use this relay, you must first enter the General Alarm menu and assign a different relay to the General Alarm.

Use the following table to determine which control system the relay is assigned to:

System	Relay	Code
Aux	Input #1 Alarm Control	100
Aux	Input #2 Alarm Control	200
pH	Alarm Control Low	300
pH	Range Control Low	301
pH	Range Control High	302
pH	Alarm Control High	303
ORP	Alarm Control Low	400
ORP	Range Control Low	401
ORP	Range Control High	402
ORP	Alarm Control High	403
DO	Alarm Control Low	500
DO	Range Control Low 2	501
DO	Range Control Low 1	502
DO	Range Control High 1	503
DO	Range Control High 2	504
DO	Alarm Control High	505
Conductivity	Alarm Control Low	600
Conductivity	Range Control Low	601
Conductivity	Range Control High	602
Conductivity	Alarm Control High	603
Temperature	Alarm Control Low	700
Temperature	Range Control Low	701
Temperature	Range Control High	702
Temperature	Alarm Control High	703
Timer1	Alarm Control	800
Timer2	Alarm Control	900
Timer3	Alarm Control	A00
Timer4	Alarm Control	B00
General Alarm	Alarm Control	C00
Feed Timer	Alarm Control	D00

Section 14. Warranty and Service Information

This YSI 5200 Recirculating Monitor ("YSI 5200") is warranted by YSI for two years from date of purchase by the end user who first places the YSI 5200 into operation ("First End User") against defects in materials and workmanship (excluding components and materials for the YSI 5200 which are separately warranted below). All cables, probe modules and sensors for the YSI 5200 which are sold by YSI are warranted by YSI for one year from date of purchase by the First End User against defects in material and workmanship. Each chemical and reagent for the YSI 5200 which is sold by YSI is warranted by YSI to meet any specifications set forth on such item's packaging and label for a time period ending on the expiration date listed on such packaging or label. Within the applicable warranty period, YSI will repair or replace, at its sole discretion, free of charge, any product that YSI determines to be not in compliance with any of the foregoing applicable warranties.

To make a claim under any such warranty, write or call your local YSI representative, or contact YSI Customer Service in Yellow Springs, Ohio. Send the product and proof of purchase, transportation prepaid, to the Authorized Service Center selected by YSI. The end user making a claim under any of these warranties is responsible for any loss or damage occurring in transit to YSI. Repaired and replacement products will be returned transportation prepaid, and YSI is responsible for any loss or damage during such return. Each such repaired or replaced product is covered under the applicable warranty for the balance of the original warranty period, or at least 90 days from date of repair or replacement. The end user making a claim under any of these warranties is responsible for all product removal and reinstallation costs related to any product repair or replacement under any such warranty.

Limitation of Warranty

The foregoing warranties do not apply to any product damage or failure caused by (i) failure to install, operate or use the product in accordance with YSI's written instructions, (ii) abuse or misuse of the product, (iii) failure to maintain the product in accordance with YSI's written instructions, (iv) any improper, incorrect or substandard repairs to the product not performed by YSI, (v) use by anyone (other than YSI) of any defective or improper component or part in servicing or repairing the product, or (vi) modification of the product in any way not expressly authorized by YSI.

THE EXPRESS WARRANTIES PROVIDED HEREIN ARE IN LIEU OF ALL OTHER WARRANTIES, EXPRESS OR IMPLIED, INCLUDING ANY WARRANTY OF MERCHANTABILITY OR FITNESS FOR A PARTICULAR PURPOSE. YSI'S LIABILITY UNDER EACH OF THE WARRANTIES PROVIDED HEREIN IS LIMITED TO REPAIR OR REPLACEMENT OF THE PRODUCT, AND THIS SHALL BE THE SOLE AND EXCLUSIVE REMEDY FOR ANY DEFECTIVE PRODUCT COVERED BY ANY SUCH WARRANTY. IN NO EVENT SHALL YSI BE LIABLE FOR ANY SPECIAL, INDIRECT, INCIDENTAL OR CONSEQUENTIAL DAMAGES RESULTING FROM OR CAUSED BY ANY DEFECTIVE PRODUCT COVERED BY ANY OF THE WARRANTIES PROVIDED HEREIN.

International Service Centers

YSI Incorporated • Repair Center • 1725 Brannum Lane • Yellow Springs, Ohio • 45387 •
Phone: (937) 767-7241 • E-Mail: support@ysi.com

Hydrodata Services (UK) Ltd. • Unit 8 • Business Centre West • Avenue One • Letchworth •
Herts • SG6 2HB • Phone: (44-1462) 673581 • Fax: (44-1462) 673582 • Email:
hydrodatauk@cs.com

YSI Nanotech • Kaizuka 1-15-4, Kawasaki-Ku • Kawaskaki City • Japan • 210-0014 • Ph: 011-
814-4222-0009 • Fax: 011-81-44-221102 • E-mail: Nanotech@ysi.com

U. S. Service Centers

Ohio

YSI Incorporated • Repair Center • 1725 Brannum Lane • Yellow Springs, Ohio • 45387 •
Phone: (800) 765-4974 • (937) 767-7241 • E-Mail: info@ysi.com

Florida

Aquatic Eco Systems, Inc. • 1767 Benbow Court • Apopka, Florida • Phone: (407) 886-3939 •
Fax: (407) 886-6787

Cleaning Instructions

NOTE: Before they can be serviced, equipment exposed to biological, radioactive, or toxic materials must be cleaned and disinfected. Biological contamination is presumed for any instrument, probe, or other device that has been used with body fluids or tissues, microorganisms or with wastewater. Radioactive contamination is presumed for any instrument, probe or other device that has been used near any radioactive source.

If an instrument, probe, or other part is returned or presented for service without a Cleaning Certificate, and if in our opinion it represents a potential biological or radioactive hazard, our service personnel reserve the right to withhold service until appropriate cleaning, decontamination, and certification have been completed. We will contact the sender for instructions as to the disposition of the equipment. Disposition costs will be the responsibility of the sender.

When service is required, either at the user's facility or at YSI, the following steps must be taken to insure the safety of our service personnel.

1. In a manner appropriate to each device, decontaminate all exposed surfaces, including any containers. 70% isopropyl alcohol or a solution of 1/4 cup bleach to 1 gallon tap water are suitable for most disinfecting. Instruments used with wastewater may be disinfected with 0.5% Lysol if this is more convenient to the user. Autoclavable products may be autoclaved.
2. The user shall take normal precautions to prevent radioactive contamination and must use appropriate decontamination procedures should exposure occur.
3. If exposure has occurred, the customer must certify that decontamination has been accomplished and that no radioactivity is detectable by survey equipment.
4. Cleaning must be completed and certified on any product before returning it to YSI.
5. Any product being returned to the YSI Repair Center should be packed securely to prevent damage.

Packing Instructions

1. Clean and decontaminate items to insure the safety of the handler.
2. Complete and include the Cleaning Certificate.
3. Place the product in a plastic bag to keep out dirt and packing material.
4. Use a large carton, preferably the original, and surround the product completely with packing material.
5. Insure for the replacement value of the product.



Ship to one of the following locations:
 YSI Service Center
 1725 Brannum Lane
 Yellow Springs, OH
 45387
 +1 937 767 7241

YSI Service Center
 12231 Industriplex Blvd
 Suite A
 Baton Rouge, LA
 70809
 +1 225 753 2650

Product Return Form

If known, please provide your:

YSI Customer # _____

Service Request # _____

Step 1: Provide your billing and shipping information

BILL TO	SHIP TO	RETURN SHIPPING
		VIA (CIRCLE ONE)
		DHL FedEx UPS
		Account #:
		Please note: Shipping is prepaid and add.
CONTACT:	CONTACT:	METHOD (CIRCLE ONE)
PHONE: ()	PHONE: ()	Ground Next Day AM
FAX: ()	FAX: ()	2 Day Next Day PM
EMAIL:	EMAIL:	Other:

Step 2: Provide information on your equipment

MODEL NUMBER:	SERIAL NUMBER:
PLEASE DESCRIBE THE PROBLEM(S):	

Step 3: Provide your method of payment

PAYMENT METHOD FOR FASTER SERVICE, SPECIFY 'PRE-APPROVAL' AND PROVIDE THE AMOUNT AND PAYMENT METHOD
<input type="checkbox"/> Pre-approval with PO <u>or</u> Credit Card # included Amount: _____ Signature: _____ X _____
<input type="checkbox"/> Purchase Order (please attach) PO Number: _____
<input type="checkbox"/> Credit Card (circle one) VISA MasterCard American Express Name on Card: _____ Number: _____ Expiration Date: _____
<input type="checkbox"/> Prepayment
<input type="checkbox"/> Quote Required
Please note: There is an estimate fee of approximately \$35 to \$80 (product dependent) which is waived if service is approved.

Step 4: Fill out the Cleaning Certificate

CLEANING CERTIFICATE
Model Number:
Lot/Serial Number:
Contaminants (if known):
Cleaning Agents used:
<input type="checkbox"/> Radioactive Decontamination Certified (check only if product has been exposed to radiation and successfully decontaminated.)
Cleaning Certified by: Signature: _____ X _____
Date: _____

For more information call +1 937 767 7241 or 800-897-4151 (US), email environmental@ysi.com or visit www.ysi.com.

©2006 YSI

1006 Rev C

Section 15. System Specifications

Temperature	
Sensor type	10,000 ohm @ 25°C YSI Precision™ thermistor
Range	0 to 45°C 32 to 113°F
Accuracy	± 0.2 °C
Resolution	0.1°C
Dissolved Oxygen	
Sensor type	Membrane covered steady state polarographic
Range	0 to 500% air saturation 0 to 60 mg/L
Accuracy	±2% or ±0.2 mg/L, whichever is greater (0–200%) ±6% of reading (200–500%)
Resolution	0.1% or 0.01 mg/L (0–10 mg/L) 1% or 0.1 mg/L (10–60 mg/L)
Response time	98% of reading in 5 minutes
pH	
Range	0.0 to 14.0 pH
Accuracy	0.1 pH
Resolution	0.01 pH
ORP	
Range	-1000 mV to +1000 mV
Accuracy	±10 mV
Resolution	1 mV
Conductivity	
Sensor type	4 electrode, Cell constant of 5.0 ±5%
Ranges	0 to 200 µS 0 to 2000 µS 0 to 20 mS 0 to 200 mS
Accuracy	0 µS to 100 mS, ±0.5% of range 100 mS to 200 mS, ±1.0% of reading
Resolution	1.0 µS, 0.1mS / Range dependent

Salinity	
Sensor type	calculation from temperature and conductivity
Range	0 to 80 ppt
Accuracy	±2% or ±0.1 ppt
Resolution	0.1 ppt

Power Requirements (DC operation)	
Nominal	12 VDC
Operating Range	8.5 to 16.5 VDC (below 8.5 VDC reverts to optional battery back up)
Operating Current	500–800 mA Depending on mode of operation
Control Output Relays	
Type	SPDT
Maximum Current	5 amp
Maximum Voltage	125 VAC
Frequency	50/60 HZ
Auxiliary Inputs	
Type	1 analog (0 to 1.0 VDC, 0 to 5.0 VDC, or 4 to 20mA selectable) or digital (contact open/close w/current source)
	1 digital (contact open/close w/current source)
Instrument Operating Range	
Temperature	-15 to 70°C (23 to 158°F)
Pollution Degree	II per UL3101
Installation Category	III per UL3101
Enclosure Rating	NEMA 4X - direct exposure to outside conditions
Electrical Safety	UL, CUL and CE

Section 16. Factory Default Settings

Setting	Factory Default Value	Your Value
Parameters—Auxiliary		
Aux Input 1	Disabled	
Aux Input 1 Control	Close	
Aux Input 1 Hold Off	15 Sec	
Aux Input 1 Alarm	No	
Aux Input 1 Relay	Disabled	
Aux Input 2	Disabled	
Aux Input 2 Mode	Digital	
Aux Input 2 Control	Close	
Aux Input 2 Hold Off	15 Sec	
Aux Input 2 Alarm	No	
Aux Input 2 Alarm Low	-2000	
Aux Input 2 Alarm High	+2000	
Aux Input 2 Relay	Disabled	
Aux Input 2 Range	0–1V	
Aux Input 2 Format	0	
Aux Input 2 Min	-5000	
Aux Input 2 Max	+5000	
Aux Input 2 Suffix	(blank)	
Aux Input 2 Label	(blank)	
Parameters—Conductivity		
Conductivity	Enabled	
Conductivity Range	Auto	
Conductivity Temp Comp	1.91	
Conductivity Set Point	1,600 uS	
Conductivity High Control	1,800 uS	
Conductivity High Control Relay	Disabled	
Conductivity Low Control	1,400 uS	
Conductivity Low Control Relay	Disabled	
Conductivity High Alarm	1,900 uS	
Conductivity High Alarm Relay	Disabled	
Conductivity Low Alarm	1,300 us	
Conductivity Low Alarm Relay	Disabled	
Conductivity Dose Up Time	30 Seconds	
Conductivity Dose Up Wait	15 Minutes	
Conductivity Dose Down Time	30 Seconds	
Conductivity Dose Down Wait	15 Minutes	

Setting	Factory Default Value	Your Value
Conductivity Alarms	No	
Parameters—DO		
DO	Enabled	
DO Interval	Continuous	
DO Range	Auto	
DO Units	mg/L	
DO Membrane Type	Teflon	
DO Set Point	8.30	
DO High Control #1	8.50	
DO High Control #1 Relay	Disabled	
DO High Control #2	8.70	
DO High Control #2 Relay	Disabled	
DO Low Control #1	8.10	
DO Low Control #1 Relay	Disabled	
DO Low Control #2	7.90	
DO Low Control #2 Relay	Disabled	
DO High Alarm	8.90	
DO High Alarm Relay	Disabled	
DO Low Alarm	7.70	
DO Low Alarm Relay	Disabled	
DO Alarms	No	
Parameters—ORP		
ORP	Enabled	
ORP Set Point	400mV	
ORP High Control	425mV	
ORP High Control Relay	Disabled	
ORP Low Control	375mV	
ORP Low Control Relay	Disabled	
ORP High Alarm	435mV	
ORP High Alarm Relay	Disabled	
ORP Low Alarm	300mV	
ORP Low Alarm Relay	Disabled	
ORP Alarms	No	
Parameters—pH		
pH	Enabled	
pH Cal	2 point	
pH Set Point	7.00	
pH High Control	7.50	
pH High Control Relay	Disabled	
pH Low Control	6.50	

Setting	Factory Default Value	Your Value
pH Low Control Relay	Disabled	
pH High Alarm	8.00	
pH High Alarm Relay	Disabled	
pH Low Alarm	6.00	
pH Low Alarm Relay	Disabled	
pH Dose Up Time	5 Minutes	
pH Dose Up Wait	15 Minutes	
pH Dose Down Time	30 Seconds	
pH Dose Down Wait	15 Minutes	
pH Alarms	No	
Parameters—Salinity		
Salinity	Enabled	
Parameters—Temperature		
Temperature	Enabled	
Temperature Set Point	25°C	
Temperature High Control	26°C	
Temperature High Control Relay	Disabled	
Temperature Low Control	24°C	
Temperature Low Control Relay	Disabled	
Temperature High Alarm	26.5°C	
Temperature High Alarm Relay	Disabled	
Temperature Low Alarm	23.5°C	
Temperature Low Alarm Relay	Disabled	
Temperature Units	Centigrade	
Temperature Alarms	No	
Pager		
Pager	Disabled	
Pager Phone Number	—	
Pager Delay	10 Sec	
Pager Retries	3 Minutes	
Pager Retransmit	10 Minutes	
Pager Tone/Pulse	Tone	
Timers		
Alarm Hold Off	Enabled	
Alarm Hold Off Time	15 Seconds	
Feed Timer	Disabled	
Feed Timer Feed Days	NNNNNNN	
Feed Timer Start Date	Power on date	
Feed Timer End Date	Power on date	
Feed Timer Feed Mode	Timed	

Setting	Factory Default Value	Your Value
Feed Timer Start Time	10:00	
Feed Timer End Time	16:00	
Feed Timer Daily Weight	000.1	
Feed Timer Daily Feedings	03	
Feed Timer FCR	Disabled	
Feed Timer FCR Factor	1.5%	
Feed Timer Biomass	00001	
Feed Timer Feed % Biomass	3.0%	
Feed Timer Parameter	Disabled	
Feed Timer DO Low	06.0	
Feed Timer DO High	08.0	
Feed Timer DO Change	2.0%	
Feed Timer Temp Low	23.0°C	
Feed Timer Temp High	27.0°C	
Feed Timer Temp Change	3.0%	
Feed Timer pH Low	06.00	
Feed Timer pH High	08.00	
Feed Timer pH Change	2.5%	
Feed Timer Relay	Disabled	
Feed Timer Relay On Time	180 Seconds	
Feed Timer Scale	oz	
Service Hold	Enabled	
Service Hold Time	300 Seconds (5 minutes)	
Timer 1	Disabled	
Timer 1 Start Time	—	
Timer 1 Stop Time	—	
Timer 1 Relay	Disabled	
Timer 2	Disabled	
Timer 2 Start Time	—	
Timer 2 Stop Time	—	
Timer 2 Relay	Disabled	
Timer 3	Disabled	
Timer 3 Start Time	—	
Timer 3 Stop Time	—	
Timer 3 Relay	Disabled	
Timer 4	Disabled	
Timer 4 Start Time	—	
Timer 4 Stop Time	—	
Timer 4 Relay	Disabled	
Advanced		

Setting	Factory Default Value	Your Value
Baud Rate	19200	
Clean Probes	Enabled	
Clean Probes Interval	90 Days	
Data Log Interval	60 Minutes	
Display Speed	15	
Display Mode	Normal	
General Alarm	Disabled	
General Alarm Relay	Disabled	
Locale	USA	
Log Events	No	
Network Mode	Master	
Password System	Disabled	
Password	—	
Slave Sub Node Address	01	

Node Log Sheet

Node Name _____ Serial Number 52- _____

Software Version _____ Boot Version _____
 Network Mode Master/Slave Sub Node Address _____
 Password Yes/No _____
 Event Logging Yes/No _____
 General Alarm Yes/No Relay _____
 Clean Probes Yes/No Duration (Days) _____
 Paging Yes/No Phone Number _____ Delay (Sec) _____
 Retry (Min) _____ Re-Transmit (Min) _____
 Locale US/Intl _____
 Display Speed _____ Display Mode Normal/Inverse _____
 Sample Interval (Min) _____
 Baud Rate _____

DO

Enabled Yes/No Alarm Yes/No Scale 0-20 0-60
 Alarm High _____ Relay _____ Display Mg/L %Sat
 Range 2 High _____ Relay _____ Interval _____
 Range 1 High _____ Relay _____ Salinity Compensation Auto/Manual
 Setpoint _____ Membrane Type PE/Teflon
 Range 1 Low _____ Relay _____
 Range 2 Low _____ Relay _____
 Alarm Low _____ Relay _____

pH

Enabled Yes/No Alarm Yes/No
 Alarm High _____ Relay _____ Dose Down Time (Sec) _____
 Range High _____ Relay _____ Dose Down Wait Time (Min) _____
 Setpoint _____
 Range Low _____ Relay _____ Dose Up Time (Min) _____
 Alarm Low _____ Relay _____ Dose Up Wait Time (Min) _____

ORP

Enabled Yes/No Alarm Yes/No
 Alarm High _____ Relay _____
 Range High _____ Relay _____
 Setpoint _____
 Range Low _____ Relay _____
 Alarm Low _____ Relay _____

Temperature

Enabled	Yes/No	Alarm	Yes/No	Temperature Scale	°F/°C
Alarm High	_____	Relay	_____		
Range High	_____	Relay	_____		
Setpoint	_____				
Range Low	_____	Relay	_____		
Alarm Low	_____	Relay	_____		

Conductivity

Enabled	Yes/No	Alarm	Yes/No	Range	_____
Alarm High	_____	Relay	_____	Dose Down Time (Sec)	_____
Range High	_____	Relay	_____	Dose Down Wait Time (Min)	_____
Setpoint	_____			Temp Comp %/°C	_____
Range Low	_____	Relay	_____	Dose Up Time (Sec)	_____
Alarm Low	_____	Relay	_____	Dose Up Wait Time (Min)	_____

Salinity Display

Enabled Yes/No

Aux Input 1

Enabled	Yes/No	Alarm	Yes/No
Control	Open/Closed	Relay	_____
Holdoff Time (Sec)	_____		

Aux Input 2

Enabled	Yes/No	Alarm	Yes/No	Mode	Digital/User Def
Control	Open/Closed	Relay	_____	Range	0-1V 0-5V 4-20mA
Holdoff Time (Sec)	_____			Format	0 / 0.0 / 0.00
Suffix	_____	Min	_____	Alarm Low	_____
Label	_____	Max	_____	Alarm High	_____

Timers

Alarm Holdoff	Yes/No	Time (Sec)	_____		
Service Hold Timer	Yes/No	Time (Sec)	_____		
Timer 1	Yes/No	Start Time	_____	Relay	_____
		Stop Time	_____		
Timer 2	Yes/No	Start Time	_____	Relay	_____
		Stop Time	_____		
Timer 3	Yes/No	Start Time	_____	Relay	_____
		Stop Time	_____		
Timer 4	Yes/No	Start Time	_____	Relay	_____
		Stop Time	_____		

Node Log Sheet

Node Name _____ Serial Number 52-_____

Feed Timer

Enabled	Yes/No	Feed Days	S M T W T F S	Scale	oz / lb / kg / g
Start Date	_____	Feed Mode	Timed / Cont	Daily Weight	_____
End Date	_____	Start Time	_____	Daily Feedings	_____
		End Time	_____	Relay	_____
FCR	Yes/No	Biomass	_____	Feed % Biomass	_____
		Daily Weight	_____	FCR Factor	_____
Parameter	Yes/No	DO Low	_____	DO Change	_____
		DO High	_____		
		Temp Low	_____	Temp Change	_____
		Temp High	_____		
		pH Low	_____	pH Change	_____
		pH High	_____		

Section 17. International Modem Support

The YSI 5201 Modem is FCC Part 68 approved, and UL 1950 and CSA C22.2 950 recognized. For modem support outside the US, local regulations may require an external modem registered for use within the local country.

USRobotics Sportster 33.6K and 56K modems have been found to be compatible with the 5200 for use outside the US. These modems may be purchased locally and used in place of the YSI 5201 Modem.

External Modem Installation and Configuration

1. Connect the Sportster modem to the 5200 using an RJ-45 to DB-25P adapter cable.
2. The Sportster modem has an 8 position DIP Switch located on the back of the unit. The switches must be configured to ensure proper operation of the modem with the YSI 5200. The required switch settings are:

D = Down

U = Up

Switch	1	2	3	4	5	6	7	8
	D	U	D	U	U	U	D	D

3. The Sportster modem is powered by a wall-mount transformer. Plug the end of the cable from the power transformer into the back of the modem. It is important to ensure that the modem is powered up at the same time as the YSI5200 to ensure proper configuration of the modem.
4. Refer to the AquaManager help menu, and *Section 7 Alarm/Pager* for more information.

Section 18. Health and Safety

YSI Conductivity solutions: 3161, 3163, 3165, 3167, 3168 and 3169

INGREDIENTS:

θ Potassium Chloride

θ Water

 **CAUTION: AVOID INHALATION, SKIN CONTACT, EYE CONTACT OR INGESTION. MAY EVOLVE TOXIC FUMES IN FIRE.**

Harmful if ingested or inhaled. Skin or eye contact may cause irritation. Has a corrosive effect on the gastro-intestinal tract, causing abdominal pain, vomiting, and diarrhea. Hyper-sensitivity may cause conjunctivitis, bronchitis, skin rashes etc. Evidence of reproductive effects.

FIRST AID

SKIN CONTACT: Remove contaminated clothing immediately. Wash affected area thoroughly with large amounts of water. In severe cases seek medical attention.

EYE CONTACT: Wash eyes immediately with large amounts of water, (approx. 10 minutes). Seek medical attention immediately.

INGESTION: Wash out mouth thoroughly with large amounts of water and give plenty of water to drink. Seek medical attention immediately.

YSI pH 4.00, 7.00, and 10.00 Buffer Solutions: 3821, 3822, 3823

pH 4 INGREDIENTS:

- θ Potassium Hydrogen Phthalate
- θ Formaldehyde
- θ Water

pH 7 INGREDIENTS:

- θ Sodium Phosphate, Dibasic
- θ Potassium Phosphate, Monobasic
- θ Water

pH 10 INGREDIENTS:

- θ Potassium Borate, Tetra
- θ Potassium Carbonate
- θ Potassium Hydroxide
- θ Sodium (di) Ethylenediamine Tetraacetate
- θ Water

 **CAUTION: AVOID INHALATION, SKIN CONTACT, EYE CONTACT OR INGESTION. MAY AFFECT MUCOUS MEMBRANES.**

Inhalation may cause severe irritation and be harmful. Skin contact may cause irritation; prolonged or repeated exposure may cause Dermatitis. Eye contact may cause irritation or conjunctivitis. Ingestion may cause nausea, vomiting and diarrhea.

FIRST AID

INHALATION: Remove victim from exposure area to fresh air immediately. If breathing has stopped, give artificial respiration. Keep victim warm and at rest. Seek medical attention immediately.

SKIN CONTACT: Remove contaminated clothing immediately. Wash affected area with soap or mild detergent and large amounts of water (approx. 15-20 minutes). Seek medical attention immediately.

EYE CONTACT: Wash eyes immediately with large amounts of water (approx. 15-20 minutes), occasionally lifting upper and lower lids. Seek medical attention immediately.

INGESTION: If victim is conscious, immediately give 2 to 4 glasses of water and induce vomiting by touching finger to back of throat. Seek medical attention immediately.

YSI Zobell Solution: 3682

INGREDIENTS:

- θ Potassium Chloride
- θ Potassium Ferrocyanide Trihydrate
- θ Potassium Ferricyanide

 **CAUTION: AVOID INHALATION, SKIN CONTACT, EYE CONTACT OR INGESTION. MAY AFFECT MUCOUS MEMBRANES.**

May be harmful by inhalation, ingestion, or skin absorption. Causes eye and skin irritation. Material is irritating to mucous membranes and upper respiratory tract. The chemical, physical, and toxicological properties have not been thoroughly investigated.

Ingestion of large quantities can cause weakness, gastrointestinal irritation and circulatory disturbances.

FIRST AID

INHALATION: Remove victim from exposure area to fresh air immediately. If breathing has stopped, give artificial respiration. Keep victim warm and at rest. Seek medical attention immediately.

SKIN CONTACT: Remove contaminated clothing immediately. Wash affected area with soap or mild detergent and large amounts of water (approx. 15-20 minutes). Seek medical attention immediately.

EYE CONTACT: Wash eyes immediately with large amounts of water (approx. 15-20 minutes), occasionally lifting upper and lower lids. Seek medical attention immediately.

INGESTION: If victim is conscious, immediately give 2 to 4 glasses of water and induce vomiting by touching finger to back of throat. Seek medical attention immediately.

YSI Replacement Desiccant 065802

INGREDIENTS

Ø Calcium Sulfate and Calcium Chloride

 **CAUTION: AVOID INHALATION, SKIN CONTACT, EYE CONTACT OR INGESTION. MAY AFFECT MUCOUS MEMBRANES.**

FIRST AID

SKIN CONTACT: Flush with water.

EYE CONTACT: Flush with water. If irritation continues, obtain medical attention.

INGESTION: If patient is conscious, induce vomiting. Obtain medical attention.

Section 19. Required Notice

The Federal Communications Commission defines this product as a computing device and requires the following notice.

This equipment generates and uses radio frequency energy and if not installed and used properly, may cause interference to radio and television reception. It has been type tested and found to comply with the limits for a Class A or Class B computing device in accordance with the specification in Subpart J of Part 15 of FCC Rules, which are designed to provide reasonable protection against such interference in a residential installation. However, there is no guarantee that interference will not occur in a particular installation. If this equipment does cause interference to radio or television reception, which can be determined by turning the equipment off and on, the user is encouraged to try to correct the interference by one or more of the following measures:

- θ Reorient the receiving antenna
- θ Relocate the computer with respect to the receiver
- θ Move the computer away from the receiver
- θ Plug the computer into a different outlet so that the computer and receiver are on different branch circuits.

If necessary, the user should consult the dealer or an experienced radio/television technician for additional suggestions. The user may find the following booklet, prepared by the Federal Communications Commission, helpful: "How to Identify and Resolve Radio-TV Interference Problems". This booklet is available from the U.S. Government Printing Office, Washington, D.C. 20402, Stock No.0004-000-00345-4.

Section 20. Accessories

Optional Accessories for 5200 Monitor

- 5579 Power Supply 12 VDC, 1A, 110VAC
- 5578 Power Supply 12 VDC, 1A, 230VAC
- 5209 AquaManager Software (see *Section 10 AquaManager Software*)
- 065926 Conduit Fittings (industrial encapsulant required)
- 065921 Industrial Encapsulant
- 6505 Weather Shield (see *3.4.3 Optional 6505 – Weather shield*)
- 6506 Desiccant Kit (see *3.3.1 Sealants, Desiccants and Securing the Monitor*)
- 5562 Probe Assy 12', 25' or 50' (see *4.3 Features of the YSI 5562 Probe Module*)
- 5204 DO Membrane Kit, 2 Mil Teflon
- 5909 DO Membrane Kit, 2 Mil polyethylene (PE)
- 5561 DO/Temperature Probe Assy 12', 25' or 50' (see *4.2 Features of the YSI 5561 Probe Module*)
- 5285 RS232 Opto-Isolator – DB-9 to RJ-45
- Fittings for In-line Sampling
- 6509 Rail Mount Kit – Mounting the 5200 Monitor to a rail (see *3.4.2 Optional 6509 – Rail Mount Kit*)
- 6510 Panel Mount Kit – Mounting the 5200 Monitor to a panel (see *3.4.4 Optional 6510 – Panel Mount Kit*)
- 5205 Sonde Mount Kit – Mounting the 5562 Probe Assembly (see *3.5.2 5205 and 6511 – Optional Probe Mount Kits for 5562 Probes*)
- 6511 Sonde Mount Kit (with rail mounting clamps)– Mounting the 5562 Probe Assembly (see *3.5.2 5205 and 6511 – Optional Probe Mount Kits for 5562 Probes*)
- 5201 Modem (Internal) (see *3.7.2 5201 Modem*)–for use only within the United States. (see *Section 17* for international modem support)

Section 21. Solubility and Pressure/Altitude Tables

Table 1: Solubility of Oxygen (mg/L) in Water Exposed to Water-Saturated Air at 760 mm Hg Pressure.

Salinity = Measure of quantity of dissolved salts in water.

Chlorinity = Measure of chloride content, by mass, of water.

$$S(^{0}/_{00}) = 1.80655 \times \text{Chlorinity } (^{0}/_{00})$$

$^{0}/_{00} = \text{ppt}$

Temp °C	Chlorinity 0 Salinity: 0	5.0 ppt 9.0 ppt	10.0 ppt 18.1 ppt	15.0 ppt 27.1 ppt	20.0 ppt 36.1 ppt	25.0 ppt 45.2 ppt
0.0	14.62	13.73	12.89	12.10	11.36	10.66
1.0	14.22	13.36	12.55	11.78	11.07	10.39
2.0	13.83	13.00	12.22	11.48	10.79	10.14
3.0	13.46	12.66	11.91	11.20	10.53	9.90
4.0	13.11	12.34	11.61	10.92	10.27	9.66
5.0	12.77	12.02	11.32	10.66	10.03	9.44
6.0	12.45	11.73	11.05	10.40	9.80	9.23
7.0	12.14	11.44	10.78	10.16	9.58	9.02
8.0	11.84	11.17	10.53	9.93	9.36	8.83
9.0	11.56	10.91	10.29	9.71	9.16	8.64
10.0	11.29	10.66	10.06	9.49	8.96	8.45
11.0	11.03	10.42	9.84	9.29	8.77	8.28
12.0	10.78	10.18	9.62	9.09	8.59	8.11
13.0	10.54	9.96	9.42	8.90	8.41	7.95
14.0	10.31	9.75	9.22	8.72	8.24	7.79
15.0	10.08	9.54	9.03	8.54	8.08	7.64
16.0	9.87	9.34	8.84	8.37	7.92	7.50
17.0	9.67	9.15	8.67	8.21	7.77	7.36
18.0	9.47	8.97	8.50	8.05	7.62	7.22
19.0	9.28	8.79	8.33	7.90	7.48	7.09
20.0	9.09	8.62	8.17	7.75	7.35	6.96

Temp °C	Chlorinity 0 Salinity: 0	5.0 ppt 9.0 ppt	10.0 ppt 18.1 ppt	15.0 ppt 27.1 ppt	20.0 ppt 36.1 ppt	25.0 ppt 45.2 ppt
21.0	8.92	8.46	8.02	7.61	7.21	6.84
22.0	8.74	8.30	7.87	7.47	7.09	6.72
23.0	8.58	8.14	7.73	7.34	6.96	6.61
24.0	8.42	7.99	7.59	7.21	6.84	6.50
25.0	8.26	7.85	7.46	7.08	6.72	6.39
26.0	8.11	7.71	7.33	6.96	6.62	6.28
27.0	7.97	7.58	7.20	6.85	6.51	6.18
28.0	7.83	7.44	7.08	6.73	6.40	6.09
29.0	7.69	7.32	6.96	6.62	6.30	5.99
30.0	7.56	7.19	6.85	6.51	6.20	5.90
31.0	7.43	7.07	6.73	6.41	6.10	5.81
32.0	7.31	6.96	6.62	6.31	6.01	5.72
33.0	7.18	6.84	6.52	6.21	5.91	5.63
34.0	7.07	6.73	6.42	6.11	5.82	5.55
35.0	6.95	6.62	6.31	6.02	5.73	5.46
36.0	6.84	6.52	6.22	5.93	5.65	5.38
37.0	6.73	6.42	6.12	5.84	5.56	5.31
38.0	6.62	6.32	6.03	5.75	5.48	5.23
39.0	6.52	6.22	5.98	5.66	5.40	5.15
40.0	6.41	6.12	5.84	5.58	5.32	5.08
41.0	6.31	6.03	5.75	5.49	5.24	5.01
42.0	6.21	5.93	5.67	5.41	5.17	4.93
43.0	6.12	5.84	5.58	5.33	5.09	4.86
44.0	6.02	5.75	5.50	5.25	5.02	4.79
45.0	5.93	5.67	5.41	5.17	4.94	4.72

Table 2: Calibration Values for Various Atmospheric Pressures and Altitudes

PRESSURE			ALTITUDE		CALIBRATION VALUE
Inches Hg	mmHg	Millibars	Feet	Meters	Percent Saturation
30.23	768	1023	-276	-84	101
29.92	760	1013	0	0	100
29.61	752	1003	278	85	99
29.33	745	993	558	170	98
29.02	737	983	841	256	97
28.74	730	973	1126	343	96
28.43	722	963	1413	431	95
28.11	714	952	1703	519	94
27.83	707	942	1995	608	93
27.52	699	932	2290	698	92
27.24	692	922	2587	789	91
26.93	684	912	2887	880	90
26.61	676	902	3190	972	89
26.34	669	892	3496	1066	88
26.02	661	882	3804	1160	87
25.75	654	871	4115	1254	86
25.43	646	861	4430	1350	85
25.12	638	851	4747	1447	84
24.84	631	841	5067	1544	83
24.53	623	831	5391	1643	82
24.25	616	821	5717	1743	81
23.94	608	811	6047	1843	80
23.62	600	800	6381	1945	79
23.35	593	790	6717	2047	78
23.03	585	780	7058	2151	77
22.76	578	770	7401	2256	76
22.44	570	760	7749	2362	75
22.13	562	750	8100	2469	74
21.85	555	740	8455	2577	73
21.54	547	730	8815	2687	72
21.26	540	719	9178	2797	71
20.94	532	709	9545	2909	70
20.63	524	699	9917	3023	69
20.35	517	689	10293	3137	68
20.04	509	679	10673	3253	67
19.76	502	669	11058	3371	66

Table 3: Conversion Factors for Feet/Meters, Celsius/Fahrenheit, mg/L/ppm

TO CONVERT FROM	TO	EQUATION
Feet	Meters	Multiply by 0.305
Meters	Feet	Multiply by 3.28
Degrees Celsius	Degrees Fahrenheit	$5/9 \times (^{\circ}\text{F} - 32)$
Degrees Fahrenheit	Degrees Celsius	$9/5 \times (^{\circ}\text{C}) + 32$
Milligrams per liter (mg/L)	Parts per million (ppm)	Multiply by 1

Table 4. Conversion Factors for Common Units of Pressure

	kilo Pascals	mm Hg	millibars	inches H ₂ O	PSI	inches Hg
1 atm	101.325	760.000	1013.25	406.795	14.6960	29.921
1 kiloPascal	1.00000	7.50062	10.0000	4.01475	0.145038	0.2953
1 mmHg	0.133322	1.00000	1.33322	0.535257	0.0193368	0.03937
1 millibar	0.100000	0.750062	1.00000	0.401475	0.0145038	0.02953
1 inch H ₂ O	0.249081	1.86826	2.49081	1.00000	.0361	0.07355
1 PSI	6.89473	51.7148	68.9473	27.6807	1.00000	2.0360
1 inch Hg	3.38642	25.4002	33.8642	13.5956	0.49116	1.00000
1 hectoPascal	0.100000	0.75006	1.00000	0.401475	0.0145038	0.02953
1 cm H ₂ O	0.09806	0.7355	9.8×10^{-7}	0.3937	0.014223	0.02896

Section 22. YSI Conductivity Calibration Solution Values

Temperature	3161/3167	3163/3168	3165
20°C	904µS/cm	9,066µS/cm	91,260µS/cm
21°C	923µS/cm	9,251µS/cm	92,980µS/cm
22°C	942µS/cm	9,437µS/cm	94,730µS/cm
23°C	961µS/cm	9,624µS/cm	96,480µS/cm
24°C	981µS/cm	9,812µS/cm	98,230µS/cm
25°C	1,000µS/cm	10,000µS/cm	100,000µS/cm
26°C	1,020µS/cm	10,190µS/cm	101,800µS/cm
27°C	1,039µS/cm	10,380µS/cm	103,600µS/cm
28°C	1,059µS/cm	10,570µS/cm	105,400µS/cm
29°C	1,079µS/cm	10,760µS/cm	107,100µS/cm
30°C	1,098µS/cm	10,960µS/cm	109,000µS/cm

Section 23. Declaration of Conformity

Manufacturer: YSI Incorporated
1725 Brannum Lane
P.O. Box 279
Yellow Springs, OH 45387
USA

Product Name: Recirculating System Monitor

Model Numbers: 5200 (Instrument) Accessories: 5578 Power Supply, 5563 Probe

Conforms to the following:
Directives: EMC Directive

Harmonized Standards: EN 61326: Electrical Equipment for Measurement Control and Laboratory Use. *Specifically the following:* Radiated Emissions Standard (EN 55011: Class B; Residential, Commercial & Light Industrial). Conducted Emissions (EN61000-3-2, EN61000-3-3). Immunity Standards (IEC Publications 1000-4-2 Criteria B, 1000-4-3 Criteria A, 1000-4-4 Criteria B, 1000-4-5 Criteria B, 1000-4-6 Criteria A, 1000-4-8 Criteria A, 1000-4-11 Criteria B). Safety Standard (IEC 1010-1/UL 3101-1)

Supplementary information: Model 5578 Power Supply: Safety Standard EN 60950



Lisa M. Abel
Director, Quality Assurance & Corporate Responsibility
Date: 11/17/2006

Authorized EU-representative: YSI (UK) Limited
119 Fleet Road
Fleet, Hampshire
GU51 3PD
United Kingdom



YSI Environmental

YSI Environmental
1700/1725 Brannum Lane
Yellow Springs, OH 45387 USA
800.897.4151
937.767.7241
937.767.9353 fax
environmental@YSI.com

Endeco/YSI
508.748.0366
508.748.2543 fax
environmental@YSI.com

YSI Hydrodata
European Support Centre
44.1462.673581
44.1462.673582 fax
sales@hydrodata.co.uk

YSI (Hong Kong) Limited
852.2891.8154
852 2834.0034 fax
hongkong@YSI.com

YSI (Qingdao) Limited
86.532.389.6648
86.532.389.6647 fax
china@YSI.com

YSI/Nanotech (Japan)
81.44.222.0009
81.44.221.1102 fax
nanotech@YSI.com

www.YSI.com

©2006 YSI Incorporated

A605226F
605226
March 2007