

Systems

Input/Output Configuration Program User's Guide and Reference

MVS/System Product:

JES2 Version 1 5740-XYS

JES3 Version 1 5740-XYN

JES2 Version 2 5740-XC6

JES3 Version 2 5665-291

VM/System Product, 5664-167

VM/System Product High

Performance Option, 5664-173

VM/Extended Architecture

Systems Facility, 5664-169

3081 Processor Complex

3083 Processor Complex

3084 Processor Complex

9081 Processor Complex

9083 Processor Complex

The IBM logo, consisting of the letters "IBM" in a bold, sans-serif font with horizontal stripes through the letters.

Sixth Edition (October, 1985)

This is a major revision of, and obsoletes GC28-1027-4. See the Summary of Amendments following the Contents for a summary of the changes made to this manual.

This edition applies to:

- MVS/System Product Version 1 (Program Numbers 5740-XYS and 5740-XYN)
- MVS/System Product Version 2 (Program Numbers 5740-XC6 and 5665-291)
- VM/System Product (Program Number 5664-167)
- VM/System Product High Performance Option (Program Number 5664-173)
- VM/Extended Architecture (VM/XA) Systems Facility (Program Number 5664-169)
- The stand-alone version of IOCP in support of the 3081, 3083, 3084, 9081, and 9083 Processor Complexes

This edition also applies to all subsequent releases until otherwise indicated in new editions or Technical Newsletters. Changes are continually made to the information herein; before using this publication in connection with the operation of IBM systems, consult the latest *IBM System/370 Bibliography*, GC20-0001, for the editions that are applicable and current.

References in this publication to IBM products, programs, or services do not imply that IBM intends to make these available in all countries in which IBM operates. Any reference to an IBM program product in this publication is not intended to state or imply that only IBM's program product may be used. Any functionally equivalent program may be used instead.

Publications are not stocked at the address given below. Requests for IBM publications should be made to your IBM representative or the IBM branch office serving your locality.

A form for reader's comments is provided at the back of this publication. If the form has been removed, comments may be addressed to IBM Corporation, Information Development, Department D58, Building 921-2, PO Box 390, Poughkeepsie, N.Y. 12602. IBM may use or distribute whatever information you supply in any way it believes appropriate without incurring any obligation to you.

Note to all users:

All options and values that were valid on the JCL EXEC statement, the IOCP command, and the menu screens in previous levels of IOCP are still valid.

If your processor complex has only two I/O configuration data sets, the following changes apply throughout this manual:

- There are only two I/O configuration data sets, the LVL0 IOCDS and the LVL1 IOCDS. When the manual refers to the A0 IOCDS, this is the LVL0 IOCDS; the A1 IOCDS is the LVL1 IOCDS. Ignore all references to an A2, A3, and B side (B0, B1, B2, and B3) IOCDS and to any options that contain AB (such as WRTCDS = ABx).
- IOCP can write only to the LVL1 IOCDS.
- You select the active IOCDS and do a power-on reset from the CONFIG (SYS020) frame. Action A3 on the CONFIG frame switches the LVL0 and LVL1 IOCDS. Ignore all references to the IOCDSM (SYS021) frame.

If your processor complex does not have a B side, ignore all references to the B side throughout the manual. This includes ignoring all references to:

- The B0, B1, B2, and B3 IOCDS
- Options that contain AB (such as WRTCDS = ABx)
- Processors 1 and 3
- Channel paths 40 through 47, 50 through 57, and 60 through 67

If you have a 3084 Processor Complex, it must be configured as a multiprocessor for the options that contain AB (for example REPORT = AB) to be executed. B side options cannot be executed on the A side of a physically partitioned 3084 Processor Complex; while A side options cannot be executed on the B side of a physically partitioned 3084 Processor Complex.

Preface

This publication is intended for system programmers and customer engineers who are responsible for defining, installing, and configuring the channels, control units, and I/O devices on the processor complexes listed on the cover of this manual. It assumes the reader has a knowledge of the appropriate processor complex and the characteristics of its I/O resources.

Note that where the term “processor complex” appears in this manual, all the processor complexes listed on the cover are implied, unless an exception is explicitly made at that point in the text. The term “uniprocessor” in this manual refers to a processor complex that physically contains only one processor.

The input/output configuration program (IOCP) is used to define I/O configuration data required by the processor complex to control I/O requests. This publication does not include information on how to configure I/O resources, only on how to define the configuration via IOCP.

This publication describes the MVS version, the VM version,¹ and the stand-alone version of IOCP. Chapters 1, 5, and 6, and the appendixes contain information for all versions of IOCP. Chapter 2 contains information for the MVS version, Chapter 3 contains information for the VM version, and Chapter 4 contains information for the stand-alone version.

The chapters and appendixes are:

Chapter 1. Introduction - presents an overview of the input/output configuration program (IOCP) and the I/O configuration process.

Chapter 2. Executing the MVS Version of IOCP - describes how to code IOCP macro instructions and how to execute IOCP under control of the MVS system control program (MVS/370 or MVS/XA).

Chapter 3. Executing the VM Version of IOCP - describes how to code IOCP macro instructions and how to execute IOCP under control of the VM/SP, the VM/SP High Performance Option or the VM/XA Systems Facility system control program.

Chapter 4. Executing the Stand-Alone Version of IOCP - describes how to execute IOCP from the system console or the service support console.

¹ “The VM version of IOCP” means that version of IOCP that runs under all releases of the following operating systems: VM/System Product (5664-167), VM/System Product High Performance Option (5664-173), and the VM/Extended Architecture Systems Facility (VM/XA) (5664-169).

Chapter 5. IOCP Configuration Reports - shows the configuration reports that IOCP produces.

Chapter 6. IOCP Messages - lists the messages (prefix ICP and DMSICP) that IOCP issues.

Appendix A. Coding IOCP Macro Instructions - describes the rules for coding IOCP macro instructions and the notation used in this book to illustrate the syntax of the macro instructions.

Appendix B. Listings of Macro Instruction Input - shows sample listings of IOCP input decks.

Appendix C. Characteristics of the I/O Interface Timeout Function- contains detailed information about the timeout function.

Appendix D. List of I/O Devices and Control Units - shows the IOCP parameter values that you specify on the IODEVICE and CNTLUNIT macro instructions.

Glossary of Terms and Abbreviations - defines some terms and abbreviations used in this book.

Related Publications

The following publications contain information for topics related to IOCP.

Processor Complexes

IBM System/370 Input/Output Configurator, GA22-7002, lists the devices available on the System/370 processors.

IBM 3081 Functional Characteristics, GA22-7076, provides an overview of the 3081 Processor Complex.

IBM 3083 Functional Characteristics, GA22-7083, provides an overview of the 3083 Processor Complex.

IBM 3084 Functional Characteristics, GA22-7088, provides an overview of the 3084 Processor Complex.

IBM 3081 and 3083 Channel Characteristics and Configuration Guide, GA22-7077, provides information about channel operations and guidelines for configuring channel loads.

IBM 3081 Operator's Guide for the System Console, GC38-0034, describes how to operate the 3081 Processor Complex.

IBM 3083 Operator's Guide for the System Console, GC38-0036, describes how to operate the 3083 Processor Complex.

IBM 3084 Operator's Guide for the System Console, GC38-0037, describes how to operate the 3084 Processor Complex.

IBM 3081, 3083, and 3084 Messages for the System Console, GC38-0035, lists and defines the messages that are displayed during operation of the system console.

IBM 9081 and 9083 RPQ Information Supplement, GL22-7086, is a supplement for the 9081 and 9083 Processor Complexes to *IBM 3083 Functional Characteristics* and *IBM 3081 and 3083 Channel Characteristics and Configuration Guide*.

IBM 9081 and 9083 RPQ Operator Information Supplement, GL22-7087, is a supplement for the 9081 and 9083 Processor Complexes to *IBM 3083 Operator's Guide for System Console* and *IBM 3081, 3083 and 3084 Messages for System Console*.

MVS/370

OS/VS2 MVS/System Product General Information Manual, GC28-1025, describes the MVS system requirements for MVS/System Product Version 1 (Program Numbers 5740-XYS and 5740-XYN).

OS/VS2 System Programming Library: System Generation Reference, GC26-3792, provides information necessary to install an MVS/370 system control program.

OS/VS2 MVS JCL, GC28-0692, contains the information necessary to code MVS/370 job control language statements.

MVS/XA

MVS/System Product Version 2 General Information Manual, GC28-1118, describes the MVS system requirements for MVS/System Product Version 2 (Program Numbers 5740-XC6 and 5665-291).

Data Facility Product: General Information, GC26-4007, (Program Number 5665-0284) describes the system generation requirements for MVS/System Product Version 2.

MVS/Extended Architecture System Generation Reference, GC26-4009, provides information necessary to install an MVS/XA system control program.

MVS/Extended Architecture Job Control Language (JCL), GC28-1148, contains the information necessary to code MVS/XA job control language statements.

VM/SP

IBM Virtual Machine/System Product General Information, GC20-1838, describes the features of the IBM Virtual Machine/System Product (VM/SP) Program Product and includes a list of devices supported by VM/SP.

IBM Virtual Machine/System Product: Planning Guide and Reference, SC19-6201, describes information about generating a VM/SP system on a processor complex.

IBM Virtual Machine/System Product: Installation Guide SC24-5237, provides procedural information about the VM/SP installation process.

IBM Virtual Machine/System Product: System Programmer's Guide, SC19-6203, describes the DIAGNOSE X'80' instruction, which is the CP (control program) interface that allows you to read from and write to the I/O configuration data sets in the processor controller.

VM/SP High Performance Option (VM/SP HPO)

IBM Virtual Machine/System Product High Performance Option General Information Manual, GC19-6221, describes the features of the VM/SP HPO Program Product and includes a list of devices supported by VM/SP HPO.

IBM Virtual Machine/System Product High Performance Option: Planning and System Generation Guide, SC19-6223, describes information about generating a VM/SP HPO system on a processor complex.

IBM Virtual Machine/System Product High Performance Option: System Programmer's Guide, SC19-6224, describes the DIAGNOSE X'80' instruction, which is the CP (control program) interface that allows you to read from and write to the I/O configuration data sets in the processor controller.

VM/XA Systems Facility

Virtual Machine/Extended Architecture Systems Facility General Information Manual, GC19-6213, describes the features of the VM/XA Systems Facility.

Virtual Machine/Extended Architecture Systems Facility: Installation, Administration, and Service, SC19-6217, describes information about generating a VM/XA system on a processor complex.



Contents

Chapter 1. Introduction	1-1
I/O Configuration Process	1-4
Card-Image Input to IOCP	1-4
Console Input to IOCP	1-4
I/O Configuration Data Sets	1-4
Levels of the IOCDS	1-6
Compatibility Considerations	1-7
370-XA Mode	1-7
Logical Control Units	1-8
Channel Path Selection	1-13
Preferred Path	1-13
Rotation Algorithm	1-14
Device Address	1-15
Device Number	1-16
Control Unit Types	1-17
Versions of IOCP	1-18
Overview of the MVS Version of IOCP	1-18
IOCP and MVS System Generation	1-18
Overview of the VM Version of IOCP	1-21
IOCP and System Generation of a VM Operating System	1-21
Overview of the Stand-Alone Version of IOCP	1-23
Chapter 2. Executing the MVS Version of IOCP	2-1
Specifying IOCP Macro Instructions	2-1
Summary of I/O Configuration Rules	2-4
CHPID	2-6
CNTLUNIT	2-10
ID	2-15
IODEVICE	2-16
Generating an IOCDS	2-23
Coding the JCL EXEC Statement for Generating an IOCDS	2-24
JCL Examples of Generating an IOCDS	2-27
Producing Configuration Reports	2-28
Coding the JCL EXEC Statement for Producing Configuration Reports	2-28
Conditions for Coding the REPORT Option	2-29
JCL Example of Producing Configuration Reports	2-30
Return Codes	2-30
Methods of Executing the MVS Version of IOCP	2-31
Initial Definition of I/O Configuration Data	2-31
Subsequent Definition and Replacement of I/O Configuration Data	2-32
Chapter 3. Executing the VM Version of IOCP	3-1
Specifying IOCP Macro Instructions	3-1

IOCP and VM/SP (or VM/SP HPO) System Generation	3-2
IOCP and VM/XA Systems Facility System Generation	3-4
Summary of Configuration Rules	3-5
CHPID	3-7
CNTLUNIT	3-10
ID	3-16
IODEVICE	3-17
IOCP Functions	3-27
Generating an IOCDS	3-27
Producing Configuration Reports	3-29
The IOCP Command	3-30
IOCP Command General Usage Notes	3-37
IOCP Command Usage Notes for VM/SP and VM/SP HPO	3-38
IOCP Command Usage Notes for the VM/XA Systems Facility	3-39
Examples of Generating an IOCDS	3-42
Examples of Producing a Configuration Report	3-43
Return Codes	3-44
Methods of Executing the VM Version of IOCP	3-45
Initial Definition of I/O Configuration Data	3-45
Subsequent Definition and Replacement of I/O Configuration Data	3-46
Chapter 4. Executing the Stand-Alone Version of IOCP	4-1
Guide to Using the Stand-Alone Version of IOCP	4-2
Starting and Ending IOCP	4-3
Layout of the Menu Screens	4-5
Screen Commands	4-6
Menu Screens	4-7
Primary Menu	4-7
Display Selection	4-9
Add Selection	4-10
Alter Selection	4-11
Delete Selection	4-12
Channel Path Display	4-13
Add Channel Path	4-14
Alter Channel Path	4-15
Control Unit Display	4-16
Add Control Unit	4-17
Alter Control Unit	4-18
I/O Device Display	4-19
Add I/O Device	4-20
Alter I/O Device	4-21
Build IOCDS from Cards	4-22
Print IOCDS Configuration Reports with Service Aid Facility	4-24
Service Aid Facility	4-24
Read IOCDS from the Processor Controller File	4-26
Write IOCDS to the Processor Controller File	4-28
End IOCP	4-30
Methods of Executing the Stand-Alone Version of IOCP	4-31
Generating an IOCDS on a New Processor Complex	4-31
Replacing an IOCDS by Using Card-Image Input	4-33
Steps IOCP Performs to Build an IOCDS	4-35
Dumping IOCP Storage	4-37
IOCP Wait State Codes	4-39
Enabled Wait States	4-39

Disabled Wait States 4-39

Chapter 5. IOCP Configuration Reports 5-1

Conditions for Producing Reports 5-2

Configuration Report Headings 5-3

Chapter 6. IOCP Messages 6-1

IOCP Messages (ICP Prefix) 6-1

IOCP Messages (DMSICP Prefix) 6-53

Appendix A. Coding IOCP Macro Instructions A-1

Rules for Coding IOCP Macro Instructions A-1

Format and Coding Conventions A-2

Appendix B. Listings of Macro Instruction Input B-1

Appendix C. Characteristics of the I/O Interface Timeout Function C-1

Timeout Considerations C-3

Appendix D. List of I/O Devices and Control Units D-1

Glossary X-1

Index X-3



Figures

- 1-1. Channel Path Configuration for a non-3084 Processor Complex 1-2
- 1-2. Channel Path Configuration for a 3084 Processor Complex 1-3
- 1-3. Valid Logical Control Units 1-10
- 1-4. Invalid Logical Control Units 1-12
- 1-5. Channel Path Selection on a 3084 Processor Complex 1-15
- 1-6. MVS Version of IOCP - Overview 1-20
- 1-7. VM Version of IOCP - Overview 1-22
- 1-8. Stand-Alone Version of IOCP - Overview 1-24
- 2-1. Typical Combined Input Deck (IOCP and MVS System Generation) 2-3
- 3-1. Correspondence between IOCP Macro Instructions and DMKRIO Macro Instructions 3-3
- 3-2. Correspondence between IOCP Macro Instructions and HCPRIO Macro Instructions 3-4
- 4-1. Primary Menu Screen 4-8
- 4-2. Display Selection Screen 4-9
- 4-3. Add Selection Screen 4-10
- 4-4. Alter Selection Screen 4-11
- 4-5. Delete Selection Screen 4-12
- 4-6. Channel Path Display Screen 4-13
- 4-7. Add Channel Path Screen 4-14
- 4-8. Alter Channel Path Screen 4-15
- 4-9. Control Unit Display Screen 4-16
- 4-10. Add Control Unit Screen 4-17
- 4-11. Alter Control Unit Screen 4-18
- 4-12. I/O Device Display Screen 4-19
- 4-13. Add I/O Device Screen 4-20
- 4-14. Alter I/O Device Screen 4-21
- 4-15. Build IOCDS from Cards Screen 4-23
- 4-16. Print IOCDS Configuration Reports Screen 4-25
- 4-17. Read IOCDS from the Processor Controller File Screen 4-27
- 4-18. Write IOCDS to the Processor Controller File Screen 4-29
- 4-19. End IOCP Screen 4-30
- 5-1. Channel Path Identifier (CHPID) Summary Report 5-5
- 5-2. I/O Device Report 5-6
- 5-3. Logical Control Unit Report 5-9
- 5-4. Channel Path Identifier (CHPID) Report 5-12
- B-1. A Combined Input Deck (IOCP and MVS System Generation) B-2
- B-2. A Combined Input Deck Processed by IOCP B-7
- B-3. IOCP Macro Instruction Input B-9
- B-4. DMKRIO File for VM/SP and VM/SP HPO System Generation B-10
- B-5. HCPRIO File for VM/XA Systems Facility B-11
- D-1. IOCP Parameter Values for IODEVICE and CNTLUNIT Macro Instructions D-2



Summary of Amendments

Summary of Amendments for GC28-1027-5

Changes throughout this publication describe a new level of the input/output configuration program (IOCP) to support:

- A change in the VM IOCP command. The VM IOCP command now supports a processor option.
- An added step for starting the stand-alone version of IOCP.

There are also minor technical and editorial changes.

Summary of Amendments for GC28-1027-4

Changes throughout this publication describe a new level of the input/output configuration program (IOCP) to support the 3880 Model 21 device. There are also minor technical and editorial changes.

Summary of Amendments for GC28-1027-3

Changes throughout this publication describe a new level of the input/output configuration program (IOCP). The new level of IOCP is still referred to as a 370/370-XA level of IOCP, to distinguish it from the older levels that produced an IOCDS that could be used only in 370 mode. Changes throughout this publication also reflect support of IOCP by the Virtual Machine/Extended Architecture Migration Aid (VM/XA Migration Aid).

These changes include:

- The new level of IOCP supports the 9081 Processor Complex and the 3084 Processor Complex.
- A 3084 Processor Complex has two sides, called side A and side B. Each side has four I/O configuration data sets. The I/O configuration data sets on side A are called A0, A1, A2, and A3; on side B they are called B0, B1, B2, and B3. Except for the 3081 Model D Processor Complex, all of the other processor complexes listed on the cover of this manual have only side A and four I/O configuration data sets.
- The 3081 Model D Processor Complex has only a LVL0 and LVL1 IOCDS. (This is also true for any other processor complexes that are not at the engineering change (EC) level that supports four I/O configuration data sets.) IOCP can read either IOCDS, but can write only to the LVL1 IOCDS. The active IOCDS is selected on the CONFIG (SYS020) frame.
- IOCP can write to any IOCDS that is not write-protected, except on a processor complex with only two I/O configuration data sets. (You can write-protect an IOCDS or remove the write-protection by using the IOCDSM frame.)
- The active IOCDS is selected on the IOCDSM (SYS021) frame, except on a processor complex with only two I/O configuration data sets.
- There are new options on the JCL EXEC statement and the IOCP command for generating an IOCDS and producing reports.
- UNITADD is a new optional keyword on the IODEVICE macro instruction that allows you to assign a device number that does not contain the actual physical unit address of the device. The UNITADD parameter overrides the unit address (second and third digits) specified on the ADDRESS keyword.
- The I/O device report and the channel path identifier (CHPID) report have a new column called SIDE that indicates whether the I/O device or channel path identifier is on the A side or B side of the processor complex. (If you do not have a 3084 Processor Complex, everything is on the A side.)

- The term “VM/SP version of IOCP” was changed to “VM version of IOCP.” Note that where the term “VM version of IOCP” appears in this manual, it refers to that version of IOCP that runs under all releases of the following operating systems: VM/System Product (5664-167), VM/System Product High Performance Option (5664-173), and the VM/Extended Architecture Migration Aid (VM/XA Migration Aid) (5664-169).
- References to VM/SP and VM/SP HPO are expanded to include the VM/XA Migration Aid, where appropriate.
- References to VM/XA Migration Aid publications are added, where appropriate.
- Examples showing the correspondence between VM/XA Migration Aid real I/O configuration macro instructions (contained in the HCPRIO file) and the IOCP source file macro instructions are added.
- A sample HCPRIO file is added to Appendix B.
- The IOCP command usage notes were restructured to show the differences between running IOCP under VM/SP or VM/SP HPO and running it under the VM/XA Migration Aid.
- Some descriptions of IOCP command options, IOCP return codes, and IOCP command examples were expanded.
- Minor technical and editorial changes.



Chapter 1. Introduction

In the processor complex¹ the channel subsystem, which controls channel operations, requires specific data about the hardware I/O configuration.

To define the I/O configuration for the channel subsystem, you execute the input/output configuration program (IOCP). Required in this definition are the:

- Channel paths on the processor complex
- Control units attached to the channel paths
- I/O devices assigned to the control units

To meet your changing I/O requirements, you can replace an existing I/O configuration with a new configuration by executing IOCP.

Figure 1-1 and Figure 1-2 show the processors and channel paths that are available on each side of a processor complex. All of the processor complexes have side A. Side A may consist of processors 0 and 2 and channel paths 00 through 07, 10 through 17, and 20 through 27. (A uniprocessor has only processor 2.) If the processor complex has both side A and side B, side B consists of processors 1 and 3 and channel paths 40 through 47, 50 through 57, and 60 through 67.

The control units and I/O devices attached to the channel paths complete the channel subsystem. You must use IOCP to define all control units and I/O devices that attach to the processor complex.

See the *IBM System/370 Input/Output Configurator* for the control units and I/O devices available. Your operating system may not support all the devices IOCP supports.

¹ Note that where the term “processor complex” appears in this manual, the term implies all the processor complexes listed on the cover of this manual, unless at that point, the text makes an explicit exception.

This chapter presents an overview of the following topics:

- I/O configuration process
- Input/output configuration data set (IOCDs)
- IOCP changes for 370-XA mode
- Versions of IOCP (MVS, VM,² and stand-alone)

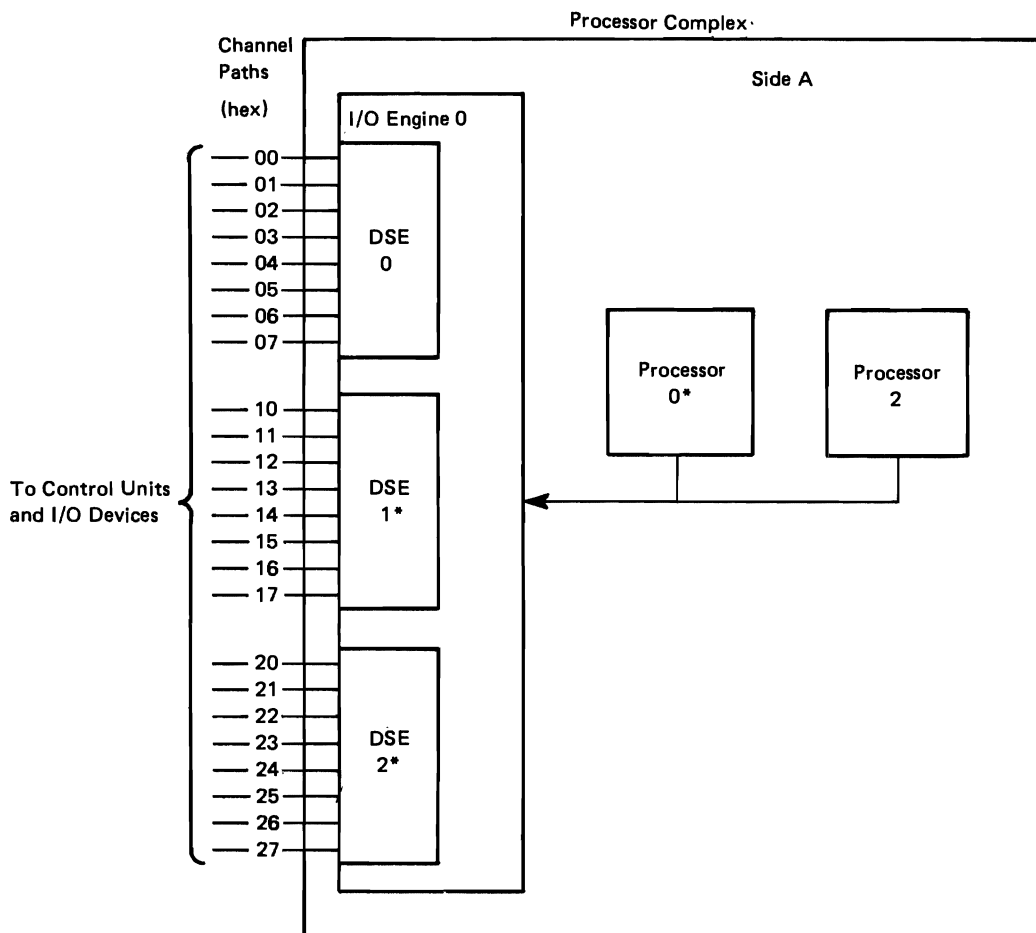

Legend:

- * Optional by model
- DSE — Data server element

Figure 1-1. Channel Path Configuration for a non-3084 Processor Complex

² “The VM version of IOCP” means that version of IOCP that runs under all releases of the following operating systems: VM/System Product (5664-167), VM/System Product High Performance Option (5664-173), and the VM/Extended Architecture (VM/XA) Systems Facility (5664-169).

Figure 1-2. Channel Path Configuration for a 3084 Processor Complex

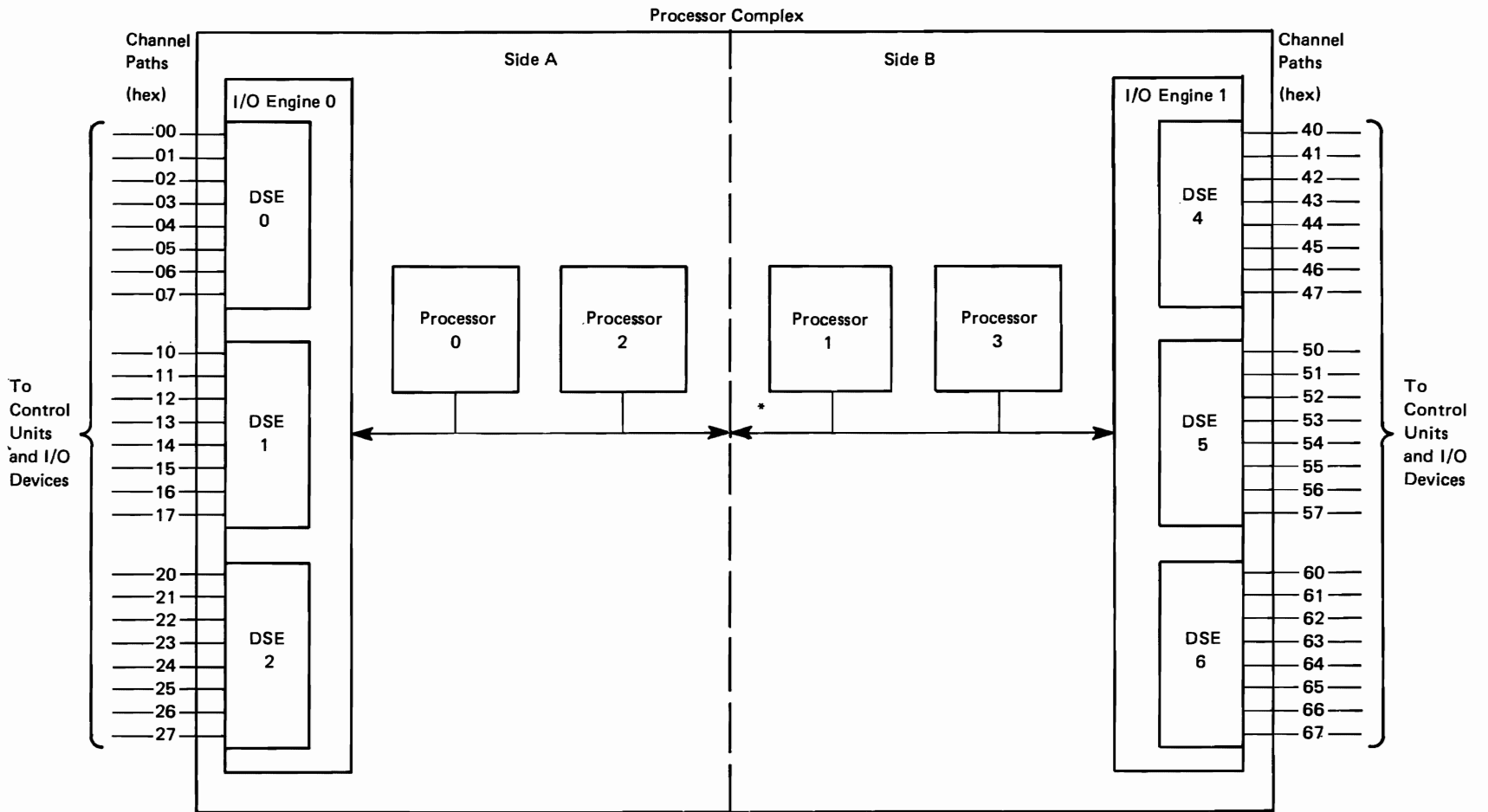

Legend:

- * If the processor complex is partitioned, Side A and Side B are independent of each other.
- DSE — Data server element

I/O Configuration Process

You specify I/O configuration data to IOCP in either of two ways: coding the data on card-image macro instructions read from an input device, or entering the data from the system console or service support console. In either situation, IOCP performs the same process to build a configuration definition in storage and to write reports. IOCP stores the data in an input/output configuration data set (IOCDS) on the processor controller file in the processor controller for use by the channel subsystem.

Card-Image Input to IOCP

You code the following card-image macro instructions and use them to define your I/O configuration data when you execute (1) the MVS version of IOCP, (2) the VM version of IOCP, or (3) the stand-alone version of IOCP with the card-image option. When IOCP processes these macro instructions, it also produces reports that allow you to check the configuration.

Macro Instruction	Description
ID	An optional macro instruction that specifies identification information printed in the heading of IOCP configuration reports. It is also the source of the customer name for the IOCDS on the IOCDSM frame.
CHPID	A required macro instruction that specifies the channel paths installed on the processor complex.
CNTLUNIT	A required macro instruction that specifies the control units attached to channel paths.
IODEVICE	A required macro instruction that specifies the I/O devices assigned to control units.

“Specifying IOCP Macro Instructions” in Chapter 2 (MVS) and Chapter 3 (VM) fully describes the IOCP macro instructions

Console Input to IOCP

When you execute the stand-alone version of IOCP, IOCP displays menus on the display screen of the system console or the service support console. On the screen, you enter I/O configuration data and IOCP screen commands to control the functions of IOCP. For a full description of the stand-alone version of IOCP, see “Chapter 4. Executing the Stand-Alone Version of IOCP.”

I/O Configuration Data Sets

Each side of the processor complex has four input/output configuration data sets for storing I/O configuration data. On the A side, the IOCDS names are A0, A1, A2, and A3. On the B side, the IOCDS names are B0, B1, B2, and B3. The data sets reside on an integrated processor controller file in the processor complex. Each IOCDS consists of 256-byte records (sectors) containing I/O configuration data. The channel subsystem uses the I/O configuration data to control I/O

requests. Each side provides four I/O configuration data sets to allow you to define and test new configurations without affecting an existing configuration.

IOCP processes your definitions of channel paths, control units, and I/O devices in a working area of main storage named IOCDS. When you request, and if IOCP has found no errors, IOCP writes the IOCDS generated in storage to an IOCDS in the processor controller.

IOCP accesses and transforms the configuration data in the IOCDS to a data format that the microcode in the channel subsystem uses when you perform either of the following actions:

- A power-on reset -- action A2 on the CONFIG (SYS020) frame
- The SYSIML CLEAR function -- action O8 on the OPRCTL (CC-010 or CC/010) frame

(For more information, see the operator's guide for the system console that applies to your processor complex.) The channel subsystem controls I/O requests using the configuration data from the IOCDS specified for the power-on reset.

IOCP can read from any IOCDS (for example, to produce reports). However, IOCP can write only to an IOCDS not write-protected.

You can write-protect each IOCDS individually by using the IOCDSM (SYS021) frame. This restriction prevents you from accidentally using IOCP to write over and destroy the configuration data in an IOCDS. Before writing an IOCDS, you must use the IOCDSM frame and remove the write protection from that IOCDS. (For more information, see the operator's guide for the system console that applies to your processor complex.)

When defining a new configuration, you can:

- Use the configuration in an existing IOCDS as your operating configuration.
- Execute IOCP to generate and write a new I/O configuration to another IOCDS.
- Perform a power-on reset and use the new configuration to test the system.
- After successful testing, you can write-protect the new IOCDS by using the IOCDSM (SYS021) frame.

If your processor complex has only two I/O configuration data sets (LVL0 and LVL1), switch the LVL0 and LVL1 IOCDS after successful testing by using the CONFIG (SYS020) frame. The newly tested configuration now resides in the LVL0 IOCDS and the previous configuration resides in the LVL1 IOCDS. The LVL1 IOCDS provides a backup. You can use the LVL1 IOCDS to test another new configuration.

Notes:

- 1. If you partition a processor complex with an A and B side, you can use an IOCDS that has I/O configuration data for both the A and B sides. However, the processors cannot access control units and devices attached only to channel paths on the other side.*
- 2. If available during the installation of the new processor complex, the CE uses a card-image input deck containing IOCP macro instructions (prepared and checked by the installation) to configure the processor complex. The CE then tests the processor complex using the configuration supplied by the installation. The methods of execution in Chapter 2 (MVS), Chapter 3 (VM), and Chapter 4 (stand-alone) describe the steps that the CE and the installation perform to define configuration data.*
- 3. If your processor complex has an A and B side, you should define critical configurations on both A and B side IOCDS(s).*

Levels of the IOCDS

The processor complex can operate in either 370 mode or 370-XA mode. You select the mode on the CONFIG (SYS020) frame. Power-on reset sets the mode.

In 370 mode, the processor complex operates in accordance with System/370 architecture, the hardware architecture that the processor complex shares with other IBM processors, such as the IBM 303x processors and the IBM 4300 processors. One major characteristic of 370 mode is 24-bit addressing.

In 370-XA mode, the processor complex operates in accordance with System/370 Extended Architecture. Two main characteristics of 370-XA mode are 31-bit addressing and the use of a channel subsystem to direct the flow of information between I/O devices and main storage.

This book describes the 370/370-XA level of IOCP, which creates an IOCDS that either 370 mode or 370-XA mode can use (a 370/370-XA IOCDS). Some previous levels of IOCP (370 IOCP) created an IOCDS for use only in 370 mode (a 370 IOCDS). A 370/370-XA IOCP creates a 370/370-XA IOCDS regardless of the mode of the processor complex at power-on reset.

A processor complex can use a 370/370-XA IOCDS in either 370 mode or 370-XA mode. If you do not specify the channel number and channel set for a channel path on the CHPID macro instruction, the processor complex cannot access the devices on that channel path when operating in 370 mode.

Most of the information on the IOCP macro instructions applies to both 370 mode and 370-XA mode. When the processor complex operates in 370-XA mode, it ignores information valid only for 370 mode. Similarly, when the processor complex operates in 370 mode, it ignores information valid only for 370-XA mode.

Compatibility Considerations

Before you can initialize a processor complex (by a power-on reset) in 370-XA mode, IOCP must generate a 370/370-XA IOCDS. The IOCP generation process requires as input an I/O configuration deck containing IOCP macro instructions. (You can use a combined input deck containing both IOCP and MVS system generation macro instructions. None of IBM's VM operating systems allow a combined deck.) To generate a 370/370-XA IOCDS, you can use the 370/370-XA level of the stand-alone version of IOCP. You can also generate a 370/370-XA IOCDS by running the 370/370-XA level of IOCP under the control of MVS/370, MVS/XA, VM/SP, VM/SP HPO, or the VM/XA Systems Facility.

A 370 IOCDS does not support the operation of a processor complex in 370-XA mode. You cannot use a 370 level IOCP to read or produce reports of a 370/370-XA IOCDS. (You also cannot use an older level 370/370-XA IOCP to read or produce reports of a 370/370-XA IOCDS produced by a newer level 370/370-XA IOCP.) If you attempt this operation, the system issues message ICP404I, indicating that the level of the IOCDS directory is invalid.

Note: I/O configurations that are valid in 370 mode may be invalid in 370-XA mode. It is important to fully understand the concepts and requirements of logical control units. If the requirements for logical control units have not been met, it may be necessary to physically reconfigure a system. You must review the current configuration to insure that the configuration is valid for 370-XA mode. This is necessary even when running in 370 mode.

370-XA Mode

To create a 370/370-XA level IOCDS, you can use without change macro instructions coded to create a 370 level IOCDS. MVS/XA or the VM/XA Systems Facility might not support all of the defined devices. See *MVS/Extended Architecture System Generation Reference* or the *Virtual Machine/Extended Architecture Systems Facility: Installation, Administration and Service*. Although you can use the same macro instructions, you might consider making the following changes:

- If there are channel paths and attached devices that you want to access only in 370-XA mode, remove the channel number and channel set for those channel paths from the CHPID macro instruction(s). IOCP requires a channel number and channel set only if you will access the channel path and its attached devices in 370 mode.
- To use the preferred path in 370-XA mode, code the PATH parameter on the IODEVICE macro instruction. The channel subsystem attempts to use the preferred path to initiate I/O requests. The PATH parameter is optional and applies only to 370-XA mode. The processor complex ignores the preferred path in 370 mode.

Notes:

1. *You can use, without change, the macro instructions coded for the 370 level of IOCP to create an IOCDS for 370-XA mode operation. However, you must generate a new 370/370-XA IOCDS (with a 370/370-XA level of IOCP) before a processor complex can operate in 370-XA mode.*
2. *For an MVS/370 system generation if you specified the PATH or UNITADD parameter the IODEVICE macro instruction, you cannot use a combined input deck (IOCP and MVS system generation macro instructions).*
3. *If you use the PATH parameter or the UNITADD parameter on an IODEVICE macro instruction, you must use a 370/370-XA IOCP to test an IOCP input deck in 370 mode.*
4. *MVS/370, VM/SP, and VM/SP HPO do not support operation of the processor complex in 370-XA mode.*

The 370/370-XA IOCP produces reports that are different from the reports produced by a 370 IOCP. Some of the new terms that appear in the reports and that 370-XA mode uses are:

- Logical control units
- Preferred path
- Rotation algorithm
- Device number
- Control unit type

Logical Control Units

For 370-XA mode, the channel subsystem uses logical control units to represent a set of physical control units that physically or logically attach I/O devices in common. For example, the channel subsystem uses the logical control unit to establish a queue for I/O requests for the devices associated with the attaching physical control units and to establish a channel path selection order for the attaching channel paths.

IOCP builds logical control units from the information specified on the CNTLUNIT macro instructions. If a device attaches to more than one physical control unit, then those control units will form part of (or the whole of) a logical control unit. IOCP builds a logical control unit for:

- Each control unit with no devices or no devices shared with other control units.

Note: Logical control units with no devices are listed at the end of the logical control unit report. The user should verify that the report accurately describes the user's configuration.

- Each group of two to four control units that share devices between them.

As it builds each logical control unit, IOCP assigns a unique hexadecimal identifier to the logical control unit. It also ensures that the logical control unit is valid, that it does not violate any of the following restrictions:

- Maximum of four channel paths per system can attach to one logical control unit.
- Each occurrence of a channel path counts as one channel path.
- Maximum of four physical control units in one logical control unit.
- A physical control unit can belong to only one logical control unit.
- Physical control units within a logical control unit must all have the same characteristics (SHARED = Y, YB, or N; PROTOCL = D or S).
- Maximum of 256 logical control units per system.

Figure 1-3 shows examples of valid logical control units.

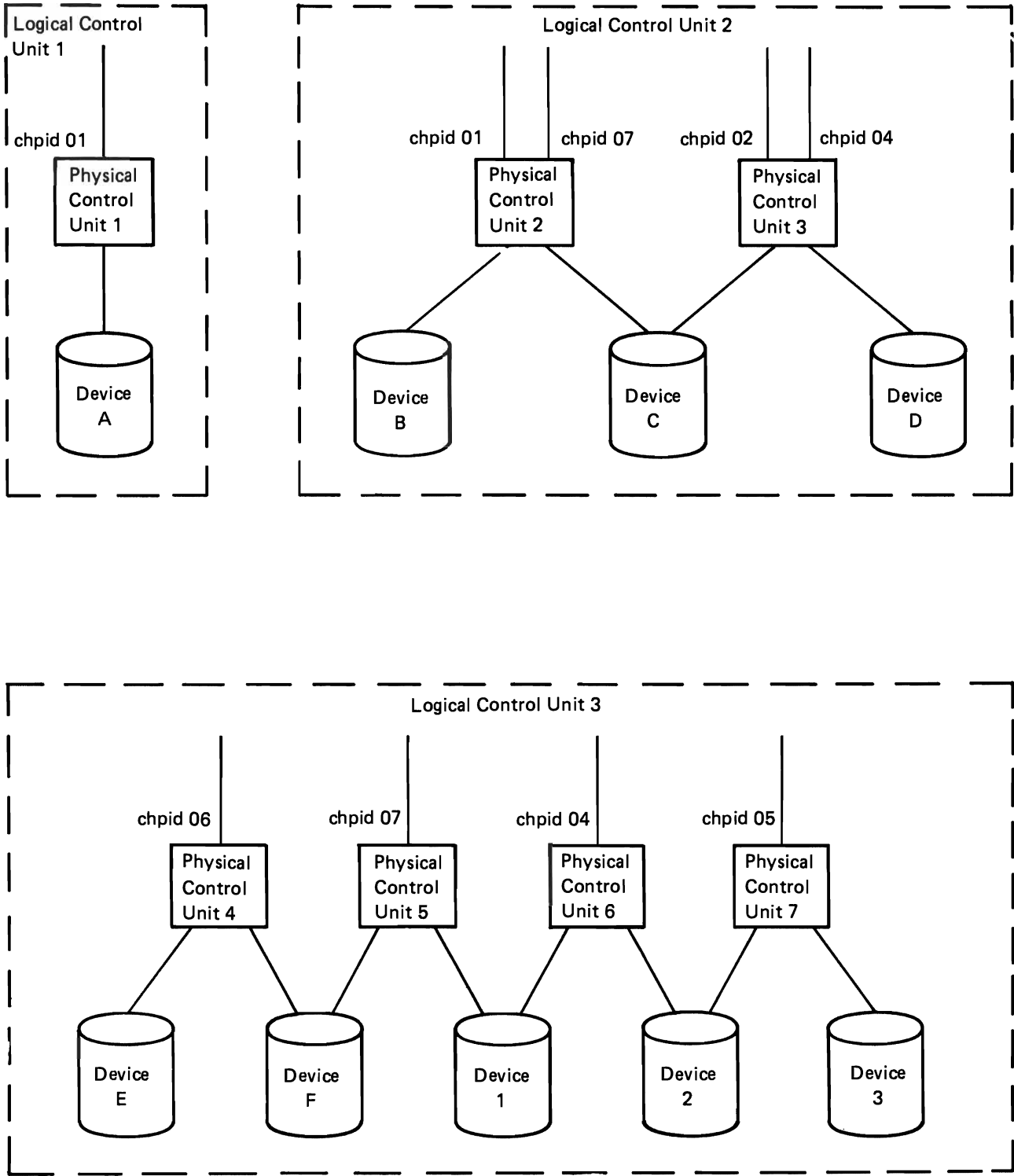

Figure 1-3. Valid Logical Control Units

Figure 1-4 shows examples of invalid logical control units.

Logical control unit 5 is invalid because the control units have a combined total of more than four channel paths. Logical control unit 3 in Figure 1-3 would become invalid if you attached another physical control unit to any of the devices in the logical control unit.

Logical control unit 6 is invalid also because the combined total of channel paths is six and the maximum permitted is four. (Each occurrence of a channel path counts as one channel path.)

The logical control unit report (See “Chapter 5. IOCP Configuration Reports”) describes the logical control unit structure. If it detects any invalid logical control units, IOCP issues error messages.

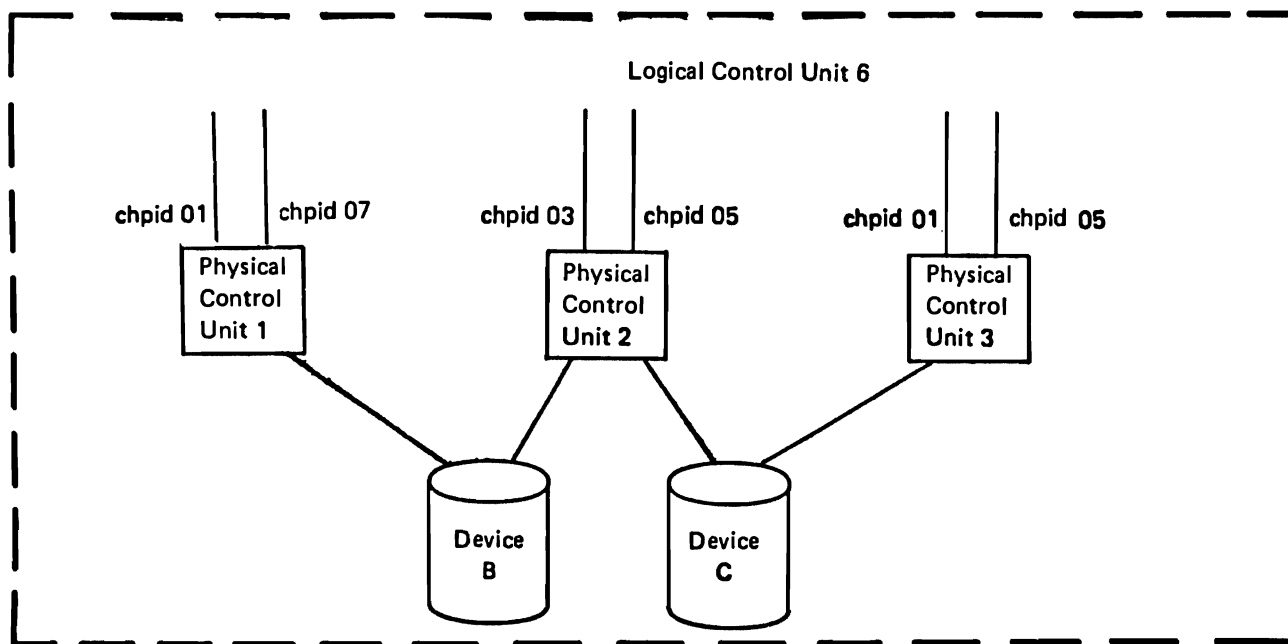
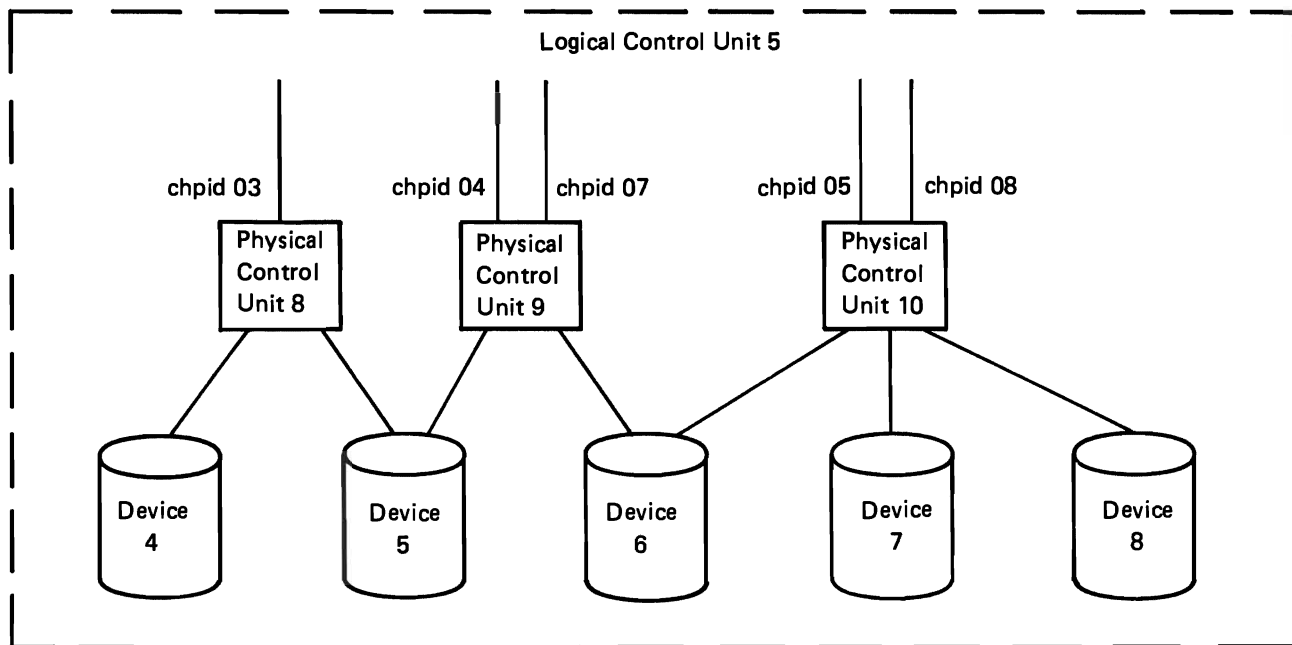

Figure 1-4. Invalid Logical Control Units

Channel Path Selection

In 370-XA mode, the channel subsystem attempts to use the preferred path, if specified, for the initiation of I/O requests. If the preferred path is busy or is not specified, the channel subsystem uses the rotation algorithm (for the associated logical control unit) to initiate I/O requests.

Preferred Path

The optional PATH parameter on the IODEVICE macro instruction and the ADD and the ALTER I/O device screens allows you to specify a preferred path for 370-XA mode. When the processor complex is operating in 370 mode, the channel subsystem ignores the preferred path. When the processor complex is operating in 370-XA mode, the channel subsystem attempts to use the preferred path to initiate I/O requests. The channel subsystem tries to initiate every I/O request for the desired device using the preferred channel path first (before it attempts to initiate the request on other attaching channel paths, if any exist).

If the channel subsystem cannot initiate the I/O request on the preferred path either because of a busy condition or because the channel path, control unit, or device is already known to be busy, the channel subsystem tries to initiate the request on the other attaching channel paths.

If no preferred channel path is specified, the channel subsystem uses the rotation algorithm to initiate I/O requests associated with the device's logical control unit. The channel subsystem attempts to initiate each new I/O request using a channel path rotation algorithm. For example, if you attach a device to four channel paths, the channel subsystem tries to initiate the first I/O request on the first channel path, the second request on the second channel path, the fifth request on the first channel path, and so forth.

The preferred channel path parameter is useful in controlling the path selection logic of the channel subsystem to minimize contention for a device. For example, consider the following configuration:

- Two strings of DASDs (0-7 and 8-F), each attached to two 3830 control units (A and B).
- Control unit A attaches to channel path 01 and control unit B attaches to channel path 02.

In this configuration, the channel subsystem is capable of initiating I/O requests to any of the devices from either of the two attaching channel paths. You can use the preferred path to minimize string busy conditions that the channel subsystem might encounter as it tries to initiate requests for the devices. By defining each string of devices with a different preferred channel path (for devices 0-7, specify PATH=01; for devices 8-F, specify PATH=02), you minimize the device busy conditions.

Rotation Algorithm

Each logical control unit has one to four channel paths. IOCP establishes a channel path rotation order for the initiation of I/O requests when the processor is operating in 370-XA mode. You can affect the rotation by changing the order of the channel path identifiers on the CNTLUNIT macro instructions.

To establish the rotation order, IOCP checks the control units within the logical control unit in ascending order of control unit numbers (specified on the CNTLUNIT macro instructions). IOCP takes the first user-entered channel path (on the CNTLUNIT macro instruction) from each control unit. IOCP then repeatedly checks the control units in ascending order. Each time, IOCP takes the next user-entered channel path, if there is one, until it orders all the channel paths in the logical control unit.

Logical control unit 2 in Figure 1-3 shows an example of how specifying the paths in a logical control unit can affect the path rotation order. If you specify PATH=(01,07) on the CNTLUNIT macro instruction for physical control unit 2, and PATH=(02,04) for physical control unit 3, the rotation order is 01, 02, 07, 04. However, if you specify PATH=(07,01) on the CNTLUNIT macro instruction for control unit 2, and PATH=(02,04) for control unit 3, the rotation order is 07, 02, 01, 04.

The channel subsystem attempts to initiate each new I/O request on a rotating channel path basis. If a device has a preferred path, the channel subsystem always tries the preferred path first, the channel path following the preferred path in the rotation order next, and so forth.

If a device does not have a preferred path, the channel subsystem first tries the next channel path in the rotation order following the last channel path used for an I/O request to a device in that logical control unit. If the first channel path tried is busy, the channel subsystem continues in the established rotation order.

Note: The same channel path connected to more than one control unit in the same logical control unit, appears only once in the rotation order. IOCP removes duplicate channel path identifiers from the logical control unit provided that the total number was 4 or less.

Channel Path Selection on a 3084 Processor Complex: On a 3084 Processor Complex with both sides configured, each side has its own rotation algorithm for channel path selection. Figure 1-5 shows an example of a device attached to two control units, with each control unit attached to a channel path on both the A side and the B side. If you specify PATH=(02,42) on the CNTLUNIT macro instruction for control unit 13, and PATH=(12,52) for control unit 14, the rotation order in the IOCDS for the logical control unit is 02, 12, 42, 52.

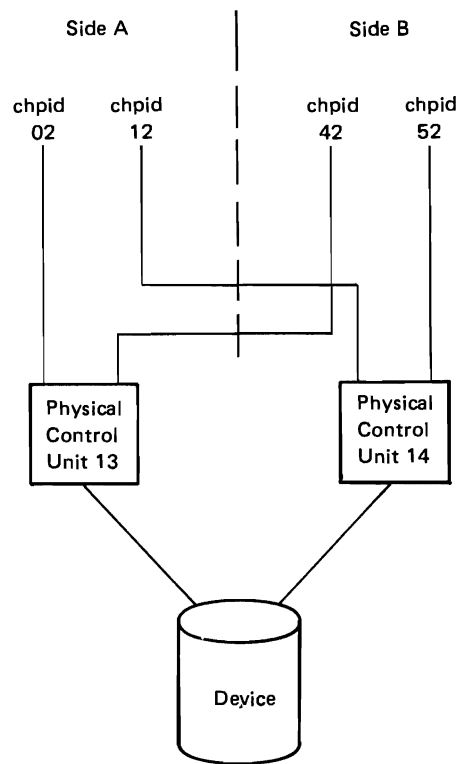

Figure 1-5. Channel Path Selection on a 3084 Processor Complex

If the device does not have a preferred path, or if the preferred path is busy, the channel subsystem tries the next channel path in the rotation order (for the logical control unit) that is on the side on which it attempts to initiate the I/O request. If the last channel path used is 02 on the A side and 42 on the B side, then 12 is the next channel path tried on the A side and 52 is the next channel path tried on the B side. It is unpredictable whether the channel subsystem will try channel path 12 or 52 next. It is even possible that the channel subsystem will try channel path 52, and then 42 next (before channel path 12) because the two sides are independent in their selection of channel paths.

Device Address

In 370 mode, a **device address** consists of three hexadecimal digits that uniquely identify an I/O device. (The device address is assigned in the ADDRESS parameter on the IODEVICE macro instruction and is a term used in 370 mode. The term device number is used in 370-XA mode.) The first digit of the device address must specify the channel number that corresponds to the lowest-numbered channel path assigned to the device (370-XA mode does not have this requirement). This channel path is the primary channel address for the device. The second and third digits specify the physical unit address of the device.

Device Number

In 370-XA mode, a **device number** uniquely identifies an I/O device. (The device number is assigned in the ADDRESS parameter on the IODEVICE macro instruction.) The device number consists of three hexadecimal digits that can be the same as the device address used in 370 mode. If you want to use the IOCDS *only* in 370-XA mode, you can choose the first digit of the device number arbitrarily, with the exception that MVS requires that the first digit must be the same for each device on a single control unit or for each DASD on a single string. The second and third digits are the physical unit address. If you want to use the same IOCDS for both 370 mode and 370-XA mode operation, you must specify the device numbers for 370-XA mode the same way you specify device addresses for 370 mode.

When defining an I/O configuration for 370-XA mode with a large number of I/O devices, there may be situations when it is difficult or undesirable to assign device numbers that contain the physical unit address of the device. You may find it is necessary to assign the same unit address to more than 16 devices each on a separate channel path. However, this is not possible using only the ADDRESS parameter because you are limited to one hexadecimal digit and device numbers must be unique.) For example, you wish to assign the unit address 'F0' to 20 devices. The devices would have the device numbers as follows: 1F0, 2F0, 3F0 FF0 (the sixteenth device). The remainder of the devices would have duplicate device numbers which is not permitted (device numbers must be unique).

When this occurs, you may want to use the UNITADD parameter on the IODEVICE macro instruction.

UNITADD is an optional parameter that allows you to assign a device number in the ADDRESS parameter on the IODEVICE macro instruction that does not have the actual physical unit address of the I/O device as the two rightmost digits of the device number. (The device number is the three hexadecimal digits specified in the ADDRESS parameter.) The channel subsystem uses the two hexadecimal digits that you specify on the UNITADD parameter to address the device rather than the unit address specified in the ADDRESS parameter. When you use the UNITADD parameter on the IODEVICE macro instruction the unit address (the two rightmost digits in the ADDRESS parameter) is not required to be the physical unit address. Because the channel subsystem uses the two digits specified in the UNITADD parameter to address the device, these two hexadecimal digits must be the the physical unit address of the I/O device.

Specify the UNITADD parameter on the IODEVICE macro instruction *only* for an IOCDS used exclusively for 370-XA mode operation. If you use the UNITADD parameter to create an IOCDS for both 370 mode and 370-XA mode operation, the device number for 370-XA mode will not be the same as the device address for 370 mode. They are not the same because the two hexadecimal digits you specify on the UNITADD parameter become the second and third digits of the device address. (The second and third digits of the device address must be the physical unit address of the device.)

Use the UNITADD parameter carefully. See Appendix D for the exceptions and recommendations that apply to specific device types.

Notes:

1. *The device number is always the three hexadecimal digits that you specify in the ADDRESS parameter of the IODEVICE macro instruction in 370-XA mode. (The UNITADD parameter does not change the device number.)*
2. *If you specify the UNITADD parameter on the IODEVICE macro instruction, these two digits become the physical unit address that the channel uses to address the selected control unit in both 370 mode and 370-XA mode.*
3. *If you use the UNITADD parameter on the IODEVICE macro instruction when you are operating in 370 mode the two digits specified in the UNITADD parameter replace the two rightmost digits specified in the ADDRESS parameter as the physical unit address. The UNITADD parameter on the IODEVICE macro instruction changes the device address. This changing of the device address (370 mode) could result in operational and serviceability problems.*

Control Unit Types

When defining a 370 mode I/O configuration, you use the SHARED parameter on the CNTLUNIT macro instruction to indicate whether the control unit allows shared or nonshared subchannels. With 370-XA architecture, shared subchannels do not exist. Every device has its own subchannel.

For 370-XA mode, IOCP defines control units as type 1 or type 2. Type 1 control units allow only a single channel program at any one time. Type 2 control units allow multiple channel programs concurrently. IOCP uses the SHARED parameter to determine the control unit type as follows:

- If the user specifies SHARED = Y or SHARED = YB, IOCP defines the control unit as type 1. The channel subsystem supports only one I/O request at a time (serializes).
- If the user specifies SHARED = N, IOCP assigns the control unit as type 2. The channel subsystem supports multiple requests.

You specify the SHARED parameter in the same way for both 370 mode and 370-XA mode.

Note: The processor complexes listed on the cover of this manual define control units as only type 1 and type 2. The processor complexes treat a type 3 control unit as a type 1. To define a type 3 control unit, specify SHARED = YB for 370 mode and SHARED = Y or SHARED = YB for 370-XA mode. *IBM System/360 and System/370 I/O Interface Channel to Control Unit Original Equipment Manufacturer's Information*, GA22-6974 define control unit types.

Versions of IOCP

There are three versions of IOCP: the MVS version, the VM version, and the stand-alone version.

Overview of the MVS Version of IOCP

The MVS version of IOCP runs as a job under control of MVS (MVS/370 or MVS/XA).

You invoke the MVS version of IOCP via MVS JCL statements. By coding options on the PARM parameter of the EXEC statement, you can request the following IOCP functions:

- Generating an IOCDS -- IOCP reads, validates, and checks the syntax of the input macro instructions. It generates an IOCDS in storage based on the configuration defined on the macro instructions and produces reports of the IOCDS generated in storage. When requested, IOCP writes the generated IOCDS to one or more IOCDS(s) in the processor controller.
- Producing Configuration Reports -- IOCP reads one or more IOCDS(s) from the processor controller into storage and prints the IOCP configuration reports. (See “Chapter 5. IOCP Configuration Reports” for examples.)

The MVS version of IOCP has an advantage over the stand-alone version; you may modify an IOCDS while other system operations continue. Then, at a convenient time, shut down MVS, power-on reset the processor complex with the new IOCDS, and re-load MVS. This method minimizes the amount of time that the system must be inactive while you reconfigure the I/O devices.

See “Chapter 2. Executing the MVS Version of IOCP” for a full description of the MVS version of IOCP.

IOCP and MVS System Generation

For an MVS (MVS/370 or MVS/XA) system generation, we recommend that you combine the IOCP and MVS system generation macro instructions to form one combined input deck for use by both IOCP and MVS system generation. One combined input deck ensures that the definitions of your software and hardware I/O configurations are identical for a processor complex.

IOCP processes the IOCP macro instructions (ID, CHPID, and CNTLUNIT) and the IOCP-related parameters on the IODEVICE macro instructions to define the hardware I/O configuration. The macro instructions that MVS system generation processes to define the software depends on whether it is an MVS/370 system generation or an MVS/XA system generation.

Below is a summary of changes to the MVS/370 system generation macro instructions and the processing for a combined deck:

- The IOCP CHPID macro instruction replaces the system generation CHANNEL macro instruction. For an MVS/370 system generation, the

CHANNEL and CHPID macro instructions are mutually exclusive. That is, you cannot specify them in the same input deck. MVS/370 system generation obtains the channel number and channel type from the CHPID macro instruction for its own processing.

- MVS/370 system generation ignores the IOCP-related parameters CUNUMBR and TIMEOUT on the IODEVICE macro instruction. However, if the PATH parameter or UNITADD parameter is on any of the IODEVICE macro instructions, you cannot use a combined deck for an MVS/370 system generation. All other parameters remain unchanged for system generation processing.
- MVS/370 system generation ignores the IOCP ID and CNTLUNIT macro instructions.
- All other MVS/370 system generation macro instructions and parameters remain unchanged.

Below is a summary of changes to the MVS/XA system generation macro instructions and the processing for a combined deck:

- MVS/XA system generation ignores the IOCP-related parameters CUNUMBR, PATH, TIMEOUT and UNITADD on the IODEVICE macro instruction. All other parameters remain unchanged for MVS system generation processing.
- MVS/XA system generation ignores the IOCP CHPID, CNTLUNIT, and ID macro instructions.
- All other MVS/XA system generation macro instructions and parameters remain unchanged.

In the combined input deck, you can also define channels and devices for use only by processor complexes other than the processor complexes listed on the cover of this manual. These channel and device definitions are for MVS system generation only, and you instruct IOCP to exclude them from the IOCDS. For information on coding these channels and devices, see the descriptions of the PATH parameter on the CHPID macro instruction and the CUNUMBR parameter on the IODEVICE macro instruction in Chapter 2.

Appendix B shows a listing of a typical combined input deck containing both IOCP and MVS system generation macro instructions. This deck is input both for an MVS/370 system generation and a 370/370-XA level of IOCP. MVS/XA may not support some of the devices defined in this deck. (See *MVS/Extended Architecture System Generation Reference*.)

MVS system generation processes the IOCP macro instructions, in the same manner as the system generation macro instructions. IOCP itself does not use a macro generation process. IOCP processes its macro instructions in the same way as it processes control statements.

For a full description of the IOCP macro instructions and the IOCP-related parameters on the IODEVICE macro instruction, see “Specifying IOCP Macro Instructions” in Chapter 2. For a full description of MVS system generation

macro instructions, see *OS/VS2 System Programming Library: System Generation Reference* or *MVS/Extended Architecture System Generation Reference*.

Figure 1-6 shows an overview of the processing performed by the MVS version of IOCP.

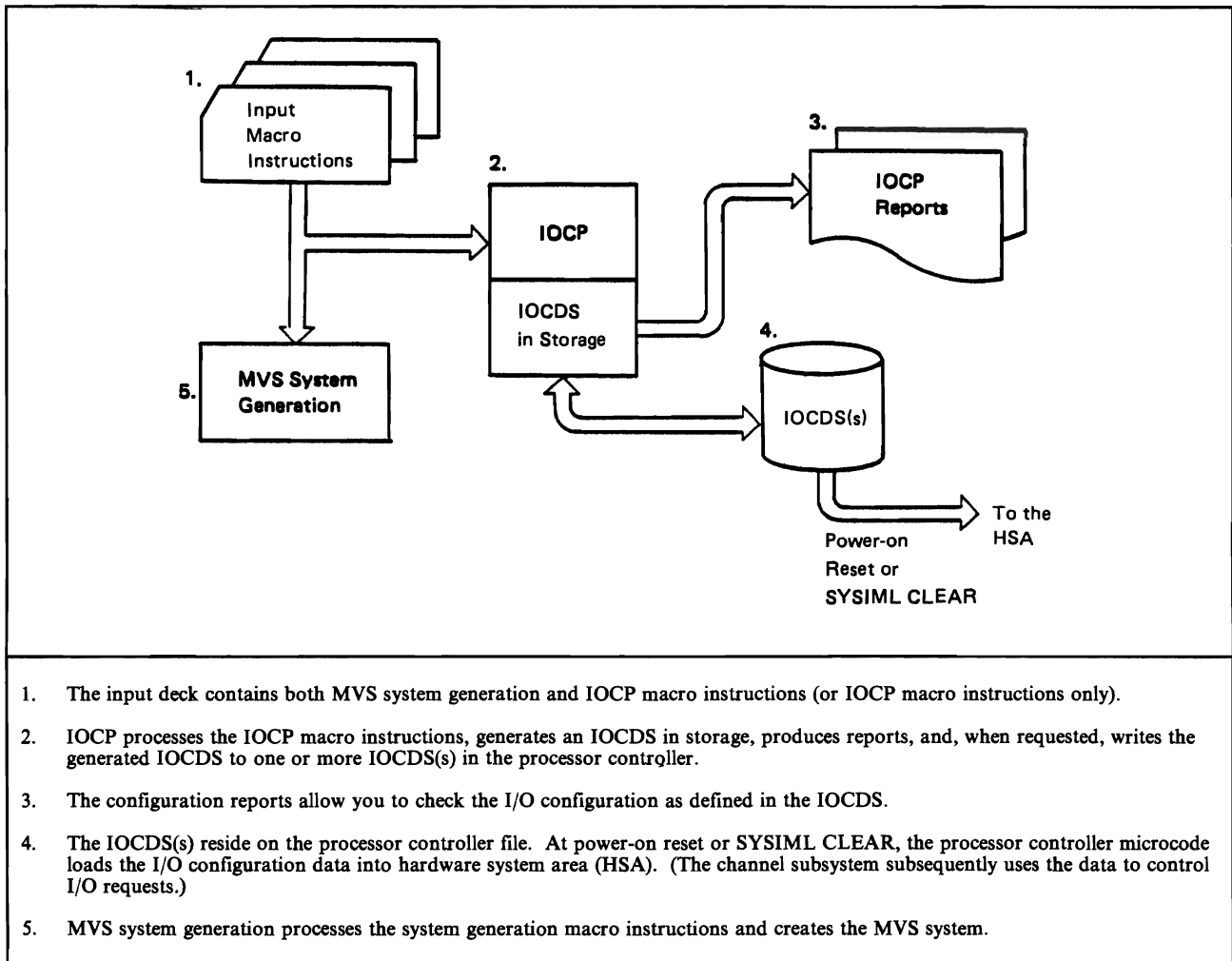

Figure 1-6. MVS Version of IOCP - Overview

Overview of the VM Version of IOCP

The VM version of IOCP runs under the control of either the VM/System Product (VM/SP), the VM/System Product High Performance Option (VM/SP HPO), or the VM/Extended Architecture Systems Facility (VM/XA Systems Facility).

You invoke the VM version of IOCP in the CMS environment. The CMS IOCP command executes IOCP and has options that allow you to request the following IOCP functions:

- **Generating an IOCDS** -- IOCP reads, validates, and checks the syntax of the input macro instructions. It generates an IOCDS in storage based on the configuration defined by the macro instructions and produces reports of the IOCDS generated in storage. When requested, IOCP writes the generated IOCDS to one or more IOCDS in the processor controller.
- **Producing Configuration Reports** -- IOCP reads one or more IOCDS(s) from the processor controller into storage and prints the IOCP configuration reports. (See “Chapter 5. IOCP Configuration Reports” for examples.)

The VM version of IOCP has an advantage over the stand-alone version: you may modify an IOCDS while other system operations continue. Then, at a convenient time, shut down your VM/SP, VM/SP HPO, or VM/XA Systems Facility system, power-on reset the processor complex (with the new IOCDS), and re-load VM/SP, VM/SP HPO, or the VM/XA Systems Facility. This method minimizes the amount of time that the system must be inactive while you reconfigure the I/O devices.

For a full description of the VM version of IOCP, see “Chapter 3. Executing the VM Version of IOCP.”

IOCP and System Generation of a VM Operating System

You must define your I/O configuration to both software and hardware.

To define your I/O configuration to software, you use a set of I/O macro instructions in the real I/O configuration file for your VM operating system:

- For VM/SP or VM/SP HPO, the real I/O configuration file is the DMKRIO file.
- For the VM/XA Systems Facility, the real I/O configuration file is the HCPRIO file.

When you perform system generation, the Control Program (CP) uses the macro instructions in the real I/O configuration file to define the I/O configuration to the operating system.

To define your I/O configuration to hardware, you use another set of I/O macro instructions in a separate IOCP file. When you enter the IOCP command, the IOCP program uses the I/O macro instructions in the IOCP file to define the I/O configuration to the processor complex.

For more information about performing these tasks, see “Methods of Executing the VM Version of IOCP” in Chapter 3.

Figure 1-7 shows an overview of the processing performed by the VM version of IOCP.

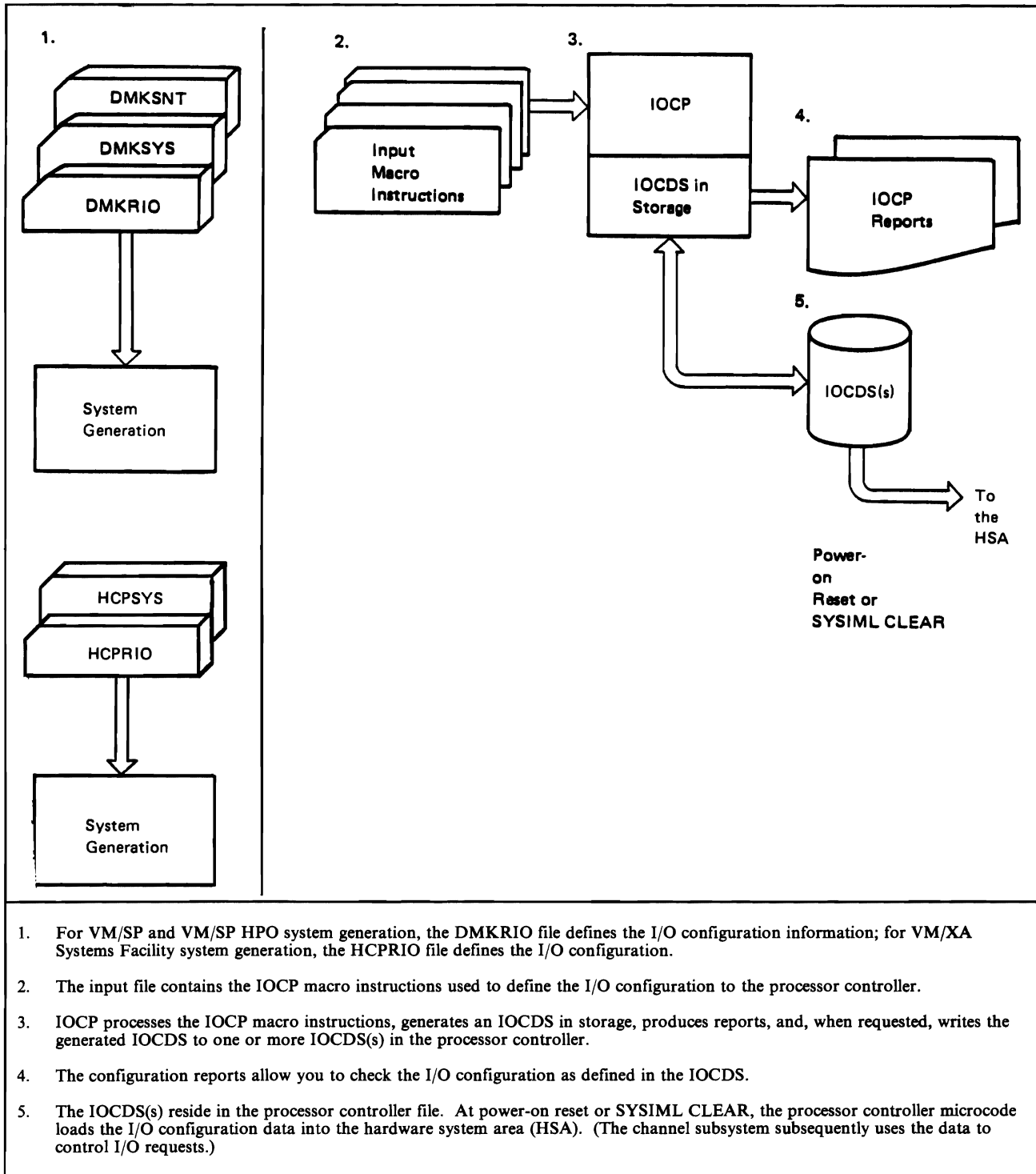

Figure 1-7. VM Version of IOCP - Overview

Overview of the Stand-Alone Version of IOCP

The stand-alone version of IOCP is a stand-alone program operated from the system console or the service support console on the processor complex.

You execute the stand-alone version of IOCP to define I/O configuration data when you are operating your system before installing MVS, VM/SP, VM/SP HPO, or the VM/XA Systems Facility, or when you are operating your system with a control program other than these.

You start IOCP from the system console or the service support console. Briefly, the functions you can request are:

- Read an IOCDS from the processor controller into the IOCDS area of main storage.
- Display, add, alter, and delete I/O configuration data from the IOCDS in storage.
- Print reports of the IOCDS that is in storage.
- Build an IOCDS in storage (which also produces reports) based on the card-image macro instructions read from a card reader or magnetic tape.
- Write the IOCDS (generated or modified) in storage to an IOCDS in the processor controller.

Also, when you are executing the stand-alone version of IOCP, you can dump the IOCP storage area, which includes the IOCDS in storage.

For a full description of the stand-alone version of IOCP, see “Chapter 4. Executing the Stand-Alone Version of IOCP.”

Figure 1-8 shows an overview of the processing performed by the stand-alone version of IOCP.

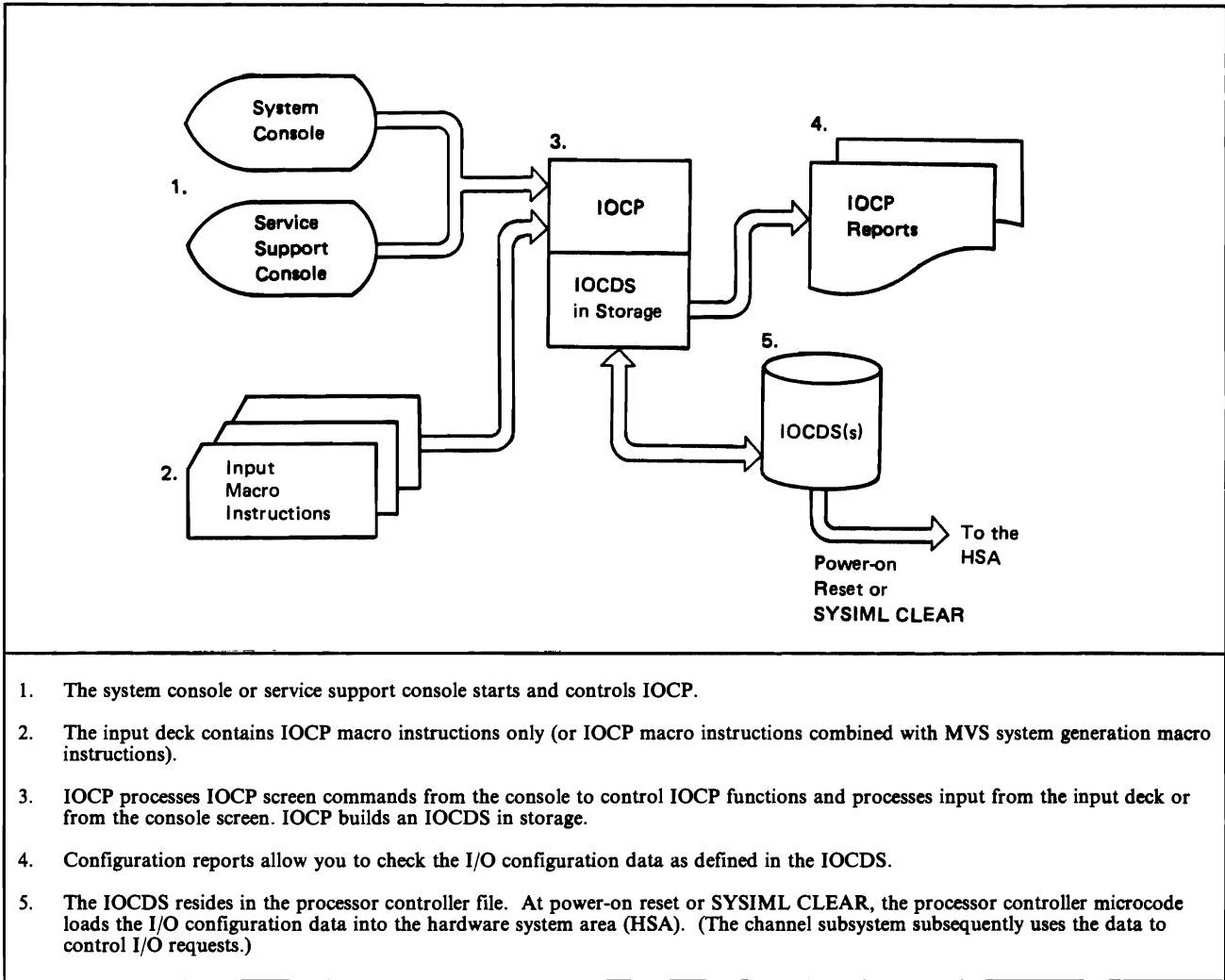

Figure 1-8. Stand-Alone Version of IOCP - Overview

Chapter 2. Executing the MVS Version of IOCP

The MVS version of the input/output configuration program (IOCP) runs as a job under control of MVS (MVS/370 or MVS/XA). The IOCP program name is ICPIOCP.

You use JCL statements to execute IOCP. On the EXEC statement, you code options on the PARM parameter to request one of the following two IOCP functions:

- **Generating an IOCDS** - IOCP reads, validates, and checks the syntax of input macro instructions. It generates an IOCDS in storage based on the configuration defined on the macro instructions and produces reports of the IOCDS generated in storage. When requested, IOCP writes the generated IOCDS to one or more IOCDS(s) in the processor controller.
- **Producing Configuration Reports** - IOCP reads one or more IOCDS(s) from the processor controller into storage and prints the IOCP configuration reports. (See “Chapter 5. IOCP Configuration Reports” for examples.)

The following topics describe:

- How to specify IOCP macro instructions
- The two functions IOCP performs
- The JCL statements required to execute these functions (with examples)
- The return codes IOCP can set
- How to initially define the I/O configuration or to redefine an existing I/O configuration.

Specifying IOCP Macro Instructions

This section describes the purpose of the IOCP macro instructions and explains how to code them. The first topic in this chapter summarizes the I/O configuration rules that apply to the IOCP macro instructions. Subsequent topics describe the IOCP macro instructions in alphabetic order.

The rules for coding the IOCP card-image macro instructions are the same as the rules for coding MVS system generation macro instructions. They are the rules of assembler language. See “Appendix A. Coding IOCP Macro Instructions” for a

summary of the rules for coding the macro instructions and the notation used in this book to illustrate the macro instructions.

IOCP has four macro instructions: CHPID, CNTLUNIT, IODEVICE, and ID. IOCP requires the CHPID, CNTLUNIT, and IODEVICE macro instructions. The CHPID, CNTLUNIT, and IODEVICE macro instructions define respectively the channel paths, control units, and I/O devices in your configuration. The ID macro instruction is optional. If you want specific identification information in the heading of the IOCP configuration reports, code the ID macro instruction.

The following general rules apply to the sequence of the IOCP macro instructions in the input deck.

- You can code the ID macro instruction only once and it must precede other IOCP macro instructions.
- A CHPID macro instruction that defines the channel path must precede a CNTLUNIT macro instruction that refers to the channel path.
- A CNTLUNIT macro instruction must follow the CHPID macro instruction that defines the channel path to which the control unit attaches.
- An IODEVICE macro instruction must follow the CNTLUNIT macro instruction that defines the control unit to which the device is assigned.
- You can insert IOCP comment cards (specified by the characters *IOCP in columns 1 through 5) in the input deck where desired.

We suggest that you group all CHPID macro instructions together, followed by all CNTLUNIT macro instructions, and then all IODEVICE macro instructions. Or, you might group all CHPID macro instructions together, followed by groups of related CNTLUNIT and IODEVICE macro instructions (as shown in Appendix B).

Figure 2-1 shows a typical combined input deck containing IOCP macro instructions and, MVS system generation macro instructions. Appendix B shows a listing of a typical combined input deck containing both IOCP and system generation macro instructions.

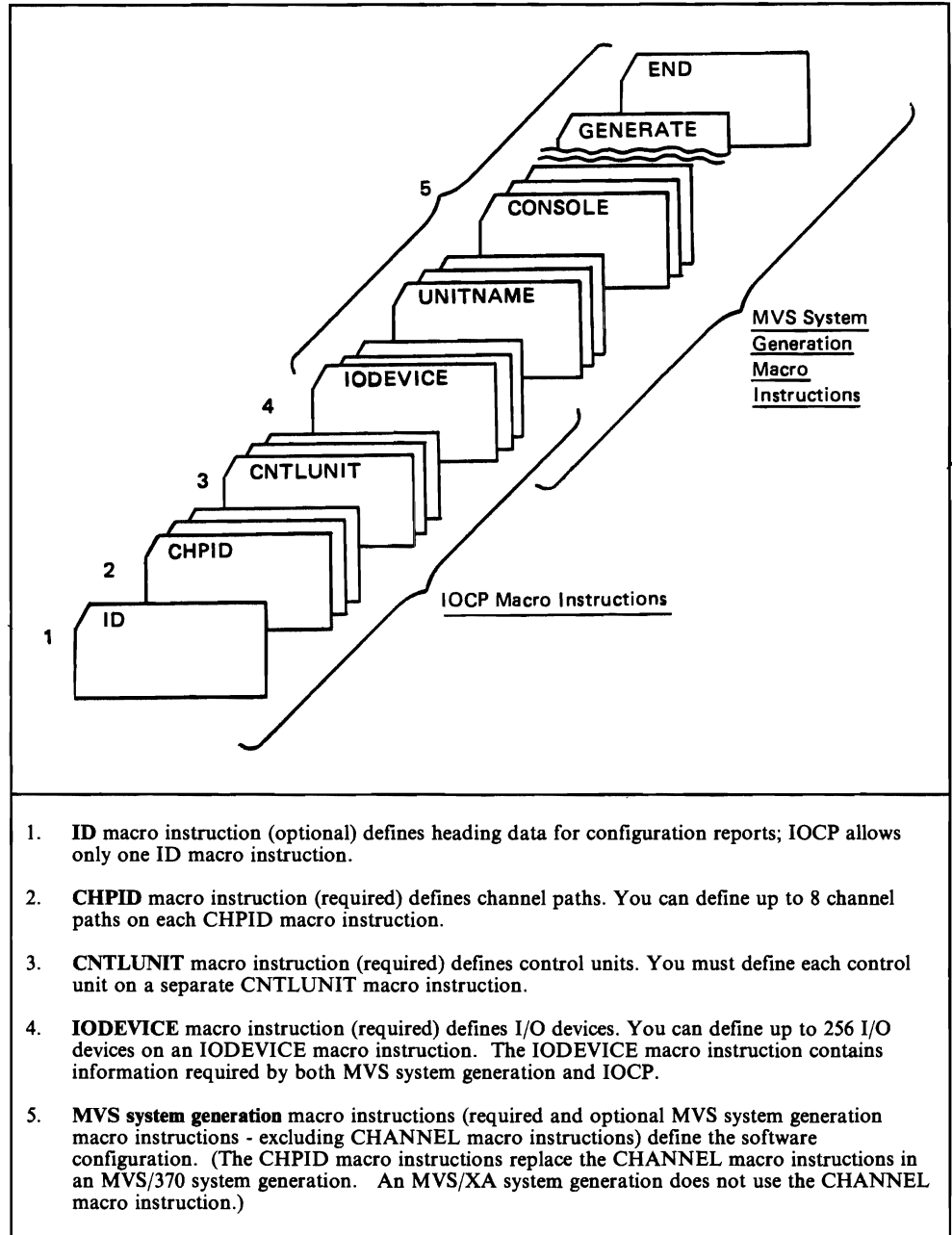

Figure 2-1. Typical Combined Input Deck (IOCP and MVS System Generation)

Summary of I/O Configuration Rules

Here for your convenience is a summary of the rules and restrictions for IOCP macro instructions described in the following topics.

For channel paths:

- You can specify all channel paths as block multiplexer
- You can specify, for the A side, only channel paths 00, 01, 02, 03, 10, 11, 12, and 13 (hex) as byte multiplexer.
- You can specify, for the B side, only channel paths 40, 41, 42, 43, 50, 51, 52, and 53 (hex) as byte multiplexer.
- You can specify a maximum of four channel paths on each side as byte multiplexer.

For control units:

- You can attach a physical control unit to a maximum of four channel paths per system.
- You can assign a maximum of 16 control units to one channel path.
- Only a non-shared control unit (specified by SHARED=N on the CNTLUNIT macro instruction) can attach to a channel path that operates in byte multiplexer mode.
- Only a control unit attached to a block multiplexer channel path can use the data streaming interface protocol. That is, if PROTOCL=S on the CNTLUNIT macro instruction, the channel path(s) to which the control unit attaches must have TYPE=BL specified on the CHPID macro instruction(s).

For I/O devices:

- The maximum number of I/O devices is 4080.
- The sum of the number of I/O devices plus the number of logical control units cannot exceed 4096.
- You can assign a maximum of 256 I/O devices to one channel path.
- You can assign a device to a maximum of four control units.
- When you assign a device to more than one control unit, each control unit must: (1) recognize the same unit address for the device, (2) not attach to the same channel path, (3) have the same PROTOCL value, and (4) have the same characteristics, such as shared, shared block, or nonshared.
- You can assign a device only to a combined maximum of four channel paths (even though you can assign a device to up to four control units and attach a control unit to up to four channel paths).

- You cannot assign a device that has the I/O interface timeout function inhibited to a channel path that operates in byte multiplexer mode.
- Each I/O device must have a unique device address/number within the I/O configuration. IOCP does not allow duplicate device addresses/numbers.

For 370-XA mode:

- If you have a deck of IOCP macro instructions coded for the 370 level of IOCP, in most cases you can use the same deck as input to create a 370/370-XA IOCDS. MVS/XA may not support all of the defined devices.

Note: I/O configurations that are valid for the 370 level of IOCP or for 370 only machines may be invalid for the 370-XA level of IOCP. It is important to fully understand the concepts and requirements of logical control units. It may be necessary to physically reconfigure a system if the requirements for logical control units have not been met. You must review the current configuration to insure that the configuration is valid for the 370-XA level of IOCP. This is necessary whether you are running your processor in 370 mode or in 370-XA mode.

- You can define a channel path and its attached I/O devices exclusively for 370-XA mode by removing the channel number and channel set for that channel path from the CHPID macro instruction.
- The PATH parameter on the IODEVICE macro instruction specifies a preferred path. The preferred path is an optional parameter used only for 370-XA mode operation.

CHPID

CHPID, a required macro instruction, describes:

- The characteristics of channel paths
- The correspondence of channel paths to channel numbers and channel sets

You must specify each channel path in your I/O configuration on a CHPID macro instruction in order to use the channel path. You can specify up to eight channel paths on one CHPID macro instruction. When using an input deck containing MVS system generation and IOCP macro instructions, you can define, to MVS system generation, channels used only by processors other than the processor complexes listed on the cover of this manual. (See the note in the description of `chpid` number on the `PATH` parameter.)

Note: For an MVS/370 system generation, the CHPID macro instruction is mutually exclusive with the system generation CHANNEL macro instruction. You cannot specify the CHPID and CHANNEL macro instructions in the same input deck to the MVS system generation process. On the CHPID macro instruction, the channel number on the PATH parameter replaces the ADDRESS parameter of the CHANNEL macro instruction, and the TYPE=BL and TYPE=BY parameters replace the TYPE=BLKMPXR and TYPE=MULTIPLEXOR parameters respectively. The CHPID macro instruction does not support the TYPE=SELECTOR and TYPE=HISPEEDMPXR parameters on the CHANNEL macro instruction.

The CHPID macro instruction must follow the ID macro instruction, if you specified the ID macro instruction). The CHPID macro instruction must precede any CNTLUNIT macro instructions that refer to the channel path.

The format of the CHPID macro instruction is:

[symbol]	CHPID	PATH=((chpid number[,channel number [,channel set]]),...) TYPE={BL BY}
----------	-------	--

PATH =

specifies one or more channel path identifiers. If the devices on a channel path are for use in 370 mode, you must specify the channel path's corresponding channel number. Optionally, you may specify the channel path's associated channel set. You can specify a maximum of eight channel paths on one CHPID macro instruction. If you specify more than one channel path on a macro instruction, all channel paths must have the same TYPE characteristic. You cannot specify a channel set without specifying a channel number.

chpid number

specifies the channel path identifier. For the A side, you must specify two hexadecimal digits in the range of 00 through 07, 10 through 17, or 20 through 27. (Channel paths 10 through 17 and 20 through 27 are optional by model.) For the B side, you must specify two hexadecimal digits in the range of 40 through 47, 50 through 57, or 60 through 67.

Note: Specify ** (two asterisks) instead of a chpid number when defining, to MVS system generation, a channel used only by processors other than the processor complexes listed on the cover of this manual. You can code ** only if you use card-image input and specify IGNORE = YES. IOCP ignores the channel number and channel set following **; it does not include them in the IOCDS.

For example, the 3081 Processor Complex can have up to 24 channel paths while the 3033 Processor Complex can have up to 32 channel paths. In a combined input deck used by both IOCP and MVS system generation, you specify ** to have IOCP ignore (not include in the IOCDS) the additional channels of the 3033 Processor Complex.

For devices you assign to channels used only by processors other than the processor complexes listed on the cover of this manual, you must code the IODEVICE macro instruction so that IOCP does not include the devices in the IOCDS. See the description of the CUNUMBR parameter on the IODEVICE macro instruction.

channel number

specifies the channel number that corresponds to the channel path when the processor complex operates in 370 mode. You specify one hexadecimal digit in the range of 0 through F. Channel numbers must be unique and consecutive within a channel set.

To specify a channel set, you must specify a channel number. If you do not specify the channel number, you cannot access the devices attached to the channel path when the processor complex operates in 370 mode.

channel set

specifies the channel set used for 370 mode. You specify a value of 0 or 1 for the channel set. If you do not specify a channel set, IOCP assigns the channel path to channel set 0.

On a processor complex with both an A side and a B side, each side has two channel sets (0 and 1) in 370 mode.

On the uniprocessors, MVS/370 can access only channel paths assigned to channel set 0. Therefore, you must either specify a value of 0 or accept the default of 0. (You can assign channel paths to channel set 1; however, MVS/370 cannot access these channel paths on a uniprocessor.)

A channel set cannot have more than 16 channel paths assigned to it. The two channel sets (0 and 1) can have a maximum combined total of 24 channel paths on each side. (For example, 16 channel paths assigned to channel set 0 and 8 channel paths assigned to channel set 1, or 12 channel paths assigned to channel set 0 and 12 channel paths assigned to channel set 1.)

For the processor complex, you must assign consecutive channel numbers within a channel set. (For example, channel numbers 0, 1, 2,

3, 4, 5, or channel numbers 8, 9, A, B, C, D.) The channel path identifiers do not need to be consecutive.

For a uniprocessor, processor 2 (the only processor) always connects to channel set 0 at power-on reset, SYSIML or SYSIML CLEAR. For a processor complex with more than one processor, channel set connection at power-on reset, SYSIML or SYSIML CLEAR depends on whether the processor complex has one or both processors configured.

When the processor complex has both processors configured, channel set 0 connects to processor 0, and channel set 1 connects to processor 2 at power-on reset, SYSIML or SYSIML CLEAR. (If the processor complex has a B side, channel set 0 on the B side connects to processor 1, and channel set 1 on the B side connects to processor 3.) When the processor complex subsequently resets (such as a system reset or load), channel set 0 reconnects to processor 0 (or processor 1 on the B side) and channel set 1 reconnects to processor 2 (or processor 3 on the B side).

If you remove either processor from the processor complex (the processor fails or you take it offline), channel set 0 and channel set 1 both remain configured. However when you remove a processor, a subsequent reset causes the connection of channel set 0 to the remaining processor on that side. The reset does not connect channel set 1, but you can connect channel set 1 after IPL by activating channel set switching. Therefore, we recommend that you assign critical asymmetrically attached devices (such as the operator's console) to a channel path assigned to channel set 0.

TYPE =

specifies the mode of I/O operation for the channel path. If you specify more than one channel path on a macro instruction, all channel paths must have the same TYPE characteristic.

BL

specifies that the channel path is a block multiplexer channel, which operates in burst mode only and allows multiplexing between blocks. You can specify TYPE = BL for all channel paths with the exception that MVS system generation requires that the channel path assigned as 370 channel number 0 be a byte multiplexer channel.

BY

specifies that the channel path is a byte multiplexer channel, which operates in burst mode or byte-interleave mode, depending on the attached control unit. You can specify TYPE = BY for only channel paths 00 through 03 and 10 through 13 (hex) on the A side, and for channel paths 40 through 43 and 50 through 53 (hex) on the B side. You can specify a maximum of four channel paths on each side as TYPE = BY.

Note: All channel paths defined with the same channel number must specify the same type value.

Example: The following macro instruction (named CHSET1) defines two channel paths (hex 15 and 16) with their corresponding channel numbers (hex 8 and 9) in channel set 1. It also defines a channel (using ** instead of a chpid number) with channel number hex A in channel set 1. By using **, you define the channel to MVS system generation for use by processors other than the processor complexes listed on the cover of this manual. IOCP excludes from the IOCDS the channel number and channel set following **. The channel paths are to operate in block multiplexer mode.

```
CHSET1 CHPID PATH=((15,8,1),(16,9,1),(**,A,1)),TYPE=BL
```

Example: The following macro instruction (named CHP17) defines channel path 17. The channel path operates in block multiplexer mode. Because no channel number is specified, the processor complex can access the devices attached to this channel path only when it operates in 370-XA mode.

```
CHP17 CHPID PATH=17,TYPE=BL
```

CNTLUNIT

CNTLUNIT, a required macro instruction, describes:

- The characteristics of the control unit
- The channel paths to which the control unit attaches
- The unit addresses that the control unit recognizes

You must specify each physical control unit in your I/O configuration in a separate CNTLUNIT macro instruction to use the physical control unit. This requirement includes control units that reside either in the same physical unit as an I/O device or another control unit.

You can attach a control unit to a maximum of four channel paths. You can assign a maximum of 16 control units to one channel path.

See Appendix D for a list of control unit types and their characteristics.

Based on information in the CNTLUNIT macro instruction(s), IOCP constructs logical control units for the channel subsystem to use when the processor runs in 370-XA mode. A logical control unit is a logical representation of one to four physical control units. IOCP builds a logical control unit for:

- Each control unit with no devices or no devices shared with other control units.
- Each group of two to four control units that share devices between them.

The channel subsystem uses the logical control units for queuing I/O requests for the devices attached to the associated physical control units. There is one I/O request queue for each logical control unit. The channel subsystem queues all I/O requests for all devices in the logical control unit (all the devices attached to the set of physical control units in the logical control unit) to the same I/O request queue.

IOCP also establishes a rotation order for the channel paths associated with each logical control unit. When initiating I/O requests queued to the logical control unit, the channel subsystem uses this rotation order to determine the sequence for selecting channel paths. The section “Rotation Algorithm” in Chapter 1 describes how IOCP establishes the rotation order of the channel paths.

The CNTLUNIT macro instruction must follow any CHPID macro instructions that specify channel paths used by the control unit. The CNTLUNIT macro instruction must precede any IODEVICE macro instructions that refer to the control unit.

The format of the CNTLUNIT macro instruction is:

[symbol]	CNTLUNIT	CUNUMBR=number PATH=(chpid[,chpid]...) [PROTOCL={D S}] SHARED={Y YB N} UNIT=type UNITADD=((address[,number]),...)
----------	----------	--

CUNUMBR = number

specifies the hexadecimal number assigned to the control unit. You specify three hexadecimal digits in the range of 000 through FFF. You must assign a unique number to each control unit. However, you can arbitrarily assign the numbers.

PATH = chpid

specifies the channel path(s) attached to the control unit. You specify one to four channel path identifiers for the control unit. You must specify two hexadecimal digits for each channel path identifier.

Note: If you specify the control unit as shared (SHARED = Y) or shared block (SHARED = YB), then you cannot specify channel paths that operate in byte multiplexer mode for the control unit.

PROTOCL =

specifies the interface protocol that the control unit uses when operating with the channel paths specified on the PATH parameter.

D

specifies the D. C. interlock protocol. This protocol is the standard I/O interface that requires the demand response. D is the default if you do not code PROTOCL.

S

specifies the data streaming protocol. This protocol does not require the demand response but continues at the rate governed by the control unit. S is valid only for a control unit attached to block multiplexer channel paths.

Note: Incorrect specification of the PROTOCL parameter may produce unpredictable results. For example, if you specify S (data streaming) for a control unit that supports the D. C. interlock protocol, I/O requests can result in either detected errors (such as data overruns or interface control checks) or in undetected errors.

SHARED =

specifies the level of concurrency of I/O requests that the channel allows for the control unit. In 370 mode, the parameter specifies the assignments of subchannels. In 370-XA mode, IOCP sets the control unit type (1 or 2) automatically based on the SHARED parameter that you specify. See Appendix D for more information on specifying the SHARED parameter. (For further information on control unit types, see the topic “Logical Control Units” in Chapter 1.)

Y

specifies that the control unit (such as the 3803 for magnetic tape units) has one or both of the following attributes:

- The control unit supports only one I/O request at a time, regardless of the number of I/O devices attached.

- The control unit clears pending sense information in the control unit for an I/O device if the channel initiates an I/O request for another attached I/O device.

For 370 mode, assigned to all the devices attached to a control unit is a single shared subchannel (for each attaching channel path) and the channel operates in selector mode. For 370-XA mode, you assign the control unit as type 1 and each device as a subchannel.

In both modes, the channel ensures processing of only one I/O request at a time for all devices sharing the control unit. For 370-XA mode, if sense information is pending in the control unit for an I/O device attached to the control unit, the channel ensures that I/O requests for other I/O devices attached to the control unit are not initiated until the system control program issues an I/O request to clear the pending sense information.

You cannot specify SHARED = Y for control units that attach to a byte multiplexer channel path.

YB

specifies that the control unit (such as the 3258, 3272, or 3274) has one or both of the attributes of SHARED = Y, but supports disconnect command chaining (DCC) operations.

For 370 mode, assigned to all the devices attached to a control unit is a single shared subchannel (for each attaching channel path) and the channel operates in block multiplexer mode.

For 370-XA mode, you assign the control unit as type 1 and each device as a subchannel.

In both modes, the channel ensures processing of only one I/O request at a time for all devices sharing the control unit. For 370-XA mode, if sense information is pending in the control unit for an I/O device attached to the control unit, the channel ensures that I/O requests for other I/O devices attached to the control unit are not initiated until the system control program issues an I/O request to clear the pending sense information.

You cannot specify SHARED = YB for control units that attach to a byte multiplexer channel path.

N

specifies that the control unit supports multiple I/O requests concurrently (one for each attached I/O device).

Each I/O device attached to the control unit is assigned a separate subchannel. For 370-XA mode, the control unit is assigned as type 2.

The channel accepts and initiates one I/O request for each I/O device and operates in either block or byte multiplexer mode, depending on how you specified the attaching channel path.

UNIT = type

specifies the type of control unit. You specify up to five alphanumeric characters that identify the type of control unit. IOCP checks only the syntax for alphanumeric characters. IOCP does not validate the type value.

You must specify a type for every control unit in your I/O configuration. You specify a type on the UNIT parameter in one of two ways:

- For devices that do not have a separately assigned control unit type (for example, when the control unit function is built into the same physical unit as the device), you can specify the device type on the UNIT parameter. For example, for the 3800 Printing Subsystem you can specify UNIT = 3800 on the UNIT parameter of the CNTLUNIT macro instruction (as well as UNIT = 3800 on the IODEVICE macro instruction).
- For devices that do have a separately assigned control unit type, you must specify the specific control unit type on the UNIT parameter (such as UNIT = 3803).

UNITADD =**address**

specifies the unit addresses of the I/O devices that the control unit recognizes. You specify two hexadecimal digits in the range of 00 through FF. You must specify at least one unit address. A unit address need not represent an attached device. (For example, UNITADD = ((0A),(0B),(0F)) specifies that the control unit recognizes unit addresses 0A,0B, and 0F.)

number

specifies the number of sequential unit addresses recognized by the control unit. You specify a one-, two-, or three-digit decimal value in the range of 1 through 256. (For example, UNITADD = ((0A,3)) specifies that the control unit recognizes unit addresses 0A, 0B, and 0C.) The unit address plus the number of addresses must not exceed a hexadecimal address of FF. If you omit a number, a value of 1 is assumed.

You can specify a maximum of eight addresses and/or sets of address and number values. If you do not specify the UNITADD parameter on the IODEVICE macro instruction, the unit addresses specified must include the device addresses (the second and third digits) specified on the ADDRESS parameter of the IODEVICE macro instruction for the attached devices. If you specify the UNITADD parameter on the IODEVICE macro instruction, the unit addresses specified must include the unit addresses specified on the UNITADD parameter for the attached devices.

Note: See Appendix D for the exceptions and recommendations that apply to specific device types.

You must specify the full range of unit addresses that the control unit can address whether devices are attached or not.

Example: The following macro instruction assigns the control unit number of 10A to an IBM 2821 Control Unit, names channel path 06 to which the control unit attaches, and defines unit addresses 0A, 0B, and 0C that the control unit recognizes. D is the default for PROTOCL.

```
CU10A CNTLUNIT CUNUMBR=10A,PATH=06,SHARED=N, X
          UNIT=2821,UNITADD=(0A,3)
```

Example: The following macro instruction assigns the control unit number of 00E to a 3803 Tape Control, names channel path 05 to which the control unit attaches, specifies the D. C. interlock protocol, and defines unit addresses 80 through 8F that the control unit recognizes.

```
CU00E CNTLUNIT CUNUMBR=00E,PATH=05,PROTOCL=D, X
          SHARED=Y,UNIT=3803,UNITADD=(80,16)
```

Example: The following macro instruction assigns the control unit number 11A to a control unit that the customer has named DUMMY, names two channel paths 06 and 07 to which the control unit is attached, and defines unit addresses 90 through 9F and A0 through AF that the control unit recognizes.

```
CU11A CNTLUNIT CUNUMBR=11A,PATH=(06,07),PROTOCL=D, X
          SHARED=Y,UNIT=DUMMY, X
          UNITADD=(90,16),(A0,16)
```

Example: The following macro instruction assigns the control unit number of 031 to an IBM 3272 Control Unit, names channel path 04 to which the control unit is attached, and defines unit addresses D0 through DF that the control unit recognizes.

```
CU031 CNTLUNIT CUNUMBR=031,PATH=04,PROTOCL=D, X
          SHARED=YB,UNIT=3272, X
          UNITADD=(D0,16)
```

ID

ID is an optional macro instruction that describes the identification information printed on the ID1 and ID2 lines of the IOCP configuration report headings. It is also the source of the customer name (data set name) for the IOCDS that appears on the IOCDSM (SYS021) frame.

See “Chapter 5. IOCP Configuration Reports” for examples of the headings used on the reports.

When specified, the ID macro instruction must precede all CHPID, CNTLUNIT, and IODEVICE macro instructions in the input stream. You can specify the ID macro instruction only once in the input deck. If you do not specify the ID macro instruction, the ID1 and ID2 lines of the heading do not have identifying information.

The format of the ID macro instruction is:

[symbol]	ID	{ MSG1='message',MSG2='message' } { MSG1='message' MSG2='message' }
----------	----	---

MSG1 =

specifies the identification information printed on the ID1 line of the heading on IOCP configuration reports. The processor controller also uses the first eight characters of MSG1 = (bytes 1 through 8) as the customer name for the IOCDS that appears on the IOCDSM (SYS021) frame. (For more information, see the operator’s guide for your system console.)

MSG2 =

specifies the identification information printed on the ID2 line of the heading on IOCP configuration reports.

‘message’

specifies a string of 1 through 64 alphanumeric characters used as identification information. You must enclose the string within apostrophes. Two consecutive apostrophes count as one character and indicate an apostrophe within the string (such as, MSG1 = ‘John’s I/O Report’).

Example: The following macro instruction defines the identification information printed on lines ID1 and ID2 on the heading of the IOCP configuration reports. TPCONFIG is the customer name for the IOCDS that appears on the IOCDSM (SYS021) frame.

```
ID00B ID MSG1='TPCONFIG Configuration for Processor B',      X
      MSG2='Revised by Plan 3'
```

IODEVICE

IODEVICE, a required macro instruction, describes:

- The I/O device address/number
- The device characteristics
- The control units to which the device is assigned

An IODEVICE macro instruction used for I/O requests must specify each uniquely addressable I/O device in your I/O configuration. When using an input deck containing MVS system generation macro instructions and IOCP macro instructions, you can define, to MVS system generation, devices used only by processors other than the processor complexes listed on the cover of this manual. (See the note in the description of the CUNUMBR parameter on this macro instruction.)

See Appendix D for a list of I/O device types and their characteristics.

Note: MVS/System Product Version 1 or Version 2 does not necessarily support devices supported by IOCP. For a list of the devices supported by MVS/System Product Version 1, see *OS/VS2 MVS/System Product General Information Manual*; for MVS/System Product Version 2, see *MVS/System Product Version 2 General Information Manual*.

You can assign up to 256 devices to one channel path. You can assign one device to a maximum of four control units. Although you can attach a control unit to a maximum of four channel paths, you can only assign a device to a combined maximum of four channel paths.

Each I/O device must have a unique device address/number within the I/O configuration. IOCP does not allow duplicate addresses.

To assign an I/O device to both channel set 0 and channel set 1 (for 370 mode channel sets), specify the device address/number on an IODEVICE macro instruction and the device's unit address on the CNTLUNIT macro instruction(s) that define(s) the control unit(s) attached to channel paths in both channel sets. (On a uniprocessor, MVS/370 can access only channel set 0; therefore, you must assign all I/O devices you want to use to channel set 0.)

The IODEVICE macro instruction must follow any CNTLUNIT macro instructions that specify control units used by the device.

The format of the IODEVICE macro instruction is:

[symbol]	IODEVICE	ADDRESS=(address[,number]) CUNUMBR=(number[,number]...) [MODEL=model] [PATH=chpid] [TIMEOUT={Y N}] UNIT=device [UNITADD=address]
----------	----------	--

Notes:

1. *If you are coding the IODEVICE macro instruction for use with an MVS system generation, use the description of the IODEVICE macro instruction found in OS/VS2 System Programming Library: System Generation Reference or MVS/Extended Architecture System Generation Reference. The parameters that IOCP uses are a subset of the IODEVICE parameters used by system generation (except the CUNUMBR, PATH, TIMEOUT, and UNITADD parameters, which only IOCP uses).*
2. *When you use card-image input and specify IGNORE= YES on the PARM parameter of the JCL EXEC statement, IOCP checks the syntax and validity of the OPTCHAN parameter, if present, on the IODEVICE macro instruction. Note that IOCP allows only one hexadecimal digit as the keyword value for OPTCHAN.*

ADDRESS =

address

specifies the device address in 370 mode and the device number in 370-XA mode. You specify three hexadecimal digits in the range of 000 through FFF.

For 370 mode operation, the first hexadecimal digit (0-F) must specify the channel number that corresponds to the lowest-numbered channel path to which the device is assigned. This channel path is the primary channel address for the device.

In 370-XA mode, the first hexadecimal digit does not have to correspond to the 370 channel number. If you want to use the same IOCDS to operate in both 370 mode and 370-XA mode, specify the first hexadecimal digit for 370-XA mode the same way you do for 370 mode.

MVS requires that the first digit must be the same for each device on a single control unit or for each DASD on a single string. In all cases, specify a hexadecimal digit in the range of 0 through F.

If you do not specify the UNITADD parameter on the IODEVICE macro instruction, the second and third hexadecimal digits of the ADDRESS parameter specify the physical unit address that is transmitted on the channel path to select the device. You specify two hexadecimal digits in the range of 00 through FF. These two hexadecimal digits must match one of the unit addresses specified on the UNITADD parameter of the CNTLUNIT macro instruction that defines the control units assigned to the device.

If you do specify the UNITADD parameter on the IODEVICE macro instruction, then the second and third digits of the ADDRESS parameter can have any value that follows the rules in Appendix D and makes the device address/number unique. The two digits specified on the UNITADD parameter must be the physical unit address. See Appendix D for the exceptions and recommendations that apply to specific device types.

number

specifies the number of sequential device addresses/numbers to be assigned. You specify a one, two, or three-digit decimal value in the range of 1 through 256. (For example, ADDRESS=(10A,3) specifies that the device addresses of 10A, 10B, and 10C are assigned.)

If you do not use the UNITADD parameter on the IODEVICE macro instruction, the physical unit address (second and third digits) specified on the ADDRESS parameter plus the number of addresses minus one must not exceed a hexadecimal value of FF.

If you do use the UNITADD parameter, the device address/number specified on the ADDRESS parameter plus the number of addresses minus one must not exceed a hexadecimal value of FFF.

If you omit number (when using card-image input) and you specify IGNORE=NO on the PARM parameter of the JCL EXEC statement, IOCP assumes a default value of 1. If IGNORE=YES, IOCP assumes a default value of 1 except for some devices, as noted in Appendix D.

For example, if you use card-image input and specify IGNORE=YES, IOCP checks the syntax of the number subparameter for the 2305 Fixed Head Storage and the 3838 Array Processor, but IOCP unconditionally assigns eight addresses to these devices.

Each device address specified must be unique within the I/O configuration. IOCP does not allow duplicate addresses.

Note: See Appendix D for the exceptions and recommendations that apply to specific device types.

CUNUMBR = number

specifies the control unit numbers assigned to the control units (specified on the CUNUMBR parameter of the CNLUNIT macro instruction) to which the device attaches. You specify three hexadecimal digits in the range of 000 through FFF for each control unit.

You can assign a device to a maximum of four control units. Although you can attach each control unit to a maximum of four channel paths, you can only assign a device to a combined maximum of four channel paths.

When you attach the device to more than one control unit (for example, via a string switch), you must specify each control unit.

If you attach a device to more than one control unit, all control units that attach the device must:

- Use the same address to access the device assigned to the device on the ADDRESS parameter of the IODEVICE macro instruction.
- Have the same SHARED characteristic (Y, YB, or N).

- Use the same interface protocol. You must use either D. C. interlock or data streaming for the commonly attached device.
- Not be attached to the same channel path.

Note: Specify *** (three asterisks) instead of a number when defining, to MVS system generation, a device or devices used only by processors other than the processor complexes listed on the cover of this manual. (You must code *** if you coded ** for the CHPID number on the CHPID macro instruction that defines the channel to which you are assigning the devices.) You can code *** only if you use card-image input and specify IGNORE = YES on the PARM parameter of the JCL EXEC statement. IOCP ignores the device(s); that is, it does not include them in the IOCDS.

MODEL = model

specifies the model number, if any, for the device. You specify one or two alphanumeric characters that represent the model number of the device. IOCP only checks the syntax for alphanumeric characters. IOCP does not validate the model value.

PATH = chpid

specifies the preferred channel path. You specify two hexadecimal digits that must correspond to a channel path identifier of an attaching channel path.

In 370-XA mode, the channel subsystem always attempts to use the preferred channel path to initiate I/O requests. The channel subsystem will attempt to initiate all I/O requests for the desired device using the specified preferred channel path first, before it attempts to initiate requests on any of the other attaching channel paths. When operating in 370 mode, the processor complex ignores the preferred channel path. See “Preferred Path” in Chapter 1 for more information.

TIMEOUT =

specifies whether the eight-second I/O interface timeout function is to be active for the I/O interface tag sequences between the channel and I/O device.

Y

specifies that the I/O interface timeout function is to be active for all sequences on the I/O interface except as noted in Appendix C. With the timeout function active, if the I/O device fails to complete a tag sequence within eight seconds or a delay occurs in a dependent tag sequence that exceeds eight seconds, the channel terminates the I/O request to the I/O device and generates an interface-control-check interruption.

TIMEOUT = Y is the default if you do not code the TIMEOUT parameter.

N

specifies that the I/O interface timeout function is to be inactive (timeout is inhibited) for some of the sequences on the I/O interface as described in Appendix C. With the timeout function inactive, the

channel waits until the I/O device completes the tag sequence or initiates the next dependent sequence.

TIMEOUT=N is not valid for I/O devices assigned to byte multiplexer channel paths.

We recommend that you specify or use the default TIMEOUT=Y for all IBM I/O devices. However, for certain I/O devices, normal I/O sequences sometimes require more than eight seconds to complete. For example, some I/O sequences on a channel-to-channel (CTC) adapter might require more than eight seconds to complete. For these devices, you may choose to specify TIMEOUT=N. See Appendix C for additional information about the timeout function.

Note: When operating in 370 mode, the TIMEOUT specification for the lowest device address on a shared control unit (SHARED=Y or SHARED=YB) overrides the timeout specification of the other devices connected to the same control unit. For example, device 1A0 connects to a shared control unit and has TIMEOUT=Y; device 1A1 connects to the same control unit and has TIMEOUT=N. In 370 mode, both devices are timed. In 370-XA mode, device 1A0 is timed; device 1A1 is not timed.

UNIT = device

specifies the device type. You specify up to five alphanumeric characters to define the device type (such as, 3330 or 2540R). IOCP only checks the syntax for alphanumeric characters. IOCP does not validate the device value. For certain device types (such as 3350P), IOCP takes special actions. See Appendix D for more information.

UNITADD = address

specifies the physical unit address that is transmitted on the channel path to select the I/O device. You specify two hexadecimal digits in the range of 00 through FF. These two hexadecimal digits must match one of the unit addresses specified on the UNITADD parameter of the CNTLUNIT macro instruction that defines the control units to which the device is assigned.

UNITADD allows you to assign a device number in the ADDRESS parameter on the IODEVICE macro instruction that does not have the actual physical unit address of the I/O device as the two rightmost digits of the device number. (The device number is the three hexadecimal digits specified in the ADDRESS parameter.) There may be situations when it is difficult or undesirable to assign device numbers that contain the physical unit address of the device. The UNITADD parameter allows you to assign a device number in the ADDRESS parameter on the IODEVICE macro instruction that does not have the physical unit address of the I/O device as the two rightmost digits of the device number. The UNITADD parameter that you specify becomes the physical unit address that the channel uses to address the selected device in both 370 and 370-XA mode.

We recommend you specify the UNITADD parameter on the IODEVICE macro instruction *only* for an IOCDS that will be used exclusively for 370-XA mode operation. Operational and serviceability problems are likely to occur if you defined the IOCDS with UNITADD for use in 370 mode.

If you specified a value for number in the ADDRESS parameter, that same number of sequential device numbers applies to the UNITADD parameter. However, the UNITADD parameter plus the number of device numbers (or device addresses) must not exceed a hexadecimal value of FF.

Notes:

- 1. If you use the UNITADD parameter, you must follow the same rules and restrictions that apply to the second and third digits of the ADDRESS parameter. For example, notes in Appendix D that apply to the unit address specified on the ADDRESS parameter also apply to the unit address specified on the UNITADD parameter.*
- 2. For an MVS/370 system generation if you use the UNITADD parameter, you cannot use a combined input deck (IOCP and MVS system generation macro instructions).*
- 3. If you specify the UNITADD parameter and use the IOCDS for 370 mode operation, the two digits specified in the UNITADD parameter replace the two rightmost digits of the device address. The UNITADD parameter changes the device address and makes it different from the device number. For example, ADDRESS=180,UNITADD=90 produces a device address (370 mode) of 190 (if the device is connected to a channel path defined for 370 mode as channel 1). However, the device number (370-XA mode) is still 180. Thus, messages and error records for the same device will be issued using different device identifiers, 190 in 370 mode and 180 in 370-XA mode. It is also possible that messages and error records for a device identifier (a device address or device number) could actually represent more than one device.*

Example: The following macro instruction defines a 2540 Card Read Punch Model 1 with an address of 00D. It is attached to a 2821 Control Unit that has a control unit number of 10A.

```
DEV00D IODEVICE ADDRESS=00D,CUNUMBR=10A,MODEL=1, X
        UNIT=2540P,TIMEOUT=Y
```

Example: The following macro instruction defines eight 3330 Disk Storage Model 1 devices. The 3830 Storage Control has been assigned control unit number 11B and recognizes the device addresses/numbers of 210 through 217.

```
DEV2DD IODEVICE ADDRESS=(210,8),CUNUMBR=11B, X
        MODEL=1,UNIT=3330,TIMEOUT=Y
```

Example: The following macro instruction defines eight 3420 Magnetic Tape Units. The 3803 Tape Control has been assigned control unit number 00E and recognizes the device addresses/numbers of D80 through D87.

```
DEVDTT IODEVICE ADDRESS=(D80,8),CUNUMBR=00E, X
        MODEL=3,UNIT=3420,TIMEOUT=Y
```

Example: The following macro instruction defines eight 3420 Magnetic Tape Units attached to two 3803 Tape Controls via the tape switching feature. The control units are assigned the numbers 01B and 01C. Both control units recognize the unit addresses of 40 through 47. (Note: In this case the control units must be attached to different channel paths to ensure that unit addresses are not duplicated on the same channel path.) The channel number that corresponds to the lower numbered channel path to which the devices are assigned is C.

```
DEVTUU IODEVICE ADDRESS=(C40,8),CUNUMBR=(01B,01C),      X
          MODEL=3,UNIT=3420,TIMEOUT=Y
```

Example: The following macro instruction defines eight 3420 Magnetic Tape Units to MVS system generation for use only by processors other than the processor complexes listed on the cover of this manual. IOCP does not include the devices in the IOCDS.

```
DEVTUX IODEVICE ADDRESS=(E80,8),CUNUMBR=***,          X
          MODEL=3,UNIT=3420
```

Example: The following macro instruction defines two 3350 I/O devices for use as paging devices by the 3880 Model 11 Paging Storage Subsystem. The 3880 Model 11 Paging Storage Director has been assigned control unit number 14B.: IOCP generates four device addresses/numbers for each 3350P (a 3350 used as a paging device by the 3880 Model 11): the base address as specified on the ADDRESS parameter, and three additional addresses at intervals of eight.

This macro instruction causes IOCP to generate addresses 440, 448, 450, and 458 for base address 440, and addresses 441, 449, 451, and 459 for base address 441.

```
DEV4DD IODEVICE ADDRESS=(440,2),CUNUMBR=14B,          X
          UNIT=3350P,TIMEOUT=Y
```

Example: The following macro instruction defines eight 3420 Magnetic Tape Units. The 3803 Tape Control has been assigned the control unit number 530. The device numbers (for 370-XA mode) are 180 through 187. But the devices respond to the unit addresses of 90 through 97 (not 80 through 87) in both 370-XA mode and 370 mode. Thus, the device addresses (for 370 mode) are actually 190 through 197.

```
DEV1UA IODEVICE ADDRESS=(180,8),CUNUMBR=530,          X
          MODEL=3,UNIT=3420,UNITADD=90
```

Generating an IOCDS

IOCP performs the following steps when you specify that you want to generate an IOCDS.

Note: IOCP repeats steps 1 through 5 for each input macro instruction it reads (unless it finds an error as indicated in Steps 3 and 4).

IOCP:

1. **Reads** each macro instruction from the input device.
2. **Prints** each macro instruction on the output printer.
3. **Checks the syntax** of each macro instruction for correct format. If it finds a syntax error (such as a missing parenthesis), IOCP prints an error message on the output printer following the macro instruction that contains the error. IOCP stops checking the syntax of a macro instruction when it encounters the first syntax error on that macro instruction. If there are two or more syntax errors on a single macro instruction, IOCP finds the second and following errors on subsequent runs.

If IOCP finds an error in Step 3, IOCP returns to Step 1 and continues reading, printing, and checking the syntax of the following macro instructions, but does not perform any of the following steps.

4. **Checks the validity** of each macro instruction. For example, IOCP checks that a CNTLUNIT macro instruction specified a channel path previously defined on a CHPID macro instruction. If it finds an error, IOCP prints an error message on the output printer following the macro instruction that contains the error.

If IOCP finds an error in Step 4, IOCP returns to Step 1 and performs only Steps 1 through 3 for the remainder of the macro instructions. If there are two or more validity errors in your input deck, IOCP finds the second and following errors on subsequent runs.

5. **Builds** the appropriate identification, channel path, control unit, or I/O device record and enters the record into the IOCDS in storage.

If more macro instructions remain to be read, IOCP returns to Step 1.

After it processes all of the input macro instructions and enters all of the records into the IOCDS in storage, IOCP performs Step 6.

6. **Generates** the IOCDS in storage and makes additional checks. For example, IOCP checks that the channel numbers within a channel set are consecutive. If IOCP finds an error, IOCP issues an error message and then terminates.

After IOCP has successfully generated an IOCDS in storage, IOCP performs Step 7.

7. **Produces** the IOCP configuration reports of the IOCDS generated in storage.

If requested (by a WRTCDS option other than NO), IOCP performs Step 8.

8. **Writes** the generated IOCDS from storage to one or more IOCDS(s) in the processor controller. This step requires permission from the system operator (via message ICP050D) before IOCP writes to the processor controller.

Coding the JCL EXEC Statement for Generating an IOCDS

On the EXEC statement, you code the name of the IOCP program on the PGM parameter and the following PARM options in order to generate an IOCDS. (The examples later in this chapter describe the JOB and DD statements for an IOCP job.)

Note: The defaults (on the PARM parameter) allow you to generate an IOCDS in storage and produce reports, but not write to the processor controller.

```
PARM= ' IGNORE=YES | NO , WRTCDS=YES | Ax | Bx | ABx | NO , LINECOUNT=n | 55 '
```

IGNORE =

YES

specifies that IOCP is to ignore non-IOCP input macro instructions and non-IOCP parameters on the IODEVICE macro instruction. Except for the OPTCHAN parameter, which is an MVS system generation parameter on the IODEVICE macro instruction, IOCP processes and prints only IOCP input and indicates only those errors found on IOCP macro instructions and parameters. If OPTCHAN is coded, IOCP checks its syntax and uses the OPTCHAN value to test for a path from the device(s) to the alternate channel by which the device(s) can be addressed.

If columns 1 through 5 contain *IOCP, IOCP prints the comment cards.

YES is the default if you do not code IGNORE.

Use IGNORE = YES when you have a combined input deck; that is, the deck contains both MVS system generation and IOCP macro instructions. Otherwise, IOCP will flag MVS system generation macro instructions as errors and prevent the generation of an IOCDS in storage.

Also, use IGNORE = YES when defining, to MVS system generation, channels and I/O devices used only by processors other than the processor complexes listed on the cover of this manual. When you use card-image input and specify IGNORE = YES, IOCP does not include these channels and devices if you also:

- Code ** instead of a chpid number on the PATH parameter of the CHPID macro instruction.

- Code *** instead of a number on the CUNUMBR parameter of the IODEVICE macro instruction.

Note: If you use IGNORE = YES and misspell an IOCP macro instruction name, IOCP assumes the macro instruction is not an IOCP macro instruction, ignores the macro instruction, and does not indicate an error. For example, if you specify an IODEVICE macro instruction as IDEVICE, IOCP does not indicate an error and does not define the device. However, note that MVS system generation processing will indicate an error because a misspelled macro instruction name is not a valid system generation or IOCP macro instruction name.

NO

specifies that IOCP is to process all input macro instructions and parameters. IOCP flags non-IOCP input as errors and also indicates errors found on IOCP macro instructions and parameters. IOCP prints all input, including all comment cards (all cards with an * in column 1 or a .* in columns 1 and 2).

Use IGNORE = NO when your input deck contains only IOCP macro instructions, IOCP-related parameters on the IODEVICE macro instruction, and comment cards.

Note: If you use a combined input deck, IGNORE = NO prevents the generation of an IOCDS in storage. Using IGNORE = NO causes flagging of the MVS system generation macro instructions as errors. If you use IGNORE = NO, IOCP assumes a default value of 1 when the number of units is not specified in the IODEVICE macro. Appendix D lists the default number of units assigned by IOCP when using IGNORE = YES. If you do not use IGNORE = YES, be certain you have specified the correct number of units when you write the IOCDS. See the IODEVICE macro for other implications of the IGNORE parameter.

WRTCDS =

specifies whether or not IOCP is to write an IOCDS generated in storage to one or more IOCDS(s) in the processor controller of the processor complex. All of the WRTCDS options except NO cause IOCP to write an IOCDS.

IOCP writes the IOCDS only if:

- It finds no errors on the input macro instructions
- It encounters no errors during IOCP processing of the IOCDS in storage
- The system operator grants permission in response to message ICP050D
- You did not write-protect the IOCDS (see the IOCDSM frame)

You request IOCP to write the IOCDS only after you have (1) checked the syntax of the input macro instructions, (2) generated an IOCDS in storage, (3) received reports on the generated IOCDS, and (4) checked to see whether or not the I/O configuration generated by IOCP is correct. If you

want to write to an IOCDS that is write-protected, you must also remove the write-protection using the IOCDSM (SYS021) frame.

When IOCP writes the generated IOCDS to an IOCDS in the processor controller, it overlays the previous configuration data in that IOCDS. The data in that IOCDS is lost, even if that IOCDS is the active IOCDS. (The IOCDS used for the last power-on reset or SYSIML CLEAR is the active IOCDS).

The valid options for WRTCDS depend on the number of I/O configuration data sets that your processor complex supports:

- For two I/O configuration data sets (LVL0 and LVL1), the valid options are YES, A1, and NO.
- For four I/O configuration data sets, the valid options on the A side are YES, Ax, and NO; on the B side they are YES, Bx, and NO.
- For eight I/O configuration data sets, all of the options are valid.

YES

specifies that IOCP is to write the IOCDS generated in storage to the A1 IOCDS (or the LVL1 IOCDS) in the processor controller.

Ax

specifies that IOCP is to write the Ax IOCDS (where x is 0, 1, 2, or 3) generated in storage to the level x IOCDS in the processor controller on the A side.

Bx

specifies that IOCP is to write the Bx IOCDS (where x is 0, 1, 2, or 3) generated in storage to the level x IOCDS in the processor controller on the B side.

ABx

specifies that IOCP is to write the x IOCDS (where x is 0, 1, 2, or 3) generated in storage to the level x IOCDS in the processor controller on both the A side and the B side.

NO

specifies that IOCP can not write the IOCDS generated in storage to an IOCDS in the processor controller.

NO is the default if you do not code WRTCDS.

Code or use the default WRTCDS=NO when you are testing the input deck and do not want to write to the processor controller until you have successfully tested and checked the input deck. Also, you must code or use the default WRTCDS=NO when you are executing IOCP on a processor other than the processor complexes listed on the cover of this manual.

LINECOUNT =

n

specifies the number of lines that IOCP is to print on a page of the IOCP output listing and configuration reports, including the heading of the report. You code a decimal value in the range of 10 through 99.

55

is the default number of lines (including the heading) that IOCP prints on a page of the IOCP output listing and configuration reports.

JCL Examples of Generating an IOCDS

Example 1: The following example shows the JCL statements used to check an input deck containing only IOCP macro instructions. IOCP requires the ddnames SYSIN for the input data set and SYSPRINT for the output data set. IOCP sends reports to SYSOUT.

```
//IOCP1      JOB    REGION=300K
//TEST1     EXEC   PGM=ICPIOCP , PARM=' IGNORE=NO , WRTCDS=NO ,
//          LINECOUNT=60 '
//SYSIN     DD     DSNAME=USER . IOC1 . CARDS , DISP=SHR
//SYSPRINT  DD     SYSOUT=A , DCB=( RECFM=FA )
```

In the example:

- IOCP1** specifies the JOB statement. Code parameters on the JOB statement required by your installation. Use a region size of 300K to ensure sufficient space for the job.
- TEST1** specifies the EXEC statement and the program (ICPIOCP) to be executed. The PARM options are: IGNORE=NO, which specifies flagging of non-IOCP input as errors; WRTCDS=NO, which specifies that the IOCDS generated in storage is not to be written to the processor controller; LINECOUNT=60, which specifies 60 lines of output on the reports IOCP produces.
- SYSIN** specifies the DD statement that defines the input data set, which consists of macro instructions with a record length of 80 bytes.
- SYSPRINT** specifies the DD statement that defines the output data set to receive messages and reports. (Note that IOCP records contain ANSI device control characters and have a length of 133 bytes.)

Example 2: The following example shows the JCL statements used to process a combined input deck, generate an IOCDS, and write the generated IOCDS to the A0 IOCDS in the processor controller. IOCP sends reports of the generated IOCDS to SYSOUT.: IOCP requires the ddnames SYSIN for the input data set and SYSPRINT for the output data set.

```
//IOCP2      JOB    REGION=300K
//WRITE1     EXEC   PGM=ICPIOCP , PARM=' WRTCDS=A0 '
//SYSIN     DD     DSNAME=USER . IOC2 . CARDS , DISP=SHR
//SYSPRINT  DD     SYSOUT=A , DCB=( RECFM=FA )
```

In the example:

- IOCP2** specifies the JOB statement. Code parameters on the JOB statement required by your installation. Use a region size of 300K to ensure sufficient space for the job.

- WRITE1** specifies the EXEC statement and the program (ICPIOCP) to be executed. The PARM options are: WRTCDS = A0, which specifies that the IOCDS generated in storage is to be written to the A0 IOCDS in the processor controller; IGNORE = YES (the default), which specifies that IOCP is to ignore non-IOCP macro instructions and parameters; LINECOUNT = 55 (the default), which specifies the number of lines of output for each page on the configuration reports.
- SYSIN** specifies the DD statement that defines the input data set, which consists of macro instructions with a record length of 80 bytes.
- SYSPRINT** specifies the DD statement that defines the output data set to receive messages and reports. (Note that IOCP records contain ANSI device control characters and have a length of 133 bytes.)

Producing Configuration Reports

IOCP performs the following steps when you request configuration reports.

IOCP:

- **Reads** one or more IOCDS(s) from the processor controller into storage.
- **Prints** the IOCP configuration reports.

If IOCP encounters any errors during processing, IOCP sends appropriate error messages to the output printer. For examples of IOCP configuration reports, see “Chapter 5. IOCP Configuration Reports.”

Coding the JCL EXEC Statement for Producing Configuration Reports

On the EXEC statement, you code the name of the IOCP program on the PGM parameter and the following PARM options to produce configuration reports. (The example later in this chapter describes the JOB and DD statements for an IOCP job.)

You must code the REPORT option in order to receive reports of an IOCDS.

```
PARM='REPORT=(CD0|CD1|BOTH|Ax|Bx|A|B|AB),LINECOUNT=n|55'
```

REPORT =

specifies one or more IOCDS(s) to be read from the processor controller into storage in order to produce configuration reports. You can code more than one REPORT option. If you code only one option, you can omit the parentheses.

The valid options for REPORT = depend on the number of I/O configuration data sets that your processor complex supports:

- For two I/O configuration data sets (LVL0 and LVL1), the valid options are CD0, A0, CD1, A1, and BOTH.

- For four I/O configuration data sets, the valid options on the A side are CD0, CD1, BOTH, Ax, and A; on the B side they are CD0.
- For eight I/O configuration data sets, all of the options are valid.

CD0
specifies the A0 IOCDS.

CD1
specifies the A1 IOCDS.

BOTH
specifies both the A0 and the A1 IOCDS.

Ax
specifies the Ax IOCDS, where x is 0, 1, 2, or 3.

Bx
specifies the Bx IOCDS, where x is 0, 1, 2, or 3.

A
specifies the entire A side (the A0, A1, A2, and A3 IOCDS).

B
specifies the entire B side (the B0, B1, B2, and B3 IOCDS).

AB
specifies every IOCDS on both the A side and the B side.

LINECOUNT =

n
specifies the number of lines that IOCP is to print on a page of the IOCP output listing and configuration reports, including the heading of the report. You code a decimal value in the range of 10 through 99.

55
is the default number of lines (including the heading) that IOCP prints on a page of the IOCP output listing and configuration reports.

Conditions for Coding the REPORT Option

- You can code REPORT only when you execute IOCP on a 308x processor complex because you must read an IOCDS from the processor controller.
- You cannot code REPORT if you code either the IGNORE or WRTCDs option. That is, you cannot read an input deck and generate an IOCDS (which includes reports of the generated IOCDS), and produce reports via the REPORT option in the same job.
- You can code several REPORT options. IOCP does not allow redundant and/or duplicate values. For example, REPORT=(A0,A1,A2,A3,BOTH,CD0,CD1,A0,B) is the same as

REPORT=(A,B) or REPORT=AB. Regardless of the order in which you specify the options, the reports are always produced, if they are specified, in the following order: A0, A1, A2, A3, B0,

JCL Example of Producing Configuration Reports

Example: The following example shows the JCL statements used to produce IOCP reports of the A0 and A1 IOCDS in the processor controller. IOCP sends reports to SYSOUT. Note that you do not need a DD statement to access an IOCDS in the processor controller.

IOCP requires the ddname SYSPRINT for the output data set.

```
//IOCP5      JOB      REGION=300K
//REPORT2   EXEC     PGM=ICPIOCP,PARM='REPORT=BOTH'
//SYSPRINT  DD       SYSOUT=A,DCB=(RECFM=FA)
```

In the example:

- IOCP5** specifies the JOB statement. Code the parameters on the JOB statement required by your installation. Use a region size of 300K to ensure sufficient space for the job.
- REPORT2** specifies the EXEC statement and the program (ICPIOCP) to be executed. The PARM option of REPORT=BOTH specifies that both the A0 and the A1 IOCDS are to be read from the processor controller to produce reports.
- SYSPRINT** specifies the DD statement that defines the output data set to receive messages and reports. (Note that IOCP records contain ANSI device control characters and have a length of 133 bytes.)

Return Codes

When you execute the MVS version of IOCP, IOCP returns one of the following codes at the completion of the job.

Return Code		Description/Action
Decimal	Hex	
0	0	IOCP completed the requested function without error.
4	4	IOCP completed the requested function without error, but has issued one or more warning messages. The warning messages in the output listings or the reports describe the specific conditions.
8	8	IOCP encountered an error and has terminated processing before completing the requested function. The error message in the output listing describes the specific condition.
12	C	IOCP terminated because the output data set DCB failed to open. IOCP was unable to print messages or reports. You must correctly specify the DD statement for the output data set.
16	10	IOCP terminated because it could not obtain the needed storage via the GETMAIN macro instruction. Use a region size of 300K bytes (on the REGION parameter of the JOB statement) to ensure sufficient space for the job.

Methods of Executing the MVS Version of IOCP

This topic suggests the steps that the installation can use to execute the MVS version of IOCP in order to (1) initially define and check the I/O configuration data to prepare for a new processor complex, and (2) subsequently redefine and replace an I/O configuration on an installed processor complex.

Initial Definition of I/O Configuration Data

The following example describes the steps that an installation can use to initially define and check the I/O configuration data in order to prepare for the installation of a new processor complex. The example suggests that you develop a combined card-image input deck (consisting of IOCP and MVS system generation macro instructions) and check the deck on an existing system. The customer engineer (CE) uses this input deck to generate the I/O configuration data during the installation of the new processor complex.

1. Determine, from your physical plan, the I/O configuration requirements that must be met to install the processor complex.
2. Prepare a combined input deck (containing both IOCP and system generation macro instructions) that defines your I/O configuration and system requirements. You use this deck for both IOCP execution and MVS system generation, as described in the following steps. (Appendix B shows a listing of a typical input deck containing both IOCP and system generation macro instructions.)

Validate the IOCP macro instruction input by executing IOCP on the generating system before executing the complete system generation, which will use the same input deck. This allows you to correct IOCP-related errors in the input deck before doing the system generation.

During your preparation for an MVS system generation, perform the following steps (3, 4, 5, and 6) after you have loaded the distribution libraries (via the SMP procedure) and before you execute Stage 1 of the system generation. The SYS1.AOSC5 data set of the distribution library (DLIB) contains the IOCP program. The program name is ICPIOCP.

During the SMP procedure, IOCP is link edited from the DLIB into SYS1.LINKLIB as an APF-authorized program (authorization code AC = 1) with the load module name of ICPIOCP.

3. If you want, you can link-edit the IOCP program from the DLIB into one of your private libraries in the generating system. The program must be link edited into a single load module. The program does not need to be authorized to perform the rest of the steps in this example. The 15 CSECTs to be included are: ICPCARDS, ICPCARDX, ICPCGET, ICPCGNDS, IPCINIT, ICPCIOCP, ICPCIOCU, ICPCIODV, ICPCMSG, ICPCPUT, ICPCRDDS, ICPCRPT, ICPCRTNS, ICPCWTDS, and ICPPCNTL. Use ICPPCNTL for the entry point in the ICPIOCP load module to receive control.

Note: The IOCP program used in Step 4 does not need to be an authorized program. You may want to keep this non-authorized program to validate subsequent I/O configuration input decks.

4. Execute IOCP via JCL statements to validate the IOCP macro instructions. On the PARM parameter of the EXEC statement, use IGNORE = YES and WRTCDS = NO.
5. If there are any errors in the IOCP macro instructions, correct the errors and rerun IOCP (Step 4).
6. Analyze the IOCP configuration reports (produced in Step 4) to ensure that you defined the desired I/O configuration. If necessary, revise the IOCP macro instructions and rerun IOCP.
7. Execute the MVS system generation for the MVS/System Product and use the input deck created in Step 2 and processed by IOCP in Step 4.

Note: During the MVS system generation, IOCP is link edited from the DLIB into SYS1.LINKLIB of the generated system as an APF-authorized program (authorization code AC = 1) with the load module name of ICPIOCP. You can use this APF-authorized program to subsequently replace I/O configuration data in an IOCDS as described in “Subsequent Definition and Replacement of I/O Configuration Data.” Also, for additional security, you may want to change the name of the IOCP program or move the program to another data set and password-protect or RACF-protect the data set. This added protection will reduce the possibility of having the I/O configuration data in an IOCDS inadvertently destroyed.

8. If IOCP encounters errors during the system generation, correct the errors. If the errors involve IOCP-related macro instructions (CHPID or IODEVICE), rerun IOCP (Steps 4, 5, and 6) to ensure that the corrections have not affected IOCP processing. Then rerun the appropriate portions of system generation.
9. Save the validated input deck for use by the CE during installation of the processor complex.

Note: During the physical installation of the processor complex, the CE uses your validated input deck (with the stand-alone version of IOCP) to configure and test the I/O configuration for the new processor complex. “Generating an IOCDS on a New Processor Complex” in Chapter 4 provides an example for the CE.

Subsequent Definition and Replacement of I/O Configuration Data

The following example describes the steps the installation can use to replace the existing I/O configuration data on a processor complex. You use this procedure when the I/O configuration for your processor complex changes and you need to execute IOCP and perform an MVS system generation.

You can do steps 1 through 6 on an existing system (such as a 3033) that has an MVS/System Product installed.

1. Update your combined input deck that contains the IOCP and MVS system generation macro instructions to reflect your new I/O configuration.
2. Execute the MVS version of IOCP (either an APF-authorized or non-authorized IOCP program) to check the input deck you updated in Step 1. On the PARM parameter of the EXEC statement, use the IGNORE = YES and WRTCD S = NO options.
3. If necessary, correct any errors on the IOCP macro instructions, and rerun IOCP (Step 2).
4. Analyze the IOCP configuration reports (produced in Step 2) to ensure that you defined the desired I/O configuration. If necessary, revise the IOCP macro instructions and rerun IOCP (Step 2).
5. Execute the complete system or I/O device generation using the input deck prepared and checked in Steps 1 through 4.
6. If IOCP encountered errors during system generation, correct the errors. If the errors involve IOCP-related macro instructions (CHPID or IODEVICE), rerun IOCP (Steps 2, 3, and 4) to ensure that the corrections have not affected IOCP processing. Then rerun the appropriate portions of system generation.

You must perform the following steps on the processor complex that is to have its IOCDS initialized.

7. Execute an APF-authorized IOCP program with the IGNORE = YES and a WRTCD S option other than NO. IOCP writes the I/O configuration to the specified IOCDS in the processor controller. Note that the system operator must respond YES to IOCP message ICP050D before IOCP writes to the processor controller.
8. Perform a power-on reset of the processor complex with the appropriate IOCDS specified as the source of your configuration data. You use the IOCDSM (SYS021) frame to select the IOCDS and the CONFIG (SYS020) frame to perform the power-on reset. (See the operator's guide for the system console that applies to your processor complex.)
9. Test the new configuration following the procedures established for your installation.
10. If your processor complex has only a level A0 and A1 (LVL0 and LVL1) IOCDS, switch them after testing the new I/O configuration. To switch data sets, use action 3 (SWITCH DS A/B) on the CONFIG (SYS020) frame. This action allows you to execute IOCP again and write to and test another I/O configuration in the A1 IOCDS.
11. Save the card-image input you used in Step 2 to provide a backup.



Chapter 3. Executing the VM Version of IOCP

The VM version of IOCP runs under the control of:

- the VM/System Product (VM/SP)
- the VM/SP High Performance Option (VM/SP HPO)
- the VM/Extended Architecture Systems Facility (VM/XA Systems Facility)

You invoke the VM version of IOCP in the CMS environment. The CMS IOCP command executes IOCP and has options that allow you to request the following IOCP functions:

- **Generating an IOCDS** - IOCP reads, validates, and checks the syntax of the input macro instructions. It generates an IOCDS in storage based on the configuration defined by the macro instructions and produces reports of the IOCDS generated in storage. When requested, IOCP writes the generated IOCDS to one or more IOCDS(s) in the processor controller.
- **Producing Configuration Reports** - IOCP reads one or more IOCDS(s) from the processor controller into storage and prints the IOCP configuration reports. (See “Chapter 5. IOCP Configuration Reports” for examples.)

The following topics describe:

- How to specify IOCP macro instructions
- The two functions IOCP performs
- The CMS IOCP command that invokes these functions (with examples)
- The return codes IOCP can set
- How to initially define the I/O configuration or to redefine an existing I/O configuration

Specifying IOCP Macro Instructions

This section describes the purpose of the IOCP macro instructions and explains how to code them. The first topic in this section summarizes the I/O configuration rules that apply to the IOCP macro instructions. Subsequent topics describe the IOCP macro instructions in alphabetic order.

The rules for coding the IOCP card-image macro instructions are those of assembler language. See “Appendix A. Coding IOCP Macro Instructions” for a

summary of the rules for coding the macro instructions and the notation used in this book to illustrate the macro instructions.

IOCP has four macro instructions: CHPID, CNTLUNIT, IODEVICE, and ID. IOCP requires the CHPID, CNTLUNIT, and IODEVICE macro instructions. The CHPID, CNTLUNIT, and IODEVICE macro instructions define respectively, the channel paths, control units, and I/O devices in your configuration. The ID macro instruction is optional. If you want specific identifying information in the heading of the IOCP configuration reports, code the ID macro instruction.

The following general rules apply to the sequence of the IOCP macro instructions in the input file.

- You can code the ID macro instruction only once and it must precede other IOCP macro instructions.
- A CHPID macro instruction that defines the channel path must precede a CNTLUNIT macro instruction that refers to the channel path.
- A CNTLUNIT macro instruction must follow the CHPID macro instruction that defines the channel path to which the control unit attaches.
- An IODEVICE macro instruction must follow the CNTLUNIT macro instruction that defines the control unit to which the device is assigned.
- You can insert IOCP comment cards, specified by the characters *IOCP in columns 1 through 5, in the input file where desired.

We suggest that you group all CHPID macro instructions together, followed by all CNTLUNIT macro instructions, and then all IODEVICE macro instructions (as shown in Figure B-3). Or, you might group all CHPID macro instructions together, followed by groups of related CNTLUNIT and IODEVICE macro instructions.

IOCP and VM/SP (or VM/SP HPO) System Generation

The information on some VM/SP (or VM/SP HPO) system generation macro instructions must correspond to IOCP macro instructions. Figure 3-1 shows that correspondence. This chapter contains detailed information about the correspondence between VM/SP and VM/SP HPO system generation macro instructions and IOCP macro instructions.

Do not mix IOCP macro instructions and VM/SP (or VM/SP HPO) system generation macro instructions in the same file. You must maintain two distinct files, the IOCP source file and the corresponding real I/O configuration file (DMKRIO).

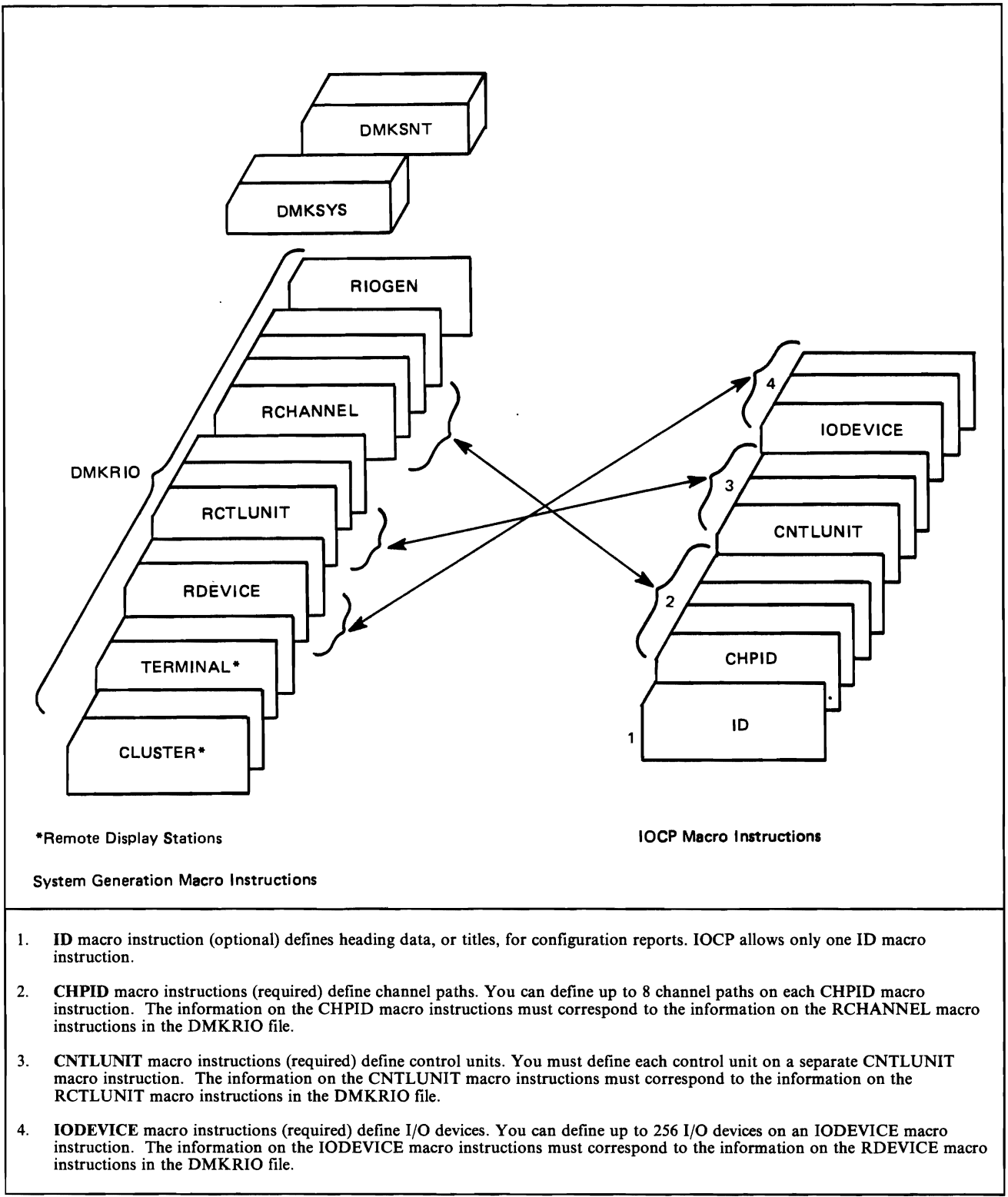

Figure 3-1. Correspondence between IOCP Macro Instructions and DMKRIO Macro Instructions

IOCP and VM/XA Systems Facility System Generation

The information on some VM/XA Systems Facility system generation macro instructions must correspond to IOCP macro instructions. Figure 3-2 shows that correspondence. This chapter contains detailed information about the correspondence between VM/XA Systems Facility system generation and IOCP macro instructions.

Do not mix IOCP and VM/XA Systems Facility system generation macro instructions in the same file. You must maintain two distinct files, the IOCP source file and the corresponding real I/O configuration file (HCPRIO).

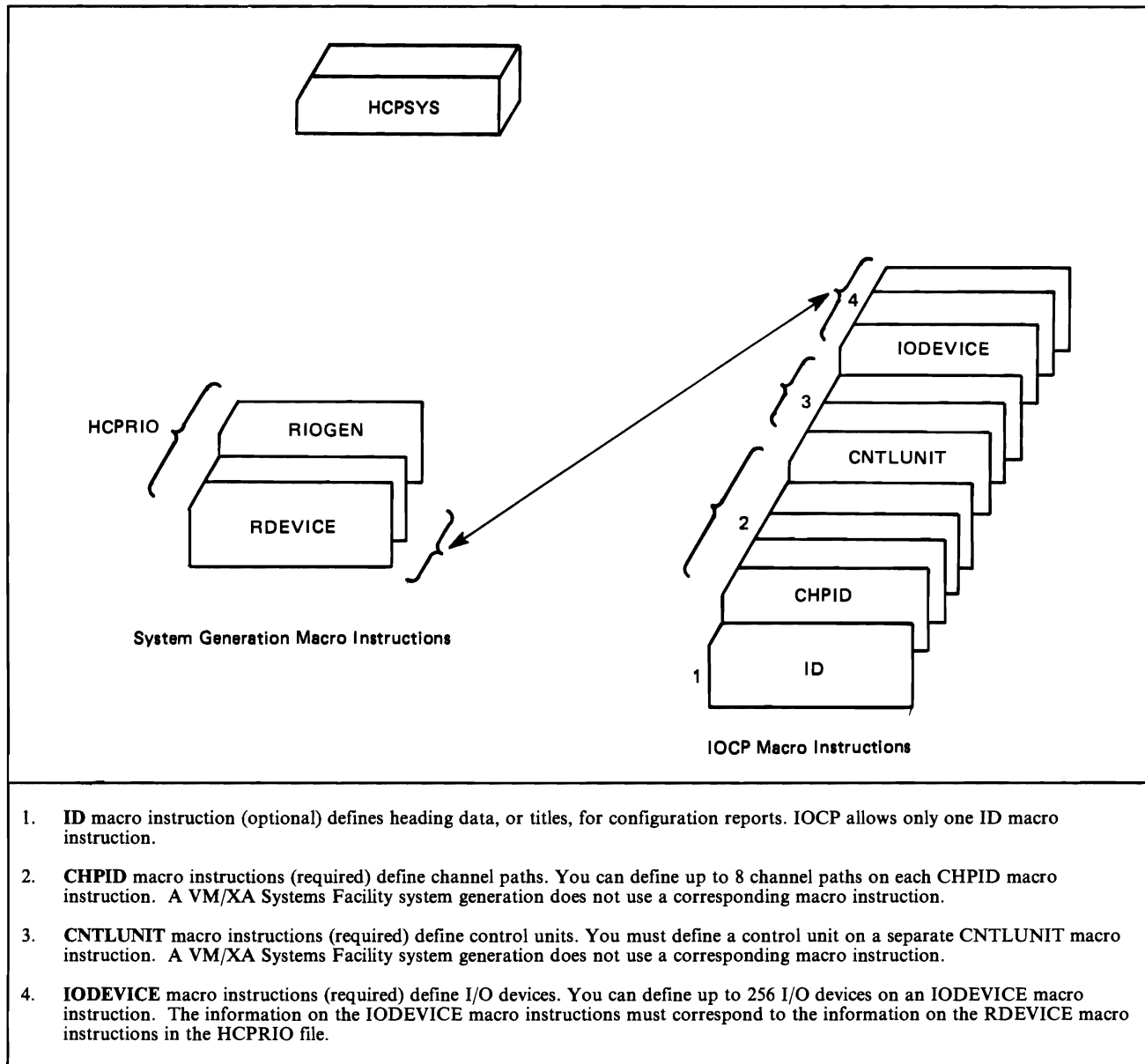

Figure 3-2. Correspondence between IOCP Macro Instructions and HCPRIO Macro Instructions

Summary of Configuration Rules

Here for your convenience is a summary of the rules and restrictions described in the following topics:

For channel paths:

- You can specify all channel paths as block multiplexer.
- You can specify for the A side, only channel paths 00, 01, 02, 03, 10, 11, 12, and 13 (hex) byte multiplexer.
- For the B side, you can specify only channel paths 40, 41, 42, 43, 50, 51, 52, and 53 (hex) as byte multiplexer.
- You can specify a maximum of four channel paths on each side as byte multiplexer.

For control units:

- You can attach a physical control unit to a maximum of four channel paths per system.
- You can assign a maximum of 16 control units to one channel path.
- You can attach only a nonshared control unit (specified by `SHARED=N` on the `CNTLUNIT` macro instruction) to a channel path that operates in byte multiplexer mode.
- Only a control unit attached to a block multiplexer channel path can use the data streaming interface protocol. That is, if `PROTOCL=S` on the `CNTLUNIT` macro instruction, the channel path(s) to which the control unit attaches must have `TYPE=BL` specified on the `CHPID` macro instruction(s).

For I/O devices:

- The maximum number of I/O devices is 4080.
- The sum of the number of I/O devices plus the number of logical control units cannot exceed 4096.
- You can assign a maximum of 256 I/O devices to one channel path.
- You can assign a device to a maximum of four control units.
- When you assign a device to more than one control unit, each control unit must: (1) recognize the same unit address for the device, (2) not be attached to the same channel path, and (3) have the same shared characteristics and use the same interface protocol.
- You can only assign a device to a combined maximum of four channel paths (even though you can assign a device to up to four control units and you can attach a control unit to up to four channel paths).

- You cannot assign a device that has the I/O interface timeout function inhibited to a channel path that operates in byte multiplexer mode.
- Each I/O device must have a unique device address/number within the I/O configuration. IOCP does not allow duplicate device addresses/numbers.

For 370-XA mode:

If you plan to create an IOCDS for VM/SP or VM/SP HPO **and** the VM/XA Systems Facility or another operating system that supports extended architecture, the following apply:

- If you code a file of IOCP macro instructions for the 370 level of IOCP, you can use the same file as input to create a 370/370-XA IOCDS. (However, the operating system that supports extended architecture may not support all of the defined devices.
- You can define a channel path and its attached I/O devices exclusively for 370-XA mode. To do this, remove the channel number and channel set for that channel path from the CHPID macro instruction.
- The PATH parameter on the IODEVICE macro instruction specifies a preferred path. The preferred path is an optional parameter used only for 370-XA mode operation.

CHPID

CHPID, a required macro instruction, describes:

- The characteristics of channel paths
- The correspondence of channel paths to channel numbers and channel sets

You must specify each channel path in your I/O configuration on a CHPID macro instruction to use the channel path. You can specify up to eight channel paths on one CHPID macro instruction.

The CHPID macro instruction must follow the ID macro instruction (if you specified the ID macro instruction). The CHPID macro instruction must precede any CNTLUNIT macro instructions that refer to the channel path.

The format of the CHPID macro instruction is:

[symbol]	CHPID	PATH=((chpid number[,channel number [,channel set]]),...) TYPE={BL BY}
----------	-------	--

PATH=

specifies one or more channel path identifiers. If you use the devices on a channel path in 370 mode, you must specify the channel path's corresponding channel number. Optionally, you may specify the channel path's associated channel set. You can specify a maximum of eight channel paths on one CHPID macro instruction. If you specify more than one channel path on a macro instruction, all channel paths must have the same TYPE characteristic. You cannot specify a channel set without specifying a channel number.

chpid number

specifies the channel path identifier. For the A side, you must specify two hexadecimal digits in the range of 00 through 07, 10 through 17, or 20 through 27. (Channel paths 10 through 17 and 20 through 27 are optional by model.) For the B side, you must specify two hexadecimal digits in the range of 40 through 47, 50 through 57, or 60 through 67.

channel number

specifies the channel number that corresponds to the channel path when the processor complex operates in 370 mode. You specify one hexadecimal digit in the range of 0 through F. Channel numbers must be unique and consecutive within a channel set.

To specify a channel set, you must specify a channel number. If you do not specify the channel number, you cannot access the devices attached to the channel path when the processor complex operates in 370 mode.

For a system on which you generate VM/SP or VM/SP HPO: To code the channel number, first find the real address of the channel as

specified on the ADDRESS parameter of the RCHANNEL macro instruction in the DMKRIO file. This value is the channel number.

For example, the following macro instruction was coded for the DMKRIO file:

```
RCHANNEL ADDRESS=2, . . .
```

The corresponding IOCP macro instruction is:

```
CHPID PATH=( (17,2,0) ), . . .
```

channel set

specifies the channel set used for 370 mode. You specify a value of 0 or 1 for the channel set. If you do not specify a channel set, IOCP assigns the channel path to channel set 0.

On a processor complex with both an A side and a B side, each side has two channel sets (0 and 1) in 370 mode.

On the uniprocessors, VM/SP and VM/SP HPO can access only channel paths assigned to channel set 0. Therefore, you must either specify a value of 0 or accept the default of 0. (You can assign channel paths to channel set 1; however, neither VM/SP and VM/SP HPO, nor any of their virtual machines, can access these channel paths on a uniprocessor.)

A channel set cannot have more than 16 channel paths assigned to it. The two channel sets (0 and 1) can have a maximum combined total of 24 channel paths on each side. (For example, 16 channel paths assigned to channel set 0 and 8 channel paths assigned to channel set 1, or 12 channel paths assigned to channel set 0 and 12 channel paths assigned to channel set 1.)

For the processor complex, you must assign consecutive channel numbers within a channel set. (For example, channel numbers 0, 1, 2, 3, 4, 5, or channel numbers 8, 9, A, B, C, D.) The channel path identifiers do not need to be consecutive.

For a uniprocessor, processor 2 (the only processor) always connected to channel set 0 at power-on reset, SYSIML or SYSIML CLEAR. For a processor complex with more than one processor, channel set connection at power-on reset, SYSIML or SYSIML CLEAR depends on whether the processor complex has one or both processors configured.

When the processor complex has both processors configured, channel set 0 connects to processor 0, and channel set 1 connects to processor 2. (If the processor complex has a B side, channel set 0 on the B side connects to processor 1, and channel set 1 on the B side connects to processor 3.) When the processor complex subsequently resets (such as a system reset or load), channel set 0 reconnects to processor 0 (or processor 1 on the B side) and channel set 1 reconnects to processor 2 (or processor 3 on the B side).

If you remove either processor from the processor complex (the processor fails or you take it offline), channel set 0 and channel set 1 both remain configured. However when you remove a processor, a

subsequent reset causes the connection of channel set 0 to the remaining processor on that side. The reset does not connect channel set 1, but you can connect channel set 1 after IPL by activating channel set switching. Therefore, we recommend that you assign critical asymmetrically attached devices (such as the operator's console) to a channel path assigned to channel set 0.

TYPE =

specifies the mode of I/O operation for the channel path. If you specify more than one channel path on a macro instruction, all channel paths must have the same TYPE characteristic.

BL

specifies that the channel path is a block multiplexer channel, which operates in burst mode only and allows multiplexing between blocks. You can specify TYPE = BL for all channel paths.

BY

specifies that the channel path is a byte multiplexer channel, which operates in burst mode or byte-interleave mode, depending on the attached control unit. You can specify TYPE = BY for only channel paths 00 through 03 and 10 through 13 (hex) on the A side, and for channel paths 40 through 43 and 50 through 53 (hex) on the B side. You can specify a maximum of four channel paths on each side as TYPE = BY.

For a system on which you generate VM/SP or VM/SP HPO: Code TYPE = BL on the CHPID macro instruction for CHTYPE = SELECTOR on the RCHANNEL macro instruction in the DMKRIO file. Although SELECTOR has no corresponding value on the CHPID macro instruction, the channel operates in the selector mode if you code SHARED = Y on the CNTLUNIT macro instruction. See the description of the CNTLUNIT macro instruction in this chapter.

Example: The following macro instruction (named CHSET1) defines three channel paths (hex 15, 16, and 17) with their corresponding channel numbers (hex 8, 9, and A) in channel set 1. The channel paths are to operate in block multiplexer mode.

```
CHSET1 CHPID PATH=((15,8,1),(16,9,1),
                  (17,A,1)),TYPE=BL *
```

Note that the three channel paths are unique numbers arbitrarily assigned.

Example: The following macro instruction (named CHP17) defines channel path 17. The channel path operates in block multiplexer mode. Because you did not specify a channel number, the processor complex can access the devices attached to this channel path only when it operates in 370-XA mode.

```
CHP17 CHPID PATH=17,TYPE=BL
```

CNTLUNIT

CNTLUNIT, a required macro instruction, describes:

- The characteristics of the control unit
- The channel paths to which the control unit attaches
- The unit addresses the control unit recognizes

You must specify each physical control unit in your I/O configuration in a separate CNTLUNIT macro instruction to use the control unit. This requirement includes control units residing either in the same physical unit as an I/O device or another control unit.

You can attach a control unit to a maximum of four channel paths. You can assign a maximum of 16 control units to one channel path.

See Appendix D for a list of control unit types and their characteristics.

Based on information in the CNTLUNIT macro instructions, IOCP constructs logical control units for the channel subsystem to use when the processor runs in 370-XA mode. A logical control unit is a logical representation of one to four physical control units. IOCP builds a logical control unit for:

- Each control unit with no devices or no devices shared with other control units.
- Each group of two to four control units that share devices between them.

The channel subsystem uses the logical control units for queuing I/O requests for the devices attached to the associated physical control units. There is one I/O request queue for each logical control unit. The channel subsystem queues all I/O requests for all devices in the logical control unit (all the devices attached to the set of physical control units in the logical control unit) to the same I/O request queue.

IOCP also establishes a rotation order for the channel paths associated with each logical control unit. When initiating I/O requests queued to the logical control unit, the channel subsystem uses this rotation order to determine the sequence for selecting channel paths. The section “Rotation Algorithm” in Chapter 1 describes how IOCP establishes the rotation order of the channel paths.

The CNTLUNIT macro instruction must follow any CHPID macro instructions that specify channel paths used by the control unit. The CNTLUNIT macro instruction must precede any IODEVICE macro instructions that refer to the control unit.

The format of the CNTLUNIT macro instruction is:

[symbol]	CNTLUNIT	CUNUMBR=number PATH=(chpid[,chpid]...) [PROTOCL={D S}] SHARED={Y YB N} UNIT=type UNITADD=((address[,number]),...)
----------	----------	--

CUNUMBR = number

specifies the hexadecimal number assigned to the control unit. You specify three hexadecimal digits in the range of 000 through FFF. You must assign each control unit a unique number. You can arbitrarily assign the numbers.

PATH = chpid

specifies the channel path(s) attached to the control unit. You specify one to four channel path identifiers for the control unit. You must specify two hexadecimal digits for each channel path identifier.

Note: If you specify the control unit as shared (SHARED=Y) or shared block (SHARED=YB), then you cannot specify channel paths that operate in byte multiplexer mode for the control unit.

For a system on which you generate VM/SP or VM/SP HPO: The PATH parameter corresponds to information found on the ADDRESS parameter of the RCTLUNIT macro instruction in the DMKRIO file.

The leftmost digit of the ADDRESS parameter of the RCTLUNIT macro instruction is the channel address of the control unit. When you code the CHPID macro instruction, you use the channel address for the channel number.

Find the channel path identifier that you coded with the channel number on the CHPID macro instruction. Code this value for the PATH parameter.

For example, the following RCTLUNIT macro instruction resides in DMKRIO:

```
RCTLUNIT ADDRESS=4A0, . . .
```

The channel address is 4. The CHPID coded for channel address 4 could be:

```
CHPID PATH=((12,4,0)), . . .
```

The channel path identifier you need for the PATH parameter on the CNTLUNIT macro instruction is 12.

```
CNTLUNIT . . . ,PATH=12, . . .
```

PROTOCL =

specifies the interface protocol that the control unit uses when operating with the channel paths specified on the PATH parameter.

D

specifies the D. C. interlock protocol. This protocol is the standard I/O interface that requires the demand response. D is the default if you do not code PROTOCL.

S

specifies the data streaming protocol. This protocol does not require the demand response but continues at the rate governed by the control unit. S is valid only for a control unit attached to block multiplexer channel paths.

Note: Incorrect specification of the PROTOCL parameter may produce unpredictable results. For example, if you specified S (data streaming) for a control unit that supports the D. C. interlock protocol, I/O requests can result in either detected errors (such as data overruns or interface control checks) or undetected errors.

SHARED=

specifies the level of concurrency of I/O requests that the channel allows for the control unit. In 370 mode, the parameter specifies how to assign subchannels. In 370-XA mode, IOCP sets the control unit type (1 or 2) automatically based on the SHARED parameter that you specify. See Appendix D for more information on specifying the SHARED parameter. (For further information on control unit types, see the topic “Logical Control Units” in Chapter 1.)

Y

specifies that the control unit (such as the 3803 for magnetic tape units) has one or both of the following attributes:

- The control unit supports only one I/O request at a time, regardless of the number of I/O devices attached.
- The control unit clears pending sense information in the control unit for an I/O device if the channel initiates an I/O request for another attached I/O device.

For 370 mode, assigned to all the devices attached to the control unit is a single shared subchannel (for each attaching channel path) and the channel operates in selector mode.

For 370-XA mode, you assign the control unit as type 1 and each device as a subchannel.

In both modes, the channel ensures processing of only one I/O request at a time for all devices sharing the control unit. For 370-XA mode, if sense information is pending in the control unit for an I/O device attached to the control unit, the channel ensures that I/O requests for other I/O devices attached to the control unit are not initiated until the system control program has issued an I/O request to clear the pending sense information.

You cannot specify SHARED=Y for control units that attach to a byte multiplexer channel path.

YB

specifies that the control unit (such as the 3258, 3272, or 3274) has one or both of the attributes of SHARED=Y, but supports disconnect command chaining (DCC) operations.

For 370 mode, assigned to all the devices attached to the control unit is a single shared subchannel (for each attaching channel path) and the channel operates in block multiplexer mode.

For 370-XA mode, you assign the control unit as type 1 and each device as a subchannel.

In both modes, the channel ensures processing of only one I/O request at a time for all devices sharing the control unit. For 370-XA mode, if sense information is pending in the control unit for an I/O device attached to the control unit, the channel ensures that I/O requests for other I/O devices attached to the control unit are not initiated until the system control program has issued an I/O request to clear the pending sense information.

You cannot specify SHARED=YB for control units that attach to a byte multiplexer channel path.

N

specifies that the control unit supports multiple I/O requests concurrently (one for each attached I/O device).

Each I/O device attached to the control unit is assigned a separate subchannel. For 370-XA mode, the control unit is assigned as type 2.

The channel accepts and initiates one I/O request for each I/O device and operates in either block or byte multiplexer mode, depending on how you specify the attaching channel path.

UNIT = type

specifies the type of control unit. You specify up to five alphanumeric characters that identify the type of control unit. IOCP only checks the syntax for alphanumeric characters. IOCP does not validate the type value.

You must specify a type for every control unit in your I/O configuration. You specify a type on the UNIT parameter in one of two ways:

- For devices that do not have a separately assigned control unit type (for example, when the control unit function is built into the same physical unit as the device), you can specify the device type on the UNIT parameter. For example, for the 3800 Printing Subsystem you can specify UNIT=3800 on the UNIT parameter of the CNTLUNIT macro instruction (as well as UNIT=3800 on the IODEVICE macro instruction)
- For devices that do have a separately assigned control unit type, you must specify the specific control unit type on the UNIT parameter (such as UNIT=3803)

For a system on which you generate VM/SP or VM/SP HPO: The UNIT parameter is the same as the CUTYPE parameter on the RCTLUNIT macro instruction in the DMKRIO file. For example, the following macro instruction appears in the DMKRIO file:

```
RCTLUNIT . . . ,CUTYPE=3811
```

The corresponding IOCP macro instruction is:

```
CNTLUNIT . . . ,UNIT=3811, . . .
```

UNITADD =

address

specifies the unit addresses of the I/O devices that the control unit recognizes. You specify two hexadecimal digits in the range of 00 through FF. You must specify at least one unit address. A unit address need not represent an attached device. (For example, UNITADD = ((0A),(0B),(0F)) specifies that the control unit recognizes unit addresses 0A, 0B, and 0F.)

number

specifies the number of sequential unit addresses recognized by the control unit. You specify a one-, two-, or three-digit decimal value in the range of 1 through 256. (For example, UNITADD = ((0A,3)) specifies that the control unit recognizes unit addresses 0A, 0B, and 0C.) The unit address plus the number of addresses must not exceed a hexadecimal address of FF. If number is omitted, a value of 1 is assumed.

You can specify a maximum of eight addresses and/or sets of address and number values. If you do not specify the UNITADD parameter on the IODEVICE macro instruction, the unit addresses specified must include the unit addresses (the second and third digits) specified on the ADDRESS parameter of the IODEVICE macro instruction for the attached devices. If you specify the UNITADD parameter on the IODEVICE macro instruction, the unit addresses specified must include the unit addresses specified on the UNITADD parameter for the attached devices.

Note: See Appendix D for the exceptions and recommendations that apply to specific device types.

You must specify the full range of unit addresses that the control unit can address whether the devices are attached or not.

For a system on which you generate VM/SP or VM/SP HPO: The UNITADD parameter corresponds to information found on the ADDRESS parameter and the FEATURE parameter of the RCTLUNIT macro instruction in the DMKRIO file. The address portion of UNITADD is the same number as the two rightmost digits of the ADDRESS parameter on the RCTLUNIT macro instruction. The number portion of UNITADD is the same as the FEATURE number.

For example, the RCTLUNIT macro instruction is:

```
RCTLUNIT ADDRESS=4A0 , . . . , FEATURE=16-DEVICE
```

The corresponding CNTLUNIT macro instruction is:

```
CNTLUNIT . . . , UNITADD = ( ( A0 , 16 ) )
```

For the RCTLUNIT macro instruction, the default FEATURE number is 8. Always code 8 as the number portion of UNITADD = if you do not explicitly code the FEATURE parameter on the RCTLUNIT macro instruction.

Example: The following macro instruction assigns the control unit number of 10A to an IBM 2821 Control Unit, names channel path 06 as the channel path to which the control unit attaches, and defines unit addresses 0A through 0C as recognized by the control unit. D is the default for PROTOCL.

```
CU10A CNTLUNIT CUNUMBR=10A,PATH=06,SHARED=N, X
          UNIT=2821,UNITADD=(0A,3)
```

Example: The following macro instruction assigns the control unit number of 00E to a 3803 Tape Control, names channel path 05 as the channel path to which the control unit attaches, specifies the D. C. interlock protocol, and defines unit addresses 80 through 8F as recognized by the control unit.

```
CU00E CNTLUNIT CUNUMBR=00E,PATH=05,PROTOCL=D, X
          SHARED=Y,UNIT=3803,UNITADD=(80,16)
```

Example: The following macro instruction assigns the control unit number 11A to a control unit that the customer has named DUMMY, names two channel paths 06 and 07 as the channel paths to which the control unit attaches, and defines unit addresses 90 through 9F and A0 through AF as recognized by the control unit.

```
CU11A CNTLUNIT CUNUMBR=11A,PATH=(06,07),PROTOCL=D, X
          SHARED=Y,UNIT=DUMMY, X
          UNITADD=(90,16),(A0,16)
```

Example: The following macro instruction assigns the control unit number of 031 to an IBM 3272 Control Unit, names channel path 04 as the channel path to which the control unit attaches, and defines unit addresses D0 through DF as recognized by the control unit.

```
CU031 CNTLUNIT CUNUMBR=031,PATH=04,PROTOCL=D, X
          SHARED=YB,UNIT=3272, X
          UNITADD=(D0,16)
```

ID

ID is an optional macro instruction that describes the identification information printed on the ID1 and ID2 lines of the IOCP configuration report headings. It is also the source of the customer name (data set name) for the IOCDS that appears on the IOCDSM (SYS021) frame.

See “Chapter 5. IOCP Configuration Reports” for examples of the headings used on the reports.

When specified, the ID macro instruction must precede all CHPID, CNTLUNIT, and IODEVICE macro instructions in the input file. You can specify the ID macro instruction only once in the input file. If you do not specify the ID macro instruction, IOCP prints no identifying information on the ID1 and ID2 lines of the heading.

The format of the ID macro instruction is:

[symbol]	ID	{ MSG1='message',MSG2='message' MSG1='message' MSG2='message' }
----------	----	---

MSG1 =

specifies the identification information printed on the ID1 line of the heading on IOCP configuration reports. The processor controller also uses the first eight characters of MSG1 = (bytes 1 through 8) as the customer name for the IOCDS that appears on the IOCDSM (SYS021) frame. (For more information, see the operator’s guide for your system console.)

MSG2 =

specifies the identification information printed on the ID2 line of the heading on IOCP configuration reports.

‘message’

specifies a string of 1 to 64 alphanumeric characters for use as identification information. You must enclose the string within apostrophes. Two consecutive apostrophes count as one character indicating an apostrophe within the string (such as, MSG1 = ‘John’s I/O Report’).

Example: The following macro instruction defines the identification information printed on lines ID1 and ID2 of the IOCP configuration report headings. TPCONFIG is the customer name for the IOCDS that appears on the IOCDSM (SYS021) frame.

```
ID00B ID MSG1='TPCONFIG Configuration for Processor B',      X
          MSG2='Revised by Plan 3'
```

IODEVICE

IODEVICE, a required macro instruction, describes:

- The I/O device address/number
- The device characteristics
- The control units to which the device is assigned

You must specify each uniquely addressable I/O device in your I/O configuration on an IODEVICE macro instruction to use the device for I/O requests.

See Appendix D for a list of I/O device types and their characteristics.

Note: VM/SP, VM/SP HPO, or the VM/XA Systems Facility does not necessarily support devices supported by IOCP. For a list of the devices supported by VM/SP, see the latest edition of *IBM Virtual Machine/System Product General Information Manual*; for VM/SP HPO, see the *IBM VM/SP High Performance Option General Information Manual*. For a list of devices supported by the VM/XA Systems Facility, see the *Virtual Machine/Extended Architecture Systems Facility: General Information Manual*.

You can assign up to 256 devices to one channel path. You assign one device to a maximum of four control units. Although you can attach a control unit to a maximum of four channel paths, you can assign a device only to a combined maximum of four channel paths.

Each I/O device must have a unique device address/number within the I/O configuration. IOCP does not allow duplicate addresses.

To assign an I/O device to both channel set 0 and channel set 1 (for 370 mode channel sets), specify the device address/number on an IODEVICE macro instruction and the device's unit address on the CNTLUNIT macro instruction(s) that define(s) the control unit(s) attached to channel paths in both channel sets. (On a uniprocessor, VM/SP and VM/SP HPO can access only channel set 0; therefore, you must assign all I/O devices you want to use to channel set 0.)

The IODEVICE macro instruction must follow any CNTLUNIT macro instructions that specify control units used by the device.

The format of the IODEVICE macro instruction is:

[symbol]	IODEVICE	ADDRESS=(address[,number]) CUNUMBR=(number[,number]...) [MODEL=model] [PATH=chpid] [TIMEOUT={Y N}] UNIT=device [UNITADD=address]
----------	----------	--

ADDRESS =

address

specifies the device address in 370 mode and the device number in 370-XA mode. You specify three hexadecimal digits in the range of 000 through FFF.

For 370 mode operation, the first hexadecimal digit (0-F) must specify the channel number that corresponds to the lowest-numbered channel path assigned to the device. This channel path is the primary channel address for the device.

In 370-XA mode, the first hexadecimal digit does not have to correspond to the 370 channel number. If you want to use the same IOCDs to operate in both 370 mode and 370-XA mode, specify the first hexadecimal digit for 370-XA mode the same way you do for 370 mode. In all cases, specify a hexadecimal digit in the range of 0 through F.

If you do not specify the UNITADD parameter on the IODEVICE macro instruction, the second and third hexadecimal digits of the ADDRESS parameter specify the physical unit address that is transmitted on the channel path to select the device. You specify two hexadecimal digits in the range of 00 through FF. These two hexadecimal digits must match one of the unit addresses specified on the UNITADD parameter of the CNTLUNIT macro instruction that defines the control units assigned to the device.

If you do specify the UNITADD parameter on the IODEVICE macro instruction, the second and third digits of the ADDRESS parameter can be any value that follows the rules in Appendix D and makes the device address/number unique. See Appendix D for the exceptions and recommendations that apply to specific device types.

number

specifies the number of sequential device addresses/numbers assigned to the devices. You specify a one, two, or three-digit decimal value in the range of 1 through 256. (For example, ADDRESS=(10A,3) specifies that the device addresses of 10A, 10B, and 10C are assigned.)

If you do not use the UNITADD parameter on the IODEVICE macro instruction, the unit address (second and third digits) specified on the ADDRESS parameter plus the number of addresses minus one must not exceed a hexadecimal value of FF.

If you do use the UNITADD parameter, the device address/number specified on the ADDRESS parameter plus the number of addresses minus one must not exceed a hexadecimal value of FFF.

If you omit number (when using file input) and you specify NOIGNORE on the IOCP command, IOCP assumes a default value of 1. If you specify IGNORE, IOCP assumes a default value of 1 except for some devices, as noted in Appendix D.

For example, if you use file input and specify IGNORE, IOCP checks the syntax of the number subparameter for the 2305 Fixed Head Storage and the 3838 Array Processor, but IOCP unconditionally assigns eight addresses to these devices.

Each device address specified must be unique within the I/O configuration. IOCP does not allow duplicate addresses.

Note: See Appendix D for the exceptions and recommendations that apply to specific device types.

For a system on which you generate VM/SP or VM/SP HPO: The ADDRESS=(address“,number”) parameter on the IODEVICE macro instruction in the IOCP input file has the same value as the ADDRESS=cuu|(cuu,nn) parameter on the RDEVICE macro instruction in the DMKRIO file.

For example, this RDEVICE macro instruction is in the DMKRIO file:

```
RDEVICE ADDRESS=(018,7),...
```

The corresponding IODEVICE macro instruction is:

```
IODEVICE ADDRESS=(018,7),...
```

For a system on which you generate the VM/XA Systems Facility: The ADDRESS=(address[,number]) parameter on the IODEVICE macro instruction in the IOCP input file has the same value as the DEVNO=rdevno|(rdevno,nnn) parameter on the RDEVICE macro instruction in the HCPRIO file.

For example, this RDEVICE macro instruction is in the HCPRIO file:

```
RDEVICE DEVNO=(190,4),...
```

The corresponding IODEVICE macro instruction is:

```
IODEVICE ADDRESS=(190,4),...
```

CUNUMBR = number

specifies the control unit numbers assigned to the control units attached to the device. You specify three hexadecimal digits in the range of 000 through FFF for each control unit.

You can assign a device to a maximum of four control units. Although you can attach each control unit to a maximum of four channel paths, you can assign a device only to a combined maximum of four channel paths.

When you attach the device to more than one control unit (for example, via a string switch), you must specify each control unit.

If you attach a device to more than one control unit, all control units that attach the device must:

- Use the same unit address to access the device.
- Have the same SHARED characteristic (Y, YB, or N).
- Use the same interface protocol. For the commonly attached device, you must use either D.C. interlock or data streaming.
- Not be attached to the same channel path.

For a system on which you generate VM/SP or VM/SP HPO: To code the control unit number, you must make a number of cross-references between the IODEVICE macro instruction and the RDEVICE macro instruction in the DMKRIO file.

Find the RDEVICE macro instruction for this device in the DMKRIO file. The leftmost digit on the ADDRESS=cuu parameter of this macro instruction is the channel address to which the device attaches. The two rightmost digits represent the unit address transmitted on the channel path to select the device.

Find the CHPID macro instruction coded for the channel address found in the RDEVICE macro instruction. Use the channel path identifier from this CHPID macro instruction and the unit address from the RDEVICE macro instruction for the next cross-reference.

Find the CNTLUNIT macro instruction that has (1) a channel path that matches your channel path identifier and (2) a unit address that matches the unit address on the RDEVICE macro instruction. Use the value coded for the CUNUMBR parameter on the CNTLUNIT macro instruction for the control unit number on the IODEVICE macro instruction.

For example, the RDEVICE macro instruction for a 3330 magnetic disk could be:

```
RDEVICE ADDRESS=(350,8),DEVTYPE=3330,...
```

The channel address to which this device attaches is 3. The CHPID macro instruction coded for this channel address is:

```
CHPID PATH=((03,3,0)),...
```

The channel path identifier is 03 in this case. In the above RDEVICE macro instruction, the unit address is 50. The CNTLUNIT macro instruction with a channel path 03 and unit address 50 is:

```
CNTLUNIT CUNUMBR=032,PATH=(03),...,UNITADD=((50,8))
```

The CUNUMBR parameter on the IODEVICE macro instruction should be 032:

```
IODEVICE ADDRESS=(350,8),CUNUMBR=032, ..., UNIT=3330
```

For a system on which you generate the VM/XA Systems Facility: To code the control unit number for a device, you must find the correct CNTLUNIT macro instruction.

When you generate an operating system that supports extended architecture, the device number for a given device does not need to correspond to either a channel path identifier or the unit address by which the control unit recognizes the device. You must know the following about your hardware I/O configuration:

- What channel path identifier the device and its control unit are attached to.
- How the control unit recognizes the device, that is, by what unit address.

Find the CNTLUNIT macro instructions that has (1) a channel path that matches your channel path identifier to which the device and control unit are attached and (2) a unit address that matches the unit address by which the control unit recognizes the device. Use the value coded for the CUNUMBR parameter on the CNTLUNIT macro instruction for the control unit number on the IODEVICE macro instruction.

For example, eight 3330 magnetic disks and their control unit are attached to channel path identifier 07. The control unit recognizes the disks as attached at unit addresses 40 through 47.

However, the RDEVICE macro instruction for this group of magnetic disks could be:

```
RDEVICE DEVNO=(350,8),DEVTYPE=3330,....
```

The device numbers for these disks range from 350 to 357.

The CHPID macro instruction coded for the channel path identifier is:

```
CHPID PATH=((07,6,0)),....
```

The channel path identifier is 07; it corresponds to channel 6 and to channel set 0 when the processor complex operates in 370 mode.

The physical unit addresses of these devices are 40 through 47. The CNTLUNIT macro instruction that has channel path 07 and unit addresses ranging from 40 to 47 is:

```
CNTLUNIT CUNUMBR=032,PATH=(07),....,UNITADD=((40,8))
```

The CUNUMBR parameter on the IODEVICE macro instruction should be 032:

```
IODEVICE ADDRESS=(350,8),CUNUMBR=032,....,UNIT=3330,UNITADD=40
```

(The UNITADD parameter on the IODEVICE macro instruction has the same number of unit addresses (8) as the number specified in the ADDRESS parameter.)

Note: This example uses the UNITADD parameter that allows you to define device numbers (350 to 357) that do not contain their physical unit addresses (40 to 47). If you operate the processor complex in 370 mode with this IOCDS, the processor complex would recognize the devices as 640 to 647 (channel 6, physical unit addresses 40 to 47).

We recommend you specify the UNITADD parameter on the IODEVICE macro instruction *only* for an IOCDS that will be used exclusively for 370-XA mode operation. If you plan to generate an operating system that only supports 370 architecture, define your device numbers so that they follow 370 restrictions:

- The leftmost digit corresponds to a channel address.
- The two rightmost digits correspond to the physical unit address by which the control unit recognizes the device.

For more information, see the description of the UNITADD parameter on the IODEVICE macro instruction in this chapter.

MODEL = model

specifies the model number, if any, for the device. You specify one or two alphanumeric characters that represent the model number of the device. IOCP only checks the syntax for alphanumeric characters. IOCP does not validate the model value.

For a system on which you generate VM/SP or VM/SP HPO: The MODEL = model parameter on the IODEVICE macro instruction in the IOCP input file has the same value as the MODEL = model parameter on the RDEVICE macro instruction in the DMKRIO file.

For example, the following RDEVICE macro instruction is in the DMKRIO file:

```
RDEVICE ... ,MODEL=3
```

The corresponding IODEVICE macro instruction is:

```
IODEVICE ... ,MODEL=3,...
```

For a system on which you generate the VM/XA Systems Facility: The MODEL = model parameter on the IODEVICE macro instruction in the IOCP input file has the same value as the MODEL = model parameter on the RDEVICE macro instruction in the HCPRIO file.

For example, the following RDEVICE macro instruction is in the HCPRIO file:

```
RDEVICE ... ,MODEL=11
```

The corresponding IODEVICE macro instruction is:

```
IODEVICE ... ,MODEL=11,...
```

PATH = chpid

specifies the preferred channel path. You specify two hexadecimal digits that must correspond to a channel path identifier of an attaching channel path.

In 370-XA mode, the channel subsystem always attempts to use the preferred channel path to initiate I/O requests. The channel subsystem will attempt to initiate all I/O requests for the desired device using the specified preferred channel path first, before it attempts to initiate requests on any of the other attaching channel paths. When operating in 370 mode, the processor complex ignores the preferred channel path. See "Preferred Path" in Chapter 1 for more information.

TIMEOUT =

specifies whether the eight-second I/O interface timeout function is to be active for the I/O interface tag sequences between the channel and I/O device.

Y

specifies that the I/O interface timeout function is to be active for all sequences on the I/O interface except as noted in Appendix C. With the timeout function active, if the I/O device fails to complete a tag sequence within eight seconds or a delay occurs in a dependent tag sequence that exceeds eight seconds, the channel terminates the I/O request to the I/O device and generates an interface-control-check interruption.

TIMEOUT = Y is the default if you do not code the TIMEOUT parameter.

N

specifies that the I/O interface timeout function is inactive (timeout inhibited) for some of the sequences on the I/O interface as described in Appendix C. With the timeout function inactive, the channel waits until the I/O device completes the tag sequence or initiates the next dependent sequence.

TIMEOUT = N is not valid for I/O devices assigned to byte multiplexer channel paths.

We recommend that you specify or use the default TIMEOUT = Y for all IBM I/O devices. However, for certain I/O devices, normal I/O sequences sometimes require more than eight seconds to complete. For example, some I/O sequences on a channel-to-channel (CTC) adapter might require more than eight seconds to complete. For these devices, you may choose to specify TIMEOUT = N.

See Appendix C for additional information about the timeout function.

Note: When operating in 370 mode, the TIMEOUT specification for the lowest device address on a shared control unit (SHARED = Y or SHARED = YB) overrides the timeout specification of the other devices connected to the same control unit. For example, device 1A0 connects to a shared control unit and has TIMEOUT = Y; device 1A1 connects to the

same control unit and has TIMEOUT=N. In 370 mode, both devices are timed. In 370-XA mode, device 1A0 is timed; device 1A1 is not timed.

UNIT = device

specifies the device type. You specify up to five alphanumeric characters to define the device type (such as, 3330 or 2540R). IOCP only checks the syntax for alphanumeric characters. IOCP does not validate the device value. However, for certain device types (such as 3350P), IOCP takes special actions. See Appendix D for more information.

For a system on which you generate VM/SP or VM/SP HPO: The UNIT=device parameter on the IODEVICE macro instruction in the IOCP input file has the same value as the DEVTYPE=type parameter on the RDEVICE macro instruction in the DMKRIO file.

For example, assume the following RDEVICE macro instruction is in the DMKRIO file:

```
RDEVICE . . . ,DEVTYPE=3279 , . . .
```

The corresponding IODEVICE macro instruction is:

```
IODEVICE . . . ,UNIT=3279 , . . .
```

For a system on which you generate the VM/XA Systems Facility: The UNIT=device parameter on the IODEVICE macro instruction in the IOCP input file has the same value as the DEVTYPE=type parameter on the RDEVICE macro instruction in the HCPRIO file.

For example, assume the following RDEVICE macro instruction is in the HCPRIO file:

```
RDEVICE . . . ,DEVTYPE=2540P , . . .
```

The corresponding IODEVICE macro instruction is:

```
IODEVICE . . . ,UNIT=2540P , . . .
```

UNITADD = address

specifies the unit address transmitted on the channel path to select the I/O device. You specify two hexadecimal digits in the range of 00 through FF. These two hexadecimal digits must match one of the unit addresses specified on the UNITADD parameter of the CNTLUNIT macro instruction that defines the control units to which the device is assigned.

UNITADD allows you to assign a device number in the ADDRESS parameter that does not contain the actual physical unit address of the device; this might be necessary because channel numbers may only have one hexadecimal digit and device numbers must be unique. The UNITADD parameter that you specify becomes the unit address that the control unit recognizes for the device in both 370 mode and 370-XA mode.

Specify the UNITADD parameter *only* for an IOCDs that will be used exclusively for 370-XA mode operation. Operational and serviceability

problems are likely to occur if you use the IOCDS (defined with UNITADD) in 370 mode.

If you specified a value for number in the ADDRESS parameter, that same number of sequential device numbers applies to the UNITADD parameter. However, the UNITADD parameter plus the number of device numbers (or device addresses) must not exceed a hexadecimal value of FF.

Notes:

- 1. If you use the UNITADD parameter, you must follow the same rules and restrictions that apply to the second and third digits of the ADDRESS parameter. For example, notes in Appendix D that apply to the unit address specified on the ADDRESS keyword also apply to the unit address specified on the UNITADD parameter.*
- 2. If you specify the UNITADD parameter and use the IOCDS for 370 mode operation, the two digits specified in the UNITADD parameter replace the two rightmost digits of the device address. UNITADD changes the device address and makes it different from the device number. For example, ADDRESS=180,UNITADD=90 produces a device address (370 mode) of 190 (if the device connects to a channel path defined for 370 mode as channel 1). However, the device number (370-XA mode) is still 180. Thus, messages and error records for the same device will be issued using different device identifiers, 190 in 370 mode and 180 in 370-XA mode. It is also possible that messages and error records for a device identifier (a device address or device number) could actually represent more than one device.*

For a system on which you generate VM/SP or VM/SP HPO: We recommend that you specify the UNITADD parameter only for an IOCDS that you use exclusively for 370-XA mode operation. If you operate the processor complex in 370 mode and the active IOCDS has devices defined with the UNITADD parameter, operational and serviceability problems are likely to occur.

For a system on which you generate the VM/XA Systems Facility: To code the UNITADD parameter, you must know how the control unit recognizes the device, that is by what unit address. You must code the actual physical unit address for the UNITADD parameter on the IODEVICE macro instruction.

For example, the RDEVICE macro instruction for a group of eight 3330 magnetic disks could be:

```
RDEVICE DEVNO=(350,8),DEVTYPE=3330,....
```

The device numbers for these disks range from 350 to 357. The control unit, however, recognizes the disks as being attached at unit addresses 40 through 47.

The UNITADD parameter on the IODEVICE macro instruction should be 40:

```
IODEVICE ADDRESS=(350,8),....UNIT=3330,UNITADD=40
```

(The UNITADD parameter on the IODEVICE macro instruction takes the same number (8) as specified in the ADDRESS parameter.)

Note: This example uses the UNITADD parameter to define device numbers (350 to 357) that do not contain their physical unit addresses (40 to 47). If you were to operate the processor complex in 370 mode with this IOCDS, the processor complex would recognize the devices as 340 to 347 (channel 3, physical unit address 40 to 47).

We recommend, however, that if you specify the UNITADD parameter on an IODEVICE macro instruction, you operate the processor complex with that IOCDS *only* in 370-XA mode. If you plan to generate an operating system that only supports 370 architecture, define your device numbers so that they follow 370 restrictions:

- The leftmost digit corresponds to a channel address.
- The two rightmost digits correspond to the unit address by which the control unit recognizes the device.

Example: The following macro instruction defines a 2540 Card Read Punch Model 1 with an address of 00D. It attaches to a 2821 Control Unit that has a control unit number of 10A.

```
DEV00D IODEVICE ADDRESS=00D,CUNUMBR=10A,MODEL=1, X
                UNIT=2540P,TIMEOUT=Y
```

Example: The following macro instruction defines eight 3330 Disk Storage Model 1 devices. The 3830 Storage Control has a control unit number 11B and recognizes the device addresses/numbers of 210 through 217.

```
DEV2DD IODEVICE ADDRESS=(210,8),CUNUMBR=11B, X
                MODEL=1,UNIT=3330,TIMEOUT=Y
```

Example: The following macro instruction defines eight 3420 Magnetic Tape Units. The 3803 Tape Control has the control unit number 00E and recognizes the device addresses/numbers of D80 through D87.

```
DEVDTT IODEVICE ADDRESS=(D80,8),CUNUMBR=00E, X
                MODEL=3,UNIT=3420,TIMEOUT=Y
```

Example: The following macro instruction defines eight 3420 Magnetic Tape Units attached to two 3803 Tape Controls via the tape switching feature. The control units are assigned the numbers 01B and 01C. Both control units recognize the unit addresses of 40 through 47. (Note: In this case the control units must attach to different channel paths to ensure that unit addresses are not duplicated on the same channel path.) C is the channel number that corresponds to the lower numbered channel path assigned to the device.

```
DEVTTU IODEVICE ADDRESS=(C40,8),CUNUMBR=(01B,01C), X
                MODEL=3,UNIT=3420,TIMEOUT=Y
```

Example: The following macro instruction defines two 3350 I/O devices for use as paging devices by the 3880 Model 11 Paging Storage Subsystem. The 3880 Model 11 Paging Storage Director has been assigned control unit number 14B.: IOCP generates four device addresses/numbers for each 3350P (a 3350 used as a paging device by the 3880 Model 11): the base address as specified on the ADDRESS parameter, and three additional addresses at intervals of eight.

This macro instruction causes IOCP to generate addresses 440, 448, 450, and 458 for base address 440, and addresses 441, 449, 451, and 459 for base address 441.

```
DEV4DD IODEVICE ADDRESS=(440,2),CUNUMBR=14B, X
      UNIT=3350P,TIMEOUT=Y
```

Example: The following macro instruction defines eight 3420 Magnetic Tape Units. The 3803 Tape Control has been assigned the control unit number 530. The device numbers (for 370-XA mode) are 180 through 187. But the devices respond to the unit addresses of 90 through 97 (not 80 through 87) in both 370-XA mode and 370 mode. Thus, the device addresses (for 370 mode) are actually 190 through 197.

```
DEV1UA IODEVICE ADDRESS=(180,8),CUNUMBR=530, X
      MODEL=3,UNIT=3420,UNITADD=90
```

IOCP Functions

You invoke the VM version of IOCP in the CMS environment. Issue the CMS IOCP command to execute IOCP under VM/SP, VM/SP HPO or the VM/XA Systems Facility. The IOCP command has options that allow you to request the following IOCP functions:

- Generate a new IOCDS from a file containing source IOCP macro instructions
- Produce configuration reports from an existing IOCDS.¹

Generating an IOCDS

IOCP performs the following steps when you specify that you want to generate an IOCDS.

Note: IOCP repeats steps 1 through 5 for each input macro instruction read (unless IOCP finds an error as indicated in Steps 3 and 4).

IOCP:

1. **Reads** each macro instruction from the input device.
2. **Prints** each macro instruction on the output printer.
3. **Checks the syntax** of each macro instruction for correct format. If it finds a syntax error (such as a missing parenthesis), IOCP prints an error message on the output printer following the macro instruction that contains the error.

¹ The CMS IOCP module DMSICP generates DIAGNOSE X'80' when you use the IOCP command to read from or to write to an IOCDS. The Control Program (CP) uses DIAGNOSE X'80' to communicate with the processor controller. For a description of DIAGNOSE X'80', see *VM/SP System Programmer's Guide*, *VM/SP HPO System Programmer's Guide*, or *VM/XA Systems Facility CP Command and Diagnose Code Reference*.

IOCP stops checking the syntax of a macro instruction when it encounters the first syntax error on that macro instruction. Therefore, if there are two or more syntax errors on a single macro instruction, IOCP finds the second and following errors on subsequent runs.

If IOCP finds an error in Step 3, IOCP returns to Step 1 and continues reading, printing, and checking the syntax of the remaining macro instructions, but does not perform any of the following steps.

4. **Checks the validity** of each macro instruction. For example, IOCP checks that a CNTLUNIT macro instruction has specified a channel path previously defined on a CHPID macro instruction. If it finds an error, IOCP prints an error message on the output printer following the macro instruction that contains the error.

If IOCP finds an error in Step 4, IOCP returns to Step 1 and performs only Steps 1 through 3 for the remainder of the macro instructions. Therefore, if there are two or more validity errors in your input file, IOCP finds the second and following errors on subsequent runs.

5. **Builds** the appropriate identification, channel path, control unit, or I/O device record and enters the record into the IOCDS in storage.

If more macro instructions remain to be read, IOCP returns to Step 1.

After processing all of the input macro instructions and entering all of the records into the IOCDS in storage, IOCP performs Step 6.

6. **Generates** the IOCDS in storage and makes additional checks. For example, IOCP checks that the channel numbers within a channel set are consecutive. If IOCP finds an error, IOCP issues an error message and then terminates.

After IOCP has successfully generated an IOCDS in storage, IOCP performs Step 7.

7. **Produces** the IOCP configuration reports of the IOCDS generated in storage.

If you specify a generation option of the IOCP command other than NOWRTCDS and you are authorized to do so, IOCP performs Step 8.

8. **Writes** the generated IOCDS from storage to one or more IOCDS(s) in the processor controller. The Control Program (CP) checks your privilege class. If you are running IOCP under the VM/SP or VM/SP HPO, you must have privilege class C to write to the IOCDS in the processor controller. If you are running IOCP under the VM/XA Systems Facility, you must have privilege classes C, F, and G to write to the IOCDS in the processor controller.

Producing Configuration Reports

IOCP performs the following steps when you request configuration reports.

IOCP:

- **Reads** one or more IOCDS(s) from the processor controller into storage.
- **Prints** the IOCP configuration reports that you specify.

If IOCP encounters any errors during processing, IOCP sends appropriate error messages to the output printer. For examples of IOCP configuration reports, see “Chapter 5. IOCP Configuration Reports.”

The IOCP Command

The format of the IOCP command is:

IOCP	<pre>[fn] [(options . . . [])] Processor Options: [308X] [xxxx] IOCDS Generation options: [NOIGNORE] [NOWRTCDS] [IGNORE] [WRTCDS] [WRTAx] [WRTBx] Configuration Report options: [BOTHRPT] [CDORPT] [CD1RPT] [RPTAx] [RPTBx] [RPTA] [RPTB] Listing Control options: [LINECOUN (55)] [DISK] [LINECOUN (nn)] [PRINT] [NOPRINT] System Terminal options: [TERMINAL] [WARNING] [NOTERM] [NOWARN]</pre>
------	---

where:

fn is the filename of the input or output file, depending on options you specify on the command line.

You must specify a filename only when input is from disk or output is to disk.

When you specify IOCDS generation options, **fn** is:

- The filename of the input file. The input file contains the IOCP macro instructions.
- The filename of the output file. If IOCP finds no errors, the output file will contain the configuration reports of the IOCDS IOCP generate from your input as well as a listing of your input. If IOCP does find errors, the output file will contain only a listing of the input file and any errors that IOCP finds.

When you specify configuration report options, fn is:

- The filename of the output file. The output file will contain the configuration reports of the IOCDS(s) you request from the processor controller.

IOCP issues, by default, the following CMS FILEDEF commands for the SYSIN (input to IOCP) and SYSPRINT (output from IOCP) ddnames:

```
FILEDEF SYSIN DISK fn IOCP * (RECFM FB LRECL 80  
BLOCK 800
```

```
FILEDEF SYSPRINT DISK fn LISTING fm (RECFM FBA  
LRECL 133 BLOCK 1330
```

IOCP obtains fn from the filename entered on the IOCP command.

IOCP obtains fm by checking the disk that contains the input file. If the disk is read/write, IOCP writes back to the same disk. However, if the disk is an extension to a disk, IOCP writes to the parent disk. If neither of these is true, IOCP writes to the A-disk (provided it is read/write).

Because the default FILEDEF commands specify DISK, you must use a filename on the IOCP command unless you override those default FILEDEF commands. If you want to override a default FILEDEF command, issue your own FILEDEF command before executing IOCP. Note that if you specify PRINT or NOPRINT on the IOCP command, you will automatically override SYSPRINT FILEDEF.

The input filetype is, by default, IOCP. If you want the the input file to have a filetype other than IOCP, issue a FILEDEF command to override the default filetype.

The output filetype is, by default, LISTING. If you want the the output file to have a filetype other than LISTING, issue a FILEDEF command to override the default filetype.

Options:

IOCDS Generation Options:

The valid options for writing an IOCDS depend on the number of I/O configuration data sets that your processor complex supports:

- For two I/O configuration data sets (LVL0 and LVL1), the valid options are NOWRTCDS, WRTCDS, and WRTA1. (WRTA1 is the same as WRTCDS.)
- For four I/O configuration data sets, the valid options on the A side are NOWRTCDS, WRTCDS, and WRTAx. The valid options on the B side are NOWRTCDS, WRTCDS, and WRTBx.

IOCP writes an IOCDS to the processor controller (in response to all the generation options except NOWRTCDS) only if:

- It finds no errors on the input macro instructions
- It encounters no errors during IOCP processing of the IOCDS in storage
- The user issuing the IOCP command has the proper privilege class
- You did not write-protect the IOCDS (on the IOCDSM frame)

Use a write option (WRTCDS, WRTAx, or WRTBx) after you have (1) checked the syntax of the input macro instructions, (2) generated an IOCDS in storage, (3) received reports on the generated IOCDS, and (4) checked to see whether or not the I/O configuration generated by IOCP corresponds to the I/O configuration in the DMKRIO file (for VM/SP or VM/SP HPO) or in the HCPRIO file (for the VM/XA Systems Facility). If you want to write to an IOCDS that is write-protected, you must also remove the write-protection using the IOCDSM (SYS021) frame.

When IOCP writes the generated IOCDS to an IOCDS in the processor controller, the previous configuration data in that IOCDS is overlaid and lost, even if that IOCDS is the active IOCDS. (The IOCDS used for the last power-on reset or SYSIML CLEAR is the active IOCDS).

NOIGNORE

NOIGN

specifies that IOCP is to process all input macroinstructions and parameters. IOCP flags as errors any non-IOCP input data. If IOCP finds an error, it does not generate an IOCDS in storage.

Use the NOIGNORE option when your deck contains only IOCP macro instructions and IOCP comment cards. This option is a default.

IGNORE

IGN

specifies that IOCP is to ignore all non-IOCP macroinstructions and non-IOCP parameters on the IODEVICE macro instruction.

NOWRTCDS

NOWRT

specifies that IOCP is not to write the IOCDS that is in storage to an IOCDS in the processor controller. This option is a default.

Use the NOWRTCDS option when (1) you are checking the syntax of the input file and do not want to write to the processor controller until you have successfully checked the input file, or (2) when you are operating on a processor complex not listed on the cover of this manual.

When you specify the NOWRTCDS option and IOCP finds no errors, the output file will contain the configuration reports of the IOCDS IOCP will generate from your input along with a listing of your input file. If IOCP finds errors, your output file will contain only a listing of your input file and any errors that IOCP finds.

WRTCDS**WRT**

specifies that IOCP is to write the IOCDS that is in storage to the A1 IOCDS (LVL1 IOCDS) in the processor controller.

WRTAx**WAx**

specifies that IOCP is to write the IOCDS that is in storage to the level Ax (where x is 0, 1, 2 or 3) IOCDS in the processor controller.

WRTBx**WBx**

specifies that IOCP is to write the IOCDS that is in storage to the level Bx (where x is 0, 1, 2, or 3) IOCDS in the processor controller. (WRTBx is valid only on the B side of a processor complex.)

Configuration Report Options

The valid options for reading an IOCDS and producing configuration reports depend on the number of I/O configuration data sets that your processor complex supports:

- For two I/O configuration data sets (LVL0 and LVL1), the valid options are BOTHRPT, CD0RPT, CD1RPT, RPTA0, and RPTA1.
- For four I/O configuration data sets, all of the configuration report options are valid on the A side except RPTBx and RPTB. On the B side, all of the configuration report options are valid except RPTAx and RPTA.

BOTHRPT**BOTH**

specifies that IOCP is to read both the A0 and A1 IOCDS from the processor controller into storage and is to generate configuration reports of both data sets.

CD0RPT**CD0**

specifies that IOCP is to read the A0 IOCDS from the processor controller into storage and is to generate a configuration report of that data set.

CD1RPT**CD1**

specifies that IOCP is to read the A1 IOCDS from the processor controller into storage and is to generate a configuration report of that data set.

RPTAx**RAx**

specifies that IOCP is to read the level Ax (where x is 0, 1, 2, or 3) IOCDS from the processor controller into storage and is to generate a configuration report of that data set. (RPTAx is valid only on the A side of a processor complex.)

RPTBx**RBx**

specifies that IOCP is to read the level Bx (where x is 0, 1, 2, or 3) IOCDS from the processor controller into storage and is to generate a configuration report of that data set. (RPTBx is valid only on the B side of a processor complex.)

RPTA**RA**

specifies that IOCP is to read the entire A side (the A0, A1, A2, and A3 IOCDS) from the processor controller into storage and is to generate configuration reports of those data sets. (RPTA is valid only on the A side of a processor complex.)

RPTB**RB**

specifies that IOCP is to read the entire B side (the B0, B1, B2, and B3 IOCDS) from the processor controller into storage and is to generate configuration reports of those data sets. (RPTB is valid only on the B side of a processor complex.)

Listing Control Options:**LINECOUN (55)****LINECOUN (nn)**

specifies the number of lines (from 10 to 99) that is to be printed on each page. The default is LINECOUN (55). If you use this option, note that you must specify the number of lines.

DISK**DI**

specifies that IOCP is to place the output listing in a file on a minidisk. DISK is a default option.

PRINT**PR**

specifies that IOCP is to send the output listing to the printer.

NOPRINT**NOPR**

specifies that IOCP is not to generate any output listing.

System Terminal Options:**TERMINAL****TERM**

specifies that IOCP is to write diagnostic information from the IOCP program to your terminal. TERMINAL is a default option. Diagnostic information consists of either of the following:

- An IOCP message (see "Chapter 6. IOCP Messages") and, preceding this message, the nonblank line that caused the diagnostic message
- A display of the total message count for the IOCP output

NOTERM

specifies that IOCP is to suppress display of diagnostic messages at your terminal.

WARNING**WARN**

specifies that IOCP is to write IOCP warning messages to the terminal. This option is valid only if you specify the **TERMINAL** option. **WARNING** is a default option.

NOWARN

specifies that IOCP is to suppress the writing of warning messages at your terminal.

Processor Options:

Select the appropriate processor option to perform an IOCDS generation. The IOCDS must be generated on the same processor complex that is designated by the selected processor option.

Select the appropriate processor option to perform syntax checking of input IOCP macro instructions on another processor complex. Syntax checking can be performed when the required processor complex is not available.

Errors will occur if the **WRTCDS**, **WRTAx**, **WRTBx**, or any of the Configuration Report options are selected and the processor option that is specified does not match the identification of the processor to which the IOCP command is given; errors will occur when an attempt is made to read or write an IOCDS if the processor option does not match the processor you are running on.

The valid processor options are:

308X

The **308X** option specifies that IOCP is to process the command options and input file for an IOCDS generation for a processor complex in the **308X** series or the **908X** series. This option is the default if the IOCP command is given, without specifying a processor option, to a **308X** or **908X** processor complex or any processor complex that does not support IOCP.

xxxx

xxxx is a four digit number associated with a non-**308X** processor family complex that is supported by IOCP. The **xxxx** option specifies that IOCP is to process the command options and input file for an IOCDS generation for a processor complex that is supported by IOCP and is not a **308X** or **908X**. If the IOCP command is given without specifying a processor option on any processor complex supported by IOCP, this option will default to the current processor ID.

See the IOCP User's Guide that is associated with the processor complex for which the verification and/or generation is being run.

Restrictions:

1. You cannot issue the IOCP command while in the CMS/DOS environment.
2. If VM/SP or VM/SP HPO Release 1 is running with single processor mode active, do not issue the IOCP command with any write options (WRTCDs, WRTAx, or WRTBx) or with any configuration report option (BOTHRPT, CD0RPT, CD1RPT, RPTAx, RPTBx, RPTA, or RPTB). If single processor mode is active and you issue the IOCP command:

- From a virtual machine operating in the V = R area, results are unpredictable.
- From a virtual machine operating in the V = V area, IOCP issues the following messages:

```
ICP402I  MSSFCALL RETURNED AN UNEXPECTED RESPONSE  
        CODE OF 01F0 HEX
```

```
ICP051I  IOCP TERMINATED.  CODE=xx
```

IOCP sends a return code 8 to CMS.

To execute IOCP when single processor mode is active, follow the steps in “Method 2” under “Subsequent Definition and Replacement of I/O Configuration Data” in this chapter.

Note: Restriction 2 does not apply to VM/SP HPO Release 2 and subsequent releases. If VM/SP HPO (Release 2 or later) is operating in single processor mode, and any virtual machine (CMS or MVS/SP) causes IOCP to read from or write to the processor controller, CP locates and stops (SIGP STOP) the processor dedicated to the virtual=real virtual machine. Then CP executes the read or write function. When the service signal external interruption occurs, CP restarts the dedicated processor.

IOCP Command General Usage Notes

This section lists some general notes to keep in mind when you issue the IOCP command. Some aspects of using the command, vary with the operating system on which you run IOCP. For usage notes specific to your operating system, see the sections immediately following.

1. Some IOCP command options cancel other IOCP command options. For this reason, when you code the IOCP command, do not combine IOCDS generation options with configuration report options. (IOCP allows multiple configuration report options.)

If you inadvertently code conflicting options on the same IOCP command, IOCP will use the last-entered of those conflicting options. IOCP issues no warning message.

2. If the IOCDS you wish to write to is write-protected, the write options (WRTCDS, WRTAx, and WRTBx) are invalid. (To add or remove the write protection for an IOCDS, use the IOCDSM frame.)
3. The **TERMINAL** and **WARNING** options are not active if you issue your own CMS FILEDEF SYSPRINT command.

IOCP Command Usage Notes for VM/SP and VM/SP HPO

1. If you are running IOCP under VM/SP or VM/SP HPO, CP checks your privilege class when IOCP issues a DIAGNOSE X'80' to read from or write to an IOCDS. You must have privilege class E or C to read from an IOCDS; you must have privilege class C to write to an IOCDS. If you attempt to read from an IOCDS and if you are not a class C or E user, you receive the message

```
ICP402I  MSSFCALL RETURNED AN UNEXPECTED RESPONSE  
        CODE OF 01F0 HEX
```

IOCP prints the message and the response code on the SYSPRINT device.

If you are not a class C user and you attempt to write to the IOCDS, you receive the message

```
ICP051I  IOCP TERMINATED.  CODE=09
```

and IOCP processing stops.

2. If you attempt to update an IOCDS while running on a processor complex that does not support IOCP, and do not specify a processor option, you receive the following message on the SYSPRINT device and IOCP processing stops.

```
ICP400I  READ/WRITE OF IOCDS IS INVALID ON THIS  
        PROCESSOR  
ICP051I  IOCP TERMINATED.          CODE =10
```

The messages are printed on the SYSPRINT device. IOCP then stops processing.

If you request a configuration report while running on a processor complex that does not support IOCP, you receive the same message, ICP400I, printed on the SYSPRINT device.

3. If you attempt to update an IOCDS or request a configuration report for an IOCDS while running on a processor complex that supports IOCP and is not a 308X or 908X and the 308X processor option was specified, you receive an error message. If you attempt to update an IOCDS or request a configuration report for an IOCDS while running on a 308X or 908X processor complex and any other processor option was specified, you receive an error message.

```
ICP400I  READ/WRITE OF IOCDS IS INVALID ON THIS  
        PROCESSOR  
ICP051I  IOCP TERMINATED.          CODE =10
```

The messages are printed on the SYSPRINT device. IOCP then stops processing.

4. If you and another user attempt to read the same IOCDS at the same time, you will receive the following message:

```
ICP402I  MSSFCALL RETURNED AN UNEXPECTED RESPONSE
        CODE OF 41F0 HEX
```

Wait several minutes and again attempt to read that IOCDS by issuing another IOCP command.

5. You must define your I/O configuration for the processor complex using IOCP macro instructions; define that same configuration for VM/SP or VM/SP HPO in the DMKRIO file.
6. If you are attempting to write an IOCDS to the processor controller and either the IOCP program abnormally terminates, or you issue the CMS command HALT EXECUTION (HX) while IOCP is running, you may prevent another authorized user from writing the same IOCDS to the processor controller. Under these circumstances the system may have locked the IOCDS for you. The other user will receive the following messages:

```
ICP402I  MSSFCALL RETURNED AN UNEXPECTED RESPONSE
        CODE OF 41F0 HEX
```

```
ICP051I  IOCP TERMINATED.          CODE =xx
```

where xx is a code that indicates IOCP encountered an error while trying to write the IOCDS locked for you.

The other user will receive these messages each time he tries to write the locked IOCDS until you do one of the following:

- Rerun the IOCP program to completion, successfully writing the locked IOCDS to the processor controller.
- Issue a SYSTEM RESET command to reset your virtual machine.
- Issue a LOGOFF command to log off your virtual machine.

The other user will then be able to write the IOCDS that the CP previously locked for you.

IOCP Command Usage Notes for the VM/XA Systems Facility

1. If you are running IOCP under the VM/XA Systems Facility, CP checks your privilege class when IOCP issues a DIAGNOSE X'80' to read from or write to an IOCDS. To read from an IOCDS you must have privilege classes F, G, and either E or C; to write to an IOCDS you must have privilege classes C, F, and G.

If you attempt to read from an IOCDS and you do not have the required privilege classes, you receive the following messages:

```
ICP402I  MSSFCALL RETURNED AN UNEXPECTED RESPONSE
        CODE OF 42F0 HEX
ICP051I  IOCP TERMINATED.  CODE=xx
```

where xx is a code that indicates the IOCDS you were trying to read. The messages are printed on the SYSPRINT device. IOCP then stops processing.

If you attempt to write to an IOCDS and you do not have the required privilege classes, you receive the following messages:

```
ICP402I  MSSFCALL RETURNED AN UNEXPECTED RESPONSE
          CODE OF 42F0 HEX
ICP051I  IOCP TERMINATED.  CODE=xx
```

where xx is a code that indicates the IOCDS you were trying to write. The messages are printed on the SYSPRINT device. IOCP then stops processing.

2. If you attempt to update an IOCDS while running on a processor complex that does not support IOCP, and do not specify a processor option, you receive the following message on the SYSPRINT device and IOCP processing stops.

```
ICP400I  READ/WRITE OF IOCDS IS INVALID ON THIS
          PROCESSOR
ICP051I  IOCP TERMINATED.  CODE= 10
```

If you request a configuration report while running on a processor complex that does not support IOCP, you receive the same messages, ICP400I and ICP051I, printed on the SYSPRINT device.

3. If you attempt to update an IOCDS or request a configuration report for an IOCDS while running on a processor complex that supports IOCP and is not a 308X or 908X and the 308X processor option was specified, you receive an error message.

```
ICP400I  READ/WRITE OF IOCDS IS INVALID ON THIS
          PROCESSOR
ICP051I  IOCP TERMINATED.  CODE= 10
```

If you request a configuration report while running on a processor complex that does not support IOCP, you receive the same messages, ICP400I and ICP051I, printed on the SYSPRINT device.

If you attempt to update an IOCDS or request a configuration report for an IOCDS while running on a 308X or 908X processor complex and any other processor option was specified, you receive an error message.

4. If you and another user attempt to read the same IOCDS at the same time, you will receive the following message at your terminal:

```
HCPPCA837I  IOCP READ SEQUENCE REJECTED, LOCKED BY
             userid
```

where userid is the userid of the other user. This will be followed by:

```
ICP402I  MSSFCALL RETURNED AN UNEXPECTED RESPONSE
          CODE OF 01F0 HEX
ICP051I  IOCP TERMINATED.  CODE=xx
```

where xx is a code that indicates which IOCDS you were trying to read. Wait several minutes and again attempt to read that IOCDS by issuing another IOCP command.

where xx is a code that indicates which IOCDS you were trying to read. Wait several minutes and again attempt to read that IOCDS by issuing another IOCP command.

5. You must define your I/O configuration for the processor complex using IOCP macro instructions; define that same configuration for VM/XA Systems Facility in the HCPRIO file.
6. If you are running IOCP and it does not complete successfully, you may prevent another authorized user from running IOCP. You may be attempting to either read or write an IOCDS. IOCP may fail to complete successfully either because it abnormally terminates or because you issue the CMS command HALT EXECUTION (HX) while IOCP is running. Under these circumstances, CP may lock all IOCDS(s) for you while trying to access one of them.

The other user will receive a number of messages. If the other user tries to write to an IOCDS, the user will receive the following message:

```
HCPPCA836I  IOCP WRITE SEQUENCE REJECTED, LOCKED BY
            yourid
```

where yourid is your userid.

If the other user tries to read an IOCDS, the user will receive:

```
HCPPCA837I  IOCP READ SEQUENCE REJECTED, LOCKED BY
            yourid
```

where yourid is the userid of the other user.

In either case, the other user will receive the following additional messages:

```
ICP402I  MSSFCALL RETURNED AN UNEXPECTED RESPONSE
            CODE OF 01F0 HEX
ICP051I  IOCP TERMINATED.  CODE=xx
```

where xx is a code that indicates the IOCDS the user was trying to access and whether the user was trying to read or write.

The other user will receive these messages each time he tries to run IOCP until you do one of the following:

- Rerun the IOCP program to completion. IOCP must complete the same operation that was interrupted (read or write) for the same IOCDS.
- Issue a SYSTEM RESET command to reset your virtual machine.
- Issue a LOGOFF command to log off your virtual machine.

The other user will then be able to access any of the IOCDS(s).

Examples of Generating an IOCDS

Example 1: This example shows the IOCP command options you use to check an input file containing only IOCP macro instructions. IOCP displays any warning or error messages at your terminal. The output file MIFILE LISTING will contain the configuration reports for the configuration described by the input file MIFILE IOCP.

```
IOCP MIFILE (NOIGNORE NOWRTCDS LINECOUN (60)
```

where:

MIFILE

is the name of the CMS file (filetype IOCP) that contains only IOCP macro instructions.

NOIGNORE

specifies that IOCP is to flag as errors all data that are not IOCP macro instructions.

NOWRTCDS

specifies that IOCP is not to write the IOCDS generated in storage to an IOCDS in the processor controller.

LINECOUN (60)

specifies that IOCP is to print 60 lines of output on each page of the configuration reports.

Example 2: This example shows the IOCP command options you use to:

- Process an input file containing only IOCP macro instructions
- Generate an IOCDS in storage
- Write the generated IOCDS to the level A0 IOCDS in the processor controller

The output file NEWIOCDS LISTING will contain a listing of the input in NEWIOCDS IOCP and configuration reports of the generated IOCDS.

```
IOCP NEWIOCDS (WRTA0
```

where:

NEWIOCDS

is the name of the CMS file that contains only IOCP macro instructions.

WRTA0

specifies that IOCP is to write the IOCDS generated in storage to the level A0 IOCDS in the processor controller.

Examples of Producing a Configuration Report

Example 1: This example shows the IOCP command options you use to produce a report of every IOCDS on the A side of the processor complex. These reports allow you to analyze your installation's present I/O configuration.

```
IOCP IOCDSRPT (RPTA LINECOUN (65) DISK NOTERM
```

where:

IOCDSRPT

is the filename of the output file that will contain the configuration reports. Note that the filetype will be LISTING.

RPTA

specifies that IOCP is to create a listing of every IOCDS on the A side (the A0, A1, A2, and A3 IOCDS).

LINECOUN (65)

specifies that IOCP is to produce a listing that contains 65 lines of output per page.

DISK

specifies that IOCP is to send its output to disk.

NOTERM

specifies that IOCP is not to display any diagnostic messages at the terminal.

Example 2: This example shows the IOCP command options you use to write a test configuration source file to the A1 IOCDS in the processor controller.

```
IOCP PS13 (WRT IGNORE PR
```

where:

PS13

is the filename of the CMS file containing your input IOCP macro instructions. The filetype is IOCP.

WRT

specifies that IOCP is to write the configuration defined in PS13 to the level A1 IOCDS in the processor controller.

IGNORE

specifies that IOCP is to ignore all non-IOCP macro instructions and parameters contained in the PS13 data set.

PR

indicates that IOCP is to send the configuration report of the PS13 data set to the printer.

Return Codes

When you execute the VM version of IOCP, IOCP returns one of the following codes at the completion of the job.

Return Code (Decimal)	Description/Action
0	IOCP completed the requested function without error.
4	IOCP completed the requested functions without error but issued one or more warning messages. The warning messages in the output listings or the report describe the specific conditions that caused the warning.
8	IOCP encountered an error and terminated processing before completing the requested function. The error message in the output listing describes the specific condition that caused the error.
12	IOCP terminated because the output data set DCB failed to open. IOCP was unable to print messages or reports. Ensure that the FILEDEF command for the output data set is correct. You may query the data definitions for all files by issuing the CMS FILEDEF command without operands.
16	IOCP terminated because it could not obtain enough storage. Define more virtual storage for your virtual machine, re-IPL CMS, and issue the IOCP command again.

In addition to the return codes listed, the CMS-IOCP interface module, DMSICP, issues its own error messages with corresponding return codes for each message. For the return codes generated with error messages, see “IOCP Messages (DMSICP Prefix)” in “Chapter 6. IOCP Messages.”

Methods of Executing the VM Version of IOCP

This topic suggests ways that you can execute the VM version of IOCP to: (1) initially define and check the I/O configuration data for a new processor complex, and (2) subsequently redefine and replace the I/O configuration on an installed processor complex.

Initial Definition of I/O Configuration Data

There are two methods you can use to initially define and validate the I/O configuration data for a new processor complex:

- If you have time to prepare an IOCP input file on an existing system before installing the processor complex, use Method One.
- If you can use the starter IOCDS shipped with the processor complex, use Method Two.

Method One:

Before installing the processor complex, you can create an IOCP input file on an existing system. The customer engineer (CE) uses this input file during the installation of the new processor complex. To prepare an input file, follow these steps:

1. Determine, from your physical plan, the I/O configuration requirements that must be met in order to install the processor complex.
2. Prepare an input file of IOCP macro instructions that define your I/O configuration and system requirements. The customer engineer will use this file when he installs the processor complex. For a sample input file containing IOCP macro instructions, see Figure B-3 in Appendix B.
3. Check the IOCP macro instruction input by executing the IOCP command under CMS. Code NOWRTCDS and NOIGNORE on the IOCP command. This command allows you to check the syntax of the IOCP macro instructions as well as to check the configuration reports for the desired configuration data.

Note: The I/O information in the DMKRIO file (for VM/SP or VM/SP HPO) or HCPRIO file (for the VM/XA Systems Facility) used in system generation should correspond to the information you code in the IOCP macro instructions. Figure B-4 in Appendix B contains a sample DMKRIO file that corresponds to the sample IOCP input file shown in Figure B-3. Figure B-5 in Appendix B contains a sample HCPRIO file that corresponds to the sample IOCP input file shown in Figure B-3.

4. If there are any errors in the IOCP macro instructions, correct the errors and rerun IOCP (Step 3).
5. Analyze the IOCP configuration reports (produced in Step 3) to ensure that the desired I/O configuration is defined. If necessary, revise the IOCP macro instructions and rerun IOCP.

6. Create a tape or card deck of IOCP macro instructions from the input file you have created.

Note: During the physical installation of the processor complex, the CE uses your validated input deck (with the stand-alone version of IOCP) to configure and test the I/O configuration for the new processor complex. An example for the CE is provided under “Generating an IOCDS on a New Processor Complex” in Chapter 4.

Method Two:

The processor complex is shipped with a starter IOCDS. You can decide whether or not this starter IOCDS meets your I/O needs. To use the starter IOCDS, follow these steps:

1. Determine the I/O devices your installation uses and whether the starter IOCDS defines these devices. If you will generate VM/SP or VM/SP HPO, make sure the addresses in the IOCDS correspond to the addresses for these devices in the DMKRIO file. If you will generate the VM/XA Systems Facility, make sure the addresses in the IOCDS correspond to the addresses for these devices in the HCPRIO file.
2. Proceed with the installation of the processor complex if the starter IOCDS defines enough DASD to IPL a VM/SP, VM/SP HPO, or VM/XA Systems Facility system. Use the IOCDS shipped with the processor complex.
3. Reconfigure your I/O, once you initialize VM/SP, VM/SP HPO, or the VM/XA Systems Facility according to the particular physical configuration of your installation. (See “Subsequent Definition and Replacement of I/O Configuration Data” in this chapter.)

Note: If the starter IOCDS shipped with the processor complex does not correspond to your particular I/O configuration, your customer engineer must execute the stand-alone version of IOCP. (See “Chapter 4. Executing the Stand-Alone Version of IOCP.”)

Subsequent Definition and Replacement of I/O Configuration Data

There are two methods you can use to replace the existing I/O configuration data on a processor complex:

- If VM/SP or VM/SP HPO Release 1 is not running in single processor mode, or you have installed VM/SP HPO **Release 2** or a subsequent release, use Method One.
- If VM/SP or VM/SP HPO Release 1 is running in single processor mode, use Method Two.
- If you are running the VM/XA Systems Facility, use Method One.

Method One:

The following steps describe how your installation can replace the existing I/O configuration data on a processor complex when VM/SP or VM/SP HPO Release 1 is not running in single processor mode. You may follow these steps for VM/SP HPO Release 2 and subsequent releases, regardless of the system mode. You may also follow these steps for the VM/XA Systems Facility:

1. Update the input file that contains the IOCP macro instructions to reflect your new I/O configuration. Figure B-3 in Appendix B contains a listing of a sample input file.
2. Execute the VM version of IOCP to check the input file you updated in Step 1. Use the NOWRTCDS option on the CMS IOCP command.
3. Correct any errors on the IOCP macro instructions and rerun IOCP (Step 2).
4. Analyze the IOCP configuration reports (produced in Step 2) to ensure that the desired I/O configuration is defined. If necessary, revise the IOCP macro instructions and rerun IOCP (Step 2).
5. Execute the IOCP program by issuing the IOCP command with a write option (WRTCDS, WRTAx, or WRTBx). This option writes the I/O configuration to the specified IOCDS in the processor controller. All users running under VM/SP or VM/SP HPO must have privilege class C to write. All users running under the VM/XA Systems Facility must have privilege classes C, F, and G to write.

Note: Continue with Steps 6 through 11 when you wish to use the new IOCDS created in Step 5. Perform these steps at a convenient time, because these steps require disrupting installation operations.

6. Revise the real I/O configuration file to reflect the changes made by IOCP. The real I/O configuration file is DMKRIO for VM/SP and VM/SP HPO; for the VM/XA Systems Facility, it is HCPRIO. Figure B-4 in Appendix B contains a sample DMKRIO listing that corresponds to the IOCP listing mentioned in Step 1 (Figure B-1). Figure B-5 in Appendix B contains a sample HCPRIO listing that also corresponds to Figure B-1.
7. Generate the new VM/SP, VM/SP HPO, or VM/XA Systems Facility system.
8. Shut down VM/SP, VM/SP HPO, or the VM/XA Systems Facility.
9. Perform a power-on reset of the processor complex with the new IOCDS specified as the source of your configuration data. You use the IOCDSM (SYS021) frame to select the active IOCDS and the CONFIG (SYS020) frame to perform a power-on reset. (See the operator's guide for the system console that applies to your processor complex.)
10. Load (IPL) VM/SP, VM/SP HPO or the VM/XA Systems Facility.
11. Test the new configuration. Follow the procedures established for your installation.

12. If your processor complex has only a level A0 and A1 (LVL0 and LVL1) IOCDS, switch the two data sets after the new I/O configuration has been tested. To switch data sets, use action 3, SWITCH DS A/B, on the CONFIG (SYS020) frame. This action allows you to execute IOCP again and to write to and test another I/O configuration in the A1 IOCDS.
13. Save the file you used in Step 2 to provide a backup.

Method Two:

This method shows how an installation can redefine and replace an existing I/O configuration data set when VM/SP or VM/SP HPO Release 1 is running in single processor mode. Single processor mode allows an installation to dedicate a processor to an MVS V=R virtual machine. When single processor mode is active, do not issue an IOCP command with a write option or a configuration report option. (Note that the MVS V=R user cannot run the MVS version of IOCP when single processor mode is active if the user specifies that IOCP is to write to the processor controller or read from the processor controller.)

Note: See “Restrictions” earlier in this chapter for information about running IOCP under VM/SP HPO in single processor mode.

Follow these steps:

You may perform Steps 1 through 5 when single processor mode is active. Because you can do these steps while single processor mode is active, you can check IOCP macro instructions for errors without disrupting normal installation operations.

1. Update the input file that contains the IOCP macro instructions to reflect your new I/O configuration. Figure B-3 in Appendix B contains a listing of a sample IOCP input file.
2. Execute the VM version of IOCP to check the input file you updated in Step 1 above. Use the NOWRTCDS option on the CMS IOCP command. Do not specify any configuration report options on the IOCP command.
3. Correct any errors on the IOCP macro instructions and rerun IOCP (Step 2).
4. Revise the DMKRIO file to reflect the changes made by IOCP. Figure B-4 in Appendix B contains a sample DMKRIO listing that corresponds to the IOCP listing mentioned in Step 1.
5. Generate the new VM/SP or VM/SP HPO system.

Steps 6 through 8 require disrupting operation of the MVS virtual machine.

6. Quiesce the MVS system, then reset the MVS virtual machine. The MVS V=R user must issue the CP command SYSTEM RESET or LOGOFF.
7. Turn single processor mode off.
8. Execute the IOCP program by issuing the IOCP command with a write option (WRTCDS, WRTAx, or WRTBx). This option writes the I/O

configuration to the specified IOCDS in the processor controller. Note that you must have privilege class C.

You perform Steps 9 through 14 when you wish to use the new IOCDS you created in Step 8. Perform these steps at a convenient time, because these steps require disrupting installation operations.

9. Shut down VM/SP or VM/SP HPO.
10. Perform a power-on reset of the processor complex with the new IOCDS specified as the source of your configuration data. You use the IOCDSM (SYS021) frame to select the active IOCDS and the CONFIG (SYS020) frame to perform the power-on reset. (See the operator's guide for the system console that applies to your processor complex.)
11. Load (IPL) VM/SP or VM/SP HPO.
12. Test the new configuration. Follow the procedures established for your installation.
13. If your processor complex has only a level A0 and A1 (LVL0 and LVL1) IOCDS, switch the data sets after the new I/O configuration has been tested. To switch data sets, use action 3, SWITCH DS A/B, on the CONFIG (SYS020) frame. This action allows you to execute IOCP again and to write to and test another I/O configuration in the A1 IOCDS.
14. Vary the second processor logically offline by issuing the command VARY OFFLINE PROCESSOR VLOG.
15. Turn single processor mode on.
16. Load (IPL) MVS.
17. Save the file you used in Step 2 to provide a backup.



Chapter 4. Executing the Stand-Alone Version of IOCP

The stand-alone version of IOCP is shipped with the processor complex as a software program in a partitioned data set on the integrated processor controller file in the processor controller. You execute the stand-alone version of IOCP to define I/O configuration data when you are operating your system before installation of MVS, VM/SP, VM/SP HPO or the VM/XA Systems Facility, or when you are operating your system with a control program other than these. The stand-alone version can run in either 370 mode or 370-XA mode.

You start and control the stand-alone version of IOCP from the system console or the service support console on the processor complex. When started, IOCP displays the IOCP primary menu (shown in Figure 4-1), which lists the available functions. From this menu, you select the function you want to perform. IOCP then displays menus on which you enter data for a specific function, or enter a screen command to select another function.

Note: When you enter configuration data on the menus, the characteristics, values, and restrictions that apply to the configuration data you enter for channel paths, control units, and I/O devices are the same as those described for the macro instructions. See “Specifying IOCP Macro Instructions” in Chapter 2 (MVS) or Chapter 3 (VM) for full information on specifying configuration data on the CHPID, CNTLUNIT, and IODEVICE macro instructions.

To help you use the information in this chapter, the next topic provides a map of IOCP functions with references to the topics and menus in this chapter. The other topics in this chapter describe:

- How to start and end IOCP
- The layout of the IOCP menus
- The IOCP screen commands
- The menus displayed by IOCP
- Selected examples of executing functions of IOCP
- How to dump the IOCP storage area
- The wait state codes issued by IOCP

Guide to Using the Stand-Alone Version of IOCP

To help you use the information in this chapter, the following diagram provides a map of the IOCP functions with references to the topics and figures in this chapter that describe how to perform the function.

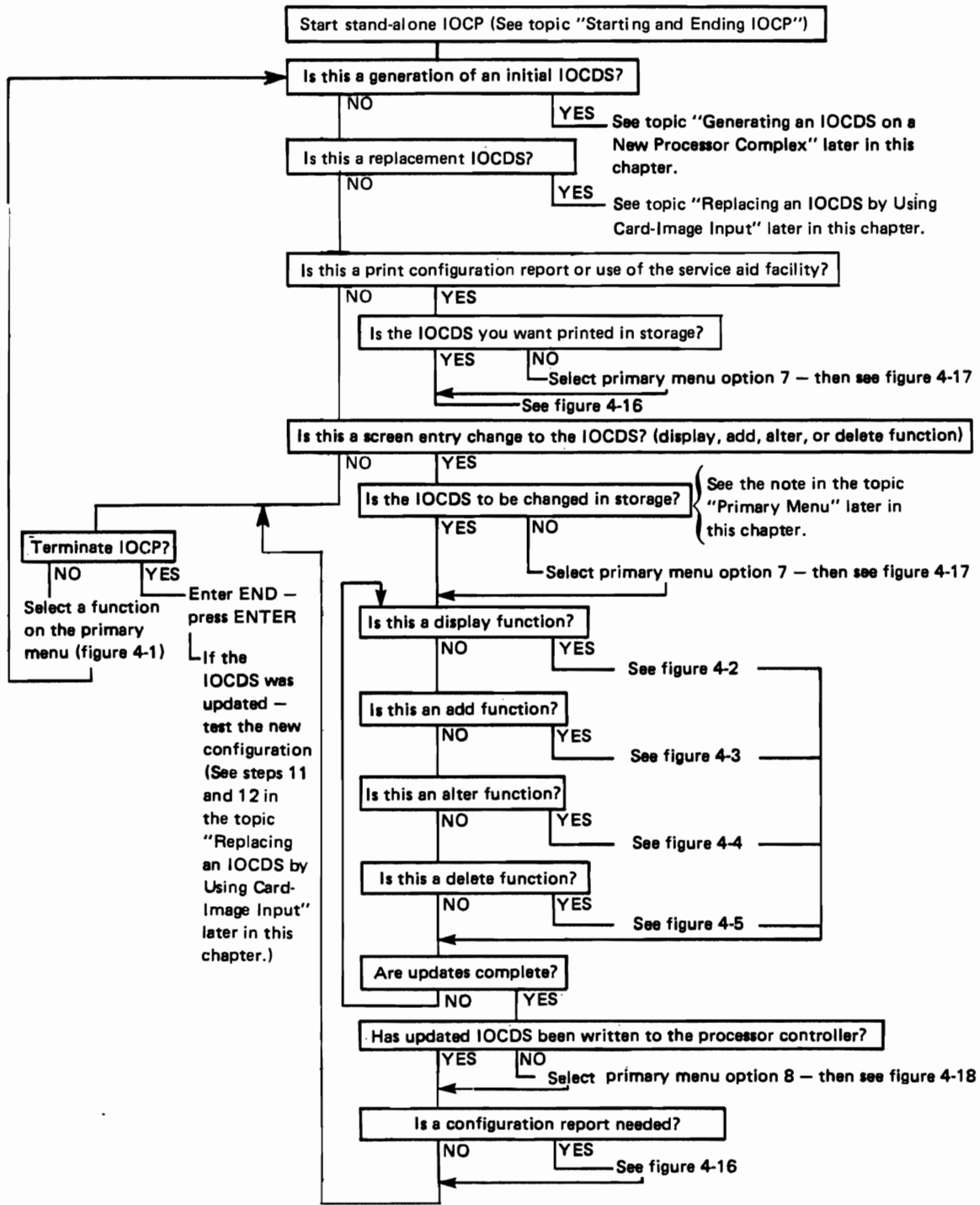

Starting and Ending IOCP

To start the stand-alone version of IOCP, you must use a console correctly configured with the processor that will execute IOCP. Although you can execute IOCP on only one processor at a time, the stand-alone version of IOCP requires the entire processor complex to operate. (The command IOCPn causes a system reset and the clearing of storage before loading IOCP.)

The following steps describe how you start the stand-alone version of IOCP on the system console or the service support console.

1. Determine if there are any analysis routines (ARs) currently running by hitting the ATTN key on the service console. If there are analysis routines running, you will receive the following message:

```
"ATTN Flag now set  
To continue, enter DGO. To terminate, enter DEND."
```

If you do not receive this message, go to Step2.

Either enter DGO to allow the analysis routines to complete and run IOCP at a later time, or enter DEND to cancel the analysis routines. (The analysis routine that is currently running will complete.) Go to Step 2.

If you cancel the analysis routines to run IOCP, restart the routines at the completion of IOCP by entering:

```
"F MMC060"
```

and selecting "Resume LOGOUT Analysis."

This will resume LOGOUT analysis.

2. Key in the following console command, replacing n with the number of the processor (0, 1, 2, or 3) that will execute IOCP. (The A side has processors 0 and 2; the B side has processors 1 and 3. A uniprocessor has only processor 2.)

```
IOCPn
```

Press ENTER.

3. Wait for a response.

If the console is in program mode, IOCP displays the primary menu (Figure 4-1). Go to Step 5.

If the console is not in program mode, IOCP displays the following message:

```
ICP501A TYPE "PRG": PRESS "ALT", "CMD" KEYS:  
TYPE "PRGATTN": PRESS "ENTER"
```

4. Respond to message ICP501A by performing the following steps, which put the console in program mode and cause a program attention.

- a. To put the console in program mode, key in the following console command:

PRG

- b. To display the following message, press and hold down the ALT key and then press the CMD key while holding down the ALT key.

CONSOLE MODE CHANGED

- c. To cause a program attention, key in the following console command:

PRGATTN

- d. Press ENTER.

5. IOCP displays the primary menu (Figure 4-1) and you can start operating IOCP.

For you to communicate with IOCP, the console must be in program mode. Whenever the console is in FDC (frame dependent command) mode and IOCP tries to change any line in the display other than the message line, the processor displays message CF INVOCATION ERROR. RC = 52. This message means the console is not in program mode. IOCP also displays message ICP501A (except when IOCP is changing line 11 of Figure 4-17 and Figure 4-18). Use Steps 3a and 3b to put the console into program mode.

To end IOCP operation, enter the END screen command on any IOCP menu. IOCP enters a disabled wait state and the audible alarm may sound. To reset the audible alarm, you must be in FDC mode (the console is still in program mode).

To take the console out of program mode; key in FDC, press and hold down the ALT key, and press the CMD key while holding down the ALT key. Once you are in FDC mode, type RSTALM on the bottom line and press ENTER to reset the alarm.

To restart IOCP (when IOCP is in storage and the console is in FDC mode), key in SYSRESET and press ENTER. Then key in RESTART CPn, where n is the processor number (0, 1, 2, or 3), and press ENTER. IOCP displays message ICP501A. (When you restart IOCP, the IOCDS in storage is reinitialized.)

Layout of the Menu Screens

IOCP uses 24 lines to display menus. The lines contain the following data:

Line	Description
1	I/O CONFIGURATION PROGRAM
2	IOCP menu name (function to be performed)
3	blank
4-18	variable - contains specific instructions for the menus. You use these lines to enter configuration data and to select options.
19	blank
20-21	lists the IOCP screen commands available for you to enter on line 24 of the menu currently displayed. Screen commands allow you to select and change the functions you want to perform.
22	system status indicators - not used by IOCP.
23	displays the messages that indicate error conditions or the completion of requested functions.
24	used to enter IOCP screen commands.

Although they do not appear on the IOCP screens, line numbers are shown next to the screens in this manual and are referred to in the text to describe the menus.

When a menu is displayed, the cursor position is to the right of the arrow where you can start to enter data. In the event of an entry error, the cursor position is at the incorrect data.

Figure 4-1 through Figure 4-19 show the IOCP menus.

In Figure 4-6 through Figure 4-8, the optional 370 information (channel number and channel set) is information required only for 370 mode operation.

In Figure 4-12 through Figure 4-14, the optional information (preferred path) applies only to 370-XA mode operation.

Screen Commands

The screen commands that you can issue when a specific menu is displayed are shown on lines 20 and 21 of the menu. To issue a screen command, enter the command on line 24 and press ENTER.

The ADD, ALTER, and DISPLAY screen commands can be entered in the form “command=value.” This “command=value” screen command allows you to switch to or repeat a function without the need to return to the selection menu or primary menu. For example, if you have the control unit display menu (Figure 4-9) on the screen and want to add control unit number 2AA, enter ADD=2AA and press ENTER to select the add control unit menu (Figure 4-10) for control unit number 2AA.

The IOCP screen commands are:

Command	Description
ADD A	Terminates the function in use for the menu currently displayed and selects the add selection menu (Figure 4-3).
ADD=value A=value	Terminates the function in use for the menu currently displayed and performs the function of the add selection menu (Figure 4-3) for the specified value. <ul style="list-style-type: none">● Enter ADD=value on the display, add, or alter channel path menus (Figure 4-6, Figure 4-7, or Figure 4-8) to select the add channel path menu (Figure 4-7) for the channel path specified by value.● Enter ADD=value on the display, add, or alter control unit menus (Figure 4-9, Figure 4-10, or Figure 4-11) to select the add control unit menu (Figure 4-10) for the control unit specified by value.● Enter ADD=value on the display, add, or alter I/O device menus (Figure 4-12, Figure 4-13, or Figure 4-14) to select the add I/O device menu (Figure 4-13) for the I/O device specified by value.
ALTER AL	Terminates the function in use for the menu currently displayed and selects the alter selection menu (Figure 4-4).
ALTER=value AL=value	Use ALTER=value to switch to or repeat the alter function in the same manner as described for ADD=value.
DELETE	Terminates the function in use for the menu currently displayed and selects the delete selection menu (Figure 4-5).
DISPLAY D	Terminates the function in use for the menu currently displayed and selects the display selection menu (Figure 4-2).
DISPLAY=value D=value	Use DISPLAY=value to switch to or repeat the display function in the same manner as described for ADD=value.
END	Terminates IOCP. If you have modified the IOCDS in storage, and have not written the IOCDS to an IOCDS in the processor controller, IOCP does not terminate until you respond to the end IOCP menu (Figure 4-19). When IOCP enters the disabled wait state, the audible alarm may sound. If the alarm sounds, put the console into FDC mode, type RSTALM on the bottom line, and press ENTER to reset the alarm.
MENU M	Terminates the function in use for the menu currently displayed and displays the primary menu (Figure 4-1).
RESHOW R	Clears the screen and restores the previous IOCP menu to the screen. IOCP restores user-entered data, if IOCP received the data. Any message previously displayed is not reshown.
WRITE W	Terminates the function in use for the menu currently displayed and selects the write IOCDS to the processor controller file menu (Figure 4-18).

Menu Screens

This topic describes the menus displayed by IOCP and explains how you use the menus.

Primary Menu

The primary menu shown in Figure 4-1 appears when you start IOCP or issue the MENU screen command to request the primary menu.

You select the function that you want to perform by keying in a menu number (1 through 8) on line 14 and pressing ENTER.

The menu displayed when you enter a number on the primary menu is:

Menu Number	Menu Displayed and Function
1	Display Selection (Figure 4-2) - Used to display configuration data from the IOCDS in storage.
2	Add Selection (Figure 4-3) - Used to add configuration data to the IOCDS in storage.
3	Alter Selection (Figure 4-4) - Used to alter configuration data in the IOCDS in storage.
4	Delete Selection (Figure 4-5) - Used to delete configuration data from the IOCDS in storage.
5	Build IOCDS from Cards (Figure 4-15) Used to read card-image macro instructions from a card reader or magnetic tape, generate an IOCDS in storage, and produce reports of the generated IOCDS.
6	Print IOCDS Configuration Reports with Service Aid Facility (Figure 4-16) - Used to produce configuration reports from the IOCDS in storage on a channel-attached printer, or to access the service aid facility to swap channel path information in the IOCDS and then print reports.
7	Read IOCDS from the Processor Controller File (Figure 4-17) - Used to read one or more IOCDS(s) from the processor controller into the IOCDS storage area.
8	Write IOCDS to the Processor Controller File (Figure 4-18) - Used to write the IOCDS in storage to one or more IOCDS(s) in the processor controller.

```
Line 1          I/O CONFIGURATION PROGRAM
2          PRIMARY MENU
3
4  SELECT MENU NUMBER AND ENTER BELOW:
5      1. DISPLAY CHANNEL PATH, CONTROL UNIT, OR I/O DEVICE INFORMATION
6      2. ADD CHANNEL PATH, CONTROL UNIT, OR I/O DEVICE
7      3. ALTER CHANNEL PATH, CONTROL UNIT, OR I/O DEVICE
8      4. DELETE CHANNEL PATH, CONTROL UNIT, OR I/O DEVICE
9      5. BUILD IOCDS FROM CARDS
10     6. PRINT IOCDS CONFIGURATION REPORTS WITH SERVICE AID FACILITY
11     7. READ IOCDS FROM THE PROCESSOR CONTROLLER FILE
12     8. WRITE IOCDS TO THE PROCESSOR CONTROLLER FILE
13
14  ENTER MENU NUMBER ==>
15
16
17
18
19
20          END    RESHOW
21          MENU
22  system status
23  message line
24  command line
```

Figure 4-1. Primary Menu Screen

Note: IOCP processes your requests to display, add, alter, delete, and print configuration data (menu numbers 1, 2, 3, 4, and 6) from the IOCDS located in central storage. This IOCDS in storage represents one of the following:

- The IOCDS previously read into storage using the read IOCDS from the processor controller file menu (number 7).
- The IOCDS previously generated in storage from card-image input using the build IOCDS from cards menu (number 5).
- A null IOCDS in storage created when you start IOCP.

If you modify the IOCDS in storage and want to write the modified IOCDS to one or more IOCDS(s) in the processor controller file, use menu number 8.

See the examples later in this chapter for detailed information on executing functions of IOCP.

Display Selection

The screen shown in Figure 4-2 appears when you enter menu number 1 on the primary menu screen (Figure 4-1) or enter the DISPLAY screen command.

You use this menu to select the data you want to display from the IOCDs in storage.

On line 5, 6, or 7, key in the channel path identifier, control unit number, or I/O device address/number for the record you want to display.

Press ENTER. IOCP displays the requested data on the channel path display screen (Figure 4-6), the control unit display screen (Figure 4-9), or the I/O device display screen (Figure 4-12).

```
Line 1          I/O CONFIGURATION PROGRAM
     2          DISPLAY SELECTION
     3
     4  ENTER DISPLAY SELECTION FOR ONLY ONE OF THE FOLLOWING:
     5      CHANNEL PATH ID_____ (2 HEX) ==>
     6      CONTROL UNIT NUMBER____ (1 TO 3 HEX) ==>
     7      DEVICE ADDRESS/NUMBER__ (1 TO 3 HEX) ==>
     8
     9
    10
    11
    12
    13
    14
    15
    16
    17
    18
    19
    20  ADD          END      RESHOW
    21  ALTER        DELETE   MENU
    22  system status
    23  message line
    24  command line
```

Figure 4-2. Display Selection Screen

Add Selection

The screen shown in Figure 4-3 appears when you enter menu number 2 on the primary menu screen (Figure 4-1) or enter the ADD screen command.

You use this menu to specify the channel path, control unit, or I/O device that you want to add to the IOCDS in storage. Before adding a control unit to the IOCDS, you must add the channel path(s) to which the control unit attaches. Before adding an I/O device, you must add the control unit(s) to which the I/O device is assigned.

On line 5, 6, or 7, key in the channel path identifier, control unit number, or I/O device address/number for the record you want to add.

Press ENTER. IOCP displays the add channel path screen (Figure 4-7), the add control unit screen (Figure 4-10), or the add I/O device screen (Figure 4-13) to allow you to enter complete data for the record you want to add.

```
Line 1          I/O CONFIGURATION PROGRAM
     2          ADD SELECTION
     3
     4  ENTER ADD SELECTION FOR ONLY ONE OF THE FOLLOWING:
     5  CHANNEL PATH ID_____ (2 HEX) ==>
     6  CONTROL UNIT NUMBER____ (1 TO 3 HEX) ==>
     7  DEVICE ADDRESS/NUMBER__ (1 TO 3 HEX) ==>
     8
     9
    10
    11
    12
    13
    14
    15
    16
    17
    18
    19
    20          DISPLAY      END      RESHOW
    21  ALTER      DELETE      MENU
    22  system status
    23  message line
    24  command line
```

Figure 4-3. Add Selection Screen

Alter Selection

The screen shown in Figure 4-4 appears when you enter menu number 3 on the primary menu screen (Figure 4-1) or enter the ALTER screen command.

You use this menu to select and identify the channel path, control unit, or I/O device whose data you want to alter in the IOCDS in storage.

On line 5, 6, or 7, key in the channel path identifier, control unit number, or I/O device address/number that identifies the record that you want to alter.

Press ENTER. IOCP displays the alter channel path screen (Figure 4-8), the alter control unit screen (Figure 4-11), or the alter I/O device screen (Figure 4-14) to allow you to alter the existing data for the record selected.

```
Line 1
2
3
4 ENTER ALTER SELECTION FOR ONLY ONE OF THE FOLLOWING:
5 CHANNEL PATH ID_____ (2 HEX) ==>
6 CONTROL UNIT NUMBER____ (1 TO 3 HEX) ==>
7 DEVICE ADDRESS/NUMBER__ (1 TO 3 HEX) ==>
8
9
10
11
12
13
14
15
16
17
18
19
20 ADD DISPLAY END RESHOW
21 DELETE MENU
22 system status
23 message line
24 command line
```

Figure 4-4. Alter Selection Screen

Delete Selection

The screen shown in Figure 4-5 appears when you enter menu number 4 on the primary menu screen (Figure 4-1) or enter the DELETE screen command.

You use this menu to delete a channel path, control unit, or I/O device record from the IOCDS in storage.

If you delete a channel path, IOCP deletes all references to that channel path from control unit and I/O device records. Any control unit and/or I/O device record that references only that channel path will be deleted entirely.

If you delete a control unit, IOCP deletes all references to that control unit from I/O device records. Any I/O device record that references only that control unit will be deleted entirely.

On line 5, 6, or 7, key in the channel path identifier, control unit number, or I/O device address/number for the record that you want to delete.

Press ENTER. The selected record is deleted from the IOCDS in storage.

```
Line 1          I/O CONFIGURATION PROGRAM
     2          DELETE SELECTION
     3
     4  ENTER DELETE SELECTION FOR ONLY ONE OF THE FOLLOWING:
     5  CHANNEL PATH ID_____ (2 HEX) ==>
     6  CONTROL UNIT NUMBER____ (1 TO 3 HEX) ==>
     7  DEVICE ADDRESS/NUMBER__ (1 TO 3 HEX) ==>
     8
     9
    10
    11
    12
    13
    14
    15
    16
    17
    18
    19
    20  ADD          DISPLAY      END      RESHOW
    21  ALTER          MENU
    22  system status
    23  message line
    24  command line
```

Figure 4-5. Delete Selection Screen

Channel Path Display

The screen shown in Figure 4-6 appears when you have entered a channel path identifier on line 5 of the display selection screen (Figure 4-2) or entered the DISPLAY=value screen command.

This screen displays, to the right of the arrows, the data for the requested channel path. The optional information (channel number and channel set) is displayed only if it was specified. For 370-XA mode, the optional information is optional. For 370 mode, the optional information is information required for the processor to access the devices attached to the channel path.

Enter a screen command and press ENTER to select another menu.

```
Line 1
2
3
4
5
6
7
8
9
10
11
12
13
14
15
16
17
18
19
20
21
22
23
24
```

```

                                I/O CONFIGURATION PROGRAM
                                CHANNEL PATH DISPLAY

REQUIRED INFORMATION:
CHANNEL PATH ID_____ (2 HEX) ==>
CHANNEL TYPE_____ (BL,BY) ==>

OPTIONAL 370 INFORMATION:
CHANNEL NUMBER_____ (1 HEX) ==>
CHANNEL SET_____ (0,1) ==>

ADD          DISPLAY      END      RESHOW
ALTER        DELETE      MENU
system status
message line
command line
```

Figure 4-6. Channel Path Display Screen

Add Channel Path

The screen shown in Figure 4-7 appears when you have entered a channel path identifier on line 5 of the add selection screen (Figure 4-3) or entered the ADD = value screen command.

You use this menu to add a channel path to the IOCDS in storage.

On line 5, IOCP displays the channel path identifier of the channel path you are adding.

On lines 6, 9, and 10, key in the channel path information for the channel path that you want to add. For 370-XA mode, the optional information is optional. For 370 mode, the optional information is required for the processor to access the devices attached to the channel path.

Press ENTER to add the channel path record to the IOCDS in storage.

```
Line 1          I/O CONFIGURATION PROGRAM
     2          ADD CHANNEL PATH
     3
     4  ENTER REQUIRED INFORMATION:
     5      CHANNEL PATH ID _____ (2 HEX) ==>
     6      CHANNEL TYPE _____ (BL,BY) ==>
==>
     7
     8  ENTER OPTIONAL 370 ASSIGNMENT:
     9      CHANNEL NUMBER _____ (1 HEX) ==>
    10      CHANNEL SET _____ (0,1) ==>
==>
    11
    12
    13
    14
    15
    16
    17
    18
    19
    20  ADD      DISPLAY      END      RESHOW
    21  ALTER      DELETE      MENU
    22  system status
    23  message line
    24  command line
```

Figure 4-7. Add Channel Path Screen

Alter Channel Path

The screen shown in Figure 4-8 appears when you have entered a channel path identifier on line 5 of the alter selection screen (Figure 4-4) or entered the ALTER=value screen command.

You use this menu to alter the definition of an existing channel path in the IOCDS in storage. When this screen is displayed, it shows the existing information for the channel path you have selected to alter.

On line 5, IOCP displays the channel path identifier of the channel path you are altering. You cannot alter the channel path identifier itself on this screen. To alter the channel path identifier, delete the existing definition of the channel path from the IOCDS in storage and add a new one.

On lines 6, 9, and 10, IOCP displays the existing channel path information, which you can alter by keying in new information to define the channel path. The data that you can alter is intensified on the screen.

For 370-XA mode, the optional information (lines 9 and 10) is optional.

For 370 mode, the optional information is information required for the processor to access the device attached to the channel path.

Press ENTER to add the altered channel path record to the IOCDS in storage.

```
Line 1          I/O CONFIGURATION PROGRAM
      2          ALTER CHANNEL PATH
      3
      4  ENTER REQUIRED INFORMATION:
      5  CHANNEL PATH ID_____ (2 HEX) ==>
      6  CHANNEL TYPE_____ (BL,BY) ==>
      7
      8  ENTER OPTIONAL 370 ASSIGNMENT:
      9  CHANNEL NUMBER_____ (1 HEX) ==>
     10  CHANNEL SET_____ (0,1) ==>
     11
     12
     13
     14
     15
     16
     17
     18
     19
     20  ADD          DISPLAY      END      RESHOW
     21  ALTER        DELETE      MENU
     22  system status
     23  message line
     24  command line
```

Figure 4-8. Alter Channel Path Screen

Control Unit Display

The screen shown in Figure 4-9 appears when you have entered a control unit number on line 6 of the display selection screen (Figure 4-2) or entered the DISPLAY=value screen command.

This screen displays, to the right of the arrows, the data for the requested control unit.

Enter a screen command and press ENTER to select another menu.

```
Line 1          I/O CONFIGURATION PROGRAM
      2          CONTROL UNIT DISPLAY
      3
      4  REQUIRED INFORMATION:
      5  CONTROL UNIT NUMBER_(1 TO 3 HEX) ==>
      6  CU TYPE NUMBER_____(1 TO 5 ALPHA) ==>
      7  CONTROL UNIT SHARED?____(Y,YB,N) ==>
      8  PROTOCOL_____ (D,S) ==>
==>
      9  CHPID #1_____ (2 HEX) ==>
==>
     10  UA SET #1: FROM_____ (2 HEX) ==>
     11  UA SET #1: TO_____ (2 HEX) ==>
     12  ADDITIONAL CHPID(S):
     13  CHPID#2 =>          CHPID#3 =>          CHPID#4 =>
     14  ADDITIONAL UNIT ADDRESS SET(S):
     15  SET FROM TO      SET FROM TO      SET FROM TO
     16  2 =>              3 =>              4 =>
     17  5 =>              6 =>              7 =>
     18  8 =>
     19
     20  ADD      DISPLAY      END      RESHOW
     21  ALTER      DELETE      MENU
     22  system status
     23  message line
     24  command line
```

Figure 4-9. Control Unit Display Screen

Add Control Unit

The screen shown in Figure 4-10 appears when you have entered a control unit number on line 6 of the add selection screen (Figure 4-3) or entered the `ADD =` value screen command.

You use this menu to add a control unit to the IOCDS in storage. Before adding a control unit, you must add the channel path(s) to which the control unit attaches.

On line 5, IOCP displays the control unit number of the control unit you are adding.

On lines 6 through 18, key in the control unit information for the control unit that you want to add. If the control unit connects to more than one channel path, enter the additional channel path identifiers (chpids) on line 13. If the control unit can recognize sets of unit addresses, enter the additional sets on lines 16 through 18. You can specify a maximum of eight sets of addresses.

Press `ENTER` to add the control unit record to the IOCDS in storage.

```
Line 1          I/O CONFIGURATION PROGRAM
     2          ADD CONTROL UNIT
     3
     4  ENTER REQUIRED INFORMATION:
     5  CONTROL UNIT NUMBER____(1 TO 3 HEX) ==>
     6  CU TYPE NUMBER_____(1 TO 5 ALPHA) ==>
     7  CONTROL UNIT SHARED?_____(Y,YB,N) ==>
     8  PROTOCOL_____ (D,S) ==>
     9  CHPID #1_____ (2 HEX) ==>
    10  UA SET #1: FROM_____ (2 HEX) ==>
    11  UA SET #1: TO_____ (2 HEX) ==>
    12  ENTER ADDITIONAL CHPID(S):
    13  CHPID#2 =>      CHPID#3 =>      CHPID#4 =>
    14  ENTER ADDITIONAL UNIT ADDRESS SET(S):
    15  SET FROM TO      SET FROM TO      SET FROM TO
    16  2 =>              3 =>              4 =>
    17  5 =>              6 =>              7 =>
    18  8 =>
    19
    20  ADD      DISPLAY      END      RESHOW
    21  ALTER   DELETE      MENU
    22  system status
    23  message line
    24  command line
```

Figure 4-10. Add Control Unit Screen

Alter Control Unit

The screen shown in Figure 4-11 appears when you have entered a control unit number on line 6 of the alter selection screen (Figure 4-4) or entered the ALTER=value screen command.

You use this menu to alter the definition of an existing control unit in the IOCDS in storage. When the screen is displayed, it shows the existing information for the control unit you have selected to alter.

On line 5, IOCP displays the control unit number of the control unit you are altering. You cannot alter the control unit number itself on this screen. To alter the control unit number, delete the existing definition of the control unit from the IOCDS in storage and add a new one.

On lines 6 through 18, IOCP displays the existing control unit information, which you can alter by keying in new information to define the control unit. The data that you can alter is intensified on the screen.

If the control unit connects to more than one channel path, enter the additional channel path identifiers (chpids) on line 13. If the control unit can recognize sets of unit addresses, enter the additional sets on lines 16 through 18. You can specify a maximum of eight sets of addresses.

Press ENTER to add the altered control unit record to the IOCDS in storage.

```
Line 1          I/O CONFIGURATION PROGRAM
2          ALTER CONTROL UNIT
3
4  ENTER REQUIRED INFORMATION:
5  CONTROL UNIT NUMBER____(1 TO 3 HEX) ==>
6  CU TYPE NUMBER_____(1 TO 5 ALPHA) ==>
7  CONTROL UNIT SHARED?_____(Y,YB,N) ==>
8  PROTOCOL_____ (D,S) ==>
9  CHPID #1_____ (2 HEX) ==>
10 UA SET #1: FROM_____ (2 HEX) ==>
11 UA SET #1: TO_____ (2 HEX) ==>
12 ENTER ADDITIONAL CHPID(S):
13   CHPID#2 =>      CHPID#3 =>      CHPID#4 =>
14 ENTER ADDITIONAL UNIT ADDRESS SET(S):
15   SET FROM TO      SET FROM TO      SET FROM TO
16   2 =>             3 =>             4 =>
17   5 =>             6 =>             7 =>
18   8 =>
19
20 ADD      DISPLAY   END      RESHOW
21 ALTER   DELETE    MENU
22 system status
23 message line
24 command line
```

Figure 4-11. Alter Control Unit Screen

I/O Device Display

The screen shown in Figure 4-12 appears when you have entered an I/O device number/address on line 5 of the display selection screen (Figure 4-2) or entered the DISPLAY=value screen command.

This screen displays, to the right of the arrows, the data for the requested I/O device.

The optional information appears only if it was defined for 370-XA mode.

Enter a screen command and press ENTER to select another menu.

```
Line 1
2
3
4
5
6
7
8
9
10
11
12
13
14
15
16
17
18
19
20
21
22
23
24
```

```

                I/O CONFIGURATION PROGRAM
                I/O DEVICE DISPLAY

REQUIRED INFORMATION:
DEVICE NUMBER/ADDRESS__ (1 TO 3 HEX) ==>
UNIT ADDRESS_____ (2 HEX) ==>
DEVICE TYPE NUMBER___ (1 TO 5 ALPHA) ==>
DEVICE TYPE MODEL____ (1 TO 2 ALPHA) ==>
CONTROL UNIT NUMBER____ (1 TO 3 HEX) ==>
TIMEOUT?_____ (Y,N) ==>
OPTIONAL INFORMATION:
PREFERRED PATH_____ (2 HEX) ==>

ADDITIONAL CONTROL UNIT NO(S):
CU NO#2 =>          CU NO#3 =>          CU NO#4 =>

ADD      DISPLAY    END      RESHOW
ALTER    DELETE     MENU
system status
message line
command line
```

Figure 4-12. I/O Device Display Screen

Add I/O Device

The screen shown in Figure 4-13 appears when you have entered an I/O device address/number on line 5 of the add selection screen (Figure 4-3) or entered the ADD= value screen command.

You use this menu to add an I/O device or set of I/O devices to the IOCDS in storage. Before adding an I/O device or set of I/O devices, you must add the control unit(s) to which the I/O device(s) are assigned.

On line 5, IOCP displays the device address/number of the I/O device you are adding.

On lines 6 through 18, key in the I/O device information for the I/O device(s) that you want to add. To add more than one I/O device, key in the ending address of the added devices on line 18. For example, if you have selected to add device 210 (which appears on line 5) and want to add a set of devices with addresses 210 through 21F; then key in 1F on line 18.

Specify the optional information (preferred path) only for a device used in 370-XA mode.

Press ENTER to add the I/O device record(s) to the IOCDS in storage.

```
Line 1          I/O CONFIGURATION PROGRAM
2          ADD I/O DEVICE
3
4  ENTER REQUIRED INFORMATION:
5      DEVICE NUMBER/ADDRESS__ (1 TO 3 HEX) ==>
6      UNIT ADDRESS_____ (2 HEX) ==>
7      DEVICE TYPE NUMBER__ (1 TO 5 ALPHA) ==>
8      DEVICE TYPE MODEL___ (1 TO 2 ALPHA) ==>
9      CONTROL UNIT NUMBER___ (1 TO 3 HEX) ==>
10     TIMEOUT?_____ (Y,N) ==>
11  ENTER OPTIONAL INFORMATION:
12     PREFERRED PATH_____ (2 HEX) ==>
13
14  ENTER ADDITIONAL CONTROL UNIT NO(S):
15     CU NO#2 =>          CU NO#3 =>          CU NO#4 =>
16
17  ENTER - IF ADDING MULTIPLE DEVICES:
18     LAST UNIT ADDRESS_____ (2 HEX) ==>
19
20  ADD      DISPLAY      END      RESHOW
21  ALTER   DELETE       MENU
22  system status
23  message line
24  command line
```

Figure 4-13. Add I/O Device Screen

Alter I/O Device

The screen shown in Figure 4-14 appears when you have entered an I/O device address on line 7 of the alter selection screen (Figure 4-4) or entered the ALTER =value screen command.

You use this menu to alter the definition of an existing I/O device in the IOCDS in storage. When the screen is displayed, it shows the existing information for the I/O device you have selected to alter.

On line 5, IOCP displays the I/O device number/address of the I/O device you are altering. You cannot alter the device number/address itself on this screen. To alter the device number/address, delete the existing definition of the I/O device from the IOCDS in storage and add a new one.

On lines 6 through 15, IOCP displays the existing I/O device information, which you can alter by keying in new information to define the I/O device. The data that you can alter is intensified on the screen.

The optional information appears only if it was defined for 370-XA mode.

Press ENTER to add the altered I/O device record to the IOCDS in storage.

```
Line 1          I/O CONFIGURATION PROGRAM
2          ALTER I/O DEVICE
3
4  ENTER REQUIRED INFORMATION:
5      DEVICE NUMBER/ADDRESS__ (1 TO 3 HEX) ==>
6      UNIT ADDRESS_____ (2 HEX) ==>
7      DEVICE TYPE NUMBER__ (1 TO 5 ALPHA) ==>
8      DEVICE TYPE MODEL_____ (1 TO 2 ALPHA) ==>
9      CONTROL UNIT NUMBER_____ (1 TO 3 HEX) ==>
10     TIMEOUT?_____ (Y,N) ==>
11  ENTER OPTIONAL INFORMATION:
12     PREFERRED PATH_____ (2 HEX) ==>
13
14  ENTER ADDITIONAL CONTROL UNIT NO(S):
15     CU NO#2 =>          CU NO#3 =>          CU NO#4 =>
16
17
18
19
20  ADD      DISPLAY      END      RESHOW
21  ALTER    DELETE      MENU
22  system status
23  message line
24  command line
```

Figure 4-14. Alter I/O Device Screen

Build IOCDS from Cards

The screen shown in Figure 4-15 appears when you enter menu number 5 on the primary menu screen (Figure 4-1).

You use this menu to read card-image macro instructions from a card reader or magnetic tape, to generate an IOCDS in storage, and to produce reports of the generated IOCDS. For additional information on this menu, see the topic “Replacing an IOCDS by Using Card-Image Input” later in this chapter.

Note that the input and output devices you specify on this menu must be defined in the I/O configuration processed on the previous power-on reset or SYSIML CLEAR and must be available to the processor you are using to execute IOCP. The printer must also be initialized (the forms and print buffer must be loaded). While executing IOCP, assign exclusively to IOCP any devices and control units that IOCP uses. (Other systems should not share the devices and control units.)

On line 5, key in the device address/number of the input device that is to read the card-image input deck. On line 7, key in the type of input device (C for card reader or T for magnetic tape). IOCP assumes that the input records have a length of 80 bytes and a block size of 80 to 32,800 bytes.

On line 8, key in either Y (yes) to ignore non-IOCP input (for example, when you have a combined input deck containing IOCP and system generation macro instructions), or N (no) to flag non-IOCP input as errors (for example, when your input deck contains only IOCP macro instructions and parameters).

If the input device is a tape drive: on line 11, key in the number of the physical file on the reel (such as 1, 2, or 3) that contains the IOCP input deck. The number on line 11 should include any leading tape marks and/or files containing tape labels. IOCP will issue a rewind command followed by “n” (where n is one less than the number you specify on line 11) forward space file command(s) to position the tape to the requested file.

If the input device is a tape drive: on line 12, key in the appropriate mode set command that applies to the tape drive (if other than the default of 03).

On line 9, key in the device address/number of the printer that is to print IOCP messages and reports or, key in NA if you do not have a printer available. If you use NA, all IOCP messages and reports are lost. On line 14, key in Y (yes), N (no), or NA (not applicable) for blocking printer data checks depending on the characteristics of the printer. On line 15, key in the maximum number of lines that you want on an output page (you can specify up to 99). The default is 55. (IOCP also defaults to 55 if you specify a value less than 11.)

On lines 16 and 17, respectively, IOCP displays time and date information that will appear at the top of each page of the IOCP configuration reports. The time and date displayed are either zeroes or values you provided on a previous menu screen. You can change the time and/or date displayed by keying in the values you want printed on the reports. On line 16, key in the hour and minute values; on line 17, key in the year and day values. (Note that the time and date entries you make do not activate the time-of-day clock.)

Press ENTER to build the IOCDS in storage from the card-image input.

```

Line
1          I/O CONFIGURATION PROGRAM
2          BUILD IOCDS FROM CARDS
3
4  ENTER REQUIRED INFORMATION:
5      INPUT DEVICE ADDRESS/NUMBER_____ (3 HEX) ==>
6      INPUT DEVICE TYPE_____ (C=CARD READER)
7      _____ (T=TAPE DRIVE) ==>
8      IGNORE UNKNOWN CARD STATEMENTS?___ (Y,N) ==>
9      OUTPUT PRINTER ADDR/NUMBER___ (3 HEX,NA) ==>
10     ENTER IF THE "INPUT DEVICE TYPE" IS A TAPE DRIVE:
11     FILE NUMBER_____ (1 to 2 DECIMAL) ==>
12     MODE SET CMD_____ (DEFAULT=03 (HEX)) ==>
13     ENTER IF YOU SPECIFY AN "OUTPUT PRINTER ADDRESS":
14     BLOCK PRINTER DATA CHECKS?_____ (Y,N,NA) ==>
15     LINES PER PAGE___ (DEFAULT=55 (DECIMAL)) ==>
16     TIME (HOUR.MINUTE)_____ (HH.MM) ==>
17     DATE (YEAR.DAY (JULIAN)) _____ (YY.DDD) ==>
18
19
20          END    RESHOW
21          MENU
22
23 system status
24 message line
25 command line

```

Figure 4-15. Build IOCDS from Cards Screen

Print IOCDS Configuration Reports with Service Aid Facility

The screen shown in Figure 4-16 appears when you enter menu number 6 on the primary menu screen (Figure 4-1).

You use this menu to produce IOCP configuration reports of the IOCDS that is in storage. This menu also allows you to use the service aid facility to swap channel path information (reports are also produced when you use the service aid facility). See Chapter 5 for examples of IOCP configuration reports.

Note that the output printer that you specify on this menu must be defined in the I/O configuration that was processed on the previous power-on reset or SYSIML CLEAR and must be available to the processor you are using to execute IOCP. The printer must also be initialized (the forms and print buffer must be loaded). While executing IOCP, assign exclusively to IOCP any devices and control units that IOCP uses. (Other systems should not share the devices and control units.)

On line 5, key in the address/number of the printer that is to print the IOCP messages and reports. On line 6, key in Y (yes), N (no), or NA (not applicable) for blocking printer data checks depending on the characteristics of the printer. On line 7, key in the maximum number of lines that you want on an output page (you can specify up to 99). The default is 55. (IOCP also defaults to 55 lines if you specify a value less than 11.)

On lines 8 and 9, respectively, IOCP displays time and date information that will appear at the top of each page of the reports. The time and date displayed are either zeroes or values you provided on a previous menu screen. You can change the time and/or date displayed by keying in the values you want printed on the reports. On line 8, key in the hour and minute values; on line 9, key in the year and day values. (Note that the time and date entries you make do not activate the time-of-day clock.)

Note: This menu allows you to obtain reports of an IOCDS in storage that is in error. If you use this menu and the IOCDS in storage is in error, IOCP produces the reports followed by the appropriate error message describing the first detected error (such as one of the messages ICP300I through ICP307I).

Press ENTER to produce the reports of the IOCDS in storage.

Service Aid Facility

Lines 12 and 13 are intended for use only by service personnel who are swapping (exchanging) cables to isolate channel path, control unit, or I/O device failures. To use the service aid facility, the unswapped (original) IOCDS must be in storage.

Make the required entries on lines 5 through 9. On lines 12 and 13, you enter the channel path identifiers (chpids) that identify the cables you want to swap. Note that both channel paths must be the same type, either block or byte multiplexer.

Press ENTER to swap the chpids and print reports. Before printing reports of the IOCDS in storage, IOCP will swap the two chpids on every control unit and I/O device entry in which they appear. In addition, IOCP also swaps (exchanges) all the channel path information between the two entered chpids.

The service personnel should review the printed configuration reports to verify the correct swapping of the channel paths. If the swapping is correct, use menu 8 (Figure 4-18) to write the changed (new) IOCDS to one or more IOCDS(s) in the processor controller. You must use action A2 on the CONFIG (SYS020) frame to activate the new IOCDS.

```
Line 1          I/O CONFIGURATION PROGRAM
     2          PRINT IOCDS CONFIGURATION REPORTS
     3
     4  ENTER REQUIRED INFORMATION:
     5      OUTPUT PRINTER ADDRESS/NUMBER___(3 HEX) ==>
     6      BLOCK PRINTER DATA CHECKS?___(Y,N,NA) ==>
     7      LINES PER PAGE___DEFAULT=55 (DECIMAL)) ==>
     8      TIME (HOUR.MINUTE)___(HH.MM) ==>
     9      DATE (YEAR.DAY(JULIAN))___(YY.DDD) ==>
    10
    11  ENTER IF USING SERVICE AID FACILITY:
    12      CHPID #1 (SWAP WITH CHPID #2)___(2 HEX) ==>
    13      CHPID #2 (SWAP WITH CHPID #1)___(2 HEX) ==>
    14
    15
    16
    17
    18
    19
    20          END    RESHOW
    21          MENU
    22  system status
    23  message line
    24  command line
```

Figure 4-16. Print IOCDS Configuration Reports Screen

Read IOCDS from the Processor Controller File

The screen shown in Figure 4-17 appears when you enter menu number 7 on the primary menu screen (Figure 4-1).

You use this menu to read an IOCDS from the processor controller into the IOCDS storage area.

On line 5, key in the level of the IOCDS. You can enter only one value. The valid entries depend on the number of I/O configuration data sets that your processor complex supports:

- For two I/O configuration data sets, the valid entries are 0, A0, 1, and A1.
- For four I/O configuration data sets, the valid entries on the A side are 0, 1, A0, A1, A2, and A3; on the B side they are 0, 1, B0, B1, B2, and B3.
- For eight I/O configuration data sets, all of the entries are valid on a 3084 Processor Complex operating in MP mode.

Note: The value 0 is the same as A0; 1 is the same as A1.

Press ENTER to read the selected data set into storage. (After the read operation is completed, you can use menu 8 to display MSG1 and MSG2 of the IOCDS read into storage.) You can now add, alter, display, and delete configuration data from the IOCDS in storage; you can also obtain reports of the IOCDS in storage.

On line 11, IOCP displays the status of the read operation. After you press ENTER and IOCP begins read processing, the text on line 11 varies between NO READ/WRITE IN PROGRESS and READ/WRITE IN PROGRESS FOR SECTOR nnnn (where nnnn is the first sector of a group of seven sectors being processed).

```
Line 1          I/O CONFIGURATION PROGRAM
2          READ IOCDS FROM THE PROCESSOR CONTROLLER FILE
3
4  ENTER REQUIRED INFORMATION:
5          IOCDS TO BE READ_____ (0,1,A0-A3,B0-B3) ==>
6
7
8
9  IOCDS READ/WRITE STATUS:
10         NO READ/WRITE IN PROGRESS.           see text
11         READ/WRITE IN PROGRESS FOR SECTOR nnnn
12
13
14
15
16
17
18
19
20                 END   RESHOW
21                 MENU
22  system status
23  message line
24  command line
```

Figure 4-17. Read IOCDS from the Processor Controller File Screen

Write IOCDS to the Processor Controller File

The screen shown in Figure 4-18 appears when you enter menu number 8 on the primary menu (Figure 4-1) or enter the WRITE screen command.

You use this menu to write the IOCDS in storage to one or more IOCDS(s) in the processor controller. The new configuration can become the active IOCDS if it is selected on a following power-on reset or on the next SYSIML CLEAR.

If you do not want to write the IOCDS in storage to any IOCDS at this time, key in N on line 5 and press ENTER. N returns you to the primary menu. (Use N to exit from this frame after reviewing/altering MSG1 and/or MSG2 without writing the IOCDS to the processor controller.)

On line 5, key in the level of the IOCDS to which you want IOCP to write the IOCDS in storage. The valid entries depend on the number of I/O configuration data sets that your processor complex supports:

- For two I/O configuration data sets, the valid entries are Y, A1, and N.
- For four I/O configuration data sets, the valid entries on the A side are Y, N, A0, A1, A2, and A3; on the B side they are N, B0, B1, B2, and B3.
- For eight I/O configuration data sets, all of the entries are valid for a 3084 Processor Complex operating in MP mode. In addition, you can specify ABx (where x is 0, 1, 2, or 3) to write the IOCDS in storage to the specified IOCDS on both side A and side B.

Notes:

1. *Specifying Y is the same as specifying A1.*
2. *If your processor complex has only a LVL0 and LVL1 IOCDS, IOCP writes the IOCDS from storage to the LVL1 IOCDS. Test the new configuration in the LVL1 IOCDS; then switch the LVL1 IOCDS with the LVL0 IOCDS.*

On lines 6 and 7, respectively, IOCP displays the time and date that will be used to time stamp the IOCDS when it is written to the processor controller. (The time stamp will be used on the IOCP configuration reports of this IOCDS to indicate when it was written.) The time and date displayed are either zeroes or values you provided on a previous menu screen. You can change these values: on line 6, key in the hour and minute values; on line 7, key in the year and day values. (Note that the time and date entries you make do not activate the time-of-day clock.)

If you want to write to an IOCDS that is write-protected, you must first remove the write-protection using the IOCDSM (SYS021) frame. Then press ENTER to write the IOCDS in storage to an IOCDS in the processor controller.

On line 11, IOCP displays the status of the write operation. After you press ENTER and IOCP begins write processing, the text on line 11 varies between NO READ/WRITE IN PROGRESS and READ/WRITE IN PROGRESS FOR SECTOR nnnn (where nnnn is the first sector of a group of seven sectors being processed).

On line 15, IOCP displays the contents of MSG1. This information appears on the ID1 line in the heading of the configuration reports. Bytes 1 through 8 are also the source of the customer name (dsname) for the IOCDS that appears on the IOCDSM (SYS021) frame. On line 16, IOCP displays the contents of MSG2. This information appears on the ID2 line in the heading of the configuration reports. MSG1 and MSG2 can be modified before writing the IOCDS to the processor controller.

Any alphabetic characters entered will appear in upper case in the display even if the user entered those characters in lower case.

Note: If you write a new IOCDS to the processor controller, there might be an inconsistency between the system configuration created by a system generation and the I/O configuration in the new IOCDS.

```
Line
1          I/O CONFIGURATION PROGRAM
2          WRITE IOCDS TO THE PROCESSOR CONTROLLER FILE
3
4  ENTER REQUIRED INFORMATION:
5  WRITE IOCDS___(Y,N,A0-A3,B0-B3,AB0-AB3) ==>
6  TIME (HOUR.MINUTE)_____ (HH.MM) ==>
7  DATE (YEAR.DAY(JULIAN))_____ (YY.DDD) ==>
8
9  IOCDS READ/WRITE STATUS:
10         NO READ/WRITE IN PROGRESS.          see text
11         READ/WRITE IN PROGRESS FOR SECTOR nnnn
12
13  ENTER CHANGES FOR MSG1 AND/OR MSG2:
14         NOTE: -DSNAME- IS THE FIRST EIGHT BYTES OF MSG1.
15         MSG1 ==>
16         MSG2 ==>
17
18
19
20         END      RESHOW
21         MENU
22
23  system status
24  message line
25  command line
```

Figure 4-18. Write IOCDS to the Processor Controller File Screen

End IOCP

The screen shown in Figure 4-19 appears when you enter END on line 24 of a menu screen and the IOCDS in storage has been generated or modified but has not been written to any IOCDS in the processor controller.

You use this menu to terminate IOCP and confirm the destruction of the IOCDS in storage (END), continue IOCP operation (MENU), or select the write IOCDS to the processor controller file menu (WRITE).

On line 24, key in END, MENU, or WRITE.

Press ENTER.

If you keyed in END and the audible alarm sounds, put the console into FDC mode. Then type RSTALM on the command line and press ENTER to reset the alarm.

```
Line 1          I/O CONFIGURATION PROGRAM
     2          END IOCP
     3
     4          *****
     5          * ATTENTION: THE IOCDS IN STORAGE HAS *
     6          * BEEN MODIFIED OR GENERATED BUT NOT *
     7          * WRITTEN TO THE PROCESSOR CONTROLLER *
     8          * FILE.                               *
     9          *****
    10
    11 SELECT COMMAND AND ENTER ON BOTTOM LINE:
    12   ___ TO DESTROY THE IOCDS IN STORAGE, ENTER END.
    13   ___ TO CONTINUE WITH IOCP OPERATION, ENTER MENU.
    14   ___ TO BRING UP THE WRITE IOCDS MENU, ENTER WRITE.
    15
    16
    17
    18
    19
    20          END    RESHOW
    21          MENU   WRITE
    22 system status
    23 message line
    24 command line
```

Figure 4-19. End IOCP Screen

Methods of Executing the Stand-Alone Version of IOCP

This topic suggests steps that can be used to execute the stand-alone version of IOCP in order to (1) generate an IOCDS during the installation of a new processor complex by the customer engineer (CE), and (2) replace an IOCDS by using card-image input on an existing processor complex.

Generating an IOCDS on a New Processor Complex

Note: The steps in this example are performed by the customer engineer (CE) as part of the installation procedure for a processor complex. This example assumes that the installation has previously prepared the card-image input macro instructions for use by the CE. This input deck should define the initial I/O configuration for the new processor complex and can consist of IOCP macro instructions only or IOCP macro instructions combined with MVS system generation macro instructions.

During the installation of a new processor complex, the CE needs to create at least a minimum IOCDS before generating the complete IOCDS from card-image input macro instructions. This minimum IOCDS consists of an input device (card reader or magnetic tape) to read the installation-prepared input macro instructions and an output printer to receive messages and reports. (You can execute IOCP without an output printer; however, all IOCP messages and reports are lost.)

By using the appropriate console commands and IOCP menus, the CE follows these steps to generate an IOCDS for the new processor complex.

1. Determine the addresses and characteristics of the installed channel path(s), control unit(s), and I/O devices to be used as the input and output devices needed for the minimum IOCDS.

Note: The starter configuration (shipped as an IOCDS in the processor controller) might have defined the needed devices, in which case Steps 2 through 7 can be skipped. Compare the configuration reports provided for the starter configuration with the physically installed devices.

2. Start IOCP from the system console or the service support console. When you start IOCP, IOCP initializes a null IOCDS in storage.
3. Add the definitions of the channel path(s), control unit(s), and I/O devices needed to read the input deck and print messages and reports. (See Figure 4-3, Figure 4-7, Figure 4-10, and Figure 4-13.)
4. Display the channel path(s), control unit(s), and I/O devices you added in Step 3 to ensure they are correctly defined. (See Figure 4-2, Figure 4-6, Figure 4-9, and Figure 4-12.)
5. Write the IOCDS in storage to one or more IOCDS(s) in the processor controller. (See Figure 4-18.)
6. End IOCP. (See Figure 4-19.)

7. Perform a power-on reset of the system with the appropriate IOCDS as the source of the configuration data to be used by the channel subsystem. Use the IOCDSM (SYS021) frame to select the IOCDS and the CONFIG (SYS020) frame to perform the power-on reset. The channel subsystem can now perform I/O requests to the needed input and output devices.
8. Prepare the input device with the installation-prepared input deck.
9. Prepare the output printer. Note that the printer buffer must have been previously initialized before IOCP can print to it.
10. Start IOCP.
11. Build an IOCDS from card-image input. (See Figure 4-15.) If the input deck contains MVS system generation macro instructions, use the IGNORE=Y option on the build IOCDS from cards menu. (For more details, see “Steps IOCP Performs to Build an IOCDS,” in this chapter.)
12. Analyze the configuration reports produced in Step 11 to ensure that the generated IOCDS in storage matches the installation’s I/O configuration plan. If it does not, consult with the installation’s system programmer.
13. Write the IOCDS generated in storage in Step 11 to one or more IOCDS(s) in the processor controller. (See Figure 4-18.)
14. End IOCP.
15. If your processor complex only has a level A0 and A1 (LVL0 and LVL1) IOCDS, switch the the data sets after the new I/O configuration has been tested. To switch data sets, use action 3 (SWITCH DS A/B) on the CONFIG (SYS020) frame. The A0 IOCDS now contains the installation’s initial IOCDS. The A1 IOCDS contains the starter configuration.
16. Perform a power-on reset of the system and use the appropriate IOCDS as the source of configuration data.
17. Start IOCP.
18. Read the active IOCDS into storage. (See Figure 4-17.)
19. Produce reports of the IOCDS in storage. (See Figure 4-16.) These configuration reports represent the active I/O configuration for the processor complex.
20. Return the input deck to the installation’s system programmer. The deck is used by the installation on subsequent definitions of an IOCDS based on changes to the I/O configuration.
21. End IOCP.
22. Continue with the installation of the new processor complex. This includes testing the I/O subsystem using the I/O configuration defined by the installation.

Replacing an IOCDS by Using Card-Image Input

This example describes the steps the installation can use to replace the I/O configuration data in an IOCDS on an installed processor complex. (For an MVS system, you can also use the MVS version of IOCP. See “Subsequent Definition and Replacement of I/O Configuration Data” in Chapter 2 for the required steps. For a VM/SP, VM/SP HPO, or VM/XA Systems Facility system, you can also use the VM version of IOCP. See “Subsequent Definition and Replacement of I/O Configuration Data” in Chapter 3 for the required steps.) The following procedure describes how to use the stand-alone version of IOCP to change the I/O configuration for your processor complex.

1. Update your input deck to reflect the new I/O configuration for your processor complex. This deck can consist of IOCP macro instructions only or IOCP macro instructions combined with MVS system generation macro instructions.
2. Start IOCP from the system console.
3. Prepare the input device with the new input deck.
4. Prepare the printer. The printer must be initialized (the forms and print buffer must be loaded).
5. On the primary menu (Figure 4-1), enter menu number 5 to select the build IOCDS from cards menu (Figure 4-15).
6. Key in the appropriate data and press ENTER.

IOCP reads, checks the syntax, and validates the input macro instructions; it generates an IOCDS in storage; and it produces configuration reports of the IOCDS generated in storage. (For more details, see “Steps IOCP Performs to Build An IOCDS” in this chapter.)

7. Analyze the configuration reports produced in Step 6 to ensure that the desired I/O configuration has been generated.
8. If the input deck needs to be changed: end IOCP, modify the input deck, and start again at Step 2.
9. If the input deck is correct: return to the primary menu, select the write IOCDS to the processor controller file menu (Figure 4-18), and write the generated IOCDS to the level xx IOCDS in the processor controller.
10. End IOCP.

The I/O configuration data in the level xx IOCDS now contains your new configuration. On a following power-on reset, you activate this new configuration by selecting the level xx IOCDS as the source of the configuration data the channel subsystem uses to control I/O requests. Use the IOCDSM (SYS021) frame to select the IOCDS and the CONFIG (SYS020) frame to perform a power-on reset.

11. Test the new configuration following the procedures established for your installation.
12. If your processor complex has only a level A0 and A1 (LVL0 and LVL1) IOCDS, switch the data sets after the new I/O configuration has been tested. To switch data sets, use action 3 (SWITCH DS A/B) on the CONFIG (SYS020) frame. This action places the new I/O configuration in the A0 IOCDS. (The A1 IOCDS contains the configuration previously defined in the A0 IOCDS.) Before the next power-on reset, specify the A0 IOCDS as the source of configuration data for the channel subsystem.
13. Save the card-image input used in Step 5 to provide a backup.

Notes:

1. *For an MVS system, if you change the hardware configuration with the stand-alone version of IOCP, execute an MVS system generation with an input deck modified to reflect the changes. This action ensures consistency between the software and hardware configurations.*
2. *For a VM/SP, VM/SP HPO, or VM/XA Systems Facility system, if you change the hardware configuration with the stand-alone version of IOCP, modify the real I/O configuration file and re-generate your operating system. This action ensures consistency between the software and hardware configurations. (The real I/O configuration file for VM/SP and VM/SP HPO is DMKRIO; for the VM/XA Systems Facility, it is HCPRIO.)*

Steps IOCP Performs to Build an IOCDS

IOCP performs the following steps when you specify that you want to generate an IOCDS.

Note: Steps 1 through 5 are repeated for each input macro instruction as it is read (unless an error is found as indicated in Steps 3 and 4).

IOCP:

1. **Reads** each macro instruction from the input device.
2. **Prints** each macro instruction on the output printer.
3. **Checks the syntax** of each macro instruction for correct format. If a syntax error is found (such as a missing parenthesis), IOCP prints an error message on the output printer following the macro instruction that contains the error. IOCP stops checking the syntax of a macro instruction when it encounters the first syntax error on that macro instruction. Therefore, if there are two or more syntax errors on a single macro instruction, the second and following errors are found on subsequent runs of IOCP.

If IOCP finds an error in Step 3, IOCP returns to Step 1 and continues reading, printing, and checking the syntax of the following macro instructions, but does not perform any of the following steps.

4. **Checks the validity** of each macro instruction. For example, IOCP checks that a CNTLUNIT macro instruction has specified a channel path that has been previously defined on a CHPID macro instruction. If an error is found, IOCP prints an error message on the output printer following the macro instruction that contains the error.

If IOCP finds an error in Step 4, IOCP returns to Step 1 and performs only Steps 1 through 3 for the remainder of the macro instructions. Therefore, if there are two or more validity errors in your input deck, the second and following errors are found on subsequent runs of IOCP.

5. **Builds** the appropriate identification, channel path, control unit, or I/O device record and enters the record into the IOCDS in storage.

If more macro instructions remain to be read, IOCP returns to Step 1.

After all of the input macro instructions have been processed and all of the records entered into the IOCDS in storage, IOCP performs Step 6.

6. **Generates** the IOCDS in storage and makes additional checks. For example, IOCP checks that the channel numbers within a channel set are consecutive. If IOCP finds an error, IOCP issues an error message and waits for the next command.

After IOCP has successfully generated an IOCDS in storage, IOCP performs Step 7.

7. **Produces** the IOCP configuration reports of the IOCDS generated in storage.

After checking the configuration reports to ensure that the correct configuration was generated, you can write the IOCDS generated in storage to one or more IOCDS(s) in the processor controller. (See Figure 4-18.)

Dumping IOCP Storage

To help you debug IOCP problems, the stand-alone version of IOCP provides a dump function that allows you to dump the IOCP storage area (including the IOCDS in storage) to a printer or tape drive. Note that the dump routine has no I/O recovery procedures.

To invoke the dump function, perform the following steps:

1. Prepare the output device:
 - If the output device is a printer, make the printer ready. (IOCP uses LRECL = 120)
 - If the output device is a tape drive: mount an unlabeled tape, rewind the tape to the load point, and make the tape drive ready. (IOCP uses LRECL = 121 and RECFM = FA.)

Note that the output device must be defined in the I/O configuration that was processed on the previous power-on reset or SYSIML CLEAR and must be available to the processor you are using to execute IOCP. While executing IOCP, assign exclusively to IOCP any devices and control units that IOCP uses. (Other systems should not share the devices and control units.)

2. With the console in frame dependent command (FDC) mode, key in SYSRESET and press ENTER. (To put the console in FDC mode: key in FDC, press and hold down the ALT key, and press the CMD key while holding down the ALT key.)
3. Key in F ALTCPn (or F CP-n20).

Replace n with the processor you are using to execute IOCP: enter 0, 1, 2, or 3.

Press ENTER.

4. When system frame ALTCPn (CP-n20) is displayed, key in an appropriate option as indicated on the frame, and press ENTER to display the floating point registers.

Alter floating point register 0 as follows:

- If the output device is a printer, set the three rightmost hexadecimal digits to the device address/number of the printer. Set all other digits to 0.
- If the output device is a tape drive, set the three rightmost hexadecimal digits to the device address/number of the tape drive. Set the two leftmost hexadecimal digits to the hexadecimal value of the tape mode set command. (To use reset mode, use a value of 03.) Set all other digits to 0.

Press ENTER. Ensure that the contents of the register were correctly altered.

5. Key in an appropriate option as indicated on the frame, and press ENTER to display the current PSW.

Alter the PSW to: 000C00000000FFFC.

Press ENTER. Ensure that the contents of the PSW were correctly altered.

6. Key in START CPn.

Replace n with the processor you are using to execute IOCP: enter 0, 1, 2, or 3.

Press ENTER. A dump is taken of the IOCP storage area and IOCDS in storage.

When the dump has completed, IOCP loads a disabled PSW with a wait state code of B20 and issues message ICP515W to the console. If the audible alarm sounds when IOCP enters the disabled wait state, type RSTALM on the bottom line and press ENTER to reset the alarm.

In 370-XA mode, a wait state code of B23 occurs if IOCP was unable to match the device number in floating point register 0 with a subchannel information block. You must enter a device number in floating point register 0 that is defined in the active IOCDS (the IOCDS used in the previous power-on reset or SYSIML CLEAR).

IOCP Wait State Codes

Enabled Wait States

During execution of the stand-alone version of IOCP, the processor enters many enabled (PSW Bit 7 is on) wait states. These are normal conditions while IOCP waits for the processor controller to respond to IOCP requests such as a read or write to a console or IOCDS. If the processor stays in an enabled wait state, other than waiting for operator input on a console, for an extended period of time (1 - 3 minutes), the processor controller is busy. The user may either wait for the processor controller to finish or put the console in to FDC mode, do a SYSRESET to the processor running IOCP and restart IOCP at a later time. If the problem persists take an IOCP dump and contact IBM for programming support.

Disabled Wait States

During execution of the stand-alone version of IOCP, IOCP issues the following wait state codes when the indicated conditions occur. (Note that the MVS and VM versions of IOCP do not issue wait state codes.) If the audible alarm sounds when IOCP enters the disabled wait state, put the console into FDC mode (if it isn't already). Then type RSTALM on the bottom line and press ENTER to reset the alarm.

B20

Explanation: The console operator who is executing the stand-alone version of IOCP has ended IOCP processing, or the IOCP dump function has been completed.

Operator Response: None.

B21

Explanation: A program check interruption has occurred during execution of the stand-alone version of IOCP.

Operator Response: Notify your system programmer.

Problem Determination: Save all associated output. Take an IOCP dump. Contact IBM for programming support.

B22

Explanation: A machine check interruption has occurred during execution of the stand-alone version of IOCP.

Operator Response: Notify Your system programmer.

Problem Determination: Save all associated output. Contact IBM for hardware support.

B23

Explanation: (1) An uncorrectable I/O error has occurred during execution of the stand-alone version of IOCP. (2) The user requested a dump of IOCP storage in 370-XA mode, but IOCP was unable to find a subchannel information block for the device number entered in floating point register 0.

Operator Response: (1) Notify your system programmer. (2) Enter the correct device number in floating point register 0 and try the IOCP dump procedure again.

Problem Determination: (1) Save all associated output. Take an IOCP dump. Contact IBM for hardware support. (2) None.

B24

Explanation: During execution of the stand-alone version of IOCP, IOCP has encountered an error in the processor controller and cannot communicate with the person operating IOCP.

Operator Response: Notify your system programmer.

Problem Determination: Save all associated output. Take an IOCP dump. Contact IBM for hardware support.

Chapter 5. IOCP Configuration Reports

This chapter describes the IOCP configuration reports. You use the reports to check the I/O configuration data in an IOCDS. Following is a brief description of each configuration report with references to report examples:

- The channel path identifier (CHPID) summary report lists the channel path identifiers defined in the IOCDS. For each channel path identifier, the report shows the corresponding channel number, the channel set, and the mode of I/O operation. Figure 5-1 is an example of the CHPID summary report.

If you do not enter a 370 channel number and channel set, N/A appears in those columns in the report.

- The I/O device report lists, by 370-XA device number, the I/O devices defined in the IOCDS. The report shows the side (side A if the CHPID is less than 40, otherwise side B), control units, and channel path identifiers to which each device is assigned. The report also provides other information, such as subchannel assignment (shared, shared block, or nonshared subchannel.) Figure 5-2 consists of pages from an I/O device report.

If you do not enter a 370 channel number (370 CHANNEL ADDR on the report) and channel set, N/A appears in those columns in the report. If a 370/370-XA IOCP reads a 370 IOCDS, N/A appears in the report under 370-XA SUB-CHAN NUMBER and 370-XA LOG CNTL UNIT NUMBER.

If applicable, the I/O device report lists warning message ICP054I (the I/O device is not connected to the specified primary channel address).

- The logical control unit report lists the 370-XA logical control units in the IOCDS by logical control unit number. For each logical control unit, the report lists the rotation order for 370-XA mode (under DEVICE CHPID ORDER). For each device in a logical control unit, the report shows the device number, the attaching control units, and the preferred channel path. Figure 5-3 consists of pages from the logical control unit report.

Note: Logical control units with no devices are listed at the end of the logical control unit report. The user should verify that the logical control unit report accurately describes the user's configuration.

A logical control unit report is not produced if IOCP (370 or 370/370-XA) reads and prints a 370 IOCDS, or if the IOCDS in storage contains an error.

If you operate your system *only* in 370 mode, you can disregard the logical control unit report.

- The channel path identifier (CHPID) report, like the CHPID summary report, lists the channel path identifiers defined in the IOCDS. In addition to the information given in the CHPID summary report (Figure 5-1), the CHPID report shows the side the channel path is assigned to for 370 mode, and the control units and I/O devices assigned to each channel path. It also provides other information, such as the interface protocol (D. C. interlock or data streaming) used by the control unit(s) attached to the channel path. Figure 5-4 consists of pages from the channel path identifier report.

If you do not enter a 370 channel number and channel set, N/A appears in those columns in the report. If a 370/370-XA IOCP reads and prints a 370 IOCDS, N/A appears in the report under 370-XA LOG CNTL UNIT NUMBER.

Notes:

1. *A 370 level IOCP cannot read a 370/370-XA IOCDS. (IOCP issues error message ICP404I and does not print reports.)*
2. *The Device Configuration Frame (DEVCSA) provides real-time device configuration data for 370-XA mode operation. For each subchannel number, the DEVCSA frame displays the corresponding device number, unit address, and attaching channel path identifiers. You can minimize requesting IOCP configuration reports by using the DEVCSA frame.*

Conditions for Producing Reports

If no error occurs, the MVS version of IOCP produces reports when:

- IOCP generates an IOCDS. The reports show the configuration data in the IOCDS that is generated in storage based on the input macro instructions.
- You code the REPORT option on the PARM parameter of the EXEC statement. The reports show the configuration data contained in each IOCDS that you specified on REPORT=.

If no error occurs, the VM version of IOCP produces reports when:

- IOCP generates an IOCDS in response to the CMS IOCP command with IOCDS generation options. The reports show the configuration data in the IOCDS that IOCP generates in storage from the input macro instructions.
- You use configuration report options (BOTH RPT, CD0RPT, CD1RPT, RPTAx, RPTBx, RPTA, or RPTB) on the CMS IOCP command. The reports show the configuration data contained in each specified IOCDS.

If no error occurs, the stand-alone version of IOCP produces reports, when

- You use the build IOCDS from cards menu (Figure 4-15). The reports show the configuration data in the IOCDS that is generated in storage based on the input macro instructions.

- You use the print IOCDS configuration reports menu (Figure 4-16). The reports show the configuration data contained in the IOCDS in storage. In this case, the configuration data represents one of the following:
 - The IOCDS that has been previously read into storage using the read from the processor controller file menu (Figure 4-17)
 - The IOCDS that has been previously generated in storage from card-image input using the build IOCDS from cards menu (Figure 4-15)
 - The IOCDS in storage after starting IOCP and adding configuration data to the null IOCDS from the console screen

Note: If the IOCDS in storage contains an error and you use the print IOCDS configuration reports menu, IOCP produces the reports (except the logical control unit report), followed by the appropriate error message describing the first detected error (such as one of the messages ICP300I through ICP307I). In addition, if the IOCDS in storage contains an error, N/A appears in the reports for the subchannel numbers and the logical control unit numbers.

Configuration Report Headings

There are four heading lines for each configuration report. The first line of the heading shows:

- The time and date IOCP produced the reports¹
- The IOCP version and level number. The versions are:
 - Version 1 is a 370 IOCP.
 - Version 2 is a 370/370-XA IOCP that supports only the LVL0 and LVL1 IOCDS.
 - Version 3 is a 370/370-XA IOCP that supports four I/O configuration data sets on each side of the processor complex
- The type of configuration report (CHPID, DEVICE, LOGICAL CONTROL UNIT, or CHANNEL PATH ID)
- The report page number

The second line of the heading shows:

- The report's source, which can be card input, an IOCDS from a processor controller, or screen input

¹ The MVS and VM versions of IOCP take the time and date from the operating system; the stand-alone version takes the time and date entered on the menu screens.

- Whether the IOCDS in storage was modified by screen input. YES indicates that either the IOCDS was originally created from screen input or was modified by screen input after being generated from card input. NO indicates the IOCDS was generated from card input and was not modified by screen input.
- When the report source is an IOCDS from a processor controller, if it is the active IOCDS: where YES indicates the data set was the active data set at the last power-on reset or SYSIML CLEAR, NO indicates the data set was not active at the last power-on reset or SYSIML CLEAR, and NA indicates not applicable (for a report source of card or screen input)
- When the report source is the active IOCDS, if it was updated: where YES indicates the active data set was updated (written to) after the last power-on reset or SYSIML CLEAR, NO indicates the active data set was not updated (not written to) after the last power-on reset or SYSIML CLEAR, and NA indicates not applicable (for a report source of card or screen input)

The third line of the heading (ID1 =) shows:

- Any identification information that you specified on the ID macro instruction. (Bytes 1 through 8 of ID1 = are the same as the customer name of the IOCDS that appears on the IOCDSM (SYS021) frame.)
- When the report source is an IOCDS from a processor controller, the time and date IOCP last wrote the IOCDS from storage to the processor controller.²

The fourth line of the heading (ID2 =) shows:

- When the report source is an IOCDS from the processor controller, the processor controller time stamp.³ (The processor controller time stamp also appears on the IOCDSM (SYS021) frame.)
- Any additional identification information that you specified on the ID macro instruction.

Note: Figure 5-2 , Figure 5-3, and Figure 5-4 contain only representative pages from the configuration reports; they do not show every page of every report.

² The MVS and VM versions of IOCP take the time and date from the operating system; the stand-alone version takes the time and date entered on the menu screens.

³ Time stamp information appears if the IOCDS was timestamped when the IOCDS was written to the processor controller.

TIME 14.52 DATE 85.246

IOCP VERSION 3 LEVEL 2 CHPID REPORT
REPORT SOURCE IS LVL A1 IOCDS, MODIFIED BY SCREEN INPUT=NO, ACTIVE=NO, UPDATED=NO

ID1=PRACTICE IOCP GENERATION
ID2=SAMPLE CONFIGURATION WITH THREE BYTE CHANNELS

WRITTEN TO PROCESSOR CONTROLLER ON: TIME 14.50
PROCESSOR CONTROLLER TIMESTAMP: TIME 14.50

***** CHANNEL PATH IDENTIFICATION SUMMARY *****

<u>CHPID</u>	<u>CHANNEL NUMBER</u>	<u>CHANNEL SET</u>	<u>MODE</u>	<u>SIDE</u>
00	0	0	BYTE	A
01	6	0	BLOCK	A
02	1	0	BLOCK	A
03	2	0	BLOCK	A
04	3	0	BLOCK	A
05	4	0	BLOCK	A
06	5	0	BLOCK	A
07	7	0	BLOCK	A
10	5	1	BLOCK	A
11	6	1	BLOCK	A
12	7	1	BLOCK	A
13	8	1	BLOCK	A
14	9	1	BLOCK	A
15	A	1	BLOCK	A
16	B	1	BLOCK	A
17	C	1	BLOCK	A
20	8	0	BLOCK	A
21	9	0	BLOCK	A
22	A	0	BLOCK	A
23	B	0	BLOCK	A
24	1	1	BLOCK	A
25	2	1	BLOCK	A
26	3	1	BLOCK	A
27	4	1	BLOCK	A

Figure 5-1. Channel Path Identifier (CHPID) Summary Report

TIME 14.52 DATE 85.246 IOCP VERSION 3 LEVEL 2 DEVICE REPORT PAGE 001
 REPORT SOURCE IS LVL A1 IOCD5, MODIFIED BY SCREEN INPUT=NO, ACTIVE=NO, UPDATED=NO
 ID1=PRACTICE IOCP GENERATION WRITTEN TO PROCESSOR CONTROLLER ON: TIME 14.50 DATE 85.246
 ID2=SAMPLE CONFIGURATION WITH THREE BYTE CHANNELS PROCESSOR CONTROLLER TIMESTAMP: TIME 14.50 DATE 85.246

370-XA DEVICE NUMBER	UNIT ADDR	370-XA SUB-CHAN NUMBER	370-XA LOG. CNTL UNIT NUMBER	370-XA CNTL UNIT TYPE	DEVICE TYPE	MODEL	TIMEOUT	CNTL UNIT NUMBER	PROTOCOL	CHAN PATH IDS _ _ _ _	SIDE	370 CHANNEL SET ADDR	370 SUB-CHAN ASSIGNED
002	02	000	00	2	3211		YES	001	DCI	00	A	0 002	UNSHARED
004	04	001	01	2	3211		YES	002	DCI	00	A	0 004	UNSHARED
012	12	002	02	2	3505		YES	003	DCI	00	A	0 012	UNSHARED
013	13	003	02	2	3525		YES	003	DCI	00	A	0 013	UNSHARED
04D	4D	004	03	2	BSC1		YES	004	DCI	00	A	0 04D	UNSHARED
04E	4E	005	03	2	BSC1		YES	004	DCI	00	A	0 04E	UNSHARED
04F	4F	006	03	2	BSC1		YES	004	DCI	00	A	0 04F	UNSHARED
050	50	007	03	2	BSC1		YES	004	DCI	00	A	0 050	UNSHARED
051	51	008	03	2	BSC1		YES	004	DCI	00	A	0 051	UNSHARED
052	52	009	03	2	BSC1		YES	004	DCI	00	A	0 052	UNSHARED
053	53	00A	03	2	BSC1		YES	004	DCI	00	A	0 053	UNSHARED
054	54	00B	03	2	BSC1		YES	004	DCI	00	A	0 054	UNSHARED
055	55	00C	03	2	BSC1		YES	004	DCI	00	A	0 055	UNSHARED
056	56	00D	03	2	BSC1		YES	004	DCI	00	A	0 056	UNSHARED
057	57	00E	03	2	BSC1		YES	004	DCI	00	A	0 057	UNSHARED
058	58	00F	03	2	BSC1		YES	004	DCI	00	A	0 058	UNSHARED
059	59	010	03	2	BSC1		YES	004	DCI	00	A	0 059	UNSHARED
05A	5A	011	03	2	BSC1		YES	004	DCI	00	A	0 05A	UNSHARED
05B	5B	012	03	2	BSC1		YES	004	DCI	00	A	0 05B	UNSHARED
07F	7F	013	03	2	2741P		YES	004	DCI	00	A	0 07F	UNSHARED
080	80	014	03	2	2741P		YES	004	DCI	00	A	0 080	UNSHARED
081	81	015	03	2	2741P		YES	004	DCI	00	A	0 081	UNSHARED
082	82	016	03	2	2741P		YES	004	DCI	00	A	0 082	UNSHARED
083	83	017	03	2	2741P		YES	004	DCI	00	A	0 083	UNSHARED
084	84	018	03	2	2741P		YES	004	DCI	00	A	0 084	UNSHARED
085	85	019	03	2	2741P		YES	004	DCI	00	A	0 085	UNSHARED
086	86	01A	03	2	2741P		YES	004	DCI	00	A	0 086	UNSHARED
087	87	01B	03	2	2741P		YES	004	DCI	00	A	0 087	UNSHARED
088	88	01C	03	2	2741P		YES	004	DCI	00	A	0 088	UNSHARED
089	89	01D	03	2	2741P		YES	004	DCI	00	A	0 089	UNSHARED
08A	8A	01E	03	2	2741P		YES	004	DCI	00	A	0 08A	UNSHARED
08B	8B	01F	03	2	2741P		YES	004	DCI	00	A	0 08B	UNSHARED
0A0	A0	020	03	2	BSC3		YES	004	DCI	00	A	0 0A0	UNSHARED
0A1	A1	021	03	2	BSC3		YES	004	DCI	00	A	0 0A1	UNSHARED
0A2	A2	022	03	2	BSC3		YES	004	DCI	00	A	0 0A2	UNSHARED
0A3	A3	023	03	2	BSC3		YES	004	DCI	00	A	0 0A3	UNSHARED
0A4	A4	024	03	2	BSC3		YES	004	DCI	00	A	0 0A4	UNSHARED
0A5	A5	025	03	2	BSC3		YES	004	DCI	00	A	0 0A5	UNSHARED
0A6	A6	026	03	2	BSC3		YES	004	DCI	00	A	0 0A6	UNSHARED
0A7	A7	027	03	2	BSC3		YES	004	DCI	00	A	0 0A7	UNSHARED
0A8	A8	028	03	2	BSC3		YES	004	DCI	00	A	0 0A8	UNSHARED
0A9	A9	029	03	2	BSC3		YES	004	DCI	00	A	0 0A9	UNSHARED
0AA	AA	02A	03	2	BSC3		YES	004	DCI	00	A	0 0AA	UNSHARED
0AB	AB	02B	03	2	BSC3		YES	004	DCI	00	A	0 0AB	UNSHARED
0AC	AC	02C	03	2	BSC3		YES	004	DCI	00	A	0 0AC	UNSHARED

Figure 5-2 (Part 1 of 3). I/O Device Report

TIME 14.52 DATE 85.246

PAGE 002

370-XA DEVICE NUMBER	UNIT ADDR	370-XA SUB-CHAN NUMBER	370-XA LOG. CNTL UNIT NUMBER	370-XA CNTL UNIT TYPE	DEVICE TYPE	MODEL	TIMEOUT	CNTL UNIT NUMBER	PROTOCOL	CHAN PATH IDS _ _ _ _ _	SIDE	370 CHANNEL SET ADDR	370 SUB-CHAN ASSIGNED
0AD	AD	02D	03	2	BSC3		YES	004	DCI	00	A	0 0AD	UNSHARED
0AE	AE	02E	03		BSC3		YES	004	DCI	00	A	0 0AE	UNSHARED
0AF	AF	02F	03		BSC3		YES	004	DCI	00	A	0 0AF	UNSHARED
0B2	B2	030	03		BSC3		YES	004	DCI	00	A	0 0B2	UNSHARED
0B3	B3	031	03		BSC3		YES	004	DCI	00	A	0 0B3	UNSHARED
0B4	B4	032	03		BSC3		YES	004	DCI	00	A	0 0B4	UNSHARED
0B5	B5	033	03		BSC3		YES	004	DCI	00	A	0 0B5	UNSHARED
0B6	B6	034	03		BSC3		YES	004	DCI	00	A	0 0B6	UNSHARED
0B7	B7	035	03		BSC3		YES	004	DCI	00	A	0 0B7	UNSHARED
0B8	B8	036	03		BSC3		YES	004	DCI	00	A	0 0B8	UNSHARED
0B9	B9	037	03		BSC3		YES	004	DCI	00	A	0 0B9	UNSHARED
0BA	BA	038	03		BSC3		YES	004	DCI	00	A	0 0BA	UNSHARED
0BB	BB	039	03		BSC3		YES	004	DCI	00	A	0 0BB	UNSHARED
0BC	BC	03A	03		BSC3		YES	004	DCI	00	A	0 0BC	UNSHARED
0BD	BD	03B	03		BSC3		YES	004	DCI	00	A	0 0BD	UNSHARED
0BE	BE	03C	03		BSC3		YES	004	DCI	00	A	0 0BE	UNSHARED
0BF	BF	03D	03		BSC3		YES	004	DCI	00	A	0 0BF	UNSHARED
0C0	C0	03E	03		BSC3		YES	004	DCI	00	A	0 0C0	UNSHARED
0C1	C1	03F	03		BSC3		YES	004	DCI	00	A	0 0C1	UNSHARED
0C2	C2	040	03		BSC3		YES	004	DCI	00	A	0 0C2	UNSHARED
0C3	C3	041	03		BSC3		YES	004	DCI	00	A	0 0C3	UNSHARED
0C4	C4	042	03		BSC3		YES	004	DCI	00	A	0 0C4	UNSHARED
0C5	C5	043	03		BSC3		YES	004	DCI	00	A	0 0C5	UNSHARED
0C6	C6	044	03		BSC3		YES	004	DCI	00	A	0 0C6	UNSHARED
0C7	C7	045	03		BSC3		YES	004	DCI	00	A	0 0C7	UNSHARED
0C8	C8	046	03		BSC3		YES	004	DCI	00	A	0 0C8	UNSHARED
0C9	C9	047	03		BSC3		YES	004	DCI	00	A	0 0C9	UNSHARED
0CA	CA	048	03		BSC3		YES	004	DCI	00	A	0 0CA	UNSHARED
0CB	CB	049	03		BSC3		YES	004	DCI	00	A	0 0CB	UNSHARED
0CC	CC	04A	03		BSC3		YES	004	DCI	00	A	0 0CC	UNSHARED
0CD	CD	04B	03		BSC3		YES	004	DCI	00	A	0 0CD	UNSHARED
0CE	CE	04C	03		BSC3		YES	004	DCI	00	A	0 0CE	UNSHARED
0CF	CF	04D	03		BSC3		YES	004	DCI	00	A	0 0CF	UNSHARED
0D0	D0	04E	03		BSC3		YES	004	DCI	00	A	0 0D0	UNSHARED
0D1	D1	04F	03		BSC3		YES	004	DCI	00	A	0 0D1	UNSHARED
0D2	D2	050	03		BSC3		YES	004	DCI	00	A	0 0D2	UNSHARED
0D3	D3	051	03		BSC3		YES	004	DCI	00	A	0 0D3	UNSHARED
0D4	D4	052	03		BSC3		YES	004	DCI	00	A	0 0D4	UNSHARED
0D5	D5	053	03		BSC3		YES	004	DCI	00	A	0 0D5	UNSHARED
0D6	D6	054	03		BSC3		YES	004	DCI	00	A	0 0D6	UNSHARED
0D7	D7	055	03		BSC3		YES	004	DCI	00	A	0 0D7	UNSHARED
0D8	D8	056	03		BSC3		YES	004	DCI	00	A	0 0D8	UNSHARED
0D9	D9	057	03		BSC3		YES	004	DCI	00	A	0 0D9	UNSHARED
0DA	DA	058	03		BSC3		YES	004	DCI	00	A	0 0DA	UNSHARED
0DB	DB	059	03		BSC3		YES	004	DCI	00	A	0 0DB	UNSHARED
0DC	DC	05A	03		BSC3		YES	004	DCI	00	A	0 0DC	UNSHARED
0DD	DD	05B	03		BSC3		YES	004	DCI	00	A	0 0DD	UNSHARED
0DE	DE	05C	03		BSC3		YES	004	DCI	00	A	0 0DE	UNSHARED
0DF	DF	05D	03		BSC3		YES	004	DCI	00	A	0 0DF	UNSHARED

Figure 5-2 (Part 2 of 3). I/O Device Report

TIME 14.52 DATE 85.246

PAGE 011

370-XA DEVICE NUMBER	UNIT ADDR	370-XA SUB-CHAN NUMBER	370-XA LOG. CNTL UNIT NUMBER	370-XA CNTL UNIT TYPE	DEVICE TYPE	MODEL	TIMEOUT	CNTL UNIT NUMBER	PROTOCOL	CHAN PATH IDS _ _ _ _	SIDE	370 CHANNEL SET ADDR	370 SUB-CHAN ASSIGNED
BBD	BD	129	1C	2	3330V		YES	0B0	DCI	23	A	0	BBD
								0B1		16	A	1	BBD
BBE	BE	12A	1C	2	3330V		YES	0B0	DCI	23	A	0	BBE
								0B1		16	A	1	BBE
BBF	BF	12B	1C	2	3330V		YES	0B0	DCI	23	A	0	BBF
								0B1		16	A	1	BBF
CC0	C0	12C	1D	2	CTC		NO	0C0	DCI	17	A	1	CC0

TOTALS FOR DEVICES AND CONTROL UNITS:

A SIDE 370 MODE--DEVICE CONTROL BLOCKS- 0300 SET 0, 0195 SET 1 (INCLUDES 17 DUMMIES/SET)
 B SIDE 370 MODE--DEVICE CONTROL BLOCKS- 0017 SET 0, 0017 SET 1 (INCLUDES 17 DUMMIES/SET)
 370-XA MODE--0301 DEVICES, 03 DUMMY DEVICES, 030 LOGICAL CONTROL UNITS, 032 PHYSICAL CONTROL UNITS

TOTAL MESSAGES FOR I/O DEVICE REPORT: 0000 WARNING MESSAGES: 0000 ERROR MESSAGES: 0000

Figure 5-2 (Part 3 of 3). I/O Device Report

TIME 14.52 DATE 85.246

IOCP VERSION 3 LEVEL 2 LOGICAL CONTROL UNIT REPORT
REPORT SOURCE IS LVL A1 IOCDs, MODIFIED BY SCREEN INPUT=NO, ACTIVE=NO, UPDATED=NO

PAGE 001

ID1=PRACTICE IOCP GENERATION
ID2=SAMPLE CONFIGURATION WITH THREE BYTE CHANNELS

WRITTEN TO PROCESSOR CONTROLLER ON: TIME 14.50 DATE 85.246
PROCESSOR CONTROLLER TIMESTAMP: TIME 14.50 DATE 85.246

370-XA LOG. CONTROL UNIT NUMBER	DEVICE CHPID ORDER _ _ _ _	DEVICE NUMBER	PREFERRED CHPID	ATTACHING CNTL UNIT NUMBER	ATTACHING CHPIDS _ _ _ _
00	00	002	NONE	001	00
01	00	004	NONE	002	00
02	00	012	NONE	003	00
		013	NONE	003	00
03	00	04D	NONE	004	00
		04E	NONE	004	00
		04F	NONE	004	00
		050	NONE	004	00
		051	NONE	004	00
		052	NONE	004	00
		053	NONE	004	00
		054	NONE	004	00
		055	NONE	004	00
		056	NONE	004	00
		057	NONE	004	00
		058	NONE	004	00
		059	NONE	004	00
		05A	NONE	004	00
		05B	NONE	004	00
		07F	NONE	004	00
		080	NONE	004	00
		081	NONE	004	00
		082	NONE	004	00
		083	NONE	004	00
		084	NONE	004	00
		085	NONE	004	00
		086	NONE	004	00
		087	NONE	004	00
		088	NONE	004	00
		089	NONE	004	00
		08A	NONE	004	00
		08B	NONE	004	00
		0A0	NONE	004	00
		0A1	NONE	004	00
		0A2	NONE	004	00
		0A3	NONE	004	00
		0A4	NONE	004	00
		0A5	NONE	004	00
		0A6	NONE	004	00
		0A7	NONE	004	00
		0A8	NONE	004	00
		0A9	NONE	004	00
		0AA	NONE	004	00
		0AB	NONE	004	00
		0AC	NONE	004	00

Figure 5-3 (Part 1 of 3). Logical Control Unit Report

TIME 14.52 DATE 85.246

PAGE 002

<u>370-XA LOG. CONTROL UNIT NUMBER</u>	<u>DEVICE CHPID ORDER</u> _ _ _ _	<u>DEVICE NUMBER</u>	<u>PREFERRED CHPID</u>	<u>ATTACHING CNTRL UNIT NUMBER</u>	<u>ATTACHING CHPIDS</u> _ _ _ _
		0AD	NONE	004	00
		0AE	NONE	004	00
		0AF	NONE	004	00
		0B2	NONE	004	00
		0B3	NONE	004	00
		0B4	NONE	004	00
		0B5	NONE	004	00
		0B6	NONE	004	00
		0B7	NONE	004	00
		0B8	NONE	004	00
		0B9	NONE	004	00
		0BA	NONE	004	00
		0BB	NONE	004	00
		0BC	NONE	004	00
		0BD	NONE	004	00
		0BE	NONE	004	00
		0BF	NONE	004	00
		0C0	NONE	004	00
		0C1	NONE	004	00
		0C2	NONE	004	00
		0C3	NONE	004	00
		0C4	NONE	004	00
		0C5	NONE	004	00
		0C6	NONE	004	00
		0C7	NONE	004	00
		0C8	NONE	004	00
		0C9	NONE	004	00
		0CA	NONE	004	00
		0CB	NONE	004	00
		0CC	NONE	004	00
		0CD	NONE	004	00
		0CE	NONE	004	00
		0CF	NONE	004	00
		0D0	NONE	004	00
		0D1	NONE	004	00
		0D2	NONE	004	00
		0D3	NONE	004	00
		0D4	NONE	004	00
		0D5	NONE	004	00
		0D6	NONE	004	00
		0D7	NONE	004	00
		0D8	NONE	004	00
		0D9	NONE	004	00
		0DA	NONE	004	00
		0DB	NONE	004	00
		0DC	NONE	004	00
		0DD	NONE	004	00
		0DE	NONE	004	00
		0DF	NONE	004	00
		0E0	NONE	004	00

Figure 5-3 (Part 2 of 3). Logical Control Unit Report

TIME 14.52 DATE 85.246

370-XA LOG. CONTROL UNIT NUMBER	DEVICE CHPID ORDER _ _ _ _	DEVICE NUMBER	PREFERRED CHPID	ATTACHING CNTL UNIT NUMBER	ATTACHING CHPIDS _ _ _ _
		BB5	NONE	0B1 0B0	16 23
		BB6	NONE	0B1 0B0	16 23
		BB7	NONE	0B1 0B0	16 23
		BB8	NONE	0B1 0B0	16 23
		BB9	NONE	0B1 0B0	16 23
		BBA	NONE	0B1 0B0	16 23
		BBB	NONE	0B1 0B0	16 23
		BBC	NONE	0B1 0B0	16 23
		BBD	NONE	0B1 0B0	16 23
		BBE	NONE	0B1 0B0	16 23
		BBF	NONE	0B1 0B0	16 23
1D	17	CC0	NONE	0B1 0C0	16 17

TOTAL MESSAGES FOR LOGICAL CONTROL UNIT REPORT: 0000

WARNING MESSAGES: 0000

ERROR MESSAGES: 0000

Figure 5-3 (Part 3 of 3). Logical Control Unit Report

TIME 14.52 DATE 85.246				IOCP VERSION 3 LEVEL 2				CHANNEL PATH ID REPORT				PAGE 001	
REPORT SOURCE IS LVL A1 IOCDS, MODIFIED BY SCREEN INPUT=NO, ACTIVE=NO, UPDATED=NO													
ID1=PRACTICE IOCP GENERATION				ID2=SAMPLE CONFIGURATION WITH THREE BYTE CHANNELS				WRITTEN TO PROCESSOR CONTROLLER ON: TIME 14.50 DATE 85.246				PROCESSOR CONTROLLER TIMESTAMP: TIME 14.50 DATE 85.246	
CHPID	370 CHAN NUMB SET	SIDE	MODE	CONTROL UNIT NUMBER	TYPE-MODEL	370-XA CNTL UNIT TYPE	370-XA LOG. CNTL UNIT NUMBER	PROTOCOL	UNIT ADDR RANGE FROM	TO	370-XA DEVICE NUMBER	UNIT ADDR	DEVICE TYPE-MODEL
00	0 0	A	BYTE	001	3811	2	00	DCI	02	02	002	02	3211
				002	3811	2	01	DCI	04	04	004	04	3211
				003	3505	2	02	DCI	12	12			
									13	13			
				004	3705	2	03	DCI			012	12	3505
											013	13	3525
									4D	5B			
									7F	86			
									87	8B			
									A0	AF			
									B2	EF			
									FF	FF			
											04D	4D	BSC1
											04E	4E	BSC1
											04F	4F	BSC1
											050	50	BSC1
											051	51	BSC1
											052	52	BSC1
											053	53	BSC1
											054	54	BSC1
											055	55	BSC1
											056	56	BSC1
											057	57	BSC1
											058	58	BSC1
											059	59	BSC1
											05A	5A	BSC1
											05B	5B	BSC1
											07F	7F	2741P
											080	80	2741P
											081	81	2741P
											082	82	2741P
											083	83	2741P
											084	84	2741P
											085	85	2741P
											086	86	2741P
											087	87	2741P
											088	88	2741P
											089	89	2741P

Figure 5-4 (Part 1 of 3). Channel Path Identifier (CHPID) Report

CHPID	370 CHAN		SIDE	MODE	CONTROL UNIT		370-XA CNTL UNIT TYPE	370-XA LOG. CNTL UNIT NUMBER	PROTOCOL	UNIT ADDR RANGE		370-XA DEVICE NUMBER	UNIT ADDR	DEVICE	
	NUMB	SET			NUMBER	TYPE-MODEL				FROM	TO			TYPE-MODEL	MODEL
					022	3830	2	07	DCI	40	4F	216 217	16 17	3330 3330	1 1
					023	3830	2	08	DCI	60	6F	240 241 242 243	40 41 42 43	3350 3350 3350 3350	
					024	3880	2	09	STREAM	80	8F	260 261 262 263	60 61 62 63	3350 3350 3350 3350	
26	3	1	A	BLOCK	130	3272	1	0C	DCI	E0	EF	280 281 282 283	80 81 82 83	3380 3380 3380 3380	
					131	3705	2	0D	DCI	F0	F0	3E0 3E1 3E2 3E3	E0 E1 E2 E3	3277 3277 3277 3277	2 2 2 2
27	4	1	A	BLOCK	041	3830	2	0E	DCI	10	1F	3F0	F0	3705	
					042	3830	2	0F	DCI	40	4F	410 411 412 413 414 415 416 417	10 11 12 13 14 15 16 17	3330 3330 3330 3330 3330 3330 3330 3330	1 1 1 1 1 1 1 1
					043	3830	2	10	DCI	60	6F	440 441 442 443	40 41 42 43	3350 3350 3350 3350	

Figure 5-4 (Part 2 of 3). Channel Path Identifier (CHPID) Report

TIME 14.52 DATE 85.246

PAGE 014

CHPID	370 CHAN			MODE	CONTROL UNIT		370-XA	370-XA LOG.	PROTOCOL	UNIT ADDR RANGE		370-XA	UNIT	DEVICE
	NUMB	SEI	SIDE		NUMBER	TYPE-MODEL	CNTL UNIT	CNTL UNIT		FROM	TO	NUMBER		ADDR
												460	60	3350
												461	61	3350
												462	62	3350
												463	63	3350

TOTAL MESSAGES FOR CHANNEL PATH ID REPORT: 0000 WARNING MESSAGES: 0000 ERROR MESSAGES: 0000

Figure 5-4 (Part 3 of 3). Channel Path Identifier (CHPID) Report

Chapter 6. IOCP Messages

This chapter describes the IOCP messages for both:

- ICP prefix
- DMSICP prefix

IOCP Messages (ICP Prefix)

This section describes the messages produced by all versions of IOCP. The messages are described in alphanumeric order by message identifier and include, for each message:

- The module that detects the need for the message (detecting module)
- The module that issues the message or calls the message module (issuing module)
- The module that contains the message text (containing module)

Message ICP050D is sent to the MVS system operator's console and requests action by the system operator. The operator later receives either message ICP0506I or ICP0507I to indicate whether the IOCP job was successful or failed. All other messages are sent to the output printer for the IOCP programmer (running the MVS or VM version of IOCP) and/or the console screen for the IOCP operator (running the stand-alone version of IOCP).

The message format is:

ICPnnns text

where:

nnn is the message serial number.

s is the type code:

- A Action; the operator must perform a specific action
- D Decision; the operator must choose an alternative
- I Information; no operator action is required
- W Wait; processing stops until an action is determined and performed

text is the message text.

ICP000I UNDEFINED MESSAGE CODE. CODE = xxxxxxxx HEX

Explanation: Message code xxxxxxxx has been generated by IOCP for which a message has not been defined. A logical error has occurred in IOCP.

System Action: IOCP action is unpredictable.

Programmer Response: Rerun the IOCP job. If the problem occurs again, save the console sheet and all associated output. Notify your system programmer.

Detecting Module: ICPCMSG

Issuing Module: ICPCMSG

Containing Module: ICPCMSG

ICP050D SHOULD jobname WRITE TO LEVEL xxx IOCDS? REPLY 'YES', 'NO', OR 'CANCEL'

Explanation: A job with name "jobname" is executing IOCP with a WRTCD S option other than NO on the PARM parameter of the EXEC statement. IOCP issues this message to request permission from the MVS system operator for the job to write to the level xxx IOCDS in the processor controller.

Note: If two (or more) jobs are allowed to concurrently update (write to) the level xxx IOCDS, the outcome could be an IOCDS that is logically inconsistent with the input from any one job. Using this IOCDS at power-on reset or SYSIML CLEAR could produce undesirable results.

System Action: An operator reply of 'YES' allows the job to continue executing and, if no errors are encountered, to replace the input/output configuration data in the level xxx IOCDS in the processor controller with the input/output configuration data generated by this job. The operator should use the IOCDSM frame to ensure the level xxx IOCDS is not write-protected. A reply of 'NO' allows the job to continue generating input/output configuration data in storage and to produce reports, but does not permit the job to replace the input/output configuration data in the level xxx IOCDS in the processor controller. A reply of 'CANCEL' terminates the job immediately with the system code X'222'.

Operator Response: Contact your system programmer and respond as instructed.

Programmer Response: Follow your installation procedures and advise the operator.

Detecting Module: ICPPCNTL

Issuing Module: ICPPCNTL

Containing Module: ICPPCNTL

Routing Codes: 1 and 11

Descriptor Code: 7

ICP051I IOCP TERMINATED. CODE = xx

Explanation: IOCP has terminated for one of the following reasons:

Code	Description
01	An unknown keyword value was found on the PARM parameter of the EXEC statement. (This code can result from an extra left parenthesis after the REPORT keyword.)
02	A duplicate keyword was found on the PARM parameter of the EXEC statement.
03	An unknown keyword was found on the PARM parameter of the EXEC statement.
04	The keyword value on the LINECOUNT keyword on the PARM parameter of the EXEC statement was not within the allowed range.
05	Conflicting keywords were found on the PARM parameter of the EXEC statement.
06	An extra or missing comma was found on the PARM parameter of the EXEC statement. This code can result from unbalanced parentheses around the REPORT parameter(s).
07	One or more errors were found in the input card-image macro instructions. See the listing for related error messages.
08	An error was found while IOCP was generating the IOCDS in storage. See the listing for related error messages.
09	The operator replied 'NO' to message ICP050D or the VM user did not have privilege class C. The level xxx IOCDS in the processor controller was not replaced.
0A	IOCP encountered an error while writing the LVL1 IOCDS in the processor controller. See the listing for related error messages.
0B	IOCP encountered an error while reading the LVL0 IOCDS from the processor controller. See the listing for related error messages.
0C	IOCP encountered an error while reading the LVL1 IOCDS from the processor controller. See the listing for related error messages.
10	A REPORT or WRTCDS option has been specified but ICPIOCP only reads or writes an IOCDS on a 308x processor.
4x	IOCP encountered an error while reading/writing the level Ax IOCDS (where x is 0, 1, 2, or 3) from/to the processor controller. See the listing for related error messages.
5x	IOCP encountered an error while reading/writing the level Bx IOCDS (where x is 0, 1, 2, or 3) from/to the processor controller. See the listing for related error messages.
6x	IOCP encountered an error while doing a dual write of the Ax and Bx IOCDS (where x is 0, 1, 2, or 3) to the processor controller. See the listing for related error messages.

System Action: If IOCP encountered an error while doing anything other than reading an IOCDS, it terminates with return code 8. If IOCP encountered an error while reading an IOCDS, it terminates the read operation for that IOCDS. However, IOCP will attempt to read each additional IOCDS that was specified before it terminates with return code 8.

Programmer Response: Ensure that the PARM parameter on the EXEC statement is coded correctly. For processor controller errors, save the output listings and report the problem to the customer engineer.

Detecting Module:

ICPPCNTL detects codes 01 through 06, 09 and 10
ICPCARDS detects code 07
ICPCGNDS detects code 08
ICPCRTNS detects codes 0A, 0B, 0C, 4x, 5x, and 6x

Issuing Module: ICPPCNTL

Containing Module: ICPCMSG

ICP052I DCB DID NOT OPEN - SYSIN DD STATEMENT MAY BE MISSING/INVALID

Explanation: The DCB for the data set specified on the SYSIN DD statement did not open when IOCP issued the OPEN macro instruction.

System Action: IOCP terminates.

Programmer Response: Ensure that the DD statement for the SYSIN data set is valid.

Detecting Module: ICPCGET

Issuing Module: ICPCARDS

Containing Module: ICPCMSG

ICP054I **WARNING THE ABOVE I/O DEVICE IS NOT CONNECTED TO THE SPECIFIED PRIMARY CHANNEL ADDRESS**

Explanation: IOCP has found an I/O device that is not assigned to its primary channel. (For example, a device with address 180 is not assigned to channel 1.) You define the primary channel address for a device on the ADDRESS parameter of the IODEVICE macro instruction by specifying the channel number that corresponds to the lowest numbered channel path to which the device is assigned.

System Action: IOCP prints this warning message following the I/O device in question. IOCP continues processing.

Programmer Response: Ensure that the I/O configuration is correctly defined.

Detecting Module: ICPCRPT

Issuing Module: ICPCRPT

Containing Module: ICPCMSG

ICP055I **WARNING DEVICE NUMBER DOES NOT MATCH UNIT ADDRESS**

Explanation: The second and third digits of the device number (specified on the ADDRESS keyword) do not match the unit address specified on the UNITADD keyword of the IODEVICE macro instruction.

System Action: IOCP prints this warning message following the I/O device in question. IOCP continues processing.

Programmer Response: Remember this difference if the device is used in 370 mode or if you are reviewing EREP reports.

Detecting Module: ICPCRPT

Issuing Module: ICPCRPT

Containing Module: ICPCMSG

ICP056I IOCP JOB jobname FAILED. DID NOT BUILD LEVEL xxx IOCDs.

Explanation: A job with name "jobname" was executing IOCP with the WRTCDs=xxx option on the PARM parameter of the EXEC statement. IOCP issues this message to inform the MVS system operator (who previously responded to message ICP050D) that this job failed to build the level xxx IOCDs.

System Action: IOCP terminates the job with return code 8.

Operator Response: Tell your system programmer that the job failed.

Programmer Response: Review the messages on the job listing and take the necessary actions.

Detecting Module: ICPPCNTL

Issuing Module: ICPPCNTL

Containing Module: ICPPCNTL

Routing Codes: 2 and 11

Descriptor Code: 6

ICP057I IOCP JOB jobname SUCCESSFUL. LEVEL xxx IOCDs REPLACED.

Explanation: A job with name "jobname" was executing IOCP with the WRTCDs=xxx option on the PARM parameter of the EXEC statement. IOCP issues this message to inform the MVS system operator (who previously granted permission to write the IOCDs in response to message ICP050D) that this job successfully replaced the level xxx IOCDs.

System Action: IOCP terminates the job with return code 0 or 4.

Operator Response: Follow your installation procedures.

Detecting Module: ICPPCNTL

Issuing Module: ICPPCNTL

Containing Module: ICPPCNTL

Routing Codes: 2 and 11

Descriptor Code: 6

**ICP100I SYMBOL IN NAME FIELD EXCEEDS 8 CHARACTERS AND/OR
CONTAINS INVALID CHARACTERS**

Explanation: The symbolic name that appears in the name field contains more than 8 characters and/or contains invalid characters.

System Action: IOCP continues to check the syntax of the remaining macro instructions, but does not generate an IOCDS in storage and does not produce configuration reports.

Programmer Response: Correct the name field.

Detecting Module: ICPCARDS

Issuing Module: ICPCARDS

Containing Module: ICPCMSG

ICP101I OP CODE NOT FOUND ON FIRST OR ONLY CARD

Explanation: The operation field (macro instruction name) was not found before column 72.

System Action: IOCP continues to check the syntax of the remaining macro instructions, but does not generate an IOCDS in storage and does not produce configuration reports.

Programmer Response: Check for format errors and correct the errors.

Detecting Module: ICPCARDS

Issuing Module: ICPCARDS

Containing Module: ICPCMSG

ICP102I UNSUPPORTED OP CODE

Explanation: The operation field does not contain a valid IOCP macro instruction name.

System Action: IOCP continues to check the syntax of the remaining macro instructions, but does not generate an IOCDS in storage and does not produce configuration reports.

Programmer Response: Use a valid IOCP macro instruction name in the operation field, or set IGNORE= YES to ignore non-IOCP macro instruction names.

Detecting Module: ICPCARDS

Issuing Module: ICPCARDS

Containing Module: ICPCMSG

ICP103I **WARNING ID STATEMENT IGNORED - OUT OF SEQUENCE**

Explanation: IOCP found an ID macro instruction after processing one or more other IOCP macro instructions.

System Action: IOCP ignores the ID macro instruction that is out of sequence and continues processing.

Programmer Response: Ensure that the ID macro instruction is the first IOCP macro instruction in the input.

Detecting Module: ICPCARDS

Issuing Module: ICPCARDS

Containing Module: ICPCMSG

ICP104I **WARNING MORE THAN ONE ID STATEMENT - ONLY THE FIRST WAS USED**

Explanation: More than one ID macro instruction was found in the input macro instructions. Only one ID macro instruction can be specified.

System Action: IOCP processes the first ID macro instruction, ignores any following ID macro instructions, and continues processing.

Programmer Response: Ensure that there is only one ID macro instruction in the input and that it is the first IOCP macro instruction.

Detecting Module: ICPCARDS

Issuing Module: ICPCARDS

Containing Module: ICPCMSG

ICP105I OPERAND FIELD NOT FOUND

Explanation: The operand field was not found before column 72. On a continuation card, the operand field must start in column 16.

System Action: IOCP continues to check the syntax of the remaining macro instructions, but does not generate an IOCDS in storage and does not produce configuration reports.

Programmer Response: Correct the operand field.

Detecting Module: ICPCARDS

Issuing Module: ICPCARDS

Containing Module: ICPCMSG

ICP106I NON-BLANK CHARACTER(S) FOUND IN COLUMNS 1-15 OF CONTINUATION CARD

Explanation: A non-blank character was found in columns 1 to 15. On a continuation card, columns 1 to 15 must be blank and the operand field must start in column 16. (The preceding card had a non-blank character in column 72, indicating that this is a continuation card.)

System Action: IOCP continues to check the syntax of the remaining macro instructions, but does not generate an IOCDS in storage and does not produce configuration reports.

Programmer Response: Ensure that the operand field on the continuation card starts in column 16.

Detecting Module: ICPCARDS

Issuing Module: ICPCARDS

Containing Module: ICPCMSG

ICP107I **WARNING EXCEEDED THE ALLOWED NUMBER OF COMMENT CONTINUATION CARDS**

Explanation: More than two continuation cards were found for an IOCP comment card.

System Action: IOCP prints the extra comment continuation cards and continues processing.

Programmer Response: Restructure the comment so that it can be contained in a total of three comment cards, or code an asterisk in column 1 (or *IOCP in columns 1 to 5) and remove the continuation characters in column 72 of the preceding card(s).

Detecting Module: ICPCARDS

Issuing Module: ICPCARDS

Containing Module: ICPCMSG

ICP108I UNEXPECTED END OF FILE ON SYSTEM INPUT (SYSIN)

Explanation: A continuation card was expected when an end-of-file occurred on the input data set. The last card contains a non-blank character in column 72.

System Action: IOCP does not generate an IOCDS in storage and does not produce configuration reports.

Programmer Response: Ensure that no macro instructions or comment cards are missing in the input.

Detecting Module: ICPCARDS

Issuing Module: ICPCARDS

Containing Module: ICPCMSG

ICP109I MISSING LEFT PARENTHESIS

Explanation: A missing left parenthesis was detected. The parameter requires the keyword value field to be enclosed in parentheses.

System Action: IOCP continues to check the syntax of the remaining macro instructions, but does not generate an IOCDS in storage and does not produce configuration reports.

Programmer Response: Correct the parameter.

Detecting Module: ICPCARDS, ICPCARDX

Issuing Module: ICPCARDS

Containing Module: ICPCMSG

ICP110I EXTRA LEFT PARENTHESSES

Explanation: The parameter requires 1 or 2 left parentheses to start the keyword value field. More than the required 1 or 2 were found.

System Action: IOCP continues to check the syntax of the remaining macro instructions, but does not generate an IOCDS in storage and does not produce configuration reports.

Programmer Response: Correct the parameter.

Detecting Module: ICPCARDS, ICPCARDX

Issuing Module: ICPCARDS

Containing Module: ICPCMSG

ICP111I **WARNING PATH INFORMATION DEFINED WITH ** IS EXCLUDED FROM IOCDS**

Explanation: The characters ** were detected instead of a chpid number on the PATH parameter. The ** indicate a channel used only by processors other than the processor complexes listed on the cover of this manual.

System Action: IOCP prints this warning message following the CHPID macro instruction that contains **. IOCP does not include in the IOCDS the channel number and channel set following the characters **. Processing continues.

Programmer Response: Ensure that the characters ** were specified for the intended channel number and channel set.

Detecting Module: ICPCARDS

Issuing Module: ICPCARDS

Containing Module: ICPCMSG

ICP112I DELIMITER ERROR, EXPECT BLANK OR COMMA

Explanation: A character (such as a right parenthesis) was found where a blank or comma is required, or a keyword value contained too many digits.

System Action: IOCP continues to check the syntax of the remaining macro instructions, but does not generate an IOCDS in storage and does not produce configuration reports.

Programmer Response: Correct the parameter or the delimiter.

Detecting Module: ICPCARDX

Issuing Module: ICPCARDS

Containing Module: ICPCMSG

ICP113I DELIMITER ERROR, EXPECT COMMA OR RIGHT PARENTHESIS

Explanation: A character (such as a blank) was found where a comma or right parenthesis is required.

System Action: IOCP continues to check the syntax of the remaining macro instructions, but does not generate an IOCDS in storage and does not produce configuration reports.

Programmer Response: Correct the parameter or the delimiter.

Detecting Module: ICPCARDX

Issuing Module: ICPCARDS

Containing Module: ICPCMSG

ICP114I INVALID DELIMITER, ONLY BLANK, COMMA OR RIGHT PARENTHESIS IS EXPECTED

Explanation: A character other than a blank, comma, or right parenthesis was found where a valid delimiter is required, or a keyword value contained too many digits.

System Action: IOCP continues to check the syntax of the remaining macro instructions, but does not generate an IOCDS in storage and does not produce configuration reports.

Programmer Response: Correct the parameter and/or supply the correct ending delimiter.

Detecting Module: ICPCARDX

Issuing Module: ICPCARDS

Containing Module: ICPCMSG

ICP115I DELIMITER ERROR, EXPECT RIGHT PARENTHESIS

Explanation: A character (such as a blank or comma) was found where a right parenthesis is required, a keyword value contained too many digits, or too many keyword values were specified.

System Action: IOCP continues to check the syntax of the remaining macro instructions, but does not generate an IOCDS in storage and does not produce configuration reports.

Programmer Response: Correct the parameter and/or correct the invalid delimiter with a right parenthesis.

Detecting Module: ICPCARDX

Issuing Module: ICPCARDS

Containing Module: ICPCMSG

ICP116I DELIMITER ERROR, EXPECT LEFT PARENTHESIS

Explanation: A character other than a left parenthesis was found where a left parenthesis is required.

System Action: IOCP continues to check the syntax of the remaining macro instructions, but does not generate an IOCDS in storage and does not produce configuration reports.

Programmer Response: Check for incorrect characters in the parameter and/or correct the delimiter.

Detecting Module: ICPCARDS, ICPCARDX

Issuing Module: ICPCARDS

Containing Module: ICPCMSG

ICP117I **WARNING THE ABOVE DEVICE(S) EXCLUDED FROM IOCDs**

Explanation: The characters *** were detected as the keyword value for the CUNUMBR parameter. The *** indicate that the I/O device(s) are used only by processors other than the processor complexes listed on the cover of this manual.

System Action: IOCP prints this warning message following the IODEVICE macro instruction that contains ***. IOCP does not include the device(s) in the IOCDs. Processing continues.

Programmer Response: Ensure that the device(s) defined by the IODEVICE macro instruction are to be excluded from the IOCDs.

Detecting Module: ICPCARDX

Issuing Module: ICPCARDX

Containing Module: ICPCMSG

ICP118I **WARNING OPTCHAN SYNTAX/VALUE ERRORS DETECTED**

Explanation: The OPTCHAN parameter on the IODEVICE macro instruction contains one or more syntax or value errors. The possible errors are:

- OPTCHAN keyword was specified more than once.
- Invalid delimiter follows the keyword value.
- Keyword value is not a hexadecimal digit or contains more than one hexadecimal digit.
- Keyword value specifies an alternate channel that is not greater than the primary channel.

System Action: IOCP prints this warning message following the IODEVICE macro instruction in question. Because of the error, IOCP does not attempt to validate that a path exists from the device(s) to the alternate channel specified by the OPTCHAN keyword value. IOCP continues processing.

Programmer Response: Ensure that the OPTCHAN parameter is correctly coded.

Detecting Module: ICPCARDX

Issuing Module: ICPCARDX

Containing Module: ICPCMSG

ICP119I BEGINNING APOSTROPHE NOT FOUND

Explanation: The beginning apostrophe was not found in a parameter that requires the keyword value to be enclosed in apostrophes.

System Action: IOCP continues to check the syntax of the remaining macro instructions, but does not generate an IOCDS in storage and does not produce configuration reports.

Programmer Response: Correct the parameter.

Detecting Module: ICPCARDS

Issuing Module: ICPCARDS

Containing Module: ICPCMSG

ICP120I ENDING APOSTROPHE NOT FOUND

Explanation: The ending apostrophe was not found in a parameter that requires the keyword value to be enclosed in apostrophes.

System Action: IOCP continues to check the syntax of the remaining macro instructions, but does not generate an IOCDS in storage and does not produce configuration reports.

Programmer Response: Correct the parameter.

Detecting Module: ICPCARDS

Issuing Module: ICPCARDS

Containing Module: ICPCMSG

ICP121I OPERAND FIELD IS TOO LONG TO PROCESS

Explanation: The length of the operand field is greater than the length IOCP can process for operand fields.

System Action: IOCP continues to check the syntax of the remaining macro instructions, but does not generate an IOCDS in storage and does not produce configuration reports.

Programmer Response: Check that the macro instruction and continuation cards are correctly specified.

Detecting Module: ICPCARDS

Issuing Module: ICPCARDS

Containing Module: ICPCMSG

ICP122I NOT ALL THE REQUIRED PARAMETERS WERE SPECIFIED

Explanation: At least one of the required parameters was not found on the macro instruction. This message may indicate that a continuation character was missing from column 72.

System Action: IOCP continues to check the syntax of the remaining macro instructions, but does not generate an IOCDS in storage and does not produce configuration reports.

Programmer Response: Ensure that all required parameters are specified. Ensure that all continuation characters are correctly specified.

Detecting Module: ICPCARDS, ICPCARDX

Issuing Module: ICPCARDS

Containing Module: ICPCMSG

ICP123I DUPLICATE KEYWORDS ON STATEMENT

Explanation: A keyword parameter was found more than once on the macro instruction. Keyword parameters cannot be repeated on the same macro instruction.

System Action: IOCP continues to check the syntax of the remaining macro instructions, but does not generate an IOCDS in storage and does not produce configuration reports.

Programmer Response: Ensure that keyword parameters are not duplicated.

Detecting Module: ICPCARDS, ICPCARDX

Issuing Module: ICPCARDS

Containing Module: ICPCMSG

ICP124I TOO MANY KEYWORD VALUES SPECIFIED

Explanation: More than the allowed number of keyword values were found on the parameter.

System Action: IOCP continues to check the syntax of the remaining macro instructions, but does not generate an IOCDS in storage and does not produce configuration reports.

Programmer Response: Ensure that the number of keyword values does not exceed the maximum allowed.

Detecting Module: ICPCARDS, ICPCARDX

Issuing Module: ICPCARDS

Containing Module: ICPCMSG

ICP125I PARAMETER CONTAINS NON-NUMERIC CHARACTERS

Explanation: A character other than 0 through 9 was found on a parameter for a keyword value that requires a decimal value.

System Action: IOCP continues to check the syntax of the remaining macro instructions, but does not generate an IOCDS in storage and does not produce configuration reports.

Programmer Response: Correct the keyword value.

Detecting Module: ICPCARDX

Issuing Module: ICPCARDS

Containing Module: ICPCMSG

ICP126I PARAMETER CONTAINS NON-HEXADECIMAL CHARACTERS

Explanation: A character other than 0 through 9 or A through F was found on a parameter for a keyword value that requires a hexadecimal value, or not enough digits were specified on a keyword value. (Note that the channel path identifier on the PATH parameter requires two digits.)

System Action: IOCP continues to check the syntax of the remaining macro instructions, but does not generate an IOCDS in storage and does not produce configuration reports.

Programmer Response: Correct the keyword value.

Detecting Module: ICPCARDS, ICPCARDX

Issuing Module: ICPCARDS

Containing Module: ICPCMSG

ICP127I UNKNOWN OR DUPLICATE KEYWORD

Explanation: An unknown keyword parameter was found on the macro instruction, or duplicate keyword parameters were specified. If a continuation card generates this message, a comma may be missing on the previous card.

System Action: IOCP continues to check the syntax of the remaining macro instructions, but does not generate an IOCDS in storage and does not produce configuration reports.

Programmer Response: Correct the unknown or duplicate keyword parameter. If this is an IODEVICE macro instruction and the keyword is a valid system generation keyword, set the IGNORE= YES option so that IOCP will ignore non-IOCP parameters.

Detecting Module: ICPCARDS, ICPCARDX

Issuing Module: ICPCARDS

Containing Module: ICPCMSG

ICP128I INVALID PROTOCL VALUE. MUST BE D OR S

Explanation: A character other than D or S was found as the keyword value on the PROTOCL parameter.

System Action: IOCP continues to check the syntax of the remaining macro instructions, but does not generate an IOCDs in storage and does not produce configuration reports.

Programmer Response: Correct the keyword value.

Detecting Module: ICPCARDX

Issuing Module: ICPCARDS

Containing Module: ICPCMSG

ICP129I INVALID SHARED VALUE. MUST BE Y OR N or YB

Explanation: Character(s) other than Y or N or YB were found as the keyword value on the SHARED parameter.

System Action: IOCP continues to check the syntax of the remaining macro instructions, but does not generate an IOCDs in storage and does not produce configuration reports.

Programmer Response: Correct the keyword value.

Detecting Module: ICPCARDX

Issuing Module: ICPCARDS

Containing Module: ICPCMSG

ICP130I PATH PARAMETER - CHPID VALUE INVALID

Explanation: A channel path identifier, found on the PATH parameter or entered from the console screen, is not within the range of valid channel paths.

System Action: (1) If the input is from card-image macro instructions, IOCP continues to check the syntax of the remaining macro instructions but does not generate an IOCDs in storage and does not produce configuration reports. (2) If the input is from the console screen, the channel path is not added.

Programmer Response: (1) For input from card-image macro instructions, correct the channel path identifier on the PATH parameter. (2) For input from the console screen, enter the correct channel path.

Detecting Module: ICPCARDS, ICPCARDX

Issuing Module: ICPCARDS, ICPSMAIN

Containing Module: ICPCMSG

ICP131I PATH PARAMETER - NO CHANNEL SPECIFIED

Explanation: A required channel number was not found on the PATH parameter for its associated channel path.

System Action: IOCP continues to check the syntax of the remaining macro instructions, but does not generate an IOCDS in storage and does not produce configuration reports.

Programmer Response: Supply the missing channel number.

Detecting Module: ICPCARDS

Issuing Module: ICPCARDS

Containing Module: ICPCMSG

ICP132I PATH PARAMETER - INVALID CHANNEL SET VALUE. MUST BE 0 OR 1

Explanation: A character other than 0 or 1 was found on the PATH parameter as a keyword value for the channel set.

System Action: IOCP continues to check the syntax of the remaining macro instructions, but does not generate an IOCDS in storage and does not produce configuration reports.

Programmer Response: Correct the channel set value.

Detecting Module: ICPCARDS

Issuing Module: ICPCARDS

Containing Module: ICPCMSG

ICP133I INVALID TYPE VALUE. MUST BE BY OR BL

Explanation: A keyword value other than BY or BL was found on the TYPE parameter.

System Action: IOCP continues to check the syntax of the remaining macro instructions, but does not generate an IOCDS in storage and does not produce configuration reports.

Programmer Response: Correct the keyword value.

Detecting Module: ICPCARDS

Issuing Module: ICPCARDS

Containing Module: ICPCMSG

ICP134I INVALID CONTROL UNIT NUMBER

Explanation: A control unit number other than a hexadecimal value in the range of 000 through 3FF was found on the CUNUMBR parameter or entered from the console screen.

System Action: (1) If the input is from card-image input, IOCP continues to check the syntax of the remaining macro instructions, but does not generate an IOCDS in storage and does not produce configuration reports. (2) If the input is from the console screen, the control unit is not added.

Programmer Response: (1) For input from card-image macro instructions, correct the control unit number on the CUNUMBR parameter. (2) For input from the console screen, enter the correct control unit.

Detecting Module: ICPCARDX

Issuing Module: ICPCARDS, ICPSMAIN

Containing Module: ICPCMSG

ICP135I INVALID UNITADD NUMBER

Explanation: On the UNITADD parameter, a keyword value for number was not within the allowable range of decimal 1 through 256.

System Action: IOCP continues to check the syntax of the remaining macro instructions, but does not generate an IOCDS in storage and does not produce configuration reports.

Programmer Response: Correct the keyword value.

Detecting Module: ICPCARDX

Issuing Module: ICPCARDS

Containing Module: ICPCMSG

ICP136I INVALID DEVICE ADDRESS NUMBER

Explanation: On the ADDRESS parameter, a keyword value for number was not within the allowable range of decimal 1 through 256.

System Action: IOCP continues to check the syntax of the remaining macro instructions, but does not generate an IOCDS in storage and does not produce configuration reports.

Programmer Response: Correct the keyword value.

Detecting Module: ICPCARDX

Issuing Module: ICPCARDS

Containing Module: ICPCMSG

ICP137I UNIT ADDRESS PLUS NUMBER EXCEEDS HEX ADDRESS FF

Explanation: The keyword value for the unit address (specified on either the UNITADD keyword or the ADDRESS keyword) plus the keyword value for number (specified on the ADDRESS keyword) exceeds the allowable value of hexadecimal FF for a unit address.

System Action: IOCP continues to check the syntax of the remaining macro instructions, but does not generate an IOCDS in storage and does not produce configuration reports.

Programmer Response: Correct the keyword values.

Detecting Module: ICPCARDX

Issuing Module: ICPCARDS

Containing Module: ICPCMSG

ICP138I NO IOCP STATEMENTS FOUND

Explanation: An end-of-file has occurred on the SYSIN data set before IOCP found a CHPID, CNTLUNIT, or IODEVICE macro instruction.

System Action: IOCP does not generate an IOCDS in storage and does not produce configuration reports.

Programmer Response: Ensure that the correct data set was specified for SYSIN.

Detecting Module: ICPCARDS

Issuing Module: ICPCARDS

Containing Module: ICPCMSG

**ICP139I UNIT OR MODEL PARAMETER CONTAINS
NON-ALPHANUMERIC CHARACTERS**

Explanation: A non-alphanumeric character was entered from the console screen or was found on the UNIT or MODEL parameter. The characters allowed are 0 through 9 and A through Z.

System Action: (1) If the input is from card-image input, IOCP continues to check the syntax of the remaining macro instructions, but does not generate an IOCDS in storage and does not produce configuration reports. (2) If the input is from the console screen, the I/O device is not added.

Programmer Response: (1) For input from card-image macro instructions, correct the UNIT and/or MODEL parameters. (2) For input from the console screen, enter the correct UNIT and/or MODEL values.

Detecting Module: ICPCARDX

Issuing Module: ICPCARDS, ICPSMAIN

Containing Module: ICPCMSG

ICP140I INVALID TIMEOUT VALUE. MUST BE Y OR N

Explanation: A character other than Y or N was found as the keyword value on the TIMEOUT parameter.

System Action: IOCP continues to check the syntax of the remaining macro instructions, but does not generate an IOCDS in storage and does not produce configuration reports.

Programmer Response: Correct the keyword value.

Detecting Module: ICPCARDX

Issuing Module: ICPCARDS

Containing Module: ICPCMSG

ICP141I **WARNING THE ABOVE DEVICE(S) DOES NOT HAVE A PATH TO OPTCHAN x**

Explanation: IOCP did not find a path from the device(s) to the alternate channel specified by the OPTCHAN value on the IODEVICE macro instruction.

System Action: IOCP prints this warning message following the IODEVICE macro instruction in question and continues processing.

Programmer Response: Ensure that the value specified for the OPTCHAN parameter is correct and, by checking the associated CNTLUNIT and CHPID macro instructions, ensure that there is a path from the device(s) through a control unit to the alternate channel.

Detecting Module: ICPCARDX

Issuing Module: ICPCARDX

Containing Module: ICPCMSG

ICP142I **WARNING DEFAULT OF n USED FOR NUMBER OF UNITS SUBPARAMETER**

Explanation: (1) For the 2305 Fixed Head Storage and the 3838 Array Processor, IOCP unconditionally assigns a value of 8 to the number of units subparameter. (2) When UNIT=3350P or UNIT=3351P, IOCP unconditionally assigns a value of 2 to the number of units subparameter if the user specified 1. (3) When UNIT=3351P, IOCP unconditionally assigns a value of 4 to the number of units subparameter if the user specified 3.

System Action: IOCP prints this warning message following the IODEVICE macro instruction in question and continues processing.

Programmer Response: Ensure that the UNIT and ADDRESS parameters on the IODEVICE macro instruction are correctly coded. If UNIT=2305 or UNIT=3838, code the value 8 for the number keyword on the ADDRESS parameter. If UNIT=3350P, code a value from 2 to 8. If UNIT=3351P, code a value of 2 or 4.

Detecting Module: ICPCARDX

Issuing Module: ICPCARDX

Containing Module: ICPCMSG

ICP143I **WARNING UNABLE TO VALIDATE OPTCHAN FOR CHANNEL x DUE TO NON-308X ASSIGNMENT**

Note: This message applies to all the processor complexes listed on the cover of this manual, not just the 308X Processor Complex.

Explanation: IOCP did not find a path from the device(s) to the alternate channel specified by the OPTCHAN value on the IODEVICE macro instruction. Channel x is defined as a channel used only by processors other than the processor complexes listed on the cover of this manual; therefore, channel x is not included in the IOCDS.

System Action: IOCP prints this warning message following the IODEVICE macro instruction in question and continues processing.

Programmer Response: Ensure that a path from the device(s) to the alternate channel is not needed for I/O requests on a processor complex listed on the cover of this manual.

Detecting Module: ICPCARDX

Issuing Module: ICPCARDX

Containing Module: ICPCMSG

ICP144I xyz IS AN UNACCEPTABLE BASE ADDRESS FOR UNIT 335xP

Explanation: For UNIT 3350P, the address xyz is an unacceptable base address because bits 3 and 4 of the binary value of the byte representing y and z must be zeroes. The binary value of the base address xyz must be of the form "nnnn nnn0 0nnn." Thus, y must be an even hexadecimal digit (0, 2, 4, 6, 8, A, C, or E) and z must be in the range of 0 through 7.

For UNIT 3351P, the address xyz is an unacceptable base address because bits 4 and 5 of the binary value of the byte representing y and z must be zeroes. The binary value of the base address xyz must be of the form "nnnn nnnn 00nn." Thus, y may be a hexadecimal digit of 0 through F and z must be in the range of 0 through 3.

System Action: IOCP continues to check the syntax of the remaining macro instructions, but does not generate an IOCDS in storage and does not produce configuration reports.

Programmer Response: Ensure that the UNIT and ADDRESS parameters on the IODEVICE macro instruction are correctly coded.

Detecting Module: ICPCARDX

Issuing Module: ICPCARDX

Containing Module: ICPCMSG

ICP145I DEVICE ADDRESS PLUS NUMBER OF UNITS EXCEEDS HEX FFF

Explanation: On the ADDRESS parameter, the keyword value for unit address plus the keyword value for number exceeds the allowable value of hexadecimal FFF for a device address.

System Action: IOCP continues to check the syntax of the remaining macro instructions, but does not generate an IOCDS in storage and does not produce configuration reports.

Programmer Response: Correct the keyword values.

Detecting Module: ICPCARDX

Issuing Module: ICPCARDS

Containing Module: ICPCMSG

ICP200I CHPID xx PREVIOUSLY DEFINED

Explanation: The user has defined a channel path (xx) to be added to the IOCDS, but an entry for channel path xx already exists in the IOCDS in storage.

System Action: (1) If the input is from card-image macro instructions, IOCP deletes any channel path entries that were added from multiple definitions on the CHPID macro instruction. IOCP continues to check the syntax of the remaining macro instructions, but does not generate an IOCDS in storage and does not produce configuration reports. (2) If the input is from the console screen, the channel path is not added.

Programmer Response: (1) For input from card-image macro instructions, ensure that duplicate channel paths are not specified on the CHPID macro instructions. (2) For input from the console screen, use the display, alter, and delete functions to check and correct the channel path entries.

Detecting Module: ICPCIOCP

Issuing Module: ICPCARDS, ICPSMAIN

Containing Module: ICPCMSG

ICP201I SAME CHANNEL NUMBER SPECIFIED FOR CHPID xx AND yy

Explanation: An existing entry for channel path xx contains the same channel number and channel set as the entry for channel path yy that you want to add or alter.

System Action: (1) If the input is from card-image macro instructions, IOCP deletes any channel path entries that were added from multiple definitions on the CHPID macro instructions. IOCP continues to check the syntax of the remaining macro instructions, but does not generate an IOCDS in storage and does not produce configuration reports. (2) If the input is from the console screen, the channel path is not added or altered.

Programmer Response: (1) For input from card-image macro instructions, ensure that duplicate channel numbers and channel sets are not specified on the CHPID macro instructions. If xx and/or yy is X'FF', check the CHPID macro instructions that contain the characters ** instead of a chpid number. (2) For input from the console screen, use the display, alter, and delete functions to check and correct the channel path entries.

Detecting Module: ICPCIOCP

Issuing Module: ICPCARDS, ICPSMAIN

Containing Module: ICPCMSG

ICP202I CHPID xx HAS NOT BEEN DEFINED OR IS INVALID

Explanation: You have requested a swap, display, delete, or alter function for a channel path (xx) that does not exist in the IOCDS in storage; or you entered an invalid channel path identifier; or an entry for a control unit to be added specifies a channel path (xx) that does not exist in the IOCDS or is invalid.

System Action: (1) If the input is from card-image macro instructions, IOCP does not add the control unit entry. IOCP continues to check the syntax of the remaining macro instructions, but does not generate an IOCDS in storage and does not produce configuration reports. (2) If the input is from the console screen, IOCP does not add the control unit entry or does not perform the requested channel path function.

Programmer Response: (1) For input from card-image macro instructions, ensure that the channel path is valid and has been previously defined on a CHPID macro instruction before it is specified on a CNTLUNIT macro instruction. (2) For input from the console screen, use the display, alter, and delete functions to check and correct the channel path or control unit entry.

Detecting Module: ICPCIOCP, ICPSMINT

Issuing Module: ICPCARDS, ICPSMAIN

Containing Module: ICPCMSG

ICP203I CHPID xx DOES NOT SUPPORT BYTE MULTIPLEXING OPERATIONS

Explanation: An entry to be added for channel path xx has specified byte multiplexer operation. Byte multiplexer cannot be specified for this channel path. Up to four channel paths per side can be specified as byte multiplexer. On the A side, the channel paths must be in the ranges of 00 through 03 and 10 through 13 (hex). On the B side, the channel paths must be in the ranges of 40 through 43 and 50 through 53 (hex).

System Action: (1) If the input is from card-image macro instructions, IOCP does not add the channel path, and deletes any channel path entries that were added from multiple definitions on the CHPID macro instructions. IOCP continues to check the syntax of the remaining macro instructions, but does not generate an IOCDS in storage and does not produce configuration reports. (2) If the input is from the console screen, IOCP does not add the entry.

Programmer Response: (1) For input from card-image macro instructions, ensure that the CHPID macro instructions are correctly specified. (2) For input from the console screen, use the display, alter, and delete functions to check and correct the channel path entries.

Detecting Module: ICPCIOCP

Issuing Module: ICPCARDS, ICPSMAIN

Containing Module: ICPCMSG

ICP204I ALTER NOT VALID. CONTROL UNIT xxx CANNOT BE ON A BYTE CHANNEL

Explanation: You requested, with the alter channel path function, that IOCP change the channel path from block to byte multiplexer. One or more shared control units (SHARED=Y/YB) or one or more data streaming control units (PROTOCL=S) are attached to the channel path. Shared and data streaming control units cannot be attached to byte multiplexer channel paths. Control unit xxx is the first shared or data streaming control unit that IOCP detected on the channel path.

System Action: IOCP does not alter the channel path entry.

IOCP Operator Response: Use the display and alter functions to check and correct the channel path or control unit entries.

Detecting Module: ICPCIOCP

Issuing Module: ICPSMAIN

Containing Module: ICPCMSG

**ICP205I ALTER NOT VALID. BYTE CHANNEL CAN'T INHIBIT
TIMEOUT FOR DEVICE xxx**

Explanation: For the alter channel path function, you requested that the channel path be changed from block to byte multiplexer. One or more I/O devices specified with TIMEOUT = N (timeout inhibited) are assigned to the channel path. TIMEOUT = N is not valid for I/O devices that are assigned to byte multiplexer channel paths. On the channel path, device xxx is the first detected I/O device with TIMEOUT = N specified.

System Action: IOCP does not alter the channel path entry.

IOCP Operator Response: Use the display and alter functions to check and correct the channel path or I/O device entries.

Detecting Module: ICPCIOCP

Issuing Module: ICPSMAIN

Containing Module: ICPCMSG

ICP220I CONTROL UNIT xxx PREVIOUSLY DEFINED

Explanation: The user has defined a control unit (xxx) to be added to the IOCDS, but an entry for control unit xxx already exists in the IOCDS in storage.

System Action: (1) If the input is from card-image macro instructions, IOCP does not add the control unit entry. IOCP continues to check the syntax of the remaining macro instructions, but does not generate an IOCDS in storage and does not produce configuration reports. (2) If the input is from the console screen, IOCP does not add the entry.

Programmer Response: (1) For input from card-image macro instructions, ensure that duplicate control unit numbers are not specified on the CNTLUNIT macro instructions. (2) For input from the console screen, use the display, alter, and delete functions to check and correct the control unit entries.

Detecting Module: ICPCIOCU

Issuing Module: ICPCARDS, ICPSMAIN

Containing Module: ICPCMSG

ICP221I MAXIMUM NUMBER OF CONTROL UNITS EXCEEDED

Explanation: An entry for a control unit to be added exceeds the maximum number of control units allowed by IOCP. The maximum is 768. (The maximum of 768 is for both the A and B sides combined; the actual number allowed on your system might be less.)

System Action: (1) If the input is from card-image macro instructions, IOCP does not add the control unit. IOCP continues to check the syntax of the remaining macro instructions, but does not generate an IOCDS in storage and does not produce configuration reports. (2) If the input is from the console screen, IOCP does not add the control unit entry.

Programmer Response: Check your I/O configuration listing and reports to ensure control units are correctly defined. (1) For input from card-image macro instructions, ensure that the CNTLUNIT macro instructions are specified correctly. (2) For input from the console screen, use the display, alter, and delete functions to check and correct the control unit entries.

Detecting Module: ICPCIOCU

Issuing Module: ICPCARDS, ICPSMAIN

Containing Module: ICPCMSG

ICP222I DPLICATE CHPID NUMBERS SPECIFIED

Explanation: An entry for a control unit to be added contains duplicate channel path identifiers.

System Action: (1) If the input is from card-image macro instructions, IOCP does not add the entry. IOCP continues to check the syntax of the remaining macro instructions, but does not generate an IOCDS in storage and does not produce configuration reports. (2) If the input is from the console screen, IOCP does not add the entry.

Programmer Response: (1) For input from card-image macro instructions, ensure that channel path identifiers are not duplicated on the CNTLUNIT macro instruction. (2) For input from the console screen, enter the correct channel path identifiers.

Detecting Module: ICPCIOCU

Issuing Module: ICPCARDS, ICPSMAIN

Containing Module: ICPCMSG

ICP223I NEITHER DATA STREAMING NOR SHARED C.U. ALLOWED ON BYTE CHANNEL(S)

Explanation: An entry for a shared control unit or a data streaming control unit cannot be added because it specifies one or more byte multiplexer channel paths. Shared or data streaming control units cannot be attached to byte multiplexer channels.

System Action: (1) If the input is from card-image macro instructions, IOCP does not add the control unit entry. IOCP continues to check the syntax of the remaining macro instructions, but does not generate an IOCDS in storage and does not produce configuration reports. (2) If the input is from the console screen, IOCP does not add the control unit entry.

Programmer Response: (1) For input from card-image macro instructions, ensure that shared or data streaming control units are not specified for byte multiplexer channel paths. (2) For input from the console screen, use the display, alter, add, and delete functions to check and correct the control unit entry.

Detecting Module: ICPCIOCU

Issuing Module: ICPCARDS, ICPSMAIN

Containing Module: ICPCMSG

ICP224I UNIT ADDRESS SETS EITHER OVERLAP/GENERATE HEX ADDRESS FF

Explanation: An entry for a control unit to be added contains an invalid unit address for a device. The unit address (with the number of addresses) either exceeds hexadecimal X'FF' or duplicates another unit address.

System Action: (1) If the input is from card-image macro instructions, IOCP does not add the entry. IOCP continues to check the syntax of the remaining macro instructions, but does not generate an IOCDS in storage and does not produce configuration reports. (2) If the input is from the console screen, IOCP does not add the entry.

Programmer Response: (1) For input from card-image macro instructions, ensure that the unit addresses specified on the UNITADD parameter are correctly specified. (2) For input from the console screen, use the display, alter, and add functions to check and correct the unit addresses.

Detecting Module: ICPCIOCU, ICPCIODV

Issuing Module: ICPCARDS, ICPSMAIN

Containing Module: ICPCMSG

ICP225I CONTROL UNIT NUMBER xxx HAS NOT BEEN DEFINED

Explanation: Either an entry for control unit xxx that you have attempted to display, alter, or delete does not exist in the IOCDS in storage, or an entry for an I/O device to be added specifies a control unit number (xxx) that has not been previously defined.

System Action: (1) If the input is from card-image macro instructions, IOCP does not add the I/O device entry. IOCP continues to check the syntax of the remaining macro instructions, but does not generate an IOCDS in storage and does not produce configuration reports. (2) If the input is from the console screen, IOCP does not add the I/O device entry or does not perform the requested control unit function.

Programmer Response: (1) For input from card-image macro instructions, ensure that the control unit has been previously defined on a CNTLUNIT macro instruction before the control unit number is used on the IODEVICE macro instruction. (2) For input from the console screen, use the add, display, alter, and delete functions to check and correct the control unit or I/O device entry.

Detecting Module: ICPCIOCU, ICPCIODV

Issuing Module: ICPCARDS, ICPSMAIN

Containing Module: ICPCMSG

**ICP226I ALTER NOT VALID. DEVICE xxx REQUIRES EXISTING
PROTOCOL/TYPE**

Explanation: For the alter control unit function, you requested that the protocol or type (SHARED=Y, YB, or N) values be changed for the control unit. One or more I/O devices assigned to the control unit are also assigned to other control units. If a device is assigned to more than one control unit, all control units that recognize the device must use the same protocol and type (shared) values. Device xxx is the first detected device assigned to the control unit.

System Action: IOCP does not alter the control unit entry.

IOCP Operator Response: (1) Use the display function to check the control unit or I/O device entries. (2) Use the delete function or alter I/O device function to remove I/O device(s) from the control unit. (3) Alter the control unit's protocol/type. (4) Use the add I/O device function to replace the deleted I/O device(s), or the alter I/O device function to add the deleted control unit path(s).

Detecting Module: ICPCIOCU

Issuing Module: ICPSMAIN

Containing Module: ICPCMSG

**ICP227I ALTER NOT VALID. DEVICE xxx REQUIRES A REMOVED
UNIT ADDRESS**

Explanation: For the alter control unit function, you requested the removal of one or more unit addresses from the control unit entry. One or more I/O devices assigned to the control unit have unit address(es) you are attempting to remove. Device xxx is the first detected I/O device assigned to the control unit.

System Action: IOCP does not alter the control unit entry.

IOCP Operator Response: Use the display and alter functions to check and correct the control unit or I/O device entries. If you are removing devices from the control unit, remove the unit addresses or control unit identifier from the I/O device entries first, and then remove the unit addresses from the associated control unit entry.

Detecting Module: ICPCIOCU

Issuing Module: ICPSMAIN

Containing Module: ICPCMSG

ICP240I I/O DEVICE nnn PREVIOUSLY DEFINED

Explanation: An entry for an I/O device to be added already exists in the IOCDS in storage for I/O device nnn.

System Action: (1) If the input is from card-image macro instructions, IOCP does not add the I/O device entry and deletes any I/O device entries that were added from multiple definitions on the IODEVICE macro instruction. IOCP continues to check the syntax of the remaining macro instructions, but does not generate an IOCDS in storage and does not produce configuration reports. (2) If the input is from the console screen, IOCP does not add the entry.

Programmer Response: (1) For input from card-image macro instructions, ensure that duplicate I/O device numbers/addresses are not specified on the IODEVICE macro instructions. (2) For input from the console screen, use the display, alter, and delete functions to check and correct the I/O device entries.

Detecting Module: ICPCIODV

Issuing Module: ICPCARDS, ICPSMAIN

Containing Module: ICPCMSG

ICP241I MAXIMUM NUMBER OF I/O DEVICES EXCEEDED

Explanation: An entry for an I/O device to be added exceeds the maximum number of I/O devices allowed. The maximum is 4080.

System Action: (1) If the input is from card-image macro instructions, IOCP does not add the I/O device entry and deletes any I/O device entries that were added from multiple definitions on the IODEVICE macro instruction. IOCP continues to check the syntax of the remaining macro instructions, but does not generate an IOCDS in storage and does not produce configuration reports. (2) If the input is from the console screen, IOCP does not add the entry.

Programmer Response: Check your I/O configuration to ensure that I/O devices are correctly defined. (1) For input from card-image macro instructions, ensure that the IODEVICE macro instructions are correctly specified. (2) For input from the console screen, use the display, alter, and delete functions to check and correct the I/O device entries.

Detecting Module: ICPCIODV

Issuing Module: ICPCARDS, ICPSMAIN

Containing Module: ICPCMSG

ICP242I DUPLICATE CONTROL UNIT NUMBERS SPECIFIED

Explanation: An entry for an I/O device to be added contains duplicate control unit numbers.

System Action: (1) If the input is from card-image macro instructions, IOCP does not add the entry. IOCP continues to check the syntax of the remaining macro instructions, but does not generate an IOCDS in storage and does not produce configuration reports. (2) If the input is from the console screen, IOCP does not add the entry.

Programmer Response: (1) For input from card-image macro instructions, ensure that control unit numbers are not duplicated on the IODEVICE macro instruction. (2) For input from the console screen, enter the correct control unit numbers.

Detecting Module: ICPCIODV

Issuing Module: ICPCARDS, ICPSMAIN

Containing Module: ICPCMSG

ICP243I TIMEOUT IS INVALID FOR BYTE CHANNEL (CHPID xx)

Explanation: TIMEOUT = N is specified for one or more I/O devices that are assigned to a byte multiplexer channel path. TIMEOUT = N is not valid for I/O devices assigned to byte multiplexer channel paths. CHPID xx is the first detected byte multiplexer channel path to which the device(s) are assigned.

System Action: (1) If the input is from card-image macro instructions, IOCP does not add the entry. IOCP continues to check the syntax of the remaining macro instructions, but does not generate an IOCDS in storage and does not produce reports. (2) If the input is from the console screen, IOCP does not add or alter the I/O device entry.

Programmer Response: (1) For input from card-image macro instructions, ensure that TIMEOUT = N is not specified on the IODEVICE macro instruction(s) for I/O devices assigned to byte multiplexer channel paths. (2) For input from the console screen, use the display, add, and alter functions to check and correct the channel path or I/O device entries.

Detecting Module: ICPCIODV

Issuing Module: ICPCARDS, ICPSMAIN

Containing Module: ICPCMSG

ICP244I SPECIFIED UNIT ADDRESS DOES NOT EXIST IN CONTROL UNIT nnn

Explanation: A unit address for an I/O device to be added does not exist in the range of unit addresses for control unit nnn.

System Action: (1) If the input is from card-image macro instructions, IOCP does not add the entry and deletes any I/O device entries that were added from multiple definitions on the IODEVICE macro instruction. IOCP continues to check the syntax of the remaining macro instructions, but does not generate an IOCDS in storage and does not produce configuration reports. (2) If the input is from the console screen, IOCP does not add the entry.

Programmer Response: (1) For input from card-image macro instructions, ensure that the correct range of unit addresses is specified on the CNTLUNIT macro instruction and the IODEVICE macro instruction. (2) For input from the console screen, use the display, alter, and delete functions to check and correct the control unit and I/O device entries.

Detecting Module: ICPCIODV

Issuing Module: ICPCARDS, ICPSMAIN

Containing Module: ICPCMSG

ICP245I I/O DEVICE nnn HAS NOT BEEN DEFINED

Explanation: The entry for I/O device nnn that you have attempted to display, alter, or delete does not exist in the IOCDS in storage.

System Action: None.

Programmer Response: Ensure that the I/O device you have specified is correct and that you are using the correct function.

Detecting Module: ICPCIODV

Issuing Module: ICPSMAIN

Containing Module: ICPCMSG

ICP246I PROTOCOL/TYPE FOR ATTACHED CONTROL UNITS IS INCONSISTENT

Explanation: An entry for an I/O device to be added has specified two or more control units and the control units do not have the same protocol or are not the same type (shared, shared block, or nonshared).

System Action: (1) If the input is from card-image macro instructions, IOCP does not add the entry. IOCP continues to check the syntax of the remaining macro instructions, but does not generate an IOCDS in storage and does not produce configuration reports. (2) If the input is from the console screen, IOCP does not add the entry.

Programmer Response: (1) For input from card-image macro instructions, ensure that the control units are correctly specified on the CNTLUNIT macro instructions and that the I/O device is correctly specified on the IODEVICE macro instruction. (2) For input from the console screen, use the display, alter, and delete functions to check and correct the control unit and I/O device entries.

Detecting Module: ICPCIODV

Issuing Module: ICPCARDS, ICPSMAIN

Containing Module: ICPCMSG

ICP247I I/O DEVICE CONNECTED TO MORE THAN ONE CU ON SAME CHPID

Explanation: An entry for an I/O device to be added has specified two or more control units and two or more of the control units are attached to the same channel path. When a device is assigned to more than one control unit, each control unit must be attached to a different channel path.

System Action: (1) If the input is from card-image macro instructions, IOCP does not add the entry. IOCP continues to check the syntax of the remaining macro instructions, but does not generate an IOCDS in storage and does not produce configuration reports. (2) If the input is from the console screen, IOCP does not add the entry.

Programmer Response: (1) For input from card-image macro instructions, ensure that the control units are correctly specified on the CNTLUNIT macro instructions and that the I/O device is correctly specified on the IODEVICE macro instruction. (2) For input from the console screen, use the display, alter, and delete functions to check and correct the control unit and I/O device entries.

Detecting Module: ICPCIODV

Issuing Module: ICPCARDS, ICPSMAIN

Containing Module: ICPCMSG

ICP248I NO PATH TO CHPID nn FOR THE DEVICE(S)

Explanation: IOCP did not find a path from the device(s) to the channel path that was specified by the PATH value on the IODEVICE macro instruction.

System Action: IOCP continues to check the syntax of the remaining macro instructions but does not generate an IOCDS in storage and does not produce configuration reports.

Programmer Response: Ensure that the value specified on the PATH parameter is correct. Check the associated CNTLUNIT and CHPID macro instructions to ensure that there is a path from the device(s) through a control unit to the specified channel path.

Detecting Module: ICPCIODV

Issuing Module: ICPCARDS, ICPSMAIN

Containing Module: ICPCMSG

ICP300I MINIMUM CONFIGURATION WAS NOT DEFINED

Explanation: To generate an IOCDs, you must define at least one I/O device that connects to a control unit connected to a channel path. In addition, the device must be either a card reader or magnetic tape.

System Action: IOCP does not complete the generation of an IOCDs in storage.

Programmer Response: Ensure that a minimum configuration is defined.

Detecting Module: ICPCGNDS

Issuing Module: ICPCARDS, ICPCRPT, ICPSMAIN

Containing Module: ICPCMSG

ICP301I MORE THAN 4 BYTE MULTIPLEXOR CHANNELS HAVE BEEN DEFINED

Explanation: IOCP has found more than 4 channel paths defined as byte multiplexer (TYPE = BY on CHPID macro instruction).

System Action: IOCP does not complete the generation of an IOCDs in storage.

Programmer Response: Ensure that not more than 4 channel paths are specified as byte multiplexer.

Detecting Module: ICPCGNDS

Issuing Module: ICPCARDS, ICPCRPT, ICPSMAIN

Containing Module: ICPCMSG

ICP302I CHANNEL NUMBER ASSIGNMENT IS NOT CONTIGUOUS

Explanation: Within a channel set (0 or 1), IOCP found that the assigned channel numbers were not consecutive.

System Action: IOCP does not complete the generation of an IOCDs in storage.

Programmer Response: Ensure that the assigned channel numbers within a channel set are consecutive.

Detecting Module: ICPCGNDS

Issuing Module: ICPCARDS, ICPCRPT, ICPSMAIN

Containing Module: ICPCMSG

ICP303I THIS CONFIGURATION EXCEEDS AVAILABLE SYSTEM STORAGE

Explanation: On each side, IOCP cannot allocate storage for more than 4608 control blocks for devices. (A control block represents a single path to a device; thus, a device can have up to four control blocks.) To determine the number of control blocks, IOCP performs the following two steps.

1. For each 370 channel set (0 and 1) on each side, IOCP makes two calculations:
 - a. Adds 17 to the number of control blocks. (For devices connected to a nonshared control unit (SHARED = N), IOCP generates one control block per channel path for each device. For devices connected to a shared control unit (SHARED = Y|YB), IOCP generates only one control block per channel path for all the devices connected to that shared control unit.)
 - b. Adds 17 to the product of the number of byte multiplexer channels multiplied by 256.
2. The larger result (a or b) found in Step 1 for channel set 0 is added to the larger result found in Step 1 for channel set 1.

IOCP issues this error message if the sum found in Step 2 exceeds 4608 for either side.

System Action: IOCP does not complete the generation of an IOCDS in storage.

Programmer Response: Change your I/O configuration so it requires fewer than 4608 control blocks per side.

Detecting Module: ICPCGNDS

Issuing Module: ICPCARDS, ICPCRPT, ICPSMAIN

Containing Module: ICPCMSG

ICP304I DUPLICATE UNIT ADDRESS xx IN CHPID zz - CONTROL UNIT SPECIFICATION

Explanation: When processing control unit entries, IOCP detected unit address xx duplicated on channel path zz. This error can occur if a unit address is assigned to two or more control units and the control units are attached to the same channel path.

System Action: IOCP does not complete the generation of an IOCDS in storage.

Programmer Response: Ensure that unit addresses are not duplicated on CNTLUNIT macro instructions for a specified channel path.

Detecting Module: ICPCGNDS

Issuing Module: ICPCARDS, ICPCRPT, ICPSMAIN

Containing Module: ICPCMSG

ICP305I DUPLICATE UNIT ADDRESS xx IN CHPID zz - I/O DEVICE SPECIFICATION

Explanation: When processing I/O device entries, IOCP detected unit address xx duplicated on channel path zz. This error can occur if two or more devices with the same unit address are assigned to the same control unit.

System Action: IOCP does not complete the generation of an IOCDS in storage.

Programmer Response: Ensure that unit addresses are not duplicated on CNTLUNIT or IODEVICE macro instructions for a specified channel path.

Detecting Module: ICPCGNDS

Issuing Module: ICPCARDS, ICPCRPT, ICPSMAIN

Containing Module: ICPCMSG

ICP306I I/O DEVICE xxx IS CONNECTED TO MORE THAN 4 CHPIDS

Explanation: IOCP has found that I/O device xxx, which is connected to one or more control units, is assigned to more than 4 channel paths. A device can only be assigned to a combined maximum of 4 channel paths.

System Action: IOCP does not complete the generation of an IOCDS in storage.

Programmer Response: Ensure that an I/O device is not assigned to more than 4 channel paths.

Detecting Module: ICPCGNDS

Issuing Module: ICPCARDS, ICPCRPT, ICPSMAIN

Containing Module: ICPCMSG

ICP307I MORE THAN 16 CONTROL UNITS ASSIGNED TO CHPID zz

Explanation: IOCP has found more than 16 control units assigned to channel path zz. You can assign a maximum of 16 control units to one channel path.

System Action: IOCP does not complete the generation of an IOCDS in storage.

Programmer Response: Ensure that not more than 16 control units are assigned to one channel path.

Detecting Module: ICPCGNDS

Issuing Module: ICPCARDS, ICPCRPT, ICPSMAIN

Containing Module: ICPCMSG

**ICP308I MAXIMUM NUMBER OF LOGICAL CONTROL UNITS
EXCEEDED**

Explanation: IOCP tried to generate more than 256 logical control units. A logical control unit is built for (1) each control unit with no devices or no devices shared with other control units, and (2) each group of two to four control units that share devices between them.

System Action: IOCP does not complete the generation of an IOCDs in storage.

Programmer Response: Ensure that the configuration will not exceed 256 logical control units. You may need to reduce the number of control units and/or have more control units share devices. (The total number of channel paths for a logical control unit cannot exceed four.)

Detecting Module: ICPCGNDS

Issuing Module: ICPCARDS, ICPCRPT, ICPSMAIN

Containing Module: ICPCMSG

**ICP309I DEVICE COUNT (xxxx) PLUS LOGICAL C.U. COUNT (yyy)
EXCEEDS 4096**

Explanation: The sum of the number of I/O devices (xxxx) plus the number of logical control units (yyy) is greater than 4096, the maximum combined total that the processor can handle in 370-XA mode.

System Action: IOCP does not complete the generation of an IOCDs in storage.

Programmer Response: Reduce the number of devices and/or the number of logical control units.

Detecting Module: ICPCGNDS

Issuing Module: ICPCARDS, ICPCRPT, ICPMAIN

Containing Module: ICPCMSG

**ICP310I LOGICAL CONTROL UNIT SPEC. ERROR FOUND WHILE
PROCESSING C.U. nnn**

Explanation: (1) IOCP found a specification error while building a logical control unit. A logical control unit can have a maximum of four channel paths. The logical control unit containing control unit nnn exceeds this maximum. (2) IOCP attempted to assign a physical control unit to two logical control units. A logical error has occurred in IOCP.

System Action: IOCP does not complete the generation of an IOCDs in storage.

Programmer Response: (1) If the logical control unit that contains control unit nnn has four or fewer control units, then reduce the number of channel paths. If the logical control unit that contains control unit nnn has more than four control units, reduce the number to four or fewer by changing the way devices are shared

between control units. (2) Analyze the logical control unit that contains the physical control unit. If the logical control unit is valid, save the console sheet and all associated output and notify the system programmer.

Detecting Module: ICPCGNDS

Issuing Module: ICPCARDS, ICPCRPT, ICPSMAIN

Containing Module: ICPCMSG

ICP400I READ/WRITE OF IOCDS IS INVALID ON THIS PROCESSOR

Explanation: (1) An option to print a report of an IOCDS or to write an IOCDS was specified but running ICPIOCP (MVS) or specifying 308X for the IOCP command processor option (VM) only reads or writes an IOCDS for a 308X or a 908X processor. (2) IOCP issued the MSSFCALL SVC (SVC 122) and received a return code of 12. This indicates that the MSSFCALL SVC is not available on the processor.

System Action: IOCP issues message ICP051I and terminates.

Programmer Response: (1) If you are verifying an input deck perform one of the following and run the job again:

- For MVS, omit the WRTCDS and REPORT options on the PARM parameters of the EXEC statements.
- For VM, enter the 308X processor option and omit the configuration report and IOCDS generation options in the IOCP command.

If you want to read or write an IOCDS, you must use the IOCP that is for your processor complex. (2) Rerun the job on a processor that recognizes the MSSFCALL SVC.

Problem Determination: Related message ICP051I indicates the function IOCP attempted.

Detecting Module: ICPCRTNS, ICPPCNTL

Issuing Module: ICPPCNTL

Containing Module: ICPCMSG

ICP401I IOCDS ACCESS PROBLEM. RETURNED RC = 4 x TIMES AND/OR RC = 8 y TIMES

Explanation: IOCP has issued the MSSFCALL SVC (SVC 122) nine times and has received x number of return codes of 4 and y number of return codes of 8. Return code 4 indicates that the processor controller is temporarily busy; return code 8 indicates that one of the MSSFCALL SVC control blocks (MSFCB or MSFAB) is in use.

System Action: IOCP issues message ICP051I and terminates.

Programmer Response: Rerun the job. If the problem occurs again, notify your system programmer.

Problem Determination: Related message ICP051I indicates the function IOCP attempted.

Detecting Module: ICPCRTNS, ICPPCNTL

Issuing Module: ICPPCNTL

Containing Module: ICPCMSG

ICP402I MSSFCALL RETURNED AN UNEXPECTED RESPONSE CODE OF xxxx HEX

Explanation: IOCP received an unexpected response from the MSSFCALL SVC (SVC 122). Bytes 6 and 7 of the response field in the MSSFCALL data block are indicated by xxxx (hex). IOCP was attempting to read or write an IOCDS.

System Action: IOCP terminates the read or write operation.

Programmer Response: Rerun the job. If the problem occurs again and the response is X'xx40' (indicates a processor controller warm start or hardware failure), notify your customer engineer. If the problem occurs again and the response is X'xxF0' (where xx is anything other than 41, 42, 43, 44, 45, or 46) or X'xx00', notify your system programmer.

Problem Determination:

1. A response of X'41F0' can occur when more than one user or job tries to access an IOCDS concurrently, or if the data set is not open for a read or write.
2. A response of X'42F0' indicates that the IOCDS you want to read or write is not valid on this processor complex. The response can also occur if the ability to write to the IOCDS is not supported on your processor complex.
3. For a processor complex that is partitioned, a response of X'43F0' occurs if you specify a dual write or if you try to read/write an IOCDS in the other partition.
4. If the processor complex is configured as a multiprocessor and you try to read an IOCDS or do a dual write, the following responses may occur: X'44F0' if the A side processor controller file (contains the I/O configuration data sets) is in diagnostic mode; X'45F0' if the B side processor controller file is in diagnostic mode.
5. A response of X'46F0' indicates that the IOCDS(s) you attempted to write to is write-protected. Use the IOCDSM (SYS021) frame to remove the write-protection. Then rerun the job.

If the problem was with a read or a write, system product users can refer to message ICP051I for more information on which IOCDS caused the problem.

If you are running the VM version of IOCP, see the IOCP Command Usage Notes in Chapter 3.

Detecting Module: ICPCWTDS, ICPCRDDS

Issuing Module: ICPPCNTL, ICPSMAIN

Containing Module: ICPCMSG

ICP403I LEVEL nn IOCDS IS INVALID

Explanation: IOCP received a response from the MSSFCALL SVC (SVC 122) where the response field in the MSSFCALL data block has byte 7 set to X'20' and byte 6 bit 0 set to 1. This indicates that the IOCDS that IOCP is attempting to read is either being updated or was not closed after the last time it was written to. The IOCDS is considered invalid.

System Action: IOCP terminates the read operation.

Programmer Response: Rerun the job. If the error occurs again, notify your system programmer.

Detecting Module: ICPCRDDS

Issuing Module: ICPPCNTL, ICPSMAIN

Containing Module: ICPCMSG

ICP404I LEVEL nn IOCDS DIRECTORY INVALID

Explanation: IOCP has read an IOCDS from the processor controller into storage and compared the member names and sector sizes in the directory record against the expected values. The directory does not match the expected values. This message can occur when a 370 level IOCP tries to read a 370/370-XA IOCDS, or when a lower level 370/370-XA IOCP tries to read a 370/370-XA IOCDS generated by a higher level 370/370-XA IOCP.

System Action: IOCP terminates the read operation.

Programmer Response: Rerun the job. If the problem occurs again, notify your system programmer.

Detecting Module: ICPCRDDS

Issuing Module: ICPPCNTL, ICPSMAIN

Containing Module: ICPCMSG

**ICP501A TYPE "PRG": PRESS "ALT," "CMD" KEYS: TYPE "PRGATTN":
PRESS "ENTER."**

Explanation: IOCP issues this message to instruct the IOCP operator how to enter program mode in order to operate IOCP. This message appears after the operator has started or restarted IOCP.

System Action: IOCP waits for an operator response.

IOCP Operator Response: Perform the following steps:

- To put the console in program mode, key in the following console command:

PRG

- Press and hold down the ALT key and then press the CMD key while holding down the ALT key.

The following message is displayed:

CONSOLE MODE CHANGED

- To cause a program attention, key in the following console command:

PRGATTN

Press ENTER.

IOCP displays the primary menu (Figure 4-1) and you can start operating IOCP.

To take the console out of program mode after you have completed IOCP operation, key in FDC (frame dependent command), press and hold down the ALT key, and then press the CMD key while holding down the ALT key.

Detecting Module: ICPSIO

Issuing Module: ICPSMAIN

Containing Module: ICPCMSG

**ICP502A INPUT NOT CORRECT OR MISSING AT CURSOR POSITION.
PLEASE CORRECT.**

Explanation: You have entered invalid or incomplete data in the input field where the cursor is positioned.

System Action: IOCP waits for an operator response.

IOCP Operator Response: Enter valid data (at the cursor position), or a command.

Detecting Module: ICPSMINT, ICPSSCAN

Issuing Module: ICPSMAIN

Containing Module: ICPCMSG

ICP503A MORE THAN ONE SELECTION ENTERED. ONLY ONE SELECTION ALLOWED.

Explanation: On an add, alter, delete, or display selection menu, you have entered more than one entry.

System Action: IOCP waits for an operator response.

IOCP Operator Response: Make only one entry on the menu and try the function again, or enter a command.

Detecting Module: ICPSMINT

Issuing Module: ICPSMAIN

Containing Module: ICPCMSG

ICP504A NO SELECTION HAS BEEN MADE. PLEASE MAKE SELECTION.

Explanation: On the add, alter, delete, or display selection menu, you have not made a correct entry.

System Action: IOCP waits for an operator response.

IOCP Operator Response: Key in a valid entry on the screen, or enter a command.

Detecting Module: ICPSMINT

Issuing Module: ICPSMAIN

Containing Module: ICPCMSG

ICP505A CARD INPUT ERROR(S) FOUND. CHECK PRINTER FOR LISTING. PROCEED.

Explanation: IOCP has detected errors in the macro instructions read from the input device. The output listing shows the macro instructions read and indicates the errors detected.

System Action: IOCP waits for an operator response.

IOCP Operator Response: Correct the errors and try the function again, or enter a command.

Detecting Module: ICPSMINT

Issuing Module: ICPSMAIN

Containing Module: ICPCMSG

ICP506A CARD INPUT ERROR(S) FOUND. NO PRINTER SPECIFIED - NO LISTING. PROCEED.

Explanation: IOCP has detected errors in the macro instructions read from the input device. However, you have not specified a printer, so IOCP cannot indicate the errors detected.

System Action: IOCP waits for an operator response.

IOCP Operator Response: Try the menu function again and specify a printer to receive the output listing. The listing will indicate the errors detected. Correct the errors and try the function again, or enter a command.

Detecting Module: ICPSMINT

Issuing Module: ICPSMAIN

Containing Module: ICPCMSG

ICP507A IOCDS GENERATION ERROR(S). CHECK PRINTER FOR LISTING. PROCEED.

Explanation: IOCP has detected errors in the input macro instructions while generating an IOCDS in storage. The output listing shows the macro instructions read by IOCP and indicates the errors detected.

System Action: IOCP waits for an operator response.

IOCP Operator Response: Correct the errors in the input macro instructions and try the function again, or enter a command.

Detecting Module: ICPSMINT

Issuing Module: ICPSMAIN

Containing Module: ICPCMSG

ICP508A IOCDS GENERATION ERROR(S). NO PRINTER SPECIFIED - NO LISTING. PROCEED.

Explanation: IOCP has detected errors in the input macro instructions while generating an IOCDS in storage. However, you have not specified a printer, so IOCP cannot indicate the errors detected.

System Action: IOCP waits for an operator response.

IOCP Operator Response: Try the menu function again and specify a printer to receive the output listing. The listing will indicate the errors detected. Correct the errors and try the function again, or enter a command.

Detecting Module: ICPSMINT

Issuing Module: ICPSMAIN

Containing Module: ICPCMSG

ICP509I ENTRIES BEING PROCESSED. PLEASE WAIT FOR COMPLETION.

Explanation: This message indicates that IOCP is processing the entries for the requested function.

System Action: IOCP locks the keyboard until the function is complete.

IOCP Operator Response: Wait for and respond to the next message.

Detecting Module: ICPSMINT

Issuing Module: ICPSMINT

Containing Module: ICPCMSG

ICP510I ENTRIES BEING PROCESSED. LISTING WILL BE PRINTED.

Explanation: IOCP is processing the requested function and the function includes producing an output listing.

System Action: IOCP locks the keyboard until the function is complete.

IOCP Operator Response: Wait for and respond to the next message.

Detecting Module: ICPSMINT

Issuing Module: ICPSMINT

Containing Module: ICPCMSG

ICP511I ENTRIES BEING PROCESSED. PRINTER NOT SPECIFIED.

Explanation: IOCP is processing the entries for the requested function and, because a printer was not specified, the function does not include an output listing.

System Action: IOCP locks the keyboard until the function is complete.

IOCP Operator Response: Wait for and respond to the next message.

Detecting Module: ICPSMINT

Issuing Module: ICPSMINT

Containing Module: ICPCMSG

ICP512A PROCESSING COMPLETED. PROCEED.

Explanation: IOCP has processed the data entered on the menu, completed the requested function, and detected no errors.

System Action: IOCP waits for an operator response.

IOCP Operator Response: Enter a command, or repeat the menu function.

Detecting Module: ICPSMINT

Issuing Module: ICPSMAIN

Containing Module: ICPCMSG

ICP513A PROCESSING COMPLETED. CHECK PRINTER FOR LISTING. PROCEED.

Explanation: IOCP has processed the data entered on the menu, completed the requested function, and detected no errors. An output listing was produced.

System Action: IOCP waits for an operator response.

IOCP Operator Response: Enter a command, or repeat the menu function.

Detecting Module: ICPSMINT

Issuing Module: ICPSMAIN

Containing Module: ICPCMSG

ICP514A PROCESSING COMPLETED. NO PRINTER SPECIFIED - NO LISTING. PROCEED.

Explanation: IOCP has processed the data entered on the menu, completed the requested function, and detected no errors. An output listing was not produced.

System Action: IOCP waits for an operator response.

IOCP Operator Response: Enter a command, or repeat the menu function.

Detecting Module: ICPSMINT

Issuing Module: ICPSMAIN

Containing Module: ICPCMSG

ICP515W IOCP TERMINATED. WAIT STATE CODE = B2x.

Explanation: IOCP has loaded the PSW with a wait state code of B20 through B24. See "IOCP Wait State Codes" in Chapter 4 for an explanation of the wait state codes.

System Action: IOCP terminates.

IOCP Operator Response: See Chapter 4.

Problem Determination: See Chapter 4.

Detecting Module: ICPSACP

Issuing Module: ICPSACP

Containing Module: ICPSACP

ICP516A ENTRY ON COMMAND LINE IS NOT CORRECT. RE-ENTER WITH CORRECTIONS.

Explanation: The command you have entered is not a valid command for the menu being displayed.

System Action: IOCP waits for an operator response.

IOCP Operator Response: Key in a valid command (as shown on lines 20 and 21), or enter the required menu data.

Detecting Module: ICPSBOTL, ICPSSCAN

Issuing Module: ICPSMAIN

Containing Module: ICPCMSG

ICP517A ONLY ONE "=" DELIMITER IS PERMITTED. PLEASE CORRECT.

Explanation: For a screen command in the form "command = value," you have entered more than one "=" in the command.

System Action: IOCP waits for an operator response.

IOCP Operator Response: Correct the input and enter the screen command again.

Detecting Module: ICPSSCAN

Issuing Module: ICPSMAIN

Containing Module: ICPCMSG

ICP518A VALUE AFTER “=” CONTAINS TOO MANY DIGITS. CHECK LENGTH & RE-ENTER.

Explanation: For a screen command in the form “command = value,” you have entered too many digits for “value” in the command.

System Action: IOCP waits for an operator response.

IOCP Operator Response: Correct the input and enter the screen command again.

Detecting Module: ICPSBOTL, ICPSSCAN

Issuing Module: ICPSMAIN

Containing Module: ICPCMSG

ICP519A VALUE AFTER “=” IS NOT VALID. HEX DIGITS ONLY. PLEASE CORRECT.

Explanation: For a screen command in the form “command = value,” you have entered invalid digits for “value” in the command. Only hexadecimal digits (0 through 9 and A through F) are valid on the command.

System Action: IOCP waits for an operator response.

IOCP Operator Response: Correct the input and enter the screen command again.

Detecting Module: ICPSSCAN

Issuing Module: ICPSMAIN

Containing Module: ICPCMSG

ICP521A NO VALUE ALLOWED WITH THIS COMMAND USING THIS MENU. PLEASE CORRECT.

Explanation: You have entered a screen command in the form “command = value” on a menu that does not allow this form of command. A “command = value” form of screen command can only be entered on an add, alter, or display menu.

System Action: IOCP waits for an operator response.

IOCP Operator Response: Enter a valid command.

Detecting Module: ICPSBOTL

Issuing Module: ICPSMAIN

Containing Module: ICPCMSG

ICP522A VALUE MISSING AFTER “=” DELIMITER. ENTER A VALUE.

Explanation: For a screen command in the form “command=value,” you have not entered any digits for “value” after the “=” in the command.

System Action: IOCP waits for an operator response.

IOCP Operator Response: Correct the input and enter the screen command again.

Detecting Module: ICPSSCAN

Issuing Module: ICPSMAIN

Containing Module: ICPCMSG

ICP523I SWAP REQUEST NOT VALID. BOTH CHPIDS MUST BE THE SAME CHANNEL TYPE.

Explanation: You tried to swap two channel paths, but the channel paths are not the same type. The channel paths to be swapped must be the same type, either block or byte multiplexer.

System Action: IOCP does not swap the channel paths and does not print configuration reports.

IOCP Operator Response: Enter channel paths that are the same type.

Detecting Module: ICPSMINT

Issuing Module: ICPSMAIN

Containing Module: ICPCMSG

ICP550A ddd, INT REQ, CC=3/NO PATH AVAILABLE

Explanation: IOCP received a “not operational” condition code, code 3, on the path specified. In the message, ddd indicates the device address/number of the device.

System Action: IOCP waits for the operator to correct the entry or make the path available and try the operation again.

IOCP Operator Response: (1) If the entry for the device was incorrectly specified on the screen, correct the entry and try the operation again. (2) If the path is not available, turn on the path to the device (such as setting the channel or control unit switch) and try the operation again. (3) If the path cannot be made available, run IOCP again using another device or path.

Detecting Module: ICPSINIO, ICPSOTIO

Issuing Module: ICPSMAIN

Containing Module: ICPSINIO, ICPSOTIO

ICP551A ddd,INTREQ,cm,stat,sense

Explanation: IOCP detected a device that requires operator intervention. In the message text in hexadecimal, the fields are:

ddd Device address/number.
cm Operation code of the channel command word (CCW) during whose execution the error occurred. If the channel command word cannot be found, this field appears as **.
stat Status portion of the channel status word (CSW).
sense The sense data can be up to 24 bytes long. The first two sense bytes are for the error condition.

System Action: IOCP waits for the operator to end IOCP or try the operation again.

IOCP Operator Response: Check the following and try the operation again.

- Make the unit ready. If the unit cannot be made ready, run IOCP again using another device.
- Feed more cards to the reader.
- Clear a card jam.
- Empty a stacker.
- Put paper into the printer.

Detecting Module: ICPSINIO, ICPSOTIO

Issuing Module: ICPSMAIN

Containing Module: ICPSINIO, ICPSOTIO

ICP552A ddd,err,cm,stat,sense

Explanation: An uncorrectable I/O error was detected by IOCP. Two consecutive commas or a blank field in the message text indicates that a field could not be determined.

In the message text, the fields are:

ddd Device address/number in hexadecimal.
err Description of the error based on status and sense information:
BOC bus out check.
CCC channel control check.
CDC channel data check.
CHC chaining check.
CMD command reject.
CPC channel program check.

DCK data check.

EQC equipment check.

ICC interface control check.

IOE input/output error (for errors other than those described).

OVR data overrun.

PRC channel protection check.

SEN a unit check occurred during a sense operation. (When this condition is present, the sense field does not appear in the message text.)

cm Command code, in hexadecimal, of the channel command word (CCW) being executed when the error occurred. If the channel command word cannot be found, this field appears as **.

stat Status portion, in hexadecimal, of the channel status word (CSW).

sense The sense data can be up to 24 bytes long. The first two sense bytes are for the error condition.

System Action: IOCP waits for the operator to try the operation again or end IOCP.

IOCP Operator Response: Probable user or hardware error. Try another device on another channel.

Possible values of the err field and appropriate responses are as follows:

- CMD REJECT - Command reject. Check that device entries on the screen are correct.
- BOC - bus out check.
- EQC - equipment check.
- ICC - interface control check.
- OVR - data overrun

These are permanent hardware faults. Customer engineer action is required.

Detecting Module: ICPSINIO, ICPSOTIO

Issuing Module: ICPSMAIN

Containing Module: ICPSINIO, ICPSOTIO

ICP553A ddd, INT REQ, CC = 3/NO PATH AVAILABLE

Explanation: Before reading from an input device or writing to an output device, IOCP received a “not operational” condition code, code 3, on the path specified. In the message, ddd indicates the device address/number.

System Action: IOCP waits for the operator to make the path available and signal IOCP by keying in “PRGATTN” on the command line and pressing ENTER.

IOCP Operator Response: (1) If the path is not available, turn on the path to the device (such as setting the channel or control unit switch) and try the operation again. (2) If the path cannot be made available, run IOCP again using another path or device.

Detecting Module: ICPSINIO, ICPSOTIO

Issuing Module: ICPSINIO, ICPSOTIO

Containing Module: ICPSINIO, ICPSOTIO

ICP554A ddd,INTREQ,cm,stat,sense

Explanation: Before reading from an input device or writing to an output device, IOCP detected a device that requires operator intervention. In the message text in hexadecimal, the fields are:

ddd Device address/number.

cm Operation code of the channel command word (CCW) during whose execution the error occurred. If the channel command word cannot be found, this field appears as **.

stat Status portion of the channel status word (CSW).

sense The sense data can be up to 24 bytes long. The first two sense bytes are for the error condition.

System Action: IOCP waits for the operator to key in "PRGATTN" on the command line and press ENTER.

IOCP Operator Response: Check the following:

- Make the unit ready. If the device cannot be made ready, run IOCP again using another device.
- Feed more cards to the reader.
- Clear a card jam.
- Empty a stacker.
- Put paper into the printer.

Key in "PRGATTN" on the command line and press ENTER.

Detecting Module: ICPSINIO, ICPSOTIO

Issuing Module: ICPSINIO, ICPSOTIO

Containing Module: ICPSINIO, ICPSOTIO

ICP555A ddd,err,cm,stat,sense

Explanation: While reading from an input device or writing to an output device, IOCP detected an error that can be tried again or ignored. Two consecutive commas or a blank field in the message text indicates that the field could not be determined.

In the message text, the fields are:

ddd Device address/number in hexadecimal.

err Description of the error based on status and sense information:

- DCK data check.
- EQC equipment check (card reader).

cm Command code, in hexadecimal, of the channel command word (CCW) being executed when the error occurred. If the channel command word cannot be found, this field appears as **.

stat Status portion, in hexadecimal, of the channel status word (CSW).

sense The sense data can be up to 24 bytes long. The first two sense bytes are for the error condition.

System Action: IOCP waits for the operator to signal IOCP to try the operation again by keying in "PRGATTN" on the command line and pressing ENTER. If the error occurred on the input device, IOCP tries the read operation again. If the error occurred on the output device, IOCP does not reprint the line.

IOCP Operator Response: Have IOCP try the command again (by keying in "PRGATTN" on the command line and pressing ENTER), or rerun IOCP using another device.

Detecting Module: ICPSINIO, ICPSOTIO

Issuing Module: ICPSINIO, ICPSOTIO

Containing Module: ICPSINIO, ICPSOTIO

ICP556I ddd,err,cm,stat,sense

Explanation: While IOCP was reading from an input device or writing to an output device, an uncorrectable error was detected by IOCP. Two consecutive commas or a blank field indicates that a field could not be determined.

In the message text, the fields are:

ddd Device address/number in hexadecimal.

err Description of the error based on status and sense information:

- BOC bus out check.
- CCC channel control check.
- CDC channel data check.
- CHC chaining check.

	CMD command reject.
	CPC channel program check.
	DCK data check.
	EQC equipment check.
	ICC interface control check.
	IOE input/output error (for errors other than those described).
	OVR data overrun
	PRC channel protection check.
	REC record error. (The record read was not 80 bytes or a multiple of 80 bytes.)
	SEN a unit check occurred during a sense operation. (When this condition is present, the sense field does not appear in the message text.)
cm	Command code, in hexadecimal, of the channel command word (CCW) being executed when the error occurred. If the channel command word cannot be found, this field appears as **.
stat	Status portion, in hexadecimal, of the channel status word (CSW).
sense	The sense data can be up to 24 bytes long. The first two sense bytes are for the error condition.

System Action: IOCP terminates by loading a PSW with a wait state code of B23. Probable hardware error. (Try another device on another channel.)

For a magnetic tape device, do not unconditionally accept the results of the operation. Check that the tape being used for this job has not been replaced or removed. Each message should be considered as a potential warning of a marginal condition.

For a card reader, note that some abnormal error condition occurred. Depending on the severity of the error (check status and sense information) and depending on the installation requirements, take the appropriate action.

Possible values of the err field and appropriate responses are as follows:

- CMD REJECT - Command reject. Correct the command and try the function again.
- BOC - bus out check.
- EQC - equipment check.
- ICC - interface control check.
- OVR - data overrun

These are permanent hardware faults. Customer engineer action is required.

Detecting Module: ICPSINIO, ICPSOTIO

Issuing Module: ICPSINIO, ICPSOTIO

Containing Module: ICPSINIO, ICPSOTIO

IOCP Messages (DMSICP Prefix)

The following messages are issued only by the VM version of IOCP. The messages are arranged in alphanumeric order by message identifier.

The message format is:

DMSICPnnnE text

where:

nnn is the message number

text is the message text

E is an action code that denotes an error.

Note: The CMS-IOCP interface module, DMSICP, issues these error messages with corresponding return codes (RC) for each message.

DMSICP001E NO FILENAME SPECIFIED

Explanation: The IOCP command requires that you specify the name of the file containing the source IOCP macro instructions or the name of the file to contain the IOCP output file.

System Action: Execution of the command is terminated. The system status remains the same. RC=24

User Response: Issue the command again and specify the filename of the IOCP input or output file.

DMSICP002E FILE 'filename IOCP' NOT FOUND

Explanation: The specified file was not found on the accessed disk(s). Either the file does not reside on this disk, the file identification was misspelled, or incomplete information was provided to cause the appropriate disk to be searched.

System Action: Execution of the command is terminated. The system status remains the same. RC=28

User Response: Find or create the desired file. To make sure that the file exists, issue either:

```
STATE fn ft * or  
LISTFILE fn ft *
```

Correct the command and issue it again.

DMSICP003E INVALID OPTION 'option'

Explanation: The specified option is invalid. (1) The option may have been misspelled. (2) If the option can be truncated, it may have been truncated improperly. (3) The option may conflict with another option in the command line.

System Action: Execution of the command is terminated. The system status remains the same. RC=24

User Response: Correct the command and issue it again.

DMSICP006E NO READ/WRITE DISK ACCESSED

Explanation: The user does not have access to a read/write disk on which the IOCP program can write its output file.

System Action: Execution of the command is terminated. The system status remains the same. RC=36

User Response: Access a read/write disk and issue the command again, or issue the CP LINK command to reset the A-disk to read/write mode. Access the A-disk again, and issue the command.

DMSICP007E FILE 'filename' IOCP IS NOT FIXED, 80 CHAR. RECORDS

Explanation: The specified file must have fixed length, 80-character records for the command to execute.

System Action: Execution of the command is terminated. The system status remains the same. RC=32

User Response: It is possible that an incorrect file name was specified in the command line. In this case, issue the command again. If, however, the file name was correct but the file has the wrong format or does not contain 80-character records, change the file's format and/or record length with the COPYFILE or XEDIT command.

DMSICP038E FILEID CONFLICT FOR DDNAME 'SYSIN'

Explanation: Either (1) the user issued a FILEDEF command for reader or tape input and the specified filename already exists on disk as fn IOCP, or (2) the user issued a FILEDEF command for input from disk with a filetype other than IOCP and there exists a file fn IOCP on this disk.

System Action: Execution of the command is terminated. The system status remains the same. RC=40

User Response: Check that you have specified the correct filename with the IOCP command. If it is correct, for the first explanation, issue a FILEDEF ddname CLEAR command for the file, or issue a FILEDEF command that sets the filetype correctly. For the second explanation, either use a different filename for the input file, or erase the existing disk file.

DMSICP070E INVALID PARAMETER 'parameter'

Explanation: An invalid operand was specified in the command line.

System Action: Execution of the command is terminated. The system status remains the same. RC=24

User Response: Correct the command line and issue the command again.

DMSICP075E DEVICE 'devtyp' INVALID FOR INPUT|OUTPUT

Explanation: The device specified for the input ddname is invalid. This message appears if the input device specified is DUMMY, PRINTER, PUNCH or TERMINAL.

System Action: Execution of the command is terminated. The system status remains the same. RC=40

User Response: Issue the FILEDEF command again and specify the correct input device.

DMSICP099E CMS/DOS ENVIRONMENT ACTIVE

Explanation: The IOCP command cannot execute while the CMS/DOS environment is active.

System Action: Execution of the command is terminated. The system status remains the same. RC=40

User Response: Use the SET DOS command to deactivate the CMS/DOS environment. Then issue the IOCP command again.



Appendix A. Coding IOCP Macro Instructions

This appendix describes the rules for coding IOCP card-image macro instructions and the notation used in this book to describe the macro instructions.

Rules for Coding IOCP Macro Instructions

The rules for coding IOCP macro instructions are those of the assembler language. The following paragraphs are a summary of these rules as stated in *OS/VS-DOS/VS-VM/370 Assembler Language* (GC33-4010; for 370 mode) and *Assembler H Version 2 Application Programming Language Reference* (GC26-4037; for both 370 mode and 370-XA mode).

IOCP macro instructions have the following standard format:

Name	Operation	Operand	Comments
------	-----------	---------	----------

Name symbolically identifies the macro instruction. If included, it can contain from one to eight alphanumeric characters, the first of which must be alphabetic. The name must begin in the first column of the macro instruction and must be followed by one or more blanks. The name field of an IOCP macro instruction is ignored by IOCP.

Operation identifies the macro instruction. It must be preceded and followed by one or more blanks. The operation field can start in the second column of the macro instruction if the name field is not used.

Operand contains parameters coded in any order and separated by commas. The operand field ends with one or more blanks placed after the last parameter. A parameter consists of a keyword followed by an equal sign (=) and the keyword value. The keyword value can be a single value (or subfield) or a list of values (or subfields). If the keyword value consists of more than one subfield, the subfields must be separated by commas and the list of subfields must be enclosed in parentheses. When a subfield contains multiple values (such as the UNITADD= subfield on the CNTLUNIT macro instruction), these subparameters are positional and must be coded in the order shown. The absence of a subparameter is indicated by a comma coded in its place. However, if the absent subparameter is the last one or if all following subparameters are also absent, do not code any commas to replace these subparameters.

Comments can be written on an IOCP macro instruction, but they must be separated from the last parameter of the operand field by one or more blanks.

You can use an entire card for a comment by placing an asterisk in the first column and the characters IOCP in columns 2 through 5 of each card. An * in column 1 or a .* in columns 1 and 2 are also valid comment cards but will only be printed if the IGNORE=NO parameter is coded. A maximum of two continuation cards can be used for comments.

IOCP macro instructions are coded in columns 1 through 71 of each card. You can continue a macro instruction that exceeds 71 columns onto one or more additional cards by placing a nonblank character in column 72 to indicate the continuation. The macro instruction can be interrupted either at column 71 or after any comma that separates parameters. The continued portion must begin in column 16 of the following card. Comments can appear on continued cards. Columns 73 through 80 can be used to code identification and/or sequence characters if you choose. IOCP prints but does not examine columns 73 through 80.

Note: If you incorrectly continue a macro instruction and only optional parameters appear on the continued portion, IOCP ignores the optional parameters. For example, if you do not end the last parameter on a card with a comma and code a nonblank character in column 72, IOCP ignores the information on the continuation card. To avoid this possible problem, you can code the optional parameters on the first card of the macro instruction. Also, check your I/O configuration reports to ensure that all channel paths, control units, and I/O devices are defined correctly.

Format and Coding Conventions

The conventions used in this publication to illustrate the format and coding of IOCP macro instructions are:

- Uppercase letters, numbers, and punctuation marks must be coded exactly as shown.

Exceptions to this convention are brackets, []; braces, {}; and ellipses, ...; which are never coded.
- Lowercase letters represent variables for which you must substitute information or specific values.
- Items enclosed in braces, {}, represent alternative items. Only one of the items must be coded.
- Items enclosed in brackets, [], are optional. They can be omitted. Conversely, the lack of brackets indicates that an item must be coded.
- An ellipsis, ..., indicates that the previous item or group of items can be coded two or more times in succession.
- The “or” sign, |, separates alternative items.
- If an alternative item is underlined, it is the default value. IOCP assumes the default value is your choice if you do not specify the keyword.

- Single parentheses must enclose single-value subfields, if more than one is coded. If only one subfield is specified, you can omit the parentheses. For example, you can code either CUNUMBR=(530) or CUNUMBR=530 on the IODEVICE macro instruction.
- Double parentheses must enclose the UNITADD= subfields on the CNTLUNIT macro instruction and the PATH= subfields on the CHPID macro instruction because these subfields can contain multiple values. (Single parentheses enclose each subfield; another set encloses all the subfields.) For example, you code PATH=((10,E,1),(11,F)) and PATH=((12,1)). If only a single subparameter for one subfield is specified, you can omit the parentheses. For example, you can code either UNITADD=((0A)) or UNITADD=0A.
- Parameters, subfields, and subparameters coded in the operand field must be separated by commas.

Example: A typical macro instruction might appear as:

CU10A	CNTLUNIT	CUNUMBR=10A,PATH=06,SHARED=N,	X
		UNIT=2821,UNITADD=((0A,3))	Plan 3

CU10A is the symbolic name of the macro instruction.

CNTLUNIT identifies the macro instruction to the system.

CUNUMBR=10A, PATH=06, and SHARED=N are required parameters, separated by commas, containing keywords and keyword values. Because the macro instruction is continued, a comma follows SHARED=N, and a nonblank character (X) is placed in column 72.

UNIT=2821, and UNITADD=((0A,3)) are also required parameters and start in column 16 of the continued macro instruction. Because UNITADD=((0A,3)) is the last parameter, it is followed by a blank to indicate the end of the operand field.

Plan 3 is a comment.



Appendix B. Listings of Macro Instruction Input

Figure B-1 shows a listing of a combined input deck containing both IOCP and MVS system generation macro instructions. Figure B-2 shows portions of the listing produced when IOCP processed the combined input deck shown in Figure B-1.

Figure B-3 shows a listing of IOCP input that contains only IOCP macro instructions. Figure B-4 shows a listing of a DMKRIO file used for VM/SP and VM/SP HPO system generation. The records in this file correspond to the IOCP macro instruction in Figure B-3. Figure B-5 shows a listing of a HCPRIO file used for VM/XA Systems Facility system generation. The records in this file correspond to the IOCP macro instructions in Figure B-3.

Note: See “Chapter 5. IOCP Configuration Reports” for examples of the reports IOCP produces.

```

IODEVICE ADDRESS=1E0,CUNUMBR=012,UNIT=2305,MODEL=2          01110000
IODEVICE ADDRESS=1E8,CUNUMBR=012,UNIT=2305,MODEL=2          01120000
*IOCP -----
*IOCP CHANNEL TWO
*IOCP . ALL 3830 CONNECTED SYMMETRIC WITH OPTCHAN DEFINING OTHER 01150007
*IOCP . CPU CHANNEL CONNECTIONS (CHANNELS D, E, F)             01160007
*IOCP . DEFINE 3380 DEVICES USING THE DATA STREAMING PROTOCOL 01170007
*IOCP -----
*IOCP
DA3830#1 CNTLUNIT CUNUMBR=021,PATH=(03,25),PROTOCL=D,SHARED=N, X01200001
UNIT=3830,UNITADD=((10,16)) 01210027
DA3830#2 CNTLUNIT CUNUMBR=022,PATH=(03,25),PROTOCL=D,SHARED=N, X01220001
UNIT=3830,UNITADD=((40,16)) 01230027
DA3830#3 CNTLUNIT CUNUMBR=023,PATH=(03,25),PROTOCL=D,SHARED=N, X01240001
UNIT=3830,UNITADD=((60,16)) 01250027
DA3880#1 CNTLUNIT CUNUMBR=024,PATH=(03,25),PROTOCL=S,SHARED=N, X01260001
UNIT=3880,UNITADD=((80,16)) 01270027
IODEVICE ADDRESS=(210,8),CUNUMBR=021,UNIT=3330,MODEL=1, X01280000
OPTCHAN=D,FEATURE=SHARED 01290001
IODEVICE ADDRESS=(260,4),CUNUMBR=022,UNIT=3350, X01300003
OPTCHAN=D,FEATURE=SHARED 01310001
IODEVICE ADDRESS=(260,4),CUNUMBR=023,UNIT=3350, X01320003
OPTCHAN=E,FEATURE=SHARED 01330001
IODEVICE ADDRESS=(280,4),CUNUMBR=024,UNIT=3380, X01340000
OPTCHAN=F,FEATURE=SHARED 01350001
*IOCP -----
*IOCP CHANNEL THREE
*IOCP CHANNEL SET ZERO (0) 01360000
*IOCP . DEFINE DISPLAY AND GRAPHIC DEVICES 01370000
*IOCP -----
*IOCP
GP3250 CNTLUNIT CUNUMBR=030,PATH=(04),PROTOCL=D,SHARED=YB, X01400000
UNIT=3258,UNITADD=((C0,4)) 01410000
DP3274 CNTLUNIT CUNUMBR=031,PATH=(04),PROTOCL=D,SHARED=YB, X01420001
UNIT=3274,UNITADD=((D0,16)) 01430027
IODEVICE CUNUMBR=030,ADDRESS=3C0,UNIT=2250,MODEL=3,PCU=1 01440001
IODEVICE UNIT=3278,ADDRESS=(3D0,2),CUNUMBR=031, X01450027
FEATURE=(EBKY3277,KB78KEY,SELPEN,DOCHAR, 01460000
AUDALRM),MODEL=4 01470000
IODEVICE UNIT=3278,ADDRESS=(3D2,4),CUNUMBR=031, X01480000
FEATURE=(EBKY3277,KB78KEY,SELPEN,DOCHAR, 01490000
AUDALRM),MODEL=3 01500022
IODEVICE UNIT=3286,ADDRESS=(3D6,2),MODEL=2,CUNUMBR=031, X01510000
FEATURE=DOCHAR 01520000
IODEVICE UNIT=3277,ADDRESS=(3D8,8),CUNUMBR=031, X01530000
FEATURE=(EBKY3277,KB78KEY,SELPEN,DOCHAR, 01540000
AUDALRM),MODEL=2 01550000
*IOCP -----
*IOCP CHANNEL THREE
*IOCP CHANNEL SET ONE (1) 01560000
*IOCP -----
*IOCP
DP3272 CNTLUNIT CUNUMBR=130,PATH=(26),PROTOCL=D,SHARED=YB, X01570000
UNIT=3272,UNITADD=((E0,16)) 01580000
NCP3705 CNTLUNIT CUNUMBR=131,PATH=(26),PROTOCL=D,SHARED=N, X01590000
UNIT=3705,UNITADD=F0 01600000
IODEVICE UNIT=3277,ADDRESS=(3E0,4),CUNUMBR=130, X01610000
FEATURE=(EBKY3277,KB78KEY,SELPEN,DOCHAR, 01620000
AUDALRM),MODEL=2 01630001
IODEVICE UNIT=3705,CUNUMBR=131,ADDRESS=3F0,ADAPTER=CA2 X01640027
01650000
*IOCP -----
*IOCP CHANNEL FOUR
*IOCP ALL 3830 CONNECTED SYMMETRIC WITH OPTCHAN USING 4-WAY SWITCHES 01660027
*IOCP -----
*IOCP
DA3830#4 CNTLUNIT CUNUMBR=041,PATH=(05,27,22,15),PROTOCL=D,SHARED=N, X01670000
UNIT=3830,UNITADD=((10,16)) 01680000
DA3830#5 CNTLUNIT CUNUMBR=042,PATH=(05,27,22,15),PROTOCL=D,SHARED=N, X01700000
UNIT=3830,UNITADD=((40,16)) 01710000
DA3830#6 CNTLUNIT CUNUMBR=043,PATH=(05,27,22,15),PROTOCL=D,SHARED=N, X01720000
UNIT=3830,UNITADD=((60,16)) 01730000
IODEVICE ADDRESS=(410,8),CUNUMBR=041,UNIT=3330,MODEL=1, X01740000
OPTCHAN=A 01750000
IODEVICE ADDRESS=(440,4),CUNUMBR=042,UNIT=3350, X01760000
OPTCHAN=A 01770027
IODEVICE ADDRESS=(460,4),CUNUMBR=043,UNIT=3350, X01780000
OPTCHAN=A 01790027
*IOCP -----
*IOCP CHANNEL FIVE
*IOCP -----
*IOCP
TA3803 CNTLUNIT CUNUMBR=051,PATH=(06,10),PROTOCL=D,SHARED=Y, X01800000
UNIT=3803,UNITADD=((80,8)) 01810027
IODEVICE ADDRESS=(580,8),CUNUMBR=051,UNIT=3420,MODEL=8, X01820000
FEATURE=(9-TRACK,OPT1600),OFFLINE=YES 01830000
*IOCP -----
*IOCP CHANNEL SIX (BYTE)
*IOCP CHANNEL SET ZERO (0) 01840000
*IOCP . MASS STORAGE CONTROLLER (MSC0 AND MSC1) 01850000
*IOCP . UNIT RECORD DEVICES 01860000
*IOCP -----
*IOCP
MSC#0 CNTLUNIT CUNUMBR=060,PATH=(01,11),UNIT=3851, X01870000
PROTOCL=D,SHARED=N,UNITADD=((10,1)) 02000011
MSC#1 CNTLUNIT CUNUMBR=061,PATH=(01,11),UNIT=3851, X02010000
PROTOCL=D,SHARED=N,UNITADD=((11,1)) 02020000
UR2821 CNTLUNIT CUNUMBR=062,PATH=01,UNIT=2821, X02030011
PROTOCL=D,SHARED=N,UNITADD=((0C,4)) 02040027
IODEVICE UNIT=3851,ADDRESS=(610,1),CUNUMBR=060 02050012
IODEVICE UNIT=3851,ADDRESS=(611,1),CUNUMBR=061 02060027
IODEVICE CUNUMBR=062,UNIT=2540P,ADDRESS=60C,MODEL=1, XX02070011
FEATURE=CARDIMAGE 02080000
IODEVICE CUNUMBR=062,UNIT=2540P,ADDRESS=60D,MODEL=1 02090012
IODEVICE CUNUMBR=062,UNIT=1403,ADDRESS=(60E,2),MODEL=N1, XXX0210011
FEATURE=UNVCHSET 02100000
*IOCP -----
*IOCP CHANNEL SIX (BYTE)
*IOCP CHANNEL SET ONE (1) 02110000
*IOCP 50KB TP LINE FOR NJP WITH A 2701 02120000
*IOCP -----

```

Figure B-1 (Part 2 of 5). A Combined Input Deck (IOCP and MVS System Generation)

```

*
* TP2701 CNTLUNIT CUNUMBR=160,PATH=(11),PROTOCL=D,SHARED=N,UNIT=2701, 02210000
* UNITADD=((0A,2)) X02220000
* IODEVICE CUNUMBR=160,UNIT=BSC1,ADDRESS=(60A,2),TCU=2701, X02240000
* ADAPTER=BSCA 02250000
* ----- 02260000
* IOCP CHANNEL SEVEN 02270000
* IOCP . EXAMPLE OF STRING SWITCH CONTROL UNIT # 070 AND 090 02280007
* IOCP WITH OPTIONAL AND ALTERNATE PATHS 02290019
* IOCP SEE CONTROL UNIT AND DEVICE ON CHANNEL 9 02300000
* IOCP ----- 02310000
* DA3830#7 CNTLUNIT CUNUMBR=070,PATH=(07,14),PROTOCL=D,SHARED=N, X02330000
* UNIT=3830,UNITADD=((40,16)) 02340027
* ----- 02350000
* IOCP CHANNEL EIGHT 02360000
* IOCP CHANNEL SET ZERO ( 0 ) 02370006
* IOCP DEFINE 3800 PRINTER 02380006
* IOCP . CYRPTO UNIT ( 3848 ) DEFINED TO USE DATA STREAMING PROTOCOL 02390004
* IOCP ----- 02400000
* PR3800 CNTLUNIT CUNUMBR=081,PATH=(20,13),PROTOCL=D,SHARED=N, X02420000
* UNITADD=((01,1)),UNIT=3800 02430027
* CU3848 CNTLUNIT CUNUMBR=082,PATH=(20),PROTOCL=S,SHARED=N, X02440006
* UNIT=3848,UNITADD=((C0,1)) 02450027
* IODEVICE CUNUMBR=081,UNIT=3800,ADDRESS=801,FEATURE=CGS2 02460000
* IODEVICE CUNUMBR=082,ADDRESS=(8C0),UNIT=3848,MODEL=1 02470006
* ----- 02480006
* IOCP CHANNEL EIGHT 02490006
* IOCP CHANNEL SET ONE ( 1 ) 02500006
* IOCP . DEFINE THE ARRAY PROCESSOR (3838) 02510006
* IOCP ----- 02520006
* AR3838 CNTLUNIT CUNUMBR=183,PATH=(13),PROTOCL=D,SHARED=N, X02530006
* UNITADD=((E0,8)),UNIT=3838 02550027
* IODEVICE CUNUMBR=183,UNIT=3838,ADDRESS=8E0 02560009
* ----- 02570000
* IOCP CHANNEL NINE 02580000
* IOCP . DEFINE STRING SWITCH DASH ON CONTROL UNIT # 070 , 090 02590000
* IOCP WITH OPTIONAL AND ALTERNATE PATHS 02600019
* IOCP ----- 02610000
* DA3830#8 CNTLUNIT CUNUMBR=090,PATH=(12,21),PROTOCL=D,SHARED=N, X02630000
* UNIT=3830,UNITADD=((40,16)) 02640027
* DA3830#9 CNTLUNIT CUNUMBR=091,PATH=(14,21),PROTOCL=D,SHARED=N, X02650000
* UNIT=3830,UNITADD=((20,16)) 02660027
* STRINGSM IODEVICE ADDRESS=(740,4),CUNUMBR=(070,090),UNIT=3350, X02670000
* OPTCHAN=9,FEATURE=(ALTCtrl) 02680000
* IODEVICE ADDRESS=(920,4),CUNUMBR=091,UNIT=3350 02690000
* ----- 02700000
* IOCP CHANNEL A 02710000
* IOCP . DEFINE DUMMY UNIT FOR OPTCHAN FROM CHANNEL FOUR (4) 02720007
* IOCP ----- 02730000
* OPTCHAN CNTLUNIT CUNUMBR=0A0,PATH=(22,15),PROTOCL=D,SHARED=N, X02750000
* UNIT=DUMMY,UNITADD=((00)) 02760000
* IODEVICE CUNUMBR=0A0,UNIT=DUMMY,ADDRESS=A00,DEVTYPE=30000001, X02770000
* ERRTAB=223 02780000
* ----- 02790000
* IOCP CHANNEL B 02800000
* IOCP . TWO MSS STAGING ADAPTERS (3830-3) WITH A PATH TO EACH 02810018
* IOCP STAGING ADAPTER AND THE IODEVICES STRING SWITCHED 02820018
* IOCP ----- 02830000
* MSS5TG1 CNTLUNIT CUNUMBR=0B0,PATH=(23),PROTOCL=D,SHARED=N, X02850026
* UNIT=3830,UNITADD=((80,64)) 02860012
* MSS5TG2 CNTLUNIT CUNUMBR=0B1,PATH=(16),PROTOCL=D,SHARED=N, X02870016
* UNIT=3830,UNITADD=((80,64)) 02880020
* ----- 02890018
* IOCP DEFINE THE MSS TABLE PACKS 02900022
* IODEVICE CUNUMBR=(0B0,0B1),UNIT=3330,ADDRESS=(B80,2),MODEL=11,X02910022
* FEATURE=(ALTCtrl,SHARED) 02920024
* IODEVICE CUNUMBR=(0B0,0B1),UNIT=3330,ADDRESS=(B88,2),MODEL=11,X02930022
* FEATURE=(ALTCtrl,SHARED) 02940025
* ----- 02950018
* IOCP DEFINE THE MSS CONVERTIBLE PACKS 02960022
* IODEVICE CUNUMBR=(0B0,0B1),UNIT=3330,ADDRESS=(B83,2),MODEL=11,X02970022
* FEATURE=(ALTCtrl,SHARED) 02980025
* IODEVICE CUNUMBR=(0B0,0B1),UNIT=3330,ADDRESS=(B8A,2),MODEL=11,X02990022
* FEATURE=(ALTCtrl,SHARED) 03000025
* ----- 03010018
* IOCP DEFINE THE MSS STAGING VOLUMES 03020022
* IODEVICE CUNUMBR=(0B0,0B1),UNIT=3330V,ADDRESS=(B82,1), X03030018
* FEATURE=(ALTCtrl,SHARED) 03040025
* IODEVICE CUNUMBR=(0B0,0B1),UNIT=3330V,ADDRESS=(B85,3), X03050018
* FEATURE=(ALTCtrl,SHARED) 03060025
* IODEVICE CUNUMBR=(0B0,0B1),UNIT=3330V,ADDRESS=(B8C,52), X03070018
* FEATURE=(ALTCtrl,SHARED) 03080025
* ----- 03090000
* IOCP CHANNEL C 03100000
* IOCP . DEFINE CHANNEL-TO-CHANNEL ADAPTER (CTC) 03110007
* IOCP ----- 03120000
* CTC CNTLUNIT CUNUMBR=0C0,PATH=17,PROTOCL=D,SHARED=N, X03140000
* UNIT=CTC,UNITADD=C0 03150000
* IODEVICE ADDRESS=CC0,CUNUMBR=0C0,UNIT=CTC,FEATURE=370, X03160000
* TIMEOUT=N 03170000
* ----- 03180001
* IOCP CHANNEL D 03190001
* IOCP . THIS CHANNEL IS NOT CONNECTED TO THIS 3081 03200007
* IOCP DEVICES ARE OPTCHAN'D FROM CHANNEL 2 03210007
* IOCP ----- 03220001
* IODEVICE CUNUMBR=***,UNIT=DUMMY,ADDRESS=D00,DEVTYPE=30000001, X03240001
* ERRTAB=223 03250001
* ----- 03260001
* IOCP CHANNEL E 03270001
* IOCP . THIS CHANNEL AND DEVICES ARE NOT CONNECTED TO THIS 3081 03280007
* IOCP DEVICES ARE OPTCHAN'D FROM CHANNEL 2 03290007
* IOCP ----- 03300001

```

Figure B-1 (Part 3 of 5). A Combined Input Deck (IOCP and MVS System Generation)

```

M ***** M 04470000
M M M M M 04480000
M M M M SVC TABLE M M M M 04490000
M M M M M M M M 04500000
M ***** M 04510000
SVCTAB SVCTABLE SVC-255-T1-FC00, X04520000
      SVC-254-T4-FC00, X04530000
      SVC-253-T4-FC00, X04540000
      SVC-252-T3-FC00, X04550000
      SVC-251-T3-FC00, X04560000
      SVC-250-T4-FC00, X04570000
      SVC-249-T4-FC00, X04580000
      SVC-248-T4-FC00, X04590000
      SVC-247-T4-FC00, X04600000
      SVC-246-T4-FC00, X04610000
      SVC-245-T4-FC00, X04620000
      SVC-244-T1-FC00, X04630000
      SVC-243-T1-FC00, X04640000
      SVC-242-T4-FC00, X04650000
      SVC-241-T4-FC00, X04660000
      SVC-240-T4-FC00, X04670000
      SVC-239-T4-FC00, X04680000
      SVC-238-T4-FC00, X04690000
      SVC-237-T4-FC00, X04700000
      SVC-236-T4-FC00, X04710000
      SVC-235-T4-FC00, X04720000
      SVC-234-T4-FC00, X04730000
      SVC-233-T4-FC00, X04740000
      SVC-232-T4-FC00, X04750000
      SVC-231-T4-FC00, X04760000
      SVC-230-T4-FC00, X04770000
      SVC-229-T4-FC00, X04780000
      SVC-228-T4-FC00, X04790000
      SVC-227-T4-FC00, X04800000
      SVC-226-T4-FC00, X04810000
      SVC-225-T4-FC00, X04820000
      SVC-224-T4-FC00, X04830000
      SVC-223-T3-FC00, X04840000
      SVC-222-T3-FC00, X04850000
      SVC-221-T3-FC00, X04860000
      SVC-220-T1-FC00, X04870000
      SVC-219-T3-FC00, X04880000
      SVC-218-T3-FC00, X04890000
      SVC-217-T3-FC00, X04900000
      SVC-216-T3-FC00, X04910000
      SVC-215-T3-FC00, X04920000
      SVC-214-T3-FC00, X04930000
      SVC-213-T3-FC00, X04940000
      SVC-212-T2-FC00, X04950000
      SVC-211-T2-FC00, X04960000
      SVC-210-T2-FC00, X04970000
      SVC-209-T3-FC00, X04980000
      SVC-208-T3-FC00, X04990000
      SVC-207-T3-FC00, X05000000
      SVC-206-T3-FC00, X05010000
      SVC-205-T3-FC00, X05020000
      SVC-204-T3-FC00, X05030000
      SVC-203-T1-FC00, X05040000
      SVC-202-T3-FC00, X05050000
      SVC-201-T3-FC00, X05060000
      SVC-200-T3-FC00, X05070000
      SVC-199-T1-FC00, X05080000
      SVC-198-T1-FC00, IMS-VS 1.1.1 OS-VS2 REL4 SVCS X05090000
      SVC-197-T2-FC00, IMS-VS 1.1.1 OS-VS2 REL4 SVCS X05100000
      SVC-196-T2-FC00, IMS-VS 1.1.1 OS-VS2 REL4 SVCS X05110000
      SVC-195-T4-FC00, IMS-VS 1.1.1 OS-VS2 REL4 SVCS X05120000
      SVC-194-T4-FC00, IMS-VS 1.1.1 OS-VS2 REL4 SVCS 05130000
      EJECT 05140000
M ***** M 05150000
M M M M M 05160000
M M M M DATA SETS M M M M 05170000
M M M M M M M M 05180000
M ***** M 05190000
      DATASET IMAGLIB,VOL=(DRV308,3330) 05200000
      DATASET JES3LIB,VOL=(DRV308,3330) 05210000
      DATASET LINKLIB,VOL=(DRV308,3330) 05220000
      DATASET MACLIB,VOL=(DRV308,3330) 05230000
      DATASET MANX,VOL=(DRV308,3330) 05240000
      DATASET MANY,VOL=(DRV308,3330) 05250000
      DATASET NUCLEUS,VOL=(DRV308,3330) 05260000
      DATASET PROCLIB,VOL=(DRV308,3330) 05270000
      DATASET SVCLIB,VOL=(DRV308,3330) 05280000
      DATASET TELCLIB,VOL=(DRV308,3330) 05290000
      DATASET UADS,VOL=(DRV308,3330) 05300000
      DATASET SAMPLIB,VOL=(DRV308,3330) 05310000
      DATASET BRODCAST,VOL=(DRV308,3330) 05320000
      DATASET CMDLIB,VOL=(DRV308,3330) 05330000
      DATASET DCMLIB,VOL=(DRV308,3330) 05340000
      DATASET HELP,VOL=(DRV308,3330) 05350000
      DATASET PARMLIB,VOL=(DRV308,3330) 05360000
      DATASET LPALIB,VOL=(DRV308,3330) 05370000
      DATASET VTAMLIB,VOL=(DRV308,3330) 05380000
      DATASET VSCATLG,VOL=(PAGE08,3330),NAME=PAGE08.CATALOG 05390000
      DATASET PAGEDSH=SYS1.PG33301 05400000
      DATASET PAGEDSH=SYS1.PG33302 05410000
      DATASET PAGEDSH=SYS1.PG33303 05420000
      DATASET STGINDEX,VOL=(PAGE08,3330) 05430000
      EJECT 05440000
M ***** M 05450000
M M M M M 05460000
M M M M AFFINITY M M M M 05470000
M M M M M M M M 05480000
M ***** M 05490000
      AFFINITY AFF-AFFPGM01-1,AFF-AFFPGM02-0,AFF-AFFPGM03-1, X05500000
      AFF-AFFPGM04-0,AFF-AFFPGM05-1, X05510000
      AFF-AFFPGM06-0,AFF-AFFPGM07-1 05520000
      EJECT 05530000
M ***** M 05540000
M M M M M 05550000
M M M M GENERATE M M M M 05560000
M M M M M M M M 05570000
M ***** M 05580000
      GENERATE GENTYPE=(IO,1), X05590013
      OBJPDS=SYS1.S5SPDS, X05600000
      RESVOL=(DRVJHM,3330), X05610000
      INDEX=S5S1, X05620000
      JCLASS=M, X05630000
      OCLASS=M 05640000
M ***** M 05650015
M M M M M 05660015
M M M M INCLUDE MACRO FDR 3848 CRYPTO SUPPORT M M M M 05670021
M M M M M M M M 05680015
M ***** M 05690015
      ICUCUSP 05700000
      END 05710000

```

Figure B-1 (Part 5 of 5). A Combined Input Deck (IOCP and MVS System Generation)

```

*IOCP X00030000
*IOCP 00040000
*IOCP 00050000
*IOCP 00060000
*IOCP 00070000
*IOCP 00080000
*IOCP 00090000
*IOCP 00100000
*IOCP 00110000
*IOCP 00120000
*IOCP 00130000
*IOCP 00140000
*IOCP 00150000
*IOCP 00160000
*IOCP 00170000
*IOCP 00180000
*IOCP 00190000
*IOCP 00200000
*IOCP 00210000
*IOCP 00220000
*IOCP 00230000
*IOCP 00240000
*IOCP 00250000
*IOCP 00260000
*IOCP 00270000
*IOCP 00280000
*IOCP 00290000
*IOCP 00300000
*IOCP 00310000
*IOCP 00320000
*IOCP 00330000
*IOCP 00340000
*IOCP 00350000
*IOCP 00360000
*IOCP 00370000
*IOCP 00380000
*IOCP 00390000
*IOCP 00400000
*IOCP 00410000
*IOCP 00420000
*IOCP 00430000
*IOCP 00440000
*IOCP 00450000
*IOCP 00460000
*IOCP 00470000
*IOCP 00480001
*IOCP 00490001
*IOCP 00500003

      DEFINE MVS CHANNELS TO CHPID
      CHANNEL SET 0      CHANNEL SET 1
      C C      C C
      H H      H H
      P A      P A
      I N      I N
      D D      D D
      DSE 0      DSE 1
      00 0      5 10
      01 6      6 11
      02 1      7 12
      03 2      8 13
      04 3      9 14
      05 4      A 15
      06 5      B 16
      07 7      C 17

      DSE 2
      CHAN | 8 | 9 | A | B | 1 | 2 | 3 | 4 |
      CHPID | 20 | 21 | 22 | 23 | 24 | 25 | 26 | 27 |

      CHAN      CHPIDS
      CHPID PATH=((00,0,0)),TYPE=BY      0      00
      CHPID PATH=((02,1,0),(24,1,1)),TYPE=BL      1      02 24
      CHPID PATH=((03,2,0),(25,2,1)),TYPE=BL      2      03 25
      CHPID PATH=((04,3,0),(26,3,1)),TYPE=BL      3      04 26
      CHPID PATH=((05,4,0),(27,4,1)),TYPE=BL      4      05 27
      CHPID PATH=((06,5,0),(10,5,1)),TYPE=BL      5      06 10
      CHPID PATH=((01,6,0),(11,6,1)),TYPE=BY      6      01 11
      CHPID PATH=((07,7,0),(12,7,1)),TYPE=BL      7      07 12
      CHPID PATH=((20,8,0),(13,8,1)),TYPE=BL      8      20 13
      CHPID PATH=((21,9,0),(14,9,1)),TYPE=BL      9      21 14
      CHPID PATH=((22,A,0),(15,A,1)),TYPE=BL      A      22 15
      CHPID PATH=((23,B,0),(16,B,1)),TYPE=BL      B      23 16
      CHPID PATH=((17,C,1)),TYPE=BL      C      17

*IOCP DEFINE CHANNELS NOT PRESENT ON THIS 3081
*IOCP      CHPID PATH=((M,D,0)),TYPE=BL      D      -- --
ICP1111 **WARNING** PATH INFORMATION DEFINED WITH ** IS EXCLUDED FROM IOCDs
      CHPID PATH=((M,E,0)),TYPE=BL      E      -- --      00510003
ICP1111 **WARNING** PATH INFORMATION DEFINED WITH ** IS EXCLUDED FROM IOCDs
      CHPID PATH=((M,F,0)),TYPE=BL      F      -- --      00520003
ICP1111 **WARNING** PATH INFORMATION DEFINED WITH ** IS EXCLUDED FROM IOCDs

      NOTES:
      . FORMAT FOR THE CUNUMBR OPERAND IS
      CUNUMBR=XYZ
      X = CHANNEL SET ID
      Y = CHANNEL NUMBER
      Z = SEQUENTIAL NUMBER FROM 0 TO F
      . ALL 3830 CONTROL UNITS ARE FEATURED WITH AN ADDRESS
      RANGE OF 16 WHICH IS SPECIFIED ON THE UNITADD OPERAND
      OF THE CNTLUNIT MACRO.
      . IOCP SYNTAX CHECKING PERFORMED IN FOREGROUND ON TSO
      ALLOC F(SYSPRINT) DA(*)
      ALLOC F(SYSIN) DA('CONFIG.IOCPGEN.ASM(IOCP)') SHR
      CALL 'TEST.LOAD(ICPIOCP)'

      CHANNEL ZERO ( BYTE )
      CHANNEL SET ZERO (0)
      UR3811#1 CNTLUNIT CUNUMBR=001,PATH=00,PROTOCL=D,SHARED=N,
      UNIT=3811,UNITADD=02
      UR3811#2 CNTLUNIT CUNUMBR=002,PATH=00,PROTOCL=D,SHARED=N,
      UNIT=3811,UNITADD=04
      UR3505#1 CNTLUNIT CUNUMBR=003,PATH=00,PROTOCL=D,SHARED=N,
      UNIT=3505,UNITADD=((12),(13)) 12 IS 3505,13 IS 3525
      TP3705#P CNTLUNIT CUNUMBR=004,PATH=00,PROTOCL=D,SHARED=N,
      UNIT=3705,UNITADD=((4D,15),(7F,8),(87,5),(AD,16),
      (B2,62),(FF,13))
      IODEVICE ADDRESS=002,CUNUMBR=001,UNIT=3211
      IODEVICE ADDRESS=004,CUNUMBR=002,UNIT=3211
      IODEVICE ADDRESS=012,CUNUMBR=003,UNIT=3505
      IODEVICE ADDRESS=013,CUNUMBR=003,UNIT=3525,FEATURE=THOLINE
      IODEVICE UNIT=B5C1,ADDRESS=(04D,15),TCU=2701,ADAPTER=BSCA,
      CUNUMBR=004
      IODEVICE UNIT=2741P,ADDRESS=(07F,8),TCU=2702,ADAPTER=IBM1,
      SETADDR=1,CUNUMBR=004
      IODEVICE UNIT=2741P,ADDRESS=(087,5),TCU=2702,ADAPTER=IBM1,
      SETADDR=1,FEATURE=AUTOANSR,CUNUMBR=004
      IODEVICE UNIT=B5C3,ADDRESS=(0A0,16),TCU=2703,
      FEATURE=AUTOPOLL,ADAPTER=BSCA,CUNUMBR=004
      IODEVICE UNIT=B5C3,ADDRESS=(0B2,62),TCU=2703,
      FEATURE=AUTOPOLL,ADAPTER=BSCA,CUNUMBR=004
      IODEVICE UNIT=3705,ADDRESS=0FF,ADAPTER=CA1,CUNUMBR=004

      CHANNEL ONE
      . SYMMETRIC DEFINITION OF 2505 DRUMS ACROSS CHANNEL SETS
  
```

Figure B-2 (Part 1 of 2). A Combined Input Deck Processed by IOCP

```

*IOCP      IODEVICE ADDRESS=(920,4),CUNUMBR=091,UNIT=3350          02690000      TIME 15.20 DATE 82.035      PAGE 006
*IOCP      -----
*IOCP      CHANNEL A
*IOCP      . DEFINE DUMMY UNIT FOR OPTCHAN FROM CHANNEL FOUR (4)    02710000
*IOCP      -----
OPTCHAN    CNTLUNIT CUNUMBR=0A0,PATH=(22,15),PROTOCL=D,SHARED=N,    X02750000
            UNIT=DUMMY,UNITADD=(00)
            IODEVICE CUNUMBR=0A0,UNIT=DUMMY,ADDRESS=A00,DEVTYPE=30000001,X02770000
            ERRTAB=223
*IOCP      -----
*IOCP      CHANNEL B
*IOCP      . TWO MSS STAGING ADAPTERS (3830-3) WITH A PATH TO EACH  02810018
*IOCP      STAGING ADAPTER AND THE IODEVICES STRING SWITCHED      02820018
*IOCP      -----
MSSSTG1    CNTLUNIT CUNUMBR=0B0,PATH=(23),PROTOCL=D,SHARED=N,      X02850026
            UNIT=3830,UNITADD=(80,64)
            MSSSTG2 CNTLUNIT CUNUMBR=0B1,PATH=(16),PROTOCL=D,SHARED=N,  X02870016
            UNIT=3830,UNITADD=(80,64)
            IODEVICE CUNUMBR=(0B0,0B1),UNIT=3330,ADDRESS=(B80,2),MODEL=11,X02910022
            FEATURE=(ALCTRL,SHARED)
            IODEVICE CUNUMBR=(0B0,0B1),UNIT=3330,ADDRESS=(B88,2),MODEL=11,X02930022
            FEATURE=(ALCTRL,SHARED)
            IODEVICE CUNUMBR=(0B0,0B1),UNIT=3330,ADDRESS=(B83,2),MODEL=11,X02970022
            FEATURE=(ALCTRL,SHARED)
            IODEVICE CUNUMBR=(0B0,0B1),UNIT=3330,ADDRESS=(B8A,2),MODEL=11,X02990022
            FEATURE=(ALCTRL,SHARED)
            IODEVICE CUNUMBR=(0B0,0B1),UNIT=3330V,ADDRESS=(B82,1),    XX03030018
            FEATURE=(ALCTRL,SHARED)
            IODEVICE CUNUMBR=(0B0,0B1),UNIT=3330V,ADDRESS=(B85,3),    XX03050018
            FEATURE=(ALCTRL,SHARED)
            IODEVICE CUNUMBR=(0B0,0B1),UNIT=3330V,ADDRESS=(B8C,52),   XX03070018
            FEATURE=(ALCTRL,SHARED)
            IODEVICE CUNUMBR=(0B0,0B1),UNIT=3330V,ADDRESS=(B8C,52),   X03080025
            FEATURE=(ALCTRL,SHARED)
            -----
*IOCP      CHANNEL C
*IOCP      . DEFINE CHANNEL-TO-CHANNEL ADAPTER (CTC)                03100000
*IOCP      -----
*IOCP      CTC
*IOCP      CNTLUNIT CUNUMBR=0C0,PATH=17,PROTOCL=D,SHARED=N,        X03140000
            UNIT=CTC,UNITADD=C0
            IODEVICE ADDRESS=CC0,CUNUMBR=0C0,UNIT=CTC,FEATURE=370,    X03160000
            TIMEOUT=N
            -----
*IOCP      CHANNEL D
*IOCP      . THIS CHANNEL IS NOT CONNECTED TO THIS 3081
*IOCP      DEVICES ARE OPTCHAN'D FROM CHANNEL 2
*IOCP      -----
            IODEVICE CUNUMBR=***,UNIT=DUMMY,ADDRESS=D00,DEVTYPE=30000001,X03240001
            ERRTAB=223
            03250001
ICP117I ***WARNING** THE ABOVE DEVICE(S) EXCLUDED FROM THE IOCDs

*IOCP      -----
*IOCP      CHANNEL E
*IOCP      . THIS CHANNEL AND DEVICES ARE NOT CONNECTED TO THIS 3081  03260001
*IOCP      DEVICES ARE OPTCHAN'D FROM CHANNEL 2
*IOCP      -----
            IODEVICE ADDRESS=(E10,8),CUNUMBR=***,UNIT=3330,MODEL=1    03320000
            03340001
ICP117I ***WARNING** THE ABOVE DEVICE(S) EXCLUDED FROM THE IOCDs
            IODEVICE ADDRESS=(E40,4),CUNUMBR=***,UNIT=3350,          X03330001
            OPTCHAN=F
            03340001
ICP117I ***WARNING** THE ABOVE DEVICE(S) EXCLUDED FROM THE IOCDs
            -----
*IOCP      CHANNEL F
*IOCP      . THIS CHANNEL AND DEVICES ARE NOT CONNECTED TO THIS 3081  03350001
*IOCP      DEVICES ARE OPTCHAN'D FROM CHANNEL 2
*IOCP      -----
            IODEVICE CUNUMBR=***,UNIT=DUMMY,ADDRESS=F00,DEVTYPE=30000001,X03410001
            ERRTAB=223
            03420001
ICP117I ***WARNING** THE ABOVE DEVICE(S) EXCLUDED FROM THE IOCDs
            IODEVICE ADDRESS=(F10,8),CUNUMBR=***,UNIT=3330,MODEL=1    03430001
ICP117I ***WARNING** THE ABOVE DEVICE(S) EXCLUDED FROM THE IOCDs
            IODEVICE ADDRESS=(F60,4),CUNUMBR=***,UNIT=3350          03440001
ICP117I ***WARNING** THE ABOVE DEVICE(S) EXCLUDED FROM THE IOCDs
TOTAL MESSAGES FOR SYNTAX CHECKING: 0013      WARNING MESSAGES: 0013      ERROR MESSAGES: 0000

```

Figure B-2 (Part 2 of 2). A Combined Input Deck Processed by IOCP

```

ID      MSG1='SAMPLE IOCP FILE'
CHPID  PATH=( (00,0,0) ),TYPE=BY
CHPID  PATH=( (01,1,0) ),TYPE=BL
CHPID  PATH=( (02,2,0) ),TYPE=BL
CHPID  PATH=( (03,3,0) ),TYPE=BL
CHPID  PATH=( (04,4,0) ),TYPE=BL
CNTLUNIT CUNUMBR=000,PATH=00,SHARED=N,UNIT=3811,
        UNITADD=( (00,8) )
CNTLUNIT CUNUMBR=001,PATH=00,SHARED=N,UNIT=3811,
        UNITADD=( (08,8) )
CNTLUNIT CUNUMBR=002,PATH=00,SHARED=N,UNIT=3505,
        UNITADD=( (10,8) )
CNTLUNIT CUNUMBR=003,PATH=00,SHARED=N,UNIT=3274,
        UNITADD=( (18,8) )
CNTLUNIT CUNUMBR=004,PATH=00,SHARED=N,UNIT=3705,
        UNITADD=( (30,48) )
CNTLUNIT CUNUMBR=006,PATH=00,SHARED=N,UNIT=2955,
        UNITADD=( (80,8) )
CNTLUNIT CUNUMBR=007,PATH=00,SHARED=N,UNIT=3705,
        UNITADD=BO
CNTLUNIT CUNUMBR=010,PATH=01,SHARED=Y,UNIT=3803,
        UNITADD=( (80,8) )
CNTLUNIT CUNUMBR=011,PATH=01,SHARED=Y,UNIT=3803,
        UNITADD=( (90,8) )
CNTLUNIT CUNUMBR=020,PATH=02,SHARED=N,UNIT=3830,
        UNITADD=( (00,64) )
CNTLUNIT CUNUMBR=021,PATH=02,SHARED=N,UNIT=3830,
        UNITADD=( (40,8) )
CNTLUNIT CUNUMBR=024,PATH=02,SHARED=N,UNIT=3851,
        UNITADD=( (A0,8) )
CNTLUNIT CUNUMBR=025,PATH=02,SHARED=N,UNIT=2835,
        UNITADD=( (D0,8) )
CNTLUNIT CUNUMBR=031,PATH=03,SHARED=N,UNIT=3830,
        UNITADD=( (30,8) )
CNTLUNIT CUNUMBR=032,PATH=(03,04),SHARED=N,UNIT=3830,
        UNITADD=( (50,16) )
CNTLUNIT CUNUMBR=033,PATH=03,SHARED=N,UNIT=CTCA,
        UNITADD=( (D0,8) )
CNTLUNIT CUNUMBR=034,PATH=03,SHARED=N,UNIT=3830,
        UNITADD=( (40,8) )
CNTLUNIT CUNUMBR=040,PATH=04,SHARED=N,UNIT=3830,
        UNITADD=( (00,64) )
CNTLUNIT CUNUMBR=041,PATH=04,SHARED=N,UNIT=3880,
        UNITADD=( (40,16) )
CNTLUNIT CUNUMBR=042,PATH=04,SHARED=N,UNIT=3851,
        UNITADD=( (A0,8) )
IODEVICE ADDRESS=002,UNIT=3211,CUNUMBR=000
IODEVICE ADDRESS=00C,UNIT=2540R,CUNUMBR=001
IODEVICE ADDRESS=00D,UNIT=2540P,CUNUMBR=001
IODEVICE ADDRESS=00E,UNIT=1403,CUNUMBR=001
IODEVICE ADDRESS=00F,UNIT=1403,CUNUMBR=001
IODEVICE ADDRESS=012,UNIT=3505,CUNUMBR=002
IODEVICE ADDRESS=013,UNIT=3525,CUNUMBR=002
IODEVICE ADDRESS=(018,7),UNIT=3279,MODEL=3,CUNUMBR=003
*IOCP DUMMY DEVICE FOR CP ONLY
*IOCP IODEVICE ADDRESS=01F,UNIT=3215,CUNUMBR=003
IODEVICE ADDRESS=(030,16),UNIT=3705,CUNUMBR=004
IODEVICE ADDRESS=(040,16),UNIT=3705,CUNUMBR=004
IODEVICE ADDRESS=(050,16),UNIT=3705,CUNUMBR=004
IODEVICE ADDRESS=080,UNIT=2955,CUNUMBR=006
IODEVICE ADDRESS=0B0,UNIT=3705,CUNUMBR=007
IODEVICE ADDRESS=(180,2),UNIT=3420,MODEL=7,CUNUMBR=010
IODEVICE ADDRESS=190,UNIT=3420,MODEL=8,CUNUMBR=011
IODEVICE ADDRESS=(200,2),UNIT=3330,MODEL=1,CUNUMBR=020
IODEVICE ADDRESS=(208,2),UNIT=3330,MODEL=1,CUNUMBR=020
IODEVICE ADDRESS=(210,48),UNIT=3330,MODEL=1,CUNUMBR=020
IODEVICE ADDRESS=(240,8),UNIT=3350,CUNUMBR=(021,034)
IODEVICE ADDRESS=2A0,UNIT=3851,CUNUMBR=024
IODEVICE ADDRESS=2D0,UNIT=2305,MODEL=2,CUNUMBR=025
IODEVICE ADDRESS=(330,8),UNIT=3330,MODEL=1,CUNUMBR=031
IODEVICE ADDRESS=(350,8),UNIT=3330,MODEL=1,CUNUMBR=032
IODEVICE ADDRESS=(358,2),UNIT=3330,MODEL=11,CUNUMBR=032
IODEVICE ADDRESS=3D0,UNIT=CTC,CUNUMBR=033,TIMEOUT=N
IODEVICE ADDRESS=(410,48),UNIT=3330,MODEL=1,CUNUMBR=040
IODEVICE ADDRESS=(440,16),UNIT=3380,CUNUMBR=041
IODEVICE ADDRESS=4A0,UNIT=3851,CUNUMBR=042
DMK00010
DMK00020
DMK00030
DMK00040
DMK00050
DMK00060
*DMK00070
DMK00080
*DMK00090
DMK00100
*DMK00110
DMK00120
*DMK00130
DMK00140
*DMK00150
DMK00160
*DMK00170
DMK00180
*DMK00190
DMK00200
*DMK00210
DMK00220
*DMK00230
DMK00240
*DMK00250
DMK00260
*DMK00270
DMK00280
*DMK00290
DMK00300
*DMK00310
DMK00320
*DMK00330
DMK00340
*DMK00350
DMK00360
*DMK00370
DMK00380
*DMK00390
DMK00400
*DMK00410
DMK00420
*DMK00430
DMK00440
*DMK00450
DMK00460
DMK00470
DMK00480
DMK00490
DMK00500
DMK00510
DMK00520
DMK00530
DMK00540
DMK00550
DMK00560
DMK00570
DMK00580
DMK00590
DMK00600
DMK00610
DMK00620
DMK00630
DMK00640
DMK00650
DMK00660
DMK00670
DMK00680
DMK00690
DMK00700
DMK00710
DMK00720
DMK00730
DMK00740
DMK00750
DMK00760

```

Figure B-3. IOCP Macro Instruction Input

FILE: DMKRIO ASSEMBLE A1

```
DMKRIO CSECT
RDEVICE ADDRESS=002,DEVTYPE=3211,CLASS=(X,A),FEATURE=UNVCHSET
RDEVICE ADDRESS=00C,DEVTYPE=2540R
RDEVICE ADDRESS=00D,DEVTYPE=2540P,CLASS=(X,A)
RDEVICE ADDRESS=00E,DEVTYPE=1403,CLASS=(X,A),FEATURE=UNVCHSET
RDEVICE ADDRESS=00F,DEVTYPE=1403,CLASS=(S),FEATURE=UNVCHSET
RDEVICE ADDRESS=012,DEVTYPE=3505
RDEVICE ADDRESS=013,DEVTYPE=3525,CLASS=(X,A)
RDEVICE ADDRESS=(018,7),DEVTYPE=3279,MODEL=3
RDEVICE ADDRESS=01F,DEVTYPE=3215
RDEVICE ADDRESS=(030,16),DEVTYPE=3705,ADAPTER=BSCA,BASEADD=0B0
RDEVICE ADDRESS=(040,16),DEVTYPE=3705,ADAPTER=IBM1,BASEADD=0B0
RDEVICE ADDRESS=(050,16),DEVTYPE=3705,ADAPTER=TELE2,BASEADD=0B0
RDEVICE ADDRESS=080,DEVTYPE=2955
RDEVICE ADDRESS=0B0,DEVTYPE=3705,ADAPTER=TYPE4,MODEL=F4,CPTYPE=EP
RDEVICE ADDRESS=(180,2),DEVTYPE=3420,FEATURE=DUALDENS,MODEL=7
RDEVICE ADDRESS=190,DEVTYPE=3420,FEATURE=DUALDENS,MODEL=8
* DEVICE ADDRESSES 200, 201, 208, 209 ALLOW ACCESS TO MSC TABLES
RDEVICE ADDRESS=(200,2),DEVTYPE=3330,MODEL=1
RDEVICE ADDRESS=(208,2),DEVTYPE=3330,MODEL=1
RDEVICE ADDRESS=(210,48),DEVTYPE=3330,MODEL=1,FEATURE=SYSVIRT
RDEVICE ADDRESS=(240,8),DEVTYPE=3350,ALTCU=340
RDEVICE ADDRESS=2A0,DEVTYPE=3851
RDEVICE ADDRESS=2D0,DEVTYPE=2305,MODEL=2
RDEVICE ADDRESS=(330,8),DEVTYPE=3330,MODEL=1
RDEVICE ADDRESS=(350,8),DEVTYPE=3330,MODEL=1
RDEVICE ADDRESS=(358,2),DEVTYPE=3330,MODEL=11
RDEVICE ADDRESS=3D0,DEVTYPE=CTCA
RDEVICE ADDRESS=(410,48),DEVTYPE=3330,MODEL=1,FEATURE=VIRTUAL
RDEVICE ADDRESS=(440,16),DEVTYPE=3380
RDEVICE ADDRESS=4A0,DEVTYPE=3851
RCTLUNIT ADDRESS=000,CUTYPE=3811
RCTLUNIT ADDRESS=008,CUTYPE=2821
RCTLUNIT ADDRESS=010,CUTYPE=3505
RCTLUNIT ADDRESS=018,CUTYPE=3274
RCTLUNIT ADDRESS=030,CUTYPE=3705,FEATURE=48-DEVICE
RCTLUNIT ADDRESS=080,CUTYPE=2955
RCTLUNIT ADDRESS=0B0,CUTYPE=3705
RCTLUNIT ADDRESS=180,CUTYPE=3803
RCTLUNIT ADDRESS=190,CUTYPE=3803
RCTLUNIT ADDRESS=200,CUTYPE=3830,FEATURE=64-DEVICE
RCTLUNIT ADDRESS=240,CUTYPE=3830
RCTLUNIT ADDRESS=2A0,CUTYPE=3851
RCTLUNIT ADDRESS=2D0,CUTYPE=2835
RCTLUNIT ADDRESS=330,CUTYPE=3830
RCTLUNIT ADDRESS=340,CUTYPE=3830
RCTLUNIT ADDRESS=350,CUTYPE=3830,FEATURE=16-DEVICE,ALTCH=4
RCTLUNIT ADDRESS=3D0,CUTYPE=CTCA
RCTLUNIT ADDRESS=400,CUTYPE=3830,FEATURE=64-DEVICE
RCTLUNIT ADDRESS=440,CUTYPE=3880,FEATURE=16-DEVICE
RCTLUNIT ADDRESS=4A0,CUTYPE=3851
RCHANNEL ADDRESS=0,CHTYPE=MULTI PLEXOR
RCHANNEL ADDRESS=1,CHTYPE=SELECTOR
RCHANNEL ADDRESS=2,CHTYPE=BLKMPXR
RCHANNEL ADDRESS=3,CHTYPE=BLKMPXR
RCHANNEL ADDRESS=4,CHTYPE=BLKMPXR
RIOGEN CONS=01F,ALTCONS=018
END
DMK00010
DMK00020
DMK00030
DMK00040
DMK00050
DMK00060
DMK00070
DMK00080
DMK00090
DMK00100
DMK00110
DMK00120
DMK00130
DMK00140
DMK00150
DMK00160
DMK00170
DMK00180
DMK00190
DMK00200
DMK00210
DMK00220
DMK00230
DMK00240
DMK00250
DMK00260
DMK00270
DMK00280
DMK00290
DMK00300
DMK00310
DMK00320
DMK00330
DMK00340
DMK00350
DMK00360
DMK00370
DMK00380
DMK00390
DMK00400
DMK00410
DMK00420
DMK00430
DMK00440
DMK00450
DMK00460
DMK00470
DMK00480
DMK00490
DMK00500
DMK00510
DMK00520
DMK00530
DMK00540
DMK00550
DMK00560
DMK00570
DMK00580
```

Figure B-4. DMKRIO File for VM/SP and VM/SP HPO System Generation

FILE: HCPRIO ASSEMBLE A1

```
RIO TITLE 'SAMPLE HCPRIO ASSEMBLE FILE'
RDEVICE DEVNO=002,DEVTYPE=3211,CLASS=(X,A),FEATURE=UNVCHSET
RDEVICE DEVNO=00C,DEVTYPE=2540R
RDEVICE DEVNO=00D,DEVTYPE=2540P,CLASS=(X,A)
RDEVICE DEVNO=00E,DEVTYPE=1403,CLASS=(X,A),FEATURE=UNVCHSET
RDEVICE DEVNO=00F,DEVTYPE=1403,CLASS=(S),FEATURE=UNVCHSET
RDEVICE DEVNO=012,DEVTYPE=3505
RDEVICE DEVNO=013,DEVTYPE=3525,CLASS=(X,A)
RDEVICE DEVNO=(018,7),DEVTYPE=3279,MODEL=3
* VM/XA MIGRATION AID DOES NOT SUPPORT 3215
* THE PRIMARY CONSOLE WILL BE A 3279 INSTEAD
*
RDEVICE DEVNO=01F,DEVTYPE=3215
RDEVICE DEVNO=(030,16),DEVTYPE=3705,ADAPTER=BSCA,BASEADD=0B0
RDEVICE DEVNO=(040,16),DEVTYPE=3705,ADAPTER=IBM1,BASEADD=0B0
RDEVICE DEVNO=(050,16),DEVTYPE=3705,ADAPTER=TELE2,BASEADD=0B0
* VM/XA MIGRATION AID DOES NOT SUPPORT 2955
*
RDEVICE DEVNO=080,DEVTYPE=2955
RDEVICE DEVNO=0B0,DEVTYPE=3705,ADAPTER=TYPE4,
MODEL=F4,CPNAME=E
RDEVICE DEVNO=(180,2),DEVTYPE=3420,FEATURE=DUALDENS,MODEL=7
RDEVICE DEVNO=190,DEVTYPE=3420,FEATURE=DUALDENS,MODEL=8
* DEVICES 200, 201, 208, 209 ALLOW ACCESS TO MSC TABLES
RDEVICE DEVNO=(200,2),DEVTYPE=3330,MODEL=1
RDEVICE DEVNO=(208,2),DEVTYPE=3330,MODEL=1
RDEVICE DEVNO=(210,48),DEVTYPE=3330,FEATURE=VUA
RDEVICE DEVNO=(240,8),DEVTYPE=3350
RDEVICE DEVNO=2A0,DEVTYPE=3851
RDEVICE DEVNO=2D0,DEVTYPE=2305,MODEL=2
RDEVICE DEVNO=(330,8),DEVTYPE=3330,MODEL=1
RDEVICE DEVNO=(350,8),DEVTYPE=3330,MODEL=1
RDEVICE DEVNO=(358,2),DEVTYPE=3330,MODEL=11
RDEVICE DEVNO=3D0,DEVTYPE=CTCA
RDEVICE DEVNO=(410,48),DEVTYPE=3330,FEATURE=VUA
RDEVICE DEVNO=(440,16),DEVTYPE=3380
RDEVICE DEVNO=4A0,DEVTYPE=3851
* THE PRIMARY CONSOLE IS A 3279-3, NOT A 3215
RIOGEN CONS=018,ALTCONS=019
END
```

HCP00010
HCP00020
HCP00030
HCP00040
HCP00050
HCP00060
HCP00070
HCP00080
HCP00090
HCP00100
HCP00110
HCP00120
HCP00130
HCP00140
HCP00150
HCP00160
HCP00170
XHCP00180
HCP00190
HCP00200
HCP00210
HCP00220
HCP00230
HCP00240
HCP00250
HCP00260
HCP00270
HCP00280
HCP00290
HCP00300
HCP00310
HCP00320
HCP00330
HCP00340
HCP00350
HCP00360
HCP00370
HCP00380

Figure B-5. HCPRIO File for VM/XA Systems Facility



Appendix C. Characteristics of the I/O Interface Timeout Function

On the processor complex, each channel path has an eight-second I/O interface timeout function that times the control unit delays in completing I/O tag sequences and delays that occur between dependent tag sequences. For additional information about these tag sequences, see *IBM System/360 and System/370 I/O Interface Channel to Control Unit Original Equipment Manufacturer's Information*, GA22-6974.

Malfunctions in control units and I/O devices can cause a channel path to be unusable to other control units and I/O devices. The timeout function detects these malfunctions.

When the timeout function is active, any control unit delay in completing an I/O tag sequence that exceeds eight seconds or a delay between one sequence and the next dependent sequence that exceeds eight seconds results in the channel terminating the I/O request to the control unit and generating an interface-control-check interruption. For example, the timeout function times the delay between two tag sequences used to transfer data between the channel and the control unit.

When the timeout function is inactive (timeout is inhibited), control unit delays are not timed and the channel unconditionally waits until the control unit completes the sequence or initiates the next tag sequence. If the control unit fails to complete a sequence because of a malfunction, the channel path remains active to the control unit. In this case, the channel path is unusable for I/O requests to other control units until the failing control unit drops all in-tags (except metering-in and request-in) or the channel path is reset.

You specify whether the timeout function is to be active or inactive with the TIMEOUT parameter, which you specify on the IODEVICE macro instruction or the add or alter I/O device screen.

Note: The TIMEOUT parameter has no effect on delays between channel end and device end status presentations when the channel is operating in 370 selector mode. The I/O interface timeout function is always inactive during that time.

The channel times I/O requests as follows:

- If TIMEOUT = Y is specified, the I/O interface timeout function is active and the channel times all I/O tag sequences and delays between dependent tag sequences that are initiated by either the channel or the control unit. Some examples are: the initial selection sequence resulting from an SIO or SIOF instruction, a request-in tag sequence initiated by the control unit to reconnect to the I/O interface, and delays between data transfer tag sequences.

- If TIMEOUT=N is specified, the I/O interface timeout function is inactive (timeout is inhibited) for:
 - Data transfer tag sequences
 - Delays between data transfer tag sequences
 - Non-reconnect ending status tag sequences
 - Initial selection sequences due to non-reconnect command chaining

When the timeout function is inactive, these delays are not timed and the channel waits until the I/O device completes the tag sequence or initiates the next dependent sequence.

When TIMEOUT=N is specified, the I/O interface timeout function is still active for:

- Selection sequences initiated by the control unit
- Initial selection sequences for the first command after reconnect command chaining
- Any initial selection sequence (such as the SIO, RIO, or TIO instructions) when the device is not connected

Some examples showing when the timeout function is inactive if TIMEOUT=N is specified are:

Example A. Channel initiated sequence (e.g. SIO)

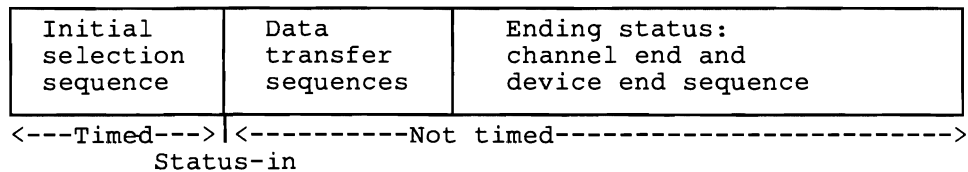

Example B. Command chaining control unit initiated reconnection sequence

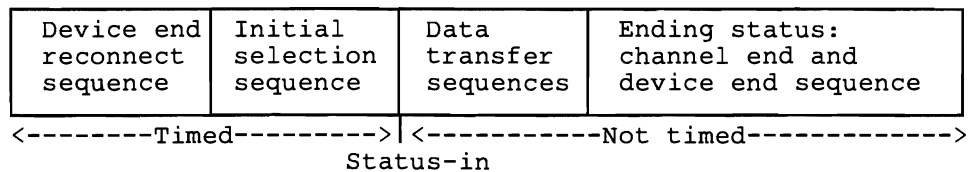

Example C. Split channel end and device end sequence

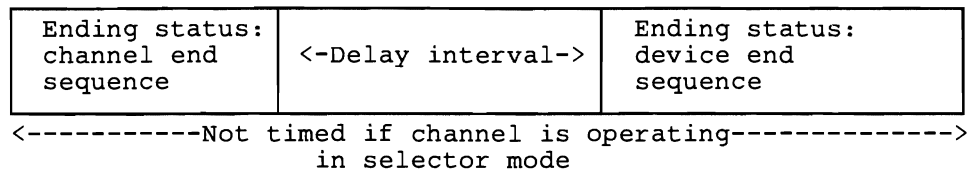

When a timeout condition is detected, the channel terminates the I/O request to the control unit by issuing a selective reset to the control unit and then generating

an interface-control-check interruption. In 370 mode, if the control unit fails to respond to the selective reset and does not drop all in-tags (except metering-in and request-in) to the I/O interface within 16 microseconds, the limited channel logout that accompanies the interface-control-check indicates an interface-inoperative condition. In 370-XA mode, a channel report word (CRW) is made pending which indicates a channel-path-terminal condition.

If `TIMEOUT = N` is specified then detection of a timeout condition as a result of an interface associated malfunction may not occur (see the beginning of this appendix for a description of sequences which are not timed when `TIMEOUT = N` is specified.) Failure to detect and recover this condition may make various resources unavailable to the control program. If continued operation is dependent on the availability of these resources, system degradation may be experienced until those resources are recovered. Recovery may occur as a consequence of detecting a secondary error the 308X may develop from failing to detect the timeout condition. Generally, this will not occur and recovery of the resources will require operator intervention. For these reasons `TIMEOUT = N` should be coded only when you decide there is a real need which justifies the exposure.

Timeout Considerations

Some control units and I/O devices have valid operational conditions that exceed the eight-second timeout function limit. If timeout is active when such a condition occurs, the channel terminates the I/O request and generates an interface-control-check interruption, even though no malfunction exists. For example:

- A timeout might occur during a read operation to a tape unit if the tape being read is blank. While the tape unit searches for a data byte or the end-of-tape mark, it might exceed the eight-second timeout function limit.
- A channel-to-channel adapter between two systems might time out if one system attempts to communicate with the other system while the other system is in a stopped state.

Thus, when timeout is active, the channel might terminate an I/O request and generate an interface-control-check interruption even though no control unit or I/O device malfunction has occurred.

Note: For a device that can exceed eight seconds with valid operational conditions, inhibit the timeout function by specifying `TIMEOUT = N` on the `IODEVICE` macro instruction. For other IBM I/O devices, it is recommended that you specify or use the default `TIMEOUT = Y`. However, you may chose to specify `TIMEOUT = N`.

Appendix D. List of I/O Devices and Control Units

For the processor complex, Figure D-1 provides a list of I/O devices and shows the keyword values you specify for the UNIT, MODEL, and TIMEOUT keywords on the IODEVICE macro instruction. Also, the figure lists the control units that attach the I/O devices and shows the keyword values you specify for the UNIT, SHARED, and PROTOCL keywords on the CNTLUNIT macro instruction. Notes, which are referenced in the list of devices and control units, contain additional information for specific I/O devices and control units.

See “Specifying IOCP Macro Instructions” in Chapter 2 (MVS) or Chapter 3 (VM) for a full description of the IODEVICE and CNTLUNIT macro instructions and the meanings of the keyword values shown in Figure D-1.

If you are coding the IODEVICE macro instruction for use with an MVS system generation, see *OS/VS2 System Programming Library: System Generation Reference* or *MVS/Extended Architecture System Generation Reference* for a full description of the non-IOCP parameters on the IODEVICE macro instruction. You should also refer to this book for the correct keyword value for the UNIT keyword when you are using a common deck.

See *IBM System/370 Input/Output Configurator* for information about the attachment of I/O equipment used in System/370.

General Notes:

1. Devices that are supported by IOCP are not necessarily supported by your operating system.
2. On processor complex (such as the 3084 Processor Complex) that you have partitioned, if a control unit is attached to multiple channel paths and the channel paths are divided between the A side and the B side, the “MULTITAG” switch (if the control unit has one) must be set to the on position.
3. If you use the UNITADD keyword on the IODEVICE macro instruction, you must follow the same rules and restrictions that apply to the second and third digits of the ADDRESS parameter.
4. If you specify the UNITADD parameter on the IODEVICE macro instruction, then the second and third digits of the ADDRESS parameter can be different from the device’s physical unit address (except for the 3344, 3330V, 3350P, and 3351P direct access devices) if you follow these rules:
 - All device rules for addressing must be followed.

- For magnetic tapes and local display devices, all device numbers on a control unit must be consecutive and the lowest device number must be modulo¹ to the number of devices that can be attached to the control unit.
- For direct access devices:
 - Device numbers on a string must be consecutive (except for the 3344).
 - The lowest device number on a string of 3330s (and 3350s in emulation mode) must be modulo¹ to the maximum string size.

IODEVICE Macro Instruction				CNTLUNIT Macro Instruction				
UNIT=	MODEL=	TIMEOUT=	Notes	UNIT=	Model	SHARED=	PROTOCL=	Notes
<u>Direct Access Devices</u>								
2305	2	Y	1	2835	2	N	D	2
3330	1,2,11	Y	3,4	3830	2	N	D	
				3880	1,2,11	N	D/S	5,6
3330V	-	Y	8	3830	3	N	D	8
3350V	-	Y	8,8a	3830	3	N	D	8
3333	1,11	Y	7	3830	2	N	D	
				3880	1,2,11	N	D/S	5,6
3340	-	Y	4,9	3830	2	N	D	
				3880	1,2	N	D/S	5,6
3344	-	Y	9,10	3830	2	N	D	
				3880	1,2	N	D/S	5,6
3350	-	Y	4,9,11	3830	2	N	D	
				3880	1,2,11	N	D/S	5,6
3350P	-	Y	4,9,11	3880	11	N	D/S	5,6,12
3351P	-	Y	4,14	3880	21	N	D/S	5,6,15
3375	-	Y	9	3880	1,2	N	D/S	5,6
3380	-	Y	9	3880	2,3	N	D	5,6,13
				3880	2,3	N	S	5,6
				3880	13	N	S	5
				3880	23	N	S	5

Figure D-1 (Part 1 of 6). IOCP Parameter Values for IODEVICE and CNTLUNIT Macro Instructions

¹ Modulo means that the device number must be evenly divisible by the number of devices in hexadecimal. For example, if there are 16 (10 in hex) devices, the last digit of the device number must be 0. If there are 4 devices, the last digit must be 0, 4, 8, or C.

NOTES:

1. For the 2305, specify ADDRESS=(aaa,8). IOCP unconditionally assigns eight addresses for the device.
2. For the 2835, specify UNITADD=((aa,n)), where n=8 or 16 depending on the number of 2305 unit addresses required.
- 3.* Specify the 3330 Model 2 as MODEL=1. (Note that the 3330 attaches to the 3830 via the 3333.)
- 4.* On the ADDRESS parameter, if you do not specify the number of sequential device addresses to be assigned, a default of 2 is used. For the 3350P or 3351P, IOCP unconditionally assigns two base addresses if the user specifies none or 1. For the 3351P, IOCP unconditionally assigns four base addresses if the user specifies 3.
5. For the 3880, one CNTLUNIT macro instruction must be specified for each 3880 Storage Director.
6. Each channel path attaching to the 3880 Model 1, 2, 3, or 11 can operate independently in either data streaming mode or offset interlock mode. The 3880 has eight channel speed control switches for setting the mode of operation. Regardless of the device types attached to the 3880, it is recommended that the user: (a) set all 3880 channel speed control switches for channel paths attached to the processor complex to data streaming mode; (b) specify PROTOCL=S on the CNTLUNIT macro instructions for each 3880 storage director. These actions allow the maximum data transfer rates and the use of longer cable lengths.

The processor complex requires all control units attaching a common device to the processor complex to use the same interface protocol. Therefore, when both a 3880 and a 3830 attach a common device to the processor complex, the user must specify PROTOCL=D on both (a) the CNTLUNIT macro instruction for the 3830 storage director, and (b) the CNTLUNIT macro instruction(s) for the attached 3880 storage director(s). In this case, you must set the 3880 channel speed control switches for the channel paths that attach the 3880 storage director(s) to the non-data streaming mode.
- 7.* Specify the 3333 as UNIT=3330.
8. For the 3330V (virtual volume for MSS), you must also specify the 3851 on an IODEVICE macro instruction. See the entry for 3851 under "Control Units."
- 8a.* For virtual volumes for MSS using 3350 devices as staging devices, specify UNIT=3330V.
- 9.* Do not specify the MODEL parameter if the IODEVICE macro instruction is to be used as input to MVS system generation.
- 10.* Specify the 3344 as UNIT=3340.
11. Specify UNIT=3350P for each 3350 that is attached to the paging storage director of a 3880 Model 11. For each 3350P, IOCP defines four device addresses. IOCP takes the base address from the ADDRESS parameter. IOCP forms three additional addresses by adding the decimal values 8, 16, and 24 to the base address.

The base address (xyz) must be specified correctly. Bits 3 and 4 of the binary value of the byte representing the last two digits of the base address must be zeroes. (The binary value of the base address xyz must be of the form "nnnn nnn0 0nnn.") Thus, y must be an even hexadecimal digit (0, 2, 4, 6, 8, A, C, or E) and z must be in the range of 0 through 7.

Specify UNIT=3350 for each 3350 that is attached to the non-paging storage director of a 3880 Model 11, to a 3880 Model 1 or 2, or to a 3830.
12. Specify the paging storage director of a 3880 Model 11 as UNIT=3880P. Also, specify UNITADD=((aa,32)). Bits 3 through 7 of the binary value of the byte representing aa must be zeroes.

Specify the non-paging storage director of a 3880 Model 11 as UNIT=3880.
13. The 3880 Speed Matching Buffer feature is required.
14. Specify UNIT=3351P for each 3350 that is attached to the paging storage director of a 3880 Model 21. For each 3351P, IOCP defines four device addresses. IOCP takes the base address from the ADDRESS parameter. IOCP forms three additional addresses by adding the decimal values 4, 8, and 12 to the base address.

The base address (xyz) must be specified correctly. Bits 4 and 5 of the binary value of the byte representing the last two digits of the base address must be zeroes. (The binary value of the base address xyz must be of the form "nnnn nnnn 00nn.") Thus z must be in the range of 0 through 3.
15. Specify the paging storage director of a 3880 Model 21 as UNIT=3880P. Also, specify UNITADD=((aa,16)). Bits 4 through 7 of the binary value of the byte representing aa must be zeroes.

*Indicates that the note applies only when you are specifying the IODEVICE macro instruction for use with an MVS system generation, where the input deck contains both MVS system generation macro instructions and IOCP macro instructions.

Figure D-1 (Part 2 of 6). IOCP Parameter Values for IODEVICE and CNTLUNIT Macro Instructions

IODEVICE Macro Instruction				CNTLUNIT Macro Instruction				
UNIT=	MODEL=	TIMEOUT=	Notes	UNIT=	Model	SHARED=	PROTOCL=	Notes
<u>Display Devices</u>								
2250	3	Y	-	2840	2	Y	D	-
3250	-	Y	16	3258	-	YB	D	-
3262	3,13	Y	17	3272	1,2	N,YB	D	18
				3274	1A,21A, 31A,1B, 21B,1D, 21D,31D	N,YB	D	19
3277	1,2	Y	-	3272	1,2	N,YB	D	18
				3274	1A,21A, 31A,1B, 21B,1D, 21D,31D	N,YB	D	19
3278	-	Y	-	3272	1,2	N,YB	D	18
				3274	1A,21A, 31A,1B, 21B,1D, 21D,31D	N,YB	D	19
3279	2A,2B, 3A,3B	Y	-	3274	1A,21A, 31A,1B, 21B,1D, 21D,31D	N,YB	D	19
3284	1,2	Y		3272	1,2	N,YB	D	18
				3274	1A,21A, 31A,1B, 21B,1D, 21D,31D	N,YB	D	19
3286	1,2	Y		3272	1,2	N,YB	D	18
				3274	1A,21A, 31A,1B, 21B,1D, 21D,31D	N,YB	D	19
3287	1,1C, 2,2C	Y	17,20	3272	1,2	N,YB	D	18
				3274	1A,21A, 31A,1B, 21B,1D, 21D,31D	N,YB	D	19
3288	2	Y	17	3272	1,2	N,YB	D	18
				3274	1A,21A, 31A,1B, 21B,1D, 21D,31D	N,YB	D	19
3289	1,2	Y	17	3272	1,2	N,YB	D	18
				3274	1A,21A, 31A,1B, 21B,1D, 21D,31D	N,YB	D	19

Figure D-1 (Part 3 of 6). IOCP Parameter Values for IODEVICE and CNTLUNIT Macro Instructions

NOTES:

- 16.* Specify the 3250 as UNIT = 2250,MODEL = 3.
- 17.* Specify the 3262, 3287, 3288, and 3289 as UNIT = 3284 or UNIT = 3286. If the 3287, 3288, or 3289 will be used as an MVS/XA operator's console, specify UNIT = 3286,MODEL = 2.
18. For a 3272 attached to a block multiplexer channel path, the recommended specification is SHARED = YB if multiple devices are attached to the control unit. SHARED = N is required if a 3272 is attached to a byte multiplexer channel path.

If SHARED = N is specified and multiple devices are attached to the control unit, special error recovery program (ERP) processing is required for possible zero sense data. (See *IBM 3271 Control Unit, 3272 Control Unit, 3275 Display Station Description and Programmer's Guide, GA23-0060.*) Also, this increases the possibility of additional overhead in the control program resulting from deferred condition code 1 I/O interruptions. If a single device is attached to the control unit, SHARED = N can be specified without special ERP support and without increasing the overhead in the control program for interruption processing.
19. For a 3274 attached to a block multiplexer channel path, the recommended specification is SHARED = YB if multiple devices are attached to the control unit. If necessary, you can specify SHARED = N when multiple devices are attached to the control unit. (For 370 mode, specify SHARED = N for the control unit that interfaces with the master and alternate consoles.) However, specifying SHARED = N increases the possibility of additional overhead in the control program resulting from deferred condition code 1 I/O interruptions.

If a single device is attached to the control unit (as is always the case for the 3274 Model 1A), SHARED = N can be specified and does not increase the overhead in the control program for interruption processing.
- 20.* Specify the Model 1C as Model 1; Model 2C, as Model 2.

*Indicates that the note applies only when you are specifying the IODEVICE macro instruction for use with an MVS system generation, where the input deck contains both MVS system generation macro instructions and IOCP macro instructions.

Figure D-1 (Part 4 of 6). IOCP Parameter Values for IODEVICE and CNTLUNIT Macro Instructions

IODEVICE Macro Instruction				CNTLUNIT Macro Instruction				
UNIT=	MODEL=	TIMEOUT=	Notes	UNIT=	Model	SHARED=	PROTOCL=	Notes
<u>Magnetic Tapes</u>								
3420	3,4,5, 6,7,8	Y	21	3803	1,2	Y	D	21
3480	-	Y	-	3480	-	N	S	-
<u>Magnetic Ink Character Readers</u>								
3890	A,B	Y	-	3890	A,B	N	D	-
<u>Unit Record Devices</u>								
1403	N1,N2, N7	Y	-	2821	1,2,3,5	N	D	-
2501	B1,B2	Y	-	2501	B1,B2	N	D	-
2540	1	Y	22	2821	1,4,5,6	N	D	-
3203	5	Y	23	3203	4	N	D	-
3211	-	Y	24	3811	1	N	D	-
3505	-	Y	24	3505	B1,B2	N	D	-
3525	-	Y	24	3505	B1,B2	N	D	-
3540	-	Y	24	3540	B1,B2	N	D	-
3800	-	Y	25,34,	3800	1,2,3	N	D	-
4245	-	Y	-	4245	-	N	D	-
4248	-	Y	-	4248	-	N	D	-
<u>Control Units</u>								
3851	-	Y	24,28	3851	all	N	D	28
<u>Others</u>								
CTC	-	Y	29	CTC	-	N	D	-
3088	-	Y	32	3088	1,2	N	D/S	33
3838	-	Y	24,26	3838	1,2,3	N	D/S	27
3848	-	Y	24	3848	1	N	D/S	-
Series/1	-	Y	-	Series/1	-	N	D	-
<u>Telecommunications</u>								
uuuuu	-	Y	30	2701	1	N	D	-
3704	-	Y	24	3704	all	N	D	-
uuuuu	-	Y	31	3704	all	N	D	-
3705	-	Y	24	3705	all	N	D	-
uuuuu	-	Y	31	3705	all	N	D	-
3725	-	Y	24	3725	-	N	D	-
uuuuu	-	Y	31	3725	-	N	D	-
3791L	-	Y	24	3791L	1,2	N	D	-
<u>Graphics System</u>								
5081	-	Y	35	5088	-	N	D/S	36

Figure D-1 (Part 5 of 6). IOCP Parameter Values for IODEVICE and CNTLUNIT Macro Instructions

NOTES:

21. If the magnetic tape subsystem contains 2 to 4 control units that access the same group of magnetic tape units, define each control unit separately. Each of the control units must have a different channel path identifier, but all of the control units should specify the same address range. Specify on the IODEVICE macro instruction that the tape units are attached to all of the control units. (The tape units may actually be only logically attached, but they are specified as though they are physically attached.)
- 22.* Specify the 2540 with two IODEVICE macro instructions: one with UNIT=2540R, the other with UNIT=2540P.
- 23.* For the 3203, only the Model 5 is supported, but you specify the Model 5 as MODEL=4.
- 24.* Do not specify the MODEL parameter if the IODEVICE macro instruction is to be used as input to MVS system generation.
25. Specify TIMEOUT=Y when IBM-supplied programs are used with the 3800. Non-IBM programs might require TIMEOUT=N for the 3800 because I/O requests might require more than eight seconds to complete.
26. For the 3838, specify ADDRESS=(aa0,8). The last digit of the unit address must be 0; and IOCP unconditionally assigns eight unit addresses to the device.
27. For the 3838, specify UNITADD=((a0,8)). (Note 24 contains related information.)
28. For the 3330V (virtual volume for MSS), you must also specify the 3851 on an IODEVICE macro instruction. See the entry for 3851 under "Control Units."
29. For the channel-to-channel adapter (CTC), you may choose to specify TIMEOUT=N because I/O sequences on the CTC might require more than eight seconds to complete. Because TIMEOUT=N, the CTC cannot be attached to a byte multiplexer channel path.
- 30.* On the UNIT parameter, you can specify any device or line that is attached to the 2701.
- 31.* On the UNIT parameter, you can specify any device or line that is attached to the 3704,3705 and 3725.. (This applies only to EP mode and byte multiplexer mode.)
32. For a 3088, specify ADDRESS=(aa0,n), where n = 32 or 64 depending on the number of unit addresses required.
33. For a 3088, specify UNITADD=(a0,n), where n = 32 or 64 depending on the number of unit addresses required. Note 32 contains related information.
34. Attach the 3800 to a block multiplexer channel (TYPE=BL) for optimum system performance.
35. If you are using one combined input deck, the UNIT parameter must be respecified. When you are using the 5081 in a 3250-compatibility mode (for example when attached to a 3258), specify the 5081 as UNIT=2250, MODEL=3. When you are using the 5081 in full function mode, specify the 5081 as UNIT=HFGD. (For more information, see Graphics Access Method/System Product: Initialization, Resource Definition, and Customization, SC33-0141-0.)
36. The 5088 device can run in either D.C. interlock protocol or data streaming protocol, depending on the channel. Ensure that the interface protocol specified matches the protocol specified in the 5088.

*Indicates that the note applies only when you are specifying the IODEVICE macro instruction for use with an MVS system generation, where the input deck contains both MVS system generation macro instructions and IOCP macro instructions.

Figure D-1 (Part 6 of 6). IOCP Parameter Values for IODEVICE and CNTLUNIT Macro Instructions



Glossary

The following terms are defined as they are used in this book. If you do not find the term you are looking for, refer to the Index or to the *Vocabulary for Data Processing, Telecommunications, and Office Systems*, GC20-1699.

channel path. A connection between a processor and control unit along which signals and data can be sent to perform I/O requests. Analogous to channel.

channel set. A collection of channels that can be addressed by one of the processors of a processor complex.

data streaming. The I/O interface protocol that operates at the rate governed by the control unit. This protocol does not require the demand response. (See D. C. interlock.)

D. C. interlock. The I/O interface protocol that is the standard I/O interface and requires a demand response.

device address. Three hexadecimal digits that uniquely identify an I/O device in 370 mode.

device number. Three hexadecimal digits that uniquely identify an I/O device in 370-XA mode.

I/O configuration. The collection of channel paths, control units, and I/O devices that attaches to the processor complex.

I/O engine. An integrated unit of hardware (consisting of one channel processing element, one to three data server elements, and 8, 16, or 24 interface adapter elements) that performs the I/O operations to all attached I/O devices. Note: There are two I/O engines in a 3084 Processor Complex.

input/output configuration data set (IOCDS). The data set, located in the processor controller file, that contains the I/O configuration definition.

input/output configuration program (IOCP). An IBM-supplied program that creates the I/O configuration definition (IOCDS) based on user-defined input.

IOCDS. Input/output configuration data set.

IOCP. Input/output configuration program.

logical control unit. A logical representation of (1) a control unit that does not share devices, or (2) two to four control units that do share devices.

uniprocessor. A processor complex that physically contains only one processor.

unit address. The last two digits of a device address or a device number.



Index

*

* IOCP comment card 2-2, 2-24, 3-2, A-1

** keyword value

on PATH parameter 2-7

*** keyword value

on CUNUMBR parameter 2-19

A

A keyword value

on REPORT option 2-29

A side

See side A

AB keyword value

on REPORT option 2-29

ABx keyword value

on WRTCDS option 2-26

add channel path menu 4-14

add control unit menu 4-17

add I/O device menu 4-20

ADD screen command 4-6

add selection menu 4-10

ADD=value screen command 4-6

ADDRESS keyword

on IODEVICE macro instruction 2-17, 3-18

alter channel path menu 4-15

alter control unit menu 4-18

alter I/O device menu 4-21

ALTER screen command 4-6

alter selection menu 4-11

ALTER=value screen command 4-6

authorized IOCP program 2-31, 2-32, 2-33

Ax keyword value

on REPORT option 2-29

on WRTCDS option 2-26

B

B keyword value

on REPORT option 2-29

B side

See side B

BL keyword value 2-8, 3-9

block multiplexer channel 2-8, 3-9

BOTH keyword value

on REPORT option 2-29

BOTHRPT option on IOCP command 3-33

build IOCDS from cards menu 4-22

burst mode 2-8, 3-9

Bx keyword value

on REPORT option 2-29

on WRTCDS option 2-26

BY keyword value 2-8, 3-9

byte multiplexer channel 2-8, 3-9

byte-interleave mode 2-8, 3-9

C

card-image input

introduction 1-4

IOCP macro instructions 2-1

CD0 keyword value

on REPORT option 2-29

CD0RPT option on IOCP command 3-33

CD1 keyword value

on REPORT option 2-29

CD1RPT option on IOCP command 3-33

CE 1-6, 2-32, 3-45, 4-31

CHANNEL macro instruction 1-18, 2-6

channel number 2-7, 3-7

channel path display 4-13

channel path selection

for 370-XA mode 1-13

on a 3084 Processor Complex 1-14

preferred path 1-13

rotation algorithm 1-14

channel paths

add menu 4-14

alter menu 4-15

configuration report 5-5, 5-14

corresponding side (A or B) 1-1

delete menu 4-12

display menu 4-13

introduction 1-1

specifying on CHPID macro instruction 2-6, 3-7

summary of restrictions 2-4, 3-5

channel set 2-7, 3-8

channel set switching 2-8, 3-9

channel subsystem 1-1

CHPID macro instruction

correspondence with DMKRIO file 3-3

correspondence with HCPRIO file 3-4

description 2-6, 3-7

examples 2-9, 3-9

for 370-XA mode 1-6

format 2-6, 3-7

introduction 1-4

with MVS system generation 1-18

chpid number 2-6, 3-7

CMS/DOS 3-36

CNTLUNIT macro instruction

correspondence with DMKRIO file 3-3

correspondence with HCPRIO file 3-4

description 2-10, 3-10

examples 2-14, 3-15

format 2-10, 3-10

introduction 1-4

keyword values D-1

- logical control units 2-10, 3-10
- with MVS system generation 1-19
- codes
 - return 2-30, 3-44
 - wait state 4-39
- command = value form of screen command 4-6
- commands, screen 4-6
- comment cards, IOCP 2-2, 2-24, 3-2, A-1
- compatibility considerations 1-7
- configuration data
 - initially defining 2-31, 3-45
 - introduction 1-1
 - specifying 1-4
 - subsequently defining 2-32, 3-46
 - updating 2-32, 3-46, 4-33
- configuration reports
 - conditions for producing 5-2
 - description 5-1
 - examples 5-5, 5-8, 5-11, 5-14
 - heading, ID macro instruction 2-15, 3-16
 - JCL example 2-28
 - menu screen 4-24
 - producing 2-1, 2-28, 3-27, 3-29
- console
 - See system console or service support console
- control unit display menu 4-16
- control unit types 1-17
- control units
 - add menu 4-17
 - alter menu 4-18
 - delete menu 4-12
 - display menu 4-16
 - introduction 1-1
 - specifying on CNTLUNIT macro instruction 2-10, 3-10, D-1
 - specifying on IODEVICE macro instruction D-1
 - on CUNUMBR keyword 3-19
 - on CUNUMBR parameter 2-18
 - summary of restrictions 2-4, 3-5
 - types 1-17
- CUNUMBR keyword
 - on CNTLUNIT macro instruction 2-11, 3-11
 - on IODEVICE macro instruction 2-18, 3-19
- customer engineer
 - See CE
- customer name for the IOCDS 2-15, 3-16, 4-29

D

- D keyword value
 - on PROTOCL keyword 2-11, 3-11
- D. C. interlock protocol
 - definition X-1
 - on PROTOCL = D parameter 2-11, 3-11
- data server element (DSE) 1-2, 1-3
- data streaming protocol
 - definition X-1
 - on PROTOCL = S parameter 2-11, 3-11
- DELETE screen command 4-6

- delete selection menu 4-12
- DEVCSA frame 5-2
- device address
 - definition X-1
- Device Configuration Frame 5-2
- device number
 - definition X-1
- DIAGNOSE X'80' 3-27
- DISK option on IOCP command 3-34
- display channel path menu 4-13
- display control unit menu 4-16
- display I/O device menu 4-19
- DISPLAY screen command 4-6
- display selection menu 4-9
- DISPLAY = value screen command 4-6
- DMKRIO file 3-3
- DMSICP module 3-27
- DSE (data server element) 1-2, 1-3
- dumping IOCP storage 4-37

E

- end IOCP menu 4-30
- END screen command 4-6
- executing IOCP
 - MVS version 1-18, 2-1
 - stand-alone version 1-23, 4-1
 - VM version 1-21, 3-1

F

- FILEDEF command 3-30
- fileid 3-30
- format of macro instructions
 - CHPID 2-6, 3-7
 - CNTLUNIT 2-10, 3-10
 - ID 2-15, 3-16
 - IODEVICE 2-17, 3-18
 - rules for coding A-1

G

- generating an IOCDS
 - MVS version 1-18, 2-23
 - JCL examples 2-27
 - stand-alone version 1-23, 4-31
 - VM version 1-21, 3-1
 - examples 3-42
 - VM/SP version 3-27
- generating an IOCDS on a new processor complex 4-31
- glossary of terms and abbreviations X-1

H

- HALT EXECUTION 3-39

HCPRIO file 3-4

I

I/O configuration

definition requirements 1-1

process 1-4

I/O device display menu 4-19

ID macro instruction

description 2-15, 3-16

example 2-15, 3-16

format 2-15, 3-16

introduction 1-4

on configuration reports 5-4

with MVS system generation 1-19

identification information

See ID macro instruction

ID1 =, ID2 = 2-15, 3-16, 5-4

IGNORE option

condition for coding 2-29

on build IOCDS from cards menu 4-22

on PARM parameter of EXEC statement 2-24

on the IOCP command 3-32

input to IOCP

introduction 1-4

IOCP macro instructions 2-1, 3-1

input/output configuration data set

See IOCDS

input/output configuration program

See IOCP

integrated processor controller file 4-1

See also processor controller

invoking stand-alone IOCP 4-3

I/O configuration data

channel path configuration for a non-3084 1-2

channel path configuration for a 3084 1-3

specifying 1-4, 2-1, 3-1

I/O configuration data set

See IOCDS

I/O devices

add menu 4-20

alter menu 4-21

configuration report 5-8

delete menu 4-12

display menu 4-19

introduction 1-1

specifying on IODEVICE macro instruction 2-16, 3-17, D-1

summary of restrictions 2-4, 3-5

I/O engine 1-2, 1-3

definition X-1

I/O interface timeout function C-1

See also TIMEOUT keyword

IOCDS

compatibility considerations 1-7

configuration reports 2-28, 3-27, 5-1

customer name 2-15, 3-16, 4-29

generating an IOCDS

MVS version 1-18, 2-23

stand-alone version 1-23, 4-22, 4-31

VM version 1-21, 3-1

VM/SP version 3-27, 3-42

initially defining 2-31, 3-45

levels 1-6

overview 1-4

read IOCDS from the processor controller file

menu 4-26

subsequently defining 2-32, 3-46

write IOCDS to the processor controller file 4-28

write-protecting 1-5

370-XA mode 1-7

IOCDSM frame 1-5, 2-15, 3-16

IOCP

card image input 1-4

CMS IOCP command 3-27

codes 2-30, 3-44, 4-39

comment card 2-2, 3-2

compatibility considerations 1-7

configuration reports 5-1

console input 1-4

dump function 4-37

executing the MVS version 2-1

executing the stand-alone version 4-1

executing the VM version 3-1

functions 2-23, 3-27

introduction 1-1

keyword values D-1

levels 1-6

macro instructions 2-1, 3-1

messages 6-1

MVS system generation 1-18

return codes 2-30, 3-44

specifying macro instructions 2-1, 3-1

version number on the reports 5-3

versions v, 1-18

wait state codes 4-39

370-XA mode 1-7

IOCP command 3-30

BOTHRPT option 3-33

CD0RPT option 3-33

CD1RPT option 3-33

DISK option 3-34

IGNORE option 3-32

LINECOUN option 3-34

NOIGNORE option 3-32

NOPRINT option 3-34

NOTERM option 3-35

NOWARN option 3-35

NOWRTCDS option 3-32

PRINT option 3-34

RPTA option 3-34

RPTAx option 3-33

RPTB option 3-34

RPTBx option 3-34

TERMINAL option 3-34

WARNING option 3-35

WRTAx option 3-33

WRTBx option 3-33

WRTCDS option 3-33

IODEVICE macro instruction, IOCP
 correspondence with DMKRIO file 3-3
 correspondence with HCPRIO file 3-4
 description 2-16, 3-17
 examples 2-21, 3-26
 format 2-17, 3-18
 introduction 1-4
 keyword values D-1
 with MVS system generation 1-19, 2-16
IODEVICE macro instruction, MVS system
 generation 1-19, 2-16

J

JCL statements (MVS version)
 generating an IOCDS 2-24
 introduction 1-18, 2-1
 producing configuration reports 2-28

K

keyword values
 on IODEVICE and CNTLUNIT macro
 instructions D-1

L

layout of menu screens 4-5
levels of the IOCDS 1-6
LINECOUN option on IOCP command 3-34
LINECOUNT option
 on PARM parameter of EXEC statement 2-27,
 2-29
logical control unit
 CNTLUNIT macro instruction 2-10, 3-10
 configuration report 5-11
 definition 1-8
 examples 1-10, 1-12
 introduction 1-8
 restrictions 1-9

M

macro instruction
 IOCP
 CHPID 2-6, 3-7
 CNTLUNIT 2-10, 3-10
 ID 2-15, 3-16
 IODEVICE 2-16, 3-17
 listing of input B-1
 MVS system generation
 CHANNEL 2-6
 IODEVICE 2-16
 rules for coding A-1
menu numbers (primary menu) 4-7
MENU screen command 4-6

menu screens
 add channel path 4-14
 add control unit 4-17
 add I/O device 4-20
 add selection 4-10
 alter channel path 4-15
 alter control unit 4-18
 alter I/O device 4-21
 alter selection 4-11
 build IOCDS from cards 4-22
 configuration reports 4-24
 delete selection 4-12
 display channel path 4-13
 display control unit 4-16
 display I/O devices 4-19
 display selection 4-9
 end IOCP 4-30
 layout of screens 4-5
 primary menu 4-7
 read IOCDS from the processor controller file 4-26
 service aid facility 4-24
 write IOCDS to the processor controller file 4-28

messages, IOCP

 DMSICP prefix 6-53
 ICP prefix 6-1

methods of executing IOCP

 MVS version 2-31
 stand-alone version 4-31
 VM version 3-45

MODEL keyword

 on IODEVICE macro instruction 2-19, 3-22

MSG1 keyword

 on ID macro instruction 2-15, 3-16

MSG2 keyword

 on ID macro instruction 2-15, 3-16

MVS System Generation 1-18

MVS version of IOCP

 executing 2-23
 JCL statements 2-24, 2-28
 methods of executing 2-31
 overview 1-18
 using 2-1

N

N keyword value

 on SHARED keyword 3-13
 on SHARED parameter 2-12
 on TIMEOUT keyword 3-23
 on TIMEOUT parameter 2-19

NO keyword value

 on IGNORE parameter 2-25
 on WRTCDs option 2-26

NOIGNORE option on IOCP command 3-32

NOPRINT option on IOCP command 3-34

NOTERM option on IOCP command 3-35

NOWARN option on IOCP command 3-35

NOWRTCDs option on IOCP command 3-32

O

OPTCHAN keyword
on IODEVICE macro instruction 2-17, 2-24

P

PARM options

generating an IOCDS 2-1
on EXEC statement 1-18, 2-1
producing configuration reports 2-28

PATH keyword

on CHPID macro instruction 2-6, 3-7
on CNTLUNIT macro instruction 2-11, 3-11
on IODEVICE macro instruction 2-19, 3-23

power-on reset 1-5, 1-20, 1-22, 1-24

preferred path

introduction 1-13
on IODEVICE macro instruction 2-19, 3-23

primary menu 4-7

print IOCDS configuration reports with Service Aid Facility 4-24

PRINT option on IOCP command 3-34

privilege class 3-38, 3-39

processor complex

channel path configuration 1-2, 1-3
definition v
side A 1-1
side B 1-1
3084 Processor Complex 1-1

processor controller

with MVS version of IOCP
generating an IOCDS 2-23, 2-27
overview 1-18
producing configuration reports 2-28
with stand-alone version of IOCP
executing IOCP 4-7
overview 1-23
with END command 4-30
with read IOCDS from the processor controller file menu 4-26
with write IOCDS to the processor controller file menu 4-28
with VM/SP version of IOCP
generating an IOCDS 3-42
overview 1-21
producing configuration reports 3-29

PROTOCL keyword

on CNTLUNIT macro instruction 2-11, 3-11

R

read IOCDS from the processor controller file menu 4-26

replacing an IOCDS by using card-image input 4-33

REPORT option

condition for coding 2-29
on PARM parameter of EXEC statement 2-28

reports

See configuration reports
RESHOW screen command 4-6
restarting IOCP 4-4
return codes 2-30, 3-44
rotation algorithm
examples 1-14
introduction 1-14
RPTA option on IOCP command 3-34
RPTAx option on IOCP command 3-33
RPTB option on IOCP command 3-34
RPTBx option on IOCP command 3-34
rules for coding macro instructions A-1

S

S keyword value

on PROTOCL keyword 2-11, 3-11
screen

See menu screen

screen commands 4-6

service aid facility 4-24

service support console

executing IOCP 4-1
input to IOCP 1-4
starting IOCP 1-23, 4-3

SHARED keyword

on CNTLUNIT macro instruction 2-11, 3-12

side A

definition 1-1

side B

definition 1-1

single processor mode 3-36, 3-48

specifying I/O configuration data 1-4

specifying IOCP macro instructions 2-1, 3-1

stand-alone version of IOCP

methods of executing 4-31
overview 1-23
using 4-1

starting and ending IOCP 4-3

steps IOCP performs to build an IOCDS 4-35

syntax of macro instructions

CHPID 2-6, 3-7
CNTLUNIT 2-10, 3-10
ID 2-15, 3-16
IODEVICE 2-16, 3-17
rules for coding A-1

SYSIML CLEAR 1-5, 1-20, 1-22, 1-24

SYSIN FILEDEF 3-30

SYSPRINT FILEDEF 3-30

system console

executing IOCP 1-4, 4-1
input to IOCP 1-4
starting IOCP 1-23, 4-3

system generation, MVS

combined input deck 2-3
macro instructions
CHANNEL 1-18, 2-6
IODEVICE 1-19, 2-16

- relationship to IOCP 1-18
- system generation, VM
 - macro instructions
 - RCHANNEL 3-3, 3-4
 - RCTLUNIT 3-3, 3-4
 - RDEVICE 3-3, 3-4
 - relationship to IOCP 1-21
 - system status indicators 4-5

T

- TERMINAL option on IOCP command 3-34
- timeout function C-1
- TIMEOUT keyword
 - on IODEVICE macro instruction 2-19, 3-23, C-1
- TYPE keyword
 - on CHPID macro instruction 2-8, 3-9

U

- uniprocessor
 - definition v, X-1
 - specifying channel set 2-7, 3-8
- unit address
 - definition X-1
- UNIT keyword
 - on CNTLUNIT macro instruction 2-13, 3-13
 - on IODEVICE macro instruction 2-20, 3-24
- UNITADD keyword
 - on CNTLUNIT macro instruction 2-13, 3-14
 - on IODEVICE macro instruction 2-20, 3-24

V

- versions of IOCP v, 1-18
- VM version of IOCP
 - CMS IOCP command 3-27
 - methods of executing 3-45
 - overview 1-21
 - using 3-1

W

- wait state codes 4-39
- WARNING option on IOCP command 3-35
- write IOCDS to the processor controller file menu 4-28
- WRITE screen command 4-6
- write-protecting 1-5, 2-25, 3-32, 4-28
- WRTAx option on IOCP command 3-33
- WRTBx option on IOCP command 3-33
- WRTCDS option
 - condition for coding 2-29
 - on PARM parameter of EXEC statement 2-25
- WRTCDS option on IOCP command 3-33

Y

- Y keyword value
 - on SHARED keyword 3-12
 - on SHARED parameter 2-11
 - on TIMEOUT keyword 3-23
 - on TIMEOUT parameter 2-19
- YB keyword value
 - on SHARED keyword 3-12
 - on SHARED parameter 2-12
- YES keyword value
 - on IGNORE parameter 2-24
 - on WRTCDS option 2-26

3

- 3084 Processor Complex
 - channel path configuration 1-3
 - channel path selection 1-14
 - processors and channel paths 1-1
- 370-XA mode 1-7
 - channel path selection 1-13, 1-14
 - on a 3084 Processor Complex 1-14
 - preferred path 1-13, 1-14
 - rotation algorithm 1-14
 - control unit types 1-17
 - input 1-7, 2-5, 3-6
 - logical control units 1-8





Printed in U.S.A.

Input/Output
Configuration
Program User's Guide
and Reference

GC28-1027-5

READER'S
COMMENT
FORM

This manual is part of a library that serves as a reference source for systems analysts, programmers, and operators of IBM systems. You may use this form to communicate your comments about this publication, its organization, or subject matter, with the understanding that IBM may use or distribute whatever information you supply in any way it believes appropriate without incurring any obligation to you.

Note: Copies of IBM publications are not stocked at the location to which this form is addressed. Please direct any requests for copies of publications, or for assistance in using your IBM system, to your IBM representative or to the IBM branch office serving your locality.

Possible topics for comment are:

Clarity Accuracy Completeness Organization Coding Retrieval Legibility

If you wish a reply, give your name, company, mailing address, and date:

What is your occupation? _____

How do you use this publication? _____

Number of latest Newsletter associated with this publication: _____

Thank you for your cooperation. No postage stamp necessary if mailed in the U.S.A. (Elsewhere, an IBM office or representative will be happy to forward your comments or you may mail directly to the address in the Edition Notice on the back of the title page.)

Note: Staples can cause problems with automated mail sorting equipment.
Please use pressure sensitive or other gummed tape to seal this form.

Cut or Fold Along Line

Reader's Comment Form

Cut or Fold Along Line

Fold and tape

Please Do Not Staple

Fold and tape



NO POSTAGE
NECESSARY
IF MAILED
IN THE
UNITED STATES

BUSINESS REPLY MAIL
FIRST CLASS PERMIT NO. 40 ARMONK, N.Y.

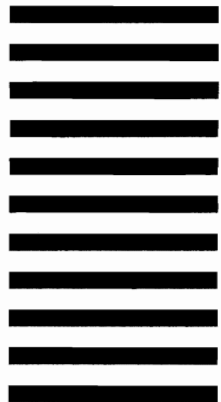

POSTAGE WILL BE PAID BY ADDRESSEE

International Business Machines Corporation
Department D58, Building 921-2
PO Box 390
Poughkeepsie, New York 12602

Fold and tape

Please Do Not Staple

Fold and tape

Printed in U.S.A.

