

VIBRATOR TESTING

Notes on the Checking and Adjustment of Vibrator Power Supply Systems

BY JOHN F. RIDER

WITH the auto radio season once more approaching its height, it is appropriate to devote some attention to an important phase of auto radio work which has hitherto received very little consideration. We are referring to the all-important vibrator, without which auto radio today might not have reached its present popularity.

In servicing vibrator power supplies, there is no radical change in the procedure which must be followed, but rather all the rules which govern trouble-shooting in conventional a-c power supplies should be observed. Unfortunately, however, the problem is complicated by the fact that the vibrator embodies certain mechanical as well as electrical properties. A further complication takes place because the vibrator must be considered as an integral part of the circuit and in fact in most cases will function satisfactorily only in conjunction with the components of a particular circuit. It is thus difficult to test vibrators apart from the circuit in which they are designed to work. Note that this is in marked contrast to the condition which exists as far as condensers, resistors, tubes, and other components are concerned; these can invariably be easily checked independ-

ently of the circuit in which they are used.

As is the case with many other tests in radio, the substitution method is one of the most useful ways of checking vibrators and vibrator power supplies. In this method, the suspected vibrator is replaced by a unit known to be in good condition. If the power supply functions properly with the new unit, then, of course, it follows that the replaced vibrator is defective.

This substitution method should be used with caution since many vibrator failures are due to a defect in some other part of the circuit—such as a defective buffer condenser—and in cases of this sort there is a possibility of injuring the new vibrator. For this rea-

son, where a suspected vibrator is replaced with a new one, the new vibrator should be kept in operation only long enough to determine whether it produces an improvement in the performance of the receiver.

Check of Power Supply Performance

Unlike a conventional a-c power supply where the operation is not dependent upon the value of input voltage, the performance of a vibrator-type power supply depends to a marked extent upon the value of d-c voltage which is supplied to the circuit. Since in practice the input voltage may vary from a value somewhat higher than 4 volts to voltages up to 8 volts, it is desirable to check the output of the power supply for voltages in this range, before assuming that the power supply is functioning satisfactorily.

For this purpose it is convenient to use two cells of a storage battery totaling slightly over 4 volts to supply the power. If the vibrator fails to start consistently at this low voltage, then it should in general be considered unsatisfactory as it will probably function erratically even on the higher voltages. In addition to the starting test at 4.2 volts, the performance and starting

(Please turn to page 3)

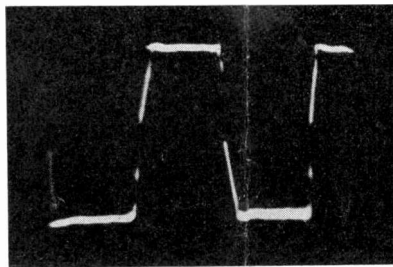

Fig. 1. Waveform of a standard non-synchronous vibrator operating under ideal conditions with the proper buffer condenser, normal circuit and load conditions.

Sparton 676

Due to an error in the manufacturer's specifications, an incorrect reference was printed in the latest *Rider Manual Index*. Model 676 is referred back to Model 30. This should be deleted, as Model 676 is an automobile receiver. The data on 676 will be published in *Volume IX of Rider's Manuals*.

RCA 85K

This is a console model employing a chassis similar to Model 85T1, the service data for which will be found on pages 8-112 to 8-114 in *Rider's Volume VIII*. These service data apply to Model 85K with the following exceptions.

The loud speaker used is No. 84091-1 and its cable connects to the chassis as follows: Brown lead (L13) to positive (center) terminal of C24; Brown-black lead (L13-T2) to "SG" terminal of the 42 output tube; Black lead (T2) to "P" terminal of the same tube. The resistance values for this speaker are: field coil (L13), 1300 ohms; voice coil (L11), 2.4 ohms; hum neutralizing coil (L12), 0.16 ohm; output transformer (T2) primary, 520 ohms and the secondary, 0.37 ohm. The voice coil impedance is 2.6 ohms at 400 cycles.

The following corrections should be made in the service data and they apply to all models 85T1 and 85K:

The resistance of the antenna coil, L2, should be changed from 0.07 ohm to 1.3 ohms in the large schematic at the top of page 8-113 and in the small diagram marked "Ant. Coil Connections" on the same page.

In the small schematic marked "Record Player Connections" a shield extension should be shown on the cable and connected to the chassis.

In the voltage diagram on page 8-114 the voltage from the negative terminal of C24 to chassis should be designated as -17 volts. The voltage from the negative terminal of C10 should be 0 volts instead of -17. The value of C8 has been changed from 450 mmf to 470 mmf. Make this change on both diagrams on page 8-113.

Different power transformers (T1) are used in Model 85K. Stock No. 30607 is rated at 105-125/200-250 volts, 50-60 cycles and Stock No. 30571 is rated at 105-125 volts, 25-60 cycles. The complete speaker has a stock number 14613 and the output transformer (T2), 14615.

Philco I-F Transformers

The i-f transformers of several models have been changed and are listed below. In each case the new part number of the first i-f transformer is 32-2296 and that of the second i-f transformer is 32-2298.

Model	Parts List on Page	Rider's Volume
37-33	7-15	VII
37-34	8-17	VIII
37-38*	7-17	VII
37-623	7-55	VII
37-624	8-23	VIII

The second i-f transformer has a tertiary winding which is connected in series with the screen-grid circuit of the 1D5G i-f tube.

*In order to prevent oscillation in the i-f circuit of Model 37-38, a tubular condenser, Part No. 30-4020, 0.05 mf, is connected from the screens of the 1C7G detector-oscillator and the 1D5G i-f tubes to ground.

Philco 38-7, Codes 121,124

Run No. 2 To provide uniform performance of the oscillator circuit, a 20-ohm resistor was connected in series with the cathode of the 6A8G detector-oscillator tube. See schematic on page 8-65 of *Rider's Volume VIII*.

In order to reduce bass response, the following parts were changed in the Code 124 chassis:

Condenser, No. 24, was changed from 0.01 mf to 0.001 mf, Part No. 30-4201. Resistor, No. 32, was changed from 51,000 ohms to 40,000 ohms, Part No. 33-340339. Condenser, No. 38, was changed from 0.006 mf to 0.01 mf, Part No. 30-4479.

Run No. 3. To reduce frequency drift further at the high-frequency end of the broadcast range, the compensator, No. 7A, was replaced with Part No. 31-6206. Also a new thermal compensator was connected in parallel with compensator, No. 7A and mounted near resistor No. 12. The resistor is mounted in the chassis with a mounting clamp and an asbestos insulator. The resistor must be mounted like this or else the thermal compensator will not function properly.

Run No. 4. The thermal compensator added to the chassis in Run No. 3, was replaced by two fixed condensers, Part No. 30-1097.

Run No. 5. The 20-ohm resistor added in Run No. 2 was removed.

The part numbers of Nos. 26, 39, and 48 found in the list of parts on page 8-66 are correct for Models 38-8 and 38-9. The correct part numbers for Model 38-7, both codes, follow:

No. 26, Volume Control, Part No. 33-5225; No. 39, Tone Control, Part No. 42-1347; and No. 48, Range Switch, Part No. 42-1339.

Philco 38-8, Code 121

Run No. 2. In order to increase the sensitivity of the shadowmeter, the following changes were made: Resistor, No. 12, was changed from 10,000 ohms to 13,000 ohms, Part No. 33-313639 and condenser, No. 17, was changed from 0.05 mf to 0.25 mf, Part No. 30-4134. See schematic on page 8-65 of *Rider's Volume VIII*.

Run No. 3. To provide uniform performance of the oscillator circuit, a 20-ohm resistor was connected in series with the cathode of the 6A8G detector-oscillator tube.

Run No. 4. In order to increase the a-f response in the high frequencies, condenser No. 40, was changed from 0.008 mf to 0.004 mf, Part No. 30-4456.

Run No. 5. The 20-ohm resistor added in Run No. 3, was removed.

Philco 38-9, Code 121

In Run No. 2, a 20-ohm resistor was connected in series with the cathode of the 6A8G detector-oscillator tube to provide uniform performance of the oscillator circuit. The next run, this resistor was removed. See schematic on page 8-65 of *Rider's Volume VIII*.

Crosley 163

The following notations should be made on the schematic of this set, which will be found on page 3-33 of *Rider's Volume III* and on page 757 of the *Rider Combination Manual*.

Draw a connection between the lower end of the secondary of the first i-f transformer and the arm of the volume control. A 10,000-ohm resistor should be shown between the B plus lead going to the primary of the first i-f transformer and the cathode of the 78 i-f tube. No connection should be shown between the windings of the second i-f transformer. The value of the resistor in the cathode circuit of the 77 second detector is 150,000 ohms.

Vibrator Testing

(Continued from page 1)

characteristics of the vibrator should be checked with an input voltage of 6.3 volts. For this value of input voltage, the d-c output voltage under rated current drain should be normal; otherwise the vibrator is defective, assuming of course that the remaining parts of the circuit have been checked and

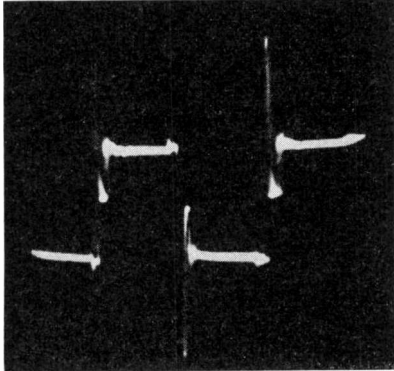

Fig. 2. Waveform produced by the vibrator of Fig. 1 operating under the same conditions but with an open buffer condenser. Note the change in waveform and the ragged corners.

found satisfactory. A test of the performance for an input voltage of 8.4 volts (4 cells) is sometimes made to check for excessive sparking at the contacts.

With reference to the production of r-f interference by vibrators, this much can be said: a vibrator which produces a steady value of d-c output voltage will practically never cause excessive interference. On the other hand, where cases of fluctuating voltage output are encountered, it is practically always true that these are accompanied by excessive sparking and r-f noise. In general, any vibrator that has a fluctuating output should be rejected as being defective.

The Adjustment of Vibrators

The adjustment of vibrators is admittedly a specialized and difficult job, as many servicemen will attest who

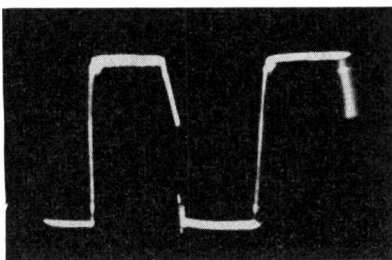
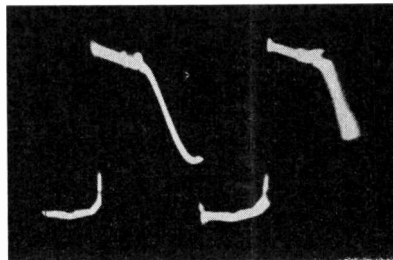

Fig. 3. Waveform of the vibrator of Fig. 1 when one contact point is too close. This will cause overheating and damage to the points and reed.

have tried their hands at it with little or no success. Although vibrators are made on a mass production scale and are durable units, their adjustment is still essentially critical and requires a great deal of skill and experience. And even where the serviceman is skilled in the mechanical technique for making the required adjustments, many cases arise in practice where a successful readjustment of a defective vibrator is impossible.

Thus the failure of a vibrator is often caused by the breakdown of some other part, such as the buffer condenser, the transformer, the rectifier tube, etc. A vibrator damaged in this way often cannot be successfully readjusted; in many cases the adjustment actually has not changed, but the failure to perform properly is due to the loss of temper of the spring materials and in some cases to the damaging of the tungsten contact points. The life of vibrators which have been damaged in this way



Oscillograms courtesy of William W. Garstang
Fig. 4. When one of the contacts is improperly adjusted—too great a gap—the vibrator of Fig. 1 gives this waveform. Note lack of symmetry.

is as a general rule exceedingly short, even though the vibrator may perform quite satisfactorily for a short time after it is readjusted.

General Principles of Vibrator Adjustment

There are several principal locations in a vibrator where adjustment may be required. The first and most important is the gap or space between the contact points; the second is the air gap between the armature on the vibrating reed and the pole face of the electromagnet; and the third is the position of the armature with reference to the electromagnet.

In the non-synchronous vibrator of the type used in auto radios, the gap between the contact points is generally about .006 inch, although in certain types of vibrators this gap is somewhat larger. In general a gap of about .006 inch provides the largest possible gap consistent with the maintenance of good electrical efficiency and good start-

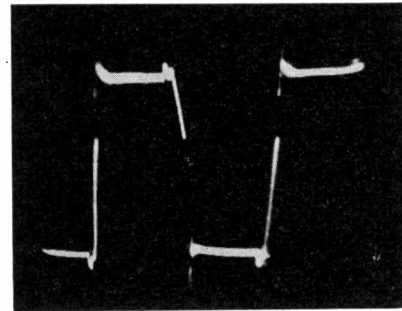

Fig. 5. An ideal waveform produced by the standard synchronous vibrator operating under normal conditions.

ing characteristics. There is always less chance of arcing at the contacts and less chance of rapid wear of the points if the points are spaced wide enough from each other to provide for the passage of air between the contacts on each cycle, which both cools the surface of the contacts and quenches any arc which may tend to form.

In the case of a synchronous vibrator, the primary (interruptor) contact points are generally adjusted slightly closer than the secondary (rectifier) contact points. This difference in adjustment of the primary and secondary contacts provides a mechanical phase correction which improves the efficiency of the vibrator power supply. Furthermore, in the case of vibrators which have a shunt coil arrangement for driving the vibrator, the secondary points must be slightly wider so that the primary points will hit first and actuate the magnet. If the secondary points hit first, the primary points may not engage and the vibrator will in all probability not start to operate.

In addition to the correct spacing of the contact points, the following adjustments should be checked: (1) The contact points should come together so that their flat surfaces are parallel, in order to avoid a continued burning action at the point of contact which will cause excessive wear of the tungsten. (2) The armature must be close to the

(Please turn to page 6)

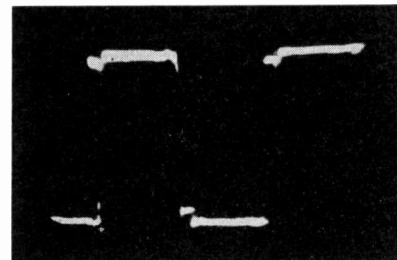

Fig. 6. Waveform produced by the vibrator of Fig. 5 operating in the same circuit but with the buffer condenser open. The absence of vertical traces indicate rapid voltage surges that cause r-f interference.

G.E. B-40

The schematic of this receiver, which is the same as RCA M-34, is shown on *RCA page 3-14 of Rider's Volume III and page 1854 of the Rider Combination Manual*. The change explained below will increase the audio gain on medium and strong signals and also improve the A.V.C. action. The partial schematic shown herewith are the original and revised circuits.

Interchange the connections at the terminal board of the red and green wires from the volume control. This places the grid coupling condenser in the circuit of the movable arm of the volume control. Then disconnect the green A.V.C. lead from the terminal board. (This lead is connected to the second terminal from the end on the bottom side of the terminal strip.) Solder a small 2-megohm resistor to this lead and solder the other end of the resistor to the lug on the terminal board to which the green lead from the volume control is attached.

**Emerson C134LW, C136LW,
C138LW, C139LW, C140LW and
C142LW**

The schematic is the same as is given in *Rider's Vol. VII, page 7-36*, with the exception that C11 is a 0.00005-mf. fixed condenser shunted by a trimmer, C50, which is part of the long-wave coil assembly. The r-f. primary of T5, position 2, is shunted by a fixed condenser of 0.0001 mf. (C45), and a 2000-ohm resistor (R30).

The Long-Wave band has been substituted for the Police band in position 2. T2 is a long-wave antenna coil, T5 is the long-wave detector coil, and T8 is the long-wave oscillator coil.

C6 and C9 trimmers were supplied separately and later incorporated as part of SW Antenna and Detector coil assemblies.

The alignment of the long-wave band is as follows:

Set the wave-band switch at the long-wave (central) position and the pointer to 150. Feed 150 kc. through a standard dummy antenna to the antenna terminal and adjust the long-wave series padder for maximum response. Move the pointer to 345, feed 345 kc. and adjust the long-wave oscillator trimmer. Then adjust the r-f. trimmer, and next the antenna trimmer for maximum response. Return to 150 kc. and re-adjust the long-wave series padder for maximum response. Return to 345 kc. and re-adjust all three trimmers. Return again to 150 and check the alignment. Repeat the entire procedure until no appreciable re-adjustment is required.

The layout of the tuner unit is shown below for this long-wave chassis.

Continental 78,780

Models 77 and 770, *page 8-20 of Rider's Volume VIII*, employ an electrodynamic loud speaker. Models 78 and 780 use exactly the same chassis as the Model 77, but in this case the speaker is an 8-inch permanent-magnet type. Please add this information to your index under Continental Radio & Television Corp.

Philco 37-9, Code 121

Run No. 2. Condenser No. 35 has been changed from 16 mf to 18 mf, Part No. 30-2194.

To improve the operation of the i-f circuit, a 0.1-mf condenser, Part No. 30-4455, has been connected from the red lead of the primary of the i-f transformer, No. 53, to ground.

To prevent distortion at minimum volume, the green-white wire connecting the center lug of the volume control, No. 67, to the automatic tuning dial a-f switch, No. 93, must be kept

clear of the compensator, No. 54, and the diode circuit of the 6Q7G.

Run No. 3. Condensers 70 and 70A have been replaced by 8- and 10-mf condensers respectively, Part No. 30-2201. The 8-mf condenser, No. 72, has been replaced by a 18-mf condenser, Part No. 30-2200.

The schematic of this receiver will be found on *page 8-11 of Rider's Volume VIII*. Note that the dial calibration notes of Model 37-10, see *page 8-15*, can be used for calibrating the dial of Model 37-9.

Grigsby-Grunow 310-B Chassis

Please change the value of C-16 of the *early* model from 11 mf to 0.11 mf. The parts list in which this error appears is on *Majestic page 3-22 of Rider's Volume III and page 1214 of the Rider Combination Manual*.

"How It Works"

The following correction should be noted for the last paragraph on page 13 of the "How It Works" section of *Rider's Volume VIII*. In checking the oscillator, assuming that the set is tuned to 20,000 kc and that the oscillator works *above* the signal frequency, then it should be possible to pick up the 20,000-kc signal with the receiver tuned to 19,060 kc. If the oscillator works *below* the signal frequency, it will be possible to pick up the signal with the receiver tuned to 20,940 kc. (We are sorry these errata got by—unlucky page 13.)

Philco 116

A 50-mmf. condenser has been added from the end terminal of condenser No. 63 (see schematic on *page 6-11 of Rider's Volume VI*) to ground. This addition was made to prevent oscillation.

As of *Run No. 14*, the 1-megohm resistor, No. 81, has been changed from Part No. 4409 to 33-510344.

A change has been made in the design of the volume control, No. 66 on the schematic, the old part number was 33-5022 and this has been replaced with Part No. 33-5153.

The Model K-17 speaker, Part No. 36-1025, is used on the new Model 116-B. The cone assembly number is 02996; the field coil and pot assembly is 36-3104.

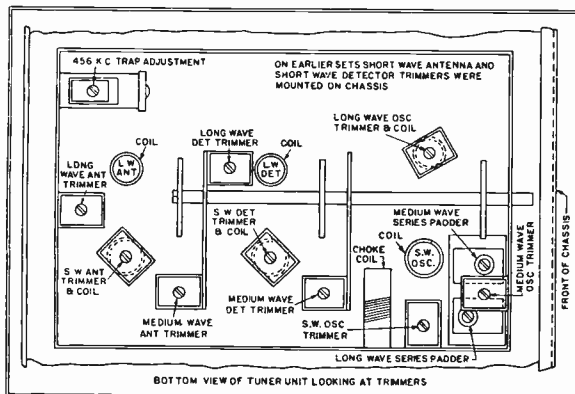

The chassis layout of the long-wave Emerson chassis used in models C134LW, C136LW, C138LW, C139LW, C140LW, and C142LW shown at the left differs from the chassis which includes the police band instead of the long-wave band.

Successful SERVICING

Reg. U. S. Pat. Off.

Dedicated to financial and technical advancement of the radio service man.

Published by

John F. Rider, Publisher
1440 Broadway New York City

John F. Rider.....Editor
G. C. B. Rowe.....Assoc. Editor

This publication is the house organ of the publisher and if due credit line is given, permission is hereby granted editors to reproduce material contained herein.

Vol. 4 Jan.-Feb.-March, 1938 No. 3

SUPER-SERVICING

SOME time ago, we mentioned that a threat to the very existence of the independent serviceman was in the formulative state. Naturally, as was expected, many servicemen ridiculed the idea. So we repeat and add that, as stated previously, the formation of super-service stations spread over the United States is even closer to realization.

It is true that such plans cannot be brought to completion over night and that much time will elapse before these stations start operating in the radio service industry and their effects are felt. However, be that as it may, it is of paramount importance for the servicing industry to realize the significance of this threat. No doubt members of the radio service industry wonder why such threats to their existence are in the offing. . . . Expressed in the simplest language: it is because much fear is felt in certain quarters concerning the ability of the radio service industry, as it now stands, to cope with future technical problems. This does not mean television only, but in addition, the general run of modern complicated receivers.

It is possible that the radio service industry will awaken and take its job seriously and take those steps which will prepare it for that which is to come. Then again it is possible that it will not do so; in which case there will be a definite decrease—and a major decrease at that—in the number of independent service men.

Parts jobbers too should take some interest in this matter, because the formulation of super radio service stations

in different parts of the country will without a doubt influence the distribution of replacement parts and may definitely alter the parts jobber set-up. Particularly so if these super-service stations represent one single concern. Of course we are not certain of the manner in which such stations would buy their replacement parts, but it is possible that buying would be done from a central point.

The personnel of such a service organization also is a matter of conjecture, but it is possible that the men would be college graduates with engineering training. Attractive remuneration would be possible as the result of proper business control and sales effort. Furthermore, if by chance this group would do what would be tantamount to general electronic servicing,—for industry, motion picture theatres, large apartment houses, etc.—on contract, similar to other presently existing maintenance organizations, the general level of operations would be raised to a point which the independent man would have difficulty in reaching.

As stated once before, this would not mean the complete elimination of

NOTICE

SUCCESSFUL SERVICING will continue to be published as the house-organ of John F. Rider, Publisher, and there is no connection whatsoever between it and any other magazine, nor will it be replaced by any other magazine.—Editor.

the independent radio serviceman, but he would find himself operating on the fringe, as for example in small communities or sparsely settled sections of the country. Obviously the income would be commensurate with the limited sales of service.

Such is the status of the situation. More definite or specific information we cannot give. It is up to those interested to do all that they can not only to elevate the standard of radio servicing but to see to it that the independent serviceman is in a position where he can cope with the service problems presented by the development and sale of the modern highly technical radio receiver and that he will be prepared when the television receiver appears upon the market.

JOHN F. RIDER

KNOWING the problems with which servicemen are faced daily, we established the SUCCESSFUL SERVICING Laboratory with the thought to solve some of these difficulties. That we have been successful in some small measure is shown by the research work on cathode-ray oscillographs which we gave the service industry in our "Cathode-Ray Tube at Work." For the past year we have been working on another book which in our opinion will fill a long-felt need and as a by-product, if you please, of this book, we have developed an instrument which we believe is revolutionary and with which servicemen can solve quickly and simply one of the most baffling and annoying problems encountered in servicing. . . . That is all we have to say at this time.

JOHN F. RIDER

Manufacturers, Please Notice

Editor, SUCCESSFUL SERVICING,

Every once in a while I come across a receiver that I can not identify. The manufacturer's name and the serial number are generally on the name plate that is fastened to the chassis, but the model number is seldom there—that may be on a paper label pasted somewhere inside the cabinet and again it may not. Sometimes if there is such a label, it is often illegible or has been torn off. Not knowing the model number or the chassis number makes it tough when it comes to looking up the schematic and other dope in your manuals. Why can't some identification number be stamped on the chassis itself or on the name plate along with the serial number? It sure would help a lot.

N. B. PLATT,

3235 N. 17th St., Philadelphia, Pa.

(This is not the first communication on this subject that has come to our desk and we are running it in hopes that some means of chassis identification can be worked out. It seems to us that some system of numbers or letters would simplify matters all around.—Editor.)

After April 30, 1938, our quarters will be located at 404 Fourth Avenue, New York City.

High-Frequency Alignment Note

Alignment at the higher frequencies in receivers using pentagrid converters, among which are the 6A7 and 6A8 types, is often complicated by interaction between the oscillator and signal circuits. For the most part this is due to coupling between the two sections of the converter tube, and in the October, 1935 issue of *SUCCESSFUL SERVICING*, page 10, we showed how a rocking procedure can be used to eliminate the undesirable effects of this coupling and to secure perfect tracking of the two circuits.

A recent note from the RCA Laboratories points out how this difficulty in aligning the high-frequency bands of receivers using pentagrid converters, can be reduced. It is suggested that a resistor of approximately 50 ohms be placed in series with the signal grid (No. 4) and the tuned circuit. By reducing the interaction between the two circuits, the insertion of this resistor simplifies alignment. The sensitivity of the receiver is not affected appreciably.

Philco 116X

The resistance of the field coil, No. 95 on the schematic shown on page 6-13 of *Rider's Volume VI*, is shown as 1125 ohms. Change notes from the manufacturer state that this value is 1450 ohms.

The volume control No. 68 has been changed from Part No. 33-5110 to 33-5155.

Philco 270

Please make a note in your Index to *Rider's Manuals* that the parts list of Model 70 applies to the schematic of Model 270, found on page 1-28 of the revised edition of *Rider's Volume I*; on page *466-C of the early edition; and on page 1657 of the *Rider Combination Manual*.

RCA 5M, 6M, 6M2

On the first production of these receivers (*below* serial number 200,000), two types of variable condensers are used. These differ only in the method of mounting the drive gear. Stock Nos. 12221 and 12222 gears are used only with the tuning condenser *not* having a tapped shaft. The gears used with a tapped shaft have the following numbers: 13145 and 13146.

The following parts are in addition to those listed for the above models, which will be found on pages 7-13 and 7-28 of *Rider's Volume VII*:

13147—Pinion gear and slotted shaft assembly and 13152—on-off operating switch. These are for the control box assemblies.

13006—Tuning and volume control flexible shaft sleeve.

11984—3-contact male connector for reproducer cable, No. 12525.

The second production run of these models (*above* serial number 200,000) used a tuning drive mechanism with a tuning drive ratio of 16 to 1. The following parts are applicable to these receivers:

13371—3-gang variable tuning condenser.

13372—Tuning condenser shaft drive gear for above.

13373—Tuning condenser worm gear and mounting bracket for above.

13414—Control box complete, less flexible shafts.

Vibrator Testing

(Continued from page 3)

actuating magnet in order to take full advantage of the magnetic flux around the pole face of the magnet, yet the separation must be sufficiently great—about .008 inch—so that the armature clears the pole face. In this connection, care must be taken to remove foreign particles from this air gap. (3) The vibrating reed and its armature must be positioned eccentrically to the

pole face of the electromagnet, so that the armature is pulled over toward the pole face and away from the center position, when the circuit is closed. Note that if the armature were situated symmetrically with respect to the pole face there would be no side pull on the armature and the vibrator would fail to operate. Poor starting characteristics, especially under low voltage conditions, are often traceable to improper location of the pole face with respect to the armature.

The Oscillograph in Vibrator Adjustment

In conjunction with the measurement of the input and output currents and voltages, an examination of the waveform produced by a vibrator furnishes a useful index as to its condition. However, it should be kept in mind that the check of the vibrator waveform with the cathode-ray oscillograph is in the nature of a supplementary test and that its use does not eliminate the necessity for checking the starting characteristic of the vibrator, the voltage output, etc. The accompanying series of oscillograms, which were taken for a standard vibrator in a conventional circuit, shows the representative waveforms which are obtained under different conditions. While the exact waveform will vary for the vibrators of different manufacturers, the same general features are exhibited in practically all cases, so that the oscillograms are useful in predicting a defect from the character of the waveform produced by the vibrator.

It should again be emphasized that the above notes on the servicing of vibrator power supplies and more especially on the oscillographic examination of vibrator waveforms are given not so much from the viewpoint that it is advisable for the serviceman to repair defective vibrators as it is to assist servicemen in determining whether the vibrator or some other part of the receiver is at fault. The systematic adjustment of vibrators on a commercial scale is definitely not recommended for reasons which have been previously explained. It is significant, in this connection, to note that manufacturers of vibrators, when making a replacement of a defective unit, invariably supply a new unit rather than attempt to repair the old one—and this in spite of their complete facilities for repairing the old one if it were feasible.

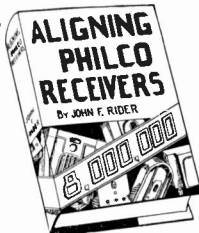

Hard Cover

TO MAKE YOUR JOB EASIER

You'll find in this book everything you need to know about the alignment of every Philco receiver — from the first up to the latest 1937 set . . . Special trimmer layouts with aligning frequencies indicated at each trimmer . . . Copious footnotes explaining any intricate procedure . . . Order it today . . .

176 Pages

\$1.00

Rolling Reporter



Random thoughts of a guy trying to write a colyum . . . Guess I'll light up the old mickey before I start pounding on Qwerty . . . What to write???. . . what to write that is the question whether it's nobler to bear the slings and arrows of outrageous criticism from my PUBLIC—wonder if I have any? Yes, I must have. Some fellow in Bombay named P. K. Lilaonevala wrote to tell me that he had seen my request for an opinion on a book covering radio math and he would like one. (You see, I have a public.) Well we're working on two books now and math will have to wait awhile . . . Let's see—what was I going to write about television. . . oh yes, I know. . . . About a year ago I wrote in this here col. that the directors of a hotel in Pittsburgh were thinking of having the rooms of the hostelry (that's a good word) wired for television. They were only thinking about it but a N. Y. dept. store thought and acted. Recently the ladies dress dept heads dolled up their good-looking and how! models in the latest scenery for the gals and pulled off a fashion show a la television . . . and that, m'hearties, is what is known as + publicity and my readers (if any) should oughter keep tucked away this thought, to wit and viz: that television is a LOT NEARER than some of the wise boys think it is and that television receivers will have to be serviced . . . wonder how many guys will remember that droplet of wisdom I just let loose on an unsuspecting world? not many, I'll bet me. . . . What's next?? wonder why the old think tank ain't working so good—guess mebbe had too many lamb kidneys for lunch . . . they were what I calls felicitous feeding the lazy brown fox jumped over—I know what it was—the jumped reminded me . . . made me think of Bryant who told me the yarn about his jumping when he was a kid in Texas. The last time he was in here he was telling me about a set he got to service the night before. He was told that another servicer had been called in to fix the hum and when the set had been returned to the customer the hum was a minimum allrightallright but so was the voll! Had to climb in the loudspeaker to hear a thing . . . While he was giving blows of the eye (tchek! tchek! that french influence again) to the set's innards he noticed gobs of something on the speaker. After investigation he found that his brother servicer(?) had amputated the hum (and the moosic) by gluing the voice coil to the polepiece!!!! Is that a pip or am I crazy???. But, gents, here is the pay-off: I told the story to another serviceman and he said quote why I've come across that several times unquote and so with a groan I gives you that yarn which should be written up as a fable or something but then nobody would believe it . . . wonder if the guy that did the gluing will read this or will there be more than one whose face will assume that boiled lobster shade???. Lobster—there I go thinking about food again . . . and speaking of red reminds me that she of the titian tresses in the outside office asked me to tell my readers that she was gettin' out the 100%er certificates as fast as she can and that 100s had been sent already; so dinna ye git impa-

tient, me mon; ye'll be gittin' yours the noo . . . that must be the scotch influence from last evening's last chaser . . . that "last one" must have been the one I should have given away. This a.m. was decidedly NOT so good . . . perhaps you know the taste—forty Arabs feet—and the playful way the alkaseltzer hides from you???. Does that guy across the area-way ever work or can he think better with his feet on the desk the way I do? And speaking of feet the Boss ran down to Richmond on Feb. 11th to speak to the servicers (150 were there), and the next day he repeated the performance in Norfolk (attendance 150 there too!) . . . soft music Car-riee me back to ole Vir-ginny . . . as long as I'm goin' geographical I might as well take a peep at this pile of letters. There's that card from my public in India I mentioned above. The stamp's value is 9 pies. Funny peculiar names for money they have over there, isn't it? Anna and pie. (Annie doesn't live here any more.) Suppose you saw a sign in a baker's window "Three pies for one pie", how many pies would you carry from the store???. There's a Brain Teaser for yuh. I'll have to tell the Boss that Mr. Lilaonevala wants the dope on Philips and Telefunken sets, but I don't see how we could include those in the Manuals with all the U. S. data we have to squeeze in. . . . And here's the letter Wm Peters of Detroit wrote when he sent in page after page of questions and answers he had framed after studying the Hour A Day books on d.c. and a.c. Unless I'm plenty wrong, there's a gent who is going places. Now get this: he made up and typed out questions AND ANSWERS on every subject covered in those two books, sending them to the Boss as a suggested addition to books which we might publish in the future. Thanks, Mr. Peters, and this colyum's hat's off to you . . . H. E. Schoonover from way out in Anadarko, Okla. says as to how he's an old-time ham and now that he's servicing it puts him in a position to appreciate "Rider's" even more. Thanks to you, sir. Aside to Frank Thompson in Cleburne, Texas: we'll pass your suggestion about the i-f response curves on to some manufacturers' service mgrs. we know . . . Thanks to Mr. Silsby, Littleton, N. H. for sending in that i-f peak . . . wonder how the skiing is at Littleton . . . Like to do some skiing myself—haven't been on a pair of skis for quite a spell . . . guess it's just as well for these old bones that I haven't. Next—ah, yes . . . here's one I want to acknowledge. It's from Wm. Yahnke upstate in Albion. He says that he won the book the Boss wrote on business and that it was an eye-opener. Before reading it, he had everything but money (I quote him there) but after applying the methods explained in the book, he's been outa the red to the extent that he moved to larger quarters, bought a lotta in-

struments, and has a good credit rating with three distributors. Well, once more I doff the derby to a guy who has the good sense and the intestinal fortitude (wow!) to revamp his business to the extent called for in that book . . . Stout fellal!!! Don't understand this one from B. S. Waite of Canton, Ill. That's the way we make up S.S. now—no changes backed-up by any other data you might want to clip. Waddaya mean, huh? . . . Here's a far-sighted guy—H. C. Stork of Columbus, Ohio. He asks J.F.R.'s advice about going into television servicing . . . says he's been in radio work for 18 years, used a catray oscillograph before they were commercially available, has built a lotta his equipment, and has every book the Boss ever published. I'd suggest you get ready for television all right (see above which was written before I read your letter)—about the rest of your letter I'll call that to J.F.R.'s notice when he returns to the city . . . Thanks to you, David Kay of parts unknown, for your nice comments on "How It Works"—we tried to make it easily understood . . . A lotta of the mfrs. give that dope you want, Mr. Frenzel of Rochester, N. Y. Sometimes those resistances are right next the voice coil or transformer windings in the schematic and other times they're in tables . . . (Aside to any Service Mgrs. who may be reading this: We've received from time to time other letters asking for resistance values of various coils . . . How's to include that dope if you don't now? 'Twould be a help . . . Thankx) I'll just about have room for one more . . . guess I'll use this one from Louis Gilfilen, Bellingham, Wash. He's used our books since 1930 and is another gent who has installed Rider's accounting system . . . He's figured out in \$\$\$ the profit on the money invested in Rider books and it's plu-enty. . . My congrats to you, sir . . . And now, gentlemen, I have news: yesterday afternoon while writing the above I was told I was going to get a new typewriter. Qwerty, on which this is being written, is going to be retired. I've struggled with her unpredictable idiosyncrasies for four years, but I must have won her affection for no matter how much she might balk or skip or skid she always acted the perfect lady when there was a rush job to be pounded out . . . For a year and a half I've used the old gal to bat out my col. for you fellows and she is the first machine J.F.R. bought when he started in business. She it was who assisted in the birth of those books which so many of you say you depend on and use. And she's going to be retired with full honors, for, the museum piece that she is, she's going to park henceforth on top of the bookcase in Rider's office . . . S'long, Qwerty, and thanks for your help . . . Requiescat in pace . . .

THE ROLLING REPORTER.

Philco 38-10, Code 121

Run No. 2. A 20-ohm resistor, Part No. 33-020339, was connected in series with the cathode of the 6A8G detector-oscillator tube to provide uniform performance of the oscillator circuit. See schematic on page 8-67 of Rider's Volume VIII.

The condenser, No. 35, should be changed from 0.02 mf to 0.06 mf, Part No. 30-4373, when power transformer Part No. 32-7627, is being used for 25-cycle operation.

The compensator numbers, 7 and 9, in Fig. 2 at the lower left side of page 8-67 should be reversed.

Sparton 1167

The accompanying illustration is the chassis and tube layout. The schematic of this receiver will be found on page 8-15, 8-16 of Rider's Volume VIII.

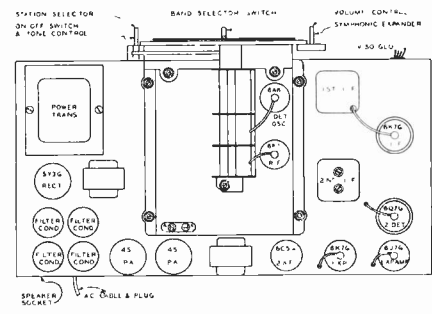

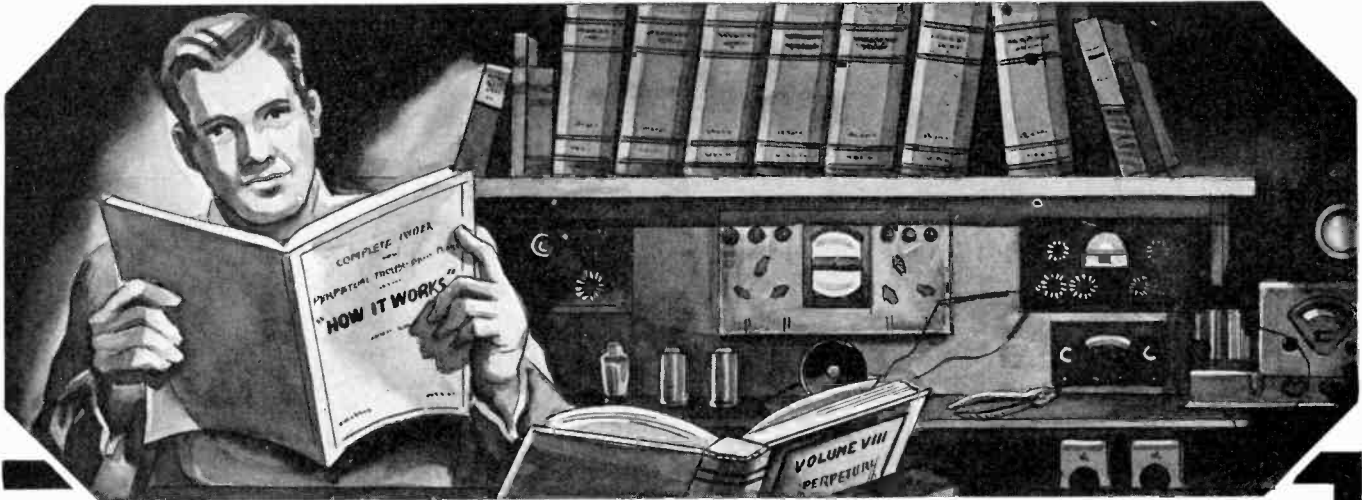

RIDER BOOKS *Banish Bewilderment!*

Successful servicemen in all parts of the world banish the bewildering complexity of modern service problems—get a sure grasp of underlying theory—by using the up-to-date Rider Books listed below. Theory and practice are combined on every page to make them doubly valuable in the crucible of daily service work.

AUTOMATIC FREQUENCY CONTROL SYSTEMS

With Automatic Frequency Control Circuits in most new higher-priced models, knowledge of "AFC" means money in your pocket! Learn the practical facts, from these easy-to-understand explanations. Get your copy today. Cash in on profitable "AFC" work. Hard covers. 144 pp. \$1.00.

THE CATHODE-RAY TUBE

Written especially so you can understand the subject. With introduction of new, cheaper Cathode-Ray Tubes, this book is even more indispensable for its complete practical information on Oscillographs, etc. 336 pp. 450 illustrations. \$2.50.

SERVICING SUPERHETERODYNES

Changes, changes, changes! That has been the history of the superheterodyne circuit. Make repairs quickly by analyzing the different parts of the circuit quickly. Rider shows you how in this revised edition which has 288 profusely illustrated pages. \$1.00.

"AN HOUR A DAY WITH RIDER" BOOKS —60¢ each

ON AUTOMATIC VOLUME CONTROL will speed up your AVC work. 96 pp. 65 illus.
ON RESONANCE & ALIGNMENT. You need this! 96 pp. 48 illus.
ON D-C VOLTAGE DISTRIBUTION IN RADIO RECEIVERS. How d-c voltages are led to tube elements, etc. 96 pp. 69 illus.
ON ALTERNATING CURRENTS IN RADIO RECEIVERS—with drawings and diagrams.

"RIDER'S Out Front Again"

*Says the Service Manager of
a Leading Set Manufacturer*

"That extra HOW IT WORKS section with the new RIDER MANUAL Volume VIII, certainly puts Rider out front again! It gives you a clean-cut explanation of the trickiest of the new circuits . . . makes clear by practical example the underlying theory of electrical and mechanical operations that you absolutely must understand when you're up against the increasingly complicated 1938 receivers. I haven't seen anything else on the market so helpful with day by day service problems."

Thank you Mr. Manager . . . and may we also call attention to another fact: Entirely apart from the 64-page HOW IT WORKS supplement, Volume VIII includes 1650 pages of essential service data on 1715 models of over 100 manufacturers—the most comprehensive service information available anywhere. Moreover, the easy-to-follow 128-page INDEX thoroughly covers all 8 Volumes comprising 9620 pages of authorized servicing data.

YOU NEED ALL EIGHT VOLUMES

Vol. VIII—	\$10.00—	1937-38
Vol. VII—	10.00—	1936-37
Vol. VI—	7.50—	1935-36
Vol. V—	7.50—	1934-35
Vol. IV—	7.50—	1933-34
Vol. III—	7.50—	1932-33
Vol. II—	7.50—	1931-32
Vol. I—	7.50—	1920-31

✓✓ Check
and order any
missing volume

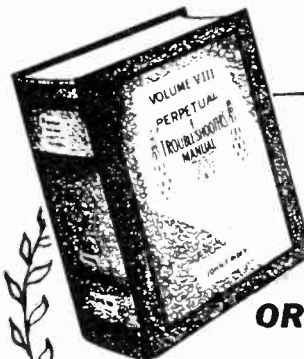

**Vol. VIII
Contains
1650 Pages**

ORDER TODAY

**The Eight Rider Manuals Now
Contain 9620 pages of
Authorized Servicing Data**

JOHN F. RIDER, Publisher, 1440 BROADWAY, NEW YORK CITY



JULY, 1938

Courtesy of Pan American Airways

THE CHANALYST

The Development that Preceded the Finished Unit

BY JOHN F. RIDER

THIS business of radio servicing has been in existence now for a good many years and the one subject that is of primary importance to every man actively connected with it is how a defective receiver should be tested or inspected in order that the fault may be found accurately, quickly, and easily, because unless the test be conducted so that these conditions are met, the chances are good that the serviceman will not show a reasonable profit on any one particular job.

Ream after ream of paper has been covered describing all manner of test procedures—some good—some fair—and others decidedly not so good. There have been advocates of one system or another and they apparently find one suited to their needs for they have built up a successful business. Yet when each and every one of these systems of testing be analyzed—taken apart to see upon what it is based, it will be found that there are almost as many bases as there are systems. Now to our way of thinking—and we feel sure that you will agree with our premise—there is

just one way to test any machine or system—no matter what its variations may be—and that is to decide what is the essential factor that is responsible for the functioning of the system; then when that has been determined, to investigate its behavior as it progresses through the system and performs useful work. All too often this thought of the power itself is sidetracked and because of some reason, a multitude of minor procedures come into practice that check the *parts* of the system but not the fundamental or driving force itself.

For example, when a steam generating plant is tested, upon what are the observations made? The live steam itself—the moving force that performs work. If you were to look in at such a test, you would find the engineers reading gauges and thermometers, watching flow meters—inspecting the condition of the steam as it progresses through the system . . . watching the force itself, as it were. True, you would find men taking the temperature of the fire with a pyrometer—checks being made on the gases going up the flue with a CO₂

analyzer—records made of the amounts of the coal and water being consumed—but these are only to calculate the overall efficiency of the installation—it is the steam itself that is the important factor.

Now apply this same line of reasoning to the testing of a radio receiver—*any* receiver, mind you—old or new or yet to be designed—a-c or d-c operated—trf or superhet. . . . Just what is the one essential factor upon which the functioning of every radio receiver ever built or ever can be built, is based? What is this common denominator of all receiving systems—the fundamental—the elemental? It is the signal itself.

What is it that is superimposed upon the carrier wave? The signal. What is it that every condenser, resistor, transformer, tube or any other part in a receiver works on? The signal. When you are called into a customer's home, you are wanted because the receiver is not functioning as it should and the *signal* has been affected in some way or other. Perhaps it has become dis-

(Please turn to page 3)

RCA D 22-1

The 800-8500-ohm resistor, No. 44-45, in the filter circuit of the 5Z3 rectifier, Tube No. 14, has been changed from its original location at the rear of the chassis to the front apron of the chassis near the power transformer. See the chassis wiring diagram on page 6-137 of *Rider's Volume VI*. The electrical connections remain the same.

Emerson Chassis F

The accompanying schematic shows the changes that were made in the circuit of receivers carrying serial numbers above 862,650. The schematic of those sets having serial numbers under 862,650 will be found on page 7-25 in *Rider's Volume VII*. Note that a 6Q7G has been substituted for the 75 second detector and that the 43 output tube has been replaced by a 25B5 in this later chassis.

Below will be found the voltage readings for those chassis having serial numbers above 862,650:

Tube	Plate	Screen	Cathode	Osc. Plate	Fil.
6A7	112	34	2.4	67	6.3
6D6	112	90	4.2	..	6.3
6Q7G	52	102	1.2	..	6.3
25B5	102	112	0	..	25

Voltage across speaker field, 126.

Voltage across filter choke, 10.

Voltage drop across ballast resistor (R-18) is 49 volts between pins 3 and 8.

The alignment data on the early chassis also applies to this receiver. See page 7-26 in *Rider's Volume VII* for these and other instructions.

Bosch 10 (Essex)

It has been brought to our attention that several errors appeared in the schematic of this receiver, which appeared on page 3-6 of *Rider's Volume III* and on page 2490 of the *Rider Combination Manual*. Please make the following corrections on the schematics on the above-mentioned pages.

The cathode of the 27 second detector should be grounded.

A connection should be indicated at the junction of the leads from R7 and R8. In other words, both of these resistors should be connected to the grid of the 27 A.V.C. tube.

A connection should be indicated at the point where the lead from R5 (in the plate circuit of the 58 first i-f tube) and the lead from the primary of the input pushpull transformer intersects the lead from the junction of R2 and R12 to the primary of the second i-f transformer.

The midpoint of the resistor R18, which is across the power transformer secondary supplying the heaters, should be grounded.

A connection should be indicated at the intersection of the leads from the screens of the 51 first detector and the first i-f tube, a 58.

During a portion of the production, the suppressor grids were removed from the cathodes and tied to the grid returns thereby placing the A.V.C. voltage on the suppressor grids. Also a change was made in the first i-f stage, a 6C5 being used instead of a 6D6. This was to eliminate the tendency towards howling.

Arvin Vibrator Noise Elimination

Any vibrator noise which may occasionally increase to an undesirable level after a period of operation of an Arvin 1937 car set may be corrected by the following procedure:

Warm up the set by playing for 20 to 30 minutes. Tighten the four screws which hold the power transformer to the radio chassis. This will effectively eliminate most cases of vibrator interference.

An additional remedy for r-f interference is to cut the grounding braid connecting the tuning condenser to the radio chassis. The particular grounding braid is located close to the point of entry of the tuning flexible shaft. Do not cut any other grounds on the tuning condenser as this might introduce motor noise.

Zenith 462

Although several minor changes in the circuit of this automobile receiver were made during production, the schematic on page 4-3 of *Rider's Volume IV* will coincide with most of these sets that have been marketed.

Philco 38-4, 38-5

When either of these models are operated on 25 cycles, a power transformer, Part No. 32-7598 must be employed. Also a 0.1-mf condenser must be connected across the speaker field coil, No. 65.

In order to reduce station rumble in the Model 38-4, the following parts were changed: the 0.01-mf condenser, No. 36, was changed to 0.0015 mf. and the 40,000-ohm resistor, No. 38, changed to 32,000 ohms.

In order to reduce frequency drift at the high-frequency end of the broadcast tuning range, in Run No. 3 the compensator No. 16, 1500 kc, Part No. 31-6196, was replaced with Part No. 31-6206, and two condensers, Part No. 30-1097, are connected in parallel with the new condenser. The range 1 oscillator transformer, No. 15, was changed from Part No. 32-2631 to 32-2894.

In Run No. 4 of 38-4 and Run No. 2 of 38-5, the 70,000-ohm resistor, No. 19, was changed to 51,000 ohms to improve the performance of the oscillator circuit on the short-wave bands. For schematic see page 8-61 in *Rider's Volume VIII*.

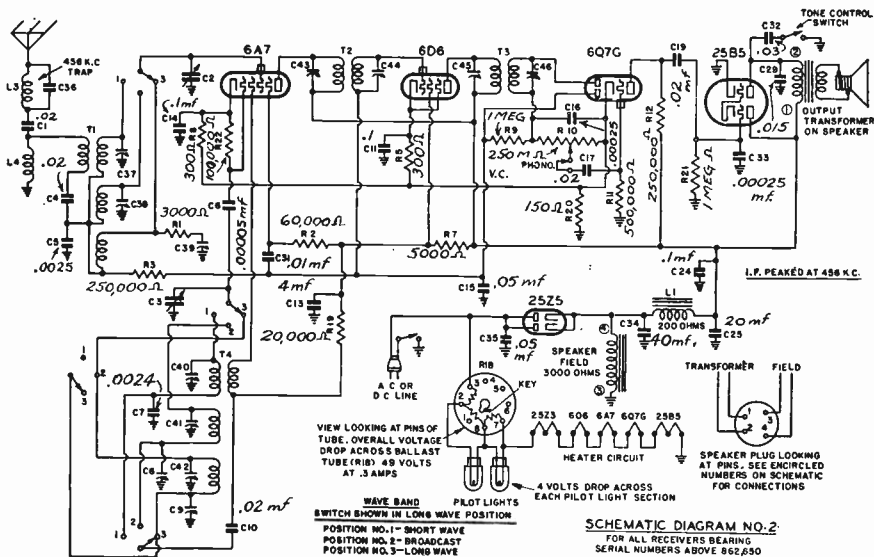

The revised schematic for Emerson models F117, F122, F133, F135, and F141 carrying serial numbers above 862,650. One of the major changes is the substitution of a 6Q7G for the 75 second detector.

The Chanalyst

(Continued from page 1)

torted—perhaps hum is superimposed upon it—maybe there is a reduction in the sensitivity or a loss of control or maybe no signal at all. . . . Any way you approach it, the signal, and the signal alone, is the all-important factor. And this is what you as a serviceman must restore to its normal state. . . . No matter *how* you do it, it is your job to fix the trouble as easily and as quickly as you can.

Diagnosis All-Important

But before the signal can be brought back to normality, the condition or conditions causing the trouble—and they may be external as well as in the set itself, although the chances are that they will be the latter—must be discovered. And that brings us back to our starting point: the testing of the receiver—the diagnosis of the condition that is affecting the signal. You know as well as we do that it is the ability of a serviceman to diagnose trouble that makes him valuable to his business. . . . The locating of the fault is 90% of the whole job of bringing back the signal and if the time to do this great percentage can be reduced, even a few minutes, then that will automatically make for increased profits.

And that is what we have been striving to do and it is our belief that we have found a way that you can localize the faulty condition in a receiver more quickly and more efficiently than it has been possible to do heretofore.

First of all, if one method of finding out what is causing the signal's abnormality could be equally well applied to *any* type of receiver, matters would be simplified enormously. Furthermore, if this method could be applied to any *new* receiver as well as those now on the market, then it would be unnecessary to clutter up your mind with a thousand and one details. Now taking the premise that in every radio receiver essentially the identical things happen to the signal, a good start towards universality has been made.

In general terms the signal in every receiver is detected, amplified at audio frequencies, and then the electrical energy is delivered to the actuating mechanism of a loud speaker. If the signal be amplified at radio frequencies before detection that still does not spoil the picture. . . . it is just an additional step—just as the introduction of avc or afc would be. . . . Also if a locally

generated current be mixed with the signal before it is detected that is just one more step that does not detract from the main idea. Think in generalities and you will find nothing complicated. If you will look into the future a bit, you will see that unless the whole system of broadcasting be entirely changed—and there is little chance of that coming to pass—receivers of the future will have exactly the same features as those of today. . . . perhaps a few refinements and embellishments, but nothing to affect the main idea. It is just like the automobile industry: new models are introduced annually with knee action, improved brakes, balloon tires and what have you, but still the same old fundamentals are there—you have a motor in which the expanding gases push a piston down and that mechanical energy makes the rear wheels revolve.

Signal Tracing

Granting that all receivers are alike fundamentally in their action on the signal, some way had to be found whereby the signal could be inspected from the instant it enters the receiver at the antenna until it arrives at the output. Moreover if some practical way of doing this existed, it would make possible the locating of the point at which the signal departed from normal. . . . where it became distorted. . . . where it weakened or where something else happened to it. Yet no matter how desirable such a procedure might prove to be, with the equipment available to the serviceman such a method was out of the question. Therefore, in order to employ this signal-checking procedure, which we consider to be universally practical, it was first necessary to develop some apparatus that would give the information required under actual operating conditions and without influencing the signal in its passage through the receiver. Moreover, theoretical analysis of the problem showed that if such apparatus could be developed, it would not only localize the fault in some particular circuit, but it would also go a long way in tracking down the part that caused the signal to depart from its normal condition.

Going another step forward in our considerations it was found that measurements of the various voltages represented the best secondary or supplementary test in finding the defective part and this measurement must be such that it can be made simultaneously

with the signal-tracing test. Furthermore, such voltage tests would have to be made without impairing the operation of the receiver. This includes readings of the control voltages developed by the signal as well as the operating voltages. If all this could be accomplished, we would have a systematic procedure based entirely on the signal itself, which we took as the fundamental basis.

With all this before us, a thorough study of existing test equipment was made. . . . apparatus that would be most likely found on the benches of progressive servicemen. True, capacity meters are valuable for checking condensers. The same thing can be said about ohmmeters for finding the d-c resistance of a circuit or component. The capabilities—and the limitations—of the signal-generator method of probing were considered and those same factors pertaining to the vacuum-tube voltmeter were weighed. We not only studied these and other instruments to see what they would do, but also—and this is indeed important—what they could not do; these factors were considered as well as their costs and ease of operation.

Accessibility of Parts

We then turned our attention to the physical side of the receivers themselves. Granting the signal-tracing system of testing to be the best, would it be possible to get at the different points in the sets where connections would have to be made and what effect would such connections have not only on the readings but on the operation of the receiver? Schematics of all kinds were examined as well as the chassis of a large number of existing receivers. . . . Design engineers were consulted concerning the electrical and physical trends in the sets to come; what would be the result if the ideas of today were incorporated in the sets of tomorrow? All our findings were encouraging; the further we went, the firmer were our convictions that we were on the right track. As far as we were able to discover the parts in the new receivers were to be as accessible as possible in order to assure simple and economical maintenance. And it goes without saying that if the parts are easily reached, then the paths along which the signal flows will also be accessible. Furthermore, as our method offered no interference with the receiver's operation, the complex interlocked circuits would

(Please turn to page 6)

New Radio Symbols

At the June, 1937, meeting of the Service Section of the Radio Manufacturers Association a committee was appointed to draw plans for the standardizing of symbols used in radio schematics. That such a committee should be formed was quite natural because the modern radio receiver utilizes components of various types of a single kind and it would be to the advantage of the entire radio service industry if all schematics illustrated the same type of component in the same manner. Furthermore, it would also be of advantage if the symbol used in the schematic immediately identified the type of component. Such was the reasoning of the various members of the committee.

At the recent meeting of this committee, namely during June, 1938, a number of symbols were proposed and we submit herewith the suggested form of standardization. These have not as yet been officially adopted by the radio industry, but examination of recently issued schematics produced by such manufacturers as Stewart-Warner, Galvin, and Wells-Gardner shows that some of the suggested symbols are already in use. Hence this information should be of value to you, because even if the suggested standardization is not accomplished (and we think that it will be), the individual receiver manufacturers have the right to use whichever symbols they see fit, and they no doubt will continue using the new symbols.

The accompanying illustrations are self-explanatory. However, a few supplementary words will not be amiss. The two types of ground connections are imperative because they appear in AC-DC receivers, wherein the chassis

and external ground are not the same. For that matter a similar arrangement may be found in some a-c receivers as well.

The variable air tuning condenser and the adjustable trimmer are distinguished both by size as well as by the fact that the tuning condenser symbol employs a curved line for the rotor, whereas the adjustable trimmer em-

upward. Perhaps it is best to say that the tail of the arrow is closest to the rotor or grounded part of the trimmer. In the event that the rotor is not grounded the same illustration is used, except that the location of the arrow then identifies the rotor plate or plates.

The fixed condenser symbol is just the same as it always has been, although certain additions will be seen upon the Motorola diagrams for 1938 receivers appearing in Rider's Manual Volume IX. For that matter if you have seen any of the new Motorola diagrams and have examined the schematics critically you no doubt noted that the variety of fixed condenser was identified by either a solid line or a dash line running through the condenser, midway between the upper and lower lines. Motorola identifies their mica condensers by means of a dash line and their paper condensers by means of a solid line.

The greatest change takes place in the symbols used for the wet and dry electrolytic condensers. Heretofore, such condensers were identified simply as fixed condensers. It is quite in order to make a change because the different types of electrolytic condensers justify individual identification. The wet condenser cannot replace the dry and it is imperative that the serviceman know the variety of electrolytic being used. For that matter, it is also necessary to mention that the suggestion was made to identify self-regulating electrolytics as against non-regulating by placing the word "regulating" or some abbreviation thereof upon the schematic, adjacent to the condenser. These wet and dry electrolytic condenser symbols are already in use by Wells-Gardner and S.-W.

Still another suggestion for standardization is identification of sections of a multi-section condenser or resistor, by the letters a, b and c, or as many as may be desired. In other words, such identification as 21a, 21b and 21c, means that the three condensers or resistors, whichever are being considered, are all parts of a multi-section unit.

Great relief is in store with respect to the comprehension of band switches. While the committee is not making a standardization suggestion for a symbol, a definite method of illustration is being recommended. This recommendation is that the switch be shown schematically on the schematic proper. The coil and other component leads are brought out directly to the proper switch terminal. Each switch terminal or lug is numbered or coded. The indi-

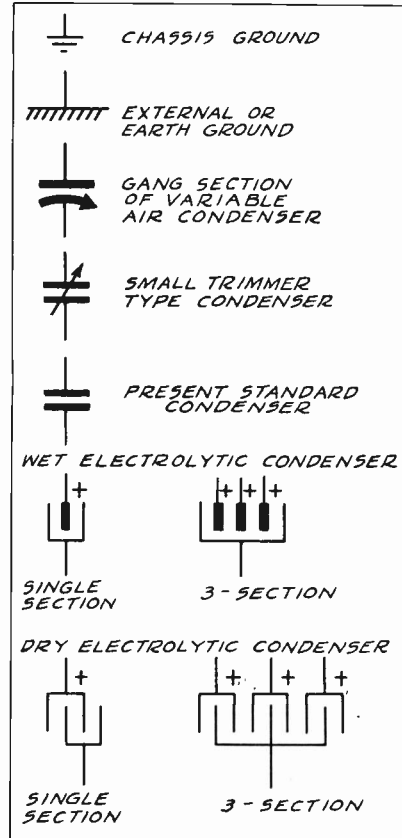

Schematic symbols prepared by the Standardization Committee of the R.M.A. Service Section.

plays a straight line penetrated by the arrow. The lower line is the rotor or grounded plate, when the arrow points

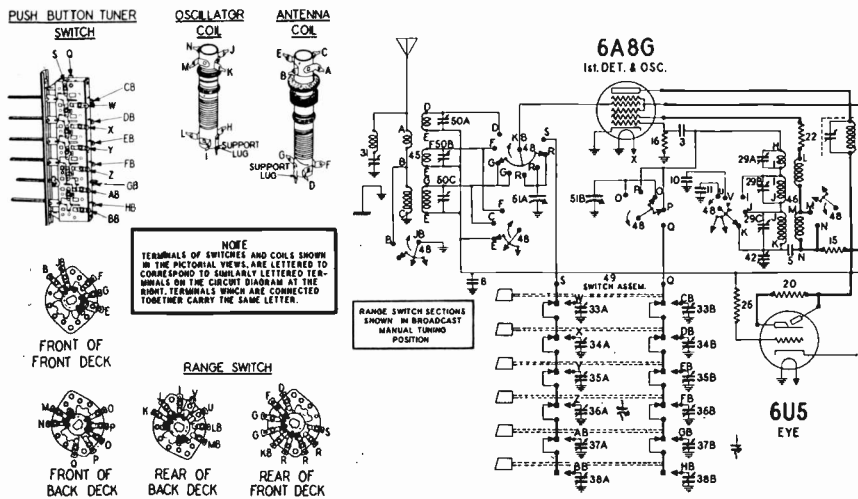

A portion of one of Stewart-Warner's latest schematics, showing the new presentation of band-switch data.

(Please turn to page 6)

The RIDER Chanalyst



The MODERN
Service
Instrument

The Greatest Advance Made in the History of Service Instruments

THE RIDER CHANALYST opens a new era in the analysis of receiver troubles. It is based upon an entirely new, easier method of attack, enabling the application of the same systematic diagnosis to all receivers—yesterday's, today's and tomorrow's. This is possible because the utility of the instrument is independent of the complications in receiver circuit design. . . Tuned radio frequency or superheterodyne receivers with all special circuits are diagnosed with equal facility.

The speed with which troubles can be positively identified is startling. . . Tests can now be made with the Chanalyst that have been impossible heretofore and these new tests are so all-revealing and so quickly made that your daily output of

serviced receivers will be increased beyond belief.

The Chanalyst will enable you to find the most elusive troubles in a receiver with an ease that will astonish you. Intermittent receivers no longer will be the radio service industry's bugbear . . . the Chanalyst has solved that problem and that is only one of its uses.

Never before has the radio service industry witnessed a test unit having such tremendous capabilities. Embracing every desirable feature—speed—easy interpretation—universal application—long life—the RIDER CHANALYST, which is independent of tube types and needs no adaptors nor plugs, is truly the MODERN service instrument for profitable servicing.

COMPARE!

THE
to c
Chanaly
FEW of

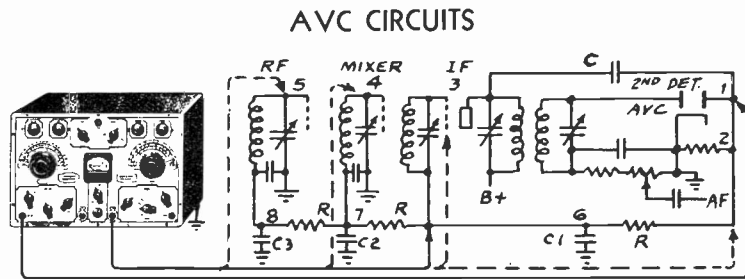

All avc circuits are checked with ease. The i-f probe placed at (1) and the rf-if channel resonated to the intermediate frequency checks the presence of the i-f signal at the diode plate. The voltmeter probe placed at (2) measures the rectified diode voltage. At points (3), (4) and (5), the avc voltage applied to the i-f, mixer and r-f control grids (with the signal present). At points (6), (7) and (8), the avc voltage along the avc bus. The voltmeter probe at point (1) without signal input checks for leakage in capacity C. The presence of the isolating resistors R does not materially influence the voltage indications and the voltmeter probe at (3), (4) and (5) does not interfere with normal operation of the receiver. The i-f probe at points (6), (7) and (8) will establish proper filtering of i-f signal from avc circuit or open by-pass condensers C1, C2, C3. Shorted by-pass condensers influence the avc voltage at (3), (4), (5), (6), (7) and (8).

POWER SUPPLY UNITS

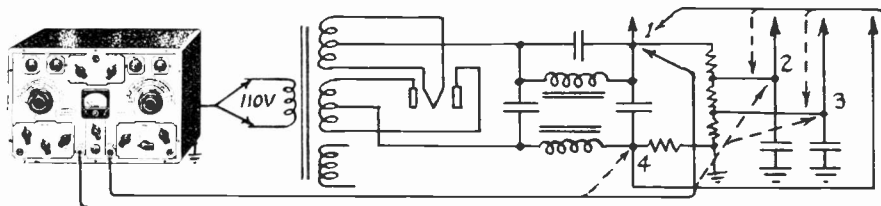

When the receiver power supply plug is inserted into the Chanalyst receptacle, the wattage consumption of the receiver is indicated. This combined with the voltmeter probe located at the various d-c voltage output points (1), (2), (3) and (4), furnishes definite data concerning the power supply. Hum is checked by placing the a-f probe at points (1), (2), (3) and (4). Shorted or open by-pass condensers are immediately indicated. Shorts in the receiver which increase or decrease the load on the power supply, are immediately detected.

AUDIO AMPLIFIERS

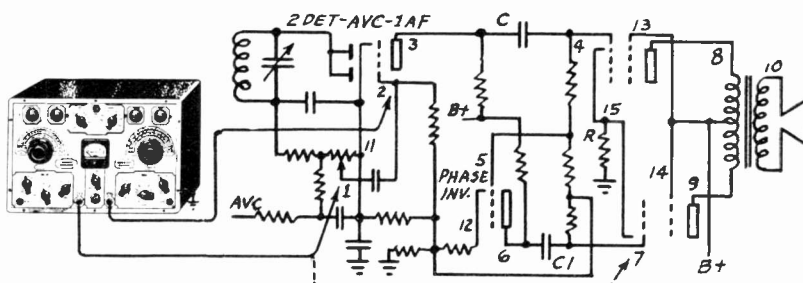

A typical a-f amplifier with phase inverter and push-pull amplification. A check of the presence of the a-f signal can be made by progressively placing the a-f probe in contact with points (1), (2), (3), (4), (5), (6), (7), (8), (9) and (10). It is, of course, possible in a rapid check to advance from (1) to (8) and (9) and thus embrace all between, but in the event of trouble in the system, each point is checked because the level of the signal at these various points can be established. Progressing in this manner through the amplifier, the same operations check the various coupling units. The voltmeter probe at points (2), (3), (4), (5), (6), (7), (8), (9), (11), (12), (13), (14) and (15) will measure the various operating voltages. Measurement of the signal level at points (4) and (7) will establish if the phase inverter output signal voltage applied to (7) is correct with respect to the signal voltage available at (3), and also if the input voltage to the output tubes is balanced. Leakage in condensers C and C1 can be checked by measuring the bias voltage at (4) and (7). High leakage through the condensers will buck or reduce this voltage. Excessive leakage will buck the bias voltage completely and even make the voltage at the grid positive.

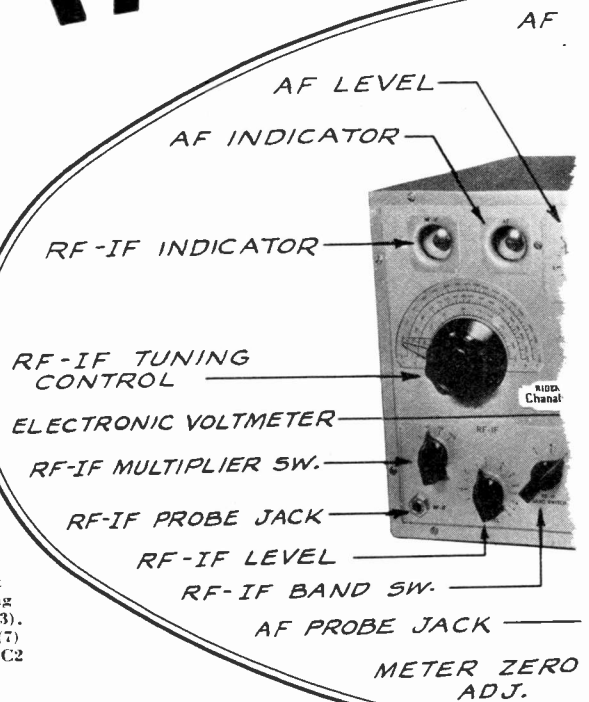

INTERMITTENT

YESTERDAY intermittents were hunted by hurried checking when the condition finally more than likely not . . . then another wait

TODAY and TOMORROW . . . a signal is fed Chanalyst have been connected at appropriate portion of the receiver in which the trouble lies.

OSCILLATORS

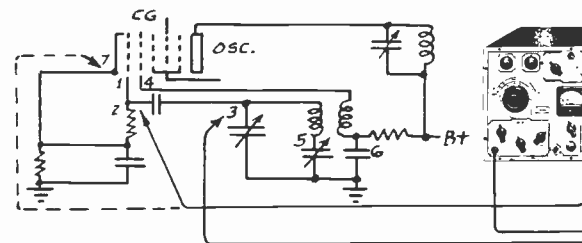

The operation of oscillators can be checked by two methods. The first is the measurement of the d-c voltage developed across the grid leak by the rectified diode current existing during oscillation. The oscillator control grid will be negative with respect to ground while the tube is oscillating and positive when the tube is not oscillating. The voltmeter probe is placed in contact with the oscillator control grid of the tube at (1), or with the grid end of the grid leak (2), or with the stator of the oscillator tuning condenser (3), if the latter is connected directly to the control grid. The most accessible of these three connections should be used. This type of test is suitable over the entire frequency range of oscillators used in all receivers. Operation of the oscillator over all bands can be checked by tuning the receiver over its entire frequency range.

This test can be made with all types of oscillator circuits, irrespective of the type of tube used. Oscillators suspected of cutting out at certain frequencies can be checked instantaneously with positive results and without the need of connecting a current meter in series with any of the circuits.

worth of a service instrument can be established in only one way: see what and how it accomplishes what it is supposed to . . . We want you to compare the RIDER CHANALYST with all other service instruments . . . You will find the first to be definitely superior in every respect and a vital necessity for profitable servicing operation . . . Here are a few of its applications . . . Note the ease with which it is possible to explore every portion of the circuit under test and the simplicity of these operations . . . The Chanalyst enables you to obtain positive information with the greatest speed . . .

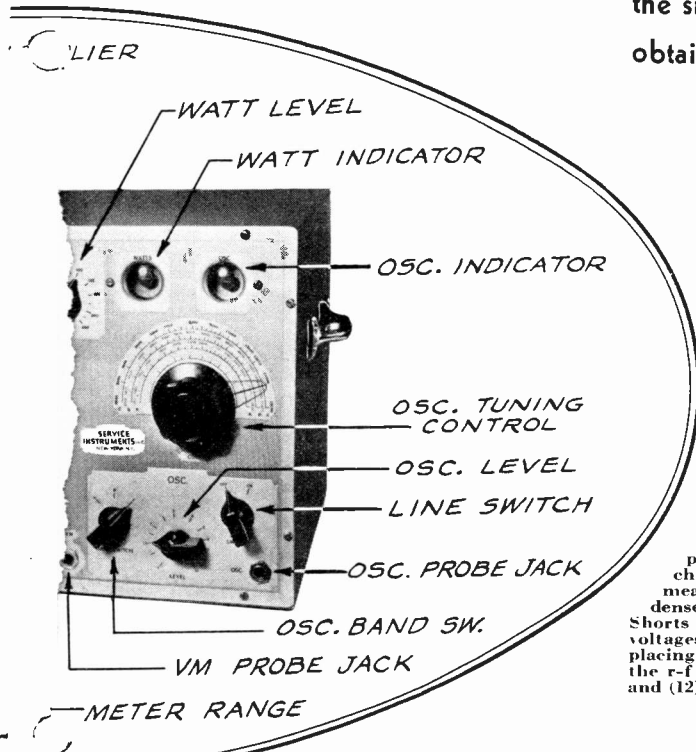

AFC CIRCUITS

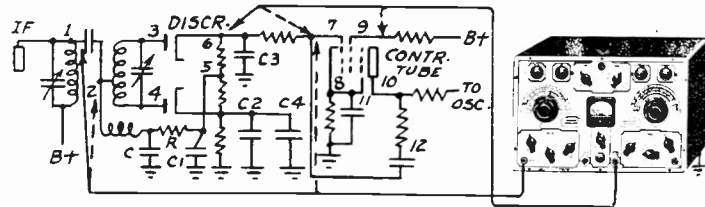

There are a number of different types of afc circuits, but the testing of them with the Chanalyst remains substantially the same—similar information being sought in each case. The i-f signal is checked at the i-f tube plate (1) which feeds the discriminator. The i-f probe at (2) checks the coupling capacity; at (3) and (4), the i-f voltage fed to the discriminator; at (5) to see if any i-f voltage gets into the discriminator load. (Filter R, C and C1.) The voltmeter probe at (6) measures the afc voltage. With this probe connected and the receiver tuned both sides of the correct carrier, the afc voltage characteristic can be plotted. The same probe moved to the control tube control grid (7) measures the control bias applied to this tube. The i-f probe at (7) shows if the i-f filter condensers C2 and C3 are intact. The a-f probe at (7) shows if the a-f filter condenser C4 is intact. Shorts in any of these circuits will naturally show up by interfering with the normal i-f or afc voltages as measured at the respective points. Control tube operating voltages are measured by placing the voltmeter probe in contact with points (8), (9), (10) and (11). Over the broadcast band the r-f channel can be used to check the oscillator signal in the control tube circuit at (7), (10) and (12).

RF-IF CIRCUITS

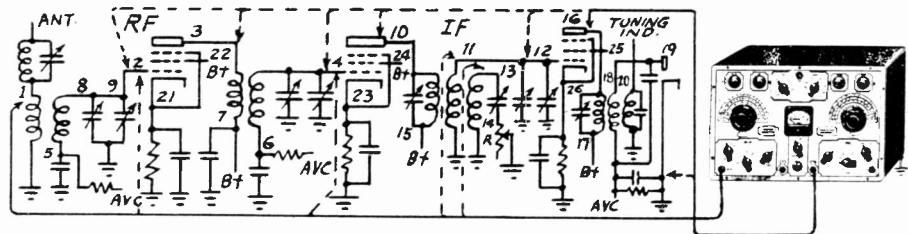

R-f signals over the broadcast band can be checked at (1), (2), (3), (4), (5), (6) and (7); in fact at any point in the tuned circuit that is above ground potential, for example, (8) and (9). I-f signals can be checked at (10), (11), (12), (13), (14), (15), (16), (17), (18), (19) and (20), as you see, including the tertiary windings. Points (13), (14) and (20) indicate such places. Point (1) is used to check the operation of the wavetrap. Minimum signal at the intermediate frequency is desired here for normal operation. In making r-f and i-f tests all that is necessary is to resonate the Chanalyst and move the probe from point to point. The voltmeter probe at (2), (3), (4), (5), (6), (10), (12), (16), (21), (23), (24), (25) and (26) measures the various operating and control voltages with the signals in the circuit. The i-f probe at (13) will show the operation of the tertiary winding resistor R. Alignment operations proceed along normal lines, but the voltmeter employed any place in the afc circuit makes an excellent output meter during such alignment. Noise can be checked by listening to the signal as it is picked off at various points in the r-f and i-f systems.

TUNING INDICATOR TESTS

This test, while identified with one particular circuit, is applicable to all similar arrangements. Presence of the i-f signal is checked at (1) by placing i-f channel probe at any point in tertiary winding circuit. I-f signal fed to rectifier diode checked by placing i-f probe at (2). To measure rectified voltage intended for Shadowgraph tube, voltmeter probe is placed at (3); then at (4), control grid of Shadowgraph tube. Plate voltage applied to Shadowgraph tube is checked at (5). I-f probe placed at (3) and (4) will indicate the condition of the by-pass condensers in the circuit in the event that Shadowgraph indication is influenced by modulation component of i-f carrier signal. Also i-f probe at (3) and (4) checks presence of higher resistances R1 and R2 by attenuation of i-f signal due to high resistances. Either voltage or signal test can be used to check resistors R1 and R2 . . . Any tuning-eye circuit can be checked in a similar, simple manner and the same holds true for tuned flasher arrangements.

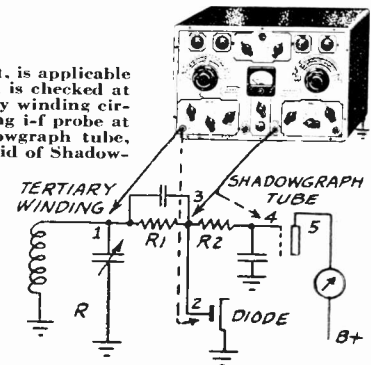

TUNING RECEIVERS

and-miss methods . . . valuable time was wasted in did show up . . . perhaps the trouble was located, . . . and into the receiver to which the five channels of the dints. The indicators are adjusted . . . When the or more of the indicators from normal identifies the

OSCILLATORS

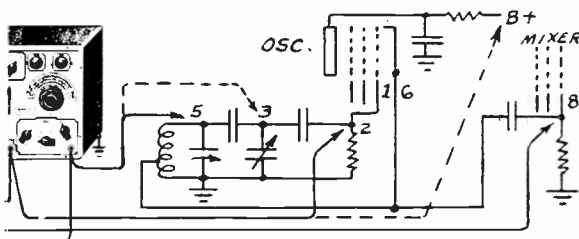

The second method will check oscillating circuits over the range between 600 kc and 15,000 kc and trace the presence of the normal in all circuits where it is supposed to flow. The oscillator probe is placed in contact with the oscillator control grid (1), plate (4), or with the tuned circuit at any point (3), (5), (6) or (7) that is convenient and above ground potential. The oscillator channel tuned circuit is resonated with the frequency of the oscillator being tested and the oscillator indicator shows the presence or absence of the signal. The oscillator signal fed from a separate oscillator tube to the mixer can be checked by placing the oscillator probe in contact with the point in the mixer that is coupled to the oscillator tube. This may be the grid (8) of the mixer, the cathode, etc., thus establishing the condition of the coupling elements between the oscillator and the mixer.

This type of test also enables fairly accurate approximation of the frequency of the signal being generated by the receiver oscillator under test. Naturally all operating voltage tests can be made in routine fashion by connecting the voltage probe to all d-c points in the oscillator system.

INSIDE THE RIDER CHANALYST

RF-IF CHANNEL

Five tubes are employed in the rf-if channel; three as tuned amplifiers, the fourth as a diode rectifier, and the fifth as a cathode-ray tuning eye indicator. The amplifier covers three frequency bands: 600 kc to 1,700 kc; 240 kc to 630 kc, and 95 kc to 260 kc, the amplification being substantially flat over each band. The input circuit is calibrated, thereby making the channel suitable for gain measurements. The sensitivity of the amplifier at the control grid of the first stage for full indication is approximately 60 microvolts and a signal of less than 6 microvolts will show an indication. The pickup for the channel is made through a shielded cable, terminating in a capacitance of less than 1 micromicrofarad. Attenuation of the input circuit over a ratio of 10,000 to 1 is provided by a continuously variable resistive attenuator and a four-step capacitive attenuator.

A three-step switch selects the frequency band. A jack in the indicator circuit permits the output of the amplifier to be fed to headphones or an oscillograph so that the signal can be heard or its waveform examined. The rectifier circuit is so designed that the output depends upon the carrier voltage and not the modulation component; therefore the indication does not depend on the percentage of modulation of the input signal.

THE OSCILLATOR CHANNEL

The oscillator channel employs three tubes: a tuned amplifier, a diode rectifier and the cathode-ray tuning eye indicator. Coverage of oscillator operation extends as high as 70 megacycles. The tuned amplifier used in the channel operates over three frequency bands: 600 kc to 1,700 kc; 1,650 kc to 4,950 kc, and from 4,800 kc to 15,000 kc. Pickup to the circuit is through a shielded cable which terminates in a capacitance of less than 1 micromicrofarad. The input circuit is equipped with a gain control.

THE A-F CHANNEL

The a-f channel employs three tubes: an amplifier, a diode rectifier and a cathode-ray tuning eye indicator. It is resistance-capacity coupled and flat over a frequency range of 50 to 50,000 cycles. The sensitivity of the amplifier is .1 volt for full indication and is operative over an input voltage range from

.1 to 1,000 volts. A jack is provided in the output circuit of the amplifier so that the signal output can be fed to headphones or to an oscillograph for aural or visual observation. The continuously variable attenuator covers a range from .1 to 10 volts and a switch-controlled, single-step attenuator extends the input voltage range to 1,000 volts.

THE WATTAGE INDICATOR

The wattage indicator employs two tubes: a diode rectifier and a cathode-

follows: -5 to 0 to +5; -25 to 0 to +25; -100 to 0 to +100; and -500 to 0 to +500. Each range is selected by means of a four-position switch. The input resistance of the instrument on all scales is 10,000,000 ohms, which means that on the low-voltage scale, the resistance is equal to 2,000,000 ohms per volt. The overall accuracy of the voltmeter is approximately 5 percent of the full-scale deflection. A single probe lead provides contact between the voltmeter and the point being checked.

All d-c operating and control voltages may be measured with the instrument, thus making it possible to measure r-f, i-f, a-f, and oscillator voltages directly at the grid and plate without interfering with the operation of the receiver. The voltmeter is thoroughly protected against damage from overload.

THE POWER SUPPLY

The power supply employs a full-wave rectifier and functions as the source of the operating voltages for all the tubes in the Chanalyst. Exceptional care has been taken in the design of the filter so that the hum level is extremely low.

THE PANEL

The panel is of heavy chromium-plated brass. All the calibrations are deeply etched to assure the maximum visibility. The various controls are grouped for greatest ease of operation, the channel and function of each being clearly designated. The cathode-ray tuning eyes are recessed behind the panel enabling easy observation of these indicators.

THE CABLES AND PROBES

Four probe leads are furnished. The cables have low capacity, are shielded, and have an outer covering of braid. The rubber insulation is of high quality and in order to obtain the greatest flexibility the wire is made up of sixteen strands of No. 34. The probe handles contain the coupling capacity for the rf-if and oscillator channels. These probes terminate in pointed prods with shafts which have an outside thread. Four small copper clips, having internally threaded sleeves, can be screwed over the prods when a permanent connection is required to the different points in a receiver, as when an intermittent receiver is being tested.

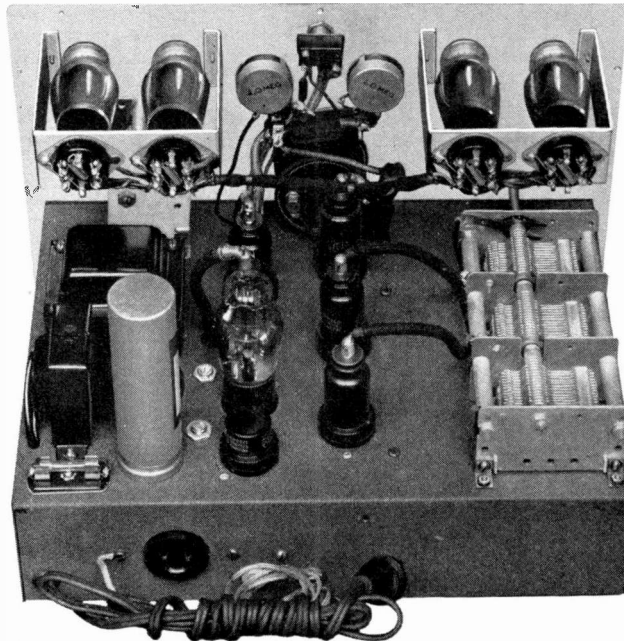

Interior of the Rider Chanalyst

Tube Complement

4-6K7	4-6E5	1-76
1-6Q7	1-6H6	1-6X5

ray tuning eye indicator. It is calibrated to indicate the power consumption of the receiver under test and covers a range from 25 to 250 watts. This unit is automatically connected into the circuit when the receiver is plugged into the receptacle provided for that purpose.

THE ELECTRONIC VOLTMETER

This voltmeter employs a tube and a meter-type indicator. As a result of design, it has a number of special features not found in other instruments. The meter has a center zero and indicates both positive and negative voltages with respect to ground. The range of voltages covered by the meter is as

Chanalyst Model A	50-60 cycles	117 volts, complete with tubes	\$107.50 net
Model AX	25-40 cycles	117 volts, complete with tubes	112.50 net
Size 14" x 9" x 9 3/4"		Weight: 26 pounds	

SERVICE INSTRUMENTS, INC.

404 Fourth Ave., New York, N. Y.

Successful SERVICING

Reg. U. S. Pat. Off.

Dedicated to financial and technical advancement of the radio service man.

Published by
John F. Rider, Publisher
404 Fourth Ave. New York City
John F. Rider.....Editor
G. C. B. Rowe.....Assoc. Editor

This publication is the house organ of the publisher and if due credit line is given, permission is hereby granted editors to reproduce material contained herein.

Vol. 4 July, 1938 No. 4

ANOTHER CHANCE

EVERY indicator visible to the eye points to vastly improved business conditions in the United States during the remainder of 1938 and during 1939. This is the consensus of opinion among people who should know, men in the upper strata of business circles and those who have much to do with the finances of the country. Wall Street shows this trend, not so much by the rise in the stock market, which naturally is significant but by the fact that the large corporations are refinancing for expansion programs. All of this means that in a short time, the service industry like others will begin to show definite improvement. As a matter of fact signs of such improvement are already upon the horizon.

However, this editorial is not intended to paint a rosy picture of the future. Instead its purpose is to remind the servicing industry that another opportunity to get its house in order is fast approaching. We have felt good service years—years which should have been highly profitable. That such was not the case was proved by what happened within three months after business began to slump in 1937. There has been much talk about instituting correct business practices in previous years. But it seems that by and large it was just so much talk. A few men grabbed the bull by the horns and really went to town financially, but the rest had the desire but neither the ambition nor the courage to charge a profitable price while it was possible.

Another opportunity is on the way in. Will the service industry take advantage of it? . . . Will the service industry prepare itself financially for

future bad years? . . . Perhaps 1940 may not be so hot! No one knows—but at any rate the man who makes it his business to make money while he can, is going to avoid embarrassment and hardship during the lean periods. . . . Now is the time for those service organizations who are interested in their own welfare to start instituting proper business principles in their establishments. Years have proved that it is possible to get profitable prices from America's radio public. Look around you and you will find profitably operated service organizations in every city. . . . But they are by far too much in the minority. . . . The service industry as a whole requires more shops of this type. . . .

The bugaboo of association effort—oftentimes suggested as one reason why the attention of the service industry was diverted from the proper channel, has been solved. . . . A solid organization, sponsored and recognized by set and parts manufacturers is making good progress. . . . The industry no longer has to worry about the association. . . . The opportunity is again here for profitable service operation. . . . Don't miss this time. . . . If you do, you may not get the chance the next time!

PROSPECTS?

A number of men have written letters asking about the prospects of earning a decent living in the radio service industry. They want to know what to do about the future. Is it worthwhile continuing studies along radio lines so as to keep abreast of developments—bearing in mind that they have never been able to establish themselves in the servicing industry?

Our answer is that the prospects of earning a living in radio servicing are good, but certain requirements must be fulfilled. Servicing is a business founded upon technical knowledge, but technical knowledge alone is not sufficient. The application of sound business principles is also essential, which means that the man who is going to prosper in radio service work must also be somewhat of a businessman. No one made a living by just trusting to luck. Work along sound lines is imperative.

Just when television will become a commercial reality is problematical, but there is no doubt about the fact that the complications present from the technical angle when servicing becomes necessary, will be so numerous as to

drive many men out of the field, thus opening the field to a greater extent to those who make an effort to stick with it. It is our opinion that it is worth the gamble. . . . After all the entire life of the individual is a gamble, but considering all things, the future of the servicing industry is sufficiently bright to justify several more years of work and study. . . . Yes, the servicing industry offers good prospects to the man who knows what he is doing both from the technical as well as the business angle.

JOHN F. RIDER.

The Cover

From now on we are planning to give SUCCESSFUL SERVICING a bit more pep and the photograph gracing this issue's page 1, is the start. We're going to try to give you SUCCESSFUL SERVICING oftener than we have recently, as we have ever so many things about which you will want to know.

The cover photograph, which was supplied through the courtesy of *Pan American Airways*, was taken on the bridge of one of the line's Sikorsky planes which flies over the erstwhile haunts of Captain Kidd—the Caribbean sea. The radio equipment on the plane is being tested under actual flying conditions.

Philco 38-38

Beginning with Run No. 3, the 8000-ohm resistor, No. 21, was removed from the 90-volt tap and reconnected to the 135-volt tap of the battery cable. At the same time the value of this resistor was changed from 8000 to 25,000 ohms, Part No. 33-325339. The battery cable assembly was changed also to Part No. 41-3394.

In Run No. 4, the 900-ohm resistor No. 38 was changed to 2000 ohms, Part No. 33-220339. This change was made to decrease current drain on the "BC" battery. For schematic see page 8-73 of *Rider's Volume VIII*.

Philco 38-39

In order to reduce maximum volume buzz, the following parts were changed: the 11.7-ohm resistor, No. 22, was changed to 12.3 ohms; the 2-megohm resistor, No. 30, was changed to 4 megohms; and the 160,000-ohm resistor, No. 27, was changed to 240,000 ohms. See schematic on page 8-75 of *Rider's Volume VIII*.

The Chanalyst

(Continued from page 3)

not offer any problem in respect to its application.

The problem was also considered from the point of view of the servicemen's technical capabilities in relation to the new design of receivers. It was clear that a new attack—a new method of approach was in order so that the trouble in a receiver could be diagnosed systematically, efficiently, and quickly. As our readers will admit, although receiver design has advanced with gigantic strides in the last few years, the serviceman's methods of trouble localization might well be described as belonging to the Stone Age. It has been conceded that some new method must be devised if the service industry is going to survive by mastering the problems presented by the new receivers. We wish that you would think back over the last few months' work and remember the number of conditions that you were unable to check in late receivers or the number of things you had to assume—mainly because it was impossible for one reason or another to check them.

Three Essentials

With all these facts marshalled before us, we arrived at the conclusion that this signal-tracing method of testing required three major items in order to be effective; it must have universal application, positive identification, and speedy operation. In no one of the methods in use up to the present time are these three factors incorporated and you can readily see that they are necessary for rapid and accurate work. Although the signal is really the basis of the system, yet its tracing through the receiver is the primary, but not the only test. It is supplemented by a voltage test which although secondary, plays an important part. The primary test locates the trouble in some certain portion of the receiver—sometimes the exact defective part. The supplementary test identifies the defective part in many cases—but in every case furnishes the required information.

Now what must we be able to do in finding the portion of the receiver that is not functioning correctly and locating the faulty component? First we must be able to trace the passage of a signal entering the receiver through the antenna post throughout the various signal-current-carrying circuits, no matter if it be at radio frequency, inter-

mediate frequency or audio frequency. Then the signal must be traced throughout the receiver without altering the constants of the circuits and as a consequence, impairing the operation of the receiver and so nullifying the observations. Simultaneously, the operation of the receiver oscillator also is checked. The voltage tests must be of such a kind that they will take care of the operating voltages and also the control voltages that are developed by the signal. These voltage measurements can be made simultaneously with the observation of the signal and at points common to both the signal and the voltage. The measurement of the d-c voltages must be made with reasonable accuracy with respect to the true voltage present at the point under test without changing the constants of the circuit.

It is our belief that you will agree that the different points outlined above would go far towards helping servicemen over many difficult spots, if it were possible to perform the signal-tracing tests and make the various voltage measurements. And all this is possible. After several years of painstaking laboratory work, a device operating upon the principles outlined has been completed. It has been turned over to a manufacturer for production and sale.

We are sure the service industry will find it of great value.

Incidentally, this unit should be of interest to radio schools, because it is the first development available to students which is capable of tracing the passage of a signal through all parts of a receiver from antenna to ground, thus supplementing the usual black-board demonstrations.

New Radio Symbols

(Continued from page 4)

vidual switch sections can be broken up for convenience in drawing if desired. Adjacent to the switch or nearby on the drawing is an actual picture or pictorial representation of the switch leaf. The lugs on the leaf have numbers or are coded in a manner corresponding to the schematic of the switch section mentioned above. An idea of what was suggested will be seen in the partial schematic of the Stewart-Warner models 91-68, 98-61 and 910-61 shown herewith.

The members of the committee were J. K. Rose, Chairman, Wells-Gardner L. E. Priscal, Sentinel Radio J. N. Golten, Stewart-Warner George Devine, General Electric F. E. Smolek, Zenith Radio

ANNOUNCING ELECTROLYTIC CONDENSERS

Their Properties, Design and Practical Uses

By PHILIP R. COURSEY

Technical Director, Dubilier Condenser Co., London, England

By special arrangement with the English publishers, Chapman and Hall, Ltd., we have secured the sole American sales rights of this authoritative and comprehensive book on Electrolytic Condensers.

☐ CONTENTS: Condensers and Dielectrics — Origin and Development of the Electrolytic Condenser — Testing Electrolytic Condensers, Methods and Apparatus — The Wet Electrolytic Condenser — The Non-Aqueous or Semi-Dry Electrolytic Condenser — The Dry Electrolytic Condenser — The Separator and its Influence on the Performance of the Condenser — The Electrical Characteristics of Electrolytic Condensers — Applications of Electrolytic Condensers.

☐ The 172 profusely illustrated pages are well indexed and will provide you with a source of reference on electrolytic condensers that critics unanimously agree is unequalled.

☐ We have only 397 copies available and they may only be purchased directly from us. Mail us your check for \$3.00 today for your copy and it will be sent parcel post, postpaid.

JOHN F. RIDER, Publisher, 404 Fourth Avenue, New York City

Rolling REPORTER



NEW 1/4 1/4 1/4

Just in case any of youse guys didn't spot that box on page 5 of the last issue of S.S. we're hereby announcing that from now on you'll find us at **404 4th Avnooo** . . . and wotta whale of a difference just a few blocks make!! As we're parked here at our desk we can look down on that sight we never tire of—*Manhattan roof-tops* . . . Where else can you see somebody's wash flapping in the breeze and almost right next door a towering apt. house with its make-believe garden around a pent-house? There's a Jap freighter tied up in the East River—yep, the one with a red and white banded funnel—and you can just make out Brooklyn through the haze . . . *Well, you know Mae West's famous saying* . . .

VIDEO STUFF

T'other afternoon we ascended to the 62nd floor of Mr. Sarnoff's edifice and got an efnul of television *a la RCA-NBC* . . . Wotta far cry that was from the demonstration Dr. Alexanderson gave up in Schenectady about 10 yrs. ago!!! Then we squatted and peered and marveled at the two-inch square plate of a neon tube with its zebra-ish picture of flaming (*sic*) youth. *Yessir, we could even see the smoke from her cigarette!!!!* But the other afternoon—there we sat about 10 ft. away from an imposing cabinet and these old eyes witnessed another marvel in the form of a black-and-white picture about 7" x 10" which had *everything a GOOD movie has* . . . Boys, we're tellin' you it was **swell stuff** and we're doffin' the derby to Dr. Zworykin and his gang . . . *As we've said before—she's a'comin'!!!!!!*

NEWS PLUS

That's wot we considers the yarn that you've read by now—yep, we mean the scoop on the serviceman's newest fra-a-nnd, **Mr. Chanalyst**. 'Stoo bad we can't tell yuh *everything* he will do (*that's comin' later*), but we can repeat something that will bear the re-telling and that's this: that there boxful is a'goin' to be **the all-fired handiest thing you've got around the shop!!!!!!** *Wanta bet, huh?*

And wait till you see it . . . Generally, we looks at instruments with a sortuva fishy eye 'cause they're all more or less alike—but NOT the Chanalyst—**NO SIR!** Yeah, we know you think we're just doin' a lotta plugging, but we're not dishin' you out a line. Honestly, when these 6E5s are twinklin' away in back of that silvery panel—boy, that's a sight for yuh—and we don't mean perhaps.

RMS + NRI

That addition indicates a tie-up between Philco and National Radio Inst. by which servicers will be able to get some skull practice which, it is conceded by all and sundry, an awful lot of servicers thither and yon

need. Seems as to how the article J.F.R. wrote a coupla issues ago is bearing fruit . . . Biggah and bettah theory—and **more of it** . . . We might finish up that equation thus **RMS + NRI = More efficient Servicers.**

FROM HERE AND THERE

Steve Podlesnik, Kemmerer, Wyo. Thanks for the nice boost you give Rider Manuals and lotsa luck to you with your course. Remember what the Boss said about theory . . . **Arturo P. Muro, Oriente, Cuba.** Glad you like the Manuals and thanks for taking the trouble to write . . . **J. M. Weaver, Bethesda, Md.** Thanks ever so much for bringing that error to our notice. *That just goes to show that we are human and can pull a boner* . . . **E. E. Ward, Brunswick, Me.** So you found that Rider's Manuals were a help, eh? Well, there are a *good many thousand other servicers all over the world* that feel the same way about 'em . . . **Geo. J. LeBlanc, San Francisco, Cal.** We give you what the manufacturers give us, but we'll pass the word along to any we see around or about that you want more socket voltages and gain-per-stage dope . . . **Chas. Seeger, N. Y. C.** No, Mr. Rider has nothing to do with the new servicing magazine you mentioned other than writing an article or two for it . . . **We're sticking to our horse, S.S.** . . . Did you notice the "Changes" pages in Vols. VII and VIII? Is that what you mean? . . . **Kwek Bock Seong, Singapore, S.S.** Many thanks from both J.F.R. and your reporter for the flock of stamps you sent . . . There were some swell ones in the batch . . . We'll reciprocate . . . Notice that you're F.R.S.A. We do a bit of pastel painting ourself during weekends . . . **R. C. Heckmann, Fort Wayne, Ind.** Hope you've received the answer to your letter by

Wanted

We have been advised by the Federal Bureau of Investigation that the man whose photograph appears below has been trying to work a racket about which you should know. He offers subscriptions to one or two radio maga-



HARRY SCHWARTZBERG

now . . . If you don't get the dope you're after, write to this dept. and we'll mount the chariot and do some scouting for you ourself . . . **J. M. Thompson, Canandaigua, N. Y.** We're glad to have your comments on the editorial in the last issue of S.S. *Wonder if the boys realize this might be the hand-writing on the wall???*

RUMORS

We've heard tell in our meanderings around and about the office that the Boss is going to get out a book on the **business end of servicing** . . . Remember *wa-a-a-ay* back in the days when S.S. was a youngster we ran some business dope? Well, all that's going to be amplified—stream-lined—and with it you'll find *full sheets for recording the operations of your servicing biz for a whole year* . . . Those sheets will be fixed so that at the end of each month you'll know whether you've been operating at a profit or whether you have to bust out the red ink . . . All the forms will be complete—nothing else to buy . . . Then when we dropped in the editorial dept. t'other day, we saw 'em dummyping up **pages for Vol. IX** and we overheard that it's goin' to be around **1650 pages** and that it'll have another "*How It Works*" section like Vol. VIII and that you'll be able to get it **Nov. 19th** . . . *More about IX anon* . . . Last but 'tain't least, there'll be a book on *dynamic testing*—sortuva **Chanalystic test procedure**, if you know what we mean . . . testing a set under operating conditions . . . **Hi!!!**

INVITE

Just in case we might forget later on, when you come to N.Y. next year to the World's Fair (*free adv. for Grover Whalen*) drop in and see us . . . If we're not at our desk here on the 10th floor and if it's a blistering day, come downstairs and across the street to the free-lunch emporium, and then yell for

THE ROLLING REPORTER.

zines and as a premium offers to sell Rider Manuals at a price far below the one advertised.

As we have stated in the past, Rider Manuals—or any of our books—are only sold through established jobbers or in connection with legitimate tube deals. . . . We do not have any such arrangements with any magazine and if this man or any other offers any of our publications as premiums, be sure there is something wrong.

Harry Schwartzberg, we have been told by an agent of the F.B.I., is a fugitive from justice and has been "wanted" for the last nine years. He is about 45 years old, 5 and a half feet tall, stocky build, blue eyes, and dark hair. He is known to have employed several aliases. If this man contacts you, notify the proper authorities at once.

AUTOMATIC FREQUENCY CONTROL SYSTEMS

Get practical AFC facts from Rider's easy-to-understand explanations. 144 pp. Profusely illustrated. \$1.00.

The Dictionary TELLS IT BEST

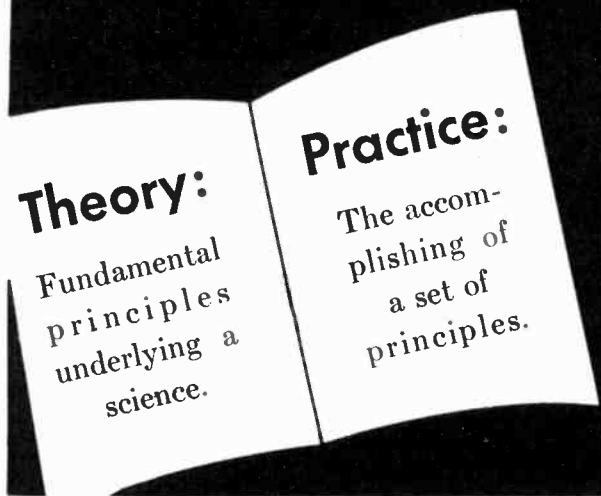

FIRST came theory, then practice. In the service industry successful practice depends upon a proper knowledge of theory. Theory is the root! Practice—the tree! Successful servicemen realize the advantages of learning theory first and are never troubled by new circuit changes or the complicated problems of modern service work. They depend upon Rider Books for basic theory and Rider Manuals for specific circuit information on American radio sets.

You Need *Theory* if you are to succeed in *Practice*

Rider Books ground you with a thorough knowledge of the basic theories underlying the ever-mounting number of new radio developments. They contain fundamental facts which will keep you ahead of radio, not forever catching up with it. No serviceman can afford to ignore the importance of

RIDER BOOKS *for theory*

The Cathode-Ray Tube at Work

With introduction of new, cheaper Cathode-Ray Tubes, this book is even more indispensable for its complete practical information on Oscillographs, etc. 336 pp. 450 ill. Price . . . \$250

Servicing Superheterodynes
Changes, changes, changes! That has been the history of the superheterodyne circuit. Make repairs quickly by analyzing the different parts of the circuit quickly. Rider shows you how. 288 pp. prof. fusely ill. Price . . . \$100

Aligning Philco Receivers

This new book presents authentic and complete instructions for fast and accurate alignment operation on ANY Philco receiver. Every trimmer is located for you. 176 pp. Hard cover. Only \$100

Servicing Receivers By Means of Resistance Measurement

Tells how to take guess-work out of servicing by using an ohmmeter. This method is in line with continuity data being furnished by set manufacturers. 203 pp. 93 ill. Price . . . \$100

"AN HOUR A DAY WITH RIDER" BOOKS

ON RESONANCE AND ALIGNMENT

A clear, easily understood explanation of what happens when a circuit is tuned to resonance. You need this! 96 pp. 48 explanatory figures . . . 60c

ON AUTOMATIC VOLUME CONTROL

In Rider's personalized style. Chock-full of information to make your AVC work easier—more profitable. 96 pp. 65 ill. Hard covers 60c

ON D-C VOLTAGE DISTRIBUTION IN RADIO RECEIVERS

Theory and practice of d-c voltages—how they are led through various types of networks to the tube elements—calculation of resistances, etc., etc. 96 pp. 69 ill. Hard covers 60c

ON ALTERNATING CURRENTS IN RADIO RECEIVERS

Illustrated with drawings and diagrams. . . . 60c

JOHN F. RIDER, Publisher
404 Fourth Avenue New York, N. Y.

RIDER MANUALS *for practice*

For practical application of your knowledge, Rider Manuals are indispensable. The eight volumes contain complete and authoritative circuit data on American-made radios and are in every-day use by thousands of servicemen as a time-saving and profit-making guide through the most complicated receiving sets. They form the most comprehensive compilation of service data available to the industry, indexed and cross-indexed to guarantee finding desired information in the least possible time.

VOLUME VIII—COVERING 1937-1938—\$10.00

1650 pages, plus 128-page index, plus 64-page "How It Works" section.

Rider Manuals are a part of any successful service business. Make sure you have all eight. If not, order the missing ones today.

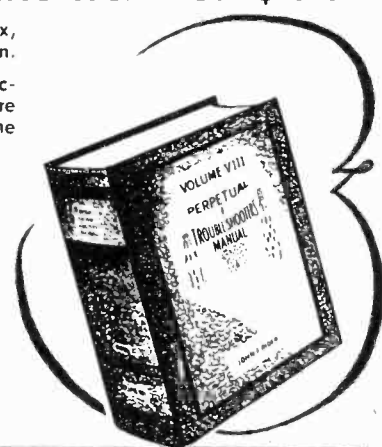

- Vol. VIII—\$10.00—1937-38
- Vol. VII — 10.00—1936-37
- Vol. VI — 7.50—1935-36
- Vol. V — 7.50—1934-35
- Vol. IV — 7.50—1933-34
- Vol. III — 7.50—1932-33
- Vol. II — 7.50—1931-32
- Vol. I — 7.50—1920-31

ORDER TODAY

YOU NEED ALL 8
Rider
MANUALS



AUGUST, 1938

Courtesy of Pickwick Motor Coach Works

NOTES ON P.A. SPEAKERS

How Size and Type of Speakers are Related to the Area Covered

BY JOHN F. RIDER

The subject of public address systems has been one that we have neglected too long in these columns. The following article is a forerunner. True, it is fundamental in its scope, but we believe that it will prove valuable in that it does contain data which can speed up estimates. We wish to acknowledge the courtesy of the Sound Service Division of RCA Manufacturing Co. for permission to use some of the technical information contained herein.—Editor.

THE selection of the proper apparatus for supplying adequate sound to all parts of a given room, hall, or outdoor area is not particularly difficult if certain facts be borne in mind. Fundamentally, sound can be manipulated and controlled with the same ease as the stream of water coming from an ordinary garden hose which has an adjustable nozzle. It can be directed to a certain area in a more or less concentrated form or it may be spread out over a wide angle

with a consequent lessening of the amount delivered per unit area. So as a starting point, it may be said that the area to be supplied must be known and also the amount of electrical power needed to supply this area with a sufficient volume of sound energy.

Of course, acoustics being what they are, no hard and fast rules can be laid down—too many variable factors exist; however, the data which follow will give a starting point and will prove approximately correct in a large percentage of cases. For instance, it can readily be seen that a much larger amount of power would be required to supply adequate sound to a group of people in a hall situated near a source of constant noise than the same people in the same hall located in a quiet neighborhood where the outside noise level is very low. Then again, the acoustical properties of the room or hall might be such that sound energy is readily absorbed—perhaps by some heavy drapes at the windows or by the

material covering the wall. Here more power would be needed than if the room were more or less bare with plaster walls and ceiling which would reflect the sound energy. Another factor which must be considered is the number of people who are present during the time the sound system is being used. The bodies of people in a crowded hall will absorb a great deal of sound energy and provision must be made for this extra amount—especially if the room be crowded over its normal capacity. Bearing these thoughts in mind, let us consider the estimating of the necessary electrical power that must be delivered to the loud speakers for certain rooms.

Table 1 (see next page) gives the number of electrical watts for different types of loud speakers needed for rooms or halls of various sizes, these being given in cubical contents. The second column is the power necessary for driving a unit that focuses the sound by means of a directional baffle of some

Philco 38-2

For 25-cycle operation, the following parts must be changed in addition to the power transformer: the 0.25-mf condenser, No. 98 on the schematic on page 8-55 of *Rider's Volume VIII*, is removed and replaced with a 1 mf-0.5 mf, part No. 30-4549. The white wires of this condenser are connected across the choke, No. 99, and the red wire to the junctions of Nos. 59, 60, and 66 (in the plate circuit of the 1st a-f tube). Also remove the 8-mf electrolytic condenser, No. 96, and replace it with a 16-mf electrolytic condenser, Part No. 30-2200.

Beginning with Run No. 2, the i-f circuit has been changed to use permeability-tuned i-f transformers. These changes and the locations of the compensators are shown on the accompanying partial schematic and layout. Note that the schematic numbers of parts differ from those in the schematic on page 8-55. The wires from each circuit, however, have been marked indicating the connecting points on the schematic in *Rider's Volume VIII*.

The compensators are adjusted as follows: The range switch of the receiver is set in the broadcast position; the volume control at maximum; the magnetic tuning switch to "off"; and the tone control in the first position. The signal generator is set at 470 kc.

Using a 0.1-mf condenser as a dummy antenna, connect the signal generator to the grid of the 6A8G detector-

oscillator tube and connect the cable ground to the set chassis. Set the attenuator of the signal generator for maximum output and adjust the i-f compensators as follows:

1. Turn compensator 1XB in until the output meter reading decreases almost to zero.
2. Now adjust the compensator 1XA and 1XC for maximum output; then readjust 1XB for maximum output.
3. Turn compensator 2XC in about three turns; then adjust 2XA and 2XB for maximum output. The adjustment procedure for 2XC is the same as that given at the bottom of page 8-56 in *Rider's Volume VIII* headed "Magnetic Tuning Circuit Adjustments."

In Run No. 3, a 250-mmf condenser, Part No. 30-1032, was connected from the screen of the 6U7G to ground to prevent parasitic oscillations.

Beginning with Run No. 4, the 6U7G r-f tube was replaced with a 6K7G to eliminate parasitic oscillations. In addition to the tube change, the green wire connecting the screen contact of the 6U7G and condenser 6 (0.05 mf) was increased in length. This wire should circle around the 6U7G socket towards the front of the r-f unit and then back to condenser No. 6. Place the wire as close to the base as possible.

The 250-mmf condenser that was added in Run No. 3 (see above) was removed in this run.

Zenith 15-Tube Receivers

In some of these receivers distortion has developed when using the set at low volume. This has been found due to some r.f. getting through to the a-f system.

The correction is an r-f filter in the a-f grid circuit as shown in the accompanying schematic. This consists of a 150,000-ohm resistor and a 0.0005-mf condenser connected as shown.

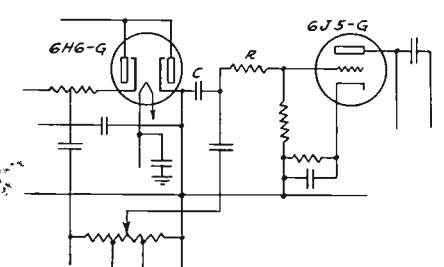

C and R form the r-f filter. For values, see above

Microphonism or a-f tube noise can be corrected by interchanging the 6J5 1st a-f tube or by replacing it with a 6C5G. The latter appears to give slightly less hum and has lower microphonic characteristics.

Mid-West 7-36

As was noted on page 7-2 in *Rider's Volume VII*, the tube complement of the late model of this receiver was changed, four metal tubes being employed. Below will be found the voltage data for both the early and the late models.

Early 7-36

Tube	Plate	Screen	Cathode	Supp.	Grid
58 R-F	235	80	0	0	AVC
56 Osc.	120	—	1	—	—
58 Mixer	215	80	1	1	AVC
58 1st I-F	190	80	0	0	AVC
55 2nd Det	35	—	0	0	—
2A5 Output	220	245	0	0	17.5
80 Rect	240	—	—	—	—

Filament voltage, 2.5

Late 7-36

Tube	Plate	Screen	Supp.	Cathode
6K7 R-F	225	100	0	0
6K7 Mixer	225	100	3	3
6C5 Osc	150	0	0	0
85 2nd Det-AF	30	0	0	0
42 Output	225	250	0	0
80 Rect	250	A-C	—	—

Filament voltage, 5.9 Volume control at maximum

Emerson Chassis AS

In sets having serial numbers above 1,294,500, the 150,000-ohm resistor, R8, was changed to 50,000 ohms and the 240-ohm resistor, R10, was changed to 310 ohms.

In sets with serial numbers above 1,294,700, C31 was changed from 0.002-mf to 0.006-mf. The speaker was changed from Part No. 4FS-274 to 4SS-278.

See schematic diagram on page 8-49 of *Rider's Volume VIII*.

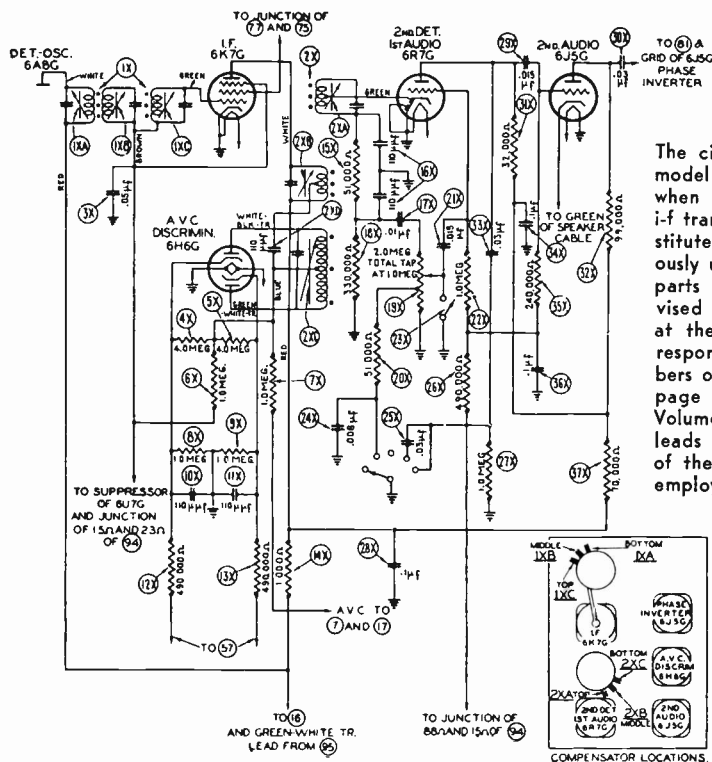

The circuit of the Philco model 38-2 was changed when permeability tuned i-f transformers were substituted for those previously used. Note that the parts numbers in the revised partial schematic at the left, do not correspond with the numbers on the schematic on page 8-55 of *Rider's Volume VIII*, but that the leads going to the parts of the circuit not shown, employ the original numbering.

type, while the other five columns are calculated for a flat baffle where the loud speaker mechanism is mounted in free space or flush in a wall with a plaque or in a box on the wall. The bottom line of the table shows the maximum number of undistorted watts output that each type of speaker is capable of handling.

As was stated above, the acoustical and local conditions of the room or hall in which the sound system is to be installed have to be considered in determining the amount of power used. For example, if the installation is to be in a quiet place, such as a guest room in a hotel or in a school room, church or hospital, the values of the power required for a given area as stated in the table can be divided by 10 and this will be sufficient for the normal reproduction of speech and incidental music. On the other hand, if the installation is to be in a room or hall where the local noise level is relatively high, it may be necessary to multiply the power values in Table 1 by a factor of 3 or as much as 4 and in extreme cases, by even a larger factor to gain the best results.

Let us take one or two examples. A large lecture hall measuring 50 feet long by 40 feet in width has a 10-foot ceiling. The cubical contents of this room is therefore 20,000 cubic feet. Even though the room is used for lectures and no noise arising within the room has to be overcome, outside conditions are such that a fairly high noise interference level exists. Therefore, to be on the safe side, the figures as they are given in Table 1 will be used.

The speaker selected naturally is a matter of cost and this must be determined before the estimations can be made. Let us assume that an electrodynamic loud speaker with a flat baffle is chosen. Starting at 20,000 in the first column, we find that 6 watts are needed if a large speaker be employed or double this value is necessary if a small dynamic be used. Going down to the bottom row of the table, it is seen that the large electro-dynamic loud speaker will accommodate 6 watts easily, as its rating is 10, but that a small speaker of the same type can be expected to handle but one half of this amount. On first thought, it would seem that the logical choice would be one large speaker as three small units of this type would be needed to handle 12 watts, each taking care of 5 watts safely. However, acoustical conditions in the room might be such that better distribution of the sound would be had

if more than one speaker were used; in which case it would be better economically to use the smaller speakers, each working well within its rating.

Let us take another example. The room to be supplied with sound is a hotel parlor and the system is to be used for paging guests or supplying incidental music—in other words, quiet conditions will generally prevail. The room is 25 feet wide, 40 feet long and has a 15-foot ceiling, giving a volume of $25 \times 40 \times 15 = 15,000$ cubic feet. Referring to Table 1, no value of power for this size room is given, so we must interpolate between 8000 and 20,000 cubic feet. This is easily done as follows:

$$20,000 - 8000 = 12,000$$

$$15,000 - 8000 = 7000$$

So the interpolating factor (A) is found by dividing

$$\frac{7000}{12,000} = \frac{7}{12} = 0.582 \quad (A)$$

Let us assume for the moment that it has been decided to use a large permanent magnet speaker and base our calculations on that. It was stated above that quiet conditions prevailed in the room, so that 1/10 the power figures in Table 1 can be used. Therefore, we have

$$8000 \text{ cubic feet need } \frac{6.4}{10} = 0.64 \text{ watt}$$

$$20,000 \text{ cubic feet need } \frac{24}{10} = 2.4 \text{ watts}$$

The difference being $2.4 - 0.64 = 1.76$ watts (B)

Interpolating, we multiply (A) by (B), so

$$1.76 \times 0.582 = 1.024 \text{ watts}$$

This is the amount of power above that for the 8000-cubic foot room, so we add 1.024 to 0.64 and have as the power requirement 1.66 watts approx-

imately. This amount of power can be easily handled by a large permanent magnet dynamic speaker whose capacity is 5 watts (see table). Also it might even be handled by a small speaker of the same type as there is more than 0.3 watt leeway.

Again the matter of the best distribution of the sound energy must be considered and if necessary two small speakers could be used on the 40-foot side of the room. If such an arrangement is used, each speaker will handle one half of the total amount of power or 0.83 watt.

While the flat type of baffle is ordinarily thought of as being non-directional, it does have a definite distribution angle, especially when the higher range of audio frequencies are considered. This angle may be thought of as 90° for both the horizontal and vertical planes. In general flat baffles should be used in rooms where the reflection of sound from ceiling, floor and walls is unimportant. This means that this type of baffle should be installed in small spaces, such as hotel rooms, school class rooms, small lecture rooms, hospital ward rooms, etc., or rooms which have been acoustically treated to give the best results.

In determining the number of speakers that should be installed in a given room for best coverage, it is a good idea to lay out the room in dimensions to scale and then place the loud speaker so that distribution over at least 75% of the horizontal area results. It has been found that if one speaker does not cover this percentage of the area, then two speakers should be employed on the same side wall and never more than 40 feet apart.

(To be continued)

TABLE I.

Volume of Room in Cubic Feet	Electrical Power in Watts to Various Types of Loud Speakers					
	Any Directional Baffle	Large Elec. Dynamic Speaker	Small Elec. Dynamic Speaker (70-80 mil field)	Large Perm. Magnet Dynamic Speaker	Small Perm. Magnet Dynamic Speaker	Magnetic Speaker
		On a Flat Baffle				
1,000	0.05	0.2	0.4	0.8	1.2	1.2
2,000	0.1	0.4	0.8	1.6	2.4	2.4
4,000	0.2	0.8	1.6	3.2	4.8	4.8
8,000	0.4	1.6	3.2	6.4	9.6	9.6
20,000	1.5	6.0	12.0	24.0	36.0	36.0
50,000	3.0	12.0	24.0			
100,000	5.0	20.0	40.0			
250,000	10.0	40.0				
600,000	20.0					
1,500,000	40.0					
Max. Undistorted Power Handling Capacity in Watts	10	10	5	5	2	0.5

Wells-Gardner 5 Tube AC-DC Models

Due to variations in 6J7 tube characteristics, distortion may be encountered at medium or low volume levels. This can be remedied by changing the .5 megohm 2nd detector screen series resistor (R5) to a .7 megohm resistor. This same result, of course, can be obtained by placing an additional .2 megohm resistor in series with the .5 megohm resistor.

Later production models have the .7 megohm resistor.

Zenith 5F233, 5F251

Complaints of short B-battery life or poor tone quality in 4- and 5-tube 2-volt receivers can be corrected by eliminating the C battery and converting the circuit to automatic bias and by by-passing the plate voltage in the set with an electrolytic condenser. The partial schematic diagram shown herewith shows where the changes are made in the chassis No. 5522 (used in the models mentioned above) as an example. See page 8-5 in *Rider's Volume VIII*.

Disconnect the negative B-battery yellow lead where it connects to the chassis inside the chassis base. Connect a 300-ohm resistor ($\frac{1}{4}$ -watt) in series with this lead to ground. See "A" in schematic. Run the bias lead from the grid of the 1H4G and the grid of the 1J6G to the yellow B lead under the chassis. Disregard the green lead as the C-battery is omitted. See "B" in schematic.

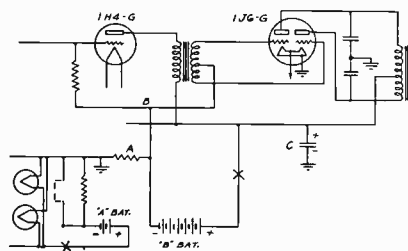

Partial schematic of Zenith 5F233, 5F251

Connect an 8-mf, 150-volt electrolytic condenser from +B to ground after the B circuit switch so that it is not connected across the B batteries when the receiver is turned off. See "C" in schematic.

These changes allow the bias voltage to drop automatically as the B voltage decreases and thereby preserves the tone quality. Originally the bias voltage remained constant when the B voltage dropped. The batteries should be useable down to about 50 volts or a 135-volt drop.

RCA 85T1, U-101, U-103

The 450-mmf condenser, C-1, which is connected in the oscillator grid circuit, has been changed to 470 mmf. It is not ordinarily required to replace this in the field, except where trouble might be experienced during re-alignment of the oscillator circuit; in which case tracking will be facilitated if the original unit is replaced with the 470-mmf type, Stock No. 30396. The schematic of model 85T1 will be found on page 8-113 and that of the other two models on page 8-147, both being in *Rider's Volume VIII*.

Emerson Chassis H

In the portable model (H-137), after approximately 135 hours of service the initial fresh battery performance may be restored by shifting the $67\frac{1}{2}$ -volt lead, which is brown, to the 90-volt terminal of the "B" batteries. This will increase the screen voltage to about its normal value.

The alignment of this chassis is conventional, using the i-f peak of 456-kc for the four i-f trimmers, the locations for which will be found on page 7-39 of *Rider's Volume VII*, and 1500-kc for the aligning of the oscillator, r-f, and antenna trimmers with a 0.0002-mf condenser as a dummy antenna.

Emerson Chassis D

In receivers having serial numbers above 850,000, a 15,000-ohm resistor has been connected from the tap on the volume control to ground. This is a $\frac{1}{4}$ -watt carbon resistor, Part No. KR-63.

In receivers having serial numbers above 864,755, the resistor, R-20 that is connected from the cathode of the 6C5 phase inverter tube to ground, has been changed from 5000 ohms to 10,000 ohms.

Please make these changes on the schematic of this chassis on page 7-37 of *Rider's Volume VII*.

Emerson U-154

In receivers having serial numbers above 1,173,551, the pre-selector coil was changed from Part No. 3UT-331 to 3UT-365; the oscillator coil was changed from Part No. 3UT-325 to 3UT-366; and the three-gang variable condenser from Part No. 3VC-319A to 3VC-359. This substitution of the variable condenser necessitates a change in the alignment. On page 8-34 of

Rider's Volume VIII the signal generator frequency for the r-f and oscillator alignment is designated as 1530 kc. This is used on those sets having a variable condenser with the part number of 3VC-319 or 3VC-319A. When this number is 3VC-359, the signal frequency is 1570 kc.

The following changes were made to receivers having serial numbers above 1,171,661: The first i-f transformer was changed from Part No. 3UT-332 to 3UT-369. A small capacity coupler was added between the oscillator (central) and i-f (front) sections of the variable condenser. These sections are C3 and C2 respectively on the schematic diagram shown on page 8-33 of *Rider's Volume VIII*. The 0.003-mf condenser, C-22, is now connected between the plate of the 41 output tube and B+ instead of ground, as it is shown in the schematic.

On sets having serial numbers above 949,553, the cathode of the 6D6 a-f amplifier tube is connected to the cathodes of the 6D6 i-f amplifier and the 76 second detector tubes through a 1000-ohm series resistor and not connected directly as shown in the schematic.

Emerson Chassis C

The revisions of this chassis as noted on page 6 of the February 1937 issue of *SUCCESSFUL SERVICING* and subsequently published on *Changes page 8-1 of Rider's Volume VIII*, have another change. The 0.01-mf condenser, No. 55, which was connected across the primary of the output transformer, is now connected from the plate of the 6L6 output tube to ground.

Also on receivers having serial numbers above 880,050 the short-wave antenna and detector coil trimmers, C6 and C9 (see schematic on page 7-36 of *Rider's Volume VII*) are mounted on their respective coils. C6 is connected directly across the secondary of the short-wave antenna coil, T3, and is not returned to ground, as shown on the schematic.

Emerson Chassis AF

The 0.25-mf condenser, C-17, that was connected between the negative side of the filament and ground, has been eliminated and now this side of the filament is grounded to the chassis. This applies to those receivers having serial numbers above 1,244,716. The schematic of this set will be found on page 8-45 of *Rider's Volume VIII*.

Servicemen who have

SHOT TROUBLE with

**The
RIDER
CHANALYST**

ARE UNANIMOUS THAT IT IS

*The Greatest Advance Ever Made in
the History of Service Instruments*

*See over for some actual Case Histories where The
Rider Chanalyst Eliminated Guesswork and Speeded Up
Diagnosis of the Trouble in Receivers.*

SERVICE INSTRUMENTS, INC.

404 Fourth Avenue

New York, N. Y.

CHANALYST CASE HISTORIES

CASE 1. This was a four-band superheterodyne. The receiver functioned properly on the short-wave bands, but its performance was erratic on the broadcast band. When the receiver was switched from a short-wave band to the broadcast band, sometimes the signal would come through satisfactorily and other times the band would be dead. As the three short-wave bands operated normally, the trouble necessarily was ahead of the i-f amplifier and in the broadcast circuit, with the functioning of the switches being suspected. But where in the switches?

A 600-kc signal was fed to the receiver between the antenna post and ground, after the set had been connected to the Chanalyst. The RF-IF probe was clipped onto the grid prong of the mixer tube and the channel resonated to 600 kc. The Oscillator probe was clipped onto the grid prong of the oscillator tube and that channel was resonated. The Electronic Voltmeter lead was placed upon the oscillator plate prong. The receiver was then switched back and forth from the short-wave to the broadcast band until no signal was heard on the latter. The indicator of the RF-IF channel showed the presence of the incoming signal at the mixer grid but there was no output from the oscillator tube indicated. The voltmeter showed plate voltage on the oscillator.

A continuity test showed that the oscillator coil was open and tracing proved that the open was at the switch contact. The trouble was located in less than five minutes.

CASE 2. The receiver was a seven tube superheterodyne. The complaint was that the receiver was "dead." The power cord of the receiver was plugged into the Wat-

tage indicator receptacle of the Chanalyst. This is located in the rear of the chassis. The receiver and Chanalyst were turned "on." The power consumption of the set was checked by turning the Watts control until the Watts indicator shadow closed. The power consumption was determined from the position of the Watts Level control and it was much higher than normal, as indicated in the service notes. The receiver was turned off. Then the voltmeter probe was connected to the heater circuit of the rectifier tube by means of the flexible connector.

The receiver was again turned "on." The power consumption was "high" and the d-c voltage between the rectifier cathode and ground was "low" . . . An overload upon the power supply was evident. The rectifier tube was removed from its socket and the power consumption decreased very materially, indicating that the trouble was in the rectifier tube, beyond the tube in the power pack, or in the voltage supply circuits being fed from the power pack.

The rectifier tube was checked and found okay. The circuit was examined and two "B" supply leads were noted between the power supply and the tubes in the receiver. The "high voltage" B lead feeding the tubes was disconnected at the power pack and the Wattage and voltage again checked. The voltage was still low, which proved that the "load" was not in the circuit fed by the main lead. The set was turned off and the main lead resoldered. The other "B" lead was disconnected at the voltage divider and the receiver turned "on" and the voltage again checked. The voltage was up, showing that the "overload" had been removed.

A resistance check in this "B" supply circuit showed that the condenser which

by-passed the resistor feeding the i-f tube plate was shorted to ground. This was replaced and operation restored. Total time elapsed did not exceed twenty minutes.

CASE 3. The receiver was a ten tube superheterodyne. The complaint was noise—a frying sound. Volume and other characteristics were normal. The receiver was connected to the Chanalyst. A broadcast signal was tuned in. The RF-IF channel was tuned to the frequency of the broadcast station and the probe placed upon the antenna terminal. A head set was plugged into the output of the RF-IF channel. The signal at the antenna was heard and it was clear. Then the probe was moved through the r-f system of the receiver—advancing from the primary to the secondary of the r-f transformer and from the grid to the plate of the r-f tube, until the control grid of the mixer was reached.

Beginning at the plate of the mixer, the RF-IF channel was tuned to the intermediate frequency and the RF-IF probe was moved from the plate of the mixer towards the second detector. The signal was clear up to the control grid of the second i-f tube. The signal at the plate of the tube was noisy.

The trouble therefore was located somewhere in the second i-f tube circuit. The resistors in the circuit were changed and as each resistor was changed the signal was checked in the headphones. When the screen resistor was changed, the noise disappeared.

The time elapsed for checking was about ten minutes and after localization of the fault, about fifteen more minutes were spent making the replacement of the plate and screen resistors.

MANUFACTURING FACTS

To give you an idea of the care taken in the manufacture of the Chanalyst, each plug terminating the voltmeter probe, is checked for leakage resistance. This is the cable that connects across the 10,000,000 ohm input. These plugs must show a leakage resistance of at least 500 megohms or 500,000,000 ohms between the live probe point and the shielded cable. This high resistance must prevail with the entire cable assembled.

The coils used in the RF-IF and Oscillator channels are checked before being inserted into the unit. This test is for the

"Q" of the coil as well as for the inductance.

The Voltmeter ranges are checked throughout the entire scale. The proper voltage over the 500-volt range is applied to the instrument. The attenuators and multipliers are tested individually to assure continuous and accurate operation.

Very high safety factors are allowed in the selection of the condensers used. For example, the line filters across the input power transformer are 600-volt condensers, although the operating voltage is only

105-125 volts. In other circuits where the voltages vary from 10 to 200 volts maximum, the lowest voltage condenser is 400 volts. Each and every resistor used in the unit has been checked for its resistance. Similar conditions prevail in the case of the resistors. Several hundred percent safety factor is allowed in the wattage dissipation. In place where the power dissipation is a hundredth of a watt, a ½ watt resistor is used.

Everything has been done to make certain that the unit will remain operative in the field.

Chanalyst Model A	50-60 cycles 117 volts, complete with tubes	\$107.50 net
Model AX	25-40 cycles 117 volts, complete with tubes	112.50 net
Size	14" x 9" x 9¾"	Weight: 26 pounds

THERE'S ONLY ONE RIDER CHANALYST!

Successful SERVICING

Reg. U. S. Pat. Off.

Dedicated to financial and technical advancement of the radio service man.

Published by
John F. Rider, Publisher
404 Fourth Ave. New York City

John F. Rider.....Editor
G. C. B. Rowe.....Assoc. Editor

This publication is the house organ of the publisher and if due credit line is given, permission is hereby granted editors to reproduce material contained herein.

Vol. 4 August, 1938 No. 5

BUSINESS CONSCIOUS

FOR the past four or five years we have endeavored to drive home to those groups of servicemen to whom we have talked the importance of combining business with their servicing of receivers. We tried to stress that if they ever expected to get anywhere with their servicing business at all, they would have to know something about costs, charge a profitable rate for their time, and install some sort of a simple system of bookkeeping.

The majority of our audiences apparently agreed with us that something should be done, but from all we could gather the inertia that seems to be inherent in most people kept them going along the same old, slipshod way. . . . They reminded us of Mark Twain's famous remark about the weather, "Everybody talks about it, but nobody ever does anything about it."

Of course, just to prove the old saw about every rule having its exceptions, we did receive a letter now and then from some serviceman saying that he had taken our words to heart, installed a system of sorts in his shop, and was gratified at the results. But such letters were few and far between. Most men, we were convinced, were content to let things slide along in the same old way and then yell to the high heavens that business was terrible, when as a matter of fact, they were not doing a single thing to help it.

But for some reason which we can not fathom, a change for the better seems to have filtered in. . . . During our travels these last few months we have repeatedly been asked questions relating to certain phases of the busi-

ness side of servicing. . . . we have overheard remarks which indicated clearly that the men were thinking as a businessman should. . . . For instance, one man said, "I made up my mind that I was going to charge more per job, then I can get that instrument, which I think will pay for itself in a few months." That is straight business talk and we firmly believe it was no line of idle patter.

We do not think that we can be blamed if we have taken a more or less pessimistic point of view on this subject in the past—in fact, we had almost come to the conclusion that our efforts were futile—but now we are positive in the belief that the serviceman is becoming business conscious—that our efforts were not entirely in vain. We are most assuredly glad. . . . No earthly reason exists that we know of why any serviceman with a modicum of good, old horse-sense plus a solid foundation of technical knowledge can not make a go of his shop if he will apply just a few simple rules of good business procedure.

We suggest you give this some thought. . . . You won't find it very painful and it might help.

OPPORTUNITY

The other day we were talking to an engineer who is responsible for a great deal of the development in electronic musical instruments, especially the piano. We had heard a demonstration of this instrument last Fall and were impressed by its versatility. We inquired how these electronic pianos had been selling and he replied that a great many jobbers had been afraid to stock them mainly because if something went wrong they would be unable to service them.

Now servicing one of these pianos is essentially a radio serviceman's job. True, it needs an experienced piano man to tune the strings correctly, but all in all who is better fitted to repair and adjust an audio amplifier and a few simple and easily understood associated circuits than a radio serviceman? The two men have to cooperate in the tuning and adjustment of the instrument and this is what apparently has scared off the dealers.

Moreover, this friend of ours told us that a number of other musical instruments had been electrified, so to speak, and that they too would need

the attention of a serviceman familiar with amplifiers. These instruments are becoming more and more popular with dance orchestras and we think will be found soon in homes. We feel that it might be worth your while to familiarize yourself with this new field of electronic music.

Here is something brand new—and a lot nearer than television.

JOHN F. RIDER.

Rider Travels

In order to acquaint servicemen and jobbers with the Chanalyst, John F. Rider is planning a series of trips to different sections of the country where he will demonstrate the new instrument. He spoke at Lancaster, Reading, and Pottsville in Pennsylvania and will speak at Ithaca, Elmira, and Binghamton, N. Y.; Kansas City, Mo., Columbia, South Carolina, Winston-Salem, North Carolina, Washington, D. C., Pittsburgh, Altoona, Harrisburg, Hazleton, Allentown, Philadelphia, Pa., and Wilmington, Del. Demonstrations have already been given in Mount Vernon, N. Y. and a special jobber session was held in the offices of Service Instruments, Inc., New York City early in August. Other dates for demonstrations are now being arranged in New England, the Middle and Far West.

MEET

KNOWITT and GESSITT



RIDER'S

Ordinarily this is the time of year when most offices are doing some relaxing—maybe on account of the heat or perhaps the thoughts of vacations are uppermost in people's minds, but right now is the time when "heat" of a different kind is applied to our edi-

VOLUME

torial department. These days scissors are snipping a bit faster—rubber-cement brushes are being wielded quicker—and the pile of dummy pages for Volume IX of Rider's Manuals is mounting higher and higher.

The last two or three years have seen the amount of servicing data re-

IX

ceived from the receiver manufacturers increase by leaps and bounds. And this year is no exception. . . . Looking over our files of data, it seems as though the manufacturers were trying to outdo their performances of the past. Never have we seen as many chassis and models and we may say that complications are the rule instead of the exception, both electrically and mechanically. As you most likely know, even the 4 and 5 tubers have their share of push-button tuners . . . and that means something more for you to fix, but you'll be told how to do it in Rider's Volume IX.

You all know that it has been our aim to make available to you data in the most usable form. An example of this is the tabular form of alignment instructions. It gives us pleasure to tell you that more and more service bulletins are coming to us with the data in tables. That, of course, means that we are able to give you servicing information on more models, as we can concentrate more on a Manual page.

The comments we received in the last year on the "How It Works" section of the Volume VIII Index has decided us to include a similar 64 pages with Rider's Volume IX. It will contain the information you need about the latest electrical developments in receiver design together with other

data that will help you speed up your diagnosis of troubles.

Rider's Volume IX will contain about 1650 pages. . . . It will have an Index telling exactly where you can find everything in all nine volumes—everything on every Manual page will be indexed and cross-indexed where necessary. . . . And here is some good news: even with production costs soaring and everything else you can think of going up, there will be no increase in price over that of Volume VIII.

The date of publication has been set for November 19, 1938. . . . The next time you are in your jobbers, tell him to reserve a copy of his first shipment for you. Remember—you can't go wrong with a Rider Manual and how wrong you can go *without* one.

The Cover

The cover photograph, supplied through the courtesy of the *Pickwick Motor Coach Works*, shows how a defective motor is removed from a bus. Instead of keeping a bus off the road for one or more days while the motor is repaired, the whole power system is pulled and another substituted.

We are planning to show servicing in fields other than radio and we would like to know what you think of the idea. We have some remarkable pictures in the file . . . watch for them. That really is successful servicing.

Schematic Symbols

We have received additional information about the proposed standardization of schematic symbols, which was published in the July issue of *SUCCESSFUL SERVICING*.

The method of showing tube sockets on schematics was discussed among other subjects at the meeting of the Service Section of the R.M.A., which was held last June, and the following was the consensus of opinion:

"The socket should be drawn schematically on the schematic with the tube element brought out to the nearest convenient point. In addition to the schematic there is a bottom view drawing of the chassis with each socket in the proper position and the bottom socket terminals shown. Voltages are shown adjacent to each terminal."

The committee on the standardization of schematic symbols has been re-

tained for another year and other recommendations will be made at future meetings. Some of the items to be discussed will be the matter of differentiation of fixed condensers (mentioned in these columns last month) and band designation in all-wave and skip-band receivers.

Wells-Gardner 6C1

The "B" issue of this series of auto-radio receivers has several changes incorporated in it and its data differ from those shown on *pages 8-17 to 8-19 in Rider's Volume VIII*. This issue can be identified by the issue letter which is stamped on the top of the chassis base and on the tube layout label on the chassis case cover. Specify this letter if parts be ordered.

The gang condenser used in the new issue does not have the cut-plate oscillator section. The new part number for the gang condenser is 14A77. A padding condenser (600 kc) was added in series with the oscillator section of this gang condenser and the oscillator coil. The padder is a part of the 2nd i-f trimmer unit and is mounted in the coil can. In other words, the 30-100 mmf condenser, C-14, and the new 900-1300-mmf condenser are mounted in the same can and have a part number 17A79.

The capacity C-15 shown within a dotted circle on the schematic in the 2nd i-f coil assembly, has been changed to an actual part and has a part number 47X57.

- The following parts have been changed in the late issue and below will be found the new parts numbers:
- T1 Antenna Transformer and Can
Assembly9A859
- T2 R-f Transformer and Can
Assembly9A860
- T3 Oscillator Coil and Can
Assembly9A862
- T5 2nd I-F Transformer and
Can Assembly9A858

The 2000-mmf molded condenser in the plate circuit of the 41 output tube has been changed, to a 0.002-mf, 1000-volt tubular condenser, Part No. 46X-219. A 15-ampere fuse is now used instead of one rated at 20 amperes. The 25-inch volume or tuning control flexible drive shaft has been changed, the Part No. now being 18A49. The changes in this last paragraph apply to all issues of the 6C1 receivers, not just the "B" issue like those above.

Rolling REPORTER



Pre-vacation and very random thoughts of a guy trying to write a colyum on a super-heated day . . .

"In the good o-o-oold sum-mer time"—**BLAH!** The guy that wrote that song must have lived someplace where the thermometer never went above 60° . . . *it's a cinch he didn't live here* . . . now I suppose I'll hear from my other reader that where he lives it never gets above 55, but then I'll bet it will be someplace like Maine where you can't step up to a polished mahogany counter with a brass rail about ten inches off the floor and say to a white-coated gent, "A cold seidel of light" . . . (*Business of smacking lips.*) Well, at that I guess Noo Yawk has its moments . . . Le's see now—I'm supposed to dish some news, the which is sorta sparse these days . . . well, for one thing when I poked my head in the editorial dept. yesterday I near lost said head . . . seems as to how the tempo as well as the temperature was up plenty. Yep, Vol. IX is bein' dummied and the gang are assuming their wild-eyed look that I've noticed graces their maps along 'bout this time of year . . . From all I can gather **Vol. IX is going to be better than any other yet** . . . As I told you last month, you can get yours, Nov. 19th . . . By chowder, I do have a hunka news that was slipped to me just before I went out this noon for the crackers and milk . . . The piano outfit that introduced the electronic piano last summer have a new model this year . . . Not only can it be played like a regular piano but it will give out music that sounds like an organ or a banjo or a guitar **AND hooked to it somehow is a radio-phonograph combination!!!!** This last is in the piano bench . . . The only thing that it won't do is shave you in the morning. And don't think that these pie-anners won't need the deft touch of a serviceman now and then. We told you about 'em last year and **we're tellin' you again!** Don't come around in a couple of years and tell us we kept this electronic music stuff a secret . . . Take a peep in Vol. VIII'S special section . . . *And there'll be more anon!!!* Yeah, that's what the weather man said about the hot weather this morning . . . and dammit, he's right for a change . . . T'other day a servicer called up and asked if there was any dope around on some Telefunken receiver . . . That's the first time we've had a request for that . . . Howrya bettin' on the Russians and Japs declaring war even tho' there's a truce??? *Wonder of it's cool in Siberia this time of year?* I had a visitor from London lately and he did a lot of lamenting over the condition of their servicing biz. His outfit specializes in U.S. receivers and because of patent situations over there, most imported superhets are taboo. *The only ones that get in the country have to be bootlegged.* T-r-f sets they let in, but few supers and you can see what *that* would do to a servicing biz . . . He did a lot of waving of the Union Jack for their television and they must be good, but the lookers-in have to pay pul-lenty for a license—much more than just for a listening license . . . oh, well, give us time—give us time and we'll all be peering at the end of a cathode-ray tube too and then we'll be able to check up on the judgment of some of these announcers

who pull all this stuff about "Here comes the beautiful Annie Whoosis to the mike, etc." From what we've seen in and about some studios, those announcers are sometimes mighty careless with their adjectives . . . either that or they're blind . . . wonder if it'll rain today??? Had to water my garden last night for the first time in weeks . . . And speaking of H₂O makes me think of the Atlantic Ocean (*how'd you like to go for a swim about now?*) and that jumps me to Europe where a friend of mine has a job with a government that buys all the licker and wine sold in the country . . . This gent told me that in the last few years, *he has tasted more than 14,000 different wines, whiskies, cognacs, and anything else you can think of* . . . He went all over the continent sampling . . . **There's a job for yuh!!!** Before I forget I want to thank **Chet Aydelotte of East Gary, Ind.**, for sending in those four schematics and for writing me that swell idiotic letter . . . They're having the schematics photostated and you'll get 'em back anon . . . They'll be in Vol. IX, I'm told . . . *Useless information*—the U.S. has about 50% of the 37,098,084 telephones in the entire world and that means that we're about 40% ahead of any other country, the next biggest user being Germany with 9.25% . . . Now I'd better look over the mail . . . sorta few this month—guess it's too hot for you guys to write and I don't blame yuh *a-tall* . . . However, here's a letter from **K. C. Gamaway of Miami** telling us about an error in Vol. VIII . . . Thanks for your trouble and it will be corrected in the next run of the Index . . . **Mitchell Vincent, South Richmond, Va.**—That's a good name you

chose for your shop and it looks to us as though you were starting off on the right foot . . . You're being sent the data you requested . . . Thanks for saying such nice things about the Manuals . . . **Charles Stephens, Detroit, Mich.**—Righto, you're on the list to get S.S. from now on . . . Hope you like it . . . The Boss told me he appreciated your kind comments about his talk in your town and hopes that his suggestions about running your biz will help some . . . **Sam Porto, Chicago**—Well, Sam, we do try to make the Manuals as complete as we can and we're always glad when somebody writes in and tells us so . . . Thanx . . . **P. V. (Auf Wieder) Zeyn, West Milton, Pa.**—The magazine you mentioned has been absorbed by another in the same company. So-o-ooo, you're an arm of the law, eh? Well, the gent mentioned last month under the colyum was heard of up in New York state. **Robt. Brown of Dolgeville** saw the notice in S.S. and when a gent answering the published description pulled the same old line on him, he put the law on his trail. We haven't heard whether the F.B.I. got their man yet . . . Any news will be duly reported . . . Well, as I said at the top of this here colyum, these are pre-vacation drippings from a parboiled mind and those days that loom up ahead look *mighty good* . . . yessir, I'm headin' for a **COOL** place that's right smack on the coast where there's rocks and sand dunes and water and trees and hills—in fact, everything that gladdens a would-be artist's heart . . . and so, gentlemen, with a graceful bow and a wave of the mahlstick, here's the temporary exit of

THE ROLLING REPORTER

New Words

Just in case you are talking to someone about cathode-ray tubes, here are a few new words which are supplied by the Allen DuMont Labs.:

Oscillotron—A cathode-ray tube for oscillograph work.

Phasmajector—Meaning an image

emitter or a tube which provides a standard video signal source to aid television experimentation.

Teletron—A cathode-ray tube for television work.

Electromalux—Meaning an electric eye or photoelectric mosaic pick-up tube for television camera work.

ELECTROLYTIC CONDENSERS

Their Properties, Design and Practical Uses

By PHILIP R. COURSEY

Technical Director, Dubilier Condenser Co., London, England

By special arrangement with the English publishers, Chapman and Hall, Ltd., we have secured the sole American sales rights of this authoritative and comprehensive book on Electrolytic Condensers.

☐ **CONTENTS:** Condensers and Dielectrics — Origin and Development of the Electrolytic Condenser — Testing Electrolytic Condensers, Methods and Apparatus — The Wet Electrolytic Condenser — The Non-Aqueous or Semi-Dry Electrolytic Condenser — The Dry Electrolytic Condenser — The Separator and its Influence on the Performance of the Condenser — The Electrical Characteristics of Electrolytic Condensers — Applications of Electrolytic Condensers.

☐ The 172 profusely illustrated pages are well indexed and will provide you with a source of reference on electrolytic condensers that critics unanimously agree is unequalled.

☐ This is a book needed in every modern technical library. It may only be purchased directly from us. Mail us your check for \$3.00 today for your copy and it will be sent parcel post, postpaid.

JOHN F. RIDER, Publisher, 404 Fourth Avenue, New York City



"NO THANKS I'VE GOT A BOOK"

It's always good for a laugh—that gag about the book salesman who was stymied by his prospect's reply: "No, thanks—I don't need any—I've got a book." Yet it isn't funny when a serviceman whose profits depend upon the speed of his work fails to recognize the importance of Rider Books to his servicing business. Rider Books explain theory—and you need—must understand—theory first if you are to succeed in practice! That's why the majority of money-making servicemen recognize the value of Rider Books. Look over the books described on this page and order today.

AUTOMATIC FREQUENCY CONTROL SYSTEMS

This new development in radio means more and more AFC sets will be coming to your shop. You must be prepared if you are to cash in on this profitable work in higher priced sets. John Rider explains AFC in his easily understood style of writing:

144 pages—hard covers—Only \$1.00

"AN HOUR A DAY WITH RIDER" BOOKS
Hard Covers 60c each



- On Resonance and Alignment**
Clear explanation of what happens when circuits are tuned to resonance. 96 pages, 48 explanatory figures.
- On Automatic Volume Control**
Check full of the stuff you need to make your AVC work more profitable. 96 pages, 65 illustrations.
- On DC Voltage Distribution in Radio Receivers**
Theory and practice of d-c voltages—how they are led through various types of networks to tubes. 96 pages, 69 illustrations.
- On Alternating Currents in Radio Receivers**
Explanation of behavior of radio-frequency currents in receivers. Illustrated with diagrams and drawings.

SERVICING SUPERHETERODYNES

A revised edition of this standard work. The history of the superheterodyne circuit is studded with changes. You need this book to analyze the different parts of the circuit quickly. With this knowledge you can work quicker and at greater profit.

288 pages—profusely illustrated—Only \$1.00

CATHODE RAY TUBE AT WORK

Written for servicemen. Gives complete, practical and accurate information on cathode-ray tubes, oscillographs, etc. Lower priced oscillographs put this modern servicing tool within reach of all. To get the most out of it learn its principles and operation from this book.

336 pages—450 illustrations—Only \$2.50

ALIGNING PHILCO RECEIVERS

This servicing aid was instantly recognized by servicemen as a *necessity*. Covering every Philco receiver up to the 1937 chassis, the Alignment instructions were compiled in cooperation with the Philco Engineering Department. This *authentic* book locates every trimmer for you. The order followed is the same you use when aligning receivers on your bench.

176 pages—hard covers—Only \$1.00

RIDER MANUAL—VOLUME IX OUT NOVEMBER

Watch for announcement of this volume covering 1938-39 receivers. Full of new helpful features.

YOU NEED ALL EIGHT VOLUMES

- Vol. VIII—\$10.00—1937-38
- Vol. VII—10.00—1936-37
- Vol. VI—7.50—1935-36
- Vol. V—7.50—1934-35
- Vol. IV—7.50—1933-34
- Vol. III—7.50—1932-33
- Vol. II—7.50—1931-32
- Vol. I—7.50—1920-31



Rider MANUALS

"The Serviceman's Most Inexpensive Necessity."

Successful SERVICING

SEPTEMBER, 1938

NOTES ON P. A. SPEAKERS

Part 2: How the Type of Baffle Affects the Distribution of Sound

By JOHN F. RIDER

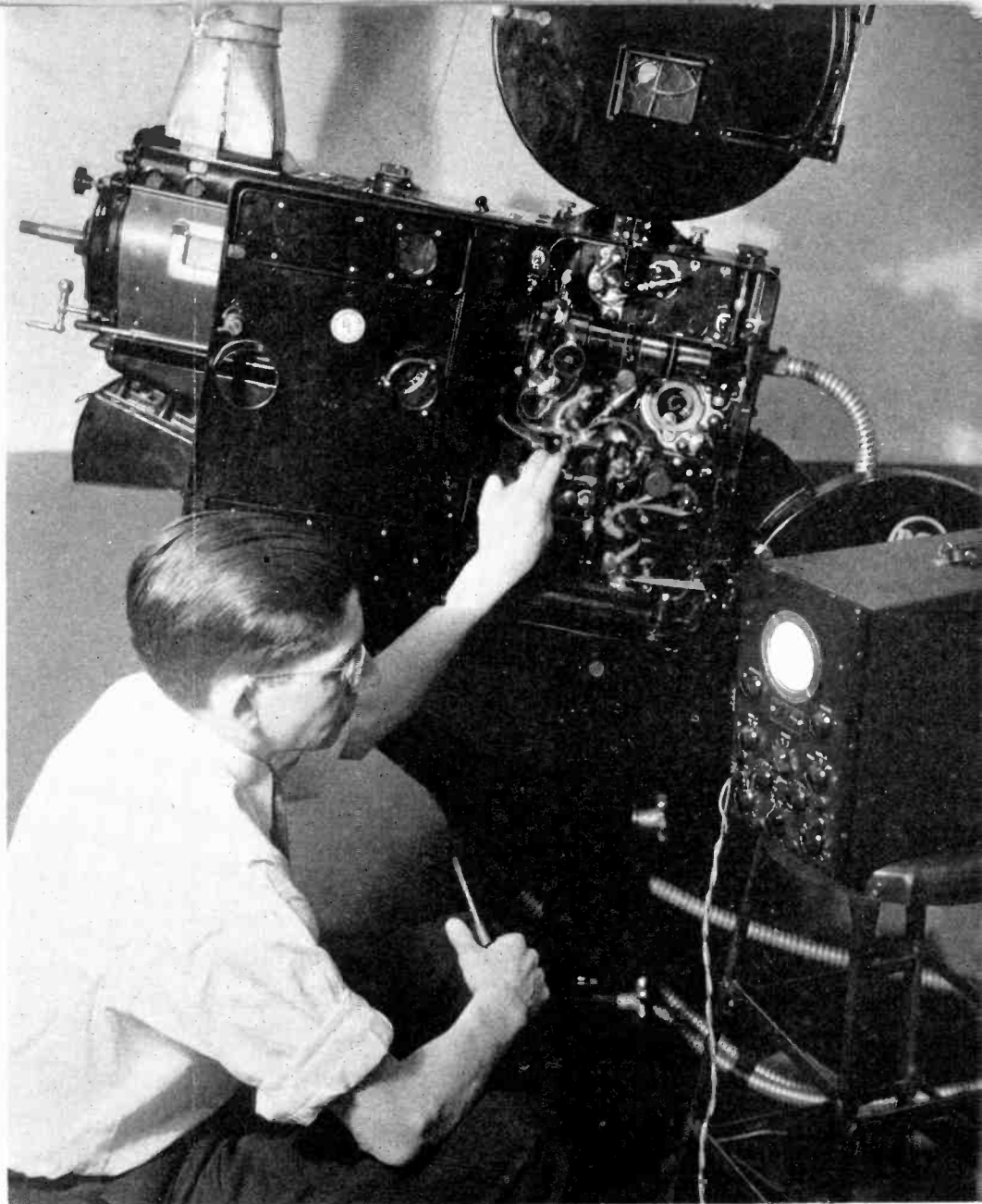

Courtesy of RCA Mfg. Co.

IN the previous half of this article, which appeared in the August issue of *SUCCESSFUL SERVICING*, it was stated that the flat type of baffle is directional, i.e., it does have a definite angle of distribution, which is approximately 90° in both the horizontal and vertical planes. This distribution is illustrated in Fig. 1, both sketches of which are self-explanatory.

Generally speaking, the vertical distribution of a flat baffle and speaker combination can be handled rather easily as their height from the floor is quite a flexible factor, as it were. By this is meant that a person sitting on a chair is well within the vertical range, even though he may be sitting quite close to the wall on which the speaker is located. Perhaps the room may be overcrowded so that people would be almost under the speakers,

but even then they would be able to hear with a fairly high efficiency.

The matter of horizontal distribution is not such a simple one with this type of baffle and an example will be used for explanation purposes. Assume that the room in which the public-address system is to be installed is 60 by 30 feet. (We will neglect the height of the ceiling and the loud speaker unit as we are now interested

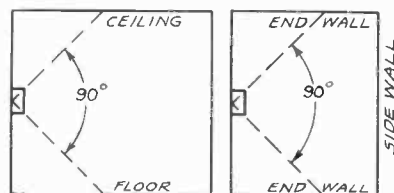

FIG. 1

The left sketch shows the vertical and the right sketch the horizontal distribution of a flat baffle used with a cone type of speaker.

only in the placement of the speaker and baffle, which discussion applies to all sizes of speakers.) Now in order to determine if the coverage of the speaker is sufficient, an easy method to follow is to draw the shape of the floor to scale and to lay out on that the coverage of the speaker. In Fig. 2 this has been done with the 60 by 30 foot room mentioned above. The loud speaker with a flat baffle is located at the middle of the side wall and is indicated in the drawing by a point. Two lines are drawn from this point at 45° with the wall on which the speaker is hung, these representing the speaker coverage and showing a distribution angle of 90° .

We now have three triangles, two of which are shaded in Fig. 2 and these represent the area of the floor

(Please turn to page 3)

Chevrolet 601574

The schematic for receivers having serial numbers under 0374000 appears on *United Motor page 6-33 in Rider's Volume VI*. Receivers having serial numbers above 0374000 have the following changes incorporated in the chassis:

Resistor No. 44 in the screen circuit of the 6F7 has been changed from 30,000 to 25,000 ohms.

Condenser No. 29 has been changed from 867 mmf to 950 mmf.

Condensers No. 18C (0.05 mf) and No. 28 (750 mmf) have been eliminated.

Resistor No. 42 in the diode circuit of the 6B7 has been changed from 150,000 to 250,000 ohms.

The volume control, No. 54, has been changed from 0.5 megohm to 1.5 megohms.

The lower end of the primary winding of the second i-f transformer, No. 9, now has a 1000-ohm resistor, No. 48, connected between it and the +B lead. This is located perpendicular to and immediately above resistor No. 42. See the top view of the parts layout on *United Motor page 6-34 in Rider's Volume VI*.

The output tube has been changed from a 41 type to a 42.

Zenith 1937 Auto Receivers

Complaints have been received that in some cases some of these receivers operate intermittently in the car and yet when they are operated on a test-bench, they perform satisfactorily.

Note that each r-f coil shield is held to the chassis by a single rivet. If this rivet becomes loosened, the grounding of the shield is not effective entirely, the set will oscillate, chatter, or give rise to other complaints.

These shields may be easily grounded by removing the bottom cover and soldering them together and to the chassis base, as indicated in the accompanying illustration. This procedure has proven to be effective and insures proper shielding of the coils.

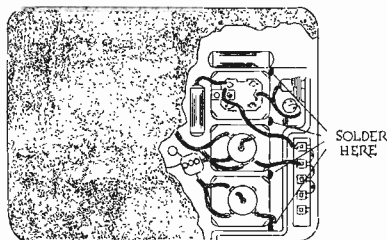

BOTTOM VIEW
Points to be soldered in 1937
Zenith auto sets.

Arvin Chassis 518

In order to correct the calibration of the dial, the following procedure is to be used:

Rotate the dial pointer to 550 kc. Press with the thumb on the dial face above its center. Rotate the tuning knob while preventing the dial pointer from moving. This will enable the position of the dial pointer to be varied with respect to the tuning condenser and makes it possible to readjust the calibration without removing the chassis from its cabinet.

For other servicing data see *pages 8-10, 8-12, and 8-13 in Rider's Volume VIII*.

Belmont 589 Series "A"

The Issue "B" of this chassis has a 0.05-mf, 400-volt condenser in parallel with the 5-mf condenser, C-10. See schematic on *page 8-5 of Rider's Volume VIII*. This new condenser has a Part No. 100-13 and is identified as C-20.

The unidentified trimmer condenser connected between the lower end of the secondary of T-1 and ground has been given a schematic number, C-21. The unidentified trimmer between the lower end of the oscillator primary (T-2) and ground is C-22. C-21 has a range from 1 to 10 mmf and C-22 from 2 to 20 mmf. Both these condensers are in the same unit, the part number of which is 124-30C.

These two trimmers being in the same unit change the bottom layout of the chassis shown on page 8-5. The adjustment nearer the trimmer marked "ANT-17 MC-TRIMMER" in the layout is the 1400-kc antenna trimmer, C-21, and the one nearer the broadcast series padder is the 1720-kc oscillator trimmer, C-22.

These changes apply to receivers having a serial number above 8E-189200.

Stromberg 150L

Complaints have been received now and then about there being too little bass response in this receiver. If more bass is desired, the following changes in the bass control circuit can be made:

Remove the 10,000-ohm resistor, No. 189 in the schematic on *page 8-7, 8 in Rider's Volume VIII*, and replace it with a 47,000-ohm unit, Part No. 26353. Also replace the 0.04-mf

condenser, No. 110 in the volume control circuit, with one having a capacity of 0.01 mf, Part No. 25149.

Note that these changes are not essential except when more bass response in this model is requested.

G.E. D-51, D-52

A switch is provided in these chassis which is used to cut in and out a series audio coupling condenser between the plate of the 6B7 second detector-avc-af tube and the control grid of the 41 output tube. In most cases it has been found best to allow this switch to remain closed all the time; therefore, its usefulness can be increased by making the following changes:

Disconnect the two wires connected to the switch, S2 in the schematic found on *RCA page 6-9 in Rider's Volume VI*, and after soldering them together, tape them.

Connect a wire from the control grid cap connector of the 6B7 to one terminal of the switch. To the other terminal of S2, connect one side of a 0.0015-mf condenser and connect the other side of the condenser to the case of the receiver.

This procedure provides a two-point tone control which is extremely effective in reducing the tube hiss on weak signals. When the incoming signal is strong, the condenser may be switched out of the circuit, which gives the best fidelity. This type of tone control is more effective in reducing noise than the usual type of control connected across the output of the 41 power amplifier.

Motorola 5T 71A

The schematic for this chassis is the same as that shown on *page 3-2 in Rider's Volume III and on page 1054 in the Rider Combination Manual*, with the following changes:

The 0.25-megohm and 1-megohm resistors in series in the plate circuit of the third 24 r-f tube and the 0.1-mf by-pass condenser from their junction, have been replaced with a choke having the same parts number as the one shown in the grid circuit of the 171A output tube. This choke is connected directly between the plate of the 24 tube and the +B lead.

The choke in the grid circuit of the output tube has been replaced with a 0.2-megohm resistor.

Notes on P. A. Speakers

(Continued from page 1)

that is not covered. The area of a triangle is found by multiplying one-half the height of the triangle by its base; therefore, the area of one of the shaded portions of the floor equals $30 \times 15 = 450$ square feet. Doubling

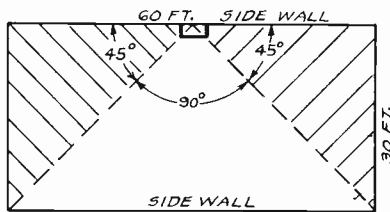

FIG. 2
The shaded portions of this floor plan represent the 50% area that is inadequately covered by sound from the single loud speaker.

this for the two triangles, we have the total amount of space not covered by the speaker equal to 900 square feet. The total area of the room is 60×30 or 1800 square feet, so the area covered by the loud speaker located in the middle of the side wall is only 50% of the total. This is too small a percentage, as the recommended figure is 75%.

The solution here is to employ two loud speakers, which should not be placed more than 40 feet apart. Another drawing is made to scale of the 60×30 foot room and two points are located on the same side wall, which are equivalent to placing the speakers 30 feet apart in order to be well within the 40-foot limit. In Fig. 3 it is indicated that the speakers are placed 15 feet on each side of the middle of the side wall. Two lines drawn at an angle of 45° are shown for each speaker, representing the distribution of sound for the speakers. This makes four triangles of the same size—base and height 15 feet each. The area of one of these triangles is $15 \times 7.5 = 112.5$ square feet. This multiplied by 4 gives the total area not covered by the speakers as 450 square feet, being

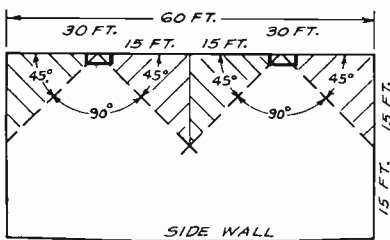

FIG. 3
By using two speakers with flat baffles, 75% of the area is adequately covered with sound. Compare this distribution with that of Fig. 2.

indicated in Fig. 3 by the shaded triangles. Now 450 divided by 1800 (the total area of the room) gives 0.25, which is the percentage of the room not covered by the loud speaker distribution. Thus 75% of the room will be covered and this is satisfactory.

The same procedure can be followed for rooms of any dimensions or shape. In the majority of cases, the area covered and not covered by the speaker or speakers can be easily divided up into triangles and the percentages simply calculated.

SO far our discussion has been limited to cone speakers used in connection with a flat baffle which has a distribution angle of approximately 90° . It is conceivable that instances might arise where this 90° angle of distribution was too great and that a more concentrated sound beam was desired. This can be procured by using a horn-type baffle, which have distribution angles as small as 30° .

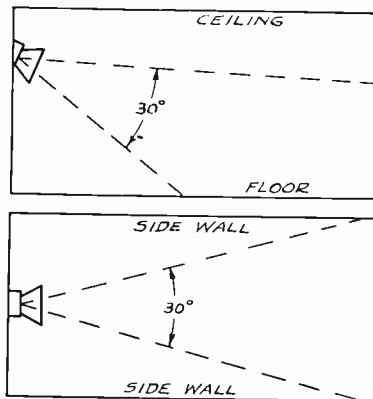

FIG. 4
Using a horn type baffle, the angle of distribution can be as small as 30° in both the vertical and horizontal planes.

The choice of directional over flat baffles is usually determined by more important factors than just the amount of coverage. Some of the reasons are:

The use of a concentrated sound beam makes it possible to avoid serious reflection effects from ceilings, walls or floors and to reduce echo to a minimum.

The use of the correct directional baffle for the area served permits a certain control of reverberation effects due to these baffles having definitely controllable low-frequency cut-off points.

Directional baffles permit the maximum power handling capacity for adequate volume conditions.

Other conditions which sometimes

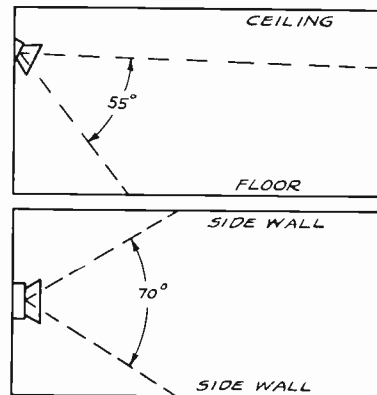

FIG. 5
A directional baffle can have two angles of distribution so that the sound can be directed to any desired portion of the area.

affect the choice are the space that is available for mounting the unit and the price. However, these last two factors should be the last to be considered if a first-class installation is to be made.

SPACE does not permit a detailed discussion of the manifold types of directional baffles and loud speakers used with them—it must suffice to state that a baffle for almost every type of installation is obtainable. However, certain factors are common to directional baffles and their use and these will be briefly covered here.

When the sides of a horn-type baffle increase uniformly so making the cross section of the horn increase uniformly, the vertical and horizontal angles of distribution are equal. See Fig. 4. Such a horn may be round, square, or rectangular in cross section. However, a horn type of baffle has been produced which has a different vertical angle of distribution from the horizontal. This is illustrated in Fig. 5, where the vertical angle of distribution is 55° and that for the horizontal is 70° . This distribution is obtained by making the slant or flare of the horn less on the bottom and top than on the sides.

As may be seen in Figs. 4 and 5 the horn can be attached to the wall so that the sound is directed towards the

(Please turn to page 6)

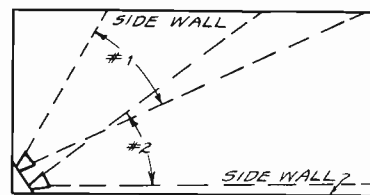

FIG. 6
When two speakers are necessary, their directional baffles are usually so arranged that the beams of sound overlap as shown in this sketch.

Silvertone 4428A, 4448A, etc.

Due to variations in the 6D8G first detector-oscillator tube, whistles and oscillations may occur at the high-frequency end of the Foreign band. To correct such oscillations, change the value of the oscillator grid leak, R-4, from 50,000 ohms to 25,000 ohms. See schematic on page 7-61 of *Rider's Volume VII*.

Chassis in which this change has already been made in production are rubber-stamped with the letter "D" or some following letter on the chassis identification sticker.

Philco 511, 521

The model 521 is for operation on 25-40 cycles and is similar to the model 511 (60-cycle operation) except as noted below. Please add 521 to the designation on page 8-107 in *Rider's Volume VIII*.

A change in the wiring has been made. The primary of the third r-f transformer instead of going to the left side of the resistor No. 17 now is connected to the other end. Plate voltage for the r-f tubes obtained from the point marked "D" in the voltage divider, No. 37, now is fed in to the resistors Nos. 7, 12, and 17 through

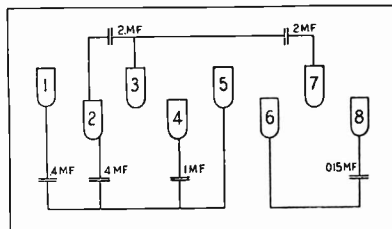

Fig. 2. Filter condenser pack of Philco Model 511 for 60-cycle operation.

the left end of this combination immediately below the first r-f tube. The primary of this r-f transformer now is connected to the right side of No. 7 in the schematic. In other words, the lead marked "D" at the right end of the three series resistors now is at the left end.

The accompanying partial schematic

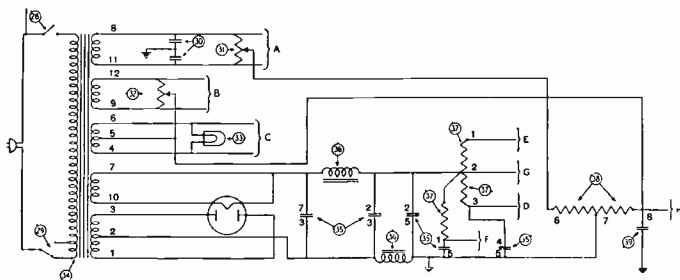

Fig. 1 of the power pack and filter carries various numberings, which correspond to those of Figs. 2 and 3 and show the capacity values of the filter condenser packs No. 35 used for model 511 and 521 respectively. Note that the connections of the 1-mf condenser, 4-5, have been changed from the way they are shown in the schematic on page 8-107. Instead of terminal 4 of No. 35 being connected to terminal 3 of No. 37 it is connected to terminal 1 of No. 35.

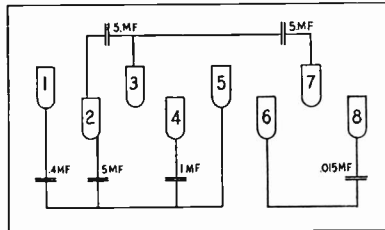

Fig. 3. Filter condenser pack of Philco Model 521 for 25-cycle operation.

The voltage readings are as follows:

Type	Circuit	Fil.	Plate	Grid	MA
26	1, 2, 3 r-f, 1 a-f	1.62	98	6	4
27	Detector	2.65	38		1.5
71	2 a-f	5.26	148	29	17
80	Rect.	5.26	375 a-c	Ea.	pl. 30

The voltages at the terminals of the power transformer, No. 34, are:

Terminals	A-C Volts
1-3	375
4-6	4.85
7-10	4.8
8-11	1.55
9-12	2.47

In the bottom view of the chassis on page 8-107, the voltage divider (in the lower left corner) has its terminals numbered corresponding to those numbers in the accompanying schematic. Some chassis of both models have been assembled with a resistor, Part No. 3088W, which does not include the detector plate section of 70,000 ohms; on other chassis Part No. 3088 is used. A separate resistor of 70,000 ohms value, Part No. Z-129, is mounted at the end of the sub-base. In this case, the terminals marked

3 and 4 in the layout must be disregarded. The values of the voltage divider sections of Part No. 3088 are as follows:

1-2	16,500 ohms
2-3	5,500 "
4-5	70,000 "
6-7	375 "
7-8	1,500 "

The values of the sections of Part No. 3088W are the same with the exceptions that section 4-5 is omitted as explained above, and the value of 7-8 is 1,590 ohms. The resistance of the volume control, No. 1, is 10,000 ohms and the value of the three resistors, Nos. 7, 12, and 17, is 100 ohms each.

Gassy Tubes

To those yet uninitiated, one of the peculiar distortions or loss of sensitivity problems in servicing can be traced to gassy tubes. Invariably the problem is further complicated by the fact that the trouble is one which develops after the receiver or amplifier has been in use for a short period and then clears up temporarily after the receiver is turned "off" for a very brief interval.

The trouble is a gassy tube and a check upon the tube checker does not show up this condition unless the tube is allowed to cook in the checker for the same period of time that is required to raise it to the gas developing temperature. Further, since it is a difficult problem to allow tubes to remain in a tube tester for 20 minutes to a half hour, the best solution is to make the tube tests after the trouble has developed in the receiver and to allow minimum time to elapse between the removal of the tube from the unit being checked and the insertion of the tube into the tube checker socket.

It has been our experience that in conditions such as the aforementioned, the most flagrant violator is the output tube. The 25L6G has come to our attention quite often. One possible way of establishing faulty operation of this tube used as an output tube is to check the plate voltage during actual operation of the tube with the signal present in the circuit. If grid current is being drawn, it will vary with the intensity of the input audio signal, assuming a broadcast station as the source of the test signal. Thus plate voltage variations will be quite radical and will swing with loud and soft passage of sound as heard from the speaker.

Fig. 1. Schematic of the power pack and filter used in Philco Models 511 and 521. The condenser values for each model can be found in Figs. 1 and 3 above.

Shipments of RIDER CHANALYSTS

Were scheduled for the week of September 26th

The Hurricane which swept over New York and New England and caused the loss of more than 600 lives, crippled all transportation and communication systems throughout this section and interfered with our raw material supply, thus interrupting our production schedule.

Please be patient with our jobbers. We are trying hard to keep up with our orders. Our jobbers will receive their Chanalysts to fill your requirements as soon as our assembly department can return to normal production, which will be within 10 days.

Thank you.

SERVICE INSTRUMENTS, Inc.
404 Fourth Ave., New York City

Here is a letter sent by a jobber in answer to an inquiry about the Chanalyst:

Mr. L. F. King
(Address given upon request)

Dear Mr. King:—

In answer to your letter regarding the Chanalyst, I can only say that *we are completely sold on this equipment and feel it will fill a long felt need in the service field.* To put it more strongly, I believe that all servicemen and dealers who do any quantity of service work, can not afford to be without it. It certainly deserves the enthusiastic support of all wholesalers, everywhere.

The servicemen have been quick to recognize the possibilities of the instrument and, in our particular case, respond immediately with very gratifying orders.

You may be interested in some of the experiences we have had with the Chanalyst following our meeting with Mr. Rider in August. In demonstrating the Chanalyst to various servicemen and dealers, we have encountered a good many of the servicemen's headaches and *through the use of the Chanalyst have quickly located the sources of trouble.*

CASE 1. A Zenith Model 9S54. This receiver was dead. The signal was traced using the RF-IF Channel of the Chanalyst up to the plate of the first detector tube but there it stopped. Investigation showed that the plate winding of the first i-f transformer was open and this unit was replaced.

The receiver then showed a tendency towards intermittent sputtering. The RF-IF Channel probe was once again used to trace the path of the signal. The probe was placed on the grids and plates of the r-f and the first detector-oscillator tubes with indications on the electron-ray indicator of a normal passage of the signal up to that point. When the probe was placed on the plate connection of the i-f tube, each time the sputtering occurred, the shadow of the indicator would flutter also. So the trouble was located as being in the plate winding of the second i-f transformer. As you know an intermittent sputtering condition of this kind is very difficult to locate and many excellent servicemen would spend hours in finding the source of the disturbance.

The man who brought in this Zenith had already placed an order for a Chanalyst and *this demonstration clearly indicated his good judgment and the merit of the Chanalyst.*

A check of this transformer by the usual method showed continuity, but when it too was replaced with another transformer, the receiver functioned perfectly.

The time consumed in locating these faults was approximately ten minutes.

CASE 2. The next receiver was a Crosley, which operated satisfactorily on the high-frequency end of the broadcast band, but there seemed to be no oscillator action on the low-frequency end, the receiver going dead after passing 800 kc.

One of our dealers from Danville brought this receiver in as he had been puzzled for sometime with its operation and I felt that it presented an excellent opportunity for a demonstration with the Chanalyst.

A check made on the oscillator circuit at the high-frequency end showed that to be operating satisfactorily and the same satisfactory condition was found at the low-frequency end. This check was made with the Electronic Voltmeter. Having determined that the oscillator of the receiver was functioning, the Oscillator Channel of the Chanalyst was used to find out at what frequency it was working. The receiver had an intermediate frequency rating of 450 kc, but when the Oscillator Channel was tuned to 450 kc there was no indication that a current of that frequency was present in the plate circuit of the first detector. Keeping the receiver tuned to the low-frequency end of the band where the trouble evidently was, the tuning condenser of the Oscillator Channel was varied until a closing of the shadow of the electron-ray indicator showed that the frequency of the i-f voltage was 220 kc instead of the rated 450. As this low frequency would not pass through the i-f transformers, the set would not function at the low-frequency end of the band, as stated above.

The components in the oscillator circuit were carefully checked and it finally developed that the low-frequency padder had become short circuited. When this unit was replaced, the receiver functioned equally well on all parts of the broadcast band.

CASE 3. A Graybar receiver after operating normally for some little time, showed a lessening of the volume. Various checks had been made, including a check on all the tubes in the receiver, and everything had stood inspection.

The RF-IF Channel of the Chanalyst was used to trace the signal through the r-f and i-f portions of the receiver after it had been allowed to operate until the volume fell off. All indications on the Chanalyst showed the signal to be normal up to the second detector and at this point a decrease in the signal strength was noted. Using the Electronic Voltmeter, it was found that there was a slight positive po-

tential on the grid of the second detector, which was unusual.

A by-pass condenser, which might have caused the trouble, was removed, but the positive potential on the grid persisted and so it was decided that the trouble lay in the tube itself, even though it had been previously checked in the regular way. It was re-checked in a tube checker and again found to be normal. However, as the trouble had been traced to the tube, it was allowed to remain in the checker for about ten minutes, which was the approximate period of time that the receiver in which the tube had been used, showed a lessening of the volume. After the ten minutes had passed, the tube was tapped sharply and the neon indicator on the checker showed a short. When another second detector tube was used in the receiver, the volume stayed constant.

The ordinary check of tubes would not have indicated anything wrong and *without an instrument as sensitive as the Chanalyst to detect signal loss and measure voltages without upsetting the circuit, a serviceman would probably spend many hours of fruitless labor.*

The fact that a serviceman can probe into any part of a radio set and determine definitely the presence or absence of a signal, increase or decrease in gain, and at the same time be able to check the quality through the use of the audio output is remarkable. *The Chanalyst eliminates the guesswork and the cut-and-try methods in radio servicing.*

We do not believe in high pressure selling, but I am so completely sold on the Chanalyst and what it can do for the serviceman that I must admit that we are putting on as much pressure as possible, *because we believe that every man who does any quantity of service work should have a Chanalyst.*

Sincerely yours,
JONES RADIO COMPANY
(Signed) George B. Jones
Pottsville, Pa.

Next month we will show you what servicemen owners of the Chanalyst think of the instrument.

Chanalyst Model A	50-60 cycles 117 volts, complete with tubes	\$107.50 net
Model AX	25-40 cycles 117 volts, complete with tubes	112.50 net
Size	14" x 9" x 9 ³ / ₄ "	Weight: 26 pounds

THERE'S ONLY ONE RIDER CHANALYST!

Successful SERVICING

Reg. U. S. Pat. Off.

Dedicated to financial and technical advancement of the radio service man.

Published by

John F. Rider, Publisher

404 Fourth Ave. New York City

John F. Rider.....Editor
G. C. B. Rowe.....Assoc. Editor

This publication is the house organ of the publisher and if due credit line is given, permission is hereby granted editors to reproduce material contained herein.

Vol. 5 September, 1938 No. 1

A BETTER STATE OF MIND

FOR the past few years it has been our privilege to address meetings of radio servicemen in all parts of the country—in small communities and in large cities. We have spoken in temporarily converted dance halls, night clubs, ball rooms, barns, basements, stores, etc. . . . We have talked to many thousands of men both from the platform and personally and in the course of time we have noticed a very definite change in our audiences—a change, we are happy to say, that reflects a new and infinitely better state of mind and one that is a long stride in the right direction.

State of mind is a most important item. Lower a man's morale and you've got him licked. On the other hand give him confidence, which is a state of mind, and he really will go places and do things. Little by little confidence is returning to the service industry. Today, much more confidence prevails than for a very long time back. . . . Thousands of servicemen in America feel that a decent livelihood can be made in the radio service industry. This is even true among those men who have found tough sledding during the past few years. . . . The lean years have licked some men, but many more have come through with confidence in the future.

Much of this can be attributed to the fact that more of a studious effort is being made. . . . The technical side of radio servicing is receiving more and more consideration and each day witnesses the transposition of a man from the purely practical worker to the

worker who combines theory and practice. . . . And with this increased knowledge comes confidence—confidence to go out and dare—confidence to ask for the price because service can be delivered.

IT is indeed gratifying to note the greater interest being displayed during the meetings. . . . The men are actually concerned with the subject being discussed. . . . More and more men are asking technical questions with full evidence of the fact that they are seeking further knowledge and also that they have a sound and logical reason for asking that a point be cleared up or some forgotten item explained.

Many more men who attend service meetings speak about the commercial side of radio servicing—the desire to make the profit so long desired, but so seldom attained. . . . It may be true that the desired amount of radio service business is not available to all men, but at least today more of the jobs being handled are profitable. . . . From every portion of the country comes comment to the effect that what seemed hopeless or impossible is really true: the customer when sold on a job will pay the price. . . . This has done much to improve the state of mind—to restore confidence.

There was a time when servicemen were willing to sell themselves short because they had lost hope. Today the serviceman is a better man technically, although still not as competent as he might be. . . . He is better dressed. . . . All of the articles published in the radio press and aimed to improve the physical appearance of the personnel of the industry have borne fruit. . . . The serviceman is becoming commercial minded. . . . There is much more to be attained in this direction, but the ball has started rolling and its momentum will grow each day. . . . In every way the state of mind is much improved—and happily so all over the country, not only in particular spots.

Now We Are Four

FOUR years ago this month the first issue of SUCCESSFUL SERVICING went out to about eight thousand servicemen and service managers of receiver manufacturers. We compiled this list from users of our publications and told our readers that we would be glad to send our house-organ to any

serviceman who would find it of use and interest in his work. Apparently our efforts have not been in vain for now SUCCESSFUL SERVICING is sent to 25,000 readers all over the world and a big percentage of these men have told us they like it.

We have endeavored to give you timely articles and to keep you up to date with the production changes of receivers as we get them from the receiver manufacturers. From time to time perhaps our editorial pen has been a bit vitriolic, but we feel very keenly about some things and when we write about them we do not believe in mincing words. When we see something that we think requires correction, we dispense with the kid gloves and write just what we think. If we step on somebody's pet corn in the process, we are sorry if we hurt him but sometimes a bit of pain is needed to effect a cure.

Once more we want to tell you that SUCCESSFUL SERVICING is *your* magazine. It is published for you and nobody else. We try to make it interesting as well as useful and if you have any suggestions about it, please let us know about them. Or if you have any suggestions that will make *any* of our publications more useful to the servicing fraternity as a whole, we want to know about them too. You might be surprised if you knew the number of excellent suggestions that we have incorporated in *Rider's Manuals* for instance, which have been sent us by men who were sufficiently interested in their brother servicemen to take the time and trouble to write us.

As we go into our fifth year of publication, things look bright. . . . You and we have been through some rather tough times together, but the outlook now is promising for a good season. . . . We want you to know we are going to do our part and if we can be of any help to any of you—well, here we are.

JOHN F. RIDER.

The Cover

The photograph reproduced on page 1 of this issue and supplied through the courtesy of RCA Mfg. Co. shows a serviceman checking the "head" amplifier of a motion-picture projector with an oscillograph. Another example of the universality of this versatile instrument!

RIDER'S VOLUME IX

Rider's Volume IX is "in the works"!

This is the peak of the year as far as the Editorial Department is concerned. Daily we receive "last-minute" data from manufacturers on their newest receivers. . . . Telegrams are being dispatched to service managers asking for the servicing material they promised would be in our hands by a certain date. . . . Dummy pages are being prepared by the make-up men as fast as they can paste them up. . . . The printer is phoning for "more copy". . . . Yes, this is our busy day. . . .

But in all this hurry and bustle the checking and re-checking of everything is carefully done. We have told you in the past that each succeeding Manual was "the best one yet" and we believe that we have made no misstatement of the facts. Once more you will find in the new Rider's Manual all the features that you have told us you wanted and which could be incorporated. We are sure you will agree with us that Rider's Volume IX is again above par in every respect.

Speaking of the incorporation of features requested by Manual users reminds us of the great number of letters we receive annually from servicemen

suggesting we do this or that to the new Manual. Every such letter gets our personal attention and if we think the idea suggested has merit and will improve the future Manuals, it is adopted. For example, prior to the publication of Rider's Volume VIII last year we received numerous letters asking how certain receivers functioned or some other technical question. Two or three men suggested a technical explanation of the new receivers and so we incorporated the 64-page special section, "How It Works" in Volume VIII with which you are doubtless familiar.

Volume IX will have a new "How It Works" section. The 15 pages devoted to alignment procedure in the former "How It Works" section will not be repeated and when the alignment instructions for a receiver in Volume IX are conventional, *you will be referred to the Volume VIII special section.* We found last year that we were able to publish information on a great many more models when we did not have to run the alignment data on each receiver when they were conventional and could refer the Manual user to the special section; so we are going to do this again.

Some of you have asked that the data on certain manufacturer's receivers be run. We make a special effort to get this information and then we run as much of it as possible. Last year you will notice that we "caught up" on Mid-West data, publishing the data on receivers that were four years old and everything in between. This year we are concentrating our efforts on *United Motors* and are doing our utmost to bring the *Delco, Chevrolet, Oldsmobile, Pontiac*, etc., material up to the minute. Of course, all the other manufacturers will have their proportionate space as in former volumes of Rider's Manuals.

While a great many of you order your latest Rider Manual as a matter of course, do not think for a second that we have the same attitude. Every page of every Rider's Manual receives the same careful attention today as was given to the pages in earlier volumes. As we said once before, we are never satisfied with anything we do editorially. . . . we always strive to make it better in the some way or other. . . . We are sure that you will agree with us when you look over your new **1650-page Rider's Volume IX** next *November* that here is another step forward. . . .

Notes on P. A. Speakers

(Continued from page 3)

lower part of the room, thus sending all the sound energy to the listeners and eliminating possible acoustic difficulties by keeping it from the ceiling. Of course, the horn is so placed on the wall that the 70-degree angle of horizontal distribution will be centrally located down the length of the room.

In cases where more than a single loud speaker is necessary, the horn baffles are arranged so that their beams of sound intersect, as is shown in Fig. 6. Although two speakers only are shown here, yet it might be necessary to use more than this, depending on the area to be supplied and the amount of power needed. In all cases where more than one speaker is employed, it must be remembered that the speakers must be connected so that they will operate in phase.

It should be borne in mind that there are two types of directional baffles. One is the large throat baffle

used with a cone speaker and the other is the small-throat horn, the driving unit here being a small diaphragm actuated by a moving coil located in a magnetic field. Of course, in either case the field may be electrically excited or it may be of the permanent magnet type. In the case of indoor installations no thought need be given to whether or not the units are weatherproof, but for outdoor installations this factor must be considered. Also in outdoor installations, sometimes the microphone and the speakers are separated by a relatively long distance, which means long lines for carrying field and voice currents and these often are a major expense item. It is suggested that the use of a permanent-magnet type of speaker be considered under such conditions, as this would eliminate one pair of lines.

We wish to acknowledge the courtesy of the Sound Division of RCA

Mfg. Co. for permission to use some of the data herein contained.

AVC in New Receivers

Practically every receiver except possibly some "midgets", that will appear in Rider's Volume IX has some sort of automatic control, the commonest being automatic volume control. With all the circuit complications in the latest receivers it is quite difficult to follow through the avc circuit and this is particularly true if the principle upon which this automatic control is based, is not understood. If you have the fundamentals of the subject at your finger-tips, you will have no trouble in localizing a defect if it happens to be in the avc circuit and if you do not—well you can imagine the job you will have on your hands. Get *An Hour a Day With Rider on Automatic Volume Control* and know your AVCs.

Rolling Reporter



mechanical optickle sitem gives pix as big as 20 x 24" and another shoots television pix on a screen as BIG as 5 x 6 ft. One combo sound-sight receiver with a 5" catray tube sells for 29 Gns or 6/4 a week. (Note to R.R. Say, will you put that in American bucks for me.Thnks)

prize numbers on the tickets. You can have number 1498 and I'll take 1499 . . . May be you could win a new hat—no never mind—forget i asked you. i forgot Im mad at you.)

AND FURTHERMOR . . .

Wile on the subject of television, we herd that a N.Y. school (*aside to the boss—its RCA Inst.*) has started a course in the teckneecalities of television for them as wants to be all outside of this seeing stuff as soon as it breaks . . . I mean the guys what takes the course can be outside of what they learn so they can be on the inside of whats going on and then they wont be on the outside looking inside instead of being inside looking outside . . . As weve said before to our readers (*yours and mine, hey boss?*) it dont make no diference ware you get your learning **just sos you get it and get it while the gettings good.**

OUTA DE MALE BAG

C. E. Head, Fort Worth, Texas—Glad to know that you get so much use outa your Rider library. We does our best to give you what you need. That's the 1st time weve herd of a firm requiring their workers to acquire a set of Rider books but theyre one of the handyest tools we know about *except maybe the chanalyst . . . I. C. Kinnes, Nadaku, Kobe, Japan*—We do try to get rid of all excess baggage in our books and to give only the meat of the subject and we're always glad to learn that someone appreciates our efforts. Youll find all about our new books in S.S. and your name is now on the list . . . **Frank Morris, Danbury, Conn.**—Thank you very much, sir, for sending us that skeematic. We hear it will be run in Vol. IX . . .

Dere R.R.

Sept. 7

You big punk, youre 14 kinds of 6 bums. If I had you here Id punch holes in the tires of that funny looking bicycle you steer around and then laugh at you ha ha when you try to patch the holes. You just wait till you get back here again and I'll show you you cant do this to me and get away with it. You, you heel, going away without writing your col. for this month. Thought you were hot stuff didnt you when you snuk away on your vacation telling the Boss youd took care of everything. Smart guy, huh? Ok, ok, OK—but I'll get you. Im MAD cause the boss says to me youre in his dept so you write this months col and me with so much work i got to work overtime. and then he tells me he says you send the col to the rolling reporter and get his ok on it and tell him to rush it back. So heres the col. you snake and get it back hear FAST. Hoping its still raining, I am

Yours truely

Aloysius Winenwiski,
Head Officeboy

P.S. Im mad at you

(Collect telegram received Sept. 9)

ALOYSIUS WINENWISKI
JOHN F. RIDER, PUBLISHER,
NEW YORK CITY
SUGGEST YOU SEND COLUMN IF
YOU WANT IT OKAYED STOP YOURE
DUMBER THAN CHARLIE MC
CARTHY WITHOUT BERGEN
ROLLING REPORTER

Sept. 10

Dere R.R.

How was I to know the redhead was going effishunt on us and mail out that letter before I put the col. in? Hears the copy and i bet youll turn green with envy wen you read it. dont you wish you could write that good? And get that masterpiece back to me fast will you huh?

Yrs truely,

Aloysius Winenwiski, Columnist

P.S. Im still mad at you you big cheese p.s. No. 2. You ought to know about C.McCarthy, you termite you, (what does it mean?)

VACASHUN DAZE

Yep, thats wot a lot of us guys has got right now . . . Boys oh boy, did we have us a *swellegant* time when we was up their on the seacoast admiring both kinds of nature . . . you know, the kind that stays put and the other kind that goes around on two legs . . . oh well nothing to look forward to now except Xmas and thats only 113 days away . . .

TELEVISUN

We seen in a British magazeen that the *beeg rah-dio show* in the capital of England (*London to you*) has a lotta televisoin receivers being shown. Most of 'em use a cat-ray tube sos you get pix about 8 x 10" but one using a

CLEVELAND R.S.A. CAVORTS

(*Good word cavorts, aint it boss?*) We are adviced through our speshul cleveland correspondint, L. Vangunten, that the R.S.A. chapter there is going to do some picknicing with dancing with baseballs with games for prizes two weeks from next Sunday thats the 25th of sept. He kindly sent yr. reporter two passes (*he called them ducats, but theyre annie oakleys to us*) for which we politely thanks him. Heres hoping your partys a BEEG sucess, Cleveland . . . (Note to R.R. Say, hows to take me out there on your handlebars? Lookit, we got 2 FREE passes and theres

ON GOOD AUTHORITY

We have it from the above mentioned source that a Noo Yawk co. is going to put out a kit for making your own television receiver. This is more than the mere rumor that we ran wa-a-a-ay back in Dec. '36 in this col. So-o-o-ooo, gents, you see you can bank on wot you read when its wrote by

A. WINENWISKI

who is running bases for the Rolling Reporter.

Double Spread Pages

In *Rider's Volume VI* we began the use of pages that were twice the size of the ordinary Manual page to accommodate large schematics. These had to be printed separately from the regular pages and they were inserted in the front of the Manual binder. They were bound together with a paper band on which was printed in large type the request that the Manual owner put them in their proper places in the book. The same procedure was followed in *Rider's Volumes VII and VIII*.

We certainly thought that this was all sufficiently clear, but evidently we were in error. Hardly a week passes that we do not get a phone call or a

letter saying that certain pages in Volumes VI, VII or VIII can not be found. Almost invariably it results that the "missing" page was right in the man's binder all the time—*right up in the front.*

Now we wish that you'd do us a favor. Will you tell your serviceman friends that **double-page spreads are going to be used in Rider's Volume IX** and that they will be found *right inside the front cover of the binder.* Furthermore, we suggest that you tell them that the best thing to do when they get their new Manual is to insert the double-page spreads the very first thing. That should eliminate any confusion. . . .

ELECTROLYTIC CONDENSERS

Their Properties, Design and Practical Uses

By PHILIP R. COURSEY

Technical Director, Dubilier Condenser Co., London, England

¶ The 172 profusely illustrated pages are well indexed and will provide you with a source of reference on electrolytic condensers that critics unanimously agree is unequalled.

¶ This is a book needed in every modern technical library. It may only be purchased directly from us. Mail us your check for \$3.00 today for your copy and it will be sent parcel post, postpaid.

JOHN F. RIDER, Publisher, 404 Fourth Avenue, New York City

Announcing
**The New RIDER MANUAL
 VOLUME IX**



**1650 PAGES
 140-PAGE INDEX
 ENTIRELY NEW
 "HOW IT WORKS" SECTION**

Out Nov. 19th - \$10.00

ANOTHER great Rider Manual—Volume IX, covering 1938-39 American-made radio sets. Here is one of the most important volumes of them all. Every serviceman—bar none—will need it. At your finger tips are 1650 pages of the most complete and authentic compilation of service data available in the industry. Rider Manual Vol. IX features an entirely new "How It Works" Section—the most "talked-of" feature of Vol. VIII. It makes clear by practical example the complicated circuits and baffling service problems which you must cope with in repairing modern radio sets. There is also a new 140-page easy-to-find index included in Vol. IX, at no extra cost, which covers all NINE volumes, now containing a total of 11,270 pages.

Remember, Rider Manual Vol. IX will be ready for you November 19th. You'll want to put this great volume to work for you right away, so place your order with your jobber without delay.

- | | |
|---|---|
| Vol. IX — \$10.00 — Covering 1938-39 sets | Vol. V — \$7.50 — Covering 1934-35 sets |
| Vol. VIII — 10.00 — Covering 1937-38 sets | Vol. IV — 7.50 — Covering 1933-34 sets |
| Vol. VII — 10.00 — Covering 1936-37 sets | Vol. III — 7.50 — Covering 1932-33 sets |
| Vol. VI — 7.50 — Covering 1935-36 sets | Vol. II — 7.50 — Covering 1931-32 sets |
| Vol. I — \$7.50 — Covering 1920-31 sets | |

**OTHER VALUABLE
 RIDER BOOKS**

**AUTOMATIC FREQUENCY
 CONTROL SYSTEMS**

With Automatic Frequency Control Circuits in most new higher-priced models, knowledge of "AFC" means money in your pocket! Learn the practical facts, from these easy-to-understand explanations. Get your copy today. Cash in on profitable "AFC" work. Hard covers. 144 pp. \$1.00.

THE CATHODE-RAY TUBE

Written especially so you can understand the subject. With introduction of new, cheaper Cathode-Ray Tubes, this book is even more indispensable for its complete practical information on Oscillographs, etc. 336 pp. 450 illustrations. \$2.50

**"AN HOUR A DAY WITH
 RIDER" BOOKS —60¢ each**

ON AUTOMATIC VOLUME CONTROL will speed up your AVC work. 96 pp. 65 illus.
ON RESONANCE & ALIGNMENT. You need this! 96 pp. 48 illus.
ON D-C VOLTAGE DISTRIBUTION IN RADIO RECEIVERS. How d-c voltages are led to tube elements, etc. 96 pp. 69 illus.
ON ALTERNATING CURRENTS IN RADIO RECEIVERS—with drawings and diagrams.

**DID YOU
 SAY 9?**

9

**YOU NEED ALL
 Rider
 MANUALS**

**YES, I
 SAID 9!**



NOW

**11,270 PAGES
 OF AUTHORIZED
 SERVICING DATA
 IN NINE VOLUMES
 OF RIDER MANUALS**

**ORDER YOURS
 TODAY**

JOHN F. RIDER, Publisher, 404 FOURTH AVE., NEW YORK CITY