

# ABB

The corporate  
technical journal

# review

---

**A world in transformation 6**

Power below the waves 33

**Transforming industry 45**

Sustainable and available 64

---



Special Report  
Transformers

Power and productivity  
for a better world™





Transformers are essential pieces of electrical equipment that help to transmit and distribute electricity efficiently and reliably. They also help maintain power quality and control, and facilitate electrical networks. ABB is a global leader in transformer technologies that enable utility and industry customers to improve their energy efficiency while lowering environmental impact. Our key technologies include small, medium and large power transformers, as well as traction and other special-purpose units and components. In this special report of *ABB Review*, we present some of the latest developments and innovations from our wide range of transformers and components, which can be found across the entire power value chain and are critical components of the grid.



# Transformers in transformation

- 6 A world in transformation**  
ABB is the world's largest transformer manufacturer and service provider
- 11 A legacy of transformation**  
ABB is a leader in voltage and power breakthroughs

---

# Transformer applications

- 17 UHVDC**  
Meeting the needs of the most demanding power transmission applications
- 22 Responding to a changing world**  
ABB launches new dry-type transformer products
- 29 The quiet life**  
ABB's ultralow-noise power transformers
- 33 Power below the waves**  
Transformers at depths of 3 km
- 37 Shrinking the core**  
Power electronic transformers break new ground in transformation and transportation
- 41 Balance of power**  
Variable shunt reactors for network stability control
- 45 Workhorses of industry**  
Industrial transformers in a DC environment

---

# Trends in transformation

- 53 Smart transformer**  
Transformers will have to do a lot more than just convert voltages
- 58 Composing with components**  
Innovative and high quality transformer components and services for diverse needs
- 64 Sustainable and available**  
Enhancing performance and reducing environmental impact of existing transformer fleets
- 69 Green-R-Trafo™**  
Safety makes a green transformation
- 71 Changing trends**  
New technologies for the evolving grid

# Transformer pioneers



**Bernhard Jucker**  
Head of Power Products division

**Dear Reader,**

The commercial application history of transformers dates back to the end of the nineteenth century. The world's first full AC power system, built by William Stanley, was demonstrated using step-up and step-down transformers in 1886. The transformer played a critical role in the outcome of the so-called war of currents, tilting the balance in favor of Tesla's AC vision. ABB (then ASEA) delivered one of the world's first transformers in 1893, integrating it with the first commercial three-phase AC power transmission link – another of the company's innovations – connecting a hydropower plant with a large iron-ore mine in Sweden.

Today, with a presence in over 100 countries, more than 50 transformer factories and 30 service centers, ABB is the world's largest transformer manufacturer and service provider with an unparalleled global installed base and a vast array of power, distribution and special application transformers. These transformers can be found wherever electricity is generated, transported and consumed – in power plants and substations, industrial complexes, skyscrapers and shopping malls, ships and oil platforms, locomotives and railway lines, wind parks, solar fields and water treatment plants.

Their most important function is to transform or adapt voltage levels, stepping them up for long-distance high-voltage transmission from the power plant, and stepping them down for distribution to consumers. ABB transformers contribute to grid stability and power reliability, while ensuring the highest safety standards and striving to increase energy efficiency and reduce environmental impact.

Besides setting new records in transformer power ratings for both AC and DC transmission, ABB has pioneered a number of innovative transformer solutions over the past 120 years. The most recent of these is the development of a 1,100 kV UHVDC converter transformer – the highest DC voltage level in

the world. This will enable up to 10,000 MW of power (the capacity of 10 large power plants) to be transmitted efficiently over distances as long as 3,000 km.

Earlier this year ABB also introduced a PETT – a revolutionary traction transformer that uses power electronics to reduce its size and weight while increasing the energy efficiency of the train and reducing noise levels.

Other recent pioneering developments include 1,200 kV AC technology, subsea transformers that can supply power at a depth of 3,000 m, ultralow sound transformers for noise-sensitive environments, and innovative amorphous core and biodegradable-oil-based transformers. ABB has also introduced high-efficiency distribution transformers, both liquid and dry-type, that can reduce energy losses by 40 to 70 percent.

ABB continues to develop innovative asset optimization, refurbishment and maintenance solutions to serve the existing global installed base.

ABB transformers can help customers address new challenges and opportunities like the integration of renewables and distributed power generation as well as accommodating new types of electrical loads such as data centers and electric vehicles – shaping the evolution of more flexible, stronger and smarter grids.

We hope you enjoy reading this *ABB Review* special report in which many of ABB's accomplished engineers share technology perspectives across a range of applications.



**Markus Heimbach**  
Head of Transformers business unit

Bernhard Jucker

Markus Heimbach









# A world in transformation

ABB is the world's largest transformer manufacturer and service provider

MAX CLAESSENS – History is marked by a series of great inventions that have swept across society, acting as stepping stones in the emergence of the modern world. Most people would agree that fire, the wheel, modern transportation and communication systems, culminating with the Internet all have a place in this list. Maybe less obvious but equally pivotal is the large-scale transmission and delivery of electrical energy over long distances. This breakthrough that would not have been possible without the transformer. This article takes a brief tour of the history and technology behind the transformer and looks at the different ways in which ABB has advanced and applied it.



---

Power transformers were the main reason that the three-phase AC transmission system could establish itself as the main T&D technology around 130 years ago.

**A**round 130 years ago a technical revolution took place that was to be a vital step in the development of modern society. That revolution was the commercial generation, transmission and usage of electrical energy. Nobody today can imagine a world without electricity. However, this article will start by taking the reader back to the early days when pioneers like Thomas Edison and George Westinghouse – and their ideas – were competing for the transmission system of the future: Should it be DC or should it be AC?

Very early electrical installations were local: The sites of generation and consumption were at most a handful of kilometers apart: Direct connections from the steam- or hydro generators to the consumers were in the range of hun-

dreds of volts. In the early 1880s, for example, the “Edison Illuminating Company” supplied 59 customers in Lower Manhattan with electricity at 110 V DC. But the energy demand of the fast growing cities and industrial centers called for an increase in power transmission capability.

The small steam- and hydro generators were no longer sufficient and larger power plants were erected more remotely from the cities. Voltage levels had to be increased to keep nominal currents on the power lines moderate and reduce losses and voltage drops. This was the time of the birth of a new component: the power transformer.

In a transformer, two coils are arranged concentrically so that the magnetic field generated by the current in one coil induces a voltage in the other. This phys-

ical principle can only be applied in AC systems, as only a time-varying magnetic field is able to induce a voltage. By using a different number of winding turns in the two coils, a higher or lower voltage can be obtained. The ability to transform from one voltage level to another one was the main reason for the breakthrough of AC three-phase transmission and distribution systems. These AC systems operate at a frequency high enough that human short perception does not see the time variation (“flickering”) and

---

**The power transmission breakthrough would not have been possible without the transformer.**

low enough that switching equipment can be operated safely. The best compromise was the well-known 50 or 60 Hz of the today’s mains supplies.

---

**Title picture**

Transformers are a vital link in the power transmission and distribution chain.





1a The world's largest transformer in 1942 (220 kV / 120 MVA)  
Värtan substation Stockholm, delivered by ASEA



1b The world's first 800 kV UHVDC power transformer for the 2,000 km  
Xiangjiaba-Shanghai transmission link, delivered by ABB in 2008

## Power transformer technology made tremendous progress during the last 130 years.

Transformers need an “amplifier” for the magnetic field so that the number of winding turns can be kept low. This “amplifier” is the so-called magnetic core. It consists of ferromagnetic iron, which contains microscopic elementary magnets that align to the transformer's magnetic field as a compass needle aligns to the Earth's magnetic field. The iron core is made of many thin ferromagnetic steel sheets that are electrically insulated against each other and stacked. This reduces classical eddy losses. The use of special alloys and manufacturing methods enables a minimum needed energy to change polarity of the elementary magnets.

This basic physical principle of transformers is still the same today as it was 130 years ago, but energy density, efficiency, costs, weight and dimensions have drastically improved. This can be compared to the history of cars and the internal combustion engine: Here too the basic principle has remained unchanged in 100 years, but technical progress has transformed the scope of possibilities almost beyond recognition. During the first decades of electrification, the main focus in transformer research and development was to increase power capacity (the power that can be transmitted by one unit). Furthermore, more and more effects concerning voltage transients became known that could endanger the transformer's insulation. These include resonance effects in the coils that can be triggered by fast excitations such as the

overvoltage impulse of a lightning strike. New coil designs mitigated these resonance effects.

Transformers are the main current-limiting element in case of short-circuit failures in the transmission system. The so-called stray reactance, which represents the magnetic flux outside of the magnetic core limits the increase in current in such an event. If high currents flow through the coils uncontrolled, mechanical forces try to press the coils apart, and may cause damage if the construction is not sufficiently robust.

Due to the resistance and inductance of the power lines themselves, the voltage level may vary depending on load conditions. This means that less voltage “arrives” at the receiving end of a power line when the load is high. To keep the voltage level within an acceptable range, power transformers usually include an on-load tap changer to vary the number of active winding turns of coil by switching between different taps. In medium voltage (MV) distribution, this is usually done offline: This means the tap changers are adjusted once before the transformer is energized and then remain fixed.

The increasing importance in recent decades of UHV (ultra-high voltage) DC transmission lines for high power transmission over very long distances (greater than 1000 km) has made it necessary to develop UHV-DC converter transformers, which are a huge challenge especially for



---

2 Distribution transformers come in two main categories

---



---

2a Liquid filled

---



---

2b Dry-type

---

the electric insulation system. The 800 kV UHV-DC Xiangjiaba-Shanghai line → 1, for example, has a capacity of up to 7200 MVA, which is roughly comparable to the consumption of Switzerland.

### Distribution transformers

On the distribution level (transmitted power up to 10 MVA) there are two main categories of transformers → 2: Liquid filled (using mineral oil or replacement fluids such as synthetic or natural esters) and dry type. The liquid filled transformers are the most compact and cost efficient solution, whereas dry type transformers are preferred in environments where fire safety is of special importance such as, for example, underground substations, mining sites, marine and some industrial applications → 3, 4.

Standard versions of distribution transformers are cooled passively as the heat generated by losses is transported away from the core by natural convection of the insulation medium. In the case of liquid filled products, this heat is then transported through the tank walls by thermal conduction and removed by the natural or forced convection of air. Dry transformers in closed environments

---

3 Dubai's 868 m high Burj Khalifa building is equipped with 78 ABB dry-type transformers

---



usually have a forced internal convection flow of air to ensure sufficient cooling of the transformer core.

AMDT (amorphous metal distribution transformers) is an upcoming technology that reduces losses inside the magnetic core. Although the amorphous materials are still more expensive than standard grain oriented steel, their application can be justified depending on how these losses are capitalized over the lifetime of the transformer.

### Power transformers

When the transmitted power exceeds around 10 MVA, special designs are required to cope with the mechanical forces of short circuit currents, higher insulation levels and increased cooling requirements. For these ratings, liquid-filled transformers are usually used. The insulation between the windings becomes more and more demanding at higher voltages. Furthermore, resonance effects inside the winding itself have to be considered to avoid insulation failures during highly dynamic impulse stresses such as lightning strikes which may reach amplitudes of one to two thousands kilovolt with a 1 μs rise time.

---

4 Single-phase pole-mounted transformers, for small power classes up to 167 kVA

---



---

5 One example of an extreme application is this 600 MVA / 230 kV phase shifter

---



---

Dry-type transformers are the preferred technology for applications in which fire safety is of special importance.

---

## 6 ABB is the world's largest transformer manufacturer and service provider, capable of delivering high-quality durable products and services all over the world

ABB transformers are found wherever electricity is generated, transported and consumed – in power plants and substations skyscrapers and shopping malls, ships and oil platforms, locomotives and railway lines, wind parks and solar fields, water and wastewater plants. The world's tallest building, the 828 meters high Burj Khalifa in Dubai is equipped with 78 dry-type ABB transformers to ensure power reliability → 3. The nearby Dubai Fountain, which is illuminated by 6.600 lights and shoots water 150 meters into the air, is also equipped with ABB transformers.

For almost 120 years, ABB has produced commercial transformers and continued to enhance them by developing new technologies and materials that raise efficiency, reliability and sustainability to a new level.

ABB has set the world records for the most powerful many times – from the world's first transformers of 400 kV and 800 kV in the 1950s and 1960s, to the most powerful UHVDC transformers for the 800 kV, 2000 km Xiangjiaba-Shanghai transmission link in China → 2. By developing new high-performance materials and using fire-resistant insulation liquids, ABB has improved the efficiency, safety and environmental friendliness of transformers. The new eco-friendly product lines can achieve energy savings of 40 – 50 percent.

For almost 120 years, ABB has produced commercial transformers. ABB has set the world record for power many times.

Transformers with power ratings above some ten MVA are a key element in the supply of large regions or industrial areas. As a rule of thumb, it can be considered that one person has an average electrical power demand of 1 kVA, which means, that a 400 MVA transformer transfers the power needed by 400,000, the equivalent of a medium sized city. Such transformers have to comply with special requirements on safety and reliability and also have to provide a very high efficiency and low sound level. In recent decades, high voltage DC lines have also become increasingly important, especially in large countries such as China where they connect industrial centers to the remote regions where the electricity is generated. ABB now offers standard solutions for DC converter transformers for up to  $\pm 800$  kV DC.

A transformers located directly next to a power plant is called GSU (Generator Step-up Unit). A GSU transforms the electric power from the medium voltage of the generators to the high voltage transmission level.

To balance power flow between parallel power lines, phase shifters can be used. These are transformers (usually with a 1:1 translation ratio) that adapt and control the phase angles of voltage and current to optimize the power transmission capacity of the lines. Phase shifters exist up to a power rating of 1,500 MVA → 5.

Today transformation efficiencies of up to 99.85 percent are achievable by using special magnetic steel qualities and optimized designs. The heat losses, even at

## 7 ABB is supplying the traction transformer for the new "Velaro D" high speed train



these high efficiencies, are still significant: For the 400 MVA unit mentioned above, for example, it would be still around 600 kW under full load conditions. The cooling system thus remains a challenge. Additionally, the weight and size of such devices has to be dimensioned carefully since there are limitations in the maximum transportation possibilities in the different countries → 6.

### Traction and special transformers

Railway vehicles use a special type of transformer that must be highly compact, reliable and robust. Operating frequencies vary (according to countries and systems) from 16.7 Hz to 60 Hz with power classes of up to 10 MVA. To permit trains to cross borders between countries, traction transformers must be compatible with the different frequencies and power systems. ABB offers optimized solutions for all these different railway applications, stretching up to high speed trains with their challenging needs → 7.

Moreover, ABB makes a variety of further transformers for special applications, for example for subsea electrification or for operating variable speed drives.

### Max Claessens

ABB Power Products, Transformers  
Zurich Switzerland  
max.claessens@ch.abb.com



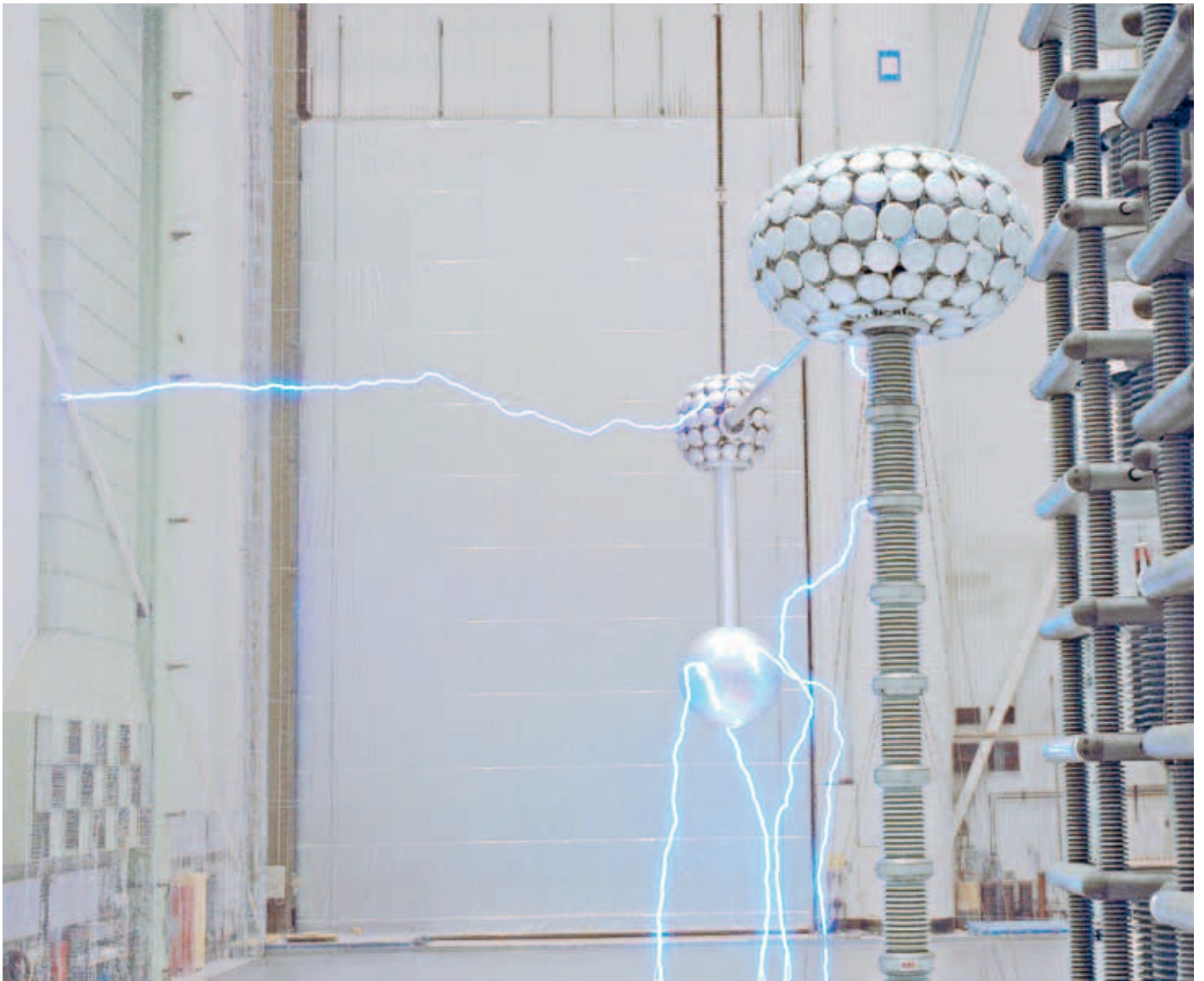

# A legacy of transformation

ABB is a leader in voltage and power extensions

ARNE HJORTSBERG, PIERALVISE FEDRIGO, THOMAS FOGELBERG – Power transformers are a very important part of ABB's business, as well as that of the original corporations that came together to form ABB. This merger created a unique opportunity to integrate the vast experiences and different technical competencies from all the founding companies. Prior to 1900, these companies pioneered different aspects of power transformer development. In 1893, ASEA, one of ABB's parent companies, supplied one of the first commercial three-phase transmissions in Sweden from a hydro power plant to a large iron ore mine some 10 km away. Transformer manufacturing soon emerged in most countries in Europe and in the United States. ASEA, BBC and other predecessor companies rapidly gained expertise in the manufacturing and installation of transformers. Today, ABB draws upon 700 years of combined experience of transformer design and manufacturing.

1 Pulling the Gotland cable ashore in 1950. The power link connected the island to Sweden's mainland power grid, supporting the development of the island's economy



**A**BB and its predecessor companies have consistently stood at the forefront of the manufacturing and development of commercial transformers → 1. As transmission distances from remote generation increased, the transmission voltage had to rise to keep losses down and to reduce the number of lines needed in parallel. In the early 1950s, Sweden commissioned ASEA for the world's first 400kV transmission system with a length of about 1,000km and 500MW capacity. This breakthrough in extra high voltage (EHV) transmission set a new standard for Europe.

In the latter part of the 1960s, the Canadian province of Quebec followed suit. Similar to the situation in Sweden, it too had abundant hydropower yet large geographic distances between the power source and industrial areas. Together, the power company Hydro-Quebec and ABB developed a 735kV EHV transmission system. In the United States, large thermal power plants, from which the power had to be distributed over long distances, were also being built. This resulted in the introduction of a 765kV system. In the early 1970s, the Tennessee Valley Authority commissioned its first

1,200MVA power plant at Cumberland, Tennessee. ABB built the first generator step-up transformers (rated 420MVA) in a single-phase design.

These transformers represented a technical breakthrough in terms of power capacity on one wound limb.

At the same time, ABB entered a development program together with American Electric Power (AEP) aiming for the highest technically feasible AC transmission voltage. For this purpose, ABB built a full-size single-phase network transformer for 1,785kV, rated at 333MVA. This test transformer was installed and successfully operated at the research facility until completion of the research program → 2. Similar development programs occurred in other countries. For example, a full-size ABB transformer and shunt reactor was built in Italy for 1,000kV and installed at the ENEL test station Savereto.

During the last few years the need for even higher capacity long-distance transmission has resulted in renewed interest in ultrahigh voltage alternating current (UHVAC) voltages in the range of 1,000 to 1,200kV AC in China and India, and the development of 800 and 1,100kV ultrahigh voltage direct

current (UHVDC) has resulted in ABB emerging as a major player in pushing transformer technology to new levels.

#### The TrafoStar technology platform

In August 1987, the Swedish ASEA and the Swiss BBC companies merged and formed ABB. Shortly afterward, ABB merged the transformer manufacturing parts of Westinghouse in the United States, which also included the former General Electric transformer technology, as well as Ansaldo in Italy and several Spanish factories. National Industri in Norway and the Finnish company Strömberg had become part of ASEA just

**ABB's HVDC technology has had a truly revolutionary impact on the way that electric energy is delivered all over the world.**

before the merger. Together, these companies contained a very large portion of all the power transformer knowledge and experience in the world.

After the merger, a number of task forces and research and development groups were established to evaluate the experience and best practices from a wide range of previously independent transformer manufacturers. Major objectives were lower costs, shorter production times, higher

**Title picture**

1,100kV ultrahigh voltage direct current transformer in the ABB HVDC test facility





ABB has promoted and successfully performed more short-circuit tests than any other supplier.

quality and reduced test room failures. These objectives have remained the main focus for ABB's continued transformer development. As a result, ABB succeeded in unifying its technology into a common platform, TrafoStar, and today it offers products with the same high standard of quality wherever in the world the transformers are manufactured → 3. The TrafoStar technology platform includes the following key ingredients:

- Common design rules based on experience from all ABB predecessor companies
- Common design system and design tools
- Common manufacturing processes, equipment and tools
- Common quality and failure analysis systems
- Common feedback and continuous improvement programs
- Common training and education systems

ABB launched the common concept, TrafoStar, more than 15 years ago, with integrated engineering tools, manufacturing accu-

racy and major suppliers with common material specifications, testing and quality management system. This concept is now used for large power transformers in all ABB plants globally. Since the inception of TrafoStar, more than 15,000 power transformers have been produced; of these, 2,000 units are very large generator step-up (GSU) transformers and intertie transformers. More than 1,000 power transformers of more than 60MVA rating are produced every year. This unique business concept has allowed ABB to amass design and manufacturing experience in a truly global way, for continuous process improvement → 4.

Since ABB is also one of the world's major suppliers of all types transformer components – insulation materials and kits, tap changers, bushings, and electronic control equipment – the company is in a unique position to control product quality and performance.

#### **Serving the new electric power markets**

Since the inception of ABB in the late 1980s several major changes in the electric power

### 3 TrafoStar

ABB's knowledgebase is built from the 700 years of combined experience from several companies including:

- |                                  |                     |
|----------------------------------|---------------------|
| - ASEA                           | - National Industri |
| - Ansaldo/Ital Trafo/IEL/OEL/OTE | - Strömberg         |
| - BBC                            | - Westinghouse      |
| - GE, United States              |                     |

ABB utilizes a common design and manufacturing platform in all 13 power transformer factories worldwide. ABB has delivered more than 14,500 power transformers (over 17,000,000MVA) based on TrafoStar, including over 20,800kV UHVDC units and over 500,735kV to 765kV AC units to all major global markets.

Through continuously improved design and manufacturing procedures, ABB has reduced test failures by 50 percent between 2000 and 2010. As a result, ABB's short-circuit withstand is now more than twice as high as the market average.

## The unique TrafoStar business concept has allowed ABB to amass design and manufacturing experience in a truly global way.

markets have occurred. As the original domestic, country-based networks have been built out and matured, markets were opened up and deregulated in the western world to promote competition and efficient interconnections and creation of regional networks and markets. This evolution led to a change in relations between transformer manufacturers and buyers, from local to more global relations, and with a greater focus on economic aspects on both sides. As a result, manufacturers also had to become more global, leading to consolidation and concentration of the industry. ABB was perfectly prepared for this development, and emerged as the world leader in power transformers.

Simultaneously, the emerging markets in Asia and South America started to have a major influence, and later dominated the demand for power transformers. The rapid build-out in China and later India and other emerging markets created a boom period for transformers during the first decade of the new century, causing very high material prices for copper and core steel, and long delivery times and various other imbalanc-

es. A very rapid build-out of manufacturing capacity occurred particularly in Asia, causing a substantial overcapacity at the end of the period, with new imbalances and instabilities in material prices. ABB, with its global position and common technology, emerged as a major forerunner during this period.

In the present market, utilities and other power transformer buyers have a much more complex procurement process. Many of their local manufacturers and sub-suppliers are gone and many new unproven players have emerged. The local service support organizations have been transformed or are no longer available. Economic pressure has increased and new load patterns and highly loaded networks are challenging demands on the reliability and stability of the networks. Safe and reliable operation is a key but requires a procurement process for transformers and other equipment that can correctly identify quality products. This is a formidable challenge. ABB supports its customers in this new challenge by delivering a very well proven and reliable product with verified quality properties as well as a stable service and support organization.

#### Power system reliability

Modern power systems are increasingly complex with a large number of individual components. To ensure reliable operation, it is essential that the key elements, such as large power transformers, have a very high degree of availability, minimizing the outages of individual components or whole blocks of power generation.

The ability to withstand short-circuits is recognized as a very crucial function of power transformers in the network. The International Electrotechnical Commission (IEC),

Institute of Electrical and Electronics Engineers (IEEE) and other commissions, specify the requirements on power transformers and how their performance should be verified. There is, however, extensive evidence that many transformers are not as short-circuit proof as assumed. Failures caused by short-circuits are still a major cause of transformer outages, and failure rates vary widely between different countries and systems, depending on network characteristics and equipment installed.

Different networks have varying problems. In rapidly developing regions with increasing demand for electric power, more and more generating capacity and interconnections are added to existing systems. However, the western world is characterized by expanding cross-border electricity trade, integration of wind and other renewables, changing load flows and aging components. Several of these circumstances mean that old as well as new transformers will be exposed to even more demanding severe short-circuit stresses.

#### Assuring transformer quality

ABB has continued its predecessors' active participation in international bodies such as CIGRE (the International Council on Large Electric Systems), IEC and IEEE helping to establish stringent standards on test levels and test procedures to verify transformer performance and quality under various operational conditions. Successful factory acceptance testing of new transformers is necessary but not in itself sufficient to demonstrate service quality in all respects. Dielectric performance is very well covered by appropriate international standards that have been developed over the years.





By the early 1950s, developments in current conversion technology led by ASEA, ABB's Swedish forerunner, enabled the company to build the world's first commercial HVDC power link between the Swedish mainland and the island of Gotland → 2.

Since this installation, ABB has continued to develop HVDC technology, replacing the fragile mercury-arc valves in the 1970s with semiconductor devices.

ABB maintains its lead in HVDC technology and to date, has installed 60,000 MW of HVDC transmission capacity in 70 projects, and is a market leader in the manufacture of high-voltage transmission cable as well. ABB's HVDC technology has had a truly revolutionary impact on the way that electric energy is delivered all over the world.

Some of the world's biggest cities, including Los Angeles, São Paulo, Shanghai and Delhi, rely on HVDC transmission to deliver huge amounts of electricity, often from thousands of kilometers away, with remarkable efficiency and minimal environmental impact.

ABB's achievements using this remarkable technology include the world's longest and most powerful HVDC installation, the Xiangjiaba- Shanghai power link currently under construction in China, which will deliver 6,400 MW of electricity over 2,000 km (shown here) and the world's longest underground cable transmission system, the 180 km Murraylink HVDC Light project in Australia → see picture 1b page 8.

The improvements achieved by ABB drives in energy efficiency, productivity and process control are truly remarkable. In 2008, ABB's installed base of low-voltage drives saved an estimated 170 TWh of electric power, enough to meet the annual needs of 42 million European households and reduce global CO<sub>2</sub> emissions by some 140 million metric tons a year. That is like taking more than 35 million cars off the road for a year. As society faces the challenge of reducing environmental impact while meeting rising demand for electricity, ABB's drives will be making a positive contribution to a better world.

The areas of thermal and mechanical integrity, however, are arenas where design and production weaknesses can pass tests without being detected. ABB has therefore made specific efforts in design, production, supply chain and testing philosophy of large power transformers to verify thermal and mechanical performance. A key measure of the mechanical integrity of the transformer

factors. In high-voltage systems, the most probable type of SC is a single-line-to-earth flashover, normally due to environmental conditions such as a lightning strike on the line, etc. The relative severity of the different types of faults depends on the characteristics of the system, in particular on the SC impedance value of the transformer and the SC apparent power of the system.

### ABB's short-circuit withstand is over twice as high as the market average.

is a short-circuit test, which ABB has promoted and successfully performed more frequently than any other supplier.

Mechanical rigidity of the transformer will become one of the most vital performance factors for the future.

There are three reasons for this:

- The ability to withstand short-circuit (SC) stresses
- Seismic requirements
- Transport handling

SC forces give rise to mechanical forces on windings that can reach hundreds of tons in milliseconds. The current peaks and the corresponding forces depend on many

Factors and related withstand criteria in windings can be split into two components: radial forces and axial forces.

The failure modes for radial forces include:

- Buckling of inner windings
- Stretching of outer windings
- Spiraling of end turns in helical windings

The failure modes for axial forces include:

- Mechanical collapse of yoke insulation, press rings and press plates, and core clamps
- Conductor tilting
- Conductor axial bending between spacers
- Possible initial dielectric failures inside windings, followed by mechanical collapse

The SC forces are calculated in ABB with advanced computer programs based on detailed finite element methods (FEM) that also take into account axial displacements

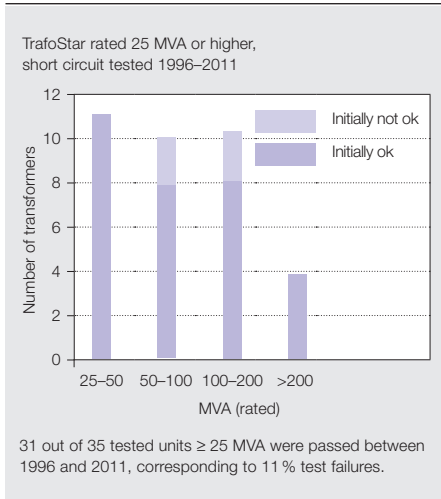

5a ABB's TrafoStar transformers

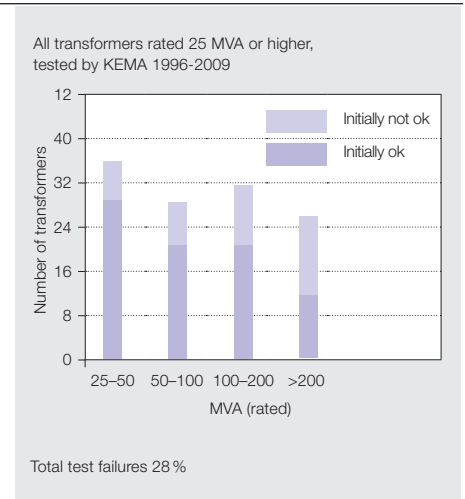

5b Transformers tested by KEMA

## ABB draws upon 700 years of combined experience of transformer design and manufacturing.

caused by workshop tolerances and pitch of helical type windings.

Windings are dimensioned for maximum compression forces, where dynamic effects are included. An extremely important feature of ABB's SC technology is that inner windings subject to radial compression are designed to be completely self-supporting with regard to collapse by "free buckling". This means that the mechanical stability of the winding is determined by the properties of the copper and conductor geometry only, a cautious design principle that has served ABB very well.

### Short-circuit strength verification

The new IEC Standard 60076-5 (2006-2) provides two options for verifying the transformer's ability to withstand the dynamic effects of a SC:

- A full SC test performed at a certified laboratory
- A theoretical evaluation of the ability to withstand the dynamic effects of SC events based on the manufacturer's design rules and construction experience, in line with the new IEC guidelines.

Due to the high investment costs of SC test equipment, such test facilities are available in only a handful of locations in the world. The test requires power capacities in the range of a large power grid together with sophisticated control and measuring equipment. One such facility is KEMA in the Netherlands, where a number of SC tests were carried out on behalf of ABB. In spite of the high cost, ABB has performed a large number of such tests to guarantee quality. 35 ABB TrafoStar power transformers of different designs have been SC tested, with a failure rate as low as 11 percent → 5.

KEMA reports presented at CIGRE and other technical conferences show the total test failure rates for power transformers to be 28 percent of the performed SC tests for the whole industry [1]. ABB's test record over the last 16 years has been 5 failures out of approximately 50 tests, or only 10 percent. When the ABB test results are compared to the result of all other manufacturers the remaining manufacturers show SC test failure rates several times higher than ABB.

### Future ambition for ABB quality efforts

In the future, new ways of rating transformers through better control of the thermal capability can help reduce the use of expensive materials. New standards should take the load profile into account, and allow for more flexible specifications to deal with more complex load patterns. This will require the integration of more intelligence. Other possibilities are to further increase the mechanical, thermal and dielectric integrity of transformers – to better equip them to deal with the greater stresses that will affect future networks. Since transformers stand

for a substantial part of the network losses, energy efficiency programs will further require transformer designs and technology with lower losses.

For more information about ABB's transformer technologies, please see "A world in transformation" on page six of this special report.

### Pieralvisè Fedrigo

ABB Power Products, Transformers  
Sesto S. Giovanni (Milan), Italy  
pialvisè.fedrigo@it.abb.com

### Arne Hjortsberg

ABB Corporate Research  
Baden-Dätwil, Switzerland  
arne.hjortsberg@ch.abb.com

### Thomas Fogelberg

ABB Power Products, Transformers  
Ludvika, Sweden  
thomas.fogelberg@se.abb.com

### References

- [1] Smeets, R.P.P., te Paske, L.H. (2010) Fourteen Years of Test Experience with Short Circuit Withstand Capability of Large Power Transformers. Travek VIIIth International Science and Technical Conference on Large Power Transformers and Diagnostic Systems, Moscow, Russia.



# UHVDC

## Meeting the needs of the most demanding power transmission applications

**THOMAS FREYHULT, MATS BERGLUND, ÅKE CARLSSON – HVDC (high-voltage direct current) power transmission is an efficient and cost competitive way of transmitting large amounts of electricity over long distances. ABB has extensive experience with HVDC technology, and has developed and built converter transformers for the most demanding projects, including products for ultrahigh-voltage transmissions. 800 kV UHVDC (ultrahigh-voltage direct current) transmission was put into commercial service in 2010; 1,100 kV UHVDC is now being developed. This article considers some important steps in the design and development of technology for the most demanding power transmission applications.**

**T**he need for electric power is rapidly increasing in the developing world. Power sources close to consumption centers have already been harnessed, and present efforts are exploring ways to generate and move power from further away, especially sources of renewable energy. Developing countries such as China, India and Brazil have large populations and are modernizing quickly, but closing the gap with the developed world will require a large amount of electric power.

HVDC is the most environmentally friendly and economical way of transmitting large amounts of electric power. Compared with AC, DC transmission needs much narrower right-of-ways, while higher voltages reduce both electricity losses and the cost of building large-scale power lines. As generation takes place further and further away, higher and higher transmission voltages are required. The highest DC transmission voltage has almost doubled during the last decade → 1.

The swift pace of economic development in certain regions has meant the time to develop equipment to support higher transmission voltage levels has been very short. Chinese customers in particular have pressed for rapid development and delivery of the first projects using UHVDC

technology, driven by the immediate need for transmission assets. Compounding the pressure, stringent reliability requirements are a prerequisite of these very large transmission projects.

### Transmission basics

The State Grid Corporation of China put the world's first 800 kV DC transmission system into commercial operation in 2010. It is a 2,000 km long power line with a capacity of 6,400 MW, generated by a large hydropower plant in Xiangjiaba and transmitted to Shanghai. The AC to DC converters are built as  $\pm 800$  kV double circuits with eight series-connected, six-pulse converters. The transformers are single phase, two-winding units. In total, 24 converter transformers are needed at both the sending and receiving ends.

Depending on the position of the transformers within the converter, four different designs are needed with different DC voltage ratings (800, 600, 400 and 200 kV) where the transformers connected to the uppermost and lowermost bridges had to be built for the highest DC potential → 2.

For the Xiangjiaba to Shanghai project ABB designed and built transformers for the receiving station. The transformers

## 1 Some of ABB's key HVDC projects

Itaipu	3,150 MW / 600 kV DC	Brazil 1982
Three Gorges projects	3,000 MW / 500 kV DC	China 2003
Xiangjiaba – Shanghai	6,400 MW / 800 kV DC	China 2010
Ningdong – Shandong	4,000 MW / 660 kV DC	China 2011
Jinping – Sunan	7,200 MW / 800 kV DC	China 2012
North East – Agra	6,000 MW / 800 kV DC	India 2015
Hami – Zhengzhou	8,000 MW / 800 kV DC	China 2014
Zhundong – Chengdu	10,000 MW / 1,100 kV DC	China 2015

## 2 Basic arrangement of transformers and converters

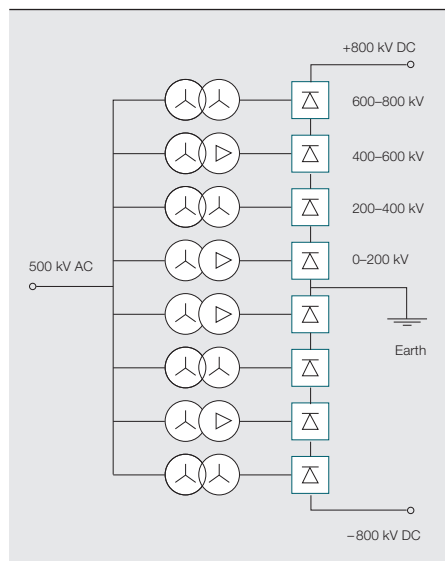

for the higher voltages were designed and manufactured in Ludvika, Sweden. The remaining units were manufactured by ABB's partners in China.

### System requirements for converter transformers

The basic function of the converter transformer is to adjust the line voltage of the AC side to the HVDC transmission voltage. In addition, it must fulfill other specific requirements, including:

- A galvanic separation between the DC and AC systems
- Specified short-circuit impedance
- High content of current harmonics
- Large range of voltage regulation

In conventional AC/DC converters, the transformer acts as a barrier to prevent DC voltage from entering the AC network. One of the transformer windings is connected to the AC side, which is also called the line-side winding. The other winding is connected to the converter valves, called the valve-side winding.

DC voltage results in additional demands on the insulation structure in comparison to AC voltages. After long and dedicated research and development, ABB has developed a successful insulation system suitable for the highest transmission voltages for AC as well as DC.

The design of the valve is such that the rate of current increase must be controlled when the valve starts carrying current. The rate of increase largely depends on the transformer reactance, which also has to be fulfilled within narrow limits for two individual transformer units.

The high content of current harmonics requires special attention be paid to controlling additional and stray losses in the transformer, when it comes to total losses and the risks of local overheating in the windings and metallic components exposed to stray flux from windings and internal current carrying leads.

In order to optimize the reactive power needed for the operation of the converter, depending on load variations the system designer generally specifies a large range of voltage ratio variation between the line and valve sides.

## 3 Measurement setup



### Pioneering work

In the late 1970s, ABB did pioneering work in this area when the first set of transformers for 600 kV DC transmission was delivered to the Itaipu HVDC project in Brazil.

The transformer concept used for Itaipu has been a template for most HVDC converter transformers: a single-phase design, with two wound limbs and two outer limbs for the return flux. The windings are arranged concentrically with the valve winding on the outside. The line winding is divided into two coils – the one for the tapped part is located closest to the core, followed by the nontapped section. This arrangement is beneficial for the topology of the valve-side, which requires AC as well as DC insulation.

The basic Itaipu concept has undergone continuous improvements, such as valve-side bushings protruding directly into the valve hall. Eliminating the need for separate bushings between the transformer terminal





and the interior of the valve hall helped to reduce the cost and complexity of station layouts. In addition, step porcelain bushing housing was replaced by composite material, and within the bushing compressed gas replaced oil. These new materials remove the risk of disastrous consequences in the event of a bushing failure.

#### AC and DC stresses

The stress patterns for AC voltage between two electrodes are fairly straightforward. The stresses of different materi-

ing application are well-known, at least for moderate voltage levels.

The stress pattern for a DC voltage applied between electrodes will have a similar distribution in the initial phase after the application of the voltage. After the initial state, the electric stress pattern goes through a transient state, finally ending up in a steady state, often after several hours. In contrast to AC, the material parameters that govern behavior under DC stress display larger variation

and the background physics is very complex. Variations of material parameters and design have large consequences for the electric stress occurring inside the transformers, and this is why in-

## ABB has developed the means to accurately measure stresses in models of the insulation systems used in HVDC converter transformers.

als in combined insulations depend primarily on the permittivity of the individual materials. In order to reach reliable operation, the stresses for each of the insulating materials must not exceed a recommended value. The insulation structures in an HVDC converter transformer are built up from cellulose-based solid insulation and mineral oil as an insulation and cooling medium. The free distance in a liquid insulating material must be controlled by intermediate insulation barriers to reduce the risk of abnormal voltage breakdowns. In short, predicting stress distributions caused by AC waveforms is straightforward, and the material parameters are stable under different operating conditions. The physics and its engineer-

insulation structures have to be designed and manufactured with great care to achieve a reliable result.

ABB has developed the means to accurately measure stresses in models of the insulation systems used in HVDC converter transformers.

Electric stress in more complex insulation structures can be modeled and measured using the electro-optic Kerr effect. Polarized light passing through transformer oil changes its polarization state depending on the electric stress applied. Detection of the phase shift between light components parallel and perpendicular to the electric field allow measurements of the magnitude

## 5 Additional dielectric tests for the valve winding together with corresponding voltages and durations

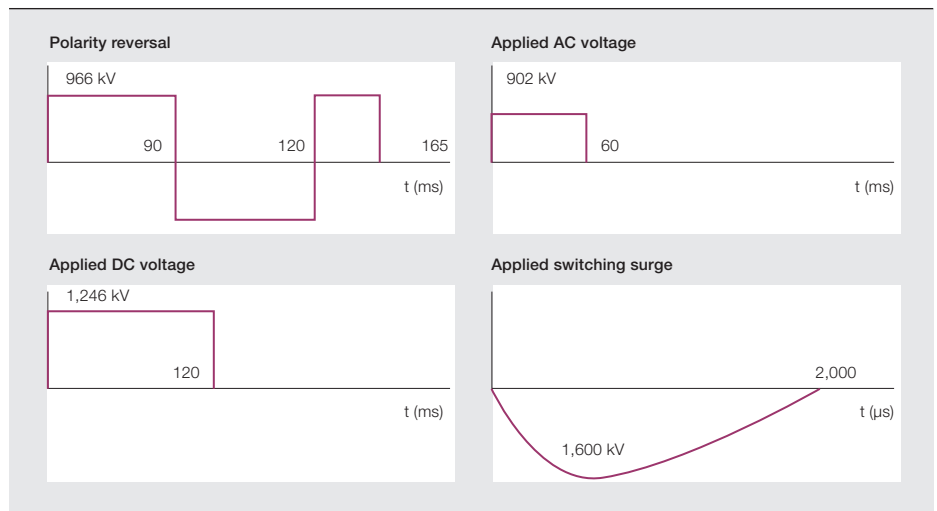

It was necessary to acquire hands-on experience with the characteristics of vital components in the transformers.

and direction of the electric field. The low numerical value of the Kerr constant of transformer oil, and fairly moderate field stress in the fluid phase of the insulation places stringent requirements on the measurement system to achieve sufficient accuracy to measure magnitude and direction of the electric field → 3.

The Kerr cell measurement has given ABB valuable information about the stress distribution in multibarrier insulation systems used in high-voltage power transformers in transient as well as steady-state conditions. For a more accurate analysis the distribution of space charges has to be considered, especially for a barrier system with small ducts between the individual barriers. The traditional method of resistive steady-state distribution has important limitations, and reliable insulation structures cannot be developed based only on such a theoretical method. However, calculation models based on true charge transport behavior developed by ABB and calibrated by real measurements are the basis for all design rules concerning reliable insulation structures for all ABB converter transformers today.

### The challenge of UHVDC

Although ABB had all the basic knowledge in-house, it was also necessary to acquire hands-on experience with the characteristics of vital components in the transformers, as well as external connections, particularly on the valve side. For that purpose, a full-scale test model was built, complete with tank, windings, internal connections and valve-side bushings for the development of equipment for use in both 800 kV and 1,100 kV DC transmis-

sions → 4. Over time, models were exposed to very demanding operational and test conditions to fully demonstrate reliable performance. Special attention was paid to components with complicated geometry, like windings and the connection between the valve winding and bushing. An intricate balance between solid and fluid insulation has to be achieved in the design of the transformer insulation.

The HVDC bushing was another component needing special attention. As its air side enters the valve hall, it is essential that a breakdown not lead to fire or damage from shattered pieces of the bushing.

For that reason, the insulation system around the bushing lead is a condenser body, and the space between the body and the cylinder-shaped insulator is filled with compressed gas. Silicon sheds are extruded on the tube outside to permit indoor or outdoor use.

Scientific advances have not only been made in transformer insulation, but also bushings. Challenges similar to those in oil and cellulose insulation also exist in air insulation systems. An ABB innovation enabled the electric field to be measured on the surface of an insulator on the bushing of an HVDC transformer. Simulation models are calibrated by actual measurements, and special phenomena are integrated into the bushing design.

### Tests

A transformer is subject to delivery tests after it is manufactured, assembled and installed on site. These tests are for verification of dielectric and operational re-



## 6 Success story: the world's most powerful UHVDC converter transformer

ABB has successfully developed and tested a 1,100kV UHVDC converter transformer, breaking the record for the highest DC voltage level ever achieved, which means more electricity can be transmitted efficiently over even longer distances.

The Xiangjiaba-Shanghai link commissioned by ABB is the world's first commercial 800kV UHVDC connection → [picture 2 on page 8](#). It has a capacity of 6,400MW and at just over 2,000km is the longest power link of its kind in operation. The new 1,100kV converter transformer technology just tested will make it possible to transmit more than 10,000MW of power over distances as long as 3,000km.

Higher voltage levels enable the transport of larger amounts of electricity across very long distances with minimal losses, using HVDC technology. Converter transformers play a critical role in HVDC transmission, serving as the vital interface between the DC link and the AC network. The development of 1,100kV transformers addresses several technology challenges, including the sheer size and scale of the units, electrical insulation including bushings and thermal performance parameters.

UHVDC transmission is a development of HVDC, a technology pioneered by ABB more than 50 years ago, and represents the biggest capacity and efficiency leap in more than two decades.

requirements set forth in the unit's specifications, as well as the internal ABB quality assurance program.

Compared with a conventional power transformer in the AC network, an HVDC converter transformer must be tested for the ability of valve-side windings to withstand DC voltages. In operation, the valve

external terminals of the winding are connected together and the voltage is applied to the two terminals simultaneously.

During the test with applied DC voltage, the level of partial discharge is measured. During the transient period after the application of voltage, there may be occasional charge movements within the

insulation system. These movements give rise to a noticeable partial discharge signal on the valve-side terminals. The phenomenon is well known and recognized in current standards. The industry has therefore accepted an upper limit on the number of occa-

sions such bursts of partial discharge can take place during the tests. Furthermore, the frequency of bursts must diminish during the course of the test.

### The world needs UHVDC

Driven by economic growth, demand for power and the need to efficiently integrate renewable power generation, it is clear from developments in AC networks that UHVDC will have a major role to play as power systems evolve. The expansion of this role is also clear from the interest in extending the capabilities of UHVDC transmission in the recent years. Given UHVDC's very high ratings, it is essential that these valuable assets operate safely, reliably and efficiently.

ABB has the proven tools and expertise needed to design and manufacture reliable UHVDC converter transformers. This solid technology background ensures that even in the fast-developing UHVDC area, customers can be sure that ABB equipment is designed, tested and built to the highest standards of operational stability. Of the UHVDC projects awarded globally, ABB is by far the largest supplier and is determined to maintain this lead with further advances in the technology → [6](#).

So what is the next step for UHVDC? China has clearly expressed an ambition to achieve even higher DC transmission voltages. That ambition has materialized in an R&D program for 1,100kV UHVDC transmission, which of course requires a range of different equipment, including converter transformers built to support these record-breaking UHVDC transmissions. Rising to the challenge of these very ambitious development plans, ABB was the first to qualify HVDC converter transformer technology at the 1,100kV voltage level as well, but how that came about in detail is a story for another day – the continuing story of ultra-efficient, ultrahigh-voltage direct current electricity transmission.

**Thomas Freyhult**

**Mats Berglund**

ABB Power Products, Transformers

Ludvika, Sweden

thomas.freyhult@se.abb.com

mats.g.berglund@se.abb.com

The authors acknowledge the contribution to this article of the late Åke Carlsson, ABB Senior Transformer Specialist.

---

Driven by economic growth, demand for power and the need to efficiently integrate renewable power generation, it is clear that UHVDC will have a major role to play as power systems evolve.

windings are exposed to an AC voltage and a superimposed DC voltage. A DC transmission must be able to handle the fast transition of power from one direction to the other. Such transitions also mean a switch in converter polarity, from positive to negative, and vice versa → [5](#).

Operation with continuous DC voltage, superimposed AC voltage and DC polarity reversal will be reflected in additional dielectric tests of the valve-side windings; tests with DC voltage, tests with AC voltage and tests with switching surge voltage are in accordance with IEC standards. All four types of test are considered to be nontransient, with a uniform voltage along the valve winding. For that reason, the two

# Responding to a changing world

## ABB launches new dry-type transformer products

**MARTIN CARLEN – Responding to new requirements in a changing world, ABB is complementing its portfolio with new dry-type transformer products that help make electricity supply systems more efficient, reliable, safe and environmentally friendly.**

**A**BB began developing dry-type transformers for medium voltage applications in the 1970s, recognizing that oil-free technologies help transformers comply with the highest safety standards for people, property and the environment. Using dry-type transformers, electric substations can be placed in commercial or industrial buildings without undue concern about fire risk. They are easy to install and maintenance free.

ABB dry-type transformers have evolved into what we now call “standard” dry transformers. They are mostly used to distribute electricity to end users, and are available with different coil technologies:

- Vacuum Cast Coil (VCC): high quality, well-protected windings
- Vacuum Pressure Impregnation (VPI): allows efficient cooling
- Resibloc: ultimate mechanical strength, qualified for extreme climactic conditions (–60 °C)

ABB recently complemented its portfolio with new products that will play a major role in future transmission and distribution (T&D) systems. ABB also offers a broad portfolio of specialty products for many, often specialist, applications → 1.

---

Customer interest in products that are both economically and ecologically efficient inspired ABB to develop a dry-type transformer product family that exceeds expectations in these areas.

### **Efficiency, space and reliability counts**

Customer interest in products that are both economically and ecologically efficient inspired ABB to develop a dry-type transformer product family that exceeds expectations in these areas. The EcoDry transformer family provides ultra-efficient products with loss values that easily meet or exceed industry standards or legal requirements. EcoDry enables customers to select a product optimized for a specific

### 1 Additional dry-type transformer and reactor products

- Rectifier and converter transformers
- Transformers for marine applications
- Transformers for wind turbines
- Air-core reactors
- Iron-core reactors
- Transformers and reactors for rolling stock

### 2 Comparison of TOC (total ownership cost) of standard and EcoDry amorphous metal core transformers (see ABB Review 2/2012, p.47)

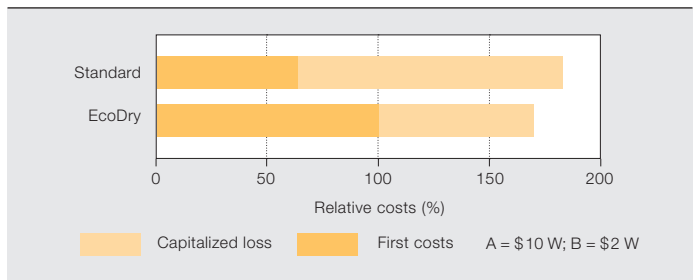

### 3 Life cycle analysis performed for a standard dry transformer and an EcoDry transformer (1,000 kVA, 20 percent load) (see ABB Review 2/2012, p.46)

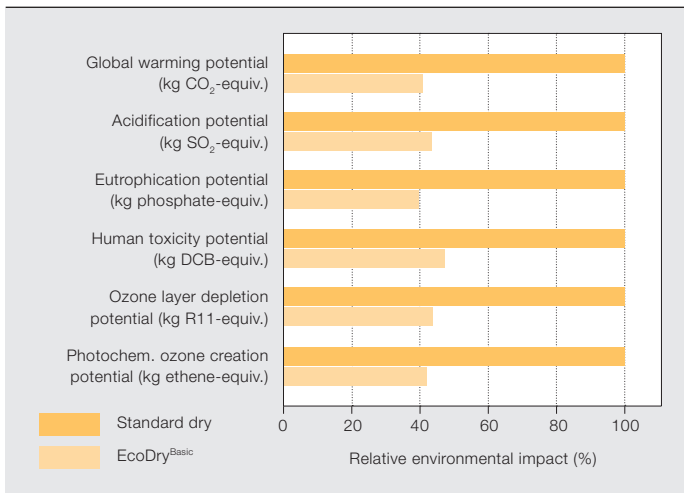

### 4 A triangular wound core which consists of three identical core rings. Left: perspective model. Right: model seen from above

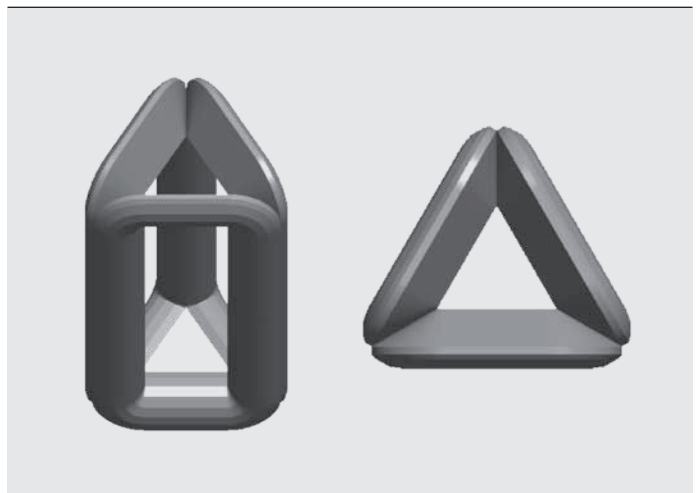

application, minimizing the cost of related investments.

Transformer losses occur in two areas: first, the load independent no-load loss, which occurs in the iron core due to the cyclic change of magnetization resulting from the connected AC voltage; and secondly, the load loss, which depends on the electrical resistance in the transformer windings and on the actual transformer current. Overall, this produces an efficiency curve that is load dependent. When the transformer load is low, the no-load loss will dominate, whereas at high load, the load loss is dominant. Analysis of the total ownership cost (TOC) [2] will help in the selection process → 2.

EcoDry<sup>Basic</sup> substantially reduces no-load loss with a core made of amorphous metal. The no-load loss of the EcoDry<sup>Basic</sup> is 30 percent that of the no-load loss in dry-type transformers fitted with normal steel laminate cores. And these savings add up: when a small, 1,000 kVA dry-type transformer is operated for 20 years, CO<sub>2</sub> emissions are reduced by 140,000 kg, which is equivalent to burning 60,000 liters of oil. Utility distribution transformers often operate at a

rather low average load of 20 percent [1]. EcoDry<sup>Basic</sup> has lower losses than low-loss, oil-immersed distribution transformers.

In industrial processes, transformers frequently run at nearly maximum capacity. In its EcoDry<sup>99Plus</sup> transformer, ABB has developed design enhancements that reduce transformer losses by 30 percent or more.

EcoDry<sup>Ultra</sup> combines features, reducing both no-load and load loss, and providing ultimate efficiency over the whole load range. In the event of strongly varying loads, for example in solar and wind power generating applications, or for operating the transformer at medium load, EcoDry<sup>Ultra</sup> is the ultimate choice.

Although EcoDry transformers require more materials in construction, energy savings over the equipment's lifetime more than compensates for this, and makes this product a winning solution environmentally, as demonstrated by life cycle assessment (LCA) [2] → 3.

Another way to increase transformer excellence that also enables compact installations and reduced losses is with the



## 5 TriDry configuration reduces weight and footprint



The core of a TriDry transformer is wound from a continuous strip of magnetic steel without any joints, therefore avoiding the related losses.

## 6 Characteristics and ratings of ABB dry-type distribution transformers

Standard dry transformer	TriDry	EcoDry
Well proven and highest reliability	Compact, efficient, safe	Ultra-efficient transformer
Core: Stacked core, 3-leg	Core: Triangular, continuously wound core	Core: Amorphous 3-leg Evans cores, or stacked core
Coils: VCC, VPI or Resibloc round, rectangular or oval	Coils: VCC round	Coils: VCC, Resibloc rectangular
Voltage: 0.1–40.5 kV Power: 5–40,000 kVA	Voltage: 1.1–36 kV Power: 100–2,500 kVA	Voltage: 1.1–36 kV Power: 100–4,000 kVA
Special characteristics: Well-established and proven	Special technical characteristics: symmetrical transformer	Special technical characteristics: Amorphous core
Benefits: Non-flammable and self-extinguishing No maintenance High short-circuit strength Easy installation Low-loss designs possible	Benefits: Low loss Different and compact footprint Low magnetic stray fields	Benefits: Minimum losses Most interesting solution in case of medium or high electricity costs Environmentally beneficial

Note: Some products may not be available globally.

## 7 Loss classes according to EN 50541-1 and positioning of TriDry and EcoDry product families

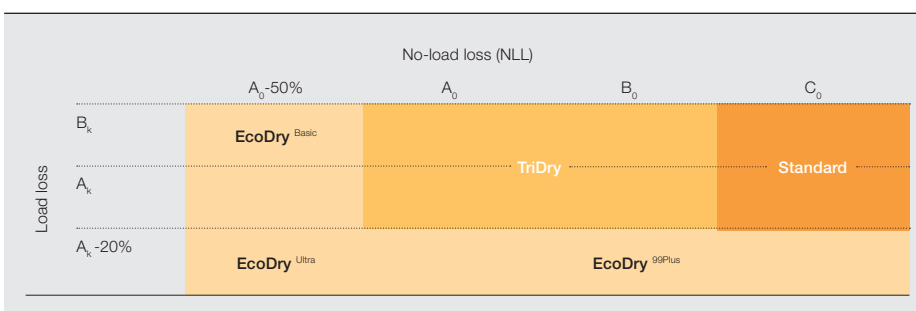

TriDry transformer. This small revolution in transformer technology uses a triangular core configuration which restores the symmetry of three-phase AC systems. Similar to a generator or motor where the poles are arranged in a circular configuration, TriDry phases also have a circular arrangement → 4. This differs from conventional transformers with a planar layout, where the phases arranged side by side result in differences between middle and outer phases, incomplete utilization of core material, and other deficiencies.

The core of a TriDry transformer is wound from a continuous strip of magnetic steel without any joints, therefore avoiding the related losses. The width of the steel sheet varies in order to produce an almost D-shaped cross section of a core ring. Three core rings of almost rectangular shape are mounted together to form a three-phase core with triangular shape. Each core leg is made up of two D-shaped parts from two core rings combined, resulting in a circular cross section. Since the core cannot be opened, the windings are directly wound onto the core and vacuum casting is also done directly onto the core.

In this symmetrical, triangular set-up, each of the three core legs is linked directly to the other two, and feature symmetrical and short distances for the magnetic flux. In addition to the usual rectangular path via the core rings, the flow of flux is also possible via the triangular arrangement of yokes. If the magnetic flux in the yoke sections of one of the core rings becomes too large and the yoke saturates, the flux can pass through the other two core rings, amounting to a flux through the three yokes arranged in a triangle.

The TriDry triangular configuration enables compact installation with a reduced footprint and up to 20 percent less weight → 5. The symmetry of the technology results in transformers of the highest reliability, reduced in-rush current, reduced sound levels, reduced magnetic stray fields and reduced losses → 6.

Standards for losses or minimum efficiency values for transformers are different in different countries. China is well advanced by having defined different efficiency classes, including standards for amorphous transformers, for a number of years. In Europe, different loss classes for dry-type transformers have been introduced only recent-

## 8 EcoDry amorphous transformers provide ultimate efficiency over the whole load range



ly, with the launch of EN 50541-1. Note that the losses of the EcoDry amorphous transformer are half those of the best loss classes specified by EN50541-1 → 7, → 8.

### Going overhead

Overhead distribution is common in many countries and in rural areas. It is an easy and fast way to set up an electricity distribution grid and provide power to consumers. Transformers, for stepping down the voltage used in overhead power lines to the level needed by customers, are directly mounted on the poles.

Traditionally, pole-mounted transformers are oil-immersed units. The oil makes very good insulation, but presents environmental and safety risks. If the transformer tank ruptures or leaks due to an internal failure or external damage, the liquid will run out and contaminate the ground. This is especially problematic in protected water areas, in rivers and lakes, or public and national parks. In addition, leaking transformers will also soon stop working.

In some countries, the theft of copper or oil from pole-mounted transformers is an important issue. Electric utilities not only have to replace the damaged units, but also clean up and dispose of the oil-contaminated ground, which is often much more expensive than replacing the transformer itself. And the risk related to inflammable oil is an issue, especially in residential and forested areas.

To eliminate these problems, ABB developed PoleDry, a dry-type transformer for pole-mount applications → 9. It is non-

## 9 PoleDry is a dry-type transformer for pole-mount applications



flammable, does not need an enclosure, and is comparable in size and weight to oil-immersed transformers. Due to its cast aluminum windings, it is also not a target for theft.

Creating the PoleDry transformer required some special considerations. Eliminating the air gap between the primary and secondary windings, which is typical of dry-type transformers, removed the risk of contamination or ingress of animals between coils, and is very important for ensuring high reliability in an outdoor transformer. PoleDry is therefore manufactured with solid insulation between the windings, and utilizes hydrophobic cycloaliphatic epoxy (HCEP) to encapsulate the windings. This epoxy provides superior outdoor performance in other applications, and is also outstanding in terms of resisting fire, UV rays, erosion and external tracking. Bushings are cast together with the windings, and are fully integrated to prevent any water penetration. Simulations and experimental tests were done to control the electric fields, optimize the design and avoid any tracking on the surface. A final important feature is the core's special corrosion protection.

PoleDry has been tested in the harsh outdoor environment of ESKOM's Koeberg Insulator Pollution Test Station (KIPTS) in Cape Town, South Africa. KIPTS is close (30 meters) to the sea, which provides an environment that includes plenty of exposure to UV, rain, wind and sand erosion, industrial pollution, salt-laden moisture, and wildlife → 10. Coils and cores were tested in a salt-fog chamber, which allows

## 10 Characteristics and ratings of PoleDry transformer and outdoor testing at KIPTS



### Ultimate safety in overhead distribution

Core:	Stacked core, 3-leg
Coils*:	VCC, with cycloaliphatic outdoor epoxy
Voltage:	1.1–24 kV
Power:	50–315 kVA, 3-phase

Special technical characteristics:  
No air-gap between primary and secondary coil  
Integrated bushings  
Corrosion resistant core protection

- Benefits:
- Dry-type transformer for pole-mount application with size and weight comparable to oil-filled unit
  - Environmentally friendly
  - Unattractive for copper theft

Dry-type transformers are easily installed in buildings or underground, and do not require costly additional protective equipment or other infrastructures.

controlled and accelerated cycling between phases with salt fog, clean fog and UV radiation up to 50 times as intense as natural UV radiation [4]. The first 20 commercial units, three-phase transformers with a 100kVA power rating and with 15 or 20kV primary voltage, are destined for the Italian utility, ENEL.

#### Going underground

An opposite approach was necessary for the submersible transformer. This unit is suitable for underground installations, in vaults or subways which are occasionally, or frequently, flooded with water → 11.

An example of submersible transformer installations is the network transformers used in the city of New York (NYC). These three-phase transformers with power ratings of 500 to 2,500 kVA are connected to a network protector, and serve loads in New York's downtown. They are typically placed in vaults under grates in the sidewalks. In the event of heavy rain the vaults, which do not have drainage systems, can become partially or fully flooded. In addition, all surface debris washed off from the streets ends up in the vaults.

In traditional oil-immersed network transformers, internal faults or short circuits can lead to large, street-level explosions and fires, which can cause significant harm to people and property. For this reason Consolidated Edison (ConEd), the electric utility in New York, approached ABB and asked for a dry version of these transformers. Pilot dry network transformers have now been in operation since the middle of 2011.

An important prerequisite was the dry transformers had to fit the dimensions of the existing vault dimensions. They also had to contain a grounding switch integrated with the VCC transformer in a robust tank. This enables easy grounding in case the network requires maintenance work. The dry transformer itself is maintenance free, and is designed to be low sound emitting for urban environments. Multiple arc-fault testing was required by ConEd in order to prove the unit's safety.

#### Feeding power-hungry cities

A burning transformer in an urban area, producing smoke and fumes and widely visible to the public is a nightmare scenario for T&D operators. Although the

### 11 Submersible dry-type transformer for network application



Safety for environment and people

Core: Stacked core, 3-leg

Coils: VCC, high temperature insulation system

Voltage: 1.1–17.5 kV

Power: 100–1,000 kVA

Special technical characteristics:

Mounted in completely sealed enclosure

Low sound level

Benefits: Transformer installation can be flooded

Non-flammable and self extinguishing

Applicable as network transformer

No risk of oil spills

risk of any piece of electrical equipment failing can never be completely excluded, the consequence of such a failure may be heavily dependent on the technology used. With new dry-type transformers, it is possible to minimize the consequences of such occurrences.

Voltage classes for dry-type transformers typically range up to 36kV, and their application is mainly in the distribution grid. Following intensive research, ABB has introduced HiDry<sup>72</sup>, a dry-type transformer for the 72.5kV voltage class. This means dry-type transformers are now available for sub-transmission voltage levels → 12, 13. Urbanization and the rapid growth of megacities requires more and more power in downtown areas, and using higher voltages to deliver it is beneficial.

Dry-type transformers are easily installed in buildings or underground, and do not require costly additional protective equipment or other infrastructures, such as oil pits, etc. Since vacant space in big cities is limited and expensive, these types of transformers not only provide optimized performance, but also an improved appearance.

A number of new concepts had to be introduced in order to produce a dry transformer at this voltage level, including



### 12 Electric field intensity in a 10 MVA, 72.5 kVA dry-type transformer

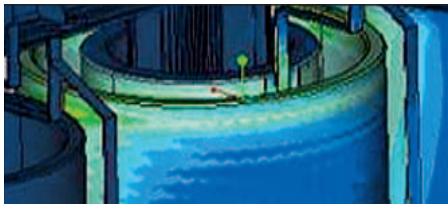

3D simulation of the electric field intensity in a 10 MVA 72.5 kV dry-type transformer and dielectric testing of the transformer beyond the limits

It is now possible to use dry-type transformers in certain applications for the very first time, thanks to ABB innovations that have increased energy efficiency and made higher voltages possible in compact outdoor and submersible installations.

shielding rings in the windings; conductive shielding pieces for the clamps and magnetic yokes; rounded corners in windings and shields; and an optimized number of barriers and barrier arrangements to control the electric field in the insulating air. The combination of numerical simulations and experimental testing on model devices and full-size prototype transformers helped ABB create competitive designs.

72.5 kV dry-type transformers require a footprint similar to oil transformers. While cooling equipment and radiators in oil transformers require considerable space, dry-type transformer coils are

### 13 Characteristics and ratings of ABB's HiDry transformer for subtransmission

#### HiDry

Getting power into cities

Core: Stacked core, 3-leg

Coils: VCC, Resibloc

Voltage: 40.5–72.5 kV

Power: 1,000–63,000 kVA

Special technical characteristics:

Dry-type transformer for sub-transmission (72.5 kV voltage class)

Benefits: Inner-city and underground installation  
Water protection and fire risk areas  
oil & gas and industrial applications

directly cooled by air. The higher temperature rise of the dry-type transformer makes cooling more efficient due to a higher temperature gradient and increased radiative cooling at higher temperatures.

However, since dry technology requires larger dielectric clearance distances, the core and therefore also the mass of the dry-type transformer is slightly larger, which also results in a somewhat increased no-load loss. The load loss is comparable to the load loss of an oil transformer, so total losses are only slightly larger with a dry-type transformer.

HiDry<sup>72</sup> transformers can be provided with an on-load tap changer. They have high short-circuit strength, thanks to strong reinforcement of the coils by the solid insulation material and their cylindrical geometry.

They are suitable for substation retrofits, or for new installations, and paralleling with existing oil transformers is possible. Besides inner city and underground substations, HiDry<sup>72</sup> is a perfect choice for power plant applications, substations in or close to buildings, in caverns or in protected water areas, and industrial applications such as chemical plants or oil and gas installations. For example, two HiDry<sup>72</sup> transformers rated 25 megavolt ampere (MVA), 66/13.8–11.9 kV with on-load tap changers will be installed in the new Estádio Fonte Nova in Salvador, Bahia, Brazil, which is one of the stadiums hosting the 2014 FIFA Soccer World Cup.

### 14 Success story: power reliability for the world's tallest building

When it was completed in January 2010, Burj Khalifa in Dubai became the world's tallest building with 164 floors and a total height of 828 meters. To ensure power reliability throughout the enormous building, it is equipped with 78 ABB dry-type transformers, which are renowned for their mechanical strength and reliability → picture 4 page 9.

The nearby Dubai Fountain, which is illuminated by 6,600 lights and shoots water 150 meters into the air, is also equipped with ABB transformers. It is the world's largest fountain.

The launch of ABB's new dry-type transformer products addresses an important need for safe and environmentally-friendly power products usable in a variety of applications, including urban settings and environmentally sensitive areas → 14. It is now possible to use dry-type transformers in certain applications for the very first time, thanks to ABB innovations that have increased energy efficiency and made higher voltages possible in compact outdoor and submersible installations.

#### Martin Carlen

ABB Power Products, Transformers  
Zürich, Switzerland  
martin.carlen@ch.abb.com

#### References

- [1] Targosz, R., Topalis, F., et al, (2008). Analysis of Existing Situation of Energy Efficient Transformers – Technical and Non-Technical Solutions, Report of EU-IEE project – SEEDT.
- [2] Carlen, M., Oeverstam, U., Ramanan, V.R.V., Tepper, J., Swanström, L., Klys, P., Striken, E., (2011 June). Life cycle assessment of dry-type and oil-immersed distribution transformers with amorphous metal core, 21st Int. Conf. on Electricity Distribution, paper 1145, Frankfurt.
- [3] Singh, B., Hartmann, Th., Pauley, W.E., Schaal, S., Carlen, M., Krivda, A. (2011, June) Dry-type transformer for pole mounted application, 21st Int. Conf. on Electricity Distribution, paper 952, Frankfurt.
- [4] Krivda, A., Singh, B., Carlen, M., Hartmann, T., Schaal, S., Mahonen, P., Le, H., (2011) Accelerated testing of outdoor power equipment, Conf. Electrical Insulation and Dielectric Phenomena, Acapulco, Mexico.



# The quiet life

## ABB's ultralow-noise power transformers

**RAMSIS GIRGIS, MATS BERNESJÖ**  
– Everyone is familiar with the characteristic hum that transformers produce. In sparsely populated areas, this drone will disturb few, but in urban areas it can be of concern and can even fall foul of local noise level regulations. Probably the strictest noise ordinance in the world is enforced in New York City, so, when ABB recently produced a number of transformers for the local power utility, these had to be very quiet indeed. This required a significant effort by ABB to develop an understanding of the processes involved in sound generation, transmission and radiation in transformers. Such knowledge has enabled ABB to supply successfully low- and ultralow-noise transformers to many major cities around the world.

### Title picture

Transformers situated in urban settings often have to comply with very strict noise regulations. Through comprehensive technology development effort, ABB has been able to produce transformers that comply with the strictest regulations around.

**T**ransformer hum is characterized by several pure tones. The frequency of a number of these is in the range where the human ear is most sensitive. Moreover, transformer noise, being of tonal character, causes irritation and discomfort. There are three sources of sound/noise in power transformers:

### Core noise

Core noise is caused by the magnetostriction property of core steel. It has components at multiples of 100 or 120 Hz (for 50 Hz and 60 Hz transformers, respectively). The relative magnitudes of the noise at the various harmonics is dependent on core material, core geometry, operating flux density and how close the resonance frequencies of the core and tank are to the exciting frequencies → 1.

### Cooling equipment noise

Fan and pump noise is mostly broadband with insignificant low frequency tones.

### Load noise

Load noise is mainly generated by the electromagnetic forces that result from the interaction of the load current in the windings and the leakage flux produced by this current. Another source of load noise is tank vibrations caused by the leakage flux impinging on tank walls. The main frequency is twice the supply frequency, ie, 100 Hz for 50 Hz transformers and 120 Hz for 60 Hz transformers.

---

Power transformers of ABB's present design generation typically have noise levels that are significantly lower than those built 20 or 30 years ago.

Transformer load noise increases with the load. Also, at higher loads, fans ramp up and add further noise → 2.

### Design features of

#### ABB low-noise transformers

Power transformers of ABB's present design generation typically have noise levels that are significantly lower than those built



1 Typical frequency spectrum of noise produced by a 60 Hz power transformer (Lp = sound pressure level)

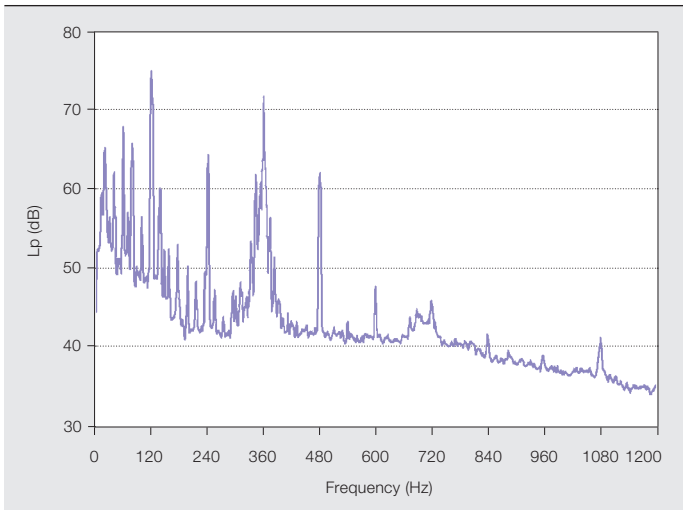

2 Noise components and total noise of a 250 MVA transformer

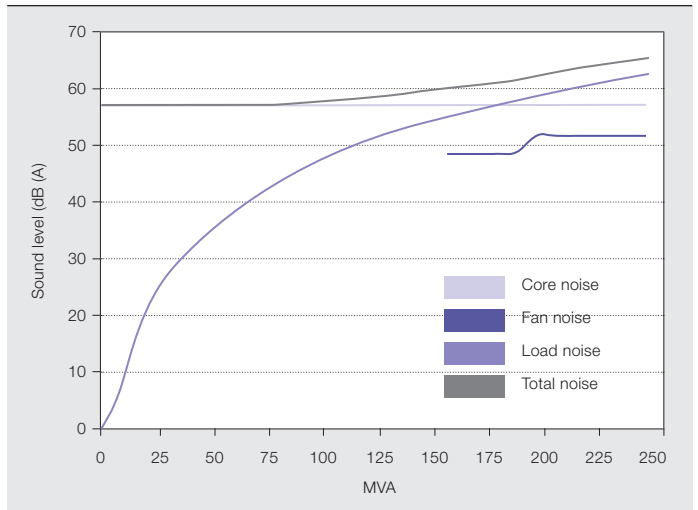

The ConEd requirements impose other design restrictions, such as tight limits on weight, width and height to permit transportation in Manhattan.

20 or 30 years ago. Some of the more important means to achieving these low levels of transformer noise are:

- Transformer cores are now designed to provide a more uniform distribution of magnetic flux with a lower content of flux harmonics in the core and core joints. Detailed 3-D magnetic field modeling allows optimization of the core and, thus, minimized core noise.
- The core is held together by a clamping structure that provides uniform pressure on the core laminations while avoiding local deformations. ABB's in-house tools calculate the vibrations of the core, taking different modes of vibrations and mechanical resonance, as well as the complex forces exciting a three-phase transformer core, into account.
- By carefully considering the dynamic properties of the transformer core and tank, it is possible to successfully de-couple core vibrations from the tank. Also, a number of techniques that attempt to reduce the transmissibility of the core vibrations, and hence the resulting sound radiation, are exploited.
- Both core and tank resonances are avoided. This entails accurate pre-determination of resonance frequencies. Acoustic simulations, verified by scale models and full-size experiments, provide the tools needed to avoid core and tank resonances and reduce sound radiation.

Sound panels or enclosures covering the entire tank, or parts thereof, have been used for transformers that must fulfill very low levels of noise.

- Winding resonance is avoided and winding designs that provide for lower magnitudes of leakage flux are used.
- Tank vibrations are significantly reduced by shielding against leakage flux.
- Low-noise fans, or sound-absorbing elements at the inlet and outlet, reduce fan noise. In the case of ultralow-noise transformers, fans may not be used at all.

#### ConEd transformer requirements

Consolidated Edison (ConEd) is a power utility serving New York City. In order to satisfy the stringent limits that the city ordinance imposes on all sources of noise in the city, the ConEd specification for new power transformers has stringent noise requirements:

ABB invested a significant R&D effort and were rewarded with a contract from ConEd to produce the first ultralow-noise 93 MVA transformers.

- A 15 to 20 dB lower total noise level than is typical for corresponding sizes of transformers.
- Guaranteed noise levels not to be exceeded at 100 percent voltage combined with 100 percent load or at maximum over-excitation combined with 40 percent load.

---

### 3 2-D modeling of mechanical resonance in a five-limb, three-phase core

---

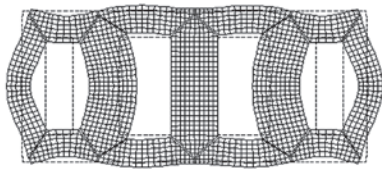

---

### 4 3-D modeling of sound radiation from the tank of a three-phase transformer

---

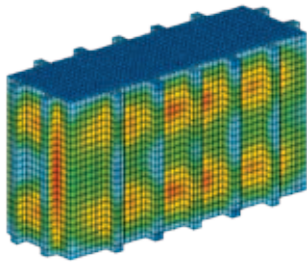

Limits are enforced not only on the total noise levels but also on each individual frequency component of the transformer noise. Taken together, the maximum allowable noise levels of the frequency components correspond to a total noise level of about 54 dB(A) at 100 percent voltage and full current. In comparison, transformers of this size would typically have noise levels in the 70 dB(A) range for no-load (core plus fans) noise alone. This demonstrates the extent of the ConEd noise requirements relative to typical, or even low-noise, transformers. Guaranteeing the level of each frequency component is an order of magnitude more difficult than guaranteeing the total noise level of a transformer.

These were not the only challenges. The ConEd requirements impose other design restrictions, such as tight limits on weight, width and height to permit transportation in Manhattan; tight limits on transformer impedance variation across the range of the tap changer; and significant overload requirements (up to 200 percent), while limiting allowed temperatures of hot-spots in the windings and structural members at different loads.

#### Ultralow-noise transformers for ConEd

Designing power transformers with such ultralow noise levels, while satisfying all the other performance and size limitations, required:

---

### 5 First generation of ultralow-noise ConEd transformers with sound enclosure



---

### 6 Second generation of ultralow-noise ConEd transformer with tank sound panels



- Accurate calculation of the frequency spectrum, and total spectrum, of core noise at different operating core flux densities.
- Accurate calculation of core, tank and winding resonances to ensure these are sufficiently removed from the main exciting frequencies of the transformer vibrations.
- Accurate calculation of load noise for different types, arrangements and dimensions of winding as a function of current density and for different tank shielding types.
- Effective methods to reduce all components of transformer noise and an understanding of the contribution of each.
- Proper transformer mounting techniques and a full understanding of their impact on the different frequency components of the transformer noise.
- Accurate indoor measuring techniques for very low noise levels in a factory environment in the absence of a sound room for testing the transformer.

More accurate calculations allow optimized design margins and improve the feasibility of meeting such tough performance specifications → 3, 4.

#### A success story

As of spring 2003, ABB had the technology to design low-noise transformers, but

---

It was possible to upgrade the design of these transformers to have significantly less core and windings weight while satisfying the ConEd requirements.

**7 Third generation of ultralow-noise ConEd transformer without sound enclosure or panels**



not to the levels required by the new ConEd ultralow-noise transformer specifications. Consequently, ABB invested significant research and development effort over a period of several years and were rewarded with a contract from ConEd to produce the first ultralow-noise 93MVA transformers. These transformers were designed using the then best technology and were delivered in 2005. The first was equipped with a sound enclosure → 5. The second and third transformers had only sound panels attached to the tank walls → 6.

After this delivery, ConEd awarded ABB an order for ultralow-noise 65 MVA transformers. These were produced with no external sound enclosure or panels → 7. In fact, the second unit was designed with significantly less winding weight while exhibiting 4 dB lower load noise than the first unit. Not only that, but, frequency components of the total noise of the transformer were

**The technology is now being used to produce optimum designs for other low- and ultralow-noise transformers and it has set new industry benchmarks for transformer noise emissions.**

between 2 and 5 dB lower than the levels specified by ConEd.

As a result of this success, ConEd ordered more of these 93 and 65 MVA transformers for delivery in 2008 and 2009. Meanwhile, it was possible to upgrade the design of these transformers to have significantly less core and windings weight while still satisfying the ConEd requirements. The technology development undertaken by ABB for the 93 MVA and 65 MVA transformers resulted in a 10 percent and 18 percent core weight reduction, respectively, compared with the original designs. Similarly, a 16 percent and 27 percent copper weight reduction was achieved, resulting in corresponding 12 percent and 22 percent reductions in active parts, respectively, while achieving 3.7 dB and 9.2 dB reductions of core and load noise for the 93 MVA transformers and 4.9 dB and 2.7 dB reductions of core and load noise for the 65 MVA transformers → 8.

This transformer technology is now being used by ABB designers worldwide to produce optimal designs for low and ultralow-noise transformers for other customers in metropolitan areas around the world.

**Application opportunities**

There are a number of situations in which low and ultra-low noise transformers are ideal:

- Substations near, or in, residential areas.
- Areas where new, lower noise limitations or complaints have arisen and a transformer is being replaced.
- In substations that were originally planned to have sound walls.
- Where old transformers that have sound enclosures are being replaced.

**8 Reduction of weights and noise levels between original and most recent designs**

MVA	93	65
Core weight	-10%	-18%
Copper weight	-16%	-27%
Active parts	-12%	-22%
Core noise (dB)	-3.7	-4.9
Load noise (dB)	-9.2	-2.7

- Where total transformer noise at full load has to be guaranteed.
- In static var compensator (SVC) transformers, where, typically, the total noise level of the transformer, including core and load noise at full capacitive loading with harmonics, has to be guaranteed.

**The most effective solution**

In the past, most transformer manufacturers used burdensome sound enclosures to achieve ultralow noise levels, or customers built expensive sound walls. Ultralow-noise transformers have advantages over these solutions:

- They are 40–50 percent more economical than using sound walls and sound walls are anyway less effective at distance and for load noise.
- They are 60–70 percent more economical than using sound enclosures.
- Enclosures are disadvantageous for maintenance and cooling.
- Walls are fire-prone and they reduce cooling efficiency.
- Walls and sound enclosures require more real estate.

The ultralow-noise transformer technology developed as a result of this project has set new industry benchmarks for transformer noise emissions and is now being used by ABB to produce designs for low and ultralow-noise transformers for other noise-sensitive metropolitan areas around the world.

**Ramsis Girgis**  
**Mats Bernesjö**

ABB Inc.  
St. Louis, MO, United States  
ramsis.girgis@us.abb.com  
mats.s.bernesjo@us.abb.com





# Power below the waves

Transformers at depths of 3 km

ESA VIRTANEN, ALPER AKDAG – As engineers place ever more infrastructure under our seas, the demand for electrical power there rises correspondingly. Central to any electrical power system is the transformer. ABB is the only company in the world delivering transformers that work at depths of up to 3 km. Just how does one design a transformer to work in such a remote and hostile environment?

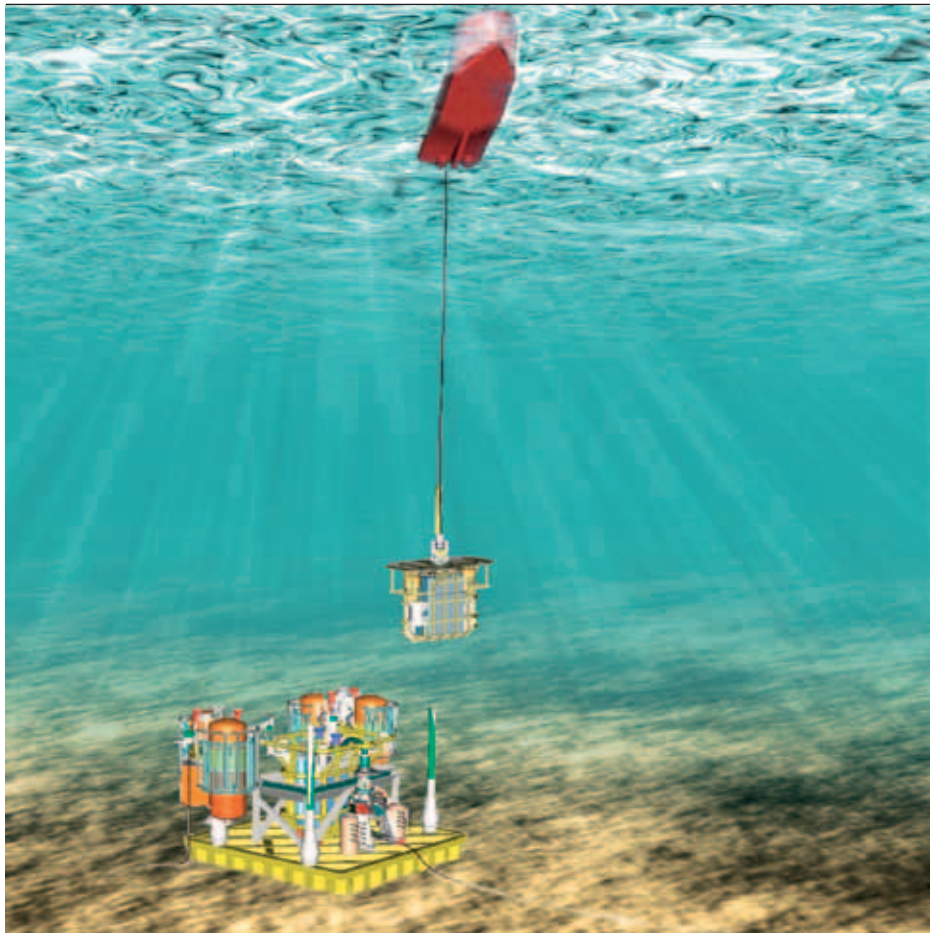

**A**BB is an innovator in subsea electrical solutions and has been involved in the development of subsea electrical equipment for many years. Feasibility studies on subsea components began in 1984 and the first commercial subsea transformer was delivered in 1998. Since then, ABB has delivered transformers and variable speed drive systems to some of the largest and most advanced offshore developments in the world.

Subsea transformers from ABB are engineered to provide superior performance and cost benefits for offshore developments that have subsea rotating equipment located far from the nearest available power supply.

The ABB subsea transformer is a liquid-filled, pressure-compensated unit suitable for power supply operations in deepwater fields. The pressure-compensating system keeps the internal pressure close to that of the outside water by immersing the internals in liquid and eliminating all air- and gas-filled voids. Cooling is provided inherently through natural convection. The unit can be delivered with a single or double

shell and has been qualified for depths of up to 3,000 meters.

Subsea transformers from ABB are used with a range of subsea equipment: boosters, pumps, compressors, pipeline heating systems, electrical distribution systems, frequency converters and wave hubs. Subsea environments are extreme, hazardous and costly places even to reach, let alone to use as sites for industrial equipment → 1. Why is it necessary to install and operate equipment at the bottom of the sea?

#### The deepwater frontier

The exploitation of offshore oil in shallow waters is declining as these relatively local reserves diminish. Often, to maximize oil extraction, seawater or gas is pumped into the well to increase pressure and drive out the remaining fuel trapped beneath the seabed.

Similar techniques are used in deepwater oil fields. As these are at much greater distances from the shore, they present additional challenges to the industry. Operations here require specialized knowledge

**ABB's subsea transformers are engineered to provide superior performance and cost benefits for subsea rotating equipment located far from a power supply.**

and expertise, particularly when powering compressors, pumps and motors at depths of several kilometers, possibly 50 or 100km away from the shore.

Subsea technology makes oil and gas production possible at a depth of several kilometers and pressure-increasing compressors enable continued production in waning oil and gas fields. The performance levels required of deep-sea equipment are very high and reliability is decisive.

#### Title picture

ABB's rugged, yet sophisticated, subsea transformers deliver the power that makes the exploitation of subsea oil and gas possible.



Bringing low-loss power to remote offshore locations requires transmission at high voltage through subsea cables. Such transmis-

air- and gas-filled voids within the outer casing must be eliminated by immersing components in liquid and a pressure-

compensating system, to keep the internal pressure close to the outside water pressure, has to be available → 2.

Since transformers get hot when they run, the type of liquid used inside the transformer is critical

to its successful operation. The high-quality insulating oil used has a low expansion coefficient and high compatibility with the other materials and components used in the transformer. Since the transformer is housed in a solid tank that cannot expand, even when hot, the oil is degassed prior to installation. The heat generated by the transformer during operation has the potential to accelerate chemical reactions, possibly enhancing the corrosive effects of seawater, and, since the transformer is cooled by natural convection, also the potential to attract living organisms to the outer surface of the casing. These factors necessitate the use of special, high-grade steel for the casing, which must also be able to cope with the high pressures associated with deep-sea locations. The largest subsea transformers so far are about 4 m tall, 7 m long and 3 m wide, and contain about 14 m<sup>3</sup> of insulating oil → 3.

Including pigtail cables, connectors and compensators, the entire unit can weigh about 60 metric tons and would most likely sink into the mud or sand if it were simply lowered onto the seabed. The entire structure is, therefore, mounted on strong piles hammered into the seabed. Tubes on the underside of the structure slot over the piles so that the structure stands a few meters above the seabed when properly installed.

Once installed on the seabed, no further maintenance is required. In fact, since the scope for doing repairs is limited, due to the expense of raising equipment to the surface, ABB has invested a great deal of time and effort to ensure all components are of the highest quality and have undergone rigorous testing. These stringent tests have ensured that all 20 ABB subsea transformers currently installed are operating reliably and safely and are providing great performance and cost benefits to offshore developments.

#### Gulf of Mexico project

In the Gulf of Mexico, at a depth of about 2,000 meters, an oil pipeline has to be warmed in order to de-solidify oil that has congealed due to pressure and cold caused by an unplanned production shutdown. A mobile plant, consisting of an electrical system, a subsea cable and a subsea skid, will be transported by ship to the place where the pipeline has frozen. The subsea skid, which will include a subsea transformer and the electrical connectors required to make contact with the pipeline, will be lowered to the seabed. With the help of a remotely operated vehicle (ROV) the electrical connectors will be attached to the pipeline and the power switched on. The ship's diesel generator will supply 480 volts and a step-up transformer will be used to raise and regulate the voltage to between 1 kV and 11 kV. On the seabed, the subsea transformer will lower the voltage to a suitable level. The pipeline will then be heated up and after a few days the blockage should dissolve.

#### Åsgard field project

The most recent subsea transformer technology will ensure continuous production in an Åsgard gas field 400 meters below the surface. Here, building a new offshore platform near the gas field was considered too costly. Moreover, the field is over 150 km from land, and 50 km from the nearest offshore platform. At these dis-

## ABB remains the world's leading manufacturer of subsea transformers capable of delivering reliable power underwater with minimal losses.

sion relies on step-up transformers to increase the voltage levels for transmission and step-down transformers to reduce the voltage to a level suitable for the specialist electrical equipment at the offshore site.

Underwater oil fields present some of the most extreme environments imaginable for transformers. ABB remains the world's leading manufacturer of subsea transformers, with many examples powering pumps and compressors that extract oil and gas from reservoirs below the seabed, thus keeping wells productive longer.

Since this specialized equipment operates deep beneath the surface of the sea, the step-down transformer must be able to operate at these depths too. ABB subsea transformers require specialized design features that enable them to operate at depth, under pressure. This means all



3 A 16.5 MVA transformer being submerged for a heat run and system testing at Vaasa harbor, Finland. The three 22 kV penetrators and two low voltage signal connectors are visible



tances, and using conventional operational voltages (6.6 kV), most of the power required to keep the compressor motors running on the seafloor would be lost. The solution is one of ABB's most recent subsea transformers, a rugged, powerful unit capable of operating at depths of up

All air- and gas-filled voids must be eliminated and pressure compensation is used to equalize with outside water pressure.

to three kilometers. With high power and voltage ratings (19 MVA/31 kV/6.6 kV) and a high operating frequency (up to 121 Hz), this specialized transformer is the most efficient on the market and is capable of reliable operation at this site. Åsgard is the first gas field to utilize subsea compressors. ABB is manufacturing nine subsea transformers for this project, scheduled for completion and testing in June 2013.

#### Wind installations

Large, open-sea wind park installations could use subsea transformers to connect to the mainland grid. Placing a grid

connection transformer on the seabed eliminates the need to build a specific transformer platform. Tidal turbine parks and wave-power converter parks could similarly benefit from ABB subsea transformer technology as they become large-scale commercialized operations. ABB has already been contacted by developers keen to understand the possibilities of subsea power technologies that relate to their specific applications.

#### Subsea distribution system (SEPDIS)

SEPDIS was born out of the idea of moving the electrical distribution system down to the seabed. This enables electrical power to be transmitted to the site in question at a high voltage and the distribution system to be located close to end consumers. Electrically, SEPDIS is a conventional transmission and distribution system with a limited number of components and functions. Mechanically, and in terms of its subsea capability, it is a very robust and sophisticated system.

Long transmission cables carrying high voltages produce large amounts of capacitive power. This increases loading on the cable, as well as on other components feeding the power chain. Shunt reactors are commonly used to eliminate this extra load. This means that, in future, subsea shunt reactors will also be needed for subsea transmission and power systems. As a leading manufacturer of shunt reactors for onshore power and transmission systems, ABB

is developing this technology for subsea applications as well.

ABB's first two operational subsea transformers, rated at 1.6 MVA 11 kV/1 kV, have been in operation since 1999 at a depth of 500 m. Since then, ABB has been incrementally developing larger units. ABB has built and tested a 60-ton subsea transformer for 20 MVA 132 kV/22.5 kV and 16.5 MVA 22 kV/3.5 kV/3.5 kV/2.8 kV. This was delivered to Nyhamna in Norway for testing equipment in the Ormen Lange gas field. Actual use in production is expected to begin in 2014. From a depth of one kilometer, it will feed power to compressors installed to improve gas production. The Ormen Lange field supplies 20 percent of the UK's natural gas via a 1,200 km long undersea pipeline.

ABB remains the world's leading manufacturer of subsea transformers capable of delivering reliable power underwater with minimal losses.

#### Esa Virtanen

ABB Oy Transformers  
Vaasa, Finland  
esa.virtanen@fi.abb.com

#### Alper Akdag

ABB Management Services Ltd.  
Zurich, Switzerland  
alper.akdag@ch.abb.com



# Shrinking the core

Power electronic transformers break new ground in transformation and transportation

TOUFANN CHAUDHURI, CHRISTIAN VETTERLI – The size of a transformer core is dictated by the frequency, and the frequency is given. Therefore, or so traditional wisdom suggests, transformers cores cannot be shrunk beyond a certain point. This paradigm, that has dictated the minimum size of power transformers for more than 120 years is

about to be broken. The innovation behind the power electronic transformer says that even though the network frequency is given, power electronics allow the local frequency to be changed. At the same time, this frequency conversion means that the input frequency need not equal the output frequency, or can even be DC.

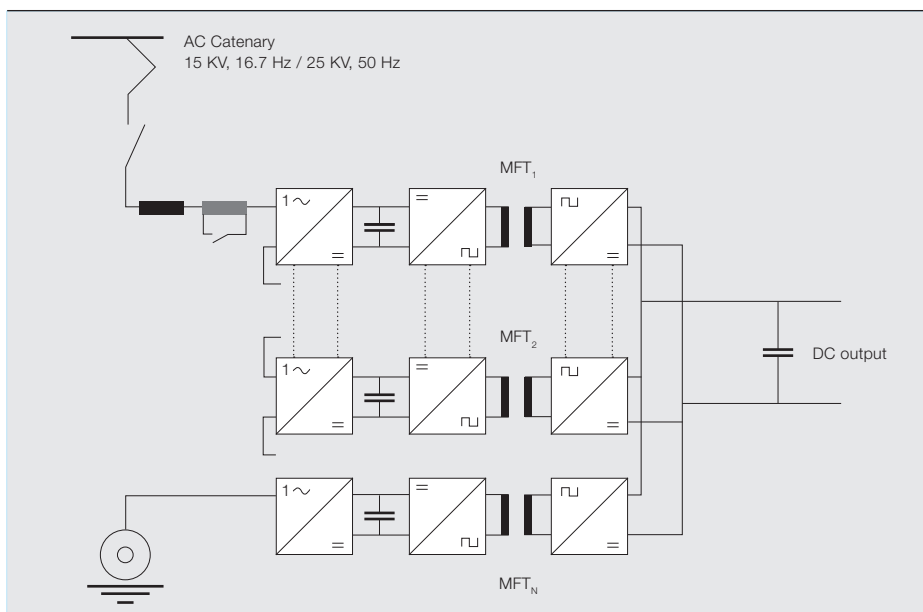

Ever since the French pioneer, Lucien Gaulard, built the first power transformer, the voltage and power levels of AC transformation have progressed. The underlying physical principles, however, remain virtually unchanged. The power electronic transformer is about to change all this. Medium-frequency transformation is on the verge of opening a new era in AC to DC and DC to DC conversion with enhanced efficiency and a low environmental footprint. Thomas Edison's dream of making a DC-DC transformer has finally come true.

### The rolling stock challenge

In rolling stock, the weight of onboard equipment is a major constraint facing train manufacturers. Traction transformers are no exception. In addition to weight, noise emissions, efficiency, safety, fire and smoke compliance must all be considered. Traditionally, measures taken to save weight in rolling stock transformers were paid for by poor efficiency. Power or current density needs to be much higher than for stationary power and distribution transformers, and thus higher copper losses are accepted as a necessary compromise. As

#### Title picture

A pilot PETT installation is currently being tested on a type Ee 933 shunting locomotive of Swiss Federal Railways.

basic technology has not made great advances since 1884, state of the art traction transformers have reached the limits of physics and no major further improvement in efficiency is to be expected. Or is it?

The size of the magnetic core of the transformer is linked to the operating frequency. The core size, in turn, influences the radius of the windings and the amount of copper used. The amount of copper is directly proportionate to the losses. A reduction in transformer size that does not compromise efficiency must thus address the size of the core. This means acting on the frequency. The grid frequency is, of course, given. Thus the only way is to act on the local frequency.

From this train of thought emerged the concept of the PETT (power electronic traction transformer) → 1. Power electronic conversion raises the frequency to several kHz, and allows a major reduction in transformer size. Compared to conventional traction transformers, medium frequency transformation utilizes less copper, less iron and less or no oil → 2. Simultaneously, power density and efficiency are drastically improved → 3.

Typical comparison power density figures are shown in → 4. The table illustrates how the power density of the traction transformers increases mostly linearly with the frequency.

### Technical challenge of the MFT

Increasing the operating frequency to decrease the size of the transformer would seem to be a simple approach whose implementation might appear straightforward. In practice, things are not as simple. Many aspects differ from conventional low frequency technology and the development of the PETT had to overcome these.

Core losses depend on the material the core is made of. When a magnetic field is applied to a ferromagnetic material, a modification of the material structure occurs (alignment of magnetic domains as

In rolling stock, the weight of onboard equipment is a major constraint facing train manufacturers. Traction transformers are no exception.

function of temperature, composition of the material, etc.). This modification changes the properties of the material, notably its permeability, hence the well-known hysteresis loop of magnetic materials. The area inside this loop defines the



## 2 Low frequency traction transformers



2a Underslung 15 kV/16.7 Hz traction transformer supplied by ABB for electrical multiple unit



2b 15 kV/16.7 Hz traction transformer supplied by ABB for double-deck electrical multiple unit trains

## 4 Power density and other key figures for low and medium frequency transformers

	Conventional "low" frequency main transformer		New medium frequency transformers (MFT)	
	15 kV 16.7 Hz	25 kV 50 Hz	5 kHz	10 kHz
Power range: <b>750 – 2200 KVA</b>			–	–
Power density [VA / kg]	220 – 350	450 – 530	2600	3500
Efficiency at full power and maximum temperature [%]	92*	95**	99.3	99.3
Oil weight [gr / kVA]	500 – 600	250 – 550	90	70
Copper weight [gr / kVA]	450 – 550	250 – 450	60	40

\* Typical accepted efficiency value for 16.7 Hz traction transformer  
 \*\* Typical accepted efficiency value for 50 Hz traction transformer

## 5 Typical B-H loop for 3.5 percent SiFe, Amorphous and nanocrystalline magnetic materials

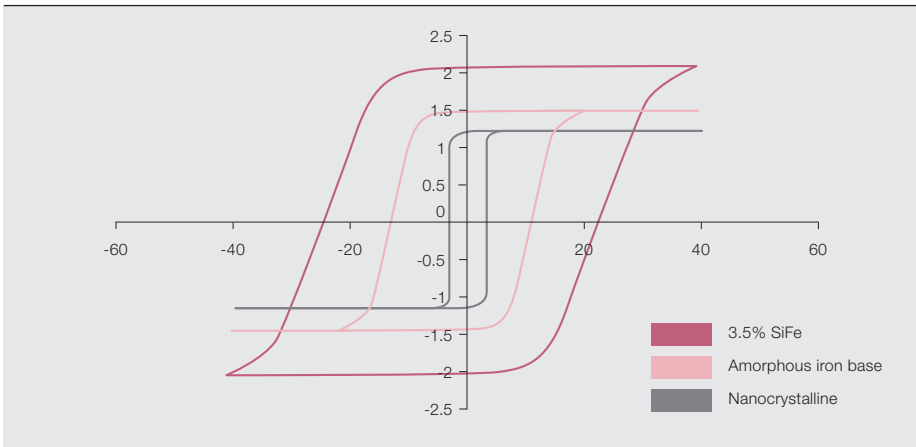

core losses at the considered operating frequency → 5.

Methods used to change the material properties and the related losses include material composition, amount of impurities, grain orientation, thickness and laser scratching. In a traditional traction transformer, 3.5 percent Silicon Steel (SiFe) sheets of various grades are used. The thicknesses are in the range of 0.2 to 0.35 mm and the saturation induction level

can be up to 2 T. The core losses are usually given in the range of 1–2 W/kg at 1.7 T and 50 Hz. When these materials are used at higher frequencies, the losses increase notably and can reach up to 50 W/kg at 1 T and 1 kHz. Such materials are obviously not suitable for high frequency ranges.

New materials such as 6.5 percent SiFe, Nickel Steel (NiFe) alloys, amorphous or nano-crystalline are available and suit high frequencies (10 kHz – MHz range). Proper-

## 3 ABB pioneers breakthrough rail innovation

ABB has successfully developed a revolutionary traction transformer that uses power electronics to reduce its size and weight while increasing the energy efficiency of the train. The new power electronic traction transformer (PETT) is based on an innovative, multilevel converter topology that uses IGBT (insulated gate bipolar transistor) power semiconductors and medium frequency transformers replacing the conventional transformers and inverter combination. In addition to its weight and size advantages, the new power electronic traction transformer helps improve efficiency and reduces noise levels.

The innovation is a breakthrough that achieves one of the rail industry's priority objectives of reducing the weight of on-board components. The traction transformer, which is traditionally made of iron and copper, is one of heavy pieces of equipment on a train.

Size is another challenge for traction transformers, because reducing the amount of space used by equipment means that more space is available for paying passengers. Over the past decade, ABB has continually made design improvements in rail components, creating compact products like roof-installed transformers that reduce equipment footprint without compromising performance.

The innovative use of power semiconductors in a core component such as traction transformers opens up new opportunities for rail markets around the world, and should be extendable across a range of other applications.

Please also see "Traction transformation: A power-electronic traction transformer (PETT)" on pages 11–17 of *ABB Review* 1/12

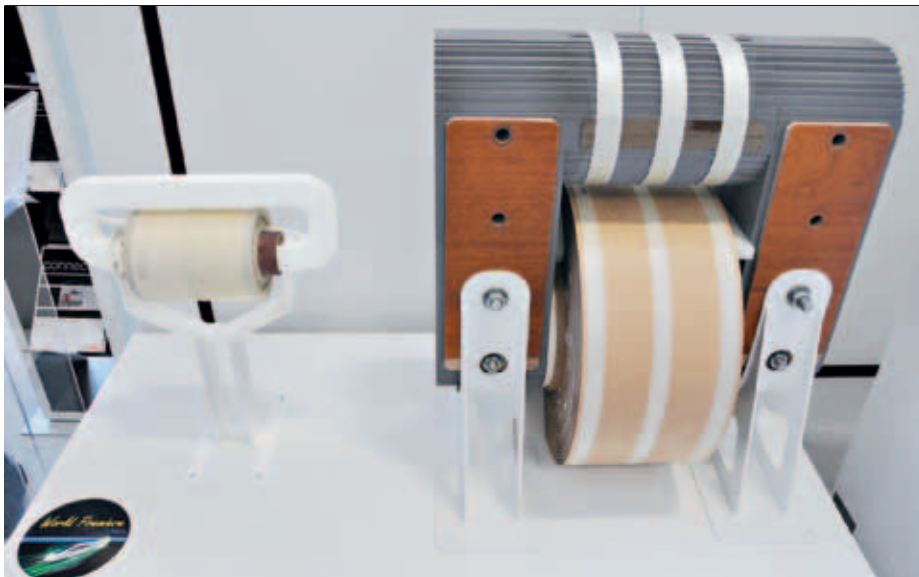

Left: 5 kHz Transformer. Right: 16.7 Hz Transformer. Both: 3.6 kV Primary, 1.5 kV Secondary.

## The minimum size of the transformer is no longer defined by the core and winding size, but by dielectric requirements.

ties of these materials vary, and the choice is be driven by design targets. The different materials suitable for high frequency are available in powder form or in steel tape form. The thicknesses of the steel bands are in the 20–35 μm range, and their production requires very specific tooling. The saturation induction is between 0.5 and 1.5 T. The inherent losses vary strongly with the induction level and the operating frequency → 5.

For the copper, high frequency currents mean higher proximity and skin effects and thus higher resistance or lower effective copper section. There are several ways to counteract these phenomena. Hollow conductors (tube type winding) or Litz wires are two possible answers. The Litz wire (named after its inventor) is a strand type wire where each single small copper conductor is insulated. Choosing the right strand size allows a reduction of AC losses to an acceptable level, but the filling factor of Litz wire increases the DC losses, since

the effective copper section is reduced in comparison to a full solid conductor.

Using a reduced core and winding size, the weight and loss reduction targets are achievable. In the railway sector, the different AC network voltages vary from a few kV up to 50 kV (mainly 15 kV/16.7 Hz and 25 kV/50 Hz). One of the main tasks of a traction transformer is to supply the galvanic isolation between the overhead line and the traction motors. In the PETF, the medium frequency transformer must fulfill this function. According to railway standards, the requirement on the dielectric insulation level can be up to 77.6 kVrms. The minimum size of the transformer is thus no longer defined by the core and winding size, but by dielectric requirements. The limit depends on the assembly type, the insulation material and the design selected for the transformer.

The mission profiles on thermal cycling for a traction transformer are usually very restricting. One million cycles for a traction transformer life is not unusual. Thermal cycling and high electric field are important stress factors for the insulation material.

Cooling is of extreme importance. Even if efficiency is high, the small size of the transformers increases the power density and at the same time the density of losses. Efficient and compact cooling methods are required. In addition, the transformer is no more a stand-alone device but must interact with its surrounding power electronics. A two phase medium, tap water or air are

### Market segments targeted by high frequency transformation with AC to DC and DC to DC conversion include:

- Rolling stock (single phase AC to DC)
  - EMU (electrical multiple unit)
  - DDEMU (double decker EMU)
  - High and very high speed train
- 
- Auxiliary converter (DC to DC conversion)
- 
- Marine (MV DC to LV DC)
  - Offshore supply vessel
  - Passenger cruise-ship
  - Drillship
  - Renewables (LV DC – to MV DC)
  - Wind mill
  - PV collection grid
- 
- Renewables (3ph MV AC – to MV DC)
  - Wind mill
- 
- DC micro grid (MV DC to LV DC)
  - DC/DC transformers

possible choices to ensure adequate cooling. Compatibility with power electronics cooling medium is of course a prerequisite.

### ABB's answer to the MFT challenge

ABB is currently working on three different types of insulation materials: air, oil, resin. For each type of these, specific design rules are considered. Matching all the above ingredients and design rules, ABB will soon be ready to offer a large variety of medium frequency transformers suited for various applications → 6, 7.

It is notable than above a certain frequency level, the size reduction or power density increase ceases to be relevant. Doubling the frequency from 5 kHz to 10 kHz does not result in a doubling of the power density but only a 30 percent increase. The reason lies in the insulation requirement, whose influence rises with the frequency compared to the size of the core and coil. The overall dimensions are no longer dictated by the frequency but a new physical limit: the insulation distances.

High insulation levels, small size, high efficiency, easy to cool will be the hallmarks of ABB's response to the medium frequency transformer challenge.

**Toufann Chaudhuri**

**Christian Vetterli**

ABB Sécheron SA

Geneva Switzerland

toufann.chaudhuri@ch.abb.com

christian.vetterli@ch.abb.com



# Balance of power

Variable shunt reactors for network stability control

CLAES BENGTTSSON – The variable shunt reactor (VSR) is an interesting alternative for controlling network voltage stability when the need for reactive power compensation varies with time or when the grid is undergoing change. VSR benefits include: The voltage steps related to switching of fixed reactors are avoided; maintaining voltage stability during seasonal or daily load variations becomes easier; and the operation of the reactors can be coordinated with static var compensators (SVCs) to maximize dynamic capacity during failures. For wind park applications, control of fluctuating reactive power exchange at connection points becomes possible at an attractive cost. The VSR has become well established and several are in successful operation in Europe and North America. This article discusses the design and application of VSRs.



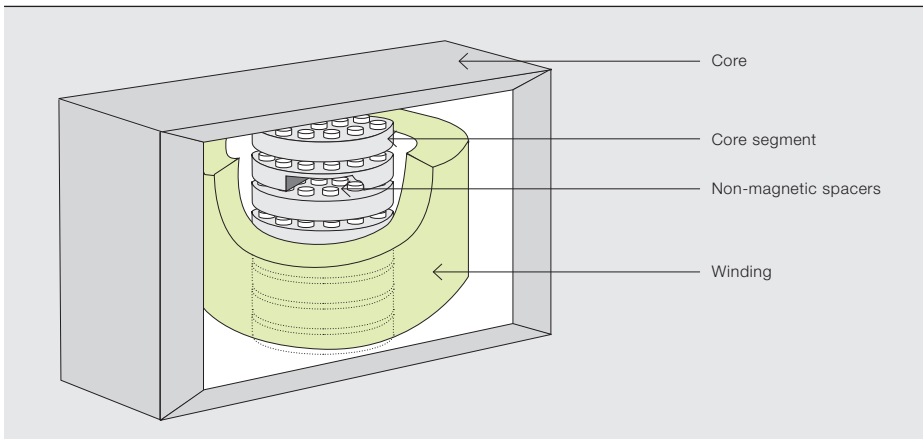

The networks that transmit and distribute electrical energy are continually facing new demands due to changes in power generation and load structure. For example, in many regions power grids are undergoing gradual change, eg, adding generation, interconnecting local/regional grids, switching from overhead lines to high voltage cables for environmental reasons, and so forth. Such changes are usually made step-wise and are often followed by revised reactive power compensation requirements.

Further, the growing use of renewable energy sources is bringing fundamental change to traditional generation structures and is placing new demands on the transmission network. The dynamic and time-varying effects associated with renewable sources play a more pronounced role in networks when the system is, as a whole, optimized for energy efficiency.

Another driver making variable reactors attractive is the emergence of smart grids. These are currently attracting a great deal of attention and are high on political and technical agendas.

**Title picture**

The title photo shows a Variable Shunt Reactor, 120–200 MVAR, 420 kV. How do such products help to control power network stability?

It is not only the active power flow in a network that has to be controlled, but the balance of reactive power too. The most commonly used device for compensating reactive power and for maintaining voltage stability is the shunt reactor. By tradition, shunt reactors have fixed ratings with no regulation. If regulation is needed, then reactors are switched in and out along with load variations. This procedure, however, has disadvantages. The large steps in reactance lead to step changes in the system voltage level and more stress on breakers. Little dynamic regulation is provided.

The VSR is product that helps solve these power distribution network issues.

The VSR is a new product type that is rapidly becoming popular. It provides regulation capability and, thereby, system benefits in terms of power quality, optimized grid operation and the possibility of interacting with other regulating devices such as SVCs.

**Reactive power compensation**

The voltage along an alternating current (AC) transmission line depends on both the capacitive charging and the loading of the line. The former is due to the capacitance between the line’s conductors and earth and depends on the line geometry. The capacitance generates so-called reactive power in the line. The reactive power is normally expressed in MVAR. The latter plays a role because both the loads and the line itself consume reactive power. In an AC system it is important to maintain the balance between the generated and the consumed reactive power. The reactive power balance determines the voltage stability of a transmission line, no matter whether it is an overhead or cable line.

If there is an excessive amount of reactive power, the voltage will increase in the system. If there is a lack of reactive power, the voltage will decrease. Therefore, the reactive power must be controlled in order to maintain voltage stability.

**Shunt reactors**

A shunt reactor is an absorber of reactive power and is the device most commonly used for reactive power compensation. The shunt reactor can be directly connected to the power line or to a tertiary winding of a three-winding transformer.

The shunt reactor could be permanently connected or switched via a circuit breaker. To improve the adjustment of the consumed reactive power the reactor can also have a variable rating. If the load variation is slow, which it normally is (seasonal, daily or hourly) a VSR could be an economical solution for some customer applications.

**The VSR in a power system**

In some applications there is a need to connect or disconnect the inductive reactive power in steps. Then, several shunt reactor units are needed. This requires several circuit breakers and, consequently, a bigger footprint. Instead of having several units, one VSR that covers the entire power range could be a more cost-effective solution. By regulating the inductance of the reactor inside the unit itself, the external circuit breakers will have fewer operations and will, thus, need less maintenance.

Generally, it can be said that when there is a slow variation of the load, the VSR works as an efficient reactive power compensator and it enables a better fine tuning of the voltage in the system to be accomplished.

## 2 Measured sound power levels of seven shunt reactors against year of manufacture: factory measurement (first column) and 2007 on-site measurement (second column)

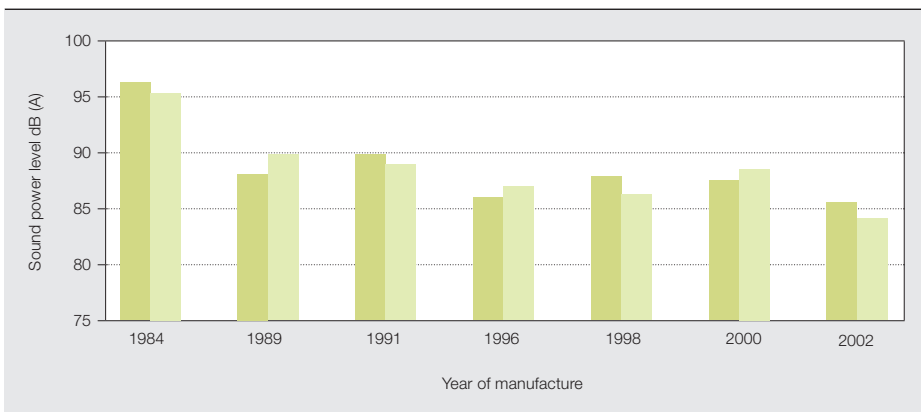

### ABB gapped core shunt reactor

Most oil-immersed shunt reactors manufactured by ABB are based on the so-called gapped core concept. This technical concept is based on the core type technology that has been used within ABB since the beginning of the 1970s. More than 2,500 reactors based on this concept have been manufactured by ABB for the global market since then and hundreds of units have been in service for thirty years or more.

#### General design

The philosophy of the design is to minimize losses, sound and vibration. Design similarities with large power transformers permit an efficient use of ABB's long experience of building large transformers, for instance in the areas of insulation build up, production handling and so on.

Each phase limb consists of a number of so-called core segments that are circular in shape. Between the segments there are non-magnetic gaps that contain oil and spacer elements. Due to the high magnetic reluctance, most of the energy of the reactor is stored in these gaps. In the case of a shunt reactor with a fixed power rating, there is only one physical winding around each phase limb. To minimize the size, and to avoid spreading of the electromagnetic flux, a magnetic core frame surrounds the phase limbs → 1.

High voltage shunt reactors are technically complex products due to the large magnetic forces, which can be tens of tonnes, acting between the core segments. These forces appear 100 times per second in 50Hz systems, so the engineering challenges with respect to long-term mechanical stability are considerable. This can be seen in the failure statistics of some utilities where there is

wide spread in failure rates depending on the design of the reactors [1, 2].

To verify the mechanical integrity of the ABB shunt reactors, an extensive study was made in which sound measurements were made on reactors that have been in operation for between 5 and 23 years [3].

These measurements were compared with the original factory acceptance tests. The study shows no increase in sound levels over time, which is a very good indication of a mechanically robust design → 2. The long-term stability in sound level can be explained by robust design, durable materials and precision in the manufacturing process.

#### VSR design

The main function of a VSR is to regulate the consumption of reactive power. This is accomplished by connecting and disconnecting electrical turns in the reactor by means of a tap changer. At the maximum power rating the minimum number of electrical turns will be connected.

The ABB VSR design is the result of extensive development work combined with well-proven power transformer and reactor technology → 3. The regulation of the reactor is accomplished by a separate regulating winding, or windings, located outside the main winding. The taps from the regulating winding are led to the tap changer. The regulating winding configuration can vary depending on the regulating range, voltage level and loss capitalization<sup>1</sup>.

The regulating range is limited by the maximum step voltage and voltage range of the tap changer. Another limitation is the electrical behavior of the regulating winding under transient voltage stresses. The

Generally, when there is a slow load variation, the VSR works as an efficient reactive power compensator.

#### Footnote

1 "Loss capitalization" – based on expected energy prices, interest rates, etc., the customer puts a financial value on each kW of losses. This is added to the price of the reactor to form a comparison price which is used for evaluating tenders.

### 3 The design principle of the active part of the VSR

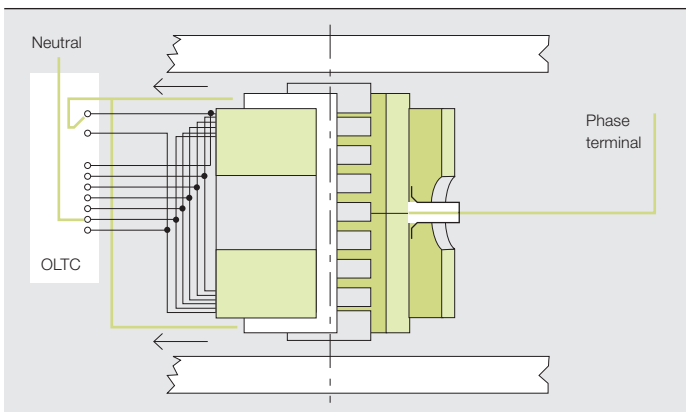

feasible regulation range depends on the voltage rating of the reactor → 4.

Today, utilities are demanding a regulation range larger than that indicated in the figure. As a result of this market demand, the VSR concept has recently been further developed to provide regulation ranges that are around 40 percent higher. As an example, 420kV VSRs with a maximum rating of 200MVar can today be regulated between 90 and 200MVar compared with the 120 to 200MVar range of a few years ago.

#### VSR field references

The main transmission line system in Norway has been upgraded from 300 kV to 420 kV. In the new 420 kV grid, the system

**HV shunt reactors are technically complex due to the large magnetic forces, which can be tens of tonnes, acting between the core segments**

operator has decided to only use VSRs instead of shunt reactor units with fixed power ratings. There are several benefits supporting this policy decision:

- Low short-circuit power. If the MVar rating of the reactor is high compared to the short-circuit power of the network, the voltage will jump when the reactor is switched in or out. To minimize this phenomenon, it is possible to switch the unit in or out at a minimum-power tap position.
- There is only one variable reactor unit instead of two units with fixed power

ratings. This minimizes footprint and the number of circuit breakers.

- The VSR is complementary to substation SVC equipment. This allows coarse tuning of the total reactive power compensation.
- Better fine tuning of the voltage to cope with seasonal and daily load variations is available.
- There is flexibility for future load conditions in the network.

The ratings of these VSR units are 80–150 MVar at 300kV, 120–200 MVar (three-phase) at 420kV and, recently, 90–200 MVar at 420kV.

Another example comes from a transmission company in the United States that began implementing inductive reactive power compensation with shunt reactors that are connected directly to the high voltage line. By now utilizing oil-immersed shunt reactors, they were also able to elimi-

nate environmental concerns surrounding electromagnetic flux spread around open air core reactors.

This company chose the ABB VSR for inductive compensation control. The extensive use of AC cables in their network placed particularly high value on the ability to control reactive power compensation. A bonus is that the reduced number of circuit breaker operations results in less maintenance.

### 4 The feasible range is the area above the curve and the feasible voltages are 110 kV to 525 kV

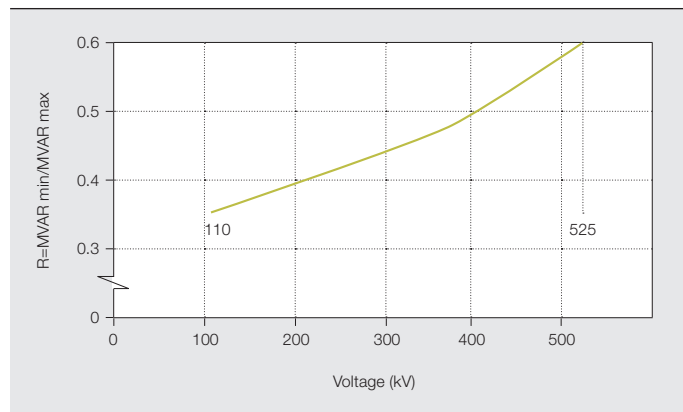

The rating of these VSR units is 50–100 MVar (three-phase) at 242 kV.

A final example is found in some African countries where relatively long transmission lines feed small load centers. The loads have a daily variation and there are also future plans to increase the load. That makes the ABB VSR a good solution for the owner of the transmission lines since it is essential to accommodate variability in the inductive reactive power compensation requirements. For these applications the size of the units has been up to 30 MVar (three-phase) and voltage ratings of between 110 and 225 kV.

In total, ABB has received orders for 38 VSRs from five countries. ABB is the market leader for this application. The market interest for this product is constantly growing.

#### Claes Bengtsson

ABB Power Transformers  
Ludvika, Sweden  
claes.t.bengtsson@se.abb.com

#### References

- [1] Petersen A. et al. (2007). Australian experience with shunt reactors – reliability, condition assessment, end of life and impact on specifications. Cigré A2/D1 Colloquium Bruges 2007, paper pp. 3–41.
- [2] Cormack R. (2007). A snapshot into one utility's experience with the operation of shunt reactors. Cigré A2/D1 Colloquium Bruges 2007, keynote p.3.
- [3] Bengtsson C. et al. (2008). Field Performance and Sound of Shunt Reactors in Service. Cigré 2008, paper A2-306.
- [4] G. Bertagnolli et al. (1998). Design and application of variable Mvar output shunt reactors with on load tap-changer. Operation experience in Africa. CIGRE Sessions 1998, Paris, France, paper 12–308.





# Workhorses of industry

## Industrial transformers in a DC environment

ANDREW COLLIER, GERHARD GREVE, SURJITH RAM VEL-DURTHI – Industrial transformers are key elements in the processes into which they are integrated. Reliability is crucial to ensure uninterrupted operation of converters, furnaces, motors and smelters used in a variety of applications including primary aluminum and steel production, chemical plants and rail networks. The

demands of modern process control systems have driven the increased use of rectifier systems in high current applications requiring accurate process or frequency control. This, in turn, has required the increased use of industrial transformers at ever-higher current ratings, many times in continuous processes where any failure could have six-figure consequences.

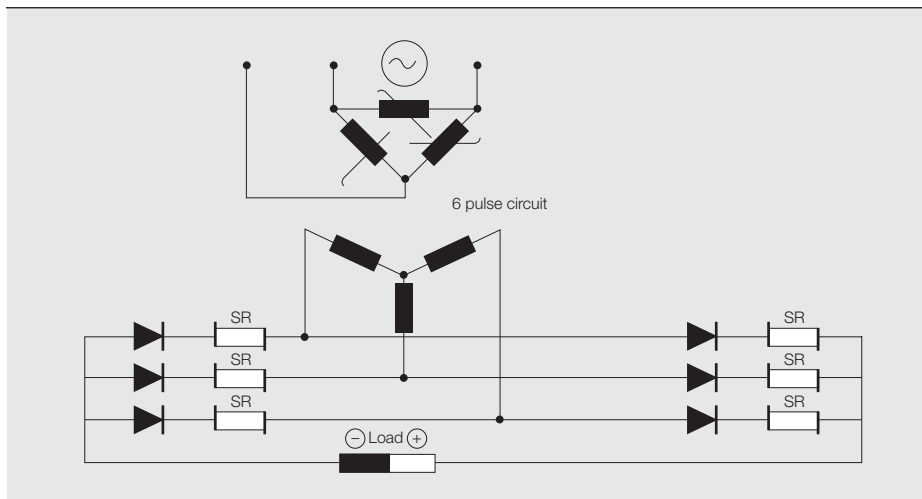

1a 3 Phase bridge connection

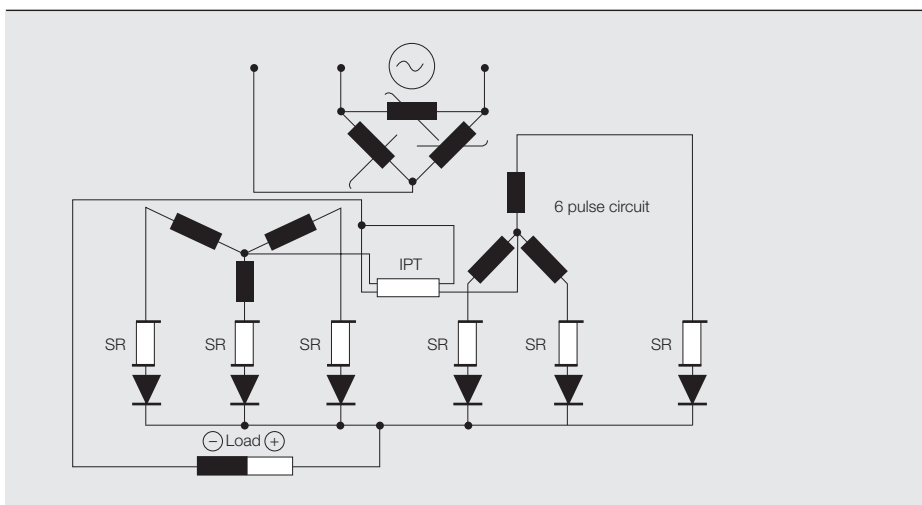

1b Double wye connection with interphase transformer

**A**BB is a true pioneer in the world of industrial direct current (DC) applications, with ASEA, an ABB parent company, designing the world's first DC arc furnace in 1885. Today, over a century later, industrial transformers are used in a diverse range of applications including DC arc furnaces, electrolysis, compressors and static frequency converters for rail applications.

**Challenges**

In addition to the need for wide regulating ranges and low secondary voltages combined with extremely high currents, the main difference from other types of transformer applications is that in a DC environment the load currents have a high harmonic content. The rectifier that is directly connected to the transformer distorts the current waveform, so currents with multiples of the network frequency flow between the rectifier and the transformer. This has to be considered when the transformer is

designed because the harmonic current leads to higher losses and higher temperatures in the transformer. Network regulations also require a reduction or limitation of harmonic distortion at the network connection point. In addition, special consideration needs to be given to areas such as short-circuit withstand and in-rush currents due to the size; remote installation of these units; and the combination of multiple transformers situated very closely together, both physically and electrically.

the use of an interphase transformer and are predominately applied as 6- or 12-pulse units where high currents are required with very low nominal voltages;

**ABB is currently installing and commissioning rectifiers in what will be the world's largest aluminum plant in Ma'aden Saudi Arabia.**

a 12-pulse DSS system can normally be supplied in a single tank. DB systems are applied as 6-, 12-, 24-, 48- or 60-pulse systems, as required to suit the harmonic mitigation and process stability requirements. A higher number of pulse groups can be applied but tend to be less commercially attractive.

**Title picture**

An ABB-built high-power converter bay at the Sohar aluminum smelter in Oman. Some of the biggest and most powerful converters (also known as rectifiers) are part of ABB's power and automation solutions for state-of-the-art aluminum smelters.

**Technology**

The rectifier technologies employed in industrial applications are commonly known as double star (DSS) or double bridge (DB) → 1. DSS systems require

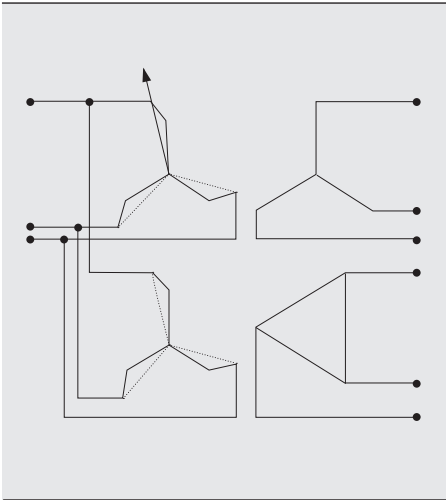

A 12-pulse DB system is made up of two 6-pulse systems, with a 30-degree phase shift typically achieved by supplying one rectifier bridge via a star (wye) wound transformer secondary and the other bridge via a delta wound transformer secondary. In a 12-pulse system the opposing phase harmonics cancel each other out, dramatically reducing the fifth and seventh harmonic content in the line side. The impact of other low denomination harmonics can be reduced by applying a phase shift to the other parallel rectifier groups → 2. As shown in the figure, the two secondary windings are often part of the same transformer, thus providing the opportunity to achieve a magnetic balance within the transformer core and provide a solution where the harmonics are again engineered to counteract each other.

Constructing the transformer core with the harmonics in mind has the additional benefit of reducing the impact the stray flux has on the current distribution within the windings → 3.

### Static converters

Industrial transformers can be used on either the front end of a converter in a large drive application or on both sides of a rail power converter. In the case of a rail converter, ABB has the experience of providing systems to convert from a three-phase network of up to 400 kV (50 Hz) to a single-phase system to suit standard rail frequencies such as 25 or 16.7 (formerly 16 2/3) Hz with ratings up to 110 kV → 4.

# ABB has invested heavily in meeting the demands of the Chinese market.

The figure displays the basic circuit diagram for a rail converter system in which the two identical inverter blocks are independent but are operated together. The active rectifier input bridges feeding the DC intermediate circuit are synchronized to handle both the high voltages and minimize the losses using state-of-the-art power module technology. The 50 Hz transformer is a 400 kV unit in which two transformers are effectively combined into one active part providing a 12-pulse feed for the two 6-pulse bridge systems; the transformer also includes a tertiary winding. The eight four-quadrant output bridges from the inverters feed the 16.7 Hz transformer, which combines the eight single-phase supplies in one active part and includes both a 110 kV single-phase output and a tertiary winding.

The tertiary windings of each transformer are connected to filters; the purpose of each filter is to further reduce the harmonic voltage distortion. The configuration shown is one of two 75 MW sister systems, however, the technology has been employed on systems up to 100 MW. More information regarding static converters for rail applications can be found in *ABB Review 2/2010*.

### DC furnace

For almost 130 years, ABB has been a key player in the DC furnace world and has supplied many customers with complete furnace packages. Although DC arc furnace transformers are often used for melting scrap metal, the ability to control the process offers benefits to customers with weak power supplies and those working in the wider metallurgical industry. Produc-



### 3 Current distribution with and without intermediate yoke

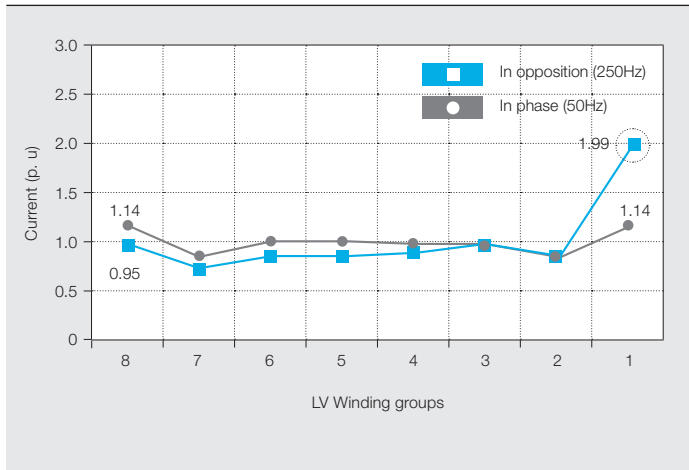

3a Upper tier C1 without intermediate yoke

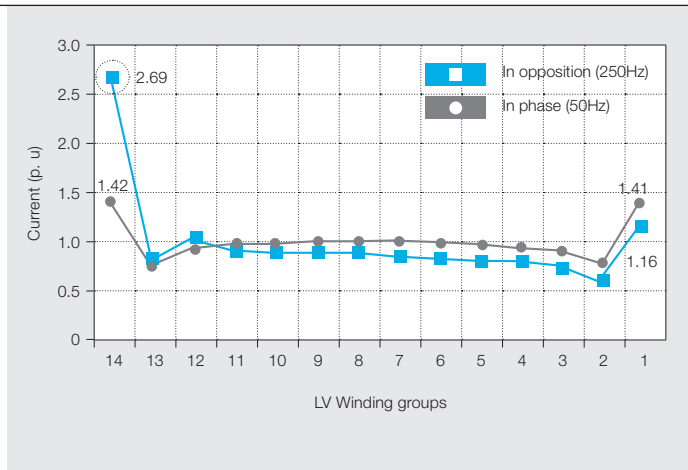

3b Lower tier C2 without intermediate yoke

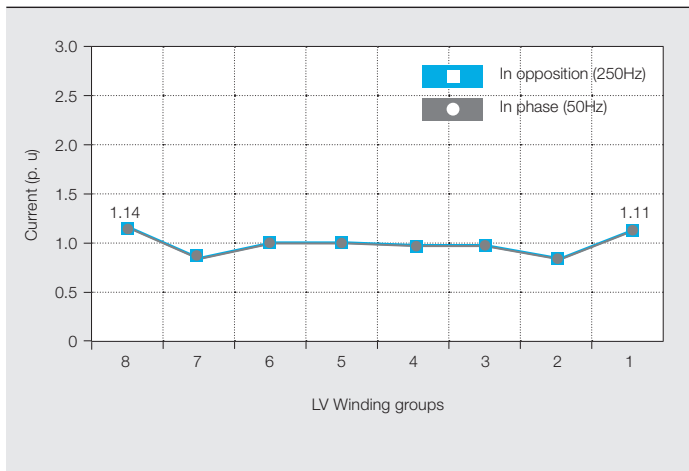

3c Upper tier C1 with intermediate yoke

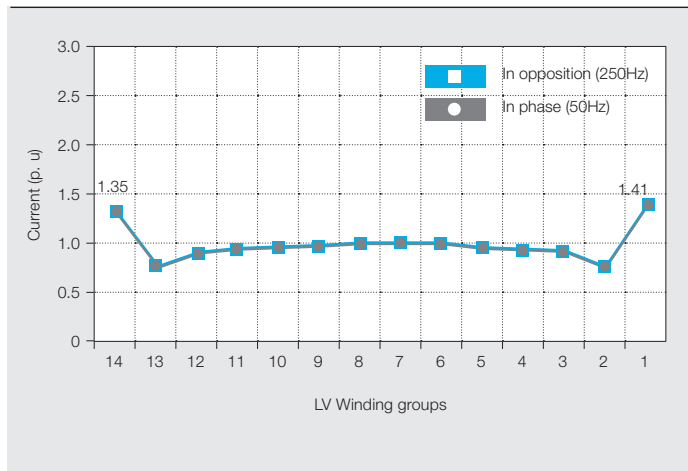

3d Lower tier C2 with intermediate yoke

ABB is a true pioneer in the world of industrial DC applications, with ASEA designing the world's first DC arc furnace in 1885.

tion of ferroalloys is also an important application; the major alloys are ferrosilicon, silicon metal and ferromanganese. Other significant alloys are ferronickel and ferrochrome.

Transformers used in the steel melting and metallurgical industry are characterized by the extreme load cycle and high secondary current (up to 160 kA electrode current); they allow a wide secondary voltage range achieved via a tap changer working together with thyristor type rectifiers and large smoothing chokes → 5.

#### Rectifiers

Regulating and rectifier transformer combinations that are applied to primary aluminum production (smelters) are affectionately known as "rectifiers"<sup>1</sup>. A typical aluminum potline is built as a 60-pulse system with five parallel 12-pulse rectifiers, each with different phase-shift windings; a 60-pulse system can be achieved by the following phase shift angles: +12°, -6°, 0°,

+6° and +12°. As mentioned, one of the characteristics of rectifiers for aluminum plants is a very large regulating voltage range, from 0 volts up to potentially 2,000 volts (DC), depending on how many pots are connected in series. When diodes are used, it is necessary to have a regulating transformer equipped with an on-load tap changer (OLTC) in series with the rectifier transformer to regulate the secondary voltage. The regulating transformer can, in some cases, be auto-connected and the extreme number of tap positions can also be achieved by a combination of off- and on-load tap changers. In combination with diode rectifiers, saturable reactors are normally required to regulate the voltage between the steps of the OLTC<sup>2</sup>. The regulating transformer that is feeding the rectifier transformer may be built inside the same tank as the rectifier transformer or it may be supplied as a separate unit. Another possibility to regulate the secondary voltage is to use thyristor rectifiers, which may negate the need for the reg-

#### 4 Rail converter system. 400kV 3 ph 50 Hz / 110kV 1 ph 16 2/3 Hz static converter

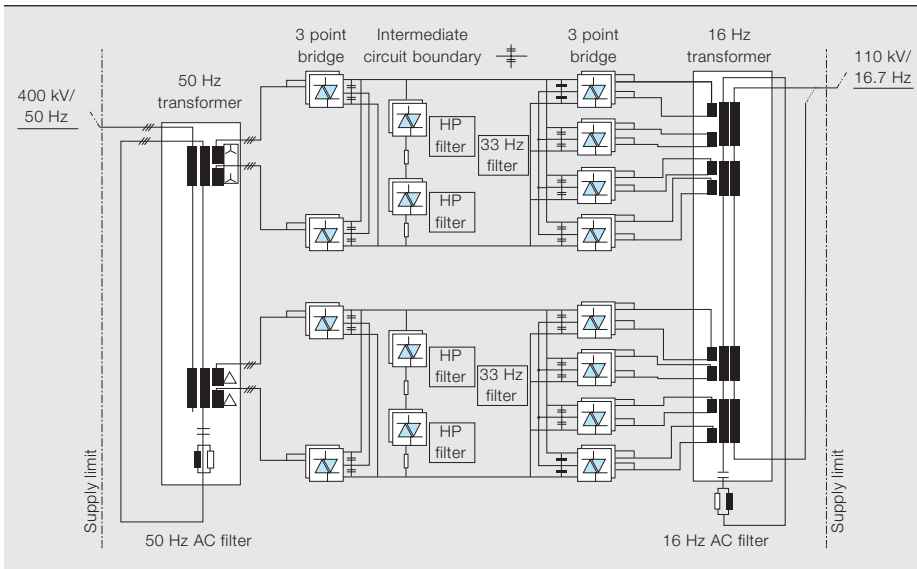

The main difference from other types of transformer applications is that in a DC environment the load currents have a high harmonic content.

#### 5 DC arc furnace schematic

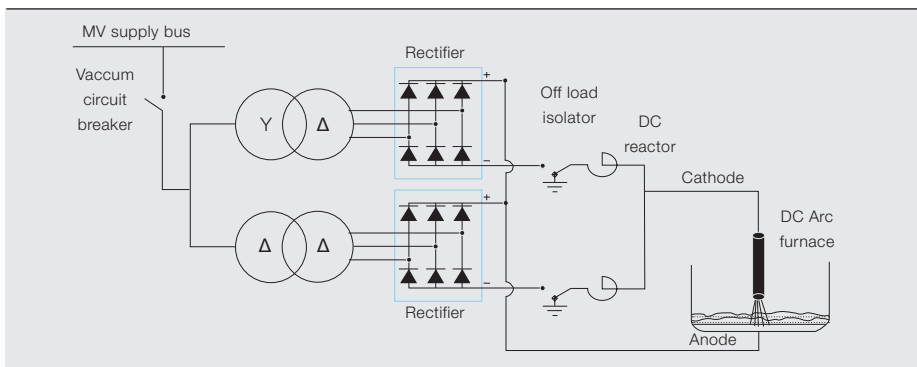

ulating transformer, the saturable reactors and in some cases the tap changer. Rectifiers can be supplied as a single tank solution for applications up to a rating of approximately 160 MVA, but for larger ratings transport limitations normally require that two transformers to be supplied as separate units. In the case of the rectifier transformers for diode type applications, they are typically supplied with saturable reactors mounted in the

main tank, however, if required these can also be housed separately → 6, 7.

#### New products

Since the turn of the millennium, the demand for primary aluminum has grown from 25 million metric tons to almost 45 and the outlook remains buoyant, with even conservative estimates forecasting that demand will exceed 65 million tons before the year 2020. To meet this thirst for aluminum the production capacity has also increased, with major investments seen in both the Middle East and China, although the smelter philosophies employed in these two aluminum powerhouses have been quite different. Middle Eastern producers have focused on very large installations and are continually looking to push the size and power of individual smelters, whereas the Chinese focus has been on constructing many smaller smelters. However, the situation in China is now changing and as the focus is moving to efficiency and reliability, the smaller (<120 kA) smelters situated in eastern China have been closing down

#### Footnotes

- 1 Other rectifier applications include chemical electrolysis, graphitizing furnaces, zinc or copper refining etc.
- 2 The purpose of the saturable reactors is to achieve fine and continuous regulation of the DC voltage in diode rectifier systems. The core area of a saturable reactor is normally made by a certain number of wound cores that are traditionally mounted horizontally to achieve the requested cross section. Through the core arrangement a bus-bar system leads the current of the power circuit and two driving circuits are wound around the magnetic core; a DC current flows through each driving circuit to control the magnetization status of the core and with that, the voltage variation.

Conservative estimates forecast that demand for primary aluminum will exceed 65 million metric tons before the year 2020.

## 6 Success story: Rectifiers

ABB has been the market leader in the field of regulating and rectifier transformers in aluminum electrolysis (smelting) for many years and, despite the demands of this application, customers still have many units in service from ABB legacy brands such as ASEA, BBC, and National Industri etc. The demand for primary aluminum has increased significantly over the last decade, as has the need for improved efficiency and the size of the potlines themselves. ABB already has plants operating at up to 1,750 V / 390 kA (DC) and is currently installing and commissioning rectifiers in what will be the world's largest integrated aluminum plant for the Ma'aden Aluminum Company in Saudi Arabia. For this very high profile project (the total project value expected to exceed \$10 billion), the industrial transformer focus factory in Bad Honnef, Germany, was selected to supply 10 regulating transformers each with 107 tap positions and rated at 230 kV feeding 10 rectifier transformers each with a secondary rating to suit 0–1,750 V and 105 kA (DC). For the Ma'aden project the engineering teams of Bad Honnef, the Minerals Process Automation group in Dättwil, Switzerland and the Power Electronics product group in Turgi, Switzerland, worked very closely together to deliver a system of transformers, rectifiers and filters that could achieve the customers' commercial goals while meeting the enormous technical challenges associated with such a high-power application in a remote and almost desert-like environment.

The 10 rectifier pairs will be split across two potlines in an N-1 configuration to provide the required pot line ratings of 1,750 V and 420 kA\*. ABB also successfully secured the orders for several of the auxiliary power transformers.

### Footnote

\*The N-1 configuration allows the customer the flexibility to achieve full production performance using any four of the five transformer and rectifier groups in each potline.

## 7 Ma'aden schematic

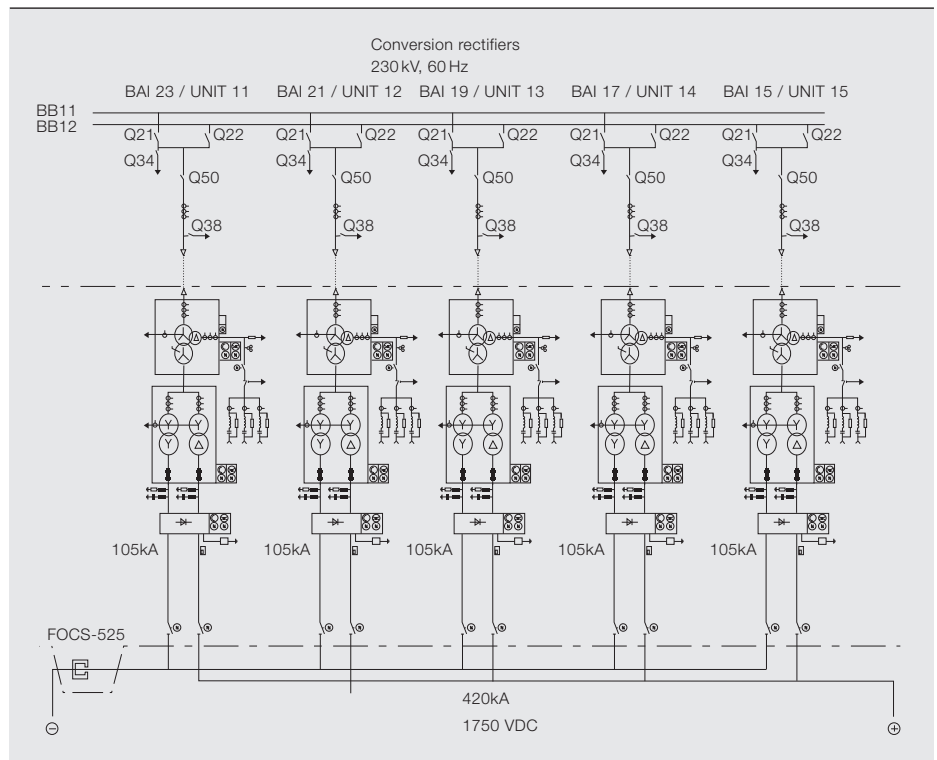

and there is a trend towards building much larger plants (>350kA) in the coal-rich northwest of the country.

Over several years ABB has listened carefully to the demands of the Chinese market. In 2012, ABB announced the launch of a product family tailored to the specific needs of Chinese aluminum producers – the ABB anti-parallel transformer system.

### Anti-parallel connection

In China, the primary aluminum industry typically employs a rectifier topology that is referred to as anti-parallel or Chinese technology. This topology is not unique to China and the term anti-parallel refers to the physical orientation of the valves, which could be either diodes or thyristors. The anti-parallel system uses two parallel valves that are mounted next to each other and switched simultaneously. The parallel valves are connected to two different



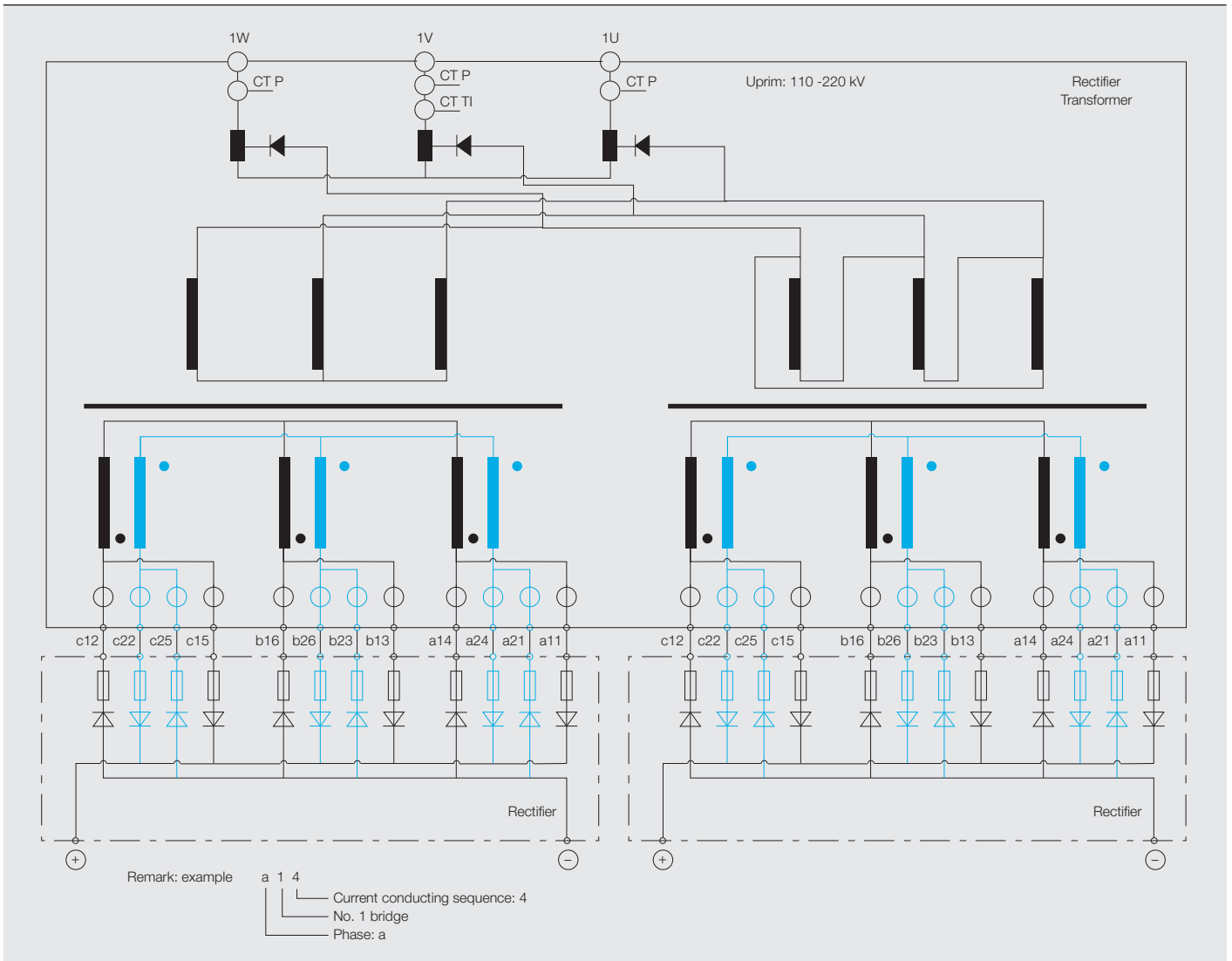

windings that are connected in phase opposition (with a phase shift of 180°) → 8.

In → 8, the valve (a11) is switched by the positive half cycle of u2 while simultaneously valve a21 is switched by the negative half cycle of u3. The adjacent secondary side exits are connected to the transformer secondary windings with an opposite winding direction; thus the effects of the currents are compensating each other. As a result, the effects of the magnetic field on the tank and structure are reduced, which results in a lower impedance and a reduction of losses.

From a transformer perspective this connection configuration requires twice the number of (parallel) LV bushings and a different low-voltage bus bar / bushing arrangement. In addition, the regulating range for the saturable reactors is typically wider than that required for the

traditional aluminum applications, thereby requiring a large core area.

For a large regulation range in combination with the LV bushing arrangement used for the anti-parallel connected rectifiers, the saturable reactors are mounted vertically. This also affects the layout for the low voltage bus bars. To reduce the physical size of the regulating transformer the system can be based on six electrical connections from the regulating transformer to the rectifier transformers and utilize a combined cooler bank to further reduce the rectifier footprint.

The anti-parallel systems are now available for ratings up to 175 MVA; however, bespoke solutions can be provided according to customers' individual requirements.

**Andrew Collier**  
**Gerhard Greve**  
**Surjith Ram Veldurthi**  
 ABB Industrial Transformers  
 Bad Honnef, Germany

andrew.collier@de.abb.com  
 gerhard.x.greve@de.abb.com  
 surjith-ram.veldurthi@de.abb.com

**Further reading**  
 ABB Review 2/2010, Railways and transportation.

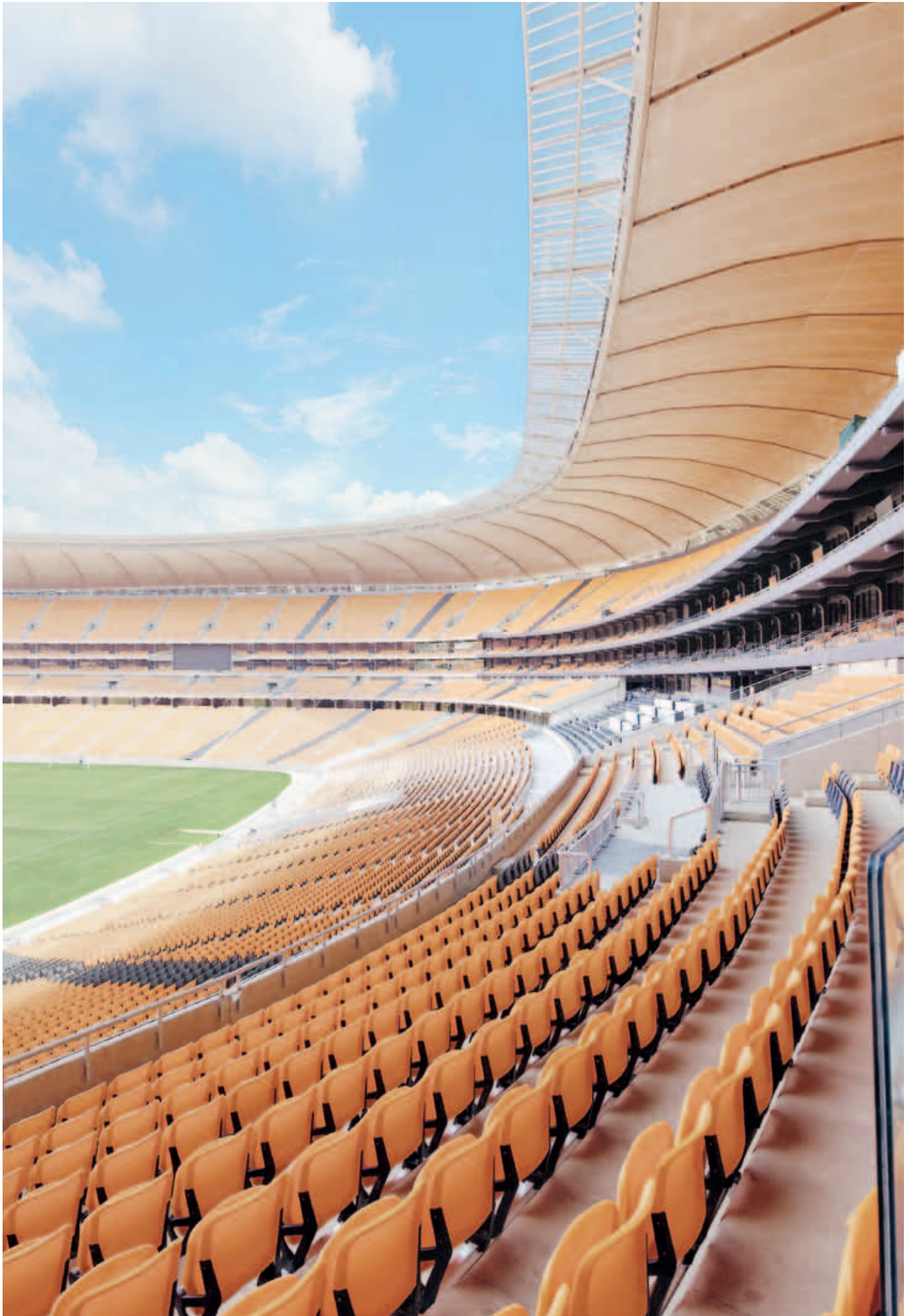

# Smart transformer

Transformers will have to do a lot more than just convert voltages

**BJORN WESTROM, INOCENCIO SOLTERIO, STEPHANE PAGE, NICOLA RAMPIN – For many decades, the transformers that populate our power grids have led a fairly one-sided existence. Now, however, their world is being shaken up and a lot more is expected of them: They should cater for the plethora of renewable power sources appearing on the grid; they are required to help maintain grid power quality; they are expected to do their bit in reducing greenhouse gas emissions; and they have to fit in with smart grids. Of course, the traditional commercial pressures to decrease all-round costs, extend asset life, improve monitoring and optimize maintenance still remain. How are ABB's smart transformers rising to this challenge?**

#### **Title picture**

Transformers help power many aspects of our society – homes, factories, transportation and recreational facilities, like the Soccer City stadium in Johannesburg, South Africa, shown here. ABB's smart transformer products are key to meeting the increased expectations being put on transformer technology.

**T**ransformers at critical nodes in electricity networks lead stressful lives. If they fail, the cost can be very high, so the reliability of these devices is paramount. However, load peaks – predictable as well as unexpected – generate high temperatures that shorten transformer lifetime. In the worst case, sudden failure may occur and cause havoc in the network, bringing financial, and other, penalties. Utilities are keen to control and monitor the status and condition of their transformer fleet so they can intervene before a failure or malfunction can occur. For many utilities, the motto is, “detect failure conditions early.”

Ongoing changes in the energy sector are adding significant challenges. For example, renewable power sources operated by a large number of small, local energy producers change the flow of power in the distribution network at the consumer end of the grid. Another example is found in the growing popularity of electric vehicles: charging these in residential areas introduces dramatic changes in consumption pat-

terns and heavy local charging activity can cause overloads of distribution transformers. Apart from these examples, there are many other indications that the number of nodes at the distribution transformer level that can be considered to be critical will multiply and this will lead to a demand for the type of monitoring and control that has, until now, been limited to large power transformers.

This development will lead not only to an increased number of transformers with inbuilt monitoring functions, but also to more sophisticated monitoring technology. Current high-end solutions include multiple intelligent electronic devices (IEDs) covering different aspects of the transformer. Using these, the asset owner can monitor the behavior of the trans-

---

**Increasingly, for many utilities, the motto is “early detection of failure conditions.”**

former core, windings, oil, tap changer and bushings.





There are many indications that the number of critical nodes will multiply, leading to a demand for monitoring and control of transformers.

Monitoring improves the reliability of the assets by constantly keeping a watchful eye on the most critical transformer components.

Compared to traditional transformer diagnostic methods, which are performed on-site with the transformer de-energized, monitoring gives the asset owner access to real-time condition information, even from remote locations. When changes in conditions are detected, the operator is notified immediately.

Through remote access, the asset owner can then evaluate the status of the equipment without dispatching an engineer to the site, saving both valuable time and resources. Since monitoring detects condition changes in real-time – versus periodically with traditional diagnostic methods – the asset owner has time to plan and act before faults occur.

#### ABB monitoring solutions

ABB provides a very modular approach to transformer monitoring. The ABB transformer electronic control (TEC) product acts as the central IED unit of the transformer, ie, as the communication hub for all other IEDs → 1.

In this way, the end customer has a single, user-friendly Web interface for all monitoring equipment as well as a single

point for setting up communication with SCADA systems. TEC has built-in monitoring of the ambient temperature as well as the transformer oil and winding temperatures. Currents are also monitored, as are several tap-changer parameters (oil temperature, operation statistics and contact wear). TEC features advanced thermal models for both the transformer and the tap-changer. These models not only calculate hot-spot temperatures

Using IEDs, the asset owner can monitor the behavior of the core, windings, oil, tap changer and bushings of the transformer.

according to IEC and IEEE standards, but also model the complete thermal behavior, allowing comparison of measured with expected thermal behavior. Based on customer requests and transformer applications, additional IEDs can be added.

The most common ones are different types of gas-in-oil IEDs. Bushing monitoring IEDs are also becoming more popular.

To cover the requirements for fleet-wide deployment, ABB also provides the entry-level model TEC Smart → 2. In essence, TEC Smart is a scaled-down version of TEC that has only a selection of the most critical TEC feature. This reduces installation time at the site and lowers costs to a

**Electronic oil level indicator (eOLI)**

- Constant monitoring of the oil level in the conservator
- Analog and digital signal proportional to the oil level inside the conservator (can be transmitted to a PLC, a PC, or an integrated monitoring system)



**Self-dehydrating air breather (SDB)**

- No silica gel salt maintenance required
- Continuous and safer control and monitoring of the silica gel salt hydration as well as regeneration



**Electronic pressure relief device (ePRD)**

- Continuous pressure monitoring
- Analog 4-20mA output
- Digital RS485 output
- Adjustable onsite pre-alarm change-over switch



**Electronic Buchholz relay (eBR)**

- Continuous gas formation monitoring
- Remote relay functioning check
- Reduction of maintenance steps
- No risk of incorrect alarm/trip
- Easy to identify alarm/trip causes
- Better risk prediction and prevention overall



level that is attractive for non-critical and/or smaller transformers.

**Smart cooling – CoolTEC**

Because it is based purely on relay technology, traditional cooling control of power transformers has many limitations. One such limitation is that the cooling is grouped into banks where the only possible operational states are no cooling, half cooling or full cooling. For large power transformers, one such bank may consist of many pumps and fans. ABB's TEC system removes this limitation by allowing independent control of six cooler banks, providing a more fine-grained regulation of cooling capacity.

In some cases, it is especially beneficial to optimize the cooling control even further – for instance when a transformer is

considerably less noise than running a few coolers at 50 Hz, while providing the same cooling capacity.

It is also possible to temporarily overdrive the coolers by increasing the frequency to above 50 Hz, thereby providing an additional cooling margin for emergency overload situations.

The use of ABB's CoolTEC in a nuclear power plant in Hungary, in which the owners sought to extend the lifetime of a 30-year-old 400/120kV substation transformer, provides a good example of the solution. The aim was to lower the transformer oil operating temperature and reduce temperature fluctuation. ABB's CoolTEC was able to continuously monitor the transformer and track the performance of the coolers. The advanced

cooling logic driving the frequency controllers allows a lower working temperature and smoother temperature changes during operation. This reduces the aging of the oil-paper

insulation system. The customer is now able to plan maintenance much more accurately, based on the new data delivered by the ABB product.

**Smart-grid-enabled devices**

The energy market is undergoing changes that are reshaping the entire transmission and distribution infrastructure.

These models not only calculate hot-spot temperatures according to IEC and IEEE standards, but also model the complete thermal behavior.

**ABB's TEC acts as the main, central IED unit of the transformer, ie, as the communication hub for all other IEDs.**

located in a densely populated area where noise level is a concern, or when mechanical stress is being minimized by reducing temperature fluctuations in the transformer oil. ABB's CoolTEC provides frequency control of the coolers, allowing stepless regulation of cooling capacity. Running all coolers at a substantially lower frequency than 50 Hz results in

---

COMEM has developed a range of traditional transformer components with digital outputs.

#### 4 ABB's PLC AC500

---



Various governments have put regulations in place that are intended to increase the proportion of energy derived from renewable sources, like solar photovoltaic and wind farms. Unlike the few, large, centralized generators that have dominated in the past, these sources are numerous, small and widely distributed. The current massive growth in such decentralized power generation is resulting in greater voltage fluctuations in the distribution network and sometimes even violations of the permitted voltage band. Grid communication will, therefore, become critical in the distribution network so that power generation and consumption can be balanced and voltage fluctuations eliminated. In this way, a continuous, reliable and efficient supply of power will be maintained and voltage band constraints will be complied with.

Obviously, transformers play a central role in power transmission and distribution networks and control and monitoring of their operation is, therefore, critical. COMEM S.p.A., an affiliate ABB company based in Italy, has developed a range of traditional transformer components with digital outputs, including an electronic oil level indicator, a pressure relief device, a Buchholz relay and a self-dehydrating air breather → 3. These are equipped with digital interfaces for easy connection to the smart grid and they can be integrated into a single system via a central control unit, such as ABB's PLC AC 500 → 4.

All the devices, whether in standalone mode or integrated into a single system, are compatible with the most common international communication protocol standards. Overall, COMEM's new electronic devices provide improved control and monitoring of the most critical transformer operational parameters by merging individual sensor data into actionable information on the transformer status. Such an integrated system is also perfectly suited to control and monitoring of retrofitted assets.

#### ABB asset health center

Asset management strives to minimize the total lifecycle cost of assets while fulfilling all commitments regarding service reliability to the consumers. This is a continuous optimization process that requires information from many sources (asset conditions, maintenance plan and costs, replacement plan and costs, etc.) to be combined. This process requires both extensive knowledge of the transformer itself and skills in planning and economics.

Deregulation of the energy markets has brought scrutiny to asset management and remaining life management, adding further to demand for power transformer monitoring. Traditionally, monitoring was performed by standalone units equipped with a few relay contacts to alert operators to changes in conditions. As such, they were very similar to traditional protection devices.





The ABB asset health center combines data from real-time sensor and monitoring devices, as well as from ERP systems and data warehouses.

The current trend is to route data from monitoring devices via substation SCA-DA systems to regional control centers. Using industrial protocol communica-

ABB has long experience in engineering, equipment monitoring and systems in the area of power transmission and distribution. The ABB asset health center

exploits this experience to provide a comprehensive, intelligent platform that enables utilities to establish enterprise-wide, end-to-end asset management business processes to manage operation and maintenance costs, minimize risk and improve

Given the increasing amount of data, manual data collection will no longer be feasible. Automated assistance is crucial to transform the data stream into useful information.

tions, such as IEC 61850, the monitoring devices can supply data a few times a day or up to several times per minute. Considering that the number of monitored data points on each transformer is increasing and that the number of monitored transformers is multiplying, this can result in a huge data stream, even for a small utility.

reliability. In other words, it translates the data into actionable information so that the transformer end-user can make the most cost-effective decision possible → 5.

The ABB asset health center combines data from a variety of sources, such as sensors and monitoring devices, as well as information from enterprise resource planning (ERP) systems, data warehouses and the like. The data is assessed using algorithms that can recommend actions based on the current conditions. The algorithms will also rank all monitored assets based on likelihood of failure in order to help the asset owner make the right maintenance and asset replacement decisions.

**Bjorn Westrom**

**Inocencio Solterio**

ABB AB, Power Transformers  
Ludvika, Sweden  
bjorn.westrom@se.abb.com  
inocencio.solteiro@se.abb.com

**Stephane Page**

ABB Power Products, Transformers  
Geneva, Switzerland  
stephane.page@ch.abb.com

**Nicola Rampin**

ABB Power Products, Transformers  
Montebello Vicentino, Italy  
nicola.rampin@it.abb.com



# Composing with components

Innovative and high quality transformer components and services for diverse needs

STEPHANE PAGE, BENGT-OLOF STENESTAM, CARLO CAROLLO, ZORAN ZIC, ANDERS HOLMBERG, MLADEN BANOVIC – Transformers are essential parts of our electric power infrastructure, and transformer components such as bushings and tap changers are essential parts of transformers, ensuring they operate reliably and safely. ABB is continually addressing major technology trends and market challenges in the transformer industry with innovative products that meet or surpass the demanding requirements of today's transformer customers. As a leading component manufacturer, ABB is active in the research and development of competitive products that improve equipment safety, power reliability and efficiency while at the same time minimizing environmental impact.

## 1 ABB's latest innovative transformer components

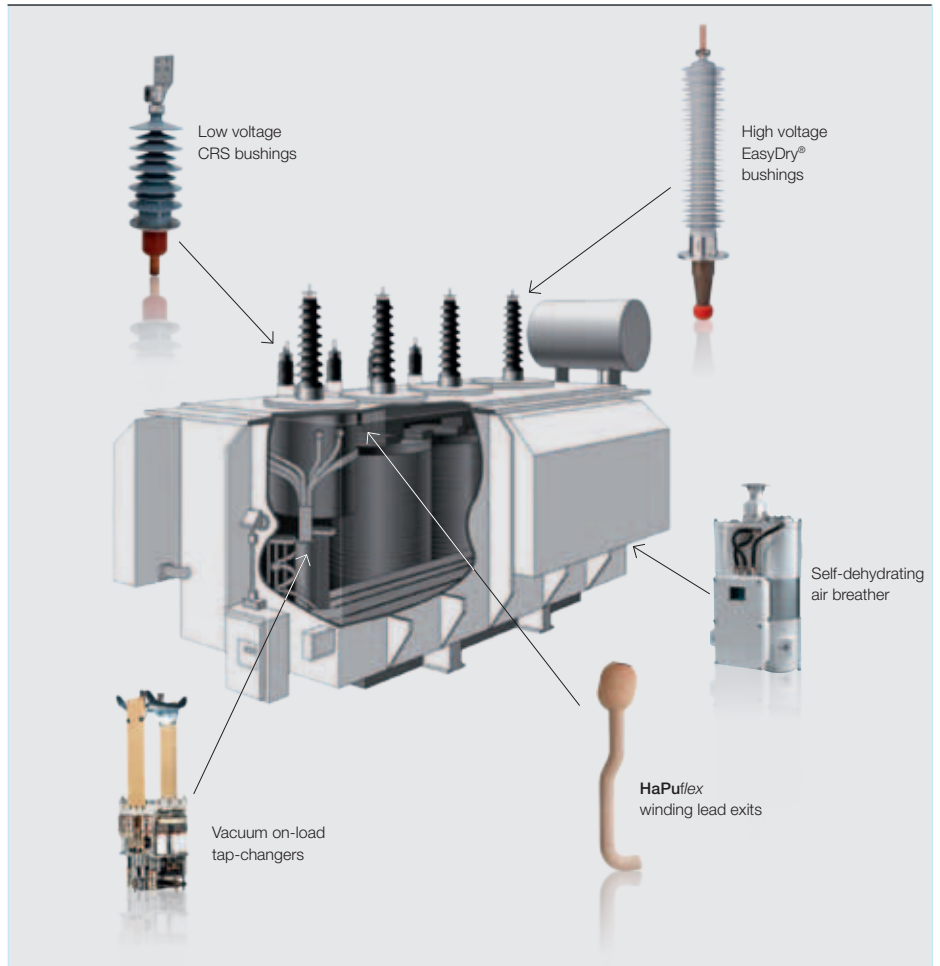

**T**ransformers are critical parts of the electric power grid, and transformer components such as bushings and tap changers are crucial for ensuring the reliability and safety of transformers in service. Some functional moving and electrically stressed transformer parts are also subjected to outdoor conditions – for example, the air side of a bushing, which insulates the high voltage line from the transformer tank ground potential under rainy and polluted conditions.

Today's strong market requirement for reliable and safe electrical equipment has led to the emergence of breakthrough technologies for transformer components. For example, vacuum interrupter technology now represents a major trend for tap changers, because it substantially reduces the maintenance cycle by preventing contamination of the insulating oil, and slowing down its aging process.

### Title picture

ABB offers a broad range of power and distribution transformer components and services to original equipment manufacturers and users of electrical apparatus. This includes tap changers, bushings, insulation material and distribution components, as well as composite insulators and components.

Another major current trend in the transformer industry is dry bushing insulating technologies, combined with silicon outer insulators to provide the safest service conditions. Many other transformer components also contribute to reliable and safe service conditions of the equipment, including air breathers, which require supervision and maintenance to securely reduce moisture ingress in the transformer and tap changer oil.

Transformer customers today are not only demanding safe, reliable electrical equipment, but also cost-effective, overall solutions. Taking all of these factors into account is extremely important when considering an essential component of transformer design, such as the connection from the windings to the bushings, which very often dictates the overall size of the transformer (and thus its overall cost), as well as assembly time.

ABB, as a leading transformer component manufacturer is continually addressing major technology trends and market challenges in the transformer industry with innovative products that meet or surpass the demanding requirements of today's transformer customers → 1.

### New vacuum on-load tap changer portfolio

A tap changer can be considered a transformer's gear box. It connects or disconnects turns in the tap winding to maintain a constant voltage out of the transformer. Both mechanical and electrical challenges must be addressed when designing a tap changer, and demand for reduced maintenance has resulted in increased use of vacuum interrupter technology. Electrical arcing that previously took place in oil is now taking place in a vacuum interrupter, which prevents arcing from contaminating the insulating oil. Typical inspection intervals for vacuum interrupter technology are between 300,000 to 500,000 operations, compared with 100,000 operations for conventional, non-vacuum arc quenching technology. Additionally, there is no time limit set for maintenance with vacuum interrupter technology, while seven years is typically applied for conventional non-vacuum technology.

An overview of the current ABB vacuum on-load tap changer portfolio is shown in → 2. The vacuum diverter switch tap changer types VUCG and VUCL have the



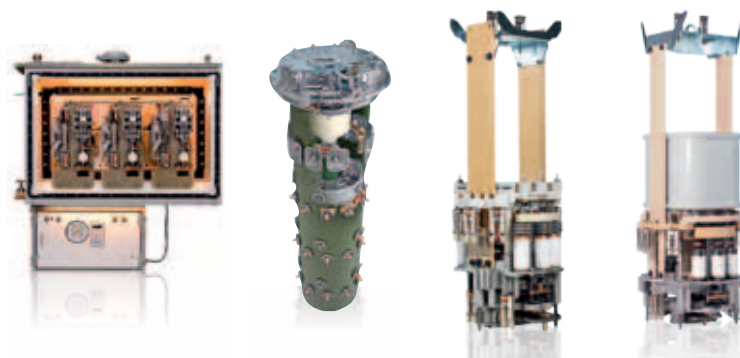

	VRLTC	VUBB	VUCG	VUCL
Type	On-tank reactance	In-tank resistive	In-tank resistive	In-tank resistive
Max BIL (kV)	150	350	1050	1050
Max current (A)	1500	600	800	1300
Typical application	Small-medium power transformers	Small power transformers	Medium power transformers	Large power transformers

advantage of being built in the same housing as ABB's conventional tap changer types UCG and UCL. Upgrading conventional units already in service, with corresponding ABB vacuum types, does not require any specific construction adaptations and makes the installation of new vacuum units straightforward. Similarly, since the vacuum selector switch tap changer type VUBB does not position the change-over selector outside the cylinder, its rotational symmetry makes installation extremely simple and easy. It is also fully insulated between the different phases, and therefore applicable to delta connection.

The new ABB vacuum reactance on-tank tap changer type VRLTC is fully insulated and mainly used for LV regulation – in this specific case, a reactor is used to bridge adjacent taps instead of a resistor. The unique electronic motor drive that controls the tap changer is fully integrated and can achieve one operation per second (compared to five seconds typically).

To secure reliable and safe service conditions, all new ABB vacuum tap changer types undergo a very demanding and extensive test program. For example, service duty test conditions – simulating typical service conditions – require 50,000 operations according to today's IEC and IEEE standard requirements. However, all new ABB vacuum tap changer types have been successfully service type-tested for 600,000 operations. In addition, several test objects of each type have been mechanically endurance-tested for over 1,200,000 operations under both warm

and cold conditions, versus the standard test requirement condition of 500,000 operations.

Another technical challenge of vacuum interrupter technology is to ensure a long and reliable lifetime of the contacts, which weld due to the pre-arc created when the interrupter is closing. For a breaker, impedance from the whole grid limits the rise time of the current in the pre-arc, but in a tap changer it is only the inductance from one step in the tap winding that limits such a rise. The standard circuit used for tap changer service duty test doesn't produce this quick rise time, so a new test circuit had to be developed in order to better reproduce actual operating conditions. In this new test circuit, the new ABB vacuum tap changer types VUBB, VUCG and VUCL were tested for 600,000 operations at service conditions.

**New self-dehydrating air breather portfolio**

Air breathers are crucial transformer components that reduce the maintenance cycle of both the transformer and tap changer by limiting moisture ingress in both the transformer tank and tap changer compartment, respectively. A pipe system is in most cases connected from the top of the conservator to the breather, which is placed at

ground level for easy access. Traditional breathers consist of a drying agent (such as silica gel) which dehydrates the air passing through, and retains the moisture. Regular inspections and replacement are needed to ensure the drying agent is not fully saturated, and can still absorb moisture.

The new COMEM self-dehydrating air breather (SDB) portfolio was developed to provide the safest and most reliable control of the air drying function, while lowering

Today's strong market requirement for reliable and safe electrical equipment has led to the emergence of breakthrough technologies for transformer components.

environmental impact and reducing overall maintenance costs → 3.

Saturation control and drying is automatic which drastically reduces maintenance time because the drying agent no longer has to be replaced. By using a patented double air breather tank system, it is ensured that the air intake in the transformer conservator is always passing through a tank with dehydrated drying agents, as the second tank is simultaneously regenerating. In other words, as one of the drying tanks is dehydrating, the other is used as the hydrator. This system guarantees a low



humidity level for incoming air in the conservator. In addition, the entire SDB portfolio is smart grid enabled, with a digital output available.

#### New oil- and paper-free transformer bushing portfolio

The main function of a transformer bushing is to take the current on high potential through the transformer tank. ABB has been producing high voltage transformer bushings for more than 100 years, and today manufactures bushings in seven countries on four continents. The first dry, resin-impregnated paper (RIP) bushings were developed in the 1960s, and today ABB is a market leader for this type of product.

ABB is well-known for technical innovations that have set new standards in dry bushings technology. Nearly ten years ago, ABB recognized the market need for a new bushing technology that would provide safety and performance benefits of traditional dry bushings, but without the hermetically sealed protection on the oil side of the bushing which is required for long-term storage, as is the case today for RIP bushings.

Several years of R&D effort produced the new EasyDry® bushing portfolio. It is based on a unique resin-impregnated synthetics (RIS) technology, and is commercially available in a full range of standardized, oil-to-air transformer condenser core bushings for 24 to 170 kilovolt (kV) AC applications → 4. The RIS technology not only provides oil-free but also fine capacitive graded, paper-free bushings. Instead of using

conventional paper insulation, the bushing's core is wound with polymeric (or synthetic) fabrics. EasyDry® bushings do not contain any water-absorbent materials, while maintaining the fire-resistant, explosion-proof characteristics of traditional dry bushings. This makes transportation, storage and installation much easier.

A major challenge during development was optimizing the curing process of the resin-impregnated, polymeric fabric wound condenser core, so that a crack- and void-free bushing body could be produced faster than a conventional RIP core. ABB successfully established an optimized curing process.

The improved process means shorter process times and fewer materials and parts used in production (hence shorter delivery times), making EasyDry® bushings more environmentally friendly than any other condenser-core bushing technology available today. Thanks to the RIS technology, EasyDry® offers a unique combination of excellent performance and cost-effective products. Oil-free, explosion-proof, class-E insulation (ie, up to 120°C), very low tangent delta (or dissipation factor), and partial-discharge free up to double-service voltage are distinctive attributes that make EasyDry® bushings a perfect fit within ABB's broad product portfolio of environmentally friendly and high-quality components for power transmission and distribution equipment. They also contribute directly to today's higher network availability, reliability and safety requirement standards → 8.



ABB is well-known for technical innovations that have set new standards in dry bushings technology.

## New combined insulation transformer bushing

ABB also has a strong presence in the lower voltage transformer bushing market segment with an extensive product portfolio. A conventional non-condenser core bushing in that voltage range is typically composed of a conductor bolt (usually brass or copper), a porcelain insulating part and oil as the primary insulator. These so-called conventional porcelain bushings are low-cost components in comparison to the valuable assets in which they are fitted. A bushing failure – after either an internal breakdown in the main transformer unit (where the bushing then acts like an exploding "plug") or an internal bushing failure – can have dramatic consequences not only for the transformer itself, but also for its immediate surroundings. Shattered porcelain projectiles are likely to cause secondary damage to any other nearby equipment or people. Additionally, after such a dramatic failure, the insulating oil spreads out in small droplets, and combined with a secondary arcing can easily ignite and caused further collateral damage.

COMEM in Italy, an affiliate company of ABB, recently launched a combined insulation (combined epoxy resin and silicon or CRS) bushing, that addresses conventional porcelain bushing weaknesses by providing reliable insulation while substantially reducing the risk of collateral damage in the event of a bushing failure.

The CRS bushing has its conductor directly molded in a primary organic resin insulation layer, which is in turn protected by a shed-formed silicone rubber overcoat → 5. This unique combination of insulation layers eliminates shattered bushing fragments (no porcelain) and drastically reduces the risk of fire (no oil), therefore greatly mitigating the risk of collateral damage after failure, while also providing excellent insulation properties in harsh environments (silicone rubber housing).

The CRS bushing consists of a full range of standardized transformer bushings for 24 to 72.5kV AC applications, up to 5,000A, with a level of partial discharges meeting the IEC 60137 standard specifications thanks to an embedded internal capacitance screen. With its exclusive combination of superior materials and robust construction, the CRS bushing addresses modern insulation requirements while simultaneously providing

## 5 COMEM's new CRS combined insulation bushing

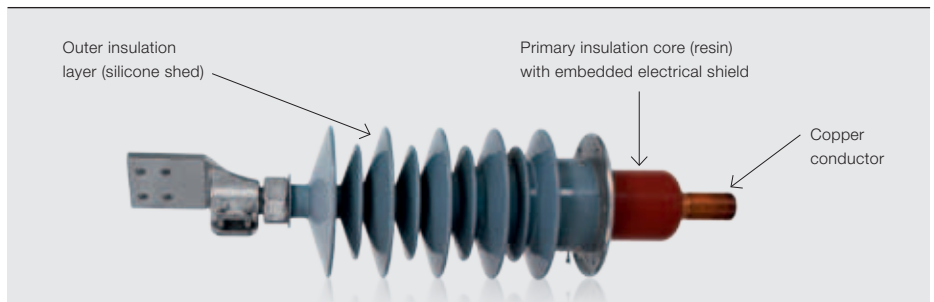

## 6 ABB's composite insulators



6a One-piece, filament-wound glass fiber reinforced epoxy cylinder



6b Seamless extruded silicone housing



6c The largest composite insulator ever built: 12-meters long for an 1100 kV HVDC wall bushing

a safer and easier solution for handling, transporting and assembling bushing units.

### Composite insulators with silicone sheds

Composite insulators offer superior insulation properties in a low weight, as well as non-brittle, and virtually maintenance free design. This insulation technology is rapidly increasing its market penetration, especially for critical components like high voltage bushings.

ABB is the technology leader in the market for hollow core composite insulators for ultra-high voltage (UHV) applications. The technology is well proven through demanding lab and field tests that often exceed standard requirements, and is supported by a unique service record from an installed base of 80,000 insulators. In-house production of the glass fiber tube and a one-piece tube design is essential in order to secure quality and enable short lead times → 6a. To achieve the best tracking, erosion and durability performance, a high temperature vulcanized (HTV) silicone

housing is used. The patented ABB helical extrusion process enables cost effective application of the housing on both small and large insulators, and directly on dry condenser bodies without any parting lines or joints → 6b. Helical extrusion also eliminates the need for part-specific investments in casting tools, which significantly reduces lead times and costs in the development of new products.

ABB recently marked another outstanding achievement by developing the largest composite insulator ever built – 12-meters long – for a 1,100 kV HVDC (high-voltage direct current) wall bushing → 6c. Despite development challenges, the project was completed in a record 10 months, from materials selection to final product design, including the installation of brand new production equipment.

### New generation of winding lead exit system

Winding lead exit systems ensure the electrical connection between windings and bush-



## 7 PUCARO's new generation of winding lead exit systems, HaPusystem

The **HaPusystem** is a new generation of complete winding lead exit systems, consisting of patented components such as the:

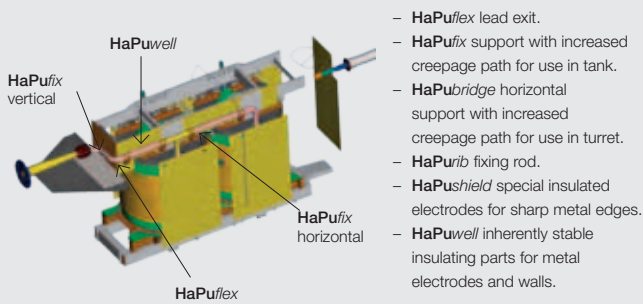

- **HaPuflex** lead exit.
- **HaPufix** support with increased creepage path for use in tank.
- **HaPubridge** horizontal support with increased creepage path for use in turret.
- **HaPurib** fixing rod.
- **HaPushield** special insulated electrodes for sharp metal edges.
- **HaPuwell** inherently stable insulating parts for metal electrodes and walls.

	230 kV	550 kV	800 kV	1200 kV
<b>HaPuflex</b>	<b>HaPuflex 230/3000</b>	<b>HaPuflex 550</b>	<b>HaPuflex 800</b>	<b>HaPuflex 1200</b>
<b>HaPufix horizontal</b>	x	x	x	x
<b>HaPufix vertical</b>	x	x	x	x
<b>HaPubridge</b>		x	x	x
<b>HaPurib</b>	x	x	x	x
<b>HaPushield</b>	x	x	x	x
<b>HaPuwell</b>	x	x	x	x

ings in high voltage power transformers. Conventional lead exits consist of insulating barriers made from cellulose-based molded parts. Manufacturing such parts is labor intensive, and is therefore very time consuming, and also greatly limits design possibilities. Additionally, problems during final assembly may extend overall assembly time, increasing the possibility of moisture adsorption which in turn increases the risk of transformer test failure from partial discharges. Even after the transformer has passed factory tests, if the electrical field is not distributed properly due to the overall design of the lead exits, electrical and/or thermal stresses can increase during operation leading to partial discharges and/or overheating of the unit, therefore further increasing the risk of early failure.

PUCARO in Germany, another affiliate company of ABB, has recently introduced **HaPusystem**, a new generation of lead exit systems → 7. This new generation provides greater flexibility during the design and assembly phase of the transformer, and also considerably limits the risk of failure during testing and later in operation.

The unique structure of **HaPusystem** components leads to more efficient cooling, better distribution of electric stresses and a significant reduction of clearance distances. With such a system, the foot-

print of transformers can be reduced, while simultaneously minimizing the risk of partial discharges in the lead exit. Due to innovative solutions and materials, **HaPusystem** lead exit barriers are produced on automatic winding machines, which allow great flexibility in the lead exit design (up to five bends) without significantly impacting its cost. It in turn provides much more flexibility in the transformer design. The **HaPusystem** standard solution with turret can be installed using a fork lift instead of an overhead crane, making its assembly much faster and more accurate.

The **HaPusystem** solution for bushing connections is also adjustable. The bushing end shield can be inclined in all directions up to 3° to compensate tolerances. Once the bushing and bushing shield are adjusted, the bushing shield position is bolted. After factory tests, the bushing is dismantled and the transformer transported on site. The bushing shield will however stay in a pre-adjusted position and the bushing can thereafter be installed without any additional adjustments. The assembly time in the workshop and more specifically on site can therefore be reduced by up to 70 percent. Reduced assembly time means limited ingress of moisture, lower risk of failure and overall cost savings for transformer manufacturers.

## 8 EasyDry® bushing success story in Indonesia

As in many other countries in Southeast Asia, Indonesian electrical utilities are very price sensitive and would typically specify oil-impregnated paper (OIP) bushings rather than more expensive dry bushings, despite the benefits an oil-free product can bring. Indonesia can therefore be considered a very challenging market in which to introduce ABB new EasyDry® bushings. EasyDry® bushings have, however, the advantage of combining all the benefits of resin-impregnated paper (RIP) bushings but at a more attractive price than conventional RIP bushings, and at the same time enable simplified storage (no moisture penetration) and faster deliveries (more streamlined production).

Indokomas, a local EPC, was commissioned to build a power substation to connect a brand new Honda Motor Company car factory to the 159kV network owned by PLN, the main electrical utility in Indonesia. The substation project had a very short delivery time, ie, only six months from when the contract was signed to when the equipment had to be commissioned. Short delivery times were therefore crucial to meet the project timetable. With EasyDry® bushings, ABB was in a unique position to meet the challenge. Hand-in-hand cooperation between ABB factories in Vietnam (transformer) and Switzerland (bushings), as well as a well-coordinated effort from front end sales and regional marketing teams, finally made this breakthrough commercial installation a reality. The end customer received high-quality, maintenance-free bushings with more safety in service within an extremely short delivery time. This first successful project definitely provides ABB with a very good first reference installation for further market expansion of EasyDry® bushings in the region.

### Stephane Page

ABB Power Products, Transformers  
Geneva, Switzerland  
stephane.page@ch.abb.com

### Bengt-Olof Stenestam

ABB Power Products, Transformers  
Ludvika, Sweden  
bengt-olof.stenestam@se.abb.com

### Carlo Carollo

COMEM S.p.A.  
Montebello Vicentino, Italy  
carlo.carollo@it.abb.com

### Zoran Zic

ABB Power Products, Transformers  
Zurich, Switzerland  
zoran.zic@ch.abb.com

### Anders Holmberg

ABB Power Products, Transformers  
Piteå, Sweden  
anders.holmberg@se.abb.com

### Mladen Banovic

ABB Power Products, Transformers  
Zagreb, Croatia  
mladen.banovic@hr.abb.com



# Sustainable and available

Enhancing performance and reducing environmental impact of existing transformer fleets

PIERRE LORIN, PRAVIN KHANNA, ROBERTO ASANO, ANDERS GRANO – Aging assets, rising energy demand, and the critical need to avoid unplanned outages are challenging utilities and industries around the world. And while financial constraints are reducing maintenance budgets and

investment, demand for increased return on investment is unabated. These apparently contradictory needs can be reconciled through optimized asset management. This, in turn, requires accurate and reliable models that can evaluate both technical and economic criteria.

## 1 Example of a fleet screening survey

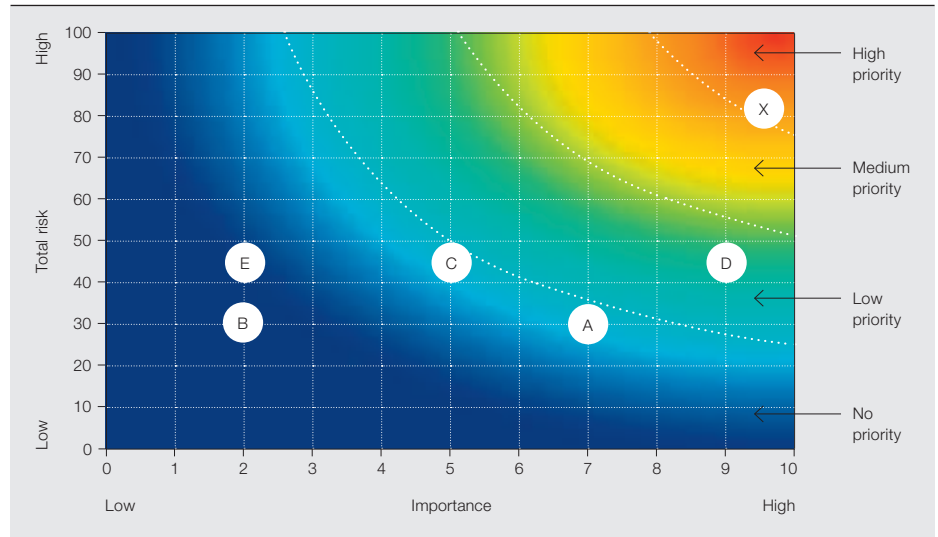

One way to control maintenance costs while achieving highly reliable power delivery with aged assets is to move from traditional time-based maintenance schemes to condition-based maintenance or reliability-centered maintenance programs.

This first step gives asset managers an overview of the “as-found condition” of their assets. It provides relevant inputs for maintenance or investment budget strategy, and is also used to select units for further investigation.

**T**he rapidly changing and dynamic business environment in which utilities and industries operate is defined by numerous paradigms. Challenges common to the different sectors include the following:

- Secure the high reliability of an aging fleet of assets
- Ensure availability of the electrical system, especially during peak periods
- Increase flexibility of grid components to cope with new types of energy production and new types of electrical loads
- Apply efficient maintenance strategies to restore asset performance within planned and shortened outages
- Use new solutions to optimize asset management by reducing life cycle costs and total cost of ownership
- Favor environmentally friendly technologies and processes
- Secure required technical expertise to maintain legacy asset through training of new staff

Meeting these challenges means new solutions are needed to maintain the installed base of assets as well as when refurbishing, repairing or upgrading legacy transformers.

### Title picture

145 kV transformer upgraded from 15 to 25 MVA with natural esters and aramid. Overload capacity: 42 MVA during 4 hours.

### Condition-based maintenance

Implementing a solid, condition-based maintenance program requires a good understanding of the condition of each asset, as well as their importance in the electrical network.

An approach based on international statistics of transformer reliability is a useful first step in estimating maintenance and investment budgets. However, experience shows that each unit must be considered specifically in order to make an informed decision about maintenance, relocation, retrofitting or replacement.

The difficulty in selecting an assessment methodology is choosing the right level of diagnosis in order to draw a reliable conclusion at a reasonable cost level.

In the late 1990s, ABB developed a modular, three step approach, in order to meet different expectations in terms of population size, level assessment and available budget [1] → 1.

#### Step 1: Fleet screening survey:

A quick scan of a large population (20 to 200 units) collects easily accessible data, such as unit name plate data, oil and dissolved-gas-in-oil data, load profile, history of the unit and sister units.

#### Step 2: Condition assessment

At this stage, transformer design experts focus on a smaller number of units (10 to 20) identified in step 1. They use modern design rules and tools to evaluate the original design. Advanced diagnostic tests are performed to assess each of the principal properties of the transformer in a structured way: mechanical status (frequency response analysis, vibration signature), thermal status (dielectric response analysis), electrical status (partial discharge tests) of the active part and the condition of the accessories such as tap changers, bushings, over-pressure valves, air-dryer system, pumps and relays.

This assessment leads to an estimate of each transformer’s risk of failure, and defines action plans to improve the reliability of each unit.

#### Step 3: Expertise

The number of units to be further analyzed is typically limited to two or three out of a population of 100 units. International experts using state of the art design and simulation tools are involved.

This third module of the assessment process provides accurate information with respect to overloading transformers, enhancing their performance (power or voltage increase) or extending their lifetime.



The transformers service solutions developed in recent years aim to help transformer owners optimize their lifetime asset management strategy, minimize cost of ownership and overcome the challenge of expertise maintenance.

2 Untanking at site of a 440 MVA/550 kV transformer to replace windings



### Priceless information

Such a modular methodology provides valuable inputs to end-user staff at different management levels, and enables them to make informed decisions that will ensure high reliability and availability of installed assets → 3. It helps to reduce the risk of unplanned outages, and to define a proper maintenance strategy and associated budget. It enables them to make the best use of available budgets by investing in those critical units that really must be maintained or exchanged. Assessment reports can also be used in discussions with insurance companies.

Valuable information to support asset managers in their decisions is also obtainable via on-line monitoring. [2] These solutions have been widely developed in the past decade and installed in increasing numbers of transformers. The technical demands of smart grids are driving the emergence of new technologies that monitor transformers with smaller ratings. At the same time, the needs of higher ratings are evolving from simple alarms and break-of-trend analysis to the ability to provide online diagnosis, prognosis and recommended actions.

As a consequence, ABB has developed sensors suitable for use on distribution transformers, but on the other side of the portfolio are high-end devices enabling the kind of intricate analysis that will soon match the detail available with off-line diagnostic studies. These devices include products for multi-gas sensing, frequency response analysis, partial discharge, transients recording, high precision bushing and tap changer monitoring.

Last but not least, products are now available that can turn raw data into actionable information at either the transformer level or a fleet level. New methods of communication as well as information technology solutions are being used to efficiently transfer data, store large quantities of data over decades and easily retrieve information that can be delivered remotely to different stake holders (CEO, CFO, asset managers, operation, maintenance) in a format suitable to their specific needs.

### The economic side of transformer fleet management.

Deregulation, increased competition, cost-cutting and the need to balance investments are making it imperative to know the exact health of the installed base of power transformers. The technical complexity of these devices and their high capital cost is driving a need to evaluate the economics of the installed base.

ABB has developed an economic model that can be applied to either a fleet of transformers or an individual unit. [3] The criteria typically used in such a model can be safety, age, operational condition, availability/reliability of the unit, maintainability, environmental concerns, legislation and the inherent risk of, and consequential costs of a fault. Comparative investment scenarios and sensitivity studies can be run by varying the replacement year or maintenance of the unit. For each scenario the associated net present value is calculated as an input to decide on the best asset management strategy.

### 3 Success story: Getting the most from a transformer

When a utility company in Brazil needed more power and overload capacity for a 26-year-old transformer, remanufacturing seemed the only solution. Not only did ABB upgrade the 15 MVA transformer to 25 MVA, but they also made the unit greener by replacing its mineral oil insulation with BIOTEMP fluid. The benefits for the customer included an overload duration of four hours up to 23 MVA, as well as a reduction in the risk of toxicity and fumes. Biodegradable BIOTEMP fluid ensures little or no clean-up costs in case of leakage, as contamination is reduced.

Similarly, when an aluminum mining company in Switzerland faced the challenge of increasing capacity by 15 percent, the solution again was to upgrade their 38-year-old transformers and 16-year-old rectifiers.

The payback for the investment was three years. To meet the customer's requirements, a feasibility study was carried out along with a condition and risk assessment, providing three different options: invest in new replacement units; refurbish and repair; refurbish, repair and monitor.

The customer chose the refurbish and repair option with online monitoring. As a result the company not only increased production by 18 percent (3 percent more than was originally expected), the old transformer gave four additional years without loss of production.

By identifying the "critical units" in need of imminent attention and combining this information with the enterprise's strategy for its power supply infrastructure, an evaluation is created that considers whether to refurbish or replace the unit. With this information, managers can set up a maintenance plan for non-critical units that still need attention, to ensure an uninterrupted power supply.

With screening, capital expenditure can be steered to the units most in need, and the investment plan can be evaluated for different service options in a pre-set time frame eg. 2012 to 2042.

#### Implementing the action plan: maintenance and repair technologies

Depending on the assessed condition, the following corrective actions can be considered, evaluated and implemented:

- Refitting the gaskets, oil processing, oil regeneration, drying the active part to improve the general condition of the transformer and reduce the aging process.
- Online oil regeneration has technical and economic advantages when applied to old transformers with aged, acidic oil. The process is more environmentally friendly than oil replacement, and demonstrates much better efficiency over the long term. This is a very efficient alternative solution to passivation, since it enables definitive removal of corrosive compounds from corrosive oils, thus avoiding the risk of copper sulphide formation.
- Reclamping the windings and the core, checking the cleats and lead structure

to improve the mechanical condition of the unit.

- Retightening connections of the active part, adding new shielding, cleaning the contacts of the off-load tap changer to improve electrical performance.
- Overhauling the on-load tap changer, maintaining the bushings, the cooling system, the fans, the pumps, the relays to increase the reliability of the accessories and thus of the transformer.
- Drying out of the active part using a low frequency heating (LFH) system. It is now also a proven solution for drying the transformer core and coil much faster without compromising quality. The drying time could be less than half of that for a traditional hot oil and vacuum process.
- On site repair [4] is an attractive approach to speeding up transformer repair in remote locations, where transportation is difficult or risky, costly and time consuming → 2.

#### On site repair

ABB on site repair is achieved by bringing the transformer factory setup to the work site. This is done by mobilizing special equipment and tools needed to perform any scope of work, from refurbishment to replacing all windings, which are manufactured in transformer factories under strict quality standards. An ABB onsite repair fulfills exactly the same quality standard as an ABB workshop repair. Such repairs have been done in many countries, on more than 400 transformers, including ultrahigh-voltage transformers, converter transformers, industrial units and shunt reactors. On site repair has saved utilities and industrial users millions of dollars by

reducing downtime by four or more weeks, in installations where production losses are worth hundreds of thousands or a million dollars per day.

Due to significant progress in power electronics, new compact high-voltage test systems are now available. Therefore, most of the high-voltage laboratory tests can be performed on site, including Applied and Induced Voltage tests with partial discharge measurements, heat run → 4 and Impulse tests → 5.

These tests can also be performed as an extra quality check on new units after transportation and installation, as a preventive measure within a condition assessment study, or to troubleshoot after a failure to identify and localize a defect, in order to reduce outage time during a repair.

Another alternative for transformer performance enhancement takes into account the increasing demand from end-users to reduce the environmental impact of new transformers and existing assets. New eco-friendly solutions are emerging that combine reusing most parts, innovative material (natural and synthetic ester oils, aramid fibers, amorphous steel) and modern technologies (dry bushings, vacuum tap changers, active control of audible noise). [6-7]

These solutions reduce the risk of fire and pollution, minimize losses and noise, recycle materials and reduce maintenance. They also address current challenges in the power industry beyond safety and environmental concerns. Extending

#### 4 High Voltage applied and induced voltage tests on a 400 kV three phase unit



the lifetime of equipment to delay reinvestment; enabling higher power ratings to increase generation profitability or to consistently meet growing demands for transmission and distribution power; extra compact transformers to increase capacity without expanding substation footprint; and improvements in overall substation safety, are just a few examples → 5.

#### Planned outcomes

The transformers service solutions developed in recent years aim to help transformer owners optimize their lifetime asset management strategy, minimize cost of ownership and overcome the challenge of expertise maintenance.

At a long term and strategic level, the condition assessment study gives top management a clear picture of maintenance and renewal investments that are required over the next 20 to 30 years to provide asset reliability and availability. It provides solid information to compare different asset management strategies and choose the approach that best supports the overall technical and financial strategy of the company. A program to extend the lifetime of aged units can, for example, postpone investments in new units and so improve the cash flow of the company.

In the medium term, asset managers obtain the input necessary to make best use of maintenance or replacement budgets. Funds can be allocated to units that show the best return on investment, while reducing technical and environmental operation risks.

In the short term, this method allows the maintenance manager to apply the right maintenance actions in order to secure the needed reliability of aged assets. It also quantifies the benefits of different maintenance actions, supporting decisions based on both technical and financial criteria.

Beyond traditional maintenance actions, innovative technologies developed to improve service quality, sustainability and reduce asset downtime are now available, addressing a complete range of solutions for asset managers.

#### Pierre Lorin

ABB Power Products, Transformers  
Geneva, Switzerland  
pierre.lorin@ch.abb.com

#### Pravin Khanna

ABB Power Products, TrafoSiteRepair  
Saint Louis, USA  
pravin.t.khanna@us.abb.com

#### Roberto Asano

ABB Power Products, TrafoSustainableRetrofit  
Guarulhos, Brazil  
roberto.asano@br.abb.com

#### Anders Granö

ABB Power Products, Transformer Service  
Västerås, Sweden  
anders.grano@se.abb.com

#### 5 Preparation for a High Voltage impulse test on a 400 kV transformer



#### References

- [1] Carrander, K., Pettersson, L., Melzer, L., Fantana, N., Lorin, P. (2002, January). Methodology for life assessment on power transformers. *TRAFOTECH-2002*, Sixth International Conference on Transformers, Mumbai, India.
- [2] Stenestam, Bengt-Olof A., Bengtsson, Claes T., Ydersten, Peter N. (2006). Electronic Transformer Control with Monitoring & Diagnostics. *CIGRE*, Paris, France
- [3] Lorin, P. (2004). Optimizing lifetime costs for transformers through informed decisions. *ABB Review Special Report Power Services*, 10–15.
- [4] Mendes, J. C., Marcondes, R. A., Westberg, J. (2002). On Site Repair of HV Power Transformers. *CIGRE*, Paris, France.
- [5] Szczechowski, J. M., Werle, P., (2010). Enhanced Methods of High Voltage Testing of Power Transformers on Site. *Proceedings of the International Conference on Condition Monitoring and Diagnosis*, Tokyo.
- [6] Oliva, M., Asano, R. (2010). New Technologies in Transformer Service. *Advanced Research Workshop on Transformers*, Santiago de Compostela, Spain.
- [7] Asano, R., Page, S., (2012). Reduced environmental impact and improved safety and performance of power transformers with natural ester dielectric insulating fluids. *PCIC – Petroleum and Chemical Industry Conference*, Prague, Czech Republic.



# Green- R-Trafo™

## Safety makes a green transformation

**DOUGLAS GETSON, PETER REHNSTRÖM, GAL BRANDES, EGIL STRYKEN – Liquid filled distribution class transformers can benefit renewable energy applications both from an environmental and financial point of view. Firstly, the sites where they are positioned can be in environmentally sensitive areas or even amongst agricultural crops. It is crucial that there be little or no impact on the environment. This is achievable with BIOTEMP®, which is biodegraded in 21 days. Furthermore, the higher fire point of 360°C (twice that of mineral oil) makes the transformer intrinsically safer. Moreover, the collector network is on average not run at peak capacity as wind and sunlight are erratic and inconsistent. So a low no-load loss design using amorphous metal (AM) core technology can keep operating costs low as no-load losses are a greater percentage of total transformer losses under lightly loaded conditions such as renewable applications.**

In a renewable application → 1, distribution transformers are used to step up the voltage to 35 kV within the collector network. At the end of the collector network, a power transformer steps up the voltage to supply power to the transmission grid. Most renewable sites are owned and operated by independent power producers (IPP), whose interest is to maximize the return on their investment.

As there is either a dry-type or liquid-filled distribution transformer per turbine and many turbines per site, a large proportion of collector losses are the result of transformer losses. To improve on today's collector network efficiency of 97–98 percent, the losses in these transformers need to be reduced. And since the load factor of these transformers is far below nameplate, reducing the no-load losses is the priority.

To quantify the financial benefits of AM core technology, a study was conducted on a renewable site in North America. The site has 70 wind turbines rated at 2.3 MW, and an equal number of 2,600 kVA RGO (regular grain oriented) electrical steel liquid-filled distribution transformers, along with associated cabling, switchgear and power transformers. A load flow study was done on the collector network, studying its present situation with RGO and comparing it with replacement by AM distribution transformers.

Collector losses were calculated using the turbine output for an entire year. For this site, the turbine output was less than 38 percent of nameplate for more than 80 percent of the hours in a year (7,313 hours) → 2. The load flow comparison resulted in the AM core transformers being more efficient by 0.42 percent, resulting in an additional 1,842 MWh that could have been sold to the grid each year → 3. This may not sound like much, but over 20 years, it is a considerable amount of revenue improving the rate of return of the site investment → 4.

AM transformers would have cost the site developer another \$450,000 on top of the \$250,000,000 original investment – less than one percent. But the higher efficiency of the collector network would have generated an additional \$129,000 per year of energy sales, assuming a PPA (power purchase agreement) of \$70/MWh. Classifying it as a good investment would require a positive net present value (NPV) and double digit internal rate return (IRR). On calculating the returns, a 30 percent income tax credit was assumed and an unleveraged investment or zero financing cost. The return on the additional \$450,000 using a \$70/MWh PPA was a 25 percent IRR and \$467,000 NPV. For a \$50/MWh PPA, the return is still an acceptable 20 percent IRR and \$300,000 NPV. So the

**1 Renewable generation is not generally run at peak capacity. A low no-load loss design can keep operating costs low as no-load losses are a greater percentage of total transformer losses**



additional investment in lower loss AM transformers would be a good investment.

The necessary financial and site specific details may not be available at the time of tendering the transformer. But without these details, the transformer manufacturers will have difficulty designing to the most optimal design relative to Total Ownership Cost (TOC). TOC being the purchase price plus cost of operating the transformer over its useful life. So ABB worked with a financial modeling company to develop an on-line tool for capitalizing the no-load (A) and load losses (B) for individual renewable sites. These factors would then be given to the transformer manufacturer at the time of transformer tender for optimizing a design to the lowest TOC. This tool is available by going to [www.abb.com/transformers](http://www.abb.com/transformers) and selecting transformer calculators.

**Douglas Getson**

ABB Power Products, Transformers  
 douglas.m.getson@us.abb.com  
 Jefferson City, MO, United States

**Peter Rehnström**

ABB Power Products, Transformers  
 Ludvika, Sweden  
 peter.rehnstrom@se.abb.com

**Gal Brandes**

ABB Power Products, Transformers  
 Genève, Switzerland  
 gal.brandes@ch.abb.com

**Egil Stryken**

ABB Power Products, Transformers  
 Drammen, Norway  
 egil.stryken@no.abb.com

**2 Annual turbine output % rating (2.3 MW)**

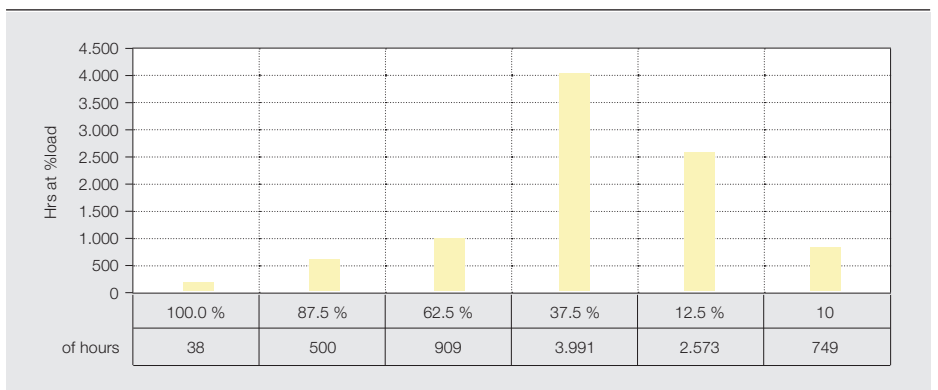

**3 Energy savings with amorphous transformers**

Turbine output (% N MPL)	Hours	GSU Transformers			
		Grain oriented		Amorphous	
		Energy sales (MW h)	Collector losses	Collector losses	Energy sales (MW h)
100.0 %	38	5.880	3.25 %	3.17 %	5.885
87.5 %	500	68.386	2.91 %	2.81 %	68.462
62.5 %	909	88.837	2.87 %	2.68 %	89.008
37.5 %	3991	234.890	2.52 %	2.17 %	235.736
12.5 %	2573	50.113	3.22 %	2.11 %	50.690
0.0 %	749	- 208	0.00 %	0.00 %	-39
<b>Total</b>	<b>8760</b>	<b>447.899</b>	<b>2.78 %</b>	<b>2.38 %</b>	<b>449.741</b>

**4 PPA Price sensitivity GSU Amorphous transformer investment**

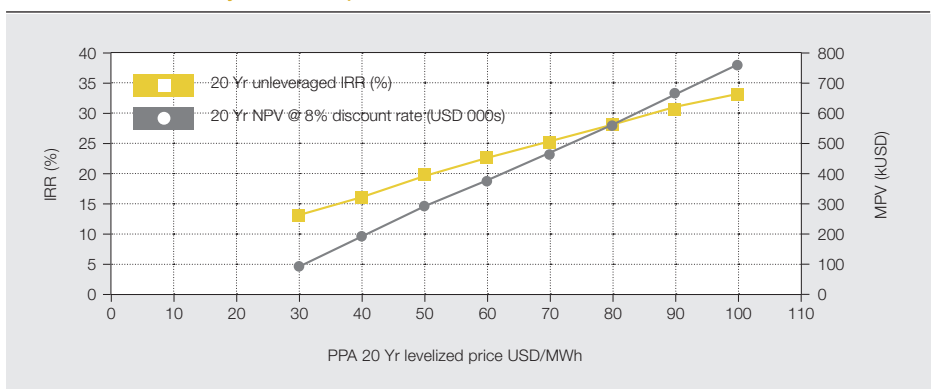



# Changing trends

## New technologies for the evolving grid

MARTIN CARLEN, PATRICK ROHAN – Our planet and our society are constantly evolving, forcing us to adapt continually to changing environments and circumstances. From all this change, global and regional trends emerge and new technologies to satisfy new needs appear. What was recently modern can swiftly become old-fashioned. Changing trends need to be quickly identified by manu-

facturers so they can respond with new or improved products. This applies even to products considered to be mature, like transformers. In this paper, key market influences determining global trends in transformer technology are identified; in two of the previous papers, ABB's innovative and leading responses for dry-type and liquid-filled distribution transformers are presented.



**1 Growth of global population between 1950 and 2050 according to United Nations, Population Division, 2011 [1]**

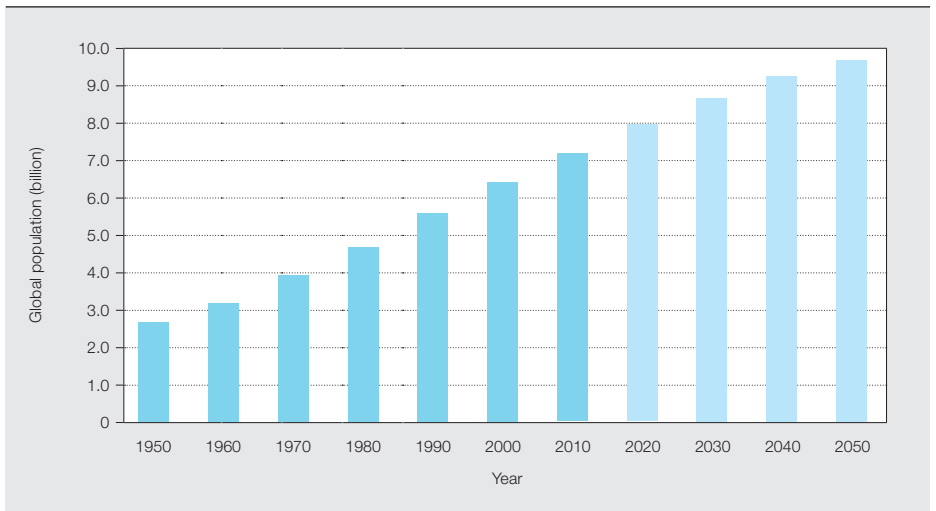

One of the most dramatic changes seen on planet Earth in the past few decades is the explosive growth of the human population. From 1950 to 2010 the population increased by a factor of 2.7 and by the end of 2011 there were more than seven billion humans living on the planet → 1. Population growth is expected to continue for several decades yet and flatten out only beyond 2050, by which time total population will have increased by 35 percent, from today's figure, to 9.2 billion people. There has been a corresponding growth in the demand for power → 2.

**Growing energy and electricity demand**

Aside from pure population growth, energy demand is also boosted by the rise of developing economies: a one percent increase in gross domestic product (GDP) increases energy demand, on average, by 0.6 percent. The overall costs of energy are around seven or eight percent of global GDP and consti-

tute, therefore, a substantial cost factor. This makes it very important to have highly efficient energy production and transportation processes. Further, when calculating energy costs, it is important to evaluate them over the total life cycle and include the costs of energy losses during the utilization phase as well as the initial equipment costs.

Of total global energy consumption, only 15 percent is actually consumed as electrical energy, though 38 percent of primary energy is used to create that portion. Since electricity is a high-quality form of energy, it can be used for any kind of application. Additionally, it does not leave any pollution or emissions at the place of use. This ensures demand will continue to increase and that electricity will continue to take an ever larger share of the market. Prominent examples are the replacement of oil or gas central heating systems by electric heat pumps or the introduction of electric vehicles.

Although overall efficiency is increasing, thus reducing primary energy needs, demand for electrical energy itself continues to increase. Whereas in developed countries the average electricity consumption is about 1.0 kW/person, the global average is only 0.3 kW/person. This is an indicator that further

strong growth will occur in developing countries, driving a demand for high-efficiency transmission and distribution equipment.

One significant factor driving an overall increase in electricity demand is the energy appetite of information systems and telecommunication infrastructure. Modern, large data centers, for example, belong to the largest users of electricity.

**Urbanization**

Another prominent trend is urbanization. More and more people are migrating from rural areas to cities. By 2050,

It is expected that the percentage of renewable energy satisfying primary energy demand will rise significantly to about 8 percent by the year 2030.

two thirds of the world's population will live in cities, up from half now → 3.

In 1950 the agglomeration of New York-Newark was the world's largest, with a population of 12.3 million. Today it is Tokyo, with a population of 37.2 million, followed by Delhi (22.6 million), Mexico City, New York-Newark and Shanghai (each slightly over 20 million). According to the United Nations Population Division, there are now 24 cities with a pop-

**Title picture**

A population that is rapidly increasing and becoming more urbanized, coupled with impending climate change, make energy efficiency one of the imperatives of our time. How do these trends influence ABB's transformer products?

## 2 Growth of global primary energy and electricity demand (IEA New Policies Scenario) [2]

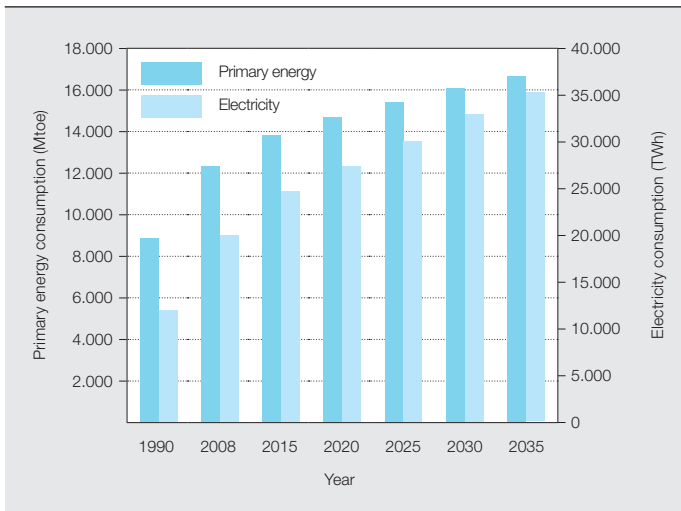

## 3 Percentage of urban population [1]

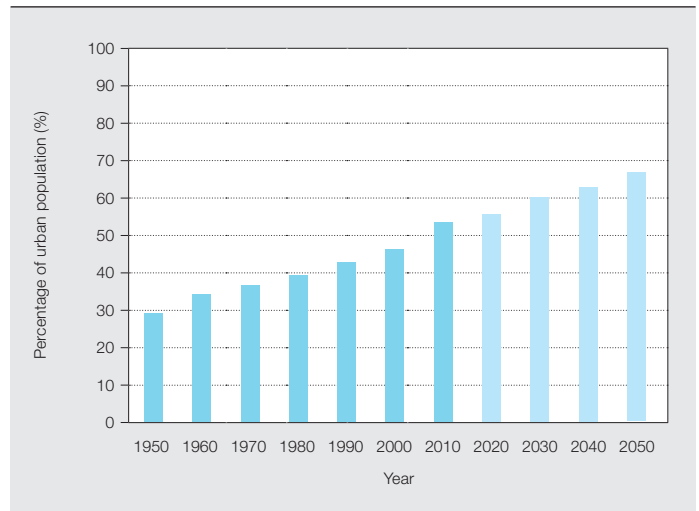

ulation of 10 million or more. Supplying these megacities with food, goods and utilities is a major logistical challenge. This also applies to the supply of electricity. The power density in areas tightly packed with skyscrapers is very high and new solutions are required to bring electric power into the city centers in a safe and reliable way. Real estate can be too expensive and hard to come by to use for substations, so these often have to be situated underground.

### Climate change

One of the most significant challenges facing the planet lies in the effects of greenhouse gases and climate change. While there are several gases that contribute to the greenhouse effect, carbon dioxide (CO<sub>2</sub>) is the principle concern. If a significant warming of the earth's surface in the next 20 years is to be avoided, then major policy changes will be required to stop irreversible climate change. In 2010, global energy-related emissions of CO<sub>2</sub> jumped by 5.3 percent to a record 30.4 Gt (Giga tons). On current trends it is estimated that CO<sub>2</sub> emissions will exceed 40 Gt before 2030, causing a global temperature increase of 3.5 C. However, under the 450 policy scenario<sup>1</sup>, global energy related

emissions are expected to peak before 2020 and then decline to 21.5 Gt by 2035.

Energy efficiencies in power networks can contribute to CO<sub>2</sub> reduction. Distribution networks are usually better than 95 percent efficient and distribution transformers better than 99 percent efficient. Despite this, the sheer size of the distribution transformer installed base means the aggregate loss accounts for a significant portion of the losses in the distribution network. So, even small improvements in transformer efficiency can significantly reduce CO<sub>2</sub> emissions in absolute terms.

Transformer efficiency is considered either from the loss value point of view, or it is given as an efficiency value.

Efficiency values are compared at 50 percent load. National standards governing losses for transformers have been undergoing significant changes in recent times as government and utility regulators seek to live up to their commitments and responsibilities with respect to energy efficiency and climate change.

Efficiency categories differ between countries → 5. The low and average categories of efficiency are being phased out and all countries are moving towards high, very high or ultra-high classifications. Ultra-high efficiency is reserved for transformers with amorphous core metal (see articles on the Green-R-Trafo and the EcoDry transformer in this publication).

The sheer size of the distribution transformer installed base means the aggregate loss accounts for a significant portion of the losses in the distribution network.

### Footnote

<sup>1</sup> The globally-agreed goal under the United Nations Framework Convention on Climate Change that would require the long term atmospheric concentration of CO<sub>2</sub> to not exceed 450 parts per million. Achieving the 450 policy will require a different energy mix in the future. The two main drivers for this are energy-efficiency improvements and significantly increased renewable energy usage → 4.

#### 4 World energy-related savings by policy measure under the 450 policy scenario, relative to reference scenario

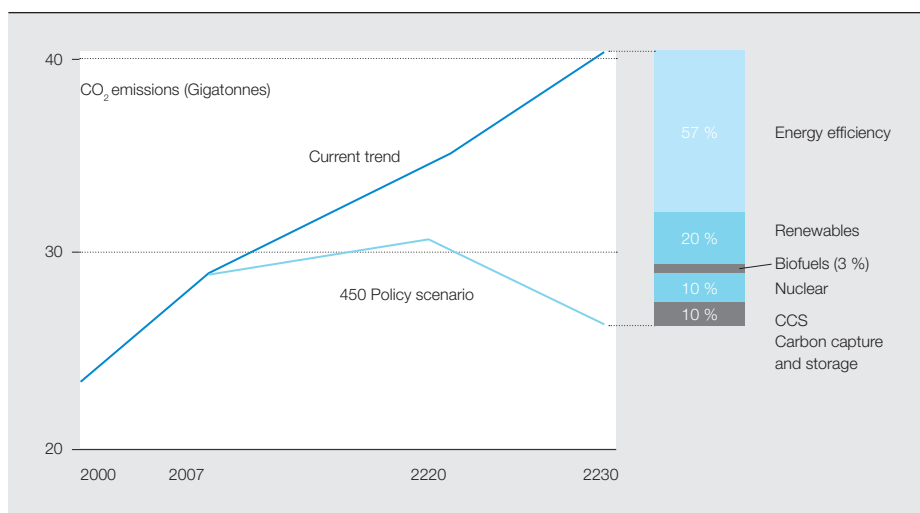

Of total global energy consumption, only 15 percent is consumed as electrical energy, though 38 percent of primary energy is used to create this.

The second key element for future avoidance of CO<sub>2</sub> emissions is the generation of electricity from wind, solar, wave or geothermal sources. In 2011, renewable power (excluding large hydro) accounted for 44 percent of the new generation capacity added worldwide. 2011 saw global investment in renewable power and fuels increase by 17 percent to a new record of \$257 billion. This is a six-fold increase on the 2004 figure [3]. According to the International Energy Agency's (IEA) world energy outlook, it is expected that the percentage of renewable energy satisfying primary energy demand will rise significantly to about 8 percent by the year 2030.

The key drivers for this growth are government incentivization and falling technology costs. In 2011, the prices for photo-voltaic modules fell by 50 percent, while the price for wind turbines decreased by 10 percent. This closes the price gap between renewable and fossil fuel sources. If this trend continues, then, according to the IEA, grid parity can be achieved in the solar market by 2020 or before, allowing for this technology to compete in the open market place against traditional fossil fuel technologies.

#### Life cycle costs

In order to support decisions on investments, a return on investment (RoI) calculation is normally performed. This should consider not only the cost of a specific element, but also the costs arising during its use. The life cycle costs contain, therefore, the initial purchase costs of the component or system; the related additional installation costs; the costs of operation, which can be the costs of energy losses; the costs for maintenance; and the disposal costs at the end of the investment's life. Although transformers have a high efficiency, typically above 99 percent, energy losses add up to a high financial value, which often significantly exceeds the initial costs. Utilities are increasingly using a special method called total owning cost (TOC) to evaluate transformer investments. TOC assigns a financial

More renewable energy sources means voltage regulation, traditionally used in HV/MV transformers, will now be required in the MV/LV network to provide local regulation.

value to the specific no-load and load loss values of a transformer. These mainly depend on the utility's energy costs and investment conditions. This issue contains a separate paper on TOC.



## 5 Efficiency classes of distribution transformers in different countries

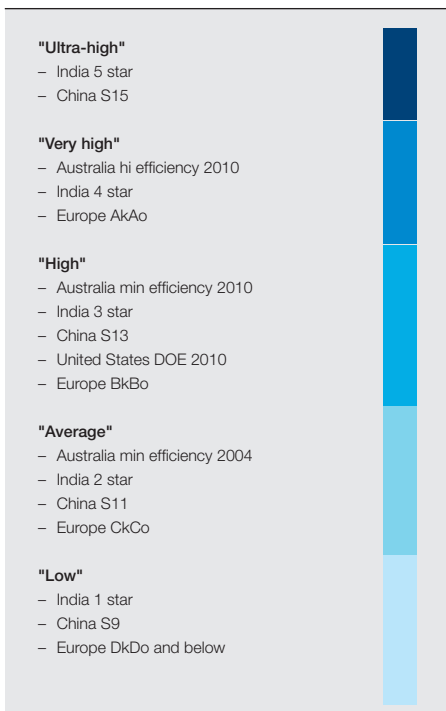

### Smart grid

One of the main challenges of integrating distributed variable generation is the effect on power quality, specifically the voltage bandwidth spanning the multi-faceted local generators and the network load requirements. In the past, power generation was centralized with unidirectional power flow and the main consideration was just the voltage drop. However, now, and increasingly in the future with increased penetration of distributed variable generation, the power flow will become more complex, leading to voltage drops and rises. This presents the challenge of regulating voltage over a much larger bandwidth. Voltage regulation, traditionally used in high-voltage and medium-voltage transformers, will now be required in the medium-voltage and low-voltage network to provide local regulation.

### Asset monitoring

Another future trend will be asset monitoring of distribution transformers in the network. This will allow operators to develop a more reliable distribution network and identify problems before a failure occurs. The fault type and location will be quickly identified and customer outage time minimized.

Traditionally, the transformer in the distribution network was a passive piece of equipment, but in the future it will

become an active component of the network that dynamically interacts to ensure capacity, reliability and efficiency in the network.

### Future perspective

Population growth and increasing energy usage are causing global CO<sub>2</sub> emissions to rise, with consequent undesirable effects on climate. In mitigation, a move towards more energy-efficient components in the power network, along with effective integration of low-carbon technologies, will be essential. ABB recognizes these future network requirements and has developed a product portfolio of distribution transformers to meet the challenges of the future.

#### Martin Carlen

ABB Power Products  
Zürich, Switzerland  
martin.carlen@ch.abb.com

#### Patrick Rohan

ABB Power Products  
Waterford Ireland  
patrick.rohan@ie.abb.com

#### References

- [1] United Nations Department of Economic and Social Affairs, Population Division: Population Estimates and Projections Section. World Urbanization Prospects, the 2011 Revision: Data on Urban and Rural Populations. Retrieved 31st July 2012 from <http://esa.un.org/unpd/wup/CD-ROM/Urban-Rural-Population.htm>
- [2] International Energy Agency. World Energy Outlook 2010 Edition. Retrieved 31st July 2012 from <http://www.worldenergyoutlook.org/publications/weo-2010/>
- [3] United Nations Environment Programme. Global Renewable Energy Investment Powers to Record \$257 Billion. Retrieved 31st July 2012 from <http://www.unep.org/newscentre/Default.aspx?DocumentID=2688&ArticleID=9163>

**ABB Review Special Report  
Transformers  
November 2012**

#### Editorial Council

##### Prith Banerjee

Chief Technology Officer and  
Executive Vice President

##### Georg Schett

Head of Technology  
Power Products division

##### Max Claessens

Technology Manager  
Transformers business unit

##### Edoardo Siano

Marketing and Sales Manager  
Transformers business unit

##### Harmeet Bawa

Head of Communications  
Power Products and Power Systems divisions

##### Kristina Holmström-Matses

Communications Manager  
Transformers business unit

##### Anna Lewandowska

Project Coordinator  
Transformers business unit

##### Andreas Moglestue

Chief Editor, ABB Review

#### Publisher

ABB Review is published by ABB Group R&D and Technology.

ABB Technology Ltd.  
ABB Review  
Affolternstrasse 44  
CH-8050 Zurich  
Switzerland  
[abb.review@ch.abb.com](mailto:abb.review@ch.abb.com)

ABB Review is published four times a year in English, French, German, Spanish, Chinese and Russian. ABB Review is free of charge to those with an interest in ABB's technology and objectives. For a subscription, please contact your nearest ABB representative or subscribe online at [www.abb.com/abbreview](http://www.abb.com/abbreview)

Partial reprints or reproductions are permitted subject to full acknowledgement. Complete reprints require the publisher's written consent.

Publisher and copyright ©2012  
ABB Technology Ltd.  
Zurich/Switzerland

#### Printer

Vorarlberger Verlagsanstalt GmbH  
AT-6850 Dornbirn/Austria

#### Layout

DAVILLA AG  
Zurich/Switzerland

#### Disclaimer

The information contained herein reflects the views of the authors and is for informational purposes only. Readers should not act upon the information contained herein without seeking professional advice. We make publications available with the understanding that the authors are not rendering technical or other professional advice or opinions on specific facts or matters and assume no liability whatsoever in connection with their use. The companies of the ABB Group do not make any warranty or guarantee, or promise, expressed or implied, concerning the content or accuracy of the views expressed herein.

ISSN: 1013-3119

[www.abb.com/abbreview](http://www.abb.com/abbreview)

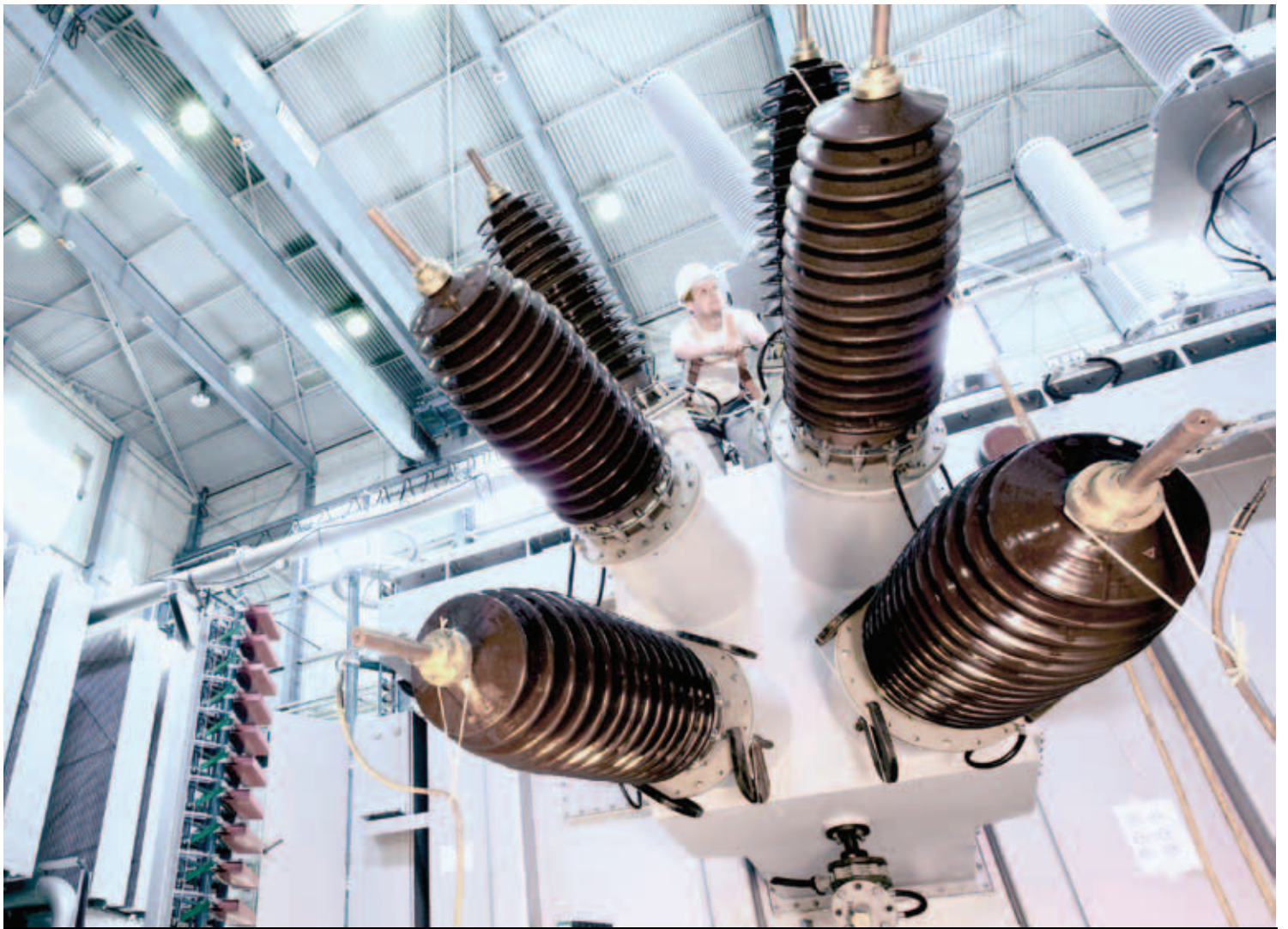

Transformer service. Lifecycle support backed by over 100 years of experience.



With over 100 years of experience and a large global installed base, we understand the value of life cycle support and total cost of ownership. We put our domain expertise and leading-edge technologies at the disposal of our customers, to help them maximize the return on their transformer assets by ensuring optimized performance, high reliability, lower life cycle costs and reduced environmental impact. ABB has over 50 transformer facilities and more than 25 service centers worldwide, offering a range of engineering solutions, condition monitoring, and preventive and predictive maintenance, off-site and on-site repair, as well as refurbishment and spare part services. [www.abb.com/transformers](http://www.abb.com/transformers)