

G500/G600

Pilot's Guide



© 2008-2018
Garmin International, Inc., or its subsidiaries
All rights reserved

Except as expressly provided herein, no part of this manual may be reproduced, copied, transmitted, disseminated, downloaded or stored in any storage medium, for any purpose without the express written permission of Garmin. Garmin hereby grants permission to download a single copy of this manual and of any revision to this manual onto a hard drive or other electronic storage medium to be viewed for personal use, provided that such electronic or printed copy of this manual or revision must contain the complete text of this copyright notice and provided further that any unauthorized commercial distribution of this manual or any revision hereto is strictly prohibited.

This manual reflects the operation of system software v7.30. Some differences in operation may be observed when comparing the information in this manual to later software versions.

SkyWatch® and Stormscope® are registered trademarks of L-3 Communications

Garmin®, FliteCharts®, and SafeTaxi® are registered trademarks of Garmin Ltd. or its subsidiaries. GDU™, SVT™, G500, and G600 are trademarks of Garmin Ltd. or its subsidiaries. These trademarks may not be used without the express permission of Garmin.

NavData® is a registered trademark of Jeppesen, Inc.; ChartView™ is a trademark of Jeppesen, Inc.

© 2018 SiriusXM Radio Inc., Sirius, XM, and all related marks and logos are trademarks of SiriusXM Radio Inc. Iridium® is a registered trademark of Iridium Communications, Inc. Canadian radar data is provided by Environment Canada. United States radar data provided by NOAA. European radar data collected and provided by Meteo France. All other marks and logos are property of their respective owners. All rights reserved.

© 2018 SD® is a registered trademark of SD-3C, LLC. All rights reserved.

Visit flyGarmin.com for aviation product support.

URL: <https://fly.garmin.com/fly-garmin/support/>

Visit Garmin's website for [aviation limited warranty](#) information.

URL: <https://www.garmin.com/en-US/legal/aviation-limited-warranty>

Software License Agreement

BY USING THE DEVICE, COMPONENT OR SYSTEM MANUFACTURED OR SOLD BY GARMIN (“THE GARMIN PRODUCT”), YOU AGREE TO BE BOUND BY THE TERMS AND CONDITIONS OF THE FOLLOWING SOFTWARE LICENSE AGREEMENT. PLEASE READ THIS AGREEMENT CAREFULLY. Garmin Ltd. and its subsidiaries (“Garmin”) grants you a limited license to use the software embedded in the Garmin Product (the “Software”) in binary executable form in the normal operation of the Garmin Product. Title, ownership rights, and intellectual property rights in and to the Software remain with Garmin and/or its third-party providers. You acknowledge that the Software is the property of Garmin and/or its third-party providers and is protected under the United States of America copyright laws and international copyright treaties. You further acknowledge that the structure, organization, and code of the Software are valuable trade secrets of Garmin and/or its third-party providers and that the Software in source code form remains a valuable trade secret of Garmin and/or its third-party providers. You agree not to reproduce, decompile, disassemble, modify, reverse assemble, reverse engineer, or reduce to human readable form the Software or any part thereof or create any derivative works based on the Software. You agree not to export or re-export the Software to any country in violation of the export control laws of the United States of America.

AOPA Airport Directory

AOPA MEMBERSHIP PUBLICATIONS, INC. AND ITS RELATED ORGANIZATIONS (HEREINAFTER COLLECTIVELY “AOPA”) EXPRESSLY DISCLAIM ALL WARRANTIES, WITH RESPECT TO THE AOPA INFORMATION INCLUDED IN THIS DATA, EXPRESS OR IMPLIED, INCLUDING, BUT NOT LIMITED TO, THE IMPLIED WARRANTIES OF MERCHANTABILITY AND FITNESS FOR A PARTICULAR PURPOSE. THE INFORMATION IS PROVIDED “AS IS” AND AOPA DOES NOT WARRANT OR MAKE ANY REPRESENTATIONS REGARDING ITS ACCURACY, RELIABILITY, OR OTHERWISE. UNDER NO CIRCUMSTANCES INCLUDING NEGLIGENCE, SHALL AOPA BE LIABLE FOR ANY INCIDENTAL, SPECIAL OR CONSEQUENTIAL DAMAGES THAT RESULT FROM THE USE OR INABILITY TO USE THE SOFTWARE OR RELATED DOCUMENTATION, EVEN IF AOPA OR AN AOPA AUTHORIZED REPRESENTATIVE HAS BEEN ADVISED OF THE POSSIBILITY OF SUCH DAMAGES. USER AGREES NOT TO SUE AOPA AND, TO THE MAXIMUM EXTENT ALLOWED BY LAW, TO RELEASE AND HOLD HARMLESS AOPA FROM ANY CAUSES OF ACTION, CLAIMS OR LOSSES RELATED TO ANY ACTUAL OR ALLEGED INACCURACIES IN THE INFORMATION. SOME JURISDICTIONS DO NOT ALLOW THE LIMITATION OR EXCLUSION OF IMPLIED WARRANTIES OR LIABILITY FOR INCIDENTAL OR CONSEQUENTIAL DAMAGES SO THE ABOVE LIMITATIONS OR EXCLUSIONS MAY NOT APPLY TO YOU.

Forward

Sec 1
System

Sec 2
PFD

Sec 3
MFD

Sec 4
Hazard
Avoidance

Sec 5
Additional
Features

Sec 6
Annun.
& Alerts

Sec 7
Symbols

Sec 8
Glossary

Appendix A

Index



WARNING: Do not use terrain avoidance displays as the sole source of information for maintaining separation from terrain and obstacles. Garmin obtains terrain and obstacle information from third party sources and cannot independently verify the accuracy of the information.



WARNING: Always refer to current aeronautical charts and NOTAMs for verification of displayed aeronautical information. Displayed aeronautical data may not incorporate the latest NOTAM information.



WARNING: Always refer to current aeronautical charts for appropriate minimum clearance altitudes. The displayed MSAs are only advisory in nature and should not be relied upon as the sole source of obstacle and terrain avoidance information.



WARNING: Do not use geometric altitude for compliance with Air Traffic Control altitude requirements. The primary barometric altimeter must be used for compliance with all Air Traffic control altitude regulations, requirements, instructions, and clearances.



WARNING: Do not use TAWS information for primary terrain or obstacle avoidance. TAWS is intended only to enhance situational awareness.



WARNING: Do not rely solely on the GDU 620 for cross-checking all redundant or correlated information available in the cockpit. Although unlikely, it may be possible for erroneous operation to occur without a fault indication shown by the GDU 620.



WARNING: Always use pressure altitude displayed by the GDU 620 PFD or other pressure altimeters in aircraft for vertical navigation. GPS altitude is geometric height above Mean Sea Level and could vary significantly from the altitude displayed by pressure altimeters or other altimeters in aircraft.



WARNING: Do not use outdated database information. Databases used in the G500/G600 systems must be updated regularly in order to ensure that the information remains current. Pilots using an outdated database do so entirely at their own risk.



WARNING: Do not use basemap information (land and water data) as the sole means of navigation. Basemap data is intended only to supplement other approved navigation data sources and should be considered only an aid to enhance situational awareness.



WARNING: Do not rely solely upon the display of traffic information for collision avoidance maneuvering. The traffic system does not provide collision avoidance resolution advisories and does not under any circumstances or conditions relieve the pilot's responsibility to see and avoid other aircraft.



WARNING: Do not use data link weather information for maneuvering in, near, or around areas of hazardous weather. Information contained within data link weather products may not accurately depict current weather conditions.



WARNING: Do not use the indicated data link weather product age to determine the age of the weather information shown by the data link weather product. Due to time delays inherent in gathering and processing weather data for data link transmission, the weather information shown by the data link weather product may be significantly older than the indicated weather product age.



WARNING: Do not rely solely upon the display of traffic information to accurately depict all of the traffic within range of the aircraft. Due to lack of equipment, poor signal reception, and/or inaccurate information from aircraft or ground stations, traffic may be present that is not represented on the display.



WARNING: Do not rely solely upon data link services to provide Temporary Flight Restriction (TFR) information. Always confirm TFR information through official sources such as Flight Service Stations or Air Traffic Control.



WARNING: Do not rely on information from a lightning detection system display as the sole basis for hazardous weather avoidance. Range limitations and interference may cause the system to display inaccurate or incomplete information. Refer to documentation from the lightning detection system manufacturer for detailed information about the system.



WARNING: Always obtain qualified instruction prior to operational use of this equipment. During flight operations, carefully compare indications from the GDU 620 to all available navigation sources, including the information from other NAVAIDs, visual sightings, charts, etc. For safety purposes, always resolve any discrepancies before continuing navigation.



WARNING: Do not exceed 200 degrees per second in pitch or roll with a GRS 77/GDC 74 installation. This may invalidate AHRS attitude provided to the GDU 620. Exceeding 450 KIAS may invalidate ADC information provided to the GDU 620. With a GSU 75/GRS 79/ GDC 72 installation, exceeding 225 degrees per second in pitch or roll may invalidate AHRS attitude provided to the GDU 620. Exceeding 435 KIAS may invalidate ADC information provided to the GDU 620.



WARNING: Do not rely on the accuracy of attitude and heading indications in geographic areas where variation in the earth's magnetic field exists. This includes: North of 72° North latitude at all longitudes; south of 70° South latitude at all longitudes; north of 65° North latitude between longitude 75° West and 120° West (Northern Canada); North of 70° North latitude and between longitude 85° East and 114° East (Northern Russia); south of 55° South latitude between longitude 120° East and 165° East (region South of Australia and New Zealand).



CAUTION: Ensure that any unit repairs are made by an authorized Garmin service center. Unauthorized repairs or modifications could void both the warranty and affect the airworthiness of the aircraft.



CAUTION: Do not clean display surfaces with abrasive cloths or cleaners containing ammonia. They will harm the anti-reflective coating.



NOTE: The United States government operates the Global Positioning System and is solely responsible for its accuracy and maintenance. The GPS system is subject to changes which could affect the accuracy and performance of all GPS equipment. Portions of the system utilize GPS as a precision electronic NAVAID. Therefore, as with all NAVAIDs, information presented by the system can be misused or misinterpreted and become unsafe.



NOTE: Interference from GPS repeaters operating inside nearby hangars can cause an intermittent loss of attitude and heading displays while the aircraft is on the ground. Moving the aircraft more than 100 feet away from the source of the interference should alleviate the condition.



NOTE: All visual depictions contained within this document, including screen images of the system panel and displays, are subject to change and may not reflect the most current system and aviation databases. Depictions of equipment may differ slightly from the actual equipment.



NOTE: This device complies with Part 15 of the FCC Rules. Operation is subject to the following two conditions: (1) this device may not cause harmful interference, and (2) this device must accept any interference received, including interference that may cause undesired operation.



NOTE: Terrain data is not displayed when the aircraft latitude is greater than 75° North or 60° South.



NOTE: This product, its packaging, and its components contain chemicals known to the State of California to cause cancer, birth defects, or reproductive harm. This notice is being provided in accordance with California's Proposition 65. If you have any questions or would like additional information, please refer to our website at www.garmin.com/prop65.



NOTE: Do not use SafeTaxi, FliteCharts, or Chartview functions as the basis for ground maneuvering. SafeTaxi, FliteCharts, and Chartview functions have not been qualified to be used as an airport moving map display (AMMD). SafeTaxi, FliteCharts, and Chartview are intended to improve pilot situational awareness during ground operations and should only be used by the flight crew to orient themselves on the airport surface.



NOTE: The FAA has asked Garmin to remind pilots who fly with Garmin database-dependent avionics of the following:

- It is the pilot's responsibility to remain familiar with all FAA regulatory and advisory guidance and information related to the use of databases in the National Airspace System.
- Garmin equipment will only recognize and use databases that are obtained from Garmin or Jeppesen. Databases obtained from Garmin or Jeppesen that have a Type 2 LOA from the FAA are assured compliance with all data quality requirements (DQRs). A copy of the Type 2 LOA is available for each applicable database and can be viewed at flyGarmin.com by selecting "Aviation Database Declarations."
- Use of a current Garmin or Jeppesen database in your Garmin equipment is required for compliance with established FAA regulatory guidance, but does not constitute authorization to fly any and all terminal procedures that may be presented by the system. It is the pilot's responsibility to operate in accordance with established AFM(S) and regulatory guidance or limitations as applicable to the pilot, the aircraft, and installed equipment.

Sec 1
System

Sec 2
PFD

Sec 3
MFD

Sec 4
Hazard
Avoidance

Sec 5
Additional
Features

Sec 6
Annun.
& Alerts

Sec 7
Symbols

Sec 8
Glossary

Appendix A

Index

Record of Revisions		
Revision	Date	Description
K	08/2018	Update reflects software v7.30 upgrade.
J	11/2016	Update reflects software v7.12 upgrade.
H	03/2015	Update reflects software v7.10 upgrade.
G	02/2015	Update reflects software v7.00 upgrade.
F	10/2012	Update reflects software v6.11 upgrade.
E	08/2011	Update reflects software v6.00 uprade.
D	11/2010	Update reflects software v4.00 and v5.00 upgrades.
C	04/2009	Update reflects software v3.0 upgrade.
B	07/2008	Update includes various content edits.
A	06/2008	Product release.

Forward
 System Sec 1
 PFD Sec 2
 MFD Sec 3
 Hazard Avoidance Sec 4

Change Description	
Page	Description
1-13	Added section 1.1.2.9 "GFC 500/600" section.
1-22	Updated figure 1-23 "System Setup Page" in section 1.4.4 "System Settings."
1-23	Added CDI/VDI Preview category to table 1-4 "Display Units Settings (System Setup Page)" in section 1.4.4 "System Settings."
2-7	Added figure 2-9 "Selected Airspeed Bug" and description to section 2.2 "Airspeed Indicator."
2-15	Added Altitude alerter description and VNAV Altitude Constraint to figure 2-21 "Altimeter" in section 2.4.1 "Setting the Altitude Bug and Alerter."
2-17	Added section 2.4.3 "VNAV Altitude Constraints (Software v7.30 or Later)."
2-19	Updated Minimums box cyan text description in section 2.4.5 "Minimum Descent Altitude/Decision Height Alerting."

Additional Features Sec 5
 Annun. & Alerts Sec 6
 Symbols Sec 7
 Glossary Sec 8
 Appendix A
 Index

Foreword	2-21	Added Required Vertical Speed to figure 2-26 "Vertical Speed Tape and Window" in section 2.5 "Vertical Speed Indicator."
	2-25	Added section 2.7.1 "CDI Preview."
Sec 1 System	2-28	Added figure 2-36 "Vertical Deviation Indicator (VNAV)" and description to section 2.7.4 "Vertical Deviation Indicator."
	2-29	Added figure 2-37 "VDI Preview" and description to section 2.7.4 "Vertical Deviation Indicator."
Sec 2 PFD	3-16	Updated description of Selected Altitude Range Arc in section 3.1.10 "Map Setup."
	3-32	Added section 3.2.1.5 "CDI/VDI Preview."
Sec 3 MFD	4-52	Added description of ADS-B Traffic map page display orientation to section 4.6.4.2 "Status."
	5-36	Added section 5.4.7.1 "GFC 500/600."
Sec 4 Hazard Avoidance	5-38	Added section 5.4.8 "Electronic Stability & Protection (ESP)."
	6-6	Added "ESP Fail" Alert message to table 6-1 "Alert Messages."
Sec 5 Additional Features	6-11	Added "SD Card 1" and "SD Card 2" alert messages to table 6-1 "Alert Messages."
	6-13	Added "TAS/TCAS has failed" and "Traffic device is inoperative or connection to GDU is lost" to "TRAFFIC" Alert Message in table 6-1 "Alert Messages."
		Added "USP" alert message to table 6-1 "Alert Messages."
Sec 6 Annun. & Alerts	7-1	Added "User Waypoint" and "New User Airport" symbols to table 7-1 "Map Page Symbols."
Sec 7 Symbols		
Sec 8 Glossary		
Appendix A		
Index		

Contents

1	System Overview	1-1	
1.1	System Description	1-1	
1.1.1	Standard System Line Replaceable Units	1-3	System
1.1.2	Optional Line Replaceable Units.....	1-10	
1.2	System Power Up	1-14	
1.3	International Geomagnetic Reference Field.....	1-16	PFD
1.4	System Operation.....	1-17	
1.4.1	Pilot Controls	1-17	
1.4.2	Using the Soft Key Controls	1-21	
1.4.3	Using the Page Menus.....	1-21	MFD
1.4.4	System Settings	1-22	
1.4.5	Display Backlighting	1-25	
2	Primary Flight Display	2-1	
2.1	PFD Soft Keys.....	2-2	
2.2	Airspeed Indicator.....	2-5	
2.2.1	Markings.....	2-8	Additional Features
2.2.2	Reference Speeds	2-9	
2.3	Attitude Indicator.....	2-10	
2.3.1	Extreme Attitude	2-12	Annun. & Alerts
2.4	Altimeter	2-14	
2.4.1	Setting the Altitude Bug and Alerter	2-15	
2.4.2	Altitude Alerting.....	2-16	
2.4.3	VNAV Altitude Constraints (Software v7.30 or Later)	2-17	Symbols
2.4.4	Changing Barometric Setting	2-18	
2.4.5	Minimum Descent Altitude/Decision Height Alerting	2-19	
2.5	Vertical Speed Indicator.....	2-21	Glossary
2.6	Horizontal Situation Indicator	2-22	
2.6.1	Setting the Heading Bug.....	2-23	
2.6.2	Turn Rate Indicator	2-24	Appendix A
2.7	Course Deviation Indicator	2-25	
2.7.1	CDI Preview	2-25	
2.7.2	Changing CDI Sources.....	2-26	
2.7.3	Changing CDI Course	2-27	Index
2.7.4	Vertical Deviation Indicator.....	2-27	

2.7.5	Auto-Slewing	2-29
2.8	Supplemental Flight Data	2-32
2.8.1	Bearing Pointers	2-32
2.8.2	Temperature Display	2-33
2.8.3	Wind Vectors	2-34
2.8.4	DME Indication.....	2-34
2.8.5	Marker Beacon Annunciations.....	2-35
2.8.6	Miscompare Annunciations.....	2-35
2.9	Radar Altimeter.....	2-37
2.10	Fast/Slow Indication.....	2-39
2.11	PFD Units	2-39
3	Multi-Function Display.....	3-1
3.1	Navigation Map Pages	3-2
3.1.1	Default Navigation Map Page	3-3
3.1.2	Map Overlay Icons.....	3-3
3.1.3	Selecting Page Options	3-4
3.1.4	Changing the Navigation Map Range	3-4
3.1.5	Decluttering Map Pages.....	3-4
3.1.6	Panning	3-6
3.1.7	Selecting Items on the Map	3-7
3.1.8	Measuring Distances	3-7
3.1.9	Customizing Navigation Map Pages.....	3-8
3.1.10	Map Setup	3-8
3.1.11	Split Screen (Optional).....	3-26
3.2	Aux Mode Pages.....	3-27
3.2.1	System Settings	3-27
3.2.2	SiriusXM Information (Optional).....	3-39
3.2.3	SiriusXM Entertainment Radio (Optional)	3-40
3.2.4	System Status.....	3-41
3.2.5	ADS-B/FIS-B Status (Optional).....	3-48
3.2.6	External Video (Optional)	3-49
3.2.7	Position Reporting (Optional).....	3-54
3.2.8	Iridium Phone Operation (Optional).....	3-57
3.3	Flight Plan Pages	3-65
3.3.1	Active Flight Plan Page	3-65
3.3.2	Waypoint Information Page	3-68
3.3.3	Charts Page (Optional)	3-75

4	Hazard Avoidance	4-1	
4.1	Terrain Configurations.....	4-2	Forward
4.1.1	Terrain System Self-Test	4-3	
4.2	Terrain Proximity	4-5	System Sec 1
4.2.1	Terrain Proximity Limitations	4-5	
4.2.2	Terrain System Status.....	4-5	
4.2.3	Displaying Terrain Proximity	4-6	PF/D Sec 2
4.2.4	Terrain Proximity Symbols	4-10	
4.3	Terrain Awareness and Warning System (Optional).....	4-12	
4.3.1	TAWS-B Requirements.....	4-12	
4.3.2	TAWS-B Limitations	4-12	MFD Sec 3
4.3.3	TAWS Self-Test	4-13	
4.3.4	TAWS Page	4-14	
4.3.5	TAWS Alerts	4-17	
4.3.6	TAWS System Status.....	4-25	Hazard Avoidance Sec 4
4.4	External TAWS	4-26	
4.5	Terrain-SVT	4-27	Additional Features Sec 5
4.5.1	Terrain-SVT Page 120° Arc or 360° Rings.....	4-28	
4.5.2	Terrain-SVT Page Aviation Data.....	4-29	
4.5.3	Inhibiting/Enabling Terrain-SVT Alerting.....	4-29	
4.5.4	Synthetic Vision Alerts and Annunciations.....	4-30	
4.6	Traffic Systems	4-32	Annun. & Alerts Sec 6
4.6.2	TAS/TCAS 1 Traffic (Optional).....	4-34	
4.6.3	TIS Traffic (Optional)	4-40	
4.6.4	ADS-B Traffic (Optional)	4-49	
4.7	SiriusXM WX Satellite Weather (Optional).....	4-54	Symbols Sec 7
4.7.1	Using SiriusXM WX Satellite Weather Products	4-55	
4.7.2	Customizing the SiriusXM WX Satellite Weather Map.....	4-56	Glossary Sec 8
4.7.3	SiriusXM WX Weather Symbols and Product Age	4-58	
4.7.4	SiriusXM Weather Legends	4-60	
4.7.5	SiriusXM NEXRAD	4-61	Appendix A
4.7.6	XM Weather Page Map Orientation.....	4-64	
4.7.7	NEXRAD Data Viewing Range.....	4-65	
4.7.8	NEXRAD Legend.....	4-65	
4.7.9	NEXRAD Source	4-66	
4.7.10	XM Echo Tops	4-67	
4.7.11	XM Cloud Tops.....	4-69	
			Index

4.7.12	XM WX Satellite Lightning	4-71
4.7.13	XM SIGMETs and AIRMETs	4-72
4.7.14	XM PIREPs	4-74
4.7.15	XM METARs	4-75
4.7.16	XM Winds Aloft	4-77
4.7.17	XM Surface Analysis and City Forecast	4-79
4.7.18	XM County Warnings.....	4-81
4.7.20	XM Cell Movement.....	4-84
4.7.21	XM AIREPs	4-85
4.7.22	XM Cyclone.....	4-87
4.7.23	XM Freezing Level	4-88
4.7.24	XM Icing	4-89
4.7.25	XM Turbulence	4-90
4.8	Weather Radar.....	4-91
4.8.1	Garmin Weather Radar Description	4-91
4.8.2	Radar Signal Reflectivity	4-97
4.8.3	Operating Distance.....	4-99
4.8.4	Basic Antenna Tilt Setup	4-100
4.8.5	Weather Mapping and Interpretation	4-101
4.8.6	Radar Operation in Weather Mode.....	4-105
4.8.7	Ground Mapping and Interpretation	4-115
4.9	Garmin Connex Satellite Services (Optional)	4-116
4.9.1	Connex Weather Registration	4-117
4.9.2	Using Weather Products	4-118
4.9.3	Customizing the Weather Map.....	4-118
4.9.4	Data Request	4-120
4.9.5	Weather Page Map Orientation.....	4-125
4.9.6	Precipitation Data Viewing Range	4-126
4.9.7	PRECIP Legend.....	4-127
4.9.8	Infrared Satellite Data Viewing Range	4-128
4.9.9	Data Link Lightning Viewing Range.....	4-129
4.9.10	SIGMETs and AIRMETs	4-130
4.9.11	AIREP/PIREP	4-132
4.9.12	METARs	4-134
4.9.13	Winds Aloft	4-137
4.9.14	TFRs.....	4-139
4.10	FIS-B Weather (Optional).....	4-140

4.10.1	NEXRAD Abnormalities.....	4-141	
4.10.2	NEXRAD Limitations.....	4-141	
4.10.3	NEXRAD Intensity.....	4-141	
4.10.4	NEXRAD.....	4-142	
4.10.5	NEXRAD Weather Setup.....	4-142	
4.11	StormScope.....	4-157	
5	Additional Features (Optional).....	5-1	
5.1	FliteCharts and ChartView.....	5-2	
5.1.1	ChartView (Optional).....	5-3	
5.1.2	FliteCharts.....	5-4	
5.1.3	Determining Chart Database Type, Coverage, and Currency....	5-5	
5.1.4	Selecting a Chart.....	5-7	
5.1.5	Using Charts.....	5-11	
5.2	SafeTaxi.....	5-18	
5.2.1	Using SafeTaxi.....	5-19	
5.2.2	SafeTaxi Cycle Number and Revision.....	5-21	
5.3	SiriusXM Satellite Radio Entertainment.....	5-22	
5.3.1	Activating SiriusXM Satellite Radio Services.....	5-22	
5.3.2	SiriusXM Satellite Radio Information.....	5-24	
5.3.3	SiriusXM Satellite Radio Entertainment.....	5-25	
5.3.4	GDL 69/69A Data Link Receiver Troubleshooting.....	5-30	
5.4	Autopilot Operation.....	5-31	
5.4.1	GAD 43 Attitude.....	5-31	
5.4.2	Heading.....	5-32	
5.4.3	Altitude Capture (Optional Upgrade).....	5-32	
5.4.4	Autopilot Navigation.....	5-33	
5.4.5	Flight Director Display.....	5-34	
5.4.6	Vertical Speed Control.....	5-35	
5.4.7	Autopilot Mode Annunciations.....	5-36	
5.4.8	Electronic Stability & Protection (ESP™).....	5-38	
5.5	Synthetic Vision Technology (Optional).....	5-40	
5.5.1	SVT Operation.....	5-41	
5.5.2	Activating and Deactivating SVT.....	5-42	
5.5.3	SVT Features.....	5-43	
6	Annunciations and Alerts.....	6-1	
6.1	Alerts.....	6-1	
6.2	System Status.....	6-15	

	7	Symbols.....	7-1
	7.1	Map Page Symbols.....	7-1
	7.2	SafeTaxi Symbols.....	7-2
	7.3	Traffic Symbols.....	7-2
	7.4	Basemap Symbols.....	7-4
	7.5	Map Tool Bar Symbols.....	7-5
	7.6	Ownship Symbols.....	7-6
	7.7	Miscellaneous Symbols.....	7-7
	8	Glossary.....	8-1
		Appendix A.....	A-1
	A1	SD Card Use and Databases.....	A-1
	A.1.1	Aviation Databases.....	A-3
	A.1.2	Garmin Databases.....	A-5
		Index.....	B-1

Foreword

 Sec 1
System

 Sec 2
PFD

 Sec 3
MFD

 Sec 4
Hazard
Avoidance

 Sec 5
Additional
Features

 Sec 6
Annun.
& Alerts

 Sec 7
Symbols

 Sec 8
Glossary

Appendix A

Index

1 SYSTEM OVERVIEW

1.1 System Description

This section provides an overview of the G500/G600 Avionics Display System. The G500/G600 system is an integrated display system that presents primary flight instrumentation, navigation, and a moving map to the pilot through large-format displays.

In normal operating mode, the Primary Flight Display (PFD) presents graphical flight instrumentation (attitude, heading, airspeed, altitude, vertical speed), replacing the traditional flight instrument cluster. The Multi-Function Display (MFD) normally displays a full-color moving map with navigation information, as well as supplemental data.

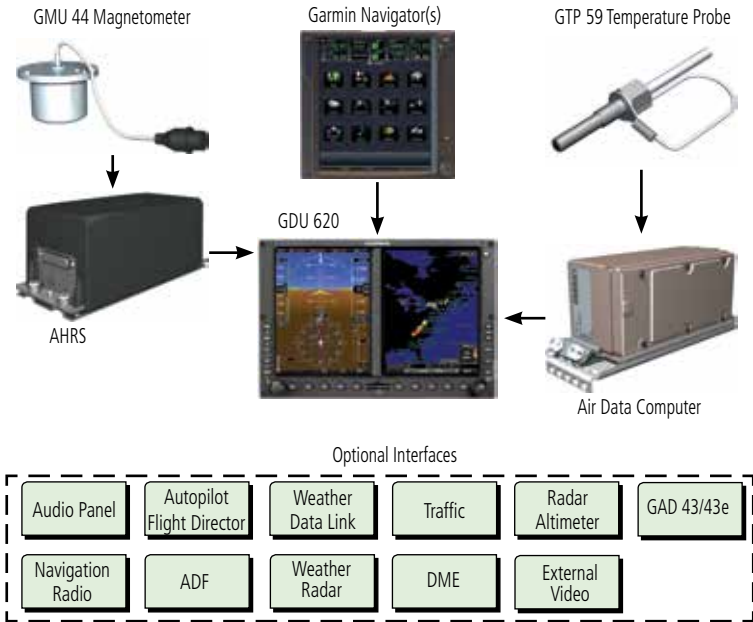

Figure 1-1 G500/G600 System (LRU Configuration)

The system consists of the following Line Replaceable Units (LRUs):

- **GDU 620** Primary Flight Display (PFD) and Multi Function Display (MFD)
- **Air Data Computer** (ADC)
- **Attitude and Heading Reference System** (AHRS)
- **Temperature Probe** (such as the GTP 59)
- **GMU 44** Magnetometer
- At least one of the following: **GNS 480**, **CNX80**, **GNS 400W series**, **GNS 500W series**, **GTN 600 series**, **GTN 700 series**, or a compatible GPS Navigator

Interfaces to various other aircraft systems and equipment are supported, including:

- **GAD 43/43e** Adapter
- **GDL 69/69A** Satellite Data Link Receiver
- **GDL 88 / GTX 345** ADS-B Transceiver
- **GSR 56** Satellite Data Link Receiver
- **NAV/COM** - Garmin GTR/GNC or SL30 NAV/COM radios, or selected third-party radios
- **Autopilot/Flight Director**
- **ADF**
- **Garmin GTS or GTX** traffic awareness systems, or selected third-party devices
- **Audio Panel**
- **Garmin GWX** radar systems or selected third-party radars
- **Radar Altimeter**
- **Video Sources**
- **Stormscope**

System Feature	G500	G600
Approved for Class 1 Aircraft (typically piston singles under 6,000 lbs.)	Yes	Yes
Approved for Class 2 Aircraft (typically piston twins and turbine aircraft under 6,000 lbs.)	Yes	Yes/No
Approved for Class 3 Aircraft (typically piston or turbine aircraft between 6,000 lbs. and 12,500 lbs.)	No	Yes
Software design assurance level	Level C	Level B
Garmin SVT Synthetic Vision Technology	Optional	Standard
GAD 43/43e replaces old A/P gyro attitude with AHRS references; GAD 43e adds additional interfaces with other avionics	Optional	Standard
GWX 68/70 Radar interface (radar LRU sold separately)	Optional	Standard
Interface support for other ARINC 708 radars	Optional	Optional
RVSM capable on select aircraft	No	Optional
Internal TAWS-B terrain alerting	No	Optional

Table 1-1 G500/G600 System Comparison

1.1.1 Standard System Line Replaceable Units

This guide covers the operation of the GDU 620 display as integrated in the G500/G600 system. The G500/G600 Avionics Display System is an avionics suite designed to replace the traditional flight instrument cluster. The system combines primary flight instrumentation, navigational information, and a moving map all displayed on dual color screens. The G500/G600 system is composed of sub-units or Line Replaceable Units (LRUs). LRUs have a modular design and can be installed directly behind the instrument panel or in a separate avionics bay if desired. This design greatly eases troubleshooting and maintenance of the G500/G600 system. A failure or problem can be isolated to a particular LRU, which can be replaced quickly and easily. Each LRU has a particular function, or set of functions, that contributes to the system's operation.

Foreword

Sec 1
System

Sec 2
PFD

Sec 3
MFD

Sec 4
Hazard
Avoidance

Sec 5
Additional
Features

Sec 6
Annun.
& Alerts

Sec 7
Symbols

Sec 8
Glossary

Appendix A

Index

1.1.1.1 GDU 620

Foreword

Sec 1
System

The GDU 620 has dual VGA (640 x 480 pixels) 6.5 inch LCD displays. The left side of the GDU is a PFD and the right side is the MFD. In some models or installations, the PFD and MFD and their controls are switched to the other side. The MFD shows a moving map, flight plan, weather, and other supplemental data. The PFD shows primary flight information, in place of traditional Pitot-static and gyroscopic systems and also provides an Horizontal Situation Indicator (HSI) for navigation.

Sec 2
PFD

Sec 3
MFD

Sec 4
Hazard
Avoidance

Sec 5
Additional
Features



Figure 1-2 GDU 620 PFD and MFD

Sec 6
Annun.
& Alerts

Sec 7
Symbols

Sec 8
Glossary



Figure 1-3 GDU 620 PFD and MFD with PFD on Right

Index

1.1.1.2 Air Data Computer

The Air Data Computer (ADC) compiles information from the Pitot-static system and an Outside Air Temperature (OAT) sensor. The ADC provides pressure altitude, airspeed, vertical speed, and OAT information to the G500/G600 system. The ADC communicates with the GDU 620 and AHRS using an ARINC 429 digital interface.



Figure 1-4 Air Data Computer

1.1.1.3 Attitude Heading Reference System



NOTE: *Aggressive maneuvering while the AHRS is not operating in normal mode may degrade AHRS accuracy.*

The Attitude and Heading Reference System (AHRS) unit provides aircraft attitude information to the G500/G600 display. The unit contains advanced accelerometers and rate sensors and interfaces with both the ADC and the GMU 44 magnetometer. The AHRS utilizes GPS data forwarded from the GDU 620. Attitude and heading information is sent to the GDU 620 using an ARINC 429 digital interface.



Figure 1-5 AHRS

The International Geomagnetic Reference Field (IGRF) model is contained in the AHRS and is updated once every five years. The IGRF model is part of the Navigation Database. At system power-up, the IGRF models in the AHRS and the Navigation Database are compared. If the IGRF model in the AHRS is out of date, the user is prompted to update. The prompt will appear after the G500/G600 start-up screen is acknowledged on the MFD.

Attitude and heading information is displayed on the PFD when the AHRS receives appropriate combinations of information from the external sensor inputs.

		AHRS Inputs			AHRS Mode	AHRS Outputs	
		GPS	Magnetometer	Air Data		Attitude	Heading
Sec 1 System	Foreword	Available	Available	Available/ Unavailable	Normal	Available	Available
	Sec 2 PFD	Available	Unavailable	Available	No Mag	Available	GPS Track
Sec 3 MFD		Available	Unavailable	Unavailable	No Air/ No Mag	Available	GPS Track
		Unavailable	Available	Available	No GPS	Available	Available
Sec 4 Hazard Avoidance		Unavailable	Unavailable	Available	No Mag	Available*/ Unavailable	Unavailable
		Unavailable	Available	Unavailable	Fail	Unavailable	Unavailable
		Unavailable	Unavailable	Unavailable	Fail	Unavailable	Unavailable

* GSU 75 only.

Table 1-2 AHRS Operation

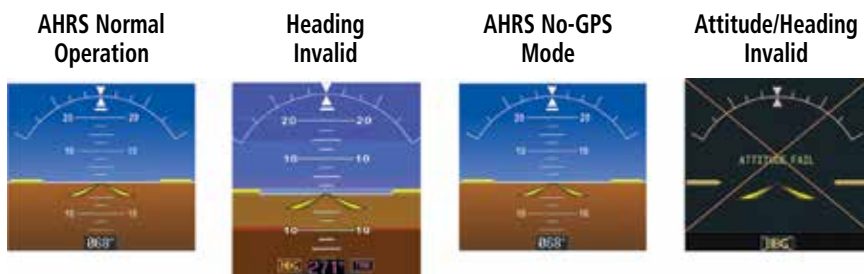

Figure 1-6 AHRS Operation

Loss of GPS, magnetometer, or air data inputs is communicated to the pilot by message advisory alerts. Refer to section 6 for specific AHRS alert information. Any failure of the internal AHRS inertial sensors results in loss of attitude and heading information. This is indicated by red “X” flags over the corresponding flight instruments.

A maximum of two GPS inputs are provided to the AHRS. If GPS information from one of the inputs fails, the AHRS uses the remaining GPS input and an alert message is issued to inform the pilot. If both GPS inputs fail, the AHRS will continue to provide attitude and heading information to the PFD as long as magnetometer and airspeed data are available and valid.

If the magnetometer input fails, the AHRS continues to output valid attitude information and GPS Track information is used. However, the PFD heading display is flagged as invalid with a red “X” and “TRK” is annunciated to the right of the Track value in magenta. The Track value color changes from white to magenta.



NOTE: *If the magnetometer fails, the magnetic standby compass and GPS ground track can be used to keep the aircraft on the desired heading.*

Map orientations change from HDG UP to TRACK UP and Map orientations will change back to HDG UP when heading is restored.

When heading fails, the heading bug is not removed and the GDU continues driving the autopilot heading error output using track in place of heading.



Figure 1-7 Track Mode shown as Active when Heading Info has failed

Failure of the air data input has no effect on the AHRS output while AHRS is receiving valid GPS information. Invalid or unavailable airspeed data, in addition to complete GPS failure, results in loss of all attitude and heading information.



NOTE: Fastest AHRS alignment is achieved with the aircraft stationary and with all AHRS inputs valid (3-D GPS position, magnetometer, and air data). During initial power up on the ground, no GPS position and/or magnetic anomalies are common. If the aircraft is taxied prior to AHRS alignment, alignment may be delayed until after a valid 3-D GPS position is available.



NOTE: During in-flight alignment of the AHRS, minimize aircraft maneuvering. The AHRS will align with shallow banking and pitch angles (less than 20 degrees of roll or 5 degrees of pitch). AHRS alignment may not be possible during more aggressive maneuvers.

Heading Considered Unreliable

When the AHRS signals that a heading is unreliable or in recovery, indications are displayed on the PFD. These indications are automatically removed once the heading alignment is corrected.



NOTE: Depending on the AHRS type and the magnitude of the heading error, the displayed indication may change directly from unreliable to reliable.

AHRS Signal	Displayed Indication
Heading unreliable	The current heading value changes from white to amber.
Heading recovery in progress	The Align Aircraft (ALN) indication appears to the left of the heading.
Heading reliable	Current heading value turns white.

Table 1-3 AHRS Signals and Indications

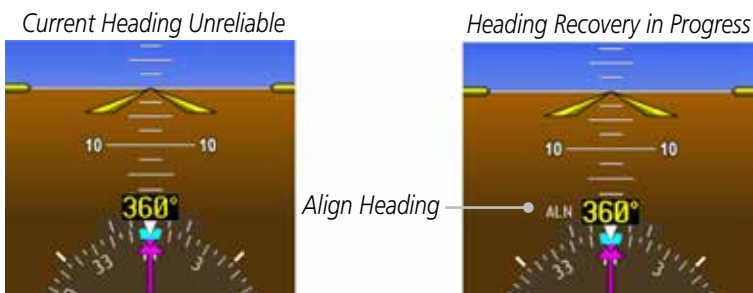

Figure 1-8 AHRS Heading Indications

1.1.1.4 GMU 44

The GMU 44 magnetometer senses the earth's magnetic field. Data is sent to the AHRS for processing to determine aircraft magnetic heading. This unit receives power directly from the AHRS and communicates with the AHRS using an RS-485 digital interface.



Figure 1-9 GMU 44 Magnetometer

1.1.1.5 GTP 59

The GTP 59 temperature probe provides Outside Air Temperature (OAT) data to the ADC.



Figure 1-10 GTP 59 Temperature Probe

1.1.1.6 Garmin Navigator Interface

The G500/G600 system requires connection to at least one external Garmin WAAS GPS navigator, such as the 400W/500W series, GTN 6XX/7XX series, or GNS 480.

1.1.2 Optional Line Replaceable Units

A variety of LRUs are available to expand and enhance the G500/G600 system.

1.1.2.1 GDL 88

The GDL 88 is a remotely mounted ADS-B transceiver. There are four models of the GDL 88. Models with a single bottom mounted UAT antenna meet TSO C154c Class A1S and are available with or without an internal GPS/SBAS receiver. Models with one top mounted and one bottom mounted antenna meet TSO C154c Class A1H and are also available with or without an internal GPS/SBAS receiver.

1.1.2.2 GTX 345

The GTX 345 is a combined mode S/ES transponder and ADS-B transceiver. Mode S/ES models have an optional internal GPS/SBAS receiver.

The GDU only displays ADS-B information, it does not control the GTX.

1.1.2.3 Weather Radar

The Garmin GWX system, or selected 3rd party radar, provides airborne weather and ground mapped radar data to the MFD.

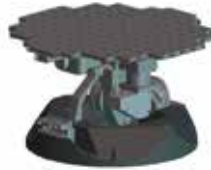

Figure 1-11 GWX 68 Weather Radar

1.1.2.4 Stormscope



NOTE: Refer to the *WX-500 Pilot's Guide* for a detailed description of the *WX-500 StormScope*.

The WX-500 StormScope Weather Mapping Sensor is a passive weather avoidance system that detects electrical discharges associated with thunderstorms within a 200 NM radius of the aircraft. The StormScope measures relative bearing and distance of thunderstorm-related electrical activity and reports the information to the display.

1.1.2.5 GSR 56

The GSR 56 is an Iridium satellite transceiver that supports voice telephone calls, SMS text messaging, aircraft position reporting, and world wide weather products.

1.1.2.6 GDL 69/69A

The GDL 69/69A is a SiriusXM Satellite Radio Data Link Receiver that receives broadcast weather data. The GDL 69A is the same as the GDL 69 with the addition of an SiriusXM Satellite Radio audio entertainment receiver. Weather data and control of audio channel and volume is displayed on the MFD, via a High-Speed Data Bus (HSDB) Ethernet connection. The GDL 69A is also interfaced to an audio panel for distribution of the audio signal. A subscription to the SiriusXM Satellite Radio Service is required to enable the GDL 69/69A capability. Subscription information is available at: <http://www.siriusxm.com/sxmaviation>.



Figure 1-12 GDL 69/69A SiriusXM Satellite Radio Data Link Receiver

1.1.2.7 GAD 43/43e

Foreword

Sec 1
System

The GAD 43 is an adapter that converts AHRS digital pitch, roll, heading and yaw rate data into analog signals used by autopilot systems. The GAD 43 is installed remotely between the AHRS and an existing autopilot. The analog signals from the GAD 43 mimic those of spinning-mass gyros that provide data to the autopilot and allow the gyro to be replaced by the AHRS and GAD 43 combination.

Sec 2
PFD

Sec 3
MFD

The GAD 43e performs the same functions as the GAD 43, but adds support for additional interfaces to various aircraft systems. The GAD 43e supports interfaces to various autopilots (for altitude preselect and vertical speed control), analog NAV radios, DME, analog radar altimeters, marker beacons, and ADF receivers.

Sec 4
Hazard
Avoidance

Sec 5
Additional
Features

Sec 6
Annun.
& Alerts



Figure 1-13 GAD 43/43e AHRS Adapter

Sec 7
Symbols

1.1.2.8 GTX 330/330D/335



NOTE: GTX 330/330D/335 can also be used to display traffic information on the GDU 620.

Sec 8
Glossary

The GTX 330/330D/335 is a solid-state transponder that provides Modes A, C, and S functions. The transponder provides traffic information to the display through an ARINC 429 digital interface. A typical GTX 330/330D Mode S Transponder is shown below.

Appendix A

Index



Figure 1-14 GTX 330/330D Mode S Transponder



CAUTION: *The GMC 605 USB port is not designed to provide power or data to external consumer devices such as smart phones, cameras, or tablet computers and should not be used in flight.*

The GFC 500 is a two axis Automatic Flight Control System (AFCS) with optional pitch trim as well as electronic stability and protection. The GFC 600 is a high performance, attitude-based AFCS that supports an extensive set of operating modes and safety features. Supported functions vary by installation. The GFC 500/600 provide the following main operating functions:

- **Flight Director (FD)** - The Flight Director function provides pitch and roll commands to guide the aircraft toward the active reference. Pitch and roll commands are displayed on the PFD as Command Bars. When the Flight Director is active, the pitch and roll commands can be hand-flown by the pilot. When the Autopilot is engaged the autopilot servos drive the flight controls to follow the commands issued by the Flight Director.
- **Autopilot (AP)** - The autopilot function is provided by servo actuators which move the flight control surfaces in response to Flight Director steering commands, aircraft attitude, and airspeed. The optional pitch auto-trim function relieves any sustained effort required by the pitch servo to keep the aircraft in trim.
- **Yaw Damper (YD)** - The optional Yaw Damper function provides Dutch Roll damping, assists in turn coordination, and provides a steady force to help maintain directional trim. If installed the YD comes on when the autopilot is engaged. It can be turned on/off independent of the autopilot and may be used during normal hand-flying maneuvers.
- **Manual Electric Trim (MET)** - The optional Manual Electric Trim uses the same servo as the auto-trim function and allows the pilot to command trim via a trim switch when the autopilot is not engaged. The MET function does not preclude the use of the aircraft's basic mechanical trim system.
- **Electronic Stability & Protection (ESP)** - The ESP function provides a soft barrier to keep the aircraft within the operating envelope when the autopilot is not engaged.

1.2 System Power Up

Foreword



NOTE: See the Aircraft Flight Manual (AFM) for specific procedures concerning avionics power application and emergency power supply operation.

Sec 1
System



NOTE: Refer to section 6 for system-specific annunciations and alerts.

Sec 2
PFD

The G500/G600 System is integrated with the aircraft electrical system and receives power directly from the electrical buses. To ensure safe operation, the GDU 620 and supporting sub-systems include both power-on and continuous built-in test features that exercise the processor, memory, external inputs, and outputs.

Sec 3
MFD

During system initialization, test annunciations are displayed. All system annunciations should disappear typically within the first 30 seconds after power-up. Upon power-up, display bezel key backlights momentarily illuminate.

Sec 4
Hazard
Avoidance

On the PFD, the AHRS begins to initialize and “AHRS ALIGN: Keep Wings Level” is displayed. The AHRS should display valid attitude and heading fields typically within the first minute after power-up. The AHRS can align itself both while taxiing and during level flight.

Sec 5
Additional
Features

Sec 6
Annun.
& Alerts



NOTE: Fastest AHRS alignment is achieved with the aircraft stationary and with all AHRS inputs valid (3-D GPS position, magnetometer, and air data). During initial power up on the ground, no GPS position and/or magnetic anomalies are common. If the aircraft is taxied prior to AHRS alignment, alignment may be delayed until after a valid 3-D GPS position is available.

Sec 7
Symbols

Sec 8
Glossary



NOTE: During in-flight alignment of the AHRS, minimize aircraft maneuvering. The AHRS will align with shallow banking and pitch angles (less than 20 degrees of roll or 5 degrees of pitch). AHRS alignment may not be possible during more aggressive maneuvers.

Appendix A

Index

When the MFD powers up, the unit displays the following information:

- Software version and part number
- Basemap database version
- Terrain database version
- Obstacle database expiration date
- Aviation database expiration date
- Airport Directory database expiration date
- Chart database status

Current databases display in white. Databases display in yellow if expired, not yet effective, or current GPS date/time is unavailable.



Figure 1-15 System Start-up Pages

1.3 International Geomagnetic Reference Field

The IGRF (International Geomagnetic Reference Field) model is contained in the AHRS and is only updated once every five years. The IGRF model is part of the Navigation Database. At system power-up, the IGRF models in the AHRS and in the Navigation Database are compared, and if the IGRF model in the AHRS is out of date, the user is prompted to update the IGRF model in the AHRS. After the G500 start-up screen is acknowledged on the MFD, the following update message appears.

For GRS 77/79:

GRS MV DB UPDATE AVAILABLE:
 UPDATE AS FOLLOWS?
 yyyy to yyyy
 ###-####-## to ##-####-##

For GSU 75:

GSU AHRS MV DB UPDATE AVAILABLE:
 UPDATE AS FOLLOWS?
 yyyy to yyyy
 ###-####-## to ##-####-##

To initiate the update process, follow the on-screen instructions.

1. When the Update message appears, press the **ENT** key with "OK" highlighted. To update at another time, turn the **Large** knob to highlight "Cancel" and then press **ENT**.

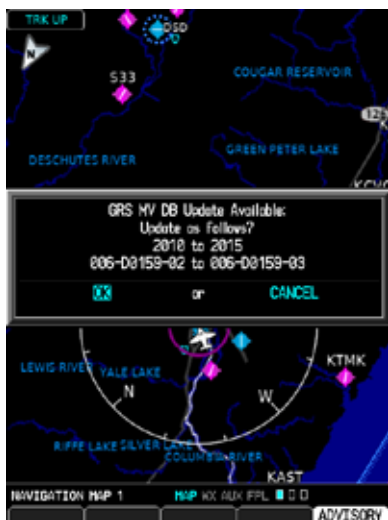

Figure 1-16 GRS MV DB Update

2. After the update is complete, press the **ENT** key to continue normal operation.

1.4 System Operation



NOTE: Refer to section 6 for detailed descriptions of all alerts and annunciations.

1.4.1 Pilot Controls

The GDU 620 controls have been designed to simplify system operation and minimize the time required to access functionality. Controls are located on the display bezels and are comprised of a PFD knob, MFD dual concentric knobs, bezel keys, and soft keys.

1.4.1.1 PFD Knob

Pressing the **PFD** knob performs the default action for the selected mode. Refer to section 1.4.1.2 for details on the PFD bezel keys.

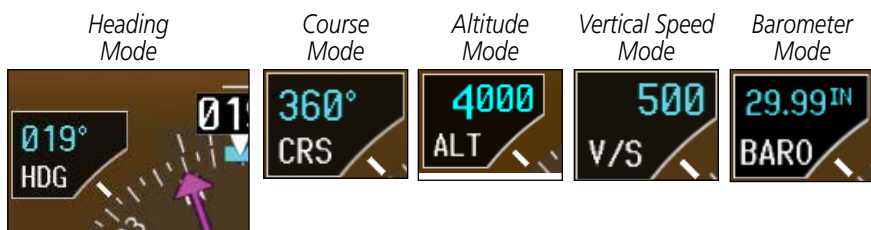

Figure 1-17 Selection Modes Adjusted with the PFD Knob



NOTE: After 10 seconds of inactivity in another mode, the **PFD** knob's selected mode reverts to Heading mode.

1. Press the desired PFD mode selection key (**HDG**, **CRS**, **ALT**, **V/S**, or **BARO**). A window will display near the HSIs upper left corner showing the current mode value.
2. Turn the **PFD** knob to select the desired value.

1.4.1.2 PFD Bezel Keys

Foreword



NOTE: See section 5.4 for autopilot functions using the PFD Bezel Keys.

Sec 1
System

Heading (HDG)

Selects Heading Select mode. This is the default mode for the **PFD** knob. Pressing the **PFD** knob in Heading mode will center the Heading Bug on the current Heading. Set the heading bug on the HSI by turning the **PFD** knob after pressing the **HDG** key.

Sec 2
PFD

Course (CRS)

Selects Course Select mode. Pressing the **PFD** knob in Course mode will center the CDI for a VOR or GPS OBS course.

Sec 3
MFD

Altimeter (ALT)

Selects Altitude Select mode. Pressing the **PFD** knob in Altitude Select mode will enter the current altitude in the Altitude Select window. Set the Altitude Bug by turning the **PFD** knob after pressing the **ALT** key.

Sec 4
Hazard
Avoidance

Sec 5
Additional
Features

Sec 6
Annun.
& Alerts

Sec 7
Symbols

Sec 8
Glossary

Appendix A

Index

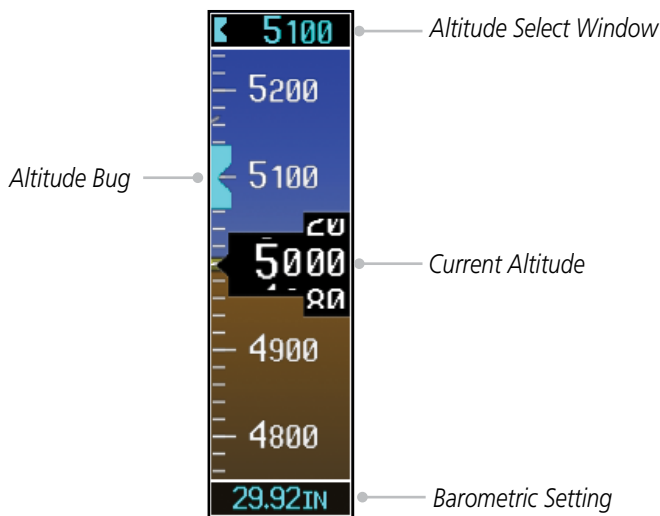

Figure 1-18 Pressing PFD Knob Sets Altitude Select to Current Altitude

Vertical Speed (V/S)

Selects Vertical Speed (V/S) mode. Pressing the **PFD** knob in V/S mode will synchronize the bug to the current vertical speed.

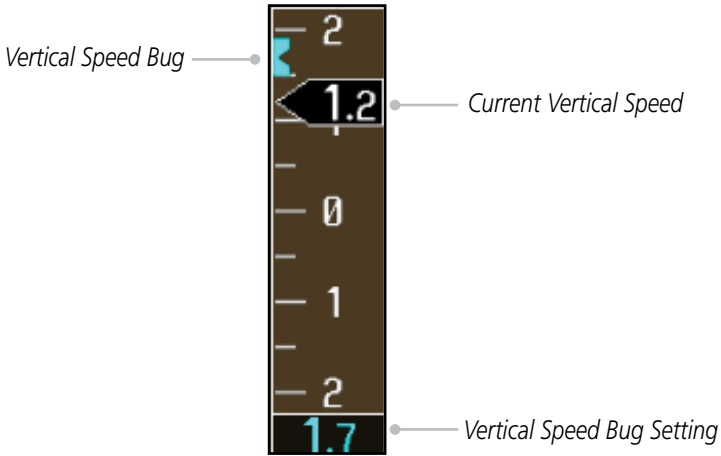

Figure 1-19 Pressing V/S Knob Sets Vertical Speed Bug to Current Vertical Speed

For aircraft with vertical speed operating limitations, red bands showing Vertical Speed Maximum and Minimum ranges will be shown on the left side of the Vertical Speed tape. When the Vertical Speed Indicator value exceeds one of its limits, the background color of the Vertical Speed Indicator will turn red.

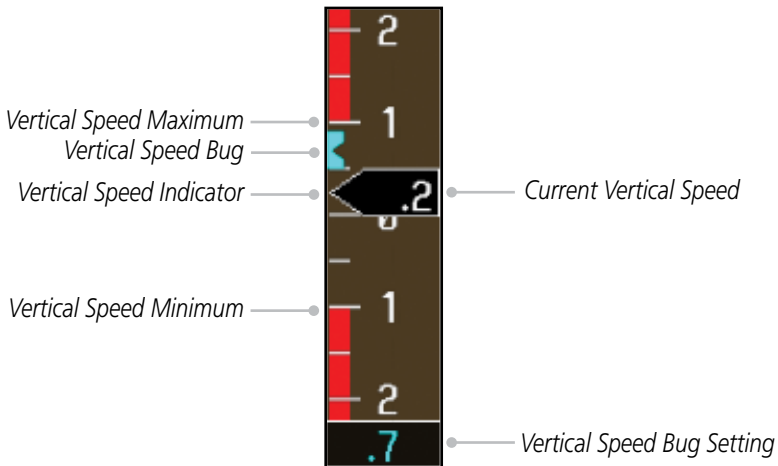

Figure 1-20 Vertical Speed Warning Indication

Barometer (BARO)

Foreword

Selects Barometric Setting Select mode. Pressing the **PFD** knob in Baro mode toggles between standard pressure (29.92 in/1013 mb) and the previously selected value.

Sec 1
System

1.4.1.3 MFD Knobs

The **MFD** knobs are for navigating and selecting information on the MFD pages. More details are provided in the MFD section.

Sec 2
PFD

Small (Inner) MFD Knob

Selects a specific page within a page group. Pressing the small **MFD** knob turns the selection cursor ON and OFF. When the cursor is ON, data may be entered in the applicable window by turning the small and large **MFD** knobs. In this case, the large **MFD** knob moves the cursor on the page and the small **MFD** knob selects individual characters or values for the highlighted cursor location.

Sec 3
MFD

Large (Outer) MFD Knob

Selects the MFD page group. When the cursor is ON, the large **MFD** knob moves the cursor to highlight available fields.

Sec 4
Hazard
Avoidance

Sec 5
Additional
Features

1.4.1.4 MFD Bezel Keys

Range (RNG)

Pressing the Range arrow keys changes the range on the Map pages. The Up arrow zooms out. The Down arrow zooms in. The keys also aid in scrolling up and down text pages.

Sec 6
Annun.
& Alerts

Sec 7
Symbols

Menu

Displays a context-sensitive list of options. This list allows the user to access additional features or make setting changes that relate to particular pages.

Sec 8
Glossary

Enter (ENT)

Validates or confirms a menu selection or data entry.

Appendix A

Clear (CLR)

Erases information, cancels entries, or removes page menus. Pressing and holding the **CLR** key displays the Navigation Map 1 page.

Index

1.4.2 Using the Soft Key Controls

The soft keys are located along the bottoms of the displays. The soft key labels shown depend on the soft key level or page being displayed. The bezel keys below the soft keys can be used to select the appropriate soft key.

MFD functions indicated by the soft key labels vary depending on the page selected and are located at the bottom of the MFD display. Press the soft key located directly below the soft key label. To select the function indicated on the soft key label, press the soft key directly below the label.

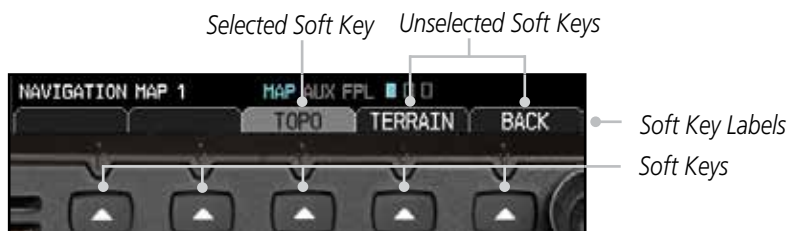

Figure 1-21 MFD Soft Key Layout

1.4.3 Using the Page Menus

The GDU 620 has a dedicated **MENU** key that when pressed displays a context-sensitive list of options for functions in the MFD. This options list allows the user to access additional features or make settings changes which specifically relate to the currently displayed window/page. There is no all-encompassing menu. Some menus provide access to additional submenus that are used to view, edit, select, and review options. Menus display “No Options” when there are no options for the window/page selected. Soft key presses do not display menus or submenus.

Navigating within a Menu

1. Press the **MENU** key to display the menu.
2. Turn the small or large **MFD** knob to scroll through a list of available options (a scroll bar always appears to the right of the window/box when the option list is longer than the window/box).
3. Press the **ENT** key to select the desired option.
4. Press the **CLR** key or **MFD** knob to remove the menu and cancel the operation.

No Options Available



Options for MAP Window



Figure 1-22 Page Menu Examples

1.4.4 System Settings

G500/G600 system settings are managed from the Aux Mode System Setup Page. For details on changing settings, refer to section 3.

1. From the first AUX page, press the small **MFD** knob and turn the large **MFD** knob to highlight the desired value.
2. Turn the small **MFD** knob to select "ON" or "OFF."
3. Press **ENTER** to save the setting.

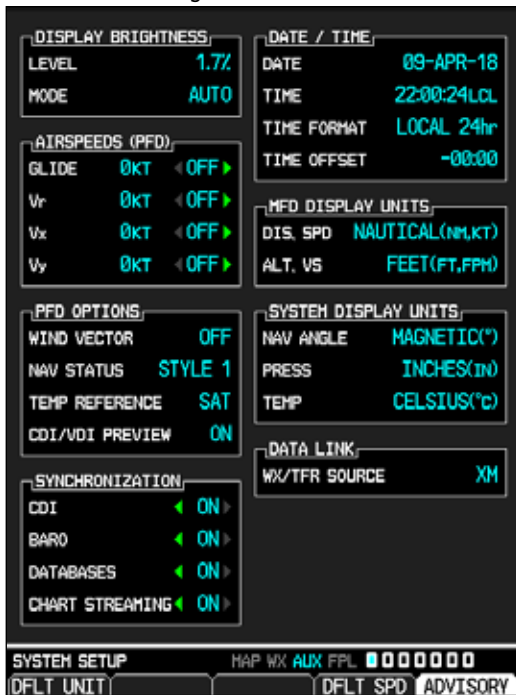

Figure 1-23 System Setup Page

Category	Settings	Affected Quantities	Exceptions
Display Brightness	Level Mode	Brightness levels on the PFD and MFD	
Airspeeds	Glide (or REF) VR VX (or V1) VY (or V2)	Reference markers on PFD airspeed tap	
Synchronization	CDI - On/Off BARO - On/Off Databases - On/Off Chart Streaming - On/Off	Share databases	
PFD Options (Wind Vector) (NAV Status)	Off, Style 1 - Style 4 Style 1-2	PFD wind vector display format. Location of GPS navigation data.	Nav Status option not available in all installations.
Data/Time	Date Time Time Format Time Offset		
Temperature Reference	SAT, TAT, ISA		
CDI/VDI Preview	On, Off		
Distance and Speed	Imperial (SM, MPH) Metric (KM, KPH) Nautical (NM, KT)	Bearing distances (information windows) Distance (information window) Flight plan distances Map ranges DIS field (Navigation Status Box) All distances on MFD All speeds on MFD	Airspeed Indicator True Airspeed Wind speed vector Map range (Traffic Page, Terrain Proximity Page)

Foreword

Sec 1
SystemSec 2
PFDSec 3
MFDSec 4
Hazard
AvoidanceSec 5
Additional
FeaturesSec 6
Annun.
& AlertsSec 7
SymbolsSec 8
Glossary

Appendix A

Index

Category	Settings	Affected Quantities	Exceptions
Altitude and Vertical Speed	Feet Meters	All elevations on MFD	Altimeter Vertical Speed Indicator
Navigation Angle	Magnetic (North) True (North)	Heading Course Bearing Track Desired Track	
Barometric Setting	Inches (in) Hectopascals (hpa)	Barometric pressure on PFD	
Temperature	Celsius Fahrenheit	All temperatures on PFD	
Data Link (WX/TFR Source)	XM FIS GFDS (for Connex Weather)	Select weather source.	

Table 1-4 Display Units Settings (System Setup Page)

Foreword

Sec 1
System

Sec 2
PFD

Sec 3
MFD

Sec 4
Hazard
Avoidance

Sec 5
Additional
Features

Sec 6
Annun.
& Alerts

Sec 7
Symbols

Sec 8
Glossary

Appendix A

Index

1.4.5 Display Backlighting

The backlighting of the PFD and MFD displays and bezel keys can be adjusted automatically or manually. The default setting (automatic backlighting adjustment) uses the photocell located at the top right corner of the bezel to automatically adjust for ambient lighting conditions. Photocell calibration curves are configured by the installer to optimize display appearance through a broad range of cockpit lighting conditions. Display backlighting adjustment can be manually controlled using the aircraft's existing instrument panel dimmer bus or performing the following procedures.

Backlighting Adjustment

1. From the first AUX page, press the small **MFD** knob to highlight the "DISPLAY BRIGHTNESS" "MODE" box.
2. Turn the small **MFD** knob to select the desired brightness Level and then press **ENTER**.



Manual Adjustment 0.1% to 50%
or Auto (1.7%)

Auto or Manual

Figure 1-24 Display Brightness Adjustment

3. Turn the large **MFD** knob to highlight the MODE field. Turn the small **MFD** knob to select "AUTO" or "MANUAL" and then press **ENT**.

Foreword

Sec 1
System

Sec 2
PFD

Sec 3
MFD

Sec 4
Hazard
Avoidance

Sec 5
Additional
Features

Sec 6
Annun.
& Alerts

Sec 7
Symbols

Sec 8
Glossary

Appendix A

Index

This page intentionally left blank

2 PRIMARY FLIGHT DISPLAY

Functions on the Primary Flight Display (PFD) are accessed by using the bezel keys on the side of the PFD and the soft keys below the PFD.

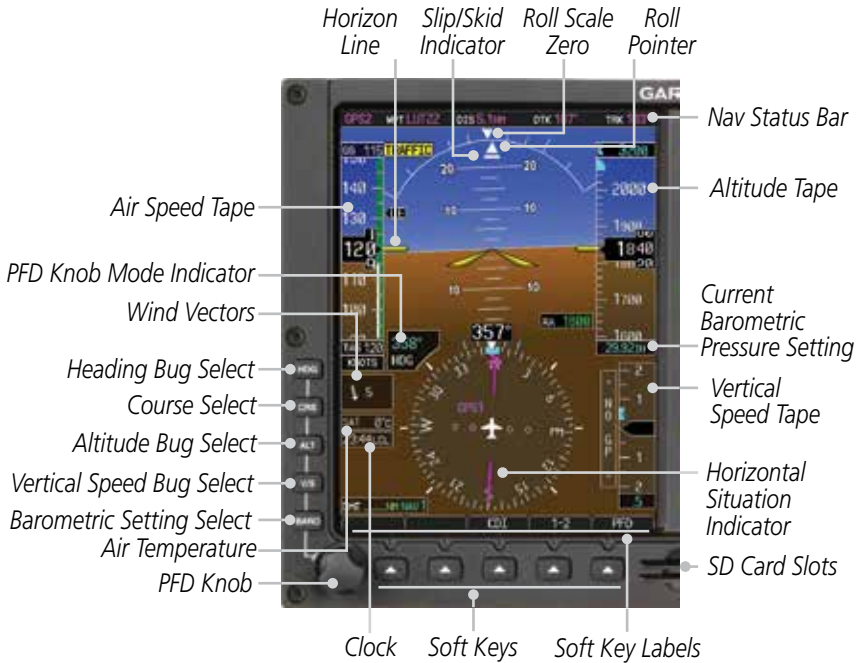

Figure 2-1 PFD Description (Ground Pointer Mode)

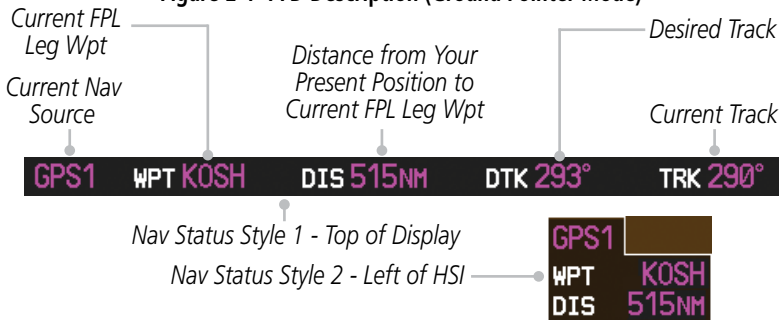

Figure 2-2 PFD Nav Status Bar Description



NOTE: When navigating to a waypoint very far away, the DTK, CRS, and TRK values displayed on the GDU 620 may differ from those displayed on the navigator, however the CDI is correct and is the primary means of navigation. This is because the GDU 620 applies magnetic variation corrections for the current aircraft location, but some navigators apply magnetic variation correction for the waypoint location.

2.1 PFD Soft Keys

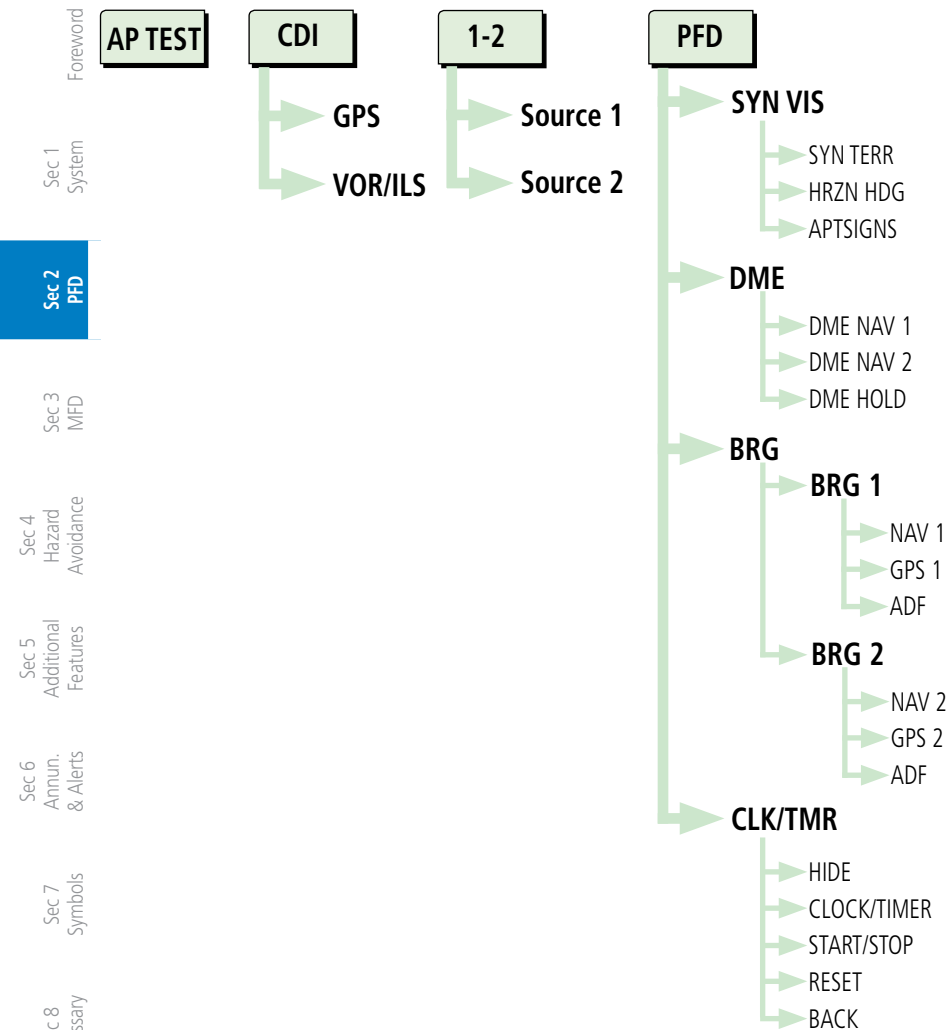

Figure 2-3 PFD Soft Key Diagram

The soft keys are located along the bottom of the displays below the soft key labels. The soft key labels shown depend on the soft key level or page being displayed. The soft keys can be used to select the appropriate soft key function.

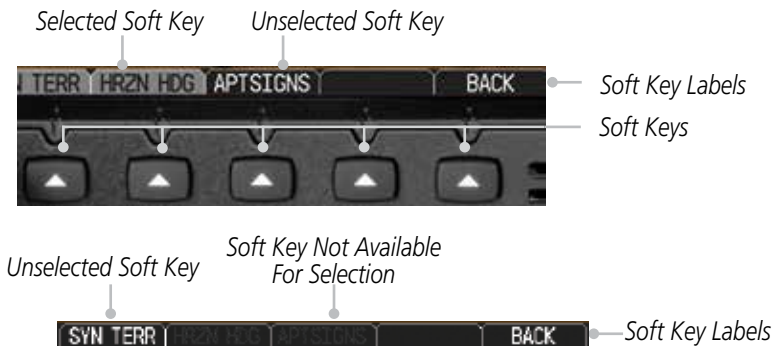

Figure 2-4 PFD Soft Key Layout

When a soft key is selected, its color changes to black text on gray background and remains this way until it is turned off, at which time it reverts to white text on black background. When a soft key function is disabled, the soft key label is subdued (dimmed).



NOTE: *If a soft key is pressed and held for longer than 1 second, it is ignored.*

AP Test

The **AP TEST** soft key is available if the GAD 43 is used to provide attitude information to an autopilot. The AP TEST soft key disengages the autopilot as part of the GAD 43 test.

CDI

The **CDI** soft key toggles between the selection of GPS or VOR/LOC as the active navigation source. In a single GDU 620 system, the GDU CDI soft key will change the source in the connected navigator and making a source change in the navigator will be reflected in the GDU 620. In a dual GDU 620 system, the CDI keys in the navigator will be disabled.

1-2

The **1-2** soft key toggles between the available receivers for selected navigation source (i.e. GPS1 and GPS2 or VOR/LOC1 and VOR/LOC2). This soft key will only be present if the system is configured for a second GPS or VOR/LOC.

Foreword

System Sec 1

PFD Sec 2

MFD Sec 3

Hazard Avoidance Sec 4

Additional Features Sec 5

Annun. & Alerts Sec 6

Symbols Sec 7

Glossary Sec 8

Appendix A

Index

PFD

Pressing the **PFD** soft key displays the **SYN VIS**, **DME**, **BRG**, and **BACK** soft keys. The **DME** and **SYN VIS** soft keys will only be present if the system is configured for these features.

BRG1

The **BRG1** soft key cycles through the available bearing 1 indicator modes (NAV1, GPS1, ADF, or None).

BRG2

The **BRG2** soft key cycles through the available bearing 2 indicator modes (NAV2, GPS2, ADF, or None). This soft key will only be present if the system is configured for a second GPS or VOR/LOC.

DME

The **DME NAV** soft keys select the DME submenu. For some installations, the **DME NAV** soft keys simply toggle the DME display on/off as the submenu options will not exist. The availability of the DME controls vary based on the installation.

The **DME NAV** soft keys select NAV 1 or 2 as the DME tuning source. If this soft key is pressed again when already selected, the DME display is removed from the PFD. Not all installations will have both NAV1 and NAV2 soft keys.

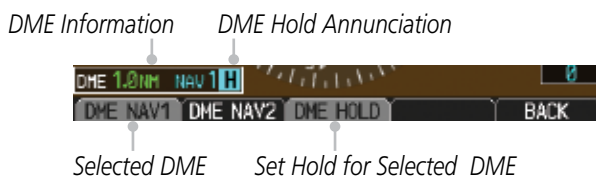

Figure 2-5 DME Soft Keys

DME HOLD

DME HOLD activates/deactivates the DME tuning hold function. DME HOLD may be selected for either DME NAV 1 or DME NAV 2. The Hold function is automatically canceled when switching between NAV1 and NAV2 tuning sources. Not all installations will have the **DME HOLD** soft key.

SYN VIS

The **SYN VIS** soft key is available if Synthetic Vision Technology is installed. It enables Synthetic Vision and displays the associated soft keys.

SYN TERR

The **SYN TERR** soft key is available if Synthetic Vision Technology is installed and enables synthetic terrain depiction.

Foreword

HRZN HDG

The **HRZN HDG** soft key is available if Synthetic Vision Technology is installed. Pressing this key enables horizon heading marks and digits.

Sec 1
System

APTSIGNS

The **APTSIGNS** soft key is available if Synthetic Vision Technology is installed and enables airport sign posts.

Sec 2
PFD

CLK/TMR

The Clock/Timer function displays a clock or timer window in the lower left corner of the PFD.

Sec 3
MFD

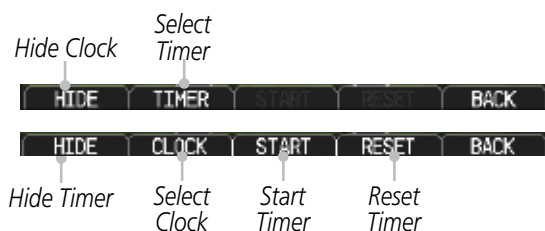

Sec 4
Hazard
Avoidance

Sec 5
Additional
Features

Figure 2-6 Clock and Timer Functions

BACK

The **BACK** soft key returns to the previous soft key menu.

Sec 6
Annun.
& Alerts

2.2 Airspeed Indicator

The Airspeed Indicator displays airspeed on a rolling number gauge using a moving tape. The numeric labels and major tick marks on the moving tape are marked at intervals of 10 units, while minor tick marks on the moving tape are indicated at intervals of five units. Speed indication starts at 20 knots, regardless of the displayed units.

Sec 7
Symbols

Sec 8
Glossary



NOTE: *Airspeed units (KTS, MPH, KPH) are configured to match the approved units for the installation.*

Appendix A

The Airspeed Indicator provides Indicated Airspeed, True Airspeed, and Ground Speed. The Airspeed Trend Indicator shows what the airspeed will be in six seconds, if the current acceleration is maintained. The actual airspeed is displayed inside the black pointer.

Index

The Airspeed Trend Vector is a vertical, pink/magenta line, extending up or down on the airspeed scale, shown to the right of the color-coded speed range strip. The end of the trend vector corresponds to the predicted airspeed in six seconds if the current acceleration is maintained. If the trend vector crosses into the overspeed range, the text of the digital airspeed readout changes to yellow. The trend vector is absent if the speed remains constant or if any data needed to calculate airspeed is not available due to a system failure.

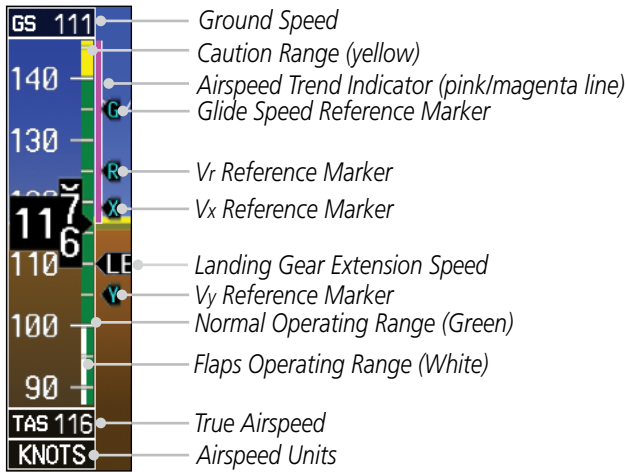

Figure 2-7 Airspeed Tape

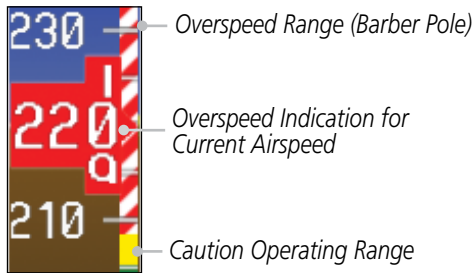

Figure 2-8 Overspeed Indication

Foreword

Sec 1
System

Sec 2
PFD

Sec 3
MFD

Sec 4
Hazard
Avoidance

Sec 5
Additional
Features

Sec 6
Annun.
& Alerts

Sec 7
Symbols

Sec 8
Glossary

Appendix A

Index

The Selected Airspeed Bug displays when IAS mode is engaged on the GFC 500/600.

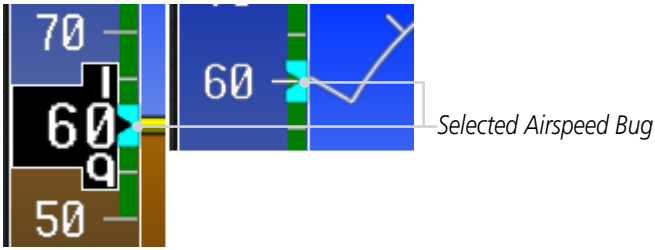

Figure 2-9 Selected Airspeed Bug

2.2.1 Markings

A color-coded (white, green, yellow, and red/white “barber pole”) speed range strip is located on the moving tape. The colors are configured to match the approved markings for the installation. Refer to the AFM/POH.

NOTE: The actual colors and patterns of the airspeed tape may vary by installation. See your AFM/POH for more details.

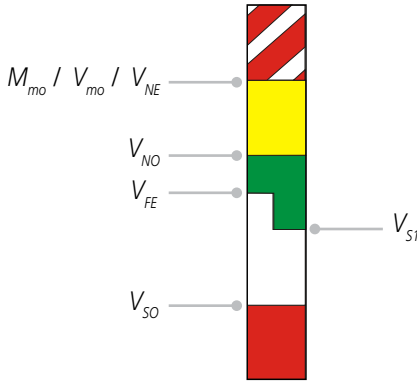

Figure 2-10 Typical Airspeed Tape Markings

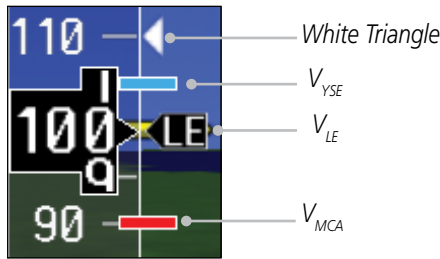

Figure 2-11 Additional Reference Markings

2.2.2 Reference Speeds

V-speeds (Glide, V_r , V_x , and V_y) default values are set during the installation process, but can be changed and turned on/off from the System Setup page on the first page of the Aux page group. When active (on), the V-speeds are displayed at their respective locations to the right of the airspeed scale.

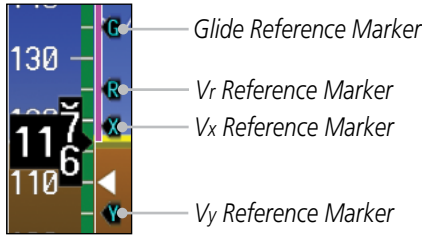

Figure 2-12 Reference Speeds

The labels for the reference markers may vary as configured during installation.

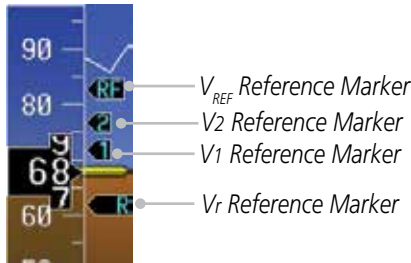

Figure 2-13 Alternate Reference Speeds

2.3 Attitude Indicator

Attitude information is displayed over a virtual blue sky and brown ground with a white horizon line. The Attitude Indicator displays pitch, roll, and slip/skid information.

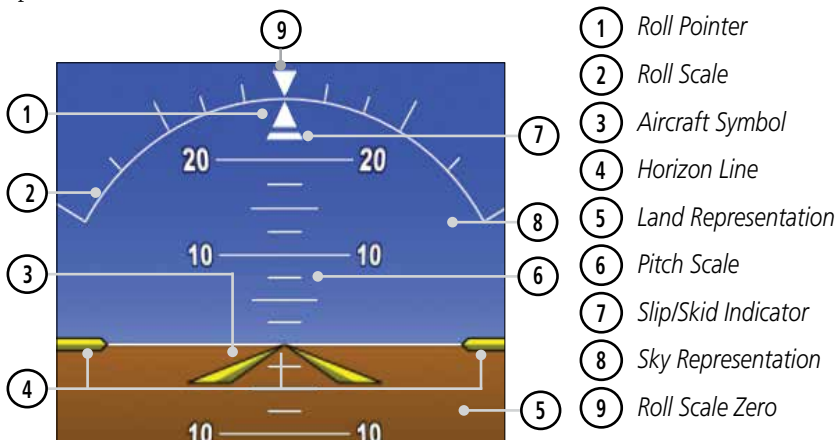

Figure 2-14 Attitude Indicator

The horizon line is part of the pitch scale. Above and below the horizon line, major pitch marks and numeric labels are shown for every 10°, up to 80°. Minor pitch marks are shown for intervening 5° increments, up to 25° below and 45° above the horizon line. Between 20° below to 20° above the horizon line, minor pitch marks occur every 2.5°.

Angle of bank is indicated by the position of the pointer on the roll scale. Major tick marks are 30° and 60° and minor tick marks are 10°, 20°, and 45° are shown to the left and right of the zero.

The Slip/Skid Indicator is the bar beneath the roll pointer. The indicator moves with the roll pointer and moves laterally away from the pointer to indicate lateral acceleration. Slip/skid is indicated by the location of the bar relative to the pointer. One bar displacement (as shown below) is equal to one ball displacement on a traditional Slip/Skid Indicator.

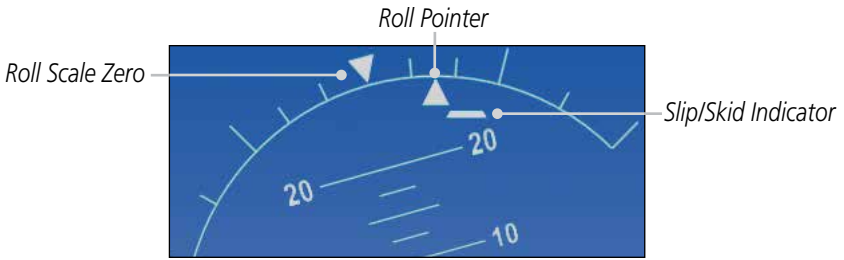

Figure 2-15 Slip/Skid Indication

The standby mechanical Attitude Indicator in your aircraft is either a Ground Pointer or a Roll Pointer configuration. The GDU 620 Attitude Indicator has been configured in either a Ground Pointer or a Roll Pointer configuration to match the configuration of your aircraft's standby Attitude Indicator. Ground/Sky Pointer mode is configured during installation and can not be changed by the pilot.

In an aircraft with an Attitude Indicator that has a Ground Pointer, the pointer above the Roll Scale shifts with the roll or bank angle of the aircraft to keep the Roll Scale Zero Pointer pointing towards the ground.



Figure 2-16 Attitude Indicator with Ground Pointer Configuration in a Left Turn

In an aircraft with an Attitude Indicator that has a Sky Pointer, the pointer below the roll scale shifts with the roll or bank angle of the aircraft to keep the Roll Pointer pointing towards the sky.



Figure 2-17 Attitude Indicator with Sky Pointer Configuration in Left Turn

Foreword

Sec 1
System

Sec 2
PFD

Sec 3
MFD

Sec 4
Hazard
Avoidance

Sec 5
Additional
Features

Sec 6
Annun.
& Alerts

Sec 7
Symbols

Sec 8
Glossary

Appendix A

Index

2.3.1 Extreme Attitude

Extreme attitude is defined as a roll greater than 65° left or right, 30° pitch up, or 20° pitch down. Red chevrons are displayed at greater than 50° pitch up and 30° pitch down. The PFD will “declutter” when the aircraft enters an extreme attitude. Only the primary functions will be displayed in these situations.

The following information is removed from the PFD (and corresponding soft keys are disabled) when the aircraft is in an unusual attitude:

- BARO and Radar Altimeter Minimums
- Clock/Timer Field
- DME Field
- Fast/Slow Indicator
- Flight Director Command Bars
- GPSS Annunciation
- Knob Mode Annunciation
- Marker Beacon Annunciation
- NAV Status
- Outside Air Temperature
- Radar Altimeter Digital Readout
- Selected Altitude, Barometer Setting, and Selected Vertical Speed
- TAS Airspeed and Airspeed Units
- Traffic and Terrain Annunciations
- Vertical Course Deviation Indicator and Glideslope Annunciation
- Wind Field

Foreword

Sec 1
System

Sec 2
PFD

Sec 3
MFD

Sec 4
Hazard
Avoidance

Sec 5
Additional
Features

Sec 6
Annum.
& Alerts

Sec 7
Symbols

Sec 8
Glossary

Appendix A

Index



Figure 2-18 Extreme Pitch Indication - Nose Down



Figure 2-19 Extreme Pitch Indication - Nose Up



Figure 2-20 Extreme Roll Indication with Display Declutter

2.4 Altimeter

Foreword

The altimeter displays the current altitude, altitude trend, altitude bug setting, altitude bug, and the current BARO setting.

Sec 1
System

The Altitude Trend Vector is a vertical, magenta line, extending up or down on the left side of the Altitude scale. The end of the trend vector corresponds to the predicted altitude in six seconds if the current vertical speed is maintained.

Sec 2
PFD

The Altitude Bug is displayed at the selected Altitude Bug setting. A portion of the Altitude Bug will be displayed at the top or the bottom of the altitude tape if the selected Altitude Bug is off of the tape.

Sec 3
MFD

When an optional Radar Altimeter is installed, the altitude received from the radar altitude will be displayed on the PFD. See the Radar Altimeter section for more details.

Sec 4
Hazard
AvoidanceSec 5
Additional
FeaturesSec 6
Annun.
& AlertsSec 7
SymbolsSec 8
Glossary

Appendix A

Index

2.4.1 Setting the Altitude Bug and Alerter

Normally the altitude alerter only allows selection of altitudes in 100 foot increments. When a value other than 100 feet is set for the minimums, it becomes a selectable value in the altitude alerter.

1. Press the **ALT** key to activate Altitude mode.
 2. Turn the **PFD** knob to move the Altitude Bug to a desired altitude.
- OR
3. Press the center of the **PFD** knob to set the selected altitude to the current altitude.

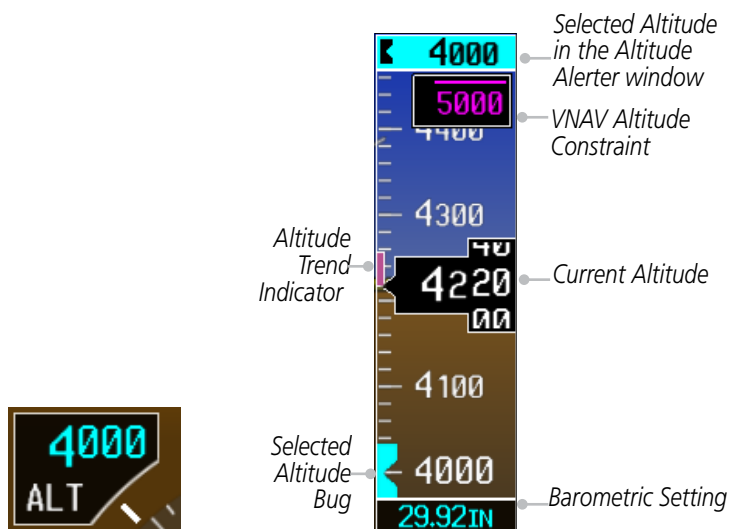

Figure 2-21 Altimeter

2.4.2 Altitude Alerting

The Altitude Alerting function provides the pilot with visual and aural alerts (if interfaced to an audio panel) when approaching the Selected Altitude. Whenever the Selected Altitude is changed, the Altitude Alerter is reset.



NOTE: *The Altitude Alerter function may be disabled in some installations. When the Altitude Alerter is disabled, pressing the ALT key will result in an "ALT KEY INOP" message.*

The following occur when approaching the Selected Altitude:

- Upon passing through 1,000 feet of the Selected Altitude, the Selected Altitude (shown above the Altimeter) changes to black text on a light blue background, and flashes for five seconds. An audio alert may be generated, if configured.
- When the aircraft passes within 200 feet of the Selected Altitude, the Selected Altitude changes to light blue text on a black background and flashes for five seconds and an aural tone may be generated, if configured.
- After reaching the Selected Altitude, if the pilot flies outside the deviation band (beyond ± 200 feet of the Selected Altitude), the Selected Altitude changes to yellow text on a black background, flashes for five seconds, and an aural tone is generated.



Figure 2-22 Altitude Alerting Visual Annunciations



NOTE: *The aural tone when approaching the selected altitude may be configured at installation for either 200 feet or 1,000 feet. The tone when deviating from the selected altitude always occurs at 200 feet.*

2.4.3 VNAV Altitude Constraints (Software v7.30 or Later)

Vertical Navigation (VNAV) altitude constraints display when guidance is received from a GTN 650/750 with software v6.50 or later. Refer to *GTN 625/635/650 Pilot's Guide* or *GTN 725/750 Pilot's Guide* for additional information. Altitudes are manually entered in the GTN or retrieved from the published altitudes in the navigation database. Altitude constraints are displayed in feet mean sea level (MSL) values to the nearest hundred. An altitude constraint in feet above ground level (AGL) is supported for airports.



Visual Annunciation	Description
	Indicates the aircraft must be at or above displayed altitude.
	Indicates the aircraft must be at or below displayed altitude.
	Indicates the aircraft must be at displayed altitude.

Table 2-1 Vertical Speed Settings

2.4.4 Changing Barometric Setting

The Barometric Setting affects the altitude values shown on the PFD. Barometric pressure units may be displayed as either inches (in) or hectopascals (hpa). For additional details, refer to section 3.

1. Press the **BARO** key to activate Baro mode.
 2. Turn the **PFD** knob to increase or decrease the altimeter setting.
- OR
3. Press the **PFD** knob while in Baro mode to toggle between Standard Pressure (29.92 in) and the currently selected barometric setting.

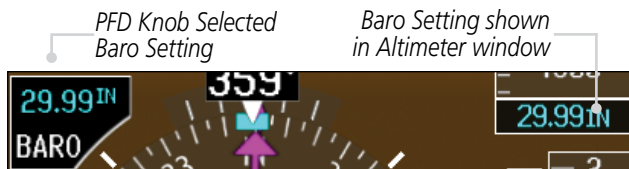

Figure 2-23 Barometric Setting

Baro-Corrected Altitude Versus GPS-MSL Altitude

Baro-corrected altitude (or indicated altitude) is derived by adjusting the altimeter setting for local atmospheric conditions. The most accurate baro-corrected altitude can be achieved by frequently updating the altimeter setting to the nearest reporting station along the flight path. However, because actual atmospheric conditions seldom match the standard conditions defined by the International Standard Atmosphere (ISA) model (where pressure, temperature, and lapse rates have fixed values), it is common for the baro-corrected altitude (as read from the altimeter) to differ from the GPS-MSL altitude. This variation results in the aircraft's true altitude differing from the baro-corrected altitude.

2.4.5 Minimum Descent Altitude/Decision Height Alerting

For altitude awareness, a barometric Minimum Descent Altitude (MDA) or Decision Height (DH) alert can be displayed on the PFD. The values are set in the Active Flight Plan page or from the Charts page menu. When active, the minimum descent altitude setting is displayed in the minimums box at the bottom left of the Altitude Tape.



NOTE: The Altitude Minimums Alerting Bug appears parked at the bottom of the altitude tape as soon as a value is set in the minimums alerter. The bug will unpark and start to move up the tape as soon as the altitude is within the range of the tape. The bug is reset when power is cycled.

The following visual annunciations occur when approaching the MDA/DH:

- The Minimums box appears with the altitude value in cyan text. Once in range, the Altitude Minimums Bug appears in cyan on the altitude tape.
- When the aircraft is within 100 feet of the selected altitude setting, the bug and text turn white.
- Once the aircraft reaches the selected altitude minimums setting, the bug and the altitude text turn yellow and the aural “Minimums, minimums” alert is made one time. The text remains in yellow until the aircraft altitude is more than 50 feet above the set altitude minimum value.



Figure 2-24 Barometric MDA/DH - Alerting Visual Annunciations

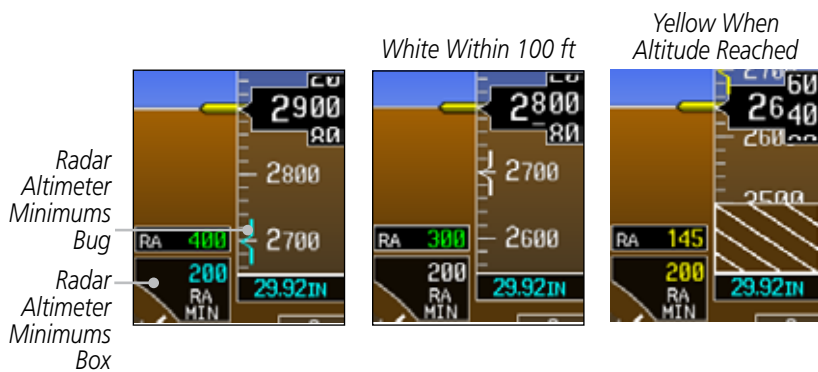

Figure 2-25 Radar Altimeter - Alerting Visual Annunciations

Alerting is inhibited while the aircraft is on the ground and until the aircraft reaches 150 feet above the selected Minimum Altitude. In dual installations, the minimums alerting altitude value may be set from either GDU 620 and will be synchronized on both units.

Setting the Altitude Minimums Bug is performed on either the FPL - Active Flight Plan page or the FPL - Charts page.

For information about setting the Altitude Minimums Bug on the Active Flight Plan page, refer to section 3.

For information about setting the Altitude Minimums Bug on the Charts page, refer to section 5.



NOTE: If you highlight the minimums Altitude field and press the CLR key, it will turn the minimums alerting functionality off.

2.5 Vertical Speed Indicator

Vertical speed (V/S) data is presented on the bottom right of the PFD. A Vertical Speed bug and a bug setting are also available.

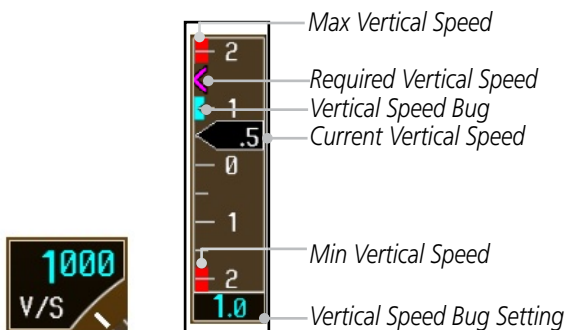

Figure 2-26 Vertical Speed Tape and Window

The Vertical Speed Indicator (VSI) displays the aircraft vertical speed using a non-moving tape. The tape can be scaled at ± 2000 , ± 3000 , or ± 4000 fpm as set by the installer. Major gradations are every 1000 fpm and minor gradations every 500 fpm. The current vertical speed is displayed in the pointer along the tape. Digits appear in the pointer when the climb or descent rate is greater than 100 fpm. If the rate of ascent/descent exceeds the vertical speed displayed on the tape, the pointer appears at the corresponding edge of the tape and the rate appears inside the pointer. The Vertical Speed Indicator range determines the airspeed tape range and altitude tape range.

VSI (set by installer)	Airspeed Tape Range	Altitude Tape Range
± 2000 fpm	60 kts	500 ft
± 3000 fpm	70 kts	600 ft
± 4000 fpm	80 kts	700 ft

Table 2-2 Vertical Speed Settings

Setting the Vertical Speed Indicator Bug

1. Press the **V/S** key to activate Vertical Speed mode.
2. Turn the **PFD** knob to change the Vertical Speed Bug.
3. Press the center of the **PFD** knob to set the Vertical Speed value to the current vertical speed.

2.6 Horizontal Situation Indicator

The Horizontal Situation Indicator (HSI) displays a rotating compass card in a heading-up orientation. Letters indicate the cardinal points and numeric labels occur every 30°. Major tick marks are at 10° intervals and minor tick marks at 5° intervals. A digital reading of the current heading appears on top of the HSI, and the current ground track is represented on the HSI by a magenta diamond. The HSI also presents turn rate, course deviation, bearing, and navigation source information. The “MSG” annunciation will be shown in the HSI when an unacknowledged message is present on the selected navigator. When the message is acknowledged, the “MSG” annunciation will clear.

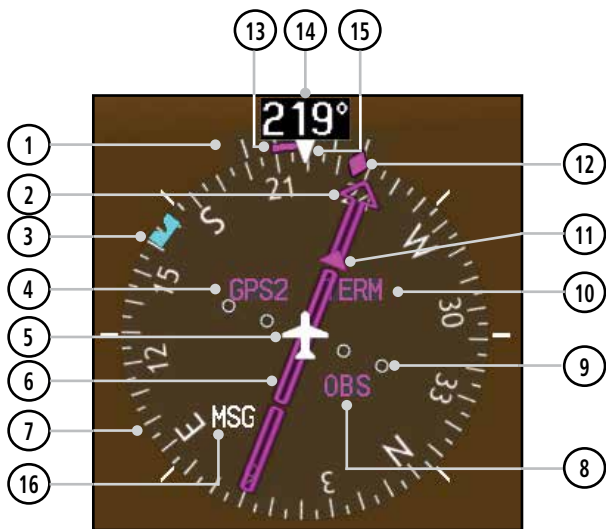

- | | |
|------------------------------------|----------------------------------|
| ① Turn Rate Indicator | ⑨ Lateral Deviation Scale |
| ② Course Pointer | ⑩ GPS Level of Service |
| ③ Heading Bug | ⑪ To/From Indicator |
| ④ Navigation Source | ⑫ Current Track Indicator |
| ⑤ Aircraft Symbol | ⑬ Turn Rate/Heading Trend Vector |
| ⑥ Course Deviation Indicator (CDI) | ⑭ Current Heading |
| ⑦ Rotating Compass Card | ⑮ Lubber Line |
| ⑧ OBS Mode Active | ⑯ MSG (Message) on Navigator |

Figure 2-27 Horizontal Situation Indicator (HSI)

The 360° HSI contains a Course Deviation Indicator (CDI), with a Course Pointer, To/From Indicator, and a sliding deviation bar and scale. The course pointer is a single line arrow (GPS1, VOR1, and LOC1) or a double line arrow (GPS2, VOR2, and LOC2) which points in the direction of the set course. “LOC” will automatically be displayed if a localizer frequency is tuned. The To/From arrow rotates with the course pointer and is displayed when the active NAVAID is received.

2.6.1 Setting the Heading Bug

The Selected Heading is shown to the upper left of the HSI for 10 seconds after being adjusted. The light blue bug on the compass rose corresponds to the Selected Heading.



NOTE: The current heading will have a "T" to the right of the heading value when the Nav Angle is set to True in the System Setup page of the Aux page group.



Figure 2-28 Heading Bug Setting

1. Press the **HDG** key to activate HDG mode.
 2. Turn the **PFD** knob to change the Heading Bug.
- OR
1. Press the **PFD** knob in HDG mode to set the Heading Bug to the current heading.

2.6.2 Turn Rate Indicator

The Turn Rate Indicator is located directly above the rotating compass card. Tick marks to the left and right of the lubber line denote half-standard and standard turn rates. A magenta Turn Rate Trend Vector shows the current turn rate. The end of the trend vector gives the heading predicted in six seconds, based on the present turn rate. A standard-rate turn is shown on the indicator by the trend vector stopping at the standard turn rate tick mark, corresponding to a predicted heading of 18° from the current heading. At rates greater than 4 degrees per second, an arrowhead appears at the end of the magenta trend vector and the prediction is no longer valid.



Figure 2-29 Turn Rate Indicator and Trend Vector

Foreword

Sec 1
System

Sec 2
PFD

Sec 3
MFD

Sec 4
Hazard
Avoidance

Sec 5
Additional
Features

Sec 6
Annun.
& Alerts

Sec 7
Symbols

Sec 8
Glossary

Appendix A

Index

2.7 Course Deviation Indicator

The Course Deviation Indicator (CDI) moves left or right from the course pointer along a lateral deviation scale to display aircraft position relative to the course. If the course deviation data is not valid, the CDI is not displayed.

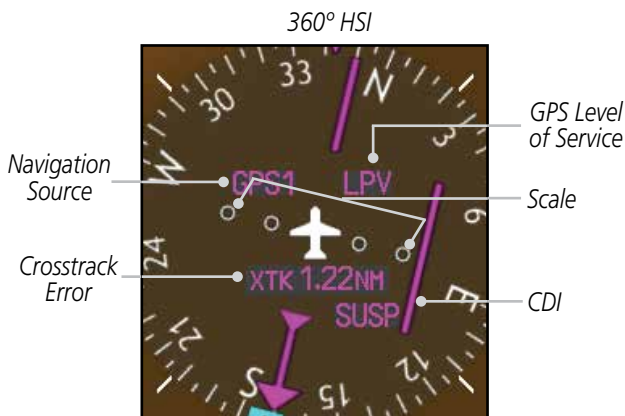

Figure 2-30 Course Deviation Indicator



NOTE: The ILS Localizer and Glideslope deviation indicators will indicate full-scale deflection for the GNS 480 navigator at the second dot. The GNS 400W/500W and GTN 6XX/7XX series navigators will indicate full-scale deflection at the edge of the display.

2.7.1 CDI Preview

When selected, CDI/VDI Preview displays the upcoming VOR/LOC approach in gray. CDI preview displays as gray hollow lines. Course angle and source displays in gray text. CDI preview displays for VLOC, LOC Backcourse, Glideslope, and Glidepath. It is not shown for GPS approaches.



Preview On



Preview Off

Figure 2-31 CDI/VDI Preview

2.7.2 Changing CDI Sources

The CDI can display two sources of navigation: GPS or NAV (VOR, and LOC). Color indicates the current navigation source: magenta (for GPS) or green (for VOR and LOC). The full-scale limits for the CDI are defined by a GPS-derived distance when coupled to GPS. When coupled to a VOR or localizer (LOC), the CDI has the same angular limits as a mechanical CDI. If the CDI exceeds the maximum deviation on the scale (two dots) while coupled to GPS, the crosstrack error (XTK) is displayed below the white aircraft symbol.

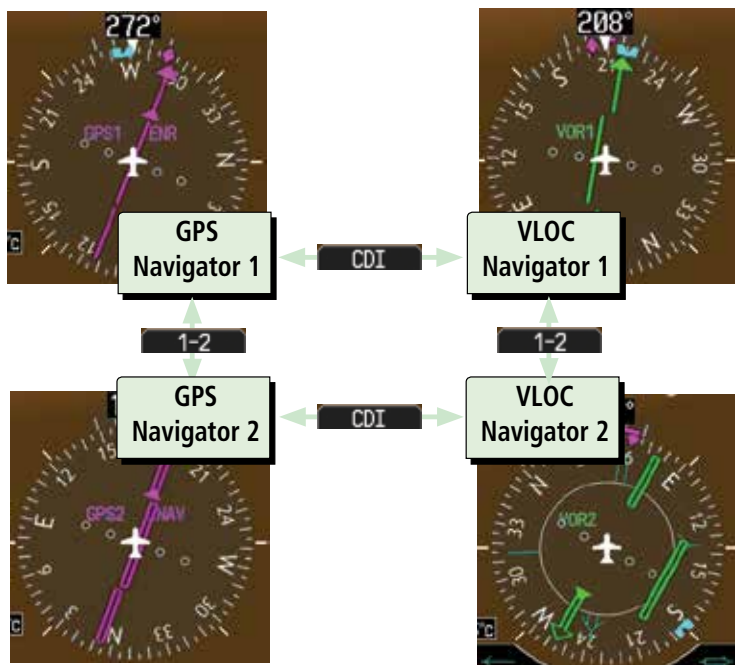

Figure 2-32 CDI Navigation Sources

1. Press the **CDI** soft key to toggle between GPS and VOR/LOC source type.
2. Press **1-2** soft key to toggle between the 1 and 2 navigators of the GPS or VOR/LOC sources.
3. Verify the navigation source by the indication on the HSI and in the upper left corner of the PFD.

NOTE: The selected navigator is the active navigator for all PFD and MFD operations, except for the supplemental bearing pointers.

2.7.3 Changing CDI Course

The Selected Course is shown to the upper left of the HSI for 10 seconds after being adjusted.



Figure 2-33 Course Setting

1. Press the **CRS** key to activate Course mode.
 2. Turn the **PFD** knob to change the Course values.
- OR
1. Press the **PFD** knob to set a Course that will center the CDI to the VOR station or waypoint if in GPS OBS mode.

2.7.4 Vertical Deviation Indicator

The Vertical Deviation (Glideslope) Indicator (VDI) appears to the left of the VSI whenever an ILS frequency is tuned in the active NAV field. A green diamond acts as the VDI Indicator, like a glideslope needle on a conventional indicator. If a localizer frequency is tuned and there is no glideslope signal, “NO GS” is annunciated. The glideslope on an ILS approach is hidden if the current track is more than 90 degrees from the selected course. This prevents the glideslope from being displayed during localizer backcourse approaches.

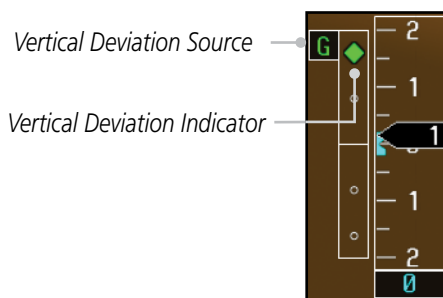

Figure 2-34 Vertical Deviation Indicator (ILS Source)

The vertical deviation is similar to the glideslope for GPS approaches supporting WAAS vertical guidance (LNAV+V, L/VNAV, LPV, LP+V). When an approach of this type is loaded into the flight plan and GPS is the selected navigation source, the Vertical Deviation Indicator appears as a magenta diamond. If the approach type downgrades to LNAV past the final approach fix (FAF), or the approach only supports LNAV service, “NO GP” is annunciated. The vertical deviation displays when a visual approach is loaded by a GTN 650/750 with software v6.30 or later.

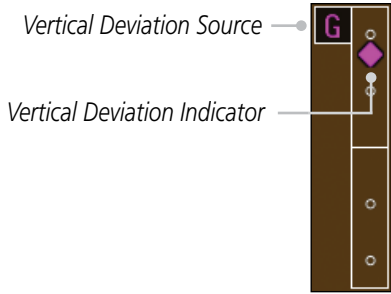

Figure 2-35 Vertical Deviation Indicator (GPS Source)

The VDI displays as a magenta chevron when VNAV guidance is received from a GTN 650/750 with software v6.50 or later. This feature is available on GDU 620s with software v7.30 or later.

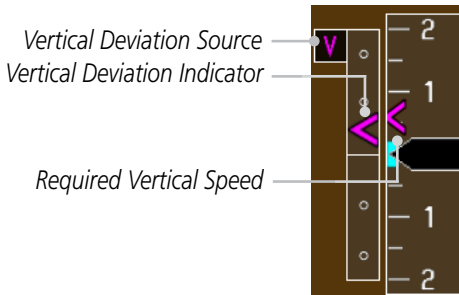

Figure 2-36 Vertical Deviation Indicator (VNAV)

Foreword

Sec 1 System

Sec 2 PFD

Sec 3 MFD

Sec 4 Hazard Avoidance

Sec 5 Additional Features

Sec 6 Annun. & Alerts

Sec 7 Symbols

Sec 8 Glossary

Appendix A

Index

When selected, CDI/VDI preview displays upcoming vertical navigation. VDI preview displays as a gray hollow diamond. VDI preview displays for VLOC, Glideslope, and Glidepath.

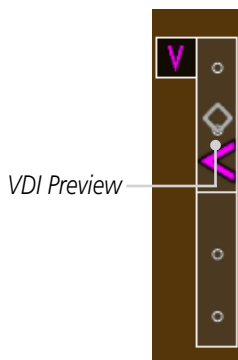

Figure 2-37 VDI Preview

2.7.5 Auto-Slewing

The G500/G600 system is designed to interface with GPS navigator units and also manage up to four different CDI course pointers (GPS1, NAV1, GPS2, NAV2) independently. The G500/G600 will automatically slew the NAV course pointer to the correct final approach course when a ILS, LOC, LOC BC, LDA or SDF approach is active in the GPS navigator and the appropriate frequency is in the active window in the navigator. The G500/G600 will Auto-Slew the HSI course pointer for an ILS, LOC, LOC BC, LDA, or SDF approach when the steps below are completed in the following order:

1. The desired approach is selected and activated in the navigator (this can be verified by the approach waypoints appearing on the GDU 620 MFD Nav Map Page or FPL Page).
2. The appropriate frequency is the active frequency in the navigator.
3. The CDI selection on the GDU 620 is changed to NAV course pointer for the active navigator.



NOTE: If the NAV course pointer is displayed for the active navigator when the approach is activated and the localizer frequency is tuned, the pilot will need to switch to another CDI source and then back to NAV for the course pointer to Auto-Slew.

For example, if NAV1 is currently selected, the pilot must:

press the CDI soft key twice: NAV1>GPS1>NAV1

OR

press the 1-2 soft key twice: NAV1>NAV2>NAV1



NOTE: For LOC BC approaches, the course pointer will slew 180 degrees from the inbound course.

Example of activating Auto-Slewing in the G500/G600:

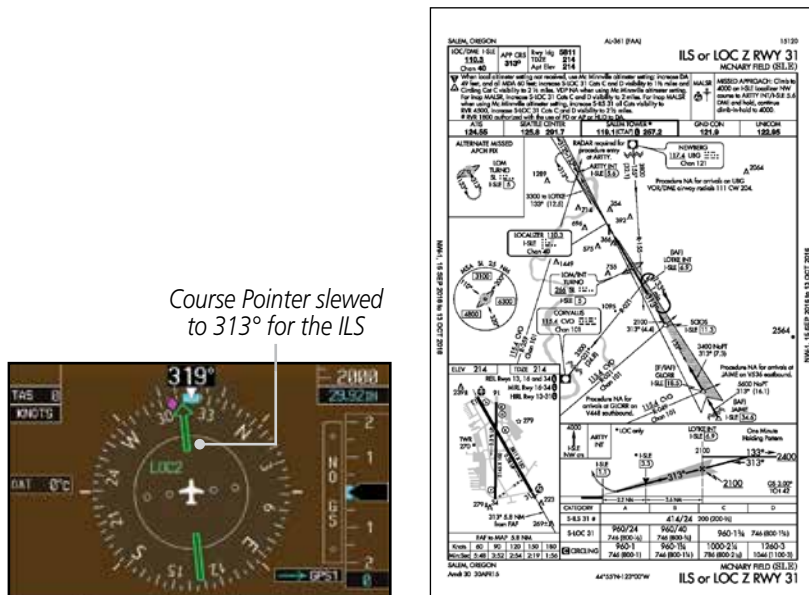

Figure 2-38 Auto-Slewing HSI with ILS Loaded (Shown with Corresponding Approach Plate)

1. The aircraft is flying vectors to final on an active ILS approach, with the appropriate approach in the GPS navigator.
2. The appropriate ILS frequency must be activate in the navigator.
3. Verify that the waypoints for the approach are displayed on the Nav Map Page or the FPL Page of the MFD.
4. Upon approaching the final course, select LOC on the HSI.



NOTE: If auto CDI switching is active on the GPS unit, the GPS will force the GPS/GDU 620 to NAV when the aircraft is close to the LOC course.

5. The CDI and course pointer will change from magenta to green and the pointer will move, or slew, to the final approach course (or 180° from the final approach course for LOC BC approaches).

Course Pointer slewed to 313° for the Backcourse to Runway 13

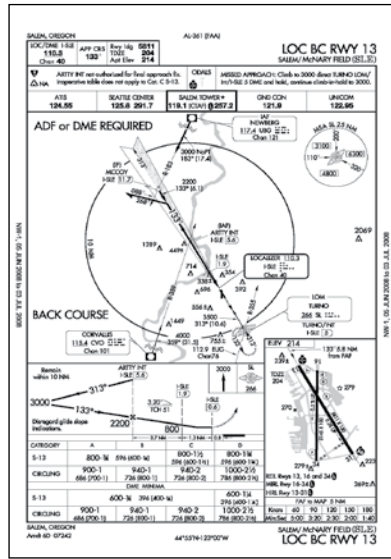

Figure 2-39 Auto-Slewing HSI with Localizer Backcourse Loaded (Shown with Corresponding Approach Plate)

2.8 Supplemental Flight Data

2.8.1 Bearing Pointers

Two Bearing Pointers can be displayed on the HSI for NAV and GPS sources. The pointers are light blue and are single- (BRG1) or double-lined (BRG2); an icon is shown in the respective information window to indicate the pointer type. The system must be configured for a second navigation source to show the BRG2 selection.

When a Bearing Pointer is displayed, its associated information window is also displayed.

The Bearing Information windows are displayed to the lower sides of the HSI and show:

- Bearing source (GPS, NAV, or ADF)
- Pointer icon (BRG1 = single line, BRG2 = double line)

The Bearing Pointer is removed from the HSI if:

- The NAV radio is not receiving the tuned VOR station
- The NAV radio is tuned to a Localizer frequency
- GPS is the bearing source and an active waypoint is not selected
- ADF is selected and a signal is not received (if you have an ADF that supports a valid flag then the bearing pointer will be removed. If your ADF system does not include a valid flag then the bearing pointer will still be displayed, regardless of ADF signal validity.)

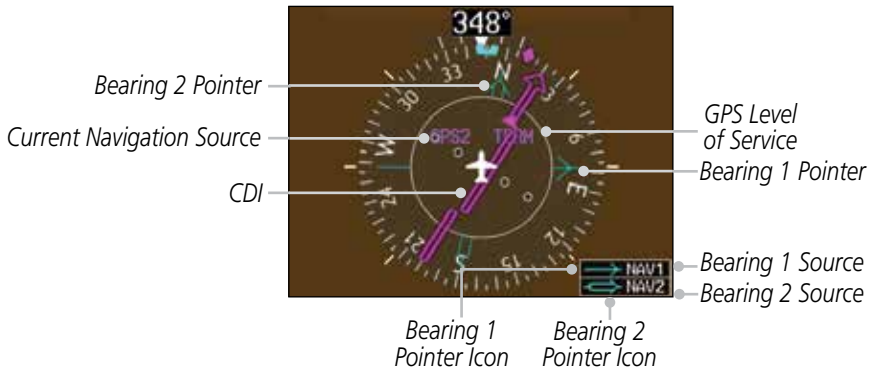

Figure 2-40 HSI with Bearing Information

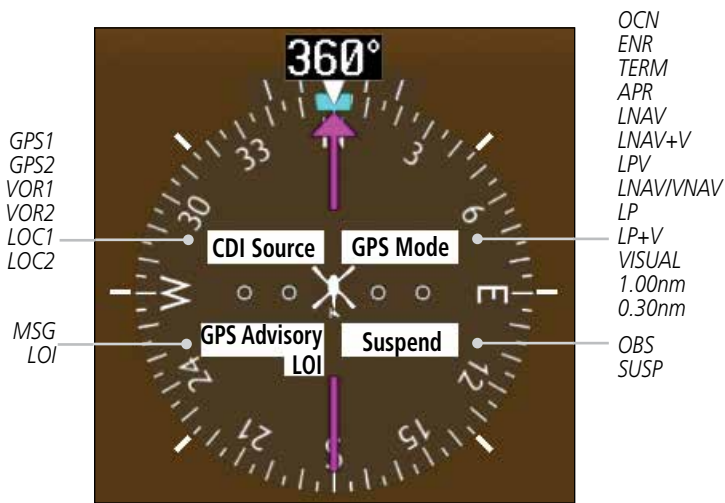

Figure 2-41 PFD HSI Annunciations

1. Press the **PFD** soft key to display the navigation source keys.
2. Press the **BRG 1** or **BRG 2** soft keys to toggle between the available Nav receivers of the selected source (such as: GPS, NAV, or ADF).



NOTE: The Bearing Line for navigation source 1 (BRG1) will be a single line. The Bearing Line for navigation source 2 (BRG2) will be a double line.

2.8.2 Temperature Display

The outside air temperature is displayed to the left of the HSI. The air data computer calculates the temperature based on temperature probe and Pitot-static inputs. The units (°C or °F) and temperature reference are selected on the AUX – SYSTEM SETUP page. The temperature reference can be selected to one of the following choices:

- Static Air Temperature (SAT) – This is the calculated temperature of the stationary (static) outside air. Conceptually, this is the temperature that would be read on a thermometer floating stationary at the current location.
- Total Air Temperature (TAT) – This is the calculated temperature of the outside air as it moves past the aircraft, including the rise in temperature due to air compression and friction at the current airspeed.
- Difference from International Standard Atmosphere (ISA) – This is the difference between SAT and standard (ISA) temperature at the current altitude. This provides an indication of how much warmer/colder the temperature is from a “standard” atmosphere.



Figure 2-42 Outside Air Temperature Selection

2.8.3 Wind Vectors

When selected, wind vector information is displayed in a window on the PFD to the left of the HSI. The Wind Vector style is configured in the Aux Mode System Setup page. While on the ground, the Wind Vector window will indicate “No Wind Data.”



Figure 2-43 Wind Vector with No Wind Data

Four styles are available as shown below.



Figure 2-44 Wind Vector Style

2.8.4 DME Indication

When selected, DME information is displayed in a window in the lower left corner of the PFD. The distance to the station and the Nav source used are shown.

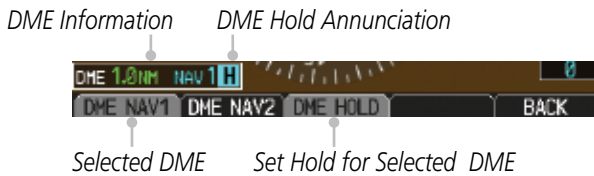

Figure 2-45 DME Indication

NOTE: The capability of providing DME information requires installation of the GAD 43e.

2.8.5 Marker Beacon Annunciations

A visual annunciation of marker beacons will be shown on the display when the aircraft flies over a marker beacon. The marker beacon annunciation will appear to the left of the altitude tape below the terrain annunciator on the PFD.



Figure 2-46 Marker Beacon Location

Current Beacon	Icon (Standard)	Icon (Blink)
Inner Marker	I	I
Middle Marker	M	M
Outer Marker	0	0

Table 2-3 Marker Beacons

2.8.6 Miscompare Annunciations

Miscompare annunciations are capable of being displayed on the PFD if the miscompare Monitor is enabled during the installation configuration.

Messages will appear in the MFD alerts window if monitors are enabled and required data is not present.

A miscompare condition is triggered if the difference between the data reported by GDU 1 and GDU 2 exceeds the threshold described in the following table for at least one second.

Parameter	Range of Trigger	Threshold
Altitude	ALL	200 feet
Indicated Airspeed	Both IAS < 35 kts	Inhibited
Indicated Airspeed	Either IAS >= 35 kts	10 kts
Indicated Airspeed	Either IAS >= 80 kts	7 kts
Pitch	ALL	5 degrees
Roll	ALL	6 degrees

Table 2-4 Mismatch Conditions

A “MISCOMP” annunciation is displayed on the airspeed tape if a mismatch condition exists for indicated airspeed. A “MISCOMP” annunciation is displayed on the altitude tape if a mismatch condition exists for altitude. A “PITCH MISCOMP” annunciation is displayed over the pitch ladder if a mismatch condition exists for pitch and not roll. A “ROLL MISCOMP” annunciation is displayed over the pitch ladder if a mismatch condition exists for roll and not pitch. An “ATTITUDE MISCOMP” annunciation is displayed over the pitch ladder if a mismatch condition exists for both pitch and roll.

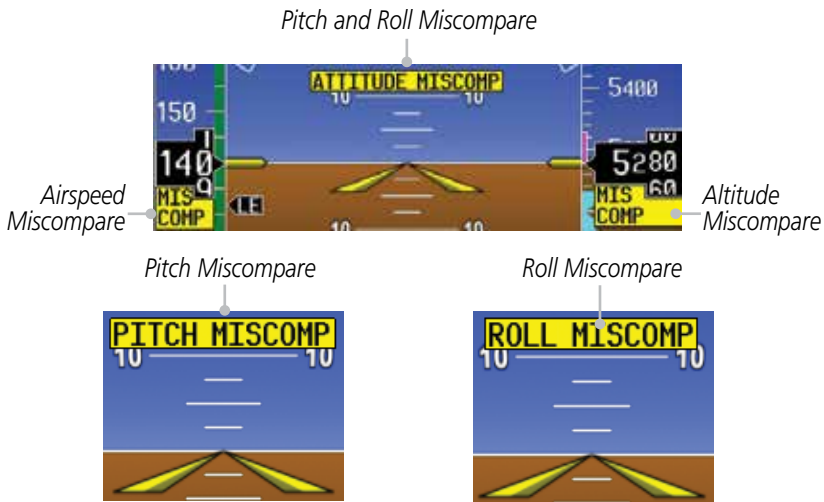

Figure 2-47 Mismatch Annunciations

2.9 Radar Altimeter

When an optional Radar Altimeter is installed, the altitude received from the radar altitude will be displayed on the PFD.



NOTE: See the Radar Altimeter documentation for details on the radar altimeter performance and limitations.

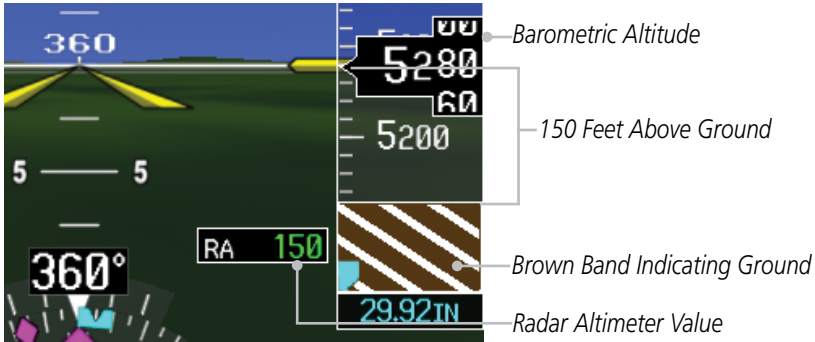

Figure 2-48 Radar Altimeter Display - 150 ft RA Altitude

When the radar altitude is 0, the brown band will be level with the altitude tape pointer. As the radar altitude increases above 0, the brown band will move down the tape in an amount equal to the current radar altitude.

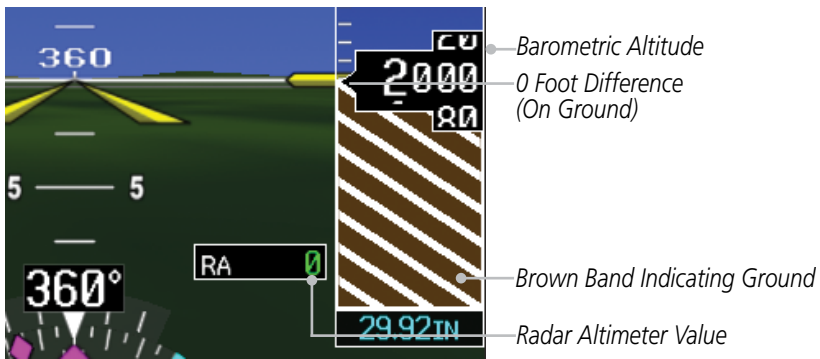

Figure 2-49 Radar Altimeter Display - 0 ft RA Altitude

The Radar Altimeter self-test process will be annunciated on the PFD above the Radar Altimeter altitude value. The self-test is a wiring test to indicate communication between the GDU and the Radar Altimeter. The self-test will be cancelled after 15 seconds, the Test key is pressed again, or you leave the System Setup page.



NOTE: *Not all Radar Altimeters have the TEST function.*

1. Turn the large **MFD** knob to Aux mode and then turn the small **MFD** knob to the System Setup page.
2. Press the **RA TEST** soft key. "RA TEST" will be annunciated above the Radar Altimeter value. The Radar Altimeter value will show a certain number to indicate that communication is taking place between the Radar Altimeter and the GDU. See your Radar Altimeter documentation for the appropriate value.



Figure 2-50 Radar Altimeter Test Annunciation

3. Press the **RA TEST** key again to stop the self-test.
4. If the unit fails the self-test, the RA value will not match the expected value. The "RA FAIL" annunciation will appear on the PFD when the GDU is not receiving any Radar Altimeter data. "RA FAIL" is not related to the self-test.



Figure 2-51 Radar Altimeter Failure Annunciation

Radar Altimeter Configurations

Depending on the installation, the pilot will have one of the following options: BARO or RAD ALT minimums altitude alert (pilot selectable).

- The minimums alerting value is defaulted OFF with a setting of 0 feet.
- The pilot can select alerts ON or OFF and can select the alert altitude based on either barometric or radar altitude.
- The alert upon descending through the selected altitude is the aural "minimums, minimums" callout.
- The altitude required to arm the alerting is 150 feet above the selected altitude.

2.10 Fast/Slow Indication

The Fast/Slow indication as provided from an external system is shown on the left side of the PFD along the horizon line. See your AFM for details on operation.

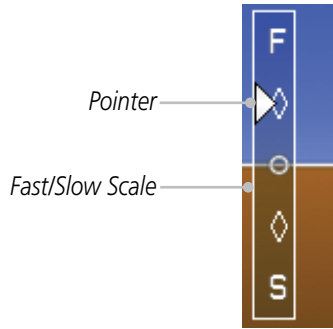

Figure 2-52 Fast/Slow Scale and Pointer

2.11 PFD Units

PFD units may be set to standard or metric units by the installer. MFD units may still be selected by the user in the System Setup page of Aux mode.

This page intentionally left blank

3 MULTI-FUNCTION DISPLAY

The Multi-Function Display (MFD) presents a color moving map with navigation information. Moving map information is shown on the two Navigation Map pages and the optional Weather (WX) pages. The Navigation Map displays aviation data (e.g., airports, VORs, airways, airspaces), geographic data (e.g., cities, lake, highways, borders), topographic data (map shading indicating elevation), and hazard data (e.g., traffic, terrain, weather). The map options set for Navigation Map page 1 are used as the default settings for the optional Weather (WX) pages. Which data is displayed can be controlled by the DCLTR soft key and map page MENU selections. The Navigation Map can be oriented four different ways: North Up (NORTH UP), Track Up (TRACK UP), Desired Track Up (DTK UP), or Heading Up (HDG UP).



Figure 3-1 MFD Description

The nose of the aircraft icon is placed on the Navigation Map at the location corresponding to the calculated present position. The aircraft position and the flight plan legs are based on information received from the currently selected GPS navigator. The leg of the active flight plan currently being flown is shown as a magenta line on the navigation map. The other legs are shown in white.

Foreword

System Sec 1

PFD Sec 2

MFD Sec 3

Avoidance Hazard Sec 4

Additional Features Sec 5

Annun. & Alerts Sec 6

Symbols Sec 7

Glossary Sec 8

Appendix A

Index

There are map ranges available, from 500 feet to 500 NM. The range is now indicated in the box on the range ring at the 11 o'clock position relative to the ownership. To change the map range on any map, press the **RNG** keys on the right side of the bezel.

3.1 Navigation Map Pages

Map displays are used extensively in the GDU 620 to provide situational awareness in flight. The following information can be displayed on the Navigation Map Pages:

- Airports, NAVAIDs, airspace, airways, land data (highways, cities, lakes, rivers, borders, etc.) with names
- Map Pointer information (distance and bearing to pointer, location of pointer, name, and other pertinent information)
- Map range
- Wind direction and speed
- Map orientation
- Icons for enabled map features
- Aircraft icon (representing present position)
- Enhanced Range Ring
- Flight plan legs
- Track vector
- Topography scale
- Topography data
- SiriusXM NEXRAD Weather
- SiriusXM Lightning
- SiriusXM Storm Cells
- Traffic
- Stormscope
- Top of Climb
- Terrain data (includes terrain, obstacles, and power lines)

For details about the symbols used on the MFD, refer to section 7.



NOTE: Page Group and Page are shown at the bottom of the MFD.



Figure 3-2 Page Group and Page Locator

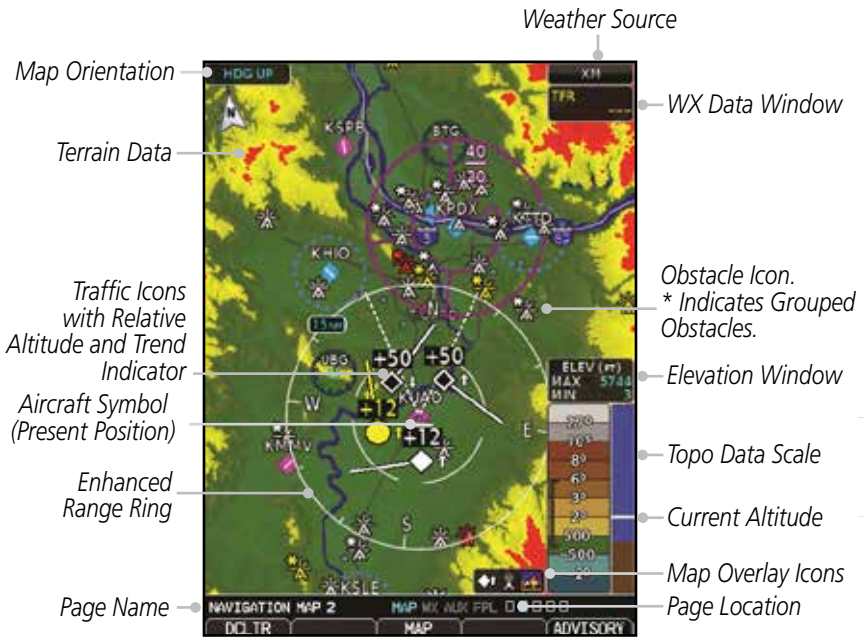

Figure 3-3 MFD Map Description

3.1.1 Default Navigation Map Page

While on any page of the MFD, you may easily return to the first Navigation Map page of the Map group by pressing and holding the **CLR** key to return to the first page (Home Page) of the Map group.

3.1.2 Map Overlay Icons

Overlay icons are displayed to indicate data that will be depicted on the map pages. The icons are shown in the following figure. If the icon is not displayed, either the menu selection is not ON to display the data or the display range makes the data ineligible for display. If the icon has a white X over it then the data is selected ON and the zoom scale is correct, but the underlying data is not available for some reason. All of the icons may not be displayed at the same time. In some cases if one feature is selected, another icon and feature may be disabled. The pilot should check the dedicated page for the feature that the icon represents to determine why the data is not available for display (e.g., fail, standby).

- Foreword
- System Sec 1
- PFD Sec 2
- MFD Sec 3**
- Avoidance Sec 4
- Hazard Sec 4
- Additional Features Sec 5
- Annun. & Alerts Sec 6
- Symbols Sec 7
- Glossary Sec 8
- Appendix A
- Index



Figure 3-4 Map Overlay Icon Samples

3.1.3 Selecting Page Options

1. Change the fields or the setup of a page by pressing the **MENU** key and make the necessary adjustments with the **MFD** knobs.
2. Turn the large **MFD** knob to select desired item.
3. Turn the small **MFD** knob to change the highlighted value.
4. Press **ENT** to accept the displayed value.
5. Press the small **MFD** knob to cancel selection or to end editing.

3.1.4 Changing the Navigation Map Range

The Range (RNG) keys on the right side of the bezel are used to change the map display range. Pressing the **▲ RNG** key will zoom out (increasing the displayed map range) and pressing the **▼ RNG** key will zoom in (decreasing the displayed map range). The Map Range is shown on the outer range ring. The map ranges available are from 250 feet to 500 NM.

3.1.5 Decluttering Map Pages

The Map Declutter feature allows the pilot to progressively step through four levels of decluttering to remove map information. The declutter level is displayed in the **DCLTR** soft key.



Figure 3-5 Map Declutter Soft Key

1. There are four levels of decluttering. DCLTR (0) shows the most detail. DCLTR-3 removes the most detail.
2. While viewing one of the Navigation Map pages, press the **DCLTR** soft key. Each successive press of the **DCLTR** soft key will toggle through the declutter levels. In the following table, features marked with a "•" are shown at the indicated Declutter Level. Features shown at level 0 will be displayed at all Declutter levels.



NOTE: Traffic is automatically decluttered from Nav Map pages when the map scale is above 40 NM.

Feature	0	1	2	3	Feature	0	1	2	3
Airways	•				Intersections	•	•		
Land/Country Text	•				Tower	•	•		
Large City	•				TRSA	•	•		
Medium City	•				ADIZ	•	•		
Small City	•				Alert Areas	•	•		
Small Town	•				Caution Areas	•	•		
Freeways	•				Danger Areas	•	•		
Highways	•				Warning Areas	•	•		
Roads	•				Large Airports	•	•	•	
Railroads	•				Medium Airports	•	•	•	
Political Boundaries	•				Prohibited Areas	•	•	•	
Traffic Symbols	•				MOAs	•	•	•	
Lat/Lon Grids	•	•			Runway Labels	•	•	•	
VORs	•	•			Lightning Strike Data	•	•	•	
VRPs	•	•			NEXRAD Data	•	•	•	
NDBs	•	•			River/Lake Names	•	•	•	•
Class B Airspace	•	•			Traffic Labels	•	•	•	•
Class C Airspace	•	•			Water Detail	•	•	•	•
Class D Airspace	•	•			Active FPL Legs	•	•	•	•

Table 3-1 Features Shown at Each Decluttering Level

3.1.6 Panning

The Panning Map Page function allows you to move the map beyond its current limits without adjusting the map scale and to examine information at the pointer location. When you select the panning function — by pressing the small **MFD** knob — a target pointer flashes on the map display. A window also appears at the top of the map display showing the latitude/longitude position of the pointer, the ETE from your present position to the pointer, elevation at the pointer, and bearing and distance to the pointer from your present position.

Information is related to the tip of the pointer

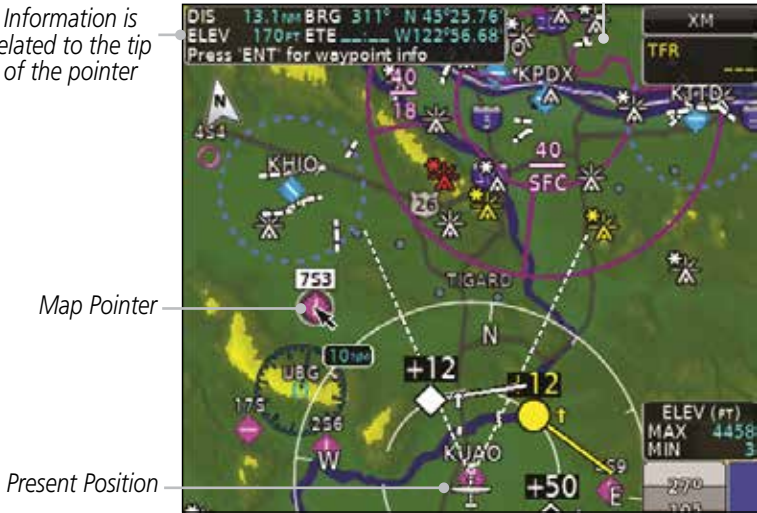

Figure 3-6 Navigation Map Pointer Location Information

1. While viewing a Map, press the small **MFD** knob. A flashing pointer will appear in the tip of the ownship symbol. The measured information is referenced to the tip of the arrow.



Figure 3-7 Navigation Map Initial Pointer Location

2. Turn the large **MFD** knob to move the cursor horizontally. Turn the small **MFD** knob to move the cursor vertically.
3. Press the small **MFD** knob again to cancel panning. The display will return to the previous map view.

3.1.7 Selecting Items on the Map

When the target pointer is placed on an object, the name of that object is highlighted (even if the name wasn't originally displayed on the map). This feature applies to airports, NAVAIDs, user-created waypoints, roads, lakes, rivers — just about everything displayed on the map except route lines. When an airport, NAVAID, or user waypoint is selected on the map display, you can review information about the item.

1. While viewing the Navigation Map pages of the Map page group, press the small **MFD** knob to activate panning.
2. Move the cursor with the small and large **MFD** knobs to highlight a feature.
3. Press **ENT** to display information about the highlighted feature.
4. Press one of the soft keys for details of the selected topic.
5. Press the small **MFD** knob again to return to panning.

3.1.8 Measuring Distances

The “Measure Bearing/Distance” function provides a quick and easy method to determine the bearing and distance between any two points on the Navigation Map.

1. While viewing one of the Navigation Map pages of the Map page group, press **MENU**.
2. Turn the large or small **MFD** knobs to highlight “Measure Bearing/Distance” and then press **ENT**.



Figure 3-8 Navigation Map Measure Distance Function

3. Your present position will be marked as the starting reference point. To choose a different starting reference point, turn the large or small **MFD** knobs to desired point and press **ENT**.



Figure 3-9 Measure Distance Starting Reference Point

4. Turn the large or small **MFD** knobs to move the cursor to a reference point. The distance and bearing is displayed at the top of the display.

Distance and Bearing Between Start and End Points

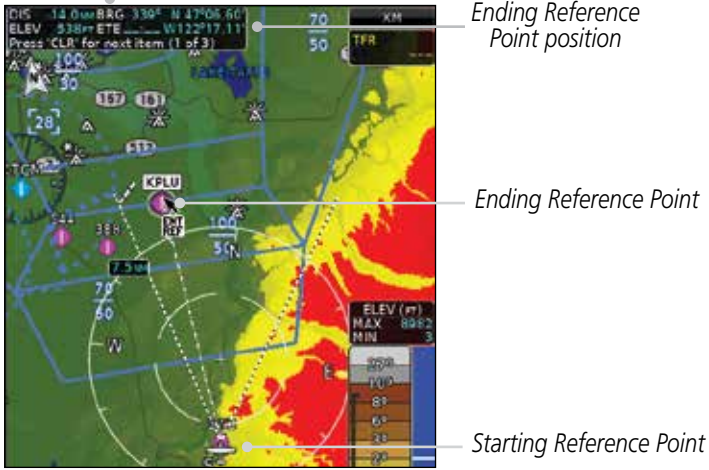

Figure 3-10 Bearing/Distance Measurement

5. Press the small **MFD** knob to stop measuring.

3.1.9 Customizing Navigation Map Pages

The Navigation Map pages are customized by selecting options from the Page Menu. The Page Menu options include choices for Map Setup and Measure Bearing/Distance. The Map Setup choice covers selections for Map, Weather, Traffic, and Aviation depending on the installed equipment of a given aircraft.

3.1.10 Map Setup

The Map Setup selection from the Page Menu allows you to select which data will be displayed on the map.

1. While viewing one of the Navigation Map pages of the Map page group, press the **MENU** key to display the Navigation Map Page Menu.



Figure 3-11 Navigation Map Page Menu

- With the cursor flashing on the "Map Setup," press the **ENT** key to display the Map Setup Menu.
- Use the large and small **MFD** knobs to select the Group and press **ENT** to allow editing of the selected group. The groups shown depend on the features available for equipment installed in your aircraft.



Figure 3-12 Navigation Map Page Menu Map Group Selection

- Press the small **MFD** knob to return to the Navigation Map Page.

Map Group		Weather Group (optional)		Traffic Group (optional)		Aviation Group	
Menu Item	Settings	Menu Item	Settings	Menu Item	Adjustment	Menu Item	Settings
Orientation	North Up Track Up DTK Up HDG Up	NEXRAD Viewing Range	Off/Range	Traffic	Off All Traffic TA/PA TA Only	Safe Taxi Viewing Range	Off/Range
North Up At	Off/Range	NEXRAD Cell Mov	Off/Range			Rwy Extension Range	Off/Range
Auto Zoom	On/Off	NEXRAD Legend	On/Off			INT/NDB Viewing Range*	Off/Range
Land Data	On/Off	NEXRAD Source	US/Canada CONUS/ Regional/ Combined ***			VOR Viewing Range*	Off/Range
Track Vector Length	Off/Time	XM Ltng	Off/Range			Class B/ TMA *	Off/Range
Wind Vector	On/Off	Stormscope Viewing Range	Off/Range			Class C/ TCA *	Off/Range
Enhanced Range Ring	On/Off	Stormscope Strike/Cell Mode	Strike/Cell			Class D *	Off/Range

Map Group		Weather Group (optional)		Traffic Group (optional)		Aviation Group	
Menu Item	Settings	Menu Item	Settings	Menu Item	Adjustment	Menu Item	Settings
Topo Data	On/Off	PRECIP Data Viewing Range	Off/Range			Restricted*	Off/Range
Topo Scale	On/Off	PRECOP Legend	On/Off			MOA (Military)*	Off/Range
Terrain Data	On/Off	DL LTNG Data Viewing Range	Off/Range			Other/ADIZ *	Off/Range
Obstacle Viewing Range	Off/Range					TFR *	Off/Range
Power Line Viewing Range	Off/Range					Airways	Off/Modes
Lat/Lon Viewing Range	Off/Range					Smart Airspace	On/Off
Field of View**	On/Off					Show Airspaces	All/Altitude
Selected Alt Range Arc	On/Off					Airspace Labels	On/Off
						VRP Viewing Range	Off/Range

* Shown if the Aviation database is current.

** Shown if Synthetic Vision is available.

*** Shown if FIS-B is NEXRAD weather source.

Table 3-2 Navigation Map Page Menu Selections

3.1.10.1 Map Feature Options

Choose the options to determine the values for display on each Navigation Map. The options you select will be retained until changed. The options may be selecting by using the following procedure:

1. While viewing the Navigation Map 1 or 2 of the Map page group, press the **MENU** key. With "Map Setup" highlighted, press **ENT**. With the Map Group active, turn the large **MFD** knob to highlight the desired option.
2. Turn the small **MFD** knob to change the highlighted value.

3. Press **ENT** to accept the displayed value. The next option will be highlighted.
4. Press the small **MFD** knob to cancel selection or to end editing and return to the Navigation Map page or turn the large **MFD** knob to the next option.

Map Orientation

The Orientation option sets the orientation of the Navigation Map.



Figure 3-13 Navigation Map Orientation

North Up At

The North Up At option allows you to select the map range where at and above the selected value the Map Orientation will automatically change to North Up. For example, with the 500 NM value selected and the map range of the MFD is 500 NM or more, the map orientation will automatically become North Up.

Auto Zoom

With a valid flight plan, the Auto Zoom feature will automatically change the Navigation Map range depending on the distance to the next waypoint in the flight plan. If enabled, it will also automatically zoom to the SafeTaxi zoom range when the aircraft is on the ground. Auto Zoom can be overridden at any time by manually zooming with the **RNG** keys or enabling OBS mode. Auto Zoom is re-enabled during any one of the following conditions:

- The active waypoint changes during flight.
- The aircraft lands.
- OBS mode is disabled.
- The Navigation Map's Auto Zoom settings are changed.

Land Data

The Land Data option selects whether detailed land features, such as rivers, roads, cities, are displayed. Topo features, traffic, terrain, and obstacles will still be displayed, even with Land Data turned off.

Track Vector Length

When turned on, the Track Vector Length option will show a dashed line and arrow extending from the aircraft icon illustrating the current Track and the distance the aircraft will travel in the selected time.



Figure 3-14 Navigation Map Track Vector

Wind Vector

The Wind Vector option when turned on will show a box in the top right corner of the MFD indicating the wind direction and speed.



Figure 3-15 Navigation Map Wind Vector Display

Enhanced Range Ring

When selected ON, the Enhanced Range Ring function provides a second ring at 1/2 the distance of the primary ring to allow the pilot to accurately judge the distance to objects depicted on the map.

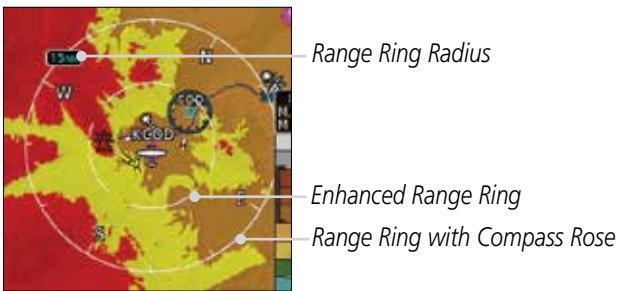

Figure 3-16 Navigation Map Range Ring

Topo Data

The Topo Data option selects whether the colored topographical features are displayed. Traffic, Land Data, Terrain, and Obstacles will still be displayed even with Topo Data turned off.

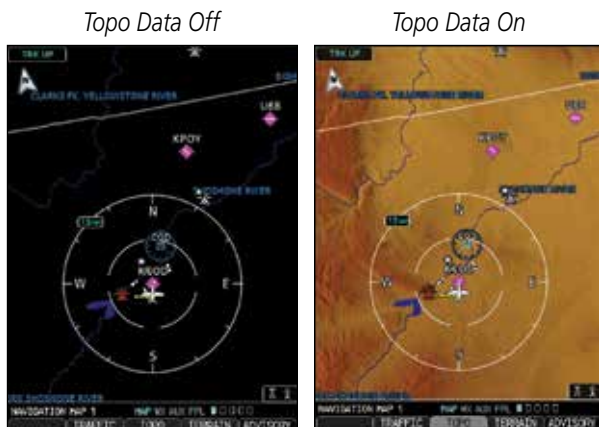

Figure 3-17 Navigation Map Topo Data

Topo Scale

The Topo Scale option selects whether the elevation scale for topographical features on the Navigation Map is displayed. The scale will be located on the right side of the display.

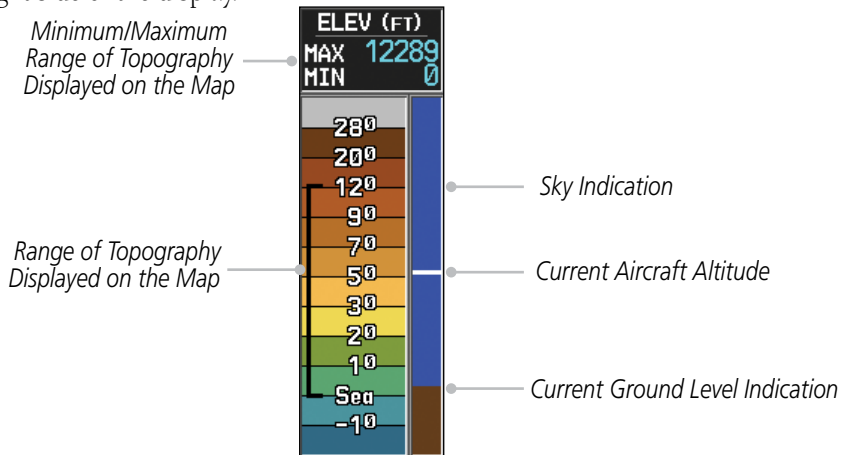



Figure 3-18 Navigation Map Topo Scale

Terrain Data

The Terrain Data option selects whether Terrain Data is shown on the Navigation Map. The Terrain Data Icon  will be shown when Terrain has been selected.

Terrain Data Off

Terrain Data On

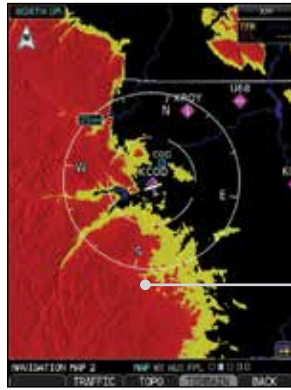

Terrain Data

Terrain Data Icon

Figure 3-19 Navigation Map Terrain Data

Obstacle Data Viewing Range

The Obstacle Data Viewing Range option selects whether the Obstacle Data is shown on the Navigation Map. Obstacles will be shown at and below the selected map range. Map ranges above this value will not show the Obstacle Data.

Obstacles Between 100 and 1000 feet of Aircraft

Obstacles Within 100 feet or Above Aircraft



Figure 3-20 Navigation Map Obstacle Data

Obstacle databases created for software version 7.00 or later may include HOT lines depending on the type of obstacle database installed. Hazardous Obstacle Transmission (HOT) Lines are power lines that have been identified as a potential hazard to aircraft. The installed obstacle database type can be verified on the System Status page. Power line data is available for the contiguous United States as well as small parts of Canada and Mexico.

Lat/Lon Viewing Range

The Lat/Lon Viewing Range option selects whether Lat/Lon line is shown on the MFD.



Figure 3-21 Navigation Map Lat/Lon Information

Field of View

The Field of View represented by the synthetic terrain data used for the Synthetic Vision Technology (SVT) option (when enabled) can be represented on the MFD Navigation Map Page lateral image. Two dashed lines forming a V-shape in front of the aircraft symbol on the MFD, represent the forward viewing area shown on the PFD.

Foreword

Sec 1 System

Sec 2 PFD

Sec 3 MFD



Field of View Borders

Figure 3-22 Navigation Map Field of View on the MFD

Sec 4 Hazard Avoidance

Sec 5 Additional Features

Sec 6 Annun. & Alerts

Sec 7 Symbols

Sec 8 Glossary

Appendix A

Index

Selected Altitude Range Arc

The range to altitude arc may be selected for display on the MFD navigation map to predict where the ownship will be when it reaches the altitude selected on the altitude alerter on the PFD. The distance from the ownship to the arc is based on ground speed, baro altitude, selected altitude, and vertical speed. The arc is shown when the aircraft is moving toward the selected altitude at a vertical speed of at least 150 feet per minute. Depending on the zoom range and lateral distance, the arc disappears when near the ownship icon.



Selected Altitude Range Arc

Figure 3-23 Selected Altitude Range Arc

3.1.10.2 Weather Feature Options (Optional)



NOTE: For steps on how to select a weather source, refer to section 3.2.1.10.

The Weather group selection from the Map Setup Page Menu allows you to customize the NEXRAD Viewing Range, NEXRAD Cell Movement, and Lightning Viewing range. Weather is an optional feature that requires a GDL 69/69A and an SiriusXM Weather subscription, or other weather product (such as Connex Weather).

1. While viewing the Navigation Map 1 or 2 page of the Map page group, press the **MENU** key to display the Navigation Map Page Menu.



Figure 3-24 Navigation Map Page Menu

2. With the cursor flashing on the "Map Setup" option, press the **ENT** key to display the Map Setup Menu.
3. Use the large and small **MFD** knobs to select the Weather Group and press **ENT** to allow editing of the selected group. The groups shown depend on the features available for equipment installed in your aircraft.



Figure 3-25 Navigation Map Page Menu Weather Group Selection

4. Press the small **MFD** knob to return to the Navigation Map Page.

NEXRAD Data Viewing Range

The NEXRAD Viewing Range option selects whether the NEXRAD weather products is shown on the MFD. NEXRAD weather products will be shown at and below the selected map range. When Off is selected, NEXRAD weather will not be shown. Map ranges above the selected value will not show the NEXRAD weather products. Where 100 NM is selected, the NEXRAD weather products will be shown at map ranges of 100 NM and lower.

NEXRAD Cell Movement

The NEXRAD Cell Movement option selects whether NEXRAD Cell Movement is shown on the Navigation Map.

NEXRAD Legend

The NEXRAD Legend selection provides the option of displaying an abbreviated version of the NEXRAD legend in the top right region of the MFD.

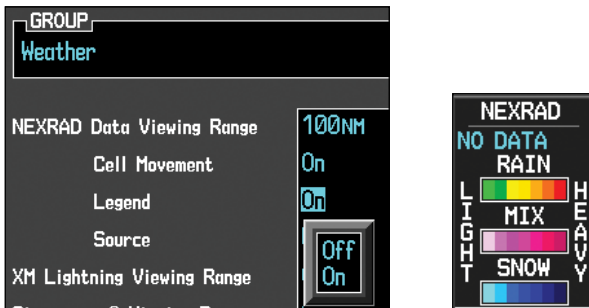

Figure 3-26 NEXRAD Legend Selection

Data Link Lightning Viewing Range

The Lightning Viewing Range option selects whether the data link provided Lightning weather products is shown on the Navigation Map. Lightning weather products will be shown at and below the selected map range. When Off is selected, Lightning weather will not be shown. Where 100 NM is selected, Lightning symbols will be shown at map ranges of 100 NM and lower.

XM/FIS-B NEXRAD Source

The XM/FIS-B NEXRAD Source selection allows the choice of the available sources for NEXRAD weather products.



Figure 3-27 NEXRAD Weather Source Selection

Stormscope Viewing Range

The Stormscope Viewing Range option selects Stormscope cells or strikes are shown on the Navigation Map. Products will be shown at and below the selected map range. When Off is selected, cells or strikes will not be shown. Where 100 NM is selected, symbols will be shown at map ranges of 100 NM and lower.



NOTE: The selected lightning display type, cell or strike, will be shown the same on both the StormScope and the Map pages.



NOTE: StormScope data is displayed on the Map Page only if aircraft heading is available.



NOTE: The G500/G600 will display StormScope data with or without a heading source. If no heading source is available, the display will indicate this by placing "HDG N/A" in the upper right portion of the display. If no heading is available, the pilot must clear the strikes after each heading change.

Strike/Cell Mode

When the Stormscope Viewing Range option has a range greater than zero, the Stormscope cells or strikes option is made available and can determine which type are shown on the Navigation Map.

3.1.10.3 Traffic Feature Options (Optional)

The Traffic group selection from the Map Setup Page Menu allows you to customize the display of traffic on the Navigation Map. The Traffic function requires the installation of a compatible traffic device.



NOTE: As a decluttering function, traffic labels will not be drawn when the map scale is above 15 NM and traffic symbols will not be drawn when the map scale is above 40 NM.

Traffic Selection	Display Result
Off	No traffic displayed
All Traffic	All types of traffic displayed
TA/PA	Traffic Alerts and Proximity Alerts displayed
TA Only	Traffic Alerts Only displayed

Table 3-3 Navigation Map Traffic Display Options

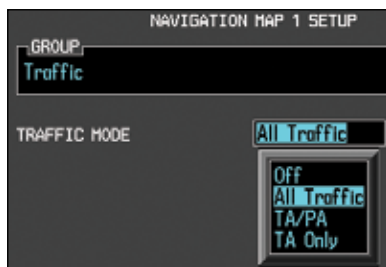

Figure 3-28 Navigation Map Page Menu Traffic Group Selection

1. While viewing the Navigation Map Setup page and the Traffic Group active, turn the large **MFD** knob to highlight the "Traffic" options.
2. Turn the small **MFD** knob to change the highlighted value.
3. Press **ENT** to accept the displayed value.
4. Press the small **MFD** knob to cancel selection or to end editing and return to the Navigation Map page or turn the large **MFD** knob to the next option.

When the Traffic overlay is active on a Map page, a Traffic icon will be displayed on the Map page where it is selected.



Figure 3-29 Navigation Map Traffic Overlay

3.1.10.4 Aviation Feature Options

The Aviation group selection from the Map Setup Page Menu allows you to customize the display of SafeTaxi information, Runway Extensions, Intersection/NDB locations, VOR locations, and TFR icons on the Navigation Map.



Figure 3-30 Navigation Map Page Menu Aviation Group Selection

SafeTaxi Viewing Range

The SafeTaxi viewing range option selects the range at which SafeTaxi information is shown on the Navigation Map. SafeTaxi will be shown at and below the selected map range. When Off is selected, SafeTaxi information will not be shown. Where 1 NM is selected, the SafeTaxi information will be shown at map ranges of 1 NM and lower.

Runway Extension Range

The Runway Extension Range option selects the whether Runway Extensions is shown for the flight plan destination airport runway and will extend 10 NM. Runway Extensions will be shown at and below the selected map range. When Off is selected, Runway Extensions will not be shown.

Foreword

Sec 1
System

Sec 2
PFD

Sec 3
MFD

Sec 4
Hazard
Avoidance

Sec 5
Additional
Features

Sec 6
Annun.
& Alerts

Sec 7
Symbols

Sec 8
Glossary

Appendix A

Index

INT/NDB Viewing Range

The INT/NDB viewing range option selects whether Intersection and NDB information is shown on the Navigation Map. Intersection and NDB information will be shown at and below the selected map range. When Off is selected, the information will not be shown. Where 15 NM is selected, INT/NDBs will be shown at map ranges of 15 NM and lower.

VOR Viewing Range

The VOR viewing range option selects whether VOR information is shown on the Navigation Map. VOR information will be shown at and below the selected map range. When Off is selected, the information will not be shown. Where 150 NM is selected, VOR information will be shown at map ranges of 150 NM and lower.

Class B/TMA Airspace Viewing Range

The Class B/TMA airspace viewing range option selects whether Class B/TMA airspace information is shown on the Navigation Map. Class B/TMA airspace information will be shown at and below the selected map range. When Off is selected, the information will not be shown. Where 100 NM is selected, Class B/TMA airspace information will be shown at map ranges of 100 NM and lower.

Class C/TCA Airspace Viewing Range

The Class C/TCA airspace viewing range option selects whether Class C/TCA airspace information is shown on the Navigation Map. Class C/TCA airspace information will be shown at and below the selected map range. When Off is selected, the information will not be shown. Where 100 NM is selected, Class C/TCA airspace information will be shown at map ranges of 100 NM and lower.

Class D Airspace Viewing Range

The Class D airspace viewing range option selects whether Class D airspace information is shown on the Navigation Map. Class D airspace information will be shown at and below the selected map range. When Off is selected, the information will not be shown. Where 100 NM is selected, Class D airspace information will be shown at map ranges of 100 NM and lower.

Foreword

Sec 1
SystemSec 2
PFDSec 3
MFDSec 4
Hazard
AvoidanceSec 5
Additional
FeaturesSec 6
Annun.
& AlertsSec 7
SymbolsSec 8
Glossary

Appendix A

Index

Restricted Airspace Viewing Range

The Restricted airspace viewing range option selects whether the map range is shown on the Navigation Map. Restricted airspace information will be shown at and below the selected map range. When Off is selected, the information will not be shown. Where 100 NM is selected, Restricted airspace information will be shown at map ranges of 100 NM and lower.

MOA (Military) Viewing Range

The MOA (Military) viewing range option selects whether MOA (Military) information is shown on the Navigation Map. MOA airspace information will be shown at and below the selected map range. When Off is selected, the information will not be shown. Where 100 NM is selected, MOA airspace information will be shown at map ranges of 100 NM and lower.

Other/ADIZ Airspace Viewing Range

The Other/ADIZ airspace viewing range option selects whether Other/ADIZ airspace information is shown on the Navigation Map. Other/ADIZ airspace information will be shown at and below the selected map range. When Off is selected, the information will not be shown. Where 100 NM is selected, Other/ADIZ airspace information will be shown at map ranges of 100 NM and lower.

TFR Viewing Range (Optional)

The Temporary Flight Restriction (TFR) viewing range option selects whether TFR information is shown on the Navigation Map. TFR information will be shown at and below the selected map range. When Off is selected, the information will not be shown. Where 100 NM is selected, TFR information will be shown at map ranges of 100 NM and lower. This optional feature requires an active data link receiver. TFRs are provided through the data link. Some TFRs may exist that are not available to the data link provider and as such will not be displayed.

Airways

The Airways option allows you to select the airways that are shown on the Navigation Map. All, Low only, and Hi only Airways may be selected. When Off is selected, airways will not be shown.

Smart Airspace

The Smart Airspaces selection filters airspaces to show the ones appropriate for your altitude. Garmin's Smart Airspace™ feature aids visual clarity on-screen by de-emphasizing airspace that's well above or below the aircraft's current altitude. The vertical separation is 1,000 feet at sea level and the vertical separation will gradually increase to 2,000 feet until the aircraft reaches 10,000 feet. Anything above 10,000 feet keeps the 2,000 feet vertical separation.



NOTE: *Smart Airspace only changes the depiction of the airspace on the moving map display. It does not alter the Airspace Alerts that can be set on the System-Alerts portion of the system.*

Smart Airspaces - De-Emphasized



Smart Airspaces - Emphasized (On)



Figure 3-31 Display of Smart Airspaces (Airspace Borders Grayed When Emphasized)

Show Airspace

The Airspace viewing range options select whether the Airspaces are shown on the Map and at and below the selected map ranges.

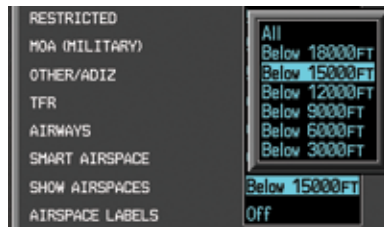

Figure 3-32 Display of Smart Airspaces

Airspace Labels

The Airspace Label feature displays the airspace altitude limits when zoomed into 15 nm or less.

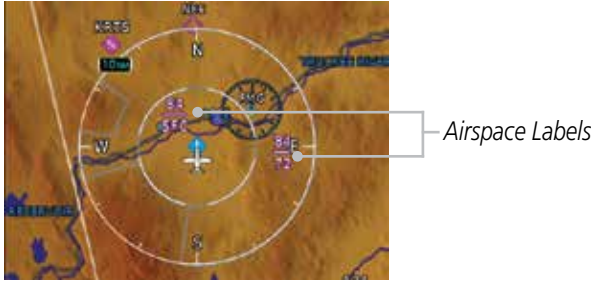

Figure 3-33 Airspace Labels

Visual Reporting Points

The Visual Reporting Points (VRPs) viewing range option selects whether VRP information is shown on the Navigation Map. VRP information will be shown at and below the selected map range. When Off is selected, the information will not be shown. Where 15 NM is selected, the VRPs will be shown for map ranges at and below 15 NM.

3.1.11 Split Screen (Optional)

External Video is an optional function that displays video provided by an externally mounted video source on the aircraft.

1. While viewing the Map function, turn the small **MFD** knob to the third Navigation Map page.

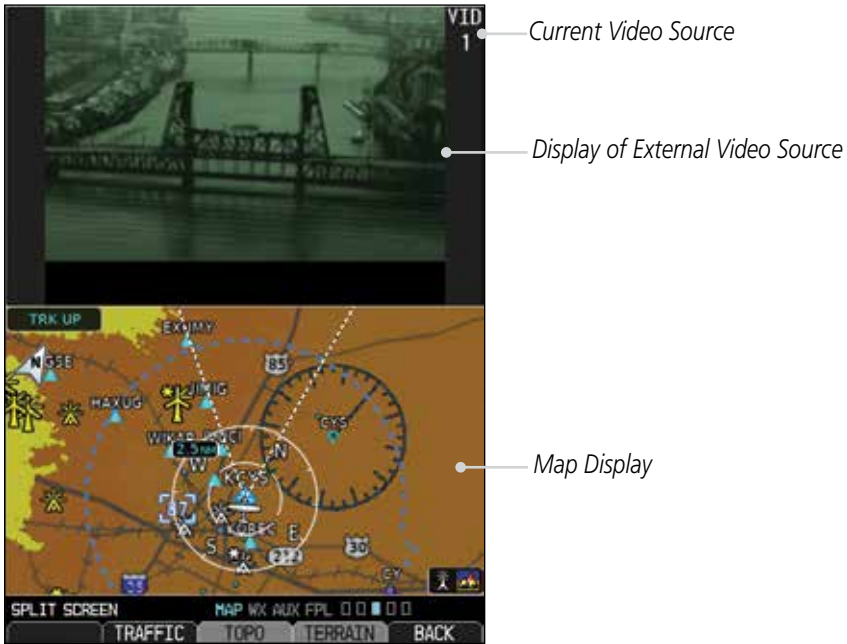

Figure 3-34 External Video

2. The External Video page will show the external video on the top half of the MFD and a Navigation Map will be shown on the lower half.
3. To select the other external video source, press the **MENU** key.
4. Turn the large or small **MFD** knobs to highlight the Video selection and then press **ENT**.



Figure 3-35 Aux Mode System Setup Page Menu

3.2 Aux Mode Pages

The Aux mode provides pages for System Setup, SiriusXM Information (if installed), and system Status.

3.2.1 System Settings

G500/G600 system settings are managed from the Aux Mode System Setup Page. The following settings can be changed:

- Display Brightness (Mode and Level)
- Airspeeds (Glide-REF, V_R , V_X - V_1 , and V_Y - V_2)
- PFD Options (Wind Vector, Nav Status Styles, CDI/VDI Preview, and Temp Reference)
- Dual Unit Synchronization (CDI, Baro, and some Databases)
- Date/Time (Date, Time, Time Format, and Time Offset)
- MFD Display Units (Distance/Speed and Altitude/Vertical Speed)
- System Display Units (Navigation Angle Reference, Pressure Units, and Temperature Units)
- Data Link (FIS, XM, or GFDS for Connxt Weather)



Figure 3-36 Aux Mode System Setup Page

The default values set by the installer during installation are restored by using the Page Menu options or soft keys. The “Restore Unit Defaults” menu selection and the **DFLT UNIT** soft key restores the default MFD Display and System Display Units settings. The “Restore Airspeed Defaults” menu selection or **DFLT SPD** soft key restores the default PFD Airspeeds settings.

The **RA TEST** soft key activates the Radar Altimeter test mode. For more details, refer to section 2.

NOTE: *Not all Radar Altimeters have the TEST function.*

1. While viewing the Aux mode System Setup page, press the **MENU** key.



Figure 3-37 Aux Mode System Setup Page Menu

2. Turn the large or small **MFD** knobs to highlight the desired selection and then press **ENT**.

3.2.1.1 Display Brightness

Display brightness mode may be set to manual or automatic. The automatic mode will set the display brightness based on the ambient light. The manual mode allows the setting of display brightness between 0 and 100%.

1. Turn the large **MFD** knob to reach the AUX page group. Press the small **MFD** knob to activate the cursor.
2. The Level will be highlighted. Turn the small **MFD** knob to select the Display Brightness Level and then press **ENT**.



Figure 3-38 Aux Mode Display Brightness Level Selection

3. If the Level was changed, Manual will be selected. Press the cursor to save the settings. If you press **ENT** the Mode setting will be highlighted.

- With the Mode value highlighted, turn the small **MFD** knob to select Auto or Manual and then press **ENT**.



Figure 3-39 Aux Mode Display Brightness Mode Selection

3.2.1.2 Airspeed Reference Marks

The Best Glide (or REF), Vr, Vx (or V1), and Vy (or V2) airspeed reference marks for the PFD are adjusted with this function. A marker will appear on the PFD Airspeed tape at the selected speed when the value is “On.” Default reference airspeeds are set during installation. When power is cycled, the values you set will be reset to the default values.



NOTE: When power is cycled, the Airspeed Reference values are reset. During preflight, the Airspeed Reference values should be checked and set appropriately for the current aircraft configuration and performance.

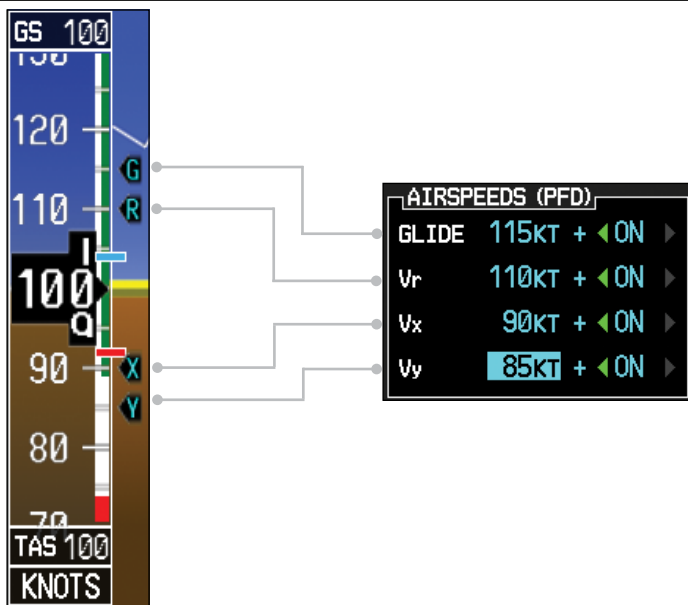

Figure 3-40 Airspeed References shown on PFD when activated

3.2.1.3 PFD Options - Wind Vector

When selected, wind vector information is displayed on the PFD to the left of the HSI. Four styles are available.

1. While viewing the System Setup page of the AUX page group, press the small **MFD** knob to activate the cursor. Turn the large **MFD** knob to highlight the desired Wind Vector value.
2. Turn the small **MFD** knob to select the style and press **ENT**.

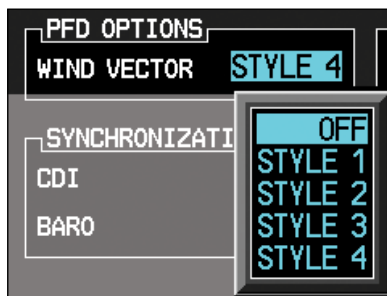

Figure 3-41 Wind Vector Style

3. When a Wind Vector style is selected, a Wind Vector box with the chosen style will be displayed to the left of the HSI on the PFD. When OFF is selected, the Wind Vector box will not be displayed.

3.2.1.4 PFD Options - Nav Status

When selected, Nav Status information is displayed on the PFD either on the top of the display (Style 1) or to the left of the HSI (Style 2).

1. While viewing the System Setup page of the AUX page group, press the small **MFD** knob to activate the cursor. Turn the large **MFD** knob to highlight the desired Nav Status value.
2. Turn the small **MFD** knob to select the style and press **ENT**.

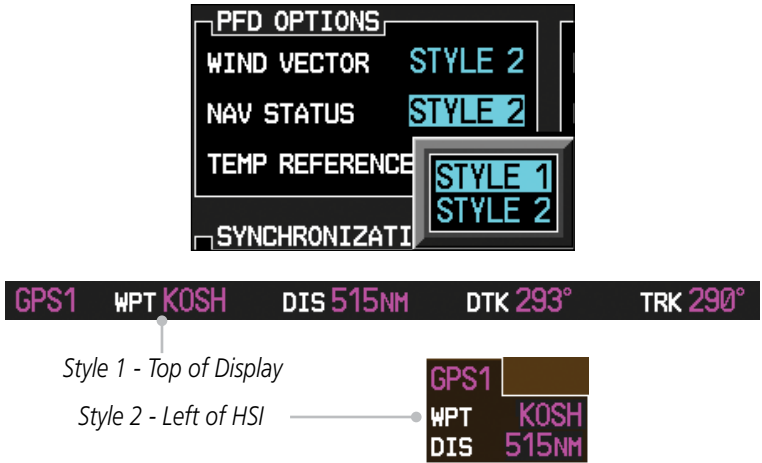

Figure 3-42 Nav Status Style

- After the Nav Status style is selected, the chosen style will be displayed on the PFD.



NOTE: Nav Status option is not available for all installations.

3.2.1.5 CDI/VDI Preview

1. While viewing the System Setup page of the AUX page group, press the small **MFD** knob to activate the cursor. Turn the large **MFD** knob to highlight the CDI/VDI Preview value.
2. Turn the small **MFD** knob to select "ON" or "OFF."
3. Press **ENT**.

3.2.1.6 Temperature Reference

The computer calculates the temperature based on temperature probe and Pitot-static inputs. The units (°C or °F) and temperature reference are selected on the AUX – SYSTEM SETUP page. The temperature reference can be selected to one of the following choices:

- Static Air Temperature (SAT) – This is the calculated temperature of the stationary (static) outside air. Conceptually, this is the temperature that would be read on a thermometer floating stationary at the current location.
- Total Air Temperature (TAT) – This is the calculated temperature of the outside air as it moves past the aircraft, including the rise in temperature due to air compression and friction at the current airspeed.
- Difference from International Standard Atmosphere (ISA) – This is the difference between SAT and standard (ISA) temperature at the current altitude. This provides an indication of how much warmer/colder the temperature is from a "standard" atmosphere.

1. While viewing the System Setup page of the AUX page group, press the small **MFD** knob to activate the cursor. Turn the large **MFD** knob to highlight the desired Temp Reference value.
2. Turn the small **MFD** knob to select the Temp Reference type and press **ENT**.



Figure 3-43 Outside Air Temperature Selection

3.2.1.7 Synchronization

Dual GDU 620 units when connected in the aircraft may be set up to communicate and share information by “Crossfilling” or synchronizing information between the two units. A single GDU 620 may be set up to synchronize the database with a navigator.

Crossfill synchronization for CDI and Baro Corrections are selected in the System Setup page of the Aux page group. Database Synchronization is managed in the DB Sync function on the System Status page of the Aux page group.

1. While viewing the first page of the AUX page group, press the small **MFD** knob and turn the large **MFD** knob to highlight “CDI,” “BARO,” “Databases,” or “Chart Streaming” in the “Synchronization” box in both units.



NOTE: Chart Streaming appears only when the Databases option is turned on.

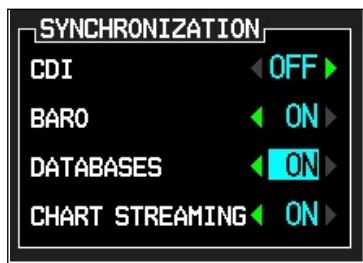

Figure 3-44 Dual Unit Synchronization

2. Turn the small **MFD** knob to select “ON” or “OFF.”
3. Press **ENT**.

The following information is always synchronized between both GDU 620 units:

- Selected Altitude
- Selected Heading
- Selected Course
- Selected Vertical Speed
- Airspeed Bug Values
- Airspeed Color Band Values
- System Pressure Units
- System Temperature Units

The following information can be synchronized between GDU 620s, or changed independently, depending on the Crossfill Synchronization Settings:

- Barometric Correction (default ON)
- Selected CDI (default OFF)

When Barometric Correction is synchronized, any changes to the Barometric Setting on either GDU will change it on both GDUs.

When the CDI is synchronized, any changes to the selected CDI on either GDU will change it on both GDUs. Either pilot can change the OBS course on either GPS. If the pilot selects GPS1 on the CDI and GPS1 is in OBS mode, any course changes will move the OBS on GPS1, GDU1, and GDU2 (if the copilot has GPS1 displayed on the CDI). Similarly, if the pilot selects GPS2 on the CDI and GPS2 is in OBS mode, any course changes will move the OBS on GPS2, GDU1, and GDU2 (if the copilot has GPS2 displayed on the CDI).

AHRS 1 and ADC 1 will only be displayed on GDU1. AHRS2 and ADC2 will only be displayed on GDU2.

The **CDI** soft key toggles between selection of GPS or VOR/LOC as the active navigation source. In a single GDU 620 system, the GDU **CDI** soft key will change the source in the connected navigator and making a source change in the navigator will be reflected in the GDU 620. In a dual GDU 620 system, the **CDI** keys in the navigator are disabled.

3.2.1.8 Date and Time

The Date and Time options allow you to select the time to change UTC time to local time with a time offset.

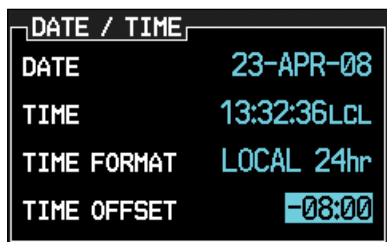

Figure 3-45 Time Format and Offset

Time Zone	Local Standard Time Offset	Local Daylight Savings Time Offset
Atlantic	-4 hours	-3 hours
Eastern	-5 hours	-4 hours
Central	-6 hours	-5 hours
Mountain	-7 hours	-6 hours
Pacific	-8 hours	-7 hours
Alaskan	-9 hours	-8 hours
Hawaiian	-10 hours	-9 hours

Table 3-4 U.S. Time Zone Offsets

1. While viewing the System Setup page of the AUX page group, press the small **MFD** knob to activate the cursor. Turn the large **MFD** knob to highlight "Time Format."
2. Turn the small **MFD** knob to select Local 12hr, Local 24hr, or UTC and then press **ENT**. When Local 12 or 24 hour mode is selected, the Time Offset value will then be highlighted.
3. Turn the small **MFD** knob to select the desired offset and then press **ENT**.

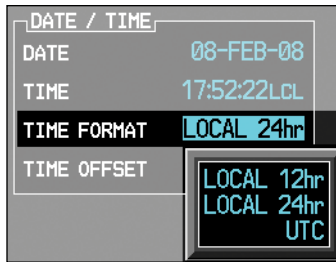

Figure 3-46 Date and Time Values

4. A Time Offset may be entered by using the large and small **MFD** knobs to change the values. Press **ENT** after completing any changes.
5. Press the small **MFD** knob to exit adjustments.

3.2.1.9 MFD Display Units

The MFD Display Units options allow you to select the units of measurement conventions displayed on the MFD. Distance and Speed selections are Imperial, Metric, or Nautical. Altitude and Vertical speed selections are Feet or Meters. Traffic information is always shown in Nautical Miles (distance) and Feet (altitude).

1. While viewing the System Setup page of the AUX page group, press the small **MFD** knob to activate the cursor. Turn the large **MFD** knob to highlight the Distance and Speed (DIS, SPD) units of measurement.

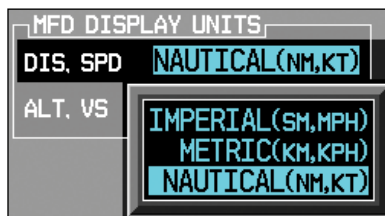

Figure 3-47 Distance and Speed MFD Display Units

2. Turn the small **MFD** knob to select Imperial, Metric, or Nautical and then press **ENT**. The Altitude and Vertical Speed units selection will now be highlighted.
3. Turn the small **MFD** knob to select Feet or Meters and then press **ENT**.

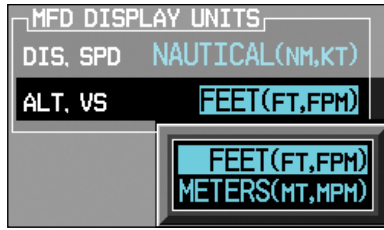

Figure 3-48 Altitude and Vertical Speed MFD Display Units

3.2.1.10 System Display Units

The System Display Units options allows the selection of units to display values for Navigation Angle (Magnetic or True), Barometric Setting (inches or Hectopascals), and Temperature (Fahrenheit or Celsius). Pressing the **DLT UNIT** soft key will restore the Default Unit settings.

1. While viewing the System Setup page of the AUX page group, press the small **MFD** knob to activate the cursor. Turn the large **MFD** knob to highlight the System Display Units selection titled "Nav Angle."



CAUTION: The Nav Angle display units (Magnetic or True) must be set to the same type in both the GDU 620 and GPS navigators.

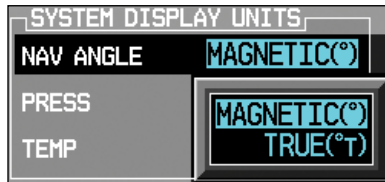

Figure 3-49 Nav Angle System Display Units

2. Turn the small **MFD** knob to select Magnetic or True and then press **ENT**. The Barometric Pressure Setting value will now be highlighted. When True is selected, a "T" will appear to the right of the heading value on the PFD.

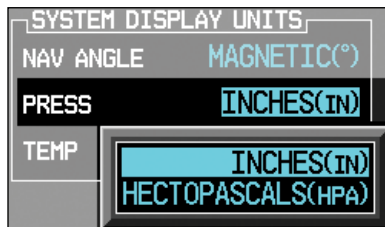

Figure 3-50 Barometric Setting System Display Units

- Turn the small **MFD** knob to select the Barometric Setting units and then press **ENT**. The Temperature value will now be highlighted.

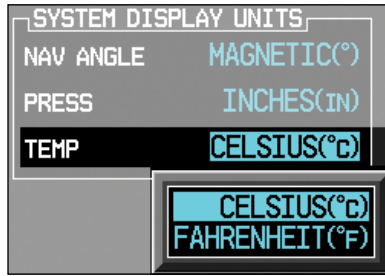

Figure 3-51 Temperature System Display Units

- Turn the small **MFD** knob to select the Temperature units and then press **ENT**.

3.2.1.11 Data Link

The Data Link WX/TFR Source menu allows users to select the source of weather that is displayed on the MFD. Only the options that are installed will be displayed.

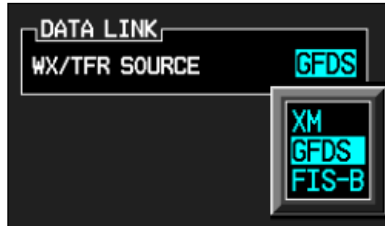

Figure 3-52 WX/TFR Source Options

To select a weather source:

- Open the System Setup page of the AUX page group.
- Press the small **MFD** knob to activate the cursor.
- Turn the large **MFD** knob to highlight the WX/TFR Source field.
- Turn the small **MFD** knob to select XM, GFDS, or FIS-B, and then press **ENT**.
- Press the small **MFD** knob to exit adjustments.

3.2.2 SiriusXM Information (Optional)

The Aux mode XM Information page displays information about the SiriusXM Satellite radios, service, and products when the GDL 69/69A is installed and the SiriusXM Satellite Radio service is activated.



Figure 3-53 XM Information

3.2.3 SiriusXM Entertainment Radio (Optional)

Audio entertainment is available through the SiriusXM Satellite Radio Service when activated in the optional installation of the GDL 69A. The GDU 620 serves as the display and control head for your remotely mounted GDL 69A. SiriusXM Satellite Radio allows you to enjoy a variety of radio programming over long distances without having to constantly search for new stations. Based on signal from satellites, coverage far exceeds land-based transmissions. When enabled, the SiriusXM Satellite Radio audio entertainment is accessible in Aux Mode.

The information on the SiriusXM Satellite Radio display is composed of four areas: the Active Channel, Available Channels, Category of the highlighted Channel, and the Volume setting. The Active Channel window shows the Channel Name and Number, Artist, Song Title, and Category.

1. Turn the large **MFD** knob to the AUX page group.
2. Turn the small **MFD** knob to the XM Radio page.



Figure 3-54 XM Entertainment Radio

A description of SiriusXM Satellite Radio audio entertainment is provided in section 5.

3.2.4 System Status

The System Status Page displays the statuses, serial numbers, and software version numbers for all detected system LRUs. Pertinent information on all system databases is also displayed. Active LRUs are indicated by green check marks; failed LRUs by red “X’s.” Failed LRUs should be noted and a service center or Garmin-authorized dealer informed. Database SYNC allows a database to be synchronized with more than two LRUs (G500/G600 and GTNs) at once.

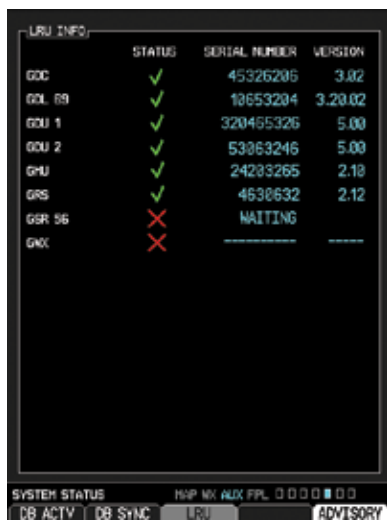

Figure 3-55 LRU and Database Information

Foreword

Sec 1
System

Sec 2
PFD

Sec 3
MFD

Sec 4
Hazard
Avoidance

Sec 5
Additional
Features

Sec 6
Annun.
& Alerts

Sec 7
Symbols

Sec 8
Glossary

Appendix A

Index

1. Turn the large **MFD** knob to the AUX page group.
2. Turn the small **MFD** knob to the System Status page.
3. Press the **LRU** soft key to highlight the first item in the LRU Info window.
4. Turn the small **MFD** knob to scroll through the items in the LRU Info window in case more items are available than are displayed. If more items are available than can be displayed in the window, a scroll bar will show on the right side of the window.
5. Press the **DB ACTV** soft key to display the active databases.
6. Press the **DB SYNC** soft key to display the status of Database SYNC operations. The synchronization happens automatically regardless of whether the soft key is used.

3.2.4.1 Database Sync Operation

Database SYNC allows the G500/G600 to synchronize databases from a single unit. The pilot only needs to update a single database card and the new databases are automatically SYNC'd through the units connected in the cockpit and configured for Database Syncing.

The following databases can be synchronized between using Database SYNC:

- Navigation
- Chartview (when support is added by Jeppesen)
- Obstacle
- FliteCharts
- SafeTaxi
- Basemap
- Airport Directory

When Database SYNC is enabled in the LRUs and a database card is inserted that is created for Database SYNC, the G500/G600 will coordinate with the other LRUs in the cockpit to determine which unit has the newest databases. Once the determination has occurred, the connected LRUs will begin to transfer the databases. This process may take several minutes. Charts are meant to be transferred while in-flight, before the new chart database is effective, as this could take an hour or more. The status of the database transfers to a unit can be viewed in the System Status function on the DB SYNC page. The G500/G600 will display the source of the received databases. If a database transfer is pending, completed, or not authorized, the status will also be indicated.

When the transfer is complete, if there are new and current databases to be used, and if the aircraft is stopped and has yet to take-off, the pilot will be prompted with the option to restart the unit that contains the new databases.



NOTE: This feature is available in SW Versions 7.00, and later.



NOTE: Restarting the G500/G600 must only be performed when the aircraft is on the ground as navigation and communication from the restarted unit will be lost for a period of time.

1. With the G500/G600 turned off, insert the database card.
2. Turn the G500/G600 on. The Database SYNC will occur automatically in the background. During the Database SYNC process, normal operation of the G500/G600 is not affected.
3. On the System Status page, press the **DB SYNC** soft key to view the transfer process.



Figure 3-56 One Database Transfer In Process and One Pending



Figure 3-57 Database Transfer Complete



Figure 3-58 Database Transfer Not Authorized and DB Sync Conflict

- Once all of the database transfers have completed, if the G500/G600 determines that at least one of the newly transferred databases is effective and the aircraft is on the ground and stopped prior to a flight, a pop-up and confirmation will be presented to restart the unit. No pop-up will appear if the aircraft is moving or has been in the air since the unit was turned on.
- Press the **Restart** soft key to continue updating the database.



Figure 3-59 System Restart - Step 1



WARNING: The unit will reset and all GPS navigation and moving map functions may be lost while the unit regains GPS position.

3.2.4.2 Resolving Database Conflicts

If the G500/G600 determines that there are multiple LRUs with the newest cycle of a database, but they have different regions or types of that database (i.e., Fixed-wing vs. Rotorcraft navigation database, different regions of the navigation database, or different obstacle database types) then a database conflict will occur. When a database conflict occurs, that database will not be SYNC'd until the pilot resolves the conflict. Initiate the resolve conflicts function on the unit that contains the databases which the pilot wishes to use. These databases will then be sent to other units.

1. Press the **DB SYNC** soft key, and then select the **Resolve Conflicts** function on the LRU with the desired databases.



Figure 3-60 Database Conflicts

2. Select **YES** to continue and push the database to all other LRUs.

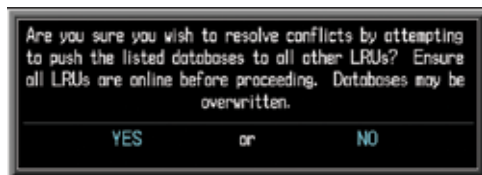

Figure 3-61 Confirm Database Sync

- Once sync'd, the desired database will be SYNC'd to the other LRUs and "Initiating" will be displayed on the **Sync Conflicts** window.



Figure 3-62 Database Conflicts Resolved (Initiating)

3.2.4.3 Chart Streaming

While the chart database is synchronizing in the background, the GDU will stream individual charts to other compatible displays. This enables all Garmin displays to use the latest chart database information even though the database is currently installed only on a single unit. Chart Streaming will not begin until after the chart database has begun synchronizing.

3.2.5 ADS-B/FIS-B Status (Optional)

Foreword

When an optional ADS-B/FIS-B receiver is installed, the ADS-B/FIS-B Status page will show the status of satellite communications, FIS-B weather products, and the traffic applications.

Sec 1
System

Sec 2
PFD

Sec 3
MFD

Sec 4
Hazard
Avoidance

Sec 5
Additional
Features

Sec 6
Annun.
& Alerts

Sec 7
Symbols

Sec 8
Glossary

Appendix A

Index



Figure 3-63 ADS-B/FIS-B Status Page

3.2.6 External Video (Optional)

External Video is an optional function that displays video provided by an externally mounted video source on the aircraft.

1. Turn the large **MFD** knob to the Aux page group.
2. The External Video page is the first page in the Aux page group.

Foreword

Sec 1
System

Sec 2
PFD

Sec 3
MFD

Sec 4
Hazard
Avoidance

Sec 5
Additional
Features

Sec 6
Annun.
& Alerts

Sec 7
Symbols

Sec 8
Glossary

Appendix A

Index

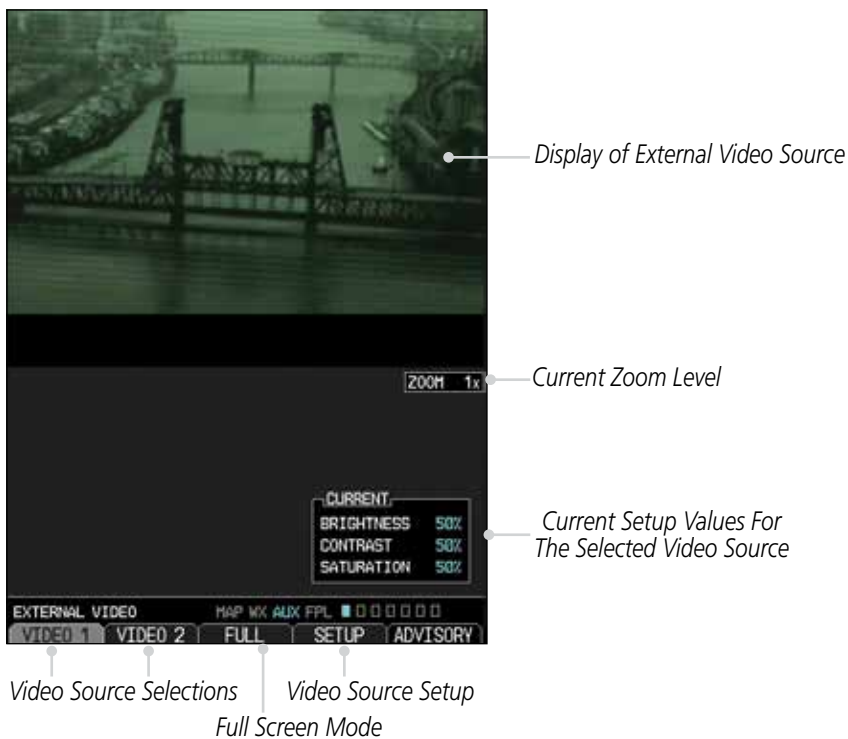

Figure 3-64 External Video

3.2.6.1 Select Video Source

If more than one video source is available, the **Video 1** and **Video 2** soft keys will be available at the bottom of the display.

1. Press the **Video 1** soft key to select Video 1 source for viewing and setup.
2. Press the **Video 2** soft key to select Video 2 source for viewing and setup.

3.2.6.2 Zoom

1. While viewing the External Video function, press the **Up Rng Arrow** key to increase the zoom up to 10x magnification. Zoom level is made through digital magnification.
2. Press the **Down Rng Arrow** key to decrease the zoom level down to a minimum of 1x.
3. Pressing the **FULL** soft key toggles between a half and full page view.

3.2.6.3 Panning

1. While viewing the External Video function, press the small **MFD** knob to activate panning.
2. Turn the small **MFD** knob clockwise to pan up (the map will move down).
3. Turn the small **MFD** knob counterclockwise to pan down (the map will move up).
4. Turn the large **MFD** knob clockwise to pan to the right (the map will move left).
5. Turn the large **MFD** knob counterclockwise to pan to the left (the map will move right).
6. Press the small **MFD** knob to exit panning.

3.2.6.4 Setup

The display of each video source is set up individually.

1. While viewing the External Video page, press the soft key for the desired Video source (**Video 1** or **Video 2**).
2. Press the **Setup** soft key.
3. The Current value for Brightness will be selected. Use the following directions for each value.



Figure 3-65 External Video Setup

4. After selecting the desired settings, press the small **MFD** knob or the **Setup** soft key to exit editing.

Brightness Adjustment

1. While viewing the External Video page and the desired Video source, press the **Setup** soft key.
2. The Current value for Brightness will be selected. Turn the small **MFD** knob to adjust the Brightness value.



Figure 3-66 External Video Brightness Adjustment

3. After selecting the desired setting, turn the large **MFD** knob to highlight the next value or press the small **MFD** knob to exit editing.

Contrast Adjustment

1. While viewing the External Video page and the desired Video source, press the **Setup** soft key.
2. The Current value for Brightness will be selected. Turn the large **MFD** knob to highlight the Contrast value. Turn the small **MFD** knob to adjust the Contrast value.



Figure 3-67 External Video Contrast Adjustment

3. After selecting the desired setting, turn the large **MFD** knob to highlight the next value or press the small **MFD** knob to exit editing.

Saturation Adjustment

1. While viewing the External Video page and the desired Video source, press the **Setup** soft key.
2. The Current value for Brightness will be selected. Turn the large **MFD** knob to highlight the Saturation value. Turn the small **MFD** knob to adjust the Saturation value.



Figure 3-68 External Video Saturation Adjustment

3. After selecting the desired setting, press the small **MFD** knob to exit editing.

3.2.6.5 Restore Defaults

The Restore Defaults selection will return the Brightness, Contrast, and Saturation values to their original settings.

1. While viewing the External Video page, press the **MENU** key.



Figure 3-69 Restore Video Defaults Menu Selection

2. "Restore Defaults" will be highlighted. Press the **ENT** key.

3.2.6.6 Full Screen

The Full selection allows selection of the part of the video information for display.

1. While viewing the External Video page, press the **FULL** key.



Figure 3-70 Full Video Selection

2. Press the small **MFD** knob to activate the selection window.
3. Turn the large **MFD** key to move the selection window.
4. Press the small **MFD** knob to accept the selected display area shown in the window.

3.2.7 Position Reporting (Optional)

Position Reporting is a system which collects system variables and transmits them over the Iridium® satellite at a given interval through the GSR 56.

3.2.7.1 Status

The Status window shows the time until the next data transmission and the status of the reporting system.



NOTE: The GSR 56 does not report its serial number until 90 seconds after power up of the GDU. As a result, for that period, the product info for the GSR 56 will show "Waiting."

Time Until Transmit

The Time Until Transmit field is a countdown timer that shows the time until the next data transmission. This field is blank when the aircraft is on the ground.



Countdown Time Until Transmit

Figure 3-71 Position Reporting Time Until Transmit

Position Reporting Status

Position Reporting will be enabled when the aircraft is in the air.

Status	Description
Idle	The reporting system is not using the GSR 56 for reporting at this time.
Initializing	The GSR 56 and its driver are currently initializing.
Transferring	A position report is currently being transmitted.
Unavailable	The GSR 56 is currently not usable by the reporting system.

Table 3-5 Position Reporting Status

3.2.7.2 Report Type

Standard

When the Standard reporting type is used, the Position Reporting Period may be set to Off or Automatic. The Automatic Position Reporting Period can be set to intervals of 2 to 60 minutes.

1. Turn the large **MFD** knob to reach the Aux page group. Turn the small **MFD** knob to reach the Position Reporting page.
2. Press the small **MFD** knob to select the Report Type.
3. Turn the small **MFD** knob to highlight Standard and then press the **ENT** key.



Figure 3-72 Select Standard Reporting

4. The Position Reporting Period type will now be selected. Turn the small **MFD** knob to highlight "Off" or "Automatic" and then press the **ENT** key. The Position Reporting Period interval will now be selected.
5. Turn the small **MFD** knob to select the reporting frequency.



Figure 3-73 Select Standard Reporting Period Frequency

6. Press the small **MFD** knob to exit editing.
7. With the Standard Reporting Type, the reporting period may be manually overridden by pressing the **SEND** soft key to send data.



Figure 3-74 Press SEND to Override the Reporting Period

Automatic Flight Following (AFF)

The G500/G600 system, when combined with a GSR 56 Iridium data link, can send position reports that contain data as required by the U.S. Government Automated Flight Following system. The GSR 56 account will allow configuration to forward data to the Automated Flight Following system.

1. While viewing the Position Reporting function, press the small **MFD** knob to select the Report Type.
2. Turn the small **MFD** knob to highlight "AFF" and then press the **ENT**.



Figure 3-75 Select Automatic Flight Following (AFF) Reporting Type

3. Turn the small **MFD** knob to select "OFF" or the default "Every 2 Min" value.



Figure 3-76 Select AFF Reporting Period Frequency

3.2.8 Iridium Phone Operation (Optional)

Optional satellite telephone operation is available through the Iridium® satellite system that is interfaced through the Garmin GSR 56.

3.2.8.1 Status

The Status section shows the Call Time, Phone Status, and Call Suppression selected. The Call Time value shows the length of the call time for the current call using the Iridium phone. Phone Status shows the current operating status of the Iridium phone.

Status	Description
Idle	The Iridium phone is not using the GSR 56 for communicating at this time.
Initializing	The GSR 56 and its driver are currently initializing.
Connected	The GSR 56 is connected to the called number.
Connecting Call	The GSR 56 is in the process of connecting to the called number.
Changing Volume	The volume level on the GSR 56 is changing.
Busy	The phone is in use by another service and the call may not be made.
Dialing	The GSR 56 is dialing the called number.
Incoming Call	A call is being made to the GSR 56.
Hanging Up	The GSR 56 is disconnecting from the current call.
Unavailable	The GSR 56 is currently not usable by the Iridium phone system.

Table 3-6 Iridium Phone Status

Call Suppression controls calling when use of the Iridium phone system is allowed.

1. Turn the large **MFD** knob to reach the Aux page group. Turn the small **MFD** knob to reach the Iridium Phone page.
2. Press the small **MFD** knob to select the Call Suppression type.

Status	Description
Off	Call Suppression is turned off. Calls may be transmitted and received through the Iridium phone.
On	Call Suppression is turned on. The incoming call pop-up will not be shown. The call may still be answered on the phone page. Outgoing calls are not affected.
On During APR/ MAPR/TERM	Call Suppression is turned on during Approach, Missed Approach, and Terminal operations. The incoming call pop-up will not be shown. The call may still be answered on the phone page. Outgoing calls are not affected.

Table 3-7 Call Suppression

3. Turn the small **MFD** knob to highlight the desired selection.

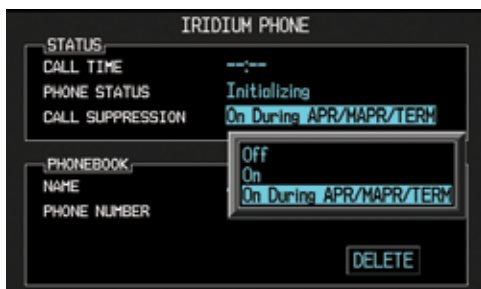

Figure 3-77 Select Call Suppression

4. Press the **ENT** key. Press the small **MFD** knob again to cancel the selection cursor.

3.2.8.2 Managing the Phone Book

The Phone Book is stored on the SD card in the bottom slot. The Phone Book will only be available for use when the SD card is in the bottom slot. The Phone Book may hold up to 128 entries. A phone number may be entered and dialed without saving it to the Phone Book. Note that it is necessary to dial a “1,” the area code, and then the number.

Foreword
System Sec 1

Creating Phone Number Names

1. Turn the large **MFD** knob to reach the Aux page group. Turn the small **MFD** knob to reach the Iridium Phone page.
2. Press the small **MFD** knob to activate the cursor and then turn the large **MFD** knob to highlight the Name item in the Phone Book. The Name field will blink.
3. If items already exist in the catalog, turn the large **MFD** knob to select the Phone Book Catalog icon. Then, turn the small **MFD** knob to display the contents of the Phone Book Catalog and highlight the New Entry selection and press **ENT**.

Sec 2
PFD
Sec 3
MFD

Sec 4
Hazard
Avoidance

Sec 5
Additional
Features

Sec 6
Annun.
& Alerts



"New Entry" Selected for Phone Book Catalog Entry

Figure 3-78 "New Entry" Selected for Phone Book Catalog Entry

4. Turn the small **MFD** knob to select the first character of the name and then turn the large **MFD** knob to select the next character. When the name is complete, press the **ENT** key.

Sec 7
Symbols

Sec 8
Glossary

Appendix A



Figure 3-79 Phone Book Name Entry

Index

Creating Phone Numbers with the Rotary Knobs

1. Turn the large **MFD** knob to the Phone Number field. Turn the small **MFD** knob to select the first character of the number and then turn the large **MFD** knob to select the next character. When the number is complete, press the **ENT** key.

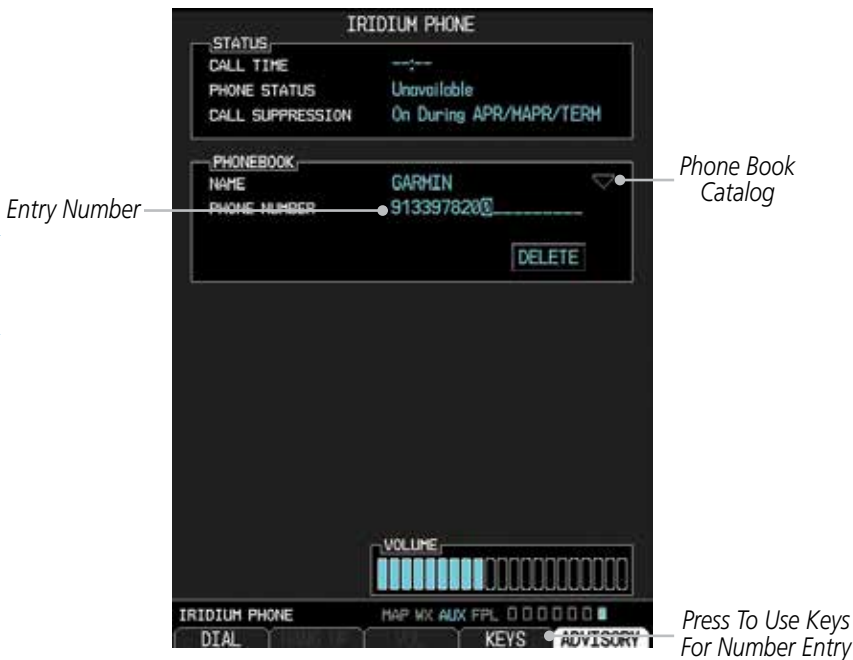

Figure 3-80 Phone Book Number Entry

2. Press the small **MFD** knob again to cancel the selection cursor.

Creating Phone Numbers with Soft Keys

1. Numbers may also be entered using the soft keys at the bottom of the display. Press the **Keys** key at the bottom of the display.



Figure 3-81 Phone Book Number Entry Using Hot Keys

2. Press the key for the group of desired numbers.



Press for numbers 1, 2, 3, and 4

Press for numbers 5, 6, 7, and 8

Press for numbers 9 and 0, and symbols * and #

Figure 3-82 Selecting Numeric Groups for Phone Book Number Entry

3. Press the key for the desired number. Repeat as necessary and then press **ENT** when the number is complete.



Press Keys For Number Entry

Figure 3-83 Selecting Individual Numbers for Phone Book Number Entry

Selecting a Phone Book Catalog Entry

1. Press the small **MFD** knob to activate the cursor and then turn the large **MFD** knob to select the Phone Book Catalog icon.

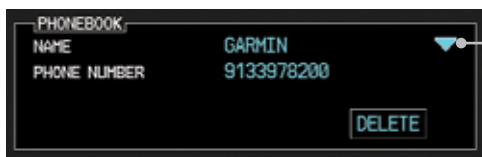

Phone Book icon. When Highlighted, turn small MFD knob to view list.

Figure 3-84 Selecting the Phone Book Catalog

2. Turn the small **MFD** knob to display the contents of the Phone Book Catalog and highlight the desired entry.

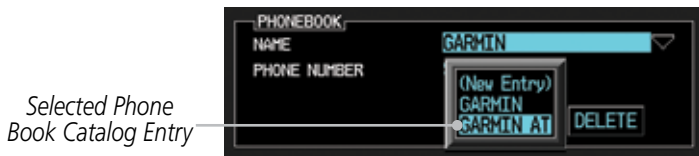

Figure 3-85 Selected Phone Book Catalog Entry

3. Press the **ENT** key. Press the small **MFD** knob again to cancel the selection cursor.

Deleting a Phone Book Catalog Entry

1. Press the small **MFD** knob to activate the cursor and then turn the large **MFD** knob to select the Phone Book Catalog icon.
2. Turn the small **MFD** knob to display the contents of the Phone Book Catalog and highlight the desired entry. Press **ENT** to select the catalog entry.
3. Turn the large **MFD** knob to highlight the **DELETE** key. Press **ENT** to delete the catalog entry. Press the small **MFD** knob again to cancel the selection cursor.

Editing a Phone Book Catalog Entry

1. Press the small **MFD** knob to activate the cursor and then turn the large **MFD** knob to select the Phone Book Catalog icon.
2. Turn the small **MFD** knob to display the contents of the Phone Book Catalog and highlight the desired entry. Press **ENT** to select the catalog entry.
3. Use the large **MFD** and small **MFD** knobs to make changes to the name or number. Press **ENT** to save the changes. Press the small **MFD** knob again to cancel the selection cursor.

3.2.8.3 Phone Volume

Use the Phone Volume controls to adjust the loudness of the phone calls you hear. Volume controls will only be available when the Idle, Connected, or Changing Volume states are displayed.

Adjusting the Phone Volume with the Rotary Knobs

1. While viewing the Iridium Phone page, press the small **MFD** knob and then turn the large **MFD** knob to select the Volume control. The volume bar graph will blink when selected.
2. Turn the small **MFD** knob to set the desired volume level.
3. Press the **ENT** key. Press the small **MFD** knob again to cancel the selection cursor.

Adjusting the Phone Volume with the Soft Keys

1. While viewing the Iridium Phone page, press the **VOL** key at the bottom of the display.



Figure 3-86 Select Soft Keys for Phone Volume Adjustment

2. Press the **VOL +** or **VOL -** keys as necessary to adjust the phone volume.

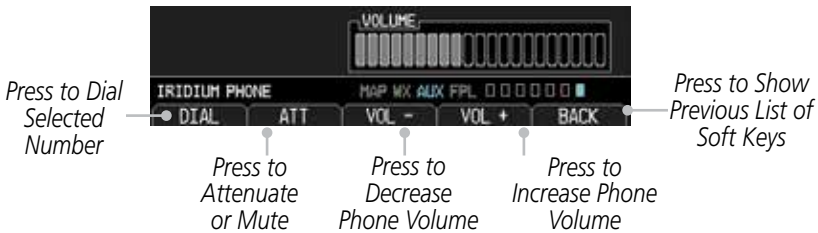

Figure 3-87 Using Soft Keys for Phone Volume Adjustment

3. Pressing the **ATT** soft key will attenuate the volume. Press the **ATT** soft key again to return to the previous volume.

3.2.8.4 Making a Phone Call

1. While viewing the Iridium Phone page, enter a phone number, or select one from the Phone Book catalog.
2. Press the **DIAL** key.
3. After completing the call, press the **HANG UP** key.

3.2.8.5 Answering a Phone Call

An incoming phone call will generate a pop-up announcing the call. When a call is accepted, the pop-up will show that the call is connected and the cumulative call time will be shown.

1. When an incoming call is available, press the **ENT** key or the **ANSWER** soft key to answer the call. Or, press the **CLR** key or the **HANG UP** soft key to not answer the call and hang up.

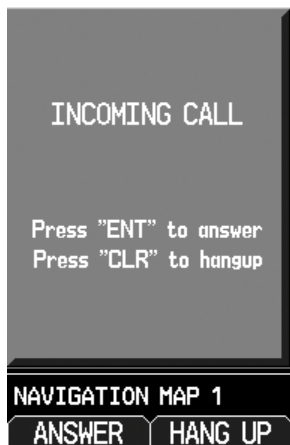

Figure 3-88 Incoming Call Pop-Up

2. After a called is accepted and connected, the connection time will be shown on the pop-up. Press the **ATT** soft key to attenuate the call volume; pressing it again will return to normal volume. Press the **HANG UP** soft key to end the call. Press the **VOL -** or **VOL +** keys to adjust the call volume.

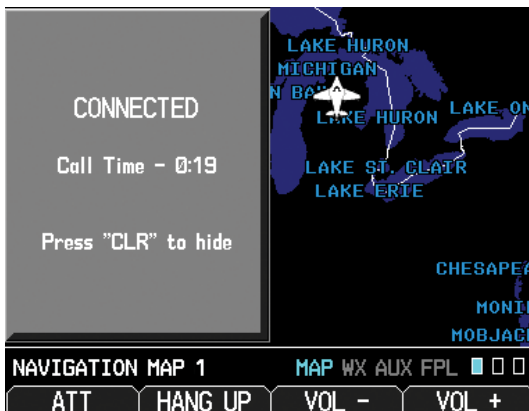

Figure 3-89 Connected Call Pop-Up

3.3 Flight Plan Pages

Use the Flight Plan page group to view details about your flight plan route. The Flight Plan Function shows the Current Flight Plan that is active in the navigation source displayed on the CDI.

3.3.1 Active Flight Plan Page

The Active Flight Plan box shows all of the legs of your flight plan with the current leg indicated in magenta. Listed are each leg with the Desired Track (DTK), Distance (DIS), and Estimated Time of Arrival (ETA) for the legs. METARs are shown for waypoints in the flight plan. In the Minimums window, the source and selected value are shown. For details about Minimum Descent Altitude or Decision Height, refer to section 2.4.4. In the Active Leg Info box in the lower part of the display, the Course with beginning and ending waypoints, Active Leg En Route Safe Altitude (ESA), and Route ESA are shown. METAR information is in section 4.

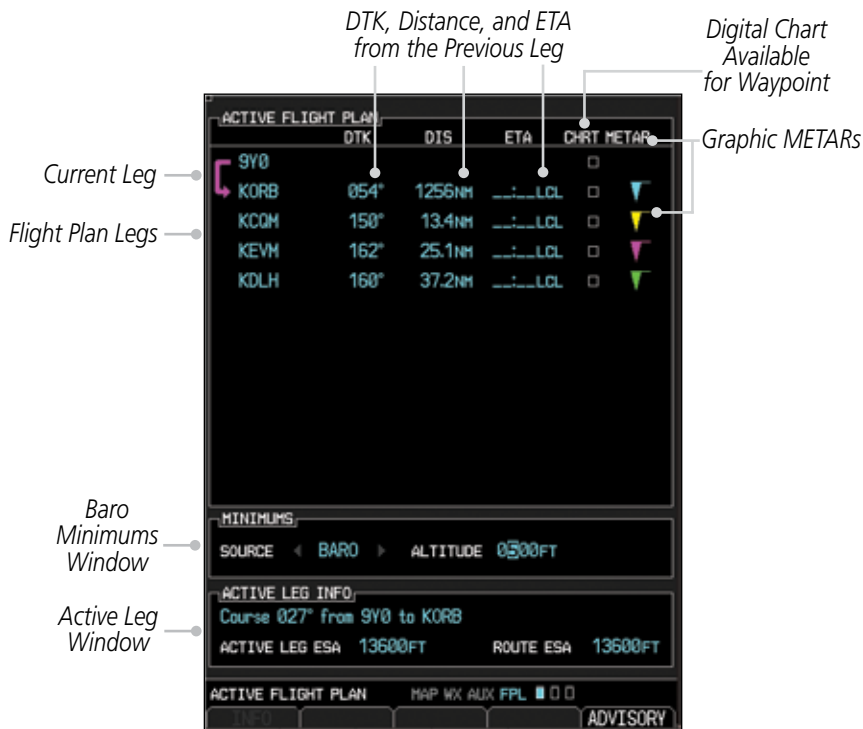

Figure 3-90 Flight Page 1 (Active Flight Plan)

Foreword

System Sec 1

PFD Sec 2

MFD Sec 3

Avoidance Hazard Sec 4

Additional Features Sec 5

Annun. & Alerts Sec 6

Symbols Sec 7

Glossary Sec 8

Appendix A

Index

3.3.1.1 Active Flight Plan Detail

The active flight plan is shown on the first page of the Flight Plan page group. Further information may be available for each waypoint as shown by the **INFO** or **WX** soft keys. The **WX** soft key will only appear if a data link receiver is installed and there is a Weather subscription.

1. Press the **MFD** knob and then use the large and small **MFD** knobs to highlight waypoints in the flight plan.
2. Press the **INFO** soft key, if available, to view information about the highlighted waypoint.
3. Press the **WX** soft key, if available, to view SiriusXM weather information about the highlighted waypoint.
4. Press the small **MFD** knob to return to the Active Flight Plan page.

3.3.1.2 Active Flight Plan Options

The Active Flight Plan page provides information for the flight plan currently in use for navigation.

To change data fields on the Active Flight Plan Page:

1. While viewing the Active Flight Plan Page of the FPL page group, press **MENU** to display the Active Flight Plan Page Options window.
2. Turn the large **MFD** knob to highlight "Change Fields?" and then press **ENT**.



Figure 3-91 Active Flight Plan Page Menu Option Selection

3. Turn the large **MFD** knob to highlight the field you wish to change.



Figure 3-92 Active Flight Plan Page Menu Change Fields Option Selection

4. Turn the small **MFD** knob to select the desired data item and press **ENT**.
5. Press the small **MFD** knob to remove the cursor.

To restore factory default settings for data fields on the Active Flight Plan Page:

1. While viewing the Active Flight Plan Page of the FPL page group, press **MENU** to display the Active Flight Plan Page Options window.
2. Turn the large **MFD** knob to highlight "Restore Defaults?" and then press **ENT**.



Figure 3-93 Active Flight Plan Page Menu Option Selection to Restore Defaults

3.3.1.3 Setting the Altitude Minimums Alerter

The Altitude Alerting function provides the pilot with visual and aural alerts (if interfaced to an audio panel) when approaching the Selected Altitude. For additional details about Minimum Descent Altitude/Decision Height Alerting, refer to section 2.4.4.

1. While viewing the Charts Page of the FPL page group, press the **Menu** key. With the Set Minimums item highlighted, press **ENT**.
2. With the Minimums Source highlighted, select the Altitude Minimums Alerter source with small **MFD** knob.



Figure 3-94 Minimums Source Selection

3. Turn the large **MFD** knob to highlight the Altitude Minimums value. Turn the large and small **MFD** knobs to change the Altitude Minimums value.



Figure 3-95 Minimums Altitude Selection

4. Press **ENT** to activate the selected value.

In dual installations, the minimums alerting altitude value may be set from either GDU 620 and will be synchronized on both units.

Foreword



NOTE: If you highlight the Minimums Altitude field on the FPL page and press the CLR key, it will turn the minimums functionality off.

Sec 1
System

3.3.2 Waypoint Information Page

Sec 2
PFD

The Waypoint Information page provides details about a particular waypoint. You can show a waypoint by selecting it by Ident, Facility Name, or by City. The Map window shows the selected waypoint in the center of the map. The Range keys zoom in and out on the map. The Info window at the bottom of the display shows the Bearing and Distance from your present position to the selected waypoint as well as its region and Lat/Lon coordinates.

Sec 3
MFD

Sec 4
Hazard
Avoidance

Facility Identifier
Facility Name
Facility Location



Facility Type

Sec 5
Additional
Features

Bearing & Distance
to Wpt from
Present Position



Map Region

Lat/Lon

Sec 6
Annun.
& Alerts

Map Orientation



Map Window

Sec 7
Symbols

Info/Map Soft Key



Wpt Weather
Info Soft Key

Rwy/Freq Soft Key

Airport Directory Soft Key

Appendix A



Figure 3-96 Flight Plan Waypoint Info/Map Page

NOTE: Waypoint information is shown on the second page of the Flight Plan page group.

Index

3.3.2.1 Selecting a Waypoint

1. While viewing the Waypoint Information Info/Map page of the FPL page group, press the **MFD** knob and use the large and small **MFD** knobs to move the cursor to select the identifier for the waypoint.



Figure 3-97 Waypoint Selection - Info/Map Page

2. Press the **ENT** key to select the waypoint.
- OR
1. While viewing the Waypoint Information Info/Map page of the FPL page group, press the small **MFD** knob.
 2. Turn the small **MFD** knob counterclockwise.



Figure 3-98 Waypoint Category Selection

Foreword

Sec 1
System

Sec 2
PFD

Sec 3
MFD

Sec 4
Hazard
Avoidance

Sec 5
Additional
Features

Sec 6
Annun.
& Alerts

Sec 7
Symbols

Sec 8
Glossary

Appendix A

Index

- Turn the small **MFD** knob to show FPL, NRST, or RECENT.
- Turn the large **MFD** knob to highlight the desired airport, and then press **ENT**.

OR

- While viewing Navigation Map 1 or 2 of the MAP page group, press the **MFD** knob and use the large and small **MFD** knobs to move the cursor to select the identifier for the waypoint.



Figure 3-99 Waypoint Selection - Nav Map Page

- Press the **ENT** key to select the waypoint.

3.3.2.2 Waypoint/Runway/Frequency Information Detail

More detailed information about a selected waypoint is available by pressing the **RWY/FREQ** or **APT DIR** soft keys on the Waypoint Information page. The current destination waypoint is the default item shown. You may select a different Ident, Facility, or Location. In the Runway window, you may view information about the runways. In the Frequency window, a scroll bar is shown on the right side of the window when more frequencies are available.



Figure 3-100 Flight Plan Waypoint Info Detail

- Foreword
- Sec 1 System
- Sec 2 PFD
- Sec 3 MFD**
- Sec 4 Hazard Avoidance
- Sec 5 Additional Features
- Sec 6 Annun. & Alerts
- Sec 7 Symbols
- Sec 8 Glossary
- Appendix A
- Index

Ident/Facility/City Selection

The current destination Identifier, Facility Type with icon, Facility Name, and City (location) are shown in the top window of the Flight Plan mode Waypoint Information page. The default is the Nearest airport if there is no active flight plan.



Figure 3-101 Flight Plan Ident/Facility/City Detail

1. While viewing the Waypoint Information page of the FPL page group, press the **RWY/FREQ**, **APT DIR**, or **WX** soft keys to view information about the waypoint.
2. The current destination Ident, Facility, and City is shown, but may be changed to find information about other choices. Press the small **MFD** knob to activate the cursor. These fields may not be selected if the RWY, APT DIR, or WX pages are selected. If viewing those pages, press the soft key for that page again to return to the Waypoint Information page.
3. Use the large **MFD** knob to highlight the field you wish to change and use the small **MFD** knob to change the value.
4. Press the **ENT** key to save the selected value or press the small **MFD** knob to cancel editing.

Runway Information Selection

Information is provided for each runway showing the following detail: runway number, runway length, surface type, and the frequency for Pilot-Controlled Lighting (PCL).



Figure 3-102 Waypoint Runway Information

1. While viewing the Waypoint Information page of the FPL page group, press the **RWY/FREQ** soft key to view information about the waypoint and press the small **MFD** knob to activate the cursor.
2. Use the large **MFD** knob to highlight the Runway and use the small **MFD** knob to display the available runways.
3. Press the small **MFD** knob to cancel editing.

Facility Frequency Selection

The Frequency window at the bottom of the Waypoint Information page shows the frequencies available for the selected waypoint. A scroll bar is shown on the right side of the Frequency window if more frequencies are available.

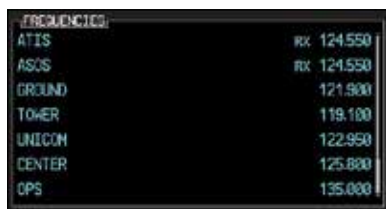

Figure 3-103 Waypoint Frequency Information

1. While viewing the Waypoint Information page of the FPL page group, press the **RWY/FREQ** soft key to view information about the waypoint and then press the small **MFD** knob to activate the cursor.
2. Turn the small **MFD** knob to scroll through the available frequencies.
3. Press the small **MFD** knob to exit.

3.3.2.3 Airport Directory

The Airport Directory lists extensive information about the selected airport and the surrounding area. The **RWY/FREQ** and **APT DIR** soft keys are inactive unless the selected waypoint is an airport or heliport.

NOTE: *Airport Directory information comes from a database provided by various 3rd parties. For details on the installed Airport Directory database, refer to the Database information in the AUX – SYSTEM STATUS page.*

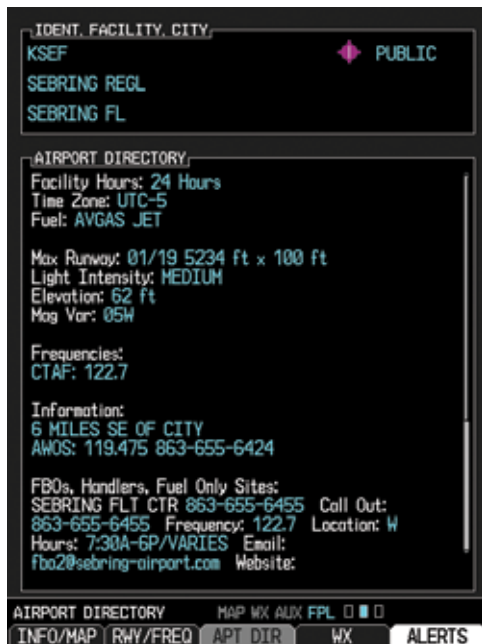

Figure 3-104 Airport Directory Information

1. While viewing the Waypoint Information page of the FPL page group, press the **APT DIR** soft key to view more information about the waypoint.
2. Press the small **MFD** knob to activate the cursor.
3. Use the small or large **MFD** knob to scroll through the information.
4. Press the small **MFD** knob to deactivate the cursor. Press the **APT DIR** soft key again to return to the Waypoint Information page.

3.3.2.4 Waypoint Weather Information (Optional)

The Weather information function is available if a data link receiver is installed and weather information is available for the selected waypoint. METAR and TAF text are displayed on the Waypoint Weather Information Page. Pressing the **WX/NOTAM** soft key will show the weather information page. Highlighting the Product selection and turning the small **MFD** knob will display METAR data, Terminal Area Forecast (TAF) information, and NOTAMs as they are available. NOTAMs are also available when FIS-B is available.

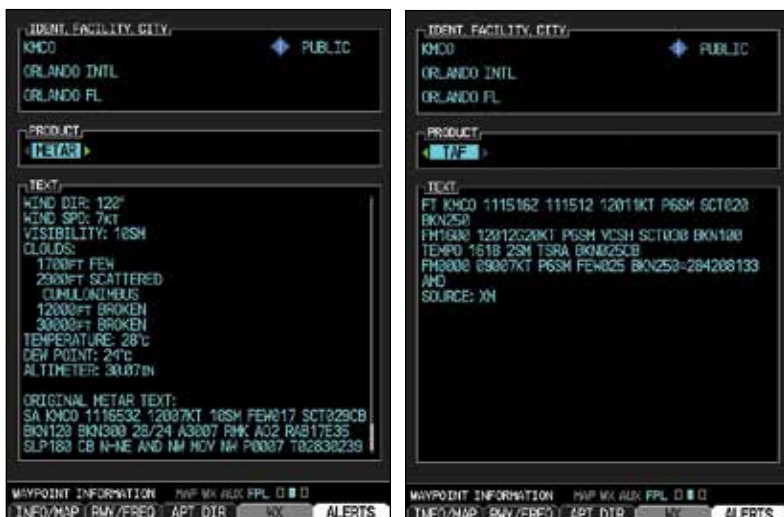

Figure 3-105 Waypoint Weather Information (Textual METARs and TAFs)

1. While viewing the Waypoint Information page of the FPL page group, press the **WX** soft key to view weather information for the waypoint.
2. Use the small **MFD** knob or the large **MFD** knob to scroll through the available information.
3. Press the small **MFD** knob to return to the main Flight Plan page.

3.3.3 Charts Page (Optional)

When the Chart function is available, charts will be shown on the third page of the Flight Plan page group.

For more information, refer to section 5.1.

Foreword

Sec 1
System

Sec 2
PFD

**Sec 3
MFD**

Sec 4
Hazard
Avoidance

Sec 5
Additional
Features

Sec 6
Annun.
& Alerts

Sec 7
Symbols

Sec 8
Glossary

Appendix A

Index

This page intentionally left blank

4 HAZARD AVOIDANCE

The G500/G600 hazard avoidance features are designed to provide advisory information of potential hazards to flight safety associated with weather, terrain, and air traffic.

This section is divided into the following groups:

Terrain Avoidance

- Terrain Proximity
- TAWS-B (Optional)
- Terrain-SVT (Optional)

Traffic Avoidance

- Traffic Advisory System (Optional)
- Traffic Information Service (TIS) (Optional - GTX 33/330 Transponder required)
- ADS-B (Optional - ADS-B/FIS-B receiver required)

Weather

- GDL 69/69A SiriusXM Satellite Weather (Optional)
- Weather Radar (Optional)
- Connex Weather with the Iridium satellite system through GSR 56 (Optional)
- FIS-B Weather with ADS-B/FIS-B receiver (Optional)
- Stormscope (Optional)

4.1 Terrain Configurations

The following terrain awareness configurations and alerting are available in the G500/G600 system:

- TAWS-B - A system developed to meet the terrain alerting and ground proximity requirements for Class B TAWS systems as defined in TSO-C151c. Garmin's G500/G600 Terrain Awareness and Warning System (TAWS-B) is an optional feature and is intended to provide the flight crew with both aural and visual alerts to aid in preventing inadvertent Controlled Flight Into Terrain (CFIT).
- Terrain-SVT - Refers to a subset of Class B TAWS that will meet the terrain alerting requirements outlined in Section 7.b of AC 23-26. Terrain-SVT is a subset of Class B TAWS that provides a Class B TAWS FLTA functionality, including visual alerting and aural alerting. Terrain-SVT is provided with the Synthetic Vision functionality and not marketed separately.

NOTE: *Terrain-SVT is not a fully functional TAWS and does not meet the TAWS TSO-C151c.*

- Terrain-Proximity - Refers to the display of the relative terrain elevations on the moving map. No aural or visual alerts of any type are provided by a Terrain-Proximity configuration.

- Foreword
- Sec 1 System
- Sec 2 PFD
- Sec 3 MFD
- Sec 4 Hazard Avoidance**
- Sec 5 Additional Features
- Sec 6 Annun. & Alerts
- Sec 7 Symbols
- Sec 8 Glossary
- Appendix A
- Index

4.1.1 Terrain System Self-Test

During power-up of the GDU 620, the terrain/obstacle database versions are displayed along with a disclaimer. At the same time, the Terrain system self-test begins. A failure message is issued if the terrain test fails (a message will not be issued for Terrain Proximity).

Terrain Configuration	Alert Source			
	PFD Annunciator Text	SVT Terrain/Obstacle Shading [1]	MFD Terrain/Obstacle Alerts	Aural Callouts
Terrain Proximity w/no other system	-	-	-	-
Synthetic Vision w/no other system	G500/600	G500/600	G500/600	G500/600
Terrain Proximity or Synthetic Vision w/GNS TAWS [3] [5]	GNS	-	-	GNS
Terrain Proximity or Synthetic Vision w/GTN TAWS or Terrain Alerting [2] [3] [4]	GTN	GTN	GTN	GTN
Terrain Proximity or Synthetic Vision w/3rd-party TAWS [5]	-	-	-	3rd-party TAWS
G500/G600 TAWS-B	G500/G600	G500/G600	G500/G600	G500/G600

Table 4-1 G500/G600 Terrain Annunciations

[1] SVT Terrain/Obstacle shading is only available when SVT is enabled and displayed.

[2] Depending on configuration, some installations may behave similarly to the GNS.

[3] If the GNS or GTN alerting source is unavailable while Synthetic Vision is enabled, the G500/600 will revert to Synthetic Vision w/no other system. An advisory message indicates when reversion to Terrain-SVT alerting has occurred.

[4] For GTN TAWS, GTN sw v5.10 or later and GDU sw v7.00 or later are required. For prior versions, see Synthetic Vision w/GNS TAWS.

[5] Prior to GDU sw v7.00, SVT Shading and MFD Alerts were generated by the G500/600 when Synthetic Vision was enabled and a GNS TAWS or 4rd-party TAWS was installed and generating the PFD Annunciation and Aural Callouts.

Foreword

Sec 1
SystemSec 2
PFDSec 3
MFD**Sec 4
Hazard
Avoidance**Sec 5
Additional
FeaturesSec 6
Annun.
& AlertsSec 7
SymbolsSec 8
Glossary

Appendix A

Index

GNS/GTN TAWS may be provided by a GNS 500WT-series or GTN-series navigator with TAWS. The GNS/GTN TAWS must be interfaced to the G500/G600 as GPS 1.

Each of the terrain awareness configurations are detailed in the following sections.

4.2 Terrain Proximity

Garmin Terrain Proximity is a non-TSO-C151c terrain awareness system provided as a standard feature of GDU 620 to increase situational awareness and help reduce controlled flight into terrain (CFIT). Terrain Proximity may be displayed on the Map page group Navigation Map and Terrain pages.

Terrain Proximity requires the following to operate properly:

- The system must have a valid 3-D GPS position solution.
- The system must have valid terrain/obstacle databases.

4.2.1 Terrain Proximity Limitations

Terrain Proximity displays terrain and obstructions relative to the altitude of the aircraft. The displayed terrain is advisory in nature only. Individual obstructions may be shown if available in the database. However, all obstructions may not be available in the database and data may be inaccurate. Never use this information for navigation or to maneuver to avoid obstacles.

Terrain information is based on terrain elevation information in a database that may contain inaccuracies. Terrain information should be used as an aid to situational awareness. Never use it for navigation or to maneuver to avoid terrain.

Terrain uses terrain and obstacle information supplied by government sources. The displayed information should never be understood as being all-inclusive.



WARNING: *The data contained in the TERRAIN databases comes from government agencies. Garmin accurately processes and cross-validates the data but cannot guarantee the accuracy and completeness of the data.*

4.2.2 Terrain System Status

The Terrain system continually monitors several system-critical items, such as database validity, hardware status, and GPS status. Should the system detect a failure, a failure message will be displayed.

4.2.3 Displaying Terrain Proximity

The Terrain Proximity page is in the Map page group. Terrain is also selectable on the Navigation Map pages.

4.2.3.1 Terrain Proximity Page Display on the Terrain Page

1. Turn the large **MFD** knob to the MAP page group.
2. Turn the small **MFD** knob to the Terrain page.
3. Press the **VIEW** soft key to show the **360** and **ARC** soft keys.

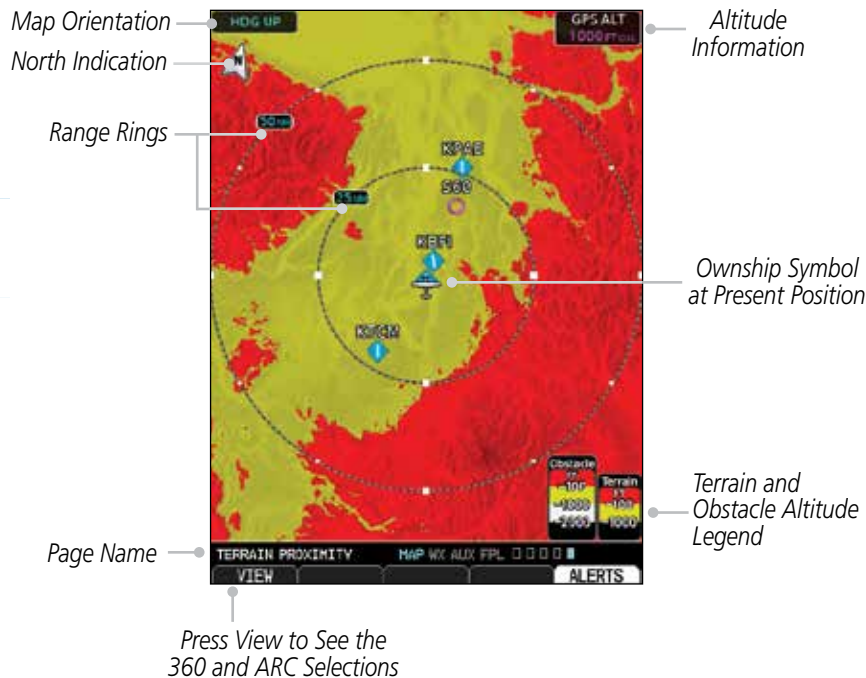

Figure 4-1 Terrain Page with Aviation Data Displayed and 360° View

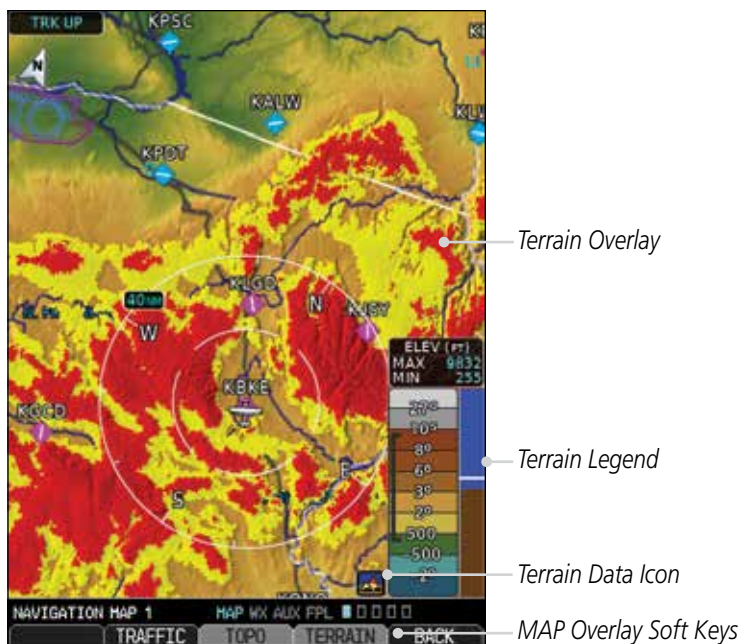

Figure 4-2 Terrain on Navigation Map Page

4.2.3.2 Terrain Proximity Page Display on a Navigation Map Page

1. Turn the large **MFD** knob to the MAP page group.
2. On Navigation Map page 1 or 2, press the **MAP** soft key to show the **TERRAIN** soft key.
3. Press the **TERRAIN** soft key to overlay terrain on the Navigation Map.



NOTE: *Terrain Proximity and NEXRAD are mutually exclusive on the map page.*

4.2.3.3 Terrain Proximity Page 120° Arc or 360° Rings

Select the 120° Arc or 360° rings overlay for the Terrain page with either the 360/Arc soft keys or from the Page Menu.

1. Press the **VIEW** soft key to show the 360 and ARC soft keys.
2. Press the **360** or **Arc** soft key.

OR

Press **MENU** and with the View Arc or View 360° selection highlighted press **ENT**.



Figure 4-3 Terrain Page Menu Viewing Selections

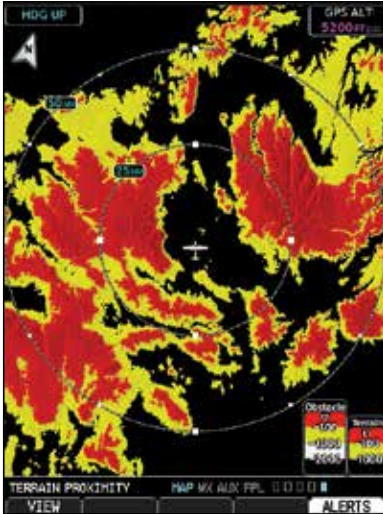

Figure 4-4 Terrain Page with 360° Rings

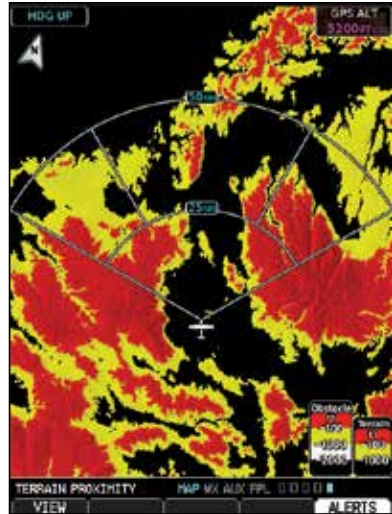

Figure 4-5 Terrain Page with 120° Arc

4.2.3.4 Terrain Proximity Page Aviation Data

The Page Menu selections allow you to hide or show aviation data overlay on the Terrain page.

1. While viewing the Terrain page of the MAP page group, press **MENU** for Map selections to hide or show aviation data overlay on the Terrain page.



Figure 4-6 Show/Hide Aviation Data on the Terrain Page

2. Press **ENT** to save the highlighted value.

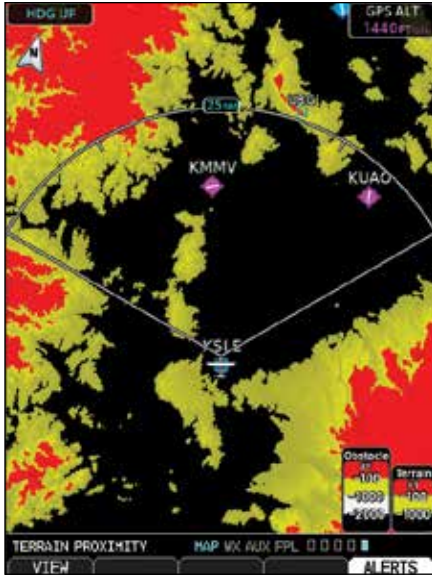

Figure 4-7 Terrain Page with Aviation Data Displayed and 120° Arc View



Figure 4-8 Navigation Map Page with Terrain Data Displayed

4.2.4 Terrain Proximity Symbols

Terrain Proximity uses colors and symbols to depict terrain, obstacles, and potential impact points. Amber (caution) and red (warning) indicate terrain and obstacle alerts relative to aircraft altitude. These colors adjust automatically as the aircraft altitude changes.

Terrain/Obstacle Altitude Legend

The Terrain/Obstacle legend is displayed at the bottom right corner of the Navigation Map. This option is available in the Map page group.



Figure 4-9 Terrain/Obstacle Altitude Legend

Color	Description
Red	Terrain is at or within 100 ft below the current aircraft altitude
Yellow	Terrain is between 100 ft and 1,000 ft below the aircraft altitude
Black	Terrain is more than 1,000 ft below the current aircraft altitude

Table 4-2 Terrain Altitude Color Descriptions

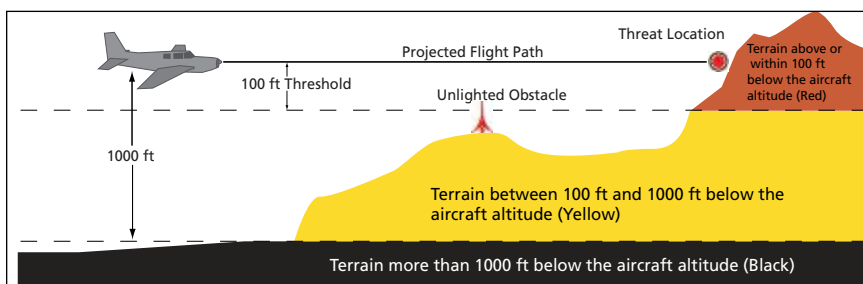

Figure 4-10 Terrain Altitude Colors

Obstacle Icons



NOTE: If an obstacle or terrain cell and the projected flight path of the aircraft intersect, the display automatically zooms in to the closest threat location on the TAWS page.

With the exception of power lines, any number of obstacles within close proximity of each other may display as a group on the Navigation Map. The MFD groups obstacles when they would otherwise overlap at the current zoom scale. When a group is drawn, only the most immediate threat is depicted. An asterisk at the upper left of an obstacle indicates that it is a group. The relative altitude of the highest obstacle in the group determines the asterisk's color.

To view obstacles individually, increase the current zoom scale.







Icon	Description
	Unlighted Obstacle (height is less than 1,000 ft AGL)
	Lighted Obstacle (height is less than 1,000 ft AGL)
	Unlighted Obstacle (height is greater than 1,000 ft AGL)
	Lighted Obstacle (height is greater than 1,000 ft AGL)
	Windmill
	Windmill in Group
	Power Line

Table 4-3 Obstacle Icon Types

Color	Description
Red	Obstacle is at or within 100 ft below current aircraft altitude
Yellow	Obstacle is between 100 ft and 1,000 ft below current aircraft altitude
White	Obstacle is between 1,000 ft and 2,000 ft below current aircraft altitude

Table 4-4 Obstacle Altitude Color Descriptions

4.3 Terrain Awareness and Warning System (Optional)

TAWS (Terrain Awareness and Warning System) is an optional feature to increase situational awareness and aid in reducing controlled flight into terrain (CFIT). TAWS provides visual and aural annunciations when terrain and obstacles are within the given altitude threshold from the aircraft.

TAWS satisfies TSO-C151c Class B requirements for certification. Class B TAWS is required for all Part 91 turbine aircraft operations with six or more passenger seats and for Part 135 turbine aircraft operations with six to nine passenger seats (FAR Parts 91.223, 135.154).

4.3.1 TAWS-B Requirements

TAWS requires the following to operate properly:

- A valid terrain/obstacle
- A valid 3-D GPS position solution

4.3.2 TAWS-B Limitations



WARNING: *The data contained in the TAWS databases comes from government agencies. Garmin accurately processes and cross-validates the data but cannot guarantee the accuracy and completeness of the data.*

TAWS displays terrain and obstructions relative to the altitude of the aircraft. Refer to AFM for TAWS alert procedures.

TAWS uses terrain and obstacle information supplied by government sources. Terrain information is based on terrain elevation information in a database that may contain inaccuracies. Individual obstructions may be shown if available in the database. The data undergoes verification by Garmin to confirm accuracy of the content, per TSO-C151c.

4.3.3 TAWS Self-Test

During G500/G600 power-up, the terrain/obstacle database versions display with a disclaimer. A TAWS self-test runs simultaneously. One of the following aural messages is generated:

- “TAWS System Test OK”
- “TAWS System Failure”

TAWS information can be displayed on the MFD in the TAWS page of the MAP page group. Terrain and obstacles with heights greater than 200 feet Above Ground Level (AGL) are contained in the database.

Computing GPS Altitude for TAWS

TAWS uses information provided from the GPS receiver to provide a horizontal position and altitude. GPS altitude is derived from satellite measurements. GPS altitude is converted to a Mean Sea Level (MSL)-based altitude (GPS-MSL altitude) and is used to determine TAWS alerts. GPS-MSL altitude accuracy is affected by factors such as satellite geometry, but it is not subject to variations in pressure and temperature that normally affect pressure altitude devices. GPS-MSL altitude does not require local altimeter settings to determine MSL altitude. Therefore, GPS altitude provides a highly accurate and reliable MSL altitude source to calculate terrain and obstacle alerts.

The terrain and obstacle databases used by TAWS are referenced to Mean Sea Level. Using the GPS position and GPS-MSL altitude, TAWS displays a 2-D (or 3-D with SVT) picture of the surrounding terrain and obstacles relative to the position and altitude of the aircraft. Furthermore, the GPS position and GPS-MSL altitude are used to calculate and “predict” the aircraft’s flight path in relation to the surrounding terrain and obstacles. In this manner, TAWS can provide advanced alerts of predicted dangerous terrain conditions.

Foreword

Sec 1
System

Sec 2
PFD

Sec 3
MFD

Sec 4
Hazard
Avoidance

Sec 5
Additional
Features

Sec 6
Annun.
& Alerts

Sec 7
Symbols

Sec 8
Glossary

Appendix A

Index

4.3.4 TAWS Page

TAWS information is displayed on the last page of the Map page group. The TAWS Page is specialized to show terrain, obstacle, and Threat Area Indication data in relation to the aircraft's current altitude, without clutter from the basemap. Aviation data (airports, VORs, and other NAVAIDs) can be displayed for reference. The display automatically zooms in to the closest potential point of impact on the TAWS Page.

Aircraft orientation on this map is always heading up unless there is no valid heading. If orientation is not heading up, it will be track up. Two views are available relative to the position of the aircraft: the 360° default display and the radar-like ARC (120°) display. Map range is adjustable with the **RNG** keys from 1 to 200 NM, as indicated by the map range rings (or arcs).

Displaying TAWS Information

- 1) In MAP page group, turn the small **MFD** knob to reach the TAWS Page.
- 2) Press the **RNG** keys to display a larger or smaller area.

Foreword
 Sec 1 System
 Sec 2 PFD
 Sec 3 MFD
 Sec 4 Hazard Avoidance
 Sec 5 Additional Features
 Sec 6 Annun. & Alerts
 Sec 7 Symbols
 Sec 8 Glossary
 Appendix A
 Index

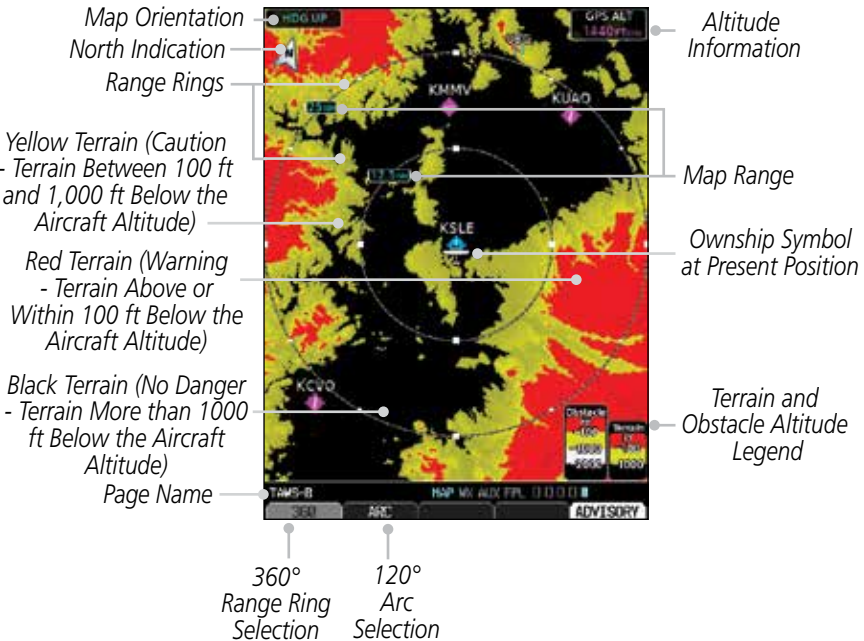

Figure 4-11 360° View on the TAWS Page

Changing the TAWS Page View Between 360 and Arc

1. In MAP page group, turn the small **MFD** knob to reach the TAWS page.
2. Press **VIEW** and then the **360** or **ARC** soft key to select the desired view.
OR
1. While viewing the TAWS page, press the **MENU** key.
2. Turn the large or small **MFD** knob to highlight “View Arc” or “View 360°” and then press **ENT**.



Figure 4-12 Select TAWS Display View (360 or Arc)

Showing/Hiding Aviation Information on the TAWS Page

1. In MAP page group, turn the small **MFD** knob to reach the TAWS page.
2. Press the **MENU** key. Turn the large or small **MFD** knob to highlight “Show Aviation Data” or “Hide Aviation Data” and then press **ENT**.



Figure 4-13 Show/Hide Aviation Data

Manually Testing the TAWS System

1. Select the TAWS page.
2. Press the **MENU** key and then turn the large or small **MFD** knob to highlight “Test TAWS.”



Figure 4-14 TAWS Page Menu

3. Press the **ENT** key to confirm the selection.

One of the following aural messages is generated:

- “TAWS System Test OK”
- “TAWS System Failure”

TAWS TEST is annunciated in yellow on the TAWS page and in white on the PFD.

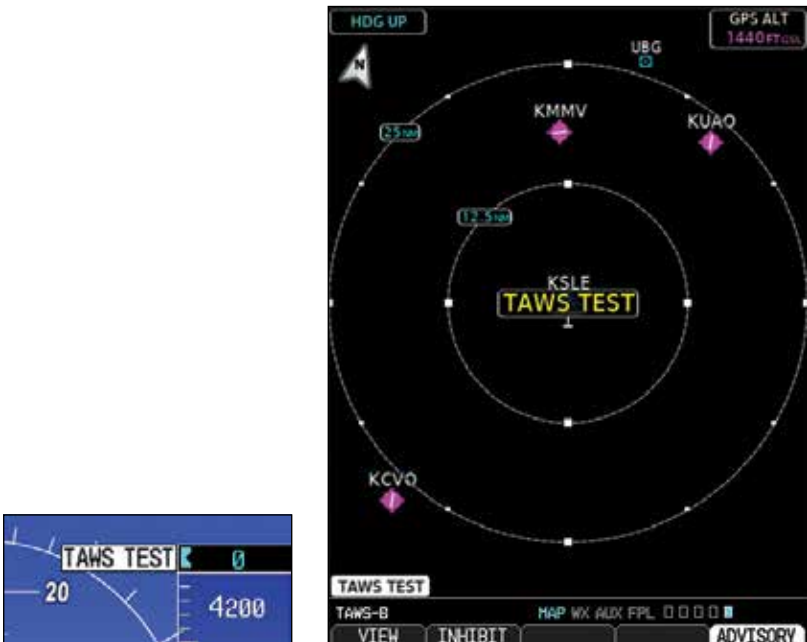

Figure 4-15 TAWS Test Display and PFD Annunciation

Foreword
 Sec 1 System
 Sec 2 PFD
 Sec 3 MFD
 Sec 4 Hazard Avoidance
 Sec 5 Additional Features
 Sec 6 Annun. & Alerts
 Sec 7 Symbols
 Sec 8 Glossary
 Appendix A
 Index

4.3.5 TAWS Alerts

Alerts are issued when flight conditions meet parameters that are set within TAWS software algorithms. When an alert is issued, visual annunciations are displayed and aural alerts are simultaneously issued. TAWS alert types are shown in the TAWS Alerts Summary (Table 4-6) with corresponding annunciations and aural messages.

When an alert is issued, annunciations appear on the PFD and MFD (TAWS map page only). The TAWS Alert Annunciation is shown to the upper left of the Altimeter on the PFD and below the Terrain Legend on the MFD. If the TAWS page is not displayed at the time, a pop-up alert appears on the MFD on the page being viewed.

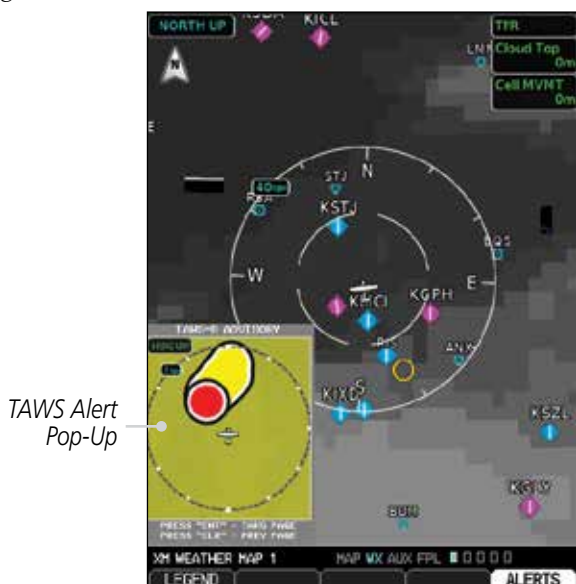

Figure 4-16 TAWS Alert Pop Up

To acknowledge the pop-up alert:

- Press the **CLR** key (returns to the currently viewed page)
- OR
- Press the **ENT** key (accesses the TAWS Page)

If the pilot takes no action, the pop-up will be removed when the alert is no longer active.



Figure 4-17 TAWS Alert Annunciations (Pull Up)

4.3.5.1 TAWS-B Alerting Colors and Symbology

Color and symbols are also associated with TAWS alerts. The three TAWS alert levels and their associated text coloring as well as any associated symbology are shown in the following table.





Alert Level	Annunciator Text	Threat Area Indication Symbol	Example Visual Annunciation
Warning	White text on red background		
Caution	Black text on yellow background		

Table 4-5 TAWS Alert Colors and Symbology

Alert Type	PFD/MFD Alert Annunciation	Aural Message
Excessive Descent Rate Warning (EDR-W)	PULL UP	"Pull Up"
FLTA Terrain Warning (RTC-W, ITI-W)	PULL UP	"Terrain Ahead, Pull Up; Terrain Ahead, Pull Up"* "Terrain, Terrain; Pull Up, Pull Up"
FLTA Obstacle Warning (ROC-W, IOI-W)	PULL UP	"Obstacle Ahead, Pull Up; Obstacle Ahead, Pull Up"* "Obstacle, Obstacle; Pull Up, Pull Up"
FLTA Wire Warning (ILI-W, RLC-W)	PULL UP	"Wire Ahead, Pull Up; Wire Ahead, Pull Up"* "Wire, Wire, Pull Up, Pull Up"
FLTA Terrain Caution (RTC-C, ITI-C)	TERRAIN	"Terrain Ahead; Terrain Ahead"* "Caution, Terrain; Caution, Terrain"
FLTA Obstacle Caution (ROC-C, IOI-C)	OBSTACLE	"Obstacle Ahead; Obstacle Ahead"* "Caution, Obstacle; Caution, Obstacle"
FLTA Wire Caution (ILI-C, RLC-C)	WIRE	"Wire Ahead; Wire Ahead"* "Caution, Wire; Caution; Wire"
Premature Descent Alert Caution (PDA)	TERRAIN	"Too Low, Terrain"
Voice Callout (VCO-500)	None	"Five-Hundred"
Excessive Descent Rate Caution (EDR-C)	TERRAIN	"Sink Rate"
Negative Climb Rate Caution (NCR-C)	TERRAIN	"Don't Sink"* "Too Low, Terrain"

* Alerts with multiple messages are configurable at installation and are installation-dependent. Alerts for the default configuration are indicated with asterisks.

Table 4-6 TAWS-B Alerts Summary

4.3.5.2 Excessive Descent Rate Alert

The purpose of the Excessive Descent Rate (EDR) alert is to provide notification when the aircraft is determined to be descending upon terrain at an excessive rate. The parameters for the alert as defined by TSO-C151c are shown below.

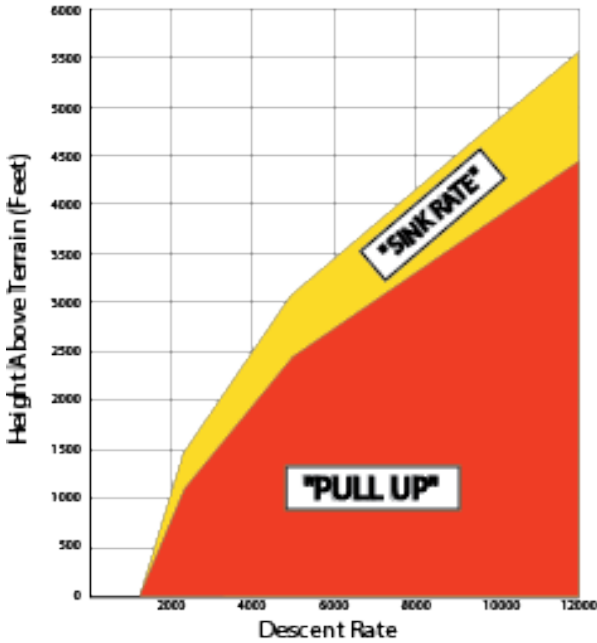

Figure 4-18 Excessive Descent Rate Alert Criteria

Foreword

Sec 1
System

Sec 2
PFD

Sec 3
MFD

**Sec 4
Hazard
Avoidance**

Sec 5
Additional
Features

Sec 6
Annun.
& Alerts

Sec 7
Symbols

Sec 8
Glossary

Appendix A

Index

4.3.5.3 Forward Looking Terrain Avoidance

Reduced Required Terrain Clearance (RTC) and Reduced Required Obstacle Clearance (ROC) alerts are issued when the aircraft flight path is above terrain, yet is projected to come within the minimum clearance values in the FLTA Alert Minimum Terrain and Obstacle Clearance Values table. When an RTC alert and/or a ROC is issued, a potential impact point is displayed on the TAWS Page.

Imminent Terrain Impact (ITI) and Imminent Obstacle Impact (IOI) alerts are issued when the aircraft is below the elevation of a terrain or obstacle cell in the aircraft's projected path. ITI and IOI alerts are accompanied by a potential impact point displayed on the TAWS Page. The alert is annunciated when the projected vertical flight path is calculated to come within minimum clearance altitudes in the following table.

Flight Phase	Minimum Clearance Altitude (feet)	
	Level Flight	Descending
En Route	700	500
Terminal	350	300
Approach	150	100
Departure	100	100

Table 4-7 FLTA Alert Minimum Terrain and Obstacle Clearance Values

During final approach, FLTA alerts are automatically inhibited when the aircraft is below 200 feet AGL while within 0.5 NM of the approach runway or below 125 feet AGL while within 1.0 NM of the runway threshold.

Foreword

Sec 1
System

Sec 2
PFD

Sec 3
MFD

Sec 4
Hazard
Avoidance

Sec 5
Additional
Features

Sec 6
Annu.
& Alerts

Sec 7
Symbols

Sec 8
Glossary

Appendix A

Index

4.3.5.4 Premature Descent Alerting

Foreword

A Premature Descent Alert (PDA) is issued when the system detects that the aircraft is significantly below the normal approach path to a runway.

Sec 1
System

PDA alerting begins when the aircraft is within 15 NM of the destination airport and ends when the aircraft is either 0.5 NM from the runway threshold or is at an altitude of 125 feet AGL while within 1.0 NM of the threshold. During the final descent, algorithms set a threshold for alerting based on speed, distance, and other parameters.

Sec 2
PFD

Sec 3
MFD

Sec 4
Hazard
Avoidance

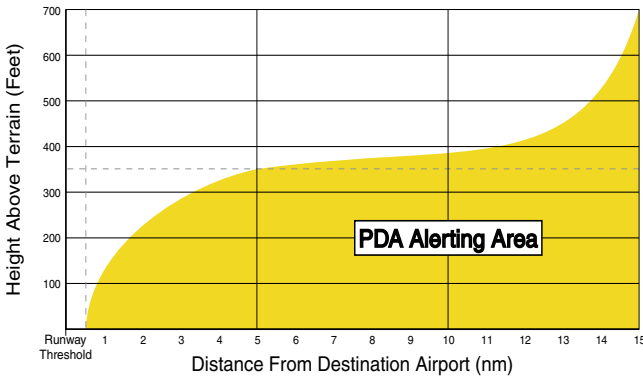

Figure 4-19 PDA Alerting Threshold

Sec 5
Additional
Features

PDA and FLTA aural and visual alerts can be manually inhibited. Discretion should be used when inhibiting TAWS and the system should be enabled when appropriate. When TAWS is inhibited, the alert annunciation “TAWS INHB” is shown on the PFD and MFD (Figure 4-16).

Sec 6
Annun.
& Alerts

Sec 7
Symbols

Sec 8
Glossary

Appendix A

Index

4.3.5.5 Inhibiting/Enabling TAWS Alerting

TAWS also has an inhibit mode that deactivates the PDA/FLTA aural and visual alerts. Pilots should use discretion when inhibiting TAWS and always remember to enable the system when appropriate. Only the PDA and FLTA alerts are disabled in the inhibit mode.



NOTE: See AFMS for guidance on inhibiting TAWS.

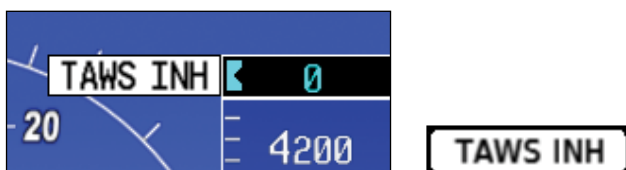

Figure 4-20 TAWS Alerting Disabled (TAWS Inhibited) Annunciation (PFD & MFD)

1. In MAP page group, turn the small **MFD** knob to reach the TAWS Page.
2. Press the **INHIBIT** soft key to inhibit or enable TAWS (choice dependent on current state).

OR

1. Press the **MENU** key.
2. Use the large or small **MFD** knob to highlight “Inhibit TAWS” or “Enable TAWS” (choice dependent on current state) and press the **ENT** key.

4.3.5.6 Five-Hundred Aural Alert

The purpose of the aural alert message “Five-hundred” is to provide an advisory alert that the aircraft is 500 feet above terrain. When the aircraft descends within 500 feet of terrain, the aural message “Five-hundred” is generated. There are no display annunciations or pop-up alerts that accompany the aural message.



NOTE: The five-hundred aural callout provided by TAWS-B is not in relation to the optional radar altimeter, if installed.

4.3.5.7 Negative Climb Rate After Take-Off Alert

The Negative Climb Rate (NCR) After Take-Off alert (also referred to as “Altitude Loss After Take-Off”) provides alerts when the system determines the aircraft is losing altitude (closing upon terrain) after takeoff. The aural message “Don’t Sink” is given for NCR alerts, accompanied by an annunciation and a pop-up terrain alert on the display. NCR alerting is only active when departing from an airport and when the following conditions are met:

- Height above the terrain is less than 700 feet
- Distance from the departure airport is 2 NM or less
- Heading change from the departure heading is less than 110°

The NCR alerting parameters as defined by TSO-C151c are shown below.

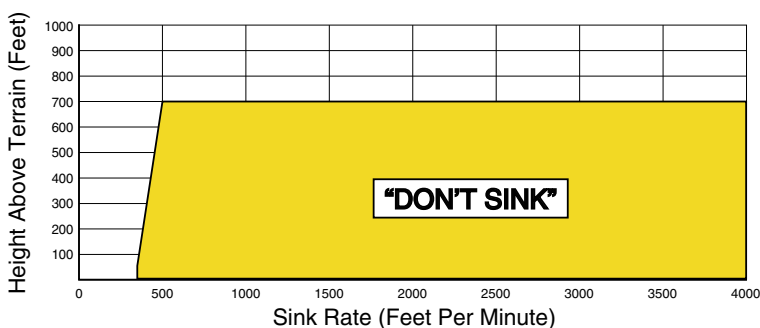
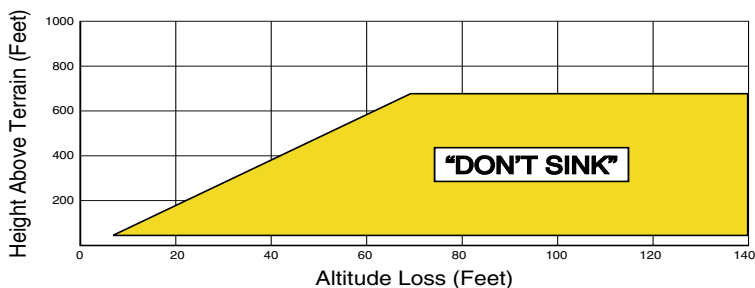

Figure 4-21 Negative Climb Rate (NCR) Alert Criteria

4.3.5.8 TAWS Not Available Alert

TAWS requires a 3-D GPS position solution along with specific vertical accuracy minimums. Should the position solution become degraded or if the aircraft is out of the database coverage area, the annunciation “TAWS N/A” is generated in the annunciation window and on the TAWS page. The aural message “TAWS Not Available” is generated. When the GPS signal is re-established and the aircraft is within the database coverage area, the aural message “TAWS Available” is generated.

4.3.5.9 TAWS Failure Alert

TAWS continually monitors several system-critical items such as database validity, hardware status, and GPS status. If the terrain/obstacle database is not available, the aural message “TAWS System Failure” is generated along with a ‘TAWS FAIL’ annunciation.

4.3.6 TAWS System Status

During power-up, TAWS conducts a self-test of its aural and visual annunciations. The system test can also be manually initiated. An aural alert is issued at test completion. TAWS System Testing is disabled when ground speed exceeds 30 knots.

Alert Type	PFD/MFD Alert Annunciation	Aural Message
TAWS Available	None	“TAWS Available”
TAWS System Test in Progress	TAWS TEST	None
TAWS System Test Pass	None	“TAWS System Test OK”
TAWS N/A	TAWS N/A	TAWS Not Available
TAWS Alerting is Disabled	TAWS INH	None
TAWS System Test Fail	TAWS FAIL	“TAWS System Failure”

Table 4-8 TAWS-B System Test Status Annunciations

4.4 External TAWS

If a GNS 500WT-series with TAWS or a GTN-series with TAWS or Terrain Alerting is interfaced as GPS 1, text alerts generated by the GNS/GTN will be displayed on the PFD. Other visual alert depictions may appear on the PFD and/or MFD as well, depending on the configuration. See Section 4.1 for additional information. Refer to the GNS 500WT-series or GTN-series Pilot's Guides and/or Addendums for more information regarding these TAWS alerts. Text alerts received from the GNS/GTN TAWS unit will be displayed to the left and aligned with the top of the Altitude Tape on the PFD. A new annunciation will flash for approximately five seconds.

- TAWS annunciations can only be received from the #1 GPS unit.
- If the Garmin GPS/TAWS is not available and Terrain-SVT is enabled, the G500/G600 Terrain-SVT will generate PFD text alerts and aural callouts. An advisory message will indicate when reversion to Terrain-SVT alerting has occurred.
- Depending on configuration, some installations with a GTN-series unit generate terrain impact points on the MFD from crossfilled GTN data.



Figure 4-22 TAWS Annunciations from a GNS/GTN TAWS

Terrain Configurations	PFD/MFD Visual Annunciations	MFD Pop-up Alert	Aural Alerting
GTN w/ External TAWS Unit Installed (HSDB)	When configured for External TAWS (HSDB), the GDU will not generate any alerts; all alerts are crossfilled from the GTN.	None	None
G500/G600 Terrain Proximity w/ External TAWS Unit Installed (500W-series)	PFD annunciations are generated from the External TAWS Unit. No MFD Annunciations.	None	None

Terrain Configurations	PFD/MFD Visual Annunciations	MFD Pop-up Alert	Aural Alerting
G500/G600 w/ Terrain-SVT and External TAWS Unit Installed (500W-series)	PFD annunciations are generated from the External TAWS Unit. No MFD Annunciations are generated from the G500/G600. Terrain impact shading on the PFD SVT is generated through the internal Terrain-SVT alerting.	None	G500/G600 aural alerts are suppressed.
G500/G600 w/ TAWS-B	Annunciations generated from the G500/G600.	Generated from the G500/G600.	Not suppressed.

Table 4-9 G500/G600 TAWS Annunciations

4.5 Terrain-SVT



WARNING: Do not use Terrain-SVT information for primary terrain avoidance. Terrain-SVT is intended only to enhance situational awareness.



NOTE: Terrain-SVT is standard when the Synthetic Vision Technology (SVT) option is installed. The TAWS option will take precedence over Terrain-SVT.

Garmin Terrain-SVT refers to a subset of Class B TAWS that meets the terrain alerting requirements outlined in Section 7.b of AC 23-26. Terrain-SVT is a subset of Class B TAWS that provides a Class B TAWS FLTA functionality with visual alerting and aural alerting. Terrain-SVT is provided with Synthetic Vision Technology (SVT) functionality and not marketed separately.

Garmin Terrain-SVT alerting consists of the following alert types:

- Forward Looking Terrain Avoidance (FLTA) Alerting which consists of:
 - Required Terrain Clearance (RTC) / Required Obstacle Clearance (ROC) Alerting
 - Imminent Terrain Impact (ITI) / Imminent Obstacle Impact (IOI) Alerting

Garmin Terrain-SVT is available in G500/G600 GDU 620 SW version 3.00, and later.

Garmin Terrain-SVT is required for those SVT installations that do not have TAWS-A or TAWS-B enabled.

4.5.1 Terrain-SVT Page 120° Arc or 360° Rings

Foreword

Select the 120° Arc or 360° rings overlay for the Terrain page with either the 360/Arc soft keys or from the Page Menu.

Sec 1
System

Sec 2
PFD

Sec 3
MFD

Sec 4
Hazard
Avoidance

Sec 5
Additional
Features

Sec 6
Annun.
& Alerts

Sec 7
Symbols

Sec 8
Glossary

Appendix A

Index

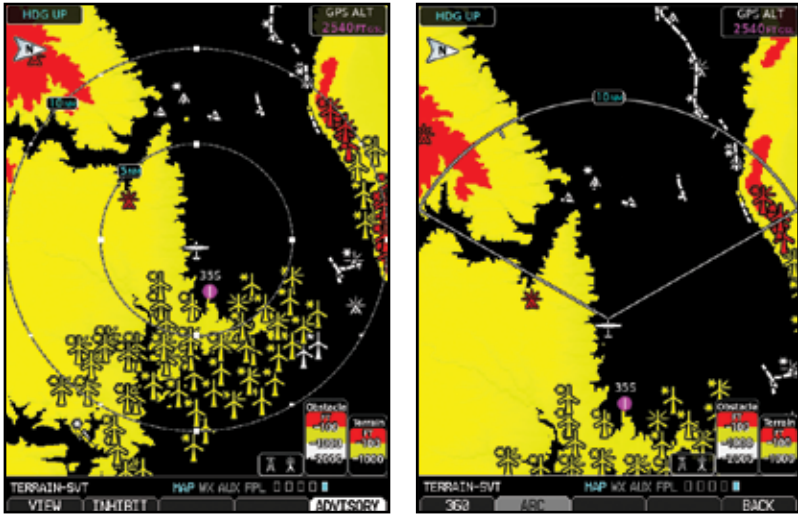

Figure 4-23 Terrain-SVT 360 and Arc Views

1. Press **VIEW** and then the **360** or **Arc** soft key.
OR
2. Press **MENU** and with the "View Arc" or "View 360°" selection highlighted press **ENT**.



Figure 4-24 Terrain-SVT Page Menu Viewing Selections

4.5.2 Terrain-SVT Page Aviation Data

Select the display of Aviation data on the Terrain-SVT page. The Page Menu selections allow you to hide or show aviation data overlay on the Terrain or the Map Setup options for the Navigation Map pages.

1. While viewing the Terrain page of the MAP page group, press **MENU** for Map selections to hide or show aviation data overlay on the Terrain or the Map Setup options for the Navigation Map pages.



Figure 4-25 Show/Hide Aviation Data on the Terrain-SVT Page

2. Press **ENT** to save the highlighted value.

4.5.3 Inhibiting/Enabling Terrain-SVT Alerting

Terrain-SVT has an inhibit mode that deactivates the FLTA aural and visual alerts. Pilots should use discretion when inhibiting Terrain-SVT and always remember to enable the system when appropriate.



Figure 4-26 Terrain-SVT Alerting Disabled (Alerts Inhibited) Annunciation (PFD & MFD)

1. In MAP page group, turn the small **MFD** knob to reach the Terrain SVT Page.
2. Press the **INHIBIT** soft key to inhibit or enable Terrain SVT (choice dependent on current state).
OR
1. Press the **MENU** key.
2. Use the large or small **MFD** knob to highlight "Inhibit Terrain" or "Enable Terrain" (choice dependent on current state) and press the **ENT** key.

4.5.4 Synthetic Vision Alerts and Annunciations

Terrain-SVT alerts typically employ a CAUTION or a WARNING alert severity level, or both. When an alert is issued, visual annunciations are displayed and aural alerts are simultaneously issued.

When an alert is issued, annunciations appear on the PFD and MFD (Terrain-SVT page only). The TAWS/Terrain Alert Annunciation is shown to the upper left of the Altimeter on the PFD and below the Terrain Legend on the MFD. If the Terrain-SVT page is not displayed at the time, a pop-up alert appears on the MFD.

To acknowledge the pop-up alert:

Press the **CLR** key (returns to the currently viewed page)

OR

Press the **ENT** key (accesses the Terrain-SVT Page)

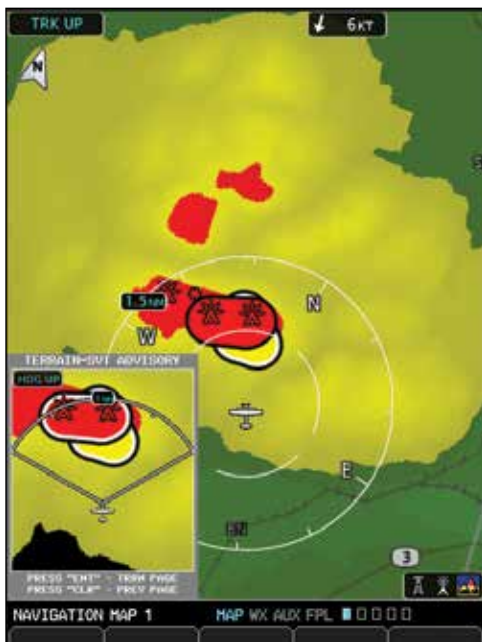

Figure 4-27 Terrain-SVT Advisory Pop-Up on the MFD

Alert Type	PFD/MFD Alert Annunciation	Aural Message
GPS signal re-established	None	"Terrain System Available"
Terrain System Test Successful	None	"Terrain System test OK"
Terrain System Test in Progress	TER TEST	None
Terrain Alerting is disabled	TER INH	None
No GPS position Excessively degraded GPS signal	TER N/A	"Terrain System Not Available"
Terrain SVT System Test Fail	TER FAIL	"Terrain System Failure"

Table 4-10 Terrain-SVT System Test Status Annunciations

Alert Type	PFD/MFD Alert Annunciation	Aural Message
FLTA Terrain Caution (RTC-C, ITI-C)	TERRAIN	"Caution, Terrain, Terrain"
FLTA Terrain Caution (RLC-C, ILI-C)	WIRE	"Caution, Wire, Wire"
FLTA Terrain Warning (RTC-W, ITI-W)	TERRAIN	"Warning, Terrain, Terrain"
FLTA Terrain Warning (RLC-W, ILI-W)	WIRE	"Warning, Wire, Wire"
FLTA Obstacle Caution (ROC-C, IOI-C)	OBSTACLE	"Caution, Obstacle, Obstacle"
FLTA Obstacle Warning (ROC-W, IOI-W)	OBSTACLE	"Warning, Obstacle, Obstacle"

Table 4-11 Terrain-SVT Alerts Summary

4.6 Traffic Systems

The Traffic function requires the installation of a compatible traffic device and will then provide a separate traffic page in the Map page group as well as the overlay of traffic on the Map Navigation pages. TIS and TAS cannot be displayed at the same time. If the aircraft has a TAS unit installed, the GDU 620 will be configured for TAS. If no TAS unit is installed and a GTX Mode-S transponder is installed then the GDU 620 will be configured for TIS. A pilot can tell which data is being displayed by the label in the top left corner (TAS/TCAS: OPER for TAS/TCAS data and TIS: OPER for TIS data). TIS data comes from a GTX transponder. Coverage is limited to specific areas as shown in the Aeronautical Information Manual (AIM). TAS data comes from a TAS unit such as a Garmin GTS 800 or 820, Skywatch 497, KTA 810, or other unit. Coverage follows the aircraft. In the Navigation Map page setup you can select the maximum range at which traffic symbols are shown. Once outside of the selected range, traffic will be decluttered. The Traffic soft key will still be available. The Garmin GDL 88 can provide TIS-B and ADS-B information. The Garmin GTS ADS-B products can also provide ADS-B information.

Foreword

Sec 1
SystemSec 2
PFDSec 3
MFD**Sec 4
Hazard
Avoidance**Sec 5
Additional
FeaturesSec 6
Annun.
& AlertsSec 7
SymbolsSec 8
Glossary

Appendix A

Index

4.6.1 TRAFFIC POP-UP

When the GDU 620 MFD is displaying any page (other than the Traffic page) and a traffic alert becomes active, the Traffic pop-up will be displayed.



NOTE: *The traffic pop-up will not appear when your aircraft is on the ground.*

Press **ENT** to go directly to the Traffic page.

OR

Press **CLR** to return to the previously viewed page.

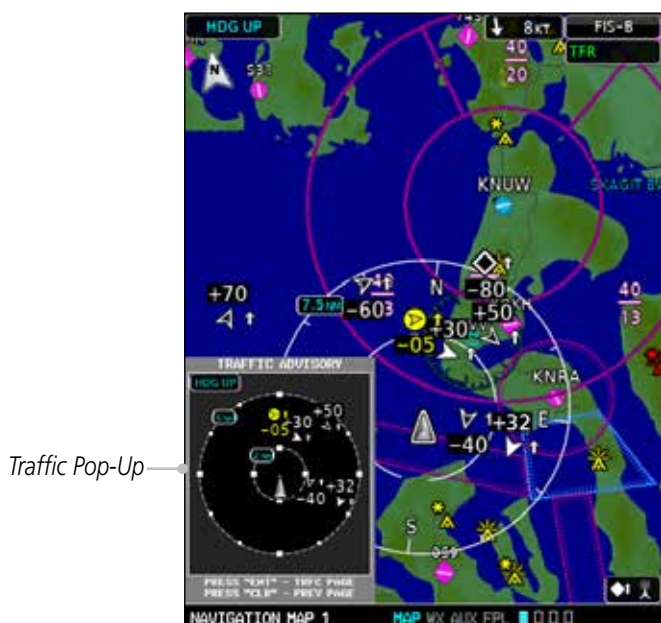

Figure 4-28 Traffic Pop-Up

4.6.2 TAS/TCAS 1 Traffic (Optional)

TAS refers to an active Traffic Advisory System that may be optionally displayed on the PFD and/or MFD. The TAS is installed separately from the G500/G600 system. There are variations in performance and control among the various G500/G600-compatible TAS systems. Refer to the appropriate TAS documentation for detailed information on the operation of the TAS system. This section describes the display and control functions available on the G500/G600 system.



NOTE: *TIS and TAS are mutually exclusive.*



NOTE: *Aircraft without an operating transponder are invisible to both Traffic Advisory Systems (TAS) and TIS. Aircraft without altitude reporting capability are shown without altitude separation data or climb descent indication.*



NOTE: *Traffic is also displayed in the SVT feature on the PFD.*

- Foreword
- Sec 1 System
- Sec 2 PFD
- Sec 3 MFD
- Sec 4 Hazard Avoidance**
- Sec 5 Additional Features
- Sec 6 Annun. & Alerts
- Sec 7 Symbols
- Sec 8 Glossary
- Appendix A
- Index

4.6.2.1 Displaying and Operating Traffic (TAS/TCAS Systems)

The Traffic Map Page shows surrounding TAS/TCAS traffic data in relation to the aircraft's current position and altitude. Traffic page orientation is always heading up. The traffic mode and altitude filter mode are announced in the upper left corner.

Foreword

Sec 1
System

Sec 2
PFD

Sec 3
MFD

Sec 4
Hazard
Avoidance

Sec 5
Additional
Features

Sec 6
Annu-
& Alerts

Sec 7
Symbols

Sec 8
Glossary

Appendix A

Index

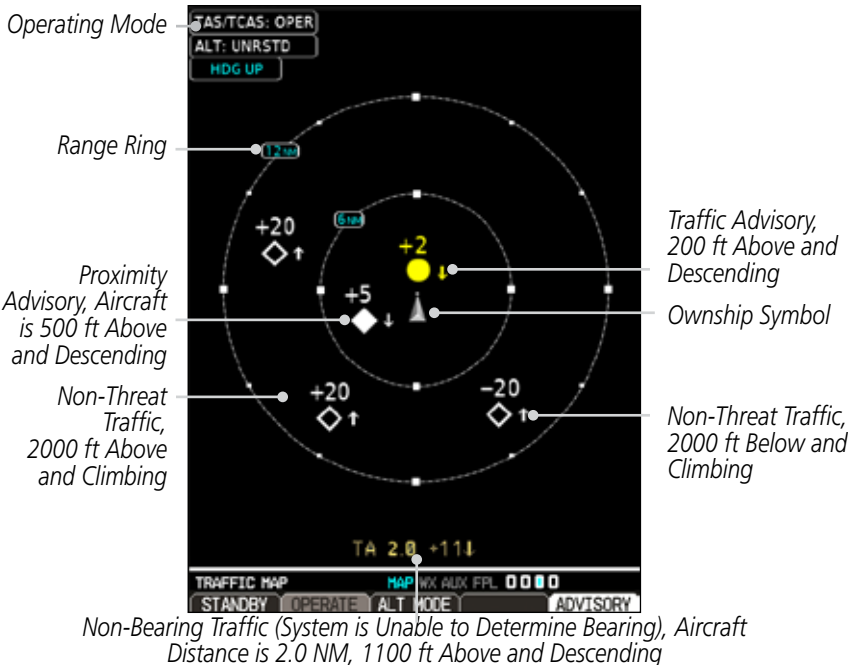

Non-Bearing Traffic (System is Unable to Determine Bearing), Aircraft Distance is 2.0 NM, 1100 ft Above and Descending

Figure 4-29 Traffic Map Page - TAS/TCAS

4.6.2.2 Switching from Standby Mode to Operating Modes

The unit must be in operating mode for traffic to be displayed.

1. While viewing the Traffic Page of the MAP page group, select the **OPERATE** soft key to select Operating Mode.
2. To switch to Standby Mode from the Traffic Page, select the **STANDBY** soft key.



NOTE: Not all TAS systems can be controlled from the G500/G600. The Operate/Standby soft keys may not be displayed. An alert will be generated when Standby is selected and the aircraft is in the air.

4.6.2.3 Range Ring

Pressing the **RNG** keys will zoom in and out in preset steps depending on the installed equipment.

4.6.2.4 Altitude Display

Changing the altitude display mode

1. Press the **ALT MODE** soft key to change the altitude filter.
2. Select the desired altitude filter by pressing the **BELOW**, **NORMAL**, **ABOVE**, or **UNRSTD** (unrestricted) soft keys. The selection is displayed in the Altitude mode field.

Altitude Mode	Displayed Traffic Range (ft)
Below	-9,900 to 2,700
Normal	-2,700 to 2,700
Above	-2,700 to 9,900
Unrestricted	All Traffic Shown (-9,900 to 9,900)

Table 4-12 Displayed Traffic Range

NOTE: *Traffic Advisories (TAs) are always displayed, regardless of altitude mode.*

Foreword
 Sec 1 System
 Sec 2 PFD
 Sec 3 MFD
 Sec 4 Hazard Avoidance
 Sec 5 Additional Features
 Sec 6 Annun. & Alerts
 Sec 7 Symbols
 Sec 8 Glossary
 Appendix A
 Index

4.6.2.5 TAS/TCAS Symbolology

Traffic is displayed using four different symbols.





TAS Symbol	Description
	Other Traffic
	Proximity Advisory (PA)
	Traffic Advisory (TA)
	Traffic Advisory Off Scale

Table 4-13 TAS/TCAS Traffic Symbol Description

The traffic system determines the type of symbol used for each target. Refer to the traffic system documentation for information regarding the criteria used to determine target type.

A Traffic Advisory (TA) alerts the crew to a potentially hazardous intruding aircraft. Closing rate, distance, and vertical separation meet TA criteria for the specific traffic system. A Traffic Advisory that is beyond the selected display range is indicated by a half TA symbol at the edge of the screen at the relative bearing of the intruder.

4.6.2.6 Traffic System Status



NOTE: Refer to the equipment documentation for information on the self-test and operating modes.

The traffic mode is indicated in the upper left corner of the Traffic Map Page.

Mode	Traffic Mode Annunciation (Traffic Map Page)
TAS Self-test Initiated	TEST (also shown in white in center of page)
TAS Operating	OPERATING
TAS Standby	STANDBY (also shown in white in center of page)

Table 4-14 TAS Modes

If the unit fails, an annunciation as to the cause of the failure is shown in the center of the Traffic Map Page.

Traffic Map Page Annunciation	Description
NO DATA	Data is not being received from the TAS unit.
TRFC FAIL	TAS unit has failed (unit is self-reporting a failure or sending incorrectly formatted data).
NO TRFC DATA	Data is not being received from the TAS unit.
DATA FAILED	Data is being received from the TAS unit, but the unit is self-reporting a failure.
FAILED	Incorrect data format received from the TAS unit.

Table 4-15 TAS Failure Annunciations

The annunciations to indicate the status of traffic information appear in a banner at the lower left corner of maps on which traffic can be displayed.

Traffic Status Banner Annunciation	Description
TA OFF SCALE*	A Traffic Advisory is outside the selected display range. Annunciation is removed when traffic comes within the selected display range.
TA X.X ± XX ↑**	System cannot determine bearing of Traffic Advisory. Annunciation indicates distance in NM, altitude separation in hundreds of feet, and altitude trend arrow (climbing/descending).
TA/ X.XNM/± XX ↓**	System cannot determine bearing of Traffic Advisory. Annunciation indicates distance in NM, altitude separation in hundreds of feet, and altitude trend arrow (climbing/descending). The system distance units are set to Metric or Imperial and are shown as such in all other cases except for the traffic distance annunciation.

*Shown as symbol on Traffic Map Page.

**Shown centered on the bottom of Traffic Map Page.

Table 4-16 TAS Traffic Status Annunciations

For TAS traffic, TEST MODE can be initiated from the Page Menu (press the **MENU** key) when the traffic device is in Standby mode.

4.6.3 TIS Traffic (Optional)

Foreword



WARNING: *The Traffic Information Service (TIS) is intended for advisory use only. TIS is intended to help the pilot locate traffic visually. It is the responsibility of the pilot to see and maneuver to avoid traffic.*

Sec 1
System



NOTE: *TIS is available only when the aircraft is within the service volume of a TIS-capable terminal radar site. Aircraft without an operating transponder are invisible to both Traffic Advisory Systems (TAS) and TIS. Aircraft without altitude reporting capability are shown without altitude separation data or climb descent indication.*

Sec 2
PFD

Sec 3
MFD



NOTE: *TIS and TAS are mutually exclusive.*



NOTE: *Traffic is also displayed in the SVT feature of the PFD.*

Sec 4
Hazard
Avoidance

The type of traffic systems that is installed is determined by the traffic page display in the upper left corner of the MFD.

Sec 5
Additional
Features

If Traffic Information Service (TIS) is configured, TIS will be displayed in the upper left corner of the MFD.

Sec 6
Annun.
& Alerts

Traffic Information Service (TIS) is designed to help in detection and avoidance of other aircraft. TIS uses the Mode S transponder for the traffic data link. TIS receives traffic information from ground stations, and is updated every five seconds. The GDU 620 displays up to eight traffic targets within a 7.5 NM radius, from 3,000 feet below to 3,500 feet above the requesting aircraft. Traffic is displayed according to TCAS symbology using three different symbols.

Sec 7
Symbols

4.6.3.1 Traffic Map Page

Sec 8
Glossary

The Traffic Map Page is configured to show surrounding TIS traffic data in relation to the aircraft's current position and altitude, without clutter from the basemap. Aircraft orientation on this map is always heading up unless there is no valid heading.

Appendix A

The traffic mode is annunciated in the upper left corner of the Traffic Map Page. When the aircraft is on the ground, TIS automatically enters Standby Mode. Once the aircraft is airborne, TIS switches from Standby to Operating Mode and the GDU 620 begins to display traffic information.

Index

Displaying traffic on the Traffic Map Page

1. Turn the large **MFD** knob to select the Map Page Group.
2. Turn the small **MFD** knob to select the Traffic Map Page.
3. Confirm TIS is in Operating Mode:

Select the **OPERATE** soft key to begin displaying traffic.

OR

1. Press the **MENU** key.
2. Select Operate Mode (shown if TIS is in Standby Mode) and then press the **ENT** key.

Operating Mode

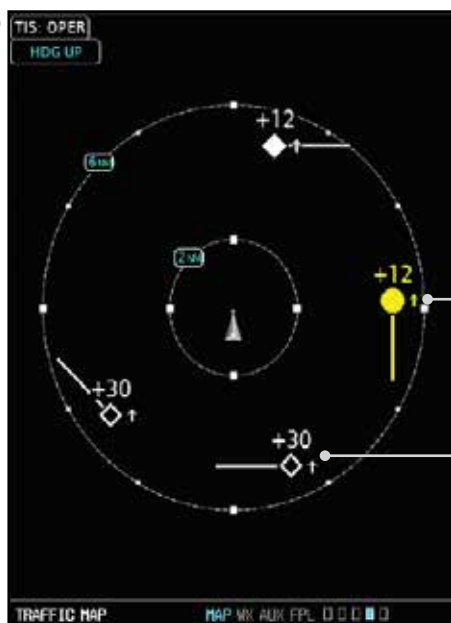

Traffic Advisory, Aircraft is 1200 feet above, climbing, and moving in the direction of the line

Other Traffic, Aircraft is 3000 feet above, climbing and moving in the direction of the line

Figure 4-30 Traffic Map Page - TIS

4.6.3.2 TIS Symbology

Foreword
 Sec 1 System
 Sec 2 PFD
 Sec 3 MFD
 Sec 4 Hazard Avoidance
 Sec 5 Additional Features
 Sec 6 Annun. & Alerts
 Sec 7 Symbols
 Sec 8 Glossary
 Appendix A
 Index





TIS Symbol	Description
	Non-Threat Traffic
	Proximity Advisory (PA)
	Traffic Advisory (TA)
	Traffic Advisory Off Scale

Table 4-17 TIS Traffic Symbols

A Traffic Advisory (TA) alerts the crew to a potentially hazardous intruding aircraft. Closing rate, distance, and vertical separation meet TA criteria. A Traffic Advisory that is beyond the selected display range is indicated by a half TA symbol at the edge of the screen at the relative bearing of the intruder.

TIS also provides a vector line showing the direction in which the traffic is moving, to the nearest 45°. Traffic information for which TIS is unable to determine the bearing (non-bearing traffic) is displayed in the bottom center of the Traffic Map Page or in a banner at the lower left corner of other map pages on which traffic can be displayed.

The altitude difference between the requesting aircraft and other intruder aircraft is displayed above/below the traffic symbol in hundreds of feet. If the other aircraft is above the requesting aircraft, the altitude separation appears above the traffic symbol; if below, the altitude separation appears below. Altitude trend is displayed as an up/down arrow (for speeds greater than 500 fpm in either direction) to the right of the target symbol. Traffic symbols for aircraft without altitude reporting capability appear without altitude separation or climb/descent information.

4.6.3.3 TIS Limitations



NOTE: *This section on TIS Limitations is not comprehensive. Garmin recommends the user review the TIS Limitations section of the Aeronautical Information Manual.*

TIS is NOT intended to be used as a collision avoidance system and does not relieve the pilot of responsibility to “see and avoid” other aircraft. TIS should not be used for avoidance maneuvers during IMC or other times when there is no visual contact with the intruder aircraft. TIS is intended only to assist in visual acquisition of other aircraft in VMC. No recommended avoidance maneuvers are provided, nor authorized, as a direct result of a TIS intruder display or TIS advisory.

While TIS is a useful aid to visual traffic avoidance, it has some system limitations that must be fully understood to ensure proper use. Many of these limitations are inherent in secondary radar surveillance. In other words, the information provided by TIS will be no better than that provided to ATC. TIS will only display aircraft with operating transponders installed.

TIS relies on surveillance of the Mode S radar, which is a “secondary surveillance” radar similar to the ATCRBS. TIS operation may be intermittent during turns or other maneuvering. TIS is dependent on two-way, “line-of-sight” communication between the aircraft and the Mode S radar. Whenever the structure of the client aircraft comes between the transponder antenna (usually located on the underside of the aircraft) and the ground-based radar antenna, the signal may be temporarily interrupted. Other limitations and anomalies associated with TIS are described in the AIM.



Garmin is not responsible for Mode S geographical coverage. Operation of the ground stations is the responsibility of the FAA. Refer to the Aeronautical Information Manual for a Terminal Mode S Radar Site Map covering the U.S.

NOTE: *TIS will be unavailable at low altitudes in many areas of the U.S., particularly in mountainous regions. Also, when flying near the “floor” of radar coverage in a particular area, intruders below the client aircraft may not be detected by TIS.*

TIS information is collected one radar scan prior to the scan during which the uplink occurs. Therefore, the surveillance information is approximately five seconds old. In order to present the intruders in a “real time” position, the TIS ground station uses a “predictive algorithm” in its tracking software. This algorithm uses track history data to extrapolate intruders to their expected positions consistent with the time of display in the cockpit. Occasionally, aircraft maneuvering will cause this algorithm to induce errors in the display. These errors primarily affect relative bearing information and traffic target track vector (it will lag); intruder distance and altitude will remain relatively accurate and may be used to assist in “see and avoid.” Some of the more common examples of these errors follow:

- When client or intruder aircraft maneuvers excessively or abruptly, the tracking algorithm may report incorrect horizontal position until the maneuvering aircraft stabilizes.
- When a rapidly closing intruder is on a course that crosses the client aircraft course at a shallow angle (either overtaking or head on) and either aircraft abruptly changes course within 0.25 NM, TIS may display the intruder on the opposite side of the client than it actually is.

These are relatively rare occurrences and will be corrected in a few radar scans once the course has stabilized.

Foreword

Sec 1 System

Sec 2 PFD

Sec 3 MFD

Sec 4 Hazard Avoidance

Sec 5 Additional Features

Sec 6 Annun. & Alerts

Sec 7 Symbols

Sec 8 Glossary

Appendix A

Index

4.6.3.4 TIS Alerts

When the number of Traffic Advisories (TAs) on the Traffic Map Page increases from one scan to the next, the following occur:

- A single “Traffic” voice alert is generated.
- A TRAFFIC Annunciation appears to the top left of the Attitude Indicator on the PFD, flashing for 5 seconds and remaining displayed until no TAs are detected in the area.

To reduce the number of nuisance alerts due to proximate aircraft, the “Traffic” voice alert is generated only when the number of TAs increases. For example, when the first TA is displayed, a voice and visual annunciation are generated. As long as a single TA remains on the display, no additional voice alerts are generated. If a second TA appears on the display or if the number of TAs initially decreases and then subsequently increases, another voice alert is generated.

A “Traffic Not Available” (TNA) voice alert is generated when the TIS service becomes unavailable or is out of range.

Traffic may not be displayed in the radar coverage area due to the following:

- Radar site TIS Mode S sensor is not operational or is out of service.
- Traffic or requesting aircraft is beyond the maximum range of the TIS-capable Mode S radar site.
- Traffic or requesting aircraft is above the radar site in the cone of silence and out of range of an adjacent site.
- Traffic or requesting aircraft is below radar coverage. In flat terrain, the coverage extends from about 3,000 feet upward at 55 miles. Terrain and obstacles around the radar site can further decrease radar coverage in all directions.
- Traffic does not have an operating transponder.

4.6.3.5 TIS System Status

The GDU 620 performs an automatic test of TIS during power-up. If TIS passes the test, TIS enters Standby Mode on the ground or Operating Mode in the air. If TIS fails the power up test, an annunciation is shown in the center of the Traffic Map Page.

Traffic Map Page Annunciation	Description
NO DATA*	Data is not being received from the transponder
DATA FAILED*	Data is being received from the transponder, but a failure is detected in the data stream
FAILED*	The transponder has failed
UNAVAILABLE	TIS is unavailable or out of range

* Contact a service center or Garmin dealer for corrective action.

Table 4-18 TIS Failure Annunciations

The traffic mode is annunciated in the upper left corner of the Traffic Map Page. When the aircraft is on the ground, TIS automatically enters Standby Mode. If traffic is selected for display on another map while Standby Mode is selected, the traffic display enabled icon is crossed out (also the case when TIS has failed). Once the aircraft is airborne, TIS switches to Operating Mode and traffic information is displayed. The mode can be changed manually using soft keys or the page menu.



Mode	Traffic Mode Annunciation (Traffic Map Page)	Traffic Display Enabled Icon (Other Maps)
TIS Operating	OPERATING	
TIS Standby	STANDBY (Also shown in white in center of page)	
TIS Failed*	FAIL	

Table 4-19 TIS Modes

Switching Between TIS Operating Modes

1. Turn the large **MFD** knob to the MAP page group and then turn the small **MFD** knob to the Traffic Map Page.
2. Select the **STANDBY** or **OPERATE** soft key to switch between modes. The mode is displayed in the upper left corner of the Traffic Map Page.

OR

1. Press the **MENU** key.
2. Select Operate mode or Standby mode whether airborne or on the ground.
3. Press the **ENT** key.



NOTE: *An alert will be generated when Standby is selected and the aircraft is in the air.*

The annunciations indicate the status of traffic information appear in a banner at the lower left corner of maps on which traffic can be displayed.

		Traffic Status Banner Annunciation	Description
Foreword			
Sec 1	System	TA OFF SCALE*	A Traffic Advisory is outside the selected display range. Annunciation is removed when traffic comes within the selected display range.
Sec 2	PFD	TA X.X ± XX↓**	System cannot determine bearing of Traffic Advisory. Annunciation indicates distance in NM, altitude separation in hundreds of feet, and altitude trend arrow (climbing/ descending).
Sec 3	MFD	TA/ X.X_{NM}/± XX↓**	System cannot determine bearing of Traffic Advisory. Annunciation indicates distance in NM, altitude separation in hundreds of feet, and altitude trend arrow (climbing/ descending). The system distance units are set to Metric or Imperial and are shown as such in all other cases except for the traffic distance annunciation.
Sec 4	Hazard Avoidance		
Sec 5	Additional Features	AGE MM:SS	Appears if traffic data is not refreshed within 6 seconds. If after another 6 seconds data is not received, traffic is removed from the display. The quality of displayed traffic information is reduced as the age increases.
Sec 6	Annun. & Alerts	TRFC COAST	The displayed data is not current (6 to 12 seconds since last message). The quality of displayed traffic information is reduced when this message is displayed.
Sec 7	Symbols	TRFC RMVD	Traffic is removed because it is too old for coasting (12 to 60 seconds since last message). Traffic may exist within the selected display range, but it is not displayed.
Sec 8	Glossary	TRFC FAIL	Traffic data has failed.
Appendix A		NO TRFC DATA	Traffic has not been detected.
		TRFC UNAVAIL	The traffic service is unavailable or out of range.

* Shown as symbol on Traffic Map Page.

** Shown centered on the bottom of Traffic Map Page.

Table 4-20 TIS Traffic Status Annunciations

4.6.4 ADS-B Traffic (Optional)

ADS-B In allows a properly-equipped aircraft to receive TIS-B and other aircraft equipped with ADS-B out capability.

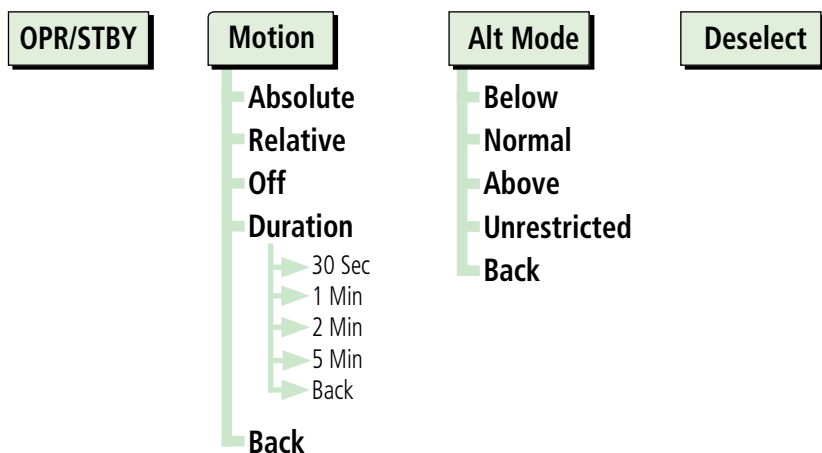

Figure 4-31 ADS-B Traffic Page Functional Diagram

Availability of the **OPR/STBY** soft key depends on the installation. When in Standby mode, press the **MENU** key to display the Page menu to place the traffic LRU into Test mode.

4.6.4.1 Target Selection

Traffic targets displayed on the dedicated traffic page may be selected in order to obtain additional information about a traffic target.

1. Press the small **MFD** knob to start target selection.
2. Turn the small or large **MFD** knobs clockwise or counter-clockwise to step through selection of the available targets.
3. After selecting a target, you can press the small **MFD** knob to leave the target selected, and return the small **MFD** to page selection mode.
4. Use the **DESELECT** soft key to turn off selected traffic.

Foreword

Sec 1 System

Sec 2 PFD

Sec 3 MFD

Sec 4 Hazard Avoidance

Sec 5 Additional Features

Sec 6 Annun. & Alerts

Sec 7 Symbols

Sec 8 Glossary

Appendix A

Index

ADS-B and TCAS Status and Altitude Filter

Map Orientation

Range Ring Radius

Basic Directional Traffic, 4000 ft Below and Climbing

Selected Vector Motion and Duration

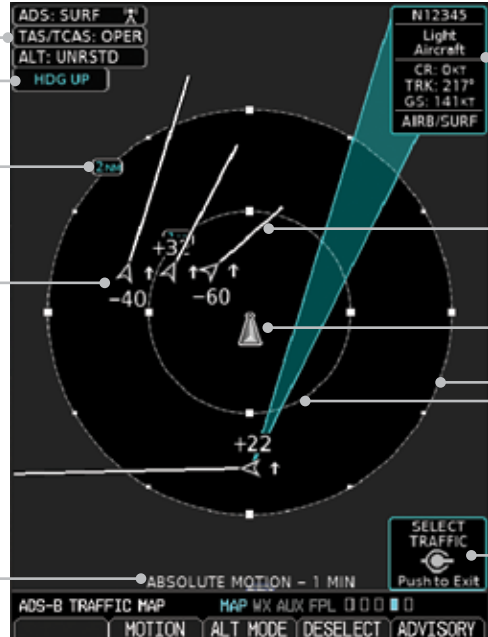

Selected Traffic Info

Traffic Motion Vector

Ownship Icon

Range Rings

Turn Cursor Knob for Next Target

Figure 4-32 ADS-B Traffic Page (Absolute Motion)



NOTE: Traffic targets within 1200 ft vertical separation and 6NM from the ownship are depicted as proximate targets.













Symbol	Description
	Basic Non-Directional Traffic
	Basic Directional Traffic
	Basic Off-scale Selected Traffic
	Proximate Non-Directional Traffic
	Proximate Directional Traffic
	Proximate Off-scale Selected Traffic
	Non-Directional Alerted Traffic
	Off-Scale Non-Directional Alerted Traffic
	Directional Alerted Traffic
	Off-Scale Directional Alerted Traffic
	Non-Directional Surface Vehicle
	Directional Surface Vehicle

Table 4-21 ADS-B Traffic Symbols



NOTE: Color of basic and proximate traffic is dependent on airborne/on-ground status of target (target is brown when on the ground, see the surface vehicles).

4.6.4.2 Status

ADS-B Status

ADS-B Status displays the current status of traffic application: Off, Surface, Airborne, N/A, Fail, or Test.

TCAS Status

If a TCAS system is integrated with the ADS-B system then this shows the current status of the TCAS system. When the ADS-B system is integrated with a TCAS system, the controls are provided on the installed navigator and the **OPR/STBY** soft key is not available.

The ADS-B traffic map page orients heading up. If heading is not valid, the display reverts to track up. If heading and track are invalid, the display latches to the last known orientation.

Altitude Filter

The Altitude Filter limits the traffic displayed to the Below, Normal, Above or Unrestricted altitude block as listed in the “Displayed Traffic Range” table. The filter altitudes are relative to ownship altitude. Press the Alt Mode smart key to display the altitude smart keys. Press the smart key to select the altitude filter value.

Altitude Mode	Displayed Traffic Range (ft)
Below	-9,900 to 2,700
Normal	-2,700 to 2,700
Above	-2,700 to 9,900
Unrestricted	All Traffic Shown (-9,900 to 9,900)

Table 4-22 Displayed Traffic Range

4.6.4.3 Motion Vector

When Absolute Motion Vectors are selected, the vectors extending from the traffic targets depict the target reported track and speed over the ground. When Relative Motion Vectors are selected, the vectors extending from the traffic targets display how the traffic target is moving relative to your aircraft. These vectors are calculated using the traffic targets track and ground speed and your aircraft's track and ground speed. These two values are combined to depict where the traffic target is moving with respect to your aircraft and indicates where the traffic target will be, relative to your aircraft, at the time specified by the length of the vector.



NOTE: Absolute motion vectors match the color of the intruder (white or yellow). Relative motion vectors are green except for Traffic Advisories whose Relative Motion vectors are yellow. The annunciation on the bottom of the dedicated traffic page indicates which vector type is selected and their length.



Figure 4-33 Absolute Motion (White Vectors)



NOTE: Relative Motion vectors are unavailable when the aircraft is on the ground. The duration will be annunciated as UNAVAIL after "RELATIVE MOTION -" at the bottom of the screen.



Figure 4-34 Relative Motion (Green Vectors)

Vector Duration

The Vector Duration selection sets the time that the vector will show the calculated distance and direction of the traffic target. A longer duration will result in a longer vector. Press the smart key for the desired duration.

4.7 SiriusXM WX Satellite Weather (Optional)

The primary map for viewing SiriusXM WX Satellite Weather data are the Weather Data Link Pages in the Map Page Group. These are the only GDU 620 map displays capable of all available SiriusXM WX Satellite weather products. The SiriusXM WX Satellite Weather pages may be oriented to either Track Up or North Up.

4.7.1 Using SiriusXM WX Satellite Weather Products

When a weather product is active on the Weather Data Link Page or the Navigation Map Page, the age of the data is displayed on the screen. The age of the product is based on the time difference between when the data was assembled on the ground and the current GPS time. Weather products are refreshed at specific intervals.

If a weather product is not received within the 30, 60, 90, or 120 minute Expiration Time intervals, the data is considered expired and is removed from the display. This ensures that the displayed data is consistent with what is currently being broadcast by SiriusXM WX Satellite Radio services. If more than half of the expiration time has elapsed from the time the data is received, the color of the product age displayed changes to yellow.

4.7.2 Customizing the SiriusXM WX Satellite Weather Map

Each Wx Data Link Map page may be customized individually. The Wx Data Link Map pages are customized by selecting options from the Page Menu. The Page Menu options include choices for Weather Setup and displaying the Weather Legends. The Weather Setup choice covers selections for adjusting the viewing ranges of the weather products.

1. While viewing a WX Data Link Map page of the WX page group, press the **MENU** key to display the Page Menu Options. The cursor flashes on the “Weather Setup” option. Press **ENT**.

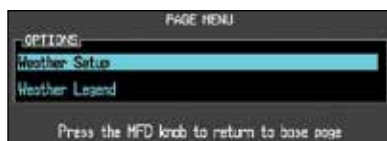

Figure 4-35 Weather Page Menu Options

2. Turn the Large or Small **MFD** knob to select Weather Setup (1/2) or Weather Setup (2/2) and press **ENT**.



Figure 4-36 Weather Setup Group Selection

3. With the Data Link Setup Menu displayed, turn the Large **MFD** knob to highlight the desired item and then turn the small **MFD** knob to select the desired weather feature value. Where a value (such as 100 NM) is selected, weather data will be shown at map ranges of the selected value (100 NM) and lower.
4. Press **ENT** to save a selection.
5. Turn the large **MFD** knob to the next desired option or press the small **MFD** knob to cancel and return to the XM WX Satellite Weather Data Link Map Page.

WX Page Menu - Weather Setup	
Menu Item	Adjustment
Map Orientation	North Up, Track Up
NEXRAD Data Viewing Range	Off, 10 NM to 500 NM
NEXRAD Legend	On/Off
Source	US, Canada
Echo Top Data Viewing Range	Off, 10 NM to 500 NM
Cloud Top Data Viewing Range	Off, 10 NM to 500 NM
Lightning Data Viewing Range	Off, 10 NM to 500 NM
Cell Mov Data Viewing Range	Off, 10 NM to 500 NM
SIG/AIR Viewing Range	Off, 10 NM to 500 NM
PIREPS Data Viewing Range	Off, 10 NM to 500 NM
METAR Data Viewing Range	Off, 10 NM to 500 NM
Surface Data Viewing Range	Off, 10 NM to 500 NM
Frz Lvl Data Viewing Range	Off, 10 NM to 500 NM
Wnds Aloft Data Viewing Range	Off, 10 NM to 500 NM
County Data Viewing Range	Off, 10 NM to 500 NM
TFR Data Viewing Range	Off, 10 NM to 500 NM
AIREPS Data Viewing Range	Off, 10 NM to 500 NM
Icing Data Viewing Range	Off, 10 NM to 500 NM
Turbulence Data Viewing Range	Off, 10 NM to 500 NM
Cyclone Data Viewing Range	Off, 10 NM to 500 NM

Table 4-23 Weather Page Menu Setup Options

Foreword

Sec 1
System

Sec 2
PFD

Sec 3
MFD

Sec 4
Hazard
Avoidance

Sec 5
Additional
Features

Sec 6
Annun.
& Alerts

Sec 7
Symbols

Sec 8
Glossary

Appendix A

Index

4.7.3 SiriusXM WX Weather Symbols and Product Age

The broadcast rate represents the interval at which SiriusXM WX Satellite Radio broadcasts new signals that may or may not contain new weather data. It does not represent the rate at which weather data is updated or new content is received by the Data Link Receiver. Weather data is updated at intervals that are defined and controlled by SiriusXM Satellite Radio and its data vendors.

The product label in the legend will turn yellow at half the expiration time and gray when expired. Expired products will not be shown on the display.



WARNING: *Do not use data link weather information for maneuvering in, near, or around areas of hazardous weather. Information contained within data link weather products may not accurately depict current weather conditions.*



WARNING: *Do not use the indicated data link weather product age to determine the age of the weather information shown by the data link weather product. Due to time delays inherent in gathering and processing weather data for data link transmission, the weather information shown by the data link weather product may be significantly older than the indicated weather product age.*



NOTE: *Product age for individual reports of SiriusXM AIRMETS, SIGMETs, City Forecasts, County Warnings, Cell Movement and TFRs are not provided by SiriusXM Weather Service.*

Product age indication for SiriusXM Icing Potential and Turbulence is not included on the weather map. The valid time for these products is displayed on the weather map in place of the generation time.

The valid time indication for SiriusXM Freezing Level, Winds Aloft and Canada Winds Aloft is not displayed. Instead, the generation time for these is displayed.

Foreword

Sec 1 System

Sec 2 PFD

Sec 3 MFD

Sec 4 Hazard Avoidance

Sec 5 Additional Features

Sec 6 Annun. & Alerts

Sec 7 Symbols

Sec 8 Glossary

Appendix A

Index













Symbol	Description
	Flood
	Severe Thunderstorm
	Tornado
	Sunny
	Part Sun
	Cloudy
	Rainy
	T-Storm
	Snow
	Windy
	Foggy
	Haze
	High/Low Temp

Table 4-24 Weather Symbols

4.7.4 SiriusXM Weather Legends

The **LEGEND** soft key displays a pop-up legend of the currently used weather products. Pressing the **LEGEND** soft key again, the **MFD** knob, the **ENT**, or **CLR** keys will remove the legend.

1. A full page legend can be selected by selecting the Weather Legend option in the XM Weather Map Menu or pressing the **LEGEND** soft key on the Weather Map Page. The legend displayed will match the selected weather products. Turn the large or small **MFD** knobs to scroll through the legend, if necessary.

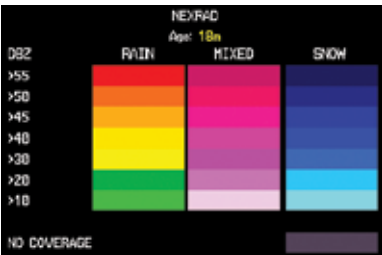
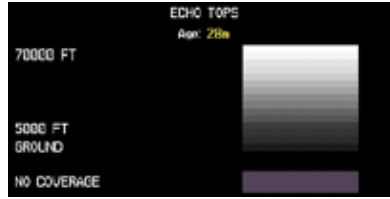
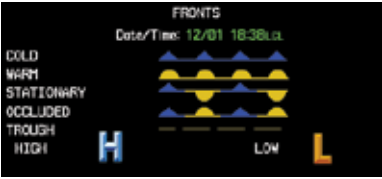



Figure 4-37 Weather Legends

- An abbreviated legend may be displayed on the upper right side of a WX Data Link Map page for the applicable weather products when selected in the Page Menu options for Weather.

4.7.5 SiriusXM NEXRAD

WSR-88D, or NEXRAD (NEXt-generation RADar), is a network of 158 high-resolution Doppler radar systems that are operated by the National Weather Service (NWS). NEXRAD data provides centralized meteorological information for the continental United States and selected overseas locations. The maximum range of a single NEXRAD radar site is 250 NM. The NEXRAD network provides important information about severe weather for air traffic safety.

NEXRAD data is not real-time. The lapsed time between collection, processing, and dissemination of NEXRAD images can be significant and may not reflect the current radar synopsis. Due to the inherent delays and the relative age of the data, it should be used for long-range planning purposes only. Never use NEXRAD data or any radar data to penetrate hazardous weather. Instead, use it in an early-warning capacity of pre-departure and en route evaluation.

Foreword

Sec 1
System

Sec 2
PFD

Sec 3
MFD

Sec 4
Hazard
Avoidance

Sec 5
Additional
Features

Sec 6
Annun.
& Alerts

Sec 7
Symbols

Sec 8
Glossary

Appendix A

Index



Figure 4-38 XM Weather - NEXRAD

Composite data from all the NEXRAD radar sites in the United States is shown. This data is composed of the maximum reflectivity from the individual radar sweeps. The display of the information is color-coded to indicate the weather severity level. All weather product legends can be viewed on the Weather Data Link Page. For the NEXRAD legend, select the **LEGEND** soft key when NEXRAD is selected for display.

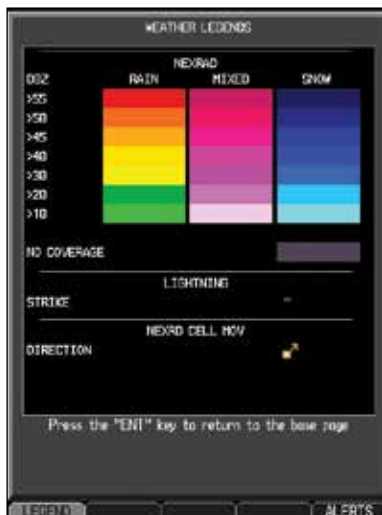

Figure 4-39 NEXRAD Weather Legend

Foreword
 Sec 1 System
 Sec 2 PFD
 Sec 3 MFD
 Sec 4 Hazard Avoidance
 Sec 5 Additional Features
 Sec 6 Annun. & Alerts
 Sec 7 Symbols
 Sec 8 Glossary
 Appendix A
 Index

The display of radar coverage is always active when either NEXRAD or ECHO TOPS is selected. Areas where NEXRAD radar coverage and Echo Tops information is not currently available or is not being collected are indicated in grayish-purple.

4.7.5.1 Reflectivity

Reflectivity is the amount of transmitted power returned to the radar receiver. Colors on the NEXRAD display directly correlate to the level of detected reflectivity. Reflectivity as it relates to hazardous weather can be very complex.

The role of radar is essentially to detect moisture in the atmosphere. Simply put, certain types of weather reflect radar better than others. The intensity of a radar reflection is not necessarily an indication of the weather hazard level. For instance, wet hail returns a strong radar reflection, while dry hail does not. Both wet and dry hail can be extremely hazardous.

The different NEXRAD echo intensities are measured in decibels (dB) relative to reflectivity (Z). NEXRAD measures the radar reflectivity ratio, or the energy reflected back to the radar receiver (designated by the letter Z). The value of Z increases as the returned signal strength increases.

4.7.5.2 NEXRAD Limitations

NEXRAD radar images may have certain limitations:

- NEXRAD composite reflectivity does not provide sufficient information to determine cloud layers or precipitation characteristics. For example, it is not possible to distinguish between wet snow, wet hail, and rain.
- NEXRAD composite reflectivity is sampled at the minimum antenna elevation angle. An individual NEXRAD site cannot depict high altitude storms at close ranges. It has no information about storms directly over the site.
- When zoomed in to a range of 30 NM, each square block on the display represents an area of four square kilometers. The intensity level reflected by each square represents the highest level of NEXRAD data sampled within the area.

The following may cause abnormalities in displayed NEXRAD radar images:

- Ground clutter
- Strokes and spurious radar data
- Sun strokes (when the radar antenna points directly at the sun)
- Interference from buildings or mountains, which may cause shadows
- Metallic dust from military aircraft, which can cause alterations in radar scans



NOTE: At present, NEXRAD data can age significantly by the time the mosaic image is created. Although such situations are not believed to be typical, in extreme latency and mosaic-creation scenarios, the actual age of the oldest NEXRAD data in the mosaic can exceed the age indication in the cockpit by 15-20 minutes. Even small time differences between the age indicator and actual conditions can be important for safety of flight, especially when considering fast-moving weather hazards, quickly developing weather scenarios, and/or fast-moving aircraft.

4.7.6 XM Weather Page Map Orientation

The Orientation option sets the orientation of the Wx Data Link Map pages.

1. While viewing the Wx Data Link Map 1, 2, or 3 of the Wx page group, press the **MENU** key. With “Weather Setup” highlighted, press **ENT**.
2. Turn the small **MFD** knob to select “Weather Setup 1/2” and press **ENT**.
3. With the “Map Orientation” option active, turn the small **MFD** knob to change the highlighted value.



Figure 4-40 Weather Page Map Orientation

4. Press **ENT** to accept the displayed value. The next option will be highlighted.
5. Press the small **MFD** knob to cancel selection or to end editing and return to the Navigation Map page or turn the large **MFD** knob to the next option.

4.7.7 NEXRAD Data Viewing Range

The NEXRAD Viewing Range option allows you to select the map range where at and below the selected value NEXRAD weather products will be shown on the selected MFD Wx Data Link Map page (1, 2, or 3). When Off is selected, NEXRAD weather data will not be shown. For the value (such as 100 NM) that is selected, NEXRAD data will be shown at the selected map ranges (such as 100 NM) and lower.

1. While viewing a WX Data Link Map page of the WX page group, press the **MENU** key to display the Page Menu Options. The cursor flashes on the "Weather Setup" option. Press **ENT**.
2. Turn the small **MFD** knob to select "Weather Setup 1/2" and press **ENT**.
3. Turn the large **MFD** knob to highlight the NEXRAD Data Viewing Range value. Turn the small **MFD** knob to highlight the desired value.
4. Press **ENT** to accept the displayed value. The next option will be highlighted.
5. Press the small **MFD** knob to cancel selection or to end editing and return to the previously viewed page or turn the large **MFD** knob to the next option.

4.7.8 NEXRAD Legend

The NEXRAD Legend selection provides the option of displaying an abbreviated version of the NEXRAD legend in the top right region of the MFD. The full legend is available by pressing the **LEGEND** soft key.



Figure 4-41 NEXRAD Legend Selection

1. While viewing Weather Setup 1/2 menu, turn the large **MFD** knob to highlight the NEXRAD Legend value.
2. Turn the small **MFD** knob to highlight Off or On. Press **ENT** to accept the displayed value. The next option will be highlighted.
3. Press the small **MFD** knob to cancel selection or to end editing and return to the Navigation Map page or turn the large **MFD** knob to the next option.

4.7.9 NEXRAD Source

The NEXRAD Legend selection provides the option of using US or Canadian Nexrad data.



Figure 4-42 NEXRAD Source Selection

1. While viewing Weather Setup 1/2 menu, turn the large **MFD** knob to highlight the NEXRAD Legend value.
2. Turn the small **MFD** knob to highlight US or Canada. Press **ENT** to accept the displayed value.

Foreword

Sec 1 System

Sec 2 PFD

Sec 3 MFD

Sec 4 Hazard Avoidance

Sec 5 Additional Features

Sec 6 Annun. & Alerts

Sec 7 Symbols

Sec 8 Glossary

Appendix A

Index

4.7.10 XM Echo Tops



NOTE: Due to similarities in color schemes, Echo Tops cannot display at the same time as Cloud Tops or NEXRAD.

Echo Tops data shows the location, elevation, and direction of the highest radar echo. The highest radar echo does not indicate the top of a storm or clouds; rather it indicates the highest altitude at which precipitation is detected. Information is derived from NEXRAD data.



Figure 4-43 XM Weather - Echo Tops

The display of radar coverage is always active when either NEXRAD or ECHO TOPS is selected. Areas where NEXRAD radar coverage and Echo Tops information is not currently available or is not being collected are indicated in grayish-purple.

Echo Top Data Viewing Range

The Echo Top Data Viewing Range option allows you to select the map range where at and below that value Echo Top weather products will be shown on the selected MFD Wx Data Link Map page (1, 2, or 3). When Off is selected, Echo Tops will not be shown. Where a value (such as 250 NM) is selected, Echo Top data will be shown at map ranges of the selected value (250 NM) and lower.

1. While viewing Weather Setup 1/2 menu, turn the large **MFD** knob to highlight the Echo Top Data Viewing Range value.
2. Turn the small **MFD** knob to highlight the desired value. Press **ENT** to accept the displayed value. The next option will be highlighted.
3. Press the small **MFD** knob to cancel selection or to end editing and return to the previously viewed page, or turn the large **MFD** knob to the next option.

Cloud Top Data Viewing Range

The Cloud Top Data Viewing Range option allows you to select the map range where at and below that value Cloud Top weather products will be shown on the selected MFD Wx Data Link Map page (1, 2, or 3). When Off is selected, Cloud Tops will not be shown. Where a value (such as 150 NM) is selected, Cloud Top data will be shown at map ranges of that value (150 NM) and lower.

1. While viewing Weather Setup 1/2 menu, turn the large **MFD** knob to highlight the Cloud Top Data Viewing Range value.
2. Turn the small **MFD** knob to highlight the desired value. Press **ENT** to accept the displayed value. The next option will be highlighted.
3. Press the small **MFD** knob to cancel selection or to end editing and return to the previously viewed page or turn the large **MFD** knob to the next option.

Foreword

Sec 1
System

Sec 2
PFD

Sec 3
MFD

**Sec 4
Hazard
Avoidance**

Sec 5
Additional
Features

Sec 6
Annun.
& Alerts

Sec 7
Symbols

Sec 8
Glossary

Appendix A

Index

4.7.13 XM SIGMETs and AIRMETs

Foreword
Sec 1 System

SIGMETs (SIGnificant METeorological Information) and AIRMETs (AIRmen’s METeorological Information) are broadcast for potentially hazardous weather considered of importance to aircraft. A Convective SIGMET is issued for hazardous convective weather. A localized SIGMET is a significant weather condition occurring at a localized geographical position.

Sec 2 PFD

When enabled, SIGMET/AIRMETs advise the pilot of potentially hazardous weather to all aircraft. SIGMET/AIRMET data covers icing, turbulence, dust, and volcanic ash as issued by the National Weather Service. The update rate is every 12 minutes.

Sec 3 MFD

Sec 4 Hazard Avoidance



Figure 4-46 XM Weather - AIRMETs (Graphic)

Sec 5 Additional Features

Sec 6 Annun. & Alerts

Sec 7 Symbols

Sec 8 Glossary

When enabled, the following AIRMETs are available for display:

- Icing
- Turbulence
- IFR conditions
- Mountain obscuration
- Surface winds

Appendix A

Index

SIGMET/AIRMET Viewing Range

The SIGMET/AIRMET Viewing Range option allows you to select the map range where at and below that value SIGMET/AIRMET products will be shown on the selected MFD Wx Data Link Map page (1, 2, or 3). When Off is selected, SIGMET/AIRMET will not be shown. Where a value (such as 100 NM) is selected, SIGMET/AIRMET data will be shown at map ranges of the selected value (100 NM) and lower.

1. While viewing Weather Setup 1/2 menu, turn the large **MFD** knob to highlight the SIG/AIR Viewing Range value.
2. Turn the small **MFD** knob to highlight the desired value. Press **ENT** to accept the displayed value. The next option will be highlighted.
3. Press the small **MFD** knob to cancel selection or to end editing and return to the previously viewed page or turn the large **MFD** knob to the next option.

Viewing Textual Sigmet/Airmets

Textual Sigmet/Airmets can be viewed by selecting the Sigmet/Airmet outline on the Weather (WX) page.

1. While viewing a Map or Weather page, Use the small and large **MFD** knobs to move the cursor to highlight a Sigmet/Airmet line. Press **ENT**.
2. The Sigmet/Airmet information will be shown. Press the small **MFD** knob to return to the previously viewed page.



Figure 4-47 XM Weather - AIRMETs (Text)

4.7.14 XM PIREPs

Pilot Weather Reports (PIREPs) provide timely weather information for a particular route of flight. When significant weather conditions are reported or forecast, Air Traffic Control (ATC) facilities are required to solicit PIREPs. A PIREP may contain non-forecast adverse weather conditions, such as low in-flight visibility, icing conditions, wind shear, and turbulence. PIREPs are issued as either Routine (UA) or Urgent (UUA).



Figure 4-48 XM Weather PIREPs

1. While viewing Weather Setup 1/2 menu, turn the large **MFD** knob to highlight the PIREPs value.
2. Turn the small **MFD** knob to highlight the desired value. Press **ENT** to accept the displayed value. The next option will be highlighted.
3. Press the small **MFD** knob to cancel selection or to end editing and return to the Navigation Map page or turn the large **MFD** knob to the next option.

4.7.15 XM METARS



NOTE: Atmospheric pressure reported for METARs is given in hectopascals (hPa), except in the United States, where it is reported in inches of mercury (in Hg). Temperatures are reported in Celsius.



NOTE: METAR information is only displayed within the installed aviation database service area.

METAR (METEorological Aerodrome Report), known as an Aviation Routine Weather Report, is the standard format for current weather observations. METARs are updated hourly and are considered current. METARs typically contain information about the temperature, dew point, wind, precipitation, cloud cover, cloud heights, visibility, and barometric pressure. They can also contain information on precipitation amounts, lightning, and other critical data. METARs are shown as colored flags at airports that provide them.



Figure 4-49 XM Weather - Graphic METARS

METAR Viewing Range

The METAR Viewing Range option allows you to select the map range where at and below that value METAR weather products will be shown on the selected MFD Wx Data Link Map page (1, 2, or 3). When Off is selected, METARs will not be shown. Where a value (such as 150 NM) is selected, METAR data will be shown at map ranges of the selected value (150 NM) and lower.

Foreword

Sec 1
System

Sec 2
PFD

Sec 3
MFD

Sec 4
Hazard
Avoidance

Sec 5
Additional
Features

Sec 6
Annun.
& Alerts

Sec 7
Symbols

Sec 8
Glossary

Appendix A

Index

1. While viewing Weather Setup 1/2 menu, turn the large **MFD** knob to highlight the METAR Data Viewing Range value.
2. Turn the small **MFD** knob to highlight the desired value. Press **ENT** to accept the displayed value. The next option will be highlighted.
3. Press the small **MFD** knob to cancel selection or to end editing and return to the previously viewed page or turn the large **MFD** knob to the next option.

Viewing Textual METARs

Textual METARs can be viewed by selecting an airport on the Map or Weather (WX) pages.

1. While viewing a Map or Weather page, Use the small and large **MFD** knobs to move the cursor to highlight an airport with a METAR flag. Press **ENT**.
2. The Waypoint Information page for that airport will now be shown. Press the **WX** soft key to view weather information for the waypoint.



Figure 4-50 XM Weather - Textual METARs

3. Use the small **MFD** knob or the large **MFD** knob to scroll through the available information.
4. Press the small **MFD** knob to return to the previously viewed page.

4.7.16 XM Winds Aloft

The Winds Aloft Altitude option allows you to select the altitude where and below that value Winds Aloft weather products will be shown on the selected MFD Wx Data Link Map page (1, 2, or 3). Altitude can be selected in 3000 foot increments from the surface up to 42,000 feet MSL. “ALT UNAVBL” is displayed when the altitude is unsupported for a specific product and will never show data on the map.

Pressing the **WX Alt Dn** or **WX Alt Up** soft keys steps down or up in the 3,000 foot increments. In the figure below where 9,000 feet is selected, Winds Aloft data will be shown at 9,000 feet.



Figure 4-51 XM Weather - Winds Aloft



Figure 4-52 XM Weather - Winds Aloft Legend

Foreword

Sec 1
System

Sec 2
PFD

Sec 3
MFD

Sec 4
Hazard
Avoidance

Sec 5
Additional
Features

Sec 6
Annun.
& Alerts

Sec 7
Symbols

Sec 8
Glossary

Appendix A

Index

Winds Aloft Data Viewing Range

The Winds Aloft Data Viewing Range option allows you to select the map range where at and below that value Winds Aloft weather products will appear on the selected MFD Wx Data Link Map page (1, 2, or 3). When Off is selected, Winds Aloft will not be shown. Where a value (such as 100 NM) is selected, Winds Aloft data will be shown at map ranges of the selected value (100 NM) and lower.

1. While viewing Weather Setup 1/2 menu, turn the large **MFD** knob to highlight the Winds Aloft Data Viewing Range value.
2. Turn the small **MFD** knob to highlight the desired value. Press **ENT** to accept the displayed value. The next option will be highlighted.
3. Press the small **MFD** knob to cancel selection or to end editing and return to the previously viewed page or turn the large **MFD** knob to the next option.

Foreword

Sec 1
SystemSec 2
PFDSec 3
MFD**Sec 4
Hazard
Avoidance**Sec 5
Additional
FeaturesSec 6
Annun.
& AlertsSec 7
SymbolsSec 8
Glossary

Appendix A

Index

4.7.17 XM Surface Analysis and City Forecast



NOTE: Surface Analysis and City Forecast data are displayed only within the installed Aviation Database service area.

Surface Analysis and City Forecast information is available for current and forecast weather conditions. Forecasts are available for intervals of 12, 24, 36, and 48 hours by pressing the **SRFC TIME** soft key or in the Page Menu Weather Setup options.

When enabled, the Surface Analysis forecast shows frontal lines indicating weather fronts and the direction they are moving. High and Low pressure centers are noted with a large H or L. The Forecast Time menu item will step through the intervals manually.



Figure 4-53 XM Weather - Surface Analysis and City Forecast

A Cold Front is a front where cold air replaces warm air. A blue line with blue triangles that point in the direction of the cold air flow.

Figure 4-54 XM Weather - Cold Front

A Warm Front is where warm air replaces cold air. An orange line with orange half moons that point in the direction of the warm air flow.

Figure 4-55 XM Weather - Warm Front

A Stationary Front is a front with very little horizontal movement. The line alternates with orange and blue sections which point in opposite directions to symbolize little movement.



Figure 4-56 XM Weather - Stationary Front

An Occluded Front is where a cold front has overtaken and merged with a warm front. The line alternates with the blue triangle and orange half moon symbols on the same side of the line pointing in the direction the front is moving.



Figure 4-57 XM Weather - Occluded Front

Surface Data Viewing Range

The Surface Data Viewing Range option allows you to select the map range where at and below that value Surface Data weather products will be shown on the selected MFD Wx Data Link Map page (1, 2, or 3). When Off is selected, Surface Data will not be shown. Where a value (such as 150 NM) is selected, Surface data will be shown at map ranges of the selected value (150 NM) and lower.

1. While viewing Weather Setup 1/2 menu, turn the large **MFD** knob to highlight the Surface Data Viewing Range value.
2. Turn the small **MFD** knob to highlight the desired value. Press **ENT** to accept the displayed value. The next option will be highlighted.
3. Press the small **MFD** knob to cancel selection or to end editing and return to the previously viewed page or turn the large **MFD** knob to the next option.

Forecast Time

The Forecast Time option allows you to select the forecast time when the Surface and City Forecast weather products will appear on the selected MFD Wx Data Link Map page (1, 2, or 3). Forecasts are available for intervals of current, 12, 24, 36, and 48 hours. The interval is selected by pressing the **FCST TIME** soft key on the Wx Data Link Map page.

4.7.18 XM County Warnings

County data provides specific public awareness and protection weather warnings from the National Weather Service (NWS). This can include information on fires, tornadoes, severe thunderstorms, flood conditions, and other natural disasters.

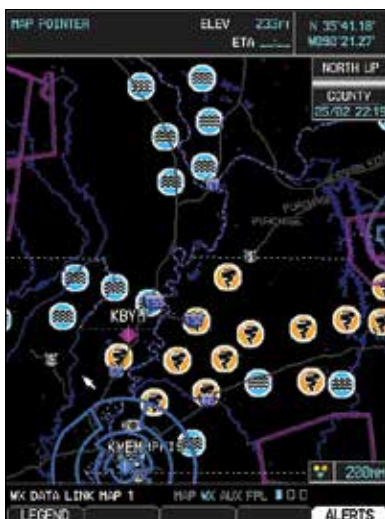

Figure 4-58 XM Weather - County Warnings

County Data Viewing Range

The County Data Viewing Range option allows you to select the map range where at and below that value County weather products will be shown on the selected MFD Wx Data Link Map pages (1, 2, or 3). When Off is selected, County Data will not be shown. Where a value (such as 100 NM) is selected, County data will be shown at map ranges of the selected value (100 NM) and lower.

1. While viewing Weather Setup 1/2 menu, turn the large **MFD** knob to highlight the County Data Viewing Range value.
2. Turn the small **MFD** knob to highlight the desired value. Press **ENT** to accept the displayed value. The next option will be highlighted.
3. Press the small **MFD** knob to cancel selection or to end editing and return to the previously viewed page or turn the large **MFD** knob to the next option.

4.7.19 XM TFRs

Temporary Flight Restrictions (TFRs) provide detailed information for local short term restrictions. The update rate is approximately every 20 minutes.

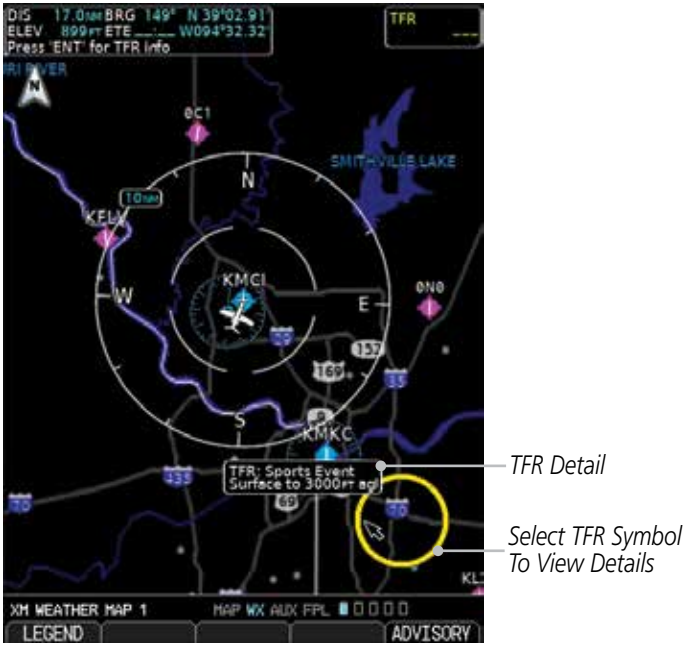

Figure 4-59 XM Weather - TFRs

The Temporary Flight Restriction (TFR) viewing range option selects whether TFR information is shown on the Weather Map. TFR information will be shown at and below the selected map range. When Off is selected, the information will not be shown. For the value (such as 500 NM) selected, TFR information will be shown at map ranges of that value (500 NM), and lower.

1. While viewing Weather Setup 1/2 menu, turn the large **MFD** knob to highlight the TFR Data Viewing Range option.
2. Turn the small **MFD** knob to highlight the desired value. Press **ENT** to accept the displayed value. The next option will be highlighted.
3. Press the small **MFD** knob to cancel selection or to end editing and return to the previously viewed page or turn the large **MFD** knob to the next option.

Viewing Textual TFRs

Textual TFRs can be viewed by selecting a TFR outline on the Weather (WX) pages.

1. While viewing a XM Weather page, Use the small and large **MFD** knobs to move the cursor to highlight a TFR symbol (yellow circle). Press **ENT**.
2. The TFR details will be shown.
3. Press the small **MFD** knob or ENT to return to the Weather page.



Figure 4-60 XM Weather - Textual TFRs and Legend

Foreword

Sec 1
System

Sec 2
PFD

Sec 3
MFD

Sec 4
Hazard
Avoidance

Sec 5
Additional
Features

Sec 6
Annun.
& Alerts

Sec 7
Symbols

Sec 8
Glossary

Appendix A

Index

4.7.20 XM Cell Movement

Foreword

Cell Movement data shows the location and movement of storm cells as identified by a ground-based system. Cells are represented by yellow squares, with direction of movement indicated with short, orange arrows.

Sec 1 System

Sec 2 PFD

Sec 3 MFD

Sec 4 Hazard Avoidance

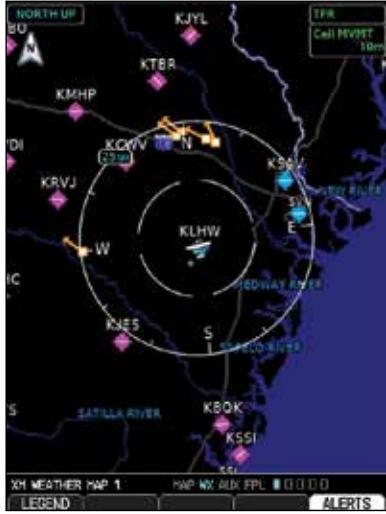

Figure 4-61 XM Weather - Cell Movement

Sec 5 Additional Features

Sec 6 Annun. & Alerts

Sec 7 Symbols

Sec 8 Glossary

Appendix A

Index

On most applicable maps, Cell Movement data is selected for display along with NEXRAD. On the Weather Data Link Page, Cell Movement data can be selected independently.

Cell Movement Data Viewing Range

The Cell Movement Data Viewing Range option allows you to select the map range and below where Cell Movement weather products will appear on the selected MFD Wx Data Link Map page (1, 2, or 3). When Off is selected, Cell Movement will not be shown. Where a value (such as 100 NM) is selected, Cell Movement data will be shown at map ranges of the selected value (100 NM) and lower.

1. While viewing Weather Setup 2/2 menu, turn the large **MFD** knob to highlight the Cell Movement Data Viewing Range option.
2. Turn the small **MFD** knob to highlight the desired value. Press **ENT** to accept the displayed value. The next option will be highlighted.
3. Press the small **MFD** knob to cancel selection or to end editing and return to the previously viewed page or turn the large **MFD** knob to the next option.

4.7.21 XM AIREPs

Air Reports (AIREPs) are messages from an aircraft, typically from commercial aircraft, to a ground station. AIREPs are similar to PIREPs.

1. While viewing Weather Setup 2/2 menu, turn the large **MFD** knob to highlight the AIREPs Viewing Range option.
2. Turn the small **MFD** knob to highlight the desired value. Press **ENT** to accept the displayed value. The next option will be highlighted.
3. Press the small **MFD** knob to cancel selection or to end editing and return to the previously viewed page or turn the large **MFD** knob to the next option.



Figure 4-62 XM Weather - AIREPs

Foreword

System Sec 1

PFD Sec 2

MFD Sec 3

Sec 4
Hazard
Avoidance

Sec 5
Additional
Features

Sec 6
Annun.
& Alerts

Sec 7
Symbols

Sec 8
Glossary

Appendix A

Index

Viewing Textual AIREPs/PIREPs

Textual AIREPs/PIREPs can be viewed by selecting a AIREP on the Map or Weather (WX) pages.

1. While viewing a Map or Weather page, Use the small and large **MFD** knobs to move the cursor to highlight an airport with a AIREP.
2. Press **ENT** to view text information. Press **ENT** again to return to the previous page.



Figure 4-63 XM Weather - AIREP Text Detail

Foreword

Sec 1
System

Sec 2
PFD

Sec 3
MFD

Sec 4
Hazard
Avoidance

Sec 5
Additional
Features

Sec 6
Annun.
& Alerts

Sec 7
Symbols

Sec 8
Glossary

Appendix A

Index

4.7.22 XM Cyclone

The current location of the cyclone is shown along with its projected path with the date and time.

1. While viewing Weather Setup 2/2 menu, turn the large **MFD** knob to highlight the Cyclone Data Viewing Range option.
2. Turn the small **MFD** knob to highlight the desired value. Press **ENT** to accept the displayed value. The next option will be highlighted.
3. Press the small **MFD** knob to cancel selection or to end editing and return to the previously viewed page or turn the large **MFD** knob to the next option.



Projected Path With Date And Time

Current Position Of Cyclone

Figure 4-64 XM Weather - Cyclone

4.7.23 XM Freezing Level

Freezing Level data shows the color-coded contour lines for the altitude and location at which the Freezing Level is found. When no data is displayed for a given altitude, the data for that altitude has not been received, or is out of date and has been removed from the display. New data appears at the next update.



Figure 4-65 XM Weather - Freezing Levels

Freezing Level Viewing Range

The Freezing Level Viewing Range option allows you to select the map range where at and below that value Freezing Level weather products will be shown on the selected MFD Wx Data Link Map page (1, 2, or 3). When Off is selected, Freezing Level Data will not be shown. Where a value (such as 100 NM) is selected, Freezing Level data will be shown at map ranges of the selected value (100 NM) and lower.

1. While viewing Weather Setup 2/2 menu, turn the large **MFD** knob to highlight the Frz Lvl Viewing Range value.
2. Turn the small **MFD** knob to highlight the desired value. Press **ENT** to accept the displayed value. The next option will be highlighted.
3. Press the small **MFD** knob to cancel selection or to end editing and return to the previously viewed page or turn the large **MFD** knob to the next option.

4.7.24 XM Icing

The Icing product shows a graphic view of the current icing environment in four categories: light, moderate, severe, and extreme (not specific to aircraft type). The Icing product is not a forecast, but a presentation of the current conditions at the time of the analysis. Supercooled Large Droplet (SLD) icing conditions are characterized by the presence of relatively large, super cooled water droplets indicative of freezing drizzle and freezing rain aloft. SLD threat areas are depicted as black and red blocks over the Icing colors. Icing and SLD data are shown between 1,000 feet and 30,000 feet in 3,000 foot increments.

1. While viewing Weather Setup 2/2 menu, turn the large **MFD** knob to highlight the Icing Data Viewing Range value.
2. Turn the small **MFD** knob to highlight the desired value. Press **ENT** to accept the displayed value. The next option will be highlighted.
3. Press the small **MFD** knob to cancel selection or to end editing and return to the Navigation Map page or turn the large **MFD** knob to the next option.

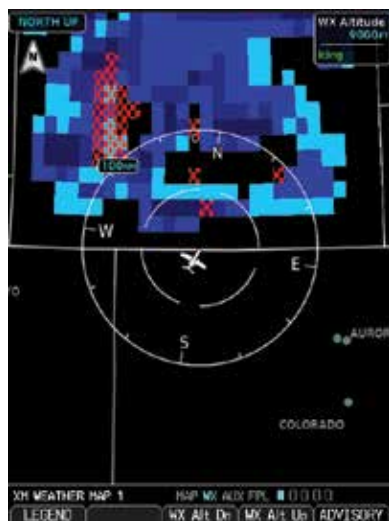

Figure 4-66 XM Weather - Icing and SLD

4. Press the **WX Alt Dn** or **WX Alt Up** keys to increase or decrease the reporting altitude of icing in 3,000 foot increments. The selected altitude is shown in a window above the altitude keys.

4.7.25 XM Turbulence

Turbulence data identifies the potential for erratic movement of high-altitude air mass associated winds. Turbulence is classified as light, moderate, severe or extreme, at altitudes between 21,000 and 45,000 feet. Turbulence data is intended to supplement AIRMETs and SIGMETs.

1. While viewing Weather Setup 2/2 menu, turn the large **MFD** knob to highlight the Turbulence Viewing Range value.
2. Turn the small **MFD** knob to highlight the desired value. Press **ENT** to accept the displayed value. The next option will be highlighted.
3. Press the small **MFD** knob to cancel selection or to end editing and return to the previously viewed page or turn the large **MFD** knob to the next option.
4. Press the **WX Alt Dn** or **WX Alt Up** keys to increase or decrease the reporting altitude of icing in 3,000 foot increments. The selected altitude is shown in a window above the altitude keys.

Foreword

Sec 1
SystemSec 2
PFDSec 3
MFD
**Sec 4
Hazard
Avoidance**
Sec 5
Additional
FeaturesSec 6
Annun.
& AlertsSec 7
SymbolsSec 8
Glossary

Appendix A

Index

4.8 Weather Radar

The G500/G600 can display weather radar from a Garmin GWX system or from selected 3rd-party radars. Only one weather radar system may be interfaced to the system. For detailed information on the operation of 3rd-party radars, refer to their specific documentation.

4.8.1 Garmin Weather Radar Description

The Garmin GWX 68 and GWX 70 Airborne Color Weather Radars combine excellent range and adjustable scanning profiles with a high-definition target display.

To focus radar scanning on specific areas, Sector Scanning offers pilot-adjustable horizontal scan angles of 20°, 40°, 60°, or 90° (up to 120° with the GWX 70). A vertical scanning function helps to analyze storm tops, gradients, and cell buildup activity at various altitudes.

Refer to the documentation of each radar for specific features.

4.8.1.1 Synchronized Radar - GWX 68 Only

The GWX 68 synchronizes the following radar functions across all connected displays.

- Mode
- Range
- Bearing
- Tilt
- On/Off controls

An adjustment to any of these settings for one display will be simultaneously reflected on the others.

Refer to the GWX 68 documentation for additional information.

4.8.1.2 Independent Radar - GWX 70 Only

The GWX 70 allows all connected displays to show independent radar sweeps. In the case when two displays have the same radar settings, the radar sweep is identical on both displays.

Changes made to the following functions affect only the associated display.

- Mode
- Range
- Bearing
- Tilt
- On/Off controls

For example, the operating mode may be switched to Weather on one display, while Ground Mapping mode is enabled on another.

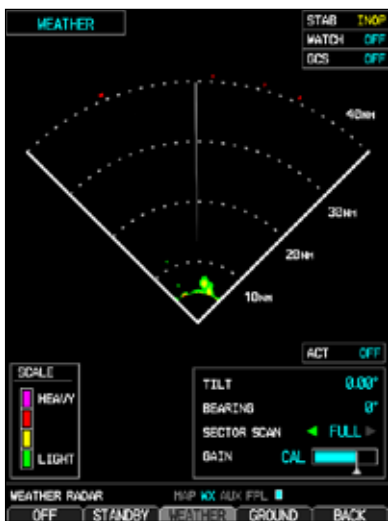

Figure 4-67 Weather Radar Display



Figure 4-68 Ground Mapping Display

When the GWX 70 is turned off on all displays, the “OFF” message appears on the Advisory page of the GDU.



Figure 4-69 Radar Off Advisory

If the GWX 70 is turned off on the GDU, but another display is still actively scanning, the “RADAR ACTIVE” advisory appears.

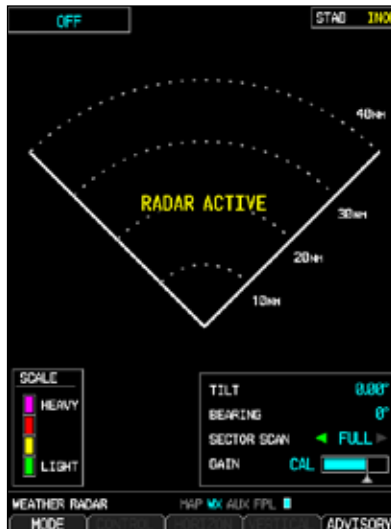

Figure 4-70 Radar Active Advisory

Refer to the GWX 70 documentation for additional information.

4.8.1.3 Principles of Pulsed Airborne Weather Radar

The term RADAR is an acronym for RAdio Detecting and Ranging. Pulsed radar locates targets by transmitting a microwave pulse beam that, upon encountering a target, is then reflected back to the radar receiver as a return “echo.” The microwave pulses are focused and radiated by the antenna, with the most intense energy in the center of the beam and decreasing intensity near the edge. The same antenna is used for both transmitting and receiving. The returned signal is then processed and displayed on the G500/G600 MFD.

Radar detection is a two-way process that requires 12.36 micro-seconds for the transmitted microwave pulses to travel out and back for each nautical mile of target range. It takes 123.6 micro-seconds for a transmitted pulse to make the round trip if a target is 10 NM away.

The GWX weather radar should be used to avoid severe weather, not for penetrating severe weather. The decision to fly into an area of radar targets depends on target intensity, spacing between the targets, aircraft capabilities and pilot experience. Pulse type weather radar detects only precipitation, not clouds or turbulence. The display may indicate clear areas between intense returns, but this does not necessarily mean it is safe to fly between them. Only Doppler radar can detect turbulence.

Airborne weather radar has other capabilities beyond weather detection. It also has the ability to detect and provide distance to objects on the ground, such as, cities, mountains, coastlines, rivers, lakes, and oceans.

- Foreword
- Sec 1 System
- Sec 2 PFD
- Sec 3 MFD
- Sec 4 Hazard Avoidance**
- Sec 5 Additional Features
- Sec 6 Annun. & Alerts
- Sec 7 Symbols
- Sec 8 Glossary
- Appendix A
- Index

4.8.1.4 Antenna Beam Illumination

It is important to understand the concept of the antenna beam illumination. The radar beam is much like the beam of a spotlight. The farther the beam travels, the wider it gets. The radar is only capable of “seeing” what is inside the boundaries of the beam.

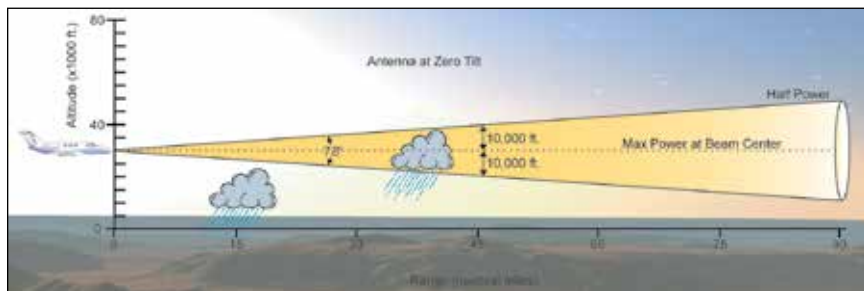

Figure 4-71 Radar Beam from 12 inch Antenna

The vertical dimensions of the radar beam are shown in the figure above and the same holds true for the horizontal dimensions. In other words, the beam will be as wide as it is tall. Note that it is possible not to see areas of precipitation on the radar display because of the antenna tilt setting. With the antenna tilt set to zero in this illustration, the beam overshoots the precipitation at 15 NM. The curvature of the earth can also be a factor, especially at range settings of 150 NM or more.

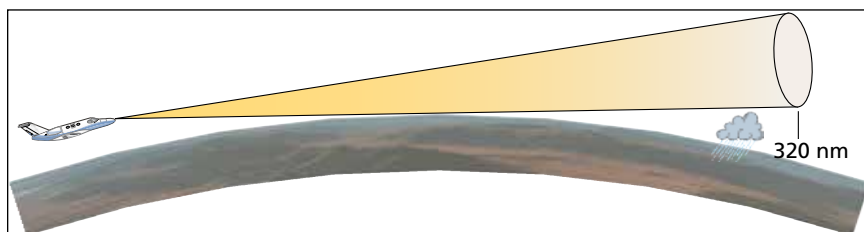

Figure 4-72 Radar Beam in Relation to the Curvature of the Earth

4.8.1.5 Radar Signal Attenuation

The phenomena of weather attenuation needs to be kept in mind whenever operating the weather radar. When the radar signal is transmitted, it is progressively absorbed and scattered, making the signal weaker. This weakening, or attenuation, is caused by two primary sources, distance and precipitation.

Attenuation because of distance is due to the fact that the amount of radar energy at a distance from the antenna is inversely proportional to the square of the distance. The reflected radar energy from a target 40 miles away that fills the radar beam will be one fourth the energy reflected from an equivalent target 20 miles away. This would appear to the operator that the storm is gaining intensity as the aircraft gets closer. Internal circuitry within the GWX system compensates for much of this distance attenuation.

Attenuation due to precipitation is not as predictable as distance attenuation. It is also more intense. As the radar signal passes through moisture, a portion of the radar energy is reflected back to the antenna. However, much of the energy is absorbed. If precipitation is very heavy, or covers a large area, the signal may not reach completely through the area of precipitation. The weather radar system cannot distinguish between an attenuated signal and area of no precipitation. If the signal has been fully attenuated, the radar will display a “radar shadow.” This appears as an end to the precipitation when, in fact, the heavy rain may extend much further. A cell containing heavy precipitation may block another cell located behind the first, preventing it from being displayed on the radar. Never fly into these shadowed areas and never assume that all of the heavy precipitation is being displayed unless another cell or a ground target can be seen beyond the heavy cell. The WATCH™ feature of the GWX Weather Radar system can help in identifying these shadowed areas. Areas in question will appear as “shadowed” or gray area on the radar display. Proper use of the antenna tilt control can also help detect radar shadows.

Attenuation can also be due to poor maintenance or degradation of the radome. Even the smallest amount of wear and tear, pitting, and pinholes on the radome surface can cause damage and system inefficiency.

Foreword

Sec 1 System

Sec 2 PFD

Sec 3 MFD

Sec 4 Hazard Avoidance

Sec 5 Additional Features

Sec 6 Annun. & Alerts

Sec 7 Symbols

Sec 8 Glossary

Appendix A

Index

4.8.2 Radar Signal Reflectivity

4.8.2.1 Precipitation

Precipitation or objects more dense than water, such as earth or solid structures, will be detected by the weather radar. The weather radar will not detect clouds, thunderstorms or turbulence directly. It detects precipitation associated with clouds, thunderstorms, and turbulence. The best radar signal reflectors are raindrops, wet snow or wet hail. The larger the raindrop the better it reflects. The size of the precipitation droplet is the most important factor in radar reflectivity. Because large drops in a small concentrated area are characteristic of a severe thunderstorm, the radar displays the storm as a strong return. Ice, dry snow, and dry hail have low reflective levels and often will not be displayed by the radar. A cloud that contains only small raindrops, such as fog or drizzle, will not reflect enough radar energy to produce a measurable target return.



Figure 4-73 Precipitation Type and Reflectivity

4.8.2.2 Ground Returns

The intensity of ground target returns depends upon the angle at which the radar beam strikes the ground target (Angle of Incidence) and the reflective properties of that target. The gain can be adjusted so shorelines, rivers, lakes, and cities are well defined. Increasing gain too much causes the display to fill in between targets, thus obscuring some landmarks.

Cities normally provide a strong return signal. While large buildings and structures provide good returns, small buildings can be shadowed from the radar beam by the taller buildings. As the aircraft approaches, and shorter ranges are selected, details become more noticeable as the highly reflective regular lines and edges of the city become more defined.

Bodies of water such as lakes, rivers, and oceans are not good reflectors, and normally do not provide good returns. The energy is reflected in a forward scatter angle with inadequate energy being returned. They can appear as dark areas on the display. However, rough or choppy water is a better reflector and will provide stronger returns from the downwind sides of the waves.

Mountains also provide strong return signals to the antenna, but also block the areas behind. However, over mountainous terrain, the radar beam can be reflected back and forth in the mountain passes or off canyon walls using up all or most of the radar energy. **In this case, no return signal is received from this area causing the display to show a dark spot which could indicate a pass where no pass exists.**

4.8.2.3 Angle of Incidence

The angle at which the radar beam strikes the target is called the Angle of Incidence. Incident angle (“A”) is illustrated below. This directly affects the detectable range, the area of illumination, and the intensity of the displayed target returns. A large incident angle gives the radar system a smaller detectable range and lower display intensity due to minimized reflection of the radar energy.

Foreword
Sec 1 System
Sec 2 PFD
Sec 3 MFD
Sec 4 Hazard Avoidance
Sec 5 Additional Features
Sec 6 Annun. & Alerts
Sec 7 Symbols
Sec 8 Glossary
Appendix A
Index

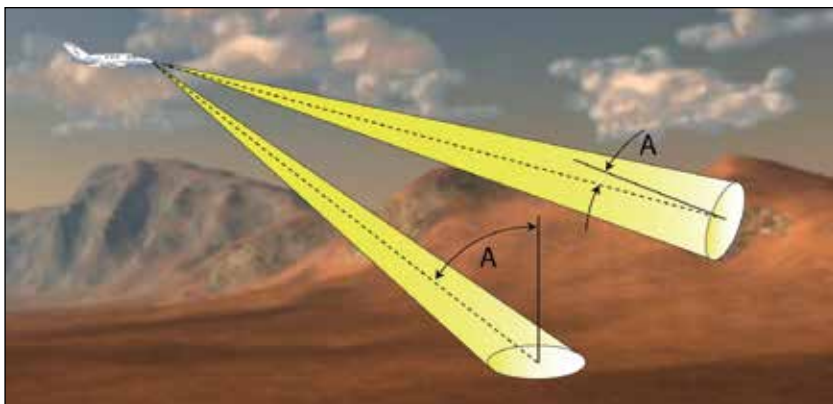

Figure 4-74 Angle of Incidence

A smaller incident angle gives the radar a larger detectable range of operation and the target display will show a higher intensity. Since more radar energy is reflected back to the antenna with a low incident angle, the resulting detectable range is increased for mountainous terrain.

4.8.3 Operating Distance

The following information establishes a minimum safe distance from the antenna for personnel near an operating airborne weather radar. The minimum safe distance is based upon the FCC's exposure limit at 9.3 to 9.5 GHz for general population/uncontrolled environments which is 1 mW/cm². See Advisory Circular 20-68B for more information on safe distance determination.

4.8.3.1 Maximum Permissible Exposure Level (GWX 68)

The zone in which the radiation level exceeds the US Government standard of 1 mW/cm², is the semicircular area of at least 11 feet from the 12 inch antenna as indicated in the illustration below. All personnel must remain outside of this zone. With a scanning or rotating beam, the averaged power density at the Maximum Permissible Exposure Level (MPEL) boundary is significantly reduced.

4.8.3.2 Maximum Permissible Exposure Level (Other Radars)

For more information about MPEL, refer to the appropriate documentation.

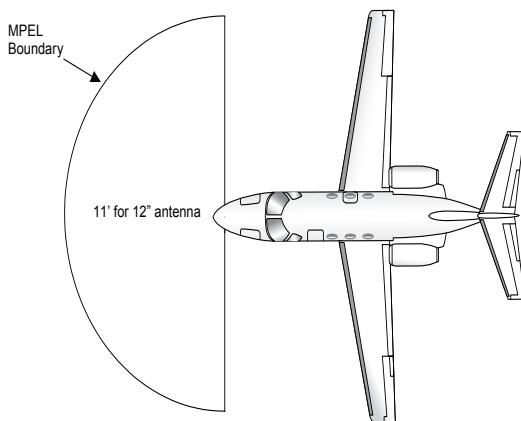

Figure 4-75 MPEL Boundary

4.8.4 Basic Antenna Tilt Setup

The following discussion is a simple method for setting up the weather radar antenna tilt for most situations. It is not to be considered an all encompassing setup that will work in all situations, but this method does provide good overall parameters for the monitoring of threats. Ultimately, it is desired to have the antenna tilted so that the bottom of the radar beam is four degrees below parallel with the ground. The following discussion explains one way of achieving this.

With the aircraft flying level, adjust the antenna tilt so ground returns are displayed at a distance that equals the aircraft's current altitude (AGL) divided by 1,000. For example, if the aircraft is at 14,000 feet, adjust the tilt so the front edge of ground returns are displayed at 14 NM. Note this antenna tilt angle setting. Now, raise the antenna tilt 6° above this setting. The bottom of the radar beam is now angled down 4° from parallel with the ground.

Practical Application Using the Basic Tilt Setup

At this point, when flying at altitudes between 2,000 and 30,000 feet AGL, any displayed target return should scrutinized. If the displayed target advances on the screen to 5 NM of the aircraft, avoid it. This may be either weather or ground returns that are 2,000 feet or less below the aircraft. Raising the antenna tilt 4° can help separate ground returns from weather returns in relatively flat terrain. This will place the bottom of the radar beam level with the ground. Return the antenna tilt to the previous setting after a few sweeps.

If the aircraft is above 29,000 feet, be cautious of any target return that gets to 30 NM or closer. This is likely a thunderstorm that has a top high enough that the aircraft cannot fly over it safely.

If the aircraft altitude is 15,000 feet or lower, set the displayed range to 60 NM. Closely monitor anything that enters the display.

Also, after setting up the antenna tilt angle as described previously, ground returns can be monitored for possible threats. The relationship between antenna tilt angle, altitude, and distance is one degree of tilt equals 100 feet of altitude for every one nautical mile.

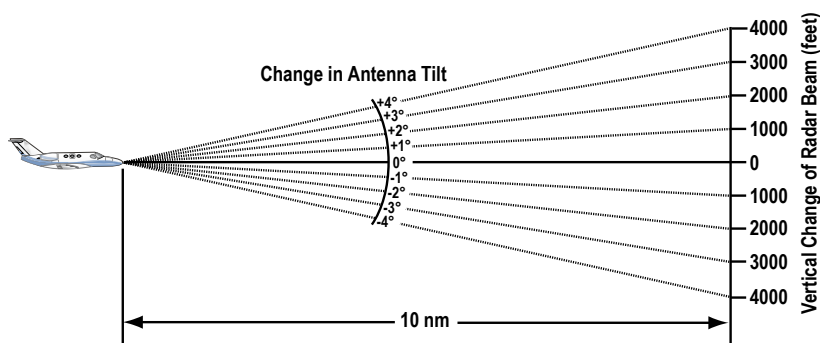

Figure 4-76 Vertical Change in Radar Beam per Nautical Mile

Therefore, with the antenna tilt set so that the bottom of the beam is four degrees below parallel with the ground, a target return at 10 NM is approximately 4,000 feet below the aircraft; at 20 NM, 8,000 feet; at 50 NM, 20,000 feet. In other words, at this tilt setting, a ground return (such as a mountain peak) being displayed at 10 NM would have a maximum distance below the aircraft of 4,000 feet. If that ground target return moves to 5 NM, maximum distance below the aircraft will be 2,000 feet.

This setup will provide a good starting point for practical use of the GWX radar. There are many other factors to consider in order to become proficient at using weather radar in all situations.

4.8.5 Weather Mapping and Interpretation

4.8.5.1 Weather Display Interpretation

When evaluating various target returns on the weather radar display, the colors denote approximate rainfall intensity and rates as shown in the table below.

Weather Mode Color	GWX 68 Radars		GWX 70 Radars	3rd Party Radars
	Approximate Intensity	Approximate Rainfall Rate (in/hr)	Approximate Intensity	Radar Return Level (see radar documentation for details)
BLACK	< 23 dBZ	< .01	< 23 dBZ	0
GREEN	23 dBZ to < 33 dBZ	.01 - 0.1	23 dBZ to < 33 dBZ	1
YELLOW	33 dBZ to < 41 dBZ	0.1 - 0.5	33 dBZ to < 41 dBZ	2
RED	41 dBZ to < 50 dBZ	0.5 - 2	41 dBZ to < 50 dBZ	3
MAGENTA	50 dBZ and greater	> 2	50 dBZ and greater	4
WHITE			Turbulence Detection	

Table 4-25 Precipitation Intensity Levels

4.8.5.2 Thunderstorms

Updrafts and downdrafts in thunderstorms carry water through the cloud. The more severe the drafts, the greater the number and size of the precipitation droplets. With this in mind, the following interpretations can be made from what is displayed on the weather radar. Avoid these areas by an extra wide margin.

- In areas where the displayed target intensity is red or magenta (indicating large amounts of precipitation), the turbulence is considered severe.
- Areas that show steep color gradients (intense color changes) over thin bands or short distances suggest irregular rainfall rate and strong turbulence.
- Areas that show red or magenta are associated with hail or turbulence, as well as heavy precipitation. Vertical scanning and antenna tilt management may be necessary to identify areas of maximum intensity.

Along squall lines (multiple cells or clusters of cells in a line), individual cells may be in different stages of development. Areas between closely spaced, intense targets may contain developing clouds not having enough moisture to produce a return. However, these areas could have strong updrafts or downdrafts. Targets showing wide areas of green are generally precipitation without severe turbulence.

Irregularities in the target return may also indicate turbulence, appearing as “hooks,” “fingers,” or “scaloped” edges. These irregularities may be present in green areas with no yellow, red, or magenta areas and should be treated as highly dangerous areas. Avoid these areas as if they were red or magenta areas.

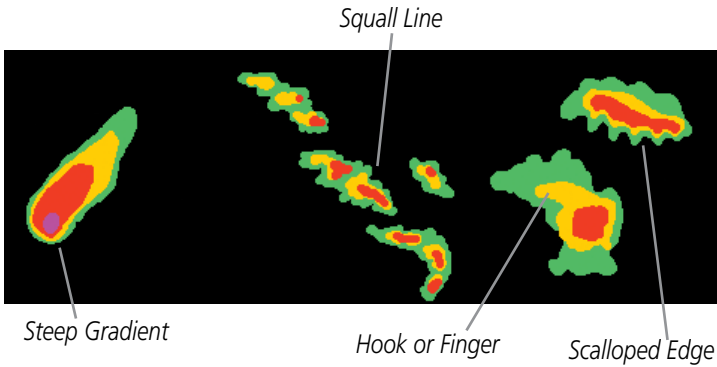

Figure 4-77 Cell Irregularities

Thunderstorm development is rapid. A course may become blocked within a short time. When displaying shorter ranges, periodically select a longer range to see if problems are developing further out. That can help prevent getting trapped in a “blind alley” or an area that is closed at one end by convective weather.

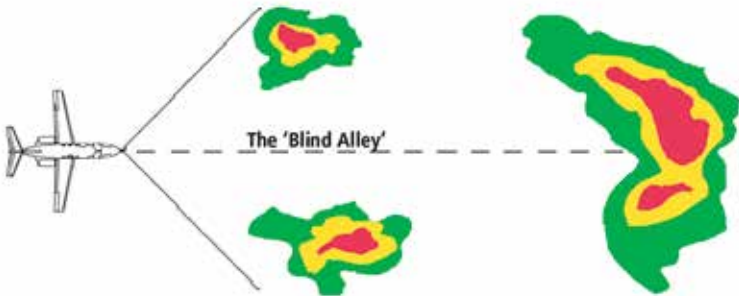

Figure 4-78 The “Blind Alley” Overhead View

In areas of multiple heavy cells, use the Vertical Scan feature along with antenna tilt management to examine the areas. Remember to avoid shadowed areas behind targets.

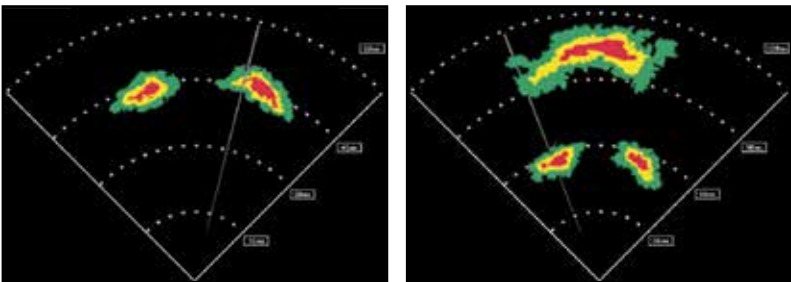

Figure 4-79 The “Blind Alley” Horizontal Scan

4.8.5.3 Tornadoes

There is no conclusive radar target return characteristics which will identify a tornado, however, tornadoes may be present if the following characteristics are observed:

- A narrow, finger-like portion, as shown on the previous page, extends and, in a short time, curls into a hook and closes on itself.
- A “hook” which may be in the general shape of the numeral “6,” especially if bright and projecting from the southwest quadrant (northeast quadrant in the southern hemisphere) of a major thunderstorm.
- V-shaped notches.
- Doughnut shapes.

These shapes do not always indicate tornadoes, nor are tornado returns limited to these characteristics. Confirmed radar observations of tornadoes most often have not shown shapes different from those of a normal thunderstorm display.

4.8.5.4 Hail

Hail results from updrafts carrying water high enough to freeze. Therefore, the higher the top of a thunderstorm, the greater the probability that it contains hail. Vertically scanning the target return can give the radar top of a thunderstorm that contains hail. Radar top is the top of a storm cell *as detected by radar*. It is not the actual top, or true top of the storm. The actual top of a storm cell is seen with the eyes in clear air and may be much higher than the radar top. The actual top does not indicate the top of the hazardous area.

Hail can fall below the minimum reflectivity threshold for radar detection. It can have a film of water on its surface, making its reflective characteristics similar to a very large water droplet. Because of this film of water, and because hail stones usually are larger than water droplets, thunderstorms with large amounts of wet hail return stronger signals than those with rain. Some hail shafts are extremely narrow (100 yards or less) and make poor radar targets. In the upper regions of a cell where ice particles are “dry” (no liquid coating), target returns are less intense.

Hail shafts are associated with the same radar target return characteristics as tornados. U-shaped cloud edges 3 to 7 miles across can also indicate hail. These target returns appear quite suddenly along any edge of the cell outline. They also change in intensity and shape in a matter of seconds, making vigilant monitoring essential.

Foreword
 Sec 1 System
 Sec 2 PFD
 Sec 3 MFD
 Sec 4 Hazard Avoidance
 Sec 5 Additional Features
 Sec 6 Annun. & Alerts
 Sec 7 Symbols
 Sec 8 Glossary
 Appendix A
 Index

4.8.6 Radar Operation in Weather Mode



WARNING: Begin transmitting only when it is safe to do so. When transmitting while the aircraft is on the ground, no personnel or objects should be within 11 feet of the antenna.



CAUTION: In Standby mode, the antenna is parked at the center line. It is always a good idea to put the radar in Standby mode before taxiing the aircraft to prevent the antenna from bouncing on the bottom stop and possibly causing damage to the radar assembly.

When the weather radar system is in the Weather or Ground Map mode, the system automatically switches to Standby mode on landing.

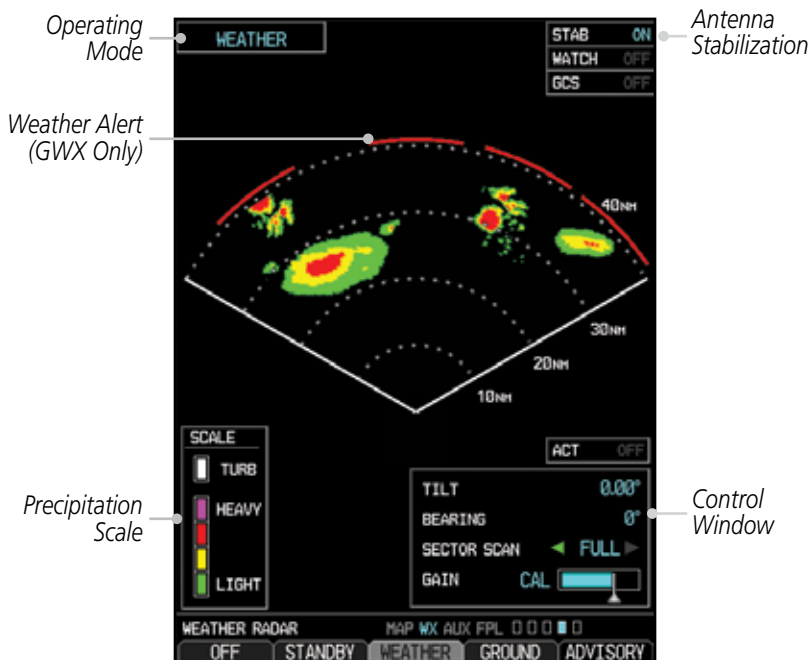

Figure 4-80 Horizontal Scan Display

Foreword

System Sec 1

PFD Sec 2

MFD Sec 3

Hazard Avoidance Sec 4

Additional Features Sec 5

Annun. & Alerts Sec 6

Symbols Sec 7

Glossary Sec 8

Appendix A

Index

4.8.6.1 Displaying Weather on the Weather Radar Page



NOTE: Distances on the Weather Radar page are always shown in NM.

1. While viewing the Weather Radar page of the Wx page group, press the **MODE** soft key.
 2. While on the ground, press the **STANDBY** soft key. A warm-up period is initiated (countdown is displayed on the screen - GWX radars only). After the warm-up is complete, the radar enters the Standby Mode.
 3. When the aircraft is airborne, press the **WEATHER** soft key.
- OR
1. Select the **WEATHER** soft key. A confirmation window is displayed.

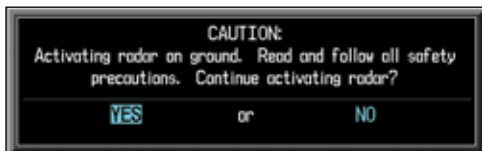

Figure 4-81 Caution for Radar Activation Confirmation

2. Turn the large **MFD** Knob to highlight **YES** and press the **ENT** key to continue radar activation.
- OR
1. If the aircraft is airborne, select the **WEATHER** soft key. A warm-up period is initiated (countdown is displayed on the screen - GWX radars only). After the warm-up is complete, the radar begins transmitting.
 2. Press the **RNG** keys to select the desired range.

- Foreword
- Sec 1 System
- Sec 2 PFD
- Sec 3 MFD
- Sec 4 Hazard Avoidance
- Sec 5 Additional Features
- Sec 6 Annun. & Alerts
- Sec 7 Symbols
- Sec 8 Glossary
- Appendix A
- Index

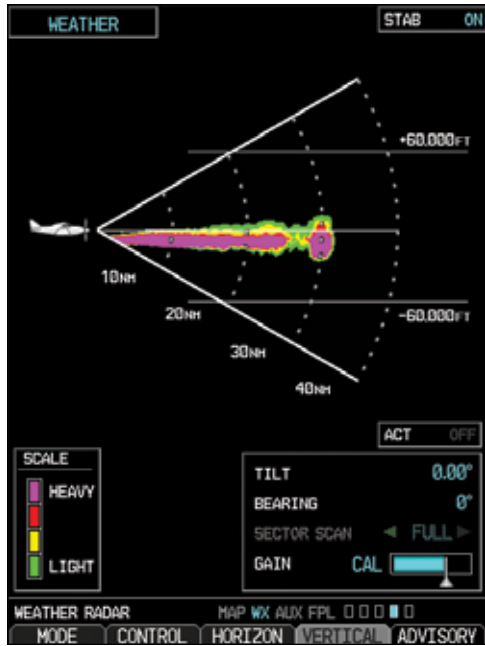

Figure 4-82 Vertical Scan Display

4.8.6.2 Vertically Scanning a Storm Cell (Not available with all radars)

When vertically scanning with stabilization ON, the actual physical area that the radar is sweeping may not match the GDU vertical scan display. This occurs whenever the aircraft pitch is not at 0 degrees. To compensate for this, the GDU vertical display will “erase” the portion of the vertical display that is no longer being scanned. It will appear that the vertical sweep “wraps around” when reaching the end of the GDU vertical display. The radar is simply “erasing” the portion of the vertical display that is not currently being scanned.



NOTE: Vertical scanning of a storm cell should be done with the aircraft wings level to avoid constant adjustment of the Bearing Line.

1. While in the Horizontal Scan view, press the **CONTROL** and then the **BRG** soft keys. This displays the Bearing Line.

OR

Press **MENU** and turn the large or small **MFD** knobs to highlight the “Show Bearing Line” menu item and press the **ENT** key. This displays the Bearing Line.

2. Press the **MFD** knob to activate the Bearing Line Adjustment in the Control window. Turn the Large **MFD** knob to highlight the Bearing value.
3. Turn the small **MFD** knob to place the Bearing Line on the desired storm cell or other area to be vertically scanned.

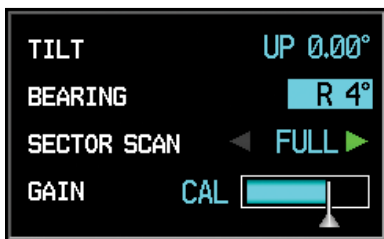

Figure 4-83 Bearing Line Adjustment

4. Press the **VERTICAL** soft key. A vertical “slice” of the selected area will now be displayed.
5. With the Bearing value still highlighted, the small **MFD** Knob may be used to move the scanned “slice” a few degrees right or left.
6. Press the **RNG** keys to adjust the range.
7. Press the **MFD** Knob to remove the cursor.
8. To select a new area to be vertically scanned, select the **HORIZON** soft key to return to the Horizontal Scan view and repeat the previous steps.

4.8.6.3 Adjusting the Antenna Tilt Angle

In order to make an accurate interpretation of a storm cell, the radar beam should be pointed at the wet part of the weather cell to record the proper rainfall intensity (color level). The ideal aiming point is just below the freezing level of the storm. The best way to find this point is to use the Vertical Scan feature. The antenna tilt angle can be centered on the strongest return area in the vertical scan to get a more accurate view of the coverage and intensity of the target in the horizontal scan.

Adjusting Antenna Tilt on the Horizontal Scan Display

1. Press the **MFD** knob.
2. With the Tilt value highlighted in the Control window, turn the small **MFD** knob to adjust the Tilt.

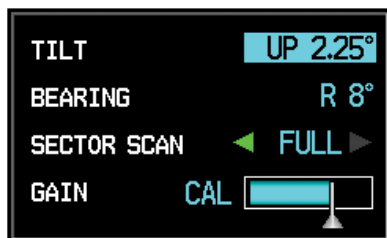

Figure 4-84 Adjusting Tilt

Adjusting Antenna Tilt on the Vertical Scan Display (Not available with all radars)

1. While in the Vertical Scan view, press the **CONTROL** and then the **TILT** soft keys. This displays the Tilt Line.

OR

Press **MENU** and turn the large or small **MFD** knobs to highlight the “Show Tilt Line” menu item and press the **ENT** key. This displays the Tilt Line.

2. Press the **MFD** knob to activate the Tilt Adjustment in the Control window. Turn the large **MFD** knob to highlight the Tilt value.
3. Turn the small **MFD** knob to adjust the Tilt value.

4.8.6.4 Adjusting Gain

The gain is used to adjust the sensitivity of the radar receiver. It can be used to adjust the characteristics of the returns.

Gain adjustment is shown in the Gain bar graph. The white reference line on the right side of the bar graph indicates the calibration reference point.



WARNING: Changing the gain in weather mode will cause precipitation intensity to be displayed as a color not representative of the true intensity. Remember to return the gain setting to: “Calibrated” for viewing the actual intensity of precipitation.



NOTE: Gain can be adjusted in Weather mode on the GWX radars only.

1. While viewing the Weather Radar page of the Wx page group, press the **MENU** key.

2. Turn the large **MFD** knob to highlight “Manual Gain” and press **ENT**. This will highlight the Gain value in the Control window.

3. Turn the small **MFD** knob to adjust the Gain.

OR

1. Press the **MFD** knob and turn the large **MFD** knob to highlight the Gain value in the Control window.

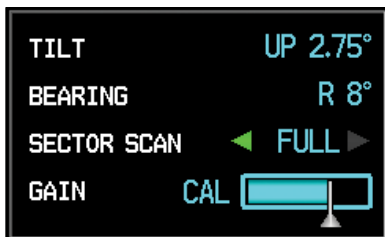

Figure 4-85 Highlight Gain Cal Value

2. Turn the small **MFD** knob to adjust the Gain Cal value. Press the **MFD** knob again to accept the value and end editing.

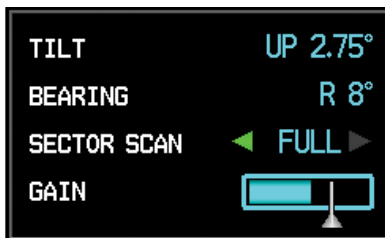

Figure 4-86 Adjust Gain Cal Value

Restore Calibrated Gain

1. While viewing the Weather Radar page of the Wx page group, press the **MENU** key.

2. Turn the large **MFD** knob to highlight “Restore Calibrated Gain” and press **ENT**.



Figure 4-87 Restore Calibrated Gain

OR

1. While viewing the Weather Radar page of the Wx page group, press the **CONTROL** soft key.
2. Press the **GAIN CAL** soft key to restore the calibrated gain value. Press the **MFD** knob again to accept the value and end editing.

4.8.6.5 Sector Scan - GWX Radars Only

Adjusting the Sector Scan reduces the scan angle from Full in increments of $\pm 20^\circ$, $\pm 40^\circ$, and $\pm 60^\circ$ in horizontal scanning. Sector scanning is not available for vertical scanning.

1. While viewing the Weather Radar page of the Wx page group, press the **CONTROL** soft key.
2. Press the **BRG** soft key to display the Bearing Line.
3. Turn the small **MFD** knob to place the Bearing Line in the desired position. The location of the Bearing Line will become the center point of the Sector Scan.
4. Turn the large **MFD** knob to place the cursor in the SECTOR SCAN field.

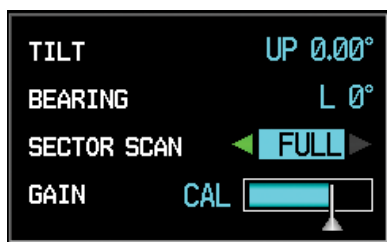

Figure 4-88 Sector Scan - Full

- Turn the small **MFD** knob to select FULL, 60°, 40°, or 20° scan.

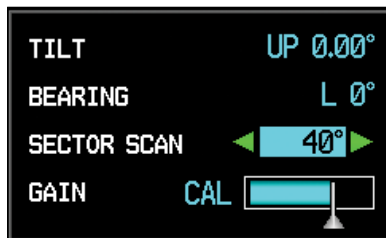

Figure 4-89 Sector Scan - 40°

- If desired, readjust the Bearing Line as discussed previously to change the center of the Sector Scan.
- Remove Sector Scanning by returning the SECTOR SCAN value to FULL.

4.8.6.6 Antenna Stabilization

- While viewing the Weather Radar page of the Wx page group, press the **CONTROL** soft key.
- To activate or deactivate the antenna stabilization, press the **STAB ON** soft key to activate antenna stabilization or press the **STAB OFF** soft key to deactivate. The current stabilization condition is shown in the upper right of the weather radar display.

4.8.6.7 Weather Attenuated Color Highlight - GWX Radars Only

While in horizontal scan mode, the Weather Attenuated Color Highlight (WATCH™) feature can be used as a tool to determine areas of possible inaccuracies in displayed intensity due to weakening of the radar energy. This weakening is known as “attenuation.” The radar energy weakens as it passes through areas of intense precipitation, large areas of lesser precipitation, and distance. Issues with the radome will also attenuate the radar energy. All these factors have an effect on the return intensity. The more energy that dissipates, the lesser the displayed intensity of the return. Accuracy of the displayed intensity of returns located in the shaded areas are suspect. Make maneuvering decisions with this information in mind. Proper antenna tilt management should still be employed to determine the extent of attenuation in a shaded area.

- While viewing the Weather Radar page of the Wx page group, press the **CONTROL** soft key.
- To activate or deactivate the WATCH™ feature, press the **WATCH** soft key.

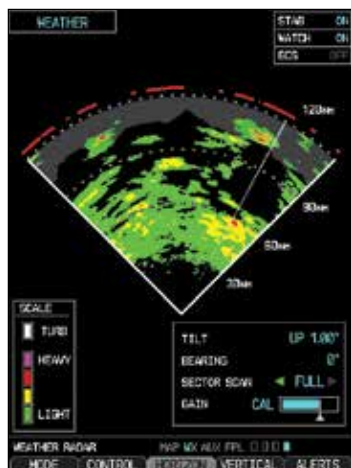
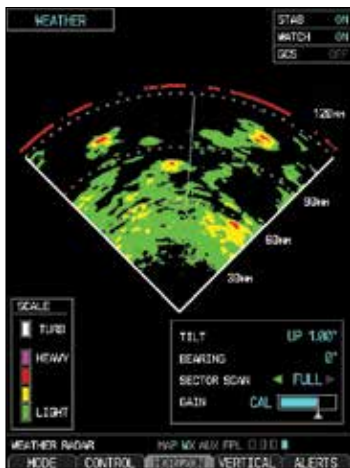

Figure 4-90 Horizontal Scan without WATCH™ Figure 4-91 Horizontal Scan with WATCH™

4.8.6.8 Weather Alert - GWX Radars Only

The Weather Alert feature indicates the presence of heavy radar returns beyond the currently displayed range. Weather Alert targets appear as red bands along the outer range ring at the approximate azimuth of the detected returns.

If the antenna tilt is adjusted too low, a weather alert can be generated by ground returns.

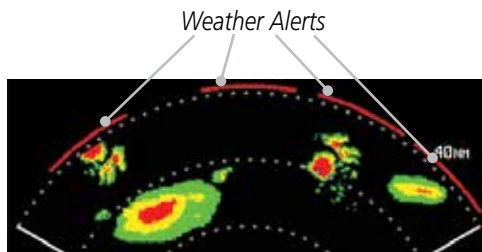

Figure 4-92 Weather Alert Display

If a Weather Alert is detected within $\pm 10^\circ$ of the aircraft heading, a text alert will be displayed on the MFD in the Alerts Window. These text Weather Alerts can be deactivated without deactivating the red bands on the radar display.

1. While viewing the Weather Radar page of the Wx page group, press the **MENU** key.
2. To activate or deactivate Weather Alerts, turn the large or small **MFD** knob to highlight either "Enable Weather Alert" or "Inhibit Weather Alert."

4.8.6.9 Altitude Compensated Tilt - GWX 70 Only

Altitude Compensated Tilt (ACT) automatically adjusts the tilt to compensate for altitude changes as you climb or descend.

1. While viewing the Weather Radar Menu, turn the small or large **MFD** knob to highlight Enable Altitude Compensated Tilt (ACT) and then press **ENT**.



Figure 4-93 Weather Radar Page Menu

2. To deactivate ACT, repeat the sequence.

4.8.6.10 Turbulence Detection - GWX 70 Only (Optional)

Turbulence Detection activates a feature that detects and displays severe turbulence. Turbulence Detection is inactive at ranges greater than 160 NM. This optional feature requires a separate enablement. See your dealer for details. If Turbulence Detection is enabled and available, Turbulence Detection will be reported as Inactive in any of the following conditions:

- Scan orientation is not Horizontal
- Scan range is greater than 160 NM
- Radar mode is not Weather

1. While viewing the Weather Radar Menu, turn the small or large **MFD** knob to highlight Enable Turbulence Detection and then press **ENT**.
2. To deactivate Turbulence Detection, repeat sequence.

4.8.6.11 Ground Clutter Suppression - GWX 70 Only (Optional)

Ground Clutter Suppression (GCS) reduces the amount of returns as a result of highly reflective objects on the ground, such as buildings or cities, while maintaining the intensity and size of weather returns. This optional feature requires a separate enablement. See your dealer for details.

1. While viewing the Weather Radar Menu, turn the small or large **MFD** knob to highlight Enable Ground Clutter Suppression (GCS) and then press **ENT**.
2. To deactivate Ground Clutter Suppression, repeat the sequence.

4.8.7 Ground Mapping and Interpretation

A secondary use of the weather radar system is for the presentation of terrain. This can be a useful tool for verifying aircraft position. A “picture” of the ground is represented much like a topographical map that can be used as a supplement to the navigation map on the MFD.

Ground Map mode uses a different gain range than Weather mode. Different colors are also used to represent the intensity levels. The displayed intensity of ground target returns are defined in the following table. Use of the **GAIN** and **TILT** controls will help improve contrast so that specific ground targets can be recognized more easily. As previously discussed, the type and orientation of the target in relation to the aircraft affects the intensity displayed.

Ground Map Mode Color	GWX Radars Intensity	3rd Party Radars Level
BLACK	0 dB	0
LIGHT BLUE	> 0 dB to < 9 dB	1
YELLOW	9 dB to < 18 dB	2
MAGENTA	18 dB to < 27 dB	3 and above
BLUE	27 dB and greater	Not Used

Table 4-26 Ground Target Return Intensity Levels

1. Press the **MODE** soft key.
2. Press the **GROUND** soft key to place the radar in Ground Map mode. A pop-up regarding caution in operating radar on the ground will appear. Turn the large **MFD** knob to highlight “YES” and then press **ENT**.

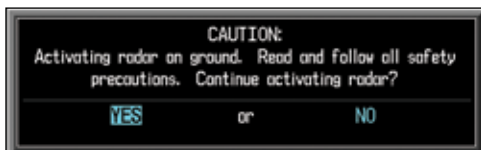

Figure 4-94 Ground Radar Operation Caution

3. Press the **BACK** soft key.
4. Press the **MFD** knob to activate the cursor.

5. Turn the large **MFD** knob to place the cursor in the TILT field.
6. Adjust the antenna tilt angle by turning the small **MFD** knob to display ground returns at the desired distance.
7. Press the **MFD** knob to remove the cursor.

4.9 Garmin Connex Satellite Services (Optional)



NOTE: *Garmin Connex Satellite Services was formerly called GFDS and may still display as GFDS on GDUs.*

Garmin Connex Satellite Services (GCSS) is an optional feature available with the Iridium satellite system that is interfaced through the optional Garmin GSR 56. The primary maps for viewing Connex Weather data are the Weather Data Link Pages in the Map Page Group. These are the only GDU 620 map displays capable of all available weather products. The WX Weather pages may be oriented to either Track Up or North Up. Both Connex and SiriusXM Weather may be installed and selected individually. Connex Weather coverage is available throughout most of Europe, Canada and the U.S. Additional radar coverage areas are being added continuously. Selection of the Weather Source is made on the Aux - System Setup page.

More detail on Garmin Connex Weather products and coverage can be found at: <https://fly.garmin.com/fly-garmin/connex/worldwide-weather/>



NOTE: *A system can be configured for both SiriusXM and Connex Weather, but both cannot be displayed at the same time.*

4.9.1 Connex Weather Registration

4.9.1.1 Registering Connex Weather

It is necessary to register the GDU to utilize the weather products.

1. Visit flyGarmin.com to create a Connex Weather account. Provide the GDU System ID and airframe info (model, tail number, etc).
2. An access code will be issued to enter on the GFDS Registration page.
3. While viewing a WX Map page of the WX page group, press the **MENU** key to display the Page Menu Options.
4. Turn the large **MFD** knob to highlight "Register With GFDS." Press **ENT**.



Figure 4-95 Select Registration

5. Turn the small **MFD** knob to select values and the large **MFD** knob to move to the next position. Highlight **REGISTER** and press **ENT** to complete the process. The GDU will contact the Connex servers using the GSR 56 transceiver. If the access code and system ID are correct, it will download and display the airframe info.



Figure 4-96 Registration Page (Default and Completed)

4.9.1.2 Deactivating Unit Registration

Registration of the GDU unit can be deactivated so that the unit can no longer make requests. This does not cancel the subscription.

1. While viewing a WX Map page of the WX page group, press the **MENU** key to display the Page Menu Options.
2. Turn the large **MFD** knob to highlight "Register With GFDS." Press **ENT**.
3. With the Access Code field highlighted, press **CLR** to remove the access code.
4. Any weather requests will now fail and the system will no longer be linked to the account.

4.9.2 Using Weather Products

When a weather product is active on the Weather Data Link Page or the Navigation Map Page, the age of the data is displayed on the screen. The age of the product is based on the time difference between when the data was assembled on the ground and the current GPS time. Weather products are refreshed at selectable intervals.

If for any reason, a weather product is not refreshed within the 30, 60, 90, or 120 minute Expiration Time intervals, the data is considered expired and is removed from the display. This ensures that the displayed data is consistent with what is currently being broadcast by Garmin Connex Weather Services. If more than half of the expiration time has elapsed from the time the data is received, the color of the product age displayed changes to yellow.

4.9.3 Customizing the Weather Map

Each Wx Map page may be customized individually. The Wx Map pages are customized by selecting options from the Page Menu. The Page Menu options include choices for Weather Setup and displaying the Weather Legends. The Weather Setup choice covers selections for adjusting the viewing ranges of the weather products.

NOTE: *If multiple weather sources are installed, then the weather source must first be selected on the AUX System Setup page. Refer to section 3.2.1.10.*

Foreword
 Sec 1 System
 Sec 2 PFD
 Sec 3 MFD
 Sec 4 Hazard Avoidance
 Sec 5 Additional Features
 Sec 6 Annun. & Alerts
 Sec 7 Symbols
 Sec 8 Glossary
 Appendix A
 Index

1. While viewing a WX Map page of the WX page group, press the **MENU** key to display the Page Menu Options. Turn the large **MFD** knob to highlight the “Weather Setup” option. Press **ENT**.



Figure 4-97 Weather Page Menu Options

2. With the Weather Setup Menu displayed, turn the Large **MFD** knob to select the desired item.



Figure 4-98 Weather Data Link Setup Menu Options

3. Turn the small **MFD** knob to select the desired weather feature option.
4. Press **ENT** to save a selection.
5. Turn the large **MFD** knob to the next desired option or press the small **MFD** knob to cancel and return to the Connex Weather Data Link Map Page.

WX Page Menu - Weather Setup	
Menu Item	Adjustment
Map Orientation	North Up, Track Up
PRECIP Data Viewing Range	Off, 50 NM to 500 NM
PRECIP Legend	On/Off
IR SAT Data Viewing Range	Off, 10 NM to 500 NM
Lightning Data Viewing Range	Off, 10 NM to 500 NM
SIG/Air Viewing Range	Off, 10 NM to 500 NM
PIREPS Viewing Range	Off, 10 NM to 500 NM
METAR Data Viewing Range	Off, 10 NM to 500 NM
Wnd Aloft Data Viewing Range	Off, 10 NM to 500 NM
TFR Data Viewing Range	Off, 10 NM to 500 NM

Table 4-27 Weather Page Menu Setup Options

4.9.4 Data Request

It is necessary to request the downloading of weather products. Requests can be sent manually or set to automatically update at a selected rate.

1. While viewing a WX Map page of the WX page group, press the **MENU** key to display the Page Menu Options.
2. Turn the large **MFD** knob to highlight "GFDS Data Request." Press **ENT**.



Figure 4-99 Select Data Request

3. Turn the small **MFD** knob to select values and the large **MFD** knob to move to the next position.



Figure 4-100 Data Request Page

4.9.4.1 Data Request Coverage

Present Position Data Request

1. While viewing a WX Data Link Map page of the WX page group, press the **MENU** key to display the Page Menu Options.
2. Turn the large **MFD** knob to highlight "GFDS Data Request." Press **ENT**.
3. Turn the large **MFD** knob to highlight "Present Position." Press **ENT**.
4. The Present Position box will be checked and weather information will be requested around your present position.
5. To deselect Present Position reporting, turn the large **MFD** knob to highlight "Present Position." Press **ENT**.

Destination Data Request

1. Turn the large **MFD** knob to highlight "Destination." Press **ENT**.
2. The Destination box will be checked and weather information will be requested around your flight plan destination.
3. To deselect Destination reporting, turn the large **MFD** knob to highlight "Destination." Press **ENT**.

Flight Plan Data Request

1. Turn the large **MFD** knob to highlight "Flight Plan." Press **ENT**.
2. The range list will now be highlighted. Turn the small **MFD** knob to highlight the desired range and press **ENT**.

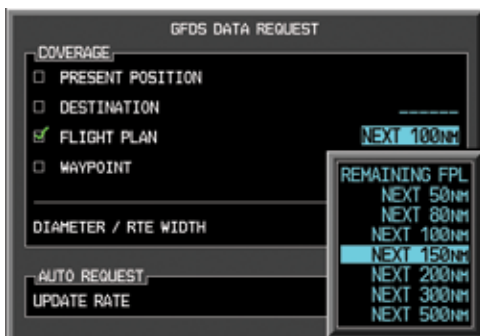

Figure 4-101 Flight Plan Data Request

3. The Flight Plan box will be checked and weather information will be requested along your flight plan forward of your present position for the range selected.
4. To deselect Flight Plan reporting, turn the large **MFD** knob to highlight "Flight Plan." Press **ENT**.

Waypoint Data Request

1. Turn the large **MFD** knob to highlight “Waypoint.” Press **ENT**.
2. The Waypoint Selection field will now be highlighted. Turn the small **MFD** knob to select the first character. Turn the large **MFD** knob to highlight the next character. When finished selecting the waypoint name, press **ENT**.



Figure 4-102 Waypoint Data Request

3. The Waypoint box will be checked and weather information will be requested around the selected waypoint for the range selected (next operation).

Diameter/Route Width Data Request

Foreword

1. After selecting a coverage option in the previous section, the Diameter/Route Width field will now be highlighted.

Sec 1
System

Sec 2
PFD

Sec 3
MFD



Figure 4-103 Waypoint Data Request Range

2. Turn the small **MFD** knob to select the desired Diameter/Route Width and then press **ENT**.

Sec 4
Hazard
Avoidance

Sec 5
Additional
Features

4.9.4.2 Data Request Auto Request

Sec 6
Annun.
& Alerts

1. Turn the large **MFD** knob to highlight "Auto Request - Update Rate."
2. Turn the small **MFD** knob to select "Off" or an Update Rate. When finished selecting the Update Rate, press **ENT**. The Update Rate will default to "OFF" at each power cycle.

Sec 7
Symbols

Sec 8
Glossary



Figure 4-104 Data Request Auto Update Rate

Appendix A

Index

4.9.4.3 Data Request Manual Request

Connex Weather data may be updated at any time regardless of the automatic update timing by selecting a Manual Request. When multiple requests are made, some products are merged with the old data (SIGMETs/AIRMETs, TAFs, TFRs, and METARs), but the old data of other products is discarded.

1. Turn the large **MFD** knob to highlight “Manual Request - Send Req.”
2. Press **ENT**.

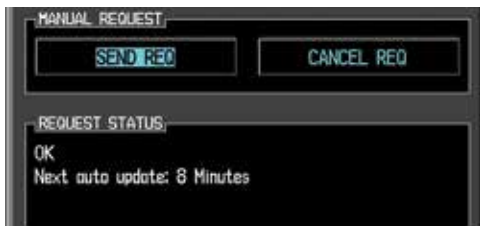

Figure 4-105 Manual Data Request

3. The update request will occur immediately. The action will be noted in the Request Status window. The Auto Request time will be reset to the selected value.

4.9.4.4 Data Request Status Window

The Request Status window will show a response such as “OK” when manual requests are made. The time for the next auto update will be shown.

4.9.5 Weather Page Map Orientation

The Orientation option sets the orientation of the Wx Data Link Map pages.

1. While viewing the Weather Map 1, 2, or 3 of the Wx page group, press the **MENU** key. With “Weather Setup” highlighted, press **ENT**.
2. With the “Map Orientation” option active, turn the small **MFD** knob to change the highlighted value.
3. Press **ENT** to accept the displayed value. The next option will be highlighted.
4. Press the small **MFD** knob to cancel selection or to end editing and return to the WX page or turn the large **MFD** knob to the next option.

4.9.6 Precipitation Data Viewing Range

The Precipitation (PRECIP) Viewing Range option allows you to select the map range where at and below the selected value PRECIP weather products will be shown on the selected MFD Wx Data Link Map page (1, 2, or 3). When Off is selected, PRECIP weather data will not be shown. In the figure below where 500 NM is selected, PRECIP data will be shown at map ranges of 500 NM and lower. TFRs and METARs are the only weather products shown below 10 NM.

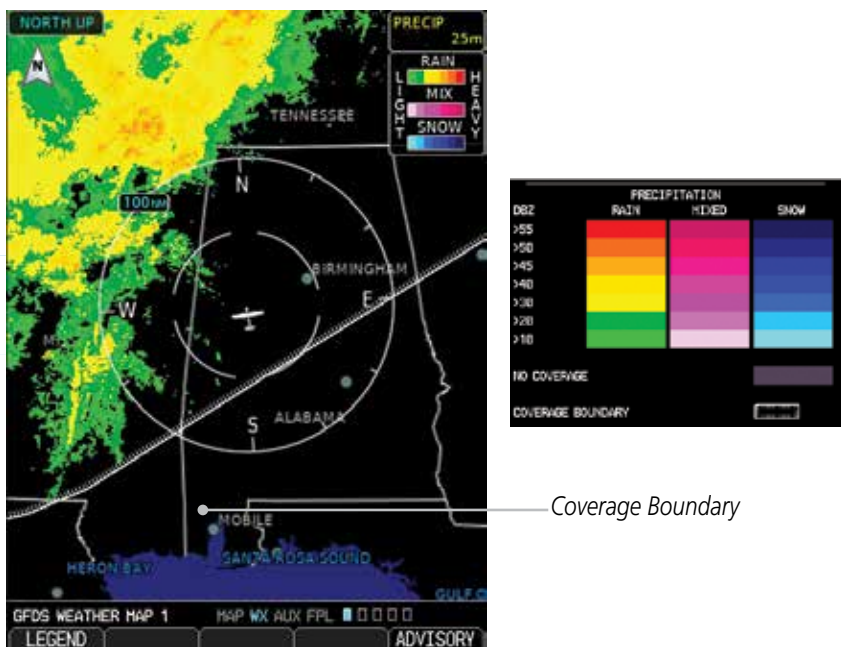

Figure 4-106 PRECIP Weather Map Display and Legend

1. While viewing a WX Data Link Map page of the WX page group, press the **MENU** key to display the Page Menu Options. The Weather Setup option will be highlighted. Press **ENT**.
2. Turn the large **MFD** knob to highlight PRECIP Data Viewing Range. Turn the small **MFD** knob to highlight the desired value.
3. Press **ENT** to accept the displayed value. The next option will be highlighted.
4. Press the small **MFD** knob to cancel selection or to end editing and return to the WX page or turn the large **MFD** knob to the next option.

4.9.7 PRECIP Legend

The PRECIP Legend selection provides the option of displaying an abbreviated version of the PRECIP legend in the top right region of the MFD. The full legend is available by pressing the **LEGEND** soft key.



Figure 4-107 PRECIP Legend

1. While viewing a Weather Map page of the WX page group, press the **MENU** key to display the Page Menu Options. The Weather Setup option will be highlighted. Press **ENT**.
2. Turn the large **MFD** knob to highlight PRECIP Legend.
3. Turn the small **MFD** knob to highlight Off or On. Press **ENT** to accept the displayed value. The next option will be highlighted.
4. Press the small **MFD** knob to cancel selection or to end editing and return to the WX page or turn the large **MFD** knob to the next option.

4.9.8 Infrared Satellite Data Viewing Range

Infrared Satellite (IR SAT) data is available over North America and Europe and depicts cloud top temperatures from satellite imagery. Brighter cloud top colors indicate cooler temperatures occurring at higher altitudes. Information is updated every half hour.



Figure 4-108 GCSX Infrared Satellite Data Map Display and Legend

IR SAT Data Viewing Range

The IR SAT Data Viewing Range option allows you to select the map range where at and below that value IR SAT weather products will be shown on the selected MFD Weather Map page (1, 2, or 3). When Off is selected, IR SAT will not be shown. For the selected value (such as 250 NM) is selected, IR SAT data will be shown at map ranges of the selected value (250 NM) and lower.

1. While viewing a Weather Map page of the WX page group, press the **MENU** key to display the Page Menu Options. Turn the large **MFD** knob to highlight the Weather Setup option and press **ENT**.
2. Turn the large **MFD** knob to highlight IR SAT Data Viewing Range. Turn the small **MFD** knob to highlight the desired value.
3. Turn the small **MFD** knob to highlight the desired value. Press **ENT** to accept the displayed value. The next option will be highlighted.
4. Press the small **MFD** knob to cancel selection or to end editing and return to the WX page or turn the large **MFD** knob to the next option.

4.9.9 Data Link Lightning Viewing Range

Data Link Lightning (DL LTNG) shows the approximate location of cloud-to-ground lightning strikes. A strike icon represents a strike that has occurred within a two-kilometer region. The exact location of the lightning strike is not displayed. Only cloud to ground strikes are reported in the US and extreme southern Canada (cloud to cloud strikes are not reported).



Figure 4-109 Data Link Lightning and Legend

The Lightning Data Viewing Range option allows you to select the map range where at and below that value Lightning weather products will be shown on the selected MFD Weather Map page (1, 2, or 3). When Off is selected, Lightning will not be shown. Where a value (such as 250 NM) is selected, data will be shown at map ranges of the selected value (250 NM) and lower.

1. While viewing a Weather Map page of the WX page group, press the **MENU** key to display the Page Menu Options. Turn the large **MFD** knob to highlight the Weather Setup option and press **ENT**.
2. Turn the large **MFD** knob to highlight DL LTNG Data Viewing Range.
3. Turn the small **MFD** knob to highlight the desired value. Press **ENT** to accept the displayed value. The next option will be highlighted.
4. Press the small **MFD** knob to cancel selection or to end editing and return to the WX page or turn the large **MFD** knob to the next option.

4.9.10 SIGMETs and AIRMETs

SIGMETs (SIGnificant METeorological Information) and AIRMETs (AIRmen's METeorological Information) are broadcast for potentially hazardous weather considered of importance to aircraft. A Convective SIGMET is issued for hazardous convective weather. A localized SIGMET is a significant weather condition occurring at a localized geographical position.



Figure 4-110 Weather Page - AIRMETS/SIGMETs

When enabled, SIGMET/AIRMETs advise the pilot of potentially hazardous weather to all aircraft. SIGMET/AIRMET data covers icing, turbulence, dust, and volcanic ash as issued by the National Weather Service. The update rate is every 12 minutes in the U.S. Elsewhere, updates are made as they are issued.

Viewing Textual SIGMETs/AIRMETs

Textual SIGMET/AIRMETs can be viewed by selecting an SIGMET/AIRMET line on the Map or Weather (WX) pages.

1. While viewing a Map or Weather page, Use the small and large **MFD** knobs to move the cursor to highlight a SIGMET/AIRMET line. Press **ENT**.
2. The Waypoint Information page for that line will now be shown. Press the **WX** soft key to view weather information.

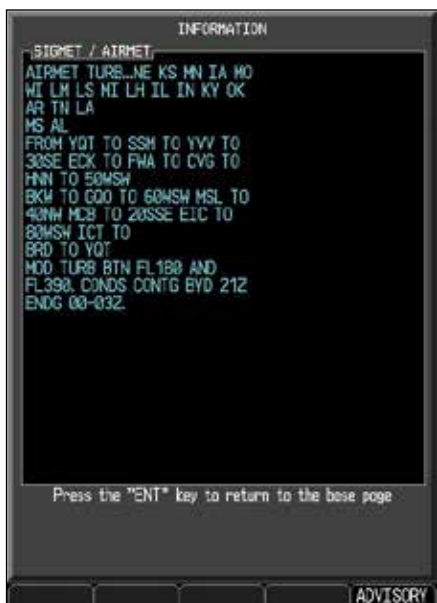

Figure 4-111 Weather - AIRMETs/SIGMETs Detail and Legend

When enabled, the following AIRMETs are available for display:

- Icing
- Turbulence
- IFR conditions
- Mountain obscuration
- Surface winds

SIGMET/AIRMET Viewing Range

The SIGMET/AIRMET Viewing Range option allows you to select the map range where at and below that value SIGMET/AIRMET products will be shown on the selected MFD Wx Data Link Map page (1, 2, or 3). When Off is selected, SIGMET/AIRMET will not be shown. Where a value (such as 250 NM) is selected, SIGMET/AIRMET data will be shown at map ranges of the selected value (250 NM) and lower.

1. While viewing a WX Data Link Map page of the WX page group, press the **MENU** key to display the Page Menu Options. Turn the large **MFD** knob to highlight the Weather Setup option and press **ENT**.
2. Turn the large **MFD** knob to highlight SIG/AIR Viewing Range.
3. Turn the small **MFD** knob to highlight the desired value. Press **ENT** to accept the displayed value. The next option will be highlighted.
4. Press the small **MFD** knob to cancel selection or to end editing and return to the WX page or turn the large **MFD** knob to the next option.

4.9.11 AIREP/PIREP

Pilot Weather Reports (PIREPs) provide timely weather information for a particular route of flight. When significant weather conditions are reported or forecast, Air Traffic Control (ATC) facilities are required to solicit PIREPs. A PIREP may contain non-forecast adverse weather conditions, such as low in-flight visibility, icing conditions, wind shear, and turbulence. PIREPs are issued as either Routine (UA) or Urgent (UUA).

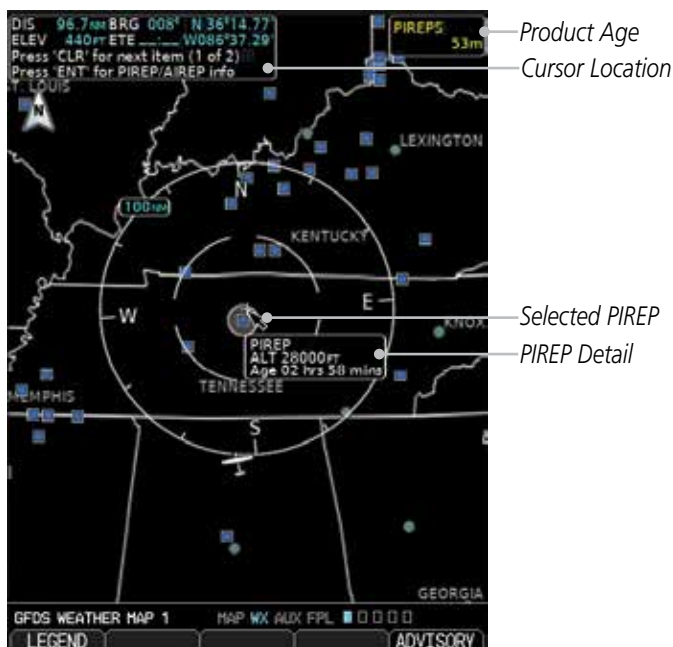

Figure 4-112 Weather - AIREPs/PIREPs

1. While viewing a WX Data Link Map page of the WX page group, press the **MENU** key to display the Page Menu Options. The cursor flashes on the "Weather Setup" option. Press **ENT**.
2. Turn the large **MFD** knob to highlight the PIREPS Viewing Range value.
3. Turn the small **MFD** knob to highlight the desired value. Press **ENT** to accept the displayed value. The next option will be highlighted.
4. Press the small **MFD** knob to cancel selection or to end editing and return to the Navigation Map page or turn the large **MFD** knob to the next option.

Viewing Textual AIREPs/PIREPs

Textual AIREPs/PIREPs can be viewed by selecting an AIREP/PIREP on the Map or Weather (WX) pages.

1. While viewing a Map or Weather page, Use the small and large **MFD** knobs to move the cursor to highlight an airport with an AIREP/PIREP. Press **ENT**.
2. The Waypoint Information page for that airport will now be shown. Press the **WX** soft key to view weather information for the waypoint.

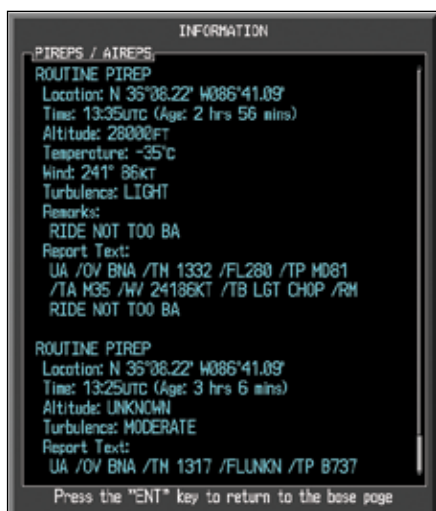

Figure 4-113 Weather - AIREPs/PIREPs Detail and Legend

4.9.12 METARs

Foreword



NOTE: Atmospheric pressure reported for METARs is given in hectopascals (hPa), except in the United States, where it is reported in inches of mercury (in Hg). Temperatures are reported in Celsius.

Sec 1 System



NOTE: METAR information is only displayed within the installed aviation database service area.

Sec 2 PFD

Sec 3 MFD

Sec 4 Hazard Avoidance

Sec 5 Additional Features

Sec 6 Annun. & Alerts

Sec 7 Symbols

Sec 8 Glossary

Appendix A

Index

METAR (METeorological Aerodrome Report), known as an Aviation Routine Weather Report, is the standard format for current weather observations. METARs are generally updated hourly, but some sites are more frequent. Special updates are done as conditions warrant. METARs typically contain information about the temperature, dew point, wind, precipitation, cloud cover, cloud heights, visibility, and barometric pressure. They can also contain information on precipitation amounts, lightning, and other critical data. METARs are shown as colored flags at airports that provide them.

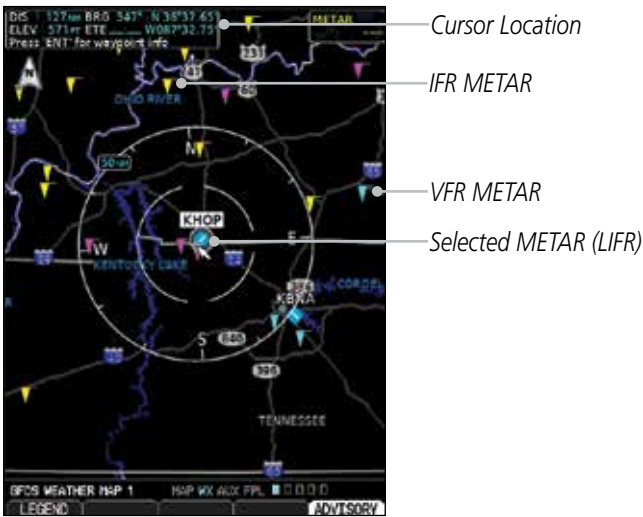

Figure 4-114 Weather - Graphic METARs

Viewing Textual METARs

Textual METARs can be viewed by selecting an airport on the Map or Weather (WX) pages.

1. While viewing a Map or Weather page, Use the small and large **MFD** knobs to move the cursor to highlight an airport with a METAR flag. Press **ENT**.
2. The Waypoint Information page for that airport will now be shown. Press the **WX** soft key to view weather information for the waypoint.

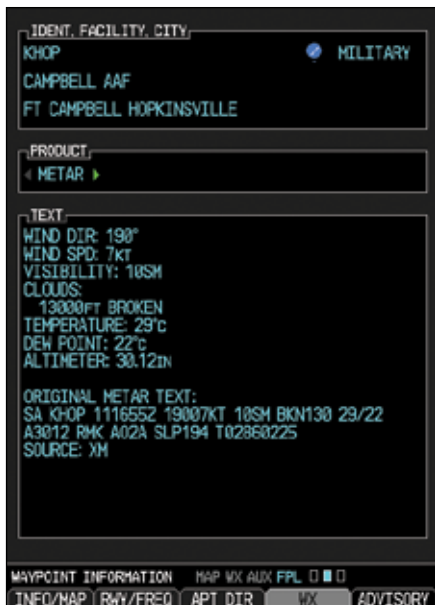

Figure 4-115 Weather - METARs Detail and Legend

Foreword

System Sec 1

PFD Sec 2

MFD Sec 3

Avoidance
Hazard Sec 4

Additional Sec 5
Features

Annun. Sec 6
& Alerts

Symbols Sec 7

Glossary Sec 8

Appendix A

Index

METAR Viewing Range

The METAR Viewing Range option allows you to select the map range where at and below that value METAR weather products will be shown on the selected MFD Wx Data Link Map page (1, 2, or 3). When Off is selected, METARs will not be shown. Where a value (such as 150 NM) is selected, METAR data will be shown at map ranges of the selected value (150 NM) and lower.

1. While viewing a WX Data Link Map page of the WX page group, press the **MENU** key to display the Page Menu Options. Turn the large **MFD** knob to highlight the Weather Setup option and press **ENT**.
2. Turn the large **MFD** knob to highlight METAR Data Viewing Range.
3. Turn the small **MFD** knob to highlight the desired value. Press **ENT** to accept the displayed value. The next option will be highlighted.
4. Press the small **MFD** knob to cancel selection or to end editing and return to the WX page or turn the large **MFD** knob to the next option.

Foreword

Sec 1
SystemSec 2
PFDSec 3
MFDSec 4
Hazard
AvoidanceSec 5
Additional
FeaturesSec 6
Annun.
& AlertsSec 7
SymbolsSec 8
Glossary

Appendix A

Index

4.9.13 Winds Aloft

Winds Aloft data shows the forecast wind speed and direction at the surface and at selected altitudes. Altitudes can be selected in 3000 foot increments from the surface up to 42,000 feet MSL. Pressing the **WX Alt Dn** or **WX Alt Up** soft keys steps down or up in 3,000 foot increments.

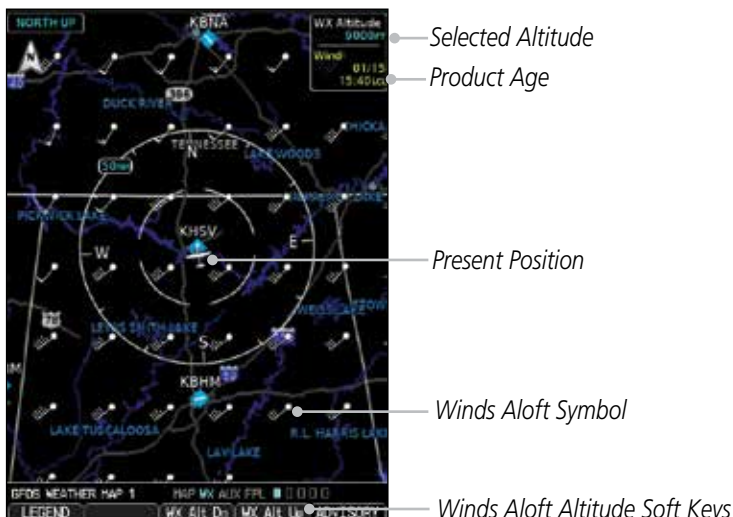

Figure 4-116 Weather - Winds Aloft



Figure 4-117 Weather - Winds Aloft Legend

Winds Aloft Data Viewing Range

The Winds Aloft Data Viewing Range option allows you to select the map range where at and below that value Winds Aloft weather products will appear on the selected MFD Wx Data Link Map page (1, 2, or 3). When Off is selected, Winds Aloft will not be shown. Where 150 NM is selected, Winds Aloft data will be shown at map ranges of 150 NM and lower.

1. While viewing a WX Data Link Map page of the WX page group, press the **MENU** key to display the Page Menu Options. Turn the large **MFD** knob to highlight the Weather Setup option and press **ENT**.
2. Turn the large **MFD** knob to highlight Winds Aloft Data Viewing Range.
3. Turn the small **MFD** knob to highlight the desired value. Press **ENT** to accept the displayed value. The next option will be highlighted.
4. Press the small **MFD** knob to cancel selection or to end editing and return to the WX page or turn the large **MFD** knob to the next option.

Foreword

Sec 1
System

Sec 2
PFD

Sec 3
MFD

Sec 4
Hazard
Avoidance

Sec 5
Additional
Features

Sec 6
Annun.
& Alerts

Sec 7
Symbols

Sec 8
Glossary

Appendix A

Index

4.9.14 TFRs

Temporary Flight Restrictions (TFRs) provide detailed information for local short term restrictions. The update rate is approximately every 20 minutes.



Figure 4-118 Weather - TFRs

The Temporary Flight Restriction (TFR) viewing range option selects whether TFR information is shown on the Weather Map. TFR information will be shown at and below the selected map range. When Off is selected, the information will not be shown. For the value (such as 500 NM) selected, TFR information will be shown at map ranges of that value (500 NM), and lower.

1. While viewing a Weather Map page of the WX page group, turn the large **MFD** knob to highlight the TFR Data Viewing Range option.
2. Turn the small **MFD** knob to change the highlighted value.
3. Press **ENT** to accept the displayed value.
4. Press the small **MFD** knob to cancel selection or to end editing and return to the Weather Map page.

Viewing Textual TFRs

Textual TFRs can be viewed by selecting a TFR outline on the Weather (WX) pages.

1. While viewing a Weather page, Use the small and large **MFD** knobs to move the cursor to highlight a TFR symbol (yellow circle). Press **ENT**.
2. The TFR details will be shown.
3. Press the small **MFD** knob or ENT to return to the Weather page.



Figure 4-119 Weather - Textual TFRs and Legend

4.10 FIS-B Weather (Optional)

WSR-88D weather surveillance radar or NEXRAD (NEXt generation RADar) is a Doppler radar system that has greatly improved the detection of meteorological events such as thunderstorms, tornadoes, and hurricanes. An extensive network of NEXRAD stations provides almost complete radar coverage of the continental United States, Alaska, and Hawaii. The unobstructed range of each NEXRAD is 124 nautical miles. The ADS-B/FIS-B receiver sends the FIS-B information to the GDU 620.



NOTE: The ADS-B/FIS-B receiver will send all FIS-B weather and NOTAM/TFR information that it receives. There may be more information available than is received by the ADS-B/FIS-B receiver. This can lead to the ADS-B/FIS-B receiver, and subsequently the GDU 620, displaying the status of the FIS-B data as "received" and "current" even though some of the data for the region is missing.

4.10.1 NEXRAD Abnormalities

There are possible abnormalities regarding displayed NEXRAD images. Some, but not all, causes of abnormal displayed information include:

- Ground Clutter
- Strokes and spurious radar data
- Sun strobes, when the radar antenna points directly at the sun
- Military aircraft deploy metallic dust which can cause alterations in radar scans
- Interference from buildings or mountains, which may cause shadows
- Scheduled maintenance may put a radar off-line

4.10.2 NEXRAD Limitations

Certain limitations exist regarding the NEXRAD radar displays. Some, but not all, are listed for the user's awareness:

- The Regional NEXRAD “pixels” are 1.5 minutes (1.5 nautical miles = 2.78 km) wide by 1 minute (1 nautical miles = 1.852 km) tall. The CONUS NEXRAD “pixels” are 7.5 minutes (7.5 nautical miles = 13.89 km) wide by 5 minutes (5 nautical miles = 9.26 km) wide. Above 60 degrees of latitude the Regional NEXRAD “pixels” are 3 minutes/nautical miles. CONUS NEXRAD is not available above 60 degrees of latitude. The intensity level reflected by the pixel will be the highest level sampled within the area covered by each pixel.



NOTE: *Where it is noted that NOTAM data is available, it is possible only a subset of the data is available and that more NOTAM reports may arrive in future updates. Updates occur approximately every ten minutes.*

4.10.3 NEXRAD Intensity

Colors are used to identify the different NEXRAD echo intensities (reflectivity) measured in dBZ (decibels of Z). “Reflectivity” is the amount of transmitted power returned to the radar receiver. Reflectivity (designated by the letter Z) covers a wide range of signals (from very weak to very strong). So, a more convenient number for calculations and comparison, a decibel (or logarithmic) scale (dBZ), is used. The dBZ values increase as the strength of the signal returned to the radar increases.

4.10.4 NEXRAD

When enabled, NEXRAD weather information is shown. Composite data from all of the NEXRAD radar sites in the United States is shown. This data is composed of the maximum reflectivity from the individual radar sweeps. The display of the information is color-coded to indicate the weather level severity. Refer to the legend for a description of the color code.

The NEXRAD option has selections of Regional, CONUS, or Combined NEXRAD. CONUS NEXRAD includes a composite of available NEXRAD radar imagery across the 48 states. Regional NEXRAD is a composite of available NEXRAD radar imagery in a local area, showing a more detailed image than CONUS NEXRAD. FIS-B weather data reception requires line-of-site communication between the receiver and the ADS-B ground station. Incomplete Regional and/or CONUS NEXRAD imagery displayed on the MAP and FIS-B Weather Pages of the affected products is an indicator of poor FIS-B reception.

Affected Areas

Any area in the continental United States (CONUS) or Alaska where the distance from ADS-B ground stations, or the combined effect of distance and low altitude, is sufficiently great may cause poor reception. A good source of information for ground station coverage can be found at: <https://www.faa.gov/>

Reception will improve in some affected areas as the FAA completes the NextGen ADS-B ground station infrastructure. However, due to line-of-sight broadcast characteristics, operators with properly installed and functioning equipment may still receive incomplete FIS-B data when signal reception is limited by the distance from ground stations combined with a low altitude.

4.10.5 NEXRAD Weather Setup

1. While viewing the FIS-B weather page, press the **Menu** key.
2. With the Weather Setup selection highlighted, press **ENT**.

4.10.5.1 Weather Page Map Orientation

The Orientation option sets the orientation of the Wx Data Link Map pages.

1. While viewing the FIS-B Weather Map 1, 2, or 3 of the Wx page group, press the **MENU** key. With “Weather Setup” highlighted, press **ENT**.
2. With the “Map Orientation” option active, turn the small **MFD** knob to change the highlighted value.

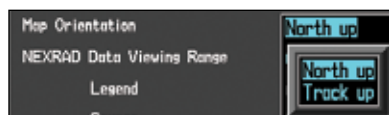

Figure 4-120 Weather Page Map Orientation

3. Press **ENT** to accept the displayed value. The next option will be highlighted.
4. Press the small **MFD** knob to cancel selection or to end editing and return to the Navigation Map page or turn the large **MFD** knob to the next option.

4.10.5.2 NEXRAD Data Viewing Range

The NEXRAD Viewing Range option allows you to select the map range where at and below the selected value NEXRAD weather products will be shown on the selected MFD FIS-B Weather Map page (1, 2, or 3). When Off is selected, NEXRAD weather data will not be shown. Where a value (such as 250 NM) is selected, NEXRAD data will be shown at map ranges of that value (250 NM) and lower.

1. While viewing a FIS-B Weather Map page of the WX page group, press the **MENU** key to display the Page Menu Options. The cursor flashes on the “Weather Setup” option. Press **ENT**.
2. The NEXRAD Data Viewing Range value will be highlighted. Turn the small **MFD** knob to highlight the desired value.
3. Press **ENT** to accept the displayed value. The next option will be highlighted.
4. Press the small **MFD** knob to cancel selection or to end editing and return to the Navigation Map page or turn the large **MFD** knob to the next option.

Foreword

Sec 1
System

Sec 2
PFD

Sec 3
MFD

Sec 4
Hazard
Avoidance

Sec 5
Additional
Features

Sec 6
Annun.
& Alerts

Sec 7
Symbols

Sec 8
Glossary

Appendix A

Index

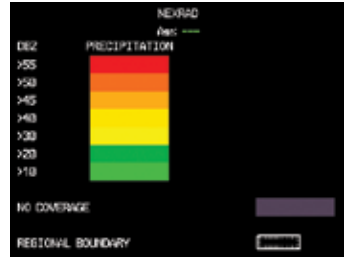

Figure 4-121 FIS-B NEXRAD Precipitation and Legend

4.10.5.3 NEXRAD Legend

The NEXRAD Legend selection provides the option of displaying an abbreviated version of the NEXRAD legend in the top right region of the MFD. The full legend is available by pressing the **LEGEND** soft key.

1. While viewing a FIS-B Weather Map page of the WX page group, press the **MENU** key to display the Page Menu Options. The cursor flashes on the "Weather Setup" option. Press **ENT**.
2. Turn the large **MFD** knob to highlight the NEXRAD Legend value.
3. Turn the small **MFD** knob to highlight Off or On. Press **ENT** to accept the displayed value. The next option will be highlighted.
4. Press the small **MFD** knob to cancel selection or to end editing and return to the Navigation Map page or turn the large **MFD** knob to the next option.

4.10.5.4 NEXRAD Source

Selecting NEXRAD in the FIS-B Weather Menu

1. While viewing the FIS-B weather page, press the **Menu** key.
2. With the Weather Setup selection highlighted, press **ENT**.
3. Turn the large **MFD** knob to highlight the NEXRAD Data Viewing Range Source option.
4. Turn the small **MFD** knob to select the desired Source option and press **ENT**.

Continental US NEXRAD (CONUS)

The Display CONUS NEXRAD selection shows NEXRAD radar information for the entire continental United States. CONUS NEXRAD data is updated every 15 minutes.

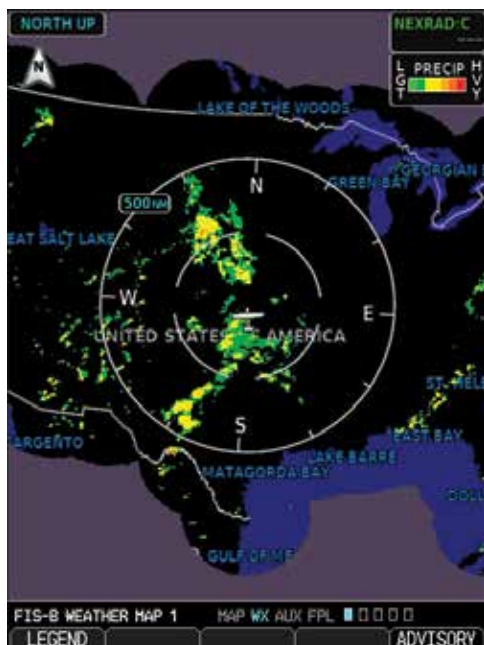

Figure 4-122 FIS-B CONUS NEXRAD

Regional NEXRAD

The Regional NEXRAD selection shows available regional NEXRAD radar information from reporting ground stations within 500 NM of the aircraft location.

Foreword

Sec 1
System

Sec 2
PFD

Sec 3
MFD

**Sec 4
Hazard
Avoidance**

Sec 5
Additional
Features

Sec 6
Annun.
& Alerts

Sec 7
Symbols

Sec 8
Glossary

Appendix A

Index



Figure 4-123 FIS-B Regional NEXRAD

Combined NEXRAD

Regional NEXRAD data and CONUS NEXRAD data are shown together. The two types of NEXRAD are separated by a white stippled border. This boundary is updated whenever new Regional or CONUS NEXRAD data is received. The radius of the boundary is fixed at 150 NM.



Figure 4-124 FIS-B Combined NEXRAD

4.10.5.5 SIGMETs and AIRMETs

SIGMETs (SIGNificant METeorological Information) and AIRMETs (AIRmen's METeorological Information) are broadcast for potentially hazardous weather considered of importance to aircraft. A Convective SIGMET is issued for hazardous convective weather. A localized SIGMET is a significant weather condition occurring at a localized geographical position.

When enabled, SIGMET/AIRMETs advise the pilot of potentially hazardous weather to all aircraft. SIGMET/AIRMET data covers icing, turbulence, dust, and volcanic ash as issued by the National Weather Service. The update rate is every 12 minutes.

Foreword

Sec 1 System

Sec 2 PFD

Sec 3 MFD

Sec 4 Hazard Avoidance

Sec 5 Additional Features

Sec 6 Annun. & Alerts

Sec 7 Symbols

Sec 8 Glossary

Appendix A

Index



Cursor Location

Turbulence Line

Cursor On AIRMET/SIGMET Line

Surface Winds Line

IFR and Mountain Obscured Line

Figure 4-125 FIS-B - AIRMETS/SIGMETs

SIGMET/AIRMET Viewing Range

The SIGMET/AIRMET Viewing Range option allows you to select the map range where at and below that value SIGMET/AIRMET products will be shown on the selected MFD FIS-B Weather Map page (1, 2, or 3). When Off is selected, SIGMET/AIRMET will not be shown. For a value selected (such as, 150 NM), SIGMET/AIRMET data will be shown at map ranges of that value (150 NM), and lower.

1. While viewing a FIS-B Weather Map page of the WX page group, press the **MENU** key to display the Page Menu Options. The cursor flashes on the "Weather Setup" option. Press **ENT**.
2. Turn the large **MFD** knob to highlight the SIGMET/AIRMET Viewing Range value.
3. Turn the small **MFD** knob to highlight the desired value. Press **ENT** to accept the displayed value. The next option will be highlighted.
4. Press the small **MFD** knob to cancel selection or to end editing and return to the Navigation Map page or turn the large **MFD** knob to the next option.

Viewing Textual SIGMETs/AIRMETs

Textual SIGMET/AIRMETs can be viewed by selecting an SIGMET/AIRMET line on the Map or Weather (WX) pages.

1. While viewing a Map or Weather page, Use the small and large **MFD** knobs to move the cursor to highlight a SIGMET/AIRMET line. Press **ENT**.
2. The Waypoint Information page for that line will now be shown. Press the **WX** soft key to view weather information.



Figure 4-126 FIS-B AIRMETS/SIGMETs Detail and Legend

When enabled, the following AIRMETS are available for display:

- Icing
- Turbulence
- IFR conditions
- Mountain obscuration
- Surface winds

Foreword

Sec 1
System

Sec 2
PFD

Sec 3
MFD

Sec 4
Hazard
Avoidance

Sec 5
Additional
Features

Sec 6
Annun.
& Alerts

Sec 7
Symbols

Sec 8
Glossary

Appendix A

Index

4.10.5.6 AIREP/PIREP

Foreword

Sec 1 System

Pilot Weather Reports (PIREPs) provide timely weather information for a particular route of flight. When significant weather conditions are reported or forecast, Air Traffic Control (ATC) facilities are required to solicit PIREPs. A PIREP may contain non-forecast adverse weather conditions, such as low in-flight visibility, icing conditions, wind shear, and turbulence. PIREPs are issued as either Routine (UA) or Urgent (UUA).

Sec 2 PFD

1. While viewing a FIS-B Weather Map page of the WX page group, press the **MENU** key to display the Page Menu Options. The cursor flashes on the "Weather Setup" option. Press **ENT**.

Sec 3 MFD

2. Turn the large **MFD** knob to highlight the PIREPS Viewing Range value.
 3. Turn the small **MFD** knob to highlight the desired value. Press **ENT** to accept the displayed value. The next option will be highlighted.

Sec 4 Hazard Avoidance

4. Press the small **MFD** knob to cancel selection or to end editing and return to the Navigation Map page or turn the large **MFD** knob to the next option.

Sec 5 Additional Features

Sec 6 Annun. & Alerts

Sec 7 Symbols

Sec 8 Glossary

Appendix A

Index



Figure 4-127 FIS-B AIREPs/PIREPs

Viewing Textual AIREPs/PIREPs

Textual AIREPs/PIREPs can be viewed by selecting an AIREP/PIREP on the Map or Weather (WX) pages.

1. While viewing a Map or Weather page, Use the small and large **MFD** knobs to move the cursor to highlight a AIREP/PIREP. Press **ENT**.
2. Press **ENT** or the small **MFD** knob to return to the Weather page.

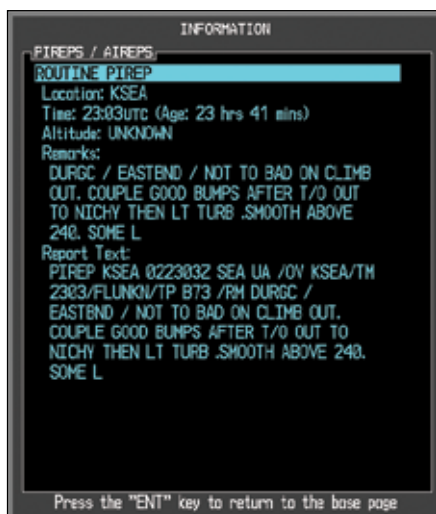

Figure 4-128 FIS-B AIREPs/PIREPs Detail and Legend

Foreword

Sec 1
System

Sec 2
PFD

Sec 3
MFD

Sec 4
Hazard
Avoidance

Sec 5
Additional
Features

Sec 6
Annun.
& Alerts

Sec 7
Symbols

Sec 8
Glossary

Appendix A

Index

4.10.5.7 METARs

Foreword



NOTE: Atmospheric pressure reported for METARs is given in hectopascals (hPa), except in the United States, where it is reported in inches of mercury (in Hg). Temperatures are reported in Celsius.

Sec 1 System



NOTE: METAR information is only displayed within the installed aviation database service area.

Sec 2 PFD

Sec 3 MFD

METAR (METEorological Aerodrome Report), known as an Aviation Routine Weather Report, is the standard format for current weather observations. METARs are updated hourly and are considered current. METARs typically contain information about the temperature, dew point, wind, precipitation, cloud cover, cloud heights, visibility, and barometric pressure. They can also contain information on precipitation amounts, lightning, and other critical data. METARs are shown as colored flags at airports that provide them.

Sec 4 Hazard Avoidance

Sec 5 Additional Features

Sec 6 Annun. & Alerts

Sec 7 Symbols

Sec 8 Glossary



Cursor Location

Selected METAR (VFR)

Figure 4-129 FIS-B Weather - Graphic METARs

Appendix A

METAR Viewing Range

Index

The METAR Viewing Range option allows you to select the map range where at and below that value METAR weather products will be shown on the selected MFD FIS-B Weather Map page (1, 2, or 3). When Off is selected, METARs will not be shown. For a value (such as 150 NM) selected, METAR data will be shown at map ranges of that value (150 NM), and lower.

1. While viewing a FIS-B Weather Map page of the WX page group, press the **MENU** key to display the Page Menu Options. The cursor flashes on the “Weather Setup” option. Press **ENT**.
2. Turn the large **MFD** knob to highlight the METAR Data Viewing Range value.
3. Turn the small **MFD** knob to highlight the desired value. Press **ENT** to accept the displayed value. The next option will be highlighted.
4. Press the small **MFD** knob to cancel selection or to end editing and return to the Navigation Map page or turn the large **MFD** knob to the next option.

Viewing Textual METARs

Textual METARs can be viewed by selecting an airport on the Map or Weather (WX) pages.

1. While viewing a Map or Weather page, Use the small and large **MFD** knobs to move the cursor to highlight an airport with a METAR flag. Press **ENT**.
2. The Waypoint Information page for that airport will now be shown. Press the **WX** soft key to view weather information for the waypoint.



Figure 4-130 FIS-B Weather - Textual METARs

4.10.5.8 Winds Aloft

Winds Aloft data shows the forecast wind speed and direction at the surface and at selected altitudes. Altitudes can be selected in 3000 foot increments from the surface up to 42,000 feet MSL by pressing the **WX Alt Dn** or **WX Alt Up** soft keys.



Figure 4-131 FIS-B Weather - Winds Aloft Legend

The Winds Aloft Data Viewing Range option allows you to select the map range where at and below that value Winds Aloft weather products will appear on the selected MFD FIS-B Weather Map page (1, 2, or 3). When Off is selected, Winds Aloft will not be shown. For the value (such as 150 NM) selected, Winds Aloft data will be shown at map ranges of that value (such as 150 NM), and lower.

1. While viewing a FIS-B Weather Map page of the WX page group, press the **MENU** key to display the Page Menu Options. The cursor flashes on the "Weather Setup" option. Press **ENT**.
2. Turn the large **MFD** knob to highlight the Winds Aloft Data Viewing Range value.
3. Turn the small **MFD** knob to highlight the desired value. Press **ENT** to accept the displayed value. The next option will be highlighted.
4. Press the small **MFD** knob to cancel selection or to end editing and return to the Navigation Map page or turn the large **MFD** knob to the next option.

4.10.5.9 FIS-B TFRs

Temporary Flight Restrictions (TFRs) provide detailed information for local short term restrictions.



Select TFR Outline
To View Details

TFR Detail

Figure 4-132 FIS-B Weather - TFRs

The Temporary Flight Restriction (TFR) viewing range option selects whether TFR information is shown on the FIS-B Weather Map. TFR information will be shown at and below the selected map range. When Off is selected, the information will not be shown. For the value (such as 500 NM) selected, TFR information will be shown at map ranges of that value (500 NM), and lower.

1. While viewing a FIS-B Weather Map page of the WX page group, turn the large **MFD** knob to highlight the TFR Data Viewing Range option.
2. Turn the small **MFD** knob to change the highlighted value.
3. Press **ENT** to accept the displayed value.
4. Press the small **MFD** knob to cancel selection or to end editing and return to the FIS-B Weather Map page.

Viewing Textual TFRs

Textual TFRs can be viewed by selecting a TFR outline on the Weather (WX) pages.

1. While viewing a Weather page, Use the small and large **MFD** knobs to move the cursor to highlight a TFR outline (yellow circle). Press **ENT**.
2. A summary of the TFR will be shown and the first TFR will be highlighted. In the case of multiple TFRs, turn the small or large **MFD** knobs to highlight the desired TFR.
3. Press the **VIEW TEXT** soft key to view the full TFR text.
4. Press **ENT** to return to the Weather page.



Figure 4-133 FIS-B Weather - Textual TFRs and Legend

- Foreword
- Sec 1 System
- Sec 2 PFD
- Sec 3 MFD
- Sec 4 Hazard Avoidance**
- Sec 5 Additional Features
- Sec 6 Annun. & Alerts
- Sec 7 Symbols
- Sec 8 Glossary
- Appendix A
- Index

4.11 StormScope



NOTE: Refer to the *WX-500 Pilot's Guide* for a detailed description of the *WX-500 StormScope*.

The WX-500 StormScope Weather Mapping Sensor is a passive weather avoidance system that detects electrical discharges associated with thunderstorms within a 200 NM radius of the aircraft. StormScope measures relative bearing and distance of thunderstorm-related electrical activity and reports the information to the display. **Interfaces are currently only available for the WX-500 StormScope System.**

For lightning display interpretation, study the examples in the WX-500 Pilot's Guide that are designed to help you relate the cell or strike patterns shown on the display to the size and location of thunderstorms that may be near your aircraft.

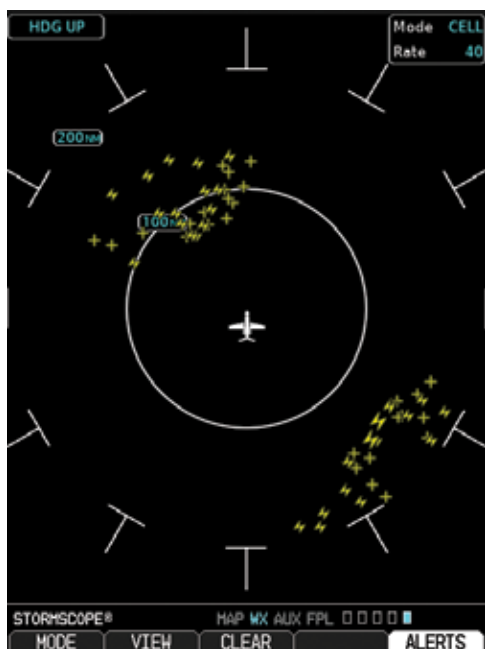

Figure 4-134 Stormscope





Symbol	Time Since Strike (Seconds)
	Less than 6
	Less than 60
	Less than 120
	Less than 180

Table 4-28 Stormscope Symbols

Mode

The Mode selection allows you to select the display of storm cells or strikes.



NOTE: Cell mode uses a clustering program to identify clusters of electrical activity that indicate cells. Cell mode is most useful during periods of heavy storm activity. Displaying cell data during these periods frees the user from sifting through a screen full of discharge points and helps to better determine where the storm cells are located.

View

The Mode selection allows you to select 360° or Arc views.

Clearing the StormScope Page

Routinely clearing the StormScope Page of all discharge points is a good way to determine if a storm is building or dissipating. In a building storm discharge points reappear faster and in larger numbers. In a dissipating storm discharge points appear slower and in smaller numbers.

1. While viewing the Weather StormScope page, press the **Clear** key to clear lightning strikes.
2. Lightning strikes will be cleared from the display and the Rate value will be reset.



NOTE: When Heading is not available (N/A), the pilot must clear the strikes after each turn.

5 ADDITIONAL FEATURES (OPTIONAL)



NOTE: The availability of SafeTaxi, ChartView, or FliteCharts in electronic form may not preclude the requirement to carry paper charts aboard the aircraft. See the AFMS for more information.



NOTE: ChartView is an optional feature that requires enablement by a Garmin dealer.

Additional features of the GDU 620 include the following:

- ChartView and FliteCharts electronic charts
- SafeTaxi diagrams
- SiriusXM Satellite Radio entertainment
- SiriusXM WX Satellite Weather (covered in Section 4.7)
- Traffic (covered in Sections 4.5 and 4.6)
- Synthetic Vision Technology (SVT)

The optional ChartView and FliteCharts provide on-board electronic terminal procedures charts. Electronic charts offer the convenience of rapid access to essential information. Either ChartView or FliteCharts may be configured in the system.

SafeTaxi diagrams provide detailed taxiway, runway, and ramp information at more than 700 airports in the United States. By decreasing the range on an airport that has a SafeTaxi diagram available, a close up view of the airport layout can be seen.

The optional SiriusXM Satellite Radio entertainment audio feature of the GDL 69A Data Link Receiver handles more than 170 channels of music, news, and sports. SiriusXM Satellite Radio offers more entertainment choices and longer range coverage than commercial broadcast stations.

XM WX Satellite Weather is an optional service that provides the ability to display graphic weather data overlaid on the MFD Nav Map and Weather Data Link pages.

The Traffic Map Page shows surrounding TAS or TIS traffic data in relation to the aircraft's current position and altitude. The Traffic option is designed to assist in detection and avoidance of other aircraft.

The optional Synthetic Vision Technology (SVT) is a visual enhancement to the G500/G600. SVT is displayed as a forward-looking display of the topography immediately in front of the aircraft. SVT information is shown on the primary flight display (PFD).

5.1 FliteCharts and ChartView

When the Chart feature is available, charts will be shown on the third page of the Flight Plan page group. The Chart page will default to the nearest airport if no flight plan or destination airport is present. While you are on the ground, the displayed charts will default to the current airport location regardless of flight plan.

Both ChartView and FliteCharts may be geo-referenced. The icon will have an “x” through it the selected chart does not support geo-referencing.



NOTE: *The availability of SafeTaxi, ChartView, or FliteCharts in electronic form may not preclude the requirement to carry paper charts aboard the aircraft. See the AFMS for more information.*

NOTE: *The Chart feature provides a digital representation of a paper chart and provides no vertical or lateral course guidance. Flight Plan and Procedures are separate from charts, and do provide vertical and lateral course guidance for the loaded route or procedure shown on the Flight Plan page. The term “Chart Unavailable” means that the chart cannot be viewed on the Chart page due to either a chart not being published, or an error in the chart database, but does not preclude its availability or inclusion of the procedure in the Flight Plan or Procedures portion of the system. The absence of a chart for a particular Departure, Arrival, or Approach does not preclude its availability or inclusion in the Flight Plan. The absence of a particular Departure, Arrival, or Approach under the Flight Plan does not preclude the ability to view the chart.*

NOTE: *Do not use SafeTaxi or Chartview functions as the basis for ground maneuvering. SafeTaxi and Chartview functions do not comply with the requirements of AC 20-159 and are not qualified to be used as an airport moving map display (AMMD). SafeTaxi and Chartview are to be used by the flight crew to orient themselves on the airport surface to improve pilot situational awareness during ground operations.*



NOTE: The chart for the destination airport or loaded approach will automatically be selected.

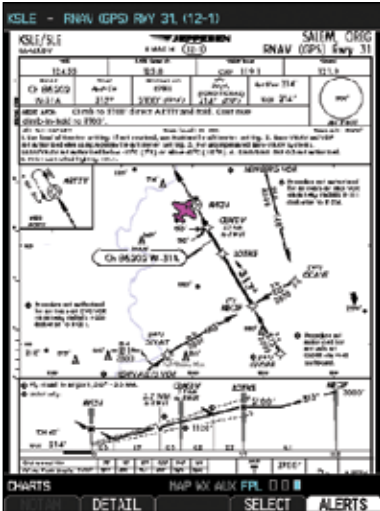

Figure 5-1 ChartView Chart Page

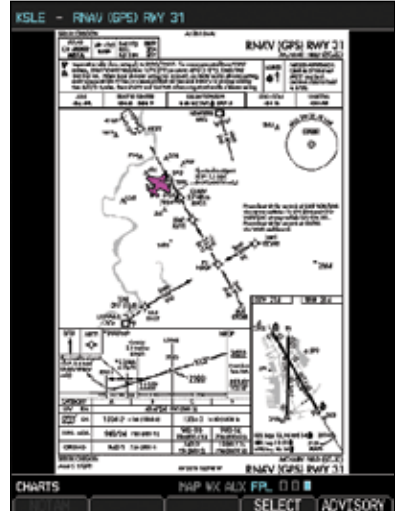

Figure 5-2 FliteChart Chart Page

1. Turn the large **MFD** knob to the Flight Plan (FPL) page group.
2. Turn the small **MFD** knob to the Chart page.

5.1.1 ChartView (Optional)

ChartView resembles the paper version of Jeppesen terminal procedures charts. The charts are displayed in full color with high-resolution. The MFD depiction shows the aircraft position on the moving map in the plan view of approach charts and on airport diagrams.

The ChartView database subscription is available from Jeppesen, Inc. ChartView is an optional feature that requires enablement by a Garmin dealer. Available data includes:

- Arrivals (STAR)
- Departure Procedures (DP)
- Approaches
- Airport Diagrams
- Chart NOTAMs

Foreword

Sec 1
System

Sec 2
PFD

Sec 3
MFD

Sec 4
Avoidance
Hazard

Sec 5
Additional
Features

Sec 6
& Alerts
Annun.

Sec 7
Symbols

Sec 8
Glossary

Appendix A

Index

Cycle Number and Revision

The ChartView database is revised every 14 days. Charts are still viewable during a period that extends from the cycle expiration date to the disables date. ChartView is disabled 70 days after the expiration date and is no longer available for viewing upon reaching the disable date. When turning on the GDU 620, the Power-up Page indicates any of nine different possible criteria for ChartView availability. See the table below for the various ChartView Power-up Page displays and the definition of each.

5.1.2 FliteCharts

FliteCharts resemble the paper version of FAA-published terminal procedures charts. FliteChart data may also be provided by sources other than the FAA. The charts are displayed with high-resolution and in color for applicable charts. The MFD FliteCharts depiction shows the aircraft position on the moving map in the plan view of approach charts.

FliteCharts database subscription is available from Garmin. Available data includes:

- Arrivals (STAR)
- Departure Procedures (DP)
- Approaches
- Airport Diagrams (not geo-referenced)

Cycle Number and Revision

FliteCharts data is revised every 28 days. Charts are still viewable during a period that extends from the cycle expiration date to the disables date. FliteCharts is disabled 180 days after the expiration date and are no longer available for viewing upon reaching the disables date. When turning on the GDU 620, the Power-up page indicates any of five different possible criteria for chart availability. These indications are whether the databases are not configured, not available, current, out of date, or disabled. See table 5-1 for the various FliteCharts Power-up page displays and the definition of each.

Foreword

Sec 1 System

Sec 2 PFD

Sec 3 MFD

Sec 4 Hazard Avoidance

Sec 5 Additional Features

Sec 6 Annun. & Alerts

Sec 7 Symbols

Sec 8 Glossary

Appendix A

Index

5.1.3 Determining Chart Database Type, Coverage, and Currency

Chart Database Type

Select the **DBASE** soft key for scrolling through the database information. Scroll through the database with the **MFD** knob or **ENT** key.

1. Turn the large **MFD** knob to select AUX.
2. Press the **DB ACTV** key to view the databases.
3. Press the small **MFD** knob and then turn the small or large **MFD** knobs to highlight Chart Type. The field will show Not Available, ChartView, or FliteCharts.

CHART CYCLE	1505
CHART TYPE	Jeppesen ChartView
CHART EXPIRES	12-MAR-15
CHART DISABLES	21-MAY-15

Figure 5-3 ChartView Database Information

CHART REGION	US
CHART CYCLE	1503
CHART TYPE	FliteCharts
CHART EFFECTIVE	05-MAR-15
CHART EXPIRES	02-APR-15
CHART DISABLES	29-SEP-15

Figure 5-4 FliteChart Database Information

Chart Coverage















The chart databases cover the area that was selecting during the download process. FliteCharts will note the region covered by the installed chart database; ChartView does not.

Chart Currency



NOTE: Messages displayed in yellow also appear in a message banner along the bottom of the Chart page.

The date currency of the installed chart databases are shown both during power-up and on the AUX - System Status page.

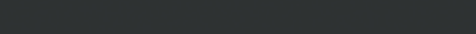
Power-up Page Display		Definition
Foreword	 FliteCharts 1408, Effective 24-JUL-2014	Database's effective date is in the future. [2]
Sec 1 System	 FliteCharts 1408, Effective 24-JUL-2014	Database's effective date is the current day. [1] [2]
Sec 2 PFD	 ChartView 1503, Expires 12-FEB-2015	Current date is unknown (e.g., no GPS fix yet).
	 FliteCharts 1408, Expires 21-AUG-2014	
Sec 3 MFD	 ChartView 1503, Expires 12-FEB-2015	Database is active.
	 FliteCharts 1408, Expires 21-AUG-2014	
Sec 4 Hazard Avoidance	 ChartView 1503, Expires 12-FEB-2015	Database's expiration date is the current day. [1]
	 FliteCharts 1408, Expires 21-AUG-2014	
Sec 5 Additional Features	 ChartView 1503, Expired 12-FEB-2015	Database's expiration date has passed. Expired notes that the database expired less than 70 days ago, but may still be used.
	 FliteCharts 1408, Expired 21-AUG-2014	
Sec 6 Annun. & Alerts	 ChartView 1503, Disabled 23-APR-2015	Database's disable data has passed. Disabled notes that the database expired more than 70 days ago and is no longer available for use.
	 FliteCharts 1408, Disabled 17-FEB-2015	
Sec 7 Symbols	 Chart Data Verifying...	System is verifying database when new cycle is installed.
Sec 8 Glossary	 Chart Data Corrupt!	Database verification failed.
	 Chart Data N/A	No database is installed.
Appendix A		Blank line. GDU 620 system is not configured for any chart data. Contact a Garmin-authorized service center for configuration.

[1] When the effective or expiration date is the current day, the following message is displayed at the bottom of the page: "Check local rules for database effective times."
 [2] ChartView does not have "Effective" dates.

Table 5-1 Power-up Page Annunciations and Definitions

5.1.4 Selecting a Chart



NOTE: When the charts database synchronizes with another LRU, and Chart Streaming is not available, a message banner at the bottom of the Chart page displays “Getting newer charts.” This process can take several minutes.

The G500/G600 will only allow the pilot to select the chart type in normal mode if it is configured for ChartView. When in-air, the pilot cannot select the field to change the chart source, and a small message is displayed underneath the Chart Type line that reads “Chart Type can only be changed when on ground”. The ability to select a chart type is absent from normal mode if configured for FliteCharts.

5.1.4.1 Selecting FliteCharts or ChartView

When configured during installation and when both chart types are available, you can select which chart type will be used. Only one chart type can be used at a time.



Figure 5-5 Chart NOTAM

1. Turn the large **MFD** knob to highlight the Chart Type sections.
2. Turn the small **MFD** knob to select ChartView or FliteCharts.
3. Press the **ENT** key to save the selected value.
4. Changing chart type requires a restart of the unit. With OK selected, press the **ENT** key to restart the unit and change to the selected chart type.



Figure 5-6 Changing Chart Type

5.1.4.2 Selecting a New Chart by FPL, NRST, or RECENT

You may select other charts to display based on your flight plan (FPL), charts of the nearest airport (NRST), or your most recently selected airports (RECENT).



Figure 5-7 Chart Category Selection

1. While viewing the Chart page of the FPL page group, press the **SELECT** soft key.
2. Turn the small **MFD** knob counterclockwise to show FPL, NRST, or RECENT.
3. Turn the large **MFD** knob to select the desired identifier and then press **ENT**.

5.1.4.3 Selecting a Chart Manually

A chart for a different airport may be chosen by selecting the identifier for the desired airport.

Airport Identifier Selection —

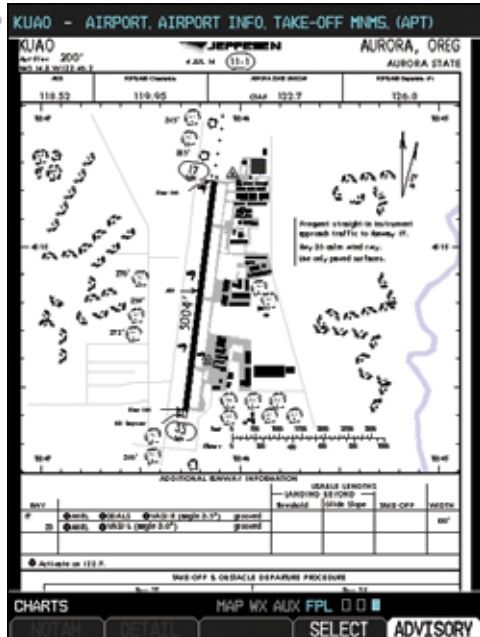

Figure 5-8 Airport Identifier Selection

1. While viewing the Chart page of the FPL page group, press the **SELECT** soft key to change the airport.
2. Use the small **MFD** knob to change the character.
3. Use the large **MFD** knob to move the cursor to highlight a character.
4. Press **ENT** to accept the selected airport.

5.1.4.4 Chart Auto-Selection

The Chart page will automatically select a chart to display when the page is opened.



NOTE: *The chart for the destination airport or loaded approach will automatically be selected.*

- While on the ground, the nearest airport diagram will be displayed.
- If an approach is loaded in the selected GPS navigator, the chart for that approach will be displayed. In some cases, the pilot may be prompted to select the correct chart from a list of possible matches.
- If an approach is not loaded, the airport diagram for the destination airport will be displayed.
- If no destination airport exists, the nearest airport diagram will be displayed.



NOTE: *Automatic chart selection only occurs when the Chart page is opened. For example, if a new approach is loaded while the Chart page is open, a different MFD page must be selected and the Chart page re-opened for the new approach chart to be automatically displayed.*

When the pilot has manually selected a chart to display, a different chart will not be automatically selected until one of the following events occurs:

- The aircraft takes off or lands
 - A new or different approach is loaded
1. While viewing the Chart page of the FPL page group, press the **SELECT** soft key to activate chart selection.
 2. Turn the large **MFD** knob to highlight the field to the right of the airport identifier.

3. Turn the small **MFD** knob to highlight the desired chart.

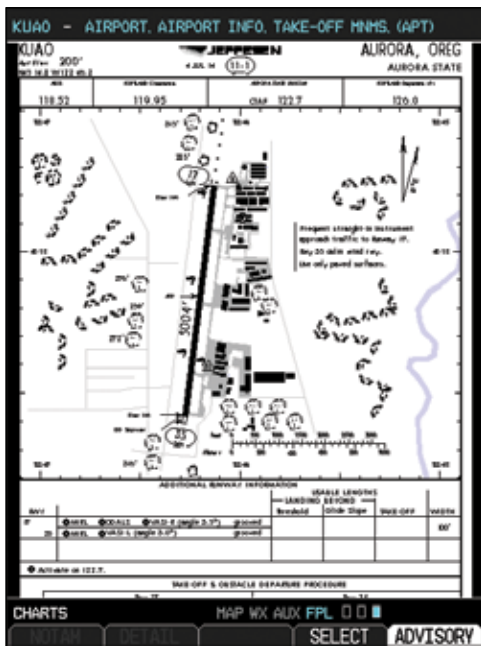

Figure 5-9 Activate Chart Selection for the Current Airport (ChartView)

4. Press **ENT** to accept and view the selected chart.

Foreword

Sec 1
System

Sec 2
PFD

Sec 3
MFD

Sec 4
Hazard
Avoidance

**Sec 5
Additional
Features**

Sec 6
Annun.
& Alerts

Sec 7
Symbols

Sec 8
Glossary

Appendix A

Index

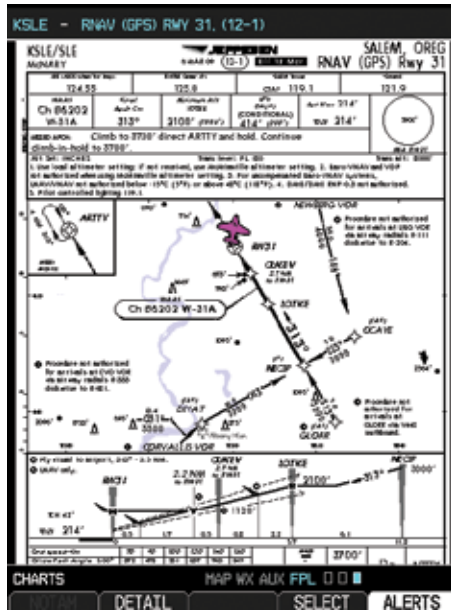

Figure 5-10 Selected Chart for the Current Airport (ChartView)

5.1.5 Using Charts

More detail on the displayed chart can be viewed by zooming in with the Range keys and moving the chart around with pan mode. The Detail soft key allows access to more details for the currently displayed chart.

5.1.5.1 Chart Zooming and Panning

Chart zooming and Panning allows viewing charts closer to examine details.



NOTE: Panning mode is indicated by the presence of scroll bars.

Foreword

Sec 1
System

Sec 2
PFD

Sec 3
MFD

Sec 4
Hazard
Avoidance

Sec 5
Additional
Features

Sec 6
Annun.
& Alerts

Sec 7
Symbols

Sec 8
Glossary

Appendix A

Index

5.1.5.2 Viewing Chart Details in ChartView



NOTE: The chart for the destination airport or loaded approach will automatically be selected.



NOTE: Chart details are only available for instrument approach procedure charts. Chart details are not available for airport diagrams or SID/STAR charts.

1. Press the **Detail** key to view detailed views of the current chart. The **Detail** key is only available with ChartView.

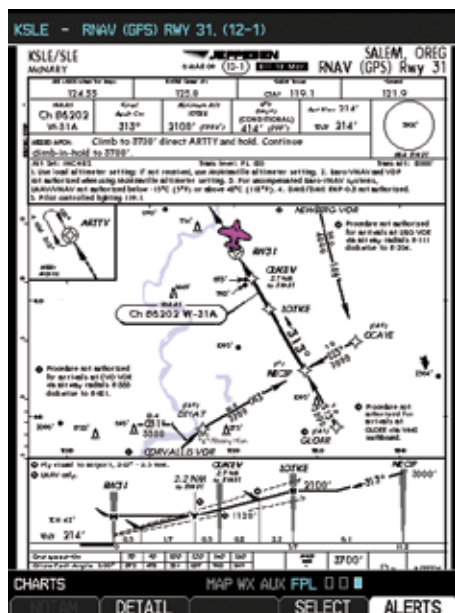

Figure 5-12 Selected Chart for the Current Airport (ChartView)

- Press the **Header, Plan, Profile, or Minimums** keys to view detailed sections for the chart for those topics. An aircraft icon will show in the lower right corner of the display if your aircraft is in the chart area.



Figure 5-13 Detail of the Selected Chart (Header Shown)

- Press the **Back** key to return to the view of the full chart.

5.1.5.3 Setting the Altitude Minimums Alerter

1. While viewing the Chart page of the FPL page group, press the **Menu** key. With the Set Minimums item highlighted, press **ENT**.
2. With the Minimums Source highlighted, select the Altitude Minimums Alerter source with small **MFD** knob.



Figure 5-14 Minimums Source Selection

3. Turn the large **MFD** knob to highlight the Altitude Minimums value. Turn the large and small **MFD** knobs to change the Altitude Minimums value and then press **ENT** to activate the selected value.



Figure 5-15 Minimums Altitude Selection

Alerting is inhibited while the aircraft is on the ground and until the aircraft reaches 150 feet above the MDA. The Minimum altitude will be available in the Altitude Alerter.

In dual installations, the minimums alerting altitude value may be set from either GDU 620 and will be synchronized on both units.



NOTE: If you highlight the Minimums Altitude field on the FPL page and press the CLR key, it will turn the minimums functionality off.

5.1.5.4 Viewing Chart NOTAMs

If an active NOTAM (Notice to Airmen) exists for the selected chart, the **NOTAM** soft key will be available. Press the **NOTAM** soft key to view the NOTAM or select View NOTAMs from the Chart Options menu.



Figure 5-16 Chart NOTAM

Foreword

Sec 1
System

Sec 2
PFD

Sec 3
MFD

Sec 4
Hazard
Avoidance

Sec 5
Additional
Features

Sec 6
Annun.
& Alerts

Sec 7
Symbols

Sec 8
Glossary

Appendix A

Index

5.1.5.5 Day/Night View

Chart pages can be displayed on a white or black background for day or night viewing. The Day View offers a better presentation in a bright environment. The Night View gives a better presentation for viewing in a dark environment. .

When AUTO is selected, it allows the user to set a threshold for the transition between the Day and Night color schemes.



Figure 5-17 Chart Color Scheme Auto Selection and Aux Display Brightness

The threshold is compared to the Display Brightness Level that is displayed on the Aux System Setup page. If the color scheme percentage on the Chart Setup page is less than the display brightness percentage selected on the Aux System Setup page, then the Chart AUTO Color Scheme will draw the chart as though the NIGHT scheme were selected. Otherwise, the AUTO scheme will draw the chart as though the DAY scheme were selected.

1. In the FPL page group, turn the small **MFD** knob to reach the Chart page.
2. Press **MENU** to display the Options menu.
3. Press **ENT** to go to Chart Setup. The Color Scheme option will be highlighted.
4. Turn the small **MFD** knob to select Day - AUTO - Night.
5. If Auto is selected, turn the large **MFD** knob CW to the percentage value and turn the small **MFD** knob to change the value.
6. Press the small **MFD** knob or the **ENT** key to save the selected value and return to the Chart page.



NOTE: Once an adjustment is made to the percentage field in Auto mode, the chart must be redrawn (zoomed in or out, or another chart selected) before the switch from Day to Night is seen.

5.2 SafeTaxi

SafeTaxi is an enhanced feature that gives greater map detail when zooming in on airports at close range. The airport display on the map reveals runways with numbers, taxiways with identifying letters/numbers, airport Hot Spots, and airport landmarks including ramps, buildings, control towers, and other prominent features. Resolution is greater at lower map ranges. When the aircraft location is within the screen boundary, including within SafeTaxi ranges, an aircraft symbol is shown on any of the navigation map views for enhanced position awareness.

Designated Hot Spots are recognized at airports with many intersecting taxiways and runways, and/or complex ramp areas. Airport Hot Spots are outlined to caution pilots of areas on an airport surface where positional awareness confusion or runway incursions happen most often. Hot Spots are defined with a magenta circle or outline around the region of possible confusion.



Figure 5-18 SafeTaxi Depiction on the Navigation Map Page

NOTE: Do not use SafeTaxi or Chartview functions as the basis for ground maneuvering. SafeTaxi and Chartview functions do not comply with the requirements of AC 20-159 and are not qualified to be used as an airport moving map display (AMMD). SafeTaxi and Chartview are to be used by the flight crew to orient themselves on the airport surface to improve pilot situational awareness during ground operations.

5.2.1 Using SafeTaxi

Any map page that displays the navigation view can also show the SafeTaxi® airport layout within the maximum configured range. The following is a list of pages where the SafeTaxi feature can be seen:

- Navigation Map Page
- Weather Data Link Page
- Airport Information Page
- Intersection Information Page
- NDB Information Page
- VOR Information Page
- User Waypoint Information Page

During ground operations the aircraft's position is displayed in reference to taxiways, runways, and airport features. When panning over the airport, features such as runway holding lines and taxiways are shown.

5.2.1.1 Decluttering

The **DCLTR** soft key (declutter) label advances to DCLTR-1, DCLTR -2, and DCLTR-3 each time the soft key is selected for easy recognition of decluttering level. Selecting the **DCLTR** soft key removes the taxiway markings and airport feature labels. Selecting the **DCLTR-1** soft key removes VOR station ID, the VOR symbol, and intersection names if within the airport plan view. Selecting the **DCLTR-2** soft key removes the airport runway layout, unless the airport in view is part of an active route structure. Pressing the **DCLTR-3** soft key cycles back to the original map detail. With Auto-Zoom enabled, the map will automatically zoom to 1 NM and DCLTR-0 upon landing so SafeTaxi can be viewed. For additional information, refer to section 3.1.

5.2.1.2 Hot Spot Information

Hot Spots can contain more information about the area that can be displayed when selected.

1. While viewing the Hot Spot area on the Navigation Map page, press the small **MFD** knob to activate the cursor.
2. Turn the **MFD** knobs to move the cursor on the Hot Spot border or into the Hot Spot area and then press the **ENT** key.

Hot Spot Name Location Info



Figure 5-19 SafeTaxi Hot Spot Information

- An information window will be shown on the MFD. After viewing, press the small **MFD** knob, **CLR**, or **ENT** keys to remove the information window. Press the small **MFD** knob again to cancel the cursor.

5.2.2 SafeTaxi Cycle Number and Revision

The SafeTaxi database is revised every 56 days. SafeTaxi is always available for use after the expiration date. When turning on the GDU 620, the Power-up Page indicates whether the databases are current, out of date, or not available. The Power-up Page shows the SafeTaxi database is current when the “SafeTaxi Expires” date is shown in white. When the SafeTaxi cycle has expired, the “SafeTaxi Expires” date appears in yellow. The message “SafeTaxi: N/A” appears in white if no SafeTaxi data is available on the database card.



Figure 5-20 Power-up Page, SafeTaxi Database

The SafeTaxi Region, Version, Cycle, Effective date and Expires date of the database cycle can also be found on the AUX - System Status page. SafeTaxi information appears in white and yellow text. The EFFECTIVE date appears in white when data is current and in yellow when the current date is before the effective date. The EXPIRES date appears in white when data is current and in yellow when expired. SafeTaxi REGION NOT AVAILABLE appears in white if SafeTaxi data is not available on the database card. Expired SafeTaxi data is never disabled.

5.3 SiriusXM Satellite Radio Entertainment



NOTE: Refer to section 4 for information about SiriusXM WX Satellite Weather products.

The optional SiriusXM Satellite Radio entertainment feature of the GDL 69A Data Link Receiver is available for the pilot's and passengers' enjoyment. The GDL 69A can receive SiriusXM Satellite Radio entertainment services at any altitude throughout the Continental U.S. Entertainment audio is not available on the GDL 69 Data Link Receiver.

SiriusXM Satellite Radio offers a variety of radio programming over long distances without having to constantly search for new stations. Based on signals from satellites, coverage far exceeds land-based transmissions. SiriusXM Satellite Radio services are subscription-based. For more information on specific service packages, visit <https://www.siriusxm.com/sxmaviation>.

5.3.1 Activating SiriusXM Satellite Radio Services

The service is activated by providing SiriusXM Satellite Radio with either one or two coded IDs, depending on the equipment. Either the Audio Radio ID or the Data Radio ID, or both, must be provided to SiriusXM Satellite Radio to activate the entertainment subscription. The SiriusXM Satellite Radio Activation Instructions are included with the unit (also available at flyGarmin.com, P/N 190-00355-04).

SiriusXM Satellite Radio and Weather subscriptions are sold separately. It is not required to activate both the entertainment and weather service subscriptions with the GDL 69A. Either or both services can be activated. SiriusXM Satellite Radio uses one or both of the coded IDs to send an activation signal that, when received by the GDL 69A, allows it to play entertainment programming.

These IDs are located:

- On the label on the back of the Data Link Receiver
- On the XM Information Page on the MFD

Contact the installer if the Data Radio ID and the Audio Radio ID cannot be located.



NOTE: The **LOCK** soft key on the XM Information Page (Auxiliary Page Group) is used to save GDL 69A activation data when the SiriusXM Satellite Radio services are initially set up. It is not used during normal SiriusXM Satellite Radio operation, but there should be no adverse effects if inadvertently selected during flight. Refer to the GDL 69/69A SiriusXM Satellite Radio Activation Instructions (190-00355-04, Rev G, or later) for further information.

If XM WX Satellite weather services have not been activated, the weather product names will be displayed in gray (see below) on the XM Information Page and a yellow Activation Required message is displayed in the center of the Weather Data Link Page (Map Page Group). The Service Class refers to the groupings of weather products available for subscription.

Foreword

Sec 1
System

Sec 2
PFD

Sec 3
MFD

Sec 4
Hazard
Avoidance

Sec 5
Additional
Features

Sec 6
Annun.
& Alerts

Sec 7
Symbols

Sec 8
Glossary

Appendix A

Index

5.3.2 SiriusXM Satellite Radio Information

The Aux mode XM Information page displays information about the SiriusXM Satellite radios, service class, and products when the GDL 69/69A is installed and the SiriusXM Satellite Radio service is activated. The Data and Audio radios have separate Identification Numbers. The Service Class determines the features that are available. Products that are not part of the subscription are displayed in gray. Products that are part of the active subscription, but are waiting to receive data are white. Products that are part of the active subscription and have data are green.



Figure 5-21 SiriusXM Satellite Radio Information

1. In the AUX page group, turn the small **MFD** knob to display XM Information.
2. The **LOCK** soft key is used to “lock” your SiriusXM Satellite Radio subscription activation. This is only used for the initial subscription or to make a change.



NOTE: Refer to the *GDL 69/69A SiriusXM Satellite Radio Activation Instructions (190-00355-04, Rev G, or later)* for further information.

5.3.3 SiriusXM Satellite Radio Entertainment

Audio entertainment is available through the SiriusXM Satellite Radio Service when activated in the optional installation of the GDL 69A. The GDU 620 serves as the display and control head for your remotely mounted GDL 69A. SiriusXM Satellite Radio allows you to enjoy a variety of radio programming over long distances without having to constantly search for new stations. Based on signal from satellites, coverage far exceeds land-based transmissions. When enabled, the SiriusXM Satellite Radio audio entertainment is accessible in Aux page group.

The information on the SiriusXM Satellite Radio display is composed of four areas: the Active Channel, Available Channels, Category of the highlighted channel, and the Volume setting. The Active Channel window shows the Channel Name and Number, Artist, Song Title, and Category.

1. Turn the large **MFD** knob to Aux Mode.
2. Turn the small **MFD** knob to the XM Radio page.

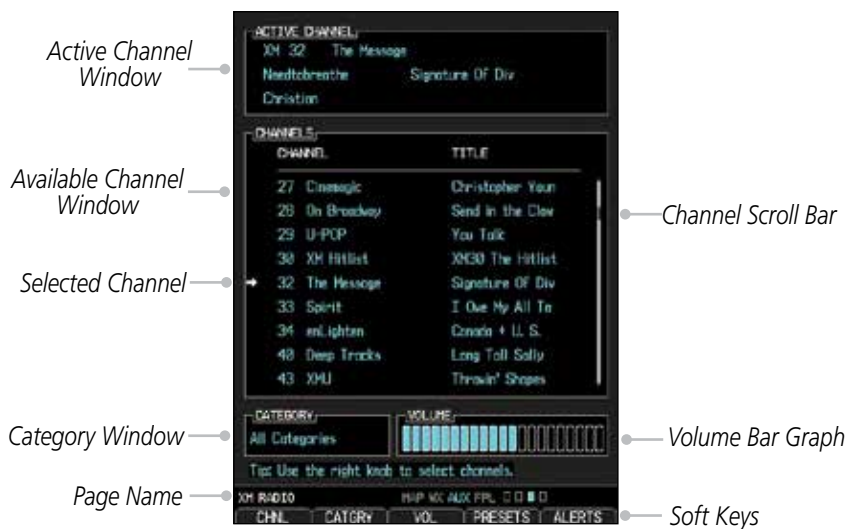

Figure 5-22 SiriusXM Satellite Radio

5.3.3.1 Channel Categories

The Category window displays the currently selected category of audio. Categories of channels, such as Jazz, Rock, or News, can be selected to list the available channels for a type of music or other contents.

1. While viewing the XM Radio page of the AUX page group, press the **CATGRY** soft key to activate Category selection.
2. Turn the small **MFD** knob to select the desired category. When the MFD knob is turned to select a category, the soft keys will not be shown.



Figure 5-23 XM Category List

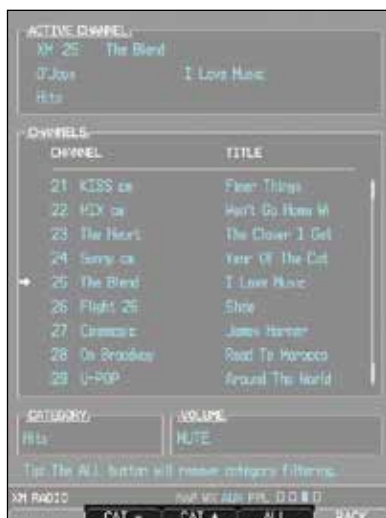

Figure 5-24 XM Category Soft Keys

3. Press **ENT** to display the list of channels for the highlighted category in the Channels window.
4. Press the small **MFD** knob to cancel selection or to end editing.
OR
1. Press **CATGRY** and then the **CAT +** or **CAT -** soft keys to increment up or down one category at a time.
2. Press **ALL** to show the channels for all categories. Use the large and small **MFD** knobs to select desired channel.
3. Press **ENT** to save the selection or press the small **MFD** knob to cancel selection.

5.3.3.2 Selecting a SiriusXM Satellite Radio Channel

The Channel feature is used to navigate through the channels in the selected category.

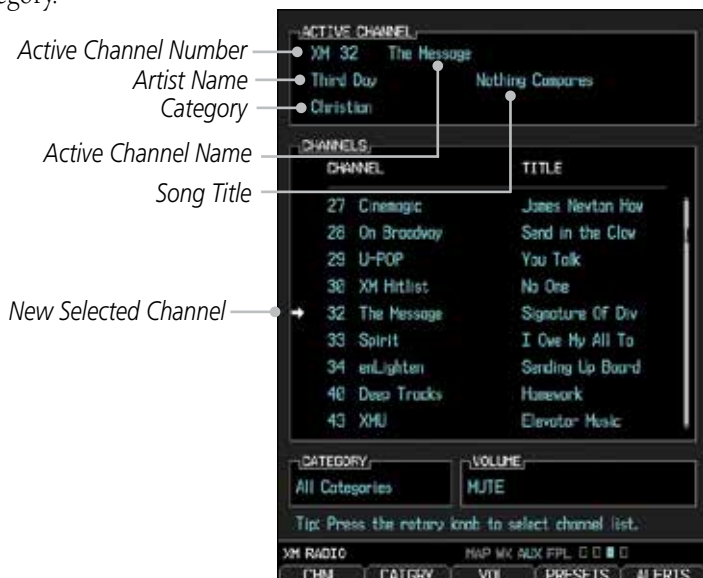

Figure 5-25 XM Channel Selection

1. While viewing the XM Radio page of the AUX page group, press the small **MFD** knob and then turn the small **MFD** knob to select the desired channel.
2. Press **ENT** to make the highlighted channel the Active Channel.



NOTE: A delay of several seconds may occur when selecting a channel. The listed title may end before the radio begins playing the current Active Channel material.

3. Press the small **MFD** knob to cancel selection or to end editing.
OR
4. Press **CHNL** and then the **CH +** or **CH -** soft keys to increment up or down one channel at a time in the active category.
OR
5. Press **CHNL** and then the **DIR CH** soft key to directly select a channel in the active category. Use the large and small **MFD** knobs to select desired channel.
6. Press **ENT** to save the selection or press the small **MFD** knob to cancel selection.

5.3.3.3 SiriusXM Satellite Radio Volume

The Volume control allows you to set the audio volume level, as well as mute the audio.



Volume Bar Graph

Volume Soft Key Label

Figure 5-26 XM Radio Volume Setting

1. While viewing the XM Radio page of the AUX page group, press the **VOL** soft key.
2. Press the **VOL +** or **VOL -** soft keys, or turn the small **MFD** knob, to adjust the radio volume.



Volume Bar Graph

Volume Soft Key Labels

Figure 5-27 XM Radio Volume Controls

3. Press **MUTE** to mute the radio volume.
4. Press **MUTE** again or the **VOL +** or **VOL -** soft keys to unmute the radio volume.

5.3.3.4 SiriusXM Satellite Radio Channel Presets

The **PRESET** soft key allows you to store the Active Channel into a selected preset position for easy later recall. A delay of several seconds can occur when setting or recalling a preset.



Figure 5-28 XM Radio Presets

Setting a Preset

1. While viewing the XM Radio page of the AUX page group, you may set a preset for the Active Channel. Press the **PRESETS** soft key.
2. Press and hold a preset soft key, such as **PS1**.
3. Press the **MORE** soft key to display the next series of presets.

Recalling a Preset

1. While viewing the XM Radio page of the AUX page group, press the **PRESETS** soft key.
2. Press the preset soft key for the desired stored channel, such as **PS1**.
3. Press the **MORE** soft key to display the next series of presets.

5.3.4 GDL 69/69A Data Link Receiver Troubleshooting

Some quick troubleshooting steps listed below can be performed to find the possible cause of a failure.

- Ensure the owner/operator of the aircraft in which the Data Link Receiver is installed has subscribed to SiriusXM Satellite Radio
- Ensure the SiriusXM Satellite Radio subscription has been activated
- Perform a quick check of the circuit breakers to ensure that power is applied to the Data Link Receiver

For troubleshooting purposes, check the LRU Information Box on the AUX - System Status Page for Data Link Receiver (GDL 69/69A) status, serial number, and software version number. If a failure has been detected in the GDL 69/69A the status will be marked with a red "X."

1. Turn the large **MFD** knob to select the AUX Page Group.
2. Turn the small **MFD** knob to select the System Status Page (the last page in the AUX Page Group).

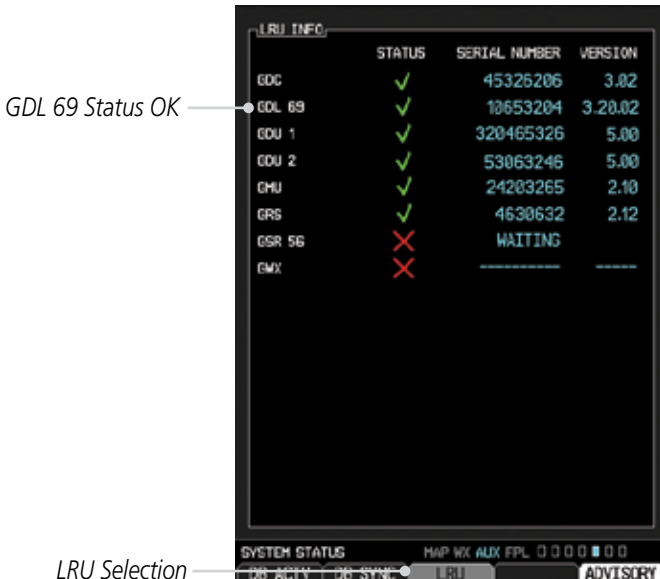

Figure 5-29 LRU Status Window

5.4 Autopilot Operation

The G500/G600 is able to interface to certain autopilot systems to provide the functions described in this section. Please refer to your particular Airplane Flight Manual and autopilot documentation for specific information and operating instructions.

5.4.1 GAD 43 Attitude

The GAD 43 Adapter may Optionally provide attitude information from a Garmin Attitude and Heading Reference System to certain autopilots. The GAD 43 has the ability to disconnect the autopilot if an error in the GAD 43 output or AHRS is detected. This disconnect mechanism must be tested prior to each flight in the following manner:

1. Allow all avionics to complete power up and begin normal operation.
2. Engage the autopilot while on the ground.
3. Press the **AP TEST** soft key and verify that the autopilot disconnects normally.



CAUTION: Do not use the autopilot if the AP TEST does not disengage the autopilot normally.

Autopilot Disconnect

When the GDU 620 attitude monitors have detected an AHRS malfunction, or the inability to actively monitor the AHRS, a “Check Attitude” annunciation will be displayed on the PFD and the autopilot will automatically disconnect.



NOTE: Only appears with the installation of an optional GAD 43 Adapter.



Figure 5-30 - Check Attitude - Autopilot Automatically Disconnected

Fly the aircraft manually and crosscheck the GDU 620 attitude indication with the standby attitude indicator and other sources of attitude information (airspeed, heading, altitude, etc.).

5.4.2 Heading

The GDU 620 heading bug may be used in conjunction with the “Heading” mode of supported autopilots. When the autopilot is in “heading” mode and the heading bug is adjusted in the normal manner, and the autopilot will turn to and maintain the selected heading. Refer to the Airplane Flight Manual and autopilot system documentation for instructions on how to use the autopilot heading mode.



Figure 5-31 Adjusting the Heading Bug

5.4.3 Altitude Capture (Optional Upgrade)

The GDU 620 altitude bug may be used to automatically capture a selected altitude with certain autopilots. Refer to the Airplane Flight Manual and autopilot system documentation for instructions on how to use the altitude preselect feature, if available.

Adjust the altitude bug in the normal manner when using the altitude capture interface. Some autopilot installations support arming and disarming of the selected altitude using the ALT key on the PFD. The PFD knob window will indicate when this function is available. The selected altitude may be alternately armed or disarmed by pressing and holding the ALT key on the PFD bezel.



Figure 5-32 Pressing and Holding the ALT Key to Arm/Disarm the Selected Altitude

5.4.4 Autopilot Navigation

The HSI may be used in conjunction with the appropriate navigation modes of supported autopilots. The GDU 620 provides the autopilot with the selected course and lateral/vertical deviations. The GDU 620 acts as a switching source between the installed navigation sources (e.g GPS/VLOC, 1-2). The navigation source that is displayed on the HSI is sent to the autopilot. Refer to the Airplane Flight Manual and autopilot system documentation for instructions on how to use the autopilot navigation functions.

GPS Steering (GPSS) provides roll command signals calculated by the GPS navigator to the autopilot in order to allow the aircraft to anticipate turns, make smooth transitions when passing waypoints, and fly leg types such as Procedure Turns and Holding Patterns. The autopilot must have the ability to interpret the GPSS commands. The G500/G600 can provide GPSS information to autopilots that have built-in support for GPSS commands, as well as to older autopilots that do not have built-in support for GPSS.

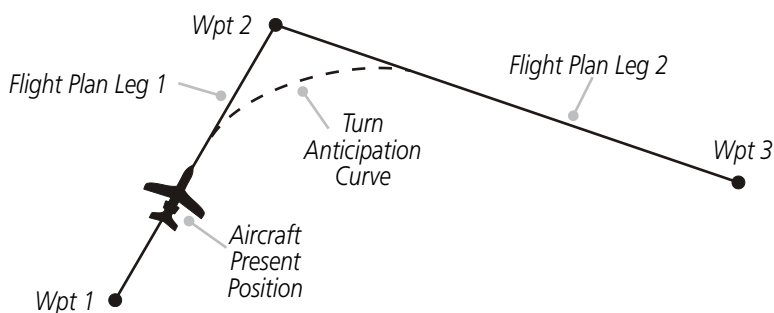

Figure 5-33 GPSS Turn Anticipation

5.4.4.1 Autopilot Operation with GPSS Enabled Autopilots

Some autopilots have built-in support for GPS Steering (GPSS) commands from a GPS navigator. The GDU 620 will send the GPSS commands from the displayed GPS source to the autopilot. For example, if GPS 1 is displayed on the HSI, the GPSS commands from GPS 1 will be sent to the autopilot. Refer to the Airplane Flight Manual and autopilot system documentation for instructions on how to use the autopilot's GPSS function.



NOTE: GPSS commands are not sent to the autopilot when a VLOC source is displayed on the HSI.

5.4.4.2 Autopilot Operation with the GDU 620 Emulating GPSS

In order to provide GPSS functionality for autopilots that do not have built-in GPSS support, the GDU 620 can convert the GPSS commands into a heading signal. When GPSS mode is turned on, the autopilot heading mode will follow the GPSS commands instead of the heading bug. Refer to the Airplane Flight Manual and autopilot system documentation for instructions on how to use the autopilot heading mode.

Depending on the installation, GPSS mode may be toggled on/off with an external switch or by pressing and holding the **HDG** key on the PFD. If the installation uses the **HDG** key on the PFD, the **PFD** knob window will display the GPSS/HDG mode options.



Figure 5-34 GPSS Mode Control with the HDG Key

When GPSS mode is on, the heading bug on the HSI changes to a hollow outline and a crossed-out heading bug appears in the PFD Knob Mode Indicator, indicating that the autopilot is not coupled to the heading bug. The bug is still controllable and may still be used by the pilot for reference. GPSS is annunciated in the lower left portion of the PFD. The GPSS mode annunciation depends on the location of the NAV STATUS information, as shown in the following figure.



Figure 5-35 GPSS Mode Annunciations

5.4.5 Flight Director Display

If autopilot flight director commands are interfaced to the G500/G600, they will be presented as a single cue flight director on the PFD. Control of the flight director is accomplished via the autopilot/flight director controller; there are no pilot controls or adjustments for the flight director on the G500/G600.

The G500/G600 system limits the distance the flight director pitch commands may deviate from the aircraft attitude icon. In the event that the pitch command provided by the autopilot flight director is greater than the distance allowed by the G500/G600, the command bars will be displayed at the maximum distance allowed by the G500/G600. As the aircraft pitch changes to satisfy the command bars, the bars will continue to be displayed at the maximum distance from the aircraft attitude icon until the aircraft pitch deviation is within the command display limit.

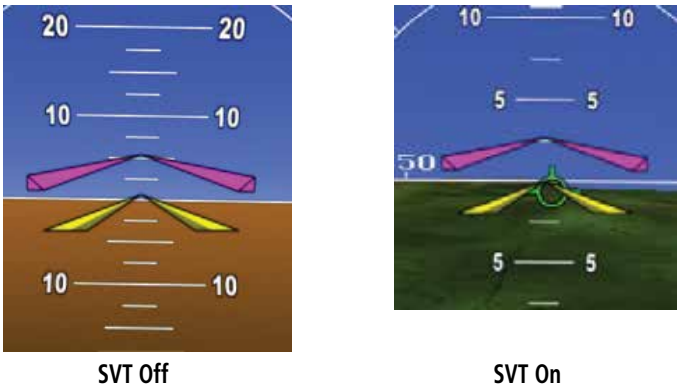

Figure 5-36 Flight Director Bars Showing Aircraft Pitch

5.4.6 Vertical Speed Control

The GDU 620 vertical speed bug may be used to control vertical speed with certain autopilots. Refer to the Airplane Flight Manual and autopilot system documentation for instructions on how to use the vertical speed mode, if available.

Adjust the vertical speed bug in the normal manner when using the vertical speed mode interface. Some autopilot installations support engaging/disengaging the vertical speed mode using the VS key on the PFD. The PFD knob window will indicate when this function is available. The vertical speed mode may be alternately engaged or disengaged by pressing and holding the VS key on the PFD bezel.



Figure 5-37 Pressing and Holding the VS Key to Engage/Disengage VS mode

- Foreword
- System Sec 1
- PFD Sec 2
- MFD Sec 3
- Avoidance Sec 4
- Hazard Sec 4
- Additional Features Sec 5
- Annun. & Alerts Sec 6
- Symbols Sec 7
- Glossary Sec 8
- Appendix A
- Index

5.4.7 Autopilot Mode Annunciations

Some autopilots support mode annunciations located at the top of the PFD. Refer to the Airplane Flight Manual and autopilot system documentation for details on the autopilot mode annunciations.

When autopilot annunciations are displayed at the top of the PFD, the Nav Status information will be located to the left of the HSI (NAV STATUS Style 2).



Figure 5-38 Autopilot Annunciations on Top of PFD

5.4.7.1 GFC 500/600 Annunciations

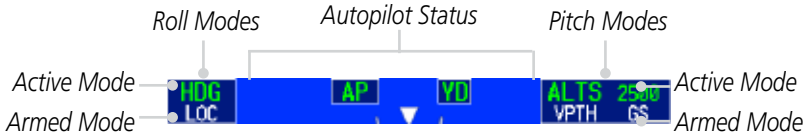

Figure 5-39 GFC Autopilot Annunciations

Mode Annunciations	
AP	Autopilot
CWS	Control Wheel Steering
PFT	Preflight test in progress
YD	Yaw Damper

Table 5-2 Autopilot Status Annunciations

Lateral Mode Annunciations	
BC	Backcourse Navigation
GPS	GPS Approach
	GPS Navigation
HDG	Heading
LVL	Level Hold
LOC	Localizer Approach
	Localizer Navigation
NAV	Navigation
ROL	Roll Hold
VAPP	VOR Approach
VOR	VOR Navigation

Vertical Mode Annunciations	
ALT	Altitude Hold
ALTS	Selected Altitude Capture
APR	Approach
GA	Go Around
GP	Glidepath
GS	Glideslope
IAS	Indicated Airspeed
LVL	Level Hold
PIT	Pitch Hold
VNAV	Vertical Navigation
VPTH	Vertical Path
VS	Vertical Speed

Table 5-3 Lateral and Vertical GFC Annunciations

Foreword

Sec 1
System

Sec 2
PFD

Sec 3
MFD

Sec 4
Hazard
Avoidance

Sec 5
Additional
Features

Sec 6
Annun.
& Alerts

Sec 7
Symbols

Sec 8
Glossary

Appendix A

Index

5.4.8 Electronic Stability & Protection (ESP™)



WARNING: Do not assume ESP will provide stability protection in all circumstances. There are in-flight situations that can exceed the capabilities of ESP technology.

The GFC 500/600 supports ESP. The ESP feature is intended to monitor the aircraft and provide control input feedback when necessary to discourage operating the aircraft at potentially unsafe attitudes and/or airspeeds. This feature will only function when the aircraft is above 200 feet AGL and the autopilot is not engaged.

The servo torque limit is configured such that when ESP is active the pilot can always overpower the servo and hand-fly the aircraft. Refer to *Garmin GFC 600 Pilot's Guide* and *G5 Electronic Flight Instrument Pilot's Guide for Certified Aircraft* for details on ESP functionality.

5.4.8.1 Roll Engagement

Roll Limit Indications display on the roll scale to indicate where ESP will engage. As roll attitude exceeds the limit, ESP will engage and the Roll Limit Indicator will move in indicate where ESP will disengage as roll attitude decreases.

Once engaged, ESP force will be applied. The force increases as roll attitude increases and decreases as roll attitude decreases. The applied force is intended to encourage pilot input that returns the airplane to a more normal roll attitude. As roll attitude decreases, ESP will disengage.

5.4.8.2 Pitch Engagement

ESP pitch engagement thresholds are configured for each airframe type. Thresholds are established for both nose-up and nose-down attitudes. Most aircraft are configured such that the torque applied by ESP increases to its maximum value when pitch attitude has exceeded the configured nose-up or nose-down pitch limits. The opposing force increases or decreases depending on the pitch angle and the direction of pitch travel. This force is intended to encourage movement in the pitch axis in the direction of the normal pitch attitude range for the aircraft. As the pitch attitude moves back towards the normal envelope the ESP force ramps down to zero and disengages when pitch is less than the configured nose-up and nose-down pitch limits.

ESP will disengage if the aircraft exceeds the ESP engagement limits.

There are no indications marking the pitch ESP engage and disengage limits in these nose-up/nose-down conditions.

5.4.8.3 Airspeed Protection



CAUTION: *Low Speed ESP is only supported with a valid terrain database. All other ESP modes are functional at any altitude.*

Low Speed Protection

When the stall warning system determines a stall condition is imminent, ESP will engage and apply a force in the nose down direction. After stall warning becomes inactive, the force will smoothly be reduced to zero and ESP will disengage.

Low Speed Protection is inhibited when the aircraft is below 200' above ground level. If the AFCS is not receiving height above ground information from an external source, Low Speed Protection will not be available.

High Speed Protection

Exceeding the airspeed limit will result in ESP applying force to raise the nose of the aircraft. When the high airspeed condition is remedied, ESP force is no longer applied.

Refer to the the AFMS for the High Airspeed ESP limits of a specific aircraft.

5.5 Synthetic Vision Technology (Optional)

The optional Synthetic Vision Technology (SVT) is a visual enhancement to the G500/G600. SVT is displayed as a forward-looking display of the topography immediately in front of the aircraft. SVT information is shown on the primary flight display (PFD). The depicted imagery is derived from the aircraft attitude, heading, GPS three-dimensional position, and a database of terrain, obstacles, and other relevant features.

The following SVT enhancements appear on the PFD:

- Flight Path Marker
- Horizon Heading Marks
- Traffic Display
- Airport Signs
- Runway Display
- Terrain Alerting
- Obstacle Alerting
- Water
- Zero-Pitch Line

SVT offers a three-dimensional view of terrain and obstacles. Terrain and/or obstacles that pose a threat to the aircraft in flight are shaded yellow or red.

NOTE: SVT will become disabled if the databases necessary to display SVT are unavailable (generating a GDU DB ERR or SVT DISABLED alert) or AHRS or GPS data is unavailable.



Figure 5-40 Synthetic Vision Imagery - PFD

5.5.1 SVT Operation

SVT™ is activated from the PFD using the soft keys located along the bottom edge of the display. Pressing the soft keys turn the related function on or off.

SVT functions are displayed on three levels of soft keys. The **PFD** soft key leads into the PFD function soft keys, including synthetic vision. Pressing the **SYN VIS** soft key enables synthetic vision and displays the **SYN TERR**, **HRZN HDG**, and **APTSIGNS** soft keys. The **BACK** soft key returns to the previous level of soft keys.

HRZN and **APTSIGNS** soft keys are dependent upon the state of the **SYN TERR** soft key. When Synthetic Terrain is deactivated, the **SYN TERR** soft key appears illuminated while the remaining SVT soft keys are unavailable for selection and subdued (black with dark-gray characters). If Synthetic Terrain is deactivated, all other SVT features are also deactivated. With Synthetic Terrain activated, all other SVT features may be turned on or off at the pilot's discretion.

- SYN TERR soft key enables synthetic terrain depiction.
- HRZN HDG soft key enable horizon heading marks and digits.
- APTSIGNS soft key enables airport signposts.

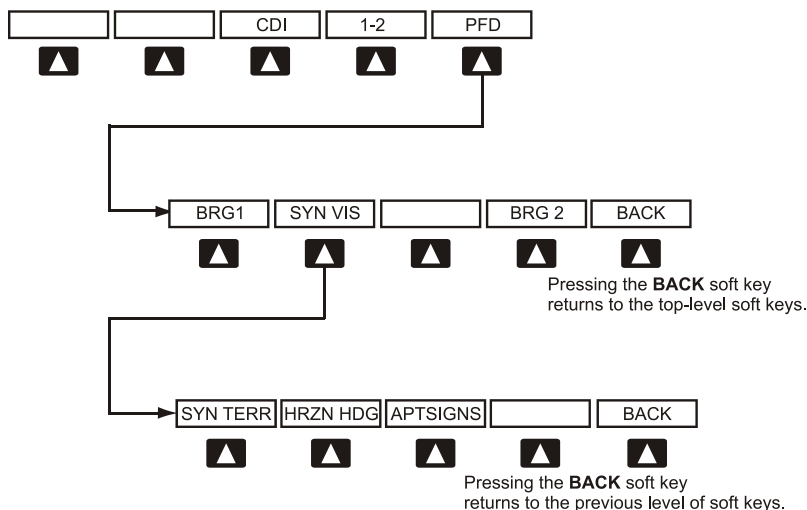

Figure 5-41 SVT Soft Keys

5.5.2 Activating and Deactivating SVT



NOTE: In some instances, such as temporary loss of GPS signal, the SVT functionality will be disabled.

To enable SVT:

1. Press the **PFD** soft key.
2. Press the **SYN VIS** soft key.
3. Press the **SYN TERR** soft key to view the SVT display.

When SVT™ is enabled, the pitch ladder will display a different pitch scale.

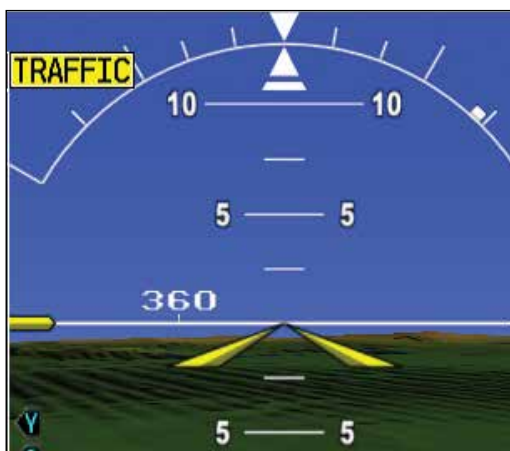

Figure 5-42 Pitch Scale with SVT Enabled



Figure 5-43 Pitch Scale with SVT Disabled

5.5.3 SVT Features



Figure 5-44 SVT on Primary Flight Display



WARNING: Use appropriate primary systems for navigation, terrain, obstacle, and traffic avoidance. Garmin SVT is intended as an aid to situational awareness only and may not provide either the accuracy or reliability upon which to solely base decisions and/or maneuvers to avoid terrain, obstacles, or traffic.



NOTE: SVT features are not a substitute for standard course and altitude deviation information using the CDI, VSI, and VDI presentations.

5.5.3.1 Flight Path Marker

The Flight Path Marker (FPM) is also known as a Velocity Vector. It is displayed on the PFD at ground speeds above 30 knots. The FPM depicts approximate projected path of the aircraft.

Foreword

Sec 1
System

Sec 2
PFD

Sec 3
MFD

Sec 4
Hazard
Avoidance

Sec 5
Additional
Features

Sec 6
Annun.
& Alerts

Sec 7
Symbols

Sec 8
Glossary

Appendix A

Index

5.5.3.2 Zero-Pitch Line

The Zero-Pitch Line is drawn completely across the display and provides a reference line by which to judge aircraft attitude with respect to the horizon. It is not necessarily aligned with the terrain horizon, particularly when the terrain is sloped or mountainous.

5.5.3.3 Horizon Heading

The Horizon Heading is synchronized with the HSI and shows compass headings in 30-degree increments on the Zero-Pitch Line. Horizon heading tick marks and digits appearing on the zero-pitch line are not visible when they are behind either the airspeed or altitude display. Horizon Heading is activated and deactivated by pressing the **HRZN HDG** soft key.

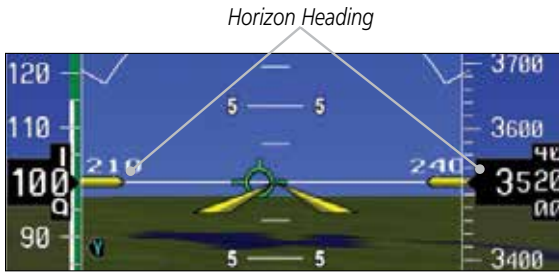

Figure 5-45 Horizon Heading

5.5.3.4 Airport Signs

Airports Signs provide a visual representation of airport location and identification on the synthetic terrain display. When activated, the signs appear on the display when the aircraft is approximately 15 NM from an airport and disappear at approximately 4.5 NM. Airport signs are shown without the identifier until the aircraft is approximately 9 NM from the airport. Airport signs are shown behind the airspeed or altitude display. Airport signs are activated and deactivated by pressing the **APT SIGNS** soft key.

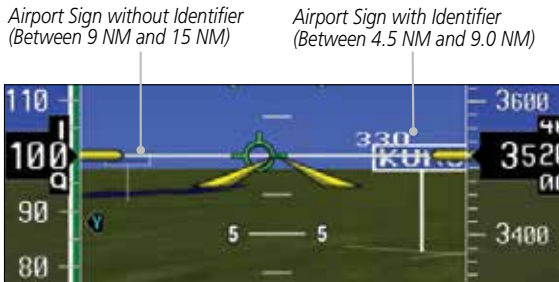

Figure 5-46 Airport Signs

5.5.3.5 Runway Depiction



WARNING: Do not use the Garmin SVT runway depiction as the sole means for determining the proximity of the aircraft to the runway or for maintaining the proper approach path angle during landing.

Runways are shown on the PFD in various ways. Soft surface runways, such as grass runways, are depicted in green. Hard surface runways, such as asphalt, are depicted in gray. Your flight plan will determine how the runway is displayed on the PFD.

Without a loaded flight plan, a runway is shown as dark gray with the boundaries of the runway in light gray.



Runway

Figure 5-47 Depiction of Runway with a Loaded Flight plan

A runway that is not in a loaded flight plan is shown as dark gray with no other colors.



Runway

Figure 5-48 Depiction of Runway Not in Loaded Flight plan

A runway that is associated with an approach in the loaded flight plan is outlined with a white rectangle, with the actual runway, in that rectangle.

Foreword

Sec 1
System

Sec 2
PFD

Sec 3
MFD

Sec 4
Hazard
Avoidance

Sec 5
Additional
Features

Sec 6
Annun.
& Alerts

Sec 7
Symbols

Sec 8
Glossary

Appendix A

Index

Foreword
 Sec 1 System
 Sec 2 PFD
 Sec 3 MFD
 Sec 4 Hazard Avoidance
 Sec 5 Additional Features
 Sec 6 Annun. & Alerts
 Sec 7 Symbols
 Sec 8 Glossary
 Appendix A
 Index



Figure 5-49 Depiction of Runway with Loaded Approach

5.5.3.6 Traffic

Traffic symbols are displayed in their approximate respective location as determined by the related traffic systems. TIS, TAS and ADS-B traffic are all displayed. Traffic is displayed in three dimensions, appearing larger as they are getting closer, and smaller when they are further away.



Figure 5-50 Traffic Depiction on PFD and MFD

5.5.3.7 Obstacles

Obstacles are represented on the synthetic display by two-dimensional tower or windmill symbols found on the MFD maps and charts. Obstacle symbols appear in the perspective view with relative height above terrain and distance from the aircraft.



Figure 5-51 Obstacle Depiction on PFD

Unlike the MFD moving map display, obstacles on the synthetic terrain display do not change colors based on relative altitude but will be colored to match any SVT TERRAIN or TAWS Alert from that obstacle. Obstacles greater than 1000 feet below the aircraft's altitude are not shown. Obstacles are shown behind the airspeed and altitude displays.

Foreword

Sec 1
System

Sec 2
PFD

Sec 3
MFD

Sec 4
Hazard
Avoidance

Sec 5
Additional
Features

Sec 6
Annun.
& Alerts

Sec 7
Symbols

Sec 8
Glossary

Appendix A

Index

5.5.3.8 Field of View

The PFD Field of View can be represented on the MFD Navigation Map Page lateral image. Two dashed lines forming a V-shape in front of the aircraft symbol on the MFD with an angle of approximately 50° represent the forward horizontal field of view shown on the PFD.

- Foreword
- Sec 1 System
- Sec 2 PFD
- Sec 3 MFD
- Sec 4 Hazard Avoidance
- Sec 5 Additional Features**
- Sec 6 Annun. & Alerts
- Sec 7 Symbols
- Sec 8 Glossary
- Appendix A
- Index



V-Shaped Lines Depict PFD Field of View (angle is approx. 50°)



Figure 5-52 MFD and PFD Field of View Comparison

To configure the Field of View:

1. While viewing the Navigation Map 1 or 2 of the Map Page Group, press the **MENU** key to display the **PAGE MENU**.

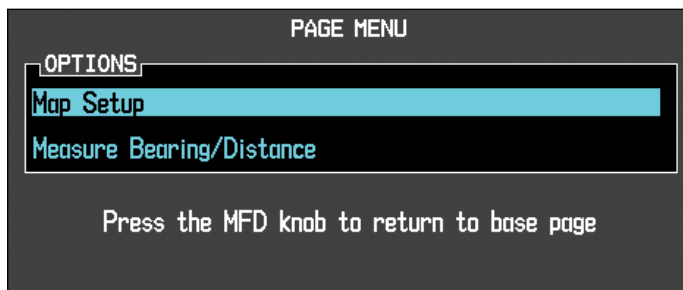

Figure 5-53 Page Menu

2. Press the **ENT** key to bring up the setup page.

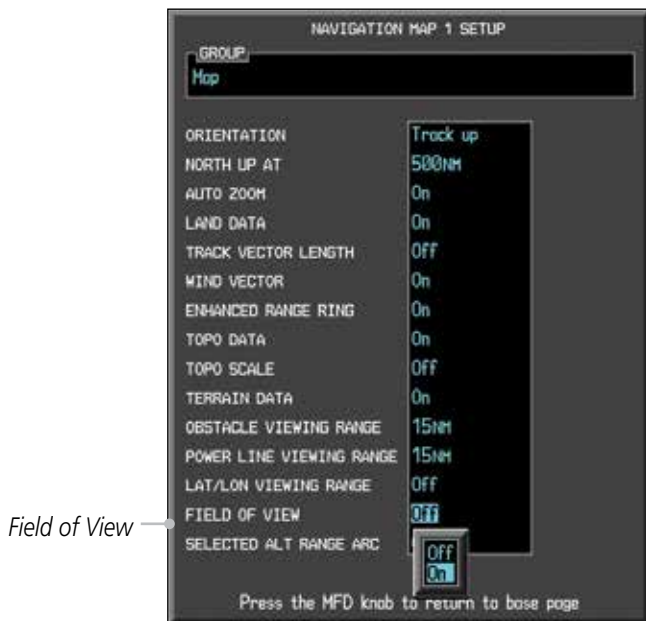

Figure 5-54 Map Setup Items

3. Turn the large **MFD** knob to scroll through the options to **FIELD OF VIEW**.
4. Turn the small **MFD** knob to select **On** or **Off**. Press the **ENT** key to confirm your selection.
5. Press the small **MFD** knob to return to the Navigation Map Page.

5.5.3.9 Unusual Attitudes

Unusual attitudes are displayed with red chevrons overlaid on the display, pointing to the direction to fly to correct the unusual attitude condition. The display shows either a brown or blue band of color at the top or bottom of the screen to represent earth or sky. This is intended to prevent losing sight of the horizon during extreme pitch attitudes.

Two conditions that inhibit SVT and generate alerts on the PFD:

- The position of the aircraft exceeds the range of the terrain database.
- The terrain database is out of date using an older terrain database card.



Figure 5-55 Unusual Attitude Display - Blue Band

Foreword
 Sec 1 System
 Sec 2 PFD
 Sec 3 MFD
 Sec 4 Hazard Avoidance
 Sec 5 Additional Features
 Sec 6 Annun. & Alerts
 Sec 7 Symbols
 Sec 8 Glossary
 Appendix A
 Index



Figure 5-56 Unusual Attitude Display - Brown Band

Foreword	
Sec 1 System	
Sec 2 PFD	
Sec 3 MFD	
Sec 4 Hazard Avoidance	
Sec 5 Additional Features	
Sec 6 Annun. & Alerts	
Sec 7 Symbols	
Sec 8 Glossary	
Appendix A	
Index	

Foreword

Sec 1
System

Sec 2
PFD

Sec 3
MFD

Sec 4
Hazard
Avoidance

**Sec 5
Additional
Features**

Sec 6
Annun.
& Alerts

Sec 7
Symbols

Sec 8
Glossary

Appendix A

Index

This page intentionally left blank

6 ANNUNCIATIONS AND ALERTS

6.1 Alerts

Alerts are displayed on the MFD and are accessible via the **ALERTS MFD** soft key. When a new advisory is present, the **ALERTS** soft key text changes to **ADVISORY** and flashes until the alerts page is viewed.

The MFD **ALERTS** page may have two additional soft keys (**TRND/ACK** and **CAPTURE**) which are present when interfaced to an optional ADAS+ Engine Trend Monitor (ETM). Pressing the **TRND/ACK** soft key is equivalent to pressing the **ETM Trend** key for one second. Pressing the **CAPTURE** soft key is equivalent to pressing the **ETM Trend** key for five seconds. Refer to the Airplane Flight Manual and ADAS+ ETM documentation for the system description and operating procedures.

Alert Message	Description	Action
ADC(1/2) ALT EC	<ul style="list-style-type: none"> • ADC 1 or ADC 2 Altitude Error Correction is unavailable. • Alert is enabled and the ADC is reporting that altitude correction is unavailable. 	<ul style="list-style-type: none"> • Contact a Garmin dealer for service.
ADC(1/2) SERVICE	<ul style="list-style-type: none"> • ADC 1 or ADC 2 requires service. 	<ul style="list-style-type: none"> • Contact a Garmin dealer for service.
ADC CONFIG	<ul style="list-style-type: none"> • ADC configuration error. 	<ul style="list-style-type: none"> • Contact a Garmin dealer for service.
AHRS(1/2) CAL	<ul style="list-style-type: none"> • AHRS 1 or AHRS 2 calibration version error. 	<ul style="list-style-type: none"> • Contact a Garmin dealer for service.

Alert Message	Description	Action
<p>AHRS(1/2) GPS</p>	<ul style="list-style-type: none"> • AHRS 1 or AHRS 2 is not receiving any GPS information. • AHRS 1 or AHRS 2 is operating exclusively in no-GPS reversionary mode. • AHRS 1 or AHRS 2 is using the backup GPS source. • AHRS 1 or AHRS 2 is not receiving backup GPS information. • Two GPS devices are configured as present and AHRS 1 is not receiving GPS data from the backup (2nd) device. 	<ul style="list-style-type: none"> • Verify that navigators are on and have a GPS signal. • Verify that self-test mode is not enabled. • Check the AFMS for limitations. • Contact a Garmin dealer for service.
<p>AHRS(1/2) SRVC</p>	<ul style="list-style-type: none"> • AHRS 1 or AHRS 2 magnetic-field model requires update. 	<ul style="list-style-type: none"> • Upgrade AHRS magnetic field model. • Contact a Garmin dealer for service.
<p>AHRS(1/2) TAS</p>	<ul style="list-style-type: none"> • AHRS 1 or AHRS 2 is not receiving true airspeed from the ADC. • Displayed heading and attitude data is still valid. • Additional loss of GPS data will cause loss of heading and attitude data. 	<ul style="list-style-type: none"> • Contact a Garmin dealer for service.
<p>AHRS CONFIG</p>	<ul style="list-style-type: none"> • AHRS configuration error. 	<ul style="list-style-type: none"> • Contact a Garmin dealer for service.

Foreword

Sec 1
System

Sec 2
PFD

Sec 3
MFD

Sec 4
Hazard
Avoidance

Sec 5
Additional
Features

Sec 6
Annun.
& Alerts

Sec 7
Symbols

Sec 8
Glossary

Appendix A

Index

Alert Message	Description	Action
AHRS MAG DB	<ul style="list-style-type: none"> AHRS/GDU magnetic field model database version mismatch. 	<ul style="list-style-type: none"> Reload MAG DB.
ALT KEY INOP	<ul style="list-style-type: none"> The ALT key function is disabled. ALT key not available. 	
ALT NO COMP	<ul style="list-style-type: none"> No data from one or more altitude sensors. 	<ul style="list-style-type: none"> Contact a Garmin dealer for service.
ARINC 429 CONFIG	<ul style="list-style-type: none"> ARINC 429 configuration error. 	<ul style="list-style-type: none"> Contact a Garmin dealer for service.
ARINC 708 CONFIG	<ul style="list-style-type: none"> ARINC 708 configuration error. 	<ul style="list-style-type: none"> Contact a Garmin dealer for service.
AUD NOT AVAIL	<ul style="list-style-type: none"> Audio system is not available. 	<ul style="list-style-type: none"> Contact a Garmin dealer for service.
AUD SYS FAIL	<ul style="list-style-type: none"> Audio system failure. 	<ul style="list-style-type: none"> Contact a Garmin dealer for service.
AVTN DB	<ul style="list-style-type: none"> Reduced functionality due to missing aviation database. Datacard may have been ejected. 	<ul style="list-style-type: none"> Install the missing database. Reinsert the datacard, if necessary.
CAL LOST	<ul style="list-style-type: none"> Calibration data is lost. 	<ul style="list-style-type: none"> Contact a Garmin dealer for service.
CHT DB ERR	<ul style="list-style-type: none"> Datacard's charts database is incomplete. Some charts may be unavailable. 	<ul style="list-style-type: none"> Reload charts database.
CHT STREAM	<ul style="list-style-type: none"> Chart streaming is not available. GDU reverts to the datacard's charts. 	
CNFG MISMATCH	<ul style="list-style-type: none"> GDU 1-2 airframe configuration settings disagree. 	<ul style="list-style-type: none"> Contact a Garmin dealer for service.

Foreword

System
Sec 1PFD
Sec 2MFD
Sec 3Hazard
Avoidance
Sec 4Additional
Features
Sec 5Annun.
& Alerts
Sec 6Symbols
Sec 7Glossary
Sec 8

Appendix A

Index

Alert Message	Description	Action
CNFG MODULE	<ul style="list-style-type: none"> • GDU configuration module is inoperative. 	<ul style="list-style-type: none"> • Contact a Garmin dealer for service.
DATALINK	<ul style="list-style-type: none"> • ADS-B fault: UAT receiver. • ADS-B fault: 1090 receiver. • FIS-B weather has failed. • GDL 88 ADS-B Failure. Unable to transmit ADS-B messages. • GDL 88 ADS-B fault. • GDL 88 needs service. • GDL 88 ADS-B is not transmitting position. Check GPS devices. • GDL 88 control panel input fault. Check transponder mode. • GDL 88 ADS-B fault. Pressure altitude source inoperative. • GDL 88 external traffic system inoperative or connection is lost. 	<ul style="list-style-type: none"> • Contact a Garmin dealer for service.

Foreword

Sec 1
SystemSec 2
PFDSec 3
MFDSec 4
Hazard
AvoidanceSec 5
Additional
FeaturesSec 6
Annun.
& AlertsSec 7
SymbolsSec 8
Glossary

Appendix A

Index

Alert Message	Description	Action
DATALINK (cont)	<ul style="list-style-type: none"> • GDL 88 configuration module needs service. • GDL 88 is inoperative or connection to GDU is lost. • GDL 88 CSA failure. • GDL 88 external traffic system has a low battery. • GDL 88 external traffic system in standby for more than 60 seconds. 	<ul style="list-style-type: none"> • Contact a Garmin dealer for service.
DATA LOST	<ul style="list-style-type: none"> • Pilot stored data is lost. All pilot configurable items return to their default settings. 	<ul style="list-style-type: none"> • Confirm the data is lost. • Reconfigure all personal settings.
DB ERR	<ul style="list-style-type: none"> • Database found on top card. 	<ul style="list-style-type: none"> • Remove database card or move card to bottom slot.
DB SYNC COMPLETE	<ul style="list-style-type: none"> • Database sync complete. • Restart required to use new databases. 	<ul style="list-style-type: none"> • Restart GDU.
DB SYNC DISABLED	<ul style="list-style-type: none"> • No database card found to receive databases. 	<ul style="list-style-type: none"> • Contact a Garmin dealer for service.
DB SYNC ERROR	<ul style="list-style-type: none"> • Not enough space to receive one or more databases. 	<ul style="list-style-type: none"> • Contact a Garmin dealer for service.
DIAG MODE	<ul style="list-style-type: none"> • System is in Diagnostic mode. 	
DSCRT CONFIG	<ul style="list-style-type: none"> • Discrete input/output configuration error. 	<ul style="list-style-type: none"> • Contact a Garmin dealer for service.
ENG SENSOR UNIT (1/2)	<ul style="list-style-type: none"> • Configuration error. • Communication with sensors is halted or lost. 	<ul style="list-style-type: none"> • Contact a Garmin dealer for service.

Foreword

Sec 1
SystemSec 2
PFDSec 3
MFDSec 4
Hazard
AvoidanceSec 5
Additional
FeaturesSec 6
Annun.
& AlertsSec 7
SymbolsSec 8
Glossary

Appendix A

Index

Foreword

Sec 1 System

Sec 2 PFD

Sec 3 MFD

Sec 4 Hazard Avoidance

Sec 5 Additional Features

Sec 6 Annun. & Alerts

Sec 7 Symbols

Sec 8 Glossary

Appendix A

Index

Alert Message	Description	Action
ESP FAIL	<ul style="list-style-type: none"> Electronic Stability & Protection (ESP) has failed. 	
ETM CAPTURE	<ul style="list-style-type: none"> Engine Trend Monitor data capture. ADAS+ engine monitoring system is recording trend data. 	<ul style="list-style-type: none"> Refer to the ADAS+ literature.
ETM EXCEED	<ul style="list-style-type: none"> Engine Trend Monitor exceedance/advisory. ADAS+ engine monitoring system is reporting an exceedance or advisory condition. 	<ul style="list-style-type: none"> Refer to the ADAS+ literature.
ETM FAULT	<ul style="list-style-type: none"> Engine Trend Monitor needs service. ADAS+ engine monitoring system is reporting a system fault. 	<ul style="list-style-type: none"> Refer to the ADAS+ literature.
FAN (1/2) FAIL	<ul style="list-style-type: none"> Cooling fan no. 1 or no. 2 has failed. Unit may operate at extreme temperatures Extended operation at high temperatures is not recommended as damage to the GDU may occur. PFD/MFD coloration may be incorrect. Backlight may dim to reduce power and heat. 	<ul style="list-style-type: none"> Contact a Garmin dealer for service.

Alert Message	Description	Action
GAD 43	• GAD 43 communication is lost.	• Contact your Garmin dealer for service.
	• Gyro Emulation Type Mismatch fault.	• Contact a Garmin dealer for service.
	• Yaw Rate Scale Factor Mismatch fault.	• Contact a Garmin dealer for service.
	• GDU AHRS Monitor fault.	• Contact a Garmin dealer for service.
	• Pitch Deviation fault.	• Contact a Garmin dealer for service.
	• Roll Deviation fault.	• Contact a Garmin dealer for service.
	• Yaw Rate Deviation fault.	• Contact a Garmin dealer for service.
	• AHRS A429 Attitude Timeout fault.	• Contact a Garmin dealer for service.

Foreword

Sec 1
System

Sec 2
PFD

Sec 3
MFD

Sec 4
Hazard
Avoidance

Sec 5
Additional
Features

Sec 6
Annun.
& Alerts

Sec 7
Symbols

Sec 8
Glossary

Appendix A

Index

Alert Message	Description	Action
GAD 43	<ul style="list-style-type: none"> AHRS A429 Attitude Invalid fault. 	<ul style="list-style-type: none"> Contact a Garmin dealer for service.
	<ul style="list-style-type: none"> AHRS Pitch Out of Range fault. 	<ul style="list-style-type: none"> Contact a Garmin dealer for service.
	<ul style="list-style-type: none"> AHRS Attitude Invalid fault. 	<ul style="list-style-type: none"> Contact a Garmin dealer for service.
	<ul style="list-style-type: none"> AHRS A429 Heading Timeout fault. 	<ul style="list-style-type: none"> Contact a Garmin dealer for service.
	<ul style="list-style-type: none"> AHRS A429 Heading Invalid fault. 	<ul style="list-style-type: none"> Contact a Garmin dealer for service.
	<ul style="list-style-type: none"> Power Supply fault. 	<ul style="list-style-type: none"> Contact a Garmin dealer for service.
	<ul style="list-style-type: none"> AC reference is lost. 	<ul style="list-style-type: none"> Contact a Garmin dealer for service.
	<ul style="list-style-type: none"> Application SCI integrity fault. 	<ul style="list-style-type: none"> Contact a Garmin dealer for service.
	<ul style="list-style-type: none"> Configuration integrity fault. 	<ul style="list-style-type: none"> Contact a Garmin dealer for service.
	<ul style="list-style-type: none"> Calibration integrity fault. 	<ul style="list-style-type: none"> Contact a Garmin dealer for service.
<ul style="list-style-type: none"> Unit fault. 	<ul style="list-style-type: none"> Contact a Garmin dealer for service. 	
GAD 43E CONFIG	<ul style="list-style-type: none"> GAD 43e configuration error. Communication is halted. 	<ul style="list-style-type: none"> Contact a Garmin dealer for service.
GATE MODE	<ul style="list-style-type: none"> Automated testing is on. 	
GDL69	<ul style="list-style-type: none"> GDL 69 has failed. 	<ul style="list-style-type: none"> Contact a Garmin dealer for service.

Foreword
 Sec 1 System
 Sec 2 PFD
 Sec 3 MFD
 Sec 4 Hazard Avoidance
 Sec 5 Additional Features
Sec 6 Annun. & Alerts
 Sec 7 Symbols
 Sec 8 Glossary
 Appendix A
 Index

Alert Message	Description	Action
GEO LIMITS	<ul style="list-style-type: none"> AHRS 1 is too far north or south. No magnetic heading provided. Operation in extreme north latitudes has rendered the heading data unreliable. 	<ul style="list-style-type: none"> Return to a geographic position within the reliable operating area, or use an alternate means of navigation. Check the AFMS for limitations.
GPS(1/2) FAIL	<ul style="list-style-type: none"> Communication with GPS 1 or GPS 2 is lost. 	<ul style="list-style-type: none"> Use an alternate navigation source.
GPS(1/2) PPS FAIL	<ul style="list-style-type: none"> Timing data from GPS 1 or GPS 2 is lost. 	<ul style="list-style-type: none"> Contact a Garmin dealer for service.
GSR FAIL	<ul style="list-style-type: none"> GSR has failed. 	<ul style="list-style-type: none"> Contact a Garmin dealer for service.
GWX CONFIG	<ul style="list-style-type: none"> GWX configuration error. Configuration is required. 	<ul style="list-style-type: none"> Contact a Garmin dealer for service.
GWX SERVICE	<ul style="list-style-type: none"> GWX requires service. 	<ul style="list-style-type: none"> Contact a Garmin dealer for service.
HDG FAULT	<ul style="list-style-type: none"> AHRS1 or AHRS 2 in no-magnetometer reversionary mode. Heading fault occurs on the AHRS. Heading data is unreliable. 	<ul style="list-style-type: none"> Check the AFMS for limitations. Use a compass or other course information. Contact a Garmin dealer for service.
HDG LOST	<ul style="list-style-type: none"> HDG features are disabled or defaulted to GPS1 TRK. GDU is in the reversionary track-based mode. 	

Foreword

Sec 1
SystemSec 2
PFDSec 3
MFDSec 4
Hazard
AvoidanceSec 5
Additional
FeaturesSec 6
Annun.
& AlertsSec 7
SymbolsSec 8
Glossary

Appendix A

Index

Alert Message	Description	Action
HTAWS	<ul style="list-style-type: none"> External HTAWS is not available. Internal TERRAIN-HSVT alerting is enabled. External HTAWS configuration mismatch. 	<ul style="list-style-type: none"> Contact a Garmin dealer for service.
IAS NO COMP	<ul style="list-style-type: none"> No data from one or more airspeed sensors. 	<ul style="list-style-type: none"> Contact a Garmin dealer for service.
<LRU> CAL	<ul style="list-style-type: none"> Error in the calibration of the indicated LRU. 	<ul style="list-style-type: none"> Calibration service required. Contact a Garmin dealer for service.
<LRU> CONFIG	<ul style="list-style-type: none"> Error in the configuration of the indicated LRU. 	<ul style="list-style-type: none"> Configuration is required. Contact a Garmin dealer for service.
<LRU> COOLING	<ul style="list-style-type: none"> The indicated LRU has insufficient cooling. Display is automatically dimmed to reduce power usage. 	<ul style="list-style-type: none"> Contact a Garmin dealer for service.
<LRU> DB ERR	<ul style="list-style-type: none"> Error exists with the indicated LRU database. 	<ul style="list-style-type: none"> Replace or update database.
<LRU> KEYSTK	<ul style="list-style-type: none"> The indicated LRU key is stuck. 	<ul style="list-style-type: none"> Contact a Garmin dealer for service.
<LRU> SERVICE	<ul style="list-style-type: none"> The indicated LRU requires service. 	<ul style="list-style-type: none"> Contact a Garmin dealer for service.
<LRU> VOLTAGE	<ul style="list-style-type: none"> The indicated LRU has low voltage. Display is automatically dimmed to reduce power usage. 	<ul style="list-style-type: none"> Contact a Garmin dealer for service.
MANIFEST	<ul style="list-style-type: none"> LRU software mismatch. Communication is halted. 	<ul style="list-style-type: none"> Contact a Garmin dealer for service.

Foreword

Sec 1
SystemSec 2
PFDSec 3
MFDSec 4
Hazard
AvoidanceSec 5
Additional
FeaturesSec 6
Annun.
& AlertsSec 7
SymbolsSec 8
Glossary

Appendix A

Index

Alert Message	Description	Action
NAV(1/2)	<ul style="list-style-type: none"> • Communication with NAV 1 or NAV 2 is lost. • No data from the indicated navigation receiver. 	<ul style="list-style-type: none"> • Switch to alternate form of navigation (GPS or otherwise), if available.
NO RADAR DATA	<ul style="list-style-type: none"> • No data is being sent to the GDU. 	<ul style="list-style-type: none"> • Contact a Garmin dealer for service.
PIT NO COMP	<ul style="list-style-type: none"> • No data from one or more pitch attitude sensors. 	<ul style="list-style-type: none"> • Contact a Garmin dealer for service.
PREV EXCEED	<ul style="list-style-type: none"> • Previous Engine Trend Monitor exceedance. • ADAS+ engine trend monitor is reporting a previous exceedance. 	<ul style="list-style-type: none"> • Refer to the ADAS+ literature.
RADAR CONTROLS DISAGREE	<ul style="list-style-type: none"> • Data does not match for a duration of 15 seconds or longer. 	<ul style="list-style-type: none"> • Contact a Garmin dealer for service.
REGISTER GFDS	<ul style="list-style-type: none"> • Data services are inoperative. Connex Satellite Services are not registered. 	<ul style="list-style-type: none"> • Register with Connex Satellite Services.
ROL NO COMP	<ul style="list-style-type: none"> • No data from one or more roll attitude sensors. 	<ul style="list-style-type: none"> • Contact a Garmin dealer for service.
RS-232 CONFIG	<ul style="list-style-type: none"> • RS-232 configuration error. 	<ul style="list-style-type: none"> • Contact a Garmin dealer for service.
RS-485 CONFIG	<ul style="list-style-type: none"> • RS-485 configuration error. 	<ul style="list-style-type: none"> • Contact a Garmin dealer for service.
SD CARD 1	<ul style="list-style-type: none"> • Top SD Card disabled due to errors. 	Replace card.
SD CARD 2	<ul style="list-style-type: none"> • Bottom SD Card disabled due to errors 	Replace card.

Foreword

System
Sec 1PFD
Sec 2MFD
Sec 3Hazard
Avoidance
Sec 4Additional
Features
Sec 5Annun.
& Alerts
Sec 6Symbols
Sec 7Glossary
Sec 8

Appendix A

Index

Alert Message	Description	Action
SIMULATOR	<ul style="list-style-type: none"> • Simulator mode is active. Do not use for navigation. 	
STORMSCOPE	<ul style="list-style-type: none"> • Stormscope has failed or connection is lost. 	<ul style="list-style-type: none"> • Contact a Garmin dealer for service.
SVT DISABLED	<ul style="list-style-type: none"> • Outside of terrain database coverage area. • Terrain database resolution is too low. 	<ul style="list-style-type: none"> • Repeat steps to reactivate SVT with the appropriate PFD soft keys. • Install 9 arc-second database (GDU 620 SW v6.21 or earlier) or 4.9 arc second database (GDU 620 SW v7.00 or later).
SW MISMATCH	<ul style="list-style-type: none"> • GDU software version mismatch. No GDU crossfill. 	<ul style="list-style-type: none"> • Contact a Garmin dealer for service.
TAWS	<ul style="list-style-type: none"> • External TAWS is not available. Internal TERRAIN-SVT alerting enabled. • External TAWS configuration mismatch. 	<ul style="list-style-type: none"> • Contact a Garmin dealer for service.
TDB	<ul style="list-style-type: none"> • Airframe does not support Terrain database. 	
TERRAIN DSP	<ul style="list-style-type: none"> • Terrain or obstacle database error in TAWS B or TERRAIN-SVT only. 	<ul style="list-style-type: none"> • Update database.

Foreword

Sec 1
SystemSec 2
PFDSec 3
MFDSec 4
Hazard
AvoidanceSec 5
Additional
FeaturesSec 6
Annun.
& AlertsSec 7
SymbolsSec 8
Glossary

Appendix A

Index

Alert Message	Description	Action
TRAFFIC	<ul style="list-style-type: none"> • ADS-B In traffic alerting has failed. • ADS-B In traffic has failed. • TAS/TCAS has been in standby for more than 60 seconds. • TAS/TCAS is inoperative or connection is lost. • TAS/TCAS has failed. • Traffic device is inoperative or connection to GDU is lost. 	<ul style="list-style-type: none"> • Contact a Garmin dealer for service.
TRAFFIC CONFIG	<ul style="list-style-type: none"> • ADS-B traffic data does not match configuration. 	<ul style="list-style-type: none"> • Contact a Garmin dealer for service.
TRAFFIC FAIL	<ul style="list-style-type: none"> • Traffic device has failed. • Traffic data is no longer displayed. 	<ul style="list-style-type: none"> • Contact a Garmin dealer for service.
TRAFFIC STDBY	<ul style="list-style-type: none"> • Traffic is in Standby mode while airborne. 	<ul style="list-style-type: none"> • Check traffic system controls on the MFD Traffic Map page or traffic system.
TRK LOST	<ul style="list-style-type: none"> • Heading and track from active GPS is lost. HSI is using secondary GPS track. 	
USP	<ul style="list-style-type: none"> • Air data inputs to the GMC 605 have failed. Functions dependent on air data may not be supported and AFCS performance may be degraded. 	

Foreword

System
Sec 1PFD
Sec 2MFD
Sec 3Hazard
Avoidance
Sec 4Additional
Features
Sec 5Annun.
& Alerts
Sec 6Symbols
Sec 7Glossary
Sec 8

Appendix A

Index

Foreword
 Sec 1 System
 Sec 2 PFD
 Sec 3 MFD
 Sec 4 Hazard Avoidance
 Sec 5 Additional Features
Sec 6 Annun. & Alerts
 Sec 7 Symbols
 Sec 8 Glossary
 Appendix A
 Index

Alert Message	Description	Action
WX ALERT	<ul style="list-style-type: none"> Possible severe weather ahead. 	<ul style="list-style-type: none"> Check weather radar.
WX RADAR	<ul style="list-style-type: none"> Communication with weather radar is lost. 	<ul style="list-style-type: none"> Contact a Garmin dealer for service.
WX RDR SERVICE	<ul style="list-style-type: none"> Weather radar requires service. 	<ul style="list-style-type: none"> Contact a Garmin dealer for service.
WXR INPUT FAULT	<ul style="list-style-type: none"> Weather radar is not receiving one or more inputs. 	<ul style="list-style-type: none"> Contact a Garmin dealer for service.
XPDR (1/2)	<ul style="list-style-type: none"> GTX1 or GTX 2 requires service. GTX 1 or GTX 2 is inoperative or connection to GDU is lost. 	<ul style="list-style-type: none"> Contact a Garmin dealer for service.

Table 6-1 Alert Messages

6.2 System Status

The System Status page of Aux mode shows the status, serial number, and software version of LRUs and the date of databases. There are no menu pages. In the LRU Status column, a green check means the unit is present and operating properly, while a red “X” indicates an absence or failure.



Active Databases

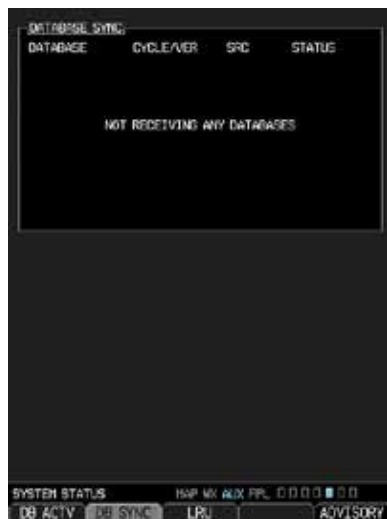

Database Sync

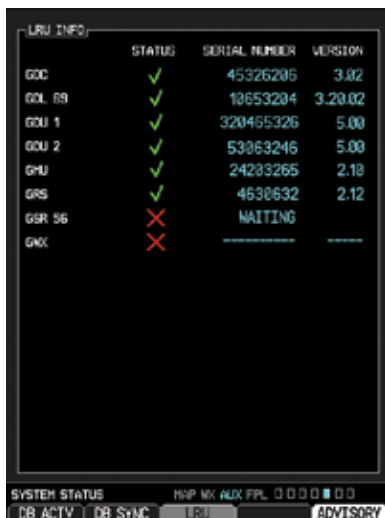

System LRUs

Figure 6-1 System Status Displays

Foreword

Sec 1
System

Sec 2
PFD

Sec 3
MFD

Sec 4
Hazard
Avoidance

Sec 5
Additional
Features

**Sec 6
Annun.
& Alerts**

Sec 7
Symbols

Sec 8
Glossary

Appendix A

Index

This page intentionally left blank

7 SYMBOLS

The following tables describe the symbols that are found on the MFD Map displays.

7.1 Map Page Symbols





















Symbol	Description
	Unknown Airport
	Non-towered, Non-serviced Airport
	Towered, Non-serviced Airport
	Non-towered, Serviced Airport
	Towered, Serviced Airport
	Soft Surface, Serviced Airport
	Soft Surface, Non-serviced Airport
	Private Airport
	Heliport
	Intersection
	LOM (compass locator at outer marker)
	NDB (Non-directional Radio Beacon)
	VOR
	VOR/DME
	ILS/DME or DME-only
	VORTAC
	TACAN
	VRP (Visual Reporting Point)
	User Waypoint
	New User Airport

Table 7-1 Map Page Symbols

7.2 SafeTaxi Symbols





Symbol	Description
	Helipad
	Airport Beacon
	Under Construction Zones
	Designated Water Areas

Table 7-2 SafeTaxi Symbols

7.3 Traffic Symbols



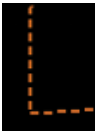

Symbol	Description (Highest to Lowest Priority)
	Traffic Advisory (TA), In Range
	Traffic Advisory (TA), Out of Range
	Proximate Advisory (PA)
	Other Traffic

Table 7-3 Traffic Symbols













Symbol	Description
	Basic Non-Directional Traffic
	Basic Directional Traffic
	Basic Off-scale Selected Traffic
	Proximate Non-Directional Traffic
	Proximate Directional Traffic
	Proximate Off-scale Selected Traffic
	Non-Directional Alerted Traffic
	Off-Scale Non-Directional Alerted Traffic
	Directional Alerted Traffic
	Off-Scale Directional Alerted Traffic
	Non-Directional Surface Vehicle
	Directional Surface Vehicle

Table 7-4 ADS-B Traffic Symbols



NOTE: Color of basic and proximate traffic is dependent on airborne/on-ground status of target (target is brown when on the ground, see the surface vehicles).

7.4 Basemap Symbols





Symbol	Description
	Interstate Highway
	State Highway
	US Highway
	National Highway - 2-digit drawn inside
	Small City or Town
	Medium City
	Large City

Table 7-5 Basemap Symbols

Foreword

Sec 1
System

Sec 2
PFD

Sec 3
MFD

Sec 4
Hazard
Avoidance

Sec 5
Additional
Features

Sec 6
Annun.
& Alerts

**Sec 7
Symbols**

Sec 8
Glossary

Appendix A

Index

7.5 Map Tool Bar Symbols











Symbol	Description
	Terrain Proximity Enabled and Available Indicator
	Terrain Proximity Enabled and Not Available Indicator
	Point Obstacle Enabled and Available Indicator (Software version 5.12 and later)
	Point Obstacle Enabled and Not Available Indicator (Software version 5.12 and later)
	Wire Obstacles Enabled and Available Indicator (Software version 5.12 and later)
	Wire Obstacles Enabled and Not Available Indicator (Software version 5.12 and later)
	StormScope
	StormScope Enabled and Not Available Indicator
	Traffic Enabled and Available Indicator
	Traffic Enabled and Not Available Indicator

Table 7-6 Map Tool Bar Symbols

Foreword

Sec 1
System

Sec 2
PFD

Sec 3
MFD

Sec 4
Hazard
Avoidance

Sec 5
Additional
Features

Sec 6
Annun.
& Alerts

Sec 7
Symbols

Sec 8
Glossary

Appendix A

Index

7.6 Ownship Symbols











Symbol	Description
	Generic Airplane
	Low-Wing Prop
	High-Wing Prop
	Kit Plane
	Turboprop
	Twin-Engine Prop
	Single-Engine Jet
	Business Jet
	Simple Airplane
	2-Blade Rotorcraft
	3-Blade Rotorcraft
	4-Blade Rotorcraft

Table 7-7 Ownship Symbols

Foreword

Sec 1
System

Sec 2
PFD

Sec 3
MFD

Sec 4
Hazard
Avoidance

Sec 5
Additional
Features

Sec 6
Annun.
& Alerts

**Sec 7
Symbols**

Sec 8
Glossary

Appendix A

Index

7.7 Miscellaneous Symbols













Symbol	Description
	Arrow
	Default Map Cursor
	Measuring Cursor
	MFD Wind Vector (w/ valid GPS solution)
	PFD Wind Vector styles
	Parallel Track Waypoint
	Restricted/Prohibited/Warning/Alert
	TFR (Temporary Flight Restrictions)
	MOA
	Class B Airspace
	Class C Airspace
	Class D Airspace
	Airspace Altitude Label (Upper/Lower Limits)

Table 7-8 Miscellaneous Symbols

Foreword

Sec 1
System

Sec 2
PFD

Sec 3
MFD

Sec 4
Hazard
Avoidance

Sec 5
Additional
Features

Sec 6
Annun.
& Alerts

Sec 7
Symbols

Sec 8
Glossary

Appendix A

Index

Foreword

Sec 1
System

Sec 2
PFD

Sec 3
MFD

Sec 4
Hazard
Avoidance

Sec 5
Additional
Features

Sec 6
Annun.
& Alerts

Sec 7
Symbols

Sec 8
Glossary

Appendix A

Index

This page intentionally left blank

8 GLOSSARY

ACT, ACTV	active, activate	Foreword
ADC	Air Data Computer	
ADF	Automatic Direction Finder	
ADI	Attitude Direction Indicator	
ADS-B	Automatic Dependent Surveillance - Broadcast	System Sec 1
AFF	Automatic Flight Following	
AFM	Airplane Flight Manual	
AFMS	Airplane Flight Manual Supplement	PFD Sec 2
AGL	Above Ground Level	
AHRS	Attitude and Heading Reference System	
AIM	Airman's Information Manual	
AIRMET	Airman's Meteorological Information	MFD Sec 3
ALT	altitude	
AP	autopilot	
APR	approach	Hazard Sec 4
APT	airport, aerodrome	Avoidance
ARINC	Aeronautical Radio Incorporated	
ARSPC	airspace	
ARTCC	Air Route Traffic Control Center	Additional Sec 5
AS	airspeed	Features
ASOS	Automated Surface Observing System	
ATC	Air Traffic Control	
ATCRBS	ATC Radar Beacon System	Annun. & Alerts Sec 6
ATIS	Automatic Terminal Information Service	
AUX	auxiliary	
AWOS	Automated Weather Observing System	Symbols Sec 7
BARO	barometric setting	
BC	backcourse	
Bearing	The compass direction from the present position to a destination waypoint	Glossary Sec 8
BRG	bearing	
C	center runway	
°C	degrees Celsius	
CDI	Course Deviation Indicator	
CHNL	channel	Appendix A
CLD	cloud	
CLR	clear	
CONFIG	configuration	Index

		Course	The line between two points to be followed by the aircraft
	Foreword	Crosstrack Error	The distance the aircraft is off a desired course in either direction, left or right
		CRS	course
		CRSR	cursor
Sec 1	System	CTA	Control Area
		CTRL	control
		CUM	The total of all legs in a flight plan.
	Sec 2	D ALT	density altitude
		DB, DBASE	database
		DCLTR, DECLTR	declutter
	Sec 3	deg	degree
		DEP	departure
		Desired Track (DTK)	The desired course between the active “from” and “to” waypoints
Sec 4	Hazard Avoidance	DEST	destination
		DFLT	default
		DIS	distance
	Sec 5	Distance	The ‘great circle’ distance from the present position to a destination waypoint
	Additional Features	DME	Distance Measuring Equipment
		DP	Departure Procedure
Sec 6	Annun. & Alerts	DPRT	departure
		DSBL	disabled
		DTK	Desired Track
	Sec 7	EDR	Excessive Descent Rate
	Symbols	ELEV	elevation
		EMI	Electromagnetic Interference
Sec 8	Glossary	ENR	en route
		En Route Safe Altitude	The recommended minimum altitude within ten miles left or right of the desired course on an active flight plan or direct-to
	Appendix A	ENT	enter
		ERR	error
		ESA	En route Safe Altitude
	Index	ETA	Estimated Time of Arrival
		ETE	Estimated Time En Route

°F	degrees Fahrenheit	
FAA	Federal Aviation Administration	
FCC	Federal Communication Commission	Foreword
FCST	forecast	
FD	flight director	
FIS-B	Flight Information Services-Broadcast	Sec 1
FISDL	Flight Information Service Data Link	System
FLTA	Forward Looking Terrain Avoidance	
FPL	flight plan	
FREQ	frequency	Sec 2
FRZ	freezing	PFD
FSS	Flight Service Station	
ft	foot/feet	Sec 3
		MFD
G/S, GS	glideslope	
GCSS	Garmin Connex Satellite Service	
GDC	Garmin Air Data Computer	Sec 4
GDL	Garmin Satellite Data Link	Hazard Avoidance
GDU	Garmin Display Unit	
GEO	geographic	Sec 5
GLS	Global Navigation Satellite Landing System	Additional Features
GMA	Garmin Audio Panel System	
GMT	Greenwich Mean Time	
GMU	Garmin Magnetometer Unit	Sec 6
GPS	Global Positioning System	Annun. & Alerts
GPSS	GPS Roll Steering	
Ground Speed	The velocity that the aircraft is travelling relative to a ground position	Sec 7
Ground Track	<i>see Track</i>	Symbols
GRS	Garmin Reference System	
GS	Ground Speed	
GTX	Garmin Transponder	Sec 8
		Glossary
HDG	heading	
Heading	The direction an aircraft is pointed, based upon indications from a magnetic compass or a properly set directional gyro	Appendix A
HFOM	Horizontal Figure of Merit	
Hg	mercury	
hPa	hectopascal	Index
HPL	Horizontal Protection Level	

	Foreword	HSDB	High-Speed Data Bus
		HSI	Horizontal Situation Indicator
		Hz	Hertz
	Sec 1 System	IAF	Initial Approach Fix
		ICAO	International Civil Aviation Organization
		IFR	Instrument Flight Rules
		IGRF	International Geomagnetic Reference Field
	Sec 2 PFD	ILS	Instrument Landing System
		IMC	Instrument Meteorological Conditions
		IOI	Imminent Obstacle Impact
		INFO	information
	Sec 3 MFD	in HG	inches of mercury
		INT	intersection(s)
		INTEG	integrity (RAIM unavailable)
		ITI	Imminent Terrain Impact
	Sec 4 Hazard Avoidance	L	left, left runway
		LAT	latitude
	Sec 5 Additional Features	LCD	Liquid Crystal Display
		LCL	local
		LED	Light Emitting Diode
		Leg	The portion of a flight plan between two waypoints
	Sec 6 Annun. & Alerts	LIFR	Low Instrument Flight Rules
		LNAV	Lateral Navigation
		LOC	localizer
	Sec 7 Symbols	LOI	loss of integrity (GPS)
		LON	longitude
		LPV	Localizer Performance with Vertical guidance
		LRU	Line Replacement Unit
	Sec 8 Glossary	LT	left
		LTNG	lightning
	Appendix A	MAG	Magnetic
		MAG VAR	Magnetic Variation
		MapMX	A proprietary data format used to forward navigation information from the Garmin GPS units to the GDU 620
	Index	MAX	maximum
		MAXSPD	maximum speed (overspeed)
		MDA	barometric minimum descent altitude

METAR	Aviation Routine Weather Report	
MFD	Multi Function Display	
MIN	minimum	Foreword
Minimum Safe Altitude	Uses Grid MORAs to determine a safe altitude within ten miles of the aircraft present position	
MKR	marker beacon	
MOA	Military Operations Area	Sec 1
MOV	movement	System
mpm	meters per minute	
MSA	Minimum Safe Altitude	Sec 2
MSG	message	PFD
MSL	Mean Sea Level	
MT	meter	
mV	millivolt(s)	Sec 3
MVFR	Marginal Visual Flight Rules	MFD
NAV	navigation	
NAVAID	NAVigation AID	Sec 4
NCR	Negative Climb Rate	Hazard
NDB	Non-Directional Beacon	Avoidance
NEXRAD	Next Generation Radar	Sec 5
OAT	Outside Air Temperature	Additional
OBS	Omni Bearing Selector	Features
PA	Proximity Advisory	
PC	personal computer	
PDA	Premature Descent Alert	
PFD	Primary Flight Display	Sec 6
P. POS	Present Position	Annun. & Alerts
PTK	parallel track	Sec 7
QTY	quantity	Symbols
		Sec 8
		Glossary
		Appendix A
		Index

		R	right, right runway
		RAIM	Receiver Autonomous Integrity Monitoring
	Foreword	RAM	random access memory
		REF	reference
		REQ	required
Sec 1	System	REV	reverse, revision, revise
		RMI	Radio Magnetic Indicator
		RNG	range
		RNWX	runway
Sec 2	PFD	ROC	Reduced Required Obstacle Clearance
		RT	right
		RTC	Reduced Required Terrain Clearance
Sec 3	MFD	SBAS	Satellite-Based Augmentation System
		SCIT	Storm Cell Identification and Tracking
		SD	Secure Digital
Sec 4	Hazard Avoidance	SFC	surface
		SIAP	Standard Instrument Approach Procedures
		SID	Standard Instrument Departure
Sec 5	Additional Features	SIGMET	Significant Meteorological Information
		SLP/SKD	slip/skid
		SMBL	symbol
		SPD	speed
Sec 6	Annun. & Alerts	SRVC, SVC	service
		STAR	Standard Terminal Arrival Route
		STATS	statistics
		STBY	standby
Sec 7	Symbols	STD	standard
		SUA	Special Use Airspace
		SUSP	suspend
Sec 8	Glossary	SVT	Synthetic Vision
		SW	software
		SYS	system
Appendix A		T	true
		TA	Traffic Advisory
		TACAN	Tactical Air Navigation System
Index		TAF	Terminal Aerodrome Forecast
		TAS	True Airspeed
		TAS	Traffic Advisory System
		TAT	Total Air Temperature

TAWS	Terrain Awareness and Warning System	
TCA	Terminal Control Area	
TCAS	Traffic Collision Avoidance System	Foreword
TEMP	temperature	
TERM	terminal	
TFR	Temporary Flight Restriction	Sec 1
T HDG	True Heading	System
TIS	Traffic Information System	
TMA	Terminal Maneuvering Area	
Topo	topographic	Sec 2
Track	Direction of aircraft movement relative to a ground position; also 'Ground Track'	PFD
TRK	track	
TRSA	Terminal Radar Service Area	Sec 3 MFD
UNAVAIL	unavailable	
USR	user	Sec 4
UTC	Coordinated Universal Time	Hazard Avoidance
UTM/UPS	Universal Transverse Mercator/ Universal Polar Stereographic Grid	Additional Features
V, Vspeed	velocity (airspeed)	Sec 5
VAR	variation	
VFR	Visual Flight Rules	Sec 6
VHF	Very High Frequency	Annun. & Alerts
VLOC	VOR/Localizer Receiver	
VMC	Visual Meteorological Conditions	
VNAV, VNV	vertical navigation	Sec 7 Symbols
VOR	VHF Omni-directional Range	
VORTAC	very high frequency omnidirectional range station and tactical air navigation	Sec 8 Glossary
VS	Vertical speed	
VSI	Vertical Speed Indicator	
WAAS	Wide Area Augmentation System	Appendix A
WGS-84	World Geodetic System - 1984	
WPT	waypoint(s)	
WX	weather	
XPDR	transponder	Index
XTK	cross-track	

Foreword

Sec 1
System

Sec 2
PFD

Sec 3
MFD

Sec 4
Hazard
Avoidance

Sec 5
Additional
Features

Sec 6
Annun.
& Alerts

Sec 7
Symbols

**Sec 8
Glossary**

Appendix A

Index

This page intentionally left blank

A1 SD Card Use and Databases

The G500/G600 System uses Secure Digital (SD) cards to load and store various types of data. For basic flight operations, SD cards are required for database storage as well as database updates.

SD cards are required for Terrain, Obstacle, FliteChart, SafeTaxi, ChartView, and Aviation database storage as well as Aviation, Jeppesen aviation and ChartView database updates. For database updates, the database update datacard must be inserted in the top SD card slot while the appropriate database card is located in the bottom SD card slot. ChartView is an optional feature that requires enablement by a Garmin dealer.

The unit will generate an error in the event that a database SD card is inserted into the top slot. Aviation databases can be loaded from an SD card in either slot. If the aviation database on the SD card is more than two cycles expired, and the pilot declines the system's prompt to update the aviation database, the system will provide a second prompt that allows the pilot to suppress future prompts to update to that particular aviation database on that SD card.



NOTE: *Ensure the GDU 620 is powered off before inserting or removing an SD card.*



NOTE: *Refer to Appendix A.1 for instructions on updating the aviation database.*

Inserting an SD Card

1. Insert the SD card in the SD card slot (the front of the card should be flush with the face of the display bezel).
2. To eject the card, gently press on the SD card to release the spring latch.

Database Name	Function	Where Stored	Update Cycle	Provider	Notes
Aviation	Airport, NAVAID, Waypoint, and Airspace information	Internal GDU 620 memory or SD card	28 days (on Thursdays)	fly.garmin.com	Updates installed via SD card and copied into internal memory
IGRF model	AHRS magnetic variation model	Internal AHRS memory	5 years	fly.garmin.com	Included with Aviation database
SafeTaxi	Airport surface diagrams	SD card	56 days (on Thursdays)	fly.garmin.com	
Terrain	Topographic map, SVT, Terrain/TAWS	SD card	As required	fly.garmin.com	9 arc-second or higher resolution required for SVT
Obstacle	Obstacle information for map, SVT, and TAWS	SD card	56 days (on Thursdays)	fly.garmin.com	
Basemap	Boundary and road information	Internal Memory or SD card	As required	fly.garmin.com	
Airport Directory	Airport facility and FBO information	SD card	56 days	fly.garmin.com	Database may be available in different versions. Update cycle and content may vary.
FliteCharts	FAA-published terminal procedures	SD card	28 days (on Thursdays)	fly.garmin.com	Disables 180 days after expiration date.
ChartView	Jeppesen terminal procedures	SD card	14 days (on Fridays)	jeppesen.com	Optional feature that requires Garmin dealer enablement. Disables 70 days after expiration date.

Table A-1 Database List

A.1.1 Aviation Databases

The aviation database is updated on a 28 day cycle. Aviation database updates are provided by Garmin and may be downloaded from the Garmin website fly.garmin.com onto a Garmin provided Supplemental datacard. Contact Garmin at fly.garmin.com for aviation database updates and update kits. The Aviation database is stored on an SD card. This datacard is used to transfer the database from the top SD card slot to the datacard located in the bottom SD card slot. Removal of the datacard in the bottom SD card slot is not required.

The optional ChartView database is updated on a 14 day cycle. The ChartView database is provided directly from Jeppesen. ChartView is an optional feature that requires enablement by a Garmin dealer. Contact Jeppesen (www.jeppesen.com) for ChartView subscription and update information.

Updating the Aviation Database

1. With the G500/G600 System OFF, insert the SD card containing the aviation database update into the either card slot of the GDU 620 to be updated (label of SD card should face up).
2. Turn the G500/G600 System ON.
3. Verify the correct update cycle is loaded during power-up. Press the **ENT** key to continue or the **CLR** key to cancel loading.



Figure A-1 Database Initialization Display

Foreword

Sec 1
System

Sec 2
PFD

Sec 3
MFD

Sec 4
Hazard
Avoidance

Sec 5
Additional
Features

Sec 6
Annun.
& Alerts

Sec 7
Symbols

Sec 8
Glossary

Appendix A

Index

4. A notice on the display will indicate successful updating of the database.

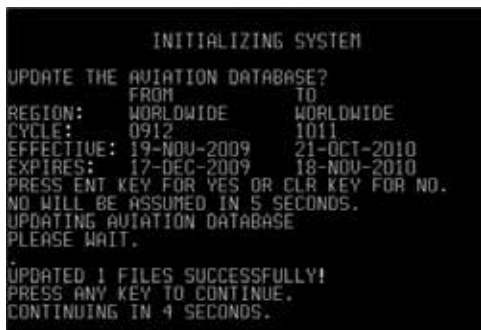

Figure A-2 Database Loading Completed

5. The following display will show the databases and their current status.



Figure A-3 Start-up Screen Database Information

6. Use the large **MFD** knob to select the AUX page group and then small **MFD** knob to reach the System Status Page.
7. Press the **DBASE** soft key to place the cursor in the "DATABASE" window.
8. Turn the small **MFD** knob to scroll through the list and check that all databases are current and there are no errors. If a database is highlighted in yellow, it is either expired or the G500/G600 can not determine the date.
9. Power down the GDU 620.

A.1.2 Garmin Databases



WARNING: *The data contained in the terrain and obstacle databases comes from government agencies. Garmin accurately processes and cross-validates the data, but cannot guarantee the accuracy and completeness of the data.*

The following GDU 620 databases are stored on Supplemental datacards provided by Garmin:

- Aviation – The aviation database contains airport, airspace, NAVAID, and waypoint information. This database is updated on a 28 day cycle.
- Terrain – The terrain database contains terrain mapping data. This database is updated periodically and has no expiration date.
- Obstacle – The obstacles database contains data for obstacles, such as towers, that pose a potential hazard to aircraft. Obstacles 200 feet and higher are included in the obstacle database. The rotorcraft database includes all reported obstacles regardless of height. It is very important to note that not all obstacles are necessarily charted and therefore may not be contained in the obstacle database. This database is updated on a 56-day cycle. Obstacles will still be shown after the database has expired. Several obstacle database options are available. Obstacle databases created for GTN software version 5.10 or later include all power lines or only HOT lines depending on the type of obstacle database installed. Hazardous Obstacle Transmission (HOT) Lines are power lines that are co-located with other FAA-identified obstacles. The installed obstacle database type can be verified on the System Status page. Power line data is available for the contiguous United States as well as small parts of Canada and Mexico.
- SafeTaxi – The SafeTaxi database contains detailed airport diagrams for selected airports. These diagrams aid in following ground control instructions by accurately displaying the aircraft position on the map in relation to taxiways, ramps, runways, terminals, and services. This database is updated on a 56-day cycle. SafeTaxi will still be shown after it has expired.
- FliteCharts – The FliteCharts database contains procedure charts for the United States only. This database is updated on a 28-day cycle. If not updated within 180 days of the expiration date, FliteCharts no longer functions.

Foreword

System Sec 1

PFD Sec 2

MFD Sec 3

Avoidance Hazard Sec 4

Additional Features Sec 5

Annun. & Alerts Sec 6

Symbols Sec 7

Glossary Sec 8

Appendix A

Index

- Airport Directory (optional) – The airport directory database contains airport facility and FBO information. This database is optional and “N/A” will be displayed in white text on the startup screen if the database is not installed. This database may be available in multiple versions with varying update cycles and/or content.

Since these databases are not stored internally in the GDU 620, a Supplemental Data Card containing identical database versions must be kept in each display unit for dual installations. After subscribing to the desired database product, the database product will need to be downloaded to a Supplemental Data Card. Insert the Supplemental Data Card into the lower card slot shown in Figure A-4. The Supplemental Data Card should not be removed except to update the databases stored on the card. The upper slot is typically used for updating the navigation database and is then normally left open. The Navigation card may be inserted in either slot, but should use the same slot each time.

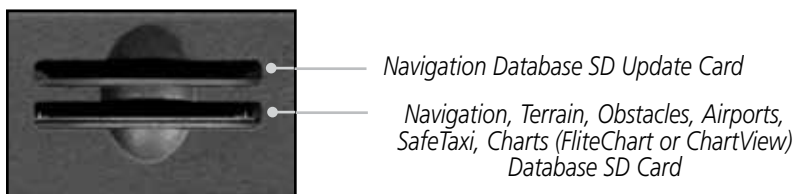

Figure A-4 SD Card Database Location

The Garmin databases can be updated by following the instructions detailed in the “Navigation Databases” section of the Garmin web site (fly.garmin.com). Once the updated files have been downloaded from the web site, a PC equipped with an appropriate SD card reader is used to unpack and program the new databases onto the existing Supplemental Data Cards. The following equipment is required to perform the update:

- Windows-compatible PC computer (Windows 2000, XP, Vista, or Windows 7 recommended)
- SanDisk SD Card Reader, P/Ns SDDR-93 or SDDR-99 or equivalent card reader
- Updated database obtained from the Garmin web site
- Existing Supplemental Database SD Card (P/N 010-00769-xx)

It may be necessary to have the system configured by a Garmin authorized service facility in order to use certain database features.

Updating Garmin Databases

1. Download the data to the data cards from the appropriate web site.
2. Insert the Database SD card in an empty card slot of the GDU 620. The SD card containing the Aviation, ChartView, FliteCharts, SafeTaxi, or any other database must be inserted into the lower slot on the GDU 620.
3. Apply power to the G500/G600 System. View the MFD start-up screen. Check that the databases are initialized and displayed. When updating the terrain and FliteCharts databases, an "in progress" message may be seen. If this message is present, wait for the system to finish loading before proceeding. Some databases can take up to 15 minutes to update.
4. Acknowledge the Power-up Page agreement by pressing the **ENT** key or the right-most soft key. If a database is highlighted in yellow, it is either expired or the G500/G600 can not determine the date.



Figure A-5 Start-up Screen Database Information

5. Use the large **MFD** knob to select the AUX page group and then the small **MFD** knob to reach the System Status Page.
6. Press the **DBASE** soft key to place the cursor in the "DATABASE" window.
7. Turn the small **MFD** knob to scroll through the list and check that all databases are current and there are no errors.
8. Power down the GDU 620.

Foreword

Sec 1
System

Sec 2
PFD

Sec 3
MFD

Sec 4
Hazard
Avoidance

Sec 5
Additional
Features

Sec 6
Annun.
& Alerts

Sec 7
Symbols

Sec 8
Glossary

Appendix A

Index

This page intentionally left blank

INDEX

Symbols

1-2 key 2-3

A

Above Ground Level 4-11
 ACT 4-110
 Activating XM 5-22
 Active flight plan 2-15, 3-1, 3-67, 3-68, 3-69
 Additional features 5-1
 ADF 1-1, 1-2, 2-2, 2-4, 2-28, 8-1
 ADIZ 3-6, 3-11, 3-27
 ADS-B 4-47
 AFF 3-58
 Age 4-55
 AHRS iii, 1-1, 1-5, 1-6, 1-12, 3-37, 6-2, 6-7, 6-9
 Aircraft symbol 2-9, 2-19, 3-3
 Air Data Computer 1-1, 1-5
 AIREP 4-128, 4-145
 AIRMETs 4-56, 4-70, 4-126, 4-142, 4-151
 Airport beacon 7-2
 Airport diagram 5-3, 5-4, A-5
 Airport Directory 3-75, A-6
 Airport signs 2-5, 5-42
 Airspace labels 3-29
 Airspeed Indicator 1-21, 2-5–2-6
 Airspeed reference 1-21, 2-8, 3-33
 Airspeed tape 2-6, 2-7, 2-18, 3-33
 Airspeed trend vector 2-6
 Air temperature 1-5, 1-8, 2-1
 Airways 3-2, 3-6, 3-11, 3-28
 Alerts 2-14, 2-15, 3-69, 4-16, 4-17, 4-19, 4-24, 4-29, 4-40, 4-43, 6-1
 Altimeter ii, 2-13, 2-15, 4-4
 Altitude 1-1, 1-5, 1-16, 1-21, 2-11, 2-14, 2-15, 3-17, 3-31, 3-37, 3-39, 3-69
 Altitude alerter 2-14, 5-15
 Altitude alerting 2-14
 Altitude Bug 1-16, 2-1, 2-13
 Altitude capture 5-32

Altitude Display Mode 4-32, 4-33
 Altitude minimums 3-69, 5-15
 Altitude select 1-16
 Altitude trend vector 2-13
 Angle of incidence 4-94
 Annunciations 1-12, 2-14, 2-15, 2-30, 4-10, 4-16, 4-17, 4-24, 4-29, 4-35, 4-36, 4-44, 4-46, 5-6, 6-1
 Answering a phone call 3-66
 Antenna 4-136
 Antenna stabilization 4-108
 Antenna tilt 4-91, 4-92, 4-96, 4-104, 4-108, 4-112
 Approaches 2-24, 2-25, 4-20, 5-3, 5-4, 5-9, 5-13, 5-43, 8-1
 Apt Dir 3-75
 AP Test 2-3
 APTSIGNS 2-5
 Arc 4-6, 4-8, 4-13, 4-27
 Arrivals 5-3, 5-4
 Attitude 1-1, 1-5, 1-6, 1-12, 2-9, 2-11, 5-31, 6-7, 8-1
 Attitude and Heading Reference System (AHRS) 1-5, 1-6, 1-12, 6-2
 Attitude Indicator 2-9–2-10
 Aural message 4-11, 4-15, 4-16, 4-18, 4-22, 4-23, 4-24, 4-30
 Automatic flight following 3-58
 Autopilot 1-1, 2-3, 5-31
 Autopilot disconnect 5-31
 Auto-slewing 2-25
 Auto zoom 3-11, 3-12
 Aux mode 3-31
 AUX - System Status Page 5-21
 Aviation map data 3-25

B

Backcourse 2-24, 2-25
 Backlighting 1-22
 Baro-corrected altitude 4-4
 Barometric minimum 2-15

Foreword

System Sec 1

PFD Sec 2

MFD Sec 3

Avoidance Hazard Sec 4

Additional Features Sec 5

Annun. & Alerts Sec 6

Symbols Sec 7

Glossary Sec 8

Appendix A

Index

Barometric pressure 1-18, 1-22, 2-15, 3-40
 Basemap symbols 7-5
 Beacon 7-1, 7-2
 Bearing information 2-27–2-28
 Bearing line 2-28, 4-104, 4-107, 4-108
 Bearing Pointers 2-23, 2-27
 Best glide 2-8, 3-33
 Bezel keys 1-16, 1-18
 Blind Alley 4-99
 BRG 1-2 2-4
 Brightness 1-21, 1-22, 3-31, 3-32

C

Calibrated gain 4-106
 Call suppression 3-60
 Canadian Nexrad 4-64
 Cautions iv, 3-6, 3-40, 4-13, 4-17, 4-30, 4-101, 4-102, 4-112, 5-31
 CDI 1-16, 1-21, 2-2, 2-3, 2-19, 2-20, 2-21, 2-22, 2-23, 2-25, 3-31, 3-36, 3-37, 3-67
 CDI source 2-22, 2-25, 2-28
 Cell movement 3-21, 3-22, 4-56, 4-82
 Channel 1-10, 3-42, 5-25, 5-26, 5-27, 5-29

Chart category 3-71, 5-8
 Charts 3-77, 5-1, 5-2, 5-4, 5-17
 ChartView 5-1, 5-2, 5-3, A-1, A-3, A-7
 ChartView database 5-3, 5-4, A-1, A-3
 ChartView subscription A-3
 Check attitude 5-31

City 3-6, 3-70, 3-73, 4-56, 4-94
 City forecast 4-56, 4-77, 4-78
 Class B airspace 3-6, 3-26, 7-7
 Class C airspace 3-6, 3-26, 7-7
 Class D airspace 3-6, 3-27, 7-7
 Cloud tops 4-56, 4-67, 4-68
 Cloudy 4-57

Cold front 4-77
 Color scheme 5-17
 Combined NEXRAD 4-142
 Compass card 2-19, 2-21
 Continental US NEXRAD 4-140

CONUS 4-140
 County warnings 4-56, 4-79
 Course Deviation Indicator (CDI) 2-19, 2-20, 2-21–2-22
 Course pointer 2-19, 2-20, 2-21, 2-25
 Course select 1-16, 2-1, 2-23
 Crossfill 1-21, 3-36
 Cross track error 2-22
 Current heading 1-16, 2-19, 2-20, 2-21, 2-24
 Current track indicator 2-19, 2-21
 Cursor 1-18, 3-7, 3-8, 3-9, 3-10, 3-21, 3-32, 3-34, 3-35, 3-36, 3-73, 3-75, 7-7
 Customizing maps 3-10
 Customizing Nav Map pages 3-10
 Cycle number 5-4, 5-21
 Cyclone 4-54, 4-56, 4-85

D

Database 1-5, 1-14, 3-11, 3-43, 4-9, 4-24, 4-73, 4-77, 4-130, 4-147, 5-3, 5-4, 5-21, 6-10, 6-14, A-1, A-5
 Databases A-1
 Database SYNC 3-44
 Data fields 3-68, 3-69
 Data link 1-2, 1-10, 4-38, 4-52, 4-55, 4-59, 4-62, 4-66, 4-68, 4-69, 4-71, 4-73, 4-75, 4-76, 4-78, 4-79, 4-82, 4-86, 4-112, 4-121, 4-127, 4-131, 4-133, 4-138, 4-151
 Data Link Receiver troubleshooting 5-30
 Date 1-21, 3-31, 3-38, 5-4, 5-21, 6-14, A-5
 Day view 5-17
 DCLTR soft key 3-5, 5-18, 5-19
 Decision Height (DH) 3-67
 Declutter 2-11, 3-5, 3-6, 4-31, 5-19
 Departures 4-20, 5-3, 5-4
 Display brightness 1-21, 1-22, 3-31, 3-32
 Display units 1-22, 2-34, 3-31, 3-39, 3-40
 Distance 1-21, 3-7, 3-9, 3-10, 3-12, 3-13, 3-39, 3-67, 3-70

Foreword

Sec 1 System

Sec 2 PFD

Sec 3 MFD

Sec 4 Hazard Avoidance

Sec 5 Additional Features

Sec 6 Annun. & Alerts

Sec 7 Symbols

Sec 8 Glossary

Appendix A

Index

- Distance measuring 3-9
 - DME 2-30, 7-1
 - Don't sink 4-18, 4-23
 - DP 5-3, 5-4
 - Dual installation 2-16, 3-36, 3-70, 5-15, A-6
- E**
- Echo tops 4-56, 4-61, 4-65, 4-66, 4-67
 - ETA 3-67
 - Excessive descent rate alert 4-18, 4-19
 - Expiration time 4-52, 4-55, 4-151
 - Exposure level 4-95
 - External TAWS 4-25
 - Extreme attitude 2-11
 - Extreme Pitch 2-11, 5-45
 - Extreme Roll 2-12
- F**
- Facility 3-70, 3-72, 3-73
 - Fast/Slow indication 2-34
 - Field of view 3-11, 3-19
 - Five-hundred aural alert 4-18, 4-22
 - Flight director 5-34
 - Flight path marker 5-37, 5-41
 - Flight phase 4-20
 - Flight plan 1-21, 2-15, 2-24, 3-1, 3-2, 3-12, 3-67, 5-8
 - FliteCharts 5-3, 5-4, A-5, A-7
 - FliteCharts database 5-4, A-7
 - Flood 4-57, 4-79
 - Fog 4-57, 4-93
 - Forecast time 4-78
 - Forward looking terrain avoidance 4-20, 4-26, 4-28
 - Freezing level 4-56, 4-86, 4-104
 - Frequency 2-20, 2-24, 2-25, 2-26, 2-27, 3-72, 3-74
- G**
- GAD 43 1-1, 1-2, 2-3, 5-31, 6-6
 - GCSS 4-115
 - GDC 74A ii, 1-1, 1-5, 1-8
 - GDL 69/69A 1-2, 1-10, 3-21, 3-41, 3-42, 4-1, 5-1, 5-22, 5-24, 5-25, 5-30
 - GDL 69 troubleshooting 5-30
 - GDL 88 models 1-9
 - GDU 620 1-1, 1-4
 - GDU 1040 1-1
 - GFDS 4-115, see also GCSS
 - Glideslope 2-22, 2-24
 - Glossary 8-1
 - GMU 44 1-1, 1-2, 1-8
 - GPS altitude ii, 4-4
 - GPS level of service 2-19, 2-21, 2-28
 - GPSS 5-34
 - Ground Clutter Suppression 4-110
 - Ground mapping 4-111, 4-112
 - Ground pointer 2-1, 2-10
 - Ground Radar 4-112
 - Ground return 4-94, 4-96, 4-112
 - Ground speed 2-5, 2-6, 2-11, 4-24, 5-41
 - GRS 77 1-1, 1-5, 1-14, 5-31
 - GSR 56 1-9, 3-56, 3-59
 - GTP 59 1-2
 - GTX 33 1-11, 4-1
 - GTX 330/330D 1-11
 - GWX 68 4-89
- H**
- Hail 4-61, 4-93, 4-98, 4-100
 - Hazard avoidance 4-1
 - Haze 4-57
 - Heading 1-6, 1-16, 2-19, 2-20, 3-1, 3-37, 4-13, 4-32, 4-38, 5-32
 - Heading bug 1-16, 2-1, 2-19, 2-20
 - Heading select 1-16
 - Helipad 7-2
 - Heliport 7-1
 - Home page 3-3
 - Horizon heading 2-5, 5-37, 5-39, 5-42
 - Horizon line 2-9
 - Horizontal scan 4-89, 4-101, 4-104, 4-107, 4-108, 4-109
 - Horizontal Situation Indicator (HSI) 1-4, 1-16, 2-1, 2-19–2-34, 5-42
 - Hot spots 5-18, 5-19

Foreword
 System Sec 1
 Sec 2
 PFD
 Sec 3
 MFD
 Sec 4
 Hazard Avoidance
 Sec 5
 Additional Features
 Sec 6
 Anun. & Alerts
 Sec 7
 Symbols
 Sec 8
 Glossary
 Appendix A

Hrzn Hdg 2-5
Hurricanes 4-136

Foreword

I

Icing 4-70, 4-87, 4-126, 4-127, 4-142, 4-144

Sec 1 System

Identifier 3-70, 3-71, 3-73, 5-8, 5-9, 5-42

IFR 4-70, 4-127, 4-144

IGRF model 1-5, 1-14

ILS 2-22, 2-24, 2-25, 2-26, 7-1

Sec 2 PFD

Imminent obstacle impact 4-20, 4-26

Imminent terrain impact 4-20, 4-26

INFO soft key 3-68

Infra-Red 4-124

Sec 3 MFD

Inhibit alerting 4-28

Intersection 3-6, 3-25, 3-26, 5-19, 7-1

Iridium 1-9, 3-56, 3-59, 4-1, 4-112

Sec 4 Hazard Avoidance

J

Jeppesen 5-3, A-1, A-3

Jeppesen database A-3, A-7

Sec 5 Additional Features

L

Land data 3-2, 3-11, 3-13, 3-15

Lateral deviation scale 2-19, 2-21

Lat/Lon 3-6, 3-11, 3-18, 3-70

LDA 2-25

Legend 3-11, 3-22, 4-5, 4-16, 4-53, 4-54, 4-58, 4-60, 4-63, 4-67, 4-75, 4-123, 4-132, 4-139, 4-149

Level 1-21, 3-5, 3-6, 3-31, 3-32, 4-17, 4-20, 4-86, 4-98

Lighting 1-22, 3-74

Lightning 3-2, 3-6, 3-21, 3-22, 4-54, 4-56, 4-69, 4-73, 4-116, 4-125, 4-130, 4-147

Sec 8 Glossary

Limitations 4-9, 4-10, 4-41, 4-61, 4-136

Localizer 2-20, 2-22, 2-25, 2-27

Loc BC 2-25

LPV 2-28

LRU 1-1, 1-3, 1-9, 3-43, 5-30, 6-14

Lubber line 2-19, 2-21

Index

M

Magnetometer 1-2, 1-6, 1-8

Making a phone call 3-65

Map 3-2

Map orientation 3-1, 3-3, 3-12, 3-70, 4-5, 4-13, 4-54, 4-62, 4-116, 4-121, 4-138

Map panning 3-7

Map pointer 3-2, 3-7

Map range 1-21, 3-2, 3-5, 3-12, 4-13, 5-18

Map setup 3-10, 4-28

Map symbols 7-1, 7-5

Map toolbar symbols 7-6

Marker beacon 2-30

Markings 2-7, 5-18, 5-19

Measuring distance 3-9

Menu Key 1-18, 1-19, 3-4, 3-10

Menus 1-18, 1-19

Message 2-19, 4-18, 4-24, 4-30

METARs 3-67, 3-76, 4-54, 4-56, 4-73, 4-116, 4-130, 4-131, 4-147, 4-151

MFD 1-1, 1-4, 1-15, 1-18, 3-1

MFD display units 3-31, 3-39

Military 3-11, 3-27, 4-62

Minimum Descent Altitude (MDA) 2-15

Minimums 5-15

Miscellaneous symbols 7-7

Miscompare 2-31

MOA 3-6, 3-11, 3-27, 7-7

Motion vector 4-50

Mountains 4-136

Moving map 1-1, 1-4, 1-18, 3-1, 3-2, 3-11

MPEL 4-95

MSL 4-4

Mute 5-28

N

National Weather Service 4-59, 4-70, 4-79, 4-126, 4-142

Nav angle 1-22, 2-20, 3-40

Navigation database 1-5, 1-14, A-3, A-6

Navigation map 1-13, 1-18, 3-1, 3-2,

3-10, 4-5, 4-28, 4-52, 5-18, 5-19
Navigation source iii, 2-3, 2-19, 2-22–2-24, 2-27, 2-28, 3-37, 3-67
Nav range ring 3-2, 3-11, 3-13
Nav Status Bar 2-1
Nav status style 2-1, 3-31, 3-35
NDB 3-6, 3-11, 3-25, 3-26, 5-19, 7-1
Negative climb rate 4-18, 4-23
NEXRAD 3-21, 4-56, 4-59, 4-137, 4-138, 4-151
 Legend 4-63, 4-139
 Limitations 4-61
 Viewing range 4-63, 4-138
NEXRAD Legend 3-22
Nexrad source 4-64
NEXRAD Viewing Range 3-22
Night view 5-17
Normal display operation 1-1
North up 3-1, 3-11, 3-12, 4-52, 4-54, 4-116
NOTAM 5-3, 5-16
Notes v
NRST 5-8

O

OAT 1-5, 1-8
OBS 1-16, 2-19, 2-23, 2-28, 3-37, 8-5
Obstacle data 3-17, 4-4, 4-24, A-5
Obstacles 3-13, 3-15, 3-17, 4-4, 4-9, 4-10, 4-11, 4-43, 5-44, 7-4, A-5
Obstructions 4-9, 4-10
Occluded front 4-78
Operating distance 4-95
Other airspace 3-27
Outside air temperature 1-5, 1-8, 2-1
Overspeed 2-6
Overview 1-1

P

Page group 1-18, 3-2
Page menus 1-18, 1-19, 1-20, 3-10, 3-11, 3-21, 3-24, 3-25, 3-32, 3-68, 4-6, 4-14, 4-27, 4-53, 4-54
Panning 3-7, 5-12, 5-19

Parallel track 7-7
Part Sun 4-57
PFD 1-4, 1-15
PFD display units 2-34
PFD options 1-21, 3-31, 3-34, 3-35
PFD soft keys 2-2
Phone book 3-61
Phone call 3-65
Phone volume 3-64
Photocell 1-22
Pilot Controlled Lighting 3-74
PIREP 4-72, 4-128, 4-145
Pitch indication 2-9, 2-11
Pitch scale 2-9, 5-40
Position reporting 3-56
Power 4-137
Power-up 1-5, 1-12, 1-14, 4-11, 4-24, 4-44, 5-4, 5-21, A-3, A-7
Precipitation 4-61, 4-65, 4-73, 4-90, 4-92, 4-93, 4-101, 4-108, 4-122, 4-130, 4-147
Precipitation intensity levels 4-98, 4-105
Premature descent alerting 4-20
Preset 5-29
Product age 4-52, 4-55
Proximate advisory 7-2
Proximity advisory 4-32

R

Radar 4-41, 4-43, 4-59, 4-61, 4-65, 4-89, 4-136, 4-137
Radar altimeter 2-13, 2-17, 2-32, 3-32
Radar gain 4-105
Rainy 4-57
Range keys 1-18, 3-5, 3-70, 5-11
Range ring 3-2, 3-11, 3-13, 4-5, 4-13, 4-32, 4-33, 4-48, 4-109
RECENT 5-8
Record of Revisions vi
Reduced required obstacle clearance 4-20
Reduced required terrain clearance 4-20
Reference speed 2-8
Reflectivity 4-60, 4-61, 4-93, 4-100, 4-137

Foreword

System
Sec 1

PFD
Sec 2

MFD
Sec 3

Hazard
Avoidance
Sec 4

Additional
Features
Sec 5

Annun.
& Alerts
Sec 6

Symbols
Sec 7

Glossary
Sec 8

Appendix A

Index

Regional NEXRAD 4-141
 Register with GFDS 4-113
 Restore defaults 3-32, 3-69
 Restricted airspace 3-27
 Roll pointer 2-9
 Roll Scale 2-9, 2-10
 Roll scale pointer 2-1, 2-10
 Roll Scale Zero 2-9
 Route 3-8, 3-67, 5-19
 Runway depiction 5-43
 Runway extension 3-25, 3-26
 Runway information 3-72, 3-74

S

SafeTaxi 3-12, 3-25, 5-1, 5-18, 5-19,
 5-21, A-1, A-5, A-7
 SafeTaxi symbols 7-2
 Satellite telephone 3-59
 Scale 2-6, 2-8, 2-9, 2-10, 2-13, 2-19,
 2-20, 2-21, 3-2, 3-5, 3-7, 3-11,
 3-15, 4-3, 4-34, 4-111, 5-40
 Scroll bars 5-12
 SDF 2-25
 Sector scan 4-89, 4-107
 Secure Digital (SD) card 2-1, 3-1, A-1
 Selected Altitude 2-11, 2-13, 2-14, 2-15,
 3-37, 4-132, 4-149
 Selected altitude range arc 3-20
 Selected Course 2-23, 3-37
 Selected Heading 2-20, 3-37
 Serial numbers 3-43, 5-30, 6-14
 Service Class 5-23, 5-24
 SIGMET 4-56, 4-70, 4-71, 4-126, 4-127,
 4-142, 4-143, 4-151
 Sky pointer 2-10
 Sky representation 2-9, 5-45, 5-46
 Slewing 2-25
 Slip/Skid Indicator 2-1, 2-9
 Smart airspace 3-28
 Snow 4-57, 4-61, 4-93
 Soft keys 1-15, 1-19, 2-1, 2-2, 2-11, 3-1,
 4-31, 4-44, 5-26, 5-39, 5-41
 Software version 3-43, 5-30, 6-14
 Speed 1-5, 1-21, 2-5, 2-8, 2-11, 2-18,

3-13, 3-31, 3-33, 3-39, 4-20, 4-40
 Speed range 2-7
 STAB 4-108
 Stabilization 4-101, 4-108
 STAR 5-3, 5-4
 Stationary front 4-78
 Stormscope 1-9, 4-152
 Sunny 4-57
 Surface analysis 4-56, 4-77
 Surface data 4-54, 4-78
 Surface winds 4-70, 4-127, 4-144
 Symbols 4-17, 4-34, 4-40, 4-55, 4-57,
 5-44, 7-1
 Synchronization 1-21, 3-31, 3-36, 3-37
 Syn Terr 2-5
 Synthetic Vision v, 2-4, 2-5, 3-11, 3-19,
 4-26, 4-29, 5-1, 5-37
 Synthetic Vision alerts 4-29
 Syn Vis 2-4
 System description 1-1
 System display units 3-31, 3-40
 System power 1-5, 1-12, 1-14
 System settings 1-20, 3-31
 System status 3-43, 4-9, 4-24, 4-35, 4-44,
 6-14

T

TACAN 7-1
 TAF 3-76, 4-73, 4-130, 4-147
 Target selection 4-47
 TAS 4-31, 4-101, 5-1
 TAWS alerts 4-4, 4-16, 4-17
 TAWS-B 4-1, 4-10
 TAWS failure alert 4-24
 TAWS-SVT 4-1, 4-26
 TAWS system test 4-11, 4-14, 4-24
 TCA 3-11, 3-26
 Temperature 1-22, 3-40, 4-57
 Temperature probe 1-1, 1-2, 1-8
 Temperature reference 2-29, 3-31
 Terrain 1-21, 2-11, 3-1, 3-13, 3-15,
 4-1, 4-5, 4-10, 4-26, 4-43, 4-94,
 4-111, 7-4, A-1
 Terrain alerts 4-23, 4-26, 4-29, 4-30, 5-37

Terrain data 3-11, 3-16, 4-8, 4-9, A-5
 Terrain obstacle symbols 4-12, 7-4

Terrain proximity ii, 1-21, 4-1, 4-5, 4-11, 7-6
 Terrain scale 4-6
 Terrain-SVT iv, 4-2, 4-26
 Textual METARs 4-74, 4-131, 4-148
 TFR 3-11, 3-25, 3-27, 4-80, 4-134, 4-150, 7-7
 Thunderstorm 4-136
 Thunderstorms 4-57, 4-79, 4-93, 4-97, 4-98, 4-100
 Time 1-21, 3-13, 3-31, 3-38, 4-52, 4-56, 4-77, 4-78, 4-151
 Time zone 3-38
 TIS 4-31, 4-38, 4-40, 4-41, 4-43, 5-1
 TMA 3-11, 3-26
 To/From Indicator 2-19, 2-20
 Topo data 3-11, 3-15
 Topo scale 3-11, 3-15
 Tornadoes 4-57, 4-79, 4-100
 Tornados 4-136
 Track indicator 2-19, 2-21
 Track vector 3-2, 3-11, 3-13, 4-42
 Traffic Advisory 3-24, 4-1, 4-31, 4-34, 4-38, 7-2
 Traffic Pop-Up 4-37
 Traffic symbols 4-40, 4-49, 5-44, 7-2
 Transponder 1-11, 4-1, 4-31, 4-38, 4-41, 4-43, 4-44
 Trend Vector 2-6, 2-13, 2-19, 2-21
 True Airspeed 1-21, 2-6, 2-11
 True North 2-20, 3-40
 Turbulence 4-70, 4-88, 4-90, 4-93, 4-98, 4-126, 4-142
 Turbulence Detection 4-110
 Turn Rate 2-19
 Turn Rate Indicator 2-19, 2-21

U

Unusual attitude 2-11, 5-45

V

VDI 2-24, 5-41
 Vector Duration 4-51
 Vector motion 4-50
 Version 1-12, 3-43, 4-11, 4-26, 5-21, A-6
 Vertical deviation 2-24
 Vertical scan 4-89, 4-98, 4-99, 4-103, 4-105, 4-107
 Vertical speed 1-1, 1-5, 1-17, 1-21, 2-1, 2-11, 2-13, 2-18, 3-31, 3-37, 3-39
 Vertical Speed Indicator (VSI) 1-21, 2-18
 Video 3-51
 VNAV 2-24, 2-28
 VNV 8-7
 Voice alert 4-43
 Volume 1-10, 3-42, 5-25, 5-28
 VOR 1-16, 2-3, 2-20, 2-22, 2-27, 3-1, 3-6, 3-11, 3-25, 3-26, 3-37, 4-12, 5-19, 7-1
 VORTAC 7-1
 Vspeeds 2-8, 3-33

W

WAAS 1-8, 2-24
 Warm front 4-77, 4-78
 Warnings ii
 WATCH 4-92, 4-109
 Waypoint information 3-70, 3-72, 3-76, 5-19
 Waypoint selection 3-71
 Waypoint weather 3-76
 Weather 3-21, 3-76, 4-52, 4-112, 4-136
 Weather legend 4-53, 4-58, 4-60
 Weather mapping 4-97
 Weather product 3-22, 4-52, 4-55, 4-58, 4-63, 4-122, 4-138, 5-23
 Weather radar 1-2, 4-1, 4-89
 Weather symbols 4-55
 Wind 1-21, 2-29, 3-2, 3-11, 3-13, 3-31, 3-34, 4-56, 4-57, 4-70, 4-73, 4-75, 4-127, 4-130, 4-132, 4-144, 4-147, 4-149, 4-151, 7-7
 Winds aloft 4-56, 4-75, 4-132, 4-149, 4-151
 Winds aloft altitude 4-133, 4-149

Foreword

System Sec 1

PFD Sec 2

MFD Sec 3

Avoidance Hazard Sec 4

Additional Features Sec 5

Annun. & Alerts Sec 6

Symbols Sec 7

Glossary Sec 8

Appendix A

Index

Wind speed 3-13
 Wind vector 1-21, 2-29, 3-11, 3-13, 3-31,
 3-34, 7-7
 WX-500 1-9, 4-152
 WX soft key 3-68

Foreword

X

Sec 1 System XM 3-41, 3-42, 4-52, 5-22
 XM channel categories 5-26
 XM entertainment radio 5-22
 Sec 2 PFD XM radio activation 5-22
 XM radio channel presets 5-29
 XM radio channels 5-27
 XM radio volume 5-28
 Sec 3 MFD XM Satellite Radio 1-10, 5-22
 XM troubleshooting 5-30
 XM weather 3-68, 4-52
 XM weather/radio 1-10
 Sec 4 Hazard Avoidance XTK 2-22

Z

Zero pitch line 5-41

Sec 5 Additional Features

Sec 6 Annun. & Alerts

Sec 7 Symbols

Sec 8 Glossary

Appendix A



www.garmin.com

Part Number 190-00601-02 Rev. K