

CARDIMAX

FX-7202

ELECTROCARDIOGRAPH

Ver.04

OPERATION MANUAL



- Before using this device, read this operation manual.
- Store this manual in a location near the unit for future reference.



This device bears a CE label in accordance with the provisions of Medical Device Directive 93/42/EEC.

PERSONS RESPONSIBLE FOR SUPPLYING DEVICES TO THE EC MARKET UNDER MDD 93/42/EEC.

NAME: FUKUDA DENSHI UK
ADDRESS: 13 WESTMINSTER COURT, HIPLEY STREET OLD WOKING,
SURREY GU22 9LG, U.K.

Copyright © 2008 Fukuda Denshi Co., Ltd.

No part of this document may be copied or transmitted in any form without the prior written permission of Fukuda Denshi Co., Ltd.

Printed in Japan

Note:
Only qualified physicians or persons under instructions from physicians are allowed to use the FX-7202.

This Operation Manual is for FX-7202 Version 04.

How to Use the Operation Manual

Congratulations on the purchase of your new electrocardiograph from Fukuda Denshi!

This operation manual is intended as a guide for proper operation of the Cardimax FX-7202.

Be sure to read and understand this manual thoroughly before using the Cardimax FX-7202 so you can perform each task smoothly and fully utilize the functions offered by this device.

If you have any questions or views about our product or manual, contact your local Fukuda Denshi sales and service representative.

This manual is organized into 8 chapters, with 4 appendices, glossary, and index.

Chapter 1, "General Information" deals with a general introduction to the Cardimax FX-7202. This chapter contains illustrations of the Cardimax FX-7202 so you can become familiar with the equipment before beginning use.

Chapter 2, "Preparing the Cardimax FX-7202" provides you with a step-by-step procedure to set up the Cardimax FX-7202. This chapter also contains the procedure for charging the rechargeable battery.

Chapter 3, "Operating the Cardimax FX-7202: Recording a Standard 12-lead ECG in the Automatic Recording Mode" describes step-by-step the entire operation flow starting from connecting the patient cable to the electrode and attaching the electrodes to the patient, to recording the electrocardiogram using—as an example—the Automatic Recording of the standard 12-lead ECG. This chapter also provides information about the screen and keys on the touch-panel and operation panel.

Chapter 4, "Recording the Electrocardiogram: Standard ECG Mode" contains information on how to record the electrocardiogram using the standard ECG mode.

Chapter 5, "Recording the Electrocardiogram: Advanced Features" contains information on how to record the electrocardiogram using advanced features, including the Review Recording, R-R Trend Test Mode, Arrhythmia ECG Mode, and Arrhythmia Automatic Extension Recording Modes. (The Arrhythmia ECG Mode and Arrhythmia Automatic Extension Recording Mode are available only when the PC-7403 program cartridge is installed.)

Chapter 6, "Managing ECG Data Files" contains information on how to read ECG data from the built-in memory.

Chapter 7, "Setting Up the Parameters of the Cardimax FX-7202" contains information on how to set up parameters such as the number of display channels and recording format using the SET UP MODE screens in accordance with your purposes.

Chapter 8, "Maintenance and Troubleshooting" deals with basic maintenance procedures. It also provides information on what to do when you are unable to measure an accurate electrocardiogram, and includes a list of error messages and their recovery actions.

Appendix A, "Specifications" gives you the main specifications for the Cardimax FX-7202.

Appendix B, "Daily Check Lists" summarizes the daily check items and their procedures.

Appendix C, "Periodic Check Lists" summarizes the periodic check items and their procedures.

Appendix D, "LAN communication function" explains the LAN connection method and the SCP-ECG Data Structures.

The Glossary explains the technical terms used in this manual.

The Index is provided to locate specific information quickly.

Conventions

Keys

The step-by-step operation procedures in this manual are shown with screens and text. When you operate the Cardimax FX-7202, you use the Operation Panel keys and function keys of the Touch-panel. In this manual, the keys are indicated in the following manner.

Example of an Operation Panel key: **[START/STOP]**

Press the relevant key on the Operation Panel.

Example of a function key on the Touch-panel: **[MANUAL]**

Touch the relevant function key on the Touch-panel.

Optional features

This manual provides information on the operation of the Cardimax FX-7202 and the additional functions it can provide when you plug in the PC-7403 program cartridge. Some of the functions are available only when the program cartridge is installed. The operation of the FX-7202 varies depending on the installed program cartridge. In this manual, the functions inherent to the PC-7403 program cartridge are identified with the following icon to set them apart:



Indicates the function available only when you have installed the PC-7403 program cartridge in the Cardimax FX-7202.



Special Notice to User

Malfunction caused by EMC

The Cardimax FX-7202 complies with the safety standards IEC60601-2-25 (1999) and IEC60601-1-2 (2001). However, if there is a strong electromagnetic wave nearby that exceeds the prescribed limit, the device could malfunction. If this happens, provide the required countermeasures.

Influence of radiation electromagnetic wave:

The use of a cellular phone could affect the operation of the FX-7202. Alert persons in a facility where medical electronic equipment is installed to turn off their cellular phones and small radio equipment.

Influence of bursts and conduction electromagnetic wave:

High-frequency noise from other equipment may infiltrate into the FX-7202 through the AC outlet. Identify the noise source and stop use of the relevant equipment if possible. If this equipment cannot be shut down, provide the countermeasures for this noise route using a noise suppressing device, etc.

Influence of static electricity:

The discharge of static electricity could affect the operation of the FX-7202 in a dry environment (room), particularly in winter. Before using the FX-7202, humidify the room or discharge static electricity from a patient and person who will record the ECG.

Influence of surge (lightening):

If there is a thunderstorm occurring nearby, it might cause a voltage surge in the FX-7202. If you expect any danger, unplug the power supply cord from the AC outlet and run the FX-7202 on built-in battery power (optional). Also use an uninterruptible power supply, if you have one.

Equipment classification

The Cardimax FX-7202 falls under the following equipment classifications:



- 1) Protection against electrical shock
Class I, Internally powered
- 2) Type against electrical shock
Applied part: Type CF
- 3) Protection against liquids entering the device
General equipment standards
- 4) Operating safety in the presence of air-inflammable anesthetic gases or oxygen/nitrous oxide-anesthetic gases
The equipment must be used in an environment free from inflammable anesthetic gases or inflammable cleaning agents.
- 5) Running mode
Continuous running mode

Safety Precautions

- Before using the Cardimax FX-7202, be sure to read this section to ensure safety and correct operation.
- Be sure to follow the precautions given below. These are important matters related to safety.



Safety notifications

The following three safety notices alert the user to the level of hazard and damage that may result from not following the instructions or from misuse of the equipment.

 DANGER	Ignoring these instructions could cause death, serious injury, or major fire.
 WARNING	Ignoring these instructions could cause death, serious injury, or fire.
 CAUTION	Ignoring these instructions could cause injury or damage to the equipment.

Safety icons

The following icons appear with the instructions given in safety notices. They basically categorize what you should do or not do in the following manner:

	Indicates actions that are prohibited.
	Provides instructions for dangers, warnings, and cautions.
	Indicates actions that must be performed.



Precautions on analysis program

 CAUTION
<p>Interpretation and Minnesota codes given by the Cardimax FX-7202 do not instruct the physician as to the kind and degree of cardiac disease. Accordingly, four value judgments are given for electrocardiogram (ECG) waveform and although "abnormal" indicates a large possibility of organic cardiac disease, there are cases where no cardiac disease exists despite an abnormal ECG (that is, an abnormal ECG may be caused by something other than the heart). On the other hand, care should be taken in the event any preclinical coronary arteriosclerosis could be present despite a normal ECG interpretation. Therefore, for a proper diagnosis, the ECG should be integrated with other interpretations. This program is not an arrhythmia monitor. The FX-7202 has no arrhythmia alarms.</p>



Precautions on measurement program

 CAUTION
<p>The equipment may measure the ECG waveform incorrectly due to external noise (such as a drift of baseline, electromyogram, AC interference, etc.). Another matter which requires careful consideration is that tiny R waves in V1 and V2 may be overlooked and the S wave could be interpreted as Q wave.</p>



Precautions on battery pack

 DANGER	
	<ul style="list-style-type: none"> • Be sure to use the specified battery pack (T8HRAAU-4713). • Be sure to charge the battery using the Cardimax FX-7202. Charging the battery using other equipment could lead to a hazard.
	<ul style="list-style-type: none"> • Do not disassemble or mutilate the battery. You could burn yourself. • Do not incinerate or heat the battery. You could burn yourself, or the battery could burst or leak toxic substances. • Do not short the battery. You could burn yourself. • Keep away from children. • If the liquid contained in the battery gets into your eyes, do not rub them. Wash your eyes thoroughly with water and see a doctor immediately.



Nonexplosion proof

 DANGER	
	Do not operate the FX-7202 in an environment where there is a risk of explosion. Do not operate the FX-7202 in the presence of flammable anesthetics.



Magnetic resonance imaging

 WARNING	
	Do not operate the FX-7202 during Magnetic Resonance Imaging (MRI) scanning. The conducting current may cause burns. Operating the FX-7202 may affect the MRI image, while the MRI may affect the accuracy of the FX-7202.



High-frequency surgery

 WARNING	
	The patient cable (CP-104T, CP-104L or CP-104J) contains resistors installed in the lead wire plugs to prevent damage to the equipment when used in the presence of high frequency surgery apparatus. These components reduce the risk of not only device damage, but also the risk of burns to the patient.



Defibrillation protection

 WARNING	
	The FX-7202 may remain connected to the patient during defibrillation only if the proper patient cable provided with defibrillator protection is being used. The patient cable (CP-104T, CP-104L or CP-104J) is provided with defibrillation protection. The FX-7202 will not be damaged when these cables are used, even if the defibrillator paddles come into contact with the ECG electrodes.

Connection

 DANGER	
	<ul style="list-style-type: none">• This isolation measure is provided to protect the patient. Operation is bypassed if the electrodes on the patient cable come into contact with any other metal object or other electrically conductive objects, including the operator's hands. When such contacts occur, there is a risk of electric shock, regardless of whether or not the objects are grounded.• All ECG wires (patient connections), connectors, and amplifiers are electronically isolated from the rest of the device and from ground. This isolation restricts the current that can pass through a patient to less than 10 microamperes.• If the power supply cords of several different units are connected together in a multiple outlet tap, an increase in chassis leakage current can create a potential hazard.• When a cardiac pacemaker or other electrical stimulator is connected to the patient, it increases the risk of a potential hazard. Pay particular attention to safety measures to record ECG in such conditions. Appropriate measures must be taken to assure that the chassis leakage current is at a safe level.• The FX-7202 is Type CF equipment. It must not, however, be placed in direct contact with the area of the heart.
	<p>Be sure to connect the power supply cord to a hospital-grade wall AC outlet. If no hospital-grade wall outlet is available, connect the potential equalization cable securely to a proper ground. If no proper grounding is available, operate the FX-7202 on its rechargeable battery.</p>



Preventive maintenance

 CAUTION	
	<p>The purpose of preventive maintenance is to assure that the device is always in a safe operating condition and to prevent possible future problems. Preventive maintenance should be performed at least once during each 12-month period. Preventive maintenance consists of a thorough inspection of the device, all connections, and all attached cables for signs of physical damage. Immediate maintenance must be performed if:</p> <ul style="list-style-type: none">• The device was subject to extreme mechanical stress; e.g., after a heavy fall.• Liquid or fluids have spilled on or into the device.• The device does not function, or functions improperly.• Parts of the device cabinet are cracked, broken, or damaged.• The power supply cord or the patient cable and interconnecting cables show signs of deterioration.



Transportation

 CAUTION	
	<p>When transporting the FX-7202, pack it with the specified packing materials.</p>





Disposing of the FX-7202, accessories, and options

 WARNING	
	<p>When you dispose of the FX-7202, accessories, or optional parts, entrust them to specialized industrial waste dealers.</p>

Paper loading

 WARNING	
	<p>When the recording paper will be loaded, be careful about edge. Failure to do so may cause injury.</p>

General precautions

 CAUTION	
	<ul style="list-style-type: none"> • Do not use or store the FX-7202 in a place where it may be exposed to a liquid spill. Liquid in the equipment can be a source of danger such as electric shocks to a patient or operator of the FX-7202. • Do not subject the FX-7202 to a strong impact or vibration and do not drop it. Such damage to the equipment could cause an electric shock or fire. If you unintentionally drop the FX-7202, contact your local Fukuda Denshi sales and service representative. • Do not subject the liquid crystal display to a strong impact. The device can be damaged by unwarranted force.
	<ul style="list-style-type: none"> • Make sure that a patient does not come in contact with the FX-7202, other electric appliances, or metal. Such contact increases the leakage current and can become a source of danger to a patient.
	<ul style="list-style-type: none"> • When you unplug a cord, be sure to hold the plug to remove the cord (do not pull the cord itself). Also, do not plug/unplug the cord with wet hands. This could cause an electric shock, short circuit, or injury. • Operate the touch-panel display with a finger. If you tap the touch-panel screen with a tool instead of your finger, this could damage the surface of the touch-panel screen and cause the device to malfunction. • Wipe off dirt on the surface of the touch-panel display with a soft cloth moistened using ethanol or with the silicon cloth supplied with the accessories. <p>Checks:</p> <ul style="list-style-type: none"> • Perform the daily checks to assure the safety of the FX-7202. • Perform the periodical checks every three to four months to assure the safety of the FX-7202. <p>Perform the periodical checks to be performed by a specialist every 12 months to assure the safety of the FX-7202.</p>

Equipment Symbols

The following symbols are printed on the Cardimax FX-7202.



Attention: Read the Operation Manual.



Type CF equipment



Potential equalization terminal



AC power supply



LAN port

Guidance for Electromagnetic Compatibility (EMC) _____

Details about the electromagnetic compatibility (EMC) of the Cardimax FX-7202 are given below. Before using the FX-7202, be sure to read and understand the following information.

Compliance with electromagnetic emissions

The Cardimax FX-7202 is intended for use in the electromagnetic environment specified in the following table. Before using the FX-7202, check the environment of the site where it is used.

Emissions test	Compliance	Electromagnetic environment/guidance
RF emissions CISPR 11	Group 1	The Cardimax FX-7202 uses RF energy for its internal functions only. Therefore, its RF emissions are very low and are not likely to cause any interference in electronic equipment installed nearby.
RF emissions CISPR 11	Class B	The Cardimax FX-7202 is suitable for use in all types of buildings, including private houses. It can be used by direct connection to the commercial low-voltage power supply in buildings used for domestic purposes.
Harmonic emissions IEC61000-3-2	Class A	
Voltage fluctuations/flicker emissions IEC61000-3-3	Compliance	

Compliance with electromagnetic immunity 1

The Cardimax FX-7202 is intended for use in the electromagnetic environment specified in the following table. Before using the FX-7202, check the environment of the site where it is used.

Immunity test	IEC 60601 test level	Compliance level	Electromagnetic environment/guidance
Electrostatic discharge (ESD) IEC 61000-4-2	±6kV: Contact ±8kV: Air	±6kV: Contact ±8kV: Air	The desirable floor materials are wood, concrete, or ceramic tiles. If the floors are covered with synthetic material, the relative humidity should be at least 30%.
Electrical fast transition/burst IEC 61000-4-4	±2kV: Power supply lines ±1kV: Input/output lines	±2kV: Power supply lines ±1kV: Input/output lines	The power supply quality should be that of a standard commercial or hospital environment.
Surge IEC 61000-4-5	±1kV: Differential mode ±2kV: Common mode	±1kV: Differential mode ±2kV: Common mode	The power supply quality should be that of a standard commercial or hospital environment.
Voltage drops, dips, and fluctuations of input power supply line IEC 61000-4-11	<5% U_T (>95% drop in U_T) for 0.5 cycle <40% U_T (>60% drop in U_T) for 5 cycles <70% U_T (>30% drop in U_T) for 25 cycles <5% U_T (>95% drop in U_T) for 5 seconds	<5% U_T (>95% drop in U_T) for 0.5 cycle <40% U_T (>60% drop in U_T) for 5 cycles <70% U_T (>30% drop in U_T) for 25 cycles <5% U_T (>95% drop in U_T) for 5 seconds	The power supply quality should be that of a standard commercial or hospital environment. If the FX-7202 user requires continuous operation even during a power failure, it is recommended to use an uninterruptible power supply or a battery (optional).
Magnetic field of commercial frequency (50/60Hz) IEC 61000-4-8	3 A/m	3 A/m	The power frequency magnetic field should have the same characteristics as that of general locations in a standard commercial or hospital environment.

Note:

U_T puts priority on the AC power supply voltage over the applied test level.

Compliance with electromagnetic immunity 2

The Cardimax FX-7202 is intended for use in the electromagnetic environment specified in the following table. Before using the FX-7202, check the environment of the site where it is used.

Immunity test	IEC 60601 test level	Compliance level	Electromagnetic environment/guidance
Conducted RF IEC 61000-4-6	3 Vrms 150kHz to 80MHz	3 Vrms	<p>Portable and mobile RF communications equipment must not be operated closer to any part of the FX-7202 (including cables) than the recommended separation distance calculated from the formula applicable to the transmitter frequency.</p> <p>Recommended separation distance:</p> $d=1.2\sqrt{P}$ $d=1.2\sqrt{P} \quad 80\text{MHz to } 800\text{MHz}$ $d=2.3\sqrt{P} \quad 800\text{MHz to } 2.5\text{GHz}$ <p>Where \sqrt{P} is the maximum output power rating of the transmitter in watts (W) according to the transmitter manufacturer, and d is the recommended separation distance in meters (m).</p> <p>Field strengths from fixed RF transmitters (determined by an electromagnetic site survey*) must be lower than the compliance level in each frequency range**.</p> <p>Interference may occur in the vicinity of equipment marked with the following symbol:</p> 
Radiated RF IEC 61000-4-3	3 V/m 80kHz to 2.5GHz	3 V/m	

Notes:

- The higher frequency range is between 80MHz and 800MHz.
 - These guidelines may not apply in all situations. Electromagnetic propagation is affected by reflection and absorption from buildings, objects, and people.
- *: The field strengths of fixed transmitters, such as base stations for radio (cellular/cordless) phones and land mobile radios, amateur radio, AM/FM radio broadcast and TV broadcast base stations cannot be predicted theoretically with accuracy. To assess the electromagnetic environment produced by fixed RF transmitters, an electromagnetic site survey should be considered. If the measured field strength in the site where the FX-7202 is used exceeds the applicable RF compliance level above, the equipment should be monitored to assure normal operation. If an abnormality is observed, additional measures may be necessary, such as re-orienting or relocating the FX-7202.
- ** : Over the frequency range 150kHz to 80MHz, field strengths should be less than 3 V/m.

Recommended separation distance between portable/mobile RF communications equipment and the FX-7202

The Cardimax FX-7202 is intended for use in an electromagnetic environment where RF emission interference is controlled. The electromagnetic interference can be prevented during operation by providing a minimum distance between portable/mobile RF communications equipment (transmitters) and the FX-7202 as recommended below (according to the maximum output power of the transmitter).

Rated maximum output power of transmitter (W)	Separation distance according to frequency of transmitter (m)		
	26MHz to 80MHz $d=1.2\sqrt{P}$	80MHz to 800MHz $d=1.2\sqrt{P}$	800MHz to 2.5GHz $d=2.3\sqrt{P}$
0.01	0.12	0.12	0.23
0.1	0.38	0.38	0.73
1	1.2	1.2	2.3
10	3.8	3.8	7.3
100	12	12	23

For transmitters rated at a maximum output power not listed above, the recommended separation distance d in meters (m) can be estimated using the formula applicable to the frequency of the transmitter. P in the formula is the maximum output power rating of the transmitter in watts (W) according to the transmitter manufacturer.



Notes:

- The separation distance is applied for the higher frequency range of 80MHz to 800MHz.
- These guidelines may not apply in all situations. Electromagnetic propagation is affected by reflection and absorption from buildings, objects, and people.



Contents

How to Use the Operation Manual	i
Special Notice to User	iii
Safety Precautions	v
Chapter 1. General Information	1
Introduction	1
Names and Functions of Parts.....	4
Accessories.....	8
Optional Parts and Consumables	11
Chapter 2. Preparing the Cardimax FX-7202	13
Loading the Recording Paper	14
Connecting the Power Supply Cord.....	17
Connecting the Ground.....	18
Connecting the Patient Cable	19
Turning ON Power	20
Adjusting the Display Contrast.....	22
Setting the Date Format and Built-in Clock.....	23
Setting the Hospital Name	26
Setting the Language.....	28
Using the Battery (Option)	30
Installing the Program Cartridge (Option).....	33
Connecting the Cardimax FX-7202 to Optional Equipment.....	35
Chapter 3. Operating the Cardimax FX-7202:Recording a Standard 12-lead ECG in the Automatic Recording Mode	36
Connecting the Patient Cable to the Electrodes.....	36
Attaching the Electrodes to the Patient.....	37
Operation Panel	39
Touch-Panel Display.....	41
Main Menus.....	44
Entering Patient Data.....	45
Recording the ECG	53
Chapter 4. Recording the Electrocardiogram: Standard ECG Mode	56
Automatic Recording Mode.....	58
Manual Recording Mode.....	62

Chapter 5.	Recording the Electrocardiogram: Advanced Features	66
	Review Recording	67
	R-R Trend Test Mode	69
	 Arrhythmia ECG Mode	73
	 Arrhythmia Automatic Extension Recording	77
	Compressed Recording	79
Chapter 6.	Managing ECG Data Files	82
	Reading ECG Data from the Built-in Memory	83
	Deleting ECG Data	89
Chapter 7.	Setting Up Parameters of the Cardimax FX-7202	90
	Overview of Parameters	90
	General Flow of the Parameter Setup Procedure	98
	Selecting the Number of Waveform Display Channels	102
	Selecting the Recording Format	103
	Changing the Patient Data Parameters	118
	Selecting the Filters	120
	Initializing Parameters	121
Chapter 8.	Maintenance and Troubleshooting	123
	Performing the Self-diagnostics Test	123
	Cardimax FX-7202 Maintenance	130
	When You cannot Record an Accurate ECG	132
	When an Error Message is Displayed	133
Appendix A.	Specifications	136
Appendix B.	Daily Check List	139
Appendix C.	Periodic Check List	140
Appendix D.	LAN communication function	142
1.	Setting the Network Connection	142
	Initial Network Setup	143
2.	Managing ECG Data Files	155
	Reading ECG Data from the Built-in Memory	156
	Transmitting ECG Data to a PC	161

3. Additional Settings	164
Overview of Parameters	164
4. ECG Data	165
List of SCP-ECG Data Structures	165
Section Configurations.....	167
G lossary	175
I ndex	177

Chapter 1

General Information



Introduction

Welcome to the new electrocardiograph from Fukuda Denshi. The Cardimax FX-7202 measures a standard 12-lead electrocardiogram (ECG) using advanced microprocessor technology. The FX-7202 is compact and portable. With an optional rechargeable battery, you can take it anywhere to perform a medical examination.

Configurations of The Cardimax FX-7202

The configuration of the Cardimax FX-7202 varies depending on whether or not the optional program cartridge PC-7403 is installed.

When the PC-7403 program cartridge is installed, you can perform the optional functions of the Cardimax FX-7202. The following table summarizes the functions available with or without the PC-7403.

Function	CTRG	
	None	PC-7403
Standard ECG Mode	Yes	Yes
 Analysis Recording	No	Yes
Measurement Recording	Yes	No
Manual Recording	Yes	Yes
R-R Trend Test Mode	Yes	Yes
 Arrhythmia ECG Mode	No	Yes
Compressed Recording	Yes	Yes
ECG Data File	Yes	Yes

Before using your Cardimax FX-7202, determine its configuration and find the supported functions from the above table.

Main Features

Standard 12-lead ECG

Records the standard 12-lead waveform. When the optional program cartridge is installed, you can analyze the ECG waveform.

- ☞ See Chapter 4, "Recording the Electrocardiogram: Standard ECG Mode" (page 56) and Chapter 5, "Recording the Electrocardiogram: Advanced Features" (page 66).

R-R Trend Test Mode

Monitors the selected 1-lead ECG for 1 to 5 minutes or 100 or 200 pulses and measures the variation of the R-R interval. The measurement results (Standard Deviation, Coefficient of Variation, Trend Graph, Histogram) are recorded together with the ECG waveform.

- ☞ See "R-R Trend Test Mode" in Chapter 5, "Recording the Electrocardiogram: Advanced Features" (page 69).



Arrhythmia ECG Mode

Monitors the selected 3-lead ECG for 1 to 3 minutes and analyzes the arrhythmia. The analysis results are recorded as a report together with the ECG waveform.

- ☞ See "Arrhythmia ECG Mode" in Chapter 5, "Recording the Electrocardiogram: Advanced Features" (page 73).

Various recording formats

The waveform recording channels and report format can be changed in accordance with the application. The recorder incorporates a high-density thermal printer that provides a clear recording on paper.

- ☞ See "Selecting the Recording Format" in Chapter 7, "Setting Up Parameters of the Cardimax FX-7202" (page 103).

User-friendly touch-panel liquid crystal display (LCD)

The FX-7202 uses a high-resolution LCD to provide a sharp screen display. You can easily verify the ECG waveforms, pulse rate, electrode condition, and analysis data on this screen. You can also enter alphabet letters and numerical values directly by touching the touch-panel display.

- ☞ See "Operation Panel" and "Touch-Panel Display" in Chapter 3, "Operating the Cardimax FX-7202" (pages 39 to 43).

ECG data file management function

The Cardimax FX-7202 allows you to save ECG data in the built-in memory. You can store a maximum 128 ECG data files in the built-in memory.

■👉 See Chapter 6, "Managing ECG Data Files" (page 82).

Portable electrocardiograph

You can record the ECG data in a remote location (where there is no AC wall outlet) by using the optional battery pack to power the FX-7202.

■👉 See "Using the Battery (Option)" in Chapter 2, "Preparing the Cardimax FX-7202" (page 30).



Names and Functions of Parts

Front view

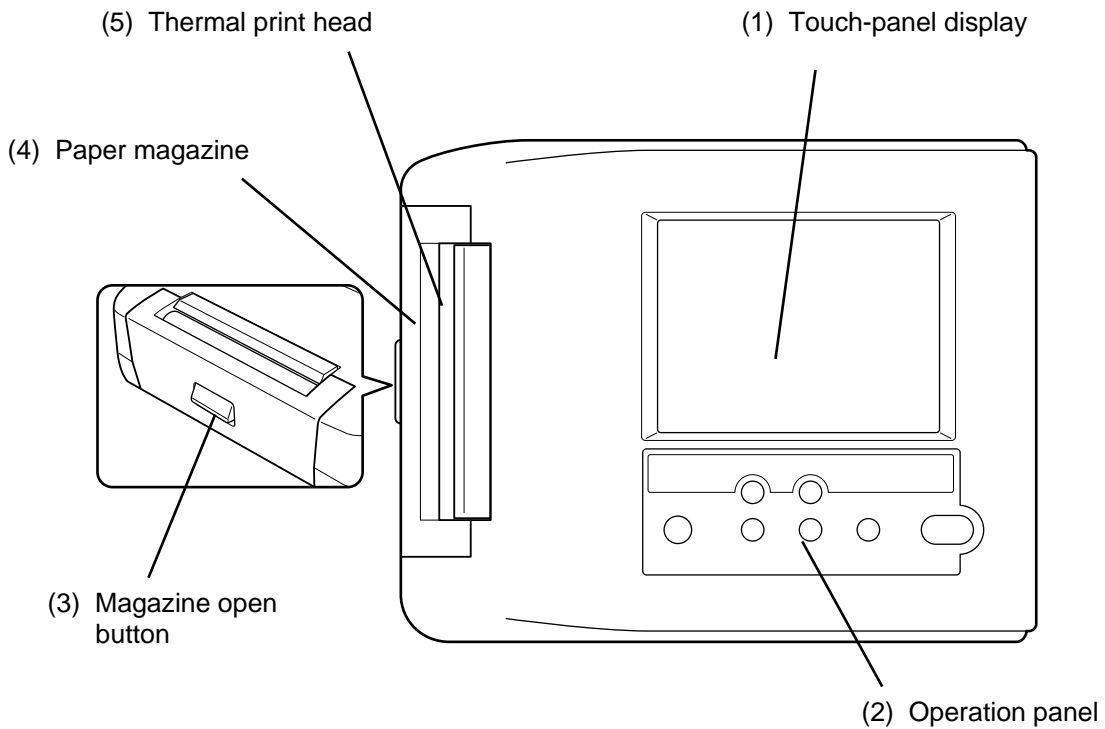

(1) Touch-panel display

Displays ECG waveforms, patient information, and equipment status. Used also to enter patient data or perform various operations by touching the touch-panel keys (soft keys) provided on the screen.

 CAUTION	
<ul style="list-style-type: none">• Do not place a heavy object on the touch-panel display or subject it to shock. Otherwise, it could be damaged.• Operate the touch-panel display with a finger. If the surface of the touch-panel display is scratched, it could damage the LCD.• Wipe off dirt on the surface of the touch-panel display with a soft cloth moistened using ethanol or with the silicon cloth supplied with the accessories.• When not using the FX-7202, keep it covered to prevent liquid spilling into the LCD.	

(2) *Operation panel*

Provides the controls for the Cardimax FX-7202 operation.

-  See "Operation Panel" and "Touch-Panel Display" in Chapter 3, "Operating the Cardimax FX-7202" (pages 39 to 43) for further information about the keys on the operation panel and touch-panel display.

(3) *Magazine open button*

Push to open the magazine cover.

(4) *Paper magazine*

Load the recording paper here.

(5) *Thermal print head*

Records (prints) the ECG waveforms and characters, such as the measured values.

Side, rear, and bottom views

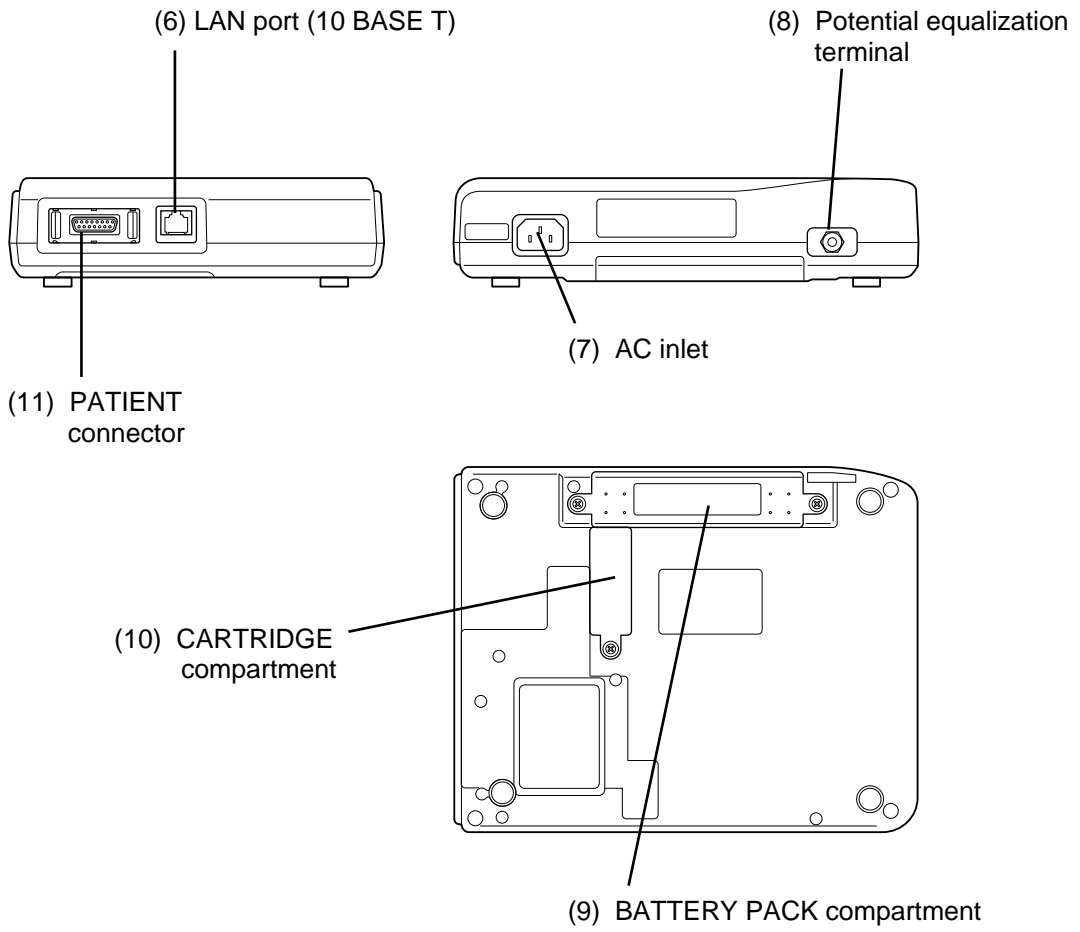

(6) LAN port (10 BASE T)

Connect the LAN cable here for connection to a personal computer.

(7) AC inlet

Plug in the matching end of the power supply cord here.

(8) Potential equalization terminal

Connect the potential equalization cable (CE-12) to this terminal.

 **CAUTION**

- When using the FX-7202 in conjunction with other instruments, use the specified potential equalization cable (CE-12) to equalize the ground potential.
- When using the FX-7202 in conjunction with other instruments, pay special attention to the combined leakage current of all instruments. Refer to "Connection" in "Safety Precautions" before using in this manner. Be sure to follow the operating instructions for the other instruments.

(9) BATTERY PACK compartment

Install the optional battery pack (T8HRAAU-4713) in this compartment.

(10) PROGRAM CARTRIDGE compartment

Install the optional program cartridge (PC-7403) in this compartment.

(11) PATIENT connector

Plug in the patient cable here.

 **CAUTION**

- Do not use a cable other than the specified patient cable (CP-104T, CP-104L or CP-104J).
- Do not use this connector for any purpose other than ECG input.
- The FX-7202 is designed to comply with the requirements of IEC for Class I, type CF. Protection against a defibrillator is only available when used with the proper patient cable. Be sure to use the patient cable (CP-104J or CP-104T) when using with a defibrillator. Refer to "Accessories" in this chapter for the appropriate cable.



Accessories

The common accessories of the FX-7202 required by all users are included in the same box as the main unit. The special accessories used under a different environment are provided in a separate box. There are three special accessory packages: (1) ASE-02G General Accessories Package, (2) ASE-02A Accessories Package for U.S. and (3) ASE-02E Accessories Package for Europe. Make sure that you have the correct accessory package.

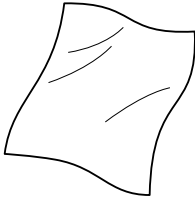
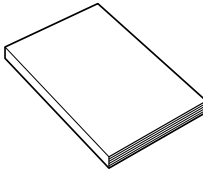
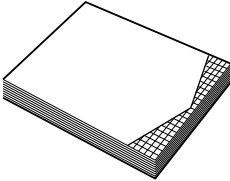
Common Accessories

<p>1 Silicon Cloth (1 pc)</p> 	<p>2 Operation Manual (this document)</p> 
<p>3 Z-fold paper (1 pc)</p> 	

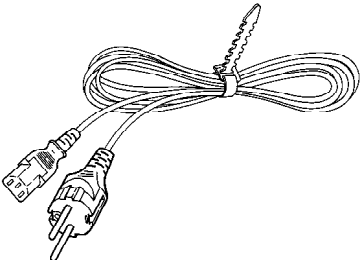
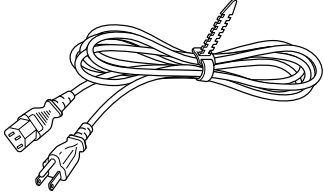
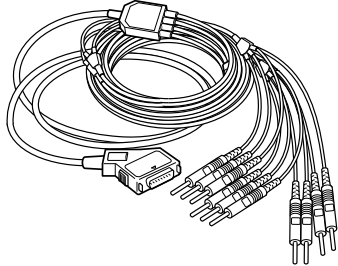
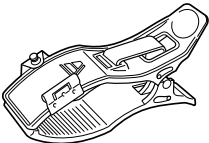
ASE-02G General Accessories Package

<p>1 Power supply cord CS-18(1 pc)</p> 	<p>2 Power supply cord CS-20 (1 pc)</p> 	<p>3 Patient cable CP-104J (1 pc)</p> 
<p>4 Limb electrode TE-43 (1 set)</p> 	<p>5 Chest electrode TE-01 (6 pc)</p> 	<p>6 Keratin cream OJ-02 (1 pc)</p> 



 **CAUTION**

- When you use the ASE-02G general accessories package and the ASE-02A accessories package, the accessories do not comply with European Community (CE) requirements.
- Use the ASE-02E accessories package for Europe to comply with the CE requirements.

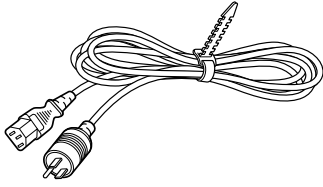
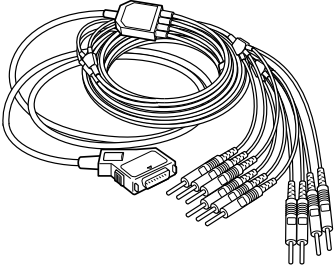
ASE-02A Accessories Packages for U.S.

<p>1 Power supply cord CS-24 (1 pc)</p>  A power supply cord with a three-pronged AC plug on one end and a two-pronged DC plug on the other. The cord is coiled.	<p>2 Patient cable CP-104L (1 pc)</p>  A patient cable with a multi-pin connector on one end and several individual leads with different connectors on the other. The cable is coiled.	
---	---	--

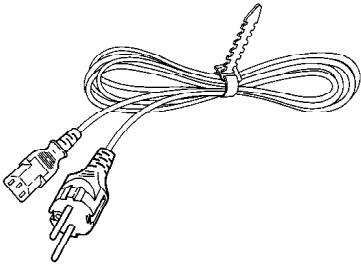
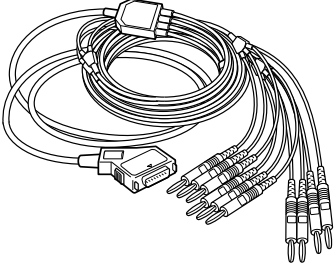
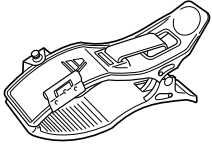
ASE-02E Accessories Package for Europe

<p>1 Power supply cord CS-18 (1 pc)</p>  A power supply cord with a two-pronged AC plug on one end and a two-pronged DC plug on the other. The cord is coiled.	<p>2 Patient cable CP-104T (IEC) (1 pc)</p>  A patient cable with a multi-pin connector on one end and several individual leads with different connectors on the other. The cable is coiled.	<p>3 Limb electrode TEE-43RG (1 set)</p>  A limb electrode with a rectangular shape and several leads extending from it.
<p>4 Chest electrode TEE-01RA (6 pc)</p>  A chest electrode with a circular disc and a lead.	<p>5 Keratin cream OJ-02 (1 pc)</p>  A rectangular box of Keratin cream with the brand name and product details visible.	

Optional Parts and Consumables

The following optional parts and consumables are available for the FX-7202.

Program cartridge PC-7403

The PC-7403 program cartridge provides additional features including Arrhythmia ECG Mode and analysis recording in the Standard ECG Mode.

- ☞ See "Introduction" in Chapter 1, "General Information" for further information about the program cartridge and its functions (page 1).

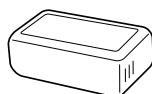

Battery pack T8HRAAU-4713

Used as the power supply for the Cardimax FX-7202 in a remote location where there is no AC wall outlet.

- ☞ See "Using the Battery (Option)" in Chapter 2, "Preparing the Cardimax FX-7202" (page 30).

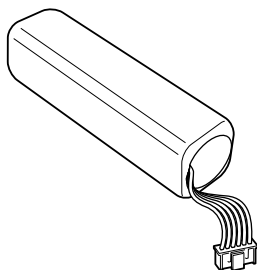

Recording paper (Z-fold paper OP-222TE)

Spare recording paper.

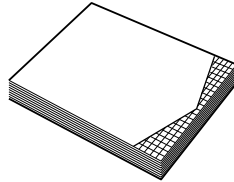

- ☞ See "Loading the Recording Paper" in Chapter 2, "Preparing the Cardimax FX-7202" (page 14).

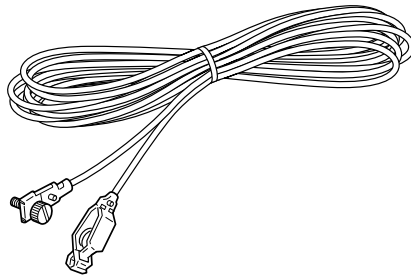

Potential equalization cable CE-12

Used as a ground cable.



 WARNING	
	<ul style="list-style-type: none">• Be sure to connect the optional potential equalization cable (CE-12) when using the Cardimax FX-7202 in a location where no hospital-grade 3-pin wall outlet is available.• When you use the Cardimax FX-7202 together with other equipment, perform potential equalization using the optional potential equalization cable (CE-12).

Chapter 2

Preparing the Cardimax FX-7202

This chapter will help you to choose an installation site, configure, and set-up the Cardimax FX-7202. Follow the instructions provided here to ensure that your electrocardiograph installation process is smooth and trouble-free. Be sure to provide a ground connection using the optional potential equalization cable (CE-12) if the FX-7202 is installed in a place where there are no hospital-grade 3-pin wall outlets.

Site selection

The FX-7202 has been designed so that in addition to use in hospitals and clinics, you can easily carry and battery-operate it anywhere, for field activities such as a group examination. As you decide where you want to locate the Cardimax FX-7202, take the following matters into consideration to get accurate ECG recordings:

- Keep the Cardimax FX-7202 and the patient's bed away from high-tension wires or high-voltage power lines. If there is an intense radiation source near the Cardimax FX-7202, the ECG will absorb noise interference.
- Do not install the Cardimax FX-7202 near X-ray units, ultrasonic equipment, radios, and fluorescent lamps. They could easily become sources of trouble.
- Use the Cardimax FX-7202 in an environment where the room temperature is maintained at 10 to 40 degrees Celsius (50 to 104 degrees Fahrenheit).
- Use the Cardimax FX-7202 in an environment where the relative humidity is from 10 to 95 percent (non-condensing).
- Install the Cardimax FX-7202 in a place where a hospital-grade 3-pin wall outlet is available or a site that provides a secure ground connection.

Route of leakage current, electrostatic induction, and electromagnetic induction

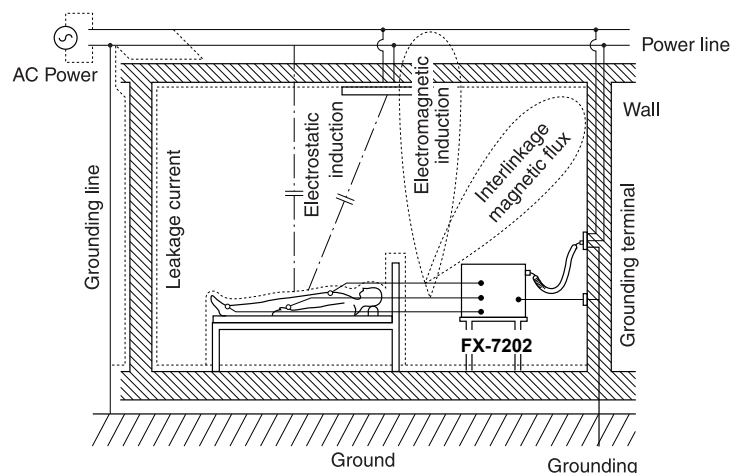

Loading the Recording Paper

Follow the steps below to load paper into the magazine.

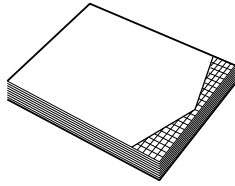

Z-fold paper OP-222TE

Operation

1 Press the paper magazine open button.

The magazine cover will open slightly.

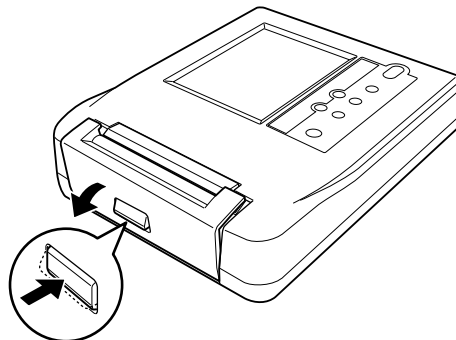

2 Open the magazine cover.

Lift up and completely swing open the magazine cover.

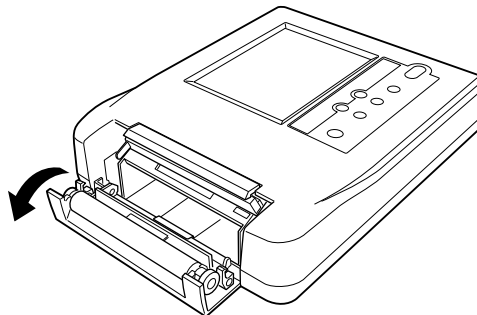

- 3 The first page of the paper is placed on the exterior, and the remainder is inserted into the FX-7202.

 WARNING	
	When the recording paper will be loaded, be careful about edge. Failure to do so may cause injury.

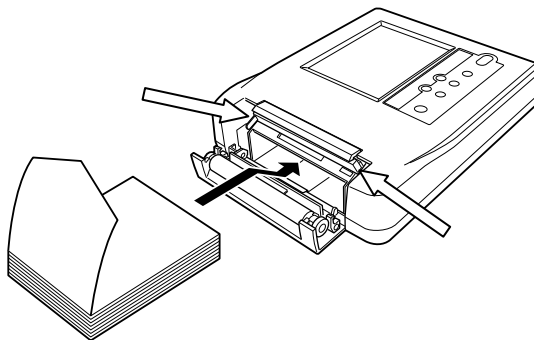

- 4 Hold the free edge of the Z-fold paper and pull upward.

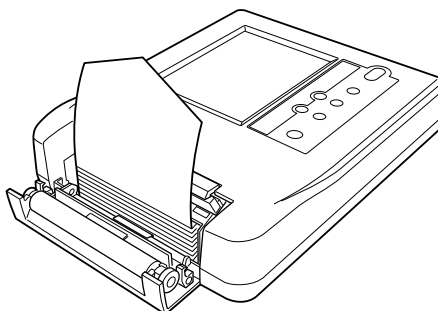

- 5 Close the magazine cover.

Hold the free edge of the Z-fold paper and pull out approximately 14 cm of paper. Then, firmly press the side of the magazine cover until it clicks shut.



6 Tear off the extended portion of paper.

Tear off the extended portion of the paper on the paper cutter edge.





Notes:

- Do not expose the recording paper to direct sunlight or leave it in a room with high temperature and humidity. The paper becomes discolored at 70 degrees Celsius (158 degrees Fahrenheit). If this happens, the printed data will be rendered unreadable.
- Do not leave the recording paper under fluorescent lamps for a long time. The light of the lamps will discolor the paper and make the printed data unreadable.
- Do not store the recording paper in polyvinyl chloride film.
- Do not store the recording paper for a long time with printed surfaces pressed against each other. Pressure may transfer printed waveforms from one paper to another.

Connecting the Power Supply Cord

Connect the mating end of the power supply cord to the AC inlet on the rear of the Cardimax FX-7202, and plug the opposite end into a hospital-grade wall outlet (3-pin outlet with grounding terminal).

 WARNING	
	<ul style="list-style-type: none"> • Be sure to connect the power supply cord to a hospital-grade 3-pin wall outlet. • If there is no hospital-grade wall outlet available, be sure to connect the optional potential equalization cable (CE-12) to a ground connection. If the ground connection is not performed properly, the patient could be in danger.

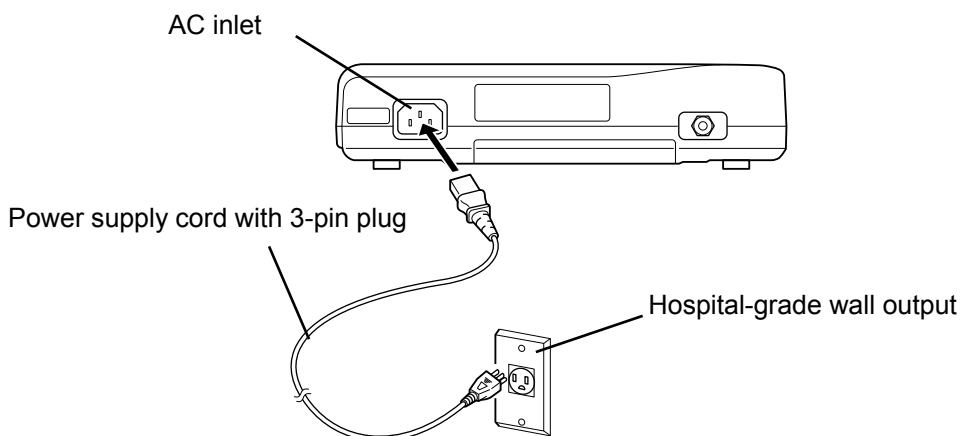



✓ Additional information:

The Cardimax FX-7202 can be operated on batteries when no AC wall outlets are available.

 See "Using the Battery (Option)" in this chapter (page 30).

Connecting the Ground

When hospital-grade 3-pin wall outlets are unavailable, be sure to connect one end of the optional potential equalization cable (CE-12) to the potential equalization terminal of the Cardimax FX-7202 and the opposite end to ground. (When the power supply cord is connected to a hospital-grade wall outlet, ground is provided automatically and therefore this procedure can be omitted.)

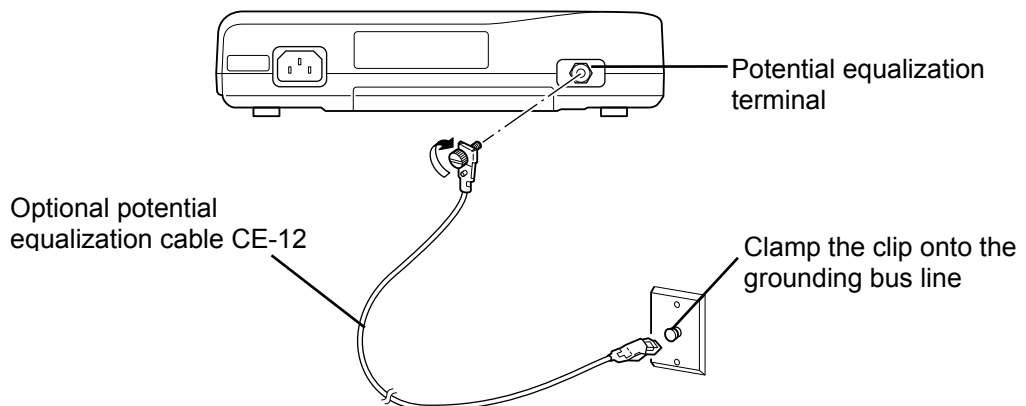

 WARNING	
	<ul style="list-style-type: none"> • If there is no hospital-grade wall outlet, be sure to connect the optional potential equalization cable (CE-12) properly to a ground. • When the Cardimax FX-7202 is used together with other equipment, connect the Cardimax FX-7202 and the other equipment with the optional potential equalization cable (CE-12). <p>This equalization feature protects the patient from electric shocks even if leakage currents flow from each device.</p>
	<p>Precautions on ground connection</p> <ul style="list-style-type: none"> • Never make a ground connection to a gas pipe. Such an arrangement could create a highly dangerous situation. • Do not make a ground connection to ungrounded objects such as window frames, vinyl water pipes, or grounding terminals of other unrelated equipment. • Do not make a ground connection to a water pipe. This arrangement may not provide proper grounding.

 CAUTION	
<p>Precautions on ground connection</p> <ul style="list-style-type: none"> • Make sure the optional potential equalization cable (CE-12) is connected properly and there is no breakage in the line. • If there is no suitable object to which a ground connection can be made, bury a metal rod in the ground (earth) and connect the ground to this rod. 	



Connecting the Patient Cable

Connect the mating end of the patient cable to the PATIENT connector on the right side of the Cardimax FX-7202. At this time, make sure the arrow mark on the cable plug is facing up.

 WARNING	
	<ul style="list-style-type: none"> • Do not use a cable other than the specified patient cable (CP-104T, CP-104L or CP-104J). • Do not use the patient cable for purposes other than ECG input.

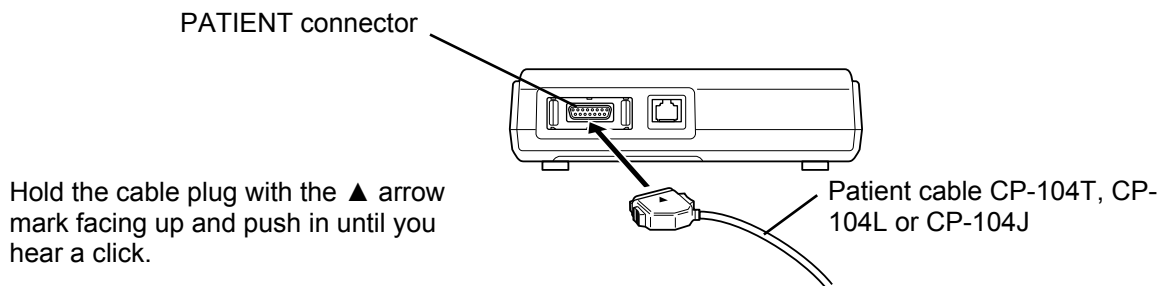

Removing the patient cable

Hold and press the buttons on both sides of the cable plug and pull from the PATIENT connector.

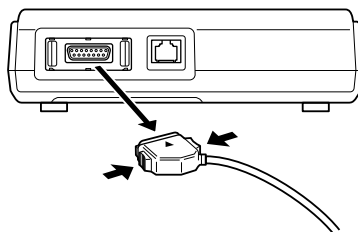

Turning ON Power

To turn ON the Cardimax FX-7202, use the **[POWER ON/OFF (stby)]** key on the Operation Panel of the Cardimax FX-7202. Before you turn ON the Cardimax FX-7202, make sure that the power supply cord, potential equalization cable, and patient cable are connected properly.

Operation

Turning ON power

Press the **[POWER ON/OFF (stby)]** key on the Operation Panel of the Cardimax FX-7202. At this time, the Main Power lamp will light. When the initial screen (power-on screen) appears, the Cardimax FX-7202 is ready for operation.

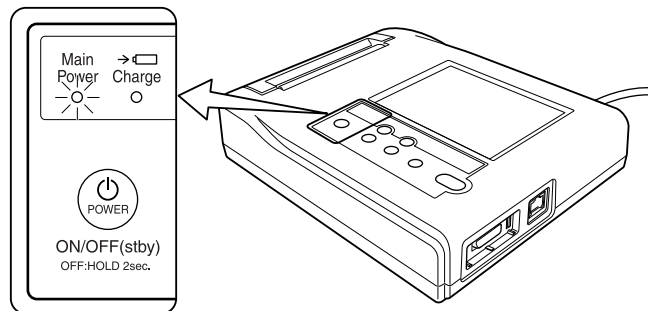

Note:**The initial screen shows the following information:**

CTL: Version number of control program

NO: Management number of control program

PC-7403

ANL: Version number of analysis program

PC-7403

ARRH: Version number of arrhythmia ECG analysis program

About the standby status

When the power supply cord is connected to the AC connector of the Cardimax FX-7202 and a wall outlet, the FX-7202 is put on standby status and the Main Power lamp will light.

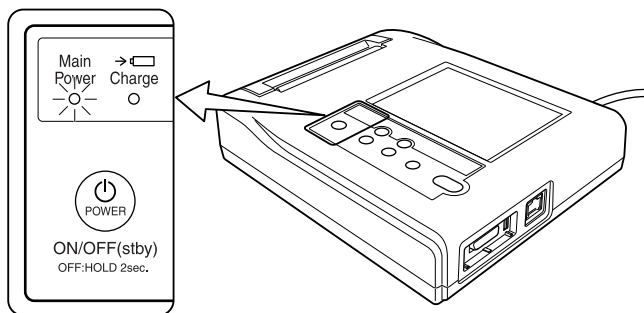

Pressing [**POWER ON/OFF (stby)**] will cancel the standby status and the initial screen will appear.

Turning OFF power

Press and hold [**POWER ON/OFF (stby)**] on the Operation Panel of the Cardimax FX-7202 for more than 2 seconds. At this time, the FX-7202 is put on standby status and the Main Power lamp will remain lit. To turn off power, remove the power supply cord from the wall outlet.

✓ Additional information:

- When you use the battery as a power source, press [**POWER ON/OFF (stby)**] on the operation panel to turn the Cardimax FX-7202 ON and OFF. If you do not operate the unit for 5 minutes or more, power is turned OFF automatically to prevent unnecessary battery consumption.
- If you press and hold [**POWER ON/OFF (stby)**] for more than 5 seconds during operation, the power is turned OFF.

Adjusting the Display Contrast

If the liquid crystal display (LCD) is not clearly visible, adjust the display contrast.

Only STANDARD ECG MODE,ARRHTHMIA ECG MODE,and R-R TREND TEST MODE are effective.

Operation

1 Touch [➡] first and next, [CONTRAST].

The Contrast adjustment screen will appear.

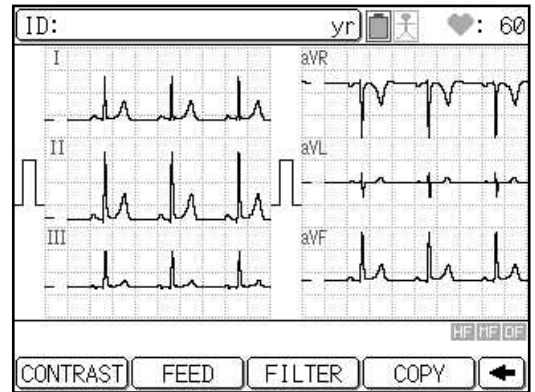

2 Touch [◀] or [▶] to adjust contrast.

Adjustments of contrast are in 16 stages.

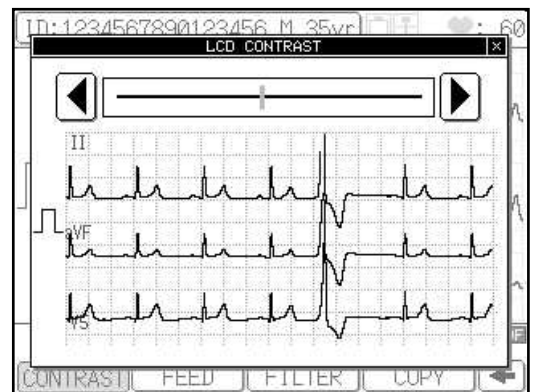

3 Close screen.

Setting the Date Format and Built-in Clock

Set the date display format and built-in clock to record the accurate date and time.

Operation

- 1 Turn ON the Cardimax FX-7202. Touch [MENU] on the touch-panel display.

The Mode select screen will appear.

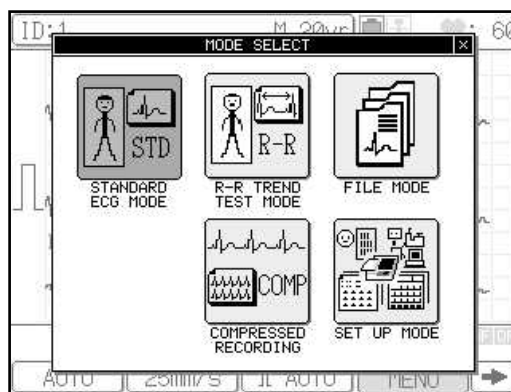

- 2 Touch [SET UP MODE].

The SET UP MODE (MENU) screen will appear.

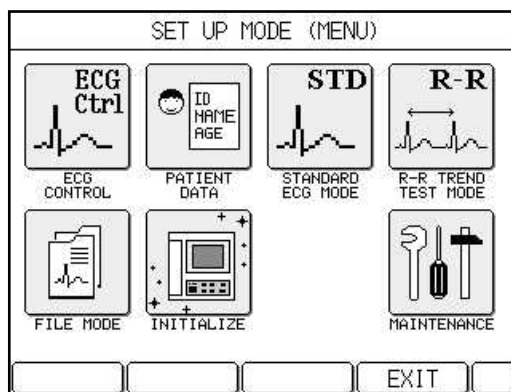

- 3 Touch [ECG CONTROL].

The SET UP MODE (ECG CONTROL) screen will appear.



4 Touch [Next ▼] to display the next page.

5 Change the [Date Type] parameter if necessary.

The date/time display format at the time of shipment is set to "MM-dd-yy". To change the date/time display format to "dd-MM-yy", touch the radio button of "dd-MM-yy" to turn it on (highlight the button). Otherwise, skip this step.

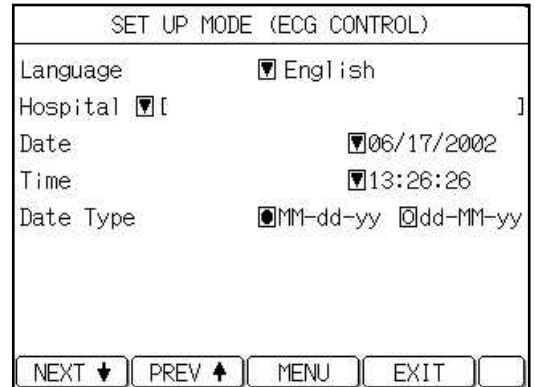

6 Touch the down arrow key ([▼]) of the [Date] parameter on the left of the currently set date.

The DATE keypad will appear.

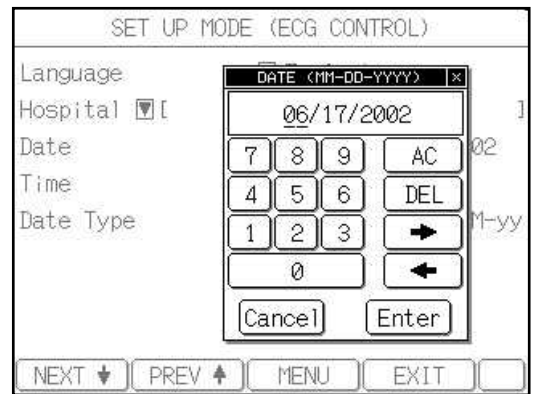

7 Enter the date.

Use the number keys (0 to 9) on the touch-panel display to enter data. Use the left and right arrow keys to move the cursor. If the data you entered are incorrect, touch [AC] to clear all data or [DEL] to clear one digit. After you finish setting the date, touch [Enter] to close the DATE keypad. To cancel the input operation, touch [Cancel].

8 Touch the down arrow key ([▼]) of the [Time] parameter on the left of the currently set time.

The TIME keypad will appear.

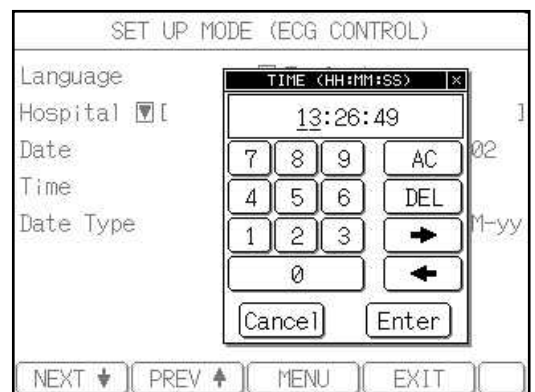

9 Enter the time.

Use the number keys (0 to 9) on the touch-panel display to enter data. Use the left and right arrow keys to move the cursor. If the data you entered are incorrect, touch [AC] to clear all data or [DEL] to clear one digit. After you finish setting the time, touch [Enter] to close the TIME keypad. To cancel the input operation, touch [Cancel].

10 After completing the required settings, touch [EXIT].

The previous screen reappears.

Setting the Hospital Name

Enter your hospital name. The hospital name you enter here will be printed on the reports.

Operation

- 1 Turn ON the Cardimax FX-7202. Touch [MENU] on the touch-panel display.

The Mode select screen will appear.

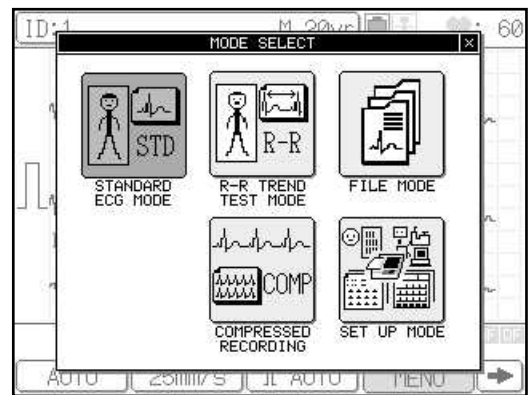

- 2 Touch [SET UP MODE].

The SET UP MODE (MENU) screen will appear.

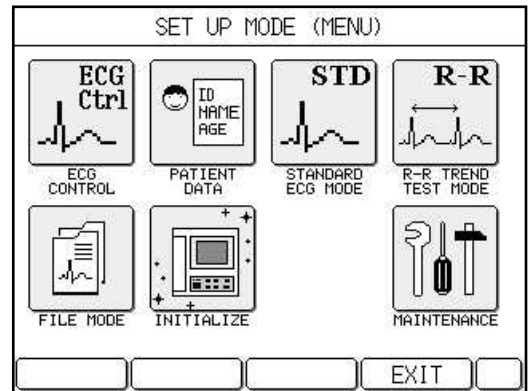

- 3 Touch [ECG CONTROL].

The SET UP MODE (ECG CONTROL) screen will appear.

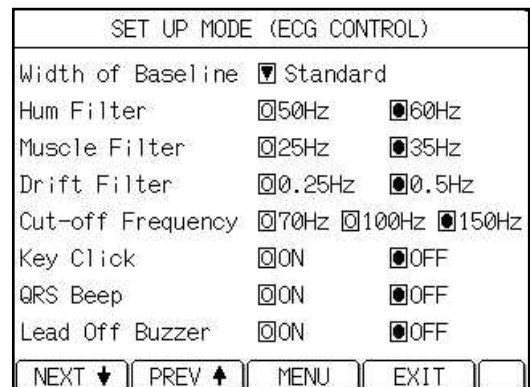

4 Touch [NEXT ↓] to display the next page.



5 Touch the down arrow key ([▼]) of the [Hospital] parameter on the left of the currently set name (if any).

The **HOSPITAL NAME** keyboard will appear. This window has two pages, each showing a different keyboard for letters and numbers/symbols respectively. To change the keyboard page, touch [1/2 ↓] or [2/2 ↑].



6 Enter the hospital name.

Use the letter and number keys (0 to 9) displayed on the keyboard window to enter the name. To enter uppercase letters, touch [CAPS] on the letter (lowercase) screen (page 1/2). Use the left and right arrow keys to move the cursor position. If the data you have entered are incorrect, touch [AC] to clear all data or [DEL] to clear a digit. To enter a space, touch [Space] bar. After you finish setting the name, touch [Enter] to close the HOSPITAL NAME keyboard. To cancel the input operation, touch [Cancel].

7 After completing the required setting, touch [EXIT].

The previous screen reappears.

Setting the Language

The Cardimax FX-7202 supports five languages: English, German, French, Spanish, and Italian. The language is set to "English" at the time of shipment. Change the language if necessary.

Operation

- 1 Turn ON the Cardimax FX-7202. Touch [MENU] on the touch-panel display.

The **Mode select** screen will appear.

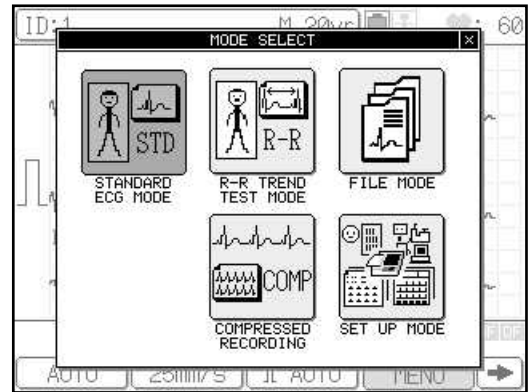

- 2 Touch [SET UP MODE].

The **SET UP MODE (MENU)** screen will appear.

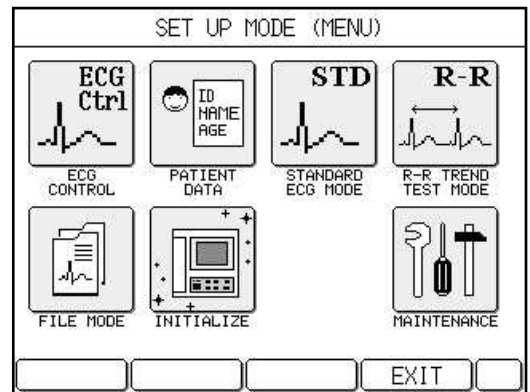

3 Touch [ECG CONTROL].

The **SET UP MODE (ECG CONTROL)** screen will appear.

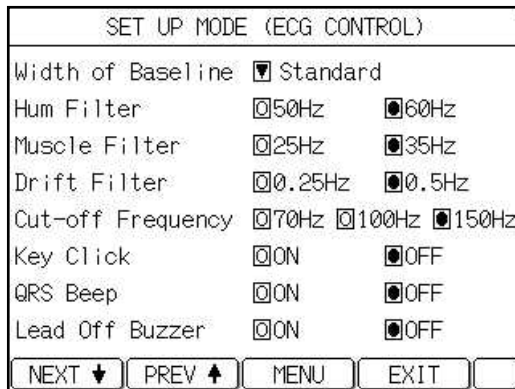

4 Touch [Next ▼] to display the next page.



5 Touch the down arrow key ([▼]) of the [Language] parameter on the left of the currently set language.

The language window will appear.



6 Touch the desired language.

The selected language will appear in the SET UP MODE (ECG CONTROL) window.



7 After completing the required setting, touch [EXIT].

The previous screen reappears.

Using the Battery (Option)

If you install an optional battery pack (T8HRAAU-4713), you can operate the FX-7202 in a remote place where there is no AC power source. Battery power is automatically supplied when there is a power failure.

When you use the batteries as a power source, unplug the power supply cord from the wall outlet. Press **[POWER ON/OFF (stby)]** on the Operation Panel to turn on/off the FX-7202. If you do not operate the unit for 5 minutes or more, the power is turned off automatically to prevent unnecessary battery consumption.

 DANGER	
	<ul style="list-style-type: none"> • Be sure to use the dedicated battery pack (T8HRAAU-4713). • Be sure to charge the battery pack with the FX-7202. Using non-specified charging devices to charge the battery pack could be hazardous.
	<ul style="list-style-type: none"> • Do not disassemble or mutilate the battery pack. Burns could result. • Do not incinerate or heat the battery pack--the battery pack could burst, leak toxic substances, or give you burns. • Do not short the battery. Burns could result. • Keep away from children. • If the liquid contained in the battery gets into your eyes, do not rub them. Wash eyes thoroughly with water and seek medical attention immediately.

 CAUTION	
<ul style="list-style-type: none"> • If you do not intend to use the FX-7202 for a long period of time, remove the battery from the machine. Even if you do not use the FX-7202, fully charge the battery every three months with the machine. If you fail to recharge the battery, it discharges automatically and may not be used again. • Do not use the battery in an environment where the room temperature is below 0 degrees Celsius (32 degrees Fahrenheit) or higher than 40 degrees Celsius (104 degrees Fahrenheit). • Charge the battery in an environment where the room temperature is maintained at 10 to 30 degrees Celsius (50 to 86 degrees Fahrenheit) • Store the battery in an environment where the room temperature is maintained at 0 to 30 degrees Celsius (32 to 86 degrees Fahrenheit). • Repeated cycles of brief discharging and recharging of the battery will prevent it from operating at full capacity. Make sure that the battery is completely exhausted before recharging it. • Once the battery is exhausted, recharge it even if it is not going to be used immediately. If you failed to recharge the battery, it discharges automatically and may not be used again. • The battery life depends on the operating conditions. Normally, replace the battery after 300 charging/discharging cycles. As the battery life nears its end, its capacity is drastically reduced. If this happens, replace with a new battery. 	

Installing the battery pack

Operation

1 Turn OFF the power and unplug the power supply cord.

Press the [POWER ON/OFF (stby)] on the Operation Panel and unplug the power supply cord.

2 Open the BATTERY PACK compartment cover.

Place the FX-7202 on a table with the bottom facing up. Use a Phillips (+) screwdriver to remove two screws (with washers) on the cover. Put your finger into the indentation and lift the cover carefully in the direction of the arrow, as shown in the figure below.

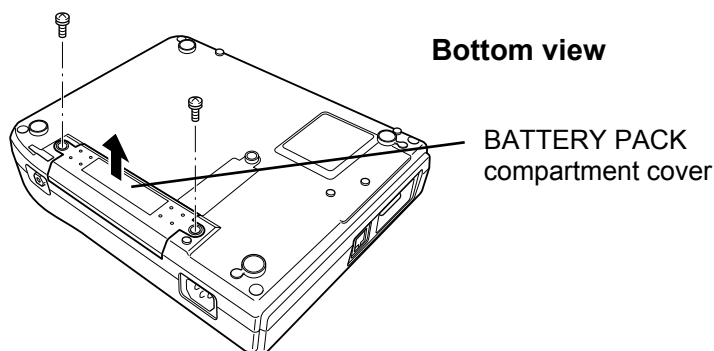

3 Connect the power supply cord of the rechargeable battery.

Connect the power supply cord of the rechargeable battery to the 6-pin power connector in the battery compartment. Place the battery pack in the compartment.

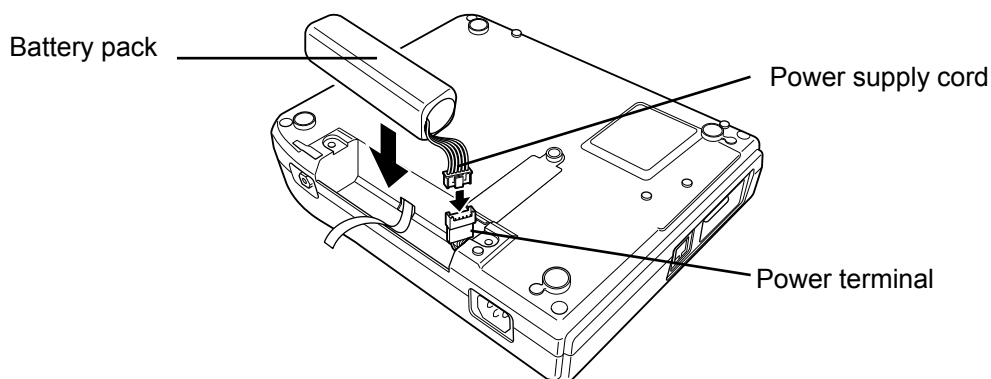

4 Close the BATTERY PACK compartment cover.

Insert the tabs on the cover in place and close the battery compartment cover. Tighten the two screws (with washers) removed in step 2.

Charging the battery

If the battery is not charged, it automatically starts recharging as soon as the FX-7202 is connected to the AC outlet. It takes approximately 3 hours to fully charge the battery. When the battery is fully charged, the FX-7202 can perform continuous recording for approximately 30 minutes (for 6-channel recording at 20 degrees Celsius (68 degrees Fahrenheit)).

Operation

1 Plug in the power supply cord.

Plug in the power supply cord and leave the FX-7202 on standby status. At this time, the Main Power lamp is lit.

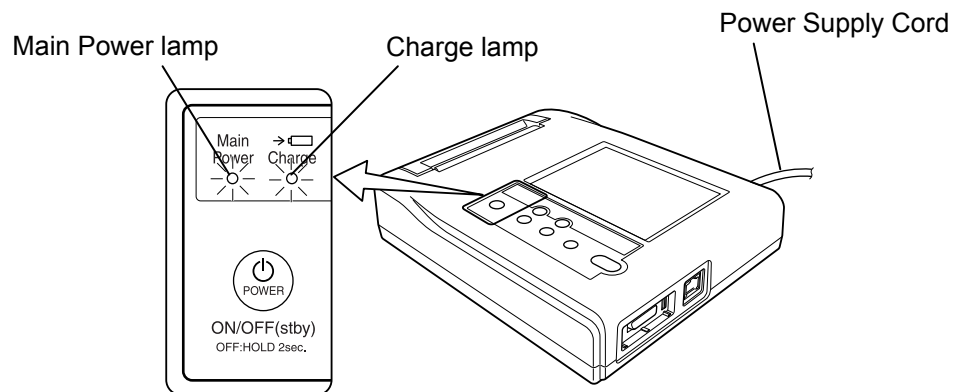

Charging of the battery pack will start.

While the battery is being charged, the Charge lamp will light blue. When the charging is complete, the Charge lamp will turn off.

✓ Additional information:

- The battery is not charged while the FX-7202 is operating. To recharge the battery, turn off the power.
- If any trouble such as abnormal battery temperature, battery voltage, or charge current occurs during charging, the Charge lamp will light amber. If the Charge lamp turns amber when you try recharging, contact your local Fukuda Denshi sales and service representative.
- The operating time of the battery with a one-time recharge varies widely depending on the operating environment and conditions.

Installing the Program Cartridge (Option)

When the PC-7403 program cartridge is installed in the FX-7202, the following functions will be supported:

PC-7403

PC-7403:

- Analysis Recording of the Standard ECG Mode
- Arrhythmia ECG Mode



CAUTION

- When plugging in or removing the program cartridge, be sure to turn OFF the Cardimax FX-7202.
- Do not install a cartridge other than those specified for the Cardimax FX-7202.

Operation

1 Turn OFF the power and unplug the power supply cord.

Press [**POWER ON/OFF (stby)**] on the Operation Panel. Unplug the power supply cord.

2 Remove the CARTRIDGE compartment cover.

Place the FX-7202 on a table with the bottom facing up. Use a Phillips (+) screwdriver to remove one screw (with washer) on the PROGRAM CARTRIDGE compartment cover. Put your finger in the indentation and lift the cover in the direction of the arrow, as shown in the figure below.

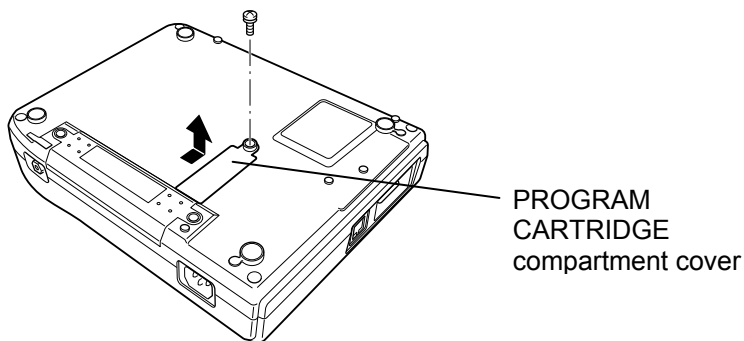

3 Install the program cartridge.

Gently push the program cartridge into the connector until it is seated securely.

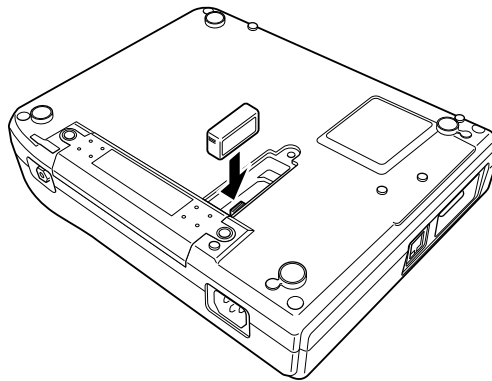

4 Reinstall the CARTRIDGE compartment cover removed in step 2.

Insert the tab on the cover in place and close the PROGRAM CARTRIDGE compartment cover. Tighten the screw (with the washer) removed in step 2.

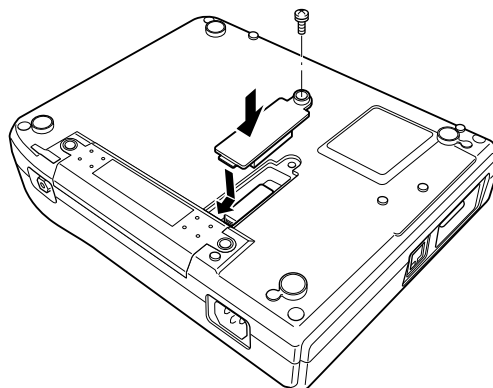



Connecting the Cardimax FX-7202 to Optional Equipment

When upgrading the software of the FX-7202, this port and a PC are connected.

Operation

Personal Computer _____

 WARNING	
	<ul style="list-style-type: none"> • Before you connect your PC, unplug the power supply cord from the FX-7202.

Plug the LAN cable (LAN:10 base T) into the LAN port on the rear of the Cardimax FX-7202.

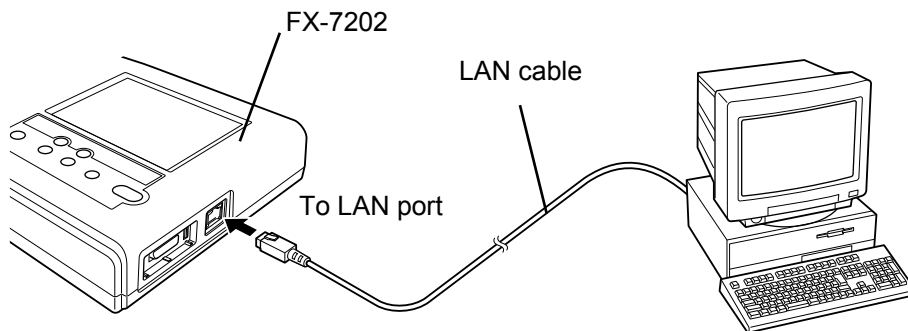

 See the document attached to upgrade software for the detailed information about connection and operation of the FX-7202 and a PC.

Chapter 3

Operating the Cardimax FX-7202:

Recording a Standard 12-lead ECG in the Automatic Recording Mode

This chapter describes the basic operation of the FX-7202 and the main aspects of ECG recording.

Connecting the Patient Cable to the Electrodes

Make sure the matching end of the patient cable is properly connected to the patient connector on the right side of the FX-7202. Connect the opposite end of the patient cable to the electrodes.

Match the color of each patient cable and corresponding electrode for proper connection. The table below summarizes lead tip codes and corresponding locations for the electrodes.

Patient Cable		Electrode position									
		Right hand	Left hand	Left leg	Right leg	①	②	③	④	⑤	⑥
CP-104T	Cable/Tip color	Red/Red	Yellow/Yellow	Green/Green	Black/Black	White/Red	White/Yellow	White/Green	White/Brown	White/Black	White/Purple
	Symbol	R	L	F	N	C1	C2	C3	C4	C5	C6
CP-104J	Cable/Tip color	Red/Red	Yellow/Yellow	Green/Green	Black/Black	White/Red	White/Yellow	White/Green	White/Brown	White/Black	White/Purple
	Symbol	R	L	F	N	C1	C2	C3	C4	C5	C6
CP-104L	Cable/Tip color	White/White	Black/Black	Red/Red	Green/Green	Brown/Red	Brown/Yellow	Brown/Green	Brown/Blue	Brown/Orange	Brown/Violet
	Symbol	RA	LA	LL	RL	V1	V2	V3	V4	V5	V6

Attaching Electrodes to the Patient

Follow the instructions below to attach electrodes to the patient. Placing the electrodes in their proper locations is one of the most important factors for accurate ECG recording. Much care must be taken to ensure good electrical contact.

Before attaching the electrodes to a patient

Check the condition of the patient

Check the condition of the patient and make sure they are resting quietly and comfortably. If the patient is tense, relieve tension by talking to the patient. For example, ask them to "Relax your arms and legs and feel completely at ease" or "Breathe normally". You cannot record an accurate ECG if the arms and legs of the patient are tense or the patient keeps moving about. This will cause problems such as electromyogram interference and unstable baseline.

Cleaning the skin

Use an alcohol-moistened cloth and wipe parts of the patient's body where the electrodes are going to be attached to remove dirt and fatty oil. If foreign substances remain on the skin or an electrode, the contact resistance will increase and the recording will become unstable.

Applying Keratin cream

Apply Keratin cream for better contact between the skin and electrode. Rub the cream into the patient's skin until the skin becomes slightly reddish. When applying the cream to different parts of the chest to attach electrodes, make sure the cream on these different parts does not overlap or touch. If adjacent electrode locations on the chest become linked through Keratin cream applied too generously, an accurate ECG will not be recorded.

Attaching the limb electrodes (4 locations)

Clamp the arms and legs (several centimeters above the wrist and ankle) firmly with the electrode clips. Make sure the patient does not experience pain or discomfort.

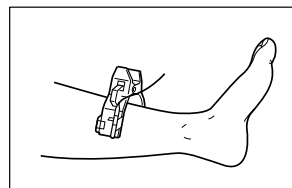
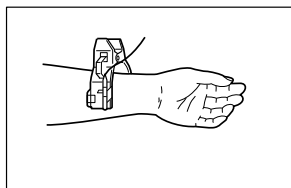

Attaching the chest electrodes (6 locations)

Attach the chest electrodes in the following locations: Make sure the patient does not feel pain or discomfort.

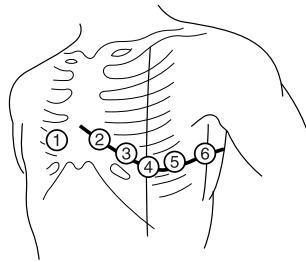

- ①: The fourth intercostal space on the right sternal border.
- ②: The fourth intercostal space on the left sternal border.
- ③: Midway between locations ② and ④.
- ④: The fifth intercostal space on the left mid-clavicular line.
- ⑤: On the left anterior axillary line on the same horizontal level as ④.
- ⑥: On the left mid-axillary line on the same horizontal level as ④ and ⑤.

Operation Panel

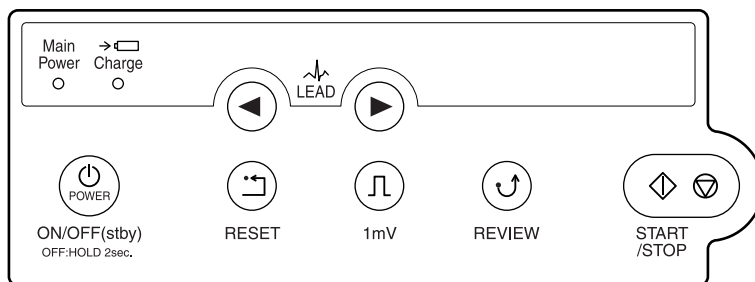

The functions of the operation panel keys and lamps are outlined below.

(1) [POWER ON/OFF (stby)] key

Press this key to switch the FX-7202 to power ON from standby status. Press this key for 2 seconds or more to switch the FX-7202 from power ON to standby status. Also, press this key for 5 seconds or more to turn OFF the FX-7202 in case there is system trouble.

When you operate the FX-7202 on the rechargeable battery, use this key to turn the power ON and OFF. If the power supply cord is connected to a wall outlet and the rechargeable battery is installed, the FX-7202 will start charging the battery as soon as the unit is placed in the standby status (power is OFF).

(2) [1mV] key

Press this key to display and record the calibrated 1mV waveform.

(3) [RESET] key

Press and hold down this key to reset the ECG waveform. The ECG waveform input starts when you release this key.

(4) LEAD [◀] and [▶] keys

Press these keys to change the leads to be monitored.

(5) [REVIEW] key

Press this key to perform Review Recording. Review Recording starts printing waveforms from those sampled 10 seconds prior to pressing [REVIEW].

(6) [START/STOP] key

Press this key to start and stop the various recording (sampling) tasks.

(7) Main Power lamp

This lamp lights during the standby and power ON status.

(8) Charge lamp

The charge lamp lights in blue when the rechargeable battery is being charged. The charge lamp turns amber if any trouble such as abnormal battery temperature, battery voltage, or charge current occurs during charging. If the Charge lamp turns amber when you try recharging, contact your local Fukuda Denshi sales and service representative.

Touch-Panel Display

This screen displays patient information, equipment status, heart rate, function keys, various messages, and menus, in addition to the ECG waveform. You can also touch the areas or keys displayed on the screen to display a specific menu or perform a specific function.

Layout of the touch-panel display

A typical screen display is shown below. The actual data displayed on the screen varies depending on the function mode and operation.

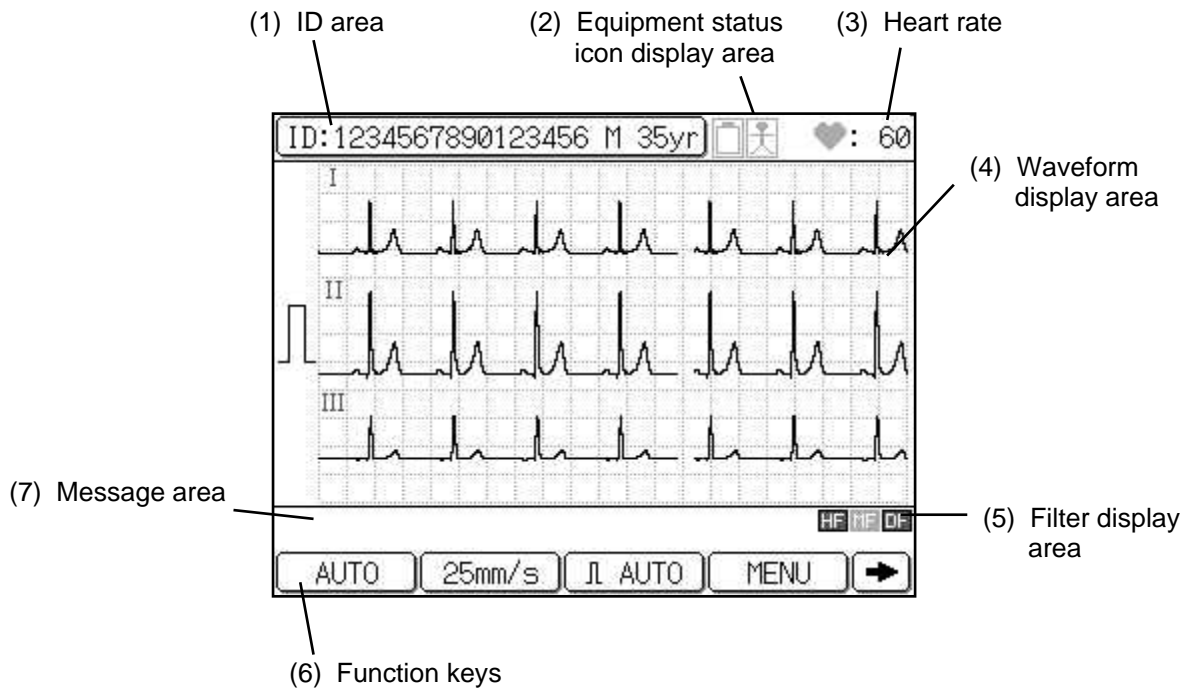

(1) ID area

The patient's information is displayed here.

ID :Patient ID

MALE/FEMALE :Sex of patient

nn yr :Age of patient (0 to 999)

When you touch this area, a more detailed patient information window will pop up. See "Entering Patient Data" for further information about entering patient information (page 45).

(2) Equipment status icon display area

You can check the current status of the electrodes attached to a patient, as well as the battery and recorder.

• Warning icon for detached electrode



This icon is displayed when an electrode becomes detached from a patient.

• Battery level icon

Three different battery level icons are provided to alert you of the remaining battery power. A darker icon means more power. This icon is displayed only when the FX-7202 is operated on batteries (that is, when the power supply cord is not connected to a wall outlet).



Battery level 100 to 60%. Enough battery charge.



Battery level 59 to 20%. Low battery. Charge the battery.



Battery level 19 to 1%. No battery charge. Power off and charge the battery.

(3) Heart rate

The heart rate of a patient is displayed in this location together with the heart icon. This icon flashes in synchronization with the patient's heartbeat.

Notes:

- The heart rate is displayed between 20 and 300 bpm. When an ECG waveform with a heart rate outside of this range is input, asterisks (***) are displayed.
- The heart rate detection accuracy is ± 2 bpm.

(4) Waveform display area

The FX-7202 has three display modes for the ECG waveform: 3-channel, 6-channel, and 12-channel.

(5) Filter display area

The currently selected filter is indicated here.

(6) Function keys

The keys used to perform various functions are displayed here. You can touch a key to perform the corresponding function. Touch the left or right arrow key to scroll the function keys. The displayed keys vary depending on the selected test mode and configurations of the FX-7202.

(7) Message area

Messages such as an error message for detached electrodes or out of recording paper pops up here.

Main Menu

The Cardimax FX-7202 has five operating modes: STANDARD ECG MODE, ARRHYTHMIA ECG MODE (PC-7403), R-R TREND TEST MODE, FILE MODE, and SET UP MODE. You can select the mode using the Mode select window.

Outline of each operation mode

STANDARD ECG MODE: Display, record, analyze (PC-7403 program cartridge), and measure the standard 12-lead ECG.

ARRHYTHMIA ECG MODE: Performs arrhythmia ECG analysis using three selected leads. This mode is displayed only when the PC-7403 program cartridge is installed.

R-R TREND TEST MODE: Performs the R-R trend test using one selected lead.

FILE MODE: plays back the ECG data from the built-in memory.

SET UP MODE: Sets each function mode. Also includes the installation mode for adding the optional program and the maintenance mode for user self-diagnostics, such as a recording test.

Selecting a menu

Touch [MENU] to display the **Mode select** window.

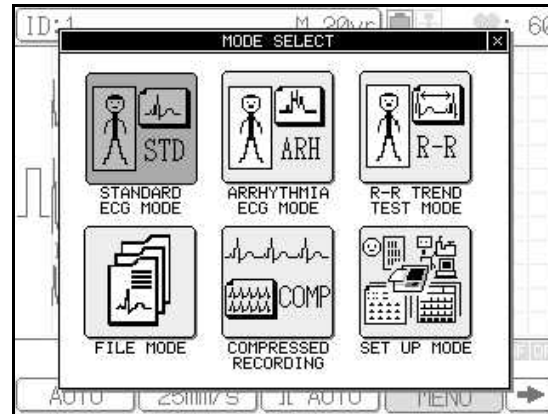

Touch the mode you wish to enter. To cancel the mode selection operation and close the window, touch the [X] in the upper right corner.

Entering Patient Data

You can enter data for each patient in the Standard ECG Mode, Arrhythmia ECG Mode (PC-7403 program cartridge), and R-R Trend Test Mode. The information you enter here will be displayed on the screen, printed on reports, and is used as reference for ECG analysis (PC-7403 program cartridge).

The items to be entered as patient data are summarized in the table below.

Parameter name	Description
ID	Patient identification number (max. 16 digits)
SEX	Male or Female
AGE	Age (max. 3 digits)
NAME	Patient name (alphanumeric, symbols, space)
RACE	Ethnicity of a patient
HT	Height (cm or inches in 3 digits)
WT	Weight (kg or lbs in 3 digits)
BP	Blood pressure systolic and diastolic (3 digits each, unit: mmHg)
DRUG	Medication number from the displayed medication list
SYMP	Symptom number from the displayed symptom list
COMT	Comment (alphanumeric, symbols, space)
WARD	Patient's ward number or arbitrary number (max. 8 digits)
DEPT	Patient's department number (max. 8 digits)

Of the above information, ID, SEX, and AGE data are always displayed in the ID area. The other information, however, can be set so they will not be displayed as patient data.

☞ See "Changing the Patient Data Parameters" in Chapter 7, "Setting Up Parameters of the Cardimax FX-7202" (page 118).

 **Note:**

PC-7403

Be sure to enter the correct age and sex of the patient. The FX-7202 analyzes ECG data based on the patient age and sex. Therefore, if you enter the wrong age and/or sex, the ECG interpretation will be incorrect.

Operation

1 Touch the ID area.

The ID input window will pop up.

✓ Additional information:

You can switch the measurement unit to be used for "HT" between "cm" (default) and "inches", and for "WT" between "kg" (default) and "lb" using the SET UP MODE menu.

- ☞ See "Changing the Patient Data Parameters" in Chapter 7, "Setting Up Parameters of the Cardimax FX-7202" (page 118).

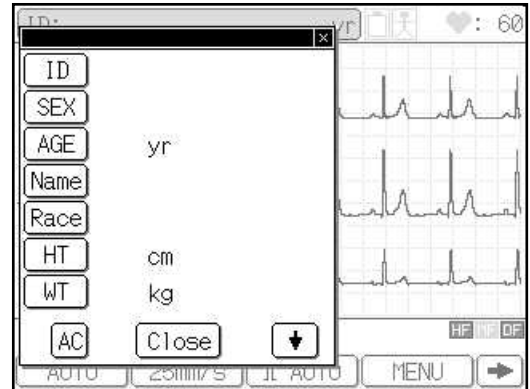

2 Enter the patient's ID (maximum 16 digits).

Touch [ID]. The **ENTER THE ID** keypad will appear. Touch the number keys ([0] to [9]) to enter the ID and touch [Enter]. To enter a hyphen (-), touch [-]. To increment or decrement the ID number, touch [+1] or [-1], respectively.

If you have entered an incorrect number, touch [DEL] to clear the digit you just entered and reenter data. To clear all the digits you have entered, touch [AC]. To cancel the data input operation, touch [Cancel].

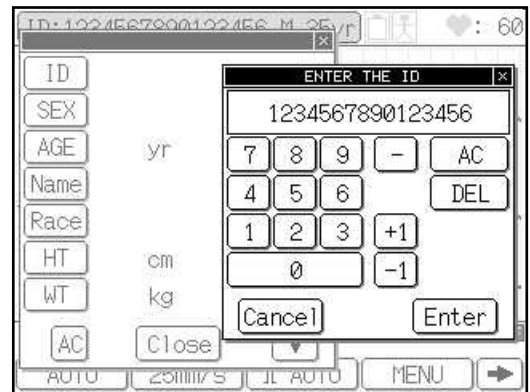

✓ Additional information:

You can enter a fixed number for the upper digits (instead of entering each and every number) or increment the patient's ID number automatically.

- ☞ See "Changing the Patient Data Parameters" in Chapter 7, "Setting Up Parameters of the Cardimax FX-7202" (page 118).

3 Enter the patient's sex.

The **ENTER THE SEX** window will appear. (Or, touch [SEX] to display the Enter the sex window.) Touch [Male] or [Female] to specify the patient's sex and touch [Enter].

To change the data you selected, touch [AC]. To cancel the data input operation, touch [Cancel].

 **Note:**

When no data has been entered for a patient, the **ENTER THE SEX** window will appear immediately after you enter ID data and exit from the **ENTER THE ID** window (step 2). In other words, you do not need to touch [SEX] to open the **ENTER THE SEX** window. This will be the same for the rest of the patient data input items (that is, as soon as you finish selecting data, the window for entering the next item will automatically pop up). You will need to touch the specific patient data item only when you are editing data that has been input already.

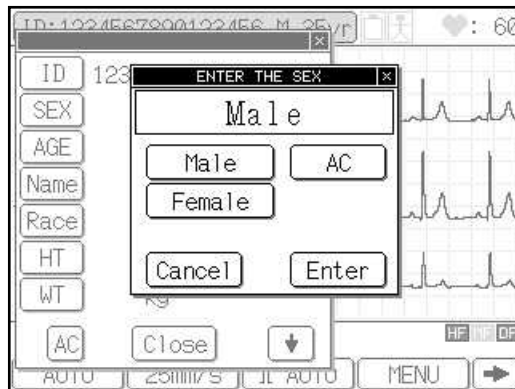

4 Enter the patient's age.

a. Direct input method

The **ENTER THE AGE** keypad will appear. (Or, touch [AGE] to display the "ENTER THE AGE" keypad.)

When the **Input Birthday** parameter of the **SET UP MODE (PATIENT DATA)** screen is set to OFF, touch the number keys ([0] to [9]) to enter the patient's age directly and touch [Enter].

If you have entered an incorrect number, touch [DEL] to clear the digit you just entered and reenter data. To clear all the digits you have entered, touch [AC]. To cancel the data input operation, touch [Cancel].

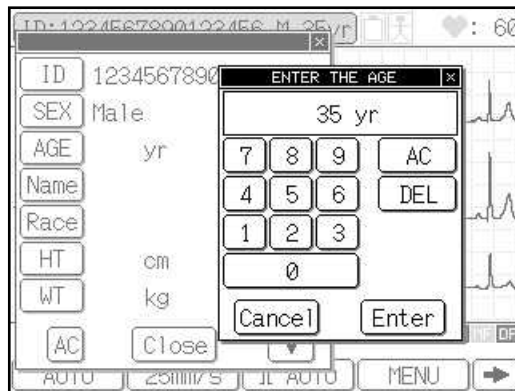

 See "Changing the Patient Data Parameters" in Chapter 7, "Setting Up Parameters of the Cardimax FX-7202" (page 118).

b. Birthday input method

The **BIRTHDAY** keypad will appear. (Or, touch [AGE] to display the BIRTHDAY keypad.)

When the **Input Birthday** parameter of the **SET UP MODE (PATIENT DATA)** screen is set to ON, enter the patient's date of birth, which calculates and sets the patient's age. After you set the patient's sex (step 3) or touch [AGE], the **BIRTHDAY** keypad will appear and the cursor is displayed at the month input (when the date display format is set to "MM-dd-yy"). Touch the number keys ([0] to [9]) to enter the patient's month of birth and touch [Enter]. The cursor moves to the date input. Enter the patient's date of birth and touch [Enter]. Enter the patient's year of birth and touch [Enter].



The FX-7202 will calculate and display the age of a patient based on the birthday input.

☞ See "Changing the Patient Data Parameters" in Chapter 7, "Setting Up Parameters of the Cardimax FX-7202" (page 118).

5 Enter the patient's name.

The **ENTER THE NAME** keyboard will appear. (Or, touch [Name] to display the **ENTER THE NAME** keyboard.) This window has two pages, each showing a different keyboard for letters and numbers/symbols respectively. To change the keyboard page, touch [1/2 ↓] or [2/2 ↑]. Touch the letters to enter the patient's name and touch [Enter]. To enter uppercase letters, touch [CAPS] on the letter (lowercase) screen (page 1/2). To move the cursor position, touch [←] or [→]. To enter a space, touch [Space] bar.



If you have entered an incorrect letter, touch [DEL] to clear the letter you just entered and reenter data. To clear all the letters you have entered, touch [AC]. To cancel the input operation, touch [Cancel].

6 Enter the patient's ethnicity.

The **ENTER THE RACE** window will appear. (Or, touch [Race] to display the **ENTER THE RACE** window.) Touch the ethnicity of a patient from the list displayed in the window and touch [Enter].

If you have entered an incorrect ethnicity, touch [AC] to clear the data and touch the correct ethnicity. To cancel the data input operation, touch [Cancel].



7 Enter the patient's height.

The **ENTER THE HEIGHT** keypad will appear. (Or, touch [HT] to display the **ENTER THE HEIGHT** keypad.) Touch the number keys ([0] to [9]) to enter the patient's height (cm or inches in 3 digits) and touch [Enter].

If you have entered an incorrect value, touch [DEL] to clear the digit you just entered and reenter data. To clear all the digits you have entered, touch [AC]. To cancel the data input operation, touch [Cancel].



8 Enter the patient's weight.

The **ENTER THE WEIGHT** keypad will appear. (Or, touch [WT] to display the **ENTER THE WEIGHT** keypad.) Touch the number keys ([0] to [9]) to enter the patient's weight (kg or lbs in 3 digits) and touch [Enter].

If you have entered an incorrect value, touch [DEL] to clear the digit you just entered and reenter data. To clear all the digits you have entered, touch [AC]. To cancel the data input operation, touch [Cancel].



9 Touch [↓] to display the next page of the patient's information window (if it is not displayed automatically).

10 Enter the patient's blood pressure.

The **ENTER THE BP** keypad will appear. (Or, touch [BP] to display the **ENTER THE BP** keypad.) Touch the number keys ([0] to [9]) to enter the systolic and diastolic blood pressure (3 digits each, unit: mmHg) and touch [Enter]. To move the cursor to the right side of the slash (/), touch [Enter] or [←] or [→].

If you have entered an incorrect value, touch [DEL] to clear the digit you just entered and reenter data. To clear all the digits you have entered, touch [AC]. To cancel the data input operation, touch [Cancel].

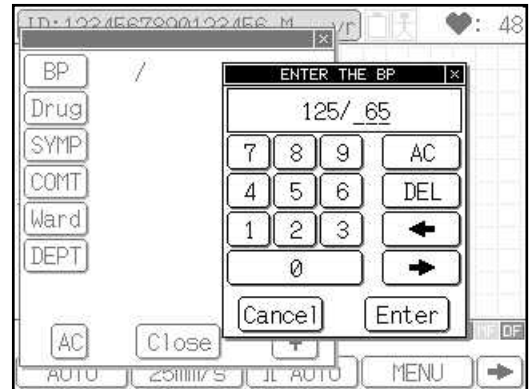

11 Enter the patient's medication.

The **ENTER THE MEDICATION** window will appear. (Or, touch [Drug] to display the **ENTER THE MEDICATION** window.) Touch the relevant medication number from the list displayed in the window and touch [Enter]. The **ENTER THE MEDICATION** window has 10 pages. To scroll the page, touch [↓] or [↑].

Numbers 0 to 9 on the first page of this window lists fixed medication data. Numbers 10 to 99 (pages 2 to 10) are reserved for your use so that you can enter a medication you wish to add. To add a new medication to the list, touch the number. The **ENTER THE NAME** keyboard will appear. You can enter the name of medication (up to 12 characters) in the same manner as entering the patient's name. See step 5 for keyboard operation of letters and numbers/symbols.



If you have entered an incorrect number, touch [AC] to clear the data and then touch the correct number. To cancel the data input operation, touch [Cancel].

12 Enter the patient's symptoms.

The "ENTER THE SYMPTOMS" window will appear. (Or, touch [SYMP] to display the **ENTER THE SYMPTOMS** window.) Touch the symptom number from the list displayed in the window and touch [Enter]. The **ENTER THE SYMPTOMS** window has 10 pages. To scroll the page, touch [↓] or [↑].

Numbers 0 to 9 on the first page of this window lists the fixed symptoms data. Numbers 10 to 99 (pages 2 to 10) are reserved for your use so that you can enter a symptom you wish to add. To add a new symptom to the list, touch the number. The **ENTER THE NAME** keyboard will appear. You can enter the name of



the symptom (up to 12 characters) in the same manner as entering the patient's name. See step 5 for keyboard operation of letters and numbers/symbols.

If you have entered an incorrect number, touch [AC] to clear the data and then touch the correct number. To cancel the data input operation, touch [Cancel].

13 Enter a comment.

The **ENTER THE COMMENT** keyboard will appear. (Or, touch [COMT] to display the **ENTER THE COMMENT** keyboard.) Touch the alphabet letters to enter a comment and touch [Enter]. You can enter the comment in the same manner as entering the patient's name. See step 5 for keyboard operation of letters and numbers/symbols.

If you have entered an incorrect letter, touch [DEL] to clear the letter you just entered and reenter data. To clear all the letters you have entered, touch [AC]. To cancel the data input operation, touch [Cancel].



14 Enter the patient's ward number (8 digits).

The **ENTER THE WARD** keypad will appear. (Or, touch [Ward] to display the **ENTER THE WARD** keypad.) Touch the number keys ([0] to [9]) to enter the patient's ward number and touch [Enter].

If you have entered an incorrect number, touch [DEL] to clear the digit you just entered and reenter data. To clear all the digits you have entered, touch [AC]. To cancel the data input operation, touch [Cancel].

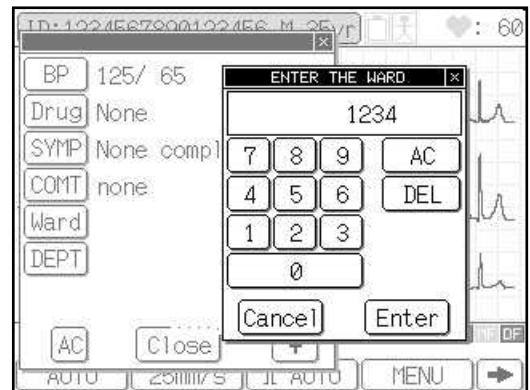

15 Enter the patient's department number (8 digits).

The **ENTER THE DEPT** keypad will appear. (Or, touch [DEPT] to display the **ENTER THE DEPT** keypad.) Touch the number keys ([0] to [9]) to enter the patient's department number and touch [Enter].

If you have entered an incorrect number, touch [DEL] to clear the digit you just entered and reenter data. To clear all the digits you have entered, touch [AC]. To cancel the data input operation, touch [Cancel].



16 Touch [Close] to end the patient's information input operation.

The patient information you have just entered is saved in the memory and the previous screen reappears. To delete all values you have entered, touch [AC].

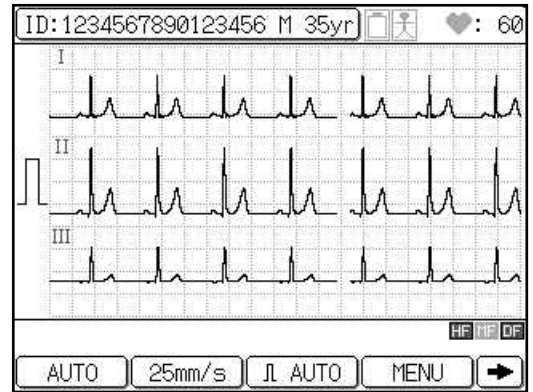

Recording the ECG

After you finish the preparations described above, record the ECG. This section overviews the general ECG recording procedure using the Automatic Recording Mode as an example.

Operation

1 Touch [MENU].

The **Mode select** window will appear.

 **Note:**

The mode screen varies depending on the configuration. The mode screen shown above is displayed when the PC-7403 program cartridge is installed.

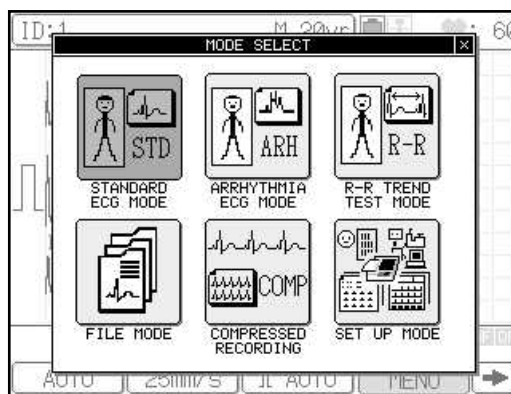

2 Touch [STANDARD ECG MODE].

The Standard ECG Mode is selected.

Functions keys available in the Standard ECG Mode screen

[AUTO] or [MANUAL]: Switches between Automatic Recording Mode and Manual Recording Mode.

[25mm/s] or [50mm/s]: Switches the recording speed of the ECG waveform.

[AUTO] or [**mm]: Switches the display and recording sensitivity of the ECG waveform. (Where “**” indicates 2.5, 5, 10, and 20mm.)

[MENU]: Displays the Mode select window.

[FEED]: Feeds the recording paper.

[FILTER]: Displays the Filter set up window and allows you to set HF, MF, or DF filters to ON/OFF.

[COPY]: Starts writing the automatic recording ECG data, which was recorded immediately before pressing this key, to the built-in memory.

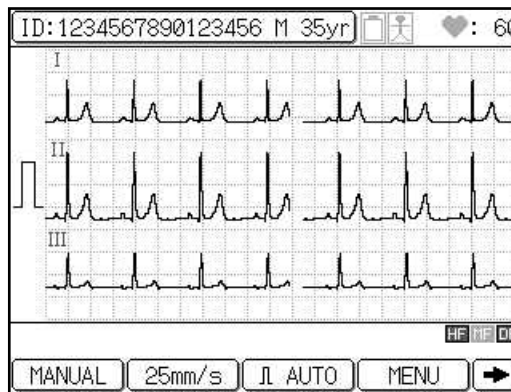

[MARK]: Prints a mark on the recording paper during ECG data printing.

[➡]: Displays the functions keys on the next page.

[⬅]: Displays the function keys on the previous page.

✓ **Additional information:**

When you turn ON the FX-7202, the Standard ECG Mode is selected.

3 Select the Automatic Recording Mode.

If the [MANUAL] function key is displayed, touch [MANUAL] to select the Automatic Recording Mode. If [AUTO] is displayed, skip this step.

When [AUTO] is displayed, the recording is set to the Automatic Recording Mode. If [MANUAL] is displayed, the recording is set to the Manual Recording Mode.

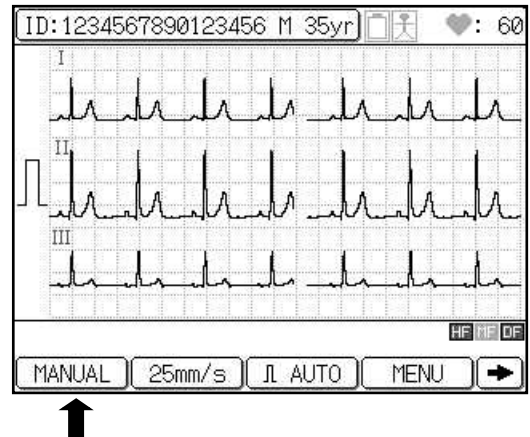

4 Check the ECG waveforms.

Check the current waveforms displayed on the screen. To switch the lead, press **LEAD** [⬅] or [➡] on the Operation Panel. When 3-channel or 6-channel waveforms are displayed, you can switch the leads to be displayed.

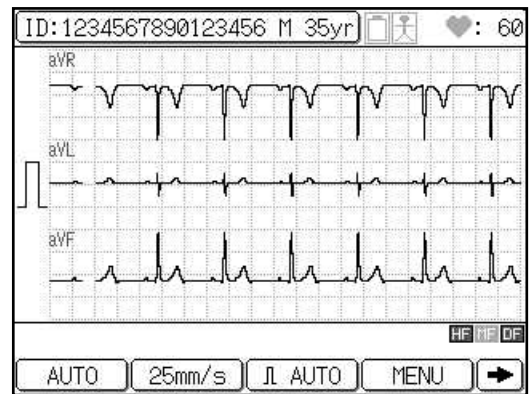

5 Press [START/STOP] or [REVIEW].

Once the displayed waveforms are stable, press [START/STOP] or [REVIEW] to start printing the ECG.

When the recording is complete, the process stops automatically.

✓ Additional information:

- To cancel the recording, press [START/STOP] again.
- If you cannot record an accurate ECG, see "When You Cannot Record an Accurate ECG" in Chapter 8, "Maintenance and Troubleshooting" (page 132).
- The recording data and format can be changed as required.
- ☞ See "Selecting the Recording Format" in Chapter 7, "Setting Up Parameters of the Cardimax FX-7202" (page 103).

ECG waveform recording example

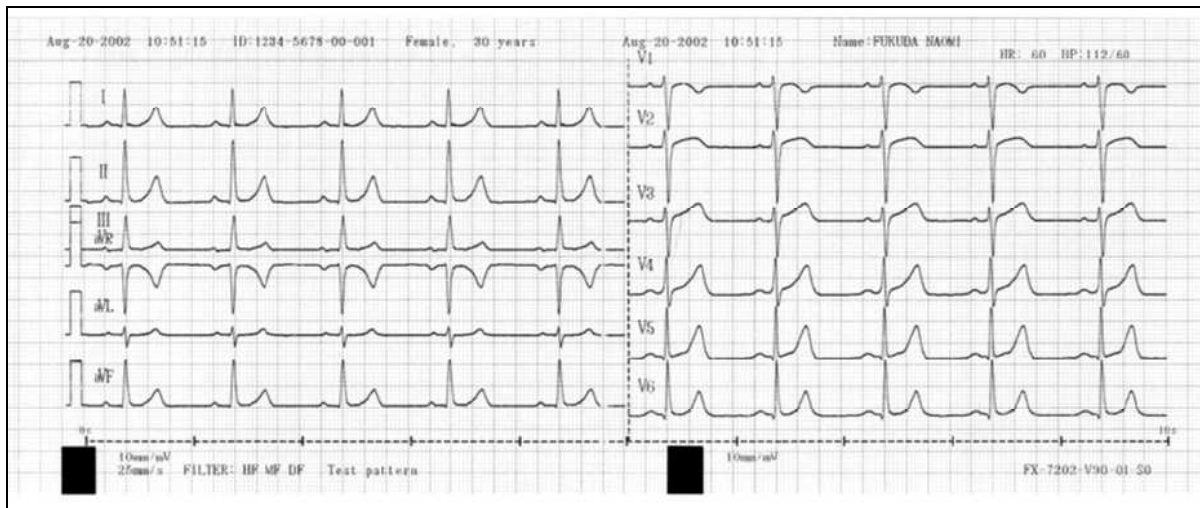

Chapter 4

Recording the Electrocardiogram:

Standard ECG Mode

The Cardimax FX-7202 can be operated in three different function modes: Standard ECG Mode, Arrhythmia ECG Mode, and R-R Trend Test Mode. The Arrhythmia ECG Mode, however, is available only when the PC-7403 program cartridge is installed. This chapter discusses how to record ECG in the Standard ECG Mode.

What is the Standard ECG Mode?

The Standard ECG Mode is used to display and record the standard 12-lead ECG. To perform ECG recording, you must select the recording method (operation mode). Two recording methods, i.e. Automatic Recording and Manual Recording are provided as standard functions. Also, if you select the Automatic Recording Mode, measurement recording and analysis recording (when the PC-7403 program cartridge is installed) are available.

The chart below shows the structure of the recording methods.

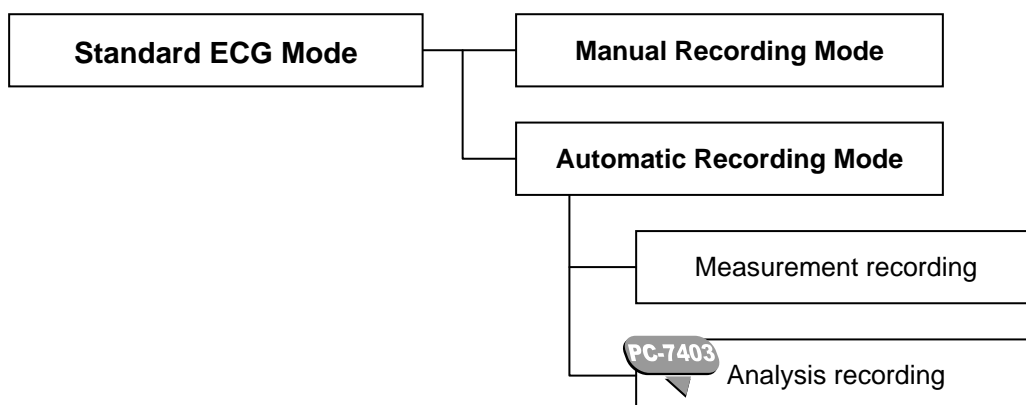

The available operation modes are summarized in the table below.

Configuration	Available operation mode
Without program cartridge	Automatic Recording Mode (measurement recording), Manual Recording Mode
 With PC-7403 program cartridge	Automatic Recording Mode (analysis recording), Manual Recording Mode

Automatic Recording Mode (AUTO)

Automatically changes the leads to be recorded, applies the calibrated 1mV waveform, and records the 12-lead ECG.

Measurement recording

Measures each waveform of the 12-lead ECG and prints the measurement results together with the ECG waveform.



Analysis recording

Analyzes each waveform of the 12-lead ECG and prints the interpretation together with the ECG waveform.

Manual Recording Mode (MANUAL)

Requires manual changing of the leads to be recorded, applies the calibrated 1mV waveform, and records the 12-lead ECG.

Automatic Recording Mode

The Automatic Recording Mode allows automatic changing of the leads to be recorded and records the standard 12-lead ECG.

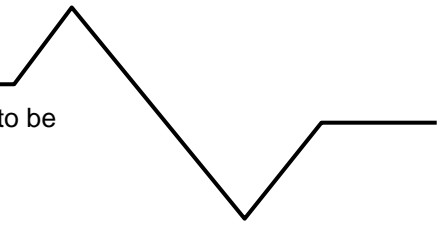

The Automatic Recording Mode includes measurement and analysis recording.

The available recording methods are summarized in the table below.

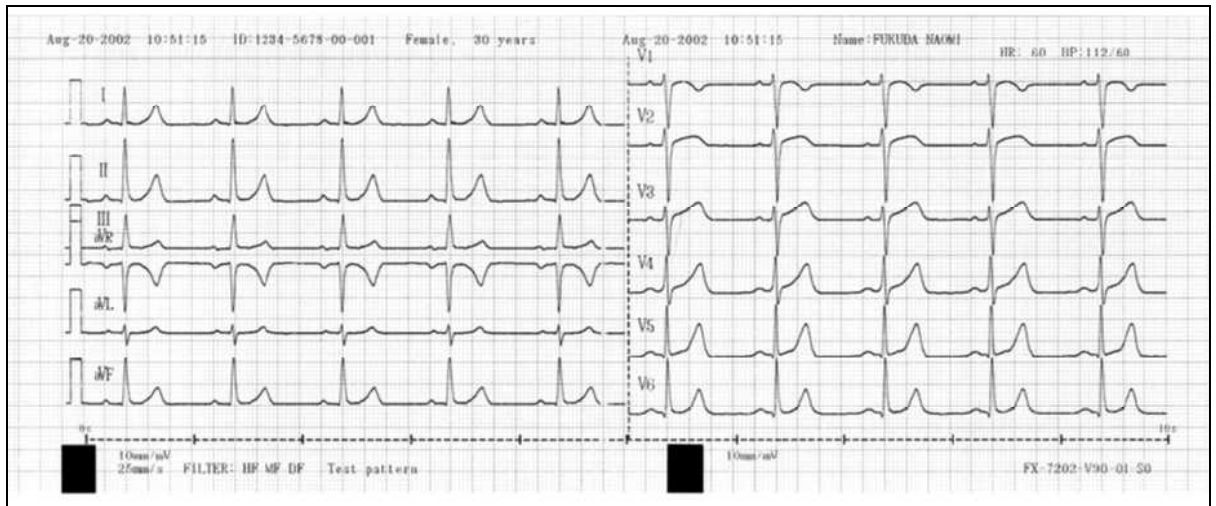

Configuration	Available recording method
Without program cartridge	Measurement recording
 With PC-7403 program cartridge	Analysis recording

ECG waveforms



✓ Additional information:

You can change the number of display channels and recording channels as required.

-  See "Selecting the Number of Waveform Display Channels" in Chapter 7, "Setting Up Parameters of the Cardimax FX-7202" (page 102).
-  See "Selecting the Recording Format" in Chapter 7, "Setting Up Parameters of the Cardimax FX-7202" (page 103).

Operation

1 Display the Mode select window.

Touch [MENU] to display the **Mode select** window.

Note:

The mode screen varies depending on the FX-7202 configuration. The mode screen shown above is displayed when the PC-7403 program cartridge is installed.

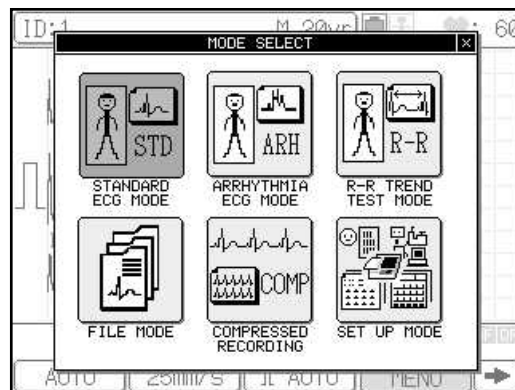

2 Touch [STANDARD ECG MODE].

The Standard ECG Mode is selected.

Function keys available in the Standard ECG Mode screen

[AUTO] or [MANUAL]: Switches between Automatic Recording and Manual Recording.

[25mm/s] or [50mm/s]: Switches the recording speed of the ECG waveforms.

[AUTO] or [**mm]: Switches the display and recording sensitivity of the ECG waveforms. (Where “**” indicates 2.5, 5, 10, and 20mm/mV.)

[MENU]: Displays the Mode select window.

[➡]: Displays the function keys on the next page.

[FEED]: Feeds the recording paper without recording.

[FILTER]: Displays the Filter set up window and allows you to set the HF, MF, and DF filters ON/OFF.

☞ See "Setting the filter ON/OFF" in "Additional information" in this chapter (page 61), and "Selecting the Filters" in Chapter 7, "Setting Up Parameters of the Cardimax FX-7202" (page 120).

[COPY]: Starts reprinting the automatic recording ECG data, which was recorded immediately before pressing this key.

[MARK]: Prints a mark on the recording paper during ECG data printing.

[←]: Displays the function keys on the previous page.

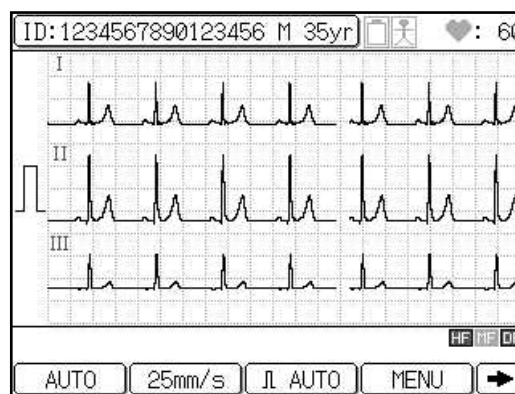

✓ **Additional information:**

When the FX-7202 is turned ON, the Standard ECG Mode is selected.

3 Select the Automatic Recording Mode.

If the [MANUAL] function key is displayed, touch [MANUAL] to select the Automatic Recording Mode. [AUTO] will be displayed.

✓ **Additional information:**

The recording mode that was in use when the FX-7202 was turned OFF last time is selected.

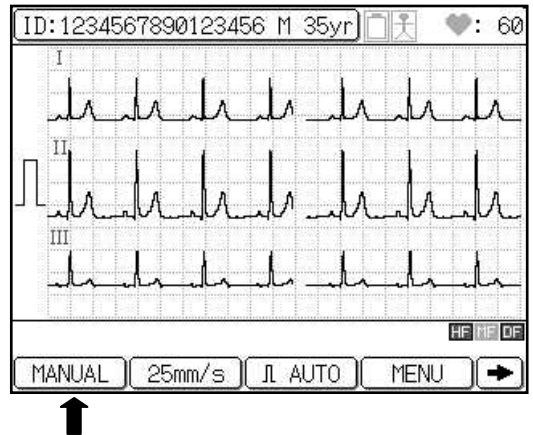

4 Check the ECG waveform.

Check the current waveforms displayed on the screen. To switch the leads, press **LEAD** [◀] or [▶]. When 3-channel or 6-channel waveforms are displayed, you can switch the leads to be displayed.

Note:

When 12-lead waveforms are displayed, you cannot switch a lead by pressing **LEAD** [◀] or [▶].

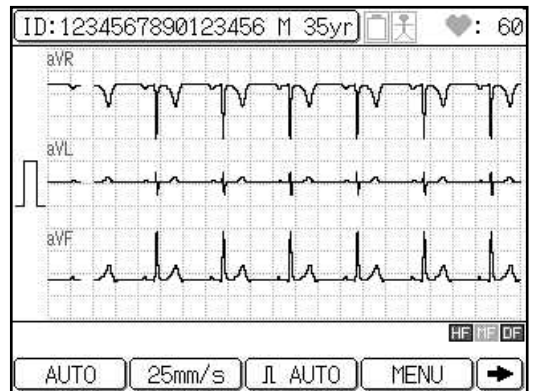

5 Press [START/STOP] or [REVIEW] to start recording.

Once the displayed waveforms are stable, press **[START/STOP]** to start recording the ECG in real time. Or, press **[REVIEW]** to start recording ECG including 10 seconds of ECG that occurred before pressing **[REVIEW]**.

The printout starts and the tracings are printed in accordance with the preset format. When the recording is complete, it will stop automatically.

See "Review Recording" in Chapter 5, "Recording the Electrocardiogram: Advanced Features" (page 67).

See "STANDARD ECG MODE" in Chapter 7, "Setting Up Parameters of the Cardimax FX-7202" (page 94).

✓ Additional information:

- Automatic real-time recording samples the ECG data and records and measures/analyzes (PC-7403 program cartridge) the waveforms after [START/STOP] is pressed. Real-time recording starts sampling ECG data as soon as the P wave is detected. On the other hand, automatic review recording samples the ECG data and records and measures/analyzes (PC-7403 program cartridge) waveforms from those sampled 10 seconds prior to pressing [REVIEW].
- You can touch the ID area to enter patient data. You cannot enter patient data when the FX-7202 is performing a recording or displaying the function menu.
- **Setting the filter ON/OFF**
To change the HF, MF, and DF filter ON/OFF setting, touch [FILTER]. The Filter set up window will appear. Touch [HF ON/OFF], [MF ON/OFF], or [DF ON/OFF] to change the setting. Touch [Close] to return to the previous screen. The frequency characteristics of each filter are set using the **SET UP MODE (ECG CONTROL)**. When the filter is set to ON, the relevant filter icon ("HF", "MF", "DF") will appear in the current status display area.
 See "Selecting the Filters" in Chapter 7, "Setting Up Parameters of the Cardimax FX-7202" (page 120).
- **Changing the sensitivity**
To change the sensitivity, touch the sensitivity key ([AUTO] or [**mm]). Sensitivity settings of 2.5mm/mV, 5mm/mV, 10mm/mV, 20mm/mV, and AUTO (automatic) are available. When you set AUTO, the optimal sensitivity for recording and displaying data is selected automatically from 2.5mm/mV, 5mm/mV or 10mm/mV.
- **Changing the recording speed**
To change the recording speed, touch the speed key ([25mm/s] or [50mm/s]). Speed settings of 25mm/s and 50mm/s are available. The waveform drawing speed on the LCD is fixed regardless of this setting.
- To cancel the recording, press [START/STOP] again.
- If you cannot record an accurate ECG, see "When You cannot Record an Accurate ECG" in Chapter 8, "Maintenance and Troubleshooting" (page 132).

Manual Recording Mode

The Manual Recording Mode enables you to manually change the leads to be recorded, apply the calibrated 1mV waveform, and record the standard 12-lead ECG.

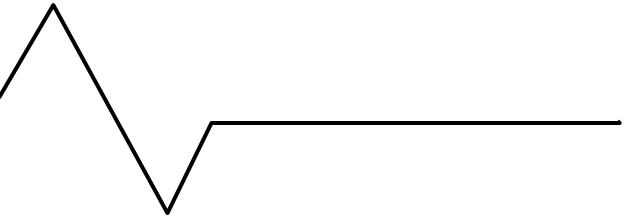

ECG waveforms

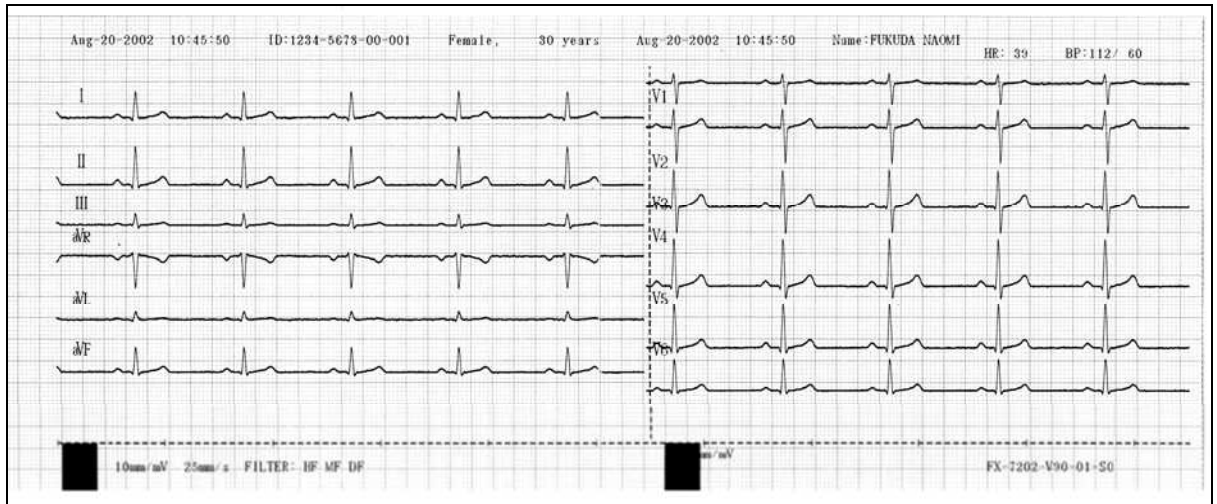

✓ Additional information:

You can change the number of display channels as required. The number of channels to be displayed in Manual Recording Mode complies with the "Manual Recording CH." parameter setting of the SET UP MODE (SANDARD ECG MODE). For example, if "6CH" is selected for the "Manual Recording CH." parameter, six channels are always displayed regardless of the Display Channel parameter setting.

- ☞ See "Selecting the Number of Waveform Display Channels" in Chapter 7, "Setting Up Parameters of the Cardimax FX-7202" (page 102).

Operation

1 Display the Mode select window.

Touch [MENU] to display the **Mode select** window.

Note:

The mode screen varies depending on the FX-7202 configuration. The mode screen shown above is displayed when the PC-7403 program cartridge is installed.

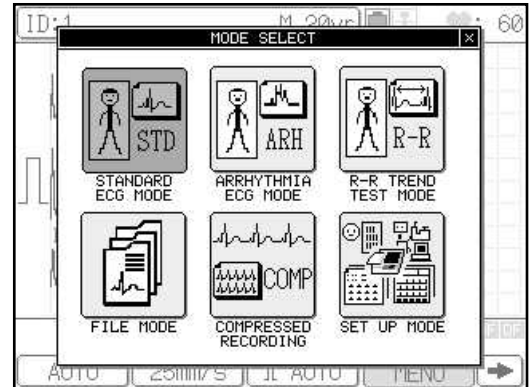

2 Touch [STANDARD ECG MODE].

The Standard ECG Mode is selected.

Function keys available in the Standard ECG Mode screen

[AUTO] or [MANUAL]: Switches between Automatic Recording and Manual Recording.

[**mm/s]: Switches the recording speed of ECG waveforms. (Where “**” indicates 10, 12.5, 25, and 50mm/s.)

[AUTO] or [**mm]: Switches the display and recording sensitivity of ECG waveforms. (Where “**” indicates 2.5, 5, 10, and 20mm/mV.)

[MENU]: Displays the Mode select window.

[➡]: Displays the function keys on the next page.

[FEED]: Feeds the recording paper without recording.

[FILTER]: Displays the Filter set up window and enables you to set the HF, MF, and DF filters ON/OFF.

☞ See "Setting the filter ON/OFF" in "Additional information" in this chapter (page 64), and "Selecting the Filters" in Chapter 7, "Setting Up Parameters of the Cardimax FX-7202" (page 120).

[MARK]: Prints a mark on recording paper during ECG data printing.

[←]: Displays the function keys on the previous page.

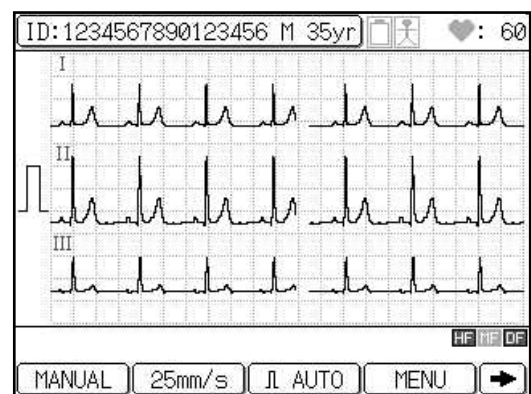

✓ **Additional information:**

When the FX-7202 is turned ON, the Standard ECG Mode is selected.

3 Select the Manual Recording Mode.

If the [AUTO] function key is displayed, touch [AUTO] to select the Manual Recording Mode. [MANUAL] will be displayed.

✓ **Additional information:**

The recording mode that was in use when the FX-7202 was turned OFF last time is selected.

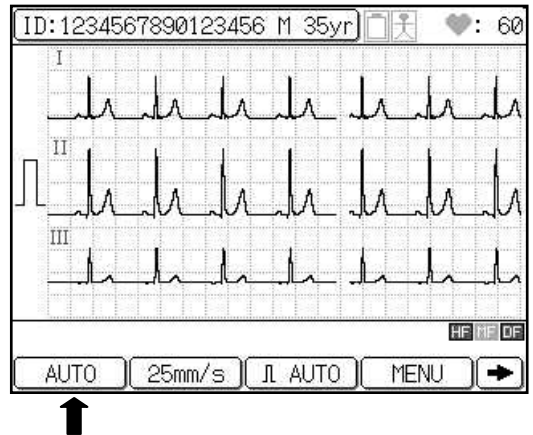

4 Check the ECG waveform.

Check the current waveforms displayed on the screen. To switch the leads, press **LEAD** [◀] or [▶]. When 3-channel or 6-channel waveforms are displayed, you can switch the leads to be displayed.

Note:

When 12-lead waveforms are displayed, you cannot switch the lead by pressing **LEAD** [◀] or [▶].

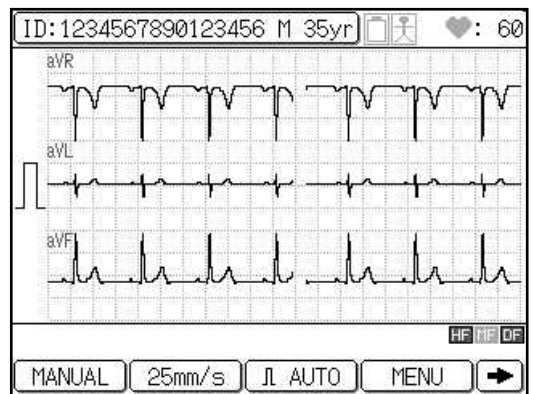

5 Press [START/STOP] to start recording.

Once the displayed waveforms are stable, press **[START/STOP]** to start recording the ECG. To switch the leads, press **LEAD** [◀] or [▶].

✓ **Additional information:**

- You can select the number of recording channels from 3ch (default) and 6ch using the "Manual Recording CH." parameter of the **SET UP MODE (STANDARD ECG MODE)** menu.
- ☞ See "STANDARD ECG MODE" in Chapter 7, "Setting Up Parameters of the Cardimax FX-7202" (page 94).
- You can touch the ID area to enter patient data. You cannot enter patient data when the FX-7202 is performing a recording or displaying the function menu.
- **Setting the filter ON/OFF**
To change the HF, MF, and DF filter ON/OFF setting, touch [FILTER]. The Filter set up window will appear. Touch [HF ON/OFF], [MF ON/OFF], or [DF ON/OFF] to change the setting. Touch [Close] to return to the previous screen.

- The frequency characteristics of each filter are set using **SET UP MODE (ECG CONTROL)**. When a filter is set to ON, the relevant filter icon ("HF", "MF", "DF") will appear in the current status display area.
- ☞ See "Selecting the Filters" in Chapter 7, "Setting Up Parameters of the Cardimax FX-7202" (page 120).
- **Changing the sensitivity**
To change the sensitivity, touch the sensitivity key ([AUTO] or [****mm**]). Sensitivity settings of 2.5mm/mV, 5mm/mV, 10mm/mV, 20mm/mV, and AUTO (automatic) are available. When AUTO is set, optimal sensitivity for recording and displaying data is selected automatically from 2.5mm/mV, 5mm/mV or 10mm/mV.
- **Changing the recording speed**
To change the recording speed, touch the speed key ([****mm/s**]). Speed settings of 10mm/s, 12.5mm/s, 25mm/s, and 50mm/s are available. The waveform drawing speed on the LCD is fixed regardless of this setting.
- To record a calibrated waveform, press [**1mV**].
- To cancel the recording, press [**START/STOP**] again.
- If you cannot record an accurate ECG, see "When You cannot Record an Accurate ECG" in Chapter 8, "Maintenance and Troubleshooting" (page 132).

6 Press [**START/STOP**] again to stop recording.

Chapter 5

Recording the Electrocardiogram:

Advanced Features

The Cardimax FX-7202 can perform various examinations such as arrhythmia analysis and R-R trend test in addition to the standard 12-lead ECG recording. This chapter describes how to use these advanced features supported by the FX-7202.

The Standard ECG Mode supports the following advanced features.

Review recording

Records and measures 10 seconds of ECG that occurred prior to pressing [REVIEW] on the Operation Panel. The recording and measuring is continued.

The FX-7202 also provides R-R Trend Test and Arrhythmia ECG Modes in addition to the Standard ECG Mode described in Chapter 4. The Arrhythmia ECG Mode is available only when the PC-7403 program cartridge is installed.

R-R Trend Test Mode

Monitors a specified ECG lead for a maximum of 5 minutes, or 100, or 200 pulses and measures the variation of the R-R interval. The results are recorded as an R-R trend test report together with the ECG waveform.



Arrhythmia ECG Mode

Monitors a specified 3-leads of the ECG for 1 to 3 minutes and performs an arrhythmia analysis. The analysis results are recorded as an arrhythmia analysis report together with the ECG waveform.



Arrhythmia automatic extension recording

Automatically performs an arrhythmia analysis when a condition such as arrhythmia is detected during analysis recording.

Compressed recording

Performs manual recording with 5mm/s image.

The advanced features are summarized in the table below.

Configuration	Advanced features supported
Without program cartridge	Review recording, R-R Trend Test recording, Compressed recording
 With PC-7403 program cartridge	Arrhythmia ECG Mode, Arrhythmia automatic extension recording, Review recording, R-R Trend Test recording, Compressed recording

Review Recording

Standard ECG Mode,
Arrhythmia ECG Mode,
R-R Trend Test Mode

The Review Recording feature allows recording and measuring of 10 seconds of ECG that occurred prior to pressing [REVIEW] on the Operation Panel when you are performing a Standard ECG Mode (Automatic Recording), Arrhythmia ECG Mode, or R-R Trend Test Mode Recording. Recording and measuring is continued in the selected mode.

Review Recording begins with data that occurred 10 seconds prior to the current time. For example, pressing [START/STOP] as soon as arrhythmia is detected on the screen might not record this condition because it has already passed. In that case, using the Review Recording function ensures that the waveform detected on the screen earlier is recorded.

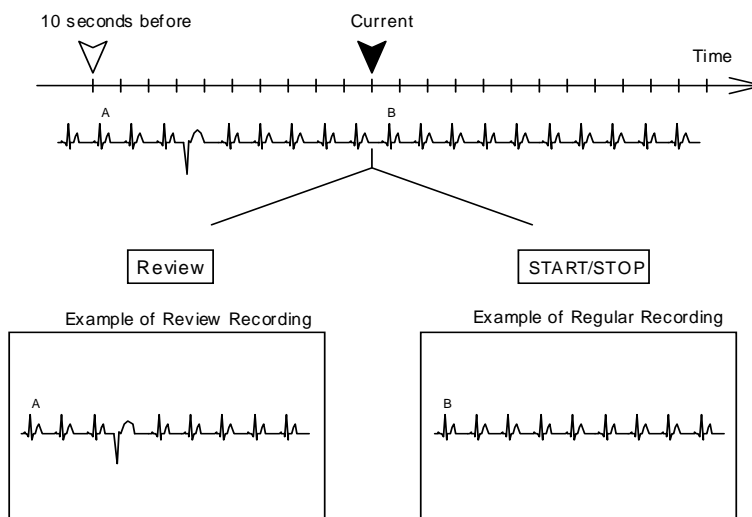

Operation

1 Display the Mode select window.

Touch [MENU] to display the **Mode select** window.

Note:

The mode screen varies depending on the FX-7202 configuration. The mode screen shown is displayed when the PC-7403 program cartridge is installed.

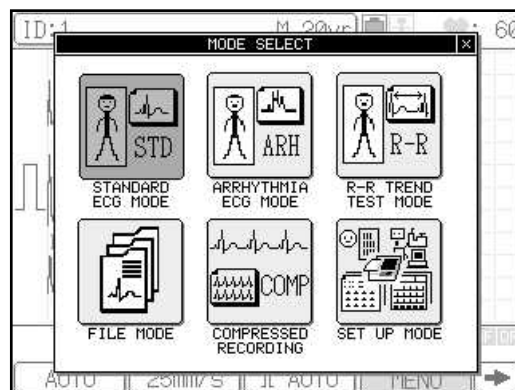

2 Touch [STANDARD ECG MODE], [ARRHYTHMIA ECG MODE], or [R-R TREND TEST MODE].

Select the desired recording mode.

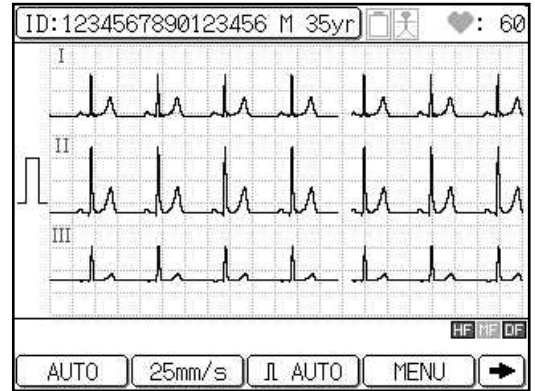

3 Select the Automatic Recording Mode.

If the [MANUAL] function key is displayed, touch [MANUAL] to select the Automatic Recording Mode. [AUTO] will be displayed.

✓ Additional information:

- ☞ See Chapter 4, "Recording the Electrocardiogram: Standard ECG Mode" (page 56), or Chapter 5 (this chapter), "R-R Trend Test Mode" (page 69) or "Arrhythmia ECG Mode" (page 73) for the detailed procedure.

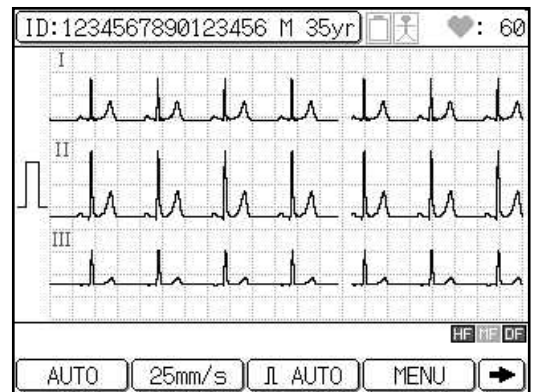

4 Press [REVIEW] to start the Review Recording.

The ECG Review Recording starts.

✓ Additional information:

- The rest of the Review Recording operation is the same as the normal recording method of the Standard ECG Mode, Arrhythmia ECG Mode, or R-R Trend Test Mode.
- ☞ See Chapter 4, "Recording the Electrocardiogram: Standard ECG Mode" (page 56).
- To cancel the recording, press [START/STOP]. When [REVIEW] is pressed, recording will start even if an electrode is detached from a patient.

R-R Trend Test Mode

The R-R Trend Test Mode allows monitoring of a specified ECG lead for a maximum of 5 minutes or 100 or 200 pulses and measures the variation of the R-R interval. The measurement results (Standard Deviation, Coefficient of Variation, Trend graph, and Histogram) are recorded as an R-R trend test report together with the ECG waveform.

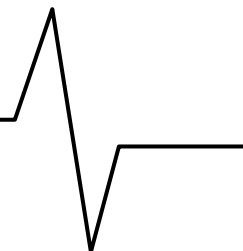

CAUTION



The measurement results should be reviewed and correlated to the printed ECG waveform. The FX-7202 may measure the ECG waveform incorrectly due to external noise (such as a drift of baseline, electromyogram, AC interference, etc.).

R-R trend test (ECG test report)



Select the desired measuring period from the following by touching [TARGET]: 100BT, 200BT, 1 min, 2 min, 3 min, 4 min, 5 min. The test automatically stops when the selected time elapsed.

The recording format can be changed as required.

☞ See "R-R Trend Test Mode" of "Selecting the Recording Format" in Chapter 7, "Setting Up Parameters of the Cardimax FX-7202" (page 116).

✓ Additional information:

In this mode, one channel that is selected by the **R-R Trend Lead** parameter of the **SET UP MODE (R-R TREND TEST MODE)** is displayed.

Operation

1 Display the Mode select window.

Touch [MENU] to display the Mode select window.

Note:

The mode screen varies depending on the FX-7202 configuration. The mode screen shown is displayed when the PC-7403 program cartridge is installed.

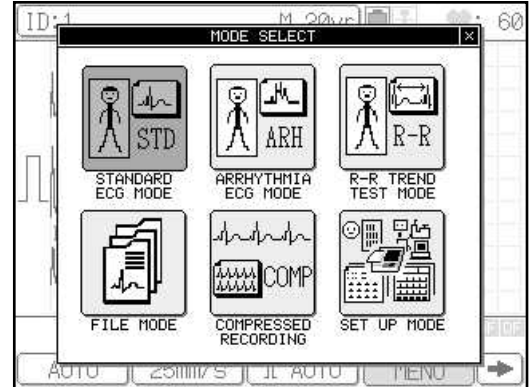

2 Touch [R-R TREND TEST MODE].

The R-R Trend Test Mode is selected.

Function keys available in the R-R Trend Test Mode screen

[TARGET]: Displays the TARGET SELECT window and allows you to select the measuring period (1min, 2min, 3min, 4min, 5min, 100BT, 200BT).

[COPY]: Starts reprinting the R-R measurement data, which was recorded immediately before pressing this key.

[AUTO] or [**mm]: Switches the display and recording sensitivity of ECG waveforms. (Where “**” indicates 2.5, 5, 10, and 20mm/mV.)

[MENU] :Displays the Mode select window.

[➡] :Displays the function keys on the next page.

[FEED]: Feeds the recording paper.

[FILTER]: Displays the Filter set up window and allows you to turn the HF, MF, and DF filters ON/OFF.

[⬅] :Displays the function keys on the previous page.

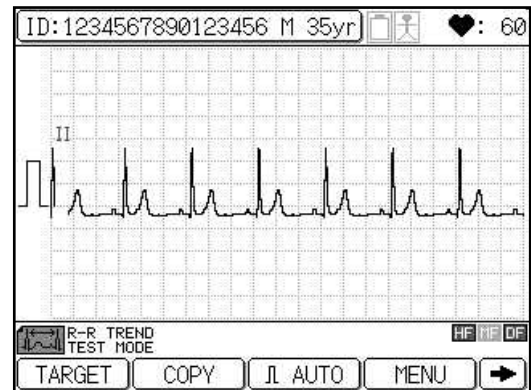

✓ Additional information:

When the FX-7202 is turned ON, the Standard ECG Mode is selected.

3 Select the measuring period.

Touch [TARGET]. The **TARGET SELECT** window will appear. Select the measuring period from the following: 100BT, 200BT, 1 min, 2 min, 3 min, 4 min, 5 min. Touch [Close] to return to the previous screen.

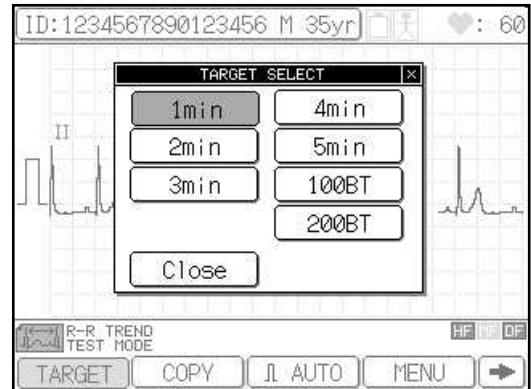

4 Press [START/STOP] or [REVIEW] to start recording.

When [START/STOP] is pressed, the FX-7202 starts sampling the waveforms of the lead selected by the **R-R Trend Lead** parameter of the **SET UP MODE (R-R TREND TEST MODE)**.

When [REVIEW] is pressed, the FX-7202 starts sampling waveforms from those sampled 10 seconds prior to pressing [REVIEW].

The lead is recorded for a specified period (or for a specified number of pulses). During data sampling, the message "SAMPLING" is displayed together with either the number of sampled R waves and selected number of pulses or elapsed time and selected measuring period. If either 100BT or 200BT is set in the **TARGET SELECT** window, the sampling will end automatically when the number of counted R waves reaches the number of pulses set in the **TARGET SELECT** window or when 5 minutes have elapsed. If 1 to 5 minutes is set in the **TARGET SELECT** window, the sampling will end automatically when the time set in the **TARGET SELECT** window has elapsed.

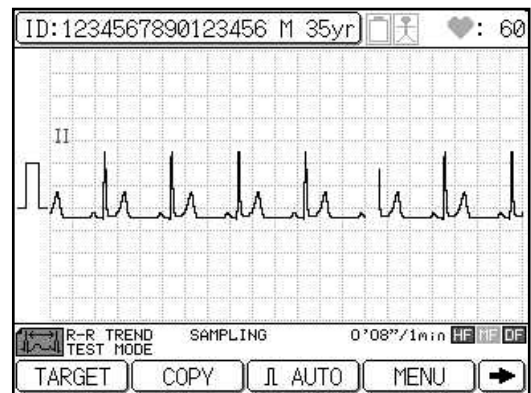

When the test is completed, the R-R trend test report is recorded.

✓ Additional information:

- You can touch the ID area to enter patient data. You cannot enter patient data when the FX-7202 is performing a recording or displaying the function menu.
 - Waveform sampling of the lead is canceled if no QRS is detected in 7 seconds immediately after the test is started. Sampling is also canceled if the number of R-R intervals exceeds 216 per minute when the measuring period (1 to 5 minutes) is set.
 - **Setting the filter ON/OFF**
To change the HF, MF, and DF filter ON/OFF setting, touch [FILTER]. The Filter set up window will appear. Touch [HF ON/OFF], [MF ON/OFF], or [DF ON/OFF] to change the setting. Touch [Close] to return to the previous screen. The frequency characteristics of each filter are set using **SET UP MODE (ECG CONTROL)**. When a filter is set to ON, the relevant filter icon ("HF", "MF", "DF") will appear in the current status display area.
- ☞ See "Selecting the Filters" in Chapter 7, "Setting Up Parameters of the Cardimax FX-7202" (page 120).

- **Changing the sensitivity**

To change the sensitivity, touch the sensitivity key ([AUTO] or [**mm]). Sensitivity settings of 2.5mm/mV, 5mm/mV, 10mm/mV, 20mm/mV, and AUTO (automatic) are available. When you select AUTO, the optimal sensitivity for recording and displaying data is selected automatically from 2.5mm/mV, 5mm/mV or 10mm/mV.

- To record a calibrated waveform, press [**1mV**].
 - The recording will start even if an electrode is detached from a patient.
 - To cancel the test, press [**START/STOP**].
 - You can use the **ECG Report** parameter of the **SET UP MODE (R-R TREND MODE)** to select the waveform recording speed from either Standard (25mm/s) or Compress (12.5mm/s).
 - If the **Analysis Report** parameter of the **SET UP MODE (R-R TREND TEST MODE)** is set to ON, you can automatically print the R-R trend graph and R-R histogram.
 - If the **Measured Value** parameter of the **SET UP MODE (R-R TREND TEST MODE)** is set to ON, you can automatically print detailed measurement values.
-  See "R-R Trend Test Mode" of "Selecting the Recording Format" in Chapter 7, "Setting Up Parameters of the Cardimax FX-7202" (page 116).

PC-7403

Arrhythmia ECG Mode

The Arrhythmia ECG Mode allows monitoring of a specified 3-lead ECG for 1 to 3 minutes and analyzes the arrhythmia condition. The analysis results are recorded as an arrhythmia ECG report together with ECG waveforms.

Arrhythmia ECG report



Select the desired measuring period from the following by touching [TARGET]: 1 min, 2 min, 3 min. The test stops automatically when the selected time has elapsed.

The recording format can be changed as required.

☞ See "Arrhythmia ECG Mode" of "Selecting the Recording Format" in Chapter 7, "Setting Up Parameters of the Cardimax FX-7202" (page 114).

✓ Additional information:

In this mode, three channels selected by the **Arrhythmia Lead 1CH, 2CH, and 3CH** parameters of the **SET UP MODE (ARRHYTHMIA ECG MODE)** are displayed.

Operation

1 Press the Mode select window.

Touch [MENU] to display the **Mode select** window.

Note:

The mode screen varies depending on the FX-7202 configuration. The mode screen shown is displayed when the PC-7403 program cartridge is installed.

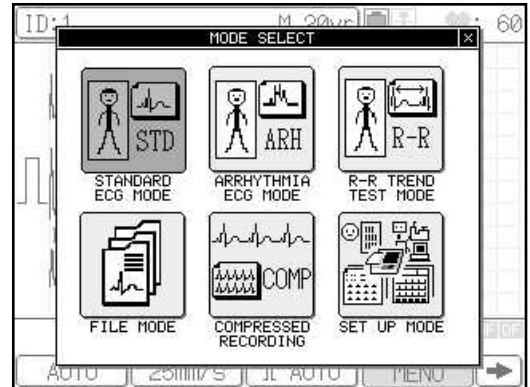

2 Touch [ARRHYTHMIA ECG MODE].

The Arrhythmia ECG Mode is selected.

Function keys available in the Arrhythmia ECG Mode screen

[TARGET]: Displays the TARGET SELECT window and allows you to select the measuring period (1min, 2min, 3min).

[COPY]: Starts reprinting the arrhythmia ECG measurement data, which was recorded immediately before pressing this key.

[AUTO] or [**mm]: Switches the display and recording sensitivity of ECG waveforms. (Where “**” indicates 2.5, 5, 10, and 20mm/mV.)

[MENU]: Displays the Mode select window.

[➡]: Displays the function keys on the next page.

[FEED]: Feeds the recording paper without recording.

[FILTER]: Displays the Filter set up window and allows you to turn the HF, MF, and DF filters ON/OFF.

[⬅]: Displays the function keys on the previous page.

✓ Additional information:

When the FX-7202 is turned ON, the Standard ECG Mode is selected.

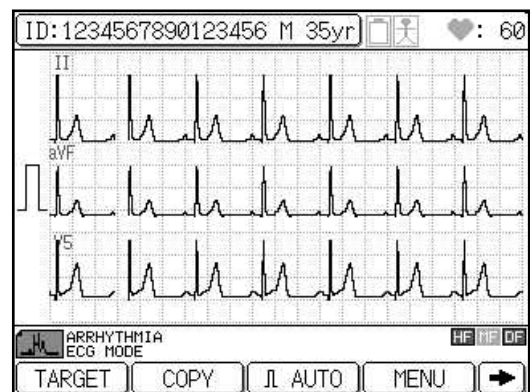

3 Select the measuring period.

Touch [TARGET]. The **TARGET SELECT** window will appear. Select the measuring period from the following: 1 min, 2 min, 3 min. Touch [Close] to return to the previous screen.

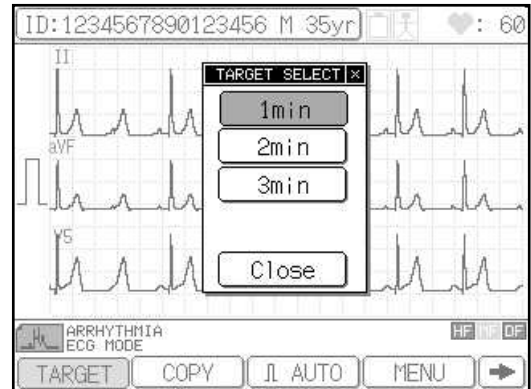

4 Press [START/STOP] or [REVIEW] to start recording.

When [START/STOP] is pressed, the FX-7202 starts sampling the waveforms of the three leads selected by the **Arrhythmia Lead 1CH, 2CH, and 3CH** parameters of the **SET UP MODE (ARRHYTHMIA ECG MODE)**.

When [REVIEW] is pressed, the FX-7202 starts sampling waveforms from those sampled 10 seconds prior to pressing [REVIEW].

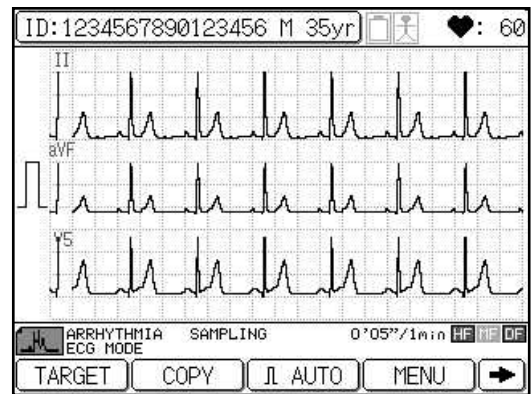

The lead is recorded for a specified period. During data sampling, the message "ARRHYTHMIA SAMPLING" is displayed together with the elapsed time and selected measuring period. If 1 to 3 minutes is set in the **TARGET SELECT** window, the sampling will automatically end when the time set in the **TARGET SELECT** window has elapsed.

When the analysis is complete, the arrhythmia ECG report and the measured values are recorded.

✓ Additional information:

- You can touch the ID area to enter patient data. You cannot enter patient data when the FX-7202 is performing a recording or displaying the function menu.
 - Waveform sampling of the lead is canceled when no QRS is detected in the 7 seconds immediately after the test is started.
 - **Setting the filter ON/OFF**
To change the HF, MF, and DF filter ON/OFF setting, touch [FILTER]. The Filter set up window will appear. Touch [HF ON/OFF], [MF ON/OFF], or [DF ON/OFF] to change the setting. Touch [Close] to return to the previous screen. The frequency characteristics of each filter are set using **SET UP MODE (ECG CONTROL)**. When a filter is set to ON, the relevant filter icon ("HF", "MF", "DF") will appear in the current status display area.
- ☞ See "Selecting the Filters" in Chapter 7, "Setting Up Parameters of the Cardimax FX-7202" (page 120).

- **Changing the sensitivity**
To change the sensitivity, touch the sensitivity key ([AUTO] or [****mm**]). Sensitivity settings of 2.5mm/mV, 5mm/mV, 10mm/mV, 20mm/mV, and AUTO (automatic) are available. When you select AUTO, the optimal sensitivity for recording and displaying data is selected automatically from 2.5mm/mV, 5mm/mV or 10mm/mV.
- To record a calibrated waveform, press [**1mV**].
- The recording will start even if the electrode is detached from a patient.
- To cancel the test, press [**START/STOP**].
- If the analysis is disabled, the message "Unanalyzable" will appear and printing of the Analysis Report is canceled.
- You can use the **ECG Report** parameter of the **SET UP MODE (ARRHYTHMIA ECG MODE)** to select the waveform recording speed from either Standard (25mm/s) or Compress (12.5mm/s).
- If the **Analysis Report** parameter of the **SET UP MODE (ARRHYTHMIA ECG MODE)** is set to ON, you can print a report after compiling the analysis observation result and event waveforms.
- If the **Measured Value** parameter of the **SET UP MODE (ARRHYTHMIA ECG MODE)** is set to ON, you can automatically print the detailed measurement values.
- ☞ See "Arrhythmia ECG Mode" of "Selecting the Recording Format" in Chapter 7, "Setting Up Parameters of the Cardimax FX-7202" (page 114).
- If 121 or more arrhythmia values are detected, up to 118 waveforms are printed for the arrhythmia analysis report and the comment "Many irregular pulse were detected." is printed at the end of the printing operation. If "Measured Value" is set to ON, the measurement values are printed after the above.

PC-7403

Arrhythmia Automatic Extension Recording

Standard ECG Mode

Automatically executes the arrhythmia analysis recording when a specific interpretation such as arrhythmia is detected during the 12-lead analysis recording.

After performing analysis recording in the Standard ECG Mode, the Arrhythmia ECG Mode is executed automatically and the arrhythmia ECG report is printed.

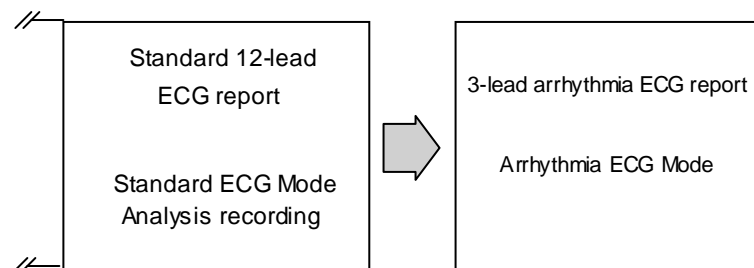

Interpretation criteria for arrhythmia automatic extension recording

ATRIO-VENTRICULAR CONDUCTION DEFECT

412	A-V Block 2 (Wenckebach)	414	2:1 A-V Block
413	A-V Block 2 (Mobitz)	415	Complete A-V Block

ARRHYTHMIA

803	A-V Junctional Rhythm	847	PAC Bigeminy
804	A-V Dissociation	848	PVC Bigeminy
816	Extreme Bradycardia	851	S-A Block or Marked S. Arrhythmia
831	Escape Beat	862	Runs of PAC
841	Supraventricular Premature Beat	864	Runs of PVC
842	Ventricular Premature Beat	865	Ventricular Rhythm
843	PAC Trigeminy	871	Arterial Fibrillation
844	PVC Trigeminy	872	Arterial Flutter
845	Frequent PAC	881	Undefined Arrhythmia
846	Frequent PVC		

Operation

1 Enable the arrhythmia automatic extension recording.

Display the **SET UP MODE (STANDARD ECG MODE)**. Touch the [Auto Mode Change] parameter and select ON.

✓ Additional information:

- ☞ See "Auto Mode Change" of the "Standard ECG Mode" in Chapter 7, "Setting Up Parameters of the Cardimax FX-7202" (page 94).

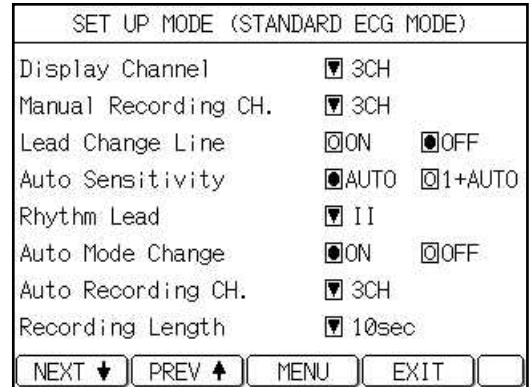

2 Perform Analysis Recording in Standard ECG Mode.

✓ Additional information:

- ☞ See "Automatic Recording Mode" in Chapter 4, "Recording the Electrocardiogram: Standard ECG Mode" (page 58) for further information about this procedure.

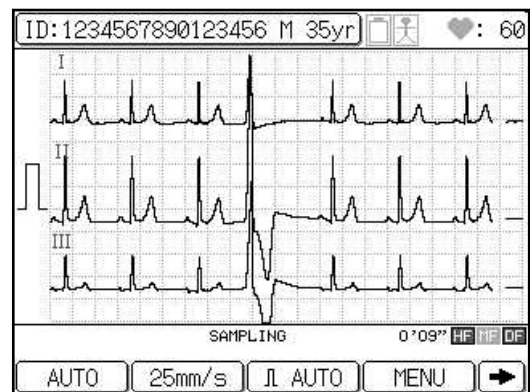

3 Arrhythmia analysis.

When a specific interpretation such as arrhythmia is detected as a result of the analysis, the arrhythmia analysis recording starts automatically. When the analysis is completed, an arrhythmia ECG report is recorded.

✓ Additional information:

- When the **ECG View** parameter of the **SET UP MODE (STANDARD ECG MODE)** is set to OFF, the FX-7202 starts sampling the data used for arrhythmia analysis recording after the ECG analysis is completed. When this parameter is set to ON, the FX-7202 starts sampling the data after you have confirmed the analysis (ECG View).

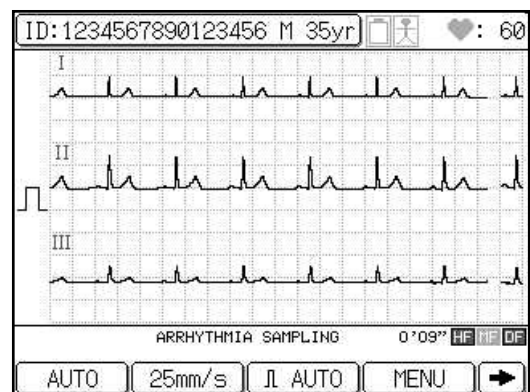

Compressed Recording

Standard 12-lead waveform will be recorded with 5mm/s image.

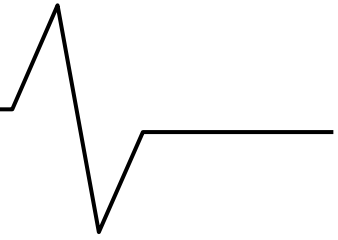



CAUTION

The recorded data of compressed waveform will not be stored in the memory.

Operation

1 Touch [MENU].

MODE SELECT window will be displayed.

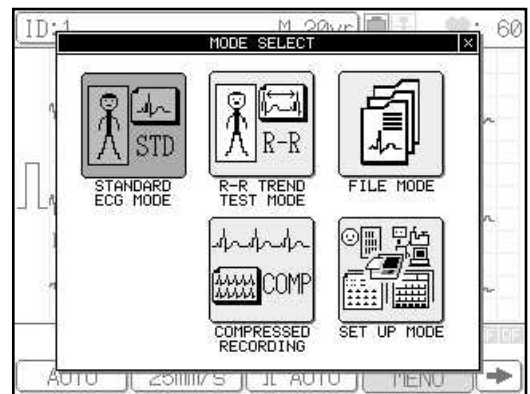

2 Touch [COMPRESSED RECORDING].

COMPRESSED RECORDING MODE will be displayed.

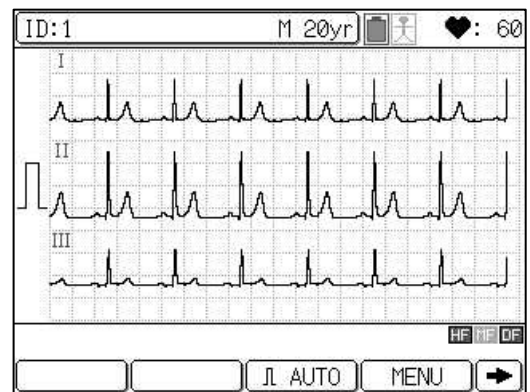

The displayed function keys are as follows.

- [AUTO] or [**mm]:
Selects the size of ECG waveform. (2.5, 5, 10, or 20 will be displayed for **.)
- [MENU]: Displays the MODE SELECT window.
- [FEED]: Feeds the recording paper.
- [FILTER]: Displays the filter setup window. ON/OFF for HF, MF, DF filter can be set.
- [➡]: Displays the function keys on the next page.
- [⬅]: Displays the function keys on the previous page.

✓ **Additional information:**

For the FX-7202, STANDARD ECG MODE will be initially selected when the power is turned ON.

3 Check the ECG waveform.

Check the ECG waveform displayed on the screen.
To change the lead, press **LEAD [◀] or [▶]** on the control panel.
3-lead or 6-lead waveform can be displayed.

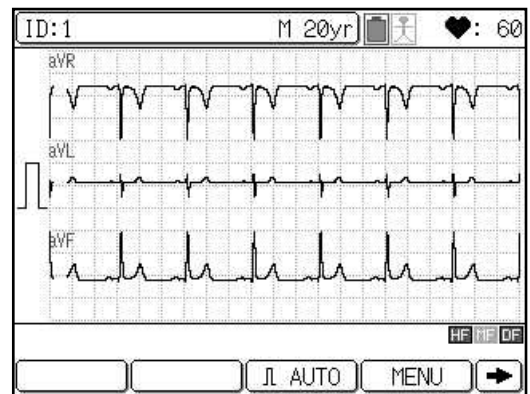

4 Press [START/STOP] to start the recording.

When the waveform is stable, press **[START/STOP]** to start recording the ECG waveform. Press **LEAD [◀] or [▶]** to change the lead.
The compressed waveform will be printed every 24 seconds.

✓ Additional information:

- The number of recording channels can be selected from “3ch” (default) or “6ch” for “Manual Recording CH” under **SETUP MODE (STANDARD ECG MODE)**.
- ☞ See Chapter 7, "Setting Up Parameters of the Cardimax FX-7202: Standard ECG Mode".
- Patient information can be entered by touching the ID area.
However, patient information cannot be entered if the function menu is displayed.
- **Filter ON/OFF Setup**
Touch [FILTER] to display the filter setup window. On this window, ON/OFF for HF, MF, DF filter can be set. Touch [HF ON/OFF], [MF ON/OFF], [DF ON/OFF] to change the setting. Touch [Close] to close the window.
- To change the frequency characteristic of the filter, use the **SETUP MODE (ECG CONTROL)**. When the filter is set to ON, corresponding icon for “HF”, “DF” or “MF” will be displayed on the status area.
- **Sensitivity**
To change the sensitivity, touch the sensitivity key ([AUTO] or [**mm]). Sensitivity settings of 2.5mm/mV, 5mm/mV, 10mm/mV, 20mm/mV, and AUTO (automatic) are available. When AUTO is set, optimal sensitivity for recording and displaying data is selected automatically from 2.5mm/mV, 5mm/mV or 10mm/mV.
- **Recording Speed**
The recording speed is fixed as 5mm/s.
- By pressing [1mV], calibrated waveform can be recorded.
- By pressing [START/STOP] again, recording operation can be suspended.
- If proper ECG waveform cannot be recorded, see Chapter 8 “Maintenance and Troubleshooting: When You cannot Record an Accurate ECG”.

5 Press [START/STOP] again to stop recording.

Chapter 6

Managing ECG Data Files

This chapter provides information on how to read ECG data from the built-in memory.

The Cardimax FX-7202 has a built-in memory for storing ECG data. The ECG data recorded by analysis and measurement are always saved in the built-in memory. The built-in memory can store a maximum of 128 ECG data files.

Notes:

- The maximum number of files that can be saved in the built-in memory depends on the recording mode and recording length. You can save 128 files when recording is performed in the standard ECG mode.
- When the built-in memory space becomes full, new data are written over from the oldest data.

Reading ECG Data from the Built-in Memory

You can read ECG data from the built-in memory.

Operation

1 Display the Mode select window.

Touch [MENU] to display the **Mode select** window.

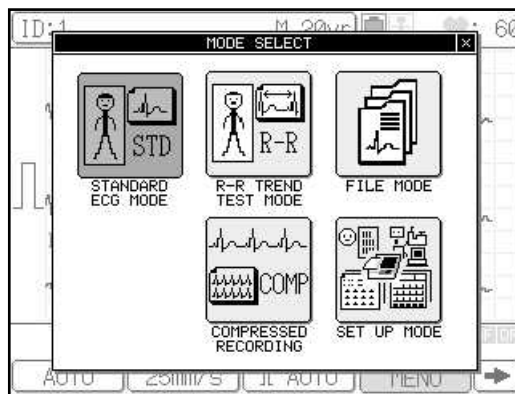

2 Touch [FILE MODE]

The **FILE MODE (ECG DATA READING)** window appears. It displays a list of the ECG data saved in the built-in memory. To scroll the page, touch [↓] or [↑].

ECG DATA READING			
NO.	ID No.	DATE/TIME	SEX AGE
1		JUL/ 9/2002 14:36:03	
2		JUL/ 9/2002 14:29:14	
3		JUL/ 9/2002 14:20:06	
4		JUL/ 9/2002 14:08:19	
5		JUL/ 8/2002 21:43:06	
6		JUL/ 8/2002 21:23:03	
7		JUL/ 8/2002 21:14:54	
8		JUL/ 8/2002 21:00:26	
9		JUL/ 8/2002 20:57:54	
10		JUL/ 8/2002 20:55:17	

At the top of the table area, there are controls: '1/12' with up and down arrows. At the bottom, there are buttons: 'READ', 'SEARCH', 'EXIT', and a right arrow.

3 Select the data to be read.

Touch the data number of the data to be read. You can select two or more data. The selected data number is highlighted. If you select wrong data by mistake, touch the highlighted number again to cancel the selection of this data.

Touch [➡] and then [ALL], if you want select all of the data.

ECG DATA READING			
NO.	ID No.	DATE/TIME	SEX AGE
1		JUL/ 9/2002 14:36:03	
2		JUL/ 9/2002 14:29:14	
3		JUL/ 9/2002 14:20:06	
4		JUL/ 9/2002 14:08:19	
5		JUL/ 8/2002 21:43:06	
6		JUL/ 8/2002 21:23:03	
7		JUL/ 8/2002 21:14:54	
8		JUL/ 8/2002 21:00:26	
9		JUL/ 8/2002 20:57:54	
10		JUL/ 8/2002 20:55:17	

1/12

READ SEARCH [] EXIT ➡

4 Read and print the selected ECG data.

Touch [READ] to read the selected ECG data. The selected ECG data are read in an ascending order according to the data number and is printed automatically.

After a data file is read, the highlighted number of the data being read is turned off.

To cancel printing, press [START/STOP] while the ECG data are being printed.

Notes:

- You can touch the [↓] or [↑] keys to display the previous page and next page, if these pages are available.
- If the magazine is open or recording paper runs out while the ECG data are being printed, printing is canceled automatically.
- Touch [EXIT] to display the Mode select window.

Searching ECG data

You can search for the ECG data to be read by ID number, date, last date, or name.

Operation

- 1 Perform steps 1 to 2 of “Reading ECG Data from the Built-in Memory.”
- 2 Touch [SEARCH] on the FILE MODE (DATA READING) window.

The **SEARCH CONDITIONS** window appears.

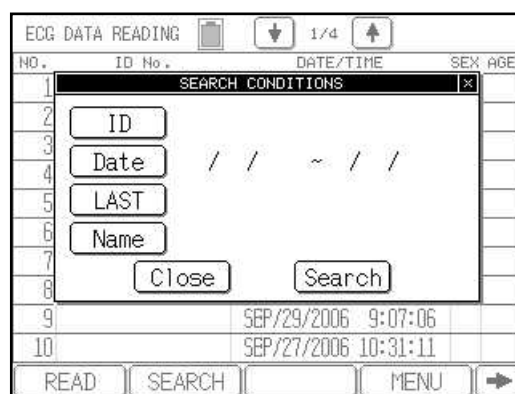

- 3 Touch the search target.

To search by ID number, touch [ID]. To search by test date, touch [DATE].

Search by ID

When you touch [ID], the **ENTER THE ID** window appears.

Touch the number keys ([0] to [9]) to enter the ID to be searched.

Touch [Enter] to set the input value and close the **ENTER THE ID** window.

Note:

To clear all input values, touch [AC]. To clear an input value preceding the cursor position, touch [DEL]. To increment or decrement the entered value, touch [+1] or [-1]. To cancel the ID input and close the **Enter the ID** window, touch [Cancel].

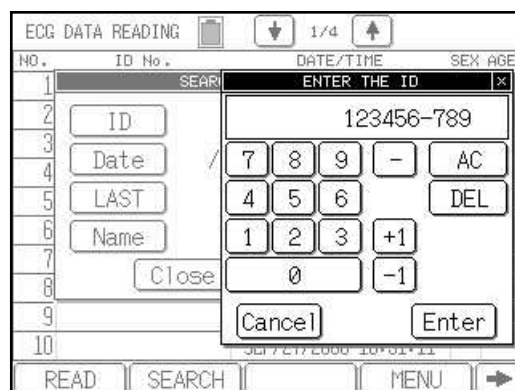

Search by date

When you touch [Date], the **DATE** window appears.

Touch the number keys ([0] to [9]) to enter the starting and ending test dates for a search. If you omit the starting date, the data preceding the ending date will be searched; and if you omit the ending date, the data after the starting date will be searched. If you omit both dates, all data will be searched.

Touch [Enter] to set the input values and close the Enter the date window.

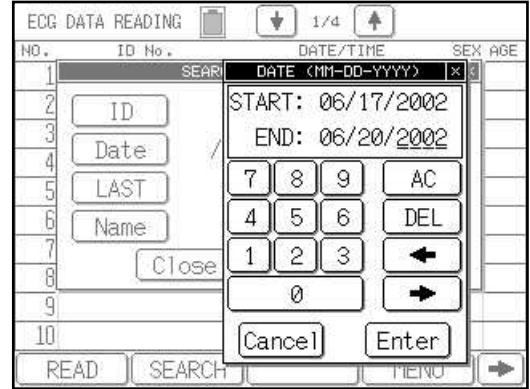

Notes:

- To clear all input values, touch [AC]. To clear an input value preceding the cursor position, touch [DEL]. To move the cursor, touch [←] or [→]. To cancel the date input and close the DATE window, touch [Cancel].
- The date display format (mm-dd-yy or dd-mm-yy) complies with the [Date Type] parameter setting of the **SET UP MODE (ECG CONTROL)**.
- If you enter an invalid date, this date is ignored and a warning beep is emitted.

Search by last date

When you touch [LAST], the data of latest recorded day in the built-in memory are searched.

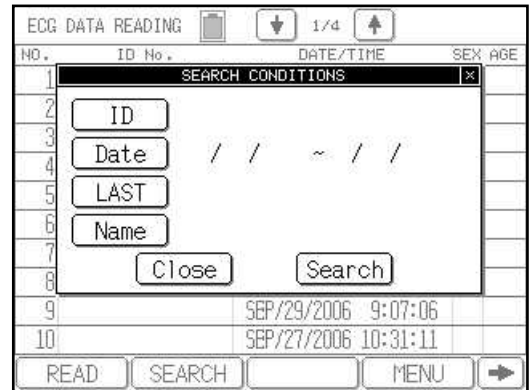

Search by name

Touch [Name] to display the “ENTER THE NAME” keyboard.

There are 2 windows where different alphanumeric symbols are displayed. The windows can be switched by touching [1/2↓] or [2/2↑] keys.

Enter the patient name and press [ENTER].

To enter a capital letter, touch [CAPS].

To move the cursor, touch [←] [→] keys.

To insert a space, touch [Space].

To delete one character, touch [DEL].

To delete all the entered characters, touch [Cancel].





CAUTION

- A wildcard character “*” can be used to search a name. By adding, “*” at the end of the entered characters, a prefix search can be performed for the entered characters before “*”. However, if any character is entered after the wildcard character “*”, or if the wildcard character “*” is not used, an exact search will be performed.
- Maximum of 30 characters can be entered for a name. If all 30 characters are entered, a prefix search will be performed for these 30 characters. If less than 30 characters are entered, an exact search will be performed.

Printing a list of ECG data

You can print a list of the ECG data saved in the built-in memory.

Operation

- 1 Perform steps 1 to 2 of “Reading ECG Data from the Built-in Memory.”
- 2 Touch [➡] to display the next page.

Function keys on the next page will appear.

ECG DATA READING			
		1/4	
NO.	ID No.	DATE/TIME	SEX AGE
1		JUL/ 8/2008 18:24:32	
2		JUN/19/2008 13:52:49	
3		MAR/17/2008 14:20:28	
4		MAR/17/2008 14:19:01	
5		OCT/31/2006 9:52:38	
6		OCT/30/2006 19:04:45	
7		OCT/ 3/2006 19:43:49	
8		OCT/ 3/2006 19:42:44	
9		SEP/29/2006 9:07:06	
10		SEP/27/2006 10:31:11	

LIST DELETE ALL ←

- 3 Touch [LIST] or press [START/STOP] to start printing the ECG data list.

To stop printing while the list is being printed, touch [STOP] or press [START/STOP].

Note:

If the magazine is open or recording paper runs out while printing the ECG data list, printing is canceled automatically.

Deleting ECG Data

The data stored in the memory can be deleted.

CAUTION

Once the data is deleted, it cannot be restored. Be cautious when performing the delete process.

Operation

- 1 Perform steps 1 to 2 of “Reading ECG Data from the Built-in Memory”.
- 2 Select the data to be deleted.

Touch the data number of the data to be deleted. You can select more than one data. The selected data number is highlighted. If you select wrong data by mistake, touch the highlighted number again to cancel the selection of this data. Touch [➡] and then [ALL], if you want to select all data.

ECG DATA READING			
NO.	ID No.	DATE/TIME	SEX AGE
1		JUL/ 8/2008 18:24:32	
2		JUN/19/2008 13:52:49	
3		MAR/17/2008 14:20:28	
4		MAR/17/2008 14:19:01	
5		OCT/31/2006 9:52:38	
6		OCT/30/2006 19:04:45	
7		OCT/ 3/2006 19:43:49	
8		OCT/ 3/2006 19:42:44	
9		SEP/29/2006 9:07:06	
10		SEP/27/2006 10:31:11	

- 3 Delete the selected ECG data.

Touch [➡] and then [DELETE]. A confirmation message to delete the data will be displayed. Touch [YES] to delete the selected data.

ECG DATA READING			
NO.	ID No.	DATE/TIME	SEX AGE
1		JUL/ 8/2008 18:24:32	
2		JUN/19/2008 13:52:49	
DATA DELETE			
Selected data is deleted. Are you sure ?			
YES		NO	
9		SEP/29/2006 9:07:06	
10		SEP/27/2006 10:31:11	

Chapter 7

Setting Up Parameters of the Cardimax FX-7202

You can use the SET UP MODE menus to change the FX-7202 parameters such as the recording format and filters in order to meet the requirements of your ECG recording.



Overview of Parameters

The parameters you can change using the SET UP MODE are summarized in the table below.

The parameters of the ARRHYTHMIA ECG MODE menu are available only when the PC-7403 program cartridge is installed.

ECG CONTROL

Parameter	Setting	Description
Width of Baseline	Thin, Standard*, Thick	Set the thickness of the waveform base line to be used for display and reports.
Hum Filter (HF)	50Hz, 60Hz*	Specify the cut-off frequency of the hum filter. See "Selecting the Filters" in this chapter (page 120).
Muscle Filter (MF)	25Hz, 35Hz*	Specify the cut-off frequency of the muscle filter. See "Selecting the Filters" in this chapter (page 120).
Drift Filter (DF)	0.25Hz, 0.5Hz*	Specify the cut-off frequency of the drift filter. See "Selecting the Filters" in this chapter (page 120).
Cut-off Frequency	70Hz, 100Hz, 150Hz*	Specify the cut-off frequency of the high-frequency filter.
Key Click	ON, OFF*	Set this parameter ON to have the unit sound a tone every time you touch the keys on the screen or press the keys on the Operation Panel. Otherwise, set to OFF.

Parameter	Setting	Description
QRS Beep	ON, OFF*	Set this parameter ON to have the unit sound beeps synchronized with heartbeat detection. Otherwise, set to OFF.
Lead Off Buzzer	ON, OFF*	Set this parameter ON to have the unit sound beeps when any one of the electrodes gets detached from a patient. Otherwise, set to OFF.
Language	English*, German, French, Spanish, Italian, Russian	Set the language to be used for display and recording.
Hospital		Set the name of your hospital or clinic to be printed on the reports.  See "Setting the Hospital Name" in Chapter 2, "Preparing the Cardimax FX-7202" (page 26).
Date	Jan/01/2002	Set the current date.
Time	00:00:00	Set the current time.
Date Type	MM-dd-yy*, dd-MM-yy	Select the date format for indicating the date.  See "Setting the Date Format and Built-in Clock" in Chapter 2, "Preparing the Cardimax FX-7202" (page 23).

: The settings marked with an asterisk () are the default settings.

PATIENT DATA







Parameter	Setting	Description
Auto ID No. Inc	ON, OFF*	Set this parameter ON to assign patient IDs automatically. Each time an Automatic Recording during the REST status is completed successfully, the ID number is automatically incremented by 1. To assign each patient's ID manually, set this parameter OFF.
Fixed ID Number	[9999999999999999], OFF*	Use this parameter to fix the upper digits of the patient's ID to a specified number.
Input Birthday	ON, OFF*	Set this parameter ON to enable automatic setting of the patient's age by simply entering the patient's date of birth. This way, the patient's age does not have to be entered.
Name	ON*, OFF	Set this parameter ON to include the patient's name in the patient data. Otherwise, set to OFF.
Race	ON*, OFF	Set this parameter ON to include the patient's ethnicity in the patient data. Otherwise, set to OFF.
Height	cm*, inch, OFF	Set this parameter to cm or inch to include the patient's height in the patient data. Or, set to OFF.
Weight	kg*, lb, OFF	Set this parameter to kg or lb to include the patient's weight in the patient data. Or, set to OFF.
Blood Pressure	ON*, OFF	Set this parameter ON to include the patient's blood pressure information in the patient data. Otherwise, set to OFF.
Drug	ON*, OFF	Set this parameter ON to include the patient's medication information in the patient data. Otherwise, set to OFF.
Symptoms	ON*, OFF	Set this parameter ON to include the patient's symptoms in the patient data. Otherwise, set to OFF.
Comment	ON*, OFF	Set this parameter ON to include a comment in the patient data. Otherwise, set to OFF.
Ward	ON*, OFF	Set this parameter ON to include the patient's ward information in the patient data. Otherwise, set to OFF.

Parameter	Setting	Description
Department	ON*, OFF	Set this parameter ON to include the patient's department information in the patient data. Otherwise, set to OFF.

: The settings marked with an asterisk () are the default settings.

STANDARD ECG MODE

Parameter	Setting	Description
Display Channel	3CH*, 6CH, 12CH	Specify the number of channels of ECG waveforms to be displayed simultaneously on the same screen. You can select from: 3 channels, 6 channels, and 12 channels. This data can be specified for Automatic Recording. See "Selecting the Number of Waveform Display Channels" in this chapter (page 102).
Manual Recording CH.	3CH*, 6CH	Specify the number of channels of ECG waveforms to be recorded simultaneously during Manual Recording.
Lead Change Line	ON, OFF*	Set this parameter ON to print the lead change line upon changing leads during Automatic Recording.
Auto Sensitivity	AUTO*, 1+AUTO	Set this parameter to AUTO to display and print the ECG waveforms by selecting the optimal sensitivity automatically. Or, set this parameter to 1+AUTO to display and print ECG waveforms using a sensitivity of 10mm/mV and then print ECG waveforms using the automatically selected optimal sensitivity.
Rhythm Lead	I to V6 (II*)	Specify the lead to be used as the rhythm lead when the Recording Channel parameter is set to "3+R" (3CH + rhythm lead). This parameter should be set when executing Automatic Recording.
 Auto Mode Change	ON*, OFF	Set this parameter ON to print the arrhythmia analysis automatically if an arrhythmia-related observation comment is available in the ECG analysis data after completing ECG analysis. Otherwise, set to OFF.
Auto Recording CH.	3CH*, 3+R1, 6CH	Specify the number of ECG waveforms channels to be printed simultaneously during Automatic Recording Mode. You can select from: 3 channels, 3 channels + rhythm lead, 6 channels. This data can be specified for Automatic Recording. See "Selecting the Recording Format" in this chapter (page 103).
Recording Length	10* ,15 , 20sec.	Set the recording period from 10,15, or 20 seconds.

Parameter	Setting	Description
Report Format	NONE*, DOM1, DOM3, COVER	Specify the format of the analysis report or measurement report to be output during Analysis Recording (PC-7403) or Measurement Recording respectively. When this parameter is set to NONE, the analysis report or measurement report is not recorded.  See "Analysis report" and "Measurement report" of "Selecting the Recording Format" in this chapter respectively (pages 107 and 111).
 ECG View	ON, OFF*	Set this parameter ON to confirm the analysis (including interpretation results) on the screen before printing the analysis data during Analysis Recording.
 Comment	ON, OFF*	Set this parameter ON to print the analysis comment after the analysis report during Analysis Recording.
Measured Value	ON, OFF*	Set this parameter ON to print detailed measurement values after printing the analysis/analysis comment report (PC-7403) or measurement report during Automatic Recording.  See the relevant "Detailed measurement values" section of "Selecting the Recording Format" in this chapter (pages 108 and 112).
Full Lead Waveforms	CONTINUOUS*, COHERENT, COHERENT ALL	Set the print format for the ECG waveform.  See "Standard ECG Mode – Measurement Recording" in this chapter (page 103).
Measurement Wave	DOM*, AVE	Set the waveform type to perform the ECG measurement.  See "Standard ECG Mode – Measurement Recording" in this chapter (page 103).

: The settings marked with an asterisk () are the default settings.

✓ Additional information:

The Recording Channel parameters are invalid for the Arrhythmia ECG Mode or R-R Trend Test Mode. The number of channels to be displayed complies with the Manual Record Channel parameter setting when manual recording of the Standard ECG Mode is executed.

PC-7403

ARRHYTHMIA ECG MODE

Parameter	Setting	Description
Arrhythmia Lead 1ch	I to V6 (II*)	Specify the lead (1st channel) to be used for arrhythmia analysis.
Arrhythmia Lead 2ch	I to V6 (aVF*)	Specify the lead (2nd channel) to be used for arrhythmia analysis.
Arrhythmia Lead 3ch	I to V6 (V5*)	Specify the lead (3rd channel) to be used for arrhythmia analysis.
ECG Report	NONE, Standard*, Compress	Set this parameter to select the waveform recording speed from either Standard (25mm/s) or Compress (10mm/s). When this parameter is set to NONE, the ECG report is not recorded.
Analysis Report	ON*, OFF	Set this parameter ON to automatically print a report after compiling the analysis observation result and event waveforms. Otherwise, set to OFF.
Measured Value	ON, OFF*	Set this parameter ON to print the measured values after the arrhythmia ECG report during the Arrhythmia ECG Mode execution.

: The settings marked with an asterisk () are the default settings.

R-R TREND TEST MODE

Parameter	Setting	Description
R-R Trend Lead	I to V6 (II*)	Specify the lead to be used for R-R trend test.
ECG Report	NONE, Standard*, Compress	Set this parameter to select the waveform recording speed from either Standard (25mm/s) or Compress (10mm/s). When this parameter is set to NONE, the ECG report is not recorded.
Analysis Report	ON*, OFF	Set this parameter ON to automatically print a report after compiling the R-R trend graph and histogram. Otherwise, set to OFF.
Measured Value	ON, OFF*	Set this parameter ON to print the measured values after printing the R-R trend test report during the R-R Trend Test. Otherwise, set to OFF.

: The settings marked with an asterisk () are the default settings.

General Flow of the Parameter Setup Procedure

The SET UP MODE screens consist of 7 menus: ECG CONTROL, PATIENT DATA, STANDARD ECG MODE, ARRHYTHMIA ECG MODE, R-R TREND TEST MODE, INITIALIZE, and MAINTENANCE. For further information about the operation of a specific parameter such as the recording format, see the following sections in this chapter.

The ECG CONTROL, PATIENT DATA, STANDARD ECG MODE, and R-R TREND TEST MODE screens contain parameters that are valid for all function modes. The ARRHYTHMIA ECG MODE parameters can be used only when the PC-7403 program cartridge is installed. The INITIALIZE menu is used to initialize the settings and restore the default settings.

- ☞ See “Performing the Self-diagnostics Test” in Chapter 8, “Maintenance and Troubleshooting”, for further information about the MAINTENANCE menu (page 123).

Operation

1 Display the Mode select window.

Touch [MENU] to display the **Mode select** window.

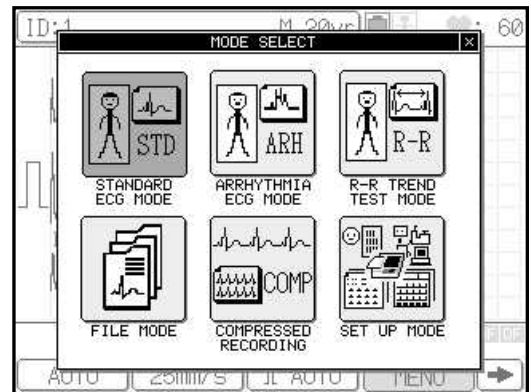

2 Touch [SET UP MODE].

The **SET UP MODE (MENU)** window will appear.

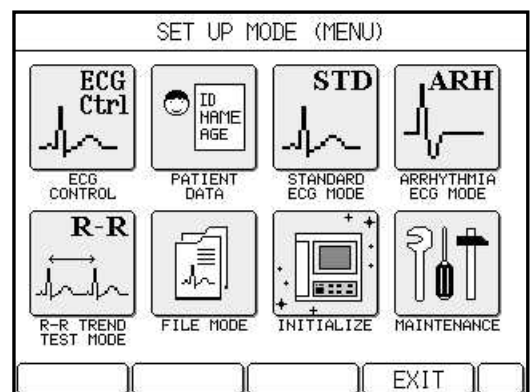

3 Select the desired SET UP MODE menu.

Note that the **ARRHYTHMIA ECG MODE** menu is displayed only when the PC-7403 program cartridge is installed.

4 Select the parameter to be changed.

When the **SET UP MODE** screen displays a parameter to be changed, touch and select that parameter. To display the next page, touch [NEXT ↓].

SET UP MODE (ECG CONTROL)		
Width of Baseline	▼ Standard	
Hum Filter	<input type="checkbox"/> 50Hz	<input checked="" type="checkbox"/> 60Hz
Muscle Filter	<input type="checkbox"/> 25Hz	<input checked="" type="checkbox"/> 35Hz
Drift Filter	<input type="checkbox"/> 0.25Hz	<input checked="" type="checkbox"/> 0.5Hz
Cut-off Frequency	<input type="checkbox"/> 70Hz	<input type="checkbox"/> 100Hz <input checked="" type="checkbox"/> 150Hz
Key Click	<input type="checkbox"/> ON	<input checked="" type="checkbox"/> OFF
QRS Beep	<input type="checkbox"/> ON	<input checked="" type="checkbox"/> OFF
Lead Off Buzzer	<input type="checkbox"/> ON	<input checked="" type="checkbox"/> OFF
<input type="button" value="NEXT ↓"/> <input type="button" value="PREV ↑"/> <input type="button" value="MENU"/> <input type="button" value="EXIT"/> <input type="button" value=""/>		

5 Select the setting.

Touch the radio button of the setting that you want to select (●). To change the setting of an item with a down arrow (▼) next to it, touch the down arrow. A window that provides choices for this setting (or three consecutive touch keyboard pages for character input such as a hospital name) will appear. Touch the desired setting in this window and touch [Enter] to finish the new setting.

☞ See “Selecting the radio button”, “Changing the setting of an item with the down arrow(▼) button”, “Entering letters”, and “Entering numeric values” for further information about the input procedures (pages 100 to 101).

SET UP MODE (ECG CONTROL)		
Language	▼ English	
Hospital	▼ []	
Date	▼ 06/17/2002	
Time	▼ 13:26:26	
Date Type	<input checked="" type="checkbox"/> MM-dd-yy	<input type="checkbox"/> dd-MM-yy
<input type="button" value="NEXT ↓"/> <input type="button" value="PREV ↑"/> <input type="button" value="MENU"/> <input type="button" value="EXIT"/> <input type="button" value=""/>		

6 Touch [EXIT] to end the setting operation.

Display another **SET UP MODE** screen if necessary and set the required parameter. After you finish all the required settings, touch [EXIT] to end the setting operation and return to the test mode screen.

To return to the **SET UP MODE (MENU)** screen, touch [MENU].

Selecting the radio button

You can turn on the radio button for selecting the desired value or item from two or more choices.

Example:

[●]: Selected

[○]: Not selected

SET UP MODE (PATIENT DATA)			
Auto ID No.Inc	<input type="checkbox"/> ON	<input checked="" type="checkbox"/> OFF	
Fixed ID Number	<input type="checkbox"/> []
Input Birthday	<input type="checkbox"/> ON	<input checked="" type="checkbox"/> OFF	
Name	<input checked="" type="checkbox"/> ON	<input type="checkbox"/> OFF	
Race	<input checked="" type="checkbox"/> ON	<input type="checkbox"/> OFF	
Height	<input checked="" type="checkbox"/> cm	<input type="checkbox"/> inch	<input type="checkbox"/> OFF
Weight	<input checked="" type="checkbox"/> kg	<input type="checkbox"/> lb	<input type="checkbox"/> OFF
Blood Pressure	<input checked="" type="checkbox"/> ON	<input type="checkbox"/> OFF	
<input type="button" value="NEXT ↓"/> <input type="button" value="PREV ↑"/> <input type="button" value="MENU"/> <input type="button" value="EXIT"/>			

Changing the setting of an item with the down arrow (▼) button

When there is a down arrow (▼) to the left of the current setting, touch this arrow. A window that provides choices for this setting will appear. Touch the desired setting in this window.

Example:

SET UP MODE (ECG CONTROL)			
Width of Baseline	<input type="checkbox"/> Standard		
Hum Filter	<input type="checkbox"/> 50Hz	<input checked="" type="checkbox"/> 60Hz	
Muscle Filter	<input type="checkbox"/> 25Hz	<input checked="" type="checkbox"/> 35Hz	
Drift Filter	<input type="checkbox"/> 0.25Hz	<input checked="" type="checkbox"/> 0.5Hz	
Cut-off Frequency	<input type="checkbox"/> 70Hz	<input type="checkbox"/> 100Hz	<input checked="" type="checkbox"/> 150Hz
Key Click	<input type="checkbox"/> ON	<input checked="" type="checkbox"/> OFF	
QRS Beep	<input type="checkbox"/> ON	<input checked="" type="checkbox"/> OFF	
Lead Off Buzzer	<input type="checkbox"/> ON	<input checked="" type="checkbox"/> OFF	
<input type="button" value="NEXT ↓"/> <input type="button" value="PREV ↑"/> <input type="button" value="MENU"/> <input type="button" value="EXIT"/>			

SET UP MODE (ECG CONTROL)			
Width of Baseline	<input type="checkbox"/> Thin		
Hum Filter	<input checked="" type="checkbox"/> Standard		60Hz
Muscle Filter	<input type="checkbox"/> Thick		35Hz
Drift Filter	<input type="checkbox"/> 0.25Hz	<input checked="" type="checkbox"/> 0.5Hz	
Cut-off Frequency	<input type="checkbox"/> 70Hz	<input type="checkbox"/> 100Hz	<input checked="" type="checkbox"/> 150Hz
Key Click	<input type="checkbox"/> ON	<input checked="" type="checkbox"/> OFF	
QRS Beep	<input type="checkbox"/> ON	<input checked="" type="checkbox"/> OFF	
Lead Off Buzzer	<input type="checkbox"/> ON	<input checked="" type="checkbox"/> OFF	
<input type="button" value="NEXT ↓"/> <input type="button" value="PREV ↑"/> <input type="button" value="MENU"/> <input type="button" value="EXIT"/>			

Entering letters

When there is a down arrow (▼) preceding the current setting, touch this arrow. If the setting requires an input of letters such as a hospital name, the alphanumeric keyboard window will pop up. Two keyboard pages are available: letters and symbols/number. Touch [1/2 ↓] or [2/2 ↑] to switch the keyboards and key in the letters. To enter uppercase letters, touch [CAPS] on the letter (lowercase) screen. To enter a space, touch [Space] bar. If you enter a wrong letter, touch [DEL] to delete a letter; or touch [AC] to delete all letters. You can touch [←] or [→] to move the cursor position. After you enter data, touch [Enter]. The previous screen reappears.

Example:



Entering numeric values

When there is a down arrow (▼) preceding the current setting, touch this arrow. If the setting requires an input of numeric values such as the date, the keypad window will pop up. Touch the number keys to enter the desired value. If you enter a wrong number, touch [DEL] to delete a digit; or touch [AC] to delete all digits. You can touch [←] or [→] to move the cursor position. After you enter data, touch [Enter]. The previous screen reappears.

Example:

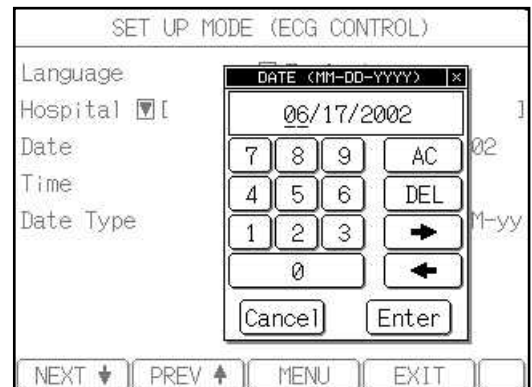

Selecting the Number of Waveform Display Channels

Use the following procedure to set the ECG waveform display format.

Select the number of ECG waveform channels to be displayed simultaneously on the screen. Set the **Display Channel** parameter on the **SET UP MODE (STANDARD ECG MODE)** screen.

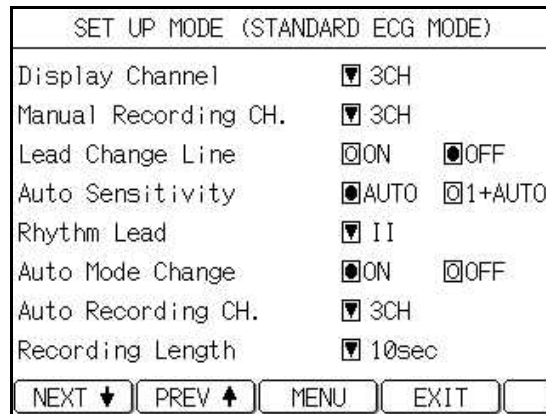

Note:

The mode screen varies depending on the FX-7202 configuration. The mode screen shown is displayed when the PC-7403 program cartridge is installed.

Additional information:

The number of channels to be displayed complies with the **Manual Recording CH.** parameter setting when Manual Recording of the Standard ECG Mode is executed.

3CH

Displays the lead groups for 3 channels on the screen. Each time you press **LEAD** [◀] or [▶], the lead group will be changed in the following order:

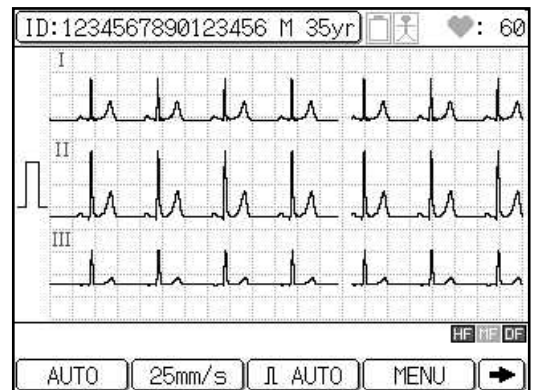
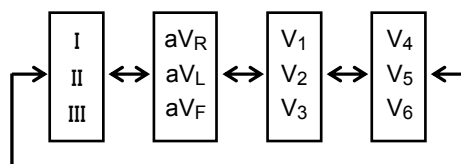

6CH

Displays the lead groups for 6 channels on the screen. Each time you press **LEAD** [◀] or [▶], the lead group will be changed in the following order:

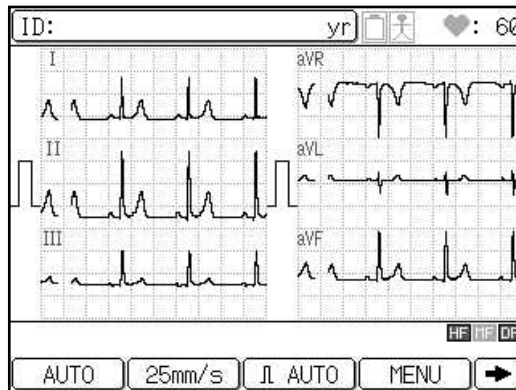
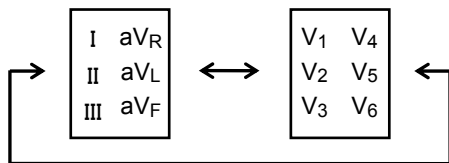

12CH

Displays the lead groups for 12 channels on the screen. When 12CH is selected, the latest 1 beat for every second is displayed.

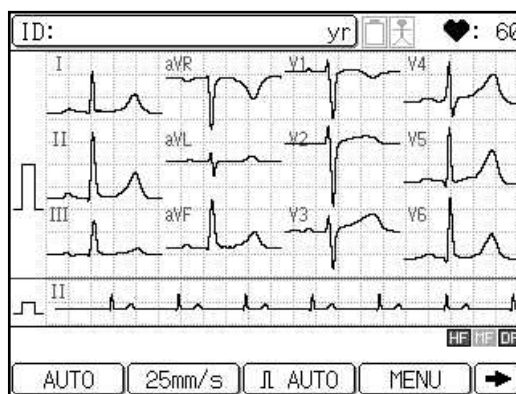

Selecting the Recording Format

Use the following procedure to set the printout format to be applied for each test mode.

Standard ECG Mode - Measurement Recording _____

Measurement Recording has 3 types of print formats: ECG waveforms, measurement report, and detailed measurement values. These formats can be enabled or disabled for the printed reports of the ECG waveform and detailed measurement values. Also, the print formats of all 3 reports can be selected.

ECG waveforms	Measurement report	Detailed measurement values
---------------	--------------------	-----------------------------

The following **SET UP MODE** screens are used to select the parameters related to the recording format of Measurement Recording:

SET UP MODE (STANDARD ECG MODE) screen (page 1/2)

SET UP MODE (STANDARD ECG MODE)	
Display Channel	<input type="button" value="v"/> 3CH
Manual Recording CH.	<input type="button" value="v"/> 3CH
Lead Change Line	<input checked="" type="checkbox"/> ON <input type="checkbox"/> OFF
Auto Sensitivity	<input checked="" type="checkbox"/> AUTO <input type="checkbox"/> 1+AUTO
Rhythm Lead	<input type="button" value="v"/> II
Auto Recording CH.	<input type="button" value="v"/> 3CH
Recording Length	<input type="button" value="v"/> 10sec
Report Format	<input type="button" value="v"/> DOM1
<input type="button" value="NEXT v"/> <input type="button" value="PREV ^"/> <input type="button" value="MENU"/> <input type="button" value="EXIT"/> <input style="width: 20px; height: 20px;" type="button" value=" "/>	

 **Note:**

The mode screen varies depending on the FX-7202 configuration. The mode screen shown is displayed when the PC-7403 program cartridge is installed.

SET UP MODE (STANDARD ECG MODE) screen (page 2/2)

SET UP MODE (STANDARD ECG MODE)	
Measured Value	<input checked="" type="checkbox"/> ON <input type="checkbox"/> OFF
Full Lead Waveforms	<input type="button" value="v"/> CONTINUOUS
Measurement Wave	<input checked="" type="checkbox"/> DOM1 <input type="checkbox"/> AVE.
<input type="button" value="NEXT v"/> <input type="button" value="PREV ^"/> <input type="button" value="MENU"/> <input type="button" value="EXIT"/> <input style="width: 20px; height: 20px;" type="button" value=" "/>	

ECG waveforms

You can select the following parameters for Measurement Recording:

- Auto Recording CH.: Select the number of channels of ECG waveform to be recorded simultaneously. (3CH, 3CH+R1, or 6CH)
- Rhythm Lead: Select the lead to be used as the rhythm lead when the **Auto Recording CH.** parameter is set to "3CH +R1".
- Recording Length: Set the length of the recording to 10, 15, or 20 seconds.
- Full Lead Waveforms: Select the print format for the ECG waveform.
 - CONTINUOUS: Prints the waveform in the order of the waveform block.
 - COHERENT: Prints all waveforms starting from the same time.
 - COHERENT ALL: Prints all waveforms of all leads starting from the same time.

- Measurement Wave: Select the extracting waveform.
 DOM: Sets the dominant waveform including the analyzing heartbeat as the extracting waveform.
 AVE: Sets the average waveform including the analyzing heartbeat as the extracting waveform.



CAUTION

If "3CH+R1" is selected for the Auto Recording CH. and "COHERENT ALL" is selected for the Full Lead Waveforms, 3CH ECG waveform will be recorded.

ECG waveforms (3CH)



ECG waveforms (3CH + rhythm lead)



ECG waveforms (6CH, CONTINUOUS)



ECG waveforms (6CH, COHERENT)



ECG waveforms (6CH, COHERENT ALL)



Measurement report

These are basic measurement values and measurement waveforms. You can select the following parameter:

Report Format:

Select the format of the measurement report to be printed. (NONE, DOM1, DOM3, or COVER) When this parameter is set to "NONE", the measurement report is not recorded.

Measurement report (DOM1)

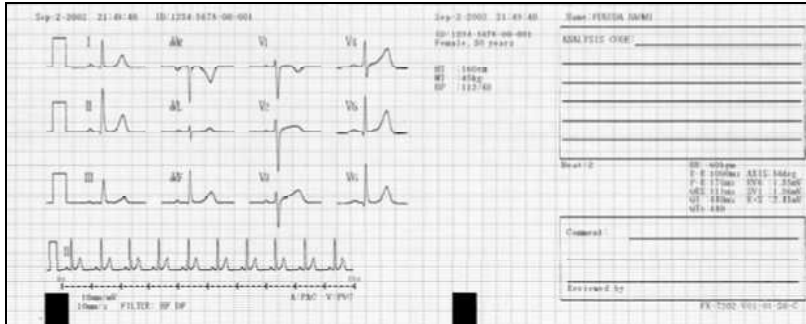

Measurement report (DOM3)

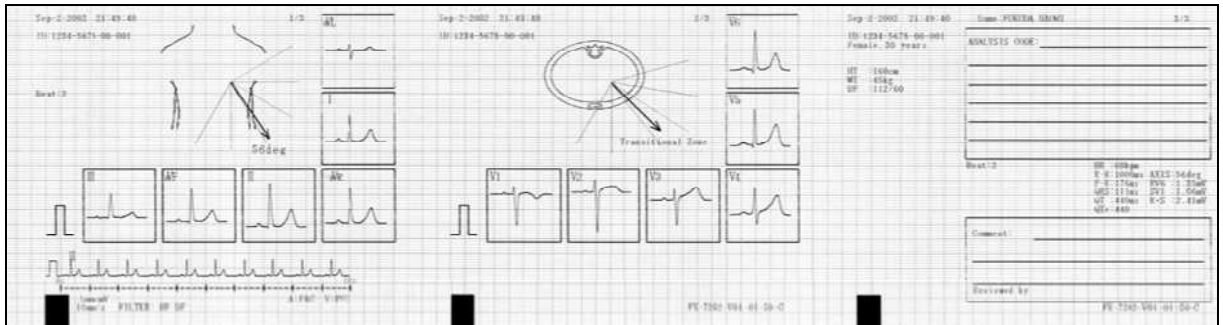

Measurement report (COVER)

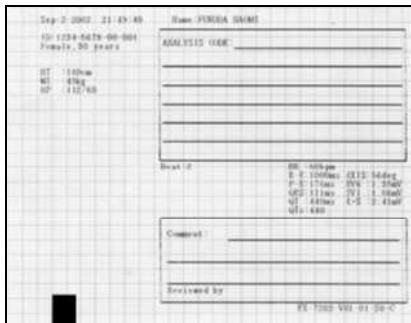

Detailed measurement values

These are detailed measurement values related to dominant waveforms used for Measurement Recording.

Measured Value: Set this parameter "ON" to print the detailed measurement values. Otherwise, set to "OFF".

Detailed measurement values

The screenshot displays two pages of ECG measurement data. The left page shows parameters for 'ECG MEASURED VALUES' (I-VVF) and 'ECG MEASURED VALUES' (VI-VVI). The right page shows 'ADDITIONAL MEASURED VALUES' with columns for 'No.', 'P-R', 'P-R', 'QRS', 'P', 'F', 'ARI', 'AK2', 'FK1', 'FK2', 'AK1', 'AK2', and 'K'. The data includes numerical values for each parameter across multiple rows.



Standard ECG Mode - Analysis Recording

The analysis recording printout prints the following 4 types of data: ECG waveforms, analysis report, analysis comment, and detailed measurement values. The printing of the ECG waveform, analysis comment, and detailed measurement values can be enabled or disabled. The print format for all 4 reports can be selected.

ECG waveforms	Analysis report	Analysis comment	Detailed measurement values
---------------	-----------------	------------------	-----------------------------

The following **SET UP MODE** screens are used to set the parameters related to the recording format of analysis recording:

SET UP MODE (STANDARD ECG MODE) screen (page 1/2)

SET UP MODE (STANDARD ECG MODE)

Display Channel ▼ 3CH

Manual Recording CH. ▼ 3CH

Lead Change Line ON OFF

Auto Sensitivity AUTO 1+AUTO

Rhythm Lead ▼ II

Auto Mode Change ON OFF

Auto Recording CH. ▼ 3CH

Recording Length ▼ 10sec

SET UP MODE (STANDARD ECG MODE) screen (page 2/2)

SET UP MODE (STANDARD ECG MODE)	
Report Format:	<input type="checkbox"/> DOM1
ECG View:	<input checked="" type="checkbox"/> ON <input type="checkbox"/> OFF
Comment:	<input checked="" type="checkbox"/> ON <input type="checkbox"/> OFF
Measured Value:	<input checked="" type="checkbox"/> ON <input type="checkbox"/> OFF
Full Lead Waveforms:	<input type="checkbox"/> CONTINUOUS
Measurement Wave:	<input checked="" type="checkbox"/> DOM1 <input type="checkbox"/> AVE.

NEXT ↓ PREV ↑ MENU EXIT

ECG waveforms

You can select the following parameters for the ECG waveforms to be used for Analysis Recording:

- Auto Recording CH.:** Select the number of channels of the ECG waveform to be recorded simultaneously. (3CH, 3CH+R1, or 6CH)
- Rhythm Lead:** Select the lead to be used as the rhythm lead when the Recording Channel parameter is set to "3CH+R1".
- Recording Length:** Set the length of the recording to 10, 15, or 20 seconds.
- Full Lead Waveforms:** Select the print format for the ECG waveform.
CONTINUOUS: Prints the waveform in the order of the waveform block.
COHERENT: Prints all waveforms starting from the same time.
COHERENT ALL: Prints all waveforms of all leads starting from the same time.
- Measurement Wave:** Select the extracting waveform.
DOM: Sets the dominant waveform including the analyzing heartbeat as the extracting waveform.
AVE: Sets the average waveform including the analyzing heartbeat as the extracting waveform.

ECG waveforms (3CH)

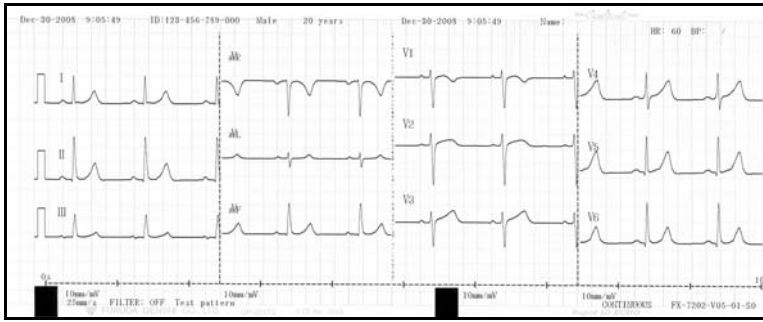

ECG waveforms (3CH + rhythm lead)



ECG waveforms (6CH, CONTINUOUS)



ECG waveforms (6CH, COHERENT)



ECG waveforms (6CH, COHERENT ALL)



Analysis report

These are basic measurement values, interpretation, and analysis waveforms. The following parameter can be selected:

Report Format: Select the format of the analysis report to be printed. (NONE, DOM1, DOM3, COVER) When this parameter is set to "NONE", the analysis report is not recorded.

Analysis report (DOM1)

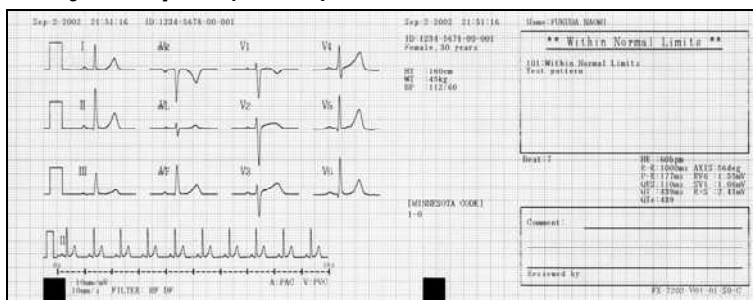

Analysis report (DOM3)

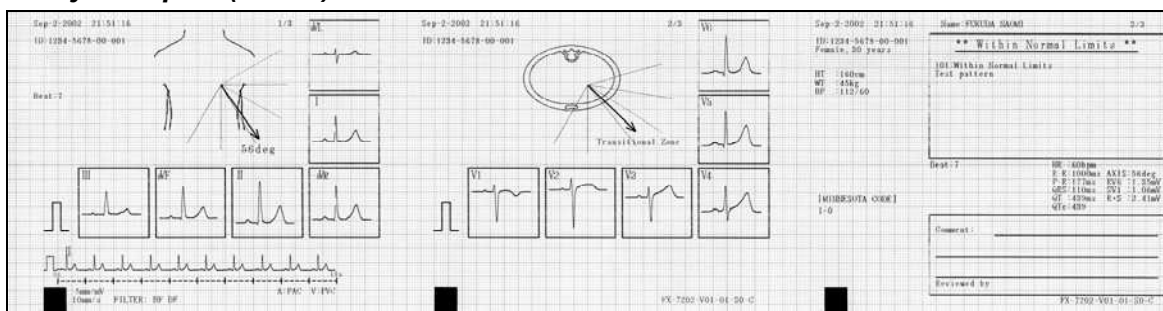

Analysis report (COVER)

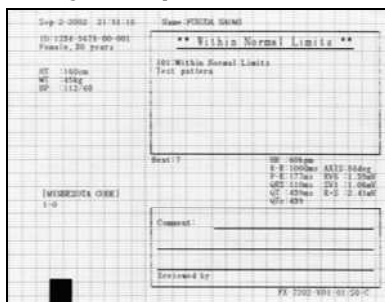

Analysis comment

This is a comment for the interpretation, waveforms, and measured values.

Comment: Set this parameter “ON” to print the comment. Otherwise, set to “OFF”.

Analysis comment

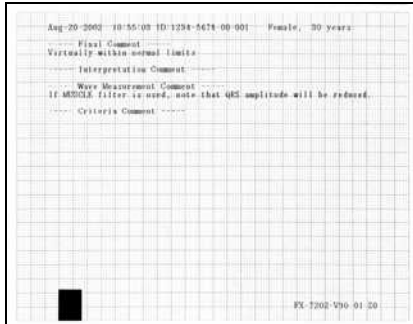

Detailed measurement values

These are detailed measurement values related to dominant waveforms used for Analysis Recording.

Measured Value: Set this parameter “ON” to print the detailed measurement values. Otherwise, set to “OFF”.

Detailed measurement values

PRP	PPA	PTA	PTB	PTC	PTD	PTA	PTB	PTC	PTD
0.12	0.11	0.10	0.11	0.11	0.11	0.11	0.11	0.11	0.11
0.30	0.30	0.30	0.30	0.30	0.30	0.30	0.30	0.30	0.30

Additional information:

Before printing the report, confirm the analysis information.

If the ECG View parameter (**SET UP MODE (STANDARD ECG MODE)** (page 2/2)) is set to “ON”, a part of the analysis information can be displayed. The information can be checked first, and then printed.

Standard ECG Mode : _____ **Manual Recording**

Manual Recording prints the ECG waveform that is the same as the waveform on the screen.

You can change the lead and sensitivity, reset the input waveform, and record a calibrated 1mV waveform during Manual Recording, as required. See "Manual Recording Mode" in Chapter 4, "Recording the Electrocardiogram: Standard ECG Mode" (page 62).

Manual Recording (3CH)

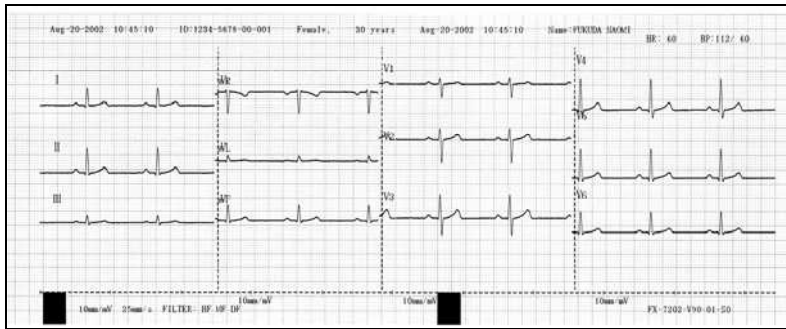

Manual Recording (6CH)

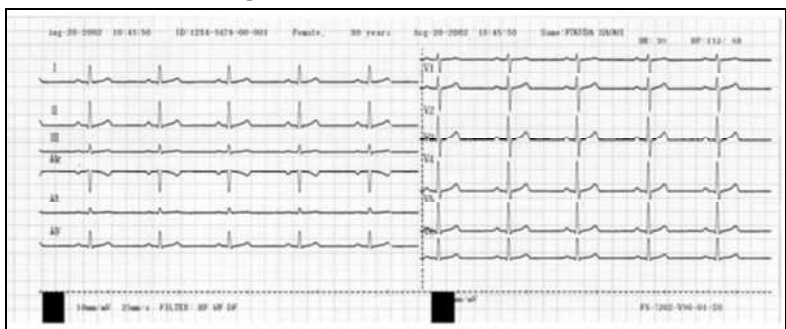

Arrhythmia ECG Mode

The arrhythmia analysis prints the arrhythmia ECG report and measured values. Select the report format for the arrhythmia ECG report and measured values.

The **SET UP MODE (ARRHYTHMIA ECG MODE)** screen is used to set the parameter related to the recording format of the Arrhythmia ECG Mode.

SET UP MODE (ARRHYTHMIA ECG MODE) screen

SET UP MODE (ARRHYTHMIA ECG MODE)	
Arrhythmia Lead 1ch	<input type="button" value="▼"/> II
Arrhythmia Lead 2ch	<input type="button" value="▼"/> aVF
Arrhythmia Lead 3ch	<input type="button" value="▼"/> V5
ECG Report	<input type="button" value="▼"/> Standard
Analysis Report	<input checked="" type="checkbox"/> ON <input type="checkbox"/> OFF
Measured Value	<input type="checkbox"/> ON <input checked="" type="checkbox"/> OFF
<input type="button" value="NEXT ▼"/> <input type="button" value="PREV ▲"/> <input type="button" value="MENU"/> <input type="button" value="EXIT"/> <input type="button" value=""/>	

ECG Report:

Select the waveform recording speed from either "Standard" (25mm/s) or "Compress" (10mm/s). When this parameter is set to "NONE", the ECG report is not recorded.

Analysis Report:

Set this parameter "ON" to automatically print a report after compiling the analysis observation result and event waveforms. Otherwise, set to "OFF".

Measured Value:

Set this parameter "ON" to print the measured values. Otherwise, set to "OFF".

Arrhythmia analysis (arrhythmia ECG report)



Arrhythmia analysis (analysis report)

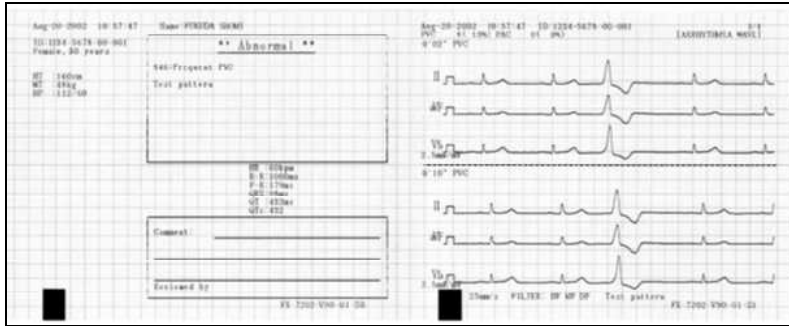

Arrhythmia analysis (measured values)

Aug-20-2002 10:57:47 ID:1234-5678-00-001 Female, 30 years 1/3												Aug-20-2002 10:57:47 Same: PENDING (NAME) 2/3																	
[ARRHYTHMIA MEASURED VALUES]												[ARRHYTHMIA MEASURED VALUES]																	
No.	S-A	P-R	QRS	P	F	ARI	ARD	PK1	PK2	ARI	ARD	PK1	PK2	ARI	ARD	#	No.	S-A	P-R	QRS	P	F	ARI	ARD	PK1	PK2	ARI	ARD	#
1	154	85	1	1	0.23	422	222	237	25	37							27	100	100	94	1	1	0.43	422	222	237	25	29	
2	100	180	98	1	1	321	415	220	237	26	25						28	100	180	104	1	1	0.44	420	221	237	24	28	
3	172	8	220	9	0	2818	2796	656	617	37	30	V					29	100	180	96	1	1	0.37	418	222	238	26	28	
4	128	174	92	2	0	525	422	220	237	26	25						30	100	180	100	1	1	0.58	423	223	240	25	25	
5	100	180	100	1	1	351	423	222	238	26	25						31	100	180	108	1	1	0.44	420	221	237	26	25	
6	100	180	94	1	1	341	420	221	237	26	25						32	100	178	98	1	1	0.32	423	220	237	24	24	
7	100	180	94	1	1	320	422	221	237	26	25						33	110	0	220	0	0	0.824	2791	656	617	37	30	W
8	100	180	96	1	1	345	423	222	237	26	25						34	128	172	100	3	0	0.41	423	221	236	25	25	
9	100	180	100	1	1	354	423	222	237	26	25						35	100	180	98	1	1	0.41	422	222	237	26	26	
10	100	178	98	1	1	325	424	220	237	26	25						36	100	180	100	1	1	0.46	423	221	237	26	25	
11	172	0	220	0	0	2820	2796	656	617	37	30	W					37	100	180	94	1	1	0.37	424	222	238	24	24	
12	176	176	98	1	1	347	422	221	236	26	25						38	100	180	100	1	1	0.38	423	222	240	26	25	
13	100	180	100	1	1	351	422	220	237	26	25						39	100	180	100	1	1	0.37	423	221	237	26	24	
14	100	158	98	1	1	320	422	221	237	26	25						40	100	178	108	1	1	0.42	423	220	237	25	24	
15	100	178	96	1	1	326	427	223	238	26	25						41	172	0	220	0	0	0.840	2796	656	617	37	30	W
16	100	180	94	1	1	356	423	222	237	26	25						42	128	174	100	3	0	0.42	421	221	236	25	25	
17	100	180	100	1	1	348	422	221	237	26	25						43	100	180	98	1	1	0.41	422	221	237	26	24	
18	100	178	96	1	1	320	421	220	237	26	25						44	100	150	98	1	1	0.31	429	221	237	25	20	
19	172	0	220	0	0	2824	2796	656	617	37	30	W					45	100	180	96	1	1	0.37	418	222	238	25	26	
20	128	174	98	1	1	341	423	221	236	26	25						46	100	180	100	1	1	0.40	423	220	238	25	25	

R-R Trend Test Mode

The R-R trend test will print the test report together with ECG waveforms, and measured values. Select the report format for these reports.

The **SET UP MODE (R-R TREND TEST MODE)** screen is used to set the parameters related to the recording format of the R-R Trend Test Mode.

SET UP MODE (R-R TREND TEST MODE) screen

SET UP MODE (R-R TREND TEST MODE)	
R-R Trend Lead	▼ II
ECG Report	▼ Standard
Analysis Report	<input checked="" type="checkbox"/> ON <input type="checkbox"/> OFF
Measured Value	<input type="checkbox"/> ON <input checked="" type="checkbox"/> OFF

NEXT ▼ PREV ▲ MENU EXIT

ECG Report: Select the waveform recording speed from either “Standard” (25mm/s), or “Compress” (10mm/s). When this parameter is set to “NONE”, the ECG report is not recorded.

Analysis Report: Set this parameter “ON” to automatically print a report after compiling the R-R trend graph and R-R histogram. Otherwise, set to “OFF”.

Measured Value: Set this parameter “ON” to print the measured values. Otherwise, set to “OFF”.

R-R trend test (ECG test report)



R-R trend test (analysis report)

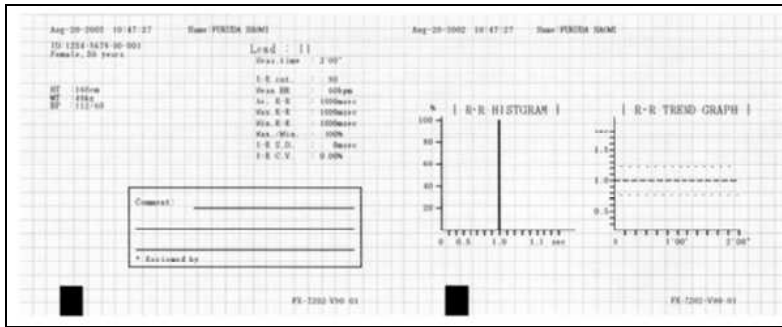

R-R trend test (measured values)

Aug-20-2002 10:47:27 ID:1224-5478-00-001 Female, 30 years: 1/2

R-R MEASURED VALUES

No.	R-R(sec)	No.	R-R(sec)	No.	R-R(sec)	No.	R-R(sec)	No.	R-R(sec)
1	1000	21	1000	41	1000	61	1000	81	1000
2	1000	22	1000	42	1000	62	1000	82	1000
3	1000	23	772*	43	1000	63	772*	83	1000
4	1000	24	1223*	44	1000	64	1223*	84	1000
5	1000	25	1000	45	1000	65	1000	85	1000
6	1000	26	1000	46	1000	66	1000	86	1000
7	772*	27	1000	47	772*	67	1000	87	772*
8	1223*	28	1000	48	1223*	68	1000	88	1223*
9	1000	29	1000	49	1000	69	1000	89	1000
10	1000	30	1000	50	1000	70	1000	90	1000
11	1000	31	772*	51	1000	71	772*	91	1000
12	1000	32	1223*	52	1000	72	1223*	92	1000
13	1000	33	1000	53	1000	73	1000	93	1000
14	1000	34	1000	54	1000	74	1000	94	1000
15	772*	35	1000	55	772*	75	1000	95	772*
16	1223*	36	1000	56	1223*	76	1000	96	1223*
17	1000	37	1000	57	1000	77	1000	97	1000
18	1000	38	1000	58	1000	78	1000	98	1000
19	1000	39	772*	59	1000	79	772*	99	1000
20	1000	40	1223*	60	1000	80	1223*	100	1000

Changing the Patient Data Parameters

Add or delete items to be entered as patient data.

To change the patient data parameters, use the **SET UP MODE (PATIENT DATA)** screen (page 1 and page 2).

SET UP MODE (PATIENT DATA) screen (1/2)

SET UP MODE (PATIENT DATA)			
Auto ID No.Inc	<input type="checkbox"/> ON	<input checked="" type="checkbox"/> OFF	
Fixed ID Number	▼ []
Input Birthday	<input type="checkbox"/> ON	<input checked="" type="checkbox"/> OFF	
Name	<input checked="" type="checkbox"/> ON	<input type="checkbox"/> OFF	
Race	<input checked="" type="checkbox"/> ON	<input type="checkbox"/> OFF	
Height	<input checked="" type="checkbox"/> cm	<input type="checkbox"/> inch	<input type="checkbox"/> OFF
Weight	<input checked="" type="checkbox"/> kg	<input type="checkbox"/> lb	<input type="checkbox"/> OFF
Blood Pressure	<input checked="" type="checkbox"/> ON	<input type="checkbox"/> OFF	
<input type="button" value="NEXT ▼"/> <input type="button" value="PREV ▲"/> <input type="button" value="MENU"/> <input type="button" value="EXIT"/> <input type="button" value=""/>			

SET UP MODE (PATIENT DATA) screen (2/2)

SET UP MODE (PATIENT DATA)			
Drug	<input checked="" type="checkbox"/> ON	<input type="checkbox"/> OFF	
Symptoms	<input checked="" type="checkbox"/> ON	<input type="checkbox"/> OFF	
Comment	<input checked="" type="checkbox"/> ON	<input type="checkbox"/> OFF	
Ward	<input checked="" type="checkbox"/> ON	<input type="checkbox"/> OFF	
Department	<input checked="" type="checkbox"/> ON	<input type="checkbox"/> OFF	
<input type="button" value="NEXT ▼"/> <input type="button" value="PREV ▲"/> <input type="button" value="MENU"/> <input type="button" value="EXIT"/> <input type="button" value=""/>			

Select the following parameters:

- Auto ID No. Inc:** Set this parameter "ON" to automatically assign the patient IDs. Each time Measurement Recording (without a program cartridge) or Analysis Recording (PC-7403) during the REST status is finished, the ID number is incremented by 1. To assign each patient's ID manually, set this parameter "OFF".
- Fixed ID Number:** Specify the number you want to use as fixed number for the upper digits of the patient ID.
- Input Birthday:** Set this parameter "ON" to enable automatic setting of the patient's age by simply entering the patient's date of birth. You do not have to enter the patient's age.
- Name:** Set this parameter "ON" to include the patient's name in the patient data. Otherwise, set to "OFF".

Race:	Set this parameter to include the patient's ethnicity in the patient data. Otherwise, set to "OFF".
Height:	Set this parameter to "cm" or "inch" to include the patient's height in the patient data. Otherwise, set to "OFF".
Weight:	Set this parameter to "kg" or "lbs" to include the patient's weight in the patient data. Otherwise, set to "OFF".
Blood Pressure:	Set this parameter "ON" to include the patient's blood pressure information in the patient data. Otherwise, set to "OFF".
Drug:	Set this parameter "ON" to include the patient's medication information in the patient data. Otherwise, set to "OFF".
Comment:	Set this parameter "ON" to include a comment in the patient data. Otherwise, set to "OFF".
Symptoms:	Set this parameter "ON" to include the patient's symptoms in the patient data. Otherwise, set to "OFF".
Ward:	Set this parameter "ON" to include the patient's ward information in the patient data. Otherwise, set to "OFF".
Department:	Set this parameter "ON" to include the patient's department information in the patient data. Otherwise, set to "OFF".

Selecting the Filters

Set the cut-off frequency of the hum filter (HF), muscle filter (MF), drift filter (DF), and high-cut filter.

Once the filter parameters are set, they can be turned ON and OFF by simply touching [FILTER] during sampling.

SET UP MODE (ECG CONTROL) screen (1/2)

SET UP MODE (ECG CONTROL)		
Width of Baseline	<input checked="" type="checkbox"/> Standard	
Hum Filter	<input type="checkbox"/> 50Hz	<input checked="" type="checkbox"/> 60Hz
Muscle Filter	<input type="checkbox"/> 25Hz	<input checked="" type="checkbox"/> 35Hz
Drift Filter	<input type="checkbox"/> 0.25Hz	<input checked="" type="checkbox"/> 0.5Hz
Cut-off Frequency	<input type="checkbox"/> 70Hz	<input type="checkbox"/> 100Hz <input checked="" type="checkbox"/> 150Hz
Key Click	<input type="checkbox"/> ON	<input checked="" type="checkbox"/> OFF
QRS Beep	<input type="checkbox"/> ON	<input checked="" type="checkbox"/> OFF
Lead Off Buzzer	<input type="checkbox"/> ON	<input checked="" type="checkbox"/> OFF
<input type="button" value="NEXT ↓"/> <input type="button" value="PREV ↑"/> <input type="button" value="MENU"/> <input type="button" value="EXIT"/> <input type="button" value=""/>		

Select the following parameters:

- | | |
|--------------------|---|
| Hum Filter: | Select the cut-off frequency of the hum filter (50/60Hz). |
| Muscle Filter: | Select the cut-off frequency of the muscle filter (25/35Hz). |
| Drift Filter: | Select the cut-off frequency of the drift filter (0.25/0.5Hz). |
| Cut-off Frequency: | Select the cut-off frequency of the high-cut filter (70/100/150Hz). |

Note:

Be careful about setting the cut-off frequency of the muscle filter. When it is set to 25Hz or 35Hz, the amplitude of the QRS complex will be reduced.

Initializing Parameters

You can reset the parameters to their default settings (excluding date and time setting).

Operation

1 Display the Mode select window.

Touch [MENU] to display the **Mode select** window.

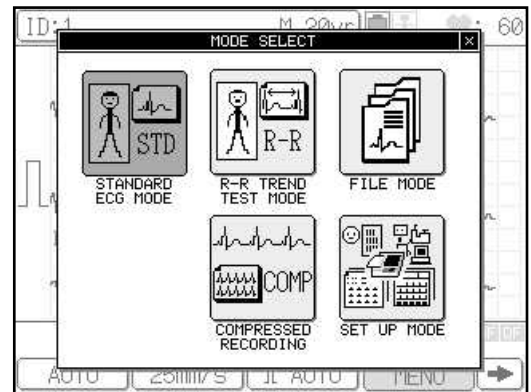

2 Touch [SET UP MODE].

The **SET UP MODE (MENU)** window will appear.

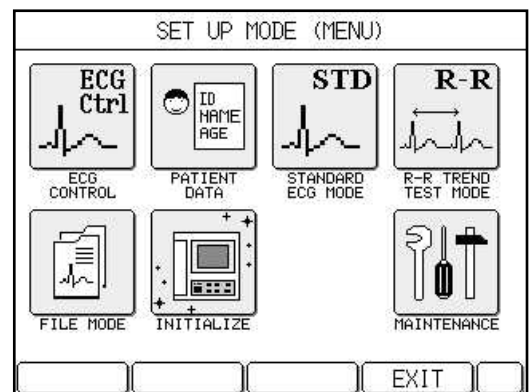

3 Touch [INITIALIZE].

The **INITIALIZE** window will appear with a confirmation message.

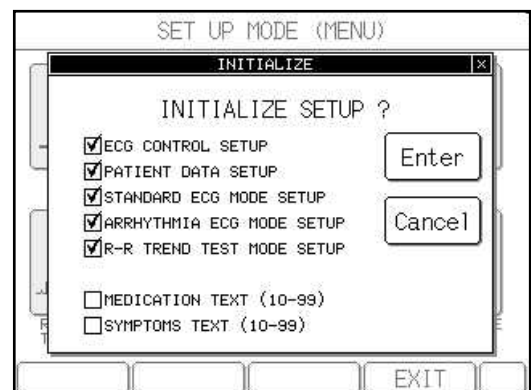

4 Touch [Enter].

The parameters are reset to their default settings. To cancel the initialization operation, touch [Cancel].

Chapter 8

Maintenance and Troubleshooting

Performing the Self-diagnostics Test

The FX-7202 provides the following five types of user menus for the daily machine check.

- **TEST PATTERN** Menu for selecting the built-in ECG test pattern waveform used for operation checks and demonstration.
- **RECORDING TEST** Menu for performing the overall recording test.
- **KEY TEST** Menu for performing the key operation test.
- **LCD TEST** Menu to check for missing dots of the LCD and halftones.
- **BUZZER TEST** Menu for checking the sounds.

Starting the test menu

Use the following procedure to start the **MAINTENACE** menu.

Operation

1 Display the Mode select window.

Touch [MENU] to open the **Mode select** window.

 **Note:**

The mode screen will be different depending on the configuration. The above mode screen is displayed when the PC-7403 program cartridge is installed.

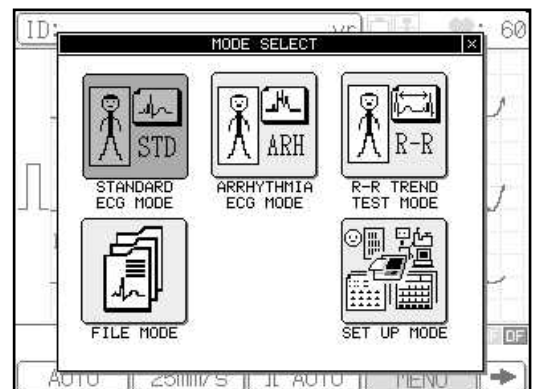

2 Touch [SET UP MODE].

The **SET UP MODE (MENU)** window will appear.

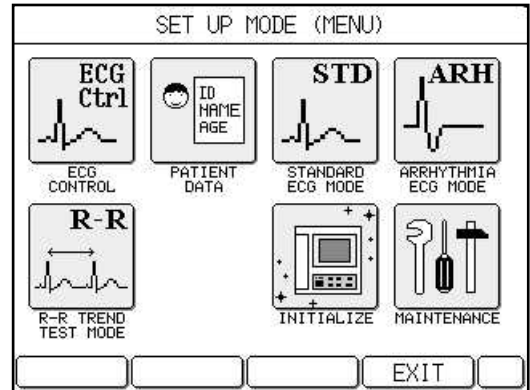

3 Touch [MAINTENANCE].

The **SET UP MODE (MAINTENANCE)** window will appear.

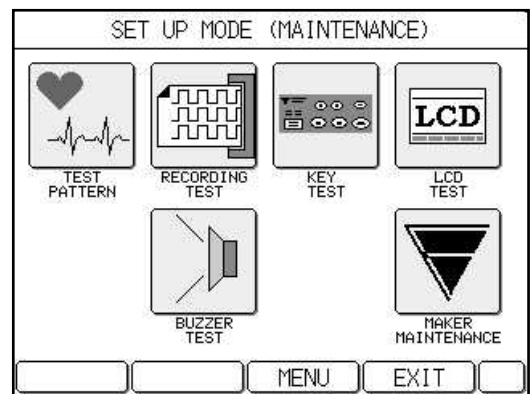

4 See the corresponding section for the detailed operation of each test.

Note:

You cannot access the **MAKER MAINTENANCE** menu. The manufacturer uses it for checks and adjustment of this machine during the manufacturing process and product inspection.

Selecting the ECG test pattern waveform _____

Use the following procedure to run the **TEST PATTERN** menu.

You can select from the following three types of test pattern waveforms.

NONE: Makes a test pattern waveform invalid.

NORMAL: Normal pattern waveform

PVC WAVE: Arrhythmia pattern waveform PVC

Operation

1 Open the SET UP MODE (MAINTENANCE) window.

Perform steps 1 to 3 of "Starting the test menu" (pages 123 to 124) to open the **SET UP MODE (MAINTENANCE)** window.

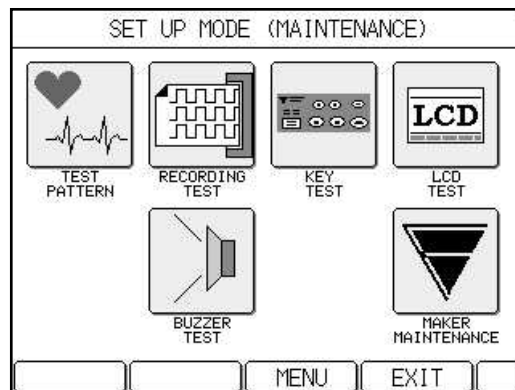

2 Touch [TEST PATTERN].

The **MAINTENANCE (TEST PATTERN)** window will appear.

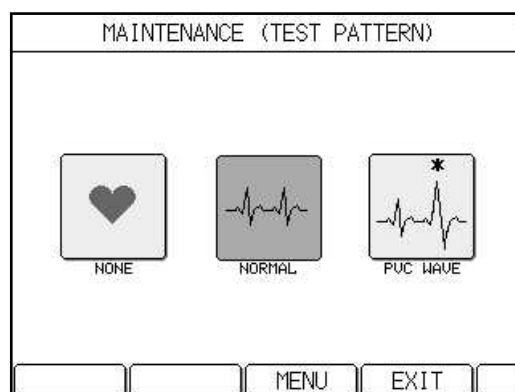

3 Touch the desired test pattern waveform.

The ECG standard mode screen will appear and the selected test pattern waveform appears on the ECG standard mode screen. The selected test pattern is highlighted.

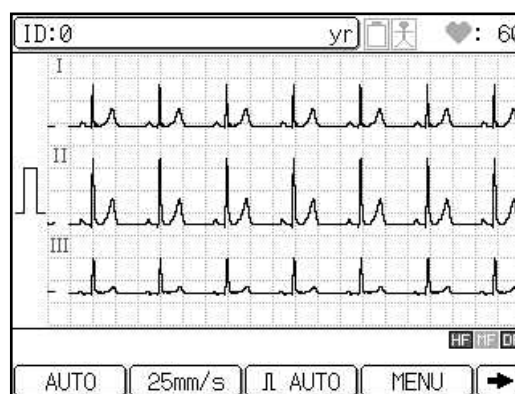

4 Touch [MENU].

The test pattern setting takes effect and the **SET UP MODE (MAINTENANCE)** window reappears.

Notes:

- "NORMAL" or "PVC WAVE" will appear respectively during the recording if you select NORMAL or PVC WAVE.
- The detached electrode information is ignored if you select "NORMAL" or "PVC WAVE".
- Always "NONE" is selected at the time of power-on and initialization. The test pattern information is not saved.

Performing the recording test

The RECORDING TEST records the following waveforms using a sequence of four different feeding speeds: 10mm/second, 12.5mm/second, 25mm/second, and 50mm/second.

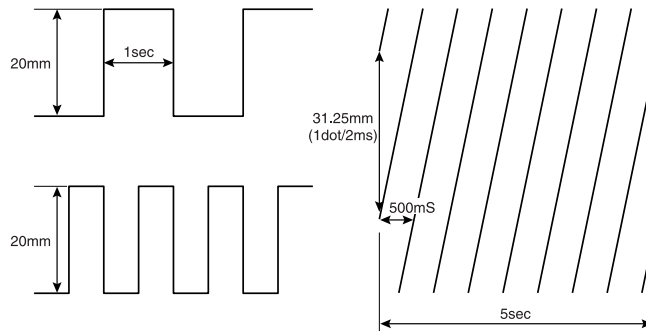

Use the following procedure to run the RECORDING TEST menu.

Operation

1 Open the SET UP MODE (MAINTENANCE) window.

Perform steps 1 to 3 of "Starting the test menu" (pages 123 to 124) to open the **SET UP MODE (MAINTENANCE)** window.

2 Touch [RECORDING TEST].

The **MAINTENANCE (RECORDING TEST)** window will appear.

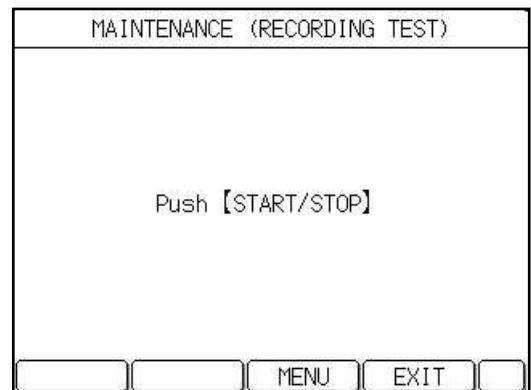

3 Press [START/STOP] key.

When all recording tests are complete (the recording test in 50mm/second is finished), the **MAINTENANCE (RECORDING TEST)** window reappears.

Notes:

- You can end the recording test by pressing [**START/STOP**]. The **MAINTENANCE (RECORDING TEST)** window reappears.
- If you touch [MENU] while recording is terminated, the **SET UP MODE (MAINTENANCE)** window reappears.
- If you touch [EXIT] while recording is terminated, the ECG test screen will reappear.

Performing the key test

Use the following procedure to run the **KEY TEST** menu.

Operation

1 Open the **SET UP MODE (MAINTENANCE)** window.

Perform steps 1 to 3 of "Starting the test menu" (pages 123 to 124) to open the **SET UP MODE (MAINTENANCE)** window.

2 Touch [KEY TEST].

The **MAINTENANCE (KEY TEST)** window will appear.

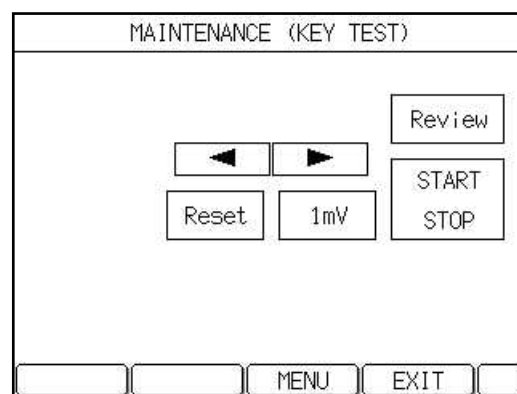

3 Press a key on the operation panel and make sure that the corresponding key is highlighted on the screen.

For example, press [START/STOP]. The [START STOP] indication on the screen will be highlighted.

4 After you finish the test, touch [MENU].

The **SET UP MODE (MAINTENANCE)** window will reappear.

 **Note:**

If you touch [EXIT], the ECG test screen will reappear.

Performing the LCD test _____

Use the following procedure to run the **LCD TEST** menu.

Operation

1 Open the **SET UP MODE (MAINTENANCE)** window.

Perform steps 1 to 3 of "Starting the test menu" (pages 123 to 124) to open the **SET UP MODE (MAINTENANCE)** window.

2 Touch [LCD TEST].

The LCD test will start, using the predefined format.

When the LCD test is complete, the **SET UP MODE (MAINTENANCE)** window reappears.

Performing the buzzer test _____

Use the following procedure to run the **BUZZER TEST** menu.

Operation

1 Open the **SET UP MODE (MAINTENANCE)** window.

Perform steps 1 to 3 of "Starting the test menu" (pages 123 to 124) to open the **SET UP MODE (MAINTENANCE)** window

2 Touch **[BUZZER TEST]**.

The **MAINTENANCE (BUZZER TEST)** window will appear.

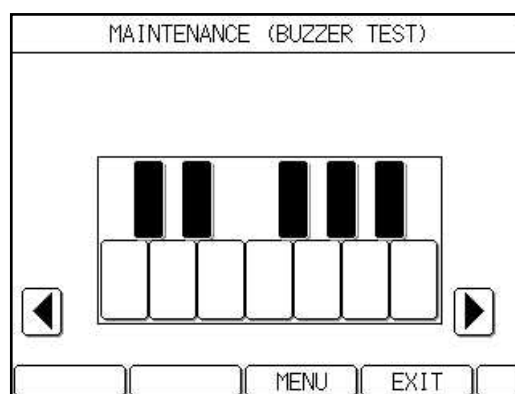

3 Touch **[BUZZER]**.

The buzzer will be sounded for approximately 0.5 seconds.

4 After you finish the test, touch **[MENU]**.

The **SET UP MODE (MAINTENANCE)** window will reappear.



Note:

If you touch **[EXIT]**, the ECG test screen reappears.

Cardimax FX-7202 Maintenance

Maintenance instructions

Follow the procedures described in this chapter for the maintenance of the FX-7202. For maintenance safety, functions, performance, and reliability, you must implement "Daily Checks" prior to operation, as well as "Periodic Checks". Note that Fukuda Denshi assumes no responsibility for an accident resulting from the lack of maintenance.

 CAUTION	
	<ul style="list-style-type: none"> • Do not open the cabinet of the FX-7202. • Make sure that liquids such as alcohol do not spill into the interior of the FX-7202.

Daily checks



Perform the daily checks in accordance with Appendix B, "Daily Check Lists" (page 139). If any item in the daily check list fails to satisfy the required criteria, the overall judgment must also be "failed." Take corrective actions for failed items. Use the FX-7202 only after all items qualify as required.

Periodic checks

Periodic checks of medical electronic equipment are indispensable for prevention of faults and accidents and for the maintenance of safety and performance. For more information, contact your local Fukuda Denshi service representative.

If any item in Appendix C, "Periodic Check Lists" (page 140) fails, the overall judgment is also "failed." Take corrective actions for failed items. Use the FX-7202 only after all items qualify as required.

Cleaning and disinfecting _____



 CAUTION	
	Do not heat sterilize with water, steam, or air.

Electrodes (clips, cups, plates):

Use the following procedures for the electrodes.

Cleaning: Use a cloth moistened with a household cleaning agent and wipe the entire electrode. Next, wipe with a new cloth that is moistened with ordinary touch water and let the electrodes dry.

Disinfecting: Use a high level disinfecting solution, such as Cidex™. Always follow manufacturers disinfecting instructions.



 WARNING	
	Reusable electrodes may transport bacteria from one patient to another resulting in a risk of infection. Always disinfect reusable electrodes after each use.

Main unit and patient cables:

Use the following procedures for the external cabinet and patient cable.

Cleaning: Use a cloth moistened with water that contains an ordinary household cleaning agent. Next, wipe with a new cloth that is moistened with ordinary touch water and allow the cabinet and cable to dry.

Disinfecting: Thoroughly spray the outside cabinet or patient cable with a high level disinfecting solution, such as Cidex™. Always follow manufacturers disinfecting instructions.

 CAUTION	
	Under no circumstances should the Patient Cable be immersed in any cleaning fluid. Do not spray any connector parts on the main unit and patient cable. Do not use ether or benzene, as it may damage the cabinet.

When You cannot Record an Accurate ECG

If accurate ECG samples cannot be obtained, check the following items and retry the operation:

1. Are the examination conditions appropriate?

- Make sure the FX-7202 is not used near devices that cause noise, such as X-ray units, ultrasonic equipment, cellular phone, or other electrical appliances. When there are such appliances nearby, turn off the power of those devices or move to another examination area where there will be no interference from those devices. If the patient's bed is made of metal, connect the ground for the bed.
- Make sure the temperature in the examination area is maintained at 20 to 25 degrees Celsius (68 to 77 degrees Fahrenheit).
- Make sure the examination area has a low humidity conditions.

2. Is the power supply cord connected properly? (When using AC power supply)

- Make sure the plug is not loose.
- Make sure no other cables are touching the power supply cord.

3. Is the patient cable connected properly?

- Make sure the connector is not loose.
- Make sure the cable is kept away from the power supply cord.
- Make sure the lead tips of the patient cable are connected to the corresponding electrodes.

4. Are the electrode conditions satisfactory?

- Make sure fatty oil on the patient's skin (in contact with electrodes) is wiped off properly and Keratin cream has been applied.
- Make sure the electrodes are clean. If electrodes are dirty, wash them with alcohol or soapy water. If this does not remove dirt, lightly sandpaper the electrodes.
- Make sure the electrode attachment is not loose. If loose, tighten it properly. At this time, however, make sure the patient does not feel pain.
- Make sure old and new electrodes or different types of electrodes are not used together.

5. *Is the patient's condition satisfactory?*

- Make sure the patient is comfortable. If the patient is tense, reassure him or her that the ECG examination is simple and harmless.
- Make sure the patient does not move or speak during the examination.
- Make sure the bed is not too small.
- Make sure the patient's arms or legs do not come in contact with metal parts of the bed.

6. *Is enough paper in the machine?*

- Make sure there is enough recording paper for the test.

When an Error Message is Displayed

If an error message appears during operation, take the required action.

Error messages related to the rechargeable battery _____

LOW BATTERY!

Cause:

The rechargeable battery is unable to provide the power needed for operation.

Action to be taken:

Charge the battery. See "Using the Battery" (page 30).

Error messages related to the magazine and recording paper _____

MAGAZINE UP

Cause:

The paper magazine is open.

Action to be taken:

Make sure the magazine cover is closed properly. See "Loading the Recording Paper" (pages 14 to 16).

NO PAPER

Cause:

The paper magazine has run out of recording paper.

Action to be taken:

Load new recording paper. See "Loading the Recording Paper" (pages 14 to 16).

CHECK PAPER

Cause:

The paper cue mark is not able to be detected.

Action to be taken:

Use the exclusive Z-fold paper for the FX-7202.

Error message related to ECG waveforms _____

QRS DETECT ERROR

Cause:

The recorded waveform cannot be analyzed during the Analysis Recording and Measurement Recording.

Action to be taken:

Check the condition of the electrodes and patient, then retry the operation.

Cause:

The measured waveform cannot be analyzed during the R-R Trend Test Recording.

Action to be taken:

Check the condition of the electrodes and patient, then change the test lead if necessary to retry the operation.

 See "When You cannot Record an Accurate ECG" (page 132).

Error messages related to equipment control

SYSTEM ERROR

Cause:

An error occurred in the FX-7202.

Action to be taken:

Note the displayed error code (2-digit number preceded by a \$ sign) and turn OFF the FX-7202 immediately. Contact your local Fukuda Denshi sales and service representative and give them the error code.

RECORDER OVER HEAT

Cause:

The thermal recording head is overheated.

Action to be taken:

Turn OFF the FX-7202 immediately. This is assumed as a machine failure. Contact your local Fukuda Denshi sales and service representative and ask for repairs.

ECG AMP ERROR!

Cause:

ECG amplifier control failure.

Action to be taken:

Turn OFF the FX-7202 immediately. This is assumed as a machine failure. Contact your local Fukuda Denshi sales and service representative and ask for repairs.

Appendix A. Specifications

Electrocardiograph

Leads:	Standard 12 leads
Sensitivity:	1/4, 1/2, 1, 2cm/mV, or automatic
Polarization voltage:	±550mV or greater
Frequency response:	0.05 to 150Hz
Time constant:	3.2 sec.
Common mode rejection:	2mmp-p or lower (103dB or more)
Input impedance:	50M ohms or greater
Input circuit current:	5×10^{-8} A or lower
Internal noise:	20 μ Vp-p or lower
Calibrated voltage:	1mV±2% or lower
Sampling rate:	8000/Sec/CH
Filters	
HUM filter:	-20dB or less at 50/60Hz
Muscle filter:	-3dB (-6dB/oct) at 25/35Hz
Drift filter:	-3dB or less at 0.25/0.5Hz
Recording system:	Thermal array head
Recording speed:	10, 12.5, 25, 50mm/sec.
Recording resolution	
Deflection axis:	8 dots/mm
Time axis:	500 μ sec.
Recording channels:	3CH, 3CH+rhythm lead, 6CH
Recording paper	
Z-fold paper:	OP-222TE (110mm x 20M)

Display

Type:	Liquid crystal display (LCD) with backlighting
Resolution:	320 dot (horizontal) x 240 dot (vertical)
Patient data:	ID number, age, sex, height, weight, etc.

Measurement operation

Basic measurement value:	Heart rate, R-R time, P-R time, QRS time, QT time, QTc, electrical axis, SV1, RV5(6)
Heart Rate measurement:	20 to 300 BPM
Accuracy:	±2 BPM

Analysis operation (When the PC-7403 program cartridge is installed)

Interpretation and code:	Approx. 110 types
Minnesota code:	Approx. 130 types
Grade judgment:	4 types

General

Safety standard:	IEC60601-1 (Class I, type CF; Internally powered equipment, type CF)
Power supply	
AC power supply:	100 to 240V AC (±10%), 50/60Hz, Power consumption: 80VA
DC power supply:	Ni-MH battery (T8HRAAU-4713), Power consumption: 45W
Dimensions:	260mm (W) x 200mm (D) x 64mm (H) (10.24" x 7.87" x 2.52")
Weight:	Approx. 2.5kg (5.5 lbs.)

Operating environment

Temperature:	+10 to +40 degrees Celsius (50 to 104 degrees Fahrenheit)
Humidity:	25 to 95% (no condensation)
Atmospheric pressure:	70 to 106kPa (700 to 1060mbar)

Storage environment

Temperature:	-10 to +55 degrees Celsius (14 to 131 degrees Fahrenheit)
Humidity:	10 to 95% (no condensation)
Atmospheric pressure:	70 to 106kPa (700 to 1060mbar)

Appendix B. Daily Check List

Type of check	Check item	Procedure	Criterion	
Visual check	Appearance	1. Exterior flaws, cracks, deformation, rust	Visually check for exterior flaws, cracks, deformation, and rust.	There should be no exterior flaws, cracks, deformation, and rust.
		2. Peeling off and dirt on nameplate and panel	Visually check for peeling off of nameplate and panel and dirt on them.	There should be no peeling off of nameplate and panel and no dirt on them.
		3. Keys	Visually check for damage to keys.	There should be no damage to keys.
	Accessories	1. Power supply cord, patient cable	Visually check for flaws and damage.	There should be no flaws and damage.
		2. Limb electrode, chest electrode	Visually check for dirt, rust, flaws, and damage.	There should be no dirt, rust, flaws, and damage.
		3. Recording paper	Check whether the recording paper is loaded properly.	The recording paper must be loaded properly.
		4. Operation Manual	Check whether the Operation Manual is being kept in its specified place.	The Operation Manual must be kept in its specified place.
Mechanical check	Main unit	1. Keys	Make sure the keys operate smoothly.	The keys must operate smoothly.
		2. Recorder	Make sure the operation of the recorder is smooth and no abnormal noise can be heard.	The operation of the recorder must be smooth and no abnormal noise should be heard.
	Accessories	1. Power supply cord, patient cable	Make sure the power supply cord and patient cable are connected firmly to the Cardimax FX-7202.	The power supply cord and patient cable must be connected firmly to the Cardimax FX-7202.
		2. Limb electrode, chest electrode	Make sure the limb electrodes and chest electrodes are connected properly to the patient cables.	The limb electrodes and chest electrodes must be connected to the patient cables properly.
Electrical check	Performance	1. Power supply	Turn ON the power to make sure the initial screen (power-on screen) is displayed.	When the power is turned ON, the initial screen (power-on screen) must be displayed.
		2. Display	Make sure the LCD displays the waveforms on the waveform display screen.	The LCD must display the waveforms on the waveform display screen.
		3. Recording	Make sure the waveforms are printed.	The waveforms must be printed.
		4. Recording speed: 25mm/s	Make sure that ten seconds of recording corresponds to a length of 25cm (9.8") (error must be within $\pm 3\%$).	The error of ten seconds must be within $\pm 3\%$ (24.25 to 25.75cm or 9.5" to 10.1").

Appendix C. Periodic Check List

Type of check		Check item	Procedure	Criterion
Visual check	Appearance	1. Exterior flaws, cracks, deformation, rust	Visually check for exterior flaws, cracks, deformation, and rust.	There should be no exterior flaws, cracks, deformation, and rust.
		2. Peeling off and dirt on nameplate and panel	Visually check for peeling off of nameplate and panel and dirt on them.	There should be no peeling off of nameplate and panel and no dirt on them.
		3. Keys	Visually check for damage to keys.	There should be no damage to keys.
	Accessories	1. Power supply cord, patient cable	Visually check for flaws and damages.	There should be no flaws and damages.
		2. Limb electrode, chest electrode	Visually check for dirt, rust, flaws, and damage.	There should be no dirt, rust, flaws, and damage.
		3. Recording paper	Check whether the recording paper is loaded properly.	The recording paper must be loaded properly.
		4. Operation Manual	Check whether the Operation Manual is being kept in its specified place.	The Operation Manual must be kept in its specified place.
Mechanical check	Main unit	1. Keys	Make sure the keys operate smoothly.	The keys must operate smoothly.
		2. Recorder	Make sure the operation of the recorder is smooth and no abnormal noise can be heard.	The operation of the recorder must be smooth and no abnormal noise should be heard.
	Accessories	1. Power supply cord, patient cable	Make sure the power supply cord and patient cable are connected firmly to the Cardimax FX-7202.	The power supply cord and patient cable must be connected firmly to the Cardimax FX-7202.
		2. Limb electrode, chest electrode	Make sure the limb electrodes and chest electrodes are connected properly to the patient cables.	The limb electrodes and chest electrodes must be connected to the patient cables properly.

Type of check	Check item	Procedure	Criterion	
Self-diagnostics test	Performance	1. Recording speed	Execute the RECORDING TEST (MAINTENANCE menu) to make sure the paper feed condition is normal.	The RECORDING TEST results must show a normal paper feed condition.
		2. Print condition	Execute the RECORDING TEST (MAINTENANCE menu) to make sure the printing condition is normal.	The RECORDING TEST results must show a normal printing condition.
		3. Keys	Execute the KEY TEST (MAINTENANCE menu) to make sure the key operations are normal.	The KEY TEST results must show normal key operations.
		4. Display	Execute the LCD TEST (MAINTENANCE menu) to check dots on the screen.	The LCD TEST results must show normal dots on the screen.
		5. Buzzer	Execute the BUZZER TEST (MAINTENANCE menu) to make sure a buzzer sound is emitted for 1 second upon pressing keys.	The BUZZER TEST results must show that a buzzer sound is emitted for 1 second upon pressing keys.
	Others	1. Power supply	Make sure the FX-7202 can be turned ON and OFF during use of both AC power and rechargeable battery.	The FX-7202 must be turned ON and OFF by both AC power and rechargeable battery.
		2. Power supply cord	Check for continuity using a tester.	The power supply cord must be conducting.

Appendix D.

LAN communication function

1. Setting the Network Connection

This chapter provides an explanation of the procedure for configuration parameters for transmitting ECG data.

The network-based filing function provided by the FX-7202 uses the FTP protocol. Since the FX-7202 operates as an FTP client, a personal computer (PC) is required that is provided with an FTP server function when connected to the network. In this chapter, an explanation is provided using Windows 2000 Professional or Windows XP Professional as the OS of the PC.

The procedure may differ in the case of using a different PC provided with an FTP server function. Refer to Chapter 3 for information on the communication settings of the FX-7202.

Initial Network Setup

This section provides an explanation of the reference procedure for connecting the FX-7202 to a network using a PC at the facility where the FX-7202 is installed.

Notes:

- The setup procedure described below provides an example of setting up operation based on the default values of the FX-7202.

TCP/IP Setup (Windows 2000)

1 Open the Control Panel.

Click the [Start] button located in the lower left corner of the screen, and then open the Control Panel from the [Setup] menu.



2 Display the [Local Area Connection Status] window.

Double-click on the [Network and Dialup Connections] icon of the control panel to display the [Network and Dialup Connections] window. Then double-click on [Local Area Connections] to display the [Local Area Connection Status Window].



3 Display [Internet Protocol (TCP/IP) Properties].

Click on [Properties (P)] of the [Local Area Connection Status] window to display the [Local Area Connection Properties] window, and then click on [Properties (R)] after having selected the [Internet Protocol (TCP/IP)] list.



4 Set the IP Address.

Select the [Use the following IP address] radio button, enter [192.168.2.127] for the IP address and [255.255.255.0] for the subnet mask, and then click the [OK] button. Similarly, click the [OK] button of the [Local Area Connection Properties] window as well as the [Close (C)] button of the [Local Area Connection Status] window to close each window.

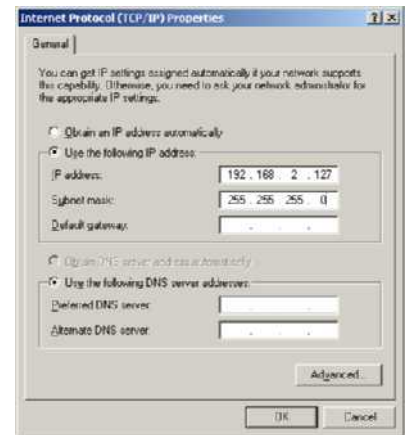

TCP/IP Setup (Windows XP)

1 Open the Control Panel.

Click the [Start] button located in the lower left corner of the screen, and then open the Control Panel from the [Setup] menu.

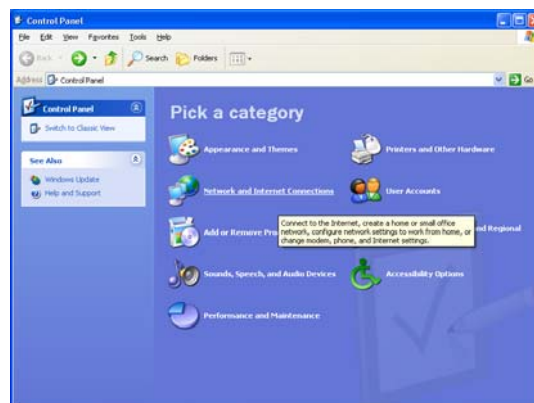

2 Display the [Local Area Connection Status] window.

Double-click on the [Network Connections] icon of the control panel to display the [Network Connections] window. Then double-click on the [Local Area Connections] list to display the [Local Area Connection Status Window].

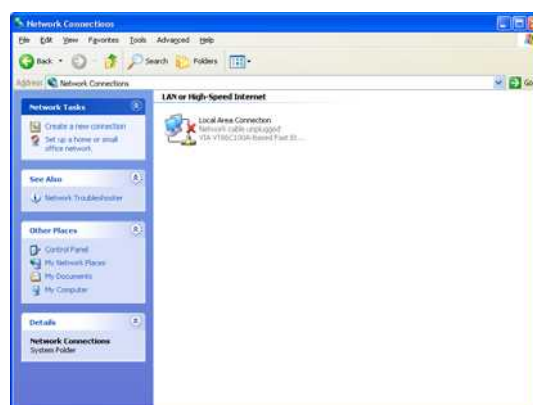

3 Display [Internet Protocol (TCP/IP) Properties].

Click on [Properties (P)] of the [Local Area Connection Status] window to display the [Local Area Connection Properties] window, and then click on [Properties (R)] after having selected the [Internet Protocol (TCP/IP)] list.

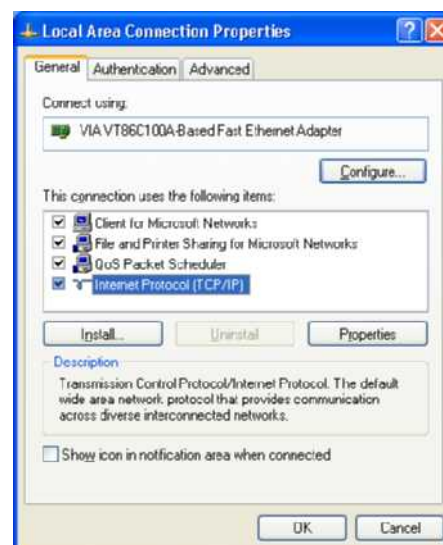

4 Set the IP Address.

Select the [Use the following IP address] radio button, enter [192.168.2.127] for the IP address and [255.255.255.0] for the subnet mask, and then click the [OK] button. Similarly, click the [OK] button of the [Local Area Connection Properties] window as well as the [Close (C)] button of the [Local Area Connection Status] window to close each window.

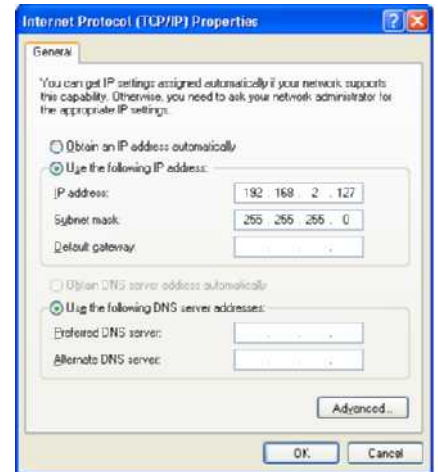

Network Connection Setup

This section provides an explanation of the procedure for setting up the FTP server connection using Internet Service Manager (IIS). Please refer to the other procedure if you do not use IIS.

Notes:

- The following procedure is to be performed by a user that has an administrator privilege.

Installing the FTP Server (Windows 2000)

1 Open the Control Panel.

Click the [Start] button located in the lower left corner of the screen, and then open the Control Panel from the [Setup] menu.



2 Display the [Windows Component Wizard].

Double-click on the [Add/Remove Programs] icon of the control panel to display the [Add/Remove Programs] window. Then click on the [Add/Remove Windows Components] icon to the left of that window to display the [Windows Component Wizard].

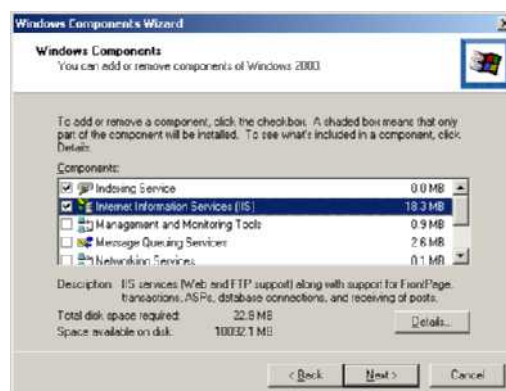

3 Select the FTP server.

Click on the [Details] button after having selected Internet Information Service (IIS) to display the [Internet Information Service (IIS)] window of the Internet Information Service (IIS), check the check box of the File Transfer Protocol (FTP) server, and then click the [OK] button to close the window.

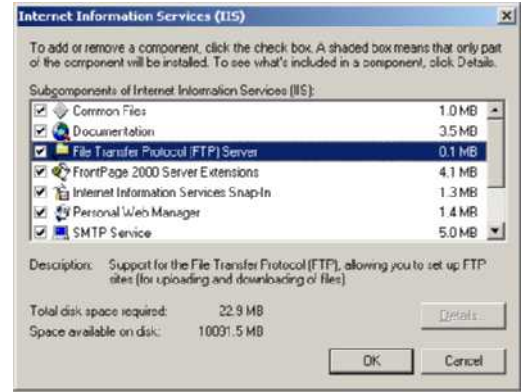

4 Complete installation.

Click the [Next] button after returning to the Windows Component Wizard to install the selected component. A window confirming completion of installation will be displayed after a short while. Click the [Finish] button to complete installation of the FTP server.

Setting Up the FTP Server (Windows 2000)

1 Open the Control Panel.

Click the [Start] button located in the lower left corner of the screen, and then open the Control Panel from the [Setup] menu.



2 Display the [Administrative Tools] window.

Double-click on the [Administrative Tools] icon of the control panel to display the [Administrative Tools] window.

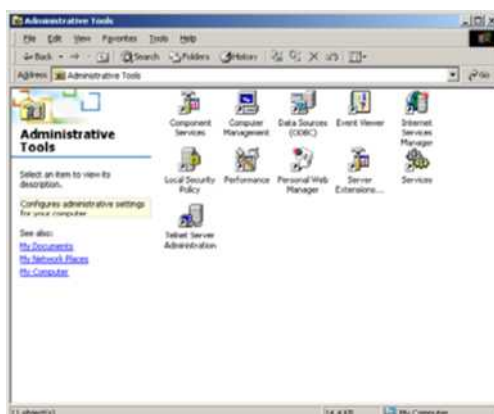

3 Display [Internet Information Service].

Double-click on the [Internet Service Manager] icon of the [Administrative Tools] window to display the [Internet Information Service] window. Then expand the icon of the computer displayed to the left to display the [Default FTP Site].

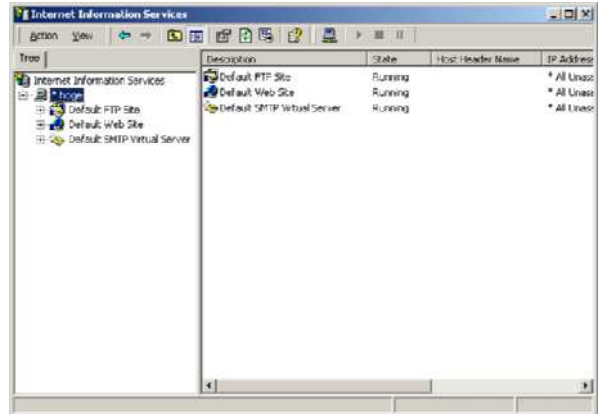

4 Set the security account.

Right-click on [Default FTP Site] and select [Properties] to display the [Default FTP Site Properties] window, and then select the [Security Accounts] tab. Remove the [Allow Anonymous Connections] check box. Remove the [Allow Anonymous Connections] check box.

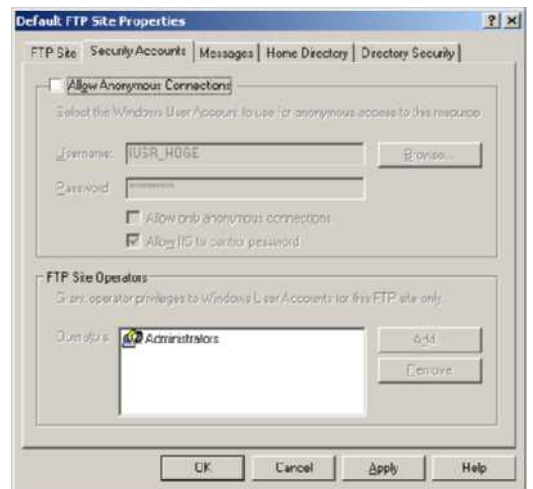

5 Set the home directory.

Select the [Home Directory] tab of the [Default FTP Site Properties] window. Check the [Write (W)] check box for setting the [FTP Site Directory]. The folder where data transmitted from the FX-7202 is stored is indicated as a local path. Set this as necessary (it may also be left at the default setting).

Click the [OK] button to complete setup of the FTP server.

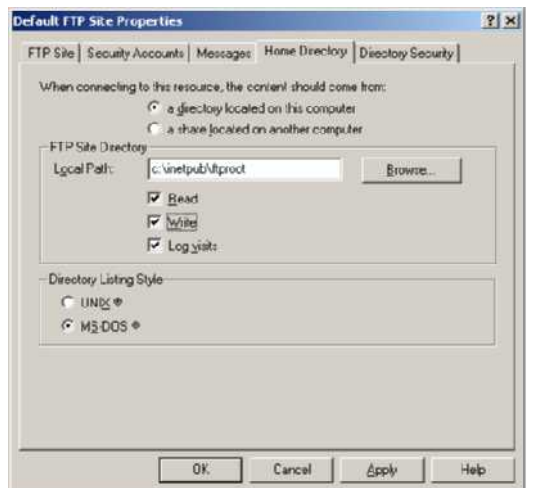

Installing the FTP Server (Windows XP)

1 Open the Control Panel.

Click the [Start] button located in the lower left corner of the screen, and then open the Control Panel from the [Setup] menu.

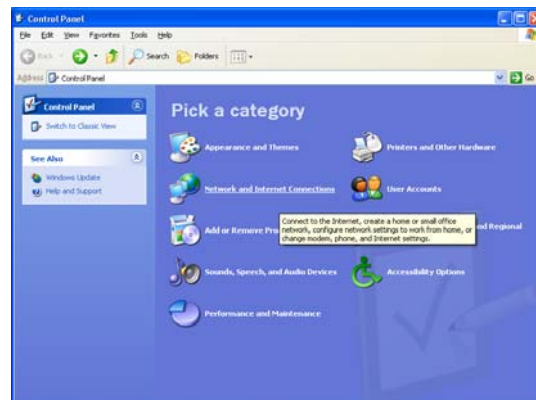

2 Display the [Windows Component Wizard].

Double-click on the [Add/Remove Programs] icon of the control panel to display the [Add/Remove Programs] window. Then click on the [Add/Remove Windows Components] icon to the left of that window to display the [Windows Component Wizard].

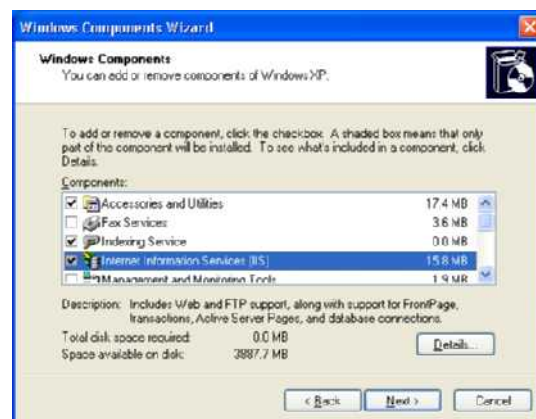

3 Select the FTP server.

Click on the [Details] button after having selected Internet Information Service (IIS) to display the [Internet Information Service (IIS)] window of the Internet Information Service (IIS), check the check box of the File Transfer Protocol (FTP) server, and then click the [OK] button to close the window.

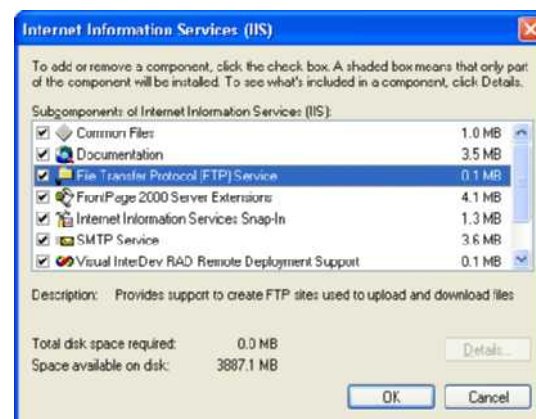

4 Complete installation.

Click the [Next] button after returning to the Windows Component Wizard to install the selected component. A window confirming completion of installation will be displayed after a short while. Click the [Finish] button to complete installation of the FTP server.

Setting Up the FTP Server (Windows XP)

1 Open the Control Panel.

Click the [Start] button located in the lower left corner of the screen, and then open the Control Panel from the [Setup] menu.

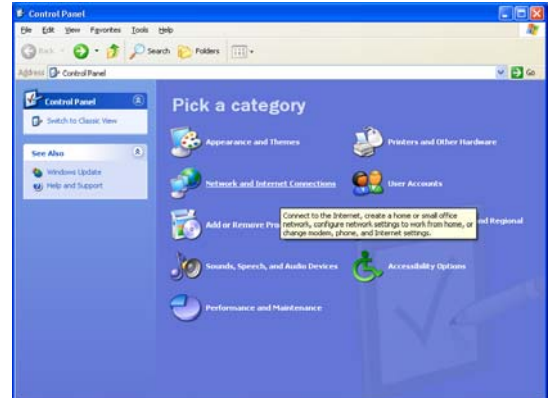

2 Display the [Administrative Tools] window.

Double-click on the [Administrative Tools] icon of the control panel to display the [Administrative Tools] window.

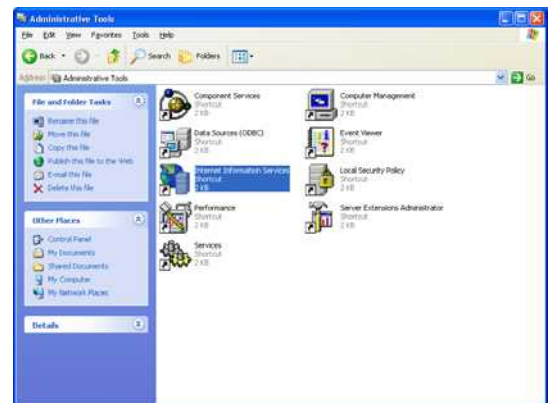

3 Display [Internet Information Service].

Double-click on the [Internet Service Manager] icon of the [Administrative Tools] window to display the [Internet Information Service] window. Then expand the icon of the computer displayed to the left to display the [Default FTP Site].

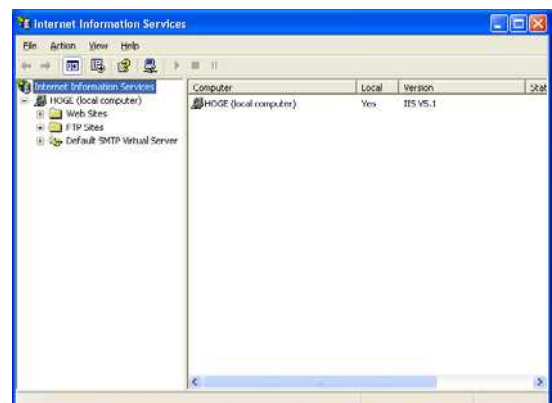

4 Set the security account.

Right-click on [Default FTP Site] and select Properties to display the [FTP Site Properties] window, and then select the [Security Account] tab. Remove the [Allow Anonymous Connections] check box.

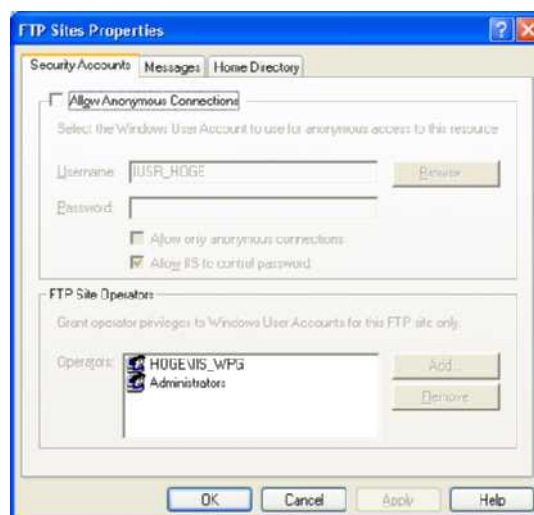

5 Set the home directory.

Select the [Home Directory] tab of the [FTP Site Properties] window. Check the [Write (W)] check box for setting the [FTP Site Directory]. The folder where data transmitted from the FX-7202 is stored is indicated as a local path. Set this as necessary (it may also be left at the default setting).

Click the [OK] button to complete setup of the FTP server.

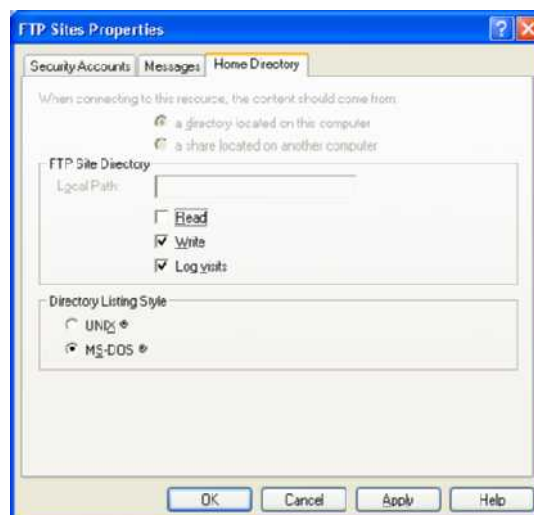

2. Managing ECG Data Files

This chapter provides an explanation of the procedure for reading ECG data from the memory of the FX-7202 and transmitting that data to a PC.

The Cardimax FX-7202 has built-in memory for storing ECG data. The ECG data recorded by analysis and measurement are saved in the built-in memory. The built-in memory can store a maximum of 128 ECG data files.

Notes:

- The maximum number of files that can be saved in the built-in memory depends on the recording mode and recording length. You can save 128 files when recording is performed in the standard ECG mode.
- When the built-in memory space becomes full, new data will be written over the oldest data.
- Data cannot be deleted from the built-in memory.
- The ECG recorded in standard ECG MODE can be altogether transmitted regardless of the record time, in the case of R-R TREND MODE and ARRHYTHMIA ECG MODE, only the ECG for 1 minute can transmit.

Reading ECG Data from the Built-in Memory

ECG data can be read from the built-in memory.

Operation

1 Display the Mode select window.

Touch [MENU] to display the **Mode select** window.

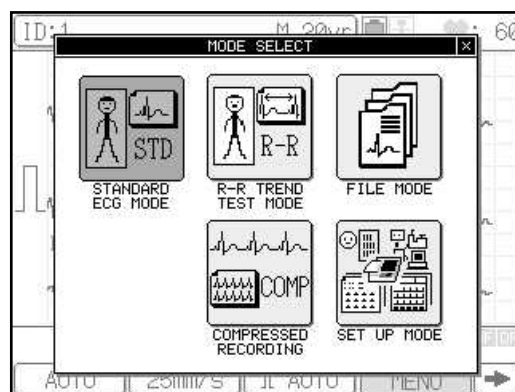

2 Touch [FILE MODE].

The FILE MODE (MENU) window appears.

3 Touch [ECG DATA READING]

The **FILE MODE (ECG DATA READING)** window appears. It displays a list of the ECG data saved in the built-in memory. To scroll the page, touch [↑] or [↓].

ECG DATA READING				1/12	
NO.	ID No.	DATE/TIME	SEX	AGE	
1		JUL/ 9/2002 14:36:03			
2		JUL/ 9/2002 14:29:14			
3		JUL/ 9/2002 14:20:06			
4		JUL/ 9/2002 14:08:19			
5		JUL/ 8/2002 21:43:06			
6		JUL/ 8/2002 21:23:03			
7		JUL/ 8/2002 21:14:54			
8		JUL/ 8/2002 21:00:26			
9		JUL/ 8/2002 20:57:54			
10		JUL/ 8/2002 20:55:17			

At the bottom of the table are buttons: READ, SEARCH, and EXIT.

4 Select the data to be read.

Select the data number of the data to be read. You can select two or more data. The selected data number is highlighted. If you select a data number in error, touch the highlighted number again to cancel the selection. Touch [➡] and then [ALL], if you want select all of the data.

ECG DATA READING			
		1/12	
NO.	ID No.	DATE/TIME	SEX AGE
1		JUL/ 9/2002 14:36:03	
2		JUL/ 9/2002 14:29:14	
3		JUL/ 9/2002 14:20:06	
4		JUL/ 9/2002 14:08:19	
5		JUL/ 8/2002 21:43:06	
6		JUL/ 8/2002 21:23:03	
7		JUL/ 8/2002 21:14:54	
8		JUL/ 8/2002 21:00:26	
9		JUL/ 8/2002 20:57:54	
10		JUL/ 8/2002 20:55:17	

READ SEARCH [] EXIT ➡

5 Read and print the selected ECG data.

Select [READ] to read the selected ECG data. The selected ECG data files are read in an ascending order according to the data number and are printed automatically.

After a data file is read, the highlighted number of the data being read is turned off.

To cancel printing, press [START/STOP] while the ECG data is being printed.

Notes:

- You can touch the [↓] or [↑] keys to display the previous page and next page, if these pages are available.
- If the magazine is open or recording paper runs out while the ECG data are being printed, printing is automatically canceled.

6 Touch [MENU]

The display returns to FILE MODE (MENU).

Searching ECG data

You can search for the ECG data to be read by ID number, date, or last date.

Operation

- 1 Perform steps 1 to 3 of “Reading ECG Data from the Built-in Memory.”
- 2 Select [SEARCH] on the FILE MODE (DATA READING) window.

The **SEARCH CONDITIONS** window appears.

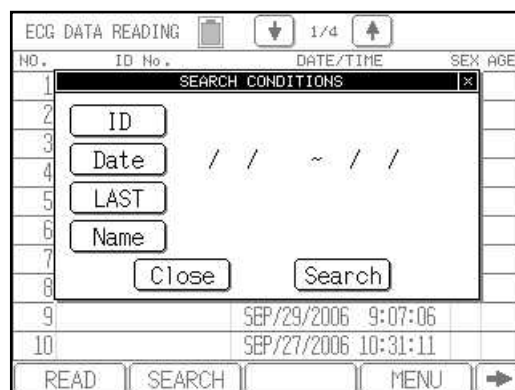

- 3 Select the search target.

To search by ID number, select [ID]. To search by test date, select [DATE].

Search by ID

When you select [ID], the **ENTER THE ID** window appears.

Select the number keys ([0] to [9]) to enter the ID to be searched.

Select [Enter] to set the input value and close the **ENTER THE ID** window.

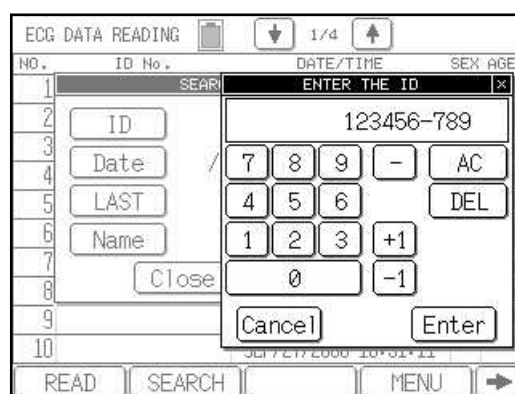

Note:

To clear all input values, select [AC]. To clear an input value preceding the cursor position, select [DEL]. To increment or decrement the entered value, touch [+1] or [-1]. To cancel the ID input and close the **Enter the ID** window, select [Close].

Search by date

When you select [Date], the **DATE** window appears.

Press the number keys ([0] to [9]) to enter the starting and ending test dates for a search. If you omit the starting date, the data preceding the ending date will be searched; and if you omit the ending date, the data after the starting date will be searched. If you omit both dates, all data will be searched. Select [Enter] to set the input values and close the Enter the date window.

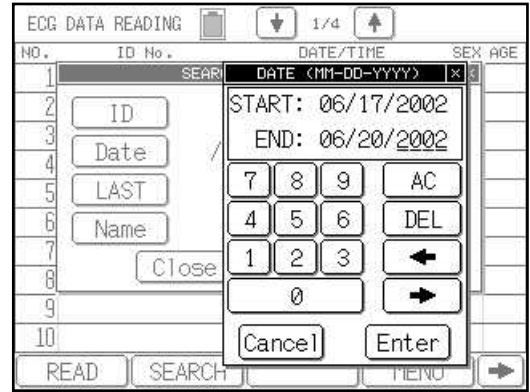

Notes:

- To clear all input values, select [AC]. To clear an input value preceding the cursor position, select [DEL]. To move the cursor, touch [←] or [→]. To cancel the date input and close the DATE window, select [Close].
- The date display format (mm-dd-yy or dd-mm-yy) complies with the [Date Type] parameter setting of the **SET UP MODE (ECG CONTROL)**.
- If you enter an invalid date, this date is ignored and a warning beep is emitted.

Search by last date

When you select [LAST], the data of most recent recorded day in the built-in memory is searched.

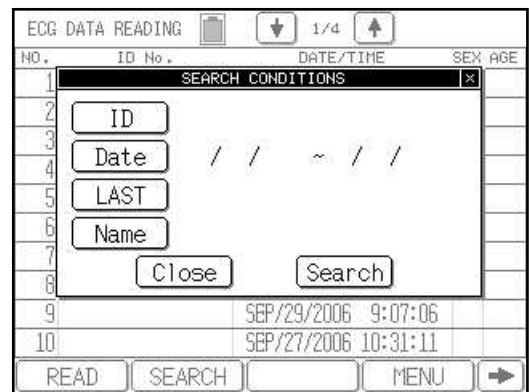

Search by name

Touch [Name] to display the “ENTER THE NAME” keyboard. There are 2 windows where different alphanumeric symbols are displayed. The windows can be switched by touching [1/2↓] or [2/2↑] keys. Enter the patient name and press [ENTER]. To enter a capital letter, touch [CAPS]. To move the cursor, touch [←] [→] keys. To insert a space, touch [Space]. To delete one character, touch [DEL]. To delete all the entered characters, touch [Cancel].

CAUTION

- A wildcard character “*” can be used to search a name. By adding, “*” at the end of the entered characters, a prefix search can be performed for the entered characters before “*”. However, if any character is entered after the wildcard character “*”, or if the wildcard character “*” is not used, an exact search will be performed.
- Maximum of 30 characters can be entered for a name. If all 30 characters are entered, a prefix search will be performed for these 30 characters. If less than 30 characters are entered, an exact search will be performed.

Printing a list of ECG data

You can print a list of the ECG data saved in the built-in memory.

Operation

- 1 Perform steps 1 to 3 of “Reading ECG Data from the Built-in Memory.”
- 2 Touch [➡] to display the next page.

Function keys on the next page will appear.

ECG DATA READING			
NO.	ID No.	DATE/TIME	SEX AGE
1		AUG/22/2002 19:52:40	
2		AUG/22/2002 19:47:28	
3		AUG/22/2002 19:46:44	
4		AUG/22/2002 19:46:09	
5		AUG/22/2002 19:42:32	
6		AUG/22/2002 19:41:58	
7		AUG/22/2002 19:41:09	
8		AUG/22/2002 13:52:46	
9		AUG/20/2002 16:42:05	
10		AUG/20/2002 16:41:31	

1/10

LIST [] [] ALL [←]

- 3 Select [LIST] or press [START/STOP] to start printing the ECG data list.

To stop printing while the list is being printed, touch [STOP] or press [START/STOP].

Note:

If the magazine is open or recording paper runs out while printing the ECG data list, printing is canceled automatically.

Transmitting ECG Data to a PC

ECG data stored in the memory of the FX-7202 can be transmitted to a PC. In addition, this data can be transmitted automatically.

When you select data transmission to a PC via a LAN, you can choose either SCP-ECG or Fukuda Original as the data format. To view Fukuda Original data on a PC, EFS-200 must be installed. See Appendix D for more information on the SCP-ECG format and on how to connect to a LAN.

Operation

1 Perform an electrocardiogram examination.

Select [**START/STOP**] in any examination mode and perform a single electrocardiogram examination.

2 Display the Mode select window.

Select [**MENU**] to display the **Mode select** window.

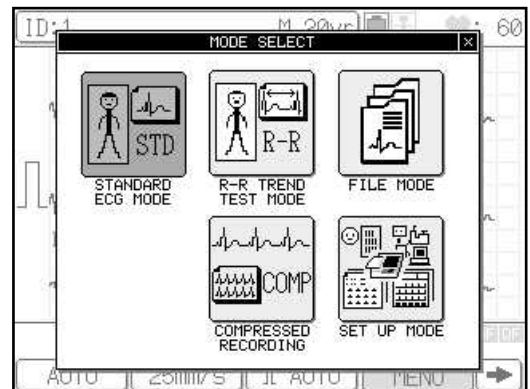

3 Select [**FILE MODE**].

The FILE MODE (MENU) window appears.

4 Touch [**ECG DATA TRANSMITTING**].

When there is data stored in memory, the ECG Data Transmitting window is displayed. When there is no data, the [NO DATA] message is displayed.

Touch [**REVIEW**] when you want to check the contents of the data before transmitting.

Notes:

- The display example shows the display prior to transmitting ECG data. Only [STOP] is displayed during transmission.

5 Select [SEND] to transmit the ECG data to the PC.

ECG data is transmitted to the PC when [SEND] is touched. During transmission, the [ECG DATA SENDING] message is displayed.

Notes:

- The same ECG data may be transmitted as many times as desired.

6 Select [MENU].

The display returns to FILE MODE (MENU).

Notes:

- Automatic Transmission
ECG data can also be transmitted to a PC following completion of an electrocardiogram examination without having to perform the above procedure. To do this, set [AUTO SENDING] to [ON] on the **SET UP MODE (MENU)** window.

Transmitting ECG Data Stored in Memory to a PC

ECG data stored in memory of the FX-7202 can be selected from a record list and then transmitted to a PC.

Operation

1 Perform steps 1 to 3 of “Transmitting ECG Data to a PC.”

Display the **ECG DATA TRANSMITTING** window of the FILE MODE.

2 Touch [MEDIA] on the FILE MODE (ECG DATA TRANSMITTING) window.

A record list is displayed on the ECG DATA TRANSMITTING window. A list is displayed of data stored in memory of the FX-7202.

Notes:

- The display example shows an example of the display prior to transmitting ECG data. Only [STOP] is displayed during transmission.

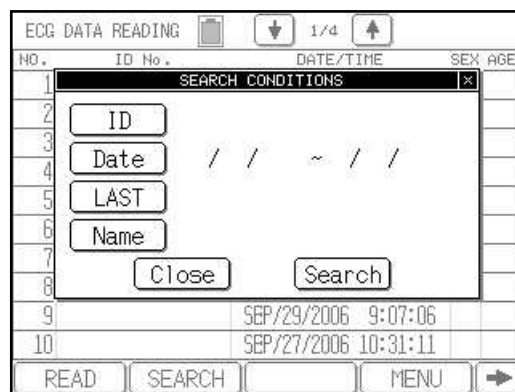

3 Select the data to be transmitted.

Touch the number of the data to be transmitted. You can also collectively select multiple data all at once. The selected data is highlighted.

When a mistake has been made in selecting the data, touch the number of the data to be transmitted again. The previous selection is canceled.

4 Transmit the selected ECG data.

The selected ECG data is transmitted in numerical order when [SEND] is touched. Touch [STOP] to interrupt transmission after it has begun.

Notes:

- You can touch the [↓] or [↑] keys to display the previous page and next page, if these pages are available.

5 Select [MENU].

The display returns to FILE MODE (MENU).

3. Additional Settings

This chapter provides an explanation of additional settings. Refer to Chapter 7 of the FX-7202 Operation Manual for information on other settings and operating procedures.

Overview of Parameters

FILE MODEL

Parameter	Setting	Description
Auto Sending	ON, OFF*	Automatically transmits result data to a PC after completing an examination.
ECG IP Address		Used to enter the IP address assigned to the FX-7202. The IP address is required to be unique within the network. Determine the address after consulting with the network administrator.
Host IP Address		Used to enter the IP address of the host installed with the FTP server.
FTP User Name		Used to enter the user name when verifying the FTP and the FTP server.
FTP Password		Used to enter the password when verifying the FTP and the FTP server.
Path		Used to enter the directory path where data transmitted from the FX-7202 is to be saved. Enter a path that is below the directory set for the local path set of the FTP server.
Data format	SCP-ECG Fukuda Original*	Specifies the output data format when the data is sent via a LAN. To view data in Fukuda Original format on a PC, EFS-200 must be installed.

4. ECG Data

The following provides an explanation of the ECG data sent as a reply from the FX-7202 to the PC.

Data can be output in either Fukuda Original format or SCP-ECG (Standard Communications Protocol for Computer-Assisted Electrocardiography) format. Use Set Up mode to select the format.

Data in Fukuda Original format can only be viewed on a PC with EFS-200 installed. The SCP-ECG format is compliant with the IEC 62D/443/NP protocol (proposed on August 17, 2001).

An explanation of the SCP-ECG format output by the FX-7202 is given below.

List of SCP-ECG Data Structures

Data Structures of 12-Lead Electrocardiograms

Record Header	Checksum CCITT over the entire record	
Record Header	Size of the entire ECG record (in bytes)	
Section 0	Pointers to data areas in the record	
Section 1	Header Information Patient data / ECG acquisition data	
Section 3	ECG Lead definition	
Section 6	Encoded rhythm data	
Section 7	Global measurements	
Section 8	Textual diagnosis from the "INTERPRETIVE" device	PC-7403
Section 10	Lead measurement results	

Data Structures of Arrhythmia ECG Mode PC-7403

Record Header	Checksum CCITT over the entire record
Record Header	Size of the entire ECG record (in bytes)
Section 0	Pointers to data areas in the record
Section 1	Header Information Patient data / ECG acquisition data
Section 3	ECG Lead definition
Section 6	Encoded rhythm data
Section 7	Global measurements

Section 8	Textual diagnosis from the "INTERPRETIVE" device
Section 10	Lead measurement results

Data Structures of R-R Trend Test Mode

Record Header	Checksum CCITT over the entire record
Record Header	Size of the entire ECG record (in bytes)
Section 0	Pointers to data areas in the record
Section 1	Header Information Patient data / ECG acquisition data
Section 3	ECG Lead definition
Section 6	Encoded rhythm data
Section 128	Lead measurement results (only for R-R Trend Test Mode)

Section Configurations

This section provides an explanation of the data of each section set with the FX-7202. Explanations are omitted for those sections for which data has already been set by SCP-ECG.

Section 0

This section contains data that has already been set by SCP-ECG.

Section 1

This section contains data that already been set by SCP-ECG. Since tag information is set in section 1, an explanation is only provided for tag data set with the FX-7202.

List of Tags Used

Tag No.	Description	
0	Name	Since the FX-7202 does not distinguish between first name and last name, name information is set here.
2	Patient ID	
4	Age	
5	Date-of-birth	
6	Height	
7	Weight	
8	Sex	
9	Race	
10	Drugs	
11	Systolic blood pressure	
12	Diastolic blood pressure	
14	Machine ID Acquiring Device	
15	Machine ID Analyzing Device	PC-7403
16	Acquiring Institution Description	
17	Analyzing Institution Description	PC-7403
18	Acquiring Department Description	
19	Analyzing Department Description	PC-7403
20	Referring Physician	
21	Latest Confirming Physician	
22	Technician Description	
25	Date of Acquisition	
26	Time of Acquisition	
27	Baseline Filter	
28	Low-pass Filter	
29	Filter Bit Map	
30	Free Text Field	

200	Affiliation	FX-7202 original data
201	Avg. blood pressure	FX-7202 original data
202	Medication information 2	FX-7202 original data
203	Subjective symptoms	FX-7202 original data
204	BMI	FX-7202 original data
205	Presentation	FX-7202 original data
206	Respiration rate	FX-7202 original data
207	Load category	FX-7202 original data
208	Load information	FX-7202 original data
209	Terminal no.	FX-7202 original data
210	Physician name	FX-7202 original data
211	Name of correcting person	FX-7202 original data
212	Correction date	FX-7202 original data
213	Correction time	FX-7202 original data
214	Order no.	FX-7202 original data
254	Comments	FX-7202 original data
255	None (demographic section terminator)	

The following provides an explanation of FX-7202 original data.

TAG	LENGTH	VALUE (Parameter data)		
200	96	Additional affiliation data (Text Character)		
			Byte	Contents
			1-32	Affiliation 2
			33-64	Affiliation 3
		65-96	Affiliation 4	
201	2	Avg. blood pressure (binary)- units: mmHg		
202	Arbitrary	Medication information (Text Character)		
203	Arbitrary	Subjective symptoms (Text Character)		
204	4	BMI (binary)		
			Byte	Contents
			1-2	BMI
			3	Location of decimal point
		4	Reserved	

205	2	Presentation (binary)	
206	2	Respiration rate (binary)	
207	4	Load category (binary)	
208	34	Load information (binary)	
		Byte	Contents
		1-2	Type of load device
		3-4	Elapsed time (hours)
		5-6	Elapsed time (minutes)
		7-8	Elapsed time (seconds)
		9-10	Protocol
		11-12	Stage no.
		13-14	Stage time (minutes)
		15-16	Stage time (seconds)
		17-18	Watts
		19-20	RPMs
		21-34	Findings at rest code A maximum of 7 codes are set with 2 bytes
209	2	Terminal no. (binary)	
210	196	Physician name (Text Characters)	
		Byte	Contents
		1-64	Physician name 2
		65-128	Physician name 3
		129-196	Physician name 4
211	64	Name of correcting person (Text Characters)	
212	6	Correction date (binary)	
		Byte	Contents
		1-2	Correction year
		3-4	Correction month
		5-6	Correction date
213	6	Correction time (binary)	
		Byte	Contents
		1-2	Correction hours
		3-4	Correction minutes
		5-6	Correction seconds

214	256	Order no. (Text Characters)	
		Byte	Contents
		1-128	Order no. 1
		129-256	Order no. 2
254	Arbitrary	Comments (Text Characters)	

Section 3

This section contains data that has already been set by SCP-ECG.

Section 6

This section contains data that has already been set by SCP-ECG. Furthermore, waveform data is set in the manner shown below. Waveform data is indicated with coded 2-byte data.

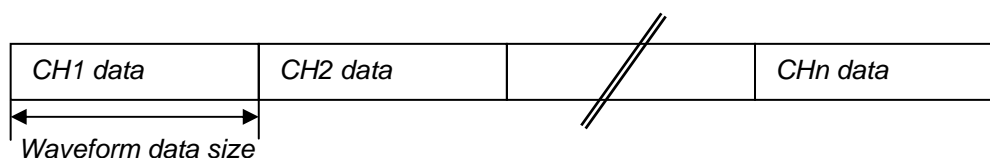

Section 7

This section contains data that has already been set by SCP-ECG.

Section 8

This section contains data that has already been set by SCP-ECG.

Section 10

This section contains data that has already been set by SCP-ECG. In addition, 56 bytes of data are also set as information specified by the manufacturer. The contents of information specified by the manufacturer are as shown below. Furthermore, all data is in the form of coded 2-byte data, and the initial value is 0.

LENGTH	VALUE (Parameter data)
2	R-R time (binary)
2	P-R time (binary)
2	QRS time (binary)
2	ST1 time (binary) * This differs from the ST1 time of SCP-ECG.
2	ST2 time (binary) * This differs from the ST2 time of SCP-ECG.
2	ST3time (binary) * This differs from the ST3 time of SCP-ECG.
2	QRS peak-to-peak (binary)
2	FVT time (binary)
2	VAT1 time (binary)
2	VAT2 time (binary)
2	Noise value (binary)
2	QTc time (binary)
2	U wave amplitude (binary)

2	Notch (binary)
2	Noise level (binary)
2	Defective recording information (binary)
2	Trigger point (binary)
2	P wave beginning point (binary)
2	P wave ending point (binary)
2	QRS wave beginning point (binary)
2	QRS wave ending point (binary)
2	T wave beginning point (binary)
2	T wave ending point (binary)
2	Next R-R (binary)
2	Pre-compensation value (binary)
2	Post-compensation value (binary)
2	ST measurement interval (binary)
2	Reserved (binary)

Section 128

This is an original section that has not already been set by SCP-ECG, and is set for only the R-R Trend Test Mode. Contents relating to measured values of the R-R Trend Test Mode are set in section 128.

The following provides an explanation of the data of section 128.

LENGTH	VALUE (Parameter data)
600	Typical measured value
608	R-R histogram data
150	Heart beat flag 1
Arbitrary	R wave position
Arbitrary	R-R time
Arbitrary	Heart beat flag 2
Arbitrary	Heart beat flag V
Arbitrary	Heart beat flag A

The following provides an explanation of individual data.

Typical Measured Value Data

LENGTH	VALUE (Parameter data)
2	Sampling interval (binary) Sampling interval is set in μ sec units with coded 2-byte data.
2	Test time (binary) Test time is set in second units with coded 2-byte data.
2	No. of test R waves (binary) The number of R waves detected during the testing time is set with coded 2-byte data.
2	Average heart rate (binary) Average heart rate is set with coded 2-byte data.

2	Average R-R time (binary) Average R-R time is set with coded 2-byte data.
2	Maximum R-R time (binary) Maximum R-R time is set with coded 2-byte data.
2	Minimum R-R time (binary) Minimum R-R time is set with coded 2-byte data.
2	Maximum/minimum R-R time (binary) The ratio of maximum R-R time to minimum R-R time is set with coded 2-byte data.
2	Standard deviation (binary) The standard deviation of R-R interval is set with coded 2-byte data.
2	Coefficient of variation (binary) The coefficient of variation of R-R interval is set with coded 2-byte data.
2	Test conditions (binary) The test conditions of the R-R Trend Test Mode are set. -1: Undefined 0: 1 min. 1: 2 min. 2: 3 min. 3: 4 min. 4: 5 min. 5: 100 beats 6: 200 beats 7: 40 sec. 8: 6 min. 9: 7 min. 10: 8 min. 11: 9 min. 12: 10 min.
2	Respiration rate (binary) Respiration rate is set with coded 2-byte data.
2	Presentation (binary) The presentation is set. -1: Undefined 1: Lying 2: Sitting 3: Standing
2	Analysis sampling unit (binary) The analysis sampling unit during R-R measurement is set in μ sec units with coded 2-byte data.
2	Analysis version no. (binary) The analysis version used during R-R measurement is set.
30	Reserved

R-R Histogram Data

LENGTH	VALUE (Parameter data)	
4	Data for R-R interval of less than 30 seconds (binary)	
	Byte	Contents
	1-2	No. of data records
	3-4	Ratio (units: %)
4	Data for R-R interval of 0.30 to less than 0.31 seconds (binary)	
	Byte	Contents
	1-2	No. of data records
	3-4	Ratio (units: %)
4	Data for R-R interval of 0.31 to less than 0.32 seconds (binary)	
	Byte	Contents
	1-2	No. of data records
	3-4	Ratio (units: %)
Data is similarly set in 0.01 second intervals.		
4	Data for R-R interval of 1.79 to less than 1.80 seconds (binary)	
	Byte	Contents
	1-2	No. of data records
	3-4	Ratio (units: %)
4	Data for R-R interval of 1.80 seconds or longer (binary)	
	Byte	Contents
	1-2	No. of data records
	3-4	Ratio (units: %)

Heart Beat Flag

Heart beats are set as being normal or abnormal for up to 1200 detected beats from the start of testing. When a heart beat has been judged to be abnormal, a "1" is set for the corresponding BIT. An example of the manner in which data is set is as shown below.

BIT 7	BIT 6	BIT 5	BIT 4	BIT 3	BIT 2	BIT 1	BIT 0
1st beat	2nd beat	3rd beat	4th beat	5th beat	6th beat	7th beat	8th beat
1st byte	2nd byte	//		150th byte			
Beats 1-8	Beats 9-16	//		Beats 1193-1200			

R Wave Position

The position of the detected R wave is set. Information on R wave position is set in several sets of detected R waves.

LENGTH	VALUE (Parameter data)
2	Parameter length (binary) The size of the data set for R wave position information is set with coded 2-byte data.
4 x No. of R waves	R wave position (binary) R wave position from the start of testing is set in msec units in the order of detection with non-coded 4-byte data.

R-R Time

The R-R time is set based on the detected R waves. Information on R-R time is set for several sets of detected R-R times.

LENGTH	VALUE (Parameter data)
2	Parameter length (binary) The size of data set for R-R time information is set with coded 2-byte data.
2 x No. of R-R Times	R-R time (binary) R-R time is set in msec units in the order of detection with non-coded 2-byte data.

Heart Beat Flag 2

Data is set for whether a detected heart beat is normal or abnormal. Differing from the previously described Heart Beat Flag, information is set for the entire duration of testing. The size of heart beat flag 2 is set for the first 2 bytes of Heart Beat Flag 2. The data configuration of heart beat flag 2 is the same as that of the Heart Beat Flag.

BIT 7	BIT 6	BIT 5	BIT 4	BIT 3	BIT 2	BIT 1	BIT 0								
1st beat	2nd beat	3rd beat	4th beat	5th beat	6th beat	7th beat	8th beat								
<table border="1" style="width: 100%; border-collapse: collapse;"> <tr> <td style="width: 25%;">1st byte</td> <td style="width: 25%;">2nd byte</td> <td style="width: 25%; text-align: center;">//</td> <td style="width: 25%;">Nth byte</td> </tr> <tr> <td>Beats 1-8</td> <td>Beats 9-16</td> <td style="text-align: center;">//</td> <td>Beats n-7 to n</td> </tr> </table>								1st byte	2nd byte	//	Nth byte	Beats 1-8	Beats 9-16	//	Beats n-7 to n
1st byte	2nd byte	//	Nth byte												
Beats 1-8	Beats 9-16	//	Beats n-7 to n												

Heart Beat Flag V

Data is set for whether a detected heart beat is PVC. The size of Heart Beat Flag V is set for the first 2 bytes of heart beat flag V. When a detected heart beat has been judged to be PVC, a "1" is set for the corresponding BIT. The data configuration of Heart Beat Flag V is the same as that of Heart Beat Flag 2.

BIT 7	BIT 6	BIT 5	BIT 4	BIT 3	BIT 2	BIT 1	BIT 0
1st beat	2nd beat	3rd beat	4th beat	5th beat	6th beat	7th beat	8th beat
1st byte	2nd byte					Nth byte	
Beats 1-8	Beats 9-16					Beats n-7 to n	

Heart Beat Flag A

Data is set for whether a detected heart beat is PAC. When a detected heart beat has been judged to be PAC, a “1” is set for the corresponding bit. The data configuration of Heart Beat Flag A is the same as that of Heart Beat Flag 2.

BIT 7	BIT 6	BIT 5	BIT 4	BIT 3	BIT 2	BIT 1	BIT 0
1st beat	2nd beat	3rd beat	4th beat	5th beat	6th beat	7th beat	8th beat
1st byte	2nd byte					Nth byte	
Beats 1-8	Beats 9-16					Beats n-7 to n	

Glossary

Backup battery:

A Lithium battery used for retaining clock data. For replacement, contact your local Fukuda Denshi service representative.

Coefficient of variation (CV):

The R-R Trend Test Mode measures the R-R interval of the sampled ECG waveform and calculates the coefficient of variation using the following formula:

$$\text{Coefficient of variation (CV)} = \frac{\text{Standard deviation}}{\text{Average RR}} \times 100\%$$

Dominant waveform:

Removes beats suspected to be a premature beat, beats with baseline disturbance, and noise used for measuring each waveform (P wave, R wave, etc.) among the ECG waveforms sampled for 12-lead analysis, picks the best beat as a typical waveform. This is called a dominant waveform.

The Dominant waveform is used to calculate the following parameters in Analysis and Measurement Recording:

P-R, QRS, QTc, AXIS, RV5(6), SV1, and R+S.

For a complete discussion of waveform parameters, see the supplied "Program Guide Book" (PI-13).

Electrical axis:

The FX-7202 calculates the electrical axis of the QRS complex using the following formula:

$$\text{Electrical axis (}^\circ\text{)} = \text{Tan}^{-1} \left(\frac{\sqrt{3} (\text{II} + \text{III})}{2 \times \text{I} + \text{II} - \text{III}} \right)$$

Filter:

Noise such as AC interference (50/60Hz), electromyogram (25Hz or more), and drift (0.5Hz or less) may become mixed with the ECG signal. The filters can eliminate such noise. The FX-7202 performs digital processing using a microcomputer. Note, however, when the muscle filter is used, the amplitude of the QRS complex could be reduced.

Heart rate indication:

The FX-7202 displays the heart rate on the screen. The lead specified for the RHYTHM LEAD parameter (SET UP MODE (STANDARD ECG MODE)) is used and the average of 4 beats are calculated. This value is displayed as the heart rate.

Histogram:

Displayed on the R-R trend test result report. The measured R-R interval is indicated on the horizontal axis and its frequency is indicated as a percentage on the vertical axis.

A histogram picks up only the normal beat from all the R-R intervals measured, and represents these normal beats in a graph.

Minnesota code:

The Minnesota code was developed by the University of Minnesota in the U.S., and is designed so the 12-lead ECG can be classified objectively by a common standard. For details about the Minnesota code, see the supplied "Program Guide Book" (PI-18).

Standard deviation (SD):

The R-R Trend Test Mode measures the R-R interval of the sampled ECG waveform and calculates the standard deviation using the following formula:

$$\text{Standard deviation (SD)} = \sqrt{\frac{\sum_{n=1}^N (\text{RR}_n - \text{Average RR})^2}{N}}$$

Transitional zone:

Normally, the R wave gradually becomes larger from the V1 lead to V6 lead, and the S wave gradually becomes shallow. The lead portion where the R wave and S wave are nearly equal is called the transitional zone.

Trend graph:

Displayed on the R-R trend test result report. The elapsed time is indicated on the horizontal axis and the measured R-R interval is indicated on the vertical axis.

A trend graph represents all R-R intervals measured in a graph.

Index

A	
AC inlet	6, 7, 17
AC power supply	xi
age (AGE)	41, 45, 47, 48
ANL	20, 21
analysis comment	112
analysis recording	1, 56, 57, 108
analysis report	111, 114, 116
ARRH	20, 21
arrhythmia	77
Arrhythmia automatic extension recording	66, 77 to 78
Arrhythmia ECG Mode	1, 2, 44, 66, 73 to 76, 114
Arrhythmia ECG report	73, 114, 115
Automatic Recording Mode (AUTO)	53, 56, 57, 58 to 61
B	
backup battery	175
battery	7, 11, 30
battery level icon	42
charging the battery	32
installing the battery pack	31
battery pack	See battery.
BATTERY PACK compartment	6, 7, 31
BATTERY PACK compartment cover	31
blood pressure (BP)	45, 50
built-in clock	See clock.
C	
calibrated 1mV waveform	39, 57, 65
CARTRIDGE compartment	6, 7, 33
CARTRIDGE compartment cover	33, 34
Charge lamp	32, 39, 40
chest electrode	9, 10, 38
attaching the chest electrodes	38
clock	23
setting the built-in clock	23 to 25
coefficient of variation (CV)	175
comment (COMT)	45, 51
consumables	11 to 12
CONTRAST	22
conventions	ii
CTL	20, 21
cut-off frequency	90, 120
D	
daily checks	130, 139
date format	23
setting the date format	23 to 25
department (DEPT)	45, 51
detailed measurement values	108, 112
display contrast	22
adjusting the display contrast	22
dominant waveform	175
down arrow button	100, 101
drift filter	90, 120
E	
ECG	1, 53, 56, 66
recording the ECG	53 to 55, 56 to 81
ECG data file management	1, 3, 82 to 89
printing a list of ECG data	88
reading ECG data from the built-in memory	83 to 88
searching ECG data	85 to 87
ECG mode	56
ECG waveforms	4, 53, 54, 55, 58, 62, 104 to 106, 109 to 111
analysis recording	108 to 112
Automatic Recording Mode	58
Manual Recording Mode	62
measurement recording	103 to 108
setting the ECG waveform display format	102 to 103
electrical axis	175
electrocardiograms	See ECG.
electrode	9, 10, 37
attaching the electrodes to the patient	37 to 38
warning icon for detached electrode	42
equipment symbols	xi
error message	133 to 135

F			
File Mode		44, 83	
filter		53, 59, 63, 70, 74, 175	
setting the filter ON/OFF		61, 64, 71, 75	
selecting filters		120	
filter display area		41, 42	
function keys		41, 42	
G			
ground		18	
connecting the ground		18	
H			
heart rate		41, 42, 175	
height (HT)		45, 49	
high-cut filter		120	
histogram		176	
hospital name		26, 91	
setting the hospital name		26 to 27	
hum filter		90, 120	
I			
ID		41, 45, 46	
ID area		41, 45, 46	
initial screen		20, 21	
installation site		13	
K			
Keratin cream		9, 10	
applying Keratin cream		37	
key		39	
L			
language		28, 91	
setting the language		28 to 29	
LAN port		xi, 6, 7, 35	
LCD		2, 22	
letters		101	
limb electrode		9, 10, 37	
attaching the limb electrodes		37	
M			
magazine cover		5, 14	
magazine open button		4, 5, 14	
main menus		44	
outline of each operation mode		44	
selecting a menu		44	
Main Power lamp		20, 21, 32, 39, 40	
Manual Recording Mode (MANUAL)		1, 56, 57, 62 to 65, 113	
measurement recording		1, 56, 57, 103	
measurement report		107	
medication (DRUG)		45, 50	
message area		41, 43	
Minnesota code		176	
Mode select window		44	
muscle filter		90, 120	
N			
name (NAME)		45, 48	
NO		20, 21	
numeric value		101	
O			
operation panel		4, 5, 39 to 40	
optional parts		11 to 12	
P			
paper magazine		4, 5	
patient cable		9, 10, 19	
connecting the patient cable		19	
connecting the patient cable to the electrodes		36	
removing the patient cable		19	
PATIENT connector		6, 7, 19	
patient data		45	
changing the patient data parameters		118 to 119	
entering the patient data		45 to 52	
periodic checks		130, 140 to 141	
personal computer		35	
potential equalization cable		12, 18	
potential equalization terminal		xi, 6, 7, 18	
power		20	
turning OFF power		21	
turning ON power		20	
power supply cord		7, 9, 10, 17	
connecting the power supply cord		17	
precautions		v to x	
program cartridge		ii, 1, 7, 11, 56	
installing the program cartridge		33 to 34	
Q			
QRS complex		175	

R		T	
race (RACE)	45, 49	thermal print head	4, 5
radio button	99, 100	touch-panel display	4, 41 to 43
rechargeable battery	See battery.	adjusting the display contrast	22
recording format	103 to 117	transitional zone	176
Arrhythmia ECG Mode	114 to 115	trend graph	176
Standard ECG Mode (analysis recording)	108 to 112		
Standard ECG Mode (manual recording)	113	W	
Standard ECG Mode (measurement recording)	103 to 108	ward (WARD)	45, 51
R-R Trend Test Mode	116 to 117	waveform display area	41, 42
recording paper	12, 14	waveform display channel	94, 102
loading the recording paper	14 to 16	selecting the number of waveform display channels	102 to 103
recording speed	53, 59, 61, 63, 65	weight (WT)	45, 49
changing the recording speed	61, 65		
review recording	61, 66, 67 to 68	Z	
R-R Trend Test Mode	1, 2, 44, 66, 69 to 72, 116 to 117	z-fold paper	8, 12, 14
R-R trend test report	69, 72, 117	loading the recording paper	14 to 16
S		Keys	
Safety icons	v	[1mV]	39
safety notifications	v	LEAD [◀] / [▶]	39
self-diagnostics test	123 to 129, 141	[POWER ON/OFF (Stby)]	20, 21, 39
sensitivity	53, 59, 61, 63, 70, 74	[RESET]	39
changing the sensitivity	61, 65, 72, 76	[REVIEW]	39
Set Up Mode	44, 90 to 120	[START/STOP]	39
ARRHTHMIA ECG MODE	96	SET UP parameters	
ECG CONTROL	90 to 91	ARRHTHMIA ECG MODE	
PATIENT DATA	92 to 93, 118 to 119	Analysis Report	96, 111
R-R TREND TEST MODE	97	Arrhythmia Lead 1CH	96
STANDARD ECG MODE	94 to 95	Arrhythmia Lead 2CH	96
SET UP MODE menu	90, 98	Arrhythmia Lead 3CH	96
SET UP parameters	90 to 97	ECG Report	96, 114
general flow of the parameter setup procedure	98 to 101	Measured Value	96, 114
initializing parameters	121 to 122	ECG CONTROL	
sex (SEX)	41, 45, 47	Cut-off Frequency	90, 120
silicon cloth	8	Date	24, 91
standard deviation (SD)	176	Date Type	24, 91
Standard ECG Mode	1, 44, 53, 56, 59, 63, 68	Drift Filter	90, 120
standard 12-lead ECG	1, 2	Hospital	27, 91
standby status	21	Hum Filter	90, 120
standby screen	See initial screen.	Key Click	90
symptom (SYMP)	45, 50	Language	29, 91
		Lead Off Buzzer	91
		Muscle Filter	90, 120
		QRS Beep	91
		Time	24, 91
		Width of Baseline	90

PATIENT DATA

Auto ID No. Inc	92, 118
Blood Pressure	92, 119
Comment	92, 119
Department	93, 119
Drug	92, 119
Fixed ID Number	92, 118
Height	92, 119
Input Birthday	48, 92, 118
Name	92, 118
Race	92, 119
Symptoms	92, 119
Ward	92, 119
Weight	92, 119

R-R TREND TEST MODE

Analysis Report	97, 116
ECG Report	97, 116
R-R Trend Lead	97
Measured Value	97, 116

STANDARD ECG MODE

Auto Mode Change	94
Auto Recording CH.	94, 104, 109
Auto Sensitivity	94
Comment	95, 112
Display Channel	94, 102
ECG View	95
Lead Change Line	94
Manual Record CH.	94
Measured Value	95, 108
Recording Length	94, 104, 109
Report Format	95, 107, 111
Rhythm Lead	94, 104, 109



FUKUDA DENSHI CO.,LTD.

39-4, Hongo 3-chome, Bunkyo-ku, Tokyo, Japan

Phone:+81-3-3815-2121 Fax:+81-3-3814-1222

4L002987E 200810