



**Southeast Toyota Distributors, LLC  
Accessory Installation Instructions**

# 2018 Tacoma Power Tailgate Lock

Year & Model:	2018 Tacoma
Part Number:	00016-34092
Accessory Code:	TL1000
PIO / DIO:	PIO / DIO
Business Partner:	J64

## Conflicts

Note: Vehicles Without Power Door Locks.

## General Applicability

Fits Models	
1	2018 Models With Power Door Locks.

## Additional Items Required For Installation

Item#	Description:
1.	N/A

### Sequence of Application

Item#	Accessory:
1.	N/A







#### **SPECIALNOTE: Installation Sequences**

After TMS & Safety mandated preparatory steps have been taken, the installation sequence is the suggested method for completing the accessory installation. In some instances the suggested sequence is written for one associate to install & in others the sequence is given as part of a team accessory installation. Unless otherwise stated in the document, the associates may perform the installation steps in any order to make the installation as efficient as possible while maintaining consistent quality.

### Recommended Tools

Safety Tools	Notes
Safety Glasses	Required
Installation Tools	Notes
Torx (Star) Bit/ Driver	T-30
Pliers	7/64" with 2" Drill Stop
Screwdriver	Small Flat Head
Drill Bit	11/32"
Wrench	10mm
Torque Wrench	48 in.lbs.
Box Blade Cutter	
Special Chemicals	
VPC Approved Silicon Sealant	
Special Tools	Notes
N/A	

### Legend

-  **STOP:** Damage to the vehicle may occur. Do not proceed until process has been complied with.
-  **OPERATOR SAFETY:** Use caution to avoid risk of injury.
-  **CAUTION:** A process that must be carefully observed in order to reduce the risk of damage to the accessory/vehicle and to ensure a quality installation.
-  **TOOLS & EQUIPMENT:** Used in Figures calls out the specific tools and equipment recommended for this process.
-  **REVISION MARK:** This mark highlights a change in installation with respect to previous issue.
-  **SAFETY TORQUE:** This mark indicates that torque is related to safety.

**Table of Contents**

---

- I. Preparation.....1-5
  - a.) Table of Contents.....2
  - b.) Kit/Hardware & Wire Harness Bag Contents.....3
  - c.) Parts for Installation.....4
  - d.) Service & Warranty Information.....5
  
- II. Procedures
  - a.) Battery Removal.....6
  - b.) Vehicle Disassembly –Installation Process.....6-16
  
- III. Re-install Battery.....16
- IV. Function and Quality Check.....17
- V. Diagnostic /Block Diagrams & Connectors Procedures.....18
- VI. Warranty Statement.....18-20

**Kit/Hardware Bag Contents:**

<b>Item #</b>	<b>Quantity</b>	<b>Description</b>
1.	2	Wire Taps
2.	25	Cable Ties

**Parts for Installation:**

Care must be taken when installing this accessory to ensure damage does not occur to the vehicle. The installation of this accessory should follow approved guidelines to ensure a quality installation. These guidelines can be found in the “Accessory Installation Practices” document.

This document covers such items as:

- Vehicle Protection (use of covers and blankets, cleaning chemicals, etc.).
- Safety (eye protection, re-checking torque procedure, etc.).
- Vehicle Disassembly/ Reassembly (panel removal, part storage, etc.).
- Electrical Component Disassembly/Reassembly (battery disconnection, connector removal, etc.).

Item #	Quantity	Description
1.	1	Power Lock assembly
2.	1	Long Wire Harness
3.	1	Short Wire Harness
4.	2	Wire Taps
5.	25	Cable Ties



**Service & Warranty Information:**

Image Key	Parts information		Warranty Information	
	Part Number	Description	Warranty Time	Labor Op. Code
A	00016-34092	Tailgate Power Lock	0.5	ALO001

Labor times include consideration for diagnosis and Administration time.

If you are a dealer located outside of the Southeast Region, please contact the SET Accessory Warranty Department at (888) 851-2722 or email [Accessory.Warranty@SEToyota.com](mailto:Accessory.Warranty@SEToyota.com) for claim payment instructions.

**Image:**





Figure 1

**Battery Removal**

- 1. Remove the negative battery cable. See Figure 1.



**DO NOT** come in contact with the positive terminal during the removal of the negative cable.



**NOTE:** Wait a minimum of 90 seconds for the SRS system to power down.

**Vehicle Disassembly and Installation**

- 2. Remove the T-30 Torx screws that hold the access panel on the inside of the tailgate and remove the access panel. See Figure 2.



Figure 2

- 3. Unclip and remove passenger side latch rod. Do this by rotating the clip off the rod and lifting the rod out of the clip (You may need to use a small screw driver to rotate clip). Lay it to the side. See Figure 3.



Figure 3



- 4. Remove the passenger side mounting bolt with a 10 MM wrench. See Figure 4.

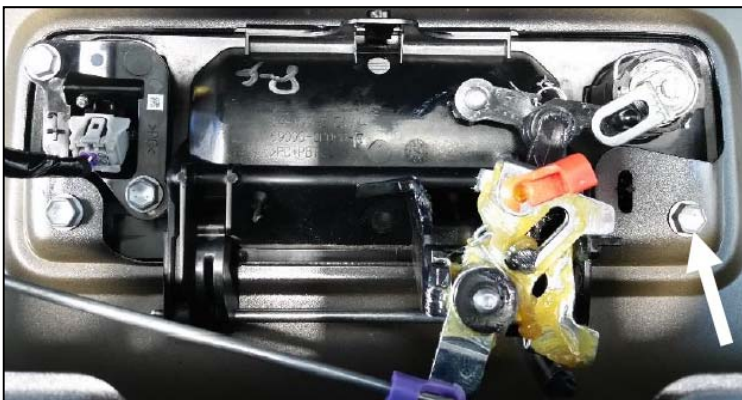

Figure 4





Figure 5a

5. Mount the power lock inside the tailgate to the passenger side of the handle. One hole in the bracket will align with the mounting bolt remove in the last step. The other hole will straddle a plastic post on the handle. Insert the handle mounting bolt into the hole and tighten. The factory locking arm will lie between the two tabs on the power lock slide bar. See Figures 5a and 5b.



**NOTE: The actuator obscures the mounting bolt, you will have to start the mounting bolt by hand and tighten it using a wrench.**



Figure 5b



6. Locate the 2 plastic wire holders underneath the tailgate where the factory wire harness runs from under the truck bed and into the bottom of the tailgate. Drill an 11/32" hole through both plastic wire holders. From underneath the truck bed insert the bullet connectors through the hole now drilled through the plastic wire holder located at the bottom of the truck bed. Then insert them through the hole now drilled in the plastic wire holder at the bottom of the tailgate. Pull the bullet connectors and all the wire from the short harness up through the tailgate leaving only about 2 inches of wire and the Delphi plug exposed. This will make it easy to unplug for tailgate removal. See Figure 6.



Figure 6



Figure 7

7. Connect the bullet connectors from the short cable to the actuator on the power lock maintaining green to green and blue to blue. Roll up and secure extra wire with a cable tie to the center tailgate support. Ensure that the wire is tied not to get entangled with any of moving handle or power lock parts. See Figure 7.

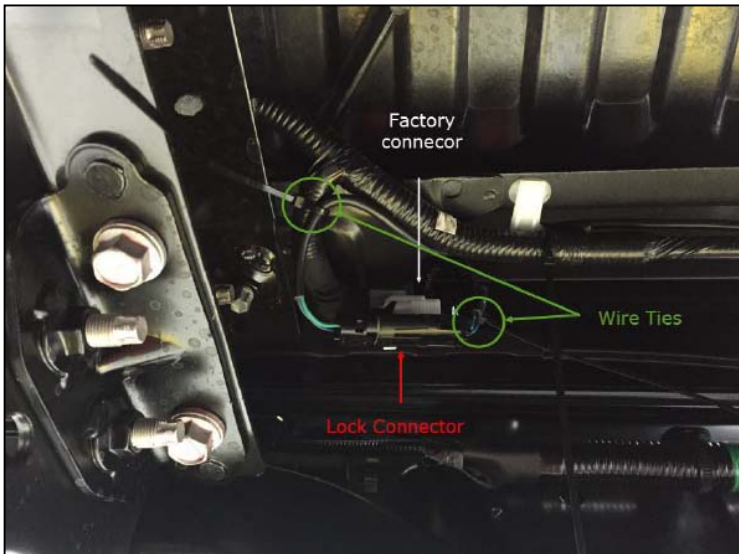

Figure 8

8. Plug the waterproof connector of the long wire harness into the waterproof connector of the short harness. Secure the long wire harness under the truck bed maintaining easy access to the Delphi plug for tailgate removal. Also make sure the taigate can be open and closed without pinching any part of the connector or the wire. See Figure 8.



**NOTE: Do not secure any part of the short harness to the actual truck or tailgate won't be able to be removed.**





Figure 9

9. Run the Long Wiring Cable along the main factory wiring harness that runs across the back of the truck towards the driver side. Secure it about every 16 inches with the cable ties. See Figure 9.



**NOTE: When running the wiring cables make sure to secure the wire so it does not touch the exhaust or get pinched.**

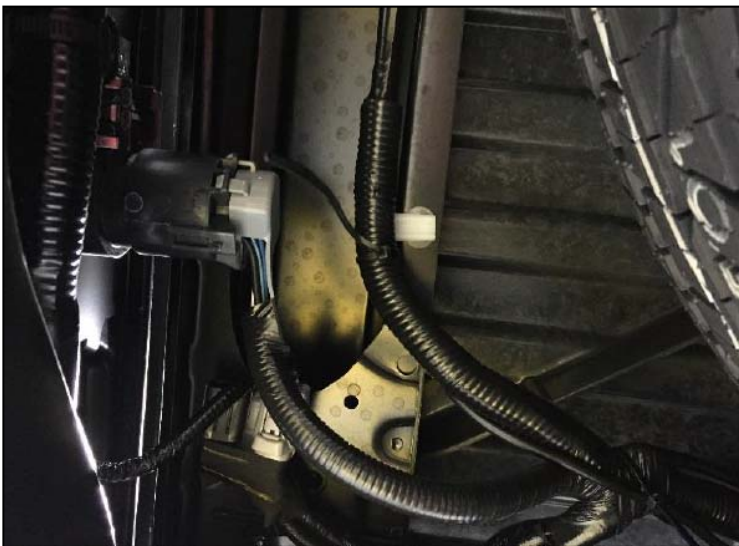

Figure 10a

10. Continue to run the Long Wiring Cable along the main factory wiring harness from the rear driver side of the truck up to the rubber grommet located under the front driver seat. Secure it about every 16 inches with the cable ties. See Figures 10a and 10b.



Figure 10b



Figure 11a

11. Remove the driver side step plate. Start by gently pulling up at the end towards the front and continue to pull up working towards the rear of the truck. Be careful not to break the snap clips while pulling up. Remove the driver side kick panel. Start by removing the nut that hold the kick panel on. Gently pull the panel towards you carefully not to break any of the plastic. See Figures 11a and 11b.



Figure 11b

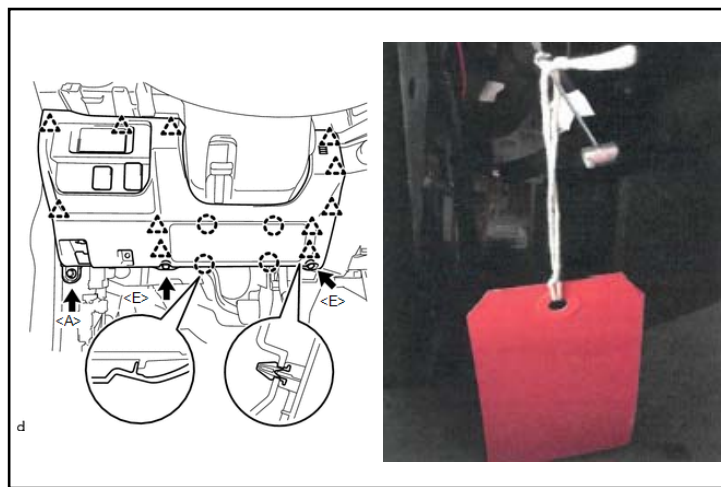

Figure 12

12. Remove the bolt. Remove the 2 screws. Disengage the 11 clips and 4 claws. Disconnect the connectors to remove the instrument panel lower finish panel sub-assembly.

**Note:** Place Red Tag on instrument panel sub-assembly or hood release cable when removing hood latch cable from the hood latch release lever. See Figure 12. Red Tag required for PIO only. Tag is not part of the kit contents.

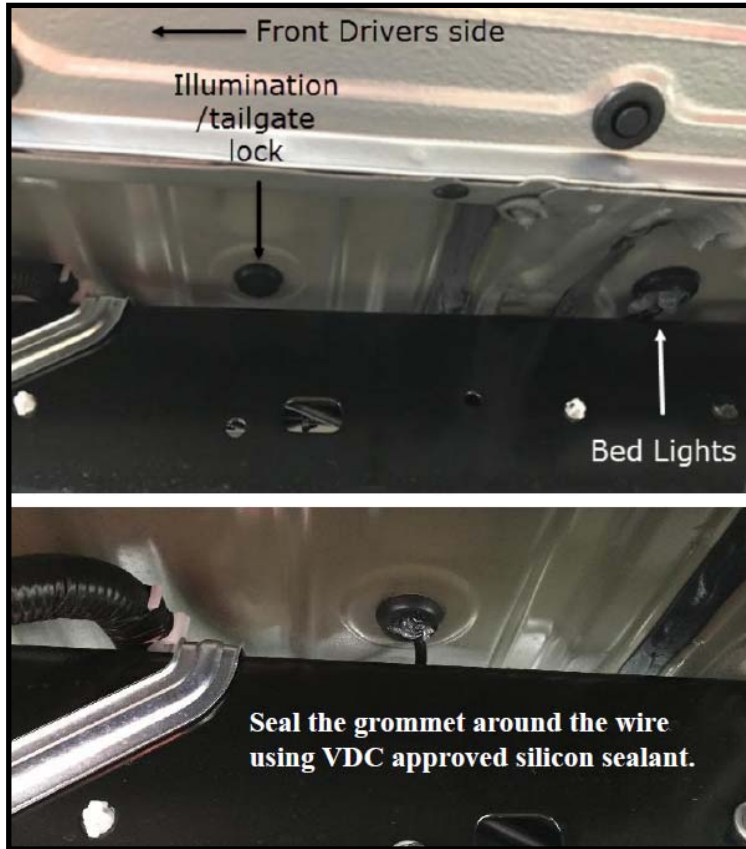

Figure 13

13. Locate the rubber grommet underneath the driver seat. Cut a small slit in the rubber grommet. Snake the rest of the long wiring cable up through the slit, and run the wire from under the carpet and into the step sill area. See Figure 13.



Figure 14

14. Run the wire along the step sill area up into the driver side kick panel securing under factory white plastic wire holders. See Figure 14.



**STOP Manual Transmission Vehicles Only**

15. Remove the (2) 10MM nuts on the driver side junction Block. See Figure 15.

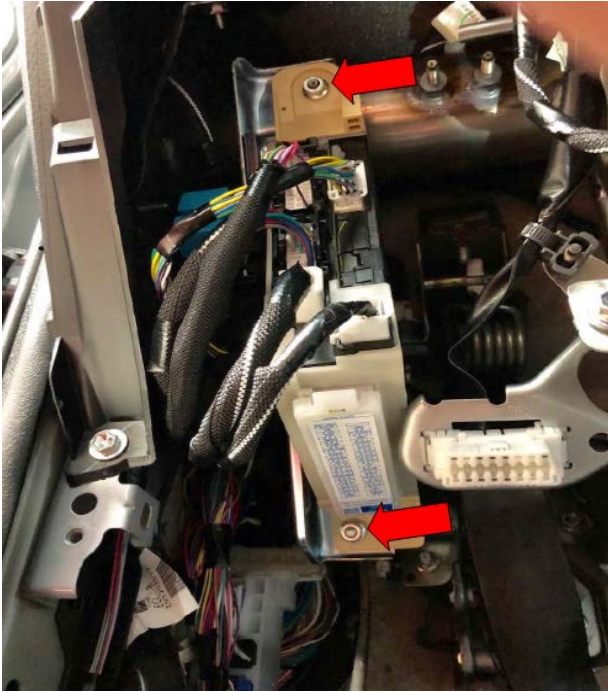

Figure 15

16. Only disconnect the 1D Connector on the back side of the Driver Side J/B. See Figure 16.

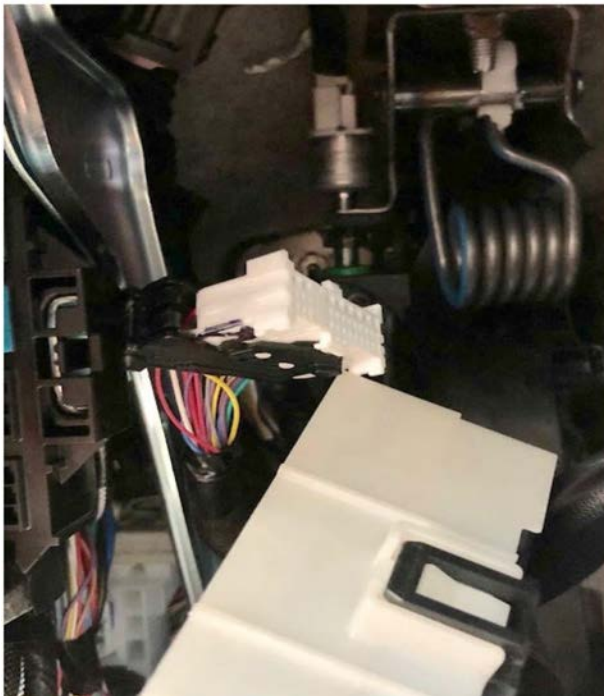

Figure 16



**Automatic Transmission Vehicles**

**DO NOT Remove the 10MM nuts on the JB.**

- 17. Locate the 1D Connector on the back side of the Driver Side J/B. See Figure 17.

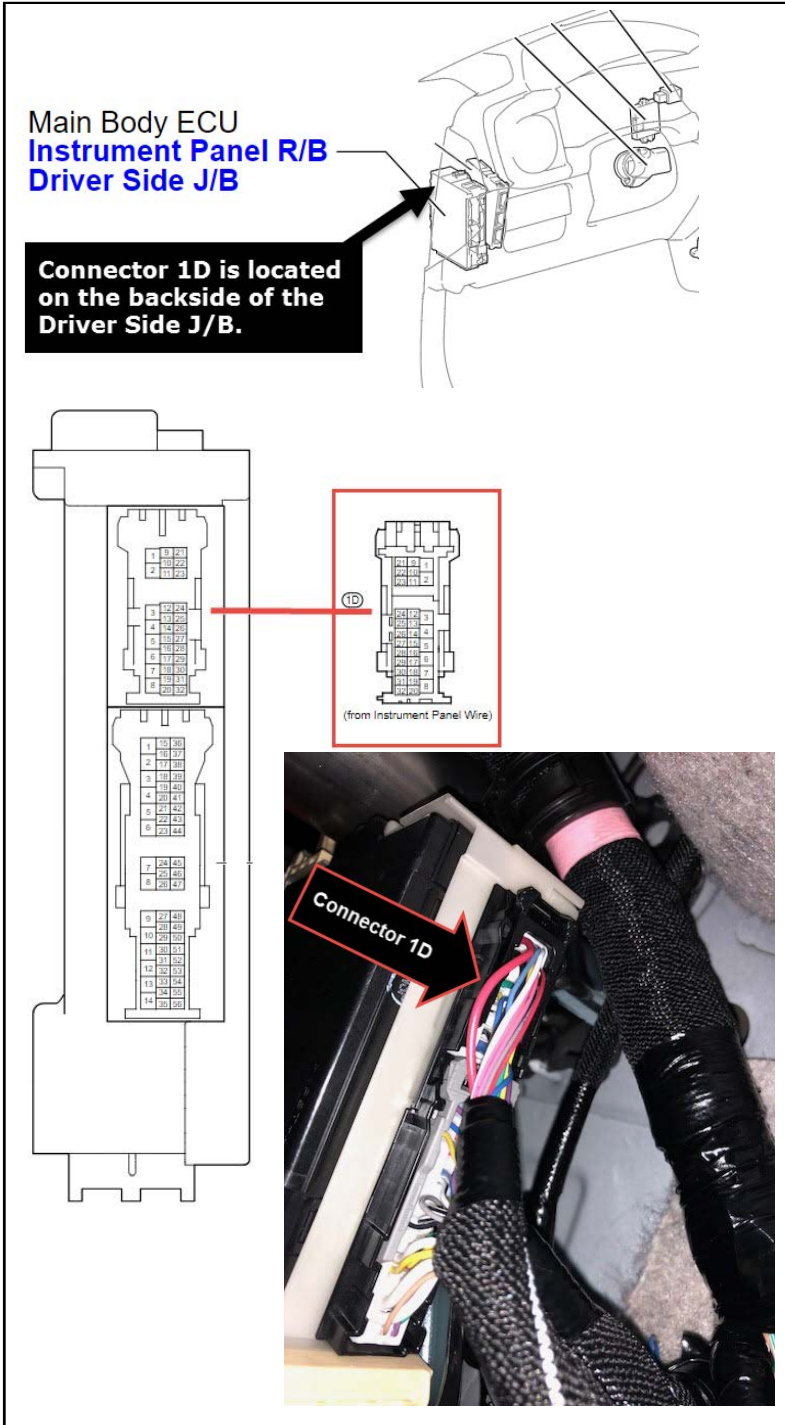
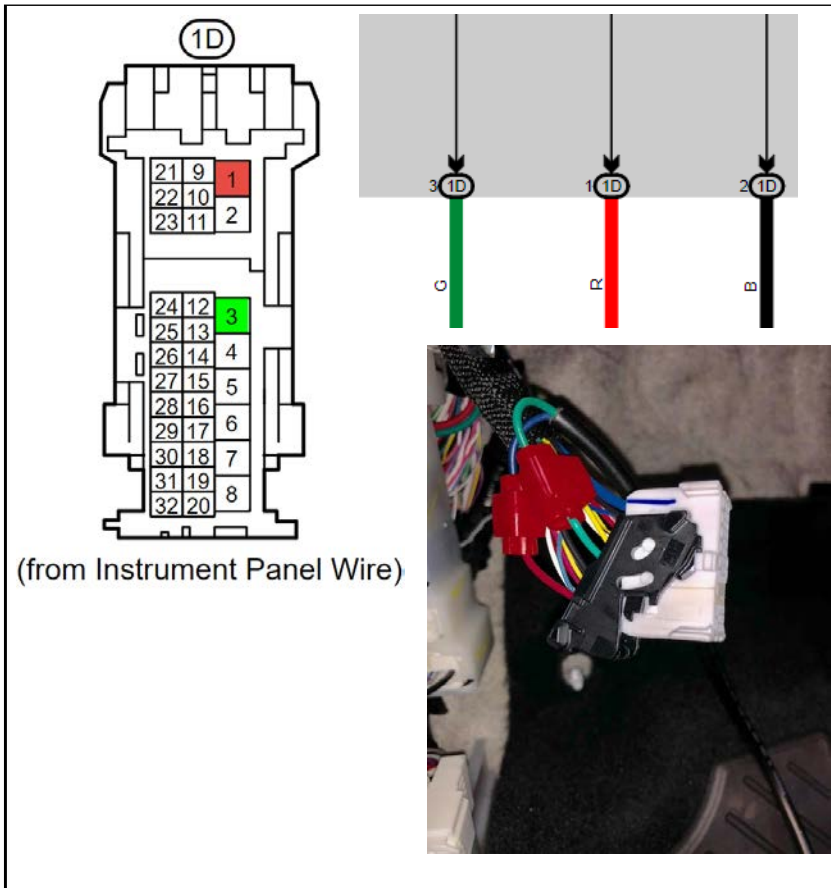

Figure 17





18. Locate the green wire at pin 3 and use the splice connector to attach the green wire from the long wiring cable. Locate the red wire at pin 1 and use the splice connector to attach the blue wire from the long wiring cable. See Figures 18a and 18b.

Figure 18a



Figure 18b

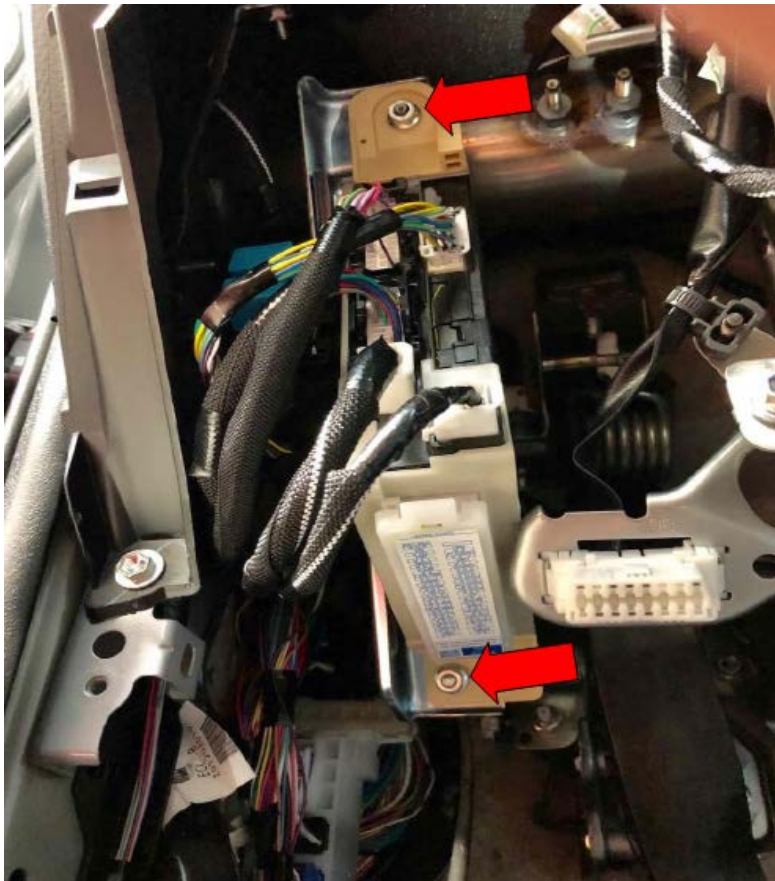

Figure 19

**STOP Manual Transmission Vehicles Only**

19. Re-install the Driver side J/B onto bracket. Torque the 10MM nuts to 48 in. lbs. See Figure 19.



**Note: Carefully hand start nut and hand tighten. DO NOT use impact gun or power tools.**



**Torque: 48 in. lbs.**



Figure 20

- 20. Using wire ties, secure the excess wire harness to the vehicle factory harnesses as shown. See Figure 20.
- 21. The power lock should lock and unlock the tailgate with the remote or door switch. See Figure 21.

**NOTE: The tailgate still can be locked and unlock with the factory key.**

**Troubleshooting Note: If the power lock functions opposite of the doors locks, switch the wires at the bullet connectors. Connect the blue to green and green to blue.**

**Troubleshooting Note: If the lock has no power hold the quick splicer and give the wire going into a little twist. This will help ensure that the quick splice cuts through the plastic shielding on the wire.**

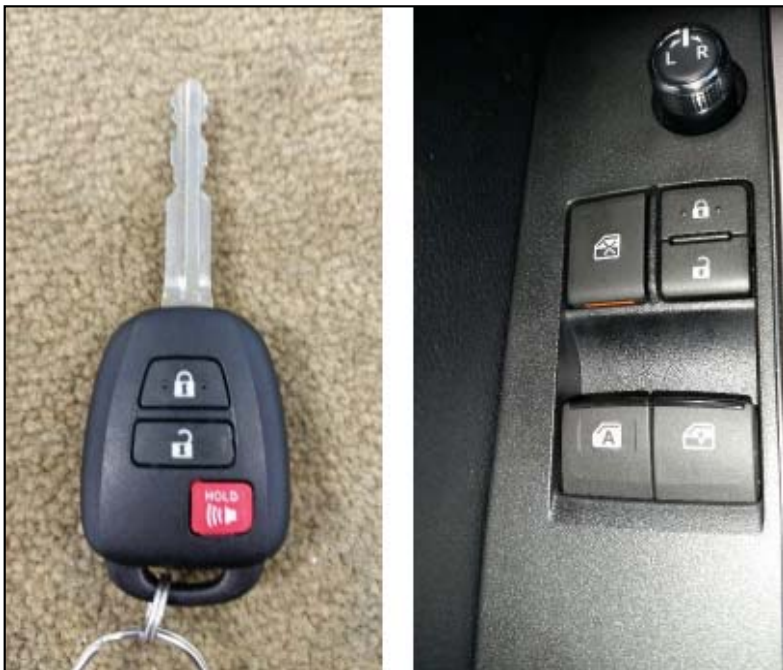

Figure 21

- 22. If the power lock functions properly reinstall the driver side kick panel and tailgate access panel.
- 23. After all panels, covers and components have been reinstalled, that were removed, test thoroughly all mechanical and electrical components disconnected and or removed from the vehicle during the installation of this accessory.
- 24. Print Warranty Statement and place in the glove box, DIO only.

**Re-install Battery**

- 25. Reconnect negative battery terminal.  
**Torque terminal to 48 in. lbs.**



**FUNCTION AND QUALITY CHECK**

These points **MUST** be checked to ensure a quality installation.

**ACCESSORY FUNCTION CHECK****LOOK FOR:**

- |                                |   |
|--------------------------------|---|
| ✓ Factory Door Lock Switch     | The power lock should lock and unlock the tailgate with the factory door switch.                |
| ✓ Factory Key FOB.             | The power lock should lock and unlock the tailgate with the Factory Key FOB.                    |
| <b>Vehicle Function Check:</b> |   |
| ✓ Check Factory Door Locks     | The factory vehicle door locks should lock and unlock with the factory door switch and Key FOB. |
| ✓ Warranty Statement           | Place Warranty Statement in the glove box, DIO Only.  |



Diagnostic /Block Diagrams & Connectors Procedures

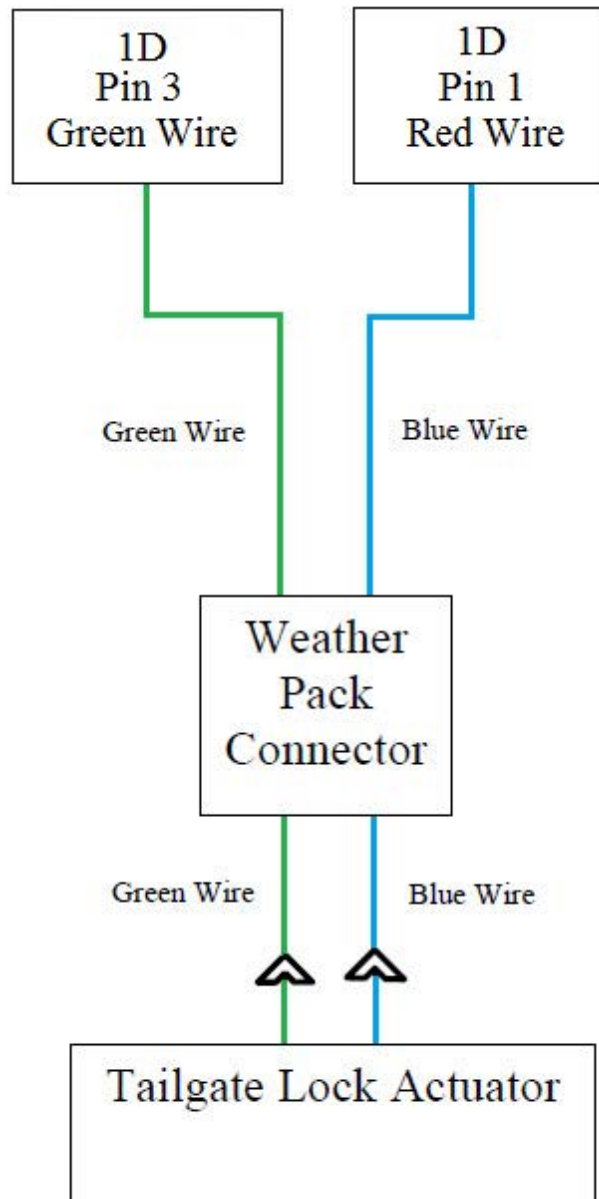



## LIMITED WARRANTY – SOUTHEAST TOYOTA

SOUTHEAST TOYOTA DISTRIBUTORS, LLC (“we,” “our” and “us”) provides the following limited warranty on our accessories, excluding tires, (“Accessories” or “Accessory”) installed on a Toyota. This limited warranty is not provided by and does not bind or provide benefit to the vehicle dealer, the manufacturer, or Toyota Motor Sales, U.S.A., Inc. This limited warranty does not apply to tires; please consult the tire manufacturer and/or its materials accompanying the vehicle for any warranty terms concerning tires. This limited warranty also does not apply to ToyoGuard Exterior Paint Sealant and ToyoGuard Interior Protector; please consult the ToyoGuard Limited Warranty Certificate for the warranty terms concerning those products.

### SCOPE OF LIMITED WARRANTY:

#### A. Protection:

- i. **Accessories Installed by Southeast Toyota Distributors, LLC on a new Toyota vehicle.** We warrant that, for a period of 36 months or 36,000 miles, whichever occurs first, we will repair or replace (includes labor), free of charge, any defect in such an Accessory due to faulty material or workmanship, or, at our option, provide a full refund of the purchase price of the Accessory. The warranty period begins on the vehicle’s In-Service Date, which is the first date the new vehicle is either delivered to an ultimate purchaser, leased, or used as a company car or demonstrator. Accessories installed by Southeast Toyota Distributors, LLC are identified on the vehicle’s window sticker (Monroney Label).
- ii. **Accessories Installed by a Toyota Dealer on a Toyota vehicle.** We warrant that, for 12 months, regardless of mileage, from the date such an Accessory was installed on the vehicle or the remainder of the Toyota new vehicle warranty, whichever is longer, we will repair or replace (includes labor), free of charge, any defect in the Accessory due to faulty material or workmanship, or, at our option, provide a full refund of the purchase price of the Accessory. For a new vehicle, the warranty period begins on the vehicle’s In-Service Date, which is the first date the new vehicle is either delivered to an ultimate purchaser, leased, or used as a company car or demonstrator.
- iii. **Accessories purchased from a Toyota Dealer but not installed by the Toyota Dealer.** We warrant that, for a period of 12 months, regardless of mileage, from the date the accessory was purchased, we will repair or replace (does not include labor), free of charge, any defect in the Accessory due to faulty material or workmanship, or, at our option, provide a full refund of the purchase price of the Accessory.

**B. Limitation of Warranty.** This limited warranty does not apply to, and we will not repair, replace, or reimburse you for: (1) wheel balancing and wheel alignments, except for one wheel balancing or alignment during the first 12 months or 12,000 miles, whichever occurs first, from the vehicle’s In-Service Date, as defined above, (2) abrasions or dents, whatever their cause, and any failure or damage resulting directly or indirectly from accidents, collisions, impacts from foreign objects, fire, theft, larceny, explosion, malicious mischief, vandalism, civil commotion, riots, war, or any other similar causes, (3) any failure or damage resulting directly or indirectly from lightning, windstorms, hail, water, floods, subfreezing temperatures, airborne chemicals, tree sap, dust, salt, and any other environmental conditions or similar causes, (4) any failure or damage caused by: (a) a failure of any part, other than the Accessory, (b) any misuse, abuse, improper towing, negligence or lack of maintenance of the vehicle or Accessory, (c) the alteration, modification or repair of the Accessory by anyone other than persons expressly authorized by us to perform such alteration, modification or repair, or (d) the use of the vehicle for commercial purposes, competitive driving or racing, (5) any failure or damage, if the Accessory has not been installed according to instructions, (6) any failure or damage occurring outside of Canada, the United States of America, its territories or possessions, (7) except to the extent required by the state whose laws govern this limited warranty, any consequential, secondary, or unreasonable costs that may be suffered as a result of the need to repair or replace the Accessory, including without limitation any loss of use of the vehicle, road service, towing, storage charges, inconvenience, loss of wages and/or income, additional expense incurred, loss of transportation, rental car expense, or any derivative damage to persons or things other than the Accessory, including other parts of the vehicle, or (8) liability for damage to property or for injury to or death of any person, arising out of the operation, maintenance or use of your vehicle whether or not related to the covered Accessory.

**C. Exclusive Remedy.** If there is a valid claim under this limited warranty for a defect due to faulty material or workmanship in the Accessory, we will, at our option, either: (i) repair, (ii) replace or (iii) provide a full refund of the purchase price of the Accessory. We have no other obligations under this limited warranty. Refunds will be made to the vehicle owner. If the vehicle is leased, the refund will be made to the leasing company.

**HOW TO MAKE A CLAIM:** In the event of a warranty claim, please contact the nearest Toyota dealer to arrange for repairs. The dealership must receive our prior authorization before making repairs covered by this limited warranty. The dealer will contact Southeast Toyota Distributors, LLC at 1-888-851-2722, select option #5 (Warranty Department), then option #4 (Repairs), for instructions on processing a warranty claim, if they are not already familiar with the process. If you have any questions or concerns regarding repairs covered by this limited warranty, please contact our Customer Assistance Hotline at 1-800-301-6859.

**OUR DISPUTE RESOLUTION PROGRAM:** Your satisfaction is our highest priority. In keeping with that focus, in the event that an issue arises related to this Limited Warranty, we invite you to call our Customer Assistance Hotline at 1-800-301-6859 to discuss it. In most cases, we expect that a satisfactory resolution of your issue can be reached through engagement with that Department. If our Customer Loyalty Department is unable to resolve your issue to your satisfaction, we offer a dispute resolution program administered by the National Center for Dispute Settlement (NCDS) (“the Program”). The purpose of the Program is to resolve disputes in an informal setting before an impartial arbitrator. The Program is free of charge to you (although you must bear the cost of any expert witness or attorney you elect to employ). You are required to complete the Program before exercising rights or seeking remedies under the federal Magnuson-Moss Warranty Act, 15 U.S.C. § 2301 et seq. (“the Act”). If you choose to seek remedies that are not created by the Act, you are not required to use the Program before pursuing such remedies – although the Program is still available to you to resolve the dispute. When utilizing the Program, you will need to provide (a) the vehicle identification number of your vehicle, (b) the identity of your selling and servicing dealerships, (c) the mileage on your vehicle at relevant times, (d) the date and nature of any relevant repairs, (e) legible copies of repair orders and other relevant documents, (f) a summary of the unresolved issue and the requested action, and (g) your contact information. In most cases, the dispute resolution process under the Program will be completed within forty (40) days of your submission of your request and will consist of steps such as an initial eligibility determination, an opportunity for you and us to submit information in writing relating to your claim, an oral hearing, and a decision from the arbitrator. A decision will be binding on you only if you choose to accept it. You may submit a request to NCDS by telephone at their toll free number: (877)-276-8848 or in writing at P.O. Box 463196, Mt. Clemens, MI 48046. You may obtain additional information regarding the Program at [www.ncdsusa.org](http://www.ncdsusa.org). In the event that the NCDS does not exist or no longer handles disputes for us at the time that you seek to submit a request, you may contact our Customer Assistance Hotline at 1-800-301-6859 to obtain current information about our dispute resolution programs.

**GENERAL LIMITATION OF WARRANTY:** THIS LIMITED WARRANTY IS IN LIEU OF ALL OTHER EXPRESS WARRANTIES OR LIABILITIES. IN NO EVENT SHALL WE BE LIABLE FOR ANY CONSEQUENTIAL OR INCIDENTAL DAMAGES FOR BREACH OF THIS OR ANY OTHER WARRANTY. SOME STATES DO NOT ALLOW THE EXCLUSIONS OR LIMITATIONS OF INCIDENTAL OR CONSEQUENTIAL DAMAGES, SO THE ABOVE INFORMATION OR EXCLUSION MAY NOT APPLY. NO EXPRESS WARRANTY OF FITNESS OR MERCHANTABILITY IS GRANTED BY THIS LIMITED WARRANTY. THERE ARE NO WARRANTIES WHICH EXTEND BEYOND THOSE DESCRIBED IN THIS DOCUMENT. ANY IMPLIED WARRANTIES, INCLUDING THE IMPLIED WARRANTY OF MERCHANTABILITY OR FITNESS FOR A PARTICULAR PURPOSE, WHICH MAY BE APPLICABLE BY OPERATION OF LAW SHALL BE LIMITED TO THE PERIOD OF THIS WRITTEN LIMITED WARRANTY. SOME STATES DO NOT ALLOW LIMITATIONS ON HOW LONG AN IMPLIED WARRANTY LASTS, SO THE ABOVE LIMITATIONS MAY NOT APPLY. THIS LIMITED WARRANTY PROVIDES SPECIFIC LEGAL RIGHTS, AND THERE MAY BE OTHER RIGHTS WHICH VARY FROM STATE TO STATE. ANY ACTION FOR BREACH OF ANY WARRANTY HEREUNDER, INCLUDING ANY IMPLIED WARRANTY OF MERCHANTABILITY, MUST BE BROUGHT WITHIN A PERIOD NOT EXCEEDING 12 MONTHS AFTER EXPIRATION OF THIS LIMITED WARRANTY. THE REMEDIES SPECIFIED HEREIN AND THOSE SPECIFIED BY APPLICABLE LAW ARE THE ONLY REMEDIES AVAILABLE. WE ASSUME NO OTHER OBLIGATION OR RESPONSIBILITY WITH REGARD TO THE ACCESSORY. WE NEITHER ASSUME, NOR AUTHORIZE ANYONE TO ASSUME FOR US, ANY ADDITIONAL LIABILITY IN CONNECTION HEREWITH.

**GENERAL:** This limited warranty describes the complete and exclusive rights that result from the purchase of Accessories. No oral representations or statements may be relied upon. This limited warranty may not be amended or modified, and additional rights may not be granted, unless in a written statement signed by one of our officers. This limited warranty shall be governed by the laws of the state where the vehicle is purchased, excluding laws concerning conflicts of law. We may delegate the performance of our duties and obligations and assign our rights and benefits hereunder. For inquiries regarding this limited warranty, we can be contacted directly at **Customer Assistance Hotline at 1-800-301-6859**, or by mail to: **Southeast Toyota Distributors, LLC, Attention: Customer Loyalty Department, 100 Jim Moran Boulevard, Deerfield Beach, Florida 33442.**