

Reference Guide for Microprocessor Controller

Please read and save these instructions for future reference. Read carefully before attempting to assemble, install, operate or maintain the product described. Protect yourself and others by observing all safety information. Failure to comply with these instructions will result in voiding of the product warranty and may result in personal injury and/or property damage.

TAP v2.60
Version Date: 1/1/18

Energy Recovery & Make-Up Air Technical Support
Call 1-800-240-0870, press 1 for Service



Introduction

Program Features

The microprocessor controller offers improved control through easy monitoring and adjustment of unit parameters by way of a lighted graphical display and an integral push-button keypad.

Pre-Programmed Operating Sequences

The controller has been pre-programmed to offer multiple control sequences to provide tempered air. Factory default settings allow for easy setup and commissioning. The sequence parameters are fully adjustable. Refer to the Sequence of Operation for details.

BMS Communication

With the addition of an optional BMS communication card, the user can remotely adjust set points, view unit status points and alarms. The microprocessor controller is capable of communicating over several protocols:

- BACnet® MSTP
- LonWorks®
- BACnet® IP/Ethernet
- ModBus

See Points List for a complete list of BMS points.

Internal Time Clock (Schedule)

The controller has an internal programmable time clock, allowing the user to add up to seven different occupancy schedules. The user may also add holidays for additional energy savings. The time clock option also has morning warm-up capability for optimal comfort at the time of occupancy.

Alarm Management

The microprocessor controller will monitor the unit's status for alarm conditions. Upon detecting an alarm, the controller will record the alarm description, time, date, temperatures, and unit status for user review. A digital output is reserved for remote alarm indication. Alarms are also communicated via BMS (if communication card is equipped).

Occupancy Modes

If equipped with a microprocessor controller, there are three modes of determining occupancy: a dry contact, the internal time clock or the BMS. If in the unoccupied mode the unit will either be shut down, or will cycle on to maintain adjustable unoccupied room temperature set points (room temperature sensor is optional).

Remote Display Keyboard (Optional)

A touchpad display keyboard allows for remote monitoring and adjustment of parameters, allowing ease of control access without going outdoors.









WARNING

Electrical shock hazard. Can cause personal injury or equipment damage. Service must be performed only by personnel that are knowledgeable in the operation of the equipment being controlled.

WARNING

Mechanical high static protection cutoffs must be installed by others to protect the system and equipment from over-pressurization when using factory provided control sensors. The manufacturer does not assume responsibility for this.

Table of Contents

Sequence of Operation	
General Operation	2
Set Point Control.	3
Heating.	3
Cooling.	3
Economizer	4
Supply Fan VFD	4
Outdoor Air and Recirculation (Recirc) Air	4
Alarms	4
pCO _e Controller Overviews	5
Small Controller Overview	6
Display Use	6
Example of Parameter Adjustment	7
Alarms	7
Unit Alarm Descriptions	8
Furnace Alarm Descriptions	9
Menu Overview	10-11
Main Menu Overview	12-13
Menus	
A.  On/Off Unit	14
B.  Setpoint	15-18
C.  Clock/Scheduler	19
D.  Input/Output	20
E.  Data Logger	20
F.  Board Switch.	20
G.  Service	
a. Information.	20
b. Overrides	20-22
c. BMS Config	22-23
d. Service Settings	24
e. Commissioning	
a. Furnace Commissioning	24
H.  Manufacturer	
a. Configuration	25
b. I/O Configuration	25
c. Factory Settings	26-30
d. Initialization	31
Points List	
LonWorks®	32-33
ModBus/BACnet®	34-35
Remote Display	36
NTC Temperature Sensor Chart	36
Economizer Commissioning Tool	37
Troubleshooting	37
Appendix A:	
BACnet® MSTP Quick Start	38
BACnet® IP/Eth Quick Start.	39
Appendix B: Room Thermostat Quick Start.	40-41
Appendix C: Expansion I/O (pCO _e) Quick Start.	42
Maintenance Log	43
Our Commitment.	Backcover

Sequence of Operation

The microprocessor controller can be configured for multiple make-up air applications. Each application utilizes similar technologies for heating and cooling: chilled water, hot water, indirect gas, electric heat, and packaged DX cooling. All set points, lockouts and delays are user adjustable via the integral keypad display.

General Operation

UNIT START COMMAND: The microprocessor controller requires a digital input to enable operation. The unit can then be commanded on or off by this digital input, the BMS or internal time clock.

- Initial delay
- Factory mounted and wired dampers are powered, *if equipped*. (Outdoor air and recirculation air dampers).
- Exhaust fan, *if equipped*
- Supply fan starts after the exhaust fan has proven
- Tempering operation begins

UNIT STOP COMMAND (OR DE-ENERGIZED):

- Supply fan, exhaust fan (*if equipped*), and tempering, are de-energized
- Outdoor air dampers are closed. Recirculation air dampers spring open.

OCCUPIED/UNOCCUPIED MODES: The microprocessor controller offers three modes of determining occupancy: a dry contact, the internal time clock or the BMS. When in the unoccupied mode, the unit can be configured to shut down, or cycle on to maintain the unoccupied room set points (night setback). The unit can be temporarily overridden to the occupied mode via a digital input or the keypad display.

- **Occupied Mode:**
 - Exhaust fan on, *if equipped*
 - Supply fan on
 - Heating (refer to Heating section)
 - Cooling (refer to Cooling section)
 - Damper control (refer to Outdoor Air and Recirculated Air section), *if equipped*.
- **Unoccupied Mode (Unit Off):** Unit remains off when in unoccupied mode.

- **Unoccupied Mode (Cycle on Room):** When a room temperature sensor is connected to the controller, the unit can be programmed to cycle on to maintain unoccupied room set points if there is a call for unoccupied heating or cooling in the space.
 - Exhaust fan off, *if equipped*
 - Supply fan on
 - If the unit is equipped with a VFD-(VAV) the supply fan will run at the VFD's minimum frequency.
 - If the unit is equipped with a mixing box, the recirculation air damper will open and the OA damper will be placed at a minimum position.
 - Tempering operations begin

Set Point Control (Occupied)

The supply air temperature set point can be configured as constant (local), or can be reset by either outside air temperature, or room temperature. If equipped with BMS communications, the user can also directly command the supply temperature set point, or room temperature set point (*if equipped with an optional room temp sensor*).

- **Outdoor Air Temperature Reset Function:** The controller will default to supply temperature reset based on outdoor air temperature. The controller will monitor the OA temperature and reset the supply temperature set point based upon the outdoor air reset function.
- **Room Temperature Reset (optional):** With a room temperature sensor, the controller will adjust the supply air temperature set point between the minimum (55°F adj.) and maximum (90°F adj.), to satisfy the desired room temperature.

Set Point Control (Unoccupied)

When equipped with an optional room temperature sensor, the unit can cycle on to maintain the unoccupied room set points.

- **Unoccupied Heating:** If equipped with heating, the unit is enabled when the room temperature is less than the unoccupied heating set point minus differential (65°F - 5°F). The supply air temperature set point will be set to the supply maximum reset limit (90°F). The unit cycles off when the room temperature reaches the unoccupied heating set point.
- **Unoccupied Cooling:** If equipped with cooling, the unit is enabled when the room temperature is greater than the unoccupied cooling set point plus differential (80°F+5°F). The supply air temperature set point will be set to the supply minimum reset limit (55°F). The unit cycles off when the room temperature reaches the unoccupied cooling set point.

Heating

The heating is controlled to maintain the supply temperature set point. The heating will be locked out when the outside air temperature is above the heating lockout (65°F adj.).

- **Direct Gas-Fired Burner:** Microprocessor controller will modulate the direct gas burner to maintain the supply temperature set point.
- **Indirect Gas Furnace:** Microprocessor controller will modulate the indirect gas furnace to maintain the supply temperature set point.
- **Hot Water Coil:** Microprocessor controller will modulate a hot water valve (provided by others) to maintain the supply temperature set point (0-10 Vdc). **Coil freeze protection must be provided by others in the field!**
- **Steam Coil:** Microprocessor controller will modulate a steam valve (provided by others) to maintain the supply temperature set point (0-10 Vdc). **Coil freeze protection must be provided by others in the field!**
- **Electric Heater:** Microprocessor controller will modulate an electric heater to maintain the supply temperature set point (0-10 Vdc).
- **Morning Warm-Up:** The unit uses an algorithm involving space temperature and heating/cooling rate of the previous day to determine the time required to efficiently temper the space occupied set point prior to occupancy (*optional room temp sensor is required*).

Cooling

The cooling is controlled to maintain the supply temperature set point. The mechanical cooling will be locked out when the outside air temperature is below the cooling lockout (80°F).

- **Chilled Water:** Microprocessor controller will modulate a chilled water valve (provided by others) to maintain supply air set point. **Coil freeze protection must be provided by others in the field!**
- **Packaged/Split DX Cooling (Standard Scroll):** Microprocessor controller will enable stages of cooling based on the outdoor air temperature.
- **Evaporative Cooling:** Microprocessor controller will enable and disable (stage on/off) the evaporative cooler solely based on the outdoor air temperature. If the outdoor air is above the OA set point in the Microprocessor (adj.), then evaporative cooling will be enabled.

Economizer

If the application requires cooling, and the outdoor air conditions are suitable for free cooling, the controller may enter the economizer state. If the unit is economizing and the discharge temperature set point is not being met, the controller may bring on mechanical cooling. If equipped with a modulating outdoor air and recirculated air damper, the dampers will modulate between the minimum OA and maximum positions to maintain the supply temperature set point.

- **Temperature:** The economizer will be locked out when:
 - The outside air is less than the economizer low lockout (40°F).
 - The outside air is greater than the economizer high lockout (65°F).
 - There is a call for heating.

Supply Fan VFD Sequence

If the factory has installed a VFD, the unit can be either constant volume, 2-speed, or variable air volume (VAV). The maximum speed can be adjusted for any airflow arrangement. For 2-speed operation both the high and low fan speeds can be set on the controller, and a field-wired switch to a digital input on the controller will switch the fan between the 2 speeds. If the unit has been configured for VAV operation, the minimum speed can also be adjusted during the test and balance. During VAV operation, the microprocessor controller will modulate the supply fan speed per one of the below listed control options. **Note:** If the MUA has been equipped with a protocol card, the supply fan speed can also be directly controlled through the BMS, *if equipped*.

- **Optional Room CO2 Sensor:** The controller will modulate the supply fan based upon a comparison of the CO2 set point to the actual CO2 levels reported from the sensor.
- **Optional Duct Static Pressure Sensor:** The controller will modulate the supply fan based upon a comparison of the duct static pressure set point to the actual duct static pressure level reported from the sensor.
- **Optional Building Static Pressure Sensor:** The controller will modulate the supply fan based upon a comparison of the building static pressure set point to the actual building static pressure level reported from the sensor.

Outdoor Air and Recirculating (Recirc) Air Damper Control

If equipped with a modulating outdoor air and recirculating air damper, the recirculated air damper will operate inverse of the outdoor air damper. The outdoor air damper will open to a Minimum Outdoor Air Position (Min OA) when in occupied mode. If the controller is configured to modulate the mixing box, the minimum and maximum OA positions can be modulated based on optional control types. The unit may also be configured to modulate the damper between two preset positions by using a dry contact. If equipped with BMS communications, the user can also directly reset the damper position up to the maximum OA position.

- **Optional Room/Duct CO2 Sensor:** The controller will proportionally modulate the OA/RA dampers based upon a comparison of the CO2 set point to the actual CO2 level reported from the sensor. As the CO2 level rises, the controller will proportionally modulate the outdoor air damper open, between the minimum and maximum OA position.
- **Optional Building Pressure:** The OA/RA dampers will modulate based upon the signal from a building static pressure sensor. The controller will modulate the dampers, between the minimum and maximum OA positions, based upon a comparison of the building static pressure set point to the actual building static pressure level reported from the sensor.

Alarms

The microprocessor controller includes a digital output for remote indication of an alarm condition, which connects via the **J15** port. Possible alarms include:

- **Dirty Filter Alarm:** If the outside air or return air filter differential pressure rises above the differential pressure switch set point, the microprocessor controller will activate an alarm.
- **Supply and Exhaust Air Proving Alarm:** Microprocessor controller monitors proving switch on each blower and displays an alarm in case of blower failure.
- **Sensor Alarm:** Microprocessor controller will send an alarm if a failed sensor is detected (temperature and pressure).
- **Supply Air Low Limit:** If the supply air temperature drops below the supply air low limit (35°F), the microprocessor controller will de-energize the unit and activate the alarm output after a preset time delay (300s).
- **Other Alarms:** High/Low Refrigerant Pressure, Standard Furnace Alarms, Flame Failure.

pCOe - 4:1 Furnace Overview

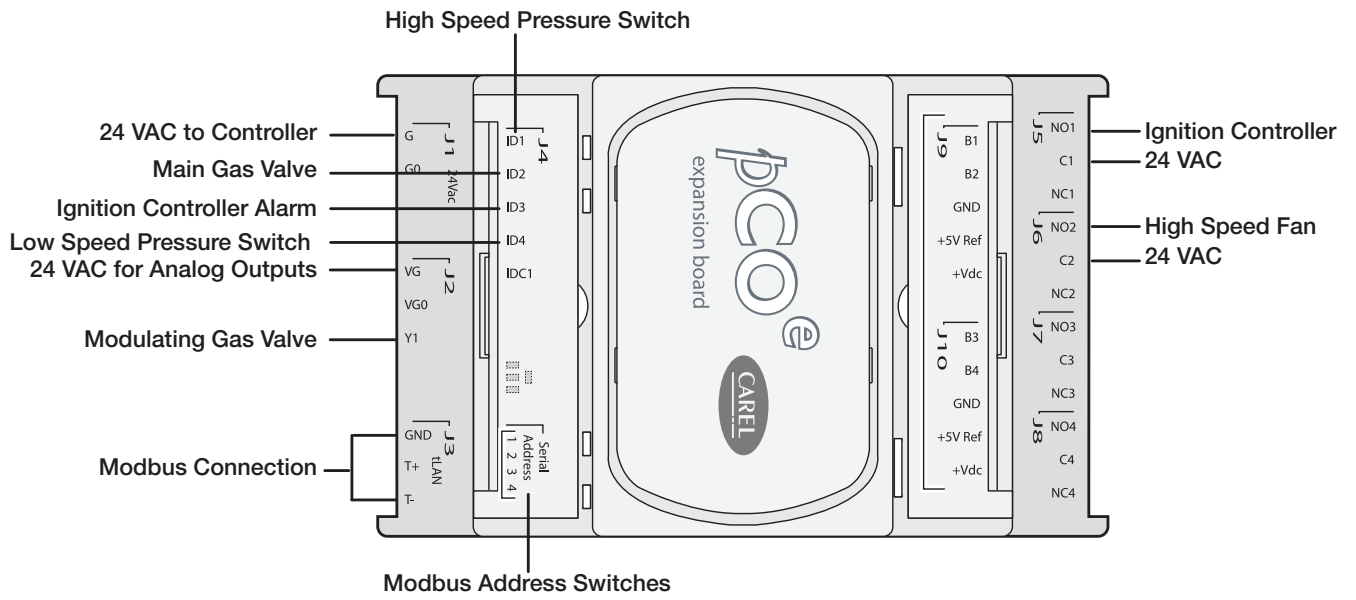

pCOe - High Turndown Furnace

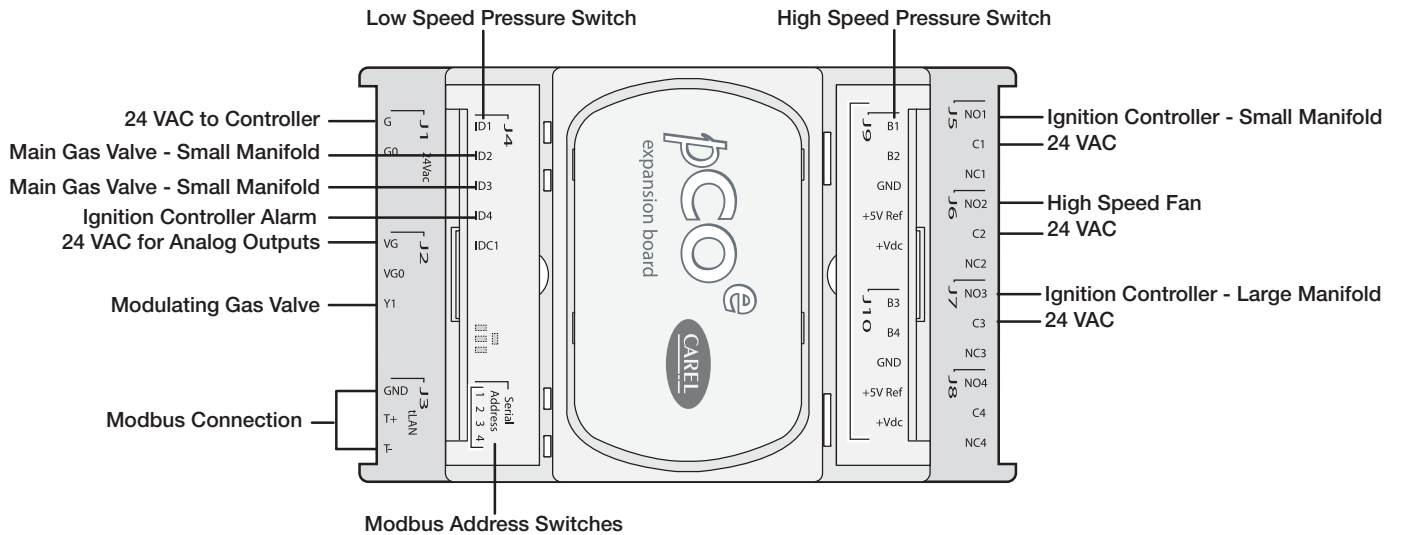

pCOe - Staged Furnace (2 and 3 furnace units)

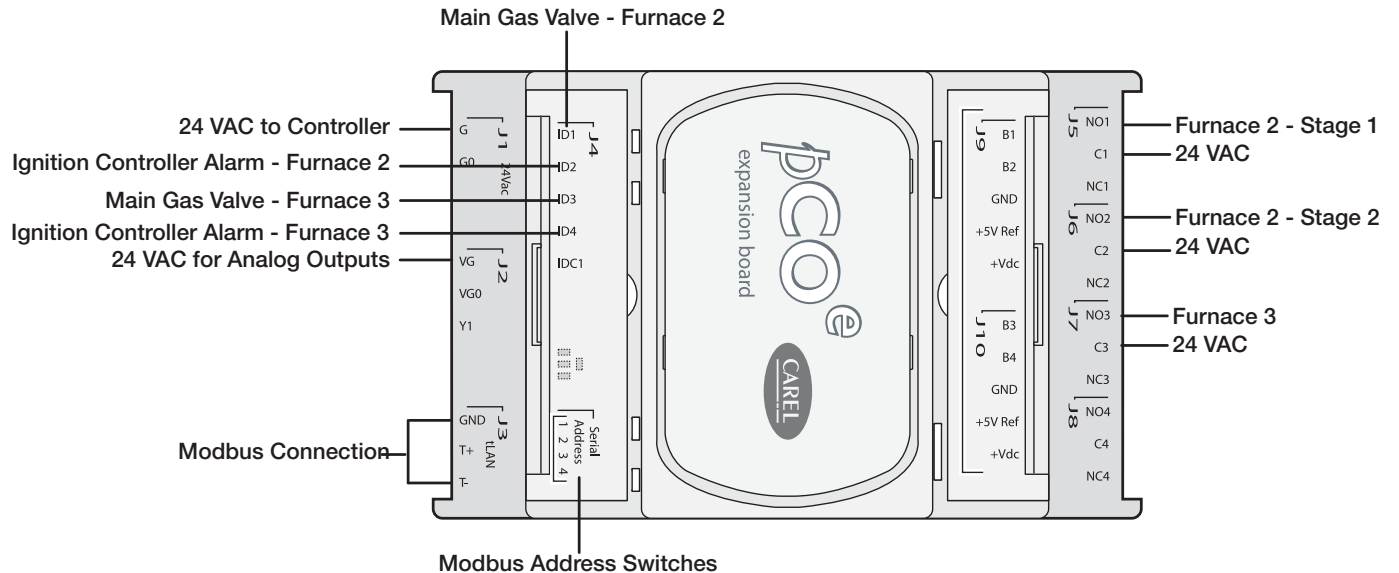

Small Controller Overview

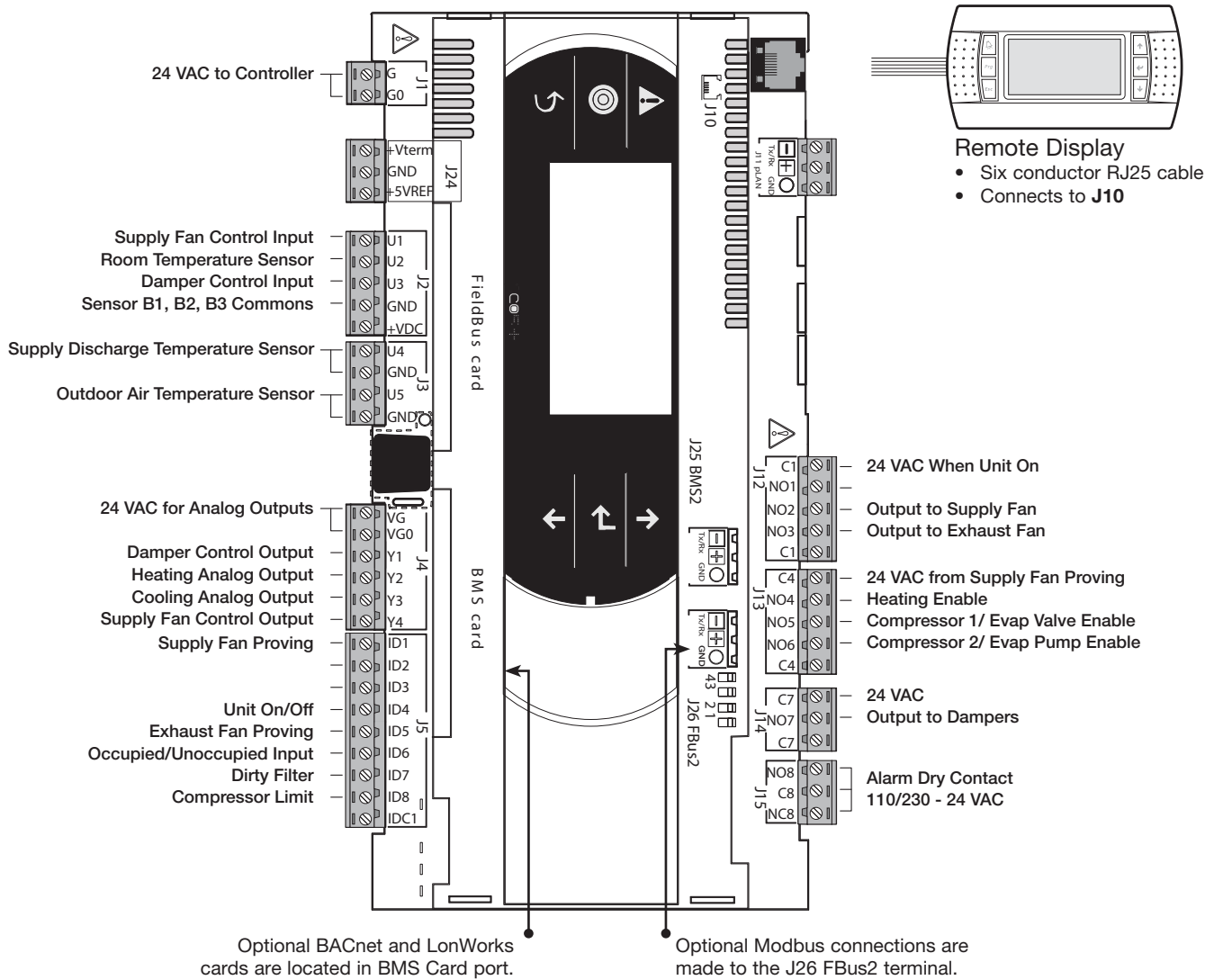

Display Use

The microprocessor controller is located in the unit control center. The face of the controller has six keys, allowing the user to view unit conditions and alter parameters. The microprocessor controller is pre-programmed with easy to use menus. To change the display contrast, hold the Enter and Escape button while pressing the up and down arrows. A remote display is also available, which connects via the **J10** port. A six wire patch cable is needed.

Keypad Description

Keypad Description		
	Alarm	Button will blink red, indicating an alarm condition. Press to review current alarms. To review previous alarms, access the DATA LOGGER through the main menu.
	Down Arrow	The arrow keys allow the user to scroll through different screens and adjust parameters.
	Up Arrow	
	Enter	A. In screens with adjustable parameters, pressing the Enter key moves the cursor from the upper left corner of the screen to the parameter. The arrow keys can then be used to adjust the parameter. B. To move to the next parameter on the same screen, press the Enter button. C. To save the change, press the Enter button until the cursor moves back to the upper left corner of the screen.
	Escape	Allows the user to exit the current menu, jumping to the Main Menu.
	Program	Pressing the Prg (Program) button allows the user to enter the Main Program Menu.

Example of Parameter Adjustment



Supply air low limit

Alarm when supply is below: 35.0° F
Alarm delay: 300s

The cursor always begins in the upper left corner of the display and will be blinking. Press the  key to move the cursor down for parameter adjustment.

Supply air low limit

Alarm when supply is below: 32.0° F
Alarm delay: 300s

Once the cursor has reached the desired parameter, press the   keys to adjust the value.

Supply air low limit

Alarm when supply is below: 32.0° F
Alarm delay: 300s





When satisfied with the adjustment, press the  key to save the parameter. When finished, make certain the cursor is in the upper left corner. If the cursor is not in the upper left corner, the changes will not be saved. The cursor must be in the upper left corner to enable screen advancement.

Alarms

If an alarm occurs, the  button will glow red on the controller and the remote display (if installed).

Alarms

Press DOWN to review current alarm(s).
Press ESC to exit.
Press ALARM to reset.

To view alarm, press the  button once. This will display the most recent alarm. Press the  button again to reset the alarm. If the alarm cannot be cleared, the cause of the alarm has not been fixed. Press the   buttons to view any additional occurring alarms.

Outside Air Temperature
Sensor U01 Failure

This is an example of an outdoor air sensor failure.

Alarms

No active alarm
 Press ENTER
to DATA LOGGER

This screen appears if there are no active alarms.

To view all saved alarms, press the  button to enter the DATA LOGGER. For more information, see the Data Logger menu.

Unit Alarm Descriptions

Outdoor air temperature sensor failure	Failure of outside air temperature sensor.	Alarm only
Supply air temperature sensor failure	Failure of supply air temperature sensor.	Alarm & Shutdown
Room temperature sensor failure	Failure of room temperature sensor. (If Unoccupied - Cycle On Room is enabled)	Alarm only
System has exceeded the set number of run hours	The unit has been operating for a period longer than the maintenance set point.	Alarm only
Supply airflow	Indicates a loss of airflow in the supply fan.	Alarm & Shutdown
Exhaust airflow	Indicates a loss of airflow in the exhaust fan.	Alarm & Shutdown
Filter alarm	Indicates a buildup of pressure across the filters.	Alarm only
A compressor limit switch has tripped	Indicates a high or low refrigerant pressure switch has tripped.	Alarm only
Supply temperature low limit alarm	Indicates a supply air temperature lower than the supply low limit set point.	Alarm & Shutdown
pCOe offline	Indicates communication with pCOe auxiliary I/O has failed.	Alarm only
pCOe - Analog input probe on channel number disconnected or broken	Indicates an analog probe failure on the pCOe. Check integrity of auxiliary I/O analog probes.	Alarm only
Building pressure sensor failure	Failure of building pressure sensor.	Alarm & minimum fan speed
Duct pressure sensor failure	Failure of duct pressure sensor.	Alarm & minimum fan speed
CO2 sensor failure	Failure of CO2 sensor.	Alarm & minimum fan speed
Modbus T-Stat offline	Failure of a room Modbus T-Stat.	Alarm only
DG burner flame safeguard alarm	DG flame safeguard has alarmed out, check for manual reset on the flame safeguard if applicable. See unit Installation and Operation Manual for additional flame safeguard information.	Alarm and Burner Lockout

IG Furnace Alarm (AL) Descriptions

IG No Flame 3 Try AL	Indicates a furnace failure to light or properly sense flame after 3 trials.	Alarm only
IG combustion fan high pressure switch failure	Indicates a call for high speed combustion fan but high pressure switch did not close.	Alarm only
IG furnace ignition control	Indicates an alarm from the ignition controller.	Alarm only
Pressure switch closed with combustion fan off	Indicates low pressure switch was closed with no call for combustion fan.	Alarm only
Combustion fan not proved	Indicates a call for low speed combustion fan but low pressure switch did not close.	Alarm only
IG furnace max retry	Indicates that the max number of retries was reached.	Alarm and Furnace lockout
IG High Temp AL	Indicates that power was lost from the High Temp Limit Sensor. Check for high limit trip.	Alarm only
IG offline	Indicates communication with furnace control has failed.	Alarm only
IG LG Man No Flame AL	No flame after 3 trials for ignition on the large manifold.	Alarm only
IG Staged Furn offline	Indicates communication with staged furnaces have failed.	Alarm only
IG 2 Stge No Flame AL	No flame after 3 trials for ignition on 2-stage furnace.	Alarm only
IG 2 Stge Ignition AL	Indicates an alarm from the ignition controller on 2-stage furnace.	Alarm only
IG 1 Stge No Flame AL	No flame after 3 trials for ignition on 1-stage furnace.	Alarm only
IG 1 Stge Ignition AL	Indicates an alarm from the ignition controller on 1-stage.	Alarm only
IG 2 Stge Max Retry AL	Indicates the max number of retries was reaches on 2-stage.	Alarm and Furnace lockout
IG 1 Stge Max Retry AL	Indicates the max number of retries was reaches on 1-stage.	Alarm and Furnace lockout

Menu Overview

Press  to enter menus.

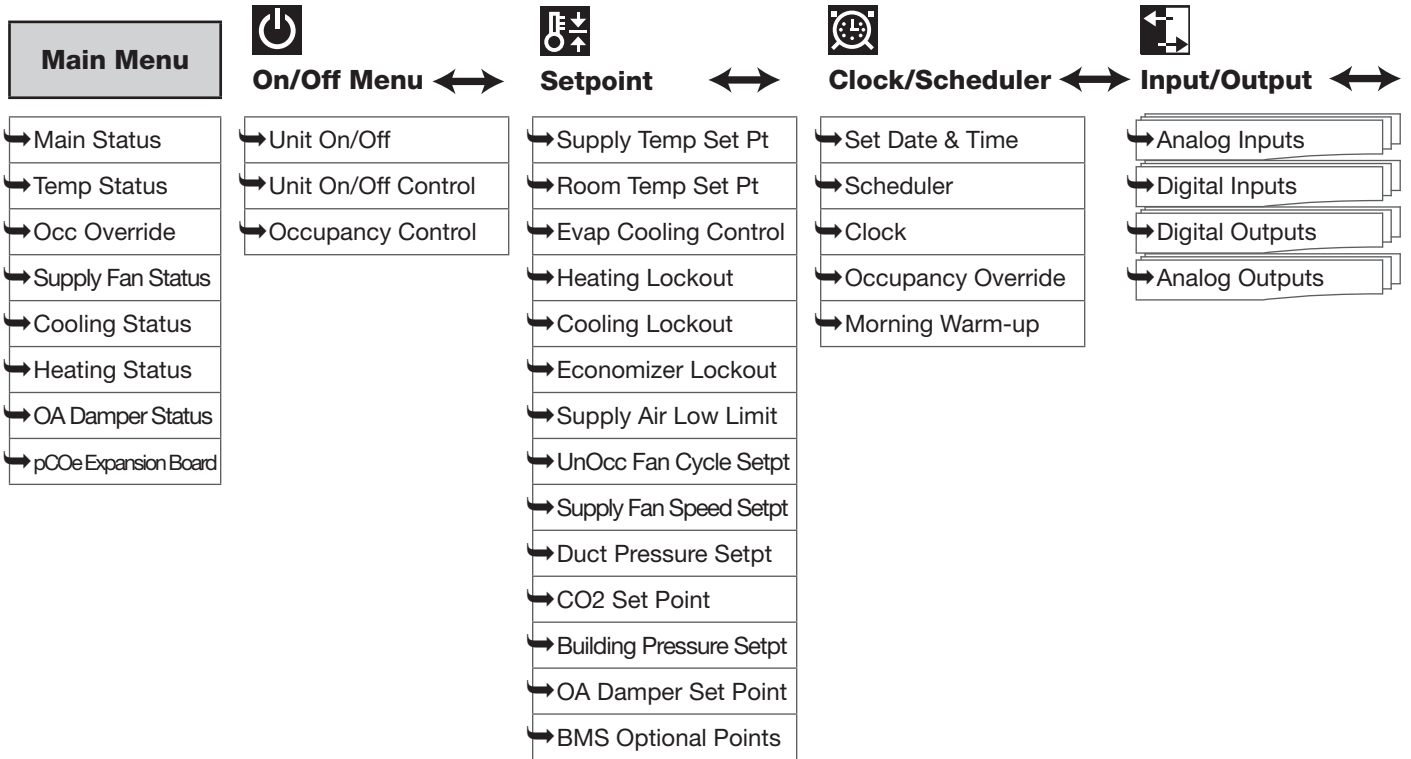

NOTE

Your controller may not show all menus depending on unit configuration.

Menu Overview

Press  to enter menus.



Data Logger

→ Alarms



Board Switch

→ Board Switch



Service

Information

→ Information

→ Information2

Overrides

→ Analog Inputs

→ Digital Inputs

→ Relay Outputs

→ Analog Outputs

→ Control Loops

BMS Config

→ BMS Configuration

→ Modbus Setup

→ MSTP Setup

→ TCP/IP Setup1

→ TCP/IP Setup2

→ BACnet Read/Write

Service Setting

→ Working Hours Set

→ Maintenance Hours

→ Probe Adjustment

→ Analog Inputs

→ Password/Default

→ User Default

→ User Default Settings

→ Program Menu Lock

Commissioning

→ Furnace Commissioning



Manufacturer

Configuration

→ Unit Code

→ Expansion I/O

→ Controller pLAN Setup

→ T-Stat Config

I/O Config

→ Inputs/Outputs

Factory Settings

→ Economizer Controller

→ Evap Control

→ Cooling Controller

→ Compressor Rotation

→ Compressor Timers

→ Compressor Staging

→ Heater Controller

→ IG Heater Setup (2)

→ HTD Furnace Config 1 (2)

→ IG Quick Comp. Loop (2)

→ IG Staged Furnaces 1 (2)

→ Heat/Cool Delay

→ Unoccupied Mode Setup

→ Unoccupied Override Setup

→ Damper Setup

→ Fan/Airflow Proving

→ CO2 Controller

→ Duct Pressure Controller

→ Building Ps Controller

→ Max Ventilation

→ Unit Off Protection

→ Temperature Scale

→ I/O Screens



Initialization

→ Factory Settings

→ New Password

→ Initialization

Main Menu Overview

The microprocessor controller will revert to a default main menu loop. This loop includes several screens to view the operating conditions of the unit. Scroll through the menu screens by using the   keys. **Screens with a dashed line border are dependent upon an optional accessory and may not always appear.**

TIME	DATE	UNIT##
 <i>Building Value in Air.</i>		
TAP v2.60 GUL1X000XNNU		
STATUS LINE		

THE INITIAL MENU SCREEN DISPLAYS THE PROGRAM VERSION, UNIT CODE AND STATUS LINE. THE STATUS LINE DISPLAYS WHICH MODE THE UNIT IS IN.

Possible modes include:

- Initial Delay
- Opening Dampers
- Exhaust Fan Starting
- Supply Fan Starting
- System On
- Sys On - Econ+Cooling
- Sys On - Economizer
- Sys On - Heating
- Sys On - Cooling
- Unoccupied - Unit On
- Unoccupied - Unit Off
- Unoccupied - Heating
- Unoccupied - Cooling
- Manual Override
- Max Ventilation
- Remote Off
- Press Alarm Button!!!
- Temp Occupied

TIME	DATE	UNIT##
Supply Air:		000.0°F
Outside Air:		000.0°F
OA Humidity		00.0%
Room Temp:		000.0°F
STATUS LINE		

THE SENSOR STATUS SCREEN DISPLAYS REAL TIME CONDITIONS FROM THE SENSORS LOCATED IN THE UNIT AND THE ROOM (IF INSTALLED).

Occupancy Override

Clock Override:	OFF
Override Time:	1 hr

OCCUPANCY OVERRIDE (IF UNOCCUPIED)

If the unit is currently unoccupied, the occupancy can be temporarily overridden for a period of override time. The override time parameter can be set from one to three hours.

Supply Fan Status

Supply Fan Ramp:	0%
(0%=Min Speed by VFD)	
Duct Ps Control	
Duct Pressure:	0.00"wc
STATUS LINE	

SUPPLY FAN STATUS (IF EQUIPPED WITH VFD)

If equipped with a supply fan VFD, this screen will display the supply fan ramp being sent from the controller to the VFD. The minimum and maximum speeds are set in the VFD (see unit Installation and Operation Manual for VFD programming). The controller can modulate the fan between the min and max speeds via an analog output. This screen also displays the method of fan control and the parameter it is controlling.

Possible methods include: constant speed, duct pressure control, building pressure control, and room/duct CO2 control.

Cooling Status

Cooling Control:	000%
Compressor	1&2
STATUS LINE	

COOLING STATUS IS DISPLAYED, ALONG WITH COMPRESSOR OPERATION. (IF EQUIPPED)

This screen only appears if a cooling option is provided.

Chilled Water: The cooling control percent is directly proportional to the 0-10 VDC output signal.

- 0% Cooling = 0 VDC
- 100% Cooling = 10 VDC

The cooling control output can be configured to direct/reverse acting, along with the minimum and maximum output voltages by entering the manufacturer menu.

Packaged/Split DX Cooling: The cooling control displays internal cooling ramp as a percent. Compressor operation is displayed when engaged.

- 1 = First staged compressor operation
- 2 = Second staged compressor operation

Evaporative Cooling: The cooling control displays a percentage to show whether the evaporative cooling is enabled or not.

Note: With evaporative cooling the cooler will be enabled based on OA temperature set point.

- % = Evaporative Cooling Off
- 100% = Evaporative Cooling On

Heating Status	
Heater Control:	000%
STATUS LINE	

HEAT AND REHEAT OPERATION IS DISPLAYED. (IF EQUIPPED)

Heater Control displays the proportional percentage of the heater analog output.
Electric Heater: The heater control percent is proportional to the 0-10 VDC signal being sent to the SCR controller, located in the electric heater control center.
 0% Heating = 0 VDC - 0 kW output
 100% Heating = 10 VDC - Max kW output

Hot Water/Steam: The heater control percent is proportional to the 0-10 VDC signal being sent to the heating control valve (by others). The heating control output can be configured to direct/reverse acting, along with the minimum and maximum output voltages by entering the manufacturer menu.
 0% Heating = 0 VDC
 100% Heating = 10 VDC

Indirect-Direct Gas: The heater control percent is proportional to the output signal being used to control the heat modulation. The heat is enabled at 1% heater control. The heat will then modulate proportionally from minimum to maximum capacity as needed. The heat is subject to minimum on/off times, deadbands and heating lockouts.

Indirect Gas:
 0% = 0 VDC – Off
 1% = 0 VDC – Minimum turndown available
 1 - 100% = 0 - 10 VDC = Furnace modulation

Direct Gas:
 0% = 2 VDC – Off
 1% = 2 VDC – Minimum turndown available
 1 - 100% = 2-8 VDC = Burner modulation

Outdoor Damper Status	
Damper Position:	50%
Active on Minimum	OA%
CO2 Level:	0PPM
STATUS LINE	

OUTDOOR AIR DAMPER STATUS. (IF EQUIPPED WITH MODULATING OUTDOOR AND RECIRCULATED AIR DAMPERS)



This screen will display the outdoor air damper position commanded by the controller and which method the damper position is actively utilizing.
 Possible methods include: active on minimum OA%, active on economizer, active on CO2, active on BMS, active on building pressure, and active on 2-position max ventilation.

pCOe Expansion Board				
		ID		NO
B1:	32.0	1: _____	1:	_____
B2:	32.0	2: _____	2:	_____
B3:	32.0	3: _____	3:	_____
B4:	32.0	4: _____	4:	_____
Y1:	0.0			

PCOE EXPANSION BOARD (IF EQUIPPED)

This screen appears if the unit is equipped with a pCOe to allow for additional monitoring points.

Menus

The controller is equipped with several menus to help guide users with altering program parameters. The following menus can be accessed by pressing the  key. To enter the desired menu, press the  key.

A. On/Off Unit

The **On/Off Unit** menu allows the user to view the detailed On/Off status of the controller.

Unit On/Off

Actual state:
Off by DIG INPUT (ID4)
Change to: SWITCH ON
*Power ID4 to start...

The unit ships from the factory in a disabled state. To allow the unit to operate, the controller must receive a run command from digital input ID4. **Jumper unit terminals R - G to allow the unit to operate.**

Actual State: The controller may be in following on/off states:

- Unit on - Unit is on, functioning normally
- Off by alarm - Unit is off due to an alarm. View alarms by pressing alarm button.
- Off by pLAN - Unit is off by pLAN network
- Off by BMS - Unit is OFF by BMS command
- Off by unoccupied - Unit is off by unoccupied command
- Off by digital input (ID4) - Unit is off by digital input 4 (ID4)
- Off by keypad - Unit is commanded off by this screen

Change to (Switch Off/Switch On): Enables user the ability to turn unit on/off via display. Unit terminal G must have 24 VAC power to enable the unit.

Unit ON/OFF Control

Enable unit OnOff
By digit input: Yes
By BMS: No

THIS SCREEN ALLOWS THE USER TO ADJUST WHICH SYSTEM CONTROLS THE UNIT ON/OFF STATE.

Digital Input: Factory default to yes. Unit terminal G must have 24 VAC power to enable the unit.

The user can also use the BMS or internal time clock to command the unit on/off state. If scheduling is desired, go to the clock/scheduler menu to set a schedule.

BMS: Yes allows BMS to control unit on/off state.

Occupancy Control

Type: Unit OFF
Source: Input ID6

THIS SCREEN DISPLAYS WHAT THE UNIT WILL DO IN UNOCCUPIED MODE.

This screen allows the user to select the source of determining occupancy. The factory default is terminal **ID6** on the controller.

Input ID6: Typically used with a remote time clock, motion sensor or switch (default).

BMS: BMS control (see Points List). BMS can be overridden with ID6.

Time Clock: Internal time clock (scheduler). See clock/scheduler menu for more information. The scheduler can be overridden with digital input ID6.

B. Setpoint

The **Setpoint** menu allows the user to view and adjust temperature related parameters.

Supply Temp Set Point

Active StPt:	70.0°F
Supply Temp:	69.8°F
Source: Local	70.0°F
Max:	90.0°F
Min:	55.0°F

Supply Temp Set Point

Active StPt:	72.0°F
Supply Temp:	71.8°F
Source: BMS	72.0°F
Max:	90.0°F
Min:	55.0°F

Supply Temp Set Point

Active StPt:	55.0°F
Supply Temp:	54.8°F
Source: OA Reset	
Outside	Supply
80.0°F	75.0°F
60.0°F	65.0°F

Supply Temp Set Point

Active StPt:	72.0°F
Supply Temp:	71.8°F
Source: Room Reset	
Max:	90.0°F
Min:	55.0°F

Room Temp Set Point

Active StPt:	72.0°F
Supply Temp:	71.8°F
Source: Local	72.0°F

Room Temp Set Point

Active StPt:	72.0°F
Supply Temp:	71.8°F
Source: BMS	72.0°F

THIS SCREEN DISPLAYS THE SUPPLY AIR TEMPERATURE SET POINT SCREEN PARAMETERS.

When operating, the unit will control the heating and cooling (except during evaporative cooling) to maintain the active supply temperature set point. The active set point will be determined by the set point source selection.

Possible Set Point Sources:

Local - The supply set point will be constant set from screen. (i.e. 72°F).

BMS - The BMS can directly control the supply air temperature set point (requires BMS communication option).

OA Reset - The controller monitors the outdoor air temperature and adjusts the desired supply temperature set point accordingly. For example, when the outdoor air is above 80°F, the controller will change the supply set point to 75°F. If the outdoor air is below 55°F, the controller will change the supply set point to 60°F. If the outdoor air temperature is between 55°F and 80°F, the supply set point changes according to the outdoor air reset function. A visual representation of the outdoor air reset function is shown below.

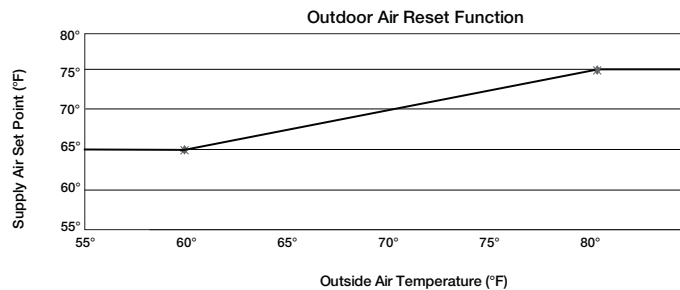

Room Reset – The controller will reset the supply air temperature set point to maintain the room temperature set point (requires room temp sensor). See the Room Temp Set Point screen in this menu for more information.

Evap Cooling Control

Run when OA is above: 75.0°F
Source: Local 75.0°F
Max: 90.0°F
Min: 55.0°F

!!WARNING!!

Evap run temp is below cooling lockout temp adjust cooling lockout temp lower in the cooling lockout menu. Press Esc to return or Prg for lockout menu.

Heating Lockout

Lockout heating when outside above: 65.0°F
Differential: 2.0°F

Cooling Lockout

Lockout cooling when outside below: 80.0°F
Differential: 2.0°F

Economizer Lockout

Type: DryBulb
Below: 40.0°F (Dry Bulb)
Above: 65.0°F (Dry Bulb)

Differential: 2.0°F
Free Cooling Available

Supply Air Low Limit

Alarm when supply is below: 35.0°F
Alarm delay: 300s

THIS SCREEN DISPLAYS THE EVAPORATIVE COOLING CONTROL.

This screen only appears if the unit the unit is equipped with evaporative cooling.

The evaporative cooling is controlled solely based on the outdoor air temperature. If the outdoor air is above the OA Set point, the evaporative cooling will be enabled. Once the evaporative cooling drops below the set point and a two degree differential, the evaporative will shut down.

THIS SCREEN DISPLAYS THE EVAPORATIVE COOLING WARNING.

This screen only appears if the unit the unit is equipped with evaporative cooling.

If the Evaporative set point drops below the cooling lockout set point, the evaporative cooling operation will not be enabled until the OA temp is above the cooling lockout temp. This alarm is notifying the user that the cooling lockout will be overriding the evaporative set point unless it is changed.

THIS SCREEN DISPLAYS THE HEATING LOCKOUT.

This screen only appears if the unit the unit is equipped with heating.

There is a built-in hysteresis of 2°F which prevents the heating from short cycling. The hysteresis is similar to a deadband above and below the lockout set point. (Example: If Lockout = 65°F, heating is locked out above 67°F and enabled below 63°F outside air temperature.)

THIS SCREEN DISPLAYS THE COOLING LOCKOUT.

This screen only appears if the unit is equipped with cooling.

There is a built-in hysteresis of 2°F which prevents the cooling from short cycling. The hysteresis is similar to a deadband above and below the lockout set point. (Example: If Lockout = 80°F, cooling is locked out below 82°F and enabled above 78°F outside air temperature.)

THIS SCREEN DISPLAYS THE ECONOMIZER LOCKOUTS.

This screen only appears if economizer functionality was provided with the unit.

The lockouts determine when economizer is available, based on the outdoor air temperature. The low temperature lockout prevents outdoor air from entering the unit at too cold of a temperature that could freeze coils. There is a built-in differential that is similar to a deadband, above and below the lockout set point. If an outdoor relative humidity sensor was provided with the unit, the user can change the economizer lockout control type.

Possible Control Types:

DryBulb – The economizer will be locked out based on the outdoor dry-bulb temperature.

THIS SCREEN DISPLAYS THE LOW SUPPLY AIR TEMPERATURE LIMIT.

If the unit supply air temperature falls below supply air low limit for a period of alarm delay, the unit will shut down and an alarm will be signaled. The purpose of the supply low limit is to protect the building and contents from cold supply air. It is NOT designed to protect the air handling unit.

If the unit does not have chilled water (CW) or hot water (HW) coils, it should not need additional protection from freezing. **If the unit does have CW or HW coils, field-provided coil freeze protection may be necessary.**

UnOcc Fan Cycle Setup

UnOcc Room Set Points:	
Heating:	65.0°F
Cooling:	80.0°F
Temp Diff:	5.0°F

Supply Fan Speed SetPt

Active StPt:	100%
Supply Fan Ramp:	100%
Source: Local	100%
UnOccupied Cycle	100%
(0%=Min Speed by VFD)	

Supply Fan Speed SetPt

Active StPt:	50%
Supply Fan Ramp:	50%
Source: Local	50%
Hi Spd/Max Vent:	100%
UnOccupied Cycle:	100%

Duct Pressure SetPt

Active StPt:	0.25" wc
Duct Pressure:	0.26" wc
Source: Local	0.25" wc
Min:	0.25" wc
Max:	2.00" wc

CO2 Set Point

Active StPt:	1000PPM
CO2 Level:	1000PPM
Source: Local	1000PPM

Building Press SetPt

Active StPt:	+0.010" wc
Building Ps:	+0.009" wc
Source: Local	+0.010" wc

THIS SCREEN DISPLAYS THE ROOM SET POINTS DURING THE UNOCCUPIED MODE.

This screen only appears if equipped with unoccupied mode and an optional room temp sensor.

In the unoccupied mode, the unit will monitor the room temperature sensor. The unit will cycle on to maintain the unoccupied room set points by tempering recirculated air. The differential prevents short cycling. For example, in heating, the unit cycles on at 60°F and turns off at 65°F.

THIS SCREEN DISPLAYS THE SUPPLY FAN SPEED SET POINTS.

This screen only appears if equipped with a supply fan VFD controlled by the microprocessor.

The speed set point is the proportional percent of the analog output from the controller to the VFD.

0% Speed = Min Speed (determined by VFD)

100% Speed = Max Speed (determined by VFD)

UnOccupied Cycle - The supply fan speed when the unit is on during unoccupied cycle times.

Possible Set Point Sources:

Local – The fan speed will be constant. Set from screen (i.e. 100%).

BMS – The BMS can directly control the fan speed (requires BMS communication option).

Duct Pressure – Fan speed is determined by duct pressure control loop. *(During unoccupied mode, if the unit is cycled on, the duct pressure control option is the only control option that will reference the control setpoint vs. unoccupied cycle setpoint.)*

Building Pressure - Fan speed is determined by building pressure control loop.

CO2 - Fan speed is determined by CO2 control loop.

2-Speed - Supply fan speed is reset to “2 Spd Fan Hi Setpt:” when a contact closure is made. The 2-speed fan operation can also be setup to bring the unit into temporary occupied mode until the contact is broken (Max Ventilation Mode).

THIS SCREEN DISPLAYS THE DUCT PRESSURE SET POINT.

This screen only appears if equipped with a duct pressure sensor.

The unit will modulate the supply fan to maintain the local duct pressure set point.

Set point source must be changed to BMS to allow for BMS control.

THIS SCREEN DISPLAYS THE CO2 SET POINT.

This screen only appears if equipped with a CO2 sensor.

Depending on unit configuration, the unit will either modulate the supply fan or outdoor air damper to maintain the CO2 set point.

Set point source must be changed to BMS to allow for BMS control.

THIS SCREEN DISPLAYS THE BUILDING PRESSURE SET POINT.

This screen only appears if equipped with a building pressure sensor.

The unit will modulate the supply fan to maintain the local building pressure set point.

Set point source must be changed to BMS to allow for BMS control.

OA Damper Set Point	
Active StPt:	100%
Damper Position:	100%
Source: SF RESET	
SupplyFan: 0%	100%
Min OA: 30%	20%
2 PosMax/Max Econ:	100%

OA Damper Set Point	
Active StPt:	50%
Damper Position:	50%
Source: SF RESET	
SupplyFan: 0% --->	100%
Min OA: 50% --->	40%
2 PosMax/Max Econ:	100%

OA Damper Set Point	
Active StPt:	30%
Damper Position:	30%
Source: DCV CO2 -->	
SupplyFan: 0% -->	100%
Min OA: 30% -->	20%
Max CO2: 50%	40%
2 PosMax/Max Econ:	100%

OA Damper Set Point	
Active StPt:	25%
Damper Position:	25%
Source: BMS	25%
Max BMS:	50%
2 PosMax/Max Econ:	100%

THIS SCREEN DISPLAYS THE OUTDOOR AIR DAMPER SET POINT.

This screen only appears if equipped with a modulating outdoor air and recirculating damper.

The set point is the proportional percentage of the modulating outdoor air damper (% open).

- 0% = Full recirculation air
- 100% = Full outdoor air

Minimum Position – When in the occupied mode, the Active set point will be equal to a local minimum OA set point, which may be constant or reset by fan speed if equipped with a modulating supply fan. The OA damper set point can then be further adjusted between the minimum and maximum OA settings with sequences such as DCV CO2, Building Pressure and Economizer.

Maximum Position – Each sequence that can adjust the OA damper set point contains a maximum position to prevent excess OA. The Active set point will be determined based on the greatest demand of the configured sequences. For example, if a unit is equipped with a DCV CO2 and an economizer sequence, the OA damper set point will react to an economizer demand even if the CO2 set point is satisfied. Likewise, if economizer is not available but CO2 is above set point, the OA damper will open to satisfy the CO2 set point.

Supply Fan Reset of OA Damper Position

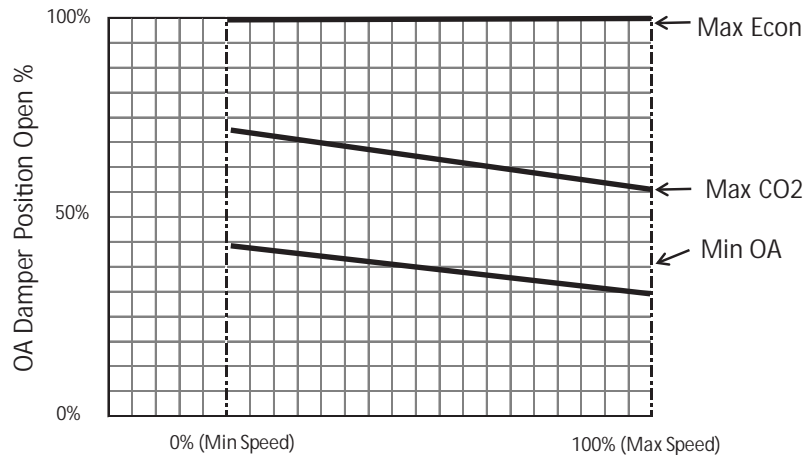

Economizer – The Active set point will be reset based on Economizer demand, between the minimum and maximum positions.

Possible Set Point Sources:

Local – The minimum outdoor air percentage is constant, set by the controller.

SF Reset – The min and max positions are reset by the supply fan speed.

BMS – The BMS can directly control the OA damper position up to the Max BMS percentage.

Building Pressure – Damper position is reset by a building pressure control loop.

DCV CO2 – Damper position is reset by a demand-controlled ventilation control loop based on room CO2 levels.

2 Position – Damper position is reset to “2-Pos/Max Econ:” set point when a contact closure is made. The 2-position damper operation can also be setup to bring the unit into temporary occupied mode until the contact is broken (Max Ventilation Mode - enabled in manufacturer menu settings).

THIS SCREEN ALLOWS THE USER TO CHANGE THE VALUE FROM SENSOR TO BMS

This screen only appears if BMS communication is set.

If the BMS is reading one or more of these values from a weather station or some other device, the user has the ability to write the values to the controller. The controller will then control from these values.

BMS Optional Points		
OA Temp:	76.0	BMS
Room Temp:	71.0	Sensor



C. Clock/Scheduler

The **Clock/Scheduler** menu allows the user to view and alter the time and date. The user can also add up to seven schedules for occupancy requirements.

Set Date & Time	
Day:	Monday
Date:	MM/DD/YY
Hour:	15:30

Scheduler	
Number of schedules:	0

Holidays	
Holiday = unoccupied mode for 24 hours.	
Number of Holidays:	0

Scheduler	
Schedule #:	#
Time On:	07:00
Time Off:	15:00
Days Enabled:	MTWTFSS

Clock	
Daylight Savings Time	
DST:	ENABLE
Transition time:	60min
Start:	SECOND SUNDAY
in MARCH	at 2.00
End:	FIRST SUNDAY
in NOVEMBER	at 2.00

Holiday #1	
Month:	MM
Day:	DD
Unoccupied for 24 hrs	

Occupancy Override	
Override Time:	1 hr

Morning Warm-up	
Morning Warmup Off	
Temperature Diff:	2.0°F

THE CLOCK SCREEN ALLOWS THE USER TO ADJUST THE TIME AND DATE.

THIS SCREEN ALLOWS THE USER TO ADD THE NUMBER OF UNOCCUPIED SCHEDULES AND HOLIDAYS.

The number of schedules corresponds to the number of unoccupied periods the user wishes to add. By setting the number of schedules to a value greater than zero, the unoccupied mode will automatically be set to the time clock. The program supports up to seven separate schedules.

A holiday is a single occurrence in which you would like the unit to be unoccupied for 24 hours. A maximum of 15 holidays can be set. Holidays must be reconfigured each year.

THIS SCREEN ALLOWS THE USER TO ADJUST SCHEDULES.

This screen only appears if a schedule was added in the screen above.

Each schedule will require the user to enter a time on, time off and which days the schedule is applicable for.

THIS SCREEN ALLOWS THE USER TO MODIFY THE DAYLIGHT SAVINGS TIME FUNCTION.

The internal clock is set by default to adjust for daylight savings time. On this screen the user can enable, disable, or change when the unit compensates for daylight savings time.

THIS SCREEN ALLOWS THE USER TO SET HOLIDAY DATES (IF ENABLED).

This screen only appears if Holidays are enabled.

The internal time clock will go into unoccupied mode as long as the date is equal to the holiday date (always a 24 hour period).

THIS SCREEN ALLOWS THE USER TO SET THE OCCUPANCY OVERRIDE DURATION.

This menu allows the user to set the Occupancy Override Duration that will be used if the unit is going to be manually cycled out of unoccupied mode.

THIS SCREEN ALLOWS THE USER TO ENABLE THE MORNING WARM-UP SEQUENCE AND THE DIFFERENTIAL REQUIRED TO ALLOW THE SEQUENCE TO OCCUR.

This screen only appears if unoccupied tempering is available and schedule is set.

The morning warm-up sequence calculates the time required to temper the space to the occupied set point prior to occupancy. This sequence is limited between 10 to 60 minutes. The controller will re-evaluate the heating and cooling rate daily to continually adjust to the changing climate.

D. Input/Output

The **Input/Output** menu allows the user to quickly view the status of the controller inputs and outputs.

Analog Input

Outside Temperature
Input U001: 75.0°F

To manually control I/O values, go to the **Service menu > Overrides**.

Similar screens appear for all controller inputs and outputs.

The controller may not utilize all of the equipped inputs and outputs shown. See unit wiring diagram for your specific built-to-order configuration.

E. Data Logger

The **Data Logger** menu allows the user to view up to 100 past alarms.

13:21:04 MM/DD/YY

OA TEMP SENSOR
Outside Air T: -623.3
Discharge T: 52.8
Cold Coil T: 55.9
Room T: 72.5

SYS ON-HEATING

THIS SCREEN IS AN EXAMPLE OF A RECORDED ALARM.

The unit conditions are displayed for past alarm events. The date, time, temperatures and unit status are recorded.

To clear recorded alarms, press  and  simultaneously.

F. Board Switch

The **Board Switch** menu allows the user to jump between different controllers with a remote display. This requires a remote display, along with additional controllers. Setup done in a pLAN network. A pLAN can consist of up to 32 devices, in different combinations, but a maximum of 31 controllers.

Board Switch

Unit Address: 1
Switch to unit: 1
1 16
17 32

WHEN VIEWING THIS SCREEN FROM A REMOTE DISPLAY, THE USER IS ABLE TO CHANGE WHICH CONTROLLER'S MENU SHOULD BE DISPLAYED.

Unit Address: The pLAN address of the controller the display is currently accessing.

Switch to unit: The pLAN address of the controller the display would like to access.

G. Service

The **Service** menu allows the user to access several sub-menus regarding controller information, controller overrides, operating hours, BMS configuration, I/O manual management and Probe Adjustment. The user can also change the default **Service Password (1000)** by accessing the Service Settings sub-menu. By accessing the BMS Config sub-menu, the user can adjust BMS protocol settings. (BACnet®, LonWorks®, Modbus®)

G. Service

a. Information

Information

Greenheck Fan
Code: GWKDX000XXXX
Furnace Code: GUSXSX
Ver.2.60 1/1/18
Manual/IOM: 483235
Bios: 6.27 07/09/04
Boot: 5.00 07/09/04

ENTERING THE INFORMATION SUB-MENU WILL DISPLAY INFORMATION ABOUT THE CONTROLLER AND THE PROGRAM LOADED ON THE CONTROLLER.

Code: Controller setup code determines functionality of program. When contacting the factory, please reference this code.

Ver: Displays the current program version and data code of the current program.

Manual: The manufacturer part number for the corresponding Installation, Operation and Maintenance (IOM) Manual.

G. Service

b. Overrides

- a. Analog Inputs
- b. Digital Inputs
- c. Relay Outputs
- d. Analog Outputs
- e. Control Loops

The **Overrides** menu is for start-up, commissioning and troubleshooting. This menu allows the user to override the control loops and specific inputs and outputs. To access the overrides sub-menus, enter the service password (**Default=1000**).

Caution: Overriding components and I/O can be dangerous to the equipment. Always cycle power to the unit when finished with the override.

Analog Input	
Outside Temperature	
Manual Control 4005:	OFF
Manual Position	0.0
Value	73.5

Control Loop Overrides

Unit must be ON.
To resume normal operation, cycle unit power.

Cooling Override	
Cooling Control:	Auto
Cooling:	100%

Heating Override	
Heating Control:	Auto
Heating:	100%

THIS SCREEN IS AN EXAMPLE OF A MANUALLY MANAGED TEMPERATURE ANALOG INPUT.

To manually control an analog input, change manual control to on. Move cursor to manual position and alter value. The altered value will be displayed below.

Similar screens exist for the remaining I/O. To resume normal operation, simply cycle power to the unit. Contact the factory for more details.

To manually override a control loop, the unit must be on. In each respective screen, change the control from auto to manual.

To resume normal operation after overriding the controller, simply cycle power to the unit.

THIS SCREEN ALLOWS THE USER TO OVERRIDE THE COOLING OPERATION.

This screen only appears if a cooling operation was provided with the unit.

When the Cooling Control is in the manual mode, use the arrow buttons to vary the cooling output.

Chilled Water: The cooling percent is directly proportional to the 0 - 10 VDC output signal.

- 0% Cooling = 0 VDC
- 100% Cooling = 10 VDC

Packaged Cooling: The cooling percent displays compressor engagement as a percent. The compressors are subject to the minimum On/Off times and Heating/Cooling Lockouts. Compressors engage in sequence as described in the Compressor Staging screen in the **Manufacturer > Factory Settings** menu.

THIS SCREEN ALLOWS THE USER TO OVERRIDE THE HEATING OPERATION.

This screen only appears if a heating operation was provided with the unit.

When the heating control is in the manual mode, use the arrow buttons to vary the heating output.

Electric Heater: The heater control percent is proportional to the 0-10 VDC signal being sent to the SCR controller, located in the electric heater control center.

- 0% Heating = 0 VDC - 0 kW output
- 100% Heating = 10 VDC - Max kW output

Hot Water/Steam: The heater control percent is proportional to the 0-10 VDC signal being sent to the heating control valve (by others). The heating control output can be configured to direct/reverse acting, along with the minimum and maximum output voltages by entering the manufacturer menu.

- 0% Heating = 0 VDC
- 100% Heating = 10 VDC

Indirect or Direct Gas: The heater control percentage is proportional to the output signal being used to control the heat modulation. The heat is enabled at 1% heater control. The heat will then modulate proportionally from minimum to maximum capacity as needed. The heat is subject to minimum on/off times, deadbands and heating lockouts.

- Indirect Gas:**
- 0% = 0 VDC – Off
 - 1% = 0 VDC – Minimum turndown available
 - 1 - 100% = 0 - 10 VDC = Furnace modulation

- Direct Gas:**
- 0% = 2 VDC – Off
 - 1% = 2 VDC – Minimum turndown available
 - 1 - 100% = 2-8 VDC = Burner modulation

Supply VFD Override

Supply Fan VFD
Loop Control: Auto
Speed: 0%
(0%=Min Speed by VFD)

OA/RA Damper Override

Outdoor Damper
Loop Control: Auto
Open: 0%

G. Service

c. BMS Config 

BMS Configuration

Protocol: BACnet MSTP
BACnet Plugin? YES

MODBUS SETUP

Address: 1
Baudrate: 9600
Stop bit: 2
Parity mode: NONE

THIS SCREEN ALLOWS THE USER TO OVERRIDE THE SUPPLY FAN VFD SPEED.

This screen only appears if the unit is equipped with a supply fan VFD controlled by the microprocessor.

The Speed is the proportional percent of the analog output from the controller to the VFD.

0% Speed = Min Speed (determined by VFD)
100% Speed = Max Speed (determined by VFD)
(See unit Installation, Operation and Maintenance Manual for VFD Programming.)

THIS SCREEN ALLOWS THE USER TO OVERRIDE THE POSITION OF THE OUTDOOR AIR DAMPER.

This screen only appears if the unit is equipped with a modulating outdoor air damper.

0% Open = Outdoor air damper closed
100% Open = Outdoor air damper fully open

The **BMS Config** menu allows the user to view and alter BMS protocol settings. If the BMS protocol is BACnet or Modbus, additional screens allow further configuration. See below for details. To access the BMS Config sub-menu, enter the service password (**Default=1000**). See *Appendix A: BACnet® MSTP or BACnet® IP/Eth Quick Start* for more information.

THIS SCREEN ALLOWS THE USER TO SELECT THE BMS PROTOCOL. ALL BMS PROTOCOLS REQUIRE A COMMUNICATIONS CARD INSTALLED IN THE SERIAL CARD PORT LOCATED ON THE FACE OF THE CONTROLLER.

If the protocol is BACnet MSTP or BACnet IP/Eth, the user can change common BACnet parameters via the controller. The BACnet plugin must be set to yes.

THIS SCREEN ALLOWS THE USER TO ADJUST MODBUS PARAMETERS.

This screen only appears if the selected BMS protocol is set to Modbus.

The address is the Modbus address of the card installed in the serial card port located on the face of the controller. (**Factory Default Address = 1**).

MSTP SETUP

Instance:	77000
Baudrate	38400
MAC Addr:	0
MaxMasters:	127
MaxInfoFrames:	20

BACnet Read/Write

To save:	Change
Function:	to write and update to Yes. Then cycle unit power to confirm write command.
Function:	Read
Update?	Yes

TCP/IP SETUP

Instance:	77000
IP set by:	DHCP
IP:	128.2.104.134
Subnet:	255.255.000.000
Gateway:	128.2.0.12

TCP/IP SETUP

DNS 1:	193.168.001.001
DNS 2:	193.168.001.001
Type:	IP

BACnet Read/Write

Function:	Read
Update?	Yes

*Cycle unit power to confirm write command.

THIS SCREEN ALLOWS THE USER TO ADJUST BACNET MSTP PARAMETERS.

This screen only appears if the selected BMS protocol is set to BACnet MSTP and BACnet plugin = yes







If a BACnet MSTP card has been installed, the default parameters can be changed via the controller display. Factory settings are shown in the screen to the left.

To view current parameters:

1. Power on controller and allow several minutes to initialize.
2. Go to BMS configuration menu and view BACnet read/write screen.
3. Change function to read and update? to yes.

Current BACnet MSTP parameters should now be displayed in the BACnet MSTP setup screen. If all values appear to be zeros, consult the factory. (Make sure you have allowed several minutes for the controller to initialize). **Values may appear to be zero prior to setting the Function to READ.*

To change BACnet MSTP parameters:

1. Power on controller and allow several minutes to initialize.
2. Go to BMS configuration menu and view MSTP setup screen.
3. Move cursor to desired parameter by pressing the   buttons. Press  to select the parameter to change. Press the   buttons to adjust the parameter. Press  to save adjusted value.
4. Once desired parameters have been entered, go to BACnet read/write screen. Change function to write and update? to yes.
5. Reboot the controller by cycling power to the unit. Allow several minutes for the controller to initialize.
6. View MSTP parameters. If changed values did not save, contact the factory.

THIS SCREEN ALLOWS THE USER TO ADJUST BACNET IP PARAMETERS.

This screen only appears if the selected BMS protocol is set to BACnet IP/Eth and BACnet plugin = yes.

If a BACnet IP card has been installed, the default parameters can be changed via the controller display. The card is in DHCP mode from the factory. Once communication is established, the user can enter static IP parameters.







To view current parameters:

1. Power on controller and allow several minutes to initialize.
2. Go to BMS configuration menu and view BACnet read/write screen.
3. Change function to read and update? to yes.

Current BACnet IP parameters should now be displayed in the BACnet TCP/IP setup screen. If all values appear to be zeros, consult the factory. (Make sure you have allowed several minutes for the controller to initialize).

**Values may appear to be zero prior to setting the function to read.*

To change BACnet TCP/IP parameters:

1. Power on the controller and allow several minutes to initialize.
2. Go to BMS configuration menu and view TCP/IP setup screen.
3. Move cursor to desired parameter by pressing the   buttons. Press  to select the parameter to change. Press the   buttons to adjust the parameter. Press  to save adjusted value.
4. Once desired parameters have been entered, go to BACnet read/write screen. Change function to write and update? to yes.
5. Reboot the controller by cycling power to the unit. Allow several minutes for the controller to initialize.
6. View TCP/IP parameters. If changed values did not save, contact the factory.

G. Service

- d. Service Settings
 - a. Working hour set
 - b. Probe adjustment
 - c. Password/Defaults

MAINTENANCE HOURS

SYSTEM	
Run hours:	0000h
Set Point:	0000h
Reset to Zero?	No

Analog Input

Outside Temperature	
Offset:	0.0°F
Value:	70.5°F

User Default



Insert new service password (PW1):	1000
------------------------------------	------

User Default Settings



Save?	No
Restore?	No

Program Menu Lock



Lock program menus using service password? (PW1):	No
---	----

G. Service

- e. Commissioning
 - a. Furnace Commissioning

Furnace Commissioning

Enter Furnace Commissioning:	No
------------------------------	----

The **Service Settings** menu allows the user to change the default Service Password (1000), save and restore default parameters, and adjust probe values.

THIS SCREEN ALLOWS THE USER TO VIEW UNIT RUN HOURS, AND ALTER SET POINTS FOR MAINTENANCE.

Run hours: The amount of time in hours that the unit has been powered.

Set Point: The amount of running time in hours before a maintenance alarm will occur.

Reset to Zero: Reset the measured amount of run time.

THE PROBE ADJUSTMENT MENU ALLOWS THE USER TO CALIBRATE SENSOR PROBES WITH AN OFFSET VALUE.

Similar screens are available for remaining sensor probes.

THIS SCREEN ALLOWS THE USER TO CHANGE THE SERVICE LEVEL PASSWORD (PW1)

THIS SCREEN ALLOWS THE USER TO SAVE AND RESTORE THE DEFAULT PARAMETERS STORED IN MEMORY.

If the user would like to save their settings, move the cursor to the save position and change to yes. This will save all of the current parameters into memory as Service Settings. To restore these values, move the cursor to the restore position, and select yes. The controller defaults to these user-saved settings.

THIS SCREEN ALLOWS THE USER TO LOCK THE PROGRAM MENU.

Locking the program menu will prohibit users from changing any parameters. Only menus normally accessed by pressing  will be locked. Users will still be able to view unit status, alarms and temperatures.

The **Commissioning** menu allows the user to go through a pre-programmed step-by-step process to set up different unit functions in the field. To successfully commission the unit, additional tools will be required to make adjustments. To access the Commissioning sub-menu, enter the service password (**Default=1000**).

THIS SCREEN ALLOWS THE USER TO ENTER IG FURNACE COMMISSIONING

This screen only appears if an indirect gas furnace was provided with the unit.

Entering the furnace commissioning menu will step the user through the furnace start-up.

H. Manufacturer

a. Configuration

Configuration menu allows the user to change the setup code for the unit, enable Scheduling, Holidays, expansion I/O and change Field Card settings. Users are welcomed to enable Scheduling and Holidays. **However, code changes and expansion I/O enabling are to be done under factory advice only!**

Unit Code	
Select DDC configuration code here.	
Code:	GUK2X000XXXX
Furnace Code:	GUSXDX
Save Config:	No

THIS SCREEN DISPLAYS AND ALLOWS ADJUSTMENT OF THE UNIT CODE.

This code is set from the factory to operate the components selected with the unit. When troubleshooting, refer to the wiring diagram sent with the unit (located on the control center door) to verify the unit code is correct. The code will be listed on the wiring diagram. If changes to the setup code are required, save the configuration by changing save configuration to yes.

Unit Expansion I/O	
Enable Expansion:	No

THIS SCREEN ALLOWS THE USER TO ENABLE ADDITIONAL I/O POINTS.

Unit I/O expansion requires the installation of a pCOe and field card.

Enabling the I/O expansion allows the user to add the following points for monitoring:

- Four analog inputs (0/1vdc, 0/5vdc, 0/20mA, 4/20mA, NTC Temp)
- One analog output (0/10vdc)
- Four digital inputs
- Four digital outputs

The additional I/O points available on the pCOe expansion module allow the user to monitor and control the additional points over the BMS and user display. See *Appendix C: Expansion I/O (pCOe) Quick Start* for more information.

Controller pLAN Setup	
Current pLAN Addr:	1
New pLAN Addr:	1
pLAN Port	
Protocol:	pLAN

THIS SCREEN ALLOWS THE USER TO VIEW AND CHANGE THE CONTROLLER pLAN ADDRESS.

A pLAN (pCO Local Area Network) is a Carel® proprietary local area network, allowing the user to connect multiple controllers to one remote display panel. Each controller on a pLAN must have a unique address. This address is only applicable for units connected on a pLAN. For BACnet, LonWorks or Modbus parameters, go to **Service > BMS Config**.

H. Manufacturer

b. I/O Configuration

The **I/O Configuration** menu allows adjustment of all controller inputs and outputs. Similar to the **Probe Adjustment** menu, the **I/O Configuration** menu also allows adjustment of the factory default 'normal' states of the digital inputs and the direction of the analog outputs. It also allows adjustment of the physical location of each I/O. **ADJUSTMENT OF I/O PHYSICAL LOCATION MUST ONLY BE DONE UNDER FACTORY GUIDANCE! IMPROPER ADJUSTMENT MAY RESULT IN SYSTEM DAMAGE!**

Analog Input	
Outside Temperature	
En: ON	Ch: U005
Normal	NTC
Offset:	0.0°F
Value:	70.5°F

This is an example of an analog input configuration screen.

In the I/O configuration screens, the user can alter the physical location and type of each point.

Similar configuration screens appear for the remaining I/O.

Alarm Time Delay	
Outside Temperature Input B0005:	73.5°F
Out of Range Alarm	
Power Delay:	30s
Run Delay:	30s
Units:	Temperature

Digital Input	
Remote On/Off	
Enable: ON Channel:	4
Action:	CLOSED
Delay:	0s
Status:	Closed

Relay Output	
Defrost	
Enable:	Yes
Channel:	1
Status:	OFF

Analog Output Config	
Cool:	
Enable:	Yes
Channel:	3
Action:	DIRECT
Minimum:	0.0vdc
Maximum:	10.0vdc

H. Manufacturer

c. Factory Settings

The **Factory Settings** menu allows adjustment of parameters that are critical for proper unit operation. Adjustment of these parameters is only recommended with factory guidance. To access the Factory Settings menu, enter the manufacturer password (**Default=1000**).

Economizer Controller

Allow mechanical cooling during econ?	Yes
Offset from minOA:	5%
Hysteresis:	3%

Evap Control

Off Temp Diff:	2.0°F
Pump On Delay:	90s
Pump Off Delay:	10s
Flush evap for 10 min after 24 hrs of runtime	
Evap Runtime:	0hrs
# of Evap Flush:	0

Cooling Controller

Integration:	300s
Band:	20°F
Cooling Loop:	0.0%
Cold Coil Loop:	0.0%

Compressor Rotation

# of stages:	2
Rotation:	LIFO

Compressor Timers

Minimum ON:	30s
Minimum OFF:	180s
Between Stages:	30s

THIS SCREEN ALLOWS THE ADJUSTMENT OF THE ECONOMIZER FUNCTION.

This screen only appears if an economizer mode was selected with the unit.

If the unit was selected with cooling and economizer, the user has the option to allow mechanical cooling during the economizer mode.

THIS SCREEN ALLOWS THE ADJUSTMENT OF THE EVAPORATIVE COOLING CONTROL PARAMETERS.

This screen only appears if evaporative cooling was provided with the unit.

The controller operates the evaporative cooling based on the outdoor air temp. The additional adjustable parameters associated to the evaporative cooling control operation includes a temp differential used to delay on and off cycling on shoulder days, a pump on delay to ensure that water is in the sump prior to turning on the pump, a pump off delay to ensure enough water has been drained to prevent over filling the sump, and a flush timer to ensure the sump is drained thus preventing a buildup of mineral on the evaporative cooling material.

There are also counters showing how many hours the evaporative cooling has been running since the last sump drain, or “Flush” sequence, and how many “Flush sequences” have taken place since the unit has been running.

THIS SCREEN ALLOWS ADJUSTMENT OF THE COOLING PI CONTROL LOOP.

This screen only appears if cooling option was provided with the unit.

The controller utilizes a PI loop control for cooling. This allows for less sporadic changes in supply temperature, resulting in a smooth reaction to changing conditions. To speed up reaction time, decrease the integration time. For slower reaction time, increase the integration time. When making adjustments, make them in small increments and test the system to determine if the new setting is adequate prior to further adjustment. The band is the range that the integration will occur between.

THIS SCREEN DISPLAYS THE NUMBER OF STANDARD COMPRESSOR STAGES PROVIDED WITH THE UNIT AND SHOWS THE ROTATION SEQUENCE.

This screen only appears if DX cooling was provided with the unit.

The number of stages displayed is equal to the number of non-modulating compressors. **Factory default compressor rotation is LIFO (Last In, First Out).**

THIS SCREEN DISPLAYS THE COMPRESSOR MINIMUM ON AND OFF TIMES.

This screen only appears if DX cooling was provided with the unit.

The compressor minimum on/off times prevents short cycling of the compressors.

Compressor Staging

Stage1: ON @ 50% OFF 0%
Stage2: ON @100% OFF50%

Heater Controller

Band: 60°F
Integration: 300s
Derivative: 0s
Off Delay: 60s
Enable Deadband: Yes
Deadband: 5°F
Temp Protection:

IG Heater Setup

Modbus Address Fur1: 3
Modbus Address Fur2: 7
Alarm lockout: 60s
Lockout Retrys: 5
Max Retry Time: 1H
Modulation Type: HTD

IG Heater Setup 2

High Speed StPt: 50.0
High Speed Diff: 5.0
Mod Output: Linear
High Max Temp: 125.0°F
High Diff Temp: 85.0°F

THIS SCREEN DISPLAYS WHEN EACH COMPRESSOR IN A SINGLE OR DUAL STAGE DX UNIT WILL ENGAGE/DISENGAGE.

This screen only appears if DX cooling was provided with the unit.

Each compressor will engage and disengage based upon the percentage of cooling capacity the controller requires.

THIS SCREEN ALLOWS ADJUSTMENT OF THE HEATING PID CONTROL LOOP.

This screen only appears if heating option was provided with the unit.

The controller utilizes a PID loop control for heating. This allows for less sporadic changes in supply temperature, resulting in a smooth reaction to changing conditions. To speed up reaction time, decrease the integration time. For slower reaction time, increase the integration time. When making adjustments, make them in small increments and test the system to determine if the new setting is adequate prior to further adjustment. The band is the range that the integration will occur between. The off delay allows the heating output to temporarily overshoot the set point without dropping the call for heat to prevent unwanted cycling. The deadband prevents the PID loop from shutting off the heat until the supply temperature is outside the specified temperature range.

When the system requirements are met, the temp protection functionality enables the supply fan on 100% OA units or OA/RA damper on partial recirculation units to modulate down to help the unit keep up with the heating demand as failure outside design conditions change. Once set point is achieved, the unit goes back to normal operation.

THIS SCREEN ALLOWS ADJUSTMENT OF THE INDIRECT GAS FURNACE.

This screen only appears if indirect gas furnace was provided with the unit.

Allows changes to the Modbus address of Furnace 1 and Furnace 2 if supplied. Alarm lockout delay between retries of furnace alarms and the number of retries the furnace is allowed before its lockout within the maximum retry time. Modulation type is available when a HTD furnace is selected to be supplied with the unit. This setting allows the user to lock the furnace to a 4:1 operation instead of HTD.

THIS SCREEN ALLOWS ADJUSTMENT OF THE INDIRECT GAS FURNACE.

This screen only appears if indirect gas furnace was provided with the unit.

High speed set point is the heating percentage that sends the combustion fan to high speed. High speed differential is the heating percentage below the set point that the combustion fan goes to low speed. Mod Output is linear or scaled based on the modulating gas value used. High max temp is the temperature the supply discharge must exceed before the high diff temp alarm is generated. High differential temperature is the temperature the supply discharge must be reduced too for the high discharge temperature alarm to reset.

Caution: Adjusting these settings incorrectly can significantly impair heater performance and reduce heater life. Consult factory before adjusting.

HTD Furnace Config 1

Stage Up Setpts

Stge up heat%:	99%
Diff below setpt:	2°F
Stage up delay:	30s
Heat % reset lo:	20%

HTD Furnace Config 2

Stage Up Setpts

Stge dn heat%:	2%
Diff above setpt:	0°F
Stage dn delay:	30s
Heat % reset hi:	95%

IG Quick Comp. Loop

Disable QC:	No
Temp Diff:	3.0F
Diff Time:	60s
Max QC time:	600s

IG Quick Comp. Loop

QC Heat Band:	30°F
QC Integration:	210s
QC Derivative:	20s
QC Deadband:	5°F
QC ReturnDiff:	2°F
QC Return Time:	20s

IG Staged Furnaces 1

Stage Up Setpts

Stge up heat%:	95%
Diff below setpt:	3°F
Stage up delay:	30s
Heat % reset lo:	50%

IG Staged Furnaces 2

Stage Up Setpts

Stge dn heat%:	20%
Diff above setpt:	3°F
Stage dn delay:	20s
Heat % reset hi:	50%

Heat/Cool Delay

Time delay between heating, cooling &/or economizer modes. Delay:	180s
---	------

THIS SCREEN ALLOWS ADJUSTMENT OF THE HTD INDIRECT GAS FURNACE.

This screen only appears if a HTD indirect gas furnace was provided with the unit.

Stge up/dn heat% is the percentage at which the furnace must be firing at in order for the second manifold of the furnace to turn on. Diff above/below setpt is the amount the furnace must be away from set point before the second manifold can turn on. Stage up/dn delay is the amount of time the furnace remains at the current state before a manifold is started / shut off. Heat % reset hi/lo is the modulation percentage that the furnace is reset to after turning a manifold on or off.

Caution: Adjusting these settings incorrectly can significantly impair heater performance and reduce heater life. Consult factory before adjusting.

THIS SCREEN ALLOWS ADJUSTMENT OF THE INDIRECT GAS FURNACE.

This screen appears if indirect gas furnace was provided with the unit.

Quick compensation allows a separate control loop to quickly and accurately ramp the furnace up to the desired discharge temp without overshooting. Once the furnace tubes are warmed up and the discharge temperature has stabilized, the control switches back to the normal furnace control loop. Adjustable parameters include control loop temp differential, required time in temp differential and max run time of quick compensation loop.

THIS SCREEN ALLOWS ADJUSTMENT OF THE INDIRECT GAS FURNACE.

This screen only appears if indirect gas furnace was provided with the unit and force start is enabled.

The quick compensation uses a PID control loop. The heat band is the proportional characteristic of the loop. The greater the heat band, the less time the furnace is at 100% heating in order to achieve the temperature set point. Decreasing the heat band may result in the furnace overshooting the discharge set point on initial start up. The integration and derivative adjust the proportional band with respect to time and temperature. To decrease the reaction time of the loop, increase the integration and/or derivative time. To increase the reaction time of the loop, decrease the integration and/or derivative time. The deadband prevents the PID loop from shutting off the heat until the supply temp is outside the specified temp range. QC return diff/time are parameters that allow the quick compensation loop to be turned back on once the loop has ended.

THIS SCREEN ALLOWS ADJUSTMENT OF THE STAGED INDIRECT GAS FURNACE.

This screen only appears if a staged indirect gas furnace was provided with the unit.

Stge up/dn heat% is the percentage at which the furnace must be firing at in order for the next stage of the staged furnace(s) to turn on. Differential above/below set point is the amount the furnace must be away from setpt before the next stage can turn on.

Stge up/dn delay is the amount of time the furnace remains at the current state before a stage is started/shut off. Heat percent reset hi/lo is the modulation percent that the furnace is reset to after turning a stage on or off.

Caution: Adjusting these settings incorrectly can significantly impair heater performance and reduce heater life. Consult factory before adjusting.

THIS SCREEN ALLOWS ADJUSTMENT OF THE DELAY BETWEEN HEAT AND COOL MODES.

The time delay prevents short cycling between heating, cooling and/or economizer modes.

Unoccupied Mode Setup

Type: Cycle Supply Fan
Source: Input ID6
Heat Off Delay: 60s
Unocc OA Damper Min: 100%
Open Unocc Damper during unocc cycle? YES

Unocc Override Setup

Contact: Momentary

Damper Setup

Allow the dampers to open for: 10 seconds before starting the fans.

Fan/Airflow Proving

Alarm delay: 30s
(inputs ID1 & ID5)

CO2 Controller

Integration: 600s
Band 500PPM

Duct Pressure Controller

Integration: 15s
Band 5.00"wc
Min On Time: 30s
Overshoot Limit: YES
Hi Limit Diff: 0.50"wc

THIS SCREEN DISPLAYS ADDITIONAL PARAMETERS THAT MAY BE USED DURING UNOCCUPIED FAN CYCLING.

After the unoccupied heating set point has been satisfied, the supply fan will continue to run for the heat off delay.

On 100% outdoor air (OA) units, the OA damper can be configured to open to allow unoccupied fan cycling.

THIS SCREEN ALLOWS THE USER TO CHANGE THE TEMPORARY OCCUPANCY OVERRIDE CONTACT FROM MOMENTARY TO MAINTAINED.

The default temporary occupancy override functionality is a momentary contact at ID6 that will override unoccupied mode for a user adjustable 1, 2, or 3 hours. This screen allows the user to change the setting and allow the unit to override unoccupied mode as long as the contact at **ID6** is closed. This works well in applications that have a motion detector, rotary timers, etc.

THIS SCREEN ALLOWS ADJUSTMENT OF THE FAN START DELAY.

This timer allows the damper time to open before the fan start sequence begins. This prevents the fans from having to overcome higher static pressure when the damper(s) are opening. **(Factory Default = 10 seconds)**

THIS SCREEN ALLOWS ADJUSTMENT OF THE FAN AIRFLOW PROVING SWITCH TIME DELAY.

Since the unit is only part of a complete system, the airflow(s) may momentarily change (ie. If a downstream damper closes). This delay is intended to prevent false loss of airflow alarms. **(Factory Default = 30 seconds)**

THIS SCREEN ALLOWS ADJUSTMENT OF THE CO2 CONTROL LOOP.

This screen only appears if unit is controlled by a CO2 sensor.

The controller utilizes a PI loop control for CO2 control. To speed up reaction time, decrease the integration time. For slower reaction time, increase the integration time. For less overshoot, increase the band. When making adjustments, make them in small increments and test the system to determine if the new setting is adequate prior to further adjustment.

THIS SCREEN ALLOWS ADJUSTMENT OF THE DUCT PRESSURE CONTROL LOOP.

This screen only appears if equipped with a duct pressure sensor.

The controller utilizes a PI loop control for duct pressure control. To speed up reaction time, decrease the integration time. For slower reaction time, increase the integration time. For less overshoot, increase the band. When making adjustments, make them in small increments and test the system to determine if the new setting is adequate prior to further adjustment.

To allow the duct pressure to stabilize, the supply fan will remain at minimum speed for Min On Time. This prevents unnecessary overshooting at start-up.

To minimize excessive duct pressurization, the overshoot limit can be enabled. This will allow the user to enter an offset from the duct pressure set point. If the duct pressure exceeds the set point by the value of Hi Limit Diff **(Factory Default = 0.50 inch wc)**, the supply fan will reset to its minimum speed.

Building Ps Controller	
Integration:	200s
Band	.100"wc

THIS SCREEN ALLOWS ADJUSTMENT OF THE BUILDING PRESSURE CONTROL LOOP.

This screen only appears if unit is equipped with a building pressure sensor.

The controller utilizes a PI loop control for building pressure control. To speed up the reaction time, decrease the integration time. For slower reaction time, increase the integration time. For less overshoot, increase the band. When making adjustments, make them in small increments and test the system to determine if the new setting is adequate prior to further adjustment.

Max Ventilation	
Enable Max Vent:	No
2 Spd Fan:	On
2 Pos Damper:	Off

THIS SCREEN ALLOWS THE USER TO ENABLE THE MAX VENTILATION SEQUENCE.

This screen only appears if modulating/2-speed fan or modulating/2-position damper operation was supplied with the unit.

2-speed fan and/or 2-position damper operation allows the user to send the fan and/or damper to a higher operating position through a digital input to the controller. Maximum ventilation is a sequence that will allow the digital input contact closer to bring the unit out of unoccupied mode. During this operation, the unit will run with the fan and/or damper at the 2-position or 2-speed set point for the duration of the contact closure.

Unit Off Protection	
Enable when OA < 40°F	
Hot Water:	Enable
Open HW Value:	30%
Chilled Water:	Disable

THIS SCREEN ALLOWS THE USER TO ENABLE "UNIT OFF PROTECTION."

This screen only appears if hot water heating and/or cold water cooling is supplied with the unit.

Unit off protection allows the unit to open the hot water and cold water valves to a preset position when the unit is off and the outdoor air is below the specified set point. This will keep water moving in the coils, to reduce the chance of freezing the coils.

Temperature Scale	
Select:	Fahrenheit
Display Properties	
Buzzer:	Disable
Backlight:	Always On
Timeout:	300s

THIS SCREEN ALLOWS THE USER TO ADJUST WHAT UNIT SYSTEM THE CONTROLLER SHOULD DISPLAY AND SOME OTHER DISPLAY PROPERTIES.

The temperature unit of measurement can be set to Fahrenheit or Celsius. If using Celsius, the user will need to change the factory default parameters in each menu.

The display buzzer is only applicable when an optional remote display is attached to the controller. If an alarm were to occur, the remote display would begin buzzing (if the buzzer was enabled) and would show the alarm status.

The controller and/or remote display LED backlight can be configured to shut off after the Timeout period. Otherwise, the LED backlight will always be on.

I/O Screens	
Enable all I/O screens?	Yes

THIS SCREEN ENABLES THE VISIBILITY OF ALL I/O RELATED SCREENS.

The controller automatically hides screens related to irrelevant I/O points.

Enabling this functionality will give the user visibility of all I/O related screens and will also make these values available for monitoring on a BMS.



H. Manufacturer

d. Initialization

The **Initialization Menu** allows the user to save and restore the controller's default parameters. The controller can be restored with either the manufacturer's default parameters from shipment, or an unconfigured factory default.

Factory Settings



Save?	No
Restore?	No

THIS SCREEN ALLOWS THE USER TO SAVE AND RESTORE THE FACTORY DEFAULT PARAMETERS STORED IN MEMORY.

The factory settings include the factory default parameters and the unit setup code. If the user would like to restore to these parameters, move the cursor to the restore position and change to yes.

New Password



Insert new manufacturer password (PW2):	0000
---	------

THIS SCREEN ALLOWS THE USER TO CHANGE THE MANUFACTURER PASSWORD (PW2)

Initialization

DEFAULT INSTALLATION	
Erase user settings and install global default values:	No

THIS SCREEN ALLOWS THE USER TO RESTORE BACK TO THE ORIGINAL FACTORY DEFAULT PARAMETERS.

Restoring to the original default parameters will result in a non-customized controller. The user should not restore to these settings unless instructed by the factory.

Points List • LonWorks®

Type	NV_Index/Bit	Name NV	Type NV	Read (Unit to BMS) Write (BMS to unit)	Description
Analog	23	nvoOutsideTemp	105	Read	Outdoor Air Temp (###.#°F)
Analog	3	nviOutsideTemp	105	Write*	Writeable Outdoor Air Temp (###.#°F) (*To write enable point. See Menus, B. Set point, Building Press SetPt screen)
Analog	24	nvoSupplyAirTemp	105	Read	Supply Air Temp (###.#°F)
Analog	25	nvoColdCoilDisch	105	Read	Cold Coil Temp (###.#°F)
Analog	26	nvoRoomTemp	105	Read	Room AirTemp (if installed) (###.#°F)
Analog	4	nviRoomTemp	105	Write*	Writeable Room AirTemp (if installed) (###.#°F) (*To write enable point. See Menus, B. Set point, Building Press SetPt screen)
Analog	27	nvoOA_Humidity	81	Read	Outdoor Relative Humidity (###.##%)
Analog	5	nviOAHumidity	81	Write*	Writeable Outdoor Relative Humidity (###.##%) (*To write enable point. See Menus, B. Set point, Building Press SetPt screen)
Analog	28	nvoRoomHumidity	81	Read	Room Relative Humidity (###.##%)
Analog	6	nviRoomHumidity	81	Write*	Writeable Room Relative Humidity (###.##%) (*To write enable point. See Menus, B. Set point, Building Press SetPt screen)
Analog	7	nviTempSetPt	105	Write	Temperature SetPt (read/write) (###.#F) (See Set Point Menu)
Analog	29	nvoActiveTempSP	105	Read	Active Temperature Set Point (###.#F)
Analog	8	nviDehumidSetPt	81	Write	Dehumidification SetPt (write) (##.#F, ##.##%) (See Set Point Menu)
Integer	34	nvoStatus	8	Read	Note 1 (See below)
Integer	35	nvoHeating	81	Read	Heater output (0-100%)
Integer	36	nvoCooling	81	Read	Cooling output (0-100%)
Integer	37	nvoWheel	81	Read	Energy recovery wheel speed (0-100%)
Integer	38	nvoReheat	81	Read	Hot gas reheat output (0-100%)
Integer	39	nvoCO2_Level	29	Read	CO2 Levels (ppm)
Integer	10	nviCO2_SetPt	29	Write	CO2 Set Point (ppm)
Integer	40	nvoSupVFDSpeed	81	Read	Supply Fan VFD Speed (0-100%)
Integer	11	nviSF_SetPt	81	Write	Supply Fan VFD Set Point (0-100%)
Integer	41	nvoExhVFDSpeed	81	Read	Exhaust Fan VFD Speed (0-100%)
Integer	12	nviEF_SetPt	81	Write	Exhaust Fan VFD Set Point (0-100%)
Integer	42	nvoOADamperPos	81	Read	Outdoor Damper Position (0-100%)
Integer	13	nviOADamperSetPt	81	Write	Minimum OA Damper Position (0-100%)
Integer	43	nvoDuctPressure	8	Read	Supply Duct Pressure (value/100=#.##" WC)
Integer	14	nviDuctPsSetPt	8	Write	Supply Duct Pressure Set Point (value/100=#.##" WC)
Integer	44	nvoBldgPressure	9	Read	Building Pressure (value/1000 = 0.###" WC)
Integer	15	nviBldgPsSetPt	9	Write	Building Pressure Set Point (value/1000 = 0.###" WC)
Integer	16	nviOccUnocc	8	Write	Occupied/unoccupied command (0=occupied, 1=unoccupied, 2=MWU)
Integer	45	nvoIG_Alarm	8	Read	IG Alarm - For alarm detail, Convert to binary (See IG Alarm chart below)
pCOe Analog Variables					
Analog	37	nvoAux_AI1	9	Read	pCOe Analog Input Probe Value 1
Analog	38	nvoAux_AI2	9	Read	pCOe Analog Input Probe Value 2
Analog	39	nvoAux_AI3	9	Read	pCOe Analog Input Probe Value 3
Analog	40	nvoAux_AI4	9	Read	pCOe Analog Input Probe Value 4
Analog	9	nviAux_AO1	81	Write	pCOe Auxillary Analog Out (0-10V)

IG Alarm (Ref. IG_Alarm point 1019)

Bit 0	Bit 1	Bit 2	Bit 3	Bit 4
No Flame	Ignition Controller	Max Retries	High Limit	IG Furnace Offline

Note 1: Unit Status Index

0 System Off	5 System On	10 System On - Economizer & Cooling	15 Unoccupied - Heating	20 Remote off
1 Initial Delay	6 Defrost Mode Active	11 System On - Dehumidifying	16 Unoccupied - Cooling	21 Alarm
2 Opening Dampers	7 System On - Economizer	12 System On - Dehumidifying & Reheat	17 Unoccupied -Dehumidifying	22 Temp Occupied
3 Exhaust Fan Starting	8 System On - Heating	13 Unoccupied - Unit off	18 Unoccupied -Dehumid&Reheat	23 Max Ventilation
4 Supply Fan Starting	9 System On - Cooling	14 Unoccupied - Unit on	19 Manual Override	24 Unit Off Protection

Points List • LonWorks®

Type	NV_Index/Bit	Name NV	Type NV	Read (Unit to BMS) Write (BMS to unit)	Description
Digital	46	nvoOnOffStat	95	Read	Unit ON/OFF status
Digital	47	nvoSupplyFan	95	Read	Supply fan status
Digital	48	nvoExhaustFan	95	Read	Exhaust fan status
Digital	49	nvoOccupancyStat	95	Read	Occupancy Status (0=Unoccupied, 1=Occupied)
Digital	50	nvoStageComp1	95	Read	Stage Compressor #1 status
Digital	51	nvoStageComp2	95	Read	Stage Compressor #2 status
Digital	52	nvoDefrostMode	95	Read	Defrost mode status
Digital	53	nvoDigScrollStat	95	Read	Digital Scroll status
Digital	17	nviStartStop	95	Write	Unit start/stop command
Digital	18	nviResetAlarms	95	Write	Reset alarms command
Digital	54	nvoStageComp3	95	Read	Stage Compressor #3 status
Digital	55	nvoStageComp4	95	Read	Stage Compressor #4 status
Digital	56	nvoGlobalAlarm	95	Read	Global alarm indication (active when there is at least one alarm)
	57	nvoAlarms	83		Alarms
Digital	(LSB) bit0	SupplyFanAlm		Read	Supply airflow proving alarm
Digital	bit1	WhlPressurAlm		Read	High wheel pressure (high airflow or dirty wheel)
Digital	bit2	WhlRotateAlm		Read	Wheel rotation alarm
Digital	bit3	ExhaustFanAlm		Read	Exhaust airflow proving alarm
Digital	bit4	FilterAlm		Read	Dirty filter alarm
Digital	bit5	CompTripAlm		Read	Compressor trip alarm
Digital	bit6	SupplyTempAlm		Read	Supply air temperature low limit alarm
	58	SensorAlarm	95		A sensor has failed
Digital	(LSB) bit0			Read	Sensor#1 out of range (outside air temperature)
Digital	bit1			Read	Sensor#2 out of range (supply air temperature)
Digital	bit2			Read	Sensor#3 out of range (cold coil leaving air temperature)
Digital	bit3			Read	Sensor#4 out of range (room temperature)
Digital	bit4			Read	Sensor#5 out of range (room humidity)
Digital	bit5			Read	Sensor#6 out of range (outdoor humidity)
Digital	bit6			Read	Sensor#7 out of range (building pressure sensor)
Digital	bit7			Read	Sensor#8 out of range (duct pressure sensor)
Digital	bit8			Read	Sensor#9 out of range (CO2 sensor)
Digital	bit9			Read	Sensor#10 out of range (auxiliary temp)
pCOe Digital Variables					
Digital	52	nvoAux_DI1	95	Read	pCOe Auxillary Digital Input1
Digital	53	nvoAux_DI2	95	Read	pCOe Auxillary Digital Input2
Digital	54	nvoAux_DI3	95	Read	pCOe Auxillary Digital Input3
Digital	55	nvoAux_DI4	95	Read	pCOe Auxillary Digital Input4
Digital	21	nviAux_DO1	95	Read/Write	pCOe Auxillary Digital Output1
Digital	22	nviAux_DO2	95	Read/Write	pCOe Auxillary Digital Output2

Points List • Modbus/BACnet®

Type	BACnet Device Instance: 77000 (default) Analog = AV, Integer = AV, Digital = BV			Modbus Address: 1	Read Write	Description
	Instance	Name	Units	Register		
Analog	1	Outside_Air_Temp	°F	40002	R/W*	Outdoor Air Temp (###.##°F) (*To write enable point. See Menus, B. Set point, Building Press SetPt screen)
Analog	2	Supply_Air_Temp	°F	40003	R	Supply Air Temp (###.##°F)
Analog	3	Cold_Coil_Leaving_Temp	°F	40004	R	Cold Coil Temp (###.##°F)
Analog	4	Room_Air_Temp	°F	40005	R/W*	Room AirTemp (if installed) (###.##°F) (*To write enable point. See Menus, B. Set point, Building Press SetPt screen)
Analog	5	Outside_Humidity	percent	40006	R/W*	Outdoor Relative Humidity (###.##%) (*To write enable point. See Menus, B. Set point, Building Press SetPt screen)
Analog	6	Room_Humidity	percent	40007	R/W*	Room Relative Humidity (###.##%) (*To write enable point. See Menus, B. Set point, Building Press SetPt screen)
Analog	11	Temp_Set_Point	°F	40012	R/W	Temperature SetPt (read/write) (###.##°F) (See Set Point Menu)
Analog	12	Active_Temp_Set_Point	°F	40013	R	Active Temperature Set Point (###.##°F)
Analog	13	Dehumid_Set_Point	percent	40014	R/W	Dehumidification SetPt (read/write) (##.##, ##.##%) (See Set Point Menu)
Integer	1001	Unit_Status_Index	no-units	45003	R	Note 1 (See below)
Integer	1002	Heating_Control_Loop	percent	45004	R	Heater output (0-100%)
Integer	1003	Cooling_Control_Loop	percent	45005	R	Cooling output (0-100%)
Integer	1004	Energy_Wheel_Speed	percent	45006	R	Energy recovery wheel speed (0-100%)
Integer	1005	Reheat_Control_Loop	percent	45007	R	Hot gas reheat output (0-100%)
Integer	1006	CO2_Level	ppm	45008	R	CO2 Levels (ppm)
Integer	1007	CO2_Set_Point	ppm	45009	R/W	CO2 Set Point (ppm)
Integer	1008	Supply_VFD_Speed	percent	45010	R	Supply Fan VFD Speed (0-100%)
Integer	1009	Supply_VFD_SetPt	percent	45011	R/W	Supply Fan VFD Set Point (0-100%)
Integer	1010	Exhaust_VFD_Speed	percent	45012	R	Exhaust Fan VFD Speed (0-100%)
Integer	1011	Exhaust_VFD_SetPt	percent	45013	R/W	Exhaust Fan VFD Set Point (0-100%)
Integer	1012	OA_Damper_Position	percent	45014	R	Outdoor Damper Position (0-100%)
Integer	1013	OA_Damper_SetPt	percent	45015	R/W	Minimum OA Damper Position (0-100%)
Integer	1014	Duct_Pressure	no-units	45016	R	Supply Duct Pressure (value/100=#.##" WC)
Integer	1015	Duct_Pressure_SetPt	no-units	45017	R/W	Supply Duct Pressure Set Point (value/100=#.##" WC)
Integer	1016	Building_Pressure	no-units	45018	R	Building Pressure (value/1000 = 0.###" WC)
Integer	1017	Building_Pressure_SetPt	no-units	45019	R/W	Building Pressure Set Point (value/1000 = 0.###" WC)
Integer	1018	Occupied_Unoccupied	no-units	45020	R/W	Occupied/unoccupied command (0=occupied, 1-unoccupied, 2-MWU)
Integer	1019	IG_Alarm	no-units	45021	R	IG Alarm - For alarm detail, Convert to binary (See IG Alarm chart below)
Integer	1021	Airflow_CFM1	no-units	45023	R	Airflow monitoring station 1 CFM value
Integer	1022	Airflow_CFM2	no-units	45024	R	Airflow monitoring station 2 CFM value
Integer	1023	Airflow_CFM3	no-units	45025	R	Airflow monitoring station 3 CFM value
Integer	1024	User_Def_Exh_SetPt	no-units	45026	R/W	User defined exhaust fan control set point
Integer	1025	User_Def_Exh_Input	no-units	45027	R	User defined exhaust fan control input value
pCOe Analog Variables						
Analog	21	Aux_AI1	°F or Percent	40022	R	pCOe Analog Input Probe Value 1
Analog	22	Aux_AI2	°F or Percent	40023	R	pCOe Analog Input Probe Value 2
Analog	23	Aux_AI3	°F or Percent	40024	R	pCOe Analog Input Probe Value 3
Analog	24	Aux_AI4	°F or Percent	40025	R	pCOe Analog Input Probe Value 4
Analog	25	Aux_AO1	percent	40026	R/W	pCOe Auxillary Analog Out (0-10V)

IG Alarm (Ref. IG_Alarm point 1019)

Bit 0	Bit 1	Bit 2	Bit 3	Bit 4
No Flame	Ignition Controller	Max Retries	High Limit	IG Furnace Offline

Note 1: Unit Status Index

0 System Off	5 System On	10 System On - Economizer & Cooling	15 Unoccupied - Heating	20 Remote off
1 Initial Delay	6 Defrost Mode Active	11 System On - Dehumidifying	16 Unoccupied - Cooling	21 Alarm
2 Opening Dampers	7 System On - Economizer	12 System On - Dehumidifying & Reheat	17 Unoccupied -Dehumidifying	22 Temp Occupied
3 Exhaust Fan Starting	8 System On - Heating	13 Unoccupied - Unit off	18 Unoccupied -Dehumid&Reheat	23 Max Ventilation
4 Supply Fan Starting	9 System On - Cooling	14 Unoccupied - Unit on	19 Manual Override	24 Unit Off Protection



Points List • Modbus/BACnet®

Type	BACnet Device Instance: 77000 (default) Analog = AV, Integer = AV, Digital = BV				Modbus Address: 1	Read Write	Description
		Inactive_Text	Active_Text				
Digital	1	On_Off_Stat	Off	On	10002	R	Unit ON/OFF status
Digital	2	Supply_Fan_Status	Off	On	10003	R	Supply fan status
Digital	3	Exhaust_Fan_Status	Off	On	10004	R	Exhaust fan status
Digital	4	Occupancy_Status	Unoccupied	Occupied	10005	R	Occupancy Status (0=Unoccupied, 1=Occupied)
Digital	5	Stage_Compressor1_Status	Off	On	10006	R	Stage Compressor #1 status
Digital	6	Stage_Compressor2_Status	Off	On	10007	R	Stage Compressor #2 status
Digital	7	Defrost_Mode	Off	On	10008	R	Defrost mode status
Digital	8	Digital_Scroll_Status	Off	On	10009	R	Digital Scroll status
Digital	10	Unit_Start_Stop	Stop	Start	10011	R/W	Unit start/stop command
Digital	11	Reset_Alarms	Don't Reset	Reset Alarms	10012	R/W	Reset alarms command
Digital	13	Stage_Compressor3_Status	Off	On	10014	R	Stage Compressor #3 status
Digital	14	Stage_Compressor4_Status	Off	On	10015	R	Stage Compressor #4 status
Digital	20	Global_Alarm	Off	Alarm	10021	R	Global alarm indication (active when there is at least one alarm)
Digital	21	Supply_air_proving	Off	Alarm	10022	R	Supply airflow proving alarm
Digital	22	High_Wheel_Pressure	Off	Alarm	10023	R	High wheel pressure (high airflow or dirty wheel)
Digital	23	Wheel_Rotation	Off	Alarm	10024	R	Wheel rotation alarm
Digital	24	Exhaust_air_proving	Off	Alarm	10025	R	Exhaust airflow proving alarm
Digital	25	Dirty_filter	Off	Alarm	10026	R	Dirty filter alarm
Digital	26	Compressor_trip	Off	Alarm	10027	R	Compressor trip alarm
Digital	27	Supply_air_low_limit	Off	Alarm	10028	R	Supply air temperature low limit alarm
Digital	28	Sensor1_out_of_range	Off	Alarm	10029	R	Sensor#1 out of range (outside air temperature)
Digital	29	Sensor2_out_of_range	Off	Alarm	10030	R	Sensor#2 out of range (supply air temperature)
Digital	30	Sensor3_out_of_range	Off	Alarm	10031	R	Sensor#3 out of range (cold coil leaving air temperature)
Digital	31	Sensor4_out_of_range	Off	Alarm	10032	R	Sensor#4 out of range (room temperature)
Digital	32	Sensor5_out_of_range	Off	Alarm	10033	R	Sensor#5 out of range (room humidity)
Digital	33	Sensor6_out_of_range	Off	Alarm	10034	R	Sensor#6 out of range (outdoor humidity)
Digital	34	Sensor7_out_of_range	Off	Alarm	10035	R	Sensor#7 out of range (building pressure sensor)
Digital	35	Sensor8_out_of_range	Off	Alarm	10036	R	Sensor#8 out of range (duct pressure sensor)
Digital	36	Sensor9_out_of_range	Off	Alarm	10037	R	Sensor#9 out of range (CO2 sensor)
Digital	37	Sensor10_out_of_range	Off	Alarm	10038	R	Sensor#10 out of range (auxiliary temp)
pCOe Analog Variables							
Digital	51	Aux_DI1	Off	On	10052	R	pCOe Auxiliary Digital Input1
Digital	52	Aux_DI2	Off	On	10053	R	pCOe Auxiliary Digital Input2
Digital	53	Aux_DI3	Off	On	10054	R	pCOe Auxiliary Digital Input3
Digital	54	Aux_DI4	Off	On	10055	R	pCOe Auxiliary Digital Input4
Digital	55	Aux_DO1	Off	On	10056	R/W	pCOe Auxiliary Digital Output1
Digital	56	Aux_DO2	Off	On	10057	R/W	pCOe Auxiliary Digital Output2
Digital	57	Aux_DO3	Off	On	10058	R/W	pCOe Auxiliary Digital Output3
Digital	58	Aux_DO4	Off	On	10059	R/W	pCOe Auxiliary Digital Output4

Remote Display (pGD1)

The pGD1 is an optional remote display for use with manufacturer’s microprocessor controllers. The remote display allows for remote monitoring and adjustment of parameters of the unit mounted controller. The remote display allows identical access to menus and screens as the unit mounted controller display.



Specifications	
Carel Model	PGD1000W00
Power Supply	Power supplied from unit controller through RJ25 cable
Max distance from unit controller	150 feet
Required Cable	6P6C RJ25/RJ12 Cable (straight)
Operating Conditions	-4°F to 140°F, 90%RH (non-condensing)
Display Type	Backlit LED with lighted buttons

Installation

The remote display connects to the unit mounted controller through a six-wire RJ25 or RJ12 telephone cable (straight). When ordered from the factory, a 10 ft. cable is provided with the remote display. The display and cable can be used to assist with start-up and maintenance.

Connecting Cable

If mounted remotely, the factory cable can either be extended or replaced with a longer cable to obtain the necessary distance. The resulting cable connections should be a “straight through cable,” where pins on one end correspond identically to the pins on the opposite end. If making your own cable, use the same pin-out for each end.

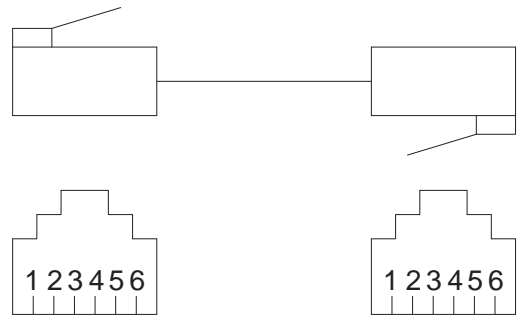

NTC Temperature Sensor Chart

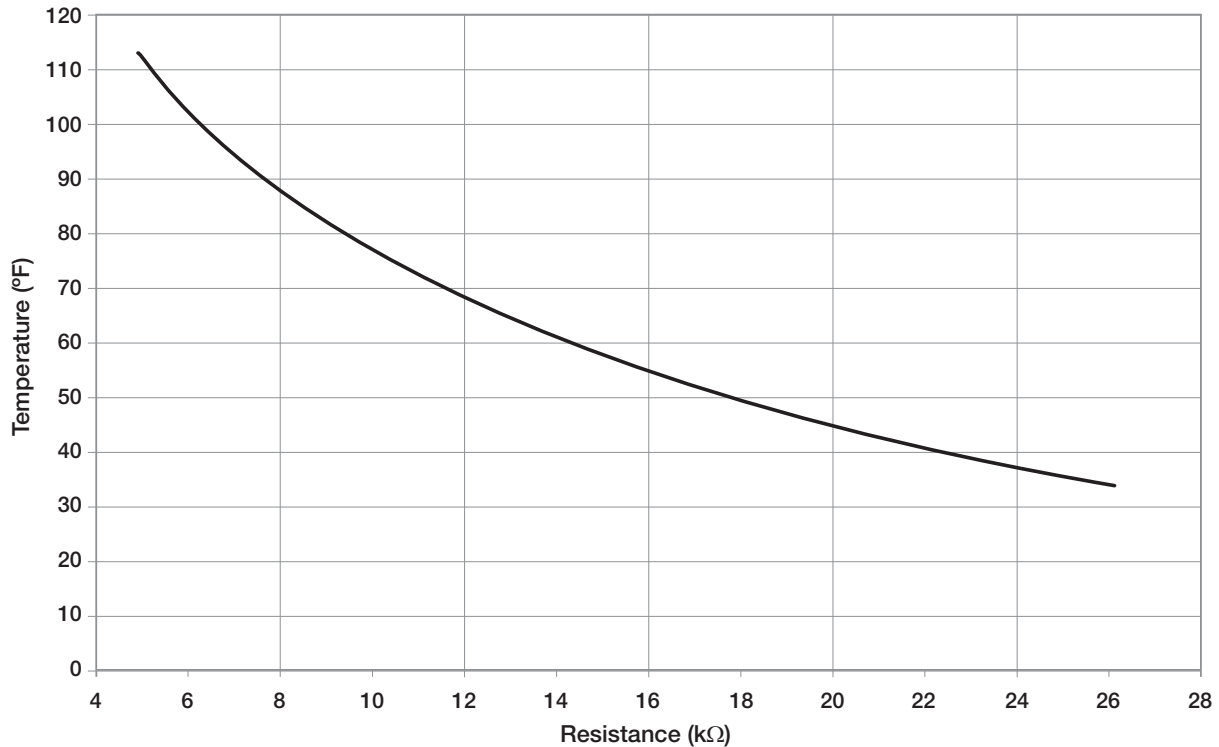

Economizer Commissioning Tool

Service Menu

- a. Information
- b. Overrides**
- c. BMS Config



I/O Manual Control

- E. Components
- A. Analog**
- B. Digital Inputs



Analog Input

```

Outside Temperature
ManualControl U005:   ON
ManualPosition:      57.1
Value                 57.1
    
```

This tool includes information on commissioning the economizer functionality of the DDC controller. The instructions below are based on factory default values. Results may vary depending on the current settings of the unit.

The unit may delay up to three (3) minutes before going into economizer mode.

Commissioning the economizer functionality is done by overriding the outdoor air and supply air conditions to simulate a scenario in which economizer is used for cooling. **NOTE: Overriding the physical inputs can be dangerous to the equipment. Use caution when adjusting these values and RESET POWER WHEN FINISHED!!!**

The table below indicates the necessary override values for the corresponding sensor to simulate economizer. The 'Supply Temp Source' can be found on the 'Supply Temp Set Point' screen. Navigate to the Analog Inputs Override menu (Service > Overrides > Analog Inputs) and refer to the table below for the appropriate override value.

In situations where mechanical cooling is available during economizer, increase the outdoor air temperature to 57.1° F to unlock the cooling.

Econ Type	Supply Temp Source	Outdoor Air Temp	Cold Coil Temp	Discharge Temp	Room Air Temp	Outdoor Air Relative Humidity
Temp Only	Outdoor Air Reset	53.0°F	75.0°F	75.0°F	-	-
	Room Air Reset	53.0°F	75.0°F	75.0°F	75.0°F	-
	Local/BMS	53.0°F	75.0°F	75.0°F	-	-
Temp and Dew Point	Outdoor Air Reset	53.0°F	75.0°F	75.0°F	-	30%
	Room Air Reset	53.0°F	75.0°F	75.0°F	75.0°F	30%
	Local/BMS	53.0°F	75.0°F	75.0°F	-	30%

Troubleshooting

Display is hard to read.	Unit Controller Display: Hold ESC and ENTER at the same time, while pressing DOWN or UP to adjust display contrast. Remote Display: Hold ALARM, PRG, and ESC at the same time, while pressing DOWN or UP to adjust display contrast.
Remote display panel displays "NO LINK" or is blank.	Hold DOWN, UP and ENTER for 4 seconds. Set the display address to 32. The display requires a standard 24 AWG six conductor phone cable connected to the unit controller.
Red alarm button is flashing.	Press the ALARM button to review and clear unit alarms. Enter the DATA LOGGER menu to view previous alarms.
Controller resets itself or is not on.	Check the supply voltage to the controller at terminals G-G0. The board requires 24VAC. Check the 24VAC transformer in the unit control center.
Menus are locked with a password.	The factory default Manufacturer Password = 1000. The factory default Service Password = 1000.
Temperature sensor failure.	Check the analog input terminal block (labeled terminals B1, B2, B3, etc) for loose wires. Disconnect temperature sensors to check sensor resistance.

The card is loaded with the following default BACnet MSTP parameters.

Parameter	Factory	Minimum	Maximum
Device Instance	77000	0	4194303
Station Address	0	0	127
Max Master	127	0	127
Max Info Frames	20	0	255
Baudrate	38400	9600-19200-38400-76800	

G. Service

c. BMS Config

To view the current parameters, go the **BMS Config** menu within the controller by pressing the  key.

To access the **BMS Config** sub-menu, enter the service-password (Default=1000).

Protocol must be **BACnet MSTP** and **BACnet Plugin** must be **YES**.

Press the  button arrow to view next screen.

Current BACnet MSTP parameters should be displayed. If values appear to be zero, follow the procedure below.

To read current settings:
1. Power on controller and allow several minutes to initialize.

BMS Configuration	
Protocol:	BACnet MSTP
BACnet Plugin?	YES

MSTP SETUP	
Instance:	77000
Baudrate	38400
MAC Addr:	0
MaxMasters:	127
MaxInfoFrames:	20

NOTE: Example Only!







BACnet Read/Write	
To save:	Change
To function:	To write and update to Yes. Then cycle unit poser to confirm write command.
Function:	Read
Update?	YES

2. Go to **BMS Config** menu and view BACnet Read/Write screen.

3. Change **Function** to **Read** and **Update?** to **YES**.

Current BACnet MSTP parameters should now be displayed in the BACnet MSTP SETUP screen. If all values appear to be zeros, consult the factory. (Make sure you have allowed several minutes for the controller to initialize). **Values may appear to be zero prior to setting the Function to READ.*

To change BACnet MSTP parameters:

1. Power on the controller and allow several minutes to initialize.
2. Go to **BMS Config** menu and view MSTP SETUP screen.
3. Move cursor to desired parameter by pressing the   buttons. Press  to select the parameter to change. Press the   buttons to adjust the parameter. Press  to save adjusted value.

4. Once desired parameters have been entered, go to BACnet Read/Write screen. Change **Function** to **Write** and **Update?** to **YES**.
5. Reboot the controller by cycling power to the unit. Allow several minutes for the controller to initialize.
6. View MSTP parameters. If changed values did not save, contact the factory.

The communication card is located in the **Serial Card** port on the face of the controller. The card includes two sets of LED lights for communication troubleshooting.

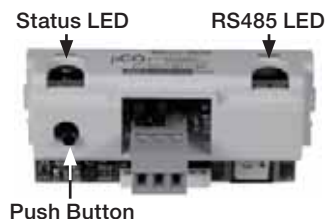

Status LED: Indicates the status of communication between the card and controller.

- Quick green-off-green if communication with controller is ok.
- Slow red-off-red if communication is not established.

RS485 LED: Indicates the status of communication with the BACnet MSTP network. Wait for 40 seconds to determine status of communication.

- Green with occasional red, communication is OK.
- Green and red both on, communications is not established.

Communication Troubleshooting

See Carel Data sheet for more info.

If attempting to communicate with the controller over BACnet MSTP, refer to the card LEDs for system information.

Status LED slow red blink

- Confirm card is firmly plugged in.
- Confirm BMS Protocol is set to BACnet MSTP.

RS485 LED green and red both on

- Confirm system and card baudrate are the same.
- Confirm card Max Master is equal to or greater than the Station (MAC) Address of the Master with the highest address.

Recalling Factory Parameters

Follow this procedure to revert to factory parameters for one power cycle. When restarted, the card will resume using the previous user parameters.

1. With controller off, hold the push button located on the BACnet MSTP card, while powering the controller back on.
2. Continue to hold the button, while watching the **Status LEDs**. Wait for the Status LEDs to blink red slowly, and release before the third slow flash.
3. Wait for about one minute for the factory parameters to be loaded.

***The BACnet IP/Eth card is configured for DHCP from the factory.**

To view the current parameters, go the **BMS Config** menu within the controller by pressing the  key.

G. Service
c. BMS Config 

BMS Configuration	
Protocol:	BACnet IP/Eth
BACnet Plugin?	YES

TCP/IP SETUP	
Instance:	77000
IP set by:	DHCP
IP:	128.1.104.134
Subnet:	255.255.000.000
Gateway:	128.1.0.12







NOTE: Example Only!

TCP/IP Setup	
DNS 1:	193.168.001.001
DNS 2:	193.168.001.001
Type: IP	

BACnet Read/Write	
To save:	Change
To function:	To write and update to Yes. Then cycle unit power to confirm write command.
Function:	Read
Update?	YES

screen. If all values appear to be zeros, consult the factory. (Make sure you have allowed several minutes for the controller to initialize). ***Values may appear to be zero prior to setting the Function to READ.**

To change BACnet TCP/IP parameters:

1. Power on the controller and allow several minutes to initialize.
2. Go to **BMS Config** menu and view TCP/IP SETUP screen.
3. Move cursor to desired parameter by pressing the   buttons. Press  to select the parameter to change. Press the   buttons to adjust the parameter. Press  to save adjusted value.
4. Once desired parameters have been entered, go to BACnet Read/Write screen. Change **Function** to **Write** and **Update?** to **YES**.
5. Reboot the controller by cycling power to the unit. Allow several minutes for the controller to initialize.
6. View TCP/IP parameters. If changed values did not save, contact the factory.

To access the **BMS Config** sub-menu, enter the service password (**Default=1000**).

Protocol must be **BACnet IP/Eth** and **BACnet Plugin** must be **YES**.

Press  arrow button to view next screen.

Current BACnet IP parameters should be displayed. If values appear to be zero, follow the procedure below.

To read current parameters:

1. Power on controller and allow several minutes to initialize.
2. Go to **BMS Config** menu and view BACnet Read/Write screen.
3. Change **Function** to **Read** and **Update?** to **YES**.

Current BACnet IP parameters should now be displayed in the BACnet TCP/IP SETUP

The communication card is located in the **Serial Card** port on the face of the controller. The card includes two sets of LED lights for communication troubleshooting.

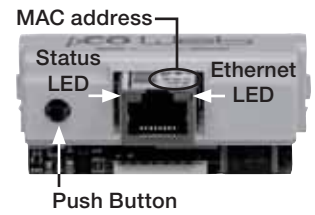

Status LED: Indicates the status of communication between the card and controller.

- Quick green-off-green if communication with controller is ok.
- Slow red-off-red if communication is not established.

Ethernet LED: Indicates the status of communication with the network. Wait for 40 seconds to determine status of communication.

- Flashing green, communication is OK.
- Steady red, communications is not established.

Communication Troubleshooting

See Carel Data sheet for more info.

If attempting to communicate with the controller over BACnet IP/Eth, refer to the card LEDs for system information.

Status LED slow red blink

- Confirm card is firmly plugged in.
- Confirm BMS Protocol is set to BACnet IP/Eth.

Ethernet LED red on

- Confirm card is connected to the network.

Recalling Factory Parameters

Follow this procedure to revert to factory parameters for one power cycle. When restarted, the card will resume using the previous user parameters.

Factory Default IP address: 172.16.0.1

1. With controller off, hold the push button located on the BACnet IP/Eth card, while powering the controller back on.
2. Continue to hold the button, while watching the **Status LED**. Wait for the Status LED to blink red slowly, and release before the third slow flash.
3. Wait for about one minute for the factory parameters to be loaded.
4. Follow the procedure to read the current parameters to confirm factory defaults have been loaded.

Factory pCOWeb Configuration	
Device Instance	77000
IP Address	172.16.0.1
Subnet Mask	255.255.0.0
User Datagram Protocol (UDP)	47808
Username	admin
Password	fadmin

Appendix B: Room Thermostat Quick Start



The room thermostat gives users the ability to view the room temperature and relative humidity (optional) and control the active room set points from the adjustable display. The room thermostat also has the ability to send the unit into temporary occupied mode. It is also provides with the functionality to average up to 4 temperature readings through the microprocessor. The room thermostat is shipped loose with installation by others and is a Modbus connected device.



Room thermostat functions:

- Temporary occupancy override control
- Temperature and relative humidity monitoring
- Temperature and relative humidity set point adjustability
- Status icon on LCD display with push buttons
- Optional temperature monitoring up to 4 sensors

Display

If more than one room thermostat is provided for averaging, only one room thermostat will be provided with a display and push buttons for adjustment.

Adjusting SET POINT - The default display will show the current temperature value for the room. Use the scroll button to index through additional sensor parameters. Parameters with the "SET POINT" icon displayed above the temperature display are adjustable. Use the Up/Down buttons to adjust the set point, and use the scroll button to view the next parameter or return to the normal display mode.

Up/Down Button Function - The Up/Down buttons are used to adjust editable parameters including the temperature and humidity set point.

Override Button Function - The display shows a person in the lower left corner of the display at all times. If the person is solid, the unit is operating in occupied mode. If it is an outline of the person, the unit is in unoccupied mode. Pushing the Override button when the unit is in unoccupied mode will allow a temporary override sequence to Occupied mode for a period of 1 to 3 hours (adjustable at the unit microprocessor).

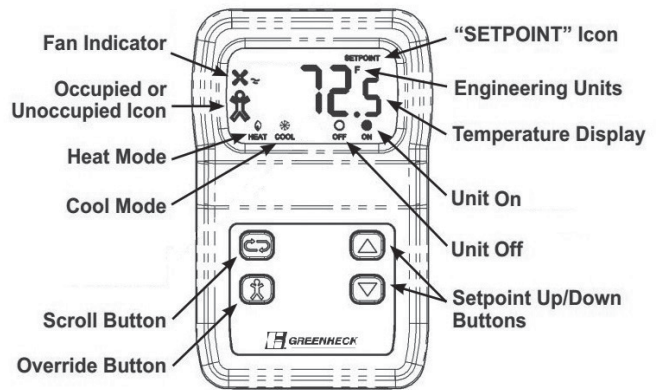

Initial Setup and Communication Configuration

The Room Thermostat is a ModBus connected device. There can be up to three additional ModBus temperature sensors added for room temperature averaging. The sensors must all be connected in a daisy chain configuration.

The microprocessor controller will be pre-configured for 1 Room Thermostat. If room temperature averaging is desired, additional field setup will be required both in the controller and on the ModBus room sensors. In the Controller, enter the Manufacturing Menu and access the Configuration Menu. Scroll down in the Configuration Menu to select the T-Stat Config screen. Choose the number of room sensors being used (1-4) and adjust the Modbus device addresses on the following screens based on the number of sensors.

T-Stat Config	
Modbus Address:	10
Online:	No
T-Stat Temp:	0.0°F
Number of T-Stats:	2

Each room sensor must have the dip switches adjusted on the back of the sensor to the corresponding switches shown in the Room Thermostat Modbus Address

table. Once the addresses are set and the wires are connected, the "Status" LED should be a steady green and the "Network" LED should be a quick blinking amber/green color.

Status LED

Green indicates that the unit is operating properly.
Red indicates that there is a problem with the unit.

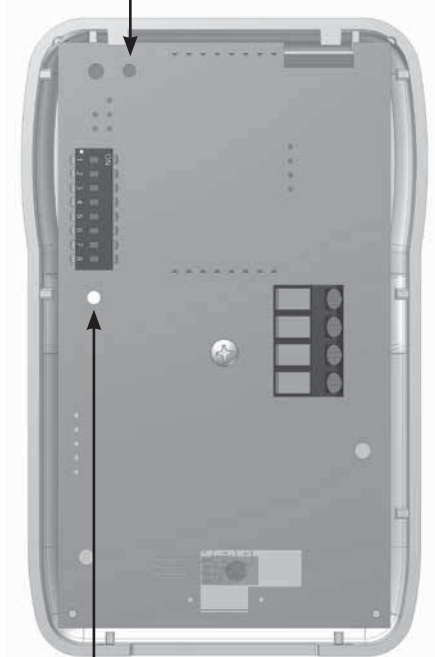

Terminal	Description
GND	Power Supply Ground (common to the controller)
Net B	RS485 network connection (Data -)
Net A	RS485 network connection (Data +)
Power	Power supply hot

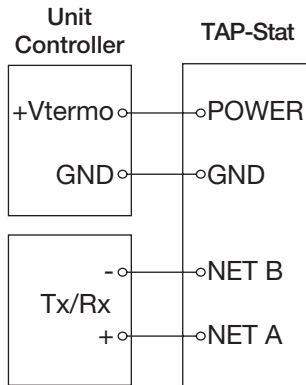

Network LED

Flashing Red Slowly indicates that there has been no communications for 60 seconds.
Flashing Green Slowly indicates that there have been normal communications within the last 60 seconds.
Flashing Green Slowly with Quick Red Flashes; the quick red flashes indicate active communications.

Room Thermostat Modbus Address

	T-Stat 1 (Display)	T-Stat 2	T-Stat 3	T-Stat 4
Address in Microprocessor	10	11	12	13
Dip Switch Set on Stat	Sw 2 + Sw 8	Sw 1 + Sw 2 + Sw 8	Sw 4 + Sw 8	Sw 1 + Sw 4

Baud Rate Setting

In order for the room thermostat to communicate with the microprocessor, the correct baud rate must be set in the room thermostat. To set the baud rate, the “PROG” dip switch on the back of the room thermostat must be flipped to the right. Use the down arrow button to display P11 on the room thermostat. Push the scroll button and use the up and down buttons to adjust the baud rate to 192. Once 192 is displayed, push the scroll button again to save the setting. Once the setting is saved, P11 should appear on the display. Flip the “PROG” dip switch on the back of the room thermostat back to the left. The room thermostat should communicate and be set back to normal mode.

Occupancy Override Time Adjustment

If the occupancy override time needs to be adjusted, push the down arrow on the microprocessor control from the main menu screen when the unit is in unoccupied mode. Scroll down from the main screen to find the “Occupancy Override” screen. This screen provides the current status of the occupancy override and adjustment of the override time from 1 to 3 hours. If the occupancy override is enabled from the Room Thermostat or the Unit Microprocessor, it will override for the period of time set on this menu screen.

Occupancy Override	
Time Override:	Off
Override Time:	1hr
UNOCCUPIED-UNIT OFF	

Appendix C: I/O Expansion Board (pCOe) Quick Start



The pCOe expansion board is an I/O module that can be used to monitor additional statuses within the unit or provide commands. The pCOe allows the user to view and control:

- 4 Digital Inputs
- 4 Digital Outputs
- 4 Analog Inputs
- 1 Analog Output

The inputs and outputs can be monitored and controlled either via the controller display or Building Management System. See Points List for detailed point information.

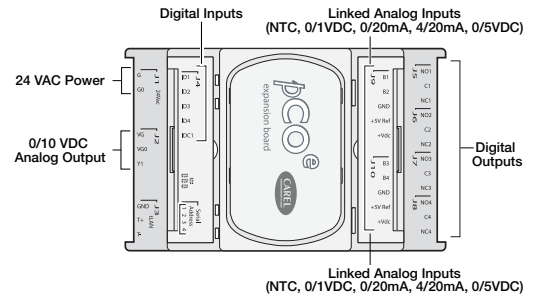

Setup

In order for the controller to communicate with the pCOe, several parameters must be adjusted. If you have a pCOe installed from the factory, the controller is already set up for communication with the main controller.

Unit Expansion I/O

Enable Expansion	Yes
------------------	-----

Analog Inputs pCOe1

Aux AI Pair 1	
Channels: B1 & B2	
Type:	Carel NTC

Analog Input pCOe1

Aux AI Pair 2	
Channels: B3 & B4	
Type:	4 . . 20 mA
B3 Min:	0.0
B3 Max:	10.0
B4 Min:	0.0
B4 Max:	10.0

Digital Inputs pCOe1

Channel ID1:	Closed
Channel ID2:	Closed
Channel ID3:	Closed
Channel ID4:	Closed

Analog Inputs pCOe1

Input B1:	32.0°F
Input B2:	32.0°F
Input B3:	0.0°F
Input B4:	0.0°F

Digital Outputs pCOe1

Output NO1:	OFF
Output NO2:	OFF
Output NO3:	OFF
Output NO4:	OFF

Analog Outputs pCOe1

Output Y1:	0.0vdc
------------	--------

Enabling the pCOe in the Main Controller - To enable the pCOe expansion I/O module, go to **Manufacturer > Configuration**. You will have to enter the Manufacturer password (Default = 1000). Enabling the pCOe expansion module allows additional screens to appear in other menus (see below).

Configuring the pCOe Analog Inputs - The analog inputs are grouped in pairs (Channels B1-B2 and Channels B3-B4). Each pair must be configured as the same analog input type (Carel NTC, 0/1 VDC, 0/20 mA, 4/20 mA or 0/5 VDC).

To setup the analog inputs:

1. Go to **Manufacturer > I/O Configuration > Analog Inputs**.
2. Find the pCOe Analog input screens.
3. Select desired channels and input type. If only one channel is to be used, select the desired channel to prevent nuisance sensor alarms.

If using a non-Carel NTC type, scale the input to match the probe range.

Viewing pCOe I/O Values - To view input values, go to the Input/Output menu.

The pCOe I/O values can be viewed on the BMS. The digital and analog outputs can be changed through the BMS. See Points List for more details.

Maintenance Log

Date _____ Time _____ AM/PM

Notes: _____

Date _____ Time _____ AM/PM

Notes: _____

Date _____ Time _____ AM/PM

Notes: _____

Date _____ Time _____ AM/PM

Notes: _____

Date _____ Time _____ AM/PM

Notes: _____

Date _____ Time _____ AM/PM

Notes: _____

Date _____ Time _____ AM/PM

Notes: _____

Date _____ Time _____ AM/PM

Notes: _____

Date _____ Time _____ AM/PM

Notes: _____

Date _____ Time _____ AM/PM

Notes: _____

Date _____ Time _____ AM/PM

Notes: _____

Date _____ Time _____ AM/PM

Notes: _____

Our Commitment

As a result of our commitment to continuous improvement, Greenheck reserves the right to change specifications without notice.

Specific Greenheck product warranties are located on greenheck.com within the product area tabs and in the Library under Warranties.

AMCA Publication 410-96, Safety Practices for Users and Installers of Industrial and Commercial Fans, provides additional safety information. This publication can be obtained from AMCA International, Inc. at www.amca.org.

