

**FUJIFILM**

DIGITAL CAMERA

# **GFX 50sII**

**FF210001**

Owner's Manual

## Introduction

Thank you for your purchase of this product. Be sure that you have read this manual and understood its contents before using the camera. Keep the manual where it will be read by all who use the product.

### For the Latest Information

The latest versions of the manuals are available from:

*<http://fujifilm-dsc.com/en/manual/>*



The site can be accessed not only from your computer but also from smartphones and tablets. It also contains information on the software license.



For information on firmware updates, visit:

*<https://fujifilm-x.com/support/download/firmware/cameras/>*



## Chapter Index

---

<b>Menu List</b>	iv
<b>1 Before You Begin</b>	1
<b>2 First Steps</b>	33
<b>3 Basic Photography and Playback</b>	49
<b>4 Movie Recording and Playback</b>	55
<b>5 Taking Photographs</b>	63
<b>6 The Shooting Menus</b>	109
<b>7 Playback and the Playback Menu</b>	177
<b>8 The Setup Menus</b>	203
<b>9 Shortcuts</b>	245
<b>10 Peripherals and Optional Accessories</b>	261
<b>11 Connections</b>	277
<b>12 Technical Notes</b>	295

## Menu List



Camera menu options are listed below.







### Shooting Menus

Adjust settings when shooting photos or movies.

 See page 109 for details.





### Photo Menus























 Items marked with both  and  icons are available in both the still photography and movie shooting menus. Changes to these items in either menu also apply to the item in the remaining menu.

























 IMAGE QUALITY SETTING		 IMAGE QUALITY SETTING	
<b>IMAGE SIZE</b>	:110	<b>CLARITY</b>	:124
<b>IMAGE QUALITY</b>	:111	<b>LONG EXPOSURE NR</b>	:124
<b>RAW RECORDING</b>	:112	<b>LENS MODULATION OPTIMIZER</b>	:125
<b>FILM SIMULATION</b>	:113	<b>COLOR SPACE</b>	:125
$\frac{1}{3}$ <b>MONOCHROMATIC COLOR</b>	:115	$\frac{3}{3}$ <b>PIXEL MAPPING</b>	:126
<b>GRAIN EFFECT</b>	:115	<b>EDIT/SAVE CUSTOM SETTING</b>	:126
<b>COLOR CHROME EFFECT</b>	:115	<b>AUTO UPDATE CUSTOM SETTING</b>	:126
<b>COLOR CHROME FX BLUE</b>	:116	  <b>MOUNT ADAPTOR SETTING</b>	:127
<b>SMOOTH SKIN EFFECT</b>	:116		
<b>DYNAMIC RANGE</b>	:117		
<b>D RANGE PRIORITY</b>	:118		
$\frac{2}{3}$ <b>WHITE BALANCE</b>	:119		
<b>TONE CURVE</b>	:123		
<b>COLOR</b>	:123		
<b>SHARPNESS</b>	:123		
<b>HIGH ISO NR</b>	:124		

<b>AF/MF SETTING</b>			<b>SHOOTING SETTING</b>		
1/3	<b>FOCUS AREA</b>	130	<b>SELF-TIMER</b>	142	
	<b>AF MODE</b>	130	<b>SAVE SELF-TIMER SETTING</b>	143	
	<b>STORE AF MODE BY ORIENTATION</b>	131	<b>SELF-TIMER LAMP</b>	143	
	<b>RAPID AF</b>	131	<b>INTERVAL TIMER SHOOTING</b>	144	
	<b>LOW LIGHT PRIORITY AF-S</b>	131	1/2 <b>INTERVAL TIMER SHOOTING EXPOSURE SMOOTHING</b>	145	
	<b>AF POINT DISPLAY</b>	131	<b>AE BKT SETTING</b>	146	
	<b>NUMBER OF FOCUS POINTS</b>	132	<b>FILM SIMULATION BKT</b>	146	
	<b>PRE-AF</b>	132	<b>FOCUS BKT SETTING</b>	146	
	<b>AF ILLUMINATOR</b>	132	<b>PHOTOMETRY</b>	146	
	<b>FACE/EYE DETECTION SETTING</b>	133	<b>SHUTTER TYPE</b>	147	
2/3	<b>AF+MF</b>	135	<b>FLICKER REDUCTION</b>	148	
	<b>MF ASSIST</b>	136	2/2 <b>ISO</b>	148	
	<b>FOCUS CHECK</b>	136	<b>IS MODE</b>	149	
	<b>INTERLOCK SPOT AE &amp; FOCUS AREA</b>	137	<b>35mm FORMAT MODE</b>	150	
	<b>INSTANT AF SETTING</b>	137	<b>WIRELESS COMMUNICATION</b>	151	
	<b>DEPTH-OF-FIELD SCALE</b>	138			
3/3	<b>RELEASE/FOCUS PRIORITY</b>	138	<b>FLASH SETTING</b>		
	<b>AF RANGE LIMITER</b>	139	<b>FLASH FUNCTION SETTING</b>	152	
	<b>TOUCH SCREEN MODE</b>	140	<b>RED EYE REMOVAL</b>	152	
			<b>TTL-LOCK MODE</b>	153	
			<b>LED LIGHT SETTING</b>	153	
			<b>COMMANDER SETTING</b>	154	
			<b>CH SETTING</b>	154	

## Movie Menus

  Items marked with both  and  icons are available in both the still photography and movie shooting menus. Changes to these items in either menu also apply to the item in the remaining menu.





 MOVIE SETTING		 IMAGE QUALITY SETTING	
<b>MOVIE MODE</b>	155	 <b>FILM SIMULATION</b>	162
<b>FIX MOVIE CROP MAGNIFICATION</b>	155	 <b>MONOCHROMATIC COLOR</b>	162
<b>FULL HD MOVIE OUTPUT</b>	156	 <b>WHITE BALANCE</b>	163
<b>HDMI OUTPUT INFO DISPLAY</b>	157	 <b>tone CURVE</b>	163
$\frac{1}{2}$ <b>HDMI REC CONTROL</b>	157	$\frac{1}{2}$  <b>COLOR</b>	163
 <b>PHOTOMETRY</b>	157	 <b>SHARPNESS</b>	164
 <b>IS MODE</b>	158	 <b>HIGH ISO NR</b>	164
 <b>IS MODE BOOST</b>	158	 <b>PERIPHERAL LIGHT CORRECTION</b>	165
 <b>ISO</b>	159	$\frac{2}{2}$   <b>Mount ADAPTOR SETTING</b>	165
<b>ZEBRA SETTING</b>	159		
<b>ZEBRA LEVEL</b>	159		
$\frac{2}{2}$ <b>MOVIE OPTIMIZED CONTROL</b> 	160		
<b>TALLY LIGHT</b>	160		
 <b>EDIT/SAVE CUSTOM SETTING</b>	161		
<b>AUTO UPDATE CUSTOM SETTING</b>	161		
  <b>WIRELESS COMMUNICATION</b>	161		

<b>AF/MF SETTING</b>			<b>AUDIO SETTING</b>		
1/2	 <b>FOCUS AREA</b>	166	 <b>INTERNAL MIC LEVEL ADJUSTMENT</b>	172	
	 <b>AF MODE</b>	166	 <b>EXTERNAL MIC LEVEL ADJUSTMENT</b>	172	
	 <b>AF ILLUMINATOR</b>	166	 <b>MIC JACK SETTING</b>	173	
	 <b>FACE/EYE DETECTION SETTING</b>	167	 <b>MIC LEVEL LIMITER</b>	173	
	 <b>MF ASSIST</b>	167	 <b>WIND FILTER</b>	173	
	 <b>FOCUS CHECK</b>	168	 <b>LOW CUT FILTER</b>	173	
	 <b>INSTANT AF SETTING</b>	168	 <b>HEADPHONES VOLUME</b>	173	
2/2	 <b>DEPTH-OF-FIELD SCALE</b>	168	<b>TIME CODE SETTING</b>		
	 <b>AF RANGE LIMITER</b>	168	 <b>TIME CODE DISPLAY</b>	174	
	 <b>TOUCH SCREEN MODE</b>	169	 <b>START TIME SETTING</b>	174	
	<b>FOCUS CHECK LOCK</b>	171	 <b>COUNT UP SETTING</b>	174	
			 <b>DROP FRAME</b>	175	
			 <b>HDMI TIME CODE OUTPUT</b>	175	

## The Playback Menu

Adjust playback settings.

 See page 183 for details.









 PLAY BACK MENU		 PLAY BACK MENU	
<b>SWITCH SLOT</b>	183	<b>RED EYE REMOVAL</b>	192
<b>RAW CONVERSION</b>	184	<b>VOICE MEMO SETTING</b>	193
<b>ERASE</b>	186	<b>RATING</b>	194
<b>SIMULTANEOUS DELETE</b> (RAW SLOT1/JPG SLOT2)	188	<b>COPY</b>	195
<b>CROP</b>	188	<b>IMAGE TRANSFER ORDER</b>	196
<b>RESIZE</b>	189	 <b>WIRELESS COMMUNICATION</b>	197
<b>PROTECT</b>	190	<b>PHOTOBOOK ASSIST</b>	198
<b>IMAGE ROTATE</b>	191	<b>PRINT ORDER (DPOF)</b>	200
		<b>instax PRINTER PRINT</b>	201
		<b>DISP ASPECT</b>	202



## Setup Menu

Adjust basic camera settings.

 See page 203 for details.

USER SETTING 		SCREEN SETTING 		
1/2	FORMAT	204	EVF BRIGHTNESS	211
	DATE/TIME	205	EVF COLOR	211
	TIME DIFFERENCE	205	EVF COLOR ADJUSTMENT	211
	 言語/LANG.	206	LCD BRIGHTNESS	212
	 MY MENU SETTING	206	LCD COLOR	212
	 MY MENU SETTING	206	LCD COLOR ADJUSTMENT	212
	SENSOR CLEANING	207	IMAGE DISP.	213
	BATTERY AGE	207	AUTOROTATE DISPLAYS	213
2/2	RESET	208	PREVIEW EXP./WB IN MANUAL MODE	214
	REGULATORY	208	NATURAL LIVE VIEW	214
SOUND SETTING 		2/3	FRAMING GUIDELINE	215
AF BEEP VOL.	209		AUTOROTATE PB	216
SELF-TIMER BEEP VOL.	209		PLAYBACK MAGNIFICATION	216
OPERATION VOL.	210		FOCUS SCALE UNITS	216
SHUTTER VOLUME	210		DUAL DISPLAY SETTING	217
SHUTTER SOUND	210		DISP. CUSTOM SETTING	217
PLAYBACK VOLUME	210		LARGE INDICATORS MODE(EVF)	218
			LARGE INDICATORS MODE(LCD)	218
			LARGE INDICATORS DISP. SETTING	219
			INFORMATION CONTRAST ADJ.	219
		3/3	SUB MONITOR SETTING	220
			SUB MONITOR BACKGROUND COLOR	222
			 Q MENU BACKGROUND	223
			 Q MENU BACKGROUND	223

	<b>BUTTON/DIAL SETTING</b>				<b>SAVE DATA SETTING</b>		
	FOCUS LEVER SETTING		224		FRAME NO.		235
	EDIT/SAVE QUICK MENU		224		SAVE ORG IMAGE		236
	EDIT/SAVE QUICK MENU		224		EDIT FILE NAME		236
1/3	FUNCTION (Fn) SETTING		225	1/2	CARD SLOT SETTING		236
	COMMAND DIAL SETTING		225		CARD SLOT SETTING		237
	COMMAND DIAL DIRECTION		226		SELECT SLOT( SEQUENTIAL)		237
	SHUTTER AF		226		SELECT SLOT( SEQUENTIAL)		237
	SHUTTER AE		227		SELECT FOLDER		238
	SHOOT WITHOUT LENS		228	2/2	COPYRIGHT INFO		238
	SHOOT WITHOUT CARD		228		CONNECTION SETTING		
	FOCUS RING		229		Bluetooth SETTINGS		239
2/3	FOCUS RING OPERATION		229		NETWORK SETTING		240
	AE/AF-LOCK MODE		230		instax PRINTER CONNECTION SETTING		241
	AWB-LOCK MODE		230		CONNECTION MODE		242
	EXPO. COMP. BUTTON SETTING		230		USB POWER SUPPLY SETTING		243
	TOUCH SCREEN SETTING		231		GENERAL SETTINGS		244
3/3	LOCK		232		INFORMATION		244
	POWER MANAGEMENT				RESET WIRELESS SETTING		244
	AUTO POWER OFF		233				
	SHOOTING STAND BY MODE		234				
	AUTO POWER SAVE		234				
	AUTO POWER OFF TEMP.		234				



## Table of Contents

<b>Introduction</b> .....	<b>ii</b>
For the Latest Information .....	ii
<b>Menu List</b> .....	<b>iv</b>
Shooting Menus .....	iv
The Playback Menu .....	viii
Setup Menus .....	ix
<b>Supplied Accessories</b> .....	<b>xxiii</b>
<b>About This Manual</b> .....	<b>xxiv</b>
Symbols and Conventions .....	xxiv
Terminology .....	xxiv

### **1 Before You Begin** **1**

<b>Parts of the Camera</b> .....	<b>2</b>
The Serial Number Plate .....	5
The Memory Card Slot Cover (Detachable) .....	5
The Focus Stick (Focus Lever) .....	5
The Mode Dial .....	6
The STILL/MOVIE Mode Switch .....	7
The DRIVE Button .....	7
The Command Dials .....	8
The Indicator Lamp .....	9
The LCD Monitor .....	10
The Eye Cup .....	11
Focusing the Viewfinder .....	11
<b>Camera Displays</b> .....	<b>12</b>
The Electronic Viewfinder .....	12
The LCD Monitor .....	14
Choosing a Display Mode .....	16
Adjusting Display Brightness .....	17
Display Rotation .....	17
The DISP/BACK Button .....	18
The Dual Display .....	19
Customizing the Standard Display .....	20
The Secondary LCD Monitor .....	22

Using the Menus.....	25
The Menu .....	25
Selecting a Menu Tab.....	26
<b>Touch Screen Mode.....</b>	<b>27</b>
Shooting Touch Controls .....	27
Playback Touch Controls .....	31

## **2 First Steps 33**

Attaching the Strap .....	34
Attaching a Lens .....	35
Inserting the Battery .....	36
Inserting Memory Cards .....	38
Using Two Cards.....	39
Compatible Memory Cards.....	40
Charging the Battery.....	41
Turning the Camera On and Off.....	44
Checking the Battery Level.....	45
Basic Setup.....	46
Choosing a Different Language .....	48
Changing the Time and Date.....	48





## **3 Basic Photography and Playback 49**











Taking Photographs (Mode P) .....	50
Viewing Pictures .....	53
Deleting Pictures .....	54































## **4 Movie Recording and Playback 55**

Recording Movies.....	56
Adjusting Movie Settings .....	59
Viewing Movies.....	60

<b>5 Taking Photographs</b>	<b>63</b>
P, S, A, and M Modes .....	64
Mode P: Program AE .....	64
Mode S: Shutter-Priority AE .....	66
Mode A: Aperture-Priority AE .....	68
Mode M: Manual Exposure .....	70
Custom Modes .....	74
Autofocus .....	80
Focus Mode .....	81
Autofocus Options (AF Mode) .....	83
Focus-Point Selection .....	85
Manual Focus .....	88
Checking Focus .....	90
Sensitivity .....	92
AUTO .....	93
Metering .....	94
Exposure Compensation .....	95
Focus/Exposure Lock .....	96
Other Controls .....	97
Bracketing .....	98
<b>ISO</b> ISO BKT .....	99
<b>WB</b> WHITE BALANCE BKT .....	99
<b>BKT</b> Bracketing .....	100
Continuous Shooting (Burst Mode) .....	103
Multiple Exposures .....	105
Pixel-Shift Multi-Shot .....	107
<b>6 The Shooting Menus</b>	<b>109</b>
IMAGE QUALITY SETTING (Still Photography) .....	110
IMAGE SIZE .....	110
IMAGE QUALITY .....	111
RAW RECORDING .....	112
FILM SIMULATION .....	113
MONOCHROMATIC COLOR .....	115
GRAIN EFFECT .....	115
COLOR CHROME EFFECT .....	115

COLOR CHROME FX BLUE.....	116
SMOOTH SKIN EFFECT .....	116
DYNAMIC RANGE.....	117
D RANGE PRIORITY.....	118
WHITE BALANCE.....	119
TONE CURVE .....	123
COLOR.....	123
SHARPNESS.....	123
HIGH ISO NR.....	124
CLARITY.....	124
LONG EXPOSURE NR.....	124
LENS MODULATION OPTIMIZER.....	125
COLOR SPACE .....	125
PIXEL MAPPING.....	126
EDIT/SAVE CUSTOM SETTING.....	126
AUTO UPDATE CUSTOM SETTING .....	126
 MOUNT ADAPTOR SETTING.....	127
<b>AF/MF SETTING (Still Photography).....</b>	<b>130</b>
FOCUS AREA .....	130
AF MODE.....	130
STORE AF MODE BY ORIENTATION.....	131
RAPID AF .....	131
LOW LIGHT PRIORITY AF-S .....	131
AF POINT DISPLAY  .....	131
NUMBER OF FOCUS POINTS .....	132
PRE-AF.....	132
 AF ILLUMINATOR.....	132
FACE/EYE DETECTION SETTING.....	133
AF+MF.....	135
MF ASSIST .....	136
FOCUS CHECK.....	136
INTERLOCK SPOT AE & FOCUS AREA .....	137
 INSTANT AF SETTING.....	137
 DEPTH-OF-FIELD SCALE .....	138
RELEASE/FOCUS PRIORITY .....	138

 	AF RANGE LIMITER .....	139
 	TOUCH SCREEN MODE.....	140
<b>SHOOTING SETTING (Still Photography).....</b>		<b>142</b>
	SELF-TIMER.....	142
	SAVE SELF-TIMER SETTING .....	143
	SELF-TIMER LAMP .....	143
	INTERVAL TIMER SHOOTING.....	144
	INTERVAL TIMER SHOOTING EXPOSURE SMOOTHING .....	145
	AE BKT SETTING.....	146
	FILM SIMULATION BKT .....	146
	FOCUS BKT SETTING.....	146
	PHOTOMETRY .....	146
	SHUTTER TYPE.....	147
	FLICKER REDUCTION .....	148
	ISO.....	148
	IS MODE.....	149
	35mm FORMAT MODE.....	150
 	WIRELESS COMMUNICATION .....	151
<b>FLASH SETTING (Still Photography).....</b>		<b>152</b>
	FLASH FUNCTION SETTING.....	152
	RED EYE REMOVAL .....	152
	TTL-LOCK MODE.....	153
	LED LIGHT SETTING.....	153
	COMMANDER SETTING.....	154
	CH SETTING.....	154
<b>MOVIE SETTING (Movie Recording) .....</b>		<b>155</b>
	MOVIE MODE.....	155
	FIX MOVIE CROP MAGNIFICATION .....	155
	FULL HD MOVIE OUTPUT.....	156
	HDMI OUTPUT INFO DISPLAY .....	157
	HDMI REC CONTROL.....	157
	PHOTOMETRY .....	157
	IS MODE.....	158
	IS MODE BOOST .....	158
	ISO.....	159
	ZEBRA SETTING.....	159

ZEBRA LEVEL.....	159
MOVIE OPTIMIZED CONTROL  .....	160
TALLY LIGHT.....	160
 EDIT/SAVE CUSTOM SETTING .....	161
AUTO UPDATE CUSTOM SETTING .....	161
  WIRELESS COMMUNICATION .....	161
<b>IMAGE QUALITY SETTING (Movie Recording) .....</b>	<b>162</b>
 FILM SIMULATION .....	162
 MONOCHROMATIC COLOR.....	162
 WHITE BALANCE.....	163
 TONE CURVE .....	163
 COLOR.....	163
 SHARPNESS .....	164
 HIGH ISO NR.....	164
 PERIPHERAL LIGHT CORRECTION .....	165
  MOUNT ADAPTOR SETTING.....	165
<b>AF/MF SETTING (Movie Recording) .....</b>	<b>166</b>
 FOCUS AREA.....	166
 AF MODE .....	166
  AF ILLUMINATOR.....	166
  FACE/EYE DETECTION SETTING.....	167
 MF ASSIST.....	167
 FOCUS CHECK .....	168
  INSTANT AF SETTING.....	168
  DEPTH-OF-FIELD SCALE .....	168
  AF RANGE LIMITER.....	168
  TOUCH SCREEN MODE.....	169
FOCUS CHECK LOCK.....	171
<b>AUDIO SETTING (Movie Recording).....</b>	<b>172</b>
INTERNAL MIC LEVEL ADJUSTMENT .....	172
EXTERNAL MIC LEVEL ADJUSTMENT .....	172
MIC JACK SETTING .....	173
MIC LEVEL LIMITER.....	173
WIND FILTER.....	173
LOW CUT FILTER .....	173
HEADPHONES VOLUME.....	173





TIME CODE SETTING (Movie Recording).....	174
TIME CODE DISPLAY .....	174
START TIME SETTING.....	174
COUNT UP SETTING .....	174
DROP FRAME.....	175
HDMI TIME CODE OUTPUT .....	175





## **7 Playback and the Playback Menu 177**





The Playback Display.....	178
The DISP/BACK Button .....	179
Viewing Pictures .....	181
Playback Zoom.....	182
Multi-Frame Playback.....	182
The Playback Menu.....	183
SWITCH SLOT .....	183
RAW CONVERSION .....	184
ERASE .....	186
SIMULTANEOUS DELETE(RAW SLOT1/JPG SLOT2) .....	188
CROP .....	188
RESIZE .....	189
PROTECT.....	190
IMAGE ROTATE .....	191
RED EYE REMOVAL .....	192
VOICE MEMO SETTING .....	193
RATING.....	194
COPY .....	195
IMAGE TRANSFER ORDER.....	196
 WIRELESS COMMUNICATION .....	197
PHOTOBOOK ASSIST .....	198
PRINT ORDER (DPOF).....	200
instax PRINTER PRINT .....	201
DISP ASPECT .....	202

## 8 The Setup Menus

203

<b>USER SETTING</b> .....	<b>204</b>
FORMAT .....	204
DATE/TIME.....	205
TIME DIFFERENCE .....	205
 言語/LANG.....	206
 MY MENU SETTING .....	206
 MY MENU SETTING.....	206
SENSOR CLEANING.....	207
BATTERY AGE.....	207
RESET .....	208
REGULATORY .....	208
<b>SOUND SETTING</b> .....	<b>209</b>
AF BEEP VOL.....	209
SELF-TIMER BEEP VOL.....	209
OPERATION VOL.....	210
SHUTTER VOLUME.....	210
SHUTTER SOUND.....	210
PLAYBACK VOLUME.....	210
<b>SCREEN SETTING</b> .....	<b>211</b>
EVF BRIGHTNESS.....	211
EVF COLOR.....	211
EVF COLOR ADJUSTMENT .....	211
LCD BRIGHTNESS.....	212
LCD COLOR.....	212
LCD COLOR ADJUSTMENT .....	212
IMAGE DISP.....	213
AUTOROTATE DISPLAYS .....	213
PREVIEW EXP/WB IN MANUAL MODE.....	214
NATURAL LIVE VIEW.....	214
FRAMING GUIDELINE.....	215
AUTOROTATE PB .....	216
PLAYBACK MAGNIFICATION .....	216
FOCUS SCALE UNITS.....	216
DUAL DISPLAY SETTING.....	217

DISP. CUSTOM SETTING.....	217
LARGE INDICATORS MODE(EVF).....	218
LARGE INDICATORS MODE(LCD).....	218
LARGE INDICATORS DISP. SETTING.....	219
INFORMATION CONTRAST ADJ.....	219
SUB MONITOR SETTING.....	220
SUB MONITOR BACKGROUND COLOR.....	222
 Q MENU BACKGROUND.....	223
 Q MENU BACKGROUND.....	223
<b>BUTTON/DIAL SETTING.....</b>	<b>224</b>
FOCUS LEVER SETTING.....	224
 EDIT/SAVE QUICK MENU.....	224
 EDIT/SAVE QUICK MENU.....	224
FUNCTION (Fn) SETTING.....	225
COMMAND DIAL SETTING.....	225
COMMAND DIAL DIRECTION.....	226
SHUTTER AF.....	226
SHUTTER AE.....	227
SHOOT WITHOUT LENS.....	228
SHOOT WITHOUT CARD.....	228
FOCUS RING.....	229
FOCUS RING OPERATION.....	229
AE/AF-LOCK MODE.....	230
AWB-LOCK MODE.....	230
EXPO. COMP. BUTTON SETTING.....	230
TOUCH SCREEN SETTING.....	231
LOCK.....	232
<b>POWER MANAGEMENT.....</b>	<b>233</b>
AUTO POWER OFF.....	233
SHOOTING STAND BY MODE.....	234
AUTO POWER SAVE.....	234
AUTO POWER OFF TEMP.....	234
<b>SAVE DATA SETTING.....</b>	<b>235</b>
FRAME NO.....	235
SAVE ORG IMAGE.....	236

EDIT FILE NAME.....	236
 CARD SLOT SETTING .....	236
 CARD SLOT SETTING.....	237
SELECT SLOT(  SEQUENTIAL) .....	237
SELECT SLOT(  SEQUENTIAL).....	237
SELECT FOLDER .....	238
COPYRIGHT INFO .....	238
<b>CONNECTION SETTING .....</b>	<b>239</b>
Bluetooth SETTINGS.....	239
NETWORK SETTING.....	240
instax PRINTER CONNECTION SETTING .....	241
CONNECTION MODE.....	242
USB POWER SUPPLY SETTING.....	243
GENERAL SETTINGS.....	244
INFORMATION.....	244
RESET WIRELESS SETTING.....	244

## **9 Shortcuts 245**

Shortcut Options .....	246
<b>MY MENU .....</b>	<b>247</b>
MY MENU SETTING.....	247
<b>The Quick Menu.....</b>	<b>249</b>
The Quick Menu Display .....	249
Viewing and Changing Settings.....	251
Editing the Quick Menu.....	252
<b>Function Controls.....</b>	<b>255</b>
The Function Buttons.....	255
Touch-Function Gestures .....	259

## **10 Peripherals and Optional Accessories 261**

<b>Lenses .....</b>	<b>262</b>
Lens Parts.....	262
Lens Care.....	263
Removing Lens Caps.....	263
Attaching Lens Hoods .....	263
Aperture Rings.....	264

<b>External Flash Units</b> .....	<b>265</b>
Flash Settings .....	266
SYNC TERMINAL.....	267
SHOE MOUNT FLASH .....	268
COMMANDER(OPTICAL).....	271
<b>Handgrips</b> .....	<b>275</b>
Attaching the Handgrip .....	275
<b>11 Connections</b> .....	<b>277</b>
<b>HDMI Output</b> .....	<b>278</b>
Connecting to HDMI Devices .....	278
Shooting.....	279
Playback.....	279
<b>Wireless Connections (Bluetooth®, Wireless LAN/Wi-Fi)</b> .....	<b>280</b>
Smartphones and Tablets: FUJIFILM Camera Remote.....	280
Tethered Shooting: Capture One Pro Fujifilm/ Adobe® Photoshop® Lightroom® Classic CC + FUJIFILM Tether Shooting Plug-in PRO for GFX/FUJIFILM X Acquire.....	282
<b>Connecting via USB</b> .....	<b>283</b>
Tethered Shooting: Capture One Pro Fujifilm/Adobe® Photoshop® Lightroom® Classic CC + FUJIFILM Tether Shooting Plug-in PRO for GFX/ FUJIFILM X Acquire/FUJIFILM Pixel Shift Combiner.....	286
Copying Pictures from a Memory Card to a Computer.....	287
Using Your Camera as a Webcam (FUJIFILM X Webcam) .....	287
Converting RAW Images: FUJIFILM X RAW STUDIO .....	288
Backing up and Restoring Camera Settings (FUJIFILM X Acquire) .....	288
Connecting to Smartphones .....	289
<b>instax SHARE Printers</b> .....	<b>292</b>
Establishing a Connection .....	292
Printing Pictures.....	293

<b>12 Technical Notes</b>	<b>295</b>
Accessories from Fujifilm .....	296
Software for Use with Your Camera .....	298
FUJIFILM Camera Remote .....	298
RAW FILE CONVERTER EX powered by SILKYPIX .....	298
Capture One Express Fujifilm .....	298
Capture One Pro Fujifilm .....	298
Adobe® Photoshop® Lightroom® Classic CC + FUJIFILM Tether Shooting Plug-in PRO for GFX.....	299
FUJIFILM X Acquire .....	299
FUJIFILM X Webcam .....	299
FUJIFILM X RAW STUDIO .....	300
FUJIFILM Pixel Shift Combiner .....	300
For Your Safety .....	301
Product Care.....	311
Cleaning the Image Sensor.....	312
Firmware Updates .....	313
Checking the Firmware Version.....	313
Troubleshooting .....	314
Warning Messages and Displays.....	322
Memory Card Capacity.....	326
Specifications.....	327

## Supplied Accessories

The following are included with the camera:

- NP-W235 rechargeable battery
- AC-5VJ AC power adapter
- Plug adapter
- USB cable (approx. 0.6 m/2 ft.)
- Body cap (comes attached to camera)
- Shoulder strap
- Cable protector
- Hot shoe cover (comes attached to hot shoe)
- *Basic Manual*

 The battery is not charged at shipment. Charge the battery before use (📖 41).



 • The plug adapter supplied varies with the country or region.  
• For information on compatible computer software, see “Software for Use with Your Camera” (📖 298).

## About This Manual

This manual contains instructions for your FUJIFILM GFX50S II digital camera. Be sure you have read and understood its contents before proceeding.

### Symbols and Conventions

The following symbols are used in this manual:

-  Information that should be read to prevent damage to the product.
-  Additional information that may be helpful when using the product.
-  Pages on which related information may be found.

Menus and other text in the displays are shown in **bold**. Illustrations are for explanatory purposes only; drawings may be simplified, while photographs are not necessarily taken with the model of camera described in this manual.

### Terminology

The optional SD, SDHC, and SDXC memory cards the camera uses to store pictures are referred to as “memory cards”. The electronic viewfinder may be referred to as the “EVF” and the LCD monitor as the “LCD”. Smartphones and tablets are referred to as “smartphones”.



# Before You Begin



## Parts of the Camera

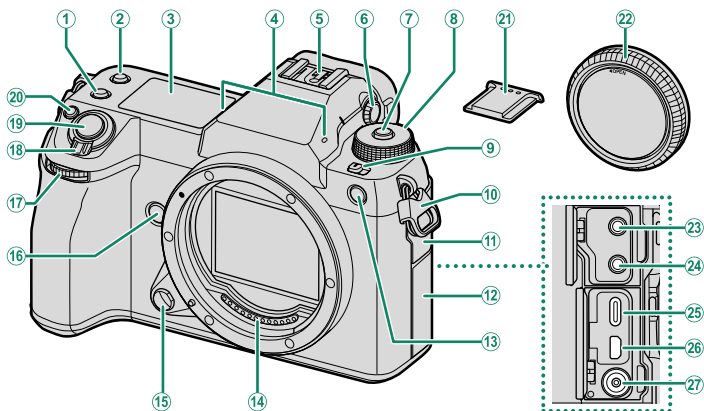

① <b>Fn2</b> button.....	255	⑭ <b>Lens</b> signal contacts	
② <b>Fn3</b> button.....	255	⑮ <b>Lens</b> release button.....	35
③ <b>Secondary</b> LCD monitor.....	22	⑯ <b>Fn4</b> button.....	255
④ <b>Microphone</b> .....	57, 172	⑰ <b>Front</b> command dial.....	8, 225
⑤ <b>Hot shoe</b> .....	266	⑱ <b>ON/OFF</b> switch.....	44
⑥ <b>Diopter</b> adjustment control.....	11	⑲ <b>Shutter</b> button.....	52
⑦ <b>Dial</b> lock release.....	50, 56	⑳ <b>Fn1</b> button.....	255
⑧ <b>Mode</b> dial.....	6	☑ (exposure compensation) button.....	95
⑨ <b>STILL/MOVIE</b> mode switch.....	50, 56	㉑ <b>Hot shoe</b> cover.....	266
⑩ <b>Strap</b> clip.....	34	㉒ <b>Body</b> cap.....	35
⑪ <b>Connector</b> cover 1		㉓ <b>Microphone</b> jack.....	57
⑫ <b>Connector</b> cover 2		㉔ <b>Headphone</b> jack.....	173
⑬ <b>AF-assist</b> illuminator.....	132	㉕ <b>USB</b> connector (Type-C).....	41, 283
<b>Self-timer</b> lamp.....	142	㉖ <b>HDMI</b> Micro connector (Type D).....	278
<b>Tally</b> light.....	160	㉗ <b>Sync</b> terminal.....	267

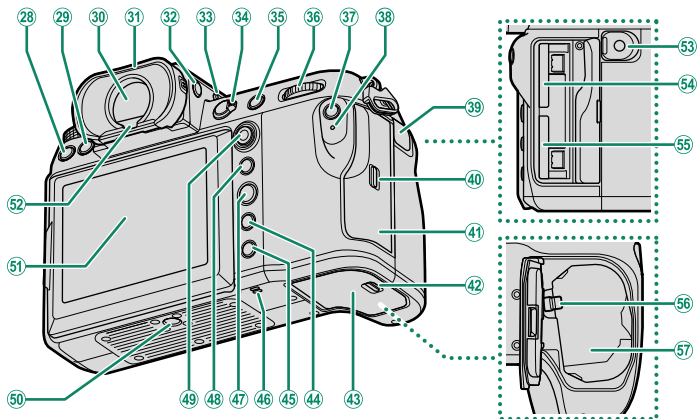

28	<b>DRIVE</b> button.....	7	43	Battery-chamber cover.....	36
29	⏏ (delete) button.....	54	44	<b>DISP</b> (display)/ <b>BACK</b> button.....	18, 179
30	Electronic viewfinder (EVF) .....	12, 16, 17, 27	45	▶ (playback) button.....	53
31	Eye cup (lockable).....	11	46	Speaker.....	60, 210
32	<b>VIEW MODE</b> button.....	16	47	<b>MENU/OK</b> button.....	25
33	Secondary monitor backlight button.....	24	48	<b>AEL</b> (exposure lock) button.....	97, 255
34	Focus mode selector.....	81	49	Focus stick (focus lever).....	5, 85, 224
35	<b>AFON</b> button.....	97, 255	50	Tripod mount	
36	Rear command dial.....	8, 181, 225	51	LCD monitor.....	10, 14, 16
37	<b>Q</b> (quick menu) button.....	249		Touch screen.....	27, 140, 231
38	Indicator lamp.....	9, 160	52	Eye sensor.....	16
	Tally light.....	160	53	Remote release connector.....	73
39	Remote release connector cover.....	73	54	Memory card slot 2.....	38
40	Memory card slot cover latch.....	38	55	Memory card slot 1.....	38
41	Memory card slot cover (detachable).....	38	56	Battery latch.....	37
42	Battery-chamber cover latch.....	36	57	Battery chamber.....	36

## The Cable Protector

Attach the protector as shown to prevent accidental disconnection.

- ① Insert the tab on the connector into the matching slot on the camera.
- ② Position the protector on the camera.
- ③ Tighten the lock screw.
- ④ Connect the cable and pass it through the protector as shown.

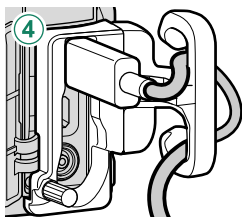
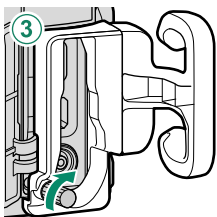
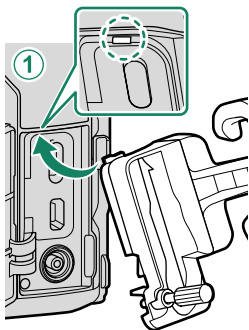

## The Serial Number Plate

Do not remove the serial number plate, which provides the CMIIT ID, serial number, and other important information.

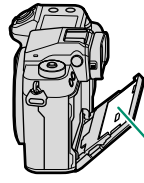

Serial number plate

## The Memory Card Slot Cover (Detachable)

The memory card slot cover can be removed by lowering the interior latch. Remove the cover for ease of access when a camera rig is attached or in other situations that make it difficult to open or close the cover.

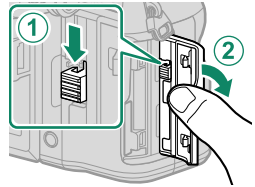

## The Focus Stick (Focus Lever)

Tilt or press the focus stick to select the focus area. The focus stick can also be used to navigate the menus.

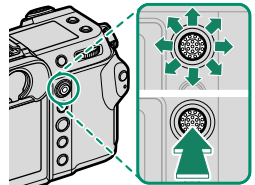

## The Mode Dial

To select a shooting mode, rotate the dial until the icon for the desired mode aligns with the index.

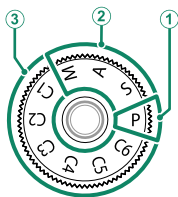

Mode	Description	
① <b>P</b> (PROGRAM AE)	Aperture and shutter speed can be adjusted using program shift.	64
② <b>S</b> (SHUTTER PRIORITY AE) <b>A</b> (APERTURE PRIORITY AE) <b>M</b> (MANUAL)	Select for full control over camera settings, including aperture ( <b>M</b> and <b>A</b> ) and/or shutter speed ( <b>M</b> and <b>S</b> ).	66 68 70
③ <b>C1/C2/C3/C4/C5/C6</b> (CUSTOM 1/2/3/4/5/6)	Take pictures using previously-stored settings.	74

 Rotate the mode dial only after pressing the dial lock release to release the dial.

## The STILL/MOVIE Mode Switch

Slide the **STILL/MOVIE** mode switch to **STILL** to take photographs or to **MOVIE** to record movies.

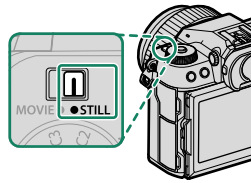





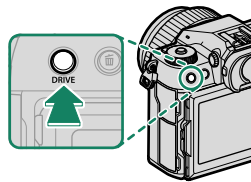

## The DRIVE Button

Press the **DRIVE** button to adjust shooting settings. The options displayed vary with the position of the **STILL/MOVIE** mode switch.

- Pressing the button when **STILL** is selected displays drive mode options.









Mode	
	Single frame
	Burst mode
	ISO BKT
	WHITE BALANCE BKT

Mode	
<b>BKT</b>	Bracketing
	Multiple Exposure
	PIXEL SHIFT MULTI SHOT

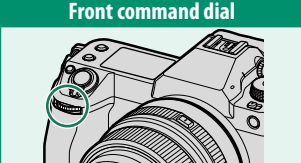
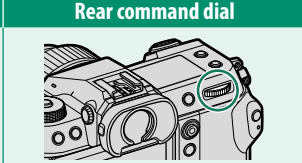
- Pressing the button when **MOVIE** is selected displays frame rate options.

## The Command Dials

Rotate or press the command dials to:

	Front command dial	Rear command dial
 		
  <b>Rotate</b>	<ul style="list-style-type: none"><li>• Select menu tabs or page through menus</li><li>• Adjust aperture<sup>1,2</sup></li><li>• View other pictures during playback</li></ul>	<ul style="list-style-type: none"><li>• Highlight menu items</li><li>• Choose the desired combination of shutter speed and aperture (program shift)</li><li>• Choose a shutter speed<sup>1,4</sup></li><li>• Adjust exposure compensation by pressing the  button and rotating the dial<sup>1</sup></li><li>• Adjust settings in the quick menu</li><li>• Choose the size of the focus frame</li><li>• Zoom in or out in full frame playback</li><li>• Zoom in or out in multi-frame playback</li></ul>
 <b>Press</b>	<ul style="list-style-type: none"><li>• Switch between aperture and ISO sensitivity<sup>2</sup></li><li>• Press and hold to choose the option selected for  <b>BUTTON/DIAL SETTING</b> &gt; <b>COMMAND DIAL SETTING</b> in the  (setup) menu</li></ul>	<ul style="list-style-type: none"><li>• Zoom in on the active focus point<sup>3</sup></li><li>• Press and hold to choose the manual focus mode focus display<sup>3</sup></li><li>• Zoom in on the active focus point during playback</li></ul>

1 Can be changed using  **BUTTON/DIAL SETTING** > **COMMAND DIAL SETTING**.

2 If the lens is equipped with an aperture ring with an "A" or "C" position, the aperture ring must be in the **A** or **C** position.

3 Available only if **FOCUS CHECK** is assigned to a function button.

4 Only if a value other than auto is selected for shutter speed.

 The rotation direction for the command dials can be selected using  **BUTTON/DIAL SETTING** > **COMMAND DIAL DIRECTION**.



## The Indicator Lamp

Camera status is shown by the indicator lamp.

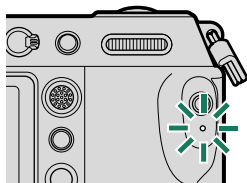

Indicator lamp	Camera status
Glows green	Focus locked.
Blinks green	Focus or slow shutter speed warning. Pictures can be taken.
Blinks green and orange	<ul style="list-style-type: none"> <li>• <b>Camera on:</b> Recording pictures, or picture displayed for confirmation after being taken with option other than <b>OFF</b> selected for <b>SCREEN SETTING &gt; IMAGE DISP.</b> (additional pictures can be taken).</li> <li>• <b>Camera off:</b> Uploading pictures to a smartphone or tablet.*</li> </ul>
Glows orange	Recording pictures. No additional pictures can be taken at this time.
Blinks orange	Flash charging; flash will not fire when picture is taken.
Blinks red	Lens or memory error.

\* Displayed only if pictures are selected for upload.

- Warnings may also appear in the display.
- The indicator lamp remains off while your eye is to the viewfinder.
- The **MOVIE SETTING > TALLY LIGHT** option can be used to choose the lamp (indicator or AF-assist) that lights during movie recording and whether the lamp blinks or remains steady.

## The LCD Monitor

The LCD monitor can be tilted for easier viewing, but be careful not to touch the wires or trap fingers or other objects behind the monitor. Touching the wires could cause camera malfunction.

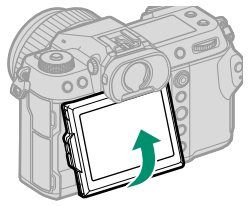

- The LCD monitor also functions as a touch screen that can be used for:
  - Touch photography (📖 28)
  - Focus area selection (📖 27)
  - Function selection (📖 30)
  - Movie optimized control (🎛️) (📖 29)
  - Playback (📖 31)

### “Tall” (Portrait) Orientation

The display can also be tilted to take pictures from high or low angles when the camera is rotated to take pictures in “tall” (portrait) orientation.

- Press the tilt lock release and tilt the display as shown in Figure 1.
- To take high-angle shots, hold the camera in the orientation shown in Figure 2.

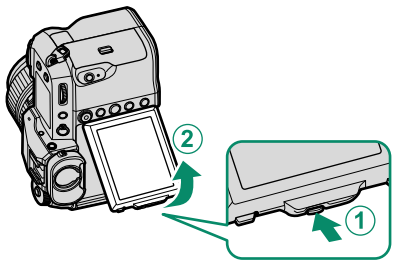

Figure 1

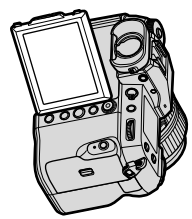
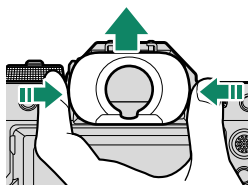

Figure 2

## The Eye Cup

To remove the eye cup, hold the buttons on either side and slide eye cup up.



## Focusing the Viewfinder

If the indicators displayed in the viewfinder are blurred, put your eye to the viewfinder and rotate the diopter adjustment control until the display is in sharp focus.

To focus the viewfinder:

- ① Lift the diopter adjustment control.
- ② Rotate the control to adjust viewfinder focus.
- ③ Return the control to its original position and lock it in place.

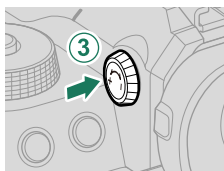
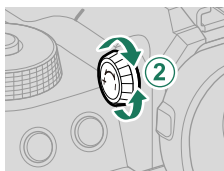
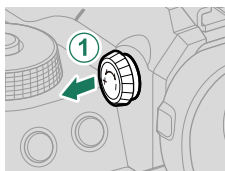

**!** Lift the control before use. Failure to observe this precaution could cause product malfunction.



① Crop factor.....	155	②⑥ Virtual horizon.....	21
② IS mode <sup>2</sup> .....	149	②⑦ Focus frame.....	85, 96
③ Flash (TTL) mode.....	268	②⑧ Histogram.....	21
④ Flash compensation.....	268	②⑨ Power supply.....	43
⑤ Self-timer indicator.....	142	③⑩ Battery level.....	45
⑥ Continuous mode.....	103	③① Sensitivity.....	92
⑦ Shutter type.....	147	③② Exposure compensation.....	95
⑧ AF+MF indicator <sup>2</sup> .....	135	③③ Aperture.....	65, 68, 70
⑨ Bluetooth ON/OFF.....	239	③④ Shutter speed.....	65, 66, 70
⑩ White balance.....	119	③⑤ TTL lock.....	153, 258
⑪ AWB lock.....	230	③⑥ AE lock.....	97, 230
⑫ Film simulation.....	113	③⑦ Metering.....	94
⑬ Dynamic range.....	117	③⑧ Shooting mode.....	64
⑭ D-range priority.....	118	③⑨ Focus mode <sup>2</sup> .....	81
⑮ Image transfer status.....	239, 280	④⑩ Focus indicator <sup>2</sup> .....	82
⑯ Date and time.....	46, 48, 205	④① Manual focus indicator <sup>2</sup> .....	81, 88
⑰ Movie mode.....	56, 155	④② AF lock.....	97, 230
⑱ Recording time available/ elapsed recording time.....	57	④③ Distance indicator <sup>2</sup> .....	90
⑲ Card slot options.....	39, 236	④④ Recording level <sup>2</sup> .....	172
⑳ Number of available frames <sup>1</sup> .....	326	④⑤ Time code.....	174
㉑ Image size.....	110	④⑥ Exposure indicator.....	70, 95
㉒ Image quality.....	111	④⑦ Location data download status.....	244, 280
㉓ Touch screen mode.....	27, 140	④⑧ 35mm format mode.....	150
㉔ Temperature warning.....	325	④⑨ Depth-of-field preview.....	69, 90
㉕ Control lock <sup>3</sup> .....	232	⑤⑩ Focus check.....	91, 136

1 Shows "9999" if there is space for over 9999 frames.

2 Not displayed when **ON** is selected for **SCREEN SET-UP > LARGE INDICATORS MODE(EVF)**.

3 Displayed when controls have been locked by pressing and holding the **MENU/OK** button. Control lock can be ended by pressing and holding the **MENU/OK** button again.

## The LCD Monitor

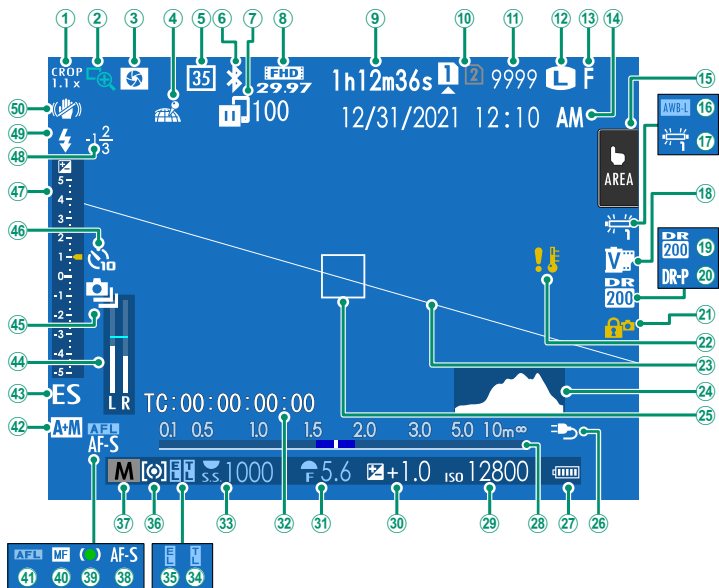

① Crop factor.....	155	②⑥ Power supply.....	43
② Focus check.....	91, 136	②⑦ Battery level.....	45
③ Depth-of-field preview.....	69, 90	②⑧ Distance indicator <sup>2</sup> .....	90
④ Location data download status.....	244, 280	②⑨ Sensitivity.....	92
⑤ 35mm format mode.....	150	③⑩ Exposure compensation.....	95
⑥ Bluetooth ON/OFF.....	239	③① Aperture.....	65, 68, 70
⑦ Image transfer status.....	239, 280	③② Time code.....	174
⑧ Movie mode.....	56, 155	③③ Shutter speed.....	65, 66, 70
⑨ Recording time available/ elapsed recording time.....	57	③④ TTL lock.....	153, 258
⑩ Card slot options.....	39, 236	③⑤ AE lock.....	97, 230
⑪ Number of available frames <sup>1</sup> .....	326	③⑥ Metering.....	94
⑫ Image size.....	110	③⑦ Shooting mode.....	64
⑬ Image quality.....	111	③⑧ Focus mode <sup>2</sup> .....	81
⑭ Date and time.....	46, 48, 205	③⑨ Focus indicator <sup>2</sup> .....	82
⑮ Touch screen mode <sup>3</sup> .....	27, 140	④⑩ Manual focus indicator <sup>2</sup> .....	81, 88
⑯ AWB lock.....	230	④① AF lock.....	97, 230
⑰ White balance.....	119	④② AF+MF indicator <sup>2</sup> .....	135
⑱ Film simulation.....	113	④③ Shutter type.....	147
⑲ Dynamic range.....	117	④④ Recording level <sup>2</sup> .....	172
⑳ D-range priority.....	118	④⑤ Continuous mode.....	103
㉑ Control lock <sup>4</sup> .....	232	④⑥ Self-timer indicator.....	142
㉒ Temperature warning.....	325	④⑦ Exposure indicator.....	70, 95
㉓ Virtual horizon.....	21	④⑧ Flash compensation.....	268
㉔ Histogram.....	21	④⑨ Flash (TTL) mode.....	268
㉕ Focus frame.....	85, 96	⑤⑩ IS mode <sup>2</sup> .....	149

1 Shows "9999" if there is space for over 9999 frames.

2 Not displayed when **ON** is selected for **SCREEN SET-UP > LARGE INDICATORS MODE(LCD)**.



3 Camera functions can also be accessed via touch controls.

4 Displayed when controls have been locked by pressing and holding the **MENU/OK** button. Control lock can be ended by pressing and holding the **MENU/OK** button again.

## Choosing a Display Mode

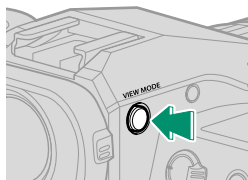
Press the **VIEW MODE** button to cycle through the following display modes.



Option	Description
 <b>EYE SENSOR</b>	Putting your eye to the viewfinder turns the viewfinder on and the LCD monitor off; taking your eye away turns the viewfinder off and LCD monitor on.
<b>EVF ONLY</b>	Viewfinder on, LCD monitor off.
<b>LCD ONLY</b>	LCD monitor on, viewfinder off.
<b>EVF ONLY +</b> 	Putting your eye to the viewfinder turns the viewfinder on; taking it away turns the viewfinder off. The LCD monitor remains off.
 <b>EYE SENSOR + LCD IMAGE DISP.</b>	Putting your eye to the viewfinder during shooting turns the viewfinder on, but the LCD monitor is used for the display of images once you remove your eye from the viewfinder after shooting. The options selected for <b>SCREEN SET-UP &gt; IMAGE DISP.</b> apply to display in the LCD monitor.

### The Eye Sensor

- The eye sensor may respond to objects other than your eye or to light shining directly on the sensor.
- The eye sensor is disabled while the LCD monitor is tilted.

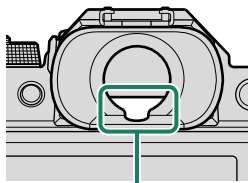

Eye sensor



## Adjusting Display Brightness

The brightness and saturation of the viewfinder and LCD monitor can be adjusted using the items in the **SCREEN SET-UP** menu. Choose **EVF BRIGHTNESS** or **EVF COLOR** to adjust viewfinder brightness or saturation, **LCD BRIGHTNESS** or **LCD COLOR** to do the same for the LCD monitor.

## Display Rotation

When **ON** is selected for **SCREEN SET-UP > AUTOROTATE DISPLAYS**, the indicators in the viewfinder and LCD monitor automatically rotate to match camera orientation.

## The DISP/BACK Button

The **DISP/BACK** button controls the display of indicators in the viewfinder and LCD monitor.

 Indicators for the EVF and LCD must be selected separately. To choose the EVF display, place your eye to the viewfinder while using the **DISP/BACK** button.

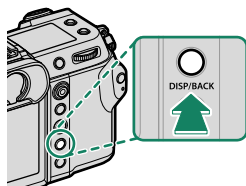

## Viewfinder

*Full screen*

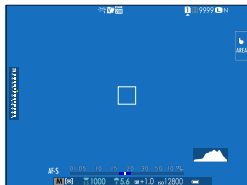

*Full screen  
(no indicators)*



*Dual display  
(manual focus mode only)*

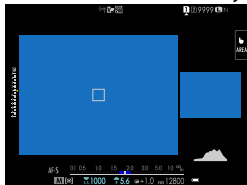

*Standard indicators*



*Standard (no indicators)*



## LCD Monitor

*Standard indicators*

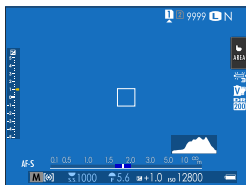

*No indicators*

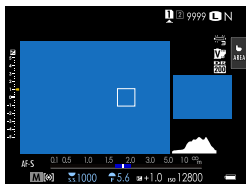

*Dual display*

*(manual focus mode only)*

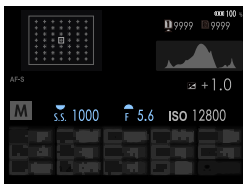

*Info display*



## The Dual Display

The dual display consists of a large full-frame window and a smaller close-up of the focus area.

## Customizing the Standard Display

To choose the items shown in the standard indicator display:

### 1 Display standard indicators.

Use the **DISP/BACK** button to display standard indicators.

### 2 Select DISP. CUSTOM SETTING.

Select **SCREEN SET-UP > DISP. CUSTOM SETTING** in the setup menu.

### 3 Choose items.

Highlight items and press **MENU/OK** to select or deselect.

Item	Default		Item	Default	
	STILL	MOVIE		STILL	MOVIE
FRAMING GUIDELINE	<input type="checkbox"/>	<input type="checkbox"/>	CONTINUOUS MODE	<input checked="" type="checkbox"/>	—
ELECTRONIC LEVEL	<input type="checkbox"/>	<input type="checkbox"/>	DUAL IS MODE	<input checked="" type="checkbox"/>	<input checked="" type="checkbox"/>
FOCUS FRAME	<input checked="" type="checkbox"/>	<input checked="" type="checkbox"/>	TOUCH SCREEN MODE	<input checked="" type="checkbox"/>	<input checked="" type="checkbox"/>
AF DISTANCE INDICATOR	<input type="checkbox"/>	<input type="checkbox"/>	WHITE BALANCE	<input checked="" type="checkbox"/>	<input checked="" type="checkbox"/>
MF DISTANCE INDICATOR	<input checked="" type="checkbox"/>	<input checked="" type="checkbox"/>	FILM SIMULATION	<input checked="" type="checkbox"/>	<input checked="" type="checkbox"/>
HISTOGRAM	<input type="checkbox"/>	<input type="checkbox"/>	DYNAMIC RANGE	<input checked="" type="checkbox"/>	—
LIVE VIEW HIGHLIGHT ALERT	<input type="checkbox"/>	<input type="checkbox"/>	FRAMES REMAINING	<input checked="" type="checkbox"/>	—
SHOOTING MODE	<input checked="" type="checkbox"/>	<input checked="" type="checkbox"/>	IMAGE SIZE/QUALITY	<input checked="" type="checkbox"/>	—
APERTURE/S-SPEED/ISO	<input checked="" type="checkbox"/>	<input checked="" type="checkbox"/>	MOVIE MODE & REC. TIME	—	<input checked="" type="checkbox"/>
INFORMATION BACKGROUND	<input checked="" type="checkbox"/>	<input checked="" type="checkbox"/>	35mm FORMAT MODE	<input checked="" type="checkbox"/>	—
Expo. Comp. (Digit)	<input type="checkbox"/>	<input type="checkbox"/>	IMAGE TRANSFER ORDER	<input checked="" type="checkbox"/>	<input checked="" type="checkbox"/>
Expo. Comp. (Scale)	<input checked="" type="checkbox"/>	<input checked="" type="checkbox"/>	MIC LEVEL	—	<input checked="" type="checkbox"/>
FOCUS MODE	<input checked="" type="checkbox"/>	<input checked="" type="checkbox"/>	GUIDANCE MESSAGE	<input checked="" type="checkbox"/>	<input checked="" type="checkbox"/>
PHOTOMETRY	<input checked="" type="checkbox"/>	<input checked="" type="checkbox"/>	BATTERY LEVEL	<input checked="" type="checkbox"/>	<input checked="" type="checkbox"/>
SHUTTER TYPE	<input checked="" type="checkbox"/>	—	FRAMING OUTLINE	<input type="checkbox"/>	<input type="checkbox"/>
FLASH	<input checked="" type="checkbox"/>	—			

### 4 Press DISP/BACK to save changes.

### 5 Press DISP/BACK as needed to exit the menus and return to the shooting display.

## Virtual Horizon

Selecting **ELECTRONIC LEVEL** displays a virtual horizon. The camera is level when the two lines overlap. Note that the virtual horizon may not be displayed if the camera lens is pointed up or down. For a 3D display (shown), press the function button to which **ELECTRONIC LEVEL** is assigned (📖 225, 255).

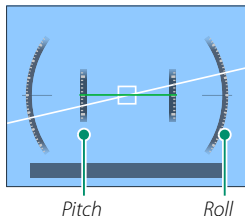

## Framing Outline

Enable **FRAMING OUTLINE** to make the borders of the frame easier to see against dark backgrounds.

## Histograms

Histograms show the distribution of tones in the image. Brightness is shown by the horizontal axis, the number of pixels by the vertical axis.

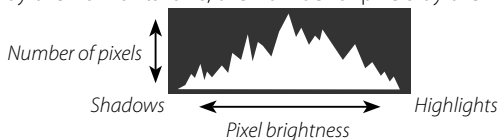

- **Optimal exposure:** Pixels are distributed in an even curve throughout the tone range.
- **Overexposed:** Pixels are clustered on the right side of the graph.
- **Underexposed:** Pixels are clustered on the left side of the graph.

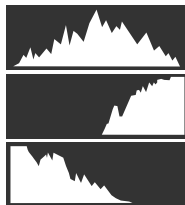

To view separate RGB histograms and a display showing areas of the frame that will be overexposed at current settings superimposed on the view through the lens, press the function button to which **HISTOGRAM** is assigned (📖 225, 255).

- ① Overexposed areas blink
- ② RGB histograms

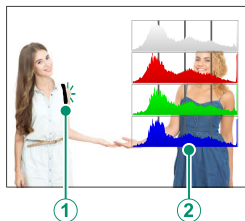

## The Secondary LCD Monitor

Among the settings that can be viewed in the secondary LCD monitor are shutter speed, aperture, and ISO sensitivity.

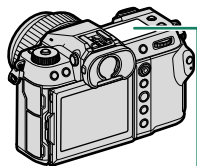

Secondary LCD monitor

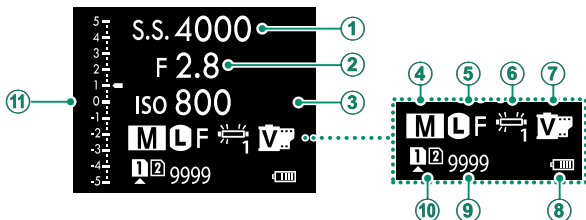

### Default

① SHUTTER SPEED	⑦ FILM SIMULATION
② APERTURE	⑧ BATTERY LEVEL
③ ISO	⑨ FRAMES REM.
④ SHOOTING MODE	⑩ CARD SLOT OPTIONS
⑤ IMAGE SIZE/QUALITY	⑪  Scale
⑥ WHITE BALANCE	

The settings displayed can be selected using **SCREEN SET-UP > SUB MONITOR SETTING.**

## Cycling Through Indicators in the Secondary LCD Monitor

The indicators displayed in the secondary LCD monitor change each time the secondary LCD monitor mode button is pressed.

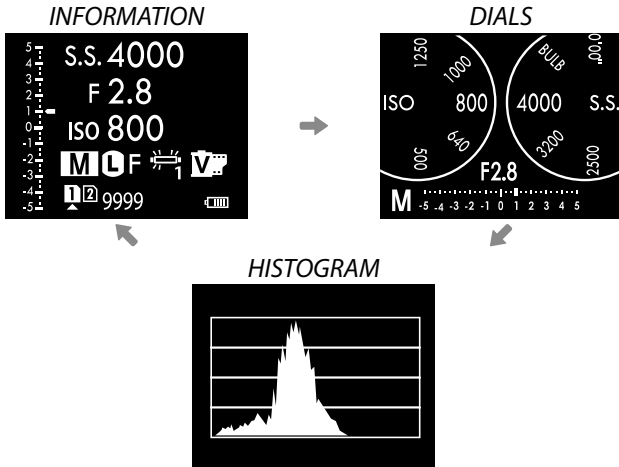
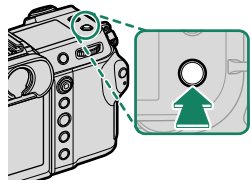

### The secondary monitor backlight button

To turn on the secondary LCD monitor backlight when you find the secondary LCD monitor too dark to read, press the secondary monitor backlight button. Press the button again to turn the backlight off.

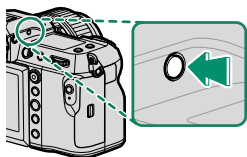

### Background Color

The background color (black or white) for the secondary LCD monitor can be selected using the **SCREEN SET-UP > SUB MONITOR BACKGROUND COLOR** option in the (setup) menu. Note that the background is displayed in white whenever the secondary LCD monitor backlight is on.







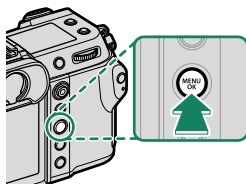

## Using the Menu

To display the menus, press **MENU/OK**.

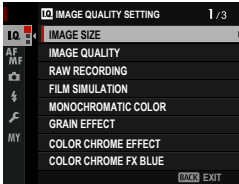

### The Menu

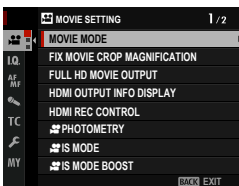
Different menus are displayed during still photography, movie recording, and playback.

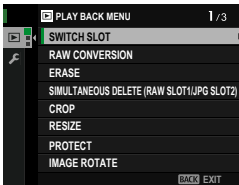
Shooting	 <p><b>STILL/MOVIE mode switch set to STILL</b></p>		 <p><b>IMAGE QUALITY SETTING 1/3</b></p> <ul style="list-style-type: none"><li>IMAGE SIZE</li><li>IMAGE QUALITY</li><li>RAW RECORDING</li><li>FILM SIMULATION</li><li>MONOCHROMATIC COLOR</li><li>GRAIN EFFECT</li><li>COLOR CHROME EFFECT</li><li>COLOR CHROME FX BLUE</li></ul> <p>BACK EXIT</p>
	 <p><b>STILL/MOVIE mode switch set to MOVIE</b></p>		 <p><b>MOVIE SETTING 1/2</b></p> <p><b>MOVIE MODE</b></p> <ul style="list-style-type: none"><li>FIX MOVIE CROP MAGNIFICATION</li><li>FULL HD MOVIE OUTPUT</li><li>HDMI OUTPUT INFO DISPLAY</li><li>HDMI REC CONTROL</li><li>PHOTOMETRY</li><li>IS MODE</li><li>IS MODE BOOST</li></ul> <p>BACK EXIT</p>
Playback	 <p><b>During playback</b></p>		 <p><b>PLAY BACK MENU 1/3</b></p> <p><b>SWITCH SLOT</b></p> <ul style="list-style-type: none"><li>RAW CONVERSION</li><li>ERASE</li><li>SIMULTANEOUS DELETE (RAW SLOT1/JPG SLOT2)</li><li>CROP</li><li>RESIZE</li><li>PROTECT</li><li>IMAGE ROTATE</li></ul> <p>BACK EXIT</p>

## Selecting a Menu Tab

To navigate the menus:

- 1 Press **MENU/OK** to display the menus.

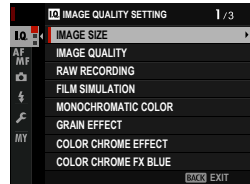
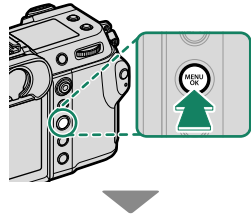

- 2 Press the focus stick (focus lever) left to highlight the tab for the current menu.

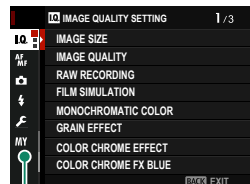

Tab

- 3 Press the focus stick up or down to highlight the tab containing the desired item.
- 4 Press the focus stick right to place the cursor in the menu.

 Use the front command dial to select menu tabs or page through menus and the rear command dial to highlight menu items.

## Touch Screen Mode

The LCD monitor also functions as a touch screen.

### Shooting Touch Controls

To enable touch controls, select **ON** for **☑️ BUTTON/DIAL SETTING > TOUCH SCREEN SETTING > 📷 TOUCH SCREEN SETTING**.

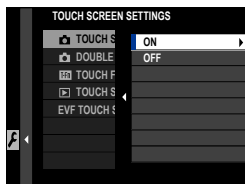

### EVF

The LCD monitor can be used to select the focus area while pictures are being framed in the electronic viewfinder (EVF). Use **☑️ BUTTON/DIAL SETTING > TOUCH SCREEN SETTING > EVF TOUCH SCREEN AREA SETTINGS** to choose the area of the monitor employed for touch controls.

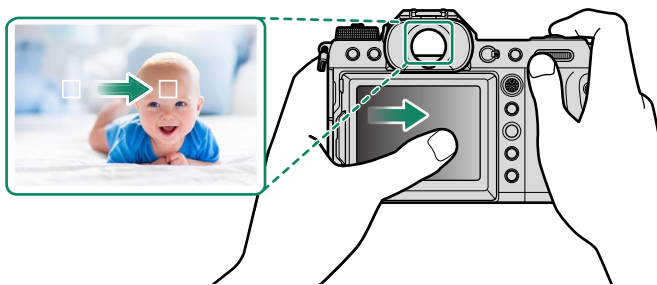





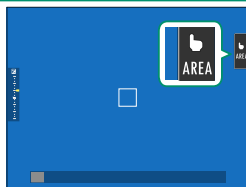

**📷** If **FACE SELECT**  is enabled when **FACE DETECTION ON** is selected for **📷 AF/MF SETTING > FACE/EYE DETECTION SETTING**, the face used for focus can be chosen via touch controls.







## LCD Monitor

The operation performed can be selected by tapping the touch screen mode indicator in the display. Touch controls can be used for the following operations:



Mode	Description
 <b>AF</b> ↓ ↑  <b>AF OFF</b>	<ul style="list-style-type: none"><li>• In focus mode <b>S</b> (AF-S), the camera focuses when you tap your subject in the display. Focus locks at the current distance until you tap the <b>AF OFF</b> icon.</li><li>• In focus mode <b>C</b> (AF-C), the camera initiates focus when you tap your subject display. The camera will continue to adjust focus for changes in the distance to the subject until you tap the <b>AF OFF</b> icon.</li><li>• In manual focus mode (MF), you can tap the display to focus on the selected subject using autofocus.</li></ul>
 <b>AREA</b>	Tap to select a point for focus or zoom. The focus frame will move to the selected point.
 <b>OFF</b>	Touch controls disabled.

 Different touch controls are used during focus zoom ( 141).



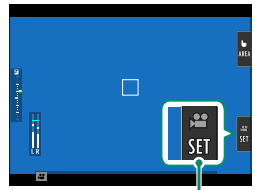

- To disable touch controls and hide the touch screen mode indicator, select **OFF** for  **BUTTON/DIAL SETTING** > **TOUCH SCREEN SETTING** >  **TOUCH SCREEN SETTING**.
- Touch control settings can be adjusted using  **AF/MF SETTING** >  **TOUCH SCREEN MODE**. For information on the touch controls available during movie recording, see “Movie Recording ( **TOUCH SCREEN MODE**;  169)”.

## MOVIE OPTIMIZED CONTROL

Selecting **ON** for **MOVIE SETTING > MOVIE OPTIMIZED CONTROL ** or tapping the movie-optimized mode button in the shooting display optimizes the command dials and touch controls for movie recording. This can be used to prevent camera sounds being recorded with movie footage.



*Movie-optimized mode button*

- SHUTTER SPEED
- APERTURE
- EXPOSURE COMPENSATION
- ISO
- INTERNAL MIC LEVEL  
ADJUSTMENT/EXTERNAL MIC  
LEVEL ADJUSTMENT
- WIND FILTER
- HEADPHONES VOLUME
-  FILM SIMULATION
-  WHITE BALANCE
-  IS MODE
-  IS MODE BOOST



- Enabling movie-optimized controls disables the aperture ring.
- When movie-optimized control is enabled, the movie-optimized mode button can be used to change shooting settings or disable movie-optimized control.

## Touch Function

Functions can be assigned to the following flick gestures in much the same way as function buttons (📖 255):

- Flick up: **T-Fn1**
- Flick left: **T-Fn2**
- Flick right: **T-Fn3**
- Flick down: **T-Fn4**

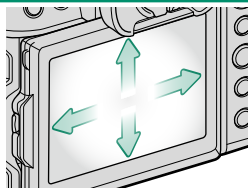

- In some cases, touch-function flick gestures display a menu; tap to select the desired option.

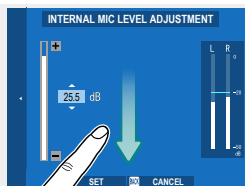

- Touch-function gestures are disabled by default. To enable touch-function gestures, select **ON** for **▶ BUTTON/DIAL SETTING > TOUCH SCREEN SETTING > T-Fn TOUCH FUNCTION**.

## Playback Touch Controls

When **ON** is selected for **▶️ BUTTON/DIAL SETTING > TOUCH SCREEN SETTING > ▶️ TOUCH SCREEN SETTING**, touch controls can be used for the following playback operations:

- **Swipe:** Swipe a finger across the display to view other images.



- **Pinch-out:** Place two fingers on the display and spread them apart to zoom in.



- **Pinch-in:** Place two fingers on the display and slide them together to zoom out.



Pictures can be zoomed out until the entire image is visible but no further.

- **Double-tap:** Tap the display twice to zoom in on the focus point.



- **Drag:** View other areas of the image during playback zoom.

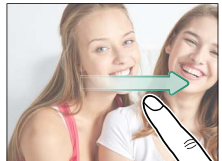





## First Steps

# 2

## Attaching the Strap

Attach the strap.

Attach the strap to the two strap clips as shown below.

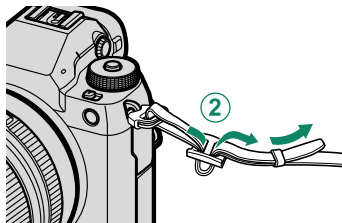
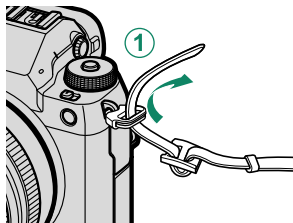

**!** To avoid dropping the camera, be sure the strap is correctly secured.

## Attaching a Lens

The camera can be used with lenses for the FUJIFILM G-mount.

Remove the body cap from the camera and the rear cap from the lens. Place the lens on mount, keeping the marks on the lens and camera aligned (①), and then rotate the lens until it clicks into place (②).

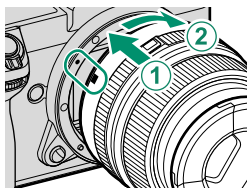

- ❗ When attaching lenses, ensure that dust or other foreign matter does not enter the camera.
- Be careful not to touch the camera's internal parts.
- Rotate the lens until it clicks securely into place.
- Do not press the lens release button while attaching the lens.

### Removing Lenses

To remove the lens, turn the camera off, then press the lens release button (①) and rotate the lens as shown (②).

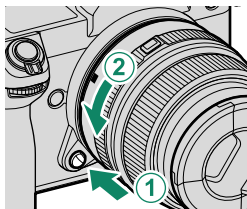

- ❗ To prevent dust accumulating on the lens or inside the camera, replace the lens caps and camera body cap when the lens is not attached.

### Lenses and Other Optional Accessories

The camera can be used with lenses and accessories for the FUJIFILM G-mount.

- ❗ Observe the following precautions when attaching or removing (exchanging) lenses.
- Check that the lenses are free of dust and other foreign matter.
- Do not change lenses in direct sunlight or under another bright light source. Light focused into the interior of the camera could cause it to malfunction.
- Attach the lens caps before exchanging lenses.
- See the manual provided with the lens for information on use.

## Inserting the Battery

Insert the battery in the camera as described below.

### 1 Open the battery-chamber cover.

Slide the battery-chamber cover latch as shown and open the battery-chamber cover.

- ⚠ Do not open the battery-chamber cover when the camera is on. Failure to observe this precaution could damage image files or memory cards.
- Do not use excessive force when handling the battery-chamber cover.

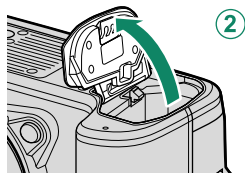
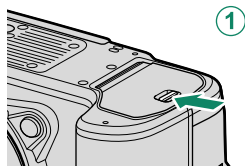

### 2 Insert the battery as shown.

- ⚠ Insert the battery in the orientation shown. *Do not use force or attempt to insert the battery upside down or backwards.*
- Confirm that the battery is securely latched.

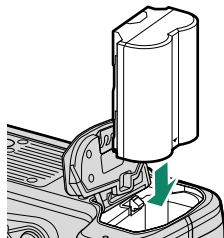

### 3 Close the battery-chamber cover.

Close and latch the cover.

⚠ If the cover does not close, check that the battery is in the correct orientation. Do not attempt to force the cover shut.

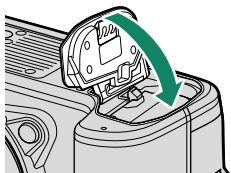

### Removing the Battery

Before removing the battery, *turn the camera off* and open the battery-chamber cover.

To remove the battery, press the battery latch to the side, and slide the battery out of the camera as shown.

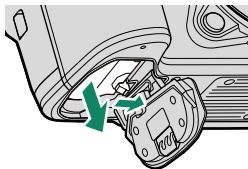

⚠ The battery may become hot when used in high-temperature environments. Observe caution when removing the battery.

## Inserting Memory Cards

Pictures are stored on memory cards (sold separately).

 The camera can be used with two cards, one in each of its two slots.

### 1 Open the memory card slot cover.

Unlatch and open the cover.

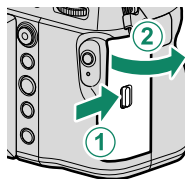

 *Do not turn the camera off or remove the memory card while the memory card is being formatted or data are being recorded to or deleted from the card. Failure to observe this precaution could damage the card.*

### 2 Insert the memory card.

Holding the card in the orientation shown, slide it in until it clicks into place at the back of the slot. Close and latch the memory card slot cover.

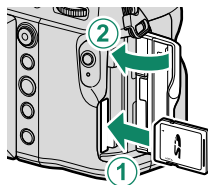

 Be sure card is in the correct orientation; do not insert at an angle or use force.

## Removing Memory Cards

Before removing memory cards, *turn the camera off* and open the memory card slot cover.

Press and release the card to eject it part way (to prevent the card falling from the slot, press the center of the card and release it slowly, without removing your finger from the card). The card can then be removed by hand.

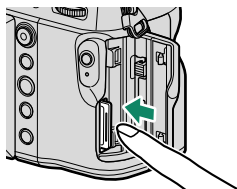

## Using Two Cards

The camera can be used with two cards, one in each of its two slots. At default settings, photos are saved to the card in the second slot only when the card in the first slot is full. This can be changed using **SAVE DATA SET-UP > CARD SLOT SETTING** (236). The card used to store movies can be selected using **SAVE DATA SET-UP > CARD SLOT SETTING** (237).

Option	Description	Display
<b>SEQUENTIAL</b> (default)	The card in the second slot is used only when the card in the first slot is full. If the second slot is selected for <b>SAVE DATA SET-UP &gt; SELECT SLOT (SEQUENTIAL)</b> , recording will start on the card in the second slot and switch to the first slot when the card in the second slot is full.	
<b>BACKUP</b>	Each picture is recorded twice, once to each card.	
<b>RAW / JPEG</b>	As for <b>SEQUENTIAL</b> , except that the RAW copy of pictures taken with <b>SUPER FINE+RAW</b> , <b>FINE+RAW</b> , or <b>NORMAL+RAW</b> selected for <b>IMAGE QUALITY SETTING &gt; IMAGE QUALITY</b> will be saved to the card in the first slot and the JPEG copy to the card in the second slot.	

## Compatible Memory Cards

- The camera can be used with SD, SDHC, and SDXC memory cards. Both the UHS-I and UHS-II bus interfaces are supported.
- Use a UHS Speed Class 1 or better memory card when recording movies.
- A list of supported memory cards is available on the Fujifilm website. For details, visit: <https://fujifilm-x.com/support/compatibility/cameras/>.

**!** • Do not turn the camera off or remove the memory card while the memory card is being formatted or data are being recorded to or deleted from the card. Failure to observe this precaution could damage the card.

- Memory cards can be locked, making it impossible to format the card or to record or delete images. Before inserting a memory card, slide the write-protect switch to the unlocked position.

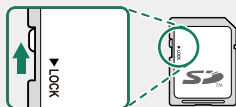

- Memory cards are small and can be swallowed; keep out of reach of children. If a child swallows a memory card, seek medical assistance immediately.
- miniSD or microSD adapters that are larger or smaller than memory cards may not eject normally; if the card does not eject, take the camera to an authorized service representative. Do not forcibly remove the card.
- Do not affix labels or other objects to memory cards. Peeling labels can cause camera malfunction.
- Movie recording may be interrupted with some types of memory card.
- Formatting a memory card in the camera creates a folder in which pictures are stored. Do not rename or delete this folder or use a computer or other device to edit, delete, or rename image files. Always use the camera to delete pictures; before editing or renaming files, copy them to a computer and edit or rename the copies, not the originals. Renaming the files on the camera can cause problems during playback.



## Charging the Battery

For reasons of safety, the battery is not charged at shipment. The camera will not function if the battery is not charged; be sure to charge the battery before use. Before charging the battery, turn the camera off.

- An NP-W235 rechargeable battery is supplied with the camera.
- Charging takes about 180 minutes.

### 1 Attach the plug adapter to the AC power adapter.

Attach the plug adapter as shown, making sure that it is fully inserted and clicks into place on the AC power adapter terminals.

- The supplied plug adapter is for use exclusively with the AC-5VJ AC power adapter. Do not use it with other devices.
- The shape of the plug adapter varies with the country of sale.

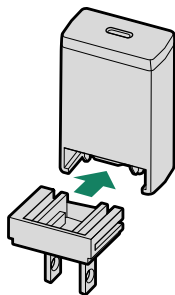

### 2 Charge the battery.

Connect the camera to the supplied AC power adapter using the supplied USB cable. Then plug the AC power adapter into an indoor power outlet.

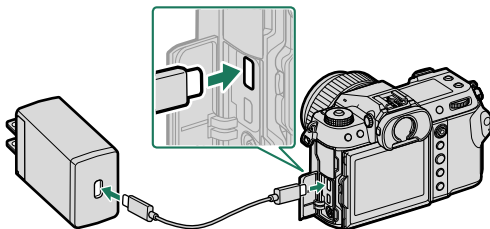

- Connect the cable to the camera's USB connector (Type-C).
- Be sure the connectors are fully inserted.

## Charge Status

The indicator lamp shows battery charge status as follows:

Indicator lamp	Battery status
On	Battery charging
Off	Charging complete
Blinks	Charging error

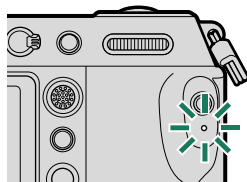

- ❗ The supplied AC power adapter is compatible with power supplies of 100 to 240 V (a plug adapter may be needed for overseas use).
- Do not use the AC power adapter or USB cable with other devices, as this could cause malfunction.
- Do not affix labels or other objects to the battery. Failure to observe this precaution could make it impossible to remove the battery from the camera.
- Do not short the battery terminals. The battery could overheat.
- Read the cautions in “The Battery and Power Supply”.
- Use only genuine Fujifilm rechargeable batteries designated for use in this camera. Failure to observe this precaution could result in product malfunction.
- Do not remove the labels from the battery or attempt to split or peel the outer casing.
- The battery gradually loses its charge when not in use. Charge the battery one or two days before use.
- If the battery fails to hold a charge, it has reached the end of its charging life and must be replaced.
- Unplug the AC power adapter from the power outlet when it is not in use.
- If the battery is left for long periods without charging, you may find that its quality degrades or that it no longer holds a charge. Charge the battery regularly.
- Remove dirt from the battery terminals with a clean, dry cloth. Failure to observe this precaution could prevent the battery from charging.
- Note that charging times increase at low or high temperatures.

- If the camera is turned on during charging, charging will end and the USB connection will instead be used to power the camera. The battery level will begin to gradually decline (📖 243).



- The camera will display a “power supply” icon when powered via USB.

### Charging via Computer

The camera can be charged via USB. USB charging is available with computers with a manufacturer-approved operating system and USB interface.

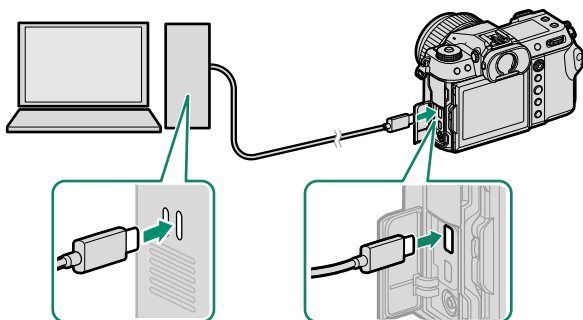

*Leave the computer on during charging.*

- ⚠ • The battery will not charge while the camera is on.
- Connect the supplied USB cable.
- Connect the camera directly to the computer; do not use a USB hub or keyboard.
- Charging stops if the computer enters sleep mode. To resume charging, activate the computer and disconnect and reconnect the USB cable.
- Charging may not be supported depending on the model of computer, computer settings, and the computer's current state.
- The battery takes about 600 minutes to charge with a charging input of 5 V/500 mA.

## Turning the Camera On and Off

Use the **ON/OFF** switch to turn the camera on and off.

Slide the switch to **ON** to turn the camera on, or to **OFF** to turn the camera off.

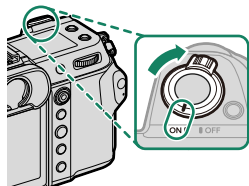

**!** Fingerprints and other marks on the lens or viewfinder can affect pictures or the view through the viewfinder. Keep the lens and viewfinder clean.

- 📖**
- Pressing the **▶** button during shooting starts playback.
  - Press the shutter button halfway to return to shooting mode.
  - The camera will turn off automatically if no operations are performed for the length of time selected for **▶ POWER MANAGEMENT > AUTO POWER OFF**. To reactivate the camera after it has turned off automatically, press the shutter button halfway or turn the **ON/OFF** switch to **OFF** and then back to **ON**.

## Checking the Battery Level

After turning the camera on, check the battery level in the display.

Battery level is shown as follows:

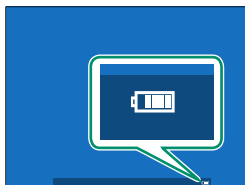

Indicator	Description
	Battery partially discharged.
	Battery about 80% full.
	Battery about 60% full.
	Battery about 40% full.
	Battery about 20% full.
 (red)	Low battery. Charge as soon as possible.
 (blinks red)	Battery exhausted. Turn camera off and recharge battery.

## Basic Setup

When you turn the camera on for the first time, you can choose a language and set the camera clock. At default settings, you can also pair the camera with a smartphone or tablet so that you can later synchronize the clocks or download pictures. Follow the steps below when turning the camera on for the first time.

 If you intend to pair the camera with a smartphone or tablet, install and launch the latest version of the FUJIFILM Camera Remote App on the smart device before proceeding. For more information, visit: [http://app.fujifilm-dsc.com/en/camera\\_remote/](http://app.fujifilm-dsc.com/en/camera_remote/)

### 1 Turn the camera on.

A language-selection dialog will be displayed.

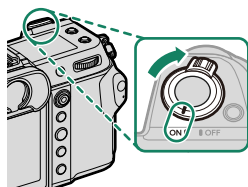

### 2 Choose a language.

Highlight a language and press **MENU/OK**.

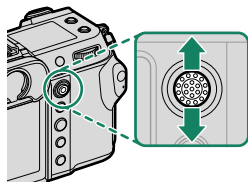

### 3 Pair the camera with the smartphone or tablet.

Press **MENU/OK** to pair the camera with a smartphone or tablet running the FUJIFILM Camera Remote app.

 To skip pairing, press **DISP/BACK**.

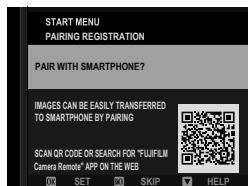

#### 4 Check the time.

When pairing is complete, you will be prompted to set the camera clock to the time reported by the smartphone or tablet. Check that the time is correct.

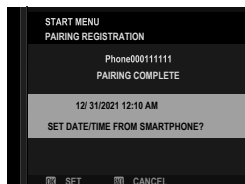

 To set the clock manually, press **DISP/BACK** (📖 48).

#### 5 Synchronize the camera settings with the settings configured on your smartphone or tablet.

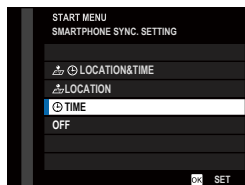



 The option selected can be changed at any time using **CONNECTION SETTING > Bluetooth SETTINGS**.

#### 6 Set the clock.

Press **MENU/OK** to set the camera clock to the time reported by the smartphone or tablet and exit to shooting mode.

#### 7 Format the memory card (📖 204).

 Format memory cards before first use, and be sure to reformat all memory cards after using them in a computer or other device.

 If the battery is removed for an extended period, the camera clock will be reset and the language-selection dialog will be displayed when the camera is turned on.



#### Skipping the Current Step

If you skip a step, a confirmation dialog will be displayed; select **NO** to avoid repeating any steps you skipped the next time the camera is turned on.

## Choosing a Different Language

To change the language:

---

- 1 Display language options.**  
Select  **USER SETTING** >  **言語/LANG..**
- 2 Choose a language.**  
Highlight the desired option and press **MENU/OK**.

## Changing the Time and Date

To set the camera clock:

---

- 1 Display DATE/TIME options.**  
Select  **USER SETTING** > **DATE/TIME**.
- 2 Set the clock.**  
Press the focus stick (focus lever) left or right to highlight the year, month, day, hour, or minute and press up or down to change. Press **MENU/OK** to set the clock.



# Basic Photography and Playback

# 3

## Taking Photographs (Mode P)

This section describes how to take pictures using program AE (mode P). See pages 64–73 for information on S, A, and M modes.

- 1 Slide the **STILL/MOVIE** mode switch to **STILL**.

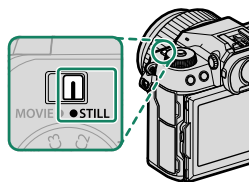

- 2 Rotate the focus mode selector to S.

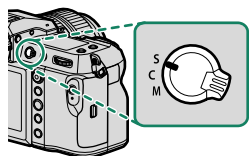

- 3 Rotate the mode dial to P.

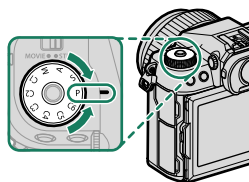

 Rotate the mode dial only after pressing the dial lock release to release the dial.

- 4 Confirm that **P** appears in the display.

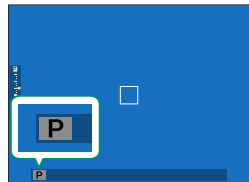

## 5 Ready the camera.

- Hold the camera steady with both hands and brace your elbows against your sides. Shaking or unsteady hands can blur your shots.

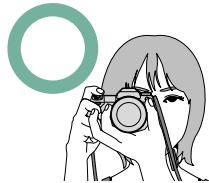

- To prevent pictures that are out of focus or too dark (underexposed), keep your fingers and other objects away from the lens and AF-assist illuminator.

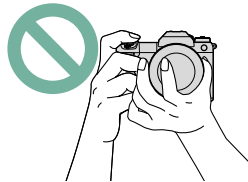

## 6 Frame the picture.

### Lenses with Zoom Rings

Use the zoom ring to frame the picture in the display. Rotate the ring left to zoom out, right to zoom in.

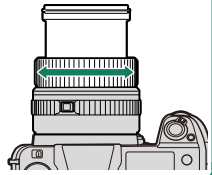

**7** Focus.

Press the shutter button halfway to set focus and exposure.

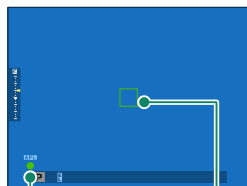

Focus indicator

Focus frame

- **If the camera is able to focus**, the focus frame and focus indicator will glow green.
- **If the camera is unable to focus**, the focus frame will turn red, **!AF** will be displayed, and the focus indicator will blink white.



- If the subject is poorly lit, the AF-assist illuminator may light to assist the focus operation.
- Focus and exposure will lock when the shutter button is pressed halfway. Focus and exposure remain locked while the button is kept in this position (AF/AE lock).
- The camera will focus on subjects at any distance in the macro and standard focus ranges for the lens.

**8** Shoot.

Smoothly press the shutter button the rest of the way down to take the picture.



## Viewing Pictures

Pictures can be viewed in the viewfinder or LCD monitor.

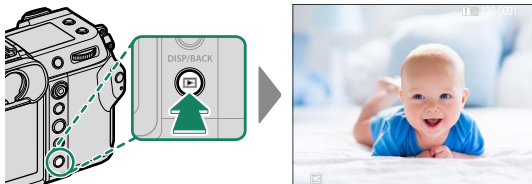

To view pictures full frame, press .



Additional pictures can be viewed by pressing the focus stick (focus lever) left or right or rotating the front command dial. Press the focus stick or rotate the dial right to view pictures in the order recorded, left to view pictures in reverse order. Keep the focus stick pressed to scroll rapidly to the desired frame.

 Pictures taken using other cameras are marked with a  ("gift image") icon to warn that they may not display correctly and that playback zoom may not be available.

### Two Memory Cards

If two memory cards are inserted, you can press and hold the  button to choose a card for playback. You can also select a card using the  **PLAY BACK MENU > SWITCH SLOT** option.

## Deleting Pictures

Use the  button to delete pictures.

 Deleted pictures cannot be recovered. Protect important pictures or copy them to a computer or other storage device before proceeding.

- 1 With a picture displayed full frame, press the  button and select **FRAME**.

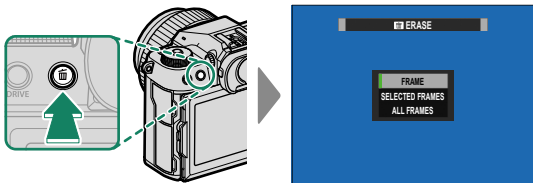

- 2 Press the focus stick (focus lever) left or right to scroll through pictures and press **MENU/OK** to delete (a confirmation dialog is not displayed). Repeat to delete additional pictures.

 Protected pictures cannot be deleted. Remove protection from any pictures you wish to delete (📖 190).

- Pictures can also be deleted from the menus using the  **PLAY BACK MENU > ERASE** option (📖 186).

# Movie Recording and Playback

# 4

## Recording Movies

This section describes how to film movies in auto mode.

- 1 Slide the **STILL/MOVIE** mode switch to **MOVIE**.

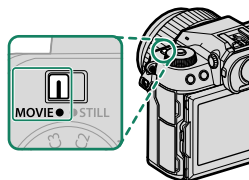

- 2 Rotate the mode dial to **P**.

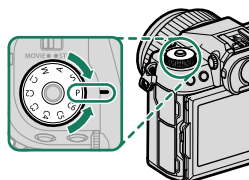

**AUTO** will appear in the display.

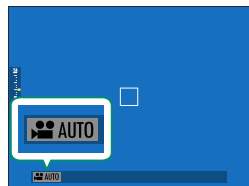

-  Rotate the mode dial only after pressing the dial lock release to release the dial.



- 3 Press the shutter button all the way down.

Recording will start.

- A recording indicator (●) is displayed while recording is in progress.
- The time remaining is shown by a countdown display, while another display counts up to show the recording time.

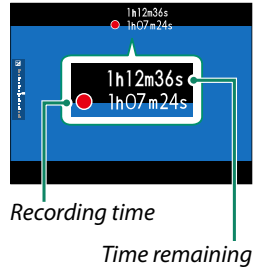

- 4 Press the button again to end recording. Recording ends automatically when the maximum length is reached or the memory card is full.

#### Temperature Warnings

The camera automatically turns off to protect itself when its temperature or the temperature of the battery rises. If a temperature warning is displayed, image noise may increase. Turn the camera off and wait for it to cool before turning it on again (📖 234, 325).

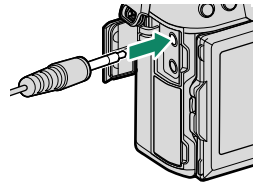

#### Using an External Microphone

Sound can be recorded with external microphones that connect using jacks 3.5 mm in diameter; microphones that require plug-in power cannot be used. See the microphone manual for details.



- ❗ Sound is recorded via the built-in microphone or an optional external microphone. Do not cover the microphone during recording.
- Note that the microphone may pick up lens noise and other sounds made by the camera during recording.
- Vertical or horizontal streaks may appear in movies containing very bright subjects. This is normal and does not indicate a malfunction.



- The indicator lamp lights while recording is in progress (the  **MOVIE SETTING > TALLY LIGHT** option can be used to choose the lamp—indicator or AF-assist—that lights during movie recording and whether the lamp blinks or remains steady). During recording, you can change exposure compensation by up to  $\pm 2$  EV and adjust zoom using the zoom ring on the lens (if available).
- While recording is in progress, you can:
  - Adjust sensitivity
  - Refocus using any of the following methods:
    - Press the shutter button halfway
    - Press a function button to which **AF-ON** is assigned
    - Use touch screen controls
  - Display a histogram or artificial horizon by pressing the button to which **HISTOGRAM** or **ELECTRONIC LEVEL** has been assigned
- Recording may be unavailable at some settings, while in other cases settings may not apply during recording.
- To choose the focus area for movie recording, select  **AF/MF SETTING > FOCUS AREA** and use the focus stick (focus lever) and rear command dial ( 85).

## Adjusting Movie Settings

- Pressing **MENU/OK** when **MOVIE** is selected with the **STILL/MOVIE** mode switch displays the movie menu.
- The frame rate can be selected using **MOVIE SETTING > MOVIE MODE**.
- To choose the card used to store movies, use **SAVE DATA SET-UP > CARD SLOT SETTING**.
- Focus mode is selected using the focus mode selector; for continuous focus adjustment, select **C**, or choose **S** and enable Intelligent Face Detection. Intelligent Face Detection is not available in focus mode **M**.

### Depth of Field

Choose low f-numbers to soften background details. Aperture can be adjusted when the mode dial is set to **A** (aperture-priority AE) or **M** (manual).

## Viewing Movies

View movies on the camera.

In full-frame playback, movies are identified by a  icon. Press the focus stick (focus lever) down to start movie playback.



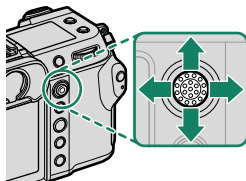

The following operations can be performed while a movie is displayed:

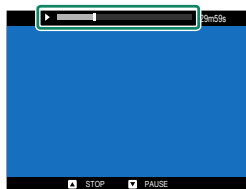

Focus stick (focus lever)	Full-frame playback	Playback in progress (▶)	Playback paused (⏸)
Up	—	End playback	
Down	Start playback	Pause playback	Start/resume playback
Left/right	View other pictures	Adjust speed	Single frame rewind/advance

Progress is shown in the display during playback.



 Do not cover the speaker during playback.

 Press **MENU/OK** to pause playback and display volume controls. Press the focus stick (focus lever) up or down to adjust the volume; press **MENU/OK** again to resume playback. Volume can also be adjusted using **▶ SOUND SET-UP > PLAYBACK VOLUME**.

**Playback Speed**

Press the focus stick (focus lever) left or right to adjust playback speed during playback. Speed is shown by the number of arrows (▶ or ◀).

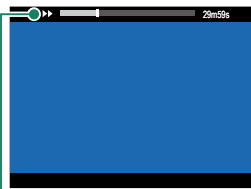

Arrows



# Taking Photographs

5

## P, S, A, and M Modes

P, S, A, and M modes give you varying degrees of control over shutter speed and aperture.

### Mode P: Program AE

Let the camera choose shutter speed and aperture for optimal exposure. Other values that produce the same exposure can be selected with program shift.

- 1 Slide the **STILL/MOVIE** mode switch to **STILL**.

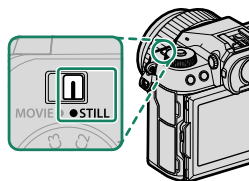

- 2 Rotate the mode dial to P.

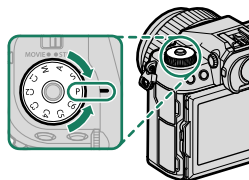

P will appear in the display.

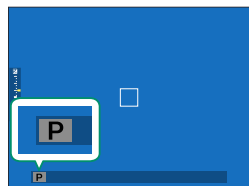

- If the subject is outside the metering range of the camera, the shutter speed and aperture displays will show “-- --”.
- Rotate the mode dial only after pressing the dial lock release to release the dial.



### Program Shift

If desired, you can rotate the rear command dial to select other combinations of shutter speed and aperture without altering exposure (program shift).

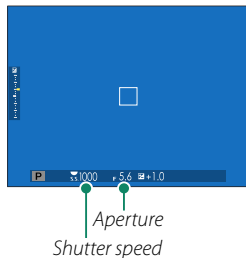

- !** Program shift is not available in any of the following circumstances:
- When **TTL** is selected for **FLASH SETTING > FLASH FUNCTION SETTING**
  - When an auto option is selected for **IMAGE QUALITY SETTING > DYNAMIC RANGE**
  - In movie mode

**📵** To cancel program shift, turn the camera off.



- ❗ • If the correct exposure cannot be achieved at the selected shutter speed, aperture will be displayed in red.
  - If the subject is outside the metering range of the camera, the aperture display will show “— —”.
  - Rotate the mode dial only after pressing the dial lock release to release the dial.
- 📷 • Shutter speed can be adjusted while the shutter button is pressed halfway.
  - At shutter speeds slower than 1 second, a count-down timer will be displayed while the exposure is in progress.
  - To reduce “noise” (mottling) in long time-exposures, select **ON** for **📷 IMAGE QUALITY SETTING > LONG EXPOSURE NR.** Note that this may increase the time needed to record images after shooting.
  - The picture will go out of focus if the camera is moved during a long time-exposure; use of a tripod is recommended.

## Mode A: Aperture-Priority AE

Choose an aperture and let the camera adjust shutter speed for optimal exposure.

- 1 Slide the **STILL/MOVIE** mode switch to **STILL**.

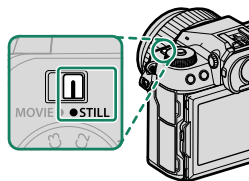

- 2 Rotate the mode dial to **A**.

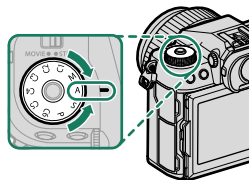

A will appear in the display.

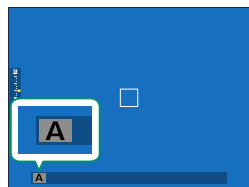

- 3 Rotate the lens aperture ring to choose an aperture.



- If the lens is not equipped with an aperture ring, aperture can be adjusted using the front command dial on the camera.
- If the lens is equipped with an aperture ring with an "A" or "C" position, the front command dial can be used to adjust aperture when the aperture ring is rotated to **A** or **C**.
- The roles played by the front command dial can be changed using **■ BUTTON/DIAL SETTING > COMMAND DIAL SETTING**.

- ❗ If the correct exposure cannot be achieved at the selected aperture, shutter speed will be displayed in red.
- If the subject is outside the metering range of the camera, the shutter speed display will show “— —”.
- Rotate the mode dial only after pressing the dial lock release to release the dial.

📁 Aperture can be adjusted even while the shutter button is pressed halfway.

### Previewing Depth of Field

When **PREVIEW DEPTH OF FIELD** is assigned to a function button, pressing the button displays a  icon and stops aperture down to the selected setting, allowing depth of field to be previewed in the display.

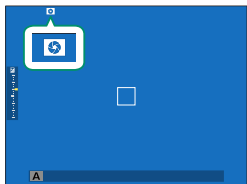

## Mode M: Manual Exposure

In manual mode, the user controls both shutter speed and aperture. Shots can be deliberately overexposed (brighter) or underexposed (darker), opening the door for a variety of individual creative expression. The amount the picture would be under- or over-exposed at current settings is shown by the exposure indicator; adjust shutter speed and aperture until the desired exposure is reached.

- 1 Slide the **STILL/MOVIE** mode switch to **STILL**.

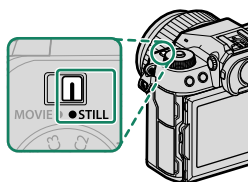

- 2 Rotate the mode dial to **M**.

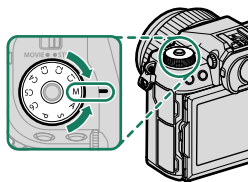

**M** will appear in the display.

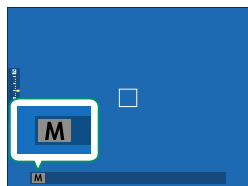

- 3 Rotate the rear command dial to choose a shutter speed and the lens aperture ring to choose the aperture.

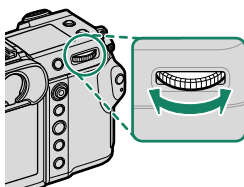

- The manual exposure display includes an exposure indicator that shows the amount the picture would be under- or over-exposed at current settings.
- If the lens is not equipped with an aperture ring, aperture can be adjusted using the front command dial on the camera.
- If the lens is equipped with an aperture ring with an "A" or "C" position, the front command dial can be used to adjust aperture when the aperture ring is rotated to **A** or **C**.
- The roles played by the front command dial can be changed using **FUNCTION/SETTING > COMMAND DIAL SETTING**.

- !** Rotate the mode dial only after pressing the dial lock release to release the dial.

## BULB

Select a shutter speed of **BULB** for long time-exposures in which you open and close the shutter manually. Use of a tripod is recommended to prevent the camera moving during the exposure.

- 1 Set shutter speed to **BULB**.

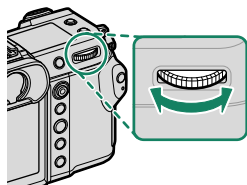

- 2 Press the shutter button all the way down.
  - The shutter will remain open for up to 60 minutes while the shutter button is pressed.
  - The display shows the time elapsed since the exposure started.
  - Releasing the shutter button closes the shutter, ending the exposure. Processing will begin, and the camera will display the processing time remaining.



- Selecting an aperture of **A** fixes shutter speed at 30 s.
- To reduce “noise” (mottling) in long time-exposures, select **ON** for **IMAGE QUALITY SETTING > LONG EXPOSURE NR**. Note that this may increase the time needed to record images after shooting.



### Using a Remote Release

A remote release can be used for long time-exposures. When using an optional RR-100 remote release or an electronic release from third-party suppliers, connect it to the camera's remote release connector.

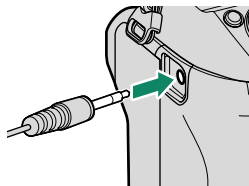

### Exposure Preview

To preview exposure in the LCD monitor, select **PREVIEW EXP./WB** for **SCREEN SET-UP > PREVIEW EXP./WB IN MANUAL MODE**.



Select an option other than **PREVIEW EXP./WB** when using the flash or on other occasions on which exposure may change when the picture is taken.

## Custom Modes

Rotate the mode dial to any of modes **C1 (CUSTOM 1)** through **C6 (CUSTOM 6)** to take pictures using previously-saved shooting menu settings. Settings can be saved or edited using **IMAGE QUALITY SETTING > EDIT/SAVE CUSTOM SETTING**.

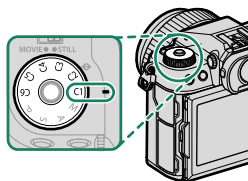

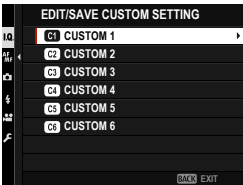
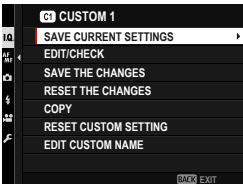
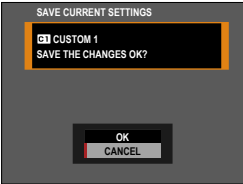

### Saving Current Settings

Save current settings in a custom settings bank.

- 1 Select **IMAGE QUALITY SETTING > EDIT/SAVE CUSTOM SETTING** in the shooting menu and press **MENU/OK**.
- 2 Highlight a destination bank for current settings (**C1** through **C6**) and press **MENU/OK**.  
A screenshot of the camera's menu system. The title is 'EDIT/SAVE CUSTOM SETTING'. The options are: C1 CUSTOM 1, C2 CUSTOM 2, C3 CUSTOM 3, C4 CUSTOM 4, C5 CUSTOM 5, and C6 CUSTOM 6. The 'C1 CUSTOM 1' option is highlighted with a white bar. At the bottom right, there is a 'MENU/OK EXIT' button.
- 3 Highlight **SAVE CURRENT SETTINGS** and press **MENU/OK**.  
A screenshot of the camera's menu system. The title is 'C1 CUSTOM 1'. The options are: SAVE CURRENT SETTINGS, EDIT/CHECK, SAVE THE CHANGES, RESET THE CHANGES, COPY, RESET CUSTOM SETTING, and EDIT CUSTOM NAME. The 'SAVE CURRENT SETTINGS' option is highlighted with a white bar. At the bottom right, there is a 'MENU/OK EXIT' button.
- 4 Highlight **OK** and press **MENU/OK**. Current settings will be saved to the selected bank.  
A screenshot of the camera's menu system. The title is 'SAVE CURRENT SETTINGS'. The options are: C1 CUSTOM 1 and SAVE THE CHANGES OK?. The 'SAVE THE CHANGES OK?' option is highlighted with a white bar. At the bottom, there are two buttons: 'OK' and 'CANCEL'.

## Editing Custom Settings

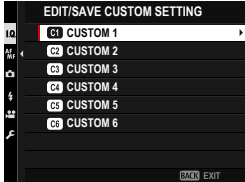
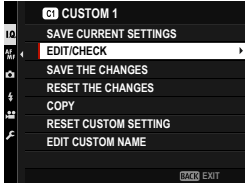
Edit existing custom settings banks.

- 1 Select **Q** **IMAGE QUALITY SETTING > EDIT/SAVE CUSTOM SETTING** in the shooting menu and press **MENU/OK**.
- 2 Highlight the desired custom settings bank and press **MENU/OK**.
 
- 3 Highlight **EDIT/CHECK** and press **MENU/OK**.
 
- 4 The camera will display a list of shooting menu items; highlight an item you wish to edit and press **MENU/OK**. Adjust the selected item as desired.
 

**5** Press **MENU/OK** to save the changes and return to the shooting menu list.

Adjust additional items as desired.



If **DISABLE** is selected for **IMAGE QUALITY SETTING > AUTO UPDATE CUSTOM SETTING**, red dots will appear next to the edited items but the changes will not be saved automatically.

- To save the changes for selected items, highlight the items in the list and press **Q**.
- To save changes for all items, return to Step 3 and select **SAVE THE CHANGES**. To cancel all changes and restore the previous settings, select **RESET THE CHANGES**.
- If you copy an item marked by a red dot, the item will be copied with the changes intact.

## Copying Custom Settings

Copy custom settings from one bank to another, overwriting the settings in the destination bank. If the source bank has been re-named, the name will also be copied to the destination bank.

- 1 Select **IMAGE QUALITY SETTING > EDIT/SAVE CUSTOM SETTING** in the shooting menu and press **MENU/OK**.

- 2 Highlight the source bank and press **MENU/OK**.

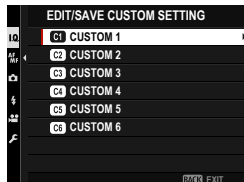

- 3 Highlight **COPY** and press **MENU/OK**.

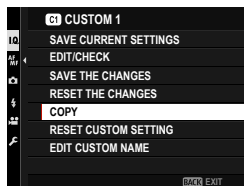

- 4 Highlight the destination bank (C1 through C6) and press **MENU/OK**. A confirmation dialog will be displayed.



Any changes to custom settings in the destination bank will be overwritten.

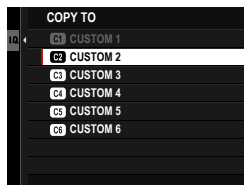

- 5 Highlight **OK** and press **MENU/OK**. The selected settings will be copied to the destination bank, overwriting any existing settings.

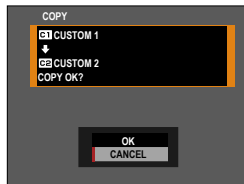

## Resetting Custom Settings

Reset selected custom settings banks.

- 1 Select **Q** **IMAGE QUALITY SETTING** > **EDIT/SAVE CUSTOM SETTING** in the shooting menu and press **MENU/OK**.

- 2 Highlight the desired custom settings bank and press **MENU/OK**.

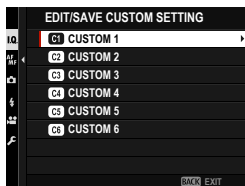

- 3 Highlight **RESET CUSTOM SETTING** and press **MENU/OK**.

A confirmation dialog will be displayed.

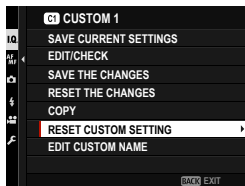

- 4 Highlight **OK** and press **MENU/OK**. The selected bank will be reset.

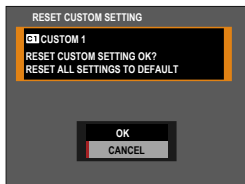

## Renaming Custom Settings Banks

Rename selected custom settings banks.

- 1 Select **IMAGE QUALITY SETTING > EDIT/SAVE CUSTOM SETTING** in the shooting menu and press **MENU/OK**.

- 2 Highlight the desired custom settings bank and press **MENU/OK**.

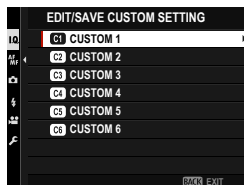

- 3 Highlight **EDIT CUSTOM NAME** and press **MENU/OK**.

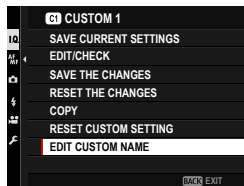

- 4 Enter a new name for the custom settings bank and select **SET**.  
The selected bank will be renamed.

## Autofocus

Take pictures using autofocus.

- 1 Rotate the focus mode selector to S or C (📖 81).

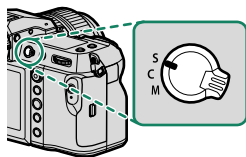

- 2 Choose an AF mode (📖 83).
- 3 Choose the position and size of the focus frame (📖 85).

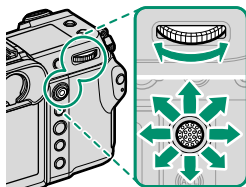

- 4 Take pictures.



## Focus Mode

Use the focus mode selector to choose how the camera focuses.

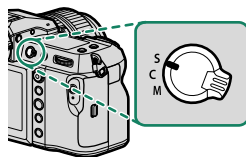

Choose from the following options:

Mode	Description
<b>S</b> (AF-S)	<b>Single AF:</b> Focus locks while the shutter button is pressed halfway. Choose for stationary subjects.
<b>C</b> (AF-C)	<b>Continuous AF:</b> Focus is continually adjusted to reflect changes in the distance to the subject while the shutter button is pressed halfway. Use for subjects that are in motion.
<b>M</b> (manual)	<b>Manual:</b> Focus manually using the lens focus ring. Choose for manual control of focus or in situations in which the camera is unable to focus using autofocus (📖 88).

- Regardless of the option selected, manual focus will be used when the lens is in manual focus mode.
- If **ON** is selected for **AF/MF SETTING > PRE-AF**, focus will be adjusted continuously in modes **S** and **C** even when the shutter button is not pressed.
- Focus does not track the subject during burst photography, even when **C** is selected for focus mode.

## The Focus Indicator

Focus status is shown by the focus indicator.

Focus indicator	Focus status
( )	Camera focusing.
● (lights green)	Subject in focus; focus locked (focus mode <b>S</b> ).
● (lights green)	Subject in focus (focus mode <b>C</b> ).
○ (blinks white)	Focus is automatically adjusted for changes in distance to subject.
MF	Manual focus (focus mode <b>M</b> ).

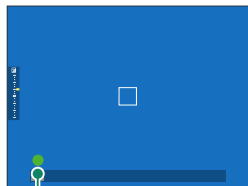

Focus indicator









## Autofocus Options (AF Mode)

Focus can be adapted to a variety of subjects by changing the combination of settings selected for focus and AF modes.

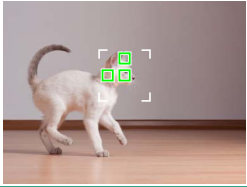





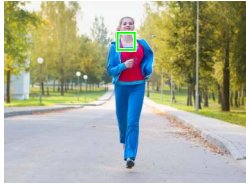

- 1 Press **MENU/OK** and go to the shooting menu.
- 2 Select **AF/MF SETTING > AF MODE**.
- 3 Choose an AF mode.

How the camera focuses depends on the focus mode.

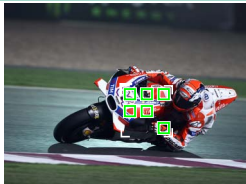
### Focus Mode S (AF-S)

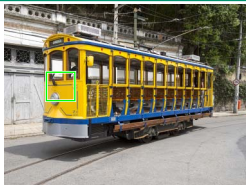
Option	Description	Sample image
 <b>SINGLE POINT</b>	Camera focuses on subject in selected focus point. Use for pinpoint focus on selected subject.	
 <b>ZONE</b>	Camera focuses on subject in selected focus zone. Focus zones include multiple focus points, making it easier to focus on subjects in motion.	
 <b>WIDE</b>	Camera focuses automatically on high-contrast subjects; display shows areas in focus.	
 <b>ALL</b>	Rotate the rear command dial in the focus-point selection display (85, 86) to cycle through AF modes in the following order:  <b>SINGLE POINT</b> ,  <b>ZONE</b> , and  <b>WIDE</b> .	

## Focus Mode C (AF-C)

Option	Description	Sample image
 <b>SINGLE POINT</b>	Focus tracks subject at selected focus point. Use for subjects moving toward or away from camera.	
 <b>ZONE</b>	Camera tracks focus in selected focus zone. Use for subjects that are moving fairly predictably.	
 <b>TRACKING</b>	Focus tracks subjects moving through wide area of frame.	
 <b>ALL</b>	Rotate the rear command dial in the focus-point selection display ( 85, 86) to cycle through AF modes in the following order:  <b>SINGLE POINT</b> ,  <b>ZONE</b> , and  <b>TRACKING</b> .	

## Focus-Point Selection

Choose a focus point for autofocus.

### Viewing the Focus-Point Display





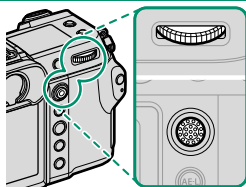

- 1 Press **MENU/OK** and go to the shooting menu.
- 2 Select **AF/MF SETTING > FOCUS AREA** to view the focus-point display.
- 3 Use the focus stick (focus lever) and rear command dial to choose a focus area.

 The focus point can also be selected using touch controls (📖 27).

### Selecting a Focus Point

Use the focus stick (focus lever) to choose the focus point and the rear command dial to choose the size of the focus frame. The procedure varies with the option selected for AF mode.







AF mode	Focus stick		Rear command dial	
	 Tilt	 Press	 Rotate	 Press
	Select focus point	Select center focus point	Choose from 6 frame sizes	Restore original size
			Choose from 3 frame sizes	
			—	

 Manual focus-point selection is not available when **WIDE/TRACKING** is selected in focus mode **S**.

## The Focus-Point Display

The focus-point display varies with the option selected for AF mode.

 Focus frames are shown by small squares (□), focus zones by the large squares.

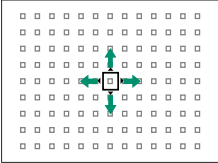
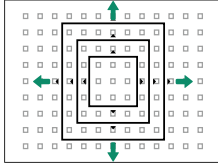
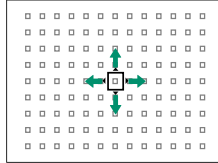
AF mode		
 SINGLE POINT	 ZONE	 WIDE/TRACKING
		
Number of points available can be selected using <b>AF/MF SETTING &gt; NUMBER OF FOCUS POINTS.</b>	Choose from zones with $7 \times 7$ , $5 \times 5$ , or $3 \times 3$ focus points.	Position focus frame over subject you want to track using continuous AF.

### Autofocus

Although the camera boasts a high-precision autofocus system, it may be unable to focus on the subjects listed below.

- Very shiny subjects such as mirrors or car bodies.
- Subjects photographed through a window or other reflective object.
- Dark subjects and subjects that absorb rather than reflect light, such as hair or fur.
- Insubstantial subjects, such as smoke or flame.
- Subjects that show little contrast with the background.
- Subjects positioned in front of or behind a high-contrast object that is also in the focus frame (for example, a subject photographed against a backdrop of highly contrasting elements).

### Checking Focus

To zoom in on the current focus area for precise focus, press the center of the rear command dial. Use the focus stick (focus lever) to choose another focus area. Press the center of the rear command dial again to cancel zoom.

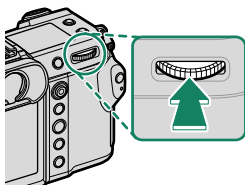



Normal display



Focus zoom



- In focus mode **S**, zoom can be adjusted by rotating the rear command dial.
- The focus stick can be used to select the focus area while zoom is in effect.
- In focus mode **S**, select  **SINGLE POINT** for **AF MODE**.
- Focus zoom is not available in focus mode **C** or when  **AF/MF SETTING** > **PRE-AF** is on.
- Use  **BUTTON/DIAL SETTING** > **FUNCTION (Fn) SETTING** to change the function performed by the center of the rear command dial. You can also assign its default function to other controls (📖 255).

## Manual Focus

Adjust focus manually.

- 1 Rotate the focus mode selector to M.

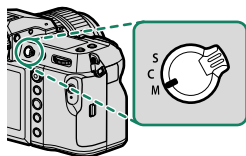

**MF** will appear in the display.

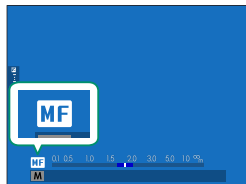

- 2 Focus manually using the lens focus ring. Rotate the ring left to reduce the focus distance, right to increase.

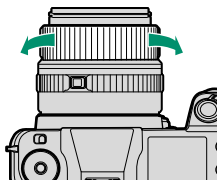

- 3 Take pictures.



- Use **FUNCTION/DIAL SETTING** > **FOCUS RING** to reverse the direction of rotation of the focus ring.
- Regardless of the option selected, manual focus will be used when the lens is in manual focus mode.



**Quick Focus**

- To use autofocus to focus on the subject in the selected focus area, press the button to which focus lock or **AF-ON** has been assigned (the size of the focus area can be chosen with the rear command dial).
- In manual focus mode, you can use this feature to quickly focus on a chosen subject using either single or continuous AF according to the option chosen for  **AF/MF SETTING > INSTANT AF SETTING**.

## Checking Focus

A variety of options are available for checking focus in manual focus mode.

### The Manual Focus Indicator

The white line indicates the distance to the subject in the focus area (in meters or feet according to the option selected for **SCREEN SET-UP > FOCUS SCALE UNITS** in the setup menu), the blue bar the depth of field, or in other words the distance in front of and behind the subject that appears to be in focus.

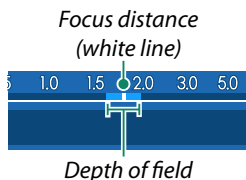

- If both **AF DISTANCE INDICATOR** and **MF DISTANCE INDICATOR** are selected in the **SCREEN SET-UP > DISP. CUSTOM SETTING** list, the manual focus indicator can also be viewed using the depth-of-field indicator in the standard display. Use the **DISP/BACK** button to display standard indicators.
- Use the **AF/MF SETTING > DEPTH-OF-FIELD SCALE** option to choose how depth of field is displayed. Choose **FILM FORMAT BASIS** to help you make practical assessments of depth of field for pictures that will be viewed as prints and the like, **PIXEL BASIS** to help you assess depth of field for pictures that will be viewed at high resolutions on computers or other electronic displays.

## Focus Zoom

If **ON** is selected for **AF/MF SETTING > FOCUS CHECK**, the camera will automatically zoom in on the selected focus area when the focus ring is rotated. Press the center of the rear command dial to exit zoom.

- Use the focus stick (focus lever) to choose another focus area.
- Zoom can be adjusted by rotating the rear command dial.

## Focus Peaking

Select **FOCUS PEAK HIGHLIGHT** for **AF/MF SETTING > MF ASSIST** to highlight high-contrast outlines. When focusing, rotate the focus ring until the subject is highlighted.

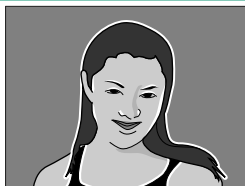

- The **MF ASSIST** menu can be displayed by pressing and holding the center of the rear command dial.

## Sensitivity

Adjust the camera's sensitivity to light.

Set sensitivity using  **SHOOTING SETTING > ISO**.

Option	Description
<b>AUTO1</b> <b>AUTO2</b> <b>AUTO3</b>	Sensitivity is automatically adjusted in response to shooting conditions according to combination of standard and maximum sensitivity and minimum shutter speed chosen for  <b>SHOOTING SETTING &gt; ISO</b> . Choose from <b>AUTO1</b> , <b>AUTO2</b> , and <b>AUTO3</b> (📖 93).
<b>100–12800</b>	Adjust sensitivity manually. Selected value is shown in display.
<b>L (50)</b> <b>H (25600/51200/102400)</b>	Choose for special situations. Note that mottling may appear in pictures taken at <b>H</b> , while <b>L</b> reduces dynamic range.



- Sensitivity is not reset when the camera is turned off.
- If desired, you can use  **BUTTON/DIAL SETTING > COMMAND DIAL SETTING** to configure the camera so that ISO sensitivity can be adjusted using the front or rear command dial.

### Adjusting Sensitivity

High values can be used to reduce blur when lighting is poor, while lower values allow slower shutter speeds or wider apertures in bright light; note, however, that mottling may appear in pictures taken at high sensitivities.

## AUTO

Choose the base sensitivity, maximum sensitivity, and minimum shutter speed for **AUTO1**, **AUTO2**, and **AUTO3**.

Item	Options	Default		
		AUTO1	AUTO2	AUTO3
<b>DEFAULT SENSITIVITY</b>	100–12800	100		
<b>MAX. SENSITIVITY</b>	200–12800	800	1600	3200
<b>MIN. SHUTTER SPEED</b>	$\frac{1}{500}$ – $\frac{1}{4}$ SEC, AUTO	AUTO		

The camera automatically chooses a sensitivity between the default and maximum values; sensitivity is only raised above the default value if the shutter speed required for optimal exposure would be slower than the value selected for **MIN. SHUTTER SPEED**.





-  • If the value selected for **DEFAULT SENSITIVITY** is higher than that selected for **MAX. SENSITIVITY**, **DEFAULT SENSITIVITY** will be set to the value selected for **MAX. SENSITIVITY**.
- The camera may select shutter speeds slower than **MIN. SHUTTER SPEED** if pictures would still be underexposed at the value selected for **MAX. SENSITIVITY**.
- If **AUTO** is selected for **MIN. SHUTTER SPEED**, the camera will automatically adjust the minimum shutter speed according to the focal length of the lens (the setting remains the same whether image stabilization is on or off).

## Metering

Choose how the camera meters exposure.

**SHOOTING SETTING > PHOTOMETRY** offers a choice of the following metering options:

**!** The selected option will only take effect when **AF/MF SETTING > FACE/EYE DETECTION SETTING** is **OFF**.

Mode	Description
 <b>MULTI</b>	The camera instantly determines exposure based on an analysis of composition, color, and brightness distribution. Recommended in most situations.
 <b>CENTER-WEIGHTED</b>	The camera meters the entire frame but assigns the greatest weight to the area at the center.
 <b>SPOT</b>	The camera meters lighting conditions in an area equivalent to 2% of the frame. Recommended with backlit subjects and in other cases in which the background is much brighter or darker than the main subject.
 <b>AVERAGE</b>	Exposure is set to the average for the entire frame. Provides consistent exposure across multiple shots with the same lighting, and is particularly effective for landscapes and portraits of subjects dressed in black or white.

**📄** To meter the subject in the selected focus area, choose **ON** for **AF/MF SETTING > INTERLOCK SPOT AE & FOCUS AREA** (📖 137).

## Exposure Compensation

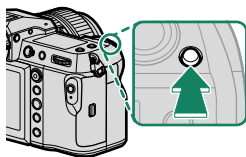

Adjust exposure.

Hold the  button and rotate the rear command dial until the desired value is displayed in the viewfinder or LCD monitor.



 The amount of compensation available varies with the shooting mode.

### The Button

If **ON/OFF SWITCH** is selected for **Fn BUTTON/DIAL SETTING > EXPO. COMP. BUTTON SETTING**, exposure compensation can be set by pressing the  button once, rotating the rear command dial, and then pressing the  button again. Exposure compensation can be assigned to other controls using **Fn BUTTON/DIAL SETTING > FUNCTION (Fn) SETTING**.

## Focus/Exposure Lock

Focus and exposure lock when the shutter button is pressed halfway.

- 1 Position the subject in the focus frame and press the shutter button halfway to lock focus and exposure. Focus and exposure will remain locked while the shutter button is pressed halfway (AF/AE lock).

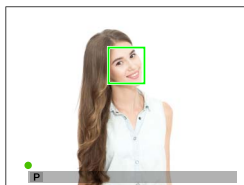

- 2 Press the button all the way down.

 Focus and exposure lock via the shutter button is only available when **ON** is selected for **☑️ BUTTON/DIAL SETTING > SHUTTER AF, SHUTTER AE**.



## Other Controls

Focus and exposure can also be locked using function buttons. At default settings, you can use the **AEL** button to lock exposure without locking focus. If the **AFON** button is assigned **AF LOCK ONLY** (📖 255), it can similarly be used to lock focus without locking exposure.

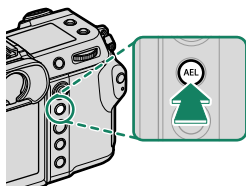

**AEL** button  
(exposure lock)

- While the assigned control is pressed, pressing the shutter button halfway will not end the lock.
- If **AE&AF ON/OFF SWITCH** is selected for **FUNCTION/DIAL SETTING > AE/AF-LOCK MODE**, the lock can only be ended by pressing the control a second time.

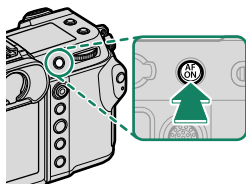

**AFON** button

- The focus lever (focus stick) can be used to reposition the focus point during exposure lock.
- Function buttons can be assigned other roles using **FUNCTION/DIAL SETTING > FUNCTION (Fn) SETTING**. Exposure and focus lock can also be assigned to other function buttons (📖 255).

## Bracketing

Automatically vary settings over a series of pictures.

- 1 Press the **DRIVE** button to display drive mode options.

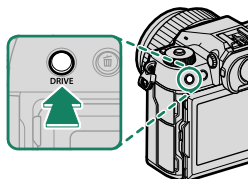

- 2 Press the focus stick (focus lever) up or down to highlight one of the following:

Option		Option	
<b>ISO</b> ISO BKT	99	<b>BKT</b> Bracketing	100
<b>WB</b> WHITE BALANCE BKT	99		

- 3 Press the focus stick left or right to highlight the desired bracketing settings.
- 4 Press **MENU/OK** to select.
- 5 Take pictures.

**ISO| ISO BKT**

Select a bracketing amount ( $\pm\frac{1}{3}$ ,  $\pm\frac{2}{3}$ , or  $\pm 1$ ) in the drive mode display. Each time the shutter is released, the camera will take a picture at the current sensitivity and process it to create two additional copies, one with sensitivity raised and the other with sensitivity lowered by the selected amount.

**WB| WHITE BALANCE BKT**

Select a bracketing amount ( $\pm 1$ ,  $\pm 2$ , or  $\pm 3$ ) in the drive mode display. Each time the shutter is released, the camera takes one shot and processes it to create three copies: one at the current white balanced setting, one with fine-tuning increased by the selected amount, and another with fine-tuning decreased by the selected amount.

## BKT Bracketing

### AE BKT

Use  **SHOOTING SETTING** > **AE BKT SETTING** to choose the bracketing amount, bracketing order, and number of shots. The camera will take the specified number of shots in sequence: one using the metered value for exposure and the others over- or under-exposed by multiples of the selected bracketing amount.

 Regardless of the bracketing amount, exposure will not exceed the limits of the exposure metering system.

### FILM SIMULATION BKT

Each time the shutter is released, the camera takes one shot and processes it to create copies with different film simulation settings, chosen using  **SHOOTING SETTING** > **FILM SIMULATION BKT**.

### DYNAMIC RANGE BKT

Each time the shutter button is pressed, the camera takes three shots with different dynamic ranges: 100% for the first, 200% for the second, and 400% for the third.

 While dynamic range bracketing is in effect, sensitivity will be restricted to a minimum of ISO 400; the sensitivity previously in effect is restored when bracketing ends.

**FOCUS BKT**

Each time the shutter button is pressed, the camera takes a series of photos, varying focus with each shot. The **SHOOTING SETTING > FOCUS BKT SETTING** item offers a choice of **MANUAL** and **AUTO** bracketing.

- Do not adjust zoom during shooting.
- Use of a tripod is recommended.

**MANUAL**

In **MANUAL** mode, you choose the following.

Option	Description
<b>FRAMES</b>	Choose the number of shots.
<b>STEP</b>	Choose the amount focus changes with each shot.
<b>INTERVAL</b>	Choose the interval between shots.

**Focus and FRAMES/STEP**

The relation between focus and the options chosen for **FRAMES** and **STEP** is shown in the illustration.

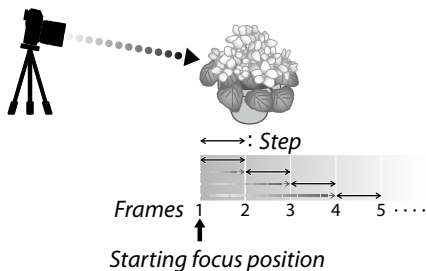



- Focus proceeds from the starting position toward infinity.
- Small **STEP** values translate to small changes in focus, larger values to larger changes.
- Regardless of the option chosen for **FRAMES**, shooting ends when focus reaches infinity.

**AUTO**

In **AUTO** mode, the camera calculates **FRAMES** and **STEP** automatically.

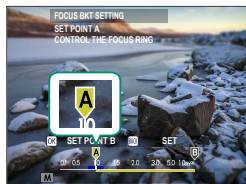
- 1 Select **SHOOTING SETTING** in the shooting menu, highlight **FOCUS BKT SETTING**, and press **MENU/OK**.
- 2 Select **AUTO** and choose an **INTERVAL**.  
The view through the lens will be displayed.
- 3 Focus on the nearest end of the subject and press **MENU/OK**.  
The selected focus distance appears as **A** on the focus distance indicator.



 The same focus range can be chosen by focusing on the farthest end of the subject first.

- 4 Focus on the farthest end of the subject and press **DISP/BACK**.  
The selected focus distance (**B**) and focus range (**A to B**) appear on the focus distance indicator.

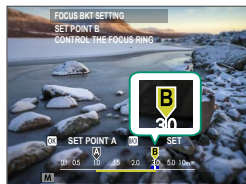

 Instead of pressing the **DISP/BACK** button, you can press **MENU/OK** and select **A** again.

- 5 Take photographs.  
The camera will calculate values for **FRAMES** and **STEP** automatically. The number of frames will appear in the display.

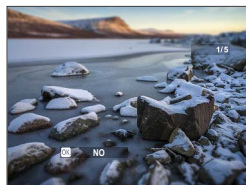

## Continuous Shooting (Burst Mode)

Capture motion in a series of pictures.

- 1 Press the **DRIVE** button to display drive mode options.

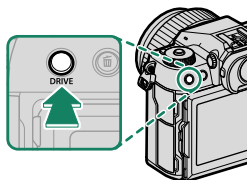



- 2 If **CONTINUOUS** is selected, the camera will take pictures continuously while the shutter-release button is pressed.

Shooting ends when the shutter button is released or the memory card is full.

- ! If file numbering reaches 9999 before shooting is complete, the remaining pictures will be recorded to a new folder.
- Shooting ends when the memory card is full; the camera will record all photos shot to that point. Burst shooting may not begin if the space available on the memory card is insufficient.
- Frame rates may slow as more shots are taken.
- Frame rate varies with the scene, shutter speed, sensitivity, and focus mode.
- Depending on shooting conditions, frame rates may slow or the flash may not fire.
- Recording times may increase during burst shooting.

**Exposure**

To vary exposure with each shot, select **OFF** for  **BUTTON/DIAL SETTING > SHUTTER AE**.

 Depending on such factors as aperture, sensitivity, and exposure compensation, exposure may not be adjusted automatically.



## Multiple Exposures

Create a photograph that combines multiple exposures.

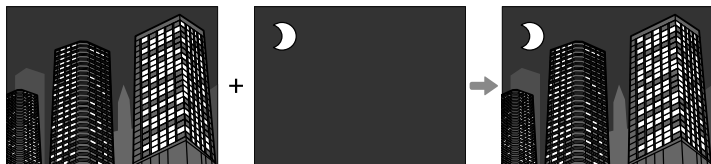

- 1 Press the **DRIVE** button to display the drive mode options and select **MULTIPLE EXPOSURE**.

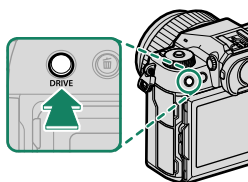

- 2 Choose a blend mode.

Option	Description
<b>ADDITIVE</b>	The camera adds the exposures together. You may need to lower exposure compensation depending on the number of shots.
<b>AVERAGE</b>	The camera automatically optimizes exposure for the final picture. The background in series shot without changing the composition will be optimally exposed.
<b>BRIGHT</b>	The camera compares the exposures and chooses only the brightest pixel at each location. Colors may be mixed depending on their brightness and hue.
<b>DARK</b>	The camera compares the exposures and chooses only the darkest pixel at each location. Colors may be mixed depending on their brightness and hue.

- 3 Take the first shot.

- 4 Press **MENU/OK**. The first shot will be shown superimposed on the view through the lens and you will be prompted to take the second shot.

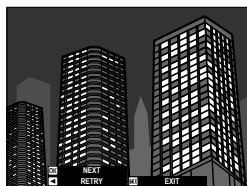

- To return to the previous step and retake the first shot, press the focus stick (focus lever) left.
- To save the first shot and exit without creating a multiple exposure, press **DISP/BACK**.

- 5 Take the second shot, using the first frame as a guide.

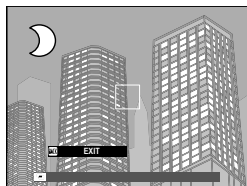

- 6 Press **MENU/OK**. The combined exposures will be displayed as a guide to composing the next shot.



- To return to the previous step and retake the second shot, press the focus stick left.
- To end shooting and create a multiple exposure from the shots taken to this point, press **DISP/BACK**.

- 7 Make additional exposures.  
Each photograph can contain up to nine exposures.

- 8 Press **DISP/BACK** to end shooting.  
The camera will create the combined image and multiple exposure shooting will end.

## Pixel-Shift Multi-Shot

The camera takes a series of 16 shots, using in-body image stabilization to move the image sensor by half a pixel with each shot and recording each frame in RAW format. Using specialized computer software, the frames can then be combined to create a high-resolution RAW picture.

- 1 Press the **DRIVE** button to view drive mode options.
- 2 Select **PIXEL SHIFT MULTI SHOT** and choose a value for **INTERVAL**.
  - We recommend setting **INTERVAL** to **SHORTEST**.
  - If you intend to use the flash with every shot, choose a value for **INTERVAL** long enough to allow the flash to charge between shots.
- 3 Press the shutter button to start shooting.
  - The shots are recorded to the memory card in RAW format.
  - To minimize vibration, use the self-timer or a remote release.
- 4 Combine the shots on a computer.
  - The shots can be combined using FUJIFILM Pixel Shift Combiner.
  - To save high-resolution RAW pictures in other formats, use Capture One Express Fujifilm, Capture One Pro Fujifilm, or Capture One Pro, available from Capture One A/S. FUJIFILM X RAW STUDIO and RAW FILE CONVERTER EX powered by SILKYPIX cannot be used for this purpose.



• Visit the websites below to learn more about or download the following computer software:

– **FUJIFILM Pixel Shift Combiner:**

<https://fujifilm-x.com/products/software/pixel-shift-combiner/>

– **Capture One Express Fujifilm:**

<https://www.captureone.com/products-plans/capture-one-express/fujifilm>

– **Capture One Pro Fujifilm:**

<https://www.captureone.com/explore-features/fujifilm>

– **Capture One Pro:**

<https://www.captureone.com/explore-features>

• Pixel-shift multi-shot photography can be performed via tethered shooting. For this purpose, use FUJIFILM Pixel Shift Combiner.

• The flash will synchronize with the shutter at shutter speeds of  $\frac{1}{3}$  s or slower.

• The following limitations apply to the use of the pixel-shift multi-shot option:

- Pixel-shift multi-shot photography can only be performed using the electronic shutter.
- Sensitivity is restricted to a maximum of ISO 1600. Choosing higher values or a setting of **AUTO** results in a sensitivity of ISO 1600, while lower values remain unchanged.
- The only option available for **RAW RECORDING** is **LOSSLESS COMPRESSED**.
- Pictures taken with **C** (AF-C) selected for focus mode will be shot in focus mode **S** (AF-S). Pictures taken with **S** (AF-S) or **M** (manual) selected are shot in the chosen focus mode.
- If the subject or camera moves during shooting, the desired results may not be achieved when the shots are combined.
-  **SHOOTING SETTING > FLICKER REDUCTION** is automatically set to **OFF**.
- The value selected for exposure compensation applies to all 16 shots.

### Playback

Pictures taken using the pixel-shift multi-shot option are indicated by a pixel-shift multi-shot icon in full-frame playback (📖 178).

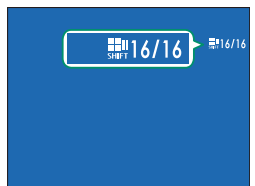

# The Shooting Menus

6

## IMAGE QUALITY SETTING (Still Photography)

Adjust image quality settings for still photography.

To display image quality settings, press **MENU/OK** in the photo shooting display and select the **IQ** (IMAGE QUALITY SETTING) tab.

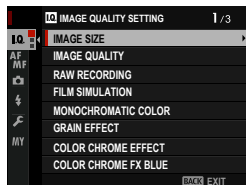

 The options available vary with the shooting mode selected.

## IMAGE SIZE

Choose the size and aspect ratio at which still pictures are recorded.

Option	Image size	Option	Image size
<b>L</b> 4:3	8256 × 6192	<b>S</b> 4:3	4000 × 3000
<b>L</b> 3:2	8256 × 5504	<b>S</b> 3:2	4000 × 2664
<b>L</b> 16:9	8256 × 4640	<b>S</b> 16:9	4000 × 2248
<b>L</b> 1:1	6192 × 6192	<b>S</b> 1:1	2992 × 2992
<b>L</b> 65:24	8256 × 3048	<b>S</b> 65:24	4000 × 1480
<b>L</b> 5:4	7744 × 6192	<b>S</b> 5:4	3744 × 3000
<b>L</b> 7:6	7232 × 6192	<b>S</b> 7:6	3504 × 3000

 **IMAGE SIZE** is not reset when the camera is turned off or another shooting mode is selected.

## IMAGE QUALITY

Choose a file format and compression ratio.

Option	Description
<b>SUPER FINE</b>	Very low compression ratios are used for maximum image quality.
<b>FINE</b>	Low compression ratios are used for higher-quality images.
<b>NORMAL</b>	Higher compression ratios are used to increase the number of images that can be stored.
<b>SUPER FINE + RAW</b>	Record both RAW and super-fine quality JPEG pictures.
<b>FINE + RAW</b>	Record both RAW and fine-quality JPEG images.
<b>NORMAL + RAW</b>	Record both RAW and normal-quality JPEG images.
<b>RAW</b>	Record RAW images only.

### The Function Buttons

To toggle RAW image quality on or off for a single shot, assign **RAW** to a function button (📖 255). Press the button once to select the option in the right column, again to return to the original setting (left column).

Option currently selected for IMAGE QUALITY	Option selected by pressing function button to which RAW is assigned
<b>SUPER FINE</b>	<b>SUPER FINE + RAW</b>
<b>FINE</b>	<b>FINE + RAW</b>
<b>NORMAL</b>	<b>NORMAL + RAW</b>
<b>SUPER FINE + RAW</b>	<b>SUPER FINE</b>
<b>FINE + RAW</b>	<b>FINE</b>
<b>NORMAL + RAW</b>	<b>NORMAL</b>
<b>RAW</b>	<b>FINE</b>

## RAW RECORDING















Choose whether to compress RAW images.





Option	Description
<b>UNCOMPRESSED</b>	RAW images are not compressed.
<b>LOSSLESS COMPRESSED</b>	RAW images are compressed using a reversible algorithm that reduces file size with no loss of image data. The images can be viewed in Capture One Express Fujifilm, RAW FILE CONVERTER EX powered by SILKYPPIX, FUJIFILM X RAW STUDIO, or other software that supports “lossless” RAW compression. Quality is the same as <b>UNCOMPRESSED</b> , but the resulting files are anywhere from about 30 to 90 percent of their uncompressed size.
<b>COMPRESSED</b>	RAW images are compressed using a “lossy”, non-reversible algorithm. Quality is about the same as <b>UNCOMPRESSED</b> , but the resulting files are anywhere from about 25 to 35 percent of their uncompressed size.



## FILM SIMULATION

Simulate the effects of different kinds of film, including black-and-white (with or without color filters). Choose a palette according to your subject and creative intent.

Option	Description
 <b>PROVIA/STANDARD</b>	Ideal for a wide range of subjects.
 <b>Velvia/VIVID</b>	Vibrant reproduction, ideal for landscape and nature.
 <b>ASTIA/SOFT</b>	Softer color and contrast for a more subdued look.
 <b>CLASSIC CHROME</b>	Soft color and enhanced shadow contrast for a calm look.
 <b>PRO Neg. Hi</b>	Ideal for portrait with slightly enhanced contrast.
 <b>PRO Neg. Std</b>	Ideal for portrait with soft gradations and skin tones.
 <b>CLASSIC Neg.</b>	Enhanced color with hard tonality to increase image depth.
 <b>NOSTALGIC Neg.</b>	Amber tinted highlights and rich shadow tone for printed photo look.
 <b>ETERNA/CINEMA</b>	Soft color and rich shadow tone suitable for film look movie.
 <b>ETERNA BLEACH BYPASS</b>	Unique color with low saturation and high contrast. Suitable for still and movie.
 <b>ACROS</b>	Shoot in Black and White In rich details with sharpness. Available with yellow ( <b>Ye</b> ), red ( <b>R</b> ), and green ( <b>G</b> ) filters, which deepen shades of gray corresponding to hues complementary to the selected color. <ul style="list-style-type: none"> <li>•  <b>ACROS+Ye FILTER:</b> Slightly enhances contrast and darkens skies.</li> <li>•  <b>ACROS+R FILTER:</b> Enhances contrast and darkens skies considerably.</li> <li>•  <b>ACROS+G FILTER:</b> Produces pleasing skin tones in portrait.</li> </ul>

Option	Description
 <b>MONOCHROME</b>	Shoots in black and white. Available with yellow ( <b>Ye</b> ), red ( <b>R</b> ), and green ( <b>G</b> ) filters, which deepen shades of gray corresponding to hues complementary to the selected color. <ul style="list-style-type: none"> <li>•  <b>MONOCHROME+Ye FILTER</b>: Slightly enhances contrast and darkens skies.</li> <li>•  <b>MONOCHROME+R FILTER</b>: Enhances contrast and darkens skies considerably.</li> <li>•  <b>MONOCHROME+G FILTER</b>: Produces pleasing skin tones in portrait.</li> </ul>
 <b>SEPIA</b>	Shoots in sepia tone.

-  Film simulation options can be combined with tone and sharpness settings.
- Film simulation settings can also be accessed via shortcuts (📖 246).
- For more information, visit:  
[https://fujifilm-x.com/global/tag/the-world-of-film-simulation/?post\\_type=xstories](https://fujifilm-x.com/global/tag/the-world-of-film-simulation/?post_type=xstories)

## MONOCHROMATIC COLOR

Add a reddish or bluish tinge (warm or cool color cast) to the **A** **ACROS** and **B** **MONOCHROME** monochrome film simulations. Color can be adjusted on the **WARM-COOL** and **G** (Green)–**M** (Magenta) axes.

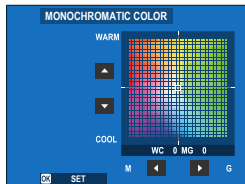

## GRAIN EFFECT

Add a film grain effect.

### ROUGHNESS

Option	Description
<b>STRONG</b>	Choose for rougher grains.
<b>WEAK</b>	Choose for smoother grains.
<b>OFF</b>	Turn the effect off.

### SIZE

Option	Description
<b>LARGE</b>	Choose for coarser grains.
<b>SMALL</b>	Choose for finer grains.

## COLOR CHROME EFFECT

Increase the range of tones available for rendering colors that tend to be highly saturated, such as reds, yellows, and greens.

Option	Description
<b>STRONG</b>	Choose for a strong effect.
<b>WEAK</b>	Choose for a weak effect.
<b>OFF</b>	Turn the effect off.

## COLOR CHROME FX BLUE

Increase the range of tones available for rendering blues.

Option	Description
<b>STRONG</b>	Choose for a strong effect.
<b>WEAK</b>	Choose for a weak effect.
<b>OFF</b>	Turn the effect off.





## SMOOTH SKIN EFFECT

Smooth complexions.





Options		
<b>STRONG</b>	<b>WEAK</b>	<b>OFF</b>

## DYNAMIC RANGE

Adjust dynamic range. Wide dynamic ranges reduce loss of detail in highlights for more natural results with high-contrast or backlit scenes.

Option		Description
AUTO	 100%	Choose for increased contrast. 
	 200%	
 400%		Reduce loss of detail in highlights.

 Mottling may appear in pictures taken at higher values. Choose a value according to the scene.

-  If **AUTO** is selected, the camera will automatically choose either  **100%** or  **200%** according to the subject and shooting conditions. Shutter speed and aperture will be displayed when the shutter button is pressed halfway.
-  **200%** is available at sensitivities of from ISO 200 to ISO 12800,  **400%** at sensitivities of from ISO 400 to 12800.

## D RANGE PRIORITY

Reduce loss of detail in highlights and shadows for natural-looking results when photographing high-contrast scenes.













Option	Description
<b>AUTO</b>	Contrast is adjusted automatically in response to lighting conditions.
<b>STRONG</b>	Adjust dynamic range by a large amount for very high-contrast scenes.
<b>WEAK</b>	Adjust dynamic range by a smaller amount for moderately high-contrast scenes.
<b>OFF</b>	Contrast reduction off.







- **WEAK** is available at sensitivities of from ISO 200 to ISO 12800, **STRONG** at sensitivities of from ISO 400 to 12800.
- When an option other than **OFF** is selected, **TONE CURVE**, and **DYNAMIC RANGE** will be adjusted automatically; if you wish to adjust these settings manually, choose **OFF**.

## WHITE BALANCE

For natural colors, choose a white balance option that matches the light source.

Option	Description
 <b>AUTO WHITE PRIORITY</b>	White balance is adjusted automatically. Choose for whiter whites in scenes lit by incandescent bulbs.
<b>AUTO</b>	White balance is adjusted automatically.
 <b>AUTO AMBIENCE PRIORITY</b>	White balance is adjusted automatically. Choose for warmer whites in scenes lit by incandescent bulbs.
 <b>CUSTOM 1</b>	Measure a value for white balance.
 <b>CUSTOM 2</b>	
 <b>CUSTOM 3</b>	
 <b>COLOR TEMPERATURE</b>	Choose a color temperature.
 <b>DAYLIGHT</b>	For subjects in direct sunlight.
 <b>SHADE</b>	For subjects in the shade.
 <b>FLUORESCENT LIGHT-1</b>	Use under “daylight” fluorescent lights.
 <b>FLUORESCENT LIGHT-2</b>	Use under “warm white” fluorescent lights.
 <b>FLUORESCENT LIGHT-3</b>	Use under “cool white” fluorescent lights.
 <b>INCANDESCENT</b>	Use under incandescent lighting.
 <b>UNDERWATER</b>	Reduces the blue cast typically associated with underwater lighting.

-  In conditions in which **AUTO** fails to produce the desired results—for example, under certain types of lighting or in close-ups of portrait subjects—use custom white balance or choose a white balance option suited to the light source.
- White balance is adjusted for flash lighting only in **AUTO**,  **AUTO WHITE PRIORITY**,  **AUTO AMBIENCE PRIORITY**, and  modes. Turn the flash off using other white balance options.
- White balance options can also be accessed via shortcuts (📖 246).

## Fine-Tuning White Balance

Pressing **MENU/OK** after selecting a white balance option displays a fine-tuning dialog; use the focus stick (focus lever) to fine-tune white balance.

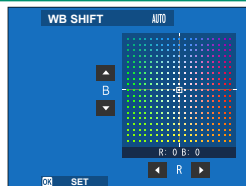

- To exit without fine-tuning white balance, press **DISP/BACK** after selecting a white balance option.
- You cannot tilt the focus stick diagonally when fine-tuning white balance.



## Custom White Balance

Choose  $\mathcal{Q}_1$ ,  $\mathcal{Q}_2$ , or  $\mathcal{Q}_3$  to adjust white balance for unusual lighting conditions using a white object as a reference (colored objects can also be used to lend photos a color cast). A white balance target will be displayed; position and size the target so that it is filled by the reference object and press the shutter button all the way down to measure white balance (to select the most recent custom value and exit without measuring white balance, press **DISP/BACK**, or press **MENU/OK** to select the most recent value and display the fine-tuning dialog).

- If **“COMPLETED!”** is displayed, press **MENU/OK** to set white balance to the measured value.
- If **“UNDER”** is displayed, raise exposure compensation and try again.
- If **“OVER”** is displayed, lower exposure compensation and try again.

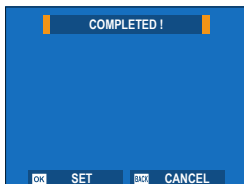
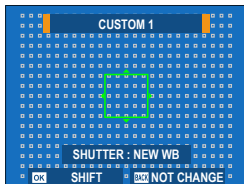

## **K**: Color Temperature

Adjust white balance to match the color temperature of the light source.

 Color temperature can be adjusted to make pictures “warmer” or “colder” or deliberately produce colors that differ radically from those in real life.

- 1 Select **K** in the white balance menu. The option currently selected for color temperature will be displayed.

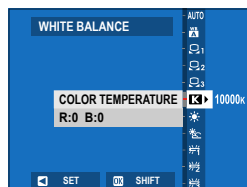

- 2 Edit the color temperature using the focus stick (focus lever) and press **MENU/OK**. A fine-tuning dialog will be displayed.

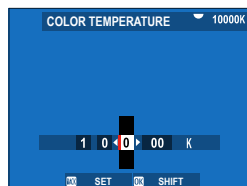

-  You can also adjust color temperature in increments of 10 K by rotating the rear command dial.
- Choose from values of from 2500 to 10000 K.
- To exit without fine-tuning white balance, press **DISP/BACK** after choosing a color temperature.

- 3 Highlight a fine-tuning amount using the focus stick.
- 4 Press **MENU/OK**. The changes will be applied. The selected color temperature will appear in the display.

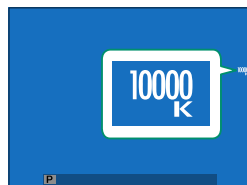

**Color Temperature**

Color temperature is an objective measure of the color of a light source, expressed in Kelvin (K). Light sources with a color temperature close to that of direct sunlight appear white; light sources with a lower color temperature have a yellow or red cast, while those with a higher color temperature are tinged with blue.

**tone CURVE**

With reference to a tone curve, adjust the appearance of highlights or shadows, making them harsher or softer. Choose higher values to make shadows and highlights harsher, lower values to make them softer.

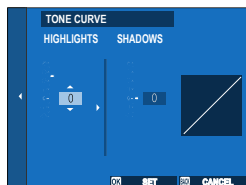

Option	Description
<b>HIGHLIGHTS</b>	-2 to +4
<b>SHADOWS</b>	-2 to +4

**COLOR**

Adjust color density.

Options								
-4	-3	-2	-1	0	+1	+2	+3	+4

**SHARPNESS**

Sharpen or soften outlines.

Options								
-4	-3	-2	-1	0	+1	+2	+3	+4

## HIGH ISO NR

Reduce noise in pictures taken at high sensitivities. Choose higher values to reduce noise and smooth outlines, lower values to leave outlines visible.

Options								
-4	-3	-2	-1	0	+1	+2	+3	+4

## CLARITY

Increase definition while altering tones in highlights and shadows as little as possible. Choose higher values for increased definition, lower values for a softer effect.

Options										
-5	-4	-3	-2	-1	0	+1	+2	+3	+4	+5

 The additional processing required at settings other than 0 increases the time need to save each shot.

## LONG EXPOSURE NR

Select **ON** to reduce mottling in long time-exposures.

Options	
<b>ON</b>	<b>OFF</b>

 The additional processing required when **ON** is selected increases save times.

**LENS MODULATION OPTIMIZER**

Select **ON** to improve definition by adjusting for diffraction and the slight loss of focus at the periphery of the lens.

Options	
<b>ON</b>	<b>OFF</b>

**COLOR SPACE**

Choose the gamut of colors available for color reproduction.

Option	Description
<b>sRGB</b>	Recommended in most situations.
<b>Adobe RGB</b>	For commercial printing.

## PIXEL MAPPING

Use this option if you notice bright spots in your pictures.

- 1 Press **MENU/OK** in the shooting display and select the  **IMAGE QUALITY SETTING** tab.
- 2 Highlight **PIXEL MAPPING** and press **MENU/OK** to perform pixel mapping.



- Results are not guaranteed.
- Be sure the battery is fully charged before beginning pixel mapping.
- Pixel mapping is not available when the camera temperature is elevated.
- Processing may take a few seconds.

## EDIT/SAVE CUSTOM SETTING

Save custom camera settings for commonly-encountered situations. Saved settings can be recalled by rotating the mode dial to positions **C1 (CUSTOM 1)** through **C6 (CUSTOM 6)** ( 74).



## AUTO UPDATE CUSTOM SETTING

Choose whether changes to saved custom settings apply automatically.

Option	Description
<b>ENABLE</b>	Changes to custom settings banks <b>CUSTOM 1</b> through <b>CUSTOM 6</b> apply automatically.
<b>DISABLE</b>	Changes do not apply automatically. Any changes to custom settings must be applied manually (  75).

## MOUNT ADAPTOR SETTING

Adjust settings for lenses attached via a mount adapter.

 Any changes made using this item also apply in movie mode ( 165).

### Shutter Select

When using lenses with an internal shutter, choose whether to use the shutter on the camera (**BODY**) or the lens (**LENS**).

 This option may have no effect with some lenses.

### Saved Settings

Store settings for up to 6 lenses, or choose **OFF** to disable corrections for focal length, distortion, color shading, and peripheral illumination.

#### Choosing a Focal Length

Use the focus stick (focus lever) to enter the focal length.

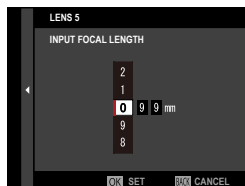

#### Distortion Correction

Choose from **STRONG**, **MEDIUM**, or **WEAK** options to correct **BARREL** or **PINCUSHION** distortion.

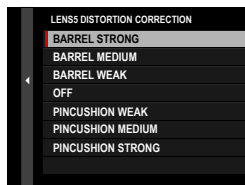

## **Color Shading Correction**

Color (shading) variations between the center and edges of the frame can be adjusted separately for each corner.

To use color shading correction, follow the steps below.

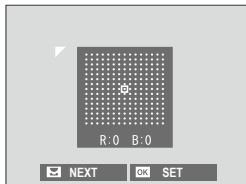

- 1** Rotate the rear command dial to choose a corner. The selected corner is indicated by a triangle.
- 2** Use the focus stick (focus lever) to adjust shading until there is no visible difference in color between the selected corner and the center of the image.
  - Press the focus stick left or right to adjust colors on the cyan–red axis.
  - Press the focus stick up or down to adjust colors on the blue–yellow axis.

 To determine the amount required, adjust color shading correction while taking photos of blue sky or a sheet of gray paper.



**Peripheral Illumination Correction**

Choose from values between  $-5$  and  $+5$ . Choosing positive values increases peripheral illumination, while choosing negative values reduces peripheral illumination. Positive values are recommended for vintage lenses, negative values to create the effect of images taken with an antique lens or a pinhole camera.

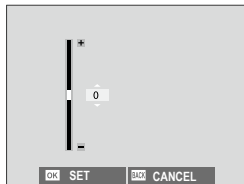

 To determine the amount required, adjust peripheral illumination correction while taking photos of blue sky or a sheet of gray paper.

**EDIT LENS NAME**

Change the lens name.

## AF/MF SETTING (Still Photography)

Adjust focus settings for still photography.

To display AF/MF settings, press **MENU/OK** in the photo shooting display and select the **AF/MF** (AF/MF SETTING) tab.

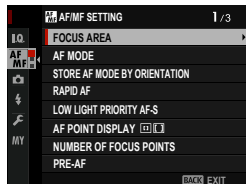

 The options available vary with the shooting mode selected.

### FOCUS AREA

Choose the focus area for autofocus, manual focus, and focus zoom ( 85).

### AF MODE

Choose the AF mode for focus modes **S** and **C** ( 83).

## STORE AF MODE BY ORIENTATION

Choose whether the AF mode used when the camera is in portrait orientation is stored separately from that used when the camera is in landscape orientation.

Option	Description
<b>OFF</b>	The same settings are used in both orientations.
<b>FOCUS AREA ONLY</b>	The focus area for each orientation can be selected separately.
<b>ON</b>	The focus mode and focus area can be selected separately.

## RAPID AF

Select **ON** for faster focus times. Display quality will drop while the camera focuses.

Options	
<b>ON</b>	<b>OFF</b>

## LOW LIGHT PRIORITY AF-S

Selecting **ON** increases exposure times for low-light AF so that the camera can focus when lighting is poor.

Options	
<b>ON</b>	<b>OFF</b>

## AF POINT DISPLAY

Choose whether individual focus frames are displayed when **ZONE** or **WIDE/TRACKING** is selected for  **AF/MF SETTING** > **AF MODE**.

Options	
<b>ON</b>	<b>OFF</b>

## NUMBER OF FOCUS POINTS

Choose the number of focus points available for focus-point selection in manual focus mode or when **SINGLE POINT** is selected for **AF MODE**.

Option	Description
<b>117 POINTS</b> (9 × 13)	Choose from 117 focus points arranged in a 9- by 13-point grid.
<b>425 POINTS</b> (17 × 25)	Choose from 425 focus points arranged in a 17- by 25-point grid.

## PRE-AF

If **ON** is selected, the camera will continue to adjust focus even when the shutter button is not pressed halfway. The camera adjusts focus continuously, allowing it to focus faster when the shutter button is pressed halfway. Choosing this option helps prevent missed shots.

Options	
<b>ON</b>	<b>OFF</b>

 Choosing **ON** increases the drain on the battery.

## AF ILLUMINATOR

If **ON** is selected, the AF-assist illuminator will light to assist autofocus.

Options	
<b>ON</b>	<b>OFF</b>





-  • The camera may be unable to focus using the AF-assist illuminator in some cases.
- If the camera is unable to focus, try increasing the distance to the subject.
  - Avoid shining the AF-assist illuminator directly into your subject's eyes.

 Any changes made using this item also apply in movie mode (📖 166).

## FACE/EYE DETECTION SETTING





If the camera detects human faces, it will assign them priority over the background and adjust settings appropriately for portraits when setting focus and exposure. You can also choose whether the camera focuses on the left or right eye when face detection is on.



Option	Description
<b>FACE DETECTION ON</b>	Adjust settings for Intelligent Face Detection. You can also adjust eye detection settings. <ul style="list-style-type: none"> <li>•  <b>EYE OFF:</b> Intelligent Face Detection only.</li> <li>•  <b>EYE AUTO:</b> The camera automatically chooses which eye to focus on when a face is detected.</li> <li>•  <b>RIGHT EYE PRIORITY:</b> The camera focuses on the right eye of subjects detected using Intelligent Face Detection.</li> <li>•  <b>LEFT EYE PRIORITY:</b> The camera focuses on the left eye of subjects detected using Intelligent Face Detection.</li> </ul>
<b>OFF</b>	Intelligent Face Detection and eye priority off.



-  • If the subject moves as the shutter button is pressed, the face may not be in the area indicated by the green border when the picture is taken.
- In some modes, the camera may set exposure for the frame as a whole rather than the portrait subject.



- The face selected by the camera is indicated by a green border. Any other faces detected by the camera are indicated by gray borders. To have the camera focus on a different subject, tap inside the gray border. The  icon will change from white to green.
- You can also switch subjects by pressing the function button to which **FACE SELECT**  is assigned and then using the focus stick (focus lever) or (during viewfinder photography) touch controls ( 27).
- To switch from face detection to manual focus-area selection, press the center of the focus stick (focus lever). Press again to re-enable face detection.
- If the selected subject leaves the frame, the camera will wait a set time for its return and consequently the green frame may sometimes appear in locations where no face is seen.
- Depending on shooting conditions, face selection may be suspended at the close of burst shooting.
- Faces can be detected with the camera in vertical or horizontal orientation.
- If the camera is unable to detect the subject's eyes because they are hidden by hair, glasses, or other objects, the camera will instead focus on faces.
- Face/eye detection options can also be accessed via shortcuts ( 246).

## AF+MF

If **ON** is selected in focus mode **S** and focus has been locked (whether by pressing the shutter button halfway or by other means), focus lock can be ended and focus adjusted manually by rotating the focus ring.

Options	
ON	OFF
 <ul style="list-style-type: none"> <li>Lenses with a focus distance indicator must be set to manual focus mode (MF) before this option can be used. Selecting MF disables the focus distance indicator.</li> <li>If the lens is equipped with a focus distance indicator, set the focus ring to the center, as the camera may fail to focus if the ring is set to infinity or the minimum focus distance.</li> </ul>	
 <p>Focus peaking can be used to check focus. To enable focus peaking, select <b>FOCUS PEAK HIGHLIGHT</b> for <b>MF ASSIST</b>.</p>	

### AF + MF Focus Zoom

When **ON** is selected for **AF/MF SETTING > FOCUS CHECK** and **SINGLE POINT** selected for **AF MODE**, focus zoom can be used to zoom in on the selected focus area. The zoom ratio can be selected using the rear command dial.

## MF ASSIST

Choose how focus is displayed in manual focus mode.

Option	Description
<b>STANDARD</b>	Focus is displayed normally.
<b>FOCUS PEAK HIGHLIGHT</b>	The camera heightens high-contrast outlines. Choose a color and peaking level.

 You can also choose MF assist options by holding the center of the rear command dial.

## FOCUS CHECK

If **ON** is selected, the display will automatically zoom in on the selected focus area when the focus ring is rotated in manual focus mode.

Options	
ON	OFF

-  Pressing the center of the rear command dial cancels focus zoom.
- The zoom position is centered on the current focus area and changes when the focus area is changed.



## INTERLOCK SPOT AE & FOCUS AREA



Choose **ON** to meter the current focus frame when **SPOT** or **MULTI** metering is selected.

Options	
<b>ON</b>	<b>OFF</b>

## INSTANT AF SETTING

Choose whether the camera focuses using single AF (**AF-S**) or continuous AF (**AF-C**) when a button to which focus lock or **AF-ON** is assigned is pressed in manual focus mode.



Options	
<b>AF-S</b>	<b>AF-C</b>

 Any changes made using this item also apply in movie mode ( 168).

## **DEPTH-OF-FIELD SCALE**

Choose **FILM FORMAT BASIS** to help you make practical assessments of depth of field for pictures that will be viewed as prints and the like, **PIXEL BASIS** to help you assess depth of field for pictures that will be viewed at high resolutions on computers or other electronic displays.

Options	
<b>PIXEL BASIS</b>	<b>FILM FORMAT BASIS</b>

 Any changes made using this item also apply in movie mode ( 168).

## **RELEASE/FOCUS PRIORITY**

Choose how the camera behaves when the shutter button is pressed all the way down. Settings for **AF-S** and **AF-C** focus modes can be selected separately.

Option	Description
<b>RELEASE</b>	Shutter response is prioritized over focus. Pictures can be taken when the camera is not in focus.
<b>FOCUS</b>	Focus is prioritized over shutter response. Pictures can be only taken when the camera is in focus.



 Regardless of the option selected, pictures can still be taken when the camera is not in focus if **ON** is selected for **AF+MF**.

## **AF RANGE LIMITER**

Limit the range of available focus distances for increased focus speed.





Option	Description
<b>OFF</b>	Focus limiter disabled.
<b>CUSTOM</b>	Limit focus to a range of distances defined by a minimum and maximum. <ul style="list-style-type: none"> <li>• <b>OK</b>: Limit focus to the selected range.</li> <li>• <b>SET</b>: Choose two objects and limit focus to the distance between them.</li> </ul>
<b>PRESET1</b>	Limit focus to a preset range.
<b>PRESET2</b>	



-  • Choosing a focus range that includes distances shorter than the minimum focus distance of the lens disables the focus limiter.
- The values listed and displayed for the focus limiter may differ from the actual focus distance.

-  • The following additional operations can be performed when **CUSTOM** is selected:
  - You can tap objects in the touch screen display to choose the focus range.
  - Instead of tapping an object in the display, you set the maximum focus distance to infinity by rotating the focus ring.
- Any changes made using this item also apply in movie mode ( 168).

## TOUCH SCREEN MODE

Choose the shooting operations performed using touch controls.

Mode	Description
 <b>AF</b> ↓ ↑  <b>AF OFF</b>	<ul style="list-style-type: none"><li>• In focus mode <b>S</b> (AF-S), the camera focuses when you tap your subject in the display. Focus locks at the current distance until you tap the <b>AF OFF</b> icon.</li><li>• In focus mode <b>C</b> (AF-C), the camera initiates focus when you tap your subject display. The camera will continue to adjust focus for changes in the distance to the subject until you tap the <b>AF OFF</b> icon.</li><li>• In manual focus mode (MF), you can tap the display to focus on the selected subject using autofocus.</li></ul>
 <b>AREA</b>	Tap to select a point for focus or zoom. The focus frame will move to the selected point.
 <b>OFF</b>	Touch controls disabled.

- To disable touch controls and hide the touch screen mode indicator, select **OFF** for  **BUTTON/DIAL SETTING > TOUCH SCREEN SETTING >  TOUCH SCREEN SETTING**.
- Any changes made using this item also apply in movie mode ( 169).

**Touch Controls for Focus Zoom**

Different touch controls are used during focus zoom (focus check enabled).

**Central Area**

Tapping the center of the display performs the operations below.

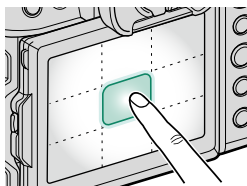

Mode	Operation performed
AF	AF-S: AF
	MF: Instant AF
AREA	AF-S: AF
	MF: Instant AF
OFF	AF-S/MF: OFF

**Other Areas**

Tapping other areas simply scrolls the display, whether during still photography or movie recording and regardless of the option selected for touch screen mode.

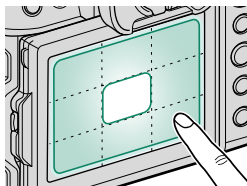

## SHOOTING SETTING (Still Photography)

Adjust shooting options for still photography.

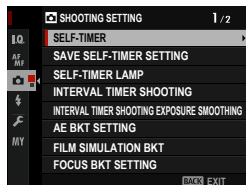

To display shooting settings, press **MENU/OK** in the photo shooting display and select the  (**SHOOTING SETTING**) tab.



 The options available vary with the shooting mode selected.

### SELF-TIMER

Choose a shutter release delay.

Option	Description
 <b>2 SEC</b>	The shutter is released two seconds after the shutter button is pressed. Use to reduce blur caused by the camera moving when the shutter button is pressed. The self-timer lamp blinks as the timer counts down.
 <b>10 SEC</b>	The shutter is released ten seconds after the shutter button is pressed. Use for photographs in which you wish to appear yourself. The self-timer lamp blinks immediately before the picture is taken.
<b>OFF</b>	Self-timer off.

If an option other than **OFF** is selected, the timer will start when the shutter button is pressed all the way down. The display shows the number of seconds remaining until the shutter is released. To stop the timer before the picture is taken, press **DISP/BACK**.



-  Stand behind the camera when using the shutter button. Standing in front of the lens can interfere with focus and exposure.
- The self-timer turns off automatically when the camera is turned off.

## SAVE SELF-TIMER SETTING

If **ON** is selected, the chosen self-timer setting will remain in effect after a picture is taken or the camera is turned off.

Options	
<b>ON</b>	<b>OFF</b>

## SELF-TIMER LAMP

If **ON** is selected, the self-timer lamp will light during self-timer photography. Select **OFF** when shooting night scenes or in other situations in which you would prefer that the lamp remain unlit.

Options	
<b>ON</b>	<b>OFF</b>

## INTERVAL TIMER SHOOTING

Configure the camera to take photos automatically at a preset interval.

- 1 Highlight **INTERVAL TIMER SHOOTING** in the  (**SHOOTING SETTING**) tab and press **MENU/OK**.

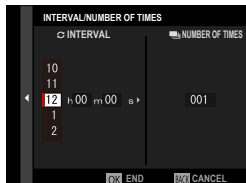

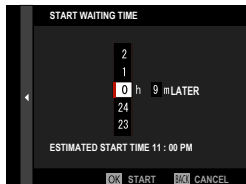

- 2 Use the focus stick (focus lever) to choose the interval and number of shots. Press **MENU/OK** to proceed.

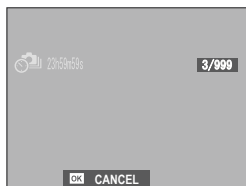

- 3 Use the focus stick to choose the starting time and then press **MENU/OK**. Shooting will start automatically.



 Interval timer photography cannot be used at a shutter speed of “bulb” or with multiple exposure photography. In burst mode, only one picture will be taken each time the shutter is released.

-  Use of a tripod is recommended.
- We recommend using an AC-5VJ AC power adapter.
- The display turns off between shots and lights a few seconds before the next shot is taken.
- The display can be activated at any time by pressing the shutter button.
- To continue shooting until the number of shots taken equals the number of exposures remaining at the time interval-timer photography started, set the number of shots to ∞.



**INTERVAL TIMER SHOOTING EXPOSURE SMOOTHING**

Select **ON** to automatically adjust exposure during interval-timer photography to prevent it changing dramatically between shots.

Options	
<b>ON</b>	<b>OFF</b>

-  Large changes in subject brightness may make exposure appear erratic. We recommend that you choose shorter values for **INTERVAL TIMER SHOOTING > INTERVAL** with subjects that brighten or dim dramatically during shooting.
- In manual mode (mode **M**), exposure smoothing is only available if an AUTO option is selected for **ISO**.

## AE BKT SETTING

Adjust exposure bracketing settings.

Option	Description
<b>FRAMES/STEP SETTING</b>	Choose the number of shots in the bracketing sequence and the amount exposure is varied with each shot. <ul style="list-style-type: none"><li>• <b>FRAMES:</b> Choose the number of shots in the bracketing sequence.</li><li>• <b>STEP:</b> Choose the amount exposure is varied with each shot.</li></ul>
<b>1 FRAME/CONTINUOUS</b>	<ul style="list-style-type: none"><li>• <b>1 FRAME:</b> The shots in the bracketing sequence are taken one at a time.</li><li>• <b>CONTINUOUS:</b> The shots in the bracketing sequence are taken in a single burst.</li></ul>
<b>SEQUENCE SETTING</b>	Choose the order in which the shots are taken.

## FILM SIMULATION BKT

Choose the three film simulation types used for film simulation bracketing (📖 113).

## FOCUS BKT SETTING

Choose from **AUTO** and **MANUAL** focus bracketing modes (📖 101).

## PHOTOMETRY



Choose how the camera meters exposure (📖 94).

## SHUTTER TYPE

Choose the shutter type. Choose the electronic shutter to mute the shutter sound.

Option	Description
<b>MS MECHANICAL SHUTTER</b>	Take pictures with the mechanical shutter.
<b>ES ELECTRONIC SHUTTER</b>	Take pictures with the electronic shutter.
<b>EF E-FRONT CURTAIN SHUTTER</b>	The camera chooses the mechanical or electronic front curtain shutter according to shooting conditions.
<b>M/E MECHANICAL + ELECTRONIC</b>	The camera chooses the mechanical or electronic shutter according to shooting conditions.
<b>EF<sub>E</sub> E-FRONT + ELECTRONIC</b>	The camera chooses the mechanical, electronic, or electronic front curtain shutter according to shooting conditions.

If **EF E-FRONT CURTAIN SHUTTER** is selected, **MS MECHANICAL SHUTTER** will automatically take effect at high shutter speeds.

-  • When using the electronic shutter, note the following:
  - Distortion may be visible in shots of moving subjects.
  - Distortion may also be visible in hand-held shots taken at high shutter speeds; use of a tripod is recommended.
  - Banding and fog may occur in shots taken under fluorescent lights or other flickering or erratic illumination.
  - When taking pictures with the shutter muted (🔇 210), respect your subjects' image rights and right to privacy.
- When using the electronic front-curtain shutter, note the following:
  - Faster shutter speeds are more likely to result in uneven exposure and loss of resolution in out-of-focus areas of the frame.
-  The following restrictions apply when the electronic shutter is used:
  - Sensitivity is restricted to values of ISO 12800–100
  - Long exposure noise reduction has no effect
  - The flash will not fire unless pixel-shift multi-shot is enabled.

## FLICKER REDUCTION

Reduce flicker in pictures and the display when shooting under fluorescent lighting and other similar light sources.

Option	Description
<b>ALL FRAMES</b>	Flicker reduction is applied to all frames continuous shooting frame rate reduces.
<b>FIRST FRAME</b>	Flicker measurement is taken prior to the first frame only and the same reduction amount is applied to all subsequent frames that flicker may occur.
<b>OFF</b>	Flicker reduction disabled.

- ❗ • Flicker reduction increases the time needed to record pictures.
- **OFF** is selected for **FLICKER REDUCTION** when the electronic shutter is used.
- Flicker reduction is not available during movie recording.

## ISO

Adjust the camera's sensitivity to light (📖 92).

**IS MODE**

Turn image stabilization on or off.

Option	Description
<b>CONTINUOUS</b>	Image stabilization on.
<b>SHOOTING ONLY</b>	Image stabilization enabled only when the shutter button is pressed halfway (focus mode <b>C</b> ) or the shutter is released.
<b>OFF</b>	Image stabilization off;  appears in the display. Choose when the camera is mounted on a tripod or otherwise fixed in place.



- The setting selected with the lens image stabilization switch, if any, takes priority over the setting chosen with **IS MODE**.
- Note that vibration or camera sounds may be noticeable as image stabilization takes effect.

## 35mm FORMAT MODE

Enabling **SHOOTING SETTING > 35mm FORMAT MODE** in the shooting menu sets the picture angle to 35 mm; the change is reflected in the display.



Option	Description
<b>ON</b>	The picture angle is set to 35 mm; the change is reflected in the display.
<b>OFF</b>	35 mm format mode disabled.
<b>AUTO</b>	35 mm format mode is enabled automatically when a mount adapter that supports automatic detection is attached.

- The **SCREEN SET-UP > DISP. CUSTOM SETTING** item in the setup menu (📖 20, 217) includes an option (enabled by default) for displaying a **35mm FORMAT MODE** icon.
- The **IMAGE QUALITY SETTING > IMAGE SIZE** item in the shooting menu is fixed at **3:2**.

## WIRELESS COMMUNICATION

Connect to smartphones running the latest version of the FUJIFILM Camera Remote app. The smartphone can then be used to:

- Control the camera and take pictures remotely
- Receive pictures uploaded from the camera
- Browse the pictures on the camera and download selected pictures
- Upload location data to the camera



For downloads and other information, visit:

[http://app.fujifilm-dsc.com/en/camera\\_remote/](http://app.fujifilm-dsc.com/en/camera_remote/)

## FLASH SETTING (Still Photography)

Adjust flash-related settings for still photography.

To display flash settings, press **MENU/OK** in the photo shooting display and select the **⚡ (FLASH SETTING)** tab.

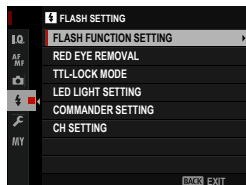

### FLASH FUNCTION SETTING

Choose a flash control mode, flash mode, or sync mode or adjust the flash level. The options available vary with the flash.

For more information on flash settings, see “External Flash Units” (265) in “Peripherals and Optional Accessories”.

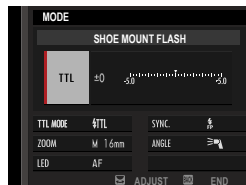

### RED EYE REMOVAL

Remove red-eye effects caused by the flash.

Option	Description
<b>FLASH+REMOVAL</b>	A red-eye reduction pre-flash is combined with digital red-eye removal.
<b>FLASH</b>	Flash red-eye reduction only.
<b>REMOVAL</b>	Digital red-eye removal only.
<b>OFF</b>	Flash red-eye reduction and digital red-eye removal off.

- Flash red-eye reduction can be used in TTL flash control mode.
- Digital red-eye removal is performed only when a face is detected.
- Digital red-eye removal is not available with RAW images.



## TTL-LOCK MODE

Instead of adjusting flash level with each shot, TTL flash control can be locked for consistent results across a series of photographs.

Option	Description
<b>LOCK WITH LAST FLASH</b>	Flash output is locked at the value metered for the most recent photo.
<b>LOCK WITH METERING FLASH</b>	The camera emits a series of pre-flashes and locks flash output at the metered value.

- To use TTL lock, assign **TTL-LOCK** to a camera control and then use the control to enable or disable TTL lock (📖 255).
- Flash compensation can be adjusted while TTL lock is in effect.
- Selecting **LOCK WITH LAST FLASH** displays an error message if no previously metered value exists.

## LED LIGHT SETTING

Choose whether to use the flash unit's LED video light (if available) as a catchlight or AF-assist illuminator when taking photos.

Option	Role of LED video light in still photography
<b>CATCHLIGHT</b>	Catchlight
<b>AF ASSIST</b>	AF-assist illuminator
<b>AF ASSIST+CATCHLIGHT</b>	AF-assist illuminator and catchlight
<b>OFF</b>	None

- In some cases, this option can also be accessed via the **FLASH FUNCTION SETTING** menu.

## COMMANDER SETTING

Choose groups when using the camera flash unit as a commander for Fujifilm optical wireless remote flash control. This option is available when the camera is used with clip-on flash units that support Fujifilm optical wireless flash control.

Options			
Gr A	Gr B	Gr C	OFF



In some cases, this option can also be accessed via the **FLASH FUNCTION SETTING** menu.

## CH SETTING

Choose the channel used for communication between the commander and remote flash units. Separate channels can be used for different flash systems or to prevent interference when multiple systems are operating in close proximity.

Options			
CH1	CH2	CH3	CH4

## MOVIE SETTING (Movie Recording)

Adjust movie-recording options.

To display options for movie recording, press **MENU/OK** in the movie shooting display and select the  (MOVIE SETTING) tab.

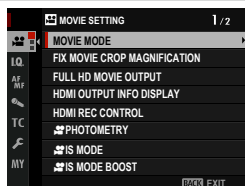

### MOVIE MODE

Choose a frame rate for movie recording.

#### Options

 1080/29.97P

 1080/25P

 1080/24P

 1080/23.98P

### FIX MOVIE CROP MAGNIFICATION

Fix the movie crop ratio at 1.1:1. This makes it easier to match crops after changing movie settings.





#### Options

ON

OFF

## FULL HD MOVIE OUTPUT

Choose the destination for Full HD movies shot while the camera is connected to an HDMI device.

Option	Description
 <b>FHD</b>  <b>FHD</b>	Full HD movies are output to the HDMI device and recorded to the camera memory card.
 <b>—</b>  <b>FHD</b>	Full HD movies are not recorded to the camera memory card but are output to the HDMI device.

 When **OFF** is selected for **HDMI OUTPUT INFO DISPLAY**, movies will be output to the HDMI device in 4:2:2 10-bit format.

## HDMI OUTPUT INFO DISPLAY

If **ON** is selected, HDMI devices to which the camera is connected will mirror the information in the camera display.

Options	
<b>ON</b>	<b>OFF</b>

## HDMI REC CONTROL

Choose whether the camera sends movie start and stop signals to the HDMI device when the shutter button is pressed to start and stop movie recording.

Options	
<b>ON</b>	<b>OFF</b>

## PHOTOMETRY

Options are the same as those for still photography, but settings must be adjusted separately ( 94).

## IS MODE

Turn image stabilization on or off.



Option	Description
<b>IBIS/OIS</b>	Enable in-body (IBIS) and optical (OIS) image stabilization. IBIS is used with lenses that do not support OIS.
<b>IBIS/OIS + DIS</b>	Enable in-body (IBIS), optical (OIS), and digital (DIS) image stabilization. The crop is adjusted according to the option selected for <b>MOVIE MODE</b> .
<b>OFF</b>	Image stabilization off;  appears in the display. Choose when the camera is mounted on a tripod or otherwise fixed in place.

-  The setting selected with the lens image stabilization switch, if any, takes priority over the setting chosen with the IS mode.
- Note that vibration or camera sounds may be noticeable as image stabilization takes effect.

## IS MODE BOOST

Choose the image stabilization level.

Option	Description
<b>ON</b>	Suitable for hand-held shooting with no panning.
<b>OFF</b>	Suitable for hand-held shooting with panning.

-  Assigning **IS MODE BOOST** to a function button allows the image stabilization level to be changed while recording is in progress ( 255).



## ISO

Adjust the camera's sensitivity to light.

Option	Description
<b>200–6400</b>	Adjust sensitivity manually. Selected value is shown in display.
<b>AUTO</b>	Sensitivity is automatically adjusted in response to shooting conditions.

## ZEBRA SETTING

Highlights that may be overexposed are shown by zebra stripes in the movie mode display.

Option	Description
<b>ZEBRA RIGHT</b>	 Right-slanting stripes.
<b>ZEBRA LEFT</b>	 Left-slanting stripes.
<b>OFF</b>	Stripes off.

## ZEBRA LEVEL

Choose the brightness threshold for the zebra stripe display.

Options										
50	55	60	65	70	75	80	85	90	95	100

## MOVIE OPTIMIZED CONTROL

Select **ON** to allow movie settings to be adjusted using only the command dials and touch-screen controls. You may find this helpful in preventing the sounds of camera controls being recorded with movies ( 29).

Options	
<b>ON</b>	<b>OFF</b>

## TALLY LIGHT



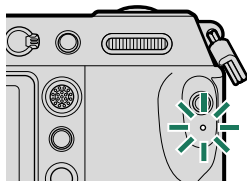



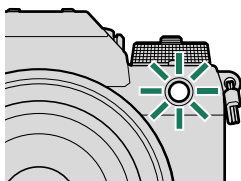

Choose the lamp (indicator or AF-assist) that lights during movie recording and whether the lamp blinks or remains steady.



*Indicator lamp*



*AF-assist illuminator*

Option	Description
<b>FRONT OFF</b> <b>REAR</b> 	The indicator lamp lights during movie recording.
<b>FRONT OFF</b> <b>REAR</b> 	The indicator lamp blinks during movie recording.
<b>FRONT</b>  <b>REAR</b> 	The indicator and AF-assist lamps light during movie recording.
<b>FRONT</b>  <b>REAR OFF</b>	The AF-assist lamp lights during movie recording.
<b>FRONT</b>  <b>REAR</b> 	The indicator and AF-assist lamps blink during movie recording.
<b>FRONT</b>  <b>REAR OFF</b>	The AF-assist lamp blinks during movie recording.
<b>FRONT OFF</b> <b>REAR OFF</b>	The indicator and AF-assist lamps remain off during movie recording.



### EDIT/SAVE CUSTOM SETTING

Options are the same as those for still photography, but settings must be adjusted separately ( 74).

### **AUTO UPDATE CUSTOM SETTING**

This item is also found in the photo menu ( 126).

### WIRELESS COMMUNICATION

This item is also found in the photo menu ( 151).

## IMAGE QUALITY SETTING (Movie Recording)

Adjust image quality settings for movies.

To display image quality settings, press **MENU/OK** in the movie shooting display and select the **IQ** (IMAGE QUALITY SETTING) tab.

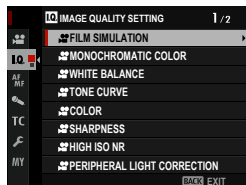

 The options available vary with the shooting mode selected.

### FILM SIMULATION

Options are the same as those for still photography, but settings must be adjusted separately ( 113).

### MONOCHROMATIC COLOR

Options are the same as those for still photography, but settings must be adjusted separately ( 115).

## WHITE BALANCE

Options are the same as those for still photography, but settings must be adjusted separately ( 119).

## TONE CURVE

Options are the same as those for still photography, but settings must be adjusted separately ( 123).

## COLOR

Options are the same as those for still photography, but settings must be adjusted separately ( 123).

## SHARPNESS



Options are the same as those for still photography, but settings must be adjusted separately ( 123).

## HIGH ISO NR

Options are the same as those for still photography, but settings must be adjusted separately ( 124).

## PERIPHERAL LIGHT CORRECTION

Select **ON** to enable peripheral illumination correction during movie recording.

Options	
ON	OFF
 <ul style="list-style-type: none"> <li>If <b>ON</b> is selected when a lens that does not transmit data to the camera is attached, peripheral illumination will be adjusted according to the option selected for  <b>IMAGE QUALITY SETTING</b> &gt;  <b>MOUNT ADAPTER SETTING</b> &gt; <b>PERIPHERAL ILLUMINATION CORRECTION</b> in the shooting menu (📖 129).</li> <li>Select <b>OFF</b> if you notice banding in movies recorded using this option.</li> </ul>	

## MOUNT ADAPTOR SETTING

This item is also found in the photo menus (📖 127). Changes to one apply to the other.

## AF/MF SETTING (Movie Recording)

Adjust focus settings for movies.

To display AF/MF settings, press **MENU/OK** in the movie shooting display and select the **AF/MF** (AF/MF SETTING) tab.

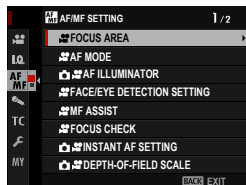

 The options available vary with the shooting mode selected.

### FOCUS AREA

Choose the focus area for autofocus, manual focus, and focus zoom ( 85).

 The focus area for movie recording cannot be resized.

### AF MODE

Choose how the camera selects the focus point for movie recording.

Option	Description
<b>MULTI</b>	The camera selects the focus area automatically.
<b>AREA</b>	The camera focuses on the subject in the selected focus area.

### AF ILLUMINATOR

This item is also found in the photo menus ( 132). Changes to one apply to the other.

## FACE/EYE DETECTION SETTING

Enable or disable Intelligent Face Detection when recording movies.

Option	Description
<b>FACE DETECTION ON</b>	See "FACE/EYE DETECTION SETTING" (📖 133).
<b>OFF</b>	Intelligent Face Detection and eye priority off.

 When Intelligent Face Detection is enabled, the camera will focus using continuous AF even when single AF (**S**) is chosen with the focus mode selector. Intelligent Face Detection is not available in manual focus mode.

## MF ASSIST

Choose how focus is displayed in manual focus mode.

Option	Description
<b>STANDARD</b>	Focus is displayed normally (focus peaking is not available).
<b>FOCUS PEAK HIGHLIGHT</b>	The camera heightens high-contrast outlines. Choose a color and peaking level.

## FOCUS CHECK

Options are the same as those for still photography, but settings must be adjusted separately ( 136).

## INSTANT AF SETTING

This item is also found in the photo menus ( 137). Changes to one apply to the other.

## DEPTH-OF-FIELD SCALE

This item is also found in the photo menus ( 138). Changes to one apply to the other.



## AF RANGE LIMITER

This item is also found in the photo menus ( 139). Changes to one apply to the other.



## TOUCH SCREEN MODE

Choose the shooting operations performed using touch controls.

Mode	Description
 <b>AF</b>	<p>Tapping the display focuses the camera on the selected point. <i>Use the shutter button to start and stop recording.</i></p> <ul style="list-style-type: none"> <li>• In focus mode <b>S</b> (AF-S), you can refocus at any time by tapping your subject in the display.</li> <li>• In focus mode <b>C</b> (AF-C), the camera will continuously adjust focus for changes in the distance to the subject at point selected by tapping the display.</li> <li>• When shooting movies in focus mode <b>M</b> (MF), you can tap the display before recording begins to focus on the selected point using Instant AF, and tap the display during recording to position the focus point.</li> </ul>
 <b>AREA</b>	<p>Tap to position the focus area. <i>Use the shutter button to start and stop recording.</i></p> <ul style="list-style-type: none"> <li>• In focus mode <b>S</b> (AF-S), you can reposition the focus area at any time by tapping your subject in the display. To focus, use the button to which <b>AF-ON</b> is assigned.</li> <li>• In focus mode <b>C</b> (AF-C), the camera will continuously adjust focus for changes in the distance to the subject at point selected by tapping the display.</li> <li>• In manual focus mode (MF), you can tap the display to position the focus area over your subject.</li> </ul>
 <b>OFF</b>	<p>Touch controls disabled.</p>



- To disable touch controls and hide the touch screen mode indicator, select **OFF** for **☑️ BUTTON/DIAL SETTING > TOUCH SCREEN SETTING > 📷 TOUCH SCREEN SETTING**.
- This item is also found in the photo menus (📖 140). Changes to one apply to the other.

### Touch Controls for Focus Zoom

Different touch controls are used during focus zoom (focus check enabled).

#### Central Area

Tapping the center of the display performs the operations below.

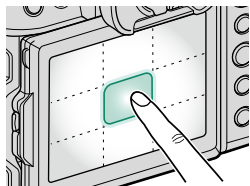

Mode	Operation performed
<b>AF</b>	<b>AF-S:</b> AF
	<b>MF:</b> Instant AF
<b>AREA</b>	<b>AF-S:</b> AF
	<b>MF:</b> Instant AF
<b>OFF</b>	<b>AF-S/MF:</b> OFF

#### Other Areas

Tapping other areas simply scrolls the display, whether during still photography or movie recording and regardless of the option selected for touch screen mode.

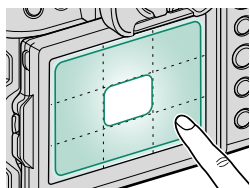

**FOCUS CHECK LOCK**

Choose whether focus zoom remains in effect once movie recording begins.

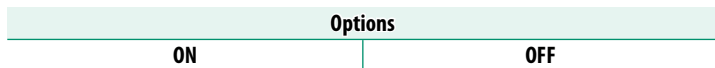

## AUDIO SETTING (Movie Recording)

Adjust settings for audio recorded during filming.

To display audio settings, press **MENU/OK** in the movie shooting display and select the  (**AUDIO SETTING**) tab.

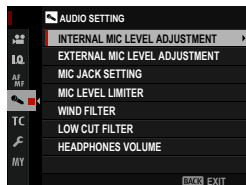

### INTERNAL MIC LEVEL ADJUSTMENT

Adjust the recording level for the built-in microphone.

Option	Description
<b>AUTO</b>	The camera adjusts the recording level automatically.
<b>MANUAL</b>	Adjust the recording level manually. Press the focus stick (focus lever) right to choose from 25 recording levels.
<b>OFF</b>	Turn the built-in microphone off.

### EXTERNAL MIC LEVEL ADJUSTMENT

Adjust the recording level for external microphones.

Option	Description
<b>AUTO</b>	The camera adjusts the recording level automatically.
<b>MANUAL</b>	Adjust the recording level manually. Press the focus stick (focus lever) right to choose from 25 recording levels.
<b>OFF</b>	Disable recording using external microphones.

**MIC JACK SETTING**

Specify the type of hardware connected to the microphone jack.

Option	Description
<b>MIC</b>	Choose this option for direct connection to an external microphone.
<b>LINE</b>	Choose this option for external audio devices connected via line output.

**MIC LEVEL LIMITER**

Reduces distortion caused by input that exceeds the limits of the microphone's audio circuits.

Options	
<b>ON</b>	<b>OFF</b>

**WIND FILTER**

Choose whether to enable wind noise reduction during movie recording.

Options	
<b>ON</b>	<b>OFF</b>

**LOW CUT FILTER**

Choose whether to enable the low-cut filter, reducing low-frequency noise during movie recording.

Options	
<b>ON</b>	<b>OFF</b>

**HEADPHONES VOLUME**

Adjust the headphone volume.

Option	Description
<b>0</b>	Mute output to the headphones.
<b>1—10</b>	Choose a volume of from 1 to 10.

## TIME CODE SETTING (Movie Recording)

Adjust time code (hour, minute, second, and frame number) display settings for movie recording.

To display time code settings, press **MENU/OK** in the movie shooting display and select the **TC** (TIME CODE SETTING) tab.

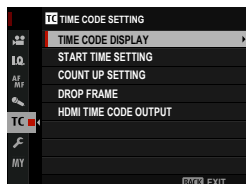

### TIME CODE DISPLAY

Select **ON** to display time codes during movie recording and playback.

Options	
<b>ON</b>	<b>OFF</b>

### START TIME SETTING

Choose the time code starting time.

Option	Description
<b>MANUAL INPUT</b>	Highlight this option and press the focus stick (focus lever) right to choose a start time manually.
<b>CURRENT TIME</b>	Set the start time to the current time.
<b>RESET</b>	Set the start time to 00:00:00.

### COUNT UP SETTING

Choose whether time is clocked continuously or only during movie recording.

Option	Description
<b>REC RUN</b>	Time is clocked only during movie recording.
<b>FREE RUN</b>	Time is clocked continuously.

## DROP FRAME

At frame rates of 29.97P, a discrepancy will gradually develop between the time code (measured in seconds) and the actual recording time (measured in fractions of a second). Choose whether the camera drops frames as necessary to match the recording time to the time code.

Option	Description
ON	The camera drops frames as necessary to maintain a strict match between the time code and the actual recording time.
OFF	Frames are not dropped.

- The time code display varies with the option selected.



TC:00:00:00.00

ON

TC:00:00:00.00

OFF

- Selecting a frame rate of **23.98P** disables frame drop.

## HDMI TIME CODE OUTPUT

Choose whether time codes are output to HDMI devices.

Options	
ON	OFF





# Playback and the Playback Menu

# 7

## The Playback Display

This section lists the indicators that may be displayed during playback.

**!** For illustrative purposes, displays are shown with all indicators lit.

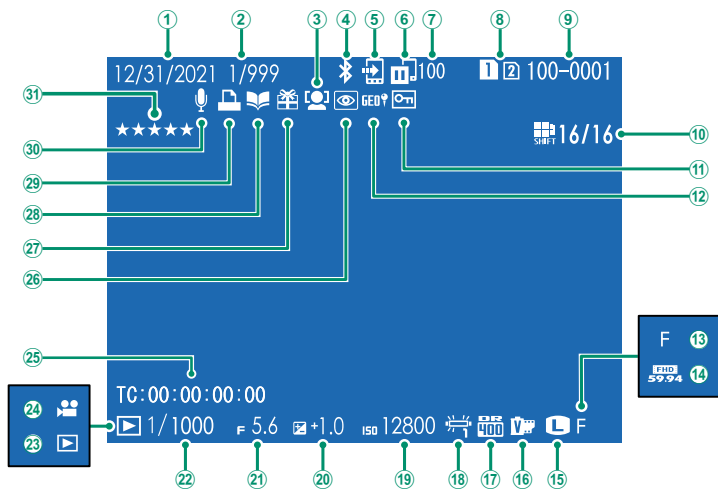

① Date and time.....	46, 48, 205	①7 Dynamic range .....	117
② Frame-number display		①8 White balance .....	119
③ Face detection indicator .....	133	①9 Sensitivity .....	148
④ Bluetooth ON/OFF.....	239	②0 Exposure compensation .....	95
⑤ Image transfer order.....	196	②1 Aperture.....	65, 68, 70
⑥ Image transfer status .....	239, 280	②2 Shutter speed .....	65, 66, 70
⑦ Number of frames selected for upload...	196	②3 Playback mode indicator .....	53
⑧ Card slot.....	183	②4 Movie icon .....	60
⑨ Frame number.....	235	②5 Time code .....	174
⑩ Pixel-shift multi-shot .....	107	②6 Red-eye removal indicator.....	152, 192
⑪ Protected image.....	190	②7 Gift image.....	53
⑫ Location data.....	244, 281	②8 Photobook assist indicator .....	198
⑬ Image quality.....	111	②9 DPOF print indicator.....	200
⑭ Movie mode .....	155	③0 Voice memo .....	193
⑮ Image size.....	110	③1 Rating.....	194
⑯ Film simulation .....	113		

## The DISP/BACK Button

The **DISP/BACK** button controls the display of indicators during playback.

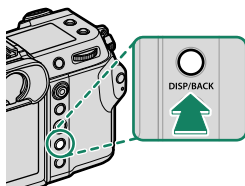

*Standard*



*Information off*

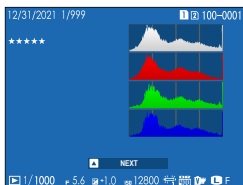
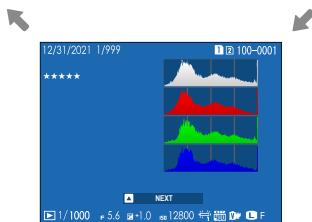

*Info display*

**Viewing Photo Information**

The photo information display changes each time the focus stick (focus lever) is pressed up.

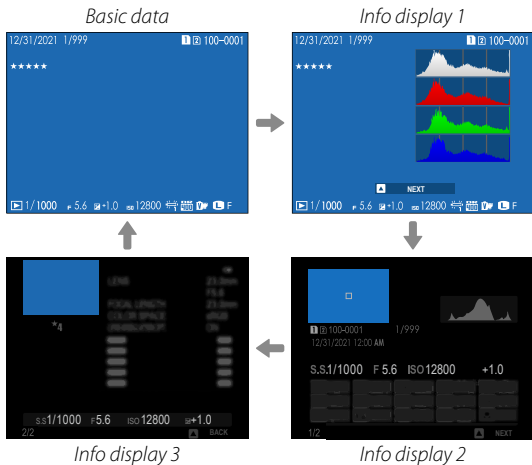
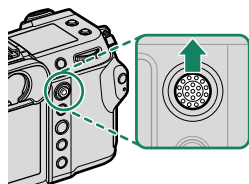
**Zooming in on the Focus Point**

Press the center of the rear command dial to zoom in on the focus point. Press again to return to full-frame playback.

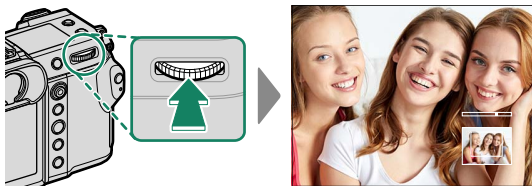

## Viewing Pictures

Read this section for information on playback zoom and multi-frame playback.

Use the rear command dial to go from full-frame playback to playback zoom or multi-frame playback.

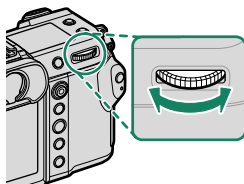

Full-frame playback

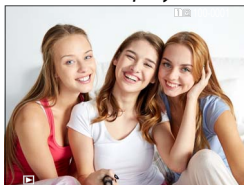

Multi-frame playback



Nine-frame view



Hundred-frame view

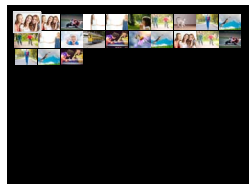

Playback zoom

DISP/BACK  
MENU/OK



Medium zoom



Maximum zoom



## Playback Zoom

Rotate the rear command dial right to zoom in on the current picture, left to zoom out. To exit zoom, press **DISP/BACK**, **MENU/OK**, or the center of the rear command dial.

- The maximum zoom ratio varies with the option selected for **IMAGE QUALITY SETTING > IMAGE SIZE**.
  - Playback zoom is not available with cropped or resized copies saved at a size of **640**.

### Scroll

When the picture is zoomed in, the focus stick (focus lever) can be used to view areas of the image not currently visible in the display.



*Navigation window*

## Multi-Frame Playback

To change the number of images displayed, rotate the rear command dial left when a picture is displayed full frame.

- Use the focus stick (focus lever) to highlight images and press **MENU/OK** to view the highlighted image full frame.
  - In the nine- and hundred-frame displays, press the focus stick up or down to view more pictures.

## The Playback Menu

Adjust playback settings.

The playback menu is displayed when you press **MENU/OK** in playback mode.

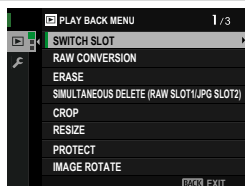

### SWITCH SLOT

Choose the card from which images will be played back.



If two memory cards are inserted, you can press and hold the  button to choose a card for playback.

## RAW CONVERSION

Even if you don't have a computer, you can use the camera to modify RAW pictures and save them in other formats.

### Saving RAW Pictures in Another Format

- 1 Display a RAW picture.
- 2 Highlight **RAW CONVERSION** in the playback menu.
- 3 Press **MENU/OK**.  
A list of settings will be displayed.

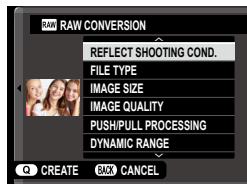

- 4 Press the focus stick (focus lever) up or down to highlight a setting.
- 5 Press the focus stick right to display options.

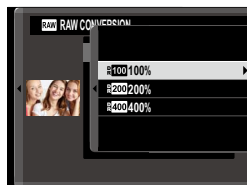

- 6 Press the focus stick up or down to highlight the desired option.
- 7 Press **MENU/OK** to select the highlighted option. The settings list shown in Step 3 will be displayed. Repeat Steps 4 to 7 to adjust additional settings.
- 8 Press the **Q** button.  
A preview of the copy will be displayed.
- 9 Press **MENU/OK**.  
The copy will be saved.

 RAW conversion options can also be displayed by pressing the **Q** button when a RAW picture is displayed during playback.



The settings that can be adjusted when converting pictures from RAW to another format are:

Setting	Description
<b>REFLECT SHOOTING COND.</b>	Create a copy using the settings in effect at the time the photo was taken.
<b>FILE TYPE</b>	Choose a file format.
<b>IMAGE SIZE</b>	Choose an image size.
<b>IMAGE QUALITY</b>	Adjust image quality.
<b>PUSH/PULL PROCESSING</b>	Adjust exposure.
<b>DYNAMIC RANGE</b>	Enhance details in highlights for natural contrast.
<b>D RANGE PRIORITY</b>	Reduce loss of detail in highlights and shadows for natural-looking results when photographing high-contrast scenes.
<b>FILM SIMULATION</b>	Simulate the effects of different types of film.
<b>MONOCHROMATIC COLOR</b>	Choose a monochrome tint for photographs taken using <b>FILM SIMULATION</b> > <b>ACROS</b> and <b>MONOCHROME</b> .
<b>GRAIN EFFECT</b>	Add a film grain effect.
<b>COLOR CHROME EFFECT</b>	Increase the range of tones available for rendering colors that tend to be highly saturated, such as reds, yellows, and greens.
<b>COLOR CHROME FX BLUE</b>	Increase the range of tones available for rendering blues.
<b>SMOOTH SKIN EFFECT</b>	Smooth complexions.
<b>WHITE BALANCE</b>	Adjust white balance.
<b>WB SHIFT</b>	Fine-tune white balance.
<b>TONE CURVE</b>	Adjust highlights and shadows.
<b>COLOR</b>	Adjust color density.
<b>SHARPNESS</b>	Sharpen or soften outlines.
<b>HIGH ISO NR</b>	Process the copy to reduce mottling.
<b>CLARITY</b>	Increase definition.
<b>LENS MODULATION OPTIMIZER</b>	Improve definition by adjusting for diffraction and the slight loss of focus at the periphery of the lens.
<b>COLOR SPACE</b>	Choose the color space used for color reproduction.

 Some settings may be unavailable depending on the options chosen when the picture was taken.

## ERASE

Delete individual pictures, multiple selected pictures, or all pictures.

 Deleted pictures cannot be recovered. Protect important pictures or copy them to a computer or other storage device before proceeding.

Option	Description
<b>FRAME</b>	Delete pictures one at a time.
<b>SELECTED FRAMES</b>	Delete multiple selected pictures.
<b>ALL FRAMES</b>	Delete all unprotected pictures.

## FRAME

- 1 Select **FRAME** for **ERASE** in the playback menu.
- 2 Press the focus stick (focus lever) left or right to scroll through pictures and press **MENU/OK** to delete.

 • A confirmation dialog is not displayed before pictures are deleted; be sure the correct picture is selected before pressing **MENU/OK**.

- Additional pictures can be deleted by pressing **MENU/OK**. Press the focus stick left or right to scroll through pictures and press **MENU/OK** to delete.

## SELECTED FRAMES

- 1 Select **SELECTED FRAMES** for **ERASE** in the playback menu.
- 2 Highlight pictures and press **MENU/OK** to select.
  - Selected pictures are indicated by check marks (☑).
  - To deselect a highlighted picture, press **MENU/OK** again.
- 3 When the operation is complete, press **DISP/BACK** to display a confirmation dialog.
- 4 Highlight **OK** and press **MENU/OK** to delete the selected pictures.



Pictures in photobooks or printer orders are shown by **!**.



## ALL FRAMES

- 1 Select **ALL FRAMES** for **ERASE** in the playback menu.
- 2 A confirmation dialog will be displayed; highlight **OK** and press **MENU/OK** to delete all unprotected pictures.



- Pressing **DISP/BACK** cancels deletion; note that any pictures deleted before the button was pressed cannot be recovered.
- If a message appears stating that the selected images are part of a DPOF print order, press **MENU/OK** to delete the pictures.

## SIMULTANEOUS DELETE(RAW SLOT1/JPG SLOT2)

Taking photos with **RAW/JPEG** selected for  **SAVE DATA SET-UP** >  **CARD SLOT SETTING** creates two copies. Choose whether deleting the RAW image will also delete the JPEG copy.

Option	Description
<b>ON</b>	Deleting the RAW image from the card in Slot 1 also deletes the JPEG copy from the card in Slot 2.
<b>OFF</b>	Deleting the RAW image from the card in Slot 1 does not delete the JPEG copy from the card in Slot 2.

## CROP

Create a cropped copy of the current picture.

- 1 Display the desired picture.
- 2 Select **CROP** in the playback menu.
- 3 Use the rear command dial to zoom in and out and press the focus stick (focus lever) up, down, left, or right to scroll the picture until the desired portion is displayed.
- 4 Press **MENU/OK** to display a confirmation dialog.
- 5 Press **MENU/OK** again to save the cropped copy to a separate file.

-  • The higher the zoom ratio, the smaller the number of pixels in the cropped copy.
- If the size of the final copy will be **640**, **YES** will be displayed in yellow.
- All copies have an aspect ratio of 4:3.

## RESIZE

Create a small copy of the current picture.

---

- 1 Display the desired picture.
- 2 Select **RESIZE** in the playback menu.
- 3 Highlight a size and press **MENU/OK** to display a confirmation dialog.
- 4 Press **MENU/OK** again to save the resized copy to a separate file.



The sizes available vary with the size of the original image.

## PROTECT

Protect pictures from accidental deletion. Highlight one of the following options and press **MENU/OK**.

Option	Description
<b>FRAME</b>	Protect selected pictures. Press the focus stick (focus lever) left or right to view pictures and press <b>MENU/OK</b> to select or deselect. Press <b>DISP/BACK</b> when the operation is complete.
<b>SET ALL</b>	Protect all pictures.
<b>RESET ALL</b>	Remove protection from all pictures.

 Protected pictures will be deleted when the memory card is formatted.

- 
- Protecting images currently selected for upload to paired smart-phones or tablets removes upload marking.
  - Protection can also be added or removed by pressing the **AFON** button during playback.

## IMAGE ROTATE

Rotate pictures.

- 1 Select **ON** for  **SCREEN SET-UP > AUTOROTATE PB.**
- 2 Display the desired picture.
- 3 Select **IMAGE ROTATE** in the playback menu.
- 4 Press the focus stick (focus lever) down to rotate the picture 90° clockwise, up to rotate it 90° counterclockwise.
- 5 Press **MENU/OK**. The picture will automatically be displayed in the selected orientation whenever it is played back on the camera.



- Protected pictures cannot be rotated. Remove protection before rotating pictures.
- The camera may not be able to rotate pictures created with other devices. Pictures rotated on the camera will not be rotated when viewed on a computer or on other cameras.
- Pictures taken with  **SCREEN SET-UP > AUTOROTATE PB** are automatically displayed in the correct orientation during playback.

## RED EYE REMOVAL

Remove red-eye from portraits. The camera will analyze the image; if red-eye is detected, the image will be processed to create a copy with reduced red-eye.

- 1 Display the desired picture.
- 2 Select **RED EYE REMOVAL** in the playback menu.
- 3 Press **MENU/OK**.



- Results vary depending on the scene and the camera's success in detecting faces.
- The amount of time needed to process the image varies with the number of faces detected.
- Red eye cannot be removed from pictures that have already been processed using red-eye removal, which are indicated by a  icon during playback.
- Red eye removal cannot be performed on RAW images.



## VOICE MEMO SETTING

Add a voice memo to the current photograph.

- 1 Select **ON** for **VOICE MEMO SETTING** in the playback menu.
- 2 Display a photo to which you wish to add a voice memo.
- 3 Press and hold the center of the front command dial to record the memo. Recording ends after 30 s or when you release the dial.

-  • The new memo will be recorded over any existing memos.
- Voice memos cannot be added to protected pictures.
- Deleting the picture also deletes the memo.

### Playing Voice Memos

Pictures with voice memos are indicated by  icons during playback.

- To play a memo, select the picture and press the center of the front command dial.
- A progress bar will be displayed while the memo plays back.
- Volume can be adjusted by pressing **MENU/OK** to pause playback and then pressing the focus stick (focus lever) up or down to adjust the volume. Press **MENU/OK** again to resume playback. Volume can also be adjusted using  **SOUND SET-UP > PLAYBACK VOLUME**.

## RATING

### Rate pictures using stars.

- 1 Select **RATING** in the playback menu.
- 2 Rotate the front command dial to choose a picture and the rear command dial to choose a rating of from 0 to 5 stars ("★").



- The focus stick (focus lever) can be used in place of the front command dial to choose a picture.
- The rating dialog can also be displayed by pressing the **AEL** button in single-frame, nine-frame, or hundred-frame playback.
- Use touch controls to zoom in or out.
- Ratings cannot be applied to:
  - Protected pictures
  - Movies
  - "Gift" pictures (pictures taken with other cameras)

**COPY**

Copy pictures between the cards in the first and second slots.

- 1 Select **COPY** in the playback menu.
- 2 Highlight one of the following options.

Option	Description
<b>SLOT1 → SLOT2</b>	Copy pictures from the card in the first slot to the card in the second slot.
<b>SLOT2 → SLOT1</b>	Copy pictures from the card in the second slot to the card in the first slot.

- 3 Press the focus stick (focus lever) right.
- 4 Highlight one of the following options and press **MENU/OK**.

Option	Description
<b>FRAME</b>	Copy selected pictures. Press the focus stick left or right to view pictures and press <b>MENU/OK</b> to copy the current picture.
<b>ALL FRAMES</b>	Copy all pictures.

- ⓘ • Copying ends when the destination is full.
- If you attempt to copy a file over 4 GB in size to a memory card with a capacity of 32 GB or less, copying will end and the file will not be copied.

## IMAGE TRANSFER ORDER

Select photos for upload to a paired smartphone or tablet.

- 1 Select **IMAGE TRANSFER ORDER > SELECT FRAMES** in the playback menu.
- 2 Highlight photos and press **MENU/OK** to select or deselect. Repeat until all the desired photos have been selected.
- 3 Press **DISP/BACK** to exit to playback.



If **ON** is selected for both **CONNECTION SETTING > Bluetooth SETTINGS > Bluetooth ON/OFF** and **AUTO IMAGE TRANSFER**, upload will begin shortly after you exit to playback or turn the camera off.



- Image transfer orders can contain a maximum of 999 pictures.
- The following cannot be selected for upload:
  - Protected pictures
  - Movies
  - RAW images
  - "Gift" pictures (pictures taken with other cameras)
- If **PAIRING/TRANSFER ORDER** is selected for **CONNECTION SETTING > GENERAL SETTINGS > BUTTON SETTING**, photos can also be marked for upload using the button.
- To remove upload marking from all pictures in the current order, select **IMAGE TRANSFER ORDER > RESET ORDER**.
- If **ON** is selected for **CONNECTION SETTING > Bluetooth SETTINGS > AUTO IMAGE TRANSFER**, photos will automatically be marked for upload as they are taken.

## WIRELESS COMMUNICATION



Connect to smartphones running the latest version of the FUJIFILM Camera Remote app. The smartphone can then be used to:

- Control the camera and take pictures remotely
- Receive pictures uploaded from the camera
- Browse the pictures on the camera and download selected pictures
- Upload location data to the camera



• For downloads and other information, visit:



[http://app.fujifilm-dsc.com/en/camera\\_remote/](http://app.fujifilm-dsc.com/en/camera_remote/)

- If **WIRELESS COMMUNICATION** is selected for  **CONNECTION SETTING** > **GENERAL SETTINGS** >  **BUTTON SETTING**, you can connect to the smartphone using the  button.

## PHOTOBOOK ASSIST

Create books from your favorite photos.

### Creating a Photobook

- 1 Select **NEW BOOK** for  **PLAY BACK MENU > PHOTOBOOK ASSIST**.
- 2 Scroll through the images and press the focus stick (focus lever) up to select or deselect. Press **MENU/OK** to exit when the book is complete.
  -  • Neither photographs **640** or smaller nor movies can be selected for photobooks.
  - The first picture selected becomes the cover image. Press the focus stick down to select the current image for the cover instead.
- 3 Highlight **COMPLETE PHOTOBOOK** and press **MENU/OK** (to select all photos for the book, choose **SELECT ALL**). The new book will be added to the list in the photobook assist menu.

-  • Books can contain up to 300 pictures.
- Books that contain no photos are automatically deleted.

## Viewing Photobooks

---

Highlight a book in the photobook assist menu and press **MENU/OK** to display the book, then press the focus stick (focus lever) left or right to scroll through the pictures.

## Editing and Deleting Photobooks

---

Display the photobook and press **MENU/OK**. The following options will be displayed; select the desired option and follow the on-screen instructions.

- **EDIT:** Edit the book as described in “Creating a Photobook”.
- **ERASE:** Delete the book.

## PRINT ORDER (DPOF)

Create a digital “print order” for DPOF-compatible printers.

- 1 Select **PLAY BACK MENU > PRINT ORDER (DPOF)**.
- 2 Select **WITH DATE** to print the date of recording on pictures, **WITHOUT DATE** to print pictures without dates, or **RESET ALL** to remove all pictures from the print order before proceeding.
- 3 Display a picture you wish to include in or remove from the print order.
- 4 Press the focus stick (focus lever) up or down to choose the number of copies (up to 99).

To remove a picture from the order, press the focus stick down until the number of copies is 0.

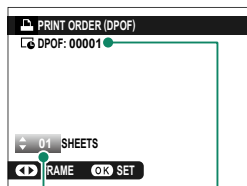

Total number  
of prints

Number of copies

Repeat steps 3–4 to complete the print order.

- 5 The total number of prints is displayed in the monitor. Press **MENU/OK** to exit.

- The pictures in the current print order are indicated by a  icon during playback.
- Print orders can contain a maximum of 999 pictures from a single memory card.
- If a memory card is inserted containing a print order created by another camera, you will need to delete the order before creating as described above.



## instax PRINTER PRINT

To print pictures to optional Fujifilm instax SHARE printers, first select **CONNECTION SETTING** > **instax PRINTER CONNECTION SETTING** and enter the instax SHARE printer name (SSID) and password, then follow the steps below.

- 1 Turn the printer on.
- 2 Select **PLAY BACK MENU** > **instax PRINTER PRINT**. The camera will connect to the printer.



- 3 Use the focus stick (focus lever) to display the picture you want to print, then press **MENU/OK**. The picture will be sent to the printer and printing will start.



- Pictures taken with other cameras cannot be printed.
- The area printed is smaller than the area visible in the LCD monitor.
- The displays may vary depending on the printer connected.

## DISP ASPECT

Choose how High Definition (HD) devices display pictures with an aspect ratio of 4:3 (this option is available only when an HDMI cable is connected).

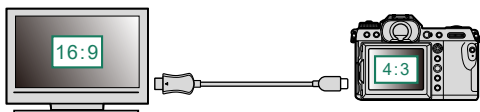

		Option	
		16:9	4:3
Display			

 Select 16:9 to display the image so that it fills the screen with its top and bottom cropped out, 4:3 to display the entire image with black bands at either side.

# The Setup Menus

# 8

## USER SETTING

Adjust basic camera settings.

To access basic camera settings, press **MENU/OK**, select the **[SET UP]** tab, and choose **USER SETTING**.

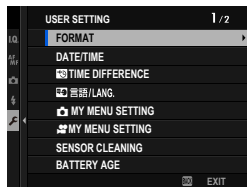



## FORMAT

To format a memory card:

- 1 Select **[USER SETTING] > FORMAT** in the **[SET UP]** tab.
- 2 Highlight the slot containing the card you wish to format and press **MENU/OK**.
- 3 A confirmation dialog will be displayed. To format the memory card, highlight **OK** and press **MENU/OK**.

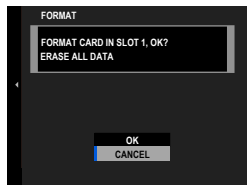
 To exit without formatting the memory card, select **CANCEL** or press **DISP/BACK**.





-  All data—including protected pictures—will be deleted from the memory card. Be sure important files have been copied to a computer or other storage device.
- Do not open the battery-chamber cover during formatting.

 The format menu can also be displayed by pressing the center of the rear command dial while pressing and holding the **[trash]** button.

## DATE/TIME



To set the camera clock:

- 1 Select  **USER SETTING** > **DATE/TIME** in the  (**SET UP**) tab.
- 2 Press the focus stick (focus lever) left or right to highlight the year, month, day, hour, or minute and press up or down to change. To change the order in which the year, month, and day are displayed, highlight the date format and press the focus stick up or down.
- 3 Press **MENU/OK** to set the clock.



## TIME DIFFERENCE

Switch the camera clock instantly from your home time zone to the local time at your destination when traveling. To specify the difference between your local and home time zone:

- 1 Highlight  **LOCAL** and press **MENU/OK**.
- 2 Use the focus stick (focus lever) to choose the time difference between local time and your home time zone. Press **MENU/OK** when settings are complete.

To set the camera clock to local time, highlight  **LOCAL** and press **MENU/OK**. To set the clock to the time in your home time zone, select  **HOME**.



Options	
 <b>LOCAL</b>	 <b>HOME</b>

 If  **LOCAL** is selected,  will be displayed in yellow for about three seconds when the camera is turned on.



## 言語/LANG.

Choose a language.

## MY MENU SETTING

Edit the items listed in the  (MY MENU) tab, a personalized custom menu of frequently-used photo menu options ( 247).

## MY MENU SETTING

Edit the items listed in the  (MY MENU) tab, a personalized custom menu of frequently-used movie menu options ( 247).

## SENSOR CLEANING

Remove dust from the camera image sensor.

Option	Description
<b>OK</b>	Clean the sensor immediately.
<b>WHEN SWITCHED ON</b>	Sensor cleaning will be performed when the camera is turned on.
<b>WHEN SWITCHED OFF</b>	Sensor cleaning will be performed when the camera turns off (sensor cleaning is not however performed if the camera turns off in playback mode).

 Dust that cannot be removed using sensor cleaning can be removed using a blower (📖 312).

## BATTERY AGE

Check battery age. Age is expressed as a number between 0 and 4. The higher the number, the older the battery.

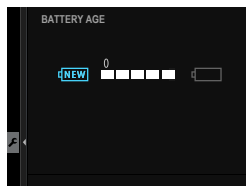

 The older the battery, the faster it loses its charge. We recommend that batteries be replaced as they wear out.

## RESET

Reset shooting or setup menu options to default values.

- 1 Highlight the desired option and press **MENU/OK**.

Option	Description
<b>STILL MENU RESET</b>	Reset all photo menu settings other than custom white balance and custom settings banks created using <b>EDIT/SAVE CUSTOM SETTING</b> to default values.
<b>MOVIE MENU RESET</b>	Reset all movie menu settings other than custom white balance and custom settings banks created using <b>EDIT/SAVE CUSTOM SETTING</b> to default values.
<b>SET-UP RESET</b>	Reset all setup menu settings other than <b>DATE/TIME</b> , <b>TIME DIFFERENCE</b> , <b>COPYRIGHT INFO</b> , and connection-related <b>CONNECTION SETTING</b> options to default values.

- 2 A confirmation dialog will be displayed; highlight **OK** and press **MENU/OK**.

## REGULATORY

To view electronic copies of the product model number, and other certificates, select **USER SETTING > REGULATORY** in the setup menu.



## SOUND SETTING

Make changes to camera sounds.

To access sound settings, press **MENU/OK**, select the **[SET UP]** tab, and choose **SOUND SET-UP**.

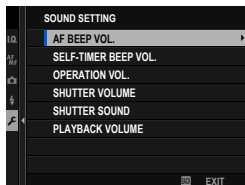

### AF BEEP VOL.

Choose the volume of the beep that sounds when the camera focuses. The beep can be muted by selecting **[OFF]**.

#### Options

**[Speaker icon]** (high)

**[Speaker icon]** (medium)

**[Speaker icon]** (low)

**[OFF]** (mute)

### SELF-TIMER BEEP VOL.

Choose the volume of the beep that sounds while the self-timer is active. The beep can be muted by selecting **[OFF]**.

#### Options

**[Speaker icon]** (high)

**[Speaker icon]** (medium)

**[Speaker icon]** (low)

**[OFF]** (mute)

**OPERATION VOL.**

Adjust the volume of the sounds produced when camera controls are operated. Choose OFF to disable control sounds.

**Options** (high) (medium) (low)OFF (mute)**SHUTTER VOLUME**

Adjust the volume of the sounds produced by the electronic shutter. Choose OFF to disable the shutter sound.

**Options** (high) (medium) (low)OFF (mute)**SHUTTER SOUND**

Choose the sound made by the electronic shutter.

**Options** 1 SOUND 1 2 SOUND 2 3 SOUND 3**PLAYBACK VOLUME**

Adjust the volume for movie playback.

**Options**

0

1

2

3

4

5

6

7

8

9

10

## SCREEN SETTING

Make changes to display settings.

To access display settings, press **MENU/OK**, select the **SET UP** tab, and choose **SCREEN SET-UP**.

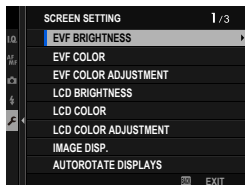

### EVF BRIGHTNESS

Adjust the brightness of the display in the electronic viewfinder.

Option	Description
<b>AUTO</b>	Automatic brightness adjustment.
<b>MANUAL</b>	Adjust brightness manually; choose from options between $-7$ and $+5$ .

### EVF COLOR

Adjust the saturation of the display in the electronic viewfinder.

Options										
-5	-4	-3	-2	-1	0	+1	+2	+3	+4	+5

### EVF COLOR ADJUSTMENT

Adjust the color of the display in the electronic viewfinder.

- 1 Adjust colors using the focus stick (focus lever).

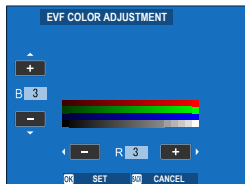

- 2 Press **MENU/OK**.

## LCD BRIGHTNESS

Adjust monitor brightness.

Options										
-5	-4	-3	-2	-1	0	+1	+2	+3	+4	+5

## LCD COLOR

Adjust monitor saturation.

Options										
-5	-4	-3	-2	-1	0	+1	+2	+3	+4	+5

## LCD COLOR ADJUSTMENT

Adjust the color of the display in the LCD monitor.

- 1 Adjust colors using the focus stick (focus lever).
- 2 Press **MENU/OK**.

**IMAGE DISP.**

Choose how long images are displayed after shooting.

Option	Description
<b>CONTINUOUS</b>	Pictures are displayed until the <b>MENU/OK</b> button is pressed or the shutter button is pressed halfway. To zoom in on the active focus point, press the center of the rear command dial; press again to cancel zoom.
<b>1.5 SEC</b>	Pictures are displayed for the selected time or until the shutter button is pressed halfway.
<b>0.5 SEC</b>	
<b>OFF</b>	Pictures are not displayed after shooting.



- Colors may differ slightly from those in the final image.
- “Noise” mottling may be visible at high sensitivities.

**AUTOROTATE DISPLAYS**

Choose whether the indicators in the viewfinder and LCD monitor rotate to match camera orientation.

Options	
<b>ON</b>	<b>OFF</b>

## PREVIEW EXP./WB IN MANUAL MODE

Choose whether to enable exposure and/or white balance preview in manual exposure mode.

Option	Description
<b>PREVIEW EXP./WB</b>	Enable exposure and white balance preview.
<b>PREVIEW WB</b>	Preview white balance only. Choose this option in situations in which exposure and white balance are likely to change during shooting, as may be the case when you use a flash with an incandescent monitoring lamp.
<b>OFF</b>	Disable exposure and white balance preview. Choose this option when using a flash or on other occasions on which exposure may change when the picture is taken.

## NATURAL LIVE VIEW

Choose whether the effects of film simulation, white balance, and other settings are visible in the monitor.

Option	Description
<b>ON</b>	The effects of camera settings are not visible in the monitor, but shadows in low-contrast, back-lit scenes and other hard-to-see subjects more visible. Colors and tone will differ from those in the final picture. The display will however be adjusted to show the effects of monochrome and sepia settings.
<b>OFF</b>	The effects of film simulation, white balance, and other settings can be previewed in the monitor.

## FRAMING GUIDELINE

Choose a framing grid for shooting mode.

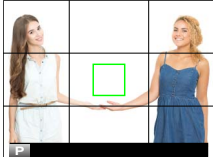
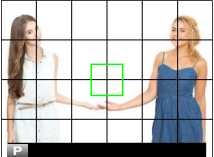
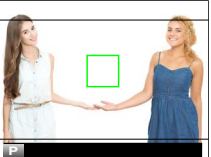
			Option		
			GRID 9	GRID 24	HD FRAMING
Display					
	<i>For "rule of thirds" composition.</i>	<i>A six-by-four grid.</i>	<i>Frame HD pictures in the crop shown by the lines at the top and bottom of the display.</i>		

 Framing guides are not shown at default settings but can be displayed using **SCREEN SET-UP > DISP. CUSTOM SETTING** (📖 20).

## AUTOROTATE PB

Choose **ON** to automatically rotate “tall” (portrait-orientation) pictures during playback.

Options	
<b>ON</b>	<b>OFF</b>

## PLAYBACK MAGNIFICATION

Choose the zoom ratio selected when the center of the rear command dial is pressed during playback.

Option	Description
<b>2x (FROM CENTER)</b>	View the center area of the picture at the selected zoom ratio. Regardless of the setting selected, pictures will not be displayed at greater than actual size.
<b>4x (FROM CENTER)</b>	
<b>8x (FROM CENTER)</b>	
<b>ACTUAL SIZE (FROM FOCUS POINT)</b>	View the picture at actual size, centered on the focus area. The zoom ratio varies with the size of the image.
<b>PREVIOUS MAG. (FROM CENTER)</b>	Display each picture at the same zoom ratio as the previous picture, starting at the center of the image. Pictures will not, however, be displayed at greater than actual size.

## FOCUS SCALE UNITS

Choose the units used for the focus distance indicator.

Options	
<b>METERS</b>	<b>FEET</b>



## DUAL DISPLAY SETTING

Choose the content of the two windows in the dual display.

Option	Description
<b>R:FOCUS L:FRAME</b>	The right (small) window shows a close-up of the focus area, while the left (large) window shows the entire frame.
<b>R:FRAME L:FOCUS</b>	The right (small) window shows the entire frame, while the left (large) window shows a close-up of the focus area.

## DISP. CUSTOM SETTING

Choose the items shown in the standard indicator display (📖 20).

## LARGE INDICATORS MODE(EVF)

Select **ON** to display large indicators in the electronic viewfinder. The indicators displayed can be selected using **SCREEN SET-UP > LARGE INDICATORS DISP. SETTING**.

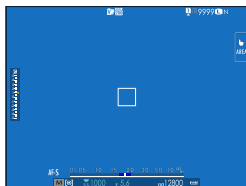

**OFF**

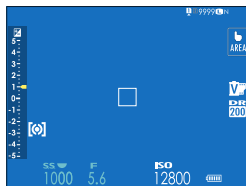

**ON**

! Some icons are not displayed when **ON** is selected for **LARGE INDICATORS MODE(EVF)** (13).

☑ If **LARGE INDICATORS MODE** is assigned to a function button, the button can be used to toggle **LARGE INDICATORS MODE** on (**ON**) and off (**OFF**) (255).

## LARGE INDICATORS MODE(LCD)

Select **ON** to display large indicators in the LCD monitor. The indicators displayed can be selected using **SCREEN SET-UP > LARGE INDICATORS DISP. SETTING**.



**OFF**

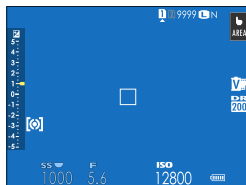

**ON**

! Some icons are not displayed when **ON** is selected for **LARGE INDICATORS MODE(LCD)** (15).

☑ If **LARGE INDICATORS MODE** is assigned to a function button, the button can be used to toggle **LARGE INDICATORS MODE** on (**ON**) and off (**OFF**) (255).

## LARGE INDICATORS DISP. SETTING

Choose the indicators displayed when **ON** is selected for **SCREEN SET-UP > LARGE INDICATORS MODE(EVF)** or **LARGE INDICATORS MODE(LCD)**.

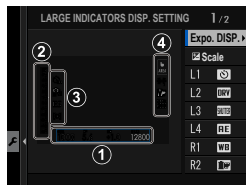

Option	Description
① <b>Expo. DISP.</b>	Choose the items listed at the bottom of the display. Selected items are indicated by check marks (☑); to deselect, highlight the check marks and press <b>MENU/OK</b> .
② <b>Scale</b>	Select <b>ON</b> to display the exposure indicator.
③ <b>L1, L2, L3, L4</b>	Choose up to four large icons for display on the left side of the screen.
④ <b>R1, R2, R3, R4</b>	Choose up to four large icons for display on the right side of the screen.

## INFORMATION CONTRAST ADJ.

Adjust display contrast.

Option	Description
<b>HIGH CONTRAST</b>	High contrast.
<b>STANDARD</b>	Normal contrast.
<b>LOW CONTRAST</b>	Low contrast.
<b>DARK AMBIENT LIGHTING</b>	Contrast adjusted for dim ambient lighting.

## SUB MONITOR SETTING

Choose the indicators displayed in the secondary LCD monitor. Separate displays are available for still photography and movie recording. Choose from the following:

Option	Description
<b>INFORMATION</b>	Display camera settings. You can choose the settings displayed.
<b>DIALS</b>	Display dials showing ISO sensitivity and shutter speed.
<b>HISTOGRAM</b>	Display a histogram.

 You can switch between displays by pressing the secondary LCD monitor mode button.

### The INFORMATION Display

Follow the steps below to choose the indicators shown in the INFORMATION display.

- 1 Select  **SCREEN SET-UP > SUB MONITOR SETTING** in the setup menu.
- 2 Highlight **STILL MODE** or **MOVIE MODE** and press **MENU/OK**.
- 3 Highlight **INFORMATION** and press **MENU/OK**.

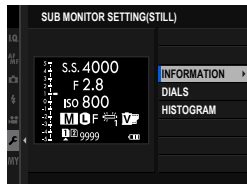

#### 4 Highlight the indicator you wish to change and press **MENU/OK**.

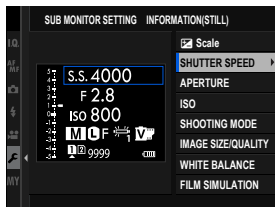

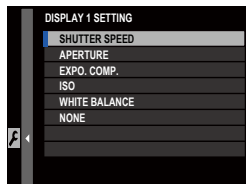

#### 5 Highlight the indicator you wish to display and press **MENU/OK**.



#### Choose from:

- SHUTTER SPEED
- APERTURE
- EXPO. COMP.
- ISO
- MOVIE MODE
- SHOOTING MODE
- PHOTOMETRY
- DRIVE MODE
- FOCUS MODE
- WHITE BALANCE
- IMAGE SIZE/QUALITY
- SHUTTER TYPE
- FILM SIMULATION
- DYNAMIC RANGE
- 35mm FORMAT MODE
- DUAL IS MODE
- SELF-TIMER
- NONE

## 6 Repeat Steps 4 and 5 to change additional indicators.

 The  **Scale** indicator can only be enabled or disabled.

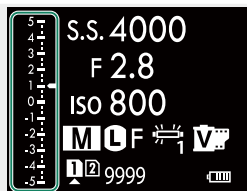

 *Scale*

## SUB MONITOR BACKGROUND COLOR

Adjusting the background color of the secondary LCD monitor according to lighting conditions makes the display easier to read.

Option	Description
<b>BLACK</b>	Recommended for use with dark ambient lighting.
<b>WHITE</b>	Recommended for use with bright ambient lighting.

 The background is displayed in white when the secondary LCD monitor backlight is on.

**📷 Q MENU BACKGROUND**

Choose the background color used for the quick menu when it is displayed during still photography.

Options	
<b>TRANSPARENT</b>	<b>BLACK</b>

**🎥 Q MENU BACKGROUND**

Choose the background color used for the quick menu when it is displayed during movie recording.

Options	
<b>TRANSPARENT</b>	<b>BLACK</b>

## BUTTON/DIAL SETTING

Access options for camera controls.

To access control options, press **MENU/OK**, select the **SET UP** tab, and choose **BUTTON/DIAL SETTING**.

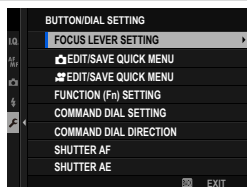

## FOCUS LEVER SETTING

Choose the functions performed by the focus stick (focus lever).

Option	Description
<b>LOCK (OFF)</b>	The focus stick cannot be used during shooting.
<b>PUSH  TO UNLOCK</b>	Press the stick to view the focus-point display and tilt the stick to select a focus point.
<b>ON</b>	Tilt the stick to view the focus-point display and select a focus point.

## EDIT/SAVE QUICK MENU

Choose the items displayed in the quick menu during still photography ( 249).

## EDIT/SAVE QUICK MENU

Choose the items displayed in the quick menu when filming movies ( 249).



## FUNCTION (Fn) SETTING

Choose the roles played by the function buttons (📖 255).

## COMMAND DIAL SETTING

Choose the roles played by the command dials.

Option	Description
<b>FRONT COMMAND DIAL 1</b>	Assign shutter speed ( <b>S.S. (PROGRAM SHIFT)</b> ) or aperture ( <b>APERTURE</b> )* to <b>FRONT COMMAND DIAL 1</b> .
<b>FRONT COMMAND DIAL 2</b>	Assign shutter speed ( <b>S.S. (PROGRAM SHIFT)</b> ), aperture ( <b>APERTURE</b> )*, sensitivity ( <b>ISO</b> ), or no role ( <b>NONE</b> ) to <b>FRONT COMMAND DIAL 2</b> or <b>FRONT COMMAND DIAL 3</b> .
<b>FRONT COMMAND DIAL 3</b>	
<b>REAR COMMAND DIAL</b>	Assign shutter speed ( <b>S.S. (PROGRAM SHIFT)</b> ), aperture ( <b>APERTURE</b> )*, sensitivity ( <b>ISO</b> ), or no role ( <b>NONE</b> ) to the rear command dial.
<b>EXP. COMPENSATION ASSIGNMENT</b>	Exposure compensation can be adjusted using either or both of the front and rear command dials while the  (exposure compensation) button is pressed.

\* Aperture ring rotated to **A** or **C** in mode **A** (aperture-priority AE) or **M** (manual).

-  • **COMMAND DIAL SETTING** can also be accessed by pressing and holding the center of the front command dial.
- You can also press the center of the front command dial to cycle through settings in the order **FRONT COMMAND DIAL 1**, **FRONT COMMAND DIAL 2**, and **FRONT COMMAND DIAL 3**.

## COMMAND DIAL DIRECTION

Choose the direction in which the command dials are rotated to choose values. Settings for the front and rear command dials can be adjusted separately.

Option	Description
- ----- +	Rotate the dial right for higher values or to move to the next item.
+ ----- -	Rotate the dial left for higher values or to move to the next item.

## SHUTTER AF

Choose whether the camera focuses when the shutter button is pressed halfway.

Option	Description
<b>AF-S</b>	<ul style="list-style-type: none"><li>• <b>ON</b>: Focus locks when the shutter button is pressed halfway.</li><li>• <b>OFF</b>: No focus operation is performed when the shutter button is pressed halfway.</li></ul>
<b>AF-C</b>	<ul style="list-style-type: none"><li>• <b>ON</b>: The camera focuses while the shutter button is pressed halfway.</li><li>• <b>OFF</b>: No focus operation is performed when the shutter button is pressed halfway.</li></ul>

## SHUTTER AE

If **ON** is selected, exposure will lock while the shutter button is pressed halfway. The setting for focus mode **C** (AF-C) can be adjusted separately from that for modes **S** (AF-S) and **M** (manual focus).

Options	
<b>ON</b>	<b>OFF</b>

 Select **OFF** to allow the camera to adjust exposure before each shot taken in burst mode.

## SHOOT WITHOUT LENS

Choose **ON** to enable the shutter release when no lens is attached.

Options	
<b>ON</b>	<b>OFF</b>



## SHOOT WITHOUT CARD

Choose whether the shutter can be released without a memory card inserted in the camera.

Option	Description
<b>ON</b>	When no memory card is inserted, the shutter can be released to test camera function and the shooting and setup menus can be displayed.
<b>OFF</b>	The shutter is disabled if no memory card is inserted, preventing accidental loss of pictures taken without a memory card.

## FOCUS RING

Choose the direction in which the focus ring is rotated to increase the focus distance.

Options	
 <b>CW</b> (clockwise)	 <b>CCW</b> (counterclockwise)

## FOCUS RING OPERATION

Choose how the camera adjusts focus in response to the movement of the focus ring.

Option	Description
<b>NONLINEAR</b>	Focus is adjusted at the same rate as the ring is rotated.
<b>LINEAR</b>	Focus is adjusted linearly according to the amount the ring is rotated, but the focusing speed is unaffected by the speed the ring is rotated.

## AE/AF-LOCK MODE

This option determines the behavior of the button to which exposure and/or focus lock is assigned.

Option	Description
<b>AE&amp;AF ON WHEN PRESSING</b>	Exposure and/or focus will lock while the button is pressed.
<b>AE&amp;AF ON/OFF SWITCH</b>	Exposure and/or focus will lock when the button is pressed and remain locked until it is pressed again.

## AWB-LOCK MODE

Choose the behavior of function buttons assigned auto white balance (AWB) lock. Auto white balance lock is used to lock white balance at the value metered by the camera when **WB AUTO WHITE PRIORITY, AUTO,** or **WB AUTO AMBIENCE PRIORITY** is selected for white balance.

Option	Description
<b>AWB ON WHEN PRESSING</b>	Auto white balance locks while the button is pressed.
<b>AWB ON/OFF SWITCH</b>	Press the button once to lock auto white balance and again to end the lock.

## EXPO. COMP. BUTTON SETTING

Control the behavior of the rear command dial and the button to which exposure compensation is assigned. If **ON WHEN PRESSING** is selected, exposure compensation can be adjusted by holding the button while rotating dial; if **ON/OFF SWITCH** is selected, exposure compensation can be set by pressing the button once, rotating the dial, and then pressing the button again.

Options	
<input checked="" type="checkbox"/> <b>ON WHEN PRESSING</b>	<input checked="" type="checkbox"/> <b>ON/OFF SWITCH</b>

## TOUCH SCREEN SETTING

Enable or disable touch-screen controls.

### TOUCH SCREEN SETTING

Option	Description
<b>ON</b>	The LCD monitor functions as a touch screen during shooting.
<b>OFF</b>	Touch controls disabled.

### DOUBLE TAP SETTING

Option	Description
<b>ON</b>	Tap the LCD monitor twice to zoom in on your subject during shooting.
<b>OFF</b>	Touch zoom disabled.

### TOUCH FUNCTION







Option	Description
<b>ON</b>	Enable touch-function gestures.
<b>OFF</b>	Disable touch-function gestures.

### TOUCH SCREEN SETTING

Option	Description
<b>ON</b>	The LCD monitor functions as a touch screen during playback.
<b>OFF</b>	Touch controls disabled.

## EVF TOUCH SCREEN AREA SETTINGS

Select the area of the LCD monitor used for touch controls while the viewfinder is active. The area used for touch controls can be selected from:

Option	Description
	All.
	Right half.
	Top right quarter.
	Bottom right quarter.
	Left half.
	Top left quarter.
	Bottom left quarter.
<b>OFF</b>	Touch controls disabled.

## LOCK

Lock selected controls to prevent unintended operation.

Option	Description
<b>LOCK SETTING</b>	Choose from the following: <ul style="list-style-type: none"> <li>• <b>UNLOCK</b>: Reset lock options.</li> <li>• <b>ALL FUNCTION</b>: Lock all controls in the <b>FUNCTION SELECTION</b> list.</li> <li>• <b>SELECTED FUNCTION</b>: Lock only the controls selected in the <b>FUNCTION SELECTION</b> list.</li> </ul>
<b>FUNCTION SELECTION</b>	Choose the controls locked when <b>SELECTED FUNCTION</b> is chosen for <b>LOCK SETTING</b> .

 The controls selected using **SELECTED FUNCTION** can be locked at any time during shooting by pressing and holding **MENU/OK**. To unlock the controls, press and hold the button again.



## POWER MANAGEMENT

Adjust power management settings.

To access power management settings, press **MENU/OK**, select the **SET UP** tab, and choose **POWER MANAGEMENT**.

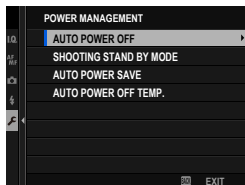

### AUTO POWER OFF

Choose the length of time before the camera turns off automatically when no operations are performed. Shorter times increase battery life; if **OFF** is selected, the camera must be turned off manually.

Options					
5 MIN	2 MIN	1 MIN	30 SEC	15 SEC	OFF

## SHOOTING STAND BY MODE

Choose the delay before the camera enters shooting standby mode.

Option	Description
<b>5 MIN</b>	The camera will suspend all functions and enter power-saving (standby) mode if no operations are performed for the selected period. To exit shooting standby mode, press the <b>MENU/OK</b> button or another control.
<b>2 MIN</b>	
<b>1 MIN</b>	
<b>30 SEC</b>	
<b>15 SEC</b>	
<b>OFF</b>	Shooting standby mode disabled.

## AUTO POWER SAVE

If **ON** is selected, the display frame rate will drop to save power if no operations are performed for a short period, but the normal frame rate can be restored by operating camera controls.

Options	
<b>ON</b>	<b>OFF</b>

## AUTO POWER OFF TEMP.

If its temperature rises beyond a certain point, the camera will first display a message and then, if the temperature rise continues, automatically end shooting and power down. Choose the temperature at which the camera turns off automatically.

Option	Description
<b>STANDARD</b>	The camera turns off automatically when its temperature reaches the <b>STANDARD</b> value.
<b>HIGH</b>	Shooting can continue at temperatures higher than the <b>STANDARD</b> value, extending the time available to record movies and the like. Because remaining in contact with the camera at these high temperatures could result in low-temperature burns, this option should only be used after mounting the camera on a tripod or taking other steps to avoid prolonged contact with the camera.

## SAVE DATA SETTING

Make changes to file management settings.

To access file management settings, press **MENU/OK**, select the **⌘ (SET UP)** tab, and choose **SAVE DATA SET-UP**.

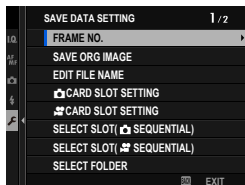

### FRAME NO.

New pictures are stored in image files named using a four-digit file number assigned by adding one to the last file number used. The file number is displayed during playback as shown. **FRAME NO.** controls whether file numbering is reset to 0001 when a new memory card is inserted or the current memory card is formatted.

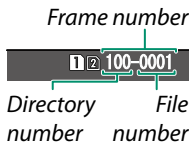

Option	Description
<b>CONTINUOUS</b>	Numbering continues from the last file number used or the first available file number, whichever is higher. Choose this option to reduce the number of pictures with duplicate file names.
<b>RENEW</b>	Numbering is reset to 0001 after formatting or when a new memory card is inserted.

- If the frame number reaches 999-9999, the shutter release will be disabled. Turn the camera off and insert a formatted memory card before resuming shooting.
- Selecting **⌘ USER SETTING > RESET** sets **FRAME NO.** to **CONTINUOUS** but does not reset the file number.
- Frame numbers for pictures taken with other cameras may differ.

## SAVE ORG IMAGE

Choose **ON** to save unprocessed copies of pictures taken using **RED EYE REMOVAL**.

Options	
<b>ON</b>	<b>OFF</b>

## EDIT FILE NAME

Change the file name prefix. sRGB images use a four-letter prefix (default "DSCF"), Adobe RGB images a three-letter prefix ("DSF") preceded by an underscore.

Option	Default prefix	Sample file name
sRGB	DSCF	ABCD0001
AdobeRGB	_DSF	_ABC0001

## 📷 CARD SLOT SETTING

Choose the role played by the card in the second slot.

Option	Description
<b>SEQUENTIAL</b>	The card in the second slot is used only when the card in the first slot is full.
<b>BACKUP</b>	Each picture is recorded twice, once to each card.
<b>RAW / JPEG</b>	RAW pictures will be saved to the card in the first slot and JPEG pictures to the card in the second slot. This option only takes effect when <b>SUPER FINE+RAW</b> , <b>FINE+RAW</b> or <b>NORMAL+RAW</b> is selected for <b>📷 IMAGE QUALITY SETTING &gt; IMAGE QUALITY</b> .

## CARD SLOT SETTING

Choose the role played by the card in the second slot.

Option	Description
<b>SEQUENTIAL</b>	The card in the second slot is used only when the card in the first slot is full.
<b>BACKUP</b>	Each picture is recorded twice, once to each card.

-  • The current movie mode applies to both copies; settings for backup copies cannot be adjusted separately.
- Backup recording may not be available with movies, depending on the option selected for movie mode.

### SELECT SLOT( SEQUENTIAL)

Choose the card that is recorded to first when **SEQUENTIAL** is selected for  **CARD SLOT SETTING**.

Options	
<b>SLOT 1</b>	<b>SLOT 2</b>

### SELECT SLOT( SEQUENTIAL)

Choose the card that is recorded to first when **SEQUENTIAL** is selected for  **CARD SLOT SETTING**.

Options	
<b>SLOT 1</b>	<b>SLOT 2</b>

## SELECT FOLDER

Create folders and choose the folder used to store subsequent pictures.

Option	Description
<b>SELECT FOLDER</b>	To choose the folder in which subsequent pictures will be stored, press the focus stick (focus lever) up or down to highlight an existing folder and press <b>MENU/OK</b> .
<b>CREATE FOLDER</b>	Enter a five-character folder name. The new folder will be created with the next picture you take and subsequent pictures will be stored in that folder.

## COPYRIGHT INFO

Copyright information, in the form of Exif tags, can be added to new images as they are taken. Changes to copyright information are reflected only in images taken after the changes are made.

Option	Description
<b>DISP COPYRIGHT INFO</b>	View the current copyright information.
<b>ENTER AUTHOR'S INFO</b>	Enter the creator's name.
<b>ENTER COPYRIGHT INFO</b>	Enter the name of the copyright holder.
<b>DELETE COPYRIGHT INFO</b>	Delete the current copyright information. This change applies only to images taken after this option is selected; copyright information recorded with existing images is not affected.

## CONNECTION SETTING

Adjust settings for connection to other devices.

To access connection settings, press **MENU/OK**, select the **SET UP** tab, and choose **CONNECTION SETTING**.

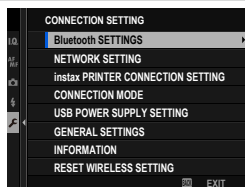

For more information on wireless connections, visit:  
<http://fujifilm-dsc.com/wifi/>

### Bluetooth SETTINGS

Adjust Bluetooth settings.

Option	Description
<b>PAIRING REGISTRATION</b>	Pair the camera with a smartphone running the FUJIFILM Camera Remote app.
<b>SELECT PAIRING DESTINATION</b>	Choose a connection from a list of devices with which the camera has been paired using <b>PAIRING REGISTRATION</b> . Select <b>NO CONNECTION</b> to exit without connecting.
<b>DELETE PAIRING REG.</b>	Delete pairing information for selected devices. Choose the device in the device list. The selected device will also be removed from the devices listed in <b>SELECT PAIRING DESTINATION</b> .
<b>Bluetooth ON/OFF</b>	<ul style="list-style-type: none"><li>• <b>ON</b>: The camera automatically establishes a Bluetooth connection with paired devices when turned on.</li><li>• <b>OFF</b>: The camera does not connect via Bluetooth.</li></ul>
<b>AUTO IMAGE TRANSFER</b>	<ul style="list-style-type: none"><li>• <b>ON</b>: Mark photos for upload as they are taken. Mark JPEG photos for upload as they are taken.</li><li>• <b>OFF</b>: Photos are not marked for upload as they are taken.</li></ul>
<b>SMARTPHONE SYNC. SETTING</b>	Choose whether to synchronize the camera to the time and/or location provided by a paired smartphone. <ul style="list-style-type: none"><li>• <b>LOCATION&amp;TIME</b>: Synchronize the time and location.</li><li>• <b>LOCATION</b>: Synchronize the location.</li><li>• <b>TIME</b>: Synchronize the time.</li><li>• <b>OFF</b>: Synchronization off.</li></ul>



- Install the latest version of the FUJIFILM Camera Remote app on your smartphone or tablet before pairing the device with your camera or uploading images.
- When **ON** is selected for both **Bluetooth ON/OFF** and **AUTO IMAGE TRANSFER** or images are currently selected for upload using the **IMAGE TRANSFER ORDER** option in the  (playback) menu, upload to paired devices will begin shortly after you exit to playback or turn the camera off. **IMAGE TRANSFER ORDER** can also be used to select pictures for upload when **AUTO IMAGE TRANSFER** is off.

## NETWORK SETTING

Adjust settings for connection to wireless networks.

Option	Description
<b>WIRELESS ACCESS POINT SETTING</b>	<ul style="list-style-type: none"><li>• <b>SIMPLE SETUP:</b> Connect to an access point using simple settings.</li><li>• <b>MANUAL SETUP:</b> Manually adjust settings for connection to a wireless network. Choose the network from a list (<b>SELECT FROM NETWORK LIST</b>) or enter the name manually (<b>ENTER SSID</b>).</li></ul>
<b>WIRELESS IP ADDRESS SETTING</b>	<ul style="list-style-type: none"><li>• <b>AUTO:</b> The IP address is assigned automatically.</li><li>• <b>MANUAL:</b> Assign an IP address manually. Manually choose the IP address (<b>IP ADDRESS</b>), network mask (<b>NETMASK</b>), and gateway address (<b>GATEWAY ADDRESS</b>).</li></ul>









## CONNECTION MODE

Adjust settings for connection to external devices.

Option	Description
<b>USB CARD READER</b>	Connecting the camera to a computer via USB automatically enables data transfer mode, allowing data to be copied to the computer. The camera functions normally when not connected.
<b>USB TETHER SHOOTING AUTO</b>	<p>The camera can be controlled from computers, gimbals, drones, or other devices connected via USB. The camera automatically enters “tethered shooting” (i.e., remote-control) mode when the external device is turned on and returns to normal operation when the external device turned off or disconnected.</p> <ul style="list-style-type: none"><li>• Photographs can be taken remotely and automatically downloaded to computers running Capture One, Adobe® Photoshop® Lightroom® + Tether Plugin, FUJIFILM X Acquire, or FUJIFILM Pixel Shift Combiner. FUJIFILM X Acquire can also be used to save and load camera settings.</li><li>• The camera can be used as a webcam when connected to a computer running FUJIFILM X Webcam.</li><li>• Remote photography and movie recording are available when the camera is connected to a compatible device such as a gimbal or drone. Use camera controls to switch between still photography and movie recording. The features available vary with the device connected.</li></ul>
<b>USB TETHER SHOOTING FIXED</b>	As for <b>USB TETHER SHOOTING AUTO</b> , except that the camera remains in “tethered shooting” (remote-control) mode when the external device is off or not connected, allowing the device to resume control when the connection is re-established after an accidental disconnection or other disruption. At default settings, pictures are not recorded to the memory card.

Option	Description
<b>WIRELESS TETHER SHOOTING FIXED</b>	Choose this option for wireless remote photography. Select a network using  <b>CONNECTION SETTING &gt; NETWORK SETTING</b> .
<b>USB RAW CONV./BACKUP RESTORE</b>	Connecting the camera to a computer via USB automatically enables USB RAW conversion/backup restore mode. The camera functions normally when not connected. <ul style="list-style-type: none"> <li>• <b>USB RAW CONV. (requires FUJIFILM X RAW STUDIO)</b>: Use the camera's image processing engine to rapidly convert RAW files to other formats while maintaining image quality.</li> <li>• <b>BACKUP RESTORE (requires FUJIFILM X Acquire)</b>: Save and load camera settings. Reconfigure the camera in an instant or share settings with other cameras of the same type.</li> </ul>

  **POWER MANAGEMENT > AUTO POWER OFF** settings also apply during tethered shooting. To prevent the camera turning off automatically, select **OFF** for **AUTO POWER OFF**.

 For information on compatible computer software, see "Software for Use with Your Camera" (📖 298).

## USB POWER SUPPLY SETTING

Choose whether power is supplied to the camera when it is connected to a computer or other device via a USB cable.







Option	Description
<b>ON</b>	The camera draws power from the connected device, reducing the drain on the camera battery.
<b>OFF</b>	The camera does not draw power from the connected device.

 The camera cannot draw power from Lightning connections or from devices that do not supply power. Select **OFF** before connecting the camera to such devices. The connection may not be available for data transfer or the like when **ON** is selected.

 Regardless of the option selected, the battery will charge while the camera is off.

## GENERAL SETTINGS

Adjust settings for connection to wireless networks.

Option	Description
<b>NAME</b>	Choose a name ( <b>NAME</b> ) to identify the camera on the wireless network (the camera is assigned a unique name by default).
<b>RESIZE IMAGE FOR SMARTPHONE</b> 	Choose whether to resize images for upload to smartphones. Resizing applies only to the copy uploaded to the smartphone; the original is not affected. <ul style="list-style-type: none"> <li>• <b>ON</b>: Larger images are resized to  for upload. This setting is recommended.</li> <li>• <b>OFF</b>: Images are uploaded at their original size.</li> </ul>
<b>GEOTAGGING</b>	Choose whether location data downloaded from a smartphone are embedded in pictures as they are taken.
<b>LOCATION INFO</b>	Display the location data last downloaded from a smartphone.
 <b>BUTTON SETTING</b>	Choose the role played by the  button during playback. <ul style="list-style-type: none"> <li>•  <b>PAIRING/TRANSFER ORDER</b>: The button can be used for pairing and selecting images for transfer.</li> <li>•  <b>WIRELESS COMMUNICATION</b>: The button can be used for wireless connections.</li> </ul>

## INFORMATION

View the camera's MAC, Bluetooth, and wireless network IP addresses.

## RESET WIRELESS SETTING

Restore wireless settings to their default values.

# 9

## Shortcuts

## Shortcut Options

Customize camera controls to suit your style or situation.

Frequently-used options can be added to the Q menu or a custom “my” menu or assigned to a function button or touch-function gesture for direct access:

Shortcut Option	Description	
“My menu”	Add frequently-used options to this custom menu, which can be viewed by pressing <b>MENU/OK</b> and selecting the <b>my</b> (“MY MENU”) tab.	247
The Quick Menu	The <b>Q</b> menu is displayed by pressing the <b>Q</b> button. Use the <b>Q</b> menu to view or change the options selected for frequently-used menu items.	249
The function buttons	Use the function buttons for direct access to selected features.	255
Touch-function gestures	Use touch function button flick gestures ( <b>T-Fn1</b> , <b>T-Fn2</b> , <b>T-Fn3</b> , and <b>T-Fn4</b> ) for direct access to selected features.	259

## MY MENU

Access a personalized menu of frequently-used options.

To display “my menu”, press **MENU/OK** in the shooting display and select the **MY** (MY MENU) tab.



 The **MY** tab is only available if options have been assigned to **MY MENU**.

## MY MENU SETTING

To choose the items listed in the **MY** (MY MENU) tab:

- 1 In the setup menu, select **USER SETTING > MY MENU SETTING** or **MY MENU SETTING**.

 To reorder items, select **RANK ITEMS**.  
To delete items, select **REMOVE ITEMS**.

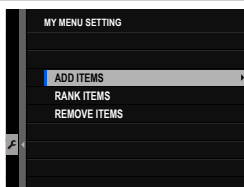

- 2 Press the focus stick (focus lever) up or down to highlight **ADD ITEMS** and press **MENU/OK**. Options that can be added to “my menu” are highlighted in blue.

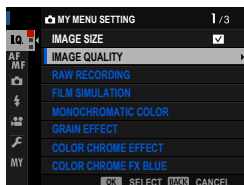

 Items currently in “my menu” are indicated by check marks.

- 3 Choose a position for the item and press **MENU/OK**. The item will be added to “my menu”.

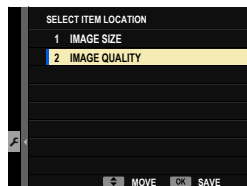

- 4 Press **MENU/OK** to return to the edit display.
- 5 Repeat Steps 3 and 4 until all the desired items have been added.

 “My menu” can contain up to 16 items.



## The Quick Menu

Use the quick menu for quick access to selected options. To view the quick menu, press the **Q** button.

### The Quick Menu Display

The quick menu offers different options in photo and movie modes. At default settings, it contains the following items:

#### Still photography

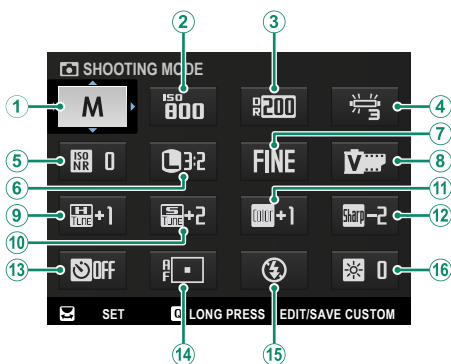

#### Default



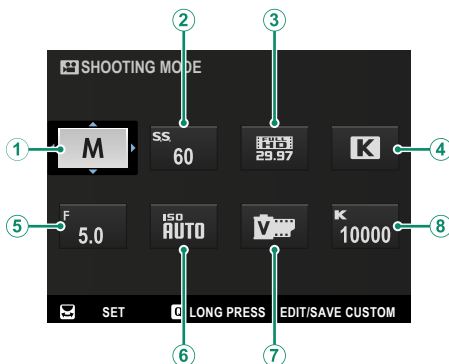

① SHOOTING MODE	⑨ HIGHLIGHT TONE
② ISO	⑩ SHADOW TONE
③ DYNAMIC RANGE	⑪ COLOR
④ WHITE BALANCE	⑫ SHARPNESS
⑤ HIGH ISO NR	⑬ SELF-TIMER
⑥ IMAGE SIZE	⑭ AF MODE
⑦ IMAGE QUALITY	⑮ FLASH FUNCTION SETTING
⑧ FILM SIMULATION	⑯ EVF/LCD BRIGHTNESS

The quick menu shows the options currently selected for items ②–⑯, which can be changed.

## Movie recording



### Default

① SHOOTING MODE	⑤ APERTURE (MOVIE OPTIMIZED CONTROL  )
② SHUTTER SPEED	⑥  ISO
③ MOVIE MODE	⑦ FILM SIMULATION
④  WHITE BALANCE	⑧ WHITE BALANCE COLOR TEMP. (WHEN  SELECTED)

The quick menu shows the options currently selected for items ②–⑧, which can be changed.

## Viewing and Changing Settings

- 1 Press **Q** to display the quick menu during shooting.

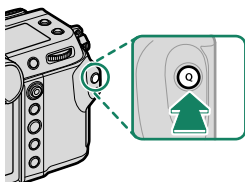

- 2 Use the focus stick (focus lever) to highlight items and rotate the rear command dial to change.

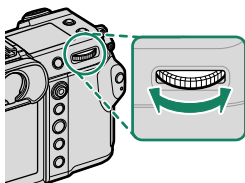

- To jump to the **EDIT/SAVE CUSTOM SETTING** menu, press and hold the **Q** button when the quick menu is displayed.

- 3 Press **Q** to exit when settings are complete.

- The quick menu can also be edited using touch controls.
- Using **FUNCTION (Fn) SETTING**, you can assign the **Q** button roles normally reserved for the function buttons or assign the **Q** button's default role to a function button (see 255).
- To disable the **Q** (quick menu) button, select **NONE** for **FUNCTION (Fn) SETTING > Q BUTTON SETTING**.

## Editing the Quick Menu



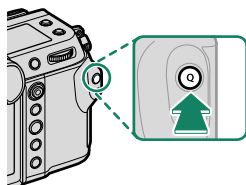

To choose the items displayed in the quick menu:

- 1 Press and hold the **Q** button during shooting.



 The camera displays the photo quick menu during still photography and the movie quick menu when in movie mode.

- 2 The current quick menu will be displayed; use the focus stick (focus lever) to highlight the item you wish to change and press **MENU/OK**.
- 3 Highlight the item you wish to change and press **MENU/OK**. The following can be assigned to the quick menu.

 The quick menus can also be edited using  **BUTTON/DIAL SETTING** >  **EDIT/SAVE QUICK MENU** or  **EDIT/SAVE QUICK MENU**.



## Available Items (Still Photography)

### Choose from:

- IMAGE SIZE
- IMAGE QUALITY
- FILM SIMULATION
- GRAIN EFFECT
- COLOR CHROME EFFECT
- COLOR CHROME FX BLUE
- SMOOTH SKIN EFFECT
- DYNAMIC RANGE
- D RANGE PRIORITY
- WHITE BALANCE
- WHITE BALANCE COLOR TEMP.  
(WHEN **K** SELECTED)
- HIGHLIGHT TONE
- SHADOW TONE
- COLOR
- SHARPNESS
- CLARITY
- HIGH ISO NR
- AF MODE
- FACE/EYE DETECTION SETTING
- MF ASSIST
- TOUCH SCREEN MODE
- SELF-TIMER
- PHOTOMETRY
- SHUTTER TYPE
- FLICKER REDUCTION
- ISO
- FLASH FUNCTION SETTING
- FLASH COMPENSATION
- EVF/LCD BRIGHTNESS
- EVF/LCD COLOR
- NONE

 To disable the function button, choose **NONE**.

## Available Items (Movies)

- FILM SIMULATION
- WHITE BALANCE
- WHITE BALANCE COLOR TEMP.  
(WHEN **K** SELECTED)
- HIGHLIGHT TONE
- SHADOW TONE
- COLOR
- SHARPNESS
- HIGH ISO NR
- FACE/EYE DETECTION SETTING
- MF ASSIST
- TOUCH SCREEN MODE
- PHOTOMETRY
- MOVIE ISO
- MOVIE MODE
- MOVIE AF MODE
- FIX MOVIE CROP MAGNIFICATION
-  IS MODE
-  IS MODE BOOST
- SHUTTER SPEED
- APERTURE  
(MOVIE OPTIMIZED CONTROL )
- INTERNAL/EXTERNAL MIC LEVEL  
ADJUSTMENT
- EVF/LCD BRIGHTNESS
- EVF/LCD COLOR
- NONE

 To disable the function button, choose **NONE**.

## Function Controls

Assign a role to each function button or touch-function gesture for quick access to the selected feature.

### The Function Buttons

Assign a role to the function buttons for quick access to the selected feature.

### Function Button Defaults

The default assignments are:

#### Back-of-Camera Function Buttons

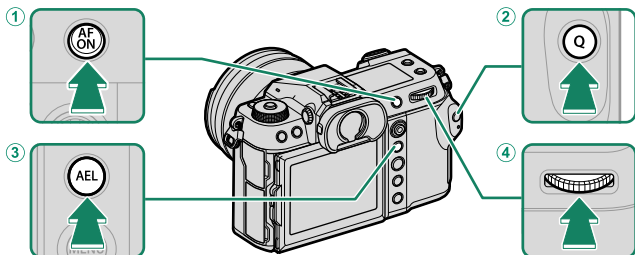

Function buttons	Default
① AFON button	AF-ON
② Q (quick menu) button	QUICK MENU
③ AEL (exposure lock) button	AE LOCK ONLY
④ Center of rear command dial	FOCUS CHECK

## Front-of-Camera Function Buttons

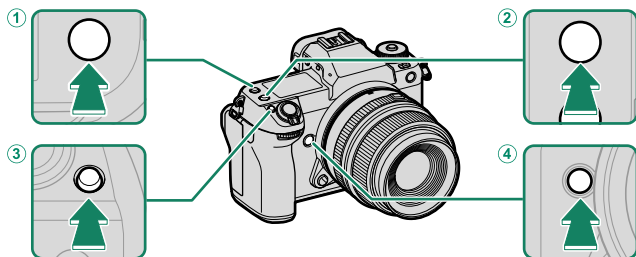



Function buttons	Default
① Fn3 button	SUB MONITOR MODE
② Fn2 button	FACE DETECTION ON/OFF
③ Fn1 button	EXPO. COMP.
④ Fn4 button	RAPID AF



## Assigning Roles to the Function Buttons

The roles played by the function buttons can be selected using the  **BUTTON/DIAL SETTING > FUNCTION (Fn) SETTING** option in the setup menu.

- EXPO. COMP.
- IMAGE SIZE
- IMAGE QUALITY
- RAW
- FILM SIMULATION
- GRAIN EFFECT
- COLOR CHROME EFFECT
- COLOR CHROME FX BLUE
- SMOOTH SKIN EFFECT
- DYNAMIC RANGE
- D RANGE PRIORITY
- WHITE BALANCE
- CLARITY
- FOCUS AREA
- FOCUS CHECK
- AF MODE
- RAPID AF
- LOW LIGHT PRIORITY AF-S
- FACE SELECT 
- FACE DETECTION ON/OFF
- AF RANGE LIMITER
- FOCUS CHECK LOCK
- SELF-TIMER
- AE BKT SETTING
- FOCUS BKT SETTING
- PHOTOMETRY
- SHUTTER TYPE
- FLICKER REDUCTION
- ISO
- IS MODE
- 35mm FORMAT MODE
- WIRELESS COMMUNICATION
- FLASH FUNCTION SETTING
- TTL-LOCK
- MODELING FLASH
- FIX MOVIE CROP MAGNIFICATION
-  IS MODE BOOST
- ZEBRA SETTING
- INTERNAL/EXTERNAL MIC LEVEL ADJUSTMENT
- MOVIE OPTIMIZED CONTROL 
- SUB MONITOR MODE
- PREVIEW DEPTH OF FIELD
- PREVIEW EXP/WB IN MANUAL MODE
- NATURAL LIVE VIEW
- HISTOGRAM
- ELECTRONIC LEVEL
- LARGE INDICATORS MODE
- AE LOCK ONLY
- AF LOCK ONLY
- AE/AF LOCK
- AF-ON
- AWB LOCK ONLY
- S.S. LOCK
- LOCK SETTING
- AUTO IMAGE TRANSFER
- SELECT PAIRING DESTINATION
- Bluetooth ON/OFF
- QUICK MENU
- PLAYBACK
- NONE

 To disable the function button, choose **NONE**.

## AF-ON

Controls to which **AF-ON** is assigned can be used for autofocus.



## MODELING FLASH

If **MODELING FLASH** is selected when a compatible shoe-mounted flash unit is attached, you can press the control to test-fire the flash and check for shadows and the like (modeling flash).

## TTL-LOCK

If **TTL-LOCK** is selected, you can press the control to lock flash output according to the option selected for **FLASH SETTING > TTL-LOCK MODE** (📖 153).

## FACE SELECT

**FACE SELECT**  can be enabled or disabled by pressing the button to which **FACE SELECT**  is assigned. Enabling **FACE SELECT**  allows the focus stick (focus lever) or (during viewfinder photography) touch controls (📖 27) to be used to select the face that will be used for focus.





The following features can be accessed using the focus stick or during viewfinder photography when **FACE SELECT**  is enabled:

- The face used to set focus can be selected using the focus stick. To switch from face detection to manual focus-area selection, press the center of the focus stick (focus lever) (📖 85). Press again to re-enable face detection.
- The touch screen (monitor) or focus stick can be used to select the face used to set focus during viewfinder photography.

## Touch-Function Gestures

Assign roles to touch-function gestures (**T-Fn1**, **T-Fn2**, **T-Fn3**, or **T-Fn4**) for quick access to selected features.

 Touch-function gestures are disabled by default. To enable touch-function gestures, select **ON** for  **BUTTON/DIAL SETTING > TOUCH SCREEN SETTING >  TOUCH FUNCTION.**

### Touch-Function Gesture Defaults

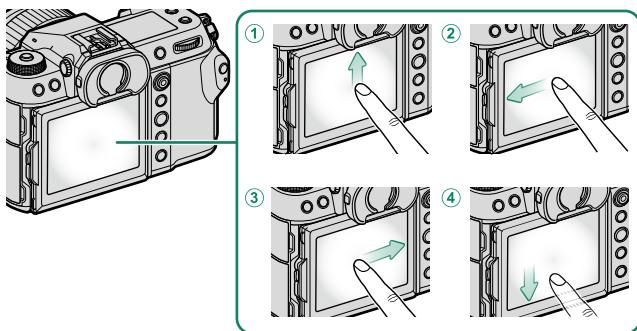

The default assignments for the different gestures are:



Touch-Function Gestures	Default
① <b>T-Fn1</b> (flick up)	HISTOGRAM
② <b>T-Fn2</b> (flick left)	FILM SIMULATION
③ <b>T-Fn3</b> (flick right)	WHITE BALANCE
④ <b>T-Fn4</b> (flick down)	ELECTRONIC LEVEL

## Assigning Roles to Touch-Function Gestures

The roles played by touch-function gestures can be selected using the  **BUTTON/DIAL SETTING > FUNCTION (Fn) SETTING** option in the setup menu.

- IMAGE SIZE
- IMAGE QUALITY
- RAW
- FILM SIMULATION
- GRAIN EFFECT
- COLOR CHROME EFFECT
- COLOR CHROME FX BLUE
- SMOOTH SKIN EFFECT
- DYNAMIC RANGE
- D RANGE PRIORITY
- WHITE BALANCE
- CLARITY
- FOCUS AREA
- FOCUS CHECK
- AF MODE
- RAPID AF
- LOW LIGHT PRIORITY AF-S
- FACE SELECT 
- FACE DETECTION ON/OFF
- AF RANGE LIMITER
- FOCUS CHECK LOCK
- SELF-TIMER
- AE BKT SETTING
- FOCUS BKT SETTING
- PHOTOMETRY
- SHUTTER TYPE
- FLICKER REDUCTION
- ISO
- IS MODE
- 35mm FORMAT MODE
- WIRELESS COMMUNICATION
- FLASH FUNCTION SETTING
- TTL-LOCK
- MODELING FLASH
- FIX MOVIE CROP MAGNIFICATION
-  IS MODE BOOST
- ZEBRA SETTING
- INTERNAL/EXTERNAL MIC LEVEL ADJUSTMENT
- MOVIE OPTIMIZED CONTROL 
- SUB MONITOR MODE
- PREVIEW DEPTH OF FIELD
- PREVIEW EXP./WB IN MANUAL MODE
- NATURAL LIVE VIEW
- HISTOGRAM
- ELECTRONIC LEVEL
- LARGE INDICATORS MODE
- S.S. LOCK
- LOCK SETTING
- AUTO IMAGE TRANSFER
- SELECT PAIRING DESTINATION
- Bluetooth ON/OFF
- QUICK MENU
- PLAYBACK
- NONE

 To disable touch-function gestures, choose **NONE**.

# 10 Peripherals and Optional Accessories

## Lenses

The camera can be used with lenses for the FUJIFILM G-mount.

### Lens Parts

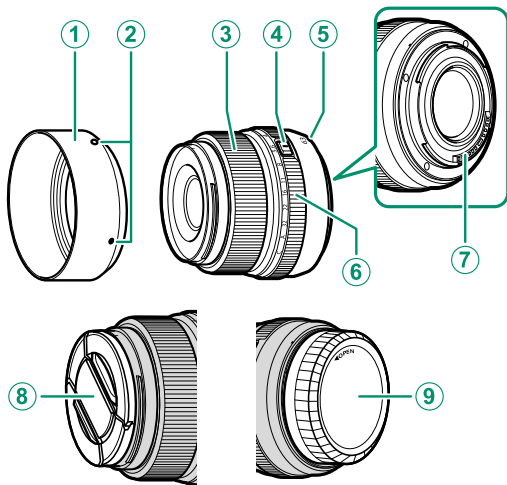

① Lens hood

② Mounting marks

③ Focus ring

④ Aperture ring lock release

⑤ Mounting marks (focal length)

⑥ Aperture ring

⑦ Lens signal contacts

⑧ Front lens cap

⑨ Rear lens cap

 A GF63mmF2.8 R WR lens is used here for illustrative purposes.

## Lens Care

- Use a blower to remove dust, then gently wipe with a soft, dry cloth. Any remaining stains can be removed by wiping gently with a piece of Fujifilm lens-cleaning paper to which a small amount of lens-cleaning fluid has been applied.
- Replace the front and rear caps when the lens is not in use.

## Removing Lens Caps

Remove lens caps as shown.

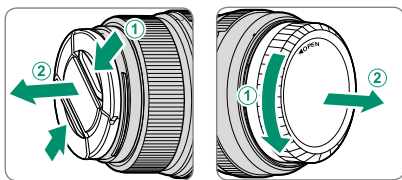

ⓘ Lens caps may differ from those shown.

## Attaching Lens Hoods

When attached, lens hoods reduce glare and protect the front lens element.

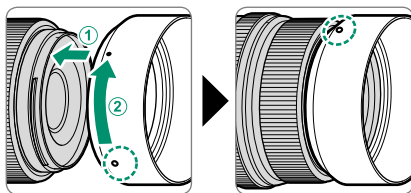

## Aperture Rings

In modes **A** (aperture-priority AE) and **M** (manual), you can choose the aperture (f-number) by rotating the lens aperture ring.

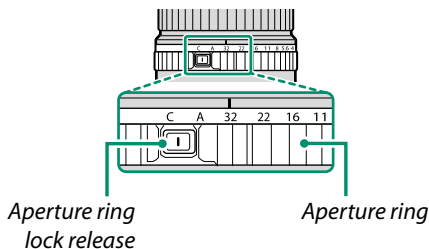

Setting	Description
<b>C</b> (C)	With the aperture ring in the <b>C</b> or <b>A</b> position, you can choose the aperture (f-number) by rotating the camera command dial.
<b>A</b> (A)	
<b>Other values</b> (32)	Set aperture to the selected value.

 To select **C** or **A**, or to select another value after selecting **C** or **A**, press the aperture ring lock release while rotating the aperture ring.





## External Flash Units

Use optional external flash units for flash photography. Some units support high-speed sync (FP) and can be used at shutter speeds faster than the flash sync speed, while others can function as commanders controlling remote units via optical wireless flash control.

 You may be unable to test-fire the flash in some circumstances, for example when a setup menu is displayed on the camera.

### Red-Eye Removal

Red-eye removal is available when an option other than **OFF** is selected for  **FLASH SETTING > RED EYE REMOVAL** and  **AF/MF SETTING > FACE/EYE DETECTION SETTING** is **FACE DETECTION ON**. Red-eye removal minimizes “red-eye” caused when light from the flash is reflected from the subject’s retinas.

## Flash Settings

- 1 Connect the unit to the camera.
- 2 In shooting mode, select **FLASH FUNCTION SETTING** in the **FLASH SETTING** menu tab. The options available vary with the flash unit.

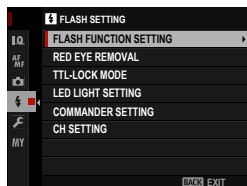

Menu	Description	
<b>SYNC TERMINAL</b>	Displayed when no compatible flash unit is connected or if a unit is connected via the sync terminal or uses only the X-contact on the hot shoe.	267
<b>SHOE MOUNT FLASH</b>	Displayed when an optional flash unit is mounted on the hot shoe and turned on.	268
<b>COMMANDER (OPTICAL)</b>	Displayed if an optional flash unit functioning as a commander for Fujifilm optical wireless remote flash control is connected and turned on.	271

 **SYNC TERMINAL** will be also displayed if an incompatible flash unit or no flash unit is connected.

- 3 Highlight items using the focus stick (focus lever) and rotate the rear command dial to change the highlighted setting.

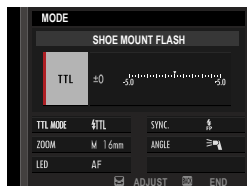

- 4 Press **DISP/BACK** to put the changes into effect.

## SYNC TERMINAL

The following options are available when no compatible flash unit is connected or if a unit is connected via the sync terminal or uses only the X-contact on the hot shoe.

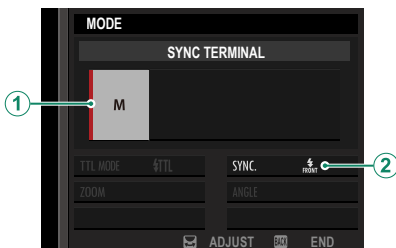

Setting	Description
① Flash control mode	<p>Choose from the following options:</p> <ul style="list-style-type: none"> <li>• <b>M</b>: A trigger signal is transmitted via the hot shoe X contacts when a picture is taken. Choose a shutter speed slower than the sync speed; even slower speeds may be required if the unit uses long flashes or has a slow response time.</li> <li>• <b>OFF (OFF)</b>: The trigger signal is disabled.</li> </ul>
② Sync	<p>Choose whether the flash is timed to fire immediately after the shutter opens (<math>\frac{1}{2}</math> FRONT/<b>1ST CURTAIN</b>) or immediately before it closes (<math>\frac{1}{2}</math> REAR/<b>2ND CURTAIN</b>). <b>1ST CURTAIN</b> is recommended in most circumstances.</p>

### The Sync Terminal

Use the sync terminal to connect flash units that require a sync cable.

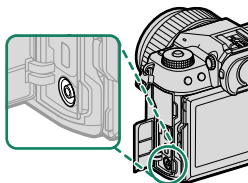





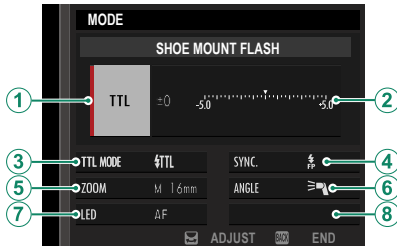



## SHOE MOUNT FLASH

The following options are available when an optional shoe-mounted flash unit is attached and turned on.



Setting	Description
① Flash control mode	<p>The flash control mode selected with the flash unit. This can in some cases be adjusted from the camera; the options available vary with the flash.</p> <ul style="list-style-type: none"> <li>• <b>TTL</b>: TTL mode. Adjust flash compensation (②).</li> <li>• <b>M</b>: The flash fires at the selected output regardless of subject brightness or camera settings. Output in some cases can be adjusted from the camera (②).</li> <li>• <b>MULTI</b>: Repeating flash. Compatible shoe-mounted flash units will fire multiple times with each shot.</li> <li>• <b>OFF (OFF)</b>: The flash does not fire. Some flash units can be turned off from the camera.</li> </ul>

Setting	Description
② Flash compensation/ output	<p>The options available vary with flash control mode.</p> <ul style="list-style-type: none"> <li>• <b>TTL</b>: Adjust flash compensation (the full value may not be applied if the limits of the flash control system are exceeded). In the cases of the EF-X20, EF-20, and EF-42, the selected value is added to the value selected with the flash unit.</li> <li>• <b>M/MULTI</b>: Adjust flash output (compatible units only). Choose from values expressed as fractions of full power, from 1/4 (mode <b>M</b>) or 1/4 (<b>MULTI</b>) down to 1/512 in increments equivalent to 1/3 EV. The desired results may not be achieved at low values if they exceed the limits of the flash control system; take a test shot and check the results.</li> </ul>
③ Flash mode (TTL)	<p>Choose a flash mode for TTL flash control. The options available vary with the shooting mode (<b>P</b>, <b>S</b>, <b>A</b>, or <b>M</b>) selected.</p> <ul style="list-style-type: none"> <li>• <b>FLASH AUTO</b>: The flash fires only as required; flash level is adjusted according to subject brightness. A  icon displayed when the shutter button is pressed halfway indicates that the flash will fire when the photo is taken.</li> <li>• <b>STANDARD</b>: The flash fires with every shot if possible; flash level is adjusted according to subject brightness. The flash will not fire if not fully charged when the shutter is released.</li> <li>• <b>SLOW SYNC.</b>: Combine the flash with slow shutter speeds when photographing portrait subjects against a backdrop of night scenery. The flash will not fire if not fully charged when the shutter is released.</li> </ul>

Setting	Description
④ Sync	Control flash timing. <ul style="list-style-type: none"> <li>•  (1ST CURTAIN): The flash fires immediately after the shutter opens (generally the best choice).</li> <li>•  (2ND CURTAIN): The flash fires immediately before the shutter closes.</li> <li>•  (AUTO FP(HSS)): High-speed sync (compatible units only). The camera automatically engages front-curtain high-speed sync at shutter speeds faster than the flash sync speed. Equivalent to <b>1ST CURTAIN</b> when <b>MULTI</b> is selected for flash control mode.</li> </ul>
⑤ Zoom	The angle of illumination (flash coverage) for units that support flash zoom. Some units allow the adjustment to be made from the camera. If <b>AUTO</b> is selected, zoom will automatically be adjusted to match coverage to lens focal length.
⑥ Lighting	If the unit supports this feature, choose from: <ul style="list-style-type: none"> <li>•  (FLASH POWER PRIORITY): Gain range by slightly reducing coverage.</li> <li>•  (STANDARD): Match coverage to picture angle.</li> <li>•  (EVEN COVERAGE PRIORITY): Slightly increase coverage for more even lighting.</li> </ul>
⑦ LED light	Choose how the built-in LED light functions during still photography (compatible units only): as a catchlight (  /CATCHLIGHT), as an AF-assist illuminator ( <b>AF/AF ASSIST</b> ), or as both a catchlight and an AF-assist illuminator (  /AF ASSIST+CATCHLIGHT). Choose <b>OFF</b> to disable the LED during photography.
⑦ Number of flashes*	Choose the number of times the flash fires each time the shutter is released in <b>MULTI</b> mode.
⑧ Frequency*	Choose the frequency at which the flash fires in <b>MULTI</b> mode.

\* Full value may not be applied if limits of flash control system are exceeded.

## COMMANDER(OPTICAL)

The options will be displayed if the unit is currently functioning as a commander for Fujifilm optical wireless remote flash control.

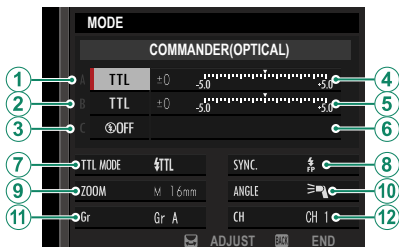





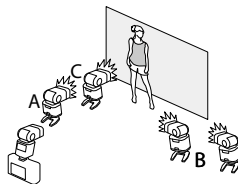





Fujifilm optical wireless remote flash control offers a choice of four channels (Channels 1 through 4) for the exchange of optical signals between the commander and remote flash units. Separate channels can be used for different flash systems or to prevent interference when multiple systems are operating in close proximity.

The flash units can also be placed in up to three groups (A, B, and C) and flash mode and flash level adjusted separately for each group.



Setting	Description
① Flash control mode (group A)	<p>Choose flash control modes for groups A, B, and C. <b>TTL%</b> is available for groups A and B only.</p> <ul style="list-style-type: none"> <li>• <b>TTL</b>: The units in the group fire in TTL mode. Flash compensation can be adjusted separately for each group.</li> <li>• <b>TTL%</b>: If <b>TTL%</b> is selected for either group A or B, you can specify the output of the selected group as a percentage of the other and adjust overall flash compensation for both groups.</li> </ul>
② Flash control mode (group B)	<ul style="list-style-type: none"> <li>• <b>M</b>: In mode <b>M</b>, the units in the group fire at the selected output (expressed as a fraction of full power) regardless of subject brightness or camera settings.</li> </ul>
③ Flash control mode (group C)	<ul style="list-style-type: none"> <li>• <b>MULTI</b>: Choosing <b>MULTI</b> for any group sets all the units in all groups to repeating flash mode. All units will fire multiple times with each shot.</li> <li>• <b>OFF (OFF)</b>: If <b>OFF</b> is selected, the units in the group will not fire.</li> </ul>
④ Flash compensation/output (group A)	<p>Adjust flash level for the selected group according to option selected for flash control mode. Note that the full value may not be applied if the limits of the flash control system are exceeded.</p>
⑤ Flash compensation/output (group B)	<ul style="list-style-type: none"> <li>• <b>TTL</b>: Adjust flash compensation.</li> <li>• <b>M/MULTI</b>: Adjust flash output.</li> </ul>
⑥ Flash compensation/output (group C)	<ul style="list-style-type: none"> <li>• <b>TTL%</b>: Choose the balance between groups A and B and adjust overall flash compensation.</li> </ul>



Setting	Description
<p>⑦ Flash mode (TTL)</p>	<p>Choose a flash mode for TTL flash control. The options available vary with the shooting mode (<b>P</b>, <b>S</b>, <b>A</b>, or <b>M</b>) selected.</p> <ul style="list-style-type: none"> <li>●  (<b>FLASH AUTO</b>): The flash fires only as required; flash level is adjusted according to subject brightness. A  icon displayed when the shutter button is pressed halfway indicates that the flash will fire when the photo is taken.</li> <li>●  (<b>STANDARD</b>): The flash fires with every shot if possible; flash level is adjusted according to subject brightness. The flash will not fire if not fully charged when the shutter is released.</li> <li>●  (<b>SLOW SYNC.</b>): Combine the flash with slow shutter speeds when photographing portrait subjects against a backdrop of night scenery. The flash will not fire if not fully charged when the shutter is released.</li> </ul>
<p>⑧ Sync</p>	<p>Control flash timing.</p> <ul style="list-style-type: none"> <li>●  (<b>1ST CURTAIN</b>): The flash fires immediately after the shutter opens (generally the best choice).</li> <li>●  (<b>2ND CURTAIN</b>): The flash fires immediately before the shutter closes.</li> <li>●  (<b>AUTO FP(HSS)</b>): High-speed sync (compatible units only). The camera automatically engages front-curtain high-speed sync at shutter speeds faster than the flash sync speed. Equivalent to <b>1ST CURTAIN</b> when <b>MULTI</b> is selected for flash control mode.</li> </ul>
<p>⑨ Zoom</p>	<p>The angle of illumination (flash coverage) for units that support flash zoom. Some units allow the adjustment to be made from the camera. If <b>AUTO</b> is selected, zoom will automatically be adjusted to match coverage to lens focal length.</p>
<p>⑩ Lighting</p>	<p>If the unit supports this feature, choose from:</p> <ul style="list-style-type: none"> <li>●  (<b>FLASH POWER PRIORITY</b>): Gain range by slightly reducing coverage.</li> <li>●  (<b>STANDARD</b>): Match coverage to picture angle.</li> <li>●  (<b>EVEN COVERAGE PRIORITY</b>): Slightly increase coverage for more even lighting.</li> </ul>

Setting	Description
⑪ Commander	<p>Choose the group for units functioning as a commander for Fujifilm optical wireless remote flash control in <b>TTL</b>, <b>TTL%</b>, or <b>M</b> mode. This option is available only with clip-on flash units that support Fujifilm optical wireless remote flash control.</p> <ul style="list-style-type: none"> <li>• <b>Gr A:</b> Assign the commander to group A.</li> <li>• <b>Gr B:</b> Assign the commander to group B.</li> <li>• <b>Gr C:</b> Assign the commander to group C.</li> <li>• <b>OFF:</b> Output from the commander is held to a level that does not affect the final picture.</li> </ul>
⑪ Number of flashes	<p>Choose the number of times the flash fires each time the shutter is released in <b>MULTI</b> mode.</p>
⑫ Channel	<p>Choose the channel used by the commander for communication with the remote flash units. Separate channels can be used for different flash systems or to prevent interference when multiple systems are operating in close proximity.</p>
⑫ Frequency	<p>Choose the frequency at which the flash fires in <b>MULTI</b> mode.</p>

## Handgrips

Using a handgrip makes the camera easier to hold.

### Attaching the Handgrip

The MHG-GFX S handgrip attaches to the tripod socket.

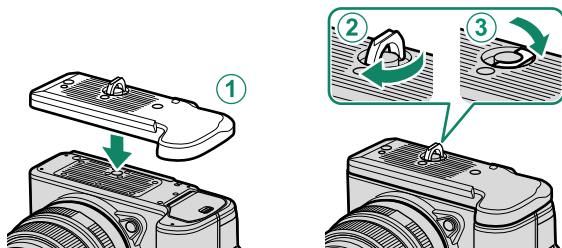



# 11 Connections

## HDMI Output

Camera shooting and playback displays can be output to HDMI devices.

### Connecting to HDMI Devices

Connect the camera to TVs or other HDMI devices using a third-party HDMI cable.

- 1 Turn the camera off.
- 2 Connect the cable as shown below.

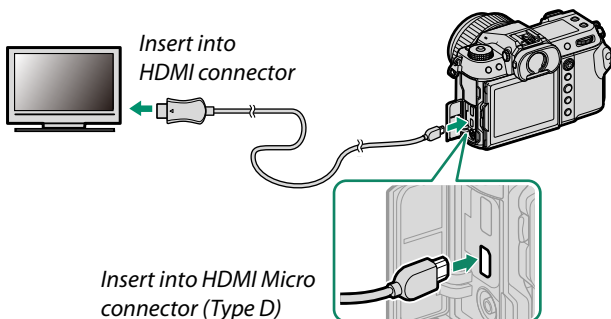

- 3 Configure the device for HDMI input as described in the documentation supplied with the device.
- 4 Turn the camera on. The contents of the camera display will be shown on the HDMI device. The camera display turns off in playback mode (📖 279).

- ! • Making sure the connectors are fully inserted.
- Use an HDMI cable no more than 1.5 m (4.9 ft.) long.

## Shooting

Display Full HD live view or movie footage on a TV or save it to an external recorder.

## Playback

To start playback, press the camera  button. The camera monitor turns off and pictures and movies are output to the HDMI device. Note that the camera volume controls have no effect on sounds played on the TV; use the television volume controls to adjust the volume.

 Some televisions may briefly display a black screen when movie playback begins.

## Wireless Connections (Bluetooth®, Wireless LAN/Wi-Fi)

Access wireless networks and connect to computers, smartphones, or tablets. For more information, visit:

<http://fujifilm-dsc.com/wifi/>

### Smartphones and Tablets: FUJIFILM Camera Remote

Connect to the camera via Bluetooth or wireless LAN.

 To establish a wireless connection to the camera, you will need to install the latest version of the FUJIFILM Camera Remote app on your smartphone or tablet.

#### FUJIFILM Camera Remote

Once a connection has been established, you can use FUJIFILM Camera Remote to:

- Control the camera and take pictures remotely
- Receive pictures uploaded from the camera
- Browse the pictures on the camera and download selected pictures
- Upload location data to the camera
- Release the camera shutter
- Update camera firmware

For downloads and other information, visit:

[http://app.fujifilm-dsc.com/en/camera\\_remote/](http://app.fujifilm-dsc.com/en/camera_remote/)



## SmartPhones and Tablets: Bluetooth® Pairing

Use **CONNECTION SETTING** > **Bluetooth SETTINGS** > **PAIRING REGISTRATION** to pair the camera with smartphones or tablets. Pairing offers a simple method for downloading photos from the camera.





- Photos are downloaded via a wireless connection.
- Once pairing is complete, you will be able to synchronize the camera clock and location data with the smartphone or tablet (☎ 239).
- You can choose a connection from up to 7 paired smartphones or tablets.

## Smartphones and Tablets: Wireless LAN

Establish wireless LAN connections to smartphones or tablets using **WIRELESS COMMUNICATION** in the **SHOOTING SETTING**, **MOVIE SETTING**, or **PLAY BACK MENU**.



## Tethered Shooting: Capture One Pro Fujifilm/ Adobe® Photoshop® Lightroom® Classic CC + FUJIFILM Tether Shooting Plug-in PRO for GFX/FUJIFILM X Acquire

- Before proceeding, adjust settings using  **CONNECTION SETTING** > **NETWORK SETTING** and then select **WIRELESS TETHER SHOOTING FIXED** for  **CONNECTION SETTING** > **CONNECTION MODE** (📖 242).
- Tethered shooting can be performed using software such as Capture One Pro Fujifilm, Adobe® Photoshop® Lightroom® Classic CC, and FUJIFILM X Acquire. If you use Adobe® Photoshop® Lightroom® Classic CC, download FUJIFILM Tether Shooting Plug-in PRO for GFX from the Adobe Exchange website. FUJIFILM Tether Shooting Plug-in PRO for GFX is available free of charge.

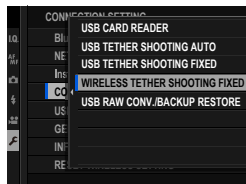

-  For more information, visit the following website:  
<http://app.fujifilm-dsc.com/en/#tether>
- For more information on FUJIFILM X Acquire and FUJIFILM Tether Shooting Plug-in PRO for GFX, see “Software for Use with Your Camera” (📖 298).

## Connecting via USB

The camera can be connected to computers and smartphones via USB.

 Before downloading pictures or taking pictures remotely, connect the camera to a computer and check that it functions normally.

- 1 Turn the computer on.
- 2 Adjust settings according to how the camera will be used.
  - “Tethered Shooting: Capture One Pro Fujifilm/Adobe® Photoshop® Lightroom® Classic CC + FUJIFILM Tether Shooting Plug-in PRO for GFX/FUJIFILM X Acquire/FUJIFILM Pixel Shift Combiner” (📖 286)
  - “Copying Pictures from a Memory Card to a Computer” (📖 287)
  - “Using Your Camera as a Webcam (FUJIFILM X Webcam)” (📖 287)
  - “Converting RAW Images: FUJIFILM X RAW STUDIO” (📖 288)
  - “Backing up and Restoring Camera Settings (FUJIFILM X Acquire)” (📖 288)
  - “Pixel Shift Multishot” (📖 107)
- 3 Turn the camera off.
- 4 Connect a USB cable.

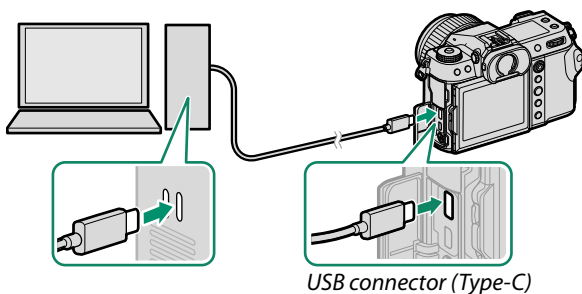

 The USB cable must be no more than 1.5 m (4.9 ft.) long and be suitable for data transfer.

- 5 Turn the camera on.
- 6 Copy pictures to your computer.
  - **Tethered shooting:** During tethered shooting, you can copy pictures using tethered shooting software such as the Capture One Pro Fujifilm/Adobe® Photoshop® Lightroom® Classic CC + FUJIFILM Tether Shooting Plug-in PRO for GFX/FUJIFILM X Acquire.
  - **Image transfer:** Use applications provided with your operating system.
  - **Using your camera as a webcam:** Launch FUJIFILM X Webcam.
  - **RAW conversion:** Process RAW images using FUJIFILM X RAW STUDIO. The power of the camera's image processing engine is used for rapid processing.
  - **Saving and loading camera settings:** Use FUJIFILM X Acquire to save or load camera settings. Save your preferred settings to a file in a single operation and copy them to multiple cameras.
  - **Pixel Shift Multishot:** Pixel-shift multi-shot photography can be performed via tethered shooting. For this purpose, use FUJIFILM Pixel Shift Combiner.

- ❗ • Turn the camera off before disconnecting the USB cable.
- When connecting USB cables, be sure the connectors are fully inserted in the correct orientation. Connect the camera directly to the computer; do not use a USB hub or keyboard.
- Loss of power during transfer could result in loss of data or damage to the memory card. Insert a fresh or fully-charged battery before connecting the camera.
- If a memory card containing a large number of images is inserted, there may be a delay before the software starts and you may be unable to import or save images. Use a memory card reader to transfer pictures.
- Make sure that the indicator lamp is off or lit green before turning the camera off.
- Do not disconnect the USB cable while transfer is in progress. Failure to observe this precaution could result in loss of data or damage to the memory card.
- Disconnect the camera before inserting or removing memory cards.
- In some cases, it may not be possible to access pictures saved to a network server using the software in the same way as on a stand-alone computer.
- Do not immediately remove the camera from the system or disconnect the USB cable once the message stating that copying is in progress clears from the computer display. If the number of images copied is very large, data transfer may continue after the message has ceased to be displayed.
- The user bears all applicable fees charged by the phone company or Internet service provider when using services that require an Internet connection.

## Tethered Shooting: Capture One Pro Fujifilm/ Adobe® Photoshop® Lightroom® Classic CC + FUJIFILM Tether Shooting Plug-in PRO for GFX/ FUJIFILM X Acquire/FUJIFILM Pixel Shift Combiner

- Before proceeding, select **USB TETHER SHOOTING AUTO** for **CONNECTION SETTING > CONNECTION MODE** in the camera menus.
- Capture One Pro Fujifilm, Adobe® Photoshop® Lightroom® Classic CC + FUJIFILM Tether Shooting Plug-in PRO for GFX, FUJIFILM X Acquire, and FUJIFILM Pixel Shift Combiner can be used for tethered shooting.

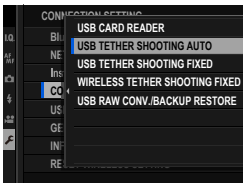

- Choose **USB TETHER SHOOTING FIXED** if the camera will be used solely for tethered shooting. Note that if the USB cable is disconnected, the camera will continue to function in tethered mode and pictures will not be saved to the camera memory card.
- For more information, visit the following website:  
<http://app.fujifilm-dsc.com/en/#tether>
- For more information on Capture One Pro Fujifilm, Adobe® Photoshop® Lightroom® Classic CC + FUJIFILM Tether Shooting Plug-in PRO for GFX, FUJIFILM X Acquire, and FUJIFILM Pixel Shift Combiner, see “Software for Use with Your Camera” (📖 298).

## Copying Pictures from a Memory Card to a Computer

- Before copying pictures to a computer, select **USB CARD READER** for **CONNECTION SETTING > CONNECTION MODE**.
- The software that can be used to copy pictures varies with your computer operating system.

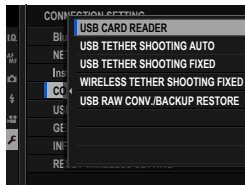

### Mac OS X/macOS

Pictures can be copied to your computer using Image Capture (supplied with your computer) or other software.

ⓘ Use a card reader to copy files over 4 GB in size.

### Windows

Pictures can be copied to your computer using applications supplied with the operating system.

## Using Your Camera as a Webcam (FUJIFILM X Webcam)

- Before proceeding, select **USB TETHER SHOOTING AUTO** for **CONNECTION SETTING > CONNECTION MODE** in the camera menus.
- Launch FUJIFILM X Webcam.

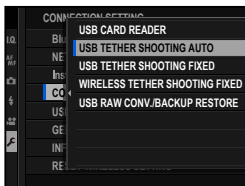

📖 For more information on FUJIFILM X Webcam, see “Software for Use with Your Camera” (📖 298).

## Converting RAW Images: FUJIFILM X RAW STUDIO

- Before proceeding, select **USB RAW CONV./BACKUP RESTORE** for **CONNECTION SETTING > CONNECTION MODE** in the camera menus.
- FUJIFILM X RAW STUDIO can be used to convert RAW images to JPEG or TIFF images.

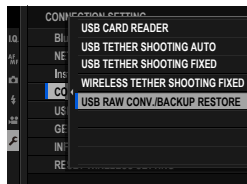

 For more information on FUJIFILM X RAW STUDIO, see “Software for Use with Your Camera” (📖 298).

## Backing up and Restoring Camera Settings (FUJIFILM X Acquire)

- Before proceeding, select **USB RAW CONV./BACKUP RESTORE** for **CONNECTION SETTING > CONNECTION MODE** in the camera menus.
- FUJIFILM X Acquire can be used to backup and restore camera settings.

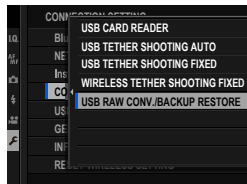

 For more information on FUJIFILM X Acquire, see “Software for Use with Your Camera” (📖 298).



## Connecting to Smartphones

To copy pictures to a smartphone, select **OFF** for **CONNECTION SETTING > USB POWER SUPPLY SETTING** and connect the camera to the phone using a USB cable.

### For Customers Using Android Devices

How you will connect the camera depends on the type of USB connector with which your smartphone is equipped.

#### Type-C

Use the supplied USB cable.

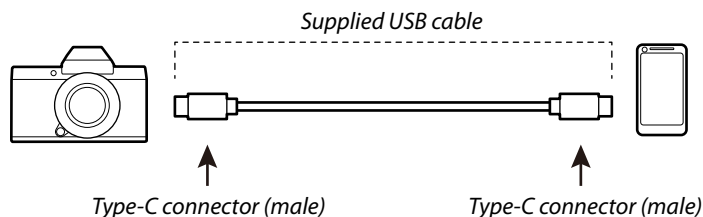

#### Micro-B

Use a USB on-the-go (OTG) cable.

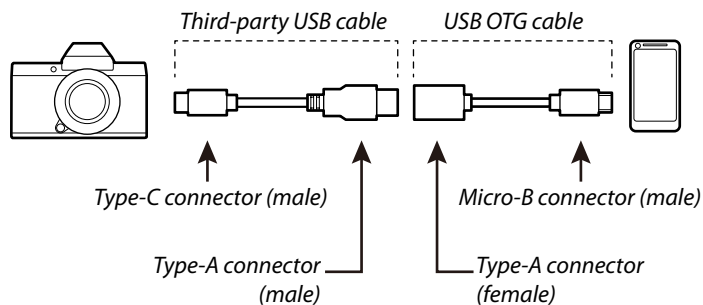

- The smartphone must support USB OTG.
- The desired results cannot be achieved with a USB Type-C-to-Micro-B cable. Use an OTG cable.

- 1 Set the camera's  **CONNECTION SETTING > USB POWER SUPPLY SETTING** to **OFF**.
- 2 Connect the camera and smartphone using a USB cable.
  -  If the smartphone asks for permission for an application other than the "Camera Importer" to access the camera, tap "Cancel" and move on to the next step.
- 3 On your smartphone, tap the notification "Connected to USB PTP".
- 4 From the recommended applications, select "Camera Importer".

The app will automatically start and allow you to import photos and movies to your smartphone.

  -  If the message "There is no MTP device connected" appears on the app, please try again from step 2.

## For Customers Using iOS

Use a camera adapter. Given that the camera is equipped with a USB Type-C connector, you will need to supply a cable with a USB Type-A connector for connection to the camera adapter.

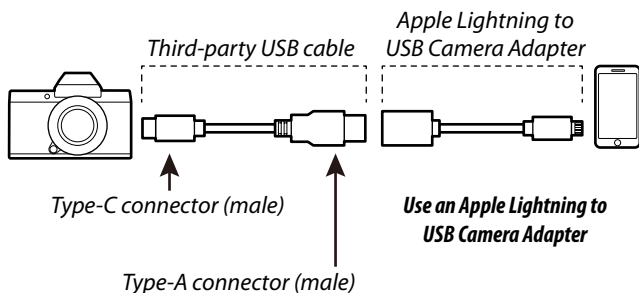

- 1 Set the camera's **CONNECTION SETTING > USB POWER SUPPLY SETTING** to **OFF**.
- 2 Connect the camera and smartphone using a USB cable. Launch the Photos app to import photos and movies to your smartphone.

- A Type-C to Type-C USB cable is required for connection to iPad Pro and iPad Air devices equipped with USB Type-C connectors.
- The desired results cannot be achieved with a USB Type-C-to-Lightning cable. Use a camera adapter.

## instax SHARE Printers

Print pictures from your digital camera to instax SHARE printers.

### Establishing a Connection

Select **CONNECTION SETTING** > **instax PRINTER CONNECTION SETTING** and enter the instax SHARE printer name (SSID) and password.

#### The Printer Name (SSID) and Password

The printer name (SSID) can be found on the bottom of the printer; the default password is "1111". If you have already chosen a different password to print from a smartphone, enter that password instead.

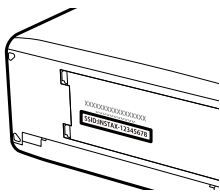

## Printing Pictures

- 1 Turn the printer on.
- 2 Select **PLAY BACK MENU > instax PRINTER PRINT**. The camera will connect to the printer.

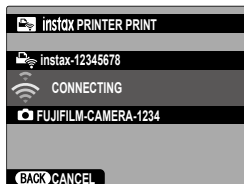

- 3 Use the focus stick (focus lever) to display the picture you want to print, then press **MENU/OK**.



- Pictures taken with other cameras cannot be printed.
- The area printed is smaller than the area visible in the LCD monitor.
- The displays may vary depending on the printer connected.

- 4 The picture will be sent to the printer and printing will start.



# 12

## Technical Notes

## Accessories from Fujifilm

The following optional accessories are available from Fujifilm. For the latest information on the accessories available in your region, check with your local Fujifilm representative or visit <https://fujifilm-x.com/support/compatibility/cameras/>.

### Rechargeable Li-ion batteries

**NP-W235:** Additional high-capacity NP-W235 rechargeable batteries can be purchased as required.

### Dual battery chargers

**BC-W235:** The BC-W235 can charge up to two NP-W235 batteries at a time. At +25 °C/+77 °F, the batteries will charge in about 200 minutes. Using a device that supplies power with an outputs of 30 W or above reduces charging times to as little as 150 minutes.

### FUJINON lenses

**GF-series lenses:** Interchangeable lenses for use exclusively with the FUJIFILM G-mount.

### Eye cups

**EC-XH W/EC-XT L/EC-XT M/EC-XT S/EC-GFX:** Attach viewfinder eyecups to prevent light leaking into the viewfinder window.

### Mount adapters

**H MOUNT ADAPTER G:** This mount adapter allows the camera to be used with SUPER EBC FUJINON accessories for the GX645AF, giving you the use of one additional teleconverter and nine different lenses.

### Macro extension tubes

**MCEX-18G WR/MCEX-45G WR:** Mount this adapter between the lens and the camera body for macro photography with large reproduction ratios.

### View camera adapters

**VIEW CAMERA ADAPTER G:** This adapter is for use with lenses for older FUJINON large-format cameras, including lenses in the CM FUJINON series.

### Shoe-mounted flash units

**EF-X500:** In addition to manual and TTL flash control, this clip-on flash unit has a Guide Number of 50/164 (ISO 100, m/ft.) and supports FP (high-speed sync), allowing it to be used at shutter speeds that exceed the flash sync speed. Featuring support for the optional EF-BP1 battery pack and Fujifilm optical wireless flash control, it can be used as a commander or remote flash unit for remote wireless flash photography.



**Shoe-mounted flash units**

**EF-BP1:** A battery pack for EF-X500 flash units. Takes up to 8 AA batteries.

**EF-60:** In addition to manual and TTL flash control, this clip-on flash unit has a Guide Number of 60/197 (ISO 100, m/ft.) and supports FP (high-speed sync), allowing it to be used at shutter speeds that exceed the flash sync speed. It can also be used as remote flash under the control of an optional EF-W1 wireless commander.

**EF-W1:** With support for the NAS<sup>\*</sup> wireless communication standard developed by Nissin Japan, this wireless flash commander can be used with optional EF-60 clip-on flash units and other NAS-compliant units.

\* NAS is a registered trademark of Nissin Japan Ltd.

**EF-42:** This clip-on flash unit (powered by four AA batteries) has a Guide Number of 42/137 (ISO 100, m/ft.) and supports manual and TTL flash control and auto power zoom in the range 24–105 mm (35 mm format equivalent). The flash head can be rotated 90° up, 180° left, or 120° right for bounce lighting.

**EF-X20:** This clip-on flash unit has a Guide Number of 20/65 (ISO 100, m/ft.). Powered by two AAA batteries, this light, compact unit features a dial for adjusting TTL flash compensation or manual flash output.

**EF-20:** This clip-on flash unit (powered by two AA batteries) has a Guide Number of 20/65 (ISO 100, m/ft.) and supports TTL flash control (manual flash control is not supported). The flash head can be rotated upwards 90° for bounce lighting.

**Remote releases**

**RR-100:** Use to reduce camera shake or keep the shutter open during a time exposure.

**Stereo microphones**

**MIC-ST1:** An external microphone for movie recording.

**Handgrips**

**MHG-GFX S:** Features an improved grip. The MHG-GFX S is equipped with a rail for quick-shoe camera mounts.

**Grip belts**

**GB-001:** Improves grip.

**Body caps**

**BCP-002:** Cover the camera lens mount when no lens is attached.

**instax SHARE printers**

**SP-1/SP-2/SP-3:** Connect via wireless LAN to print pictures on instax film.

## Software for Use with Your Camera

The camera can be used with the following software. For the latest information on software available from Fujifilm, visit <https://fujifilm-x.com/support/compatibility/cameras/>.

### FUJIFILM Camera Remote

Establish a wireless connection between your camera and a smartphone or tablet (📖 280).

[http://app.fujifilm-dsc.com/en/camera\\_remote/](http://app.fujifilm-dsc.com/en/camera_remote/)

### RAW FILE CONVERTER EX powered by SILKYPIX

RAW FILE CONVERTER EX powered by SILKYPIX is RAW conversion software from Ichikawa Soft Laboratory Co., Ltd. View RAW pictures on your computer and convert them into other formats. RAW FILE CONVERTER EX powered by SILKYPIX is available free of charge from the Fujifilm website.

<https://fujifilm-x.com/support/download/software/raw-file-converter-ex-powered-by-silkypix/>



“RAW FILE CONVERTER EX powered by SILKYPIX” is supplied by Ichikawa Soft Laboratory Co., Ltd.

### Capture One Express Fujifilm

Capture One Express Fujifilm is image edit software from Capture One A/S. View RAW pictures on your computer and convert them into other formats. Capture One Express Fujifilm is available free of charge from Capture One A/S.

<https://www.captureone.com/products-plans/capture-one-express/fujifilm>

### Capture One Pro Fujifilm

Capture One Pro Fujifilm is workflow software from Capture One A/S. Capture One Pro Fujifilm supports tethered shooting and the conversion of RAW pictures into other formats.

<https://www.captureone.com/explore-features/fujifilm>

## Adobe® Photoshop® Lightroom® Classic CC + FUJIFILM Tether Shooting Plug-in PRO for GFX

Installing this dedicated plug-in allows tethered shooting using Adobe® Photoshop® Lightroom® Classic CC. FUJIFILM Tether Shooting Plug-in PRO for GFX is available free of charge from the Adobe Exchange website.

FUJIFILM Tether Shooting Plug-in PRO for GFX

<https://fujifilm-x.com/products/software/adobe-photoshop-lightroom-tether-plugin/>

## FUJIFILM X Acquire

This application for Windows and macOS lets you connect to the camera via USB or Wi-Fi and automatically download photos to a specified folder as they are taken, or backup and restore the camera via USB.

<https://fujifilm-x.com/products/software/x-acquire/>

 Auto download (tethered shooting) is not supported with some cameras.

## FUJIFILM X Webcam

Connect the camera to a computer via USB to turn it into a webcam.

<https://fujifilm-x.com/products/software/x-webcam/>

## FUJIFILM X RAW STUDIO

When the camera is connected to a computer via USB, FUJIFILM X RAW STUDIO can use the camera's unique image processing engine to rapidly convert RAW files to create high-quality images in other formats.

*<https://fujifilm-x.com/products/software/x-raw-studio/>*

## FUJIFILM Pixel Shift Combiner

Computer software for combining pictures taken using pixel-shift multi-shot or reducing false colors (📖 107).

*<https://fujifilm-x.com/products/software/pixel-shift-combiner/>*

# For Your Safety

## IMPORTANT SAFETY INSTRUCTIONS

- **Read Instructions:** All the safety and operating instructions should be read before the appliance is operated.
- **Retain Instructions:** The safety and operating instructions should be retained for future reference.
- **Heed Warnings:** All warnings on the appliance and in the operating instructions should be adhered to.
- **Follow Instructions:** All operating and use instructions should be followed.

### Installation

**Power Sources:** This video product should be operated only from the type of power source indicated on the marking label. If you are not sure of the type of power supply to your home, consult your appliance dealer or local power company. For video products intended to operate from battery power, or other sources, refer to the operating instructions.

**Grounding or Polarization:** This video product is equipped with a polarized alternating-current line plug (a plug having one blade wider than the other). This plug will fit into the power outlet only one way. This is a safety feature. If you are unable to insert the plug fully into the outlet, try reversing the plug. If the plug should still fail to fit, contact your electrician to replace your obsolete outlet. Do not defeat the safety purpose of the polarized plug.

**Alternate Warnings:** This video product is equipped with a three-wire grounding-type plug, a plug having a third (grounding) pin. This plug will only fit into a grounding-type power outlet. This is a safety feature. If you are unable to insert the plug into the outlet, contact your electrician to replace your obsolete outlet. Do not defeat the safety purpose of the grounding type plug.

**Overloading:** Do not overload wall outlets and extension cords as this can result in a risk of fire or electric shock.

**Ventilation:** Slots and openings in the cabinet are provided for ventilation, to ensure reliable operation of the video product and to protect it from overheating, and these openings must not be blocked or covered. The openings should never be blocked by placing the video product on a bed, sofa, rug, or other similar surface.

This video product should not be placed in a built-in installation such as a bookcase or rack unless proper ventilation is provided or the manufacturer's instructions have been adhered to. This video product should never be placed near or over a radiator or heat register.

**Attachments:** Do not use attachments not recommended by the video product manufacturer as they may cause hazards.

**Water and Moisture:** Do not use this video product near water—for example, near a bath tub, wash bowl, kitchen sink, or laundry tub, in a wet basement, or near a swimming pool, and the like.

**Power-Cord Protection:** Power-supply cords should be routed so that they are not likely to be walked on or pinched by items placed upon or against them, paying particular attention to cords at plugs, convenience receptacles, and the point where they exit from the appliance.

**Accessories:** Do not place this video product on an unstable cart, stand, tripod, bracket, or table. The video product may fall, causing serious injury to a child or adult, and serious damage to the appliance. Use only with a cart, stand, tripod, bracket, or table recommended by the manufacturer, or sold with the video product. Any mounting of the appliance should follow the manufacturer's instructions, and should use a mounting accessory recommended by the manufacturer.

An appliance and cart combination should be moved with care. Quick stops, excessive force, and uneven surfaces may cause the appliance and cart combination to overturn.



### Antennas

**Outdoor Antenna Grounding:** If an outside antenna or cable system is connected to the video product, be sure the antenna or cable system is grounded so as to provide some protection against voltage surges and built-up static charges. Section 810 of the National Electrical Code, ANSI/NFPA No. 70, provides information with respect to proper grounding of the mast and supporting structure, grounding of the lead-in wire to an antenna discharge unit, size of grounding conductors, location of antenna discharge unit, connection to grounding electrodes, and requirements for the grounding electrode.

#### EXAMPLE OF ANTENNA GROUNDING AS PER NATIONAL ELECTRICAL CODE

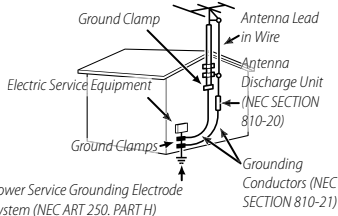

**Power Lines:** An outside antenna system should not be located in the vicinity of overhead power lines or other electric light or power circuits, or where it can fall into such power lines or circuits. When installing an outside antenna system, extreme care should be taken to keep from touching such power lines or circuits as contact with them might be fatal.

#### Use

**Cleaning:** Unplug this video product from the wall outlet before cleaning. Do not use liquid cleaners or aerosol cleaners. Use a damp cloth for cleaning.

**Object and Liquid Entry:** Never push objects of any kind into this video product through openings as they may touch dangerous voltage points or short out parts that could result in a fire or electric shock. Never spill liquid of any kind on the video product.

**Lightning:** For added protection for this video product receiver during a lightning storm, or when it is left unattended and unused for long periods of time, unplug it from the wall outlet and disconnect the antenna or cable system. This will prevent damage to the video product due to lightning and power-line surges.

#### Service

**Servicing:** Do not attempt to service this video product yourself as opening or removing covers may expose you to dangerous voltage or other hazards. Refer all servicing to qualified service personnel.

**Damage Requiring Service:** Unplug this video product from the wall outlet and refer servicing to qualified service personnel under the following conditions:

- When the power-supply cord or plug is damaged
- If liquid has been spilled, or objects have fallen into the video product.
- If the video product has been exposed to rain or water.
- If the video product has been dropped or the cabinet has been damaged.

If the video product does not operate normally follow the operating instructions. Adjust only those controls that are covered by the operating instructions as an improper adjustment of other controls may result in damage and will often require extensive work by a qualified technician to restore the video product to its normal operation.

When the video product exhibits a distinct change in performance — this indicates a need for service.

**Replacement Parts:** When replacement parts are required, be sure the service technician has used replacement parts specified by the manufacturer or have the same characteristics as the original part. Unauthorized substitutions may result in fire, electric shock or other hazards.

**Safety Check:** Upon completion of any service or repairs to this video product, ask the service technician to perform safety checks to determine that the video product is in proper operating condition.



## Be sure to read these notes before use

### Safety Notes



- Make sure that you use your camera correctly. Read these safety notes and your *Basic Manual* carefully before use.
- After reading these safety notes, store them in a safe place.

### About the Icons



The icons shown below are used in this document to indicate the severity of the injury or damage that can result if the information indicated by the icon is ignored and the product is used incorrectly as a result.

	<b>WARNING</b>	This icon indicates that death or serious injury can result if the information is ignored.
	<b>CAUTION</b>	This icon indicates that personal injury or material damage can result if the information is ignored.

The icons shown below are used to indicate the nature of the instructions which are to be observed.

	Triangular icons tell you that this information requires attention ("Important").
	Circular icons with a diagonal bar tell you that the action indicated is prohibited ("Prohibited").
	Filled circles with an exclamation mark indicate an action that must be performed ("Required").

The symbols on the product (including the accessories) represent the following:

	AC
	DC
	Class II equipment (The construction of the product is double-insulated.)











### WARNING











**If a problem arises, turn the camera off, remove the battery, disconnect the USB cable, and unplug the AC power adapter.** Continued use of the camera when it is emitting smoke, is emitting any unusual odor, or is in any other abnormal state can cause a fire or electric shock. Contact your Fujifilm dealer.



**Do not allow water or foreign objects to enter the camera or connecting cables.** Do not use the camera or connecting cables following ingress of fresh or salt water, milk, beverages, detergents, or other liquids. Should liquid find its way into the camera or connecting cables, turn the camera off, remove the battery, disconnect the USB cable, and disconnect and unplug the AC adapter. Continued use of the camera can cause a fire or electric shock. Contact your Fujifilm dealer.



 <b>WARNING</b>	
	<b>Do not use the camera in the bathroom or shower.</b> This can cause a fire or electric shock.
	<b>Never attempt to change or take apart the camera (never open the case).</b> Failure to observe this precaution can cause fire or electric shock.
	<b>Should the case break open as the result of a fall or other accident, do not touch the exposed parts.</b> Failure to observe this precaution could result in electric shock or in injury from touching the damaged parts. Remove the battery immediately, taking care to avoid injury or electric shock, and take the product to the point of purchase for consultation.
	<b>Do not change, heat or unduly twist or pull the connection cord and do not place heavy objects on the connection cord.</b> These actions could damage the cord and cause a fire or electric shock. If the cord is damaged, contact your Fujifilm dealer. Do not use cables with bent connectors.
	<b>Do not place the camera on an unstable surface.</b> This can cause the camera to fall or tip over and cause injury.
	<b>Never attempt to take pictures while in motion.</b> Do not use the camera while walking or driving. This can result in you falling down or being involved in a traffic accident.
	<b>Do not touch any metal parts of the camera during a thunderstorm.</b> This can cause an electric shock due to induced current from the lightning discharge.
	<b>Do not use the battery except as specified.</b> Load the battery as shown by the indicator.
	<b>Do not disassemble, modify, or heat batteries. Do not drop, strike, or throw batteries or otherwise subject them to strong impacts. Do not use batteries that show signs of leaking, deformation, discoloration, or other abnormalities. Use only designated chargers to recharge rechargeable batteries and do not attempt to recharge non-rechargeable Li-ion or alkaline batteries. Do not short batteries or store them with metallic objects.</b> Failure to observe these precautions could result in the batteries overheating, igniting, rupturing, or leaking, causing fire, burns, or other injury.
	<b>Use only batteries or AC power adapters specified for use with this camera. Do not use voltages other than the power supply voltage shown.</b> The use of other power sources can cause a fire.

 <b>WARNING</b>	
	<b>If the battery leaks and fluid gets in contact with your eyes, skin or clothing, flush the affected area with clean water and seek medical attention or call an emergency number right away.</b>
	<b>Do not use the charger to charge batteries other than those specified here.</b> The supplied charger is for use only with batteries of the type supplied with the camera. Using the charger to charge conventional batteries or other types of rechargeable batteries can cause the battery to leak, overheat or burst.
	<b>Using a flash too close to a person's eyes may cause visual impairment.</b> Take particular care when photographing infants and young children.
	<b>Do not remain in prolonged contact with hot surfaces. Do not leave one part of the body in contact with the product for prolonged periods while the product is on.</b> Failure to observe this precaution could result in low-temperature burns, particularly during prolonged use, at high ambient temperatures, when <b>HIGH</b> is selected for <b>AUTO POWER OFF TEMP.</b> or with users who suffer from poor circulation or reduced sensation, in which case use of a tripod or similar precautions are recommended.
	<b>Do not use in the presence of flammable objects, explosive gases, or dust.</b>
	<b>When carrying the battery, install it in a digital camera or keep it in the hard case. When storing the battery, keep it in the hard case. When discarding, cover the battery terminals with insulation tape.</b> Contact with other metallic objects or batteries could cause the battery to ignite or burst.
	<b>Keep memory cards, hot shoes, and other small parts out of the reach of small children.</b> Children may swallow small parts; keep out of reach of children. Should a child swallow a small part, seek medical attention or call emergency.
	<b>Keep out of reach of small children.</b> Among the elements that could cause injury are the strap, which could become entangled about a child's neck, causing strangulation, and the flash, which could cause visual impairment.
	<b>Follow the directions of airline and hospital personnel.</b> This product generates radio-frequency emissions that could interfere with navigational or medical equipment.

 **CAUTION**



**Do not use this camera in locations affected by oil fumes, steam, humidity or dust.** This can cause a fire or electric shock.



**Do not leave this camera in places subject to extremely high temperatures.** Do not leave the camera in locations such as a sealed vehicle or in direct sunlight. This can cause a fire.



**Do not place heavy objects on the camera.** This can cause the heavy object to tip over or fall and cause injury.



**Do not move the camera while the AC power adapter is still connected.** Do not pull on the connection cord to disconnect the AC power adapter. This can damage the power cord or cables and cause a fire or electric shock.



**Do not cover or wrap the camera or the AC power adapter in a cloth or blanket.** This can cause heat to build up and distort the casing or cause a fire.



**Do not use the plug if it is damaged or if it does not fit securely into the outlet.** Failure to observe this precaution could result in fire or electric shock.



**When you are cleaning the camera or you do not plan to use the camera for an extended period, remove the battery and disconnect and unplug the AC power adapter.** Failure to do so can cause a fire or electric shock.



**When charging ends, unplug the charger from the power socket.** Leaving the charger plugged into the power socket can cause a fire.



**When a memory card is removed, the card could come out of the slot too quickly. Use your finger to hold it and gently release the card.** Injury could result to those struck by the ejected card.



**Request regular internal testing and cleaning for your camera.** Build-up of dust in your camera can cause a fire or electric shock. Contact your Fujifilm dealer to request internal cleaning every two years. Please note that this service is not free of charge.



**Danger of explosion if battery is incorrectly replaced. Replace only with the same or equivalent type.**



**Batteries (battery pack or batteries installed) shall not be exposed to excessive heat such as sunshine, fire or the like.**



## The Battery and Power Supply

**Note:** Check the type of battery used in your camera and read the appropriate sections.

**⚠ WARNING:** Battery shall not be exposed to excessive heat such as sunshine, fire or the like.

The following describes the proper use of batteries and how to prolong their life. Incorrect use can shorten battery life or cause leakage, overheating, fire, or explosion.

### Li-ion Batteries

Read this section if your camera uses a rechargeable Li-ion battery.

The battery is not charged at shipment. Charge the battery before use. Keep the battery in its case when not in use.

#### ■ Notes on the Battery

The battery gradually loses its charge when not in use. Charge the battery one or two days before use.

Battery life can be extended by turning the camera off when not in use.

Battery capacity decreases at low temperatures; a depleted battery may not function when cold. Keep a fully charged spare battery in a warm place and exchange as necessary, or keep the battery in your pocket or other warm place and insert it in the camera only when shooting. Do not place the battery in direct contact with hand warmers or other heating devices.

#### ■ Charging the Battery

The battery can be charged using the camera and supplied AC adapter or an optional BC-W235 dual battery charger. Charging times will increase at ambient temperatures below +10°C (+50°F) or above +35°C (+95°F). Do not attempt to charge the battery at temperatures above +40°C (+104°F); at temperatures below +5°C (+41°F), the battery will not charge.

Do not attempt to recharge a fully charged battery. The battery does not however need to be fully discharged before charging.

The battery may be warm to the touch immediately after charging or use. This is normal.

#### ■ Battery Life

A noticeable decrease in the length of time the battery will hold a charge indicates that it has reached the end of its service life and should be replaced.

If the battery is left for long periods without charging, you may find that its quality degrades or that it no longer holds a charge. Charge the battery regularly.

#### ■ Storage

If the camera will not be used for an extended period, store it at room temperature with the battery charged to approximately one half to ¾ capacity.

If the camera will not be used for an extended period, remove the battery and store it in a dry place with an ambient temperature of from +15°C to +25°C (+59°F to +77°F). Do not store in locations exposed to extremes of temperature.

#### ■ Cautions: Handling the Battery

- Do not transport or store with metal objects such as necklaces or hairpins.
- Do not expose to flame or heat.
- Do not disassemble or modify.
- Do not expose to low atmospheric pressures.
- Use with designated chargers only.
- Dispose of used batteries promptly.
- Do not drop or subject to strong physical shocks.
- Do not expose to water.
- Keep the terminals clean.
- The battery and camera body may become warm to the touch after extended use. This is normal.

#### ■ Caution: Disposal

Dispose of used batteries in accord with local regulations. Attention should be drawn to the environmental aspects of battery disposal. Use the apparatus under moderate climate. Do not mechanically crush or split batteries.

### AC Power Adapters

- The AC power adapter is for indoor use only.
- Be sure the cable is securely connected to the camera.
- Turn the camera off before disconnecting the adapter. Disconnect the adapter by the plug, not the cable.
- Do not disassemble.
- Do not expose to high heat and humidity.
- Do not subject to strong physical shocks.
- The adapter may hum or become hot to the touch during use. This is normal.
- If the adapter causes radio interference, reorient or relocate the receiving antenna.

## Using the Camera

- Do not aim the camera at extremely bright light sources, including artificial light sources or natural light sources such as the sun in a cloudless sky. Failure to observe this precaution could damage the camera image sensor.
- Strong sunlight focused through the viewfinder may damage the panel of electronic viewfinder (EVF). Do not aim the electronic viewfinder at the sun.

### Take Test Shots

Before taking photographs on important occasions (such as at weddings or before taking the camera on a trip), take a test shot and view the results to ensure that the camera is functioning normally. FUJIFILM Corporation cannot accept liability for damages or lost profits incurred as a result of product malfunction.

### Notes on Copyright

Unless intended solely for personal use, images recorded using your digital camera system cannot be used in ways that infringe copyright laws without the consent of the owner. Note that some restrictions apply to the photographing of stage performances, entertainments, and exhibits, even when intended purely for personal use. Users are also asked to note that the transfer of memory cards containing images or data protected under copyright laws is only permissible within the restrictions imposed by those copyright laws.

### Handling

To ensure that images are recorded correctly, do not subject the camera to impact or physical shocks while images are being recorded.

### Liquid Crystal

In the event that the display is damaged, care should be taken to avoid contact with liquid crystal. Take the urgent action indicated should any of the following situations arise:

- **If liquid crystal comes in contact with your skin**, clean the area with a cloth and then wash thoroughly with soap and running water.
- **If liquid crystal enters your eyes**, flush the affected eye with clean water for at least 15 minutes and then seek medical assistance.
- **If liquid crystal is swallowed**, rinse your mouth thoroughly with water. Drink large quantities of water and induce vomiting, then seek medical assistance.

Although the display is manufactured using extremely high-precision technology, it may contain pixels that are always lit or that do not light. This is not a malfunction, and images recorded with the product are unaffected.

### Trademark Information

Digital Split Image is a trademark or registered trademark of FUJIFILM Corporation. Digital Micro Prism is a trademark or registered trademark of FUJIFILM Corporation. The typefaces included herein are solely developed by DynaComware Taiwan Inc. Apple, iPhone, iPad, Mac, OS X, macOS and Lightning are registered trademarks of Apple Inc. in the U.S.A. and other countries. Windows is a registered trademark of Microsoft Corporation in the U.S.A. and other countries. Android is a trademark or registered trademark of Google LLC. Adobe, the Adobe logo, Photoshop, and Lightroom are trademarks or registered trademarks of Adobe Systems Incorporated in the U.S.A. and other countries. Wi-Fi CERTIFIED Logo and Wi-Fi Protected Setup® are registered trademarks of Wi-Fi Alliance®. The Bluetooth® word mark and logos are registered trademarks owned by the Bluetooth SIG, Inc., and any use of such marks by Fujifilm is under license. The SDHC and SDXC logos are trademarks of SD-3C, LLC. The HDMI logo is a trademark or registered trademark of HDMI Licensing LLC. All other trade names mentioned in this manual are the trademarks or registered trademarks of their respective owners.

### Electrical Interference

This camera may interfere with hospital or aviation equipment. Consult with hospital or airline staff before using the camera in a hospital or on an aircraft.

### Color Television Systems

NTSC (National Television System Committee) is a color television telecasting specification adopted mainly in the U.S.A., Canada, and Japan. PAL (Phase Alternation by Line) is a color television system adopted mainly in European countries and China.

### Exif Print (Exif Version 2.32)

Exif Print is a newly revised digital camera file format in which information stored with photographs is used for optimal color reproduction during printing.

### IMPORTANT NOTICE: Read Before Using the Software

Direct or indirect export, in whole or in part, of licensed software without the permission of the applicable governing bodies is prohibited.

### Lenses and Other Accessories

- Use a screw 4.5 mm or shorter when attaching a tripod.
- Fujifilm will not be held liable for performance issues or damage caused by the use of third-party accessories.

## NOTICES

To prevent fire or shock hazard, do not expose the unit to rain or moisture.

Please read the "Safety Notes" and make sure you understand them before using the camera.

Perchlorate Material—special handling may apply. See:

<http://www.dtsc.ca.gov/hazardouswaste/perchlorate>

**For Customers in the U.S.A.**

**Tested To Comply With FCC Standards  
FOR HOME OR OFFICE USE**



Contains IC : 10293A-WMBNBM26A

Contains FCC ID : COF-WMBNBM26A

**FCC Statement:** This device complies with Part 15 of the FCC Rules. Operation is subject to the following two conditions:

- (1) This device may not cause harmful interference, and
- (2) this device must accept any interference received, including interference that may cause undesired operation.

**CAUTION:** This equipment has been tested and found to comply with the limits for a Class B digital device, pursuant to Part 15 of the FCC Rules. These limits are designed to provide reasonable protection against harmful interference in a residential installation. This equipment generates, uses, and can radiate radio frequency energy and, if not installed and used in accordance with the instructions, may cause harmful interference to radio communications. However, there is no guarantee that interference will not occur in a particular installation. If this equipment does cause harmful interference to radio or television reception, which can be determined by turning the equipment off and on, the user is encouraged to try to correct the interference by one or more of the following measures:

- Reorient or relocate the receiving antenna.
- Increase the separation between the equipment and receiver.
- Connect the equipment into an outlet on a circuit different from that to which the receiver is connected.
- Consult the dealer or an experienced radio/TV technician for help.

**FCC Caution:** Any changes or modifications not expressly approved by the party responsible for compliance could void the user's authority to operate this equipment.

This transmitter must not be co-located or operating in conjunction with any other antenna or transmitter.

**Radiation Exposure Statement:** This device meets the government's requirements for exposure to radio waves. This device is designed and manufactured not to exceed the emission limits for exposure to radio frequency (RF) energy set by the Federal Communications Commission of the U.S. Government.

The exposure standard for wireless device employs a unit of measurement known as the Specific Absorption Rate, or SAR. The SAR limit set by the FCC is 1.6W/kg. Tests for SAR are conducted using standard operating positions accepted by the FCC with the device transmitting at its highest certified power level in all tested frequency bands.

**Notes on the Grant:** To comply with Part 15 of the FCC Rules, this product must be used with a Fujifilm-specified ferrite-core A/V cable, USB cable, and DC supply cord.



A lithium ion battery that is recyclable powers the product you have purchased. Please call 1-800-8-BATTERY for information on how to recycle this battery.



California Code of Regulations, Title 20, Division 2, Chapter 4, Article 4, Appliance Efficiency Regulations, Sections 1601 through 1609

#### For Customers in Canada

#### CAN ICES-3 (B)/NMB-3(B)

**CAUTION:** This Class B digital apparatus complies with Canadian ICES-003.

**Industry Canada statement:** This device complies with Industry Canada's licence-exempt RSSs. Operation is subject to the following two conditions: (1) This device may not cause interference; and (2) This device must accept any interference, including interference that may cause undesired operation of the device.

This device and its antenna(s) must not be co-located or operating in conjunction with any other antenna or transmitter, except tested built-in radios. The County Code Selection feature is disabled for products marketed in the US/ Canada.

**Radiation Exposure Statement:** The available scientific evidence does not show that any health problems are associated with using low power wireless devices. There is no proof, however, that these low power wireless devices are absolutely safe. Low power Wireless devices emit low levels of radio frequency energy (RF) in the microwave range while being used. Whereas high levels of RF can produce health effects (by heating tissue), exposure of low-level RF that does not produce heating effects causes no known adverse health effects. Many studies of low-level RF exposures have not found any biological effects. Some studies have suggested that some biological effects might occur, but such findings have not been confirmed by additional research. GFX50S II has been tested and found to comply with IC radiation exposure limits set forth for an uncontrolled environment and meets RSS-102 of the IC radio frequency (RF) Exposure rules.

#### Disposal of Electrical and Electronic Equipment in Private Households

#### In the European Union, Norway, Iceland and

**Liechtenstein:** This symbol on the product, or in the manual and in the warranty, and/or on its packaging indicates that this product shall not be treated as household waste. Instead it should be taken to an applicable collection point for the recycling of electrical and electronic equipment.



By ensuring this product is disposed of correctly, you will help prevent potential negative consequences to the environment and human health, which could otherwise be caused by inappropriate waste handling of this product.

This symbol on the batteries or accumulators indicates that those batteries shall not be treated as household waste.



If your equipment contains easy removable batteries or accumulators please dispose these separately according to your local requirements.

The recycling of materials will help to conserve natural resources. For more detailed information about recycling this product, please contact your local city office, your household waste disposal service or the shop where you purchased the product.

#### In Countries Outside the European Union, Norway, Iceland and

**Liechtenstein:** If you wish to discard this product, including the batteries or accumulators, please contact your local authorities and ask for the correct way of disposal.

**In Japan:** This symbol on the batteries indicates that they are to be disposed of separately.



Li-ion

#### Caring for the Camera

To ensure continued enjoyment of the product, observe the following precautions.

#### Storage and Use

If the camera will not be used for an extended period, remove the battery and memory card. Do not store or use the camera in locations that are:

- exposed to rain, steam, or smoke
- very humid or extremely dusty
- exposed to direct sunlight or very high temperatures, such as in a closed vehicle on a sunny day
- extremely cold
- subject to strong vibration
- exposed to strong magnetic fields, such as near a broadcasting antenna, power line, radar emitter, motor, transformer, or magnet
- in contact with volatile chemicals such as pesticides
- next to rubber or vinyl products

### Wireless Network and Bluetooth Devices: Cautions

This product complies with the following EU Directives:

- RoHS Directive 2011/65/EU
- RE Directive 2014/53/EU

Hereby, FUJIFILM Corporation declares that the radio equipment type FF210001 is in compliance with Directive 2014/53/EU.

The full text of the EU declaration of conformity is available at the following internet address:

[https://dl.fujifilm-x.com/global/products/cameras/gfx50s-ii/pdf/gfx50s-ii\\_doc-lwb.pdf](https://dl.fujifilm-x.com/global/products/cameras/gfx50s-ii/pdf/gfx50s-ii_doc-lwb.pdf)

This compliance is indicated by the following conformity marking placed on the product:



This marking is valid for non-Telecom products and EU harmonized Telecom products (e.g. Bluetooth®).

• **Maximum radio-frequency power (EIRP):**

- WLAN: 11.96 dBm
- Bluetooth: 3.37 dBm

**IMPORTANT:** Read the following notices before using the camera's built-in wireless transmitter.

① This product, which contains encryption function developed in the United States, is controlled by the United States Export Administration Regulations and may not be exported or re-exported to any country to which the United States embargoes goods.

- **Use only a wireless network or Bluetooth device.** Fujifilm does not accept liability for damages resulting from unauthorized use. Do not use in applications requiring a high degree of reliability, for example in medical devices or other systems that may directly or indirectly impact human life. When using the device in computer and other systems that demand a greater degree of reliability than offered by wireless network or Bluetooth devices, be sure to take all necessary precautions to ensure safety and prevent malfunction.
- **Use only in the country in which the device was purchased.** This device conforms to regulations governing wireless network and Bluetooth devices in the country in which it was purchased. Observe all location regulations when using the device. Fujifilm does not accept liability for problems arising from use in other jurisdictions.
- **Do not use the device in locations subject to magnetic fields, static electricity, or radio interference.** Do not use the transmitter in the vicinity of microwave ovens or in other locations subject to magnetic fields, static electricity, or radio interference that may prevent reception of wireless signals. Mutual interference may occur when the transmitter is used in the vicinity of other wireless devices operating in the 2.4 GHz band.

• **The wireless transmitter operates in the 2.4 GHz band using DSSS, OFDM and GFSK modulation.**

• **Security:** Wireless network and Bluetooth devices transmit data via radio and consequently their use requires greater attention to security than applies in the case of wired networks.

- Do not connect to unknown networks or networks to which you do not have access rights, even if they are displayed on your device, as such access may be considered unauthorized. Connect only to networks to which you have access rights.
- Be aware that wireless transmissions may be vulnerable to interception by third parties.
- This device cannot be directly connected to telecommunications networks (including public wireless LANs) operated by providers or mobile, landline, Internet, or other telecommunications services.

• **The following may be punishable by law:**

- Disassembly or modification or this device
- Removal of device certification labels

• **This device operates on the same frequency as commercial, educational, and medical devices and wireless transmitters.**

It also operates on the same frequency as licensed transmitters and special unlicensed low-voltage transmitters used in RFID tracking systems for assembly lines and in other similar applications.

• **To prevent interference with the above devices, observe the following precautions.**

Confirm that the RFID transmitter is not in operation before using this device. Should you observe that the device causes interference in licensed transmitters used for RFID tracking, immediately stop using the affected frequency or move the device to another location. If you notice that this device causes interference in low-voltage RFID tracing systems, contact a Fujifilm representative.

• **Do not use this device on board an aircraft.** Note that Bluetooth may remain on even when the camera is off. Bluetooth can be disabled by selecting **OFF** for **CONNECTION SETTING > Bluetooth SETTINGS > Bluetooth ON/OFF**.

## Be sure to read these notes before using the lens

## Safety Notes

- Make sure that you use the lens correctly. Read these safety notes and the camera *Basic Manual* carefully before use.
- After reading these safety notes, store them in a safe place.

## About the Icons

The icons shown below are used in this document to indicate the severity of the injury or damage that can result if the information indicated by the icon is ignored and the product is used incorrectly as a result.



## WARNING

This icon indicates that death or serious injury can result if the information is ignored.



## CAUTION

This icon indicates that personal injury or material damage can result if the information is ignored.

The icons shown below are used to indicate the nature of the instructions which are to be observed.



Triangular icons tell you that this information requires attention ("Important").



Circular icons with a diagonal bar tell you that the action indicated is prohibited ("Prohibited").



Filled circles with an exclamation mark indicate an action that must be performed ("Required").



## WARNING



Do not immerse

**Do not immerse in or expose to water.** Failure to observe this precaution can cause a fire or electric shock.



Do not disassemble

**Do not disassemble (do not open the case).** Failure to observe this precaution can cause fire, electric shock, or injury due to product malfunction.



Do not touch internal parts

**Should the case break open as the result of a fall or other accident, do not touch the exposed parts.** Failure to observe this precaution could result in electric shock or in injury from touching the damaged parts. Remove the battery immediately, taking care to avoid injury or electric shock, and take the product to the point of purchase for consultation.



**Do not place on unstable surfaces.** The product may fall, causing injury.



**Do not view the sun through the lens or camera viewfinders.** Failure to observe this precaution can cause permanent visual impairment.



## CAUTION



**Do not use or store in locations that are exposed to steam, or smoke or are very humid or extremely dusty.** Failure to observe this precaution can cause fire or electric shock.



**Do not leave in direct sunlight or in locations subject to very high temperatures, such as in a closed vehicle on a sunny day.** Failure to observe this precaution can cause fire.



**Keep out of the reach of small children.** This product could cause injury in the hands of a child.



**Do not handle with wet hands.** Failure to observe this precaution can cause electric shock.



**Keep the sun out of the frame when shooting backlit subjects.** Sunlight focused into the camera when the sun is in or close to the frame can cause fire or burns.



**When the product is not in use, replace the lens caps and store out of direct sunlight.** Sunlight focused by the lens can cause fire or burns.



**Do not carry the camera or lens while they are attached to a tripod.** The product can fall or strike other objects, causing injury.

## Product Care

---

To ensure continued enjoyment of the product, observe the following precautions.

---

**Camera body:** Use a soft, dry cloth to clean the camera body after each use. Do not use alcohol, thinner, or other volatile chemicals, which could discolor or deform the leather on the camera body. Any liquid on the camera should be removed immediately with a soft, dry cloth. Use a blower to remove dust from the monitor, taking care to avoid scratches, and then gently wipe with a soft, dry cloth. Any remaining stains can be removed by wiping gently with a piece of Fujifilm lens-cleaning paper to which a small amount of lens-cleaning fluid has been applied. To prevent dust entering the camera, replace the body cap when no lens is in place.

**Image sensor:** Multiple photographs marred by spots or blotches in identical locations may indicate the presence of dust on the image sensor. Clean the sensor using  **USER SETTING > SENSOR CLEANING.**

## Cleaning the Image Sensor

Dust that cannot be removed using **USER SETTING > SENSOR CLEANING** can be removed manually as described below.

**!** Note that there will be a charge to repair or replace the image sensor if it is damaged during cleaning.

- 1 Use a blower (not a brush) to remove dust from the sensor.

**!** Do not use a brush or blower brush. Failure to observe this precaution could damage the sensor.

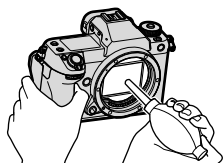

- 2 Check whether the dust has been successfully removed. Repeat Steps 1 and 2 as necessary.
- 3 Replace the body cap or lens.



## Firmware Updates

Updates to product firmware may result in changes not described in the manual. For more information, visit: <https://fujifilm-x.com/support/download/firmware/cameras/>

### Checking the Firmware Version

 The camera will only display the firmware version if a memory card is inserted.

- 1 Turn the camera off and check that a memory card is inserted.
- 2 Turn the camera on while pressing the **DISP/BACK** button. The current firmware version will be displayed; check the firmware version.
- 3 Turn the camera off.

 To view the firmware version or update firmware for optional accessories such as interchangeable lenses, shoe-mounted flash units, and mount adapters, mount the accessories on the camera.

## Troubleshooting

Consult the table below should you encounter problems using your camera. If you don't find the solution here, contact your local Fujifilm distributor.

### Power and Battery

Problem	Solution
The camera does not turn on.	<ul style="list-style-type: none"><li>• <b>The battery is exhausted:</b> Charge the battery or insert a fully-charged spare battery (📖 41).</li><li>• <b>The battery is inserted incorrectly:</b> Reinsert in the correct orientation (📖 36).</li><li>• <b>The battery-chamber cover is not latched:</b> Latch the battery-chamber cover (📖 36).</li></ul>
The monitor does not turn on.	The monitor may not turn on if the camera is turned off and then on again very quickly. Keep the shutter button pressed halfway until the monitor activates.
The battery runs down quickly.	<ul style="list-style-type: none"><li>• <b>The battery is cold:</b> Warm the battery by placing it in a pocket or other warm place and reinsert it in the camera immediately before taking a picture.</li><li>• <b>There is dirt on the battery terminals:</b> Clean the terminals with a soft, dry cloth.</li><li>• <b>ON is selected for  AF/MF SETTING &gt; PRE-AF:</b> Turn <b>PRE-AF</b> off (📖 132).</li><li>• <b>The battery has been charged many times:</b> Select <b>BATTERY AGE</b> to view the battery age; if the battery is old, replace it with a new battery (📖 207).</li></ul>
The camera turns off suddenly.	<b>The battery is exhausted:</b> Charge the battery or insert a fully-charged spare battery (📖 41).

Problem	Solution
Charging does not start.	<ul style="list-style-type: none"> <li>• Make sure that the AC power adapter is correctly plugged in (📖 41).</li> <li>• Ensure that the plug adapter is correctly connected to the AC power adapter (📖 41).</li> <li>• <b>The battery has not been recharged for an extended period:</b> If the battery has not been charged for an extended period, charging will be disabled to ensure safety. Replace it with a new battery.</li> </ul>
Charging does not start (USB).	<ul style="list-style-type: none"> <li>• Insert the camera battery (📖 36).</li> <li>• Reinsert the camera battery in the correct orientation (📖 36).</li> <li>• Confirm that the camera is connected to the computer (📖 43).</li> <li>• If the computer is off or in sleep mode, turn on or wake the computer and disconnect and reconnect the USB cable (📖 43).</li> </ul>
Charging does not start (battery charger).	<ul style="list-style-type: none"> <li>• Insert the battery.</li> <li>• Reinsert the battery in the correct orientation.</li> <li>• <b>The AC adapter is not correctly connected to the charger:</b> Check that adapter is correctly connected to the charger.</li> </ul>
Charging is slow.	Charge the battery at room temperature.
The indicator lamp blinks, but the battery does not charge.	<ul style="list-style-type: none"> <li>• <b>There is dirt on the battery terminals:</b> Clean the terminals with a soft, dry cloth (📖 36).</li> <li>• <b>The battery has been charged many times:</b> Select <b>BATTERY AGE</b> to view the battery age; if the battery is old, replace it with a new battery (📖 207). If the battery still fails to charge, contact your Fujifilm dealer (📖 296).</li> </ul>
The power supply icon is not displayed.	Confirm that <b>ON</b> is selected for <b>USB POWER SUPPLY SETTING</b> (📖 243).

## Menus and Displays

Problem	Solution
Display is not in English.	Select <b>ENGLISH</b> for <b>USER SETTING &gt; 言語/LANG.</b> (📖 48, 206).

## Shooting

Problem	Solution
No picture is taken when the shutter button is pressed.	<ul style="list-style-type: none"><li>• <b>The memory card is full:</b> Insert a new memory card or delete pictures (📖 38, 186).</li><li>• <b>The memory card is not formatted:</b> Format the memory card in the camera (📖 204).</li><li>• <b>There is dirt on the memory card contacts:</b> Clean the contacts with a soft, dry cloth.</li><li>• <b>The memory card is damaged:</b> Insert a new memory card (📖 38).</li><li>• <b>The battery is exhausted:</b> Charge the battery or insert a fully-charged spare battery (📖 41).</li><li>• <b>The camera has turned off automatically:</b> Turn the camera on (📖 44).</li><li>• <b>You are using a third-party mount adapter:</b> Select <b>ON</b> for <b>SHOOT WITHOUT LENS</b> (📖 228).</li></ul>
Mottling (“noise”) appears in the monitor or viewfinder when the shutter button is pressed halfway.	Gain is increased to aid composition when the subject is poorly lit and aperture is stopped down, which may result in noticeable mottling when images are previewed in the displays. Images taken with the camera are unaffected.
The camera does not focus.	<b>The subject is not suited to autofocus:</b> Use focus lock or manual focus (📖 96).
No face is detected.	<ul style="list-style-type: none"><li>• <b>The subject’s face is obscured by sunglasses, a hat, long hair, or other objects:</b> Remove the obstructions (📖 133).</li><li>• <b>The subject’s face occupies only a small area of the frame:</b> Change the composition so that the subject’s face occupies a larger area of the frame (📖 133).</li><li>• <b>The subject’s face is turned away from the camera:</b> Ask the subject to face the camera (📖 133).</li><li>• <b>The camera is tilted:</b> Keep the camera level.</li><li>• <b>The subject’s face is poorly lit:</b> Shoot in bright light.</li></ul>

Problem	Solution
<b>The flash does not fire.</b>	<ul style="list-style-type: none"> <li>• <b>The flash is disabled:</b> Adjust settings (📖 152).</li> <li>• <b>The electronic shutter is enabled:</b> Choose a <b>SHUTTER TYPE</b> that does not use the electronic shutter (📖 147).</li> <li>• <b>The battery is exhausted:</b> Charge the battery or insert a fully-charged spare battery (📖 41).</li> <li>• <b>The camera is in bracketing or continuous mode:</b> Select single frame mode (📖 7).</li> </ul>
<b>The flash does not fully light the subject.</b>	<ul style="list-style-type: none"> <li>• <b>The subject is not in range of the flash:</b> Position the subject in range of the flash.</li> <li>• <b>The flash window is obstructed:</b> Hold the camera correctly.</li> <li>• <b>Shutter speed is faster than the sync speed:</b> Choose a slower shutter speed (📖 66, 70, 329).</li> </ul>
<b>Pictures are blurred.</b>	<ul style="list-style-type: none"> <li>• <b>The lens is dirty:</b> Clean the lens.</li> <li>• <b>The lens is blocked:</b> Keep objects away from the lens (📖 51).</li> <li>• <b>!AF is displayed during shooting and the focus frame is displayed in red:</b> Check focus before shooting (📖 52).</li> </ul>
<b>Pictures are mottled.</b>	<ul style="list-style-type: none"> <li>• <b>Shutter speed is slow and the ambient temperature is high:</b> This is normal and does not indicate a malfunction.* Use pixel mapping (📖 126). * X-rays, cosmic rays, and other forms of radiation interacting with the image sensor may cause bright spots of various colors such as white, red, and blue. Pixel mapping helps reduce the occurrence of such bright spots.</li> <li>• <b>The camera has been used continuously at high temperatures:</b> Turn the camera off and wait for it to cool down (📖 44, 325).</li> <li>• <b>A temperature warning is displayed:</b> Turn the camera off and wait for it to cool down (📖 44, 325).</li> </ul>

## Playback

Problem	Solution
Pictures are grainy.	The pictures were taken with a different make or model of camera.
Playback zoom is unavailable.	The pictures were created using <b>RESIZE</b> or with a different make or model of camera.
No sound in movie playback.	<ul style="list-style-type: none"><li>• <b>Playback volume is too low:</b> Adjust playback volume (📖 210).</li><li>• <b>The microphone was obstructed:</b> Hold the camera correctly during recording.</li><li>• <b>The speaker is obstructed:</b> Hold the camera correctly during playback.</li></ul>
Selected pictures are not deleted.	Some of the pictures selected for deletion are protected.
Pictures remain after ERASE > ALL FRAMES is selected.	Remove protection using the device with which it was originally applied (📖 190).
File numbering is unexpectedly reset.	The battery-chamber cover was opened while the camera was on. Turn the camera off before opening the battery-chamber cover (📖 235).

## Connections

Problem	Solution
The monitor is blank.	<b>The camera is connected to a TV:</b> Pictures will be displayed on the TV instead of in the camera monitor (📖 278).
Both the TV and camera monitor are blank.	<b>The display mode selected with the VIEW MODE button is EVF ONLY + </b> : Put your eye to the viewfinder. Use the <b>VIEW MODE</b> button to choose another display mode (📖 16).
No picture or sound on TV.	<ul style="list-style-type: none"> <li>• <b>The camera is not properly connected:</b> Connect the camera properly (📖 278).</li> <li>• <b>Input on the television is set to “TV”:</b> Set input to “HDMI” (📖 278).</li> <li>• <b>The volume on the TV is too low:</b> Use the controls on the television to adjust the volume (📖 278).</li> </ul>
The computer does not recognize the camera.	Be sure the camera and computer are correctly connected (📖 283).
FUJIFILM X RAW STUDIO or FUJIFILM X Acquire fails to correctly detect the camera.	Check the option selected for <b>CONNECTION MODE</b> on the camera. Select <b>USB RAW CONV./BACKUP RESTORE</b> before connecting the USB cable (📖 288).
Cannot connect to iPhones or iPads.	<b>ON</b> is selected for <b>USB POWER SUPPLY SETTING</b> . Select <b>OFF</b> when the camera is connected via a Lightning connection to a device that do not supply power (📖 243).
Cannot connect to smartphone.	<b>Confirm that the camera is correctly connected:</b> The procedure for connecting the camera varies with the type of connector with which the smartphone is equipped (📖 289).

## Wireless Transfer

For additional information on troubleshooting wireless connections, visit:

<https://digitalcamera-support-en.fujifilm.com/>

Problem	Solution
Cannot connect to smartphone. The camera is slow to connect or upload pictures to the smartphone. Upload fails or is interrupted.	<ul style="list-style-type: none"><li>• <b>The smartphone is too far away:</b> Move the devices closer (📖 280).</li><li>• <b>Nearby devices are causing radio interference:</b> Move the camera and smartphone away from microwave ovens or cordless phones (📖 280).</li></ul>
Cannot upload images.	<ul style="list-style-type: none"><li>• <b>The smartphone is connected to another device:</b> The smartphone and camera can connect to only one device at a time. End the connection and try again (📖 280).</li><li>• <b>There are several smartphones in the vicinity:</b> Try connecting again. The presence of multiple smartphones can make connection difficult (📖 280).</li><li>• <b>The image was created on another device:</b> The camera may not be able to upload images created on other devices.</li><li>• <b>The image is a movie:</b> Uploading movies takes some time. In addition, smartphones may not accept upload of movies in formats they do not support.</li></ul>
Smartphone will not display pictures.	Select <b>ON</b> for <b>GENERAL SETTINGS &gt; RESIZE IMAGE FOR SMARTPHONE</b> 📖. Selecting <b>OFF</b> increases upload times for larger images; in addition, some phones may not display images over a certain size (📖 244).







## Miscellaneous





Problem	Solution
The camera is unresponsive.	<ul style="list-style-type: none"> <li>• <b>Temporary camera malfunction:</b> Remove and reinsert the battery (📖 36).</li> <li>• <b>The battery is exhausted:</b> Charge the battery or insert a fully-charged spare battery (📖 41).</li> <li>• <b>The camera is connected to a wireless LAN:</b> End the connection.</li> <li>• <b>The controls are locked:</b> Press and hold the <b>MENU/OK</b> button to unlock the controls (📖 13, 15).</li> </ul>
The camera does not function as expected.	Remove and reinsert the battery (📖 36). If the problem persists, contact your Fujifilm dealer.
No sound.	Adjust the volume (📖 209).
Pressing the Q button does not display the quick menu.	<b>TTL-LOCK is active:</b> End TTL-LOCK (📖 153).

## Warning Messages and Displays

The following warnings appear in the display.

Warning	Description
 (red)	Low battery. Charge the battery or insert a fully-charged spare battery.
 (blinks red)	Battery exhausted. Charge the battery or insert a fully-charged spare battery.
<b>!AF</b> (displayed in red with red focus frame)	The camera cannot focus. Use focus lock to focus on another subject at the same distance, then recompose the picture.
Aperture or shutter speed displayed in red	The subject is too bright or too dark and the picture will be over- or under-exposed. Use the flash for additional lighting when taking photographs of poorly-lit subject.
<b>FOCUS ERROR</b>	Camera malfunction. Turn the camera off, remove the lens, and check for foreign matter between the lens and the camera body, then replace the lens and turn the camera on. If the problem persists, contact a Fujifilm dealer.
<b>LENS CONTROL ERROR</b>	
<b>TURN OFF THE CAMERA AND TURN ON AGAIN</b>	
<b>CARD NOT INITIALIZED</b>	<ul style="list-style-type: none"><li>• <b>The memory card is not formatted or the memory card has been formatted in a computer or other device:</b> Format the memory card using  <b>USER SETTING &gt; FORMAT</b>.</li><li>• <b>The memory card contacts require cleaning:</b> Clean the contacts with a soft, dry cloth. If the message is repeated, format the card. If the message persists, replace the card.</li><li>• <b>Camera malfunction:</b> Contact a Fujifilm dealer.</li></ul>
<b>LENS ERROR</b>	Turn the camera off, remove the lens, and check for foreign matter between the lens and the camera body, then replace the lens and turn the camera on. If the problem persists, contact a Fujifilm dealer.



Warning	Description
<b>CARD ERROR</b>	<ul style="list-style-type: none"> <li>• <b>The memory card is not formatted for use in the camera:</b> Format the card.</li> <li>• <b>The memory card contacts require cleaning or the memory card is damaged:</b> Clean the contacts with a soft, dry cloth. If the message is repeated, format the card. If the message persists, replace the card.</li> <li>• <b>Incompatible memory card:</b> Use a compatible card.</li> <li>• <b>Camera malfunction:</b> Contact a Fujifilm dealer.</li> </ul>
<b>PROTECTED CARD</b>	The memory card is locked. Unlock the card.
<b>BUSY</b>	The memory card is incorrectly formatted. Use the camera to format the card.
<b> MEMORY FULL</b>	The memory card is full and pictures cannot be recorded. Delete pictures or insert a memory card with more free space.
<b>WRITE ERROR</b>	<ul style="list-style-type: none"> <li>• <b>Memory card error or connection error:</b> Reinsert the card or turn the camera off and then on again. If the message persists, contact a Fujifilm dealer.</li> <li>• <b>Not enough memory remaining to record additional pictures:</b> Delete pictures or insert a memory card with more free space.</li> <li>• <b>The memory card is not formatted:</b> Format the memory card.</li> <li>• <b>The memory card was removed while data were being recorded:</b> Do not remove the memory card during recording.</li> </ul>
<b>FRAME NO. FULL</b>	The camera has run out of frame numbers (current frame number is 999-9999). Insert a formatted memory card and select <b>RENEW</b> for <b> SAVE DATA SET-UP &gt; FRAME NO.</b> . Take a picture to reset frame numbering to 100-0001, then select <b>CONTINUOUS</b> for <b>FRAME NO.</b>

Warning	Description
<b>READ ERROR</b>	<ul style="list-style-type: none"> <li>• <b>The file is corrupt or was not created with the camera:</b> The file cannot be viewed.</li> <li>• <b>The memory card contacts require cleaning:</b> Clean the contacts with a soft, dry cloth. If the message is repeated, format the card. If the message persists, replace the card.</li> <li>• <b>Camera malfunction:</b> Contact a Fujifilm dealer.</li> </ul>
<b>PROTECTED FRAME</b>	An attempt was made to delete or rotate to a protected picture. Remove protection and try again.
<b>CAN NOT CROP</b>	The picture is damaged or was not created with the camera.
<b>DPOF FILE ERROR</b>	Print orders can contain no more than 999 pictures. Copy any additional pictures you wish to print to another memory card and create a second print order.
<b>CAN NOT SET DPOF</b>	The picture cannot be printed using DPOF.
 <b>CAN NOT SET DPOF</b>	Movies cannot be printed using DPOF.
<b>CAN NOT ROTATE</b>	The selected picture cannot be rotated.
 <b>CAN NOT ROTATE</b>	Movies cannot be rotated.
 <b>CANNOT EXECUTE</b>	Red-eye removal cannot be applied to movies.
 <b>CANNOT EXECUTE</b>	Red-eye removal cannot be applied to pictures created with other devices.

Warning	Description
<p>!⬇ (yellow)</p> <p><b>CAMERA IS APPROACHING STANDARD TEMPERATURE LIMIT</b></p>	<p>The camera is approaching the maximum temperature allowed when <b>STANDARD</b> is selected for <b>AUTO POWER OFF TEMP.</b> and will shortly turn off automatically. Turn the camera off and wait for it to cool.</p>
<p>!⬇ (yellow)</p> <p><b>CAMERA IS APPROACHING HIGH TEMPERATURE LIMIT.DO NOT HOLD CAMERA FOR LONG PERIODS OF TIME</b></p>	<p>The camera is approaching the maximum temperature allowed when <b>HIGH</b> is selected for <b>AUTO POWER OFF TEMP.</b> and will shortly turn off automatically. Remaining in contact with the camera could result in low-temperature burns; mount the camera on a tripod or take other steps to avoid prolonged contact with the camera. The camera will shortly turn off automatically. Turn the camera off and wait for it to cool. Mottling may increase in pictures taken when this warning is displayed.</p>
<p>!⬇ (red)</p> <p><b>HIGH TEMPERATURE LIMIT REACHED SHUTTING DOWN</b></p>	<p>The camera temperature has reached the cutoff point and the camera is about to turn off automatically. Turn the camera off and wait for it to cool. Mottling may increase in pictures taken when this warning is displayed.</p>

## Memory Card Capacity

The following table shows the recording time or number of pictures available at different image sizes. All figures are approximate; file size varies with the scene recorded, producing wide variations in the number of files that can be stored. The number of exposures or length remaining may not diminish at an even rate.

		Capacity	32 GB		
			SUPER FINE	FINE	NORMAL
Photos	 4:3	1050	1580	2520	
	RAW (UNCOMPRESSED)	300			
	RAW (LOSSLESS COMPRESSED)	580			
	RAW (COMPRESSED)	850			
Movies*		78 minutes			



\* Use a UHS speed class 1 card or better.

 If the memory card has a capacity of over 32 GB, movies will be recorded in single files, regardless of size. If the card has a capacity of 32 GB or less, movies over 4 GB in size will be recorded uninterrupted across multiple files.

## Specifications















System		
Model	FUJIFILM GFX50S II	
Product Number	FF210001	
Effective pixels	Approx. 51.4 million	
Image sensor	43.8 mm × 32.9 mm Bayer array with primary color filter	
Storage media	Fujifilm-recommended SD/SDHC/SDXC memory cards	
Memory card slots	Two SD memory card slots (UHS-II compliant)	
File format	<ul style="list-style-type: none"> <li>• <b>Still pictures:</b> Compliant with Design Rule for Camera File System (DCF2.0)               <ul style="list-style-type: none"> <li>- <b>JPEG:</b> Compliant with Exif 2.32 and Digital Print Order Format (DPOF)</li> <li>- <b>RAW (original RAF format; special purpose software required):</b> Uncompressed, or compressed using either a lossless or non-reversible algorithm; RAW+JPEG available; TIFF (RGB)</li> </ul> </li> <li>• <b>Movies:</b> MPEG-4 AVC/H.264 standard with stereo sound (MOV)</li> <li>• <b>Audio (voice memos):</b> Stereo sound (WAV)</li> </ul>	
Image size	<b>L 4:3</b> (8256 × 6192) <b>L 3:2</b> (8256 × 5504) <b>L 16:9</b> (8256 × 4640) <b>L 1:1</b> (6192 × 6192) <b>L 65:24</b> (8256 × 3048) <b>L 5:4</b> (7744 × 6192) <b>L 7:6</b> (7232 × 6192)	<b>S 4:3</b> (4000 × 3000) <b>S 3:2</b> (4000 × 2664) <b>S 16:9</b> (4000 × 2248) <b>S 1:1</b> (2992 × 2992) <b>S 65:24</b> (4000 × 1480) <b>S 5:4</b> (3744 × 3000) <b>S 7:6</b> (3504 × 3000)
	<b>RAW</b> (8256 × 6192)	<b>TIFF</b> (8256 × 6192)
Lens mount	FUJIFILM G mount	
Sensitivity	<ul style="list-style-type: none"> <li>• <b>Still pictures:</b> Standard output sensitivity equivalent to ISO 100–12800 in increments of 1/3 EV; AUTO1–3; extended output sensitivity equivalent to ISO 50, 25600, 51200, or 102400</li> <li>• <b>Movies:</b> Standard output sensitivity equivalent to ISO 200–6400 in increments of 1/3 EV; AUTO</li> </ul>	

## System

<b>Metering</b>	256-segment through-the-lens (TTL) metering; MULTI, SPOT, AVERAGE, CENTER WEIGHTED
<b>Exposure control</b>	Programmed AE (with program shift); shutter-priority AE; aperture-priority AE; manual exposure
<b>Exposure compensation</b>	<ul style="list-style-type: none"><li>• <b>Still pictures:</b> -5 EV +5 EV in increments of 1/3 EV</li><li>• <b>Movies:</b> -2 EV +2 EV in increments of 1/3 EV</li></ul>
<b>Shutter speed</b>	<ul style="list-style-type: none"><li>• <b>MECHANICAL SHUTTER, E-FRONT CURTAIN SHUTTER</b><ul style="list-style-type: none"><li>- <b>Mode P:</b> 4 s to 1/4000 s</li><li>- <b>Mode A:</b> 30 s to 1/4000 s</li><li>- <b>Modes S and M:</b> 60 min. to 1/4000 s</li><li>- <b>Bulb:</b> Max. 60 min.</li></ul></li><li>• <b>ELECTRONIC SHUTTER, MECHANICAL + ELECTRONIC, E-FRONT + ELECTRONIC</b><ul style="list-style-type: none"><li>- <b>Mode P:</b> 4 s to 1/16000 s</li><li>- <b>Mode A:</b> 30 s to 1/16000 s</li><li>- <b>Modes S and M:</b> 60 min. to 1/16000 s</li><li>- <b>Bulb:</b> Max. 60 min.</li></ul></li></ul>
<b>Continuous</b>	<ul style="list-style-type: none"><li>• <b>Available frame advance rates</b><ul style="list-style-type: none"><li>- <b>Mechanical shutter:</b> 3.0 fps</li><li>- <b>Electronic front-curtain shutter:</b> 2.2 fps</li><li>- <b>Electronic shutter:</b> 1.5 fps</li></ul></li><li>• <b>Approximate maximum number of shots per burst (JPEG, 3.0 fps):</b> 28</li></ul> <div style="border: 1px solid gray; padding: 5px;"> The frame rate and number of frames per burst varies with shooting conditions and type of memory card used.</div>
<b>Focus</b>	<ul style="list-style-type: none"><li>• <b>Mode:</b> Single or continuous AF; manual focus with focus ring</li><li>• <b>Autofocus system:</b> TTL contrast-detect AF with AF-assist illuminator</li><li>• <b>Focus-area selection:</b> SINGLE POINT, ZONE, WIDE/TRACKING, ALL</li></ul>
<b>White balance</b>	Auto (  <b>AUTO</b> WHITE PRIORITY, <b>AUTO</b> ,  <b>AUTO</b> AMBIENCE PRIORITY), Custom 1, Custom 2, Custom 3, color temperature selection, direct sunlight, shade, daylight fluorescent, warm white fluorescent, cool white fluorescent, incandescent, underwater
<b>Self-timer</b>	Off, 2 sec., 10 sec.



## System

<b>Flash mode</b>	<ul style="list-style-type: none"> <li>• <b>MODE:</b> TTL MODE (FLASH AUTO, STANDARD, SLOW SYNC.), MANUAL, MULTI, OFF</li> <li>• <b>SYNC. MODE:</b> 1ST CURTAIN, 2ND CURTAIN, AUTO FP (high-speed sync)</li> <li>• <b>RED EYE REMOVAL:</b>  FLASH+REMOVAL,  FLASH,  REMOVAL, OFF</li> </ul>				
<b>Hot shoe</b>	Accessory shoe with TTL contacts; supports sync speeds as fast as $\frac{1}{125}$ s				
<b>Sync contact</b>	X contact; supports sync speeds as fast as $\frac{1}{125}$ s				
<b>Sync terminal</b>	Provided				
<b>Electronic viewfinder (EVF)</b>	0.5-in., 3690k-dot OLED viewfinder; magnification 0.77 $\times$ with 50 mm lens (35 mm format equivalent) at infinity and diopter set to $-1.0$ m $^{-1}$ ; diagonal angle of view approximately 38 $^{\circ}$ (horizontal angle of view approximately 30 $^{\circ}$ ) <ul style="list-style-type: none"> <li>• <b>Diopter adjustment:</b> <math>-4</math> to <math>+2</math> m<math>^{-1}</math></li> <li>• <b>Eyepoint:</b> Approximately 23 mm</li> </ul>				
<b>LCD monitor</b>	<ul style="list-style-type: none"> <li>• <b>Rear monitor:</b> 3.2-in/8.1 cm, 2360k-dot color LCD touch screen with 3-way tilt</li> <li>• <b>Shoulder monitor:</b> 1.80-in/4.57 cm, 303 <math>\times</math> 230-dot memory LCD monitor</li> </ul>				
<b>Movies (with stereo sound)</b>	<ul style="list-style-type: none"> <li>• <b>Movie mode</b></li> </ul> <table border="1" data-bbox="339 856 799 920"> <tr> <td> 1080/29.97P</td> <td> 1080/24P</td> </tr> <tr> <td> 1080/25P</td> <td> 1080/23.98P</td> </tr> </table> <ul style="list-style-type: none"> <li>• <b>Recording/output format</b></li> </ul> <p><b>H.264:</b> SD card, 4:2:0, 8-bit/HDMI output, 4:2:2, 10-bit</p>	 1080/29.97P	 1080/24P	 1080/25P	 1080/23.98P
 1080/29.97P	 1080/24P				
 1080/25P	 1080/23.98P				

## Input/output terminals

<b>Microphone connector</b>	$\varnothing$ 3.5 mm mini-stereo jack
<b>Headphone jack socket</b>	$\varnothing$ 3.5 mm mini-stereo jack
<b>Remote release connector</b>	$\varnothing$ 2.5 mm 3-pole mini jack
<b>Digital input/output</b>	USB connector (Type-C) USB3.2Gen1x1
<b>HDMI output</b>	HDMI Micro connector (type D)

## Power supply/other

**Power supply** NP-W235 rechargeable battery (supplied with camera)

### Battery life

- **Battery type:** NP-W235
- **Lens:** GF63mmF2.8 R WR
- **External flash units:** Disabled
- **Shooting mode:** Mode P
- **AUTO POWER SAVE:** ON

### Number of shots

LCD	EVF
Approx. 455	Approx. 445

### Total length of footage that can be recorded on a single charge

Mode	Actual Battery life of movie capture	Continuance Battery life of movie capture
<b>FHD</b> *	Approx. 80 minutes	Approx. 140 minutes

\* At a frame rate of 29.97 fps.

CIPA standard. Measured using battery supplied with camera and SD memory card.

**Note:** Battery endurance varies with battery charge level and the figures given above are not guaranteed. Battery endurance will decline at low temperatures.

**Camera size** 150.0 mm × 104.2 mm × 87.2 mm (44.0 mm excluding projections, (W × H × D) measured at thinnest part)/5.91 in. × 4.10 in. × 3.43 in. (1.73 in.)

**Camera weight** Approx. 819 g/28.9 oz., excluding battery, accessories, and memory card

**Shooting weight** Approx. 900 g/31.7 oz., including battery and memory card

**Operating conditions**

- **Temperature:** -10 °C to +40 °C/+14 °F to +104 °F (+5 °C to +40 °C/+41 °F to +104 °F when battery is charging)
- **Humidity:** 10% to 80% (no condensation)

**Wireless transmitter****Wireless LAN**

<b>Standards</b>	IEEE 802.11b/g/n (standard wireless protocol)
------------------	---

<b>Operating frequency (center frequency)</b>	2,412 MHz–2,462 MHz (11 channels)
---	-----------------------------------

<b>Access protocols</b>	Infrastructure
-------------------------	----------------

**Bluetooth®**

<b>Standards</b>	Bluetooth version 4.2 (Bluetooth Low Energy)
------------------	--

<b>Operating frequency (center frequency)</b>	2,402 MHz–2,480 MHz
---	---------------------

**NP-W235 rechargeable battery**

<b>Nominal voltage</b>	7.2 V
<b>Nominal capacity</b>	2350 mAh
<b>Rating capacity</b>	2200 mAh
<b>Operating temperature</b>	0 °C to +40 °C/+32 °F to +104 °F
<b>Dimensions</b> (W × H × D)	38.92 mm × 22.8 mm × 52.26 mm/ 1.5 in. × 0.9 in. × 2.1 in.
<b>Weight</b>	Approx. 79 g/2.8 oz.

**AC-5VJ AC power adapter**

<b>Manufacturer</b>	Dongguan Yingjiu Power Co.,Ltd.
<b>Address</b>	No.6 Yongxing Road, Shayao Village, Shijie Town, 523292 Dongguan City, Guangdong Province, PEOPLE'S REPUBLIC OF CHINA
<b>Model name</b>	AC-5VJ
<b>Rated input</b>	100 V – 240 V AC, 50/60 Hz
<b>Input capacity</b>	Max. 50 VA
<b>Rated output</b>	DC5.0V 3.0A 15.0W
<b>Average active efficiency</b>	84.8 %
<b>Efficiency at load 10%</b>	84.2 %
<b>No-load power consumption</b>	0.02 W
<b>Operating temperature</b>	0 °C to +40 °C/+32 °F to +104 °F
<b>Weight</b>	Approx. 45 g ± 2 g/1.6 oz. ± 0.1 oz.



Weight and dimensions vary with the country or region of sale.



Specifications and performance are subject to change without notice. Fujifilm will not be held liable for any errors this manual may contain. The appearance of the product may differ from that described in this manual.







# FUJIFILM

---

## FUJIFILM Corporation

7-3, AKASAKA 9-CHOME, MINATO-KU, TOKYO 107-0052, JAPAN

<https://fujifilm-x.com>

