

XN300 slice modules

Digital I/O modules
Analog I/O modules
technology modules
power distribution

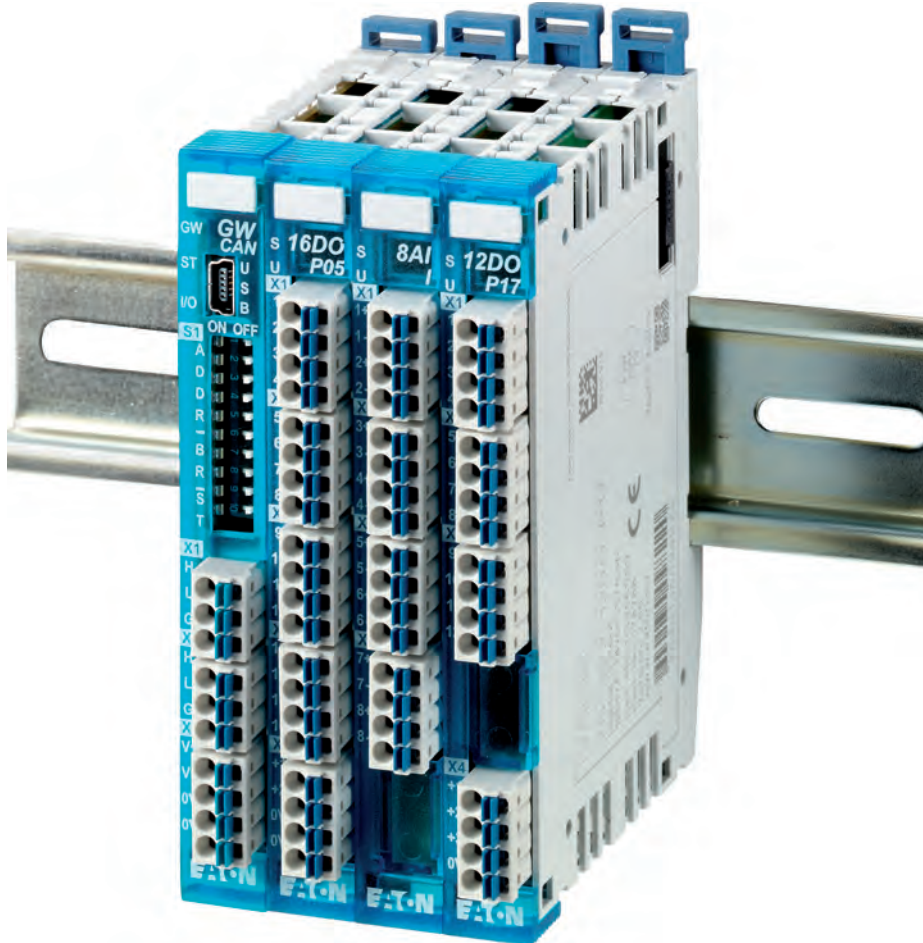

EATON

Powering Business Worldwide

Brands and products are trademarks or registered trademarks of their owners.

Break-Down Service

Please call your local representative:

<http://eaton.eu/aftersales> or www.eaton.com/CustomerSupport

or

Hotline After Sales Service:

+49 (0) 180 5 223822 (de, en)

AfterSalesEGBonn@eaton.com

Eaton Industries GmbH

Hein-Moeller-Straße 7-11,
53115 Bonn, Germany

Eaton Corporation

W126 N7250 Flint Drive
Menomonee Falls,
WI 53051, USA

Contact your regional Eaton office for additional technical support

Americas

Eaton Corporation

Electrical Sector
+1.800.426.9184
North America 1-877-ETN-CARE
www.eaton.com/CustomerSupport

Europe – Middle East – Africa – Asia Pacific

Eaton Industries GmbH

Electrical Sector EMEA
+49 (0) 180 5 223822 (de, en)
www.eaton.eu/aftersales
www.eaton.eu/xn300

Original operating manual

The German-language edition of this document is the original operating manual.

Translation of the original operating manual

All editions of this document other than those in German language are translations of the original operating manual.

1st edition 2014, publication date 12/14

2nd edition 2016, publication date 02/16

3rd edition 2016, publication date 06/16

© 2014 by Eaton Industries GmbH

Authors: Thomas Hettwer

Editor: Bettina Ewoti

All rights reserved, also for the translation.

No part of this manual may be reproduced, stored in a retrieval system, or transmitted in any form or by any means, electronic, mechanical, photocopying, micro-filming, recording or otherwise, without the prior written permission of Eaton Industries GmbH, Bonn.

Subject to alteration.

Printed on paper made from cellulose bleached without the use of chlorine or acid.



Danger! **Dangerous electrical voltage!**

Before starting with the installation

- De-energize the device
- Secure against retriggering
- Verify isolation from the supply
- Ground and short-circuit
- Cover or enclose any neighboring live parts.
- Follow the mounting instructions (AWA/IL) for the device.
- Only suitably qualified personnel in accordance with EN 50 110-1/-2 (VDE 0105 Part 100) may work on this device/system.
- Before installation and before touching the device, ensure that you are free of electrostatic charge.
- The functional earth (FE) must be connected to the protective earth (PE) or to the equipotential bonding. The system installer is responsible for implementing this connection.
- Connecting cables and signal lines should be installed in such a way that inductive and capacitive interference will not have a negative impact on the automation functions.
- Install automation devices and related operating elements in such a way that they are well protected against unintentional operation.
- Suitable safety hardware and software measures should be implemented for the I/O interface so that cable or wire breakage on the signal side will not result in undefined states in the automation devices.
- Ensure a reliable electrical isolation of the low voltage for the 24 V supply. Only use power supply units complying with IEC 60364-4-41 or HD 384.4.41 S2 (VDE 0100 Part 410).
- Deviations of the mains voltage from the nominal value must not exceed the tolerance limits given in the specifications, otherwise this may result in malfunction and hazardous states.
- Emergency stop devices complying with IEC/EN 60204-1 must remain functional in all of the automation devices' operating modes. Unlatching the emergency stop devices must not result in an automatic restart.
- Built-in devices for enclosures or cabinets must only be run and operated in an installed state; desktop devices and portable devices only when the housing is closed.
- Measures should be taken to ensure the proper restarting of programs interrupted after a voltage dip or outage. This should not result in dangerous operating states even for a short time. If necessary, emergency stop devices should be implemented.
- Wherever faults in the automation system may cause damage to persons or property, external measures must be implemented to ensure a safe operating state in the event of a fault or malfunction (for example, by means of separate limit switches, mechanical interlocks, etc.).

Contents

0	About this manual	11
0.1	List of revisions	11
0.2	Target group.....	12
0.3	Legal Disclaimer	12
0.4	Device designations and abbreviations	13
0.5	Writing conventions	14
1	XN300 slice modules	15
1.1	Proper use	15
1.2	Overview of functions.....	15
1.3	List of I/O slice module devices	15
1.4	Catalog number selection XN300.....	17
2	Installation	19
2.1	Mounting the XN300 slice modules.....	19
2.2	Removing the XN300 slice modules	22
2.3	Terminations	24
2.4	Connecting the power supply	25
2.5	Potential Relationship between the Components.....	26
3	Commissioning	27
3.1	General commissioning instructions	27
3.2	Wiring in accordance with EMC requirements	28
3.3	LED indicators	28
4	Power supply XN-322-4PS-20	29
4.1	Status LED signals and pin assignment	29
4.2	Wiring.....	30
4.3	Technical Data.....	31
4.3.1	+24 V power supply modules	31
5	Power distribution 0 V XN-322-18PD-M	33
5.1	Pin assignment.....	33
5.2	Wiring.....	34
5.3	Technical data	35
5.3.1	0 V distribution	35
6	Power distribution +24 V XN-322-18PD-P.....	37
6.1	Pin assignment.....	37
6.2	Wiring.....	38

6.3	Technical data	39
6.3.1	+24 V distribution.....	39
7	Digital input module XN-322-8DI-PD	41
7.1	Status LEDs	41
7.2	Pin assignment	42
7.3	Digital input wiring	43
7.4	Technical data for digital inputs.....	43
7.5	Memory layout.....	44
7.6	Supported CANopen objects	44
8	Digital input module XN-322-16DI-PD	45
8.1	Status LEDs	45
8.2	Pin assignment	46
8.3	Digital input wiring	47
8.4	Technical data for digital inputs.....	47
8.5	Memory layout.....	48
8.6	Supported CANopen objects	49
9	Digital input module XN-322-20DI-PD	51
9.1	Status LEDs	51
9.2	Pin assignment	52
9.3	Digital input wiring	53
9.4	Technical data for digital inputs.....	53
9.5	Memory layout.....	54
9.6	Supported CANopen objects	55
10	Digital input module XN-322-20DI-PF	57
10.1	Status LEDs	57
10.2	Pin assignment	58
10.3	Digital input wiring	59
10.4	Technical data for digital inputs.....	59
10.5	Memory layout.....	60
10.6	Supported CANopen objects	61
11	XN-322-20DI-PCNT digital input module with counter function.....	63
11.1	Status LEDs	64
11.2	Pin assignment	65
11.3	Wiring	65
11.3.1	Wiring up the digital inputs	66

11.3.2	Wiring the counter functions for inputs 1 to 4	66
11.3.3	Configuring inputs 1 to 4.....	67
11.4	Technical data for digital inputs.....	67
11.5	Memory layout	68
11.6	Supported CANopen objects.....	69
12	Digital input module XN-322-20DI-ND	71
12.1	Status LEDs	71
12.2	Pin assignment.....	72
12.3	Digital input wiring	73
12.4	Technical data for digital inputs.....	73
12.5	Memory layout	74
12.6	Supported CANopen objects.....	75
13	Relay output module XN-322-4DO-RNO	77
13.1	Status LEDs	78
13.2	Pin assignment.....	79
13.3	Wiring.....	79
13.3.1	Wiring the relay output.....	79
13.3.2	Suppressor circuit for inductive loads	81
13.4	Technical data relay outputs.....	81
13.5	Profile	82
13.6	Connection terminals	82
13.7	Memory layout.....	83
13.8	Supported CANopen objects.....	83
14	Digital output module XN-322-8DO-P05.....	85
14.1	Pin assignment and status LED signals	86
14.1.1	Wiring.....	87
14.1.2	Connecting the power supply	87
14.1.3	Connecting EN 61131-2 short-circuit proof digital outputs	87
14.1.4	Wiring digital outputs	88
14.1.5	Suppressor circuit for inductive loads	88
14.2	Technical data for digital outputs	89
14.3	Memory layout.....	90
14.4	Supported CANopen objects.....	91
15	Digital output module XN-322-12DO-P17.....	93
15.1	Status LEDs	94
15.2	Pin assignment.....	95
15.3	Wiring.....	95
15.3.1	Connecting the power supply	96

15.3.2	Connecting EN 61131-2 short-circuit proof digital outputs	96
15.3.3	Wiring digital outputs	96
15.3.4	Suppressor circuit for inductive loads	96
15.3.5	Behavior in the event of a short-circuit or overload	97
15.4	Technical data for digital outputs	97
15.5	Memory layout.....	99
15.6	Supported CANopen objects	100
16	Digital output module XN-322-16DO-P05.....	101
16.1	Pin assignment and status LED signals	102
16.1.1	Wiring	103
16.1.2	Connecting the power supply	103
16.1.3	Connecting EN 61131-2 short-circuit proof digital outputs	103
16.1.4	Wiring digital outputs	104
16.1.5	Suppressor circuit for inductive loads	104
16.2	Technical data for digital outputs	105
16.3	Memory layout.....	106
16.4	Supported CANopen objects	107
17	Digital input/output module XN-322-8DIO-PD05	109
17.1	Status LEDs	109
17.2	Pin assignment	110
17.3	Digital input wiring	111
17.4	Technical data	111
17.4.1	Digital inputs	111
17.4.2	Digital outputs.....	112
17.5	Memory layout.....	112
17.6	Supported CANopen objects	113
18	Digital input/output module XN-322-16DIO-PD05	115
18.1	Status LEDs	116
18.2	Pin assignment	117
18.3	Wiring	118
18.3.1	Digital inputs	118
18.3.2	Connecting the power supply	118
18.3.3	Connecting EN 61131-2 short-circuit proof digital outputs	118
18.3.4	Suppressor circuit for inductive loads	118
18.3.5	Wiring example	119
18.4	Technical data	120
18.4.1	Digital inputs	120
18.4.2	Digital outputs.....	120
18.5	Memory layout.....	121
18.6	Supported CANopen objects	122

19	XN-322-16DIO-PC05 digital input/output module	123
19.1	Status LEDs	124
19.2	Pin assignment.....	125
19.3	Wiring.....	126
19.3.1	Digital inputs	126
19.3.2	Counter functions for inputs 1...4.....	126
19.3.3	Configuring inputs 1 to 4.....	127
19.3.4	Connecting the power supply	127
19.3.5	Connecting the EN 61131-2 short-circuit proof digital outputs	128
19.3.6	Wiring example	128
19.4	Technical data	129
19.4.1	Digital inputs	129
19.4.2	Digital outputs	129
19.5	Memory layout.....	130
19.6	Supported CANopen objects.....	132
20	Analog input module XN-322-4AI-PTNI	135
20.1	Status LEDs	136
20.2	Pin assignment.....	137
20.3	Wiring.....	137
20.3.1	Two-wire connection.....	138
20.3.2	Three-wire connection	138
20.4	Technical Data.....	140
20.4.1	Specifications for analog resistance / temperature inputs	140
20.4.2	Measuring ranges for resistance inputs	140
20.4.3	Measuring ranges for temperature inputs	141
20.5	Diagnostics.....	141
20.6	Filters	142
20.7	Memory layout.....	143
20.8	Supported CANopen objects.....	145
21	Analog input module XN-322-7AI-U2PT	147
21.1	Status LEDs	148
21.2	Pin assignment.....	149
21.3	Wiring.....	150
21.3.1	Potentiometer measurements	150
21.3.2	Measurements using sensors / temperature inputs	150
21.4	Technical data for inputs	151
21.5	Technical data for reference outputs	152
21.6	Measurement ranges.....	152
21.7	Filters	152
21.8	Memory layout.....	154
21.9	Supported CANopen objects.....	156

22	Analog input module XN-322-8AI-I	157
22.1	Status LEDs	158
22.2	Pin assignment	159
22.3	Wiring	159
22.4	Technical data	160
22.4.1	Channels	160
22.4.2	Measurement ranges.....	161
22.4.3	Diagnostics	161
22.4.4	Filters	161
22.4.5	Memory layout.....	162
22.5	Supported CANopen objects	164
23	Analog input module XN-322-10AI-TEKT	167
23.1	Pin assignment and status LEDs	168
23.2	Wiring	169
23.2.1	Temperature measurements using thermocouples.....	169
23.2.2	Technical data for thermocouple inputs.....	171
23.2.3	Measurement ranges.....	171
23.3	Memory layout.....	172
23.4	Supported CANopen objects	175
24	Analog output module XN-322-8AO-U2	177
24.1	Status LEDs	178
24.2	Pin assignment	179
24.3	Wiring	180
24.4	Technical data for analog outputs	180
24.5	Memory layout.....	181
24.6	Supported CANopen objects	182
25	Analog input/output module ± 10 V XN-322-4AIO-U2.....	183
25.1	Status LEDs	184
25.2	Pin assignment	185
25.3	Wiring	185
25.3.1	Analog output wiring.....	186
25.3.2	Potentiometer measurements.....	186
25.3.3	Measurements using sensors	187
25.4	Diagnostics	187
25.5	Filters	188
25.6	Technical Data.....	188
25.6.1	Analog inputs ± 10 V / 0...100%	188
25.6.2	Analog outputs ± 10 V	189
25.6.3	Reference output +10V	189
25.7	Memory layout.....	190

25.8	Supported CANopen objects.....	191
26	Analog input/output module ± 10 V XN-322-8AIO-U2.....	193
26.1	Status LEDs	194
26.2	Pin assignment.....	195
26.3	Wiring.....	195
26.3.1	Analog output wiring	196
26.3.2	Potentiometer measurements	196
26.3.3	Measurements using sensors.....	197
26.4	Diagnostics.....	197
26.5	Filters	198
26.6	Technical Data.....	198
26.6.1	Analog inputs ± 10 V/0 – 100%	198
26.6.2	Analog outputs ± 10 V	199
26.6.3	Reference output +10V.....	199
26.7	Memory layout	199
26.8	Supported CANopen objects.....	201
27	Analog input/output module XN-322-4AIO-I	203
27.1	Status LED signals	204
27.2	Pin assignment.....	205
27.3	wiring	205
27.4	Technical data	206
27.4.1	Analog inputs	206
27.4.2	Analog outputs	207
27.4.3	External power supply.....	207
27.4.4	Measurement ranges.....	207
27.4.5	Diagnostics.....	208
27.4.6	Filters	208
27.4.7	Memory layout.....	209
27.5	Supported CANopen objects.....	211
28	XN-322-8AIO-I analog input/output module	213
28.1	Status LED signals	214
28.2	Pin assignment.....	215
28.3	Wiring.....	216
28.4	Technical data	216
28.4.1	Analog inputs	216
28.4.2	Analog outputs	217
28.4.3	External power supply.....	217
28.4.4	Measurement ranges.....	218
28.4.5	Diagnostics.....	218
28.4.6	Filters	218
28.4.7	Memory layout.....	219

28.5	Supported CANopen objects	222
29	Analog weigh module XN-322-2DMS-WM.....	225
29.1	Status LEDs	226
29.2	Pin assignment	227
29.3	Wiring	228
29.3.1	Four-wire connection	228
29.3.2	Six-wire connection.....	228
29.4	Sensors	229
29.5	Filter settings	229
29.6	Calibrating the force transducer.....	230
29.7	Specific technical data for the module.....	231
29.8	Memory layout.....	232
29.9	Supported CANopen objects	234
30	DC motor driver module XN-322-1DCD-B35	235
30.1	Status LEDs	236
30.2	Pin assignment	237
30.3	Wiring	238
30.3.1	Connecting the power supply for the module	238
30.3.2	Motor connection.....	238
30.3.3	Connecting LEDs	238
30.3.4	How the XN-322-1DCD-B35 works.....	239
30.4	Technical data	249
30.4.1	DC motor driver	249
30.4.2	LED drivers	250
30.5	Memory layout.....	251
30.6	Supported CANopen objects	255
31	Counter module XN-322-1CNT-8DIO	257
31.1	Status LEDs	258
31.2	Pin assignment	259
31.3	Input and output wiring.....	260
31.3.1	RS422 mode wiring	261
31.3.2	TTL mode wiring.....	261
31.4	How the counter module works	263
31.5	Technical data	263
31.5.1	Incremental encoder inputs	263
31.5.2	Digital inputs	264
31.5.3	Digital outputs.....	264
31.6	Memory layout.....	265
31.7	Supported CANopen objects	268

32	Interface module XN-322-2SSI.....	269
32.1	Status LEDs	270
32.2	Pin assignment.....	271
32.3	Wiring.....	271
32.3.1	Binary Mode.....	271
32.3.2	Gray Decoder Mode.....	272
32.3.3	Terminal type	272
32.3.4	Wiring example	273
32.4	Memory layout.....	273
32.5	Supported CANopen objects.....	276
33	Appendix.....	277
33.1	Approvals and national approvals for XN300 system devices.....	277
33.2	Dimensions	278
33.3	Technical Data.....	280
33.3.1	Ambient conditions	280
33.3.2	Power supply	281
33.3.3	Cable cross-sections	281
33.4	Definitions for short-circuit proof outputs (in accordance with IEC/EN 61131-2).....	282
	Alphabetical index	283

0 About this manual

This manual describes the installation, commissioning and programming of the XN300 slice modules.

The XN300 slice modules are an integral part of the XN300 system, as is the gateway with designation XN-312-GW-CAN.

Support center

The latest version of this manual can be found in other languages on the Internet by visiting our Support Center at:

<http://www.eaton.eu/documentation>

By entering the search keyword "XN300" into the quick search or by entering the document designation, e.g. "MN050002".

For more information on the XN-312-... gateway, please refer to the following documents:

- Manual „CANopen Gateway XN312-GW-CAN“, MN050003.

Download Center

EDS files, the XN-300 Assist engineering tool, the XSOFT-CODESYS-2 and XSOFT-CODESYS-3 software described in this manual, and updates for the operating system for XN-312-... can all be downloaded from the Eaton Download Center on the Internet at:

<http://www.eaton.eu/software>

Additional information

To get the latest XN300 library version for XN300 slice modules, please send an e-mail to the following address:

automation@eaton.com or TRCAutomation@eaton.com

0.1 List of revisions

The following significant changes have been incorporated since previous issues:

Publi- cation date	Page	Keyword	New	Changes
02/16	150	Use of 3 kΩ potentiometer → Section "21.3.1 Potentiometer measurements"	✓	
	152	Technical data for reference outputs → Section "21.5 Technical data for reference outputs"		✓
	235	The following chapter was revised → Chapter 30 "DC motor driver module XN-322-1DCD-B35"		✓

0 About this manual

0.2 Target group

06/16	135	Additional value representation parameters → Chapter 20 "Analog input module XN-322-4AI-PTNI"	✓
The following chapters were added:			
41	→ Chapter 7 "Digital input module XN-322-8DI-PD"	✓	
45	→ Chapter 8 "Digital input module XN-322-16DI-PD"	✓	
71	→ Chapter 12 "Digital input module XN-322-20DI-ND"	✓	
77	→ Chapter 13 "Relay output module XN-322-4DO-RNO"	✓	
85	→ Chapter 14 "Digital output module XN-322-8DO-P05"	✓	
109	→ Chapter 17 "Digital input/output module XN-322-8DIO-PD05"	✓	
115	→ Chapter 18 "Digital input/output module XN-322-16DIO-PD05"	✓	
123	→ Chapter 19 "XN-322-16DIO-PC05 digital input/output module"	✓	
183	→ Chapter 25 "Analog input/output module ±10 V XN-322-4AIO-U2"	✓	
203	→ Chapter 27 "Analog input/output module XN-322-4AIO-I"	✓	
213	→ Chapter 28 "XN-322-8AIO-I analog input/output module"	✓	

0.2 Target group

This manual is intended for automation technicians and engineers.

Extensive knowledge of how to work with the field bus being used will make it easier to understand the contents of this manual.

A specialist knowledge of electrical engineering is needed for commissioning and programming.

0.3 Legal Disclaimer

All information in this operator manual was provided by us to the best of our knowledge and belief and in accordance with the current state-of-the-art. However, this does not exclude the possibility of inaccuracies, meaning that we cannot accept any liability for the accuracy and completeness of the information. In particular, this information does not guarantee any particular properties.

The devices described here must only be set up and operated as specified in this manual and in the installation instructions provided with the device. Installation, commissioning, operation, maintenance and refitting of the devices must only be carried out by qualified persons. The devices must only be used in the areas recommended and only in conjunction with third-party devices and components that have been approved by us. Only use in technically faultless condition is permitted. Fault-free and safe operation of the system requires proper transport, storage, installation and commissioning as well as careful operation and maintenance. If the following safety instructions are not observed, particularly with regard to commissioning and maintenance of the devices by insufficiently qualified personnel and/or in the event of improper use of the devices, any hazards caused by the devices cannot be excluded. We assume no liability for any injury or damages incurred.

0.4 Device designations and abbreviations

- COB-ID - Communication Object Identifier
- DIP - Dual Inline Package
- EDS - Electronic Data Sheet
- PDO - Process Data Objects
- RPDO - Receive Process Data Objects
- SDO - Service Data Objects
- SSI - Synchronous Serial Interface
- TPDO - Transmit Process Data Objects
- XN300 - Device series, including the XN-312 gateway and XN-322 slice modules

Following designations XSOFT-CODESYS-2 are used:

- Module - System bus module
- Station - Coordinator
- Station address - Address of the field bus module

0.5 Writing conventions

Symbols used in this manual have the following meanings:



DANGER

Warns of hazardous situations that result in serious injury or death.



CAUTION

Warns of the possibility of hazardous situations that could result in slight injury or even death.

NOTICE

Warns about the possibility of material damage.



Indicates useful tips.

- ▶ Indicates instructions to be followed.

For greater clarity, the name of the current chapter and the name of the current section are shown at the top of each page.

1 XN300 slice modules

1.1 Proper use

XN300 slice modules include both digital and analog input and output modules, as well as various specialty modules with counting, weighing, and motor drive functionalities. These modules can be joined together without the use of tools in order to form a system block. All XN300 system slice modules communicate through the system bus and are part of the XN300 system. In addition, the XN300 system also includes a gateway that can be used to establish a connection between a higher-level PLC and the aforementioned system bus.

The system bus is not designed for transmitting safety-relevant signals and must not be used as a replacement for controllers such as burner, crane, and two-hand safety controllers.

Power supply and signal terminals must be protected against accidental contact and covered.

The XN300 system may only be operated if it has been correctly fitted and connected by qualified electrical specialists. The installation must comply with regulations for electromagnetic compatibility (EMC).



DANGER

Commissioning the XN300 slice modules and switching them on must not result in any hazards being posed by the devices being driven, e.g., unexpected motor startups and equipment becoming unexpectedly energized.

1.2 Overview of functions

XN300 slice modules include a variety of I/O modules, as well as specialty modules.

1.3 List of I/O slice module devices

All I/O slice modules can be used with the XN-312-GW-CAN gateway. In order to ensure that you will be able to fully commission all I/O slice modules and functions, make sure that the gateway operating system is up-to-date. The latest updates for the gateway operating system can be downloaded from the Download Center on the Internet → Page 11.

The I/O slice modules need to be locked in place together with the gateway in order to form a system block. For detailed information on the gateway, please refer to the following manual: „CANopen Gateway XN312-GW-CAN“, MN050003.

Please note that all the object names in the "Supported CANopen objects" chapters are specified in the form of hexadecimal values.

1 XN300 slice modules

1.3 List of I/O slice module devices

Power Distribution

- XN-322-4PS-20, power supply, 4 x 24VDC/2A,kf
- XN-322-18PD-M, power distribution,18 channels, GND
- XN-322-18PD-P, power distribution,18 channels, VCC

Digital I/O modules

- XN-322-8DI-PD
- XN-322-16DI-PD
- XN-322-20DI-PD, digital, 20 inputs, P, 24VDC, 5.0ms
- XN-322-20DI-PF, digital, 20 inputs, P, 24VDC, 0.5ms
- XN-322-20DI-PCNT, digital, 20 inputs, P, 24VDC, 2/4 CNT, 25kHz
- XN-322-20DI-ND
- XN-322-8DO-P05
- XN-322-12DO-P17, digital, 12 outputs, P, 24VDC, 1.7A, kf
- XN-322-16DO-P05, digital,16 outputs, P, 24VDC, 0.5A, kf
- XN-322-8DIO-PD05
- XN-322-16DIO-PD05
- XN-322-16DIO-PC05

Analog I/O modules

- XN-322-4AI-PTNI, analog, 4 inputs, PT/NI/KTY/R, 2/3 wire
- XN-322-7AI-U2PT, analog, 6 inputs, +/-10V,1 PT/KTY,Uref
- XN-322-8AI-I, analog, 8 inputs, 0/4-20mA
- XN-322-10AI-TEKT, analog, 8 inputs, thermocouple, 2 KTY
- XN-322-8AO-U2, analog, 8 outputs, +/-10V
- XN-322-4AIO-U2, analog, 4 outputs, +/-10V
- XN-322-8AIO-U2, analog, 4 inputs/4 outputs, +/-10V,Uref
- XN-322-4AIO-I
- XN-322-8AIO-I

Technology Modules

- XN-322-2DMS-WM, weigh module, 2DMS, 24Bit
- XN-322-1DCD-B35, DC motor driver,12-30V, brushed, 3.5A
- XN-322-1CNT-8DIO, counter,1 CNT,125kHz, 16Bit, 4 DO, 4 DI
- XN-322-2SSI, serial, 2 SSI, RS422, 32Bit
- XN-322-4DO-RNO, relay module

1.4 Catalog number selection XN300

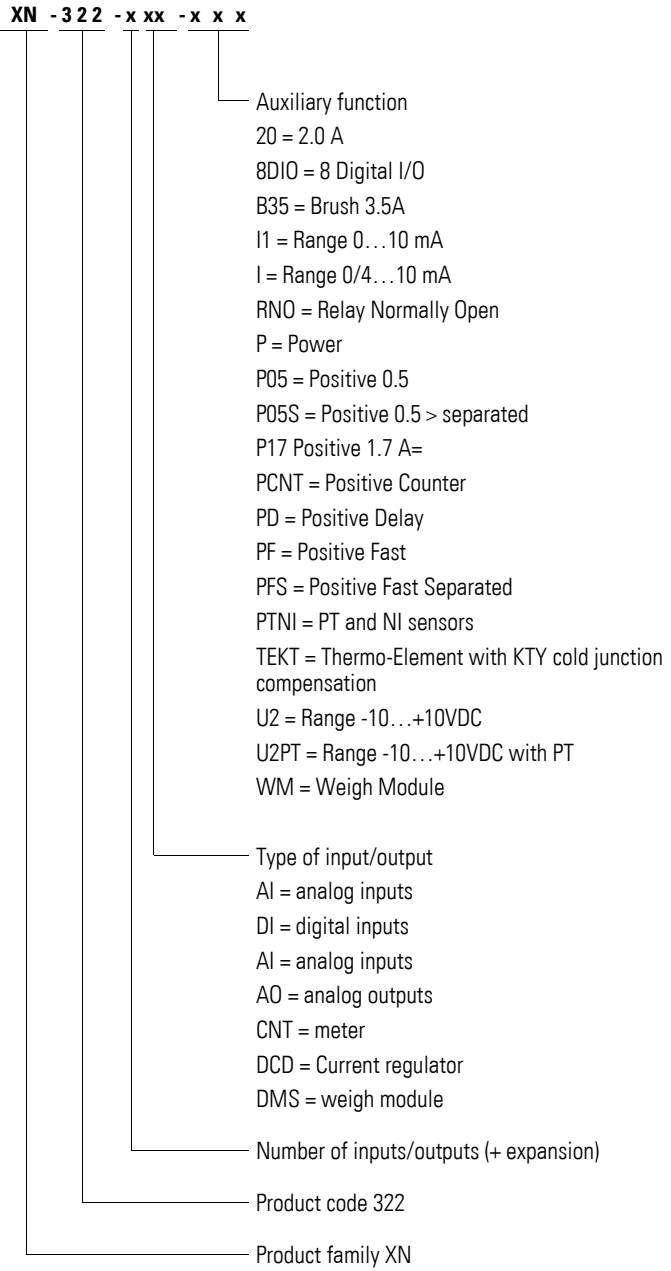

1 XN300 slice modules

1.4 Catalog number selection XN300

2 Installation



DANGER OF ELECTRIC SHOCK!

All installation work must be carried out with the entire installation in a de-energized state.

Always follow the safety rules:

- De-energize and isolate the system.
- Verify isolation from the supply.
- Secure against retriggering.
- Short-circuit and ground.
- Cover adjacent live parts.

2.1 Mounting the XN300 slice modules

Install the XN300 slice modules in a control panel, service distribution board, or enclosure so that the power supply and terminal connections cannot be touched directly during operation. Mount the XN300 slice modules on an EN/IEC 60715 DIN-rail.

The DIN-rail must establish a conductive connection to the control panel's back plate. The individual modules need to be mounted side by side on the DIN-rail and then secured in place by closing the locking elements. Please note that all the devices must be installed in a horizontal position (module designation on top)!

In order to ensure that the maximum operating ambient temperature will not be exceeded, make sure that there is enough clearance between the system block's vents and any neighboring components, as well as between the vents and the control panel's back plate.

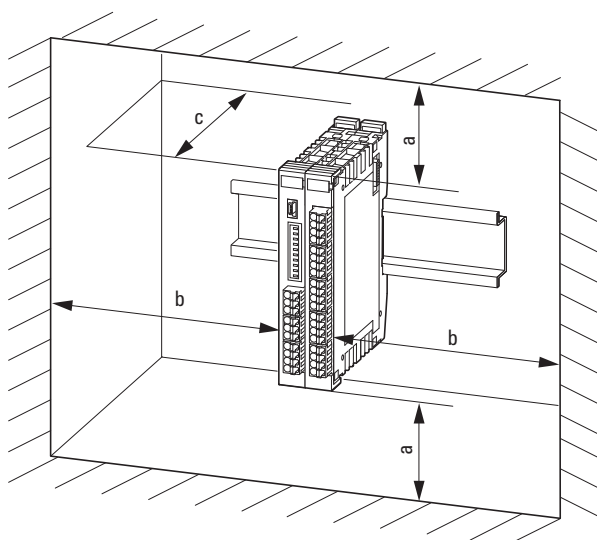

Figure 1: The XN300 slice modules must be installed in a horizontal position!

2 Installation

2.1 Mounting the XN300 slice modules

a	b	c	θ
30 mm (1.18")	30 mm (1.18")	100 mm (3.94")	≤ 55 °C (≤ 131 °F)

To mount the system on the DIN-rail, join the XN 300 slice modules and the gateway to form a system block and then snap the entire system block onto the DIN-rail.

To mount the system block, follow the steps below:

- ▶ The gateway must be the first element on the left in the system block.
- ▶ Disengage the side locking tabs on the XN300 slice modules by pulling on the front cover (blue). Make sure that all the locking tabs (blue) are pulled forward so that they will be able to engage the corresponding slice module(s). The front cover's stay-put function is intended to make this easier.



The gateway's front cover is non-detachable and cannot be removed.

- ▶ Attach an XN300 slice module from the right in such a way that the locking tabs engage the guide.

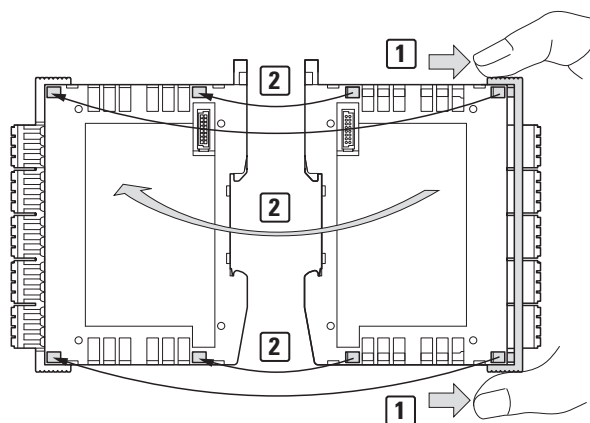

Figure 2: Joining the gateway and an XN300 slice module to form a system block

- ▶ Grab the front cover from the top and bottom and push it back towards the XN300 slice module so that the slice modules lock solidly into place with each other.

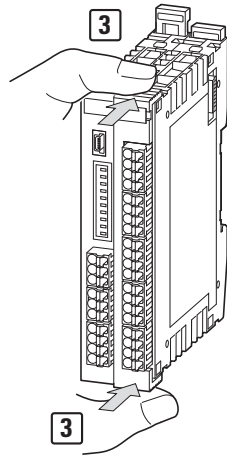

Figure 3: Locking the system block in place

- ▶ Repeat these steps until you have added all the XN300 modules you need to the system block.
- ▶ Pull the locking elements at the back of the gateway and the XN300 slice modules upwards. You can use a screwdriver to do this,

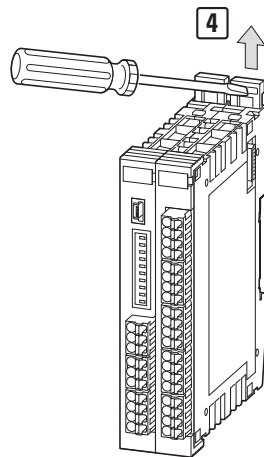

Figure 4: Securing the system block on the DIN-rail

- ▶ Tilt the system block forward and place it against the DIN-rail's bottom edge in an inclined position.

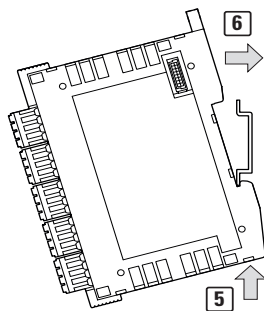

Figure 5: Placing the system block against the bottom edge of the DIN-rail

2 Installation

2.2 Removing the XN300 slice modules

- ▶ Push the system block over the DIN-rail's top edge.
- ▶ Push the locking elements on the back of all XN300 slice modules downwards in order to secure the modules. You can use a screwdriver to do this.

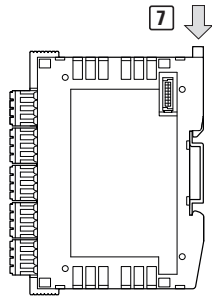

Figure 6: Locking the system block into place on the DIN-rail

- ▶ Check to make sure that the system block is solidly mounted.

2.2 Removing the XN300 slice modules

To remove the XN300 slice modules, follow the steps below:

- ▶ Slide the locking elements on the back of all XN300 slice modules upwards. You can use a screwdriver to do this.

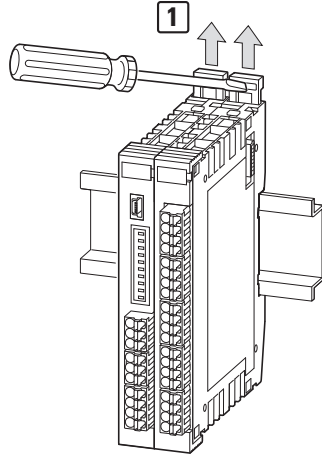

Figure 7: Disengaging the system block

- ▶ Tilt the system block forward, then pull the block, from its bottom edge, away from the DIN-rail.

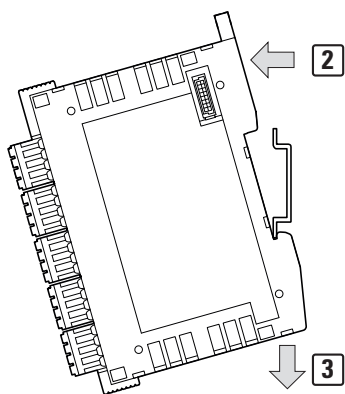

Figure 8: Placing the system block against the bottom edge of the DIN-rail

- ▶ Disengage the locking tabs between the slice modules by pulling on the front cover (blue). The front cover's stay-put function will indicate that the locking tabs have been disengaged.



The gateway's front cover is non-detachable and cannot be removed.

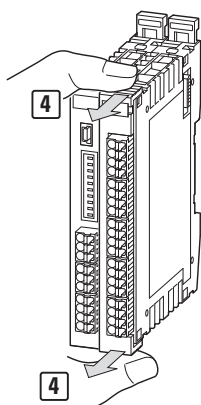

Figure 9: Disengaging the front cover

- ▶ Once the locking tabs have been disengaged, you can separate the slice modules from each other.

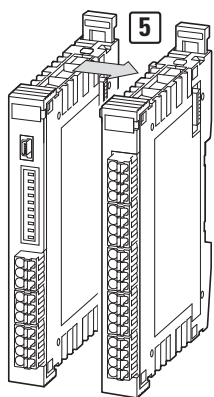

Figure 10: Separating the XN300 slice modules from the system block

2.3 Terminations

Plug connector

X1 – Xn: The required plug connectors with push-in spring-cage terminals are included as standard with every XN300 slice module. To use them, the conductor simply needs to be slid into the appropriate contact.

In order to release the conductor, simply press on the release mechanism, e.g., with a screwdriver, to pull out the conductor from the corresponding contact.

Table 1: Connection specifications



Cable cross-sectional areas			XN-322-...	XN-322-4DO-RNO
10 mm (0.39")	solid	mm ²	0.2 – 1.5	0.2 – 2.5
				
10 mm (0.39")	Flexible with uninsulated ferrule	mm ²	0.2 – 1.5	0.25 – 2.5
				
10 mm (0.39")	Flexible with insulated ferrule	mm ²	0.2 – 0.75	0.25 – 2.5
				
	Ferrule d	mm	≤ 2.8	≤ 3.8
				
	AWG		24 – 16	24 – 12
	Strip length	mm	10	10

Table 2: Technical data for plug connectors XN-322-...

Technical data as per IEC/DIN/VDE	Unit	solid	Flex-ible	Flex-ible
Insulating material group	–	I		
Overtoltage category/pollution degree	–/–	III/3	III/2	II/2
Rated voltage	V	160	200	400
Rated surge voltage	kV	2.5	2.5	2.5
Rated operational current/cross-sectional area	A/mm ²	6/1.5		

Table 3: Technical data for plug connectors XN-322-4DO-RNO

Technical data as per IEC/DIN/VDE	Unit	solid	Flex-ible	Flex-ible
Insulating material group	–	I		
Overtoltage category/pollution degree	–/–	III/3	III/2	II/2
Rated voltage	V	320	320	630
Rated surge voltage	kV	4	4	4
Rated operational current/cross-sectional area	A/mm ²	12/2.5		

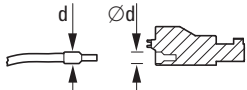
2.4 Connecting the power supply



DANGER

In safety-relevant applications, the power supply used to power the XN300 system must be a PELV power supply unit.

The system bus communication channel on the XN300 slice modules is powered with the 5 V on the system bus.

In addition, the system bus provides a 24 VDC supply voltage used to internally power the XN300 slice modules. Modules with high power consumption levels, however, will also need an additional power supply.

The XN-312-GW-CAN gateway powers the system bus with 5 VDC/1.6 A and 24 VDC/1.6 A.

The following XN300 slice modules require an external 24 VDC power supply as well:

- XN-322-8DO-P05
- XN-322-12DO-P17
- XN-322-16DO-P05
- XN-322-8DIO-PD05
- XN-322-16DIO-PD05
- XN-322-16DIO-PC05
- XN-322-8AO-U2
- XN-322-4AIO-I
- XN-322-8AIO-I
- XN-322-1DCD-B35
- XN-322-1CNT-8DIO

External 24 VDC voltages can be distributed using an XN-322-4PS-20 power distribution module or XN322-18PD-P and XN-322-18PD-M field potential distributor modules:

- Chapter 4 "Power supply XN-322-4PS-20", page 29,
- Chapter 6 "Power distribution +24 V XN-322-18PD-P", page 37,
- Chapter 5 "Power distribution 0 V XN-322-18PD-M", page 33.

You can use the XN300-Assist software program for assistance with engineering and commissioning.

2 Installation

2.5 Potential Relationship between the Components

2.5 Potential Relationship between the Components

All XN300 slice modules feature a contact point that is used to establish a functional earth connection to the DIN-rail. Moreover, all power supply earth connections are connected to the functional earth. Finally, the CANopen field bus interface and the XN300 system are galvanically isolated from each other.

Common

- 0V
- \oplus

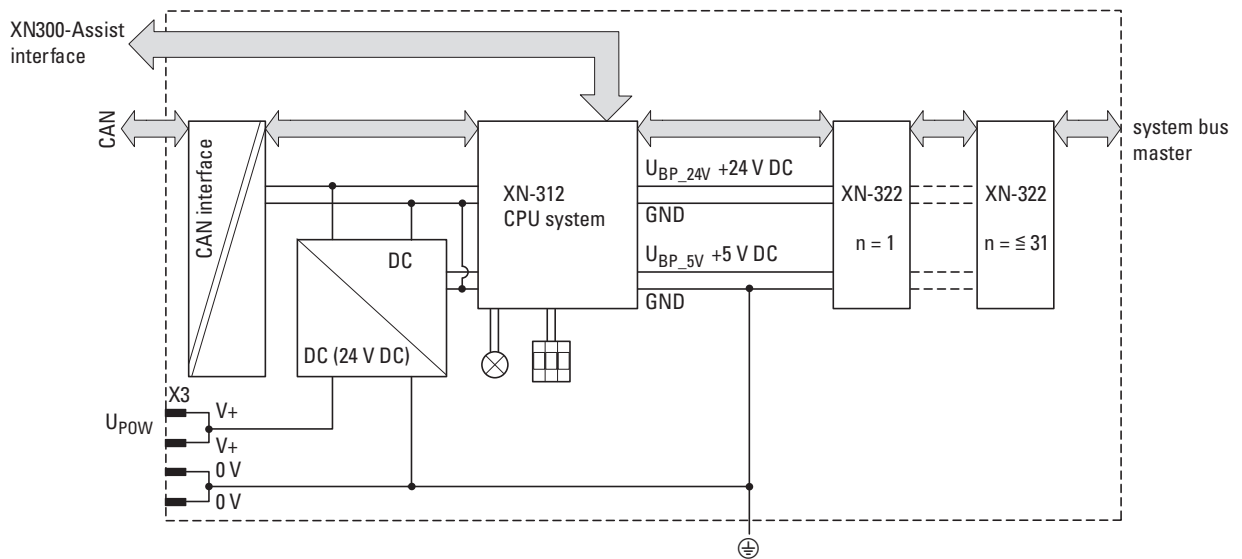

Figure 11: Functional diagram of XN300 system

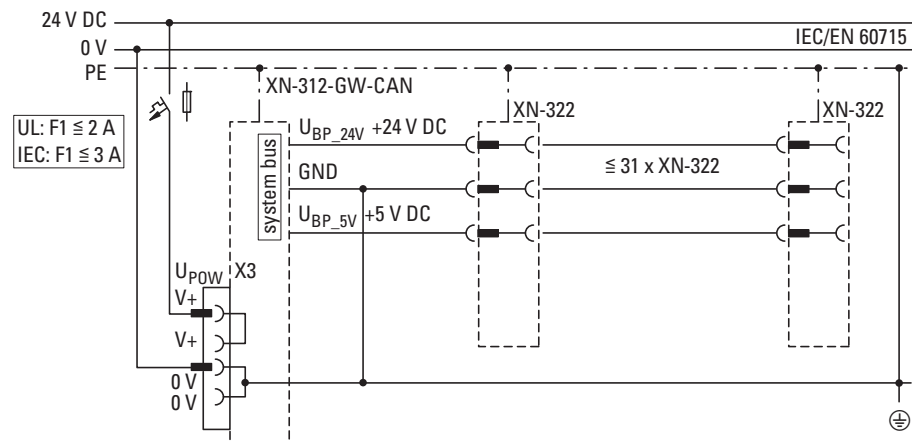

Figure 12: Gateway in XN300 system

3 Commissioning

XN300 slice modules are commissioned in the corresponding system block with the gateway. For a detailed explanation on how to commission the gateway, please refer to the "Commissioning" chapter in „CANopen Gateway XN312-GW-CAN“, MN050003.

3.1 General commissioning instructions

The signals received by analog modules are very small in comparison to digital signals. In order to ensure that these modules work properly, it is absolutely necessary to route all cables carefully:

- The DIN-rail must have a proper earth connection
- The cables used to connect to the analog signal sources must be as short as possible and must not be routed parallel to digital signal cables.
- Analog signal cables must be screened.
- The screening must be terminated at a screening bus.
- Do not route the input cables parallel to load circuits.
- Suppressor circuit for all contactor coils (RC suppressors or flyback diodes)



If possible, connect the earth bus to the control panel earth bus!

3 Commissioning

3.2 Wiring in accordance with EMC requirements

3.2 Wiring in accordance with EMC requirements

Undesired faults can occur on the field bus and the analog inputs due to electromagnetic interference. They can be limited by implementing suitable EMC measures, such as:

- A system configuration that meets EMC requirements
- Routing all analog input and field bus cables in a way that meets EMC requirements
- Measures designed to reduce potential differences
- Correctly installing the field bus system (cable, bus connector connection, etc.)
- Using shielding

For DIN-rails

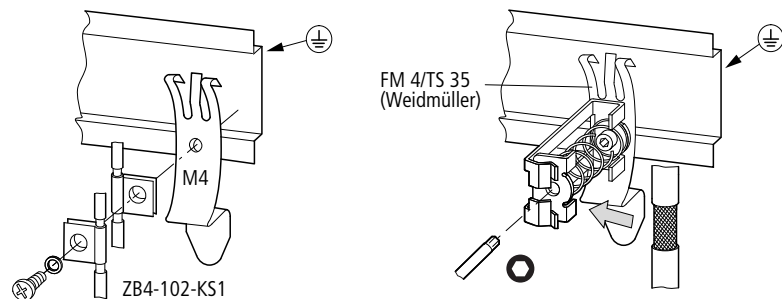

Figure 13: Field bus shielded by using shielding

XN300 slice modules feature a functional earth connection point at the back.

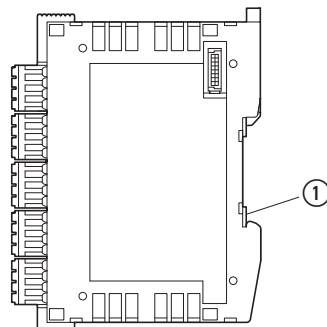

Figure 14: XN300 slice module side view

① Functional earth

3.3 LED indicators

Status LEDs are used to indicate the status of all XN300 slice modules. These LEDs have various colors in order to make it possible to easily determine which function they represent:

- Green: input
- Yellow: output
- Red: fault

4 Power supply XN-322-4PS-20

Power supply modules can be used to distribute the field supply voltage for XN300 slice modules.

The targeted use of power supply modules makes it possible to ensure that all slice modules will be properly powered and fused as required for the application in question by segmenting the power supply into sections.

XN-322-4PS-20 modules are powered via connector X5 using the 24 and 0 V pins. The slice modules then distribute this power to nine +24 VDC-Out power outputs, each with its own GND output.

The power outputs are grouped and short-circuit proof, with each group being able to deliver up to 2 A.

4.1 Status LED signals and pin assignment

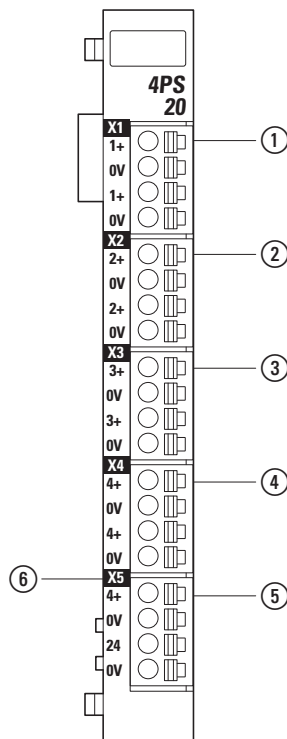

Figure 15: LED signals and pin assignment for XN-322-4PS-20

- ① X1
 - 1+ 24 VDC-Out 1, power supply group 1
 - 0 V GND 1, power supply group 1
 - 1+ 24 VDC-Out 2, power supply group 1
 - 0 V GND 2, power supply group 1
- ② X2
 - 2+ 24 VDC-Out 3, power supply group 2
 - 0 V GND 3, power supply group 2
 - 2+ 24 VDC-Out 4, power supply group 2
 - 0 V GND 4, power supply group 2
- ③ X3

4 Power supply XN-322-4PS-20

4.2 Wiring

- 3+ 24 VDC-Out 5, power supply group 3
- 0 V GND 5, power supply group 3
- 3+ 24 VDC-Out 6, power supply group 3
- 0 V GND 6, power supply group 3
- ④ X4
 - 4+ 24 VDC-Out 7, power supply group 4
 - 0 V GND 7, power supply group 4
 - 4+ 24 VDC-Out 8, power supply group 4
 - 0 V GND 8, power supply group 4
- ⑤ X5
 - 4+ 24 VDC-Out 9, power supply group 4
 - 0 V GND 9, power supply group 4
 - 24 VDC U_{e24} input
 - 0 V GND input
- ⑥ 24 VDC OK LED

Status LED signals

Module status (24 VDC OK)	green	ON	24 VDC OK Power supply group voltage ≥ 18 VDC
		OFF	No power

4.2 Wiring

Each power supply module can be used to power up to nine XN300 slice modules.

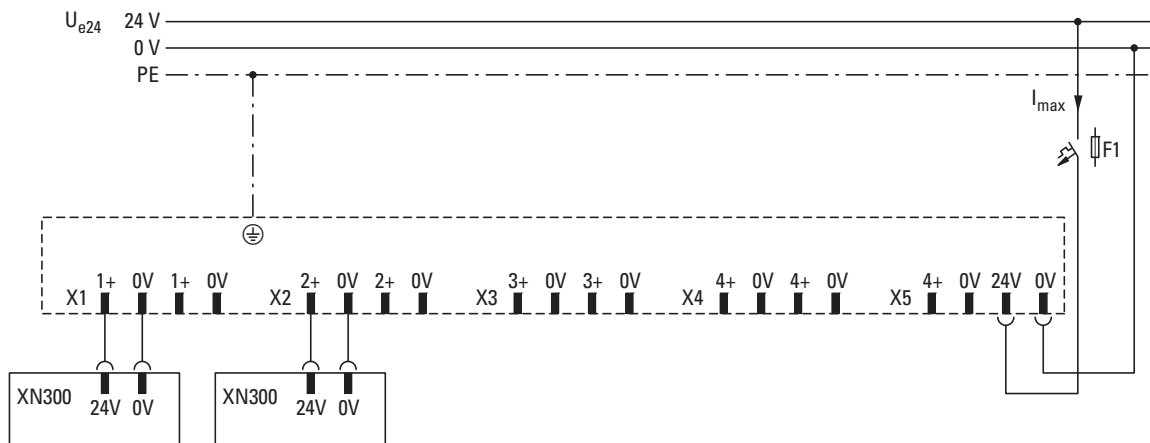

Figure 16: Wiring example using connectors X1 to X5 with a total of nine XN300 slice modules

4.3 Technical Data

4.3.1 +24 V power supply modules

Number of +24 VDC power supply outputs	9 (distributed among 4 power supply groups)
Short-circuit proof	yes
Maximum permissible continuous load current / power supply connection	2 A
Maximum permissible continuous load current / power supply group	2 A
Maximum total current / module	6 A
Potential isolation	none

4 Power supply XN-322-4PS-20

4.3 Technical Data

5 Power distribution 0 V XN-322-18PD-M

XN-322-18PD-M modules are passive XN300 field potential distribution slice modules. They provide an output potential of 0 V for a total of 18 pins. This means that this 0 V potential can be tapped without the need for additional terminal strips.

XN-322-18PD-M modules are normally used together with XN-322-18PD-P modules in order to ensure that XN300 slice modules can be segmented into groups that can be fused and switched as such. When used together with digital slice modules, these modules make it possible to use two-wire and three-wire connection configurations.

5.1 Pin assignment

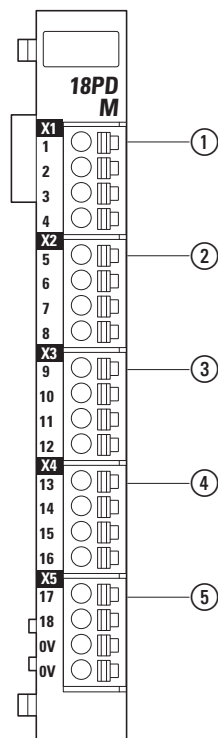

Figure 17: LED signals and pin assignment for XN-322-18PD-M

- ① X1
 - 1 GND output 1
 - 2 GND output 2
 - 3 GND output 3
 - 4 GND output 4
- ② X2
 - 5 GND output 5
 - 6 GND output 6
 - 7 GND output 7
 - 8 GND output 8
- ③ X3
 - 9 GND output 9
 - 10 GND output 10
 - 11 GND output 11

5 Power distribution 0 V XN-322-18PD-M

5.2 Wiring

- 12 GND output 12
- ④ X4
 - 13 GND output 13
 - 14 GND output 14
 - 15 GND output 15
 - 16 GND output 16
- ⑤ X5
 - 17 GND output 17
 - 18 GND output 18
 - 0 V GND input
 - 0 V GND input

5.2 Wiring

NOTICE

Connect both of the device's 0 V terminals to the power supply's 0 V!

In order to reduce the contact current flowing through the plug connector, the two 0 V input pins on the module need to be connected to the power supply's 0 V.

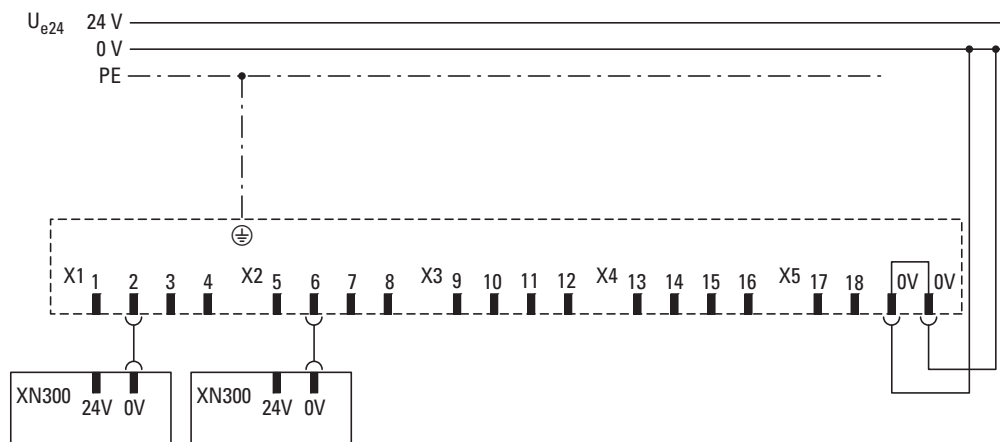

Figure 18: Wiring example

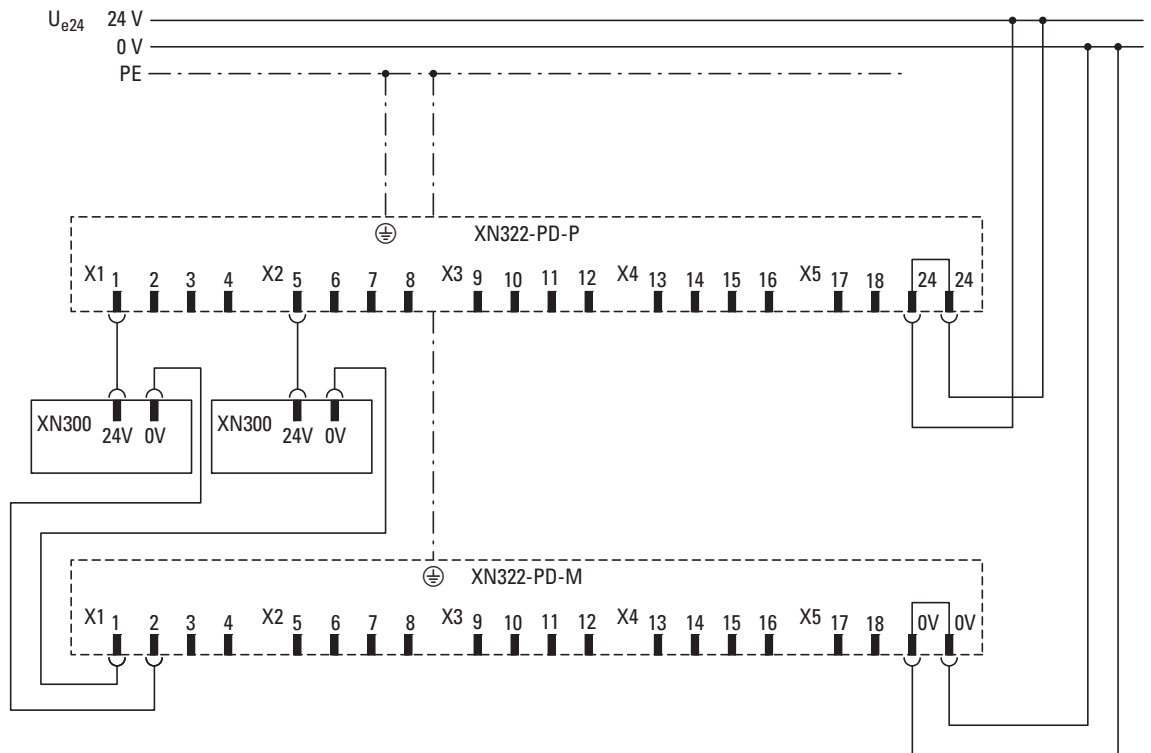

Figure 19: XN-322-18PD-M and XN-322-18PD-P wiring example showing how to power slice modules

5.3 Technical data

5.3.1 0 V distribution

Number of 0 V potentials	2
Short-circuit proof	no
Internal fusing	no
Maximum permissible continuous load current / connection	8A
Maximum total current	16 A (The maximum current of 8 A per connection must not be exceeded at the inputs or outputs!)

5 Power distribution 0 V XN-322-18PD-M

5.3 Technical data

6 Power distribution +24 V XN-322-18PD-P

XN-322-18PD-P modules are passive XN300 field potential distribution slice modules. They provide an output potential of 24 VDC for a total of 18 pins. This means that this voltage can be tapped without the need for additional terminal strips.

XN-322-18PD-P modules are normally used together with XN-322-18PD-M modules in order to ensure that XN300 slice modules can be segmented into groups that can be fused and switched as such. When used together with digital slice modules, these modules make it possible to use two-wire and three-wire connection configurations.

6.1 Pin assignment

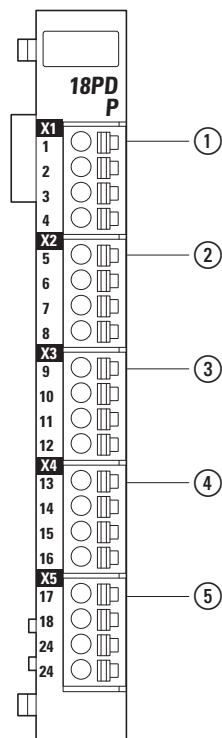

Figure 20: LED signals and pin assignment for XN-322-18PD-P

- ① X1
 - 1 24VDC output 1
 - 2 24VDC output 2
 - 3 24VDC output 3
 - 4 24VDC output 4
- ② X2
 - 5 24VDC output 5
 - 6 24VDC output 6
 - 7 24VDC output 7
 - 8 24VDC output 8
- ③ X3
 - 9 24VDC output 9
 - 10 24VDC output 10
 - 11 24VDC output 11

6 Power distribution +24 V XN-322-18PD-P

6.2 Wiring

- 12 24VDC output 12
- ④ X4
 - 13 24VDC output 13
 - 14 24VDC output 14
 - 15 24VDC output 15
 - 16 24VDC output 16
- ⑤ X5
 - 17 24VDC output 17
 - 18 24VDC output 18
 - 24 24VDC power supply
 - 24 24VDC power supply

6.2 Wiring

NOTICE

Connect both of the device's 24 V terminals to the power supply's 24 V!

In order to reduce the contact current flowing through the plug connector, the two 24 input pins on the module need to be connected to the power supply's 24 V.

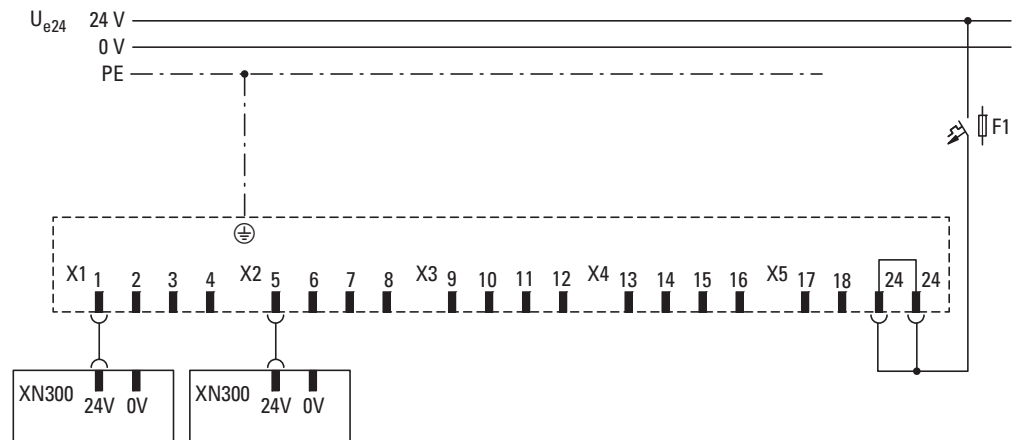

Figure 21: Wiring example

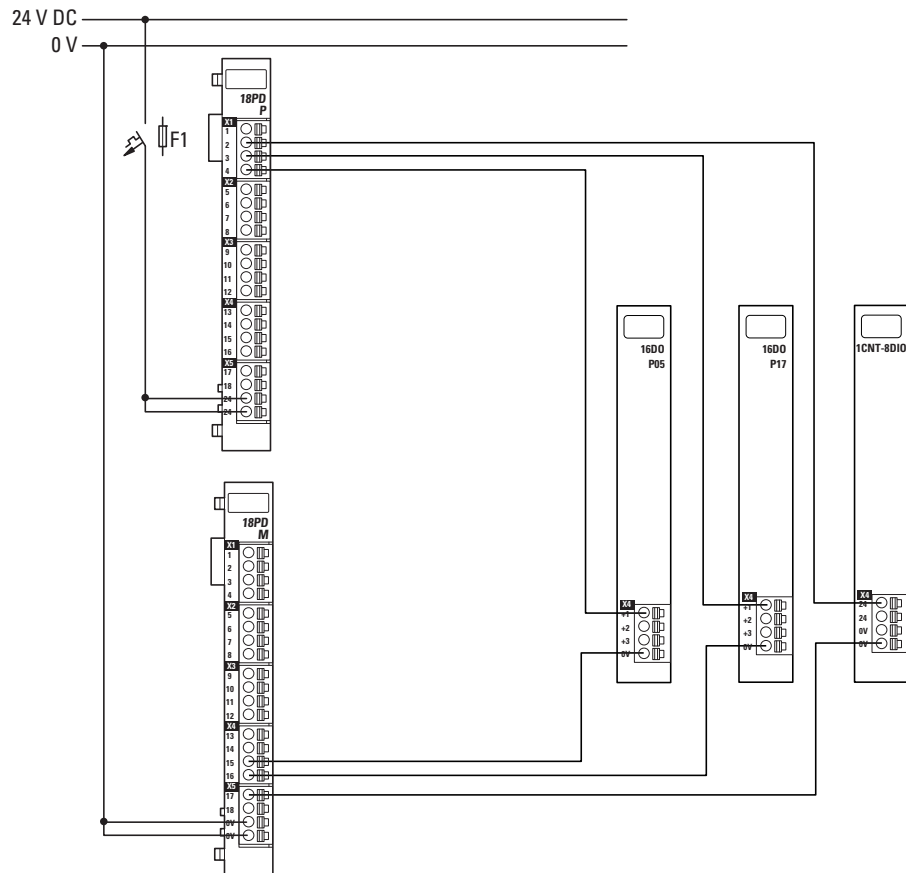

Figure 22: XN-322-18PD-P and XN-322-18PD-M wiring example showing how to power slice modules

6.3 Technical data

6.3.1 +24 V distribution

Number of +24 V outputs	2
Short-circuit proof	no
Internal fusing	no
Maximum permissible continuous load current per pin	8 A
Maximum total current	16 A (The maximum current of 8 A per pin must not be exceeded at the inputs or outputs!)

6 Power distribution +24 V XN-322-18PD-P

6.3 Technical data

7 Digital input module XN-322-8DI-PD

XN-322-8DI-PD digital input modules have 8 inputs, for a +24 V signal level, that can be used to read the logical low and logical high levels, i.e., 0 and 1. These modules feature an internal input filter designed to suppress glitches on the corresponding signal cables.

7.1 Status LEDs

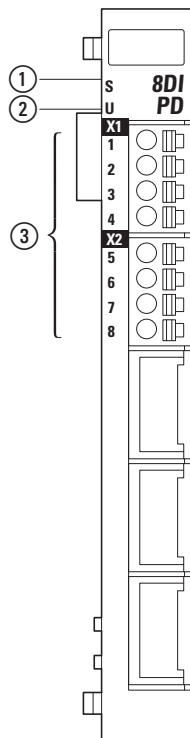

Figure 23: LED signals and pin assignment for XN-322-8DI-PD

- ① Module status LED
- ② User LED
- ③ Status LEDs for inputs 1 to 8

Module status	green	ON	System OK
		OFF	No power
		FLASHES (5 Hz)	No communications

7 Digital input module XN-322-8DI-PD

7.2 Pin assignment

User	yellow	ON	The user can set the LED signals as necessary. (For example, the visualization interface can be used to set the module's LED to flash so that it is easier to find the module inside the control panel.)
		OFF	
		FLASH (200 ms ON, 1000 ms OFF)	
		FLASH (1000 ms ON, 200 ms OFF)	
Status input 1	green	ON	Input ON
... Input 8		OFF	Input OFF

7.2 Pin assignment

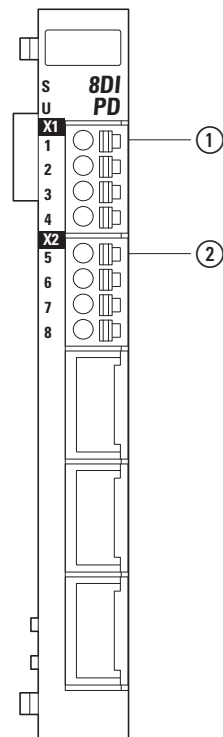

Figure 24: Pin assignment

- ① X1
 - 1 digital input 1
 - 2 digital input 2
 - 3 digital input 3
 - 4 digital input 4
- ② X2
 - 5 digital input 5
 - 6 digital input 6
 - 7 digital input 7
 - 8 digital input 8

7.3 Digital input wiring

The digital input, as defined in the EN 61131-1 type with a 5-ms input delay, is particularly suitable for connecting electronic switching devices, including relay contacts, pushbuttons, switches, etc. It is used to convert a signal with two possible states into a one-bit binary number.

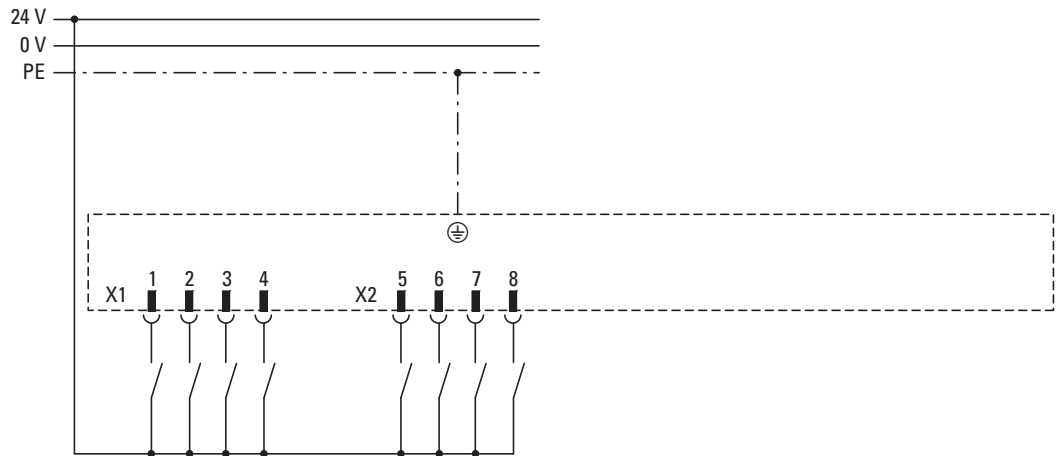

Figure 25: Input wiring

7.4 Technical data for digital inputs

designation		
Number of channels	8	
	61131-2 Type1	
Input voltage U_E	24 VDC	maximum 30 VDC
Signal level	LOW: $0 < U_E < +8$ V	HIGH: $+14$ V $< U_E < +30$ V
Switching threshold	normally +11 VDC	
Input current at $U_E=24$ Vdc	normally 3.7 mA	
Input delay	normally 5 ms	

7 Digital input module XN-322-8DI-PD

7.5 Memory layout

7.5 Memory layout

CAN Object Index		Size (byte)	Description				
0x6000 SUB x	0x3150	1	Digital input register	Byte 0:	Bit 0	Input 1	
					Bit 1	Input 2	
					Bit 2	Input 3	
					Bit 3	Input 4	
					Bit 4	Input 5	
					Bit 5	Input 6	
					Bit 6	Input 7	
					Bit 7	Input 8	

7.6 Supported CANopen objects

Product-specific CANopen objects

Index (hex)	Data Type	Name	Function	Mapping	Access	
0x6000	UNSIGNED8	I-BYTE	Digital Input 8-bit	Default	ro	PDO

Manufacturer-specific objects

Index range for the XN-322-8DI-PD module: x150 to x15F

Index (hex)	Data Type	Name	Function	Mapping	Access	
0x1027	UNSIGNED16	ModuleID	Module ID number	–	ro	SDO
0x3150	UNSIGNED8	Input1_8	Read Digital Input 1_8	Manual	ro	PDO
0x4001	VISIBLE STRING	SerialNumber	The device's serial number	–	const	SDO
0x4004	UNSIGNED8	UserLEDControl	User LED Control	–	rw	SDO
0x400C	VISIBLE STRING	ProductName	Product Name	–	ro	SDO

8 Digital input module XN-322-16DI-PD

XN-322-16DI-PD digital input modules have 16 inputs, for a +24 V signal level, that can be used to read the logical low and logical high levels, i.e., 0 and 1. The modules feature input filters designed to suppress glitches on the corresponding signal cables.

8.1 Status LEDs

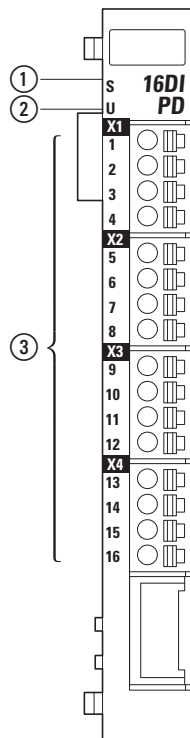

Figure 26: LED signals and pin assignment for XN-322-16DI-PD

- ① Module status LED
- ② User LED
- ③ Status LEDs for inputs 1 to 16

Module status	green	ON	System OK
		OFF	No power
		FLASHES (5 Hz)	No communication
User	yellow	ON	The user can set the LED signals as necessary. (For example, the visualization interface can be used to set the module's LED to flash so that it is easier to find the module inside the control panel.)
		OFF	
		FLASH (200 ms ON, 1000 ms OFF)	
		FLASH (1000 ms ON, 200 ms OFF)	
Status input 1 ... Input 16	green	ON	Input ON
		OFF	Input OFF

8 Digital input module XN-322-16DI-PD

8.2 Pin assignment

8.2 Pin assignment

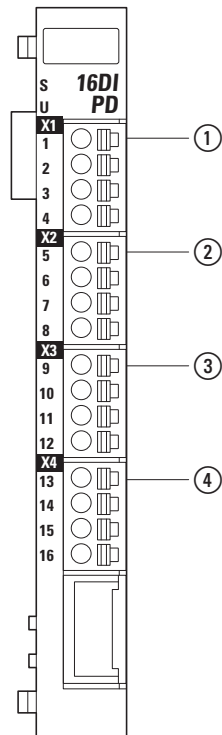

Figure 27: Pin assignment

① X1

- 1 digital input 1
- 2 digital input 2
- 3 digital input 3
- 4 digital input 4

② X2

- 5 digital input 5
- 6 digital input 6
- 7 digital input 7
- 8 digital input 8

③ X3

- 9 digital input 9
- 10 digital input 10
- 11 digital input 11
- 12 digital input 12

④ X4

- 13 digital input 13
- 14 digital input 14
- 15 digital input 15
- 16 digital input 16

8.3 Digital input wiring

The digital input, as defined in the EN 61131-1 type 1 with a 5-ms input delay, is particularly suitable for connecting electronic switching devices, including relay contacts, pushbuttons, switches, etc. It is used to convert a signal with two possible states into a one-bit binary number.

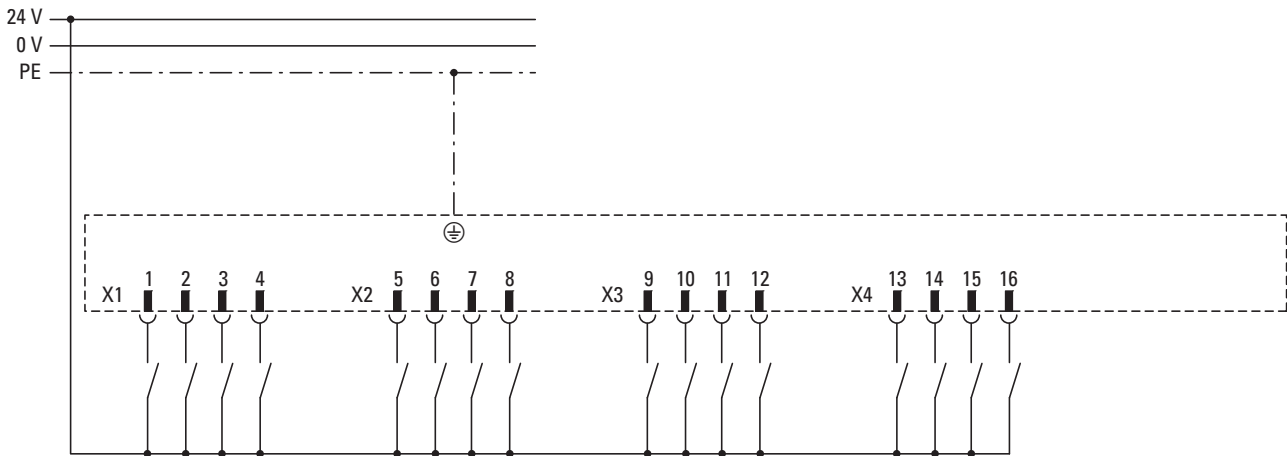

Figure 28: Input wiring

8.4 Technical data for digital inputs

designation		
Number of channels	16	
	61131-2 Type1	
Input voltage UE	24 VDC	maximum 30 VDC
Signal level	LOW: $0 < U_E < +8 \text{ V}$	HIGH: $+14 \text{ V} < U_E < +30 \text{ V}$
Switching threshold	normally +11 VDC	
Input current at $U_E=24\text{Vdc}$	normally 3.7 mA	
Input delay	normally 5 ms	

8 Digital input module XN-322-16DI-PD

8.5 Memory layout

8.5 Memory layout

CAN Object Index		Size (byte)	Description					
0x6000 SUB x	0x3140	2	Digital input register				Bit 0	Input 1
							Bit 1	Input 2
							Bit 2	Input 3
							Bit 3	Input 4
							Bit 4	Input 5
							Bit 5	Input 6
							Bit 6	Input 7
							Bit 7	Input 8
0x6000 SUB x+1							Bit 0	Input 9
							Bit 1	Input 10
							Bit 2	Input 11
							Bit 3	Input 12
							Bit 4	Input 13
							Bit 5	Input 14
							Bit 6	Input 15
							Bit 7	Input 16

8.6 Supported CANopen objects

Product-specific CANopen objects

Index (hex)	Data Type	Name	Function	Mapping	Access	
0x6000	UNSIGNED8	I-BYTE	Digital Input 8-bit	Default	ro	PDO

Manufacturer-specific objects

Index range for the XN-322-16DI-PD module: x150 to x15F

Index (hex)	Data Type	Name	Function	Mapping	Access	
0x1027	UNSIGNED16	ModuleID	Module ID number	–	ro	SDO
0x3140	UNSIGNED16	Input1_16	Read Digital Input 1_16	Manual	ro	PDO
0x4001	VISIBLE STRING	SerialNumber	The device's serial number	–	const	SDO
0x4004	UNSIGNED8	UserLEDControl	User LED Control	–	rw	SDO
0x400C	VISIBLE STRING	ProductName	Product Name	–	ro	SDO

8 Digital input module XN-322-16DI-PD

8.6 Supported CANopen objects

9 Digital input module XN-322-20DI-PD

XN-322-20DI-PD digital input modules have 20 inputs, for a +24 V signal level, that can be used to read the logical low and logical high levels, i.e., 0 and 1. These modules feature an internal input filter designed to suppress glitches on the corresponding signal cables.

9.1 Status LEDs

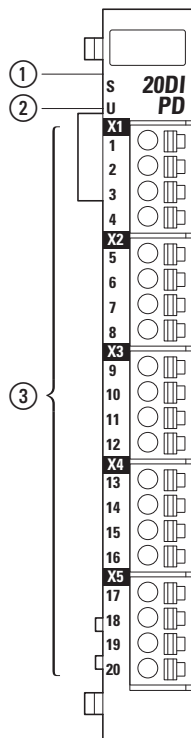

Figure 29: LED signals and pin assignment for XN-322-20DI-PD

- ① Module status LED
- ② User LED
- ③ Status LEDs for inputs 1 to 20

Module status	green	ON	System OK
		OFF	No power
		FLASHES (5 Hz)	No communication
User	yellow	ON	The user can set the LED signals as necessary. (For example, the visualization interface can be used to set the module's LED to flash so that it is easier to find the module inside the control panel.)
		OFF	
		FLASH (200 ms ON, 1000 ms OFF)	
		FLASH (1000 ms ON, 200 ms OFF)	
Status input 1 ... Input 20	green	ON	Input ON
		OFF	Input OFF

9 Digital input module XN-322-20DI-PD

9.2 Pin assignment

9.2 Pin assignment

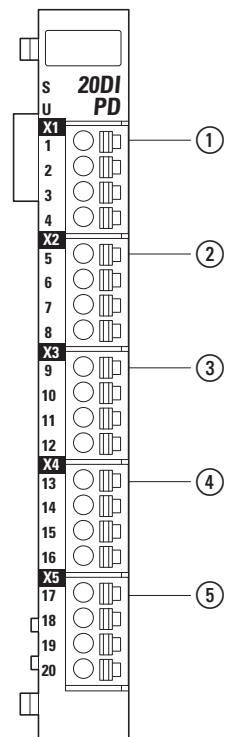

Figure 30: Pin assignment

- ① X1
 - 1 digital input 1
 - 2 digital input 2
 - 3 digital input 3
 - 4 digital input 4
- ② X2
 - 5 digital input 5
 - 6 digital input 6
 - 7 digital input 7
 - 8 digital input 8
- ③ X3
 - 9 digital input 9
 - 10 digital input 10
 - 11 digital input 11
 - 12 digital input 12
- ④ X4
 - 13 digital input 13
 - 14 digital input 14
 - 15 digital input 15
 - 16 digital input 16
- ⑤ X5
 - 17 digital input 17
 - 18 digital input 18
 - 19 digital input 19
 - 20 digital input 20

9.3 Digital input wiring

The digital input, as defined in the EN 61131-1 type with a 5-ms input delay, is particularly suitable for connecting electronic switching devices, including relay contacts, pushbuttons, switches, etc. It is used to convert a signal with two possible states into a one-bit binary number.

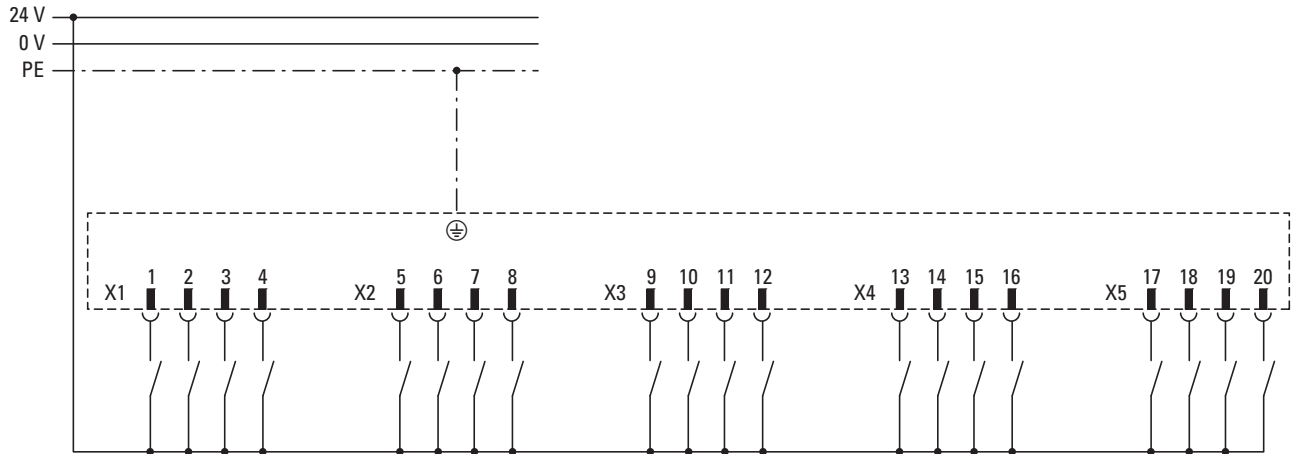

Figure 31: Input wiring

9.4 Technical data for digital inputs

designation		
Number of channels	20	
	61131-2 Type1	
Input voltage UE	24 VDC	maximum 30 VDC
Signal level	LOW: $0 < U_E < +8 \text{ V}$	HIGH: $+14 \text{ V} < U_E < +30 \text{ V}$
Switching threshold	normally +11 VDC	
Input current at $U_E=24\text{Vdc}$	normally 3.7 mA	
Input delay	normally 5 ms	

9 Digital input module XN-322-20DI-PD

9.5 Memory layout

9.5 Memory layout

CAN Object Index		Size (byte)	Description			
0x6000 SUB x	0x3010	4	Digital input register	Byte 0:	Bit 0	Input 1
					Bit 1	Input 2
					Bit 2	Input 3
					Bit 3	Input 4
					Bit 4	Input 5
					Bit 5	Input 6
					Bit 6	Input 7
					Bit 7	Input 8
0x6000 SUB x+1				1 Byte	Bit 0	Input 9
					Bit 1	Input 10
					Bit 2	Input 11
					Bit 3	Input 12
					Bit 4	Input 13
					Bit 5	Input 14
					Bit 6	Input 15
					Bit 7	Input 16
0x6000 SUB x+2				Byte 2	Bit 0	Input 17
					Bit 1	Input 18
					Bit 2	Input 19
					Bit 3	Input 20
					Bit 4	-
					Bit 5	-
					Bit 6	-
					Bit 7	-
				bytes3	Bit 0	-
					Bit 1	-
					Bit 2	-
					Bit 3	-
					Bit 4	-
					Bit 5	-
					Bit 6	-
					Bit 7	-

9.6 Supported CANopen objects

Product-specific CANopen objects

Index (hex)	Data Type	Name	Function	Mapping	Access
0x6000	UNSIGNED8	I-BYTE	Digital Input 8-bit	Default	ro PDO

Manufacturer-specific objects

Index range for the XN-322-20DI-PD module: xx10 to xx1F

Index (hex)	Data Type	Name	Function	Mapping	Access
0x1027	UNSIGNED16	ModuleID	Module ID number	–	ro SDO
0x3010	UNSIGNED32	Input1_20	Digital input channels 1 to 20	Manual	ro PDO
0x4001	VISIBLE STRING	SerialNumber	The device's serial number	–	const SDO
0x4004	UNSIGNED8	UserLEDControl	User LED Control	–	rw SDO
0x400C	VISIBLE STRING	ProductName	Product Name	–	ro SDO

9 Digital input module XN-322-20DI-PD

9.6 Supported CANopen objects

10 Digital input module XN-322-20DI-PF

XN-322-20DI-PF digital input modules have 20 inputs, for a +24 V level, that can be used to read the logical low and logical high signal levels, i.e., 0 and 1. The modules feature input filters designed to suppress glitches on the corresponding signal cables.

10.1 Status LEDs

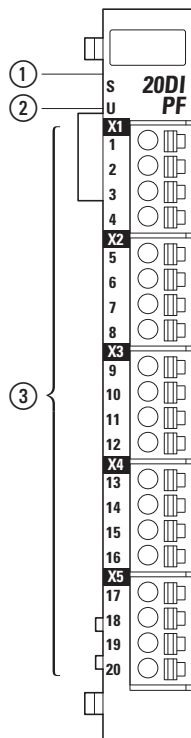

Figure 32: LED signals and pin assignment for XN-322-20DI-PF

- ① Module status LED
- ② User LED
- ③ Status LEDs for inputs 1 to 20

Module status	green	ON	System OK
		OFF	No power
		FLASHES (5 Hz)	No communication
User	yellow	ON	The user can set the LED signals as necessary. (For example, the visualization interface can be used to set the module's LED to flash so that it is easier to find the module inside the control panel.)
		OFF	
		FLASH (200 ms ON, 1000 ms OFF)	
		FLASH (1000 ms ON, 200 ms OFF)	
Status input 1 ... Status input 20	green	ON	Input ON
		OFF	Input OFF

10 Digital input module XN-322-20DI-PF

10.2 Pin assignment

10.2 Pin assignment

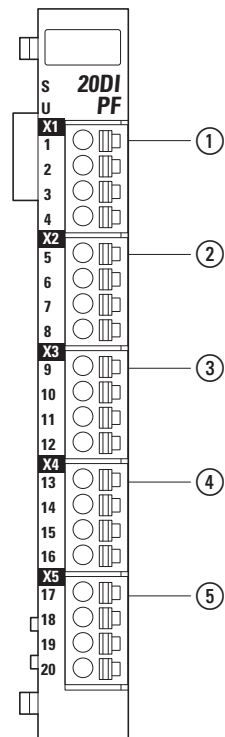

Figure 33: Pin assignment

- ① X1
 - 1 digital input 1
 - 2 digital input 2
 - 3 digital input 3
 - 4 digital input 4
- ② X2
 - 5 digital input 5
 - 6 digital input 6
 - 7 digital input 7
 - 8 digital input 8
- ③ X3
 - 9 digital input 9
 - 10 digital input 10
 - 11 digital input 11
 - 12 digital input 12
- ④ X4
 - 13 digital input 13
 - 14 digital input 14
 - 15 digital input 15
 - 16 digital input 16
- ⑤ X5
 - 17 digital input 17
 - 18 digital input 18
 - 19 digital input 19
 - 20 digital input 20

10.3 Digital input wiring

The digital input, which conforms to EN 61131-1 type 1, is suitable for connecting electronic sensors. It is used to convert a signal with two possible states into a one-bit binary number.

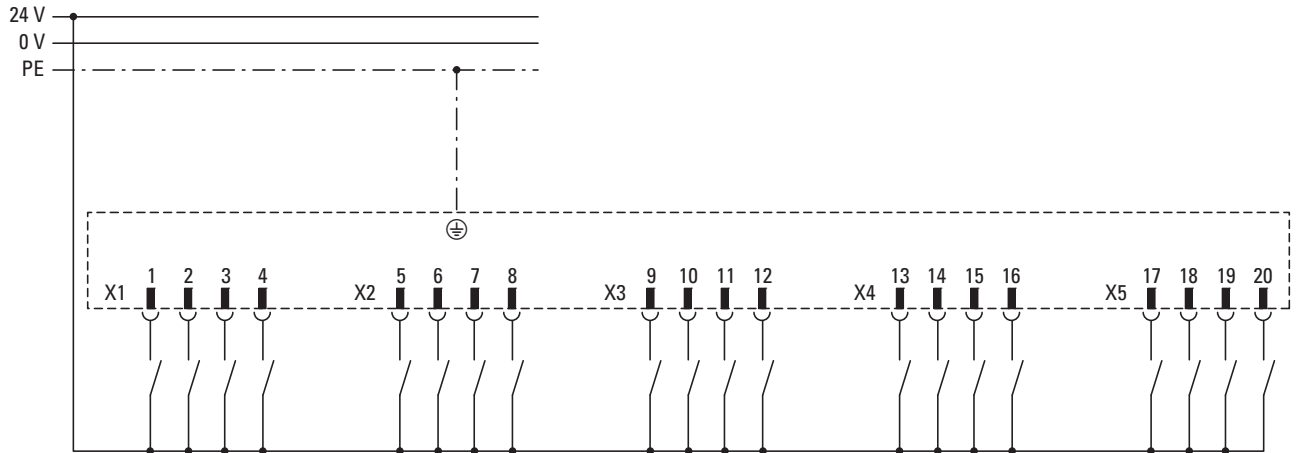

Figure 34: Input wiring

10.4 Technical data for digital inputs

designation		
Number of channels	20	
	61131-2 Type1	
Input voltage UE	24 VDC	maximum 30 VDC
Signal level	LOW: $0 < U_e < +8 \text{ V}$	HIGH: $+14 \text{ V} < U_e < +30 \text{ V}$
Switching threshold	normally +11 VDC	
Input current at $U_E=24\text{Vdc}$	normally 3.7 mA	
Input delay	normally 0.5 ms	

10 Digital input module XN-322-20DI-PF

10.5 Memory layout

10.5 Memory layout

CAN Object Index	Size (byte)	Description					
6000 SUB x	3030	Digital input register	Byte 0:	Bit 0	Input 1		
				Bit 1	Input 2		
				Bit 2	Input 3		
				Bit 3	Input 4		
				Bit 4	Input 5		
				Bit 5	Input 6		
				Bit 6	Input 7		
				Bit 7	Input 8		
6000 SUB x+1				1 Byte	Bit 0	Input 9	
					Bit 1	Input 10	
					Bit 2	Input 11	
					Bit 3	Input 12	
					Bit 4	Input 13	
					Bit 5	Input 14	
					Bit 6	Input 15	
					Bit 7	Input 16	
6000 SUB x+2				Byte 2	Bit 0	Input 17	
					Bit 1	Input 18	
					Bit 2	Input 19	
					Bit 3	Input 20	
					Bit 4	–	
					Bit 5	–	
					Bit 6	–	
					Bit 7	–	
			3 bytes	Bit 0	–		
				Bit 1	–		
				Bit 2	–		
				Bit 3	–		
				Bit 4	–		
				Bit 5	–		
				Bit 6	–		
				Bit 7	–		

10.6 Supported CANopen objects

Product-specific CANopen objects

Index (hex)	Data Type	Name	Function	Mapping	Access
0x6000	UNSIGNED8	I-BYTE	Digital Input 8-bit	Default	ro PDO

Manufacturer-specific objects

Index range for the XN-322-20DI-PF module: x030 to x03F

Index (hex)	Data Type	Name	Function	Mapping	Access
0x1027	UNSIGNED16	ModuleID	Module Identification Number	–	ro SDO
0x3030	UNSIGNED32	Input1_20	Read Digital Input 1_20	Manual	ro PDO
0x4001	VISIBLE STRING	SerialNumber	Serial Number	–	const SDO
0x4004	UNSIGNED8	UserLEDControl	User LED Control	–	rw SDO
0x400C	VISIBLE STRING	ProductName	Product Name	–	ro SDO

10 Digital input module XN-322-20DI-PF

10.6 Supported CANopen objects

11 XN-322-20DI-PCNT digital input module with counter function

XN-322-20DI-PCNT digital input modules have 20 inputs, for a +24 V level, that can be used to read the logical low and logical high signal levels, i.e., 0 and 1. The modules feature input filters designed to suppress glitches on the corresponding signal cables. In addition, digital inputs 1 – 4 feature a counter function that, when used, makes internal module registers be incremented every time there is an input pulse.

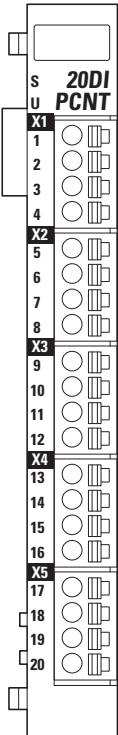

Figure 35: Device view XN-322-20DI-PCNT

11 XN-322-20DI-PCNT digital input module with counter function

11.1 Status LEDs

11.1 Status LEDs

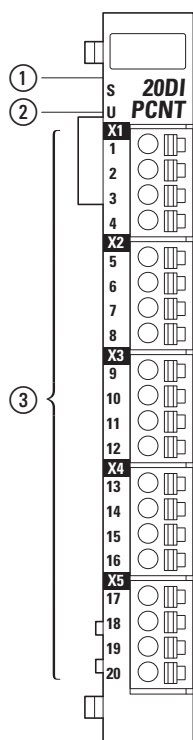

Figure 36: LED signals and pin assignment

- ① Module status LED
- ② User LED
- ③ Status LEDs for inputs 1 to 20

Module status	green	ON	System OK
		OFF	No power
		FLASHES (5 Hz)	No communication
Status User	yellow	ON	The user can set the LED signals as necessary. (For example, the visualization interface can be used to set the module's LED to flash so that it is easier to find the module inside the control panel.)
		OFF	
		FLASH (200 ms ON, 1000 ms OFF)	
		FLASH (1000 ms ON, 200 ms OFF)	
Status input 1 – 20	green	ON	Input ON
		OFF	Input OFF

11.2 Pin assignment

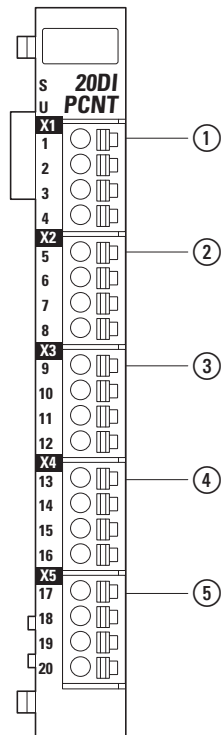

Figure 37: Pin assignment

- ① X1
 - 1 digital input 1
 - 2 digital input 2
 - 3 digital input 3
 - 4 digital input 4
- ② X2
 - 5 digital input 5
 - 6 digital input 6
 - 7 digital input 7
 - 8 digital input 8
- ③ X3
 - 9 digital input 9
 - 10 digital input 10
 - 11 digital input 11
 - 12 digital input 12
- ④ X4
 - 13 digital input 13
 - 14 digital input 14
 - 15 digital input 15
 - 16 digital input 16
- ⑤ X5
 - 17 digital input 17
 - 18 digital input 18
 - 19 digital input 19
 - 20 digital input 20

11.3 Wiring

There are four digital inputs wired to each of the four X1 to X5 connectors.

11 XN-322-20DI-PCNT digital input module with counter function

11.3 Wiring

11.3.1 Wiring up the digital inputs

The digital input, which conforms to EN 61131-1 type 1, is particularly suitable for connecting electronic sensors. It is used to convert a signal with two possible states into a one-bit binary number.

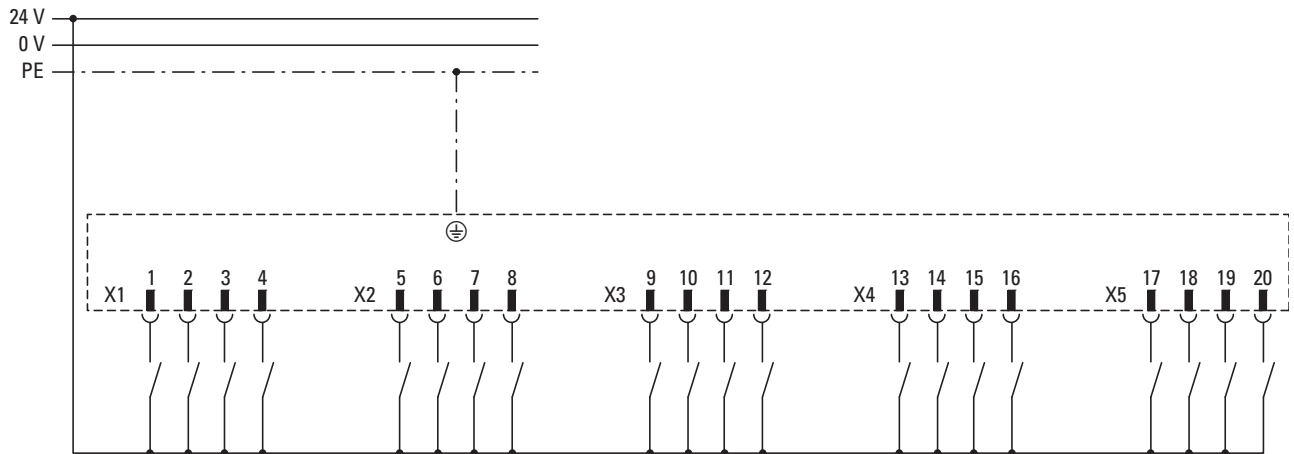

Figure 38: Input wiring

11.3.2 Wiring the counter functions for inputs 1 to 4

Inputs 1...4 are connected downstream of internal module counter registers that can be used to directly count signal pulses at these inputs.

The following modes are available:

- Counter mode (simple counting): The 8-bit counter register for an input will be incremented every time there is a rising signal pulse at that input. Objects 0x3023 to 0x3026 are the corresponding 8-bit counter registers.
- Incremental encoder mode: Counts by interpreting the signals from two inputs using AB quadrature mode with four samples encoding and incrementing a 16-bit counter register. Objects 0x3027 to 0x3028 are the corresponding 16-bit counter registers.

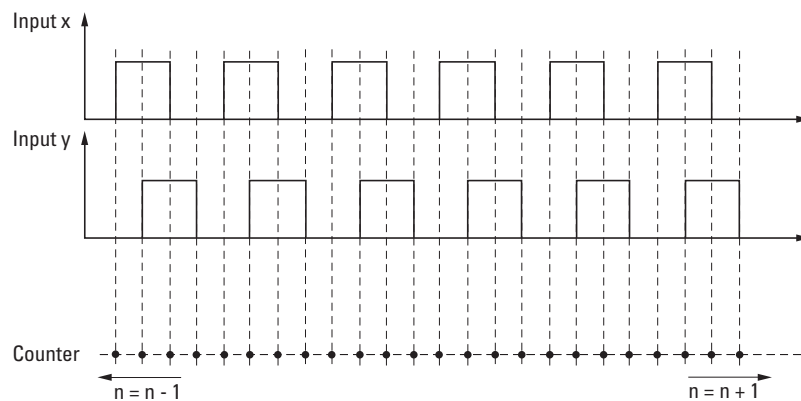

Figure 39: Timing diagram showing how the signals at the XN-322-20DI-PCNT module's inputs are used for counting when using AB quadrature mode with four samples encoding

11 XN-322-20DI-PCNT digital input module with counter function

11.4 Technical data for digital inputs

11.3.3 Configuring inputs 1 to 4

Counter mode register object 0x4020 can be used to configure the function for inputs 1 to 4 and, accordingly, select the operating mode you want to use.

In addition, any writing command to counter mode register object 0x4020 will reset counter registers 0x3023 through 0x3028 to 0x00.

The following functions are available:

Data bit	designation	Description
0	Input 1/2	0 = Counter Mode 1 = Incremental Encoder Mode
1	Input 3/4	0 = Counter Mode 1 = Incremental Encoder Mode
2 – 7		reserved

11.4 Technical data for digital inputs

designation	
Number of channels	20
	61131-2 Type1
Input voltage U_e	24 VDC maximum 30 VDC
Signal level	LOW: $0 < U_e < +8$ V HIGH: $+14$ V $< U_e < +30$ V
Switching threshold	normally +11 VDC
Input current at $U_e=24$ VDC	normally 3.7 mA
Input delay	
Inputs 1 to 4	normally 10 μ s
Inputs 5 to 20	normally 500 μ s
Max. input frequency at inputs 1 to 4 when using X1 encoding	25 kHz
Max. input frequency at inputs 1 to 4 when using four samples encoding	100 kHz

11 XN-322-20DI-PCNT digital input module with counter function

11.5 Memory layout

11.5 Memory layout

CAN Object Index	Size (byte)	Description				
0x6000 SUB x	0x3020	3	Digital input register	Byte 0:	Bit 0	Input 1
					Bit 1	Input 2
					Bit 2	Input 3
					Bit 3	Input 4
					Bit 4	Input 5
					Bit 5	Input 6
					Bit 6	Input 7
					Bit 7	Input 8
0x6000 SUB x+1	0x3021	1	1 Byte	1 Byte	Bit 0	Input 9
					Bit 1	Input 10
					Bit 2	Input 11
					Bit 3	Input 12
					Bit 4	Input 13
					Bit 5	Input 14
					Bit 6	Input 15
					Bit 7	Input 16
0x6000 SUB x+2	0x3022	2	2 bytes	2 bytes	Bit 0	Input 17
					Bit 1	Input 18
					Bit 2	Input 19
					Bit 3	Input 20
					Bit 4	-
					Bit 5	-
					Bit 6	-
					Bit 7	-
0x4020 SDO	1	Counter mode register	2 bytes	2 bytes	Bit 0, Input 1 – 2	0 = Counter Mode
						1 = Incremental Encoder Mode
					Bit 1, Input 3 – 4	0 = Counter Mode
						1 = Incremental Encoder Mode
0x3023	1	Counter 1			Counter 1 Register ¹⁾	
0x3024	1	Counter 2			Counter 2 Register ¹⁾	

1) If the inputs are configured for counter mode in the counter mode register.

2) If the inputs are configured for incremental encoder mode in the counter mode register.

11 XN-322-20DI-PCNT digital input module with counter function

11.6 Supported CANopen objects

CAN Object Index	Size (byte)	Description
0x3025	1	Counter 3 Counter 3 Register ¹⁾
0x3026	1	Counter 4 Counter 4 Register ¹⁾
0x3027	2	Incremental encoder 1 Register Incremental encoder 1 Register ²⁾
0x3028	2	Incremental encoder 2 Register Incremental encoder 2 Register ²⁾

1) If the inputs are configured for counter mode in the counter mode register.

2) If the inputs are configured for incremental encoder mode in the counter mode register.

11.6 Supported CANopen objects

Product-specific CANopen objects

Index (hex)	Data Type	Name	Function	Mapping	Access
6000	UNSIGNED8	I-BYTE	Digital Input 8-bit	Default	ro PDO

Manufacturer-specific objects

Index range for the XN-322-20DI-PCNT module: x020 to x02F

Index (hex)	Data Type	Name	Function	Mapping	Access
0x1027	UNSIGNED16	ModuleID	Module Identification Number	–	ro SDO
0x3020	UNSIGNED8	Input1_8	Read Digital Input 1_8	Manual	ro PDO
0x3021	UNSIGNED8	Input9_16	Read Digital Input 9_16	Manual	ro PDO
0x3022	UNSIGNED8	Input17_20	Read Digital Input 17_20	Manual	ro PDO
0x3023	UNSIGNED8	Counter1	Counter 1 Register	Manual	ro PDO
0x3024	UNSIGNED8	Counter2	Counter 2 Register	Manual	ro PDO
0x3025	UNSIGNED8	Counter3	Counter 3 Register	Manual	ro PDO
0x3026	UNSIGNED8	Counter4	Counter 4 Register	Manual	ro PDO
0x3027	UNSIGNED16	IncrementalEncoder1	Incremental Encoder 1 Register	Manual	ro PDO
0x3028	UNSIGNED16	IncrementalEncoder2	Incremental Encoder 2 Register	Manual	ro PDO
0x4001	VISIBLE STRING	SerialNumber	Serial Number	-	const SDO

11 XN-322-20DI-PCNT digital input module with counter function

11.6 Supported CANopen objects

0x4004	UNSIGNED8	UserLEDControl	User LED Control	–	rw	SDO
0x400C	VISIBLE STRING	ProductName	Product Name	-	ro	SDO
0x4020	UNSIGNED8	CounterModeRegister	Counter Mode Register	-	ro	SDO



Make sure to only use the data relevant to the selected operating mode. Registers for operating modes that are not selected will contain invalid values. The operating mode can be selected using the counter mode register.

12 Digital input module XN-322-20DI-ND

The XN-322-20DI-ND digital input module features 20 inputs that are pulled up to +24 V with a pull-up resistor and relay a logic level of "0" at this voltage. If an input is pulled down to GND, a signal state of "1" will be relayed for that input instead. The module features input filters designed to suppress glitches on the corresponding signal cables.

12.1 Status LEDs

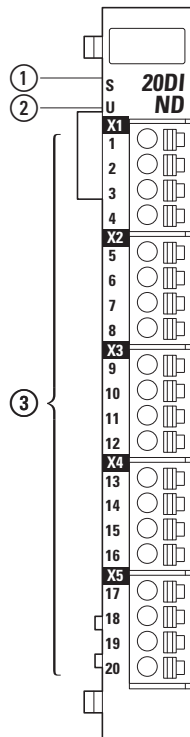

Figure 40: LED signals and pin assignment for XN-322-20DI-ND

- ① Module status LED
- ② User LED
- ③ Status LEDs for inputs 1 to 20

Module status	green	ON	System OK
		OFF	No power
		FLASHES (5 Hz)	No communication

12 Digital input module XN-322-20DI-ND

12.2 Pin assignment

User	yellow	ON	The user can set the LED signals as necessary. (For example, the visualization interface can be used to set the module's LED to flash so that it is easier to find the module inside the control panel.)
		OFF	
		FLASH (200 ms ON, 1000 ms OFF)	
		FLASH (1000 ms ON, 200 ms OFF)	
Status input 1	green	ON	Input ON
... Input 20		OFF	Input OFF

12.2 Pin assignment

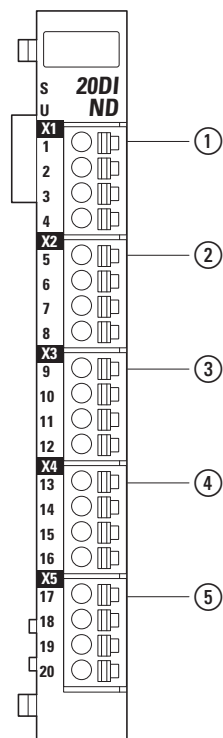

Figure 41: Pin assignment

- ① X1
 - 1 digital input 1
 - 2 digital input 2
 - 3 digital input 3
 - 4 digital input 4
- ② X2
 - 5 digital input 5
 - 6 digital input 6
 - 7 digital input 7
 - 8 digital input 8
- ③ X3
 - 9 digital input 9
 - 10 digital input 10
 - 11 digital input 11
 - 12 digital input 12
- ④ X4
 - 13 digital input 13

- 14 digital input 14
- 15 digital input 15
- 16 digital input 16
- ⑤ X5
- 17 digital input 17
- 18 digital input 18
- 19 digital input 19
- 20 digital input 20

12.3 Digital input wiring

When not switched, each digital input will deliver a LOW signal. When an input is connected to ground, its logic signal level will switch to HIGH instead.

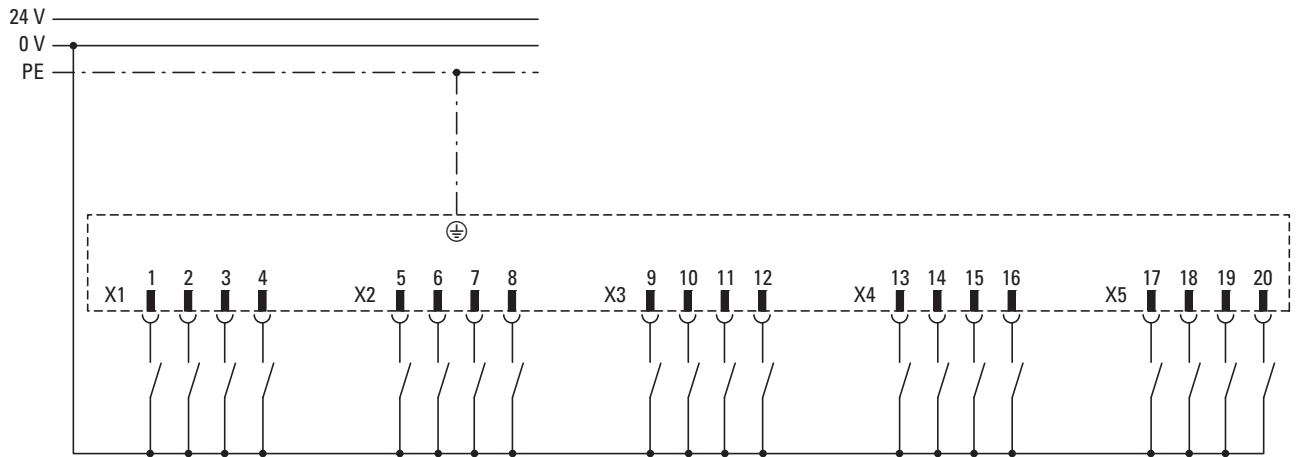

Figure 42: Input wiring

12.4 Technical data for digital inputs

designation			
Number of channels that switch when connected to GND	20		
Input voltage UE_LOW	minimum 15 VDC	24 VDC	maximum 30 VDC
Input current at IE_LOW	-1.0 mA		0 mA
Input voltage UE_HIGH	0 VDC		5 VDC
Input current at IE_LOW	-4.0 mA	-3.0 mA	-2.0 mA
Switching threshold	normally +7 VDC		
Input delay	normally 5 ms		

12 Digital input module XN-322-20DI-ND

12.5 Memory layout

12.5 Memory layout

CAN Object Index		Size (byte)	Description				
0x6000 SUB x	0x3130	4	Digital input register		Byte 0:	Bit 0	Input 1
						Bit 1	Input 2
						Bit 2	Input 3
						Bit 3	Input 4
						Bit 4	Input 5
						Bit 5	Input 6
						Bit 6	Input 7
						Bit 7	Input 8
0x6000 SUB x+1					1 Byte	Bit 0	Input 9
						Bit 1	Input 10
						Bit 2	Input 11
						Bit 3	Input 12
						Bit 4	Input 13
						Bit 5	Input 14
						Bit 6	Input 15
						Bit 7	Input 16
0x6000 SUB x+2					3 bytes	Bit 0	Input 17
						Bit 1	Input 18
						Bit 2	Input 19
						Bit 3	Input 20
						Bit 4	–
						Bit 5	–
						Bit 6	–
						Bit 7	–
					4 bytes	Bit 0	–
						Bit 1	–
						Bit 2	–
						Bit 3	–
						Bit 4	–
						Bit 5	–
						Bit 6	–
						Bit 7	–

12.6 Supported CANopen objects

Product-specific CANopen objects

Index (hex)	Data Type	Name	Function	Mapping	Access
0x6000	UNSIGNED8	I-BYTE	Digital Input 8-bit	Default	ro PDO

Manufacturer-specific objects

Index range for the XN-322-20DI-ND module: x130 to x13F

Index (hex)	Data Type	Name	Function	Mapping	Access
0x1027	UNSIGNED16	ModuleID	Module Identification Number	–	ro SDO
0x3130	UNSIGNED32	Input1_20	Read Digital Input 1_20	Manual	ro PDO
0x4001	VISIBLE STRING	SerialNumber	Serial Number	–	const SDO
0x4004	UNSIGNED8	UserLEDControl	User LED Control	–	rw SDO
0x400C	VISIBLE STRING	ProductName	Product Name	–	ro SDO

12 Digital input module XN-322-20DI-ND

12.6 Supported CANopen objects

13 Relay output module XN-322-4DO-RNO

The XN-322-4DO-RNO is an XN300 slice module with 4 relay outputs. Each relay output features an N/O with a switching power of 230 VAC/6 A / 24 VDC/6 A.

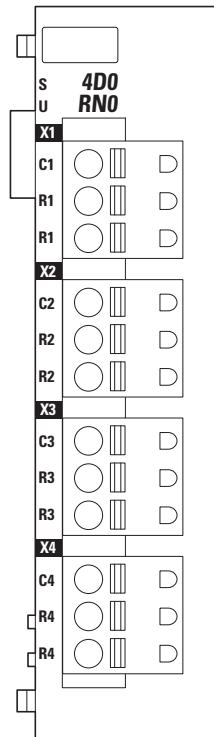

Figure 43: Device view XN-322-4DO-RNO

13 Relay output module XN-322-4DO-RNO

13.1 Status LEDs

13.1 Status LEDs

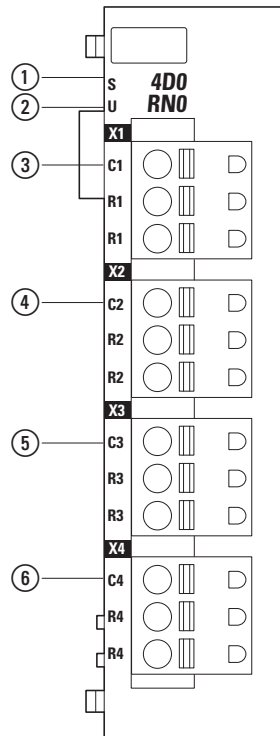

Figure 44: LED signals and pin assignment

- ① Module status LED
- ② User LED
- ③ Output 1 status LED
- ④ Output 2 status LED
- ⑤ Output 3 status LED
- ⑥ Output 4 status LED

Module status	green	ON	System OK
		OFF	No power
		FLASHES (5 Hz)	No communication
User	yellow	ON	The user can set the LED signals as necessary. (For example, the visualization interface can be used to set the module's LED to flash so that it is easier to find the module inside the control panel.)
		OFF	
		FLASH (200 ms ON, 1000 ms OFF)	
		FLASH (1000 ms ON, 200 ms OFF)	
Output status	yellow	ON	N/O active
		OFF	N/O open

13.2 Pin assignment

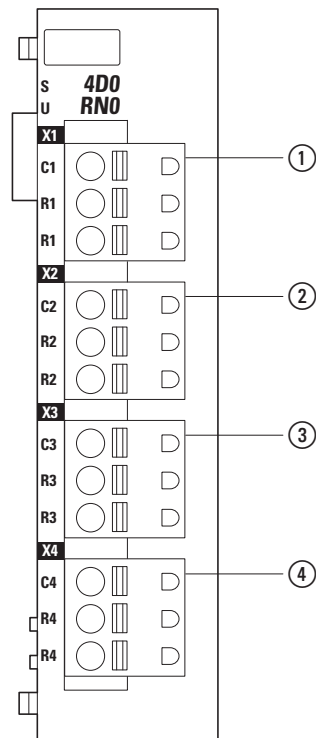

Figure 45: Pin assignment

- ① X1
 - C1 N/O
 - R1 common contact
 - R1 common contact
- ② X2
 - C2 N/O
 - R2 common contact
 - R2 common contact
- ③ X3
 - C3 N/O
 - R3 common contact
 - R3 common contact
- ④ X4
 - C4 N/O
 - R4 common contact
 - R4 common contact

13.3 Wiring

A digital output is wired to each of the four X1 to X4 connectors.

13.3.1 Wiring the relay output

The EN 609478-5-1 relay output has the properties specified in EN 61131-2.

13 Relay output module XN-322-4DO-RNO

13.3 Wiring

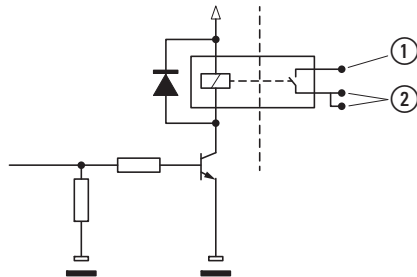

Figure 46: Internal logic for relay output

- ① N/O
- ② Common contact

NOTICE

In order for the relay coil to pick up correctly, the relay output module needs a minimum supply voltage.

The power supply module (the gateway or PLC, for example) must provide a minimum supply voltage to the relay output module. This voltage depends on the ambient temperature, as shown in the table below:

Ambient air temperature [°C]	Supply voltage [V]
-25, ... +30	18
+40	18.7
+50	19.4
+60	20.0

R_L = Cable resistance of connection cable

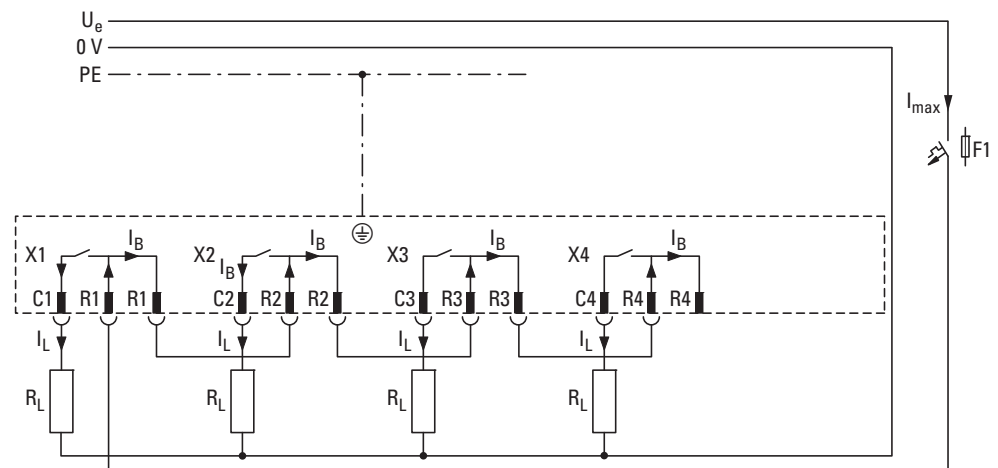

Figure 47: Wiring diagram with U_e looped through



Figure 48: Wiring diagram with U_e at all four connection terminals for total currents > 10 A

13.3.2 Suppressor circuit for inductive loads

NOTICE

When switching inductive loads, a snubber must be added at the load in order to prevent EMI. RC suppressors have proven to be particularly effective for this purpose as a result of their dynamic response. In contrast, the use of varistors is not always adequate.

13.4 Technical data relay outputs

Number of relay outputs	4	
Function	N/O	
Rated operational voltage U_e	24 V DC	230 V AC
maximum rated operating voltage	30 V DC	250 V AC
Continuous current per channel I_c	6 A DC	6 A AC
Simultaneity of all outputs	100 %	
Continuous current per connector contact	max. 10 A DC	max. 10 A AC
Current-carrying capacity of common contact link I_B	max. 10 A DC	max. 10 A AC
On-delay/off-delay	≤ 10 ms/ ≤ 10 ms	
Switching Frequency		
Mechanical switching operations	10 x 10 ⁶	
Resistive load / lamp load	2 Hz	
Inductive	0.5 Hz	
Switching frequency as per IEC 61810 (8A, 250VAC, cosφ=1, 85°C)	100x10 ³	
Making capacity		

13 Relay output module XN-322-4DO-RNO



13.5 Profile

AC-15, 250 V AC, 3 A (600 S/h)	300000 switching operations
DC-13, L/R ≤ 150ms, 24 V DC, 1 A (500 S/h)	200000 switching operations
Breaking capacity	
AC-15, 250 V AC, 3 A (600 S/h)	300000 switching operations
DC-13, L/R ≤ 150ms, 24 V DC, 1 A (500 S/h)	200000 switching operations
Filament bulb load	
1000 W at 230/240 V AC	25000 switching operations
500 W at 115/120 V AC	25000 switching operations
Fluorescent lamp load of 10 x 58 W with 230/240 VAC (with ballast, without compensation, with compensation)	25000 switching operations
Insulation test voltage	
Contact-to-contact	1500 V
Coil-to-contact	1500 V
Material	AgSnO ₂

13.5 Profile

13.6 Connection terminals

Table 4: XN-322-4DO-RNO connection specifications

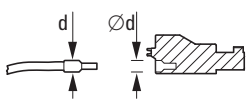
Cable cross-sectional areas			XN-322-4DO-RNO
10 mm (0.39") 	solid	mm ²	0.2 – 2.5
10 mm (0.39") 	Flexible with uninsulated ferrule	mm ²	0.25 – 2.5
10 mm (0.39") 	Flexible with insulated ferrule	mm ²	0.25 – 2.5
	Ferrule d	mm	≤ 3.8
	AWG		24 – 12
	Strip length	mm	10

13.7 Memory layout

CAN Object Index		Size (byte)	Description	Address (HEX)
0x6200	2120	1	Digital output register	0x0000
			Bit 0	Relay output 1
			Bit 1	Relay output 2
			Bit 2	Relay output 3
			Bit 3	Relay output 4
			Bit 4	–
			Bit 5	–
			Bit 6	–
			Bit 7	–
			Bit 4-15	–

13.8 Supported CANopen objects

Product-specific CANopen objects

Index (hex)	Data Type	Name	Function	Mapping	Access
0x6200	ARRAY	Q-BYTE	Digital Output 8-bit	Default	rww PDO

Manufacturer-specific objects

Index range for the XN-322-4DO-RNO module: x120 to x12F

Index (hex)	Data Type	Name	Function	Mapping	Access
0x1027	UNSIGNED16	ModuleID	Module ID number	–	ro SDO
0x2120	UNSIGNED8	Output 1_4	Write Digital Output 1_4	Manual	ro PDO
0x4001	VISIBLE STRING	SerialNumber	The device's serial number	–	const SDO
0x4004	UNSIGNED8	UserLEDControl	User LED Control	–	rw SDO
0x400C	VISIBLE STRING	ProductName	Product Name	–	ro SDO

13 Relay output module XN-322-4DO-RNO

13.8 Supported CANopen objects

14 Digital output module XN-322-8DO-P05

XN-322-8DO-P05 digital output modules feature 8 short-circuit proof digital outputs (+24 V / 0.5 A) and two supply voltages, with each of these voltages powering eight outputs. The supply voltage is monitored for undervoltage.

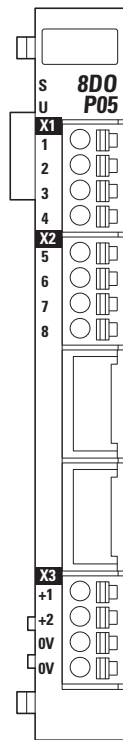

Figure 49: Device view XN-322-8DO-P05

14 Digital output module XN-322-8DO-P05

14.1 Pin assignment and status LED signals

14.1 Pin assignment and status LED signals

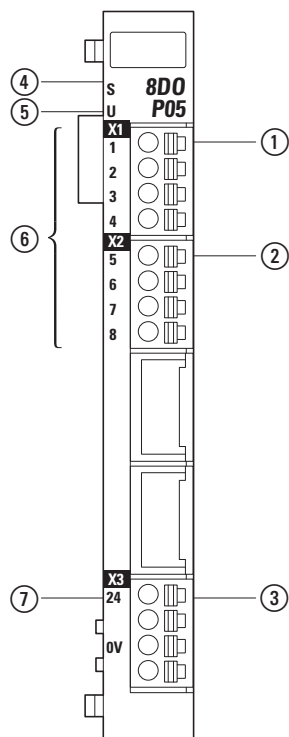

Figure 50: Pin assignment and status LED signals

① X1

- 1 digital output 1
- 2 digital output 2
- 3 digital output 3
- 4 digital output 4

② X2

- 5 digital output 5
- 6 digital output 6
- 7 digital output 7
- 8 digital output 8

③ X3

- 24 power supply +24VDC
- -
- 0V GND
- -

④ Module status LED

⑤ User status LED

⑥ Output n status LED

⑦ Power status LED for digital outputs

Table 5: Status LED signals

Module status	green	ON	System OK
		OFF	No power
		FLASHES (5 Hz)	No communication

14 Digital output module XN-322-8DO-P05

14.1 Pin assignment and status LED signals

Status User	yellow	ON	The user can set the LED signals as necessary. (For example, the visualization interface can be used to set the module's LED to flash so that it is easier to find the module inside the control panel.)
		OFF	
		FLASH (200 ms ON, 1000 ms OFF)	
		FLASH (1000 ms ON, 200 ms OFF)	
Status of output n n = 1 to 8	yellow	ON	Output is "ON"
		OFF	Output is "OFF"
Power status for digital outputs	green	ON	The digital outputs are being powered with 24 VDC
		OFF	The outputs are not being powered properly (under-voltage) or the system is not being powered at all. If the system is not being powered at all, the module status LED will be OFF.

14.1.1 Wiring

Four digital outputs can be wired to the X1 connector and another four digital outputs can be wired to the X2 connector.

14.1.2 Connecting the power supply

The cross-sectional area of the +24 V cables used to supply power must be sized for the maximum total current drawn by all the outputs.

It is impermissible to apply a voltage, at any output, that exceeds the supply voltage by more than 0.7 V.

The two 0 V pins on connector X5 are internally connected to each other.

14.1.3 Connecting EN 61131-2 short-circuit proof digital outputs

The outputs are able to drive twice their rated operational current briefly when driving loads with higher inrush currents.

14 Digital output module XN-322-8DO-P05

14.1 Pin assignment and status LED signals

14.1.4 Wiring digital outputs

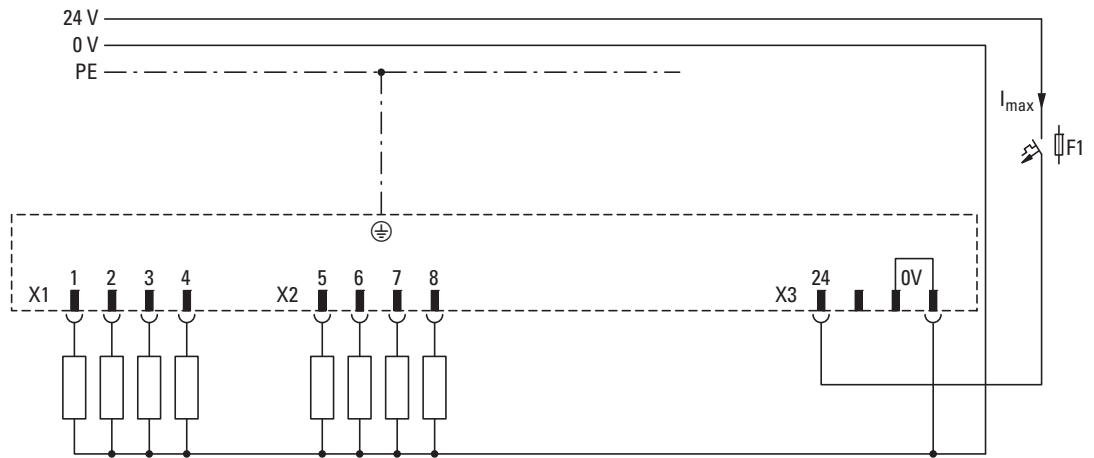

Figure 51: Wiring example

14.1.5 Suppressor circuit for inductive loads

High induced voltages may be produced when inductive loads are switched off. Because of this, the transistor outputs have internal suppressor circuits to +24 V.

As shown in the diagram below, the voltage when switching off inductive loads is limited to -29 V. In order to prevent system malfunctions caused by voltage peaks (e.g., coupling on analog cables), it is recommended to use a suppressor circuit (RC suppressors or flyback diodes) directly on inductive loads.

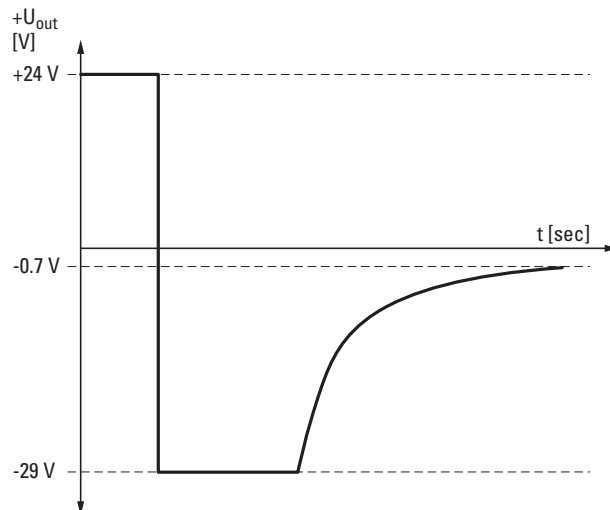

Figure 52: Voltage limiting when switching off inductive loads

14.2 Technical data for digital outputs

Quantity	8
Short-circuit proof as per EN 61131-2	yes
Power supply for digital outputs	
Number of supply voltages	1 (X3, pin on connector 24)
Rated operational voltage U_e	24 VDC
admissible range	18 – 30 VDC
Residual ripple	≤ 5 %
Maximum permissible total current per power supply group, with eight channels each, when using a duty factor of 100%	4A
Protection against polarity reversal	no
Output characteristic data	
„1“ signal	
Output voltage	$(U_e - 1V) < U_a < U_e$
Output current per channel	0.5 A
„0“ signal	
Output voltage	< 0.1 VDC
Max. output current per channel	≤ 10 μ A
Switching-on delay	< 100 μ s
Switch off delay	< 100 μ s
Maximum permissible total current for all channels when using a duty factor of 100%	4A
Maximum breaking energy of outputs (inductive load)	1 Joule/channel

14 Digital output module XN-322-8DO-P05

14.3 Memory layout

14.3 Memory layout

CAN Object Index		Size (byte)	Description	Bit	
0x6200 SUB x	0x2190	1	Digital output register	Bit 0	Output 1
				Bit 1	Output 2
				Bit 2	Output 3
				Bit 3	Output 4
				Bit 4	Output 5
				Bit 5	Output 6
				Bit 6	Output 7
				Bit 7	Output 8
0x3190		2	Module Status	Bit 0	State 24 VDC OK
				Bit 1-15	reserved

14.4 Supported CANopen objects

Product-specific CANopen objects

Index (hex)	Data Type	Name	Function	Mapping	Access	
0x6200	UNSIGNED8	Q-BYTE	Write Digital Output 8-bit	Default	rww	PDO

Manufacturer-specific objects

Index range for the XN-322-8DO-P05 module: x190 to x19F

Index (hex)	Data Type	Name	Function	Mapping	Access	
0x1027	UNSIGNED16	ModuleID	Module Identification Number	–	ro	SDO
0x2190	UNSIGNED8	Output 1_8	Write Digital Output 1_8	Manual	rww	PDO
0x3190	UNSIGNED8	Input-VoltageState	Input Voltage State Bit 0: DC 24V Output 1..8 OK	Manual	ro	PDO
0x4001	VISIBLE STRING	SerialNumber	Serial Number	–	const	SDO
0x4004	UNSIGNED8	UserLEDControl	User LED Control	–	rw	SDO
0x400C	VISIBLE STRING	ProductName	Product Name	–	ro	SDO

14 Digital output module XN-322-8DO-P05

14.4 Supported CANopen objects

15 Digital output module XN-322-12DO-P17

XN-322-12DO-P17 digital output modules feature 12 short-circuit proof digital outputs that are organized into three groups. The supply voltage for each group is monitored for undervoltage.

In accordance with the safety requirements set forth by the Institute for Occupational Safety and Health of the German Social Accident Insurance (IFA), the outputs' primary side (+5 V) is isolated from the secondary side (+24 V) with optocouplers (as required for class 3, pollution degree 2).

In addition, optocouplers are used in the monitoring circuit for the supply voltage for each channel group in order to isolate the 24 V on the primary side from the 24 V on the secondary side.

0 V / GND potentials and \ominus are connected to each other.

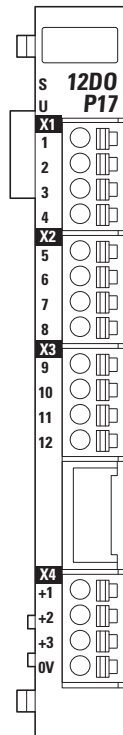

Figure 53: Device view XN-322-12DO-P17

15 Digital output module XN-322-12DO-P17

15.1 Status LEDs

15.1 Status LEDs

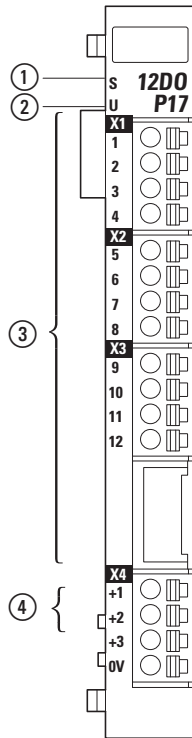

Figure 54: LED signals and pin assignment

- ① Module status LED
- ② User status LED
- ③ Status LEDs for outputs D01 to D012
- ④ Status LEDs for 24V1 to 24V3

Module status	green	ON	System OK
		OFF	No power
		FLASHES (5 Hz)	No communication
Status User	yellow	ON	The user can set the LED signals as necessary. (For example, the visualization interface can be used to set the module's LED to flash so that it is easier to find the module inside the control panel.)
		OFF	
		FLASH (200 ms ON, 1000 ms OFF)	
		FLASH (1000 ms ON, 200 ms OFF)	
Status of output n n = 1 to 12	yellow	ON	Output is "ON"
		OFF	Output is "OFF"
Status LED for group n n = 1 to 3	green	ON	Supply voltage OK
		OFF	Supply voltage not OK (undervoltage)

15.2 Pin assignment

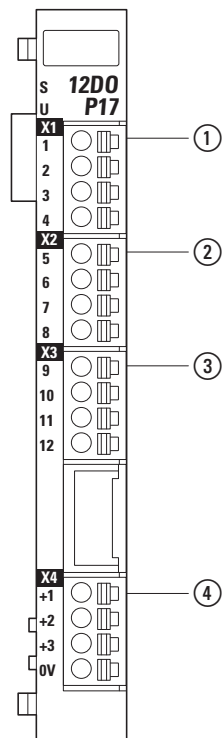

Figure 55: Pin assignment

① X1

- 1 group 1 digital output 1
- 2 group 1 digital output 2
- 3 group 1 digital output 3
- 4 group 1 digital output 4

② X2

- 5 group 2 digital output 5
- 6 group 2 digital output 6
- 7 group 2 digital output 7
- 8 group 2 digital output 8

③ X3

- 9 group 3 digital output 9
- 10 group 3 digital output 10
- 11 group 3 digital output 11
- 12 group 3 digital output 12

④ X4

- +1 power supply, group 1 +24VDC
- +2 power supply, group 2 +24VDC
- +3 power supply, group 3 +24VDC
- 0V GND

15.3 Wiring

Four digital outputs can be wired to each of the three X1 to X3 connectors.

15 Digital output module XN-322-12DO-P17

15.3 Wiring

15.3.1 Connecting the power supply

The cross-sectional area of the +24 V cables used to supply power must be sized for the maximum output current drawn by each group.

It is impermissible to apply a voltage, at any output, that exceeds the supply voltage by more than 0.7 V.

15.3.2 Connecting EN 61131-2 short-circuit proof digital outputs

The outputs are able to drive twice their rated operational current briefly when driving loads with higher inrush currents.

The outputs can be switched off by groups by using the corresponding group power supplies.

15.3.3 Wiring digital outputs

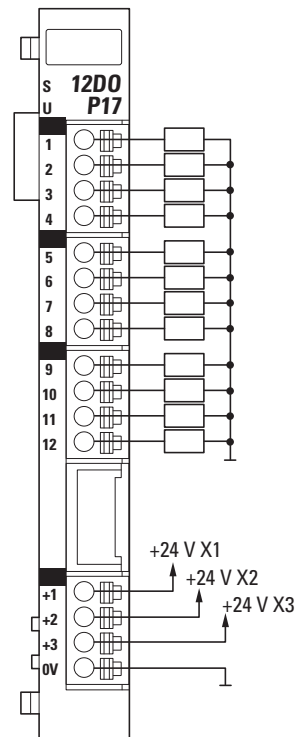

Figure 56: Wiring example

15.3.4 Suppressor circuit for inductive loads

Induced voltages may be produced when inductive loads are switched off. Accordingly, the transistor outputs have internal suppressor circuits to +24 V in order to protect the XN300 slice module.

As shown in the diagram below, the voltage when switching off inductive loads is limited to -12 V. In order to prevent system malfunctions caused by voltage peaks (e.g., coupling on analog cables), it is recommended to use a suppressor circuit (RC suppressors or flyback diodes) directly on inductive loads.

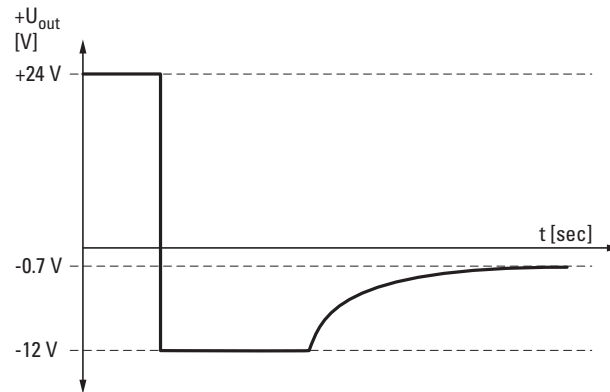

Figure 57: Voltage limiting when switching off inductive loads

15.3.5 Behavior in the event of a short-circuit or overload

15.4 Technical data for digital outputs

Quantity	12
Short-circuit proof as per EN 61131-2	yes
Power supply for digital outputs	
Number of supply voltages	3 (clamp positions +1/+2/+3)
Rated operational voltage U_e	24 VDC
admissible range	18 – 30 VDC
Residual ripple	$\leq 5\%$
Max. supply current when using a duty factor of 100%	3.4A
Protection against polarity reversal	no
Output characteristic data	
„1” signal	
Output voltage	$(U_e - 1V) < U_a < U_e$
Max. output current per channel	1.7 A
„0” signal	
Output voltage	< 0.1 VDC
Max. output current per channel	≤ 100 μ A
Switching-on delay	< 200 μ s
Switch off delay	< 200 μ s

15 Digital output module XN-322-12DO-P17

15.4 Technical data for digital outputs

Maximum permissible total current per power supply group, with four channels each, when using a duty factor of 100%	3.4A
Maximum permissible total current for all channels when using a duty factor of 100%	10.2A
Maximum breaking energy of outputs (inductive load)	0.64 Joule/channel 1.95 joules / power supply group

15.5 Memory layout

CAN Object Index	Size (byte)	Description	Bit				
0x6200 SUB x	2	Digital output register	Bit 0	Output 1			
			Bit 1	Output 2			
			Bit 2	Output 3			
			Bit 3	Output 4			
			Bit 4	Output 5			
			Bit 5	Output 6			
			Bit 6	Output 7			
			Bit 7	Output 8			
			0x6200 SUB x+1	2	Digital output register	Bit 8	Output 9
						Bit 9	Output 10
						Bit 10	Output 11
						Bit 11	Output 12
0x3040	2	Status of input voltages	Bit 0	State 24 VDC / +1			
			Bit 1	State of 24 VDC / +2			
			Bit 2	State of 24 VDC / +3			
			Bit 3-7	reserved			

15 Digital output module XN-322-12DO-P17

15.6 Supported CANopen objects

15.6 Supported CANopen objects

Index (hex)	Data Type	Name	Function	Mapping	Access
0x6200	UNSIGNED8	Q-BYTE	Write Digital Output 8-bit	Default	rww PDO

Manufacturer-specific objects

Index range for the XN-322-12DO-P17 module: x040 to x04F

Index (hex)	Data Type	Name	Function	Mapping	Access
0x1027	UNSIGNED16	ModuleID	Module Identification Number	–	ro SDO
0x2040	UNSIGNED16	Output1_12	Write Digital Output 1-12	Manual	rww PDO
0x3040	UNSIGNED8	InputVoltageState	Input Voltage State Bit 0: DC 24V Output 1..4 OK Bit 1: DC 24V Output 5..8 OK Bit 2: DC 24V Output 9..12 OK	Manual	ro PDO
0x4001	VISIBLE STRING	SerialNumber	Serial Number	–	const SDO
0x4004	UNSIGNED8	UserLEDControl	User LED Control	–	rw SDO
0x400C	VISIBLE STRING	ProductName	Product Name	–	ro SDO

16 Digital output module XN-322-16DO-P05

XN-322-16DO-P05 digital output modules feature 16 short-circuit proof digital outputs (+24 V / 0.5 A) and two supply voltages, with each of these voltages powering eight outputs. The supply voltage for each group is monitored for undervoltage.

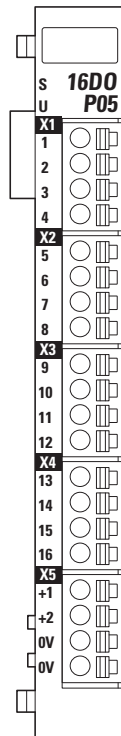

Figure 58: Device view XN-322-16DO-P05

16 Digital output module XN-322-16DO-P05

16.1 Pin assignment and status LED signals

16.1 Pin assignment and status LED signals

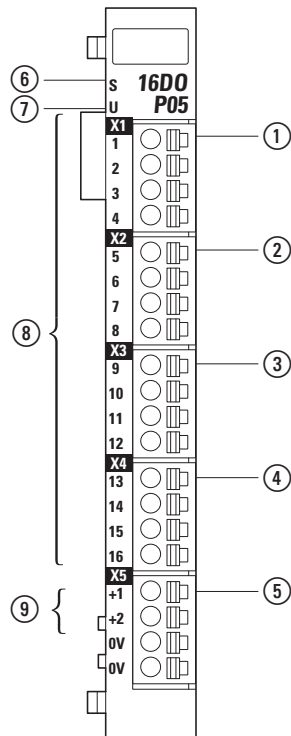

Figure 59: Pin assignment and status LED signals

- ① X1
 - 1 group 1 digital output 1
 - 2 group 1 digital output 2
 - 3 group 1 digital output 3
 - 4 group 1 digital output 4
- ② X2
 - 5 group 1 digital output 5
 - 6 group 1 digital output 6
 - 7 group 1 digital output 7
 - 8 group 1 digital output 8
- ③ X3
 - 9 group 2 digital output 9
 - 10 group 2 digital output 10
 - 11 group 2 digital output 11
 - 12 group 2 digital output 12
- ④ X4
 - 13 group 2 digital output 13
 - 14 group 2 digital output 14
 - 15 group 2 digital output 15
 - 16 group 2 digital output 16
 -
- ⑤ X5
 - +1 power supply, group 1 +24VDC
 - +2 power supply, group 2 +24VDC
 - 0V GND
 - 0V GND
- ⑥ Module status LED
- ⑦ User status LED
- ⑧ Output status LED
- ⑨ Power status LEDs for group 1 and group 2

16 Digital output module XN-322-16DO-P05

16.1 Pin assignment and status LED signals

Table 6: Status LED signals

Module status	green	ON	System OK
		OFF	No power
		FLASHES (5 Hz)	No communication
Status User	yellow	ON	The user can set the LED signals as necessary. (For example, the visualization interface can be used to set the module's LED to flash so that it is easier to find the module inside the control panel.)
		OFF	
		FLASH (200 ms ON, 1000 ms OFF)	
Status of output n n = 1 to 16	yellow	ON	Output is "ON"
		OFF	Output is "OFF"
Power status of group n n = 1 to 2	green	ON	Group n is being powered with 24 VDC
		OFF	Group n is not being powered properly (undervoltage) or the system is not being powered at all. If the system is not being powered at all, the module status LED will be OFF.

16.1.1 Wiring

Four digital outputs can be wired to each of the four X1 to X4 connectors.

16.1.2 Connecting the power supply

The cross-sectional area of the +24 V cables used to supply power must be sized for the maximum output current drawn by each group.

It is impermissible to apply a voltage, at any output, that exceeds the supply voltage by more than 0.7 V.

The two 0 V pins on connector X5 are internally connected to each other.

16.1.3 Connecting EN 61131-2 short-circuit proof digital outputs

The outputs are able to drive twice their rated operational current briefly when driving loads with higher inrush currents.

The outputs can be fused and switched off externally by groups by using the corresponding group power supplies.

16 Digital output module XN-322-16DO-P05

16.1 Pin assignment and status LED signals

16.1.4 Wiring digital outputs

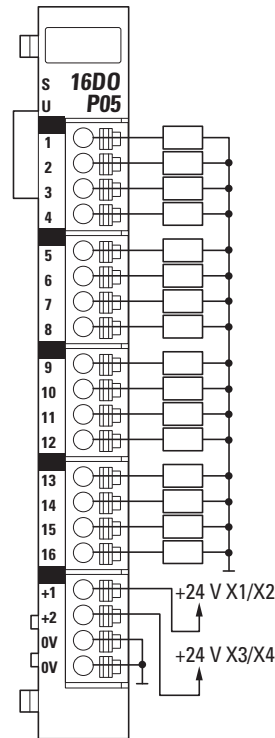

Figure 60: Wiring example

16.1.5 Suppressor circuit for inductive loads

High induced voltages may be produced when inductive loads are switched off. Because of this, the transistor outputs have internal suppressor circuits to +24 V.

As shown in the diagram below, the voltage when switching off inductive loads is limited to -29 V. In order to prevent system malfunctions caused by voltage peaks (e.g., coupling on analog cables), it is recommended to use a suppressor circuit (RC suppressors or flyback diodes) directly on inductive loads.

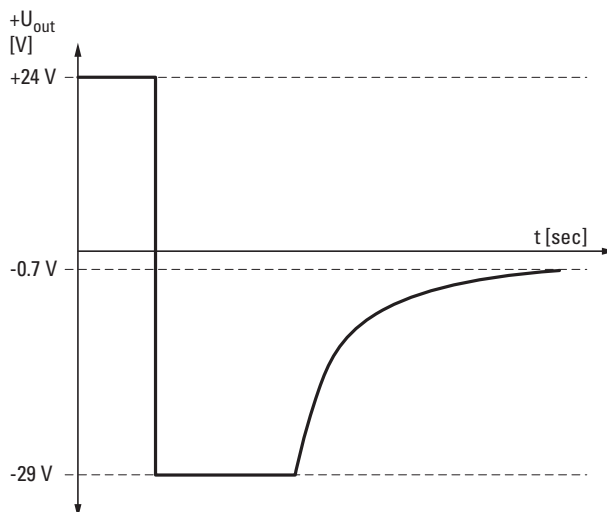

Figure 61: Voltage limiting when switching off inductive loads

16.2 Technical data for digital outputs

Quantity	16
Short-circuit proof as per EN 61131-2	yes
Power supply for digital outputs	
Number of supply voltages	2 (clamp positions +1/+2)
Rated operational voltage U_e	24 VDC
admissible range	18 – 30 VDC
Residual ripple	$\leq 5\%$
Maximum permissible total current per power supply group, with eight channels each, when using a duty factor of 100%	4A
Protection against polarity reversal	no
Output characteristic data	
„1” signal	
Output voltage	$(U_e - 1V) < U_a < U_e$
Output current per channel	0.5 A
„0” signal	
Output voltage	< 0.1 VDC
Max. output current per channel	≤ 100 μ A
Switching-on delay	< 100 μ s
Switch off delay	< 100 μ s
Maximum permissible total current for all channels when using a duty factor of 100%	8A
Maximum breaking energy of outputs (inductive load)	1 Joule/channel

16 Digital output module XN-322-16DO-P05

16.3 Memory layout

16.3 Memory layout

CAN Object Index		Size (byte)	Description	Bit					
0x6200 SUB x	0x2050	2	Digital output register	Bit 0	Output 1				
				Bit 1	Output 2				
				Bit 2	Output 3				
				Bit 3	Output 4				
				Bit 4	Output 5				
				Bit 5	Output 6				
				Bit 6	Output 7				
				Bit 7	Output 8				
				0x6200 SUB x+1				Bit 8	Output 9
								Bit 9	Output 10
								Bit 10	Output 11
								Bit 11	Output 12
								Bit 12	Output 13
								Bit 13	Output 14
								Bit 14	Output 15
								Bit 15	Output 16
0x3050		1	InputVoltageState	Bit 0	State 24 VDC / +1				
				Bit 1	State of 24 VDC / +2				
				Bit 2-7	reserved				

16.4 Supported CANopen objects

Product-specific CANopen objects

Index (hex)	Data Type	Name	Function	Mapping	Access	
0x6200	VAR	0-BYTE	Write Digital Output 8-bit	Default	rww	PDO

Manufacturer-specific objects

Index range for the XN-322-16DO-P05 module: x050 to x05F

CAN Object Index (hex)	Data Type	Name	Function	Mapping	Access	
0x1027	UNSIGNED16	ModuleID	Module Identification Number	–	ro	SDO
0x2050	UNSIGNED16	Output 1_16	Write Digital Output 1_16	Manual	rww	PDO
0x3050	UNSIGNED8	InputVoltageState	Input Voltage State Bit 0: DC 24V Output 1..8 OK Bit 1: DC 24V Output 9..16 OK	Manual	ro	PDO
0x4001	VISIBLE STRING	SerialNumber	Serial Number	-	const	SDO
0x4004	UNSIGNED8	UserLEDControl	User LED Control	–	rw	SDO
0x400C	VISIBLE STRING	ProductName	Product Name	-	ro	SDO

16 Digital output module XN-322-16DO-P05

16.4 Supported CANopen objects

17 Digital input/output module XN-322-8DIO-PD05

The XN-322-8DIO-PD05 digital input/output module has 4 inputs, for a +24 V signal level, that can be used to read the logic 0 and logic 1 levels. In addition, the module features 4 short-circuit proof digital outputs (+24 V / 0.5 A). The supply voltage for the digital outputs will be monitored for undervoltage. Finally, the module features input filters designed to suppress glitches on the corresponding input cables.

17.1 Status LEDs

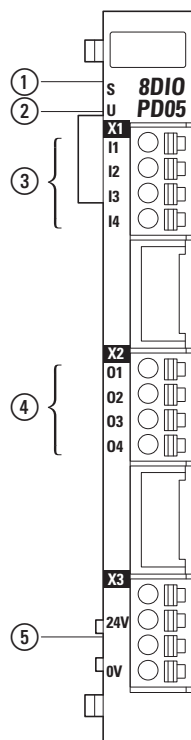

Figure 62: XN-322-8DIO-PD05 LEDs

- ① Module status LED
- ② User LED
- ③ Status LEDs for inputs 1 to 4
- ④ Status LEDs for outputs 1 to 4
- ⑤ Power status LED

Module status	green	ON	System OK
		OFF	No power
		FLASHES (5 Hz)	No communication

17 Digital input/output module XN-322-8DIO-PD05

17.2 Pin assignment

User	yellow	ON	The user can set the LED signals as necessary. (For example, the visualization interface can be used to set the module's LED to flash so that it is easier to find the module inside the control panel.)
		OFF	
		FLASH (200 ms ON, 1000 ms OFF)	
		FLASH (1000 ms ON, 200 ms OFF)	
Status input 1 ... Input 4	green	ON	Input ON
		OFF	Input OFF
Output 1 status ... Output 4	yellow	ON	Output ON
		OFF	Output OFF
Status Supply voltage	green	ON	Supply voltage OK
		OFF	Supply voltage faulty

17.2 Pin assignment

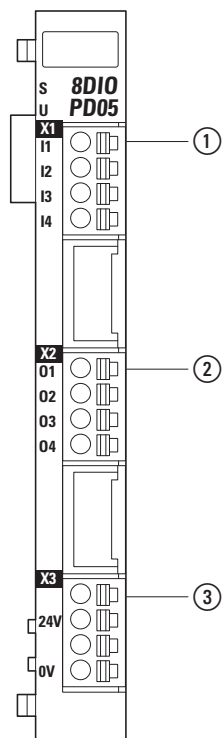

Figure 63: Pin assignment

- ① X1
 - I1 digital input 1
 - I2 digital input 2
 - I3 digital input 3
 - I4 digital input 4
- ② X2
 - O1 digital output 1
 - O2 digital output 2
 - O3 digital output 3
 - O4 digital output 4

- ③ X3
 - —
 - 24 Supply voltage 24VDC
 - —
 - 0V GND

17.3 Digital input wiring

Four digital inputs can be wired to connector X1 and four digital outputs can be wired to connector X2.

The digital input, as defined in the EN 61131-1 type with a 5-ms input delay, is particularly suitable for connecting electronic switching devices, including relay contacts, pushbuttons, switches, etc. It is used to convert a signal with two possible states into a one-bit binary number.

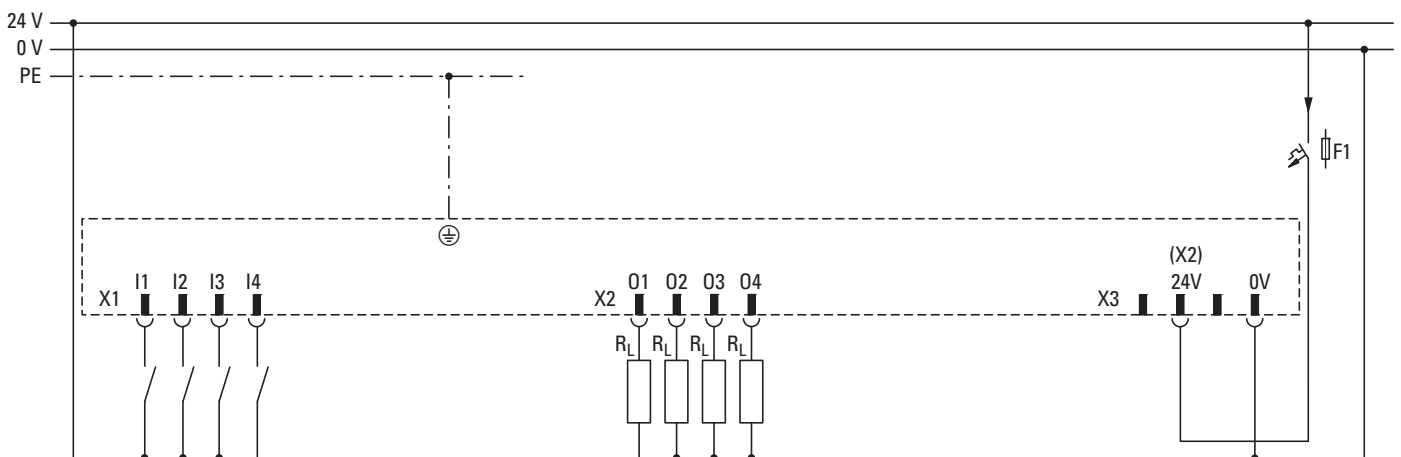

Figure 64: Wiring inputs to X1 and outputs to X2

17.4 Technical data

17.4.1 Digital inputs

designation		
Number of channels	4	
	61131-2 Type1	
Input voltage UE	24 VDC	maximum 30 VDC
Signal level	LOW: $0 < U_E < +8 \text{ V}$	HIGH: $+14 \text{ V} < U_E < +30 \text{ V}$
Switching threshold	normally +11 VDC	
Input current at $U_E=24\text{Vdc}$	normally 3.7 mA	
Input delay	normally 5 ms	

17 Digital input/output module XN-322-8DIO-PD05

17.5 Memory layout

17.4.2 Digital outputs

Quantity	16
Short-circuit proof as per EN 61131-2	yes
Power supply for digital outputs	
Number of supply voltages	1 (X3, pin on connector 24)
Rated operational voltage U_e	24 VDC
admissible range	18 – 30 VDC
Maximum permissible total current when using a duty factor of 100%	2A
Protection against polarity reversal	no
Voltage monitoring	yes
Output characteristic data	
„1” signal	
Output voltage	$(U_e - 1V) < U_a < U_e$
Output current per channel	0.5 A
„0” signal	
Output voltage	0V
Max. output current per channel	$\leq 10 \mu A$
Switching-on delay	$< 100 \mu s$
Switch off delay	$< 150 \mu s$
Maximum permissible total current for all channels when using a duty factor of 100%	2A
Maximum breaking energy of outputs (inductive load)	1 Joule/channel

17.5 Memory layout

CAN Object Index		Size (byte)	Description			
0x6000 SUB x	0x3180	1	Digital input register (read)	Byte 0:	Bit 0	Input 1
					Bit 1	Input 2
					Bit 2	Input 3
					Bit 3	Input 4
					Bit 4	–
					Bit 5	–
					Bit 6	–
					Bit 7	–

17 Digital input/output module XN-322-8DIO-PD05

17.6 Supported CANopen objects

CAN Object Index		Size (byte)	Description			
0x6200 SUB x	0x2180	1	Digital output register (write)	Byte 0:	Bit 0	Output 1
					Bit 1	Output 2
					Bit 2	Output 3
					Bit 3	Output 4
					Bit 4	–
					Bit 5	–
					Bit 6	–
					Bit 7	–
0x3181		1	Status Supply voltage	1 Byte	Bit 0	24 VDC at +1
					Bit 1	–
					Bit 2	–
					Bit 3	–
					Bit 4	–
					Bit 5	–
					Bit 6	–
					Bit 7	–

17.6 Supported CANopen objects

Product-specific CANopen objects

Index (hex)	Data Type	Name	Function	Mapping	Access	
0x6000	UNSIGNED8	I-BYTE	Digital Input 8-bit	Default	ro	PDO
0x6200	VAR	Q-BYTE	Write Digital Output 8-bit	Default	rww	PDO

Manufacturer-specific objects

Index range for the XN-322-8DIO-PD05 module: x180 to x18F

CAN Object Index (hex)	Data Type	Name	Function	Mapping	Access	
0x1027	UNSIGNED16	ModuleID	Module Identification Number	–	ro	SDO
0x2180	UNSIGNED8	Output 1_4	Write Digital Output 1_4	Manual	rww	PDO
0x3180	UNSIGNED8	Input1_4	Read Digital Inputs	Manual	ro	PDO
0x3181	UNSIGNED8	InputVoltageState	Input Voltage State	Manual	ro	PDO

17 Digital input/output module XN-322-8DIO-PD05

17.6 Supported CANopen objects

0x4001	VISIBLE STRING	SerialNumber	Serial Number	-	const	SDO
0x4004	UNSIGNED8	UserLEDControl	User LED Control	-	rw	SDO
0x400C	VISIBLE STRING	ProductName	Product Name	-	ro	SDO

18 Digital input/output module XN-322-16DIO-PD05

The XN-322-16DIO-PD05 digital input/output module has 8 inputs, for a +24 V signal level, that can be used to read the logic 0 and logic 1 levels. In addition, the module features 8 short-circuit proof digital outputs (+24 V / 0.5 A) assigned to a single power supply group. The supply voltage for this group will be monitored for undervoltage. Finally, the module features input filters designed to suppress glitches on the corresponding input cables.

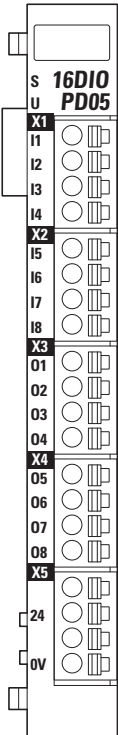

Figure 65: XN-322-16DIO-PD05 front view

18 Digital input/output module XN-322-16DIO-PD05

18.1 Status LEDs

18.1 Status LEDs

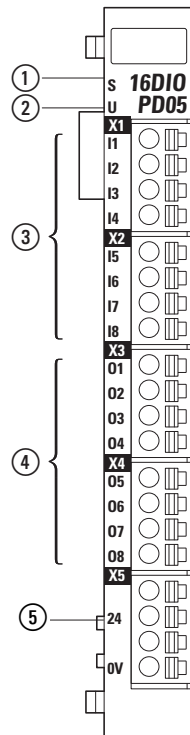

Figure 66: XN-322-16DIO-PD05 LEDs

- ① Module status LED
- ② User LED
- ③ Status LEDs for inputs 1 to 8
- ④ Status LEDs for outputs 1 to 8
- ⑤ Power status LED

Module status	green	ON	System OK
		OFF	No power
		FLASHES (5 Hz)	No communication
User	yellow	ON	The user can set the LED signals as necessary. (For example, the visualization interface can be used to set the module's LED to flash so that it is easier to find the module inside the control panel.)
		OFF	
		FLASH (200 ms ON, 1000 ms OFF)	
		FLASH (1000 ms ON, 200 ms OFF)	
Status input 1 ... Input 8	green	ON	Input ON
		OFF	Input OFF
Output 1 status ... Output 8	yellow	ON	Output ON
		OFF	Output OFF
Power supply status	green	ON	Supply voltage OK
		OFF	Supply voltage faulty

18.2 Pin assignment

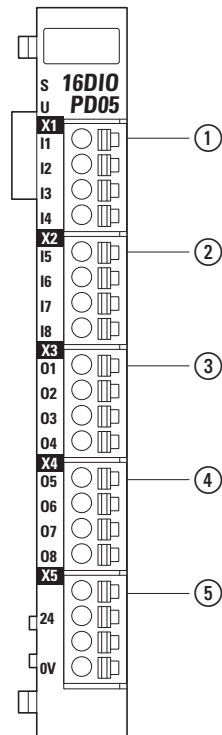

Figure 67: Pin assignment

- ① X1
 - I1 digital input 1
 - I2 digital input 2
 - I3 digital input 3
 - I4 digital input 4
- ① X2
 - I5 digital input 5
 - I6 digital input 6
 - I7 digital input 7
 - I8 digital input 8
- ② X3
 - O1 digital output 1
 - O2 digital output 2
 - O3 digital output 3
 - O4 digital output 4
- ③ X4
 - O5 digital output 5
 - O6 digital output 6
 - O7 digital output 7
 - O8 digital output 8
 -
- ④ X5
 - –
 - 24 Supply voltage 24VDC
 - –
 - 0V GND

18 Digital input/output module XN-322-16DIO-PD05

18.3 Wiring

18.3 Wiring

Four digital inputs can be wired to each of the two X1 and X2 connectors, while four digital outputs can be wired to each of the two X3 and X4 connectors.

18.3.1 Digital inputs

Four digital inputs can be wired to the X1 connector and another four digital inputs can be wired to the X2 connector.

The digital input, as defined in the EN 61131-1 type with a 5-ms input delay, is particularly suitable for connecting electronic switching devices, including relay contacts, pushbuttons, switches, etc. It is used to convert a signal with two possible states into a one-bit binary number.

18.3.2 Connecting the power supply

The cross-sectional area of the +24 V cable used to supply power at X5 must be sized for the maximum total current drawn by all the outputs.

It is impermissible to apply a voltage, at any output, that exceeds the supply voltage by more than 0.7 V.

18.3.3 Connecting EN 61131-2 short-circuit proof digital outputs

Four digital outputs can be wired to the X3 connector and another four digital outputs can be wired to the X4 connector.

The outputs are able to drive twice their rated operational current briefly when driving loads with higher inrush currents.

18.3.4 Suppressor circuit for inductive loads

High induced voltages may be produced when inductive loads are switched off. Because of this, the transistor outputs have internal suppressor circuits to +24 V.

As shown in the diagram below, the voltage when switching off inductive loads is limited to -29 V. In order to prevent system malfunctions caused by voltage peaks (e.g., coupling on analog cables), it is recommended to use a suppressor circuit (RC suppressors or flyback diodes) directly on inductive loads.

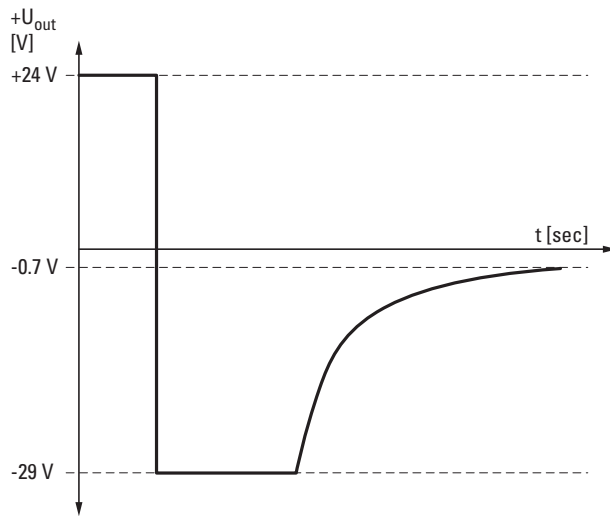

Figure 68: Voltage limiting when switching off inductive loads

18.3.5 Wiring example

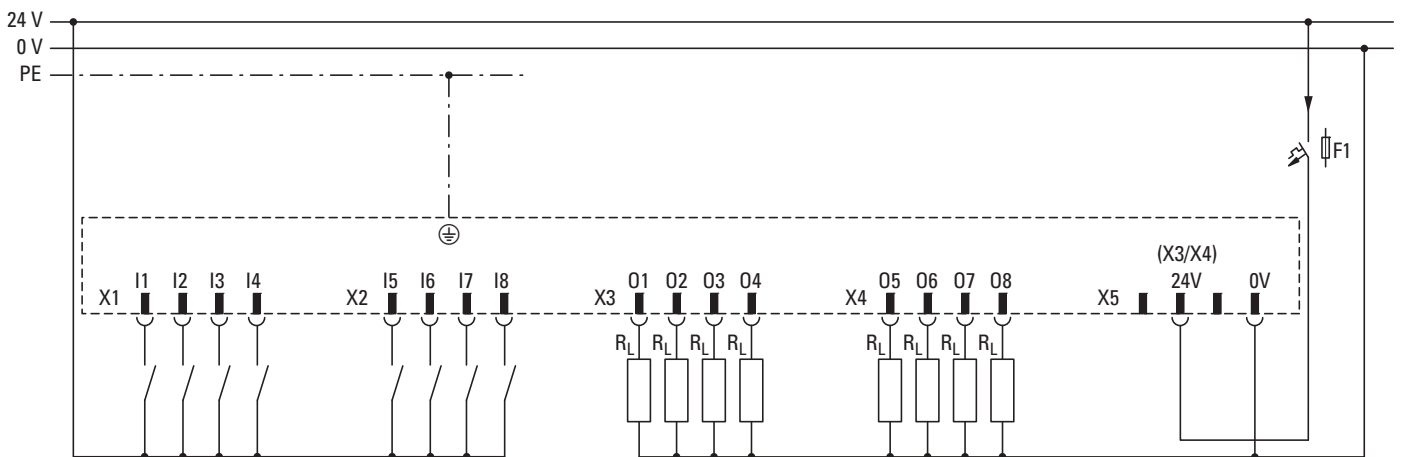

Figure 69: Wiring example showing how to connect inputs to X1/X2 and outputs to X3/X4

18 Digital input/output module XN-322-16DIO-PD05

18.4 Technical data

18.4 Technical data

18.4.1 Digital inputs

designation		
Number of channels	8	
	61131-2 Type1	
Input voltage U_E	24 VDC	maximum 30 VDC
Signal level	LOW: $0 < U_E < +8$ V	HIGH: $+14$ V $< U_E < +30$ V
Switching threshold	normally +11 VDC	
Input current at $U_E = 24$ VDC	normally 3.7 mA	
Input delay	normally 5 ms	

18.4.2 Digital outputs

Quantity	8
Short-circuit proof as per EN 61131-2	yes
Power supply for digital outputs	
Number of supply voltages	1 (X5, pin on connector 24)
Rated operational voltage U_e	24 VDC
admissible range	18 – 30 VDC
Maximum permissible total current for all output channels when using a duty factor of 100%	4A
Protection against polarity reversal	no
Voltage monitoring	yes
Output characteristic data	
„1“ signal	
Output voltage	$(U_e - 1V) < U_a < U_e$
Output current per channel	0.5 A
„0“ signal	
Output voltage	< 1 VDC
Max. output current per channel	≤ 10 μ A
Switching-on delay	< 100 μ s
Switch off delay	< 150 μ s
Maximum breaking energy of outputs (inductive load)	1 Joule/channel

18.5 Memory layout

CAN Object Index		Size (byte)	Description			
0x6000 SUB x	0x3160	1	Digital input register (read)	Byte 0:	Bit 0	Input 1
					Bit 1	Input 2
					Bit 2	Input 3
					Bit 3	Input 4
					Bit 4	Input 5
					Bit 5	Input 6
					Bit 6	Input 7
					Bit 7	Input 8
0x6200 SUB x	0x2160	1	Digital output register (write)	Byte 0:	Bit 0	Output 1
					Bit 1	Output 2
					Bit 2	Output 3
					Bit 3	Output 4
					Bit 4	Output 5
					Bit 5	Output 6
					Bit 6	Output 7
					Bit 7	Output 8
0x3161		1	Power supply status	1 Byte	Bit 0	24 VDC at +1
					Bit 1	–
					Bit 2	–
					Bit 3	–
					Bit 4	–
					Bit 5	–
					Bit 6	–
					Bit 7	–

18 Digital input/output module XN-322-16DIO-PD05

18.6 Supported CANopen objects

18.6 Supported CANopen objects

Product-specific CANopen objects

Index (hex)	Data Type	Name	Function	Mapping	Access	
0x6000	UNSIGNED8	I-BYTE	Digital Input 8-bit	Default	ro	PDO
0x6200	VAR	Q-BYTE	Write Digital Output 8-bit	Default	rww	PDO

Manufacturer-specific objects

Index range for the XN-322-16DIO-PD05 module: x160 to x16F

CAN Object Index (hex)	Data Type	Name	Function	Mapping	Access	
0x1027	UNSIGNED16	ModuleID	Module Identification Number	-	ro	SDO
0x2160	UNSIGNED8	Output 1_8	Write Digital Output 1_8	Manual	rww	PDO
0x3160	UNSIGNED8	Input1_8	Read Digital Inputs	Manual	ro	PDO
0x3161	UNSIGNED8	InputVoltageState	Input Voltage State	Manual	ro	PDO
0x4001	VISIBLE STRING	SerialNumber	Serial Number	-	const	SDO
0x4004	UNSIGNED8	UserLEDControl	User LED Control	-	rw	SDO
0x400C	VISIBLE STRING	ProductName	Product Name	-	ro	SDO

19 XN-322-16DIO-PC05 digital input/output module

The XN-322-16DIO-PC05 digital input/output module has 8 inputs, for a +24 V signal level, that can be used to read the logic 0 and logic 1 levels. In addition, the module features 8 short-circuit proof digital outputs (+24 V / 0.5 A) assigned to a single power supply group. The supply voltage for this group will be monitored for undervoltage. Moreover, the module features input filters designed to suppress glitches on the corresponding input cables. Finally, digital inputs 1 to 4 feature a counter function that, when used, makes an internal module register be incremented every time there is an input pulse.

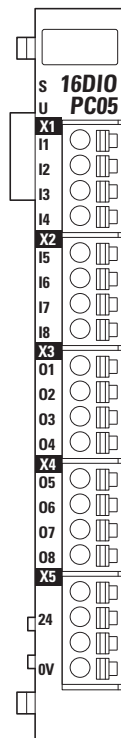

Figure 70: XN-322-16DIO-PC05 front view

19 XN-322-16DIO-PC05 digital input/output module

19.1 Status LEDs

19.1 Status LEDs

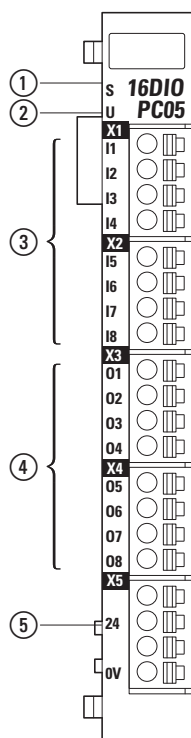

Figure 71: XN-322-16DIO-PC05 LEDs

- ① Module status LED
- ② User LED
- ③ Status LEDs for inputs 1 to 8
- ④ Status LEDs for outputs 1 to 8
- ⑤ Power status LED

Module status	green	ON	System OK
		OFF	No power
		FLASHES (5 Hz)	No communication
User	yellow	ON	The user can set the LED signals as necessary. (For example, the visualization interface can be used to set the module's LED to flash so that it is easier to find the module inside the control panel.)
		OFF	
		FLASH (200 ms ON, 1000 ms OFF)	
		FLASH (1000 ms ON, 200 ms OFF)	
Status input 1 ... Input 8	green	ON	Input ON
		OFF	Input OFF
Output 1 status ... Output 8	yellow	ON	Output ON
		OFF	Output OFF
Power supply status	green	ON	Supply voltage OK
		OFF	Supply voltage faulty

19.2 Pin assignment

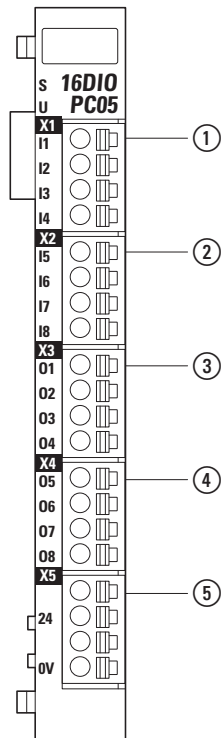

Figure 72: Pin assignment

- ① X1
 - I1 digital input 1
 - I2 digital input 2
 - I3 digital input 3
 - I4 digital input 4
- ② X2
 - I5 digital input 5
 - I6 digital input 6
 - I7 digital input 7
 - I8 digital input 8
- ③ X3
 - O1 digital output 1
 - O2 digital output 2
 - O3 digital output 3
 - O4 digital output 4
- ④ X4
 - O5 digital output 5
 - O6 digital output 6
 - O7 digital output 7
 - O8 digital output 8
 -
- ⑤ X5
 -
 -
 - 24 Supply voltage 24VDC
 -
 -
 - 0V GND

19 XN-322-16DIO-PC05 digital input/output module

19.3 Wiring

19.3 Wiring

Four digital inputs can be wired to each of the two X1 and X2 connectors, while four digital outputs can be wired to each of the two X3 and X4 connectors.

19.3.1 Digital inputs

The digital input, as defined in the EN 61131-1 type with a 5-ms input delay, is particularly suitable for connecting electronic switching devices, including relay contacts, pushbuttons, switches, etc. It is used to convert a signal with two possible states into a one-bit binary number.

19.3.2 Counter functions for inputs 1...4

Internal module counter registers are connected downstream of digital inputs 1 to 4. These counter registers make it possible to count signal pulses at the inputs.

The PLC program must manage any register overflows at the counter registers (the program's cycle times and maximum counter frequency must be taken into account).

The following counter functions can be configured:

- Counter mode (simple counting): The 8-bit counter register for an input will be incremented every time there is a rising signal pulse at that input. Objects 0x3172 to 0x3175 are the corresponding 8-bit counter registers.
- Incremental encoder mode: Counts by interpreting the signals from two inputs using four samples encoding and incrementing a 16-bit counter register. Objects 0x3176 to 0x3177 are the corresponding 16-bit counter registers.
- PWM time measuring mode: This mode supports time measurements at inputs 1 to 4.

The "high time" for an input will be the time that passes between the rising and falling edges of a signal at that input. When a rising signal edge is detected, a counter will start being incremented every μs . Then, when the corresponding falling signal edge is detected, the counter value will be recorded in the corresponding 16-bit PwmHighTime(x) counter register. Once the value is transferred to PwmHighTime(x), the counter will be reset. "High times" will be recorded in objects 0x3178, 0x317A, 0x317C, 0x317E.

Period t_p will be the time that passes between the rising edges of the signal at the digital input. When the first rising signal edge is detected, a counter will start being incremented every μs . Then, when the second rising signal edge is detected, the counter value will be recorded in the corresponding 16-bit PwmPeriodTime(x) counter register. Once the value is transferred to PwmPeriodTime(x), the counter will be reset. "Period times" will be recorded in objects 0x3179, 0x317B, 0x317D, 0x317F.

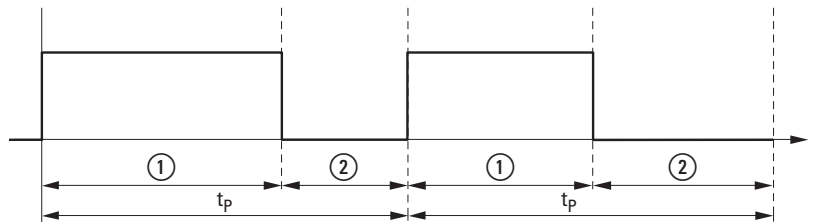

Figure 73: PWM signal measurement

- ① High Time
- ② Low Time

19.3.3 Configuring inputs 1 to 4

Counter mode register object 0x4170 can be used to configure the function for inputs 1 to 4 and, accordingly, select the operating mode you want to use.

In addition, any writing command to counter mode register object 0x4170 will reset counter registers 0x3172 through 0x3177 to 0x00.

The following functions are available:

Data bit B1	Data bit B0	designation	Description
0	0	Input 1/2	Counter Mode Every time there is a rising edge at input n, the value in the register for counter n will be incremented by one. When there is a counter overflow, the value will jump from 16#FF to 16#00.
0	1		Incremental Encoder Mode Input 1(3) and input 2(4) will be used as an incremental encoder with AB quadrature mode and four samples encoding.
1	1		PWM Time Measuring Mode (High-Time in μ s, Period Time in μ s)
Data bit B3	Data bit B2	designation	Description
0	0	Input 3/4	Counter Mode
0	1		Incremental Encoder Mode
1	1		PWM Time Measuring Mode

19.3.4 Connecting the power supply

The cross-sectional area of the +24 V cable used to supply power at X5 must be sized for the maximum total current drawn by all the outputs.

It is impermissible to apply a voltage, at any output, that exceeds the supply voltage by more than 0.7 V.

19 XN-322-16DIO-PC05 digital input/output module

19.3 Wiring

19.3.5 Connecting the EN 61131-2 short-circuit proof digital outputs

Four digital outputs can be wired to the X3 connector and another four digital outputs can be wired to the X4 connector. These outputs are able to drive twice their rated operational current briefly when driving loads with higher inrush currents.

Large currents may be produced when inductive loads are switched off. Because of this, digital outputs should be protected with a suppressor circuit.

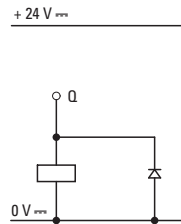

Figure 74: Example of a suppressor circuit

NOTICE

When switching inductive loads, a snubber must be added at the load in order to prevent EMI. RC snubbers have proven to be particularly effective for this purpose as a result of their dynamic response.

19.3.6 Wiring example

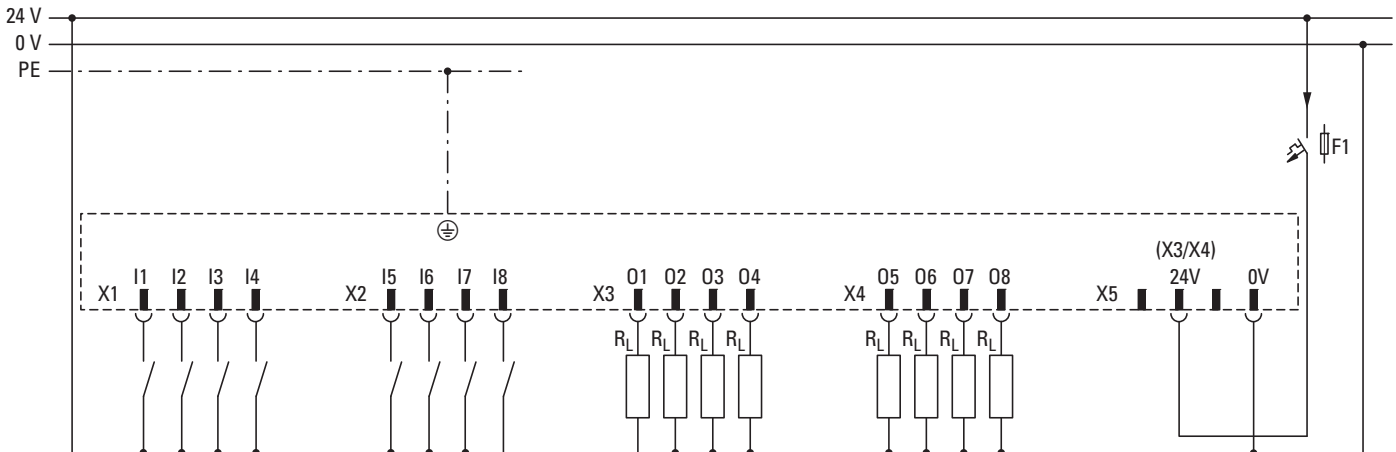

Figure 75: Wiring example showing how to connect inputs to X1/X2 and outputs to X3/X4

19.4 Technical data

19.4.1 Digital inputs

designation	
Number of channels	8
	61131-2 Type1
Input voltage UE	24 VDC
	maximum 30 VDC
Signal level	LOW: $0 < U_E < +8 \text{ V}$
	HIGH: $+14 \text{ V} < U_E < +30 \text{ V}$
Switching threshold	normally +11 VDC
Input current at $U_E=24\text{Vdc}$	normally 3.7 mA
Typical input delay	normally 5 ms
Input 1-4	1 μs
Input 5-8	5 ms
Input frequency for inputs 1-4	Max. 25 kHz
Counter frequency for inputs 1-4	Max. 25 kHz for event counting Max. 100 kHz for X4 encoding
PWM time measurement for inputs 1-4	Measures the time between edge changes in μsec .

19.4.2 Digital outputs

Quantity	8
Short-circuit proof as per EN 61131-2	yes
Power supply for digital outputs	
Number of supply voltages	1 (X5, pin on connector 24)
Rated operational voltage U_e	24 VDC
admissible range	18 – 30 VDC
Maximum permissible total current for all output channels when using a duty factor of 100%	4A
Protection against polarity reversal	no
Voltage monitoring	yes
Output characteristic data	
„1“ signal	
Output voltage	$(U_e - 1\text{V}) < U_a < U_e$
Output current per channel	0.5 A
„0“ signal	
Output voltage	< 1 VDC
Max. output current per channel	$\leq 10 \mu\text{A}$
Switching-on delay	< 100 μs
Switch off delay	< 150 μs
Maximum breaking energy of outputs (inductive load)	1 Joule/channel

19 XN-322-16DIO-PC05 digital input/output module

19.5 Memory layout

19.5 Memory layout

CAN Object Index		Size (byte)	Description				
0x6000 SUB x	0x3170	1	Digital input register (read)	Byte 0:	Bit 0	Input 1	
					Bit 1	Input 2	
					Bit 2	Input 3	
					Bit 3	Input 4	
					Bit 4	Input 5	
					Bit 5	Input 6	
					Bit 6	Input 7	
					Bit 7	Input 8	
0x6200 SUB x	0x2170	1	Digital output register (write)	Byte 0:	Bit 0	Output 1	
					Bit 1	Output 2	
					Bit 2	Output 3	
					Bit 3	Output 4	
					Bit 4	Output 5	
					Bit 5	Output 6	
					Bit 6	Output 7	
					Bit 7	Output 8	
0x3171		1	Power supply status	1 Byte	Bit 0	24 VDC at +1	
					Bit 1-7	–	
0x3172		1	Counter 1 register		8-bit counter for input 1 ¹⁾		CNT1
0x3173		1	Counter 2 register		8-bit counter for input 2 ¹⁾		CNT2
0x3176		2	Incremental encoder 1 Register		Incremental Encoder 1 Register ²⁾		ENC1
0x3178		2	PWM time measurement register 1		PWM high time counter for input 1 (resolution: 1 μ s) ³⁾		PWMHT1
0x3174		1	Counter 3 register		8-bit counter for input 3 ¹⁾		CNT3
0x3175		1	Counter 4 register		8-bit counter for input 4 ¹⁾		CNT4
0x3177		2	Incremental encoder 2 Register		Incremental Encoder 2 Register ²⁾		ENC2
0x317C		2	PWM time measurement register 3		PWM high time counter for input 3 ³⁾		PWMHT3
0x317A		2	PWM time measurement register 2		PWM high time counter for input 2 ³⁾		PWMHT2
0x317E		2	PWM time measurement register 4		PWM high time counter for input 4 ³⁾		PWMHT4

1) If the inputs are configured for counter mode in the counter mode register.

2) If the inputs are configured for incremental encoder mode in the counter mode register.

3) If the inputs are configured for PWM mode in the counter mode register. Resolution: 1 μ s.

19 XN-322-16DIO-PC05 digital input/output module
19.5 Memory layout

CAN Object Index	Size (byte)	Description																				
0x3179	2	PWM time measurement register 1	PWM period time counter for input 1 ³⁾	PWMPT1																		
0x317B	2	PWM time measurement register 2	PWM period time counter for input 2 ³⁾	PWMPT2																		
0x317D	2	PWM time measurement register 3	PWM period time counter for input 3 ³⁾	PWMPT3																		
0x317F	2	PWM time measurement register 4	PWM period time counter for input 4 ³⁾	PWMPT4																		
0x4170	1	Counter mode register 1 Note: Writing to this register will reset all counter values to 0x00!	<table border="1"> <tr> <td>Bit 0 / 1 Input 1-2</td> <td>00: Counter - Mode</td> </tr> <tr> <td></td> <td>01: Encoder - Mode</td> </tr> <tr> <td></td> <td>10: Timestamp mode (reserved)</td> </tr> <tr> <td></td> <td>11: PWM time measurement</td> </tr> <tr> <td>Bit 2 / 31 Input 3-4</td> <td>00: Counter - Mode</td> </tr> <tr> <td></td> <td>01: Encoder - Mode</td> </tr> <tr> <td></td> <td>10: Timestamp mode (reserved)</td> </tr> <tr> <td></td> <td>11: PWM time measurement</td> </tr> <tr> <td>Bit 4-7</td> <td>reserved</td> </tr> </table>	Bit 0 / 1 Input 1-2	00: Counter - Mode		01: Encoder - Mode		10: Timestamp mode (reserved)		11: PWM time measurement	Bit 2 / 31 Input 3-4	00: Counter - Mode		01: Encoder - Mode		10: Timestamp mode (reserved)		11: PWM time measurement	Bit 4-7	reserved	
Bit 0 / 1 Input 1-2	00: Counter - Mode																					
	01: Encoder - Mode																					
	10: Timestamp mode (reserved)																					
	11: PWM time measurement																					
Bit 2 / 31 Input 3-4	00: Counter - Mode																					
	01: Encoder - Mode																					
	10: Timestamp mode (reserved)																					
	11: PWM time measurement																					
Bit 4-7	reserved																					

- 1) If the inputs are configured for counter mode in the counter mode register.
2) If the inputs are configured for incremental encoder mode in the counter mode register.
3) If the inputs are configured for PWM mode in the counter mode register. Resolution: 1 μ s.

19 XN-322-16DIO-PC05 digital input/output module

19.6 Supported CANopen objects

19.6 Supported CANopen objects

Product-specific CANopen objects

Index (hex)	Data Type	Name	Function	Mapping	Access	
0x6000	UNSIGNED8	I-BYTE	Digital Input 8-bit	Default	ro	PDO
0x6200	VAR	Q-BYTE	Write Digital Output 8-bit	Default	rww	PDO

Manufacturer-specific objects

Index range for the XN-322-16DIO-PC05 module: x170 to x17F

CAN Object Index (hex)	Data Type	Name	Function	Mapping	Access	
0x1027	UNSIGNED16	ModuleID	Module Identification Number	–	ro	SDO
0x2170	UNSIGNED8	Output 1_8	Write Digital Output 1_8	Manual	rww	PDO
0x3170	UNSIGNED8	Input1_8	Read Digital Inputs	Manual	ro	PDO
0x3171	UNSIGNED8	InputVoltageState	Input Voltage State	Manual	ro	PDO
0x3172	UNSIGNED8	Counter1	Counter Register 1	Manual	ro	PDO
0x3173	UNSIGNED8	Counter2	Counter Register 2	Manual	ro	PDO
0x3174	UNSIGNED8	Counter3	Counter Register 3	Manual	ro	PDO
0x3175	UNSIGNED8	Counter4	Counter Register 4	Manual	ro	PDO
0x3176	UNSIGNED16	Incremental Encoder 1	Incremental Encoder Register 1/2	Manual	ro	PDO
0x3177	UNSIGNED16	Incremental Encoder2	Incremental Encoder Register 3/4	Manual	ro	PDO
0x3178	UNSIGNED16	PWMHighTime1	PWM High Time 1	Manual	ro	PDO
0x3179	UNSIGNED16	PWMPeriod1	PWM Period1	Manual	ro	PDO
0x317A	UNSIGNED16	PWMHighTime2	PWM High Time 2	Manual	ro	PDO
0x317B	UNSIGNED16	PWMPeriod2	PWM Period2	Manual	ro	PDO
0x317C	UNSIGNED16	PWMHighTime3	PWM High Time 3	Manual	ro	PDO
0x317D	UNSIGNED16	PWMPeriod3	PWM Period3	Manual	ro	PDO
0x317E	UNSIGNED16	PWMHighTime4	PWM High Time 4	Manual	ro	PDO
0x317F	UNSIGNED16	PWMPeriod4	PWM Period4	Manual	ro	PDO
0x4001	VISIBLE STRING	SerialNumber	Serial Number	–	const	SDO
0x4004	UNSIGNED8	UserLEDControl	User LED Control	–	rw	SDO
0x400C	VISIBLE STRING	ProductName	Product Name	–	ro	SDO
0x4170	UNSIGNED8	CounterModeRegister	Counter Mode Register	–	ro	SDO



Make sure to only use the data relevant to the selected operating mode. Registers for operating modes that are not selected will contain invalid values. The operating mode can be selected using the counter mode register.

19 XN-322-16DIO-PC05 digital input/output module

19.6 Supported CANopen objects

20 Analog input module XN-322-4AI-PTNI

XN-322-4AI-PTNI modules are XN300 slice modules with 4 analog input channels used to measure temperatures with Pt100, Pt200, Pt500, Pt1000, Ni100, Ni100, or KTY sensors or resistance values within various measuring ranges. These modules support two-wire and three-wire connections. Every channel can be individually configured.

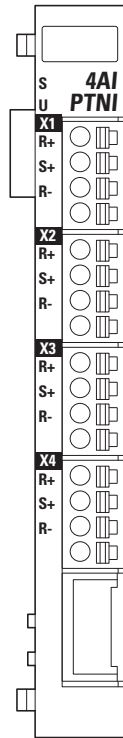

Figure 76: Device view XN-322-4AI-PTNI

20 Analog input module XN-322-4AI-PTNI

20.1 Status LEDs

20.1 Status LEDs

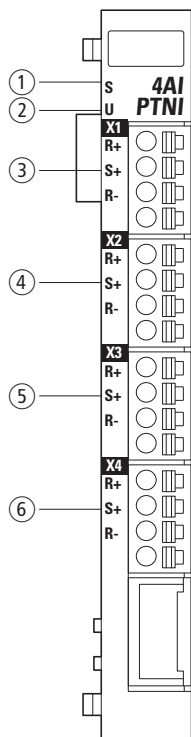

Figure 77: LED signals and pin assignment

- ① Module status LED
- ② User LED
- ③ Input 1 status LED
- ④ Input 2 status LED
- ⑤ Input 3 status LED
- ⑥ Input 4 status LED

Module status	green	ON	System OK
		OFF	No power
		FLASHES (5 Hz)	No communication
User	yellow	ON	The user can set the LED signals as necessary. (For example, the visualization interface can be used to set the module's LED to flash so that it is easier to find the module inside the control panel.)
		OFF	
		FLASH (200 ms ON, 1000 ms OFF)	
		FLASH (1000 ms ON, 200 ms OFF)	
Status input	yellow	ON	Input enabled
		FLASHES (0.5 Hz)	Measuring range fallen below
		FLASHES (4 Hz)	Measuring range exceeded or cable breakage
		OFF	Input disabled

20.2 Pin assignment

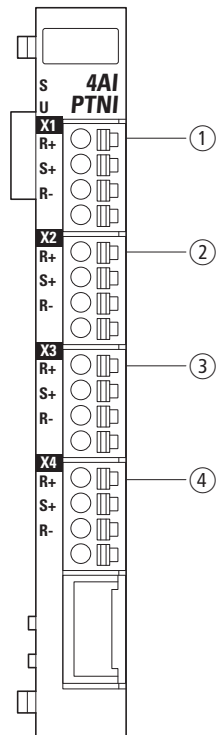

Figure 78: Pin assignment

- ① X1
 - R+ Resistor 1+
 - S+ Sense 1+
 - R- Resistor 1-
 - – not used
- ② X2
 - R+ Resistor 2+
 - S+ Sense 2+
 - R- Resistor 2-
 - – not used
- ③ X3
 - R+ Resistor 3+
 - S+ Sense 3+
 - R- Resistor 3-
 - – not used
- ④ X4
 - R+ Resistor 4+
 - S+ Sense 4+
 - R- Resistor 4-
 - – not used

20.3 Wiring

One analog input can be wired to each of the four X1 to X4 connectors. Both 2-wire and 3-wire configurations are supported.

20.3.1 Two-wire connection

When using a 2-wire configuration, the resistance value between pins 1 and 3 will be measured and interpreted as a temperature reading. The cable resistance will affect the reading in the form of an error. The advantage of using this type of configuration is the fact that it requires a small number of connection cables.

R_L = Cable resistance of connection cable

R_T = Resistance of temperature sensor

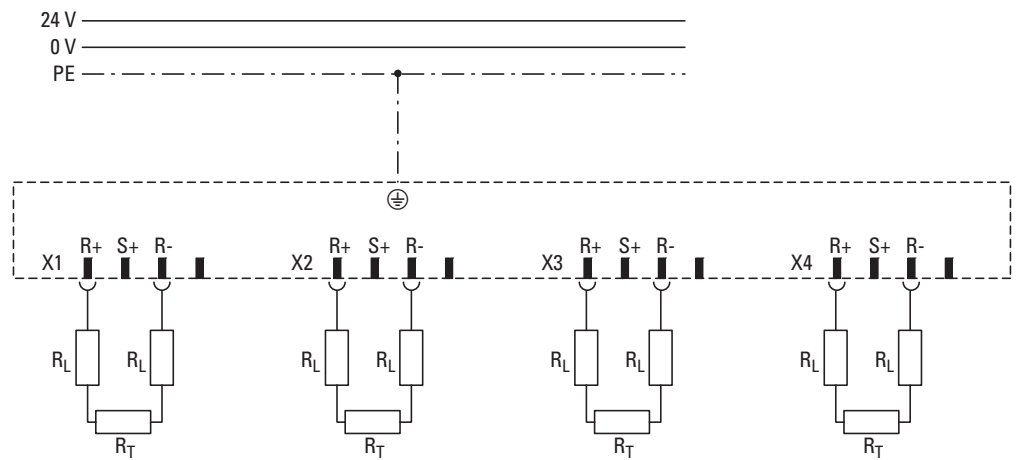

Figure 79: Wiring diagram for two-wire connections; X1, X2, X3, and/or X4 can be used with this type of configuration

20.3.2 Three-wire connection

When using a three-wire connection, the resistance value between pins 1 and 3 and between pins 1 and 2 is measured. In this type of configuration, the cable resistance will not affect the measurement, provided all cable lengths are identical.

$R_L \leq 200 \Omega$ = Cable resistance of connection cable

R_T = Resistance of temperature sensor

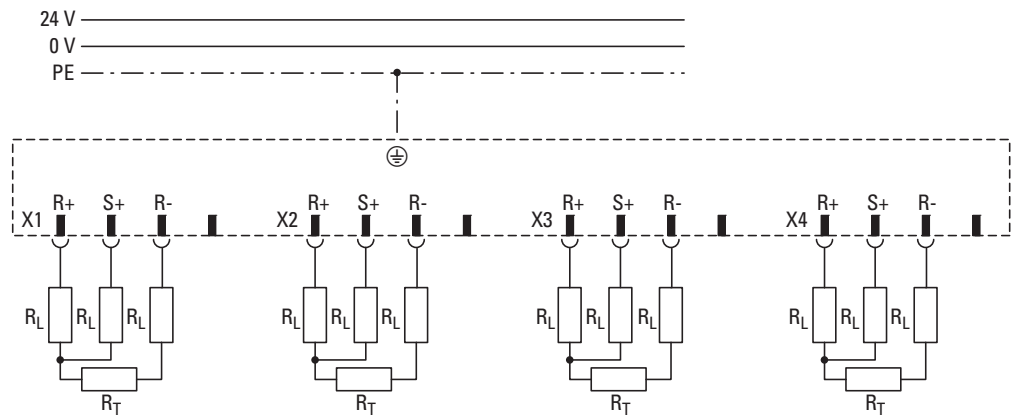

Figure 80: Wiring diagram for three-wire connections; X1, X2, X3, and/or X4 can be used with this type of configuration

20.4 Technical Data

20.4.1 Specifications for analog resistance / temperature inputs

Number of analog input channels	4
A-D converter resolution	16 bits
Configurable parameters	Pt100, Pt200, Pt500, Pt1000, NI100, NI1000, KTY11-62, KTY81-110, KTY81-120, KTY81-150, KTY81-121, KTY81-122 KTY84-130, KT84-150
Typical measuring current	< 300 μ A
Reading update	4 ms
Input resistance	> 10 M Ω
Input filter	
Built-in	10 kHz, second-order low-pass filter
parameterizable	yes
Cumulative error	\pm 0.3% of full scale value
Sensor connection cable resistance	max. 100 Ω
Insulation	
Input vs. backplane	500 V _{eff}
status display	LEDs green, yellow

20.4.2 Measuring ranges for resistance inputs

The values are represented as a decimal value in ohms with one decimal place (in 1/10 ohm).

Type	Resistance range
1	0 ... 250 Ω
2	0 ... 500 Ω
3	0 ... 1000 Ω
4	0 ... 2500 Ω
5	0 ... 5000 Ω

20.4.3 Measuring ranges for temperature inputs

The values will be represented as a decimal value in °C with one or two decimal places (in 1/10 °C or 1/100 °C). The measurement range can be configured with SDOs 0x5070 to 0x5073.

SDO value for sensor type	Type	Temperature range	Resistance range	Resolution in °C
0	Pt100	-200 ... +150 °C	18.5 ... 157.3 Ω	1/10
1	Pt100	-200 ... +850 °C	18.5 ... 390.5 Ω	1/10
2	Pt200	-200 ... +150 °C	39.0 ... 314 Ω	1/10
3	Pt200	-200 ... +850 °C	39.0 ... 780 Ω	1/10
4	Pt500	-200 ... +150 °C	92.6 ... 786.6 Ω	1/10
5	Pt500	-200 ... +850 °C	92.6 ... 1952.4 Ω	1/10
6	Pt1000	-200 ... +150 °C	185.2 ... 1573.3 Ω	1/10
7	Pt1000	-200 ... +850 °C	185.2 ... 3904.8 Ω	1/10
8	NI100	-60 ... +150 °C	69.5 ... 198.7 Ω	1/10
9	NI100	-60 ... +250 °C	69.5 ... 290.1 Ω	1/10
10	NI1000	-60 ... +150 °C	743.0 ... 1987.0 Ω	1/10
11	NI1000	-60 ... +250 °C	743.0 ... 2800.0 Ω	1/10
12	Potentiometer	0	250	1/10
13	Potentiometer	0	500	1/10
14	Potentiometer	0	1000	1/10
15	Potentiometer	0	2500	1/10
16	Potentiometer	0	5000	1/10
17	KTY11-62	-50 ... +150 °C	1035.9 ... 4575.3 Ω	1/10
18 19	KTY81-110 KTY81-120	-55 ... +150 °C	450.0 ... 2211.0 Ω	1/10
20	KTY81-121	-55 ... +150 °C	485.0 ... 2189.0 Ω	1/10
21	KTY81-122	-55 ... +150 °C	495.0 ... 2233.0 Ω	1/10
22	KTY81-150	-55 ... +150 °C	450.0 ... 2211.0 Ω	1/10
23	KTY84-130	-40 ... +300 °C	359.0 ... 2624.0 Ω	1/10
24	KTY84-150	-40 ... +300 °C	359.0 ... 2624.0 Ω	1/10
25	Pt100	-200 ... +150 °C	18.5 ... 157.3 Ω	1/100

20.5 Diagnostics

If the reading falls within the permissible measuring range and both the range and channel diagnostics read "FALSE," the valid reading will be shown.

20 Analog input module XN-322-4AI-PTNI

20.6 Filters

If the measuring range is exceeded or fallen below, but the reading still falls within the limits for range diagnostics, the fact that the permissible measuring range has been exceeded/fallen below will be indicated by setting the range diagnostics' (measuring range diagnostics) status to "TRUE." In this case, the open wire diagnostics will remain "FALSE," and a reading will be shown.

If the reading exceeds or falls below the limits for range diagnostics, the device will be unable to perform a measurement, just like in the event of a cable break. In this case, the cable break diagnostics will signal the fault by having their status set to "TRUE," while the range diagnostics will keep a status of "FALSE." When this occurs, a value of "-30000" will be shown as the reading.

If a channel is disabled, there will not be any measurements, and the open wire diagnostics will indicate this with the "TRUE" status.



Range and open wire diagnostics must be taken into account in order to ensure that the reading shown is being interpreted correctly.

20.6 Filters

The low-pass cutoff frequency can be configured for each input channel using the appropriate register. This cutoff frequency is specified in Hz without any decimal places.

Example: 50 Hz low-pass cutoff frequency; register value: 50_{dec} / 32_{hex}

The following settings are valid:

Low-pass cut-off frequency	Register value
Filter disabled (default)	0x0000
10 Hz	0x000A
25 Hz	0x0019
50 Hz	0x0032
100 Hz	0x0064

20.7 Memory layout

CAN Object Index		Size (byte)	Description		Address (HEX)	
0x3070		2	Modules Diagnostics	Bit 0	reserved	0x0080
				Bit 1	No SYNC signal	
				Bit 2	FLASH-CRC error	
				Bit 3	RAM-CRC error	
				Bit 4	Flash memory error	
				Bit 5-15	reserved	
0x3071	0x6401	2	Temperature reading 1 (AI1)		0x0082	
0x3072	0x6401	2	Temperature reading 2 (AI2)		0x0084	
0x3073	0x6401	2	Temperature reading 3 (AI3)		0x0086	
0x3074	0x6401	2	Temperature reading 4 (AI4)		0x0088	
0x0x3075		1	Open wire diagnostics	Bit 0	1: Cable break input AI1	0x008A
				Bit 1	1: Cable break input AI2	
				Bit 2	1: Cable break input AI3	
				Bit 3	1: Cable break input AI4	
				Bit 4-15	reserved	
0x3076		1	Measuring range diagnostics	Bit 0	1: Out-of-range value AI1	0x008B
				Bit 1	1: Out-of-range value AI2	
				Bit 2	1: Out-of-range value AI3	
				Bit 3	1: Out-of-range value AI4	
				Bit 4	1: Range undershoot AI1	
				Bit 5	1: Range undershoot AI2	
				Bit 6	1: Range undershoot AI3	
				Bit 7	1: Range undershoot AI4	

20 Analog input module XN-322-4AI-PTNI

20.7 Memory layout

CAN Object Index	Size (byte)	Description				Address (HEX)
0x5070	1	Sensor selection, Channel AI1	0:	Pt100	-200 ... +150°C	0x0107
			1:	Pt100	-200 ... +850°C	
0x5071	1	Sensor selection, Channel AI2	2:	Pt200	-200 ... +150°C	0x0108
			3:	Pt200	-200 ... +850°C	
0x5072	1	Sensor selection, Channel AI3	4:	Pt500	-200 ... +150°C	0x0109
			5:	Pt500	-200 ... +850°C	
0x5073	1	Sensor selection, Channel AI4	6:	Pt1000	-200 ... +150°C	0x010A
			7:	Pt1000	-200 ... +850°C	
			8:	NI100	-60 ... +150°C	
			9:	NI100	-60 ... +250°C	
			10:	NI1000	-60 ... +150°C	
			11:	NI1000	-60 ... +250°C	
			12:	R	0 ... 250 Ω	
			13:	R	0 ... 500 Ω	
			14:	R	0 ... 1000 Ω	
			15:	R	0 ... 2500 Ω	
			16:	R	0 ... 5000 Ω	
			17:	KTY11-62	-50 ... +150°C	
			18:	KTY81-110	-55 ... +150°C	
			19:	KTY81-120	-55 ... +150°C	
			20:	KTY81-121	-55 ... +150°C	
			21:	KTY81-122	-55 ... +150°C	
			22:	KTY81-150	-55 ... +150°C	
			23:	KTY84-130	-40 ... +300°C	
			24:	KTY84-150	-40 ... +300°C	
			25:	Pt100	-200 ... +150°C	
26-255		reserved				
0x5074	1	Setting for input filter	Bit 0	(AI1) 0: two-wire, 1: three-wire		0x010B
			Bit 1	(AI2) 0: two-wire, 1: three-wire		
			Bit 2	(AI3) 0: two-wire, 1: three-wire		
			Bit 3	(AI4) 0: two-wire, 1: three-wire		
			Bit 4-15	reserved		

CAN Object Index	Size (byte)	Description	Address (HEX)		
0x5075	2	Setting for AI1 input filter	Used to specify the cutoff frequency as a decimal value in Hz.		
0x5076	2	Setting for AI2 input filter			
0x5077	2	Setting for AI3 input filter			
0x5078	2	Setting for AI4 input filter			
0x5079	1	Activate channel			
			Bit 0	(AI1) 0: disabled, 1: enabled	0x0114
			Bit 1	(AI2) 0: disabled, 1: enabled	
			Bit 2	(AI3) 0: disabled, 1: enabled	
			Bit 3	(AI4) 0: disabled, 1: enabled	
			Bit 4-15	reserved	

20.8 Supported CANopen objects

Product-specific CANopen objects

Index (hex)	Data Type	Name	Function	Mapping	Access
0x6401	INTEGER16	I-WORD	Read Analog Input 16-bit	Default	ro PDO
0x6421	UNSIGNED8	AI_INTERRUPT_TRIGGER_SELECTION	Analog Input Interrupt Trigger Selection	–	rw SDO
0x6423	BOOLEAN	AnalogInputGlobalInterruptEnable	Analog Input Global Interrupt Enable	–	rw SDO
0x6424	INTEGER32	I-WORD_UPPER_LIMIT	Analog Input Interrupt Upper Limit Integer	–	rw SDO
0x6425	INTEGER32	I-WORD_LOWER_LIMIT	Analog Input Interrupt Lower Limit Integer	–	rw SDO
0x6426	UNSIGNED32	I-WORD_DELTA_VALUE	Analog Input Interrupt Delta Unsigned	–	rw SDO
0x6427	UNSIGNED32	I-WORD_NEGATIVE_DELTA_VALUE	Analog Input Interrupt Negative Delta Unsigned	–	rw SDO
0x6428	UNSIGNED32	I-WORD_POSITIVE_DELTA_VALUE	Analog Input Interrupt Positive Delta Unsigned	–	rw SDO

Manufacturer-specific objects

Index range for the XN-322-4AI-PTNI module: x070 to x07F

Index (hex)	Data Type	Name	Function	Mapping	Access
0x1027	UNSIGNED16	ModuleID	Module Identification Number	–	ro SDO
0x3070	UNSIGNED16	ModuleDiag	Module Diagnostic Messages	Manual	ro PDO
0x3071	INTEGER16	InputChannel1	Input Channel 1	Manual	ro PDO
0x3072	INTEGER16	InputChannel2	Input Channel 2	Manual	ro PDO
0x3073	INTEGER16	InputChannel3	Input Channel 3	Manual	ro PDO
0x3074	INTEGER16	InputChannel4	Input Channel 4	Manual	ro PDO
0x3075	UNSIGNED8	WireBreakDiag	Wire Break Diagnostic Messages	Manual	ro PDO
0x3076	UNSIGNED8	RangeDiag	Range Diagnostic Message	Manual	ro PDO

20 Analog input module XN-322-4AI-PTNI

20.8 Supported CANopen objects

0x3077	INTEGER16	NativeDataAI1	Analog Input 1 Native Data	Manual	ro	PDO
0x3078	INTEGER16	NativeDataAI2	Analog Input 2 Native Data	Manual	ro	PDO
0x3079	INTEGER16	NativeDataAI3	Analog Input 3 Native Data	Manual	ro	PDO
0x307A	INTEGER16	NativeDataAI4	Analog Input 4 Native Data	Manual	ro	PDO
0x307B	INTEGER16	NativeDataAI5	Analog Input 5 Native Data	Manual	ro	PDO
0x307C	INTEGER16	NativeDataAI6	Analog Input 6 Native Data	Manual	ro	PDO
0x307D	INTEGER16	NativeDataAI7	Analog Input 7 Native Data	Manual	ro	PDO
0x307E	INTEGER16	NativeDataAI8	Analog Input 8 Native Data	Manual	ro	PDO
0x4001	VISIBLE STRING	SerialNumber	Serial Number	–	const	SDO
0x4004	UNSIGNED8	UserLEDControl	User LED Control	–	rw	SDO
0x400C	VISIBLE STRING	ProductName	Product Name	–	ro	SDO
0x4070	UNSIGNED16	FirmwareVersion	Firmware Version	–	ro	SDO
0x5070	UNSIGNED8	SensorSelectChannel1	Sensor Type Selection Channel 1	–	rw	SDO
0x5071	UNSIGNED8	SensorSelectChannel2	Sensor Type Selection Channel 2	–	rw	SDO
0x5072	UNSIGNED8	SensorSelectChannel3	Sensor Type Selection Channel 3	–	rw	SDO
0x5073	UNSIGNED8	SensorSelectChannel4	Sensor Type Selection Channel 4	–	rw	SDO
0x5074	UNSIGNED8	ChannelMeasuringConfig	Channel Measuring Configuration (two-wire/three-wire measurement)	–	rw	SDO
0x5075	UNSIGNED16	FilterConfigChannel1	Filter Configuration Channel 1	–	rw	SDO
0x5076	UNSIGNED16	FilterConfigChannel2	Filter Configuration Channel 2	–	rw	SDO
0x5077	UNSIGNED16	FilterConfigChannel3	Filter Configuration Channel 3	–	rw	SDO
0x5078	UNSIGNED16	FilterConfigChannel4	Filter Configuration Channel 4	–	rw	SDO
0x5079	UNSIGNED8	ChannelActivation	Channel Activation	–	rw	SDO

21 Analog input module XN-322-7AI-U2PT

XN-322-7AI-U2PT modules are XN300 slice modules with 7 analog input channels. Out of the seven analog inputs, six are used to measure an analog input signal of ± 10 V, with the option of configuring the first channel as a temperature input (KTY, Pt1000) instead. The final, seventh analog channel is used to measure temperatures with (KTY, Pt1000) sensors.

A reference voltage source with 10 V / 15 mA and 6 outputs makes it possible to directly power potentiometers in order to read their position using the analog voltage inputs.

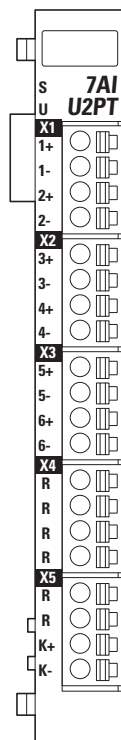

Figure 81: Device view XN-322-7AI-U2PT

21 Analog input module XN-322-7AI-U2PT

21.1 Status LEDs

21.1 Status LEDs

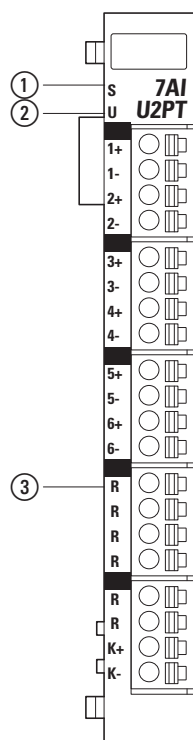

Figure 82: LED signals and pin assignment

- ① Module status LED
- ② User LED
- ③ Reference fault LED

Module Status	green	ON	System OK
		OFF	No power
		FLASHES (5 Hz)	No communications
User	yellow	ON	The user can set the LED signals as necessary. (For example, the visualization interface can be used to set the module's LED to flash so that it is easier to find the module inside the control panel.)
		OFF	
		FLASH (200 ms ON, 1000 ms OFF)	
		FLASH (1000 ms ON, 200 ms OFF)	
Error Reference	red	ON	10 V reference overload
		FLASHES (20Hz)	Overload GND; For channels configured to use measurements relative to ground.
		OFF	No fault

21.2 Pin assignment

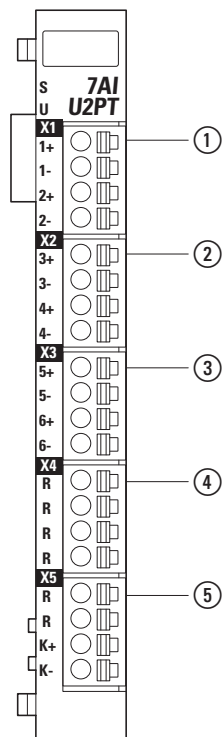

Figure 83: Pin assignment

- ① X1
 - 1+ analog input 1+(KTY+)
 - 1- analog input 1- /AGND(KTY-)
 - 2+ analog input 2+
 - 2- analog input 2-/AGND
- ② X2
 - 3+ analog input 3+
 - 3- analog input 3-/AGND
 - 4+ analog input 4+
 - 4- analog input 4-/AGND
- ③ X3
 - 3+ analog input 3+
 - 3- analog input 3-/AGND
 - SH analog input 4+
 - SH analog input 4-/AGND
- ④ X4
 - R reference output
 - R reference output
 - R reference output
 - R reference
- ⑤ X5
 - R reference
 - R reference
 - K+ KTY+ analog input
 - K- KTY- analog input

21 Analog input module XN-322-7AI-U2PT

21.3 Wiring

21.3 Wiring

21.3.1 Potentiometer measurements

When using potentiometer measurements, the potentiometer is powered using the reference voltage and AIx is connected to GND by configuring the corresponding parameters. The potentiometer's position can then be interpreted as a % by measuring the analog voltage at the potentiometer's wiper.

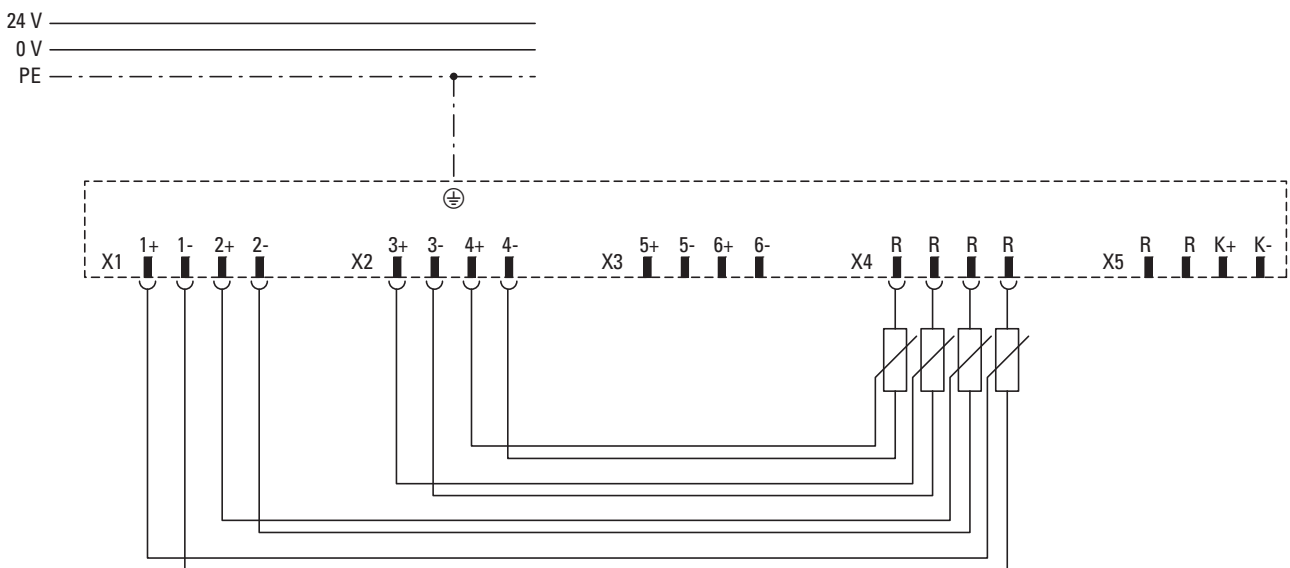

Figure 84: Potentiometer measurement at AI1, AI2, AI3 and/or AI4

21.3.2 Measurements using sensors / temperature inputs

In order to measure a sensor's output voltage via an analog input, a differential voltage measurement is carried out without connecting either input cable to earth (GND). The signal being measured must fall within the input's permissible common mode range.

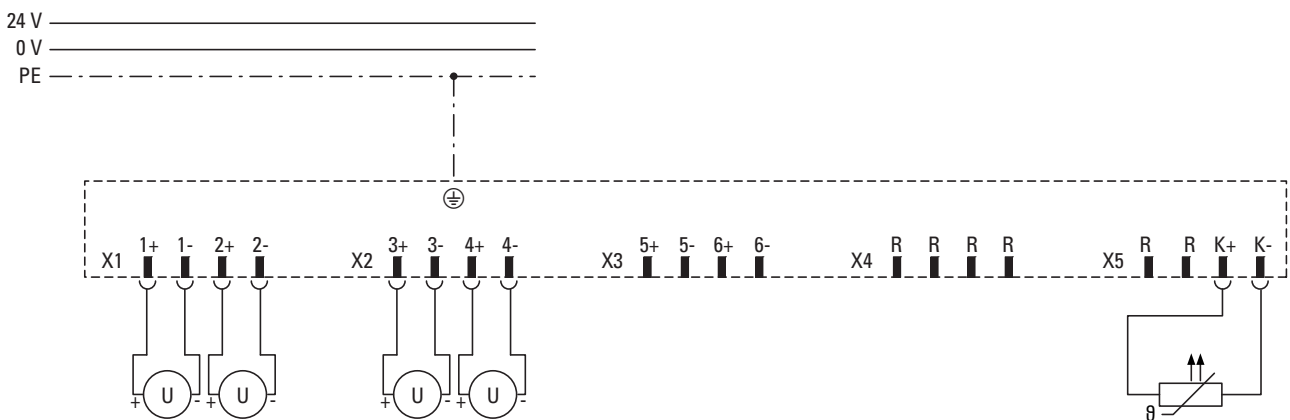

Figure 85: Connecting analog inputs for measuring a sensor at AI1, AI2, AI3, and/or AI4; temperature measurement for KTY10 at X5

21.4 Technical data for inputs

Number of analog input channels	7	
Analog inputs	6 voltage inputs ± 10 V (of which channel 1 can be configured to work as a KTY, Pt1000 input instead)	
KTY, Pt1000 - inputs	1	
Analog inputs	6	
Measuring range	-10V ... +10V	0 – 100% (potentiometer)
Measured value	-10,000 ... 10,000	0 ... 10,000
D-A converter	16 bit	
Resolution	0.3 mV / LSB	
Conversion time per channel	1 ms	
Common-mode range	± 12 V	
Input resistance	> 10 M Ω	
Open wire monitoring	yes	
Input filters		
Hardware	Typically: 1 kHz (third-order low-pass filter)	
Software (parameterizable)	parameterizable	
Measuring accuracy		
Cumulative error ± 10 V	$\pm 0.3\%$ of full scale value	
Total potentiometer error	$\pm 0.35\%$ of full scale value	
KTY, Pt1000 inputs	1 (parameterizable Pt1000/KTY10)	
	Pt1000	KTY10
	-25 ... +850 °C	-50 ... +150 °C
	502.4 – 3904.8 Ω	1035.9 – 4575.3 Ω
D-A converter	16 bits	
Resolution	0.1 °C	
Conversion time per channel	1 ms	
Input resistance	33 k Ω	
Open wire monitoring	yes	
Input filters		
Hardware	Typically: 1 kHz (third-order low-pass filter)	
Software	10 Hz	
Measuring accuracy		
Basic error limit	$\pm 0.5\%$ of full scale value	

21 Analog input module XN-322-7AI-U2PT

21.5 Technical data for reference outputs

21.5 Technical data for reference outputs

	Device version	
	1.00 or higher	3.01 or higher
Number of channels	1	
Connection points per channel	6	
Reference voltage	+10 V	
Permissible load per potentiometer input		
Max. permissible output current	≤ 2.50 mA	≤ 4.17 mA
Potentiometer	≥ 4 kΩ	≥ 2.4 kΩ
Maximum operating temperature	0...60 °C	0...55 °C
Maximum permissible capacitive load	100 nF	
Short-circuit proof	Yes, maximum 1 minute	
Cumulative error as a percentage of full scale value	±0.3 %	

21.6 Measurement ranges

Input 1				Value representation
1	U	-10...+10 V		Represented as a decimal value in mV
	Pt1000	-125...+850 °C	502.4...3904.8 Ω	Represented as a decimal value in ohms with one decimal place (in 1/10 ohm)
	KTY10	-50...+150 °C	1035.9...4575.3 Ω	
2-6	U	-10...+10V	-10000...10000	Represented as a decimal value in mV
7	Pt1000	-125...+850 °C	502.4...3904.8 Ω	Represented as a decimal value in °C with one decimal place (in 1/10 °C)
	KTY10	-50...+150 °C	1035.9...4575.3 Ω	

21.7 Filters

The low-pass cutoff frequency can be configured for each voltage input channel by using the appropriate register. This cutoff frequency is specified in Hz without any decimal places.

The following settings are valid:

Low-pass cut-off frequency	Register value
Filter disabled (default)	0x0000
10 Hz	0x000A
25 Hz	0x0019
50 Hz	0 x0032
100 Hz	0x0064

Low-pass cut-off frequency	Register value
250 Hz	0x00FA
500 Hz	0x01F4
1000 Hz	0x03E8

21 Analog input module XN-322-7AI-U2PT

21.8 Memory layout

21.8 Memory layout

CAN Object Index		Size (byte)	Description		
0x3080		2	Modules Diagnostics	Bit 0	reserved
				Bit 1	No SYNC signal
				Bit 2	FLASH-CRC error
				Bit 3	RAM-CRC error
				Bit 4	Flash memory error
				Bit 5-15	reserved
0x3081	0x6401	2	Analog input value 1 (AI1) (U/KTY/Pt1000)		
0x3082	0x6401	2	Analog input value 2 (AI2)		
0x3083	0x6401	2	Analog input value 3 (AI3)		
0x3084	0x6401	2	Analog input value 4 (AI4)		
0x3085	0x6401	2	Analog input value 5 (AI2)		
0x3086	0x6401	2	Analog input value 6 (AI3)		
0x3087	0x6401	2	Temperature reading 7 (AI7) (KTY/Pt1000)		
0x3088		2	Open wire diagnostics	Bit 0	1: Cable break input AI1
				Bit 1	1: Cable break input AI2
				Bit 2	1: Cable break input AI3
				Bit 3	1: Cable break input AI4
				Bit 4	1: Cable break input AI5
				Bit 5	1: Cable break input AI6
				Bit 6	1: Cable break input AI7
				Bit 7	1: Short-circuit at input AI1 when configured as KTY/ Pt1000
				Bit 8	1: Short-circuit input AI7
				Bit 9	1: Reference undervoltage
				Bit10	1:Reference overcurrent
Bit 11-15	reserved				

CAN Object Index	Size (byte)	Description			
5080	2	Parameter definition channel	Measured value 1 (AI1)	Bit 0	0: Analog measurement \pm 10V 1: Temperature measurement
				Bit 1	0: KTY10 Sensor 1: Pt1000 Sensor
				Bit 2	0: Differential measurement 1: Measurement relative to ground
			Measured value 2 (AI2)	Bit 3	0: Differential measurement 1: Measurement relative to ground
				Measured value 3 (AI3)	Bit 4
			Measured value 4 (AI4)	Bit 5	0: Differential measurement 1: Measurement relative to ground
				Measured value 5 (AI5)	Bit 6
			Measured value 6 (AI6)	Bit 7	0: Differential measurement 1: Measurement relative to ground
			Measured value 7 (AI7)	Bit 8	0: KTY10 Sensor 1: Pt1000 Sensor
–	Bit 9-15	reserved			
5081	2	Setting for AI1 input filter	Used to specify the cutoff frequency as a decimal value in Hz.		
5082	2	Setting for AI2 input filter			
5083	2	Setting for AI3 input filter			
5084	2	Setting for AI4 input filter			
5085	2	Setting for AI5 input filter			
5086	2	Setting for AI6 input filter			

21 Analog input module XN-322-7AI-U2PT

21.9 Supported CANopen objects

21.9 Supported CANopen objects

Product-specific CANopen objects

Index (hex)	Data Type	Name	Function	Mapping	Access	
0x6401	INTEGER16	I-WORD	Read Analog Input 16-bit	Default	ro	PDO
0x6421	UNSIGNED8	AI_INTERRUPT_TRIGGER_SELECTION	Analog Input Interrupt Trigger Selection	–	rw	SDO
0x6423	BOOLEAN	AnalogInputGlobalInterruptEnable	Analog Input Global Interrupt Enable	–	rw	SDO
0x6424	INTEGER32	I-WORD_UPPER_LIMIT	Analog Input Interrupt Upper Limit Integer	–	rw	SDO
0x6425	INTEGER32	I-WORD_LOWER_LIMIT	Analog Input Interrupt Lower Limit Integer	–	rw	SDO
0x6426	UNSIGNED32	I-WORD_DELTA_VALUE	Analog Input Interrupt Delta Unsigned	–	rw	SDO
0x6427	UNSIGNED32	I-WORD_NEGATIVE_DELTA_VALUE	Analog Input Interrupt Negative Delta Unsigned	–	rw	SDO
0x6428	UNSIGNED32	I-WORD_POSITIVE_DELTA_VALUE	Analog Input Interrupt Positive Delta Unsigned	–	rw	SDO

Manufacturer-specific objects

Index range for the XN-322-7AI-U2PT module: x080 to x08F

Index (hex)	Data Type	Name	Function	Mapping	Access	
0x1027	UNSIGNED16	ModuleID	Module Identification Number	–	ro	SDO
0x3080	UNSIGNED16	ModuleDiag	Module Diagnostic Messages	Manual	ro	PDO
0x3081	INTEGER16	InputChannel1	Input Channel 1	Manual	ro	PDO
0x3082	INTEGER16	InputChannel2	Input Channel 2	Manual	ro	PDO
0x3083	INTEGER16	InputChannel3	Input Channel 3	Manual	ro	PDO
0x3084	INTEGER16	InputChannel4	Input Channel 4	Manual	ro	PDO
0x3085	INTEGER16	InputChannel5	Input Channel 5	Manual	ro	PDO
0x3086	INTEGER16	InputChannel6	Input Channel 6	Manual	ro	PDO
0x3087	INTEGER16	InputChannel7	Input Channel 7	Manual	ro	PDO
0x3088	UNSIGNED16	WireBreakDiag	Wire Break Diagnostic Messages	Manual	ro	PDO
0x4001	VISIBLE STRING	SerialNumber	Serial Number	–	const	SDO
0x4004	UNSIGNED8	UserLEDControl	User LED Control	–	rw	SDO
0x400C	VISIBLE STRING	ProductName	Product Name	–	ro	SDO
0x4080	UNSIGNED16	FirmwareVersion	Firmware Version	–	ro	SDO
0x5080	UNSIGNED16	ChannelMeasuringConfig	Channel Measuring Configuration	–	rw	SDO
0x5081	UNSIGNED16	FilterConfigChannel1	Filter Configuration Channel 1	–	rw	SDO
0x5082	UNSIGNED16	FilterConfigChannel2	Filter Configuration Channel 2	–	rw	SDO
0x5083	UNSIGNED16	FilterConfigChannel3	Filter Configuration Channel 3	–	rw	SDO
0x5084	UNSIGNED16	FilterConfigChannel4	Filter Configuration Channel 4	–	rw	SDO
0x5085	UNSIGNED16	FilterConfigChannel5	Filter Configuration Channel 5	–	rw	SDO
0x5086	UNSIGNED16	FilterConfigChannel6	Filter Configuration Channel 6	–	rw	SDO

22 Analog input module XN-322-8AI-I

XN-322-8AI-I modules are XN300 slice modules with 8 analog input channels used to measure current input signals within a measuring range of 0 – 20 mA or 4 – 20 mA.

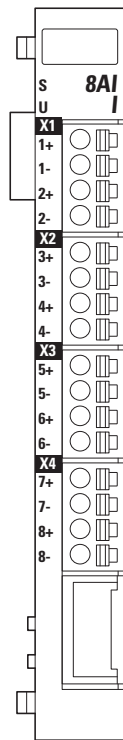

Figure 86: Device view XN-322-8AI-I

22 Analog input module XN-322-8AI-I

22.1 Status LEDs

22.1 Status LEDs

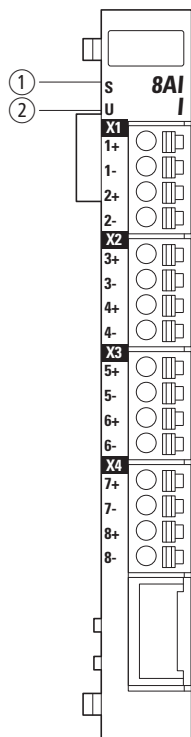

Figure 87: LED signals and pin assignment

- ① Module status LED
- ② User status LED

Module status	green	ON	System OK
		OFF	No power
		FLASHES (5 Hz)	No communication
Status User	yellow	ON	The user can set the LED signals as necessary. (For example, the visualization interface can be used to set the module's LED to flash so that it is easier to find the module inside the control panel.)
		OFF	
		FLASH (200 ms ON, 1000 ms OFF)	
		FLASH (1000 ms ON, 200 ms OFF)	

22.2 Pin assignment

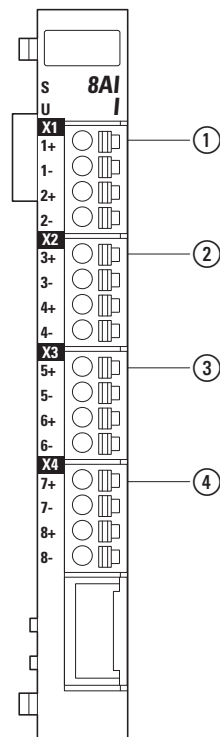

Figure 88: Pin assignment

- ① X1
 - 1+ analog input 1+
 - 1- analog input 1-
 - 2+ analog input 2+
 - 2- analog input 2-
- ② X2
 - 3+ analog input 3+
 - 3- analog input 3-
 - 4+ analog input 4+
 - 4- analog input 4-
- ③ X3
 - 5+ analog input 5+
 - 5- analog input 5-
 - 6+ analog input 6+V
 - 6- analog input 6-
- ④ X4
 - 7+ analog input 7+
 - 7- analog input 7-
 - 8+ analog input 8+
 - 8- analog input 8-

22.3 Wiring

Two analog inputs can be wired to each of the four X1 to X4 connectors.

A measuring range of 4–20 mA with open wire monitoring is supported, as is a measuring range of 0–20 mA without open wire monitoring.

22 Analog input module XN-322-8AI-I

22.4 Technical data

The current input channels use a differential voltage measurement at an internal module resistor with a resistance of 50 Ω .

It must be ensured that the input signals' voltage levels fall within the permissible common mode range.

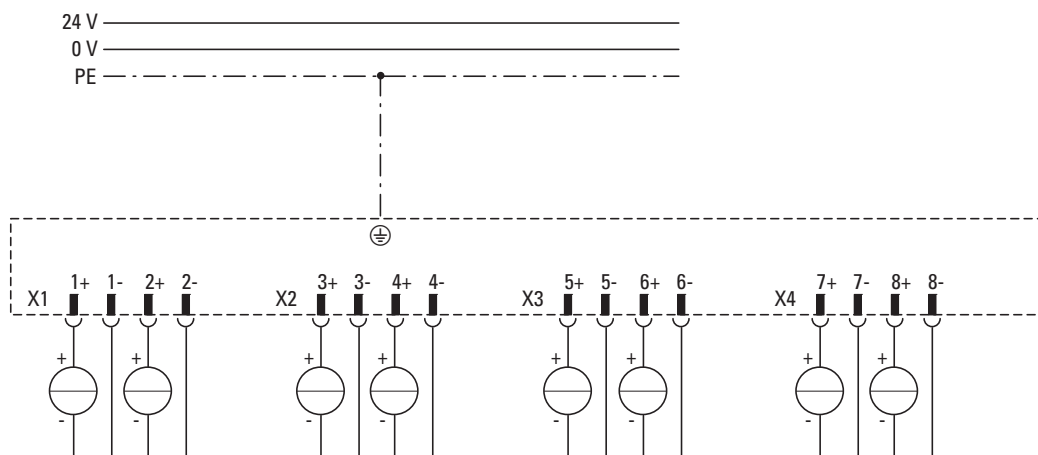

Figure 89: Connecting example for signal current sources

22.4 Technical data

22.4.1 Channels

Channels	Value
Number of channels	8 analog input channels
Measuring range	0...20mA 4...20mA
Measured value	0...20000 4000...20000
A-D converter	16 bit
Resolution	0.3 μ A / LSB
Conversion time per channel	1 ms
Common-mode range	± 10 V
Input resistance	50 Ω
Input filters	
Hardware	Typically: kHz (third-order low-pass filter)
Software (parameterizable)	parameterizable
Measuring accuracy	
Cumulative error	$\pm 0.5\%$ of full scale value

22.4.2 Measurement ranges

Current in mA	Value representation in μ A	
0 ... 20 mA	0000 20000	Represented as a decimal value
4 ... 20 mA	4000 20000	

22.4.3 Diagnostics

Open wires will only be detected with diagnostics when using the 4–20 mA measuring range. When using the 0–20 mA measuring range, the open wire detection diagnostics will always read "FALSE."



Range and channel diagnostics must be taken into account in order to ensure that the reading shown is being interpreted correctly.

Diagnostics	Measuring range in mA	
	0 – 20	4 – 20
Cable break	–	< 4 mA (diagnostics)
Under Range	–	0 ... 4 mA
Display value	Measured value	
Over Range	20 ... 21	
Overcurrent	> 21	
Display value	> 21 (no reading)	

22.4.4 Filters

The low-pass cutoff frequency can be configured for each input channel using the appropriate register. This cutoff frequency is specified in Hz without any decimal places.

The following settings are valid:

Low-pass cut-off frequency	Register value
Filter disabled (default)	0x0000
10 Hz	0x000A
25 Hz	0x0019
50 Hz	0x0032
100 Hz	0x0064
250 Hz	0x00FA
500 Hz	0x01F4
1000 Hz	0x03E8

22 Analog input module XN-322-8AI-I

22.4 Technical data

22.4.5 Memory layout

CAN Object Index		Size (byte)	Description		
0x3090		2	Modules Diagnostics	Bit 0	reserved
				Bit 1	No SYNC signal
				Bit 2	FLASH-CRC error
				Bit 3	RAM-CRC error
				Bit 4	Flash memory error
				Bit 5-15	reserved
0x3091	0x6401	2	Analog input value 1 (AI1)		
0x3092	0x6401	2	Analog input value 2 (AI2)		
0x3093	0x6401	2	Analog input value 3 (AI3)		
0x3094	0x6401	2	Analog input value 4 (AI4)		
0x3095	0x6401	2	Analog input value 5 (AI5)		
0x3096	0x6401	2	Analog input value 6 (AI6)		
0x3097	0x6401	2	Analog input value 7 (AI7)		
0x3098	0x6401	2	Analog input value 8 (AI8)		
0x3099		2	Open wire diagnostics	Bit 0	1: Cable break input AI1
				Bit 1	1: Cable break input AI2
				Bit 2	1: Cable break input AI3
				Bit 3	1: Cable break input AI4
				Bit 4	1: Cable break input AI5
				Bit 5	1: Cable break input AI6
				Bit 6	1: Cable break input AI7
				Bit 7	1: Cable break input AI8
				Bit 8-15	reserved

CAN Object Index	Size (byte)	Description		
0x5090	2	Measuring range parameter configuration	Bit 0 (AI1)	0: measurement range 0...20mA
				1: measurement range 4...20mA
			Bit 1 (AI2)	0: measurement range 0...20mA
				1: measurement range 4...20mA
			Bit 2 (AI3)	0: measurement range 0...20mA
				1: measurement range 4...20mA
			Bit 3 (AI4)	0: measurement range 0...20mA
				1: measurement range 4...20mA
			Bit 4 (AI5)	0: measurement range 0...20mA
				1: measurement range 4...20mA
Bit 5 (AI6)	0: measurement range 0...20mA			
	1: measurement range 4...20mA			
Bit 6 (AI7)	0: measurement range 0...20mA			
	1: measurement range 4...20mA			
Bit 7 (AI8)	0: measurement range 0...20mA			
	1: measurement range 4...20mA			
			Bit 8-15	reserved
0x5091	2	Setting for AI1 input filter		Used to specify the cutoff frequency as a decimal value in Hz.
0x5092	2	Setting for AI2 input filter		
0x5093	2	Setting for AI3 input filter		
0x5094	2	Setting for AI4 input filter		
0x5095	2	Setting for AI5 input filter		
0x5096	2	Setting for AI6 input filter		
0x5097	2	Setting for AI7 input filter		
0x5098	2	Setting for AI8 input filter		

22 Analog input module XN-322-8AI-I

22.5 Supported CANopen objects

22.5 Supported CANopen objects

Product-specific CANopen objects

Index (hex)	Data Type	Name	Function	Mapping	Access	
0x6401	INTEGER16	I-WORD	Read Analog Input 16-bit	Default	ro	PDO
0x6421	UNSIGNED8	AI_INTERRUPT_TRIGGER_SELECTION	Analog Input Interrupt Trigger Selection	–	rw	SDO
0x6423	BOOLEAN	AnalogInputGlobalInterruptEnable	Analog Input Global Interrupt Enable	–	rw	SDO
0x6424	INTEGER32	I-WORD_UPPER_LIMIT	Analog Input Interrupt Upper Limit Integer	–	rw	SDO
0x6425	INTEGER32	I-WORD_LOWER_LIMIT	Analog Input Interrupt Lower Limit Integer	–	rw	SDO
0x6426	UNSIGNED32	I-WORD_DELTA_VALUE	Analog Input Interrupt Delta Unsigned	–	rw	SDO
0x6427	UNSIGNED32	I-WORD_NEGATIVE_DELTA_VALUE	Analog Input Interrupt Negative Delta Unsigned	–	rw	SDO
0x6428	UNSIGNED32	I-WORD_POSITIVE_DELTA_VALUE	Analog Input Interrupt Positive Delta Unsigned	–	rw	SDO

Manufacturer-specific objects

Index range for the XN-322-8AI-I module: x090 to x09F

Index (hex)	Data Type	Name	Function	Mapping	Access	
0x1027	UNSIGNED16	ModuleD	Module Identification Number	–	ro	SDO
0x3090	UNSIGNED16	ModuleDiag	Module Diagnostic Messages	Manual	ro	PDO
0x3091	INTEGER16	InputChannel1	Input Channel 1	Manual	ro	PDO
0x3092	INTEGER16	InputChannel2	Input Channel 2	Manual	ro	PDO
0x3093	INTEGER16	InputChannel3	Input Channel 3	Manual	ro	PDO
0x3094	INTEGER16	InputChannel4	Input Channel 4	Manual	ro	PDO
0x3095	INTEGER16	InputChannel5	Input Channel 5	Manual	ro	PDO
0x3096	INTEGER16	InputChannel6	Input Channel 6	Manual	ro	PDO
0x3097	INTEGER16	InputChannel7	Input Channel 7	Manual	ro	PDO
0x3098	INTEGER16	InputChannel8	Input Channel 8	Manual	ro	PDO
0x3099	UNSIGNED16	WireBreakDiag	Wire Break Diagnostic Messages	Manual	ro	PDO
0x4001	VISIBLE STRING	SerialNumber	Serial Number	–	const	SDO
0x4004	UNSIGNED8	UserLEDControl	User LED Control	–	rw	SDO
0x400C	VISIBLE STRING	ProductName	Product Name	–	ro	SDO
0x4090	UNSIGNED16	FirmwareVersion	Firmware Version	–	ro	SDO
0x5090	UNSIGNED16	ChannelMeasuringConfig	Channel Measuring Configuration	–	rw	SDO
0x5091	UNSIGNED16	FilterConfigChannel1	Filter Configuration Channel 1	–	rw	SDO
0x5092	UNSIGNED16	FilterConfigChannel2	Filter Configuration Channel 2	–	rw	SDO
0x5093	UNSIGNED16	FilterConfigChannel3	Filter Configuration Channel 3	–	rw	SDO
0x5094	UNSIGNED16	FilterConfigChannel4	Filter Configuration Channel 4	–	rw	SDO

22 Analog input module XN-322-8AI-I

22.5 Supported CANopen objects

0x5095	UNSIGNED16	FilterConfigChannel5	Filter Configuration Channel 5	–	rw	SDO
0x5096	UNSIGNED16	FilterConfigChannel6	Filter Configuration Channel 6	–	rw	SDO
0x5097	UNSIGNED16	FilterConfigChannel7	Filter Configuration Channel 7	–	rw	SDO
0x5098	UNSIGNED16	FilterConfigChannel8	Filter Configuration Channel 8	–	rw	SDO

22 Analog input module XN-322-8AI-I

22.5 Supported CANopen objects

23 Analog input module XN-322-10AI-TEKT

XN-322-10AI-TEKT modules are XN300 slice modules with 10 analog input channels. 8 of these input channels can be used to measure temperatures with thermocouples, while the other 2 channels can be used with KTY sensors for cold-junction compensation purposes. A KTY sensor is included as standard on the bottom of the device.

The module supports all common thermocouple types for its temperature measurements.

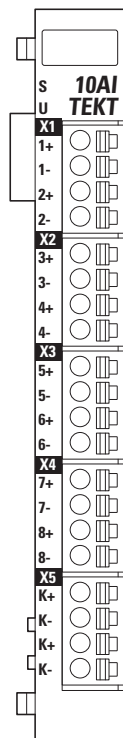

Figure 90: Device view XN-322-10AI-TEKT

23 Analog input module XN-322-10AI-TEKT

23.1 Pin assignment and status LEDs

23.1 Pin assignment and status LEDs

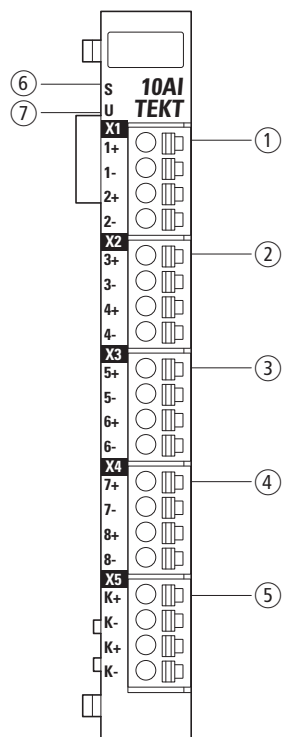

Figure 91: LED signals and pin assignment

- ① X1
 - 1+ analog input 1+
 - 1- analog input 1-
 - 2+ analog input 2+
 - 2- analog input 2-
- ② X2
 - 3+ analog input 3+
 - 3- analog input 3-
 - 4+ analog input 4+
 - 4- analog input 4-
- ③ X3
 - 5+ analog input 5+
 - 5- analog input 5-
 - 6+ analog input 6+
 - 6- analog input 6-
- ④ X4
 - 7+ analog input 7+
 - 7- analog input 7-
 - 8+ analog input 8+
 - 8- analog input 8-
- ⑤ X5
 - K+ analog input KTY 1+
 - K- analog input GND
 - K+ analog input KTY 2+
 - K- analog input GND
- ⑥ Module status LED
- ⑦ User LED

Table 7: Status LED table

Module status	green	ON	System OK
		OFF	No power
		FLASHES (5 Hz)	No communication
User	yellow	ON	The user can set the LED signals as necessary. (For example, the visualization interface can be used to set the module's LED to flash so that it is easier to find the module inside the control panel.)
		OFF	
		FLASH (200 ms ON, 1000 ms OFF)	
		FLASH (1000 ms ON, 200 ms OFF)	

23.2 Wiring

Two analog inputs can be wired to each of the five X1 to X5 connectors.

- ▶ Remove the KTY sensor included as standard from the bottom of the device.
- ▶ Insert the thermocouple's positive pin into one of the + pins, e.g., "1+".
- ▶ Insert the thermocouple's negative pin into one of the - pins, e.g., "1-".
- ▶ Wire the KTY sensor to the cold-junction compensation reference junction. You can define a total of two reference points, ϑ_{Ref1} and ϑ_{Ref2} . Reference point ϑ_{Ref} can be defined directly on the device. In this case, the KTY sensor should be wired directly to the device's K+ and K- pins. If you use input wiring for the thermocouple and reference junction ϑ_{Ref} is not directly on the connector, the KTY sensor should be wired to the transition point between the thermocouple and the input wiring.

23.2.1 Temperature measurements using thermocouples

Measuring temperatures with thermocouples takes advantage of the ability of cables made of different alloys to produce a voltage at their point of contact (junction) as a result of their electrochemical properties. The magnitude of this voltage will be small, non-linear, and extremely dependent on temperature, making this method ideal for measuring temperatures across a wide temperature range. The module will adjust for the corresponding non-linearity, representing values in °C/10 (with one decimal place).

The term "cold-junction compensation" refers to the action of correcting the value measured with the thermocouple by removing the error resulting from the corresponding pin. The reason this is necessary is that when a thermocouple's individual lead is connected to the module connector's copper, this will create a "parasitic" thermocouple, resulting in measuring errors and requiring additional correction on behalf of the module. Within this context, the KTY1 and KTY2 inputs are used to measure the temperature at precisely the aforementioned junction (not the ambient temperature).

23 Analog input module XN-322-10AI-TEKT

23.2 Wiring

If the thermocouples are wired directly to the module, it is advisable to wire the KTY sensor directly to the module as well. This will ensure that the temperature measured has a value that depends on the module's outside and inside temperatures and reflects the temperature at the thermocouple connector's pin. In fact, the conditions at the pin will be comparable, provided there are no localized temperature differences (X5 vs. X1). If this type of temperature difference exists, as is the case when a system has specific sides warm up in a localized manner during operation, it will affect the measurement in the form of an error.

In order to isolate the measurement from the system assembly's local conditions, as well as to compensate for large distances, it is possible to use wheatstone bridge compensation circuits in which the thermocouples are wired in a thermally stable environment, as is the measurement of the cold junction temperature with the KTY sensor.

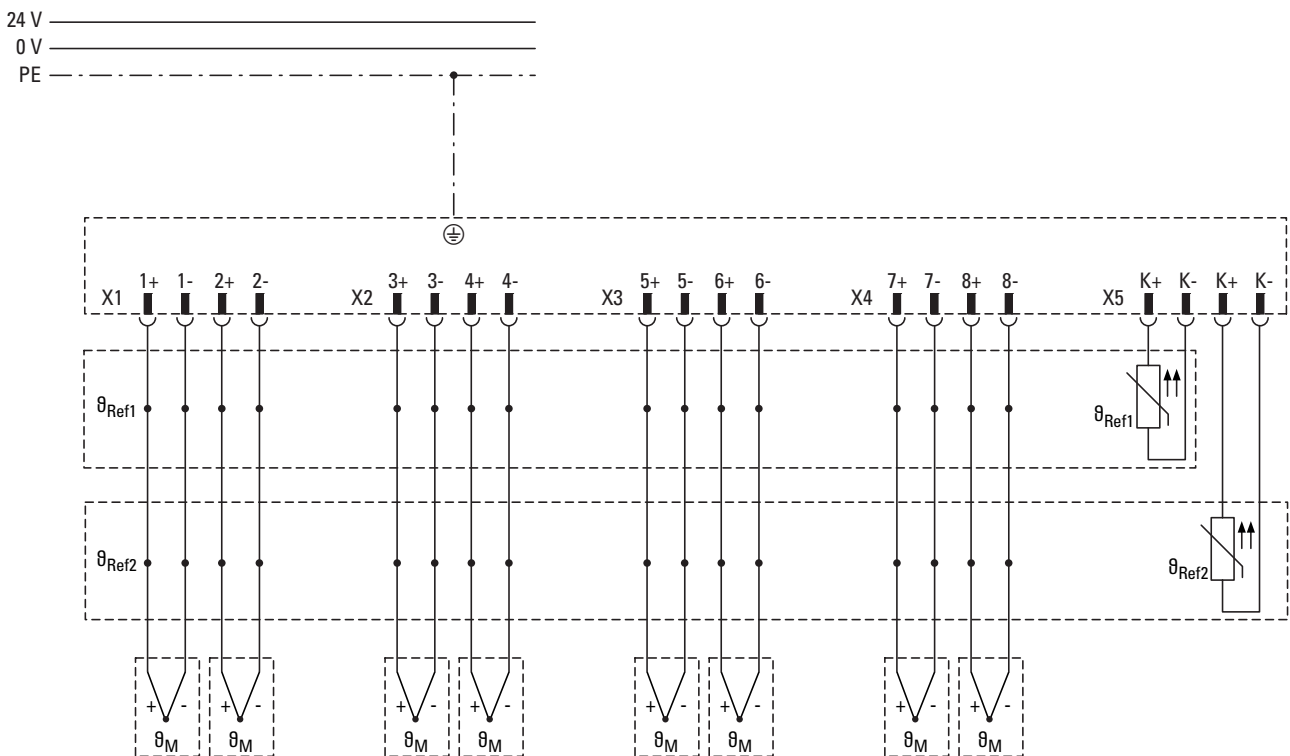

Figure 92: Wiring example with 8 thermocouples and 2 KTY sensors; the θ_M measuring points and the θ_{Ref1} and θ_{Ref2} reference junctions are clearly shown

23.2.2 Technical data for thermocouple inputs

Number of analog input channels	10
Inputs, thermocouple	8
Inputs KTY	2
Inputs, thermocouple	
D-A converter resolution	16 bits
Conversion time per channel	1 ms
Common-mode range	± 2 V
Input resistance	2 M Ω
Configurable parameters	thermocouples J, K, T, E, N, S, R, B, L, U
Open wire monitoring	yes
Input filters	
Hardware	Typically: 2 Hz; third-order low-pass filter
Measuring accuracy	
Cumulative error	$\pm 0.7\%$ of full scale value
KTY inputs for cold-junction compensation	
D-A converter resolution	16 bits
Conversion time per channel	1 ms
Sensor current	normally 0.3mA at 25°C
Open wire monitoring	yes
Input filters	
Hardware	normally 2 Hz; third-order low-pass
Measuring accuracy	
Cumulative error	$\pm 0.7\%$ of full scale value

23.2.3 Measurement ranges

The readings are represented as a decimal value in °C with one decimal place (in 1/10 °C)

Type	Thermocouple	Measuring range resistor
J	Fe-CuNi	0 ... +690 °C
K	NiCr-Ni	0 ... +940 °C
T	Cu-CuNi	0 ... +400 °C
E	NiCr-CuNi	0 ... +520 °C
N	NiCrSi-NiSi	0 ... +1080 °C
S	Pt10Rh-Pt	0 ... +1760 °C
R	Pt13Rh-Pt	0 ... +1760 °C
B	Pt30Rh-Pt6Rh	0 ... +1820 °C

23 Analog input module XN-322-10AI-TEKT

23.3 Memory layout

Type	Thermocouple	Measuring range	resistor
L	Fe-CuNi	0...+680 °C	
U	Cu-CuNi	0...+590 °C	
KTY10	–	-20 °C... +80 °C	1367...2980 Ω

23.3 Memory layout

Cold-junction compensation can be implemented by using the KTY channels. To do this, the parameters must be configured in such a way as to assign a KTY channel to each measuring channel for compensation purposes.

Measuring ranges are configured using a single byte for the two channels in each Xn connector. For example: The measuring range for 1+ and 2+ is configured using object 0x50A0, where the high nibble is used to configure 1+ and the low nibble is used to configure 2+.

CAN Object Index	Size (byte)	Description	Bit	AI	Description
30A0	2	Modules Diagnostics	Bit 0		reserved
			Bit 1		No SYNC signal
			Bit 2		FLASH-CRC error
			Bit 3		RAM-CRC error
			Bit 4		Flash memory error
			Bit 5-15		reserved
30A1	6401	2	Temperature reading 1 (AI1)	AI1	
30A2	6401	2	Temperature reading 2 (AI2)	AI2	
30A3	6401	2	Temperature reading 3 (AI3)	AI3	
30A4	6401	2	Temperature reading 4 (AI4)	AI4	
30A5	6401	2	Temperature reading 5 (AI5)	AI5	
30A6	6401	2	Temperature reading 6 (AI6)	AI6	
30A7	6401	2	Temperature reading 7 (AI7)	AI7	
30A8	6401	2	Temperature reading 8 (AI8)	AI8	
30A9	6401	2	Reference input KTY 1 for cold-junction compensation	KTY1	
30AA	6401	2	Reference input KTY 2 for cold-junction compensation	KTY2	

CAN Object Index	Size (byte)	Description	Bit	AI	Description
0x30AB	2	Open wire diagnostics	Bit 0	AI1	0 = OK 1 = Cable break
			Bit 1	AI2	
			Bit 2	AI3	
			Bit 3	AI4	
			Bit 4	AI5	
			Bit 5	AI6	
			Bit 6	AI7	
			Bit 7	AI8	
			Bit 8	KTY1	0 = OK 1 = Short-circuit
			Bit 9	KTY2	
			Bit 10	KTY1	
			Bit 11	KTY2	
		Bit 12-15		reserved	
0x50A0	1	Sensor selection, Channel 1_2	Bit 0-3	AI1	Table 8, page 174
			Bit 4-7	AI2	
0x50A1	1	Sensor selection, Channel 3_4	Bit 0-3	AI3	Table 8, page 174
			Bit 4-7	AI4	
0x50A2	1	Sensor selection, Channel 5_6	Bit 0-3	AI5	Table 8, page 174
			Bit 4-7	AI6	
0x50A3	1	Sensor selection, Channel 7_8	Bit 0-3	AI7	Table 8, page 174
			Bit 4-7	AI8	
0x50A4	1	Used to assign a cold-junction compensation channel (One of the two KTY sensors is assigned to analog input AI _n for cold-junction compensation purposes concerning the temperature readings)	Bit 0	AI1	0 = KTY 1 1 = KTY 2
			Bit 1	AI2	0 = KTY 1 1 = KTY 2
			Bit 2	AI3	0 = KTY 1 1 = KTY 2
			Bit 3	AI4	0 = KTY 1 1 = KTY 2
			Bit 4	AI5	0 = KTY 1 1 = KTY 2
			Bit 5	AI6	0 = KTY 1 1 = KTY 2
			Bit 6	AI7	0 = KTY 1 1 = KTY 2
			Bit 7	AI8	0 = KTY 1 1 = KTY 2

23 Analog input module XN-322-10AI-TEKT

23.3 Memory layout

In the registers used to select a sensor, the low nibble (bits 0-3) is used to configure the lower channel (channel 1, 3, 5, 7), while the high nibble (bits 4-7) is used to configure the upper channel (channel 2, 4, 6, 8).

Table 8: Sensor selection list

Hexadecimal value Bit 0-3 Bit 4-7	Type	Measuring range
0 _{hex}	J	0 ... +690 °C
1 _{hex}	K	0...+940 °C
2 _{hex}	T	0...+400 °C
3 _{hex}	E	0...+520 °C
4 _{hex}	N	0... +1080 °C
5 _{hex}	S	0...+1760 °C
6 _{hex}	R	0... +1760 °C
7 _{hex}	B	0... +1820 °C
8 _{hex}	L	0...+680 °C
9 _{hex}	U	0...+590 °C
A-F _{hex}	reserved	

23.4 Supported CANopen objects

Product-specific CANopen objects

Index (hex)	Data Type	Name	Function	Mapping	Access	
0x6401	INTEGER16	I-WORD	Read Analog Input 16-bit	Default	ro	PDO
0x6421	UNSIGNED8	AI_INTERRUPT_TRIGGER_SELECTION	Analog Input Interrupt Trigger Selection	–	rw	SDO
0x6423	BOOLEAN	AnalogInputGlobalInterruptEnable	Analog Input Global Interrupt Enable	–	rw	SDO
0x6424	INTEGER32	I-WORD_UPPER_LIMIT	Analog Input Interrupt Upper Limit Integer	–	rw	SDO
0x6425	INTEGER32	I-WORD_LOWER_LIMIT	Analog Input Interrupt Lower Limit Integer	–	rw	SDO
0x6426	UNSIGNED32	I-WORD_DELTA_VALUE	Analog Input Interrupt Delta Unsigned	–	rw	SDO
0x6427	UNSIGNED32	I-WORD_NEGATIVE_DELTA_VALUE	Analog Input Interrupt Negative Delta Unsigned	–	rw	SDO
0x6428	UNSIGNED32	I-WORD_POSITIVE_DELTA_VALUE	Analog Input Interrupt Positive Delta Unsigned	–	rw	SDO

Manufacturer-specific objects

Index range for the XN-322-10AI-TEKT module: x0A0 to x0AF

Index (hex)	Data Type	Name	Function	Mapping	Access	
0x1027	UNSIGNED16	ModuleID	Module Identification Number	–	ro	SDO
0x30A0	UNSIGNED16	ModuleDiag	Module Diagnostic Messages	Manual	ro	PDO
0x30A1	INTEGER16	InputChannel1	Input Channel 1	Manual	ro	PDO
0x30A2	INTEGER16	InputChannel2	Input Channel 2	Manual	ro	PDO
0x30A3	INTEGER16	InputChannel3	Input Channel 3	Manual	ro	PDO
0x30A4	INTEGER16	InputChannel4	Input Channel 4	Manual	ro	PDO
0x30A5	INTEGER16	InputChannel5	Input Channel 5	Manual	ro	PDO
0x30A6	INTEGER16	InputChannel6	Input Channel 6	Manual	ro	PDO
0x30A7	INTEGER16	InputChannel7	Input Channel 7	Manual	ro	PDO
0x30A8	INTEGER16	InputChannel8	Input Channel 8	Manual	ro	PDO
0x30A9	INTEGER16	ReferencelInput1	Input Reference 1	Manual	ro	PDO
0x30AA	INTEGER16	ReferencelInput2	Input Reference 2	Manual	ro	PDO
0x30AB	UNSIGNED16	WireBreakDiag	Wire Break Diagnostic Messages	Manual	ro	PDO
0x4001	VISIBLE STRING	SerialNumber	Serial Number	–	const	SDO
0x4004	UNSIGNED8	UserLEDControl	User LED Control	–	rw	SDO
0x400C	VISIBLE STRING	ProductName	Product Name	–	ro	SDO
0x40A0	UNSIGNED16	FirmwareVersion	Firmware Version	–	ro	SDO
0x50A0	UNSIGNED8	SensorTypeSelectChannel1_2	Sensor Type Selection Channel 1_2	–	rw	SDO
0x50A1	UNSIGNED8	SensorTypeSelectChannel3_4	Sensor Type Selection Channel 3_4	–	rw	SDO

23 Analog input module XN-322-10AI-TEKT

23.4 Supported CANopen objects

Index (hex)	Data Type	Name	Function	Mapping	Access	
0x50A2	UNSIGNED8	SensorTypeSelectChannel5_6	Sensor Type Selection Channel 5_6	–	rw	SDO
0x50A3	UNSIGNED8	SensorTypeSelectChannel7_8	Sensor Type Selection Channel 7_8	–	rw	SDO
0x50A4	UNSIGNED8	ReferenceInputSelect	Reference Input Select Cold-junction compensation configuration (KTY1,KTY2)	–	rw	SDO

24 Analog output module XN-322-8AO-U2

XN-322-8AO-U2 modules are XN300 slice modules with 8 analog output channels that can be used to output a voltage signal within a range of -10 to 10 V.

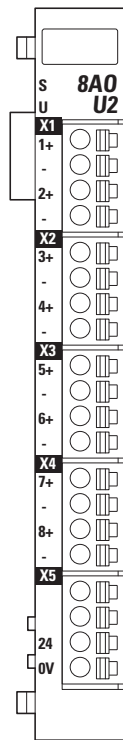

Figure 93: Device view XN-322-8AO-U2

24 Analog output module XN-322-8AO-U2

24.1 Status LEDs

24.1 Status LEDs

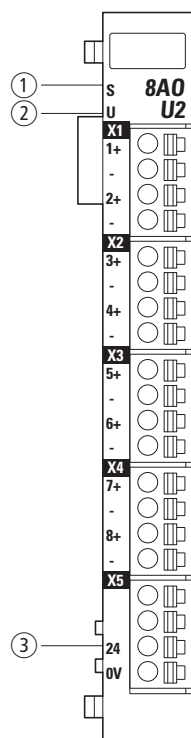

Figure 94: LED signals and pin assignment

- ① Module status LED
- ② User LED
- ③ Supply voltage status LED

Module status	green	ON	System OK
		OFF	No power
		FLASHES (5 Hz)	No communication
Status User	yellow	ON	The user can set the LED signals as necessary. (For example, the visualization interface can be used to set the module's LED to flash so that it is easier to find the module inside the control panel.)
		OFF	
		FLASH (200 ms ON, 1000 ms OFF)	
		FLASH (1000 ms ON, 200 ms OFF)	
Status Supply voltage	green	ON	Faulty supply voltage
		OFF	Supply voltage OK

24.2 Pin assignment

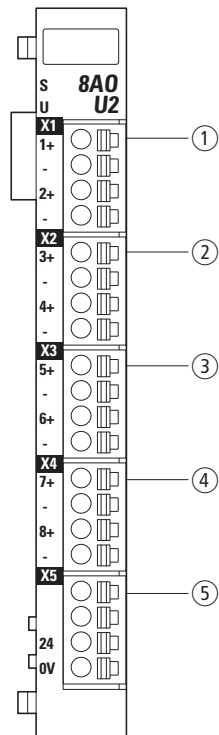

Figure 95: Pin assignment

- ① X1
 - 1+ analog output 1
 - - GND
 - 2+ analog output 2
 - - GND 1-
- ② X2
 - 3+ analog output 3
 - - GND 1+
 - 4+ analog output 4
 - - GND 1-
- ③ X3
 - 5+ analog output 5
 - - GND
 - 6+ analog output 6
 - - GND
- ④ X4
 - 7+ analog output 7
 - - GND
 - 8+ analog output 8
 - - GND
- ⑤ X5
 - nc
 - nc
 - 24VDC power supply U_{e24}
 - GND supply

24 Analog output module XN-322-8AO-U2

24.3 Wiring

24.3 Wiring

Two analog outputs can be wired to each of the four X1 to X4 connectors.

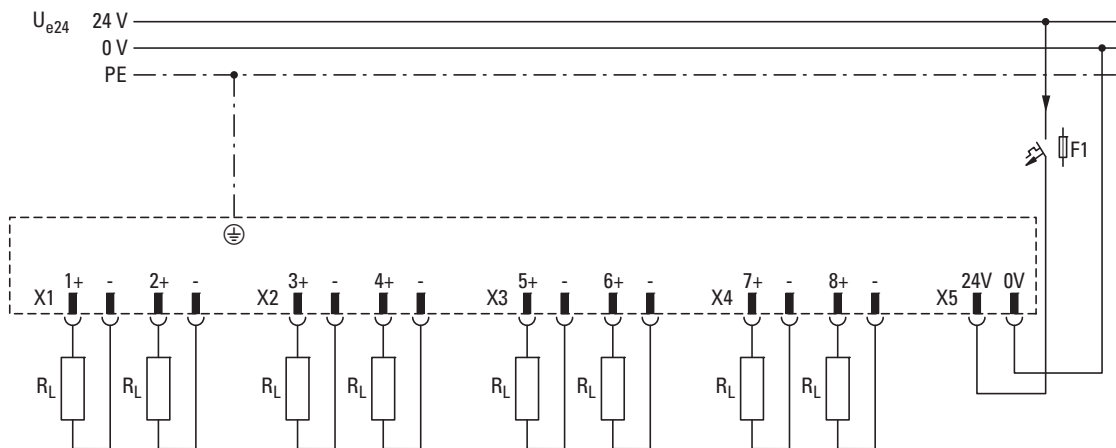

Figure 96: Connection diagram for analog outputs

24.4 Technical data for analog outputs

Number of analog channels		8
Measuring range	V	-10 ... +10
Measured value	mV	-10,000 ... +10,000
D-A converter		12 Bit
Resolution	mV/LSB	5
Internal module refresh time	ms	1
Min. load resistance	kΩ	> 5
Max. capacitive load	nF	100
short-circuit protection		yes (max. 1 minute)
Accuracy		
Cumulative error	%	± 0.5

24.5 Memory layout

CAN Object Index		Size (byte)	Description		
0x20D0	0x6411	2	Analog output value 1 (A01)		
0x20D1	0x6411	2	Analog output value 2 (A02)		
0x20D2	0x6411	2	Analog output value 3 (A03)		
0x20D3	0x6411	2	Analog output value 4 (A04)		
0x20D4	0x6411	2	Analog output value 5 (A05)		
0x20D5	0x6411	2	Analog output value 6 (A06)		
0x20D6	0x6411	2	Analog output value 7 (A07)		
0x20D7	0x6411	2	Analog output value 8 (A08)		
0x30D0		2	Modules Diagnostics	Bit 0	24 VDC supply voltage faulty
				Bit 1	No SYNC signal
				Bit 2	FLASH-CRC error
				Bit 3	RAM-CRC error
				Bit 4	Flash memory error
				Bit 5-15	reserved

24 Analog output module XN-322-8AO-U2

24.6 Supported CANopen objects

24.6 Supported CANopen objects

Product-specific CANopen objects

Index (hex)	Data Type	Name	Function	Mapping	Access	
0x6411	INTEGER16	Q-WORD	Write Analog Output 16-bit	Default	rww	PDO

Manufacturer-specific objects

Index range for the XN-322-8AO-U2 module: x0D0 to x0DF

Index (hex)	Data Type	Name	Function	Mapping	Access	
0x1027	UNSIGNED16	ModuleID	Module Identification Number	Manual	ro	PDO
0x20D0	INTEGER16	OutputChannel1	Output Channel 1	Manual	rw	PDO
0x20D1	INTEGER16	OutputChannel2	Output Channel 2	Manual	rw	PDO
0x20D2	INTEGER16	OutputChannel3	Output Channel 3	Manual	rw	PDO
0x20D3	INTEGER16	OutputChannel4	Output Channel 4	Manual	rw	PDO
0x20D4	INTEGER16	OutputChannel5	Output Channel 5	Manual	rw	PDO
0x20D5	INTEGER16	OutputChannel6	Output Channel 6	Manual	rw	PDO
0x20D6	INTEGER16	OutputChannel7	Output Channel 7	Manual	rw	PDO
0x20D7	INTEGER16	OutputChannel8	Output Channel 8	Manual	rw	PDO
0x30D0	UNSIGNED16	ModuleDiag	Module Diagnostic Messages	Manual	ro	PDO
0x4001	VISIBLE STRING	SerialNumber	Serial Number	–	const	SDO
0x4004	UNSIGNED8	UserLEDControl	User LED Control	–	rw	SDO
0x400C	VISIBLE STRING	ProductName	Product Name	–	ro	SDO
0x40D0	UNSIGNED16	FirmwareVersion	Firmware Version	–	ro	SDO

25 Analog input/output module ± 10 V XN-322-4AIO-U2

The XN-322-8AIO-U2 is an XN300 slice module that features two analog input channels that can be used to measure a voltage input signal within a range of -10 to 10 V, two analog output channels that can be used to output a voltage signal within a range of -10 to 10 V, and a reference voltage source with 10 V/10 mA and 2 pins that makes it possible to directly power potentiometers in order to read their position using the aforementioned analog voltage inputs.

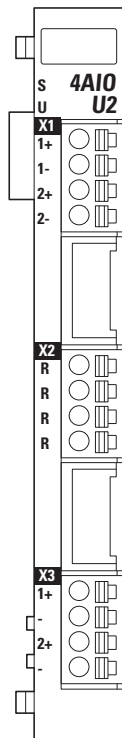

Figure 97: Device view XN-322-4AIO-U2

25 Analog input/output module ± 10 V XN-322-4AIO-U2

25.1 Status LEDs

25.1 Status LEDs

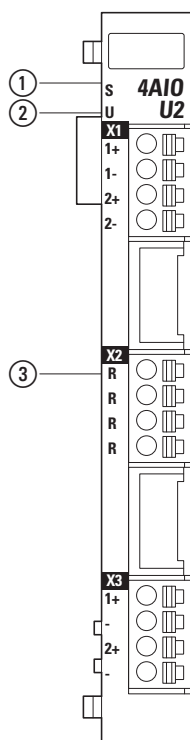

Figure 98: LED signals and pin assignment

- ① Module status LED
- ② User LED
- ③ Reference fault LED

Module status	green	ON	System OK
		OFF	No power
		FLASHES (5 Hz)	No communications
User	yellow	ON	The user can set the LED signals as necessary. (For example, the visualization interface can be used to set the module's LED to flash so that it is easier to find the module inside the control panel.)
		OFF	
		FLASH (200 ms ON, 1000 ms OFF)	
		FLASH (1000 ms ON, 200 ms OFF)	
Error Reference	red	ON	10 V reference overload
		FLASHES (20Hz)	Overload GND Evaluated if Alx is configured to be connected to GND (ground reference).
		OFF	No fault

25.2 Pin assignment

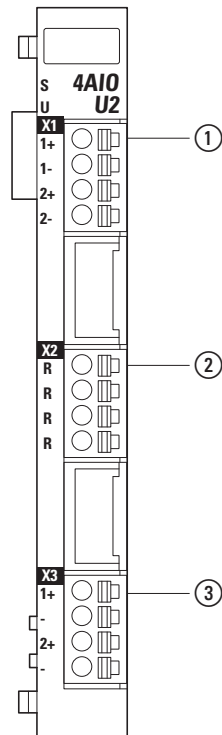

Figure 99: Pin assignment

- ① X1
 - 1+ analog input 1+
 - 1- analog input 1-
 - 2+ analog input 2+
 - 2- analog input 2-
- ② X2
 - R reference +10 V
 - R reference +10 V
 - R reference +10 V
 - R reference +10 V
- ③ X3
 - 1+ analog output 1+
 - - GND
 - 2+ analog output 2+
 - - GND

25.3 Wiring

Two analog inputs are wired to connector X1, and two analog outputs are wired to connector X3.

25 Analog input/output module ± 10 V XN-322-4AIO-U2

25.3 Wiring

25.3.1 Analog output wiring

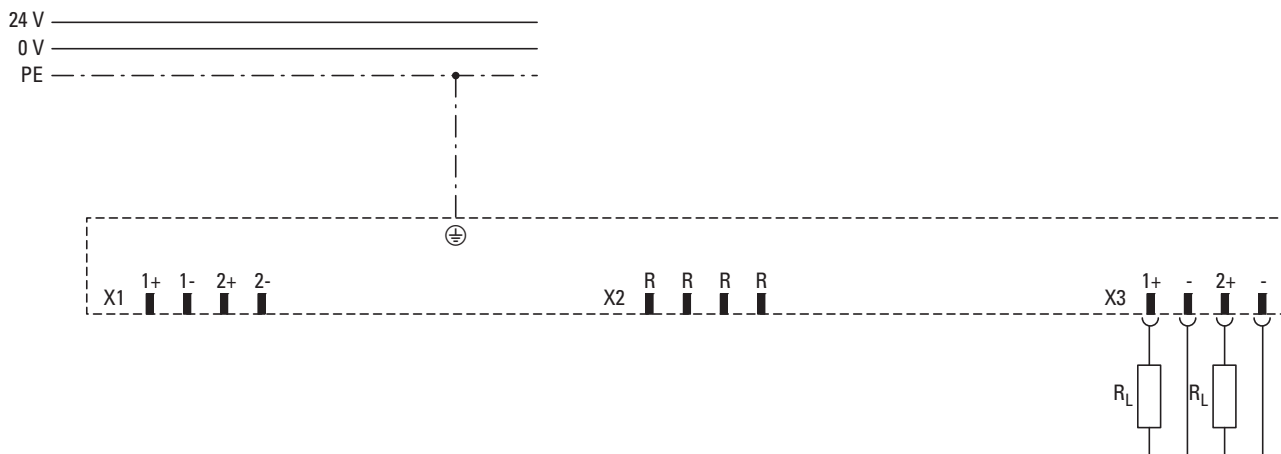

Figure 100: Analog outputs connection

25.3.2 Potentiometer measurements

When using potentiometer measurements, the potentiometer is powered using the reference voltage and A_{Ix} is directly connected to GND by configuring the corresponding parameters. These parameters can be configured using object 0x51A0.

The potentiometer's position can then be interpreted as a percentage by measuring the analog voltage at the potentiometer's wiper contact..

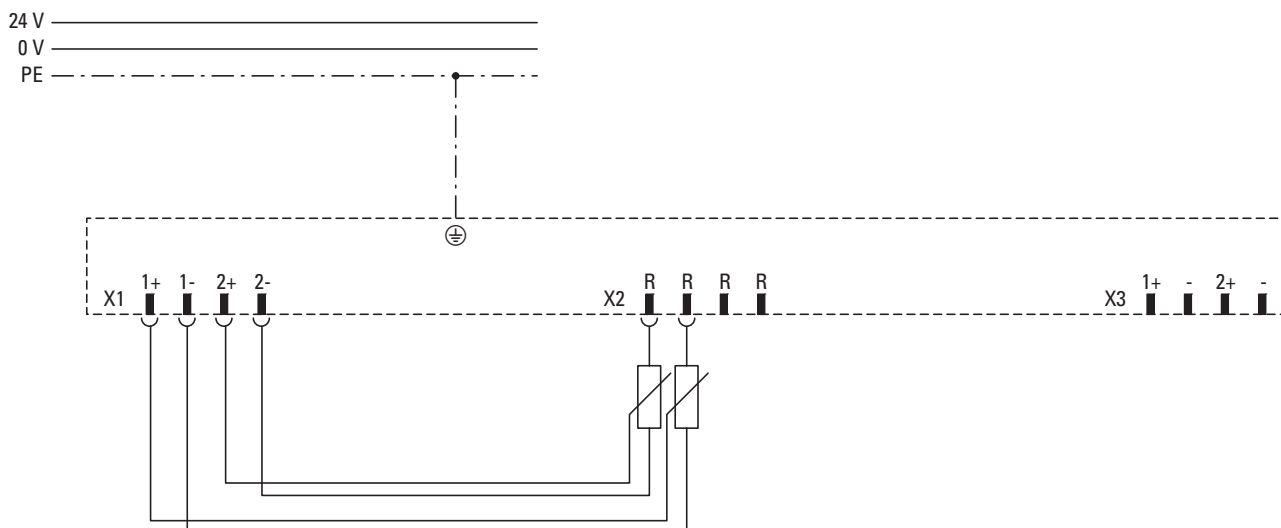

Figure 101: Potentiometer measurement wiring

25.3.3 Measurements using sensors

In order to measure a sensor's output voltage via an analog input, a differential voltage measurement is carried out without connecting either input cable to ground (GND). The signal being measured must fall within the input's permissible common mode range.

Voltage measurement for floating voltage sources

When using a non-floating voltage source (a voltage source with reference to GND), the input must be configured as a differential analog input by means of software. The corresponding parameter can be configured using object 0x51A0. In order to avoid errors in measurement caused by compensating currents, there must not be any connection between analog input AI- and GND when it comes to the analog input.

Voltage measurement for non-floating voltage sources

When using a floating voltage source (a voltage source without reference to GND), the input must be configured as a GND ground reference by means of software or an external reference to GND must be established. The corresponding parameter can be configured using object 0x51A0. The GND reference will prevent the measurement signal from moving out of the permissible measurement range.

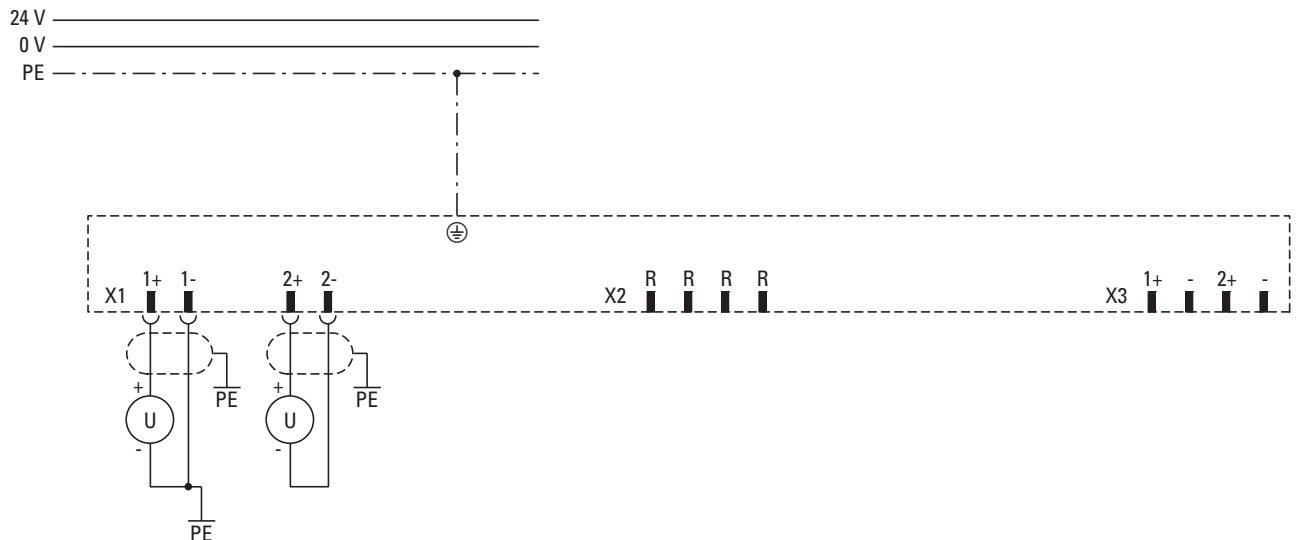

Figure 102: Wiring analog inputs in order to measure one non-floating voltage source (1+/1-) and one floating voltage source (2+/2-)

25.4 Diagnostics

Cable break diagnostics will only be run for the analog inputs. The R voltage reference outputs will be individually monitored for overcurrent, short-circuits, and an excessively high total current. Object 0x31A3 delivers the diagnostics – please refer to manual „CANopen Gateway XN312-GW-CAN“, MN050003.

25 Analog input/output module ± 10 V XN-322-4AIO-U2

25.5 Filters

25.5 Filters

The low-pass cutoff frequency can be individually configured for each input channel using the appropriate register. This cutoff frequency is specified in Hz without any decimal places.

Example: 50 Hz low-pass cutoff frequency; register value: $50_{\text{dec}} / 32_{\text{hex}}$

The following settings are valid:

Low-pass cut-off frequency	Register value
Filter disabled (default)	0x0000
10 Hz	0x000A
25 Hz	0x0019
50 Hz	0x0032
100 Hz	0x0064
250 Hz	0x00FA
500 Hz	0x01F4
1000 Hz	0x03E8

25.6 Technical Data

25.6.1 Analog inputs ± 10 V / 0...100%

Number of channels		2	
Measurement type		Differential input	Potentiometer input
Measuring range	V	-10 V ... +10 V	0 ... 100 % (potentiometer)
Measurement display		-10,000 ... +10,000	0 ... 10,000
D-A converter	Bit	16	
Resolution		0.3 mV / LSB	
Conversion time per channel	ms	1	
Common-mode range	V	± 12	
Input resistance	M Ω	> 10	
Open wire monitoring		yes	
Input filters			
Hardware		Typically: 1 kHz, third-order low-pass filter	
Software, parameterizable		parameterizable	
Cumulative error as a percentage of full scale value	%	± 0.3	± 0.35

25.6.2 Analog outputs ± 10 V

Number of channels		2
Measuring range	V	-10 ... +10
Measurement display		-10,000 ... +10,000
D-A converter	Bit	12
Resolution		approx. 5 mV / LSB
Internal module refresh time	μ s	≥ 250
Minimum load resistance	k Ω	> 5
Maximum capacitive load	nF	100
Short-circuit proof		yes (max. 1 minute)
Recovery time (typical) for		
63% of end value	μ s	50
86% of end value	μ s	100
99% of end value	μ s	250
Cumulative error as a percentage of full scale value	%	± 0.5

25.6.3 Reference output +10V

Number of channels		1
Connection points per channel		4
Reference voltage	V	+10
Permissible load per potentiometer input		
Current	mA	≤ 4.17
Potentiometer	k Ω	≥ 2.4
Maximum capacitive load	nF	100
Short-circuit proof		yes (max. 1 minute)
Cumulative error as a percentage of full scale value	%	± 0.5

25 Analog input/output module ± 10 V XN-322-4AIO-U2

25.7 Memory layout

25.7 Memory layout

CAN Object Index		Size (byte)	Description	Bit	
0x21A0	0x6411	2	Analog output value 1 (AO1)		
0x21A1	0x6411	2	Analog output value 2 (AO2)		
0x30A0		2	Modul Diagnostics	Bit 0	24 VDC supply voltage faulty
				Bit 1	No SYNC signal
				Bit 2	FLASH-CRC error
				Bit 3	RAM-CRC error
				Bit 4	Flash memory error
				Bit 5-15	reserved
0x31A1	0x6401	2	Analog input value 1 (AI1)		
0x31A2	0x6401	2	Analog input value 2 (AI2)		
0x31A3		2	Open wire diagnostics	Bit 0	1: Cable break input AI1
				Bit 1	1: Cable break input AI2
				Bit 2	reserved
				Bit 3	reserved
				Bit 4	1: Reference Low Voltage
				Bit 5	1: Reference Overcurrent
				Bit 6-15	reserved
0x51A0		2	Parameter definition channel	Bit 0 (AI1)	0: Differential measurement 1: AI1- grounded measurement
			Measured value 1 (AI1)	Bit 1 (AI2)	0: Differential measurement 1: AI2- grounded measurement
			Measured value 2 (AI2)	Bit 2-15	reserved
0x50B1		2	Setting for AI1 input filter		Used to specify the cutoff frequency as a decimal value in Hz.
0x50B2		2	Setting for AI2 input filter		

25.8 Supported CANopen objects

Product-specific CANopen objects

Index (hex)	Data Type	Name	Function	Mapping	Access	
0x6401	INTEGER16	I-WORD	Read Analog Input 16-bit	Default	ro	PDO
0x6411	INTEGER16	Q-WORD	Write Analog Output 16-bit	Default	ro	PDO
0x6421	UNSIGNED8	AI_INTERRUPT_TRIGGER_SELECTION	Analog Input Interrupt Trigger Selection	–	rw	SDO
0x6423	BOOLEAN	AnalogInputGlobalInterruptEnable	Analog Input Global Interrupt Enable	–	rw	SDO
0x6424	INTEGER32	I-WORD_UPPER_LIMIT	Analog Input Interrupt Upper Limit Integer	–	rw	SDO
0x6425	INTEGER32	I-WORD_LOWER_LIMIT	Analog Input Interrupt Lower Limit Integer	–	rw	SDO
0x6426	UNSIGNED32	I-WORD_DELTA_VALUE	Analog Input Interrupt Delta Unsigned	–	rw	SDO
0x6427	UNSIGNED32	I-WORD_NEGATIVE_DELTA_VALUE	Analog Input Interrupt Negative Delta Unsigned	–	rw	SDO
0x6428	UNSIGNED32	I-WORD_POSITIVE_DELTA_VALUE	Analog Input Interrupt Positive Delta Unsigned	–	rw	SDO

Vendor-specific objects

Index range for the XN-322-4AIO-U2 module: x1A0 to x1AF

Index (hex)	Data Type	Name	Function	Mapping	Access	
0x1027	UNSIGNED16	ModuleID	Module Identification Number	–	ro	SDO
0x20A0	INTEGER16	OutputChannel1	Output Channel 1	Manual	rww	PDO
0x21A1	INTEGER16	OutputChannel2	Output Channel 2	Manual	rww	PDO
0x31A0	UNSIGNED16	ModuleDiag	Module Diagnostic Messages	Manual	ro	PDO
0x31A1	INTEGER16	InputChannel1	Input Channel 1	Manual	ro	PDO
0x31A2	INTEGER16	InputChannel2	Input Channel 2	Manual	ro	PDO
0x31A3	UNSIGNED16	WireBreakDiag	Wire Break Diagnostic Messages	Manual	ro	PDO
0x4001	VISIBLE STRING	SerialNumber	Serial Number	–	const	SDO
0x4004	UNSIGNED8	UserLEDControl	User LED Control	–	rw	SDO
0x400C	VISIBLE STRING	ProductName	Product Name	–	ro	SDO
0x41A0	UNSIGNED16	FirmwareVersion	Firmware Version	–	ro	SDO
0x51A0	UNSIGNED16	AnalogInputSelection	Analog Input Selection	–	rw	SDO
0x51A1	UNSIGNED16	FilterConfigChannel1	Filter Configuration Channel 1	–	rw	SDO
0x51A2	UNSIGNED16	FilterConfigChannel2	Filter Configuration Channel 2	–	rw	SDO

25 Analog input/output module ± 10 V XN-322-4AIO-U2

25.8 Supported CANopen objects

26 Analog input/output module ± 10 V XN-322-8AIO-U2

The XN-322-8AIO-U2 is an XN300 slice module that features four analog input channels that can be used to measure a voltage input signal within a range of -10 to 10 V, four analog output channels that can be used to output a voltage signal within a range of -10 to 10 V, and a reference voltage source with 10 V/10 mA and 4 pins that makes it possible to directly power potentiometers in order to read their position using the aforementioned analog voltage inputs.

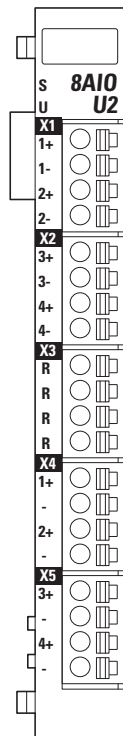

Figure 103: Device view XN-322-8AIO-U2

26 Analog input/output module ± 10 V XN-322-8AIO-U2

26.1 Status LEDs

26.1 Status LEDs

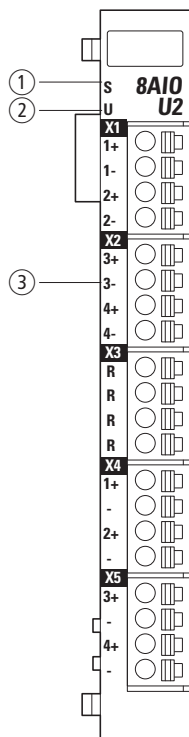

Figure 104: LED signals and pin assignment

- ① Module status LED
- ② User LED
- ③ Reference fault LED

Module status	green	ON	System OK
		OFF	No power
		FLASHES (5 Hz)	No communications
User	yellow	ON	The user can set the LED signals as necessary. (For example, the visualization interface can be used to set the module's LED to flash so that it is easier to find the module inside the control panel.)
		OFF	
		FLASH (200 ms ON, 1000 ms OFF)	
		FLASH (1000 ms ON, 200 ms OFF)	
Error Reference	red	ON	10 V reference overload
		FLASHES (20Hz)	Overload GND Evaluated if Alx is configured to be connected to GND (ground reference).
		OFF	No fault

26.2 Pin assignment

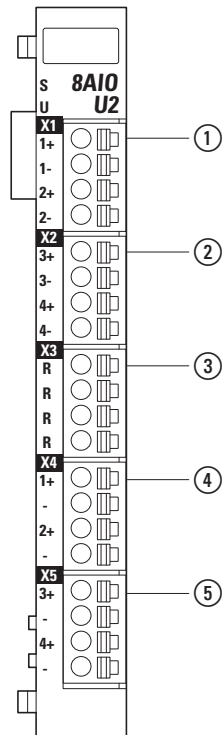

Figure 105: Pin assignment

- ① X1
 - 1+ analog input 1+
 - 1- analog input 1-
 - 2+ analog input 2+
 - 2- analog input 2-
- ② X2
 - 3+ analog input 3+
 - 3- analog input 3-
 - 4+ analog input 4+
 - 4- analog input 4-
- ③ X3
 - R reference +10 V
 - R reference +10 V
 - R reference +10 V
 - R reference +10 V
- ④ X4
 - 1+ analog output 1+
 - – GND
 - 2+ analog output 2+
 - – GND
- ⑤ X5
 - 3+ analog output 3+
 - – GND
 - 4+ analog output 4+
 - – GND

26.3 Wiring

Two analog inputs / outputs are wired to each of the four connectors.

26 Analog input/output module ± 10 V XN-322-8AIO-U2

26.3 Wiring

26.3.1 Analog output wiring

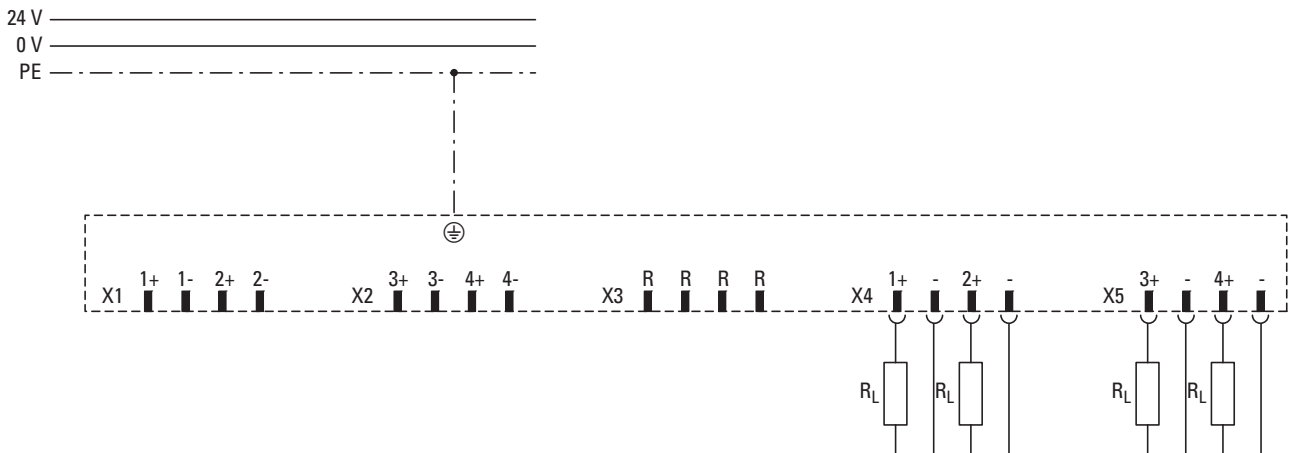

Figure 106: Analog outputs connection

26.3.2 Potentiometer measurements

When using potentiometer measurements, the potentiometer is powered using the reference voltage and A_Ix is directly connected to GND by configuring the corresponding parameters. The potentiometer's position can then be interpreted as a % by measuring the analog voltage at the potentiometer's wiper contact.

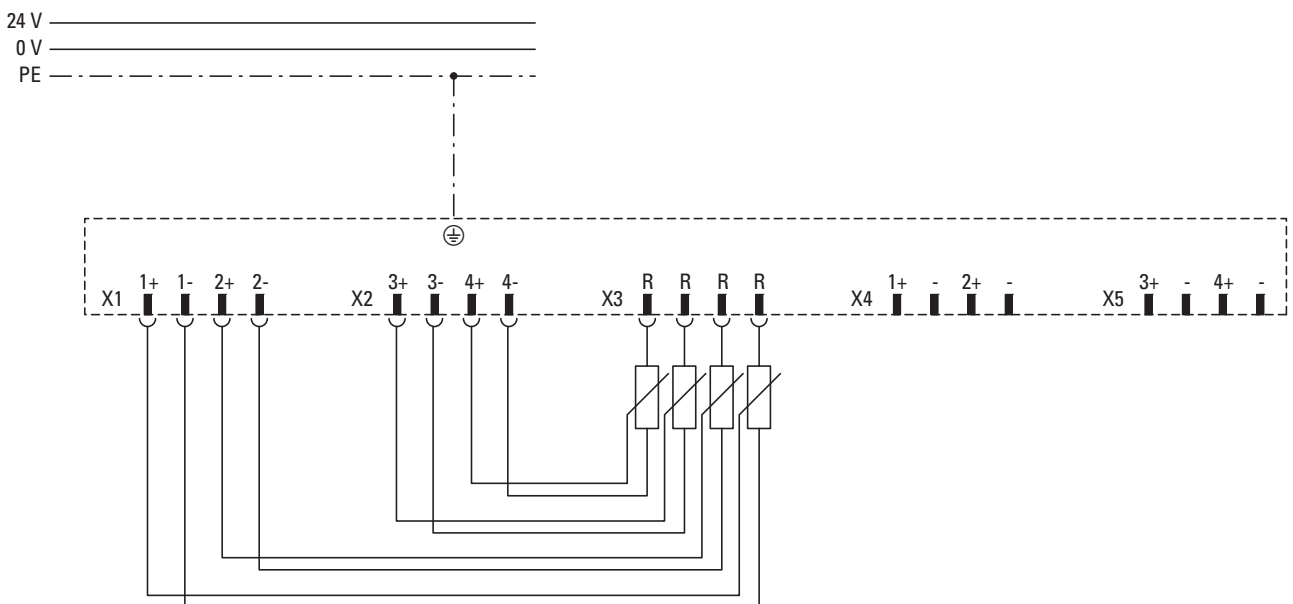

Figure 107: Potentiometer measurement wiring

26.3.3 Measurements using sensors

In order to measure a sensor's output voltage via an analog input, a differential voltage measurement is carried out without connecting either input cable to ground (GND). The signal being measured must fall within the input's permissible common mode range.

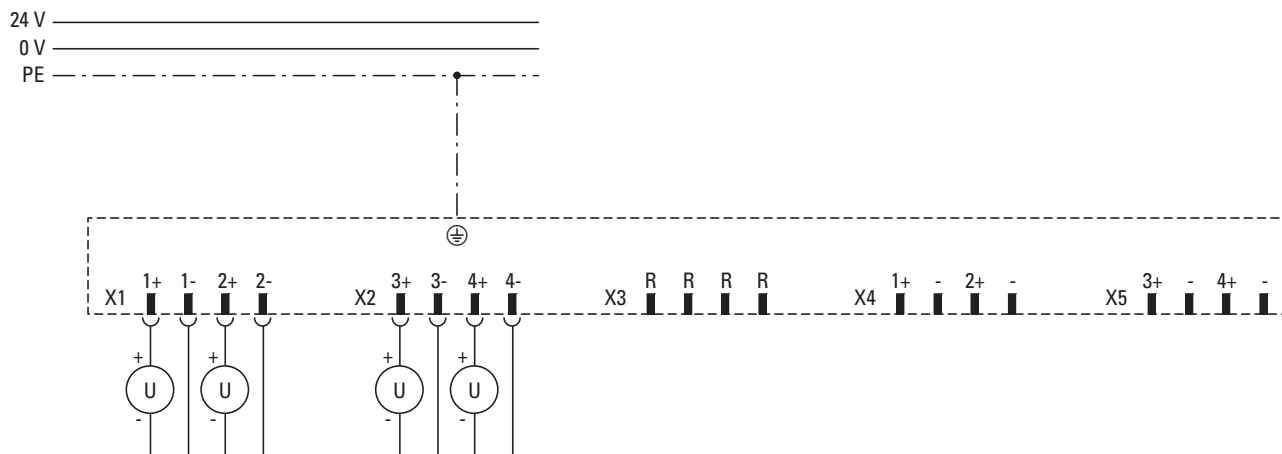

Figure 108: Wiring for analog inputs in order to measure a sensor

26.4 Diagnostics

Cable break diagnostics will only be run for the analog inputs. The R voltage reference outputs will be individually monitored for overcurrent, short-circuits, and an excessively high total current. Object 0x30B5 delivers the diagnostics – please refer to manual „CANopen Gateway XN312-GW-CAN“, MN050003.

26 Analog input/output module ± 10 V XN-322-8AIO-U2

26.5 Filters

26.5 Filters

The low-pass cutoff frequency can be configured for each input channel using the appropriate register. This cutoff frequency is specified in Hz without any decimal places.

Example: 50 Hz low-pass cutoff frequency; register value: $50_{\text{dec}} / 32_{\text{hex}}$

The following settings are valid:

Low-pass cut-off frequency	Register value
Filter disabled (default)	0x0000
10 Hz	0x000A
25 Hz	0x0019
50 Hz	0 x0032
100 Hz	0x0064
250 Hz	0x00FA
500 Hz	0x01F4
1000 Hz	0x03E8

26.6 Technical Data

26.6.1 Analog inputs ± 10 V/0 – 100%

Number of channels		4
Measurement type		Differential input Potentiometer input
Measuring range	V	-10 V ... +10 V 0 ... 100 % (potentiometer)
Measurement display		-10,000 ... +10,000 0 ... 10,000
A-D converter	Bit	16
Resolution		0.3 mV / LSB
Conversion time per channel	ms	1
Common-mode range	V	± 12
Input resistance	M Ω	> 10
Open wire monitoring		yes
Input filters		
Hardware		Typically: 1 kHz, third-order low-pass filter
Software, parameterizable		parameterizable
Cumulative error as a percentage of full scale value	%	± 0.3 ± 0.35

26.6.2 Analog outputs ± 10 V

Number of channels		4
Measuring range	V	-10 ... +10
Measurement display		-10,000 ... +10,000
A-D converter	Bit	12
Resolution		approx. 5 mV / LSB
Internal module refresh time	μ s	≥ 250
Minimum load resistance	k Ω	> 5
Maximum capacitive load	nF	100
Short-circuit proof		yes (max. 1 minute)
Cumulative error as a percentage of full scale value	%	± 0.5

26.6.3 Reference output +10V

		Device version	
		1.00 or higher	3.01 or higher
Number of channels		1	
Connection points per channel		4	
Reference voltage	V	+10	
Permissible load per potentiometer input			
Current	mA	≤ 2.50 mA	≤ 4.17 mA
Potentiometer	k Ω	≥ 4 k Ω	≥ 2.4 k Ω
Maximum operating temperature	$^{\circ}$ C	0 ... 60 $^{\circ}$ C	0 ... 55 $^{\circ}$ C
Maximum capacitive load	nF	100	
Short-circuit proof		yes (max. 1 minute)	
Cumulative error as a percentage of full scale value	%	± 0.5	

26.7 Memory layout

CAN Object Index	Size (byte)	Description	Bit
0x20B0	0x6411	2	Analog output value 1 (AO1)
0x20B1	0x6411	2	Analog output value 2 (AO2)
0x20B2	0x6411	2	Analog output value 3 (AO3)
0x20B3	0x6411	2	Analog output value 4 (AO4)

26 Analog input/output module ±10 V XN-322-8AIO-U2

26.7 Memory layout

CAN Object Index	Size (byte)	Description	Bit		
0x30B0	2	Modul Diagnostics	Bit 0	24 VDC supply voltage faulty	
			bit1	No SYNC signal	
			Bit 2	FLASH-CRC error	
			Bit3	RAM-CRC error	
			Bit 4	Flash memory error	
			Bit 5-15	reserved	
0x30B1	0x6401	2	Analog input value 1 (AI1)		
0x30B2	0x6401	2	Analog input value 2 (AI2)		
0x30B3	0x6401	2	Analog input value 3 (AI3)		
0x30B4	0x6401	2	Analog input value 4 (AI4)		
0x30B5	2	Open wire diagnostics	Bit 0	1: Cable break input AI1	
			bit1	1: Cable break input AI2	
			Bit 2	1: Cable break input AI3	
			Bit3	1: Cable break input AI4	
			Bit 4	1: Reference Low Voltage	
			Bit 5	1: Reference Overcurrent	
Bit 6-15	reserved				
0x50B0	2	Parameter definition channel	Measured value 1 (AI1)	Bit 0 (AI1)	0: Differential measurement
				1: AI1- Grounded Messung	
			Measured value 2 (AI2)	Bit 1 (AI2)	0: Differential measurement
				1: AI2- Grounded Messung	
			Measured value 3 (AI3)	Bit 2 (AI3)	0: Differential measurement
				1: AI3- Grounded Messung	
			Measured value 4 (AI4)	Bit 3 (AI4)	0: Differential measurement
				1: AI4- Grounded Messung	
Bit 4-15	reserved				
0x50B1	2	Setting for AI1 input filter		Used to specify the cutoff frequency as a decimal value in Hz.	
0x50B2	2	Setting for AI2 input filter			
0x50B3	2	Setting for AI3 input filter			
0x50B4	2	Setting for AI4 input filter			

26.8 Supported CANopen objects

Product-specific CANopen objects

Index (hex)	Data Type	Name	Function	Mapping	Access	
0x6401	INTEGER16	I-WORD	Read Analog Input 16-bit	Default	ro	PDO
0x6411	INTEGER16	Q-WORD	Write Analog Output 16-bit	Default	ro	PDO
0x6421	UNSIGNED8	AI_INTERRUPT_TRIGGER_SELECTION	Analog Input Interrupt Trigger Selection	–	rw	SDO
0x6423	BOOLEAN	AnalogInputGlobalInterruptEnable	Analog Input Global Interrupt Enable	–	rw	SDO
0x6424	INTEGER32	I-WORD_UPPER_LIMIT	Analog Input Interrupt Upper Limit Integer	–	rw	SDO
0x6425	INTEGER32	I-WORD_LOWER_LIMIT	Analog Input Interrupt Lower Limit Integer	–	rw	SDO
0x6426	UNSIGNED32	I-WORD_DELTA_VALUE	Analog Input Interrupt Delta Unsigned	–	rw	SDO
0x6427	UNSIGNED32	I-WORD_NEGATIVE_DELTA_VALUE	Analog Input Interrupt Negative Delta Unsigned	–	rw	SDO
0x6428	UNSIGNED32	I-WORD_POSITIVE_DELTA_VALUE	Analog Input Interrupt Positive Delta Unsigned	–	rw	SDO

Vendor-specific objects

Index range for the XN-322-8AIO-U2 module: x0B0 to x0BF

Index (hex)	Data Type	Name	Function	Mapping	Access	
0x1027	UNSIGNED16	ModuleID	Module Identification Number	–	ro	SDO
0x20B0	INTEGER16	OutputChannel1	Output Channel 1	Manual	rww	PDO
0x20B1	INTEGER16	OutputChannel2	Output Channel 2	Manual	rww	PDO
0x20B2	INTEGER16	OutputChannel3	Output Channel 3	Manual	rww	PDO
0x20B3	INTEGER16	OutputChannel4	Output Channel 4	Manual	rww	PDO
0x30B0	UNSIGNED16	ModuleDiag	Module Diagnostic Messages	Manual	ro	PDO
0x30B1	INTEGER16	InputChannel1	Input Channel 1	Manual	ro	PDO
0x30B2	INTEGER16	InputChannel2	Input Channel 2	Manual	ro	PDO
0x30B3	INTEGER16	InputChannel3	Input Channel 3	Manual	ro	PDO
0x30B4	INTEGER16	InputChannel4	Input Channel 4	Manual	ro	PDO
0x30B5	UNSIGNED16	WireBreakDiag	Wire Break Diagnostic Messages	Manual	ro	PDO
0x4001	VISIBLE STRING	SerialNumber	Serial Number	–	const	SDO
0x4004	UNSIGNED8	UserLEDControl	User LED control	–	rw	SDO
0x400C	VISIBLE STRING	ProductName	Product Name	–	ro	SDO
0x40B0	UNSIGNED16	FirmwareVersion	Firmware Version	–	ro	SDO
0x50B0	UNSIGNED16	AnalogInputSelection	Analog Input Selection	–	rw	SDO
0x50B1	UNSIGNED16	FilterConfigChannel1	Filter Configuration Channel 1	–	rw	SDO

26 Analog input/output module ± 10 V XN-322-8AIO-U2

26.8 Supported CANopen objects

0x50B2	UNSIGNED16	FilterConfigChannel2	Filter Configuration Channel 2	–	rw	SDO
0x50B3	UNSIGNED16	FilterConfigChannel3	Filter Configuration Channel 3	–	rw	SDO
0x50B4	UNSIGNED16	FilterConfigChannel4	Filter Configuration Channel 4	–	rw	SDO

27 Analog input/output module XN-322-4AIO-I

The XN-322-4AIO-I is an XN300 slice module with two analog input channels used to measure current input signals within a measuring range of 0 – 20 mA or 4 – 20 mA. In addition, it features two analog output channels with an output range of 0 – 20 mA. The power supply for the current inputs and outputs will be monitored for undervoltage.

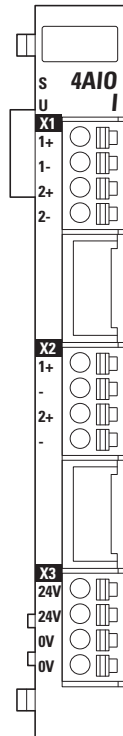

Figure 109: Device view XN-322-4AIO-I

27 Analog input/output module XN-322-4AIO-I

27.1 Status LED signals

27.1 Status LED signals

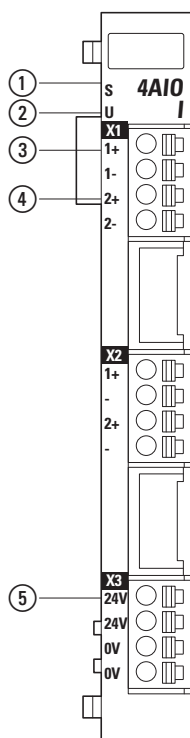

Figure 110: LED signals and pin assignment

- ① Module status LED
- ② User status LED
- ③ Cable break LED indicator for analog input 1
- ④ Cable break LED indicator for analog input 2
- ⑤ Supply voltage status LED

Module status	green	ON	System OK
		OFF	No power
		FLASHES (5 Hz)	No communication
Status User	yellow	ON	The user can set the LED signals as necessary. (For example, the visualization interface can be used to set the module's LED to flash so that it is easier to find the module inside the control panel.)
		OFF	
		FLASH (200 ms ON, 1000 ms OFF)	
		FLASH (1000 ms ON, 200 ms OFF)	
Analog input status	red	ON	Minimum current (4 mA) fallen below / cable break
		FLASH (2 Hz)	Maximum current exceeded
Power supply status	green	ON	Supply voltage for analog inputs and outputs OK
		OFF	Supply voltage for inputs and outputs faulty

27.2 Pin assignment

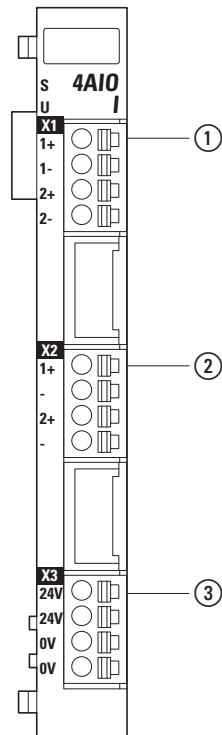

Figure 111: Pin assignment

① X1

- 1+ analog input 1+
- 1- analog input 1-
- 2+ analog input 2+
- 2- analog input 2-

② X2

- 1+ analog output 1+
- - GND
- 2+ analog output 2+
- - GND

③ X3

- 24V supply voltage +24VDC
- 24V supply voltage +24VDC
- 0V GND
- 0V GND

27.3 wiring

Two analog inputs can be wired to connector X1. A measuring range of 4–20 mA with cable break monitoring is supported, as is a measuring range of 0–20 mA without cable break monitoring.

The current input channels use a differential voltage measurement at an internal module resistor with a resistance of 50 Ω .

It must be ensured that the input signals' voltage levels fall within the permissible common mode range.

27 Analog input/output module XN-322-4AIO-I

27.4 Technical data

Two analog outputs for a burden resistance of less than 500 Ω can be wired to connector X2.

$$0 < R_{\text{burden}} < 500 \Omega$$

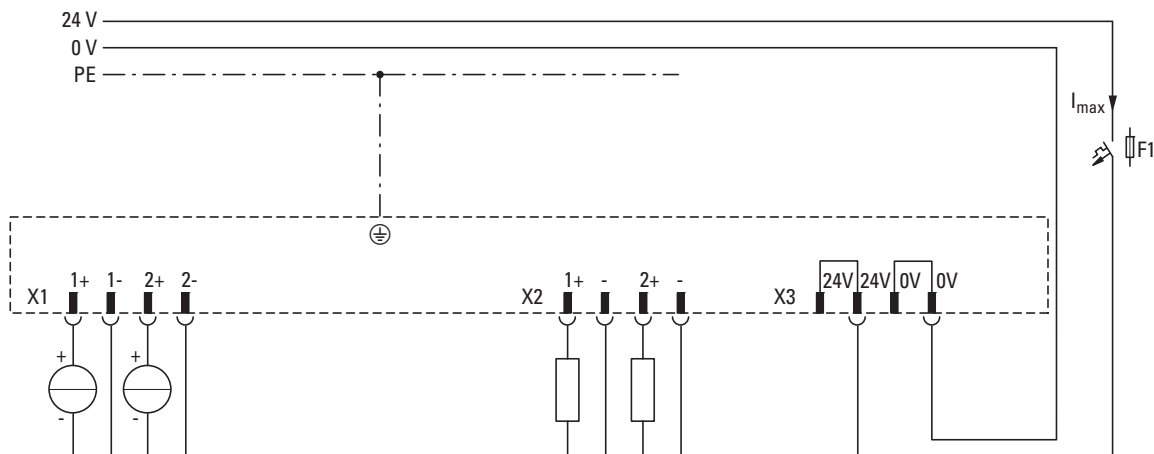

Figure 112: Connecting example showing signal current sources at X1 and burden current sources at X2

27.4 Technical data

27.4.1 Analog inputs

Channels	Value
Number of channels	2 analog input channels
Measuring range	0...20 mA
Measured value	0...20000
D-A converter	16 Bit
Resolution	0.3 μA/ LSB
Conversion time per channel	1 ms
Common-mode range	± 10 V
Input resistance	50 Ω
Input filters	
Hardware	typically 1 kHz (third-order low-pass filter)
Software (parameterizable)	parameterizable
Open wire monitoring	Yes
Measuring accuracy	
Total error limit	±0.5% of full scale value

27.4.2 Analog outputs

Channels	Value	
Number of channels	2 analog output channels	
Measuring range	0...20 mA	4...20 mA
Measured value	0...20000	4000...20000
D-A converter	12 Bit	
Resolution	5 μ A / LSB	
Conversion time per channel	1 ms	
Load resistance (burden)	$0 < R_{\text{burden}} < 500 \Omega$	
Max. permissible output capacitance	1 μ F with 50 Ω burden	
Open wire monitoring	No	
Settling time (typical) for		
63% of end value	$50 \mu\text{s} + R_{\text{burden}} \cdot R_{\text{L capacitive}}$	
86% of end value	$100 \mu\text{s} + 2 \cdot R_{\text{burden}} \cdot R_{\text{L capacitive}}$	
99% of end value	$250 \mu\text{s} + 5 \cdot R_{\text{burden}} \cdot R_{\text{L capacitive}}$	
Measuring accuracy		
Total error limit	$\pm 0.5\%$ of full scale value	

27.4.3 External power supply

The 24 VDC power supply is used to power the analog inputs and outputs.

Channels	Value
Number of supply voltages	1 (X3, pin on connector 24V)
Supply voltage +24 V	18...30 VDC
Voltage monitoring Supply voltage OK status LED	$U > 18 \text{ VDC}$
Maximum current consumption	70 mA

27.4.4 Measurement ranges

Current in mA	Value representation in μ A	
0...20 mA	0000...20000	Represented as a decimal value
4...20 mA	4000...20000	

27.4.5 Diagnostics

When it comes to the analog inputs, cable breaks will only be detected with diagnostics when using the 4–20 mA measuring range. When using the 0–20 mA measuring range, the cable break detection diagnostics will always read "FALSE."



Range and channel diagnostics must be taken into account in order to ensure that the reading shown is being interpreted correctly.

Diagnostics	Measuring range in mA	
	0 – 20	4 – 20
Cable break	–	< 4 mA (diagnostics)
Under Range	–	0 ... 4 mA
Display value	Measured value	
Over Range	20 ... 21 mA	
Overcurrent	> 21 mA	
Display value	> 21 (no reading)	

27.4.6 Filters

The low-pass cutoff frequency can be individually configured for each input channel using the appropriate register. This cutoff frequency is specified in Hz without any decimal places.

The following settings are valid:

Low-pass cut-off frequency	Register value
Filter disabled (default)	0x0000
10 Hz	0x000A
25 Hz	0x0019
50 Hz	0x0032
100 Hz	0x0064
250 Hz	0x00FA
500 Hz	0x01F4
1000 Hz	0x03E8

27.4.7 Memory layout

CAN Object Index	Size (byte)	Description	
0x21B0	0x6411	2	Analog output value 1 (AO1)
0x21B1	0x6411	2	Analog output value 2 (AO2)
0x31B0		2	Module status
		Bit 0	reserved
		Bit 1	No SYNC signal
		Bit 2	FLASH-CRC error
		Bit 3	RAM-CRC error
		Bit 4	Flash memory error
		Bit 5	Invalid configuration
		Bit 6-15	reserved
0x31B1	0x6401	2	Analog input value 1 (AI1)
0x31B2	0x6401	2	Analog input value 2(AI2)
0x31B3		1	Channel status for inputs
		Bit 0	1: Cable break input AI1
		Bit 1	1: Cable break input AI2
		Bit 2	reserved
		Bit 3	reserved
		Bit 4	1: Overcurrent at input AI1
		Bit 5	1: Overcurrent at input AI2
0x31B4		1	Power supply status
		Bit 0-6	reserved
		Bit 7	0: +24 VDC missing 1: +24 VDC OK at Analog input +1, 2+ Analog output +1, 2+
0x51B0		1	Input measuring range configuration
		AI 1	
		Bit 0 Bit 1	
		0 0	Measurement range 0...20mA
		0 1	Measurement range 4...20mA
		1 0	–
		1 1	Input disabled
		AI 2	
		Bit 2 Bit 3	
		0 0	Measurement range 0...20mA
		0 1	Measurement range 4...20mA
		1 0	–
		1 1	Output disabled

27 Analog input/output module XN-322-4AIO-I

27.4 Technical data

CAN Object Index	Size (byte)	Description			
0x51B1	1	Output measuring range configuration	A01		
			Bit 0	Bit 1	
			0	0	Measurement range 0...20mA
			0	1	–
			1	0	–
			1	1	Output disabled
			A02		
			Bit 2	Bit 3	
			0	0	Measurement range 0...20mA
			0	1	–
			1	0	–
			1	1	Output disabled
0x51B2	2	A11 cutoff frequency configuration		Used to specify the cutoff frequency as a decimal value in Hz.	
0x5092	2	A12 cutoff frequency configuration			

27.5 Supported CANopen objects

Product-specific CANopen objects

Index (hex)	Data Type	Name	Function	Mapping	Access	
0x6401	INTEGER16	I-WORD	Read Analog Input 16-bit	Default	ro	PDO
0x6411	INTEGER16	Q-WORD	Write Analog Output 16-bit	Default	ro	PDO
0x6421	UNSIGNED8	AI_INTERRUPT_TRIGGER_SELECTION	Analog Input Interrupt Trigger Selection	–	rw	SDO
0x6423	BOOLEAN	AnalogInputGlobalInterruptEnable	Analog Input Global Interrupt Enable	–	rw	SDO
0x6424	INTEGER32	I-WORD_UPPER_LIMIT	Analog Input Interrupt Upper Limit Integer	–	rw	SDO
0x6425	INTEGER32	I-WORD_LOWER_LIMIT	Analog Input Interrupt Lower Limit Integer	–	rw	SDO
0x6426	UNSIGNED32	I-WORD_DELTA_VALUE	Analog Input Interrupt Delta Unsigned	–	rw	SDO
0x6427	UNSIGNED32	I-WORD_NEGATIVE_DELTA_VALUE	Analog Input Interrupt Negative Delta Unsigned	–	rw	SDO
0x6428	UNSIGNED32	I-WORD_POSITIVE_DELTA_VALUE	Analog Input Interrupt Positive Delta Unsigned	–	rw	SDO

Vendor-specific objects

Index range for the XN-322-4AIO-I module: x1B0 to x1BF

Index (hex)	Data Type	Name	Function	Mapping	Access	
0x1027	UNSIGNED16	ModuleID	Module Identification Number	–	ro	SDO
0x21B0	INTEGER16	OutputChannel1	Output Channel 1	Manual	rww	PDO
0x21B1	INTEGER16	OutputChannel2	Output Channel 2	Manual	rww	PDO
0x30B0	UNSIGNED16	ModuleDiag	Module Diagnostic Messages	Manual	ro	PDO
0x31B1	INTEGER16	InputChannel1	Input Channel 1	Manual	ro	PDO
0x31B2	INTEGER16	InputChannel2	Input Channel 2	Manual	ro	PDO
0x31B3	UNSIGNED8	ChannelDiag	Channel Diagnostic Messages	Manual	ro	PDO
0x31B4	UNSIGNED8	InputVoltageState	Input Voltage State	Manual	ro	PDO
0x4001	VISIBLE STRING	SerialNumber	Serial Number	–	const	SDO
0x4004	UNSIGNED8	UserLEDControl	User LED Control	–	rw	SDO
0x400C	VISIBLE STRING	ProductName	Product Name	–	ro	SDO
0x41B0	UNSIGNED16	FirmwareVersion	Firmware Version	–	ro	SDO
0x51B0	UNSIGNED8	InputChannelConfig	Channel Measuring Configuration (Measurement range 0...20mA/4...20mA)	–	rw	SDO
0x51B1	UNSIGNED8	OutputChannelConfig	Channel Output Configuration (Measurement range 0...20mA)	–	rw	SDO
0x51B2	UNSIGNED16	FilterConfigChannel1	Filter Configuration Channel 1	–	rw	SDO
0x51B3	UNSIGNED16	FilterConfigChannel2	Filter Configuration Channel 2	–	rw	SDO

27 Analog input/output module XN-322-4AIO-I

27.5 Supported CANopen objects

28 XN-322-8AIO-I analog input/output module

The XN-322-8AIO-I is an XN300 slice module with four analog input channels used to measure current input signals within a measuring range of 0 – 20 mA or 4 – 20 mA. In addition, it features four analog output channels with an output range of 0 – 20 mA or 4 – 20 mA. The power supply for the current inputs and outputs will be monitored for undervoltage.

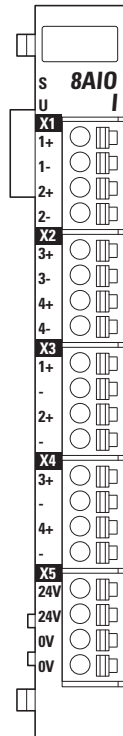

Figure 113: XN-322-8AIO-I device view

28 XN-322-8AIO-I analog input/output module

28.1 Status LED signals

28.1 Status LED signals

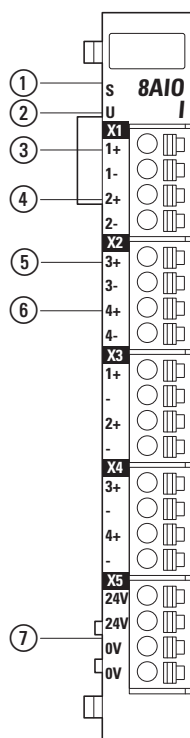

Figure 114: LED signals and pin assignment

- ① Module status LED
- ② User status LED
- ③ Cable break LED indicator for analog input 1
- ④ Cable break LED indicator for analog input 2
- ⑤ Cable break LED indicator for analog input 3
- ⑥ Cable break LED indicator for analog input 4
- ⑦ Power supply status LED

Module status	green	ON	System OK
		OFF	No power
		FLASHES (5 Hz)	No communication
Status User	yellow	ON	The user can set the LED signals as necessary. (For example, the visualization interface can be used to set the module's LED to flash so that it is easier to find the module inside the control panel.)
		OFF	
		FLASH (200 ms ON, 1000 ms OFF)	
		FLASH (1000 ms ON, 200 ms OFF)	
Analog input status	red	ON	Minimum current (4 mA) fallen below / cable break
		FLASH (2 Hz)	Maximum current exceeded
Power supply status	green	ON	Supply voltage for analog inputs and outputs OK
		OFF	Supply voltage for inputs and outputs faulty

28.2 Pin assignment

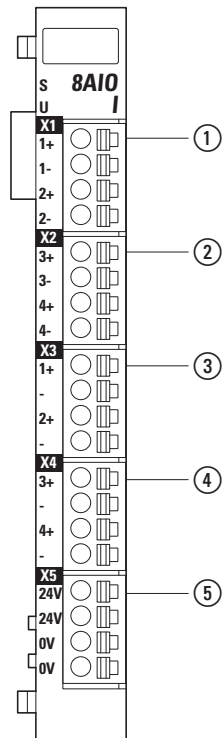

Figure 115: Pin assignment

① X1

- 1+ analog input 1+
- 1- analog input 1-
- 2+ analog input 2+
- 2- analog input 2-

② X2

- 3+ analog input 3+
- 3- analog input 3-
- 4+ analog input 4+
- 4- analog input 4-

③ X3

- 1+ analog output 1+
- - GND
- 2+ analog output 2+
- - GND

④ X4

- 3+ analog output 3+
- - GND
- 4+ analog output 4+
- - GND

⑤ X5

- 24V supply voltage +24VDC
- 24V supply voltage +24VDC
- 0V GND
- 0V GND

28 XN-322-8AIO-I analog input/output module

28.3 Wiring

28.3 Wiring

Two analog inputs can be wired to each of the two X1 and X2 connectors. A measuring range of 4–20 mA with cable break monitoring is supported, as is a measuring range of 0–20 mA without cable break monitoring.

The current input channels use a differential voltage measurement at an internal module resistor with a resistance of 50 Ω.

It must be ensured that the input signals' voltage levels fall within the permissible common mode range.

Two analog outputs for a burden resistance of less than 500 Ω can be wired to connector X2.

$$0 < R_{\text{burden}} < 500 \Omega$$

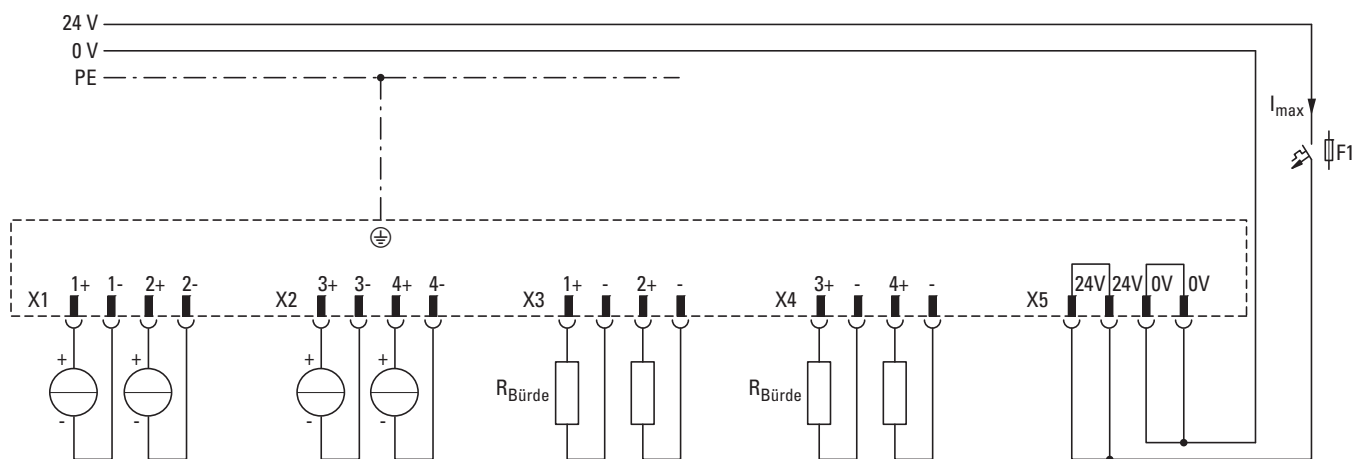

Figure 116: Connecting example showing signal current sources at X1, X2 and burden current sources at X3, X4

28.4 Technical data

28.4.1 Analog inputs

Channels	Value	
Number of channels	4 analog input channels	
Measuring range	0...20 mA	4...20 mA
Measured value	0...20000	4000...20000
D-A converter	16 Bit	
Resolution	0.3 μA/ LSB	
Conversion time per channel	1 ms	
Common-mode range	± 10 V	
Input resistance	50 Ω	
Input filters		
Hardware	typically 1 kHz (third-order low-pass filter)	

Channels	Value
Software (parameterizable)	parameterizable
Open wire monitoring	Yes
Measuring accuracy	
Total error limit	±0.5% of full scale value

28.4.2 Analog outputs

Channels	Value
Number of channels	4 analog output channels
Measuring range	0...20 mA
Measured value	0...20000
D-A converter	12 Bit
Resolution	5 µA / LSB
Conversion time per channel	1 ms
Load resistance (burden)	$0 < R_{burden} < 500 \Omega$
Max. permissible output capacitance	1 µF with 50 Ω burden
Open wire monitoring	No
Settling time (typical) for	
63% of end value	$50 \mu\text{s} + R_{burden} \cdot R_{L \text{ capacitive}}$
86% of end value	$100 \mu\text{s} + 2 \cdot R_{burden} \cdot R_{L \text{ capacitive}}$
99% of end value	$250 \mu\text{s} + 5 \cdot R_{burden} \cdot R_{L \text{ capacitive}}$
Measuring accuracy	
Total error limit	±0.5% of full scale value

28.4.3 External power supply

The 24 VDC power supply is used to power the analog inputs and outputs.

Channels	Value
Number of supply voltages	1 (X5, pin on connector 24V)
Supply voltage +24 V	18...30 VDC
Voltage monitoring Supply voltage OK status LED	$U > 18 \text{ VDC}$
Maximum current consumption	70 mA

28.4.4 Measurement ranges

Current in mA	Value representation in μ A	
0 ... 20 mA	0000 20000	Represented as a decimal value
4 ... 20 mA	4000 20000	

28.4.5 Diagnostics

When it comes to the analog inputs, cable breaks will only be detected with diagnostics when using the 4–20 mA measuring range. When using the 0–20 mA measuring range, the cable break detection diagnostics will always read "FALSE."



Range and channel diagnostics must be taken into account in order to ensure that the reading shown is being interpreted correctly.

Diagnostics	Measuring range in mA	
	0 – 20	4 – 20
Cable break	–	< 4 mA (diagnostics)
Under Range	–	0 ... 4 mA
Display value	Measured value	
Over Range	20 ... 21 mA	
Overcurrent	> 21 mA	
Display value	> 21 (no reading)	

28.4.6 Filters

The low-pass cutoff frequency can be individually configured for each input channel using the appropriate register. This cutoff frequency is specified in Hz without any decimal places.

The following settings are valid:

Low-pass cut-off frequency	Register value
Filter disabled (default)	0x0000
10 Hz	0x000A
25 Hz	0x0019
50 Hz	0 x0032
100 Hz	0x0064
250 Hz	0x00FA
500 Hz	0x01F4
1000 Hz	0x03E8

28.4.7 Memory layout

CAN Object Index		Size (byte)	Description		
0x21C0	0x6411	2	Analog output value 1 (A01)		
0x21C1	0x6411	2	Analog output value 2 (A02)		
0x21C2	0x6411	2	Analog output value 1 (A03)		
0x21C3	0x6411	2	Analog output value 2 (A04)		
0x30C0		2	Module Status	Bit 0	reserved
				Bit 1	No SYNC signal
				Bit 2	FLASH-CRC error
				Bit 3	RAM-CRC error
				Bit 4	Flash memory error
				Bit 5	Invalid configuration
				Bit 6-15	reserved
0x30C1	0x6401	2	Analog input value 1 (AI1)		
0x30C2	0x6401	2	Analog input value 2(AI2)		
0x30C3	0x6401	2	Analog input value 1 (AI3)		
0x30C4	0x6401	2	analog input value 2(AI4)		
0x30C5		2	Channel status for inputs	Bit 0	1: Cable break input AI1
				Bit 1	1: Cable break input AI2
				Bit 2	1: Cable break input AI3
				Bit 3	1: Cable break input AI4
				Bit 4	1: Overcurrent at input AI1
				Bit 5	1: Overcurrent at input AI2
				Bit 6	1: Overcurrent at input AI3
				Bit 7	1: Overcurrent at input AI4
				Bit 8-14	reserved
				Bit 15	Supply voltage +24 V OK

28 XN-322-8AIO-I analog input/output module

28.4 Technical data

CAN Object Index	Size (byte)	Description		
0x50C0	1	Input measuring range configuration	AI 1	
			Bit 1 Bit 0	
			0 0	Measurement range 0...20mA
			0 1	Measurement range 4...20mA
			1 0	–
			1 1	Output disabled
			AI 2	
			Bit 3 Bit 2	
			0 0	Measurement range 0...20mA
			0 1	Measurement range 4...20mA
			1 0	–
			1 1	Output disabled
			AI 3	
			Bit 5 Bit 4	
			0 0	Measurement range 0...20mA
			0 1	Measurement range 4...20mA
			1 0	–
			1 1	Output disabled
			AI 4	
			Bit 7 Bit 6	
0 0	Measurement range 0...20mA			
0 1	Measurement range 4...20mA			
1 0	–			
1 1	Output disabled			

CAN Object Index	Size (byte)	Description		
0x50C1	1	Output measuring range configuration	A01	
			Bit 1 Bit 0	
			0 0	Measurement range 0...20mA
			0 1	–
			1 0	–
			1 1	Output disabled
			A02	
			Bit 3 Bit 2	
			0 0	Measurement range 0...20mA
			0 1	–
			1 0	–
			1 1	Output disabled
			A03	
			Bit 5 Bit 4	
			0 0	Measurement range 0...20mA
			0 1	–
			1 0	–
			1 1	Output disabled
			A04	
			Bit 7 Bit 6	
0 0	Measurement range 0...20mA			
0 1	–			
1 0	–			
1 1	Output disabled			
0x50C2	2	AI1 cutoff frequency configuration	Used to specify the cutoff frequency as a decimal value in Hz. Permissible values: 10 to 1000 Hz Filter disabled (default)	
0x50C3	2	AI2 cutoff frequency configuration		
0x50C4	2	AI3 cutoff frequency configuration		
0x50C5	2	AI4 cutoff frequency configuration		

28 XN-322-8AIO-I analog input/output module

28.5 Supported CANopen objects

28.5 Supported CANopen objects

Product-specific CANopen objects

Index (hex)	Data Type	Name	Function	Mapping	Access	
0x6401	INTEGER16	I-WORD	Read Analog Input 16-bit	Default	ro	PDO
0x6411	INTEGER16	Q-WORD	Write Analog Output 16-bit	Default	ro	PDO
0x6421	UNSIGNED8	AI_INTERRUPT_TRIGGER_SELECTION	Analog Input Interrupt Trigger Selection	–	rw	SDO
0x6423	BOOLEAN	AnalogInputGlobalInterruptEnable	Analog Input Global Interrupt Enable	–	rw	SDO
0x6424	INTEGER32	I-WORD_UPPER_LIMIT	Analog Input Interrupt Upper Limit Integer	–	rw	SDO
0x6425	INTEGER32	I-WORD_LOWER_LIMIT	Analog Input Interrupt Lower Limit Integer	–	rw	SDO
0x6426	UNSIGNED32	I-WORD_DELTA_VALUE	Analog Input Interrupt Delta Unsigned	–	rw	SDO
0x6427	UNSIGNED32	I-WORD_NEGATIVE_DELTA_VALUE	Analog Input Interrupt Negative Delta Unsigned	–	rw	SDO
0x6428	UNSIGNED32	I-WORD_POSITIVE_DELTA_VALUE	Analog Input Interrupt Positive Delta Unsigned	–	rw	SDO

Vendor-specific objects

Index range for the XN-322-8AIO-I module: x0C0 to x0CF

Index (hex)	Data Type	Name	Function	Mapping	Access	
0x1027	UNSIGNED16	ModuleID	Module Identification Number	–	ro	SDO
0x20C0	INTEGER16	OutputChannel1	Output Channel 1	Manual	rww	PDO
0x20C1	INTEGER16	OutputChannel2	Output Channel 2	Manual	rww	PDO
0x20C2	INTEGER16	OutputChannel3	Output Channel 3	Manual	rww	PDO
0x20C3	INTEGER16	OutputChannel4	Output Channel 4	Manual	rww	PDO
0x30C0	UNSIGNED16	ModuleDiag	Module Diagnostic Messages	Manual	ro	PDO
0x30C1	INTEGER16	InputChannel1	Input Channel 1	Manual	ro	PDO
0x30C2	INTEGER16	InputChannel2	Input Channel 2	Manual	ro	PDO
0x30C3	INTEGER16	InputChannel3	Input Channel 3	Manual	ro	PDO
0x30C4	INTEGER16	InputChannel4	Input Channel 4	Manual	ro	PDO
0x30C5	UNSIGNED8	ChannelDiag	Channel Diagnostic Messages	Manual	ro	PDO
0x30C6	UNSIGNED8	InputVoltageState	Input Voltage State Bit 0: DC 24V Output 1..8 OK Bit 1: DC 24V Output 9..16 OK	Manual	ro	PDO
0x4001	VISIBLE STRING	SerialNumber	Serial Number	–	const	SDO
0x4004	UNSIGNED8	UserLEDControl	User LED Control	–	rw	SDO
0x400C	VISIBLE STRING	ProductName	Product Name	–	ro	SDO
0x40C0	UNSIGNED16	FirmwareVersion	Firmware Version	–	ro	SDO

28 XN-322-8AIO-I analog input/output module

28.5 Supported CANopen objects

0x50C0	UNSIGNED8	InputChannelConfig	Channel Measuring Configuration (measurement range 0...20mA/4...20mA)	–	rw	SDO
0x50C1	UNSIGNED8	OutputChannelConfig	Channel Output Configuration (measurement range 0...20mA)	–	rw	SDO
0x50C2	UNSIGNED16	FilterConfigChannel1	Filter Configuration Channel 1	–	rw	SDO
0x50C3	UNSIGNED16	FilterConfigChannel2	Filter Configuration Channel 2	–	rw	SDO
0x50C4	UNSIGNED16	FilterConfigChannel3	Filter Configuration Channel 3	–	rw	SDO
0x50C5	UNSIGNED16	FilterConfigChannel4	Filter Configuration Channel 4	–	rw	SDO

28 XN-322-8AIO-I analog input/output module

28.5 Supported CANopen objects

29 Analog weigh module XN-322-2DMS-WM

The XN-322-2DMS-WM features two analog input channels that can be used to operate strain gauges and load cells. Accordingly, the module can be used for uncalibrated measurements in weighing applications with the use of Wheatstone bridges with a 4-wire or 6-wire configuration. In addition, the module provides the reference voltage required in order to power the corresponding bridge measurement systems.

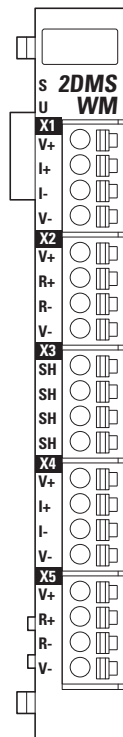

Figure 117: Device view XN-322-2DMS-WM

29 Analog weigh module XN-322-2DMS-WM

29.1 Status LEDs

29.1 Status LEDs

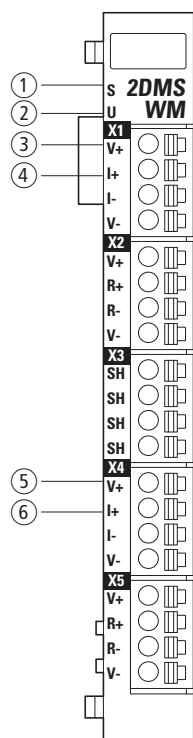

Figure 118: LED signals and pin assignment

- ① Module status LED
- ② User LED
- ③ AI1 input error LED
- ④ AI1 input status LED
- ⑤ AI2 input error LED
- ⑥ AI2 input status LED

Module Status	green	ON	System OK
		OFF	No power
		FLASHES (5 Hz)	No communication
User	yellow	ON	The user can set the LED signals as necessary. (For example, the visualization interface can be used to set the module's LED to flash so that it is easier to find the module inside the control panel.)
		OFF	
		FLASH (200 ms ON, 1000 ms OFF)	
		FLASH (1000 ms ON, 200 ms OFF)	
Input AI1/AI2	green	FLASHES (3 Hz)	A-D conversion running
		OFF	A-D conversion not running
Error AI1/AI2	red	ON	Open sensor, overload or short-circuit in the power supply for the Wheatstone bridge
		OFF	No fault

29.2 Pin assignment

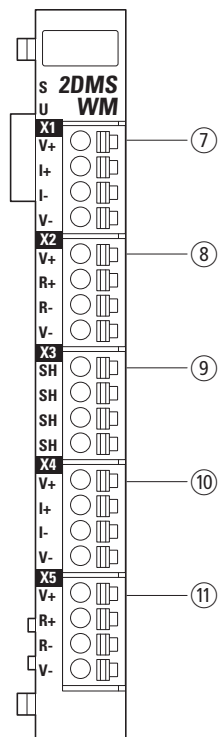

Figure 119: Pin assignment

- ① X1
 - V+ Reference output 1+
 - I+ Input 1+
 - I- Input 1-
 - V- Reference output 1-
- ② X2
 - V+ Reference output 1+
 - R+ Reference input 1+
 - R- Reference input 1-
 - V- Reference output 1-
- ③ X3
 - SH Shielding GND
 - SH Shielding GND
 - SH Shielding GND
 - SH Shielding GND
- ④ X4
 - V+ Reference output 2+
 - I+ Input 2+
 - I- Input 2-
 - V- Reference output 2-
- ⑤ X5
 - V+ Reference output 2+
 - R+ Reference input 2+
 - R- Reference input 2-
 - V- Reference output 2-

29 Analog weigh module XN-322-2DMS-WM

29.3 Wiring

29.3 Wiring

The module supports the use of two Wheatstone bridges. These bridges need to be wired with a four-wire or six-wire configuration.

29.3.1 Four-wire connection

When using a four-wire connection, only X1 or X4 is wired to the Wheatstone bridge. This means that the Wheatstone bridge will be powered via V+ / V- and that the corresponding readings will be acquired via I+ / I-.

Reference output V+ and reference input R+, as well as V- and R-, need to be connected to each other at X2 and X5.

The advantage of using this configuration is the fact that only a small number of connection cables are required. However, using this operating mode also means that the cable resistances will affect the measurement in the form of an error.

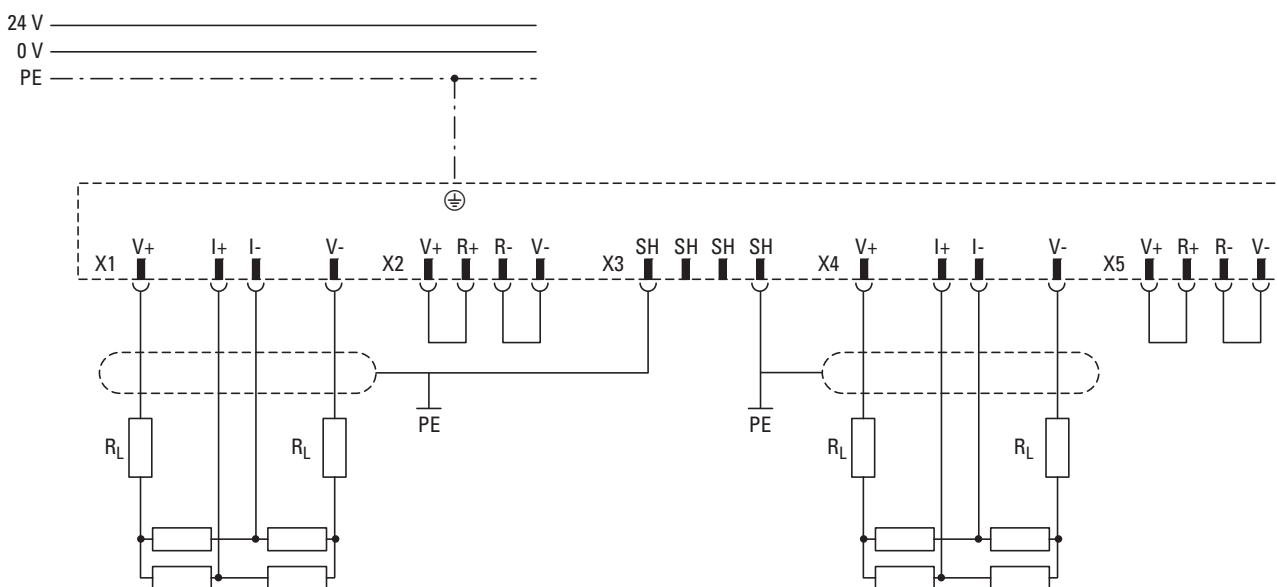

Figure 120: Wiring diagram for four-wire connection using AI1 and AI2

29.3.2 Six-wire connection

When using a six-wire connection, the voltage drop at the cable extending from the module to the Wheatstone bridge is measured via R+ and R- and taken into account in the measurement.

This means that when this operating mode is used, the cable resistance will not affect the measurement in the form of an error.

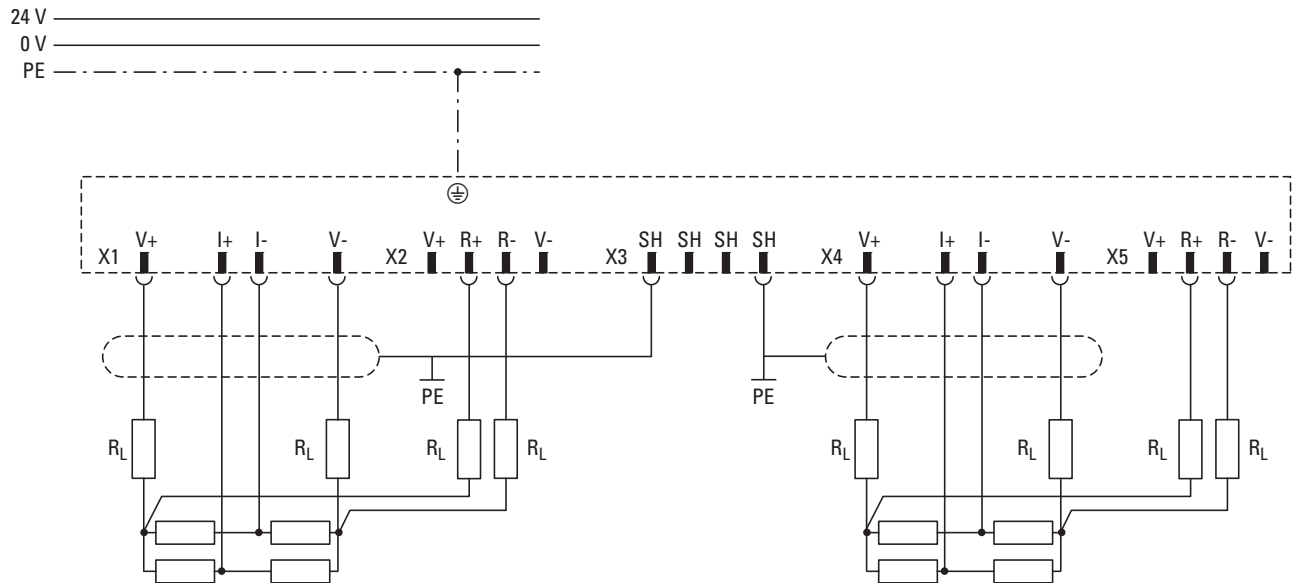

Figure 121: Wiring diagram for six-wire configuration using AI1 and AI2

29.4 Sensors

Weigh module XN-322-2DMS-WM is compatible with strain gauge load cells with the following load cell characteristic values: 0.25 mV/V; 0.5 mV/V; 1 mV/V; 2 mV/V; 16 mV/V with a supply voltage of 5 V and a working resistance of 150 Ω to 5000 Ω.

Load cell characteristic values [mV/V]	Measurement ranges [mV]
0.25	± 1.875
0.5	± 3.75
1	± 7.5
2	± 15
16	± 120

29.5 Filter settings

The reading's accuracy and stability will depend on how the filter is configured. If the filter has a high cutoff frequency, so that the goal is to have a short refresh time for the reading, the resolution will be lower. If the filter has a low cutoff frequency, resulting in a long refresh time, the measured value will be more accurate and the transmission frequency (bus load) will be lower.

The refresh frequency can be calculated by using the formula below. The cut-off frequency must be configured in CAN object 5060 → Section "0x5060", page 233.

29 Analog weigh module XN-322-2DMS-WM

29.6 Calibrating the force transducer

$$f_{\text{ADC}} = \frac{f_{\text{CLK}}}{(\text{sinc } x \cdot 1024 \cdot \text{AlxFilterDepth})}$$

f_{ADC} : ADC data rate

f_{CLK} : 4.92 MHz

AlxFilterDepth : ADC filter depth

$$t_{\text{SETTLE}} = \frac{2}{f_{\text{ADC}}} = \frac{2 \cdot (\text{sinc } x \cdot 1024 \cdot \text{AlxFilterDepth})}{f_{\text{CLK}}}$$

t_{SETTLE} : Conversion time

f_{ADC} : ADC data rate

f_{CLK} : 4.92 MHz

AlxFilterDepth : ADC filter depth

For a cutoff frequency of 3 dB, this yields:

$$f_{3\text{dB}} = 0.24 \cdot f_{\text{ADC}} = \frac{0.24 \cdot f_{\text{CLK}}}{(\text{sinc } x \cdot 1024 \cdot \text{AlxFilterDepth})}$$

f_{ADC} : ADC data rate

f_{CLK} : 4.92 MHz

AlxFilterDepth : ADC filter depth

For: $\text{sinc } x = \text{sinc } 4$, $\text{AlxFilterDepth} = 5$

$$t_{\text{SETTLE}} = \frac{2}{f_{\text{ADC}}} = \frac{2 \cdot (4 \cdot 1024 \cdot 5)}{4920000 \text{ Hz}} = 0.0083\text{s}$$

Conversion time = 8.3 ms

$$f_{3\text{dB}} = 0.24 \cdot f_{\text{ADC}} = \frac{0.24 \cdot 4920000 \text{ Hz}}{4 \cdot 1024 \cdot 5}$$

3dB limit frequency = 57.66 Hz

29.6 Calibrating the force transducer

1. The ADC's gain must be adjusted as required by the specifications in the transducer's data sheet. The way it is set should ensure that the transducer range being used takes advantage of the ADC's value range to the greatest extent possible without exceeding it.

2. The transducer's zero point (tare) is calibrated with the minimum load on the sensor and mode = 6 (configuration of cutoff frequency for Alx, bits 11-13). This defines the initial value for the scale.
3. The transducer's full-scale calibration is carried out with the maximum load on the sensor and mode = 7 (configuration of cutoff frequency for Alx, bits 11-13). This defines the final value for the scale. The final value for the scale can only be calibrated to a value between 50% and 100% of the positive measuring range.

29.7 Specific technical data for the module

Number of channels	2 Wheatstone bridges				
D-A converter	24 Bit				
Supply voltage for Wheatstone bridges	+5V				
Load cell characteristic values	0.25mV/V	0.5mV/V	1mV/V	2mV/V	16mV/V
Measurement ranges ¹⁾	± 1.875mV	± 3.75mV	± 7.5mV	± 15mV	± 120mV
Measured value	± 8388608 _{dez} = ±800000 _{hex} , zero value =800000 _{hex}				
Configurable parameters					
Filter value	2	...	5	...	1023
Filter Type	Sinc4	...	Sinc4	...	Sinc4
Limit frequency (-3 db)	144 Hz	...	57.7 Hz	...	0.282 Hz
Conversion time	4 ms	...	9 ms	...	1702 ms
Noise-free resolution ²⁾	15.5 Bit	...	16 Bit	...	20 Bit
Open sensor detection	yes				
Working resistance per channel	150 Ω - 5000 Ω				
Measuring accuracy ³⁾	±0.0031% noise for filter word 2				
Temperature drift	± 0.001% /°C				
Can be calibrated	no				

1) The measuring ranges are sized for load cell overstretching of 50%

2) Typical values with active sinc filter and measuring range of 2 mV/V

3) A system calibration with the sensor, in which the minimum and maximum values are calibrated, is required in order for the measuring accuracy value to be met. The minimum value must be calibrated first, followed by the maximum value. The maximum value can only be calibrated to a value between 50% and 100% of the positive measuring range.

29 Analog weigh module XN-322-2DMS-WM

29.8 Memory layout

29.8 Memory layout

CAN Object Index	Size (byte)	Description	Bit		
0x3060	2	Modules Diagnostics (Error bits 7 and 8 will be set to "zero" the moment the set gain matches the stored values. The application must ensure that the correct GAIN (and filter type and filter depth) is set. If the gain changes, the calibration must be repeated.)	Bit 0	reserved	
			Bit 1	no SYNC signal	
			Bit 2	FLASH-CRC error	
			Bit 3	RAM-CRC error	
			Bit 4	FLASH memory error	
			Bit 5	Bridge 1 DC not OK	
			Bit 6	Bridge 2 DC not OK	
			Bit 7	Offset ADC 1 invalid	
			Bit 8	Offset ADC 2 invalid	
			Bit 9	Filter ADC 1 not ready	
			Bit 10	Filter ADC 2 not ready	
			Bit 11...15	reserved	
0x3061	4	Measured value 1 (AI1) Current value of channel (if AI1ConfigValid and the Ready bit in AI1ADCState are set)		Measured value 1 (AI1) DWORD	
0x3062	4	Measured value 2 (AI2) Current value of channel (if AI2ConfigValid and the Ready bit in AI2ADCState are set)		Measured value 2 (AI2) DWORD	
0x3063	2	Diagnostic ADC Controller	Byte 0	ADC AI1	
				Bit 0...4	reserved
				Bit 5	Faulty reference voltage
				Bit 6	ADC measuring range error
			Bit 7	Conversion in progress	
			1 Byte	ADC AI2	
				Bit 0...4	reserved
				Bit 5	Faulty reference voltage
				Bit 6	ADC measuring range error
				Bit 7	Conversion in progress

CAN Object Index	Size (byte)	Description	Bit	
0x5060	2	Measuring configuration for channel 1 (AI1)	Bit 0...9	Filter depth of ADC 1–1023 (Default = 2)
			Bit 10	0: SINC4 filter (Default) 1: SINC3 filter
			Bit 11...13	mode
				0 = Continuous conversion mode (default)
				6 = System zero-scale calibration 7 = System full-scale calibration
			Bit 14, 15	reserved
0x5061	2	Measuring range configuration for channel 1 (AI1)	Bit 0...2	GAIN
			0: GAIN 1 ($\pm 120\text{mV}$)	
			1: reserved	
			2: reserved	
			3: GAIN 8 ($\pm 15\text{mV}$) (default)	
			4: GAIN 16 ($\pm 7.5\text{mV}$)	
			5: GAIN 32 ($\pm 3.75\text{mV}$)	
			6: GAIN 64 ($\pm 1.875\text{mV}$)	
Bit 3...15	reserved			
0x5062	2	Measuring configuration for channel 2 (AI2)	Bit 0...9	Filter depth of ADC 1–1023 (Default = 2)
			Bit 10	0: SINC4 filter (Default), 1: SINC3 filter
			Bit 11...13	mode
				0: Continuous conversion mode (default)
				6: System zero-scale calibration 7: System full-scale calibration
			Bit 14, 15	reserved
0x5063	2	Measuring range configuration for channel 2 (AI2)	Bit 0...2	GAIN
			0: GAIN 1 ($\pm 120\text{mV}$)	
			1: reserved	
			2: reserved	
			3: GAIN 8 ($\pm 15\text{mV}$) (default)	
			4: GAIN 16 ($\pm 7.5\text{mV}$)	
			5: GAIN 32 ($\pm 3.75\text{mV}$)	
			6: GAIN 64 ($\pm 1.875\text{mV}$)	
Bit 3...15	reserved			

29 Analog weigh module XN-322-2DMS-WM

29.9 Supported CANopen objects

29.9 Supported CANopen objects

Product-specific CANopen objects

- None -

Manufacturer-specific objects

Index range for the XN-322-2DMS-WM module: x060 to x06F

Index (hex)	Data Type	Name	Function	Mapping	Access	
0x1027	UNSIGNED16	ModuleID	Module Identification Number	Manual	ro	PDO
0x3060	UNSIGNED16	ModuleDiag	Module Diagnostic Messages	Manual	ro	PDO
0x3061	UNSIGNED32	InputChannel1	Input Channel 1	Manual	ro	PDO
0x3062	UNSIGNED32	InputChannel2	Input Channel 2	Manual	ro	PDO
0x3063	UNSIGNED16	ADCDiag	Analog Digital Converter Diagnostic Messages	Manual	ro	PDO
0x4001	VISIBLE STRING	SerialNumber	Serial Number	–	const	SDO
0x4004	UNSIGNED8	UserLEDControl	User LED Control	–	rw	SDO
0x400C	VISIBLE STRING	ProductName	Product Name	–	ro	SDO
0x4060	UNSIGNED16	FirmwareVersion	Firmware Version	–	ro	SDO
0x5060	UNSIGNED16	MeasuringConfigChannel1	Measuring Configuration Channel 1	–	rw	SDO
0x5061	UNSIGNED16	RangeConfigChannel1	Range Configuration Channel 1	–	rw	SDO
0x5062	UNSIGNED16	MeasuringConfigChannel2	Measuring Configuration Channel 2	–	rw	SDO
0x5063	UNSIGNED16	RangeConfigChannel2	Range Configuration Channel 2	–	rw	SDO
0x5064	INTEGER32	ZeroScaleChannel1	Zero-Scale Channel 1	–	ro	SDO
0x5065	INTEGER32	FullScaleChannel1	Full-Scale Channel 1	–	ro	SDO
0x5066	INTEGER32	ZeroScaleChannel2	Zero-Scale Channel 2	–	ro	SDO
0x5067	INTEGER32	FullScaleChannel2	Full-Scale Channel 2	–	ro	SDO

30 DC motor driver module XN-322-1DCD-B35

The XN-322-1DCD-B35 features a DC motor driver that can be used to run a brushed motor, as well as two current outputs that can be used to drive two external LEDs. These current outputs have rated operational currents of 20 mA and 350 mA.

The power control module can be used to run a DC motor with supply voltages of 12 – 30 V and a maximum motor current of 3.5 A. It can also accommodate higher inrush currents briefly. The output power is controlled with a PWM output, and the operating direction can be defined with the polarity of the switched output driver stage. Accordingly, the output power must be controlled using duty cycles.

In addition, these DC motor driver modules provide up-to-date operating data on the motor so that the information can be used for further analysis or display if necessary.

- Motor driver temperature
- Current motor current
- Motor status
- Let-through energy
- Diagnostics information

In order to integrate the motor into a speed control system, it is recommended to provide a speed feedback signal by using a rotary encoder on the motor together with an XN-322-1CNT-8DIO or XN-322-20-DI-PCNT module. This will make it possible to determine the motor's speed, operating direction, and covered distance (angle of rotation).

The LED drivers can be programmed in such a way that the corresponding LEDs will signal the information obtained by the module. For example, a motor's speed or load can be represented by different LED brightness levels.

30 DC motor driver module XN-322-1DCD-B35

30.1 Status LEDs

30.1 Status LEDs

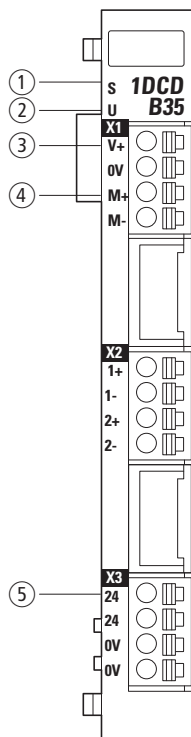

Figure 122: XN-322-1DCD-B35 LEDs

- ① Module status LED
- ② User status LED
- ③ Motor power supply status LED
- ④ Motor status LED
- ⑤ Module power supply status LED

Module status	green	ON	System OK
		OFF	No power
		FLASHES (5 Hz)	No communication
Status User	yellow	ON	The user can set the LED signals as necessary. (For example, the visualization interface can be used to set the module's LED to flash so that it is easier to find the module inside the control panel.)
		OFF	
		FLASH (200 ms ON, 1000 ms OFF)	
Motor power supply status	red	ON	Faulty motor power supply
		OFF	Motor power supply OK
Motor Status	green	ON	Motor enable signal active
		OFF	Motor enable signal not active
Module power supply status	red	ON	Faulty module power supply
		OFF	Module power supply OK

30.2 Pin assignment

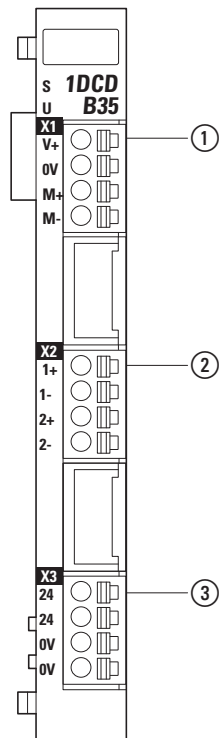

Figure 123: Pin assignment XN-322-1DCD-B35

- ① X1
 - V+ Motor+ power supply
 - 0V GND
 - M+ Motor +
 - M- Motor -
- ② X2
 - 1+ LED 1 +
 - 1- LED 1 -
 - 2+ LED 2 +
 - 2- LED 2-
- ③ X3
 - 24 +24VDC
 - 24 +24VDC
 - 0V GND
 - 0V GND

30.3 Wiring

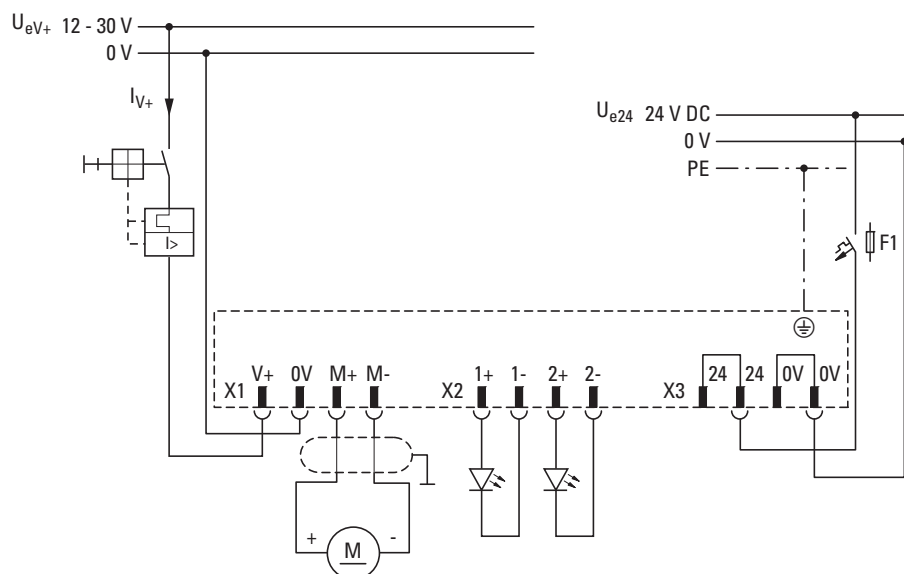

Figure 124: Diagram version 2: Wiring example for XN-322-1DCD-B35

The connection to PE is established with a DIN-rail contact at the bottom of the module.

30.3.1 Connecting the power supply for the module

The module and the LED drivers are powered through connection terminal X3. The two GND pins and the two 24 pins are internally linked.

30.3.2 Motor connection

NOTICE

The rated uninterrupted current should not exceed 3.5 A.

The connection cables for the motor power supply need to be connected to connector X1 with the output voltage for the motor.

The module can be used to control the motor's speed, output, and operating direction. To make sure you use the right operating direction, make sure to connect the motor with the right polarity.

30.3.3 Connecting LEDs

The LEDs are driven with a PWM controlled current source.



Please make sure to use the right polarity when connecting the LEDs.

30.3.4 How the XN-322-1DCD-B35 works

XN-322-1DCD-B35 slice modules can be used to run a brushed DC motor with a rated operational current of up to 3.5 and an operational voltage of up to 30 VDC. The motor can be driven in the following way:

- pulse width modulation

When using pulse width modulation, the manipulated variable is controlled by using variable pulse widths while keeping a constant period duration. The manipulated variable in this case is the power delivered to the motor.

The duration of the 4 steps, i.e., the sequence time, is specified in registers 0x32E0 to 0x20E3 with 11 bits. Meanwhile, the period duration is defined, relative to the internal clock frequency of 32 MHz, in register 0x20E4 with 16 bits.

Generating the output signal for the motor drive

The PWM output sequence for driving the motor is transmitted to the XN300 module with four subsequences using four objects, 0x20E0 to 0x20E3. These subsequences are grouped together in a fixed order in order to make up the output sequence, with each of the subsequences containing the following information:

- Operating direction: Definition of operating direction by activating the output driver.
- Time reference:
 - Relative: The sequence time's starting point will be the end of the previous sequence.
 - Absolute: The sequence time's starting point will be the start of the period. The duration of previous sequences must be taken into account.
- Sequence time: The sequence time, relative to the internal clock frequency of 32 MHz, is defined in an 11-bit register (min: 29_{hex} (1.3 μs), max: (63.9 μs))

If the defined period duration is shorter than the time defined with the sequences, the sequence will be interrupted and restarted at the end of the period duration.

The operating direction is defined with the states of bits 12 to 15 in the sequence register.

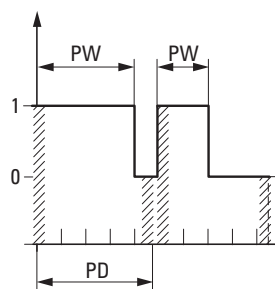

Figure 125: Pulses at output terminal X1, pin M+ module output
PD: Period duration

Each period must start with the Motor Off state. As a general rule, sequence times 1 to 4 only describe the time response when there is an edge transition from LOW to HIGH. If a period duration that is shorter than the LOW sequence time is selected, the motor will stop. Period durations that are longer than the start time for the HIGH sequence will control the motor power, with the state remaining for the rest of the period duration.

Enable

The enable signal is activated with motor control object 0x20E7, bit 0. The output sequence will not be applied at the M+/M- motor output until this enable signal is active. Once the enable signal has been activated, the relevant parameters will change directly as required for the output signal for the motor, M+, M-.

Defining the period duration

The period duration is determined based on the time value stored in object 0x20E4 and the system clock frequency (32 MHz).

$$\text{Period duration} = \frac{\text{Time value register entry (16-bit)}}{\text{System clock frequency}}$$

In turn, the period duration is used to determine the fundamental frequency.

$$\text{Fundamental frequency} = \frac{1}{\text{Period duration}}$$

Defining the motor's operating direction



CAUTION

There should be no state changes in the motor's operating direction within an output sequence. In order to reduce motor overload and the mechanical load on the motor, start by decelerating the motor's speed to "zero," then change the operating direction, and finally increase the speed back to the setpoint.

The motor's operating direction can be defined for each subsequence in objects 0x20E0 – 0x20E3 using bits 12 – 15. A state of "1" means: switch closed. These switches are implemented inside the device with the use of transistors.

Permitted switching combinations for the sequence setting	Bit 12-15 Value _{hex}	Bit 15	Bit 14	Bit 13	Bit 12
Motor Off	0 _{hex}	0	0	0	0
Operating direction right	6 _{hex}	0	1	1	0
Operating direction left	9 _{hex}	1	0	0	1
Motor armature short-circuit	C _{hex}	1	1	0	0



CAUTION

When changing the motor's operating direction, make sure to keep the motor switched off for a minimum period of 5 μs by using an armature short-circuit sequence. Otherwise, an impermissible I²dt energy flux may be produced, resulting in the XN300 slice module overheating.

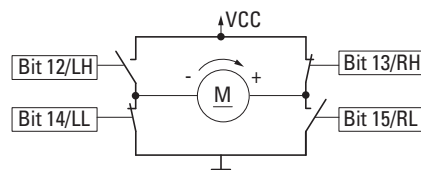

Figure 126: Block diagram for a clockwise motor operating direction

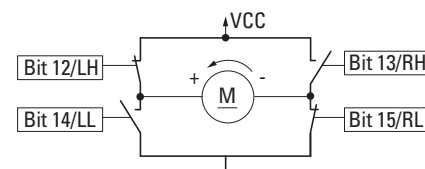



Figure 127: Block diagram for a counterclockwise motor operating direction

Motor armature short-circuit

If bits 14 and 15 are set at the same time, the motor will be short-circuited to ground. At this point, the motor will brake, as it will be working as a short-circuited generator.



CAUTION Use external mechanisms to make sure that the motor will be in a safe state after stopping.

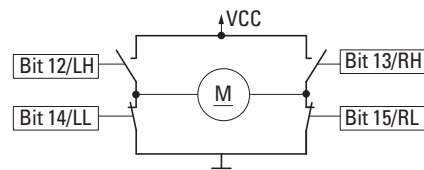

Figure 128: Block diagram showing a motor armature short-circuit

Motor Off

If all bits are set to 0, the motor will not receive any pulses and will not have a connection to ground. If there is any motor power, it will not be possible for this power to be discharged to ground.

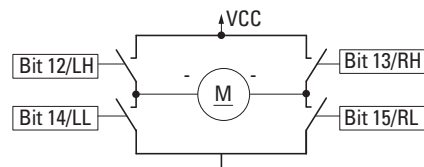

Figure 129: Block diagram showing open motor

Short-circuit fault message

If bit 12 and bit 14, or bit 13 and bit 15, were to be set at the same time (left_high and left_low), this would result in a short-circuit. The device will interpret this state as incorrect input and switch the motor off.

If the motor is switched off due to erroneous sequence input, this will be signaled with a fault message. It will not be possible to switch the motor back on until this error message is cleared with the acknowledgment bit.

Defining the sequence time

Bits 0 to 10 in registers 0x20E0 to 0x20E3 are used to store a time value. Dividing this time value by the system clock frequency (32 MHz) yields the sequence time.

$\text{Sequence time} = \frac{\text{Time value register entry (bits 0-10)}}{\text{System clock frequency}}$

Relative or absolute counting

Tc (Time control), i.e., bit 11, defines whether the time value for the subsequences will be counted as a relative or absolute value. It is possible to use both counting methods at different points within the output sequence. However, doing so is not recommended.

Bit 11 = 0: The pulse width is relative and is counted starting from the end of the last sequence. The period always starts with sequence 1.

Bit 11 = 1: The pulse width is absolute and is counted starting when the period begins. This means that the time specified for a sequence must be longer than the time specified for the previous sequence.

Relative pulse width

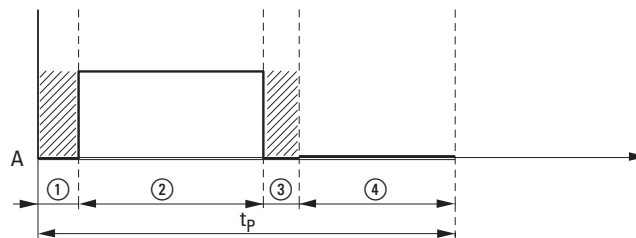

Figure 130: Four subsequences with pulses when using relative counting

- ① Subsequence 1, e.g. Motor off
- ② Subsequence 2, e.g. Operating direction right
- ③ Subsequence 3, e.g. Motor off
- ④ Subsequence 4, e.g. Armature short-circuit

Absolute pulse width

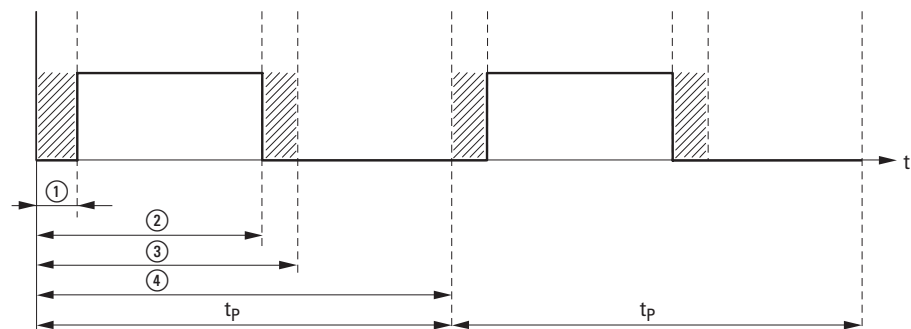

Figure 131: Four subsequences with pulses when using absolute counting

- ① Subsequence 1, e.g. Motor off
- ② Subsequence 2, e.g. Operating direction right
- ③ Subsequence 3, e.g. Motor off
- ④ Subsequence 4, e.g. Armature short-circuit

Keep the ratio of the period duration to the sequence time in mind

NOTICE

Select period duration t_p in line with the output sequence:

$$t_p = t_{\text{OutputSequence}} = t_{\text{OutputSequence1}} + \dots + t_{\text{OutputSequence4}}$$

Failure to do so may result in undesired XN300 slice module states.

Output signal when the period duration is set correctly

$$t_p = t_{\text{OutputSequence}}$$

Period duration t_p will be equal to the time that the output sequence lasts.

The following scenarios must be avoided:

Output signal with interrupted sequence

$$t_p < t_{\text{OutputSequence}}$$

If period duration t_p is shorter than the output sequence, the state at the motor output will be truncated when the period duration ends, and the period will start again with subsequence 1. This means that subsequence 4 will not be completed.

Output signal with subsequence 4 state held

$t_p > t_{\text{OutputSequence}}$ If defined period duration t_p is longer than the output sequence, the last state (subsequence 4) at the motor output will be maintained until the period ends. This means that subsequence 4 will be unintentionally extended.

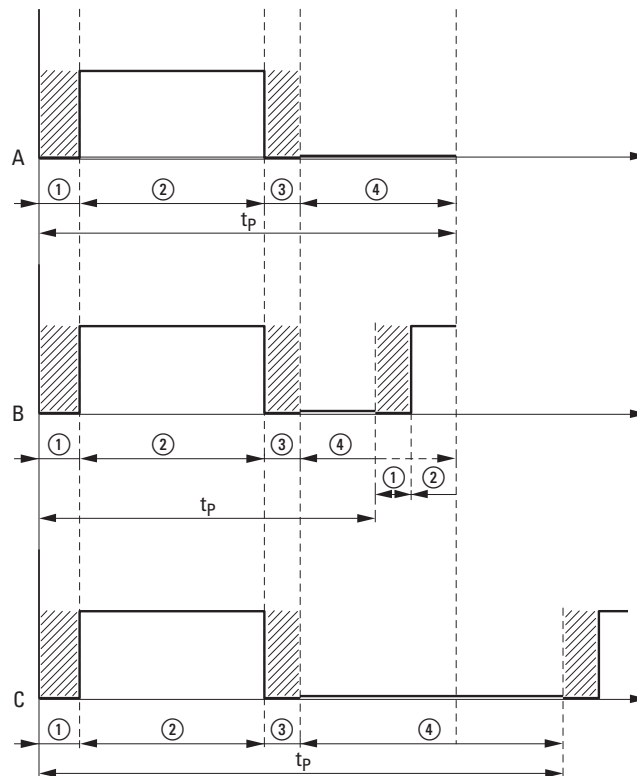

Figure 132: Output signal

A: When the period duration is set correctly

B: with interrupted sequence

C: with subsequence 4 state held

Clockwise operation example

System clock frequency: 32 MHz

Period duration register entry: 1120_{dec}

Period duration: 1120_{dec}/32 MHz = 35 μs

TC = relative

Motor	Sub-sequence values, hex	Pulse width	Motor state				TC				Binary time value				Time Value							
			15	14	13	12	11	10	9	8	7	6	5	4	3	2	1	0	dec	hex		
off	00A0 _{hex}	≈ 5 μs	0	0	0	0	0	0	0	0	0	0	1	0	1	0	0	0	0	0	160 _{dec}	A0 _{hex}
Right	6140 _{hex}	10 μs	0	1	1	0	0	0	0	1	0	1	0	0	0	0	0	0	0	0	320 _{dec}	140 _{hex}
off	00A0 _{hex}	≈ 5 μs	0	0	0	0	0	0	0	0	0	0	1	0	1	0	0	0	0	0	160 _{dec}	A0 _{hex}
Armature short-circuit	C1E0 _{hex}	15 μs	1	1	0	0	0	0	0	1	0	1	1	1	0	0	0	0	0	0	480 _{dec}	1E0 _{hex}

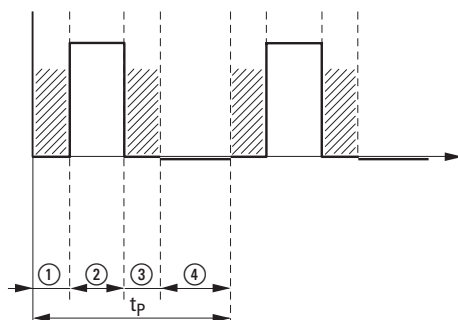

Figure 133: Output signal with clockwise operation

- ① Motor Off
- ② Clockwise motor operating direction
- ③ Motor Off
- ④ Motor armature short-circuit

Counterclockwise operation example

System clock frequency: 32 MHz

Period duration register entry: 1120_{dec}

Period duration: 1120_{dec}/32 MHz = 35 μs

TC = relative

Motor	Subsequence values, hex	Pulse width	Motor state				TC Binary time value								Time Value								
			hex	15	14	13	12	11	10	9	8	7	6	5	4	3	2	1	0	dec	hex		
off	00A0 _{hex}	≈ 5 μs	0	0	0	0	0	0	0	0	0	0	1	0	1	0	0	0	0	0	0	160 _{dec}	A0 _{hex}
Left	9140 _{hex}	10 μs	9	1	0	0	0	1	0	0	0	1	0	1	0	0	0	0	0	0	0	320 _{dec}	140 _{hex}
off	00A0 _{hex}	≈ 5 μs	0	0	0	0	0	0	0	0	0	0	1	0	1	0	0	0	0	0	0	160 _{dec}	A0 _{hex}
Armature short-circuit	C1E0 _{hex}	15 μs	c	1	1	0	0	0	0	0	1	1	1	1	0	0	0	0	0	0	0	480 _{dec}	1E0 _{hex}

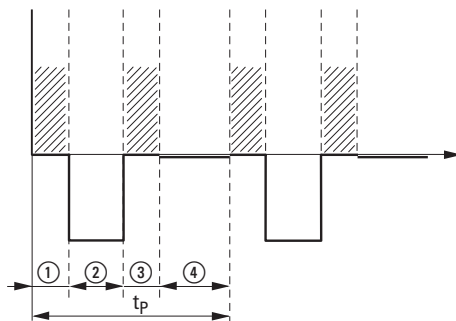

Figure 134: Pulse-width modulated signal at module output M+ for the counterclockwise motor operating direction example

- ① Subsequence 1: Motor off, 00A0_{hex}
- ② Subsequence 2: Motor operating direction left, 9140_{hex}
- ③ Subsequence 3: Motor off, 00A0_{hex}
- ④ Subsequence 1: Motor armature short-circuit, C1E0_{hex}

Example with a change in operating direction

System clock frequency: 32 MHz

Period duration register entry: 1120_{dec}

Period duration: 1120_{dec}/32 MHz = 35 μs

TC = relative

Subsequence values, hex	Pulse width	Motor state	T C	Binary time value				Time Value									
				7	6	5	4	3	2	1	0	dec	hex				
		hex	1 1 1 1 5 4 3 2	1	1	9	8	7	6	5	4	3	2	1	0	dec	hex
00A0 _{hex}	≈ 5 μs		0 0 0 0	0	0	0	0	1	0	1	0	0	0	0	0	160 _{dec}	A0 _{hex}
6140 _{hex}	10 μs		0 1 1 0	0	0	0	1	0	1	0	0	0	0	0	0	320 _{dec}	140 _{hex}
00A0 _{hex}	≈ 5 μs		0 0 0 0	0	0	0	0	1	0	1	0	0	0	0	0	160 _{dec}	A0 _{hex}
C1E0 _{hex}	15 μs		1 1 0 0	0	0	0	1	1	1	1	0	0	0	0	0	480 _{dec}	1E0 _{hex}
00A0 _{hex}	≈ 5 μs		0 0 0 0	0	0	0	0	1	0	1	0	0	0	0	0	160 _{dec}	A0 _{hex}
9140 _{hex}	10 μs		1 0 0 1	0	0	0	1	0	1	0	0	0	0	0	0	320 _{dec}	140 _{hex}
00A0 _{hex}	≈ 5 μs		0 0 0 0	0	0	0	0	1	0	1	0	0	0	0	0	160 _{dec}	A0 _{hex}
C1E0 _{hex}	15 μs		1 1 0 0	0	0	0	1	1	1	1	0	0	0	0	0	480 _{dec}	1E0 _{hex}

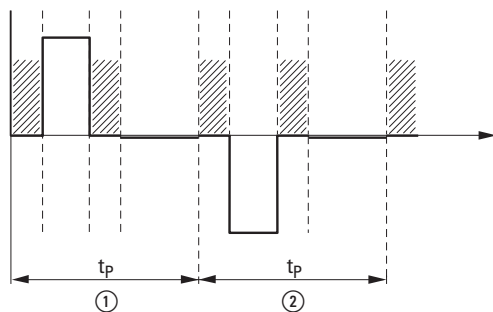

Figure 135: Pulse-width modulated signal at module output M+ for the operating direction change example

- ① Run Forward
- ② Anticlockwise operation

30.4 Technical data

30.4.1 DC motor driver

Quantity	1
Supply voltage	12 – 30 VDC
Rated operational current I_N	0 – 3.5 A
Operating mode	S3 / 50% (50% intermittent duty) with a maximum duty factor of 1.5 min
Load peak inrush current	Maximum I^2t -value = 16A ² s
Current Metering	10 Bit
Short-circuit proof	No
status display	1x LED (green)

The rated uninterrupted current for the motor should not exceed the specified value of 3.5 A continuously.

This also applies to the motor's deceleration and startup when the motor is repeatedly switched off and on.

The maximum let-through energy during motor startup is defined by integral $\int I^2 dt$. The I^2T value is the integral of the square of the current over a specified period of time. It is also a measurement of the maximum energy that the load output can deliver.

30 DC motor driver module XN-322-1DCD-B35

30.4 Technical data

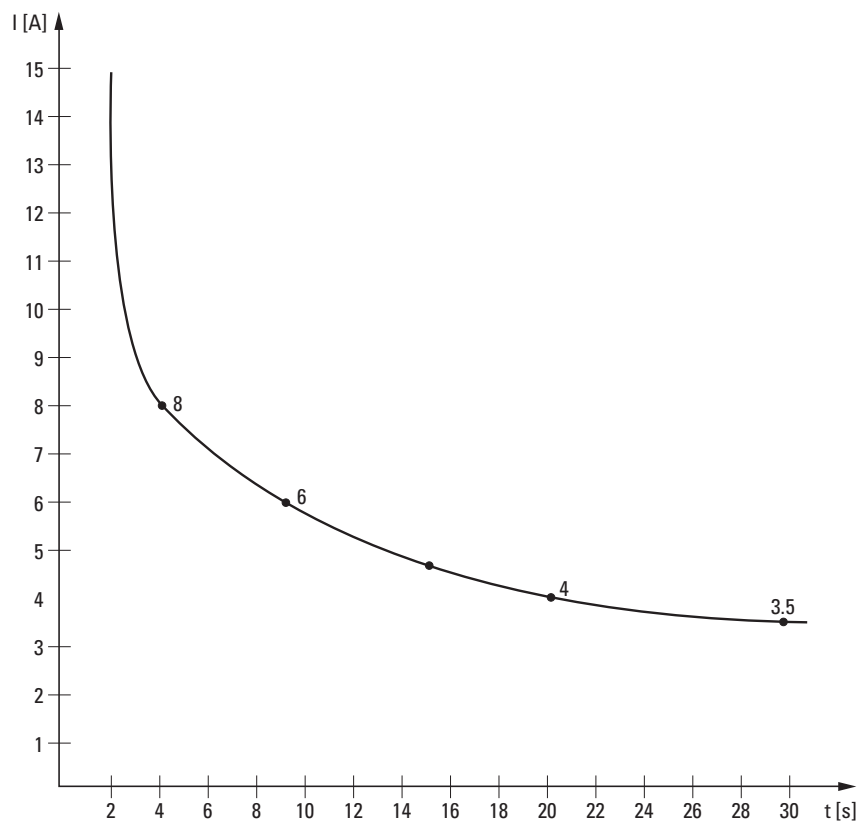

Figure 136: Permissible current curve during motor startup and continuous motor operation for the XN300 slice module as a function of time

30.4.2 LED drivers

Each of the LED drivers is a PWM controlled current source.

Number of PWM channels for LED drivers	2
LED 1	
Current	0 – 20 mA
Resolution	8 bit
LED 2 (Power LED)	
Current	0 – 350 mA
Resolution	8 bit

30.5 Memory layout

CAN object	Size (byte)	Description see → Figure 126, page 241 to → Figure 128, page 242.		
0x20E0 (Write)	2	1 OUT sequence time data	Bit 0...10	Value / system clock
			Bit 11	0: Relative time base 1: Absolute time base
			Bit 12	Motor polarity – left high
			Bit 13	Motor polarity – right high
			Bit 14	Motor polarity – left low
			Bit 15	Motor polarity – right low
0x20E1 (Write)	2	2 OUT sequence time data	Bit 0...10	Value / system clock
			Bit 11	0: Relative time base 1: Absolute time base
			Bit 12	Motor polarity – left high
			Bit 13	Motor polarity – right high
			Bit 14	Motor polarity – left low
			Bit 15	Motor polarity – right low
0x20E2 (Write)	2	3 OUT sequence time data	Bit 0...10	Value / system clock
			Bit 11	0: Relative time base 1: Absolute time base
			Bit 12	Motor polarity – left high
			Bit 13	Motor polarity – right high
			Bit 14	Motor polarity – left low
			Bit 15	Motor polarity – right low
0x20E3 (Write)	2	4 OUT sequence time data	Bit 0...10	Value / system clock
			Bit 11	0: Relative time base 1: Absolute time base
			Bit 12	Motor polarity – left high
			Bit 13	Motor polarity – right high
			Bit 14	Motor polarity – left low
			Bit 15	Motor polarity – right low
0x20E4 (Write)	2	Period duration Value / system clock		Period duration for one run through sequences 1 to 4.
0x20E5	1	LED1 closing delay		Duty factor for the LED 1 PWM output (20 mA)
0x20E6	1	LED2 closing delay		Duty factor for the LED 2 PWM output (350 mA)

30 DC motor driver module XN-322-1DCD-B35

30.5 Memory layout

CAN object	Size (byte)	Description see → Figure 126, page 241 to → Figure 128, page 242,		
0x20E7	2	Motor Control Register	Bit 0	Activate sequence output
			bit1	Resets the sequence definition error status (acknowledgment)
			Bit 2...9	reserved
			Bit 10	Internal overtemperature - activate shutdown
			Bit 11	Reset status - internal overtemperature (acknowledgment)
			Bit 12	Activate shutdown for when I ² t limit is exceeded
			Bit 13	I ² t limit exceeded; reset status (acknowledgment)
			Bit 14	Activate LED1
			Bit 15	Activate LED2
0x30E0 (Read)	2	1 IN sequence time data	Bit 0...10	Value / system clock
			Bit 11	0: Relative time base 1: Absolute time base
			Bit 12	Motor polarity – left high
			Bit 13	Motor polarity – right high
			Bit 14	Motor polarity – left low
			Bit 15	Motor polarity – right low
0x30E1 (Read)	2	2 IN sequence time data	Bit 0...10	Value / system clock
			Bit 11	0: Relative time base 1: Absolute time base
			Bit 12	Motor polarity – left high
			Bit 13	Motor polarity – right high
			Bit 14	Motor polarity – left low
			Bit 15	Motor polarity – right low
0x30E2 (Read)	2	3 IN sequence time data	Bit 0...10	Value / system clock
			Bit 11	0: Relative time base 1: Absolute time base
			Bit 12	Motor polarity – left high
			Bit 13	Motor polarity – right high
			Bit 14	Motor polarity – left low
			Bit 15	Motor polarity – right low

CAN object	Size (byte)	Description see → Figure 126, page 241 to → Figure 128, page 242,		
0x30E3 (Read)	2	4 IN sequence time data	Bit 0...10	Value / system clock
			Bit 11	0: Relative time base 1: Absolute time base
			Bit 12	Motor polarity – left high
			Bit 13	Motor polarity – right high
			Bit 14	Motor polarity – left low
			Bit 15	Motor polarity – right low
0x30E4 (Read)	2	Period duration Value / system clock		Period duration for one run through sequences 1 to 4.
0x30E5	2	Temperature in 1/16 °C		Motor driver temperature in 1/16 °C Temperature = Object value · 10/16
0x30E6	2	Motor current		Current motor power consumption in mA; the sign indicates the operating direction.
0x30E7	2	Motor diagnostics register (stored system diagnostics, excl. bit 10 and bit 12)	Bit 0	reserved
			bit1	Invalid setting in sequence (requires reset)
			Bit 2	Absolute timeout error (the absolute time values must increase with each sequence)
			Bit 3...9	reserved
			Bit 10	Internal overtemperature has shut down sequence (T > 95 °C) (reset required if internal overtemperature shut-down is activated)
			Bit 11	reserved
			Bit 12	I ² t limit exceeded, resulting in shutdown (reset required if internal overtemperature shut-down is activated)
			Bit 13	reserved
			Bit 14	reserved
Bit 15	reserved			

30 DC motor driver module XN-322-1DCD-B35

30.5 Memory layout

CAN object	Size (byte)	Description see → Figure 126, page 241 to → Figure 128, page 242,		
0x30E8	2	Motor Status Register	Bit 0	Sequence output active
			Bit 1...4	reserved
			Bit 5	DC of module supply OK
			Bit 6	DC of motor supply OK
			Bit 7...9	reserved
			Bit 10	Internal overtemperature ($T > 95^{\circ}\text{C}$)
			Bit 11	reserved
			Bit 12	I^2t limit value exceeded
			Bit 13	reserved
			Bit 14	reserved
0x30E9	4	I^2t – value	Bit 0...20	Current motor I^2t value
			Bit 21...31	reserved
30EA	2	Module diagnostics (Error bits 7 and 8 will be set to "zero" the moment the set gain matches the stored values. The application must ensure that the correct GAIN (and filter type and filter depth) is set. If the gain changes, the calibration must be repeated.)	Bit 0	Internal 24 VDC malfunctioning
			bit1	No SYNC signal
			Bit 2	FLASH-CRC error
			Bit3	RAM-CRC error
			Bit 4	Flash memory error
Bit 5...15	reserved			
40E1	2	LED 1 PWM prescaler		PWM prescaler register for LED 1 (20 mA). Reduces the 50 MHz input clock frequency to 5.55 MHz. $5.55\text{ MHz}/256$ (8-bit resolution) = Approx. 20 kHz PWM frequency. (Default =0x0009)
40E2	2	LED 2 PWM prescaler		PWM prescaler register for LED 2 (350 mA). Reduces the 50 MHz input clock frequency to 900kHz. $900\text{ kHz}/256$ (8-bit resolution) = Approx. 3.5 kHz PWM frequency. (Default =0x0037)
40E3	1	LED 1 PWM period duration		PWM period duration for LED 1 (20 mA). (Maximum value of PWM counter; default: 0xFF)
40E4	1	LED 2 PWM period duration		PWM period duration for LED 2 (350 mA). (Maximum value of PWM counter; default: 0xFF)
40E5	4	I^2t – switch off threshold (Default 0x0000 0400)	Bit 0...20	I^2t - switch off threshold
			Bit 21...31	reserved

30.6 Supported CANopen objects

Manufacturer-specific objects

Index range for the XN-322-2DCD-B35 module: x0E0 bis x0EF

Index (hex)	Data Type	Name	Function	Mapping	Access	
0x1027	UNSIGNED16	ModuleID	Module Identification Number	Manual	ro	SDO
0x20E0	UNSIGNED16	WRSeq1	Write PWM Sequence Data Seq. 1	Manual	ro	PDO
0x20E1	UNSIGNED16	WRSeq2	Write PWM Sequence Data Seq. 2	Manual	ro	PDO
0x20E2	UNSIGNED16	WRSeq3	Write PWM Sequence Data Seq. 3	Manual	ro	PDO
0x20E3	UNSIGNED16	WRSeq4	Write PWM Sequence Data Seq. 4	Manual	ro	PDO
0x20E4	UNSIGNED16	WRPeriodDurationSeq	Write Period Duration of Sequence Cycle	Manual	ro	PDO
0x20E5	UNSIGNED8	TonLED1	ON Time PWM LED 1 (20mA)	Manual	ro	PDO
0x20E6	UNSIGNED8	TonLED2	ON Time PWM LED 2 (350mA)	Manual	ro	PDO
0x20E7	UNSIGNED16	motor control	Motor Control Register	Manual	ro	PDO
0x30E0	UNSIGNED16	RDSeq1	Read PWM Sequence Data Seq. 1	Manual	ro	PDO
0x30E1	UNSIGNED16	RDSeq2	Read PWM Sequence Data Seq. 2	Manual	ro	PDO
0x30E2	UNSIGNED16	RDSeq3	Read PWM Sequence Data Seq. 3	Manual	ro	PDO
0x30E3	UNSIGNED16	RDSeq4	Read PWM Sequence Data Seq. 4	Manual	ro	PDO
0x30E4	UNSIGNED16	RDPeriodDurationSeq	Read Period Duration of Sequence Cycle	Manual	ro	PDO
0x30E5	UNSIGNED16	DCDTempK	DC driver temperature in 1/16 °C	Manual	ro	PDO
0x30E6	UNSIGNED16	DCMotorCurrent	DC Motor Current in mA	Manual	ro	PDO
0x30E7	UNSIGNED16	DCMotorDiag	DC Motor Diagnosis	Manual	ro	PDO
0x30E8	UNSIGNED16	DCMotorStatus	DC Motor Status	Manual	ro	PDO
0x30E9	UNSIGNED32	DCMotorI2T	DC Motor I ² T Value	Manual	ro	PDO
0x30EA	UNSIGNED16	ModuleDiag	Module Diagnostic Messages	Manual	ro	PDO
0x4001	VISIBLE STRING	SerialNumber	Serial Number	–	const	SDO
0x4004	UNSIGNED8	UserLEDControl	User LED Control	–	rw	SDO
0x400C	VISIBLE STRING	ProductName	Product Name	–	ro	SDO
0x40E0	UNSIGNED16	FirmwareVersion	Firmware Version	–	ro	SDO
0x40E1	UNSIGNED16	PreScaleLED1	PWM Prescaler Register LED1	–	ro	SDO
0x40E2	UNSIGNED16	PreScaleLED2	PWM Prescaler Register LED2	–	ro	SDO
0x40E3	UNSIGNED8	PDLED1	PWM Period Duration Register LED1	–	ro	SDO
0x40E4	UNSIGNED8	PDLED2	PWM Period Duration Register LED2	–	ro	SDO
0x40E5	UNSIGNED32	DCMotorI2TLimit	DC Motor I ² T Value Limit	–	rw	SDO

30 DC motor driver module XN-322-1DCD-B35

30.6 Supported CANopen objects

31 Counter module XN-322-1CNT-8DIO

The XN-322-1CNT-8DIO features an incremental encoder input (with a TTL or RS-422 level) and a 5 VDC output for powering it. In addition, the device has four digital outputs (24 VDC/2 A) and four digital inputs (24 VDC). These inputs can use the module's configurable latch function in order to have the current counter count be stored in a special register.

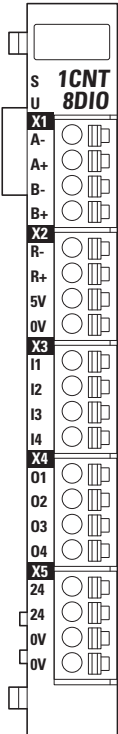

Figure 137: Device overview XN-322-1CNT-8DIO

31 Counter module XN-322-1CNT-8DIO

31.1 Status LEDs

31.1 Status LEDs

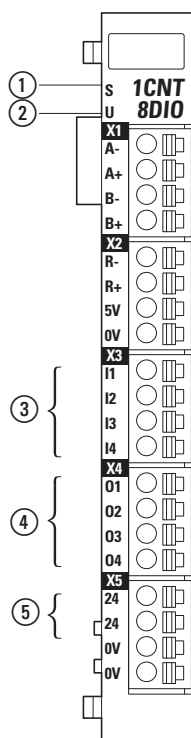

Figure 138: LED signals and pin assignment

- ① Module status LED
- ② User LED
- ③ Input status LED
- ④ Output status LED
- ⑤ +24 V error status LED

Module status	green	ON	System OK
		OFF	No power
		FLASHES (5 Hz)	No communication
Status User	yellow	ON	The user can set the LED signals as necessary. (For example, the visualization interface can be used to set the module's LED to flash so that it is easier to find the module inside the control panel.)
		OFF	
		FLASH (200 ms ON, 1000 ms OFF)	
		FLASH (1000 ms ON, 200 ms OFF)	
Input status	green	ON	Input ON
		OFF	Input OFF

Output status	yellow	ON	Output ON
		OFF	Output OFF
Status Error +24V	red	ON	Supply voltage +24V OK
		OFF	Faulty +24 V supply voltage (undervoltage) or the system is not being powered at all. If the system is not being powered at all, the module status LED will be OFF.

31.2 Pin assignment

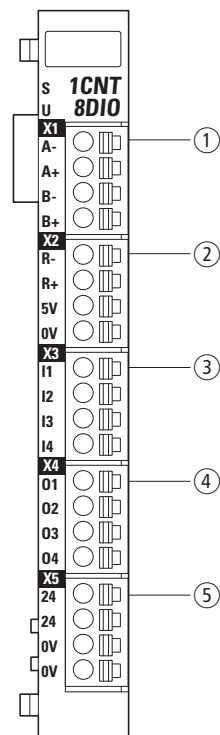

Figure 139: Pin assignment

- ① X1
 - A- RS422 incremental encoder signal (A-)
 - A+ RS422/TTL incremental encoder signal (A+)
 - B- RS422 incremental encoder signal (B-)
 - B+ RS422/TTL incremental encoder signal (B+)
- ② X2
 - R- RS422 incremental encoder signal (R-)
 - R+ RS422/TTL incremental encoder signal (R+)
 - 5 V +5 V encoder power supply
 - 0 GND
- ③ X3
 - I1 digital input 1
 - I2 digital input 2
 - I3 digital input 3
 - I4 digital input 4
- ④ X4
 - O1 digital output 1
 - O2 digital output 2
 - O3 digital output 3
 - O4 digital output 4

31 Counter module XN-322-1CNT-8DIO

31.3 Input and output wiring

- ⑤ X5
 - 24 +24V Supply digital outputs
 - 24 +24V Supply incremental encoder U_{e24}
 - 0V GND
 - 0V GND

31.3 Input and output wiring

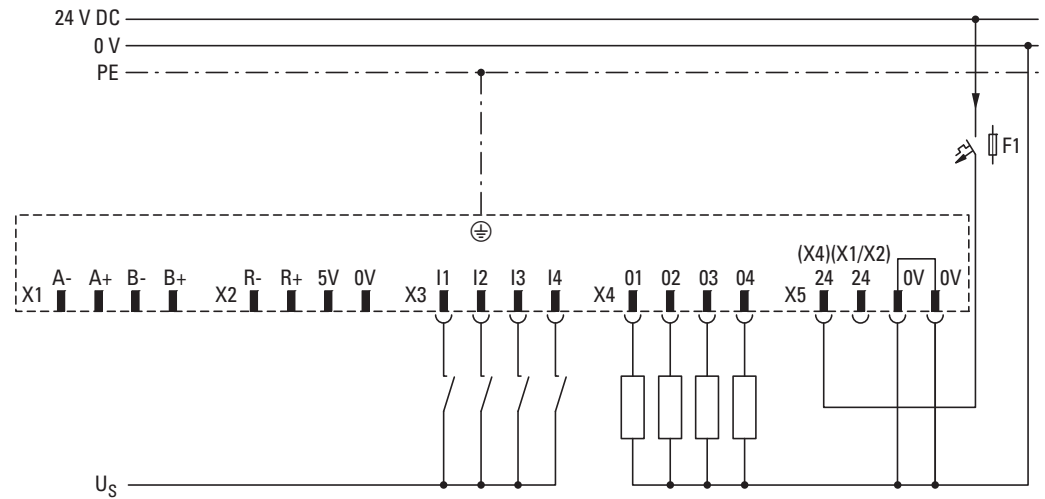

Figure 140: Wiring example for digital outputs and 4 digital inputs

31.3.1 RS422 mode wiring



Check to make sure that the encoder is suitable for operation with this module. To do this, compare the technical data for the encoder with the specifications for the XN300 slice module.

To run the counter module in RS422 mode, follow the steps below:

- ▶ Power the XN300 slice module with 24 VDC by connecting the power supply to the 24V incremental encoder supply and GND pins on terminal X5 (+24 V (X1/X2)).
- ▶ Connect the XN300 slice module's 5 V and 0 V pins to the incremental encoder's positive and negative potentials.
- ▶ Connect the incremental encoder's A, \bar{A} , B, \bar{B} , R, \bar{R} output signals to the corresponding pins on the XN300 slice module.
- ▶ Use the control software to configure the device so that it runs in RS422 mode.

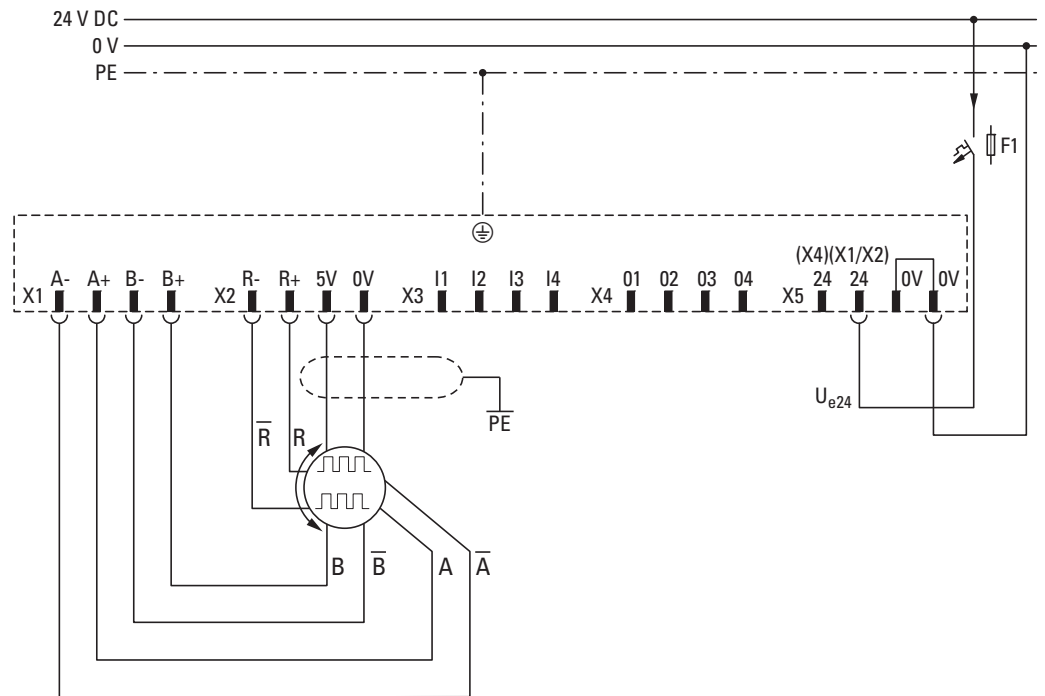

Figure 141: Wiring example for XN-322-1CNT-8DIO counter module in RS422 mode

31.3.2 TTL mode wiring



Check to make sure that the encoder is suitable for operation with this module. To do this, compare the technical data for the encoder with the specifications for the XN300 slice module.

To run the counter module in TTL mode, follow the steps below:

31 Counter module XN-322-1CNT-8DIO

31.3 Input and output wiring

- ▶ Power the XN300 slice module with 24 VDC by connecting the power supply to the 24V incremental encoder supply and GND pins on terminal X5 (+24 V (X1/X2)).
- ▶ Connect the XN300 slice module's 5 V and 0 V pins to the incremental encoder's positive and negative potentials.
- ▶ Connect the incremental encoder's A, B, R output signals to the corresponding pins on the module.
- ▶ Use the control software to configure the device so that it runs in TTL mode.

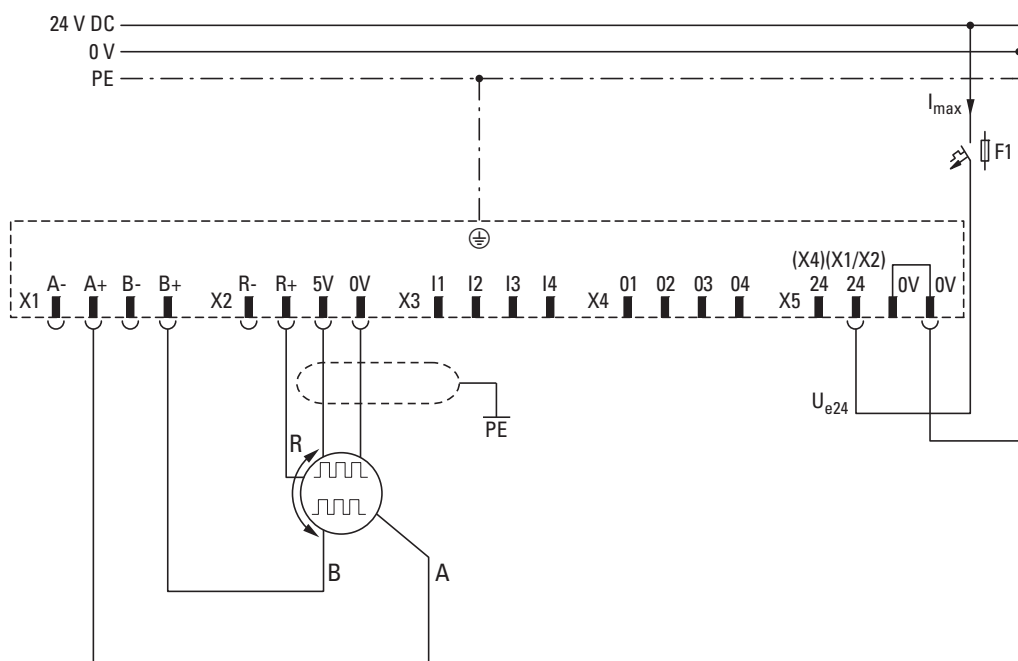

Figure 142: Wiring example for XN-322-1CNT-8DIO counter module in TTL mode

31.4 How the counter module works

In AB quadrature mode, the phase shift of the input signals at pins A and B is used to determine pulses and directions. To do this, signals A and B are evaluated for rising and falling edges. The device can be configured for X1, X2, or X4 encoding as necessary.

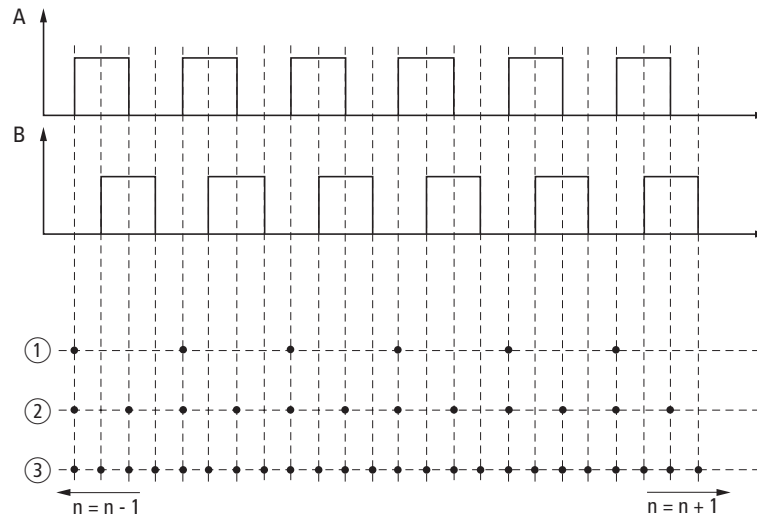

Figure 143: Signal diagram for counter module

- ① X1 encoding
- ② X2 encoding
- ③ X4 encoding

The dots represent the points at which the count changes. If the signal sequence is followed in the direction the arrow is pointing (towards the right), this corresponds to a positive counting direction. If it is followed against it, this corresponds to a negative counting direction.

31.5 Technical data

31.5.1 Incremental encoder inputs

Designation	
Quantity	1
Input signal	
Incremental encoder signal RS422	A+, A-, B+, B-, R+, R- RS422 level (120 Ω termination)
Incremental encoder signal TTL	A+, B+, R+) TTL level (1200 Ω Pull-Up)
Max. input frequency	125 kHz
Maximum counter frequency for X4 encoding	500 kHz
Signal analysis	X1, X2, X4 encoding
Encoder power supply	+5Vdc / 0.2A short-circuit proof

31 Counter module XN-322-1CNT-8DIO

31.5 Technical data

31.5.2 Digital inputs

designation		
Number of channels	4	
	61131-2 Type1	
Input voltage U_E	30 VDC	maximum 30 VDC
Signal level	LOW: $0 < U_e < +8 \text{ V}$	HIGH: $+14 \text{ V} < U_e < +30 \text{ V}$
Switching threshold	normally +11 VDC	
Input current at $U_E=24\text{Vdc}$	normally 3.7 mA	
Input delay	normally 5 ms	

31.5.3 Digital outputs

Quantity	4	
Short-circuit proof as per EN 61131-2	Yes	
Power supply for digital outputs		
Number of supply voltages	1 (X4, pin on connector 24)	
Rated operational voltage U_e	24 VDC	
admissible range	18 – 30 VDC	
Residual ripple	≤ 5 %	
Maximum permissible total current for all output channels when using a duty factor of 100%	6A	
Protection against polarity reversal	no	
Output characteristic data		
„1“ signal		
Output voltage	$(U_e - 1\text{V}) < U_a < U_e$	
Output current per channel	2A	
Maximum breaking energy of an output when there is an inductive load	0.65 Joule	
„0“ signal		
Output voltage	< 0.1 VDC	
Max. output current per channel	≤ 100 μA	
Residual current when the output has a state of "0"	≤ 12 μA	
Switching-on delay	< 200 μs	
Switch off delay	< 200 μs	
Maximum breaking energy for all outputs when there is an inductive load	1.95 Joule/channel	

31.6 Memory layout

CAN object	Size (byte)	Description					
0x40F0	1	Used to configure the latch function for the digital inputs Note: If multiple inputs are configured for the latch function, their signals will be OR'd.			Bit n+1	Bit n	
			Input 1	Bit 1-0	0	0	Latch function disabled
					0	1	Latch on rising edge
					1	0	Latch on falling edge
					1	1	Latch on rising and falling edges
			Input 2	Bit 3-2	0	0	Latch function disabled
					0	1	Latch on rising edge
					1	0	Latch on falling edge
					1	1	Latch on rising and falling edges
			Input 3	Bit 5-4	0	0	Latch function disabled
					0	1	Latch on rising edge
					1	0	Latch on falling edge
					1	1	Latch on rising and falling edges
			Input 4	Bit 7-6	0	0	Latch function disabled
					0	1	Latch on rising edge
					1	0	Latch on falling edge
1	1	Latch on rising and falling edges					
0x40F1	1	Used to configure the input so that it matches the sensor output	Bit 0	0: TTL Sensor Output			
				1: RS422 Sensor Output			
			Bit 1- 7	reserved			
0x30F0	1	Digital input register	Bit 0	Input 1			
			Bit 1	Input 2			
			Bit 2	Input 3			
			Bit 3	Input 4			
			Bit 4-7	reserved			
0x20F0	1	Digital output register	Bit 0	Output 1			
			Bit 1	Output 2			
			Bit 2	Output 3			
			Bit 3	Output 4			
			Bit 4-7	reserved			

31 Counter module XN-322-1CNT-8DIO

31.6 Memory layout

CAN object	Size (byte)	Description	
0x30F1	4	Pause time, measured by counting internal clock signals in this 32-bit counter register. The register contains the number of pulses, from an internal time reference, counted between the last two counter value increments (rising edges on signal A). The register value with the counted pulses is refreshed with a rising edge on A or when the maximum value is reached. Accordingly, this register makes it possible to represent count pulses per time unit for the frequency or speed measurement. The direction (sign) is determined based on the evaluation of the signal sequence when in AB quadrature mode.	
0x30F2	2	Counter value (16-bit incremental encoder counter value) The counter resolves edges into numbers of pulses and directions. X1, X2 and X4 encoding are available.	
0x30F3	2	Stored counter value (stored 16-bit incremental encoder counter value) This register contains the counter value stored by a latch pulse. The input that triggers this action must be configured accordingly.	
0x30F4	1	Incremental encoder status register	
		Bit 0-3	reserved
		Bit 4	Zero position
		Bit 5	reserved
		Bit 6 (State +24V X4)	24 VDC OK on supply to outputs
Bit 7 (State +24V X1/X2)	24 VDC OK on supply to incremental encoder		
0x40F2 (WRITE)	4	Max. waiting time value (count range for the waiting time register (max. 31-bit)) This register uses the register width to define the maximum value for the waiting time. When the maximum value is reached, a motor stop is identified, for example.	
0x40F3	1	Cycle prescaler for determining the waiting time $\text{Prescaler periods} = \text{Cycle [Hz]} * \text{Measuring time [sec]}$	
0x40F4 (READ)	1	Pulse frequency (System Clock) Pulse frequency in MHz	
0x40F5	2	Counter value as acyclical access (16-bit incremental encoder counter value)	
0x40F6	1	Incremental encoder configuration register	
		Bit 0 ... 1	reserved
		Bit 2	Inverted logic for R zero-position evaluation
		Bit 3	Inverted logic for B phase evaluation
		Bit 4 ... 5	Bit 5 Bit 4 Signal analysis
		0 0	off
		0 1	single encoding
		1 0	double encoding
1 1	four sample encoding		
Bit 6 ... 7	reserved		

31 Counter module XN-322-1CNT-8DIO
3.1.6 Memory layout

CAN object	Size (byte)	Description		
0x40F7	1	Incremental encoder status register (acyclical access)	Bit 0 ... 3	reserved
			Bit 4	Zero position present
			Bit 5 Bit will be automatically reset after the register is read.	Zero position has been crossed
			Bit 6...7	reserved
0x40F8	2	Stored counter value as acyclical access (stored 16-bit incremental encoder counter value) This register contains the counter value stored by a latch pulse. The input that triggers this action must be configured accordingly.		

31 Counter module XN-322-1CNT-8DIO

31.7 Supported CANopen objects

31.7 Supported CANopen objects

Manufacturer-specific objects

Index range for the XN-322-1CNT-8DIO module: x0F0 to x0FF

Index (hex)	Data Type	Name	Function	Mapping	Access	
0x1027	UNSIGNED16	ModuleID	Module Identification Number	–	ro	SDO
0x20F0	UNSIGNED8	Output1_4	Write Digital Outputs	Manual	rww	PDO
0x30F0	UNSIGNED8	Input1_4	Read Digital Inputs	Manual	ro	PDO
0x30F1	SIGNED32	IdleTime	Encoder Idle Time	Manual	ro	PDO
0x30F2	UNSIGNED16	CounterValue	Encoder Count Value	Manual	ro	PDO
0x30F3	UNSIGNED16	LatchValue	Encoder Latch Value	Manual	ro	PDO
0x30F4	UNSIGNED8	EncoderStatus	Encoder Status	Manual	ro	PDO
0x4001	VISIBLE STRING	SerialNumber	Serial Number	–	const	SDO
0x4004	UNSIGNED8	UserLEDControl	User LED Control	–	rw	SDO
0x400C	VISIBLE STRING	ProductName	Product Name	–	ro	SDO
0x40F0	UNSIGNED8	LatchConfig	Latch Input Configuration	–	rw	SDO
0x40F1	UNSIGNED8	EncoderConfig	Encoder Type Configuration	–	rw	SDO
0x40F2	SIGNED32	MaxIdleTime	Maximum Idle Time	–	rw	SDO
0x40F3	UNSIGNED8	IdleClock	Idle Clock Pre-Scaler	–	rw	SDO
0x40F4	UNSIGNED8	SystemClock	System Clock Frequency	–	ro	SDO
0x40F5	UNSIGNED16	CounterValueSDO	Encoder Measuring Value SDO	–	ro	SDO
0x40F6	UNSIGNED8	SignalConfig	Encoder Signal Configuration	–	rw	SDO
0x40F7	UNSIGNED8	EncoderStatusSDO	Encoder Status SDO	–	ro	SDO
0x40F8	UNSIGNED8	LatchValueSDO	Encoder Latch Value SDO	–	ro	SDO

32 Interface module XN-322-2SSI

The XN-322-2SSI SSI interface module can be used to read data from up to two absolute encoders and provide it to the PLC. The interface is designed for SSI encoders, e.g., absolute linear encoders, that support natural binary or Gray code.



Check to make sure that the encoder is suitable for operation with this XN300 slice module. To do this, compare the technical data for both devices.

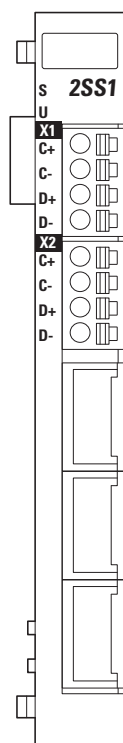

Figure 144: Device view XN-322-2SSI

32 Interface module XN-322-2SSI

32.1 Status LEDs

32.1 Status LEDs

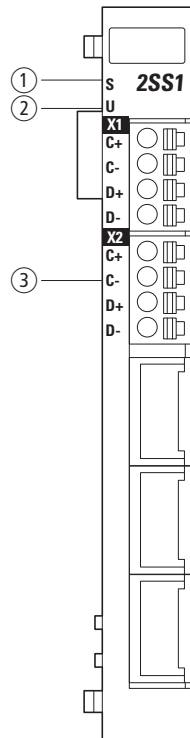

Figure 145: XN-322-2SSI LEDs

- ① Module status LED
- ② User status LED
- ③ SSI encoder LED

Module status	green	ON	System OK
		OFF	No power
		FLASHES (5 Hz)	No communication
Status User	yellow	ON	The user can set the LED signals as necessary. (For example, the visualization interface can be used to set the module's LED to flash so that it is easier to find the module inside the control panel.)
		OFF	
		FLASH (200 ms ON, 1000 ms OFF)	
		FLASH (1000 ms ON, 200 ms OFF)	
SSI encoder status	green	ON	There is communication with the SSI encoder
		OFF	No communication with the SSI encoder

32.2 Pin assignment

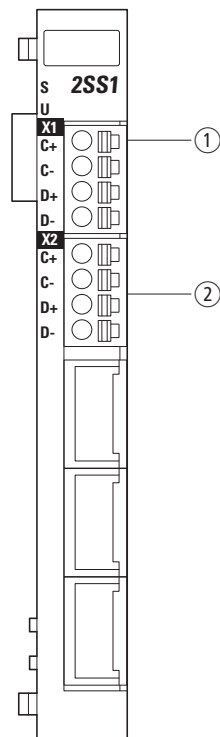

Figure 146: Pin assignment XN-322-2SSI

- ① X1
 - C+ encoder 1
 - C- encoder 1
 - D+ encoder 1
 - D- encoder 1
- ② X2
 - C+ encoder 2
 - C- encoder 2
 - D+ encoder 2
 - D- encoder 2

32.3 Wiring

SSI encoders can be run in two different modes:

- Binary Mode
- Gray Decoder Mode

32.3.1 Binary Mode

When using binary mode, Gray code decoding must be turned off (it is turned off by default). This mode can also be used when the encoder delivers Gray code data that includes unencoded extra bits, i.e., as using automatic decoding in this case would yield an incorrect final result. In this latter case, decoding must be carried out in the PLC program. The encoder's deserialized data stream will be mapped to the channel's relevant data register as a 32-bit value.

32.3.2 Gray Decoder Mode

For encoders that deliver Gray encoded data, the result will be automatically decoded (Gray code decoding ON) and provided as a 32-bit value in the channel's relevant data register. When using this mode, extra bits in the encoder's data stream must be taken into account. If there are any extra bits that are not encoded and are transmitted before the encoded measurement data in the serial data stream, automatic decoding will result in incorrect decoding. In this case, you should use binary mode instead. If the unencoded extra bits in the encoder's serial data stream come after the measurement data instead, only these extra bits will be interpreted incorrectly by automatic decoding.

32.3.3 Terminal type

A non-volatile shift register with the current measured value is loaded in the sensor. If a data value needs to be read, the device will output a clock signal on the clock cable. With this clock signal, the device will read the data from the encoder's shift register. Absolute encoders will deliver absolute data – with additional control information if applicable – in the shift register.

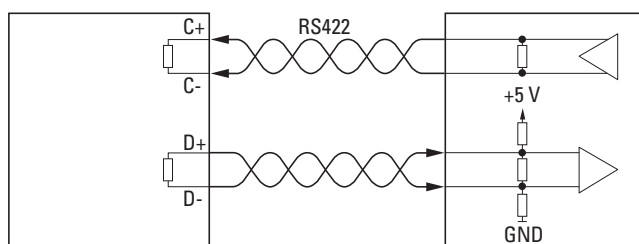

Figure 147: Application Style

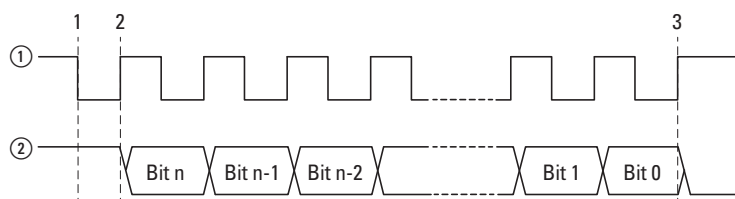

Figure 148: Application Style

- ① Clock
- ② Data

32.3.4 Wiring example

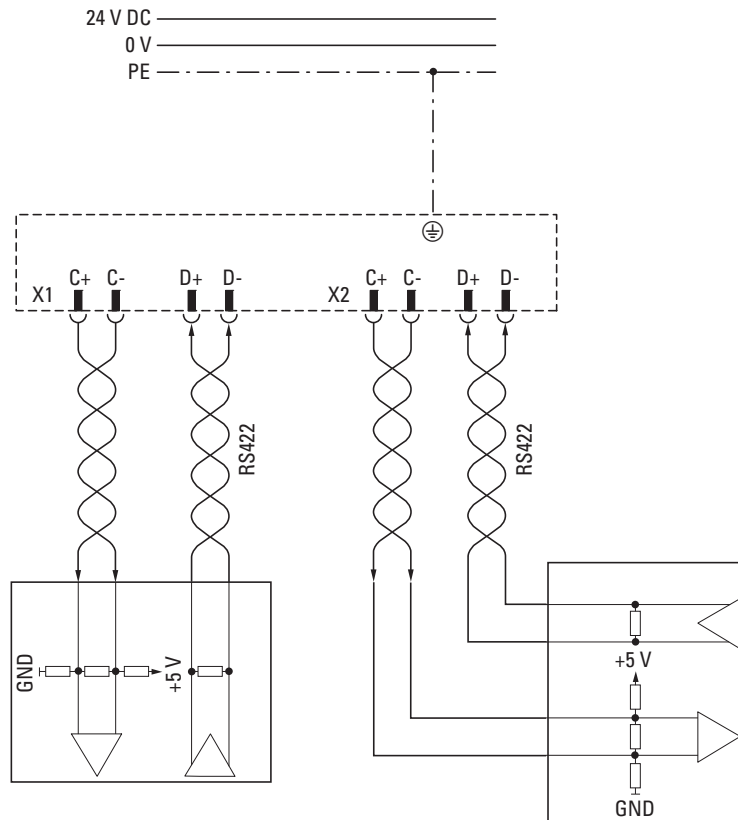

Figure 149: Wiring example XN-322-2SSI

32.4 Memory layout

CAN Object Index	Size (byte)	Description	Bit	
4100	1	Configuration Register Channel 1 (Default 0x20)	Bit 0 ... 5	SSI Shift Register ; Length: 1-32 Bit Bit 5 4 3 2 1 0 0 0 0 0 0 reserved 0 0 0 0 1 1-bit register 0 0 0 0 1 0 2-bit register ... 0 1 1 1 1 31-bit register 1 0 0 0 0 32-bit register 1 0 0 0 1 reserved ... reserved 1 1 1 1 1 reserved
			Bit 6	Read mode: 0: Single Read 1: Double Read
			Bit 7	reserved

32 Interface module XN-322-2SSI

32.4 Memory layout

CAN Object Index	Size (byte)	Description	Bit	
4101	1	State and Configuration Register Channel 1	Bit 0.1	SSI Shift Register Frequency 00 = 125 kHz 01 = 250 kHz 10 = 500 kHz 11 = 1 MHz
			Bit 2	0: Binary Data 1: Gray Code Decoding
			Bit 3	SSI busy (1= busy) (read only)
			Bit 4	Reserved
			Bit 5	Error Clear (1 = clear error) (write)
			Bit 6	Start with Sync (1= enable)
			Bit 7	Continuous Sensor Read (1= enable)
4102	1	Configuration Register Channel 2 (Default 0x20)	Bit 0 ... 5	SSI Shift Register ; Length: 1-32 Bit Bit 5 4 3 2 1 0 0 0 0 0 0 0 reserved 0 0 0 0 1 1 1-bit register 0 0 0 0 1 0 2-bit register ... 0 1 1 1 1 1 31-bit register 1 0 0 0 0 0 32-bit register 1 0 0 0 0 1 reserved ... reserved 1 1 1 1 1 1 reserved
			Bit 6	Read mode: 0: Single Read 1: Double Read
			Bit 7	reserved
4103	1	State and Configuration Register Channel 2	Bit 0.1	SSI Shift Register Frequency 00 = 125 kHz 01 = 250 kHz 10 = 500 kHz 11 = 1 MHz
			Bit 2	0: Binary Data 1: Gray Code Decoding
			Bit 3	SSI busy (1= busy) (read only)
			Bit 4	Reserved
			Bit 5	Error Clear (1 = clear error) (write)
			Bit 6	Start with Sync (1= enable)
			Bit 7	Continuous Sensor Read (1= enable)
2100	3100	Channel Control / Channel Control Status Starts read cycle	Bit 0	Start Read Channel 1
			Bit 1	Start Read Channel 2
			Bit 2...7	reserved

32 Interface module XN-322-2SSI
32.4 Memory layout

CAN Object Index	Size (byte)	Description	Bit	
3101	1	Module diagnostics / channel status data for channel 1 and channel 2	Bit 0	Channel 1 „started“
			Bit 1	Channel 1 „busy“
			Bit 2	Channel 1 „toggle“
			Bit 3	Channel 1 SSI Error/ Invalid Z-Position
			Bit 4	Channel 2 „started“
			Bit 5	Channel 2 „busy“
			Bit 6	Channel 2 „toggle“
			Bit 7	Channel 2 SSI Error/ Invalid Z-Position
3102	4	Input Data Channel 1	Bit 0...31	SSI Input Data
3103	4	Input Data Channel 2	Bit 0...31	SSI Input Data

32 Interface module XN-322-2SSI

32.5 Supported CANopen objects

32.5 Supported CANopen objects

Manufacturer-specific objects

Index range for the XN-322-2SSI module: x100 to x10F

Index (hex)	Data Type	Name	Function	Mapping	Access	
0x1027	UNSIGNED16	ModuleID	Module Identification Number	–	ro	SDO
0x2100	UNSIGNED8	StartReadCycle	Start Read Cycle	Manual	wo	PDO
0x3100	UNSIGNED8	ReadCycleState	Read Cycle State	Manual	ro	PDO
0x3101	UNSIGNED8	ModuleDiag	Module Diagnosis	Manual	ro	PDO
0x3102	UNSIGNED32	InputChannel1	Input Data Channel 1	Manual	ro	PDO
0x3103	UNSIGNED32	InputChannel2	Input Data Channel 2	Manual	ro	PDO
0x4001	VISIBLE STRING	SerialNumber	Serial Number	–	const	SDO
0x4004	UNSIGNED8	UserLEDControl	User LED Control	–	rw	SDO
0x400C	VISIBLE STRING	ProductName	Product Name	–	ro	SDO
0x4100	UNSIGNED8	ConfigurationRegisterChannel1	Configuration Register Channel 1	–	rw	SDO
0x4101	UNSIGNED8	StateRegisterChannel1	State Register Channel 1	–	rw	SDO
0x4102	UNSIGNED8	ConfigurationRegisterChannel2	Configuration Register Channel 2	–	rw	SDO
0x4103	UNSIGNED8	StateRegisterChannel2	State Register Channel 2	–	rw	SDO

33 Appendix

33.1 Approvals and national approvals for XN300 system devices

XN300 system devices are approved for use in several countries and regions.

Product Standards	<ul style="list-style-type: none"> • IEC/EN; • UL 508 (INDUSTRIAL CONTROL EQUIPMENT); • CE Marking
UL File No.	XN-312-..., XN-322-...: E135462, XN322-1DCD-B35: E172143
NA Certification	cULus
Degree of protection	IEC: IP20

33.2 Dimensions

All XN300 slice modules have the exact same dimensions, except for the XN322-4DO-RNO relay module.

Dimensions		XN322-...	XN322-4DO-RNO
Dimensions (W x H x D)	mm	16.8 x 104.2 x 80.3	29.3 x 104.7 x 89.2
	in	0.66 x 4.10 x 3.16	1.15 x 4.12 x 3.51
mounting		Snapped onto IEC/EN 60715 DIN-rail	Snapped onto IEC/EN 60715 DIN-rail
Mounting position		Horizontal	Horizontal

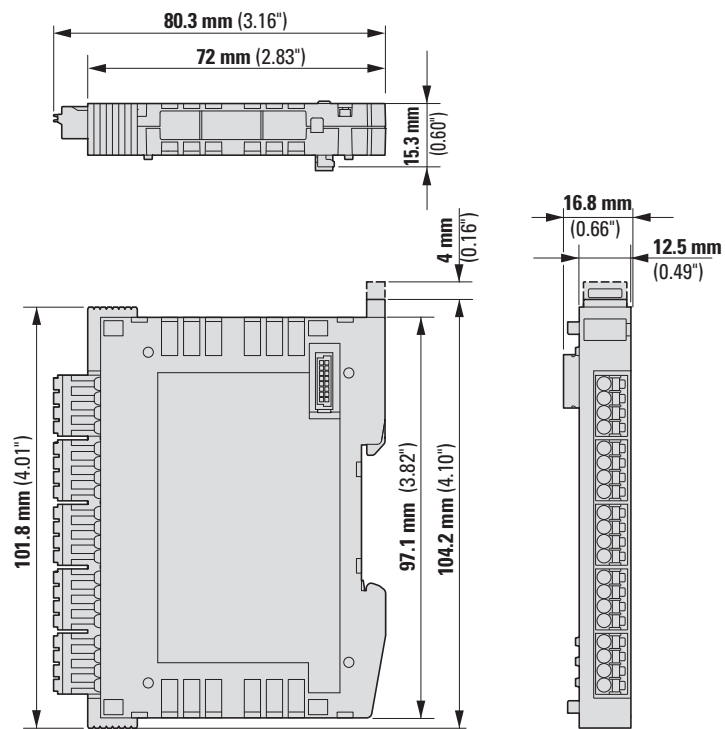

Figure 150: XN300 slice modules dimensions

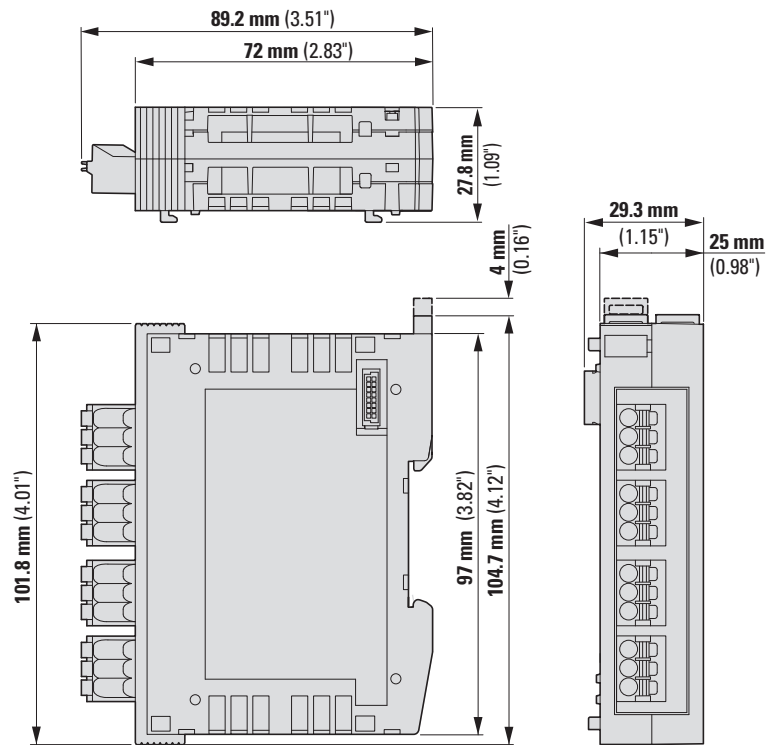

Figure 151: XN322-4DO-RNO relay module dimension

33.3 Technical Data

For specific technical data, please consult the chapter for the specific XN300 slice module you want, e.g., technical data for the XN322-1DCD-B35 motor driver can be found in → Section “30.4.1 DC motor driver”, page 249.

33.3.1 Ambient conditions



Storage temperature	-20 to +85 °C -40 to +85 °C (XN-322-4DO-RNO)	
Operating Temperature	0 to +60 °C	0 to +55 °C
	XN-322-4PS-20 XN-322-18PD-M XN-322-18PD-P XN-322-8DI-PD XN-322-16DI-PD XN-322-20DI-PCNT XN-322-20DI-ND XN-322-8DO-P05 XN-322-16DO-P05 XN-322-8DIO-PD05 XN-322-16DIO-PD05 XN-322-16DIO-PC05 XN-322-4AI-PTNI, XN-322-7AI-U2PT XN-322-8AI-I XN-322-10AI-TEKT XN-322-8AO-U2 XN-322-4AIO-U2 with potentiometer ≥ 2.4 kΩ XN-322-8AIO-U2 XN-322-4AIO-I XN-322-8AIO-I XN-322-2DMS-WM XN-322-1CNT-8DIO XN-322-2SSI	XN-322-20DI-PD XN-322-20DI-PF XN-322-12DO-P17 XN-322-1DCD-B35 XN-322-7AI-U2PT with potentiometer from 2.4 to 3.9 kΩ XN-322-8AIO-U2 with potentiometer from 2.4 to 3.9 kΩ XN-322-4AIO-U2 with potentiometer < 2.4 kΩ
	-25 to +60 °C	
	XN-322-4DO-RNO	
Humidity	0 – 95 %, non-condensing	
EMC interference immunity	As per EN 61000-6-2 (industrial environment)	
EMC emitted interference	As per EN 61000-6-4 (industrial environment)	
Vibration resistance	EN 60068-2-6	3.5 mm of 5 Hz - 8.4 Hz 1 g of 8.4 Hz - 150 Hz
Mechanical shock resistance	EN 60068-2-27	15 g
Degree of protection	EN 60529_x	IP20

33.3.2 Power supply

U_{Backplane 24V} supply voltage			
Supply voltage	U _e	V	18 – 30 VDC
Residual ripple of input voltage		%	≤ 5
Protection against polarity reversal			No
Overload proof			Yes
U_{Backplane 5V} supply voltage			
Rated operational voltage	U _e	V	5

33.3.3 Cable cross-sections

Table 9: Connection specifications

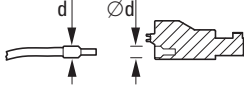
Cable cross-sectional areas			XN-322-...	XN-322-4D0-RNO
10 mm (0.39") 	solid	mm ²	0.2 – 1.5	0.2 – 2.5
10 mm (0.39") 	Flexible with uninsulated ferrule	mm ²	0.2 – 1.5	0.25 – 2.5
10 mm (0.39") 	Flexible with insulated ferrule	mm ²	0.2 – 0.75	0.25 – 2.5
	Ferrule d	mm	≤ 2.8	≤ 3.8
	AWG		24 – 16	24 – 12
	Strip length	mm	10	10

33 Appendix

33.4 Definitions for short-circuit proof outputs (in accordance with IEC/EN 61131-2)

33.4 Definitions for short-circuit proof outputs (in accordance with IEC/EN 61131-2)

The following applies to outputs that the manufacturer declares to be short-circuit proof:

- The output must continue to work with all output currents that are higher than $I_{e\ max}$ but less than two times the rated operational current I_e . Moreover, the output must be able to withstand temporary overloads. The manufacturer must provide specifics regarding temporary overload scenarios.
- The protective device must trip for all foreseeable output currents that are more than 20 times the rated value. After the protective device is reset or replaced, the PLC system must continue to work normally.
- It may be necessary to repair or replace the module after the presence of output currents within a range of 2 to 20 times or temporary overloads that exceed the limits specified by the manufacturer (see first bullet point).
- No fire or electric shock hazards must arise when there is an overload of two times I_e for 5 min. The highest temperature rise in the I/O insulation must not exceed the values specified in 4.4.2. immediately after each overload.

Alphabetical index

A	
Abbreviations	13
C	
cable protection	27
Catalog number selection	17
connection terminals	24
Counter function	66
D	
Device overview	15
Download Center	11
I	
Input module	
XN-322-20DI-PCNT	63
XN-322-20DI-PD .. 41, 45, 51, 71, 109, 115, 123	
XN-322-20DI-PF	57
Input module, analog	
XN-322-4AI-PTNI	135
XN-322-7AI-U2PT	147
XN-322-8AI-I	157, 203, 213
K	
KTY sensor	169
L	
Library XN300 slice modules	11
M	
Mounting the XN300 slice modules	19
O	
Output module	
XN-322-16DO-P05	101
XN-322-8DO-P05	85
output module	
XN-322-12DO-P17	93
P	
Period	240
Potential Relationships	26
Potentiometer measurement	150
Power Distribution	33, 37
Power supply	29
R	
Removing the XN300 slice modules	22
S	
Sensor	150
Sensor selection list	174
Strip length	24
Support Center	11
Suppressor circuit for inductive loads	96
T	
temperature input	150
Temperature measurement	
three-wire connection	81, 138
two-wire connection	79, 138
X	
XN300 system overview	26
XN-322-10AI-TEKT	
Sensor selection list	174

Eaton is dedicated to ensuring that reliable, efficient and safe power is available when it's needed most. With unparalleled knowledge of electrical power management across industries, experts at Eaton deliver customized, integrated solutions to solve our customers' most critical challenges.

Our focus is on delivering the right solution for the application. But decision makers demand more than just innovative products. They turn to Eaton for an unwavering commitment to personal support that makes customer success a top priority. For more information, visit www.eaton.eu or www.eaton.com.

Eaton addresses worldwide:
[www.eaton.com/Worldwide Sites](http://www.eaton.com/Worldwide_Sites)

E-Mail: info-bonn@eaton.com
TRCAutomation@eaton.com

Internet: www.eaton.eu/xn300
www.eaton.com/xn300

Eaton Industries GmbH
Hein-Moeller-Str. 7-11
D-53115 Bonn

© 2014 by Eaton Corporation
All rights reserved
06/16 MN050002 EN ICPD-MOC



Powering Business Worldwide