



Hisense

Refrigerator Use & Care Guide

Model:

HRF266N6CSE

For questions about features, operation/performance, parts or service, call:

1-877-465-3566

Table of Contents

Brief introduction	1
Important safety instructions	2
Installing your new appliance	4
Description of the appliance	10
Display controls	11
Using your appliance	13
Cleaning and care	17
Helpful hints and tips	19
Troubleshooting	21
Disposal of the appliance	24

Brief Introduction

Thank you for your choosing Hisense. We are sure you will find your new refrigerator a pleasure to use. Before you use the appliance, we recommend that you carefully read through these instructions , which provide details about installing and using the product.

- Please ensure that everyone using this appliance is familiar with its operation and safety features. It is important that you install the appliance correctly and pay careful attention to the safety instructions.
- We recommend that you keep this user's manual with the appliance for future reference.
- This appliance is intended to be used in households and similar applications such as:
 - Kitchen areas in shops, offices and other working environments.
 - Hotels, motels and other residential environments.
 - Bed and breakfast environments.
 - Catering and similar non-commercial applications.
- This appliance is not intended for use by persons (including children) with reduced physical, sensory or mental capabilities, or lack of experience and knowledge, unless they have supervision or been given instruction concerning use of the appliance. Children should be supervised to ensure that they do not play with the appliance.
- Do not store explosive substances such as aerosol cans with a flammable propellant in this appliance.



WARNING

- Connect to potable water supply only.
- Do not use mechanical devices or other means to accelerate the defrosting process, other than those recommended by the manufacturer.
- Do not damage the refrigerant circuit.
- Do not use electrical appliances inside the food storage compartments of the appliance, unless they are of the type recommended by the manufacturer.
- When disposing of the appliance do so only at an authorized waste disposal center. Do not expose to flame.
- If the power cord is damaged, it must be replaced by the manufacturer, its service agent or similarly qualified persons in order to avoid a hazard.

Important Safety Instructions

General safety and daily use

It is important to use your appliance safely. We recommend that you follow the guidelines below.

Store any food in accordance with the storage instructions from the manufacturer.

- Don't try to repair the appliance yourself. It is dangerous to alter the specifications or modify this product in any way. Any damage to the power cord may cause a short circuit, fire or electric shock.
- Don't place too much food directly against the air outlet on the rear wall of both the refrigerator and freezer compartment, as it may affect important air circulation.
- Don't place hot items near the plastic components of this appliance.
- Frozen food must not be refrozen once it has been thawed out.
- Don't store bottled or canned drinks (especially carbonated drinks) in the freezer compartment. Bottles and cans may explode.
- Use caution consuming popsicles or ice cubes straight from the freezer as this can cause freezer burn to the mouth and lips.

Safety for children and other persons

- Keep all packaging away from children to avoid risk of suffocation.
- Protect children from being scalded by touching the compressor at the rear bottom of appliance

- Don't place items on top of the appliance as this could cause injury should they fall off.
- Never allow children to play with the appliance by hanging or standing over or on the doors, racks, shelves and drawers etc.

Electrical Safety

To avoid the risks that are always present when using an electric appliance, we recommend that you pay attention to the instructions about electricity below.

- Unpack and check through the appliance. Should any damage be evident, don't plug in the appliance but contact the shop immediately from which you purchased it. Keep all packing materials in this case.
- We recommend that you wait for 4 hours before connecting the appliance to allow the refrigerant to flow back into the compressor.
- The appliance must be applied with single phase alternating current of 110~115V/60Hz. If the voltage fluctuates exceeding the upper limit, A.C. automatic voltage regulator of more than 350W should be applied to the refrigerator for safety use.
- The power plug must be accessible when the appliance is installed.
- This appliance must be grounded.
- This appliance is fitted with a plug, in accordance with local standard. The plug should be suitable for use in all houses fitted with sockets in accordance with current specifications.

- If the fitted plug is not suitable for your socket outlets, it should be cut off and carefully disposed of. To avoid a possible shock hazard, do not insert the discarded plug into a socket. If in doubt contact a qualified, registered electrician.

- Do not use extension cords or multiple sockets which could cause overloading of wiring circuits and could cause a fire. Always plug your appliance into its own individual electrical socket which has a voltage rating that matched the rating plate.

- Make sure that the plug is not squashed or damaged. Otherwise, it may cause short circuit, electric shock or overheat and even cause a fire.

- Do not insert the power plug if the socket is loose, there is a risk of electric shock or fire.

- Switch off the appliance and disconnect it from the main power before you clean or move it.

- Never unplug the appliance by pulling on the electrical cord. Always grip the plug firmly and pull straight out from the socket to prevent damaging the power cord.

- Do not operate the appliance without the cover of interior lighting.

- Any electrical component must be replaced or repaired by a qualified electrician or authorized service engineer. Only genuine replacement parts should be used.

- Do not use electrical appliances such as ice cream makers inside the food storage compartments of the appliance unless they are approved by the manufacturer.

- To avoid eye injury, do not look directly into the LED light located in the refrigerator compartment. If it is not functioning correctly, consult a qualified, registered electrician or replace it in accordance with the "Cleaning and Care" chapter.

Refrigerant

- The refrigerant isobutane (R600a) is contained within the refrigerant circuit of the appliance. During transportation and installation of the appliance, ensure that none of the components of the refrigerant circuit become damaged. The refrigerant (R600a) is flammable.

Caution: Risk of Fire

- Don't store products which contain flammable propellants (e.g. spray cans) or explosive substances in the appliances.

Should the refrigerant circuit be damaged:

- Avoid open flames (candles, lamps etc.) and other sources of ignition.

- Thoroughly ventilate the room in which the appliance is situated.

Installing Your New Appliance

Before using the appliance for the first time, you should be informed of the following tips.

WARNING

For proper installation, this refrigerator must be placed on a level surface of hard material that is the same height as the rest of the flooring. This surface should be strong enough to support a fully loaded refrigerator. The rollers, which are not casters, should be only used for forward or backward movement. Moving the refrigerator sideways may damage your floor and the rollers.



Ventilation of appliance

In order to improve efficiency of the cooling system and save energy, it is necessary to maintain good ventilation around the appliance for the dissipation of heat. For this reason, sufficient clear space should be available around the refrigerator.

• Suggestion:

It is advisable for there to be at least 3"(75mm) of clearance from the back of the fridge to the wall, at least 4"(100mm) of clearance from its top, at least 4"(100mm) from its side to the wall and a clear space in front to allow the doors to open 125°. As shown in the following diagrams.

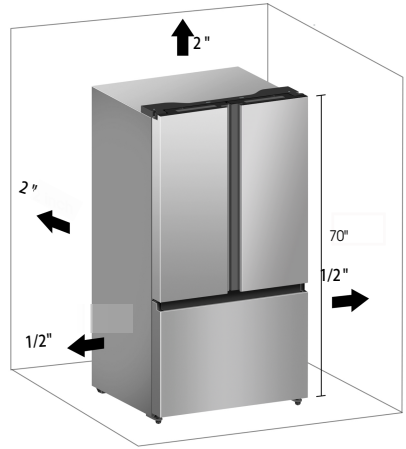

Note:

- This appliance performs well within the climate class from N to T shown in the table below. It may not work properly if left at a temperature above or below the indicated range for a long period.

Climate class	Ambient temperature
SN	+50°F to + 90°F
N	+61°F to + 100°F
SN	+61°F to + 100°F
T	+61°F to + 109°F

- Stand your appliance in a dry place to avoid high moisture.
- Keep the appliance out of direct sunlight, rain or frost. Stand the appliance away from heat sources such as stoves, fires or heaters.

Leveling of appliance

- For sufficient leveling and air circulating in the lower rear section of the appliance, the bottom feet may need to be adjusted. You can adjust them manually by hand or by using a suitable tool.
- To allow the doors to self-close, tilt the top backwards by 0.4" - 0.6".

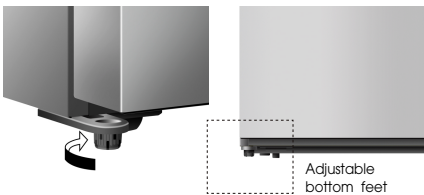
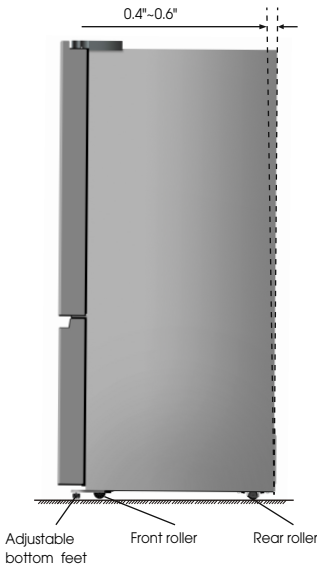

Door Removal

- In case your home access door is too narrow for the refrigerator to pass through, remove the refrigerator doors and drawers. If you do not need to remove the appliance doors, proceed to 'Installing Water Lines' on page 8. If you need to remove the doors, continue below.

Tools you will need(Not provided) :

Allen Wrench (5/32", 4mm)	Wrench (5/16", 8mm)
Phillips Screwdriver	

1. With the door closed, remove the 3 screws holding the top cover (A) with Phillips (+) screwdriver, and then remove the top cover with the entire harness attached.

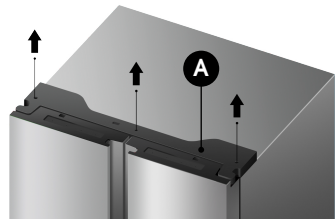

2. Remove the screws (B) fixed on the hinges with a wrench (5/16", 8mm) and 1 ground screw (C) attached to the hinge with Phillips (+) screwdriver. Remove the upper left and right door hinges (D).

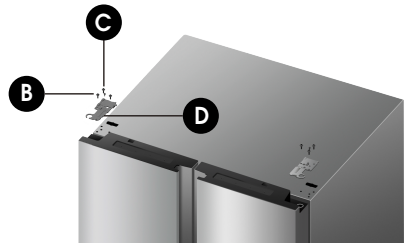

3. Use both hands to open the door more than 90°. Lift it up and take it off.



Disassembling the freezer door

1. Pull out the freezer door and the upper freezer drawer (G) to the final position.

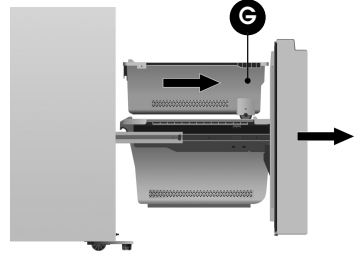

2. Take out the ice storage box (H) by lifting it up in the direction of the arrow.

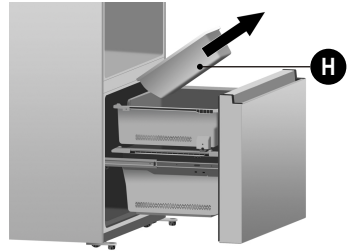

4. Remove the 4 hex head bolts hinges (E) with an Allen wrench (5/32", 4mm). Remove the lower left and right door hinges (F).

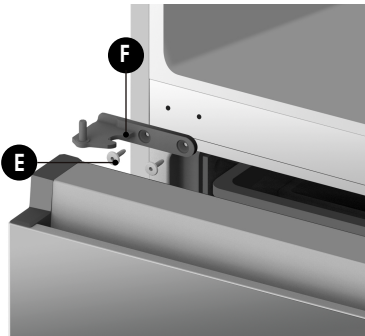

3. Take out the upper freezer drawer (G) by lifting it up from the rail system.

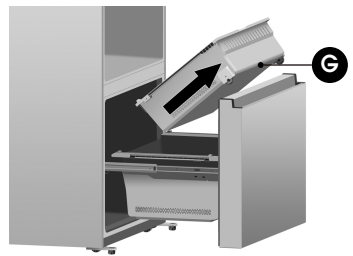

4. Remove the lower freezer drawer (C) by lifting it up.

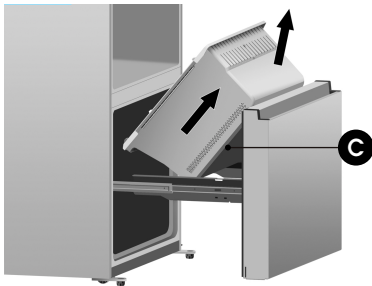

5. Remove the 4 screws attached to the supporting frame (D).

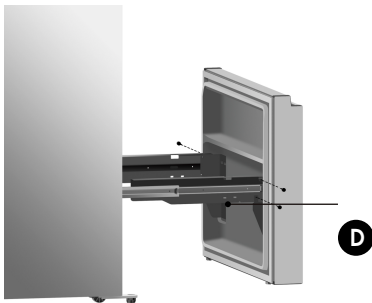

6. Pull out the freezer door and lift it up in the direction of the arrow.

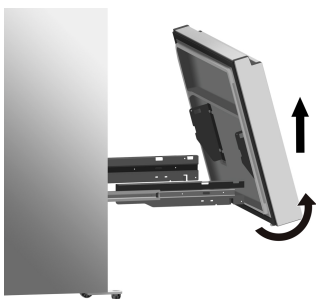

Re-assembling the freezer door

To reattach the drawer after you moved the appliance to its final location, assemble the parts in reverse order.

Installing the water lines

A water dispenser with a filter is one of the helpful features on your new appliance. To help promote better health, the water filter removes unwanted particles from your water. However, it does not sterilize or destroy microorganisms. You may need to purchase a water purifying system to do that.

In order for the ice maker to operate properly, a water line is required.

- the maximum inlet water pressure is 700kPa;
- the minimum inlet water pressure is 207kPa.

! WARNING!

The water connection must be made by a qualified plumber. Operation outside the water pressure range may cause malfunction, severe and damaging water leaks.

Under normal conditions, a 200cc (5.75 oz.) cup can be filled in about 10 seconds.

If the refrigerator is installed in an area with low water pressure (below 30psi), you can install a booster pump to compensate for the low pressure.

What you need to have before you star

1. Power drill and 1/4" drill bit.
2. 1/2" or adjustable wrench.
3. Flatblade and Philips head screwdrivers.



Saddle-type
Shut off valve
(1/4" outlet)



one 1/4"
compression



1 ferrule
(sleeve)



1/4" extension
tubing



1 Coupler



2 Clips

4. You need to purchase several items to complete this connection. You may find these items sold as a kit at local hardware store.

Connecting to the water supply line

1. First, shut off the main water supply.

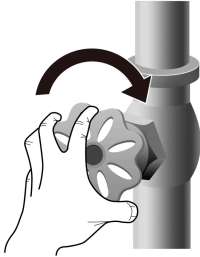

4. Flush the tubing. Turn the main water supply on and flush out the tubing until the water is clear. Then, shut the water off at the water valve after about a quart of water has flushed through the tubing.

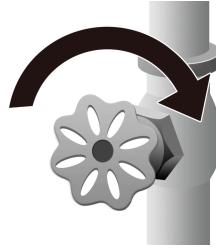

2. Using a power drill and a 1/4" drill bit drill into the cold-water line and connect the saddle-type shutoff valve.

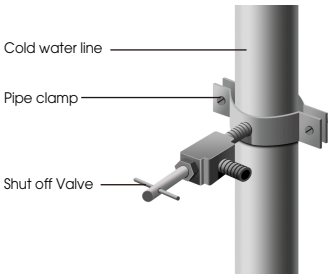

5. Connect the extension tubing line with the line on the back of the fridge via the coupler. Fully insert the extension tubing into the coupler, and then insert the clip onto the coupler to lockup the tubing. Do the same with the other end. After both clips are inserted, check the line to make sure it is held firmly by the clip.

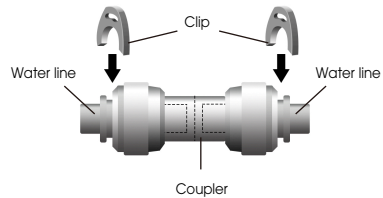

3. Connect 1/4" extension tubing to shutoff valve outlet.

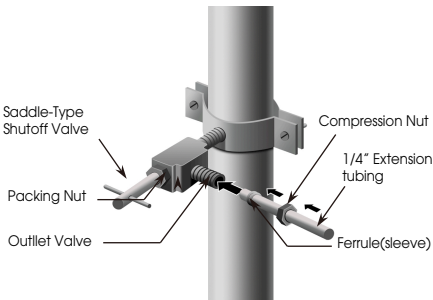

Note:

Ensure that the water line does not get pinched or bent when installing. This can result in improper water flow through the line and will affect the functionality of the fridge.

6. Turn the water on and check for leakage.

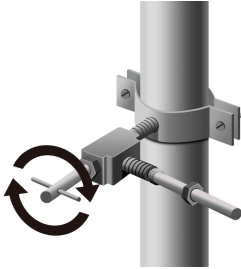

CAUTION!

Check to see if leaks occur at the water line connections

Note:

Use only the new tubing supplied with the refrigerator. Old tubing should not be used.

After connected to the water supply line, please open the water valve to flush the filter for 5 minutes before use. The initial dark discoloration of water is normal.

When you connect the water line to the appliance and press the lever of the dispenser for the first time, it is normal that there will be a sound of exhaust coming out from the appliance.



WARNING!

- 1.The water line must be connected to the cold water pipe. If it is connected to the hot water pipe, it may cause the purifier to malfunction.
- 2.Avoid contamination of pipes during installation.
- 3.Connect to potable water supply only.

Description of the Appliance

- ❶ Door bins
- ❷ Vertical baffle part
- ❸ Water dispenser (inside)
- ❹ Fruit and vegetables crisper
- ❺ Full width pantry
- ❻ Freezer LED light
- ❼ Ice maker (inside)
- ❽ Ice bucket (inside)
- ❾ Lower freezer drawer
- ❿ Adjustable bottom feet
- ⓫ Top cover
- ⓬ Control panel
- ⓭ Vertical baffle guide block
- ⓮ Water filter
- ⓯ Refrigerator LED light (inside)
- ⓰ Air channel
- ⓱ Glass shelf
- ⓲ Crisper Cover
- ⓳ Upper freezer drawer
- ⓴ Lower drawer partition (inside)
- ⓵ Roll wheel
- ⓶ Refrigerator door
- ⓷ Freezer door
- ⓸ Handles

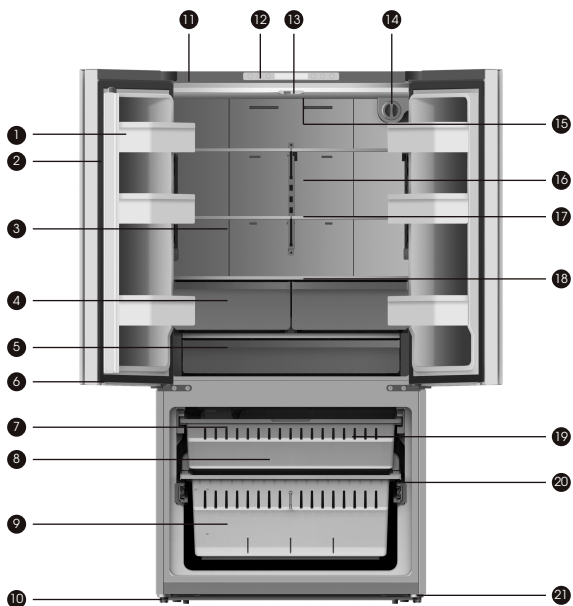

Display Controls

Your product has one control panel which is installed on the top cover. Use your appliance according to the following control guidelines.



When the appliance is powered on for the first time, the backlighting of the icons on the display panel start working. If no buttons have been touched or the doors are closed, the backlighting will turn off after 60 seconds. The control panel consists of two areas about temperature, and one area about different modes.



CAUTION!

When you set a temperature, you set an average temperature for the whole refrigerator cabinet. Temperatures inside each compartment may vary from the temperatures displayed on the panel, depending on how much food you store and where you place it. High or low room temperature may also affect the actual temperature inside the appliance.



Ice Control

This button controls the ice maker. You can touch the "Ice On/Off" button to control the ice maker. When the "Ice On/Off" function light is on, the ice maker is working. If you want to lock the ice maker, please touch the "Ice On/Off" button again until the button light is off.



Fridge Temperature Control

You can touch the "Fridge" icon to activate the mode to control the fridge temperature. When you touch the button continuously, the temperature will be set in the following sequence.

→ 47°F-46°F-45°F-44°F-43°F-42°F-41°F
-35°F-36°F-37°F-38°F-39°F-40°F ←



Super Cool

If you want to decrease the time needed to cool products in the Fridge, please touch this button. The Super Cool icon "❄️" will be illuminated, and the fridge temperature setting displays at 35°F. Super cool automatically switches off after 3 hours, and the refrigerator temperature setting will revert back to the previous setting.

When Super Cool function is on, you can touch the "Super Cool" button again to switch it off. The fridge will not retain the Super Cool function when powered off.



Freezer Temperature Control

You can touch the "Freezer" button to activate the mode to control the freezer temperature. When you press the button continuously, the temperature will be set in the following sequence.

→ 6°F-5°F-4°F-3°F-2°F-1°F-0°F--1°F--2°F--3°F--4°F
-12°F--11°F-10°F--9°F--8°F--7°F--6°F--5°F ←

Super Freeze

Super Freeze

If you want to decrease the time needed to freeze products in the freezer, please touch this button, the Super Freeze icon "❄️" will be illuminated, the freezer temperature setting displays -12°F. Super Freeze can quickly lower the temperature and freeze your food faster than usual. This can retain more of the vitamins and nutrients in fresh food and keep your food longer.

The Super Freeze mode allows you to freeze items inside with maximum speed. We recommend that you let the appliance operate for 6 hours first. Super Freeze automatically switches off after 26 hours, and the freezer temperature setting will revert back to the previous setting.

When the Super Freeze function is on, you can touch the "Super Freeze" button again to switch off. If power cutoff happens while Super Freeze is activated, the Super Freeze will not remain active after power is resupplied.

Note:

If you want to exchange the "°F" to "°C", please press and hold the "Super Cool" and "Energy Saving" buttons for 3 seconds.



Water Filter

In general, you should change the water filter every 6 months to ensure the highest possible water quality.

After the refrigerator has dispensed about 300 gallons of water, the filter icon "🔍" will blink, reminding you to replace the water filter.

First of all, you need to purchase a new water filter. You can purchase the new filter from the retailer where you purchased your refrigerator or the Hisense after-sales service system.

Before that, please check that the new filter is the same filter type that came with your fridge and can be correctly used in your refrigerator.

After you change the water filter, push and hold the "Ice On/Off" buttons for 3 seconds to make the blinking stop. When you replace the water filter, some water may leak from the filter and lines. Please let the water flow into a pan and wipe up any leakage that may have occurred.

Energy Saving

Energy Saving

You can touch this button to turn Energy Saver mode on and off. When you turn Energy Saver on, the Energy Saver icon "💡" lights up.

The temperature of the fridge is automatically switched to 42°F and the freezer to 2°F. If Energy Saver is off, the icon "💡" will go off and the temperature setting will revert back to the previous setting.

Note:

- The control panel will light up when the door is open, or you touch any button. The light will go off without touching any buttons or if the doors have been closed for over one minute.
- When the refrigerator is powered on, all the icons of the control panel will light up for 3 seconds, and a buzzer sounds. The temperature setting reverts back to the previous setting.



Demo mode (Freezer/ Fridge Temperature Indicator moving)

Demo mode is for store display, and it prevents the refrigerator from generating cool air. In this of Cooling off Mode, the refrigerator may seem like it is working but it will not make cool air. The indicators on the control panel will show double "0F". To cancel this mode, press and hold "Ice On/Off" and "Energy Saving" keys at the same time for 3 seconds until the buzzer beep three times and the display panel will light for 3 second.



CAUTION!

This Demo model can be set only within 10 minutes after startup, otherwise the refrigerator needs to be restarted.

Using your Appliance

This section tells you how to use most of the useful features. We recommend that you read through them carefully before using the appliance.

Getting Cold Water

The water dispenser is located in the left side of the fridge. Open the refrigerator doors, and push the water dispenser button to get water. Then move your glass down the dispenser lever in the suggested position and press it. Hold the glass underneath the dispenser for 2~3 seconds after releasing the dispenser button as water may continue to dispense after the button is released.

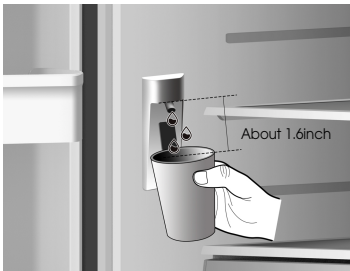

1 Changing the water filter

To drink the freshest and cleanest water from your refrigerator, change the filter on time. To change the water filter, follow these steps:

1. Shut off the water supply. Then turn the water filter (K) about a 1/4 turn, counter-clockwise.

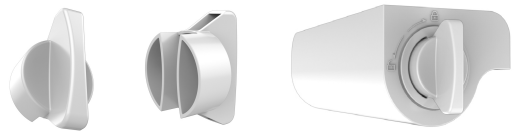

Note

When having problem with releasing water filter, please use the enclosed tool. Insert the tool into the filter housing and rotate it counterclockwise (to the left) 90 degrees. Please keep for future use when changing the water filter off the water.

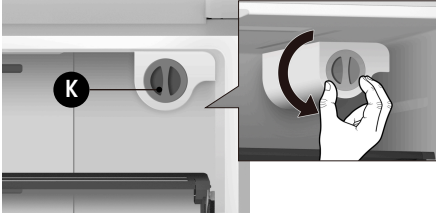

2. Pull the water filter (K) from the filter holder (L).

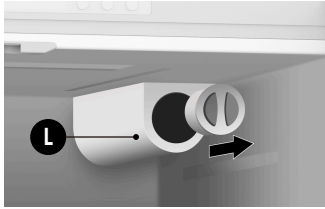

3. Insert the new filter into the filter holder.

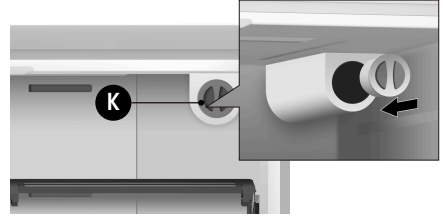

4. Push the filter, and then turn it clockwise until it locks.

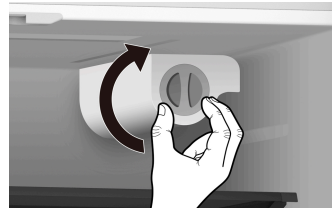

Note:

- To change the water filter easily, shut off the water supply valve.
- Sometimes, it is hard to disassemble the water filter because impurities in the water cause it to stick. If you are having difficulties, grip the water filter firmly and pull it out.
- When you pull the water filter, a little water can leak from the opening. This is normal. To minimize the water leaks, keep the filter cartridge horizontal when pulling it.
- To prevent overflow, empty the water filter tray (M) and dry around the filter case.
- To insert the new water filter, follow the directions below.

- If you have trouble inserting the water filter because of high water pressure, shut off the water supply valve.
5. If you turned off the water supply, turn it back on.

Note:

- After turning on the water supply, you should check the leaks. If leaks occur, repeat the steps 1- 5. If leaks persist, discontinue use and call Hisense customer service..

Removing any residual matter inside the water supply line after installing the water filter

1. After the water filter is replaced, dispense 2.5 gallons of water (flush for approximately 5 minutes) to remove trapped air and contaminants from the system.
2. Additional flushing may be required in some households.
3. Open the refrigerator door and make sure there are no water leaks coming from the water filter.

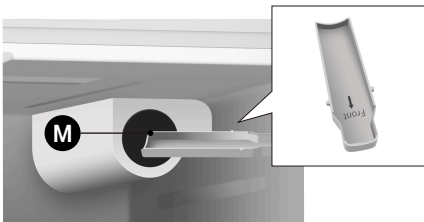

Note:

- Be sure to flush the dispenser thoroughly, otherwise water may drip from the dispenser. This means that there is still air in the line.
- Do not dispense the entire 2.5 gallon amount continuously. Depress and release the dispenser pad for cycles of 30 seconds ON and 60 seconds OFF.

Reverse osmosis water supply:

The pressure of the water supply coming out of a reverse osmosis system going to the water inlet valve of the refrigerator needs to be between 30 and 100psi (207 and 700kPa). If a reverse osmosis water system is connected to your cold water supply, the water pressure to the reverse osmosis system needs to be a minimum of 40 to 60 psi (276 to 414 kPa). If the water pressure to the reverse osmosis system is less than 40 to 60 psi (276 to 414 kPa):

- Check to see whether the sediment filter in the reverse osmosis system is blocked. Replace the filter if necessary.
- Allow the storage tank on the reverse osmosis system to refill after heavy usage.
- If your refrigerator has a water filter, it may further reduce the water pressure when used in conjunction with a reverse osmosis system. To resolve it, remove the water filter.

2 Using your fridge compartment

The refrigerator compartment is suitable for storage of vegetables and fruit. Food inside should be sealed for storage in order to avoid losing moisture or flavor permeating into other foods.

CAUTION!

Never close the refrigerator door while the shelves, crisper and/or telescopic slides are extended. It may damage both them and the refrigerator.

Door baskets

The refrigerator compartment is provided with six door baskets, which are suitable for the storage of canned liquid, bottled drinks and packaged food. To remove the door baskets, simply lift the racks up and pull straight out. To relocate the door baskets, slide it in above the desired location and push down until it stops.



WARNING!

Do not place too many heavy things in the baskets. Before you lift up the door shelf vertically, please take the food out.

Glass shelves

To remove the glass shelves, tilt up the front of the shelf in the direction shown (1) and lift it up vertically (2). Pull the shelf out.

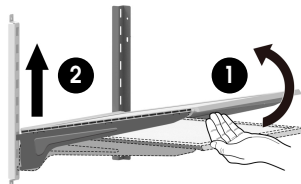

To re-install the glass shelves, tilt the front of the shelf up and guide the shelf hooks into the slots at a desired height (1). Then lower the front of the shelf so that the hooks can drop into the slots (2).

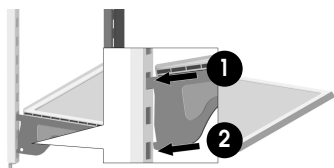

The refrigerator compartment is also provided with a foldable shelf. It can be folded as required.

To fold the shelf, hold the removable glass(N) and lift it up slightly, then push it slightly in the direction of the arrow.

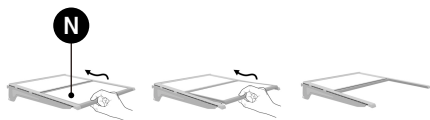

To unfold the shelf, hold the removable glass(N) and pull it out slightly in the direction of the arrow until it can't move.

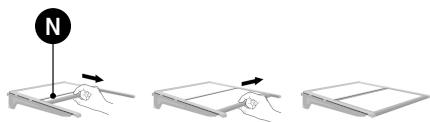

Vegetable and fruit crispers

The crispers are suitable for storage of vegetables and fruit. To take them out, open the door to the final location first. Then pull out the drawer and tilt up the front of the crisper after moving slightly in the direction of the arrow.



Using the freezer compartment

The freezer compartment is provided with an upper drawer, a lower drawer and an ice box. To remove all of them, refer to page 8 for disassembly instruction.

Press ICE On/Off to turn the ice maker On and Off. The Ice Maker icon is "❄" illuminated when the ice maker is functioning.



- Following installation, allow 24 hours to produce the first batch of ice. Discard the first three batches of ice produced. Allow 2 to 3 days to fill the ice storage container.
- If the ice in the ice container clumps, break up ice using a plastic utensil and discard. Do not use a sharp tool to break up the ice. This can cause damage to the ice container.
- Do not store any items other than ice in the ice storage container.

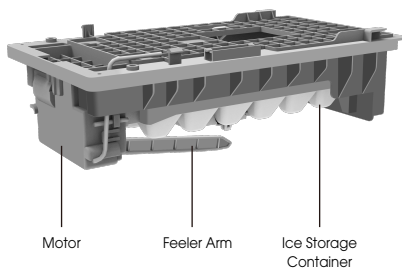

Cleaning and Care

For hygienic reasons the appliance (including exterior and interior accessories) should be cleaned at least every two months.

! WARNING!

To avoid electrical shock, the appliance must not be connected to the main power supply during cleaning. Before cleaning, switch the appliance off and remove the plug from the main socket.

Exterior cleaning

To maintain good appearance of your appliance, you should clean it regularly.

- Spray water onto a cleaning cloth instead of spraying directly on the surface of the appliance. This helps ensure an even distribution of moisture to the surface.
- Clean the doors, handles and cabinet surfaces with a mild detergent and then wipe dry with a soft cloth.

! CAUTION!

1. Don't use sharp objects to clean with, as they are likely to scratch the surface.
2. Don't use thinner, car cleaner, bleach, oil, abrasive cleansers or organic solvent such as benzene for cleaning. They may damage the surface of the appliance and may cause fire.

Interior cleaning

You should clean the appliance interior regularly. It will be easier to clean when food stocks are low. Wipe the inside of the fridge and freezer with a weak solution of baking soda and water, and then rinse with warm water using a wrung-out sponge or cloth. Wipe completely dry before replacing the shelves and baskets. Thoroughly dry all surfaces and removable parts before putting them back into place.

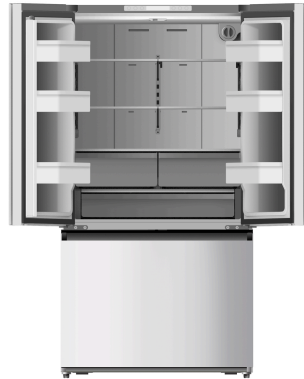

Although this appliance automatically defrosts, a layer of frost may occur on the freezer compartment's interior walls if the freezer door is opened frequently or kept open too long. If the frost is too thick, choose a time when the freezer is nearly empty and proceed as follows:

1. Remove existing food and accessory baskets, unplug the appliance from the main power and leave the doors open. Ventilate the room thoroughly to accelerate the process.
2. When defrosting is completed, clean your freezer as described above.



WARNING!

Do not use sharp objects to remove frost from the freezer compartment. Only after the interior is completely dry should the appliance be switched back on and plugged back into the main socket.

Door seals cleaning

Take care to keep door seals clean. Sticky food and drinks can cause seals to stick to the cabinet and tear when you open the door. Wash seal with a mild detergent and warm water. Rinse and dry it thoroughly after cleaning.

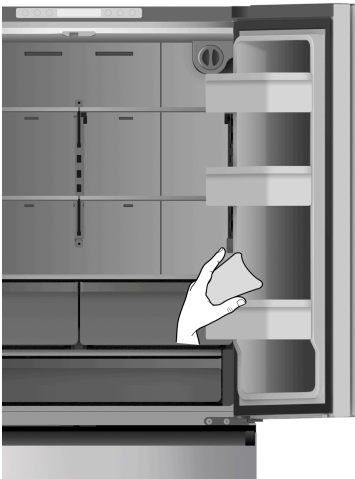

CAUTION!

Only after the door seals are completely dry should the appliance be powered on.

Replacing the LED light



WARNING!

The LED light must be replaced by a competent person. If the LED light is damaged, follow the steps below:

1. Unplug your appliance.
2. Remove the light cover by lifting up and pulling out.
3. Hold the LED light with one hand and pull it while pressing the connector latch with the other hand.
4. Replace the LED light and snap it correctly in place and replace the light cover.

Helpful Hints and Tips

Energy Saving Tips

We recommend that you follow the tips below to save energy.

- Try to avoid keeping the door open for long periods in order to conserve energy. Ensure the appliance is away from any sources of heat (direct sunlight, electric oven or cooker etc.)
- Don't set the temperature colder than necessary.
- Don't store warm food or evaporating liquid in the appliance.
- Place the appliance in a well ventilated, humidity freeroom. Please refer to Installing your New Appliance chapter.
- If the diagram shows the correct combination for the drawers, crisper and shelves, do not adjust the combination as this is designed to be the most energy efficient configuration.

Hints for fresh food refrigeration

- Do not place hot food directly into the refrigerator or freezer, the internal temperature will increase resulting in the compressor having to work harder and consume more energy.
- Do cover or wrap the food, particularly if it has a strong flavor.
- Place food properly so that air can circulate freely around it.

Hints for refrigeration

- For Meat: (all types) wrap in cling wrap and place on the glass shelf above the vegetable drawer. Always follow food storage times and use by dates suggested by manufacturers.
- Cooked food, cold dishes, etc.: They should be covered and placed on any shelf.
- Fruit and vegetables: They should be stored in the special drawer provided.
- Butter and cheese: Should be wrapped in airtight foil or plastic film wrap.
- Milk bottles: Should have a lid and be stored in the door racks.

Hints for freezing

- When first starting-up or after a period out of use, let the appliance run at least 2 hours on the higher settings before putting food in the compartment.
- Prepare food in small portions to enable it to be rapidly and completely frozen and to make it possible to subsequently thaw only the quantity required.
- Wrap up the food in aluminum foil or cling wraps which are airtight.
- Do not allow unfrozen food to touch the food which is already frozen to avoid temperature rise of the latter.

- Iced products (ice cubes, popsicles): if consumed immediately after removal from the freezer compartment, will probably cause frost burns to the skin.
- It is recommended to label and date each frozen package in order to keep track of the storage time.

Hints for the storage of frozen food

- Ensure that frozen food has been stored correctly by the food retailer
- Once defrosted, food will deteriorate rapidly and should not be re-frozen. Do not exceed the storage period indicated by the food manufacturer.

Switching off your appliance

If the appliance needs to be switched off for an extended period, the following steps should be taken to prevent mold on the appliance.

1. Remove all food.
2. Remove the power plug from the main socket.
3. Clean and dry the interior thoroughly.
4. Ensure that all the doors are wedged open slightly to allow air to circulate.

Troubleshooting

If you experience a problem with your appliance or are concerned that the appliance is not functioning correctly, you can carry out some easy checks before calling for service, please see below.

WARNING

1. Don't try to repair the appliance yourself. If the problem persists after you have made the checks mentioned below, contact a qualified electrician, authorized service technician or the shop where you purchased the product.
2. A child entrapment warning statement is included below.

DANGER

Risk of child entrapment. Before you throw away your old refrigerator or freezer:

- Take off the doors.
- Leave the shelves in place so that children may not easily climb inside.

Problem	Possible Cause & Solution
Appliance is not working correctly	Check whether the power cord is plugged into the power outlet properly.
	Check the fuse or circuit of your power supply, replace if necessary.
	The room temperature may be too low. Try setting the refrigerator or freezer temperature to a colder level to solve this problem.
	It is normal that the freezer is not operating during the defrost cycle, or for a short time after the appliance is switched on to protect the compressor.
Odors from the compartments	The interior may need to be cleaned
	Some food, containers or wrapping may cause odors.
Noise from the appliance	The sounds below are quite normal: <ul style="list-style-type: none">• Compressor running noises.• Air movement noise from the small fan motor in the freezer compartment or other compartments.• Gurgling sound similar to water boiling.• Popping noise during automatic defrosting.• Clicking noise before the compressor starts.• Clicking noise when you get the water.• The motor running noises when you get ice.
	Other unusual noises are due to the reasons below and may need you to check and take action: The cabinet is not level. The back of appliance is touching the wall. Bottles or containers have fallen or are rolling.

<p>The motor runs continuously</p>	<p>It is normal to frequently hear the sound of the motor, it will need to run more when in following circumstances:</p> <ul style="list-style-type: none"> • Temperature setting is set colder than necessary. • Large quantity of warm food has recently been stored within the appliance. • The temperature outside the appliance is high. • Doors are kept open too long or too often. • After first installing the appliance or if it has been switched off for a long time.
<p>A layer of frost occurs in the compartment</p>	<p>Check that the air outlets are not blocked by food and ensure food is placed within the appliance to allow sufficient ventilation. Ensure that door is fully closed. To remove the frost, please refer to the Cleaning and Care chapter.</p>
<p>Temperature inside is too warm</p>	<p>You may have left the doors open too long or too frequently; or the doors are kept open by some obstacle; or the appliance is located with insufficient clearance at the sides, back and top.</p>
<p>Temperature inside is too cold</p>	<p>Increase the temperature by following the "Display Controls" chapter.</p>
<p>Doors can't be closed easily</p>	<p>Check whether the top of the refrigerator is tilted back by 0.4"-0.6"(10-15mm) to allow the doors to self-close, or if something inside is preventing the doors from closing.</p>
<p>The light is not working</p>	<ul style="list-style-type: none"> • The LED light may be damaged. Refer to replace LED lights in "Cleaning and Care" chapter. • The control system has disabled the lights due to the door being kept open too long. Close and reopen the door to reactivate the lights.
<p>Hear water bubbling in the refrigerator</p>	<p>This is normal. The bubbling comes from the refrigerant coolant liquid circulating through the refrigerator.</p>

<p>Ice is not making</p>	<ul style="list-style-type: none"> • Did you wait for 12 hours after installation of the water supply line before making ice? If it is not sufficiently cool, it may take longer to make ice, such as when first installed. • Is the water line connected and the water valve open? • Did you manually stop the ice making function? Make sure you do not set the "Ice Off" mode. • Is there any ice blocked within the ice maker bucket? • Is the water pressure less than 30psi? Install a booster pump to compensate for the low pressure. • Is the freezer temperature too warm? Try setting the freezer temperature lower. • Ice maker is not making the ice fast enough. Please wait for at least 90 minutes.
<p>Water dispenser is not functioning</p>	<ul style="list-style-type: none"> • Is the water line connected and the water valve open? • Has the water line been crushed or kinked? Make sure the waterline is free and clear of any obstruction. • Is the water tank frozen because the refrigerator temperature is too low? Try selecting a warmer setting on the display panel. • Check if the filter is properly installed. If it is not properly installed, the water dispenser may not work.

Disposal of the Appliance

⚠ DANGER

It is prohibited to dispose of this appliance as household waste.

Packaging materials

Packaging materials with the recycle symbol are recyclable.

Dispose of the packaging into a suitable waste collection container to recycle it.

Before disposal of the appliance

1. Pull out the main plug from the main socket.
2. Cut off the power cord and discard with the main plug.

⚠ WARNING

Refrigerators contain refrigerant and gases in the insulation. Refrigerant and gases must be disposed of professionally as they may cause eye injuries or ignition.

Ensure that tubing of the refrigerant circuit is not damaged prior to proper disposal.

	Correct Disposal of this product
	<p>This symbol on the product or in its packing indicates that this product may not be treated as household waste. Instead, it should be taken to the appropriate waste collection point for the recycling of electrical and electronic equipment. By ensuring this product is disposed of correctly, you will help prevent potential negative consequences for the environment and human health, which could otherwise be caused by the inappropriate waste handling of this product. For more detailed information about the recycling of this product, please contact your local council, your household waste disposal service, or the shop where you purchased the product.</p>

Copyright Statement

© 2019 Hisense Company Ltd. All Rights Reserved.

All material in this User Manual is the property of Hisense Company Ltd. and its subsidiaries, and is protected under US, CANADA, MEXICO and International copyright and/or other intellectual property laws. Reproduction or transmission of the materials, in whole or in part, in any manner, electronic, print, or otherwise, without the prior written consent of Hisense Company Ltd. is a violation of Hisense Company Ltd. rights under the aforementioned laws.

No part of this publication may be stored, reproduced, transmitted or distributed, in whole or in part, in any manner, electronic or otherwise, whether or not for a charge or other or no consideration, without the prior written permission of Hisense Company Ltd.

Requests for permission to store, reproduce, transmit or distribute materials may be made to one of the following addresses:

USA: Hisense USA Corporation
7310 McGinnis Ferry Road
Suwanee, GA 30024

CANADA: Hisense Canada Co., Ltd
2283 Argentinia Road, Unit 16
Mississauga, ON, Canada
LSN 5Z2

MEXICO: Hisense Mexico S. de R.L. de C.V.
Bvd. Miguel de Cervantes Saavedra No 301
Torre Norte Piso 2, Col. Ampliación Granada
Miguel Hidalgo, Ciudad de México, C.P. 11520

Hisense, and any and all other Hisense product names, logo's, slogans or marks are registered trademarks of Hisense Company Ltd. and its subsidiaries. All other trademarks are the property of their respective holders.

© 2019. All rights reserved. Hisense and the Hisense logo are registered trademarks of Hisense. Other brand and product names are registered trademarks of their respective owners.

Disclaimer:

Images throughout this document are for illustrative purposes only and may differ from the actual product.

Hisense

life reimagined