

# Drapery

# Databook



## Glydea® and Irismo™

Glydea® 60e | Glydea® 35e | Irismo™ 45 WireFree RTS | Irismo™ 35 Mini DC

# Why Somfy?

Somfy is the leading global manufacturer of strong, quiet, motors with electronic and app controls for interior and exterior window coverings. Over 270 million users worldwide enjoy the more than 150 million motors produced since 1980. For more than four decades, Somfy engineers have designed products for both the commercial and residential markets to motorize window coverings such as interior shades, wood blinds, draperies, awnings, rolling shutters, exterior solar screens and projection screens. Somfy motorization systems are easily integrated with security, HVAC and lighting systems, providing total home or building automation.

Somfy has a committed customer support team comprised of Somfy motor and control specialists available for assistance:

**Somfy Corporate Headquarters**

800-22-SOMFY (76639)

**General Customer Service**

877-210-5327

CustomerService\_us@somfy.com

**Standard Purchase Order**

Ordering\_us@somfy.com

**Rush Purchase Order**

ExpeditedShippingOrders\_us@somfy.com

**Accounting Inquiries**

AccountsReceivable@somfy.com

**Technical Support**

877-233-0019

TechnicalSupport\_us@somfy.com

**Warranty Claim Requests**

us\_Return@somfy.com

- Somfy has a production capacity of more than 70,000 motors per day.
- Somfy motors have over 600 standards approvals worldwide.
- Somfy has certified over 100 patents since the year 2000.
- Every Somfy motor goes through an extensive quality assurance process including testing in extreme environmental conditions, for electrostatic discharge, mechanical shock, and high life cycle.
- Somfy has a network of 15,000 trained professional installers throughout the world.



Somfy operates in 60 countries, with 76 subsidiaries, and 60 agencies spread across 5 continents. With 8 production centers, Somfy is an efficient and reactive industry leader. Thanks to its strict quality standards, Somfy is able to satisfy the needs of over 270 million users worldwide.

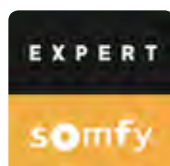

Somfy understands that training and support are critical to success. Somfy's Expert Program has been developed to provide a platform for those who want to enhance their expertise of motorization and control solutions. Visit [www.somfysystems.com/expert-program](http://www.somfysystems.com/expert-program) to learn more and sign up for training.

# TABLE OF CONTENTS

INTRODUCTION.....	2
THE DRAPERY MOTOR .....	4
<b>TECHNICAL SPECIFICATIONS</b>	
<u>WireFree (12V DC)</u>	
Irisimo™ 45 WireFree RTS .....	6
<u>Low Voltage (24V DC)</u>	
Irisimo™ 35 Mini DC .....	7
<u>Line Voltage (120V DC)</u>	
Glydea® 35e.....	8
Glydea® 60e .....	9
<u>Charts</u>	
Selection Chart .....	10
Stacking Chart .....	10-11
<b>PRODUCT SPECIFICATIONS</b>	
Carrier Arm Dimensions .....	12
Wall Bracket Dimensions.....	12
Ceiling Bracket Dimensions .....	13
TRACK CONFIGURATIONS .....	14-15
<b>CONTROLS AND ACCESSORIES</b>	
Radio Technology Somfy® (RTS) .....	16-17
Wired Technology .....	17
WIRING EXAMPLES.....	18-19
PARTS LIST .....	20-22
FABRICATED TRACK OPTIONS .....	23
CUSTOM TRACK OPTIONS .....	24
BENT DRAPERY TRACK MEASUREMENT FORM .....	25
DIRECTIONS FOR CREATING A TEMPLATE FOR DRAPERY CURVES .....	26
DRAPERY ORDER FORM.....	27-28
ENGRAVING BUTTON ORDER FORM .....	29

# Drapery Motor Range

This document presents the technical information and related accessories for Somfy's Glydea® and Irismo™ motor ranges designed specifically for draperies. It provides detailed information to facilitate the specification of this motor solution and presents information regarding options for specialty applications including bent and curved tracks. Information for Somfy's entire product range including motors, power sources, control interfaces etc. can be accessed at [www.somfysystems.com](http://www.somfysystems.com).

## Innovative

The result of years of industry experience and expertise. Reliable motor solutions offer a superior user experience as well as a wide array of features and exemplifies Somfy's continued commitment to quality.

## Competitive

Designed for residential, commercial and hospitality markets, these ranges provide a convenient solution for glare reduction and privacy while also reducing energy costs and protecting interiors from damaging UV rays.

## Adaptable

Glydea® and Irismo™ are available for all drapery types including Pinch Pleat, Ripplefold® and Accordia®. Additionally, they have been designed to easily adapt to various control technologies including infrared, dry contact, Radio Technology Somfy® (RTS), RS485, Z-Wave® and ZigBee®.

Z-Wave® is a registered trademark of Zensys, Inc. and its subsidiaries.

ZigBee® is a registered trademark of ZigBee® Alliance.

Ripplefold® and Accordia® are registered trademarks of Kirsch.

Amazon, Alexa, and all related logos are trademarks of Amazon.com, Inc. or its affiliates.



Somfy's drapery motors are compatible with the three types of draperies below.

**Pinch Pleat**

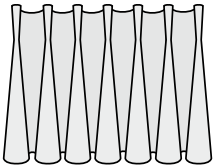

**Ripplefold®**

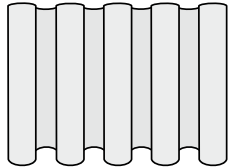

**Accordia®**

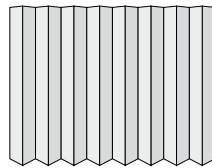

Plug-in control modules offer simple compatibility with various technologies:



As with all Somfy products, drapery motors are backed by a 5 year warranty.

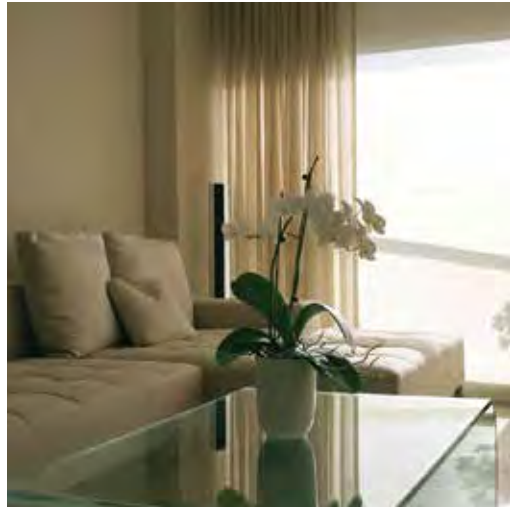
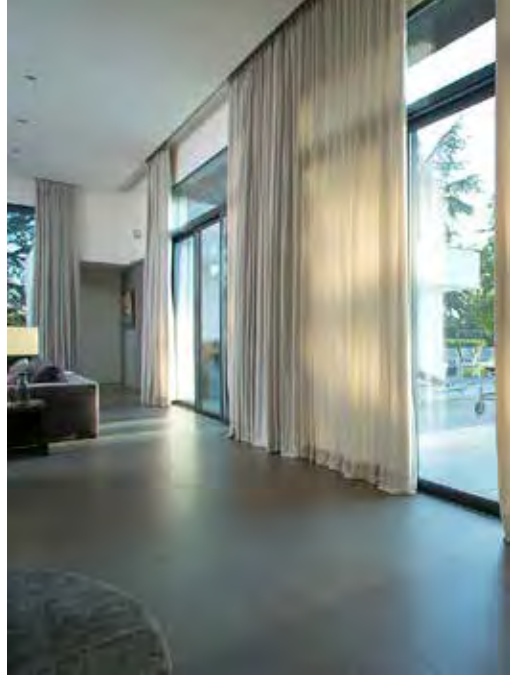

# The difference is in the details.

The sophistication is reflected in the simple form and sleek lines.

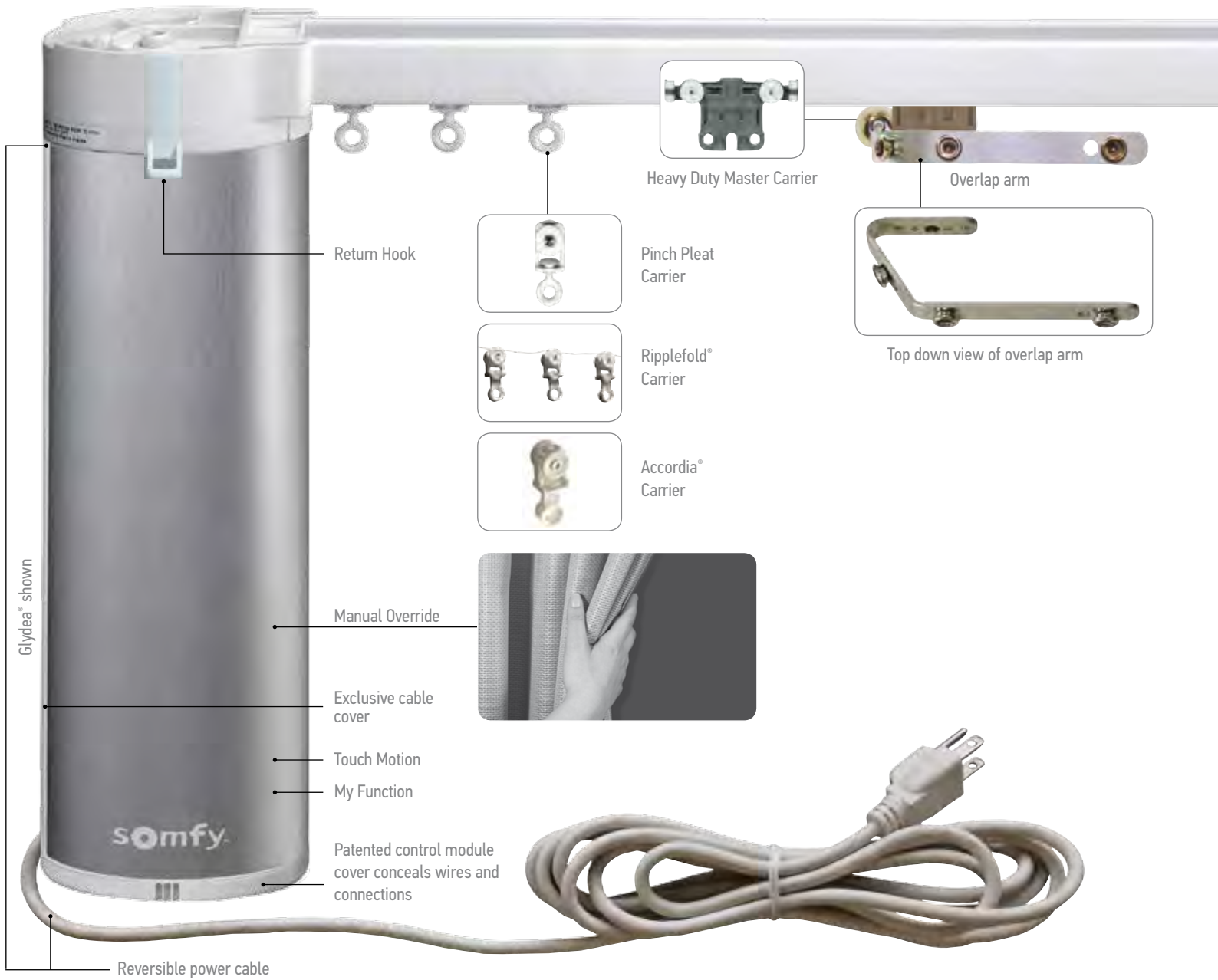

## Adaptable Control Modules



RTS Control Module



RS485 Control Module



ZigBee Control Module



Z-Wave Control Module

Track bending and curving options available



### Aesthetic

- Clean, premium motor design with built-in control modules.
- Easy to conceal behind drapery fabric
- Adjustable limit setting provides precise alignment of drapery fabric.
- Advanced track design and swivel ceiling brackets minimize light gaps.
- Soft start and soft stop drapery motion
- Improved hardware design provides greater overlap and even stack back.

### Easy Installation

- Spring loaded one-touch hardware (wall and ceiling mount)
- Motor can be installed to the right or left side of the drapery track.
- Automatic or adjustable limit setting
- Inverse (top mount) option allows the motor to be installed above the track.

### Flexible

- Patented versatile master carrier reduces friction and is adaptable to various drapery types.
- Multiple built-in control options allow seamless integration with third-party systems.
- Adjustable drapery speed control

### Quiet

- Motor design and advanced high performance belt drive system provide quiet operation (<44dBA).

### Efficient

- Touch motion feature allows the user to activate the motorized drapery simply by pulling on the fabric.
- Manual override permits the drapery to be adjusted manually. This is ideal for power outages and also protects the fabric from damage.
- The “my” function allows user to set a preferred drapery opening which provides enhanced convenience.

### Somfy quality

5 years international warranty.  
International certifications.



# Technical Specifications

Irismo™ 45 WireFree RTS

## Motor part numbers

**Irismo™ 45 Mini DC RTS**

**Part# 1002353**

## Features overview

	Irismo™ 45 WireFree RTS
<b>Motor unit main features</b>	
Soft start	✓
Soft stop	✓
Manual operation	✓
Automatic limits on end stop	✓
Intermediate position	✓
Touch motion with 2 sensitivity settings	✓
Adjustable limits	✓
Speed control & adjustment	✓
<b>Control options</b>	
Radio Technology Somfy® RTS	✓
Tandem alternative	✓
Sun control	✓
Timer control	✓
<b>Installation and setting features</b>	
LED indicators	✓
Audible sound Indicator	✓
Motor unit direction change	✓
Factory reset/programming button	✓
Inverse mounting (top mount)	✓
<b>Tracks/Draper Types</b>	
Side opening	✓
Center opening	✓
Asymmetric	✓
Pinch pleat	✓
Ripplefold® with overlap arm	✓
Ripplefold® with butt arm	✓
Accordia®	✓

## Motorized track main characteristics

	Irismo™ 45 WireFree RTS
Power supply	26.5V Li-Ion
Average linear speed	4.9 in./s - 7.86 in./s
Rechargeable battery pack	2950 mAh
Motor sound level	<44 dBA
Certifications	CE/cTUV
Track maximum length	33 ft. (10 m)
Maximum number of junctions	2
Side opening max weight	99 lbs. (45 kg)
Center opening max weight	99 lbs. (45 kg)
Tandem alternative (see pages 10, 15, 24)	198 lbs. (90 kg)

## Motor dimensions

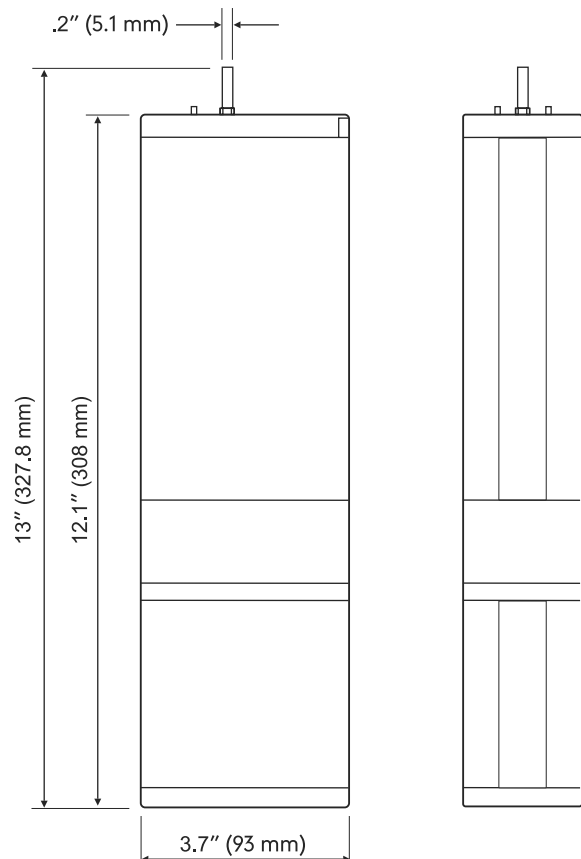



# Technical Specifications

Irismo™ 35 Mini DC

## Motor part numbers

**Irismo™ 35 Mini DC RTS**

**Part# 1002952**

**Irismo™ 35 Mini DC DCT**

**Part# 1002951**

## Features overview

	Irismo™ 35 RTS	Irismo™ 35 DCT
<b>Motor unit main features</b>		
Soft start	✓	✓
Soft stop	✓	✓
Manual operation	✓	✓
Automatic limits on end stop	✓	✓
Intermediate position	✓	✓
Touch motion with 2 sensitivity settings	✓	✓
Adjustable limits	✓	✓
Speed control & adjustment	✓	✓
<b>Control options</b>		
Dry contact individual, group and master control	✓	✓
Radio Technology Somfy® RTS	✓	
Tandem alternative	✓	✓
Sun control	✓	✓
Timer control	✓	✓
<b>Installation and setting features</b>		
Settings with buttons on motor unit	✓	
Setting with normally open dry contact switch	✓	✓
LED indicators	✓	
Motor unit direction change	✓	✓
Factory reset	✓	✓
Inverse mounting (top mount)	✓	✓
<b>Tracks/Draper Types</b>		
Side opening	✓	✓
Center opening	✓	✓
Asymmetric	✓	✓
Multiple	✓	✓
Pinch pleat	✓	✓
Ripplefold® with overlap arm	✓	✓
Ripplefold® with butt arm	✓	✓
Accordia®	✓	✓

## Motorized track main characteristics

	Irismo™ 35 RTS	Irismo™ 35 DCT
Power Supply	24V DC	
Amperage	2 A	
Average linear speed	4.9 in./s - 7.86 in./s	
Power consumption	< 3 W	
Power cable type	13.2 ft. (4 m)	
Control connector type	RJ12	
DCT control circuit voltage	5V DC	
Motor sound level	<44 dBA	
Certifications	CE	
Track maximum length	32 ft. (9.7 m)	
Maximum number of junctions	2	
Minimum bending radius	11.8 in. (30 cm)	
Minimum curving radius	118 in. (300 cm)	
Side opening max weight	77 lbs. (35 kg)	
Center opening max weight	77 lbs. (35 kg)	
Tandem alternative (see pages 10, 15, 24)	154 lbs. (70 kg)	

## Motor dimensions

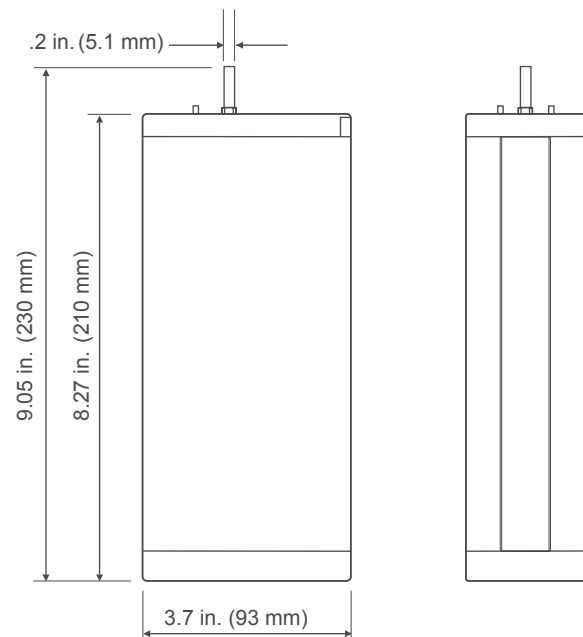

# Technical Specifications

Glydea® 35e

## Motor part numbers

<b>Glydea® 35e DCT motor</b> (with 10' cable and molded NEMA plug)	<b>Part# 1002465</b>
<b>Glydea® 35e RTS motor</b> (with 10' cable and molded NEMA plug)	<b>Part# 1001615</b>
<b>Glydea® 35e RS485 motor</b> (with 10' cable and molded NEMA plug)	<b>Part# 1002109</b>
<b>Glydea® 35e Wired motor</b> (5' long without plug)	<b>Part# 1002464</b>

## Features overview

	Glydea® 35e
<b>Motor unit main features</b>	
Soft start	✓
Manual operation	✓
Automatic limits on end stop	✓
Soft stop	✓
Intermediate position	✓
Touch motion with 2 sensitivity settings	✓
Adjustable limits	✓
Speed control & adjustment	✓
<b>Control options</b>	
3 normally open dry contacts	✓
2 normally open dry contacts	✓
2 normally open dry contact sequencing mode	✓
Dry contact individual, group and master control	✓
Radio Technology Somfy® RTS	✓
Infrared	✓
RS485 digital technology	✓
Z-Wave®	✓
ZigBee®	✓
Tandem alternative	✓
Sun control	✓
Timer control	✓
<b>Installation and setting features</b>	
Settings with buttons on motor unit	✓
Setting with 3 normally open dry contact switch	✓
LED indicators	✓
Motor unit direction change	✓
Factory reset	✓
Inverse (top mount) mounting	✓
<b>Tracks/Draper Types</b>	
Side opening	✓
Center opening	✓
Asymmetric	✓
Multiple	✓
Pinch pleat	✓
Ripplefold® with overlap arm	✓
Ripplefold® with butt arm	✓
Accordia®	✓

## Motorized track main characteristics

	Glydea® 35e
Power Supply	120V AC 50/60 HZ
Amperage	0.5 A
Average linear speed	4.9"/s - 7.86"/s
Power consumption	60 W
Power cable type	3-wire cable with molded NEMA plug 4-wire cable (wired version only)
Control connector type	RJ12
DCT control circuit voltage	3.3 VDC
Motor sound level	<44 dB(A)
Certifications	c TUV us, CE
Track maximum length	32 ft (9.7 m)
Maximum number of splices	2
Minimum bending radius	11.8 in. (30 cm)
Minimum curving radius	118 in. (300 cm)
Side opening max weight	77 lbs 35 kg
Center opening max weight	77 lbs 35 kg
Tandem alternative (see pages 10, 15, 24)	154 lbs/ 70 kgs 64 ft/ 19.4 m

## Motor dimensions

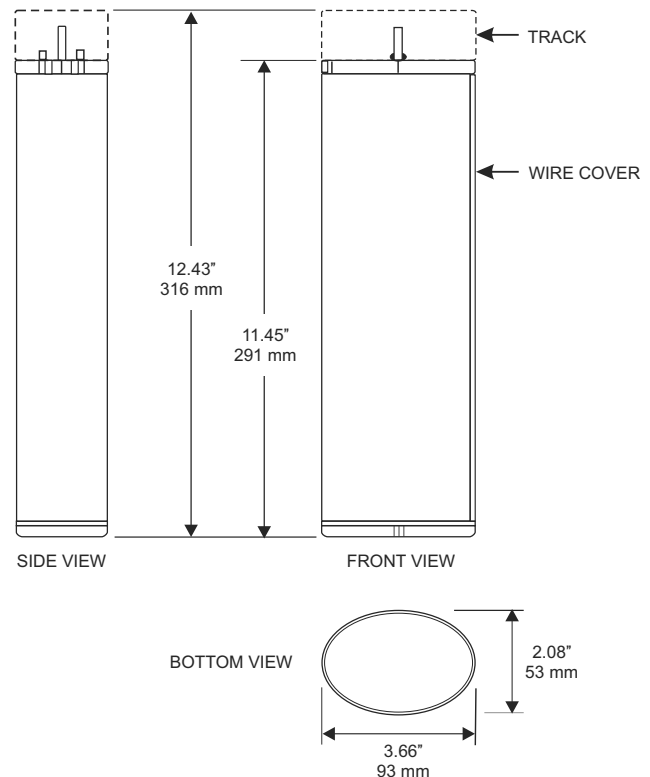

# Technical Specifications

Glydea® 60e

## Motor part numbers

<b>Glydea® 60e DCT motor</b> (with 10' cable and molded NEMA plug)	<b>Part# 1002545</b>
<b>Glydea® 60e RTS motor</b> (with 10' cable and molded NEMA plug)	<b>Part# 1001617</b>
<b>Glydea® 60e RS485 motor</b> (with 10' cable and molded NEMA plug)	<b>Part# 1002108</b>
<b>Glydea® 60e Wired motor</b> (without plug)	<b>Part# 1001537</b>

## Features overview

	Glydea® 60e
<b>Motor unit main features</b>	
Soft start	✓
Manual operation	✓
Automatic limits on end stop	✓
Soft stop	✓
Intermediate position	✓
Touch motion with 2 sensitivity settings	✓
Adjustable limits	✓
Speed control & adjustment	✓
<b>Control options</b>	
3 normally open dry contacts	✓
2 normally open dry contacts	✓
2 normally open dry contact sequencing mode	✓
Dry contact individual, group and master control	✓
Radio Technology Somfy® RTS	✓
Infrared	✓
RS485 digital technology	✓
Z-Wave®	✓
ZigBee®	✓
Tandem alternative	✓
Sun control	✓
Timer control	✓
<b>Installation and setting features</b>	
Settings with buttons on motor unit	✓
Setting with 3 normally open dry contact switch	✓
LED indicators	✓
Motor unit direction change	✓
Factory reset	✓
Inverse (top mount) mounting	✓
<b>Tracks/Drapery Types</b>	
Side opening	✓
Center opening	✓
Asymmetric	✓
Multiple	✓
Pinch pleat	✓
Ripplefold® with overlap arm	✓
Ripplefold® with butt arm	✓
Accordia®	✓

## Motorized track main characteristics

	Glydea® 60e
Power Supply	120V AC 50/60 HZ
Amperage	1A
Average linear speed	4.9''/s - 7.86''/s
Power consumption	120 W
Power cable type	3-wire cable with molded NEMA plug 4-wire cable (wired version only)
Control connector type	RJ12
DCT control circuit voltage	3.3 VDC
Motor sound level	<44 dB(A)
Certifications	c TUV us, CE
Track maximum length	36 ft (10.9 m)
Maximum number of splices	2
Minimum bending radius	11.8 in. (30 cm)
Minimum curving radius	118 in. (300 cm)
Side opening max weight	132 lbs 60 kg
Center opening max weight	132 lbs 60 kg
Tandem alternative (see pages 10, 15, 24)	264 lbs/ 120 kgs 72 ft/ 21.8 m

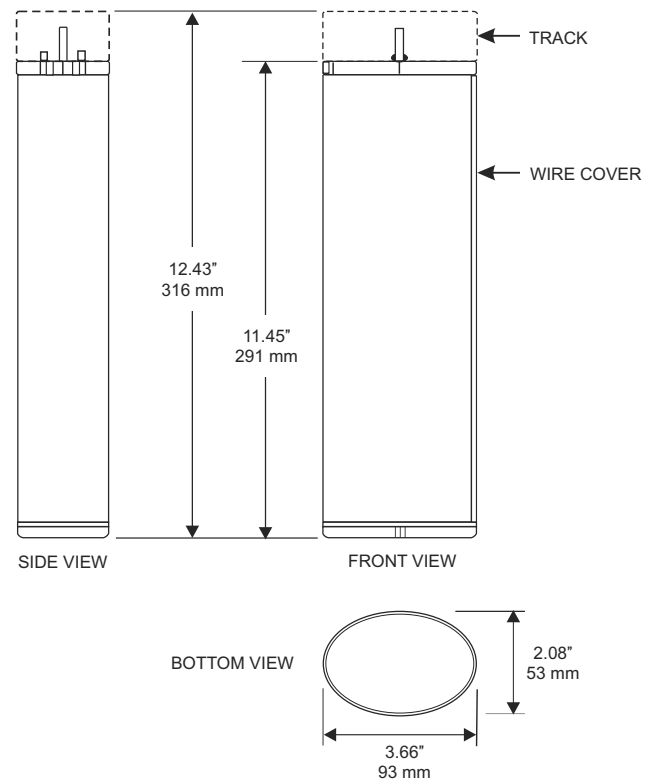

## Motor dimensions



# Technical Specifications

## SELECTION CHARTS

\*STACKING CHART - for reference only

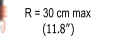
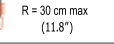
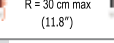
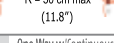
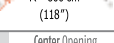
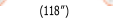
Track Type	Glydea® 35e & Irismo™ 35 Mini DC			Irismo™ 45 WireFree RTS		Glydea® 60e		
	UP TO 10 FT.	UP TO 20 FT.	UP TO 32 FT.	UP TO 33 FT.	UP TO 10 FT.	UP TO 32 FT.	UP TO 36 FT.	
<b>A</b> One Way 	77 Lbs.			99 Lbs.	132 Lbs.			
<b>B</b> Center Opening 	77 Lbs.			99 Lbs.	132 Lbs.			
<b>C</b> Asymetrical 	77 Lbs.			99 Lbs.	132 Lbs.			
<b>D</b> One Way w/ Bend  R = 30 cm max (11.8")	77 Lbs.	55 Lbs.	44 Lbs.	NA	100 Lbs.	100 Lbs.	77 Lbs.	
<b>E</b> Center Opening w/ Bend  R = 30 cm max (11.8")	77 Lbs.	55 Lbs.	44 Lbs.	NA	100 Lbs.	100 Lbs.	77 Lbs.	
<b>F</b> One Way w/2 Bends  R = 30 cm max (11.8")	33 Lbs.	22 Lbs.	-	NA	77 Lbs.	55 Lbs.	-	
<b>G</b> Center Opening w/2 Bends  R = 30 cm max (11.8")	33 Lbs.	22 Lbs.	-	NA	77 Lbs.	55 Lbs.	-	
<b>H</b> One Way w/ Continuous Curve  R = 300 cm (118")	77 Lbs.	33 Lbs.	-	NA	132 Lbs.	55 Lbs.	-	
<b>I</b> Center Opening w/ Continuous Curve  R = 300 cm (118")	66 Lbs.	22 Lbs.	-	NA	113 Lbs.	38 Lbs.	-	

TRACK SIZES	RIPPLEFOLD® - inches carrier count - ( )					
	ONE WAY 80%	ONE WAY 100%	ONE WAY 120%	CENTER OPENING 80%	CENTER OPENING 100%	CENTER OPENING 120%
	Butt Arm	Butt Arm	Butt Arm	Butt Arm	Butt Arm	Butt Arm
Up to 4 ft.	19.5 (20)	21.5 (24)	23.5 (28)	12.25 (20)	13.25 (24)	14.25 (28)
5 ft.	22 (25)	24.5 (30)	27 (35)	13.75 (26)	14.75 (30)	16.25 (36)
6 ft.	24.5 (30)	27.5 (36)	30.5 (42)	14.75 (30)	16.25 (36)	17.75 (42)
7 ft.	27 (35)	30.5 (42)	34 (49)	16.25 (36)	17.75 (42)	19.75 (50)
8 ft.	29.5 (40)	33.5 (48)	37.5 (56)	17.25 (40)	19.25 (48)	21.25 (56)
9 ft.	32 (45)	36.5 (54)	41 (63)	18.75 (46)	20.75 (54)	23.25 (64)
10 ft.	34.5 (50)	39.5 (60)	44.5 (70)	19.75 (50)	22.25 (60)	24.75 (70)
11 ft.	37 (55)	42.5 (66)	48 (77)	21.25 (56)	23.75 (66)	26.75 (78)
12 ft.	39.5 (60)	45.5 (72)	51.5 (84)	22.25 (60)	25.25 (72)	28.25 (84)
13 ft.	42 (65)	48.5 (78)	55 (91)	23.75 (66)	26.75 (78)	30.25 (92)
14 ft.	44.5 (70)	51.5 (84)	58.5 (98)	24.75 (70)	28.25 (84)	31.75 (98)
15 ft.	47 (75)	54.5 (90)	62 (105)	26.25 (76)	29.75 (90)	33.75 (106)
16 ft.	49.5 (80)	57.5 (96)	65.5 (112)	27.25 (80)	31.25 (96)	35.25 (112)
17 ft.	52 (85)	60.5 (102)	69 (119)	28.75 (86)	32.75 (102)	37.25 (120)
18 ft.	54.5 (90)	63.5 (108)	72.5 (126)	29.75 (90)	34.25 (108)	38.75 (126)
19 ft.	57 (95)	66.5 (114)	76 (133)	31.25 (96)	35.75 (114)	40.75 (134)
20 ft.	59.5 (100)	69.5 (120)	79.5 (140)	32.25 (100)	37.25 (120)	42.25 (140)
21 ft.	62 (105)	72.5 (126)	83 (147)	33.75 (106)	38.75 (126)	44.25 (148)
22 ft.	64.5 (110)	75.5 (132)	86.5 (154)	34.75 (110)	40.25 (132)	45.75 (154)
23 ft.	67 (115)	78.5 (138)	90 (161)	36.25 (116)	41.75 (138)	47.75 (162)
24 ft.	69.5 (120)	81.5 (144)	93.5 (168)	37.25 (120)	43.25 (144)	49.25 (168)
25 ft.	72 (125)	84.5 (150)	97 (175)	38.75 (126)	44.75 (150)	51.25 (176)
26 ft.	74.5 (130)	87.5 (156)	100.5 (182)	39.75 (130)	46.25 (156)	52.75 (182)
27 ft.	77 (135)	90.5 (162)	104 (189)	41.25 (136)	47.75 (162)	54.75 (190)
28 ft.	79.5 (140)	93.5 (168)	107.5 (196)	42.25 (140)	49.25 (168)	56.25 (196)
29 ft.	82 (145)	96.5 (174)	111 (203)	43.75 (146)	50.75 (174)	58.25 (204)
30 ft.	84.5 (150)	99.5 (180)	114.5 (210)	44.75 (150)	52.25 (180)	59.75 (210)
31 ft.	87 (155)	102.5 (186)	118 (217)	46.25 (156)	53.75 (186)	61.75 (218)
32 ft.	89.5 (160)	105.5 (192)	121.5 (224)	47.25 (160)	55.25 (192)	63.25 (224)
33 ft.	92 (165)	108.5 (198)	125 (231)	48.75 (166)	56.75 (198)	65.25 (232)
34 ft.	94.5 (170)	111.5 (204)	128.5 (238)	49.75 (170)	58.25 (204)	66.75 (238)
35 ft.	97 (175)	114.5 (210)	132 (245)	51.25 (176)	59.75 (210)	68.75 (246)
36 ft.	99.5 (180)	117.5 (216)	135.5 (252)	52.25 (180)	61.25 (216)	70.25 (252)

## DUAL MOTOR TANDEM ALTERNATIVE (2 one way tracks)

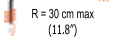
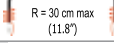
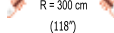
Track Type		Irismo™ 45 WireFree RTS	Glydea® 60e		Glydea® 35e & Irismo™ 35 Mini DC		
2 One Way Butted Tracks		UP TO 33 FT.	UP TO 10 FT.	UP TO 32 FT.	UP TO 10 FT.	UP TO 20 FT.	UP TO 32 FT.
<b>J</b> Center opening w/2 Straight 	(1) Straight	99 Lbs.	132 Lbs.		77 Lbs.		
	(1) Straight	99 Lbs.	132 Lbs.		77 Lbs.		
<b>K</b> Center opening w/1 Bend  R = 30 cm max (11.8")	(1) 90° Bend	NA	100 Lbs.	77 Lbs.	77 Lbs.	55 Lbs.	44 Lbs.
	(1) Straight	NA	132 Lbs.		77 Lbs.		
<b>L</b> Center opening w/2 Bends  R = 30 cm max (11.8")	(1) 90° Bend	NA	100 Lbs.	77 Lbs.	77 Lbs.	55 Lbs.	44 Lbs.
	(1) 90° Bend	NA	100 Lbs.	77 Lbs.	77 Lbs.	55 Lbs.	44 Lbs.
<b>M</b> Center opening w/2 Curves  R = 300 cm (118")	(1) Curve	NA	132 Lbs.	55 Lbs.	-	77 Lbs.	33 Lbs.
	(1) Curve	NA	132 Lbs.	55 Lbs.	-	77 Lbs.	33 Lbs.

\* Measurements do not consider drapery fabric and are calculated from end of pulley to front of master arm (shown here).

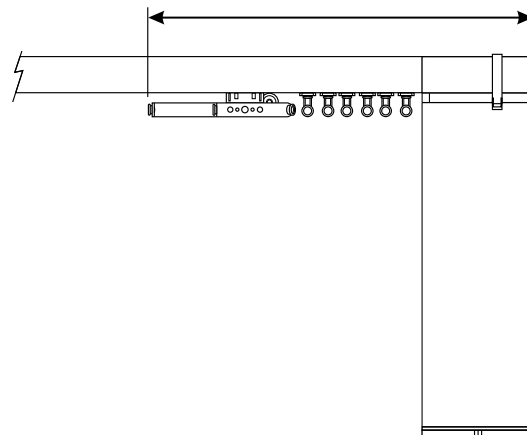

# Technical Specifications

TRACK SIZES	RIPPLEFOLD® - inches carrier count - ( )									PINCH PLEAT - inches carrier count - ( )		
	ONE WAY 80%	ONE WAY 100%	ONE WAY 120%	CENTER OPENING 80%		CENTER OPENING 100%		CENTER OPENING 120%		ONE WAY	CENTER OPENING	
	Overlap Arm	Overlap Arm	Overlap Arm	Overlap Arm	Straight Arm	Overlap Arm	Straight Arm	Overlap Arm	Straight Arm	Overlap Arm	Overlap Arm	Straight Arm
Up to 4 ft.	19.25 (20)	21.25 (24)	23.25 (28)	14 (10)	13.75 (10)	15 (12)	14.75 (12)	16.25 (14)	16 (14)	15.25 (12)	11.75 (6)	11.5 (6)
5 ft.	21.75 (25)	24.25 (30)	26.75 (35)	15.5 (13)	15.25 (13)	16.5 (15)	16.25 (15)	18.25 (18)	18 (18)	16.75 (15)	12.75 (8)	12.5 (8)
6 ft.	24.25 (30)	27.25 (36)	30.25 (42)	16.5 (15)	16.25 (15)	18 (18)	17.75 (18)	19.75 (21)	19.5 (21)	18.25 (18)	13.25 (9)	13 (9)
7 ft.	26.75 (35)	30.25 (42)	33.75 (49)	18 (18)	17.75 (18)	19.5 (21)	19.25 (21)	21.75 (25)	21.5 (25)	19.75 (21)	14.25 (11)	14 (11)
8 ft.	29.25 (40)	33.25 (48)	37.25 (56)	19 (20)	18.75 (20)	21 (24)	20.75 (24)	23.25 (28)	23 (28)	21.25 (24)	14.75 (12)	14.5 (12)
9 ft.	31.75 (45)	36.25 (54)	40.75 (63)	20.5 (23)	20.25 (23)	22.5 (26)	22.25 (26)	25.25 (32)	25 (32)	22.75 (27)	15.75 (14)	15.5 (14)
10 ft.	34.25 (50)	39.25 (60)	44.25 (70)	21.5 (25)	21.25 (25)	24 (30)	23.75 (30)	26.75 (35)	26.5 (35)	24.25 (30)	16.25 (15)	16 (15)
11 ft.	36.75 (55)	42.25 (66)	47.75 (77)	23 (28)	22.75 (28)	25.5 (33)	25.25 (33)	28.75 (39)	28.5 (39)	25.75 (33)	17.25 (17)	17 (17)
12 ft.	39.25 (60)	45.25 (72)	51.25 (84)	24 (30)	23.75 (30)	27 (36)	26.75 (36)	30.25 (42)	30 (42)	27.25 (36)	17.75 (18)	17.5 (18)
13 ft.	41.75 (65)	48.25 (78)	54.75 (91)	25.5 (33)	25.25 (33)	28.5 (39)	28.25 (39)	32.25 (46)	32 (46)	28.75 (39)	18.75 (20)	18.5 (20)
14 ft.	44.25 (70)	51.25 (84)	58.25 (98)	26.5 (35)	26.25 (35)	30 (42)	29.75 (42)	33.75 (49)	33.5 (49)	30.25 (42)	19.25 (21)	19 (21)
15 ft.	46.75 (75)	54.25 (90)	61.75 (105)	28 (38)	27.75 (38)	31.5 (45)	31.25 (45)	35.75 (53)	35.5 (53)	31.75 (45)	20.25 (23)	20 (23)
16 ft.	49.25 (80)	57.25 (96)	65.25 (112)	29 (40)	28.75 (40)	33 (48)	32.75 (48)	37.25 (56)	37 (56)	33.25 (48)	20.75 (24)	20.5 (24)
17 ft.	51.75 (85)	60.25 (102)	68.75 (119)	30.5 (43)	30.25 (43)	34.5 (51)	34.25 (51)	39.25 (60)	39 (60)	34.75 (51)	21.75 (26)	21.5 (26)
18 ft.	54.25 (90)	63.25 (108)	72.25 (126)	31.5 (45)	31.25 (45)	36 (54)	35.75 (54)	40.75 (63)	40.5 (63)	36.25 (54)	22.25 (27)	22 (27)
19 ft.	56.75 (95)	66.25 (114)	75.75 (133)	33 (48)	32.75 (48)	37.5 (57)	37.25 (57)	42.75 (67)	42.5 (67)	37.75 (57)	23.25 (29)	23 (29)
20 ft.	59.25 (100)	69.25 (120)	79.24 (140)	34 (50)	33.75 (50)	39 (60)	38.75 (60)	44.25 (70)	44 (70)	39.25 (60)	23.75 (30)	23.5 (30)
21 ft.	61.75 (105)	72.25 (126)	82.75 (147)	35.5 (53)	35.25 (53)	40.5 (63)	40.25 (63)	46.25 (74)	46 (74)	40.75 (63)	24.75 (32)	24.5 (32)
22 ft.	64.25 (110)	75.25 (132)	86.25 (154)	36.5 (55)	36.25 (55)	42 (66)	41.75 (66)	47.75 (77)	47.5 (77)	42.25 (66)	25.25 (33)	25 (33)
23 ft.	66.75 (115)	78.25 (138)	89.75 (161)	38 (58)	37.75 (58)	43.5 (69)	43.25 (69)	49.75 (81)	49.5 (81)	43.75 (69)	26.25 (35)	26 (35)
24 ft.	69.25 (120)	81.25 (144)	93.25 (168)	39 (60)	38.75 (60)	45 (72)	44.75 (72)	51.25 (84)	52 (84)	45.25 (72)	26.75 (36)	26.5 (36)
25 ft.	71.75 (125)	84.25 (150)	96.75 (175)	40.5 (63)	40.25 (63)	46.5 (75)	46.25 (75)	53.25 (88)	53 (88)	46.75 (75)	27.75 (38)	27.5 (38)
26 ft.	74.25 (130)	87.25 (156)	100.25 (182)	41.5 (65)	41.25 (65)	48 (78)	47.75 (78)	54.75 (91)	54.5 (91)	48.25 (78)	28.25 (39)	28 (39)
27 ft.	76.75 (135)	90.25 (162)	103.75 (189)	43 (68)	42.75 (68)	49.5 (81)	49.25 (81)	56.75 (95)	56.5 (95)	49.75 (81)	29.25 (41)	29 (41)
28 ft.	79.25 (140)	93.25 (168)	107.25 (196)	44 (70)	43.75 (70)	51 (84)	50.75 (84)	58.25 (98)	58 (98)	51.25 (84)	29.75 (42)	29.5 (42)
29 ft.	81.75 (145)	96.25 (174)	110.75 (203)	45.5 (73)	45.25 (73)	52.5 (87)	52.25 (87)	60.25 (102)	60 (102)	52.75 (87)	30.75 (44)	30.5 (44)
30 ft.	84.25 (150)	99.25 (180)	114.25 (210)	46.5 (75)	46.25 (75)	54 (90)	53.75 (90)	61.75 (105)	61.5 (105)	54.25 (90)	31.25 (45)	31 (45)
31 ft.	86.75 (155)	102.3 (186)	117.75 (217)	48 (78)	47.75 (78)	55.5 (93)	55.25 (93)	63.75 (108)	63.5 (108)	55.75 (93)	32.25 (47)	32 (47)
32 ft.	89.25 (160)	105.3 (192)	121.25 (224)	49 (80)	48.75 (80)	57 (96)	56.75 (96)	65.25 (112)	65 (112)	57.25 (96)	32.75 (48)	32.5 (48)
33 ft.	91.75 (165)	108.3 (198)	124.75 (231)	50.5 (83)	50.25 (83)	58.5 (99)	58.25 (99)	67.25 (116)	67 (116)	58.75 (99)	33.75 (50)	33.5 (50)
34 ft.	94.25 (170)	111.3 (204)	128.25 (238)	51.5 (85)	51.25 (85)	60 (102)	59.75 (102)	68.75 (118)	68.5 (118)	60.25 (102)	34.25 (51)	34 (51)
35 ft.	96.75 (175)	114.3 (210)	131.75 (245)	53 (86)	52.75 (86)	61.5 (105)	61.25 (105)	70.75 (123)	70.5 (123)	61.75 (105)	35.25 (53)	35 (53)
36 ft.	99.25 (180)	117.3 (216)	135.25 (252)	54 (90)	53.75 (90)	63 (108)	62.75 (108)	72.25 (126)	72 (126)	63.25 (108)	35.75 (54)	35.5 (54)

# Product Specifications

## CARRIER ARM DIMENSIONS

### Overlap Arm - #1782320

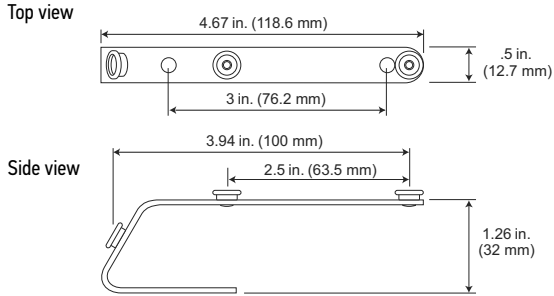

### Overlap Arm - #1780947

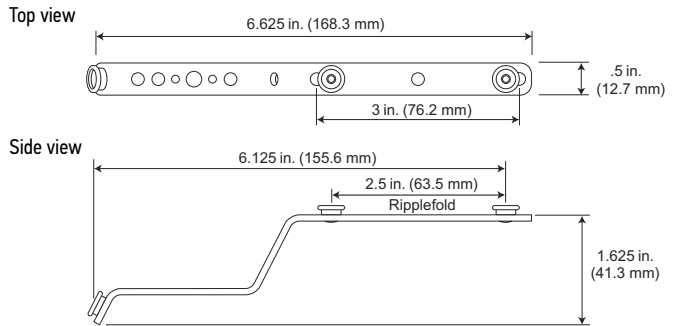

### Straight Arm\* - #1782321

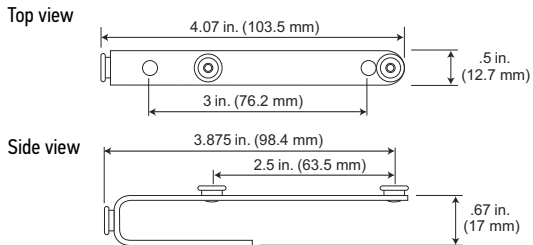

### Straight Arm - #1782662

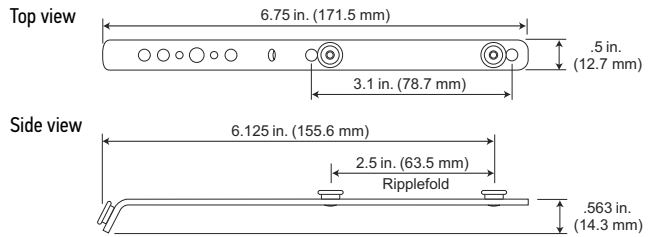

\*For use with one-way opening with standard drive pulley.

### One Way Butt Arm - #1782319

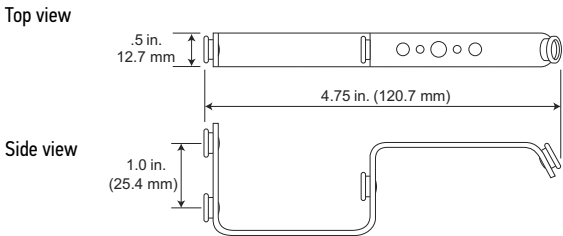

### Butt Master Arm Center Opening - #1780953

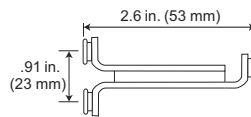

## WALL BRACKET DIMENSIONS

### Adjustable Wall Mount Bracket - #1780909

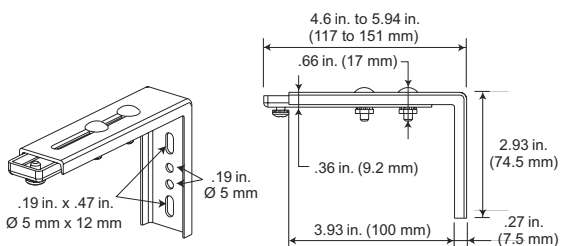

### Double Adjustable Wall Mount Bracket - #1780910

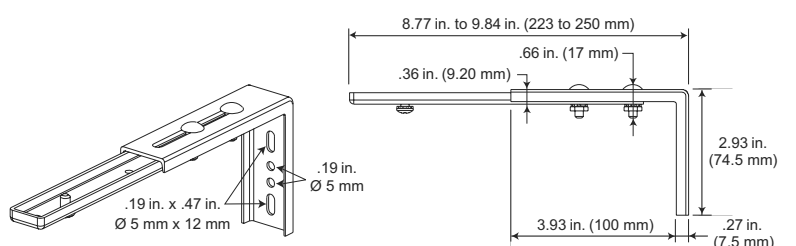

# Product Specifications

## TRACK PROFILE

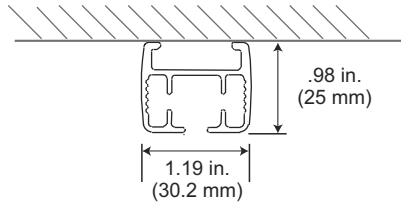

## CEILING BRACKET DIMENSIONS

### One Touch Ceiling Bracket - #1780907

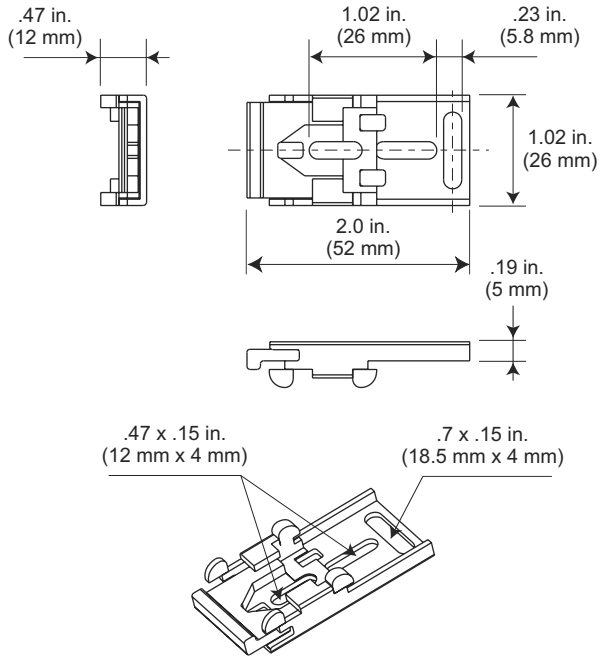

### Carriers

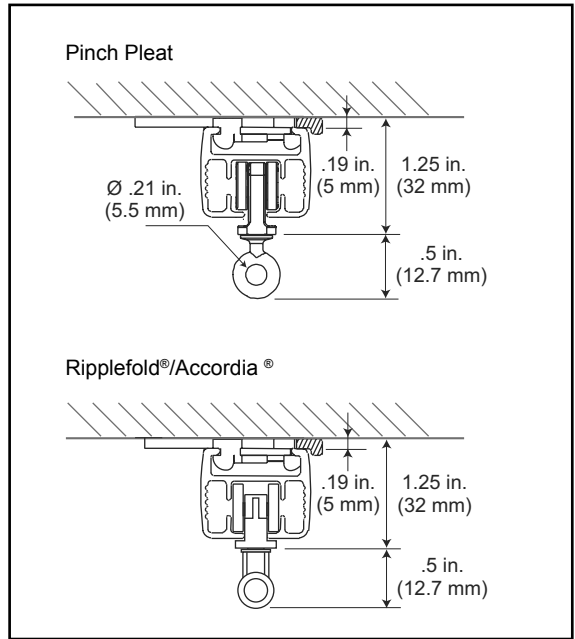

### Swivel Ceiling Bracket - #1780906

(recommended for curved tracks)

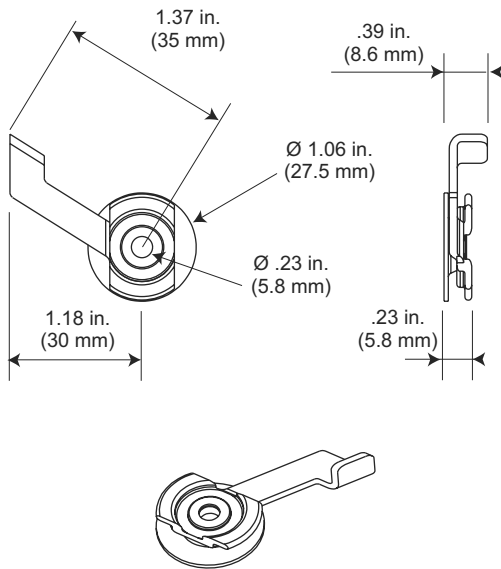

### Carriers

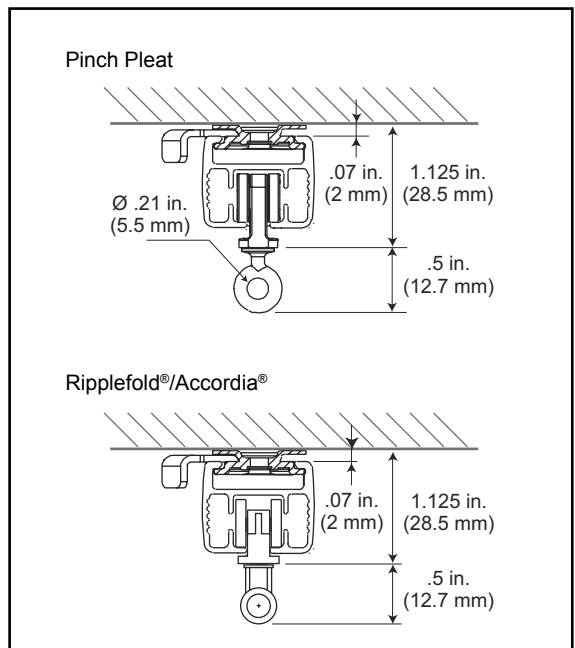

# Track Configurations

## RIPPLEFOLD®

### One Way Stacked

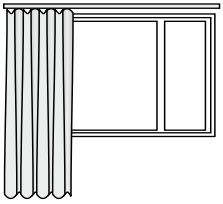

#### REQUIRED ARMS (1)



One Way Overlap Arm Kit  
#1782320



#### REQUIRED ARMS (1)



One Way Butt Arm Kit  
#1782319

Bottom up view of track and drape assembly

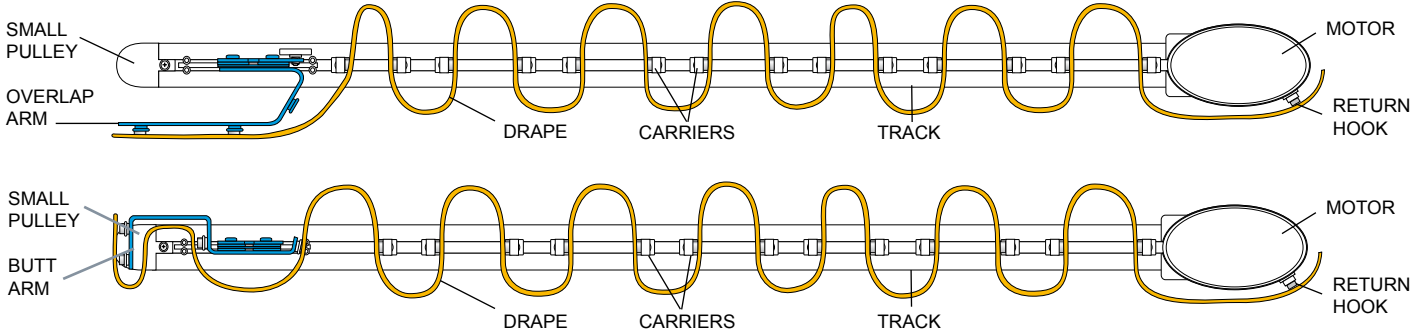

### Center Opening

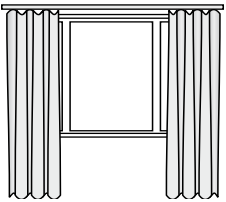

#### REQUIRED ARMS (1 each)



Straight Arm Kit - #1782321  
&  
Overlap Arm Kit - #1782320

Bottom up view of track and drape assembly

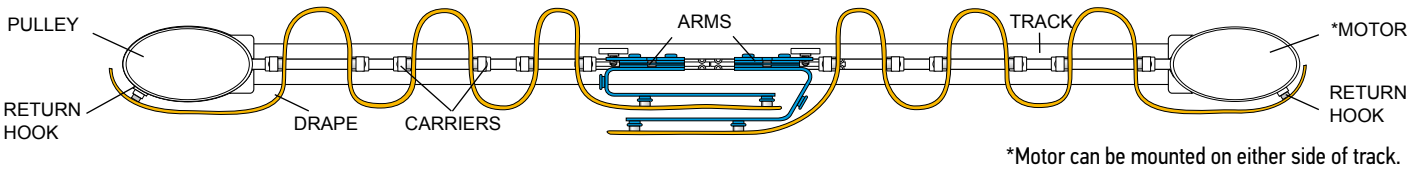

### Center Opening with Butt Master Arms

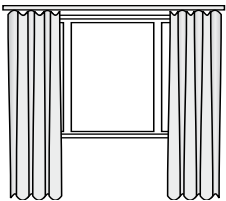

#### REQUIRED ARMS (2)



Butt Master Arms - #1780953

Bottom up view of track and drape assembly

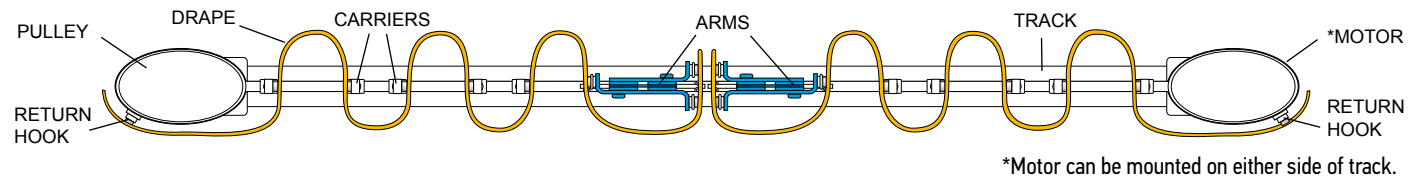



# Track Configurations

## PINCH PLEAT One Way Stacked

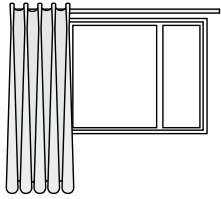

### REQUIRED ARMS (1)

One Way Overlap Arm Kit - #1782320



Bottom up view of track and drape assembly

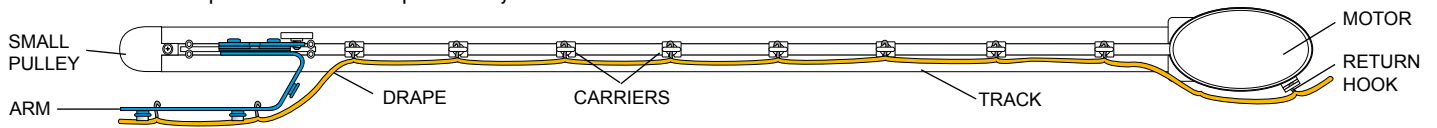

## Center Opening

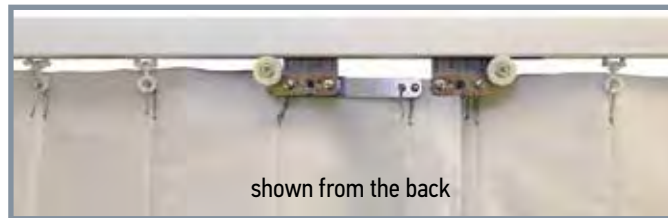
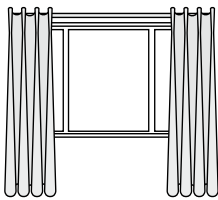

### REQUIRED ARMS (1 each)

Straight Arm Kit - #1782321



Overlap Arm Kit - #1782320

Bottom up view of track and drape assembly

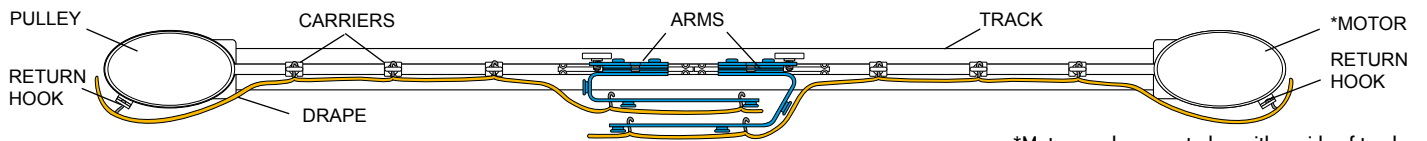

\*Motor can be mounted on either side of track.

## PINCH PLEAT AND RIPPLEFOLD® Two One Way Butted Tracks (tandem alternative)

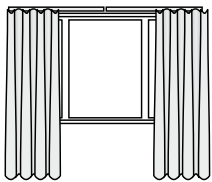

### REQUIRED ARMS (2)

One Way Butt Arm Kit - #1782319



### REQUIRED ARMS (2)

Straight Arm Kit - #1782662



Overlap Arm Kit - #1780947

Bottom up view of track and drape assembly

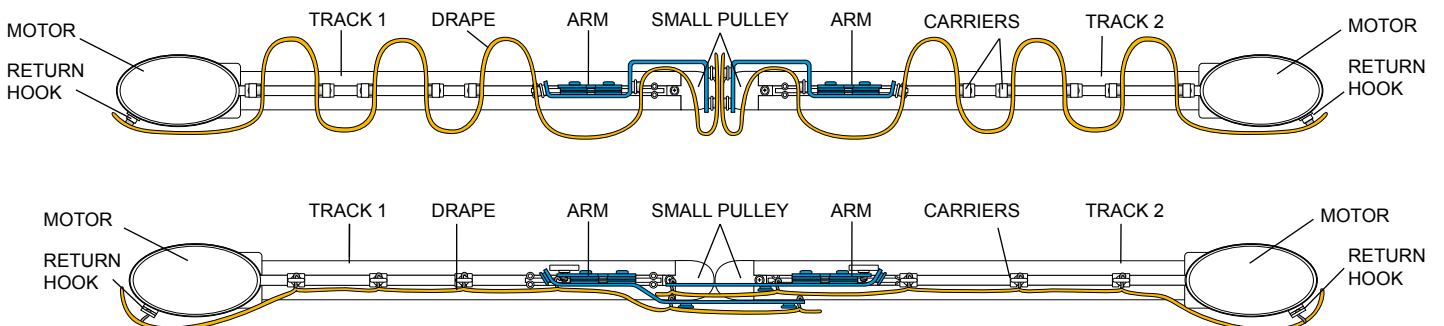

# Drapery Controls and Accessories

Learn more about controls and accessories at [www.somfy.com/controls](http://www.somfy.com/controls)

## RADIO TECHNOLOGY SOMFY® (RTS)



### TELIS HAND-HELD REMOTE COLLECTION



Telis 1 RTS Silver  
Single Channel Remote  
1810639



Telis 4 RTS Silver  
Five Channel Remote  
1810641



Telis 1 RTS Pure  
Single Channel Remote  
1810632



Telis 4 RTS Pure  
Five Channel Remote  
1810633



Telis 1 RTS Lounge  
Single Channel Remote  
1810650



Telis 4 RTS Lounge  
Five Channel Remote  
1810652



Telis 1 RTS Patio  
Single Channel Remote  
1810643



Telis 4 RTS Patio  
Five Channel Remote  
1810645



Telis 16 Channel RTS  
Pure Remote with  
On-Screen display  
1811081



Telis 16 Channel RTS  
Silver Remote with  
On-Screen display  
1811082



Telis 1 Chronis RTS  
Pure Timer  
1805237



Telis 1 Chronis RTS  
Silver Timer  
1805238

### INDOOR SENSORS

### SOMFY CONNECT™ LTI

### SOMFY CONNECT™ UNIVERSAL AUTOMATION INTERFACE (UAI) PLUS

### SOMFY CONNECT™ BMS INTERFACE



Sunis Indoor  
WireFree™ RTS  
9013707



ThermoSunis Indoor  
WireFree™ RTS  
9013708



Integrates Somfy RTS and  
Somfy Digital Network™ (SDN) motorized  
applications with RadioRA® 2,  
HomeWorks® QS, GRAFIF Eye® QS,  
and Quantum® control systems.  
1870210



Commission and integrate  
Somfy-powered  
SDN solutions over IP.  
1870272



Provides communication between  
building management systems  
and SDN motorized  
shading systems.  
1870249

### myLink™ WiFi TO RTS INTERFACE

### 16 CHANNEL INTERFACE

### RTS REPEATER

### ZRTSI II

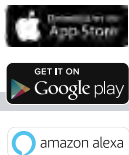

RTS Smart Phone and Tablet Interface

Control window coverings, awnings, screens and rolling shutters using your tablet, smartphone or voice. A simple on-screen set up wizard helps users create timed events, scenes and more. Compatible with iOS, Android and Amazon Alexa.

[www.somfy.com/mylink](http://www.somfy.com/mylink)

1811403



Universal RTS Interface 16-Channel  
(Converts IR, RS232, RS485 to RTS)

1810872



RTS Repeater

1810791



Z-Wave® to RTS®  
Interface 2

1811265

# Drapery Controls and Accessories

Learn more about controls and accessories at [www.somfy.com/controls](http://www.somfy.com/controls)

## RADIO TECHNOLOGY SOMFY® (RTS)



### DECOFLEX WIREFREE™ WALL SWITCHES

### SMOOVE® WALL SWITCH



DecoFlex 1 Channel RTS WireFree™ Wall Switch



DecoFlex 2 Channel RTS WireFree™ Wall Switch



DecoFlex 3 Channel RTS WireFree™ Wall Switch



DecoFlex 4 Channel RTS WireFree™ Wall Switch



DecoFlex 5 Channel RTS WireFree™ Wall Switch



Smooove® 1 RTS Pure

- Battery-operated convenience
- Surface mounts with ease
- Frames available in 7 colors

- Wall Switches shown in white. Also available in black and ivory finishes.
- Shown assembled with printed channel buttons.
- Custom engraved buttons are also available.



Black



Ivory



Pure



Silver Matte



Black



Light Bamboo



Amber Bamboo



Cherry



Walnut

### TABLE TOP ACCESSORIES



DecoFlex WireFree™ RTS Table Top Accessory Black 1811051\*



DecoFlex WireFree™ RTS Table Top Accessory Silver 1810972\*



DecoFlex WireFree™ RTS Table Top Accessory White 1811185\*

\*DecoFlex Switch sold separately from Table Top Accessory.

## WIRED TECHNOLOGY



### DRY CONTACT SWITCH

### DECORATOR PADDLE SWITCH

For use with Glydea 60e wired motors only (1001537)



White 1800219



Ivory 1800220



Maintained White 1800374  
Double Pole, Double Throw 1800375



Maintained Ivory 1800373  
Double Pole, Double Throw 1800376

# Drapery Motor Wiring Examples

## RTS RADIO CONTROL



### Individual control



### Group control

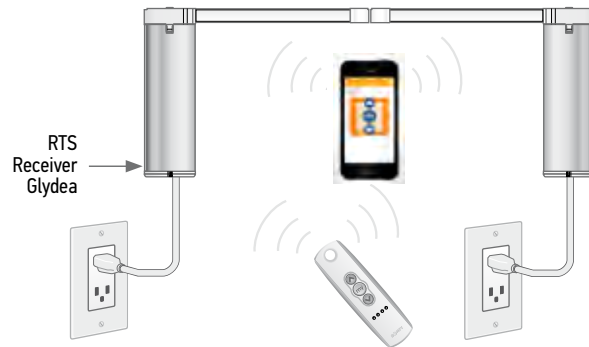

## DCT CONTROL



The Dry Contact Control can be done through devices with 2 normally open contacts (open, close) or 3 normally open contacts (open, stop, close). For devices using 2 contacts, the stop command is achieved by closing the open and close contacts. For 3 devices, the stop can also be achieved with a specific stop button. Individual, group and master DCT controls can be achieved using a DCT Splitter and a Diode boxes as shown below.

**NUMBER OF DCT DRAPERLY MOTORS AND LENGTH OF CONTROL LIMITATIONS**

WIRE CROSS-SECTION	MAXIMUM LENGTH OF CABLE	MAXIMUM NUMBER OF MOTORS
Cat5 or Equal	328 ft. (100 m)	10
0.75 mm <sup>2</sup>	656 ft. (200 m)	20

### Individual control

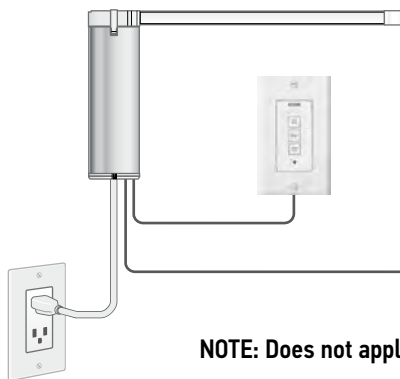

### RJ12 SOCKET PIN OUT

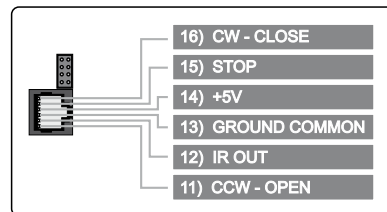

**NOTE: Does not apply to Irismo™ 45 WireFree**

### Group control

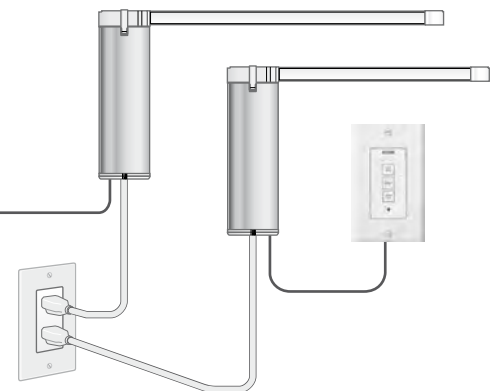

## WIRED CONTROL



### Individual control

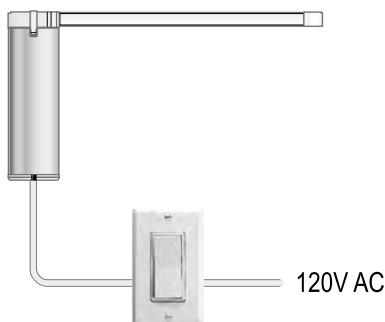

### Group control

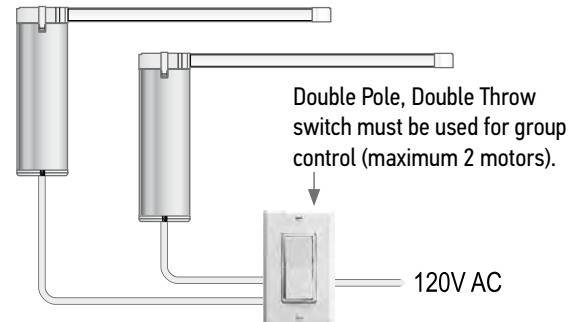

**NOTE: Examples are for illustrative purposes. Additional components may be needed depending on your installation.**

**NOTE: Applies to Glydea range only.**

# Drapery Motor Wiring Examples



## RS485 CONTROL

### Individual control

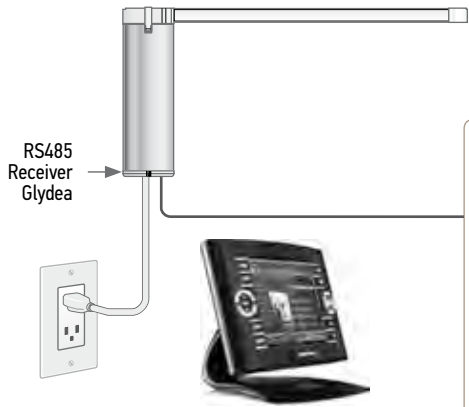

### Group and individual control

See diagram on previous page for RJ12 Socket Pin Out

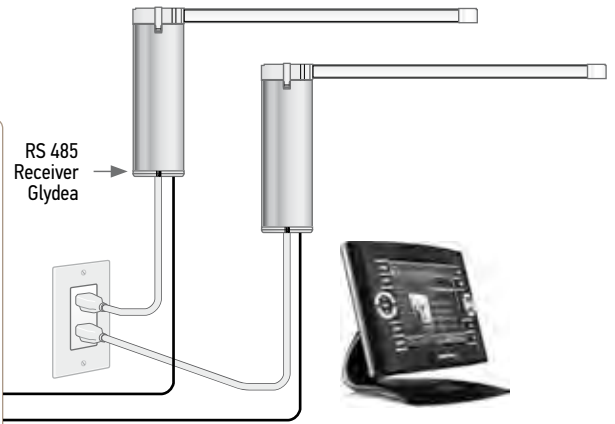
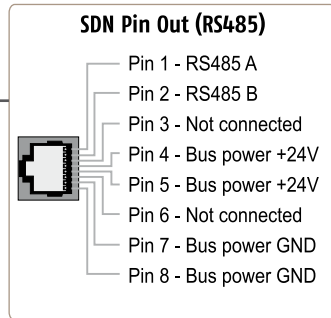

**NOTE:** Does not apply to Irismo™ 45 WireFree

## Z-WAVE® CONTROL



### Individual control

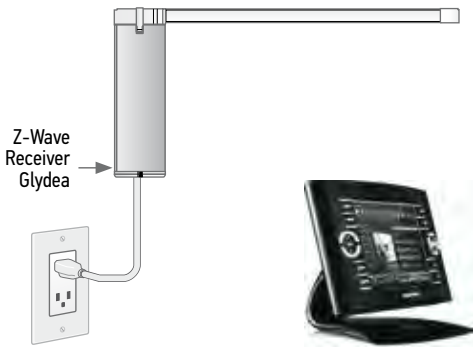

### Group and individual control



## ZIGBEE® CONTROL



### Individual control



### Group and individual control

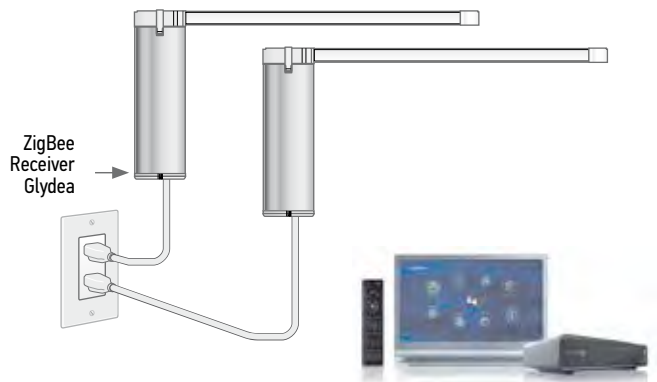

**NOTE:** Examples are for illustrative purposes. Additional components may be needed depending on your installation.

**NOTE:** Does not apply to Irismo™ 45 WireFree

# Drapery Parts list

## MOTORS AND CONTROL MODULES

### Irismo™ 35 Mini DC



**DCT** 1002951  
**RTS** 1002952  
 (24V DC power supply included)

### Glydea® 35e



**DCT** with 10' Plug 1002465  
**RTS** with 10' Plug 1001615  
**RS485** with 10' Plug 1002109  
**Wired** without Plug 1002464

### Irismo™ 45 WireFree RTS



**RTS** 1002353  
 (Rechargeable Lithium-ion battery pack included)  
 Power Charger #1002945 (Sold Separately)

### Glydea® 60e



**DCT** with 10' Plug 1002545  
**RTS** with 10' Plug 1001617  
**RS485** with 10' Plug 1002108  
**Wired** without Plug 1001537

## Integration Control Modules



Easily integrates with Z-Wave® systems using the Z-Wave® plug-in module.

Z-Wave®  
 1870228



Easily integrates with ZigBee® systems using the ZigBee® plug-in module.

ZigBee®  
 1870221



Easily integrates with Somfy Digital Network systems using the RS485 plug-in module.

RS485  
 1811129



Easily integrates with Radio Technology Somfy systems using the Dry Contact to RTS module.

RTS  
 1870172

## COMMON TRACK COMPONENTS

### Small Drive Pulley



1782318

### Small Drive Pulley (bronze)



1782861

### Drive Pulley



1780945

### Drive Pulley (bronze)



1782873

### Pulley Cover



1780898

### Pulley Cover (bronze)



1782868

### Heavy Duty Master Carrier



1781344

### High Performance 10mm Belt



198' per roll  
 1782084

### Track



96' per carton  
 (6 pcs. x 16')  
 1780899 (per ft.)







### Straight Rail Joint



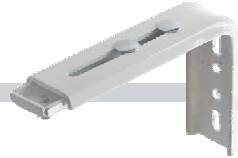

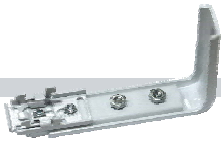
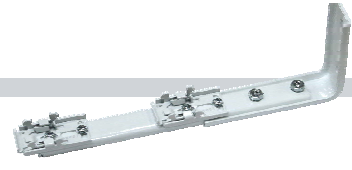

1782316

# Drapery Parts List

## BRACKETS

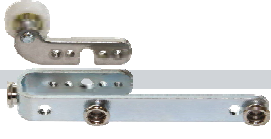
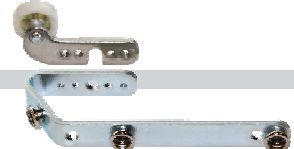
One Touch Ceiling Bracket	Adjustable Wall Mount Bracket	Double Adjustable Wall Mount Bracket	Swivel Ceiling Bracket
 <p>1780907</p>	 <p>Projection 4.5" - 6" 1780909</p>	 <p>Projection 8.75" - 10.25" 1780910</p>	 <p>1780906</p>
 <p>Bronze 1782865</p>	 <p>Bronze Projection 4.5" - 6" 1782866</p>	 <p>Bronze Projection 8.75" - 10.25" 1782867</p>	 <p>Bronze 1782864</p>
Adjustable Wall/Ceiling Mount Bracket Kit		Double Adjustable Wall/Ceiling Mount Bracket Kit	
 <p>Projection 4.5" - 6" 1782054</p>		 <p>Projection 8.75" - 10.25" 1782053</p>	

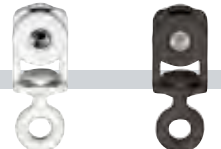
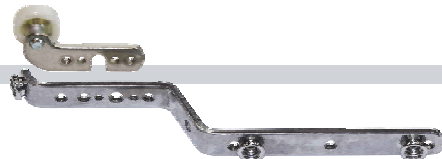
## PINCH PLEAT TRACK COMPONENTS

Straight Arm Kit	Overlap Arm Kit	Pinch Pleat Return Hook	Carrier
 <p>1782321 For use with center opening draperies.</p>	 <p>1782320 For use with one way and center opening draperies.</p>	 <p>1780895 Bronze 1782862</p>	 <p>1780892 Bronze 1782869</p>
One Way Overlap Arm Kit	Straight Arm Kit		
 <p>1780947 For use with one way opening draperies with pulley #1780945.</p>	 <p>1782662 For use with tandem butted tracks alternative draperies (to be used together).</p>		

# Drapery Parts List

## RIPPLEFOLD® & ACCORDIA® TRACK COMPONENTS

### Straight Arm Kit

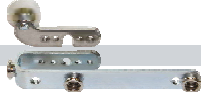

1782321  
For use with center opening draperies.

### Overlap Arm Kit

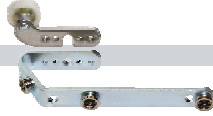

1782320  
For use with one way and center opening draperies.

### One Way Overlap Arm Kit

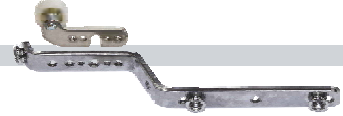

1780947  
For use with tandem alternative straight arm.

### Ripplefold® Butt Master Arms Kit



1780953  
For use with center opening draperies only.

### One Way Ripplefold® Butt Arm Kit

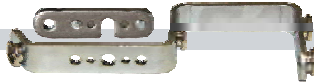

1782319  
For use with Ripplefold one way opening and double track tandem alternative.

### Straight Arm Kit



1782662  
For use with tandem butted tracks alternative draperies (to be used together).

### Ripplefold® and Accordia® Type Carriers

### Ripple Snap Tape

### Ripple Return Snap

80% Fullness  
(White)

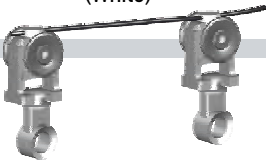

Carrier Spacing:  
2 3/8"  
Qty. per roll: 500  
1780903

100% Fullness  
(White)

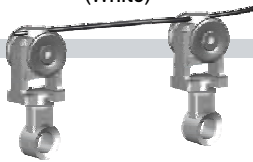

Carrier Spacing:  
2 1/8"  
Qty. per roll: 500  
1780902

120% Fullness  
(White)

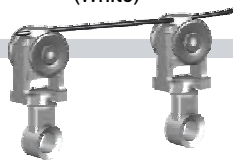

Carrier Spacing:  
1 7/8"  
Qty. per roll: 500  
1780901



100 yd. roll:  
1782301  
Per yd.  
1782542



1780905

80% Fullness  
(Bronze)



Carrier Spacing:  
2 3/8"  
Qty. per roll: 500  
1782872

100% Fullness  
(Bronze)



Carrier Spacing:  
2 1/8"  
Qty. per roll: 500  
1782871

120% Fullness  
(Bronze)

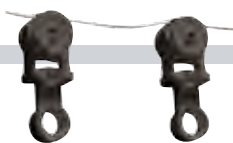

Carrier Spacing:  
1 7/8"  
Qty. per roll: 500  
1782870



1782863

Recommended for use with Somfy Ripple Snap Tape (ordered separately), but also adaptable to Kirsch and Graber snap tape.

Accordia® type carrier consists of Pinch Pleat carrier and Ripplefold® pendant.



# Drapery Fabricated Track Options\*

## AVAILABLE CARRIER ARMS

Carrier arms are included with fabricated motorized drapery tracks per the opening type.

### ONE WAY OPENING

**Overlap Arm** - For use with one way opening Pinch Pleat, one way Ripplefold® and Accordia® draperies.  
Qty 1 per drapery track.

### CENTER OPENING

**Overlap Arm** - For use with center opening Pinch Pleat, Ripplefold® and Accordia® draperies.  
Qty 1 Overlap Arm per drapery track.  
Qty 1 Straight Arm per drapery track.

### CENTER OPENING BUTT MASTER

**Butt Master Arm** - For use with Ripplefold® and Accordia® center opening draperies only.  
Qty 2 per drapery track required.

### ONE WAY OPENING OR TWO MOTOR TANDEM

**One Way Butt Arm** - For use with Ripplefold® one way draperies and 2 motor tandem alternative.  
Qty 1 per drapery track required.

### TWO MOTOR TANDEM ALTERNATIVE

**Overlap Arm/ Straight Arm** - For use with Pinch Pleat and 2 motor tandem alternative. Qty 1 per drapery track required.

**\*Fabricated tracks are available upon request.  
For more information, please contact Somfy sales.**



One Way Overlap Arm Kit  
#1782320

Overlap Arm Kit  
#1782320  
&  
Straight Arm Kit  
#1782321

**or (optional)**  
Butt Master Arms  
#1780953

One Way Butt Arm Kit  
#1782319

Straight Arm Kit  
#1782662  
&  
Overlap Arm Kit  
#1780947

## AVAILABLE CARRIERS

Carriers are included with fabricated motorized drapery tracks.

### PINCH PLEAT DRAPERIES

**Pinch Pleat Carriers:** Somfy includes a quantity of 3 carriers per foot. Additional carriers can be ordered if necessary.



Carrier  
#1780892

### Pinch Pleat Return Hook:

Qty 2 for One Way Draw (included)  
Qty 4 for Center Opening (included)



Return Hook  
#1780895

### RIPPLEFOLD®/ACCORDIA® DRAPERIES

**\*\*Somfy Ripplefold®/Accordia® Type Carriers:** The quantity of carriers needed depends on the desired fullness, reference the chart below to determine the needed quantity and standard spacing. Each carrier comes complete with pendant. See page 8-9 for Somfy's carrier count.

Item #	Fullness	**Carrier Spacing
1780903	80%	2 3/8" / 5 per ft. (included)
1780902	100%	2 1/8" / 6 per ft. (included)
1780901	120%	1 7/8" / 7 per ft. (included)



Carrier and Pendant

**\*\*Note: Quantity per ft. is included with each fabricated track. Fullness must be specified when order is placed.**  
Recommended for use with Somfy Ripple Snap Tape (ordered separately), but also adaptable to Kirsch and Graber snap tape.

### Ripple Snap Tape:



(100 yd. roll) #1782301  
(per yd.) #1782542

### Return Snap:

Qty 2 for One Way Draw (included)  
Qty 4 for Center Opening (included)



Return Snap  
#1780905

# Custom Track Options

## Tandem Alternative

Tandem alternative RTS motorized systems utilize two drapery motors and are used for draperies that exceed the maximum single motor capacity. Tandem systems are also available with dry contact control technologies and require additional accessories.

Please contact Somfy for specification details.



## Top Mount

Drapery motors can be installed above the drapery track depending on your project needs. This option provides the ability to conceal the motor in a drop ceiling or under a valance and requires an additional kit.

Top Mount Kit  
#1780908

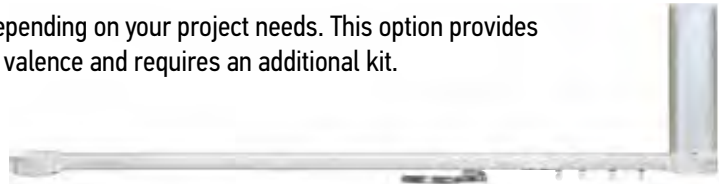

## Glystro® Conversion Kit

The Glystro® conversion kit is designed to allow adaptation to Somfy's current drapery tracks to previous Glystro® drapery tracks and associated hardware.



#1782106

## Bends (Not compatible with Irismo™ 45 WireFree RTS)

Tracks with bends are ideal for bay and corner windows. Track bends are available at a fixed radius of 11.8 in. For more information on how to measure for a bend, please see page 25.

**Bent Drapery Track Measurement Form required for all orders.**

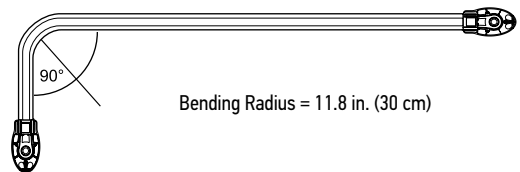

## Curves (Not compatible with Irismo™ 45 WireFree RTS)

Custom curves are ideal for bow windows and other special applications. For additional information on how to measure for a curve, and how to make a template, please see [Directions for Creating a Template for Drapery Curves](#) page 26.

**Templates are required for accuracy for all orders.**

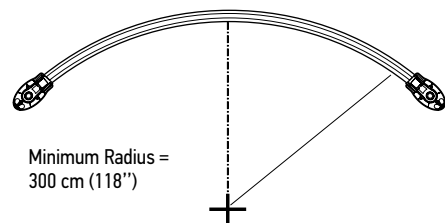

## BRACKET MOUNTING RECOMMENDATIONS (TOP VIEW OF TRACK)

Somfy recommends 1 bracket by each pulley and 1 bracket every 24 in. Also, 1 bracket should be placed on each side of a splice if used.

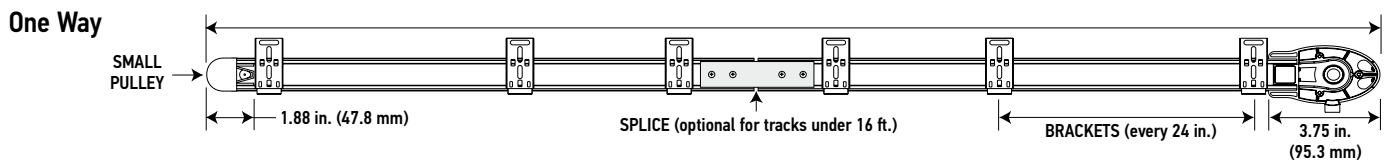
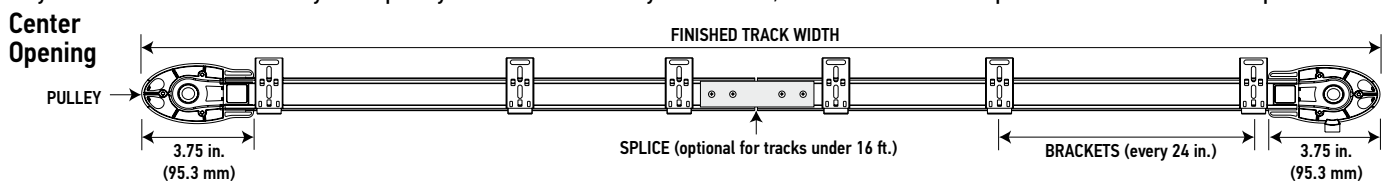

# Bent Drapery Track Measurement Form

1. Choose the design that best fits your room setup.
2. Measure the wall and degrees of all angles as in examples shown below.
  - Make sure to provide the return measurement "R" (distance from wall to front of drapery track as shown in red). The bent track measurement form represents wall measurements, therefore the "R" dimension **MUST BE** specified for accurate track fabrication. If "R" dimension **IS NOT** specified, drapery track will be fabricated according to dimensions (A, B, C, D, etc.) provided.
  - Return dimensions will not be considered, and measurements will be calculated from center of each bend.
  - When fabricating drapery, please add an additional 1.5 inches of drapery fabric to the anticipated return size.
3. Provide all measurements by filling out order form and submitting to Somfy.

**NOTE: The following dimensions are shown from top view of the track and show various wall designs.**

**STYLE 1 MEASUREMENT**

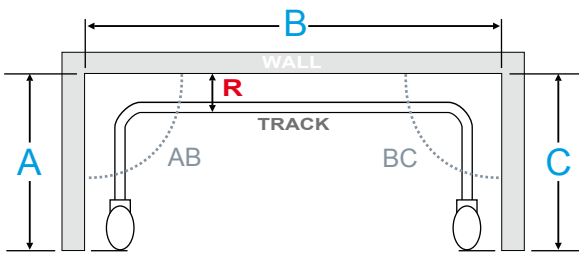

**STYLE 2 MEASUREMENT**

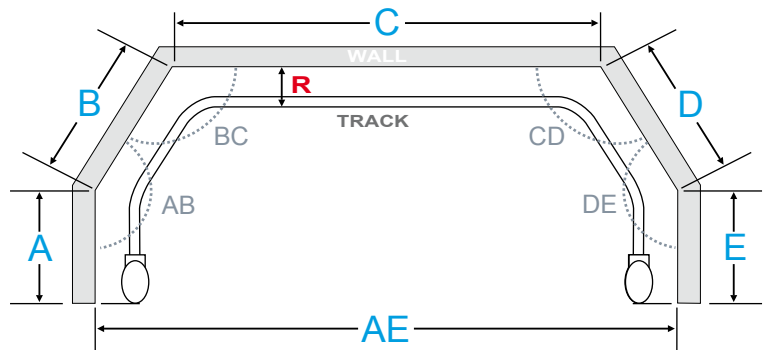

**STYLE 3 MEASUREMENT**

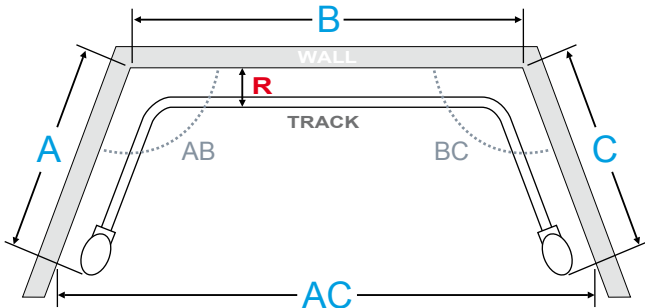

**STYLE 4 MEASUREMENT**

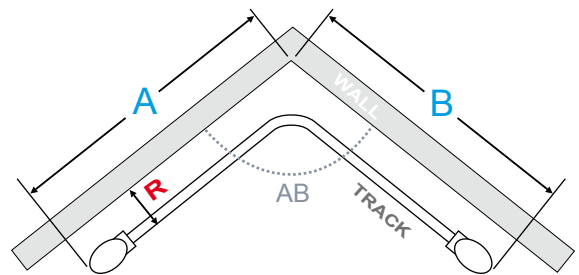

**STYLE 5 MEASUREMENT \***

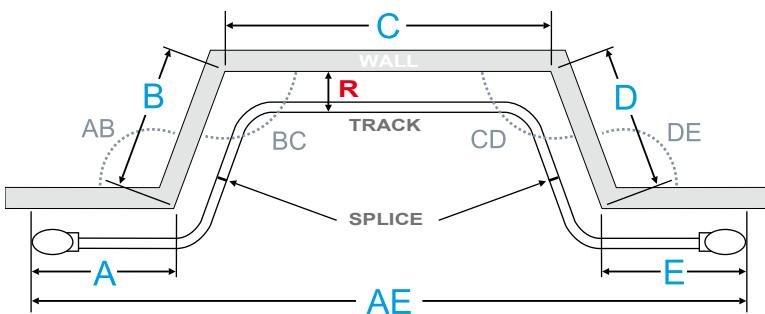

\* Splices are required for this style.

TRACK 1	
"R" Dimension	_____
Style	_____ Degree of
A	_____ Bend
B	_____ AB
C	_____ BC
D	_____ CD
E	_____ DE
AC	_____
AE	_____

TRACK 2	
"R" Dimension	_____
Style	_____ Degree of
A	_____ Bend
B	_____ AB
C	_____ BC
D	_____ CD
E	_____ DE
AC	_____
AE	_____

**NOTE: Irismo™ 45 WireFree RTS is not compatible with bends and curves.**

# Directions for Creating a Template for Drapery Curves

**What you need:** • Large piece of construction paper • Tape Measure • Marker • Tape

- 1** Start with a large piece of construction paper that exceeds the depth and length of the curve.
  - 2** Place the paper on the floor or ceiling depending on the orientation of the curve.
  - 3** Secure the paper with tape.
  - 4** Clearly define the stacking side, motor placement, pocket depth and center line of track with the marker.
  - 5** Mark the radius of the curve.
- Please call Somfy for specialty curving applications. Depending on your particular application, your project may require special attention.
- 6** Please provide as much detail as possible and all templates must include the following:
    - Indicate "room side"
    - Note how the template was created
    - Purchase order number
      - Template created on the floor facing up (See Figure 1) *preferred method*
      - Template created on the ceiling facing down (See Figure 2)
    - Customer name
    - Company name and account number
  - 7** Note the distance from the wall or the window to the center of the track.  
**NOTE: be sure to clear all possible obstructions such as handles, sills etc.**
  - 8** Identify the following measurement points:
    - Placement of motor
    - Exact stopping point of track on template
    - Total measurement of curve (See Figure 4-"C")

**FIGURE 1: TEMPLATE ON THE FLOOR FACING UP**

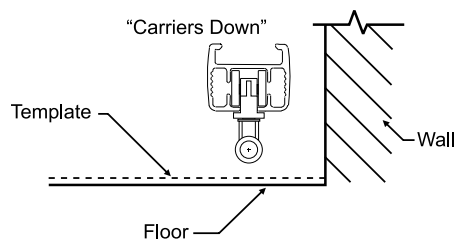

**FIGURE 2: TEMPLATE ON CEILING FACING DOWN**

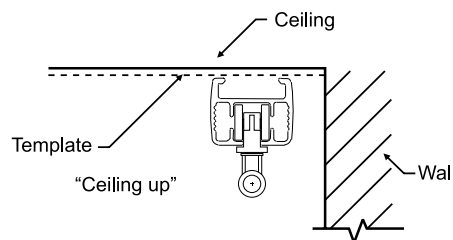

**FIGURE 3: CRITICAL DIMENSIONS OF A CURVED TRACK**

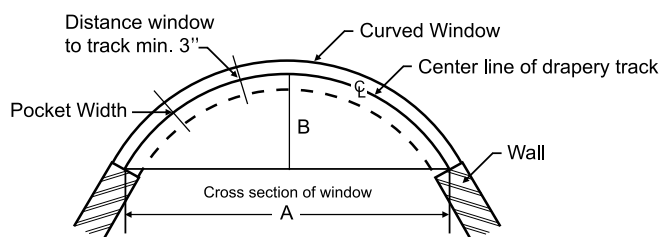

**FIGURE 4: TOTAL MEASUREMENT OF CURVE**

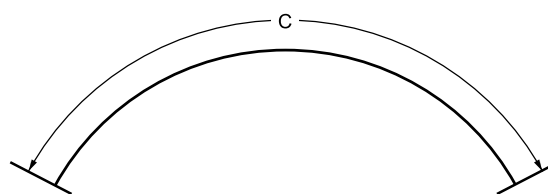

**Template Submission Instructions**

- Attach a copy of the purchase order to the template.
  - Roll up template and place in a mailing tube.
- DO NOT FOLD TEMPLATE**

**NOTE: When mailing, be sure to:**

- Get a Tracking Number
- Include your return address
- Include your purchase order number on the label

**Mail to:**

Somfy Systems, Inc.  
121 Herrod Blvd.  
Dayton, NJ 08810  
Attn: Drapery Department

**Acceptable materials for making templates:**

- Kraft Paper • Butcher Paper • Construction Paper

**Somfy will not accept template made from the following materials:**

- Newspaper • Plastic • Wax Paper • Fabric • Tissue Paper
- Roofing Paper • Existing Arch Shades • Wrapping Paper

**NOTE: If the material used to make a template stretches, tears easily, will not lay flat or will mark the fabric - IT WILL NOT BE USED.**

**NOTE: Irismo™ 45 WireFree RTS is not compatible with bends and curves.**

# Drapery Order Form

Date of Order: \_\_\_\_\_ Account # \_\_\_\_\_ P.O. # \_\_\_\_\_ Sidemark: \_\_\_\_\_

Special Shipping Directions: \_\_\_\_\_

SOLD TO:	
Business Name: _____	_____
Address: _____	_____
City: _____ State: _____ Zip: _____	_____
Phone: _____ Fax #: _____	_____
Email: _____	_____
Ordered By: _____	_____
Signature: _____	_____

SHIP TO:	
Business Name: _____	_____
Address: _____	_____
City: _____ State: _____ Zip: _____	_____
Contact Name: _____	_____
Phone: _____ Fax #: _____	_____
Email: _____	_____

**ORDER DETAIL:** Please see next page for glossary and definition of terms.

Item #	Room	QTY.	1	2	3	4	5	6	7	8	9		10	11
			Motor Part No.	Width (in.)	Tandem	Motor Side	*Track Type	Stack (L/R/S)	**If Bent: # of bends	Carrier Type	Bracket		Butt Master	Splice
ex.	Living Room	1	1001617	144		left	F	S	2	RF80	1780907	7	NO	X
1														
2														
3														
4														
5														
6														

\* For curved tracks, Somfy requires a template be provided. Please see [Directions for Creating a Template for Drapery Curves](#) for template information.

\*\* For bent tracks, Somfy does not require a template. Please include the [Bent Drapery Tracks Measurement Form](#) for exact measurements per angle and return.

**NOTE:** Somfy includes a center splice every 16' of track. Please indicate in the "SPECIAL INSTRUCTIONS" section if your requirements differ from Somfy's standard.

**CONTROLS:** In the space provided below, please list the part number(s) for the control(s) you desire.

Given the nature of custom motorization products, control options and compatibility varies dramatically. If you would like further assistance with control options, simply note it in the field below and one of our customer service specialists will contact you upon the submission of your order.

**SPECIAL INSTRUCTIONS**

**Please send to: e-mail: [ordering\\_us@somfy.com](mailto:ordering_us@somfy.com) Fax: 609-495-8117**

(Continued on next page)

1	Motor	Part Number
	Irismo™ 35 (Mini DC) RTS.....	1002952
	Irismo™ 35 (Mini DC) DCT.....	1002951
	Irismo™ 45 WireFree RTS.....	1002353
	Glydea® 35e Motor DCT with 10' plug .....	1002465
	Glydea® 35e Motor RTS with 10' plug .....	1001615
	Glydea® 35e Motor RS485 with 10' plug .....	1002109
	Glydea® 35e Wired.....	1002464
	Glydea® 60e Motor DCT with 10' plug .....	1002545
	Glydea® 60e Motor RTS with 10' plug .....	1001617
	Glydea® 60e Motor RS485 with 10' plug .....	1002108
	Glydea® 60e Wired.....	1001537

**2 Width (Inches)**

Motorized drapery tracks are custom built according to the specified width. Please note that the finished track width is measured pulley end to pulley end. For bent and curved tracks please provide the total of all wall measurements. When fabricating your drapery please add 1.5" to your return.

**3 Tandem Y=Yes N=No**

Tandem motorized systems utilize two drapery motors. Items needed for tandem systems should be noted in the Special Instructions Section of the order form.

**Dry Contact**

Splitter..... # 9015442  
 7ft Modular Cable..... # 9013346  
 25 ft. Modular Cable.... # 9013149  
 35 ft. Modular Cable.... # 9013338

**Tandem alternative = 2 one way tracks**

**4 Motor Side**

**L=Left Side R=Right Side**

Choose the motor side best suited for your installation.

**5 Track Type**

**A-I See below O=Other**

NOTE: Somfy requires a template for all curved tracks. Please see *Directions for Creating a Template for Drapery Curves* for necessary information.

<b>A</b> One way	<b>D</b> One way w/Bend R = 30 cm max (11.8")	<b>G</b> Center Opening w/2 Bends R = 30 cm max (11.8")
<b>B</b> Center Opening	<b>E</b> Center Opening w/Bend R = 30 cm max (11.8")	<b>H</b> One Way w/Continuous Curve R = 300 cm max (118")
<b>C</b> Asymetrical	<b>F</b> One way w/2Bends R = 30 cm max (11.8")	<b>I</b> Center Opening w/Continuous Curve R = 300 cm max (118")

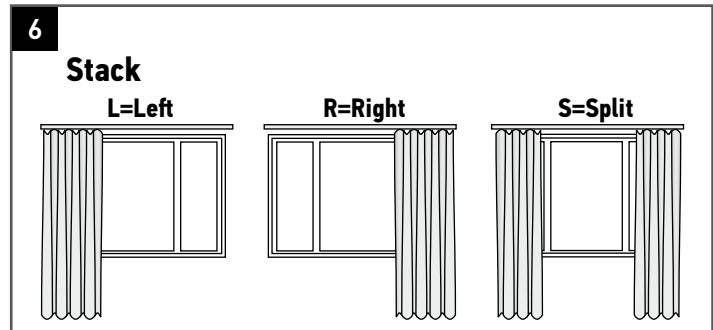

**7 If Bent: # of Bends**

**1=1 Bend, 2=2 Bends, 3=3 Bends, etc**

NOTE: Somfy requires exact angle measurements for all bent tracks. Please submit completed and signed **Bent Drapery Track Measurement Form** with all bent track orders.

**8 Carrier Type**

**1=1 Bend, 2=2 Bends, 3=3 Bends, etc**

PP=Pinch Pleat (QTY of 3 per foot included)  
 RF80 = RippleFold® 80% fullness (QTY of 5 per foot spaced every 2 3/8" included)  
 RF100 = RippleFold® 100% fullness (QTY of 6 per foot spaced every 2 1/8" included)  
 RF120 = RippleFold® 120% fullness (QTY of 7 per foot spaced every 1 7/8" included)

**9 Brackets**

NOTE: Brackets are not included and must be ordered separately.

**Part Numbers**

One Touch Ceiling Bracket (not recommended for curved tracks)....# 1780907  
 4.5"-6" Wall Mount Bracket.....# 1782054  
 8.75"-10.25" Double Wall Mount Bracket.....# 1782053  
 Swivel Ceiling Bracket (strongly recommended for curved tracks)....# 1780906

Somfy recommends one (1) bracket by each pulley and one (1) bracket every 24". Additionally, one (1) bracket should be placed on each side of a splice if used.

**10 Butt Master**

**Y=Yes N=No**

Only available for RippleFold® center opening systems. Quantity 2 required; please note item numbers in **Special Instructions Section** of the order form item #1780953.

**11 Splice**

**X=Special splice instructions**

Somfy includes a center splice every 16ft of track. Please indicate in the Special Instructions Section if your requirements differ from Somfy's standard.

# DECOFLEX RTS, SDN & DRY CONTACT

## Button Engraving Order Form

Customer Name: \_\_\_\_\_ Customer #: \_\_\_\_\_

SHIPPING

### Shipping Information

Ship to: Default Shipping Address  Drop Ship   
 Name: \_\_\_\_\_  
 Address: \_\_\_\_\_  
 City: \_\_\_\_\_ State: \_\_\_\_\_ Zip: \_\_\_\_\_  
 Phone: \_\_\_\_\_

### Project Information

Project Name: \_\_\_\_\_  
 Installer Name/Company: \_\_\_\_\_  
 P/O #: \_\_\_\_\_ Order #: \_\_\_\_\_  
 Area: \_\_\_\_\_  
 Room: \_\_\_\_\_

STYLE

### Button Color

WHITE  #9018259      IVORY  #9018260      BLACK  #9018261

### Switch Type

RTS       Somfy Digital Network (SDN) RS485       Dry Contact   
*Available in White only*

ENGRAVING OPTIONS

Buttons (A-F) 9 Characters Maximum (including spaces)		QTY.
A		
B		
C		
D		
E		
F		
G		
H		

(F): Command Button by default is labeled STOP on the DecoFlex RTS and Dry Contact Switches only.

NOTE: G and H buttons by default are labeled as follows:

(G = down ▼ icon)    WHITE - #9018263    IVORY - #9018264    BLACK - #9018265

(H = up ▲ icon):      WHITE - #9018267    IVORY - #9018268    BLACK - #9018269

If you prefer they can be substituted with an associated command

NAME (UP, DOWN, LOWER, etc.) up to 5 characters.

**Engraving Options** - Default option will be used if nothing is selected.

#### Character Types: (choose one)

ALL LETTERS CAPITALIZED (Default)       First Letters Capitalized       As written in above section

### DecoFlex RTS

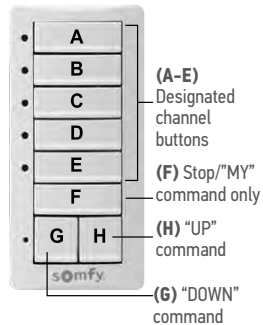

### DecoFlex SDN

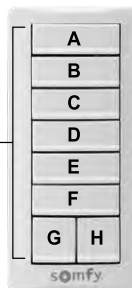

### DecoFlex Dry Contact

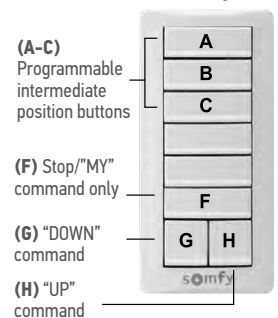

### Payment terms of your account will apply.

All engraved switches are custom made and are non-cancellable.

Please send form to: Fax # 609-495-8117 or e-mail to: [Ordering\\_us@somfy.com](mailto:Ordering_us@somfy.com)

**SOMFY SYSTEMS INC**  
 121 Herrod Blvd.  
 Dayton, NJ 08810  
 Phone: (800) 22-SOMFY  
 NJ: (609) 395-1300  
 Fax: (609) 495-8118  
[somfysystems.com](http://somfysystems.com)

**Florida**  
 6100 Broken Sound Pkwy.  
 N.W., Suite 14  
 Boca Raton, FL 33487  
 Phone: (877) 227-6639  
 Fax: (561) 995-7502

**California**  
 15291 Barranca Parkway  
 Irvine, CA 92618-2201  
 Phone: (877) 727-6639  
 Fax: (949) 727-3775

**SOMFY ULC**  
**SOMFY Canada Division**  
 5178 Everest Drive  
 Mississauga, Ontario L4W2R4  
 CN: (905) 564-6446  
 Fax: (905) 238-1491

**SOMFY®** is the leading global manufacturer of strong, quiet motors with electronic and app controls for interior and exterior window coverings. Over 270 million users worldwide enjoy the more than 150 million motors produced by Somfy. During the past 45+ years, Somfy engineers have designed products for both the commercial and residential markets to motorize window coverings such as interior shades, wood blinds, draperies, awnings, rolling shutters, exterior solar screens and projection screens. Somfy motorization systems are easily integrated with security, HVAC and lighting systems providing total home or building automation.

**SOMFY SYSTEMS INC**  
**SOMFY NORTH AMERICAN HEADQUARTERS**

121 Herrod Blvd.  
Dayton, NJ 08810  
T: (800) 22-SOMFY (76639)  
NJ: (609) 395-1300  
F: (609) 395-1776

**FLORIDA**

6100 Broken Sound Pkwy. N.W.  
Suite 14  
Boca Raton, FL 33487  
T: (800) 22-SOMFY (76639)  
F: (561) 995-7502

**CALIFORNIA**

15291 Barranca Parkway  
Irvine, CA 92618-2201  
T: (800) 22-SOMFY (76639)  
F: (949) 727-3775

**SOMFY ULC**

**SOMFY Canada Division**

5178 Everest Drive  
Mississauga, Ontario L4W2R4  
T: 1-800-66-SOMFY (76639)  
CN: (905) 564-6446  
F: (905) 238-1491

[www.somfysystems.com](http://www.somfysystems.com)

A BRAND OF **SOMFY** GROUP



© Copyright Somfy Systems, Inc. 12/2016  
Images: © SAS/Childeric