

Nikon

DIGITAL CAMERA

D5500

Reference Manual



Nikon Manual Viewer 2

Install the Nikon Manual Viewer 2 app on your smartphone or tablet to view Nikon digital camera manuals, anytime, anywhere.

Nikon Manual Viewer 2 can be downloaded free of charge from the App Store and Google Play.

En

D5500

Model Name: N1405

To get the most from your camera, please be sure to read all instructions thoroughly and keep them where they will be read by all who use the product.

Symbols and Conventions

To make it easier to find the information you need, the following symbols and conventions are used:



This icon marks cautions; information that should be read before use to prevent damage to the camera.



This icon marks notes; information that should be read before using the camera.



This icon marks references to other pages in this manual.

Menu items, options, and messages displayed in the camera monitor are shown in **bold**.

Camera Settings

The explanations in this manual assume that default settings are used.



For Your Safety

















Before using the camera for the first time, read the safety instructions in "For Your Safety" (📖 xi–xiv).

Table of Contents

For Your Safety.....	xi
Notices.....	xv
Wireless	xx
Introduction	1
<hr/>	
Getting to Know the Camera.....	1
Camera Menus: An Overview	13
Using the Touch Screen.....	17
First Steps.....	27
“Point-and-Shoot” Modes (AUTO and )	38
<hr/>	
Framing Photos in the Viewfinder	39
Viewing Photographs	42
Deleting Unwanted Pictures	43
Framing Photos in the Monitor.....	45
Viewing Photographs	48
Deleting Unwanted Pictures	49
Recording Movies.....	50
Viewing Movies.....	52
Deleting Unwanted Movies.....	53









Matching Settings to the Subject or Situation (Scene Mode)

54

 Portrait.....	55
 Landscape	55
 Child	55
 Sports	56
 Close up.....	56
 Night Portrait.....	56
 Night Landscape	57
 Party/Indoor	57
 Beach/Snow	57
 Sunset	58
 Dusk/Dawn	58
 Pet Portrait	58
 Candlelight	59
 Blossom	59
 Autumn Colors.....	59
 Food.....	60

Special Effects

61

 Night Vision	61
 VI Super Vivid.....	62
POP Pop.....	62
 Photo Illustration	62
 Toy Camera Effect.....	63
 Miniature Effect.....	63
 Selective Color	63
 Silhouette	64
 High Key	64
 Low Key	64
Options Available in Live View	66

More on Photography **71**

Choosing a Release Mode.....	71
Continuous Shooting (Burst Mode).....	72
Quiet Shutter Release.....	74
Self-Timer Mode	75
Focus (Viewfinder Photography)	78
Choosing How the Camera Focuses: Focus Mode.....	78
Choosing How the Focus Point Is Selected:	
AF-Area Mode.....	82
Focus Point Selection	85
Focus Lock.....	86
Manual Focus	88
Image Quality and Size	90
Image Quality.....	90
Image Size	92
Using the Built-in Flash	93
Auto Pop-up Modes.....	93
Manual Pop-up Modes	95
ISO Sensitivity	99
Interval Timer Photography.....	101
Remote Control Photography	107
Using an Optional ML-L3 Remote Control	107
Restoring Default Settings	110

P, S, A, and M Modes **113**

Shutter Speed and Aperture	113
Mode P (Programmed Auto).....	115
Mode S (Shutter-Priority Auto).....	117
Mode A (Aperture-Priority Auto)	118
Mode M (Manual)	119
Long Time-Exposures (M Mode Only).....	121



Exposure	125
Metering.....	125
Autoexposure Lock.....	127
Exposure Compensation	129
Flash Compensation	131
Preserving Detail in Highlights and Shadows	133
Active D-Lighting	133
High Dynamic Range (HDR)	135
White Balance	137
Fine-Tuning White Balance	140
Preset Manual.....	142
Bracketing	148
Picture Controls	152
Selecting a Picture Control	152
Modifying Picture Controls.....	154
Creating Custom Picture Controls	158
Sharing Custom Picture Controls.....	161
Live View	162
<hr/>	
Framing Photographs in the Monitor	162
Focusing in Live View	164
The Live View Display	168
Recording and Viewing Movies	174
<hr/>	
Recording Movies	174
Movie Settings.....	177
Viewing Movies	181
Editing Movies	183
Trimming Movies	183
Saving Selected Frames	186

Viewing Pictures	188
Full-Frame Playback.....	188
Thumbnail Playback	190
Calendar Playback	191
Photo Information	192
Taking a Closer Look: Playback Zoom	200
Protecting Photographs from Deletion	202
Rating Pictures	203
Rating Individual Pictures.....	203
Rating Multiple Pictures	204
Deleting Photographs	205
Full-Frame, Thumbnail, and Calendar Playback	205
The Playback Menu.....	206
Slide Shows	208
Slide Show Options.....	209

Connections





Installing ViewNX 2	210
Using ViewNX 2	211
Copy Pictures to the Computer	211
Printing Photographs	214
Connecting the Printer	214
Printing Pictures One at a Time	215
Printing Multiple Pictures	216
Creating a DPOF Print Order: Print Set.....	218
Viewing Pictures on TV	220
Standard Definition Devices.....	220
High-Definition Devices	222

What Wi-Fi Can Do for You	224
Accessing the Camera	225
WPS (Android Only).....	226
PIN Entry (Android Only)	228
SSID (Android and iOS)	229
Selecting Pictures for Upload.....	231
Selecting Individual Pictures for Upload	231
Selecting Multiple Pictures for Upload.....	232

 The Playback Menu: <i>Managing Images</i>	233
Playback Menu Options.....	233
Playback Folder	234
Playback Display Options	234
Image Review.....	234
Auto Image Rotation	235
Rotate Tall.....	235
 The Shooting Menu: <i>Shooting Options</i>	236
Shooting Menu Options	236
Reset Shooting Menu.....	237
Storage Folder	238
File Naming	240
NEF (RAW) Recording	240
ISO Sensitivity Settings	241
Color Space	243
Long Exposure NR	243
High ISO NR.....	244
Vignette Control.....	244
Auto Distortion Control.....	245
Optical VR	245

 Custom Settings: <i>Fine-Tuning Camera Settings</i>	246
Custom Settings	247
Reset Custom Settings	248
a: Autofocus	248
a1: AF-C Priority Selection	248
a2: Number of Focus Points	249
a3: Built-in AF-assist Illuminator	250
a4: Rangefinder	250
a5: Manual Focus Ring in AF Mode	251
b: Exposure	252
b1: EV Steps for Exposure Cntrl	252
b2: ISO Display	252
c: Timers/AE Lock	252
c1: Shutter-Release Button AE-L	252
c2: Auto off Timers	253
c3: Self-Timer	254
c4: Remote on Duration (ML-L3)	254
d: Shooting/Display	254
d1: Exposure Delay Mode	254
d2: File Number Sequence	255
d3: Viewfinder Grid Display	256
d4: Date Stamp	256
d5: Reverse Indicators	258
e: Bracketing/Flash	259
e1: Flash Cntrl for Built-in Flash/Optional Flash	259
e2: Auto Bracketing Set	264
f: Controls	265
f1: Assign Fn Button	265
f2: Assign AE-L/AF-L Button	267
f3: Assign Touch Fn	268
f4: Reverse Dial Rotation	269

Y	The Setup Menu: <i>Camera Setup</i>	270
	Setup Menu Options	270
	Format Memory Card	272
	Image Comment	273
	Copyright Information	274
	Time Zone and Date	275
	Language	275
	Beep Options	276
	Touch Controls	276
	Monitor Brightness	276
	Info Display Format	277
	Auto Info Display	278
	Info Display Auto Off	278
	Image Dust Off Ref Photo	279
	Flicker Reduction	281
	Slot Empty Release Lock	281
	Video Mode	281
	Accessory Terminal	282
	Eye-Fi Upload	284
	Conformity Marking	285
	Firmware Version	285
A	The Retouch Menu: <i>Creating Retouched Copies</i>	286
	Retouch Menu Options	286
	Creating Retouched Copies	288
	NEF (RAW) Processing	289
	Trim	291
	Resize	292
	D-Lighting	294
	Quick Retouch	295
	Red-Eye Correction	295
	Straighten	296
	Distortion Control	296
	Perspective Control	297

Fisheye	297
Filter Effects	298
Monochrome	299
Image Overlay	300
Color Outline.....	302
Photo Illustration.....	303
Color Sketch	303
Miniature Effect.....	304
Selective Color.....	305
Painting.....	307
Side-by-side Comparison	307
 Recent Settings/  My Menu	309
Choosing a Menu.....	309
 Recent Settings	310
 My Menu.....	310

Technical Notes

314

Compatible Lenses.....	314
Compatible CPU Lenses	314
Compatible Non-CPU Lenses	316
Optional Flash Units (Speedlights)	323
Flash Units Compatible with the Creative Lighting System (CLS)	323
Other Accessories.....	330
Approved Memory Cards.....	334
Attaching a Power Connector and AC Adapter.....	335
Caring for the Camera	337
Storage	337
Cleaning	337
Image Sensor Cleaning.....	338

Caring for the Camera and Battery: Cautions	343
Available Settings.....	348
Troubleshooting	350
Battery/Display.....	350
Shooting (All Modes)	351
Shooting (P, S, A, M)	354
Playback.....	355
Wi-Fi (Wireless Networks).....	357
Miscellaneous	357
Error Messages	358
Specifications	364
Lens Kits	377
AF-P DX NIKKOR 18–55mm f/3.5–5.6G VR and AF-P DX NIKKOR 18–55mm f/3.5–5.6G	377
AF-S DX NIKKOR 18–55mm f/3.5–5.6G VR II	383
AF-S DX NIKKOR 18–140mm f/3.5–5.6G ED VR	388
AF-S DX NIKKOR 55–200mm f/4–5.6G ED VR II.....	393
Memory Card Capacity	399
Battery Life.....	400
Index	402

For Your Safety

To prevent damage to your Nikon product or injury to yourself or to others, read the following safety precautions in their entirety before using this equipment. Keep these safety instructions where all those who use the product will read them.

The consequences that could result from failure to observe the precautions listed in this section are indicated by the following symbol:



This icon marks warnings. To prevent possible injury, read all warnings before using this Nikon product.

■ ■ WARNINGS

Keep the sun out of the frame

Keep the sun well out of the frame when shooting backlit subjects. Sunlight focused into the camera when the sun is in or close to the frame could cause a fire.

Do not look at the sun through the viewfinder

Viewing the sun or other strong light source through the viewfinder could cause permanent visual impairment.

Using the viewfinder diopter adjustment control

When operating the viewfinder diopter adjustment control with your eye to the viewfinder, care should be taken not to put your finger in your eye accidentally.

Turn off immediately in the event of malfunction

Should you notice smoke or an unusual smell coming from the equipment or AC adapter (available separately), unplug the AC adapter and remove the battery immediately, taking care to avoid burns. Continued operation could result in injury. After removing the battery, take the equipment to a Nikon-authorized service center for inspection.

Do not use in the presence of flammable gas

Do not use electronic equipment in the presence of flammable gas, as this could result in explosion or fire.

⚠ Keep out of reach of children

Failure to observe this precaution could result in injury. In addition, note that small parts constitute a choking hazard. Should a child swallow any part of this equipment, consult a physician immediately.

⚠ Do not disassemble

Touching the product's internal parts could result in injury. In the event of malfunction, the product should be repaired only by a qualified technician. Should the product break open as the result of a fall or other accident, remove the battery and/or AC adapter and then take the product to a Nikon-authorized service center for inspection.

⚠ Do not place the strap around the neck of an infant or child

Placing the camera strap around the neck of an infant or child could result in strangulation.

⚠ Do not remain in contact with the camera, battery, or charger for extended periods while the devices are on or in use

Parts of the device become hot. Leaving the device in direct contact with the skin for extended periods may result in low-temperature burns.

⚠ Do not leave the product where it will be exposed to extremely high temperatures, such as in an enclosed automobile or in direct sunlight

Failure to observe this precaution could cause damage or fire.

⚠ Do not aim a flash at the operator of a motor vehicle

Failure to observe this precaution could result in accidents.

⚠ Observe caution when using the flash

- Using the camera with the flash in close contact with the skin or other objects could cause burns.
- Using the flash close to the subject's eyes could cause temporary visual impairment. The flash should be no less than one meter (3 ft 4 in.) from the subject. Particular care should be observed when photographing infants.

⚠ Avoid contact with liquid crystal

Should the monitor break, care should be taken to avoid injury due to broken glass and to prevent the liquid crystal from the monitor touching the skin or entering the eyes or mouth.

⚠ Do not carry tripods with a lens or camera attached

You could trip or accidentally strike others, resulting in injury.

⚠ Observe proper precautions when handling batteries

Batteries may leak, overheat, rupture, or catch fire if improperly handled. Observe the following precautions when handling batteries for use in this product:

- Use only batteries approved for use in this equipment.
- Do not short or disassemble the battery.
- Do not expose the battery or the camera in which it is inserted to powerful physical shocks.
- Be sure the product is off before replacing the battery. If you are using an AC adapter, be sure it is unplugged.
- Do not attempt to insert the battery upside down or backwards.
- Do not expose the battery to flame or to excessive heat.
- Do not immerse in or expose to water.
- Replace the terminal cover when transporting the battery. Do not transport or store the battery with metal objects such as necklaces or hairpins.
- Batteries are prone to leakage when fully discharged. To avoid damage to the product, be sure to remove the battery when no charge remains.
- When the battery is not in use, attach the terminal cover and store in a cool, dry place.

- The battery may be hot immediately after use or when the product has been used on battery power for an extended period. Before removing the battery turn the camera off and allow the battery to cool.
- Discontinue use immediately should you notice any changes in the battery, such as discoloration or deformation.

⚠ Observe proper precautions when handling the charger

- Keep dry. Failure to observe this precaution could result in injury or product malfunction due to fire or electric shock.
- Do not short the charger terminals. Failure to observe this precaution could result in overheating and damage to the charger.
- Dust on or near the metal parts of the plug should be removed with a dry cloth. Continued use could result in fire.
- Do not go near the charger during thunderstorms. Failure to observe this precaution could result in electric shock.
- Do not handle the plug or charger with wet hands. Failure to observe this precaution could result in injury or product malfunction due to fire or electric shock.
- Do not use with travel converters or adapters designed to convert from one voltage to another or with DC-to-AC inverters. Failure to observe this precaution could damage the product or cause overheating or fire.

⚠ Use appropriate cables

When connecting cables to the input and output jacks, use only the cables provided or sold by Nikon for the purpose to maintain compliance with product regulations.

⚠ Follow the instructions of airline and hospital personnel

Notices

- No part of the manuals included with this product may be reproduced, transmitted, transcribed, stored in a retrieval system, or translated into any language in any form, by any means, without Nikon's prior written permission.
- Nikon reserves the right to change the appearance and specifications of the hardware and software described in these manuals at any time and without prior notice.
- Nikon will not be held liable for any damages resulting from the use of this product.
- While every effort has been made to ensure that the information in these manuals is accurate and complete, we would appreciate it were you to bring any errors or omissions to the attention of the Nikon representative in your area (address provided separately).

Notice for Customers in Canada

CAN ICES-3 B / NMB-3 B

Notices for Customers in Europe

CAUTION: RISK OF EXPLOSION IF BATTERY IS REPLACED BY AN INCORRECT TYPE. DISPOSE OF USED BATTERIES ACCORDING TO THE INSTRUCTIONS.

This symbol indicates that electrical and electronic equipment is to be collected separately.



This symbol on the battery indicates that the battery is to be collected separately.



The following apply only to users in European countries:

- This product is designated for separate collection at an appropriate collection point. Do not dispose of as household waste.
- Separate collection and recycling helps conserve natural resources and prevent negative consequences for human health and the environment that might result from incorrect disposal.
- For more information, contact the retailer or the local authorities in charge of waste management.

The following apply only to users in European countries:

- All batteries, whether marked with this symbol or not, are designated for separate collection at an appropriate collection point. Do not dispose of as household waste.
- For more information, contact the retailer or the local authorities in charge of waste management.

Notices for Customers in the U.S.A.

The Battery Charger

IMPORTANT SAFETY INSTRUCTIONS—SAVE THESE INSTRUCTIONS

DANGER—TO REDUCE THE RISK OF FIRE OR ELECTRIC SHOCK, CAREFULLY FOLLOW THESE INSTRUCTIONS

For connection to a supply not in the U.S.A., use an attachment plug adapter of the proper configuration for the power outlet if needed. This power unit is intended to be correctly oriented in a vertical or floor mount position.

Federal Communications Commission (FCC) Radio Frequency Interference Statement

This equipment has been tested and found to comply with the limits for a Class B digital device, pursuant to Part 15 of the FCC rules. These limits are designed to provide reasonable protection against harmful interference in a residential installation. This equipment generates, uses, and can radiate radio frequency energy and, if not installed and used in accordance with the instructions, may cause harmful interference to radio communications. However, there is no guarantee that interference will not occur in a particular installation. If this equipment does cause harmful interference to radio or television reception, which can be determined by turning the equipment off and on, the user is encouraged to try to correct the interference by one or more of the following measures:

- Reorient or relocate the receiving antenna.
- Increase the separation between the equipment and receiver.
- Connect the equipment into an outlet on a circuit different from that to which the receiver is connected.
- Consult the dealer or an experienced radio/television technician for help.



Nikon
D5500

CAUTIONS

Modifications

The FCC requires the user be notified that any changes or modifications made to this device that are not expressly approved by Nikon Corporation may void the user's authority to operate the equipment.

Interface Cables

Use the interface cables sold or provided by Nikon for your equipment. Using other interface cables may exceed the limits of Class B Part 15 of the FCC rules.

Notice for Customers in the State of California

WARNING: Handling the cord on this product may expose you to lead, a chemical known to the State of California to cause birth defects or other reproductive harm. *Wash hands after handling.*

Nikon Inc., 1300 Walt Whitman Road, Melville, New York 11747-3064, U.S.A.
Tel.: 631-547-4200

Notice Concerning Prohibition of Copying or Reproduction

Note that simply being in possession of material that has been digitally copied or reproduced by means of a scanner, digital camera, or other device may be punishable by law.

- **Items prohibited by law from being copied or reproduced**

Do not copy or reproduce paper money, coins, securities, government bonds, or local government bonds, even if such copies or reproductions are stamped “Sample.”

The copying or reproduction of paper money, coins, or securities which are circulated in a foreign country is prohibited.

Unless the prior permission of the government has been obtained, the copying or reproduction of unused postage stamps or post cards issued by the government is prohibited.

The copying or reproduction of stamps issued by the government and of certified documents stipulated by law is prohibited.

- **Cautions on certain copies and reproductions**

The government has issued cautions on copies or reproductions of securities issued by private companies (shares, bills, checks, gift certificates, etc.), commuter passes, or coupon tickets, except when a minimum of necessary copies are to be provided for business use by a company. Also, do not copy or reproduce passports issued by the government, licenses issued by public agencies and private groups, ID cards, and tickets, such as passes and meal coupons.

- **Comply with copyright notices**

The copying or reproduction of copyrighted creative works such as books, music, paintings, woodcuts, prints, maps, drawings, movies, and photographs is governed by national and international copyright laws. Do not use this product for the purpose of making illegal copies or to infringe copyright laws.

Disposing of Data Storage Devices

Please note that deleting images or formatting memory cards or other data storage devices does not completely erase the original image data. Deleted files can sometimes be recovered from discarded storage devices using commercially available software, potentially resulting in the malicious use of personal image data. Ensuring the privacy of such data is the user's responsibility.

Before discarding a data storage device or transferring ownership to another person, erase all data using commercial deletion software, or format the device and then completely refill it with images containing no private information (for example, pictures of empty sky). Be sure to also replace any pictures selected for preset manual (□ 146). Before discarding the camera or transferring ownership to another person, you should also use the **Wi-Fi > Network settings > Reset network settings** (□ 230) option in the camera setup menu to delete any personal network information. Care should be taken to avoid injury when physically destroying data storage devices.

AVC Patent Portfolio License

THIS PRODUCT IS LICENSED UNDER THE AVC PATENT PORTFOLIO LICENSE FOR THE PERSONAL AND NON-COMMERCIAL USE OF A CONSUMER TO (i) ENCODE VIDEO IN COMPLIANCE WITH THE AVC STANDARD ("AVC VIDEO") AND/OR (ii) DECODE AVC VIDEO THAT WAS ENCODED BY A CONSUMER ENGAGED IN A PERSONAL AND NON-COMMERCIAL ACTIVITY AND/OR WAS OBTAINED FROM A VIDEO PROVIDER LICENSED TO PROVIDE AVC VIDEO. NO LICENSE IS GRANTED OR SHALL BE IMPLIED FOR ANY OTHER USE. ADDITIONAL INFORMATION MAY BE OBTAINED FROM MPEG LA, L.L.C. SEE <http://www.mpegla.com>

Use Only Nikon Brand Electronic Accessories

Nikon cameras are designed to the highest standards and include complex electronic circuitry. Only Nikon brand electronic accessories (including chargers, batteries, AC adapters, and flash accessories) certified by Nikon specifically for use with this Nikon digital camera are engineered and proven to operate within the operational and safety requirements of this electronic circuitry.

The use of non-Nikon electronic accessories could damage the camera and may void your Nikon warranty. The use of third-party rechargeable Li-ion batteries not bearing the Nikon holographic seal shown at right could interfere with normal operation of the camera or result in the batteries overheating, igniting, rupturing, or leaking.

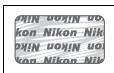

For more information about Nikon brand accessories, contact a local authorized Nikon dealer.

✔ Use Only Nikon Brand Accessories

Only Nikon brand accessories certified by Nikon specifically for use with your Nikon digital camera are engineered and proven to operate within its operational and safety requirements. THE USE OF NON-NIKON ACCESSORIES COULD DAMAGE YOUR CAMERA AND MAY VOID YOUR NIKON WARRANTY.

✔ Before Taking Important Pictures

Before taking pictures on important occasions (such as at weddings or before taking the camera on a trip), take a test shot to ensure that the camera is functioning normally. Nikon will not be held liable for damages or lost profits that may result from product malfunction.

✔ Life-Long Learning

As part of Nikon's "Life-Long Learning" commitment to ongoing product support and education, continually-updated information is available online at the following sites:

- **For users in the U.S.A.:** <http://www.nikonusa.com/>
- **For users in Europe and Africa:** <http://www.europe-nikon.com/support/>
- **For users in Asia, Oceania, and the Middle East:** <http://www.nikon-asia.com/>

Visit these sites to keep up-to-date with the latest product information, tips, answers to frequently-asked questions (FAQs), and general advice on digital imaging and photography. Additional information may be available from the Nikon representative in your area. See the following URL for contact information: <http://imaging.nikon.com/>

Wireless

This product, which contains encryption software developed in the United States, is controlled by the United States Export Administration Regulations and may not be exported or re-exported to any country to which the United States embargoes goods. The following countries are currently subject to embargo: Cuba, Iran, North Korea, Sudan, and Syria.

The use of wireless devices may be prohibited in some countries or regions. Contact a Nikon-authorized service representative before using the wireless features of this product outside the country of purchase.

Notices for Customers in the U. S. A.

This device complies with Part 15 of the FCC Rules. Operation is subject to the following two conditions: (1) this device may not cause harmful interference, and (2) this device must accept any interference received, including interference that may cause undesired operation.

FCC WARNING

The FCC requires the user to be notified that any changes or modifications made to this device that are not expressly approved by Nikon Corporation may void the user's authority to operate the equipment.

FCC Radio Frequency Interference Statement

Note: This equipment has been tested and found to comply with the limits for a Class B digital device, pursuant to part 15 of the FCC Rules. These limits are designed to provide reasonable protection against harmful interference in a residential installation. This equipment generates, uses and can radiate radio frequency energy and, if not installed and used in accordance with the instructions, may cause harmful interference to radio communications. However, there is no guarantee that interference will not occur in a particular installation. If this equipment does cause harmful interference to radio or television reception, which can be determined by turning the equipment off and on, the user is encouraged to try to correct the interference by one or more of the following measures:

- Reorient or relocate the receiving antenna.
- Increase the separation between the equipment and receiver.
- Connect the equipment into an outlet on a circuit different from that to which the receiver is connected.
- Consult the dealer or an experienced radio/TV technician for help.

Co-location

This transmitter must not be co-located or operated in conjunction with any other antenna or transmitter.

Nikon Inc., 1300 Walt Whitman Road, Melville, New York 11747-3064, U.S.A.
Tel.: 631-547-4200

Notices for Customers in Canada

This device complies with Industry Canada licence-exempt RSS standard(s). Operation is subject to the following two conditions: (1) this device may not cause interference, and (2) this device must accept any interference, including interference that may cause undesired operation of the device.

FCC/IC RF Exposure Statement

The available scientific evidence does not show that any health problems are associated with using low power wireless devices. There is no proof, however, that these low power wireless devices are absolutely safe. Low power Wireless devices emit low levels of radio frequency energy (RF) in the microwave range while being used. Whereas high levels of RF can produce health effects (by heating tissue), exposure of low-level RF that does not produce heating effects causes no known adverse health effects. Many studies of low-level RF exposures have not found any biological effects. Some studies have suggested that some biological effects might occur, but such findings have not been confirmed by additional research. The D5500, which is equipped with a LBWA1U5YR1 (FCC ID: VPYLBYR650/IC ID: 772C-LBYR650) wireless LAN module, has been tested and found to comply with FCC/IC radiation exposure limits set forth for an uncontrolled environment and meets the FCC radio frequency (RF) Exposure Guidelines in Supplement C to OET65 and RSS-102 of the IC radio frequency (RF) Exposure rules. Please refer to the SAR test report that was uploaded to FCC website.

Notices for Customers in Europe

Hereby, Nikon Corporation, declares that the D5500 is in compliance with the essential requirements and other relevant provisions of Directive 1999/5/EC. The declaration of conformity may be consulted at http://imaging.nikon.com/support/pdf/DoC_D5500.pdf



Notice for Customers in Singapore

Trade Name: Nikon Model: D5500
--

This device complies with radio-frequency regulations. The content of certification labels not affixed to the device is given below.

Complies with IDA Standards DA103423
--

Security

Although one of the benefits of this product is that it allows others to freely connect for the wireless exchange of data anywhere within its range, the following may occur if security is not enabled:

- Data theft: Malicious third-parties may intercept wireless transmissions to steal user IDs, passwords, and other personal information.
- Unauthorized access: Unauthorized users may gain access to the network and alter data or perform other malicious actions. Note that due to the design of wireless networks, specialized attacks may allow unauthorized access even when security is enabled.

Introduction

Getting to Know the Camera

Take a few moments to familiarize yourself with camera controls and displays. You may find it helpful to bookmark this section and refer to it as you read through the rest of the manual.

The Camera Body

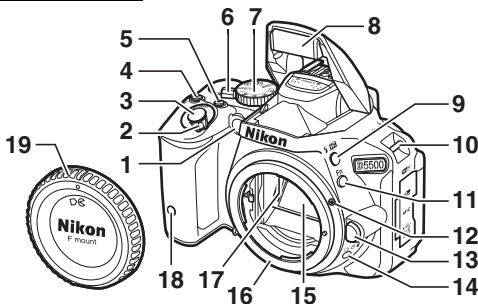

1	AF-assist illuminator	81, 250	11	Fn button	265
	Self-timer lamp.....	76	12	Mounting mark	29
	Red-eye reduction lamp	94, 96	13	Lens release button.....	37
2	Power switch.....	31	14	☐/☺/☑ button	71, 72, 74, 75, 107
3	Shutter-release button	41	15	Mirror	340
4	☑/☺ button.....	120, 129, 131	16	Lens mount	29, 89
5	Movie-record button	51, 175	17	CPU contacts	
6	Live view switch	45, 50, 162, 174	18	Infrared receiver for ML-L3 remote control (front)	108
7	Mode dial.....	4	19	Body cap	
8	Built-in flash	93			
9	☑/☺ button	93, 95, 131			
10	Eyelets for camera strap.....	27			

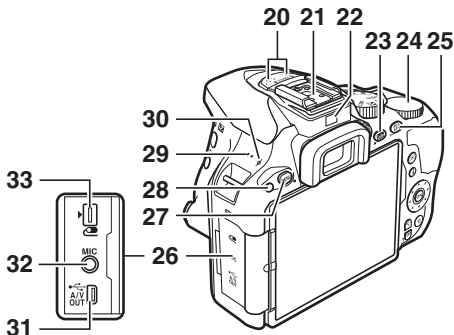

20 Stereo microphone	178	28 Infrared receiver for ML-L3 remote control (rear).....	108
21 Accessory shoe (for optional flash units)	323	29 Speaker	
22 Eye sensor.....	9, 278	30 Focal plane mark (⊕).....	89
23 info (information) button	8, 110, 170	31 USB and A/V connector.....	211, 214, 220
24 Command dial		32 Connector for external microphone	180
25 AE-L/AF-L button	87, 127, 202, 267	33 Accessory terminal.....	333
26 Connector cover			
27 MENU button.....	13, 110, 233		

✓ Close the Connector Cover

Close the connector cover when the connectors are not in use. Foreign matter in the connectors can interfere with data transfer.

✓ The Speaker

Do not place the speaker in close proximity to magnetic devices. Failure to observe this precaution could affect the data recorded on the magnetic devices.

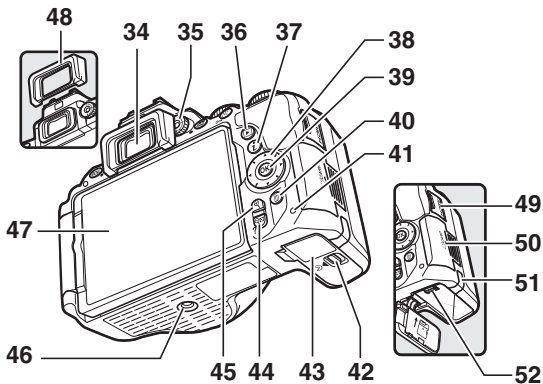

34 Viewfinder eyepiece..... 5, 33, 76	44 button.....14, 190, 200
35 Diopter adjustment control 33	45 button..... 190, 200
36 button..... 42, 188	46 Tripod socket
37 button..... 10, 171, 178, 189	47 Vari-angle monitor6, 17, 42, 45, 162, 188
38 Multi selector 12, 14	48 Rubber eyecup 76
39 (OK) button..... 12, 14	49 HDMI connector cover 222
40 button 43, 205	50 Memory card slot cover28, 35
41 Memory card access lamp..... 41, 163	51 Power connector cover for optional power connector 335
42 Battery-chamber cover latch28, 35, 335	52 Battery latch.....28, 35, 335
43 Battery-chamber cover28, 35, 335	

The Mode Dial

The camera offers a choice of the following shooting modes.

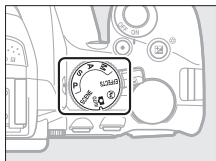

P, S, A, and M Modes:

- **P**— Programmed auto (□ 115)
- **S**— Shutter-priority auto (□ 117)
- **A**— Aperture-priority auto (□ 118)
- **M**— Manual (□ 119)

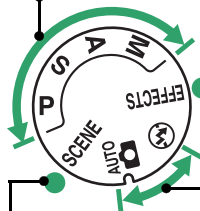

Special Effects Modes (□ 61)

Auto Modes:

-  **Auto** (□ 38)
-  **Auto (flash off)** (□ 38)

Scene Modes (□ 54)

The Viewfinder

Note: Display shown with all indicators lit for illustrative purposes.

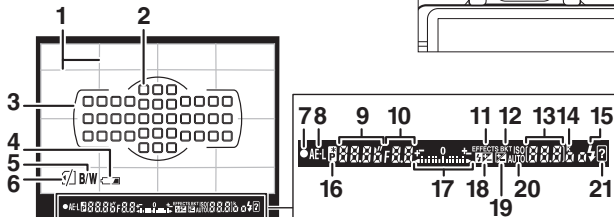
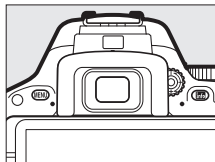

- | | |
|--|--|
| <p>1 Framing grid (displayed when On is selected for Custom Setting d3, Viewfinder grid display) ...256</p> <p>2 Focus points 85</p> <p>3 AF area brackets33, 40</p> <p>4 Low battery warning 34</p> <p>5 Monochrome indicator (displayed in  mode or when the Monochrome Picture Control or a Picture Control based on Monochrome is selected) 61, 152</p> <p>6 "No memory card" indicator 28</p> <p>7 Focus indicator40, 89</p> <p>8 Autoexposure (AE) lock indicator..... 127</p> <p>9 Shutter speed 114</p> <p>10 Aperture (f-number) 114</p> <p>11 Special effects mode indicator .. 61</p> <p>12 Bracketing indicator 148</p> | <p>13 Number of exposures remaining 34</p> <p>Number of shots remaining before memory buffer fills 73</p> <p>White balance recording indicator 143</p> <p>Exposure compensation value 129</p> <p>Flash compensation value..... 131</p> <p>ISO sensitivity 99, 252</p> <p>Capture mode indicator</p> <p>14 "k" (appears when memory remains for over 1000 exposures)..... 34</p> <p>15 Flash-ready indicator 44</p> <p>16 Flexible program indicator 116</p> <p>17 Exposure indicator 120</p> <p>Exposure compensation display 129</p> <p>Electronic rangefinder 250</p> <p>18 Flash compensation indicator... 131</p> <p>19 Exposure compensation indicator 129</p> <p>20 Auto ISO sensitivity indicator .. 241</p> <p>21 Warning indicator 358</p> |
|--|--|

The Monitor

The monitor can be angled and rotated as shown below.

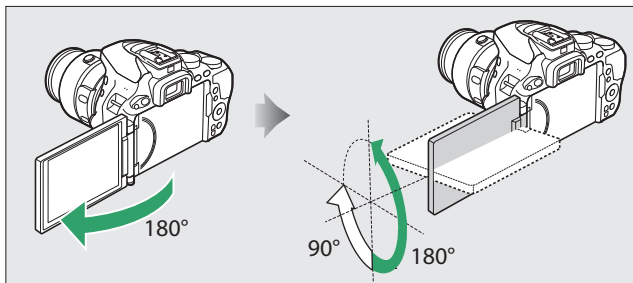

Normal use: Fold the monitor against the camera face out. The monitor is normally used in this position.

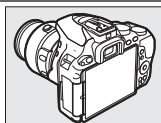

Low-angle shots: Tilt the monitor up to take shots in live view with the camera held low.

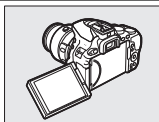

High-angle shots: Tilt the monitor down to take shots in live view with the camera held high.

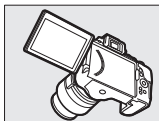

Self-portraits: Use for self-portraits in live view. The monitor shows a mirror image of what will appear in the final picture.

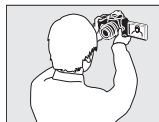
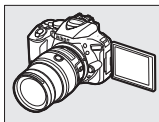

Using the Monitor

Rotate the monitor gently within the limits shown. *Do not use force.* Failure to observe these precautions could damage the camera or monitor. To protect the monitor when the camera is not in use, fold it back face down against the camera body.

Do not lift or carry the camera by the monitor. Failure to observe this precaution could damage the camera.

The Information Display

Viewing settings: To view the information display, press the **info** button.

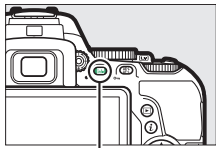

info button

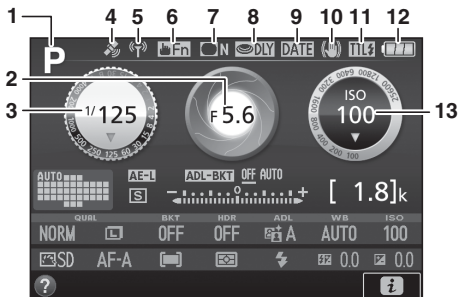

1	Shooting mode	6	Touch Fn assignment	268
	AUTO auto/ Ⓢ auto (flash off).....	7	Vignette control indicator	244
	Scene modes	8	Exposure delay mode.....	254
	Special effects mode	9	Date stamp indicator	256
	P, S, A, and M modes.....	10	Vibration reduction indicator	
2	Aperture (f-number)	37, 245
	Aperture display	11	Flash control indicator	259
3	Shutter speed		Flash compensation indicator for	
	Shutter-speed display		optional flash units.....	328
4	Satellite signal indicator	12	Battery indicator.....	34
5	Wi-Fi connection indicator	13	ISO sensitivity	99
	Eye-Fi connection indicator		ISO sensitivity display.....	99, 242
			Auto ISO sensitivity	
			indicator	242

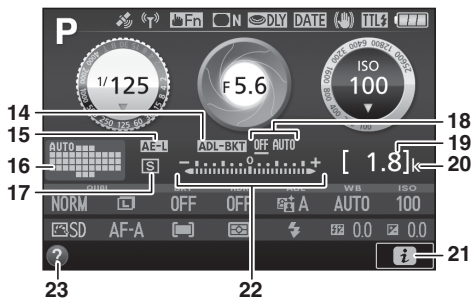

14	Bracketing indicator.....	148	20	"k" (appears when memory remains for over 1000 exposures).....	34
15	Autoexposure (AE) lock indicator.....	127	21	Info icon.....	24
16	AF-area mode indicator	82	22	Exposure indicator	120
	Focus point.....	85		Exposure compensation indicator	129
17	Release mode	71		Bracketing progress indicator	151
18	ADL bracketing amount.....	149	23	Help icon.....	358
19	Number of exposures remaining.....	34			
	White balance recording indicator.....	143			
	Capture mode indicator				

Note: Display shown with all indicators lit for illustrative purposes.

Info Display Auto Off

The eye sensor will automatically turn the info display off if you put your eye to the viewfinder while the standby timer is active. The display will turn on again when you remove your eye from the viewfinder. If desired, you can prevent the information display turning off using the **Info display auto off** option (📖 278) in the setup menu. Note, however, that regardless of the option selected the information display will turn off when the standby timer expires.

Changing settings: To change the settings at the bottom of the display, press the **i** button, then highlight items using the multi selector and press **OK** to view options for the highlighted item. You can also change settings by pressing the **i** button during live view (171, 178).

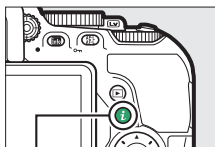

i button

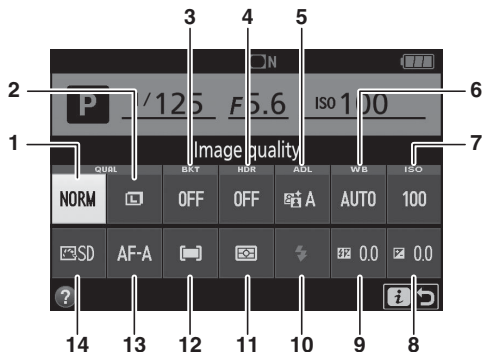





1 Image quality90	9 Flash compensation 131
2 Image size.....92	10 Flash mode 94, 96
3 Auto bracketing 149	11 Metering..... 125
4 HDR (high dynamic range)..... 135	12 AF-area mode.....82, 166
5 Active D-Lighting 133	13 Focus mode78, 164
6 White balance 137	14 Picture Control 152
7 ISO sensitivity99	
8 Exposure compensation 129	

Turning the Monitor Off

To clear shooting information from the monitor, press the  button or press the shutter-release button halfway. The monitor will turn off automatically if no operations are performed for about 8 seconds (for information on choosing how long the monitor stays on, see **Auto off timers** on page 253). The monitor will also turn off if you cover the eye sensor or look through the viewfinder.

The Multi Selector

In this manual, operations using the multi selector are represented by , , , and  icons.

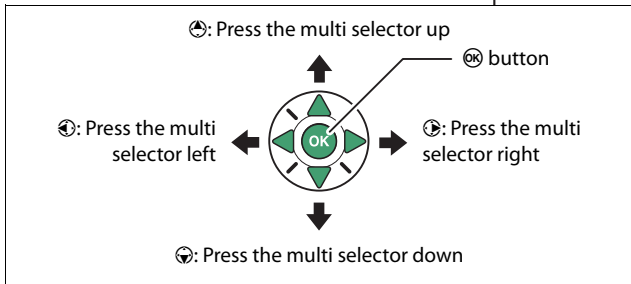
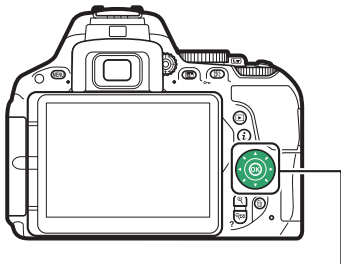

Camera Menu: An Overview

Most shooting, playback, and setup options can be accessed from the camera menu. To view the menus, press the **MENU** button.

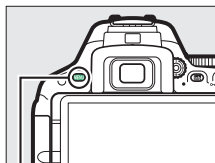

MENU button

Tabs

Choose from the following menus:

- : **Playback** (📖 233)
- : **Shooting** (📖 236)
- : **Custom Settings** (📖 246)
- : **Setup** (📖 270)
- : **Retouch** (📖 286)
- / : **Recent settings** or **My Menu** (defaults to **Recent settings**; 📖 309)

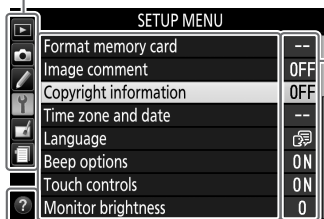

Current settings are shown by icons.

Menu options

Options in current menu.

Help icon (📖 14)

Using Camera Menus

■ Menu Controls

The multi selector and **OK** button are used to navigate the camera menus.

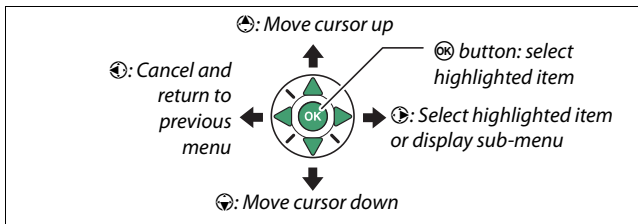

✔ The **?** (Help) Icon

If a **?** icon is displayed at the bottom left corner of the monitor, a description of the currently selected option or menu can be displayed by pressing the **?** button. Press **↑** or **↓** to scroll through the display. Press **?** again to return to the menus.

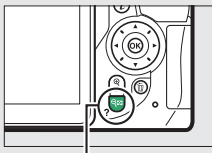

? button

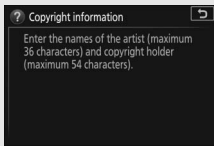

■ Navigating the Menus

Follow the steps below to navigate the menus.

1 Display the menus.

Press the MENU button to display the menus.

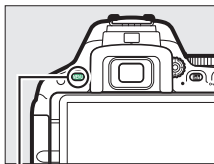

MENU button

2 Highlight the icon for the current menu.

Press  to highlight the icon for the current menu.

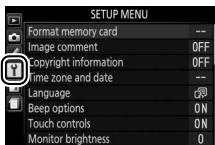

3 Select a menu.



Press  or  to select the desired menu.



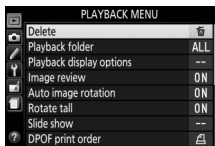

4 Position the cursor in the selected menu.

Press  to position the cursor in the selected menu.



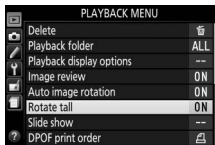

- 5 Highlight a menu item.**
Press  or  to highlight a menu item.

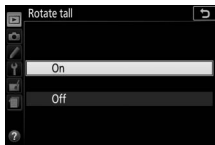

- 6 Display options.**
Press  to display options for the selected menu item.



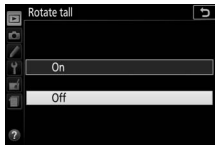

- 7 Highlight an option.**
Press  or  to highlight an option.



- 8 Select the highlighted item.**
Press  to select the highlighted item. To exit without making a selection, press the MENU button.



Note the following:

- Menu items that are displayed in gray are not currently available.
- While pressing  generally has the same effect as pressing , there are some cases in which selection can only be made by pressing .
- To exit the menus and return to shooting mode, press the shutter-release button halfway (41).

Using the Touch Screen

The touch-sensitive monitor supports the following operations:

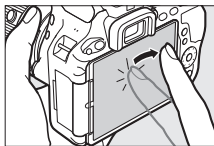

Flick

Flick a finger a short distance across the monitor.

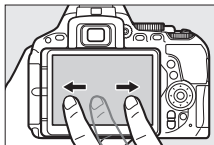

Slide

Slide a finger over the monitor.

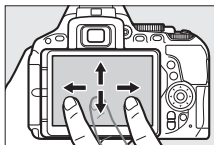

Stretch/Pinch

Place two fingers on the monitor and move them apart or pinch them together.

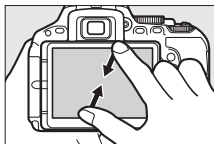
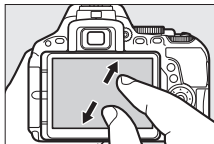

✓ **The Touch Screen**

The touch screen responds to static electricity and may not respond when covered with third-party protective films or when touched with fingernails or gloved hands. Do not use excessive force or touch the screen with sharp objects.

✓ **Using the Touch Screen**

The touch screen may not respond as expected if you attempt to operate it while leaving your palm or another finger resting on it in second location. It may not recognize other gestures if your touch is too soft, your fingers are moved too quickly or too short a distance or do not remain in contact with the screen, or if the movement of the two fingers in a pinch or stretch is not correctly coordinated.

✓ **Enabling or Disabling Touch Controls**

Touch controls can be enabled or disabled using the **Touch controls** option in the setup menu (📖 276). Select **Enable** to enable touch controls for shooting, playback, and menu navigation or **Playback only** to enable touch controls for playback only.

Touch-Screen Photography

Tap icons in the shooting display to adjust camera settings (note that not all icons will respond to touch-screen operations). During live view, you can also take photographs by tapping the monitor.

■ **Viewfinder Photography**

Use the touch screen to adjust settings in the information display (□ 8).

Scene/Effect Selection

In scene and special effects modes (□ 54, 61), you can tap the shooting mode icon to choose a scene or effect. Tap ◀ or ▶ to view the different options and tap an icon to select and return to the previous display.



Shutter Speed and Aperture

In modes **S**, **A**, and **M**, you can tap the ◀▶ icon next to the shutter speed or aperture displays to view ◀ and ▶ controls, which you can tap to choose a new value. Tap ↵ to exit when the operation is complete.



Shooting Options

To change camera settings (☰ 10), tap the **i** icon at the bottom right corner of the display and then tap icons to display options for the corresponding setting. Tap the desired option to select it and return to the previous display.



If prompted to choose a value as shown at right, edit the value by tapping ▲ or ▼ and then tap the number or tap **OK** to select it and return to the previous display.



To exit without changing settings, tap **i** ↶.

■ ■ Live View Photography

The touch screen can be used to adjust settings and take photographs.

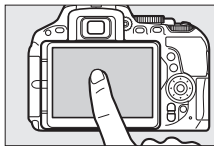

Taking Photographs (Touch Shutter)

Touch the monitor to focus and lift your finger to take the photograph.



Tap the icon shown at right to choose the operation performed by tapping the monitor in shooting mode. Choose from the following options:





Option	Description
 (touch shutter on)	Touch the monitor to position the focus point and focus (autofocus only; the touch shutter can not be used to focus when MF —manual focus—is selected for focus mode as described on page 164). The shutter is released when you lift your finger from the screen.
 (touch shutter off)	As above, except that lifting your finger from the screen does not release the shutter.

Focus locks while your finger is on the monitor. During movie recording, the touch shutter remains off () and you can refocus at any time by touching your subject in the monitor; the touch shutter options icon is not displayed.

✓ Taking Pictures Using Tap Shooting Options

Avoid moving the camera when releasing the shutter. Camera movement can result in blurred photographs.

The shutter-release button can be used to focus and take pictures even when the  icon is displayed to show that touch shooting options are active. Use the shutter-release button to take photographs in continuous shooting mode (□ 72) and during movie recording. Touch shooting options can be used only to take pictures one at a time in continuous shooting mode and can not be used to take photographs during movie recording.

While subject tracking (□ 166) is active and  (touch shutter off) is selected, you can focus on the current subject by tapping the monitor.

In self-timer mode (□ 75), focus locks on the selected subject when you touch the monitor and the timer starts when you lift your finger from the screen. At default settings, the shutter is released about 10 s after the timer starts; the delay and number of shots can be changed using Custom Setting c3 (**Self-timer**, □ 254). If the option selected for **Number of shots** is greater than 1, the camera will automatically take pictures one after the other until the selected number of shots is recorded.

Scene/Effect Selection

In scene and special effects modes (☰ 54, 61), you can tap the shooting mode icon to choose a scene or effect. Tap ◀ or ▶ to view the different options and tap an icon to select and return to the previous display.

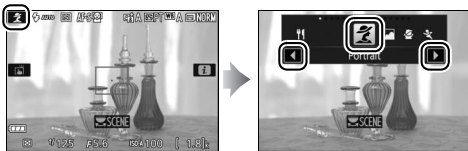

Shutter Speed and Aperture

In modes **S**, **A**, and **M**, tapping the shutter speed or aperture displays ◀ and ▶ controls, which you can tap to choose a new value. Tap ↵ to exit when the operation is complete.

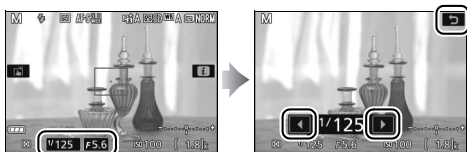

Shooting Options

In live view, pressing the **i** button or tapping the **i** icon in the monitor activates the information display (171, 178). Tap a setting to view options and then tap the desired option to select it and return to live view.

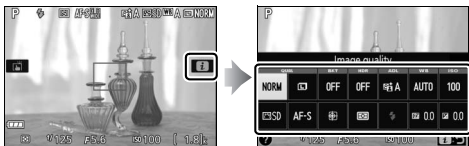

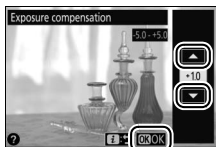

If prompted to choose a value as shown at right, edit the value by tapping **▲** or **▼** and then tap the number or tap **OK** to select it and return to the previous display.



To exit without changing settings, tap **i** or **⏪**.

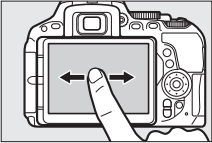
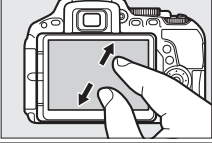
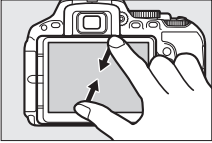

Viewing Pictures

The touch screen can be used for the following playback operations (☞ 42, 188).

View other images		Flick left or right to view other images.
Zoom in (photos only)		Use stretch and pinch gestures to zoom in and out and slide to scroll (☞ 200).
View thumbnails		To “zoom out” to a thumbnail view (☞ 190), use a pinch gesture in full-frame playback. Use pinch and stretch to choose the number of images displayed from 4, 12, or 80 frames.
View movies		Tap the on-screen guide to start movie playback (movies are indicated by a 🎬 icon). Tap the display to pause or resume, or tap 🔄 to exit to full-frame playback (note that some of the icons in the movie playback display do not respond to touch-screen operations).

Using the Menu

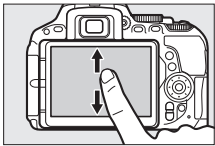
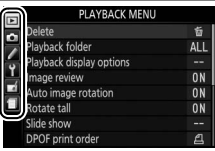
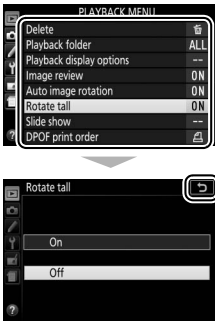
The touch screen can be used for the following menu operations.

Scroll		Slide up or down to scroll.
Choose a menu		Tap a menu icon to choose a menu.
Select options/ adjust settings		Tap menu items to display options and tap icons or sliders to change. To exit without changing settings, tap  .

First Steps

Follow the eight steps below to ready the camera for use.

1 Attach the strap.

Attach the strap as shown. Repeat for the second eyelet.

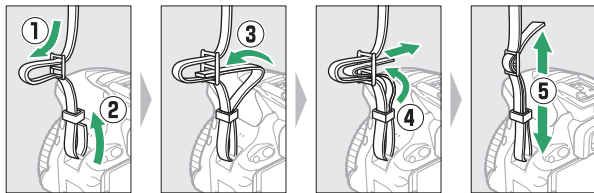

2 Charge the battery.

If a plug adapter is supplied, raise the wall plug and connect the plug adapter as shown below at left, making sure the plug is fully inserted. Insert the battery and plug the charger in. An exhausted battery will fully charge in about an hour and 50 minutes.

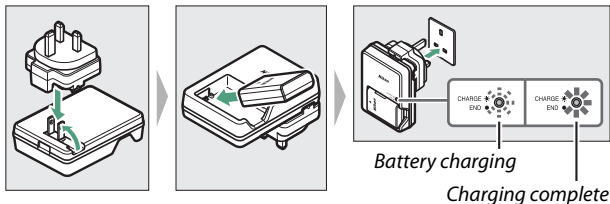

The Battery and Charger

Read and follow the warnings and cautions on pages xi–xiv and 343–347 of this manual.

3 Insert the battery and memory card.

Before inserting or removing the battery or memory cards, confirm that power switch is in the **OFF** position. Insert the battery in the orientation shown, using the battery to keep the orange battery latch pressed to one side. The latch locks the battery in place when the battery is fully inserted.

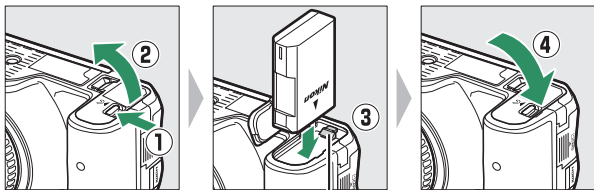

Battery latch

Slide the memory card in until it clicks into place.

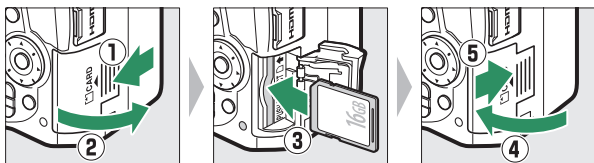

4 Attach a lens.

Be careful to prevent dust from entering the camera when the lens or body cap is removed.

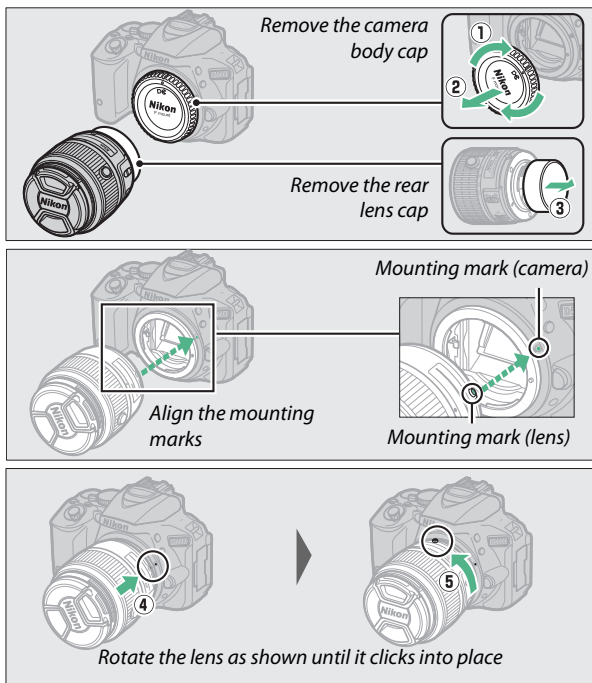

Be sure to remove the lens cap before taking pictures.

Lenses with Retractable Lens Barrel Buttons

Before using the camera, unlock and extend the lens. Keeping the retractable lens barrel button pressed (1), rotate the zoom ring as shown (2).

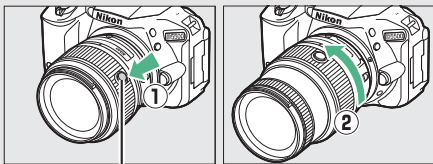

Retractable lens barrel button

Pictures can not be taken when the lens is retracted; if an error message is displayed as a result of the camera having been turned on with the lens retracted, rotate the zoom ring until the message is no longer displayed.



5 Open the monitor.

Open the monitor as shown. *Do not use force.*

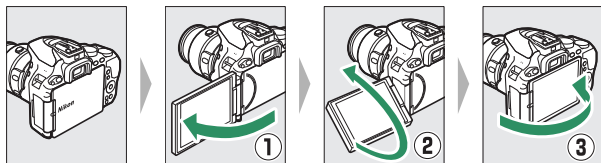

6 Turn the camera on.

A language-selection dialog will be displayed.

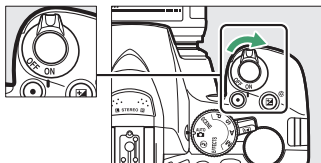

The Power Switch

Rotate the power switch as shown to turn the camera on.



Rotate the power switch as shown to turn the camera off.



7 Choose a language and set the camera clock.

Use the multi selector and **OK** button to select a language and set the camera clock.

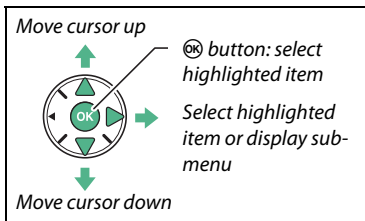

Select language

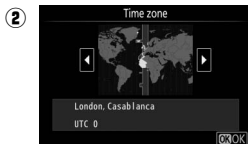

Select time zone

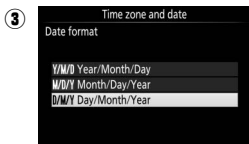

Select date format

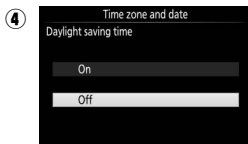

Select daylight saving time option

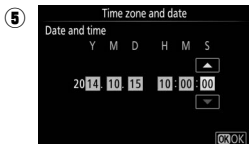

Set time and date (note that the camera uses a 24-hour clock)

The Camera Clock

The camera clock is less accurate than most watches and household clocks. Check the clock regularly against more accurate time pieces and reset as necessary.

8 Focus the viewfinder.

After removing the lens cap, rotate the diopter adjustment control until the AF area brackets are in sharp focus. When operating the control with your eye to the viewfinder, be careful not to put your fingers or fingernails in your eye.

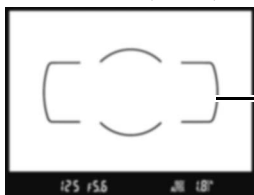
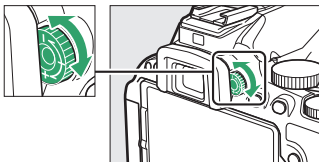

Viewfinder not in focus

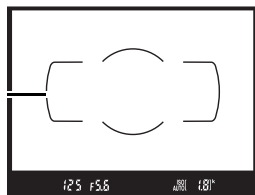

Viewfinder in focus

*AF area
brackets*

The camera is now ready for use. Proceed to page 38 for information on taking photographs.

The Clock Battery

The camera clock is powered by an independent, rechargeable power source, which is charged as necessary when the main battery is installed. Three days of charging will power the clock for about a month. If a message warning that the clock is not set is displayed when the camera is turned on, the clock battery is exhausted and the clock has been reset. Set the clock to the correct time and date.

■ ■ The Battery Level and Number of Exposures Remaining

Press the **Info** button and check the battery level and number of exposures remaining in the information display.

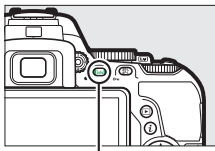

Info button



Battery level

Number of exposures remaining

Battery Level

If the battery is low, a warning will also be displayed in the viewfinder. If the information display does not appear when the **Info** button is pressed, the battery is exhausted and needs to be recharged.

Information display	Viewfinder	Description
	—	Battery fully charged.
	—	Battery partially discharged.
		Low battery. Ready fully-charged spare battery or prepare to charge battery.
 (flashes)	 (flashes)	Battery exhausted. Charge battery.

Number of Exposures Remaining

Values over 1000 are shown in thousands, indicated by the letter “k”.

■ ■ Removing the Battery and Memory Cards

Removing the Battery

Turn the camera off and open the battery-chamber cover. Press the battery latch in the direction shown by the arrow to release the battery and then remove the battery by hand.



Removing Memory Cards

After confirming that the memory card access lamp is off, turn the camera off, open the memory card slot cover, and press the card in the direction shown by the arrow to eject it (1). The card can then be removed by hand (2).

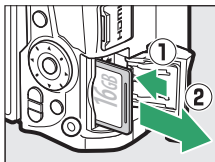

✔ The Write Protect Switch

SD memory cards are equipped with a write protect switch to prevent accidental loss of data. When this switch is in the "lock" position, the memory card can not be formatted and photos can not be deleted or recorded (a beep will sound if you attempt to release the shutter). To unlock the memory card, slide the switch to the "write" position.



Write-protect switch

Memory Cards

- Memory cards may be hot after use. Observe due caution when removing memory cards from the camera.
- Turn the power off before inserting or removing memory cards. Do not remove memory cards from the camera, turn the camera off, or remove or disconnect the power source during formatting or while data are being recorded, deleted, or copied to a computer. Failure to observe these precautions could result in loss of data or in damage to the camera or card.
- Do not touch the card terminals with your fingers or metal objects.
- Do not bend, drop, or subject to strong physical shocks.
- Do not apply force to the card casing. Failure to observe this precaution could damage the card.
- Do not expose to water, heat, high levels of humidity, or direct sunlight.
- Do not format memory cards in a computer.

■ Detaching the Lens

Be sure the camera is off when removing or exchanging lenses. To remove the lens, press and hold the lens release button (1) while turning the lens clockwise (2). After removing the lens, replace the lens caps and camera body cap.

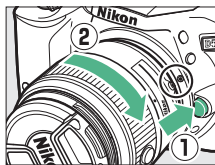

✓ A-M, M/A-M, and A/M-M Switches

When using autofocus with a lens equipped with an A-M mode switch, slide the switch to **A** (if the lens has an M/A-M or A/M-M switch, select **M/A** or **A/M**). For information on other lenses that can be used with this camera, see page 314.



✓ Vibration Reduction (VR)

Vibration reduction can be enabled by selecting **On** for **Optical VR** in the shooting menu (☐ 245), if the lens supports this option, or by sliding the lens vibration reduction switch to **ON**, if the lens is equipped with a vibration reduction switch. A vibration reduction indicator appears in the information display when vibration reduction is on.





✓ Retracting Lenses with Retractable Lens Barrel Buttons

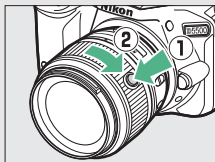

To retract the lens when the camera is not in use, press and hold the retractable lens barrel button (1) and rotate the zoom ring to the "L" (lock) position as shown (2). Retract the lens before removing it from the camera, and be careful not to press the retractable lens barrel button when attaching or removing the lens.



“Point-and-Shoot” Modes (AUTO and)

This section describes how to shoot photographs and movies in  and  modes, automatic “point-and-shoot” modes in which the majority of settings are controlled by the camera in response to shooting conditions.



Before proceeding, turn the camera on and rotate the mode dial to  or  (the only difference between the two is that the flash will not fire in  mode).

Mode dial

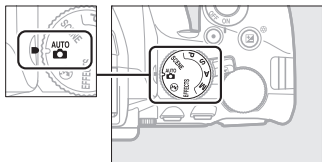

Viewfinder photography



Taking photographs  39

Viewing photographs  42

Deleting photographs  43

Live view

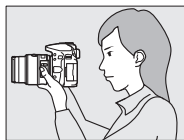

Taking photographs  45

Viewing photographs  48

Deleting photographs  49



Shooting movies  50

Viewing movies  52

Deleting movies  53

Framing Photos in the Viewfinder

1 Ready the camera.

When framing photographs in the viewfinder, hold the handgrip in your right hand and cradle the camera body or lens with your left.



When framing photographs in portrait (tall) orientation, hold the camera as shown at right.



Using a Zoom Lens

Before focusing, rotate the zoom ring to adjust the focal length and frame the photograph. Use the zoom ring to zoom in on the subject so that it fills a larger area of the frame, or zoom out to increase the area visible in the final photograph (select longer focal lengths on the lens focal length scale to zoom in, shorter focal lengths to zoom out).

If the lens is equipped with a retractable lens barrel button (30), press and hold the button while rotating the zoom ring until the lens is released and the message shown at right is no longer displayed, and then adjust zoom using the zoom ring.

Zoom in

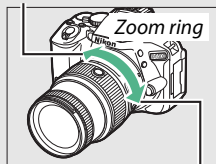

Zoom out



2 Frame the photograph.

Frame a photograph in the viewfinder with the main subject in the AF area brackets.

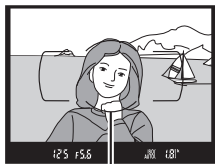

AF area brackets

3 Press the shutter-release button halfway.

Press the shutter-release button halfway to focus (if the subject is poorly lit, the flash may pop up and the AF-assist illuminator may light). When the focus operation is complete, a beep will sound (a beep may not sound if the subject is moving) and the active focus point and in-focus indicator (●) will appear in the viewfinder.

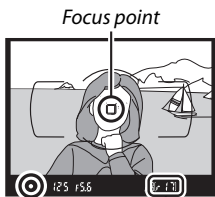

In-focus indicator

Buffer capacity

In-focus indicator	Description
●	Subject in focus.
● (flashes)	Camera unable to focus using autofocus. See page 80.

4 Shoot.

Smoothly press the shutter-release button the rest of the way down to take the photograph. The memory card access lamp will light and the photograph will be displayed in the monitor for a few seconds. *Do not eject the memory card or remove or disconnect the power source until the lamp has gone out and recording is complete.*

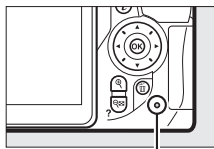

Memory card access lamp



The Shutter-Release Button

The camera has a two-stage shutter-release button. The camera focuses when the shutter-release button is pressed halfway. To take the photograph, press the shutter-release button the rest of the way down.

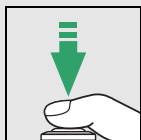
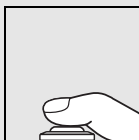

Focus: press halfway

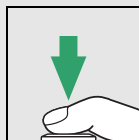

Shoot: press all the way down

Pressing the shutter-release button halfway also ends playback and readies the camera for immediate use.

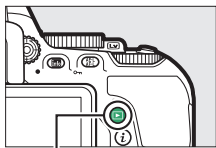

Viewing Photographs

Pressing  displays a picture in the monitor.



 button



Press  or  to view additional pictures.



Deleting Unwanted Pictures

Display the photograph you wish to delete. *Note that photographs can not be recovered once deleted.*

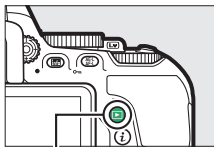

▶ button

Press ; a confirmation dialog will be displayed.

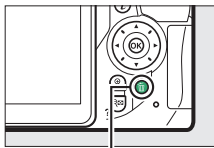

🗑 button

Press the  button again to delete the picture.

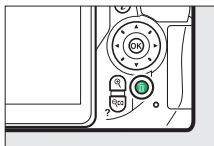

The Standby Timer (Viewfinder Photography)

The viewfinder and information display will turn off if no operations are performed for about eight seconds, reducing the drain on the battery. Press the shutter-release button halfway to reactivate the display. The length of time before the standby timer expires automatically can be selected using Custom Setting c2 (**Auto off timers**;  253).

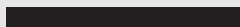

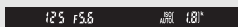

Exposure meters off



Exposure meters on

The Built-in Flash

If additional lighting is required for correct exposure in  mode, the built-in flash will pop up automatically when the shutter-release button is pressed halfway ( 93). If the flash is raised, photographs can only be taken when the flash-ready indicator () is displayed. If the flash-ready indicator is not displayed, the flash is charging; remove your finger briefly from the shutter-release button and try again.

When the flash is not in use, return it to its closed position by pressing it gently downward till the latch clicks into place.

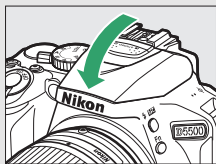
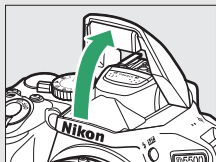

Framing Photos in the Monitor

- 1 Rotate the live view switch.**
The view through the lens will be displayed in the camera monitor (live view).

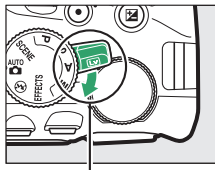

Live view switch

- 2 Ready the camera.**
Hold the handgrip in your right hand and cradle the camera body or lens with your left.

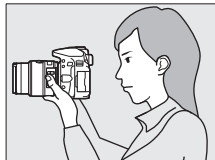

When framing photographs in portrait (tall) orientation, hold the camera as shown at right.



3 Focus.

Press the shutter-release button halfway. The focus point will flash green while the camera focuses. If the camera is able to focus, the focus point will be displayed in green; if the camera is unable to focus, the focus point will flash red.

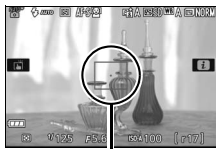

Focus point

4 Take the picture.

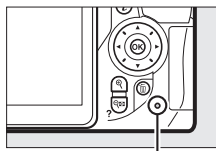

Press the shutter-release button the rest of the way down. The monitor turns off and the memory card access lamp lights during recording. *Do not eject the memory card or remove or disconnect the power source until the lamp has gone out and recording is complete.* When recording is complete, the photograph will be displayed in the monitor for a few seconds. Rotate the live view switch to exit live view.



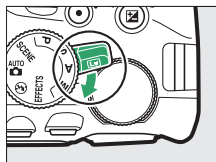







Memory card access lamp



Automatic Scene Selection (Scene Auto Selector)

If live view is selected in  or  mode, the camera will automatically analyze the subject and select the appropriate shooting mode when autofocus is enabled. The selected mode is shown in the monitor.



	Portrait	Human portrait subjects
	Landscape	Landscapes and cityscapes
	Close up	Subjects close to the camera
	Night portrait	Portrait subjects framed against a dark background
	Auto	Subjects suited to  or  mode or that do not fall into the categories listed above
	Auto (flash off)	

Live View

For more information on taking photographs in live view, see page 162.

Viewing Photographs

Pressing  displays a picture in the monitor.

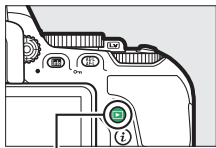

 button



Press  or  to view additional pictures.



Deleting Unwanted Pictures

Display the photograph you wish to delete. *Note that photographs can not be recovered once deleted.*

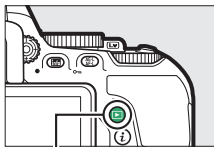

▶ button

Press ; a confirmation dialog will be displayed.

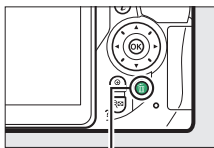

🗑 button

Press the  button again to delete the picture.

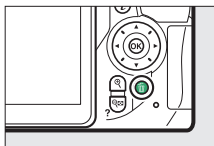

Recording Movies

Movies can be recorded in live view mode.

1 Rotate the live view switch.

The view through the lens is displayed in the monitor.

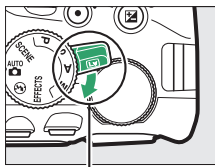

Live view switch

2 Ready the camera.

Hold the handgrip in your right hand and cradle the camera body or lens with your left.

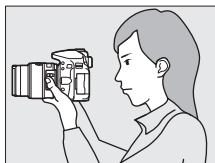

3 Focus.

Press the shutter-release button halfway to focus.



Focus point

4 Start recording.

Press the movie-record button to start recording. A recording indicator and the time available are displayed in the monitor.

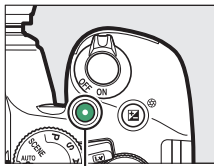

Movie-record button

Time remaining





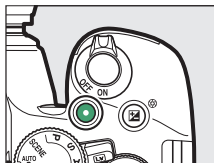

Recording indicator

5 End recording.

Press the movie-record button again to end recording. Rotate the live view switch to exit live view.



Viewing Movies

Press  to start playback and then scroll through pictures until a movie (indicated by a  icon) is displayed. Press  to start playback and press  or  to end playback. For more information, see page 181.

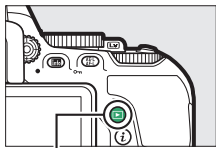

 button



Recording Movies

See page 174 for more information on recording movies.

Deleting Unwanted Movies

Display the movie you wish to delete (movies are indicated by  icons). *Note that movies can not be recovered once deleted.*

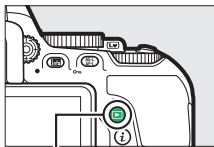

 button

Press ; a confirmation dialog will be displayed.

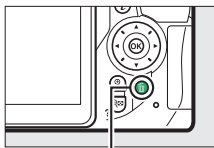

 button

Press the  button again to delete the movie.

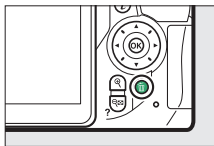

Matching Settings to the Subject or Situation (Scene Mode)

The camera offers a choice of “scene” modes. Choosing a scene mode automatically optimizes settings to suit the selected scene, making creative photography as simple as selecting a mode, framing a picture, and shooting as described on page 38.

The following scenes can be selected by rotating the mode dial to **SCENE** and rotating the command dial until the desired scene appears in the monitor.

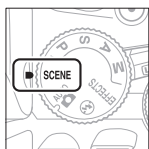

Mode dial

+

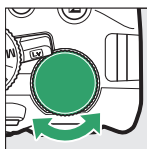

Command dial



Monitor

 Portrait

 Landscape

 Child

 Sports

 Close up

 Night Portrait

 Night Landscape

 Party/Indoor

 Beach/Snow

 Sunset

 Dusk/Dawn

 Pet Portrait

 Candlelight

 Blossom

 Autumn Colors

 Food

Portrait



Use for portraits with soft, natural-looking skin tones. If the subject is far from the background or a telephoto lens is used, background details will be softened to lend the composition a sense of depth.

Landscape

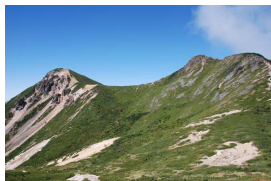

Use for vivid landscape shots in daylight.

Note

The built-in flash and AF-assist illuminator turn off.

Child



Use for snapshots of children. Clothing and background details are vividly rendered, while skin tones remain soft and natural.



Fast shutter speeds freeze motion for dynamic sports shots in which the main subject stands out clearly.

 **Note**

The built-in flash and AF-assist illuminator turn off.

 **Close up**



Use for close-up shots of flowers, insects, and other small objects (a macro lens can be used to focus at very close ranges).

 **Night Portrait**

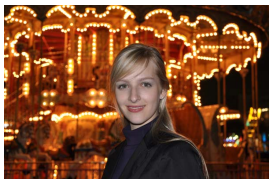

Use for a natural balance between the main subject and the background in portraits taken under low light.

Night Landscape

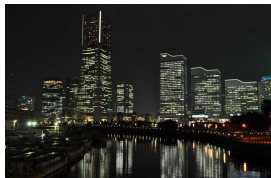

Reduce noise and unnatural colors when photographing night landscapes, including street lighting and neon signs.

Note

The built-in flash and AF-assist illuminator turn off.

Party/Indoor



Capture the effects of indoor background lighting. Use for parties and other indoor scenes.

Beach/Snow



Capture the brightness of sunlit expanses of water, snow, or sand.

Note

The built-in flash and AF-assist illuminator turn off.

Sunset

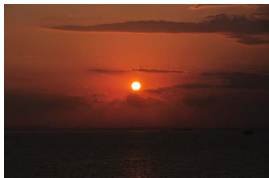

Preserves the deep hues seen in sunsets and sunrises.

Note

The built-in flash and AF-assist illuminator turn off.

Dusk/Dawn



Preserves the colors seen in the weak natural light before dawn or after sunset.

Note

The built-in flash and AF-assist illuminator turn off.

Pet Portrait



Use for portraits of active pets.

Note

The AF-assist illuminator turns off.

Candlelight



For photographs taken by candlelight.

Note

The built-in flash turns off.

Blossom



Use for fields of flowers, orchards in bloom, and other landscapes featuring expanses of blossoms.

Note

The built-in flash turns off.

Autumn Colors



Captures the brilliant reds and yellows in autumn leaves.



Note

The built-in flash turns off.



Use for vivid photographs of food.

 **Note**

For flash photography, press the  () button to raise the flash ( 95).

 **Preventing Blur**

Use a tripod to prevent blur caused by camera shake at slow shutter speeds.

Special Effects

Special effects can be used when taking photographs and shooting movies.

The following effects can be selected by rotating the mode dial to **EFFECTS** and rotating the command dial until the desired option appears in the monitor.

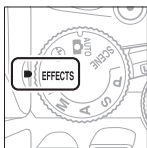

Mode dial

+

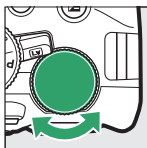

Command dial



Monitor

 Night Vision

 VI Super Vivid

 POP Pop

 Photo Illustration

 Toy Camera Effect

 Miniature Effect

 Selective Color

 Silhouette

 High Key

 Low Key

Night Vision

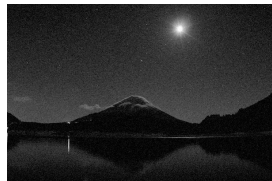

Use under conditions of darkness to record monochrome images at high ISO sensitivities.

Note

Pictures may be affected by noise in the form of randomly-spaced bright pixels, fog, or lines. Autofocus is available in live view only; manual focus can be used if the camera is unable to focus. The built-in flash and AF-assist illuminator turn off.

VI *Super Vivid*

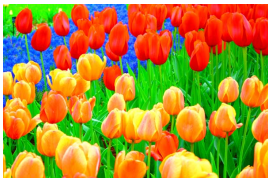

Overall saturation and contrast are increased for a more vibrant image.

POP *Pop*



Overall saturation is increased for a more lively image.

Photo Illustration



Sharpen outlines and simplify coloring for a poster effect that can be adjusted in live view (📖 66).

Note

Movies shot in this mode play back like a slide show made up of a series of stills.

Toy Camera Effect



Create photos and movies that appear to have been shot with a toy camera. The effect can be adjusted in live view (📖 67).

Miniature Effect



Create photos that appear to be pictures of dioramas. Works best when shooting from a high vantage point. Miniature effect movies play back at high speed, compressing about 45 minutes of footage shot at 1920 × 1080/30p into a movie that plays back in about three minutes. The effect can be adjusted in live view (📖 68).

Note

Sound is not recorded with movies. The built-in flash and AF-assist illuminator turn off.

Selective Color



All colors other than the selected colors are recorded in black and white. The effect can be adjusted in live view (📖 69).

Note

The built-in flash turns off.

Silhouette



Silhouette subjects against bright backgrounds.

Note

The built-in flash turns off.

High Key



Use with bright scenes to create bright images that seem filled with light.

Note

The built-in flash turns off.

Low Key







Use with dark scenes to create dark, low-key images with prominent highlights.

Note

The built-in flash turns off.

NEF (RAW)

NEF (RAW) recording is not available in , **VI**, **POP**, , , , and  modes. Pictures taken when an NEF (RAW) or NEF (RAW)+JPEG option is selected in these modes will be recorded as JPEG images. JPEG images created at settings of NEF (RAW)+JPEG will be recorded at the selected JPEG quality, while images recorded at a setting of NEF (RAW) will be recorded as fine-quality images.

and Modes

Autofocus is not available during movie recording. The live view refresh rate will drop, together with the frame rate for continuous release modes; using autofocus during live view photography will disrupt the preview.

Preventing Blur

Use a tripod to prevent blur caused by camera shake at slow shutter speeds.

Options Available in Live View

Settings for the selected effect are adjusted in the live view display but apply during live view and viewfinder photography and movie recording.

■ ■ *Photo Illustration*

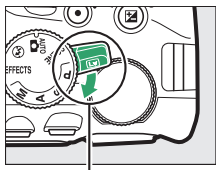

1 Select live view.

Rotate the live view switch. The view through the lens will be displayed in the monitor.



Live view switch

2 Adjust outline thickness.

Press  to display the options shown at right. Press  or  to make outlines thicker or thinner.



3 Press .

Press  to exit when settings are complete. To resume viewfinder photography, rotate the live view switch. The selected settings will continue in effect and will apply to photographs and movies recorded in live view or using the viewfinder.

1 Select live view.

Rotate the live view switch. The view through the lens will be displayed in the monitor.

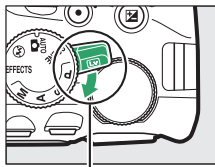

Live view switch

2 Adjust options.

Press **OK** to display the options shown at right. Press **▲** or **▼** to highlight **Vividness** or **Vignetting** and press **◀** or **▶** to change. Adjust vividness to make colors more or less saturated, vignetting to control the amount of vignetting.

**3 Press **OK**.**

Press **OK** to exit when settings are complete. To resume viewfinder photography, rotate the live view switch. The selected settings will continue in effect and will apply to photographs and movies recorded in live view or using the viewfinder.

1 Select live view.

Rotate the live view switch. The view through the lens will be displayed in the monitor.

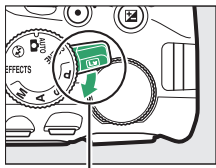
*Live view switch***2 Position the focus point.**

Use the multi selector to position the focus point in the area that will be in focus and then press the shutter-release button halfway to focus. To temporarily clear miniature effect options from the display and enlarge the view in the monitor for precise focus, press \odot . Press \odot (?) to restore the miniature effect display.

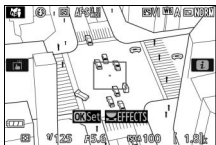
**3 Display options.**

Press \odot to display miniature effect options.

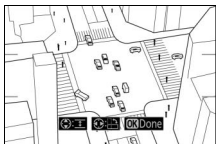
**4 Adjust options.**

Press \odot or \odot to choose the orientation of the area that will be in focus and press \odot or \odot to adjust its width.

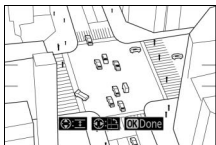

5 Press **OK**.

Press **OK** to exit when settings are complete. To resume viewfinder photography, rotate the live view switch. The selected settings will continue in effect and will apply to photographs and movies recorded in live view or using the viewfinder.

■ ■ **Selective Color**

1 Select live view.

Rotate the live view switch. The view through the lens will be displayed in the monitor.

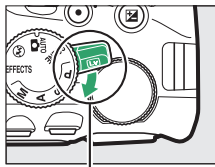

Live view switch

2 Display options.

Press **OK** to display selective color options.

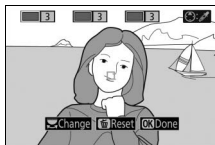

3 Select a color.

Frame an object in the white square in the center of the display and press **OK** to choose the color of the object as one that will remain in the final image (the camera may have difficulty detecting unsaturated colors; choose a saturated color). To zoom in on the center of the display for more precise color selection, press **Q**. Press **Q** (?) to zoom out.

Selected color



4 Choose the color range.

Press or to increase or decrease the range of similar hues that will be included in the final image. Choose from values between 1 and 7; note that higher values may include hues from other colors.

Color range



5 Select additional colors.

To select additional colors, rotate the command dial to highlight another of the three color boxes at the top of the display and repeat



Steps 3 and 4 to select another color. Repeat for a third color if desired. To deselect the highlighted color, press (To remove all colors, press and hold . A confirmation dialog will be displayed; select **Yes**).







6 Press .







Press to exit when settings are complete. During shooting, only objects of the selected hues will be recorded in color; all others will be recorded in black-and-white. To resume viewfinder photography, rotate the live view switch. The selected settings will continue in effect and will apply to photographs and movies recorded in live view or using the viewfinder.

More on Photography



Choosing a Release Mode

To choose how the shutter is released (release mode), press the  (/) button, then highlight the desired option and press .



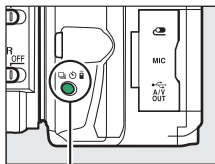

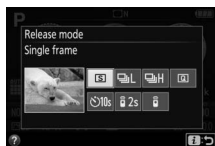

Choosing a Release Mode with the Command Dial

The release mode can also be selected by keeping the  (/) button pressed while rotating the command dial. Release the  (/) button to select the highlighted option and return to the information display.



 (/) button



Mode	Description
	Single frame: Camera takes one photograph each time shutter-release button is pressed.
	Continuous L: The camera takes photographs at a slow rate while the shutter-release button is pressed (□ 72).
	Continuous H: The camera takes photographs at a fast rate while the shutter-release button is pressed (□ 72).
	Quiet shutter release: As for single-frame, except that camera noise is reduced (□ 74).
	Self-timer: Take pictures with the self-timer (□ 75).
	Delayed remote (ML-L3): Shutter is released 2 s after shutter-release button on optional ML-L3 remote control is pressed (□ 107).
	Quick-response remote (ML-L3): Shutter is released when shutter-release button on optional ML-L3 remote control is pressed (□ 107).

Continuous Shooting (Burst Mode)

In **L** (**Continuous L**) and **H** (**Continuous H**) modes, the camera takes photographs continuously while the shutter-release button is pressed all the way down.

- 1 Press the **L** (**Continuous L**) button.

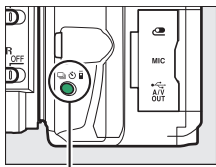

L (**Continuous L**) button

- 2 Choose a continuous release mode.
Highlight **L** (**Continuous L**) or **H** (**Continuous H**) and press **OK**.

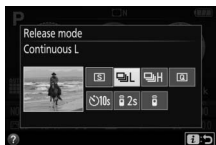

- 3 Focus.
Frame the shot and focus.



- 4 Take photographs.
The camera will take photographs while the shutter-release button is pressed all the way down.



The Memory Buffer

The camera is equipped with a memory buffer for temporary storage, allowing shooting to continue while photographs are being saved to the memory card. Up to 100 photographs can be taken in succession (an exception is if a shutter speed of 4 seconds or slower is selected in mode **S** or **M**, when there is no limit on the number of shots that can be taken in a single burst). Depending on the battery level and the number of images in the buffer, recording may take from a few seconds to a few minutes. If the battery is exhausted while images remain in the buffer, the shutter release will be disabled and the images transferred to the memory card.

Frame Rate

For information on the number of photographs can be taken in continuous release modes, see page 366. Frame rates may drop when the memory buffer is full or the battery is low.

The Built-in Flash

Continuous release modes can not be used with the built-in flash; rotate the mode dial to  (□ 38) or turn the flash off (□ 94).

Buffer Size

The approximate number of images that can be stored in the memory buffer at current settings is shown in the viewfinder exposure-count display while the shutter-release button is pressed.





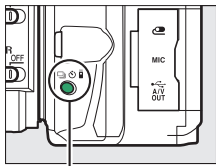

Quiet Shutter Release

Choose this mode to keep camera noise to a minimum. A beep does not sound when the camera focuses.

- 1 Press the  button.



 button

- 2 Select  (Quiet shutter release).
Highlight  (Quiet shutter release) and press .

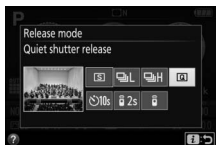

- 3 Take pictures.
Press the shutter-release button all the way down to shoot.



Self-Timer Mode

The self-timer can be used for self-portraits or group shots that include the photographer. Before proceeding, mount the camera on a tripod or place it on a stable, level surface.

- 1 Press the  (🕒/⏸) button.

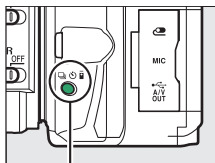

 (🕒/⏸) button

- 2 Select 🕒 (Self-timer) mode.
Highlight 🕒 (Self-timer) and press .



- 3 Frame the photograph.

4 Take the photograph.

Press the shutter-release button halfway to focus, and then press the button the rest of the way down. The self-timer lamp will start to flash and a beep will begin to sound. Two seconds before the photo is taken, the lamp will stop flashing and the beeping will become more rapid. The shutter will be released ten seconds after the timer starts.

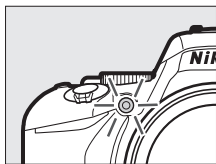

Note that the timer may not start or a photograph may not be taken if the camera is unable to focus or in other situations in which the shutter can not be released. To stop the timer without taking a photograph, turn the camera off.

Cover the Viewfinder

To prevent light entering via the viewfinder from appearing in the photograph or interfering with exposure, we recommend that you cover the viewfinder with your hand or other objects such as an optional eyepiece cap (☞ 331) when taking pictures without your eye to the viewfinder. To attach the cap, remove the rubber eyecup (①) and insert the cap as shown (②).





Rubber eyecup

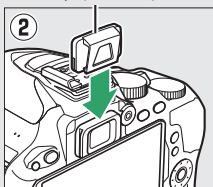

Eyepiece cap



Using the Built-in Flash

Before taking a photograph with the flash in modes that require the flash to be raised manually, press the  () button to raise the flash and wait for the  indicator to be displayed in the viewfinder ( 44). Shooting will be interrupted if the flash is raised after the self-timer has started.

Custom Setting c3 (Self-Timer)

For information on choosing the duration of the self-timer and the number of shots taken, see Custom Setting c3 (**Self-timer**;  254).

Focus (Viewfinder Photography)

This section describes the focus options available when photographs are framed in the viewfinder. Focus can be adjusted automatically or manually (see “Choosing How the Camera Focuses: Focus Mode,” below). The user can also select the focus point for automatic or manual focus (☞ 85) or use focus lock to focus to recompose photographs after focusing (☞ 86).

Choosing How the Camera Focuses: Focus Mode

Choose from the following focus modes. Note that **AF-S** and **AF-C** are available only in modes **P, S, A,** and **M**.

Option	Description
AF-A Auto-servo AF	Camera automatically selects single-servo autofocus if subject is stationary, continuous-servo autofocus if subject is moving. Shutter can only be released if camera is able to focus.
AF-S Single-servo AF	For stationary subjects. Focus locks when shutter-release button is pressed halfway. Shutter can only be released if camera is able to focus.
AF-C Continuous-servo AF	For moving subjects. Camera focuses continuously while shutter-release button is pressed halfway. At default settings, shutter can only be released if camera is able to focus, but Custom Setting a1 (AF-C priority selection , ☞ 248) can be changed to allow the shutter to be released at any time.
MF Manual focus	Focus manually (☞ 88).

1 Display focus mode options.

Press the **i** button, then highlight the current focus mode in the information display and press **OK**.

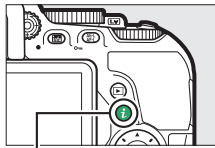

i button



Information display

2 Choose a focus mode.

Highlight a focus mode and press **OK**.



Predictive Focus Tracking

In **AF-C** mode or when continuous-servo autofocus is selected in **AF-A** mode, the camera will initiate predictive focus tracking if the subject moves toward the camera while the shutter-release button is pressed halfway. This allows the camera to track focus while attempting to predict where the subject will be when the shutter is released.

Continuous-Servo Autofocus

When **Focus** is selected for Custom Setting a1 (**AF-C priority selection**;  248) and the camera is in **AF-C** mode or continuous-servo autofocus is selected in **AF-A** mode, the camera gives higher priority to focus response (has a wider focus range) than in **AF-S** mode, and the shutter may be released before the in-focus indicator (●) is displayed.

Getting Good Results with Autofocus

Autofocus does not perform well under the conditions listed below. The shutter release may be disabled if the camera is unable to focus under these conditions, or the in-focus indicator (●) may be displayed and the camera may sound a beep, allowing the shutter to be released even when the subject is not in focus. In these cases, focus manually (☐ 88) or use focus lock (☐ 86) to focus on another subject at the same distance and then recompose the photograph.



There is little or no contrast between the subject and the background.

Example: Subject is the same color as the background.



The focus point contains objects at different distances from the camera.

Example: Subject is inside a cage.



The subject is dominated by regular geometric patterns.

Example: Blinds or a row of windows in a skyscraper.

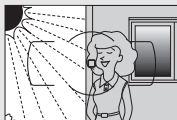

The focus point contains areas of sharply contrasting brightness.

Example: Subject is half in the shade.



Background objects appear larger than the subject.

Example: A building is in the frame behind the subject.

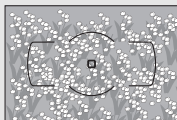

The subject contains many fine details.

Example: A field of flowers or other subjects that are small or lack variation in brightness.

The AF-Assist Illuminator

If the subject is poorly lit, the AF-assist illuminator will light automatically to assist the autofocus operation when the shutter-release button is pressed halfway (some restrictions apply; [□ 352](#)). Note that the illuminator may become hot when used multiple times in quick succession and will turn off automatically to protect the lamp after a period of continuous use. Normal function will resume after a brief pause.

AF-assist illuminator

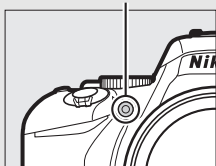

Choosing How the Focus Point Is Selected:

AF-Area Mode

Choose how the focus point for autofocus is selected. Note that [AF-C] (dynamic-area) and [3D] (3D-tracking) AF-area modes are not available when **AF-S** is selected for focus mode.

Option	Description
[AF-S] Single-point AF	For stationary subjects. Focus point is selected manually; camera focuses on subject in selected focus point only.
[AF-C] Dynamic-area AF (9 points)	For non-stationary subjects. In AF-A and AF-C focus modes , user selects focus point using multi selector (see 85), but camera will focus based on information from surrounding focus points if subject briefly leaves selected point.
[AF-C] Dynamic-area AF (21 points)	Number of focus points varies with mode selected: 9-point dynamic-area AF: Choose when there is time to compose photograph or when photographing subjects that are moving predictably (e.g., runners or race cars on a track).
[AF-C] Dynamic-area AF (39 points)	21-point dynamic-area AF: Choose when photographing subjects that are moving unpredictably (e.g., players at a football game). 39-point dynamic-area AF: Choose when photographing subjects that are moving quickly and are hard to keep in frame (e.g., birds).

Option	Description
[3D] 3D-tracking	Quickly compose pictures with subjects that are moving erratically from side to side (e.g., tennis players). In AF-A and AF-C focus modes , user selects focus point using multi selector (☐ 85). If subject moves after camera has focused, camera uses 3D-tracking to select new focus point and keep focus locked on original subject while shutter-release button is pressed halfway.
[AF-] Auto-area AF	Camera automatically detects subject and selects focus point.

1 Display AF-area mode options.

Press the **i** button, then highlight the current AF-area mode in the information display and press **OK**.

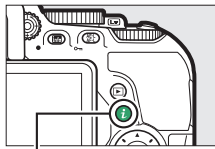

i button



Information display

2 Choose an AF-area mode.

Highlight an option and press **OK**.

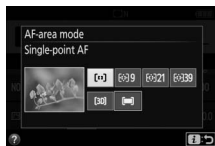

AF-Area Mode

AF-area mode selections made in shooting modes other than **P**, **S**, **A**, or **M** are reset when another shooting mode is selected.

3D-Tracking

If subject leaves the viewfinder, remove your finger from the shutter-release button and recompose the photograph with the subject in the selected focus point. Note that when the shutter-release button is pressed halfway, the colors in the area surrounding the focus point are stored in the camera. Consequently 3D-tracking may not produce the desired results with subjects that are the same color as the background.

Focus Point Selection

In manual focus mode or when autofocus is combined with AF-area modes other than  (Auto-area AF), you can choose from 39 focus points, making it possible to compose photographs with the main subject almost anywhere in the frame.

- 1 Choose an AF-area mode other than  (Auto-area AF;  83).

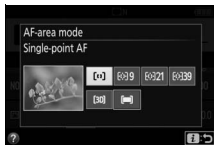

- 2 Return to the shooting display.
Press  to return to the shooting display.

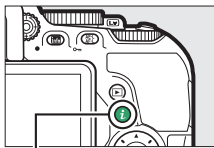

i button

- 3 Select the focus point.

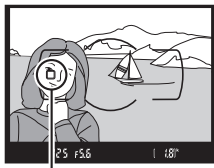

Focus point

Use the multi selector to select the focus point in the viewfinder or information display while the standby timer is on. Press  to select the center focus point.



Focus Lock

Focus lock can be used to change the composition after focusing in **AF-A**, **AF-S**, and **AF-C** focus modes (☞ 78), making it possible to focus on a subject that will not be in a focus point in the final composition. If the camera is unable to focus using autofocus (☞ 80), focus lock can also be used to recompose the photograph after focusing on another object at the same distance as your original subject. Focus lock is most effective when an option other than  (**Auto-area AF**) is selected for AF-area mode (☞ 82).

1 Focus.

Position the subject in the selected focus point and press the shutter-release button halfway to initiate focus. Check that the in-focus indicator (●) appears in the viewfinder.



2 Lock focus.

AF-A and AF-C focus modes: With the shutter-release button pressed halfway (1), press the AE-L/AF-L (O) button (2) to lock focus. Focus will remain locked while the AE-L/AF-L (O) button is pressed, even if you later remove your finger from the shutter-release button.

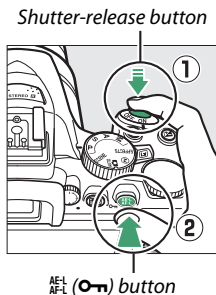

AF-S focus mode: Focus will lock automatically when the in-focus indicator (●) appears, and remain locked until you remove your finger from the shutter-release button. Focus can also be locked by pressing the AE-L/AF-L (O) button (see above).

3 Recompose the photograph and shoot.

Focus will remain locked between shots if you keep the shutter-release button pressed halfway (AF-S) or keep the AE-L/AF-L (O) button pressed, allowing several photographs in succession to be taken at the same focus setting.

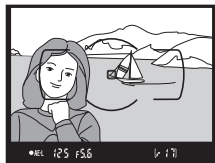

Do not change the distance between the camera and the subject while focus lock is in effect. If the subject moves, focus again at the new distance.

Autoexposure Lock

Pressing the AE-L/AF-L (O) button in Step 2 also locks exposure (□ 127).

Manual Focus

Manual focus can be used when autofocus is not available or does not produce the desired results (☞ 80).

1 Select manual focus.

If the lens is equipped with an A-M, M/A-M, or A/M-M mode switch, slide the switch to **M**.

A-M mode switch



M/A-M mode switch



If the lens is not equipped a focus-mode switch, select **MF** (manual focus) for **Focus mode** (☞ 78).

2 Focus.

To focus manually, adjust the lens focus ring until the image displayed on the clear matte field in the viewfinder is in focus. Photographs can be taken at any time, even when the image is not in focus.

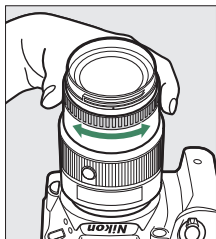

AF-P DX NIKKOR 18–55mm f/3.5–5.6G and G VR Lenses

When an AF-P DX NIKKOR 18–55mm f/3.5–5.6G VR or AF-P DX NIKKOR 18–55mm f/3.5–5.6G lens is used in manual focus mode, the in-focus indicator (●) will flash in the viewfinder (or in live view, the focus point will flash in the monitor) to warn that continuing to rotate the focus ring in the current direction will not bring the subject into focus.

■ The Electronic Rangefinder

If the lens has a maximum aperture of $f/5.6$ or faster, the viewfinder focus indicator can be used to confirm whether the subject in the selected focus point is in focus (the focus point can be selected from any of the 39 focus points). After positioning the subject in the selected focus point, press the shutter-release button halfway and rotate the lens focus ring until the in-focus indicator (●) is displayed. Note that with the subjects listed on page 80, the in-focus indicator may sometimes be displayed when the subject is not in focus; confirm focus in the viewfinder before shooting.



✔ Selecting Manual Focus with the Camera

If the lens supports M/A (autofocus with manual override) or A/M (autofocus with manual override/AF priority), manual focus can also be selected by setting the camera focus mode to **MF** (manual focus; 78). Focus can then be adjusted manually, regardless of the mode selected with the lens.

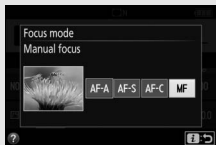

✔ Focal Plane Position

The position of the focal plane is indicated by the focal plane mark on the camera body. The distance between the lens mounting flange and the focal plane is 46.5 mm (1.83 in.).

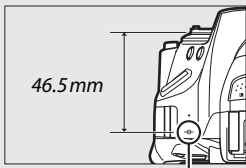

Focal plane mark

Image Quality and Size

Together, image quality and size determine how much space each photograph occupies on the memory card. Larger, higher quality images can be printed at larger sizes but also require more memory, meaning that fewer such images can be stored on the memory card (□ 399).

Image Quality

Choose a file format and compression ratio (image quality).

Option	File type	Description
NEF (RAW) + JPEG fine	NEF/ JPEG	Two images are recorded: one NEF (RAW) image and one fine-quality JPEG image.
NEF (RAW) + JPEG normal		Two images are recorded: one NEF (RAW) image and one normal-quality JPEG image.
NEF (RAW) + JPEG basic		Two images are recorded: one NEF (RAW) image and one basic-quality JPEG image.
NEF (RAW)	NEF	Raw data from the image sensor are saved without additional processing. Settings such as white balance and contrast can be adjusted after shooting.
JPEG fine	JPEG	Record JPEG images at a compression ratio of roughly 1 : 4 (fine quality).
JPEG normal		Record JPEG images at a compression ratio of roughly 1 : 8 (normal quality).
JPEG basic		Record JPEG images at a compression ratio of roughly 1 : 16 (basic quality).

NEF (RAW) + JPEG

When photographs taken at NEF (RAW) + JPEG are viewed on the camera, only the JPEG image will be displayed. When photographs taken at these settings are deleted, both NEF and JPEG images will be deleted.

- 1 Display image quality options.**
Press the **i** button, then highlight the current image quality in the information display and press **OK**.

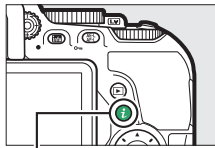

i button



Information display

- 2 Choose a file type.**
Highlight an option and press **OK**.



NEF (RAW) Images

Note that the option selected for image size does not affect the size of NEF (RAW) images. White balance bracketing (☐ 148), high dynamic range (HDR, ☐ 135), and **Date stamp** (☐ 256) are not available at image quality settings of NEF (RAW) or NEF (RAW)+JPEG.

NEF (RAW) images can be viewed on the camera or using software such as ViewNX 2 or Capture NX-D (☐ 210). JPEG copies of NEF (RAW) images can be created using the **NEF (RAW) processing** option in the retouch menu (☐ 289).

Image Size

Choose a size for JPEG images:

Image size	Size (pixels)	Print size (cm/in.)*
L Large	6000 × 4000	50.8 × 33.9/20 × 13.3
M Medium	4496 × 3000	38.1 × 25.4/15.0 × 10
S Small	2992 × 2000	25.3 × 16.9/10 × 6.7

* Approximate size when printed at 300 dpi. Print size in inches equals image size in pixels divided by printer resolution in dots per inch (dpi); 1 inch = approximately 2.54 cm).

1 Display image size options.

Press the **i** button, then highlight the current image size in the information display and press **OK**.

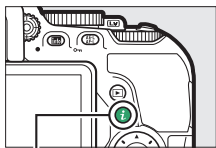

i button



Information display

2 Choose an image size.











Highlight an option and press **OK**.





Using the Built-in Flash

The camera supports a variety of flash modes for photographing poorly lit or backlit subjects.



Auto Pop-up Modes

In , , , , , , , , VI, POP, , and  modes, the built-in flash automatically pops up and fires as required.

1 Choose a flash mode.

Keeping the  () button pressed, rotate the command dial until the desired flash mode appears in the information display.



 () button

+



Command dial



Information display

2 Take pictures.



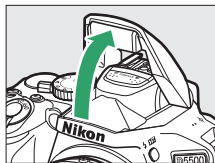

The flash will pop up as required when the shutter-release button is pressed halfway, and fire when a photograph is taken. *If the flash does not pop up*



automatically, DO NOT attempt to raise it by hand. Failure to observe this precaution could damage the flash.

Flash Modes

The following flash modes are available:

- **⚡ AUTO** (auto): When lighting is poor or the subject is backlit, the flash pops up automatically when the shutter-release button is pressed halfway and fires as required. Not available in  mode.
- **⚡👁️ AUTO** (auto + red-eye reduction): Use for portraits. The flash pops up and fires as required, but before it fires the red-eye reduction lamp lights to help reduce “red-eye.” Not available in  mode.
- **⚡👁️ AUTO SLOW** (auto slow sync + red-eye reduction): As for auto with red-eye reduction, except that slow shutter speeds are used to capture background lighting. Use for portraits taken at night or under low light. Available in  mode.
- **⚡ AUTO SLOW** (auto slow sync): Slow shutter speeds are used to capture background lighting in shots taken at night or under low light. Available in  mode.
-  (flash off): The flash does not fire.

The Information Display

Flash mode can also be selected in the information display ( 8).



Manual Pop-up Modes

In P, S, A, M, and \uparrow modes, the flash must be raised manually. The flash will not fire if it is not raised.

1 Raise the flash.

Press the \downarrow (\uparrow) button to raise the flash.

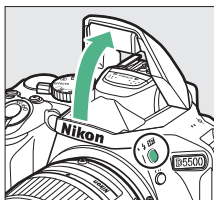

\downarrow (\uparrow) button

2 Choose a flash mode (P, S, A, and M modes only).

Keeping the \downarrow (\uparrow) button pressed, rotate the command dial until the desired flash mode appears in the information display.



\downarrow (\uparrow) button

+



Command dial



Information display

3 Take pictures.

The flash will fire whenever a picture is taken.

■ Flash Modes

The following flash modes are available:

- **⚡** (fill flash): The flash fires with every shot.
- **⚡👁** (red-eye reduction): Use for portraits. The flash fires with every shot, but before it fires, the red-eye reduction lamp lights to help reduce “red-eye.” Not available in **⌚** mode.
- **⚡👁SLOW** (slow sync + red-eye): As for “red-eye reduction”, above, except that shutter speed slows automatically to capture background lighting at night or under low light. Use when you want to include background lighting in portraits. Not available in modes **S**, **M**, and **⌚**.
- **⚡SLOW** (slow sync): As for “fill flash”, above, except that shutter speed slows automatically to capture background lighting at night or under low light. Use when you want to capture both subject and background. Not available in modes **S**, **M**, and **⌚**.
- **⚡SLOW REAR** (rear-curtain + slow sync): As for “rear-curtain sync”, below, except that shutter speed slows automatically to capture background lighting at night or under low light. Use when you want to capture both subject and background. Not available in modes **S**, **M**, and **⌚**.
- **⚡REAR** (rear-curtain sync): The flash fires just before the shutter closes, creating a stream of light behind moving light sources as shown below at right. Not available in modes **P**, **A**, and **⌚**.



Front-curtain sync



Rear-curtain sync

Lowering the Built-in Flash

To save power when the flash is not in use, press it gently downward until the latch clicks into place.

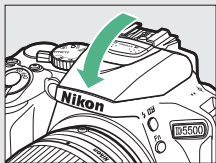













The Built-in Flash

For information on the lenses that can be used with the built-in flash, see page 320. Remove lens hoods to prevent shadows. The flash has a minimum range of 0.6 m (2 ft) and can not be used in the macro range of zoom lenses with a macro function.

The shutter release may be briefly disabled to protect the flash after it has been used for several consecutive shots. The flash can be used again after a short pause.

✓ Shutter Speeds Available with the Built-in Flash

Shutter speed is restricted to the following ranges when the built-in flash is used:

Mode	Shutter speed
 ,  ,  ,  ,  ,  ,  ,  ,  ,  , 	$1/200$ – $1/60$ s
	$1/200$ – $1/30$ s
	$1/200$ –1 s
P, S, A	$1/200$ –30 s
M	$1/200$ –30 s, Bulb, Time



✓ Aperture, Sensitivity, and Flash Range

Flash range varies with sensitivity (ISO equivalency) and aperture.

Aperture at ISO equivalent of								Approximate range	
100	200	400	800	1600	3200	6400	12800	m	ft
1.4	2	2.8	4	5.6	8	11	16	1.0–8.5	3ft 4in.–27ft 10in.
2	2.8	4	5.6	8	11	16	22	0.7–6.0	2ft 4in.–19ft 8in.
2.8	4	5.6	8	11	16	22	32	0.6–4.2	2ft–13ft 9in.
4	5.6	8	11	16	22	32	—	0.6–3.0	2ft–9ft 10in.
5.6	8	11	16	22	32	—	—	0.6–2.1	2ft–6ft 10in.
8	11	16	22	32	—	—	—	0.6–1.5	2ft–4ft 11in.
11	16	22	32	—	—	—	—	0.6–1.1	2ft–3ft 7in.
16	22	32	—	—	—	—	—	0.6–0.7	2ft–2ft 4in.

ISO Sensitivity

The camera's sensitivity to light can be adjusted according to the amount of light available. The higher the ISO sensitivity, the less light needed to make an exposure, allowing higher shutter speeds or smaller apertures. Choosing **Auto** allows the camera to set ISO sensitivity automatically in response to lighting conditions; to use auto in **P**, **S**, **A**, and **M** modes, select **Auto ISO sensitivity control** for the **ISO sensitivity settings** item in the shooting menu (☞ 241).

Mode	ISO sensitivity
AUTO,  , 	Auto
P , S , A , M	100–25600 in steps of $\frac{1}{3}$ EV
Other shooting modes	Auto; 100–25600 in steps of $\frac{1}{3}$ EV

- 1 Display ISO sensitivity options.**
Press the **i** button, then highlight the current ISO sensitivity in the information display and press **OK**.

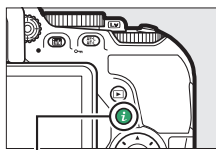

i button



Information display

-
- 2 Choose an ISO sensitivity.**
Highlight an option and press **OK**.

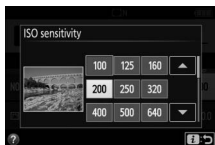

Interval Timer Photography

The camera is equipped to take photographs automatically at preset intervals.

✔ Before Shooting

Before beginning interval timer photography, take a test shot at current settings and view the results in the monitor. To ensure that shooting starts at the desired time, check that the camera clock is set correctly (☐ 275).

Use of a tripod is recommended. Mount the camera on a tripod before shooting begins. To ensure that shooting is not interrupted, be sure the battery is fully charged.

- 1 Select Interval timer shooting.**
Highlight **Interval timer shooting** in the shooting menu and press **▶** to display interval timer settings.

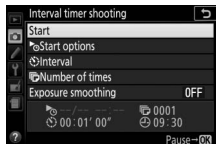
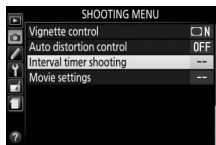

2 Adjust interval timer settings.

Choose a start option, interval, number of shots per interval, and exposure smoothing option.

- To choose a start option:

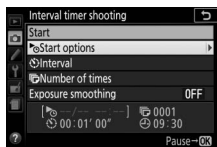

Highlight **Start options** and press **OK**.

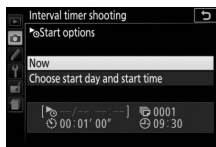

Highlight an option and press **OK**.

To start shooting immediately, select **Now**. To start shooting at a chosen date and time, select **Choose start day and start time**, then choose the date and time and press **OK**.

- To choose the interval between shots:

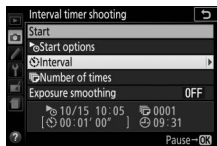

Highlight **Interval** and press **OK**.



Choose an interval (hours, minutes, and seconds) and press **OK**.

- To choose the number of intervals:

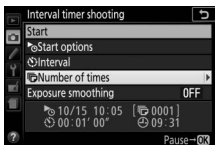

Highlight **Number of times** and press \odot .

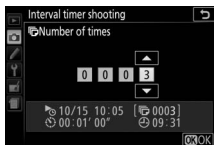

Choose the number of intervals and press \odot .

- To enable or disable exposure smoothing:

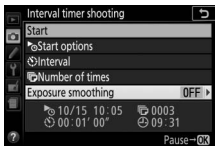

Highlight **Exposure smoothing** and press \odot .

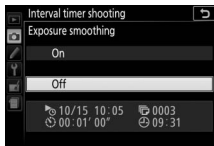

Highlight an option and press \odot .

Selecting **On** allows the camera to adjust exposure to match previous shot in modes other than **M** (note that exposure smoothing only takes effect in mode **M** if auto ISO sensitivity control is on).

3 Start shooting.

Highlight **Start** and press **OK**. The first series of shots will be taken at the specified starting time, or after about 3 s if **Now** was selected for **Start options** in Step 2. Shooting will

continue at the selected interval until all shots have been taken; while shooting is in progress, the memory card access lamp will flash at regular intervals. Note that because shutter speed and the time needed to record the image to the memory card may vary from shot to shot, intervals may be skipped if the camera is still in the process of recording the previous interval; choose an interval longer than the slowest anticipated shutter speed. If shooting can not proceed at current settings (for example, if a shutter speed of “Bulb” or “Time” is currently selected in shooting mode **M**, the interval is zero, or the start time is in less than a minute), a warning will be displayed in the monitor.

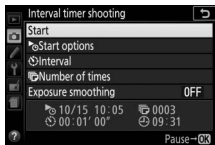

■ ■ Pausing Interval Timer Photography

Interval timer photography can be paused between intervals by pressing **OK**. To resume shooting:

Starting Now

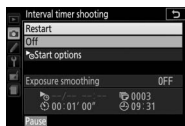

Highlight **Restart** and press **OK**.

Starting at a Specified Time

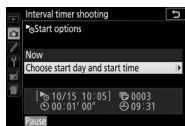

For **Start options**, highlight **Choose start day and start time** and press **OK**.

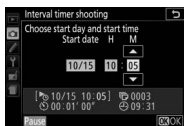

Choose a starting date and time and press **OK**.

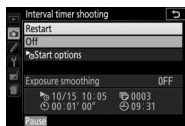

Highlight **Restart** and press **OK**.

■ ■ Ending Interval Timer Shooting

To end interval timer photography and resume normal shooting before all the photos are taken, pause shooting and select **Off** in the interval timer menu.

■ No Photograph

The camera will skip the current interval if any of the following situations persist for eight seconds or more after the interval was due to start: the photograph or photographs for the previous interval have yet to be taken, the memory card is full, or the camera is unable to focus in **AF-S** or when single-servo AF is selected in **AF-A** (note that the camera focuses again before each shot). Shooting will resume with the next interval.

✓ Out of Memory

If the memory card is full, the interval timer will remain active but no pictures will be taken. Resume shooting (☞ 105) after deleting some pictures or turning the camera off and inserting another memory card.

✓ Cover the Viewfinder

To prevent light entering via the viewfinder from appearing in the photograph or interfering with exposure, we recommend that you cover the viewfinder with your hand or other objects such as an optional eyepiece cap (☞ 331) before taking pictures without your eye to the viewfinder (☞ 76).

✓ Other Settings

Settings can not be adjusted during interval timer photography. Regardless of the release mode selected, the camera takes one photograph at each interval; in mode , camera noise will be reduced. Bracketing (☞ 148) and high dynamic range (HDR; ☞ 135) can not be used.

✓ Interrupting Interval Timer Photography

To interrupt interval timer shooting, turn the camera off or rotate the mode dial to a new setting. Returning the monitor to the storage position does not interrupt interval timer shooting.

Remote Control Photography



Using an Optional ML-L3 Remote Control

The optional ML-L3 remote control (☞ 332) can be used to reduce camera shake or for self-portraits. Before proceeding, mount the camera on a tripod or place it on a stable, level surface.

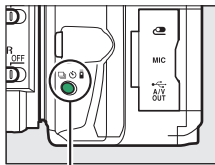
- 1 Press the  (📷/🔒) button.



 (📷/🔒) button

- 2 Select a remote control mode. Highlight  2s (**Delayed remote (ML-L3)**) or  (**Quick-response remote (ML-L3)**) and press .

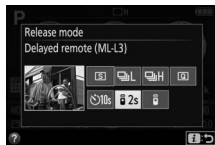

- 3 Frame the photograph.

Check focus by pressing the shutter-release button halfway.



4 Take the photograph.

From a distance of 5 m (16 ft) or less, aim the transmitter on the ML-L3 at either of the infrared receivers on the camera (□ 1, 2) and press the ML-L3 shutter-release button. *In delayed remote mode*, the self-timer lamp will light for about two seconds before the shutter is released. *In quick-response remote mode*, the self-timer lamp will flash after the shutter has been released.

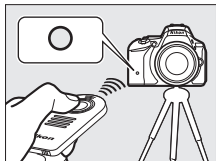

Note that the timer may not start or a photograph may not be taken if the camera is unable to focus or in other situations in which the shutter can not be released.

Before Using the ML-L3 Remote Control

Before using the ML-L3 for the first time, remove the clear plastic battery-insulator sheet.

Cover the Viewfinder

To prevent light entering via the viewfinder from appearing in the photograph or interfering with exposure, we recommend that you cover the viewfinder with your hand or other objects such as an optional eyepiece cap (□ 331) before taking pictures without your eye to the viewfinder (□ 76).



The Camera Shutter-Release Button/Other Remote Control Devices

If an ML-L3 remote release mode is selected and the shutter is released by any means other than an ML-L3 remote control (for example, the camera shutter-release button or the shutter button on an optional remote cord or wireless remote controller), the camera will function in single-frame release mode.

✍ **Exiting Remote Control Mode**

Remote control mode is cancelled automatically if no photograph is taken before the time selected for Custom Setting c4 (**Remote on duration (ML-L3)**, ☞ 254). Remote control mode will also be cancelled if the camera is turned off, a two-button reset is performed (☞ 110), or shooting options are reset using **Reset shooting menu**.

✍ **Using the Built-in Flash**

Before taking a photograph with the flash in manual pop-up modes (☞ 95), press the  (**FL**) button to raise the flash and wait for the  indicator to be displayed in the viewfinder (☞ 44). Shooting will be interrupted if the flash is raised after the shutter-release button on the ML-L3 is pressed. If the flash is required, the camera will only respond to the ML-L3 shutter-release button once the flash has charged. In auto pop-up modes, the flash will begin charging when a remote control mode is selected; once the flash is charged, it will automatically pop up and fire when required.

✍ **Wireless Remote Controllers**

Remote control is also available with various combinations of WR-R10, WR-T10, and WR-1 wireless remote controllers (☞ 332), when the shutter-release buttons on the wireless remote controllers perform the same functions as the camera shutter-release button. For more information, see the manual provided with the remote controllers.

Restoring Default Settings

The camera settings listed below and on page 112 can be restored to default values by holding the **MENU** and **info** buttons down together for more than two seconds (these buttons are marked by a green dot). The information display turns off briefly while settings are reset.

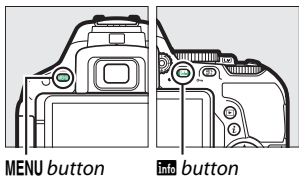

■ Settings Accessible from the Information Display









Option	Default	📖
Image quality	JPEG normal	90
Image size	Large	92
Auto bracketing		
P, S, A, M	Off	148
HDR (high dynamic range)		
P, S, A, M	Off	135
Active D-Lighting		
P, S, A, M	Auto	133
White balance		
P, S, A, M	Auto ¹	137
ISO sensitivity		
P, S, A, M	100	99
Other shooting modes	Auto	
Picture Control settings		
P, S, A, M	Unmodified ²	155

1 Fine-tuning is also reset.

2 Current Picture Control only.

Option	Default	
Focus mode		
Viewfinder		
Shooting modes other than 	AF-A	78
Live view/movie	AF-S	164
AF-area mode		
Viewfinder		
	Single-point AF	82
	Dynamic-area AF (39 points)	
AUTO  POP,  P, S, A, M	Auto-area AF	
Live view/movie		
	Face-priority AF	166
 A, M	Wide-area AF	
	Normal-area AF	
Metering		
P, S, A, M	Matrix metering	125
Flash mode		
AUTO 	Auto	94, 96
	Auto slow sync	
	Auto+red-eye reduction	
	Flash off	
P, S, A, M	Fill flash	
Flash compensation		
SCENE, P, S, A, M	Off	131
Exposure compensation		
SCENE,  P, S, A, M	Off	129

■ ■ Other Settings

Option	Default	
NEF (RAW) recording	14-bit	240
Exposure delay mode	Off	254
Release mode		
	Continuous H	71
Other shooting modes	Single frame	
Focus point	Center	85
AE/AF lock hold		
Shooting modes other than  and 	Off	267
Flexible program		
P	Off	116
Special effects mode		
		
Thickness		66
		
Vividness	0	67
Vignetting	0	
		
Orientation	Landscape	68
Width	Normal	
		
Color	Off	69
Color range	3	

P, S, A, and M Modes

Shutter Speed and Aperture

P, S, A, and M modes offer different degrees of control over shutter speed and aperture:



	Mode	Description
P	Programmed auto (☞ 115)	Recommended for snapshots and in other situations in which there is little time to adjust camera settings. Camera sets shutter speed and aperture for optimal exposure.
S	Shutter-priority auto (☞ 117)	Use to freeze or blur motion. User chooses shutter speed; camera selects aperture for best results.
A	Aperture-priority auto (☞ 118)	Use to blur background or bring both foreground and background into focus. User chooses aperture; camera selects shutter speed for best results.
M	Manual (☞ 119)	User controls both shutter speed and aperture. Set shutter speed to “Bulb” or “Time” for long time-exposures.

Shutter Speed and Aperture

Shutter speed and aperture are shown in the viewfinder and information display.

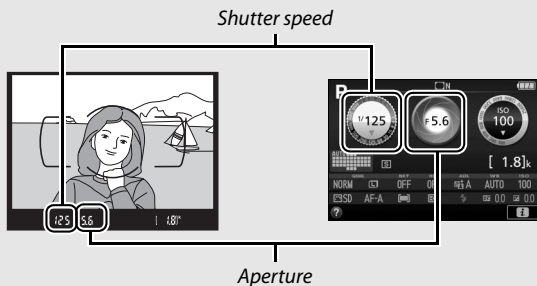

Fast shutter speeds ($1/1600$ s in this example) freeze motion.

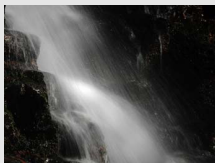

Slow shutter speeds (here 1 s) blur motion.



Large apertures (such as f/5.6; remember, the lower the f-number, the larger the aperture) blur details in front of and behind the main subject.



Small apertures (f/22 in this case) bring both background and foreground into focus.

Mode P (Programmed Auto)

This mode is recommended for snapshots or whenever you want to leave the camera in charge of shutter speed and aperture. The camera automatically adjusts shutter speed and aperture for optimal exposure in most situations.

Mode dial

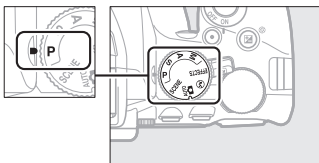

To take pictures in programmed auto mode, rotate the mode dial to **P**.

Flexible Program

In mode **P**, different combinations of shutter speed and aperture can be selected by rotating the command dial (“flexible program”). Rotate the dial right for large apertures (low f-numbers) and fast shutter speeds, left for small apertures (high f-numbers) and slow shutter speeds. All combinations produce the same exposure.

Rotate right to blur background details or freeze motion.

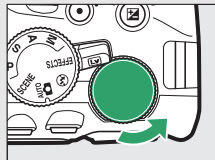

Command dial

Rotate left to increase depth of field or blur motion.

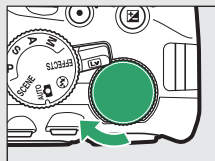

While flexible program is in effect, a **P** (**Pi**) indicator appears in the viewfinder and information display. To restore default shutter speed and aperture settings, rotate the command dial until the indicator is no longer displayed, choose another mode, or turn the camera off.



Mode S (Shutter-Priority Auto)

This mode lets you control shutter speed: choose fast shutter speeds to “freeze” motion, slow shutter speeds to suggest motion by blurring moving objects. The camera automatically adjusts aperture for optimal exposure.



Fast shutter speeds (e.g., 1/1600 s) freeze motion.

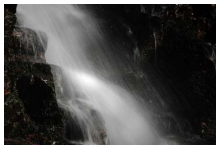

Slow shutter speeds (e.g., 1 s) blur motion.

To choose a shutter speed:

1 Rotate the mode dial to S.

Mode dial

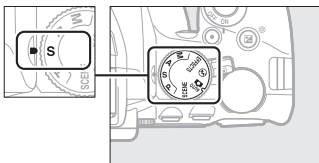

2 Choose a shutter speed.

Rotate the command dial to choose the desired shutter speed: rotate right for faster speeds, left for slower speeds.



Command dial



Mode A (Aperture-Priority Auto)

In this mode, you can adjust aperture to control depth of field (the distance in front of and behind the main subject that appears to be in focus). The camera automatically adjusts shutter speed for optimal exposure.



Large apertures (low f-numbers, e.g. f/5.6) blur details in front of and behind the main subject.



Small apertures (high f-numbers, e.g. f/22) bring the foreground and background into focus.

To choose an aperture:

1 Rotate the mode dial to A.

Mode dial

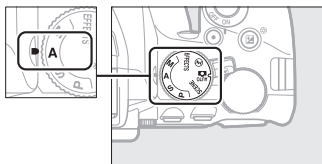

2 Choose an aperture.

Rotate the command dial left for larger apertures (lower f-numbers), right for smaller apertures (higher f-numbers).

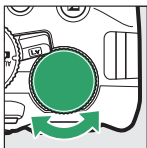

Command dial



Mode M (Manual)

In manual mode, you control both shutter speed and aperture. Shutter speeds of “Bulb” and “Time” are available for long time-exposures of moving lights, the stars, night scenery, or fireworks (📖 121).

- 1 Rotate the mode dial to M.** *Mode dial*

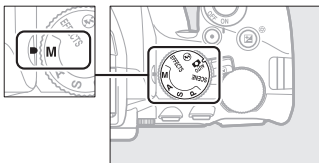

2 Choose aperture and shutter speed.

Checking the exposure indicator (see below), adjust shutter speed and aperture. Shutter speed is selected by rotating the command dial (right for faster speeds, left for slower). To adjust aperture, keep the  button pressed while rotating the command dial (left for larger apertures/lower f-numbers and right for smaller apertures/higher f-numbers).

Shutter speed

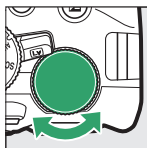

Command dial

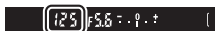

Aperture

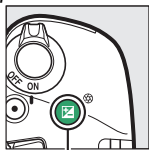

 button

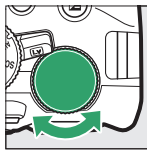



Command dial



The Exposure Indicator

If a CPU lens is attached ( 314) and a shutter speed other than “Bulb” or “Time” is selected, the exposure indicator in the viewfinder and information display shows whether the photograph would be under- or over-exposed at current settings.

Optimal exposure	Underexposed by $\frac{1}{3}$ EV	Overexposed by over 2 EV
		

Long Time-Exposures (M Mode Only)

Select the following shutter speeds for long time-exposures of moving lights, the stars, night scenery, or fireworks.

- **Bulb** (bulb icon): The shutter remains open while the shutter-release button is pressed all the way down. To prevent blur, use a tripod or an optional wireless remote controller (☞ 332) or remote cord (☞ 333).
- **Time** (- -): Start the exposure using the shutter-release button on the camera or on an optional remote control, remote cord, or wireless remote controller. The shutter remains open until the button is pressed a second time.



Length of exposure: 35 s

Aperture: f/25

Before proceeding, mount the camera on a tripod or place it on a stable, level surface. To prevent light entering via the viewfinder from appearing in the photograph or interfering with exposure, we recommend that you cover the viewfinder with your hand or other objects such as an optional eyepiece cap (☞ 331) before taking pictures without your eye to the viewfinder (☞ 76). To prevent loss of power before the exposure is complete, use a fully charged battery. Note that noise (bright spots, randomly-spaced bright pixels, or fog) may be present in long exposures. Bright spots and fog can be reduced by choosing **On** for **Long exposure NR** in the shooting menu (☞ 243).

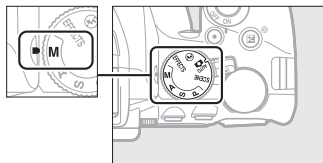
1 Rotate the mode dial to M.*Mode dial*

2 Choose the shutter speed.

Rotate the command dial to choose a shutter speed of Bulb (b u l b).

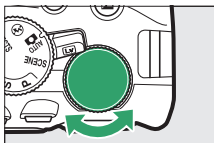
*Command dial*

3 Take the photograph.

After focusing, press the shutter-release button on the camera, optional wireless remote controller or remote cord all the way down. Take your finger from the shutter-release button when the exposure is complete.

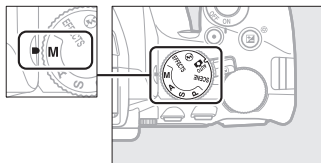
1 Rotate the mode dial to M. *Mode dial*

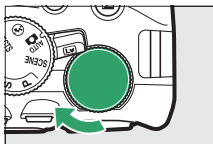
2 Choose the shutter speed.
Rotate the command dial left to choose a shutter speed of “Time” (- -).*Command dial*





3 Open the shutter.

After focusing, press the shutter-release button on the camera or optional remote control, remote cord, or wireless remote controller all the way down.

4 Close the shutter.

Repeat the operation performed in Step 3.



ML-L3 Remote Controls

If you will be using an ML-L3 remote control, select one of the following remote control modes as described on page 107:  2s (**Delayed remote (ML-L3)**) or  (**Quick-response remote (ML-L3)**). Note that if you are using an ML-L3 remote control, pictures will be taken in “Time” mode even when “Bulb”/   is selected for shutter speed. The exposure starts when the shutter-release button on the remote control is pressed and ends after 30 minutes or when the button is pressed again.

Exposure

Metering

Choose how the camera sets exposure.

Method	Description
 Matrix metering	Produces natural results in most situations. The camera meters a wide area of the frame and sets exposure according to tone distribution, color, composition, and distance.
 Center-weighted metering	Classic meter for portraits. Camera meters entire frame but assigns greatest weight to center area. Recommended when using filters with an exposure factor (filter factor) over 1x.
 Spot metering	Choose this mode to ensure that subject will be correctly exposed, even when background is much brighter or darker. Camera meters current focus point; use to meter off-center subjects.

1 Display metering options.

Press the **i** button, then highlight the current metering method in the information display and press **OK**.

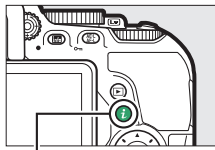

i button

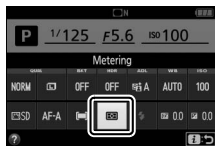

Information display





-
- 2 Choose a metering method.**
Highlight an option and press **OK**.



 **Spot Metering**

If  (**Auto-area AF**) is selected for AF-area mode during viewfinder photography (82), the camera will meter the center focus point.

Autoexposure Lock

Use autoexposure lock to recompose photographs after using  (Center-weighted metering) and  (Spot metering) to meter exposure; note that autoexposure lock is not available in  or  mode.

1 Meter exposure.

Press the shutter-release button halfway.



2 Lock exposure.

With the shutter-release button pressed halfway (1) and the subject positioned in the focus point, press the  (AE-L/AF-L) button (2) to lock exposure.

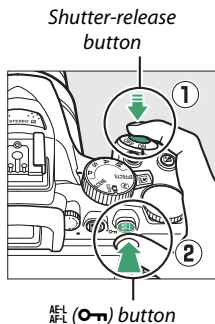

While exposure lock is in effect, an  AE-L indicator will appear in the viewfinder.

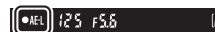

3 Recompose the photograph.

Keeping the  (AE-L/AF-L) button pressed, recompose the photograph and shoot.

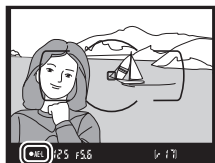



Adjusting Shutter Speed and Aperture

While exposure lock is in effect, the following settings can be adjusted without altering the metered value for exposure:

Mode	Setting
Programmed auto	Shutter speed and aperture (flexible program;  116)
Shutter-priority auto	Shutter speed
Aperture-priority auto	Aperture

The metering method itself can not be changed while exposure lock is in effect.

Exposure Compensation

Exposure compensation is used to alter exposure from the value suggested by the camera, making pictures brighter or darker (📖 367). In general, positive values make the subject brighter while negative values make it darker. It is most effective when used with  (**Center-weighted metering**) or  (**Spot metering**) (📖 125).





-1 EV





No exposure
compensation

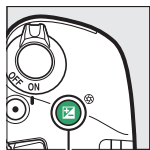

+1 EV

To choose a value for exposure compensation, keep the  () button pressed and rotate the command dial until the desired value is selected in the viewfinder or information display.



 () button

+

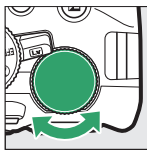

Command dial





Information display



-0.3 EV



+2 EV

Normal exposure can be restored by setting exposure compensation to ± 0 . Except in **SCENE** and  modes, exposure compensation is not reset when the camera is turned off (in **SCENE** and  modes, exposure compensation will be reset when another mode is selected or the camera is turned off).

The Information Display

Exposure compensation options can also be accessed from the information display ( 10).

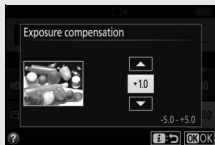

Mode M

In mode **M**, exposure compensation affects only the exposure indicator.

Using a Flash





When a flash is used, exposure compensation affects both background exposure and flash level.



Bracketing

For information on automatically varying exposure over a series of shots, see page 148.

Flash Compensation

Flash compensation is used to alter flash output from the level suggested by the camera, changing the brightness of the main subject relative to the background. Flash output can be increased to make the main subject appear brighter, or reduced to prevent unwanted highlights or reflections (□ 368).

Keep the  () and  () buttons pressed and rotate the command dial until the desired value is selected in the viewfinder or information display. In general, positive values make the main subject seem brighter while negative values make it seem darker. Normal flash output can be restored by setting flash compensation to ± 0 . Except in **SCENE** mode, flash compensation is not reset when the camera is turned off (in **SCENE** mode, flash compensation will be reset when another mode is selected or the camera is turned off).

 () button

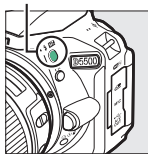

+

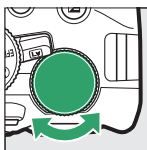



Command dial

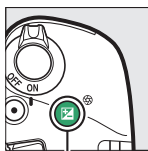

Information display



 () button



-0.3 EV



+1 EV

The Information Display

Flash compensation options can also be accessed from the information display (📖 10).

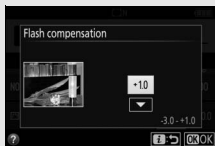



Optional Flash Units

Flash compensation is also available with optional flash units that support the Nikon Creative Lighting System (CLS; see page 323). The flash compensation selected with the optional flash unit is added to the flash compensation selected with the camera.

Preserving Detail in Highlights and Shadows

Active D-Lighting

Active D-Lighting preserves details in highlights and shadows, creating photographs with natural contrast. Use for high contrast scenes, for example when photographing brightly lit outdoor scenery through a door or window or taking pictures of shaded subjects on a sunny day. Active D-Lighting is not recommended in mode **M**; in other modes, it is most effective when used with  (**Matrix metering**;  125).

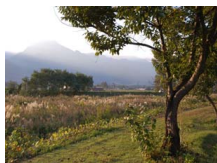



Active D-Lighting: OFF Off



Active D-Lighting:  A Auto

1 Display Active D-Lighting options.

Press the  button, then highlight Active D-Lighting in the information display and press .

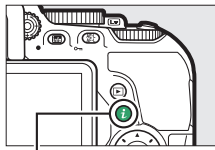

 button



Information display

- 2 Choose an option.**
Highlight an option and press **OK**
( 367).



 **Active D-Lighting**

Noise (randomly-spaced bright pixels, fog, or lines) may appear in photographs taken with Active D-Lighting. Uneven shading may be visible with some subjects.



 **“Active D-Lighting” Versus “D-Lighting”**

Active D-Lighting adjusts exposure before shooting to optimize the dynamic range, while the **D-Lighting** option in the retouch menu ( 294) brightens shadows in images after shooting.

 **Bracketing**

For information on automatically varying Active D-Lighting over a series of shots, see page 148.

High Dynamic Range (HDR)

High Dynamic Range (HDR) combines two exposures to form a single image that captures a wide range of tones from shadows to highlights, even with high-contrast subjects. HDR is most effective when used with  (**Matrix metering**) ( 125). It can not be used to record NEF (RAW) images. While HDR is in effect, the flash can not be used and continuous shooting is not available.

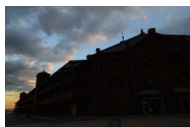

First exposure (darker)





Second exposure
(brighter)



Combined HDR image

1 Display HDR (high dynamic range) options.

Press the  button, then highlight HDR (high dynamic range) in the information display and press .

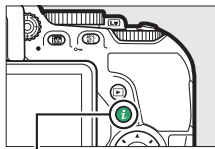

 button



Information display

2 Choose an option.

Highlight **AUTO Auto**, **HIGH* Extra high**, **HIGH High**, **NORM Normal**, **LOW Low**, or **OFF Off** and press **OK**.

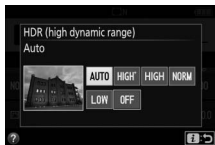

When an option other than **OFF Off** is selected, **Hdr** will be displayed in the viewfinder.



3 Frame a photograph, focus, and shoot.

The camera takes two exposures when the shutter-release button is pressed all the way down. "**Jab Hdr**"









will flash in the viewfinder while the images are combined; no photographs can be taken until recording is complete. HDR turns off automatically after the photograph is taken; to turn off HDR before shooting, rotate the mode dial to a setting other than **P**, **S**, **A**, or **M**.

Framing HDR Photographs

The edges of the image may be cropped out. The desired results may not be achieved if the camera or subject moves during shooting. Use of a tripod is recommended. Depending on the scene, the effect may not be visible, shadows may appear around bright objects, or halos may appear around dark objects. Uneven shading may be visible with some subjects.

White Balance

White balance ensures that colors are unaffected by the color of the light source. Auto white balance is recommended for most light sources; other values can be selected if necessary according to the type of source:

Option	Description
AUTO Auto	Automatic white balance adjustment. Recommended in most situations.
 Incandescent	Use under incandescent lighting.
 Fluorescent	Use with the light sources listed on page 138.
 Direct sunlight	Use with subjects lit by direct sunlight.
 Flash	Use with the flash.
 Cloudy	Use in daylight under overcast skies.
 Shade	Use in daylight with subjects in the shade.
PRE Preset manual	Measure white balance or copy white balance from existing photo (☐ 142).

1 Display white balance options.

Press the **i** button, then highlight the current white balance setting in the information display and press **OK**.

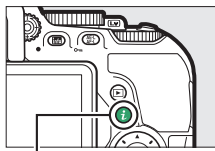

i button

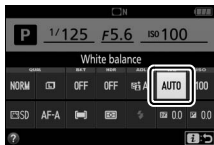

Information display

2 Choose a white balance option. Highlight an option and press **OK**.

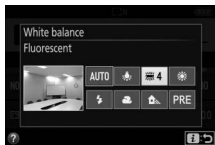

The Shooting Menu

White balance can be selected using the **White balance** option in the shooting menu (📖 236), which also can be used to fine-tune white balance (📖 140) or measure a value for preset white balance (📖 142).

The  **Fluorescent** option in the **White balance** menu can be used to select the light source from the bulb types shown at right.

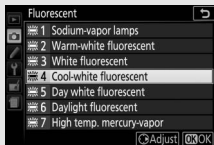
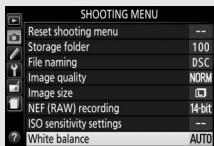



Touch Menu Navigation

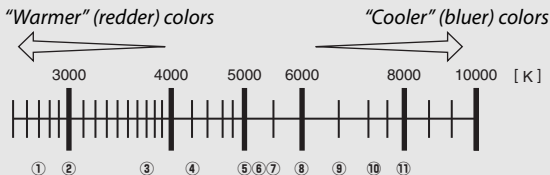

Tap an option in the white balance menu once to highlight it and again to select it and either display a menu of bulb types ( **Fluorescent**) or return to the shooting menu.

Color Temperature

The perceived color of a light source varies with the viewer and other conditions. Color temperature is an objective measure of the color of a light source, defined with reference to the temperature to which an object would have to be heated to radiate light in the same wavelengths. While light sources with a color temperature in the neighborhood of 5000–5500 K appear white, light sources with a lower color temperature, such as incandescent light bulbs, appear slightly yellow or red. Light sources with a higher color temperature appear tinged with blue.





①  (sodium-vapor lamps): 2700 K

②  (incandescent)/ (warm-white fluorescent.): 3000 K

③  (white fluorescent): 3700 K

④  (cool-white fluorescent): 4200 K

⑤  (day white fluorescent): 5000 K

⑥  (direct sunlight): 5200 K

⑦  (flash): 5400 K

⑧  (cloudy): 6000 K

⑨  (daylight fluorescent): 6500 K

⑩  (high temp. mercury-vapor): 7200 K

⑪  (shade): 8000 K

Note: All figures are approximate.

Bracketing

For information on automatically varying white balance settings over a series of shots, see page 148.

Fine-Tuning White Balance

White balance can be “fine-tuned” to compensate for variations in the color of the light source or to introduce a deliberate color cast into an image. White balance is fine-tuned using the **White balance** option in the shooting menu.

1 Display fine-tuning options.

Highlight a white balance option and press \odot (if **Fluorescent** is selected, highlight the desired lighting type and press \odot ; note that fine-tuning is not available with **Preset manual**).

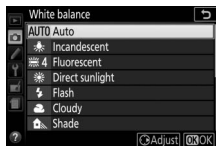

2 Fine-tune white balance.

Use the multi selector to fine-tune white balance. White balance can be fine-tuned on the amber (A)–blue (B) axis in steps of 0.5 and the green (G)–magenta (M) axis in steps of 0.25. The horizontal (amber-blue) axis corresponds to color temperature, while the vertical (green-magenta) axis has the similar effects to the corresponding color compensation (CC) filters. The horizontal axis is ruled in increments equivalent to about 5 mired, the vertical axis in increments of about 0.05 diffuse density units.

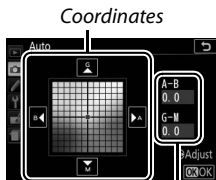







3 Save changes and exit.

Press \odot .

White Balance Fine-Tuning

The colors on the fine-tuning axes are relative, not absolute. For example, moving the cursor to **B** (blue) when a “warm” setting such as  (incandescent) is selected will make photographs slightly “colder” but will not actually make them blue.

Touch Fine-Tuning

To fine-tune an option in the white balance menu using the touch screen, tap the option once to highlight it and then tap the  **Adjust** button to view the fine-tuning display. To choose a value, tap the coordinate display or the , , , or  icons. Tap  **OK** to return to the shooting menu once white balance has been adjusted to your satisfaction.

“Mired”

Any given change in color temperature produces a greater difference in color at low color temperatures than it would at higher color temperatures. For example, a change of 1000 K produces a much greater change in color at 3000 K than at 6000 K. Mired, calculated by multiplying the inverse of the color temperature by 10^6 , is a measure of color temperature that takes such variation into account, and as such is the unit used in color-temperature compensation filters. E.g.:

- 4000 K–3000 K (a difference of 1000 K)=83 mired
- 7000 K–6000 K (a difference of 1000 K)=24 mired

Preset Manual

Preset manual is used to record and recall custom white balance settings for shooting under mixed lighting or to compensate for light sources with a strong color cast. Two methods are available for setting preset white balance:

Method	Description
Measure	Neutral gray or white object is placed under lighting that will be used in final photo and white balance measured by camera (see below).
Use photo	White balance is copied from photo on memory card (☐ 146).

■ Measuring a Value for Preset White Balance

1 Light a reference object.

Place a neutral gray or white object under the lighting that will be used in the final photograph.

- #### 2 Display white balance options.
- Highlight **White balance** in the shooting menu and press \odot to display white balance options. Highlight **Preset manual** and press \odot .

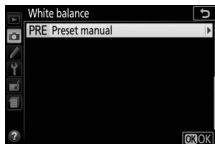

3 Select Measure.

Highlight **Measure** and press \odot .

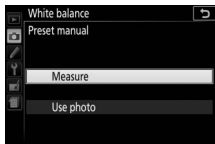

4 Select Yes.

The menu shown at right will be displayed; highlight **Yes** and press **OK**.

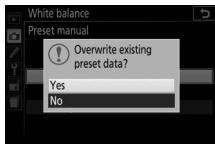

The camera will enter preset measurement mode.

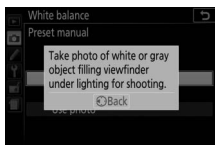

When the camera is ready to measure white balance, a flashing **P r E** (PRE) will appear in the viewfinder and information display.



5 Measure white balance.

Before the indicators stop flashing, frame the reference object so that it fills the viewfinder and press the shutter-release button all the way down. No photograph will be recorded; white balance can be measured accurately even when the camera is not in focus.



6 Check the results.

If the camera was able to measure a value for white balance, the message shown at right will be displayed and **ūd** will flash in the viewfinder and the camera will return to shooting mode. To return to shooting mode immediately, press the shutter-release button halfway.

If lighting is too dark or too bright, the camera may be unable to measure white balance. A message will appear in the information display and a flashing **no ūd** will appear in the viewfinder. Return to Step 5 and measure white balance again.



✔ Measuring Preset White Balance

If no operations are performed while the displays are flashing, direct measurement mode will end in the time selected for Custom Setting c2 (**Auto off timers**; □ 253).

✔ Preset White Balance

The camera can store only one value for preset white balance at a time; the existing value will be replaced when a new value is measured.

Note that exposure is automatically increased by 1 EV when measuring white balance; when shooting in mode **M**, adjust exposure so that the exposure indicator shows ± 0 (□ 120).

✔ Other Methods for Measuring Preset White Balance

To enter preset measurement mode (see above) after selecting preset white balance in the information display (□ 137), press **OK** for a few seconds. If white balance has been assigned to the **Fn** button (□ 265), white balance preset measurement mode can be activated by keeping the **Fn** button pressed for a few seconds after selecting preset white balance with the **Fn** button and command dial.

✔ Gray Panels

For more precise results, measure white balance using a standard gray panel.

■ Copying White Balance from a Photograph

Follow the steps below to copy a value for white balance from a photograph on the memory card.

1 Select Preset manual.

Highlight **White balance** in the shooting menu and press \odot to display white balance options. Highlight **Preset manual** and press \odot .

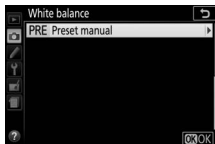

2 Select Use photo.

Highlight **Use photo** and press \odot .

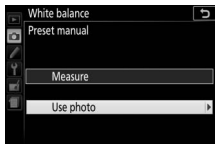

3 Choose Select image.

Highlight **Select image** and press \odot (to skip the remaining steps and use the image last selected for preset white balance, select **This image**).



4 Choose a folder.

Highlight the folder containing the source image and press \odot .

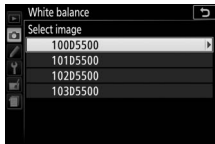

5 Highlight the source image.

To view the highlighted image full frame, press and hold the  button.



6 Copy white balance.

Press  to set preset white balance to the white balance value for the highlighted photograph.

Bracketing

Bracketing automatically varies exposure, white balance, or Active D-Lighting (ADL) settings slightly with each shot, “bracketing” the current value. Choose in situations in which it is difficult to set exposure or white balance and there is not time to check results and adjust settings with each shot, or to experiment with different settings for the same subject.

Option	Description
AE AE bracketing	Vary exposure over a series of three photographs.  <i>Shot 1: unmodified</i> <i>Shot 2: exposure reduced</i> <i>Shot 3: exposure increased</i>
WB WB bracketing	Each time the shutter is released, the camera creates three images, each with a different white balance. Not available with image qualities of NEF (RAW).
ADL ADL bracketing	Take one photo with Active D-Lighting off, and another at the current Active D-Lighting setting.

1 Choose a bracketing option.

Highlight e2 (Auto bracketing set) in the Custom Settings menu and press .

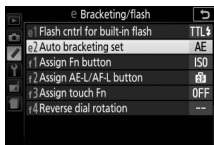

Highlight the desired bracketing type and press .

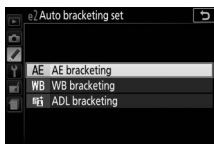

2 Display bracketing options.

Press the **i** button, then highlight the current bracketing setting and press **OK**.

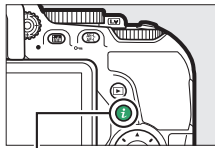

i button



Information display

3 Select a bracketing increment.

Highlight a bracketing increment and press **OK**. Choose from values between 0.3 and 2 EV (AE bracketing) or 1 to 3 (WB bracketing), or select **ADL** (ADL bracketing).

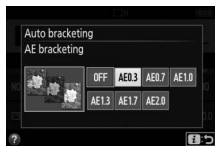

4 Frame a photograph, focus, and shoot.



AE bracketing: The camera will vary exposure with each shot. The first shot will be taken at the value currently selected for exposure compensation. The bracketing increment will be subtracted from the current value in the second shot and added in the third shot, “bracketing” the current value. The modified values are reflected in the values shown for shutter speed and aperture.

WB bracketing: Each shot is processed to create three copies, one at the current white balance setting, one with increased amber, and one with increased blue.

ADL bracketing: The first shot after bracketing is activated is taken with Active D-Lighting off, the second at the current Active D-Lighting setting (📖 133; if Active D-Lighting is off, the second shot will be taken with Active D-Lighting set to **Auto**).

In continuous high-speed and continuous low-speed release modes, shooting will pause after each bracketing cycle. If the camera is turned off before all shots in the bracketing sequence have been taken, bracketing will resume from the next shot in the sequence when the camera is turned on.

The Bracketing Progress Indicator

During AE bracketing, a bar is removed from the bracketing progress indicator with each shot (-1, 0, +1 > -1, 0, +1 > -1, 0, +1).

During ADL bracketing, the setting that will be used for the next shot is underlined in the information display.



Disabling Bracketing

To disable bracketing and resume normal shooting, select **OFF** in Step 3 (□ 149). Bracketing can also be cancelled by performing a two-button reset (□ 110). To cancel bracketing before all frames have been recorded, rotate the mode dial to a setting other than **P**, **S**, **A**, or **M**.

Exposure Bracketing







The camera modifies exposure by varying shutter speed and aperture (mode **P**), aperture (mode **S**), or shutter speed (modes **A** and **M**). If auto ISO sensitivity control is enabled, the camera will automatically vary ISO sensitivity for optimum exposure when the limits of the camera exposure system are exceeded.

Picture Controls

In **P**, **S**, **A**, and **M** modes, your choice of Picture Control determines how pictures are processed (in other modes, the camera selects a Picture Control automatically).

Selecting a Picture Control

Choose a Picture Control according to the subject or type of scene.

Option	Description
 SD Standard	Recommended for most situations, this option uses standard processing for balanced results.
 NL Neutral	A good choice for photographs that will later be processed or retouched, this option uses minimal processing for natural results.
 VI Vivid	Choose this option for photographs that emphasize primary colors. Pictures are enhanced for a vivid, photoprint effect.
 MC Monochrome	Take monochrome photographs.
 PT Portrait	Process portraits for skin with natural texture and a rounded feel.
 LS Landscape	Produces vibrant landscapes and cityscapes.
 FL Flat	Choose for photographs that will later be extensively processed or retouched. Details are preserved over a wide tone range, from highlights to shadows.

-
- 1 Display Picture Control options.**
Press the **i** button, then highlight the current Picture Control and press **OK**.

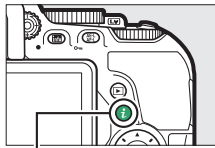

i button



Information display

-
- 2 Select a Picture Control.**
Highlight a Picture Control and press **OK**.



Touch Menu Navigation

Picture Controls can also be selected in the shooting menu (□ 236). When choosing an option from the **Set Picture Control** menu using the touch screen (□ 26), tap the option once to highlight it and again to select it.

Modifying Picture Controls

Existing preset or custom Picture Controls (📖 158) can be modified to suit the scene or the user's creative intent. Choose a balanced combination of settings using **Quick adjust**, or make manual adjustments to individual settings.

1 Select a Picture Control.

Highlight **Set Picture Control** in the shooting menu and press **Q**. Highlight the desired Picture Control and press **Q**.

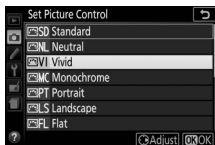

2 Adjust settings.

Press **Q** or **Q** to highlight the desired setting and press **Q** or **Q** to choose a value in increments of 1, or rotate the command dial to choose a value in increments of 0.25 (📖 155). Repeat this step until all settings have been adjusted, or select a preset combination of settings by using the multi selector to choose **Quick adjust**. Default settings can be restored by pressing the **Reset** button.



3 Save changes and exit.

Press **OK**.

Picture Controls that have been modified from default settings are indicated by an asterisk ("*").



Picture Control Settings

Option	Description	
Quick adjust	Mute or heighten the effect of the selected Picture Control (note that this resets all manual adjustments). Not available with Neutral , Monochrome , Flat , or custom Picture Controls (□ 158).	
Manual adjustments (all Picture Controls)	Sharpening	Control the sharpness of outlines. Select A to adjust sharpening automatically according to the type of scene.
	Clarity	Adjust clarity manually or select A to let the camera adjust clarity automatically. Depending on the scene, shadows may appear around bright objects or halos may appear around dark objects at some settings. Clarity is not applied to movies.
	Contrast	Adjust contrast manually or select A to let the camera adjust contrast automatically.
	Brightness	Raise or lower brightness without loss of detail in highlights or shadows.
Manual adjustments (non-monochrome only)	Saturation	Control the vividness of colors. Select A to adjust saturation automatically according to the type of scene.
	Hue	Adjust hue.
Manual adjustments (monochrome only)	Filter effects	Simulate the effect of color filters on monochrome photographs (□ 157).
	Toning	Choose the tint used in monochrome photographs (□ 157).

✔ "A" (Auto)



Results for auto sharpening, clarity, contrast, and saturation vary with exposure and the position of the subject in the frame.

✔ Switching Between Manual and Auto

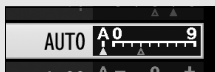
Press the  button to switch back and forth between manual and auto (A) settings for sharpening, clarity, contrast, and saturation.



✔ Custom Picture Controls

Custom Picture Controls are created through modifications to existing Picture Controls using the **Manage Picture Control** option in the shooting menu ( 158) and can be saved to a memory card for sharing among other cameras of the same model and compatible software ( 161).

✔ Previous Settings

The  indicator under the value display in the Picture Control setting menu indicates the previous value for the setting. Use this as a reference when adjusting settings.



✔ Custom Picture Control Options

The options available with custom Picture Controls are the same as those on which the custom Picture Control was based.

✔ Using the Touch Screen

To use the touch screen to modify a Picture Control in the **Set Picture Control** menu, tap the Picture Control once to highlight it and then tap the  **Adjust** button to view the menu shown in Step 2 on page 154. Tap a parameter once to highlight it and again to display options, then use the on-screen controls to choose a value (the multi selector can not be used). Note that the touch screen can only be used for this purpose if **Enable** is selected for **Touch controls**.



Filter Effects (Monochrome Only)

The options in this menu simulate the effect of color filters on monochrome photographs. The following filter effects are available:

Option		Description
Y	Yellow	Enhances contrast. Can be used to tone down the brightness of the sky in landscape photographs.
O	Orange	
R	Red	Orange produces more contrast than yellow, red more contrast than orange.
G	Green	Softens skin tones. Can be used for portraits.

Note that the effects achieved with **Filter effects** are more pronounced than those produced by physical glass filters.

Toning (Monochrome Only)

Pressing \odot when **Toning** is selected displays saturation options. Press \odot or \odot to adjust saturation in increments of 1, or rotate the command dial to choose a value in increments of 0.25. Saturation control is not available when **B&W** (black-and-white) is selected.

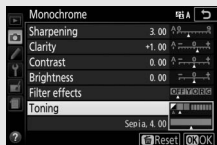

Touch-Screen Character Entry

To type, tap the letters in the keyboard area (you can select letters by sliding a finger over the screen: the letters are highlighted as you touch them and are not entered in the text area until you lift your finger). To position the cursor, tap directly in the text area or tap the \blacktriangleleft or \blacktriangleright buttons.

Creating Custom Picture Controls

The Picture Controls supplied with the camera can be modified and saved as custom Picture Controls.

1 Select Manage Picture Control.

Highlight **Manage Picture Control** in the shooting menu and press .



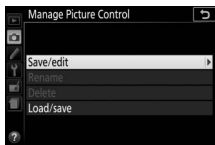

2 Select Save/edit.

Highlight **Save/edit** and press .



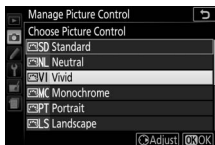

3 Select a Picture Control.

Highlight an existing Picture Control and press , or press  to proceed to Step 5 to save a copy of the highlighted Picture Control without further modification.



4 Edit the selected Picture Control.

See page 155 for more information. To abandon any changes and start over from default settings, press the  button. Press  when settings are complete.





5 Select a destination.

Highlight a destination for the custom Picture Control (C-1 through C-9) and press .



6 Name the Picture Control.

By default, new Picture Controls are named by adding a two-digit number (assigned automatically) to the name of the existing Picture Control; to use the default name, proceed to Step 7. To move the cursor in the name area, rotate the command dial. To enter a new letter at the current cursor position, use the multi selector to highlight the desired character in the keyboard area and press . To delete the character at the current cursor position, press the  button.

Custom Picture Control names can be up to nineteen characters long. Any characters after the nineteenth will be deleted.



Keyboard area

7 Press .

Press  to save changes and exit. The new Picture Control will appear in the Picture Control list.



Manage Picture Control > Rename

Custom Picture Controls can be renamed at any time using the **Rename** option in the **Manage Picture Control** menu.

Manage Picture Control > Delete

The **Delete** option in the **Manage Picture Control** menu can be used to delete selected custom Picture Controls when they are no longer needed.

The Original Picture Control Icon

The original preset Picture Control on which the custom Picture Control is based is indicated by an icon in the top right corner of the edit display.

*Original
Picture Control icon*



Sharing Custom Picture Controls

Custom Picture Controls created using Picture Control Utility 2, a utility launched from ViewNX 2 or Capture NX-D (☞ 210), can be copied to a memory card and loaded into the camera, or custom Picture Controls created with the camera can be copied to the memory card to be used in compatible cameras and software and then deleted when no longer needed.

To copy custom Picture Controls to or from the memory card, or to delete custom Picture Controls from the memory card, highlight **Load/Save** in the **Manage Picture Control** menu and press \odot . The following options will be displayed:

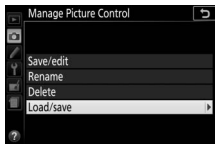

- **Copy to camera:** Copy custom Picture Controls from the memory card to custom Picture Controls C-1 through C-9 on the camera and name them as desired.
- **Delete from card:** Delete selected custom Picture Controls from the memory card.
- **Copy to card:** Copy a custom Picture Control (C-1 through C-9) from the camera to a selected destination (1 through 99) on the memory card.

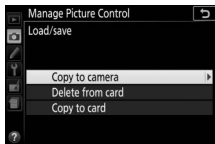

Saving Custom Picture Controls

Up to 99 custom Picture Controls can be stored on the memory card at any one time. The memory card can only be used to store user-created custom Picture Controls. The preset Picture Controls supplied with the camera can not be copied to the memory card, renamed, or deleted.

Live View

Framing Photographs in the Monitor

Follow the steps below to take photographs in live view.

- 1 Rotate the live view switch.**
The view through the lens will be displayed in the monitor.

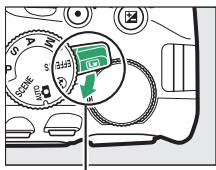

Live view switch

- 2 Position the focus point.**
Use the multi selector to position the focus point over your subject as described on page 167.

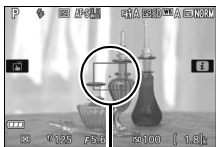

Focus point

- 3 Focus.**
Press the shutter-release button halfway. The focus point will flash green while the camera focuses. If the camera is able to focus, the focus point will be displayed in green; if the camera is unable to focus, the focus point will flash red (note that pictures can be taken even when the focus point flashes red; check focus in the monitor before shooting). Except in **AUTO** and **AE-L/AF-L** modes, exposure can be locked by pressing the **AE-L/AF-L** (**OK**) button.



4 Take the picture.

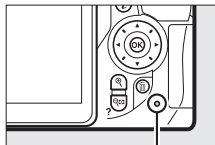

Press the shutter-release button the rest of the way down. The monitor turns off and the memory card access lamp lights during recording. *Do not remove*



Memory card access lamp

the battery or memory card until recording is complete. When shooting is complete, the photograph will be displayed in the monitor for a few seconds before the camera returns to live view mode. To exit, rotate the live view switch.

Live View Zoom Preview

Press the  button to zoom in on the selected focus point to a maximum magnification of about 8.3x. A navigation window will appear in a gray frame at the bottom right corner of the display. Use the multi selector to reposition the focus point or press  (?) to zoom out. To cancel zoom, press .

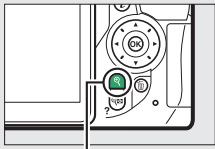

 button







Navigation window

Focusing in Live View



Follow the steps below to choose focus and AF-area modes and position the focus point.

■ Choosing How the Camera Focuses (Focus Mode)

The following focus modes are available in live view (note that full-time-servo AF is not available in , , and  modes):

Option	Description
AF-S Single-servo AF	For stationary subjects. Focus locks when shutter-release button is pressed halfway.
AF-F Full-time-servo AF	For moving subjects. Camera focuses continuously until shutter-release button is pressed. Focus locks when shutter-release button is pressed halfway.
MF Manual focus	Focus manually ( 165).

1 Display focus options.

Press the  button, then highlight the current focus mode in the information display and press .

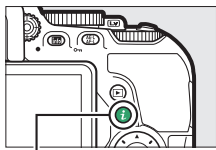

 button

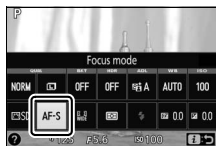

Information display

- 2 Choose a focus option.**
Highlight an option and press **OK**.

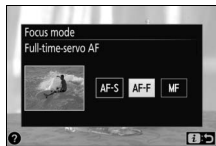

Manual Focus

To focus in manual focus mode (☞ 88), rotate the lens focus ring until the subject is in focus.

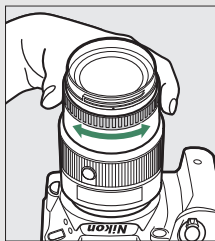



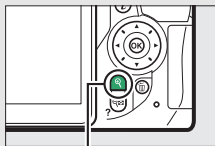

To magnify the view in the monitor for precise focus, press the **Q** button (☞ 163).



Q button

■ Choosing How the Camera Picks the Area (AF-Area Mode)

In modes other than **AUTO**, **☺**, and **☺**, the following AF-area modes can be selected in live view (note that subject-tracking AF is not available in **☺**, **☺**, **☺**, and **☺** modes):

Option	Description
 Face-priority AF	Use for portraits. The camera automatically detects and focuses on portrait subjects.
 Wide-area AF	Use for hand-held shots of landscapes and other non-portrait subjects. Use the multi-selector to select the focus point.
 Normal-area AF	Use for pin-point focus on a selected spot in the frame. A tripod is recommended.
 Subject-tracking AF	Use if you want focus to track a selected subject.

1 Display AF-area modes.

Press the **i** button, then highlight the current AF-area mode in the information display and press **OK**.

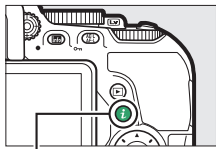

i button



Information display

- 2 Choose an AF-area mode.**
Highlight an option and press **OK**.

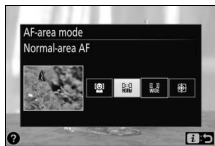

- 3 Choose the focus point.**

Face-priority AF: A double yellow border will be displayed when the camera detects a portrait subject (if multiple faces are detected, the camera will focus on the closest subject; to choose a different subject, use the multi selector). If the camera can no longer detect the subject (because, for example, the subject has turned to face away from the camera), the border will no longer be displayed.



Focus point

Wide- and normal-area AF: Use the multi selector to move the focus point anywhere in the frame, or press **OK** to position the focus point in the center of the frame.



Focus point

Subject-tracking AF: Position the focus point over your subject and press **OK**. The focus point will track the selected subject as it moves through the frame. To end focus tracking, press **OK** a second time.



Focus point

The Live View Display



Item	Description	
① Shooting mode	The mode currently selected with the mode dial.	38, 54, 61, 113
② Manual movie settings indicator	Displayed when On is selected for Manual movie settings in mode M .	179
③ Time remaining	The amount of time remaining before live view ends automatically. Displayed if shooting will end in 30 s or less.	172, 180
④ Wind noise reduction	Displayed when On is selected for Movie settings > Wind noise reduction in the shooting menu.	178
⑤ Microphone sensitivity	Microphone sensitivity for movie recording.	178
⑥ Sound level	Sound level for audio recording. Displayed in red if level is too high; adjust microphone sensitivity accordingly.	178

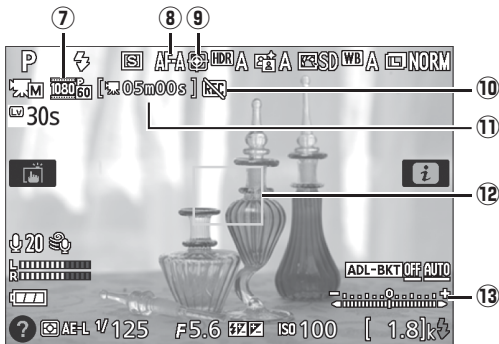

Item	Description	
7 Movie frame size	The frame size of movies recorded in movie mode.	177
8 Focus mode	The current focus mode.	164
9 AF-area mode	The current AF-area mode.	166
10 “No movie” icon	Indicates that movies can not be recorded.	—
11 Time remaining (movie mode)	The recording time remaining in movie mode.	175
12 Focus point	The current focus point. The display varies with the option selected for AF-area mode (□ 166).	167
13 Exposure indicator	Indicates whether the photograph would be under- or over-exposed at current settings (mode M only).	120

Note: Display shown with all indicators lit for illustrative purposes.

Live View/Movie Recording Display Options

Press the **info** button to cycle through display options as shown below. Circled areas indicate edges of movie frame crop.

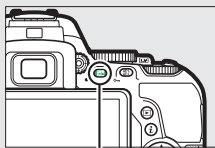

info button



Show detailed photo indicators



Show movie indicators
( 174) *



Show basic photo indicators *

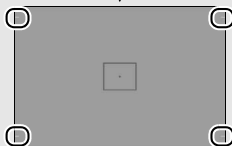

Hide indicators *

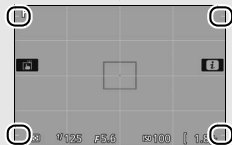

Framing grid *

* A crop showing the area recorded is displayed during movie recording when frame sizes other than 640 × 424 are selected for **Movie settings > Frame size/frame rate** in the shooting menu ( 177; the area outside the movie frame crop is grayed out when movie indicators are displayed).

Camera Settings

Except when movie indicators are displayed, you can access the following live view photography settings by pressing the **i** button: image quality (☞ 90), image size (☞ 92), bracketing increment (☞ 149), HDR (☞ 135), Active D-Lighting (☞ 133), white balance (☞ 137), ISO sensitivity (☞ 99), Picture Controls (☞ 152), focus mode (☞ 164), AF-area mode (☞ 166), metering (☞ 125), flash mode (☞ 94, 96), flash compensation (☞ 131), and exposure compensation (☞ 129). When movie indicators are displayed, movie settings can be adjusted (☞ 178).

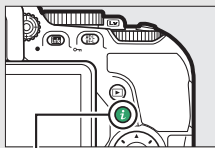

i button



Information display

Exposure

Depending on the scene, exposure may differ from that which would be obtained when live view is not used. Metering in live view is adjusted to suit the live view display, producing photographs with exposure close to what is seen in the monitor (note that exposure compensation can only be previewed in the monitor at values between +3 EV and -3 EV). To prevent light entering via the viewfinder from appearing in the photograph or interfering with exposure, we recommend that you cover the viewfinder with your hand or other objects such as an optional eyepiece cap (☞ 331) before taking pictures without your eye to the viewfinder (☞ 76).

HDMI

When the camera is attached to an HDMI video device, the video device will display the view through the lens. If the device supports HDMI-CEC, select **Off** for the **HDMI > Device control** option in the setup menu (☞ 223) before shooting in live view.

✔ Shooting in Live View Mode

Although it will not appear in the final picture, distortion may be visible in the monitor if the camera is panned horizontally or an object moves at high speed through frame. Bright light sources may leave after-images in the monitor when the camera is panned. Bright spots may also appear. Flicker and banding visible in the monitor under fluorescent, mercury vapor, or sodium lamps can be reduced using **Flicker reduction** (☞ 281), although they may still be visible in the final photograph at some shutter speeds. When shooting in live view mode, avoid pointing the camera at the sun or other strong light sources. Failure to observe this precaution could result in damage to the camera's internal circuitry.

Live view ends automatically when the monitor is closed (closing the monitor does not end live view on televisions or other external displays).

✔ The Count Down Display

A count down will be displayed 30 s before live view ends automatically (☞ 168; the timer turns red 5 s before the auto off timer expires (☞ 253) or if live view is about to end to protect the internal circuits). Depending on shooting conditions, the timer may appear immediately when live view is selected.

✔ Using Autofocus in Live View

Autofocus is slower in live view and the monitor may brighten or darken while the camera focuses. The camera may be unable to focus in the situations listed below (note that the focus point may sometimes be displayed in green when the camera is unable to focus):

- The subject contains lines parallel to the long edge of the frame
- The subject lacks contrast
- The subject in the focus point contains areas of sharply contrasting brightness, or the subject is lit by spot lighting or by a neon sign or other light source that changes in brightness
- Flicker or banding appears under fluorescent, mercury-vapor, sodium-vapor, or similar lighting
- A cross (star) filter or other special filter is used
- The subject appears smaller than the focus point
- The subject is dominated by regular geometric patterns (e.g., blinds or a row of windows in a skyscraper)
- The subject is moving

In addition, the subject-tracking AF may be unable to track subjects if they move quickly, leave the frame or are obscured by other objects, change visibly in size, color, or brightness, or are too small, too large, too bright, too dark, or similar in color or brightness to the background.

Recording and Viewing Movies

Recording Movies

Movies can be recorded in live view mode.

1 Rotate the live view switch.

The view through the lens will be displayed in the monitor.

✓ The Icon

A  icon ([book icon 169](#)) indicates that movies can not be recorded.

✓ Before Recording

Set aperture before recording in mode **A** or **M** ([book icon 118, 119](#)).

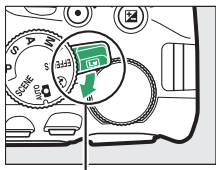

Live view switch

2 Focus.

Frame the opening shot and focus as described in Steps 2 and 3 of “Framing Photographs in the Monitor” ([book icon 162](#); see also “Focusing in Live View” on pages [book icon 164–167](#)). Note that the number of subjects that can be detected in face-priority AF drops during movie recording.



3 Start recording.

Press the movie-record button to start recording. A recording indicator and the time available are displayed in the monitor. Except in **AUTO** and **AF-L** modes, exposure can be locked by pressing the **AE-L/AF-L** (**OK**) button (☞ 127) or (in modes **SCENE**, **P**, **S**, **A**, and **AF**) altered by up to ± 3 EV in steps of $1/3$ EV by pressing the **AE-L/AF-L** (**OK**) button and rotating the command dial (☞ 129; note that depending on the brightness of the subject, changes to exposure may have no visible effect).

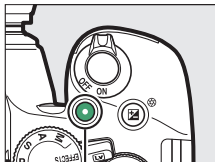

Movie-record button

Time remaining



Recording indicator

4 End recording.

Press the movie-record button again to end recording. Recording will end automatically when the maximum length is reached, the memory card is full, another mode is selected, or the monitor is closed (closing the monitor does not end recording on televisions or other external displays).

✓ Taking Photographs During Movie Recording

To end movie recording, take a photograph, and exit to live view, press the shutter-release button all the way down and hold it in this position until the shutter is released. The touch shutter (☞ 21) can not be used to take photos during movie recording.

✓ Maximum Length

The maximum length for individual movie files is 4 GB (for maximum recording times, see page 177); note that depending on memory card write speed, shooting may end before this length is reached (☞ 334).

✔ Recording Movies

Flicker, banding, or distortion may be visible in the monitor and in the final movie under fluorescent, mercury vapor, or sodium lamps or if the camera is panned horizontally or an object moves at high speed through frame (flicker and banding can be reduced using **Flicker reduction**;  281). Bright light sources may leave after-images when the camera is panned. Jagged edges, color fringing, moiré, and bright spots may also appear. Bright regions or bands may appear in some areas of the frame if the subject is briefly illuminated by a flash or other bright, momentary light source. When recording movies, avoid pointing the camera at the sun or other strong light sources. Failure to observe this precaution could result in damage to the camera's internal circuitry.

The camera can record both video and sound; do not cover the microphone ( 2) during recording. Note that the built-in microphone may record sounds made by the camera or lens during autofocus and vibration reduction.









Flash lighting can not be used during movie recording.

Matrix metering is used regardless of the metering method selected. Shutter speed and ISO sensitivity are adjusted automatically unless **On** is selected for **Manual movie settings** ( 179) and the camera is in mode **M**.

Movie Settings

Use the **Movie settings** option in the shooting menu (☞ 236) to adjust the following settings.



- **Frame size/frame rate, Movie quality:** Choose from the following options. The frame rate depends on the option currently selected for **Video mode** in the setup menu (☞ 281):

Frame size/frame rate		Maximum length (high movie quality ★/ normal movie quality) ⁴		
Frame size (pixels)	Frame rate ¹			
    	1920 × 1080	60p ² 50p ³ 30p ² 25p ³ 24p	10 min./ 20 min. 20 min./ 29 min. 59 s	
	 	1280 × 720	60p ² 50p ³	
		 	640 × 424	30p ² 25p ³

- 1 Listed value. Actual frame rates for 60p, 50p, 30p, 25p, and 24p are 59.94, 50, 29.97, 25, and 23.976 fps respectively.
- 2 Available when **NTSC** is selected for **Video mode** (☞ 281).
- 3 Available when **PAL** is selected for **Video mode**.
- 4 Movies recorded in miniature effect mode are up to three minutes long when played back.

- **Microphone:** Turn the built-in or optional stereo microphones (□ 180, 333) on or off or adjust microphone sensitivity. Choose **Auto sensitivity** to adjust sensitivity automatically, **Microphone off** to turn sound recording off; to select microphone sensitivity manually, select **Manual sensitivity** and choose a sensitivity.
- **Wind noise reduction:** Select **On** to enable the low-cut filter for the built-in microphone (optional stereo microphones are unaffected; □ 180, 333), reducing noise produced by wind blowing over the microphone (note that other sounds may also be affected). Wind-noise reduction for optional stereo microphones can be enabled or disabled using microphone controls.

The Live View Display

The movie crop can be viewed during live view by pressing the  button to select the “show movie indicators”, “hide indicators”, “framing grid”, or “show basic photo indicators” display (□ 170). When movie indicators are displayed, you can access the following movie settings by pressing the  button: movie frame size/quality, microphone sensitivity, white balance (□ 137), Picture Controls (□ 152), focus mode (□ 164), AF-area mode (□ 166), wind noise reduction, and exposure compensation (□ 129). If **On** is selected for **Movie settings > Manual movie settings** (□ 177) in mode **M**, ISO sensitivity (□ 99) can be adjusted in place of exposure compensation.

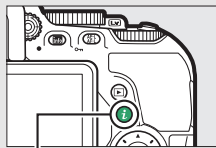

i button



Information display



- **Manual movie settings:** Choose **On** to allow manual adjustments to shutter speed and ISO sensitivity when the camera is in mode **M**. Shutter speed can be set to values as fast as $1/4000$ s; the slowest speed available varies with the frame rate: $1/30$ s for frame rates of 24p, 25p, and 30p, $1/50$ s for 50p, and $1/60$ s for 60p. If shutter speed is not in this range when live view starts, it will automatically be set to a supported value, and remain at this value when live view ends. Note that ISO sensitivity is fixed at the value selected; the camera does not adjust ISO sensitivity automatically when **On** is selected for **ISO sensitivity settings > Auto ISO sensitivity control** in the shooting menu (📖 241).

1 Select Movie settings.

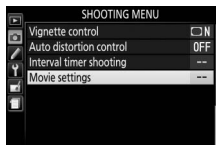
Highlight **Movie settings** in the shooting menu and press .



2 Choose movie options.

Highlight the desired item and press , then highlight an option and press .

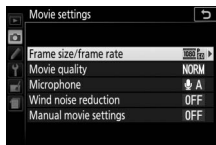

Using an External Microphone

The optional ME-1 stereo microphone can be used to reduce noise caused by lens vibration being recorded during autofocus.



The Count-Down Display

A count down will be displayed 30 s before movie recording ends automatically (☐ 168). Depending on shooting conditions, the timer may appear immediately when movie recording begins. Note that regardless of the amount of recording time available, live view will still end automatically when the timer expires. Wait for the internal circuits to cool before resuming movie recording.

HDMI





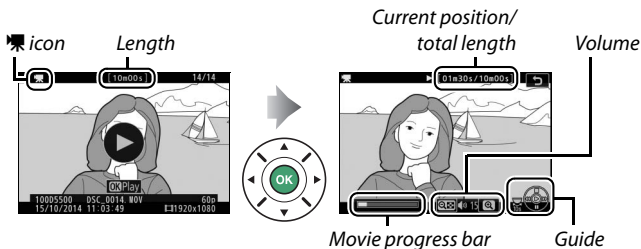

When the camera is attached to an HDMI video device, the video device will display the view through the lens. If the device supports HDMI-CEC, select **Off** for the **HDMI > Device control** option in the setup menu (☐ 223) before shooting in live view.









Viewing Movies

Movies are indicated by a  icon in full-frame playback ( 188). Press  to start playback; your current position is indicated by the movie progress bar.





The following operations can be performed:

To	Use	Description
Pause		Pause playback.
Play		Resume playback when movie is paused or during rewind/advance.
Advance/ rewind		Speed increases with each press, from 2x to 4x to 8x to 16x; keep pressed to skip to beginning or end of movie (first frame is indicated by  in top right corner of monitor, last frame by ). If playback is paused, movie rewinds or advances one frame at a time; hold for continuous rewind or advance.
Skip 10 s		Rotate the command dial one stop to skip ahead or back 10 s.

To	Use	Description
Adjust volume	 /  (?)	Press  to increase volume,  (?) to decrease.
Return to full-frame playback	 / 	Press  or  to exit to full-frame playback.

Editing Movies

Trim footage to create edited copies of movies or save selected frames as JPEG stills.

Option	Description
 Choose start/end point	Create a copy from which the opening or closing footage has been removed.
 Save selected frame	Save a selected frame as a JPEG still.

Trimming Movies

To create trimmed copies of movies:

1 Display a movie full frame.

2 Pause the movie on the new opening or closing frame.

Play the movie back as described on page 181, pressing **OK** to start and resume playback and **⏸** to pause. Pause playback when you reach the new opening or closing frame.



Movie progress bar

3 Select **Choose start/end point**.

Press the **i** button, then highlight **Choose start/end point** and press **⏵**.

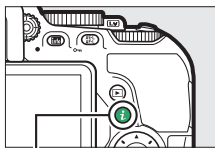

i button



4 Choose the current frame as the new start or end point.

To create a copy that begins from the current frame, highlight **Start point** and press **OK**. The frames before the current frame will be removed when you save the copy.

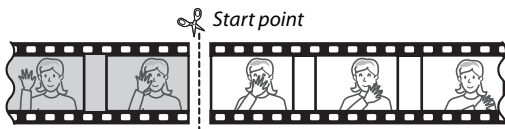
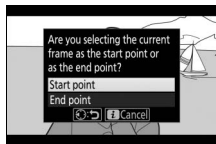

To create a copy that ends at the current frame, highlight **End point** and press **OK**. The frames after the current frame will be removed when you save the copy.

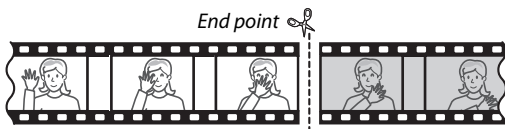

5 Confirm the new start or end point.

If the desired frame is not currently displayed, press **⏪** or **⏩** to advance or rewind (to skip to 10 s ahead or back, rotate the command dial one stop).



6 Create the copy.

Once the desired frame is displayed, press **⏸**.

7 Preview the movie.

To preview the copy, highlight **Preview** and press \odot (to interrupt the preview and return to the save options menu, press \odot). To abandon the current copy and return to Step 5, highlight **Cancel** and press \odot ; to save the copy, proceed to Step 8.

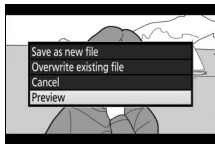

8 Save the copy.

Highlight **Save as new file** and press \odot to save the copy to a new file. To replace the original movie file with the edited copy, highlight **Overwrite existing file** and press \odot .



✓ Trimming Movies

Movies must be at least two seconds long. The copy will not be saved if there is insufficient space available on the memory card.

Copies have the same time and date of creation as the original.

✓ Choosing the Role of the Current Frame

To make the frame displayed in Step 5 the new end point (▮) instead of the new start point (▮) or vice versa, press the AE-L/AF-L (\odot) button.



AE-L/AF-L (\odot) button

Saving Selected Frames

To save a copy of a selected frame as a JPEG still:

- 1 Pause the movie on the desired frame.**

Play the movie back as described on page 181, pressing **OK** to start and resume playback and **STOP** to pause. Pause the movie at the frame you intend to copy.



- 2 Choose Save selected frame.**
Press the **i** button, then highlight **Save selected frame** and press **OK**.

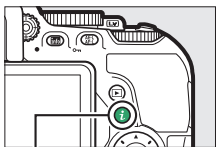

i button



- 3 Create a still copy.**
Press **OK** to create a still copy of the current frame.



4 Save the copy.

Highlight **Yes** and press **OK** to create a fine-quality (📖 90) JPEG copy of the selected frame.

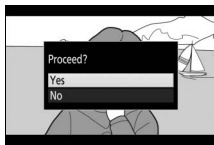

Save Selected Frame

JPEG movie stills created with the **Save selected frame** option can not be retouched. JPEG movie stills lack some categories of photo information (📖 192).

Playback and Deletion

Viewing Pictures





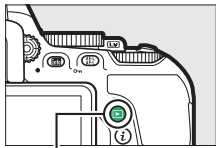







Full-Frame Playback

To play photographs back, press the  button. The most recent photograph will be displayed in the monitor.







 button



To	Use	Description
View additional photographs		Press  to view photographs in order recorded,  to view photographs in reverse order.
View additional photo info		Press  or  to view information about current photograph ( 192).
Return to shooting mode		Press the  button or press the shutter-release button halfway to exit to shooting mode.
Play movie		If current picture is marked with  icon to show that it is a movie, pressing  starts movie playback ( 181).

The **i** Button

Pressing the **i** button in full-frame, thumbnail, or calendar playback displays playback options. Highlight options and press  to rate pictures ( 203), retouch photos or edit movies ( 183, 286), or select pictures for transfer to a smart device ( 231).

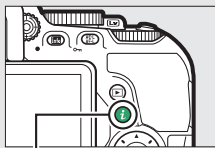





i button



Thumbnail Playback

To display images in “contact sheets” of 4, 12, or 80 images, press the  (?) button.

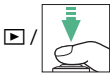

To	Use	Description
Highlight images		Use multi selector or command dial to highlight pictures.
View highlighted image		Press  to display the highlighted image full frame.
Return to shooting mode		Press the  button or press the shutter-release button halfway to exit to shooting mode.

Calendar Playback

To view images taken on a selected date, press the  (?) button when 80 images are displayed.

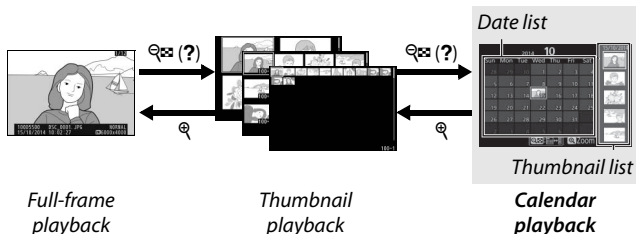

The operations that can be performed depend on whether the cursor is in the date list or the thumbnail list:













To	Use	Description
Toggle between date list and thumbnail list	 (?)	Press  (?) or  button in date list to place cursor in thumbnail list. Press  (?) again to return to date list.
		
Exit to thumbnail playback/Zoom in on highlighted photo		<ul style="list-style-type: none"> • Date list: Exit to 80-frame playback. • Thumbnail list: Press and hold  button to zoom in on highlighted picture.
Highlight dates/Highlight images		<ul style="list-style-type: none"> • Date list: Highlight date. • Thumbnail list: Highlight picture.
Toggle full frame playback		<ul style="list-style-type: none"> • Thumbnail list: View highlighted picture.
Return to shooting mode	 / 	Press the  button or press the shutter-release button halfway to exit to shooting mode.

Photo Information

Photo information is superimposed on images displayed in full-frame playback. Press or to cycle through photo information as shown below. Note that “image only”, shooting data, RGB histograms, highlights, and overview data are only displayed if corresponding option is selected for **Playback display options** (☐ 234). Location data are only displayed if an optional GP-1/GP-1A was used when the photo was taken (☐ 283).



File Information

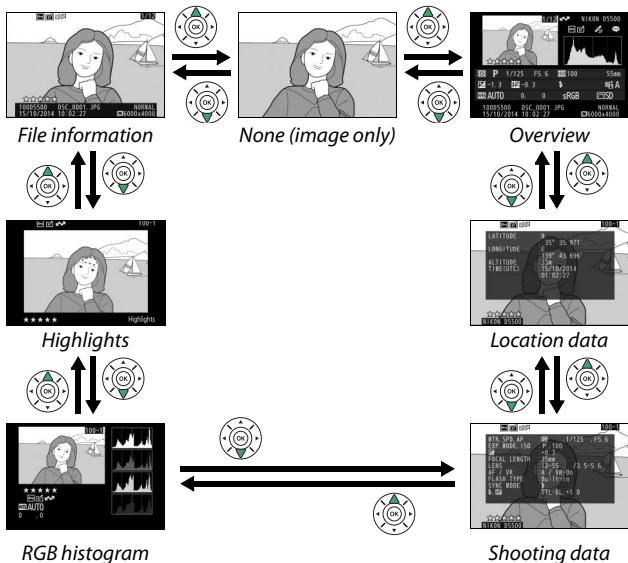
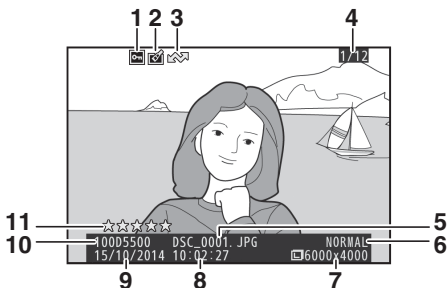

1 Protect status.....	202	7 Image size	92
2 Retouch indicator	289	8 Time of recording.....	32, 275
3 Upload marking.....	231	9 Date of recording	32, 275
4 Frame number/total number of images		10 Folder name	238
5 File name.....	240	11 Rating	203
6 Image quality	90		

Highlights*



1 Folder number—frame number.....	238	2 Image highlights
--	-----	---------------------------

* Flashing areas indicate highlights (areas that may be overexposed).

■ RGB Histogram

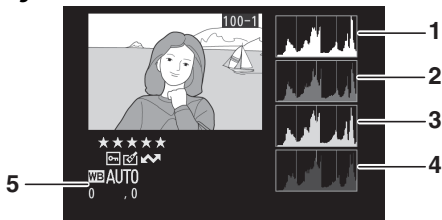

1 Histogram (RGB channel). In all histograms, horizontal axis gives pixel brightness, vertical axis number of pixels.



2 Histogram (red channel)

3 Histogram (green channel)

4 Histogram (blue channel)

5 White balance 137
White balance
fine-tuning..... 140
Preset manual 142

Playback Zoom

To zoom in on the photograph when the histogram is displayed, press . Use the  and  buttons to zoom in and out and scroll the image with the multi selector. The histogram will be updated to show only the data for the portion of the image visible in the monitor.



Histograms

Camera histograms are intended as a guide only and may differ from those displayed in imaging applications. Some sample histograms are shown below:

If the image contains objects with a wide range of brightnesses, the distribution of tones will be relatively even.



If the image is dark, tone distribution will be shifted to the left.



If the image is bright, tone distribution will be shifted to the right.



Increasing exposure compensation shifts the distribution of tones to the right, while decreasing exposure compensation shifts the distribution to the left. Histograms can provide a rough idea of overall exposure when bright ambient lighting makes it difficult to see photographs in the monitor.

■ Shooting Data

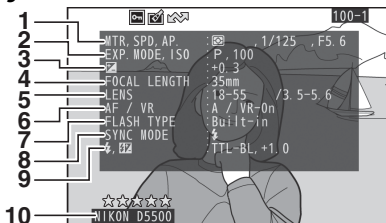

<p>1 Metering 125 Shutter speed 114 Aperture 114</p> <p>2 Shooting mode 38, 54, 61, 113 ISO sensitivity¹ 99</p> <p>3 Exposure compensation 129</p> <p>4 Focal length 322</p> <p>5 Lens data</p>	<p>6 Focus mode 78, 164 Lens VR (vibration reduction)² 37, 245</p> <p>7 Flash type 259, 323 Commander mode² 259</p> <p>8 Flash mode 94, 96</p> <p>9 Flash control 259 Flash compensation 131</p> <p>10 Camera name</p>
---	--

1 Displayed in red if photo was taken with auto ISO sensitivity control on.

2 Displayed only in photos taken with accessories that support this function.

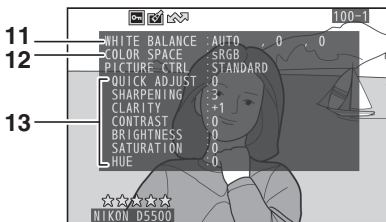

<p>11 White balance 137 White balance fine-tuning 140 Preset manual 142</p>	<p>12 Color space 243</p> <p>13 Picture Control * 152</p>
--	---

* Items displayed vary with Picture Control selected.

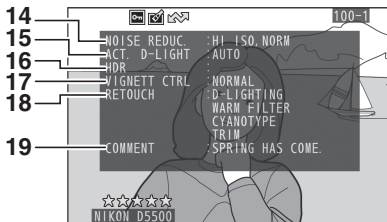

14	High ISO noise reduction ... 244	17	Vignette control.....244
15	Active D-Lighting 133	18	Retouch history.....286
16	HDR (high dynamic range)..... 135	19	Image comment273
	Long exposure noise reduction 243		

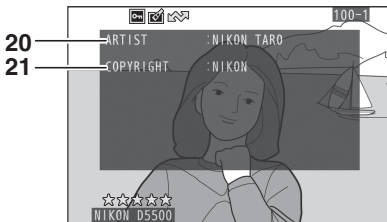

20	Name of photographer* 274	21	Copyright holder*274
-----------	---------------------------------	-----------	----------------------------

* The fourth page of the shooting data is only displayed if copyright information was recorded with the photograph as described on page 274.

Overview Data

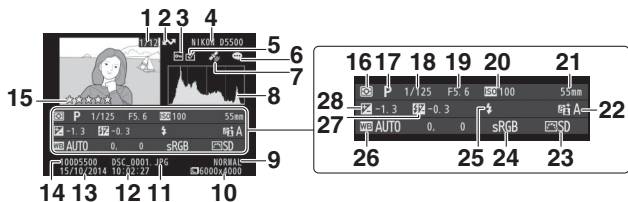

1	Frame number/total number of images	16	Metering..... 125
2	Upload marking 231	17	Shooting mode..... 38, 54, 61, 113
3	Protect status 202	18	Shutter speed..... 114
4	Camera name	19	Aperture 114
5	Retouch indicator 289	20	ISO sensitivity ¹99
6	Image comment indicator 273	21	Focal length 322
7	Location data indicator 283	22	Active D-Lighting..... 133
8	Histogram showing the distribution of tones in the image (□ 195).	23	Picture Control..... 152
9	Image quality 90	24	Color space..... 243
10	Image size..... 92	25	Flash mode..... 94, 96
11	File name 240	26	White balance 137
12	Time of recording 32, 275		White balance fine-tuning 140
13	Date of recording..... 32, 275		Preset manual 142
14	Folder name..... 238	27	Flash compensation..... 131
15	Rating..... 203		Commander mode ² 259
		28	Exposure compensation..... 129

1 Displayed in red if photo was taken with ISO sensitivity auto control on.

2 Displayed only in photos taken with accessories that support this function.

■ ■ Location Data

Location data are displayed only if an optional GP-1 or GP-1A GPS unit (📖 333) was used when the photo was taken (📖 283). In the case of movies, the data give the location at the start of recording.

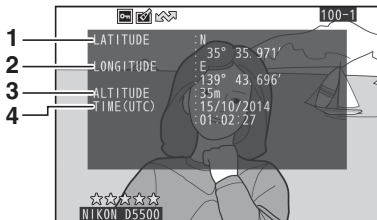

1 Latitude







2 Longitude





3 Altitude

4 Coordinated Universal Time
(UTC)



Taking a Closer Look: Playback Zoom

Press the  button to zoom in on the image displayed in full-frame playback. The following operations can be performed while zoom is in effect:

To	Use	Description
Zoom in or out	 /  (?)	Press  to zoom in to maximum of approximately 33× (large images), 25× (medium images) or 13× (small images). Press  (?) to zoom out. While photo is zoomed in, use multi selector to view areas of image not visible in monitor. Keep multi selector pressed to scroll rapidly to other areas of frame. Navigation window is displayed when zoom ratio is altered; area currently visible in monitor is indicated by yellow border. Bar under navigation window shows zoom ratio; turns green at ratio of 1 : 1.
View other areas of image		

To	Use	Description
Select/zoom in on or out from faces	i	Faces detected during zoom are indicated by white borders in navigation window. Press i and use the multi selector to view other faces, or press OK to zoom in on the currently selected face. Press i again to return to normal zoom. 
View other images		Rotate command dial to view same location in other images at current zoom ratio. Playback zoom is cancelled when a movie is displayed.
Cancel zoom		Cancel zoom and return to full-frame playback.
Return to shooting mode		Press the  button or press the shutter-release button halfway to exit to shooting mode.

Protecting Photographs from Deletion

In full-frame, zoom, thumbnail, and calendar playback, press the AE-L/AF-L (O-n) button to protect the current picture from accidental deletion. Protected files are marked with a  icon and can not be deleted using the  button or the **Delete** option in the playback menu. Note that protected images *will* be deleted when the memory card is formatted (📖 272). To remove protection from a picture so that it can be deleted, display or highlight it and press the AE-L/AF-L (O-n) button.

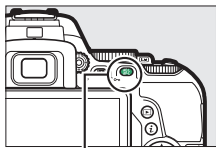

AE-L/AF-L (O-n) button



Removing Protection from All Images

To remove protection from all images in the folder or folders currently selected in the **Playback folder** menu (📖 234), press the AE-L/AF-L (O-n) and  buttons together for about two seconds during playback.

Rating Pictures

Rate pictures or mark them as candidates for later deletion. Rating is not available with protected images.

Rating Individual Pictures

1 Select an image.

Display the image in full-frame playback or playback zoom or highlight it in the thumbnail list in thumbnail or calendar playback.

2 Display playback options.

Press the **i** button to display playback options.

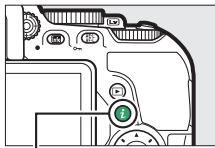





i button

3 Select Rating.

Highlight **Rating** and press .



4 Choose a rating.

Press  or  to choose a rating of from zero to five stars, or select  to mark the picture as a candidate for later deletion. Press  to complete the operation.



Rating Multiple Pictures

Use the **Rating** option in the playback menu to rate multiple pictures.

1 Select Rating.

Highlight **Rating** in the playback menu and press \odot .

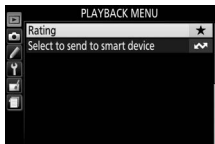

2 Rate pictures.

Press \odot or \odot to highlight pictures (to view the currently highlighted picture full frame, press and hold the \mathcal{Q} button) and press \odot or \odot to choose a rating of from zero to five stars, or select \mathcal{X} to mark the picture as a candidate for later deletion. Press \odot to complete the operation.



Deleting Photographs

To delete the photograph displayed in full-frame playback or highlighted in the thumbnail list, press the  button. To delete multiple selected photographs, all photographs taken on a selected date, or all photographs in the current playback folder, use the **Delete** option in the playback menu. Once deleted, photographs can not be recovered. Note that pictures that are protected can not be deleted.

Full-Frame, Thumbnail, and Calendar Playback

Press the  button to delete the current photograph.

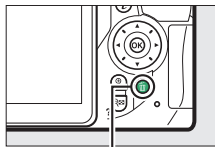

1 Press the button.

A confirmation dialog will be displayed.



 button

2 Press the button again.

To delete the photograph, press the  button again. To exit without deleting the photograph, press the  button.

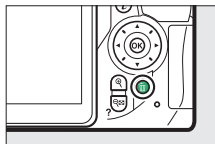



Calendar Playback

During calendar playback, you can delete all photographs taken on a selected date by highlighting the date in the date list and pressing the  button (📖 191).



The Playback Menu

The **Delete** option in the playback menu contains the following options. Note that depending on the number of images, some time may be required for deletion.

Option	Description
 Selected	Delete selected pictures.
 Select date	Delete all pictures taken on a selected date (□□ 207).
ALL All	Delete all pictures in the folder currently selected for playback (□□ 234).

■ Selected: Deleting Selected Photographs

1 Select pictures.

Use the multi selector to highlight a picture and press the  (?) button to select or deselect (to view the highlighted picture full screen, press and hold the  button). Selected pictures are marked by a  icon. Repeat as desired to select additional pictures.

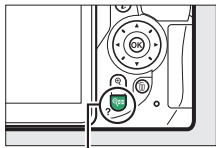

 (?) button



2 Press to complete the operation.

A confirmation dialog will be displayed; highlight **Yes** and press .



■ Select Date: Deleting Photographs Taken on a Selected Date

1 Select dates.

Highlight a date and press **OK** to select all pictures taken on the highlighted date. Selected dates are indicated by check marks. Repeat as desired to select additional dates; to deselect a date, highlight it and press **OK**.

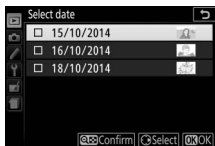

2 Press **OK** to complete the operation.

A confirmation dialog will be displayed; highlight **Yes** and press **OK**.



Slide Shows

The **Slide show** option in the playback menu is used to display a slide show of the pictures in the current playback folder (📖 234).

1 Select Slide show.

Highlight **Slide show** in the playback menu and press .

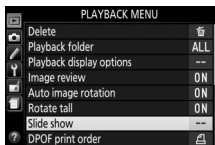





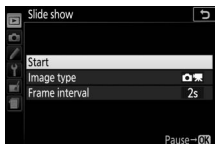





2 Start the slide show.

Highlight **Start** in the slide show menu and press .



The following operations can be performed while the slide show is in progress:

To	Use	Description
Skip back/skip ahead		Press  to return to previous frame,  to skip to next frame.
View additional photo info		Change photo info displayed (📖 192).
Pause		Pause slide show. Select Restart to resume.
Raise/lower volume	 /  (?)	Press  during movie playback to increase volume,  (?) to decrease.
Exit to playback mode		End show and return to playback mode.

The dialog shown at right is displayed when the show ends. Select **Restart** to restart or **Exit** to return to the playback menu.



Slide Show Options

Before starting a slide show, you can use the options in the slide show menu to select the images displayed by type or rating and choose how long each image is displayed.

- **Image type:** Choose from **Still images and movies**, **Still images only**, **Movies only**, and **By rating**. To include only pictures with selected ratings, highlight **By rating** and press **▶**. A list of ratings will be displayed; highlight ratings and press **▶** to select or deselect pictures with the highlighted rating for inclusion in the slide show. Selected ratings are indicated by a check mark. Press **OK** to exit when the desired ratings are selected.
- **Frame interval:** Choose how long still images are displayed.

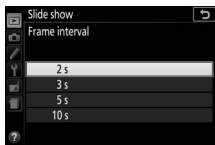
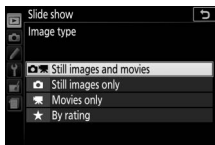

Connections

Installing ViewNX 2

To upload, view, edit, and share photos and movies, download the ViewNX 2 installer from the following website and follow the on-screen instructions to complete installation. An Internet connection is required. For system requirements and other information, see the Nikon website for your region (📖 xix).

<http://downloadcenter.nikonimglib.com/>

Nikon also offers Capture NX-D image fine-tuning software, available for download from:

<http://downloadcenter.nikonimglib.com/>

Capture NX-D

Use Nikon's Capture NX-D software to fine-tune photos or to change settings for NEF (RAW) pictures and save them in other formats. Capture NX-D also offers an Image Dust Off feature that processes NEF (RAW) images to remove image artifacts caused by dust inside the camera.

Use the Latest Versions

Be sure to use the latest version. Using a version that does not support your camera may result in difficulties copying NEF (RAW) images to your computer.

Using ViewNX 2

Copy Pictures to the Computer

Before proceeding, be sure you have installed ViewNX 2 (📖 210).

1 Connect the USB cable.

After turning the camera off and ensuring that a memory card is inserted, connect the supplied USB cable as shown and then turn the camera on.

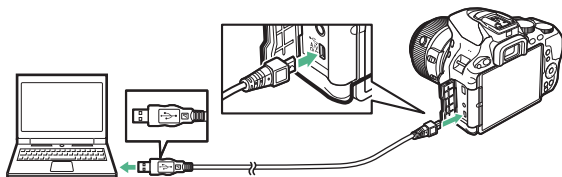

✔ Use a Reliable Power Source

To ensure that data transfer is not interrupted, be sure the camera battery is fully charged.

✔ Connecting Cables

Be sure the camera is off when connecting or disconnecting interface cables. Do not use force or attempt to insert the connectors at an angle.

✔ During Transfer

Do not turn the camera off or disconnect the USB cable while transfer is in progress.

✔ USB Hubs

Transfer may not proceed as expected if the camera is connected via a USB hub or keyboard.

2 Start Nikon Transfer 2 component of ViewNX 2.

If a message is displayed prompting you to choose a program, select Nikon Transfer 2.

Windows 7

If the following dialog is displayed, select Nikon Transfer 2 as described below.

- 1 Under **Import pictures and videos**, click **Change program**. A program selection dialog will be displayed; select **Import File using Nikon Transfer 2** and click **OK**.



- 2 Double-click **Import File**.

Windows 8.1

Windows 8.1 may display an AutoPlay prompt when the camera is connected. Tap or click the dialog and then tap or click **Import File/Nikon Transfer 2** to select Nikon Transfer 2.

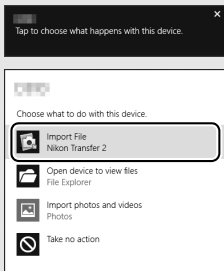

3 Click **Start Transfer**.

At default settings, pictures on the memory card will be copied to the computer.



Start Transfer

4 Terminate the connection.

When transfer is complete, turn the camera off and disconnect the USB cable.

For More Information

Consult online help for more information on using ViewNX 2.

Printing Photographs

Selected JPEG images can be printed on a PictBridge printer (☞ 374) connected directly to the camera.

Connecting the Printer

Connect the camera using the supplied USB cable. Do not use force or attempt to insert the connectors at an angle.

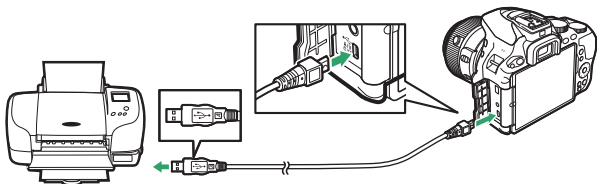

When the camera and printer are turned on, a welcome screen will be displayed in the monitor, followed by a PictBridge playback display.

✓ **Selecting Photographs for Printing**

NEF (RAW) photographs (☞ 90) can not be selected for printing. JPEG copies of NEF (RAW) images can be created using the **NEF (RAW) processing** option in the retouch menu (☞ 289).

✓ **Date Imprint**

If you select **On** for **Print date** in the PictBridge menu when printing photographs containing date information recorded using Custom Setting **d4 (Date stamp; ☞ 256)**, the date will appear twice. The imprinted date may however be cropped out if the photographs are cropped or printed without a border.

Printing Pictures One at a Time

1 Display the desired picture.



Press or to view additional pictures. Press the button to zoom in on the current frame (press to exit zoom). To view eight pictures at a time, press the (?) button. Use the multi selector to highlight pictures, or press to display the highlighted picture full frame.

2 Adjust printing options.

Press to display the following items, then press or to highlight an item and press to view options (only options supported by the current printer are listed; to use the default option, select **Printer default**). After selecting an option, press to return to the printer settings menu.

Option	Description
Page size	Choose a page size.
No. of copies	This option is listed only when pictures are printed one at a time. Press or to choose number of copies (maximum 99).
Border	Choose whether to frame photos in white borders.
Print date	Choose whether to print the times and dates of recordings on photos.
Cropping	This option is listed only when pictures are printed one at a time. To exit without cropping, highlight No cropping and press . To crop the current picture, highlight Crop and press . A crop selection dialog will be displayed; press to increase the size of the crop, (?) to decrease, and use the multi selector to position the crop. Note that print quality may drop if small crops are printed at large sizes.

3 Start printing.

Select **Start printing** and press  to start printing. To cancel before all copies have been printed, press .













Printing Multiple Pictures

1 Display the PictBridge menu.

Press the **MENU** button in the PictBridge playback display.

2 Choose an option.



Highlight one of the following options and press .

- **Print select:** Select pictures for printing. Press  or  to scroll through pictures (to view the highlighted picture full screen, press and hold the  button) and press  or  to choose the number of prints. To deselect a picture, set the number of prints to zero.
- **Select date:** Print one copy of all the pictures taken on a selected date. Press  or  to highlight a date and press  to select or deselect. To view the pictures taken on the selected date, press  (?). Use the multi selector to scroll through the pictures, or press and hold  to view the current picture full screen. Press  (?) again to return to the date selection dialog.
- **Print (DPOF):** Print the current DPOF print order ( 218). The order can be viewed and modified before printing as described in the description for **Print select**, above.
- **Index print:** To create an index print of all JPEG pictures on the memory card, proceed to Step 3. Note that if the memory card contains more than 256 pictures, only the first 256 images will be printed. A warning will be displayed if the page size selected in Step 3 is too small for an index print.

3 Adjust printer settings.

Adjust printer settings as described in Step 2 on page 215.

4 Start printing.

Select **Start printing** and press  to start printing. To cancel before all copies have been printed, press .

Creating a DPOF Print Order: Print Set

The **DPOF print order** option in the playback menu is used to create digital “print orders” for PictBridge-compatible printers and devices that support DPOF (📖 374).

1 Choose DPOF print order > Select/set.

Select **DPOF print order** in the playback menu, then highlight **Select/set** and press \blacktriangleleft (to remove all photographs from the print order, select **Deselect all**).

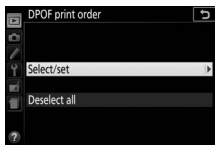

2 Select pictures.

Press \blacktriangleleft or \blacktriangleright to scroll through the pictures on the memory card (to view the highlighted picture full screen, press and hold the 🔍 button) and press \blacktriangleleft or \blacktriangleright to choose the number of prints (maximum 99). To deselect a picture, set the number of prints to zero. Press OK when all the desired pictures have been selected.



3 Select imprint options.

Highlight the following options and press  to toggle the highlighted option on or off.

- **Print shooting data:** Print shutter speed and aperture on all pictures in print order.
- **Print date:** Print date of recording on all pictures in print order.

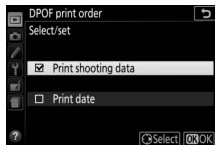

4 Complete the print order.

Press  to complete the print order.

DPOF Print Order

To print the current print order when the camera is connected to a PictBridge printer, select **Print (DPOF)** in the PictBridge menu and follow the steps in “Printing Multiple Pictures” to modify and print the current order (📖 216). DPOF print date and shooting data options are not supported when printing via direct USB connection; to print the date of recording on photographs in the current print order, use the PictBridge **Print date** option.

The **DPOF print order** option can not be used if there is not enough space on the memory card to store the print order.

NEF (RAW) photographs (📖 90) can not be selected using this option. JPEG copies of NEF (RAW) images can be created using the **NEF (RAW) processing** option in the retouch menu (📖 289).

Print orders may not print correctly if images are deleted using a computer or other device after the print order is created.

Viewing Pictures on TV

The supplied audio video (A/V) cable can be used to connect the camera to a television or video recorder for playback or recording. The optional High-Definition Multimedia Interface (HDMI) cable (📖 333) or a type C HDMI cable (available separately from third-party suppliers) can be used to connect the camera to high-definition video devices.

Standard Definition Devices

Before connecting the A/V cable to a standard television as shown, confirm that the camera video standard (📖 281) matches that used in the TV. Always turn the camera off before connecting or disconnecting the A/V cable.

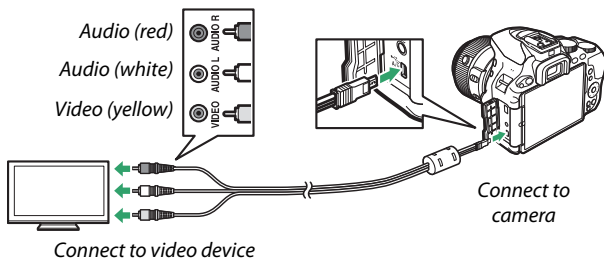

Tune the television to the video channel, then turn the camera on and press the  button. During playback, images will be displayed on the television screen. Note that the edges of images may not be displayed.

Video Mode

If no image is displayed, check that camera is correctly connected and that the option selected for **Video mode** (📄 281) matches the video standard used in the TV.

Television Playback

Use of an AC adapter (available separately) is recommended for extended playback.

High-Definition Devices

The camera can be connected to HDMI devices using an HDMI cable as shown. Always turn the camera off before connecting or disconnecting an HDMI cable.

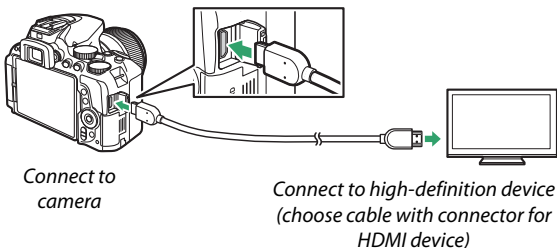

Tune the device to the HDMI channel, then turn the camera on and press the  button. During playback, images will be displayed on the high-definition television or monitor screen. Note that the edges of images may not be displayed.

Playback Volume

Volume can be adjusted using television controls; the camera controls can not be used.

■ ■ Choosing an Output Resolution

To choose the format for images output to the HDMI device, select **HDMI > Output resolution** in the camera setup menu (📖 270). If **Auto** is selected, the camera will automatically select the appropriate format.

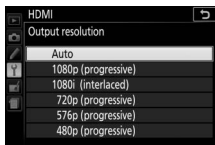

■ ■ Controlling the Camera with the TV Remote

If **On** is selected for **HDMI > Device control** in the setup menu (📖 270) when the camera is connected to a television that supports HDMI-CEC and both the camera and television are on, the television remote can be used in place of the camera multi selector and **ⓧ** button during full-frame playback and slide shows. If **Off** is selected, the television remote can not be used to control the camera, but the camera can be used to shoot photographs and movies in live view.

✔ HDMI-CEC Devices

HDMI-CEC (High-Definition Multimedia Interface–Consumer Electronics Control) is a standard that allows HDMI devices to be used to control peripherals to which they are connected. When the camera is connected to an HDMI-CEC device, **ⓧ** will appear in the viewfinder in place of the number of exposures remaining.

✔ 1920 × 1080 60p/50p

Selecting **1920 × 1080; 60p** or **1920 × 1080; 50p** for **Movie settings > Frame size/frame rate** may cause variations in the resolution and frame rate of the data output to HDMI devices during recording. During playback (📖 181), HDMI devices will display the movie only; indicators will not be displayed.

✔ HDMI > Output Resolution

Movies can not be output at resolutions of **1920 × 1080; 60p** or **1920 × 1080; 50p**. Some devices may not support an **Output resolution** setting of **Auto**; in this case, select **1080i (interlaced)**.

Wi-Fi

What Wi-Fi Can Do for You

The camera can connect via Wi-Fi wireless networks to a smart device running Nikon's dedicated Wireless Mobile Utility app (📖 225).

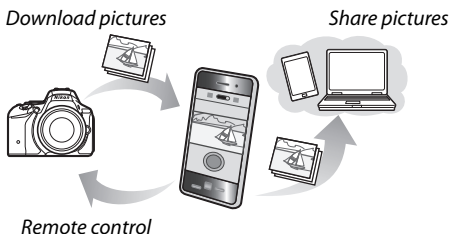

📌 Installing the App

1 Find the app.

On the smart device, connect to the Google Play service, the App Store, or another app marketplace and search for "Wireless Mobile Utility". For more information, see the instructions provided with the smart device.

2 Install the app.

Read the app description and install the app. A pdf manual for the Wireless Mobile Utility is available for download at the following URLs:

- **Android:** <http://nikonimglib.com/ManDL/WMAU/>
- **iOS:** <http://nikonimglib.com/ManDL/WMAU-ios/>



Android



iOS

Accessing the Camera

Before connecting via Wi-Fi (wireless LAN), install the Wireless Mobile Utility on your Android or iOS smart device. Instructions for accessing the camera vary with the type of connection used by the smart device.

Android

- **Push-button WPS:** If the smart device supports push-button WPS (i.e., has a **WPS button connection** option in its **Wi-Fi settings** menu), you can use this easy method to connect to the smart device (📖 226)
- **PIN-entry WPS:** If the smart device supports WPS, you can use the camera to establish a connection by entering the PIN displayed by the smart device (📖 228)
- **View SSID:** If the smart device does not support WPS, you can connect by selecting the camera SSID on the smart device (📖 229)

iOS

- **View SSID:** Connect by selecting the camera SSID on the smart device (📖 229)

✔ Security

If you do not use WPS when connecting for the first time, the connection will not be protected by a password or other form of security. Security settings can be configured in the Wireless Mobile Utility once a connection is established. More information can be found in the Wireless Mobile Utility manual, which is available for download in pdf format from the following URLs:

- **Android:** <http://nikonimglib.com/ManDL/WMAU/>
- **iOS:** <http://nikonimglib.com/ManDL/WMAU-ios/>

WPS (Android Only)

- 1 Enable the camera's built-in Wi-Fi.**
Highlight **Wi-Fi** in the setup menu and press **▶**. Highlight **Network connection** and press **▶**, then highlight **Enable** and press **OK**. Wait a few seconds for Wi-Fi to activate.

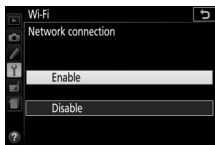
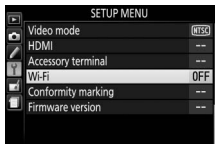

2 Connect.

Enable WPS button connections on the camera and smart device:

- **Camera:** Highlight **Network settings** and press **▶**.

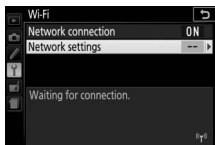

Highlight **Push-button WPS** and press **▶** to ready the camera for a WPS connection. The camera will wait about two minutes for a WPS connection request from the smart device. To extend the wait time, press **OK**.

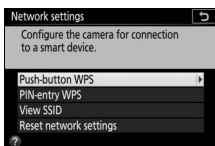



- **Smart device:** Select **Wi-Fi settings > WPS button connection**.

3 Launch the Wireless Mobile Utility.

Launch the Wireless Mobile Utility on the smart device. The main dialog will be displayed.

PIN Entry (Android Only)

- 1 Enable the camera's built-in Wi-Fi.**
Highlight **Wi-Fi** in the setup menu and press . Highlight **Network connection** and press , then highlight **Enable** and press . Wait a few seconds for Wi-Fi to activate.

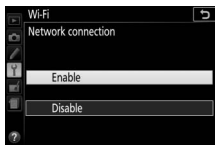
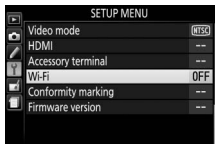

- 2 Select Network settings > PIN-entry WPS.**



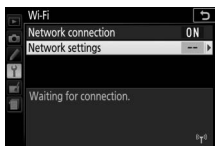

Highlight **Network settings** and press .

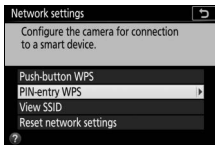

Highlight **PIN-entry WPS** and press .



- 3 Enter the PIN.**

Enter the PIN displayed by the smart device. Press  or  to highlight digits and press  or  to change. Press  when entry is complete.

- 4 Launch the Wireless Mobile Utility.**

Launch the Wireless Mobile Utility on the smart device. The main dialog will be displayed.

SSID (Android and iOS)

- 1 Enable the camera's built-in Wi-Fi.**
Highlight **Wi-Fi** in the setup menu and press **▶**. Highlight **Network connection** and press **▶**, then highlight **Enable** and press **OK**. Wait a few seconds for Wi-Fi to activate.

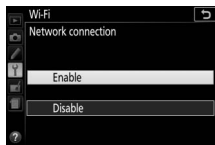
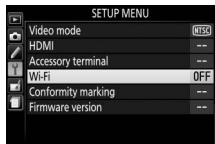

- 2 Display the camera SSID.**
Highlight **Network settings** and press **▶**.

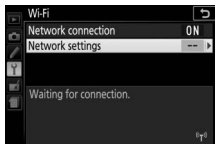

Highlight **View SSID** and press **▶**.

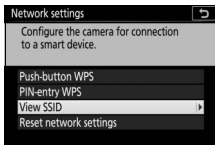

- 3 Select the camera SSID.**
Select the camera SSID in the list of networks displayed by the smart device.

- 4 Launch the Wireless Mobile Utility.**
Launch the Wireless Mobile Utility on the smart device. The main dialog will be displayed.

■ Terminating the Connection

Wi-Fi can be disabled by:

- Selecting **Wi-Fi > Network connection > Disable** in the camera setup menu
- Starting movie recording
- Turning the camera off

■ Restoring Default Settings

To restore default network settings, select **Wi-Fi > Network settings > Reset network settings**. A confirmation dialog will be displayed; highlight **Yes** and press **OK** to restore default network settings.

✓ The Wi-Fi Display

While Wi-Fi is enabled, a “**W**” icon will flash in the information display. The icon will stop flashing once a connection has been established and the camera is exchanging data with the smart device.



✓ Wi-Fi

Read the warnings on pages xx to xxii before using the Wi-Fi function. To disable Wi-Fi in settings in which its use is prohibited, select **Wi-Fi > Network connection > Disable** in the camera setup menu. Note that Eye-Fi cards can not be used while Wi-Fi is enabled and that the standby timer will not turn off while the Wireless Mobile Utility app on the smart device is communicating with the camera. If no data are exchanged for about 5 minutes, the standby timer will turn off. The camera Wi-Fi function is only available when a memory card is inserted and can not be used when a USB or HDMI cable is connected. To prevent loss of power while connected, charge the battery before enabling the network connection.

Selecting Pictures for Upload

Follow the steps below to select photos for upload to the smart device. Movies can not be selected for upload.

Selecting Individual Pictures for Upload

1 Select an image.

Display the image or highlight it in the thumbnail list in thumbnail or calendar playback.

2 Display playback options.

Press the **i** button to display playback options.

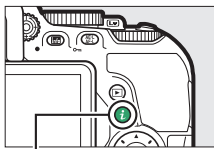

i button

3 Choose **Select to send to smart device/deselect**.

Highlight **Select to send to smart device/deselect** and press **OK**.

Pictures selected for upload are indicated by a  icon; to deselect, display or highlight the image and repeat Steps 2 and 3.



Selecting Multiple Pictures for Upload



To change the upload status of multiple pictures, use the **Select to send to smart device** option in the playback menu.

1 Choose **Select to send to smart device**.

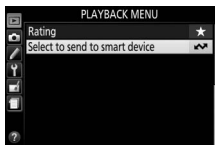
Highlight **Select to send to smart device** in the playback menu and press .



2 Select pictures.

Use the multi selector to highlight pictures and press  (?) to select or deselect (to view the highlighted picture full screen, press and hold the  button). Selected pictures are marked by a  icon.

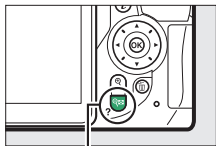

 (?) button

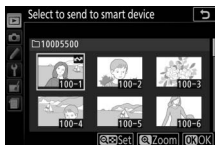

3 Press .

Press  to complete the operation.

Camera Menus

▶ The Playback Menu: *Managing Images*

To display the playback menu, press **MENU** and select the  (playback menu) tab.

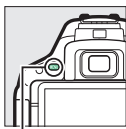

MENU button

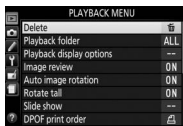
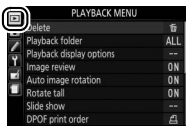

Playback Menu Options

The playback menu contains the following options:

Option	Default	
Delete	—	206
Playback folder	All	234
Playback display options	—	234
Image review	On	234
Auto image rotation	On	235
Rotate tall	On	235
Slide show		
Image type	Still images and movies	208
Frame interval	2 s	
DPOF print order	—	218
Rating	—	204
Select to send to smart device	—	232

Playback Folder





MENU button →  playback menu

Choose a folder for playback:

Option	Description
D5500	Pictures in all folders created with the D5500 will be visible during playback.
All	Pictures in all folders will be visible during playback.
Current	Only photos in the folder currently selected for Storage folder in the shooting menu ( 238) are displayed during playback.

Playback Display Options

MENU button →  playback menu

Choose the information available in the playback photo information display ( 192). Press  or  to highlight and press  to select or deselect. Selected items are indicated by check marks. To return to the playback menu, press .

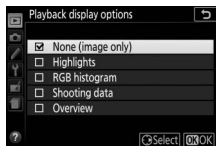



Image Review

MENU button →  playback menu

Choose whether pictures are automatically displayed in the monitor immediately after shooting.

Auto Image Rotation

MENU button →  playback menu

Photographs taken while **On** is selected contain information on camera orientation, allowing them to be rotated automatically during playback or when viewed in ViewNX 2 or Capture NX-D ( 210). The following orientations are recorded:



Landscape (wide)
orientation

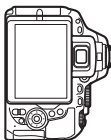

Camera rotated 90°
clockwise



Camera rotated 90°
counterclockwise

Camera orientation is not recorded when **Off** is selected. Choose this option when panning or taking photographs with the lens pointing up or down.

Rotate Tall

To automatically rotate “tall” (portrait-orientation) photographs for display during playback, select **On** for the **Rotate tall** option.

Rotate Tall

MENU button →  playback menu

If **On** is selected, “tall” (portrait-orientation) pictures will be automatically rotated for display in the monitor (pictures taken with **Off** selected for **Auto image rotation** will still be displayed in landscape orientation). Note that because the camera itself is already in the appropriate orientation during shooting, images are not rotated automatically during image review.

The Shooting Menu: *Shooting Options*

To display the shooting menu, press **MENU** and select the  (shooting menu) tab.

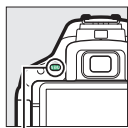

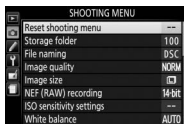

MENU button



Shooting Menu Options

The shooting menu contains the following options:

Option	Default	
Reset shooting menu	—	237
Storage folder	—	238
File naming	DSC	240
Image quality	JPEG normal	90
Image size	Large	92
NEF (RAW) recording	14-bit	240
ISO sensitivity settings		
ISO sensitivity	P, S, A, M	100
	Other modes	Auto
		99
Auto ISO sensitivity control	Off	241
White balance	Auto	137
Fluorescent	Cool-white fluorescent	138
Set Picture Control	Standard	152
Manage Picture Control	—	158
Color space	sRGB	243
Active D-Lighting	Auto	133
HDR (high dynamic range)	Off	135

Option	Default	
Release mode		
	Continuous H	71
Other modes	Single frame	
Long exposure NR	Off	243
High ISO NR	Normal	244
Vignette control	Normal	244
Auto distortion control	Off	245
Interval timer shooting		
Start options	Now	102
Interval	1 min.	102
Number of times	1	103
Exposure smoothing	Off	103
Optical VR ¹	On	245
Movie settings		
Frame size/frame rate ²	—	177
Movie quality	Normal	
Microphone	Auto sensitivity	
Wind noise reduction	Off	
Manual movie settings	Off	

1 Available only with lenses that support this item.

2 Default varies with country of purchase.

Note: Depending on camera settings, some items may be grayed out and unavailable.

Reset Shooting Menu

MENU button →  shooting menu

Select **Yes** to reset shooting menu settings.







Select the folder in which subsequent images will be stored.



■ ■ *Selecting Folders by Folder Number*

1 Choose **Select folder by number**.

Highlight **Select folder by number** and press .

2 Choose a folder number.

Press  or  to highlight a digit, press  or  to change. If a folder with the selected number already exists, a , , or  icon will be displayed to the left of the folder number:

-  : Folder is empty.
 -  : Folder is partially full.
 -  : Folder contains 999 pictures or a picture numbered 9999. No further pictures can be stored in this folder.
-

3 Save changes and exit.

Press  to complete the operation and return to the main menu (to exit without choosing the storage folder, press the MENU button). If a folder with the specified number does not already exist, a new folder will be created. Subsequent photographs will be stored in the selected folder unless it is already full.

■ ■ *Selecting Folders from a List*

- 1 Choose **Select folder from list**.**
Highlight **Select folder from list** and press .

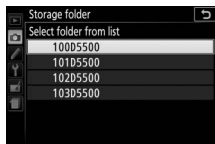

- 2 Highlight a folder.**
Press  or  to highlight a folder.

- 3 Select the highlighted folder.**
Press  to select the highlighted folder and return to the main menu. Subsequent photographs will be stored in the selected folder.

Folder and File Numbers

If the current folder is numbered 999 and contains 999 pictures or a picture numbered 9999, the shutter-release will be disabled and no further photographs can be taken. To continue shooting, create a folder with a number less than 999, or select an existing folder with a number less than 999 and less than 999 images.

Startup Time

Additional time may be required for camera startup if the memory card contains a very large number of files or folders.

File Naming

MENU button →  shooting menu

Photographs are saved using file names consisting of “DSC_” or, in the case of images that use the Adobe RGB color space (📖 243), “_DSC”, followed by a four-digit number and a three-letter extension (e.g., “DSC_0001.JPG”). The **File naming** option is used to select three letters to replace the “DSC” portion of the file name. For information on editing file names, see page 159.

Extensions

The following extensions are used: “.NEF” for NEF (RAW) images, “.JPG” for JPEG images, “.MOV” for movies, and “.NDF” for dust off reference data. In each pair of photographs recorded at image-quality settings of NEF (RAW)+JPEG, the NEF and JPEG images have the same file names but different extensions.

NEF (RAW) Recording

MENU button →  shooting menu

Choose the bit depth for NEF (RAW) images.

Option	Description
12-bit 12-bit	NEF (RAW) images are recorded at a bit depth of 12 bits.
14-bit 14-bit	NEF (RAW) images are recorded at a bit depth of 14 bits, producing larger files but increasing the amount of color data recorded.

ISO Sensitivity Settings

MENU button →  shooting menu

Adjust ISO sensitivity (☞ 99).

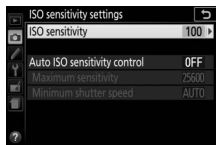

■ ■ Auto ISO Sensitivity control

If **Off** is chosen for **Auto ISO sensitivity control** in **P**, **S**, **A**, and **M** modes, ISO sensitivity will remain fixed at the value selected by the user (☞ 99). When **On** is chosen, ISO sensitivity will automatically be adjusted if optimal exposure can not be achieved at the value selected by the user. The maximum value for auto ISO sensitivity can be selected using the **Maximum sensitivity** option in the **Auto ISO sensitivity control** menu (choose lower values to prevent noise (randomly-spaced bright pixels, fog, or lines), but note that if the ISO sensitivity selected by the user is higher than that chosen for **Maximum sensitivity**, the value selected by the user will be used instead; the minimum value for auto ISO sensitivity is automatically set to ISO 100). In modes **P** and **A**, sensitivity will only be adjusted if underexposure would result at the shutter speed selected for **Minimum shutter speed** ($1/2000$ –30 s, or **Auto**; in modes **S** and **M**, sensitivity will be adjusted for optimal exposure at the shutter speed selected by the user). If **Auto** (available only with CPU lenses) is selected, the camera will choose the minimum shutter speed based on the focal length of the lens (auto shutter-speed selection can be fine-tuned by highlighting **Auto** and pressing ). Slower shutter speeds will be used only if optimal exposure can not be achieved at the ISO sensitivity value selected for **Maximum sensitivity**.

When **On** is selected, the viewfinder shows **ISO AUTO** and the information display shows **ISO-A**. These indicators flash when sensitivity is altered from the value selected by the user.



Maximum Sensitivity/Minimum Shutter Speed

When auto ISO sensitivity control is enabled, the ISO sensitivity and shutter speed graphics in the information display show the maximum sensitivity and minimum shutter speed.

Minimum shutter speed



Maximum sensitivity

Auto ISO Sensitivity Control

Noise (randomly-spaced bright pixels, fog, or lines) is more likely at higher sensitivities. Use the **High ISO NR** option in the shooting menu to reduce noise (☐ 244). Note that ISO sensitivity may be raised automatically when auto ISO sensitivity control is used in combination with slow sync flash modes (available with the built-in flash and the optional flash units listed on page 323), possibly preventing the camera from selecting slow shutter speeds. Auto ISO sensitivity control is available only in i-TTL flash control mode (☐ 259, 325); in other modes, the value selected for **ISO sensitivity** will be used for pictures taken with the built-in flash or optional flash units.

Color Space

MENU button →  shooting menu

The color space determines the gamut of colors available for color reproduction. **sRGB** is recommended for general-purpose printing and display; **Adobe RGB**, with its broader gamut of colors, for professional publication and commercial printing. Regardless of the option selected, movies are recorded in sRGB.

Adobe RGB

For accurate color reproduction, Adobe RGB images require applications, displays, and printers that support color management.

Color Space

ViewNX 2 and Capture NX-D (☐ 210) automatically select the correct color space when opening photographs created with this camera. Results can not be guaranteed with third-party software.

Long Exposure NR

MENU button →  shooting menu

If **On** is selected, photographs taken at shutter speeds slower than 1 s will be processed to reduce noise (bright spots or fog). The time required for processing roughly doubles; during processing, “**LoB NR**” will flash in the viewfinder and pictures can not be taken (noise reduction will not be performed if the camera is turned off before processing is complete).



High ISO NR

MENU button →  shooting menu

Photographs taken at high ISO sensitivities can be processed to reduce “noise.”

Option	Description
High	Reduce noise (randomly-spaced bright pixels), particularly in photographs taken at high ISO sensitivities. Choose the amount of noise reduction performed from High , Normal , and Low .
Normal	
Low	
Off	Noise reduction is performed only as required and never at an amount higher than when Low is selected.

Vignette Control

MENU button →  shooting menu

“Vignetting” is a drop in brightness at the edges of a photograph. **Vignette control** reduces vignetting for type G, E, and D lenses (PC lenses excluded). Its effects vary from lens to lens and are most noticeable at maximum aperture. Choose from **High**, **Normal**, **Low**, and **Off**.

Vignette Control

Depending on the scene, shooting conditions, and type of lens, JPEG images may exhibit noise (fog) or variations in peripheral brightness, while custom Picture Controls and preset Picture Controls that have been modified from default settings may not produce the desired effect. Take test shots and view the results in the monitor. Vignette control does not apply to movies (📺 174) or to pictures taken with lenses that support FX format.

Auto Distortion Control

MENU button →  shooting menu

Select **On** to reduce barrel distortion in photos taken with wide-angle lenses and to reduce pin-cushion distortion in photos taken with long lenses (note that the edges of the area visible in the viewfinder may be cropped out of the final photograph, and that the time needed to process photographs before recording begins may increase). This option does not apply to movies and is available only with type G, E, and D lenses (PC, fisheye, and certain other lenses excluded); results are not guaranteed with other lenses.

Optical VR

MENU button →  shooting menu

This item is displayed only with lenses that support it. Selecting **On** enables vibration reduction, which takes effect whenever the shutter-release button is pressed halfway ( 379). Select **Off** to disable vibration reduction.

The Vibration Reduction Indicator

A vibration reduction indicator appears in the information display when **On** is selected for **Optical VR**.



Custom Settings: Fine-Tuning Camera Settings

To display the Custom Settings menu, press **MENU** and select the  (Custom Settings menu) tab.

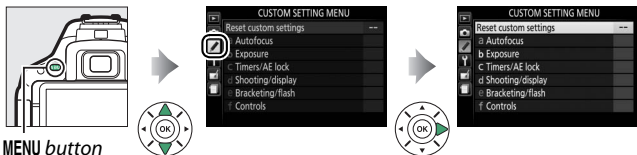

Custom Settings are used to customize camera settings to suit individual preferences.

Main menu

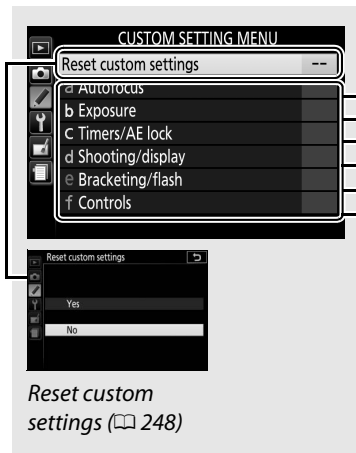

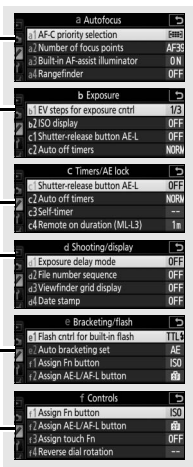

Custom Setting groups



Custom Settings

The following Custom Settings are available:

Custom Setting		Default	
Reset custom settings			248
a Autofocus			
a1	AF-C priority selection	Focus	248
a2	Number of focus points	39 points	249
a3	Built-in AF-assist illuminator	On	250
a4	Rangefinder	Off	250
a5	Manual focus ring in AF mode *	Enable	251
b Exposure			
b1	EV steps for exposure cntrl	1/3 step	252
b2	ISO display	Off	252
c Timers/AE lock			
c1	Shutter-release button AE-L	Off	252
c2	Auto off timers	Normal	253
c3	Self-timer	Self-timer delay: 10 s; number of shots: 1	254
c4	Remote on duration (ML-L3)	1 min	254
d Shooting/display			
d1	Exposure delay mode	Off	254
d2	File number sequence	Off	255
d3	Viewfinder grid display	Off	256
d4	Date stamp	Off	256
d5	Reverse indicators		258
e Bracketing/flash			
e1	Flash cntrl for built-in flash/ Optional flash	TTL	259
e2	Auto bracketing set	AE bracketing	264

Custom Setting		Default	
f Controls			
f1	Assign Fn button	ISO sensitivity	265
f2	Assign AE-L/AF-L button	AE/AF lock	267
f3	Assign touch Fn	Viewfinder grid display	268
f4	Reverse dial rotation	Exposure compensation: <input type="checkbox"/> Shutter speed/aperture: <input type="checkbox"/>	269

* Available only with lenses that support this item.

Note: Depending on camera settings, some items may be grayed out and unavailable.

Reset Custom Settings

MENU button → Custom Settings menu

Select **Yes** to restore Custom Settings to their default values.

a: Autofocus

a1: AF-C Priority Selection

MENU button → Custom Settings menu

When **AF-C** is selected for viewfinder photography (78), this option controls whether photographs can be taken whenever the shutter-release button is pressed (*release priority*) or only when the camera is in focus (*focus priority*).

Option	Description
Release	Photos can be taken whenever the shutter-release button is pressed.
Focus	Photos can only be taken once the camera has focused.

a2: Number of Focus Points

MENU button →  Custom Settings menu

Choose the number of focus points available for manual focus-point selection.

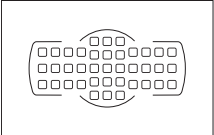
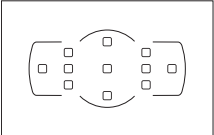
Option	Description
AF39 39 points	Choose from the 39 focus points shown at right. 
AF11 11 points	Choose from the 11 focus points shown at right. Use for quick focus-point selection. 

a3: Built-in AF-assist Illuminator

MENU button →  Custom Settings menu

Choose whether the built-in AF-assist illuminator lights to assist the focus operation when lighting is poor.

AF-assist illuminator

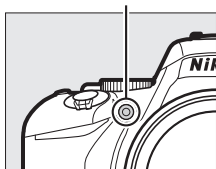







Option	Description
On	The AF-assist illuminator lights when lighting is poor (for more information, see page 352).
Off	The AF-assist illuminator does not light to assist the focus operation. The camera may not be able to focus using autofocus when lighting is poor.

a4: Rangefinder

MENU button →  Custom Settings menu

Choose **On** to use the exposure indicator to determine whether the camera is correctly focused in manual focus mode (☐ 88; note that this function is not available in shooting mode **M**, when the exposure indicator instead shows whether the subject is correctly exposed).

Indicator	Description
	Subject in focus.
	Focus point is slightly in front of subject.

Indicator	Description
	Focus point is well in front of subject.
	Focus point is slightly behind subject.
	Focus point is well behind subject.
	Camera can not determine correct focus.

Using the Electronic Rangefinder

The electronic rangefinder requires a lens with a maximum aperture of $f/5.6$ or faster. The desired results may not be achieved in situations in which the camera would be unable to focus using autofocus (☐ 80). The electronic rangefinder is not available during live view.

a5: Manual Focus Ring in AF Mode

MENU button →  Custom Settings menu

This item is displayed only with lenses that support it. Selecting **Enable** allows the lens focus ring to be used for manual focus when the camera is in autofocus mode. After pressing the shutter-release button halfway to focus, keep the button pressed halfway and adjust focus using the focus ring. To refocus using autofocus, lift your finger from the shutter-release button and then press it halfway again. To prevent the lens focus ring being used for manual focus when the camera is in autofocus mode, select **Disable**.

b: Exposure

b1: EV Steps for Exposure Cntrl

MENU button →  Custom Settings menu

Select the increments used when making adjustments to shutter speed, aperture, exposure and flash compensation, and bracketing.

b2: ISO Display

MENU button →  Custom Settings menu

Select **On** to display ISO sensitivity in the viewfinder in place of the number of exposures remaining.

c: Timers/AE Lock

c1: Shutter-Release Button AE-L



MENU button →  Custom Settings menu

If **On** is selected, exposure will lock when the shutter-release button is pressed halfway.

c2: Auto off Timers

MENU button →  Custom Settings menu

This option determines how long the monitor remains on if no operations are performed during menu display and playback (**Playback/menus**), while photographs are displayed in the monitor after shooting (**Image review**), and during live view (**Live view**), and how long the standby timer, viewfinder, and information display remain on when no operations are performed (**Standby timer**). Choose shorter auto-off delays to reduce the drain on the battery.

Option	Description (all times are approximate)				
SHORT Short NORM Normal LONG Long	Auto off timers are set to the following values:				
		Playback/ menus	Image review	Live view	Standby timer
	Short	20 s	4 s	5 min.	4 s
	Normal	5 min.	4 s	10 min.	8 s
Long	10 min.	20 s	20 min.	1 min.	
  Custom	Choose separate delays for Playback/menus , Image review , Live view , and Standby timer . When settings are complete, press  .				



Auto off Timers

The monitor and viewfinder will not turn off automatically when the camera is connected to a computer or printer via USB.

c3: Self-Timer

MENU button →  Custom Settings menu

Choose the length of the shutter release delay and the number of shots taken.

- **Self-timer delay:** Choose the length of the shutter-release delay.
- **Number of shots:** Press  and  to choose the number of shots taken each time the shutter-release button is pressed (from 1 to 9; if a value other than 1 is selected, shots will be taken at intervals of about 4 seconds).

c4: Remote on Duration (ML-L3)

MENU button →  Custom Settings menu

Choose how long the camera will wait for a signal from the optional ML-L3 remote control before cancelling remote release mode. Choose shorter times for longer battery life. This setting applies only during viewfinder photography.

d: Shooting/Display

d1: Exposure Delay Mode

MENU button →  Custom Settings menu

In situations where the slightest camera movement can blur pictures, select **On** to delay shutter release until about 1 s after the shutter-release button is pressed and the mirror is raised.

d2: File Number Sequence

MENU button →  Custom Settings menu

When a photograph is taken, the camera names the file by adding one to the last file number used. This option controls whether file numbering continues from the last number used when a new folder is created, the memory card is formatted, or a new memory card is inserted in the camera.

Option	Description
On	When a new folder is created, the memory card formatted, or a new memory card inserted in the camera, file numbering continues from the last number used or from the largest file number in the current folder, whichever is higher. If a photograph is taken when the current folder contains a photograph numbered 9999, a new folder will be created automatically and file numbering will begin again from 0001.
Off	File numbering is reset to 0001 when a new folder is created, the memory card is formatted, or a new memory card is inserted in the camera. Note that a new folder is created automatically if a photograph is taken when the current folder contains 999 photographs.
Reset	As for On , except that the next photograph taken is assigned a file number by adding one to the largest file number in the current folder. If the folder is empty, file numbering is reset to 0001.

File Number Sequence

If the current folder is numbered 999 and contains either 999 photographs or a photograph numbered 9999, the shutter-release button will be disabled and no further photographs can be taken. Choose **Reset** for Custom Setting d2 (**File number sequence**) and then either format the current memory card or insert a new memory card.

d3: Viewfinder Grid Display



MENU button →  Custom Settings menu

Choose **On** to display on-demand grid lines in the viewfinder for reference when composing photographs (📖 5).

d4: Date Stamp

MENU button →  Custom Settings menu

Choose the date information imprinted on photographs as they are taken. Date stamps can not be added to or removed from existing photos.

Option	Description
Off	The time and date do not appear on photographs.
DATE Date	The date or date and time are imprinted on 
DATE🕒 Date and time	photographs taken while this option is in effect. 
 Date counter	New photos are imprinted with a time stamp showing the number of days between the date of shooting and a selected date (see below).

At settings other than **Off**, the selected option is indicated by a  icon in the information display.



Date Stamp

The date is recorded in the order selected for **Time zone and date** (📖 275). The imprinted data may be cropped out or rendered illegible in copies created when images are retouched (📖 286). The date does not appear on NEF (RAW) or NEF (RAW)+JPEG images.

■ ■ Date Counter

Pictures taken while this option is in effect are imprinted with the number of days remaining until a future date or the number of days elapsed since a past date. Use it to track the growth of a child or count down the days until a birthday or wedding.

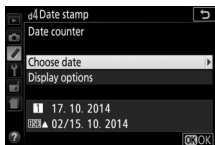

Future date (two days remaining)



Past date (two days elapsed)

The camera offers three slots for storing dates.

1 Enter the first date.

The first time you select **Date counter**, you will be prompted to enter a date for the first slot. Enter a date using the multi selector and press **OK** to exit to the date list.





2 Enter additional dates or edit existing dates.

To change a date or enter additional dates, highlight a slot, press **OK**, and enter a date as described above.



3 Choose a date.

Highlight a slot in the date list and press **OK**.



- 4 Choose a date counter format.**
Highlight **Display options** and press , then highlight a date format and press .



- 5 Exit the date counter menu.**
Press  to exit the date counter menu.

d5: Reverse Indicators

MENU button →  *Custom Settings menu*





If  (+0-) is selected, the exposure indicators in the viewfinder and information display are displayed with positive values on the left and negative values on the right. Select  (-0+) to display negative values on the left and positive values on the right.

e: Bracketing/Flash



e1: Flash Cntrl for Built-in Flash/Optional Flash

MENU button →  Custom Settings menu

Choose the flash mode for the built-in flash in **P**, **S**, **A**, and **M** modes. When an optional SB-500, SB-400, or SB-300 flash unit is attached and turned on, this option changes to **Optional flash** and is used to choose the flash mode for the optional flash unit.

Option	Description
TTL  TTL	Flash output is adjusted automatically in response to shooting conditions.
M  Manual	Choose a flash level. At full power, the built-in flash has a Guide Number of 12/39 (m/ft., ISO 100, 20 °C/68 °F).
CMD  Commander mode	This option is available when an optional SB-500 flash unit is mounted on the camera accessory shoe. In commander mode, the SB-500 functions as a master flash for wireless remote control of groups of optional off-camera flash units ( 260).

Manual

A  icon flashes in the viewfinder and  flashes in the information display when **Manual** is selected and the flash is raised.



TTL Flash Control





The following types of flash control are supported when a CPU lens is used in combination with the built-in flash (☐ 93) or optional flash units (☐ 323).

- **i-TTL Balanced Fill-Flash for Digital SLR:** Information from the 2016-pixel RGB sensor is used to adjust flash output for a natural balance between the main subject and the background.
- **Standard i-TTL Fill-Flash for Digital SLR:** Flash output is adjusted for the main subject; the brightness of the background is not taken into account.

Standard i-TTL flash control is used with spot metering or when selected with the optional flash unit. i-TTL balanced fill-flash for digital SLR is used in all other cases.

Commander Mode

When an optional SB-500 flash unit is mounted on the accessory shoe, select **Commander mode** to use the SB-500 as a master flash controlling one or more remote optional flash units in up to two groups (A and B) using advanced wireless lighting (☐ 325).

Selecting this option displays the menu shown at right. Press  or  to highlight the following options,  or  to change.

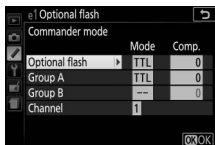

Option	Description
Optional flash	Choose a flash mode for the master (commander) flash.
TTL	i-TTL mode. Choose flash compensation from values between +3.0 and -3.0 EV in increments of $\frac{1}{3}$ EV.
M	Choose the flash level.
--	Only the remote flash units fire; the master flash does not, although it does emit monitor pre-flashes.
Group A	Choose a flash mode for all flash units in group A.
TTL	i-TTL mode. Choose flash compensation from values between +3.0 and -3.0 EV in increments of $\frac{1}{3}$ EV.
AA	Auto aperture (available only with compatible flash units; \square 325). Choose flash compensation from values between +3.0 and -3.0 EV in increments of $\frac{1}{3}$ EV.
M	Choose the flash level.
--	The flash units in this group do not fire.
Group B	Choose a flash mode for all flash units in group B. The options available are the same as those listed for Group A , above.
Channel	Choose from channels 1-4. All flash units in both groups must be set to the same channel.

Follow the steps below to take photographs in commander mode.

- 1 Adjust settings for the master flash.**
Choose the flash control mode and output level for the master flash. Note that output level can not be adjusted in -- mode.

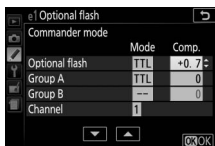

- 2 Adjust settings for group A.**
Choose the flash control mode and output level for the flash units in group A.

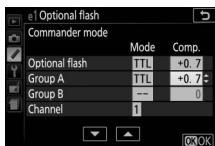

- 3 Adjust settings for group B.**
Choose the flash control mode and output level for the flash units in group B.

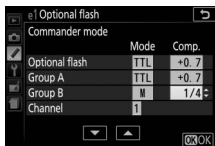

- 4 Select the channel.**
If the remote flash units include an SB-500, select channel 3.

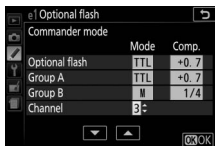

- 5 Press OK .**

6 Compose the shot.

Compose the shot and arrange the flash units as shown below. Note that the maximum distance at which the remote flash units can be placed may vary with shooting conditions.

Group A: 10 m/32 ft or less

Group B: 7 m/22 ft or less

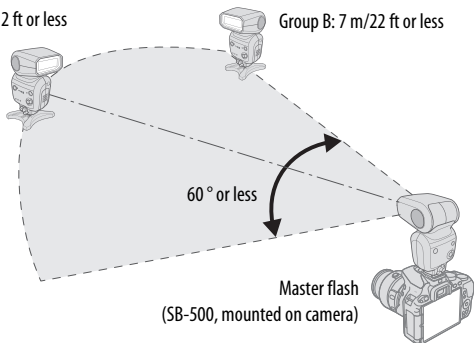

Wireless remote sensors on flash units should face camera

7 Configure the remote flash units.

Turn all the remote flash units on, adjust group settings as desired, and set them to the channel selected in Step 4. See the flash unit instruction manuals for details.







8 Frame the photograph, focus, and shoot.

After confirming that the camera flash-ready light and the flash-ready lights for all flash units are lit, frame the photograph, focus, and shoot.

The Flash Sync Mode Display

 does not appear in the information display when -- is selected for **Optional flash > Mode**.

Flash Compensation

The flash compensation value selected with the  () and  () buttons and command dial is added to the flash compensation values selected for the master flash, group A, and group B in the **Commander mode** menu. A  icon is displayed in the viewfinder when a flash compensation value other than ± 0 is selected for the master or remote flash units in TTL or AA mode. The  icon flashes when the master flash is in mode **M**.

Commander Mode

Position the sensor windows on the remote flash units to pick up the light from the master flash (particular care is required if the camera is not mounted on a tripod). The remote flash units should normally be placed closer to the subject than to the camera. Be sure that direct light or strong reflections from the remote flash units do not enter the camera lens (in TTL mode) or the photocells on the remote flash units (AA mode), as this may interfere with exposure. To prevent timing flashes emitted by the master flash from appearing in photographs taken at short range, choose low ISO sensitivities or small apertures (high f-numbers) or rotate the flash head on the master flash to point upwards. After positioning the remote flash units, take a test shot and view the results in the camera monitor.

Although there is no limit on the number of remote flash units that may be used, the practical maximum is three. With more than this number, the light emitted by the remote flash units will interfere with performance.

e2: Auto Bracketing Set

MENU button →  Custom Settings menu

Choose the setting (exposure, white balance, or Active D-Lighting) varied when bracketing is in effect ( 148).

f: Controls





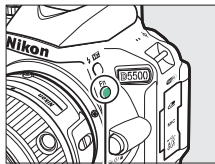

f1: Assign Fn Button







MENU button →  Custom Settings menu

Choose the role played by the **Fn** button.

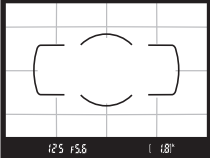

Fn button

Option	Description
QUAL Image quality/size	Keeping the Fn button pressed, rotate the command dial to select image quality and size (□ 90).
ISO ISO sensitivity	Keeping the Fn button pressed, rotate the command dial to select ISO sensitivity (□ 99).
WB White balance	Keeping the Fn button pressed, rotate the command dial to select white balance (P , S , A , and M modes only; □ 137).
 Active D-Lighting	Keeping the Fn button pressed, rotate the command dial to select Active D-Lighting (P , S , A , and M modes only; □ 133).
HDR HDR	Keeping the Fn button pressed, rotate the command dial to adjust HDR (P , S , A , and M modes only; □ 135).
+  +NEF (RAW)	If image quality is set to JPEG fine , JPEG normal , or JPEG basic , an NEF (RAW) copy will be recorded with the next picture taken after the Fn button is pressed. To exit without recording an NEF (RAW) copy, press the Fn button again. This option has no effect in the following special effects modes:  , VI , POP ,  ,  ,  , and  .

Option	Description
BKT Auto bracketing	Keeping the Fn button pressed, rotate the command dial to choose the bracketing increment (exposure and white balance bracketing) or to turn ADL bracketing on or off (P , S , A , and M modes only;  148).
 AF-area mode	Keeping the Fn button pressed, rotate the command dial to choose an AF-area mode ( 82).
 Viewfinder grid display	Press the Fn button to display or hide the viewfinder framing grid. 
 Wi-Fi	Press the Fn button to display the Wi-Fi menu ( 226).



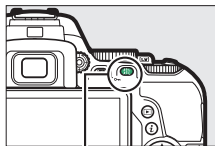

f2: Assign AE-L/AF-L Button

MENU button →  Custom Settings menu

Choose the role played by the ^{AE-L}/_{AF-L} (O_Ⓜ) button.



^{AE-L}/_{AF-L} (O_Ⓜ) button





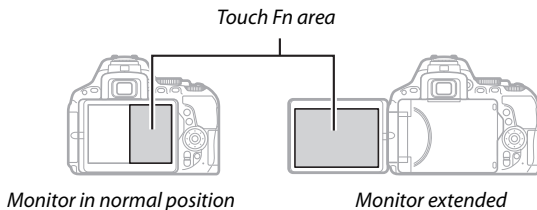

Option	Description
 AE/AF lock	Focus and exposure lock while the ^{AE-L} / _{AF-L} (O _Ⓜ) button is pressed.
 AE lock only	Exposure locks while the ^{AE-L} / _{AF-L} (O _Ⓜ) button is pressed.
 AE lock (Hold)	Exposure locks when the ^{AE-L} / _{AF-L} (O _Ⓜ) button is pressed, and remains locked until the button is pressed a second time or the standby timer expires.
 AF lock only	Focus locks while the ^{AE-L} / _{AF-L} (O _Ⓜ) button is pressed.
 AF-ON	The ^{AE-L} / _{AF-L} (O _Ⓜ) button initiates autofocus. The shutter-release button can not be used to focus.

f3: Assign Touch Fn

MENU button →  Custom Settings menu

A touch-sensitive area of the monitor can be used to control the camera after the monitor has turned off automatically. The position of this “touch Fn” area varies with the position of the monitor; the role it plays can be chosen from the options in the table below. Slide your finger left or right across the area indicated in the illustration to adjust the chosen option (note that touch Fn is not available when the monitor is facing forward). If you find that your face contacts the touch Fn area when you look through the viewfinder, use the monitor in the extended position.



Option	Description
 Focus-point selection	When an option other than  (Auto-area AF) is selected for AF-area mode, you can slide a finger over the touch Fn area to position the focus point ( 85).
ISO ISO sensitivity	Slide a finger over the touch Fn area to adjust ISO sensitivity ( 99).
 Active D-Lighting	Slide a finger over the touch Fn area to adjust Active D-Lighting (P, S, A, and M modes only;  133).
HDR HDR	Slide a finger over the touch Fn area to adjust HDR (P, S, A, and M modes only;  135).

Option	Description
BKT Auto bracketing	Slide a finger over the touch Fn area to choose the bracketing increment (exposure and white balance bracketing) or to turn ADL bracketing on or off (P , S , A , and M modes only; 148).
[*] AF-area mode	Slide a finger over the touch Fn area to choose an AF-area mode (82).
Viewfinder grid display	Tap the touch Fn area to display or hide the viewfinder framing grid. 
Aperture	Slide a finger over the touch Fn area to adjust aperture (A and M modes only; 118, 119).
None	Disable touch Fn.

Touch Fn

Touch Fn is available only if **Enable** is selected for **Touch controls** (276) and **Info display auto off** (278) is on.

f4: Reverse Dial Rotation

MENU button → Custom Settings menu

Reverse the direction of rotation of the command dial when it is used to make adjustments to exposure or flash compensation (**Exposure compensation**) and/or shutter speed and aperture (**Shutter speed/aperture**).

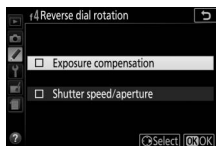

Highlight options and press to select or deselect, then press .

Y The Setup Menu: Camera Setup

To display the setup menu, press **MENU** and select the **Y** (setup menu) tab.

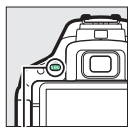

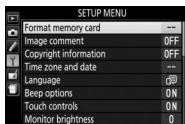
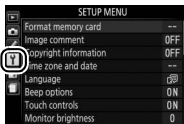

MENU button



Setup Menu Options

The setup menu contains the following options:

Option	Default	
Format memory card	—	272
Image comment	—	273
Copyright information	—	274
Time zone and date ¹		
Daylight saving time	Off	275
Language ¹	—	275
Beep options		
Beep on/off	On	276
Pitch	Low	276
Touch controls	Enable	276
Monitor brightness	0	276
Info display format		
AUTO/SCENE/EFFECTS	Graphic	277
P/S/A/M	Graphic	
Auto info display	On	278
Info display auto off	On	278
Clean image sensor		
Clean at startup/shutdown	Clean at startup & shutdown	338

Option	Default	
Lock mirror up for cleaning ²	—	340
Image Dust Off ref photo	—	279
Flicker reduction	Auto	281
Slot empty release lock	Release locked	281
Video mode ¹	—	281
HDMI		
Output resolution	Auto	223
Device control	On	
Accessory terminal		
Remote control		
Remote shutter release	Take photos	282
Assign Fn button	Same as camera  button	282
Location data		
Standby timer	Enable	283
Set clock from satellite	Yes	283
Wi-Fi		
Network connection	Disable	226
Network settings	—	
Eye-Fi upload ³	Enable	284
Conformity marking	—	285
Firmware version	—	285

1 Default varies with country of purchase.

2 Not available when battery is low.

3 Only available when compatible Eye-Fi memory card is inserted.

Note: Depending on camera settings, some items may be grayed out and unavailable.

Format Memory Card

MENU button →  setup menu

Memory cards must be formatted before first use or after being formatted in other devices. Format the card as described below.

Formatting Memory Cards

Formatting memory cards permanently deletes any data they may contain. Be sure to copy any photographs and other data you wish to keep to a computer before proceeding ( 211).

1 Highlight Yes.

To exit without formatting the memory card, highlight **No** and press .

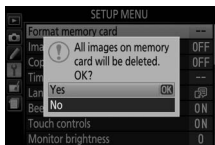



2 Press .

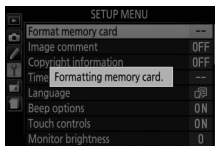

A message will be displayed while the card is formatted. *Do not remove the memory card or remove or disconnect the power source until formatting is complete.*



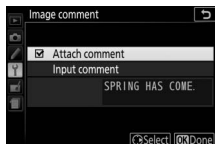

Add a comment to new photographs as they are taken. Comments can be viewed as metadata in ViewNX 2 or Capture NX-D (📖 210). The comment is also visible on the shooting data page in the photo information display (📖 197). The following options are available:

- **Input comment:** Input a comment as described on page 159. Comments can be up to 36 characters long.
- **Attach comment:** Select this option to attach the comment to all subsequent photographs. **Attach comment** can be turned on and off by highlighting it and pressing . After choosing the desired setting, press  to exit.



Add copyright information to new photographs as they are taken. Copyright information is included in the shooting data shown in the photo information display ( 197) and can be viewed as metadata in ViewNX 2 or in Capture NX-D ( 210). The following options are available:

- **Artist:** Enter a photographer name as described on page 159. Photographer names can be up to 36 characters long.
- **Copyright:** Enter the name of the copyright holder as described on page 159. Copyright holder names can be up to 54 characters long.
- **Attach copyright information:** Select this option to attach copyright information to all subsequent photographs. **Attach copyright information** can be turned on and off by highlighting it and pressing . After choosing the desired setting, press  to exit.



Copyright Information

To prevent unauthorized use of the artist or copyright holder names, make sure that **Attach copyright information** is not selected and that the **Artist** and **Copyright** fields are blank before lending or transferring the camera to another person. Nikon does not accept liability for any damages or disputes arising from the use of the **Copyright information** option.

Time Zone and Date

MENU button →  setup menu

Change time zones, set the camera clock, choose the date display order, and turn daylight saving time on or off.

Option	Description
Time zone	Choose a time zone. The camera clock is automatically set to the time in the new time zone.
Date and time	Set the camera clock (📅 32).
Date format	Choose the order in which the day, month, and year are displayed.
Daylight saving time	Turn daylight saving time on or off. The camera clock will automatically be advanced or set back one hour.

Language

MENU button →  setup menu

Choose a language for camera menus and messages.

Beep Options

MENU button →  setup menu

Beeps sound when the camera focuses, in self-timer and remote-control modes, and when touch-screen controls are used.

■ ■ Beep On/Off

Select **Off (touch controls only)** to mute the sounds the camera makes in response to touch-screen controls, or choose **Off** to prevent beeps from sounding altogether.

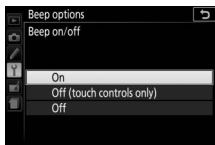

■ ■ Pitch

Choose the pitch (**High** or **Low**) of the sounds made in response to focus, self-timer, and remote-control operations.



Touch Controls

MENU button →  setup menu

Select **Disable** to prevent accidental use of touch-screen controls (📖 17), or **Playback only** to enable touch-screen controls in playback mode only.

Monitor Brightness

MENU button →  setup menu

Press  or  to choose monitor brightness. Choose higher values for increased brightness, lower values for reduced brightness.

Info Display Format

MENU button → Y setup menu

Choose an information display format (📖 8). Formats can be chosen separately for auto, scene, and special effects modes and for **P**, **S**, **A**, and **M** modes.



Classic



Graphic

- 1 Select a shooting mode option.
Highlight **AUTO/SCENE/EFFECTS** or **P/S/A/M** and press **Y**.

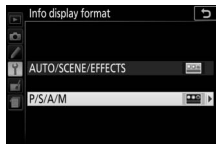

- 2 Select a design.
Highlight a design and press **OK**.



Auto Info Display

MENU button →  setup menu

If **On** is selected, the information display will appear after the shutter-release button is pressed halfway. If **Off** is selected, the information display can be viewed by pressing the  button.

Info Display Auto Off

MENU button →  setup menu

If **On** is selected, the eye sensor will turn the information display off when you put your eye to the viewfinder. Selecting **Off** prevents the display turning off when you look through the viewfinder, but also increases the drain on the battery.

Image Dust Off Ref Photo

MENU button →  setup menu

Acquire reference data for the Image Dust Off option in Capture NX-D (☞ 210; for more information, refer to Capture NX-D on-line help).

Image Dust Off ref photo is available only when a CPU lens is mounted on the camera. A lens with a focal length of at least 50 mm is recommended. When using a zoom lens, zoom all the way in.

1 Choose a start option.

Highlight one of the following options and press . To exit without acquiring image dust off data, press MENU.

- **Start:** The message shown at right will be displayed and “rEF” will appear in the viewfinder.
- **Clean sensor and then start:** Select this option to clean the image sensor before starting. The message shown at right will be displayed and “rEF” will appear in the viewfinder when cleaning is complete.

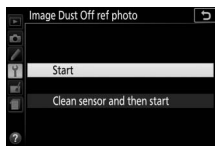

Image Sensor Cleaning

Image Dust Off reference data recorded before image sensor cleaning is performed can not be used with photographs taken after image sensor cleaning is performed. Select **Clean sensor and then start** only if the Image Dust Off reference data will not be used with existing photographs.

2 Frame a featureless white object in the viewfinder.

With the lens about ten centimeters (four inches) from a well-lit, featureless white object, frame the object so that it fills the viewfinder and then press the shutter-release button halfway.

In autofocus mode, focus will automatically be set to infinity; in manual focus mode, set focus to infinity manually.

3 Acquire Image Dust Off reference data.

Press the shutter-release button the rest of the way down to acquire Image Dust Off reference data.

If the reference object is too bright or too dark, the camera may be unable to acquire Image Dust Off reference data and the message shown at right will be displayed. Choose another reference object and repeat the process from step 1.



Image Dust Off Reference Data

The same reference data can be used for photographs taken with different lenses or at different apertures. Reference images can not be viewed using computer imaging software. A grid pattern is displayed when reference images are viewed on the camera.



Flicker Reduction

MENU button →  setup menu

Reduce flicker and banding when shooting under fluorescent or mercury-vapor lighting during live view (📖 162) or movie recording (📖 174). Choose **Auto** to allow the camera to automatically choose the correct frequency, or manually match the frequency to that of the local AC power supply.

Flicker Reduction

If **Auto** fails to produce the desired results and you are unsure as to the frequency of the local power supply, test both the 50 and 60 Hz options and choose the one that produces the best results. Flicker reduction may not produce the desired results if the subject is very bright, in which case you should select mode **A** or **M** and choose a smaller aperture (higher f-number) before starting live view. Note that flicker reduction is not available when **On** is selected for **Movie settings > Manual movie settings** (📖 179) in mode **M**.

Slot Empty Release Lock

MENU button →  setup menu

Selecting **Enable release** allows the shutter to be released when no memory card is inserted, although no pictures will be recorded (they will however be displayed in the monitor in demo mode). If **Release locked** is selected, the shutter-release button is only enabled when a memory card is inserted in the camera.

Video Mode

MENU button →  setup menu

When connecting the camera to a television or VCR, be sure the camera video mode matches the device video standard (NTSC or PAL).

Accessory Terminal

MENU button →  setup menu



Choose the role of the optional accessory connected to the accessory terminal.

Remote Control

Choose the functions performed using a remote cord or wireless remote controller (□ 332).



Remote Shutter Release

Choose whether the shutter-release button on the optional accessory is used for photography or movie recording.

Option	Description
 Take photos	The shutter-release button on the optional accessory is used to take photographs.
 Record movies	The shutter-release button on the optional accessory is used for movie recording. Press the button halfway to start live view or to focus in AF-S and AF-F modes. Press the button all the way down to start or end recording. Use the camera live view switch to end live view.

Assign Fn button

Choose the role played by the **Fn** buttons on wireless remote controllers.

Option	Description
 Same as camera button	The Fn button on the wireless remote controller performs the function currently assigned to the camera  (AE-L) button (□ 267).
 Live view	The Fn button on the wireless remote controller can be used to start and end live view.

Location Data

This item is used to adjust settings for optional GP-1 or GP-1A GPS units (☞ 333). The unit can be connected to the camera's accessory terminal (☞ 333) using the cable supplied with the device, allowing information on the camera's current position to be recorded when photographs are taken (turn the camera off before connecting the unit; for more information, see the manual provided with the device).

The **Location data** menu contains the options listed below.

- **Standby timer:** Choose whether or not the standby timer is enabled when the unit is attached.

Option	Description
Enable	Standby timer enabled. The timer expires automatically if no operations are performed for the time selected for Custom Setting c2 (Auto off timers) > Standby timer (☞ 253; to allow the camera time to acquire location data, the delay is extended by up to one minute after standby timer is activated or the camera is turned on). This reduces the drain on the battery. Note that the unit will remain active to acquire location data for a set period after the timer expires.
Disable	Standby timer disabled, ensuring uninterrupted recording of location data.



- **Position:** This item is only available if a GP-1 or GP-1A is connected, when it displays the current latitude, longitude, altitude, and Coordinated Universal Time (UTC) as reported by the unit.
- **Set clock from satellite:** Choose **Yes** to set the camera clock based on the time provided by the satellite navigation system.

Coordinated Universal Time (UTC)

UTC data is provided by the location data satellite system and is independent of the camera clock.

The Satellite Signal Indicator

Connection status is shown in the information display as follows:

-  **(static)**: Location data acquired.
-  **(flashing)**: The GP-1/GP-1A is searching for a signal. Pictures taken while the icon is flashing do not include location data.
- **No icon**: No new location data have been received from the GP-1/GP-1A for at least two seconds. Pictures taken when the  icon is not displayed do not include location data.







Eye-Fi Upload

MENU button →  setup menu

This option is displayed only when an Eye-Fi memory card (available separately from third-party suppliers) is inserted in the camera. Choose **Enable** to upload photographs to a preselected destination. Note that pictures will not be uploaded if signal strength is insufficient.

Observe all local laws concerning wireless devices and choose **Disable** where wireless devices are prohibited.

When an Eye-Fi card is inserted, its status is indicated by an icon in the information display:

- : Eye-Fi upload disabled.
- : Eye-Fi upload enabled but no pictures available for upload.
-  (static): Eye-Fi upload enabled; waiting to begin upload.
-  (animated): Eye-Fi upload enabled; uploading data.
- : Error.



✔ Eye-Fi Cards

Eye-Fi cards may emit wireless signals when **Disable** is selected. If a warning is displayed in the monitor (☐ 359), turn the camera off and remove the card.

Set Custom Setting c2 (**Auto off timers**) > **Standby timer** (☐ 253) to 30 s or more when using an Eye-Fi card.

See the manual provided with the Eye-Fi card, and direct any inquiries to the manufacturer. The camera can be used to turn Eye-Fi cards on and off, but may not support other Eye-Fi functions.

Some cards may not be available in some countries or regions; consult the manufacturer for more information. Eye-Fi cards are for use only in the country of purchase. Be sure the Eye-Fi card firmware has been updated to the latest version.

Conformity Marking

MENU button →  setup menu

View the standards with which the camera complies.

Firmware Version

MENU button →  setup menu

View the current camera firmware version.





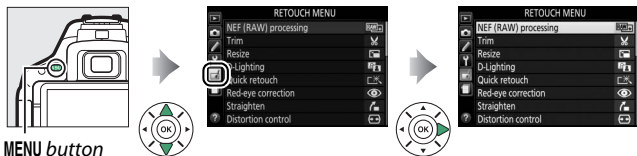















The Retouch Menu: Creating Retouched Copies

To display the retouch menu, press **MENU** and select the  (retouch menu) tab.



Retouch Menu Options

The options in the retouch menu are used to create trimmed or retouched copies of existing pictures. The retouch menu is only displayed when a memory card containing photographs is inserted in the camera.

Option		Option	
 NEF (RAW) processing	289	 Monochrome	299
 Trim	291	 Image overlay	300
 Resize	292	 Color outline	302
 D-Lighting	294	 Photo illustration	303
 Quick retouch	295	 Color sketch	303
 Red-eye correction	295	 Miniature effect	304
 Straighten	296	 Selective color	305
 Distortion control	296	 Painting	307
 Perspective control	297	 Edit movie	183
 Fisheye	297	 Side-by-side comparison*	307
 Filter effects	298		

* Available only if retouch menu is displayed by pressing **i** and selecting **Retouch** in full-frame playback when a retouched image or original is displayed.

Retouching Copies

Most options can be applied to copies created using other retouch options, although with the exceptions of **Image overlay** and **Edit movie > Choose start/end point**, each option can be applied only once (note that multiple edits may result in loss of detail). Options that can not be applied to the current image are grayed out and unavailable.

Image Quality and Size



Except in the case of copies created with **Trim** and **Resize**, copies created from JPEG images are the same size as the original, while copies created from NEF (RAW) photos are saved as large fine-quality JPEG images.

Creating Retouched Copies

To create a retouched copy:

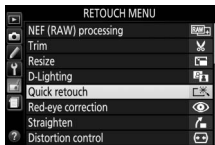
- 1 Display retouch options.**
Highlight the desired item in the retouch menu and press .



- 2 Select a picture.**
Highlight a picture and press  (to view the highlighted picture full screen, press and hold the  button).



Retouch

The camera may not be able to display or retouch images created with other devices. If the image was recorded at image quality settings of NEF (RAW) + JPEG (📄 90), retouch options apply only to the RAW copy.

- 3 Select retouch options.**
For more information, see the section for the selected item. To exit without creating a retouched copy, press **MENU**.

4 Create a retouched copy.

Press **OK** to create a retouched copy. Except in the photo information “image only” page (192), retouched copies are indicated by a  icon.



Creating Retouched Copies During Playback

To create a retouched copy of the picture currently displayed in full-frame playback (188), press **i**, then highlight **Retouch** and press **OK** and select a retouch option (**Image overlay** excluded).

NEF (RAW) Processing

MENU button →  retouch menu

Create JPEG copies of NEF (RAW) photographs.

1 Select NEF (RAW) processing.

Highlight **NEF (RAW) processing** in the retouch menu and press **OK** to display a picture selection dialog listing only NEF (RAW) images created with this camera.

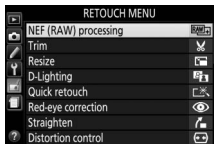

2 Select a photograph.

Use the multi selector to highlight a photograph (to view the highlighted photograph full frame, press and hold the **Q** button). Press **OK** to select the highlighted photograph and proceed to the next step.

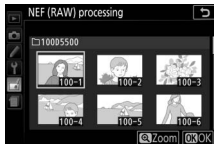

3 Choose settings for the JPEG copy.

Adjust the settings listed below. Note that white balance and vignette control are not available with pictures created with image overlay (📖 300), and that the effects of exposure compensation may differ from those that might have been expected when the photograph was taken.

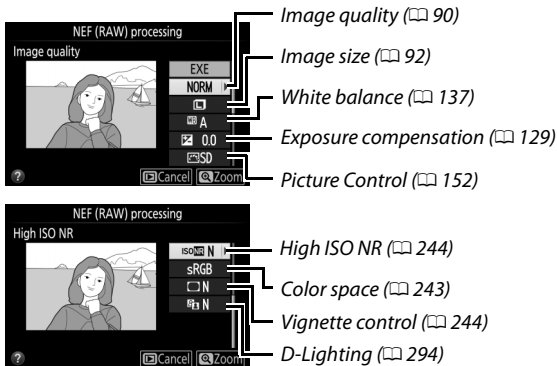

4 Copy the photograph.

Highlight **EXE** and press **OK** to create a JPEG copy of the selected photograph. To exit without copying the photograph, press the **MENU** button.



Trim

MENU button →  retouch menu

Create a cropped copy of the selected photograph. The selected photograph is displayed with the selected crop shown in yellow; create a cropped copy as described in the following table.









To	Use	Description
Increase size of crop		Press the  button to increase the size of the crop.
Reduce size of crop		Press the  button to reduce the size of the crop.
Change crop aspect ratio		Rotate the command dial to choose the aspect ratio.
Move crop		Use multi selector to position the crop.
Create copy		Save the current crop as a separate file.

Image Size

The size of the copy (which varies with crop size and aspect ratio) appears at upper left in the crop display.

Viewing Cropped Copies

Playback zoom may not be available when cropped copies are displayed.

Resize

MENU button →  retouch menu

Create small copies of selected photographs.

1 Select Resize.

To resize selected images, highlight **Resize** in the retouch menu and press .

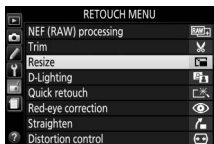

2 Choose a size.

Highlight **Choose size** and press .

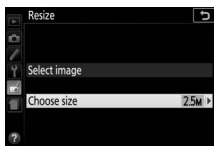



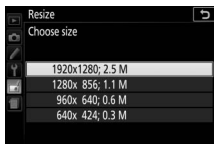

Highlight an option and press .



3 Choose pictures.

Highlight **Select image** and press .

Highlight pictures using the multi selector and press the  (?) button to select or deselect (to view the highlighted picture full screen, press and hold the  button). Selected pictures are marked by a  icon. Press  when the selection is complete.

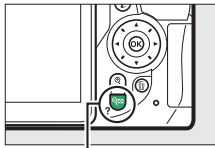
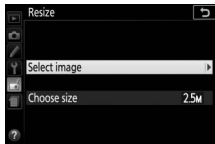

 (?) button



4 Save the resized copies.

A confirmation dialog will be displayed. Highlight **Yes** and press  to save the resized copies.

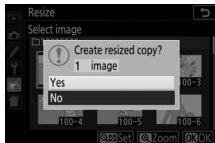

Viewing Resized Copies

Playback zoom may not be available when resized copies are displayed.

D-Lighting

MENU button →  retouch menu

D-Lighting brightens shadows, making it ideal for dark or backlit photographs.





Before

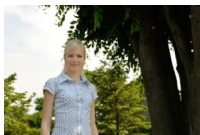

D-Lighting



*D-Lighting
(portrait subject)*

Press  or  to choose the amount of correction performed; the effect can be previewed in the edit display. Press  to copy the photograph.

■ Portrait Subjects

If **Portrait subjects** is selected, the camera will apply D-Lighting only to human portrait subjects, brightening up to three such subjects while leaving the background untouched for an effect similar to that achieved with a reflector.





Portrait Subjects

The camera automatically selects up to three subjects for portrait D-Lighting (note that portrait D-Lighting can not be applied to photos taken with **Off** selected for **Auto image rotation** in the playback menu;  235). Depending on composition and how the subjects are posed, the desired results may not be achieved; if you are not satisfied, remove the check from **Portrait subjects**.

Quick Retouch

MENU button →  retouch menu

Create copies with enhanced saturation and contrast. D-Lighting is applied as required to brighten dark or backlit subjects.

Press  or  to choose the amount of enhancement. Press  to copy the photograph.

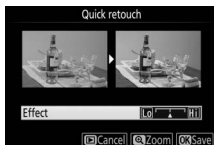



Red-Eye Correction

MENU button →  retouch menu

This option is used to correct “red-eye” caused by the flash, and is available only with photographs taken using the flash. The photograph selected for red-eye correction can be previewed in the edit display. Confirm the effects of red-eye correction and press  to create a copy. Note that red-eye correction may not always produce the expected results and may in very rare circumstances be applied to portions of the image that are not affected by red-eye; check the preview thoroughly before proceeding.

Straighten

MENU button →  retouch menu

Create a straightened copy of the selected image. Press  to rotate the image clockwise by up to five degrees in increments of approximately 0.25 degrees,  to rotate it counterclockwise (note that edges of the image will be trimmed to create a rectangular copy). Press  to save the retouched copy.

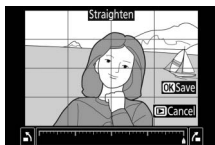



Distortion Control

MENU button →  retouch menu

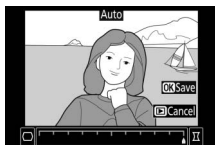
Create copies with reduced peripheral distortion. Select **Auto** to let the camera correct distortion automatically and then make fine adjustments using the multi selector, or select **Manual** to reduce distortion manually (note that **Auto** is not available with photos taken using auto distortion control; see page 245).



Press  to reduce barrel distortion,  to reduce pin-cushion distortion (note that greater amounts of distortion control result in more of the edges being cropped out). Press  to save the retouched copy.

Auto

Auto is for use only with pictures taken with type G, E, and D lenses (PC, fisheye, and certain other lenses excluded); results are not guaranteed with other lenses.

Perspective Control

MENU button →  retouch menu

Create copies that reduce the effects of perspective taken from the base of a tall object. Use the multi selector to adjust perspective (note that greater amounts of perspective control result in more of the edges being cropped out). Press **OK** to save the retouched copy.

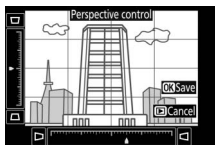

Before



After

Fisheye

MENU button →  retouch menu

Create copies that appear to have been taken with a fisheye lens. Press **+** to increase the effect (this also increases the amount that will be cropped out at the edges of the image), **-** to reduce it. Press **OK** to save the retouched copy.



Filter Effects

MENU button →  retouch menu

After adjusting filter effects as described below, press **OK** to copy the photograph.

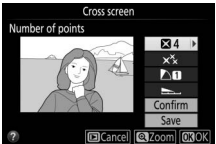
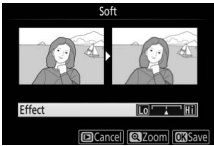

Option	Description
Skylight	Creates the effect of a skylight filter, making the picture less blue. 
Warm filter	Creates a copy with warm tone filter effects, giving the copy a “warm” red cast.
Cross screen	Add starburst effects to light sources. <ul style="list-style-type: none"> • Number of points: Choose from four, six, or eight. • Filter amount: Choose the brightness of the light sources affected. • Filter angle: Choose the angle of the points. • Length of points: Choose the length of points. • Confirm: Preview the effects of the filter. Press OK to preview the copy full frame. • Save: Create a retouched copy. 
Soft	Add a soft filter effect. Press Left Arrow or Right Arrow to choose the filter strength. 

Monochrome

MENU button →  retouch menu

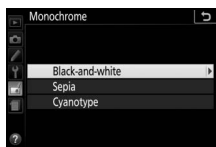
Copy photographs in **Black-and-white**, **Sepia**, or **Cyanotype** (blue and white monochrome).



Selecting **Sepia** or **Cyanotype** displays a preview of the selected image; press  to increase color saturation,  to decrease. Press  to create a monochrome copy.



Increase saturation



Decrease saturation

Image Overlay



MENU button →  retouch menu

Image overlay combines two existing NEF (RAW) photographs to create a single picture that is saved separately from the originals; the results, which make use of RAW data from the camera image sensor, are noticeably better than overlays created in an imaging application. The new picture is saved at current image quality and size settings; before creating an overlay, set image quality and size (☞ 90, 92; all options are available). To create an NEF (RAW) copy, choose an image quality of **NEF (RAW)**.

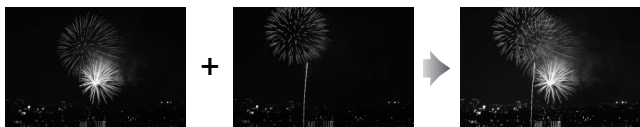

1 Select Image overlay.

Highlight **Image overlay** in the retouch menu and press .

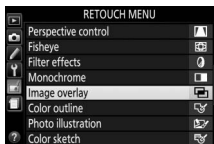

The dialog shown at right will be displayed, with **Image 1** highlighted; press  to display a list of the NEF (RAW) pictures created with this camera.

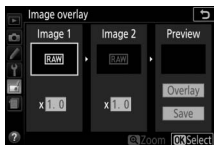

2 Select the first image.

Use the multi selector to highlight the first photograph in the overlay. To view the highlighted photograph full frame, press and hold the \mathbb{Q} button. Press \mathbb{OK} to select the highlighted photograph and return to the preview display.



3 Select the second image.

The selected image will appear as **Image 1**. Highlight **Image 2** and press \mathbb{OK} , then select the second photo as described in Step 2.

4 Adjust gain.

Highlight **Image 1** or **Image 2** and optimize exposure for the overlay by pressing \mathbb{A} or \mathbb{B} to select gain from values between 0.1 and 2.0. Repeat for the second image. The default value is 1.0; select 0.5 to halve gain or 2.0 to double it. The effects of gain are visible in the **Preview** column.

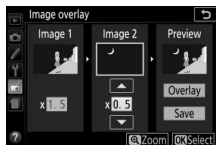

5 Preview the overlay.

To preview the composition as shown at right, press \mathbb{A} or \mathbb{B} to place the cursor in the **Preview** column, then press \mathbb{A} or \mathbb{B} to highlight **Overlay** and press \mathbb{OK} (note that colors and brightness in the preview may differ from the final image). To save the overlay without displaying a preview, select **Save**. To return to Step 4 and select new photos or adjust gain, press \mathbb{Q} (?).



6 Save the overlay.

Press **OK** while the preview is displayed to save the overlay. After an overlay is created, the resulting image will be displayed full-frame in the monitor.



Image Overlay

Only NEF (RAW) photographs with the same bit depth can be combined (📖 240). The overlay has the same photo info as the photograph selected for **Image 1**. The current image comment is appended to the overlay when it is saved; copyright information, however, is not copied.

Color Outline

MENU button → retouch menu

Create an outline copy of a photograph to use as a base for painting. Press **OK** to save the retouched copy.

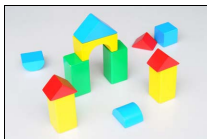

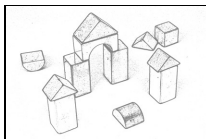

Before



After

Photo Illustration

MENU button →  retouch menu

Sharpen outlines and simplify coloring for a poster effect. Press  or  to make outlines thicker or thinner. Press  to save the retouched copy.







Before



After

Color Sketch

MENU button →  retouch menu















Create a copy of a photograph that resembles a sketch made with colored pencils. Press  or  to highlight **Vividness** or **Outlines** and press  or  to change. Vividness can be increased to make colors more saturated, or decreased for a washed-out, monochromatic effect, while outlines can be made thicker or thinner. Thicker outlines make colors more saturated. Press  to save the retouched copy.



Miniature Effect

MENU button →  retouch menu

Create a copy that appears to be a photo of a diorama. Works best with photos taken from a high vantage point. The area that will be in focus in the copy is indicated by a yellow frame.

To	Press	Description
Choose orientation	 (?)	Press  (?) to choose orientation of area that is in focus.
Choose area in focus		If area of effect is in wide orientation, press  or  to position frame showing area of copy that will be in focus.
		If area of effect is in tall orientation, press  or  to position frame showing area of copy that will be in focus.
Choose size		If area of effect is in wide orientation, press  or  to choose height.
		If area of effect is in tall orientation, press  or  to choose width.
Create copy		Create copy.

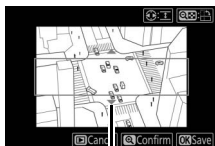

Area in focus

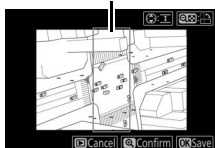

Selective Color

MENU button →  retouch menu



Create a copy in which only selected hues appear in color.

1 Select Selective color.

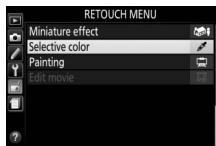
Highlight **Selective color** in the retouch menu and press .







2 Select a photograph.

Highlight a photograph and press  (to view the highlighted photograph full frame, press and hold the  button).



3 Select a color.

Use the multi selector to position the cursor over an object and press  () to select the color of the object as one that will remain in the final copy (the camera may have difficulty detecting unsaturated colors; choose a saturated color). To zoom in on the picture for precise color selection, press . Press  (?) to zoom out.

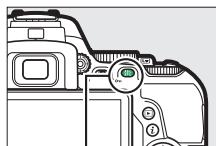

AE-L/AF-L () button

Selected color



4 Highlight the color range.

Rotate the command dial to highlight the color range for the selected color.



Color range



5 Choose the color range.

Press or to increase or decrease the range of similar hues that will be included in the final photograph. Choose from values between 1 and 7; note that higher values may include hues from other colors.



6 Select additional colors.

To select additional colors, rotate the command dial to highlight another of the three color boxes at the top of the display and repeat Steps 3–5 to select another color. Repeat for a third color if desired. To deselect the highlighted color, press (To remove all colors, press and hold . A confirmation dialog will be displayed; select **Yes**).



7 Save the edited copy.

Press to copy the photograph.



Painting

MENU button →  retouch menu

Create a copy which emphasizes detail and color for a painterly effect. Press **OK** to save the retouched copy.

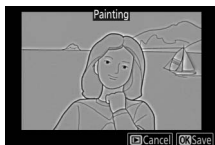

Before



After

Side-by-side Comparison

Compare retouched copies to the original photographs. This option is only available if the retouch menu is displayed by pressing the **i** button and selecting **Retouch** when a copy or original is played back full frame.

1 Select a picture.

Select a retouched copy (shown by a ) or a photograph that has been retouched in full-frame playback. Press **i**, then highlight **Retouch** and press **OK**.

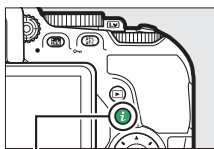

i button



- 2 Select Side-by-side comparison.**
Highlight **Side-by-side comparison** in the retouch menu and press **OK**.

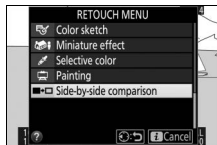

- 3 Compare the copy with the original.**

The source image is displayed on the left, the retouched copy on the right, with the options used to create the copy listed at the top of the display. Press **Left** or **Right** to switch between the source image and the retouched copy. To view the highlighted picture full frame, press and hold the **Magnifying Glass** button. If the copy was created from two images using **Image overlay**, press **Up** or **Down** to view the other source image. If multiple copies exist for the current source image, press **Up** or **Down** to view the other copies. Press **OK** to return to playback with the highlighted image displayed.

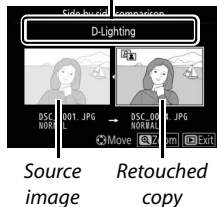

Options used to create copy



✔ Side-by-side comparison

The source image will not be displayed if the copy was created from a photograph that has since been deleted or that was protected when the copy was made (202).

Recent Settings / **My Menu**

Both recent settings, a menu listing the 20 most recently used settings, and My Menu, a custom menu listing up to 20 user-selected options, can be accessed by pressing the **MENU** button highlighting the last tab in the menu list (either  or .

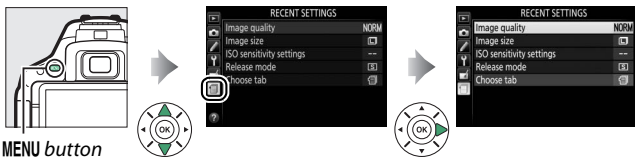

Choosing a Menu



Use the **Choose tab** option to choose the menu displayed.

1 Select **Choose tab**.

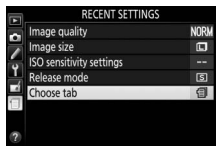
Highlight **Choose tab** and press .





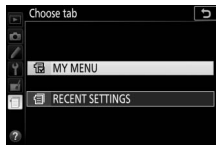

2 Select a menu.

Highlight  **MY MENU** or  **RECENT SETTINGS** and press  to display the selected menu.



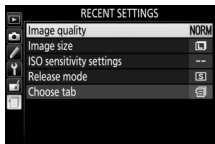

Recent Settings

When  **RECENT SETTINGS** is selected for **Choose tab**, the menu lists the 20 most recently used settings, with the most recently-used items first. Press  or  to highlight an option and press  to select.



Removing Items from the Recent Settings Menu

To remove an item from the recent settings menu, highlight it and press the  button. A confirmation dialog will be displayed; press  again to delete the selected item.

My Menu

Selecting  **MY MENU** for **Choose tab** lets you access a customized menu of up to 20 options selected from the playback, shooting, Custom Settings, setup, and retouch menus. Follow the steps below to add items to, delete items from, and reorder items in My Menu.

■ Adding Options to My Menu

1 Select Add items.

Highlight **Add items** and press .



2 Select a menu.

Highlight the name of the menu containing the option you wish to add and press .

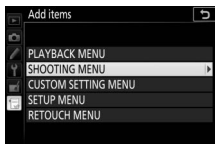

3 Select an item.

Highlight the desired menu item and press **OK**.



4 Position the new item.

Press **▲** or **▼** to move the new item up or down in My Menu. Press **OK** to add the new item. Repeat steps 1–4 to select additional items.

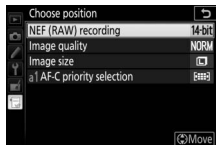

Adding Options to My Menu

The items currently displayed in My Menu are indicated by a check mark. Items indicated by a  icon can not be selected.



■ Deleting Options from My Menu

1 Select Remove items.



Highlight **Remove items** and press .

2 Select items.

Highlight items and press  to select or deselect. Selected items are indicated by a check mark.



3 Delete the selected items.

Press . A confirmation dialog will be displayed; press  again to delete the selected items.



■ Reordering Options in My Menu

1 Select Rank items.



Highlight **Rank items** and press .

2 Select an item.

Highlight the item you wish to move and press .



3 Position the item.

Press  or  to move the item up or down in My Menu and press .

Repeat Steps 2–3 to reposition additional items.



4 Exit to My Menu.

Press the **MENU** button to return to My Menu.

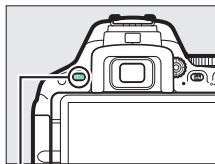

MENU button



Technical Notes

Read this chapter for information on compatible accessories, cleaning and storing the camera, and what to do if an error message is displayed or you encounter problems using the camera.

Compatible Lenses

Compatible CPU Lenses

This camera supports autofocus with AF-S, AF-P, and AF-I CPU lenses only. AF-S lenses have names beginning with **AF-S**, AF-P lenses with **AF-P**, and AF-I lenses with **AF-I**. Autofocus is not supported with other autofocus (AF) lenses. The following table lists the features available with compatible lenses in viewfinder photography:

Camera setting Lens/accessory	Focus mode			Shooting mode		Metering system		
	AF	MF (with electronic rangefinder)	MF	M	Other modes			
						3D	Color	
AF-S, AF-P, AF-I NIKKOR	✓	✓	✓	✓	✓	✓	—	✓ ¹
Other type G or D AF NIKKOR	—	✓	✓	✓	✓	✓	—	✓ ¹
PC-E NIKKOR series ^{2,3}	—	✓ ⁴	✓	✓	✓	✓	—	✓ ¹
PC Micro 85mm f/2.8D ⁵	—	✓ ⁴	✓	✓	—	✓	—	✓ ¹
AF-S/AF-I teleconverter	✓ ⁶	✓ ⁶	✓	✓	✓	✓	—	✓ ¹
Other AF NIKKOR (except lenses for F3AF)	—	✓ ⁷	✓	✓	✓	—	✓	✓ ¹
AI-P NIKKOR	—	✓ ⁸	✓	✓	✓	—	✓	✓ ¹

1 Spot metering meters selected focus point (125).

2 The tilt knob for the PC-E NIKKOR 24mm f/3.5D ED may contact the camera body when the lens is revolved.

- 3 Shifting and/or tilting the lens interferes with exposure.
 - 4 Can not be used with shifting or tilting.
 - 5 Optimal exposure will only be achieved if the lens is at maximum aperture and the lens is not shifted or tilted.
 - 6 With maximum effective aperture of f/5.6 or faster.
 - 7 When AF 80–200mm f/2.8, AF 35–70mm f/2.8, AF 28–85mm f/3.5–4.5 (New), or AF 28–85mm f/3.5–4.5 lenses are zoomed all the way in at the minimum focus distance, the in-focus indicator (●) may be displayed when the image on the matte screen in the viewfinder is not in focus. Before shooting, confirm that the image in the viewfinder screen is in focus.
 - 8 With maximum aperture of f/5.6 or faster.
- Noise in the form of lines may appear during autofocus when movies are recorded at high ISO sensitivities. Use manual focus or focus lock.

✓ IX NIKKOR Lenses

IX NIKKOR lenses can not be used.

✓ Identifying CPU and Type G, E, and D Lenses

CPU lenses can be identified by the presence of CPU contacts, type G, E, and D lenses by a letter on the lens barrel. Type G and E lenses are not equipped with a lens aperture ring.

CPU contacts

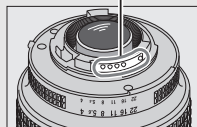

CPU lens

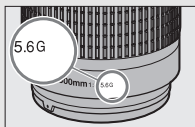

Type G or E lens

Aperture ring

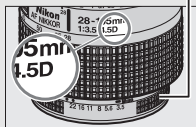

Type D lens

When using a CPU lens equipped with an aperture ring, lock the aperture ring at the minimum aperture (highest f-number).

✓ Matrix Metering

For matrix metering, the camera uses a 2016-pixel RGB sensor to set exposure according to tone distribution, color, composition, and, with type G, E, or D lenses, distance information (3D color matrix metering II; with other CPU lenses, the camera uses color matrix metering II; which does not include 3D distance information).

Compatible Non-CPU Lenses

Non-CPU lenses may only be used when the camera is in mode **M**. Selecting another mode disables the shutter release.

Aperture must be adjusted manually via the lens aperture ring and the camera metering system, i-TTL flash control, and other features requiring a CPU lens can not be used. Some non-CPU lenses can not be used; see “Incompatible Accessories and Non-CPU Lenses,” below.

Camera setting Lens/accessory	Focus mode			Shooting mode	
	AF	MF (with electronic rangefinder)	MF	M	Other modes
AI-, AI-modified NIKKOR or Nikon Series E lenses	—	✓ ¹	✓	✓ ²	—
Medical NIKKOR 120mm f/4	—	✓	✓	✓ ^{2,3}	—
Reflex NIKKOR	—	—	✓	✓ ²	—
PC NIKKOR	—	✓ ⁴	✓	✓ ²	—
AI-type Teleconverter	—	✓ ⁵	✓	✓ ²	—
PB-6 Bellows Focusing Attachment ⁶	—	✓ ¹	✓	✓ ²	—
Auto extension rings (PK-series 11A, 12, or 13; PN-11)	—	✓ ¹	✓	✓ ²	—

1 With maximum aperture of f/5.6 or faster.

2 Exposure indicator can not be used.

3 Can be used at shutter speeds slower than flash sync speed by one step or more.

4 Can not be used with shifting or tilting.

5 With maximum effective aperture of f/5.6 or faster.

6 Attach in vertical orientation (can be used in horizontal orientation once attached).

Incompatible Accessories and Non-CPU Lenses

The following accessories and non-CPU lenses can NOT be used with the D5500:

- TC-16A AF teleconverter
- Non-AI lenses
- Lenses that require the AU-1 focusing unit (400mm f/4.5, 600mm f/5.6, 800mm f/8, 1200mm f/11)
- Fisheye (6mm f/5.6, 7.5mm f/5.6, 8mm f/8, OP 10mm f/5.6)
- 2.1cm f/4
- Extension Ring K2
- 180–600mm f/8 ED (serial numbers 174041–174180)
- 360–1200mm f/11 ED (serial numbers 174031–174127)
- 200–600mm f/9.5 (serial numbers 280001–300490)
- AF lenses for the F3AF (AF 80mm f/2.8, AF 200mm f/3.5 ED, AF Teleconverter TC-16)
- PC 28mm f/4 (serial number 180900 or earlier)
- PC 35mm f/2.8 (serial numbers 851001–906200)
- PC 35mm f/3.5 (old type)
- Reflex 1000mm f/6.3 (old type)
- Reflex 1000mm f/11 (serial numbers 142361–143000)
- Reflex 2000mm f/11 (serial numbers 200111–200310)

AF-Assist Illumination

The AF-assist illuminator has a range of about 0.5–3.0 m (1 ft 8 in.–9 ft 10 in.); when using the illuminator, use a lens with a focal length of 18–200 mm and remove the lens hood. AF-assist illumination is not available with the following lenses:

- AF-S NIKKOR 14–24mm f/2.8G ED
- AF-S NIKKOR 28–300mm f/3.5–5.6G ED VR
- AF-S DX NIKKOR 55–300mm f/4.5–5.6G ED VR
- AF-S VR Zoom-Nikkor 70–200mm f/2.8G IF-ED
- AF-S NIKKOR 70–200mm f/2.8G ED VR II
- AF-S Zoom-Nikkor 80–200mm f/2.8D IF-ED
- AF-S NIKKOR 80–400mm f/4.5–5.6G ED VR
- AF-S VR Nikkor 200mm f/2G IF-ED
- AF-S NIKKOR 200mm f/2G ED VR II
- AF-S VR Zoom-Nikkor 200–400mm f/4G IF-ED
- AF-S NIKKOR 200–400mm f/4G ED VR II

At ranges under 1 m (3 ft 3 in.), the following lenses may block the AF-assist illuminator and interfere with autofocus when lighting is poor:

- AF-S DX NIKKOR 10–24mm f/3.5–4.5G ED
- AF-S NIKKOR 16–35mm f/4G ED VR
- AF-S Zoom-Nikkor 17–35mm f/2.8D IF-ED
- AF-S DX Zoom-Nikkor 17–55mm f/2.8G IF-ED
- AF-S NIKKOR 18–35mm f/3.5–4.5G ED
- AF-S DX NIKKOR 18–105mm f/3.5–5.6G ED VR
- AF-S DX VR Zoom-Nikkor 18–200mm f/3.5–5.6G IF-ED
- AF-S DX NIKKOR 18–200mm f/3.5–5.6G ED VR II
- AF-S DX NIKKOR 18–300mm f/3.5–5.6G ED VR
- AF-S DX NIKKOR 18–300mm f/3.5–6.3G ED VR
- AF-S NIKKOR 20mm f/1.8G ED
- AF-S NIKKOR 24–70mm f/2.8G ED
- AF-S VR Zoom-Nikkor 24–120mm f/3.5–5.6G IF-ED
- AF-S NIKKOR 24–120mm f/4G ED VR
- AF-S NIKKOR 28mm f/1.8G
- AF-S Zoom-Nikkor 28–70mm f/2.8D IF-ED
- AF-S NIKKOR 35mm f/1.4G
- AF-S NIKKOR 70–200mm f/4G ED
- AF-S NIKKOR 70–200mm f/4G ED VR
- AF-S NIKKOR 85mm f/1.4G
- AF-S NIKKOR 85mm f/1.8G
- AF-S VR Micro-Nikkor 105mm f/2.8G IF-ED

✓ The Built-in Flash

The built-in flash can be used with lenses with focal lengths of 18–300 mm, although in some cases the flash may be unable to entirely light the subject at some ranges or focal lengths due to shadows cast by the lens (see the illustration below), while lenses that block the subject's view of the red-eye reduction lamp may interfere with red-eye reduction. Remove lens hoods to prevent shadows.

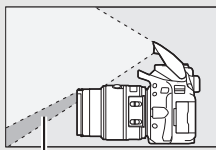

Shadow

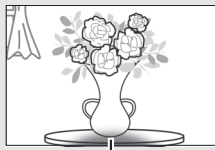

Vignetting

The flash has a minimum range of 0.6 m and can not be used in the macro range of macro zoom lenses. The flash may be unable to light the entire subject with the following lenses at ranges less than those given below:

Lens	Zoom position	Minimum distance without vignetting
AF-S DX NIKKOR 10–24mm f/3.5–4.5G ED	24 mm	1.5 m / 4 ft 12 in.
AF-S DX Zoom-Nikkor 12–24mm f/4G IF-ED	24 mm	1.0 m / 3 ft 4 in.
AF-S NIKKOR 16–35mm f/4G ED VR	35 mm	1.0 m / 3 ft 4 in.
AF-S DX NIKKOR 16–85mm f/3.5–5.6G ED VR	24–85 mm	No vignetting
AF-S Zoom-Nikkor 17–35mm f/2.8D IF-ED	28 mm	1.0 m / 3 ft 4 in.
	35 mm	No vignetting
AF-S DX Zoom-Nikkor 17–55mm f/2.8G IF-ED	28 mm	1.5 m / 4 ft 12 in.
	35 mm	1.0 m / 3 ft 4 in.
	45–55 mm	No vignetting
AF-S NIKKOR 18–35mm f/3.5–4.5G ED	24 mm	1.5 m / 4 ft 12 in.
	28 mm	1.0 m / 3 ft 4 in.
	35 mm	No vignetting
AF Zoom-Nikkor 18–35mm f/3.5–4.5D IF-ED	24 mm	1.0 m / 3 ft 4 in.
	28–35 mm	No vignetting

Lens	Zoom position	Minimum distance without vignetting
AF-P DX NIKKOR 18–55mm f/3.5–5.6G VR, AF-P DX NIKKOR 18–55mm f/3.5–5.6G	18 mm	1.0 m / 3 ft 4 in.
	24–55 mm	No vignetting
AF-S DX Zoom-Nikkor 18–70mm f/3.5–4.5G IF-ED	18 mm	1.0 m / 3 ft 4 in.
	24–70 mm	No vignetting
AF-S DX NIKKOR 18–105mm f/3.5–5.6G ED VR	18 mm	2.5 m / 8 ft 3 in.
	24 mm	1.0 m / 3 ft 4 in.
	35–105 mm	No vignetting
AF-S DX Zoom-Nikkor 18–135mm f/3.5–5.6G IF-ED	18 mm	2.0 m / 6 ft 7 in.
	24–135 mm	No vignetting
AF-S DX NIKKOR 18–140mm f/3.5–5.6G ED VR	24 mm	1.0 m / 3 ft 4 in.
	35–140 mm	No vignetting
AF-S DX VR Zoom-Nikkor 18–200mm f/3.5–5.6G IF-ED, AF-S DX NIKKOR 18–200mm f/3.5–5.6G ED VR II	24 mm	1.0 m / 3 ft 4 in.
	35–200 mm	No vignetting
AF-S DX NIKKOR 18–300mm f/3.5–5.6G ED VR	35–300 mm	1.0 m / 3 ft 4 in.
AF-S DX NIKKOR 18–300mm f/3.5–6.3G ED VR	35–300 mm	No vignetting
AF-S NIKKOR 20mm f/1.8G ED	20 mm	1.5 m / 4 ft 12 in.
	24 mm	2.5 m / 8 ft 3 in.
AF Zoom-Nikkor 20–35mm f/2.8D IF	28 mm	1.0 m / 3 ft 4 in.
	35 mm	No vignetting
AF-S NIKKOR 24mm f/1.4G ED	24 mm	1.0 m / 3 ft 4 in.
AF-S NIKKOR 24–70mm f/2.8G ED	35 mm	1.5 m / 4 ft 12 in.
	50–70 mm	No vignetting
AF-S VR Zoom-Nikkor 24–120mm f/3.5–5.6G IF-ED	24 mm	1.0 m / 3 ft 4 in.
	28–120 mm	No vignetting
AF-S NIKKOR 24–120mm f/4G ED VR	24 mm	1.5 m / 4 ft 12 in.
	28–120 mm	No vignetting
AF-S Zoom-Nikkor 28–70mm f/2.8D IF-ED	35 mm	1.5 m / 4 ft 12 in.
	50–70 mm	No vignetting
AF-S NIKKOR 28–300mm f/3.5–5.6G ED VR	28 mm	1.5 m / 4 ft 12 in.
	35 mm	1.0 m / 3 ft 4 in.
	50–300 mm	No vignetting

Lens	Zoom position	Minimum distance without vignetting
AF-S VR Zoom-Nikkor 200–400mm f/4G IF-ED, AF-S NIKKOR 200–400mm f/4G ED VR II	200 mm	4.0 m/13 ft 2 in.
	250 mm	3.0 m/ 9 ft 11 in.
	300 mm	2.5 m/ 8 ft 3 in.
PC-E NIKKOR 24mm f/3.5D ED *	24 mm	3.0 m/ 9 ft 11 in.

* When not shifted or tilted.

When used with the AF-S NIKKOR 14–24mm f/2.8G ED, the flash will be unable to light the entire subject at all ranges.

Calculating Angle of View

The size of the area exposed by a 35 mm camera is 36×24 mm. The size of the area exposed by the D5500, in contrast, is 23.5×15.6 mm, meaning that the angle of view of a 35mm camera is approximately 1.5 times that of the D5500. The approximate focal length of lenses for the D5500 in 35 mm format can be calculated by multiplying the focal length of the lens by about 1.5.

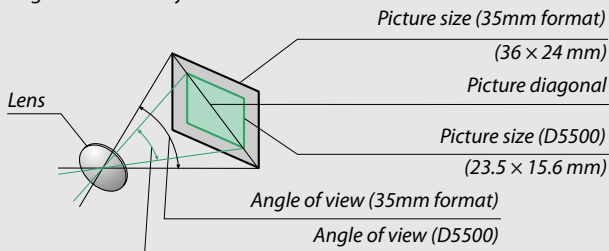



Optional Flash Units (Speedlights)

The camera supports the Nikon Creative Lighting System (CLS) and can be used with CLS-compatible flash units. The built-in flash will not fire when an optional flash unit is attached.

Flash Units Compatible with the Creative Lighting System (CLS)

The camera can be used with the following CLS-compatible flash units:

Flash unit	SB-910, SB-900 ¹	SB-800	SB-700 ¹	SB-600	SB-500 ²	SB-400 ³	SB-300 ³	SB-R200 ⁴
Feature								
Guide No. (ISO 100) ⁵	34/111	38/125	28/92	30/98	24/78	21/69	18/59	10/33

- 1 If a color filter is attached to the SB-910, SB-900, or SB-700 when **AUTO** or  (flash) is selected for white balance, the camera will automatically detect the filter and adjust white balance appropriately.
 - 2 Users of the LED light can set camera white balance to **AUTO** or  for optimal results.
 - 3 Wireless flash control is not available.
 - 4 Controlled remotely using optional SB-910, SB-900, SB-800, SB-700, or SB-500 flash unit or SU-800 wireless Speedlight commander.
 - 5 m/ft, 20 °C (68 °F), SB-910, SB-900, SB-800, SB-700, and SB-600 at 35 mm zoom head position; SB-910, SB-900, and SB-700 with standard illumination.
- **The SU-800 wireless speedlight commander:** When mounted on a CLS-compatible camera, the SU-800 can be used as a commander for remote SB-910, SB-900, SB-800, SB-700, SB-600, SB-500, or SB-R200 flash units in up to three groups. The SU-800 itself is not equipped with a flash.

The Nikon Creative Lighting System (CLS)

Nikon's advanced Creative Lighting System (CLS) offers improved communication between the camera and compatible flash units for improved flash photography. Refer to the documentation provided with the flash unit for details.

Guide Number

To calculate the range of the flash at full power, divide the Guide Number by the aperture. If, for example, the flash unit has a Guide Number of 34 m or 111 ft (ISO 100, 20 °C/68 °F); its range at an aperture of f/5.6 is $34 \div 5.6$ or about 6.1 meters (or in feet, $111 \div 5.6 =$ approximately 19 ft 10 in.). For each twofold increase in ISO sensitivity, multiply the Guide Number by the square root of two (approximately 1.4).

The following features are available with CLS-compatible flash units:

		SB-910, SB-900, SB-800	SB-700	SB-600	SB-500	SU-800	SB-R200	SB-400	SB-300		
Single flash	i-TTL	i-TTL balanced fill-flash for digital SLR ¹	✓	✓	✓	✓	—	—	✓	✓	
		Standard i-TTL fill-flash for digital SLR	✓ ²	✓	✓ ²	✓	—	—	✓	✓	
	AA	Auto aperture	✓ ³	—	—	—	—	—	—	—	
	A	Non-TTL auto	✓ ³	—	—	—	—	—	—	—	
	GN	Distance-priority manual	✓	✓	—	—	—	—	—	—	
	M	Manual	✓	✓	✓	✓ ⁴	—	—	✓ ⁴	✓ ⁴	
	RPT	Repeating flash	✓	—	—	—	—	—	—	—	
Advanced Wireless Lighting	Master	Remote flash control	✓	✓	—	✓ ⁴	✓	—	—	—	
		i-TTL i-TTL	✓	✓	—	✓ ⁴	—	—	—	—	
		[A:B]	Quick wireless flash control	—	✓	—	—	✓ ⁵	—	—	—
		AA	Auto aperture	✓ ⁶	—	—	—	—	—	—	—
		A	Non-TTL auto	✓	—	—	—	—	—	—	—
		M	Manual	✓	✓	—	✓ ⁴	—	—	—	—
		RPT	Repeating flash	✓	—	—	—	—	—	—	—
	Remote	i-TTL	i-TTL	✓	✓	✓	✓	—	✓	—	—
		[A:B]	Quick wireless flash control	✓	✓	✓	✓	—	✓	—	—
		AA	Auto aperture	✓ ⁶	—	—	—	—	—	—	—
		A	Non-TTL auto	✓	—	—	—	—	—	—	—
		M	Manual	✓	✓	✓	✓	—	✓	—	—
		RPT	Repeating flash	✓	✓	✓	✓	—	—	—	—

	SB-910, SB-900, SB-800	SB-700	SB-600	SB-500	SU-800	SB-R200	SB-400	SB-300
Color Information Communication (flash)	✓	✓	✓	✓	—	—	✓	✓
Color Information Communication (LED light)	—	—	—	✓	—	—	—	—
AF-assist for multi-area AF	✓	✓	✓	—	✓ ⁷	—	—	—
Red-eye reduction	✓	✓	✓	✓	—	—	✓	—
Camera flash mode selection	—	—	—	✓	—	—	✓	✓
Camera flash unit firmware update	✓ ⁸	✓	—	✓	—	—	—	✓

1 Not available with spot metering.

2 Can also be selected with flash unit.

3 AA/A mode selection performed on flash unit using custom settings. "A" will be selected when a non-CPU lens is used.

4 Can only be selected with camera (☞ 259).

5 Available only during close-up photography.

6 Non-TTL auto (A) is used with non-CPU lenses, regardless of mode selected with flash unit.

7 Available only in commander mode.

8 Firmware updates for the SB-910 and SB-900 can be performed from the camera.

■ Other Flash Units

The following flash units can be used in non-TTL auto and manual modes. Use with the camera in exposure mode **S** or **M** and a shutter speed of $1/200$ s or slower selected.

Flash unit	SB-80DX, SB-28DX, SB-28, SB-26, SB-25, SB-24	SB-50DX ¹	SB-30, SB-27 ² , SB-22S, SB-22, SB-20, SB-16B, SB-15	SB-23, SB-29 ³ , SB-21B ³ , SB-29S ³
A Non-TTL auto	✓	—	✓	—
M Manual	✓	✓	✓	✓
 Repeating flash	✓	—	—	—
REAR Rear-curtain sync ⁴	✓	✓	✓	✓

- 1 Select mode **P**, **S**, **A**, or **M**, lower built-in flash, and use optional flash unit only.
- 2 Flash mode is automatically set to TTL and shutter-release is disabled. Set flash unit to **A** (non-TTL auto flash).
- 3 Autofocus is available with AF-S VR Micro-Nikkor 105mm f/2.8G IF-ED and AF-S Micro NIKKOR 60mm f/2.8G ED lenses only.
- 4 Available when camera is used to select flash mode.

The AS-15 Sync Terminal Adapter



When the AS-15 sync terminal adapter (available separately) is mounted on the camera accessory shoe, flash accessories can be connected via a sync cable.

Use Only Nikon Flash Accessories

Use only Nikon flash units. Negative voltages or voltages over 250 V applied to the accessory shoe could not only prevent normal operation, but damage the sync circuitry of the camera or flash. Before using a Nikon flash unit not listed in this section, contact a Nikon-authorized service representative for more information.

✓ Notes on Optional Flash Units

Refer to the Speedlight manual for detailed instructions. If the flash unit supports CLS, refer to the section on CLS-compatible digital SLR cameras. The D5500 is not included in the “digital SLR” category in the SB-80DX, SB-28DX, and SB-50DX manuals.

If an optional flash unit is attached in shooting modes other than , , and , the flash will fire with every shot, even in modes in which the built-in flash can not be used.

i-TTL flash control can be used at ISO sensitivities between 100 and 12800. At high ISO sensitivities, noise (lines) may appear in photos taken with some optional flash units; if this occurs, choose a lower value. At values over 12800, the desired results may not be achieved at some ranges or aperture settings. If the flash-ready indicator flashes for about three seconds after a photograph is taken, the flash has fired at full power and the photograph may be underexposed (CLS-compatible flash units only; for information on the exposure and flash charge indicators on other units, see the manual provided with the flash).



When an SC-series 17, 28, or 29 sync cable is used for off-camera flash photography, correct exposure may not be achieved in i-TTL mode. We recommend that you choose spot metering to select standard i-TTL flash control. Take a test shot and view the results in the monitor.

In i-TTL, use the flash panel or bounce adapter provided with the flash unit. Do not use other panels such as diffusion panels, as this may produce incorrect exposure.



If the controls on the optional SB-910, SB-900, SB-800, SB-700 or SB-600 flash unit or SU-800 wireless Speedlight commander are used to set flash compensation,  will appear in the information display.

The SB-910, SB-900, SB-800, SB-700, SB-600, SB-500, and SB-400 provide red-eye reduction, while the SB-910, SB-900, SB-800, SB-700, SB-600, and SU-800 provide AF-assist illumination with the following restrictions:

- **SB-910 and SB-900:** AF-assist illumination is available with 17–135 mm AF lenses, however, autofocus is available only with the focus points shown at right.

17–19 mm	
20–105 mm	
106–135 mm	

- **SB-800, SB-600, and SU-800:** AF-assist illumination is available with 24–105 mm AF lenses, however, autofocus is available only with the focus points shown at right.

24–34 mm	
35–49 mm	
50–105 mm	

- **SB-700:** AF-assist illumination is available with 24–135 mm AF lenses, however, autofocus is available only with the focus points shown at right.

24–135 mm	
-----------	--

Depending on the lens used and scene recorded, the in-focus indicator (●) may be displayed when the subject is not in focus, or the camera may be unable to focus and the shutter release will be disabled.

Other Accessories

At the time of writing, the following accessories were available for the D5500.

Power sources	<ul style="list-style-type: none">• Rechargeable Li-ion Battery EN-EL14a (☐ 27): Additional EN-EL14a batteries are available from local retailers and Nikon-authorized service representatives. EN-EL14 batteries can also be used.• Battery Charger MH-24 (☐ 27): Recharge EN-EL14a and EN-EL14 batteries.• Power Connector EP-5A, AC Adapter EH-5b: These accessories can be used to power the camera for extended periods (EH-5a and EH-5 AC adapters can also be used). A power connector EP-5A is required to connect the camera to the EH-5b, EH-5a, or EH-5; see page 335 for details.
Accessory shoe covers	Accessory Shoe Cover BS-1 : A cover protecting the accessory shoe. The accessory shoe is used for optional flash units.
Filters	<ul style="list-style-type: none">• Filters intended for special-effects photography may interfere with autofocus or the electronic rangefinder.• The D5500 can not be used with linear polarizing filters. Use C-PL or C-PL II circular polarizing filters instead.• NC filters are recommended for protecting the lens.• To prevent ghosting, use of a filter is not recommended when the subject is framed against a bright light, or when a bright light source is in the frame.• Center-weighted metering is recommended with filters with exposure factors (filter factors) over 1× (Y44, Y48, Y52, O56, R60, X0, X1, C-PL, ND2S, ND4, ND4S, ND8, ND8S, ND400, A2, A12, B2, B8, B12). See the filter manual for details.

**Viewfinder
eyepiece
accessories**

- **DK-5 Eyepiece Cap** (☐ 76): Prevents light entering via the viewfinder from appearing in the photograph or interfering with exposure.
- **DK-20C Eyepiece Correction Lenses**: Lenses are available with diopters of -5 , -4 , -3 , -2 , 0 , $+0.5$, $+1$, $+2$, and $+3$ m^{-1} when the camera diopter adjustment control is in the neutral position (-1 m^{-1}). Use eyepiece correction lenses only if the desired focus can not be achieved with the built in diopter adjustment control (-1.7 to $+0.5$ m^{-1}). Test eyepiece correction lenses before purchase to ensure that the desired focus can be achieved. The rubber eyecup can not be used with eyepiece correction lenses.
- **Magnifier DG-2**: The DG-2 magnifies the scene displayed in the center of the viewfinder for greater precision during focusing. Eyepiece adapter required (available separately). Note that because the DG-2 interferes with the eye sensor, you may find it necessary to select **Off** for the **Info display auto off** item in the setup menu (☐ 278) when this accessory is attached.
- **Eyepiece Adapter DK-22**: The DK-22 is used when attaching the DG-2 magnifier. The monitor can not be rotated with the adapter in place.
- **Right-Angle Viewing Attachment DR-6**: The DR-6 attaches at a right angle to the viewfinder eyepiece, allowing the image in the viewfinder to be viewed at right angles to the lens (for example, from directly above when the camera is horizontal). The monitor can not be rotated with the attachment in place. In addition, because the DR-6 interferes with the eye sensor, you may find it necessary to select **Off** for the **Info display auto off** item in the setup menu when this accessory is attached.

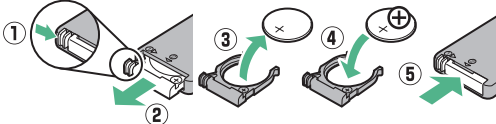
Software	<p>Camera Control Pro 2: Control the camera remotely from a computer to record movies and photographs and save photographs directly to the computer hard disk.</p> <p>Note: Use the latest versions of Nikon software; see the websites listed on page xix for the latest information on supported operating systems. At default settings, Nikon Message Center 2 will periodically check for updates to Nikon software and firmware while you are logged in to an account on the computer and the computer is connected to the Internet. A message is automatically displayed when an update is found.</p>
Body cap	<p>Body Cap BF-1B/Body Cap BF-1A: The body cap keeps the mirror, viewfinder screen, and image sensor free of dust when a lens is not in place.</p>
Remote controls/ wireless remote controller	<ul style="list-style-type: none"> • Wireless Remote Control ML-L3 (□ 107): The ML-L3 uses a 3 V CR2025 battery.  <p>Pressing the battery-chamber latch to the right (1), insert a fingernail into the gap and open the battery chamber (2). Ensure that the battery is inserted in the correct orientation (4).</p> <ul style="list-style-type: none"> • Wireless Remote Controller WR-R10/WR-T10: When a WR-R10 wireless remote controller is attached, the camera can be controlled wirelessly using a WR-T10 wireless remote controller (□ 109, 282). • Wireless Remote Controller WR-1 (□ 109, 282): The WR-1 can function as either a transmitter or a receiver and is used in combination either with another WR-1 or a WR-R10 or WR-T10 wireless remote controller. For example, a WR-1 can be connected to the accessory terminal for use as a receiver, allowing the shutter to be released remotely by another WR-1 acting as a transmitter.

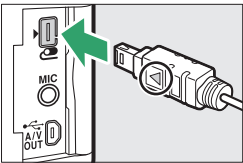
Microphones	Stereo Microphone ME-1 (□ 180)
Accessory terminal accessories	<p>The D5500 is equipped with an accessory terminal for WR-1 and WR-R10 wireless remote controllers (□ 109), MC-DC2 remote cords (□ 121), and GP-1/GP-1A GPS units (□ 283), which connect with the ◀ mark on the connector aligned with the ▶ next to the accessory terminal (close the connector cover when the terminal is not in use).</p> 
USB and A/V connector accessories	<ul style="list-style-type: none"> • UC-E23 and UC-E6 USB cables (□ 211, 214): The supplied UC-E23 cable is not available for separate purchase; purchase UC-E6 cables instead. • EG-CP16 audio/video cables
HDMI cables (□ 222)	HDMI Cable HC-E1: An HDMI cable with a type C connector for connection to the camera and a type A connector for connection to HDMI devices.

Optional Accessories

Availability may vary with country or region. See our website or brochures for the latest information.

Approved Memory Cards

The following SD memory cards have been tested and approved for use in the camera. Cards with class 6 or faster write speeds are recommended for movie recording. Recording may end unexpectedly when cards with slower write speeds are used.

	SD memory cards	SDHC memory cards ²	SDXC memory cards ³
SanDisk	2 GB ¹	4 GB, 8 GB, 16 GB, 32 GB	64 GB, 128 GB
Toshiba	—		64 GB
Panasonic	2 GB ¹	4 GB, 6 GB, 8 GB, 12 GB, 16 GB, 24 GB, 32 GB	48 GB, 64 GB
Lexar Media		4 GB, 8 GB, 16 GB, 32 GB	—
Platinum II	—	8 GB, 16 GB, 32 GB	64 GB
Professional			64 GB, 128 GB, 256 GB
Full-HD Video		4 GB, 8 GB, 16 GB	—

- 1 Check that any card readers or other devices with which the card will be used support 2 GB cards.
- 2 Check that any card readers or other devices with which the card will be used are SDHC-compliant. The camera supports UHS-I.
- 3 Check that any card readers or other devices with which the card will be used are SDXC-compliant. The camera supports UHS-I.



Other cards have not been tested. For more details on the above cards, please contact the manufacturer.

Attaching a Power Connector and AC Adapter

Turn the camera off before attaching an optional power connector and AC adapter.

1 Ready the camera.

Open the battery-chamber (1) and power connector (2) covers.

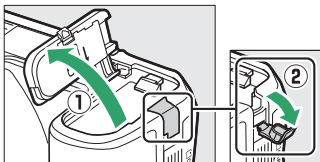

2 Insert the EP-5A power connector.

Be sure to insert the connector in the orientation shown, using the connector to keep the orange battery latch pressed to one side. Be sure the connector is fully inserted.

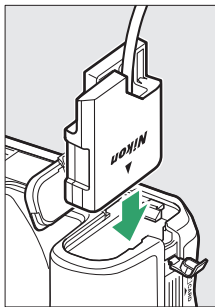

3 Close the battery-chamber cover.

Position the power connector cable so that it passes through the power connector slot and close the battery-chamber cover.

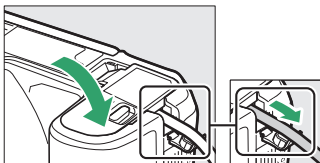

4 Connect the EH-5b AC adapter.

Connect the AC adapter power cable to the AC socket on AC adapter (3) and the power cable to the DC socket (4). A  icon is displayed in the monitor when the camera is powered by the AC adapter and power connector.

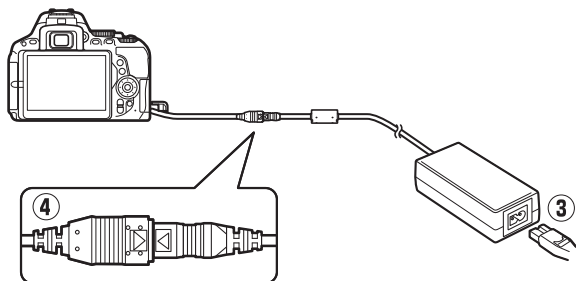

Caring for the Camera

Storage

When the camera will not be used for an extended period, remove the battery and store it in a cool, dry area with the terminal cover in place. To prevent mold or mildew, store the camera in a dry, well-ventilated area. Do not store your camera with naphtha or camphor moth balls or in locations that:

- are poorly ventilated or subject to humidities of over 60%
- are next to equipment that produces strong electromagnetic fields, such as televisions or radios
- are exposed to temperatures above 50 °C (122 °F) or below -10 °C (14 °F)

Cleaning

Camera body	Use a blower to remove dust and lint, then wipe gently with a soft, dry cloth. After using the camera at the beach or seaside, wipe off sand or salt with a cloth lightly dampened in distilled water and dry thoroughly. Important: <i>Dust or other foreign matter inside the camera may cause damage not covered under warranty.</i>
Lens, mirror, and viewfinder	These glass elements are easily damaged. Remove dust and lint with a blower. If using an aerosol blower, keep the can vertical to prevent the discharge of liquid. To remove fingerprints and other stains, apply a small amount of lens cleaner to a soft cloth and clean with care.
Monitor	Remove dust and lint with a blower. When removing fingerprints and other stains, wipe the surface lightly with a soft cloth or chamois leather. Do not apply pressure, as this could result in damage or malfunction.

Do not use alcohol, thinner, or other volatile chemicals.

Image Sensor Cleaning

If you suspect that dirt or dust on the image sensor is appearing in photographs, you can clean the sensor using the **Clean image sensor** option in the setup menu. The sensor can be cleaned at any time using the **Clean now** option, or cleaning can be performed automatically when the camera is turned on or off.

■ ■ “Clean Now”

Holding the camera base down, select **Clean image sensor** in the setup menu, then highlight **Clean now** and press **OK**. The camera will check the image sensor and then begin cleaning. **b5y** flashes in the viewfinder and other operations can not be performed while cleaning is in progress. Do not remove or disconnect the power source until cleaning ends and the setup menu is displayed.

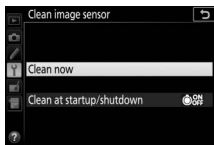
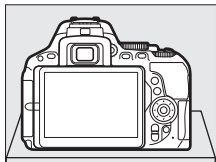

■ ■ “Clean at Startup/Shutdown”

1 Select Clean at startup/shutdown.

Select **Clean image sensor**, then highlight **Clean at startup/shutdown** and press .

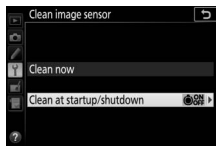

2 Select an option.

Highlight an option and press . Choose from **Clean at startup**, **Clean at shutdown**, **Clean at startup & shutdown**, and **Cleaning off**.

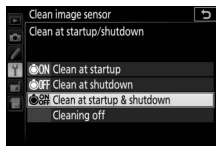

Image Sensor Cleaning

Using camera controls during startup interrupts image sensor cleaning.

Cleaning is performed by vibrating the image sensor. If dust can not be fully removed using the options in the **Clean image sensor** menu, clean the image sensor manually (📖 340) or consult a Nikon-authorized service representative.

If image sensor cleaning is performed several times in succession, image sensor cleaning may be temporarily disabled to protect the camera's internal circuitry. Cleaning can be performed again after a short wait.

Manual Cleaning

If foreign matter can not be removed from the image sensor using the **Clean image sensor** option in the setup menu (☞ 338), the sensor can be cleaned manually as described below. Note, however, that the sensor is extremely delicate and easily damaged. Nikon recommends that the sensor be cleaned only by Nikon-authorized service personnel.

1 Charge the battery.

A reliable power source is required when inspecting or cleaning the image sensor. Be sure the battery is fully charged before proceeding.

2 Remove the lens.

Turn the camera off and remove the lens.

3 Select **Lock mirror up for cleaning**.

Turn the camera on and highlight **Lock mirror up for cleaning** in the setup menu and press \blacktriangleright (note that this option is not available at battery levels of $\frac{1}{4}$ or below).

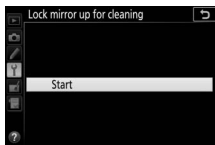

4 Press \odot .

The message shown at right will be displayed in the monitor.

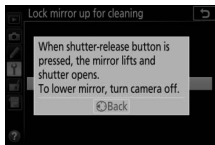

5 Raise the mirror.

Press the shutter-release button all the way down. The mirror will be raised and the shutter curtain will open, revealing the image sensor.



6 Examine the image sensor.

Holding the camera so that light falls on the image sensor, examine the interior of the camera for dust or lint. If no foreign objects are present, proceed to Step 8.

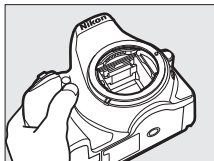

7 Clean the sensor.

Remove any dust and lint from the sensor with a blower. Do not use a blower-brush, as the bristles could damage the sensor. Dirt that can not be removed with a blower can only be removed by Nikon-authorized service personnel. Under no circumstances should you touch or wipe the sensor.

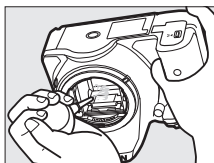

8 Turn the camera off.

The mirror will return to the down position and the shutter curtain will close. Replace the lens or body cap.

Use a Reliable Power Source

The shutter curtain is delicate and easily damaged. If the camera powers off while the mirror is raised, the curtain will close automatically. To prevent damage to the curtain, observe the following precautions:

- Do not turn the camera off or remove or disconnect the power source while the mirror is raised.
- If the battery runs low while the mirror is raised, a beep will sound and the self-timer lamp will flash to warn that the shutter curtain will close and the mirror will be lowered after about two minutes. End cleaning or inspection immediately.

✔ Foreign Matter on the Image Sensor

Foreign matter entering the camera when lenses or body caps are removed or exchanged (or in rare circumstances lubricant or fine particles from the camera itself) may adhere to the image sensor, where it may appear in photographs taken under certain conditions. To protect the camera when no lens is in place, be sure to replace the body cap provided with the camera, being careful to first remove all dust and other foreign matter that may be adhering to the camera mount, lens mount, and body cap. Avoid attaching the body cap or exchanging lenses in dusty environments.

Should foreign matter find its way onto the image sensor, use the image sensor cleaning option as described on page 338. If the problem persists, clean the sensor manually (□ 340) or have the sensor cleaned by authorized Nikon service personnel. Photographs affected by the presence of foreign matter on the sensor can be retouched using the clean image options available in some imaging applications.

✔ Servicing the Camera and Accessories

The camera is a precision device and requires regular servicing. Nikon recommends that the camera be inspected by the original retailer or Nikon-authorized service representative once every one to two years, and that it be serviced once every three to five years (note that fees apply to these services). Frequent inspection and servicing are particularly recommended if the camera is used professionally. Any accessories regularly used with the camera, such as lenses or optional flash units, should be included when the camera is inspected or serviced.

Caring for the Camera and Battery: Cautions

Do not drop: The product may malfunction if subjected to strong shocks or vibration.

Keep dry: This product is not waterproof, and may malfunction if immersed in water or exposed to high levels of humidity. Rusting of the internal mechanism can cause irreparable damage.

Avoid sudden changes in temperature: Sudden changes in temperature, such as those that occur when entering or leaving a heated building on a cold day, can cause condensation inside the device. To prevent condensation, place the device in a carrying case or plastic bag before exposing it to sudden changes in temperature.

Keep away from strong magnetic fields: Do not use or store this device in the vicinity of equipment that generates strong electromagnetic radiation or magnetic fields. Strong static charges or the magnetic fields produced by equipment such as radio transmitters could interfere with the monitor, damage data stored on the memory card, or affect the product's internal circuitry.

Do not leave the lens pointed at the sun: Do not leave the lens pointed at the sun or other strong light source for an extended period. Intense light may cause the image sensor to deteriorate or produce a white blur effect in photographs.

Turn the product off before removing or disconnecting the power source: Do not unplug the product or remove the battery while the product is on or while images are being recorded or deleted. Forcibly cutting power in these circumstances could result in loss of data or in damage to product memory or internal circuitry. To prevent an accidental interruption of power, avoid carrying the product from one location to another while the AC adapter is connected.

Cleaning: When cleaning the camera body, use a blower to gently remove dust and lint, then wipe gently with a soft, dry cloth. After using the camera at the beach or seaside, wipe off any sand or salt using a cloth lightly dampened in pure water and then dry the camera thoroughly.

The lens and mirror are easily damaged. Dust and lint should be gently removed with a blower. When using an aerosol blower, keep the can vertical to prevent discharge of liquid. To remove fingerprints and other stains from the lens, apply a small amount of lens cleaner to a soft cloth and wipe the lens carefully.

See “Image Sensor Cleaning” (☐ 338, 340) for information on cleaning the image sensor.

Do not touch the shutter curtain: The shutter curtain is extremely thin and easily damaged. Under no circumstances should you exert pressure on the curtain, poke it with cleaning tools, or subject it to powerful air currents from a blower. These actions could scratch, deform, or tear the curtain.

Storage: To prevent mold or mildew, store the camera in a dry, well-ventilated area. If you are using an AC adapter, unplug the adapter to prevent fire. If the product will not be used for an extended period, remove the battery to prevent leakage and store the camera in a plastic bag containing a desiccant. Do not, however, store the camera case in a plastic bag, as this may cause the material to deteriorate. Note that desiccant gradually loses its capacity to absorb moisture and should be replaced at regular intervals.

To prevent mold or mildew, take the camera out of storage at least once a month. Turn the camera on and release the shutter a few times before putting it away.

Store the battery in a cool, dry place. Replace the terminal cover before putting the battery away.

Notes on the monitor: The monitor is constructed with extremely high precision; at least 99.99% of pixels are effective, with no more than 0.01% being missing or defective. Hence while these displays may contain pixels that are always lit (white, red, blue, or green) or always off (black), this is not a malfunction and has no effect on images recorded with the device.

Images in the monitor may be difficult to see in a bright light.

Do not apply pressure to the monitor, as this could cause damage or malfunction. Dust or lint on the monitor can be removed with a blower. Stains can be removed by wiping lightly with a soft cloth or chamois leather. Should the monitor break, care should be taken to avoid injury from broken glass and to prevent liquid crystal from the monitor touching the skin or entering the eyes and mouth.

Moiré: Moiré is an interference pattern created by the interaction of an image containing a regular, repeating grid, such as the pattern of weave in cloth or windows in a building, with the camera image sensor grid. If you notice moiré in your photographs, try changing the distance to the subject, zooming in and out, or changing the angle between the subject and the camera.

The battery and charger: Batteries may leak or explode if improperly handled. *Read and follow the warnings and cautions on pages xi–xiv of this manual.* Observe the following precautions when handling batteries:

- Use only batteries approved for use in this equipment.
- Do not expose the battery to flame or excessive heat.
- Keep the battery terminals clean.
- Turn the product off before replacing the battery.
- Remove the battery from the camera or charger when not in use and replace the terminal cover. These devices draw minute amounts of charge even when off and could draw the battery down to the point that it will no longer function. If the battery will not be used for some time, insert it in the camera and run it flat before removing it and storing it in a location with an ambient temperature of 15 °C to 25 °C (59 °F to 77 °F; avoid hot or extremely cold locations). Repeat this process at least once every six months.

- Turning the camera on and off repeatedly when the battery is fully discharged will shorten battery life. Batteries that have been fully discharged must be charged before use.
- The internal temperature of the battery may rise while the battery is in use. Attempting to charge the battery while the internal temperature is elevated will impair battery performance, and the battery may not charge or charge only partially. Wait for the battery to cool before charging.
- Charge the battery indoors at ambient temperatures of 5 °C–35 °C (41 °F–95 °F). Do not use the battery at ambient temperatures below 0 °C (32 °F) or above 40 °C (104 °F); failure to observe this precaution could damage the battery or impair its performance. Capacity may be reduced and charging times may increase at battery temperatures from 0 °C (32 °F) to 15 °C (59 °F) and from 45 °C (113 °F) to 60 °C (140 °F). The battery will not charge if its temperature is below 0 °C (32 °F) or above 60 °C (140 °F).
- If the **CHARGE** lamp flashes quickly (about eight times a second) during charging, confirm that the temperature is in the correct range and then unplug the charger and remove and reinsert the battery. If the problem persists, cease use immediately and take battery and charger to your retailer or a Nikon-authorized service representative.
- Do not move the charger or touch the battery during charging. Failure to observe this precaution could in very rare instances result in the charger showing that charging is complete when the battery is only partially charged. Remove and reinsert the battery to begin charging again.
- Continuing to charge the battery after it is fully charged can impair battery performance.
- A marked drop in the time a fully charged battery retains its charge when used at room temperature indicates that it requires replacement. Purchase a new EN-EL14a battery.
- Use the charger with compatible batteries only. Unplug when not in use.

- Charge the battery before use. When taking photographs on important occasions, ready a spare battery and keep it fully charged. Depending on your location, it may be difficult to purchase replacement batteries on short notice. Note that on cold days, the capacity of batteries tends to decrease. Be sure the battery is fully charged before taking photographs outside in cold weather. Keep a spare battery in a warm place and exchange the two as necessary. Once warmed, a cold battery may recover some of its charge.
- Used batteries are a valuable resource; recycle in accord with local regulations.

			P, S, A, M				VI, POP		TOY			
Other settings	Metering	—	✓	—	—	—	—	—	—	—	—	—
	Bracketing	—	✓	—	—	—	—	—	—	—	—	—
	Flash compensation	—	✓	✓	✓	—	—	—	—	—	—	—
	Exposure compensation	—	✓	✓	✓	✓	—	—	—	—	—	—
	Flash mode	✓	—	✓	✓ ⁴	—	—	✓	✓	✓	—	—
Custom setting menu	a3: Built-in AF-assist illuminator	✓	✓	✓	✓ ⁵	✓ ⁶	—	✓	✓	✓	—	✓
	e1: Flash cntrl for built-in flash/Optional flash	—	—	✓	—	—	—	—	—	—	—	—
	e2: Auto bracketing set	—	—	✓	—	—	—	—	—	—	—	—

1 **Auto ISO sensitivity control** is not available.

2 Fixed at **Auto**.

3 Subject-tracking AF is not available.

4 Not available in mode.

5 Not available in mode.

6 Available only in , , and modes.

Troubleshooting

If the camera fails to function as expected, check the list of common problems below before consulting your retailer or Nikon-authorized service representative.

Battery/Display

The camera is on but does not respond: Wait for recording to end. If the problem persists, turn the camera off. If the camera does not turn off, remove and reinsert the battery or, if you are using an AC adapter, disconnect and reconnect the AC adapter. Note that although any data currently being recorded will be lost, data that have already been recorded will not be affected by removing or disconnecting the power source.

Viewfinder is out of focus: Adjust viewfinder focus (☐ 33). If this does not correct the problem, select single-servo autofocus (**AF-S**; ☐ 78), single-point AF ([*]; ☐ 82), and the center focus point, and then frame a high-contrast subject in the center focus point and press the shutter-release button halfway to focus the camera. With the camera in focus, use the diopter adjustment control to bring the subject into clear focus in the viewfinder. If necessary, viewfinder focus can be further adjusted using optional corrective lenses (☐ 331).

Viewfinder is dark: Insert a fully-charged battery (☐ 27, 28).

Displays turn off without warning: Choose longer delays for Custom Setting c2 (**Auto off timers**; ☐ 253).

Information display does not appear in monitor: Shutter-release button is pressed halfway or eye sensor has turned display off. If information display does not appear when you remove your finger from shutter-release button or uncover eye sensor, confirm that **On** is selected for **Auto info display** (☐ 278) and that battery is charged (☐ 27).

Viewfinder display is unresponsive and dim: The response times and brightness of this display vary with temperature.

Fine lines are visible around active focus point or display turns red when focus point is highlighted: These phenomena are normal for this type of viewfinder and do not indicate a malfunction.

Shooting (All Modes)

Camera takes time to turn on: Delete files or folders.

Shutter-release disabled:

- Memory card is locked, full, or not inserted (☐ 28, 35).
 - **Release locked** is selected for **Slot empty release lock** (☐ 281) and no memory card is inserted (☐ 28).
 - Built-in flash is charging (☐ 44).
 - Camera is not in focus (☐ 40).
 - CPU lens with aperture ring attached but aperture not locked at highest f-number (☐ 315).
 - Non-CPU lens is attached but camera is not in mode **M** (☐ 316).
-

Only one shot taken each time shutter-release button is pressed in continuous shooting mode: Continuous shooting is not available if built-in flash fires (☐ 73, 93).

Final photo is larger than area shown in viewfinder: Viewfinder horizontal and vertical frame coverage is approximately 95%.

Photos are out of focus:

- AF-S, AF-P, or AF-I lens is not attached: use AF-S, AF-P, or AF-I lens or focus manually.
 - Camera unable to focus using autofocus: use manual focus or focus lock (☐ 80, 86, 88).
 - Camera is in manual focus mode: focus manually (☐ 88).
-

Focus does not lock when shutter-release button is pressed halfway: Use AF-L (AF-L) (On) button to lock focus when live view is off and **AF-C** is selected for focus mode or when photographing moving subjects in **AF-A** mode (☐ 86).

Can not select focus point:

- **[] (Auto-area AF; [] 83)** is selected: choose another AF-area mode.
- Press shutter-release button halfway to start standby timer ([] 44).

Can not select AF-area mode: Manual focus selected ([] 78, 164).

AF-assist illuminator does not light:

- AF-assist illuminator does not light if **AF-C** is selected for autofocus mode ([] 78) or if continuous-servo autofocus is selected when the camera is in **AF-A** mode. Choose **AF-S**. If an option other than **[] (Auto-area AF)** is selected for AF-area mode, select center focus point ([] 82, 85).
- The camera is currently in live view or a movie is being recorded.
- **Off** is selected for Custom Setting a3 (**Built-in AF-assist illuminator**, [] 250).
- Illuminator has turned off automatically. Illuminator may become hot with continued use; wait for it to cool down.

Image size can not be changed: Image quality set to NEF (RAW) ([] 91).

Camera is slow to record photos:

- Depending on shooting conditions and memory card performance, memory card access lamp may light for up to about a minute after shooting ends in continuous release modes.
- Turn long exposure noise reduction off ([] 243).

Randomly-spaced bright pixels appear in photos:

- Choose lower ISO sensitivity or turn high ISO noise reduction on ([] 244).
 - Turn **Active D-Lighting** off to avoid heightening the effects of noise ([] 134).
-

No photo taken when remote control shutter-release button is pressed:

- Replace battery in remote control (☞ 332).
- Choose remote control release mode (☞ 107).
- Flash is charging (☞ 109).
- Time selected for Custom Setting c4 (**Remote on duration (ML-L3)**, ☞ 254) has elapsed.
- Bright light is interfering with ML-L3 remote control.

Can not choose a release mode: Release mode selection is not available when the monitor is off (☞ 71). Note that the eye sensor may turn the monitor off automatically when you put your eye to the viewfinder.

Beep does not sound:

- **Off** is selected for **Beep options > Beep on/off** (☞ 276).
- Camera is in quiet shutter-release mode (☞ 74), or movie is being recorded (☞ 174).
- **MF** or **AF-C** is selected as the focus mode or subject moves when **AF-A** is selected (☞ 78).

Smudges appear in photographs: Clean front and rear lens elements. If problem persists, perform image sensor cleaning (☞ 338).

Date is not imprinted on photos: An NEF (RAW) option is selected for image quality (☞ 91, 256).

Sound is not recorded with movies: **Microphone off** is selected for **Movie settings > Microphone** (☞ 178).

Live view ends unexpectedly or does not start: Live view may end automatically to prevent damage to the camera's internal circuits if:

- The ambient temperature is high
- The camera has been used for extended periods in live view or to record movies
- The camera has been used in continuous release modes for extended periods

If live view or movie recording does not start when you attempt to start live view, wait for the internal circuits to cool and then try again. Note that the camera may feel warm to the touch, but this does not indicate a malfunction.

Image artifacts appear during live view: The temperature of the camera's internal circuits may rise during live view, causing image "noise" in the form of bright spots, randomly-spaced bright pixels, or fog. Exit live view when the camera is not in use.

Flicker or banding appears during live view or movie recording: Choose an option for **Flicker reduction** that matches the frequency of the local AC power supply (□ 281).

Bright bands appear during live view or movie recording: A flashing sign, flash, or other light source with brief duration was used during live view or movie recording.

Menu item can not be selected: Some options are not available in all modes.

Shooting (P, S, A, M)

Shutter-release disabled:

- Non-CPU lens is attached: rotate camera mode dial to **M** (□ 316).
 - Mode dial rotated to **S** after shutter speed of "Bulb" or "Time" selected in mode **M**: choose new shutter speed (□ 117).
 - If white-balance bracketing is active, shutter release will be disabled and viewfinder exposure-count display will flash if there is insufficient space on memory card to record all images in bracketing sequence. Insert new memory card.
-

Full range of shutter speeds not available:

- Flash in use (□ 98).
 - When **On** is selected for **Movie settings > Manual movie settings** in the shooting menu, the range of available shutter speed varies with the frame rate (□ 179).
-

Can not select desired aperture: Range of available apertures varies with lens used.

Colors are unnatural:

- Adjust white balance to match light source (□ 137).
 - Adjust **Set Picture Control** settings (□ 152).
-

Can not measure white balance: Subject is too dark or too bright (☐ 144).

Image can not be selected as source for preset white balance: Image was not created with D5500 (☐ 146).

White balance bracketing unavailable: NEF (RAW) or NEF+JPEG image quality option selected for image quality (☐ 90).

Effects of Picture Control differ from image to image: **A** (auto) is selected for sharpening, clarity, contrast, or saturation. For consistent results over a series of photos, choose another setting (☐ 156).

Metering can not be changed: Autoexposure lock is in effect (☐ 127).

Exposure compensation can not be used: Camera is in mode **M**. Choose another mode (☐ 113, 129).

Noise (reddish areas or other artifacts) appears in long time-exposures: Enable long exposure noise reduction (☐ 243).

Playback

NEF (RAW) image is not played back: Photo was taken at image quality of NEF (RAW)+JPEG (☐ 90).

Can not view pictures recorded with other cameras: Pictures recorded with other makes of camera may not be displayed correctly.

Some pictures are not displayed during playback: Select **All** for **Playback folder** (☐ 234).

“Tall” (portrait) orientation photos are displayed in “wide” (landscape) orientation:

- Select **On** for **Rotate tall** (☐ 235).
 - Photo was taken with **Off** selected for **Auto image rotation** (☐ 235).
 - Photo is displayed in image review (☐ 234).
 - Camera was pointed up or down when photo was taken (☐ 235).
-

Can not delete picture:

- Picture is protected: remove protection (☐ 202).
 - Memory card is locked (☐ 35).
-

Can not retouch picture: Photo can not be further edited with this camera (☞ 287).

Can not change print order:

- Memory card is full: delete pictures (☞ 49, 205).
 - Memory card is locked (☞ 35).
-

Can not select photo for printing: Photo is in NEF (RAW) format. Create JPEG copy using **NEF (RAW) processing** or transfer to computer and print using ViewNX 2 or Capture NX-D (☞ 210).

Picture is not displayed on TV:

- Choose correct video mode (☞ 281) or output resolution (☞ 223).
 - A/V (☞ 220) or HDMI (☞ 222) cable is not correctly connected.
-

Camera does not respond to remote control for HDMI-CEC television:

- Select **On** for **HDMI > Device control** in the setup menu (☞ 223).
 - Adjust HDMI-CEC settings for the television as described in documentation provided with the device.
-

Can not transfer photos to computer: OS not compatible with camera or transfer software. Use card reader to copy photos to computer.

Image Dust Off option in Capture NX-D does not have desired effect: Image sensor cleaning changes the position of dust on the image sensor. Image Dust Off reference data recorded before image sensor cleaning is performed can not be used with photographs taken after image sensor cleaning is performed. Image Dust Off reference data recorded after image sensor cleaning is performed can not be used with photographs taken before image sensor cleaning is performed (☞ 279).

Computer displays NEF (RAW) images differently from camera: Third-party software does not display effects of Picture Controls, Active D-Lighting, or vignette control. Use ViewNX 2 or Capture NX-D (☞ 210).

Wi-Fi (Wireless Networks)

Smart devices do not display the camera SSID (network name):

- Confirm that **Enable** is selected for **Wi-Fi > Network connection** in the camera setup menu (☐ 229).
 - Try turning the smart device Wi-Fi off and then on again.
-

Miscellaneous



Date of recording is not correct: Set camera clock (☐ 32, 275).







Menu item can not be selected: Some options are not available at certain combinations of settings or when no memory card is inserted (☐ 28, 286, 348).

Error Messages

This section lists the indicators and error messages that appear in the viewfinder and monitor.





Warning Icons

A flashing  in the monitor or  in the viewfinder indicates that a warning or error message can be displayed in the monitor by pressing the  (?) button.

Indicator		Solution	
Monitor	Viewfinder		
Lock lens aperture ring at minimum aperture (largest f/-number).	 (flashes)	Set lens aperture ring to minimum aperture (highest f-number).	315
Lens not attached	 (flashes)	<ul style="list-style-type: none"> • Attach non-IX NIKKOR lens. • If non-CPU lens is attached, select mode M. 	315 119
Before taking photos, rotate the zoom ring to extend the lens.	 (flashes)	A lens with a retractable lens barrel button is attached with the lens barrel retracted. Press the retractable lens barrel button and rotate the zoom ring to extend the lens.	30
Shutter release disabled. Recharge battery.	 (flashes)	Turn camera off and recharge or replace battery.	27, 31
This battery cannot be used. Choose battery designated for use in this camera.	 (flashes)	Use Nikon-approved battery.	330
Initialization error. Turn camera off and then on again.	 (flashes)	Turn camera off, remove and replace battery, and then turn camera on again.	28, 31

Indicator		Solution	
Monitor	Viewfinder		
Battery level is low. Complete operation and turn camera off immediately.	—	End cleaning and turn camera off and recharge or replace battery.	341
Clock not set	—	Set camera clock.	32, 275
No memory card inserted	(- E -)/[?] (flashes)	Turn camera off and confirm that card is correctly inserted.	28
Memory card is locked. Slide lock to “write” position.	[d (flashes)	Memory card is locked (write protected). Slide card write-protect switch to “write” position.	35
This memory card cannot be used. Card may be damaged. Insert another card.	[d/(E r r) (flashes)	• Use approved card.	334
		• Format card. If problem persists, card may be damaged. Contact Nikon-authorized service representative.	272
		• Error creating new folder. Delete files or insert new memory card.	28, 205
		• Insert new memory card.	28
		• Eye-Fi card is still emitting wireless signal after Disable has been selected for Eye-Fi upload . To terminate wireless transmission, turn the camera off and remove the card.	284

Indicator		Solution	📖
Monitor	Viewfinder		
Not available if Eye-Fi card is locked.	$[d]/[Err]$ (flashes)	Eye-Fi card is locked (write protected). Slide card write-protect switch to “write” position.	35
This card is not formatted. Format the card.	$[For]$ (flashes)	Format card or turn camera off and insert new memory card.	28, 272
Card is full	$FuL/0/?$ (flashes)	<ul style="list-style-type: none"> • Reduce quality or size. • Delete photographs. • Insert new memory card. 	90 205 28
—	● (flashes)	Camera can not focus using autofocus. Change composition or focus manually.	40, 80, 88
Subject is too bright	? (flashes)	<ul style="list-style-type: none"> • Use a lower ISO sensitivity. • Use commercial ND filter. • In mode: <ul style="list-style-type: none"> S Increase shutter speed A Choose a smaller aperture (higher f-number) ☑ Choose another shooting mode 	100 330 117 118 4, 61
Subject is too dark		<ul style="list-style-type: none"> • Use a higher ISO sensitivity. • Use flash. • In mode: <ul style="list-style-type: none"> S Lower shutter speed A Choose a larger aperture (lower f-number) 	100 93 117 118

Indicator		Solution	📖
Monitor	Viewfinder		
No "Bulb" in S mode	 (flashes)	Change shutter speed or select mode M.	117, 119
No "Time" in S mode	- -/📷 (flashes)		
No "Bulb" in HDR mode	 (flashes)	<ul style="list-style-type: none"> • Change shutter speed. • Turn HDR off. 	120, 121 135
No "Time" in HDR mode	- -/📷 (flashes)		
Interval timer shooting	—	Menus and playback are not available while interval timer photography is in progress. To pause, press  .	101
—	 (flashes)	Flash has fired at full power. Check photo in monitor; if underexposed, adjust settings and try again.	—
—	 (flashes)	<ul style="list-style-type: none"> • Use the flash. • Change distance to subject, aperture, flash range, or ISO sensitivity. • Lens focal length is less than 18 mm: use a longer focal length. • Optional SB-400 or SB-300 flash unit attached: flash is in bounce position or focus distance is very short. Continue shooting; if necessary, increase focus distance to prevent shadows from appearing in photograph. 	93 98, 99, 118 — —

Indicator		Solution	
Monitor	Viewfinder		
Error. Press shutter release button again.	<i>Err</i> (flashes)	Release shutter. If error persists or appears frequently, consult Nikon-authorized service representative.	—
Start-up error. Contact a Nikon-authorized service representative.		Consult Nikon-authorized service representative.	—
Metering error			
Unable to start live view. Please wait for camera to cool.	—	Wait for the internal circuits to cool before resuming live view or movie recording.	353
Folder contains no images.	—	Folder selected for playback contains no images. Select folder containing images from Playback folder menu or insert memory card containing images.	28, 234
Cannot display this file.	—	File can not be played back on camera.	—
Cannot select this file.	—	Images created with other devices can not be retouched.	288
This movie cannot be edited.	—	• Movies created with other devices can not be edited.	288
		• Movies must be at least two seconds long.	185
No image for retouching.	—	Memory card does not contain NEF (RAW) images for use with NEF (RAW) processing .	289

Indicator		Solution	
Monitor	Viewfinder		
Could not connect; multiple devices detected. Try again later.	—	Multiple smart devices are attempting to connect to camera simultaneously. Wait a few minutes before trying again.	225
Error	—	Select Disable for Wi-Fi > Network connection , then select Enable again.	230
Network access not available until camera cools.	—	Turn camera off and try again after waiting for camera to cool.	—
Check printer.	—	Check printer. To resume, select Continue (if available).	—*
Check paper.	—	Paper is not selected size. Insert paper of correct size and select Continue .	—*
Paper jam.	—	Clear jam and select Continue .	—*
Out of paper.	—	Insert paper of selected size and select Continue .	—*
Check ink supply.	—	Check ink. To resume, select Continue .	—*
Out of ink.	—	Replace ink and select Continue .	—*









* See printer manual for more information.

































Specifications











■ Nikon D5500 Digital Camera



Type	
Type	Single-lens reflex digital camera
Lens mount	Nikon F mount (with AF contacts)
Effective angle of view	Nikon DX format; focal length equivalent to approx. 1.5× that of lenses with FX format angle of view
Effective pixels	
Effective pixels	24.2 million
Image sensor	
Image sensor	23.5 × 15.6 mm CMOS sensor
Total pixels	24.78 million
Dust-reduction System	Image sensor cleaning, Image Dust Off reference data (Capture NX-D software required)
Storage	
Image size (pixels)	<ul style="list-style-type: none">• 6000 × 4000 (Large)• 4496 × 3000 (Medium)• 2992 × 2000 (Small)
File format	<ul style="list-style-type: none">• NEF (RAW): 12- or 14 bit, compressed• JPEG: JPEG-Baseline compliant with fine (approx. 1 : 4), normal (approx. 1 : 8), or basic (approx. 1 : 16) compression• NEF (RAW)+JPEG: Single photograph recorded in both NEF (RAW) and JPEG formats
Picture Control System	Standard, Neutral, Vivid, Monochrome, Portrait, Landscape, Flat; selected Picture Control can be modified; storage for custom Picture Controls
Media	SD (Secure Digital) and UHS-I compliant SDHC and SDXC memory cards
File system	DCF 2.0, DPOF, Exif 2.3, PictBridge

Viewfinder	
Viewfinder	Eye-level pentamirror single-lens reflex viewfinder
Frame coverage	Approx. 95% horizontal and 95% vertical
Magnification	Approx. 0.82× (50 mm f/1.4 lens at infinity, -1.0 m^{-1})
Eyepoint	17 mm (-1.0 m^{-1} ; from center surface of viewfinder eyepiece lens)
Diopter adjustment	$-1.7 - +0.5 \text{ m}^{-1}$
Focusing screen	Type B BriteView Clear Matte Mark VII screen
Reflex mirror	Quick return
Lens aperture	Instant return, electronically controlled
Lens	
Compatible lenses	<p>Autofocus is available with AF-S, AF-P, and AF-I lenses. Autofocus is not available with other type G and D lenses, AF lenses (IX NIKKOR and lenses for the F3AF are not supported), and AI-P lenses. Non-CPU lenses can be used in mode M, but the camera exposure meter will not function.</p> <p>The electronic rangefinder can be used with lenses that have a maximum aperture of f/5.6 or faster.</p>
Shutter	
Type	Electronically-controlled vertical-travel focal-plane shutter
Speed	$1/4000 - 30 \text{ s}$ in steps of $1/3$ or $1/2 \text{ EV}$; Bulb; Time
Flash sync speed	$X = 1/200 \text{ s}$; synchronizes with shutter at $1/200 \text{ s}$ or slower

Release	
Release mode	 (single frame),  L (continuous L),  H (continuous H),  (quiet shutter release),  (self-timer),  2s (delayed remote; ML-L3),  (quick-response remote; ML-L3); interval timer photography supported
Frame advance rate	<ul style="list-style-type: none"> L: Up to 3 fps H: Up to 5 fps (JPEG and 12-bit NEF/RAW) or 4 fps (14-bit NEF/RAW) <p>Note: Frame rates assume continuous-servo AF, manual or shutter-priority auto exposure, a shutter speed of $\frac{1}{250}$ s or faster, Release selected for Custom Setting a1 (AF-C priority selection), and other settings at default values.</p>
Self-timer	2 s, 5 s, 10 s, 20 s; 1–9 exposures
Exposure	
Metering mode	TTL exposure metering using 2016-pixel RGB sensor
Metering method	<ul style="list-style-type: none"> Matrix metering: 3D color matrix metering II (type G, E, and D lenses); color matrix metering II (other CPU lenses) Center-weighted metering: Weight of 75% given to 8-mm circle in center of frame Spot metering: Meters 3.5-mm circle (about 2.5% of frame) centered on selected focus point
Range (ISO 100, f/1.4 lens, 20 °C/68 °F)	<ul style="list-style-type: none"> Matrix or center-weighted metering: 0–20 EV Spot metering: 2–20 EV
Exposure meter coupling	CPU

Exposure	
Mode	Auto modes ( auto;  auto, flash off); programmed auto with flexible program (P); shutter-priority auto (S); aperture-priority auto (A); manual (M); scene modes ( portrait;  landscape;  child;  sports;  close up;  night portrait;  night landscape;  party/indoor;  beach/snow;  sunset;  dusk/dawn;  pet portrait;  candlelight;  blossom;  autumn colors;  food); special effects modes ( night vision; VI super vivid; POP pop;  photo illustration;  toy camera effect;  miniature effect;  selective color;  silhouette;  high key;  low key)
Exposure compensation	Can be adjusted by -5 – +5 EV in increments of 1/3 or 1/2 EV in P, S, A, M, SCENE , and  modes
Exposure bracketing	3 shots in steps of 1/3 or 1/2 EV
White balance bracketing	3 shots in steps of 1
ADL bracketing	2 shots
Exposure lock	Luminosity locked at detected value with ^{AE-L} _{AF-L} () button
ISO sensitivity (Recommended Exposure Index)	ISO 100 – 25600 in steps of 1/3 EV. Auto ISO sensitivity control available
Active D-Lighting	 A Auto,  H+ Extra high,  H High,  N Normal,  L Low, OFF Off
Focus	
Autofocus	Nikon Multi-CAM 4800DX autofocus sensor module with TTL phase detection, 39 focus points (including 9 cross-type sensor), and AF-assist illuminator (range approx. 0.5–3 m/1 ft 8 in.–9 ft 10 in.)
Detection range	-1 – +19 EV (ISO 100, 20 °C/68 °F)

Focus	
Lens servo	<ul style="list-style-type: none"> • Autofocus (AF): Single-servo AF (AF-S); continuous-servo AF (AF-C); auto AF-S/AF-C selection (AF-A); predictive focus tracking activated automatically according to subject status • Manual focus (MF): Electronic rangefinder can be used
Focus point	Can be selected from 39 or 11 focus points
AF-area mode	Single-point AF, 9-, 21-, or 39- point dynamic-area AF, 3D-tracking, auto-area AF
Focus lock	Focus can be locked by pressing shutter-release button halfway (single-servo AF) or by pressing AE-L/AF-L () button
Flash	
Built-in flash	          : Auto flash with auto pop-up P, S, A, M, VI: Manual pop-up with button release
Guide Number	Approx. 12/39, 12/39 with manual flash (m/ft, ISO 100, 20 °C/68 °F)
Flash control	TTL: i-TTL flash control using 2016-pixel RGB sensor is available with built-in flash; i-TTL balanced fill-flash for digital SLR is used with matrix and center-weighted metering, standard i-TTL flash for digital SLR with spot metering
Flash mode	Auto, auto with red-eye reduction, auto slow sync, auto slow sync with red-eye reduction, fill-flash, red-eye reduction, slow sync, slow sync with red-eye reduction, rear-curtain with slow sync, rear-curtain sync, off
Flash compensation	Can be adjusted by -3 – +1 EV in increments of 1/3 or 1/2 EV in P, S, A, M, and SCENE modes
Flash-ready indicator	Lights when built-in flash or optional flash unit is fully charged; blinks after flash is fired at full output

Flash	
Accessory shoe	ISO 518 hot-shoe with sync and data contacts and safety lock
Nikon Creative Lighting System (CLS)	Advanced Wireless Lighting supported with SB-910, SB-900, SB-800, SB-700, or SB-500 as a master flash or SU-800 as commander; Flash Color Information Communication supported with all CLS-compatible flash units
Sync terminal	AS-15 sync terminal adapter (available separately)
White balance	
White balance	Auto, incandescent, fluorescent (7 types), direct sunlight, flash, cloudy, shade, preset manual, all except preset manual with fine-tuning.
Live view	
Lens servo	<ul style="list-style-type: none"> • Autofocus (AF): Single-servo AF (AF-S); full-time-servo AF (AF-F) • Manual focus (MF)
AF-area mode	Face-priority AF, wide-area AF, normal-area AF, subject-tracking AF
Autofocus	Contrast-detect AF anywhere in frame (camera selects focus point automatically when face-priority AF or subject-tracking AF is selected)
Automatic scene selection	Available in  and  modes
Movie	
Metering	TTL exposure metering using main image sensor
Metering method	Matrix

Movie	
Frame size (pixels) and frame rate	<ul style="list-style-type: none"> • 1920 × 1080, 60p (progressive)/50p/30p/25p/24p, ★ high/normal • 1280 × 720, 60p/50p, ★ high/normal • 640 × 424, 30p/25p, ★ high/normal <p>Frame rates of 30p (actual frame rate 29.97 fps) and 60p (actual frame rate 59.94 fps) are available when NTSC is selected for video mode. 25p and 50p are available when PAL is selected for video mode. Actual frame rate when 24p is selected is 23.976 fps.</p>
File format	MOV
Video compression	H.264/MPEG-4 Advanced Video Coding
Audio recording format	Linear PCM
Audio recording device	Built-in or external stereo microphone; sensitivity adjustable
ISO sensitivity	ISO 100–25600
Monitor	
Monitor	8.1 cm/3.2-in. (3 : 2), approx. 1037k-dot (720 × 480 × 3 = 1,036,800 dots), TFT vari-angle LCD touch screen with 170 ° viewing angle, approx. 100% frame coverage, brightness adjustment, and eye-sensor controlled on/off
Playback	
Playback	Full-frame and thumbnail (4, 12, or 80 images or calendar) playback with playback zoom, movie playback, photo and/or movie slide shows, histogram display, highlights, photo information, location data display, auto image rotation, picture rating, and image comment (up to 36 characters)

Interface	
USB	Hi-Speed USB; connection to built-in USB port is recommended
Video output	NTSC, PAL
HDMI output	Type C HDMI connector
Accessory terminal	Wireless remote controllers: WR-1, WR-R10 (available separately) Remote cords: MC-DC2 (available separately) GPS units: GP-1/GP-1A (available separately)
Audio input	Stereo mini-pin jack (3.5 mm diameter); supports optional ME-1 stereo microphones
Wireless	
Standards	IEEE 802.11b, IEEE 802.11g
Communications protocols	<ul style="list-style-type: none"> • IEEE 802.11b: DSSS/CCK • IEEE 802.11g: OFDM
Operating frequency	2412–2462 MHz (channels 1–11)
Range (line of sight)	Approximately 30 m/98 ft (assumes no interference; range may vary with signal strength and presence or absence of obstacles)
Data rate	54 Mbps Maximum logical data rates according to IEEE standard. Actual rates may differ.
Security	<ul style="list-style-type: none"> • Authentication: Open system, WPA2-PSK • Encryption: AES
Wireless setup	Supports WPS
Access protocols	Infrastructure

Supported languages	
Supported languages	Arabic, Bengali, Bulgarian, Chinese (Simplified and Traditional), Czech, Danish, Dutch, English, Finnish, French, German, Greek, Hindi, Hungarian, Indonesian, Italian, Japanese, Korean, Marathi, Norwegian, Persian, Polish, Portuguese (Portugal and Brazil), Romanian, Russian, Serbian, Spanish, Swedish, Tamil, Telugu, Thai, Turkish, Ukrainian, Vietnamese
Power source	
Battery	One EN-EL14a rechargeable Li-ion battery
AC adapter	EH-5b AC adapter; requires EP-5A power connector (available separately)
Tripod socket	
Tripod socket	1/4 in. (ISO 1222)
Dimensions/weight	
Dimensions (W × H × D)	Approx. 124 × 97 × 70 mm (4.9 × 3.9 × 2.8 in.)
Weight	Approx. 470 g (1 lb 0.6 oz) with battery and memory card but without body cap; approx. 420 g/14.9 oz (camera body only)
Operating environment	
Temperature	0 °C–40 °C (+32 °F–104 °F)
Humidity	85% or less (no condensation)

- Unless otherwise stated, all measurements are performed in conformity with Camera and Imaging Products Association (CIPA) standards or guidelines.
- All figures are for a camera with a fully-charged battery.
- Nikon reserves the right to change the appearance and specifications of the hardware and software described in this manual at any time and without prior notice. Nikon will not be held liable for damages that may result from any mistakes that this manual may contain.

■ ■ *MH-24 Battery Charger*

Rated input	AC 100–240 V, 50/60 Hz, 0.2 A maximum
Rated output	DC 8.4 V/0.9 A
Supported batteries	Nikon Rechargeable Li-ion Battery EN-EL14a
Charging time	Approx. 1 hour and 50 minutes at an ambient temperature of 25 °C (77 °F) when no charge remains
Operating temperature	0 °C–40 °C (+32 °F–104 °F)
Dimensions (W × H × D)	Approx. 70 × 26 × 97 mm (2.8 × 1.0 × 3.8 in.), excluding plug adapter
Weight	Approx. 96 g (3.4 oz), excluding plug adapter

The symbols on this product represent the following:

~ AC, --- DC,  Class II equipment (The construction of the product is double-insulated.)

■ ■ *EN-EL14a Rechargeable Li-ion Battery*

Type	Rechargeable lithium-ion battery
Rated capacity	7.2 V/1230 mAh
Operating temperature	0 °C–40 °C (+32 °F–104 °F)
Dimensions (W × H × D)	Approx. 38 × 53 × 14 mm (1.5 × 2.1 × 0.6 in.)
Weight	Approx. 49 g (1.7 oz), excluding terminal cover

Nikon reserves the right to change the appearance and specifications of the hardware and software described in this manual at any time and without prior notice. Nikon will not be held liable for damages that may result from any mistakes that this manual may contain.

■ ■ *Supported Standards*

- **DCF Version 2.0:** The **D**esign **R**ule for **C**amera **F**ile **S**ystems (DCF) is a standard widely used in the digital camera industry to ensure compatibility among different makes of camera.
- **DPOF:** **D**igital **P**rint **O**rders **F**ormat (DPOF) is an industry-wide standard that allows pictures to be printed from print orders stored on the memory card.
- **Exif version 2.3:** The camera supports Exif (**E**xchangeable **I**mage **F**ile **F**ormat for **D**igital **S**till **C**ameras) version 2.3, a standard in which information stored with photographs is used for optimal color reproduction when the images are output on Exif-compliant printers.
- **PictBridge:** A standard developed through cooperation with the digital camera and printer industries, allowing photographs to be output directly to a printer without first transferring them to a computer.
- **HDMI:** **H**igh-**D**efinition **M**ultimedia **I**nterface is a standard for multimedia interfaces used in consumer electronics and AV devices capable of transmitting audiovisual data and control signals to HDMI-compliant devices via a single cable connection.

Trademark Information

IOS is a trademark or registered trademark of Cisco Systems, Inc., in the United States and/or other countries and is used under license. Windows is either a registered trademark or a trademark of Microsoft Corporation in the United States and/or other countries. PictBridge logo is a trademark. The SD, SDHC, and SDXC logos are trademarks of the SD-3C, LLC. HDMI, the HDMI logo and High-Definition Multimedia Interface are trademarks or registered trademarks of HDMI Licensing, LLC.

HDMI

Wi-Fi and the Wi-Fi logo are trademarks or registered trademarks of the Wi-Fi Alliance. All other trade names mentioned in this manual or the other documentation provided with your Nikon product are trademarks or registered trademarks of their respective holders.

Conformity Marking

The standards with which the camera complies can be viewed using the **Conformity marking** option in the setup menu (📖 285).

FreeType License (FreeType2)

Portions of this software are copyright © 2012 The FreeType Project (<http://www.freetype.org>). All rights reserved.

MIT License (HarfBuzz)

Portions of this software are copyright © 2014 The HarfBuzz Project (<http://www.freedesktop.org/wiki/Software/HarfBuzz>). All rights reserved.

Certificates

• Indonesia

36708/SDPPI/2014
4588

36709/SDPPI/2014
4593

• México

COFETEL: RCPMULB13-0954
LBWA1U5YR1

• Paraguay

Número del Registro: 2014-01-I-00028

Este producto contiene un transmisor
aprobado por la CONATEL.

• Brasil



(01)0789857980 048 9

• الأردن

TRC/LPD/2013/141

• عُمان

OMAN-TRA

R/2185/14

D080093

• الإمارات العربية المتحدة

TRA

REGISTERED No:

ER47249/16

DEALER No:

DA0073692/11

Lens Kits

The camera can be purchased as a kit with the lens listed below.

AF-P DX NIKKOR 18–55mm f/3.5–5.6G VR and AF-P DX NIKKOR 18–55mm f/3.5–5.6G

These retractable lenses are for use exclusively with DX format Nikon digital SLR cameras; SLR film cameras and D4-series, D3-series, D2-series, D1-series, D800-series, D700, D610, D600, D300-series, D200, D100, D90, D80, D70-series, D60, D50, D40-series, D7000, D5100, D5000, D3200, D3100, D3000 digital SLR cameras are not supported. The parts of the lens are listed below.

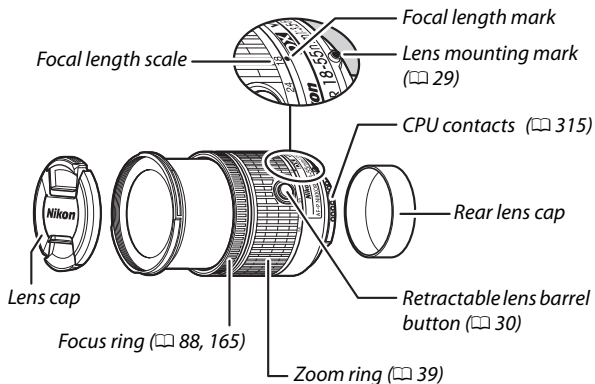

■ ■ **Focus**

The focus mode can be selected using camera controls (📖 78).

Autofocus

Focus is adjusted automatically when the camera is in autofocus mode (📖 78). The focus ring can also be used to focus the camera if the shutter-release button is kept pressed halfway (or if the AF-ON button is kept pressed); this is known as “autofocus with manual override” (M/A). Autofocus will resume when the shutter-release button is pressed halfway (or the AF-ON button is pressed) a second time. Note that touching the focus ring while autofocus is in effect will change the focus position.

Manual Focus

When the camera is in manual focus mode, focus can be adjusted by rotating the lens focus ring (📖 88). When the camera is off or the standby timer has expired, the focus ring can not be used to focus and rotating the zoom ring will change the focus position; before focusing, turn the camera on or press the shutter-release button to reactivate the standby timer.

Users of D810-series, Df, D750, D7200, D7100, and D5200 cameras should note that if the standby timer is allowed to expire, the focus position will change when the timer is restarted. Refocus before shooting. Longer standby times are recommended for manual focus and in other situations in which you may not release the shutter immediately after focusing.

■ ■ Using the Built-in Flash

When using the built-in flash, be sure the subject is at a range of at least 0.6 m (2 ft) and remove lens hoods to prevent vignetting (shadows created where the end of the lens obscures the built-in flash).

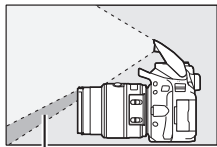

Shadow



Vignetting

Camera	Zoom position	Minimum distance without vignetting
D5500/D5300/D5200/D3300	18 mm	1.0 m/3 ft 4 in.
	24, 35, 45, and 55 mm	No vignetting

■ ■ Vibration Reduction (VR, AF-P DX NIKKOR 18–55mm f/3.5–5.6G VR Only)

When an AF-P DX NIKKOR 18–55mm f/3.5–5.6G VR is mounted on the camera, vibration reduction can be enabled or disabled using the **Optical VR** option in the shooting menu (☰ 245). If **On** is selected, vibration reduction will take effect whenever the shutter-release button is pressed halfway. Vibration reduction reduces blur caused by camera shake, allowing shutter speeds up to 4.0 stops slower than would otherwise be the case, increasing the range of shutter speeds available. The effects of VR on shutter speed are measured according to Camera and Imaging Products Association (CIPA) standards; FX-format lenses are measured using FX-format digital cameras, DX-format lenses using DX-format cameras. Zoom lenses are measured at maximum zoom.

✔ Vibration Reduction

- When using vibration reduction, press the shutter-release button halfway and wait for the image in the viewfinder to stabilize before pressing the shutter-release button the rest of the way down.
- When vibration reduction is active, the image in the viewfinder may jiggle after the shutter is released. This does not indicate a malfunction.
- When the camera is panned, vibration reduction applies only to motion that is not part of the pan (if the camera is panned horizontally, for example, vibration reduction will be applied only to vertical shake), making it much easier to pan the camera smoothly in a wide arc.
- If the camera is equipped with a built-in flash, vibration reduction will be disabled while the flash charges.
- Vibration reduction is generally recommended when the camera is mounted on a tripod, although you may prefer to turn it off depending on shooting conditions and the type of tripod.

■ ■ Supplied Accessories

- 55 mm snap-on Front Lens Cap LC-55A
- Rear Lens Cap

■ ■ Compatible Accessories

- 55 mm screw-on filters
- Rear Lens Cap LF-4
- Lens Case CL-0815
- Bayonet Hood HB-N106

Align the lens hood mounting mark (●) with the lens hood alignment mark (┌) as shown in Figure ① and then rotate the hood (②) until the ● mark is aligned with the lens hood lock mark (—○).

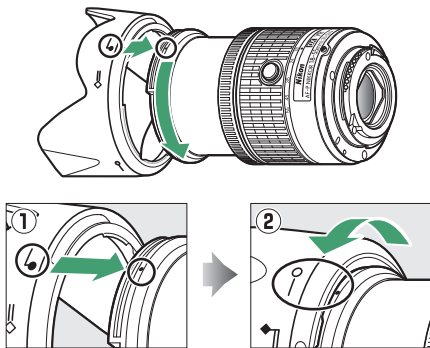

When attaching or removing the hood, hold it near the symbol on its base and avoid gripping it too tightly. Vignetting may occur if the hood is not correctly attached. The hood can be reversed and mounted on the lens when not in use.

■ Specifications

Type	Type G AF-P DX lens with built-in CPU and F mount
Focal length	18–55 mm
Maximum aperture	f/3.5–5.6
Lens construction	12 elements in 9 groups (2 aspherical lens elements)
Angle of view	76° – 28° 50'
Focal length scale	Graduated in millimeters (18, 24, 35, 45, 55)
Distance information	Output to camera
Zoom	Manual zoom using independent zoom ring
Focusing	Autofocus controlled by stepping motor; separate focus ring for manual focus
Vibration reduction (AF-P DX NIKKOR 18–55mm f/3.5–5.6G VR only)	Lens shift using voice coil motors (VCMs)
Minimum focus distance	0.25 m (0.9 ft) from focal plane (□ 89) at all zoom positions
Diaphragm blades	7 (rounded diaphragm opening)
Diaphragm	Fully automatic
Aperture range	<ul style="list-style-type: none">• 18 mm focal length: f/3.5–22• 55 mm focal length: f/5.6–38 The minimum aperture displayed may vary depending on the size of the exposure increment selected with the camera.
Metering	Full aperture
Filter-attachment size	55 mm (P = 0.75 mm)
Dimensions	Approx. 64.5 mm maximum diameter × 62.5 mm (distance from camera lens mount flange)
Weight	<ul style="list-style-type: none">• AF-P DX NIKKOR 18–55mm f/3.5–5.6G VR: Approx. 205 g (7.3 oz)• AF-P DX NIKKOR 18–55mm f/3.5–5.6G: Approx. 195 g (6.9 oz)

AF-S DX NIKKOR 18–55mm f/3.5–5.6G VR II

This retractable lens, for use exclusively with DX format Nikon digital SLR cameras, is the lens generally used in this manual for illustrative purposes. The parts of the lens are listed below.

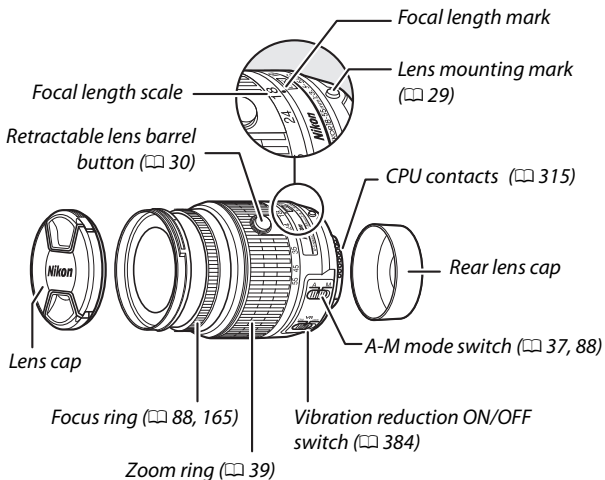

■ Focus

Focus mode is determined by the camera focus mode and the position of the lens A-M mode switch (book icon 78, 88).

■ ■ Using the Built-in Flash

When using the built-in flash, be sure the subject is at a range of at least 0.6 m (2 ft) and remove lens hoods to prevent vignetting (shadows created where the end of the lens obscures the built-in flash).

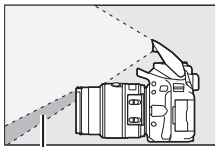

Shadow



Vignetting

■ ■ Vibration Reduction (VR)

Vibration reduction can be enabled by sliding the vibration reduction switch to **ON** and takes effect whenever the shutter-release button is pressed halfway. Vibration reduction reduces blur caused by camera shake, allowing shutter speeds up to 4.0 stops slower than would otherwise be the case (as measured at 55 mm with a DX-format camera according to Camera and Imaging Products Association [CIPA] standards; effects vary with the photographer and shooting conditions). This increases the range of shutter speeds available.



✔ Vibration Reduction

- When using vibration reduction, press the shutter-release button halfway and wait for the image in the viewfinder to stabilize before pressing the shutter-release button the rest of the way down.
- When vibration reduction is active, the image in the viewfinder may jiggle after the shutter is released. This does not indicate a malfunction.
- When the camera is panned, vibration reduction applies only to motion that is not part of the pan (if the camera is panned horizontally, for example, vibration reduction will be applied only to vertical shake), making it much easier to pan the camera smoothly in a wide arc.
- Do not turn the camera off or remove the lens while vibration reduction is in effect.
- If the camera is equipped with a built-in flash, vibration reduction will be disabled while the flash charges.
- Select **OFF** when the camera is mounted on a tripod unless the tripod head is unsecured or the camera is mounted on a monopod, in which case **ON** is recommended.

■ Supplied Accessories

- 52 mm snap-on Front Lens Cap LC-52
- Rear Lens Cap

■ Compatible Accessories

- 52 mm screw-on filters
- Rear Lens Cap LF-4
- Flexible Lens Pouch CL-0815
- Bayonet Hood HB-69

Align the lens hood mounting mark (●) with the lens hood alignment mark (↙) as shown in Figure ① and then rotate the hood (②) until the ● mark is aligned with the lens hood lock mark (—○).

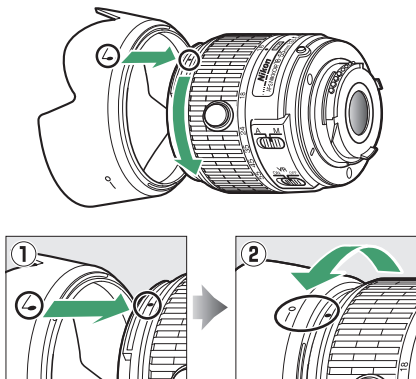

When attaching or removing the hood, hold it near the symbol on its base and avoid gripping it too tightly. Vignetting may occur if the hood is not correctly attached. The hood can be reversed and mounted on the lens when not in use.

■ Specifications

Type	Type G AF-S DX lens with built-in CPU and F mount
Focal length	18–55 mm
Maximum aperture	f/3.5–5.6
Lens construction	11 elements in 8 groups (including 1 aspherical lens element)
Angle of view	76 °–28 ° 50 ´
Focal length scale	Graduated in millimeters (18, 24, 35, 45, 55)
Distance information	Output to camera
Zoom	Manual zoom using independent zoom ring
Focusing	Autofocus controlled by Silent Wave Motor and separate focus ring for manual focus
Vibration reduction	Lens shift using voice coil motors (VCMs)
Minimum focus distance	<ul style="list-style-type: none">• AF: 0.28 m (0.92 ft) from focal plane (□ 89) at all zoom positions• MF: 0.25 m (0.82 ft) from focal plane at all zoom positions
Diaphragm blades	7 (rounded diaphragm opening)
Diaphragm	Fully automatic
Aperture range	<ul style="list-style-type: none">• 18 mm focal length: f/3.5–22• 55 mm focal length: f/5.6–38 The minimum aperture displayed may vary depending on the size of the exposure increment selected with the camera.
Metering	Full aperture
Filter-attachment size	52 mm (P=0.75 mm)
Dimensions	Approx. 66 mm diameter × 59.5 mm (distance from camera lens mount flange when lens is retracted)
Weight	Approx. 195 g (6.9 oz)

AF-S DX NIKKOR 18–140mm f/3.5–5.6G ED VR

This lens is for use exclusively with DX format Nikon digital camera. The parts of the lens are listed below.

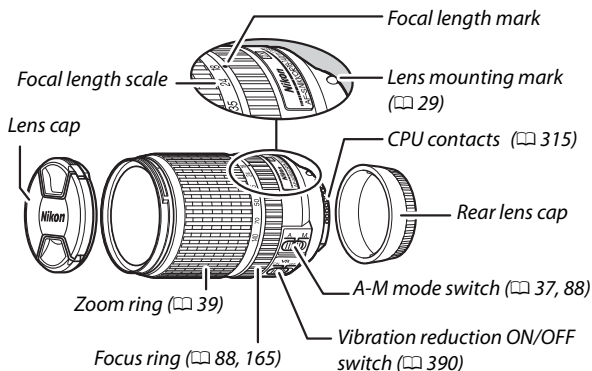

Focus

Focus mode is determined by the camera focus mode and the position of the lens A-M mode switch (page 78, 88).

Focusing with AF-S DX NIKKOR 18–140mm f/3.5–5.6G ED VR Lenses

When single-servo AF (**AF-S**) is selected as the camera focus mode and the lens A-M switch is set to **A**, focus can be adjusted by keeping the shutter-release button pressed halfway after the autofocus operation is complete and manually rotating the focus ring. To refocus using autofocus, press the shutter-release button halfway again.

■ ■ Using the Built-in Flash

When using the built-in flash, be sure the subject is at a range of at least 0.6 m (2 ft) and remove lens hoods to prevent vignetting (shadows created where the end of the lens obscures the built-in flash).

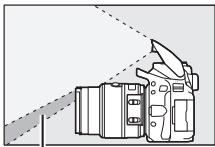

Shadow



Vignetting

Camera	Zoom position	Minimum distance without vignetting
D7100/D7000/D300 series/ D200/D100	18 mm	1.0 m/3 ft 3 in.
	24–140 mm	No vignetting
D90/D80/D50	18 mm	2.5 m/8 ft 2 in.
	24 mm	1.0 m/3 ft 3 in.
	35–140 mm	No vignetting
D5500/D5300/D5200/D5100/ D5000/D3300/D3200/D3100/ D3000/D70 series/D60/ D40 series	18 mm	1.0 m/3 ft 3 in.
	24 mm	
	35–140 mm	No vignetting

■ Vibration Reduction (VR)

Vibration reduction can be enabled by sliding the vibration reduction switch to **ON** and takes effect whenever the shutter-release button is pressed halfway. Vibration reduction reduces blur caused by camera shake, allowing shutter speeds up to 4.0 stops slower than would otherwise be the case (as measured at 140 mm with a D300s camera according to Camera and Imaging Products Association [CIPA] standards; effects vary with the photographer and shooting conditions). This increases the range of shutter speeds available.



✓ Vibration Reduction

- When using vibration reduction, press the shutter-release button halfway and wait for the image in the viewfinder to stabilize before pressing the shutter-release button the rest of the way down.
- When vibration reduction is active, the image in the viewfinder may jiggle after the shutter is released. This does not indicate a malfunction.
- When the camera is panned, vibration reduction applies only to motion that is not part of the pan (if the camera is panned horizontally, for example, vibration reduction will be applied only to vertical shake), making it much easier to pan the camera smoothly in a wide arc.
- Do not turn the camera off or remove the lens while vibration reduction is in effect. If power to the lens is cut while vibration reduction is on, the lens may rattle when shaken. This is not a malfunction, and can be corrected by reattaching the lens and turning the camera on.
- If the camera is equipped with a built-in flash, vibration reduction will be disabled while the flash charges.
- Select **OFF** when the camera is mounted on a tripod unless the tripod head is unsecured or the camera is mounted on a monopod, in which case **ON** is recommended.

■ ■ Supplied Accessories

- 67 mm snap-on Front Lens Cap LC-67
- Rear Lens Cap

■ ■ Compatible Accessories

- 67 mm screw-on filters
- Rear Lens Cap LF-4
- Flexible Lens Pouch CL-1018
- Bayonet Hood HB-32

Align the lens hood mounting mark (●) with the lens hood alignment mark (└) as shown in Figure ① and then rotate the hood (②) until the ● mark is aligned with the lens hood lock mark (—○).

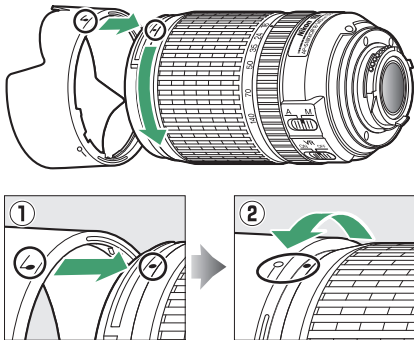

When attaching or removing the hood, hold it near the symbol on its base and avoid gripping it too tightly. Vignetting may occur if the hood is not correctly attached. The hood can be reversed and mounted on the lens when not in use.

■ Specifications

Type	Type G AF-S DX lens with built-in CPU and F mount
Focal length	18–140 mm
Maximum aperture	f/3.5–5.6
Lens construction	17 elements in 12 groups (including 1 ED lens element, 1 aspherical lens element)
Angle of view	76° – 11° 30′
Focal length scale	Graduated in millimeters (18, 24, 35, 50, 70, 140)
Distance information	Output to camera
Zoom	Manual zoom using independent zoom ring
Focusing	Nikon Internal Focusing (IF) System with autofocus controlled by Silent Wave Motor and separate focus ring for manual focus
Vibration reduction	Lens shift using voice coil motors (VCMs)
Minimum focus distance	0.45 m (1.48 ft) from focal plane (□ 89) at all zoom positions
Diaphragm blades	7 (rounded diaphragm opening)
Diaphragm	Fully automatic
Aperture range	<ul style="list-style-type: none">• 18 mm focal length: f/3.5–22• 140 mm focal length: f/5.6–38 The minimum aperture displayed may vary depending on the size of the exposure increment selected with the camera.
Metering	Full aperture
Filter-attachment size	67 mm (P = 0.75 mm)
Dimensions	Approx. 78 mm maximum diameter × 97 mm (distance from camera lens mount flange)
Weight	Approx. 490 g (17.3 oz)

AF-S DX NIKKOR 55–200mm f/4–5.6G ED VR II

This retractable lens is for use exclusively with DX format Nikon digital camera. The parts of the lens are listed below.

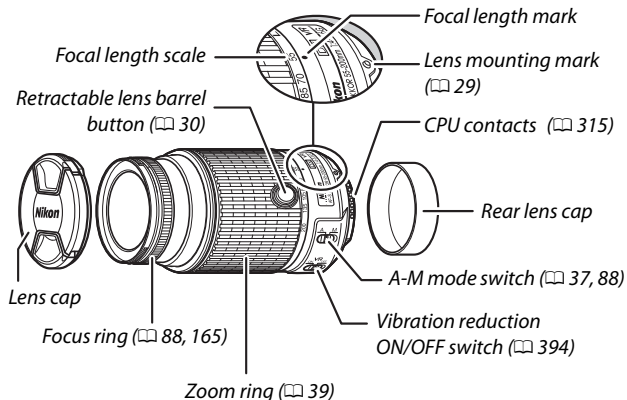

■ Focus

Focus mode is determined by the camera focus mode and the position of the lens A-M mode switch (☞ 78, 88).

■ Using the Built-in Flash

When using the built-in flash, be sure the subject is at a range of at least 0.6 m (2 ft) and remove lens hoods to prevent vignetting (shadows created where the end of the lens obscures the built-in flash).

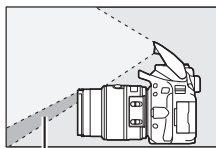

Shadow

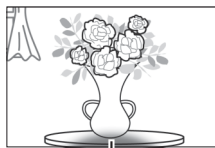

Vignetting

■ ■ **Vibration Reduction (VR)**

Vibration reduction can be enabled by sliding the vibration reduction switch to **ON** and takes effect whenever the shutter-release button is pressed halfway. Vibration reduction reduces blur caused by camera shake, allowing shutter speeds up to 4.0 stops slower than would otherwise be the case and increasing the range of shutter speeds available. The effects of VR on shutter speed are measured according to Camera and Imaging Products Association (CIPA) standards; FX-format lenses are measured using FX-format digital cameras, DX-format lenses using DX-format cameras. Zoom lenses are measured at maximum zoom.



✓ **Vibration Reduction**

- When using vibration reduction, press the shutter-release button halfway and wait for the image in the viewfinder to stabilize before pressing the shutter-release button the rest of the way down.
- When vibration reduction is active, the image in the viewfinder may jiggle after the shutter is released. This does not indicate a malfunction.
- When the camera is panned, vibration reduction applies only to motion that is not part of the pan (if the camera is panned horizontally, for example, vibration reduction will be applied only to vertical shake), making it much easier to pan the camera smoothly in a wide arc.
- Do not turn the camera off or remove the lens while vibration reduction is in effect.
- If the camera is equipped with a built-in flash, vibration reduction will be disabled while the flash charges.
- Select **OFF** when the camera is mounted on a tripod unless the tripod head is unsecured or the camera is mounted on a monopod, in which case **ON** is recommended.

■ ■ Supplied Accessories

- 52mm snap-on Front Lens Cap LC-52
- Rear Lens Cap

■ ■ Compatible Accessories

- 52 mm screw-on filters
- Rear Lens Cap LF-4
- Flexible Lens Pouch CL-0915
- Bayonet Hood HB-37

Align the lens hood mounting mark (●) with the lens hood alignment mark (└) as shown in Figure ① and then rotate the hood (②) until the ● mark is aligned with the lens hood lock mark (—○).

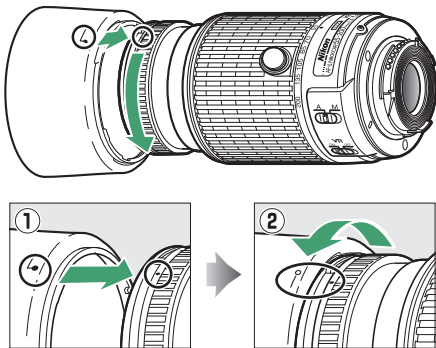

When attaching or removing the hood, hold it near the symbol on its base and avoid gripping it too tightly. Vignetting may occur if the hood is not correctly attached. The hood can be reversed and mounted on the lens when not in use. When the hood is reversed, it can be attached and removed by rotating it while holding it near the lock mark (—○).

■ Specifications

Type	Type G AF-S DX lens with built-in CPU and F mount
Focal length	55–200 mm
Maximum aperture	f/4–5.6
Lens construction	13 elements in 9 groups (including 1 ED lens element)
Angle of view	28° 50′ – 8°
Focal length scale	Graduated in millimeters (55, 70, 85, 105, 135, 200)
Distance information	Output to camera
Zoom	Manual zoom using independent zoom ring
Focusing	Nikon Internal Focusing (IF) System with autofocus controlled by Silent Wave Motor and separate focus ring for manual focus
Vibration reduction	Lens shift using voice coil motors (VCMs)
Minimum focus distance	1.1 m (3.7 ft) from focal plane (□ 89) at all zoom positions
Diaphragm blades	7 (rounded diaphragm opening)
Diaphragm	Fully automatic
Aperture range	<ul style="list-style-type: none">• 55 mm focal length: f/4–22• 200 mm focal length: f/5.6–32
Metering	Full aperture
Filter-attachment size	52 mm (P = 0.75 mm)
Dimensions	Approx. 70.5 mm maximum diameter × 83 mm (distance from camera lens mount flange when lens is retracted)
Weight	Approx. 300 g (10.6 oz)

✓ Lens Care

- Keep the CPU contacts clean.
- Use a blower to remove dust and lint from the lens surfaces. To remove smudges and fingerprints, apply a small amount of ethanol or lens cleaner to a soft, clean cotton cloth or lens-cleaning tissue and clean from the center outwards using a circular motion, taking care not to leave smears or touch the glass with your fingers.
- Never use organic solvents such as paint thinner or benzene to clean the lens.
- The lens hood or NC filters can be used to protect the front lens element.
- Attach the front and rear caps before placing the lens in its flexible pouch.
- When a lens hood is attached, do not pick up or hold the lens or camera using only the hood.
- If the lens will not be used for an extended period, store it in a cool, dry location to prevent mold and rust. Do not store in direct sunlight or with naphtha or camphor moth balls.
- Keep the lens dry. Rusting of the internal mechanism can cause irreparable damage.
- Leaving the lens in extremely hot locations could damage or warp parts made from reinforced plastic.

A Note on Wide- and Super Wide-Angle Lenses

Autofocus may not provide the desired results in situations like those shown below.

1 Objects in the background occupy more of the focus point than the main subject:

If the focus point contains both foreground and background objects, the camera may focus on the background and the subject may be out of focus.

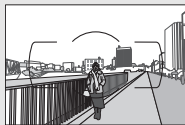

Example: *A far-off portrait subject at some distance from the background*

2 The subject contains many fine details.

The camera may have difficulty focusing on subjects that lack contrast or appear smaller than objects in the background.

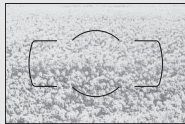

Example: *A field of flowers*

In these cases, use manual focus, or use focus lock to focus on another subject at the same distance and then recompose the photograph. For more information, see “Getting Good Results with Autofocus” (□ 80).

Memory Card Capacity

The following table shows the approximate number of pictures that can be stored on a 16 GB SanDisk Extreme Pro 95 MB/s SDHC UHS-I card at different image quality and size settings.

Image quality	Image size	File size ¹	No. of images ¹	Buffer capacity ²
NEF (RAW), Compressed, 14-bit	—	24.4 MB	428	10
NEF (RAW), Compressed, 12-bit	—	19.7 MB	511	14
JPEG fine	Large	12.3 MB	929	100
	Medium	7.9 MB	1500	100
	Small	3.9 MB	2900	100
JPEG normal	Large	6.1 MB	1800	100
	Medium	3.9 MB	3000	100
	Small	2.1 MB	5600	100
JPEG basic	Large	2.0 MB	3500	100
	Medium	1.5 MB	5700	100
	Small	1.0 MB	10300	100

- 1 All figures are approximate. Results will vary with card type, camera settings, and scene recorded.
- 2 Maximum number of exposures that can be stored in memory buffer at ISO 100. Drops when long exposure noise reduction (☐ 243), auto distortion control (☐ 245), or **Date stamp** (☐ 256) is on.

Battery Life

The movie footage or number of shots that can be recorded with fully-charged batteries varies with the condition of the battery, temperature, the interval between shots, and the length of time menus are displayed. Sample figures for EN-EL14a (1230 mAh) batteries are given below.

- **Photographs, single-frame release mode (CIPA standard ¹):**
Approximately 820 shots
- **Photographs, continuous release mode (Nikon standard ²):**
Approximately 3110 shots
- **Movies:** Approximately 65 minutes at 1080/60p and 1080/50p ³
 - 1 Measured at 23 °C/73.4 °F (± 2 °C/3.6 °F) with an AF-S DX NIKKOR 18–55mm f/3.5–5.6G VR II lens under the following test conditions: lens cycled from infinity to minimum range and one photograph taken at default settings once every 30 s; after photograph is taken, monitor is turned on; tester waits for monitor to turn off; flash fired at full power once every other shot. Live view not used.
 - 2 Measured at 20 °C/68 °F with an AF-S DX NIKKOR 18–55mm f/3.5–5.6G VR II lens under the following test conditions: vibration reduction off, continuous high-speed release mode, focus mode set to **AF-C**, image quality set to JPEG basic, image size set to **M** (medium), white balance set to **Auto**, ISO sensitivity set to ISO 100, shutter speed $1/250$ s, focus cycled from infinity to minimum range three times after shutter-release button has been pressed halfway for 3 s; six shots are then taken in succession and monitor turned on; cycle repeated once monitor has turned off.
 - 3 Measured at 23 °C/73.4 °F (± 2 °C/3.6 °F) with the camera at default settings and an AF-S DX NIKKOR 18–55mm f/3.5–5.6G VR II lens under conditions specified by the Camera and Imaging Products Association (CIPA). Individual movies can be up to 20 minutes in length or 4 GB in size; recording may end before these limits are reached if the camera temperature rises.

The following can reduce battery life:





















































- Using the monitor
- Keeping the shutter-release button pressed halfway
- Repeated autofocus operations
- Taking NEF (RAW) photographs
- Slow shutter speeds
- Using the built-in Wi-Fi function or using an optional GP-1 or GP-1A GPS unit or WR-R10/WR-1 wireless remote controller
- Using an Eye-Fi card
- Using VR (vibration reduction) mode with VR lenses
- Repeatedly zooming in and out with an AF-P lens.

To ensure that you get the most from rechargeable Nikon EN-EL14a batteries:

- Keep the battery contacts clean. Soiled contacts can reduce battery performance.
- Use batteries immediately after charging. Batteries will lose their charge if left unused.

Index

Symbols

-  (Auto mode) 4, 38
-  (Auto (flash off) mode)..... 4, 38
- SCENE** (Scene)..... 4, 54
-  (Portrait) 55
-  (Landscape)..... 55
-  (Child)..... 55
-  (Sports)..... 56
-  (Close up)..... 56
-  (Night portrait)..... 56
-  (Night landscape)..... 57
-  (Party/indoor)..... 57
-  (Beach/snow)..... 57
-  (Sunset)..... 58
-  (Dusk/dawn) 58
-  (Pet portrait) 58
-  (Candlelight)..... 59
-  (Blossom)..... 59
-  (Autumn colors)..... 59
-  (Food) 60
- EFFECTS** (Special effects) 4, 61
-  (Night vision) 61
- VI** (Super vivid) 62
- POP** (Pop) 62
-  (Photo illustration)..... 62, 66
-  (Toy camera effect) 63, 67
-  (Miniature effect) 63, 68
-  (Selective color)..... 63, 69
-  (Silhouette)..... 64
-  (High key)..... 64
-  (Low key) 64
- P** (Programmed auto) 4, 113, 115
- S** (Shutter-priority auto) 4, 113, 117
- A** (Aperture-priority auto) .4, 113, 118
- M** (Manual) 4, 113, 119
-  (flexible program)..... 116
-  (Single frame) 71
-  (Continuous L)..... 71, 72
-  (Continuous H)..... 71, 72
-  (Self-timer) 71, 75
-  2s (Delayed remote (ML-L3))71, 107
-  (Quick-response remote (ML-L3)) ... 71, 107
-  (Quiet shutter release) 71, 74
-  (Single-point AF)..... 82
-  (Dynamic-area AF)..... 82
-  (Auto-area AF)..... 83
- 3D** (3D-tracking) 83, 84
-  (Face-priority AF)..... 166, 167
-  (Wide-area AF) 166, 167
-  (Normal-area AF) 166, 167
-  (Subject-tracking AF) 166, 167
-  (Matrix metering) 125
-  (Center-weighted metering)... 125
-  (Spot metering)..... 125
- AUTO** (auto flash)..... 94
-  (red-eye reduction)..... 94, 96
- SLOW** (slow sync)..... 94, 96
- REAR** (rear-curtain sync) 96
-  (Flash compensation)..... 131
-  (Exposure compensation) 129
- AE-BKT** (AE bracketing) 148
- WB-BKT** (WB bracketing) 148
- ADL-BKT** (ADL bracketing) 148
-  (Help) 14
- WB** (White balance) 137
- PRE** (Preset manual)..... 142
-  (focus indicator)..... 40, 86, 89
-  (flash-ready indicator) 5, 44, 328
-  (live view)..... 45, 50, 162, 174
- i** button 10, 189
-  (Memory buffer)..... 73, 399

Numerics

- 2016-pixel RGB sensor 260, 315, 366, 368
- 3D color matrix metering 315
- 3D-tracking (AF-area mode).....83, 84

A

- A/V cable 220
- AC adapter 330, 335
- Access lamp 41
- Accessories 330
- Accessory terminal 282
- Accessory terminal accessories... 333
- Active D-Lighting 133
- Add items (My Menu) 310
- ADL bracketing (Auto bracketing set) 148
- Adobe RGB..... 243
- AE bracketing (Auto bracketing set). 148
- AE lock..... 127
- AE-L 127
- AE-L/AF-L** button..... 87, 127, 267
- AF 78–87, 164–167
- AF area brackets 33, 40
- AF-A..... 78
- AF-area mode 82, 166
- AF-assist illuminator..... 81, 250, 318
- AF-C..... 78, 248
- AF-F 164
- AF-S 78, 164
- A-M mode switch ... 88, 383, 388, 393
- Angle of view 322
- Aperture 114, 118, 120
- Aperture-priority auto 118
- Assign AE-L/AF-L button 267
- Assign Fn button 265
- Assign touch Fn 268
- Auto (White balance) 137
- Auto bracketing..... 148, 264

- Auto distortion control..... 245
- Auto flash..... 94
- Auto image rotation 235
- Auto info display..... 278
- Auto ISO sensitivity control 241
- Auto off timers 253
- Auto-area AF (AF-area mode) 83
- Autoexposure lock 127
- Autofocus 78–87, 164–167
- Auto-servo AF 78
- Available settings 348

B

- Battery 27, 330, 373
- Beep options 276
- Black-and-white 299
- Body cap 1, 332
- Border (PictBridge)..... 215
- Bracketing 148, 264
- Built-in AF-assist illuminator. 81, 250, 318
- Built-in flash 93, 320
- Bulb..... 121
- Burst..... 72

C

- Calendar playback..... 191
- Camera Control Pro 2..... 332
- Capture NX-D..... 210
- CEC..... 223
- Center-weighted metering 125
- Charger..... 27, 330, 373
- Choose start/end point 183
- Clean image sensor..... 338
- Clock..... 32, 275
- Clock battery 33
- Cloudy (White balance) 137
- CLS 323
- Color outline..... 302
- Color sketch..... 303
- Color space 243

Color temperature.....	139	EV steps for exposure cntrl.....	252
Commander mode.....	260	Exif version 2.3.....	374
Compatible lenses.....	314	Exposure.....	114, 125, 127, 129
Conformity marking.....	285, 375	Exposure bracketing.....	148
Continuous (Release mode).....	71, 72	Exposure compensation.....	129
Continuous-servo AF.....	78, 248	Exposure delay mode.....	254
Copyright.....	197, 274	Exposure indicator.....	120, 169
CPU contacts.....	315	Exposure lock.....	127
CPU lens.....	314	Exposure meters.....	44
Creative Lighting System.....	323	Exposure mode.....	113
Cropping (PictBridge).....	215	External microphone.....	180, 333
Cross screen (Filter effects).....	298	Eye sensor.....	9, 278
Custom Settings.....	246	Eye-Fi upload.....	284
Cyanotype.....	299		

D

Date and time.....	32, 275
Date counter.....	256, 257
Date format.....	32, 275
Date stamp.....	256
Daylight saving time.....	32, 275
DCF version 2.0.....	374
Delayed remote (ML-L3).....	71, 107
Delete.....	205
Delete all images.....	206
Delete current image.....	205
Delete selected images.....	206
Device control (HDMI).....	223
Digital Print Order Format ..	216, 218, 374
Diopter adjustment control ..	33, 331
Direct sunlight (White balance)..	137
Distortion control.....	245, 296
D-Lighting.....	294
DPOF.....	216, 218, 374
DPOF print order.....	218
Dynamic-area AF.....	82

E

Edit movie.....	183, 186
Electronic rangefinder.....	89, 250

F

Face-priority AF.....	166
File information.....	193
File naming.....	240
File number sequence.....	255
Filter effects.....	155, 157, 298
Filters.....	330
Fine-tuning white balance.....	140
Firmware version.....	285
Fisheye.....	297
Flash.....	44, 93, 323
Flash (White balance).....	137
Flash cntrl for built-in flash.....	259
Flash compensation.....	131
Flash control.....	260
Flash mode.....	94, 96
Flash range.....	98
Flash ready indicator.....	5, 44, 328
Flash sync speed.....	98, 365
Flat (Set Picture Control).....	152
Flexible program.....	116
Flicker reduction.....	176, 281
Fluorescent (White balance)	137, 138
Fn button.....	265
f-number.....	114, 118
Focal length.....	322
Focal length scale.....	377, 383, 388, 393

Focal plane mark	89
Focus.....	78–89, 164–167
Focus indicator.....	40, 86, 89
Focus lock	86
Focus mode.....	78, 164
Focus point... 40, 82, 86, 89, 166, 167, 249	
Focusing screen.....	365
Focusing the viewfinder	33
Focus-mode switch	37, 88
Format.....	272
Format memory card	272
Frame interval (Slide show)	209
Frame size/frame rate.....	177
Framing grid	170, 256
Front-curtain sync.....	96
Full-frame playback.....	188
Full-time-servo AF	164

G

GPS unit	283
----------------	-----

H

H.264.....	370
HDMI.....	222, 374
HDMI-CEC.....	223
HDR (high dynamic range)	135
Help	14
High definition	222, 374
High Dynamic Range (HDR)	135
High ISO NR.....	244
High-angle shots	6
Highlights.....	193, 234
Histogram	194, 234

I

Image comment	273
Image Dust Off ref photo	279
Image overlay	300
Image quality	90
Image review	234

Image size.....	92
Incandescent (White balance)	137
Info display auto off.....	9, 278
Info display format	277
In-focus indicator	40, 86, 89
Information display.....	8, 277
Infrared receiver	108
Interval timer shooting.....	101
ISO display.....	252
ISO sensitivity.....	99, 241
i-TTL	259, 260
i-TTL balanced fill-flash for digital SLR.....	260

J

JPEG.....	90
JPEG basic.....	90
JPEG fine	90
JPEG normal.....	90

L

Landscape (Set Picture Control) ..	152
Language.....	32, 275
Large (Image size).....	92
Lens.....	29, 314, 377, 383, 388, 393
Lens focus ring.....	88, 377, 383, 388, 393
Lens mount	1, 89
Lens vibration reduction switch... 37, 384, 390, 394	
Live view	45, 50, 162, 174
Location data	199, 283
Lock mirror up for cleaning.....	340
Long exposure NR.....	243
Low-angle shots.....	6

M

Manage Picture Control	158
Manual.....	88, 119
Manual focus	88, 164, 165
Manual movie settings	179
Matrix metering.....	125

Maximum aperture.....	89
Maximum sensitivity.....	241
Medium (Image size)	92
Memory buffer	73
Memory card.....	28, 272, 334, 399
Memory card capacity.....	399
Metering.....	125
Microphone.....	178
Miniature effect	68, 304
Minimum shutter speed.....	241
Mired	141
Mirror.....	1, 340
Mode dial	4
Monitor.....	6, 162, 188, 276
Monitor brightness.....	276
Monochrome.....	299
Monochrome (Set Picture Control) ...	152
Mounting mark.....	29, 377, 383, 388, 393
Movie quality	177
Movie settings.....	177
Movie-record button	51, 175
Movies.....	50, 174
My Menu	310

N

NEF (RAW).....	90, 240, 289
NEF (RAW) processing.....	289
NEF (RAW) recording	240
Network connection	226
Neutral (Set Picture Control).....	152
Nikon Transfer 2	212
No. of copies (PictBridge).....	215
Non-CPU lens.....	316
Normal-area AF.....	166
Number of focus points.....	249
Number of shots.....	400

O

Optional flash	323
Output resolution (HDMI).....	223

Overview data.....	198
--------------------	-----

P

Page size (PictBridge).....	215
Painting	307
Perspective control.....	297
Photo Illustration.....	66, 303
Photo information.....	192, 234
PictBridge	214, 374
Picture Controls.....	152, 154
PIN-entry WPS.....	228
Playback.....	188
Playback display options	234
Playback folder.....	234
Playback information.....	192, 234
Playback menu	233
Playback zoom	200
Portrait (Set Picture Control)	152
Power connector	330, 335
Power switch.....	31
Preset manual (White balance) ..	137, 142
Press the shutter-release button all the way down	41
Press the shutter-release button halfway	40, 41
Print (DPOF).....	216, 219
Print date (PictBridge).....	215
Print select	216
Printing.....	214
Programmed auto.....	115
Protecting photographs	202
Push-button WPS	226

Q

Quick retouch	295
Quick-response remote (ML-L3) ..	71, 107
Quiet shutter release.....	71, 74

R

Rangefinder.....	250
Rank items (My Menu).....	313
Rating	203, 209
Rear-curtain sync.....	96
Recent settings.....	309
Red-eye correction	295
Red-eye reduction	94, 96
Release mode	71
Remote control	107, 332
Remote cord.....	121, 333
Remote on duration (ML-L3).....	254
Remote shutter release	282
Remove items (My Menu)	312
Reset	110, 237, 248
Reset custom settings	248
Reset shooting menu.....	237
Resize.....	292
Retouch menu.....	286
Retractable lens barrel button.....	30, 37
Reverse dial rotation	269
Reverse indicators.....	258
RGB.....	194, 243
RGB histogram	194
Rotate tall.....	235

S

Save selected frame	186
Scene auto selector	47
Scene mode	54
Select to send to smart device	231
Selective color	69, 305
Self-portrait	6
Self-timer.....	71, 75, 254
Sensitivity.....	99, 241
Sepia	299
Set clock from satellite	283
Set Picture Control.....	154
Setup menu.....	270
Shade (White balance)	137

Shooting data	196
Shooting menu.....	236
Shutter-priority auto.....	117
Shutter-release button	41, 86, 127, 252
Shutter-release button AE-L	252
Side-by-side comparison	307
Single frame (Release mode).....	71
Single-point AF (AF-area mode)....	82
Single-servo AF.....	78, 164
Size	92, 177, 291
Skylight (Filter effects)	298
Slide show	208
Slot empty release lock.....	281
Slow sync	94, 96
Small (Image size)	92
Soft (Filter effects)	298
Special effects mode	61
Speedlight	323
Spot metering.....	125
sRGB.....	243
SSID.....	229
Standard (Set Picture Control)	152
Standard i-TTL fill-flash for digital SLR.....	260, 325
Standby timer	44, 253, 283
Start printing (PictBridge)....	216, 217
Storage folder	238
Straighten.....	296
Subject-tracking AF	166

T

Television.....	220
Thumbnail playback.....	190
Time.....	121
Time zone	32, 275
Time zone and date	275
Timer	75, 101
Toning.....	155, 157
Touch controls.....	157, 276
Touch screen	17

Touch Shutter.....	21
Trim	291
Trimming movies	183
Type D lens.....	315
Type E lens.....	315
Type G lens	315

U

USB cable	211
UTC.....	199, 283

V

Vari-angle monitor	6
Vibration reduction.....	37, 379, 384, 390, 394
Video mode.....	221, 281
View SSID	229
Viewfinder	5, 33, 365
Viewfinder eyepiece cap	76
Viewfinder grid display	256
ViewNX 2.....	210, 211
Vignette control	244
Vivid (Set Picture Control).....	152
Volume.....	182, 208

W

Warm filter (Filter effects).....	298
WB.....	137
WB bracketing (Auto bracketing set) 148	
White balance	137
Wide-area AF	166
Wi-Fi	xx, 224
Wind noise reduction	178
Wireless.....	xx, 224
Wireless Mobile Utility.....	224, 225
Wireless remote controller .	109, 282, 333

No reproduction in any form of this manual, in whole or in part (except for brief quotation in critical articles or reviews), may be made without written authorization from NIKON CORPORATION.

NIKON CORPORATION

© 2015 Nikon Corporation



SB6H03(11)
6MB25711-03