

TITANIUM™

TIG200™ INVERTER POWER SOURCE ALUMINUM AND STEEL WELDING PACKAGE

56825

Fault Codes

IMPORTANT!

Be **CERTAIN** to shut off the Welder, disconnect it from power, and discharge the electrode to ground before adjusting or troubleshooting the unit.

Fault Code Table

Code	Problem	Possible Causes	Likely Solutions
F01	Overheated	The duty cycle limit of the machine has been exceeded.	Allow the machine to cool down. Keep the machine plugged in and turned on to allow the fan to continue to run. Reduce duration or frequency of welding periods. Refer to Duty Cycle (Duration of Use) on page 15. Check for any obstructions blocking air flow into the machine and ensure proper clearance between any obstacles and the vents on all sides of the machine.
F02	Incorrect Input Voltage	The input voltage is too high or too low.	Verify the voltage at the outlet and the connection to the outlet.
F05	Torch Triggers Before Machine Is Turned On	The TIG torch trigger is stuck or is triggered when turning on the machine.	Turn OFF the machine and ensure the TIG torch trigger is reset.
F09	Output Short Circuited	Ground clamp and TIG torch or electrode holder are in contact.	Check the connection of the ground clamp and TIG torch or electrode holder to make sure they are not in contact. Lift the electrode holder or TIG torch up to take the electrode away from the workpiece and restart arc.



**Follow all Safety precautions whenever diagnosing or servicing the tool.
Disconnect power supply before service.**

Owner's Manual & Safety Instructions

Save This Manual Keep this manual for the safety warnings and precautions, assembly, operating, inspection, maintenance and cleaning procedures. Write the product's serial number in the back of the manual near the assembly diagram (or month and year of purchase if product has no number). Keep this manual and the receipt in a safe and dry place for future reference.

21c

TITANIUM™

TIG200™

INVERTER POWER SOURCE ALUMINUM AND STEEL WELDING PACKAGE

56825



Visit our website at: <http://www.harborfreight.com>
Email our technical support at: productsupport@harborfreight.com

When unpacking, make sure that the product is intact and undamaged. If any parts are missing or broken, please call 1-888-866-5797 as soon as possible.

Copyright© 2020 by Harbor Freight Tools®. All rights reserved.
No portion of this manual or any artwork contained herein may be reproduced in any shape or form without the express written consent of Harbor Freight Tools. Diagrams within this manual may not be drawn proportionally. Due to continuing improvements, actual product may differ slightly from the product described herein. Tools required for assembly and service may not be included.

⚠ WARNING

Read this material before using this product. Failure to do so can result in serious injury. **SAVE THIS MANUAL.**

Table of Contents

Safety	2	Welding Tips	20
Specifications	7	Maintenance and Service	24
Setup	8	Parts List and Diagrams	28
Basic Welding	12	Warranty	31

SAFETY





SETUP

BASIC WELDING

WELDING TIPS

MAINTENANCE

WARNING SYMBOLS AND DEFINITIONS

	This is the Safety alert symbol. It is used to alert you to potential personal injury hazards. Obey all Safety messages that follow this symbol to avoid possible injury or death.
	Indicates a hazardous situation which, if not avoided, will result in death or serious injury.
	Indicates a hazardous situation which, if not avoided, could result in death or serious injury.
	Indicates a hazardous situation which, if not avoided, could result in minor or moderate injury.
	Addresses practices not related to personal injury.

IMPORTANT SAFETY INFORMATION

WARNING

Read all Safety warnings and instructions.

Failure to follow the warnings and instructions may result in electric shock, fire and/or serious injury. Save all warnings and instructions for future reference.

General Safety

PROTECT yourself and others. Read and understand this information.

1. **Before use, read and understand manufacturer's instructions, Material Safety Data Sheets (MSDS's), employer's Safety practices, and ANSI Z49.1.**
2. **Keep out of reach of children.**
Keep children and bystanders away while operating.
3. **Place the welder on a stable location before use.**
If it falls while plugged in, severe injury, electric shock, or fire may result.
4. **Do not overreach.**
Keep proper footing and balance at all times.
5. **Stay alert, watch what you are doing and use common sense when operating a welder. Do not use a welder while you are tired or under the influence of drugs, alcohol or medication.**
A moment of inattention while operating welders may result in serious personal injury.
6. **Avoid unintentional starting.** Make sure you are prepared to begin work before turning on the Welder.
7. **Never leave the Welder unattended while energized.** Turn power off if you have to leave.
8. **The warnings, precautions, and instructions discussed in this instruction manual cannot cover all possible conditions and situations that may occur.** It must be understood by the operator that common sense and caution are factors which cannot be built into this product, but must be supplied by the operator.

Fume and Gas Safety

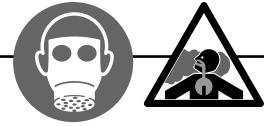

INHALATION HAZARD:
Welding and Plasma Cutting produce toxic fumes.

- Exposure to welding or cutting exhaust fumes can increase the risk of developing certain cancers, such as cancer of the larynx and lung cancer.** Also, some diseases that may be linked to exposure to welding or plasma cutting exhaust fumes are:
 - Early onset of Parkinson's Disease
 - Heart disease
 - Ulcers
 - Damage to the reproductive organs
 - Inflammation of the small intestine or stomach
 - Kidney damage
 - Respiratory diseases such as emphysema, bronchitis, or pneumoniaUse natural or forced air ventilation and wear a respirator approved by NIOSH to protect against the fumes produced to reduce the risk of developing the above illnesses.
- Do not use near degreasing or painting operations.**
- Keep head out of fumes.**
Do not breathe exhaust fumes.
- Use enough ventilation, exhaust at arc, or both, to keep fumes and gases from breathing zone and general area.** If engineering controls are not feasible, use an approved respirator.
- Work in a confined area only if it is well-ventilated, or while wearing an air-supplied respirator.**
- Have a recognized specialist in Industrial Hygiene or Environmental Services check the operation and air quality and make recommendations for the specific welding situation.**
Follow OSHA guidelines for Permissible Exposure Limits (PEL's) and the American Conference of Governmental Industrial Hygienists recommendations for Threshold Limit Values (TLV's) for fumes and gases.

Arc Ray Safety



ARC RAYS can injure eyes and burn skin.

- Wear ANSI-approved welding eye protection featuring at least a number 10 shade lens rating.**
- Wear leather leggings, fire resistant shoes or boots during use.** Do not wear pants with cuffs, shirts with open pockets, or any clothing that can catch and hold molten metal or sparks.
- Keep clothing free of grease, oil, solvents, or any flammable substances.**
Wear dry, insulating gloves and protective clothing.
- Wear an approved head covering to protect the head and neck.** Use aprons, cape, sleeves, shoulder covers, and bibs designed and approved for welding and cutting procedures.
- Wear an approved welding jacket or long sleeves to protect forearms from radiation burns.**
- When welding/cutting overhead or in confined spaces, wear flame resistant ear plugs or ear muffs to keep sparks out of ears.**

SAFETY

SETUP

BASIC WELDING

WELDING TIPS

MAINTENANCE

Electrical Safety



ELECTRIC SHOCK can KILL.

- 1. Turn off, disconnect power, and discharge Electrode to ground before setting down torch/Electrode holder and before service.**
- 2. Do not touch energized electrical parts.** Wear dry, insulating gloves. Do not touch Electrode holder, Electrode, welding torch, or welding wire with bare hand. Do not wear wet or damaged gloves.
- 3. Connect to grounded, GFCI-protected power supply only.**
- 4. Do not use near water or damp objects.**
- 5. People with pacemakers should consult their physician(s) before use.** Electromagnetic fields in close proximity to heart pacemaker could cause pacemaker interference or pacemaker failure.
- 6. Do not expose welders to rain or wet conditions.** Water entering a welder will increase the risk of electric shock.
- 7. Do not abuse the cord. Never use the cord for carrying, pulling or unplugging the welder. Keep cord away from heat, oil, sharp edges or moving parts. Damaged or entangled cords increase the risk of electric shock.**
- 8. Do not use outdoors.**
- 9. Insulate yourself from the workpiece and ground.** Use nonflammable, dry insulating material if possible, or use dry rubber mats, dry wood or plywood, or other dry insulating material large enough to cover your full area of contact with the work or ground.

Fire Safety



ARC AND SLAG can cause fire.

- 1. Clear away or protect flammable objects.** Remove or make safe all combustible materials for a radius of 35 feet (10 meters) around the work area. Use a fire resistant material to cover or block all open doorways, windows, cracks, and other openings.
- 2. Keep ABC-type fire extinguisher near work area and know how to use it.**
- 3. Maintain a safe working environment.** Keep the work area well lit. Make sure there is adequate surrounding workspace. Keep the work area free of obstructions, grease, oil, trash, and other debris.
- 4. Do not operate welders in atmospheres containing dangerously reactive or flammable liquids, gases, vapors, or dust.** Provide adequate ventilation in work areas to prevent accumulation of such substances. *Welders create sparks which may ignite flammable substances or make reactive fumes toxic.*
- 5. If working on a metal wall, ceiling, etc., prevent ignition of combustibles on the other side by moving the combustibles to a safe location.** If relocation of combustibles is not possible, designate someone to serve as a fire watch, equipped with a fire extinguisher, during the cutting process and for at least one half hour after the cutting is completed.
- 6. Do not weld or cut on materials having a combustible coating or combustible internal structure, as in walls or ceilings, without an approved method for eliminating the hazard.**
- 7. Do not dispose of hot slag in containers holding combustible materials.**
- 8. After welding, make a thorough examination for evidence of fire.** Be aware that easily visible smoke or flame may not be present for some time after the fire has started.
- 9. Do not apply heat to a container that has held an unknown substance or a combustible material whose contents, when heated, can produce flammable or explosive vapors.** Clean and purge containers before applying heat. Vent closed containers, including castings, before preheating, welding, or cutting.

Welder Use and Care

1. **Do not use the welder if the switch does not turn it on and off.** *Any welder that cannot be controlled with the switch is dangerous and must be repaired.*
2. **Disconnect the plug from the power source before making any adjustments, changing accessories, or storing welders.** *Such preventive Safety measures reduce the risk of starting the welder accidentally.*
3. **Prevent unintentional starting. Ensure the switch is in the off-position before connecting to power source or moving the welder.** *Carrying or energizing welders that have the switch on invites accidents.*
4. **Store idle welders out of the reach of children and do not allow persons unfamiliar with the welder or these instructions to operate the welder.** Welders are dangerous in the hands of untrained users.
5. **Use the welder and accessories in accordance with these instructions, taking into account the working conditions and the work to be performed.** *Use of the welder for operations different from those intended could result in a hazardous situation.*
6. **Do not use the welder for pipe thawing.**

Maintenance

1. **Maintain welders. Check for misalignment or binding of moving parts, breakage of parts and any other condition that may affect the welder's operation. If damaged, have the welder repaired before use.** *Many accidents are caused by poorly maintained welders.*
2. **Have your welder serviced by a qualified repair person using only identical replacement parts.** *This will ensure that the Safety of the welder is maintained.*
3. **Maintain labels and nameplates on the Welder.** These carry important information. If unreadable or missing, contact Harbor Freight Tools for a replacement.
4. **Unplug before maintenance.** Unplug the Welder from its electrical outlet before any inspection, maintenance, or cleaning procedures.

Gas Shielded Welding - Cylinder Safety

Cylinders can explode when damaged.



1. **Do not weld on a pressurized or closed cylinder.**
2. **Do not allow an Electrode holder, Electrode, welding torch, or welding wire to touch the cylinder.**
3. **Keep cylinders away from any electrical circuits, including welding circuits.**
4. **Keep protective cap in place over the valve except when the cylinder is in use.**
5. **Use only correct gas shielding equipment designed specifically for the type of welding you will do.** Maintain this equipment properly.
6. **Protect gas cylinders from heat, being struck, physical damage, slag, flames, sparks, and arcs.**
7. **Use proper procedures to move cylinders.**



SAVE THESE INSTRUCTIONS.

Grounding

⚠️ WARNING



TO PREVENT ELECTRIC SHOCK AND DEATH FROM INCORRECT GROUNDING WIRE CONNECTION:

Check with a qualified electrician if you are in doubt as to whether the outlet is properly grounded.

Do not use the welder if the power cord or plug is damaged. If damaged, have it repaired by a service facility before use. If the plug will not fit the outlet, have a proper outlet installed by a qualified electrician, do not use adapter plugs.

1. The green wire inside the cord is connected to the grounding system in the welder. The green wire in the cord must be the only wire connected to the welder's grounding system and must never be attached to an electrically "live" terminal. Never leave the grounding wire disconnected or modify the Power Cord Plug in any way.
2. Make sure the tool is connected to an outlet having the same configuration as the plug. If the tool must be reconnected for use on a different type of electric circuit, the reconnection should be made by qualified service personnel; and after reconnection, the tool should comply with all local codes and ordinances.

High Frequency Grounding

1. The Welder has internal grounding, there is no need to ground the Welder.
2. The metal work bench must be properly grounded in accordance with all relevant electrical codes and standards before operation. Have the work bench grounded by a qualified electrician if you are not qualified to do so.
3. To ground the work bench, connect a #12 AWG grounding wire (not included) from the work bench to a grounding rod (not included). The grounding rod must be an earth-driven copper or brass rod (electrode) which can adequately ground the work bench.
4. Refer to local regulations for ground source information.

High Frequency Radiation

1. The operator of welding equipment that causes harmful interference to radio services shall promptly take appropriate measures to correct the problem.
2. If the operator of welding equipment is notified by the FCC that operation of such equipment is endangering the functioning of a radio navigation or safety service, the operator shall immediately cease operating the equipment. Operation may be resumed on a temporary basis only for the purpose of eliminating the harmful interference. Operation may be resumed on a regular basis only after the harmful interference has been eliminated and approval from the FCC obtained.
3. When notified by the FCC that a particular installation is causing harmful interference, the operator or manufacturer shall arrange for an engineer skilled in techniques of interference measurement and control to make an investigation to ensure that the harmful interference has been eliminated. The Regional Director may require the engineer making the investigation to furnish proof of his or her qualifications.





Extension Cords







Do not use an extension cord on this welder.

Replacement Cords

1. **Use only one of the supplied power cords for this welder or an identical replacement cord.**
2. **Do not install a thinner or longer cord on this welder.**
3. **Do not patch cords of any length together for this item. Patches may allow moisture to penetrate the insulation, resulting in electric shock.**

Symbology

	Wire Feed (Speed)
	Workpiece Ground Cable
	Torch Cable
	Overheat Shutdown Indicator
	Cooling Fan
VAC	Volts Alternating Current
A	Amperes
OCV	Open Circuit Voltage
KVA	Kilovolt Amperes (Volts / 1000 * Amperes)
IPM	Inches Per Minute

AWG	American Wire Gauge
	Electric Shock Hazard. Do not touch energized parts.
	Inhalation Hazard. Keep head out of fumes and use proper ventilation.
	Read manual before setup and/or use.
	Fire Hazard. Keep flammable materials away during welding. Spatter can cause accidental fires.
	Arc Ray Hazard. Wear welding helmet with properly rated filter lens.
	Pacemaker Hazard. Welding processes may interfere with pacemakers. Consult doctor before use.

Specifications

	TIG		Stick	
	120VAC / 60Hz	240VAC / 60Hz	120VAC / 60Hz	240VAC / 60Hz
Power Input at Output	27.5A at 110A	32A at 200A	23.5A at 75A	30A at 160A
Welding Current Range	10A–110A	10A–200A	10A–75A	10A–160A
Rated Duty Cycles	25% @ 110A 100% @ 55A	20% @ 200A 100% @ 90A	25% @ 75A 100% @ 38A	20% @ 160A 100% @ 72A
Maximum OCV	13.5VDC (with VRD)		13.5VDC (with VRD)	
Weldable Materials	AC: Aluminum DC: Mild Steel, Stainless Steel, Chrome Moly		Mild Steel, Stainless Steel, Cast Materials	

Setup



Read the **ENTIRE IMPORTANT SAFETY INFORMATION** section at the beginning of this manual including all text under subheadings therein before set up or use of this product.

WARNING

TO PREVENT SERIOUS INJURY FROM ACCIDENTAL OPERATION:
Turn the Power Switch off and unplug the welder before set up.

Place the Welder on a level surface that can bear its weight near the work area. Leave space around the Welder for proper air flow.

TIG Setup

Connect Cables

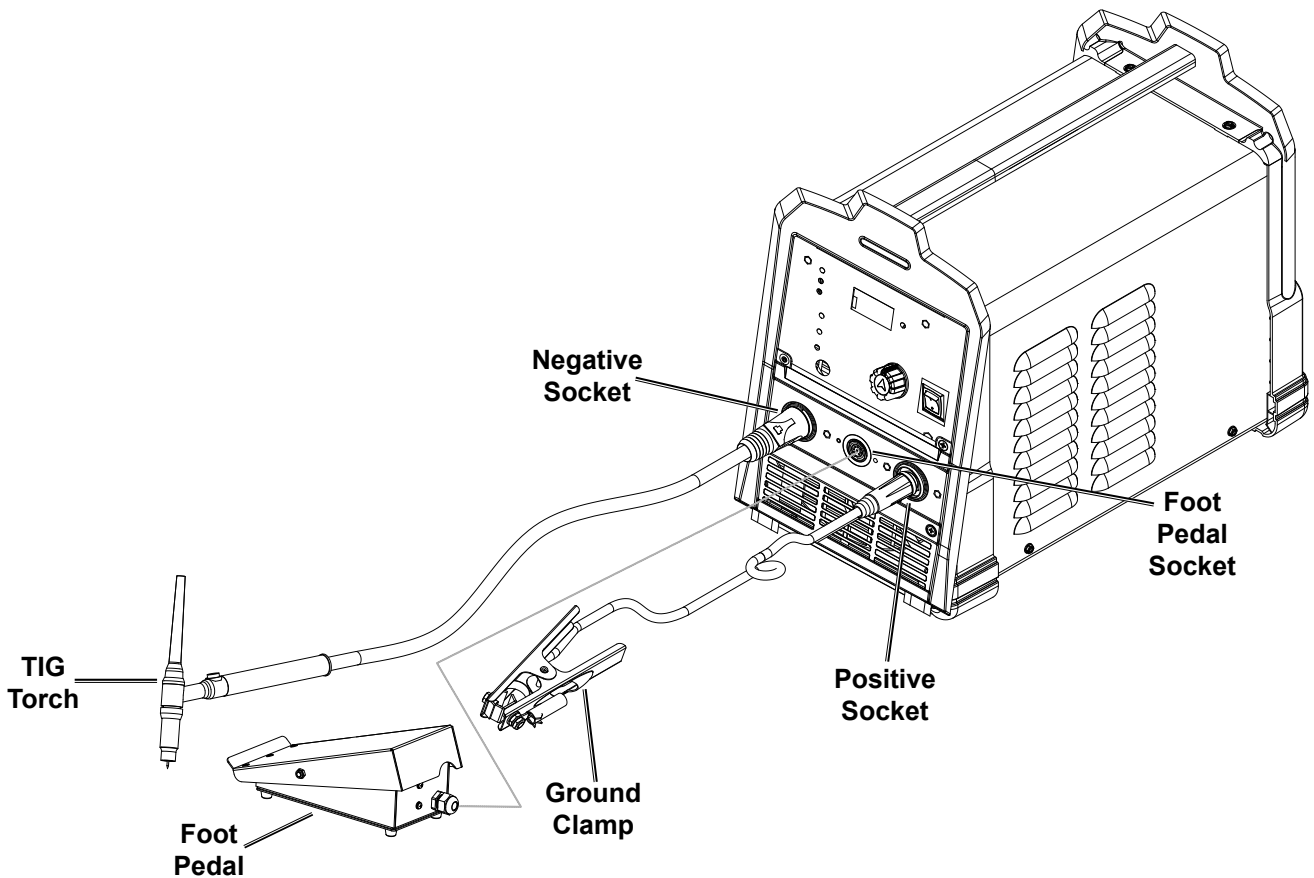

1. Plug Ground Clamp cable into Positive Socket. Twist clockwise all the way to lock in place.
2. Plug TIG Torch cable into Negative Socket. Twist clockwise all the way to lock in place.
3. Plug Foot Pedal cable into Foot Pedal Socket. Secure by turning collar clockwise until tight.

Connect Shielding Gas

1. With assistance, place an 100% Argon cylinder (not included) onto a cabinet or cart near the Welder and secure the cylinder in place with two straps (not included) to prevent tipping.
2. Remove the cylinder's cap. Stand to the side of the valve opening, then open the valve briefly to blow dust and dirt from the valve opening. Close the cylinder valve.
3. Close the Regulator's valve by backing off knob until it is loose, then thread Regulator onto cylinder and wrench tighten connection.
4. Attach the Gas Hose (included) to the Regulator's Outlet and the Welder's Gas Inlet. Wrench-tighten both connections.

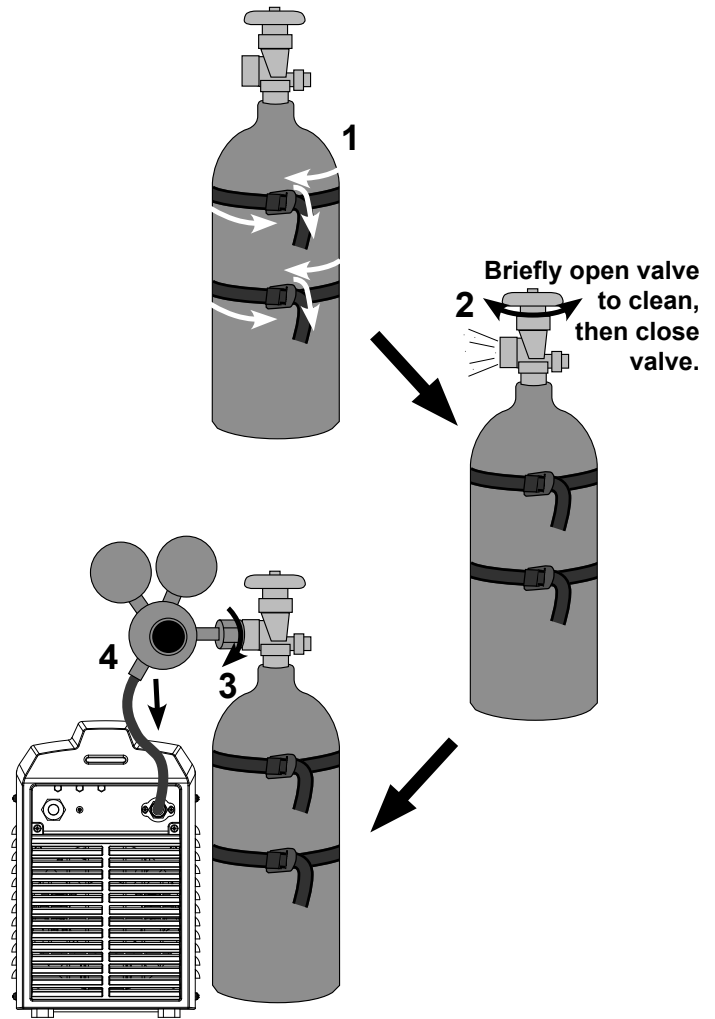

SAFETY

SETUP

BASIC WELDING

Connect Power Cord

If using 120VAC, connect the included 240V to 120V Plug Adapter to the end of the 240V Power Cord. If using 240VAC, do not use the adapter.

Note: Plug will only fit one way.

WARNING! TO PREVENT SERIOUS INJURY FROM ACCIDENTAL OPERATION: Do not plug cord into wall outlet at this time.

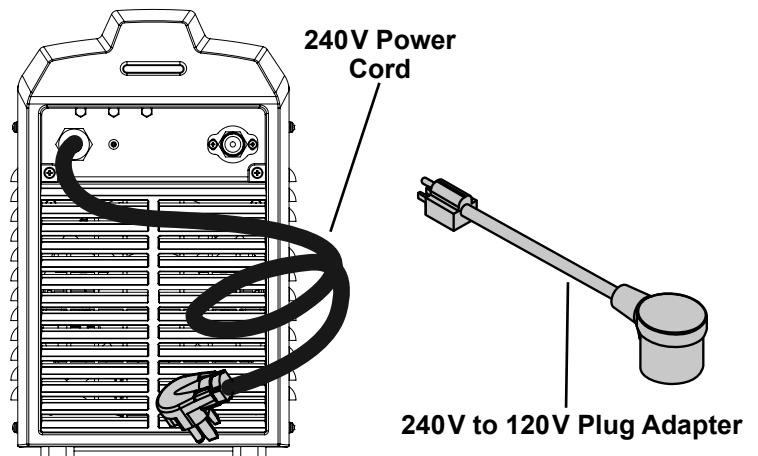

WELDING TIPS

MAINTENANCE

Sharpen Tungsten Electrode

To avoid Electrode contamination, dedicate a fine grit grinding wheel exclusively to Electrode grinding.

WARNING! TO PREVENT SERIOUS INJURY: Some Electrodes may have materials added to them that are hazardous to breathe. Wear a respirator and ANSI-approved Safety goggles when grinding an Electrode.

1. Shut off the welder and wait until Electrode and Torch have cooled enough to handle.
2. Remove Back Cap. Pull Electrode from front of Torch. (Pulling it from rear will damage Collet and create burrs on Electrode).
3. If Electrode has dulled or been otherwise contaminated, use pliers or a suitable tool to grip the Electrode above the contaminated section and snap off the end of the Electrode.

4. Lightly press Electrode tip against the surface of the grinding wheel at an angle. Rotate Electrode tip until a blunt point is formed.

Note: Grinding direction must be parallel to length of Electrode.

5. The conical portion of the ideal tip will be 2-1/2 times as long as the Electrode diameter.
6. Re-insert Electrode into Collet with tip protruding 1/8"-1/4" beyond the Ceramic Nozzle, then re-tighten the Back Cap.

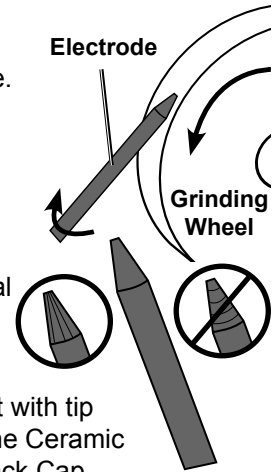

Assemble TIG Torch

1. Consult Settings Chart, on top of Welder, to determine proper Tungsten Electrode size to be used with thickness of material to be welded.
2. Match Collet and Collet Body sizes to Tungsten Electrode size.
3. Thread Collet Body into the front of the Torch.
4. Make sure Ceramic Nozzle size is appropriate for application.
5. Thread Ceramic Nozzle onto Collet Body.
6. Insert Collet into back of Torch and into Collet Body.
7. Insert tungsten Electrode into Collet on front of Torch.
8. Lock Electrode in place with Back Cap. Electrode should protrude 1/8" to 1/4" beyond the Ceramic Nozzle.

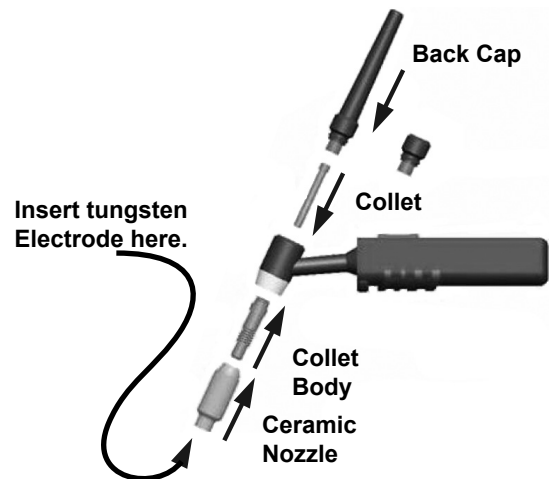

TITANIUM™

Stick Setup

Connect Cables

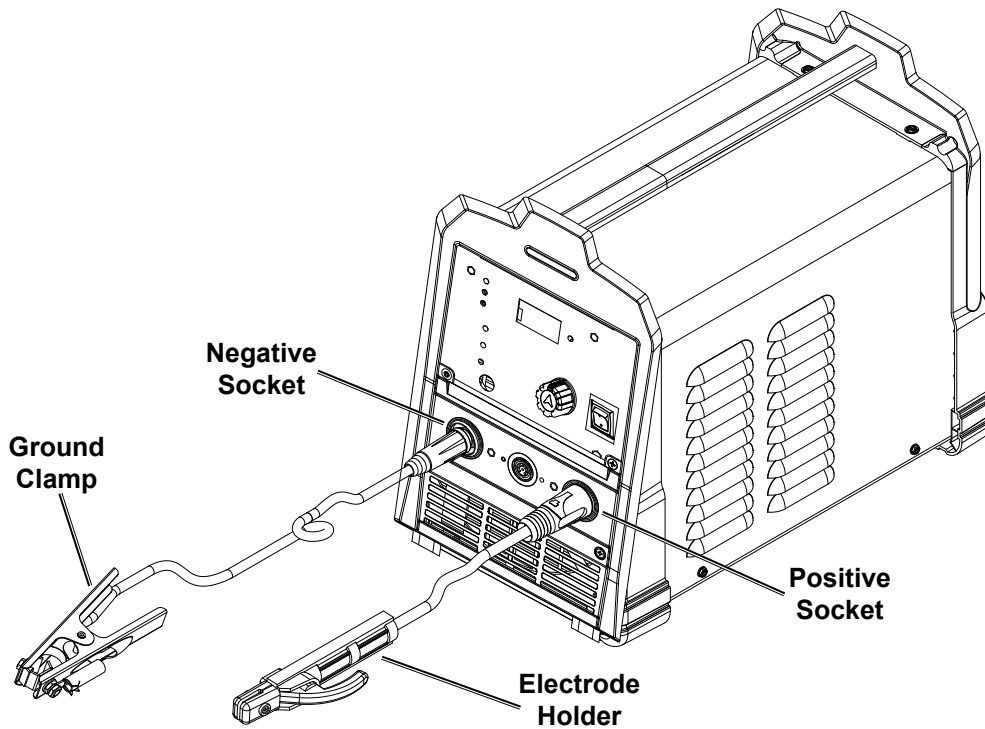

1. Plug Ground Clamp cable into Negative Socket. Twist clockwise all the way to lock in place.
2. Plug Electrode Holder cable into Positive Socket. Twist clockwise all the way to lock in place.

Connect Power Cord

If using 120VAC, connect the included 240V to 120V Plug Adapter to the end of the 240V Power Cord. If using 240VAC, do not use the adapter.

Note: Plug will only fit one way.

WARNING! TO PREVENT SERIOUS INJURY FROM ACCIDENTAL OPERATION: Do not plug cord into wall outlet at this time.

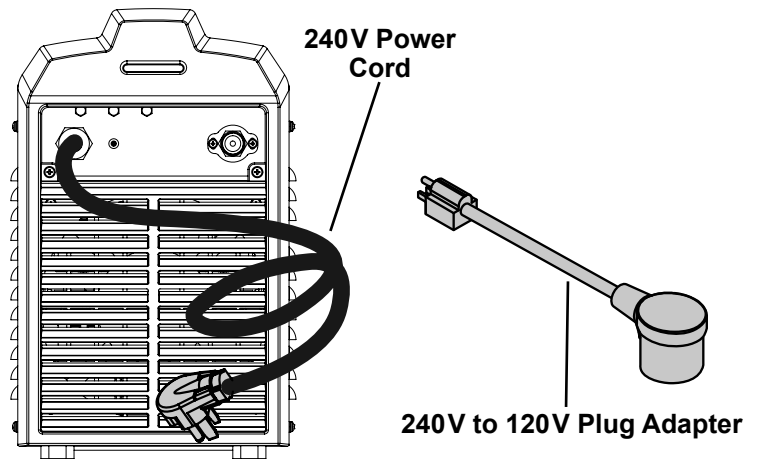

Basic Welding



Read the **ENTIRE IMPORTANT SAFETY INFORMATION** section at the beginning of this manual including all text under subheadings therein before set up or use of this product.

⚠️ WARNING

TO PREVENT SERIOUS INJURY:

Protective gear must be worn when using the Welder; minimum shade number 10 full face shield (or welding mask), ear protection, welding gloves, sleeves and apron, NIOSH-approved respirator, and fire resistant work clothes without pockets should be worn when welding.

Light from the arc can cause permanent damage to the eyes and skin.

Do not breathe arc fumes.

- DC TIG Welding is used to weld mild steel and stainless steel using a TIG Rod and shielding gas.
- AC TIG Welding is used to weld aluminum using a TIG Rod and shielding gas.
- Stick Welding is used to weld mild steel and stainless steel using a Stick Electrode without shielding gas.



Good welding takes a degree of skill and experience. Practice a few sample welds on scrap before welding your first project. Additional practice periods are recommended whenever you weld:

- a different thickness of material
- a different type of material
- a different type of connection
- using a different process



Make practice welds on pieces of scrap to practice technique before welding anything of value.

⚠️ WARNING



TO PREVENT SERIOUS INJURY, FIRE AND BURNS:
Keep welding tip clear of grounded objects whenever unit is plugged in and turned on.



Power On

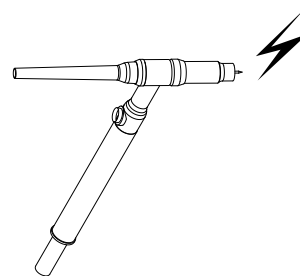

Practice your welding technique on scrap pieces before welding anything of value.

Controls

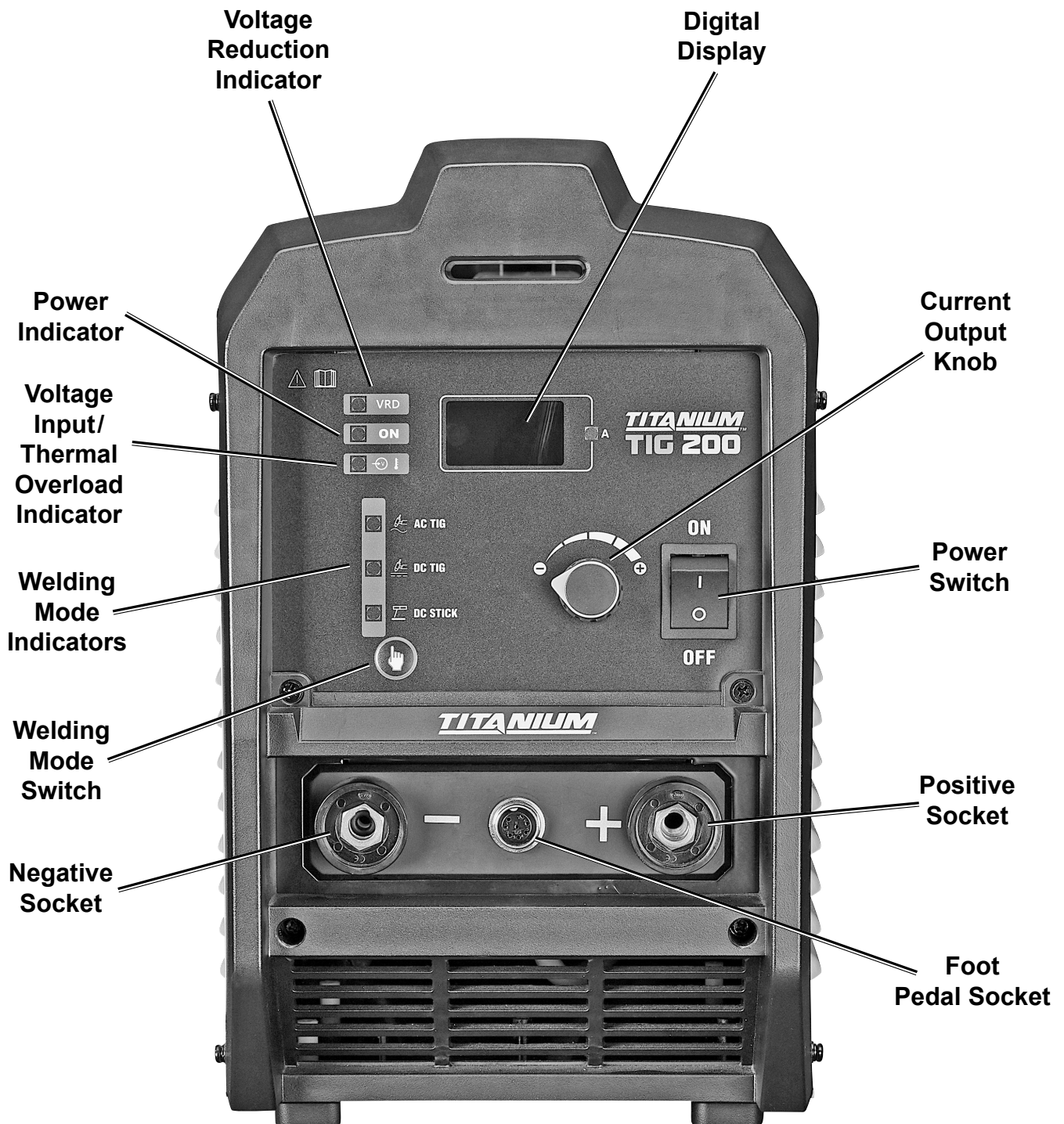

Voltage Reduction Indicator:
Lights when Voltage Reduction Device is operating.

Power Indicator:
Lights when power is on.

Voltage Input/Thermal Overload Indicator:
Lights when input voltage is outside the Welder's specifications or duty cycle has been exceeded.

Welding Mode Switch:
Press to select welding mode – AC TIG, DC TIG, or DC STICK.

Welding Mode Indicators:
Light to indicate selected welding mode.

Current Output Knob:
Set output current (A).

SAFETY

SETUP

BASIC WELDING

WELDING TIPS

MAINTENANCE

Setting up the Weld

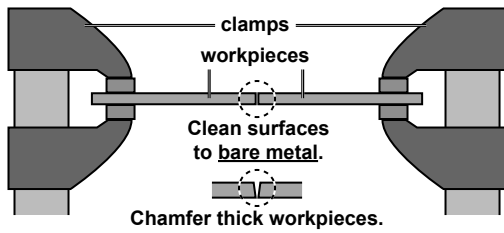

2. Use clamps (not included) to hold the workpieces in position so that you can concentrate on proper welding technique. The distance (if any) between the two workpieces must be controlled properly to allow the weld to hold both sides securely while allowing the weld to penetrate fully into the joint. The edges of thicker workpieces may need to be chamfered (or beveled) to allow proper weld penetration.

NOTE: Make practice welds on pieces of scrap the same thickness as your intended workpiece to practice technique before welding anything of value.

1. Clean the weld surfaces thoroughly with a wire brush or angle grinder; there must be no rust, paint, oil, or other materials on the weld surfaces, only bare metal.

NOTICE: When welding equipment on a vehicle, disconnect the vehicle battery power from both the positive connection and the ground before welding. This prevents damage to some vehicle electrical systems and electronics due to the high voltage and high frequency bursts common in welding.

Ground Workpiece

Attach Ground Clamp to bare metal on the workpiece near the weld area, or to metal work bench where the workpiece is clamped.

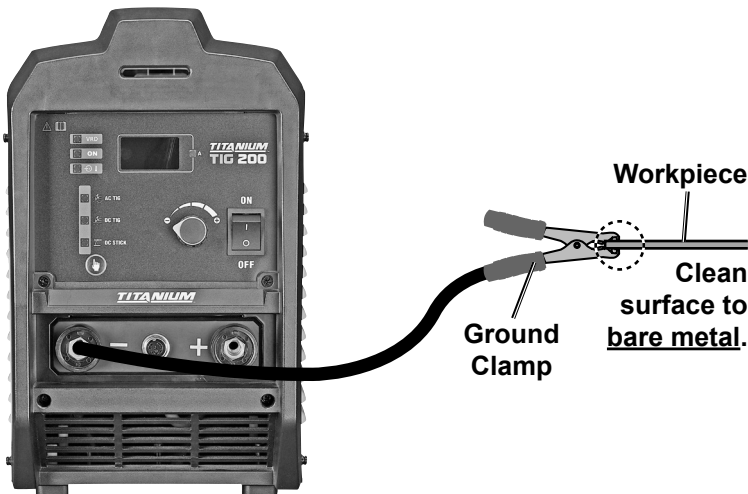

TITANIUM™

Duty Cycle (Duration of Use)

Avoid damage to the Welder by not welding for more than the prescribed duty cycle time. The Duty Cycle defines the number of minutes, within a 10 minute period, during which a given welding process can produce a particular welding current without overheating.



For example, a 30% duty cycle at 165 A welding current must be allowed to rest for at least 7 minutes after every 3 minutes of continuous welding.



Failure to carefully observe duty cycle limitations can easily over-stress a welder's power generation system contributing to premature welder failure.

This welder has an internal thermal protection system to help prevent this sort of over-stress. When the Welder overheats, it automatically shuts down and the Overload Indicator lights. The welder automatically returns to service after cooling off. Rest the Tig Torch or Electrode Holder on an electrically non-conductive, heat-proof surface, such as a concrete slab, well clear of the ground clamp.

Allow the Welder to cool with the Power Switch on, so that the internal Fan will help cool the welder.

When the Overload Indicator is no longer lit and the Welder can be used again, use shorter welding periods and longer rest periods to prevent needless wear.

TIG Rated Duty Cycles	
<p>240VAC 20% Use at 200A For 10 Continuous Minutes</p> <p>2 Minutes Welding  8 Minutes Resting</p> <p>100% Continuous Use at 90A</p>	<p>120VAC 25% Use at 110A For 10 Continuous Minutes</p> <p>2-1/2 Minutes Welding  7-1/2 Minutes Resting</p> <p>100% Continuous Use at 55A</p>

Stick Rated Duty Cycles	
<p>240VAC 20% Use at 160A For 10 Continuous Minutes</p> <p>2 Minutes Welding  8 Minutes Resting</p> <p>100% Continuous Use at 72A</p>	<p>120VAC 25% Use at 75A For 10 Continuous Minutes</p> <p>2-1/2 Minutes Welding  7-1/2 Minutes Resting</p> <p>100% Continuous Use at 38A</p>

TITANIUM™

TIG Welding

SAFETY

⚠️ WARNING

TO PREVENT SERIOUS INJURY AND DEATH:

Do not weld without Grounding Clamp.

When the operator is not holding the Torch, it must be sitting on a nonconductive, nonflammable surface. Only hold TIG Rod with an electrically insulated welding glove.

⚠️ DANGER

TO PREVENT DEATH FROM ASPHYXIATION:

Do not open gas without proper ventilation. Fix gas leaks immediately. Shielding gas can displace air and cause rapid loss of consciousness and death. **Shielding gas without carbon dioxide can be even more hazardous because asphyxiation can start without feeling shortness of breath.**

NOTICE: TIG welding is a complicated process, requiring experience and skill to achieve successful results. Training beyond the scope of this manual is required to TIG weld properly.

1. Open gas cylinder's valve all the way.
2. Set Flow Gauge to SCFH value indicated on Settings Chart on top of Welder.
3. Turn the Power Switch to the OFF position, then plug the Welder into a properly grounded, GFCI protected, 120VAC (20 amp rated) outlet or 240VAC receptacle that matches the plug. The circuit must be equipped with delayed action-type circuit breaker or fuses.
4. Set TIG Torch down on nonconductive, nonflammable surface well away from any grounded objects.
5. Turn the Power Switch ON.

6. **Select Process:** Press Welding Mode Switch to scroll to desired welding mode.



AC TIG - For welding aluminum



DC TIG - For welding mild and stainless steel



DC STICK - Go to Stick Welding on page 18.

7. Set amperage according to Settings Chart on top of Welder. Set to high end of amperage range. For example: Range is 80-100A, set amperage to 100A.

NOTE: Amperage settings are approximate. Adjust as necessary.

Other parameters like AC balance, pre-gas flow time and post-gas flow time have been preset:

- Pre-Flow: The number of seconds that gas will flow once the Foot Pedal is pushed—this is preset at 0.3 seconds. The arc will not start for that preset time, but gas will flow. Once the preset time expires, the arc will start.
- Post-Flow: The number of seconds that gas will flow once the Foot Pedal is released. This has been preset and automatically adjusts based on the preset amperage output.

WARNING! TO PREVENT SERIOUS INJURY: Protective gear must be worn when using the Welder; minimum shade number 10 full face shield (or welding mask), ear protection, welding gloves, sleeves and apron, NIOSH-approved respirator, and fire resistant work clothes without pockets should be worn when welding. Light from the arc can cause permanent damage to the eyes and skin. Do not breathe arc fumes.

SETUP

BASIC WELDING

WELDING TIPS

MAINTENANCE



Welding Mode Switch

Current Output Knob

Power Switch

After practice welding on scrap, stop, and check your progress. Perform Strike Test according to **Strike Test on page 20**. After making any necessary adjustments, continue to weld **while carefully following the DUTY CYCLE guidelines as explained on page 14**.

WARNING! TO PREVENT SERIOUS INJURY: Metal work bench must be grounded when TIG welding (see High Frequency Grounding on page 6).

8. Hold TIG Torch in one gloved hand and the TIG Rod in other gloved hand.
9. Specific Welding Techniques:

High Frequency Start

- Hold Torch away from the workpiece the same distance as 1 to 1.5 times the diameter of the Tungsten Electrode.
- Press Foot Pedal down slowly until arc ignites. Then, press Foot Pedal down all the way to reach maximum amperage. Let up on Foot Pedal to lower amperage.

NOTE: Maintain a constant distance between the Tungsten Electrode and the workpiece: between 1 and 1.5 times the diameter of the Electrode.

10. When welding puddle is hot enough, tilt torch backward about 10-15 degrees from vertical and move it back slightly. Add TIG Rod material as needed to the front end of the weld puddle.

11. Alternate between pushing the torch/weld puddle and adding the TIG Rod material.

NOTE: Back the TIG Rod off each time the Electrode is advanced, but do not remove it from the gas shield. This prevents oxidation from contaminating the weld.

12. When finished welding, release the Foot Pedal, but keep Torch on weld puddle until gas flow ends.
13. Set TIG Torch down on nonconductive, nonflammable surface away from any grounded objects.
14. Turn the Current Output Knob to the lowest setting, then turn the Power Switch off.
15. To prevent accidents, after use:
 - Allow Welder to cool down.
 - Unplug Welder's power cord from outlet.
 - Remove Ground Clamp from workpiece or table.
 - Disconnect TIG Torch, Ground and Foot Pedal Cables.
 - Close gas cylinder's valve securely, remove regulator and replace cap.
 - Disconnect Gas Hose from Welder.
 - Store and secure gas cylinder.
 - Clean, then store Welder and its accessories indoors out of children's reach.

The logo for TITANIUM, featuring the word "TITANIUM" in a bold, italicized, sans-serif font. The letters are black with a white outline. A horizontal line runs through the middle of the letters, and a small trademark symbol (TM) is located at the bottom right of the word.

Stick Welding

SAFETY

SETUP

BASIC WELDING

WELDING TIPS

MAINTENANCE

⚠️ WARNING

TO PREVENT SERIOUS INJURY AND DEATH:

Do not weld without Grounding Clamp.

When the operator is not holding the Electrode Holder, it must be sitting on a nonconductive, nonflammable surface.

1. Turn the Power Switch to the OFF position, then plug the Welder into a properly grounded, GFCI protected, 120VAC (20 amp rated) outlet or 240VAC receptacle that matches the plug. The circuit must be equipped with delayed action-type circuit breaker or fuses.
2. Set Electrode Holder down on nonconductive, nonflammable surface away from any grounded objects.
3. Turn the Power Switch ON.

WARNING! TO PREVENT SERIOUS INJURY: When Stick is selected, Welder is energized, Hot Start is activated and Open Circuit Voltage is present.

4. **Select Process:** Press Welding Mode Switch to scroll to  **DC STICK**.

5. Set Amperage according to Stick Settings Chart.

NOTE: Settings are approximate. Adjust as necessary.

Stick Settings Chart		
Electrode Type	Electrode Diameter	Amperage Range
E6013 DC+	1/16"	25-40
	3/32"	50-90
	1/8"	90-130
	5/32"	130-175
E7014 DC+	3/32"	70-110
	1/8"	90-130
	5/32"	130-175
E7018 DC+	3/32"	75-110
	1/8"	90-135
	5/32"	130-175
E7024 DC+	1/8"	120-150
	5/32"	160-175



Welding Mode Switch

Current Output Knob

Power Switch



WARNING! TO PREVENT SERIOUS INJURY: Protective gear must be worn when using the Welder; minimum shade number 10 full face shield (or welding mask), ear protection, welding gloves, sleeves and apron, NIOSH-approved respirator, and fire resistant work clothes without pockets should be worn when welding. Light from the arc can cause permanent damage to the eyes and skin. Do not breathe arc fumes.

*After practice welding on scrap, stop, and check your progress. Perform Strike Test, then clean and compare your weld's appearance with the diagrams and descriptions in the **Welding Tips** section starting on the next page. After making any necessary adjustments, continue to weld while carefully following the **DUTY CYCLE** guidelines as explained on page 14.*

6. Place the bare metal end of the Stick Electrode (sold separately) inside the jaws of the Electrode Holder.
7. Stroke the workpiece lightly to ignite the arc. Tips for igniting the arc:
 - a. Tap the surface with the Electrode.
 - b. Stroke the surface with the Electrode.
 - c. Strike the surface like a match with the Electrode.
8. After the arc ignites:
 - a. Lift the Electrode off workpiece the same distance as the diameter of the bare metal end.
 - b. Tilt Electrode back 10 to 20 degrees.
 - c. Drag Electrode to the back end of the weld puddle to deposit material as needed.
9. When finished welding, lift the Electrode from the workpiece, then set Electrode Holder down on nonconductive, nonflammable surface away from any grounded objects.
10. Turn the Power Switch OFF.
11. To prevent accidents, after use:
 - Allow Welder to cool down.
 - Unplug Welder's power cord from outlet.
 - Remove Ground Clamp.
 - Disconnect Electrode Holder and Ground Cables.
 - Clean, then store Welder and its accessories indoors out of children's reach.

TITANIUMTM

Welding Tips

A good way to test welding technique is to examine a weld's appearance after it has cooled and the slag has been removed (for Stick welds). Then, better welding can be learned by adjusting your weld technique to remedy any problems found.

NOTICE: TIG welding is a complicated process, requiring experience and skill to achieve successful results. Training beyond the scope of this manual is required to TIG weld properly.

After practice welding a couple of welding beads, STOP and examine your weld using the following guidelines.

Strike Test

A test weld on a PIECE OF SCRAP can be tested by using the following procedure. WEAR ANSI-APPROVED SAFETY GOGGLES DURING THIS PROCEDURE.

CAUTION! This test WILL damage the weld it is performed on. This test is ONLY an indicator of weld technique and is not intended to test working welds.

1. After two scraps have been welded together and the weld has cooled, clamp one side in a sturdy vise.
2. Stay clear from underneath while you strike the opposite side with a heavy hammer, preferably a dead-blow hammer.
3. A **GOOD WELD** will deform but not break, as shown on top. A **POOR WELD** will be brittle and snap at the weld, as shown on bottom.

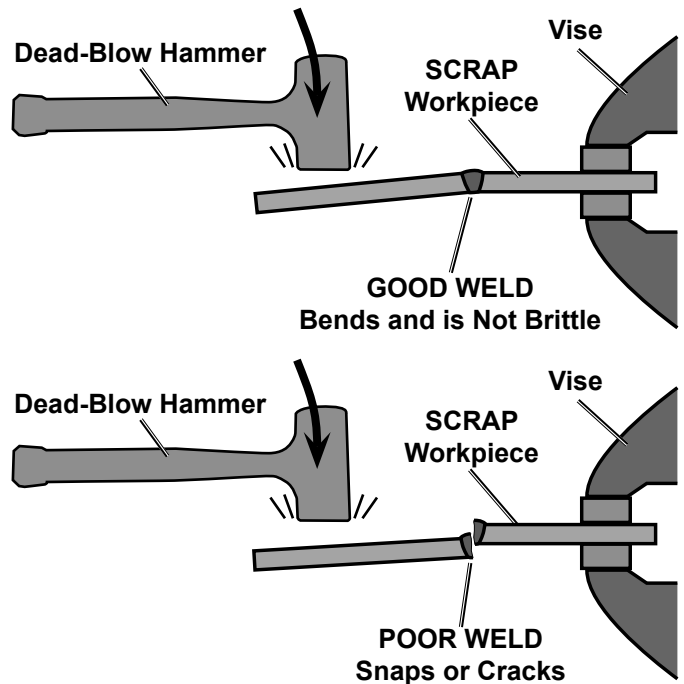

Cleaning Stick Weld

⚠ WARNING



TO PREVENT SERIOUS INJURY: Wear ANSI-approved safety goggles and protective wear when cleaning a weld. Sparks or chips may fly when cleaning.

1. A weld from Stick welding will be covered by slag. Use a chipping hammer to knock this off. **Be careful not to damage the weld or base material.**
2. Use a wire brush to further clean the weld or use an angle grinder (sold separately) to shape the weld.

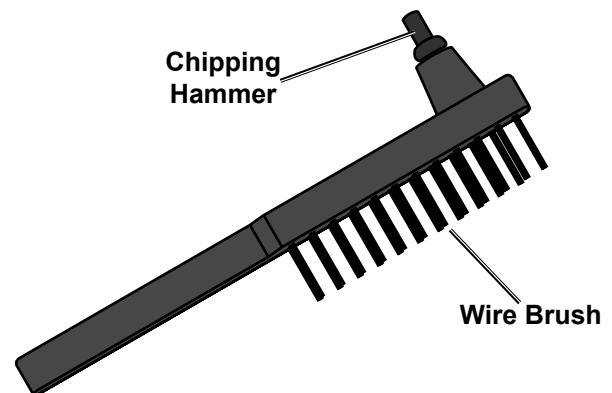

Stick Weld Diagnosis - Workpiece Heat Control / Weld Penetration

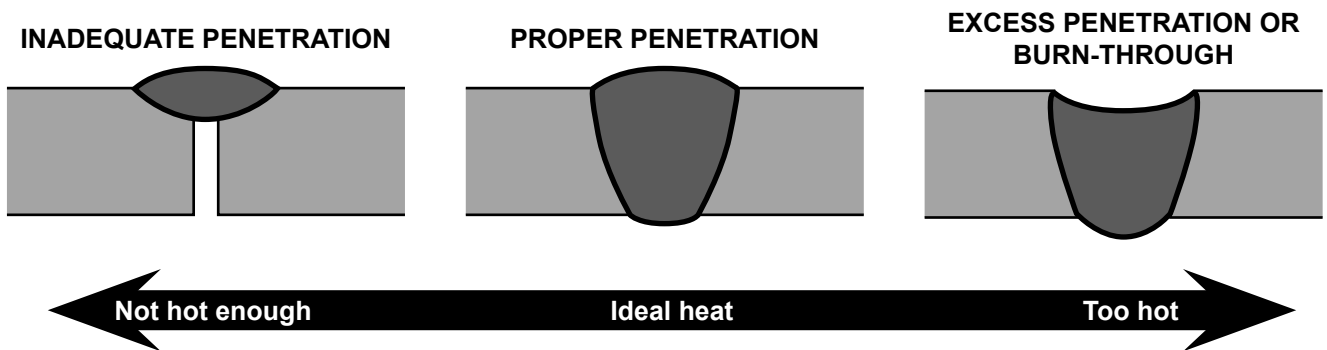

How to increase workpiece heat and increase penetration:
 (to weld **THICKER** workpieces properly)
 a. Increase current. b. Weld more slowly.

How to reduce workpiece heat and limit penetration:
 (to weld **THINNER** workpieces properly)
 a. Decrease current. b. Weld more quickly.

Stick Weld Example Diagrams

CLEAN WELDS FIRST!

Stick welds will have a coat of slag over them until cleaned.

Good Weld	Current Too Low	Current Too High	Weld Speed Too Fast	Weld Speed Too Slow	Arc Length Too Short	Arc Length Too Long
	TO CORRECT: Increase the current	TO CORRECT: Decrease the current	TO CORRECT: Weld slower	TO CORRECT: Weld faster	TO CORRECT: Increase distance	TO CORRECT: Decrease distance

SAFETY

SETUP

BASIC WELDING

WELDING TIPS

MAINTENANCE

Stick Weld Penetration (Workpiece Heat Control)

SAFETY

EXCESS PENETRATION OR BURN-THROUGH

Weld droops on top and underneath or falls through entirely, making a hole.

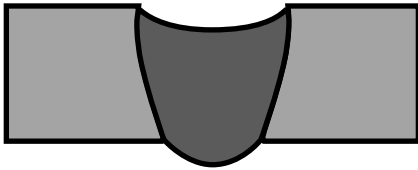

PROPER PENETRATION

Weld is visible underneath and bulges slightly on top.

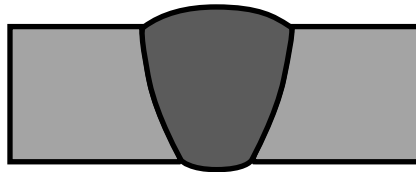

INADEQUATE PENETRATION

Weld does not contact the joint fully, just on the surface.

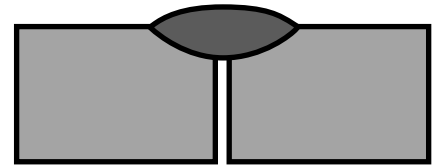

PROFILE VIEWS

SETUP

POSSIBLE CAUSES AND SOLUTIONS FOR EXCESS PENETRATION OR BURN-THROUGH

1. **Workpiece overheating:**
Reduce current.
2. **Welding speed too slow:**
Increase welding speed and ensure that welding speed is kept steady.

POSSIBLE CAUSES AND SOLUTIONS FOR INADEQUATE PENETRATION

1. **Incorrect welding technique:**
Keep arc on leading edge of weld puddle. Hold torch at proper angles.
2. **Insufficient weld heat:**
Slow down so fill material has time to melt into the weld location. Increase current.
3. **Workpieces too thick/close:**
Bevel thick workpieces, allow slight gap, and weld in several passes.
4. **Insufficient weld material:**
Increase amount of fill material.

BASIC WELDING

Stick Weld - Weld Not Adhering Properly

Gaps present between weld and previous bead or between weld and workpiece. See areas below.

POSSIBLE CAUSES AND SOLUTIONS

PROFILE VIEW

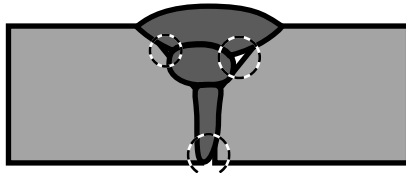

1. **Incorrect welding technique:**
Place stringer bead at correct place in joint. Adjust workpiece position or weld angle to permit proper welding to bottom of piece. Keep arc on leading edge of weld puddle. Hold Electrode and fill material at proper angles.

2. **Insufficient weld heat:**
Increase current.
3. **Dirty workpiece:**
Clean workpiece down to bare metal.
4. **Insufficient weld material:**
Increase amount of fill material.
5. **Distance between workpieces too large:**
Decrease distance and increase bevel.

WELDING TIPS

Stick Weld - Bend at Joint

POSSIBLE CAUSES AND SOLUTIONS

PROFILE VIEW

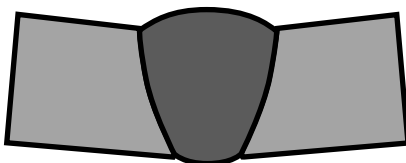

1. **Improper clamping:**
Clamp workpieces securely. Make tack welds to hold workpieces.
2. **Excessive heat:**
Weld a small portion and allow to cool before proceeding. Increase weld speed.

MAINTENANCE

Stick Weld - Coat of Slag Over Weld

TOP
VIEW



PARTIALLY CHIPPED AWAY TO SHOW WELD

Slag is a necessary part of a stick weld. It shields the weld from impurities. Clean off the slag with the Chipping Hammer and Wire Brush after welding.

Stick Weld - Porosity - Small cavities or holes in the bead.

POSSIBLE CAUSES AND SOLUTIONS

TOP
VIEW

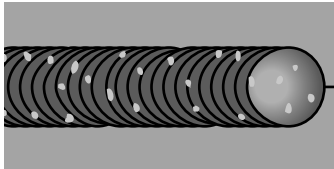

1. **Dirty workpiece or fill material:**
Clean workpiece down to bare metal.
Make certain that fill material and Electrode are clean and free from oil, coatings, and other residues.
2. **Inconsistent welding speed:**
Maintain steady weld speed.

Stick Weld - Crooked/Wavy Bead

POSSIBLE CAUSES AND SOLUTIONS

TOP
VIEW

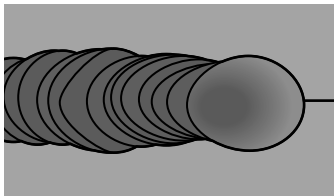

1. **Inaccurate welding:**
Use two hands or rest hand on steady surface.
2. **Inconsistent welding speed:**
Maintain steady weld speed.

Stick Weld - Excessive Spatter

POSSIBLE CAUSES AND SOLUTIONS

TOP
VIEW

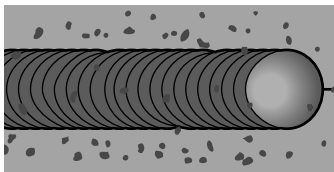

Fine spatter is normal. Spatter that is grainy and large is a problem.

Dirty workpiece or fill material:
Clean workpiece down to bare metal.
Make certain that fill material and Electrode are clean and free from oil, coatings, and other residues.

Stick Weld - Burn-Through - Base material melts away, leaving a hole in the weld.

POSSIBLE CAUSES AND SOLUTIONS

TOP
VIEW

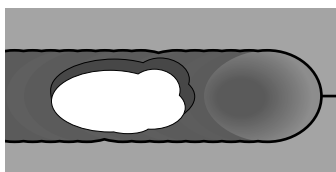

1. **Workpiece overheating:**
Reduce current.
2. **Welding speed too slow:**
Increase welding speed and ensure that welding speed is kept steady.
3. **Excessive material at weld:**
Reduce amount of fill material.

SAFETY

SETUP

BASIC WELDING

WELDING TIPS

MAINTENANCE

Maintenance and Service

WARNING



TO PREVENT SERIOUS INJURY, FIRE AND BURNS:

Unplug the Welder, rest the TIG Torch on a heat-proof, electrically non-conductive surface, and allow all parts of the Welder to cool thoroughly before service.

- BEFORE EACH USE**, inspect the general condition of the welder. Check for:
 - loose hardware
 - misalignment or binding of moving parts
 - damaged cord/electrical wiring
 - frayed or damaged cables
 - cracked or broken parts
 - any other condition that may affect its safe operation.
- PERIODICALLY**, have a qualified technician unplug the Welder, remove the Back Housing, and using compressed air, blow out all dust from the interior.
- AFTER EVERY USE**, store in a clean and dry location.

Troubleshooting

IMPORTANT!

Be CERTAIN to shut off the Welder, disconnect it from power, and discharge the electrode to ground before adjusting, cleaning, or repairing the unit.

Problem	Possible Causes	Likely Solutions
When Switched On Power Indicator Lights, But Welder Does Not Function	<ol style="list-style-type: none">1. Tripped thermal protection device.2. Ground Clamp not attached to workpiece.3. Machine is in low- or over-voltage protection.4. Shielding Gas not connected.	<ol style="list-style-type: none">1. Reduce duration or frequency of welding periods to help reduce wear on the welder. Refer to Duty Cycle (Duration of Use) on page 15.2. Attach Ground Clamp to workpiece.3. If Voltage Input/Thermal Overload Indicator is illuminated, check input voltage and ensure it falls within the specified range. If input voltage is correct, press Reset Button on back of machine.4. Connect shielding gas to Welder.
When Switched On Power Indicator Does Not Light	<ol style="list-style-type: none">1. Unit is not connected to outlet properly.2. Outlet is unpowered.3. Circuit supplies insufficient input voltage or amperage.	<ol style="list-style-type: none">1. Verify the voltage at the outlet and the connection to the outlet.2. Check circuit breaker/GFCI devices; if any are tripped, determine and remedy cause before resetting.3. Verify that the circuit is designed to supply the required input amperage as detailed in Specifications on page 7.



Follow all Safety precautions whenever diagnosing or servicing the tool. Disconnect power supply before service.

Problem	Possible Causes	Likely Solutions
Weak Arc Strength	<ol style="list-style-type: none"> 1. Incorrect line voltage. 2. Improper gauge or length of cord. 	<ol style="list-style-type: none"> 1. Check the line voltage and, if insufficient, have a licensed electrician remedy the situation. 2. Do not use an extension cord on this Welder. Use only one of the supplied power cords for this Welder or an identical replacement cord.
Welding Arc Not Stable.	<ol style="list-style-type: none"> 1. Loose electrode cable or ground cable. 2. Damaged electrode holder or loose connection within electrode holder. 3. Adjust current setting. 4. Shielding gas getting low. 	<ol style="list-style-type: none"> 1. Check to ensure that all connections are tight. 2. Have a qualified technician inspect and repair/replace as necessary. 3. Make sure setting matches recommended setting on chart. 4. Replace shielding gas cylinder.

 **Follow all Safety precautions whenever diagnosing or servicing the tool. Disconnect power supply before service.**

Fault Code Table			
Code	Problem	Possible Causes	Likely Solutions
F01	Overheated	The duty cycle limit of the machine has been exceeded.	Allow the machine to cool down. Keep the machine plugged in and turned on to allow the fan to continue to run. Reduce duration or frequency of welding periods. Refer to Duty Cycle (Duration of Use) on page 15. Check for any obstructions blocking air flow into the machine and ensure proper clearance between any obstacles and the vents on all sides of the machine.
F02	Incorrect Input Voltage	The input voltage is too high or too low.	Verify the voltage at the outlet and the connection to the outlet.
F05	Torch Triggers Before Machine Is Turned On	The TIG torch trigger is stuck or is triggered when turning on the machine.	Turn OFF the machine and ensure the TIG torch trigger is reset.
F09	Output Short Circuited	Ground clamp and TIG torch or electrode holder are in contact.	Check the connection of the ground clamp and TIG torch or electrode holder to make sure they are not in contact. Lift the electrode holder or TIG torch up to take the electrode away from the workpiece and restart arc.

PLEASE READ THE FOLLOWING CAREFULLY

SAFETY

THE MANUFACTURER AND/OR DISTRIBUTOR HAS PROVIDED THE PARTS LIST AND ASSEMBLY DIAGRAM IN THIS MANUAL AS A REFERENCE TOOL ONLY. NEITHER THE MANUFACTURER OR DISTRIBUTOR MAKES ANY REPRESENTATION OR WARRANTY OF ANY KIND TO THE BUYER THAT HE OR SHE IS QUALIFIED TO MAKE ANY REPAIRS TO THE PRODUCT, OR THAT HE OR SHE IS QUALIFIED TO REPLACE ANY PARTS OF THE PRODUCT. IN FACT, THE MANUFACTURER AND/OR DISTRIBUTOR EXPRESSLY STATES THAT ALL REPAIRS AND PARTS REPLACEMENTS SHOULD BE UNDERTAKEN BY CERTIFIED AND LICENSED TECHNICIANS, AND NOT BY THE BUYER. THE BUYER ASSUMES ALL RISK AND LIABILITY ARISING OUT OF HIS OR HER REPAIRS TO THE ORIGINAL PRODUCT OR REPLACEMENT PARTS THERETO, OR ARISING OUT OF HIS OR HER INSTALLATION OF REPLACEMENT PARTS THERETO.

SETUP

BASIC WELDING

WELDING TIPS

MAINTENANCE

Record Product's Serial Number Here: _____

Note: If product has no serial number, record month and year of purchase instead.

Note: Some parts are listed and shown for illustration purposes only, and are not available individually as replacement parts. Specify UPC 792363568258 when ordering parts.

SAFETY

SETUP

BASIC WELDING

WELDING TIPS

MAINTENANCE

Parts List

SAFETY

SETUP

BASIC WELDING

WELDING TIPS

MAINTENANCE

Part	Description	Qty
1	Handle	1
2	Top Housing	1
3	Main PCB	1
4	Control PCB	1
5	IGBT Radiator-Front	2
6	Cassette Holder	1
7	Arc PCB	1
8	Air Isolation Plate	2
9	IGBT	16
10	Front PCB	1
11	Bracket	1
12	Control Panel	1
13	TIG Torch	1
14	Electrode Holder	1
15	Knob	1
16	Negative Socket	1
17	Pneumatic Connector	1

Part	Description	Qty
18	Copper Anode	1
19	Foot Pedal Socket	1
20	Positive Socket	1
21	Switch	1
22	Copper Cathode	1
23	Ground Clamp	1
24	Front Panel	1
25	Pet	1
26	Foot Pedal	1
27	Arc Inductance	1
28	Current Sensor	1
29	Transformer	1
30	Inductance	1
31	Inverter Radiator	1
32	High Recovery Rectifier	6
33	High Recovery Tube	4
34	Rectifier Radiator	2

Part	Description	Qty
35	Output PCB	1
36	Bearing	1
37	Bottom Housing	1
38	Fan	1
39	120V Plug Adapter	1
40	Cable Clip	1
41	Power Cord	1
42	Rear Panel	1
43	Valve Interface	1
44	Fixture	1
45	Solenoid Valve	1
46	Tube Connector	1
47	IGBT	8
48	IGBT Radiator-Rear	2
49	Bridge Heat Sink	1
50	Bridge Rectifier	2

Assembly Diagram

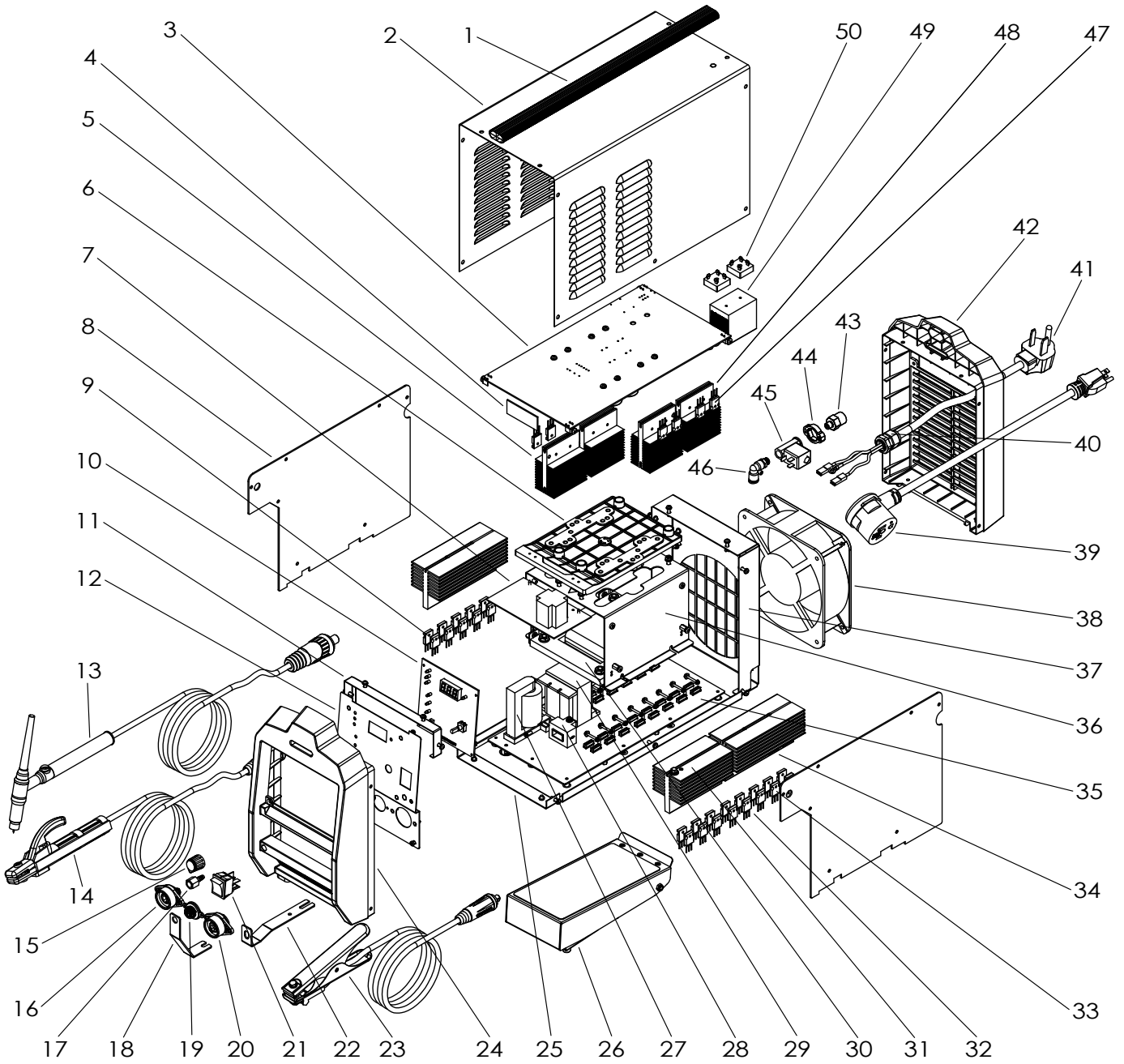

SAFETY

SETUP

BASIC WELDING

WELDING TIPS

MAINTENANCE

Wiring Diagram

SAFETY

SETUP

BASIC WELDING

WELDING TIPS

MAINTENANCE

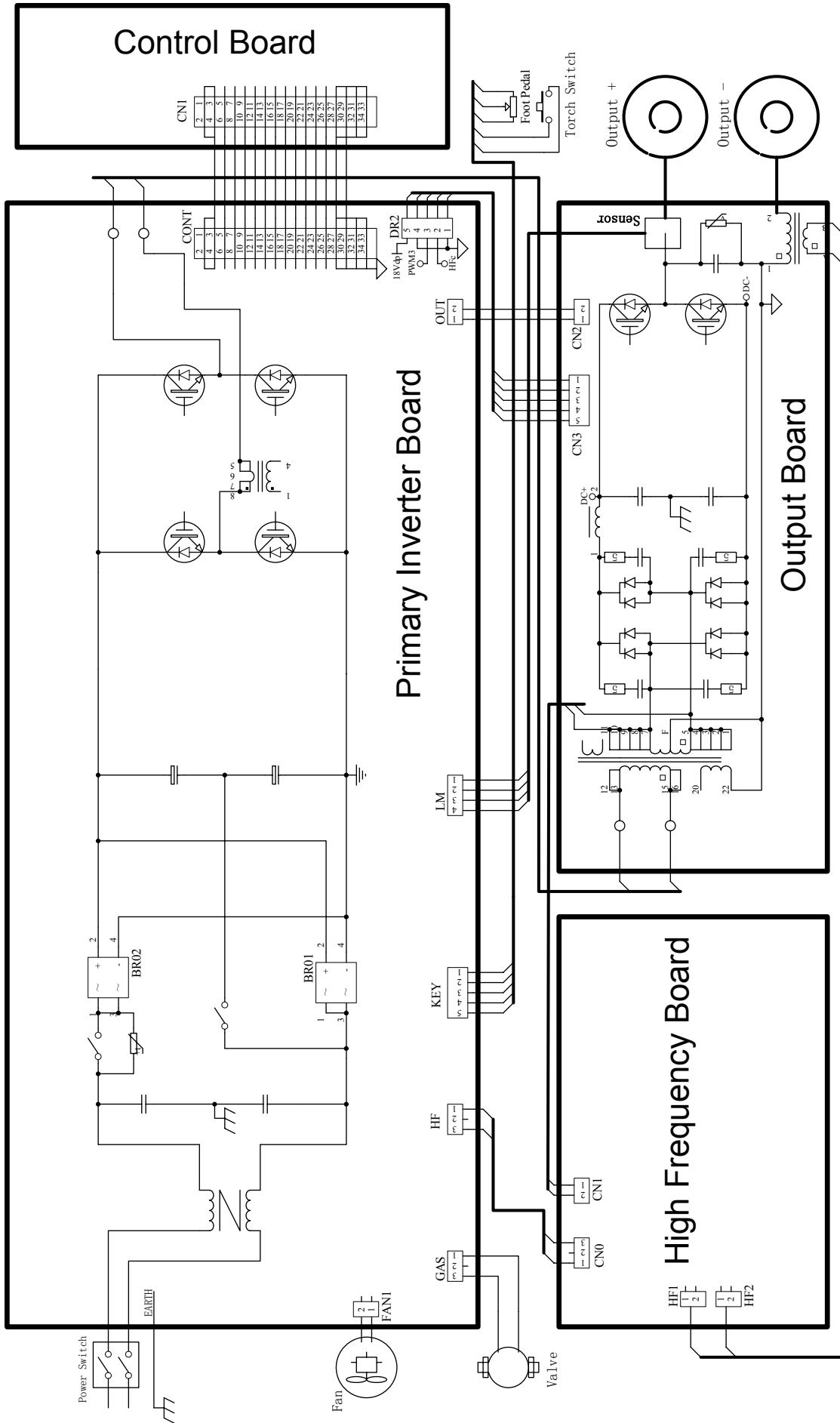

Limited One Year Warranty

Harbor Freight Tools Co. makes every effort to assure that its products meet high quality and durability standards, and warrants to the original purchaser that this product is free from defects in materials and workmanship for the period of one year from the date of purchase. This warranty does not apply to damage due directly or indirectly, to misuse, abuse, negligence or accidents, repairs or alterations outside our facilities, criminal activity, improper installation, normal wear and tear, or to lack of maintenance. We shall in no event be liable for death, injuries to persons or property, or for incidental, contingent, special or consequential damages arising from the use of our product. Some states do not allow the exclusion or limitation of incidental or consequential damages, so the above limitation of exclusion may not apply to you. THIS WARRANTY IS EXPRESSLY IN LIEU OF ALL OTHER WARRANTIES, EXPRESS OR IMPLIED, INCLUDING THE WARRANTIES OF MERCHANTABILITY AND FITNESS.

To take advantage of this warranty, the product or part must be returned to us with transportation charges prepaid. Proof of purchase date and an explanation of the complaint must accompany the merchandise. If our inspection verifies the defect, we will either repair or replace the product at our election or we may elect to refund the purchase price if we cannot readily and quickly provide you with a replacement. We will return repaired products at our expense, but if we determine there is no defect, or that the defect resulted from causes not within the scope of our warranty, then you must bear the cost of returning the product.

This warranty gives you specific legal rights and you may also have other rights which vary from state to state.

TITANIUMTM

26541 Agoura Road • Calabasas, CA 91302 • 1-888-866-5797