

2014 FOCUS ELECTRIC Owner's Manual



fordowner.com



ford.ca

2014 FOCUS ELECTRIC Owner's Manual



Table of Contents	1
<hr/>	
Introduction	7
Child Safety	15
Child seat positioning17
Booster seats19
Installing child seats22
Child safety locks30
Safety Belts	31
Fastening the safety belts33
Safety belt height adjustment36
Safety belt warning light and indicator chime37
Child restraint and safety belt maintenance40
Personal Safety System	41
Supplementary Restraints System	42
Driver and passenger airbags44
Knee airbag49
Side airbags50
Side curtain airbags51
Crash sensors and airbag indicator53
Airbag disposal54
Keys and Remote Control	55
General information on radio frequencies55
Remote control56
Replacing a lost key or remote control59
MyKey	60
Settings, MyKey60
Creating61
Clearing62
System status62
Remote start, MyKey63
Troubleshooting, MyKey65

Locks	67
Locking and unlocking67
Trunk release72
Security	73
SecuriLock® passive anti-theft system73
Steering Wheel	75
Adjusting the steering wheel75
Steering wheel controls76
Wipers and Washers	78
Windshield wipers78
Windshield washers79
Rear-window wiper and washer79
Lighting	81
Headlamps81
Autolamps82
Panel dimmer control83
Headlamp exit delay84
Daytime running lamps84
Front fog lamps84
Interior lamps85
Windows and Mirrors	89
Power windows89
Exterior mirrors91
Interior mirrors93
Sun visors94
Instrument Cluster	95
Gauges95
Warning lamps and indicators97
Audible warnings and indicators101

Table of Contents 3

Information Displays	102
Message center	102
Information messages	110
Climate Control	120
Rear window defroster	124
Seats	127
Sitting in the correct position	127
Head restraints	128
Manual seats	131
Power seats	133
Heated seats	134
Rear seats	135
Auxiliary Power Points	137
Storage Compartments	138
Overhead console	138
Starting and Stopping the Vehicle	139
Keyless starting	139
High Voltage Battery	142
High-voltage battery	142
Charging the high-voltage battery	142
High-voltage shut-off	148
Transmission	149
Automatic transmission	149
Hill start assist	152
Brakes	153
Brakes	153
Hints on driving with anti-lock brakes	154
Parking brake	155

Traction Control	156
Traction Control™	156
Stability Control	157
AdvanceTrac®	158
Parking Aids	159
Sensing system	159
Rear-view camera system	160
Cruise Control	166
Driving Aids	168
Steering	168
Load Carrying	170
Vehicle loading	170
Towing	177
Trailer towing	177
Wrecker towing	177
Recreational towing	178
Driving Hints	179
Floor mats	180
Roadside Emergencies	182
Getting roadside assistance	182
Hazard warning flashers	183
Jump starting	184
Guidance for electric and hybrid-electric vehicles	187
Customer Assistance	190
Reporting safety defects (U.S. only)	197
Reporting safety defects (Canada only)	197

Table of Contents

5

Fuses	198
Changing a fuse198
Fuse specification chart199
Maintenance	208
General information208
Motor/Electronics Coolant212
Battery216
Checking the wiper blades218
Adjusting the headlamps219
Removing a headlamp221
Changing a bulb222
Vehicle Care	227
Waxing229
Repairing minor paint damage229
Cleaning the windows and wiper blades230
Cleaning the interior231
Cleaning the instrument panel and instrument cluster lens231
Cleaning leather seats232
Cleaning the alloy wheels233
Wheels and Tires	236
Tire care236
Tire Pressure Monitoring System (TPMS)252
Temporary mobility kit256
Technical specifications264
Wheel lug nut torque264
Capacities and Specifications	265
Maintenance product specifications and capacities265
Part numbers267
Vehicle identification number267
Vehicle certification label268
Transmission code designation268

6 Table of Contents

Accessories	269
Accessories269
Ford Extended Service Plan	271
Audio System	274
AM/FM stereo with single CD276
MyFord Touch®	279
Infotainment display286
Voice recognition287
Listening to music291
Phone features312
Information Menu328
Settings341
Climate features352
Navigation system.355
Appendices	368
Scheduled Maintenance	387
Normal scheduled maintenance and log392
Index	397

The information contained in this publication was correct at the time of going to print. In the interest of continuous development, we reserve the right to change specifications, design or equipment at any time without notice or obligation. No part of this publication may be reproduced, transmitted, stored in a retrieval system or translated into any language in any form by any means without our written permission. Errors and omissions excepted.

© Ford Motor Company 2013

ABOUT THIS MANUAL

Thank you for choosing Ford. We recommend that you take some time to get to know your vehicle by reading this manual. The more that you know about it, the greater the safety and pleasure you will get from driving it.



WARNING: Always drive with due care and attention when using and operating the controls and features on your vehicle.

Note: This manual describes product features and options available throughout the range of available models, sometimes even before they are generally available. It may describe options not fitted to your vehicle.

Note: Some of the illustrations in this manual may be used for different models, so may appear different to you on your vehicle. However, the essential information in the illustrations is always correct.

Note: Always use and operate your vehicle in line with all applicable laws and regulations.

Note: Pass on this manual when selling your vehicle. It is an integral part of the vehicle.

This manual may qualify the location of a component as left-hand side or right-hand side. The side is determined when facing forward in the seat.

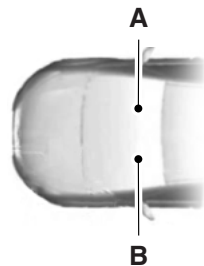

A. Right-hand side

B. Left-hand side

Protecting the Environment





















You must play your part in protecting the environment. Correct vehicle usage and the authorized disposal of waste, cleaning and lubrication materials are significant steps toward this aim.

SYMBOL GLOSSARY

 **WARNING:** You risk death or serious injury to yourself and others if you do not follow the instruction highlighted by the warning symbol.

These are some of the symbols you may see on your vehicle.

Symbol	Description	Symbol	Description	Symbol	Description
	Safety alert		See Owner's Manual		Anti-lock braking system
	Avoid smoking, flames, or sparks		Battery		Battery acid
	Brake fluid – non petroleum base		Brake system		Cabin air filter
	Check fuel cap		Child Safety Door Lock and Unlock		Child seat lower anchor
	Child seat tether anchor		Cruise control		Do not open when hot
	Engine air filter		Engine coolant		Engine coolant temperature
	Engine oil		Explosive gas		Fan warning
	Fasten safety belt		Front airbag		Front fog lamps

Symbol	Description	Symbol	Description	Symbol	Description
	Fuel pump reset		Fuse compartment		Hazard warning flasher
	Heated rear window		Interior luggage compartment release		Jack
	Lighting control		Low tire pressure warning		Maintain correct fluid level
	Panic alarm		Parking aid system		Parking brake system
	Power steering fluid		Power windows front and rear		Power window lockout
	Service engine soon		Side airbag		Stability control
	Windshield defrost and demist		Windshield washer and wiper		

DATA RECORDING

Service Data Recording

Service data recorders in your vehicle are capable of collecting and storing diagnostic information about your vehicle. This potentially includes information about the performance or status of various systems and modules in the vehicle, such as engine, throttle, steering or brake systems. In order to properly diagnose and service your vehicle, Ford Motor Company, Ford of Canada, and service and repair facilities may access or share among them vehicle diagnostic information received through a direct connection to your vehicle when diagnosing or servicing your vehicle. Additionally, when your vehicle is in for service or repair,

Ford Motor Company, Ford of Canada, and service and repair facilities may access or share among them data for vehicle improvement purposes. For U.S. only (if equipped), if you choose to use the SYNC® Vehicle Health Report, you consent that certain diagnostic information may also be accessed electronically by Ford Motor Company and Ford authorized service facilities, and that the diagnostic information may be used for any purpose. See the *SYNC®* chapter for more information.

Event Data Recording

This vehicle is equipped with an event data recorder (EDR). The main purpose of an EDR is to record, in certain crash or near crash-like situations, such as an airbag deployment or hitting a road obstacle; this data will assist in understanding how a vehicle's systems performed. The EDR is designed to record data related to vehicle dynamics and safety systems for a short period of time, typically 30 seconds or less. The EDR in this vehicle is designed to record such data as:

- **How various systems in your vehicle were operating;**
- **Whether or not the driver and passenger safety belts were buckled/fastened;**
- **How far (if at all) the driver was depressing the accelerator and/or the brake pedal;**
- **How fast the vehicle was travelling;**
- **Where the driver was positioning the steering wheel.**

This data can help provide a better understanding of the circumstances in which crashes and injuries occur.

Note: EDR data is recorded by your vehicle only if a non-trivial crash situation occurs; no data is recorded by the EDR under normal driving conditions and no personal data or information (e.g., name, gender, age, and crash location) is recorded (see limitations regarding 911 Assist and Traffic, Directions and Information privacy below). However, parties, such as law enforcement, could combine the EDR data with the type of personally identifying data routinely acquired during a crash investigation.

To read data recorded by an EDR, special equipment is required, and access to the vehicle or the EDR is needed. In addition to the vehicle manufacturer, other parties, such as law enforcement, that have such special equipment, can read the information if they have access to the vehicle or the EDR. Ford Motor Company and Ford of Canada do not access event data recorder information without obtaining consent, unless pursuant to court order or where required by law enforcement, other government authorities or other third parties acting with lawful authority. Other parties may seek to access the information independently of Ford Motor Company and Ford of Canada.

Note: Including to the extent that any law pertaining to Event Data Recorders applies to SYNC® or its features, please note the following: Once 911 Assist (if equipped) is enabled (set ON), 911 Assist may, through any paired and connected cell phone, disclose to emergency services that the vehicle has been in a crash involving the deployment of an airbag or, in certain vehicles, the activation of the fuel pump shut-off. Certain versions or updates to 911 Assist may also be capable of being used to electronically or verbally provide to 911 operators the vehicle location (such as latitude and longitude), and/or other details about the vehicle or crash or personal information about the occupants to assist 911 operators to provide the most appropriate emergency services. If you do not want to disclose this information, do not activate the 911 Assist feature. See your SYNC® chapter for more information.

Additionally, when you connect to Traffic, Directions and Information (if equipped, U.S. only), the service uses GPS technology and advanced vehicle sensors to collect the vehicle's current location, travel direction, and speed ("vehicle travel information"), only to help provide you with the directions, traffic reports, or business searches that you request. If you do not want Ford or its vendors to receive this information, do not activate the service. Ford Motor Company and the vendors it uses to provide you with this information do not store your vehicle travel information. For more information, see Traffic, Directions and Information, Terms and Conditions. See your SYNC® chapter for more information.

CALIFORNIA PROPOSITION 65

WARNING: Some constituents of engine exhaust, certain vehicle components, certain fluids contained in vehicles and certain products of component wear contain or emit chemicals known to the State of California to cause cancer and birth defects or other reproductive harm.

PERCHLORATE MATERIAL

Note: Certain components in your vehicle, such as airbag modules, safety belt pretensioners, and remote control batteries, may contain perchlorate material. Special handling may apply for service or vehicle end of life disposal. See www.dtsc.ca.gov/hazardouswaste/perchlorate for more information.

FORD CREDIT (U.S. ONLY)

Ford Credit offers a full range of financing and lease plans to help you acquire your vehicle. If you have financed or leased your vehicle through Ford Credit, thank you for your business.

For your convenience, we offer a number of ways to contact us, as well as help manage your account.

Phone: 1-800-727-7000

For more information regarding Ford Credit, as well as access to Account Manager, please go to www.fordcredit.com.

REPLACEMENT PARTS RECOMMENDATION

Your vehicle has been built to the highest standards using quality parts. We recommend that you demand the use of genuine Ford and Motorcraft parts whenever your vehicle requires scheduled maintenance or repair. You can clearly identify genuine Ford and Motorcraft parts by looking for the Ford, FoMoCo or Motorcraft branding on the parts or their packaging.

Scheduled Maintenance and Mechanical Repairs

One of the best ways for you to make sure that your vehicle provides years of service is to have it maintained in line with our recommendations using parts that conform to the specifications detailed in this owner's manual. Genuine Ford and Motorcraft parts meet or exceed these specifications.

Collision Repairs

We hope that you never experience a collision, but accidents do happen. Genuine Ford replacement collision parts meet our stringent requirements for fit, finish, structural integrity, corrosion protection and dent resistance. During vehicle development, we validate that these parts deliver the intended level of protection as a whole system. A great way to know for sure you are getting this level of protection is to use genuine Ford replacement collision parts.

Warranty on Replacement Parts

Genuine Ford and Motorcraft replacement parts are the only replacement parts that benefit from a Ford Warranty. Damage caused to your vehicle as a result of the failure of non-Ford parts may not be covered by the Ford Warranty. For additional information, see the terms and conditions of the Ford Warranty.

SPECIAL NOTICES**New Vehicle Limited Warranty**

For a detailed description of what is covered and what is not covered by your vehicle's New Vehicle Limited Warranty, see the warranty information that is provided to you along with your owner's manual.

Special Instructions

For your added safety, your vehicle is fitted with sophisticated electronic controls.



WARNING: Please read the *Supplementary Restraints System* chapter. Failure to follow the specific warnings and instructions could result in personal injury.



WARNING: Front seat mounted rear-facing child or infant seats should **NEVER** be placed in front of an active passenger airbag.

Using your vehicle with a snowplow**Do not use this vehicle for snowplowing.**

Your vehicle is not equipped with a snowplowing package.

Using your vehicle as an ambulance**Do not use this vehicle as an ambulance.**

Your vehicle is not equipped with the Ford Ambulance Preparation Package.

MOBILE COMMUNICATIONS EQUIPMENT

Using mobile communications equipment is becoming increasingly important in the conduct of business and personal affairs. However, you must not compromise your own or others' safety when using such equipment. Mobile communications can enhance personal safety and security when appropriately used, particularly in emergency situations. Safety must be paramount when using mobile communications equipment to avoid negating these benefits.

Mobile communication equipment includes, but is not limited to, cellular phones, pagers, portable email devices, text messaging devices and portable two-way radios.



WARNING: Driving while distracted can result in loss of vehicle control, crash and injury. We strongly recommend that you use extreme caution when using any device that may take your focus off the road. Your primary responsibility is the safe operation of your vehicle. We recommend against the use of any handheld device while driving and encourage the use of voice-operated systems when possible. Make sure you are aware of all applicable local laws that may affect the use of electronic devices while driving.

EXPORT UNIQUE (NON-UNITED STATES/CANADA) VEHICLE SPECIFIC INFORMATION

For your particular global region, your vehicle may be equipped with features and options that are different from the features and options that are described in this owner's manual. A market unique supplement may be supplied that complements this book. By referring to the market unique supplement, if provided, you can properly identify those features, recommendations and specifications that are unique to your vehicle. This owner's manual is written primarily for the U.S. and Canadian Markets. Features or equipment listed as standard may be different on units built for Export. **See this owner's manual for all other required information and warnings.**

GENERAL INFORMATION

See the following sections for directions on how to properly use safety restraints for children.

 **WARNING:** Always make sure your child is secured properly in a device that is appropriate for their height, age and weight. Child safety restraints must be bought separately from your vehicle. Failure to follow these instructions and guidelines may result in an increased risk of serious injury or death to your child.

 **WARNING:** All children are shaped differently. The recommendations for safety restraints are based on probable child height, age and weight thresholds from NHTSA and other safety organizations, or are the minimum requirements of law. Ford recommends checking with a NHTSA Certified Child Passenger Safety Technician (CPST) and consulting your pediatrician to make sure your child seat is appropriate for your child, and is compatible with and properly installed in your vehicle. To locate a child seat fitting station and CPST, contact the NHTSA toll free at 1-888-327-4236 or on the internet at <http://www.nhtsa.dot.gov>. In Canada, check with your local St. John Ambulance office for referral to a CPST or for further information, contact your provincial ministry of transportation, or locate your local St. John Ambulance office by searching for St. John Ambulance on the internet, or Transport Canada at 1-800-333-0371 (<http://www.tc.gc.ca>). Failure to properly restrain children in safety seats made especially for their height, age, and weight may result in an increased risk of serious injury or death to your child.

Recommendations for Safety Restraints for Children		
	Child size, height, weight, or age	Recommended restraint type
Infants or toddlers	Children weighing 40 lb (18 kg) or less (generally age four or younger).	Use a child safety seat (sometimes called an infant carrier, convertible seat, or toddler seat).

Recommendations for Safety Restraints for Children		
	Child size, height, weight, or age	Recommended restraint type
Small children	Children who have outgrown or no longer properly fit in a child safety seat (generally children who are less than 4 ft. 9 in. (1.45 m) tall, are greater than age four (4) and less than age twelve (12), and between 40 lb (18 kg) and 80 lb (36 kg) and upward to 100 lb (45 kg) if recommended by your child restraint manufacturer).	Use a belt-positioning booster seat.
Larger children	Children who have outgrown or no longer properly fit in a belt-positioning booster seat (generally children who are at least 4 ft. 9 in. (1.45 m) tall or greater than 80 lb (36 kg) or 100 lb (45 kg) if recommended by child restraint manufacturer).	Use a vehicle safety belt having the lap belt snug and low across the hips, shoulder belt centered across the shoulder and chest, and seat back upright.

- You are required by law to properly use safety seats for infants and toddlers in the United States and Canada.
- Many states and provinces require that small children use approved booster seats until they reach age eight, a height of 4 feet 9 inches (1.45 meters) tall, or 80 pounds (36 kilograms). Check your local and state or provincial laws for specific requirements about the safety of children in your vehicle.
- When possible, always properly restrain children twelve (12) years of age and under in a rear seating position of your vehicle. Accident statistics suggest that children are safer when properly restrained in the rear seating positions than in a front seating position. See *Front Passenger Sensing System* in the *Supplementary Restraints System* chapter for more information.

CHILD SEAT POSITIONING

WARNING: Airbags can kill or injure a child in a child seat.

Never place a rear-facing child seat in front of an active airbag. If you must use a forward-facing child seat in the front seat, move the vehicle seat upon which the child seat is installed all the way back. When possible, all children age 12 and under should be properly restrained in a rear seating position. If all children cannot be seated and restrained properly in a rear seating position, properly restrain the largest child in the front seat.



WARNING: Always carefully follow the instructions and warnings provided by the manufacturer of any child restraint to determine if the restraint device is appropriate for your child's size, height, weight, or age. Follow the child restraint manufacturer's instructions and warnings provided for installation and use in conjunction with the instructions and warnings provided by your vehicle manufacturer. A safety seat that is improperly installed or utilized, is inappropriate for your child's height, age or weight, or does not properly fit the child, may increase the risk of serious injury or death.



WARNING: Never let a passenger hold a child on his or her lap while your vehicle is moving. The passenger cannot protect the child from injury in a crash, which may result in serious injury or death.



WARNING: Never use pillows, books, or towels to boost a child. They can slide around and increase the likelihood of injury or death in a crash.



WARNING: Always restrain an unoccupied child seat or booster seat. These objects may become projectiles in a crash or sudden stop, which may increase the risk of serious injury.



WARNING: Never place, or allow a child to place, the shoulder belt under a child's arm or behind the back because it reduces the protection for the upper part of the body and may increase the risk of injury or death in a crash.



WARNING: To avoid risk of injury, do not leave children or pets unattended in your vehicle.

Restraint Type	Combined weight of child and child restraint seat	Use any attachment method as indicated below by X.				
		LATCH (lower anchors and top tether anchor)	LATCH (lower anchors only)	Safety belt and top tether anchor	Safety belt and LATCH (lower anchors and top tether anchor)	Safety belt only
Rear-facing child seat	Up to 65 lb (29.5 kg)		X			X
Rear-facing child seat	Over 65 lb (29.5 kg)					X
Forward-facing child seat	Up to 65 lb (29.5 kg)	X		X	X	
Forward-facing child seat	Over 65 lb (29.5 kg)			X	X	

Note: The child seat must rest tightly against the vehicle seat upon which it is installed. It may be necessary to lift or remove the head restraint. See the *Seats* chapter for information on head restraints.

BOOSTER SEATS

 **WARNING:** Never place, or allow a child to place, the shoulder belt under a child's arm or behind the back because it reduces the protection for the upper part of the body and may increase the risk of injury or death in a crash.

Use a belt-positioning booster seat for children who have outgrown or no longer properly fit in a child safety seat (generally children who are less than 4 feet 9 inches (1.45 meters) tall, are greater than age four (4) and less than age twelve (12), and between 40 pounds (18 kilograms) and 80 pounds (36 kilograms) and upward to 100 pounds (45 kilograms) if recommended by your child restraint manufacturer). Many state and provincial laws require that children use approved booster seats until they reach age eight (8), a height of 4 feet 9 inches (1.45 meters) tall, or 80 pounds (36 kilograms).

Booster seats should be used until you can answer YES to ALL of these questions when the child is seated without a booster seat.

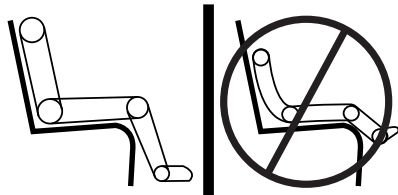

- Can the child sit all the way back against their vehicle seat with knees bent comfortably at the edge of the seat cushion?
- Can the child sit without slouching?

- Does the lap belt rest low across the hips?
- Is the shoulder belt centered on the shoulder and chest?
- Can the child stay seated like this for the whole trip?

Always use booster seats in conjunction with your vehicle lap and shoulder belt.

Types of Booster Seats

- Backless booster seats

If your backless booster seat has a removable shield, remove the shield. If a vehicle seating position has a low seat back or no head restraint, a backless booster seat may place your child's head (as measured at the tops of the ears) above the top of the seat. In this case, move the backless booster to another seating position with a higher seat back or head restraint and lap and shoulder belts, or consider using a high back booster seat.



- High back booster seats

If, with a backless booster seat, you cannot find a seating position that adequately supports your child's head, a high back booster seat would be a better choice.

Children and booster seats vary in size and shape. Choose a booster that keeps the lap belt low and snug across the hips, never up across the stomach, and lets you adjust the shoulder belt to cross the chest and rest snugly near the center of the shoulder. The following drawings compare the ideal fit (center) to a shoulder belt uncomfortably close to the neck and a shoulder belt that could slip off the shoulder. The drawings also show how the lap belt should be low and snug across the child's hips.

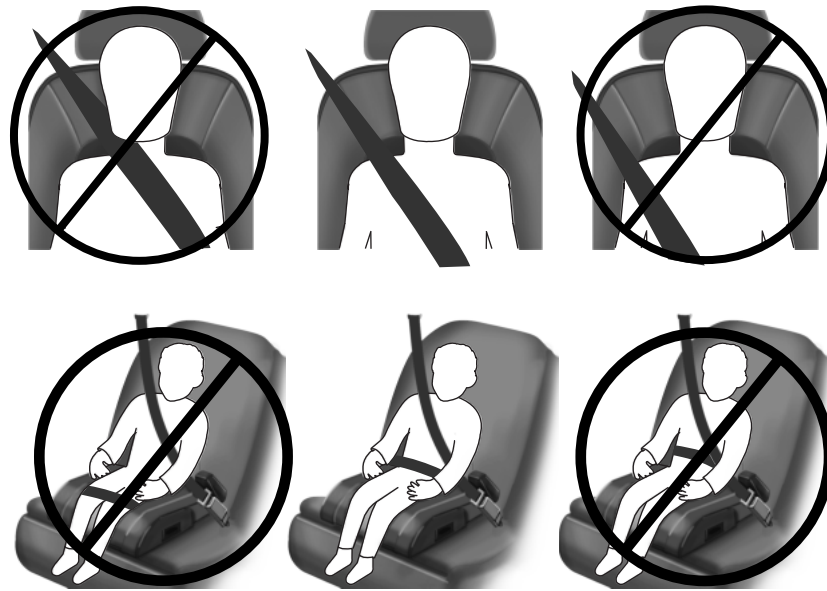

If the booster seat slides on the vehicle seat upon which it is being used, placing a rubberized mesh sold as shelf or carpet liner under the booster seat may improve this condition. Do not introduce any item thicker than this under the booster seat. Check with the booster seat manufacturer's instructions.

INSTALLING CHILD SEATS**Child Seats**

Use a child safety seat (sometimes called an infant carrier, convertible seat, or toddler seat) for infants, toddlers or children weighing 40 pounds (18 kilograms) or less (generally age four or younger).

Using Lap and Shoulder Belts

WARNING: Airbags can kill or injure a child in a child seat.

Never place a rear-facing child seat in front of an active airbag.

If you must use a forward-facing child seat in the front seat, move the seat all the way back.



WARNING: Airbags can kill or injure a child in a child seat.

Children 12 and under should be properly restrained in the rear seat whenever possible.



WARNING: Depending on where you secure a child restraint,

and depending on the child restraint design, you may block access to certain safety belt buckle assemblies or LATCH lower anchors, rendering those features potentially unusable. To avoid risk of injury, occupants should only use seating positions where they are able to be properly restrained.

When installing a child safety seat with combination lap and shoulder belts:

- Use the correct safety belt buckle for that seating position.
- Insert the belt tongue into the proper buckle until you hear a snap and feel it latch. Make sure the tongue is securely fastened in the buckle.
- Keep the buckle release button pointing up and away from the safety seat, with the tongue between the child seat and the release button, to prevent accidental unbuckling.
- Place the vehicle seat upon which the child seat will be installed in the upright position.
- Put the safety belt in the automatic locking mode. See Step 5. This vehicle does not require the use of a locking clip.

Perform the following steps when installing the child seat with combination lap and shoulder belts:

Note: Although the child seat illustrated is a forward-facing child seat, the steps are the same for installing a rear-facing child seat.



1. Position the child safety seat in a seat with a combination lap and shoulder belt.

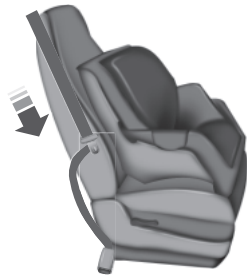

2. Pull down on the shoulder belt and then grasp the shoulder belt and lap belt together.

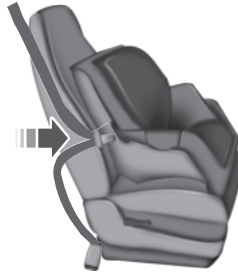

3. While holding the shoulder and lap belt portions together, route the tongue through the child seat according to the child seat manufacturer's instructions. Be sure the belt webbing is not twisted.

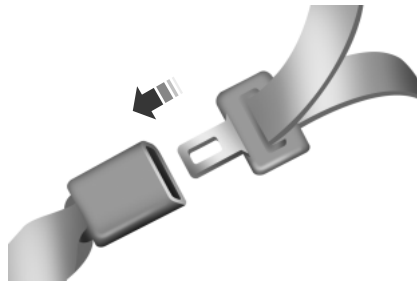

4. Insert the belt tongue into the proper buckle (the buckle closest to the direction the tongue is coming from) for that seating position until you hear a snap and feel the latch engage. Make sure the tongue is latched securely by pulling on it.



5. To put the retractor in the automatic locking mode, grasp the shoulder portion of the belt and pull downward until all of the belt is pulled out.

Note: The automatic locking mode is available on the front passenger and rear seats. This vehicle does not require the use of a locking clip.

6. Allow the belt to retract to remove slack. The belt will click as it retracts to indicate it is in the automatic locking mode.

7. Try to pull the belt out of the retractor to make sure the retractor is in the automatic locking mode. You should not be able to pull more belt out. If the retractor is not locked, unbuckle the belt and repeat Steps 5 and 6.

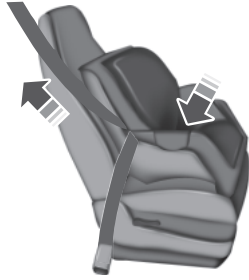

8. Remove remaining slack from the belt. Force the seat down with extra weight, for example, by pressing down or kneeling on the child restraint while pulling up on the shoulder belt in order to force slack from the belt.

This is necessary to remove the remaining slack that will exist once the extra weight of the child is added to the child restraint. It also helps to achieve the proper snugness of the child seat to your vehicle. Sometimes, a slight lean toward the buckle will provide extra help to remove remaining slack from the belt.

9. Attach the tether strap (if the child seat is equipped). See *Using Tether Straps* later in this chapter.

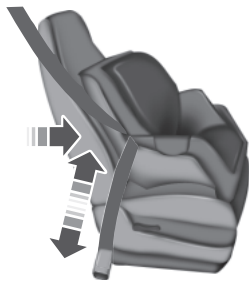



10. Before placing the child in the seat, forcibly move the seat forward and back to make sure the seat is securely held in place.

To check this, grab the seat at the belt path and attempt to move it side to side and forward and back. There should be no more than 1 inch (2.5 centimeters) of movement for proper installation.

Ford recommends checking with a NHTSA Certified Child Passenger Safety Technician to make certain the child restraint is properly installed. In Canada, check with your local St. John Ambulance office for referral to a Child Passenger Safety Technician.

Using Lower Anchors and Tethers for Children (LATCH)

 **WARNING:** Never attach two child safety seats to the same anchor. In a crash, one anchor may not be strong enough to hold two child safety seat attachments and may break, causing serious injury or death.

 **WARNING:** Depending on where you secure a child restraint, and depending on the child restraint design, you may block access to certain safety belt buckle assemblies or LATCH lower anchors, rendering those features potentially unusable. To avoid risk of injury, occupants should only use seating positions where they are able to be properly restrained.

The LATCH system is composed of three vehicle anchor points: two lower anchors located where your vehicle seat back and seat cushion meet (called the seat bight) and one top tether anchor located behind that seating position.

LATCH compatible child safety seats have two rigid or webbing mounted attachments that connect to the two lower anchors at the LATCH equipped seating positions in your vehicle. This type of attachment method eliminates the need to use safety belts to attach the child seat, however the safety belt can still be used to attach the child seat. For forward-facing child seats, the top tether strap must also be attached to the proper top tether anchor, if a top tether strap has been provided with your child seat.

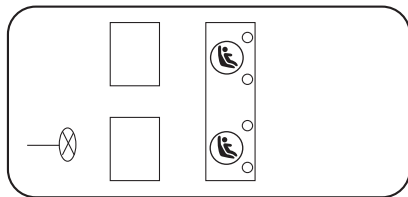

Your vehicle has LATCH lower anchors for child seat installation at the seating positions marked with the child seat symbol.



The LATCH anchors are located at the rear section of the rear seat between the cushion and seat back below the symbols as shown. Follow the child seat manufacturer's instructions to properly install a child seat with LATCH attachments.

Follow the instructions on attaching child safety seats with tether straps. See *Using Tether Straps* in this chapter.

Attach LATCH lower attachments of the child seat only to the anchors shown.

Use of Inboard Lower Anchors from the Outboard Seating Positions (Center Seating Use)



WARNING: The standardized spacing for LATCH lower anchors is 11 inches (28 centimeters) center to center. Do not use LATCH lower anchors for the center seating position unless the child seat manufacturer's instructions permit and specify using anchors spaced at least as far apart as those in this vehicle.

The lower anchors at the center of the second row rear seat are spaced 18 inches (46 centimeters) apart. A child seat with rigid LATCH attachments cannot be installed at the center seating position. LATCH compatible child seats (with attachments on belt webbing) can only be used at this seating position provided that the child seat manufacturer's instructions permit use with the anchor spacing stated. Do not attach a child seat to any lower anchor if an adjacent child seat is attached to that anchor.

Each time you use the safety seat, check that the seat is properly attached to the lower anchors and tether anchor, if applicable. Tug the child seat from side to side and forward and back where it is secured to your vehicle. The seat should move less than one inch when you do this for a proper installation.

If the safety seat is not anchored properly, the risk of a child being injured in a crash greatly increases.

Combining Safety Belt and LATCH Lower Anchors for Attaching Child Safety Seats

When used in combination, either the safety belt or the LATCH lower anchors may be attached first, provided a proper installation is achieved. Attach the tether strap afterward, if included with the child seat.

Using Tether Straps



Many forward-facing child safety seats include a tether strap which extends from the back of the child safety seat and hooks to an anchoring point called the top tether anchor.

Tether straps are available as an accessory for many older safety seats. Contact the manufacturer of your child seat for information about ordering a tether strap, or to obtain a longer tether strap if the tether strap on your safety seat does not reach the appropriate top tether anchor in the vehicle.

The rear seats of your vehicle are equipped with built-in tether strap anchors located on the back panel of the rear seat.

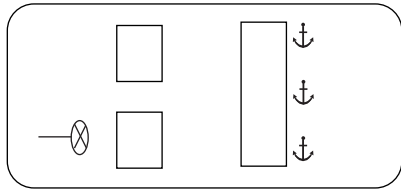

The tether strap anchors in your vehicle are in the following positions (shown from top view):

Attach the tether strap only to the appropriate tether anchor as shown. The tether strap may not work properly if attached somewhere other than the correct tether anchor.

Once the child safety seat has been installed using either the safety belt, the lower anchors of the LATCH system, or both, you can attach the top tether strap.

If you install a child seat with rigid LATCH attachments, do not tighten the tether strap enough to lift the child seat off the vehicle seat cushion when the child is seated in it. Keep the tether strap just snug without lifting the front of the child seat. Keeping the child seat just touching the vehicle seat gives the best protection in a severe crash.

Perform the following steps to install a child safety seat with tether anchors:

1. Route the child safety seat tether strap over the back of the seat.

For outboard seating positions, route the tether strap under the head restraint and between the head restraint posts. For the center seating positions, route the tether strap over the top of the head restraint. If needed, the head restraints can also be removed. See the *Seats* chapter.

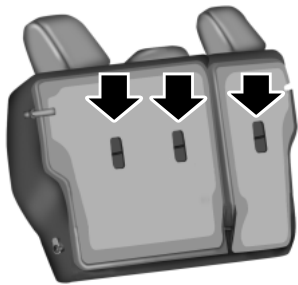

2. Locate the correct anchor for the selected seating position.

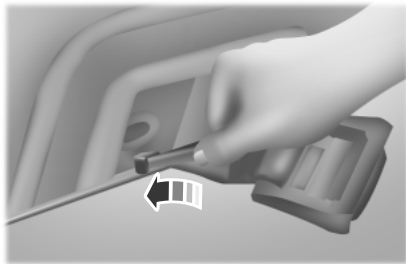

3. Rotate the tether hook, then move the hook under the anchor.

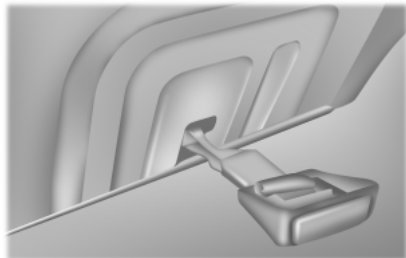

4. Clip the tether strap to the anchor as shown.

If the tether strap is clipped incorrectly, the child safety seat may not be retained properly in the event of a collision.

5. Tighten the child safety seat tether strap according to the manufacturer's instructions.

If the safety seat is not anchored properly, the risk of a child being injured in a crash greatly increases.

If your child restraint system is equipped with a tether strap, and the child restraint manufacturer recommends its use, Ford also recommends its use.

CHILD SAFETY LOCKS

When these locks are set, the rear doors cannot be opened from the inside.



The childproof locks are located on the rear edge of each rear door and must be set separately for each door.

- Driver side: turn counterclockwise to lock and clockwise to unlock.
- Passenger side: turn clockwise to lock and counterclockwise to unlock.

PRINCIPLES OF OPERATION



WARNING: Always drive and ride with your seatback upright and the lap belt snug and low across the hips.



WARNING: To reduce the risk of injury, make sure children sit where they can be properly restrained.



WARNING: Never let a passenger hold a child on his or her lap while the vehicle is moving. The passenger cannot protect the child from injury in a collision.



WARNING: All occupants of the vehicle, including the driver, should always properly wear their safety belts, even when an airbag supplemental restraint system is provided. Failure to properly wear your safety belt could seriously increase the risk of injury or death.



WARNING: It is extremely dangerous to ride in a cargo area, inside or outside of a vehicle. In a crash, people riding in these areas are more likely to be seriously injured or killed. Do not allow people to ride in any area of your vehicle that is not equipped with seats and safety belts. Be sure everyone in your vehicle is in a seat and using a safety belt properly.



WARNING: In a rollover crash, an unbelted person is significantly more likely to die than a person wearing a safety belt.



WARNING: Each seating position in your vehicle has a specific safety belt assembly which is made up of one buckle and one tongue that are designed to be used as a pair. 1) Use the shoulder belt on the outside shoulder only. Never wear the shoulder belt under the arm. 2) Never swing the safety belt around your neck over the inside shoulder. 3) Never use a single belt for more than one person.



WARNING: When possible, all children 12 years old and under should be properly restrained in a rear seating position. Failure to follow this could seriously increase the risk of injury or death.





WARNING: Safety belts and seats can become hot in a vehicle that has been closed up in sunny weather; they could burn a small child. Check seat covers and buckles before you place a child anywhere near them.



WARNING: Front and rear seat occupants, including pregnant women, should wear safety belts for optimum protection in an accident.

All seating positions in this vehicle have lap and shoulder safety belts. All occupants of the vehicle should always properly wear their safety belts, even when an airbag supplemental restraint system is provided.

The safety belt system consists of:

- lap and shoulder safety belts.
- shoulder safety belt with automatic locking mode, (except driver safety belt).
- height adjuster at the front outboard seating positions.
- safety belt pretensioner at the front outboard seating positions.
- belt tension sensor at the front outboard passenger seating position.
-  • safety belt warning light and chime. See *Safety belt warning light and indicator chime* later in this chapter.
-  • crash sensors and monitoring system with readiness indicator. See *Crash sensors and airbag indicator* in the *Supplemental Restraints System* chapter.

The safety belt pretensioners at the front seating positions are designed to tighten the safety belts when activated. In frontal and near-frontal crashes, the safety belt pretensioners may be activated alone or, if the crash is of sufficient severity, together with the front airbags. The pretensioners may also activate when a side curtain airbag is deployed.

FASTENING THE SAFETY BELTS

The front outboard and rear safety restraints in your vehicle are combination lap and shoulder belts.

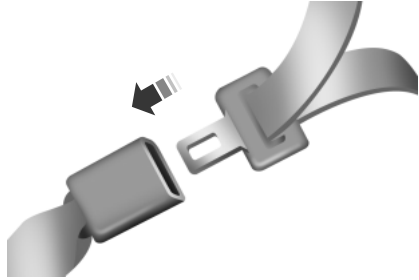

1. Insert the belt tongue into the proper buckle (the buckle closest to the direction the tongue is coming from) until you hear a snap and feel it latch. Make sure the tongue is securely fastened in the buckle.

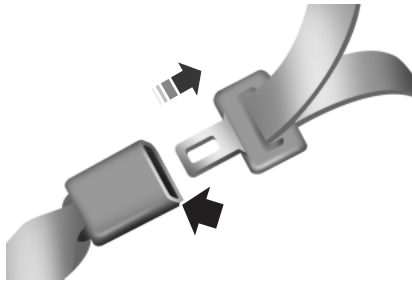

2. To unfasten, press the release button and remove the tongue from the buckle.

Restraint of Pregnant Women

 **WARNING:** Always ride and drive with your seat back upright and the safety belt properly fastened. The lap portion of the safety belt should fit snug and be positioned low across the hips. The shoulder portion of the safety belt should be positioned across the chest. Pregnant women should also follow this practice. See the following figure.

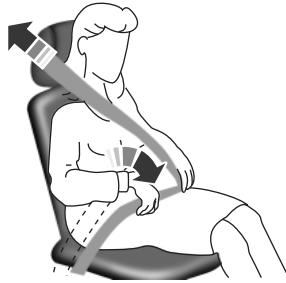

Pregnant women should always wear their safety belts. The lap belt portion of a combination lap and shoulder belt should be positioned low across the hips below the belly and worn as tight as comfort will allow. The shoulder belt should be positioned to cross the middle of the shoulder and the center of the chest.

Safety Belt Locking Modes

 **WARNING:** After any vehicle crash, the safety belt system at all passenger seating positions must be checked by an authorized dealer to verify that the automatic locking retractor feature for child seats is still functioning properly. In addition, all safety belts should be checked for proper function.

 **WARNING:** The belt and retractor assembly must be replaced if the safety belt assembly automatic locking retractor feature or any other safety belt function is not operating properly when checked by an authorized dealer. Failure to replace the belt and retractor assembly could increase the risk of injury in crashes.

All safety restraints in the vehicle are combination lap and shoulder belts. The driver safety belt has the first type of locking mode, and the front outboard passenger and rear seat safety belts have both types of locking modes described as follows:

Vehicle Sensitive Mode

This is the normal retractor mode, which allows free shoulder belt length adjustment to your movements and locking in response to vehicle movement. For example, if the driver brakes suddenly or turns a corner sharply, or the vehicle receives an impact of about 5 mph (8 km/h) or more, the combination safety belts will lock to help reduce forward movement of the driver and passengers.

In addition, the retractor is designed to lock if the webbing is pulled out too quickly. If this occurs, let the belt retract slightly and pull webbing out again in a slow and controlled manner.

Automatic Locking Mode

In this mode, the shoulder belt is automatically pre-locked. The belt will still retract to remove any slack in the shoulder belt. The automatic locking mode is not available on the driver safety belt.

When to Use the Automatic Locking Mode

This mode should be used any time a child safety seat, except a booster, is installed in passenger front or rear seating positions. Children 12 years old and under should be properly restrained in a rear seating position whenever possible. See the *Child Safety* chapter.

How to Use the Automatic Locking Mode

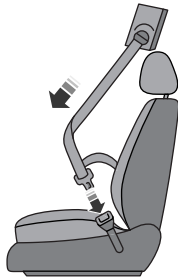

1. Buckle the combination lap and shoulder belt.
2. Grasp the shoulder portion and pull downward until the entire belt is pulled out.
3. Allow the belt to retract. As the belt retracts, you will hear a clicking sound. This indicates the safety belt is now in the automatic locking mode.

How to Disengage the Automatic Locking Mode

Unbuckle the combination lap and shoulder belt and allow it to retract completely to disengage the automatic locking mode and activate the vehicle sensitive (emergency) locking mode.

Safety Belt Extension Assembly

WARNING: Do not use extensions to change the fit of the shoulder belt across the torso.

If the safety belt is too short when fully extended, you can obtain a safety belt extension assembly from an authorized dealer.

Use only extensions manufactured by the same supplier as the safety belt. Manufacturer identification is located at the end of the webbing on the label. Also, use the safety belt extension only if the safety belt is too short for you when fully extended.

SAFETY BELT HEIGHT ADJUSTMENT

WARNING: Position the safety belt height adjusters so that the belt rests across the middle of your shoulder. Failure to adjust the safety belt properly could reduce the effectiveness of the safety belt and increase the risk of injury in a crash.

Adjust the height of the shoulder belt so the belt rests across the middle of your shoulder.



To adjust the shoulder belt height:

1. Squeeze the button and slide the height adjuster up or down.
2. Release the button and pull down on the height adjuster to make sure it is locked in place.

SAFETY BELT WARNING LIGHT AND INDICATOR CHIME



This lamp illuminates and an audible warning will sound if the driver's safety belt has not been fastened when the vehicle's ignition is turned on.

Conditions of Operation

If...	Then...
The driver's safety belt is not buckled before the ignition switch is turned to the on position...	The safety belt warning light illuminates 1-2 minutes and the warning chime sounds 4-8 seconds.
The driver's safety belt is buckled while the indicator light is illuminated and the warning chime is sounding...	The safety belt warning light and warning chime turn off.
The driver's safety belt is buckled before the ignition switch is turned to the on position...	The safety belt warning light and indicator chime remain off.

Safety Belt-Minder®

The Belt-Minder feature is a supplemental warning to the safety belt warning function. This feature provides additional reminders by intermittently sounding a chime and illuminating the safety belt warning light in the instrument cluster when the driver's or front passenger's seat is occupied and the safety belt is unbuckled.

The Belt-Minder feature uses information from the front passenger sensing system to determine if a front seat passenger is present and therefore potentially in need of a warning. To avoid activating the Belt-Minder feature for objects placed in the front passenger seat, warnings will only be given to large front seat occupants as determined by the front passenger sensing system.

Both the driver's and passenger's safety belt usages are monitored and either may activate the Belt-Minder feature. The warnings are the same for the driver and the front passenger. If the Belt-Minder warnings have expired (warnings for about five minutes) for one occupant (driver or front passenger), the other occupant can still activate the Belt-Minder feature.

If...	Then...
The driver's and front passenger's safety belts are buckled before the ignition switch is turned to the on position or less than 1-2 minutes have elapsed since the ignition switch has been turned to on...	The Belt-Minder feature will not activate.
The driver's or front passenger's safety belt is not buckled when the vehicle has reached at least 6 mph (9.7 km/h) and 1-2 minutes have elapsed since the ignition switch has been turned to on...	The Belt-Minder feature is activated - the safety belt warning light illuminates and the warning chime sounds for six seconds every 25 seconds, repeating for about five minutes or until the safety belts are buckled.
The driver's or front passenger's safety belt becomes unbuckled for about one minute while the vehicle is traveling at least 6 mph (9.7 km/h) and more than 1-2 minutes have elapsed since the ignition switch has been turned to on...	The Belt-Minder feature is activated - the safety belt warning light illuminates and the warning chime sounds for six seconds every 25 seconds, repeating for about five minutes or until the safety belts are buckled.

Deactivating and Activating the Belt-Minder® Feature (If Equipped)



WARNING: While the design allows you to deactivate your Belt-Minder, this system is designed to improve your chances of being safely belted and surviving an accident. We recommend you leave the Belt-Minder system activated for yourself and others who may use the vehicle. To reduce the risk of injury, do not deactivate or activate the Belt-Minder feature while driving the vehicle.

Note: The driver and front passenger Belt-Minder are deactivated and activated independently. When deactivating or activating one seating position, do not buckle the other position as this will terminate the process.

Read Steps 1 - 4 thoroughly before proceeding with the programming procedure.

The driver and front passenger Belt-Minder features can be deactivated or activated by performing the following procedure:

Before following the procedure, make sure that:

- the parking brake is set
 - the transmission selector lever is in position **P**
 - the vehicle is off
 - the driver and front passenger safety belts are unbuckled
1. Turn the vehicle on. Do not start the vehicle (Ready to Drive light must not be lit)
 2. Wait until the safety belt warning light turns off (about one minute).
 - Once the next step is started, the procedure must be completed within 60 seconds.
 3. For the seating position being disabled, buckle then unbuckle the safety belt four times at a moderate speed, ending in the unbuckled state.
 - After Step 3, the safety belt warning light will turn on.
 4. While the safety belt warning light is on, buckle and then unbuckle the safety belt.
 - After Step 4, the safety belt warning light will flash for confirmation.
 - This will disable the Belt-Minder feature for that seating position if it is currently enabled.
 - This will enable the Belt-Minder feature for that seating position if it is currently disabled.

CHILD RESTRAINT AND SAFETY BELT MAINTENANCE

Inspect the vehicle safety belts and child safety seat systems periodically to make sure they work properly and are not damaged. Inspect the vehicle and child seat safety belts to make sure there are no nicks, tears or cuts. Replace if necessary. All vehicle safety belt assemblies, including retractors, buckles, front safety belt buckle assemblies, buckle support assemblies (slide bar-if equipped), shoulder belt height adjusters (if equipped), shoulder belt guide on seat back (if equipped), child safety seat LATCH and tether anchors, and attaching hardware, should be inspected after a crash. Read the child restraint manufacturer's instructions for additional inspection and maintenance information specific to the child restraint.

Ford Motor Company recommends that all safety belt assemblies in use in vehicles involved in a crash be replaced. However, if the crash was minor and an authorized dealer finds that the belts do not show damage and continue to operate properly, they do not need to be replaced. Safety belt assemblies not in use during a crash should also be inspected and replaced if either damage or improper operation is noted.

For proper care of soiled safety belts, see *Cleaning the Interior* in the *Vehicle Care* chapter.

PERSONAL SAFETY SYSTEM™

The Personal Safety System provides an improved overall level of frontal crash protection to front seat occupants and is designed to help further reduce the risk of airbag-related injuries. The system is able to analyze different occupant conditions and crash severity before activating the appropriate safety devices to help better protect a range of occupants in a variety of frontal crash situations.

Your vehicle's Personal Safety System consists of:

- Driver and passenger dual-stage airbag supplemental restraints.
- Front outboard safety belts with pretensioners, energy management retractors (first row only), and safety belt usage sensors.
- Driver's seat position sensor.
- Front passenger sensing system.
- Passenger airbag off and on indicator lamp.
- Front crash severity sensors.
- Restraints control module with impact and safing sensors.
- Restraint system warning light and backup tone.
- The electrical wiring for the airbags, crash sensor(s), safety belt pretensioners, front safety belt usage sensors, driver seat position sensor, front passenger sensing system, and indicator lights.

How Does the Personal Safety System Work?

The Personal Safety System can adapt the deployment strategy of your vehicle's safety devices according to crash severity and occupant conditions. A collection of crash and occupant sensors provides information to the restraints control module. During a crash, the restraints control module may activate the safety belt pretensioners and/or either one or both stages of the dual-stage airbag supplemental restraints based on crash severity and occupant conditions.

42 **Supplementary Restraints System**

PRINCIPLES OF OPERATION

 **WARNING:** Airbags do not inflate slowly or gently, and the risk of injury from a deploying airbag is the greatest close to the trim covering the airbag module.

 **WARNING:** All occupants of your vehicle, including the driver, should always properly wear their safety belts, even when an airbag supplemental restraint system is provided. Failure to properly wear your safety belt could seriously increase the risk of injury or death.

 **WARNING:** Airbags can kill or injure a child in a child seat. Always transport children 12 years old and under in the back seat and always properly use appropriate child restraints.

 **WARNING:** Never place your arm over the airbag module, as a deploying airbag can result in serious arm fractures or other injuries.

 **WARNING:** Airbags can kill or injure a child in a child seat. Never place a rear-facing child seat in front of an active airbag. If you must use a forward-facing child seat in the front seat, move the seat upon which the child seat is installed all the way back.

 **WARNING:** Do not attempt to service, repair, or modify the airbag supplemental restraint systems or its fuses as you could be seriously injured or killed. Contact your authorized dealer as soon as possible.

 **WARNING:** Several airbag system components get hot after inflation. Do not touch them after inflation as this may result in serious injury.



WARNING: If the airbag has deployed, the airbag will not function again and must be replaced immediately. If the airbag is not replaced, the unrepaired area will increase the risk of injury in a crash.

The airbags are a supplemental restraint system and are designed to work with the safety belts to help protect the driver and right front passenger from certain upper body injuries. Airbags do not inflate slowly; there is a risk of injury from a deploying airbag.

Note: You will hear a loud bang and see a cloud of harmless powdery residue if an airbag deploys. This is normal.

The airbags inflate and deflate rapidly upon activation. After airbag deployment, it is normal to notice a smoke-like, powdery residue or smell the burnt propellant. This may consist of cornstarch, talcum powder (to lubricate the bag) or sodium compounds (for example, baking soda) that result from the combustion process that inflates the airbag. Small amounts of sodium hydroxide may be present which may irritate the skin and eyes, but none of the residue is toxic.

While the system is designed to help reduce serious injuries, contact with a deploying airbag may also cause abrasions or swelling. Temporary hearing loss is also a possibility as a result of the noise associated with a deploying airbag. Because airbags must inflate rapidly and with considerable force, there is the risk of death or serious injuries, such as fractures, facial and eye injuries or internal injuries, particularly to occupants who are not properly restrained or are otherwise out of position at the time of airbag deployment. Thus, it is extremely important that occupants be properly restrained as far away from the airbag module as possible while maintaining vehicle control.

Routine maintenance of the airbags is not required.

SOS POST-CRASH ALERT SYSTEM™

The system flashes the turn signal lamps and sounds the horn (intermittently) in the event of a serious impact that deploys an airbag equipped on your vehicle, such as front, side, side curtain or Safety Canopy.

The horn and lamps will turn off when:

- you press the hazard control button
- you press the panic button (if equipped) on the remote entry transmitter, or
- your vehicle runs out of power.

DRIVER AND PASSENGER AIRBAGS

WARNING: Never place your arm or any objects over an airbag module. Placing your arm over a deploying airbag can result in serious arm fractures or other injuries. Objects placed on or over the airbag inflation area may cause those objects to be propelled by the airbag into your face and torso causing serious injury.



WARNING: Airbags can kill or injure a child in a child seat. Never place a rear-facing child seat in front of an active airbag. If you must use a forward-facing child seat in the front seat, move the seat upon which the child seat is installed all the way back.

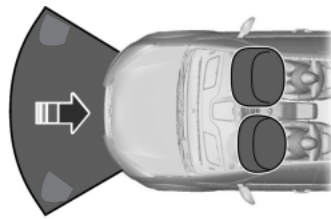

The driver and front passenger airbags will deploy during significant frontal and near-frontal crashes.

The driver and passenger front airbag system consists of:

- driver and passenger airbag modules
-  crash sensors and monitoring system with readiness indicator. See *Crash Sensors and Airbag Indicator* later in this chapter.
- front passenger sensing system

Proper Driver and Front Passenger Seating Adjustment

 **WARNING:** The National Highway Traffic Safety Administration recommends a minimum distance of at least 10 inches (25 centimeters) between an occupant's chest and the driver airbag module. Failure to follow this could seriously increase the risk of injury or death.

To properly position yourself away from the airbag:

- Move your seat to the rear as far as you can while still reaching the pedals comfortably.
- Recline the seat slightly (one or two degrees) from the upright position.

After all occupants have adjusted their seats and put on safety belts, it is very important that they continue to sit properly. Properly seated occupants sit upright, lean against the seat back, and center themselves on the seat cushion, with their feet comfortably extended on the floor. Sitting improperly can increase the chance of injury in a crash event. For example, if an occupant slouches, lies down, turns sideways, sits forward, leans forward or sideways, or puts one or both feet up, the chance of injury during a crash is greatly increased.

Children and Airbags

 **WARNING:** Airbags can kill or injure a child in a child seat. Never place a rear-facing child seat in front of an active airbag. If you must use a forward-facing child seat in the front seat, move the seat upon which the child seat is installed all the way back.





Children must always be properly restrained. Accident statistics suggest that children are safer when properly restrained in the rear seating positions than in the front seating position. Failure to follow these instructions may increase the risk of injury in a crash.

46 Supplementary Restraints System

FRONT PASSENGER SENSING SYSTEM

 **WARNING:** Even with Advanced Restraints Systems, children 12 and under should be properly restrained in a rear seating position. Failure to follow this could seriously increase the risk of injury or death.

 **WARNING:** Sitting improperly out of position or with the seat back reclined too far can take off weight from the seat cushion and affect the decision of the front passenger sensing system, resulting in serious injury or death in a crash.
Always sit upright against your seatback, with your feet on the floor.

 **WARNING:** To reduce the risk of possible serious injury:
Do not stow objects in seat back map pocket (if equipped) or hang objects off seat back if a child is in the front passenger seat. Do not place objects underneath the front passenger seat or between the seat and the center console (if equipped).
Check the passenger airbag off indicator lamp for proper airbag Status. Failure to follow these instructions may interfere with the passenger seat sensing system.

 **WARNING:** Any alteration or modification to the front passenger seat may affect the performance of the front passenger sensing system.

This system works with sensors that are part of the front passenger's seat and safety belt to detect the presence of a properly seated occupant and determine if the front passenger's frontal airbag should be enabled (may inflate) or not.



The front passenger sensing system uses a pass airbag off indicator which will illuminate and stay lit to remind you that the front passenger frontal airbag is disabled.

The indicator lamp is located under the climate controls. The indicator lamp will illuminate for a short period of time when the ignition is turned to the on position to confirm it is functional.

Note: When the passenger airbag off light is illuminated, the passenger (seat mounted) side airbag may be disabled to avoid the risk of airbag deployment injuries.

The front passenger sensing system is designed to disable (will not inflate) the front passenger's frontal airbag when the front passenger seat is unoccupied, or a rear facing infant seat, a forward-facing child restraint, or a booster seat is detected. Even with this technology, parents are **strongly** encouraged to always properly restrain children in the rear seat. The sensor also turns off the passenger front airbag and seat-mounted side airbag when the passenger seat is empty.

- When the front passenger sensing system disables (will not inflate) the front passenger frontal airbag, the passenger airbag status indicator will illuminate the OFF lamp and stay lit to remind you that the front passenger frontal airbag is disabled.
- If the child restraint has been installed and the indicator lamp is not lit, then turn the vehicle off, remove the child restraint from the vehicle and reinstall the restraint following the child restraint manufacturer's instructions.

The front passenger sensing system is designed to enable (may inflate) the front passenger's frontal airbag anytime the system senses that a person of adult size is sitting properly in the front passenger seat.

- When the front passenger sensing system enables the front passenger frontal airbag (may inflate), the indicator will be unlit and stay unlit.

If a person of adult size is sitting in the front passenger's seat, but the passenger airbag off indicator lamp is lit, it is possible that the person isn't sitting properly in the seat. If this happens:

- Turn the vehicle off and ask the person to place the seat back in the full upright position.
- Have the person sit upright in the seat, centered on the seat cushion, with the person's legs comfortably extended.
- Restart the vehicle and have the person remain in this position for about two minutes. This will allow the system to detect that person and enable the passenger's frontal airbag.
- If the indicator lamp remains lit even after this, the person should be advised to ride in the rear seat.

48 Supplementary Restraints System

Occupant	Pass Airbag Off Indicator Lamp	Passenger Airbag
Empty	Unlit	Disabled
Child	Lit	Disabled
Adult	Unlit	Enabled

After all occupants have adjusted their seats and put on safety belts, it's very important that they continue to sit properly. A properly seated occupant sits upright, leaning against the seat back, and centered on the seat cushion, with their feet comfortably extended on the floor. Sitting improperly can increase the chance of injury in a crash event. For example, if an occupant slouches, lies down, turns sideways, sits forward, leans forward or sideways, or puts one or both feet up, the chance of injury during a crash is greatly increased.

If you think that the status of the passenger airbag off indicator lamp is incorrect, check for the following:

- Objects lodged underneath the seat
- Objects between the seat cushion and the center console
- Objects hanging off the seat back
- Objects stowed in the seatback map pocket
- Objects placed on the occupant's lap
- Cargo interference with the seat
- Other passengers pushing or pulling on the seat
- Rear passenger feet and knees resting or pushing on the seat

The conditions listed above may cause the weight of a properly seated occupant to be incorrectly interpreted by the passenger sensing system. The person in the front passenger seat may appear heavier or lighter due to the conditions described in the list above.



To know if the front passenger sensing system is operating properly, see *Crash Sensors and Airbag Indicator* later in this chapter.

If the airbag readiness lamp is lit, do the following:

The driver or adult passengers should check for any objects that may be lodged underneath the front passenger seat or cargo interfering with the seat.

If objects are lodged or cargo is interfering with the seat; please take the following steps to remove the obstruction:

- Pull the vehicle over.
- Turn the vehicle off.
- Driver or adult passengers should check for any objects lodged underneath the front passenger seat or cargo interfering with the seat.
- Remove the obstruction(s) (if found).
- Restart the vehicle.
- Wait at least two minutes and verify that the airbag readiness lamp is no longer illuminated
- If the airbag readiness lamp remains illuminated, this may or may not be a problem due to the front passenger sensing system.

Do not attempt to repair or service the system. Take your vehicle immediately to an authorized dealer.

If it is necessary to modify an advanced front airbag system to accommodate a person with disabilities, contact the Ford Customer Relationship Center at the phone number shown in the *Customer Assistance* section of this *Owner's Manual*.

KNEE AIRBAG

A driver's knee airbag is located under or within the instrument panel. During a crash, the restraints control module may activate the driver's knee airbag based on crash severity and occupant conditions. Under certain crash and occupant conditions, the driver's knee airbag may deploy but the driver's front airbag may not activate. As with front and side airbags, it is important to be properly seated and restrained to reduce the risk of death or serious injury.



To know if the knee airbag is operating properly, see *Crash Sensors and Airbag Indicator* in this chapter.

SIDE AIRBAGS

WARNING: Do not place objects or mount equipment on or near the airbag cover, on the side of the seat backs (of the front seats), or in front seat areas that may come into contact with a deploying airbag. Failure to follow these instructions may increase the risk of personal injury in the event of a crash.



WARNING: Do not use accessory seat covers. The use of accessory seat covers may prevent the deployment of the side airbags and increase the risk of injury in an accident.



WARNING: Do not lean your head on the door. The side airbag could injure you as it deploys from the side of the seat back.



WARNING: Do not attempt to service, repair, or modify the airbag, its fuses or the seat cover on a seat containing an airbag, as you could be seriously injured or killed. Contact your authorized dealer as soon as possible.



WARNING: If the side airbag has deployed, the airbag will not function again. The side airbag system (including the seat) must be inspected and serviced by an authorized dealer. If the airbag is not replaced, the unrepaired area will increase the risk of injury in a crash.

The side airbags are located on the outboard side of the seat backs of the front seats. In certain sideways crashes, the airbag on the side affected by the crash will be inflated. The airbag was designed to inflate between the door panel and occupant to further enhance the protection provided occupants in side impact crashes.



The system consists of the following:

- a tag on the seat back indicating that side airbags are found on your vehicle
- side airbags located inside the seat back of the driver and front passenger seats.



- crash sensors and monitoring system with readiness indicator. See *Crash Sensors and Airbag Indicator* later in this chapter.
- front passenger sensing system.

Note: The passenger sensing system will deactivate the passenger seat-mounted side airbag if it detects an empty passenger seat.

The design and development of the side airbag system included recommended testing procedures that were developed by a group of automotive safety experts known as the Side Airbag Technical Working Group. These recommended testing procedures help reduce the risk of injuries related to the deployment of side airbags.

SIDE CURTAIN AIRBAGS



WARNING: Do not place objects or mount equipment on or near the headliner at the siderail that may come into contact with a deploying side curtain airbag. Failure to follow these instructions may increase the risk of personal injury in the event of a crash.





WARNING: Do not lean your head on the door. The curtain airbag could injure you as it deploys from the headliner.



WARNING: Do not attempt to service, repair, or modify the side curtain airbags, its fuses, the A, B, or C pillar trim, or the headliner on a vehicle containing side curtain airbags as you could be seriously injured or killed. Contact your authorized dealer as soon as possible.

 **WARNING:** All occupants of the vehicle including the driver should always wear their safety belts even when an airbag supplemental restraint system and side curtain airbag is provided. Failure to properly wear your safety belt could seriously increase the risk of injury or death.

 **WARNING:** To reduce the risk of injury, do not obstruct or place objects in the deployment path of the side curtain airbag.

 **WARNING:** If the side curtain airbags have deployed, the side curtain airbags will not function again. The side curtain airbags (including the A, B and C pillar trim and headliner) must be inspected and serviced by an authorized dealer. If the side curtain airbag is not replaced, the unrepaired area will increase the risk of injury in a crash.

A side curtain airbag will deploy during significant side crashes. The airbags are mounted to the roof side-rail sheet metal, behind the headliner, above each row of seats. In certain sideways crashes, the side curtain airbag on the impacted side of the vehicle will be activated. The side curtain airbags are designed to inflate between the side window area and occupants to further enhance protection provided in side impact crashes.

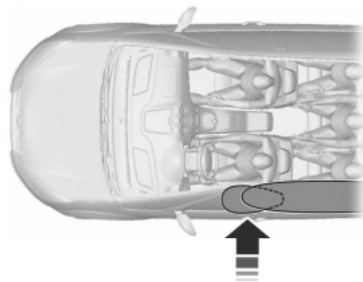

The system consists of:

- side curtain airbags located above the trim panels over the front and rear side windows identified by a label or wording on the headliner or roof-pillar trim.
- a flexible headliner which opens above the side doors to allow side air curtain deployment.
-  crash sensors and monitoring system with readiness indicator. See *Crash sensors and Airbag Indicator* later in this chapter.

Children 12 years old and under should always be properly restrained in the back seats. The side curtain airbags will not interfere with children restrained using a properly installed child or booster seat because it is designed to inflate downward from the headliner above the doors along the side window opening.

The design and development of the side curtain airbags included recommended testing procedures that were developed by a group of automotive safety experts known as the Side Airbag Technical Working Group. These recommended testing procedures help reduce the risk of injuries related to the deployment of side curtain airbags.

CRASH SENSORS AND AIRBAG INDICATOR



WARNING: Modifying or adding equipment to the front end of your vehicle (including frame, bumper, front end body structure and tow hooks) may affect the performance of the airbag system, increasing the risk of injury. Do not modify the front end of your vehicle.

Your vehicle has a collection of crash and occupant sensors which provide information to the restraints control module which deploys (activates) the front safety belt pretensioners, driver airbag, passenger airbag, knee airbag, seat mounted side airbags, and the side curtain airbags. Based on the type of crash (frontal impact or side impact) the restraints control module will deploy the appropriate safety devices.

The restraints control module also monitors the readiness of the above safety devices plus the crash and occupant sensors. The readiness of the safety system is indicated by a warning indicator light in the instrument cluster or by a backup tone if the warning light is not working. See the *Instrument Cluster* chapter. Routine maintenance of the airbag is not required.

54 **Supplementary Restraints System**

A difficulty with the system is indicated by one or more of the following:



- The readiness light will either flash or stay lit.
- The readiness light will not illuminate immediately after the ignition is turned on.
- A series of five beeps will be heard. The tone pattern will repeat periodically until the problem or light are repaired.

If any of these things happen, even intermittently, have the supplemental restraint system serviced at an authorized dealer immediately. Unless serviced, the system may not function properly in the event of a crash.

The safety belt pretensioners and the airbag supplemental restraint system are designed to activate when the vehicle sustains frontal deceleration sufficient to cause the restraints control module to deploy a safety device.

The fact that the safety belt pretensioners or front airbags did not activate for both front seat occupants in a crash does not mean that something is wrong with the system. Rather, it means the restraints control module determined the accident conditions (such as crash severity, belt usage) were not appropriate to activate these safety devices.

- The design of the front airbags is to activate only in frontal and near-frontal crashes (not rollovers, side impacts or rear impacts) unless the crash causes sufficient frontal deceleration.
- The design of the safety belt pretensioners is to activate in frontal and near-frontal crashes, and may also activate when a side curtain deploys.
- The driver's knee airbag may deploy based on crash severity and occupant conditions.
- The design of the side airbags and side curtain airbags is to inflate in certain side impact crashes. Side airbags may activate in other types of crashes if the vehicle experiences sufficient sideways motion or deformation.

AIRBAG DISPOSAL

Contact your authorized dealer as soon as possible. Airbags must be disposed of by qualified personnel.

GENERAL INFORMATION ON RADIO FREQUENCIES

This device complies with part 15 of the FCC Rules and with Industry Canada license-exempt RSS standard(s). Operation is subject to the following two conditions: (1) This device may not cause harmful interference, and (2) This device must accept any interference received, including interference that may cause undesired operation.

Note: Changes or modifications not expressly approved by the party responsible for compliance could void the user's authority to operate the equipment. The term **IC** before the radio certification number only signifies that Industry Canada technical specifications were met.

The typical operating range for your transmitter is approximately 33 feet (10 meters). Vehicles with the remote start feature will have a greater range. A decrease in operating range could be caused by:

- weather conditions
- nearby radio towers
- structures around your vehicle
- other vehicles parked next to your vehicle.

The radio frequency used by your remote control can also be used by other short-distance radio transmissions, for example amateur radios, medical equipment, wireless headphones, remote controls and alarm systems. If the frequencies are jammed, you will not be able to use your remote control. You can lock and unlock the doors with the key.

Note: Make sure your vehicle is locked before leaving it unattended.

Note: If you are in range, the remote control will operate if you press any button unintentionally.

Intelligent Access

The system uses a radio frequency signal to communicate with your vehicle and authorize your vehicle to unlock when one of the following conditions is met:

- You touch the inside of the front exterior door handle.
- You press the luggage compartment button.
- You press a button on the transmitter.

If excessive radio frequency interference is present in the area or if the transmitter battery is low, it may be necessary to mechanically unlock your door. You can use the mechanical key blade in your intelligent access key to open the driver door in this situation. Refer to *Remote Control* in this chapter for more information on the location and use of the mechanical key blade.

REMOTE CONTROL**Intelligent Access Key**

Your intelligent access keys operate the power locks and the remote start system. The key must be in your vehicle to activate the push-button start system.



The intelligent access key also contains a removable mechanical key blade that you can use to unlock the driver door. Slide the release on the back of the transmitter to release the mechanical key blade, and then pull the blade out.



Note: Your vehicle's back-up keys came with a security tag that provides important vehicle key cut information. Keep the tag in a safe place for future reference.

Replacing the Battery

Note: Refer to local regulations when disposing of transmitter batteries.

Note: Do not wipe off any grease on the battery terminals or on the back surface of the circuit board.

Note: Replacing the battery will not delete the transmitter from your vehicle. The transmitter should operate normally.

The remote control uses one coin-type three-volt lithium battery CR2032 or equivalent.

Intelligent Access Transmitter

1. Remove the backup key from the transmitter.

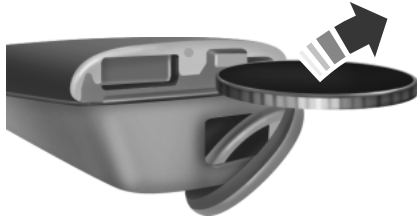

2. Twist a thin coin under the tab hidden behind the backup key head to remove the battery cover. Do not use the backup key to remove the cover or you could damage the intelligent access key.



3. Remove the old battery.

4. Insert a new battery with the **+** facing downward. Press the battery down to make sure it is fully in the housing.

5. Snap the battery cover back onto the transmitter and install the backup key.

Car Finder



Press the button twice within three seconds. The horn will sound and the turn signals will flash. We recommend you use this method to locate your vehicle, rather than using the panic alarm.

Sounding a Panic Alarm



Press the button to activate the alarm. Press the button again or switch the ignition on to deactivate.

Note: The panic alarm will only operate when the ignition is off.

Remote Start

The remote start button is on the transmitter.

This feature allows you to start your vehicle from outside your vehicle. The transmitter has an extended operating range.

Vehicles with automatic climate control can be configured to operate when the vehicle is remote started. Refer to the *Climate Control* chapter for more information.

Many states and provinces have restrictions for the use of remote start. Check your local and state or provincial laws for specific requirements regarding remote start systems.

The remote start system will not work if:

- the vehicle is on
- the alarm system is triggered
- you disable the feature
- the hood open
- the transmission is not in **P**
- the vehicle battery voltage is too low
- the powertrain malfunction/reduced power indicator was on the last time your vehicle was driven.

Remote Starting the Vehicle

Note: You must press each button within three seconds of each other. Your vehicle will not remote start and the horn will not sound if you do not follow this sequence.

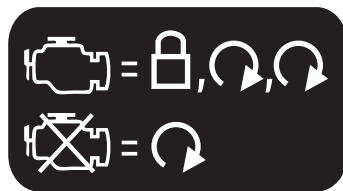

The label on your transmitter details the starting procedure.

To remote start your vehicle:

1. Press the lock button to lock all the doors.
2. Press the remote start button twice. The exterior lamps flash twice.

The horn will sound if the system fails to start, unless quiet start is on. Quiet start will run the blower fan at a slower speed to reduce noise. You can switch it on or off in the information display. See the *Information Displays* chapter.

Note: If you remote start your vehicle, you must have a programmed intelligent access key inside your vehicle and press the **START/STOP** button on the instrument panel once while applying the brake pedal before driving your vehicle.

The power windows will not work during the remote start and the radio will not turn on automatically.

The parking lamps will remain on and the vehicle will run for 5, 10, or 15 minutes, depending on the setting. See the *Information Displays* chapter to select the duration of the remote start system.

Extending the Vehicle Run Time

Repeat Steps 1 and 2 with the vehicle still running to extend the run time for another remote start duration. If the duration is set to last 10 minutes, the system will add another 10 minutes. For example, if the vehicle had been running from the first remote start for five minutes, the vehicle will continue to run now for a total of 20 minutes. You can extend the remote start up to a maximum of 30 minutes.

Wait at least five seconds before remote starting after a vehicle shutdown.

Turning the Vehicle Off After Remote Starting



Press the button once. The parking lamps will turn off.

You may have to be closer to your vehicle than when starting due to ground reflection and the added noise of the running vehicle.

You can disable or enable the remote start system through the information display. Refer to the *Information Display* chapter.

REPLACING A LOST KEY OR REMOTE CONTROL

You can purchase replacement or additional keys or remote controls from an authorized dealer. A dealer can program the transmitters to your vehicle or you may be able to program them yourself. See the *Security* chapter for information on programming your transmitters.

PRINCIPLES OF OPERATION

MyKey allows you to program keys with restricted driving modes to promote good driving habits. All but one of the keys programmed to the vehicle can be activated with these restricted modes.

Any keys that have not been programmed are referred to as administrator keys or admin keys. These can be used to:

- create a MyKey
- program configurable MyKey settings
- clear all MyKey features.

When you have programmed a MyKey, you can access the following information using the information display:

- How many admin keys and MyKeys are programmed to your vehicle.
- The total distance your vehicle has traveled using a MyKey.

Note: All MyKeys are programmed to the same settings. You cannot program them individually.

Note: For vehicles with intelligent access key (push-button start), when both a MyKey and an admin intelligent access key (fob) are present, the admin fob will be recognized to start the vehicle.

Non-configurable Settings

The following settings cannot be changed:

- Belt-Minder. You cannot disable this feature. The audio system will mute when the front seat occupants' safety belts are not fastened.
- Early distance to stop. Warnings are displayed in the information display control followed by an audible tone at 15 miles to stop.
- Driver assist features, if equipped on your vehicle, are forced on: parking aid, blind spot information system (BLIS) with cross traffic alert and the forward collision warning system.

Configurable Settings

With an admin key, you can configure certain MyKey settings when you first create a MyKey and before you recycle the key or restart the vehicle. You can also change the settings afterward with an admin key.

- A vehicle speed limit can be set. Warnings will be shown in the display followed by an audible tone when your vehicle reaches the set speed. You cannot override the set speed by fully depressing the accelerator pedal or by setting cruise control.
- Vehicle speed minders of 45, 55 or 65 mph (75, 90 or 105 km/h). Once you select a speed, it will be shown in the display, followed by an audible tone when the preselected vehicle speed is exceeded.

- Audio system maximum volume of 45%. A message will be shown in the display when you attempt to exceed the limited volume. Also, the speed-sensitive or compensated automatic volume control will be disabled.
- Always on setting. When this is selected, you will not be able to turn off AdvanceTrac (if your vehicle is equipped with this feature).

Creating a MyKey

Use the information display to create a MyKey:

1. Hold the key next to the symbol on the right side of the steering column (or next to the back-up location on the right side of the steering column).

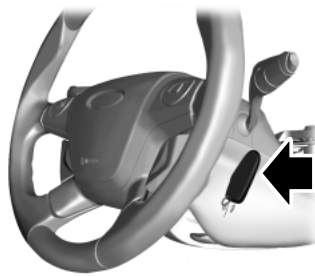

See *Starting and Stopping the Vehicle* chapter for more backup slot information.

2. Switch the ignition on.
3. Access the main menu on the information display controls, and select **Settings**, then **MyKey** by pressing **OK** or the **>** button.
4. Press **OK** to select **Create MyKey**.
5. When prompted, hold the **OK** button until you see a message informing you to label this key as a MyKey. The key will be restricted at the next start.

MyKey is successfully created. Make sure you label it so you can distinguish it from the admin keys.

You can also program configurable settings for the key(s).
See *Programming/Changing Configurable Settings*.

Programming/Changing Configurable Settings

Use the information display to access your configurable MyKey settings.

1. Switch the ignition on with an admin key.
2. Access the main menu on the information display controls, and select **Settings**, then **MyKey** by pressing **OK** or **>** button.
3. Use the arrow buttons to get to a feature.
4. Press **OK** or **>** to make a selection.

Note: You can clear or change your MyKey settings at any time during the same key cycle as you created the MyKey. Once you have switched the vehicle off, however, you will need an admin key to change or clear your MyKey settings.

CLEARING ALL MYKEYS

You can clear all MyKeys within the same key cycle as you created the MyKey. If you switch your ignition off, however, you will need to use an admin key to clear your MyKeys.

Note: When you clear your MyKeys, you remove all restrictions and return all MyKeys to their original admin key status at once.

To clear all MyKeys of all MyKey settings, use the information display to do the following:

1. Access the main menu and select **Settings**, then **MyKey**.
2. Scroll to **Clear All** and press the **OK** button.
3. Hold the **OK** button until **ALL MYKEYS CLEARED** displays .

CHECKING MYKEY SYSTEM STATUS

You can find information about your programmed MyKeys by using the information display.

MYKEY DISTANCE

Tracks the distance when drivers use a MyKey. The only way to delete the accumulated distance is by using an admin key to clear your MyKey. If the distance does not accumulate as expected, then the intended user is not using the MyKey, or an admin key user recently cleared and then recreated a MyKey.

NUMBER OF MYKEY(S)

Indicates the number of MyKeys programmed to your vehicle. Use this feature to detect how many MyKeys you have for your vehicle and determine when a MyKey has been deleted.

NUMBER OF ADMIN KEY(S)

Indicates how many admin keys are programmed to your vehicle. Use this feature to determine how many unrestricted keys you have for your vehicle, and detect if an additional MyKey has been programmed.

USING MYKEY WITH REMOTE START SYSTEMS

MyKey is not compatible with non-Ford-approved aftermarket remote start systems. If you choose to install a remote start system, please see your Ford authorized dealer for a Ford-approved remote start system .

Vehicles With Ford-approved Aftermarket Remote Start Systems

When using a Ford-approved aftermarket remote start system, the vehicle recognizes the remote start system as an additional admin key. It is the vehicle's default setting. You can also program the remote start as a MyKey. As a result, the MyKey system status menu display includes the remote start system as an additional key in the total count of **MYKEY(S) PROGRAMMED** or **ADMIN KEYS PROGRAMMED**. See *Checking MyKey System Status*.

When you start your vehicle with a Ford-approved aftermarket remote start system, the system stalls the vehicle after you open the door or shift the vehicle into gear. This is intentional. When you restart your vehicle, it reads your real key (traditional key or intelligent key fob) status instead of the remote start system's status.

As an added precaution, owners of vehicles equipped with traditional keys may want to program the remote start system as a MyKey, if the MyKey driver uses the remote start fob. That way, when the MyKey driver starts the vehicle with the remote start system, the MyKey restrictions remain active.

With a Ford-approved aftermarket remote start system, it is possible to program all real keys as MyKeys unintentionally. If this happens, then the remote start fob is the admin key. If you want to have only one real key as a MyKey, or do not want to have any MyKeys, then you need to use your remote start to clear all MyKeys. In that case, follow these steps:

- Enter the vehicle and close all doors.
- Remote start the vehicle using your remote start fob.
- See *Clearing All MyKeys*. Follow Steps 1-3.

After clearing your MyKeys, you can create a new MyKey. See *Creating a MyKey*.

Note: For vehicles with intelligent access keys (push-button start), you cannot program the remote start system as a MyKey. Always treat the remote start fob as you would any other admin key.

Vehicles With Non-Ford-approved Aftermarket Remote Start Systems

MyKey is not compatible with non-Ford-approved aftermarket remote start systems. If you choose to install a remote start system, please see a Ford authorized dealer for a Ford-approved system.

The following information **may** help customers who choose to install a non-Ford-approved remote start system. The actions provided below do not make MyKey compatible with non-Ford-approved remote start systems, but may help you retain some MyKey functions.

When using a non-Ford-approved remote start system, the vehicle may recognize the remote start system as an additional admin key with its associated privileges. If you restart the vehicle by inserting a key into the ignition cylinder and recycling the ignition completely, then you may retain some MyKey functions. This action forces your vehicle to read the traditional key instead of the remote start fob and then uses the key's associated privileges.

Note: The MyKey system status menu display may include the remote start system as an additional key in the total count of **MYKEY(S) PROGRAMMED** or **ADMIN KEYS PROGRAMMED**. See *Checking MyKey System Status*.

As an added precaution, owners of vehicles equipped with traditional keys may want to program the remote start system as a MyKey, if the MyKey driver uses the remote start fob. That way, when the MyKey driver starts the vehicle with the remote start system, the MyKey restrictions will be remain active.

With a non-Ford-approved aftermarket remote start system, it is possible to program all real keys as MyKeys unintentionally. If this happens, then the remote start fob is the admin key. If you want to have only one real key as a MyKey, or do not want to have any MyKeys, then you need to use your remote start to clear all MyKeys. In that case, follow these steps:

- Enter the vehicle and close all doors.
- Remote start the vehicle using your remote start fob.
- See *Clearing All MyKeys*. Follow Steps 1-3.

After clearing your MyKeys, you can create a new MyKey. See *Creating a MyKey*.

Note: For vehicles with intelligent access keys (push-button start), you cannot program the remote start system as a MyKey. Always treat the remote start fob as you would any other admin key.

MYKEY TROUBLESHOOTING

Condition	Potential causes
I cannot create a MyKey.	<ul style="list-style-type: none"> • The key or fob used to start the vehicle does not have admin privileges. • The key or fob used to start the vehicle is the only admin key (there always has to be at least one admin key). • Vehicles with push button start: The intelligent access key is not positioned correctly next to the steering column or placed in a backup slot. See <i>Starting and Stopping the Vehicle</i>. • SecuriLock passive anti-theft system is disabled or in unlimited mode. • The vehicle has been started using a remote start system that is not programmed with admin privileges. See <i>Using MyKey With Remote Start Systems</i>.
I cannot program the configurable settings.	<ul style="list-style-type: none"> • The key or fob used to start the vehicle does not have admin privileges. • No MyKeys are created. See <i>Creating a MyKey</i>. • The vehicle has been started using a remote start system that is not programmed with admin privileges. See <i>Using MyKey With Remote Start Systems</i>.

Condition	Potential causes
I cannot clear the MyKeys.	<ul style="list-style-type: none"> • The key or fob used to start the vehicle does not have admin privileges. • No MyKeys are created. See <i>Creating a MyKey</i>. • The vehicle has been started using a remote start system that is not programmed with admin privileges. See <i>Using MyKey With Remote Start Systems</i>
I lost the only admin key.	<ul style="list-style-type: none"> • Purchase a new key from your authorized dealer.
I lost a key.	<ul style="list-style-type: none"> • Program a spare key. See <i>SecuriLock</i> in the <i>Security</i> chapter.
I accidentally programmed all keys as MyKeys.	<ul style="list-style-type: none"> • The vehicle has a remote start system that is recognized as an admin key. Clear all MyKeys by using the remote start. See <i>Using MyKey With Remote Start Systems</i>. • Your vehicle's system does not recognize any programmed MyKeys. See <i>Creating a MyKey</i>.
MyKey total includes one additional key.	<ul style="list-style-type: none"> • An unknown key has been created as a MyKey. • The vehicle has a remote start system. See <i>Using MyKey With Remote Start Systems</i>.
Admin key total includes one additional key.	<ul style="list-style-type: none"> • An unknown key has been programmed to the vehicle as an admin key. • The vehicle has a remote start system. See <i>Using MyKey With Remote Start Systems</i>.
MyKey distances do not accumulate.	<ul style="list-style-type: none"> • The MyKey user is not using the MyKey. • An admin key holder cleared the MyKeys and created new MyKeys. • The key system has been reset.
No MyKey functions with the Intelligent Access key.	<ul style="list-style-type: none"> • An admin fob is present at the vehicle start. • No MyKeys are created. See <i>Creating a MyKey</i>.

LOCKING AND UNLOCKING

You can use the power door lock control or the remote control to lock and unlock your vehicle.

Power Door Locks

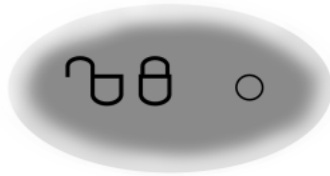

The power door lock control is located on the instrument panel near the radio.

Press the control to lock or unlock the doors. It will illuminate when you lock the doors and luggage compartment. When the light is off it indicates one or more doors are unlocked.

Remote Control

Unlocking the Doors (Two-Stage Unlock)



Press the button to unlock the driver door.

Press the button again within three seconds to unlock all doors. The turn signals will flash.

Press and hold both the lock and unlock buttons on the remote control for four seconds to disable or enable two-stage unlocking. Disabling two-stage unlocking allows all vehicle doors to unlock with one press of the button. The turn signals will flash twice to indicate a change to the unlocking mode. The unlocking mode applies to the remote control and intelligent access.

Intelligent access at the driver door will unlock all doors when you disable two-stage unlocking.

Locking the Doors



Press the button to lock all the doors. The turn signals will flash.

Press the button again within three seconds to confirm that all the doors are closed. The doors will lock again, the horn will sound and the turn signals will flash if all the doors and the luggage compartment are closed.

Note: If locking was not successful or any door or the liftgate is open, or if the hood is open on vehicles with a perimeter alarm or remote start, the horn will sound twice and the lamps will not flash.

Opening the Luggage Compartment



Press twice to unlatch the luggage compartment lid.

Mechanical Key

Turn the top of the key toward the front of your vehicle once to lock all doors.

Turn the top of the key toward the rear of your vehicle once to unlock the driver door only.

Locking the Doors Individually

If the power locks fail to operate, lock the doors individually using the key in the position shown.

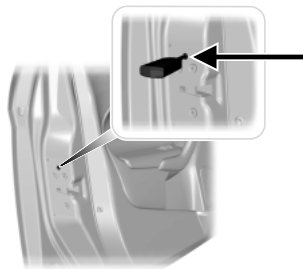

Left-Hand Side

Turn clockwise to lock.

Right-Hand Side

Turn counterclockwise to lock.

Opening a Rear Door from Inside

Pull the interior door release handle twice to unlock and open a rear door. The first pull unlocks the door and the second pull will unlatch the door.

Activating Intelligent Access

The intelligent access key must be within 3 feet (1 meter) of your vehicle.

At the Front Doors

Pull a front exterior door handle to unlock and open the door.

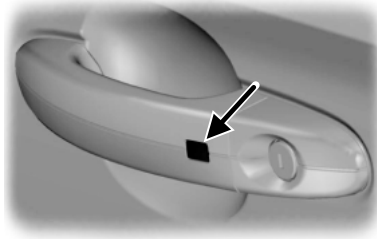

Press and hold the door handle lock sensor to lock your vehicle. To avoid unlocking the door inadvertently, be sure to only touch the lock sensor and not other areas of the door handle.

Note: Keep the door handle surface clean to avoid issues with operation.

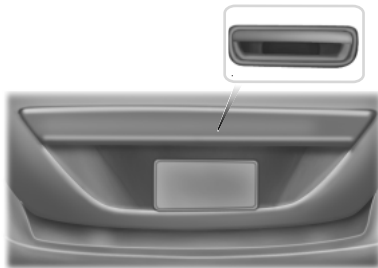
At the Luggage Compartment

Press the exterior release button above the license plate.

Autolock (If Equipped)

The autolock feature will lock all the doors when:

- all doors are closed,
- the ignition is on,
- you shift into any gear putting your vehicle in motion, and
- your vehicle attains a speed greater than 4 mph (7 km/h).

Autounlock (If Equipped)

The autounlock feature will unlock all the doors when:

- the ignition is on, all the doors are closed, and your vehicle has been in motion at a speed greater than 4 mph (7 km/h);
- your vehicle comes to a stop and you switch the ignition off or to accessory; and
- you open the driver door within 10 minutes of the switching the ignition off or to accessory.

Note: The doors will not autounlock if you electronically lock your vehicle after you switch the ignition off and before you open the driver door.

Enabling or Disabling Autolock and Autounlock

Note: Your authorized dealer can perform this procedure, or you can do the procedure yourself.

To enable or disable these features, do the following:

Note: You will have 30 seconds to complete the procedure.

1. Switch the ignition on.
2. Press the power door unlock button three times.
3. Switch the ignition off.
4. Press the power door unlock button three times.
5. Switch the ignition on. The horn will sound indicating your vehicle is in programming mode.

Autolock: Press the power door unlock button then the lock button. The horn will sound once if disabled or twice (one short and one long) if enabled.

Autounlock: Press the power door lock button then the unlock button. The horn will sound once if disabled or twice (one short and one long) if enabled.

After programming the feature, switch the ignition off. The horn will sound once indicating programming is complete.

Note: You can enable or disable the autounlock feature independently of the autolock feature.

Illuminated Entry

The interior lamps and select exterior lamps will illuminate when you unlock the doors with the remote entry system.

The illuminated entry system will turn off the lights if:

- you start your vehicle,
- you press the remote control lock button, or
- after 25 seconds of illumination.

The lights will not turn off if:

- you turn them on with the lamp control, or
- any door is open.

Illuminated Exit

The interior lamps and select exterior lamps will illuminate when all doors are closed and you switch the ignition off.

The lamps will turn off if all the doors remain closed and:

- 25 seconds elapse
- you lock your vehicle from the outside.

Battery Saver

If you leave the courtesy lamps or dome lamps on and switch the ignition off, the battery saver shuts them off after some time.

Accessory Mode Battery Saver for Intelligent Access Keys (If Equipped)

If you leave the ignition on after leaving your vehicle, it will shut off 15 minutes after you close all of the doors.

TRUNK RELEASE**With the Remote Control**

Press twice within three seconds.

From Inside Your Vehicle (If Equipped)

Press the button located on the instrument panel.

From Outside Your Vehicle

Press the release button above the license plate to unlatch the trunk. Your vehicle must be unlocked or have the intelligent access transmitter within 3 feet (1 meter) of the trunk.

Note: On a locked vehicle, you can press the trunk button on the remote control once. The vehicle will remain locked but you will have 20 seconds to press the outside release button.

SECURILOCK® PASSIVE ANTI-THEFT SYSTEM

Note: The system is not compatible with non-Ford aftermarket remote start systems. Use of these systems may result in vehicle starting problems and a loss of security protection.

Note: Metallic objects, electronic devices or a second coded key on the same key chain may cause vehicle starting issues if they are too close to the key when starting your vehicle. Prevent these objects from touching the coded key while starting your vehicle. Switch the ignition off, move all objects on the key chain away from the coded key and restart the vehicle if a problem occurs.

Note: Do not leave a duplicate coded key in the vehicle. Always take your keys and lock all doors when leaving the vehicle.

The system helps prevent the vehicle from starting unless you use a coded key programmed to your vehicle. Using the wrong key may prevent your vehicle from starting. A message may appear in the information display.

If you are unable to start your vehicle with a correctly coded key, a malfunction has happened and a message may appear in the information display.

Automatic Arming

Your vehicle arms immediately after you switch the ignition off.

Automatic Disarming

Your vehicle disarms when you switch the ignition on with a coded key.

Replacement Keys

Note: Your vehicle comes with two intelligent access keys.

The intelligent access key functions as a programmed key that operates the driver door lock and activates the intelligent access with push button start systems, as well as a remote control.

If your intelligent access key is lost or stolen and you do not have an extra coded key, you will need to have your vehicle towed to an authorized dealer. The key codes need to be erased from your vehicle and new coded keys will need to be programmed.

Store an extra programmed key away from your vehicle in a safe place to help prevent any inconveniences. See an authorized dealer to purchase additional spare or replacement keys.

Programming a Spare Intelligent Access Key

See your authorized dealer to have additional keys programmed to your vehicle.

ANTI-THEFT ALARM

The system will warn you of an unauthorized entry to your vehicle.

The park and turn lamps flash and the horn sounds if unauthorized entry is attempted while the alarm is armed. It triggers immediately if the luggage compartment or the hood opens, and after a 12-second delay if any door opens.

Take all remote controls to an authorized dealer if there is any potential alarm problem with your vehicle.

Arming the Alarm

The alarm is ready to arm when there is not a key in the ignition. Lock the vehicle to arm the alarm.



The message indicator flashes when theft protection is active.

Disarming the alarm

Disarm the alarm by any of the following actions:

- Unlock the doors or luggage compartment with the remote control.
- Turn the ignition on or start the vehicle.
- Use a key in the driver door to unlock your vehicle, then turn the ignition on within 12 seconds.

ADJUSTING THE STEERING WHEEL



WARNING: Do not adjust the steering wheel when your vehicle is moving.

Note: Make sure that you are sitting in the correct position. See *Sitting in the Correct Position* in the *Seats* chapter.

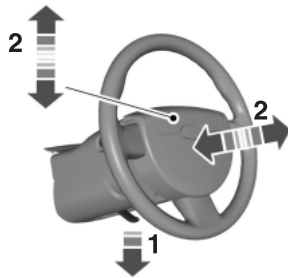

1. Unlock the steering column.
2. Adjust the steering wheel to the desired position.



3. Lock the steering column.

AUDIO CONTROL

Select the required source on the audio unit.

You can operate the following functions with the control:

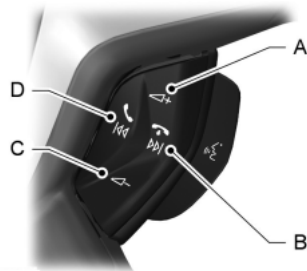

- A. Volume up
- B. Seek up or next
- C. Volume down
- D. Seek down or previous

Seek, Next or Previous

Press the seek button to:

- tune the radio to the next or previous stored preset
- play the next or previous track.

Press and hold the seek button to:

- tune the radio to the next station up or down the frequency band
- seek through a track.

VOICE CONTROL (IF EQUIPPED)

Pull the control to select or deselect voice control. See the *MyFord Touch* chapter.

CRUISE CONTROL



See the *Cruise Control* chapter.

INFORMATION DISPLAY CONTROL



Use the arrows on the left side of the steering wheel to navigate the information display. See the *Information Displays* chapter for more information.

Multimedia Controls



Use the arrows on the right side of steering wheel to navigate through the available menus. Press **OK** to make a selection.

WINDSHIELD WIPERS

Note: Fully defrost the windshield before switching on the windshield wipers.

Note: Make sure the windshield wipers are switched off before entering car wash.

Note: Clean the windshield and wiper blades if they begin to leave streaks or smears. If that does not resolve the issue, install new wiper blades.

Note: Do not operate the wipers on a dry windshield. This may scratch the glass, damage the wiper blades or cause the wiper motor to burn out. Always use the windshield washer before wiping a dry windshield.

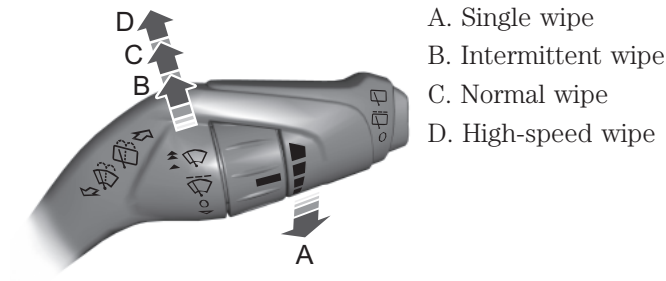
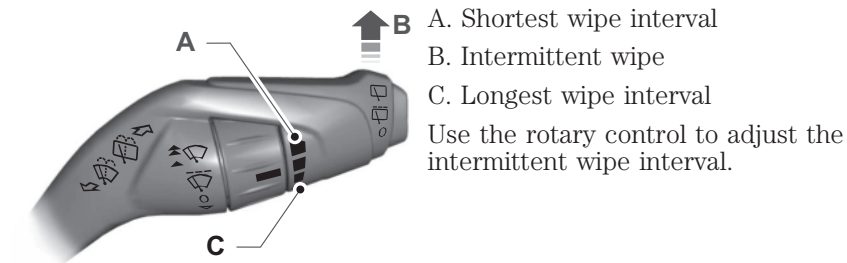
**Intermittent Wipe****Speed Dependent Wipers**

When your vehicle speed increases, the interval between wipes will decrease when intermittent wipe is selected.

WINDSHIELD WASHERS

Note: Do not operate the washers when the washer reservoir is empty. This may cause the washer pump to overheat.



Pull the lever toward you to spray the windshield. After you release the lever, the wipers will operate for a short time.

A wipe will occur a few seconds after washing to clear any remaining washer fluid.

REAR WINDOW WIPER AND WASHERS (IF EQUIPPED)

Rear Window Wiper

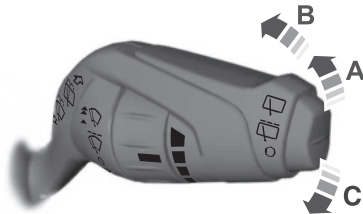

- A. Intermittent wiper
- B. Low-speed wiper
- C. Off

Press the top of the button at the end of the lever to switch on the intermittent wiper. Press the button again to switch on low-speed wiper. Press the bottom of the button to switch the wiper off, or to change the wiper speed from low-speed to intermittent.

When you shift into R (Reverse), the rear wiper will turn on to intermittent if the front wipers are activated.

Rear Window Washers

Note: Do not operate the washers when the washer reservoir is empty. This may cause the washer pump to overheat.

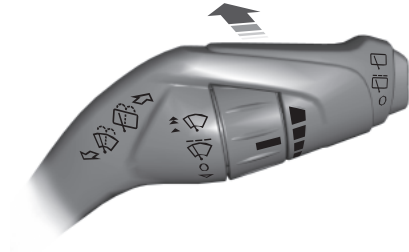

To use the rear washer function, push the lever away from you. When you release the lever, the wiper will operate for a short time.

HEADLAMP CONTROL

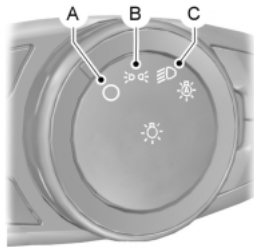

- A. Off
- B. Parking lamps, instrument panel lamps, license plate lamps and tail lamps
- C. Headlamps.

High beams

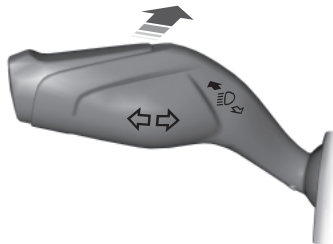

- Push the lever toward the instrument panel to activate.
- Push the lever toward the instrument panel again or pull the lever towards you to deactivate.

Flash-to-pass



Pull toward you slightly to activate and release to deactivate.

Autolamp control (if equipped)

Rotate the lighting control to  to turn the autolamps on.



The headlamps will switch on and off automatically in low light situations or during inclement weather.

The headlamps will remain on for a period of time after you switch the ignition off. You can adjust the time delay using the information display controls.

Note: It may be necessary to switch your headlamps on manually in severe weather conditions.

Note: If you switch autolamps on in conjunction with autowipers, low beam headlamps will illuminate automatically when the rain sensor activates the windshield wipers continuously.

Autolamp delay system (if equipped)

If your vehicle is equipped with autolamps, you can set the delay time to keep the headlights on for up to one minute after the key is turned off. The home light delay settings are adjusted through the message center in the instrument cluster. The default delay time from the factory is set to 20 seconds.

Note: The headlamps can be activated manually by pulling the high beam/flash-to-pass lever toward you. The headlamps are deactivated after 30 seconds or three minutes if any door is open.

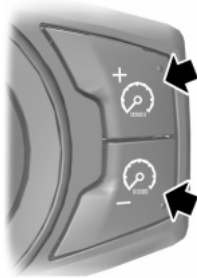
PANEL DIMMER CONTROL**With liftgate release:**

- Press repeatedly or press and hold until the desired level is reached.

**Without liftgate release:**

- Press the right control repeatedly to brighten incrementally or press and hold until the desired level is reached



- Press the left control repeatedly to dim incrementally or press and hold until the desired level is reached.

Note: If the low voltage battery under the hood is disconnected, discharged, or a new low voltage battery is installed, the dimmer will set the illuminated components to the maximum setting automatically. This will ensure that your displays are visible under all lighting conditions. The brightness can then be adjusted to the users preference.

HEADLAMP EXIT DELAY

With the ignition switch off, the headlamps can be activated manually by pulling the high beam/flash-to-pass lever toward you. You will hear a short tone. The headlamps will go off automatically after 3 minutes with any door open, or 30 seconds after the last door has been closed.

The home safe lights can be cancelled by either pulling the high beam/flash-to-pass indicator lever towards the steering wheel again or by turning the ignition switch ON.

DAYTIME RUNNING LAMPS (DRL) (IF EQUIPPED)

WARNING: Always remember to turn on your headlamps in low light situations or during inclement weather. The daytime running lamp system does not activate the tail lamps and may not provide adequate lighting during these conditions. Failure to activate your headlamps under these conditions may result in a collision.

To switch the Daytime Running Lamp system on:

1. Turn the ignition to the on position
2. Switch the lighting control to the off, autolamp or parking lamp position.

Vehicle With High Intensity Discharge Headlamps

The Daytime Running Lamp system switches the fog lamps on in day light conditions (Not available in all markets).

FRONT FOG LAMPS

Press the control to switch the fog lamps on or off.

You can switch the fog lamps on when the lighting control is in any position except off and the high beams are not on.

INTERIOR LAMPS

The lamps will switch on when one of the following conditions have been met:

- You open any door.
- You press a remote control button.
- You press switch D on the front interior lamp.

Note: Press switch C on the front interior lamp to switch the courtesy and door illumination function off when you open any door. The indicator lamp will illuminate yellow when the door function is off. When the door function is off and you open a door, the courtesy and door lamps will stay off.

Press switch C again to switch them back on. The indicator lamp will illuminate blue when the door function is on. When the door function is on and you open a door, the courtesy and door lamps will switch on.

Front Interior lamp (if equipped)

Note: Some interior lamps are equipped with a single switch for the left and right map lamps.

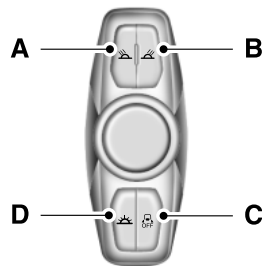

- A. Left map lamp switch, if equipped
- B. Right map lamp switch, if equipped
- C. Door function switch
- D. All lamps on and off switch

Front/Rear Interior lamp (if equipped)

Press switch A to switch individual map lamps on and off (if equipped).

Front dome/map lamp

A. Map lamp on and off switch

B. Door function switch

C. All lamps on and off switch

The dome lamp will turn on when:

- any door is opened.
- the remote control (keyfob) unlock button is pressed and the vehicle is off.
- you press switch C on the front interior lamp.

Press switch A to activate the map lamp(s).

Note: Press switch C on the front interior lamp to switch the courtesy and door illumination function off when you open any door. The indicator lamp will illuminate yellow when the door function is off. When the door function is off and you open a door, the courtesy and door lamps will stay off.

Press switch C again to switch them back on. The indicator lamp will illuminate blue when the door function is on. When the door function is on and you open a door, the courtesy and door lamps will switch on.

Rear dome/map lamp (if equipped)

Type A



The dome lamp will turn on when:

- any door is opened.
- any of the remote entry controls are pressed and the vehicle is off.
- all lamps on and off switch on the front dome/map lamp is pressed.

Press to manually turn on the map lamp(s) (if equipped).

Type B



The dome lamp will turn on when:

- any door is opened.
- any of the remote entry controls are pressed and the vehicle is off.
- all lamps on and off switch is pressed on the front dome/map lamp.

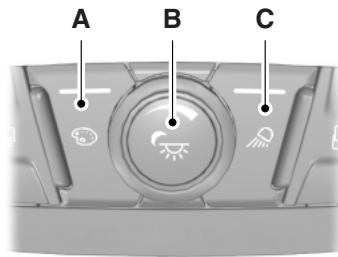
Ambient lighting (if equipped)

A. Color palette

B. Control knob

C. Search mode

- Rotate B to switch on and adjust to the desired brightness.
- Press A to cycle through the color choices.

- Press C to switch on all interior lamps and all ambient lighting. Press C again to switch off the interior lamps and return the ambient lighting to the previously selected color.

The ambient lighting will switch on when the following conditions have been met:

- you switch the ignition on
- you switch the headlamp to the parking lamp position

The ambient lighting will remain on until you switch the ignition off and one of the following conditions have been met:

- you lock your vehicle
- the accessory delay timer expires.

POWER WINDOWS

 **WARNING:** Do not leave children unattended in your vehicle and do not let them play with the power windows. They may seriously injure themselves.

 **WARNING:** When closing the power windows, you should verify they are free of obstructions and make sure that children and pets are not in the proximity of the window openings.

Note: You may hear a pulsing noise when just one of the windows is open. Lower the opposite window slightly to reduce this noise.

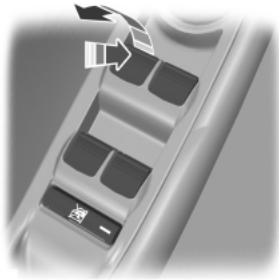

Press the switch to open the window.

Lift the switch to close the window.

One-Touch Down

Press the switch fully and release it. Press again or lift it to stop the window.

One-Touch Up

Lift the switch fully and release it. Press or lift it again to stop the window.

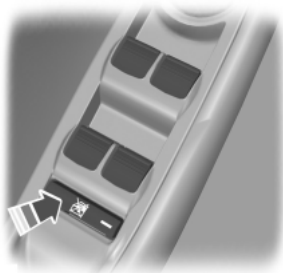
Window Lock

Press the control to lock or unlock the rear window controls. It illuminates when you lock the rear window controls.

Bounce-Back (If Equipped)

The window will stop automatically while closing. It will reverse some distance if there is an obstacle in the way.

Overriding the Bounce-Back Feature

WARNING: When you override the bounce-back feature the window will not reverse if it detects an obstacle. Take care when closing the windows to avoid personal injury or damage to your vehicle.

Proceed as follows to override this protection function when there is a resistance, for example in the winter:

1. Close the window twice until it reaches the resistance and let it reverse.
2. Close the window a third time to the resistance. The bounce-back function is disabled and you can close the window manually. The window will override the resistance and you can close it fully.

Contact your authorized dealer as soon as possible if the window does not close after the third attempt.

Resetting the Bounce-Back Feature

WARNING: The bounce-back function remains deactivated until you have reset the memory.

You must reset the bounce-back memory separately for each window after the battery has been disconnected.

1. Lift and hold the switch until the window is fully closed.
2. Release the switch.

3. Lift the switch again for one more second.
4. Press and hold the switch until the window is fully open.
5. Release the switch
6. Lift and hold the switch until the window is fully closed.
7. Open the window and then try to close it automatically.
8. Reset and repeat the procedure if the window does not close automatically.

Accessory Delay (If Equipped)

You can use the window switches for several minutes after the you switch the ignition off, or until you open either front door.

EXTERIOR MIRRORS

Power Exterior Mirrors

 **WARNING:** Do not adjust the mirror while your vehicle is in motion.

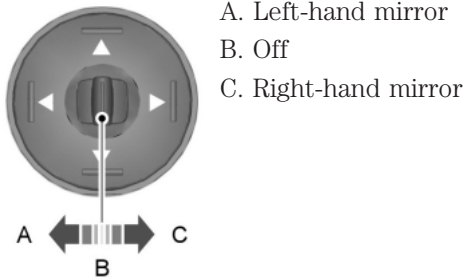

Press the arrows to adjust the mirror.

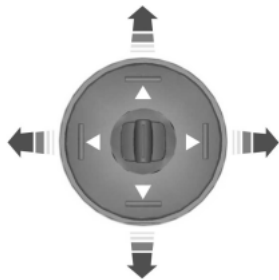

Foldaway Exterior Mirrors

Push the mirror toward the door window glass. Make sure that you fully engage the mirror in its support when returning it to its original position.

Signal Indicator Mirrors

The outer portion of the appropriate mirror housing blinks when you activate the turn signal.

Heated Exterior Mirror

The heated exterior mirrors switch on with the heated rear window. See *Heated Windows and Mirrors* in the *Climate Control* chapter.

Integrated Blind Spot Mirrors

WARNING: Objects in the blind spot mirror are closer than they appear.

Blind spot mirrors have an integrated convex mirror built into the upper outboard corner of the exterior mirrors. They are designed to assist you by increasing visibility along the side of your vehicle.

Check the main mirror first before a lane change, then check the blind spot mirror. If no vehicles are present in the blind spot mirror and the traffic in the adjacent lane is at a safe distance, signal that you are going to change lanes. Glance over your shoulder to verify traffic is clear, and carefully change lanes.

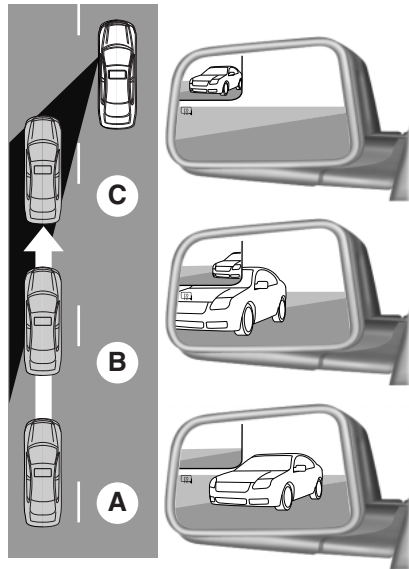

The image of the approaching vehicle is small and near the inboard edge of the main mirror when it is at a distance. The image becomes larger and begins to move outboard across the main mirror as the vehicle approaches (A). The image will transition from the main mirror and begin to appear in the blind spot mirror as the vehicle approaches (B). The vehicle will transition to your peripheral field of view as it leaves the blind spot mirror (C).

INTERIOR MIRROR



WARNING: Do not adjust the mirror when your vehicle is moving.

Note: Do not clean the housing or glass of any mirror with harsh abrasives, fuel or other petroleum or ammonia based cleaning products.

You can adjust the interior mirror to your preference. Some mirrors also have a second pivot point. This lets you move the mirror head up or down and from side to side.

Pull the tab below the mirror toward you to reduce glare at night.

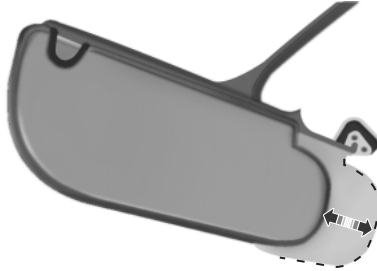
SUN VISORS**Slide-On-Rod (If Equipped)**

Rotate the visor toward the side window and extend it rearward for extra sunlight coverage.

Retract the visor before moving it back toward the windshield and storing it.

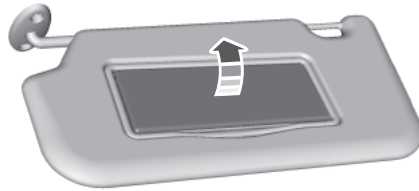
Illuminated Visor Vanity Mirror

Lift the cover to switch on the lamp.

GAUGES

Cluster shown in standard measure – metric clusters similar.

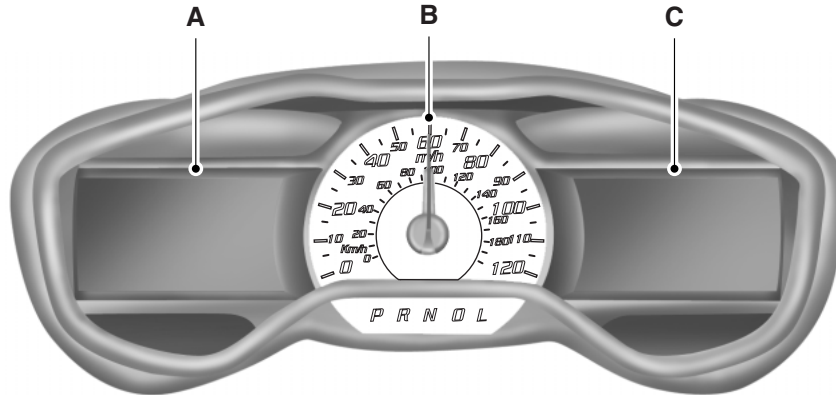

A. Left information display: See *Information Displays* for more information.

B. Speedometer

C. Right information display: See *MyTouch* for more information.

Common Displays

Note: Some features can be switched on and off through the message center.

Battery Gauge: The high voltage battery gauge appears on the right side of the message center screen. This provides State of Charge, Range Estimate and Regen Display.

- **State of Charge** - The state of charge for the high voltage battery is shown as a colored fill. The fill color is normally blue. When a low battery condition is reached the fill turns amber. When the battery is depleted the fill turns red. See the Information Messages section for details on associated Low Battery and Depleted Battery warnings.
- **Distance to Empty** - The Range Estimate in the Battery Gauge is personalized to the driver's key. This is the estimated distance the vehicle will travel before needing a recharge. The Range Estimate is based on your typical energy usage while driving. This includes your Drive Habits as well as your use of accessories such as Climate Control. Your Range Estimate may change immediately when you change your Climate Control settings.

- Regen Display - A circular arrow symbol appears in the center of the Battery Gauge when energy is being recaptured through the regenerative braking system.

Brake Coach Display: The Brake Coach appears after the vehicle has come to a stop. It coaches you to brake in a manner which maximizes the amount of energy returned through the regenerative braking system. The percent displayed is an indication of the regenerative braking efficiency with 100% representing the maximum amount of energy recovery. If desired, this feature can be disabled in the Display section of the Settings menu.

Trip Summary and Lifetime Summary: These will be displayed upon shutting off the vehicle. Trip Summary will appear first, then Lifetime Summary will be displayed. You can toggle between these displays using the up and down arrow keys on the left hand steering wheel controls.

Trip Summary data is from the last power cycle, while Lifetime Summary data is cumulative from the last Lifetime Summary reset done through the Settings menu in the message center.

Trip Summary:

- Distance - The total distance travelled, and regen distance are displayed. Regen distance is the estimated range gained from energy recaptured through regenerative braking.
- Energy Used - The total kilowatt hours and average watt hours per unit of distance are displayed. The average watt hours per mi (km) will be shown in blue if less than (better than) the lifetime average watt hours per mi (km).
- Brake Score - The percentage of braking energy recaptured and returned to the high voltage battery through regenerative braking. The brake score will be shown in blue if greater than (better than) the lifetime brake score.

Lifetime Summary:

- Distance - The total regen distance, which is the estimated range gained from energy recaptured through regenerative braking.
- Energy Used - The average watt hours per mi (km).
- Brake Score - The average percentage of braking energy recaptured and returned to the high voltage battery through regenerative braking.

WARNING LAMPS AND INDICATORS

These indicators can alert you to a vehicle condition that may become serious enough to cause expensive repairs. Many lights will illuminate when you start your vehicle to make sure they work. If any light remains on after starting the vehicle, refer to the respective system warning light for additional information.

Note: Some warning indicators are reconfigurable telltales (RTT). These indicators appear in the information display and function the same as a warning light, but do not display on startup.

Airbag readiness

If this light fails to illuminate when the ignition is turned on, continues to flash or remains on, contact your authorized dealer as soon as possible. A chime will sound when there is a malfunction in the indicator light.

Anti-lock brake system

If the ABS light stays illuminated or continues to flash, a malfunction has been detected. Contact your authorized dealer as soon as possible. Normal braking is still functional unless the brake warning light also is illuminated.

Brake system warning light

To confirm the brake system warning light is functional, it will momentarily illuminate when the vehicle is switched on, to accessory or Ready to Drive mode.

If it illuminates when you are driving, check that the parking brake is not engaged. If the parking brake is not engaged, this indicates low brake fluid level or a brake system malfunction. Have the system checked immediately by your authorized dealer.



WARNING: Driving a vehicle with the brake system warning light on is dangerous. A significant decrease in braking performance may occur. It will take you longer to stop the vehicle. Have the vehicle checked by your authorized dealer as soon as possible. Driving extended distances with the parking brake engaged can cause brake failure and the risk of personal injury.

Charging system (RTT)

Illuminates when the 12-volt battery is not charging properly. Contact your authorized dealer as soon as possible. This indicates a problem with the electrical system or a related component.

Door ajar (RTT)

Displays when the ignition is on and any door is not completely closed.

High beams

Illuminates when the high-beam headlamps are on.

High voltage battery low or depleted (RTT)

- Amber: Illuminates when the battery level is low. May also be accompanied by a message suggesting the driver reduce usage of the climate system.
- Red: Illuminates when the battery level is depleted. The vehicle must be charged before it will operate. If you are driving when this occurs, and cannot make it to a charge point, stop the vehicle in a safe place and have it towed to a charge point.

Liftgate ajar (RTT)

Displays when the ignition is on and liftgate is not completely closed.

Limited performance (RTT)

- Amber: Indicates limited vehicle performance due to a cold or hot battery. This will be accompanied by a corresponding message.
- Red: Indicates severely limited vehicle performance due to a cold or hot battery. This will be accompanied by a corresponding message. Drive with caution. Keep the vehicle plugged in when not in use to maintain battery temperature.

Low tire pressure warning

Illuminates when your tire pressure is low. If the light remains on at start up or while driving, the tire pressure should be checked. When the vehicle is first turned on, the light will illuminate for 3 seconds to ensure the bulb is working. If the light does not turn on or begins to flash, contact your authorized dealer as soon as possible.

Low washer fluid (RTT)

Illuminates when the windshield washer fluid is low.

Motor coolant overheat warning (RTT)

Illuminates when the motor cooling system is overheating. Stop the vehicle in a safe place and contact your authorized dealer.

Overdrive cancel and grade assist (if equipped)

Illuminates when the overdrive function of the transmission has been turned off and the grade assist function has been turned on.

Park lamps

Illuminates when the park lamps are on.

Powertrain malfunction/reduced power (RTT)

Illuminates when a powertrain or high-voltage charge system fault has been detected. If the indicator stays on or continues to come on, contact your authorized dealer as soon as possible.

Ready to drive

Illuminates once the vehicle has been switched on and is ready to drive. A corresponding message may display stating ready to drive or a message regarding budget if a charge point has not been entered.

Safety belt

Reminds you to fasten your safety belt. A Belt-Minder® chime will also sound to remind you to fasten your safety belt.

Speed control (if equipped) (RTT)

Illuminates when the speed control is activated. Turns off when the speed control system is deactivated.

Stability Control System

Displays when the AdvanceTrac®/Traction control is active. If the light remains on, have the system serviced immediately.

Stability Control System Off

Illuminates when AdvanceTrac®/Traction control has been disabled by the driver.

Stop safely (RTT)

Indicates electrical component fault/failure that will cause the vehicle to shutdown or enter into a limited operating mode. A message may also display.

If the indicator stays on or continues to come on, contact your authorized dealer as soon as possible

Turn signal

Illuminates when the left or right turn signal or the hazard warning flasher is turned on. If the indicators stay on or flash faster, check for a burned out bulb.

Vehicle plugged in (RTT)

Illuminates when the vehicle is plugged in. A corresponding message may display after attempting to start the vehicle.

AUDIBLE WARNINGS AND INDICATORS**Key In Ignition Warning Chime**

Sounds when the key is left in the ignition in the off or accessory position and the driver's door is opened.

Keyless Warning Alert (If Equipped)

Sounds when the keyless vehicle is in RUN and the driver's door is opened.

Headlamps On Warning Chime

Sounds when the headlamps or parking lamps are on, the ignition is off (the key is not in the ignition) and the driver's door is opened.

Parking Brake On Warning Chime

Sounds when you have left the parking brake on and drive your vehicle. If the warning chime remains on after you have released the parking brake, have the system checked by your authorized dealer immediately.

GENERAL INFORMATION

WARNING: Driving while distracted can result in loss of vehicle control, crash and injury. We strongly recommend that you use extreme caution when using any device that may take your focus off the road. Your primary responsibility is the safe operation of your vehicle. We recommend against the use of any handheld device while driving and encourage the use of voice-operated systems when possible. Make sure you are aware of all applicable local laws that may affect the use of electronic devices while driving..

Various systems on your vehicle can be controlled using the information display controls on the steering wheel. Corresponding information is displayed in the information display.

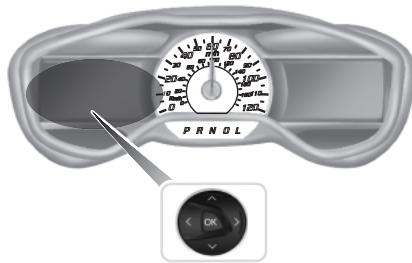
MESSAGE CENTER

- Press the up and down arrow buttons to scroll through and highlight the options within a menu.
- Press the right arrow button to enter a sub-menu.
- Press the left arrow button to exit a menu.
- Press the OK button to choose and confirm a setting/messages.

The arrows in the upper left corner of the display indicate additional content available when lit.

Main menu

From the main menu bar on the left side of the information display, you can choose from the following categories:

-  Display Mode
-  Trip 1 & 2
-  Energy
-  Information
-  Settings

Scroll up/down to highlight one of the categories, then press the right arrow key or OK to enter into that category. Press the left arrow key as needed to exit back to the main menu.

Display Mode

-  Use the arrow buttons to choose between the following display options.

Display Mode		
Budget Text View	Options	Budget Text / Help
Budget View	Options	Gauge Scale / Budget Text / Help
Range View	Options	Surplus Graphic / Budget Text / Help

Display Mode					
MyView	Options	Gauge Scale	—	—	
		Budget Text	—	—	
		Change MyView	Budget text only	Blank	
			Range View	Budget View	
			Range + Surplus	Budget + AVG.	
			Accessory Power	Accessory Power	
			Trip 1	Trip 1	
			Trip 2	Trip 2	
			Energy History	Energy Coach	
			Energy Coach	—	
		Help	—	—	

- Budget Text View: contains basic information to help you reach your next charging destination or to achieve your vehicle range estimate.

Charge pt: is the distance remaining to the next charge point you identified using the Navigation system.

Surplus: is the available range beyond your identified charge point (current Range Estimate shown on Battery Gauge minus Charge pt distance).

If you don't enter a charge point, you will see:

Budget: is set to the Range Estimate at the point of departure. This will count down with the odometer.

Status: is your performance against your Budget (current Range Estimate shown on Battery Gauge minus Budget distance). A positive Status indicates you are using less energy than typical and have extended your Range Estimate by the distance shown.

- Budget view: helps you manage your energy use.

Your current Energy Use is the white line that moves up and down in the Budget Gauge. A higher line means you are using more energy (lower is better). Your energy use includes input from the accelerator pedal as well as the accessories, such as Climate Control.

The Budget is shown by the blue cup shape around the Budget Gauge. As long as your current Energy Use is within the cup, you are staying within your budget. Your Budget represents the maximum energy usage you can maintain in order to achieve your vehicle range estimate, or reach your intended charge point. Driving for extended periods outside of the Budget Cup reduces your budget and could put you at risk of not reaching your intended charge point.

- Range view: shows your range relative to your charge point as well as performance to your budget.

A blue charge point icon means you have a Surplus. If an E appears to the left of an amber charge point icon, then you are projected to run out of charge prior to reaching your charge point.

Current performance to your budget is represented by the glow of the car icon: more Blue = better performance to budget, more Amber = worse.

The optional Surplus Graphic displays available range beyond your charge point.

If you didn't enter your charge point through the Navigation system, your budget will be set to the range estimate at the start of your trip. The gauge will show your estimated distance to E (empty) along with your current performance to budget. The optional Surplus Graphic is not available in this case.

- MyView: You can choose what to display in this view. Selecting Change MyView in the options menu allows you to use the right and left arrows to scroll through two columns of content choices. Once you have your desired content showing in each column, press OK to save. The content you select is saved to the current driver's key as MyView.

Accessory Power: Indicates electrical power demands from your vehicle's accessory systems. The gauge separately displays power demand in kilowatts (kW) for climate and other accessories.

Budget + Avg: The white pointers on the outside of the budget gauge indicate your average watt hours per mi (km) since you last charged your vehicle. Immediately after charging the white pointers will start out at the top of the gauge, as you begin driving they will reflect your average energy use.

Note: Trip data cannot be reset in MyView. You must reset Trip data from the main Trip 1 & 2 screens.

Trip 1 & 2



Use the arrow buttons to choose between the following.

Trip 1 & 2	Standard	Enhanced	Budget text
Trip distance	x	x	x
Elapsed trip time	x	x	x
XXX Wh/mi (km) – Energy used per unit of distance		x	
XX.X kWh –Energy used		x	
Budget Text			x
Total Odometer.	x	x	x
Press and hold OK to reset the currently displayed trip information.			

- Trip distance — shows the accumulated trip distance.
- Elapsed trip time — timer stops when the vehicle is turned off and restarts when the vehicle is restarted.
- XXX Wh/mi (km) — shows the average Energy (watt-hours) used per unit of distance for a given trip
- XX.X kWh — shows the total Energy (kilowatt-hours) used for a given trip.
- Budget Text — Shows the distance to your next charge point and the surplus distance available, or your budget and status if you didn't identify a charge point through the navigation system.
- Total Odometer — Displays the total distance the vehicle has traveled. This value can not be reset.

Energy



Use the arrow buttons to choose the desired energy display.

Energy		
Energy History	Options	Time intervals / Help
Energy Coach	Options	Help

- **Energy History:** This view from left to right starts with the Budget View gauge and adds historical Energy Use and Budget data. The data is represented as an average for time intervals of either 1, 2 or 6 minutes, with the leftmost interval being the most recent. Total time for the five intervals is shown at the bottom of the view. Interval time can be selected in the Options menu. Intervals shown in grey color are from the previous drive.
- **Energy Coach:** This view provides a comparison of your recent Acceleration, Braking and Cruising behavior to what is recommended for most efficient use of energy under present conditions. The horizontal bars fill from left to right with best efficiency (and Blue color) shown as at least half full. When the bars are less than half full, the color is Amber, suggesting that a change in behavior is needed to achieve better energy efficiency.

Information



In this mode, you can view different vehicle system information and perform a system check.

Warnings	
XX Warnings	Displays the number of warnings that need immediate attention in red. You can only view the warnings from the System Check menu. View them immediately by pressing OK and then OK again to enter system check. Use the up/down arrows to scroll through the warnings.

Tutorial	
Find Your Way	
Brake Coach	
Display Mode	
Trip 1 & 2	
Energy	
Surplus	
MyKey Info	
MyKeys (Number of MyKeys programmed)	
Admin Keys (Number of admin keys)	
MyKey Miles (km) (Distance traveled using a programmed MyKey)	
Driver Alert	
Displays the associated driver alert graphic.	
System Check	
All active warnings will display first if applicable. The system check menu may appear different based upon equipment options and current vehicle status. Use the up/down arrow buttons to scroll through the list.	

Settings



In this mode, you can configure different driver setting choices.

Note: Some items are optional and may not appear.

Driver Assist	
Traction Ctrl	On (default setting) / Off
Rear Park Aid	On (default on key cycle) / Off

Vehicle			
Lighting	Home Light	Manual or select time interval	
	Auto Light Rain	On / Off	
Remote Start	Climate Control (using this feature allows you to select different climate control modes when the vehicle is started using the remote start feature)	Heater – A/C	Auto / Last Settings
		Rear Defrost	Auto / Off
	Duration	5 / 10 /15 minutes	
	Quiet Start	On / Off	
	System	Enable / Disable	
Tire Mobility Kit	Expiration	Select number of years	

*MyKey	
Create MyKey	Hold OK to Create MyKey
Traction Control	Always On / User Selectable
Max Speed	Set to 80 MPH (130 km/h) / Off
Speed Minder	45 mph (72 km/h), 55 mph (89 km/h), 65 mph (105 km/h), Off
Volume Limiter	On / Off
Clear MyKeys	Hold OK to Clear All MyKeys

*Some MyKey items will only appear if a MyKey is set.

Display		
Language	Select the desired language	
Units	Distance	Select the desired units of measure
	Temperature	
Brake Coach	On / Off	
Regen Display	On / Off	
Lifetime Summary	Energy use, Regen Miles, Brake Score, Hold OK to Reset	

INFORMATION MESSAGES

Note: Depending on the vehicle options equipped with your vehicle, not all of the messages will display or be available. Certain messages may be abbreviated or shortened depending upon which cluster type you have.



Press the OK button to acknowledge and remove some messages from the information display. Other messages will be removed automatically after a short time. Certain messages need to be confirmed before you can access the menus.

Some messages will be supplemented by a system specific symbol with a message indicator.

AdvanceTrac Message	Action / Description
Service AdvanceTrac	Displayed when the system has detected a condition that requires service. Contact your authorized dealer as soon as possible.
Alarm Message	Action / Description
To Stop Alarm, Start Vehicle	Displayed when unauthorized entry into the vehicle has occurred. Turn the ignition on to stop the alarm.
Brake System Message	Action / Description
Brake Fluid Level LOW	Indicates the brake fluid level is low and the brake system should be inspected immediately.
Check Brake System	Displayed when the brake system needs servicing. If the warning stays on or continues to come on, contact your authorized dealer as soon as possible.

Brake System Message	Action / Description
Park Brake Engaged	Displayed when the parking brake is set, the vehicle is in ready to drive and the vehicle is driven more than 3 mph (5 km/h). If the warning stays on after the parking brake is released, contact your authorized dealer as soon as possible.
Charging and Electrical System Message	Action / Description
Elec system overvoltage Stop safely	Stop your vehicle as soon as it is safe to do so and switch off the ignition. Contact your authorized dealer.
Battery low Check handbook	Displays to warn of a low 12-volt battery condition. Turn off all unneeded electrical accessories. Contact your authorized dealer.
Low Battery	Displays when the estimated range is 10 mi (16 km) or 15 mi (24 km) for MyKey. The vehicle needs to be charged soon.
Low Battery Reduce climate use for more range	Displays when the estimated range is 10 mi (16 km) or 15 mi (24 km) for MyKey and the climate system is in use. Turn off unneeded climate system operation to increase vehicle range.
Depleted Battery Stop safely now	Displays when the estimated range is 0 mi (0 km). Stop the vehicle in a safe place. The vehicle must be charged.

Charging and Electrical System Message	Action / Description
Reduce Climate Use for More Range	Displays when high climate usage may make it difficult to stay within your energy budget.
Unplug Prior to Starting Vehicle	Displays when attempting to start the vehicle while plugged in.
Is Vehicle Plugged-in?	Displays when confirmation is needed that the vehicle is unplugged before a start is allowed. You must make sure the vehicle is unplugged and respond to the message prompt before starting your vehicle.
Limited Performance Due to cold battery	Displays when vehicle performance is affected by cold battery temperatures.
Severely Limited Performance Due to cold battery	Displays when vehicle performance is severely affected by cold battery temperatures. Drive with caution. Keep vehicle plugged in when not in use to maintain proper battery temperature.
Limited Performance Due to hot battery	Displays when vehicle performance is affected by hot battery temperatures.
Severely Limited Performance Due to hot battery	Displays when vehicle performance is severely affected by hot battery temperatures. Drive with caution. Keep vehicle plugged in when not in use to maintain proper battery temperature.

Charging and Electrical System Message	Action / Description
Approaching Range Limit To return Home	Displays when you have not specified a charge point through the vehicle Mytouch system and vehicle range will soon be less than what is needed to return Home. Your Home address must be specified through the vehicle Mytouch system to enable this feature.
Stop Safely Now	Displays when the stop safely hazard warning lamp is illuminated. This indicates an electrical component fault/failure that will cause the vehicle to shut down or enter into limited operating mode.
It's Hot Outside... Plug Vehicle in When Not in Use	Displays when the ambient temperature is hot. Plug in the vehicle to cool the high voltage battery for optimum performance.
It's Cold Outside... Plug Vehicle in When Not in Use	Displays when the ambient temperature is cold. Plug in the vehicle to warm the high voltage battery for optimum performance.
Ready to Drive	Displays when the vehicle is ready to drive.
Ready to Drive Budget set for xx mi (km)	Displays when the vehicle is ready to drive and you have not specified your next charge point through your vehicle navigation system. Your budget is set for the current vehicle range estimate.

Information Displays

Charging and Electrical System Message	Action / Description
Budget Set for xx mi (km)	Displays when your budget is reset because you have reached your charge point destination, or you no longer have a charge point destination identified through your vehicle navigation system. Your budget is set for the current vehicle range estimate.
Doors Message	Action / Description
X Door Ajar	Displays when the door listed is not completely closed.
Liftgate Ajar	Displays when the luggage compartment is not completely closed.
Hill Start Assist Message	Action / Description
Hill start assist not available	Displays when hill start assist is not available. Contact your authorized dealer.
Keyless Vehicle / Immobilizer Message	Action / Description
Starting System Fault	This message is displayed when there is a problem with your vehicle's starting system. See your authorized dealer for service.
Steering malfunction Service now	Contact your authorized dealer.
Steering malfunction Stop safely	Stop the vehicle in a safe place. Contact your authorized dealer.
Key Inside Vehicle	Displays to remind you that the key is in the luggage compartment. Refer to <i>Push button start system</i> in the <i>Driving</i> chapter for more information.

Keyless Vehicle / Immobilizer Message	Action / Description
Key Not Inside Car	Displays if the key is not detected by the system. Refer to <i>Push button start system</i> in the <i>Driving</i> chapter for more information.
No Key Detected	Displays if the key is not detected by the system. Refer to <i>Push button start system</i> in the <i>Driving</i> chapter for more information.
Accessory Power Active	Displayed when the vehicle is in the accessory ignition state.
Press Brake to Start	Displayed as a reminder to apply the brake as needed when starting.
Place Key in Backup Slot	Displayed as needed by the system for proper function.
Lighting Message	Action / Description
Brake lamp Bulb fault	Displays when the brake lamp bulb has burned out. Contact your authorized dealer.
Dipped beam Bulb fault	Displays when the low beam headlamp bulb has burned out. Contact your authorized dealer.
Headlamp malfunction Service req'd	Displays when an electrical system problem occurs with the headlamp system. Contact your authorized dealer.

Maintenance Message	Action / Description
Brake fluid level low Service now	Indicates the brake fluid level is low and the brake system should be inspected immediately. Refer to <i>Brake fluid</i> in the <i>Maintenance and Specifications</i> chapter. Contact your authorized dealer.
Brake system malfunction Stop safely	Displays when the brake system needs servicing. Stop the vehicle in a safe place. Contact your authorized dealer.
Washer fluid level low	Displays when the washer fluid is low and needs to be refilled. Refer to <i>Windshield washer fluid</i> in the <i>Maintenance and Specifications</i> chapter.
Motor Coolant Overtemperature	Displays when the motor electronics are overheating. Stop the vehicle as soon as safely possible, turn off the vehicle and let it cool. If the warning stays on or continues to come on, contact your authorized dealer as soon as possible.
See Manual	Indicates a powertrain or high-voltage charge system fault has been detected. If the indicator stays on or continues to come on, contact your authorized dealer as soon as possible.
Service Tire Mobility Kit	Displayed when the kit needs service. See your authorized dealer.

MyKey® Message	Action / Description
MyKey active Drive Safely	Displays when MyKey® is active.
Speed Limited to xx MPH/km/h	Displays when starting the vehicle and MyKey® is in use and the MyKey speed limit is on.
Near Vehicle Top Speed	Displays when a MyKey® is in use and the MyKey speed limit is on and the vehicle speed is approaching 80 mph (130 km/h).
Vehicle at Top Speed of MyKey Setting	Displays when a MyKey® is in use and the MyKey speed limit is on and the vehicle reaches 80 mph (130 km/h).
Check Speed Drive Safely	Displayed when a MyKey® is in use and the optional setting is on and the vehicle exceeds a preselected speed.
Buckle Up to Unmute Audio	Displays when a MyKey® is in use and Belt-Minder® is activated.
MyKey Park aid cannot be deactivated	Displays when a MyKey® is in use and park aid is activated.
Park Aid Message	Action / Description
Check Park Aid	Displayed when the transmission is in R (Reverse) and the park aid is disabled.
Rear Park Aid On Off	Displays the park aid status.

Information Displays

Power Steering Message	Action / Description
Service Power Steering	The power steering system has detected a condition that requires service. See your authorized dealer.
Service Power Steering Now	The power steering system has detected a condition within the power steering system that requires service immediately. See your authorized dealer.
Power Steering Assist Fault	The power steering system has disabled power steering assist due to a system error. See your authorized dealer.
Remote Start Message	Action / Description
Remote Start Active	Displayed when the remote start system is active.
Transmission Message	Action / Description
Transmission not in Park Select P	Displays as a reminder to shift into park.
Press brake pedal	Displays to request the operator to apply the brake as needed by the transmission.
To start press brake	Displays when starting the vehicle as a reminder to apply the brake.
Shift to Park	Displayed as a reminder to shift to park.

Tire Pressure Monitoring System (TPMS) Message	Action / Description
Low Tire Pressure	Displays when one or more tires on your vehicle have low tire pressure. Refer to <i>Inflating Your Tires</i> in the <i>Tires, Wheels and Loading</i> chapter.
Tire Pressure Monitor Fault	Displays when the tire pressure monitoring system is malfunctioning. If the warning stays on or continues to come on, contact your authorized dealer.
Tire Pressure Sensor Fault	Displays when a tire pressure sensor is malfunctioning, or your spare tire is in use. For more information on how the system operates under these conditions, refer to <i>Understanding Your Tire Pressure Monitoring System (TPMS)</i> in the <i>Tires, Wheels and Loading</i> chapter. If the warning stays on or continues to come on, contact your authorized dealer.

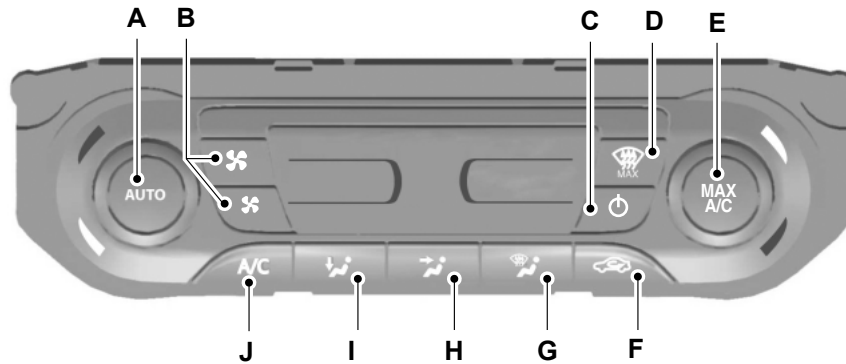
AUTOMATIC CLIMATE CONTROL

A. **AUTO:** Press to engage full automatic operation. Once you select your desired temperature using the temperature control, the system then automatically determines fan speed, airflow distribution, A/C on or off, and outside or recirculated air, to heat or cool the vehicle to reach and maintain the desired temperature.

B. **Fan speed:** Press the large fan icon to increase the fan speed; press the small fan icon to decrease the fan speed. Pressing one of the fan speed buttons while in AUTO takes the system out of AUTO fan mode.

C. **On and off button:** Press to turn the system on or off.

D. **MAX Defrost:** Distributes outside air through the windshield defroster vents and demister vents. You can use this mode to clear the windshield of fog and thin ice. Automatically turns on rear window defroster and heated mirrors. Press this button again to return to the previous airflow selection.

E. **MAX A/C:** Press to distribute recirculated air through the instrument panel vents to cool the vehicle. Air conditioning automatically turns on, the fan speed automatically adjusts to the highest speed and the temperature display returns to the full cool position. This re-cooling of the interior air is more economical and efficient than normal air conditioning. Recirculated air may help reduce undesirable odors from entering the vehicle.

F. **Recirculated air:** Press to turn air recirculation in cabin on or off. Recirculated air may reduce the amount of time to cool down the interior of the vehicle and may help reduce undesired odors from reaching the interior of the vehicle. Recirculated air engages automatically when you select MAX A/C, or manually in any airflow mode except defrost. Recirculated air may turn off automatically in all airflow modes except MAX A/C to reduce fog potential.

G. **Defrost:** Distributes air through the windshield defroster vents and demister vents. The system automatically provides outside air to reduce window fogging. Press again to turn off defrost mode.

H. **Instrument panel:** Press to distribute air through the instrument panel vents. Press again to turn off panel mode.

I. **Floor:** Distributes air through the demister vents and front and rear seat floor vents. Press again to turn off floor mode.

J. **A/C:** Press to turn air conditioning on or off. Use with recirculated air to improve cooling performance and efficiency. Air conditioning also engages automatically in some modes.

Temperature Control

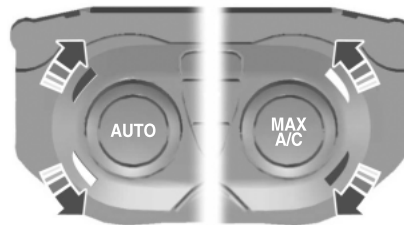

You can set the temperature between 60°F (15.5°C) and 85°F (29.5°C) in steps of 1°F (0.5°C). In position **LO**, 59°F (15°C), the system switches to permanent cooling. In position **HI**, 86°F (30°C), the system switches to permanent heating.

Single Zone Temperature Control

In this mode, the climate control system links the temperature settings for both the driver's side and passenger's side. If you adjust the setting using the rotary control on the driver's side, the system adjusts the temperature to the same setting on the passenger's side.

Dual Zone Temperature Control

Select a temperature for the passenger's side using the rotary control on the passenger's side. Single zone temperature control automatically switches off. The temperature on the driver's side remains unchanged. You can now adjust the driver's side and passenger's side temperatures independently. The display shows the temperature settings for each side.

Switching Back to Single Zone Temperature Control

Press and hold **AUTO** for 2-4 seconds. The passenger's side temperature switches to the driver's side temperature setting.

HINTS ON CONTROLLING THE INTERIOR CLIMATE

- To reduce fog build-up on the windshield during humid weather, select defrost.
- To reduce humidity build-up inside the vehicle, avoid driving with the system switched off unless you can open a window to help circulate fresh air.
- Do not put objects under the front seats that will interfere with the airflow to the back seats.
- Remove any snow, ice or leaves from the air intake area at the base of the windshield.
- To improve the air conditioning cool down, drive with the windows open for approximately 2–3 minutes after starting the vehicle or until the vehicle has “aired out.”
- The air conditioning system cools both the interior of the vehicle and the high voltage battery. In hot outside temperatures, the interior temperature may temporarily increase if the high voltage battery requires cooling. Keep the vehicle plugged in (when possible) to allow automatic battery cooling in high temperature conditions.
- An electrical heater warms the interior. Set the fan at a lower speed to get a warmer outlet temperature on cold days.
- You may feel a small amount of air from the floor vent regardless of the air distribution setting.

Maximum Cooling Performance

Press **MAX A/C**. The system defaults to single zone operation and the coldest temperature setting. **LO** appears in the display. Air conditioning and recirculated air are on and fan speed increases to the highest speed. You can adjust the fan speed while in this mode.

Side Window Defogging or Defrosting

1. Select air distribution through the floor vent.



2. Select air distribution through the panel vent.

3. Select **A/C**.

4. Adjust the temperature control to maintain comfort.

5. Set the fan to the highest speed.

6. Direct the outer instrument panel vents toward the side windows.

To increase airflow to the outer instrument panel vents, close the vents located in the middle of the instrument panel.

Improving Vehicle Drive Range

Your vehicle is equipped with a high voltage electric compressor and a high voltage electric heater. You can increase your driving range by minimizing the amount of energy expended to cool or heat the interior during the drive.

- Pre-condition the interior temperature during vehicle charging reduces the battery energy use on the interior comfort and improves range. See *Convenience charging with MyFord mobile* in the *Charging Your High Voltage Battery* chapter. **Note:** Your vehicle may not always reach the set cabin temperature due to charging and ambient temperature conditions.
- Hot and cold temperatures make your vehicle use more energy to achieve and maintain a comfortable interior temperature. Park the vehicle in the shade or in a parking structure when hot, and in a garage when cold.
- Consider partially opening a window (or windows) to let fresh air circulate, if weather conditions permit. You can achieve maximum energy savings by switching the climate system off. Do this only if conditions exist for safe vehicle operation.
- Reduce fan speed.
- Set the AUTO temperature a couple degrees cooler than you normally do on cold days and a couple degrees higher on hot days. Use the heated seats on cold days to increase interior comfort.
- Switch the air conditioning off in mild temperatures or low humidity conditions.

- Defrost mode automatically turns the air conditioning on to dehumidify the air, and cannot be switched off. If defogging or defrosting is not necessary, select a non-defrost mode and disengage air conditioning to extend vehicle range.
- Air conditioning and heating functions are automatically switched off (unless in defrost mode) when driving distance to empty is zero miles (zero km). The interior fan continues to operate, however.

HEATED WINDOWS AND MIRRORS

Rear Window Defroster

Note: The vehicle must be in Ready to Drive for this feature to work.

The rear window defroster control is located on the climate control panel and works to clear the rear window of fog and thin ice.

Press  to turn the rear window defroster on. An indicator light on the control will illuminate when active. The rear window defroster turns off automatically after a predetermined amount of time, if the system detects a low battery condition or when you turn the ignition off or to the accessory position. You can turn off the rear window defroster manually, at any time, by pressing the control again.

If your vehicle is equipped with both rear defroster and heated mirrors, the same control will activate both. Refer to *Heated outside mirrors* in the *Driver Controls* chapter.

Do not use razor blades or other sharp objects to clean the inside of the rear window or to remove decals from the inside of the rear window. This may cause damage to the heated grid lines. Your warranty does not cover this damage.

Heated Exterior Mirror

Note: Do not remove ice from the mirrors with a scraper or attempt to readjust the mirror glass that has frozen in place. These actions could cause damage to the glass and mirrors.

Note: Do not clean the housing or glass of any mirror with harsh abrasives, fuel or other petroleum-based cleaning products.

Both mirrors heat to remove ice, mist and fog when you turn the rear window defroster on.

CABIN AIR FILTER

Note: Make sure you have a cabin air filter installed at all times. This prevents foreign objects from entering the system. Running the system without a filter in place could result in degradation or damage to the system.

Your cabin air filter is located under the instrument panel in the passenger footwell area. The particulate filtration system reduces the concentration of airborne particles such as dust, spores and pollen in the air supplied to the interior of your vehicle. The particulate filtration system gives you and your passengers the following benefits:

- It improves your driving comfort by reducing particle concentration.
- It improves the interior compartment cleanliness.
- It protects the climate control components from particle deposits.

Replace the filter at regular intervals. See the *Scheduled Maintenance* chapter.

For more information about your filter, see an authorized dealer.

REMOTE START CLIMATE OPERATION

The climate control system adjusts the cabin temperature during remote start.

You cannot adjust the system during remote start operation. Turn the ignition on to return the system to its previous settings. You can now make adjustments. You will need to turn certain vehicle-dependent features back on, such as:

- heated seats
- heated mirrors
- heated rear window.

You can adjust the settings using the information display controls. See the *Information Displays* chapter.

Automatic Climate Systems***Automatic Settings***

You can set the climate control to operate in AUTO mode through the information display setting: Remote Start > Climate Control > Heater – A/C > Auto. The climate control system automatically sets the interior temperature to 72°F (22°C).

In hot weather, the system is set to 72°F (22°C).

In moderate weather, the system either heats or cools (based on previous settings). The rear defroster, heated mirrors and heated seats do not automatically turn on.

In cold weather, the system is set to 72°F (22°C). The rear defroster and heated mirrors automatically turn on.

Last Settings

You can set the climate control to operate using the last climate control settings through the information display setting: Remote Start > Climate Control > Heater – A/C > Last Settings. The climate control system automatically uses the settings last selected before you turned off the vehicle.

Heated and Cooled Devices

The climate control system controls other heated and cooled devices inside the vehicle. You can switch these devices on (if available, and selected to **AUTO** in the information displays) during remote start. Heated devices usually switch on during cold weather, and cooled devices during hot weather.

SITTING IN THE CORRECT POSITION

 **WARNING:** Sitting improperly out of position or with the seat back reclined too far can take off weight from the seat cushion and affect the decision of the passenger sensing system, resulting in serious injury or death in a crash. Always sit upright against your seat back, with your feet on the floor.

 **WARNING:** Do not recline the seat back as this can cause the occupant to slide under the seat's safety belt, resulting in severe personal injury in the event of a crash.

 **WARNING:** Do not place objects higher than the seat backs to reduce the risk of injury in a crash or during heavy braking or when stopping suddenly.

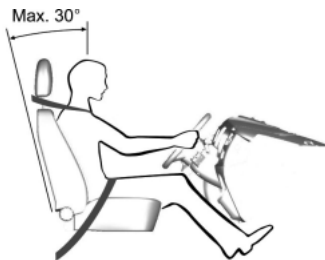

When you use them properly, the seat, head restraint, safety belt and airbags will provide optimum protection in the event of a crash.

We recommend that you follow these guidelines:

- Do not recline the seat back more than 30 degrees from vertical.
- Sit in an upright position with the base of your spine as far back as possible.
- Adjust the head restraint so that the top of it is level with the top of your head and as far forward as possible, remaining comfortable.
- Keep sufficient distance between yourself and the steering wheel. We recommend a minimum of 10 inches (250 millimeters) between your breastbone and the airbag cover.

- Hold the steering wheel with your arms slightly bent.
- Bend your legs slightly so that you can press the pedals fully.
- Position the shoulder strap of the safety belt over the center of your shoulder and position the lap strap tightly across your hips.

Make sure that your driving position is comfortable and that you can maintain full control of your vehicle.

HEAD RESTRAINTS



WARNING: To minimize the risk of neck injury in the event of a crash, the driver and passenger occupants should not sit in or operate the vehicle, until the head restraint is placed in its proper position. The driver should never adjust the head restraint while the vehicle is in motion.



WARNING: The adjustable head restraint is a safety device. Whenever possible, it should be installed and properly adjusted when the seat is occupied.



WARNING: Install the head restraint properly to minimize the risk of neck injury in the event of a crash.

Note: Adjust the seat back to an upright driving position before adjusting any head restraint. Adjust the head restraint so that the top of it is level with the top of your head and as far forward as possible, remaining comfortable. For occupants of extremely tall stature, adjust the head restraint to its highest position.

Front Seat Head Restraints

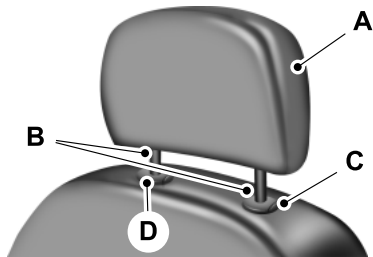

Rear Seat Outboard Head Restraints

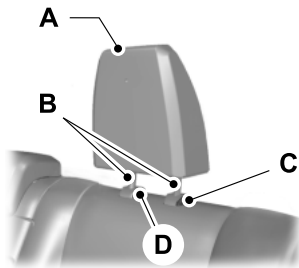

Rear Seat Center Head Restraints

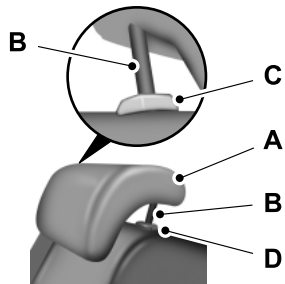

- The head restraints consist of:
- A. An energy absorbing head restraint
 - B. Two steel stems
 - C. Guide sleeve adjust and release button
 - D. Guide sleeve unlock and remove button

Adjusting the Head Restraint

Raise: Pull up the head restraint.

Lower:

1. Press and hold button C.
2. Push the head restraint down.

Remove:

1. Pull up the head restraint until it reaches the highest adjustment position.
2. Press and hold buttons C and D.
3. Pull the head restraint up.

Note: For the front head restraints, you may need to use a key or similar object to release the head restraint. Press the key into the guide sleeve unlock and remove button to release the head restraint.

Install: Align the steel stems into the guide sleeves and push the head restraint down until it locks. Make sure the front of the head restraint faces the front of the vehicle.

Tilting Head Restraints (If Equipped)

The front head restraints may have a tilting feature for extra comfort. To tilt the head restraint, do the following:





1. Adjust the seat back to an upright driving or riding position.
2. Tilt the head restraint forward by gently pulling the top of the head restraint.

Once it is in its forward-most position, tilt it forward once more to release it to the upright position.

Note: Do not attempt to force the head restraint backward after it is tilted. Instead, continue tilting it forward until the head restraint releases to the upright position.

MANUAL SEATS

 **WARNING:** Never adjust the driver's seat or seatback when the vehicle is moving.

 **WARNING:** Rock the seat backward and forward after releasing the lever to make sure that it is fully engaged.

Moving the Seat Backward and Forward

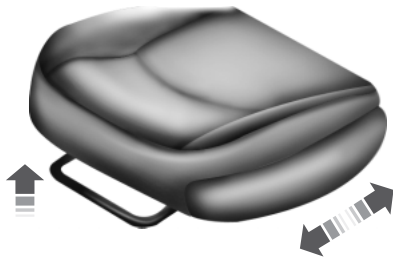

Adjust the Height of the Driver's Seat

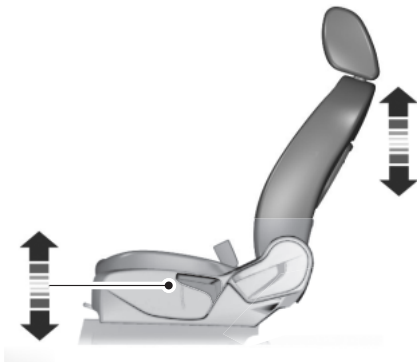

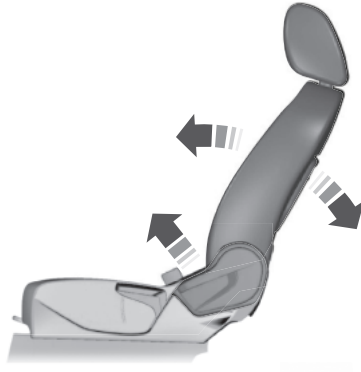
Recline Adjustment

 **WARNING:** Reclining the seatback can cause an occupant to slide under the seat's safety belt, resulting in severe personal injuries in the event of a crash.

POWER SEATS (IF EQUIPPED)

 **WARNING:** Never adjust the driver's seat or seatback when the vehicle is moving.

 **WARNING:** Reclining the seatback can cause an occupant to slide under the seat's safety belt, resulting in severe personal injuries in the event of a crash.

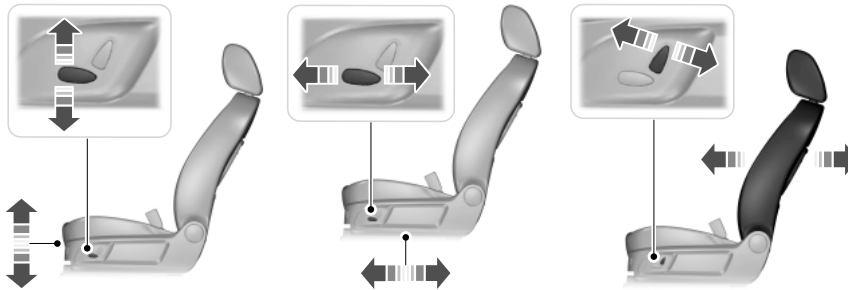

Lumbar Adjustment (If Equipped)

Use the lever located on the side of the seatback to adjust the lumbar.



HEATED SEATS (IF EQUIPPED)

WARNING: Persons who are unable to feel pain to the skin because of advanced age, chronic illness, diabetes, spinal cord injury, medication, alcohol use, exhaustion, or other physical conditions, must exercise care when using the seat heater. The seat heater may cause burns even at low temperatures, especially if used for long periods of time. Do not place anything on the seat that insulates against heat, such as a blanket or cushion, because this may cause the seat heater to overheat. Do not puncture the seat with pins, needles, or other pointed objects because this may damage the heating element which may cause the seat heater to overheat. An overheated seat may cause serious personal injury.

Note: Do not do the following:

- Place heavy objects on the seat
- Operate the seat heater if water or any other liquid is spilled on the seat. Allow the seat to dry thoroughly.
- Operate the heated seats unless the vehicle is running. Doing so could drain the vehicle's battery.



Adjust the control to the desired heat setting.

REAR SEATS

Folding the Rear Seats

Note: Before lowering the seatback(s), remove the outboard head restraints.

To lower the seatback(s) from inside the vehicle, do the following:

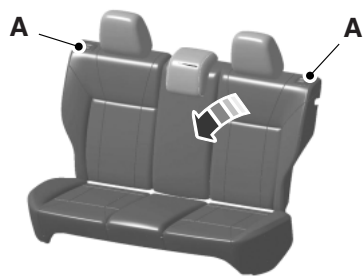

1. Press the unlock buttons (A) down.
2. Push the seatback forward.

Note: Your vehicle may have split seatbacks that must be folded individually.



3. Stow the safety belt in the belt stowage clip. This will prevent the safety belt from getting caught in the seat latch.

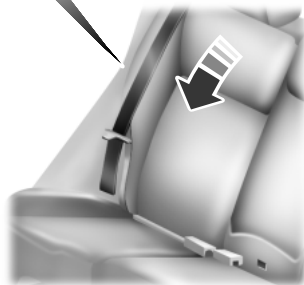

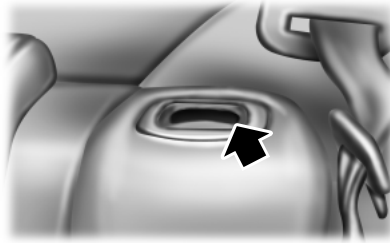

When raising the seatback(s), make sure you hear the seat latch into place and that no red portion is visible on the release button on both sides.

Flip Up Seat Cushions (If Equipped)

 **WARNING:** Before returning the seatback to its original position, make sure that cargo or any objects are not trapped behind the seatback. Make sure that the safety belt is not laying on the seat latch. After returning the seatback to its original position, pull on the seatback to make sure that it has fully latched. An unlatched seat may become dangerous in the event of a sudden stop or crash.

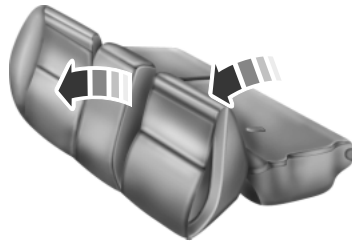

For additional cargo space, flip the seat cushions up before folding the seatback. This feature is only available on vehicles with a split folding seatback.

AUXILIARY POWER POINTS



WARNING: Do not plug optional electrical accessories into the cigarette lighter socket (if equipped). Improper use of the lighter can cause damage not covered by your warranty, and can result in fire or serious injury.

Note: If used when the vehicle is not running, the battery will discharge. There may be insufficient power to restart your vehicle.

Note: Do not insert objects other than an accessory plug into the power point. This will damage the outlet and blow the fuse.

Note: Do not hang any type of accessory or accessory bracket from the plug.

Note: Do not use the power point over the vehicle capacity of 12 volts DC 180 watts or a fuse may blow.

Note: Do not use the power point for operating a cigarette lighter element.

Note: Improper use of the power point can cause damage not covered by your warranty.

Note: Always keep the power point caps closed when not in use.

Run the vehicle for full capacity use of the power point. To prevent the battery from being discharged:

- Do not use the power point longer than necessary when the vehicle is not running.
- Do not leave devices plugged in overnight or when the vehicle is parked for extended periods.

Locations

Power points may be found:

- on the center console
- on the rear of the center console.

CENTER CONSOLE

Stow items in the cupholder carefully as items may become loose during hard braking, acceleration or collisions, including hot drinks which may spill.

Available console features include:

- Cupholders
- Utility compartment
- Auxiliary AV connections, USB port, SD slot

OVERHEAD CONSOLE (IF EQUIPPED)

The appearance of the overhead console will vary according to your option package.



Press near the rear edge of the door to open it.

GENERAL INFORMATION

The powertrain control system meets all Canadian interference-causing equipment standard requirements regulating the impulse electrical field or radio noise.

KEYLESS STARTING

Note: The keyless starting system may not function if the key is close to metal objects or electronic devices such as cellular phones.

Note: A valid key must be located inside your vehicle to switch the ignition on and start the vehicle.

Note: When locking your vehicle, any remote controls left inside the vehicle may become disabled. A message may appear in the information display indicating that there is no key detected if you try to start the vehicle. Press the unlock button on the remote control to enable it, and then start the vehicle.

Ignition Modes

Off: Turns the ignition off.

- Without applying the brake pedal, press and release the button once when the ignition is in the on mode, or when the vehicle is on but not moving.

On: All electrical circuits are operational. Warning lamps and indicators are illuminated.

- Without applying the brake pedal, press and release the button once from off mode.

Start: Starts the vehicle.

- Press the brake pedal, and then press the button for a couple seconds. The green Ready to Drive indicator light appears in the instrument cluster when the vehicle is ready for driving.

140 Starting and Stopping the Vehicle

STARTING YOUR VEHICLE

Before starting the vehicle, check the following:

- Make sure all occupants have fastened their safety belts.
- Make sure the headlamps and electrical accessories are off.
- Make sure the parking brake is on.
- Move the transmission selector lever to position **P**.

Note: Do not touch the accelerator pedal.

1. Fully press the brake pedal.
2. Press the button.

The system does not function if:

- The key frequencies are jammed.
- The key battery has no charge.

If you are unable to start your vehicle, do the following:

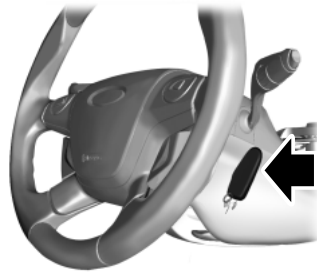

1. Hold the key next to the cap on the steering column as shown.
2. With the key in this position, press the brake pedal, then the button to switch the ignition on and start your vehicle.

Fast Restart

The fast restart feature allows you to restart the vehicle within 10 seconds of switching it off, even if a valid key is not present.

Within 10 seconds of switching the vehicle off, press the brake pedal and press the button. After 10 seconds have expired, you can no longer start the vehicle without the key present inside your vehicle.

Once the vehicle has started, it remains running until you press the button, even if the system does not detect a valid key. If you open and close a door while the vehicle is running, the system searches for a valid key. You cannot start the vehicle if the system does not detect a valid key within 10 seconds.

Stopping the Electric Vehicle's Motor When the Vehicle Is Stationary

1. Move the transmission selector lever to position **P**.
2. Press the button once.
3. Apply the parking brake.

Note: This switches off the ignition, all electrical circuits, warning lamps and indicators.

Stopping the Electric Vehicle's Motor When the Vehicle Is Moving



WARNING: Switching off the vehicle when it is still moving will result in a loss of brake and steering assistance. The steering will not lock, but higher effort will be required. When the ignition is switched off, some electrical circuits, warning lamps and indicators may also be off.

1. Move the transmission selector lever to position **N** and use the brakes to bring your vehicle to a safe stop.
2. When your vehicle has stopped, move the transmission selector lever to position **P**.
3. Switch the ignition off by pressing and holding the button for one second, or pressing it three times within two seconds.
4. Apply the parking brake.

HIGH-VOLTAGE BATTERY

WARNING: This battery pack should only be serviced by an authorized electric vehicle technician. Improper handling can result in personal injury or death.

Your vehicle consists of various high-voltage components and wiring. All of the high-voltage power flows through specific wiring assemblies which are labeled as such and/or are covered with a solid orange convolute or orange striped tape. Do not come in contact with these components.

No regular maintenance, other than regular charging is required.

The high-voltage battery system is a high-voltage, lightweight lithium-ion battery system comprised of two individual packs. One pack is located in the rear cargo area behind the second row seats, and the other is located underneath the vehicle. The high-voltage battery system uses an advanced, active liquid heating and cooling system to regulate high-voltage battery temperature and help maximize high-voltage battery life.

Note: The lithium-ion, high-voltage battery will experience gradual capacity loss with time and use, which is considered normal wear and tear.

CHARGING THE HIGH-VOLTAGE BATTERY

WARNING: Do not use the 120 volt convenience cord with an extension cord or adapter.



WARNING: In Canada, do not use the 120 volt convenience cord in commercial garages.



WARNING: This equipment has arcing or sparking parts that should not be exposed to flammable vapors. This equipment should be located at least 18 inches (80 mm) above the floor.

Charging Equipment

Note: Your vehicle comes equipped with a standard 120 volt convenience cord located in your trunk storage compartment underneath the carpeted panel. This allows you to charge the battery using a standard 120 volt household outlet. Using the standard 120 volt convenience cord takes up to 18–20 hours to completely charge from an empty battery.



Ford recommends upgrading to the optional 240 volt charging station for faster more efficient charging. Use of a 240 volt charging station will take approximately 4 hours to fully charge a empty battery.

Note: Your electrical source must meet certain requirements for the high-voltage battery to charge. The AC outlet must be a three-prong 110-120 volt AC outlet that is properly grounded, 15–20 amps (or greater), and in good condition. The line also must be dedicated, which means that no other appliances should be connected to the same circuit. If a dedicated circuit is not used, the circuit breaker could trip or open. If a dedicated circuit is not available, contact a licensed professional electrician for proper installation.

Note: The vehicle must be in (P) park to charge the high-voltage battery.



Make sure that the 120 volt convenience cord is completely unwound before charging. Always plug the cord into the AC outlet before connecting the charging coupler into the vehicle's charge port receptacle. The 120 volt convenience cord inline control box has three indicator lights that represent the charging status; power, charge and fault.

Power (green light) — this indicator lights up when the cord is plugged into the AC wall outlet.

Charge (green light) — Indicates status of charging:

- No light means the cord is not connected to the vehicle.
- Blinking light means that the charging is in process.
- Solid light means that the vehicle is connected but not charging.

Fault (red triangle light) — Lights up in case of a detected failure. No charging is possible:

- Blinking red triangle light – means that the 120 volt convenience cord is trying to reset the failure and could restart the charging cycle.
- Solid red triangle light – means that the fault is permanent. The cord needs to be unplugged and re-plugged to reset the fault. If the fault persists, contact your authorized dealer.

Charge Port and Light Ring

The charge port is located between the front left side door and front left wheel well. There is an indentation located on the charge port door. Press with your thumb to open and to close the door.

Note: Do not force the charge port door open or closed. Forcing the door open or closed will damage the charge port.

The light ring located around the charge port indicates the charge status of your vehicles battery. The charge port light ring is divided into four quadrants which display state of charge in 25 percent increments.

There is a cord acknowledgement feature that will be activated when a charge cycle is initiated. The four light quadrants will each individually flash clockwise starting with the top right light and ending with the top left, two full times confirming a charging coupler has been detected.

You can use your keyfob to view the vehicles charge status at any time by pressing the unlock button. The light ring will light up the corresponding quadrant(s) so that the current state of charge can be determined. If the charge is below 25 percent the light ring will not illuminate. Don't forget to press the lock button on your keyfob to re-lock the vehicle.

The light ring will also display the current state of charge when opening the doors.

**Charging**

Note: The vehicle must be in (P) Park to charge.

To charge your high-voltage battery:

1. Put the vehicle in (P) park and power down the vehicle.
2. With your thumb, press the indentation located on the charge port door and the door will rotate open.
3. Plug the charging coupler into the vehicles charge port receptacle and make sure the button “clicks” confirming that it is completely engaged.
4. Verify that the cord acknowledgement feature activates. This indicates the beginning of a normal charge cycle.
5. If using a 240 volt charging station, follow the instructions on the charge station to begin the charging process.

When charging, the light ring will display how far along the charge is:

- When the top right quadrant is pulsing the charge is between 0–25 percent.
- When the top right quadrant is solidly lit and the bottom right quadrant is pulsing the charge is between 25–50 percent.
- When both right side quadrants are solidly lit and the bottom left quadrant is pulsing the charge is between 50–75 percent.
- When three quadrants are solidly lit and the top left quadrant is pulsing the charge is between 75–100 percent.
- When the entire ring is solidly lit, the charge is complete.

Note: The ring will shut off one minute after reaching a full charge.

Note: If a vehicle charging system fault is detected at any point in a charge cycle the entire light ring will flash continuously for one minute and then shut off. If this happens unplug, and then re-plug the charging coupler into the charge port receptacle. If the problem persists contact your authorized dealer.

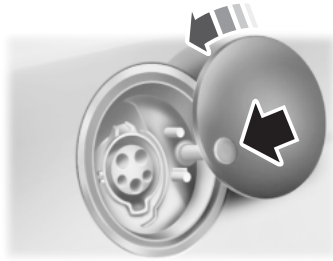

Note: Do not pull the wall plug from the wall while the vehicle is charging. Doing so may damage the outlet and the cord.

To disconnect the charging coupler:

1. Press the button on the charging coupler.
2. While holding the button, remove the charging coupler from the vehicle's charge port receptacle.

3. Close the charge port door by pressing the indentation on the charge port door. Continue pressing the indentation while the door rotates counter clockwise and closes.

Waiting to Charge

Note: See *Charge Settings* in the *MyFord Touch* Chapter for more information.

When Value Charge has been selected charging may not begin upon plugging in. The vehicle may delay charging to take advantage of off-peak electricity rates. The vehicle will optimize the charge schedule to be complete by the next GO Time.

When waiting to charge (not actively charging), the light ring will indicate the present state of charge of the high voltage battery as follows:

- When the top right quadrant is shut off the charge is between 0–25 percent.
- When the top right quadrant is solidly lit and the bottom right quadrant is shut off the charge is between 25–50 percent.
- When both right side quadrants are solidly lit and the bottom left quadrant is shut off the charge is between 50–75 percent.
- When three quadrants are solidly lit and the top left quadrant is shut off the charge is between 75–100 percent.
- When the entire ring is solidly lit, the charge is 100 percent.

Note: When the vehicle is Waiting to Charge the light ring will shut off one minute after displaying the present state of charge. When the vehicle automatically begins charging the light ring will turn on and display how far along the charge is per the section above.

Note: If a vehicle charging system fault is detected at any point in a charge cycle the entire light ring will flash continuously for one minute and then shut off. If this happens unplug, and then re-plug the charging coupler into the charge port receptacle. If the problem persists contact your authorized dealer.

The light ring illumination conditions can be modified. See the *Charge Port Light Ring Settings* in the *MyFord Touch* chapter.

Disconnecting the Charging Coupler

Note: Do not pull the wall plug from the wall while the vehicle is charging. Doing so may damage the outlet and the cord.

To disconnect the charging coupler:

1. Press the button on the charging coupler with your thumb.
2. While holding the button, remove the charging coupler from the vehicle's charge port receptacle.
3. Close the charge port door by pressing the indentation on the charge port door. Continue pressing the indentation while the door rotates counter clockwise and closes.

Convenience Charging and MyFord® Mobile

The setting up of the charging convenience features is primarily done with the MyFord Mobile smart phone application. Visit myfordmobile.com for more complete information and to set up your MyFord Mobile account.

Your electric vehicle also has some convenience features to improve your charging experience:

- **Value Charge:** The vehicle schedules charging at the lowest available utility rates. Contact your utility company to see what rates are available.
- **Charge Now:** Fully charge your vehicle at the quickest rate. The vehicle starts charging immediately after you connect the charging plug into the vehicle.
- **My GO Time:** Setting My GO times through the MyFord Mobile application allows you to set charging schedules and cabin preconditioning settings so your vehicle is ready to drive when you are. By setting a My GO time the vehicles charge can be completed before your next set drive time. A calendar view allows you to program two My GO Times per day for each of the seven days of the week. Remember, your vehicle must be plugged in for My GO time to work.

- **Cabin Preconditioning:** Get the most miles out of every charge by preconditioning your vehicle while it's still plugged in and charging. Use your smart phone to set the cabin temperature and departure time before you leave so you use energy from your home wall outlet instead of your battery to heat or cool your vehicle.

HIGH-VOLTAGE SERVICE DISCONNECT

The high-voltage service disconnect shuts off power from the high-voltage battery.

Disabling the High-Voltage Battery

Note: There are two disconnect circuits in your vehicle. Disconnecting one circuit will automatically disable the high-voltage battery.

To disable the high-voltage battery and stop all high-voltage electric activity in the vehicle you can access one or both of the two high-voltage disconnect circuits. To do this, you must unplug one of the circuits from the circuit ports connected to the battery.

The lower battery high-voltage disconnect circuit is located by the right rear wheel, accessible from under the car.

The upper battery high-voltage disconnect circuit is located behind the rear fold-down seats near the left side of the vehicle, and is more easily accessible than the lower battery circuit. To access this circuit:

1. Fold down the left rear seat.

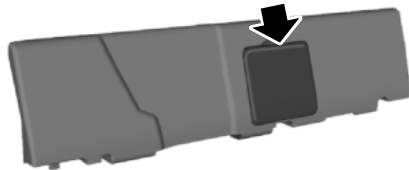

2. Locate the access door. Press the button on the top of the access door to remove the plastic cover. Remove the cover panel. A cut out area will be visible which allows your hand access to the circuit.

3. Press the tab on the top center of the circuit and rotate the handle toward you. Press again to pull the handle down.

4. Pull the handle toward you and remove the circuit from the vehicle to disable the high-voltage battery.

Reverse this procedure to reinstall the service disconnect.

Reactivating the High-Voltage Battery

Note: If you have manually disconnected your high-voltage shutoff circuits you will need to reconnect the circuits before they can be reactivated. The vehicle will detect if the electrical system is safe and reactivate automatically.

SINGLE-SPEED AUTOMATIC TRANSMISSION

WARNING: Always set the parking brake fully and make sure the gearshift lever is latched in P (Park).

The single-speed transmission is built specifically to handle the high RPM range that comes with an all-electric motor.

**P (Park)**

Note: The vehicle can only be started in P (Park).

This position locks the transmission and prevents the front wheels from turning.

To put your vehicle in gear:

- Press the brake pedal.
- Move the gearshift lever into the desired gear.

To put your vehicle in P (Park):

- Come to a complete stop.
- Move the gearshift lever and securely latch it in P (Park).

R (Reverse)

With the gearshift lever in R (Reverse), the vehicle will move backward. Always come to a complete stop before shifting into and out of R (Reverse).

N (Neutral)

With the gearshift lever in N (Neutral), the vehicle can be started and is free to roll. Hold the brake pedal down while in this position.

D (Drive)

The normal driving position for your vehicle. The transmission operates in a single gear built specifically to handle the high RPM range that comes with an all-electric motor.

L (Low)

- Provides maximum motor braking.
- Is not intended for use under extended or normal driving conditions and results in less miles per charge.
- The transmission may be shifted into L (Low) at any vehicle speed.

Brake-shift interlock

This vehicle is equipped with a brake-shift interlock feature that prevents the gearshift lever from being moved from P (Park) when the ignition is in the on position unless the brake pedal is pressed, your charge cord may be plugged into the vehicle, or there may be a fault with the associated electrical system. If this is the case, you must follow the instructions in your instrument cluster display before your vehicle will start.

If you cannot move the gearshift lever out of P (Park) with ignition on and the brake pedal pressed, it is also possible that a fuse has blown or the vehicle's brake lamps are not operating properly. Refer to *Fuses and relays* in the *Roadside Emergencies* chapter.

If your charge cord is not connected and there is not a fault with the associated electrical system, the fuse is not blown and the brake lamps are working properly, the following procedure will allow you to move the gearshift lever from P (Park):

1. Apply the parking brake, turn the ignition key to the off position and remove the key.

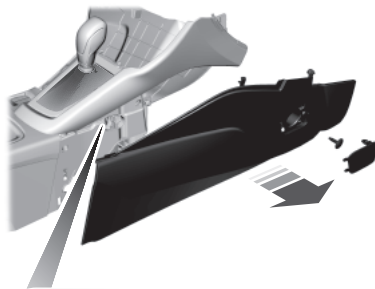

2. Using a screwdriver (or similar tool), carefully pry off and remove the passenger side access cover. Remove the fastener, then remove the console side panel to expose the inside of the shifter assembly.



3. Locate the brake shift interlock lever on the passenger side of the shifter assembly.

4. Apply the brake pedal. Using a screwdriver (or similar tool), press and hold the white brake shift interlock lever forward while pulling the gearshift lever out of the P (Park) position and into the N (Neutral) position.
5. Reinstall the console side panel and attach the fastener.
6. Reinstall the access cover.
7. Apply the brake pedal, start the vehicle and release the parking brake.

See your authorized dealer as soon as possible if this procedure is used.



WARNING: Do not drive your vehicle until you verify that the brake lamps are working.



WARNING: When doing this procedure, you will be taking the vehicle out of park which means the vehicle can roll freely. To avoid unwanted vehicle movement, always fully set the parking brake prior to doing this procedure. Use wheel chocks if appropriate.



WARNING: If the parking brake is fully released, but the brake warning lamp remains illuminated, the brakes may not be working properly. See your authorized dealer.

If Your Vehicle Gets Stuck in Mud or Snow

Note: Do not rock the vehicle if the motor is not at normal operating temperature or damage to the transmission may occur.

Note: Excessive rocking of the vehicle may eventually cause a loss of power as the powertrain protects against overheating or damage.

If your vehicle gets stuck in mud or snow, it may be rocked out by shifting between forward and reverse gears, stopping between shifts in a steady pattern. Press lightly on the accelerator in each gear.

HILL START ASSIST

WARNING: The hill start assist feature does not replace the parking brake. When you leave the vehicle, always apply the parking brake and shift the transmission into P (Park).



WARNING: You must remain in the vehicle once you have activated the hill start assist feature.



WARNING: During all times, you are responsible for controlling the vehicle, supervising the hill start assist system and intervening, if required.



WARNING: If the motor is revved excessively, or if a malfunction is detected when the hill start assist feature is active, the hill start assist feature will be deactivated.

The hill start assist feature makes it easier to pull away when the vehicle is on a slope without the need to use the parking brake. When the hill start assist feature is active, the vehicle will remain stationary on the slope for up to two seconds after you release the brake pedal. During this time, you have time to move your foot from the brake to the accelerator pedal and pull away. The brakes are released automatically once the motor has developed sufficient drive to prevent the vehicle from rolling down the slope. This is an advantage when pulling away on a slope; for example from a car park ramp, traffic lights or when reversing uphill into a parking space.

The hill start assist feature is activated automatically when the vehicle is stopped on a slope greater than five degrees. The hill start assist feature operates with the vehicle facing downhill if reverse gear is selected.

To activate hill start assist, do the following:

1. Press the brake pedal to bring the vehicle to a complete standstill. Keep the brake pedal pressed.
2. If the sensors detect that the vehicle is on a slope, the hill start assist feature will be activated automatically.
3. When you remove your foot from the brake pedal, the vehicle will remain on the slope without rolling away for approximately up to two seconds. This hold time will automatically be extended if you are in the process of driving off.
4. Drive off in the normal manner. The brakes will be released automatically.

GENERAL INFORMATION

Note: Occasional brake noise is normal. If a metal-to-metal, continuous grinding or continuous squeal sound is present, the brake linings may be worn out. Have them inspected by an authorized dealer. If your vehicle has continuous vibration or shudder in the steering wheel while braking, have your vehicle inspected by an authorized dealer.

Note: Brake dust may accumulate on the wheels, even under normal driving conditions. Some dust is inevitable as the brakes wear and does not contribute to brake noise. See the *Vehicle Care* chapter for wheel cleaning instructions.



See the *Instrument Cluster* chapter for information on the brake system warning light.

Wet brakes result in reduced braking efficiency. Gently press the brake pedal a few times when driving from a car wash or standing water to dry the brakes.

Brake Over Accelerator

In the event the accelerator pedal becomes stuck or entrapped, apply steady and firm pressure to the brake pedal to slow the vehicle and reduce motor power. If you experience this condition, apply the brakes and bring your vehicle to a safe stop. Turn the motor off, shift to position **P** and apply the parking brake, then inspect the accelerator pedal for any interferences. If none are found and the condition persists, have your vehicle towed to the nearest authorized dealer.

Brake Assist

Brake assist detects when you brake heavily by measuring the rate at which you press the brake pedal. It provides maximum braking efficiency as long as you press the pedal. Brake assist can reduce stopping distances in critical situations.

Anti-Lock Brake System

This system helps you maintain steering control during emergency stops by keeping the brakes from locking.



This lamp momentarily illuminates when you turn the ignition on. If the light does not illuminate during start-up, remains on or flashes, the anti-lock brake system may be disabled and may need to be serviced.



If the anti-lock brake system is disabled, normal braking is still effective. If the brake warning lamp illuminates with the parking brake released, have your brake system serviced immediately.

Regenerative braking system

Your vehicle uses a feature known as regenerative braking. This is used to simulate the engine braking of an internal combustion engine and assist the standard brake system while recovering some of the energy of motion and storing it in the battery to improve fuel economy. The standard brake system is designed to fully stop the car if regenerative braking is not available. During regenerative braking, the motor is spun as a generator to create electrical current. This recharges the battery and slows the vehicle. In effect, once the accelerator pedal is released, the motor changes from an energy user to an energy producer.

When the accelerator pedal is released or the brake pedal is applied, the brake controller automatically detects the amount of deceleration requested and optimizes how much of the deceleration will be produced by regenerative braking. The remaining portion is generated by standard friction braking. When the battery is almost fully charged, the amount of regenerative braking is limited to avoid overcharging, and the requested deceleration is produced by standard friction braking alone.

Regenerative braking does not take the place of the standard friction brakes; it only assists them. Regenerative braking has also been designed to interact with the anti-lock brake system. Regenerative braking is disabled when the anti-lock brake system is activated or the battery is fully charged.

HINTS ON DRIVING WITH ANTI-LOCK BRAKES

When the system is operating, the brake pedal will pulse and may travel further. Maintain pressure on the brake pedal. You may also hear a noise from the system. This is normal.

The anti-lock braking system will not eliminate the dangers inherent when:

- you drive too closely to the vehicle in front of you.
- your vehicle is hydroplaning.
- you take corners too fast.
- the road surface is poor.

PARKING BRAKE

WARNING: Always set the parking brake fully and make sure that the transmission selector lever is securely latched in position **P**.



WARNING: If the parking brake is fully released, but the brake warning lamp remains illuminated, the brakes may not be working properly. See your authorized dealer as soon as possible.

To set the parking brake, pull the parking brake handle up as far as possible.

To release the parking brake:

1. Press and hold the button located at the end of the parking brake handle.
2. Pull the handle up slightly, then push the handle down.

PRINCIPLES OF OPERATION

The traction control system helps avoid drive wheel spin and loss of traction.

If your vehicle begins to slide, the system applies the brakes to individual wheels and, when needed, reduces vehicle power at the same time. If the wheels spin when accelerating on slippery or loose surfaces, the system reduces vehicle power in order to increase traction.

USING TRACTION CONTROL

In certain situations (for example, stuck in snow or mud), turning the traction control off may be beneficial as this allows the wheels to spin with full engine power. Turn the traction control system off through the information display. See the *Information Displays* chapter.

System Indicator Lights and Messages

WARNING: If a failure has been detected within the Traction Control System, the stability control light will illuminate steadily. Verify that the Traction Control System was not manually disabled through the information display. If the stability control light still illuminates steadily, have the system serviced by an authorized dealer immediately. Operating your vehicle with Traction Control disabled could lead to an increased risk of loss of vehicle control, vehicle rollover, personal injury and death.



The stability control light temporarily illuminates on vehicle start-up and flashes when a driving condition activates the stability system.



The stability control off light temporarily illuminates on vehicle start-up and stays on when the traction control system is turned off.

When the traction control system is turned off or on, a message appears in the information display showing system status.

PRINCIPLES OF OPERATION

WARNING: Vehicle modifications involving braking system, aftermarket roof racks, suspension, steering system, tire construction and wheel or tire size may change the handling characteristics of your vehicle and may adversely affect the performance of the AdvanceTrac® system. In addition, installing any stereo loudspeakers may interfere with and adversely affect the AdvanceTrac® system. Install any aftermarket stereo loudspeaker as far as possible from the front center console, the tunnel, and the front seats in order to minimize the risk of interfering with the AdvanceTrac® sensors. Reducing the effectiveness of the AdvanceTrac® system could lead to an increased risk of loss of vehicle control, vehicle rollover, personal injury and death.



WARNING: Remember that even advanced technology cannot defy the laws of physics. It is always possible to lose control of a vehicle due to inappropriate driver input for the conditions. Aggressive driving on any road condition can cause you to lose control of your vehicle increasing the risk of personal injury or property damage. Activation of the AdvanceTrac® system is an indication that at least some of the tires have exceeded their ability to grip the road; this could reduce the operator's ability to control the vehicle potentially resulting in a loss of vehicle control, vehicle rollover, personal injury and death. If your AdvanceTrac® system activates, SLOW DOWN.

The AdvanceTrac® system helps you keep control of your vehicle when on a slippery surface. The electronic stability control portion of the system helps avoid skids and lateral slides and the traction control system helps avoid drive wheel spin and loss of traction. See the *Traction Control* chapter for details on traction control system operation.

A Vehicle without AdvanceTrac® skidding off its intended route.

B Vehicle with AdvanceTrac® maintaining control on a slippery surface.

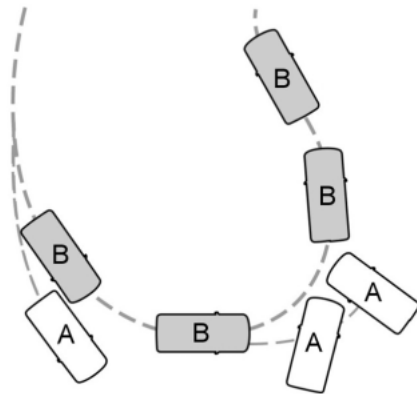



USING ADVANCETRAC®

The system automatically activates when you start your vehicle. The AdvanceTrac® system cannot be completely turned off, but the electronic stability control portion of the system is disabled when the transmission is in position **R**. You can turn off the traction control portion of the system independently. See the *Traction Control* chapter..

SENSING SYSTEM (IF EQUIPPED)

 **WARNING:** To help avoid personal injury, please read and understand the limitations of the system as contained in this section. Sensing is only an aid for some (generally large and fixed) objects when moving in reverse on a flat surface at parking speeds. Traffic control systems, inclement weather, air brakes, and external motors and fans may also affect the function of the sensing system; this may include reduced performance or a false activation.

 **WARNING:** To help avoid personal injury, always use caution when the transmission is in **R** and when using the sensing system.

 **WARNING:** This system is not designed to prevent contact with small or moving objects. The system is designed to provide a warning to assist the driver in detecting large stationary objects to avoid damaging the vehicle. The system may not detect smaller objects, particularly those close to the ground.

 **WARNING:** Certain add-on devices, such as large trailer hitches, bike or surfboard racks and any device that may block the normal detection zone of the system, may create false beeps.

Note: Keep the sensors (located on the bumper/fascia) free from snow, ice and large accumulations of dirt. If the sensors are covered, the system's accuracy can be affected. Do not clean the sensors with sharp objects.

Note: If your vehicle sustains damage to the bumper/fascia, leaving it misaligned or bent, the sensing zone may be altered causing inaccurate measurement of obstacles or false alarms.

The sensing system warns the driver of obstacles within a certain range of the bumper area. The system turns on automatically whenever the ignition is switched on.

When receiving a detection warning, the radio volume is reduced to a predetermined level. After the warning goes away, the radio volume returns to the previous level.

The system can be turned off using the information display control. See the *Information Display* chapter. If a fault is present in the system, a warning message appears in the information display and does not allow the driver to switch the faulted system on.

Using the Rear Sensing System

The rear sensors are only active when the transmission is in **R**. As the vehicle moves closer to the obstacle, the rate of the audible warning increases. When the obstacle is fewer than 12 inches (30 centimeters) away, the warning sounds continuously. If a stationary or receding object is detected farther than 12 inches (30 centimeters) from the side of the vehicle, the tone sounds for only three seconds. Once the system detects an object approaching, the warning sounds again.

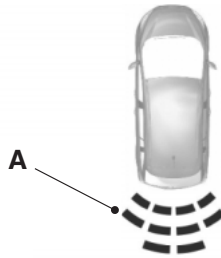

A. Coverage area of up to 6 feet (2 meters) from the rear bumper (with a decreased coverage area at the outer corners of the bumper).

The system detects certain objects while the transmission is in **R**:

- and moving toward a stationary object at a speed of 3 mph (5 km/h) or less.
- but not moving, and a moving object is approaching the rear of the vehicle at a speed of 3 mph (5 km/h) or less.

REARVIEW CAMERA SYSTEM (IF EQUIPPED)



WARNING: The rearview camera system is a reverse aid supplement device that still requires the driver to use it in conjunction with the rearview mirror and the side mirrors for maximum coverage.



WARNING: Objects that are close to either corner of the bumper or under the bumper, might not be seen on the screen due to the limited coverage of the camera system.



WARNING: Backup as slow as possible since higher speeds might limit your reaction time to stop the vehicle.

 **WARNING:** Use caution when using the rear video camera and the liftgate is ajar. If the liftgate is ajar, the camera will be out of position and the video image may be incorrect. All guidelines (if enabled) have been removed when the liftgate is ajar.

 **WARNING:** Use caution when turning ON or OFF camera features while in R (Reverse). Make sure the vehicle is not moving.



The rear video camera system, located in the rear of the vehicle above the license plate, provides a video image of the area behind the vehicle. It adds assistance to the driver while reversing or reverse parking the vehicle. To use the rear video camera system, place the transmission in R (Reverse). An image will display on the touchscreen display. The area displayed on the screen may

vary according to the vehicle orientation and/or road condition.

The rear video camera includes the following features that will assist the driver in reverse driving.

Active guidelines, fixed guidelines and centerline

The active guidelines show the path of intended motion of the vehicle while reversing. The fixed guidelines assist a driver with backing into a parking space or aligning with an object behind the vehicle. The centerline assists a driver with aligning the center of the vehicle with an object (i.e. trailer).

To turn this feature on or off when the vehicle is not in R (Reverse), do the following on the touchscreen:

1. Select Menu
2. Select Vehicle
3. Select Rear View Camera

The guideline options are ACTIVE + FIXED, FIXED and OFF.

Note: The centerline is available if Active or Fixed guidelines are ON.

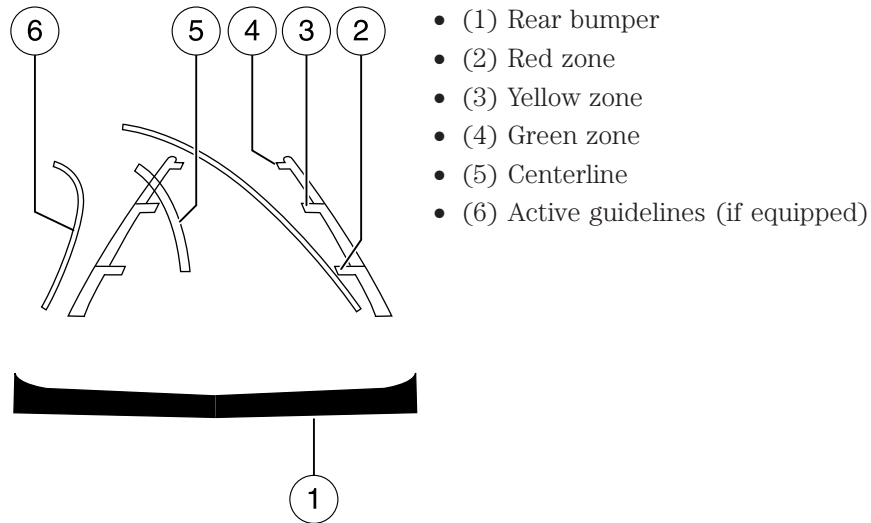

Active guidelines (6) will only be shown with fixed guidelines (2), (3) and (4).

To use active guidelines, turn the steering wheel and point the active guidelines towards an intended path. If the steering wheel position is changed while reversing, the vehicle might deviate from the original intended path.

Active guidelines project the intended path of the vehicle. Fixed guidelines show the actual direction the vehicle is moving. The fixed and active guidelines will fade in and out depending on the steering wheel position. When the steering wheel position is straight, the active guidelines will not be shown.

Always use caution while backing. Objects in the red zone (2) are closest to your vehicle and objects in the green zone (4) are further away. Objects are getting closer to your vehicle as they move from the green zone (4) to the yellow (3) or red zones (2). Use the side mirrors and rearview mirror to get better coverage on both sides and rear of the vehicle.

Visual park aid alert (if equipped)

Visual park aid alert allows the driver to see the area that is causing the reverse sensing system to beep. The visual alerts are red, yellow or green highlights which appear on top of the video image when an object is detected by the reverse sensing system. The visual alert will highlight the closest object detected by the reverse sensing system. The reverse sensing alert can be disabled and if visual park aid alert is enabled, highlighted areas will still be displayed.

To turn this feature on or off when the vehicle is not in R (Reverse), do the following on the touchscreen:

1. Select Menu
2. Select Vehicle
3. Select Rear View Camera

The visual park aid alert options are ON and OFF.

Note: The reverse sensing system is not effective at speeds above 8 mph (12 km/h) and may not detect certain angular or moving objects.

Manual zoom

WARNING: When manual zoom is on, the full area behind the vehicle is not shown. Be aware of your surroundings when using the manual zoom feature.

Note: Manual zoom is only available when the transmission is in R (Reverse).

Note: When manual zoom is enabled, only the centerline is shown.

Allows the driver to get a closer view of an object behind the vehicle. The zoomed image keeps the bumper in the image to provide a reference. The zoom is only active while the transmission is in R (Reverse), When the transmission is shifted out of R (Reverse), the feature automatically turns off and must be reset when it is used again.

Selectable settings for this feature are (+) and (-). The default setting for the manual zoom is OFF.

Rear camera delay

After shifting out of R (Reverse) and into any gear other than P (Park), the image will remain until the vehicle speed reaches 6 mph (10 km/h). This will only occur if the rear camera delay feature is on, or until any radio button is selected.

The default setting for the rear camera delay is OFF. To turn this feature on or off when the vehicle is not in R (Reverse), do the following:

1. Select Menu
2. Select Vehicle
3. Select Rear View Camera

The rear camera delay options are ON and OFF.

The camera lens for the reverse camera system is located on the liftgate. Keep the lens clean so the video image remains clear and undistorted. Clean the lens with a soft, lint-free cloth and non-abrasive cleaner.

When towing, the reverse camera system will only see what is being towed behind the vehicle. This might not provide adequate coverage as it usually provides in normal operation and some objects might not be seen.

Active guidelines, fixed guidelines, visual park aid alert and manual zoom features are only available when the vehicle is in R (Reverse).

If the vehicle is in R (Reverse) and the liftgate is ajar, no rear video camera features will be displayed. A message will be displayed on the touchscreen if the liftgate is ajar.

After activating or deactivating a rear video camera feature, the touchscreen will show a preview of the feature(s) selected.

Note: If the camera system image is not clear or seems distorted, it may be covered with water droplets, snow, mud or any other substance. If this occurs, clean the camera lens before using the camera system.

If the back end of the vehicle is hit or damaged, then check with your authorized dealer to have your rear video system checked for proper coverage and operation.

Night time and dark area use

At night time or in dark areas, the camera system relies on the reverse lamp lighting to produce an image. Therefore, it is necessary that both reverse lamps are operating in order to get a clear image in the dark. If either of the lamps are not operating, stop using the camera system, at least in the dark, until the lamp(s) are replaced and functioning.

Servicing

- If the image comes on while the vehicle is not in R (Reverse), have the system inspected by your authorized dealer.
- If the image is not clear, check if anything is covering the lens such as dirt, mud, ice, snow, etc. If the image is still not clear after cleaning, have your system inspected by your authorized dealer.

PRINCIPLES OF OPERATION

Cruise control lets you maintain a set speed without keeping your foot on the accelerator pedal.

USING CRUISE CONTROL

 **WARNING:** Do not use cruise control in heavy traffic, on winding roads or when the road surface is slippery. This could result in loss of vehicle control, serious injury or death.

 **WARNING:** When you are going downhill, your vehicle speed may increase above the set speed. The system will not apply the brakes. Change down a gear to assist the system in maintaining the set speed. Failure to do so could result in loss of vehicle control, serious injury or death.

Note: Cruise control will disengage if your vehicle speed decreases more than 10 mph (16 km/h) below your set speed while driving uphill.



The cruise controls are located on the steering wheel.

Switching Cruise Control On

Press and release **ON**.



The indicator will appear in the instrument cluster.

Setting a Speed

1. Accelerate to the desired speed.
2. Press and release **SET+**.
3. Take your foot off the accelerator pedal.

Changing the Set Speed

- Press and hold **SET+** or **SET-**. Release the control when you reach the desired speed.
- Press and release **SET+** or **SET-**. The set speed will change in approximately 1 mph (2 km/h) increments.
- Press the accelerator or brake pedal until you reach the desired speed. Press and release **SET+**.

Canceling the Set Speed

Pull **CAN** toward you and release or tap the brake pedal. You will not erase the set speed.

Resuming the Set Speed

Pull **RES** toward you and release.

Switching Cruise Control Off

Note: You will erase the set speed if you switch the system off.

Press and release **OFF** or switch the ignition off.

STEERING**Steering Tips**

If the steering wanders or pulls, check for:

- an improperly inflated tire
- uneven tire wear
- loose or worn suspension components
- loose or worn steering components
- improper vehicle alignment

A high crown in the road or high crosswinds may also make the steering seem to wander/pull.

Electric Power Steering

WARNING: The electric power steering system has diagnostic checks that continuously monitor the system to ensure proper operation. When a system error is detected a steering message will appear in the information display.



WARNING: The electric power steering system has diagnostic checks that continuously monitor the system to ensure proper operation of the electronic system. When an electronic error is detected, a message will be displayed in the information display. If this happens, stop the vehicle in a safe place, and turn off the vehicle. After at least 10 seconds, reset the system by restarting the vehicle, and watch the information display for a steering message. If a steering message returns, or returns while driving, take the vehicle to your dealer to have it checked.



WARNING: Obtain immediate service if a system error is detected. You may not notice any difference in the feel of your steering, but a serious condition may exist. Failure to do so may result in loss of steering control.

Your vehicle is equipped with an electric power-assisted steering system. There is no fluid reservoir to check or fill.

If your vehicle loses electrical power while you are driving (or if the ignition is turned off), you can steer the vehicle manually, but it takes more effort. Extreme continuous steering may increase the effort it takes for you to steer. This occurs to prevent internal overheating and permanent damage to your steering system. If this should occur, you will neither lose the ability to steer the vehicle manually nor will it cause permanent damage. Typical steering and driving maneuvers will allow the system to cool and steering assist will return to normal.

When a steering system error is detected, steering messages may appear in the information display.

REAR UNDER FLOOR STORAGE

The cargo management system consists of a storage compartment located in the cargo area.



The lid has two positions:

- Unlatched and flat (shown)
- Closed on an angle

Lift the lid and pull the handle on top of the lid toward you to fold down the supports. Lift the lid and push the handle away from you to fold the supports back under the lid.

LOAD LIMIT**Vehicle Loading**

This section will guide you in the proper loading of your vehicle to keep your loaded vehicle weight within its design rating capability. Properly loading your vehicle will provide maximum return of vehicle design performance. Before loading your vehicle, familiarize yourself with the following terms for determining your vehicle's weight ratings from the vehicle's Tire Label or Safety Compliance Certification Label:

Base Curb Weight – is the weight of the vehicle including full fluids and all standard equipment. It does not include passengers, cargo, or optional equipment.

Vehicle Curb Weight – is the weight of your new vehicle when you picked it up from your authorized dealer plus any aftermarket equipment.



Payload – is the combined weight of cargo and passengers that the vehicle is carrying. The maximum payload for your vehicle can be found on the Tire Label on the B-Pillar or the edge of the driver's door (vehicles exported outside the US and Canada may not have a Tire Label). Look for **“THE COMBINED WEIGHT OF OCCUPANTS AND CARGO SHOULD NEVER EXCEED XXX kg OR XXX lb.”** for maximum payload. The payload listed on the Tire Label is the maximum payload for the vehicle as built by the assembly plant. If any aftermarket or authorized-dealer installed equipment has been installed on the vehicle, the weight of the equipment must be subtracted from the payload listed on the Tire Label in order to determine the new payload.



WARNING: The appropriate loading capacity of your vehicle can be limited either by volume capacity (how much space is available) or by payload capacity (how much weight the vehicle should carry). Once you have reached the maximum payload of your vehicle, do not add more cargo, even if there is space available. Overloading or improperly loading your vehicle can contribute to loss of vehicle control and vehicle rollover.

Example only:

TIRE AND LOADING INFORMATION

SEATING CAPACITY TOTAL 5 FRONT 2 REAR 3

The combined weight of occupants and cargo should never exceed : **XXX kg or XXX lbs.**

TIRE	SIZE	COLD TIRE PRESSURE	SEE OWNERS MANUAL FOR ADDITIONAL INFORMATION
FRONT	LT225/75R 16.5E	200 KPA, 29 PSI	
REAR	LT225/75R 16.5E	200 KPA, 29 PSI	
SPARE	T145/80D16 P225/60R17	420 KPA, 60 PSI 200 KPA, 29 PSI	

TIRE AND LOADING INFORMATION
RENSEIGNEMENTS SUR LES PNEUS ET LE CHARGEMENT

SEATING CAPACITY TOTAL 5 FRONT 2 REAR 3
NOMBRE DE PLACES TOTAL 5 AVANT 2 ARRIERE 3

The combined weight of occupants and cargo should never exceed 492 kg or 1085 lbs.
Le poids total des occupants et du chargement ne doit jamais dépasser 492 kg ou 1085 lb.

TIRE PNEU	SIZE DIMENSIONS	COLD TIRE PRESSURE PRESSION DES PNEUS A FROID	SEE OWNER'S MANUAL FOR ADDITIONAL INFORMATION VOIR LE MANUEL DE L'USAGER POUR PLUS DE RENSEIGNEMENTS
FRONT AVANT	P235/70R16	240 KPA, 35 PSI	
REAR ARRIERE	P235/70R16	240 KPA, 35 PSI	
SPARE DE SECOURS	T145/90R17	415 KPA, 60 PSI	

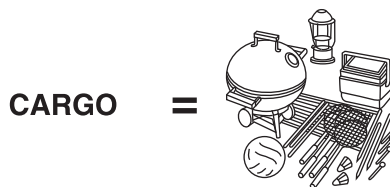

Cargo Weight – includes all weight added to the Base Curb Weight, including cargo and optional equipment.

GAW (Gross Axle Weight) – is the total weight placed on each axle (front and rear) – including vehicle curb weight and all payload.

GAWR (Gross Axle Weight Rating) – is the maximum allowable weight that can be carried by a single axle (front or rear). **These numbers are shown on the Safety Compliance Certification Label. The label shall be affixed to either the door hinge pillar, door-latch post, or the door edge that meets the door-latch post, next to the driver's seating position. The total load on each axle must never exceed its GAWR.**

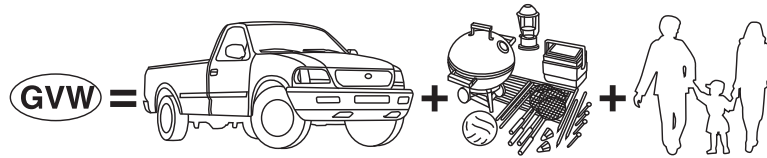

GVW (Gross Vehicle Weight) – is the Vehicle Curb Weight + cargo + passengers.

GVWR (Gross Vehicle Weight Rating) – is the maximum allowable weight of the fully loaded vehicle (including all options, equipment, passengers and cargo). **The GVWR is shown on the Safety Compliance Certification Label. The label shall be affixed to either the door hinge pillar, door-latch post, or the door edge that meets the door-latch post, next to the driver's seating position. The GVW must never exceed the GVWR.**

- Example only:

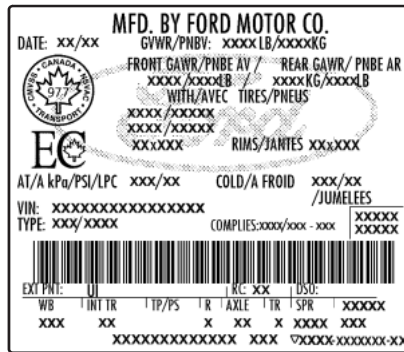
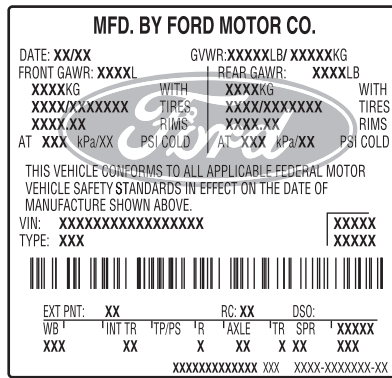

WARNING: Exceeding the Safety Compliance Certification Label vehicle weight rating limits could result in substandard vehicle handling or performance, engine, transmission and/or structural damage, serious damage to the vehicle, loss of control and personal injury.

WARNING: Do not exceed the GVWR or the GAWR specified on the Safety Compliance Certification Label.



WARNING: Do not use replacement tires with lower load carrying capacities than the original tires because they may lower the vehicle's GVWR and GAWR limitations. Replacement tires with a higher limit than the original tires do not increase the GVWR and GAWR limitations.



WARNING: Exceeding any vehicle weight rating limitation could result in serious damage to the vehicle and/or personal injury.

Steps for determining the correct load limit:

1. Locate the statement "The combined weight of occupants and cargo should never exceed XXX kg or XXX lbs." on your vehicle's placard.
2. Determine the combined weight of the driver and passengers that will be riding in your vehicle.
3. Subtract the combined weight of the driver and passengers from XXX kg or XXX lbs.
4. The resulting figure equals the available amount of cargo and luggage load capacity. For example, if the "XXX" amount equals 1,400 lbs. and there will be five 150 lb. passengers in your vehicle, the amount of available cargo and luggage load capacity is 650 lbs. (1400-750 (5 x 150) = 650 lb.).
5. Determine the combined weight of luggage and cargo being loaded on the vehicle. That weight may not safely exceed the available cargo and luggage load capacity calculated in Step 4.

The following gives you a few examples on how to calculate the available amount of cargo and luggage load capacity:

- Suppose your vehicle has a 1400 lb. (635 kg) cargo and luggage capacity. You decide to go golfing. Is there enough load capacity to carry you, 4 of your friends and all the golf bags? You and four friends average 220 lb. (99 kg) each and the golf bags weigh approximately 30 lb. (13.5 kg) each. The calculation would be: $1400 - (5 \times 220) - (5 \times 30) = 1400 - 1100 - 150 = 150$ lb. Yes, you have enough load capacity in your vehicle to transport four friends and your golf bags. In metric units, the calculation would be: $635 \text{ kg} - (5 \times 99 \text{ kg}) - (5 \times 13.5 \text{ kg}) = 635 - 495 - 67.5 = 72.5$ kg.

- Suppose your vehicle has a 1400 lb. (635 kg) cargo and luggage capacity. You and one of your friends decide to pick up cement from the local home improvement store to finish that patio you have been planning for the past 2 years. Measuring the inside of the vehicle with the rear seat folded down, you have room for 12-100 lb. (45 kg) bags of cement. Do you have enough load capacity to transport the cement to your home? If you and your friend each weigh 220 lb. (99 kg), the calculation would be: $1400 - (2 \times 220) - (12 \times 100) = 1400 - 440 - 1200 = -240$ lb. No, you do not have enough cargo capacity to carry that much weight. In metric units, the calculation would be: $635 \text{ kg} - (2 \times 99 \text{ kg}) - (12 \times 45 \text{ kg}) = 635 - 198 - 540 = -103$ kg. You will need to reduce the load weight by at least 240 lb. (104 kg). If you remove 3-100 lb. (45 kg) cement bags, then the load calculation would be: $1400 - (2 \times 220) - (9 \times 100) = 1400 - 440 - 900 = 60$ lb. Now you have the load capacity to transport the cement and your friend home. In metric units, the calculation would be: $635 \text{ kg} - (2 \times 99 \text{ kg}) - (9 \times 45 \text{ kg}) = 635 - 198 - 405 = 32$ kg.

The above calculations also assume that the loads are positioned in your vehicle in a manner that does not overload the Front or the Rear Gross Axle Weight Rating specified for your vehicle on the Safety Compliance Certification Label. The label shall be affixed to either the door hinge pillar, door-latch post, or the door edge that meets the door-latch post, next to the driver's seating position.

TOWING A TRAILER

 **WARNING:** Never tow a trailer with this vehicle. Your vehicle is not equipped to tow. No towing packages are available through an authorized dealer.

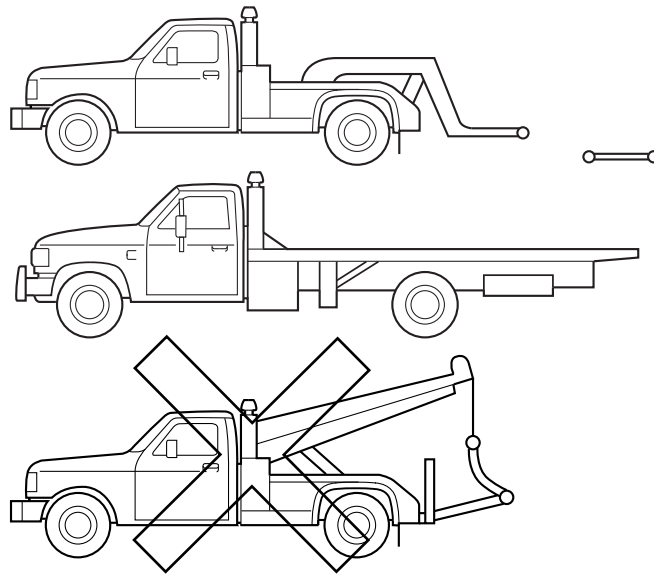
TRANSPORTING THE VEHICLE

If you need to have your vehicle towed, contact a professional towing service or, if you are a member of a roadside assistance program, your roadside assistance service provider.

We recommend the use of a wheel lift and dollies or flatbed equipment to tow your vehicle. Do not tow with a slingbelt. Ford Motor Company has not approved a slingbelt towing procedure. Vehicle damage may occur if towed incorrectly, or by any other means.

Ford Motor Company produces a towing manual for all authorized tow truck operators. Have your tow truck operator refer to this manual for proper hook-up and towing procedures for your vehicle.

It is acceptable to have your vehicle towed from the front if using proper wheel lift equipment to raise the front wheels off the ground. When towing in this manner, the rear wheels can remain on the ground.

The front wheels must be on a tow dolly when towing your vehicle from the rear using wheel lift equipment. This prevents damage to the transmission.

TOWING THE VEHICLE ON FOUR WHEELS

Emergency Towing

If your vehicle becomes inoperable (without access to wheel dollies, car-hauling trailer, or flatbed transport vehicle), it can be flat-towed (all wheels on the ground, regardless of the powertrain and transmission configuration) under the following conditions:

- Your vehicle is facing forward for towing in a forward direction.
- Place the transmission in position **N**. See *Automatic transmission* in the *Transmission* chapter if you cannot move the transmission into **N**.
- Maximum speed is 35 mph (56 km/h).
- Maximum distance is 50 miles (80 kilometers).

Recreational Towing

Follow these guidelines if you have a need for recreational towing, such as towing your vehicle behind a motorhome. We designed these guidelines to prevent damage to your transmission.

Do not tow your vehicle with any wheels on the ground, as vehicle or transmission damage may occur. It is recommended to tow your vehicle with all four (4) wheels off the ground such as when using a car-hauling trailer. Otherwise, you cannot tow your vehicle.

BREAKING-IN

You need to break in new tires for approximately 300 miles (480 kilometers). During this time, your vehicle may exhibit some unique driving characteristics. Avoid driving too fast during the first 1000 miles (1600 kilometers). Vary your speed frequently and change up through the gears early. Do not labor the engine. Do not tow during the first 1000 miles (1600 kilometers).

DRIVING THROUGH WATER

Note: Driving through deep water may allow water into the transmission and motor causing internal damage. If you drove through deep water, check the transmission and engine; if water is found, replace the fluid.

Do not drive quickly through standing water, especially if the depth is unknown. Traction or brake capability may be limited and if enough water is present, the vehicle may stall.

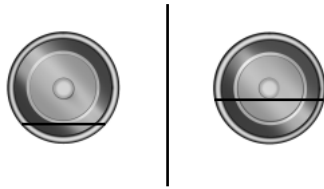

If driving through deep or standing water is unavoidable, proceed very slowly. Never drive through water that is higher than the bottom of the wheel rims.

Once through the water, always try the brakes. Wet brakes do not stop the vehicle as effectively as dry brakes. Drying can be improved by moving your vehicle slowly while applying light pressure on the brake pedal.

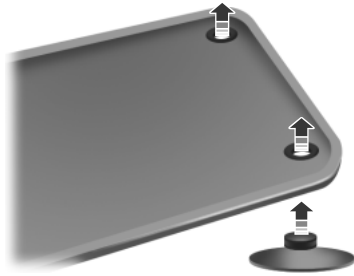
FLOOR MATS

WARNING: Always use floor mats that are designed to fit the footwell of your vehicle. Only use floor mats that leave the pedal area unobstructed. Only use floor mats that are firmly secured to retention posts so that they cannot slip out of position and interfere with the pedals or impair safe operation of your vehicle in other ways.

- Pedals that cannot move freely can cause loss of vehicle control and increase the risk of serious personal injury.
- Always make sure that the floor mats are properly attached to the retention posts in the carpet that are supplied with your vehicle. Floor mats must be properly secured to both retention posts to ensure mats do not shift out of position.
- Never place floor mats or any other covering in the vehicle footwell that cannot be properly secured to prevent them from moving and interfering with the pedals or the ability to control the vehicle.
- Never place floor mats or any other covering on top of already installed floor mats. Floor mats should always rest on top of the vehicle carpeting surface and not another floor mat or other covering. Additional floor mats or any other covering will reduce the pedal clearance and potentially interfere with pedal operation.
- Check attachment of floor mats on a regular basis. Always properly reinstall and secure floor mats that have been removed for cleaning or replacement.
- Always make sure that objects cannot fall into the driver footwell while the vehicle is moving. Objects that are loose can become trapped under the pedals causing a loss of vehicle control.



WARNING *(Continued)*

- Failure to properly follow floor mat installation or attachment instructions can potentially cause interference with pedal operation causing loss of control of vehicle.
- To install floor mats, position the floor mat so that the eyelet is over the retention post and press down to lock in.
- To remove the floor mat, reverse the installation procedure.

ROADSIDE ASSISTANCE**Vehicles Sold in the U.S.: Getting Roadside Assistance**

To fully assist you should you have a vehicle concern, Ford Motor Company offers a complimentary roadside assistance program. This program is separate from the New Vehicle Limited Warranty. The service is available:

- 24 hours a day, seven days a week
- for the coverage period listed on the Roadside Assistance Card included in your owner's manual portfolio.

Roadside assistance will cover:

- a flat tire change with a good spare (except vehicles that have been supplied with a tire inflation kit).
- battery jump start.
- lock-out assistance (key replacement cost is the customer's responsibility).
- fuel delivery – Independent Service Contractors, if not prohibited by state, local or municipal law, shall deliver up to 2.0 gallons (7.5 liters) of gasoline or 5.0 gallons (18.9 liters) of diesel fuel to a disabled vehicle. Fuel delivery service is limited to two no-charge occurrences within a 12-month period.
- winch out – available within 100 feet (30.5 meters) of a paved or county maintained road, no recoveries.
- towing – Ford and Lincoln eligible vehicles towed to an authorized dealer within 35 miles (56 kilometers) of the disablement location or to the nearest authorized dealer. If a member requests to be towed to an authorized dealer more than 35 miles (56 kilometers) from the disablement location, the member shall be responsible for any mileage costs in excess of 35 miles (56 kilometers).

Trailers shall be covered up to \$200 if the disabled eligible vehicle requires service at the nearest authorized dealer. If the trailer is disabled, but the towing vehicle is operational, the trailer does not qualify for any roadside services.

Vehicles Sold in the U.S.: Using Roadside Assistance

Complete the roadside assistance identification card and place it in your wallet for quick reference. This card is found in the owner's manual portfolio in the glove compartment.

U.S. Ford vehicle customers who require Roadside Assistance, call 1-800-241-3673.

If you need to arrange roadside assistance for yourself, Ford Motor Company will reimburse a reasonable amount for towing to the nearest dealership within 35 miles (56 kilometers). To obtain reimbursement information, U.S. Ford vehicle customers call 1-800-241-3673. Customers will be asked to submit their original receipts.

Vehicles Sold in Canada: Getting Roadside Assistance

Canadian customers who require roadside assistance, call 1-800-665-2006.

Vehicles Sold in Canada: Using Roadside Assistance

For your convenience, you may complete the roadside assistance identification card found in the centerfold of this warranty guide and retain for future reference.

Canadian roadside coverage and benefits may differ from the U.S. coverage. If you require more information, please refer to the coverage section of your warranty guide, call us in Canada at 1-800-665-2006, or visit our website at www.ford.ca.

HAZARD WARNING FLASHERS

The hazard flasher control is located on the instrument panel by the radio. Use it when your vehicle is disabled and is creating a safety hazard for other motorists.

- Press the flasher control and all front and rear direction signals will flash.
- Press the flasher control again to turn them off.

Note: With extended use, the flashers may run down your 12-volt battery.

HIGH-VOLTAGE SHUTOFF

In the event of a crash:

- Take the same actions as you would take in a crash involving a gasoline-powered vehicle — exit the vehicle safely or await the assistance of an emergency responder if they are unable to get out on their own, move a safe distance away from the vehicle, and notify the authorities of the crash.
- If possible, inform emergency responders that the vehicle is electric powered.
- Vehicle owners should not store a severely damaged vehicle in a garage or near other vehicles.

The high-voltage shutoff operation shuts off power from the high voltage battery after a collision, or if your vehicle receives a substantial physical jolt.

To reactivate the vehicle after either event perform the following steps:

1. Press the POWER START/STOP button to power the vehicle on.
2. Press the POWER START/STOP button to power the vehicle off.
3. Press the POWER START/STOP button to power the vehicle on again.

Note: After completing this procedure the vehicle will detect if the electrical system is safe and reactivate automatically. Once your vehicle determines the electrical system safe you can start your vehicle as you would normally by pressing the brake pedal in combination with the POWER START/STOP button.

JUMP STARTING THE VEHICLE (12 VOLT BATTERY ONLY)

WARNING: Batteries contain sulfuric acid which can burn skin, eyes and clothing, if contacted.

Note: This procedure is only for the low voltage, 12 volt underhood battery only. Do not attempt to jump start your high-voltage battery.

Do not attempt to push-start your automatic transmission vehicle. Automatic transmissions do not have push-start capability. Attempting to push-start a vehicle with an automatic transmission may cause transmission damage.

Preparing Your Vehicle

Note: Your vehicle has a 12 volt battery that is easily accessible under the hood. The 12 volt battery controls the switches and contacts that engage the high voltage battery. *The high-voltage battery cannot be jumped with a standard 12 volt battery.* If your high voltage battery does not accept a regular charge, your vehicle must be towed to your authorized dealership.

1. Use only a 12 volt supply to start your vehicle.
2. Do not disconnect the battery of the disabled vehicle as this could damage the vehicle's electrical system.
3. Park the booster vehicle close to the hood of the disabled vehicle making sure the two vehicles *do not* touch. Set the parking brake on both vehicles. Stay clear of the motor cooling fan and other moving parts on both vehicles.
4. Check all battery terminals and remove any excessive corrosion before you attach the battery cables. Ensure that vent caps are tight and level.
5. Turn the heater fan on in both vehicles to protect from any electrical surges. Turn all other accessories off.

Connecting the Jumper Cables



WARNING: Do not connect the end of the second cable to the negative (-) terminal of the battery to be jumped. A spark may cause an explosion of the gases that surround the battery or a surge within the battery.

Note: Do not attach the negative (-) cable to fuel lines, engine rocker covers, the intake manifold or electrical components as grounding points.

Note: In the illustration, the vehicle on the bottom is used to designate the assisting (boosting) battery.

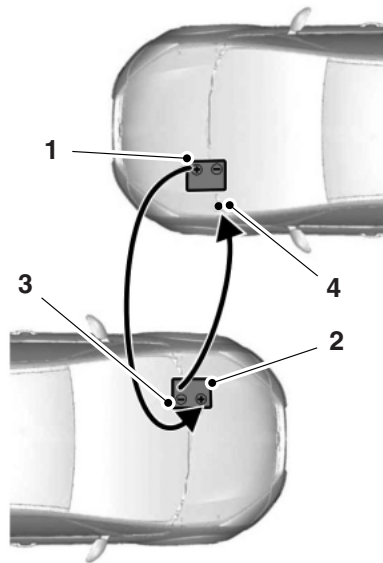

1. Connect the positive (+) jumper cable to the positive (+) terminal of the discharged battery.

2. Connect the other end of the positive (+) cable to the positive (+) terminal of the assisting battery.

3. Connect the negative (-) cable to the negative (-) terminal of the assisting battery.

4. Make the final connection of the negative (-) cable to an exposed metal part that is located under the stalled vehicle's hood, and away from the battery and carburetor or fuel injection system.

Make sure that the cables are clear of fan blades, belts and other moving parts.

Jump Starting

1. Start the booster vehicle and let it run at a moderately increased speed.
2. Switch on the disabled vehicle to Ready to Drive mode.
3. Once the disabled vehicle has been started, keep both vehicles running for an additional three minutes before disconnecting the jumper cables.

Removing the Jumper Cables

Note: In the illustration, the vehicle on the bottom is used to designate the assisting (boosting) battery.

Remove the jumper cables in the reverse order that they were connected.

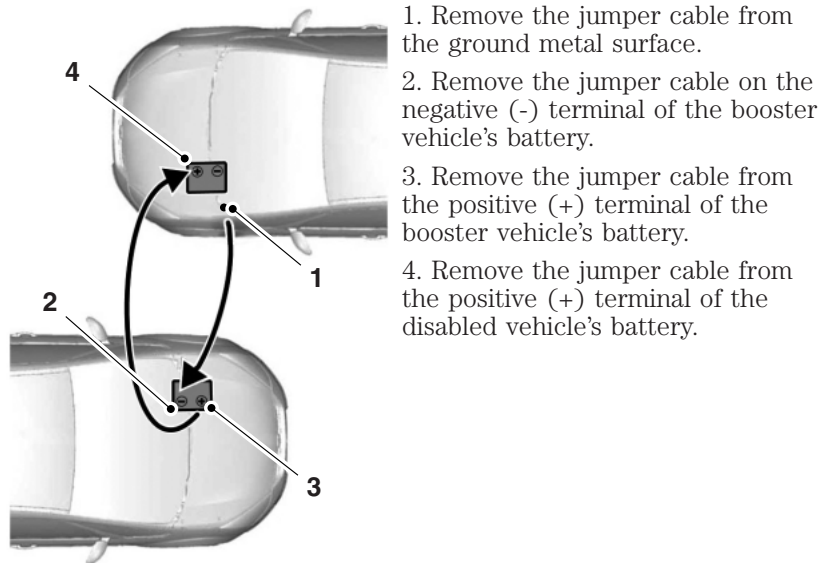

1. Remove the jumper cable from the ground metal surface.
2. Remove the jumper cable on the negative (-) terminal of the booster vehicle's battery.
3. Remove the jumper cable from the positive (+) terminal of the booster vehicle's battery.
4. Remove the jumper cable from the positive (+) terminal of the disabled vehicle's battery.

After the disabled vehicle has been started and the jumper cables removed, allow it to dwell in Ready to Drive mode for several minutes so the high-voltage battery can continue to recharge the 12-volt battery.

COLLISION, DAMAGE OR FIRE EVENT

Guidance for Ford Motor Company Electric and Hybrid-Electric Vehicles Equipped With High-Voltage Batteries (Vehicle Owner/Operator/General Public)

In the event of damage or fire involving an electric vehicle (EV) or hybrid-electric vehicle (HEV):

- Always assume the high-voltage battery and associated components are energized and fully charged.
- Exposed electrical components, wires, and high-voltage batteries present potential high-voltage shock hazards.

- Venting/off-gassing high-voltage battery vapors are potentially toxic and flammable.
- Physical damage to the vehicle or high-voltage battery may result in immediate or delayed release of toxic and/or flammable gases and fire.

Vehicle information and general safety practices:

- Know the make and model of your vehicle.
- Review the Owner's Manual and become familiar with your vehicle's safety information and recommended safety practices.
- Do not attempt to repair damaged electric and hybrid-electric vehicles yourself. Contact an authorized Ford Dealer or vehicle manufacturer representative for service.

Crashes

A crash or impact significant enough to require an emergency response for conventional vehicles would also require the same response for an electric or hybrid-electric vehicle.

If possible

- Move your car to a safe, nearby location and remain on the scene.
- Roll down windows before shutting vehicle off.
- Place vehicle in Park, set parking brake, turn off the vehicle, activate hazard lights, and move key(s) at least 16 feet (5 meters) away from the vehicle.

Always

- Call 911 if assistance is needed and advise that an electric or hybrid-electric vehicle is involved.
- Do not touch exposed electrical components or the engine compartment, as a shock hazard may exist.
- Avoid contact with leaking fluids and gases, and remain out of the way of oncoming traffic until emergency responders arrive.
- When emergency responders arrive, tell them that the vehicle involved is an electric vehicle or hybrid-electric vehicle.

Fires

As with any vehicle, call 911 immediately if you see sparks, smoke, or flames coming from the vehicle.

- Exit the vehicle immediately.
- Advise 911 that an electric or hybrid-electric vehicle is involved.
- As with any vehicle fire, do not inhale smoke, vapors, or gas from the vehicle, as they may be hazardous.
- Remain a safe distance upwind and uphill from the vehicle fire.
- Stay out of the roadway and stay out of the way of any oncoming traffic while awaiting the arrival of emergency responders.

Post-Incident

- Do not store a severely damaged vehicle with a lithium-ion battery inside a structure or within 50 feet (15 meters) of any structure or vehicle.
- Ensure that passenger and cargo compartments remain ventilated (i.e., open door, trunk or liftgate).
- For vehicles in the United States, notify Ford Motor Company 1-800-392-3673 (then follow the prompts on the voice response menu), an authorized Ford dealer or service center as soon as possible as there may be other steps to secure and/or discharge the HV battery.
- For vehicles in Canada, notify Ford Motor Company 1-800-565-3673 (then follow the prompts on the voice response menu), an authorized Ford dealer or service center as soon as possible as there may be other steps to secure and/or discharge the HV battery.
- Call 911 if you observe leaking fluids, sparks, smoke, or flames, or hear gurgling or bubbling from the HV battery.

GETTING THE SERVICES YOU NEED

Warranty repairs to your vehicle must be performed by an authorized dealer. While any authorized dealer handling your vehicle line will provide warranty service, we recommend you return to your selling authorized dealer who wants to ensure your continued satisfaction.

Please note that certain warranty repairs require special training, equipment or both, so not all authorized dealers are authorized to perform all warranty repairs. This means that, depending on the warranty repair needed, you may have to take your vehicle to another authorized dealer.

A reasonable time must be allowed to perform a repair after taking your vehicle to the authorized dealer. Repairs will be made using Ford or Motorcraft parts, or remanufactured or other parts that are authorized by Ford.

Away from Home

If you are away from home when your vehicle needs service, contact the Ford Customer Relationship Center or use the online resources listed below to find the nearest authorized dealer.

In the United States:

Mailing Address

Ford Motor Company
Customer Relationship Center
P.O. Box 6248
Dearborn, MI 48121

Telephone

1-800-392-3673 (FORD)
(TDD for the hearing impaired: 1-800-232-5952)

Online

Additional information and resources are available online at www.fordowner.com.

These are some of the items that can be found online:

- U.S. Dealer Locator by Dealer Name, City/State, or Zip Code
- Owner Manuals
- Maintenance Schedules
- Recalls
- Ford Extended Service Plans

- Ford Genuine Accessories
- Service specials and promotions.

In Canada:

Mailing address

Customer Relationship Centre
Ford Motor Company of Canada, Limited
P.O. Box 2000
Oakville, Ontario L6K 1C8

Telephone

1-800-565-3673 (FORD)

Online

www.ford.ca

Additional Assistance

If you have questions or concerns, or are unsatisfied with the service you are receiving, follow these steps:

1. Contact your Sales Representative or Service Advisor at your selling or servicing authorized dealer.
2. If your inquiry or concern remains unresolved, contact the Sales Manager, Service Manager or Customer Relations Manager.
3. If you require assistance or clarification on Ford Motor Company policies, please contact the Ford Customer Relationship Center.

In order to help serve you better, please have the following information available when contacting a Customer Relationship Center:

- Vehicle Identification Number (VIN)
- Your telephone number (home and business)
- The name of the authorized dealer and city where located
- The vehicle's current odometer reading.

In some states, you must directly notify Ford in writing before pursuing remedies under your state's warranty laws. Ford is also allowed a final repair attempt in some states.

In the United States, a warranty dispute must be submitted to the BBB AUTO LINE before taking action under the Magnuson-Moss Warranty Act, or to the extent allowed by state law, before pursuing replacement or repurchase remedies provided by certain state laws. This dispute handling procedure is not required prior to enforcing state created rights or other rights which are independent of the Magnuson-Moss Warranty Act or state replacement or repurchase laws.

IN CALIFORNIA (U.S. ONLY)

California Civil Code Section 1793.2(d) requires that, if a manufacturer or its representative is unable to repair a motor vehicle to conform to the vehicle's applicable express warranty after a reasonable number of attempts, the manufacturer shall be required to either replace the vehicle with one substantially identical or repurchase the vehicle and reimburse the buyer in an amount equal to the actual price paid or payable by the consumer (less a reasonable allowance for consumer use). The consumer has the right to choose whether to receive a refund or replacement vehicle.

California Civil Code Section 1793.22(b) presumes that the manufacturer has had a reasonable number of attempts to conform the vehicle to its applicable express warranties if, within the first 18 months of ownership of a new vehicle or the first 18000 mi (29 000 km), whichever occurs first:

1. Two or more repair attempts are made on the same nonconformity likely to cause death or serious bodily injury OR
2. Four or more repair attempts are made on the same nonconformity (a defect or condition that substantially impairs the use, value or safety of the vehicle) OR
3. The vehicle is out of service for repair of nonconformities for a total of more than 30 calendar days (not necessarily all at one time).

In the case of 1 or 2 above, the consumer must also notify the manufacturer of the need for the repair of the nonconformity at the following address:

Ford Motor Company
16800 Executive Plaza Drive
Mail Drop 3NE-B
Dearborn, MI 48126

You are required to submit your warranty dispute to BBB AUTO LINE before asserting in court any rights or remedies conferred by California Civil Code Section 1793.22(b). You are also required to use BBB AUTO LINE before exercising rights or seeking remedies created by the Federal Magnuson-Moss Warranty Act, 15 U.S.C. sec. 2301 et seq. If you choose to seek redress by pursuing rights and remedies not created by California Civil Code Section 1793.22(b) or the Magnuson-Moss Warranty Act, resorting to BBB AUTO LINE is not required by those statutes.

**THE BETTER BUSINESS BUREAU (BBB) AUTO LINE PROGRAM
(U.S. ONLY)**

Your satisfaction is important to Ford Motor Company and to your dealer. If a warranty concern has not been resolved using the three-step procedure outlined earlier in this chapter in the *Getting the Services You Need* section, you may be eligible to participate in the BBB AUTO LINE program.

The BBB AUTO LINE program consists of two parts – mediation and arbitration. During mediation, a representative of the BBB will contact both you and Ford Motor Company to explore options for settlement of the claim. If an agreement is not reached during mediation or you do not want to participate in mediation, and if your claim is eligible, you may participate in the arbitration process. An arbitration hearing will be scheduled so that you can present your case in an informal setting before an impartial person. The arbitrator will consider the testimony provided and make a decision after the hearing.

Disputes submitted to the BBB AUTO LINE program are usually decided within 40 days after you file your claim with the BBB. You are not bound by the decision, and may reject the decision and proceed to court where all findings of the BBB Auto Line dispute, and decision, are admissible in the court action. Should you choose to accept the BBB AUTO LINE decision, Ford is then bound by the decision, and must comply with the decision within 30 days of receipt of your acceptance letter.

BBB AUTO LINE Application: Using the information provided below, please call or write to request a program application. You will be asked for your name and address, general information about your new vehicle, information about your warranty concerns, and any steps you have already taken to try to resolve them. A Customer Claim Form will be mailed that will need to be completed, signed and returned to the BBB along with proof of ownership. Upon receipt, the BBB will review the claim for eligibility under the Program Summary Guidelines.

You can get more information by calling BBB AUTO LINE at 1-800-955-5100, or writing to:

**BBB AUTO LINE
3033 Wilson Boulevard, Suite 600
Arlington, Virginia 22201**

BBB AUTO LINE applications can also be requested by calling the Ford Motor Company Customer Relationship Center at 1-800-392-3673.

Note: Ford Motor Company reserves the right to change eligibility limitations, modify procedures, or to discontinue this process at any time without notice and without obligation.

**UTILIZING THE MEDIATION or ARBITRATION PROGRAM
(CANADA ONLY)**

This pertains to vehicles delivered to authorized Canadian dealers. In those cases, where you continue to feel that the efforts by Ford of Canada and the authorized dealer to resolve a factory-related vehicle service concern have been unsatisfactory, Ford of Canada participates in an impartial third party mediation or arbitration program administered by the Canadian Motor Vehicle Arbitration Plan (CAMVAP).

The CAMVAP program is a straightforward and relatively speedy alternative to resolve a disagreement when all other efforts to produce a settlement have failed. This procedure is without cost to you and is designed to eliminate the need for lengthy and expensive legal proceedings.

In the CAMVAP program, impartial third-party arbitrators conduct hearings at mutually convenient times and places in an informal environment. These impartial arbitrators review the positions of the parties, make decisions and, when appropriate, render awards to resolve disputes. CAMVAP decisions are fast, fair, and final as the arbitrator's award is binding on both you and Ford of Canada.

CAMVAP services are available in all Canadian territories and provinces. For more information, without charge or obligation, call your CAMVAP Provincial Administrator directly at 1-800-207-0685 or visit www.camvap.ca.

GETTING ASSISTANCE OUTSIDE THE U.S. AND CANADA

Before exporting your vehicle to a foreign country, contact the appropriate foreign embassy or consulate. These officials can inform you of local vehicle registration regulations and where to find unleaded fuel.

If you cannot find unleaded fuel or can only get fuel with an anti-knock index lower than is recommended for your vehicle, contact our Customer Relationship Center.

The use of leaded fuel in your vehicle without proper conversion may damage the effectiveness of your emission control system and may cause engine knocking or serious engine damage. Ford Motor Company or Ford of Canada is not responsible for any damage caused by use of improper fuel. Using leaded fuel may also result in difficulty importing your vehicle back into the United States.

If your vehicle must be serviced while you are traveling or living in Asia-Pacific Region, Sub-Saharan Africa, U.S. Virgin Islands, Central America, the Caribbean, and Israel, contact the nearest authorized dealer. If the authorized dealer cannot help you, contact:

**FORD MOTOR COMPANY
FORD EXPORT OPERATIONS & GLOBAL INITIATIVES**

Customer Relationship Center
1555 Fairlane Drive Fairlane Business Park #3
Allen Park, Michigan 48101
U.S.A.
Telephone: (313) 594-4857
FAX: (313) 390-0804 Email: expcac@ford.com

For customers in Guam, the Commonwealth of the Northern Mariana Islands (CNMI), America Samoa, and the U.S. Virgin Islands, please feel free to call our Toll-Free Number: (800) 841-FORD (3673)

If your vehicle must be serviced while you are traveling or living in Puerto Rico, contact the nearest authorized dealer. If the authorized dealer cannot help you, contact:

**FORD MOTOR COMPANY
FORD EXPORT OPERATIONS & GLOBAL INITIATIVES**

Customer Relationship Center
1555 Fairlane Drive Fairlane Business Park #3
Allen Park, Michigan 48101
U.S.A.
Telephone: (313) 594-4857
FAX: (313) 390-0804 Email: www.ford.com.pr

If your vehicle must be serviced while you are traveling or living in the Middle East, contact the nearest authorized dealer. If the authorized dealer cannot help you, contact:

**Ford Middle East
Customer Relationship Center**

P.O. Box 21470 Dubai, United Arab Emirates
Telephone: +971 4 3326084
Toll-Free Number of the Kingdom of Saudi Arabia: 800 8971409
Local Telephone Number of Kuwait: 24810575
FAX: +971 4 3327299
Email: menacac@ford.com
www.me.ford.com

If you buy your vehicle in North America and then relocate to any of the above locations, register your vehicle identification number (VIN) and new address with Ford Motor Company Export Operations & Global Growth Initiatives by emailing expcac@ford.com.

If you are in another foreign country, contact the nearest authorized dealer. In the event your inquiry is unresolved, communicate your concern with the dealership's Sales Manager, Service Manager or Customer Relations Manager. If you require additional assistance or clarification, please contact the respective Customer Relationship Center as previously listed.

Customers in the U.S. should call 1-800-392-3673.

ORDERING ADDITIONAL OWNER'S LITERATURE

To order the publications in this portfolio, contact Helm, Incorporated at:

HELM, INCORPORATED
47911 Halyard Drive
Plymouth, Michigan 48170
Attention: Customer Service

Or to order a free publication catalog, call toll free: 1-800-782-4356

Monday-Friday 8:00 a.m. - 6:00 p.m. EST

Helm, Incorporated can also be reached by their website:
www.helminc.com.

(Items in this catalog may be purchased by credit card, check or money order.)

Obtaining a French Owner's Manual

A French owner's manual can be obtained from your authorized dealer or by contacting Helm, Incorporated using the contact information listed previously in this section.

REPORTING SAFETY DEFECTS (U.S. ONLY)

If you believe that your vehicle has a defect which could cause a crash or could cause injury or death, you should immediately inform the National Highway Traffic Safety

Administration (NHTSA) in addition to notifying Ford Motor Company.

If NHTSA receives similar complaints, it may open an investigation, and if it finds that a safety defect exists in a group of vehicles, it may order a recall and remedy campaign. However, NHTSA cannot become involved in individual problems between you, your dealer, or Ford Motor Company.

To contact NHTSA, you may call the Vehicle Safety Hotline toll-free at 1-888-327-4236 (TTY: 1-800-424-9153); go to <http://www.safercar.gov>; or write to:

Administrator
1200 New Jersey Avenue, Southeast
Washington, D.C. 20590

You can also obtain other information about motor vehicle safety from <http://www.safercar.gov>.

REPORTING SAFETY DEFECTS (CANADA ONLY)

If you believe that your vehicle has a defect which could cause a crash or could cause injury or death, you should immediately inform Transport Canada, using their toll-free number: 1-800-333-0510, or online at: <http://www.tc.gc.ca/eng/roadsafety/menu.htm>

CHANGING A FUSE**Fuses**

WARNING: Always replace a fuse with one that has the specified amperage rating. Using a fuse with a higher amperage rating can cause severe wire damage and could start a fire.

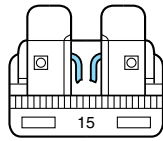

If electrical components in your vehicle are not working, a fuse may have blown. Blown fuses are identified by a broken wire within the fuse. Check the appropriate fuses before replacing any electrical components.

Standard Fuse Amperage Rating and Color

COLOR					
Fuse rating	Mini fuses	Standard fuses	Maxi fuses	Cartridge maxi fuses	Fuse link cartridge
2A	Grey	Grey	—	—	—
3A	Violet	Violet	—	—	—
4A	Pink	Pink	—	—	—
5A	Tan	Tan	—	—	—
7.5A	Brown	Brown	—	—	—
10A	Red	Red	—	—	—
15A	Blue	Blue	—	—	—
20A	Yellow	Yellow	Yellow	Blue	Blue
25A	Natural	Natural	—	Natural	Natural
30A	Green	Green	Green	Pink	Pink
40A	—	—	Orange	Green	Green
50A	—	—	Red	Red	Red
60A	—	—	Blue	Yellow	Yellow
70A	—	—	Tan	—	Brown
80A	—	—	Natural	Black	Black

FUSE SPECIFICATION CHART**Power Distribution Box**

WARNING: Always remove the high voltage battery safety connectors to make sure the high voltage batteries are disconnected, and always disconnect the 12 volt (underhood) battery before servicing high-current fuses.



WARNING: To reduce risk of electrical shock, always replace the cover to the power distribution box before reconnecting the battery or refilling fluid reservoirs.

The power distribution box is located in the underhood compartment. The power distribution box contains high-current fuses that protect your vehicle's main electrical systems from overloads.

If the battery has been disconnected and reconnected, see *Changing the Vehicle Battery* in the *Maintenance and Specifications* chapter.

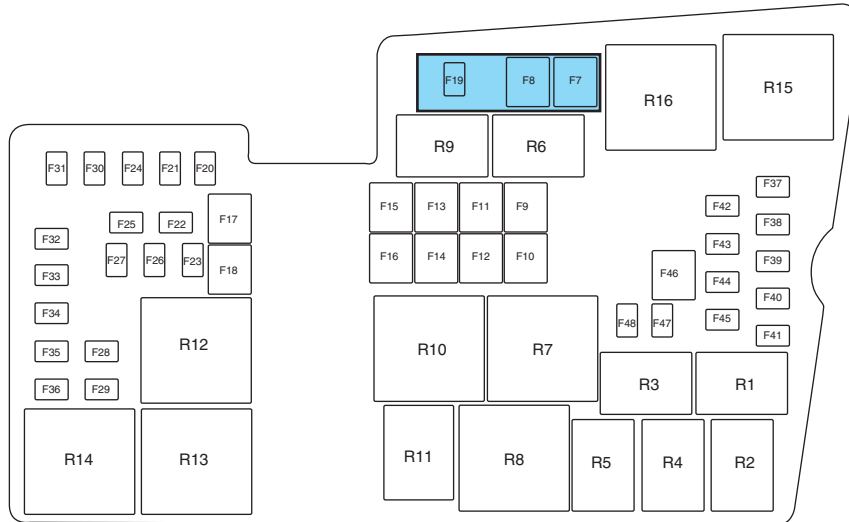

The high-current fuses are coded as follows:

Fuse or relay location	Fuse amp rating	Protected circuits
F7	40A**	Anti-lock brakes pump
F8	30A**	Anti-lock brakes valve
F9	—	Not used
F10	40A**	Heater blower motor, Temperature sensor
F11	40A**	Vacuum pump
F12	40A**	Motor control relay fuse
F13	40A**	On-board charger
F14	40A**	Heater element 1
F15	—	Not used
F16	40A**	Heater element 2
F17	—	Not used

Fuse or relay location	Fuse amp rating	Protected circuits
F18	20A**	Front wiper motor
F19	5A*	Anti-lock brake control module
F20	15A*	Horn
F21	5A*	Stop light switch
F22	15A*	Battery monitoring sensor
F23	5A*	Relay coils
F24	5A*	Light switch module
F25	—	Not used
F26	10A*	Powertrain control module
F27	15A*	Charger port light ring
F28	5A*	Vacuum pump monitor
F29	—	Not used
F30	5A*	Transmission control module
F31	10A*	Smart datalink connector; Diagnostic connector
F32	10A*	Compressor bypass valves, Coolant valves, Electronic fan control module relay
F33	10A*	Powertrain control module (PSR feedback), A/C compressor solenoid
F34	15A*	Powertrain control module (contactor sense), Battery electronics control module (PSR)
F35	—	Not used
F36	20A*	Coolant water pumps
F37	5A*	Vehicle audible speaker for pedestrians
F38	15A*	Powertrain control module (electronic control module KL15)
F39	5A*	Not used (spare)
F40	5A*	Electronic power assist steering

Fuse or relay location	Fuse amp rating	Protected circuits
F41	20A*	Body control module
F42	15A*	Rear wiper
F43	15A*	Not used (spare)
F44	—	Not used
F45	—	Not used
F46	—	Not used
F47	5A*	In-Car temperature sensor
F48	5A*	Mechanical relay
R1	—	Not used
R2	Micro relay	Horn relay
R3	—	Not used
R4	Micro relay	Contact relay
R5	—	Not used
R6	—	Not used
R7	Power relay	Heater element 3
R8	Power relay	Heater element 1 & 2
R9	—	Not used
R10	Mini relay	Anti-lock brake system vacuum pump (solid state relay)
R11	—	Not used
R12	Power relay	Electronic fan control module relay
R13	Mini relay	Heater blower relay
R14	Mini relay	Motor control relay
R15	Power relay	Mechanical relay
R16	Power relay	Ignition 15

*Mini Fuses **Cartridge Fuses

Passenger Compartment Fuse Panel

The fuse panel is located on the right side below the glove box.

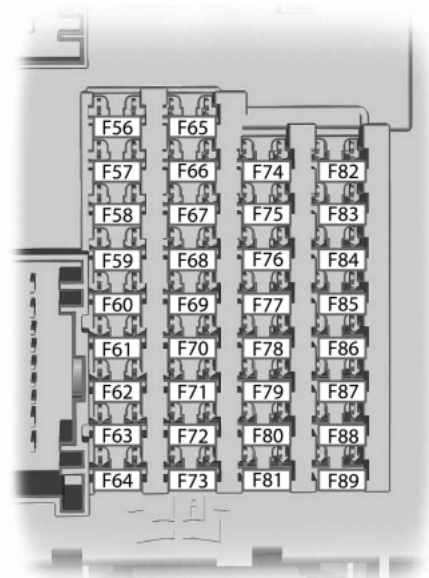

Fuse or relay number	Fuse amp rating	Protected components
F56	20A	Not used (spare)
F57	—	Not used
F58	—	Not used
F59	5A	Passive anti-theft transceiver
F60	10A	Interior light, Driver door switch pack, Glove box illumination, Overhead console switch bank
F61	20A	Cigar lighter, Power point
F62	5A	Rain sensor module
F63	—	Not used
F64	—	Not used
F65	10A	Liftgate release

Fuse or relay number	Fuse amp rating	Protected components
F66	20A	Driver door unlock supply
F67	7.5A	SYNC, Multifunction display, Global positioning system module, Compass
F68	—	Not used
F69	5A	Instrument cluster
F70	20A	Central lock and unlock supply
F71	10A	Climate control
F72	7.5A	Steering wheel module
F73	7.5A	Datalink connector
F74	15A	Low beam headlamp supply
F75	15A	Not used (spare)
F76	10A	Reversing lamp supply, Auto-dimming rear view mirror
F77	20A	Washer pump
F78	5A	Ignition switch, Start button
F79	15A	Radio, Hazard light switch, Door lock switch, Electronic finish panel
F80	20A	Not used (spare)
F81	5A	Radio frequency receiver
F82	20A	Washer pump ground
F83	20A	Central locking ground
F84	20A	Unlock supply ground
F85	7.5A	Front seat heater switch
F86	10A	Airbag module, Occupant classification sensor, Passenger airbag deactivation indicator
F87	—	Not used
F88	25A	Supply for F67, F69, F71 and F79
F89	—	Not used

Luggage Compartment Fuse Panel

The fuse panel is located in the luggage compartment behind the left side wheel well. Remove the fuse panel cover to gain access to the fuses.

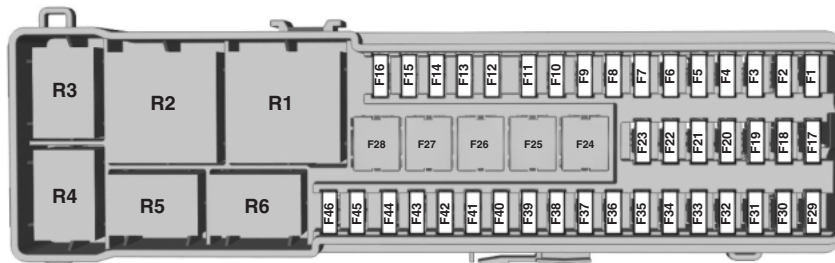

Fuse or relay number	Fuse amp rating	Protected components
F1	5A	Telematics control unit
F2	10A	Keyless vehicle module
F3	5A	Keyless vehicle door handles
F4	25A	Door control unit – front left
F5	25A	Door control unit – front right
F6	25A	Door control unit – rear left
F7	25A	Door control unit – rear right
F8	—	Not used
F9	25A	Driver seat motor
F10	25A	Rear window defroster
F11	5A	Battery electronics control module
F12	—	Not used
F13	—	Not used
F14	—	Not used
F15	—	Not used

Fuse or relay number	Fuse amp rating	Protected components
F16	—	Not used
F17	—	Not used
F18	—	Not used
F19	—	Not used
F20	—	Not used
F21	—	Not used
F22	—	Not used
F23	—	Not used
F24	—	Not used
F25	—	Not used
F26	—	Not used
F27	—	Not used
F28	—	Not used
F29	5A	Park assist camera
F30	5A	Parking aid module
F31	—	Not used
F32	—	Not used
F33	—	Not used
F34	15A	Driver seat heater
F35	15A	Passenger seat heater
F36	—	Not used
F37	—	Not used
F38	—	Not used
F39	—	Not used
F40	—	Not used
F41	—	Not used
F42	—	Not used
F43	—	Not used
F44	—	Not used
F45	—	Not used
F46	—	Not used

Fuses

207

Fuse or relay number	Fuse amp rating	Protected components
R1	—	Rear 15 relay
R2	—	Rear window defrost relay
R3	—	Rear wiper relay
R4	—	Not used
R5	—	Not used
R6	—	Not used

GENERAL INFORMATION

Have your vehicle serviced regularly to help maintain its roadworthiness and resale value. There is a large network of Ford authorized dealers who are there to help you with their professional servicing expertise. We believe that their specially trained technicians are best qualified to service your vehicle properly and expertly. They are supported by a wide range of highly specialized tools developed specifically for servicing your vehicle.

To help you service your vehicle, we provide *scheduled maintenance Information* which makes tracking routine service easy.

If your vehicle requires professional service, your authorized dealer can provide the necessary parts and service. Check your warranty information to find out which parts and services are covered.

Use only the recommended lubricants, fluids and service parts conforming to specifications. Motorcraft parts are designed and built to provide the best performance in your vehicle.

Precautions

- Always treat the high-voltage battery and electrical components with caution.
- Make sure the vehicle is off before performing any service, maintenance or repair.
- Make sure the vehicle is in (P) Park with the parking brake applied.

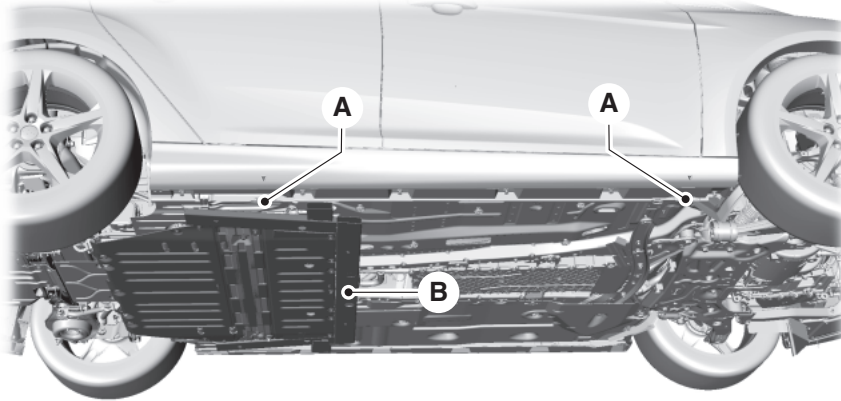
Important Information for Lifting or Jacking

A. Lifting points

B. High-voltage battery and support brace

If you need to use a floor jack or a hoist to service your vehicle, make sure the lift pads do not contact the high-voltage battery or support brace.

The high-voltage battery and the support brace are in close proximity to your vehicle's rear lifting points, which are identified with a triangle icon. Make sure the lift pads of the floor jack or hoist are positioned at the specified lifting points. Lifting the vehicle with the lift pads of the jack or hoist positioned on the high-voltage battery or the brace will damage the high-voltage battery.

Failure to follow the guidelines will result in extensive damage to the high-voltage battery.

HIGH VOLTAGE INFORMATION

WARNING: Exposure to high voltage may result in severe personal injury or death. High voltage components must be serviced by a trained service technician.

Your vehicle consists of various high-voltage components and wiring. All of the high-voltage power flows through specific wiring assemblies which are labeled as such and/or are covered with a solid orange convolute or orange stripe tape. Do not come in contact with these components.

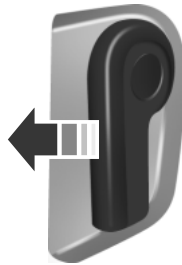
OPENING AND CLOSING THE HOOD

1. Inside the vehicle, pull the hood release handle located on the left hand side under the instrument panel.

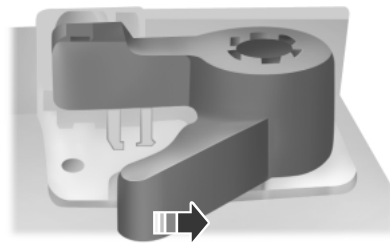

2. Go to the front of the vehicle and locate the auxiliary latch located under the front of the hood (left of center) and then release it by pushing the auxiliary latch to the right.

3. Lift the hood and locate the prop rod on the passenger side of the vehicle. Support the hood with the prop rod.

4. To close the hood, lower the hood and allow it to drop from under its own weight for the last 8-11 inches (20-30 centimeters). Make sure that the hood is closed properly.

! **WARNING:** The inverter system controller contains various high-voltage components that can cause serious bodily harm or death. The inverter system controller not serviceable and should never be touched, probed or tampered with.

Note: The under hood compartment contains many high-voltage components and wiring. Do not attempt to service any of these components.

Note: The high-voltage components are color coated orange for easy identification.

Note: The illustration shows the under hood compartment without the cover in order to show the components.

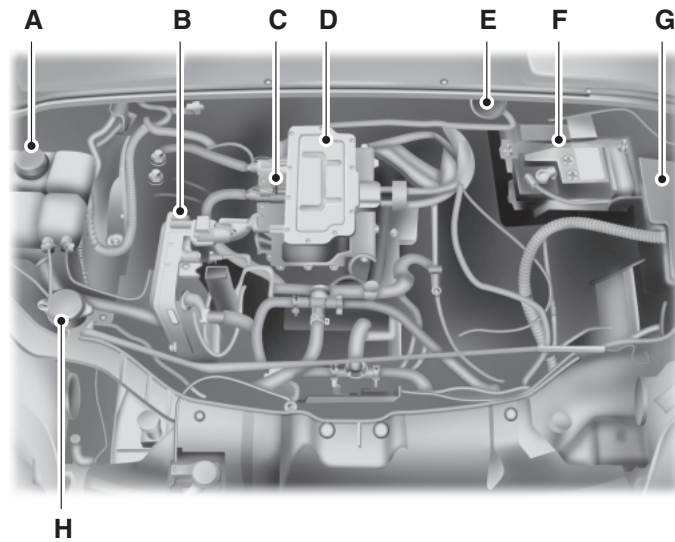

- A. Coolant reservoir
- B. DC/DC converter
- C. High voltage traction motor
- D. Inverter system controller
- E. Brake fluid reservoir
- F. 12-volt battery
- G. Power distribution box
- H. Windshield washer fluid

COOLANT**Checking the Coolant**

When the Electric Powertrain Assembly is cold, check the level of the coolant in the reservoir at the intervals listed in the *scheduled maintenance information*.

Note: Make sure that the level is between the MIN and MAX marks on the coolant reservoir.

Note: Coolant expands when it is hot. The level may extend beyond the MAX mark.

Note: If the coolant has not been checked at the recommended interval, the coolant reservoir may become low or empty. If the level is at the MIN mark, below the MIN mark, or empty, add prediluted coolant to the reservoir. See *Adding coolant* in this chapter.

Note: For best results, coolant concentration should be tested with a refractometer such as Rotunda tool 300-ROB75240E available from your dealer. Ford does not recommend the use of hydrometers or coolant test strips for measuring coolant concentrations.

Note: It is very important to use prediluted coolant meeting the Ford specification in order to avoid plugging the small coolant passageways. Use of concentrated coolant and water may cause coolant passageway plugging and void the warranty. See the technical specifications chart in the *Capacities and Specifications* chapter.

Note: Automotive fluids are not interchangeable; do not use coolant/antifreeze or windshield washer fluid outside of its specified function and vehicle location.

Adding Coolant

WARNING: Do not add coolant when the Electric Powertrain Assembly is hot. Steam and scalding liquids released from a hot cooling system can burn you badly. Also, you can be burned if you spill coolant on hot motor parts.



WARNING: Do not put coolant in the windshield washer fluid container. If sprayed on the windshield, coolant could make it difficult to see through the windshield.



WARNING: In an emergency, add water to the cooling system to reach an authorized dealer. Have the system checked by a properly trained technician as soon as possible.



WARNING: To reduce the risk of personal injury, make sure the Electric Powertrain Assembly is cool before unscrewing the coolant pressure relief cap. The cooling system is under pressure; steam and hot liquid can come out forcefully when the cap is loosened slightly.

Note: If the coolant reservoir is lower than the MIN mark, then coolant should be added. Do not add coolant above the MAX mark.

Note: Coolant replacement can only be completed by an authorized dealer. If not performed properly, damage could occur to the cooling system components and may void the warranty.

Note: Do not use stop leak pellets or cooling system sealants or additives as they can cause damage to the cooling or heating systems. This damage would not be covered under your vehicle's warranty.

Note: During normal vehicle operation, the coolant may change color from orange to pink or light red. As long as the coolant is clear and uncontaminated, this color change does not indicate the coolant has degraded nor does it require the coolant to be drained, the system to be flushed, or the coolant to be replaced.

- DO NOT MIX different colors or types of coolant in your vehicle. Make sure the correct coolant is used. Mixing of coolants may harm your cooling system. The use of an improper coolant may harm the Electric Powertrain Assembly and cooling system components and may void the warranty.
- A large amount of water without coolant may be added, in case of emergency, to reach a vehicle service location. In this instance, the cooling system must be drained, chemically cleaned with Motorcraft® Premium Cooling System Flush, and refilled with prediluted coolant as soon as possible. Water alone (without coolant) can cause damage from corrosion, overheating, freezing or plugging.
- Do not use alcohol, methanol, brine or any coolants mixed with alcohol or methanol antifreeze (coolant). Alcohol and other liquids can cause damage from overheating or freezing.
- Do not add extra inhibitors or additives to the coolant. These can be harmful and compromise the corrosion protection of the coolant.

Unscrew the cap slowly. Any pressure will escape as you unscrew the cap.

Add prediluted coolant meeting the Ford specification. See the technical specifications chart in the *Capacities and Specifications* chapter for more information.

Whenever coolant has been added, the coolant level in the coolant reservoir should be checked the next few times you drive the vehicle. If necessary, add enough prediluted coolant to bring the coolant level to the proper level.

Recycled Coolant

Ford Motor Company does not recommend the use of recycled coolant since a Ford-approved recycling process is not yet available.

Used coolant should be disposed of in an appropriate manner. Follow your community's regulations and standards for recycling and disposing of automotive fluids.

Severe Climates

If you drive in extremely cold climates:

Note: It may be necessary to have an authorized Ford dealer increase the coolant concentration above 50%.

Note: A coolant concentration of 60% will provide improved freeze point protection. Increased coolant concentrations above 60% will decrease the overheat protection characteristics of the coolant and may cause damage.

If you drive in extremely hot climates:

Note: It may be necessary to have an authorized Ford dealer decrease the coolant concentration to 40%.

Note: A coolant concentration of 40% will provide improved overheat protection. Decreased coolant concentrations below 40% will decrease the corrosion/freeze protection characteristics of the coolant and may cause damage.

Vehicles driven year-round in non-extreme climates should use prediluted coolant meeting the Ford specification for optimum cooling system protection.

Transmission

Checking single-speed transmission

The transmission does not have an underhood transmission fluid dipstick.

Your transmission does not consume fluid. It is designed to be filled for life. However, the fluid level should be checked if the transmission is not working properly, or if you notice some sign of fluid leakage.

Note: Transmission fluid should be checked and, if required, fluid should be added by an authorized dealer.

Do not use supplemental transmission fluid additives, treatments or cleaning agents. The use of these materials may affect transmission operation and result in damage to internal transmission components.

BRAKE FLUID CHECK

Note: Keep brake fluid clean. Contamination with dirt, water, petroleum products or other materials may result in brake system damage and possible failure.

The fluid level will drop slowly as the brakes wear, and will rise when the brake components are replaced. Fluid levels between the MIN and MAX lines are within the normal operating range. There is no need to add fluid. If the fluid levels are outside of the normal operating range, the performance of the system could be compromised. Seek service from your authorized dealer immediately.

POWER STEERING FLUID CHECK

Your vehicle is equipped with an electric power steering (EPS) system. There is no fluid reservoir to check or fill. For additional information on the electric power steering (EPS) system, Refer to *Driving Aids*.

WINDSHIELD WASHER FLUID



WARNING: If you operate your vehicle in temperatures below 40°F (5°C), use washer fluid with antifreeze protection. Failure to use washer fluid with antifreeze protection in cold weather could result in impaired windshield vision and increase the risk of injury or accident.

Add fluid to fill the reservoir if the level is low. In very cold weather, do not fill the reservoir completely.

Only use a washer fluid that meets Ford specifications. Do not use any special washer fluid such as windshield water repellent type fluid or bug wash. They may cause squeaking, chatter noise, streaking and smearing. See *Technical Specifications* in the *Capacities and Specifications* chapter.

State or local regulations on volatile organic compounds may restrict the use of methanol, a common windshield washer antifreeze additive. Washer fluids containing non-methanol antifreeze agents should be used only if they provide cold weather protection without damaging the vehicle's paint finish, wiper blades or washer system.

LOW-VOLTAGE BATTERY



WARNING: Batteries normally produce explosive gases which can cause personal injury. Therefore, do not allow flames, sparks or lighted substances to come near the battery. When working near the battery, always shield your face and protect your eyes. Always provide proper ventilation.



WARNING: When lifting a plastic-cased battery, excessive pressure on the end walls could cause acid to flow through the vent caps, resulting in personal injury and/or damage to the vehicle or battery. Lift the battery with a battery carrier or with your hands on opposite corners.



WARNING: Keep batteries out of reach of children. Batteries contain sulfuric acid. Avoid contact with skin, eyes or clothing. Shield your eyes when working near the battery to protect against possible splashing of acid solution. In case of acid contact with skin or eyes, flush immediately with water for a minimum of 15 minutes and get prompt medical attention. If acid is swallowed, call a physician immediately.



WARNING: Battery posts, terminals and related accessories contain lead and lead compounds. Wash hands after handling.

Your vehicle is equipped with a Motorcraft® maintenance-free battery which normally does not require additional water during its life of service.

Note: If your battery has a cover/shield, make sure it is reinstalled after the battery has been cleaned or replaced.

For longer, trouble-free operation, keep the top of the battery clean and dry. Also, make certain the battery cables are always tightly fastened to the battery terminals.

If you see any corrosion on the battery or terminals, remove the cables from the terminals and clean with a wire brush. You can neutralize the acid with a solution of baking soda and water.

It is recommended that the negative battery cable terminal be disconnected from the battery if you plan to store your vehicle for an extended period of time. This will minimize the discharge of your battery during storage.

To ensure proper operation of the battery management system, any electrical devices that are added to the vehicle should not have their ground connection made directly at the negative battery post. A connection at the negative battery post can cause inaccurate measurements of the battery condition and potential incorrect system operation.

Note: Electrical or electronic accessories or components added to the vehicle by the dealer or the owner may adversely affect battery performance and durability and may also affect the performance of other electrical systems in the vehicle.

When a battery replacement is required, the battery should only be replaced with a Ford recommended replacement battery that matches the electrical requirements of the vehicle.

Note: The clock and the preset radio stations must be reset once the battery is reconnected.

Note: Always dispose of automotive batteries in a responsible manner. Follow your local authorized standards for disposal. Call your local authorized recycling center to find out more about recycling automotive batteries.

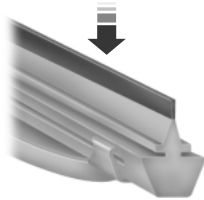
CHECKING THE WIPER BLADES

Run the tip of your fingers over the edge of the blade to check for roughness.

Clean the wiper blades with washer fluid or water applied with a soft sponge or cloth.

CHANGING THE WIPER BLADES

The wiper arms can be manually moved when the ignition is off. This allows for ease of blade replacement and cleaning under the blades.

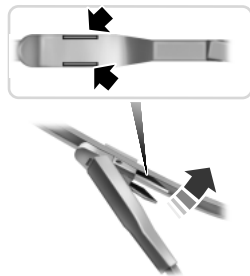

1. Turn the ignition off before removing the wiper blade.
2. Pull the wiper blade and arm away from the glass.
3. Squeeze the locking tabs to release the blade from the arm and pull the blade away from the arm to remove it.

4. Attach the new blade to the arm and snap it into place. Lower the wiper arm and blade back to the windshield. The wiper arms will automatically return to their normal position when the ignition is turned on.

Replace wiper blades at least once per year for optimum performance.

Poor wiper quality can be improved by cleaning the wiper blades and the windshield. Refer to the *Vehicle Care* chapter.

To prolong the life of the wiper blades, it is highly recommended to scrape off the ice on the windshield before turning on the wipers. The layer of ice has many sharp edges and can damage the micro edge of the wiper rubber element.

Changing the Rear Window Wiper Blade (If Equipped)

To replace the rear wiper blade:



1. Lift the wiper arm.
2. Pull the wiper blade away from the wiper arm and separate.

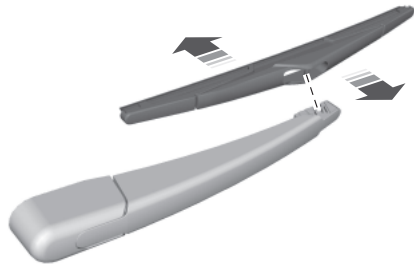

3. To attach the new wiper blade to the wiper arm, align the slot and cross pin and firmly press the wiper arm into the wiper blade until a click is heard.

ADJUSTING THE HEADLAMPS

The headlamps on your vehicle are properly aimed at the assembly plant. If your vehicle has been in an accident, an authorized dealer should check the alignment of your headlamps.

Vertical Aim Adjustment

1. Park the vehicle directly in front of a wall or screen on a level surface, approximately 25 feet (7.6 meters) away.

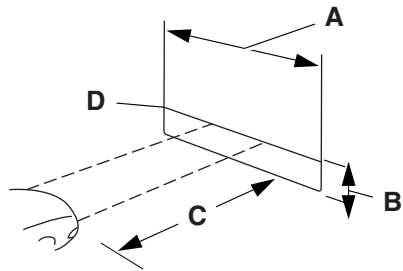

- (A) 8 feet (2.4 meters)
- (B) Center height of lamp to ground
- (C) 25 feet (7.6 meters)
- (D) Horizontal reference line

2. Measure the height of the headlamp bulb center from the ground and mark an 8 foot (2.4 meter) horizontal reference line on the vertical wall or screen at this height.

3. Turn on the low beam headlamps to illuminate the wall or screen and open the hood.

To see a clearer light pattern for adjusting, you may want to block the light from one headlamp while adjusting the other.

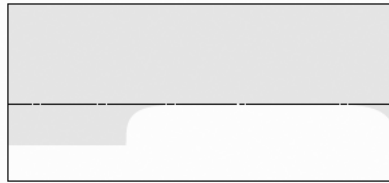
For Vehicles with Halogen Headlamps:

On the wall or screen you will observe a flat zone of high intensity light located at the top of the right hand portion of the beam pattern. If the top edge of the high intensity light zone is not at the horizontal reference line, the headlamp will need to be adjusted.

For Vehicles with HID Headlamps:

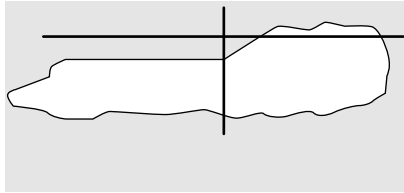

There is a distinct cut-off (change from light to dark) in the left portion of the beam pattern. The top edge of this cut-off should be positioned 2 inches (5 centimeters) below the horizontal reference line.

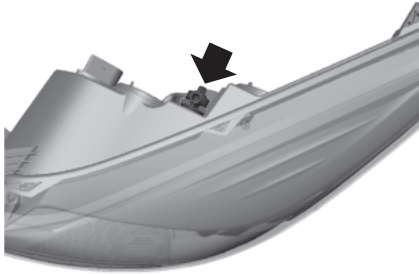

4. Locate the vertical adjuster on each headlamp. Using a Phillips #2 screwdriver, turn the adjuster either clockwise or counterclockwise in order to aim the headlamp. The horizontal edge of the brighter light should touch the horizontal reference line.

5. Close the hood and turn off the lamps.

HORIZONTAL AIM IS NOT REQUIRED FOR THIS VEHICLE AND IS NOT ADJUSTABLE.

REMOVING A HEADLAMP

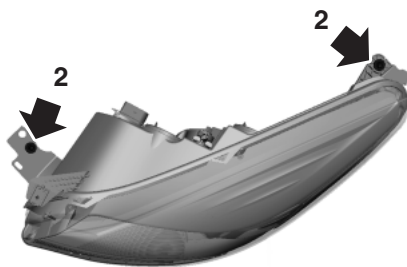

1. Make sure the headlamp control is in the off position and open the hood.
 2. Remove the two screws from the headlamp assembly.
 3. Carefully pull the headlamp assembly as far as possible towards the front of the vehicle to disengage it from the lower fixing point.

4. Carefully lift the outer side of the headlamp and remove it.

5. Disconnect the electrical connector.

CHANGING A BULB**Lamp Assembly Condensation**

Exterior lamps are vented to accommodate normal changes in pressure. Condensation can be a natural by-product of this design. When moist air enters the lamp assembly through the vents, there is a possibility that condensation can occur when the temperature is cold. When normal condensation occurs, a thin film of mist can form on the interior of the lens. The thin mist eventually clears and exits through the vents during normal operation. Clearing time may take as long as 48 hours under dry weather conditions.

These are examples of acceptable condensation:

- Presence of thin mist (no streaks, drip marks or droplets).
- Fine mist covers less than 50% of the lens.

These are examples of unacceptable moisture (usually caused by a lamp water leak):

- Water puddle inside the lamp.
- Large water droplets, drip marks or streaks present on the interior of the lens.

Take your vehicle to a dealer for service if any of the above conditions of unacceptable moisture are present.

Replacing Headlamp Bulbs

WARNING: Handle a halogen headlamp bulb carefully and keep out of children's reach. Grasp the bulb by only its plastic base and do not touch the glass. The oil from your hand could cause the bulb to break the next time the headlamps are operated.

Note: If the bulb is accidentally touched, it should be cleaned with rubbing alcohol before being used.

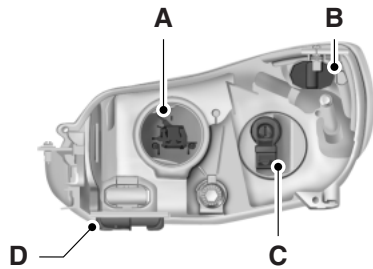

Headlamp assembly:

- A. High beam headlamp bulb
- B. Side marker bulb
- C. Low beam headlamp bulb
- D. Front parking lamp and turn signal bulb

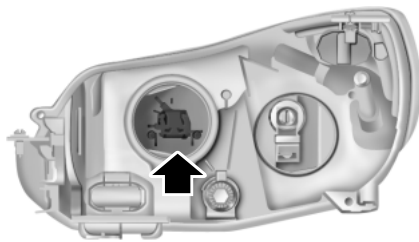

High beam headlamp bulb:

1. Remove the headlamp assembly.
2. Remove the service cap.
3. Disconnect the electrical connector.
4. Remove the bulb from the headlamp assembly by turning it counterclockwise, then pull it straight out.

Install the new bulb in reverse order.

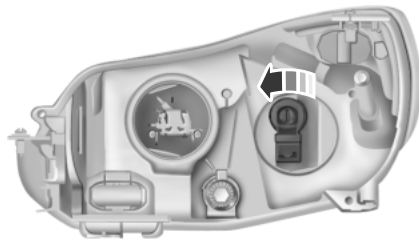

Low beam headlamp bulb:

1. Remove the headlamp assembly.
2. Remove the service cap.
3. Disconnect the electrical connector.
4. Remove the bulb from the headlamp assembly by turning it counterclockwise, then pull it straight out.

Install the new bulb in reverse order.

Note: Be sure that the spring clip is not damaged or detached from the headlamp assembly during the replacement procedure.

Replacing HID Headlamp Bulbs (If Equipped)

The low beam headlamps on your vehicle use a high intensity discharge source. These lamps operate at a high voltage. When the bulb is burned out, the bulb and starter capsule assembly must be replaced by your authorized dealer.

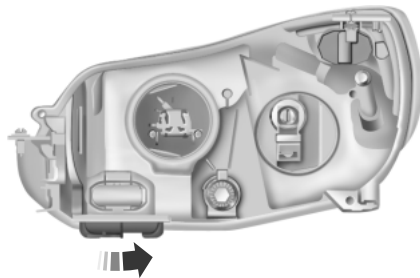
Replacing Front Parking Lamp and Turn Signal Bulbs

1. Remove the service cap by turning it counterclockwise.
2. Remove the bulb socket from the headlamp assembly by turning it counterclockwise.
3. Remove the bulb by gently pulling the bulb straight out of the socket

Install the new bulb in reverse order.

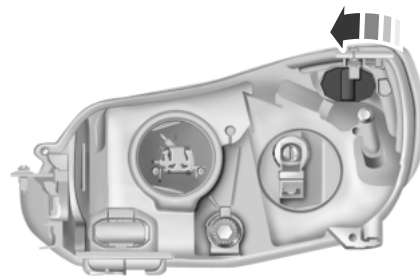
Replacing Side Marker Bulbs

1. Remove the service cap.
2. Remove the bulb socket from the headlamp assembly by turning it counterclockwise.
3. Remove the bulb by gently pulling the bulb straight out of the socket

Install the new bulb in reverse order.

Replacing Fog Lamp Bulbs (If Equipped)

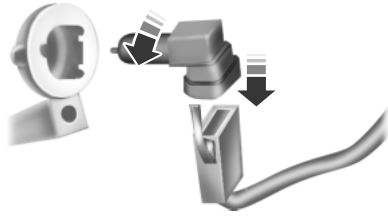

1. Make sure the lighting control switch is in the off position.
2. Reach under the front fender and remove the aero shield.
3. Remove the harness/bulb assembly from the fog lamp by turning it counterclockwise.
4. Disconnect the harness from the bulb by pulling it straight out.

Install the new bulb in reverse order.

Replacing Rear Lamps

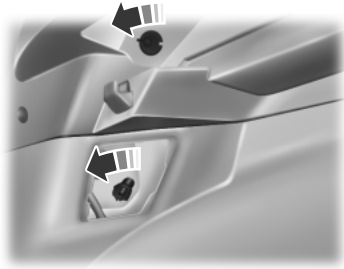

1. Make sure the headlamp control is in the off position and open the trunk.
2. Remove the trim panel from inside the luggage compartment.
3. Remove the two nuts from the lamp assembly

4. Gently pull the lamp assembly away from the vehicle
5. Remove the bulb by turning the bulb socket counterclockwise. Gently pull the bulb straight out of the socket.

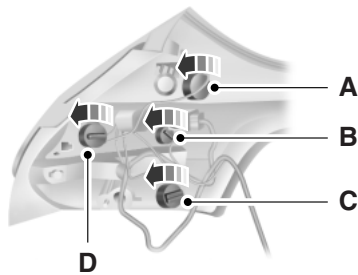

- A. Brake lamp bulb
- B. Reverse lamp bulb
- C. Tail lamp and side marker lamp bulb
- D. Turn signal bulb

Install the new bulb in reverse order.

Note: The reverse lamp bulb is located in the luggage compartment lid. If replacement is required, it is recommended that you see your authorized dealer.

Replacing License Plate Lamp Assembly

Your vehicle is equipped with an LED license plate lamp assembly. It is designed to last the life of the vehicle. If replacement is required, it is recommended that you see your authorized dealer.

Replacing High-Mount Brake Lamp Assembly

Your vehicle is equipped with an LED center high-mount stop lamp. It is designed to last the life of the vehicle. If replacement is required, it is recommended that you see your authorized dealer.

Using the right bulbs

Replacement bulbs are specified in the chart below. Headlamp bulbs must be marked with an authorized "D.O.T." for North America to ensure lamp performance, light brightness and pattern and safe visibility. The correct bulbs will not damage the lamp assembly or void the lamp assembly warranty and will provide quality bulb burn time.

Function	Trade number
* Headlamp low beam (HID)	D8S
Parking lamp/turn signal lamp (front)	W21W
* Side marker lamp (front)	LED
Brake lamp	3157K
Stop/Tail lamp	3157K
Turn lamp	3757AK
Reverse lamp	921
Dome lamp	H5W
* License plate lamp	LED
* High-mount brake lamp	LED
* To replace these lamps - see your authorized dealer.	
To replace all instrument panel lights - see your authorized dealer	

GENERAL INFORMATION

Your Ford or Lincoln authorized dealer has many quality products available to clean your vehicle and protect its finishes.

FORD AND LINCOLN CAR CARE PRODUCTS

Your Ford or Lincoln authorized dealer has many quality products available to clean your vehicle and protect its finishes. These quality products have been specifically engineered to fulfill your automotive needs; they are custom designed to complement the style and appearance of your vehicle. Each product is made from high quality materials that meet or exceed rigid specifications. For best results, use the following products or products of equivalent quality:

- Motorcraft® Bug and Tar Remover (ZC-42)
- Motorcraft® Custom Bright Metal Cleaner (ZC-15)
- Motorcraft® Detail Wash (ZC-3-A)
- Motorcraft® Dusting Cloth (ZC-24)
- Motorcraft® Multi-Purpose Cleaner (Canada only) (CXC-101)
- Motorcraft® Premium Glass Cleaner (Canada only) (CXC-100)
- Motorcraft® Premium Quality Windshield Washer Fluid (Canada only) [CXC-37-(A, B, D or F)]
- Motorcraft® Premium Windshield Wash Concentrate with Bitterant™ (U.S. only) (ZC-32-B1)
- Motorcraft® Professional Strength Carpet & Upholstery Cleaner (ZC-54)
- Motorcraft® Spot and Stain Remover (U.S. only) (ZC-14)
- Motorcraft® Ultra-Clear Spray Glass Cleaner (ZC-23)
- Motorcraft® Vinyl Cleaner (Canada only) (CXC-93)
- Motorcraft® Wheel and Tire Cleaner (ZC-37-A)

WASHING THE EXTERIOR

Wash your vehicle regularly with cool or lukewarm water and a neutral pH shampoo, such as Motorcraft Detail Wash (ZC-3-A), which is available from your authorized dealer.

- Never use strong household detergents or soap, such as dish washing or laundry liquid. These products can discolor and spot painted surfaces.
- Never wash a vehicle that is “hot to the touch” or during exposure to strong, direct sunlight.

- Always use a clean sponge or car wash mitt with plenty of water for best results.
- Dry the vehicle with a chamois or soft terry cloth towel in order to eliminate water spotting.
- It is especially important to wash the vehicle regularly during the winter months, as dirt and road salt are difficult to remove and cause damage to the vehicle.
- Immediately remove items such as gasoline, diesel fuel, bird droppings and insect deposits because they can cause damage to the vehicle's paint and trim over time. Use Motorcraft Bug and Tar Remover (ZC-42) which is available from your authorized dealer.
- Remove any exterior accessories, such as antennas, before entering a car wash.
- **Suntan lotions and insect repellents can damage any painted surface; if these substances come in contact with your vehicle, wash off as soon as possible.**

Stripes or Graphics (if equipped)

Do not use a commercial or high-pressure wand on the surface or edge of stripes and graphics. This can cause damage to the film and cause the edge of the film to peel away from the vehicle surface.

Exterior chrome

- Wash the vehicle first, using cool or lukewarm water and a neutral pH shampoo, such as Motorcraft Detail Wash (ZC-3-A).
- Use Motorcraft Custom Bright Metal Cleaner (ZC-15), available from your authorized dealer. Apply the product as you would a wax to clean bumpers and other chrome parts; allow the cleaner to dry for a few minutes, then wipe off the haze with a clean, dry rag.
- Do not apply cleaning product to hot surfaces and do not leave cleaning product on chrome surfaces for a period of time exceeding that which is recommended.
- Using other non-recommended cleaners can result in severe and permanent cosmetic damage.
- **Never use abrasive materials such as steel wool or plastic pads as they can scratch the chrome surface.**

Cleaning Plastic Exterior Parts

Use only approved products to clean plastic parts.

- For routine cleaning, use Motorcraft Detail Wash.
- If tar or grease spots are present, use Motorcraft Bug and Tar Remover.

WAXING

Regular waxing is necessary to protect your car's paint from the elements. We recommend that you wash and wax the painted surface once or twice a year.

When washing and waxing, park your vehicle in a shaded area out of direct sunlight. Always wash your vehicle before applying wax.

- Use a quality wax that does not contain abrasives.
- Follow the manufacturer's instructions to apply and remove the wax.
- Apply a small amount of wax in a back-and-forth motion, not in circles.
- Do not allow wax to come in contact with any non-body (low-gloss black) colored trim. The wax discolors or stains the parts over time, such as:
 - Bumpers
 - Grained door handles
 - Side mouldings
 - Mirror housings
 - Windshield cowl area.
- Do not apply wax to glass areas.
- After waxing, your car's paint should feel smooth, and be free of streaks and smudges.

REPAIRING MINOR PAINT DAMAGE

Your authorized dealer has touch-up paint to match your vehicle's color. Take your color code (printed on a sticker in the driver's door jamb) to an authorized dealer to make sure you get the correct color.

- Remove particles, such as bird droppings, tree sap, insect deposits, tar spots, road salt and industrial fallout, before repairing paint chips.
- Always read the instructions before using the products.

UNDER HOOD AND CHARGE PORT

WARNING: Exposure to high voltage may result in severe personal injury or death. High voltage components must be serviced by a trained service technician.

- Never use a power washer to clean under the hood or in the charge port. The high-pressure fluid could penetrate the sealed parts and cause significant damage and risk of personal injury.
- Never spray water on any of the components under the hood or in the charge port. Water ingress can damage electrical components and connections.
- Use a dry cloth to remove any excess dirt that collects under the hood or in the charge port. Always power-down the vehicle and wait five minutes before touching any electrical components.

CLEANING THE WINDOWS AND WIPER BLADES

The windows and wiper blades should be cleaned regularly. If the wipers do not wipe properly, substances on the vehicle's glass or the wiper blades may cause squeaking or chatter noise from the blades, and streaking and smearing of the windshield. To clean these items, follow these tips:

- The windows may be cleaned with a non-abrasive cleaner such as Motorcraft® Ultra-Clear Spray Glass Cleaner.
- The wiper blades can be cleaned with isopropyl (rubbing) alcohol or Motorcraft Premium Windshield Washer Concentrates in the U.S., or Motorcraft Premium Quality Windshield Washer Fluid in Canada. Replace your wiper blades when they appear worn or do not function properly.
- Do not use abrasive materials, as they may cause scratches.
- Do not use fuel, kerosene, or paint thinner to clean any parts.

If you cannot remove those streaks after cleaning with the glass cleaner or if the wipers chatter and move in a jerky motion, clean the outer surface of the windshield and the wiper blades using a sponge or soft cloth with a neutral detergent or mild-abrasive cleaning solution. After cleaning, rinse the windshield and wiper blades with clean water. The windshield is clean if beads do not form when you rinse the windshield with water.

Note: Do not use sharp objects, such as a razor blade, to clean the inside of the rear window or to remove decals, as it may cause damage to the rear window defroster's heated grid lines.

CLEANING THE INTERIOR

WARNING: Do not use cleaning solvents, bleach or dye on the vehicle's safety belts, as these actions may weaken the belt webbing.



WARNING: On vehicles equipped with seat-mounted airbags, do not use chemical solvents or strong detergents. Such products could contaminate the side airbag system and affect performance of the side airbag in a collision.

For fabric, carpets, cloth seats, safety belts and seats equipped with side airbags:

- Remove dust and loose dirt with a vacuum cleaner.
- Apply a layer of high quality foam cleaner, designed for automotive interiors, to the dry stained area (s) of the item you are cleaning and allow soaking for one minute.
- If grease or tar is present on the material, spot-clean the area first with Motorcraft Spot and Stain Remover. In Canada, use Motorcraft Multi-Purpose Cleaner.
- If a ring forms on the fabric after spot cleaning, clean the entire area immediately (but do not oversaturate) or the ring can set.
- Do not use household cleaning products or glass cleaners, which can stain and discolor the fabric and affect the flame retardant abilities of the seat materials.

CLEANING THE INSTRUMENT PANEL AND INSTRUMENT CLUSTER LENS

WARNING: Do not use chemical solvents or strong detergents when cleaning the steering wheel or instrument panel to avoid contamination of the airbag system.

Clean the instrument panel and cluster lens with a clean, damp, white, cotton cloth, then use a clean and dry, white, cotton cloth to dry these areas.

- Avoid cleaners or polishes that increase the gloss of the upper portion of the instrument panel. The dull finish in this area helps protect the driver from undesirable windshield reflection.

- Be certain to wash or wipe your hands clean if you have been in contact with certain products, such as insect repellent and suntan lotion, in order to avoid possible damage to the interior painted surfaces.
- Do not use household or glass cleaners as these may damage the finish of the instrument panel, interior trim and cluster lens.
- Do not allow air fresheners and hand sanitizers to spill on interior surfaces. If a spill occurs, wipe off immediately. Damage may not be covered by your warranty.

If a staining liquid like coffee or juice has been spilled on the instrument panel or on interior trim surfaces, clean as follows:

1. Wipe up spilled liquid using a clean, white, cotton cloth.
2. Wipe the surface with a damp, clean, white, cotton cloth. For more thorough cleaning, use a mild soap and water solution. If the spot cannot be completely cleaned by this method, the area may be cleaned using a commercially available cleaning product designed for automotive interiors.
3. If necessary, apply more soap and water solution or cleaning product to a clean, white, cotton cloth and press the cloth onto the soiled area; allow this to set at room temperature for 30 minutes.
4. Remove the soaked cloth, and if it is not soiled badly, use this cloth to clean the area by using a rubbing motion for 60 seconds.
5. Following this, wipe area dry with a clean, white, cotton cloth.

CLEANING LEATHER SEATS (IF EQUIPPED)

- Remove dust and loose dirt with a vacuum cleaner.
- Clean spills and stains as quickly as possible.
- For routine cleaning, wipe the surface with a soft, damp cloth. For more thorough cleaning, wipe the surface with a mild soap and water solution. In Canada, use Motorcraft® Vinyl Cleaner. Dry the area with a soft cloth.
- If the leather cannot be completely cleaned using a mild soap and water solution, the leather may be cleaned using a commercially available leather cleaning product designed for automotive interiors.

- To check for compatibility, first test any cleaner or stain remover on an inconspicuous part of the leather.
- Do not use household cleaning products, alcohol solutions, oil/petroleum-based leather conditioners, or solvents or cleaners intended specifically for rubber, vinyl and plastics. These products may cause premature wearing or damage to the leather.

CLEANING THE ALLOY WHEELS

Note: Do not use chrome cleaner, metal cleaner or polish on wheels and wheel covers.

A clearcoat paint finish coats aluminum wheels and wheel covers. In order to maintain their condition:

- Clean weekly with Motorcraft Wheel and Tire Cleaner. Use a sponge to remove heavy deposits of dirt and brake dust accumulation. Rinse thoroughly with a strong stream of water when you have completed the cleaning process.
- To remove tar and grease, use Motorcraft Bug and Tar Remover.
- Never apply any cleaning chemical to hot or warm wheel rims or covers.
- Some automatic car washes may cause damage to the finish on your wheel rims or covers.
- Industrial-strength (heavy-duty) cleaners, or cleaning chemicals, in combination with brush agitation to remove brake dust and dirt, could wear away the clearcoat finish over time.
- Do not use hydrofluoric acid-based or high caustic-based wheel cleaners, steel wool, fuels or strong household detergent.
- If you intend on parking your vehicle for an extended period after cleaning the wheels with a wheel cleaner, drive your vehicle for a few minutes before doing so. This reduces the risk of increased corrosion of the brake discs.

VEHICLE STORAGE

If you plan on storing your vehicle for an extended period of time (30 days or more), refer to the following maintenance recommendations to ensure your vehicle stays in good operating condition.

All motor vehicles and their components were engineered and tested for reliable, regular driving. Long term storage under various conditions may lead to component degradation or failure unless specific precautions are taken to preserve the components.

General

- Store all vehicles in a dry, ventilated place.
- Protect from sunlight, if possible.
- If vehicles are stored outside, they require regular maintenance to protect against rust and damage.

Body

- Wash vehicle thoroughly to remove dirt, grease, oil, tar or mud from exterior surfaces, rear-wheel housing and underside of front fenders. See the *Cleaning* chapter for more information.
- Periodically wash vehicles stored in exposed locations.
- Touch-up raw or primed metal to prevent rust.
- Cover chrome and stainless steel parts with a thick coat of auto wax to prevent discoloration. Rewax as necessary when the vehicle is washed. See the *Cleaning* chapter for more information.
- Lubricate all hood, door and trunk lid hinges, and latches with a light grade oil. See the *Cleaning* chapter for more information.
- Cover interior trim to prevent fading.
- Keep all rubber parts free from oil and solvents.

Cooling system

- Protect against freezing temperatures.
- When removing vehicle from storage, check coolant fluid level. Confirm there are no cooling system leaks, and fluid is at the recommended level.

Brakes

- Make sure brakes and parking brake are fully released.

Tires

- Maintain recommended air pressure.

Miscellaneous

- Make sure all linkages, cables, levers and pins under vehicle are covered with grease to prevent rust.
- Move vehicles at least 25 feet (8 m) every 15 days to lubricate working parts and prevent corrosion.

LOW AND HIGH VOLTAGE BATTERY STORAGE

If your vehicle is to be stored for 30 days or longer, the high voltage battery should be charged to above 25% state of charge and the low voltage (under hood) battery negative terminal should be disconnected.

If your vehicle is to be stored for 3 months or longer, the high voltage battery should be charged to between 80% and 100% state of charge and the low voltage (under hood) battery negative terminal should be disconnected. Failure to do this could damage the batteries.

Note: If battery cables are disconnected, it will be necessary to reset memory features.

TIRE CARE**IMPORTANT INFORMATION FOR 235/40R18 LOW-PROFILE TIRES AND WHEELS**

If your vehicle is equipped with 235/40R18 tires, they are low-profile tires. These tires and wheels are designed to give your vehicle a sport appearance. With low-profile tires, you may notice an increase in road noise and faster tire wear, depending on road conditions and driving styles. Due to their design, low-profile tires and wheels are more prone to road damage from potholes, rough or unpaved roads, car wash rails and curb contact than standard tires and wheels.

Note: Your vehicle's warranty does not cover these types of damage. Tires should always be kept at the correct inflation pressures and extra caution should be taken when operating on rough roads to avoid impacts that could cause wheel and tire damage.

Information About Uniform Tire Quality Grading

Tire Quality Grades apply to new pneumatic passenger car tires. The Tire Quality Grades can be found where applicable on the tire sidewall between tread shoulder and maximum section width. For example:

- **Treadwear 200 Traction AA Temperature A**

These Tire Quality Grades are determined by standards that the United States Department of Transportation has set.

Tire Quality Grades apply to new pneumatic passenger car tires.

They do not apply to deep tread, winter-type snow tires, space-saver or temporary use spare tires, light truck or LT type tires, tires with nominal rim diameters of 10 to 12 inches or limited production tires as defined in Title 49 Code of Federal Regulations Part 575.104(c)(2).

U.S. Department of Transportation-Tire quality grades: The U.S. Department of Transportation requires Ford Motor Company to give you the following information about tire grades exactly as the government has written it.

Treadwear

The treadwear grade is a comparative rating based on the wear rate of the tire when tested under controlled conditions on a specified government test course. For example, a tire graded 150 would wear 1½ times as well on the government course as a tire graded 100. The relative performance of tires depends upon the actual conditions of their use, however, and may depart significantly from the norm due to variations in driving habits, service practices, and differences in road characteristics and climate.

Traction AA A B C

WARNING: The traction grade assigned to this tire is based on straight-ahead braking traction tests, and does not include acceleration, cornering, hydroplaning or peak traction characteristics.

The traction grades, from highest to lowest are AA, A, B, and C. The grades represent the tire's ability to stop on wet pavement as measured under controlled conditions on specified government test surfaces of asphalt and concrete. A tire marked C may have poor traction performance.

Temperature A B C

WARNING: The temperature grade for this tire is established for a tire that is properly inflated and not overloaded. Excessive speed, underinflation, or excessive loading, either separately or in combination, can cause heat buildup and possible tire failure.

The temperature grades are A (the highest), B and C, representing the tire's resistance to the generation of heat and its ability to dissipate heat when tested under controlled conditions on a specified indoor laboratory test wheel. Sustained high temperature can cause the material of the tire to degenerate and reduce tire life, and excessive temperature can lead to sudden tire failure. The grade C corresponds to a level of performance which all passenger car tires must meet under the Federal Motor Vehicle Safety Standard No. 139. Grades B and A represent higher levels of performance on the laboratory test wheel than the minimum required by law.

Glossary of Tire Terminology

- **Tire label:** A label showing the OE (Original Equipment) tire sizes, recommended inflation pressure and the maximum weight the vehicle can carry.
- **Tire Identification Number (TIN):** A number on the sidewall of each tire providing information about the tire brand and manufacturing plant, tire size and date of manufacture. Also referred to as DOT code.
- **Inflation pressure:** A measure of the amount of air in a tire.
- **Standard load:** A class of P-metric or Metric tires designed to carry a maximum load at 35 psi [37 psi (2.5 bar) for Metric tires]. Increasing the inflation pressure beyond this pressure will not increase the tire's load-carrying capability.
- **Extra load:** A class of P-metric or Metric tires designed to carry a heavier maximum load at 41 psi [43 psi (2.9 bar) for Metric tires]. Increasing the inflation pressure beyond this pressure will not increase the tire's load-carrying capability.
- **kPa:** Kilopascal, a metric unit of air pressure.
- **PSI:** Pounds per square inch, a standard unit of air pressure.
- **Cold tire pressure:** The tire pressure when the vehicle has been stationary and out of direct sunlight for an hour or more and prior to the vehicle being driven for 1 mile (1.6 kilometers).
- **Recommended inflation pressure:** The cold inflation pressure found on the Safety Compliance Certification Label (affixed to either the door hinge pillar, door-latch post, or the door edge that meets the door-latch post, next to the driver's seating position) or Tire Label located on the B-Pillar or the edge of the driver's door.
- **B-pillar:** The structural member at the side of the vehicle behind the front door.
- **Bead area of the tire:** Area of the tire next to the rim.
- **Sidewall of the tire:** Area between the bead area and the tread.
- **Tread area of the tire:** Area of the perimeter of the tire that contacts the road when mounted on the vehicle.
- **Rim:** The metal support (wheel) for a tire or a tire and tube assembly upon which the tire beads are seated.

INFORMATION CONTAINED ON THE TIRE SIDEWALL

Both U.S. and Canada Federal regulations require tire manufacturers to place standardized information on the sidewall of all tires. This information identifies and describes the fundamental characteristics of the tire and also provides a U.S. DOT Tire Identification Number for safety standard certification and in case of a recall.

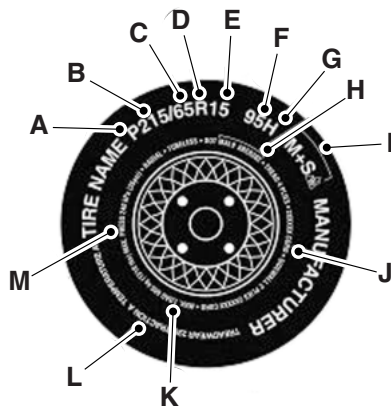
Information on P Type Tires

P215/65R15 95H is an example of a tire size, load index and speed rating. The definitions of these items are listed below. (Note that the tire size, load index and speed rating for your vehicle may be different from this example.)

A. **P:** Indicates a tire, designated by the Tire and Rim Association, that may be used for service on cars, sport utility vehicles, minivans and light trucks.

Note: If your tire size does not begin with a letter, this may mean it is designated by either the European Tire and Rim Technical Organization or the Japan Tire Manufacturing Association.

B. **215:** Indicates the nominal width of the tire in millimeters from sidewall edge to sidewall edge. In general, the larger the number, the wider the tire.

C. **65:** Indicates the aspect ratio which gives the tire's ratio of height to width.

D. **R:** Indicates a radial type tire.

E. **15:** Indicates the wheel or rim diameter in inches. If you change your wheel size, you will have to purchase new tires to match the new wheel diameter.

F. **95:** Indicates the tire's load index. It is an index that relates to how much weight a tire can carry. You may find this information in your owner's manual. If not, contact a local tire dealer.

Note: You may not find this information on all tires because it is not required by federal law.

G. **H:** Indicates the tire's speed rating. The speed rating denotes the speed at which a tire is designed to be driven for extended periods of time under a standard condition of load and inflation pressure. The tires on your vehicle may operate at different conditions for load and inflation pressure. These speed ratings may need to be adjusted for the difference in conditions. The ratings range from 81 mph (130 km/h) to 186 mph (299 km/h). These ratings are listed in the following chart.

Note: You may not find this information on all tires because it is not required by federal law.

Letter rating	Speed rating - mph (km/h)
M	81 (130)
N	87 (140)
Q	99 (159)
R	106 (171)
S	112 (180)
T	118 (190)
U	124 (200)
H	130 (210)
V	149 (240)
W	168 (270)
Y	186 (299)

Note: For tires with a maximum speed capability over 149 mph (240 km/h), tire manufacturers sometimes use the letters ZR. For those with a maximum speed capability over 186 mph (299 km/h), tire manufacturers always use the letters ZR.

H. U.S. DOT Tire Identification Number (TIN): This begins with the letters DOT and indicates that the tire meets all federal standards. The next two numbers or letters are the plant code designating where it was manufactured, the next two are the tire size code and the last four numbers represent the week and year the tire was built. For example, the numbers 317 mean the 31st week of 1997. After 2000 the numbers go to four digits. For example, 2501 means the 25th week of 2001. The numbers in between are identification codes used for traceability. This information is used to contact customers if a tire defect requires a recall.

I. M+S or M/S: Mud and Snow, or

AT: All Terrain, or

AS: All Season.

J. Tire Ply Composition and Material Used: Indicates the number of plies or the number of layers of rubber-coated fabric in the tire tread and sidewall. Tire manufacturers also must indicate the ply materials in the tire and the sidewall, which include steel, nylon, polyester, and others.

K. Maximum Load: Indicates the maximum load in kilograms and pounds that can be carried by the tire. See the Safety Compliance Certification Label (affixed to either the door hinge pillar, door-latch post, or the door edge that meets the door-latch post, next to the driver's seating position), for the correct tire pressure for your vehicle.

L. Treadwear, Traction and Temperature Grades

- **Treadwear:** The treadwear grade is a comparative rating based on the wear rate of the tire when tested under controlled conditions on a specified government test course. For example, a tire graded 150 would wear one and one-half (1½) times as well on the government course as a tire graded 100.
- **Traction:** The traction grades, from highest to lowest, are AA, A, B, and C. The grades represent the tire's ability to stop on wet pavement as measured under controlled conditions on specified government test surfaces of asphalt and concrete. A tire marked C may have poor traction performance.
- **Temperature:** The temperature grades are A (the highest), B and C, representing the tire's resistance to the generation of heat and its ability to dissipate heat when tested under controlled conditions on a specified indoor laboratory test wheel.

M. Maximum Inflation Pressure: Indicates the tire manufacturer's maximum permissible pressure or the pressure at which the maximum load can be carried by the tire. This pressure is normally higher than the vehicle manufacturer's recommended cold inflation pressure, which can be found on the Safety Compliance Certification Label (affixed to either the door hinge pillar, door-latch post, or the door edge that meets the door-latch post, next to the driver's seating position), or Tire Label which is located on the B-Pillar or the edge of the driver's door. The cold inflation pressure should never be set lower than the recommended pressure on the vehicle label.

The tire suppliers may have additional markings, notes or warnings, such as standard load or radial tubeless.

Additional Information Contained on the Tire Sidewall for LT Type Tires

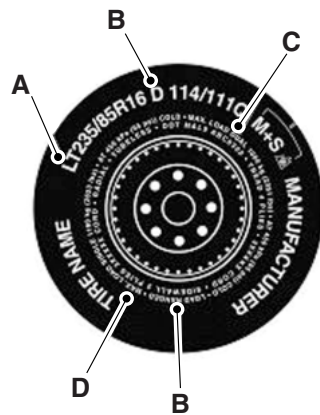

LT type tires have some additional information beyond those of P type tires. These differences are described below.

Note: Tire Quality Grades do not apply to this type of tire.

A. **LT:** Indicates a tire, designated by the Tire and Rim Association, that is intended for service on light trucks.

B. **Load Range/Load Inflation Limits:** Indicates the tire's load-carrying capabilities and its inflation limits.

C. **Maximum Load Dual lb (kg) at psi (kPa) cold:** Indicates the maximum load and tire pressure when the tire is used as a dual, defined as four tires on the rear axle (a total of six or more tires on the vehicle).

D. **Maximum Load Single lb (kg) at psi (kPa) cold:** Indicates the maximum load and tire pressure when the tire is used as a single, defined as two tires (total) on the rear axle.

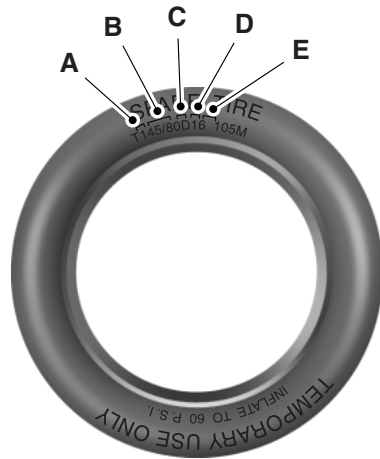
Information on T Type Tires

T type tires have some additional information beyond those of P type tires. These differences are described below.

T145/80D16 is an example of a tire size.

Note: The temporary tire size for your vehicle may be different from this example. Tire Quality Grades do not apply to this type of tire.

A. **T:** Indicates a type of tire, designated by the Tire and Rim Association, that is intended for temporary service on cars, sport-utility vehicles, minivans and light trucks.

B. **145:** Indicates the nominal width of the tire in millimeters from sidewall edge to sidewall edge. In general, the larger the number, the wider the tire.

C. **80:** Indicates the aspect ratio, which gives the tire's ratio of height to width. Numbers of 70 or lower indicate a short sidewall.

D. **D:** Indicates a diagonal type tire. **R:** Indicates a radial type tire.

E. **16:** Indicates the wheel or rim diameter in inches. If you change your wheel size, you will have to purchase new tires to match the new wheel diameter.

Location of the Tire Label

You will find a Tire Label containing tire inflation pressure by tire size and other important information located on the B-Pillar or the edge of the driver's door. See the payload description and graphic in the *Load Carrying* chapter.

INFLATING YOUR TIRES

Safe operation of your vehicle requires that your tires are properly inflated. Remember that a tire can lose up to half of its air pressure without appearing flat.

Every day before you drive, check your tires. If one looks lower than the others, use a tire gauge to check pressure of all tires and adjust if required.

At least once a month and before long trips, inspect each tire and check the tire pressure with a tire gauge (including spare, if equipped). Inflate all tires to the inflation pressure recommended by Ford Motor Company.



WARNING: Under-inflation is the most common cause of tire failures and may result in severe tire cracking, tread separation or blowout, with unexpected loss of vehicle control and increased risk of injury. Under-inflation increases sidewall flexing and rolling resistance, resulting in heat build-up and internal damage to the tire. It also may result in unnecessary tire stress, irregular wear, loss of vehicle control and accidents. A tire can lose up to half of its air pressure and not appear to be flat!

You are strongly urged to buy a reliable tire pressure gauge, as automatic service station gauges may be inaccurate. Ford recommends the use of a digital or dial-type tire pressure gauge rather than a stick-type tire pressure gauge.

Use the recommended cold inflation pressure for optimum tire performance and wear. Under-inflation or over-inflation may cause uneven treadwear patterns.

Always inflate your tires to the Ford recommended inflation pressure even if it is less than the maximum inflation pressure information found on the tire. The Ford recommended tire inflation pressure is found on the Safety Compliance Certification Label (affixed to either the door hinge pillar, door-latch post, or the door edge that meets the door-latch post, next to the driver's seating position), or Tire Label which is located on the B-Pillar or the edge of the driver's door. Failure to follow the tire pressure recommendations can cause uneven treadwear patterns and adversely affect the way your vehicle handles.

Maximum Inflation Pressure is the tire manufacturer's maximum permissible pressure or the pressure at which the maximum load can be carried by the tire. This pressure is normally higher than the manufacturer's recommended cold inflation pressure, which can be found on the Safety Compliance Certification Label (affixed to either the door hinge pillar, door-latch post, or the door edge that meets the door-latch post, next to the driver's seating position), or Tire Label which is located on the B-Pillar or the edge of the driver's door. The cold inflation pressure should never be set lower than the recommended pressure on the Safety Compliance Certification Label or Tire Label.

When weather temperature changes occur, tire inflation pressures also change. A 10°F (6°C) temperature drop can cause a corresponding drop of 1 psi (7 kPa) in inflation pressure. Check your tire pressures frequently and adjust them to the proper pressure which can be found on the Safety Compliance Certification Label or Tire Label.

To check the pressure in your tire(s):

1. Make sure the tires are cool, meaning they are not hot from driving even a mile.

Note: If you are checking tire pressure when the tire is hot (for example, driven more than 1 mile [1.6 kilometers]), never bleed or reduce air pressure. The tires are hot from driving and it is normal for pressures to increase above recommended cold pressures. A hot tire at or below recommended cold inflation pressure could be significantly under-inflated.

Note: If you have to drive a distance to get air for your tire(s), check and record the tire pressure first and add the appropriate air pressure when you get to the pump. It is normal for tires to heat up and the air pressure inside to go up as you drive.

2. Remove the cap from the valve on one tire, then firmly press the tire gauge onto the valve and measure the pressure.
3. Add enough air to reach the recommended air pressure.

Note: If you overfill the tire, release air by pressing on the metal stem in the center of the valve. Then recheck the pressure with your tire gauge.

4. Replace the valve cap.
5. Repeat this procedure for each tire, including the spare.

Note: Some spare tires operate at a higher inflation pressure than the other tires. For T-type mini-spare tires, see the *Dissimilar Spare Tire and Wheel Assembly Information* section. Store and maintain at 60 psi (4.15 bar). For full-size and dissimilar spare tires, see *Dissimilar Spare Tire and Wheel Assembly Information* under *Changing a Road Wheel* in this chapter. Store and maintain at the higher of the front and rear inflation pressure as shown on the Tire Label.

6. Visually inspect the tires to make sure there are no nails or other objects embedded that could poke a hole in the tire and cause an air leak.
7. Check the sidewalls to make sure there are no gouges, cuts or bulges.

Inspecting Your Tires and Wheel Valve Stems

Periodically inspect the tire treads for uneven or excessive wear and remove objects such as stones, nails or glass that may be wedged in the tread grooves. Check the tire and valve stems for holes, cracks, or cuts that may permit air leakage and repair or replace the tire and replace the valve stem. Inspect the tire sidewalls for cracking, cuts, bruises and other signs of damage or excessive wear. If internal damage to the tire is suspected, have the tire demounted and inspected in case it needs to be repaired or replaced. For your safety, tires that are damaged or show signs of excessive wear should not be used because they are more likely to blow out or fail.

Improper or inadequate vehicle maintenance can cause tires to wear abnormally. Inspect all your tires, including the spare, frequently, and replace them if one or more of the following conditions exist:

Tire Wear

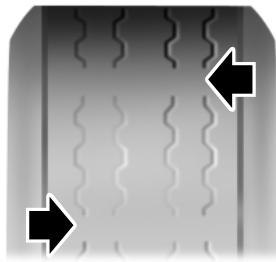

When the tread is worn down to 1/16th of an inch (2 millimeters), tires must be replaced to help prevent your vehicle from skidding and hydroplaning. Built-in treadwear indicators, or wear bars, which look like narrow strips of smooth rubber across the tread will appear on the tire when the tread is worn down to 1/16th of an inch (2 millimeters).

When the tire tread wears down to the same height as these wear bars, the tire is worn out and must be replaced.

Damage

Periodically inspect the tire treads and sidewalls for damage (such as bulges in the tread or sidewalls, cracks in the tread groove and separation in the tread or sidewall). If damage is observed or suspected, have the tire inspected by a tire professional. Tires can be damaged during off-road use, so inspection after off-road use is also recommended.

**WARNING: Age**

Tires degrade over time depending on many factors such as weather, storage conditions, and conditions of use (such as load, speed, inflation pressure) the tires experience throughout their lives. In general, tires should be replaced after six years regardless of tread wear. However, heat caused by hot climates or frequent high loading conditions can accelerate the aging process and may require tires to be replaced more frequently.

You should replace your spare tire when you replace the road tires or after six years due to aging even if it has not been used.

U.S. DOT Tire Identification Number

Both U.S. and Canada Federal regulations require tire manufacturers to place standardized information on the sidewall of all tires. This information identifies and describes the fundamental characteristics of the tire and also provides a U.S. DOT Tire Identification Number for safety standard certification and in case of a recall.

This begins with the letters DOT and indicates that the tire meets all federal standards. The next two numbers or letters are the plant code designating where it was manufactured, the next two are the tire size code and the last four numbers represent the week and year the tire was built. For example, the numbers 317 mean the 31st week of 1997. After 2000 the numbers go to four digits. For example, 2501 means the 25th week of 2001. The numbers in between are identification codes used for traceability. This information is used to contact customers if a tire defect requires a recall.

Tire Replacement Requirements

WARNING: Only use replacement tires and wheels that are the same size, load index, speed rating and type (such as P-metric versus LT-metric or all-season versus all-terrain) as those originally provided by Ford. The recommended tire and wheel size may be found on either the Safety Compliance Certification Label (affixed to either the door hinge pillar, door-latch post, or the door edge that meets the door-latch post, next to the driver's seating position), or the Tire Label which is located on the B-Pillar or edge of the driver's door. If this information is not found on these labels, then you should contact your authorized dealer as soon as possible. Use of any tire or wheel not recommended by Ford can affect the safety and performance of your vehicle, which could result in an increased risk of loss of vehicle control, vehicle rollover, personal injury and death. Additionally the use of non-recommended tires and wheels could cause steering, suspension, axle, transfer case or power transfer unit failure. If you have questions regarding tire replacement, contact your authorized dealer as soon as possible.



WARNING: To reduce the risk of serious injury, when mounting replacement tires and wheels, you should not exceed the maximum pressure indicated on the sidewall of the tire to set the beads without additional precautions listed below. If the beads do not seat at the maximum pressure indicated, re-lubricate and try again. When inflating the tire for mounting pressures up to 20 psi (1.38 bar) greater than the maximum pressure on the tire sidewall, the following precautions must be taken to protect the person mounting the tire:

1. Make sure that you have the correct tire and wheel size.
2. Lubricate the tire bead and wheel bead seat area again.
3. Stand at a minimum of 12 feet (3.66 meters) away from the tire wheel assembly.
4. Use both eye and ear protection.

For a mounting pressure more than 20 psi (1.38 bar) greater than the maximum pressure, a Ford dealer or other tire service professional should do the mounting.

Always inflate steel carcass tires with a remote air fill with the person inflating standing at a minimum of 12 feet (3.66 meters) away from the tire wheel assembly.

Your vehicle is equipped with tires designed to provide a safe ride and handling capability.

Important: Remember to replace the wheel valve stems when the road tires are replaced on your vehicle.

The two front tires or two rear tires should generally be replaced as a pair.

The tire pressure sensors mounted in the wheels (originally installed on your vehicle) are not designed to be used in aftermarket wheels.

The use of wheels or tires not recommended by Ford Motor Company may affect the operation of your tire pressure monitoring system.

If the tire pressure monitoring system indicator is flashing, the system is malfunctioning. Your replacement tire might be incompatible with your tire pressure monitoring system, or some component of the system may be damaged.

Safety Practices

WARNING: If your vehicle is stuck in snow, mud, or sand, do not rapidly spin the tires. Spinning the tires can tear the tire and cause an explosion. A tire can explode in as little as three to five seconds.



WARNING: Do not spin the wheels at over 35 mph (56 km/h). The tires may fail and injure a passenger or bystander.

Driving habits have a great deal to do with your tire mileage and safety.

- Observe posted speed limits.
- Avoid fast starts, stops and turns.
- Avoid potholes and objects on the road.
- Do not run over curbs or hit the tire against a curb when parking.

Highway Hazards

No matter how carefully you drive, there is always the possibility that you may eventually have a flat tire on the highway. Drive slowly to the closest safe area out of traffic. This may further damage the flat tire, but your safety is more important.

If you feel a sudden vibration or ride disturbance while driving, or you suspect your tire or vehicle has been damaged, immediately reduce your speed. Drive with caution until you can safely pull off the road. Stop and inspect the tires for damage. If you cannot detect a cause, have the vehicle towed to the nearest repair facility or tire dealer to have the vehicle inspected.

Tire and Wheel Alignment

A bad jolt from hitting a curb or pothole can cause the front end of your vehicle to become misaligned or cause damage to your tires. If your vehicle seems to pull to one side when you are driving, the wheels may be out of alignment. Have an authorized dealer check the wheel alignment periodically.

Wheel misalignment in the front or the rear can cause uneven and rapid treadwear of your tires and should be corrected by an authorized dealer. Front-wheel drive vehicles and those with an independent rear suspension may require alignment of all four wheels.

The tires should also be balanced periodically. An unbalanced tire and wheel assembly may result in irregular tire wear.

Tire Rotation

Note: If your tires show uneven wear ask an authorized dealer to check for and correct any wheel misalignment, tire imbalance or mechanical problem involved before tire rotation.

Note: Your vehicle may be equipped with a dissimilar spare tire and wheel assembly. A dissimilar spare tire and wheel assembly is defined as a spare tire and wheel that is different in brand, size or appearance from the road tires and wheels. If you have a dissimilar spare tire and wheel assembly, it is intended for temporary use only and should not be used in a tire rotation.

Note: After having your tires rotated, inflation pressure must be checked and adjusted to the vehicle requirements.

Rotating your tires at the recommended interval (as indicated in the scheduled maintenance information) will help your tires wear more evenly, providing better tire performance and longer tire life.

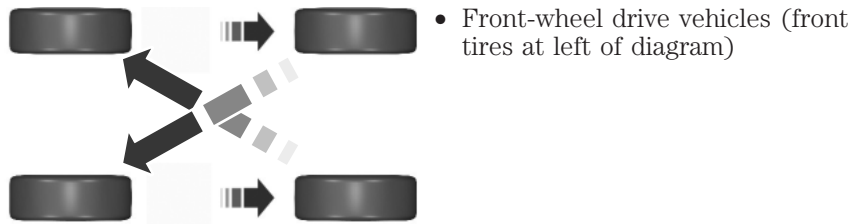

Sometimes irregular tire wear can be corrected by rotating the tires.

USING SNOW CHAINS

WARNING: Snow tires must be the same size, load index, speed rating as those originally provided by Ford. Use of any tire or wheel not recommended by Ford can affect the safety and performance of your vehicle, which could result in an increased risk of loss of vehicle control, vehicle rollover, personal injury and death. Additionally, the use of non-recommended tires and wheels could cause steering, suspension, axle, transfer case or power transfer unit failure.

The tires on your vehicle have all-weather treads to provide traction in rain and snow. Snow chains have not been approved for use on your vehicle.

TIRE PRESSURE MONITORING SYSTEM

WARNING: The tire pressure monitoring system is NOT a substitute for manually checking tire pressure. The tire pressure should be checked periodically (at least monthly) using a tire gauge. See *Inflating Your Tires* in this chapter. Failure to properly maintain your tire pressure could increase the risk of tire failure, loss of control, vehicle rollover and personal injury.



Each tire, including the spare (if provided), should be checked monthly when cold and inflated to the inflation pressure recommended by the vehicle manufacturer on the vehicle placard or tire inflation pressure label. (If your vehicle has tires of a different size than the size indicated on the vehicle placard or tire inflation pressure label, you should determine the proper tire inflation pressure for those tires.)

As an added safety feature, your vehicle has been equipped with a tire pressure monitoring system (TPMS) that illuminates a low tire pressure telltale when one or more of your tires is significantly under-inflated. Accordingly, when the low tire pressure telltale illuminates, you should stop and check your tires as soon as possible, and inflate them to the proper pressure. Driving on a significantly under-inflated tire causes the tire to overheat and can lead to tire failure. Under-inflation also reduces fuel efficiency and tire tread life, and may affect the vehicle's handling and stopping ability.

Please note that the TPMS is not a substitute for proper tire maintenance, and it is the driver's responsibility to maintain correct tire pressure, even if under-inflation has not reached the level to trigger illumination of the TPMS low tire pressure telltale.

Your vehicle has also been equipped with a TPMS malfunction indicator to indicate when the system is not operating properly. The TPMS malfunction indicator is combined with the low tire pressure telltale. When the system detects a malfunction, the telltale will flash for approximately one minute and then remain continuously illuminated. This sequence will continue upon subsequent vehicle start-ups as long as the malfunction exists.

When the malfunction indicator is illuminated, the system may not be able to detect or signal low tire pressure as intended. TPMS malfunctions may occur for a variety of reasons, including the installation of replacement or alternate tires or wheels on the vehicle that prevent the TPMS from functioning properly. Always check the TPMS malfunction telltale after replacing one or more tires or wheels on your vehicle to ensure that the replacement or alternate tires and wheels allow the TPMS to continue to function properly.

The tire pressure monitoring system complies with part 15 of the FCC rules and with RSS-210 of Industry Canada. Operation is subject to the following two conditions: (1) This device may not cause harmful interference, and (2) This device must accept any interference received, including interference that may cause undesired operation.

Changing Tires with a Tire Pressure Monitoring System

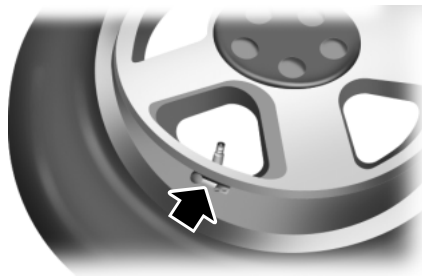

Note: Each road tire is equipped with a tire pressure sensor located inside the tire and wheel assembly cavity. The pressure sensor is attached to the valve stem. The pressure sensor is covered by the tire and is not visible unless the tire is removed. Take care when changing the tire to avoid damaging the sensor.

You should always have your tires serviced by an authorized dealer. Check the tire pressure periodically (at least monthly) using an accurate tire gauge. See *Inflating Your Tires* in this chapter.

Understanding Your Tire Pressure Monitoring System

The tire pressure monitoring system measures pressure in your four road tires and sends the tire pressure readings to your vehicle. The low tire pressure warning light will turn on if the tire pressure is significantly low. Once the light is illuminated, your tires are under-inflated and need to be inflated to the manufacturer's recommended tire pressure. Even if the light turns on and a short time later turns off, your tire pressure still needs to be checked.

When Your Temporary Spare Tire Is Installed

When one of your road tires needs to be replaced with the temporary spare, the system will continue to identify an issue to remind you that the damaged road wheel and tire assembly needs to be repaired and put back on your vehicle.

To restore the full function of the tire pressure monitoring system, have the damaged road wheel and tire assembly repaired and remounted on your vehicle.

When You Believe Your System Is Not Operating Properly

The main function of the tire pressure monitoring system is to warn you when your tires need air. It can also warn you in the event the system is no longer capable of functioning as intended. See the following chart for information concerning your tire pressure monitoring system:

Low tire pressure warning light	Possible cause	Customer action required
Solid warning light	Tire(s) under-inflated	1. Make sure tires are at the proper pressure. See <i>Inflating Your Tires</i> in this chapter. 2. After inflating your tires to the manufacturer's recommended pressure as shown on the Tire Label (located on the edge of driver's door or the B-Pillar), the vehicle must be driven for at least two minutes over 20 mph (32 km/h) before the light turns off.
	Spare tire in use	Repair the damaged road wheel and tire and reinstall it on the vehicle to restore system function. For a description on how the system functions, see <i>When Your Temporary Spare Tire is Installed</i> in this section.
	TPMS malfunction	If the tires are properly inflated and the spare tire is not in use but the light remains on, contact your authorized dealer as soon as possible.

Low tire pressure warning light	Possible cause	Customer action required
Flashing warning light	Spare tire in use	Repair the damaged road wheel and tire assembly and reinstall it on the vehicle to restore system function. For a description on how the system functions, see <i>When Your Temporary Spare Tire is Installed</i> in this section.
	TPMS malfunction	If the tires are properly inflated and the spare tire is not in use but the light remains on, contact your authorized dealer as soon as possible.

When Inflating Your Tires

When putting air into your tires (such as at a gas station or in your garage), the tire pressure monitoring system may not respond immediately to the air added to your tires.

It may take up to two minutes of driving over 20 mph (32 km/h) for the light to turn off after you have filled your tires to the recommended inflation pressure.

How Temperature Affects Your Tire Pressure

The tire pressure monitoring system monitors tire pressure in each pneumatic tire. While driving in a normal manner, a typical passenger tire inflation pressure may increase about 2 to 4 psi (14 to 28 kPa) from a cold start situation. If the vehicle is stationary overnight with the outside temperature significantly lower than the daytime temperature, the tire pressure may decrease approximately 3 psi (21 kPa) for a drop of 30°F (17°C) in ambient temperature. This lower pressure value may be detected by the tire pressure monitoring system as being significantly lower than the recommended inflation pressure and activate the system warning light for low tire pressure. If the low tire pressure warning light is on, visually check each tire to verify that no tire is flat. If one or more tires are flat, repair as necessary. Check the air pressure in the road tires. If any tire is under-inflated, carefully drive the vehicle to the nearest location where air can be added to the tires. Inflate all the tires to the recommended inflation pressure.

TEMPORARY MOBILITY KIT

Note: The temporary mobility kit sealant compound in the canister is to be used for one tire only. See your Ford authorized dealer for additional replacement sealant canisters.

The temporary mobility kit is located in the floor of the cargo area. The temporary mobility kit consists of an air compressor to reinflate the tire and a sealing compound in a canister that will seal most punctures caused by nails or similar objects. This kit will provide a temporary seal allowing you to drive your vehicle up to 120 miles (200 kilometers) at a maximum speed of 50 mph (80 km/h).

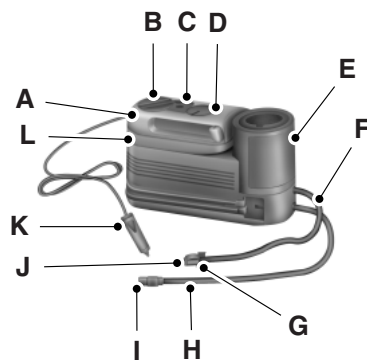

- A. Air compressor (inside)
- B. Diverter knob
- C. On and off button
- D. Air pressure gauge
- E. Sealant bottle and canister
- F. Sealant filling clear tube
- G. Sealant tube – tire valve connector
- H. Yellow cap tool
- I. Air compressor hose
- J. Air hose – tire valve connector
- K. Accessory power plug
- L. Casing and housing

General Information

WARNING: Failure to follow these guidelines could result in an increased risk of loss of vehicle control, injury or death.

Note: Do not use the temporary mobility kit if a tire has become severely damaged by driving the vehicle with a tire that has insufficient air pressure. Only punctured areas located within the tire tread can be sealed with the temporary mobility kit.

Do not attempt to repair punctures larger than ¼ inch (6 millimeters) or damage to the tire's sidewall. The tire may not completely seal.

Loss of air pressure may adversely affect tire performance. For this reason:

- **Note:** Do not drive the vehicle above 50 mph (80 km/h).
- **Note:** Do not drive further than 120 miles (200 kilometers). Drive only to your closest authorized dealer or tire repair shop to have your tire inspected.
- Drive carefully and avoid abrupt steering maneuvers.
- Periodically monitor tire inflation pressure in the affected tire; if the tire is losing pressure, have the vehicle towed.
- Read the information in the *Tips for Use of the Temporary Mobility Kit* section to make sure of safe operation of the temporary mobility kit and your vehicle.

Tips for Use of the Temporary Mobility Kit

Read the following list of tips to make sure of safe operation of the temporary mobility kit:

- Before operating the temporary mobility kit, make sure your vehicle is safely off the road and away from moving traffic. Turn on the hazard lights.
- Always set the parking brake to make sure the vehicle does not move unexpectedly.
- Do not remove any foreign objects, such as nails or screws, from the tire.
- When using the temporary mobility kit, leave the motor running so the compressor does not drain the vehicle's battery.
- Do not allow the compressor to operate continuously for more than 15 minutes; this will help prevent the compressor from overheating.
- Never leave the temporary mobility kit unattended when it is operating.
- Sealant compound contains latex. Make sure that you use the non-latex gloves provided to avoid an allergic reaction.
- Keep the temporary mobility kit away from children.
- Only use the temporary mobility kit when the ambient temperature is between -22°F (-30°C) and 158°F (70°C).

- Only use the sealing compound before the use by date. The use by date is on the lower right hand corner of the label located on the sealant canister. **Note:** Check the use by date regularly and replace the canister after four years.
- Do not store the temporary mobility kit unsecured inside the passenger compartment of the vehicle as it may cause injury during a sudden stop or crash. Always store the kit in its original location.
- After sealant use, the tire pressure monitoring system sensor and valve stem on the wheel must be replaced by an authorized Ford dealer.
- When inflating a tire or other objects, use the black air hose only. Do not use the transparent hose which is designed for sealant application only.
- Operating the temporary mobility kit could cause an electrical disturbance in radio, CD, and DVD player operation.

What to Do When a Tire Is Punctured

A tire puncture within the tire's tread area can be repaired in two stages with the temporary mobility kit:

- In the first stage, the tire will be reinflated with a sealing compound and air. After the tire has been reinflated, you will need to drive the vehicle a short distance (about 4 miles [6 kilometers]) to distribute the sealant in the tire.
- In the second stage, check the tire pressure and adjust, if necessary, to the vehicle's tire inflation pressure.

First Stage: Reinflating the Tire with Sealing Compound and Air



WARNING: Do not stand directly over the temporary mobility kit while inflating the tire. If you notice any unusual bulges or deformations in the tire's sidewall during inflation, stop and call roadside assistance.



WARNING: If the tire does not inflate to the recommended tire pressure within 15 minutes, stop and call roadside assistance.

Preparation

Park the vehicle in a safe, level and secure area, away from moving traffic. Turn the hazard lights on. Apply the parking brake and turn the motor off. Inspect the flat tire for visible damage.

Sealant compound contains latex. To avoid any allergic reactions, use the non-latex gloves located in the accessory box on the underside of the temporary mobility kit housing.

Do not remove any foreign object that has pierced the tire. If a puncture is located in the tire sidewall, stop and call roadside assistance.

1. Remove the valve cap from the tire valve.
2. Unwrap the clear tube from the compressor housing.
3. Remove the tube cap and fasten the metal connector of the tube to the tire valve, turning clockwise. Make sure the connection is tightly fastened.
4. Plug the power cable into the 12-volt power point in the vehicle.



5. Remove the warning sticker found on the canister and place it on the top of the instrument panel or the center of the dash.

6. **Note:** Start the motor only if the vehicle is outdoors or in a well-ventilated area.

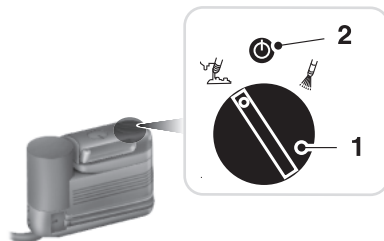

7. Turn the dial (1) counterclockwise to the sealant position. Turn on the kit by pressing the on/off button (2).

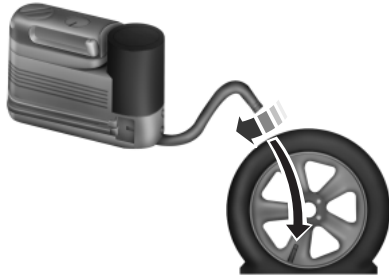

8. Inflate the tire to the pressure listed on the tire label located on the driver's door or the door jamb area.

Note: When the sealing compound is first added into the tire, the air pressure gauge reading on the compressor unit may indicate a higher value; this is normal and should be no reason for concern. The pressure will drop after about 30 seconds of operation. The tire pressure has to be checked with the compressor in the OFF position to get the correct tire pressure reading.

9. When the recommended tire pressure is reached, turn off the kit by pressing the on/off button; disconnect the kit from the tire valve and the power point. Re-install the valve cap on the tire valve, place the tube cap on the metal connector, and return the kit to the stowage area.

10. **Note:** Immediately and cautiously, drive the vehicle 4 miles (6 kilometers) to distribute the sealant evenly inside the tire. Do not exceed 50 mph (80 km/h).

Note: If you experience any unusual vibration, ride disturbance or noise while driving, reduce your speed until you can safely pull off to the side of the road to call for roadside assistance. **Note:** Do not proceed to the second stage of this operation.

11. After 4 miles (6 kilometers), stop and check the tire pressure. See *Second stage: Checking tire pressure*.

Second Stage: Checking Tire Pressure

 **WARNING:** If you are proceeding from the *First Stage: Reinflating the Tire with Sealing Compound and Air* section and have injected sealant in the tire and the pressure is below 20 psi (1.4 bar), stop and call roadside assistance. If tire pressure is above 20 psi (1.4 bar), continue to the next step.

 **WARNING:** The power plug may get hot after use and should be handled carefully while unplugging.

Check the air pressure of your tires as follows:

1. Remove the valve cap from the tire valve.
2. Unhook the black hose from the side of the compressor and fasten firmly on the valve stem by turning clockwise.
3. Press down and turn the dial clockwise to the air position. Turn on the kit by pressing the on/off button.

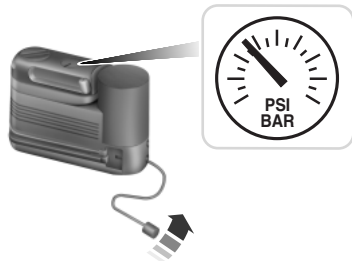

4. Adjust the tire to the recommended inflation pressure from the Tire Label located on the driver's door or door jamb area.

Note: The tire pressure has to be checked with the compressor in the OFF position to get the correct tire pressure reading.

5. Turn the compressor off by pressing the on/off button.

6. Unplug the hoses, re-install the valve cap on the tire and return the kit to the stowage area.

What To Do After the Tire Has Been Sealed

After using the temporary mobility kit to seal your tire, you will need to replace the sealant canister and clear tube (hose). Sealing compound and spare parts can be obtained and replaced at an authorized Ford Motor Company dealership or tire dealer. Empty sealant bottles may be disposed of at home. However, liquid residue from the sealing compound should be disposed by your local Ford Motor Company dealership or tire dealer, or in accordance with local waste disposal regulations.

Note: After the sealing compound has been used, the maximum vehicle speed is 50 mph (80 km/h) and the maximum driving distance is 120 miles (200 kilometers). The sealed tire should be inspected immediately.

Note: After sealant use, the tire pressure monitoring system sensor and valve stem on the wheel must be replaced by an authorized Ford dealer.

You can check the tire pressure anytime within the 120 miles (200 kilometers) by performing the procedure from *Second Stage: Checking Tire Pressure* listed previously.

Removal of the sealant canister from the temporary mobility kit:

1. Unwrap the clear tube from the compressor housing.



2. Locate the yellow cap at the end of the clear tube.



3. Using the yellow cap tool, press the tab located on the temporary mobility kit compressor housing while pulling up on the sealant canister.



Installation of the sealant canister to the temporary mobility kit:

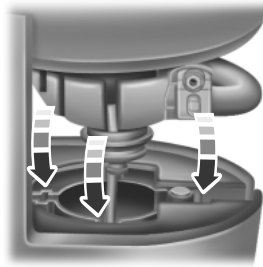

1. Align the sealant canister with the temporary mobility kit housing.



2. Once aligned, seat the sealant canister by lightly pushing down until you hear an audible click.

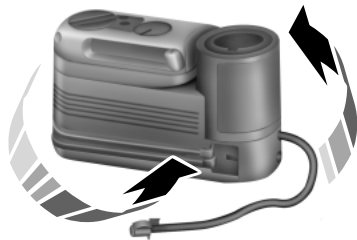

3. Wrap the clear tube around the compressor housing.

Note: If you experience any difficulties with the removal or installation of the sealant canister, consult your Ford Motor Company authorized dealer for assistance.

Use By / Utiliser avant:

Be sure to check the sealant compound's use-by date regularly. The use-by date is on the lower right hand corner of the label located on the sealant canister.

The sealant canister should be replaced after four years.

TECHNICAL SPECIFICATIONS**Wheel Lug Nut Torque Specifications**

! **WARNING:** When a wheel is installed, always remove any corrosion, dirt or foreign materials present on the mounting surfaces of the wheel or the surface of the wheel hub, brake drum or brake disc that contacts the wheel. Make sure that any fasteners that attach the rotor to the hub are secured so they do not interfere with the mounting surfaces of the wheel. Installing wheels without correct metal-to-metal contact at the wheel mounting surfaces can cause the wheel nuts to loosen and the wheel to come off while the vehicle is in motion, resulting in loss of control.

Retighten the lug nuts to the specified torque within 100 miles (160 kilometers) after any wheel disturbance (such as tire rotation, changing a flat tire, wheel removal).

Bolt size	Wheel lug nut torque*	
	ft-lb	N•m
M12 x 1.5	100	135

* Torque specifications are for nut and bolt threads free of dirt and rust. Use only Ford recommended replacement fasteners.



Note: Inspect the wheel pilot bore and mounting surface prior to installation. Remove any visible corrosion or loose particles.

MAINTENANCE PRODUCT SPECIFICATIONS AND CAPACITIES

Item	Capacity	Ford Part Name or Equivalent	Ford Part Number / Ford Specification
Brake fluid ¹	Between MIN and MAX on reservoir	DOT 4 LV Motor Vehicle Brake Fluid	PM-20 / WSS-M6C65-A2 / ISO 4925 Class 6
Door latch, hood latch, auxiliary hood latch, trunk latch, seat tracks.	—	Motorcraft Multi-Purpose Grease Spray	XL-5 or equivalent / ESB-M1C93-B
Lock cylinder	—	Motorcraft Penetrating and Lock Lubricant (US); Motorcraft Penetrating Fluid (Canada)	XL-1 (US), CXC-51-A (Canada) / —
Electric Powertrain Assembly coolant ²	15.8 quarts (15.0L)	Motorcraft Orange Antifreeze/Coolant Prediluted	VC-3DIL-B (US) CVC-3DIL-B (Canada) / WSS-M97B44-D2
Transmission fluid ³	1.32 quarts (1.25L)	Motorcraft MERCON LV ATF	XT-10-QLVC (US), CXT-10-LV12 (Canada) / MERCON LV
Windshield washer fluid	Fill as required	Motorcraft Premium Windshield Wash Concentrates	ZC-32-A1, or ZC-32-B1 (US) / WSS-M14P19-A

Item	Capacity	Ford Part Name or Equivalent	Ford Part Number / Ford Specification
A/C Refrigerant ⁴	1.31 pounds (0.59kg)	Motorcraft R-134a Refrigerant	YN-19 (US) CYN-16-R (Canada) / WSH-M17B19-A
A/C Refrigerator Compressor Oil ⁴	5.2 fluid ounces (153mL)	Motorcraft POE Refrigerant Compressor Oil	YN-32 WSS-M2C31-B2
¹ Use only Motorcraft DOT 4 LV High Performance Motor Vehicle Brake Fluid or equivalent meeting WSS-M6C65-A2 and ISO 4925 Class 6. Use of any fluid other than the recommended fluid may cause brake system damage.			
² Add the coolant type originally equipped in your vehicle.			
³ Automatic transmissions that require Motorcraft MERCON LV transmission fluid should only use Motorcraft MERCON LV transmission fluid. Use of any fluid other than the recommended fluid may cause transmission damage. Change the automatic transmission fluid and filter at the correct service interval. See Scheduled Maintenance Section for service intervals.			
⁴ Warning: The A/C refrigerant system contains refrigerant R-134a under high pressure. Opening the A/C refrigerant system can cause personal injury. A/C refrigerant system is to be serviced only by qualified personnel.			

MOTORCRAFT PART NUMBERS

Component	Part number
12 Volt battery	BXT-96R-500/BXT-96R-590
Cabin air filter	FP70
Windshield wiper blade	Driver's side: WW2802 Passenger side: WW2803
Rear wiper blade	WW1204

VEHICLE IDENTIFICATION NUMBER

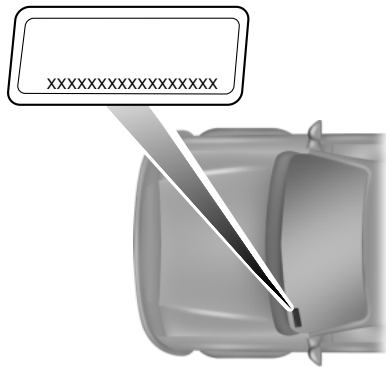

The vehicle identification number is located on the driver's side instrument panel.

Please note that in the graphic, XXXX is representative of your vehicle identification number.

The Vehicle Identification Number (VIN) contains the following information:

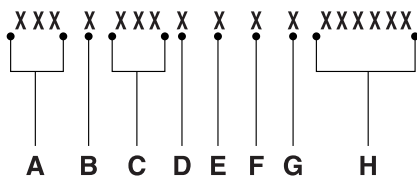

- A. World manufacturer identifier
- B. Brake system / Gross Vehicle Weight Rating (GVWR) / Restraint Devices and their location
- C. Make, vehicle line, series, body type
- D. Engine type
- E. Check digit
- F. Model year

- G. Assembly plant
- H. Production sequence number.

VEHICLE CERTIFICATION LABEL

MFD. BY FORD MOTOR CO.
 DATE: XX/XX GVWR: XXXX KG (XXXX LB)
 FRONT GAWR: REAR GAWR:
 XXXX KG (XXXX LB) WITH XXXX KG (XXXX LB) WITH
 XXXXXXXXXXXXXXXX TIRES XXXXXXXXXXXXXXXX TRES
 XXXXXXX RIMS XXXXXXX RIMS
 AT XXXX kPa/ XXX PSI COLD AT XXXX kPa/ XXX PSI COLD

THIS VEHICLE CONFORMS TO ALL APPLICABLE FEDERAL MOTOR VEHICLE SAFETY AND THEFT PREVENTION STANDARDS IN EFFECT ON THE DATE OF MANUFACTURE SHOWN ABOVE.

VIN: XXXXXXXXXXXXXXXX XXXXX
 TYPE: XXXX XXXXX



EXT PNT: XX XXXXXX IRC: XX DSO: XXXX
 WB INT TR TP/PS R AXLE TR SPR XXXX
 XXX XX XXX X XX X XXXX XXXX
 XXXXXXXXXXXX XXX XXXX-XXXXXX-XX

The National Highway Traffic Safety Administration Regulations require that a Safety Compliance Certification Label be affixed to a vehicle and prescribe where the Safety Compliance Certification Label may be located. The Safety Compliance Certification Label shall be affixed to either the door hinge pillar, the door latch post, or the edge of the door near the door latch, next to the driver's seating position.

TRANSMISSION CODE DESIGNATION

MFD. BY FORD MOTOR CO.
 DATE: XX/XX GVWR: XXXX KG (XXXX LB)
 FRONT GAWR: REAR GAWR:
 XXXX KG (XXXX LB) WITH XXXX KG (XXXX LB) WITH
 XXXXXXXXXXXXXXXX TIRES XXXXXXXXXXXXXXXX TRES
 XXXXXXX RIMS XXXXXXX RIMS
 AT XXXX kPa/ XXX PSI COLD AT XXXX kPa/ XXX PSI COLD

THIS VEHICLE CONFORMS TO ALL APPLICABLE FEDERAL MOTOR VEHICLE SAFETY AND THEFT PREVENTION STANDARDS IN EFFECT ON THE DATE OF MANUFACTURE SHOWN ABOVE.

VIN: XXXXXXXXXXXXXXXX XXXXX
 TYPE: XXXX XXXXX



EXT PNT: XX XXXXXX IRC: XX DSO: XXXX
 WB INT TR TP/PS R AXLE TR SPR XXXX
 XXX XX XXX X XX X XXXX XXXX
 XXXXXXXXXXXX XXX XXXX-XXXXXX-XX

You can find a transmission code on the Safety Compliance Certification Label. The following table tells you which transmission each code represents.

Description	Code
One-speed automatic (TR-WA)	44H

ACCESSORIES

For a complete listing of the accessories that are available for your vehicle, please contact an authorized dealer or visit our online store at **Accessories.Ford.com** (United States only).

Ford Custom Accessories are available for your vehicle through an authorized Ford or Ford of Canada dealer. Ford Motor Company will repair or replace any properly authorized dealer-installed Ford Custom Accessories found to be defective in factory-supplied materials or workmanship during the warranty period, as well as any component damaged by the defective accessories. Ford Motor Company will warrant your vehicle through the warranty that provides the greatest benefit:

- 12 months or 12000 miles (20000 kilometers) (whichever occurs first)
- The remainder of your new vehicle limited warranty

Contact an authorized dealer for details and a copy of the warranty.

Exterior style

- Splash guards
- Side window deflectors
- Graphics kit
- Custom graphics*
- Rear bumper protector
- Accent lighting

Interior Style

- Floor mats
- Stainless steel door sill plates

Lifestyle

- Ash cup / smoker's package
- Cargo net*
- Portable DVD rear seat entertainment
- Roof racks and carriers*
- Soft cargo organizers

Peace of mind

- Keyless entry keypad
- Remote start
- Vehicle security systems
- Wheel locks
- Bumper mounted parking assist system*
- Car cover

*The accessory manufacturer designs, develops and therefore warrants Ford Licensed Accessories, and does not design or test these accessories to Ford Motor Company engineering requirements. Contact an authorized Ford dealer for the manufacturer's limited warranty details,

and request a copy of the Ford Licensed Accessories product limited warranty from the accessory manufacturer.

For maximum vehicle performance, keep the following information in mind when adding accessories or equipment to your vehicle:

- When adding accessories, equipment, passengers and luggage to your vehicle, do not exceed the total weight capacity of the vehicle or of the front or rear axle (GVWR or GAWR as indicated on the Safety Compliance Certification label). Ask an authorized dealer for specific weight information.
- The Federal Communications Commission (FCC) and Canadian Radio Telecommunications Commission (CRTC) regulate the use of mobile communications systems that are equipped with radio transmitters, for example, two-way radios, telephones and theft alarms. Any such equipment installed in your vehicle should comply with Federal Communications Commission (FCC) and Canadian Radio Telecommunications Commission (CRTC) regulations and should be installed only by an authorized dealer.
- Mobile communications systems may harm the operation of your vehicle, particularly if they are not properly designed for automotive use.
- To avoid interference with other vehicle functions, for example anti-lock brake systems, do not locate amateur radio antennas in the area of the driver side hood.
- If you or an authorized Ford dealer add any non-Ford custom electrical or electronic accessories or components to your vehicle, you may adversely affect battery performance and durability, and may adversely affect the performance of other electrical systems in the vehicle.

FORD ESP EXTENDED SERVICE PLANS

PROTECT YOURSELF FROM THE RISING COST OF VEHICLE REPAIRS WITH A FORD EXTENDED SERVICE PLAN.

SERVICE PLANS (U.S. only)

More than 32 Million Ford and Lincoln owners have discovered the powerful protection Ford ESP. It is the only extended service plan backed by Ford Motor Company, and provides peace of mind protection beyond the expiration of the New Vehicle Warranty coverage.

Ford ESP can quickly pay for itself

One service bill – the cost of parts and labor – can easily exceed the price of your Ford Extended Service Plan. With Ford ESP, you minimize your risk for unexpected repair bills and rising repair costs.

Coverage for up to 500+ covered components

There are four, Extended Service Plans with different levels of coverage. Ask your dealer for details.

1. PremiumCARE – Our most comprehensive coverage. With over 500 covered components, this plan is so complete that we generally only discuss what's not covered.
2. ExtraCARE – Covers 113 components, and includes many high tech items
3. BaseCARE – Covers 84 components
4. PowertrainCARE – Covers 29 critical components

Ford ESP is honored by all Ford and Lincoln Dealers in the United States and Canada. It is the only Extended Service Plan authorized and backed by Ford Motor Company. That means you get:

- Reliable, quality service anywhere you go
- Repairs performed by factory trained technicians, using Genuine Ford and Lincoln parts

Rental Car Reimbursement

1st day Rental Benefit – You take advantage of replacement transportation if your vehicle is at the dealership for same day covered repairs.

Extended Rental Benefits – If your vehicle is kept overnight for covered repairs, you are eligible for rental car coverage, including Bumper to Bumper warranty repairs, or Field Service Actions.

Roadside Assistance

Exclusive 24/7 roadside assistance, including:

- Towing, flat-tire change and battery jump starts
- Out of fuel and lock-out assistance
- Travel Expense reimbursement for lodging, meals and rental car
- Destination assistance for taxi, shuttle, rental car coverage and emergency transportation

Transferable Coverage

If you sell your vehicle before your Ford Extended Service Plan coverage expires, you can transfer any remaining coverage to the new owner. Whenever you sell your vehicle, prospective buyers may have a higher degree of confidence that vehicle was properly maintained with Ford ESP, thereby improving resale value!

Avoid the Rising cost of vehicle maintenance

Ford ESP also offers a Premium Maintenance Plan that covers all scheduled maintenance, and select items that routinely wear out.

The coverage is prepaid, so you never have to worry about affording vehicle maintenance. It covers regular checkups, routine inspections, preventative care and replacement items that require periodic attention for normal wear:

- Windshield Wiper Blades
- Spark Plugs (except in California)
- The clutch Disc
- Brake pads and linings
- Shock Absorbers
- Belts and Hoses
- Diesel Exhaust Fluid Replenishment

Contact your selling dealership today so they can customize a Genuine Ford Extended Service Plan that fits your driving lifestyle and budget.

Interest Free Financing Options Available

Take advantage of our interest free installment payment plan. Just a 10% down payment will provide you with an affordable, no interest, no fee payment program.

Complete the information below and mail to:

Ford ESP
PO Box 8072
Royal Oak Michigan 48068-0039

To learn more, call our Ford ESP specialists at 800-367-3377. Don't forget to ask about our interest free payment program, allowing you all the security and benefits Ford ESP has to offer while paying over time. You are pre-approved with no credit checks, no hassles!

SERVICE PLANS (CANADA ONLY)

You can get more protection for your vehicle by purchasing a Ford Extended Service Plan. Ford Extended Service Plan is the only service contract backed by Ford Motor Company of Canada, Limited. Depending on the plan you purchase, Ford Extended Service Plan provides benefits such as:

- Rental reimbursement
- Protection against repair costs after your New Vehicle Limited Warranty Coverage expires
- Roadside Assistance benefits

There are several Ford Extended Service Plans available in various time, distance and deductible combinations. Each plan is tailored to fit your own driving needs, including reimbursement for towing and rental.

When you purchase Ford Extended Service Plan, you receive added peace-of-mind protection throughout Canada and the United States, provided by a network of participating Ford Motor Company dealers. The Lincoln Maintenance Protection Plan is honored at authorized Lincoln dealers.

Note: Repairs performed outside of Canada and the United States are not eligible for Ford Extended Service Plan coverage.

This information is subject to change.

For more information, visit your local Ford of Canada dealer or www.ford.ca to find the Ford Extended Service Plan that is right for you.

GENERAL INFORMATION**Radio Frequencies and Reception Factors**

AM and FM frequencies are established by the Federal Communications Commission (FCC) and the Canadian Radio and Telecommunications Commission (CRTC). Those frequencies are:

AM: 530, 540–1700, 1710 kHz

FM: 87.9–107.7, 107.9 MHz

Radio reception factors	
Distance and strength	The further you travel from an FM station, the weaker the signal and the weaker the reception.
Terrain	Hills, mountains, tall buildings, bridges, tunnels, freeway overpasses, parking garages, dense tree foliage and thunderstorms can interfere with the reception.
Station overload	When you pass a ground-based broadcast repeating tower, a stronger signal may overtake a weaker one and result in the audio system muting.

CD and CD Player Information

Note: CD units play commercially pressed 4.75-inch (12 centimeter) audio compact discs only. Due to technical incompatibility, certain recordable and re-recordable compact discs may not function correctly when used in Ford CD players.

Note: Do not insert CDs with homemade paper (adhesive) labels into the CD player as the label may peel and cause the CD to become jammed. You should use a permanent felt tip marker rather than adhesive labels on your homemade CDs. Ballpoint pens may damage CDs. Please contact your authorized dealer for further information.

Note: Do not use any irregularly shaped discs or discs with a scratch protection film attached.

Always handle discs by their edges only. Clean the disc with an approved CD cleaner only. Wipe it from the center of the disc toward the edge. Do not clean in a circular motion.

Do not expose discs to direct sunlight or heat sources for extended periods.

MP3 Track and Folder Structure

Audio systems capable of recognizing and playing MP3 individual tracks and folder structures work as follows:

- There are two different modes for MP3 disc playback: MP3 track mode (system default) and MP3 folder mode.
- MP3 track mode ignores any folder structure on the MP3 disc. The player numbers each MP3 track on the disc (noted by the .mp3 file extension) from T001 to a maximum of T255. **Note:** The maximum number of playable MP3 files may be less depending on the structure of the CD and exact model of radio present.
- MP3 folder mode represents a folder structure consisting of one level of folders. The CD player numbers all MP3 tracks on the disc (noted by the .mp3 file extension) and all folders containing MP3 files, from F001 (folder) T001 (track) to F253 T255.
- Creating discs with only one level of folders helps with navigation through the disc files.

If you are burning your own MP3 discs, it is important to understand how the system reads the structures you create. While various files may be present, (files with extensions other than mp3), only files with the .mp3 extension are played; other files are ignored by the system. This enables you to use the same MP3 disc for a variety of tasks on your work computer, home computer and your in-vehicle system.

In track mode, the system displays and plays the structure as if it were only one level deep (all .mp3 files play, regardless of being in a specific folder). In folder mode, the system only plays the .mp3 files in the current folder.

AM/FM/CD SONY AUDIO SYSTEM

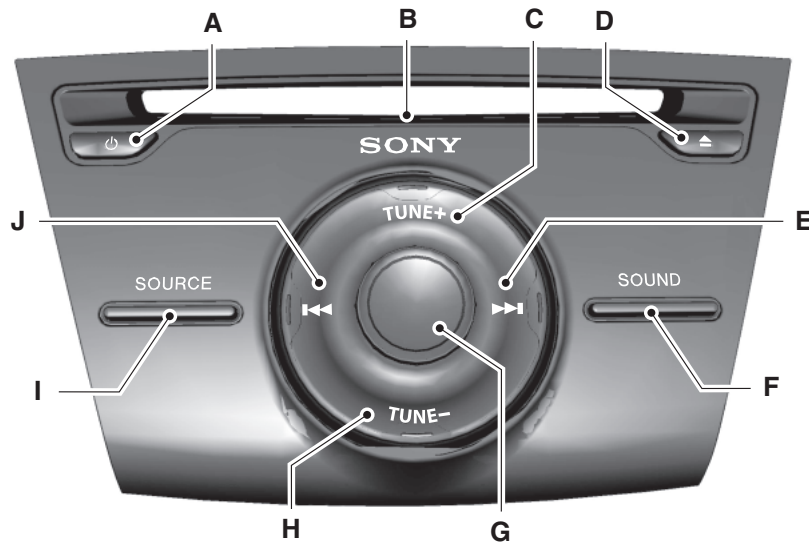

WARNING: Driving while distracted can result in loss of vehicle control, crash and injury. We strongly recommend that you use extreme caution when using any device that may take your focus off the road. Your primary responsibility is the safe operation of your vehicle. We recommend against the use of any hand-held device while driving and encourage the use of voice-operated systems when possible. Make sure you are aware of all applicable local laws that may affect the use of electronic devices while driving.

Note: The MyFord Touch® system controls most of the audio features. See the *MyFord Touch®* chapter for more information.

A. **Power:** Press this button to switch the system off and on.

B. **CD slot:** Insert a CD.

C. **TUNE +:**

- In radio mode, press this button to manually search forward through the radio frequency band.
- In Sirius mode, press this button to find the next available satellite radio station.

D. **Eject:** Press this button to eject a CD.

E. **Seek (Forward):**

- In radio mode, press this button to go to the next radio station up the frequency band.
- In Sirius mode, press this button to select the next channel. If a specific category is selected (such as Jazz, Rock or News), use this button to find the next channel in the selected category.
- In CD mode, press this button to go to the next track.

F. **SOUND:** Press this button to access settings for Treble, Middle, Bass, Balance and Fade.

G. **Volume:** Turn this control to adjust the volume.

H. **TUNE -:**

- In radio mode, press this button to manually search backward through the radio frequency band.
- In Sirius mode, press this button to find the previous available satellite radio station.

I. **SOURCE:** Press this button to access different audio modes, such as AM, FM and A/V Input or SYNC sources such as USB, iPod and Bluetooth audio.

J. **Seek (Reverse):**

- In radio mode, press this button to go to the previous radio station down the frequency band.
- In Sirius mode, press this button to select the previous channel. If a specific category is selected (such as Jazz, Rock or News), use this button to find the previous channel in the selected category.
- In CD mode, press this button to go to the previous track.

MEDIA HUB (IF EQUIPPED)

The media hub is located in the center console and has the following features:

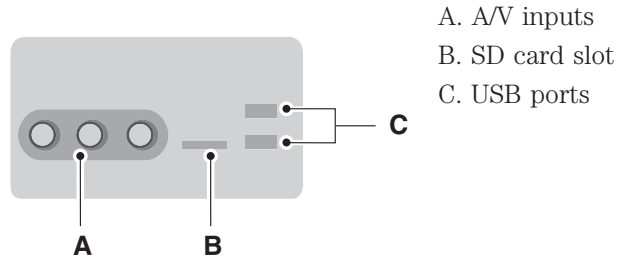

For more information, see the *MyFord Touch* chapter.

INTRODUCTION

 **WARNING:** Driving while distracted can result in loss of vehicle control, crash and injury. We strongly recommend that you use extreme caution when using any device that may take your focus off the road. Your primary responsibility is the safe operation of your vehicle. We recommend against the use of any hand-held device while driving and encourage the use of voice-operated systems when possible. Make sure you are aware of all applicable local laws that may affect the use of electronic devices while driving.

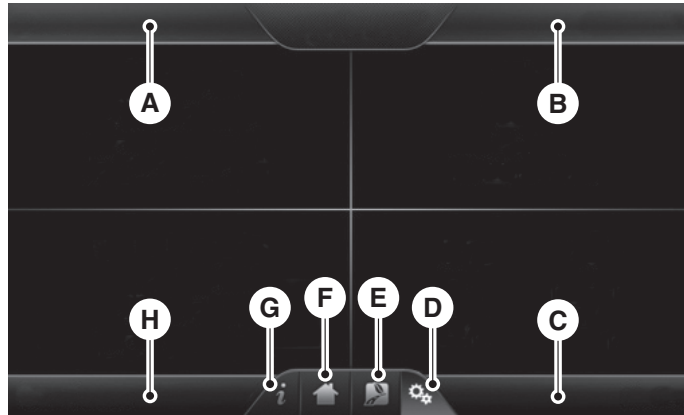

- A. Phone
- B. Navigation (or Information if your vehicle is not equipped with Navigation)
- C. Climate
- D. Settings
- E. EV Information
- F. Home
- G. Information
- H. Entertainment

This system uses a four-corner strategy to provide quick access several vehicle features and settings. The touchscreen provides easy interaction with your cellular phone, multimedia, climate control and navigation system. The corners display any active modes within those menus, such as phone status or the climate temperature.

Note: Some features are not available while your vehicle is moving.

Note: Your system is equipped with a feature that allows you to access and control audio features for 30 minutes after you switch the ignition off (and no doors open).

PHONE

Press to select any of the following:

- Making and Receiving Calls
- Quick Dial
- Phonebook
- Call History
- Text Messaging
- Settings

NAVIGATION

Press to select any of the following:

- My Home
- Favorites
- Previous Destinations
- Point of Interest
- Emergency
- Street Address
- Intersection
- City Center
- Map
- Edit Route Cancel Route

CLIMATE

Press to select any of the following:

- Driver Settings
- Recirculated Air
- Auto
- Dual
- Passenger Settings
- A/C
- Defrost

**SETTINGS**

Press to select any of the following:

- Clock
- Display
- Sound
- Vehicle
- Settings
- Help



Press to access features specific to your electric vehicle.

**HOME**

Press to access your home screen. Depending on your vehicle's option package and software, your screens may vary in appearance from the descriptions in this section. Your features may also be limited depending on your market. Check with your authorized dealer for availability.

**INFORMATION**

Press to select any of the following:

- SYNC Services
- Sirius Travel Link
- Alerts
- Calendar
- SYNC Apps

If the icon is yellow, see *Alerts* in the *Information* section of this chapter.

ENTERTAINMENT

Press to select any of the following:

- AM
- FM
- SIRIUS
- CD
- USB
- BT Stereo
- SD Card
- A/V In

Using the Touch-sensitive Controls on Your System

To turn a feature on and off, just touch the graphic with your finger. To get the best performance from the touch-sensitive controls:

- Do not press hard on the controls. They are sensitive to light touch.
- Use your bare finger to touch the center of a touch-control graphic. Touching off-center of the graphic may affect operation of a nearby control.
- Make sure your hands are clean and dry.
- Keep metal and other conductive material away from the surface of the touchscreen as this may cause electronic interference (for example, inadvertently turning on a feature other than the one you meant to turn on).

Depending on your vehicle and option package, you may also have these controls on your bezel:

- Power: Switch the media or climate features off and on.
- **VOL:** Control the volume of playing media.
- Fan: Control the speed of the climate system fan.
- Seek and Tune buttons: Use as you normally would in media modes.
- Eject: Eject a CD from the entertainment system.
- **SOURCE:** Touch the word repeatedly to see all available media modes. The screen does not change, but you see the media change in the lower left status bar.
- **SOUND:** Touch the word to access the Sound menu where you can adjust settings such as: Bass, Treble, Midrange, Balance and Fade, THX Deep Note Demo, DSP (Digital Signal Processing), Occupancy Mode and Speed Compensated Volume. (Your vehicle may not have all of these sound options.)
- Hazard flasher: Switch the hazard flashers off and on.

Cleaning the Touchscreen Display

Use a clean, soft cloth such as one used for cleaning glasses. If dirt or fingerprints are still visible, apply a small amount of alcohol to the cloth. Do not pour or spray alcohol onto the display. Do not use detergent or any type of solvent to clean the display.

Support

The SYNC support team is available to help you with any questions you cannot answer on your own.

Monday-Saturday, 8:30am-9:00pm EST.

Sunday, 10:30am-7:30pm EST.

In the United States, call: 1-800-392-3673.

In Canada, call: 1-800-565-3673.

Times are subject to change due to holidays.

Safety Information



WARNING: Driving while distracted can result in loss of vehicle control, crash and injury. We strongly recommend that you use extreme caution when using any device that may take your focus off the road. Your primary responsibility is the safe operation of your vehicle. We recommend against the use of any handheld device while driving and encourage the use of voice-operated systems when possible. Make sure you are aware of all applicable local laws that may affect the use of electronic devices while driving.

When using SYNC:

- Do not operate playing devices if the power cords or cables are broken, split or damaged. Place cords and cables out of the way, so they do not interfere with the operation of pedals, seats, compartments or safe driving abilities.
- Do not leave playing devices in your vehicle during extreme conditions as it could cause them damage. See your device's manual for further information.
- Do not attempt to service or repair the system. See your authorized dealer.

For your safety, some SYNC functions are speed-dependent. Their use is limited to when your vehicle is traveling at speeds under 3 mph (5 km/h).

Make sure that you review your device's manual before using it with SYNC.

Speed-restricted Features

Some features of this system may be too difficult to use while your vehicle is moving so they are restricted from use unless your vehicle is stationary.

- Screens that are too crowded with information, such as Point of Interest reviews and ratings, Sirius Travel Link sports scores, movie times and ski conditions.
- Any action that requires you to use a keyboard is restricted, such as entering a navigation destination or editing information.
- All lists are limited so the user can view fewer entries (such as phone contacts or recent phone call entries).

See the following chart for more specific examples:

Restricted Features	
Cellular Phone	Pairing a Bluetooth phone
	Adding phonebook contacts or uploading phonebook contacts (from a USB)
	List entries are limited for phone contacts and recent phone call entries
System Functionality	Editing the keypad code
	Enabling Valet Mode
	Editing settings while the rear view camera or Active Park Assist are active
Wi-Fi and Wireless	Editing wireless settings
	Editing the list of wireless networks
Videos, Photos and Graphics	Playing video
	Editing the screen's wallpaper or adding new wallpaper
Text Messages	Composing text messages
	Viewing received text messages
	Editing preset text messages
Navigation	Using the keyboard to enter a destination
	Demo navigation route
	Adding or Editing Address Book entries or Avoid Areas

Privacy Information

When a cellular phone is connected to SYNC, the system creates a profile within your vehicle that is linked to that cellular phone. This profile is created in order to offer you more cellular features and to operate more efficiently. Among other things, this profile may contain data about your cellular phone book, text messages (read and unread), and call history, including history of calls when your cell phone was not connected to the system. In addition, if you connect a media device, the system creates and retains an index of supported media content. The system also records a short development log of approximately 10 minutes of all recent system activity. The log profile and other system data may be used to improve the system and help diagnose any problems that may occur.

The cellular profile, media device index, and development log remain in the vehicle unless you delete them and are generally accessible only in the vehicle when the cellular phone or media player is connected. If you no longer plan to use the system or the vehicle, we recommend you perform a Master Reset to erase all stored information.

System data cannot be accessed without special equipment and access to the vehicle's SYNC module. Ford Motor Company and Ford of Canada do not access the system data for any purpose other than as described absent consent, a court order, or where required by law enforcement, other government authorities, or other third parties acting with lawful authority. Other parties may seek to access the information independently of Ford Motor Company and Ford of Canada. For further privacy information, see the sections on 911 Assist, Vehicle Health Report, and Traffic, Directions and Information.

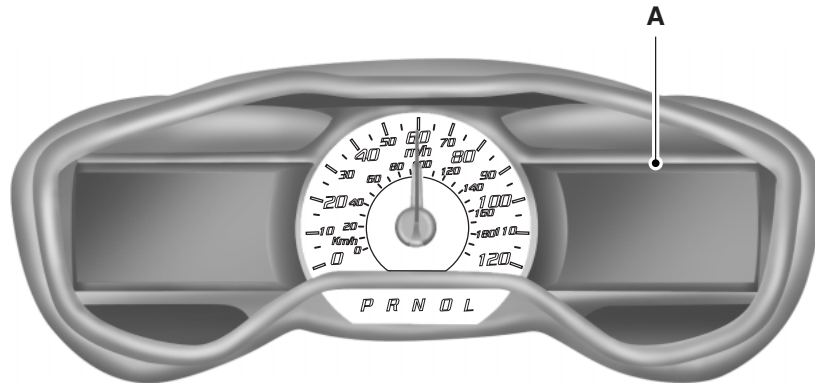
ACCESSING AND ADJUSTING MODES THROUGH YOUR RIGHT VEHICLE INFORMATION DISPLAY





The display (A) is located on the right side of your instrument cluster. You can use your steering wheel controls to view and make minor adjustments to active modes without taking your hands off the wheel. For example:

- In Entertainment mode, you can view what is now playing, change the audio source, select memory presets and make some adjustments.
- In Phone mode, you can accept or reject an incoming call.
- In Navigation mode, you can view the current route or activate a route.
- In Surplus mode, either butterflies or a gauge represents surplus (or status). The number of butterflies matches the current surplus or status distance up to a maximum of sixteen butterflies. If you entered your next charge destination in the navigation system and you see butterflies on your screen, then you should be able to make your destination (you have a Surplus). If you see butterflies but did not enter your next charge destination, then you should be able to achieve the range estimate shown at the start of your drive (you have a positive Status). See the *Instrument Cluster* chapter for more information.

When you enter or turn off the vehicle, you have the opportunity to view charging status, charge start and end times as well as the charging mode. You can also switch your charging mode between Value Charge and Charge Now. See *Convenience charging with MyFord mobile* in the *High Voltage Battery* chapter.



Use the **OK** and arrow buttons on the right side of your steering wheel to scroll through the available modes:

-  Entertainment
-  Phone
-  Navigation
-  Surplus

You can make selections from the menu by using the **OK** button. The selection menu expands and different options appear.

- Press the up and down arrows to scroll through the modes.
- Press the right arrow to enter the mode.
- Press the left or right arrows to make adjustments within the chosen mode.
- Press **OK** to confirm your selection.

USING VOICE RECOGNITION

This system helps you control many features using voice commands. This allows you to keep your hands on the wheel and focus on what is in front of you. The system provides feedback through audible tones, prompts, questions and spoken confirmations depending on the situation and the chosen level of interaction (voice settings).

The system also asks short questions (confirmation prompts) when it is not sure of your request or when there are multiple possible responses to your request.

When using voice commands, words and icons may appear in the lower left status bar indicating the status of the voice session (such as Listening, Success, Failed, Paused or Try Again).

How to Use Voice Commands with Your System



Press the voice icon. After the tone, speak your command clearly.

These commands can be said at any time.
“Cancel”
“Exit”
“Go back”
“List of commands”
“Main menu”
“Next page”
“Previous page”
“What can I say?”
“Help”

What Can I Say?

To access the available voice commands for the current session, do one of the following:

- During a voice session, press the Help icon (?) in the lower left status bar of the screen.
- Say, “What can I say?” for an on-screen listing of the possible voice commands associated with your current voice session.
- Press the voice icon. After the tone, say, “Help” to hear a list of possible voice commands.

Helpful Hints

- Make sure the interior of your vehicle is as quiet as possible. Wind noise from open windows and road vibrations may prevent the system from correctly recognizing spoken commands.
- After pressing the voice icon, wait until after the tone sounds and Listening appears before saying a command. Any command spoken prior to this does not register with the system.

- Speak naturally, without long pauses between words.
- At any time, you can interrupt the system while it is speaking by pressing the voice icon.

Accessing a List of Available Commands

- If you use the touchscreen, press the Settings icon > **Help** > **Voice Command List**.
- If you use the steering wheel control, press the voice icon. After the tone, speak your command clearly.

Voice command list
“Audio list of commands”
“Bluetooth audio list of commands”
“Browse list of commands”
“CD list of commands”
“Climate control list of commands”
“List of commands”
“Navigation list of commands”*
“Phone list of commands”
“Radio list of commands”
“SD card list of commands”
“Sirius satellite list of commands”**
“Travel link list of commands”*
“USB list of commands”
“Voice instructions list of commands”
“Voice settings list of commands”
“Help”

*This command is only available when your vehicle is equipped with the navigation system, and the navigation system SD card is in the card slot.

**This command is only available when you have an active Sirius satellite radio subscription.

Voice Settings

Voice settings allow you to customize the level of system interaction, help and feedback. The system defaults to standard interaction that uses candidate lists and confirmation prompts as these provide the highest level of guidance and feedback.

Interaction Mode: Novice mode provides detailed interaction and guidance while the advanced mode has less audible interaction and more tone prompts.

Confirmation Prompts: The system uses these short questions to confirm your voice request. If turned off, the system simply makes a best guess as to what you requested. The system may still occasionally ask you to confirm settings.

Phone/Media Candidate Lists: Candidate lists are lists of possible results from your voice commands. The system creates these lists when it has the same confidence level of several options based on your voice command.

To access these settings using the touchscreen:

1. Press the Settings icon > **Settings** > **Voice Control**.
2. Select from:
 - Interaction Mode
 - Confirmation Prompts
 - Media Candidate Lists
 - Phone Candidate Lists
 - Voice Control Volume.

To access these settings using voice commands:



Press the voice icon. Wait for the prompt “Please say a command”. Another tone sounds to let you know the system is listening.

Voice settings using voice commands
“Interaction Mode Novice”
“Interaction Mode Advanced”
“Confirmation Prompts On”
“Confirmation Prompts Off”
“Phone Candidate Lists On”
“Phone Candidate Lists Off”
“Media Candidate Lists On”
“Media Candidate Lists Off”
“Help”

Using Voice Commands with the Touchscreen Options

Your voice system has a dual mode feature which allows you to switch between using voice commands and making on-screen selections. This is available only when the system displays a list of candidates generated during a voice session. For example, when entering in a street address or trying to call a contact from the phone you paired to the system.

ENTERTAINMENT



A. AM 1 and AM AST

B. FM 1, FM 2 and FM AST

C. SIRIUS

D. CD

E. USB

F. Touch this button to scroll down for more options, such as:

- SD Card
- BT Stereo
- A/V In

G. These buttons change with the media mode you are in.

H. Radio memory presets and CD controls.

Note: Some features may not be available in your area. Contact an authorized dealer for more information.

You can access these options using the touchscreen or voice commands.

Browsing Device Content

When listening to audio on a device, you can browse through other devices without having to change sources. For example, if you are currently listening to audio on an SD card, you can browse all the artists that are stored on your USB device.



Press the voice icon on the steering wheel. When prompted, you can say:

“BROWSE” within devices
“Browse” [*]
“Browse <league> games” ^{**,*}
“Browse <Sirius category> channels” ^{**,*}
“Browse Sirius channel guide” ^{**,*}
“Browse SD card”
“Browse USB”
“Help”

^{*}If you have said “Browse”, you can then say any commands in the following chart.

^{**}This command is only usable if you have an active subscription to Sirius satellite radio.

“BROWSE”
“<League> games” [*]
“<Sirius category> channels” [*]
“SD card” ^{**}
“Sirius channel guide” [*]
“USB” ^{**}
“Help”

^{*}This command is only usable if you have an active subscription to Sirius satellite radio.

^{**}For more commands in SD card or USB mode, see the “SD card and USB Port” section of this chapter.

For a complete list of “Browse” voice commands, see *USB and SD card voice commands* and *Bluetooth audio voice commands* in the following sections.

Your voice system allows you to change audio sources with a simple voice command. For example, if you are listening to music on a USB device, then want to switch to a satellite radio channel, simply press the voice button on the steering wheel controls and say the name of the Sirius station (such as, “the Highway”). The following voice commands are available at the top level of the voice session no matter which current audio source you are listening to (such as a USB device or Sirius satellite radio). **Note:** This is only available when your MyFord Touch system language is set to North American English.

“AM <530 - 1710>”	“FM <87.7 - 107.9>”
“<530 - 1710>”	“<87.7 - 107.9>”
“Sirius <0-223>”*	“<Channel name>”*
“Play [genre] <name>”**	“Play [playlist] <name>”**
“Play [artist] <name>”**	“Play [song] <name>”**
“Play [album] <name>”**	“Play <name (song or album)> by <artist name>”
“Play <name>”	“Sports games”*

*This command is only usable if you have an active subscription to Sirius satellite radio.

**The commands that have [] around the word means that the word is optional. For example, if you say, “Play Metallica”, this is the same as the voice command, “Play [artist] <name>”.

AM and FM



Touch the **AM** or **FM** tab to listen to the radio.

To change between AM and FM presets, just touch the **AM** or **FM** tab.

Memory Presets

Save a station by pressing and holding one of the memory preset areas. There is a brief mute while the radio saves the station. Sound returns when finished.

HD Radio

Touch this button to turn HD Radio on. The light on the button illuminates when the feature is on. HD Radio allows you to receive radio broadcasts digitally, where available, providing free, crystal-clear sound. See *HD Radio information* later in this chapter.

Scan

Touch this button to go to the next strong AM or FM radio station. The light on the button illuminates when the feature is on.

Options

Sound Settings allows you to adjust settings for:

- Bass
- Midrange
- Treble
- Balance and Fade
- DSP (Digital Signal Processing)
- Occupancy Mode
- Speed Compensated Volume.

Note: Your vehicle may not have all these sound settings.

Set PTY for Seek/Scan allows you to select a category of music you would like to search for. You can then choose to either seek or scan for the stations playing that category.

RDS Text Display allows you to view the information broadcast by FM stations.

AST allows you to have the system automatically store the six strongest stations in your current location.

TAG Button is available when HD Radio is on, and allows you to tag a song to download later. When you select **On**, TAG appears on-screen when HD Radio is active. You can touch **TAG** to save the information of the song that is playing. When you plug in your portable music player, the information transfers, if supported by your device. When you are connected to iTunes, the tags appear to remind you of the songs you would like to download. See *HD Radio information* later in this chapter.

Direct Tune

Touch this button to manually enter the desired station number. Touch **Enter** when you are done.

HD Radio™ Information (If Available)

Note: HD Radio broadcasts are not available in all markets.

HD Radio technology is the digital evolution of analog AM/FM radio. Your system has a special receiver that allows it to receive digital broadcasts (where available) in addition to the analog broadcasts, it already receives. Digital broadcasts provide a better sound quality than analog broadcasts with free, crystal-clear audio and no static or distortion. For more information, and a guide to available stations and programming, please visit www.hdradio.com.

When HD Radio is on and you tune to a station broadcasting HD Radio technology, you may notice the following indicators on your screen:



HD) logo blinks when acquiring a digital station and stays solid when digital audio is playing. When this logo is available, you may also see Title and Artist fields on-screen.

Multicast indicator appears in FM mode (only) if the current station is broadcasting multiple digital broadcasts. The highlighted numbers signify available digital channels where new or different content is available.

HD1 signifies the main programming status and is available in analog and digital broadcasts. Other multicast stations (HD2 through HD7) are only available digitally.

TAG allows you to save a song to download later when you are on an acquired HD Radio station and the feature is on. To turn the feature on and use it:

1. Press **AM** or **FM** > **Options** > **TAG** button > **On**.
2. When you hear a song you like, touch **TAG**.
3. The system automatically saves the song's information and transfers it to your portable music player (if supported) when you connect it to the system. The system automatically transfers the tag to your player (if already connected) and a pop-up confirms the transfer.
4. When you access iTunes with your portable music player, the tags appear to you as a reminder. The system allows you to tag up to approximately 100 songs. For a list of devices that support tagging, see www.SYNCMYRide.com, www.SYNCMYRide.ca or www.syncmaroute.ca.

When HD Radio broadcasts are active, you can access the following functions:

- **Scan** allows you to hear a brief sampling of all available stations. This feature still works when HD Radio reception is on, although it does not scan for HD2-HD7 channels. You may see the HD logo appear if the station has a digital broadcast.

- **Memory presets** allow you to save an active channel as a memory preset. Touch and hold a memory preset slot until the sound returns. There is a brief mute while the radio saves the station. Sound returns when finished. When switching to an HD2 or HD3 memory preset, the sound mutes before the digital audio plays, because the system has to reacquire the digital signal.
 - **Note:** As with any saved radio station, you cannot access the saved station if your vehicle is outside the station's reception area.

HD Radio Reception and Station Troubleshooting

Potential Reception Issues	
Reception area	If you are listening to a multicast station and you are on the fringe of the reception area, the station may mute due to weak signal strength.
	If you are listening to HD1, the system switches back to the analog broadcast until the digital broadcast is available again. However, if you are listening to any of the possible HD2 through HD7 multicast channels, the station mutes and stays muted unless it is able to connect to the digital signal again.
Station blending	When the system first receives a station (aside from HD2-HD7 multicast stations), it first plays the station in the analog version. Once the receiver verifies the station is an HD Radio station, it shifts to the digital version. Depending on the station quality, you may hear a slight sound change when the station changes from analog to digital. Blending is the shift from analog to digital sound or digital back to analog sound.

In order to provide the best possible experience, use the contact form to report any station issues found while listening to a station broadcasting with HD Radio technology. Independent entities own and operate each station. These stations are responsible for making sure all audio streams and data fields are accurate.

Potential station issues		
Issue	Cause	Action
Echo, stutter, skip or repeat in audio. Increase or decrease in audio volume.	This is poor time alignment by the radio broadcaster.	No action required. This is a broadcast issue.
Sound fading or blending in and out.	The radio is shifting between analog and digital audio.	No action required. The reception issue may clear up as you continue to drive.
There is an audio mute delay when selecting HD2 or HD3, multicast preset or Direct Tune .	The digital multicast is not available until the HD Radio broadcast is decoded. Once decoded, the audio is available.	No action required. This is normal behavior. Wait until the audio is available.
Cannot access HD2 or HD3 multicast channel when recalling a preset or from a direct tune.	The previously stored multicast preset or direct tune is not available in your current reception area.	No action required. The station is not available in your current location.
Text information does not match currently playing audio.	Data service issue by the radio broadcaster.	Fill out the station issue form at website listed below.*
There is no text information shown for currently selected frequency.	Data service issue by the radio broadcaster.	Fill out the station issue form at website listed below.*
HD2-HD7 stations not found when Scan is pressed.	Pressing Scan disables HD2-HD7 channel search.	No action required. This is normal behavior.

*http://www.ibiquity.com/automotive/report_radio_station_experiences

HD Radio Technology manufactured under license from iBiquity Digital Corp. U.S. and foreign patents. HD Radio and the HD and HD Radio logos are proprietary trademarks of iBiquity Digital Corp. Ford Motor Company and iBiquity Digital Corp. are not responsible for the content sent using HD Radio technology. Content may be changed, added or deleted at any time at the station owner's discretion.

Radio Voice Commands

If you are listening to the radio, press the voice button on the steering wheel control. When prompted, say any of the commands in the following chart.

If you are not listening to the radio, press the voice button and, after the tone, say “Radio”, then any of the commands in the following chart.

“RADIO”	
“<87.9–107.9>”	“FM preset <#>”
“<87.9–107.9> HD”*	“FM1”
“<530–1710>”	“FM 1 preset <#>”
“AM”	“FM2”
“AM <530–1710>”	“FM 2 preset <#>”
“AM autosest”	“HD <#>”*
“AM autosest preset <#>”	“Preset <#>”
“AM preset <#>”	“Radio off”
“FM”	“Radio on”
“FM <87.9–107.9>”	“Set PTY”
“FM <87.9–107.9> HD <#>”*	“Tune”**
“FM autosest”	“Help”
“FM autosest preset <#>”	

*If available.

**If you have said, “Tune”, see the following “Tune” chart.

“TUNE”	
“<87.9–107.9>”	“FM autosest”
“<87.9–107.9> HD <#>”*	“FM autosest preset <#>”
“<530–1710>”	“FM preset <#>”
“AM”	“FM1”
“AM <530–1710>”	“FM 1 preset <#>”
“AM autosest”	“FM2”
“AM autosest preset <#>”	“FM 2 preset <#>”
“AM preset <#>”	“HD <#>”*
“FM”	“Preset <#>”
“FM <87.9–107.9>”	“Help”
“FM <87.9–107.9> HD <#>”*	

*If available.

Sirius Satellite Radio (If Activated)

Press the lower left corner of the touchscreen, then select the **SIRIUS** tab.

Presets

Save a channel by pressing and holding one of the memory preset areas. There is a brief mute while the radio saves the channel. Sound returns when finished.

ALERT

Save the current song, artist, or team as a favorite. The system alerts you when it plays again on any channel.

Replay

Replay audio on the current channel. You can replay approximately 45 minutes of audio as long as you have remained tuned to the current station. Changing stations erases the previous audio.

While in replay mode:

- Press and release the seek buttons to hear the previous or next song.
- Press and hold the seek buttons to reverse or fast forward in the current track.
- Press play or pause to play or pause the audio.
- Press **Replay** to return to live audio if you have been using the feature to replay audio.

Scan

Touch this button to hear a brief sampling of channels.

Options

Sound Settings allows you to adjust settings for:

- Bass
- Midrange
- Treble
- Balance and Fade
- DSP (Digital Signal Processing)
- Occupancy Mode
- Speed Compensated Volume.

Note: Your vehicle may not have all these sound settings.

Set Category for Seek/Scan allows you to select a category of music you would like to search for. You can then choose to either seek or scan for the stations playing that category.

Parental Lockout allows you to lock and unlock channels, change or reset your PIN or unlock all channels. To use this feature, you need your initial PIN, which is 1234.

Artist/Title/Team Alerts allows you to select Artists, Titles and Teams that you would like the system to alert you to when they are playing on other channels. Press **Edit Alerts** to delete or turn off alerts. You can also set all alerts to on or off. When an alert appears on the screen, you can choose to Tune to the channel, to Cancel the alert or to Disable Alerts. If you are listening to a sporting event, you can save your favorite teams so that the system can alert you when they are playing on a satellite radio channel.

Note: Sirius does not support the Alert feature on all channels. Ford Motor Company shall not be responsible for Alert feature variation.

Electronic Serial Number (ESN) is required when communicating with Sirius about your account.

Direct Tune

Touch this button to manually enter the desired satellite channel number. Touch **Enter** when you are done.

Browse

Touch this button to view a list of all available stations. Scroll to see more categories. Touch the station you want to listen to.

Touch **Skip** if you want to skip this channel.

Touch **Lock** if you do not want anyone to listen to this channel.

Touch **Title** or **Artist** to see song and artists on other stations.

Satellite Radio Voice Commands



If you are listening to Sirius satellite radio, press the voice button on the steering wheel control. When prompted, say any of the commands in the following chart.

If you are not listening to Sirius satellite radio, press the voice button and, after the tone, say “Sirius”, then any of the commands in the following chart.

“SIRIUS”	
“Sirius <0–223>”	“SAT 3”
“<Channel name>”	“SAT 3 preset <#>”
“Preset <#>”	“SAT preset <#>”
“SAT”	“Sirius off”

“SIRIUS”	
“SAT 1”	“Sirius on”
“SAT 1 preset <#>”	“Sports game”*
“SAT 2”	“Tune”**
“SAT 2 preset <#>”	“Help”

*If you have said, “Sports game”, see the following “Sports game” chart.

**If you have said, “Tune”, see the following “Tune” chart.

“SPORTS GAME”
“Tune to the <college name> game”
“Tune to the <team city> game”
“Tune to the <team city> <team name> game”
“Tune to the <team name> game”
“Help”

“TUNE”
“Sirius <0-223>”
“<Channel name>”
“Preset <#>”
“SAT”
“SAT 1”
“SAT 1 preset <#>”
“SAT 2”
“SAT 2 preset <#>”
“SAT 3”
“SAT 3 preset <#>”
“Help”

Sirius Satellite Radio Information

Note: Sirius reserves the unrestricted right to change, rearrange, add or delete programming including canceling, moving or adding particular channels, and its prices, at any time, with or without notice to you. Ford Motor Company shall not be responsible for any such programming changes.

Note: This receiver includes the eCos real-time operating system. eCos is published under the eCos License.



Sirius satellite radio is a subscription-based satellite radio service that broadcasts a variety of music, sports, news, weather, traffic and entertainment programming.

Your factory-installed Sirius satellite radio system includes hardware and a limited subscription term that begins on the date of sale or lease of your vehicle. See your authorized dealer for availability.

For more information on extended subscription terms (a service fee is required), the online media player and a list of Sirius satellite radio channels, and other features, please visit www.siriusxm.com in the United States, www.sirius.ca in Canada, or call Sirius at 1-888-539-7474.

Satellite radio electronic serial number (ESN): You need your ESN to activate, modify or track your satellite radio account. The ESN is on the System Information Screen (SR ESN: XXXXXXXXXXXXX). To access your ESN, press the bottom left corner of the touchscreen, then **SIRIUS > Options.**

Potential satellite radio reception issues	
Antenna obstructions	For optimal reception performance, keep the antenna clear of snow and ice build-up and keep luggage and other materials as far away from the antenna as possible.
Terrain	Hills, mountains, tall buildings, bridges, tunnels, freeway overpasses, parking garages, dense tree foliage and thunderstorms can interfere with your reception.
Station overload	When you pass a ground-based broadcast-repeating tower, a stronger signal may overtake a weaker one and the audio system may mute.
Satellite radio signal interference	Your display may show ACQUIRING . . . to indicate the interference and the audio system may mute.

Sirius troubleshooting tips		
Radio display	Condition	Possible action
Acquiring...	Radio requires more than two seconds to produce audio for the selected channel.	No action required. This message should disappear shortly.
Sat Fault/SIRIUS system failure.	There is an internal module or system failure present.	If this message does not clear shortly, or with an ignition key cycle, your receiver may have a fault. See your authorized dealer for service.
Invalid Channel.	The channel is no longer available.	Tune to another channel or choose another preset.
Unsubscribed Channel.	Your subscription does not include this channel.	Contact Sirius at 1-888-539-7474 to subscribe to the channel, or tune to another channel.
No Signal.	The signal is lost from the Sirius satellite or Sirius tower to your vehicle antenna.	The signal is blocked. When you move into an open area, the signal should return.
Updating.	Update of channel programming in progress.	No action required. The process may take up to three minutes.
Call SIRIUS 1-888-539-7474.	Your satellite service is no longer available.	Contact Sirius at 1-888-539-7474 to resolve subscription issues.
None Found. Check Channel Guide.	All the channels in the selected channels are either skipped or locked.	Use the channel guide to turn off the Lock or Skip function on that station.
Subscription Updated.	Sirius has updated the channels available for your vehicle.	No action required.

CD

Press the lower left corner of the touchscreen, and then select the **CD** tab.

You can also advance and reverse the current track or current folder, if applicable.

Repeat

Touch this button to repeat the currently playing track, all tracks on the disc or turn the feature off if already on.

Shuffle

Touch this button to play the tracks or entire albums in random order, or turn the feature off if already on.

Scan

Touch this button to hear a brief sampling of all available tracks.

More Info

Touch this button to see disc information.

Options

Sound Settings allows you to adjust settings for:

- Bass
- Midrange
- Treble
- Balance and Fade
- DSP (Digital Signal Processing)
- Occupancy Mode
- Speed Compensated Volume.

Note: Your vehicle may not have all these sound settings.

Compression allows you to turn the compression feature on and off.

Browse

Touch this button to look through all available CD tracks.

CD Voice Commands

If you are listening to a CD, press the voice button on the steering wheel control. When prompted, say any of the commands in the following chart.

If you are not listening to a CD, press the voice button and, after the tone, say “CD”, then any of the commands in the following chart.

“CD”	
“Pause”	“Repeat off”
“Play”	“Repeat track”
“Play next track”	“Shuffle”
“Play previous track”	“Shuffle CD”*
“Play track <1-512>”	“Shuffle folder”*
“Repeat”	“Shuffle off”
“Repeat folder”*	“Help”

*This applies to WMA or MP3 files only.

SD Card Slot and USB Port**SD Card Slot**

Note: Your SD card slot is spring-loaded. To remove the SD card, press the card in and the system ejects it. Do not attempt to pull the card to remove it as this could cause damage.

Note: The navigation system also uses this card slot. See *Navigation system* later in this chapter for more information.

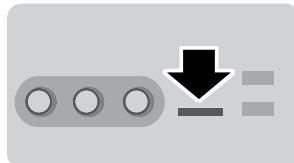

The slot is located either in the center console or behind a small access door in the instrument panel. To access and play music from your card, press the lower left corner of the touchscreen, and then select the **SD Card** tab.



SD logo is a trademark of SD-3C, LLC.

USB Port

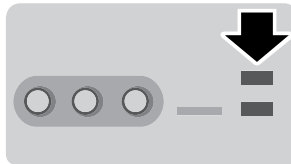

The ports are located either in the center console or behind a small access door in the instrument panel. To access and play music from your device, press the lower left corner of the touchscreen, and then select the **USB** tab.

This feature allows you to plug in media playing devices, memory sticks, flash drives or thumb drives, and charge devices if they support this feature.

In order to playback video from your iPod or iPhone, if compatible, you must have a special combination USB/RCA composite video cable, which you can buy from Apple. When you connect the cable to your iPod or iPhone, plug the other end into both the RCA jacks and the USB port.

Playing Music from Your Device

Insert your device and select the **SD Card** or **USB** tab once the system recognizes it. You can then select from the following options:

Repeat replays the currently playing song or album.

Shuffle plays music on the selected album or folder in random order.

Similar Music allows you to choose music similar to what is currently playing.

More Info displays information such as current track, artist name, album and genre.

Options allows you to view and adjust various media settings.

- **Sound Settings** allows you to adjust settings for:
 - Bass
 - Midrange
 - Treble
 - Balance and Fade
 - DSP (Digital Signal Processing)

- Occupancy Mode
- Speed Compensated Volume.

Note: Your vehicle may not have all these sound settings.

- **Media Player Settings** allows you to select more settings, which is under **Media Player**. See *Settings*.
- **Device Information** displays software and firmware information about the currently connected media device.
- **Update Media Index** indexes your device each time you connect it to make sure you have the latest voice commands available for all media on the device.

Browse allows you to view the contents of the device. It also allows you to search by categories, such as genre, artist or album.

If you want to view song information such as Title, Artist, File, Folder, Album, and Genre, touch the on-screen album art.

You can also touch **What's Playing** to hear how the system pronounces the current band and song. This can be helpful when using voice commands to make sure the system correctly plays your request.

SD Card and USB Voice Commands



If you are listening to a USB device or an SD card, press the voice button on the steering wheel control. When prompted, say any of the commands in the following chart.

If you are not listening to a USB device or an SD card, press the voice button and, after the tone, say “USB” or “SD card”, then any of the commands in the following chart.

“USB” or “SD CARD”	
“Browse”*	“Play similar music”
“Next”	“Play song <name>”
“Pause”	“Play TV show <name>”**
“Play”	“Play TV show episode <name>”**
“Play album <name>”	“Play video <name>”**
“Play all”	“Play video podcast <name>”**
“Play artist <name>”	“Play video podcast episode <name>”**
“Play audiobook <name>”	“Play video playlist <name>”**
“Play author <name>”	“Previous”
“Play composer <name>”	“Repeat all”

“USB” or “SD CARD”	
“Play folder <name>”	“Repeat off”
“Play genre <name>”	“Repeat one”
“Play movie <name>”**	“Shuffle”
“Play music video <name>”**	“Shuffle album”
“Play playlist <name>”	“Shuffle off”
“Play podcast <name>”	“What’s this?”
“Play podcast episode <name>”	“Help”

*If you have said you would like to browse your USB or SD card, the system prompts you to specify what you would like to browse. When prompted, see the following “Browse” chart.

**This command is only available in USB mode and are device-dependent.

“BROWSE”	
“Album <name>”	“All video podcasts”*
“All albums”	“All videos”*
“All artists”	“Artist <name>”
“All audiobooks”	“Audiobook <name>”
“All authors”	“Author <name>”
“All composers”	“Composer <name>”
“All folders”	“Folder <name>”
“All genres”	“Genre <name>”
“All movies” *	“Playlist <name>”
“All music videos”*	“Podcast <name>”
“All playlists”	“TV show <name>”*
“All podcasts”	“Video <name>”*
“All songs”	“Video playlist <name>”*
“All TV shows”*	“Video podcast <name>”*
“All video playlists”*	“Help”

*This command is only available in USB mode and are device-dependent.

Supported Media Players, Formats and Metadata Information

SYNC is capable of hosting nearly any digital media player, including iPod®, Zune™, plays from device players, and most USB drives. Supported audio formats include MP3, WMA, WAV and AAC.

It is also able to organize your indexed media from your playing device by metadata tags. Metadata tags, which are descriptive software identifiers embedded in the media files, provide information about the file.

If your indexed media files contain no information embedded in these metadata tags, SYNC may classify the empty metadata tags as

Unknown.

In order to playback video from your iPod® or iPhone®, (if compatible), you **MUST** have a special combination USB/RCA composite video cable (which you can buy from Apple®). When the cable is connected to your iPod® or iPhone®, plug the other end into both the RCA jacks and the USB port.

Bluetooth Audio

Your system allows you to stream audio over your vehicle's speakers from your connected, Bluetooth-enabled cellular phone.



To access, press the lower left corner on the touchscreen, then select the **BT Stereo** tab.

Bluetooth Audio Voice Commands



If you are listening to a Bluetooth audio device, press the voice button on the steering wheel control. When prompted, say "Next song", "Pause", "Play" or "Previous song".

If you are not listening to a Bluetooth audio device, press the voice button and, after the tone, say "Bluetooth Audio", then "Next song", "Pause", "Play" or "Previous song".

AV Inputs



WARNING: Driving while distracted can result in loss of vehicle control, crash and injury. We strongly recommend that you use extreme caution when using any device that may take your focus off the road. Your primary responsibility is the safe operation of your vehicle. We recommend against the use of any hand-held device while driving and encourage the use of voice-operated systems when possible. Make sure you are aware of all applicable local laws that may affect the use of electronic devices while driving.



WARNING: For safety reasons, do not connect or adjust the settings on your portable music player while your vehicle is moving.



WARNING: Store the portable music player in a secure location, such as the center console or the glove box, when your vehicle is in motion. Hard objects may become projectiles in a crash or sudden stop, which may increase the risk of serious injury. The audio extension cable must be long enough to allow the portable music player to be safely stored while your vehicle is moving.

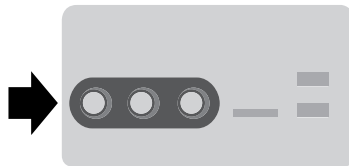

Your A/V inputs allow you to connect an auxiliary audio/video source (such as a gaming system or a personal camcorder) by connecting RCA cords (not included) to these input jacks. The jacks are yellow, red and white and are located either behind a small access door on the

instrument panel or in your center console.

You can also use the A/V inputs as an auxiliary input jack to play music from your portable music player over your vehicle's speakers. Plug in your 1/8 inch (3.5 millimeter) RCA adapter into the two left A/V input jacks (red and white).

Press the lower left corner of the touchscreen, and then select **A/V In.**

To use the auxiliary input jack feature, make sure that your portable music player is designed for use with headphones and that it is fully charged.

You also need an audio extension cable with stereo male 1/8th-inch (3.5 millimeter) connectors at one end and a RCA jack at the other.

1. Switch off the vehicle, radio and portable music player. Set the parking brake and put the transmission in position **P**.
2. Attach one end of the audio extension cable to the headphone output of your player and the other end into the adapter in one of the two left A/V input jacks (white or red) inside the center console.

3. Press the lower left corner on the touchscreen. Select either a tuned FM station or a CD (if there is a CD already loaded into the system).
4. Adjust the volume as desired.
5. Turn the portable music player on and adjust the volume to ½ the maximum.
6. Press the lower left corner on the touchscreen. Select the A/V In tab. (You should hear audio from your portable music player although it may be low.)
7. Adjust the sound on your portable music player until it reaches the level of the FM station or CD by switching back and forth between the controls.

In order to playback video from your iPod® or iPhone® (if compatible), you must have a special combination USB/RCA composite video cable (which you can buy from Apple®). When the cable is connected to your iPod® or iPhone®, plug the other end into both the RCA jacks and the USB port.

Troubleshooting

- Do not connect the audio input jack to a line level output. The jack only works correctly with devices that have a headphone output with a volume control.
- Do not set the portable music player's volume level higher than is necessary to match the volume of the CD or FM radio as this causes distortion and reduces sound quality.
- If the music sounds distorted at lower listening levels, turn the portable music player volume down. If the problem persists, replace or recharge the batteries in the portable media player.
- Control the portable media player in the same manner when used with headphones, as the auxiliary input jack does not provide control (such as Play or Pause) over the attached portable media player.

PHONE



- A. Phone
- B. Quick Dial
- C. Phonebook
- D. History
- E. Messaging
- F. Settings

Hands-free calling is one of the main features of SYNC. Once you pair your phone, you can access many options using the touchscreen or voice commands. While the system supports a variety of features, many are dependent on your cellular phone's functionality. At a minimum, most cellular phones with Bluetooth wireless technology support the following functions:

- Answering an incoming call
- Ending a call
- Using privacy mode
- Dialing a number
- Redialing
- Call waiting notification
- Caller ID.

Other features, such as text messaging using Bluetooth and automatic phonebook download, are phone-dependent features. To check your phone's compatibility, see your phone's user manual and visit www.SYNCMYRide.com, www.SYNCMYRide.ca or www.syncmaroute.ca.

Pairing Your Phone for the First Time



WARNING: Driving while distracted can result in loss of vehicle control, crash and injury. We strongly recommend that you use extreme caution when using any device that may take your focus off the road. Your primary responsibility is the safe operation of your vehicle. We recommend against the use of any hand-held device while driving and encourage the use of voice-operated systems when possible. Make sure you are aware of all applicable local laws that may affect the use of electronic devices while driving.

The first thing you must do to use the phone features of SYNC is to pair your Bluetooth-enabled cellular phone with SYNC. This allows you to use your phone in a hands-free manner.

Note: Put the transmission in position **P**. Turn on your vehicle ignition and the radio.

1. Touch **Add Phone** in the upper left corner of the touchscreen. **Find SYNC** appears on the screen and instructs you to begin the pairing process from your device.
2. Make sure that Bluetooth is set to **On** and that your cellular phone is in the proper mode. See your phone's manual if necessary.
 - Select **SYNC**, and a six-digit PIN appears on your device.
3. If you are prompted to enter a PIN on your device, it does not support Secure Simple Pairing. To pair, enter the PIN displayed on the touchscreen. Skip the next step.
4. When prompted on your phone's display, confirm that the PIN provided by SYNC matches the PIN displayed on your cellular phone.
5. The display indicates when the pairing is successful.

SYNC may prompt you with more phone options. For more information on your phone's capability, see your phone's manual and visit the website.

Pairing Subsequent Phones

Note: Put the transmission in position **P**. Turn on your vehicle ignition and the radio.

1. Press the **Phone** corner of the touchscreen > **Settings** > **BT Devices** > **Add Device**.
2. Make sure that Bluetooth is set to **On** and that your cellular phone is in the proper mode. See your phone's manual if necessary.
 - Select **SYNC**, and a six-digit PIN appears on your device.

3. If you are prompted to enter a PIN on your device, it does not support Secure Simple Pairing. To pair, enter the PIN displayed on the touchscreen. Skip the next step.
4. When prompted on your phone's display, confirm that the PIN provided by SYNC matches the PIN displayed on your cellular phone.
5. The display indicates when the pairing is successful.

SYNC may prompt you with more phone options. For more information on your phone's capability, see your phone's user guide and visit the website.

Making Calls



Press the voice button on your steering wheel controls. When prompted, say, "Call <name>" or say "Dial", then the desired number.



To end the call or exit phone mode, press this phone button.

Receiving Calls

During an incoming call, an audible tone sounds. Call information appears in the display if it is available.



Accept the call by pressing **Accept** on the touchscreen or by pressing this phone button on your steering wheel controls.



Reject the call by pressing **Reject** on the touchscreen or by pressing this phone button on your steering wheel controls.

Ignore the call by doing nothing. SYNC logs it as a missed call.

Phone Menu Options

Press the top left corner on your touchscreen to select from the following options:

Phone

Touch this button to access the on-screen numerical pad to enter a number and place a call. During an active call, you can also choose to:

- Mute the call
- Put it on hold
- Turn on privacy (returns the call to your cellular phone)
- Join two calls
- End the call.

Quick Dial

Set up favorite contacts from your phonebook or history folder.

Phonebook

Touch this button to access and call any contacts in your previously downloaded phone book. The system places the entries in alphabetical categories summarized at the top of the screen.

To turn on contact picture settings, if your device supports this feature, press **Phone > Settings > Manage Phonebook > Download photos from Phonebook > On**.

Certain smart phones may support transferring street addresses when listed with phone book contact information. If your phone supports this feature, you can select and use these addresses as destinations and save them as favorites.

History

After you connect your Bluetooth-enabled phone to SYNC, you can access any previously dialed, received or missed calls. You can also choose to save these to your **Favorites** or to **Quick Dial**.

Note: This is a phone-dependent feature. If your phone does not support downloading call history using Bluetooth, SYNC keeps track of calls made with the SYNC system.

Messaging

Send text messages using your touchscreen. See *Text messaging* later in this section.

Settings

Touch this button to access various phone settings, such turning Bluetooth on and off, managing your phonebook and more. See *Phone settings* later in this section.

Text Messaging

Note: Downloading and sending text messages using Bluetooth are phone-dependent features.

Note: Certain features in text messaging are speed-dependent and not available when your vehicle is traveling at speeds over 3 mph (5 km/h).

Note: SYNC does not download read text messages from your phone.

You can send and receive text messages using Bluetooth, read them aloud and translate text messaging acronyms, such as LOL.

1. Touch the top left corner of the display to access the **Phone** menu.
2. Select **Messaging**.
3. Choose from the following:
 - **Listen** (speaker icon)
 - **Dial**
 - **Send Text**
 - **View**
 - **Delete**.

Composing a Text Message

Note: This is a speed-dependent feature. It is unavailable when your vehicle is traveling at speeds over 3 mph (5 km/h).

Note: Downloading and sending text messages using Bluetooth are phone-dependent features.

1. Touch the top left corner of the display to access the **Phone** menu.
2. Touch **Messaging > Send Text**.
3. Enter a phone number or choose from your phone book.
4. You can select from the following options:
 - **Send** which sends the message as it is.
 - **Edit Text** allows you to customize the pre-defined message or create a message on your own.

You can then preview the message, verify the recipient as well as update the message list, and send it to a connected device (such as a USB drive).

Pre-defined text message options
I'll call you back in a few minutes.
I just left, I'll be there soon.
Can you give me a call?
I'm on my way.
I'm running a few minutes late.
I'm ahead of schedule, so I'll be there early.
I'm outside.
I'll call you when I get there.
OK
Yes
No
Thanks
Stuck in traffic.
Call me later.
LOL

Receiving a Text Message

When a new message arrives, an audible tone sounds and the screen displays a pop-up with the caller name and ID, if supported by your phone. You can press:

- **View** to view the text message.
- **Listen** for SYNC to read the message to you.
- **Dial** to call the contact.
- **Ignore** to exit the screen.

Note: If you select **View** and your vehicle is traveling over 3 mph (5 km/h), the system offers to read the message to you instead of allowing you to view it while driving.

Phone Settings

Press **Phone > Settings**.

Bluetooth Devices

Touch this tab to connect, disconnect, add or delete a device, as well as save it as a favorite.

Bluetooth

Touch this tab to turn Bluetooth off or on.

Do Not Disturb

Touch this tab if you want all calls to go directly to your voice mail and not ring in the vehicle. When this feature is on, text message notifications do not ring inside the cabin either.

911 Assist

Turn on or turn off the 911 Assist feature. See *911 Assist* in the *SYNC Services and Applications* section.

Phone Ringer

Select the ring tone you want to hear when you receive a call. Choose from possible system ring tones, your currently paired phone's ring tone, a beep, text-to-speech or a silent notification.

Text Message Notification

Select a text message notification, if supported by your phone. Choose from possible system alert tones, text-to-speech or silent.

Internet Data Connection

If your phone is compatible, use this screen to adjust your internet data connection. Select to make your connection profile with the personal area network or to turn off your connection. You can also choose to adjust your settings or have the system always connect, never connect when roaming or query on connect. Press ? for more information.

Manage Phonebook

Touch this button to access features such as automatic phonebook download, re-download your phonebook, add contacts from your phone as well as delete or upload your phonebook.

Roaming Warning

Touch this button to have the system alert you when your phone is in roaming mode.

Phone Voice Commands

Press the voice button on the steering wheel control. After the tone, say any of the following commands:

“PHONE”	
“Call”	“Join calls”*
“Call <name>”	“Listen to text message <#>”
“Call <name> at home”	“Listen to text messages”
“Call <name> at work”	“Messages”,**
“Call <name> on cell”	“Mute call”*
“Call <name> on other”	“Pair phone”
“Call voicemail”	“Privacy on”*
“Dial”	“Read text message”
“Do not disturb off”	“Reply to text messages”
“Do not disturb on”	“Turn ringer off”
“Forward text messages”	“Turn ringer on”
“Go to hands free”*	“Unmute call”*
“Hold call off”*	“Help”
“Hold on”*	

*This command is only available during an active call.

**If you have said “Messages”, see the following “Messages” chart.

“MESSAGES”
“Call”
“Forward text messages”
“Listen to text message <#>”
“Listen to text messages”
“Reply to text messages”
“Help”

ELECTRIC VEHICLE INFORMATION



Your system has special electric vehicle screens, which display power flow and charge settings. To access these screens, press the EV Info button.



A. Settings

B. Power

Settings

This screen allows you to set up the charging convenience features.

Note: You can also set up the charging convenience features using MyFord Mobile over the internet or smartphone application. For more information on MyFord Mobile, and to set up your MyFord Mobile account, visit www.myfordmobile.com.

To improve the charging experience, your vehicle has the following convenience features:

- **Value Charge:** Your vehicle schedules its charging time for when the utility rates are lowest. Contact your utility company to see what rates are available.
- **Charge Now:** Your vehicle starts charging immediately after you connect the charging plug.
- **My GO Time:** Setting GO Times allows you to control charging schedules and cabin conditioning settings so your vehicle is ready to drive when you are. By setting a GO Time, your vehicle can use your value charge settings to minimize your electricity cost but still prioritize getting a full charge before your GO Time. A calendar view allows you to program two GO Times per day for each day of the week.

Note: Remember, you must plug in your vehicle for My GO Time to work.

- **Cabin Conditioning:** Get the most miles out of every charge by conditioning your vehicle while it is plugged in. Set the cabin temperature when you set your GO Time in order to use energy from your home (or charging station) instead of from your vehicle's battery.

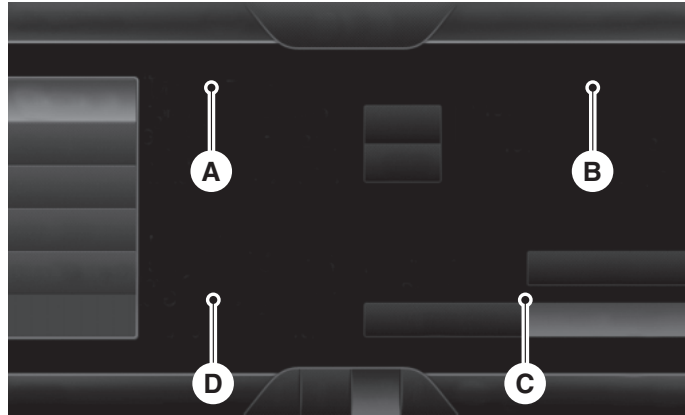

A. **My GO Time summary** displays the next GO Time and cabin temperature setting.

B. **Estimated charge time limits**

- Displays the estimated minimum and maximum times to fully charge the high-voltage battery.
- Displays the battery's present state of charge as a percentage of total capacity.

C. **Charge profile and mode** displays the charging profile and charging mode for the vehicle's present location.

D. **Charging status and actual times** displays charging status with the charging start time, end time, and duration.

My GO Time Summary

Temperature is the chosen cabin conditioning setting for this GO Time.

GO Time is the time and date of your next set drive time. Your vehicle automatically schedules charging and cabin conditioning to finish by this time.

Skip cancels the cabin conditioning for the present GO Time. Once you touch Skip, the GO Time and Temperature grey out, and the LED illuminates on the Skip button. Touch the button again to turn on the cabin conditioning. This feature allows you to ignore the present GO Time without having to delete it or having to turn off the entire schedule (see **GO Time Schedule** later in this section). After the present GO Time passes, the Skip feature resets.

Edit accesses your GO Time Schedule (see **GO Time Schedule** later in this section)

The system also alerts you to any conflicts by highlighting areas of the screen in yellow. If your battery cannot have a full charge by the scheduled drive time, the system highlights your next GO Time and Charge Complete time, and a message **Charge at GO Time: under 100%** appears. This is normal; the vehicle is informing you of the conflicting situation. This notification only displays when the gearshift selector lever is in position **P**.

Note: Charging occurs as soon as you plug the vehicle in. The system limits cabin conditioning to 15 minutes before your GO Time.

To eliminate the conflict notification immediately or to prevent a conflict in the future, try the following:

- Change the present GO Time to occur later.
- Plug the vehicle into a 240V charging station instead of the 120V convenience cord. Higher power charging yields shorter charge times.
- Plug the vehicle in sooner.

Estimated Charge Time Limits

Battery shows you the battery's current charge displayed as a percentage. A reading of 100% means the battery has a full charge. A reading of 0% means the battery has no charge.

To fully charge

- **240V** is the estimated minimum charging time from the present high-voltage battery level to full charge (100%). This represents the shortest amount of time you should expect the high-voltage battery to recharge under ideal conditions. Ideal conditions include a 240V charging station and a minimum 30A service and high-voltage battery at a moderate temperature.

Note: This charging time is only an estimate. It is normal for your actual charge duration to be longer.

Note: Some charging stations use lower voltage (208V), which result in longer charge times.

- **120V** is the estimated maximum charging time from the present high-voltage battery level to full charge (100%). This represents the longest amount of time you should expect the high-voltage battery to recharge under normal conditions. Normal conditions include a 120V convenience cord and 12A service.

Note: This charging time is only an estimate. It is possible for your actual charge duration to be longer. This occurs when the AC line voltage is low and may indicate your electrical source is not meeting certain requirements (see *Charging the high-voltage battery* in the *High Voltage Battery* chapter).

Value Charge Profile and Mode

Value Charge profile name is the name of the presently detected Value Charge Profile. The system detects a customer defined value charge profile when the vehicle is within approximately 300 feet (100 meters) of the GPS location registered for the profile. If the vehicle is close to more than one charge profile, it chooses the closest. When the vehicle is not at a defined profile, it uses the **Default Value** charge profile. The system normally displays **Default Profile** while you are driving because the vehicle is typically between defined value charge profiles.

Edit allows you to access your Value Charge profiles settings screen (see **Value Charge Profiles** later in this section).

Charge Now if you want your vehicle to immediately charge when plugged in at this profile location. This button illuminates when Charge Now is the charge mode selected for the presently detected charge profile.

Value Charge if you want to take advantage of off-peak electricity rates. The vehicle optimizes the charge schedule to be complete by the next GO Time. This button illuminates when Value Charge is the charge mode selected for the presently detected charge profile.

Charging Status and Actual Times

This is the status of the charging system, which includes the charging plug, high-voltage battery and charger.

Next Charge means the vehicle is unplugged. Charge Start and Complete information is for the present vehicle location.

Waiting to Charge means the vehicle is plugged in and ready to charge. Typical of Value Charge mode, the vehicle may not start charging right away because it is set to charge at times with lower utility costs.

Charging means the high-voltage battery is charging.

Charged means the high-voltage battery is fully charged and not currently scheduled for further charging.

Charge Fault means a fault is present that is preventing the high-voltage battery from charging. Inspect the charge plug connection, charge cord and charging station.

Start is the scheduled start time of charging.

- **At Plug In:** When the vehicle is in Charge Now mode, and unplugged, the message At Plug In appears, indicating the vehicle immediately starts charging once you plug it in. Once you plug it in, the system shows the actual charge start time.
- **Scheduled Charge Start Time:** When the vehicle is in Value Charge mode, the system displays the scheduled charge start time (for example, 8:00 PM). Once charging starts, the system continues to display the actual charge start time.

Complete is the estimated time of charge completion.

- **Charge Now Duration:** When the vehicle is in Charge Now mode, and unplugged, the system displays the charging duration in hours. Once you plug in the vehicle, the value shows the estimated time to finish charging.
- **Scheduled Charge Complete:** When the vehicle is in Value Charge mode, the system displays the estimated charge complete time. It is normal for the estimated complete time to change while charging. The vehicle keeps charging until the high-voltage battery is fully charged.

GO Time Schedule

Touch the **Edit** button in the My GO Time section of the Settings screen to see the GO Time Schedule.

On turns on the GO Time schedule.

Off turns off the GO Time schedule. This also turns off the cabin conditioning function. Use this mode to prevent using energy for cabin preconditioning when you leave your vehicle plugged in and don't plan to use it for a while, such as when on vacation.

Note: If you choose to perform Value Charging with the schedule off, the vehicle schedules charging to finish at the lowest cost within 24 hours of plugging the vehicle in.

GO Time 1 and **GO Time 2** display the GO Time day-of-week and time. The blue highlighted GO Time is the present GO Time the vehicle is using for charge scheduling and cabin conditioning. You can schedule two GO Time events per day for each day of the week.

- **GO Time** allows you to edit the GO Time and cabin conditioning temperature.
- **--:--** indicates that you can add a GO Time to this slot.

Note: If you set GO Time 2 to occur before GO Time 1, a message pops up alerting you. You need to go back to the previous screen and change the times so GO Time 1 occurs before GO Time 2.

GO Time and Cabin Conditioning

This screen allows you to enter or change the GO Time and cabin conditioning temperature.

Time Buttons (+ and -) changes the hours and minutes of your GO Time. The minutes change in increments of five. You can also change the settings for AM and PM by touching those buttons.

Cabin Conditioning Buttons (+ and -) changes the setting for your selected cabin conditioning temperature for this GO Time event. You can select from four settings:

- 65°F (18.5°C)
- 72°F (22.0°C)
- 85°F (29.5°C)
- Off.

Note: Cabin conditioning can perform differently depending on if you plug into a 120V convenience cord or 240V charging station. The power available for conditioning is limited to the charging station power available.

Note: Your vehicle may not always reach the set cabin temperature due to charging and ambient temperature conditions. This is normal operation.

Clear erases the GO Time and cabin conditioning temperature.

Save stores the GO Time and temperature settings.

- **Note:** If you select a GO Time, but choose **Off** for the temperature setting, the vehicle schedules charging to be complete by your GO Time and does not condition the cabin.
- **Note:** Make sure you save your settings before returning to the previous screen. If you do not touch **Save**, your settings are not stored in the system.

Value Charge Profiles

Press the **Edit** button next to the present charge profile on the Settings screen to go the Value Charge Profiles screen.

Default displays the charging mode and off-peak times for your Default Value Charge profile. The system displays off-peak times for weekdays; the remaining hours of the day are considered peak time. The system displays similar off-peak times for weekend days.

- **Charge Now** if you want your vehicle to immediately charge when you plug it in at this profile location.
- **Value Charge** if you want to take advantage of off-peak electricity rates. The vehicle optimizes the charge schedule to be complete by the next GO Time.
- **Edit** to access your **Default Value Charge Profile** settings screen (see **Default Value Charge Profile** later in this section).

Customer Defined Value Charge Profiles displays the Value Charge profile names and current Charge Mode for specific locations once you create profile names. You can set up and edit these profiles using the MyFord Mobile internet or smartphone application. You can program up to nine unique charge profiles.

Default Value Charge Profile

Weekday and **Weekend** display the off-peak charge times when you touch either button. Set the Weekday times and Weekend time, then touch **Save**.

Note: The system does not store your settings until you make selections for both Weekday and Weekend. If you touch the back arrow button to return to the previous screen without saving your settings, the system does not store them and you need to enter them again.

Start and **Finish** display the times, which you can modify, using the following:

- **+** and **-** allow you to change the hours and minutes of your start and finish times.
- **AM** and **PM** allow you to change the time of your start and finish time. This setting is viewable in 12-hour mode.

240V and **120V** represent the voltage service the default profile is using. The system uses this selection to calculate estimated charge times.

Clear erases the Default Value Charge preferences.

Save All stores your Default Value Charge preferences.

- **Note:** Make sure you save your settings before returning to the previous screen. If you do not touch **Save**, your settings are not stored in the system.

Power

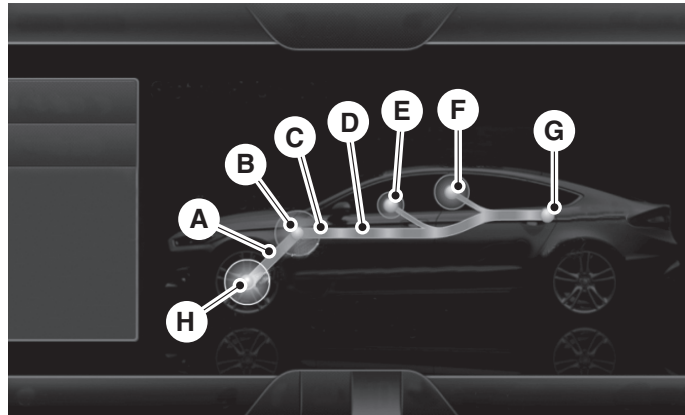

This screen displays how the electric vehicle system transfers power in order to accelerate or recharge the battery. The power flow screens show power going to or through a component. These screens are for your information only, and do not require any input from you.

Depending on your vehicle type, the power flow screen may vary in order to show the appropriate components.

Note: Vehicle configuration and status displayed may not always match actual vehicle state due to display constraints and simplified graphics.

A. **Motor-to-wheel flow** shows the direction of power flow between the wheels and the electric motor.

B. **Electric Motor** represents the electric motor. The higher the motor power is, the larger the circle around this node. Any time the vehicle is ready to be driven, the motor node illuminates.

C. **Battery-to-motor flow** shows the direction of power flow between the high-voltage battery and the electric motor. Flow toward the motor indicates the battery is providing power to accelerate the vehicle (discharging the battery). Flow toward the battery indicates the electric motor is providing power to the battery (charging the battery).

Note: The battery-to-motor flow includes battery power the vehicle is using for acceleration. It does not include energy the vehicle is using for accessories (such as air conditioning, headlights and radio). This screen displays accessories and climate usage separately.

D. **Plug** appears when you plug your vehicle into the wall. When charging the high voltage battery from the wall, you can see flow from the plug to the battery on the screen.

- **Accessories** indicates electrical power demands from your vehicle's accessory systems. Accessories use power but do not contribute to making the vehicle move. The power flow displays power usage from the climate control system and other accessories separately.

E. **Other** includes all power usage from the low voltage accessories such as the climate control fan, headlights and heated seats. The higher the power usage is from these accessories, the larger the circle around the node. This node illuminates anytime the vehicle is on since there is always some low level power in use.

F. **Climate** includes the power usage from the high-voltage climate control components such as the electric A/C compressor and the electric heater. The higher the power usage is from these components, the larger the circle around this node.

Note: The climate control system may determine A/C is necessary even when you turn it off. In this case, you may see some climate power when the A/C is off.

G. **High voltage battery power** represents your high-voltage battery. A circle illuminates around the node when the high-voltage battery is receiving power from regenerative braking or external charging (when you plug it in). The higher the power going into the high-voltage battery, the larger the circle around this node.

H. **Drive power** represents the power going to the wheels. The higher the wheel power is, the larger the circle around this node.

Status

This indicates which mode is active within the vehicle system.

Charging HV Battery

The hybrid system is storing power in the high-voltage battery.

Idle

The vehicle is either at rest, or sharing very little power between the electric system parts.

Idle with Charging

The high-voltage battery is receiving power in order to recharge.

Electric Drive

The vehicle is driving in electric mode.

Charge Complete

The high-voltage battery charging from the wall is complete.

INFORMATION

If your vehicle is equipped with Navigation, touch the i (Information) button to access these features. If your vehicle is not equipped with Navigation, touch the corner of the touchscreen with the green tab.



Under the Information menu, you can access features, such as:

- A. SYNC Services
- B. Sirius Travel Link
- C. Alerts
- D. Calendar
- E. SYNC Applications.

SYNC Services (If Equipped, United States Only)

Note: SYNC Services requires activation before use. Visit www.SYNCMYride.com to register and check your eligibility for complimentary services. Standard phone and message rates may apply. Subscription may be required. You must also have the active SYNC Services Bluetooth-enabled cellular phone paired and connected to the system in order to connect to, and use, SYNC Services. (See *Phone* earlier in this chapter for pairing instructions.)

Note: This feature does not function properly if you have enabled caller ID blocking on your mobile phone. Make sure your mobile phone is not blocking caller ID before using SYNC Services.

Note: The driver is ultimately responsible for the safe operation of the vehicle, and therefore, must evaluate whether it is safe to follow the suggested directions. Any navigation features are provided only as an aid. Make your driving decisions based on your observations of local conditions and existing traffic regulations. Do not follow the route suggestions if doing so would result in an unsafe or illegal maneuver, if you would be placed in an unsafe situation, or if you would be directed into an area that you consider unsafe. Maps used by this system may be inaccurate because of errors, changes in roads, traffic conditions or driving conditions.

Note: When you connect, the service uses GPS technology and advanced vehicle sensors to collect your vehicle's current location, travel direction and speed to help provide you with the directions, traffic reports, or business searches you request. Further, to provide the services you request, for continuous improvement, the service may collect and record call details and voice communications. For more information, see SYNC Services Terms and Conditions at www.SYNCMYride.com. If you do not want Ford or its service providers to collect your vehicle travel information or other information identified in the Terms and Conditions, do not subscribe or use the service.

SYNC Services uses advanced vehicle sensors, integrated GPS technology and comprehensive map and traffic data, to give you personalized traffic reports, precise turn-by-turn directions, business search, news, sports, weather and more. For a complete list of services, or to learn more, please visit www.SYNCMYride.com.

Connecting to SYNC Services Using Voice Commands



Press the voice button on the steering wheel controls.

1. When prompted, say "Services". This initiates an outgoing call to SYNC Services using your paired and connected Bluetooth-enabled cellular phone.
2. Once you connect to the service, follow the voice prompts to request the desired service, such as "Traffic" or "Directions". You can also say, "What are my choices?" to receive a list of available services from which to choose.
3. Say, "Services" to return to the Services main menu or for help, say, "Help".

Connecting to SYNC Services Using the Touchscreen

 If your vehicle is equipped with Navigation, touch the i (Information) button to access these features. If your vehicle is not equipped with Navigation, touch the corner of the touchscreen with the green tab.

Press **Services**.

1. Select **Connect to Services** to initiate an outgoing call to SYNC Services using your paired and connected Bluetooth-enabled cellular phone.
2. Once you connect to the service, follow the voice prompts to request the desired service, such as “Traffic” or “Directions”. You can also say, “What are my choices?” to receive a list of available services from which to choose.
3. Say, “Services” to return to the Services main menu or for help, say, “Help”.

Receiving Turn-by-Turn Directions

1. When connected to SYNC Services, say “Directions” or “Business Search”. To find the closest business or type of business to your current location, just say “Business Search” and then “Search Near Me”. If you need further assistance in finding a location, you can say “Operator” at any time within a Directions or Business search to speak with a live operator. The system may prompt you to speak with an operator when it has difficulty matching your voice request. The live operator can assist you by searching for businesses by name or by category, residential addresses by street address or by name or specific street intersections. Operator Assist is a feature of your SYNC Services subscription. For more information on Operator Assist, visit www.SYNCMyRide.com/support.
2. Follow the voice prompts to select your Destination. After the route download is finished, the phone call automatically ends.

If your vehicle is not equipped with Navigation:

- Turn-by-turn directions appear in the information display, in the status bar of your touchscreen system and on the SYNC Services screen. You also receive driving instructions from audible prompts.
- When on an active route, you can select **Route Summary** or **Route Status** using the touchscreen controls or voice commands to view the **Route Summary Turn List** or the **Route Status ETA**. You can also turn voice guidance on or off, cancel the route or update the route.

If you miss a turn, SYNC automatically asks if you want the route updated. Just say, “Yes” when prompted and the system delivers a new route to your vehicle.

If your vehicle is equipped with Navigation, SYNC Services downloads your requested destination to the navigation system. The navigation system then calculates the route and provides driving instructions. See the *Navigation system* section for more information.

Disconnecting from SYNC Services

1. Press and hold the hang-up phone button on the steering wheel.
2. Say “Good-bye” from the SYNC Services main menu.

SYNC Services quick tips	
Personalizing	You can personalize your Services feature to provide quicker access to your most used or favorite information. You can save address points, such as work or home. You can also save favorite information like sports teams, such as Detroit Lions, or a news category. You can learn more about personalization by logging onto www.SYNCMyRide.com .
Push to interrupt	Press the voice button at any time (while connected to SYNC Services) to interrupt a voice prompt or an audio clip (such as a sports report) and say your voice command.
Portable	Your subscription is associated with your Bluetooth-enabled cellular phone number, not your VIN (Vehicle Identification Number). You can pair and connect your phone to any vehicle equipped with SYNC Services and continue enjoying your personalized services.

SYNC Services Voice Commands

When a route has been downloaded (non-navigation systems), press the voice button on the steering wheel control. When prompted, say any of the following commands:

“SERVICES”
“Cancel route”
“Navigation voice off”
“Navigation voice on”
“Next turn”
“Route status”
“Route summary”
“Services”
“Update route”
“Help”

Sirius Travel Link (If Equipped and If Activated)

WARNING: Driving while distracted can result in loss of vehicle control, crash and injury. We strongly recommend that you use extreme caution when using any device that may take your focus off the road. Your primary responsibility is the safe operation of your vehicle. We recommend against the use of any hand-held device while driving and encourage the use of voice-operated systems when possible. Make sure you are aware of all applicable local laws that may affect the use of electronic devices while driving.

Note: In order to use Sirius Travel Link, your vehicle must be equipped with navigation and your navigation SD card must be in the SD card slot.

Note: A paid subscription is required to access and use these features. Go to www.siriusxm.com/travellink for more information.

Note: Visit www.siriusxm.com/traffic# and click on Coverage map and details for a complete listing of all traffic areas covered by Sirius Travel Link.

Note: Neither Sirius nor Ford is responsible for any errors or inaccuracies in the Sirius Travel Link services or its use in vehicles.

When you subscribe to Sirius Travel Link, it can help you locate the best gas prices, find movie listings, get current traffic alerts, view the current weather map, get accurate ski conditions and see scores to current sports games.



If your vehicle is equipped with Navigation, touch the i (Information) button to access these features. If your vehicle is not equipped with Navigation, touch the corner of the touchscreen with the green tab.

Traffic On Route and Traffic Nearby

Touch these buttons to identify traffic incidents on your route, nearby your vehicle's current location or near any of your favorite places, if programmed.

Fuel Prices

Touch this button to view fuel prices at stations close to your vehicle's location or on an active navigation route.

Movie Listings

Touch this button to view nearby movie theaters and their show times, if available.

Weather

Touch this button to view the nearby weather, current weather, or the five day forecast for the chosen area. Select **Map** to see the weather map, which can show storms, radar information, charts and winds. Select **Area** to select from a listing of weather locations.

Sports Info

Touch this button to view scores and schedules from a variety of sports. You can also save up to 10 favorite teams for easier access. The score automatically refreshes when a game is in progress.

Ski Conditions

Touch this button to view ski conditions for a specific area.

Sirius Travel Link Voice Commands

Note: In order to use Sirius Travel Link, your vehicle must be equipped with navigation and your navigation SD card must be in the SD card slot.



Press the voice button on the steering wheel controls and, when prompted, say any of the following:

Travel Link voice commands	
“5-day weather forecast”	“Sports scores”*
“Fuel prices”	“Traffic”
“Movie listings”	“Travel Link”**
“Sports headlines”*	“Weather”
“Sports schedule”*	“Weather map”

*If you have said, “Sports headlines”, “Sports schedule” or “Sports scores”, you may say any of the commands in the “Sports headlines, Sports schedules and Sports scores” commands chart:

**If you have said, “Travel Link”, you may say any of the commands in the “Travel Link” chart:

Sports headlines, sports schedules and sports scores voice commands	
“Baseball”	“My teams”
“College basketball”	“NBA”
“College football”	“NFL”
“Golf”	“NHL”
“MLS”	“WNBA”
“Motor sports”	

“TRAVEL LINK”		
“5-day weather forecast”	“Golf schedule”	“NBA scores”
“Baseball headlines”	“MLS headlines”	“NFL headlines”
“Baseball schedule”	“MLS schedule”	“NFL schedule”
“Baseball scores”	“MLS scores”	“NFL scores”
“College basketball headlines”	“Motor sports”	“NHL headlines”

“TRAVEL LINK”		
“College basketball schedule”	“Motor sports order”	“NHL schedule”
“College basketball scores”	“Motor sports schedule”	“NHL scores”
“College football headlines”	“Movie listings”	“Traffic”
“College football schedule”	“My team headlines”	“Weather”
“College football scores”	“My teams schedule”	“Weather map”
“Fuel prices”	“My teams scores”	“WNBA headlines”
“Golf headlines”	“NBA headlines”	“WNBA schedule”
“Golf leaderboard”	“NBA schedule”	“WNBA scores”

Alerts

 If your vehicle is equipped with Navigation, touch the i (Information) button to access these features. If your vehicle is not equipped with Navigation, touch the corner of the touchscreen with the green tab.

Press **Alerts**, and then choose from any of the following services:

- **View** the message.
- **Delete** the message.
- **Delete All** messages.

This screen displays any system messages (such as an SD card fault).

Note: The system alerts you to any messages by turning the information icon yellow. After you read or delete the messages, the icon returns to white.

Calendar

 If your vehicle is equipped with Navigation, touch the i (Information) button to access these features. If your vehicle is not equipped with Navigation, touch the corner of the touchscreen with the green tab.

Press **Calendar**. You can view the current calendar by day, week or month.

911 Assist® (If Equipped)

WARNING: Unless the 911 Assist setting is set on before a crash, the system will not dial for help, which could delay response time, potentially increasing the risk of serious injury or death after a crash.



WARNING: Do not wait for 911 Assist to make an emergency call if you can do it yourself. Dial emergency services immediately to avoid delayed response time, which could increase the risk of serious injury or death after a crash. If you do not hear 911 Assist within five seconds of the crash, the system or phone may be damaged or non-functional.



WARNING: Always place your phone in a secure location in your vehicle so it does not become a projectile or damaged in a crash. Failure to do so may cause serious injury to someone or damage the phone, which could prevent 911 Assist from working properly.

Note: The SYNC 911 Assist feature must be set on prior to the incident.

Note: Before setting this feature on, make sure that you read the 911 Assist privacy notice later in this section for important information.

Note: If any user turns 911 Assist on or off, that setting applies for all paired phones. If 911 Assist is turned off, either a voice message plays or a display message (or icon) comes on (or both) when your vehicle is started after a previously paired phone connects.

Note: Every phone operates differently. While SYNC 911 Assist works with most cellular phones, some may have trouble using this feature.

If a crash deploys an airbag (excludes knee airbags and rear inflatable safety belts [if equipped]) or activates the fuel pump shut-off, your SYNC-equipped vehicle may be able to contact emergency services by dialing 911 through a paired and connected Bluetooth-enabled phone.

You can learn more about the 911 Assist feature, visit www.SYNCMYride.com, www.SYNCMYride.ca or www.syncmaroute.ca.

- For information on airbag deployment, see the *Supplementary Restraints System* chapter.
- For information on the fuel pump shut-off, see the *Roadside Emergencies* chapter.

Setting 911 Assist On

If your vehicle is equipped with Navigation, touch the i (Information) button to access these features. If your vehicle is not equipped with Navigation, touch the corner of the touchscreen with the green tab.

Press **Apps > 911 Assist, > On.**

You can also access 911 Assist by:



- Pressing the Settings icon > **Settings > Phone > 911 Assist**, or
- Pressing the Settings icon > **Help > 911 Assist.**

To Make Sure that 911 Assist Works Properly

- SYNC must be powered and working properly at the time of the incident and throughout feature activation and use.
- The 911 Assist feature must be set on before the incident.
- You must pair and connect a Bluetooth-enabled and compatible phone to SYNC.
- A connected Bluetooth-enabled phone must have the ability to make and maintain an outgoing call at the time of the incident.
- A connected Bluetooth-enabled phone must have adequate network coverage, battery power and signal strength.
- The vehicle must have battery power and be located in the United States, Canada or in a territory in which 911 is the emergency number.

In the Event of a Crash

Not all crashes deploy an airbag or activate the fuel pump shut-off (which would trigger 911 Assist); however, SYNC tries to contact emergency services if 911 Assist triggers. If a connected phone sustains damage or loses connection to SYNC, SYNC searches for, and tries to connect to, any available previously paired phone and tries to make the call to 911.

Before making the call:

- SYNC provides a short window of time (about 10 seconds) to cancel the call. If you fail to cancel the call, SYNC attempts to dial 911.
- SYNC says the following, or a similar message: “SYNC will attempt to call 911, to cancel the call, press Cancel on your screen or press and hold the phone button on your steering wheel.”

If you do not cancel the call, and SYNC makes a successful call, a pre-recorded message plays for the 911 operator, and then the occupant(s) in your vehicle is able to talk with the operator. Be prepared to provide your name, phone number and location immediately, because not all 911 systems are capable of receiving this information electronically.

911 Assist May Not Work If

- Your cellular phone or 911 Assist hardware sustains damage in a crash.
- The vehicle's battery or SYNC system has no power.
- The phone(s) thrown from your vehicle are the ones paired and connected to the system.

911 Assist Privacy Notice

When you turn on 911 Assist, it may disclose to emergency services that your vehicle has been in a crash involving the deployment of an airbag or activation of the fuel pump shut-off. Certain versions or updates to 911 Assist may also be capable of electronically or verbally disclosing to 911 operators your vehicle location or other details about your vehicle or crash to assist 911 operators to provide the most appropriate emergency services. If you do not want to disclose this information, do not turn the feature on.

Vehicle Health Report (If Equipped, United States Only)

WARNING: Always follow scheduled maintenance instructions, regularly inspect your vehicle, and seek repair for any damage or problem you suspect. Vehicle Health Report supplements, but cannot replace, normal maintenance and vehicle inspection. Vehicle Health Report only monitors certain systems electronically monitored by your vehicle and will not monitor or report the status of any other system, (such as brake lining wear). Failure to perform scheduled maintenance and regularly inspect your vehicle may result in vehicle damage and serious injury.

Note: Your Vehicle Health Report feature requires activation prior to use. Visit www.SYNCMYride.com to register. There is no fee or subscription associated with Vehicle Health Report, but you must register to use this feature.

Note: This feature may not function properly if you have enabled caller ID blocking on your mobile phone. Before running a report, review the *Vehicle Health Report Privacy Notice*.

Note: In order to allow a break-in period for your vehicle, you may not be able to create a Vehicle Health Report until your vehicle odometer has reached 200 miles.

Note: Cellular phone and SMS charges may apply when making a report.

Register for Vehicle Health Report and set your report preferences at www.SYNCMYRide.com. After registering, you can request a Vehicle Health Report (inside your vehicle). Return to your account at www.SYNCMYRide.com to view your report. You can also choose for SYNC to remind you automatically to run reports at specific mileage intervals. Cellular phone airtime usage may apply when reporting.

The system allows you to check your vehicle's overall health in the form of a diagnostic report card. The Vehicle Health Report contains valuable information, such as:

- Vehicle Diagnostic Information
- Scheduled maintenance
- Open Recalls and Field Service Actions
- Items noted during vehicle inspections by your authorized dealer that still need servicing.

Making a Report



If your vehicle is equipped with Navigation, touch the **i** (Information) button to access these features. If your vehicle is not equipped with Navigation, touch the corner of the touchscreen with the green tab.

If you want to run a report by using the touchscreen, touch **Apps > Vehicle Health Report**.



To run a report by voice command, press the voice button on the steering wheel and, when prompted, say "Vehicle health report".

Vehicle Health Report Privacy Notice

When you create a Vehicle Health Report, Ford Motor Company may collect your cellular phone number (to process your report request) and diagnostic information about your vehicle. Certain versions or updates to Vehicle Health Report may also collect more vehicle information. Ford may use your vehicle information it collects for any purpose. If you do not want to disclose your cellular phone number or vehicle information, do not run the feature or set up your Vehicle Health Report profile at www.SYNCMYRide.com. See www.SYNCMYRide.com (Vehicle Health Report Terms and Conditions, and Privacy Statement) for more information.

SETTINGS



- A. Clock
- B. Display
- C. Sound
- D. Vehicle
- E. Settings
- F. Help



Under this menu, you can set your clock, access and adjust the display, sound and vehicle settings as well as access settings for specific modes or the help feature.

Clock

Note: You cannot manually set the date. Your vehicle's GPS does this for you.

Note: If the battery has been disconnected, your vehicle needs to acquire a GPS signal to update the clock. Once your vehicle acquires the signal, it may take a few minutes for the update to display the correct time.

1. Press the Settings icon > **Clock**.
2. Press **+** and **-** to adjust the time.

From this screen, you can also make other adjustments, such as 12- or 24-hour mode, activate GPS time synchronization and have the system automatically update for new time zones.

You can also turn the outside air temperature display on and off. It appears at the top center of the touchscreen, next to the time and date. The system automatically saves any updates you make to the settings.

Display

You can adjust the touchscreen display through the touchscreen or by pressing the voice button on your steering wheel controls and when prompted, say, "Display settings".



Press the Settings icon > **Display**, then select from the following:

Brightness allows you to make the screen display brighter or dimmer.

Mode allows you to set the screen to a certain brightness or have the system automatically change based on the outside light level, or turn the display off.

- If you select **AUTO** or **NIGHT**, you have the options of turning the display's Auto Dim feature on or off and changing the Auto Dim Manual Offset feature.

Edit Wallpaper

- You can have your touchscreen display the default photo or upload your own.

Uploading Photos for Your Home Screen Wallpaper

Note: You cannot load photos directly from your camera. You must access the photos either from your USB mass storage device or from an SD card.

Note: Photographs with extremely large dimensions (such as 2048 x 1536) may not be compatible and appear as a blank (black) image on the display.

Your system allows you to upload and view up to 32 photos.

To access, press the Settings icon > **Display** > **Edit Wallpaper**, and then follow the system prompts to upload your photographs.

Only the photograph(s), which meets the following conditions, display:

- Compatible file formats are as follows: .jpg, .gif, .png, .bmp.
- Each file must be 1.5 MB or less.
- Recommended dimensions: 800 x 384.

Sound

Press the Settings icon > **Sound**, then select from the following:

Sound Settings	
Bass	DSP*
Midrange	Occupancy Mode*
Treble	Speed Compensated Volume
Set Balance and Fade	

*If equipped.

Vehicle

Press the Settings icon > **Vehicle**, then select from the following:

- Vehicle Health Report
- Rear View Camera
- Enable Valet Mode.

Vehicle Health Report

Turn Automatic Reminders on and off and set the mileage interval at which you would like to receive the reports. Press the ? for more information on these selections.

When done making your selections, press **Run Vehicle Health Report Now** if you want your report.

Rear View Camera

This menu allows you to access settings for your rear view camera.

Press the Settings icon > **Vehicle** > **Rear View Camera**, then select from the following settings:

- Rear Camera Delay
- Visual Park Aid Alert
- Guidelines.

Enable Valet Mode

Note: If the system locks, and you need to reset the PIN, enter 3681 and the system unlocks.

Valet mode allows you to lock the system. No information is accessible until the system is unlocked with the correct PIN. You can create your own four-digit PIN to lock and unlock the system.

1. Press the Settings icon > **Vehicle** > **Enable Valet Mode**.
2. When prompted, enter a four-digit PIN.

After you press **Continue**, the system locks until you enter the PIN again.

Settings

Access and adjust system settings, voice features, as well as phone, navigation and wireless settings.

System

Press the Settings icon > **Settings** > **System**, then select from the following:

System	
Language	Select to have the touchscreen display in English, Spanish or French.
Distance	Select to display units in kilometers or miles.
Temperature	Select to display units in Celsius or Fahrenheit.
System Prompt Volume	Adjust the volume of voice prompts from the system.
Touch Screen Button Beep	Select to have the system beep to confirm choices made through the touchscreen.
Touch Panel Button Beep	Select to have the system beep to confirm button choices made through the climate or audio system.
Keyboard Layout	Have the touchscreen keyboard display in QWERTY or ABC format.
Install Applications	Install any downloaded applications or view the current software licenses.
Master Reset	Select to restore factory defaults. This erases all personal settings and personal data.

Charge Point Light Ring

Press the Settings icon > **Settings** > **Charge Port Light Ring**, then select from the following:

Charge port light ring	
On	Illuminates when plugging in, opening doors, pressing the unlock button on your remote, and while charging.
Off	Does not illuminate.
Limited	Cord Acknowledgement: Illuminates when plugging in.
	Charge Status: Illuminates when opening doors or pressing the unlock button on your remote.

Note: See the *High Voltage Battery* chapter for details on the charge port light ring functions.

Voice Control

Press the Settings icon > **Settings** > **Voice Control**, then select from the following:

Voice control	
Interaction Mode	Standard interaction mode provides more detailed interaction and guidance. Advanced mode has less audible interaction and more tone prompts.
Confirmation Prompts	Have the system ask you short questions if it has not clearly heard or understood your request. Note: Even with confirmation prompts turned off, the system may occasionally ask you to confirm settings.
Media Candidate Lists	Candidate lists are possible results from your voice commands. The system simply makes a best guess at your request with these turned off.

Voice control	
Phone Candidate Lists	Candidate lists are possible results from your voice commands. The system simply makes a best guess at your request with these turned off.
Voice Control Volume	This allows you to adjust the system's voice volume level.

Media Player

Press the Settings icon > **Settings** > **Media Player**, then select from the following:

Media player	
Autoplay	When this feature is on, the system automatically switches to the media source upon initial connection. This allows you to listen to music during the indexing process. When this feature is off, the system does not automatically switch to the inserted media source.
Bluetooth Devices	Select to connect, disconnect, add or delete a device. You can also set a device as your favorite so that the system automatically attempts to connect to that device at every ignition cycle.
Gracenote Database Info	This allows you to view the version level of the Gracenote Database.
Gracenote Mgmt	With this feature on, the Gracenote Database supplies metadata information for your music files. This overrides information from your device. This feature defaults to off.
Cover Art Priority	With this feature on, the Gracenote Database supplied cover art for your music files. This overrides any art from your device. This feature defaults to Media Player.

Navigation

Press the Settings icon > **Settings** > **Navigation**, then select from the following:

Navigation	
Map Preferences	Turn breadcrumbs on and off.
	Have the system display your turn list top to bottom or bottom to top.
	Turn the Parking POI notification on and off.
Route Preferences	Have the system display the shortest route, fastest route or ecological route.
	Have the system avoid freeways.
	Have the system avoid tollroads.
	Have the system avoid ferries or car trains.
	Have the system use high-occupancy vehicle lanes.
Navigation Preferences	Have the system use guidance prompts.
	Have the system automatically fill-in State/Province information.
Traffic Preferences	Have the system display areas where roadwork occurs.
	Have the system display incident icons.
	Have the system display areas where difficult driving conditions may occur.
	Have the system display areas where snow and ice on the road may occur.
	Have the system display any smog alerts.
	Have the system display weather warnings.
	Have the system display where there may be reduced visibility.
	Have the system turn on your radio for traffic announcements.
Avoid Areas	Enter specific areas that you would like to avoid on planned navigation routes.

Phone Settings

Press the Settings icon > **Settings** > **Phone**, then select from the following:

Phone	
Bluetooth Devices	Connect, disconnect, add or delete a device, as well as save it as a favorite.
Bluetooth	Turn Bluetooth on and off.
Do Not Disturb	Have all calls go directly to your voice mail and not ring inside your vehicle. With this feature turned on, text message notifications are also suppressed and do not ring inside your vehicle.
911 Assist	Turn on or turn off the 911 Assist feature. See <i>911 Assist</i> in the <i>SYNC applications and services</i> section.
Phone Ringer	Select the type of notification for phone calls - ring tone, beep, text to speech, or have it be silent.
Text Message Notification	Select the type of notification for text messages - alert tone, beep, text to speech, or have it be silent.
Internet Data Connection	If compatible with your phone, you can adjust your internet data connection. Select to make your connection profile with the personal area network or to turn off your connection. You can also choose to adjust your settings or have the system always connect, never connect when roaming or query on connect. Press ? for more information.
Manage Phonebook	Access features, such as automatic phonebook download, re-download your phonebook, add contacts from your phone as well as delete or upload your phonebook.
Roaming Warning	Have the system alert you when in Roaming mode.

Wireless & Internet

Your system has a Wi-Fi feature that creates a wireless network within your vehicle, thereby allowing other devices (such as personal computers or phones) in your vehicle to speak to each other, share files or play games. Using this Wi-Fi feature, everyone in your vehicle can also gain access the internet if you have a USB mobile broadband connection inside your vehicle, your phone supports personal area networking and if you park outside a wireless hotspot.



Press the Settings icon > **Settings** > **Wireless & Internet**, then select from the following:

Wireless & Internet	
Wi-Fi Settings	Wi-Fi Network (Client) Mode turns the Wi-Fi feature on and off in your vehicle. Make sure you turn it on for connectivity purposes.
	Choose a Wireless Network allows you to use a previously stored wireless network. You can categorize by alphabetical listing, priority and signal strength. You can also choose to search for a network, connect to a network, disconnect from a network, receive more information, prioritize a network or delete a network.
	Gateway (Access Point) Mode makes SYNC an access point for a phone or a computer when turned on. This forms the local area network within your vehicle for things, such as game playing, file transfer and internet browsing. Press ? for more information.
	Gateway (Access Point) Settings allows you to view and change settings for using SYNC as the internet gateway.
	Gateway (Access Point) Device List allows you to view recent connections to your Wi-Fi system.

Wireless & Internet	
USB Mobile Broadband	Instead of using Wi-Fi, your system can also use a USB mobile broadband connection to access the internet. (You must turn on your mobile broadband device on your personal computer before connecting it to the system.) This screen allows you to set up what is your typical area for your USB mobile broadband connection. (USB mobile broadband settings may not display if the device is already on.) You can select the following: Country, Carrier, Phone Number, User Name and Password.
Bluetooth Settings	Shows you the currently paired devices as well as giving you your typical Bluetooth options to connect, disconnect, set as favorite, delete and add device. Bluetooth is a registered trademark of the Bluetooth SIG.
Prioritize Connection Methods	Choose your connection methods and change them as needed. You can select to Change Order and have the system either always attempt to connect using a USB mobile broadband or using Wi-Fi.

The Wi-Fi CERTIFIED Logo is a certification mark of the Wi-Fi Alliance.



Help

Press the Settings icon > **Help**, then select from the following:

Help	
Where Am I?	View your vehicle's current location, if your vehicle is equipped with navigation. If your vehicle is not equipped with navigation, nothing displays.
System Information	Touchscreen system serial number.
	Your vehicle identification number (VIN).
	Touchscreen system software version.
	Navigation system version.
	Map database version.
	Sirius satellite radio electronic serial number (ESN).
	Gracernote Database Information and Library version.
Software Licenses	View the licenses for any software and applications installed on your system.
Driving Restrictions	Certain features are not accessible when your vehicle is moving.
911 Assist	Turn on and turn off the 911 Assist feature. See <i>911 Assist</i> in the <i>SYNC applications and services</i> section. In Case of Emergency (ICE) Speed Dial allows you to save up to two numbers as ICE contacts for quick access if there is an emergency. Select Edit to access your phonebook and then select the desired contacts. The numbers then appear as options on this screen for the ICE 1 and ICE 2 buttons. The ICE contacts you select appear at the end of the 911 Assist call process.
Voice Command List	View categorized lists of voice commands.

To access Help using the voice commands, press the voice button, then, after the tone, say “Help”. The system provides allowable voice commands for the current mode.

CLIMATE

Press the lower right corner on the touchscreen to access your climate control features. Depending on your vehicle line and option package, your climate screen may look different from the screen shown here.

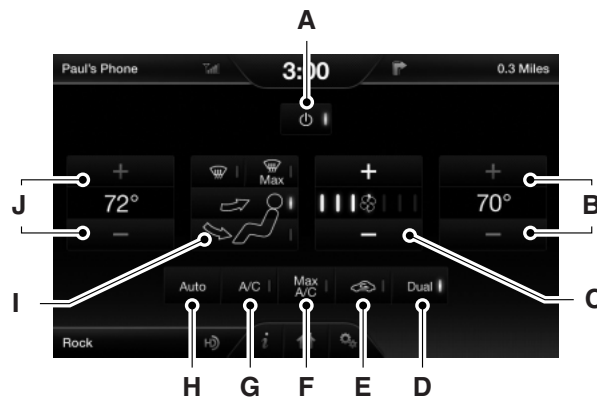

- A. **Power:** Touch to switch the system off and on. Outside air cannot enter your vehicle when you switch off the system.
- B. **Passenger settings:** Touch + or – to adjust the temperature.
- C. **Fan speed:** Touch + or – to adjust fan speed.
- D. **DUAL:** Touch to switch on the passenger temperature control.
- E. **Recirculated air:** Touch to turn the recirculated air on or off which:
- May reduce the amount of time needed to cool down the interior.
 - May help reduce odors from reaching the interior.
 - Engages automatically when MAX A/C or MAX defrost is selected.
 - May be engaged manually in any airflow mode except defrost.
 - May turn off in all airflow modes except MAX A/C and MAX defrost to reduce fog potential.
- F. **MAX A/C:** Touch to cool your vehicle with recirculated air. Touch again for normal A/C operation. MAX A/C:
- Distributes air through instrument panel vents.
 - Is more economical and efficient than normal A/C mode.
 - May help reduce odors from entering your vehicle.

- G. **A/C:** Touch to turn the air conditioning on or off.
- Use with recirculated air to improve cooling performance and efficiency.
 - Engages automatically in MAX A/C, defrost and floor/defrost.
- H. **AUTO:** Touch to engage automatic operation, then set the temperature using the temperature control. The system automatically controls:
- Fan speed
 - Airflow distribution
 - A/C on or off
 - Outside or recirculated air.
- I. **Manual controls:** Select any of the following airflow distribution modes:
- **Floor and Defrost:** Distributes air through the windshield defroster vents, demister vents, floor vents and rear seat floor vents, and provides outside air to reduce window fogging.
 - **Panel:** Distributes air through the instrument panel vents.
 - **Panel and Floor:** Distributes air through the instrument panel vents, demister vents, floor vents and rear seat floor vents.
 - **Floor:** Distributes air through the demister vents, floor vents and rear seat floor vents.
 - **MAX Defrost:** Distributes outside air through the windshield air vents and automatically switches the air conditioning on. The fan is set to the highest speed and the temperature to HI. When the air distribution is set in this position, you are unable to select recirculated air or manually adjust the fan speed and temperature control.
 - **Defrost:** Touch to clear the windshield of fog and thin ice. Touch again to return to the previous airflow selection. When on, defrost provides outside air to reduce window fogging and distributes air through the windshield defroster vents and demister vents.
- J. **Driver settings:** Touch + or – to adjust the temperature.

Climate Control Voice Commands

The following voice commands are available at the main menu level of a voice session. For example, press the voice button and after the prompt, “Say a command”; say any of the following commands:

Climate control voice commands
“Climate automatic”
“Climate off”
“Climate on”
“Climate temperature <15.5–29.5> degrees”
“Climate temperature <60–85> degrees”
“Help”

There are additional climate control commands but in order to access them, you have to say “Climate” first, then when the system is ready to listen, you may say any of the following commands:

Additional climate control voice commands	
“Automatic”	“On”
“A/C off”	“Panel floor on”
“A/C on”	“Panel off”
“Defrost off”	“Panel on”
“Defrost on”	“Recirc off”
“Dual off”	“Recirc on”
“Fan decrease”	“Temperature”*
“Fan increase”	“Temperature <15.5–29.5> degrees”
“Floor off”	“Temperature <60–85> degrees”
“Floor on”	“Temperature decrease”
“Max A/C off”	“Temperature high on”
“Max A/C on”	“Temperature increase”
“Maximum fan”	“Temperature low on”
“Maximum windshield off”	“Windshield floor on”
“Maximum windshield on”	“Windshield panel floor on”
“Minimum fan”	“Windshield panel on”
“Off”	“Help”

*If you have said “Temperature”, you can say any of the commands in the following “Temperature” chart.

“TEMPERATURE”
“<15.5–29.5> degrees”
“<60–85> degrees”
“High”
“Low”
“Help”

NAVIGATION SYSTEM (IF EQUIPPED)

Note: The navigation SD card must be in the SD card slot to operate the navigation system. If you need a replacement SD card, see your authorized dealer.

Note: The SD card slot is spring-loaded. To remove the SD card, just push the card in and release it. Do not attempt to pull the card out to remove it; this could cause damage.

Your navigation system is comprised of two main features, destination mode and map mode.

To set a destination, press the green corner of your touchscreen, then **Dest** when it appears. See *Setting a destination* later in this chapter.

To view the navigation map and your vehicle’s current location, touch the green bar in the upper right hand corner of the touchscreen, or, press **Dest > Map**. See *Map mode* later in this chapter.

Setting a Destination

Press the green corner of your touchscreen, then **Dest** when it appears. Choose any of the following:

Destination selections	
My Home	Street Address
Favorites	Intersection
Previous Destinations	City Center
Point of Interest	Map
Emergency	Edit Route Cancel Route

1. Enter the necessary information into the highlighted text fields (in any order). For address destination entry, **Go!** appears once you enter all the necessary information. Pressing **Go!** makes the address location appear on the map. If you choose **Previous Destination**, the last 20 destinations you have selected appear.
2. Select **Set as Dest** to make this your destination. You can also choose to set this as a waypoint (have the system route to this point on the way to your current destination) or save it as a favorite. The system considers any **Avoid Areas** selections in its route calculation.
3. Choose from up to three different types of routes, and then select **Start Route**.
 - **Fastest Route:** Uses the fastest moving roads possible.
 - **Shortest Route:** Uses the shortest distance possible.
 - **Eco Route:** Uses the most fuel-efficient route.

You can cancel the route or have the system demo the route for you. Select **Route Prefs** to set route preferences like avoiding freeways, tollroads, ferries and car trains as well as to use or not use high-occupancy vehicle lanes. (High-occupancy vehicle lanes are also known as carpool or diamond lanes. People who ride in buses, vanpools or carpools use these lanes.)

Note: If your vehicle is on a recognized road and you do not press the **Start Route** button, the system defaults to the **Fastest Route** option and begins guidance.

During route guidance, you can press the talking bubble icon that appears in the upper right navigation corner (green bar) if you want the system to repeat route guidance information. When the system repeats the last guidance instruction, it updates the distance to the next guidance instruction, since it detects when the vehicle is moving.

Point of Interest (POI) Categories

Your system offers a variety of points of interest categories.

Main categories	
Food/Drink & Dining	Automotive
Travel & Transportation	Shopping
Financial	Entertainment & Arts
Emergency	Recreation & Sports
Community	Government
Health & Medicine	Domestic Services

Within these main categories, there are subcategories which contain more listings:

Subcategories
Restaurant
Golf
Parking
Home & Garden
Personal Care Services
Automobile Dealership
Government Office
Public Transit
Education

To expand these listings, press the **+** in front of the point of interest listing.

When programming a point of interest destination, the system allows you to sort the resulting lists alphabetically, by distance or by cityseekr listings (if available).

Pressing the **Search Area** button allows you to search for points of interest nearby, near a city or state or near a destination, if a route is active.

Pressing the **Search By Name** button allows you to directly enter the point of interest name into the system by using the keyboard.

Range Rings and Charge Points

The navigation map can display shaded rings, which provide a rough estimate of your vehicle's present driving range. You may only see them when you zoom out, unless you are low on battery energy.

The inner circle with no shading indicates a safe range you can travel with the present battery state of charge.

The lightly shaded outer band reflects areas you may or may not be able to reach. If your charge destination lies within this band, we recommend you enter it into the navigation system and use the budget features in the instrument cluster to help you manage your vehicle's energy usage.

The darker shaded area beyond the rings is likely unreachable with the energy presently available in the battery.



You can turn off the rings in the Settings menu. Press the Settings icon > **Navigation** > **Map Preferences**.

Note: Range rings are only an approximation. Actual route distances, road grades, vehicle speed, accessory usage and other conditions all affect how far you can travel before recharging.

Note: Range rings do not show range for a round trip. They represent one direction only.

You can turn the charge point POI on and off. Touch the map, use the buttons at the bottom of the screen, and then select the POI icon button. The icons only appear at a map scale of 5 miles (8 km) and lower. You may see the generic electrical plug icon or a brand icon for certain public charging stations.

cityseekr (If Available)

Note: cityseekr point of interest information is limited to approximately 912 cities (881 in the United States, 20 in Canada and 11 in Mexico).



cityseekr, when available, is a service that provides more information about certain points of interest such as restaurants, hotels and attractions.

When you have selected a point of interest, the location and information appear, such as address and phone number. If cityseekr lists the point of interest, more information is available, such as a brief description, hotel check-in and checkout times or restaurant hours.

Press **More Information** for a longer review, a list of services and facilities, the average room or meal price as well as the website link.

This screen displays either a facility photo (if available) or point of interest icons, such as:



Hotel



Coffeehouse



Food & Drink



Nightlife



Attraction



This icon appears when your selection exists in multiple categories within the system.

When you are viewing more information for hotels, cityseekr also tells you if the hotel has certain services and facilities using icons.

Hotel services and facilities	
Restaurant	24 Hr Room Service
Business Center	Fitness Center
Handicap Facilities	Internet Access
Laundry	Pool
Refrigerator	Wi-Fi

For restaurants, cityseekr can provide information, such as star rating, average cost, review, handicap access, hours of operation, and website address.

For hotels, cityseekr can provide information, such as star rating, price category, review, check-in and check-out times, hotel service icons and website address.

Setting Your Navigation Preferences

Select settings for the system to take into account when planning your route.



Press the Settings icon > **Settings** > **Navigation**.

Map Preferences

Breadcrumbs displays your vehicle's previously traveled route with white dots. Turn this feature **ON** or **OFF**.

Turn List Format allows you to choose to have the system display your turn list **Top to Bottom** or **Bottom to Top**.

Parking POI Notification sets the automatic parking points of interest notification. Turn this feature **ON** or **OFF**. When parking points of interest notification is on, the icons display on the map when you get close to your destination. This may not be very useful in dense areas, and may clutter the map when other points of interest display.

Route Preferences

Preferred Route allows you to choose to have the system display the **Shortest**, **Fastest** or most **Ecological** route first. If you set **Always Use Preferred Route** to **Yes**, the system uses the selected route type to calculate only one route to the desired destination.

Always Use Preferred Route bypasses route selection in destination programming. The system only calculates one route based on the preferred route setting.

Eco Time Penalty allows you to select a low, medium or high cost for the calculated Eco Route. The higher the setting, the longer the time allotment is for the route.

Avoid features allows you to choose to have the system avoid freeways, toll roads, ferries and car trains when planning your route. Turn these features **ON** or **OFF**.

Use HOV Lanes allows you to choose to have the system use high-occupancy vehicle lanes, if available, when planning your route.

Navigation Preferences

Guidance Prompts allows you to choose to have the system use **Voice & Tones** or **Tone Only** on your programmed route.

Auto - Fill State/Province allows you have the system automatically fill in the state and province based on the information already entered into the system. Turn this feature **ON** or **OFF**.

Traffic Preferences

Avoid Traffic Problems allows you to choose how you want the system to handle traffic problems along your route.

- **Automatic:** Have the system reroute you to avoid traffic incidents that develop and impact the current route. The system does not provide a traffic alert notification.
- **Manual:** Have the system always provide a traffic alert notification for traffic incidents along the planned route. You have a choice to accept or ignore the notification before making the route deviation.

Traffic Alert Notification allows you to choose have the system display traffic alert notifications.

Other traffic alert features allows you to turn on certain, or all, traffic icons on the map such as road work, incident, accidents and closed roads. Scroll down to view all the different types of alerts. Turn these features **ON** or **OFF**.

Avoid Areas

Avoid Areas allows you to choose areas which you want the system to avoid when calculating a route for you.

Press **Add** to program an entry. Once you make a selection, the system tries to avoid the area(s) if possible for all routes. To delete a selection, choose the listing on the screen. When the screen changes to **Avoid Areas Edit**, you can press **Delete** at the bottom right of the screen.

Map Mode

Press the green bar in the upper right area of the touchscreen to view map mode. Map mode shows advanced viewing comprised of both 2D city maps as well as 3D landmarks (when available).

2D city maps show detailed outlines of buildings, visible land use and land elements and detailed railway infrastructure for the most essential cities around the globe. These maps also contain features, such as town blocks, building footprints, and railways.

3D landmarks appear as clear, visible objects that are typically recognizable and have a certain tourist value. The 3D landmarks appear in 3D map mode only. Coverage varies, and improves with updated map releases.

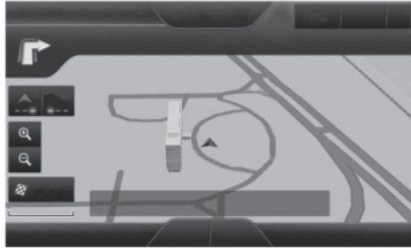

Change the appearance of the map display by repeatedly pressing the arrow button in the upper left corner of the screen. It toggles between three different map modes: Heading up, North up, and 3D.



Heading up (2D map) always shows the direction of forward travel to be upward on the screen. This view is available for map scales up to 2.5 miles (4 kilometers). The system remembers this setting for larger map scales, but shows the map in North up only. If the scale returns below this level, the system restores Heading up.



North up (2D map) always shows the northern direction to be upward on the screen.



3D map mode provides an elevated perspective of the map. This viewing angle can be adjusted and the map can be rotated 180 degrees by touching the map twice, and then dragging your finger along the shaded bar with arrows at the bottom of the map.

View switches between full map, street list and exit view in route guidance.

Menu displays a pop-up box that allows direct access to navigation settings, View/Edit Route, Sirius Travel Link, Guidance Mute and Cancel Route.



Re-center the map by pressing this icon whenever you scroll the map away from your vehicle's current location.

Auto Zoom

Press the green bar to access map mode, then select the + or - zoom button to bring up the zoom level and Auto buttons on the touchscreen. When you press **Auto**, Auto Zoom turns on and **Auto** displays in the bottom left corner of the screen in the map scale. The map zoom level then synchronizes with vehicle speed. The slower your vehicle is traveling, the farther in the map zooms in; the faster your vehicle is traveling, the farther the map zooms out. To turn the feature off, just press the + or - button again.

In 3D mode, rotate the map view by swiping your finger across the shaded bar with the arrows.

Map Icons

Vehicle mark shows the current location of your vehicle. It stays in the center of the map display, except when in scroll mode.



Scroll cursor allows you to scroll the map; the fixed icon is in the center of the screen. The map position closest to the cursor is in a window on the top center part of the screen.



Address book entry default icon(s) indicates the location on the map of an address book entry. This is the default symbol shown after the entry has been stored to the Address Book by any method other than the map. You can select from any of the 22 icons available. You can use each icon more than once.



Home indicates the location on the map currently stored as the home position. You can only save one address from the Address Book as your Home entry. You cannot change this icon.



POI (Point Of Interest) icons indicate locations of any point of interest categories you choose to display on the map. You can choose to display three point of interest categories on the map at one time.



Starting point indicates the starting point of a planned route.



Waypoints indicates the location of a waypoint on the map. The number inside the circle is different for each waypoint and represents the position of the waypoint in the route list.



Destination symbol indicates the ending point of a planned route.



Next maneuver point indicates the location of the next turn on the planned route.



No GPS symbol indicates that insufficient GPS satellite signals are available for accurate map positioning. This icon may display under normal operation in an area with poor GPS access.

Quick-touch Buttons

When in map mode, touch anywhere on the map display to access more features.

Set as Dest

Touch this button to select a scrolled location on the map as your destination. You may scroll the map by pressing your index finger on the map display. When you reach the desired location, simply let go and then touch **Set as Dest**.

Set as Waypoint

Touch this button to set the current location as a waypoint.

Save to Favorites

Touch this button to save the current location to your favorites.

POI Icons

Touch this button to select icons to display on the map. You can select up to three icons to display on the map at the same time. Turn these **ON** or **OFF**.

Cancel Route

Touch this button to cancel the active route.

View/Edit Route

Access these features when a route is active:

- View Route
- Edit Destination/Waypoints
- Edit Turn List
- Detour
- Edit Route Preferences
- Edit Traffic Preferences
- Cancel Route.

Nokia is the digital map provider for the navigation application. If you find map data errors, you may report them directly to Nokia by going to <http://mapreporter.navteq.com>. Nokia evaluates all reported map errors and responds with the result of their investigation by e-mail.

Navigation Map Updates

Annual navigation map updates are available for purchase through your dealership, by calling 1-800-NAVMAPS (in Mexico, call 01-800-557-5539) or going to www.navigation.com/ford. You need to specify the make and model of your vehicle to determine if there is an update available.

Navigation Voice Commands

When in navigation mode, press the voice button on the steering wheel control. After the tone, say any of the following commands:

Navigation system voice commands	
“Cancel next waypoint” ¹	“Navigation” ³
“Cancel route” ¹	“Navigation voice volume decrease” ¹
“Destination” ²	“Navigation voice volume increase” ¹
“Destination <nametag>”	“Repeat instruction”
“Destination <POI category>”	“Show 3D”
“Destination favorites”	“Show heading up”
“Destination home”	“Show map”
“Destination intersection”	“Show north up”
“Destination nearest <POI category>”	“Show route” ¹
“Destination nearest POI”	“Show turn list” ¹
“Destination play nametags”	“Voice guidance off”
“Destination POI”	“Voice guidance on”
“Destination POI category”	“Where am I?”
“Destination previous destination”	“Zoom in”
“Destination street address”	“Zoom out”
“Detour” ¹	“Help”

¹This command is only available when a navigation route is active.

²If you have said the command, “Destination”, you may say any of the above commands or commands in the following Destination chart.

³If you have said the command, “Navigation”, you may say any of the above commands or commands in the following Navigation chart.

“DESTINATION”
“<nametag>”
“<POI category>”
“Favorites”
“Home”
“Intersection”
“Nearest <POI category>”
“Nearest POI”
“Play nametags”
“POI category”
“Previous destination”
“Street address”
“Help”
“NAVIGATION”
“Destination”*
“Zoom city”
“Zoom country”
“Zoom in minimum”
“Zoom out maximum”
“Zoom province”
“Zoom state”
“Zoom street”
“Zoom to <distance>”
“Help”

*If you have said, “Destination”, you may say any of the commands in the Destination chart.

One-shot Destination Street Address

When you say either “Navigation destination street address” or “Destination street address”, the system asks you to say the full address. The system displays an example on-screen. You can then speak the address naturally, such as “One two three four Main Street, Anytown”.

GENERAL INFORMATION**SYNC® End User License Agreement (EULA)**

- You have acquired a device (“DEVICE”) that includes software licensed by Ford Motor Company and its affiliates (“FORD MOTOR COMPANY”) from an affiliate of Microsoft Corporation (“MS”). Those installed software products of MS origin, as well as associated media, printed materials, and “online” or electronic documentation (“MS SOFTWARE”) are protected by international intellectual property laws and treaties. The MS SOFTWARE is licensed, not sold. All rights reserved.
- The MS SOFTWARE may interface with and/or communicate with, or may be later upgraded to interface with and/or communicate with additional software and/or systems provided by FORD MOTOR COMPANY. The additional software and systems of FORD MOTOR COMPANY origin, as well as associated media, printed materials, and “online” or electronic documentation (“FORD SOFTWARE”) are protected by international intellectual property laws and treaties. The FORD SOFTWARE is licensed, not sold. All rights reserved.
- The MS SOFTWARE and/or FORD SOFTWARE may interface with and/or communicate with, or may be later upgraded to interface with and/or communicate with additional software and/or systems provided by third party software and service suppliers. The additional software and services of third party origin, as well as associated media, printed materials, and “online” or electronic documentation (“THIRD PARTY SOFTWARE”) are protected by international intellectual property laws and treaties. The THIRD PARTY SOFTWARE is licensed, not sold. All rights reserved.
- The MS SOFTWARE, FORD SOFTWARE and THIRD PARTY SOFTWARE hereinafter collectively and individually will be referred to as “SOFTWARE.”

IF YOU DO NOT AGREE TO THIS END USER LICENSE AGREEMENT (“EULA”), DO NOT USE THE DEVICE OR COPY THE SOFTWARE. ANY USE OF THE SOFTWARE, INCLUDING BUT NOT LIMITED TO USE ON THE DEVICE, WILL CONSTITUTE YOUR AGREEMENT TO THIS EULA (OR RATIFICATION OF ANY PREVIOUS CONSENT).

GRANT OF SOFTWARE LICENSE: This EULA grants you the following license:

- You may use the SOFTWARE as installed on the DEVICE and as otherwise interfacing with systems and/or services provide by or through FORD MOTOR COMPANY or its third party software and service providers.

DESCRIPTION OF OTHER RIGHTS AND LIMITATIONS:

- **Speech Recognition:** If the SOFTWARE includes speech recognition component(s), you should understand that speech recognition is an inherently statistical process and that recognition errors are inherent in the process. Neither FORD MOTOR COMPANY nor its suppliers shall be liable for any damages arising out of errors in the speech recognition process.
- **Limitations on Reverse Engineering, Decompilation and Disassembly:** You may not reverse engineer, decompile, or disassemble nor permit others to reverse engineer, decompile or disassemble the SOFTWARE, except and only to the extent that such activity is expressly permitted by applicable law notwithstanding this limitation.
- **Limitations on Distributing, Copying, Modifying and Creating Derivative Works:** You may not distribute, copy, make modifications to or create derivative works based on the SOFTWARE, except and only to the extent that such activity is expressly permitted by applicable law notwithstanding this limitation.
- **Single EULA:** The end user documentation for the DEVICE and related systems and services may contain multiple EULAs, such as multiple translations and/or multiple media versions (e.g., in the user documentation and in the software). Even if you receive multiple EULAs, you are licensed to use only one (1) copy of the SOFTWARE.
- **SOFTWARE Transfer:** You may permanently transfer your rights under this EULA only as part of a sale or transfer of the DEVICE, provided you retain no copies, you transfer all of the SOFTWARE (including all component parts, the media and printed materials, any upgrades, and, if applicable, the Certificate(s) of Authenticity), and the recipient agrees to the terms of this EULA. If the SOFTWARE is an upgrade, any transfer must include all prior versions of the SOFTWARE.
- **Termination:** Without prejudice to any other rights, FORD MOTOR COMPANY or MS may terminate this EULA if you fail to comply with the terms and conditions of this EULA.

- **Security Updates/Digital Rights Management:** Content owners use the WMDRM technology included in your DEVICE to protect their intellectual property, included copyrighted content. Portions of the SOFTWARE on your DEVICE use WMDRM software to access WMDRM-protected content. If the WMDRM software fails to protect the content, content owners may ask Microsoft to revoke the SOFTWARE's ability to use WMDRM to play or copy protected content. This action does not affect unprotected content. When your DEVICE downloads licenses for protected content, you agree that Microsoft may include a revocation list with the licenses. Content owners may require you to upgrade the SOFTWARE on your DEVICE to access their content. If you decline an upgrade, you will not be able to access content that requires the upgrade.
- **Consent to Use of Data:** You agree that MS, Microsoft Corporation, FORD MOTOR COMPANY, third party software and systems suppliers, their affiliates and/or their designated agent may collect and use technical information gathered in any manner as part of product support services related to the SOFTWARE or related services. MS, Microsoft Corporation, FORD MOTOR COMPANY, third party software and services suppliers, their affiliates and/or their designated agent may use this information solely to improve their products or to provide customized services or technologies to you. MS, Microsoft Corporation, FORD MOTOR COMPANY, third party software and systems suppliers, their affiliates and/or their designated agent may disclose this information to others, but not in a form that personally identifies you.
- **Internet-Based Services Components:** The SOFTWARE may contain components that enable and facilitate the use of certain Internet-based services. You acknowledge and agree that MS, Microsoft Corporation, FORD MOTOR COMPANY, third party software and service suppliers, their affiliates and/or their designated agent may automatically check the version of the SOFTWARE and/or its components that you are utilizing and may provide upgrades or supplements to the SOFTWARE that may be automatically downloaded to your DEVICE.
- **Additional Software/Services:** The SOFTWARE may permit FORD MOTOR COMPANY, third party software and service suppliers, MS, Microsoft Corporation, their affiliates and/or their designated agent to provide or make available to you SOFTWARE updates, supplements, add-on components, or Internet-based services components of the SOFTWARE after the date you obtain your initial copy of the SOFTWARE ("Supplemental Components").

If FORD MOTOR COMPANY or third party software and services suppliers provide or make available to you Supplemental Components and no other EULA terms are provided along with the Supplemental Components, then the terms of this EULA shall apply.

If MS, Microsoft Corporation, their affiliates and/or their designated agent make available Supplemental Components, and no other EULA terms are provided, then the terms of this EULA shall apply, except that the MS, Microsoft Corporation or affiliate entity providing the Supplemental Component(s) shall be the licensor of the Supplemental Component(s).

FORD MOTOR COMPANY, MS, Microsoft Corporation, their affiliates and/or their designated agent reserve the right to discontinue without liability any Internet-based services provided to you or made available to you through the use of the SOFTWARE.

- **Links to Third Party Sites:** The MS SOFTWARE may provide you with the ability to link to third party sites through the use of the SOFTWARE. The third party sites are not under the control of MS, Microsoft Corporation, their affiliates and/or their designated agent. Neither MS nor Microsoft Corporation nor their affiliates nor their designated agent are responsible for (i) the contents of any third party sites, any links contained in third party sites, or any changes or updates to third party sites, or (ii) webcasting or any other form of transmission received from any third party sites. If the SOFTWARE provides links to third party sites, those links are provided to you only as a convenience, and the inclusion of any link does not imply an endorsement of the third party site by MS, Microsoft Corporation, their affiliates and/or their designated agent.
- **Obligation to Drive Responsibly:** You recognize your obligation to drive responsibly and keep attention on the road. You will read and abide with the DEVICE operating instructions particularly as they pertain to safety and assumes any risk associated with the use of the DEVICE.

UPGRADES AND RECOVERY MEDIA: If the SOFTWARE is provided by FORD MOTOR COMPANY separate from the DEVICE on media such as a ROM chip, CD ROM disk(s) or via web download or other means, and is labeled "For Upgrade Purposes Only" or "For Recovery Purposes Only" you may install one (1) copy of such SOFTWARE onto the DEVICE as a replacement copy for the existing SOFTWARE, and use it in accordance with this EULA, including any additional EULA terms accompanying the upgrade SOFTWARE.

INTELLECTUAL PROPERTY RIGHTS: All title and intellectual property rights in and to the SOFTWARE (including but not limited to any images, photographs, animations, video, audio, music, text and “applets,” incorporated into the SOFTWARE), the accompanying printed materials, and any copies of the SOFTWARE, are owned by MS, Microsoft Corporation, FORD MOTOR COMPANY, or their affiliates or suppliers. The SOFTWARE is licensed, not sold. You may not copy the printed materials accompanying the SOFTWARE. All title and intellectual property rights in and to the content which may be accessed through use of the SOFTWARE is the property of the respective content owner and may be protected by applicable copyright or other intellectual property laws and treaties. This EULA grants you no rights to use such content. All rights not specifically granted under this EULA are reserved by MS, Microsoft Corporation, FORD MOTOR COMPANY, third party software and service providers, their affiliates and suppliers. Use of any on-line services which may be accessed through the SOFTWARE may be governed by the respective terms of use relating to such services. If this SOFTWARE contains documentation that is provided only in electronic form, you may print one copy of such electronic documentation.

EXPORT RESTRICTIONS: You acknowledge that the SOFTWARE is subject to U.S. and European Union export jurisdiction. You agree to comply with all applicable international and national laws that apply to the SOFTWARE, including the U.S. Export Administration Regulations, as well as end-user, end-use and destination restrictions issued by U.S. and other governments. For additional information, see <http://www.microsoft.com/exporting/>.

TRADEMARKS: This EULA does not grant you any rights in connection with any trademarks or service marks of FORD MOTOR COMPANY, MS, Microsoft Corporation, third party software or service providers, their affiliates or suppliers.

PRODUCT SUPPORT: Product support for the SOFTWARE is not provided by MS, its parent corporation Microsoft Corporation, or their affiliates or subsidiaries. For product support, please refer to FORD MOTOR COMPANY instructions provided in the documentation for the DEVICE. Should you have any questions concerning this EULA, or if you desire to contact FORD MOTOR COMPANY for any other reason, please refer to the address provided in the documentation for the DEVICE.

No Liability for Certain Damages: EXCEPT AS PROHIBITED BY LAW, FORD MOTOR COMPANY, ANY THIRD PARTY SOFTWARE OR SERVICES SUPPLIERS, MS, MICROSOFT CORPORATION AND THEIR AFFILIATES SHALL HAVE NO LIABILITY FOR ANY INDIRECT, SPECIAL, CONSEQUENTIAL OR INCIDENTAL DAMAGES ARISING FROM OR IN CONNECTION WITH THE USE OR PERFORMANCE OF THE SOFTWARE. THIS LIMITATION SHALL APPLY EVEN IF ANY REMEDY FAILS OF ITS ESSENTIAL PURPOSE. IN NO EVENT SHALL MS, MICROSOFT CORPORATION AND/OR THEIR AFFILIATES BE LIABLE FOR ANY AMOUNT IN EXCESS OF U.S. TWO HUNDRED FIFTY DOLLARS (U.S.\$250.00).

- THERE ARE NO WARRANTIES OTHER THAN THOSE THAT MAY EXPRESSLY BE PROVIDED FOR YOUR NEW VEHICLE.

Adobe

Contains Adobe® [Flash® Player] or [AIR®] technology by Adobe Systems Incorporated. This [Licensee Product] contains [Adobe® Flash® Player] [Adobe® AIR®] software under license from Adobe Systems Incorporated, Copyright © 1995-2009 Adobe Macromedia Software LLC. All rights reserved. Adobe, Flash and AIR are trademarks of Adobe Systems Incorporated.

End user notice

Microsoft® Windows® Mobile for Automotive Important Safety Information

This system Ford SYNC™ contains software that is licensed to Manufacturer FORD MOTOR COMPANY by an affiliate of Microsoft Corporation pursuant to a license agreement. Any removal, reproduction, reverse engineering or other unauthorized use of the software from this system in violation of the license agreement is strictly prohibited and may subject you to legal action.

Read and follow instructions

Before using your Windows Automotive-based system, read and follow all instructions and safety information provided in this end user manual (“User’s Guide”). Not following precautions found in this User’s Guide can lead to an accident or other serious consequences.

Keep User's Guide in Vehicle

When kept in the vehicle, the User's Guide will be a ready reference for you and other users unfamiliar with the Windows Automotive-based system. Please make certain that before using the system for the first time, all persons have access to the User's Guide and read its instructions and safety information carefully.



WARNING: Operating certain parts of this system while driving can distract your attention away from the road, and possibly cause an accident or other serious consequences. Do not change system settings or enter data non-verbally (using your hands) while driving. Stop the vehicle in a safe and legal manner before attempting these operations. This is important since while setting up or changing some functions you might be required to distract your attention away from the road and remove your hands from the wheel.

General operation**Voice Command Control**

Functions within the Windows Automotive-based system may be accomplished using only voice commands. Using voice commands while driving allows you to operate the system without removing your hands from the wheel.

Prolonged Views of Screen

Do not access any function requiring a prolonged view of the screen while you are driving. Pull over in a safe and legal manner before attempting to access a function of the system requiring prolonged attention. Even occasional short scans to the screen may be hazardous if your attention has been diverted away from your driving task at a critical time.

Volume Setting

Do not raise the volume excessively. Keep the volume at a level where you can still hear outside traffic and emergency signals while driving. Driving while unable to hear these sounds could cause an accident.

Use of Speech Recognition Functions

Speech recognition software is inherently a statistical process which is subject to errors. It is your responsibility to monitor any speech recognition functions included in the system and address any errors.

Navigation Features

Any navigation features included in the system are intended to provide turn by turn instructions to get you to a desired destination. Please make certain all persons using this system carefully read and follow instructions and safety information fully.

Distraction Hazard

Any navigation features may require manual (non-verbal) setup. Attempting to perform such set-up or insert data while driving can seriously distract your attention and could cause an accident or other serious consequences. Stop the vehicle in a safe and legal manner before attempting these operations.

Let Your Judgment Prevail

Any navigation features are provided only as an aid. Make your driving decisions based on your observations of local conditions and existing traffic regulations. Any such feature is not a substitute for your personal judgment. Any route suggestions made by this system should never replace any local traffic regulations or your personal judgment or knowledge of safe driving practices.

Route Safety

Do not follow the route suggestions if doing so would result in an unsafe or illegal maneuver, if you would be placed in an unsafe situation, or if you would be directed into an area that you consider unsafe. The driver is ultimately responsible for the safe operation of the vehicle and therefore, must evaluate whether it is safe to follow the suggested directions.

Potential Map Inaccuracy

Maps used by this system may be inaccurate because of changes in roads, traffic controls or driving conditions. Always use good judgment and common sense when following the suggested routes.

Emergency Services

Do not rely on any navigation features included in the system to route you to emergency services. Ask local authorities or an emergency services operator for these locations. Not all emergency services such as police, fire stations, hospitals and clinics are likely to be contained in the map database for such navigation features.

TeleNav Software End User License Agreement

Please read these terms and conditions carefully before you use the TeleNav Software. Your use of the TeleNav Software indicates that you accept these terms and conditions. If you do not accept these terms and conditions, do not break the seal of the package, launch, or otherwise use the TeleNav Software.

TeleNav may revise this Agreement and the privacy policy at any time, with or without notice to you. You agree to visit <http://www.telenav.com> from time to time to review the then current version of this Agreement and of the privacy policy.

1. Safe and Lawful Use

You acknowledge that devoting attention to the TeleNav Software may pose a risk of injury or death to you and others in situations that otherwise require your undivided attention, and you therefore agree to comply with the following when using the TeleNav Software: (a) observe all traffic laws and otherwise drive safely; (b) use your own personal judgment while driving. If you feel that a route suggested by the TeleNav Software instructs you to perform an unsafe or illegal maneuver, places you in an unsafe situation, or directs you into an area that you consider to be unsafe, do not follow such instructions; (c) do not input destinations, or otherwise manipulate the TeleNav Software, unless your vehicle is stationary and parked; (d) do not use the TeleNav Software for any illegal, unauthorized, unintended, unsafe, hazardous, or unlawful purposes, or in any manner inconsistent with this Agreement; (e) arrange all GPS and wireless devices and cables necessary for use of the TeleNav Software in a secure manner in your vehicle so that they will not interfere with your driving and will not prevent the operation of any safety device (such as an airbag). You agree to indemnify and hold TeleNav harmless against all claims resulting from any dangerous or otherwise inappropriate use of the TeleNav Software in any moving vehicle, including as a result of your failure to comply with the directions above.

2. Account Information

You agree: (a) when registering the TeleNav Software, to provide TeleNav with true, accurate, current, and complete information about yourself, and (b) to inform TeleNav promptly of any changes to such information, and to keep it true, accurate, current and complete.

3. Software License

Subject to your compliance with the terms of this Agreement, TeleNav hereby grants to you a personal, non-exclusive, non-transferable license (except as expressly permitted below in connection with your permanent transfer of the TeleNav Software license), without the right to sublicense, to use the TeleNav Software (in object code form only) in order to access and use the TeleNav Software. This license shall terminate upon any termination or expiration of this Agreement. You agree that you will use the TeleNav Software only for your personal business or leisure purposes, and not to provide commercial navigation services to other parties.

3.1 License limitations

You agree not to do any of the following: (a) reverse engineer, decompile, disassemble, translate, modify, alter or otherwise change the TeleNav Software or any part thereof; (b) attempt to derive the source code, audio library or structure of the TeleNav Software without the prior express written consent of TeleNav; (c) remove from the TeleNav Software, or alter, any of TeleNav's or its suppliers' trademarks, trade names, logos, patent or copyright notices, or other notices or markings; (d) distribute, sublicense or otherwise transfer the TeleNav Software to others, except as part of your permanent transfer of the TeleNav Software; or (e) use the TeleNav Software in any manner that (i) infringes the intellectual property or proprietary rights, rights of publicity or privacy or other rights of any party, (ii) violates any law, statute, ordinance or regulation, including but not limited to laws and regulations related to spamming, privacy, consumer and child protection, obscenity or defamation, or (iii) is harmful, threatening, abusive, harassing, tortuous, defamatory, vulgar, obscene, libelous, or otherwise objectionable; and (f) lease, rent out, or otherwise permit unauthorized access by third parties to the TeleNav Software without advanced written permission of TeleNav.

4. Disclaimers

To the fullest extent permissible pursuant to applicable law, in no event will TeleNav, its licensors and suppliers, or agents or employees of any of the foregoing, be liable for any decision made or action taken by you or anyone else in reliance on the information provided by the TeleNav Software. TeleNav also does not warrant the accuracy of the map or other data used for the TeleNav Software. Such data may not always reflect reality due to, among other things, road closures, construction, weather, new roads and other changing conditions. You are responsible for the entire risk arising out of your use of the TeleNav Software. For example but without limitation, you agree not to rely on the TeleNav Software for critical navigation in areas where the well-being or survival

of you or others is dependent on the accuracy of navigation, as the maps or functionality of the TeleNav Software are not intended to support such high risk applications, especially in more remote geographical areas. TELENAV EXPRESSLY DISCLAIMS AND EXCLUDES ALL WARRANTIES IN CONNECTION WITH THE TELENAV SOFTWARE, WHETHER STATUTORY, EXPRESS OR IMPLIED, INCLUDING ALL WARRANTIES WHICH MAY ARISE FROM COURSE OF DEALING, CUSTOM OR TRADE AND INCLUDING, BUT NOT LIMITED TO, THE IMPLIED WARRANTIES OF MERCHANTABILITY, FITNESS FOR A PARTICULAR PURPOSE AND NON-INFRINGEMENT OF THIRD PARTY RIGHTS WITH RESPECT TO THE TELENAV SOFTWARE. Certain jurisdictions do not permit the disclaimer of certain warranties, so this limitation may not apply to you.

5. Limitation of Liability

TO THE EXTENT PERMITTED UNDER APPLICABLE LAW, UNDER NO CIRCUMSTANCES SHALL TELENAV OR ITS LICENSORS AND SUPPLIERS BE LIABLE TO YOU OR TO ANY THIRD PARTY FOR ANY INDIRECT, INCIDENTAL, CONSEQUENTIAL, SPECIAL OR EXEMPLARY DAMAGES (INCLUDING IN EACH CASE, BUT NOT LIMITED TO, ACCESS DATA, LOSS OF DATA, LOSS OF BUSINESS, LOSS OF PROFITS, BUSINESS INTERRUPTION OR THE LIKE) ARISING OUT OF THE USE OF OR INABILITY TO USE THE TELENAV SOFTWARE, EVEN IF TELENAV HAS BEEN ADVISED OF THE POSSIBILITY OF SUCH DAMAGES.

NOTWITHSTANDING ANY DAMAGES THAT YOU MIGHT INCUR FOR ANY REASON WHATSOEVER (INCLUDING, WITHOUT LIMITATION, ALL DAMAGES REFERENCED HEREIN AND ALL DIRECT OR GENERAL DAMAGES IN CONTRACT, TORT (INCLUDING NEGLIGENCE) OR OTHERWISE), THE ENTIRE LIABILITY OF TELENAV AND OF ALL OF TELENAV'S SUPPLIERS SHALL BE LIMITED TO THE AMOUNT ACTUALLY PAID BY YOU FOR THE TELENAV SOFTWARE. SOME STATES AND/OR JURISDICTIONS DO NOT ALLOW THE EXCLUSION OR LIMITATION OF INCIDENTAL OR CONSEQUENTIAL DAMAGES, SO THE ABOVE LIMITATIONS OR EXCLUSIONS MAY NOT APPLY TO YOU.

6. Arbitration and Governing Law

You agree that any dispute, claim or controversy arising out of or relating to this Agreement or the TeleNav Software shall be settled by independent arbitration involving a neutral arbitrator and administered by the American Arbitration Association in the County of Santa Clara, California. The arbitrator shall apply the Commercial Arbitration Rules of the American Arbitration Association, and the judgment upon the award rendered by the arbitrator may be entered by any court having jurisdiction. Note that there is no judge or jury in an arbitration proceeding and the decision of the arbitrator shall be binding upon both parties. You expressly agree to waive your right to a jury trial. This Agreement and performance hereunder will be governed by and construed in accordance with the laws of the State of California, without giving effect to its conflict of laws provisions. To the extent judicial action is necessary in connection with the binding arbitration, both TeleNav and you agree to submit to the exclusive jurisdiction of the courts of the County of Santa Clara, California. The United Nations Convention on Contracts for the International Sale of Goods shall not apply.

7. Assignment

You may not resell, assign, or transfer this Agreement or any of your rights or obligations, except in totality, in connection with your permanent transfer of the TeleNav Software, and expressly conditioned upon the new user of the TeleNav Software agreeing to be bound by the terms and conditions of this Agreement. Any such sale, assignment or transfer that is not expressly permitted under this paragraph will result in immediate termination of this Agreement, without liability to TeleNav, in which case you and all other parties shall immediately cease all use of the TeleNav Software. Notwithstanding the foregoing, TeleNav may assign this Agreement to any other party at any time without notice, provided the assignee remains bound by this Agreement.

8. Miscellaneous

8.1 This Agreement constitutes the entire agreement between TeleNav and you with respect to the subject matter hereof.

8.2 Except for the limited licenses expressly granted in this Agreement, TeleNav retains all right, title and interest in and to the TeleNav Software, including without limitation all related intellectual property rights. No licenses or other rights which are not expressly granted in this Agreement are intended to, or shall be, granted or conferred by implication, statute, inducement, estoppel or otherwise, and TeleNav and its suppliers and licensors hereby reserve all of their respective rights other than the licenses explicitly granted in this Agreement.

8.3 By using the TeleNav Software, you consent to receive from TeleNav all communications, including notices, agreements, legally required disclosures or other information in connection with the TeleNav Software (collectively, "Notices") electronically. TeleNav may provide such Notices by posting them on TeleNav's Website or by downloading such Notices to your wireless device. If you desire to withdraw your consent to receive Notices electronically, you must discontinue your use of the TeleNav Software.

8.4 TeleNav's or your failure to require performance of any provision shall not affect that party's right to require performance at any time thereafter, nor shall a waiver of any breach or default of this Agreement constitute a waiver of any subsequent breach or default or a waiver of the provision itself.

8.5 If any provision herein is held unenforceable, then such provision will be modified to reflect the intention of the parties, and the remaining provisions of this Agreement will remain in full force and effect.

8.6 The headings in this Agreement are for convenience of reference only, will not be deemed to be a part of this Agreement, and will not be referred to in connection with the construction or interpretation of this Agreement. As used in this Agreement, the words "include" and "including," and variations thereof, will not be deemed to be terms of limitation, but rather will be deemed to be followed by the words "without limitation."

9. Other Vendors Terms and Conditions

The TeleNav Software utilizes map and other data licensed to TeleNav by third party vendors for the benefit of you and other end users. This Agreement includes end-user terms applicable to these companies (included at the end of this Agreement), and thus your use of the TeleNav Software is also subject to such terms. You agree to comply with the following additional terms and conditions, which are applicable to TeleNav's third party vendor licensors:

NavTeq End User License Agreement

END USER TERMS

The content provided ("Data") is licensed, not sold. By opening this package, or installing, copying, or otherwise using the Data, you agree to be bound by the terms of this agreement. If you do not agree to the terms of this agreement, you are not permitted to install, copy, use, resell or transfer the Data. If you wish to reject the terms of this agreement, and have not installed, copied, or used the Data, you must contact your retailer or NAVTEQ North America, LLC ("NT") within thirty (30) days of purchase for a refund of your purchase price. To contact NT, please visit www.navteq.com.

The Data is provided for your personal, internal use only and may not be resold. It is protected by copyright, and is subject to the following terms (this “End User License Agreement”) and conditions which are agreed to by you, on the one hand, and NAVTEQ North America, LLC (“NT”) and its licensors (including their licensors and suppliers) on the other hand.

The Data for areas of Canada includes information taken with permission from Canadian authorities, including: © Her Majesty the Queen in Right of Canada, © Queen’s Printer for Ontario, © Canada Post Corporation, GeoBase ©.

NT holds a nonexclusive license from the United States Postal Service ® to publish and sell ZIP+4 ® information.

© United States Postal Service ® 2009. Prices are not established, controlled or approved by the United States Postal Service ®. The following trademarks and registrations are owned by the USPS: United States Postal Service, USPS, and ZIP+4.

The Data for Mexico includes certain Data from Instituto Nacional de Estadística y Geografía.

TERMS AND CONDITIONS

License Limitations on Use: You agree that your license to use this Data is limited to and conditioned on use for solely personal, noncommercial purposes, and not for service bureau, timesharing or other similar purposes. Except as otherwise set forth herein, you agree not to otherwise reproduce, copy, modify, decompile, disassemble or reverse engineer any portion of this Data, and may not transfer or distribute it in any form, for any purpose, except to the extent permitted by mandatory laws.

License Limitations on Transfer: Your limited license does not allow transfer or resale of the Data, except on the condition that you may transfer the Data and all accompanying materials on a permanent basis if: (a) you retain no copies of the Data; (b) the recipient agrees to the terms of this End User License Agreement; and (c) you transfer the Data in the exact same form as you purchased it by physically transferring the original media (e.g., the CD-ROM or DVD you purchased), all original packaging, all Manuals and other documentation. Specifically, Multi-disc sets may only be transferred or sold as a complete set as provided to you and not as a subset thereof.

Additional License Limitations: Except where you have been specifically licensed to do so by NT in a separate written agreement, and without limiting the preceding paragraph, your license is conditioned on use of the Data as prescribed in this agreement, and you may not (a) use this Data with any products, systems, or applications installed or otherwise connected to or in communication with vehicles capable of vehicle navigation, positioning, dispatch, real time route guidance, fleet management or similar applications; or (b) with, or in communication with, including without limitation, cellular phones, palmtop and handheld computers, pagers, and personal digital assistants or PDAs.



WARNING: This Data may contain inaccurate or incomplete information due to the passage of time, changing circumstances, sources used and the nature of collecting comprehensive geographic Data, any of which may lead to incorrect results.

No Warranty: This Data is provided to you “as is”, and you agree to use it at your own risk. NT and its licensors (and their licensors and suppliers) make no guarantees, representations or warranties of any kind, express or implied, arising by law or otherwise, including but not limited to, content, quality, accuracy, completeness, effectiveness, reliability, fitness for a particular purpose, usefulness, use or results to be obtained from this Data, or that the Data or server will be uninterrupted or error free.

Disclaimer of Warranty: NT AND ITS LICENSORS (INCLUDING THEIR LICENSORS AND SUPPLIERS) DISCLAIM ANY WARRANTIES, EXPRESS OR IMPLIED, OF QUALITY, PERFORMANCE, MERCHANTABILITY, FITNESS FOR A PARTICULAR PURPOSE OR NON-INFRINGEMENT. Some States, Territories and Countries do not allow certain warranty exclusions, so to that extent the above exclusion may not apply to you.

Disclaimer of Liability: NT AND ITS LICENSORS (INCLUDING THEIR LICENSORS AND SUPPLIERS) SHALL NOT BE LIABLE TO YOU IN RESPECT OF ANY CLAIM, DEMAND OR ACTION, IRRESPECTIVE OF THE NATURE OF THE CAUSE OF THE CLAIM, DEMAND OR ACTION ALLEGING ANY LOSS, INJURY OR DAMAGES, DIRECT OR INDIRECT, WHICH MAY RESULT FROM THE USE OR POSSESSION OF THIS DATA; OR FOR ANY LOSS OF PROFIT, REVENUE, CONTRACTS OR SAVINGS, OR ANY OTHER DIRECT, INDIRECT, INCIDENTAL, SPECIAL OR CONSEQUENTIAL DAMAGES ARISING OUT OF YOUR USE OF OR INABILITY TO USE THIS DATA, ANY DEFECT IN THIS DATA, OR THE BREACH OF THESE TERMS OR CONDITIONS, WHETHER IN AN ACTION IN CONTRACT OR TORT OR BASED ON A WARRANTY, EVEN

IF NT OR ITS LICENSORS HAVE BEEN ADVISED OF THE POSSIBILITY OF SUCH DAMAGES. Some States, Territories and Countries do not allow certain liability exclusions or damages limitations, so to that extent the above may not apply to you.

Export Control: You agree not to export from anywhere any part of the Data or any direct product thereof except in compliance with, and with all licenses and approvals required under, applicable export laws, rules and regulations, including but not limited to the laws, rules and regulations administered by the Office of Foreign Assets Control of the U.S. Department of Commerce and the Bureau of Industry and Security of the U.S. Department of Commerce. To the extent that any such export laws, rules or regulations prohibit NT from complying with any of its obligations hereunder to deliver or distribute Data, such failure shall be excused and shall not constitute a breach of this Agreement.

Entire Agreement: These terms and conditions constitute the entire agreement between NT (and its licensors, including their licensors and suppliers) and you pertaining to the subject matter hereof, and supersedes in their entirety any and all written or oral agreements previously existing between us with respect to such subject matter.

Severability: You and NT agree that if any portion of this agreement is found illegal or unenforceable, that portion shall be severed and the remainder of the Agreement shall be given full force and effect.

Governing Law: The above terms and conditions shall be governed by the laws of the State of Illinois, without giving effect to (i) its conflict of laws provisions, or (ii) the United Nations Convention for Contracts for the International Sale of Goods, which is explicitly excluded. You agree to submit to the personal jurisdiction of the State of Illinois for any and all disputes, claims and actions arising from or in connection with the Data provided to you hereunder.

Government End Users: If the Data is being acquired by or on behalf of the United States government or any other entity seeking or applying rights similar to those customarily claimed by the United States government, this Data is a “commercial item” as that term is defined at 48 C.F.R. (“FAR”) 2.101, is licensed in accordance with this End User License Agreement, and each copy of Data delivered or otherwise furnished shall be marked and embedded as appropriate with the following “Notice of Use”, and be treated in accordance with such Notice:

NOTICE OF USE

CONTRACTOR (MANUFACTURER/ SUPPLIER)

NAME:

NAVTEQ

CONTRACTOR (MANUFACTURER/SUPPLIER)

ADDRESS:

425 West Randolph Street, Chicago, IL 60606.

This Data is a commercial item as defined in FAR 2.101 and is subject to the EndUser License Agreement under which this Data was provided.

© 2011 NAVTEQ. All rights reserved.

If the Contracting Officer, federal government agency, or any federal official refuses to use the legend provided herein, the Contracting Officer, federal government agency, or any federal official must notify NAVTEQ prior to seeking additional or alternative rights in the Data.

Wi-Fi hotspot data provided by JiWire ©2013 JiWire.

Gracenote® Copyright

CD and music — related data from Gracenote, Inc., copyright © 2000–2007 Gracenote. Gracenote Software, copyright © 2000–2007 Gracenote. This product and service may practice one or more of the following U.S. Patents #5,987,525; #6,061,680; #6,154,773, #6,161,132, #6,230,192, #6,230,207, #6,240,459, #6,330,593, and other patents issued or pending. Some services supplied under license from Open Globe, Inc. for U.S. Patent: #6,304,523.

Gracenote and CDDB are registered trademarks of Gracenote. The Gracenote logo and logotype, and the “Powered by Gracenote™” logo are trademarks of Gracenote.

Gracenote® End User License Agreement (EULA)

This device contains software from Gracenote, Inc. of 2000 Powell Street Emeryville, California 94608 (“Gracenote”).

The software from Gracenote (the “Gracenote Software”) enables this device to do disc and music file identification and obtain music-related information, including name, artist, track, and title information (“Gracenote Data”) from online servers (“Gracenote Servers”), and to perform other functions. You may use Gracenote Data only by means of the intended End User functions of this device

This device may contain content belonging to Gracenote’s providers. If so, all of the restrictions set forth herein with respect to Gracenote Data shall also apply to such content and such content providers shall be entitled to all of the benefits and protections set forth herein that are available to Gracenote.

You agree that you will use the content from Gracenote (“Gracenote Content”), Gracenote Data, the Gracenote Software, and Gracenote Servers for your own personal, non-commercial use only. You agree not to assign, copy, transfer or transmit the Gracenote Content, Gracenote Software or any Gracenote Data (except in a Tag associated with a music file) to any third party. **YOU AGREE NOT TO USE OR EXPLOIT GRACENOTE CONTENT, GRACENOTE DATA, THE GRACENOTE SOFTWARE, OR GRACENOTE SERVERS, EXCEPT AS EXPRESSLY PERMITTED HEREIN.**

You agree that your non-exclusive licenses to use the Gracenote Content, Gracenote Data, the Gracenote Software, and Gracenote Servers will terminate if you violate these restrictions. If your licenses terminate, you agree to cease any and all use of the Gracenote Content, Gracenote Data, the Gracenote Software, and Gracenote Servers. Gracenote, respectively, reserve all rights in Gracenote Data, the Gracenote Software, and the Gracenote Servers and Gracenote Content, including all ownership rights. Under no circumstances will either Gracenote become liable for any payment to you for any information that you provide, including any copyrighted material or music file information. You agree that Gracenote may enforce its respective rights, collectively or separately, under this agreement against you, directly in each company’s own name.

Gracenote uses a unique identifier to track queries for statistical purposes. The purpose of a randomly assigned numeric identifier is to allow Gracenote to count queries without knowing anything about who you are. For more information, see the web page at www.gracenote.com for the Gracenote Privacy Policy

THE GRACENOTE SOFTWARE, EACH ITEM OF GRACENOTE DATA AND THE GRACENOTE CONTENT ARE LICENSED TO YOU "AS IS." NEITHER GRACENOTE MAKES ANY REPRESENTATIONS OR WARRANTIES, EXPRESS OR IMPLIED, REGARDING THE ACCURACY OF ANY GRACENOTE DATA FROM THE GRACENOTE SERVERS OR GRACENOTE CONTENT. GRACENOTE COLLECTIVELY AND SEPARATELY RESERVE THE RIGHT TO DELETE DATA AND/OR CONTENT FROM THE COMPANIES' RESPECTIVE SERVERS OR, IN THE CASE OF GRACENOTE, CHANGE DATA CATEGORIES FOR ANY CAUSE THAT GRACENOTE DEEMS SUFFICIENT. NO WARRANTY IS MADE THAT EITHER GRACENOTE CONTENT OR THE GRACENOTE SOFTWARE OR GRACENOTE SERVERS ARE ERROR-FREE OR THAT THE FUNCTIONING OF THE GRACENOTE SOFTWARE OR GRACENOTE SERVERS WILL BE UNINTERRUPTED. GRACENOTE IS NOT OBLIGATED TO PROVIDE YOU WITH ANY ENHANCED OR ADDITIONAL DATA TYPES THAT GRACENOTE MAY CHOOSE TO PROVIDE IN THE FUTURE AND IS FREE TO DISCONTINUE ITS ONLINE SERVICES AT ANY TIME. GRACENOTE DISCLAIMS ALL WARRANTIES EXPRESS OR IMPLIED, INCLUDING, BUT NOT LIMITED TO, IMPLIED WARRANTIES OF MERCHANTABILITY, FITNESS FOR A PARTICULAR PURPOSE, TITLE, AND NON-INFRINGEMENT. NEITHER GRACENOTE WARRANTS THE RESULTS THAT WILL BE OBTAINED BY YOUR USE OF THE GRACENOTE SOFTWARE OR ANY GRACENOTE SERVER. IN NO CASE WILL GRACENOTE BE LIABLE FOR ANY CONSEQUENTIAL OR INCIDENTAL DAMAGES OR FOR ANY LOST PROFITS OR LOST REVENUES FOR ANY REASON WHATSOEVER.

© Gracernote 2007

Vehicle with SYNC only

FCC ID: KMHSG1G1 IC: 1422A-SG1G1

Vehicle with SYNC and MyFord Touch or MyLincoln Touch

FCC ID: KMHSYNG2 IC: 1422A-SYNG2

This device complies with Part 15 of the FCC Rules and with RSS-210 of Industry Canada. Operation is subject to the following two conditions: (1) This device may not cause harmful interference, and (2) this device must accept any interference received, including interference that may cause undesired operation.



WARNING: Changes or modifications not expressly approved by the party responsible for compliance could void the user's authority to operate the equipment. The term "IC:" before the radio certification number only signifies that Industry Canada technical specifications were met.

The antenna used for this transmitter must not be co-located or operating in conjunction with any other antenna or transmitter.

GENERAL MAINTENANCE INFORMATION**Why Maintain Your Vehicle?**

Carefully following the maintenance schedule helps protect against major repair expenses resulting from neglect or inadequate maintenance and may help to increase the value of your vehicle when you sell or trade it. Keep all receipts for completed maintenance with your vehicle.

We have established regular maintenance intervals for your vehicle based upon rigorous testing. It is important that you have your vehicle serviced at the proper times. These intervals serve two purposes; one is to maintain the reliability of your vehicle and the second is to keep your cost of owning your vehicle down.

It is your responsibility to have all scheduled maintenance performed and to make sure that the materials used meet the specifications identified in the *Capacities and Specifications* chapter of this owner's manual.

Failure to perform scheduled maintenance invalidates warranty coverage on parts affected by the lack of maintenance.

Why Maintain Your Vehicle at Your Dealership?***Factory-Trained Technicians***

Service technicians participate in extensive factory-sponsored certification training to help them become experts on the operation of your vehicle. Ask your dealership about the training and certification their technicians have received.

Genuine Ford and Motorcraft® Replacement Parts

Dealerships stock Ford, Motorcraft and Ford-authorized branded re-manufactured replacement parts. These parts meet or exceed our specifications. Parts installed at your dealership carry a nationwide 12-month or 12000-mile (20000 kilometers) parts and labor limited warranty.

If you do not use Ford authorized parts they may not meet our specifications and depending on the part, it could affect emissions compliance.

Convenience

Many dealerships have extended evening and Saturday hours to make your service visit more convenient and they offer one stop shopping. They can perform any services that are required on your vehicle, from general maintenance to collision repairs.

Note: Not all dealers have extended hours or body shops. Please contact your dealer for details.

Protecting Your Investment

Maintenance is an investment that pays dividends in the form of improved reliability, durability and resale value. To maintain the proper performance of your vehicle and its emission control systems, make sure you have scheduled maintenance performed at the designated intervals.

Your vehicle is very sophisticated and built with multiple, complex, performance systems. Every manufacturer develops these systems using different specifications and performance features. That is why it is important to rely upon your dealership to properly diagnose and repair your vehicle.

Ford Motor Company has recommended maintenance intervals for various parts and component systems based upon engineering testing. Ford Motor Company relies upon this testing to determine the most appropriate mileage for replacement of oils and fluids to protect your vehicle at the lowest overall cost to you and recommends against maintenance schedules that deviate from the scheduled maintenance information.

We strongly recommend the use of only genuine Ford, Motorcraft or Ford-authorized re-manufactured replacement parts engineered for your vehicle.

Additives and Chemicals

This owner's manual and the Ford Workshop Manual list the recommended additives and chemicals for your vehicle. We do not recommend using chemicals or additives not approved by us as part of your vehicle's normal maintenance. Please consult your warranty information.

Oils, Fluids and Flushing

In many cases, fluid discoloration is a normal operating characteristic and, by itself, does not necessarily indicate a concern or that the fluid needs to be changed. However, a qualified expert, such as the factory-trained technicians at your dealership, should inspect discolored fluids that also show signs of overheating or foreign material contamination immediately.

Make sure to change your vehicle’s oils and fluids at the specified intervals or in conjunction with a repair. Flushing is a viable way to change fluid for many vehicle sub-systems during scheduled maintenance. It is critical that systems are flushed only with new fluid that is the same as that required to fill and operate the system or using a Ford-approved flushing chemical.

Owner Checks and Services

Certain basic maintenance checks and inspections should be performed every month or at six-month intervals.

Check every month
Function of all interior and exterior lights.
Tires (including spare) for wear and proper pressure.
Windshield washer fluid level.
Check every six months
Battery connections. Clean if necessary.
Body and door drain holes for obstructions. Clean if necessary.
Cooling system fluid level and coolant strength.
Door weatherstrips for wear. Lubricate if necessary.
Hinges, latches and outside locks for proper operation. Lubricate if necessary.
Parking brake for proper operation.
Safety belts and seat latches for wear and function.
Safety warning lamps (brake, ABS, airbag, safety belt) for operation.
Washer spray and wiper operation. Clean or replace blades as necessary.

Multi-Point Inspection

In order to keep your vehicle running right, it is important to have the systems on your vehicle checked regularly. This can help identify potential issues and prevent major problems. Ford Motor Company recommends the following multi-point inspection be performed at every scheduled maintenance interval to help make sure your vehicle keeps running great.

Multi-point inspection – Recommended each visit	
Battery performance	Radiator, cooler, heater and A/C hoses
Exterior lamps and hazard warning system operation	Suspension component for leaks or damage
Fluid levels [*] ; fill if necessary	Tires (including spare) for wear and proper pressure ^{**}
For oil and fluid leaks	Steering and linkage
Half-shaft dust boots (if equipped)	Windshield for cracks, chips or pits
Horn operation	Washer spray and wiper operation

^{*}Brake, coolant recovery reservoir and window washer.

^{**}If your vehicle is equipped with a temporary mobility kit, check the tire sealant expiration Use By date on the canister. Replace as needed.

Be sure to ask your dealership service advisor or technician about the multi-point vehicle inspection. It's a comprehensive way to perform a thorough inspection of your vehicle. It's your checklist that gives you immediate feedback on the overall condition of your vehicle. You'll know what's been checked, what's okay, as well as those things that may require future or immediate attention. The multi-point vehicle inspection is one more way to keep your vehicle running great!

GENUINE
PARTS & SERVICE

Personal Member of:
 Personal Service & Business

Multi-Point Inspection Report Card as Recommended by Ford Motor Company

Name: _____ Days: _____ State Inspection #: _____
 Mileage: _____ Year: _____

SCHEDULED MAINTENANCE / INSPECTION

<input type="checkbox"/> Engine Air Filter	<input type="checkbox"/> Oil Filter
<input type="checkbox"/> Engine Air Filter	<input type="checkbox"/> Spark Plugs
<input type="checkbox"/> Engine Coolant	<input type="checkbox"/> Tire Rotation
<input type="checkbox"/> Fuel Filter	<input type="checkbox"/> Transmission Fluid
<input type="checkbox"/> Oil Change	

*This is only a partial list of vehicle maintenance items and is NOT all-inclusive. Please consult your Owner's Manual or visit www.ford.com/owners for vehicle specific maintenance requirements.

CHECK FLUID LEVELS AND FILL

<input type="checkbox"/> Oil and/or Oil Leaks	<input type="checkbox"/>
<input type="checkbox"/> Coolant	<input type="checkbox"/>
<input type="checkbox"/> Brake Fluid	<input type="checkbox"/>
<input type="checkbox"/> Power Steering	<input type="checkbox"/>
<input type="checkbox"/> Windshield Washer	<input type="checkbox"/>
<input type="checkbox"/> Windshield Washer	<input type="checkbox"/>
<input type="checkbox"/> Windshield Washer	<input type="checkbox"/>

BATTERY

State of Health: _____ Condition of _____

Factory spec cold cranking amps: _____

EXTERIOR BODY

None or existing exterior body damage or defects:

SYNC VEHICLE HEALTH REPORT

VMI Adherence: Yes No

CHECK FOLLOWING SYSTEMS

WASHER SYSTEM

EXHAUST SYSTEM

STEERING AND DRIVE AXLE

SAFETY

WASHER SYSTEM

EXHAUST SYSTEM

STEERING AND DRIVE AXLE

SAFETY

TIRES/BRAKE WEAR

TIRES	FRONT LEFT	FRONT RIGHT	REAR LEFT	REAR RIGHT
Tire Tread	_____ /32"	_____ /32"	_____ /32"	_____ /32"
Tire Wear Pattern	_____	_____	_____	_____
Tire Pressure - set to factory recommended PSI	_____ PSI	_____ PSI	_____ PSI	_____ PSI
Brake Lining	_____ mm /32"	_____ mm /32"	_____ mm /32"	_____ mm /32"

Comments: _____

Service Advisor: _____ Customer Signature: _____

Technician: _____

12-XXXXXXXX

© 2013 Ford Motor Company. Ford Motor Company is a registered trademark of Ford Motor Company.

2014 Focus Electric Vehicle (fob)
 Owners Guide gf, 1st Printing, May 2013
 USA (fus)

NORMAL SCHEDULED MAINTENANCE AND LOG

Normal scheduled maintenance*	
Every 12 months or 10000 miles (16000 km)	Rotate tires, inspect tire wear and measure tread depth.
	Perform multi-point inspection (recommended).
	Inspect brake pads, shoes, rotors, drums, brake linings, hoses and parking brake.
	Inspect cooling system level, strength and hoses.
	Inspect half-shaft boots.
	Inspect steering linkage, ball joints, suspension and tie-rod ends. Lubricate if equipped with grease fittings.
	Inspect wheels and related components for abnormal noise, wear, looseness or drag.

*Do not exceed one year or 10000 miles (16000 kilometers) between service intervals.

Other maintenance items	
Every 20000 miles (32000 km)*	Replace cabin air filter.
At 10 years or 150000 miles (240000 km)**	Change coolant and coolant filter.

*Cabin air filter life is dependent on exposure to dusty and dirty conditions. Vehicles operated in these conditions require frequent inspection and replacement of the cabin air filter.

**Initial replacement at 10 years or 150000 miles (240000 kilometers), then every five years or 50000 miles (80000 kilometers). The coolant must be exchanged as indicated in the Ford Motor Company *Workshop Manual*. If not performed properly, damage could occur to the cooling system components. Only use pre-mixed coolant that meets Ford Motor Company specifications found in the *Capacities and Specifications* chapter.

Scheduled Maintenance

393

Maintenance Schedule Log

DEALER VALIDATION:	DEALER VALIDATION:
P&A CODE:	P&A CODE:
RO#: HOURS:	RO#: HOURS:
DATE: MILEAGE:	DATE: MILEAGE:
DEALER VALIDATION:	DEALER VALIDATION:
P&A CODE:	P&A CODE:
RO#: HOURS:	RO#: HOURS:
DATE: MILEAGE:	DATE: MILEAGE:
DEALER VALIDATION:	DEALER VALIDATION:
P&A CODE:	P&A CODE:
RO#: HOURS:	RO#: HOURS:
DATE: MILEAGE:	DATE: MILEAGE:
DEALER VALIDATION:	DEALER VALIDATION:
P&A CODE:	P&A CODE:
RO#: HOURS:	RO#: HOURS:
DATE: MILEAGE:	DATE: MILEAGE:
DEALER VALIDATION:	DEALER VALIDATION:
P&A CODE:	P&A CODE:
RO#: HOURS:	RO#: HOURS:
DATE: MILEAGE:	DATE: MILEAGE:

Scheduled Maintenance

<p style="text-align: center;">DEALER VALIDATION:</p> <p style="text-align: center;">P&A CODE:</p> <p>RO#: HOURS:</p> <p>DATE: MILEAGE:</p>	<p style="text-align: center;">DEALER VALIDATION:</p> <p style="text-align: center;">P&A CODE:</p> <p>RO#: HOURS:</p> <p>DATE: MILEAGE:</p>
<p style="text-align: center;">DEALER VALIDATION:</p> <p style="text-align: center;">P&A CODE:</p> <p>RO#: HOURS:</p> <p>DATE: MILEAGE:</p>	<p style="text-align: center;">DEALER VALIDATION:</p> <p style="text-align: center;">P&A CODE:</p> <p>RO#: HOURS:</p> <p>DATE: MILEAGE:</p>
<p style="text-align: center;">DEALER VALIDATION:</p> <p style="text-align: center;">P&A CODE:</p> <p>RO#: HOURS:</p> <p>DATE: MILEAGE:</p>	<p style="text-align: center;">DEALER VALIDATION:</p> <p style="text-align: center;">P&A CODE:</p> <p>RO#: HOURS:</p> <p>DATE: MILEAGE:</p>
<p style="text-align: center;">DEALER VALIDATION:</p> <p style="text-align: center;">P&A CODE:</p> <p>RO#: HOURS:</p> <p>DATE: MILEAGE:</p>	<p style="text-align: center;">DEALER VALIDATION:</p> <p style="text-align: center;">P&A CODE:</p> <p>RO#: HOURS:</p> <p>DATE: MILEAGE:</p>
<p style="text-align: center;">DEALER VALIDATION:</p> <p style="text-align: center;">P&A CODE:</p> <p>RO#: HOURS:</p> <p>DATE: MILEAGE:</p>	<p style="text-align: center;">DEALER VALIDATION:</p> <p style="text-align: center;">P&A CODE:</p> <p>RO#: HOURS:</p> <p>DATE: MILEAGE:</p>

Scheduled Maintenance

395

<p style="text-align: center;">DEALER VALIDATION:</p> <p style="text-align: center;">P&A CODE:</p> <p>RO#: HOURS:</p> <p>DATE: MILEAGE:</p>	<p style="text-align: center;">DEALER VALIDATION:</p> <p style="text-align: center;">P&A CODE:</p> <p>RO#: HOURS:</p> <p>DATE: MILEAGE:</p>
<p style="text-align: center;">DEALER VALIDATION:</p> <p style="text-align: center;">P&A CODE:</p> <p>RO#: HOURS:</p> <p>DATE: MILEAGE:</p>	<p style="text-align: center;">DEALER VALIDATION:</p> <p style="text-align: center;">P&A CODE:</p> <p>RO#: HOURS:</p> <p>DATE: MILEAGE:</p>
<p style="text-align: center;">DEALER VALIDATION:</p> <p style="text-align: center;">P&A CODE:</p> <p>RO#: HOURS:</p> <p>DATE: MILEAGE:</p>	<p style="text-align: center;">DEALER VALIDATION:</p> <p style="text-align: center;">P&A CODE:</p> <p>RO#: HOURS:</p> <p>DATE: MILEAGE:</p>
<p style="text-align: center;">DEALER VALIDATION:</p> <p style="text-align: center;">P&A CODE:</p> <p>RO#: HOURS:</p> <p>DATE: MILEAGE:</p>	<p style="text-align: center;">DEALER VALIDATION:</p> <p style="text-align: center;">P&A CODE:</p> <p>RO#: HOURS:</p> <p>DATE: MILEAGE:</p>
<p style="text-align: center;">DEALER VALIDATION:</p> <p style="text-align: center;">P&A CODE:</p> <p>RO#: HOURS:</p> <p>DATE: MILEAGE:</p>	<p style="text-align: center;">DEALER VALIDATION:</p> <p style="text-align: center;">P&A CODE:</p> <p>RO#: HOURS:</p> <p>DATE: MILEAGE:</p>

COOLANT AND COOLANT FILTER CHANGE RECORD

Initial change	10 years or 150000 miles (240000 km) (whichever comes first)
After initial change	Every five years or 50000 miles (80000 km)

Coolant and Coolant Filter Change Log

<p style="text-align: center;">DEALER VALIDATION:</p> <p style="text-align: center;">P&A CODE:</p> <p>RO#: HOURS:</p> <p>DATE: MILEAGE:</p>	<p style="text-align: center;">DEALER VALIDATION:</p> <p style="text-align: center;">P&A CODE:</p> <p>RO#: HOURS:</p> <p>DATE: MILEAGE:</p>
<p style="text-align: center;">DEALER VALIDATION:</p> <p style="text-align: center;">P&A CODE:</p> <p>RO#: HOURS:</p> <p>DATE: MILEAGE:</p>	<p style="text-align: center;">DEALER VALIDATION:</p> <p style="text-align: center;">P&A CODE:</p> <p>RO#: HOURS:</p> <p>DATE: MILEAGE:</p>
<p style="text-align: center;">DEALER VALIDATION:</p> <p style="text-align: center;">P&A CODE:</p> <p>RO#: HOURS:</p> <p>DATE: MILEAGE:</p>	<p style="text-align: center;">DEALER VALIDATION:</p> <p style="text-align: center;">P&A CODE:</p> <p>RO#: HOURS:</p> <p>DATE: MILEAGE:</p>

-
- 911 Assist™337
- A**
- ABS (see Brakes)153
- Accessing and using your
USB port305
- Accessing your calendar336
- Accessory delay91
- Adding (pairing) a phone313
- Airbag supplemental restraint
system44
and child safety seats45
description44
disposal54
driver airbag44
passenger airbag44
side airbag44, 50
- Air conditioning120
- Air filter, cabin267
- Ambient mood/lighting88, 343
- Ambulance packages14
- AM/FM293
- Anti-lock brake system
(see Brakes)153
- Anti-theft system73
arming the system73–74
disarming a triggered system ..74
- Audio system
Single CD276
- Audio system (see Radio)276
- Automatic transaxle
fluid, adding215
fluid, checking215
- Automatic transmission149
fluid, refill capacities265
fluid, specification265
- Auxiliary Input Jack301
- Auxiliary powerpoint137
- A/V inputs278, 309
- B**
- Battery216
acid, treating emergencies216
jumping a disabled battery184
maintenance-free216
replacement, specifications ...267
servicing216
traction battery pack
assembly142
- Booster seats20
- Brakes153
anti-lock153
anti-lock brake system (ABS)
warning light153
brake warning light153
fluid, checking and adding215
fluid, refill capacities265
fluid, specifications265
lubricant specifications265
parking155
shift interlock150
- C**
- Capacities for refilling fluids265
- Cargo management system170
- CD276
- CD player274, 304
- CD voice commands305
- Cell phone use14
- Child safety restraints26
- Child safety seats
attaching with tether straps28

automatic locking mode (retractor)	34
LATCH	26
Child safety seats - booster seats	20
Cleaning the touchscreen	282
Cleaning your vehicle	227
engine compartment	230
instrument panel	231
interior	231
plastic parts	229
washing	227
waxing	229
wheels	233
wiper blades	230
Climate control (see Air conditioning or Heating)	120
Climate voice commands	354
Clock	341
Console	138
overhead	138
Coolant	212
checking and adding	212
refill capacities	265
specifications	265
Customer Assistance	182
Ford Extended Service Plan	271
Getting roadside assistance ...	182
Getting the service you need	190
Ordering additional owner's literature	196
Utilizing the Mediation/Arbitration Program	194
D	
Daytime running lamps (see Lamps)	84
Defrost rear window	124
Dipstick automatic transmission fluid	215
Display settings	342
Driving under special conditions	151
through water	179
E	
Electronic message center	102
Electronic stability control	158
Emergencies, roadside jump-starting	184
End user license agreement ...	368
Engine cleaning	230
service points	212
Engine fan	212
Event data recording	10
F	
Fan, Engine Cooling	209, 212
Fleet MyKey programming	60
Floor mats	180
Fluid capacities	265
Fog lamps	84
Fuses	198–199, 205

G		Instrument panel	
Gauges	95	cleaning	231
Guidance for electric and hybrid-electric vehicles	187	cluster	97
		lighting up panel and interior	83
		Intelligent Access Key	56
H		J	
Hazard flashers	183	Jump-starting your vehicle	184
HD Radio™	295	K	
Headlamps	81	Keyless entry system	
aiming	219–220	autolock	69
autolamp system	82	Keys	73
bulb specifications	226	L	
daytime running lights	84	Lamps	81
flash to pass	81	autolamp system	82
high beam	81	bulb replacement	
replacing bulbs	221–222	specifications chart	226
turning on and off	81	daytime running light	84
Head restraints	128	fog lamps	84
Heated steering wheel	352	headlamps	81
Heating		headlamps, flash to pass	81
heating and air conditioning system	120	instrument panel, dimming	83
Help	351	interior lamps	85–87
High-voltage battery		replacing bulbs	221–222
charging	142	LATCH anchors	26
service disconnect	148	Lights, warning and indicator	97
High-voltage shut off	184	Listening to music	291
Hill start assist	152	Load limits	170
Hood	210	Locks	
How to use voice commands	288	autolock	69
I		childproof	30
Illuminated visor mirror	94	doors	67
Information displays	102	Lubricant specifications	265
		Lug nuts	264

M

Making and receiving calls314
 MAP DVD - Loading and Unloading314
 Map icons364
 Map mode362
 Map preferences360
 Map updates365
 Message center102
 warning messages110
 Mirrors91, 93
 fold away92
 side view mirrors (power)91
 Motorcraft® parts227, 267
 MyFord Touch™ system279
 MyKey60

N

Navigation features355
 Navigation voice commands366
 Notifications336

P

Pairing other phones313
 Pairing your phone313
 Pairing your phone for the first time313
 Parental MyKey programming ...60
 Parking brake155
 Parts
 (see Motorcraft® parts)267
 Phone settings317, 348
 Phone voice commands318

POI categories357
 Point of Interest (POI)357
 Power distribution box
 (see Fuses)199
 Power door locks67
 Power mirrors91
 Powerpoint137
 Power steering168
 fluid, checking and adding215
 Power Windows89
 Privacy information285
 Push button start system139

Q

Quick touch buttons365

R

Radio276
 AM/FM293
 Single CD276
 Radio reception274
 Radio voice commands298
 Rear view camera display343
 Rear-view camera system160
 Receiving a text message317
 Recommendations for attaching safety restraints for children22
 Relays198–199
 Remote entry system
 illuminated entry71
 locking/unlocking doors67
 opening the trunk68
 replacing the batteries56

Reverse sensing system	160	Setting a destination	355
Roadside assistance	182	Setting a destination by voice	355
Route preferences	360	Settings	341
S		Setting the clock	341
Safety Belt Maintenance	40	Side air curtain	51
Safety belts (see Safety restraints)	33, 36	Side-curtain airbags system	51
Safety defects, reporting	197	SIRIUS® satellite radio	299
Safety information	283	SIRIUS satellite radio voice commands	300
Safety restraints	33–34, 36	SIRIUS Travel Link	333
Belt-Minder®	37	SIRIUS Travel Link voice commands	335
extension assembly	36	Snowplowing	13
for adults	33–34	SOS Post Crash Alert	43
for children	22	Special notice ambulance conversions	14
safety belt maintenance	40	Specification chart, lubricants	265
seat belt maintenance	40	Stability system	158
warning light and chime	37	Starting your vehicle	140
Safety restraints - LATCH anchors	26	jump starting	184
Safety seats for children	22	push button start system	139
Safety Compliance Certification Label	268	Steering wheel	75
Satellite Radio	299	controls	76
Scheduled Maintenance Guide Normal Scheduled Maintenance and Log	392	tilting	75
SD card	278, 305, 355	Supplemental Restraint System (SRS) (see airbags)	44
Seat belts (see Safety restraints)	33	Supported media file types	309
Seats		Supported player, media formats and metadata information	309
child safety seats	22	SYNC® customer support	283
heated	134	SYNC® Services	329
SecuriLock passive anti-theft system	73	System settings	344
Sending new text messages	316		

T

Temperature control
(see Climate control)352

Temporary mobility kit256

Text messaging315

Tilt steering wheel75

Tires236–237

- alignment250
- care236
- checking the pressure246
- inflating244
- label243
- replacing248
- rotating251
- safety practices250
- sidewall information239
- snow tires and chains251
- Temporary mobility kit256
- terminology238
- tire grades237
- treadwear237, 246

Touchscreen features
(climate)352

Towing177

- recreational towing178
- trailer towing177
- wrecker177

Traction control156

Traffic preferences360

Transmission

- brake-shift interlock (BSI)150

fluid, checking and adding
(automatic)215

fluid, refill capacities265

lubricant specifications265

Trunk72

- remote release68

U

USB port278, 305

V

Vehicle health report339

Vehicle Identification Number
(VIN)267

Vehicle loading170

Voice recognition287

W

Warning lights (see Lights)97

Washer fluid215

Water, Driving through179

Windows

- power89

- rear wiper/washer79

Windshield washer fluid and
wipers

- checking and adding fluid215

- replacing wiper blades ...218–219

Wrecker towing177