

5 YEAR
WARRANTY

Ω OMEGA™ **User's Guide**

***Shop online at
omega.com***

e-mail: info@omega.com
***For latest product manuals:
www.omegamanual.info***

iSeries



ILD24-UTP, ILD44-UTP BIG DISPLAY Universal Temperature & Process Monitor Manual



omega.com info@omega.com

Servicing North America:

**U.S.A.
Headquarters:**

Omega Engineering, Inc.
Toll-Free: 1-800-826-6342 (USA & Canada only)
Customer Service: 1-800-622-2378 (USA & Canada only)
Engineering Service: 1-800-872-9436 (USA & Canada only)
Tel: (203) 359-1660 Fax: (203) 359-7700
e-mail: info@omega.com

For Other Locations Visit omega.com/worldwide

TABLE OF CONTENTS

Part 1: Introduction	2
1.1 Description	2
1.2 Safety Considerations	3
1.3 Before You Begin	4
Part 2: Setup	5
2.1 Mounting	5
2.2 Rear Panel Connections	7
2.3 Electrical Installation	8
2.3.1 Power Connections	8
2.3.2 Thermocouple - Input Connection	9
2.3.3 Two / Three / Four Wire RTD-Hookups	10
2.3.4 Process Current - Wiring Hookup	11
2.3.5 Process Voltage - Wiring Hookup	11
2.3.6 Communication Output - Wiring Hookup.....	12
Part 3: Operation: Configuration Mode	13
3.1 Introduction	13
Turning your Instrument On for the First Time	
Buttons Functions in Configuration Mode	
3.2 Menu Configuration	14
3.2.1 ID Number	15
3.2.2 Setpoints	16
3.2.3 Configuration Menu	17
3.2.4 Input Type Menu	17
Input Type (Thermocouple)	18
Input Type (RTD).....	19
Input Type (Process)	20
3.2.5 Reading Configuration Menu	20
3.2.6 Alarm 1 Menu	24
3.2.7 Alarm 2 Menu.....	28
3.2.8 Reading Adjust Menu.....	29
3.2.9 Setpoint Deviation Menu / Field Calibration	30
3.2.10 ID Code Menu	31
3.2.11 Communication (Options) Menu.....	33
3.2.12 Display Color Selection Menu.....	39
Part 4: Specifications	42
Part 5: Factory Preset Values	45
APPROVAL INFORMATION	46

LIST OF FIGURES:

Figure 2.1	Mounting	5
Figure 2.2	Rear Panel Power Connector Labels	7
Figure 2.3	Rear Panel Input Connector Labels	7
Figure 2.4	Main Power Connections	8
Figure 2.5	Inside Cover Rear View	8
Figure 2.6	Thermocouple Wiring Hookup	9
Figure 2.7	Two/Three/Four-wire RTD	
	a) RTD-1000 ohm and 500 ohm Wiring Hookup	10
	b) RTD-100 ohm Wiring Hookup	10
Figure 2.8	Process Current Wiring Hookup (Internal and External Excitation).....	11
Figure 2.9	Process Voltage Wiring Hookup	
	a) Without Sensor Excitation	11
	b) With Sensor Excitation	11
Figure 2.10	Communication Output:	
	a) RS-232 Output – Wiring Hookup	12
	b) RS-485 Output – Wiring Hookup	12
Figure 3.1	Flow Chart for ID and Setpoints	14
Figure 3.2	Flow Chart for Configuration Menu	17
Figure 3.3	Flow Chart for Input Type Menu	17
Figure 3.4	Flow Chart for Reading Configuration	20
Figure 3.5	Flow Chart for Alarm 1	24
Figure 3.6	Flow Chart for Alarm 2	28
Figure 3.7	Flow Chart for Reading Adjust Menu	29
Figure 3.8	Flow Chart for Setpoint Deviation Menu / Field Calibration	30
Figure 3.9	Flow Chart for ID Code.....	31
Figure 3.10	Flow Chart for Communication Option	33
Figure 3.11	Flow Chart for Display Color Selection	39

LIST OF TABLES:

Table 2.1	Front Panel Annunciators.....	6
Table 2.2	Rear Panel Connector	7
Table 2.3	TC Wire Color Chart	9
Table 3.1	Button Function in Configuration Mode.....	13
Table 3.2	Conversion Table.....	23
Table 4.1	Input Properties	44
Table 5.1	Factory Preset Values	45

NOTES, WARNINGS and CAUTIONS

Information that is especially important to note is identified by following labels:

- **NOTE**
- **WARNING or CAUTION**
- **IMPORTANT**
- **TIP**



NOTE: Provides you with information that is important to successfully setup and use the Programmable Digital Meter.



CAUTION or WARNING: Tells you about the risk of electrical shock.



CAUTION, WARNING or IMPORTANT: Tells you of circumstances or practices that can effect the instrument's functionality and must refer to accompanying documents.



TIP: Provides you helpful hints.

PART 1

INTRODUCTION

1.1 Description



This device can be purchased as monitor (read process value only) or as a controller.

- The iLD Big Display monitor offers unparalleled flexibility in process measurement. Each unit allows the user to select the input type, from 10 thermocouple types (J, K, T, E, R, S, B, C, N and J DIN), Pt RTDs (100, 500 or 1000 Ω , with either 385 or 392 curve), DC voltage, or DC current. The voltage/current inputs are fully scalable to virtually all engineering units, with selectable decimal point, perfect for use with pressure, flow or other process input.
- The iLD Big Display device features a large, three color programmable display with capability to change a color every time the Alarm is triggered. Options include programmable RS-232 or RS-485 serial communication and excitation. Universal power supply accepts 100 to 240 Vac.

1.2 Safety Considerations



This device is marked with the international caution symbol. It is important to read this manual before installing or commissioning this device as it contains important information relating to Safety and EMC (Electromagnetic Compatibility).

This instrument is a panel mount device protected in accordance with EN 61010-1:2001, electrical safety requirements for electrical equipment for measurement, control and laboratory. Installation of this instrument should be done by qualified personnel. In order to ensure safe operation, the following instructions should be followed.



This instrument has no power-on switch. An external switch or circuit-breaker shall be included in the building installation as a disconnecting device. It shall be marked to indicate this function, and it shall be in close proximity to the equipment within easy reach of the operator. The switch or circuit-breaker shall meet the relevant requirements of IEC 947-1 and IEC 947-3 (International Electrotechnical Commission). The switch shall not be incorporated in the main supply cord.



Furthermore, to provide protection against excessive energy being drawn from the main supply in case of a fault in the equipment, an overcurrent protection device shall be installed.



- Do not exceed voltage rating on the label located on the top of the instrument housing.
- Always disconnect power before changing signal and power connections.
- Do not use this instrument on a work bench without its case for safety reasons.
- Do not operate this instrument in flammable or explosive atmospheres.
- Do not expose this instrument to rain or moisture.
- Unit mounting should allow for adequate ventilation to ensure instrument does not exceed operating temperature rating.
- Use electrical wires with adequate size to handle mechanical strain and power requirements. Install without exposing bare wire outside the connector to minimize electrical shock hazards.

EMC Considerations

- Whenever EMC is an issue, always use shielded cables.
- Never run signal and power wires in the same conduit.
- Use signal wire connections with twisted-pair cables.
- Install Ferrite Bead(s) on signal wires close to the instrument if EMC problems persist.

Failure to follow all instructions and warnings may result in injury!

1.3 Before You Begin

Inspecting Your Shipment:

Remove the packing slip and verify that you have received everything listed. Inspect the container and equipment for signs of damage as soon as you receive the shipment. Note any evidence of rough handling in transit. Immediately report any damage to the shipping agent. The carrier will not honor damage claims unless all shipping material is saved for inspection. After examining and removing the contents, save the packing material and carton in the event reshipment is necessary.

Customer Service:

If you need assistance, please call the nearest Customer Service Department, listed in this manual.

Manuals, Software:

The latest Operation and Communication Manual as well as free configuration software and ActiveX controls are available from **the website listed in this manual or on the CD-ROM enclosed with your shipment.**



For first-time users: Refer to the QuickStart Manual for basic operation and set-up instructions.



If you have the Serial Communications/Ethernet Option you can easily configure the controller on your computer or on-line.

To Disable Outputs:

Standby Mode is useful during setup of the instrument or when maintenance of the system is necessary. When the instrument is in standby, it remains in the ready condition but all outputs are disabled. This allows the system to remain powered and ready to go.



When the instrument is in "RUN" Mode, **push**  **twice** to disable all outputs and alarms. It is now in "STANDBY" Mode. **Push**  **once** more to resume "RUN" Mode.

PUSH  **TWICE** to disable the system during an **EMERGENCY**.

To Reset the Meter:

When the controller is in the "MENU" Mode, **push**  **once** to direct controller one step backward of the top menu item.

Push  **twice** to reset controller, prior to resuming "Run" Mode except after "Alarms", that will go to the "Run" Mode without resetting the controller.

PART 2
SETUP
2.1 Mounting

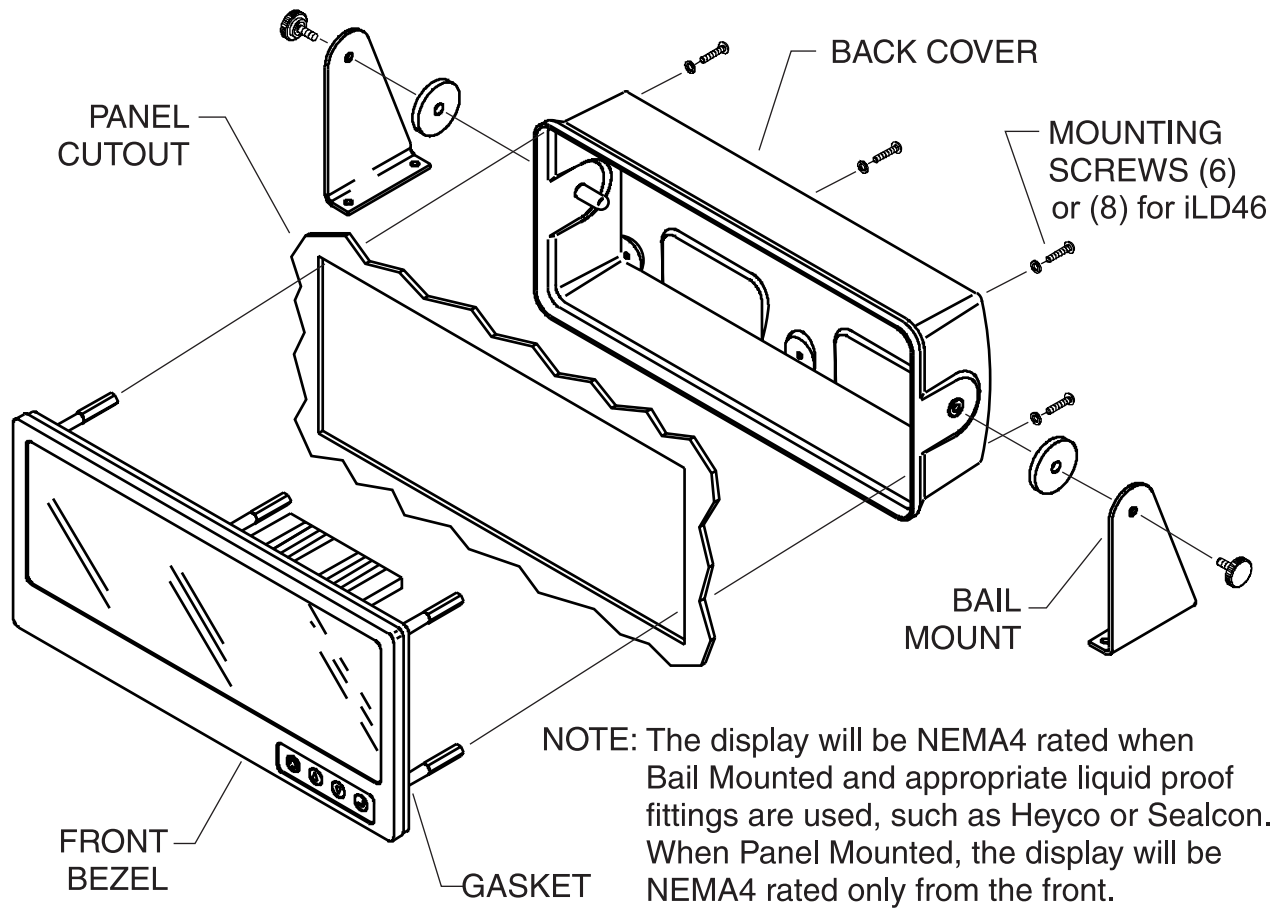

Figure 2.1 Mounting





Mounting iLD Big Display Through Panel:

1. Using the panel cutout diagram shown in your Quick Start manual, cut an opening in the panel.
2. Remove six (or eight) screws at the back of iLD Big Display to remove back cover.
3. Insert the unit into the opening from the front of the panel so the gasket seals between the bezel and the front of the panel.
4. Pass all wiring through customer drilled holes in back cover and connect wiring to terminal blocks.
5. Align back cover to iLD Big Display and reinstall screws.

Mounting iLD Big Display on Bail:

1. Remove six (or eight) screws at the back of iLD Big Display to remove back cover.
2. Pass all wiring through customer drilled holes in back cover and connect wiring to terminal blocks.
3. Align back cover to iLD Big Display and reinstall screws.
4. Mark the location of mounting screws on the flat surface.
5. Be sure to leave enough room around the bail to allow for removal and rotation of the display.
6. The display can be rotated for the best viewing angle.

Table 2.1 Front Panel Annunciators

1	Output 1/Setpoint 1/ Alarm 1 indicator
2	Output 2/Setpoint 2/ Alarm 2 indicator
°C	°C unit indicator
°F	°F unit indicator
	Changes display to Configuration Mode and advances through menu items*
	Used in Program Mode and Peak Recall*
	Used in Program Mode and Valley Recall*
	Accesses submenus in Configuration Mode and stores selected values*

* See Part 3 Operation: Configuration Mode

2.2 Rear Panel Connections

The rear panel connections are shown in Figures 2.2 and 2.3.

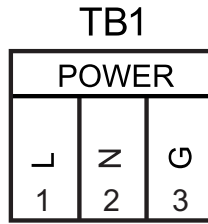

Figure 2.2 Rear Panel Power Connections

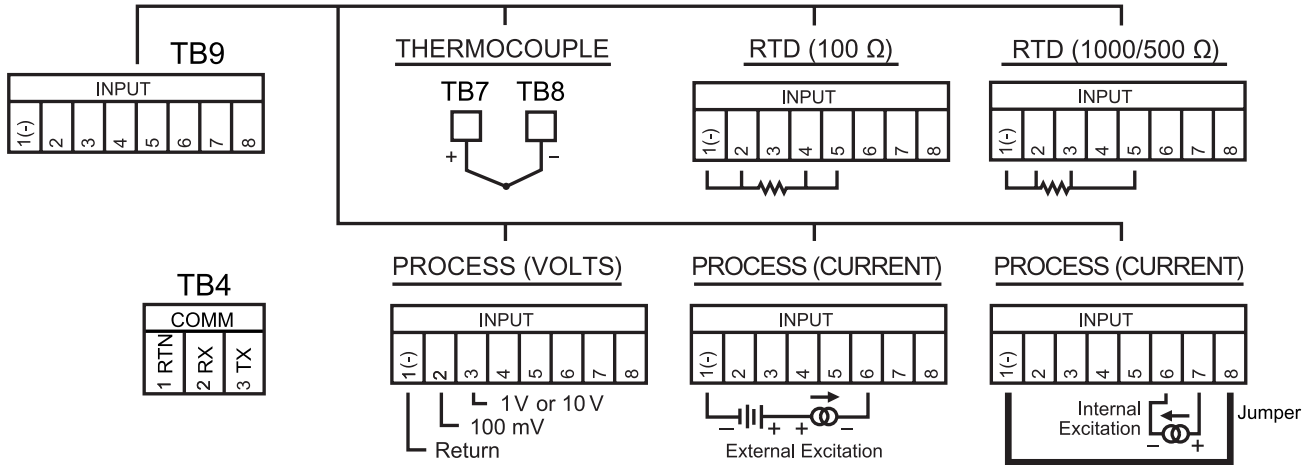

Figure 2.3 Rear Panel Input Connections

Table 2.2 Rear Panel Connector

POWER	AC Power Connector: All models
INPUT	Input Connector: TB7 & TB8 for TC models TB9 for PR (Process) & RTD models
OPTION	Based on one of the following models: RS-232C or RS-485

2.3 Electrical Installation

2.3.1 Power Connections



Caution: Do not connect power to your device until you have completed all input and output connections. Failure to do so may result in injury!

Connect the main power connections as shown in Figure 2.4.

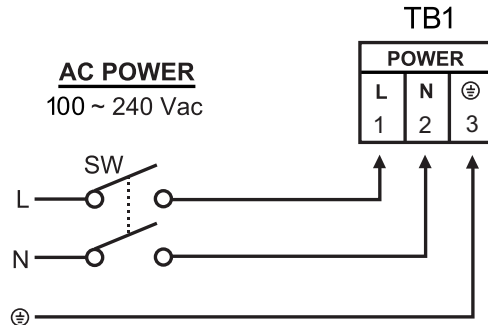

Figure 2.4 Main Power Connections

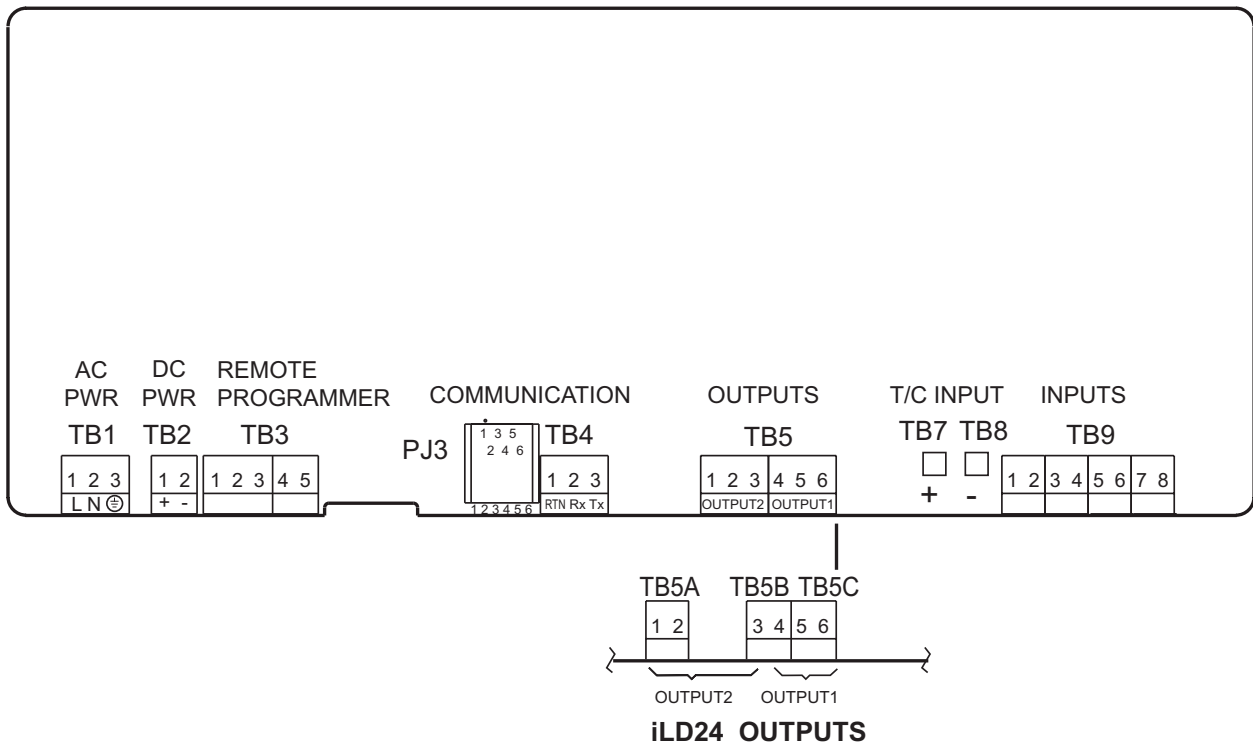

Figure 2.5 Inside Cover Rear View

2.3.2 Thermocouple

The figure below shows the wiring hookup for any thermocouple type. For example, for Type K hookup, connect the yellow wire to the TB7 terminal and the red wire to the TB8 terminal.

When configuring your controller, select Thermocouple and Thermocouple Type in the Input Type menu (see Part 3).

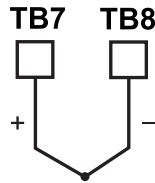

Figure 2.6 Thermocouple Wiring Hookup

Table 2.3 TC Wire Color Chart

TYPE	Input Connector		Jacket (external insulation)	
	Terminal 8 (-)	Terminal 7 (+)	Extension	Grade
J	Red	White	dark-Brown	Black
K	Red	Yellow	dark-Brown	Yellow
T	Red	Blue	dark-Brown	Blue
E	Red	Purple	dark-Brown	Purple
N	Red	Orange	dark-Brown	Brown
R	Red	Black	-	Green
S	Red	Black	-	Green
B	Red	Gray	-	Black

2.3.3 Two/Three/Four-Wire RTD

The figures below show the input connections and input connector jumpers (shown in bold lines) required to hookup a 2-, 3- or 4-wire RTD.

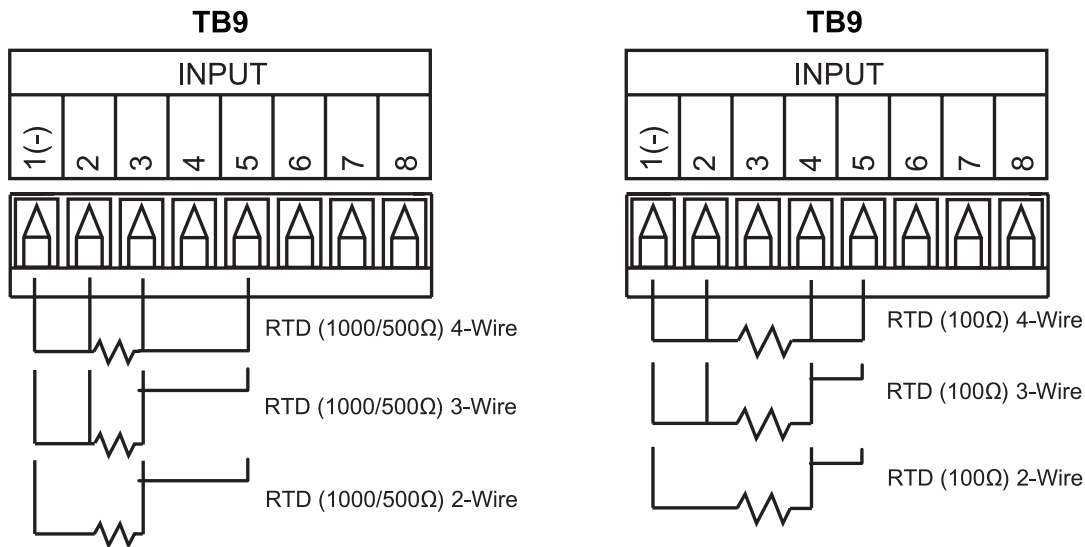

Figure 2.7

a) RTD-1000 ohm and 500 ohm Wiring Hookup

b) RTD-100 ohm Wiring Hookup

The **two-wire** connection is simplest method, but does not compensate for lead-wire temperature change and often requires calibration to cancel lead-wire resistance offset.

The **three-wire** connection works best with RTD leads closely equal in resistance. The device measures the RTD, plus upper and lower lead drop voltage and the subtracts twice the measured drop in the lower supply current lead producing excellent lead-resistance cancellation for balanced measurements.

The **four-wire** RTD hookup is applicable to unbalanced lead resistance and enables the device to measure and subtract the lead voltage, which produces the best lead-resistance cancellation.

When configuring your controller, select RTD type and RTD value in the Input Type menu (see Part 3).



If the input wires of the meter get disconnected or broken, it will display **OPN** "Input (+) Open" message except in case of 500/1000 Ω 2-wire RTD. In this case the display shows **-OPN** "Input (-) Open" message. For safety purpose you may want to set up your alarm to be triggered when input is open. See Alarm 1 & 2 chapters for details.

2.3.4 Process Current

The figure below shows the wiring hookup for Process Current 0 – 20 mA.

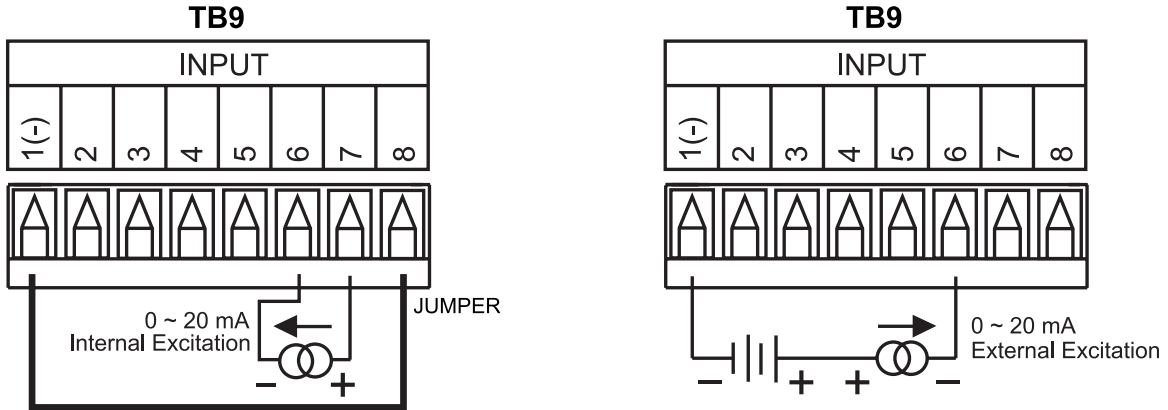

Figure 2.8 Process Current Wiring Hookup (Internal and External Excitation)

When configuring your instrument, select Process Type in the Input Type Menu (see Part 3).

2.3.5 Process Voltage

The figure below shows the wiring hookup for Process Voltage 0 – 100 mV, 0 – 1 V, 0 – 10 V.

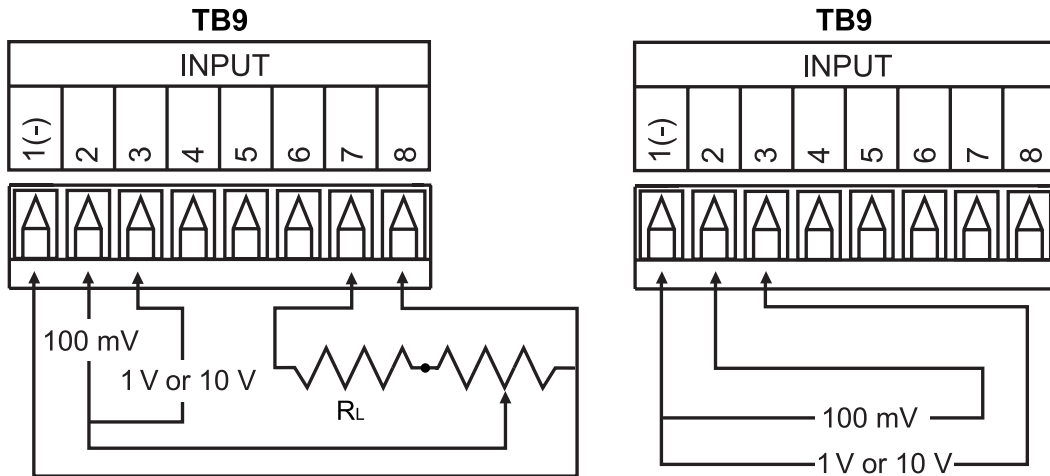

Figure 2.9
a) Process Voltage Wiring Hookup with Sensor Excitation **b) Process Voltage Wiring Hookup without Sensor Excitation**

R_L - Voltage limiting resistor, which allows conversion of the 24 Vdc internal excitation voltage to the appropriate process input value. For instance: if the potentiometer value is equal to 10 k Ω , the minimum R_L is 14 k Ω for 10 V process input.

When configuring your instrument, select Process Type in the Input Type Menu (see Part 3).

2.3.6 Communication Output

This device may have a programmable communication output. The RS-232 and RS-485 Output Connection are shown below.



Figure 2.10

a) RS-232 Output Wiring Hookup b) RS-485 Output Wiring Hookup

PART 3

OPERATION: Configuration Mode



















3.1 Introduction

The instrument has two different modes of operation. The first, Run Mode, is used to display values for the Process Variable, and to display or clear Peak and Valley values. The other mode, Menu Configuration Mode, is used to navigate through the menu options and configure the controller. Part 3 of this manual will explain the Menu Configuration Mode. For your instrument to operate properly, the user must first "program" or configure the menu options.

Turning your Controller On for the First Time

The device becomes active as soon as it is connected to a power source. It has no On or Off switch. The device at first momentarily shows the software version number, followed by reset **RSE**, and then proceeds to the Run Mode.

Table 3.1 Button Function in Configuration Mode

 MENU	<ul style="list-style-type: none"> • To enter the Menu, the user must first press  button. • Use this button to advance/navigate to the next menu item. The user can navigate through all the top level menus by pressing . • While a parameter is being modified, press  to escape without saving the parameter.
 (UP)	<ul style="list-style-type: none"> • Press the up  button to scroll through “flashing” selections. When a numerical value is displayed press this key to increase value of a parameter that is currently being modified. • Holding the  button down for approximately 3 seconds will speed up the rate at which the set point value increments. • In the Run Mode press  causes the display to flash the PEAK value – press again to return to the Run Mode.
 (DOWN)	<ul style="list-style-type: none"> • Press the down  button to go back to a previous Top Level Menu item. • Press this button twice to reset the controller to the Run Mode. • When a numerical value is flashing (except set point value) press  to scroll digits from left to right allowing the user to select the desired digit to modify. • When a setpoint value is displayed press  to decrease value of a setpoint that is currently being modified. Holding the  button down for approximately 3 seconds will speed up the rate at which the setpoint value is decremented. • In the Run Mode press  causes the display to flash the VALLEY value – press again to return to the Run Mode.
 ENTER	<ul style="list-style-type: none"> • Press the enter  button to access the submenus from a Top Level Menu item. • Press  to store a submenu selection or after entering a value — the display will flash a SEED message to confirm your selection. • To reset flashing Peak or Valley press . • In the Run Mode, press  twice to enable Standby Mode with flashing Stby.



Reset: Except for Alarms, modifying any settings of the menu configuration will reset the instrument prior to resuming Run Mode.

3.2 Menu Configuration

Note It is recommended that you put the controller in the Standby Mode for any configuration change other than Setpoints & Alarms.

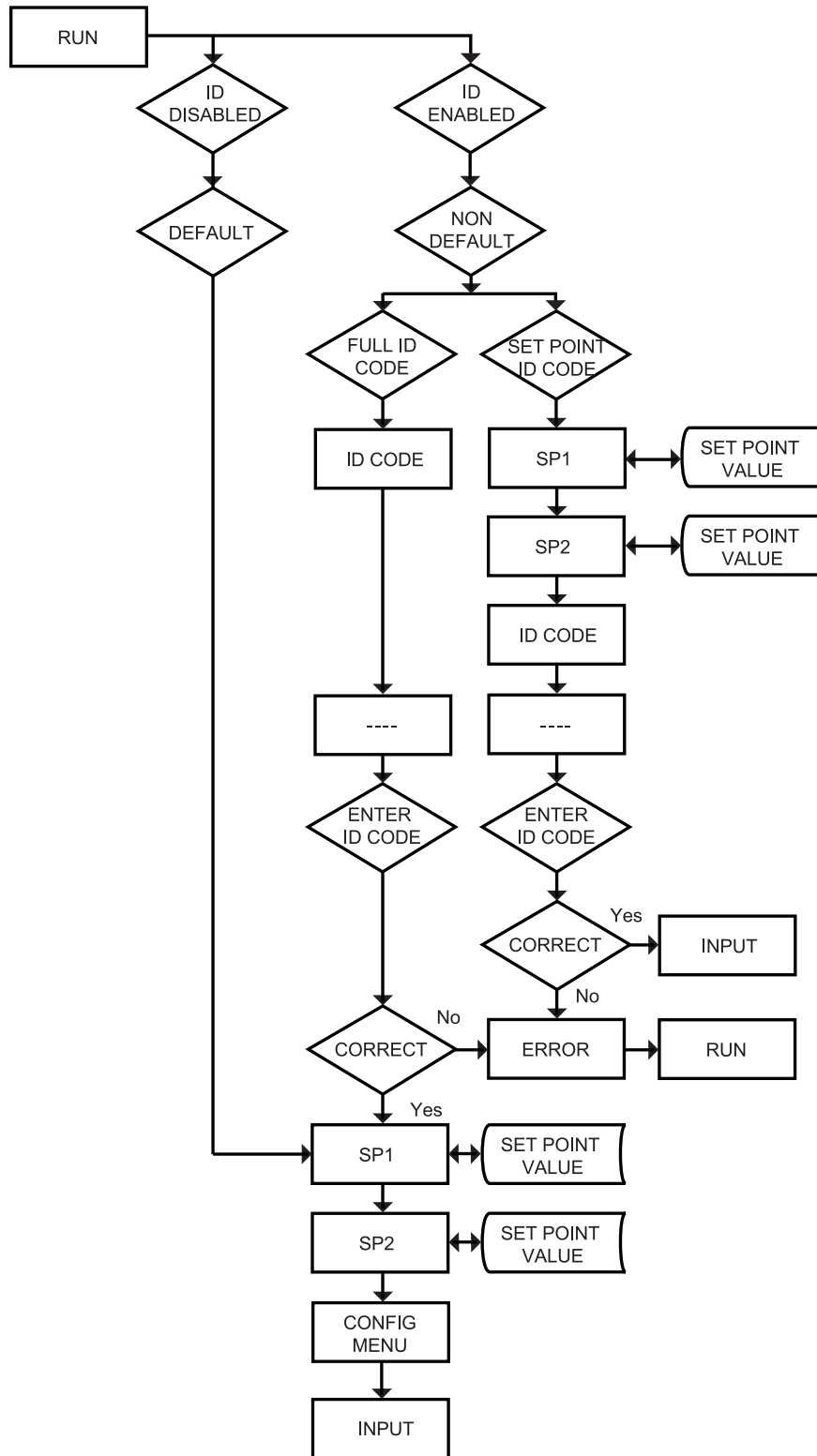

Figure 3.1 Flow Chart for ID and Setpoints

3.2.1 ID Number









SEE ID MENU SELECTION IN CONFIGURATION SECTION FOR ENABLE/DISABLE OR CHANGE ID CODE.

Note If ID Code is **Disabled** or set as **Default** (0000) the menu will skip ID step to Setpoint Menu.

If ID Code is set to **Full Security Level** and user attempts to enter the Main Menu, they will be prompted for an ID Code.









If ID Code is set to **Setpoint/ID Security Level** and user attempts to enter the Configuration Menu, they will be prompted for an ID Code.

ENTERING YOUR NON-DEFAULT FULL SECURITY ID NUMBER.

- Press  1) Display shows **Id**.
- Press  2) Display advances to **----**.
- Press  &  3) Press  to increase digit 0-9. Press  to activate next digit (flashing). Continue to use  and  to enter your 4-digit ID code.
- Press  4) If the correct ID code is entered, the menu will advance to the Setpoint 1 Menu, otherwise an error message **ERR** will be displayed and the instrument will return to the Run Mode.

Note To change ID Code, see ID Menu in the Configuration section.

ENTERING YOUR NON-DEFAULT SETPOINT/ID SECURITY ID NUMBER.







- Press  5) Display shows **SP1** Setpoint 1 Menu.
- Press  6) Display shows **SP2** Setpoint 2 Menu.
- Press  7) Display shows **Id** ID Code Menu.
- Press  8) Display advances to **----**.
- Press  &  9) Use  and  to change your ID Code.
- Press  10) If correct ID Code is entered, the display will advance to the **INPE** Input Menu, otherwise the error message **ERR** will be displayed and the controller will return to the Run Mode.

Note To prevent unauthorized tampering with the setup parameters, the instrument provides protection by requiring the user to enter the ID Code before allowing access to subsequent menus. If the ID Code entered does not match the ID Code stored, the controller responds with an error message and access to subsequent menus will be denied.







Tip Use numbers that are easy for you to remember. If the ID Code is forgotten or lost, call customer service with your serial number to access and reset the default to **0000**.

3.2.2 Set Points





SETPOINT 1:



- Press  1) Press , if necessary until **SP1** prompt appears.
Press  2) Display shows previous value of "Setpoint 1".
Press  &  3) Press  and  to increase or decrease Setpoint 1 respectively.



 Holding  &  buttons down for approximately 3 seconds will speed up the rate at which the Setpoint value increments or decrements.

- Press  &  4) Continue to use  and  to enter your 4-digit Setpoint 1 value.
Press  5) Display shows **SEtRd** stored message momentarily and then advances to **SP2** only, if a change was made, otherwise press  to advance to **SP2** Setpoint 2 Menu.

SETPOINT 2:

- Press  6) Display shows previous value of "Setpoint 2".
Press  &  7) Press  and  to increase or decrease Setpoint 2 respectively.

 Holding  &  buttons down for approximately 3 seconds will speed up the rate at which the setpoint value increments or decrements.

- Press  8) Display shows **SEtRd** stored message momentarily and then advances to **ENFG** only, if a change was made, otherwise press  to advance to **ENFG** Configuration Menu.

3.2.3 Configuration Menu

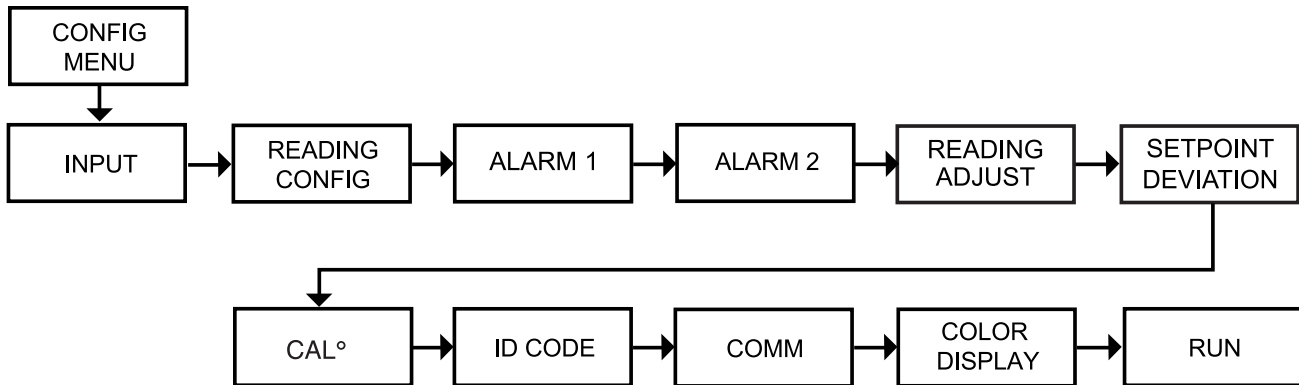

Figure 3.2 Flow Chart for Configuration Menu

Enter Configuration Menu:

- Press 1) Press , if necessary, until **ENFG** prompt appear.
- Press 2) Display advances to **INPE** Input Menu.
- Press 3) Pressing and releasing to scroll through all available menus of Configuration section.

3.2.4 Input Type Menu

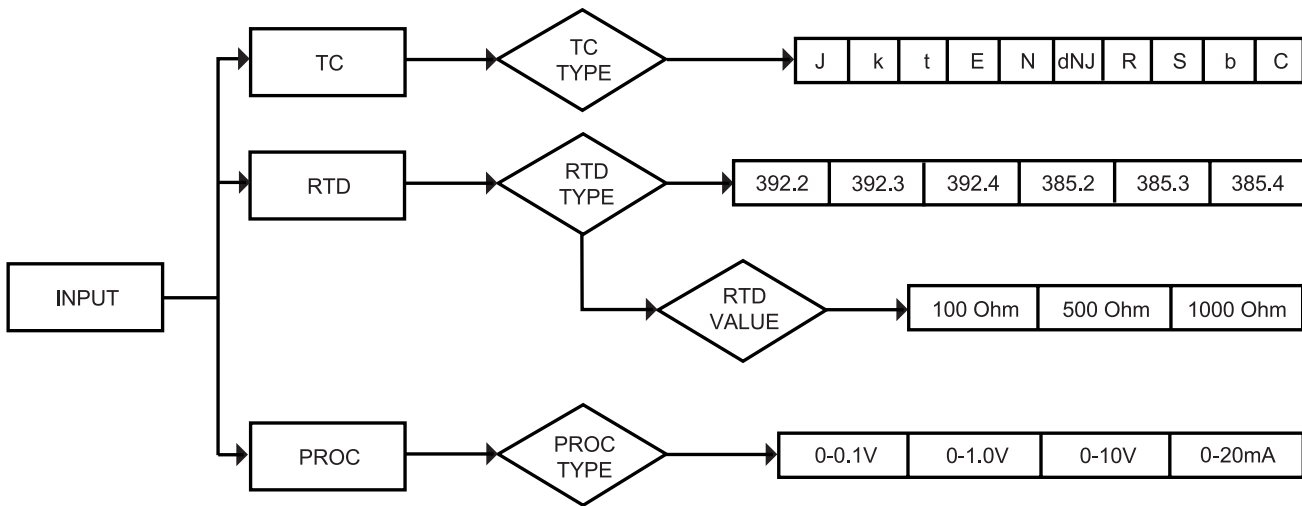

Figure 3.3 Flow Chart for Input Type Menu

Input Type (Thermocouple)

ENTER INPUT TYPE MENU:

- Press **↻** 1) Press **↻**, if necessary, until **ENFG** prompt appears.
Press **↻** 2) Display advances to **INPE** Input Menu.
Press **↻** 3) Display flashes **E.C**, **RTD** or **PROC** (Thermocouple, RTD or Process). If the displayed input type is **E.C**, press **↻** to skip to step 6 (**E.C** stops flashing).

THERMOCOUPLE SUBMENU:





- Press **▲** 4) Scroll through the available selection to **E.C** (flashing).
Press **↻** 5) Display shows **SErD** stored message momentarily and then **E.C** (not flashing).
Press **↻** 6) Display flashes previous thermocouple type selection. i.e. **J** (see below for types).
Press **▲** 7) Scroll through the available thermocouple types to the selection of your choice.
Press **↻** 8) Display shows **SErD** stored message momentarily and then advances to the **RdG** Reading Configuration Menu.

Note Use the Input Type (Thermocouple) (RTD) or (Process) and verify your Electrical Installation (see section 2.3).





Thermocouple Types: J, K, T, E, N, DIN J, R, S, B, C
Display: **J** **R** **E** **E** **N** **DNJ** **R** **S** **B** **C**

Input Type (RTD)

ENTER INPUT TYPE MENU:

- Press  1) Press , if necessary, until **ENFG** prompt appears.
Press  2) Display advances to **INPE** Input Menu.
Press  3) Display flashes **E.d**, **RTd** or **PR00** (Thermocouple, RTD or Process). If the displayed input type is **RTd**, press  to skip to step 6 (**RTd** stops flashing).



RTD SUBMENU:

- Press  4) Scroll through the available selection to **RTd** (flashing).
Press  5) Display shows **SErD** stored message momentarily and then **RTd** (not flashing).
Press  6) Display flashes previous RTD type selection i.e. **392.2** (see below for RTD types selection).
Press  7) Scroll through the available RTD types to the selection of your choice.
Press  8) Display shows **SErD** stored message momentarily and then advances to **RTd** RTD value.

RTD Types: 392 385 Two, Three or Four-wire
Display: **392.2**, **392.3**, **392.4**, **385.2**, **385.3**, **385.4**

 Last digit indicates: 2-, 3- or 4-wire input.

RTD VALUE SUBMENU:

- Press  9) Display flashes previous RTD value selection i.e. **100.0** (see below for RTD value selection).
Press  10) Scroll through the available RTD values to the selection of your choice.
Press  11) Display shows **SErD** stored message momentarily and then advances to **RdC** Reading Configuration Menu.

RTD Values: 100 ohm 500 ohm 1000 ohm
Display: **100.0** **500.0** **1000.0**

Input Type (Process)

ENTER INPUT TYPE MENU:

- Press **⏪** 1) Press **⏪**, if necessary, until **ENFG** prompt appears.
 Press **⏩** 2) Display advances to **INPE** Input Menu.
 Press **⏪** 3) Display flashes **E.C.**, **RTD** or **PROC** (Thermocouple, RTD or Process). If the displayed input type is **PROC**, press **⏪** to skip to step 6 (**PROC** stops flashing).

PROCESS SUBMENU:

- Press **⏩** 4) Scroll through the available selection to **PROC** (flashing).
 Press **⏪** 5) Display shows **SErD** stored message momentarily and then **PROC** (not flashing).
 Press **⏪** 6) Display flashes previous Process type selection. i.e. **0-10** (see below for Process types selection).
 Press **⏩** 7) Scroll through the available Process types to the selection of your choice.
 Press **⏪** 8) Display shows **SErD** stored message and then advances to **RDc** Reading Configuration Menu.

Process Types: 100 mV 1 V 10 V 0 – 20 mA
 Display: **0-0.1** **0-1.0** **0-10** **0-20**

For 4-20 mA Input select 0-20 mA then adjust the Input/Reading accordingly. To adjust 4-20 mA input, see example under INPUT/READING submenu. The factory preset value is 4-20 mA.

3.2.5 Reading Configuration

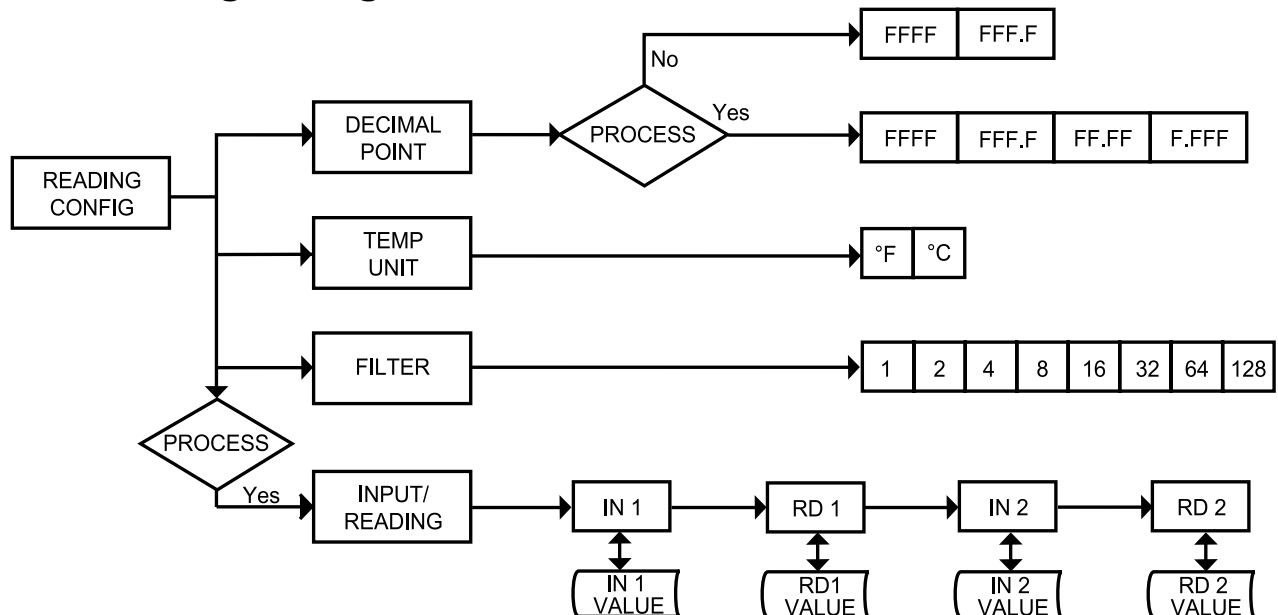









Figure 3.4 Flow Chart for Reading Configuration Menu

ENTER READING CONFIGURATION MENU:

- Press  1) Press , if necessary, until **ENFG** prompt appears.
- Press  2) Display advances to **INPE** Input Menu.
- Press  3) Display advances to **RdG** Reading Configuration Menu.
- Press  4) Display advances to **dEC** Decimal Point.



DECIMAL POINT SUBMENU:

- Press  5) Display flashes previous selection for Decimal location.
- Press  6) Scroll through the available selections and choose Decimal location: **FFFF** or **FFF.F** (also **FF.FF** and **F.FFF** — if **PROC** Process type was selected in the Input Type Menu).
- Press  7) Display shows **SEr d** stored message momentarily and then advances to **TEMP** Temperature Unit.





Note 

Decimal Point for Process Input Type is passive.

TEMPERATURE UNIT SUBMENU:

- Press  8) Display flashes previous Temperature Unit selection.
- Press  9) Scroll through the available selections to the Temperature Unit of your choice: **F** or **C**.
- Press  10) Display shows **SEr d** stored message momentarily and then advances to **FLER** Filter Constant.

FILTER CONSTANT SUBMENU:

- Press  11) Display flashes previous selection for Filter Constant.
- Press  12) Scroll through the available selections:
0001, **0002**, **0004**, **0008**, **0016**, **0032**, **0064**, **0128**
- Press  13) Display shows **SEr d** stored message momentarily only, if change was made, otherwise press  to advance to the next menu.

Note 

If Process was selected in the Input Type Menu the display will advance to **IN.Rd** Input/Reading Submenu, otherwise the display advances to the **ALR 1** Alarm 1 Menu.

The Filter Constant Submenu allows the user to specify the number of readings stored in the Digital Averaging Filter.

Tip 

For PID control select filter value 0001-0004. A filter value of 2 is approximately equal to 1 second RC low pass time constant.

Reading Configuration (If Process was selected)

INPUT/READING (SCALE AND OFFSET) SUBMENU:

Input Voltage or Current can be converted or scaled into values appropriate for the process or signal being measured. So, a reading may be displayed, for example, in units of weight or velocity instead of in amperes or volts.

The instrument determines Scale and Offset values based on two user-provided input values entered with the corresponding readings. Note that “In1” Input 1 and “In2” Input 2 are represented and entered as a product of the input voltage/current and the conversion number from the Table 3.1.

Note The following instructions include details for a specific scenario in which a 4-20 mA input (in the 20 mA Process Mode) is to be represented as a measurement of 0-100 percent.

- Press **↵** 14) Press **↵** at the **IN.Rd** prompt. Display shows **IN 1** Input 1 submenu.
- Press **↵** 15) Display shows Input 1 value with 1st digit flashing.
- Press **▲ & ▼** 16) Use **▲** and **▼** buttons to enter **IN 1** value.
The **IN 1** value = min. input value * conversion number.

Note Disregard the position of the decimal point, such that 2000 counts may actually appear as “200.0”, “20.00”, or “2.000”.

Example: 4 mA as $4(\text{mA}) \times 500 = 2000$.

- Press **↵** 17) Display advances to **Rd 1** Reading 1 Submenu.
- Press **▲ & ▼** 18) Use **▲** and **▼** buttons to enter **Rd 1** value.
This value represents **IN 1** in terms of some meaningful engineering units. To show the 4 mA as zero percent enter **Rd 1** value = 0000.
Example: **Rd 1** value = 0000.
- Press **↵** 19) Display **IN 2** Input 2 Submenu.
- Press **↵** 20) Display shows Input 2 value with 1st digit flashing.
The **IN 2** value = max. input value * conversion number.
Example: $20(\text{mA}) \times 500 = 10000$ (9999).
- Press **▲ & ▼** 21) Use **▲** and **▼** buttons to enter **IN 2** value.
- Press **↵** 22) Display advances to **Rd 2** Reading 2 Submenu.
- Press **▲ & ▼** 23) Use **▲** and **▼** buttons to enter **Rd 2** value.
Example: **Rd 2** value = 0100.
- Press **↵** 24) Display flashes **SE.Rd** stored message momentarily and then advances to **ALR 1** only, if change was made, otherwise press **↵** to advance to **ALR 1** Alarm 1 Menu.



Conversion number is a coefficient of conversion between input values and real full display range (10000 counts, shown as 9999). See Table 3.2 below for proper conversion number.

Table 3.2 Conversion Table

RANGE	CONVERSION NUMBER
100 mV	$10000 / (100 \times 1) = 100$
1 V	$10000 / (1000 \times 1) = 10$
10 V	$10000 / (1000 \times 10) = 1$
0 -20 mA	$10000 / (20 \times 1) = 500$

Example =

0 - 1 V = 0 - 100.0

In 1 = 0

Rd 1 = 0

Inp 2 = 9999

Rd 2 = 100.0

3.2.6 Alarm 1

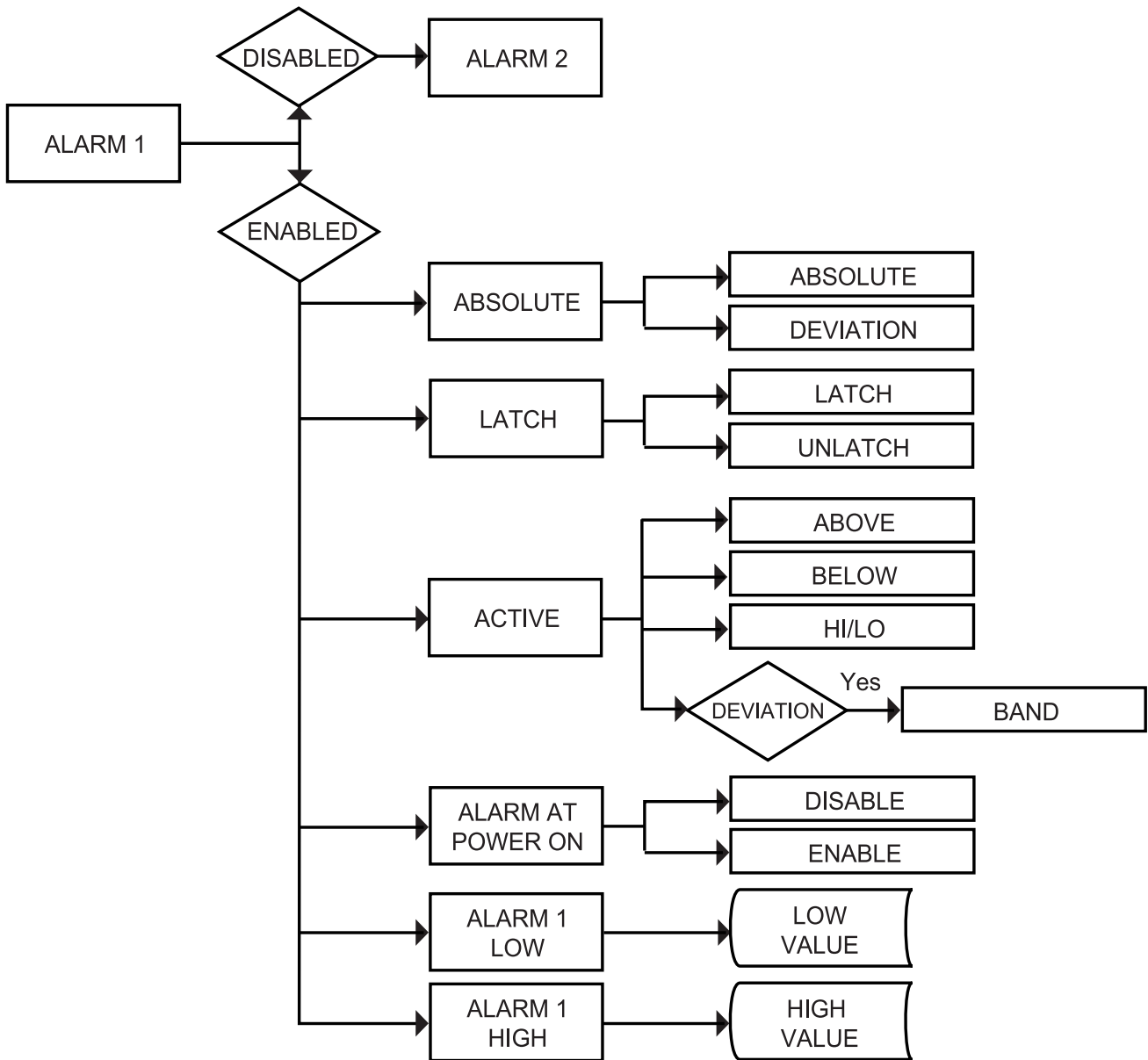

Figure 3.5 Flow Chart for Alarm 1

ENTER ALARM 1 MENU:

- Press 1) Press , if necessary, until **ENFG** prompt appears.
- Press 2) Display advances to **INPE** Input Menu.
- Press 3) Press , if necessary, until Display advances to **ALR1** Alarm 1 Menu.
- Press 4) Display advances to Alarm 1 **ENbL** Enable or **dSbL** Disable Submenu and flashes the previous selection.

ALARM 1 ENABLE/DISABLE SUBMENU:

- Press ▲ 5) Scroll through the available selection until **ENBL** displays to use Alarm 1.
- Press ⬇ 6) Display shows **SEtRd** stored message momentarily and then advances to **AbSd** only if it was changed, otherwise press ⬇ to advance to **AbSd** Alarm 1 Absolute/Deviation Submenu.



If **dSbL** Alarm 1 **Disabled** was selected, all submenus of Alarm 1 Menu will be skipped and meter advances to **ALR2** Alarm 2 Menu. If **ENBL** Alarm 1 **Enabled** was selected, Output 1 would be automatically Disabled, and reassigned as Alarm 1.

ALARM 1 ABSOLUTE/DEVIATION SUBMENU:

- Press ⬇ 7) Display flashes previous selection. Press ▲ to **AbSd** Absolute or **dEN** Deviation.
- Press ⬇ 8) Display shows **SEtRd** stored message momentarily and then advances to **LEcH** only if it was changed, otherwise press ⬇ to advance to **LEcH** Alarm 1 Latch/Unlatch Submenu.

Absolute Mode allows Alarm 1 to function independently from Setpoint 1. If the process being monitored does not change often, then "Absolute" Mode is recommended.

Deviation Mode allows changes to Setpoint 1 to be made automatically to Alarm 1. Deviation mode is typically the ideal mode if the process temperature changes often. In Deviation Mode, set Alarm 1 a certain number of degrees or counts away from Setpoint 1 — this relation remains fixed even if Setpoint 1 is changed.





ALARM 1 LATCH/UNLATCH SUBMENU:

- Press ⬇ 9) Display flashes previous selection. Press ▲ to **LEcH** Latched or **UNLE** Unlatched.
- Press ⬇ 10) Display shows **SEtRd** stored message momentarily and then advances to **CE.CL** only, if it was changed, otherwise press ⬇ to advance to **CE.CL** Contact Closure Submenu.

Latched Mode: Relay remains "latched" until reset. To reset already latched alarm, select Alarm Latch and press Max twice (i.e. Unlatch and then back to Latch) or from a Run Mode, push ⬇ twice to put the controller in Standby Mode and then push ⬇ one more time to return to the Run Mode.

Unlatched Mode: Relay remains latched only as long as the alarm condition is true.

ACTIVE SUBMENU:

- Press  11) Display flashes previous selection. Press  to scroll through the available selections: **AbOv** Above, **bELo** Below, **HI.Lo** HI/Low and **bANd** Band. (Band is active if **DEv** Deviation was selected).
- Press  12) Display shows **StRd** stored message momentarily and then advances to **A.P.oN** only if it was changed, otherwise press  to advance to **A.P.oN** Alarm Enable/Disable at Power On Submenu.

Above: Alarm 1 condition triggered when the process variable is greater than the Alarm Hi Value (Low value ignored).

Below: Alarm 1 condition triggered when the process variable is less than the Alarm Low Value (Hi value ignored).

Hi/Low: Alarm 1 condition triggered when the process variable is less than the Alarm Low Value or above the Hi Value.

Band: Alarm 1 condition triggered when the process variable is above or below the "band" set around Setpoint 1. Band equals Hi Value (Low Value ignored). A "band" is set around the Setpoint by the instrument only in the "Deviation" Mode.

ALARM ENABLE/DISABLE AT POWER ON:

- Press **↩** 15) Display flashes previous selection. Press **▲** to **ENBL** enable or **DSBL** disable.
- Press **↩** 16) Display shows **SEtPd** stored message. momentarily and then advances to **ALR.L** only if it was changed, otherwise press **↩** to advance to the **ALR.L** Alarm 1 Low Value Submenu.



If the alarm is enabled at Power On, the alarm will be active right after reset. If the alarm is disabled at Power On, the alarm will become enabled when the process value enters the non alarm area. The alarm is not active while the process value is approaching Setpoint 1.

ALARM 1 LOW VALUE SUBMENU:

- Press **↩** 17) Display flashes 1st digit of previous value. Use **▲** and **▼** to enter new value.
- Press **▲** & **▼** 18) Use **▲** and **▼** to enter Alarm 1 Low Value.
- Press **↩** 19) Display shows **SEtPd** storage message momentarily and then advances to **ALR.H** only, if it was changed, otherwise press **↩** to advance to **ALR.H** Alarm 1 Hi Value Submenu.

ALARM 1 HI VALUE SUBMENU:

- Press **↩** 20) Display flashes 1st digit of previous value. Use **▲** and **▼** to enter new value.
- Press **▲** & **▼** 21) Use **▲** and **▼** to enter Alarm1 Hi Value.
- Press **↩** 22) Display shows **SEtPd** stored message momentarily and then advances to the next menu only, if it was changed, otherwise press **↩** to advance to the next menu.

3.2.7 Alarm 2

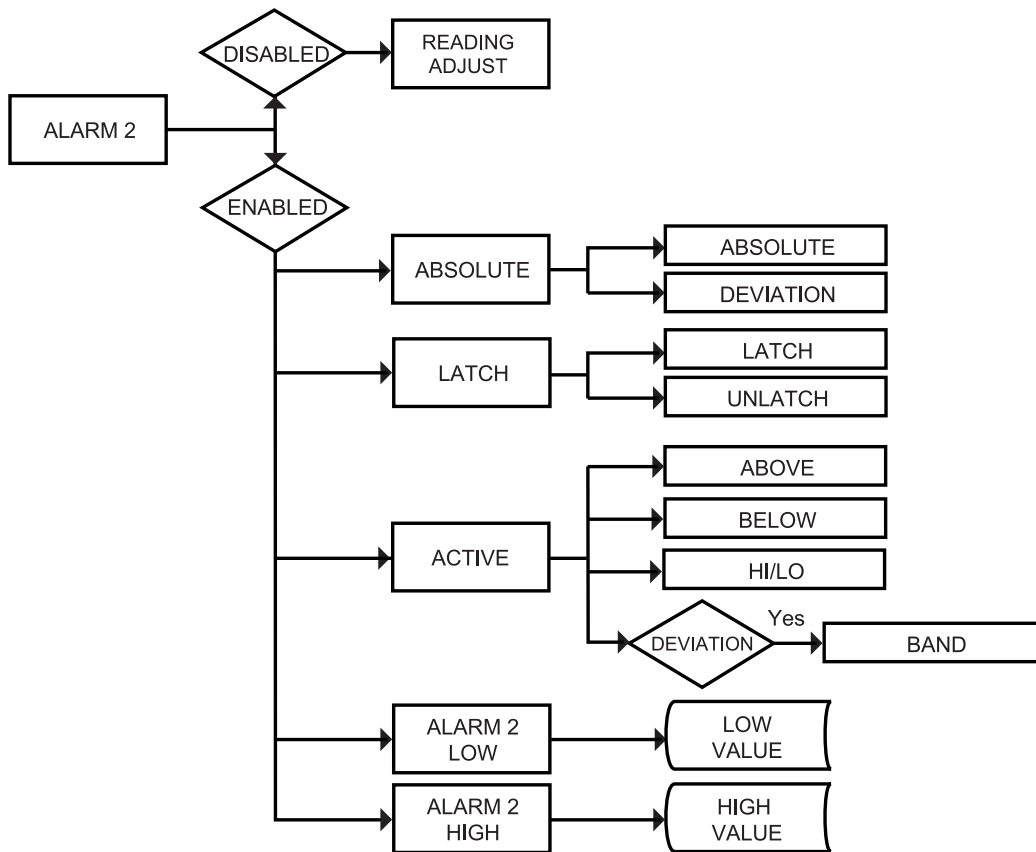

Figure 3.6 Flow Chart for Alarm 2

ENTER ALARM 2 MENU:

- Press 1) Press , if necessary, until **ENFG** prompt appears.
- Press 2) Display advances to **INPE** Input Menu.
- Press 3) Press , if necessary, until Display advances to **ALR2** Alarm 2 Menu.
- Press 4) Display advances to Alarm 2 **ENBL** Enable or **DSBL** Disable Submenu.

ALARM 2 ENABLE/DISABLE SUBMENU:

- Press 5) Display flashes previous selection. Press until **ENBL** displays to use Alarm 2.
- Press 6) Display shows **STORd** stored message momentarily and then advances to **AbSo** only if it was changed, otherwise press to advance to **AbSo** Absolute/Deviation Submenu.

If **DSBL** Alarm 2 **Disabled** was selected, all submenus of Alarm 2 will be skipped and meter advances to **R.AdJ** Cold Junction (C.J.) Reading Adjust Menu.



The remaining Alarm 2 menu items are identical to Alarm 1 Menu. Modifying Alarm Settings will not reset the instrument.

3.2.8 Reading Adjust Menu

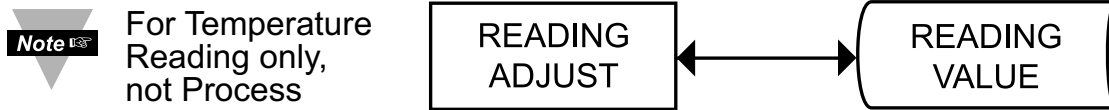

Figure 3.7 Flow Chart for Reading Adjust Menu

ENTER READING ADJUST MENU:

- Press **↩** 1) Press **↩**, if necessary, until **ENFG** prompt appears.
- Press **↩** 2) Display advances to **INPE** Input Menu.
- Press **↩** 3) Press **↩**, if necessary, until Display advances to **R.ADJ** Reading Adjust Menu.

READING ADJUST VALUE SUBMENU:

- Press **↩** 4) Display flashes 1st digit of previous Reading Adjust value.
- Press **▲** & **▼** 5) Press **▲** and **▼** buttons to enter a new Reading Adjust value (-1999 to 9999).
- Press **↩** 6) Display shows **SEr d** stored message momentarily and then advances to **SP.dV** Setpoint Deviation Menu.

Reading Offset Adjust allows the user to fine tune a minor error of the transducer, however some applications may require a large offset adjust. (Displayed Process Value = Measured Process Value ±R.ADJ). Reading Adjust value is adjustable between -1999 to 9999.

3.2.9 Setpoint Deviation Menu / Field Calibration

ENTER SETPOINT DEVIATION MENU:

- Press 1) Press , if necessary, until **ENFG** prompt appears.
- Press 2) Display advances to **INPE** Input Menu.
- Press 3) Press , if necessary, until Display advances to **SP.d4** Setpoint Deviation Menu.

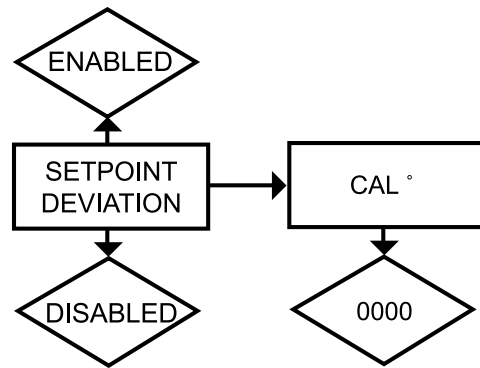

Figure 3.8 Flow Chart for Setpoint Deviation Menu / Field Calibration

SETPOINT DEVIATION ENABLE/DISABLE SUBMENU:

- Press 4) Display advances to Setpoint Deviation **ENbL** Enable or **dsbL**. Disable Submenu and flashes the previous selection.
- Press 5) Scroll through the available selections: **ENbL** or **dsbL**.
- Press 6) Display shows **SEEd** stored message momentarily and then advances to the next menu item.

Setpoint Deviation menu, if “enabled”, allows changes to Setpoint 1 to be made automatically to Setpoint 2. This mode is very helpful if the Process temperature changes often. In Setpoint Deviation Mode, set SP2 a certain number of degrees or counts away from SP1 - this relation remains fixed when SP1 is changed. For instance: Setting SP1=200 and SP2=20 and enabling **SP.d4** means that the absolute value of SP2=220. Moving SP1 to 300, the absolute value of SP2 becomes 320.

THERMOCOUPLE FIELD CALIBRATION SUBMENU:

CAUTION: Do not perform the following steps until you fully understand this entire section.

Note RTD and Process are perfectly calibrated. This section is applicable to Thermocouple (TC) calibration *only*.

Be sure that the TC being used to calibrate the meter is of the type selected in the TC submenu. Place the TC in an ice-bath (or other **0°C / 32°F** environment). In ambient temperature conditions: connect the TC to the meter, apply power to the meter.

CAUTION: Do not proceed with TC calibration unless the above conditions have been in effect for at least one hour.

- Press 7) Display shows **CAL**.
- Press 8) Display shows flashing **0000**.
- Press * 9) Display will still show flashing **0000**.
- Press * 10) Display shows **OUT 1** (meaning Calibration is complete)

* If you accidentally engage the flashing **0000** (CAL° alert) simply re-press the last button you pressed, to avoid unintentionally mis-calibrating your meter.

3.2.10 ID CODE

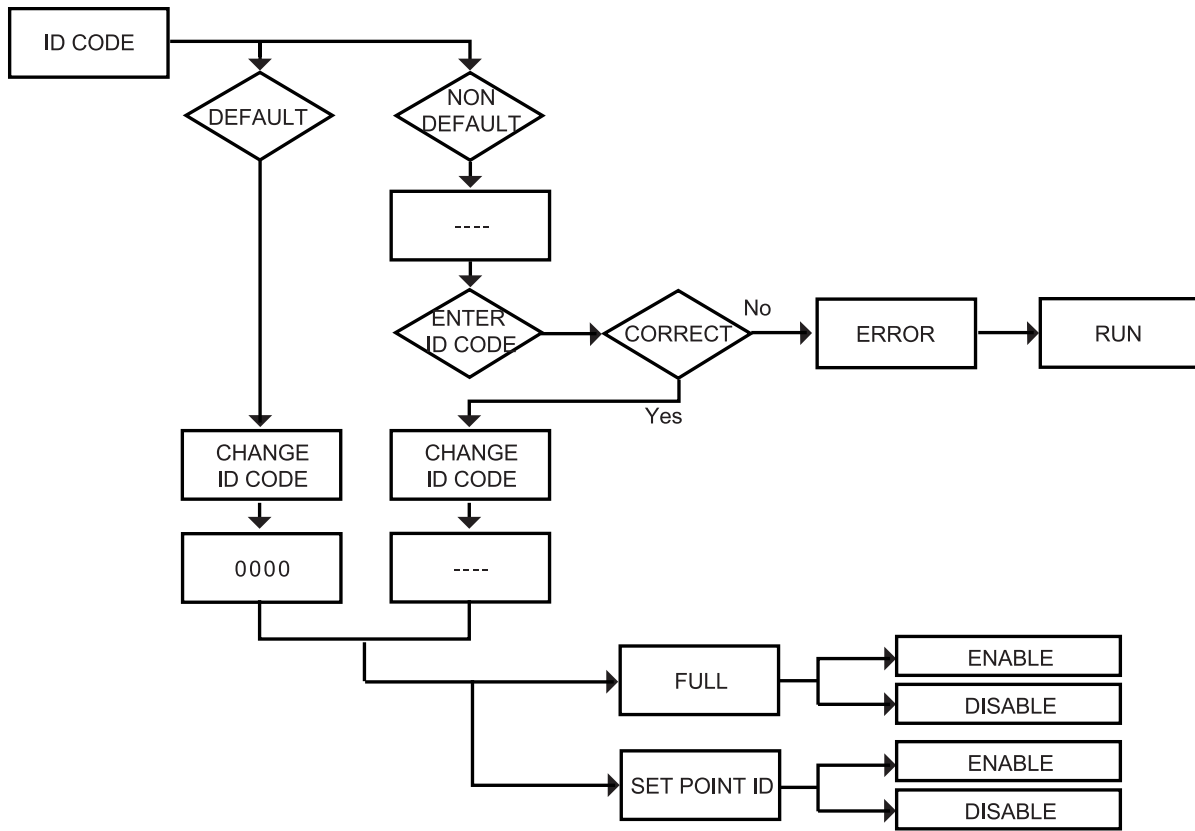

Figure 3.9 Flow Chart for ID Code

ENTER ID CODE MENU:

- Press **⏪** 1) Press **⏪**, if necessary, until **ENFG** prompt appears.
- Press **⏩** 2) Display advances to **INPE** Input Menu.
- Press **⏪** 3) Press **⏪**, if necessary, until Display advances to **Id** ID Code Menu.

ENTERING OR CHANGING YOUR (NON-DEFAULT) ID CODE:

- Press **⏩** 4) Display advances to **----** with 1st under score flashing.
- Press **▲** & **▼** 5) Press **▲** and **▼** to enter your 4-digit “ID Code” number.
- Press **⏩** 6) Display advances to **CH.Id** Change ID Code Submenu.





If entered “ID Code” is incorrect display shows **ERRd** Error message momentarily and then skips to the Run Mode.

- Press **⏩** 7) Display flashes the first digit of previous entered “ID Code” number.
- Press **▲** & **▼** 8) Press **▲** and **▼** buttons to enter your new “ID Code” number.
- Press **⏩** 9) Display shows **SEEd** stored message momentarily and then advances to the **FULL** Full Security Submenu.





ENTERING OR CHANGING YOUR (DEFAULT) ID CODE:

Enter **Id** menu (Repeat steps from 1 to 3).

- Press  10) Display advances to **CH.Id** Change ID Code Submenu.
Press  11) Display shows **0000** message with flashing 1st digit.

Note 

If you want to change your default "ID Code" you can do it now, otherwise press  and menu will skip to **FULL** Full Security Submenu.

- Press  &  12) Press  and  buttons to enter your new "ID Code" number.
Press  13) Display shows **SEtRd** stored message momentarily and then advances to the **FULL** Full Security Submenu.

FULL SECURITY LEVEL SUBMENU:

- Press  14) Display flashes **ENbL** Enable or **dSbL** Disable.
Press  15) Scroll through the available selections: "Enable" or "Disable".
Press  16) Display shows **SEtRd** stored message momentarily and then advances to **SP.Id** Setpoint/ID Submenu.

Note 

If "Full" Security Level is "Enabled" and the user attempts to enter the Main Menu, they will be prompted for an ID Code. The ID Code should be correct to enter the instrument Menu item.

SETPOINT/ID SECURITY LEVEL SUBMENU:

Note 

This Security Level can be functional only if **FULL** Security Level is Disabled.

- Press  17) Display flashes **ENbL** Enable or **dSbL** Disable.
Press  18) Scroll through the available selections: "Enable" or "Disable".
Press  19) Display shows **SEtRd** stored message momentarily and then advances to **COMM** Communication Submenu.

Note 

If "**Setpoint/ID**" Security Level is "**Enabled**" and the user attempts to advance into the **CONF** Configuration Menu, he will be prompted for ID Code number. The ID Code should be correct to proceed into the Configuration Menu, otherwise display will show an Error and skip to the Run Mode.

Note 

If "**Full**" and "**Setpoint/ID**" Security Levels are "**Disabled**", the ID code will be "Disabled" and user will not be asked for ID Code to enter the Menu items ("ID" Submenu will not show up in "ID/Setpoint" Menu).

3.2.11 COMMUNICATION OPTION

Purchasing the controller with Serial Communications permits an instrument to be configured or monitored from an IBM PC compatible computer using software available from **the website or on the CD-ROM enclosed with your shipment**. For complete instructions on the use of the Communications Option, refer to the Serial Communications Reference Manual.

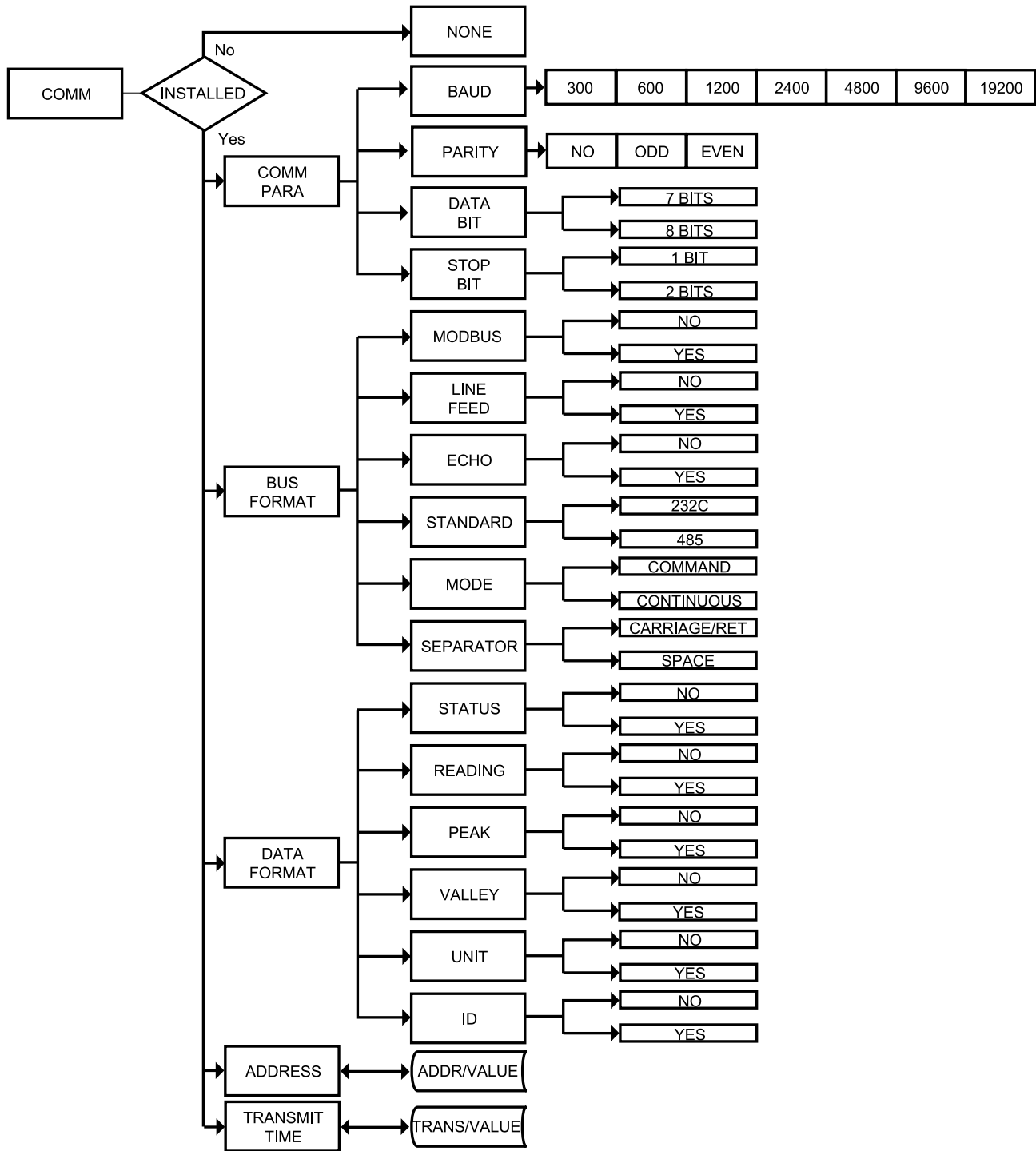







Figure 3.10 Flow Chart for Communication Option

ENTER COMMUNICATION OPTION MENU:

- Press  1) Press , if necessary, until **ENFG** prompt appears.
- Press  2) Display advances to **INPE** Input Menu.
- Press  3) Press , if necessary, until Display advances to **COMM** Communication Options Menu.
- Press  4) Display advances to **COMPAR** Communication Parameters Submenu.







If Communication Option is not installed, the display shows **NONE** and skips to the Color Display Menu.

COMMUNICATION PARAMETERS SUBMENU:





Allows the user to adjust Serial Communications Settings of the instrument. When connecting an instrument to a computer or other device, the Communications Parameters must match. Generally the default settings (as shown in Section 5) should be utilized.

- Press  5) Display advances to **BAUD** Baud Submenu.





BAUD SUBMENU:

- Press  6) Display flashes previous selection for **BAUD** value.
- Press  7) Scroll through the available selections: **300**, **600**, **1200**, **2400**, **4800**, **9600**, **19.2K**.
- Press  8) Display shows **SEED** stored message momentarily and then advances to **PREY** only, if it was changed, otherwise press  to advance to **PREY** Parity Submenu.





PARITY SUBMENU:

- Press  9) Display flashes previous selection for "Parity".
- Press  10) Scroll through the available selections: NO, ODD, EVEN.
- Press  11) Display shows **SEED** stored message momentarily and then advances to **DATA** only, if it was changed, otherwise press  to advance to **DATA** Data Bit Submenu.

DATA BIT SUBMENU:

- Press  12) Display flashes previous selection for "Data Bit".
- Press  13) Scroll through the available selections: 7-BIT, 8-BIT.
- Press  14) Display shows **SEED** stored message and then advances to **SEOP** only, if it was changed, otherwise press  to advance to **SEOP** Stop Bit Submenu.

STOP BIT SUBMENU:





- Press  15) Display flashes previous selection for “Stop Bit”.
- Press  16) Scroll through the available selections: 1-BIT, 2-BIT.
- Press  17) Display shows **SEtPd** stored message momentarily and then advances to **bUS.F** only, if it was changed, otherwise press  to advance to **bUS.F** Bus Format Submenu.

BUS FORMAT SUBMENU:

Determines Communications Standards and Command/Data Formats for transferring information into and out of the controller via the Serial Communications Bus. Bus Format submenus essentially determine how and when data can be accessed via the Serial Communications of the device.

- Press  18) Display advances to **m.bUS** Modbus Submenu.

MODBUS PROTOCOL SUBMENU:





- Press  19) Display flashes previous selection for **m.bUS**.
- Press  20) Scroll through the available selections: NO, YES.
- Press  21) Display shows **SEtPd** stored message momentarily and then advances to **_LF_** only, if it was changed, otherwise press  to advance to **_LF_** Line Feed submenu.

 **Note** To select iSeries Protocol, set Modbus submenu to “No”.
To select Modbus Protocol, set Modbus submenu to “Yes”.

 **Note** If Modbus Protocol was selected, the following Communications Parameters must be set as: No Parity, 8-bit Data Bit, 1-Stop Bit. Do not attempt to change these parameters.

LINE FEED SUBMENU:

Determines if data sent from the instrument will have a Line Feed appended to the end - useful for viewing or logging results on separate lines when displayed on communications software at a computer.

- Press  22) Display flashes previous selection for “Line Feed”.
- Press  23) Scroll through the available selections: NO, YES.
- Press  24) Display shows **SEtPd** stored message momentarily and then advances to **ECHO** only, if it was changed, otherwise press  to advance to **ECHO** Echo Submenu.

ECHO SUBMENU:

When valid commands are sent to the instrument, this determines whether the command will be echoed to the Serial Bus. Use of echo is recommended in most situations, especially to help verify that data was received and recognized by the controller.

- Press **↩** 25) Display flashes previous selection for “Echo”.
- Press **▲** 26) Scroll through the available selections: NO, YES.
- Press **↩** 27) Display flashes **SEnd** stored message momentarily and then advances to **SEnd** only if it was changed, otherwise press **↩** to advance to **SEnd** Communication Standard Submenu.

COMMUNICATION INTERFACE STANDARD SUBMENU:

Determines whether device should be connected to an RS-232C serial port (as is commonly used on IBM PC-compatible computers) or via an RS-485 bus connected through appropriate RS-232/485 converter. When used in RS-485 Mode, the device must be accessed with an appropriate Address Value as selected in the Address Submenu described later.

- Press **↩** 28) Display flashes previous selection for “Standard”.
- Press **▲** 29) Scroll through the available selections: 232C, 485.
- Press **↩** 30) Display shows **SEnd** stored message momentarily and then advances to **Mode** only, if it was changed, otherwise press **↩** to advance to **Mode** Data Flow Mode Submenu.

DATA FLOW MODE SUBMENU:

Determines whether the instrument will wait for commands and data requests from the Serial Bus or whether the instrument will send data automatically and continuously to the Serial Bus. Devices configured for the RS-485 Communications Standard operate properly only under Command Mode.

- Press **↩** 31) Display flashes previous selection for “Mode”.
- Press **▲** 32) Scroll through the available selections: **Cmd** “Command”, **Cont** “Continuous”.
- Press **↩** 33) Display shows **SEnd** stored message momentarily and then advances to **SEPR** only, if it was changed, otherwise press **↩** to advance to **SEPR** Data Separation Submenu.

DATA SEPARATION CHARACTER SUBMENU:

Determines whether data sent from the device in Continuous Data Flow Mode will be separated by spaces or by Carriage Returns.

- Press **↩** 34) Display flashes previous selection for “Separation” Submenu.
- Press **▲** 35) Scroll through the available selections: **SPCE** “Space” or **CR** “Carriage Return”.
- Press **↩** 36) Display shows **SEnd** stored message momentarily and then advances to **DATE.F** only, if it was changed, otherwise press **↩** to advance to **DATE.F** Data Format Submenu.

DATA FORMAT SUBMENU:

Preformatted data can be sent automatically or upon request from the controller. Use the Data Format Submenus to determine what data will be sent in this preformatted data string. Refer to the iSeries Communications Manual for more information about the data format. At least one of the following suboptions must be enabled and hence output data to the Serial Bus.

Note This menu is applicable for Continuous Mode of RS-232 communication.

Press **↩** 37) Display advances to **SEAL** Alarm Status Submenu.

ALARM STATUS SUBMENU:

Includes Alarm Status bytes in the data string.

Press **↩** 38) Display flashes previous selection for “Status” (alarm status).
Press **▲** 39) Scroll through the available selections: NO, YES.
Press **↩** 40) Display shows **SEAL** stored message momentarily and then advances to **RdNG** only, if it was changed, otherwise press **↩** to advance to **RdNG** Reading Submenu.

MAIN READING SUBMENU:

Includes Main Reading in the data string.

Press **↩** 41) Display flashes previous selection for “Reading”.
Press **▲** 42) Scroll through the available selections: NO, YES.
Press **↩** 43) Display shows **SEAL** stored message momentarily and then advances to **PEAK** only, if it was changed, otherwise press **↩** to advance to **PEAK** Peak Submenu.

PEAK VALUE SUBMENU:

Includes Peak Value in the data string.

Press **↩** 44) Display flashes previous selection for **PEAK** Submenu.
Press **▲** 45) Scroll through the available selections: NO, YES.
Press **↩** 46) Display shows **SEAL** stored message momentarily and then advances to **VALY** only, it was changed, otherwise press **↩** to advance to **VALY** Valley Submenu.





VALLEY VALUE SUBMENU:

Includes Valley Value in the data string.

Press **↩** 47) Display flashes previous selection for “Valley”.
Press **▲** 48) Scroll through the available selections: NO, YES.
Press **↩** 49) Display shows **SEAL** stored message momentarily and then advances to **UNTE** only, if it was changed, otherwise press **↩** to advance to **UNTE** Temperature Unit Submenu.

TEMPERATURE UNIT SUBMENU:

Includes a byte in the data string to indicate whether reading is in Celsius or Fahrenheit.







- Press  50) Display flashes previous selection for **UNIT**.
- Press  51) Scroll through the available selections: NO, YES.
- Press  52) Display shows **SEAd** stored message momentarily and then advances to **AdAd** only, if it was changed, otherwise press  to advance to **AdAd** Address Setup Submenu.

ADDRESS SETUP SUBMENU:

 This menu is applicable to the RS-485 Option only.

- Press  53) Display advances to “Address Value” (0000 to 0199) Submenu.

ADDRESS VALUE SUBMENU:

- Press  54) Display flashes 1st digit of previously stored Address Value.
- Press  &  55) Press  and  to enter new “Address Value”.
- Press  56) Display shows **SEAd** stored message momentarily and then advances to **EREM** only, if it was changed, otherwise press  to advance to **EREM** Transmit Time Interval Submenu.







TRANSMIT TIME INTERVAL SUBMENU:

 This menu is applicable if “Continuous” Mode was selected in the “Data Flow Mode” Submenu and the device is configured as an RS-232C Standard device. Also, one or more options under the Data Format Submenu must be enabled.

- Press  57) Display advances to “Transmit Time Value” Submenu.

TRANSMIT TIME INTERVAL VALUE SUBMENU:

Determines the interval at which data will be emitted to the RS-232 Serial Bus when the instrument is in Continuous Data Flow Mode.

- Press  58) Display flashes 1st digit of previous “Transmit Time Value” in seconds.
- Press  &  59) Press  and  to enter new “Transmit Time Value”, e.g. 0030 will send the data every 30 seconds in Continuous Mode.
- Press  60) Display shows **SEAd** stored message momentarily and then advances to **COLR** only, if it was changed, otherwise press  to advance to **COLR** Color Display Selection Menu.

 For more details, refer to the **Communication Manual** available at the website listed in the cover page of this manual or on the CD-ROM enclosed with your shipment.

3.2.12 DISPLAY COLOR SELECTION

This submenu allows the user to select the color of the display.

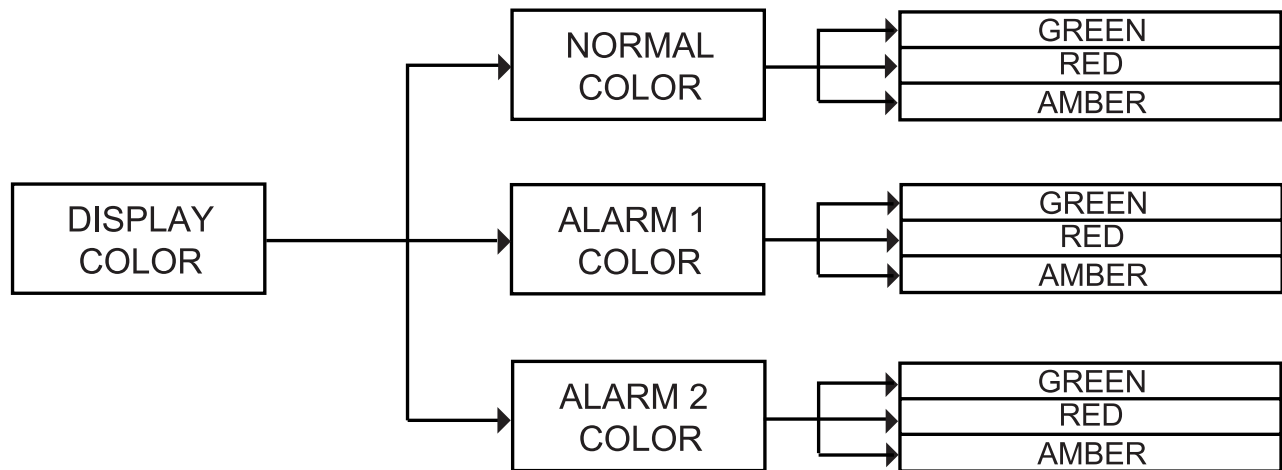

Figure 3.11 Flow Chart for Display Color Selection

ENTER DISPLAY COLOR SELECTION MENU:

- Press **⏪** 1) Press **⏪**, if necessary, until **CONF** prompt appears.
- Press **⏩** 2) Display advances to **INPE** Input Menu.
- Press **⏪** 3) Press **⏪**, if necessary, until Display advances to **COLR** Display Color Selection Menu.
- Press **⏩** 4) Display advances to **N.CLR** Normal Color Submenu.

NORMAL COLOR DISPLAY SUBMENU:



- Press **⏩** 5) Display flashes the previous selection for "Normal Color".
- Press **⏴** 6) Scroll through the available selections: **GRN**, **RED** or **AMBR**.
- Press **⏩** 7) Display shows **SEED** stored message momentarily and then advances to **1.CLR** only, if it was changed, otherwise press **⏩** to advance to **1.CLR** Alarm 1 Display Color Submenu.

The menu below allows the user to change the color of display when alarm is triggered.

ALARM 1 DISPLAY COLOR SUBMENU:

- Press **⏩** 8) Display flashes previous selection for "Alarm 1 Color Display".
- Press **⏴** 9) Scroll through the available selections: **GRN**, **RED** or **AMBR**.
- Press **⏩** 10) Display shows **SEED** stored message momentarily and then advances to **2.CLR** only, if it was changed, otherwise press **⏩** to advance to **2.CLR** Alarm 2 Display Color Submenu.

ALARM 2 DISPLAY COLOR SUBMENU:

- Press  11) Display flashes previous selection for "Alarm 2 Color Display".
- Press  12) Scroll through the available selections: **GRN**, **RED** or **AMBR**.
- Press  13) Display shows **SEtRd** stored message momentarily and then momentarily shows the software version number, followed by **RSE** Reset, and then proceeds to the Run Mode.

Tip IN ORDER TO DISPLAY ONE COLOR, SET THE SAME DISPLAY COLOR ON ALL THREE SUBMENUS ABOVE.

Note If user wants the Display to change color every time when both Alarm 1 and Alarm 2 are triggered, the Alarm values should be set in such a way that Alarm 1 value is always on the top of Alarm 2 value, otherwise value of Alarm 1 will overwrite value of Alarm 2 and Display Color would not change when Alarm 2 is triggered.

Example 1:

Alarm Setup: Absolute, Above, Alarm 2 HI Value "ALR.H" = 200, Alarm 1 HI Value "ALR.H" = 400

"Color Display" Setup: Normal Color "N.CLR" = Green, Alarm 1 Color "1.CLR" = Amber, Alarm 2 Color "2.CLR" = Red

Display Colors change sequences:



Example 2:

Alarm Setup: Absolute, Below, Alarm 2 Low Value "ALR.L" = 300, Alarm 1 Low Value "ALR.L" = 100

Color Display Setup: "N.CLR" = Green, "1.CLR" = Amber, "2.CLR" = Red

Display Colors change sequences:



Example 3:

Setpoint 1 = 300,

Setpoint 2 = 200

Alarm 1 & 2 Setup: Deviation, Band, "ALR.H" = 10

Color Display Setup: "N.CLR" = Green, "1.CLR" = Amber, "2.CLR" = Red

Display Colors change sequences:



Alarm 1 is designed to monitor the Process Value around the Setpoint 1. Alarm 2 is designed to monitor the Process Value around the Setpoint 2. If Analog Output Option board is installed (Alarm 1 is disabled), only Alarm 2 is active and only two colors are available.

Example 4:

Setpoint 1 = 200

Setpoint 2 = 200

Alarm 1 Setup: Deviation, Band, "ALR.H" = 20

Alarm 2 Setup: Deviation, Hi/Low, "ALR.H" = 10, "ALR.L" = 5

Color Display Setup: "N.CLR" = Green, "1.CLR" = Amber, "2.CLR" = Red

Display colors change sequences:



Reset: The instrument automatically resets after the last menu of the Configuration Mode has been entered. After the instrument resets, it advances to the Run Mode.

PART 4 SPECIFICATIONS

Accuracy at 25°C

±0.5°C temp nominal

0.03% rdg ±0.03% range process
and strain

Resolution

1°/0.1°; 10 µV process

Temperature Stability

1) RTD: 0.04°C/°C

2) TC @ 25°C (77°F): 0.05°C/°C

- Cold Junction Compensation

3) Process: 50 ppm/°C

NMRR

60 dB

CMRR

120 dB

A/D Conversion

Dual slope

Reading Rate

3 samples per second

Digital Filter

Programmable

Display

4-digit or 6-digit, 7-segment LED
57.2 mm (2.25") or 101.6mm (4.00")
red, green and amber programmable
colors for process variable, set point
and temperature units

Warm up to Rated Accuracy

60 min.

INPUT

Input Types

Thermocouple, RTD, Analog

Voltage, Analog Current

Thermocouple Type (ITS 90)

J, K, T, E, R, S, B, C, N, L

Thermocouple Lead Resistance

100 ohm max

RTD Input (ITS 68)

100/500/1000 Ω Pt sensor, 2-, 3- or
4-wire; 0.00385 or 0.00392 curve

Voltage Input

0 to 100 mV, 0 to 1 V, 0 to 10 Vdc

Input Impedance

10 MΩ for 100 mV

1 MΩ for 1 or 10 Vdc

Current Input

0 to 20 mA (5 ohm load)

Configuration

Single-ended

Polarity

Unipolar

Step Response

0.7 sec for 99.9%

Decimal Selection

None, 0.1 for temperature

None, 0.1, 0.01 or 0.001 for process

Setpoint Adjustment

-1999 to 9999 counts

Span Adjustment

0.001 to 9999 counts

Offset Adjustment

-1999 to +9999

NETWORK AND COMMUNICATIONS (Optional -C24, -C4EI)

Ethernet: Standards Compliance
IEEE 802.3 10Base-T

Supported Protocols: TCP/IP, ARP,
HTTPGET

RS-232/RS-422/RS-485:
Programmable 300 to 19.2 K baud;
complete programmable setup
capability; program to transmit current
display, alarm status, Peak and Valley
value.

RS-485: Addressable from 0 to 199

Connection: Screw terminals

ALARM 1 & 2 (programmable):

Operation

High/low, above/below, band,
latch/unlatch, normally open/normally
closed and process/deviation; front
panel configurations

INSULATION

Power to Input/Output

2300 Vac per 1 minute test
(RS-232/485, Input or Output)

Between Inputs

500 Vac per 1 minute test

Approvals

See Approval Section

GENERAL

Power

100-240 Vac +/-10%, 50/60 Hz
22.5 W

Fuse

4A, 250V, GFE, 5x20mm

Environmental Conditions

0 to 40°C (32 to 104°F),
90% RH non-condensing

Protection

NEMA-4x (IP65) front bezel

Dimensions and Panel Cutout

Refer to Quickstart Specifications.

Weight

Refer to Quickstart Specifications.

Table 4.1 Input Properties

TC	Input Type	Range	Accuracy*
J	Iron-Constantan	-210 to 760°C -346 to 1400°F	0.4°C 0.7°F
K	CHROMEKA®- ALOMEGA®	-270 to -160°C -160 to 1372°C -454 to -256°F -256 to 2502°F	1.0°C 0.4°C 1.8°F 0.7°F
T	Copper-Constantan	-270 to -190°C -190 to 400°C -454 to -310°F -310 to 752°F	1.0°C 0.4°C 1.8°F 0.7°F
E	CHROMEKA- Constantan	-270 to -220°C -220 to 1000°C -454 to -364°F -364 to 1832°F	1.0°C 0.4°C 1.8°F 0.7°F
R	Pt/13%Rh-Pt	-50 to 40°C 40 to 1788°C -58 to 104°F 104 to 3250°F	1.0°C 0.5°C 1.8°F 0.9°F
S	Pt/10%Rh-Pt	-50 to 100°C 100 to 1768°C -58 to 212°F 212 to 3214°F	1.0°C 0.5°C 1.8°F 0.9°F
B	30%Rh-Pt/ 6%Rh-Pt	200 to 640°C 640 to 1820°C 212 to 1184°F 1184 to 3308°F	1.0°C 0.5°C 1.8°F 0.9°F
C	5%Re-W/ 26%Re-W	0 to 2354°C 32 to 4253°F	0.4°C 0.7°F
N	Nicrosil-Nisil	-250 to -100°C -100 to 1300°C -418 to -148°F -148 to 2372°F	1.0°C 0.4°C 1.8°F 0.7°F
L	J DIN	-200 to 900°C -328 to 1652°F	0.4°C 0.7°F
RTD	Pt,0.00385, 100	-200 to 850°C / -328 to 1652°F	±0.5°C ±0.02% rdg
RTD	Pt, 0.00385, 500 ohm	-200 to 850°C / -328 to 1652°F	±0.6°C ±0.2% rdg
RTD	Pt, 0.00385, 1000 ohm	-200 to 850°C / -328 to 1652°F	±0.5°C ±0.02% rdg

Table 4.1 Input Properties (continued)

TC	Input Type	Range	Accuracy*
RTD	Pt, 0.00392, 100 ohm	-200 to 850°C / -328 to 1562°F	±0.5°C ±0.2% rdg
RTD	Pt, 0.00392, 500 ohm	-200 to 850°C / -328 to 1652°F	±0.8%°C
RTD	Pt, 0.00392, 1000 ohm	-200 to 850°C / -328 to 1652°F	±0.8%°C ±0.1% rdg
Process	Voltage	0 to 100 mV, 0 to 1 V, 0 to 10 Vdc	0.03% rdg ±0.03% range 0.03% rdg ±0.03% range
Process	Current	0 to 20 mA, 4 to 20 mA	0.03% rdg

PART 5 FACTORY PRESET VALUES

Table 5.1 Factory preset value

MENU ITEMS	FACTORY PRESET VALUES	NOTES
Set Point 1 (SP1)	000.0	
Set Point 2 (SP2)	000.0	
Input:		
Input Type (INPT)	TC, type K	
Reading Configuration (RDG):		
Decimal Point (DEC.P)	FFF.F	
Temperature unit (TEMP)	°F	
Filter value (FLTR)	0004	
Alarm 1 & 2:		
Alarm 1 (ALR1), Alarm 2 (ALR2)	Disable (DSBL)	
Absolute/Deviation (ABSO/DEV)	Absolute (ABSO)	
Latch/Unlatch (LTCH/UNLT)	Unlatch (UNLT)	
Active (ACTV)	Above (ABOV)	
Alarm At Power On (A.P.ON)	Disable (DSBL)	Alarm 1 only
Alarm Low (ALR.L)	-100.0	
Alarm High (ALR.H)	400.0	
ID:		
ID Value	0000	
Full ID (FULL)	Disable (DSBL)	
Set Point ID (ID.SP)	Disable (DSBL)	
Communication Parameters:		
Baud Rate (BAUD)	9600	
Parity (PRTY)	Odd	
Data bit (DATA)	7 bit	
Stop Bit	1 bit	
Modbus Protocol (M.BUS)	No	
Line Feed (LF)	No	
Echo (ECHO)	Yes	
Standard Interface (STND)	RS-232 (232C)	
Command Mode (MODE)	Command (CMD)	
Separation (SEPR)	Space (SPCE)	
Alarm Status (STAT)	No	
Reading (RDNG)	Yes	
Peak	No	
Valley (VALY)	No	
Units (UNIT)	No	
Multipoint Address (ADDR)	0001	
Transmit Time (TR.TM)	0016	
Display Color (COLR):		
Normal Color (N.CLR)	Green (GRN)	
Alarm 1 Color (1.CLR)	Red (RED)	
Alarm 2 Color (2.CLR)	Amber (AMBR)	

PART 6

APPROVALS INFORMATION

This product conforms to the EMC directive 89/336/EEC amended by 93/68/EEC, and with the European Low Voltage Directive 72/23/EEC.

Electrical Safety EN61010-1:2001

Safety requirements for electrical equipment for measurement, control and laboratory.

Double Insulation

Pollution Degree 2

Dielectric withstand Test per 1 min

- Power to Input/Output: 2300Vac (3250Vdc)
- Power to Relays/SSR Output: 2300Vac (3250Vdc)
- Ethernet to Inputs: 1500Vac (2120Vdc)
- Isolated RS232 to Inputs: 500Vac (720Vdc)
- Isolated Analog to Inputs: 500Vac (720Vdc)
- Analog/Pulse to Inputs: No Isolation

Measurement Category I

Category I are measurements performed on circuits not directly connected to the Mains Supply (power). Maximum Line-to-Neutral working voltage is 50Vac/dc. This unit should not be used in Measurement Categories II, III, IV.

Transients Overvoltage Surge (1.2 / 50uS pulse)

- Input Power: 2500V
- Ethernet: 1500V
- Input/Output Signals: 500V

EMC EN61326:1997 + and A1:1998 + A2:2001

Immunity and Emissions requirements for electrical equipment for measurement, control and laboratory.

- EMC Emissions Table 4, Class B of EN61326
- EMC Immunity** Table 1 of EN61326

Note: ***I/O signal and control lines require shielded cables and these cables must be located on conductive cable trays or in conduits. Furthermore, the length of these cables should not exceed 30 meters*



Refer to the EMC and Safety installation considerations (Guidelines) of this manual for additional information.

WARRANTY/DISCLAIMER

OMEGA ENGINEERING, INC. warrants this unit to be free of defects in materials and workmanship for a period of **61 months** from date of purchase. OMEGA's WARRANTY adds an additional one (1) month grace period to the normal **five (5-) year product warranty** to cover handling and shipping time. This ensures that OMEGA's customers receive maximum coverage on each product.

If the unit malfunctions, it must be returned to the factory for evaluation. OMEGA's Customer Service Department will issue an Authorized Return (AR) number immediately upon phone or written request. Upon examination by OMEGA, if the unit is found to be defective, it will be repaired or replaced at no charge. OMEGA's WARRANTY does not apply to defects resulting from any action of the purchaser, including but not limited to mishandling, improper interfacing, operation outside of design limits, improper repair, or unauthorized modification. This WARRANTY is VOID if the unit shows evidence of having been tampered with or shows evidence of having been damaged as a result of excessive corrosion; or current, heat, moisture or vibration; improper specification; misapplication; misuse or other operating conditions outside of OMEGA's control. Components in which wear is not warranted, include but are not limited to contact points, fuses, and triacs.

OMEGA is pleased to offer suggestions on the use of its various products. However, OMEGA neither assumes responsibility for any omissions or errors nor assumes liability for any damages that result from the use of its products in accordance with information provided by OMEGA, either verbal or written. OMEGA warrants only that the parts manufactured by the company will be as specified and free of defects. OMEGA MAKES NO OTHER WARRANTIES OR REPRESENTATIONS OF ANY KIND WHATSOEVER, EXPRESSED OR IMPLIED, EXCEPT THAT OF TITLE, AND ALL IMPLIED WARRANTIES INCLUDING ANY WARRANTY OF MERCHANTABILITY AND FITNESS FOR A PARTICULAR PURPOSE ARE HEREBY DISCLAIMED. LIMITATION OF LIABILITY: The remedies of purchaser set forth herein are exclusive, and the total liability of OMEGA with respect to this order, whether based on contract, warranty, negligence, indemnification, strict liability or otherwise, shall not exceed the purchase price of the component upon which liability is based. In no event shall OMEGA be liable for consequential, incidental or special damages.

CONDITIONS: Equipment sold by OMEGA is not intended to be used, nor shall it be used: (1) as a "Basic Component" under 10 CFR 21 (NRC), used in or with any nuclear installation or activity; or (2) in medical applications or used on humans. Should any Product(s) be used in or with any nuclear installation or activity, medical application, used on humans, or misused in any way, OMEGA assumes no responsibility as set forth in our basic WARRANTY/DISCLAIMER language, and, additionally, purchaser will indemnify OMEGA and hold OMEGA harmless from any liability or damage whatsoever arising out of the use of the Product(s) in such a manner.

RETURN REQUESTS/INQUIRIES

Direct all warranty and repair requests/inquiries to the OMEGA Customer Service Department. BEFORE RETURNING ANY PRODUCT(S) TO OMEGA, PURCHASER MUST OBTAIN AN AUTHORIZED RETURN (AR) NUMBER FROM OMEGA'S CUSTOMER SERVICE DEPARTMENT (IN ORDER TO AVOID PROCESSING DELAYS). The assigned AR number should then be marked on the outside of the return package and on any correspondence.

The purchaser is responsible for shipping charges, freight, insurance and proper packaging to prevent breakage in transit.

FOR **WARRANTY** RETURNS, please have the following information available BEFORE contacting OMEGA:

1. Purchase Order number under which the product was PURCHASED,
2. Model and serial number of the product under warranty, and
3. Repair instructions and/or specific problems relative to the product.

FOR **NON-WARRANTY** REPAIRS, consult OMEGA for current repair charges. Have the following information available BEFORE contacting OMEGA:

1. Purchase Order number to cover the COST of the repair,
2. Model and serial number of the product, and
3. Repair instructions and/or specific problems relative to the product.

OMEGA's policy is to make running changes, not model changes, whenever an improvement is possible. This affords our customers the latest in technology and engineering.

OMEGA is a trademark of OMEGA ENGINEERING, INC.

© Copyright 2018 OMEGA ENGINEERING, INC. All rights reserved. This document may not be copied, photocopied, reproduced, translated, or reduced to any electronic medium or machine-readable form, in whole or in part, without the prior written consent of OMEGA ENGINEERING, INC.

Where Do I Find Everything I Need for Process Measurement and Control? **OMEGA...Of Course!** *Shop online at omega.com*

TEMPERATURE

- ☑ Thermocouple, RTD & Thermistor Probes, Connectors, Panels & Assemblies
- ☑ Wire: Thermocouple, RTD & Thermistor
- ☑ Calibrators & Ice Point References
- ☑ Recorders, Controllers & Process Monitors
- ☑ Infrared Pyrometers

PRESSURE, STRAIN AND FORCE

- ☑ Transducers & Strain Gages
- ☑ Load Cells & Pressure Gages
- ☑ Displacement Transducers
- ☑ Instrumentation & Accessories

FLOW/LEVEL

- ☑ Rotameters, Gas Mass Flowmeters & Flow Computers
- ☑ Air Velocity Indicators
- ☑ Turbine/Paddlewheel Systems
- ☑ Totalizers & Batch Controllers

pH/CONDUCTIVITY

- ☑ pH Electrodes, Testers & Accessories
- ☑ Benchtop/Laboratory Meters
- ☑ Controllers, Calibrators, Simulators & Pumps
- ☑ Industrial pH & Conductivity Equipment

DATA ACQUISITION

- ☑ Communications-Based Acquisition Systems
- ☑ Data Logging Systems
- ☑ Wireless Sensors, Transmitters, & Receivers
- ☑ Signal Conditioners
- ☑ Data Acquisition Software

HEATERS

- ☑ Heating Cable
- ☑ Cartridge & Strip Heaters
- ☑ Immersion & Band Heaters
- ☑ Flexible Heaters
- ☑ Laboratory Heaters

ENVIRONMENTAL MONITORING AND CONTROL

- ☑ Metering & Control Instrumentation
- ☑ Refractometers
- ☑ Pumps & Tubing
- ☑ Air, Soil & Water Monitors
- ☑ Industrial Water & Wastewater Treatment
- ☑ pH, Conductivity & Dissolved Oxygen Instruments