



TAURUS
UCX

&

MMX-USB20

S E R I E S

Universal Switcher with HDMI 2.0 connectivity and USB 3.1 Gen1 features



The **UCX-2x1-H30 universal** switcher enhances and extends the possibilities of a meeting room and allows meeting participants to easily use their own devices such as laptops, and preferred video conference platforms while also to utilize the available assets of the meeting space, just like the HDMI displays, room cameras and other USB peripherals.

The device is designed to be a centerpiece of any collaboration space, and can be connected to **two USB peripherals** via USB-A type connectors.

Hosts then can connect their own devices to the **UCX-2x1-H30** and gain control over the rooms peripherals. By simply using a combination of **HDMI 2.0** and **USB 3.1 Gen1** connections, video and audio signals can be transferred up to a resolution of **4K@60Hz 4:4:4** and **data speeds up to 5 Gbps**.

The device allows up to two hosts to be connected to the system, and also ensures quick and easy switching between the users. Two sets of HDMI 2.0 and USB inputs makes this universal switcher a perfect fit for smaller meeting areas, involving 4-8 people.

Automated room control features are also included through **GPIO ports**, besides of **RS-232** and occupancy sensor connectivity. The switcher also thrives when it comes to **audio capabilities**, offering **analog audio de-embedding** feature.

Security is always a key concern in the corporate world, therefore our engineers ensured that the UCX-2x1-H30 adheres to the strictest security standards. A **secure corporate Ethernet interface** ensures secure device control and configuration under the SSH, SSL and HTTPS standards.

The Taurus UCX offers noiseless operation in most environments where conditions are considered regular, just like in a meeting room where temperatures do not exceed the low 20s in Celsius or about 70-75 in Fahrenheit. The built-in fan is designed to operate only if the device is installed in a cabinet or other environment with insufficient air-flow. We specified a maximum of 30dBA noise level for our ventilation system in a meeting room, to comply with the NC-30 és NR 30 standards.

In today's collaboration environments, it is key that the technology offers flexible and versatile ways for participants to unlock the full potential of a collaboration space and they clearly demand to not be limited by the default options offered by their meeting rooms.

The new **Taurus UCX product family** is Lightware's ground-breaking innovation offered for this increasingly growing demand for cutting-edge solutions in the world of Unified Communications.

Universal Switcher with HDMI 2.0 and USB-C connectivity



The **UCX-2x1-HC30 universal switcher** enhances and extends the possibilities of a meeting room and allows meeting participants to easily use their own devices such as laptops, and preferred video conference platforms while also to utilize the available assets of the meeting space, just like the HDMI displays, room cameras and other USB peripherals.

The device utilizes the **USB-C connectivity** for a simplified transmission of 4K video, audio, control signals and power, and allows data speeds of up to **5 Gbps** under the **USB 3.1 Gen1** and allowing video resolution capabilities up to **4K@60Hz at 4:4:4**.

Devices such as laptops that do not come with USB-C connectivity can also be connected quickly and easily, using a combination of **HDMI 2.0** and **USB 3.1 Gen1** connections without compromising on either video resolution or data speeds.

The device allows up to two hosts to be connected to the system, and also ensures quick and easy switching between these hosts, making this universal switcher a perfect fit for smaller meeting areas, involving 4-8 people.

Automated room control features are also included through **GPIO ports**, besides of **RS-232** and occupancy sensor connectivity, and the switcher also thrives when it comes to **audio capabilities**, offering **analog audio de-embedding**.

Secure corporate Ethernet interfaces ensure secure device control and configuration under the SSH, SSL and HTTPS standards, whilst the device can also be securely connected to a closed network of room control devices such as wall panels, or routed to the corporate system for additional control options, all via separate Ethernet layers.

The Taurus UCX offers noiseless operation in most environments where conditions are considered regular, just like in a meeting room where temperatures do not exceed the low 20s in Celsius or about 70-75 in Fahrenheit. The built-in fan is designed to operate only if the device is installed in a cabinet or other environment with insufficient air-flow. We specified a maximum of 30dBA noise level for our ventilation system in a meeting room, to comply with the NC-30 és NR 30 standards.

In today's collaboration environments, it is key that the technology offers flexible and versatile ways for participants to unlock the full potential of a collaboration space and to not be limited by the default options offered by their meeting rooms.

The new **Taurus UCX product family** is Lightware's ground-breaking innovation offered for the increasingly growing demand for cutting-edge solutions in the world of Unified Communications.

Universal Switcher with USB-C connectivity and Dante Audio



The **UCX-2x1-HC30D universal switcher** enhances and extends the possibilities of a meeting room and allows meeting participants to easily use their own devices such as laptops, and preferred video conference platforms while also to utilize the available assets of the meeting space, just like the HDMI displays, room cameras and other USB peripherals.

The device utilizes the **USB-C connectivity** for a simplified transmission of 4K video, audio, control signals and power, and allows data speeds of up to **5 Gbps** under the **USB 3.1 Gen1** and allowing video resolution capabilities up to **4K@60Hz at 4:4:4**.

Devices such as laptops that do not come with USB-C connectivity can also be connected quickly and easily, using a combination of **HDMI 2.0** and **USB 3.1 Gen1** connections without compromising on either video resolution or data speeds.

The device allows up to two hosts to be connected to the system, and also ensures quick and easy switching between these hosts, making this universal switcher a perfect fit for smaller meeting areas, involving 4-8 people.

Automated room control features are also included through **GPIO ports**, besides of **RS-232** and occupancy sensor connectivity.

The switcher also thrives when it comes to **audio capabilities**, offering **analog audio de-embedding** feature as well as support for **DANTE/AES67** network connection to send DANTE/AES67 audio stream directly to a dedicated audio system.

Security is always a key concern in the corporate world, therefore our engineers ensured that the **UCX-2x1-HC30D** adhere to the strictest security standards.

Secure corporate Ethernet interfaces ensure secure device control and configuration under the SSH, SSL and HTTPS standards, whilst the device can also be securely connected to a closed network of room control devices such as wall panels, or routed to the corporate system for additional control options, all via separate Ethernet layers.

The Taurus UCX offers noiseless operation in most environments where conditions are considered regular, just like in a meeting room where temperatures do not exceed the low 20s in Celsius or about 70-75 in Fahrenheit. The built-in fan is designed to operate only if the device is installed in a cabinet or other environment with insufficient air-flow. We specified a maximum of 30dBA noise level for our ventilation system in a meeting room, to comply with the NC-30 és NR 30 standards.

In today's collaboration environments, it is key that the technology offers flexible and versatile ways for participants to unlock the full potential of a collaboration space and to not be limited by the default options offered by their meeting rooms.

The new **Taurus UCX product family** is Lightware's groundbreaking innovation offered for the increasingly growing demand for cutting-edge solutions in the world of Unified Communications.

Universal Switcher with HDMI 2.0 and USB-C connectivity



The **UCX-4x2-HC30 universal switcher** enhances and extends the possibilities of a meeting room and allows meeting participants to easily use their own devices such as laptops, and preferred video conference platforms while also to utilize the available assets of the meeting space, just like the HDMI displays, room cameras and other USB peripherals.

The device utilizes the **USB-C connectivity** for a simplified transmission of 4K video, audio, control signals and power, and allows data speeds of up to **5 Gbps** under the **USB 3.1 Gen1** providing video resolution capabilities up to **4K@60Hz at 4:4:4**.

Devices such as laptops that do not come with USB-C ports can also be connected quickly and easily, using a combination of **HDMI 2.0** and **USB 3.1 Gen1** connections without compromising on either video resolution or data speeds.

The device allows up to four hosts to be connected to the system, and also ensures quick and easy switching between these hosts, making this universal switcher a perfect fit for smaller meeting areas, involving 6-12 people.

Automated room control features are also included through **GPIO ports**, besides of **RS-232** and occupancy sensor connectivity, and the switcher also thrives when it comes to **audio capabilities**, offering **analog audio de-embedding**.

Security is always a key concern in the corporate world, therefore our engineers ensured that the **UCX-4x2-HC30** adhere to the strictest security standards.

Secure corporate Ethernet interfaces ensure secure device control and configuration under the SSH, SSL and HTTPS standards, whilst the device can also be securely connected to a closed network of room control devices such as wall panels, or routed to the corporate system for additional control options, all via separate Ethernet layers.

The Taurus UCX offers noiseless operation in most environments where conditions are considered regular, just like in a meeting room where temperatures do not exceed the low 20s in Celsius or about 70-75 in Fahrenheit. The built-in fan is designed to operate only if the device is installed in a cabinet or other environment with insufficient air-flow. We specified a maximum of 30dBA noise level for our ventilation system in a meeting room, to comply with the NC-30 és NR 30 standards.

In today's collaboration environments, it is key that the technology offers flexible and versatile ways for participants to unlock the full potential of a collaboration space and to not be limited by the default options offered by their meeting rooms.

The new **Taurus UCX product family** is Lightware's groundbreaking innovation offered for the increasingly growing demand for cutting-edge solutions in the world of Unified Communications.

Universal Switcher with USB-C connectivity and Dante Audio



The **UCX-4x2-HC30D universal switcher** enhances and extends the possibilities of a meeting room and allows meeting participants to easily use their own devices such as laptops, and preferred video conference platforms while also to utilize the available assets of the meeting space, just like the HDMI displays, room cameras and other USB peripherals.

The device utilizes the **USB-C connectivity** for a simplified transmission of 4K video, audio, control signals and power, and allows data speeds of up to **5 Gbps** under the **USB 3.1 Gen1** providing video resolution capabilities up to **4K@60Hz at 4:4:4**.

Devices such as laptops that do not come with USB-C ports can also be connected quickly and easily, using a combination of **HDMI 2.0** and **USB 3.1 Gen1** connections without compromising on either video resolution or data speeds.

The device allows up to four hosts to be connected to the system, and also ensures quick and easy switching between these hosts, making this universal switcher a perfect fit for smaller meeting areas, involving 6-12 people.

Automated room control features are also included through **GPIO ports**, besides of **RS-232** and occupancy sensor connectivity.

The switcher also thrives when it comes to **audio capabilities**, offering **analog audio de-embedding** feature as well as support for **DANTE/AES67** network connection to send DANTE/AES67 audio stream directly to a dedicated audio system.

Security is always a key concern in the corporate world, therefore our engineers ensured that the **UCX-4x2-HC30D** adheres to the strictest security standards.

Secure corporate Ethernet interfaces ensure secure device control and configuration under the SSH, SSL and HTTPS standards, whilst the device can also be securely connected to a closed network of room control devices such as wall panels, or routed to the corporate system for additional control options, all via separate Ethernet layers.

The Taurus UCX offers noiseless operation in most environments where conditions are considered regular, just like in a meeting room where temperatures do not exceed the low 20s in Celsius or about 70-75 in Fahrenheit. The built-in fan is designed to operate only if the device is installed in a cabinet or other environment with insufficient air-flow. We specified a maximum of 30dBA noise level for our ventilation system in a meeting room, to comply with the NC-30 és NR 30 standards.

In today's collaboration environments, it is key that the technology offers flexible and versatile ways for participants to unlock the full potential of a collaboration space and to not be limited by the default options offered by their meeting rooms.

The new **Taurus UCX product family** is Lightware's ground-breaking innovation offered for the increasingly growing demand for cutting-edge solutions in the world of Unified Communications.

UCX-2x1-HC30 Application Diagram

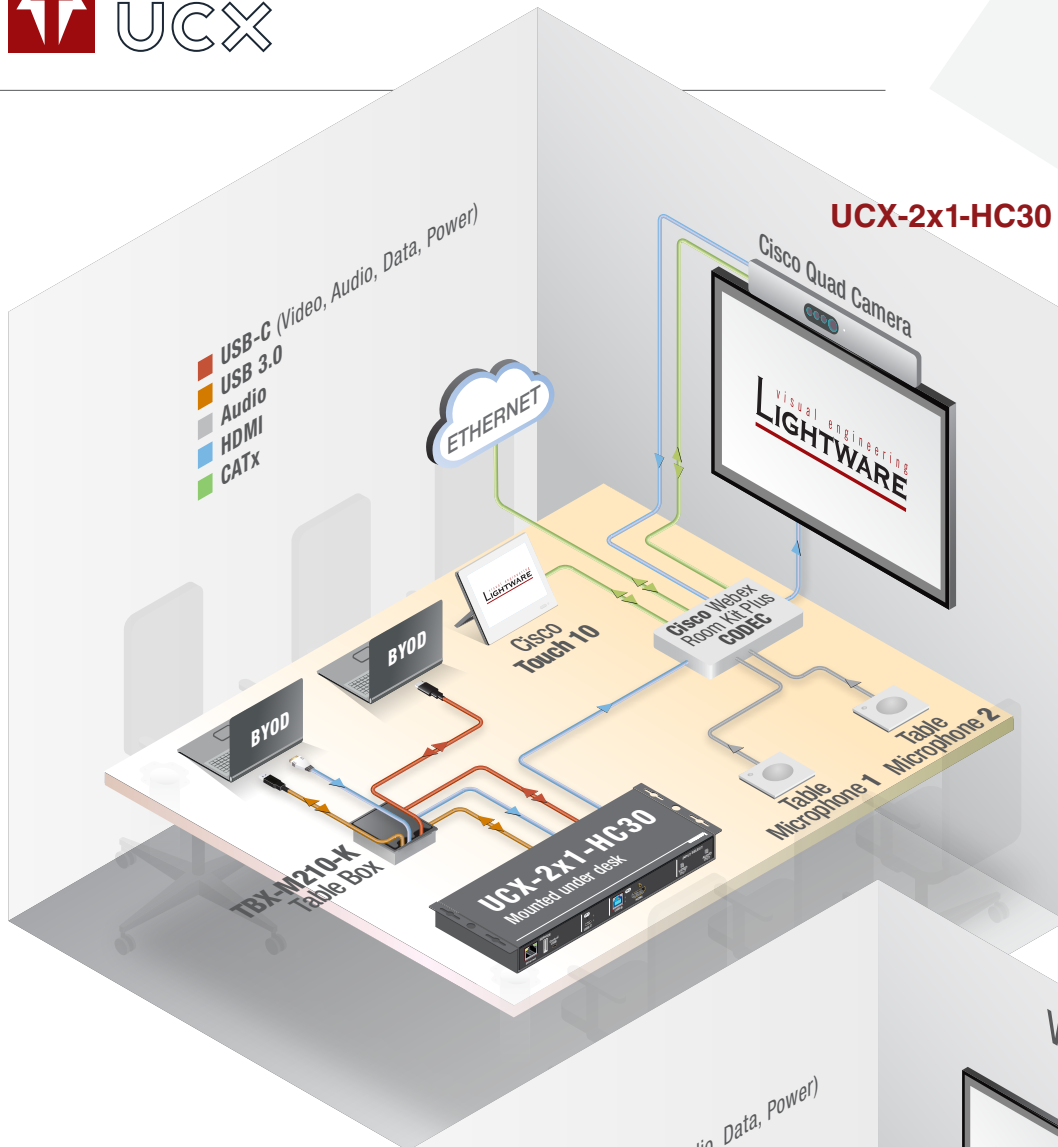

UCX4x2-HC30 Application Diagram

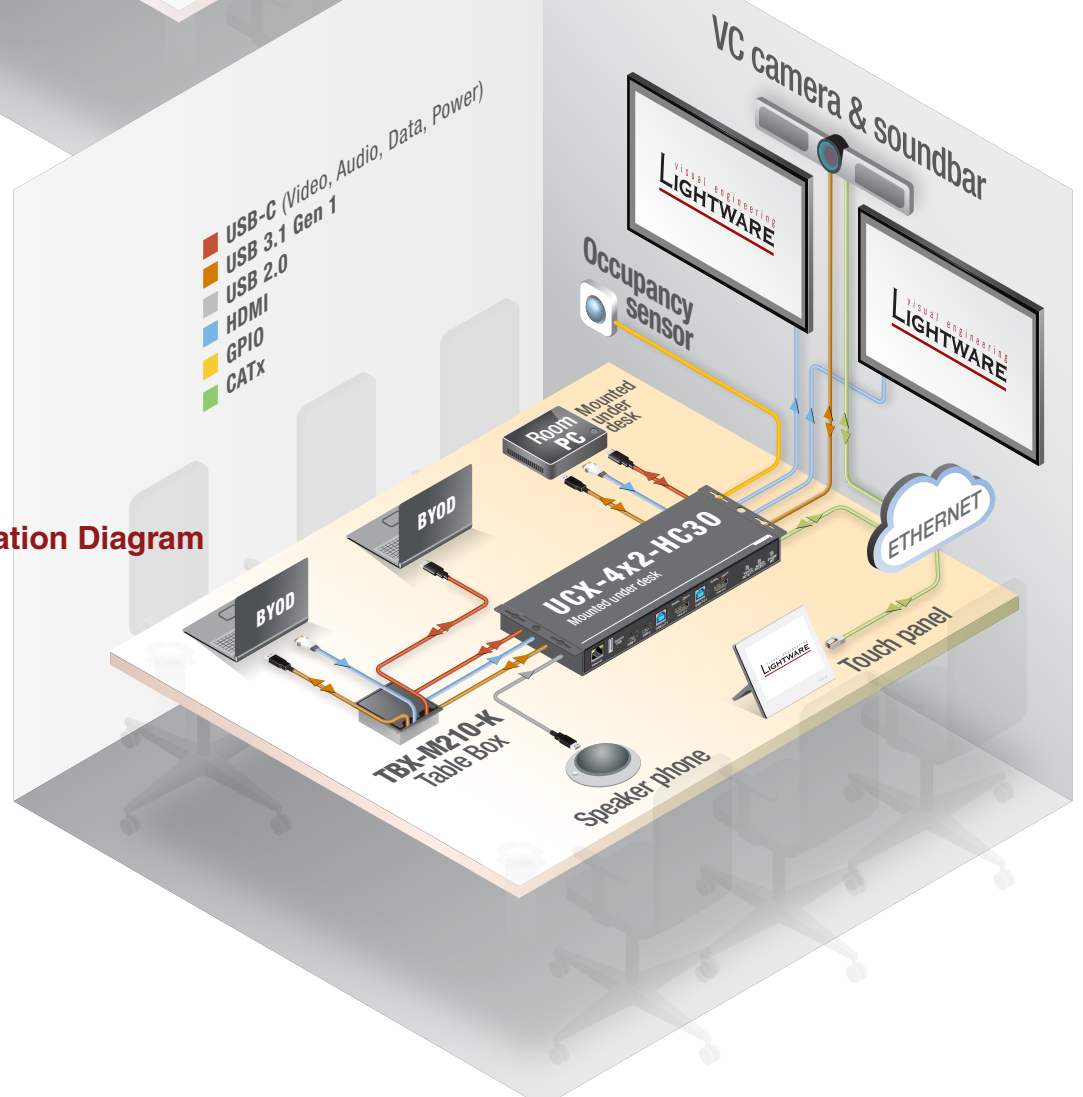

Taurus UCX Comparison Chart

		UCX-2x1-H30	UCX-2x1-HC30	UCX-2x1-HC30D	UCX-4x2-HC30	UCX-4x2-HC30D	
Video	Resolution	Up to UHD/4K@60Hz 4:4:4					
	Signal Type	DP, HDMI 2.0, HDMI 1.x, DVI					
	Maximum data rate	18 Gbps					
	Maximum pixel clock	597 MHz					
	Content protections	HDCP 1.x, HDCP 2.2					
	Connector type		2x HDMI receptacle type A with screw locking option	1x HDMI receptacle type A with screw locking option	2x HDMI receptacle type A with screw locking option		
				1x USB-C receptacle type A with screw locking option	2x USB-C receptacle type A with screw locking option		
	Video processing	Signal parameter measurement					
Standards	HDMI 2.0, HDMI 1.4, DVI						
Audio	Audio mode	Simultaneous pass-through and de-embedding to the Audio layer					
	Supported audio formats for pass-through	All HDMI2.0 audio formats					
	Supported audio formats for de-embedding	Uncompressed	LPCM (up to 8 channels, 192 kHz, 24 bits per sample)				
		Compressed	Dolby Digital, DTS				
Compressed HBR		Dolby TrueHD, DTS-HD					
Ethernet	Control	1x 100Base-T via EtherCON for Secure Control			1x 100Base-T via EtherCON for Utility AV	1x 100Base-T via EtherCON for Secure Control	
	User Data		1x 100Base-T via EtherCON for Utility AV		1x 100Base-T via EtherCON for Secure Corporate Ethernet	1x 100Base-T via EtherCON for Utility AV	
			1x 100Base-T via EtherCON for Secure Corporate Ethernet			1x 100Base-T via EtherCON for Secure Corporate Ethernet	
		Audio	1x 100Base-T via EtherCON for Dante audio (output)			1x 100Base-T via EtherCON for Dante audio (output)	
RS-232	Connector	1x 3Pol Phoenix			2x 3Pol Phoenix		
	Symbol rate	between 4800 and 115200 baud					
	Configuration	8N1					
USB	Connectors	1x mini USB Type B for LDC control	1x USB Type C with charging function (2x30W), Optional Ethernet access		2x USB Type C with charging function (2x30W), Optional Ethernet access		
		1x USB Type A for Service	1x mini USB Type B for LDC control				
		2x USB Type B for user application	1x USB Type A for Service				
		2x USB Type A for peripherals	1x USB Type B for user application			2x USB Type B for user application	
Room Occupancy Sensor	Connector	3Pol Phoenix					
GPIO	Connector	8Pol Phoenix					
General	Powering	External 120W power supply					
	Power consumption (max)	TBD					
	Thermal dissipation (max)	TBD					
	Weight	TBD					
	Operating conditions	Ambient temperature	0-50°C				
		Relative humidity	0-90% (non-condensing)				
	Transportation conditions	Ambient temperature	-20-70°C				
		Relative humidity	0-95% (non-condensing)				
Compliance		EN 55032:2015	IEC 61000-3-3:2013+AMD1:2017	FCC CFR Title 47, Part 15, Subpart B			
Warranty		3 years					

MMX4x2-HDMI-USB20-L

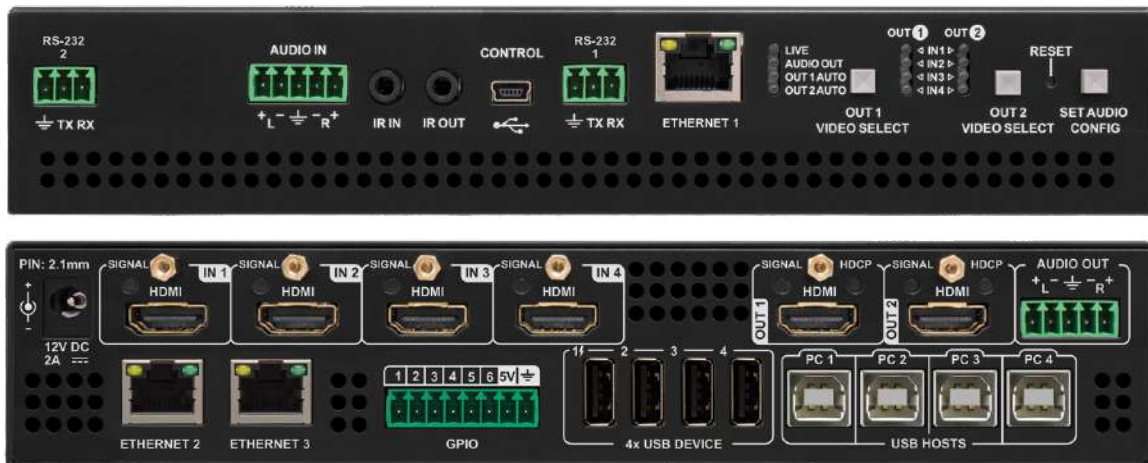

MMX4x2-HDMI-USB20-L is an integrator-friendly, 4x2 matrix switcher for HDMI video and USB2.0 peripherals.

It has four HDMI inputs and two independent HDMI outputs, as well as a USB 2.0 layer that provides the switching of four external USB peripherals (USB devices such as webcam, speakerphone, multitouch display, etc.) to four independent host computers or laptops. The 'Power Switch Delay' feature allows sinks and displays to detect any changes in the source signal, by cutting power off between the camera and the device for 2 seconds.

Unique USB functions allow seamless integration in Unified Communication and small Video Conference rooms. The USB "Host5vSense" function recognizes when a USB cable is connected and performs condition triggering for the Event Manager. For example, switch USB devices to the last connected USB laptop if configured accordingly. The "Device5vEnable" turns ON or OFF peripherals' 5 Volt over the USB cable.

One of the USB-A type connectors is capable to power connected devices with 1000mAh at 5V, and therefore allows remote charging for certain devices, such as the Huddly Go and Huddly IQ cameras, that require at least 900mAh.

"HostSelect 0" disconnects Cisco Room Kit Mini and allows Touch 10 control unit to switch between Webcam and Webex video conferencing operation modes.

The device offers two individual RS-232 interfaces to allow independent control of two separate 3rd party devices, such as a Cisco Room Kit Mini or an external display.

MMX4x2-HDMI-USB20-L and built-in Event Manager automation makes the meeting room easy, intuitive and hassle-free; it detects powered computers, turns on the screen and camera, and prepares for the next call. Based on the specific configuration it allows auto-switch for USB and video signals. In other cases USB may not follow video, according to the application.

Audio can be de-embedded from the HDMI signal to a balanced 5-pole Phoenix (Euroblock) port and external audio signal can be embedded into the HDMI stream from another 5-pole Phoenix input port. The volume and gain properties of the audio signal can be modified at both input and output.

HDMI connectors are 4K capable and HDCP compliant and additional control options are served by the USB, RS-232, IR (in and out) and Ethernet ports.

Features

- 4 x 2 Matrix Switcher with HDMI 1.4 ports
- 4K/UHD (30Hz RGB 4:4:4, 60Hz YCbCr 4:2:0)
- USB 2.0 Host switching layer for external USB 2.0 peripherals (Camera; Touch sensor; Speakerphone, etc.)
- 4 x USB 2.0 Device peripherals
- 4 x USB 2.0 Host computers
- USB Host switching is compatible with Windows, MacOS and any other operating system
- "Host5vSense" triggers Event Manager
- "Device5vEnable" function turns ON or OFF peripherals' 5 V USB power
- "HostSelect 0" disconnects Cisco Room Kit Mini's webcam
- USB-C Laptop Support (With external adaptors)
- 1 x 5-pole Phoenix connector for balanced analog audio embedding
- 1 x 5-pole Phoenix connector for balanced analog audio de-embedding
- Analog audio volume control
- Event Manager
- Command injection on IR and RS-232 connections
- Advanced EDID Management
- Zero frame delay

Applications

- Meeting and conference rooms
- Huddle Rooms with Soft VC

Connectors

Digital video inputs:	4 x HDMI connector
Digital video outputs:	2 x HDMI connector
Balanced audio input:	5-pole Phoenix (Euroblock) connector
Balanced audio output:	5-pole Phoenix (Euroblock) connector
Ethernet:	3 x RJ45
USB device:	4 x USB-A
USB power:	1 x 1000 mA & 3 x 500mA
USB host:	4 x USB-B
USB control:	mini-USB-B connector
Control:	6 x GPIO, 8-pole Phoenix (Euroblock)
IR in and out:	3.5 mm jack
Serial port:	2 x RS-232 Serial Port
Power:	Locking DC connector (2.1 / 5.5 mm)

Cisco Webex and MS Teams mixed Application

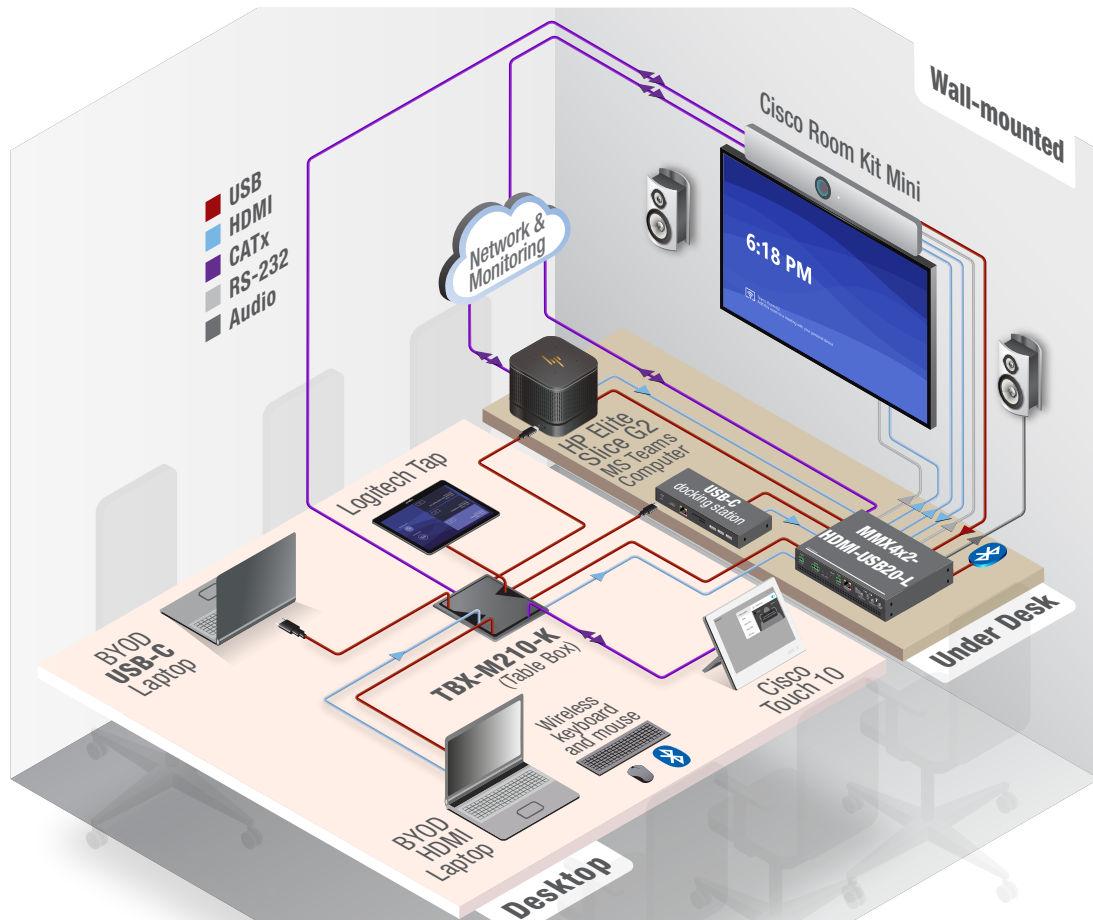
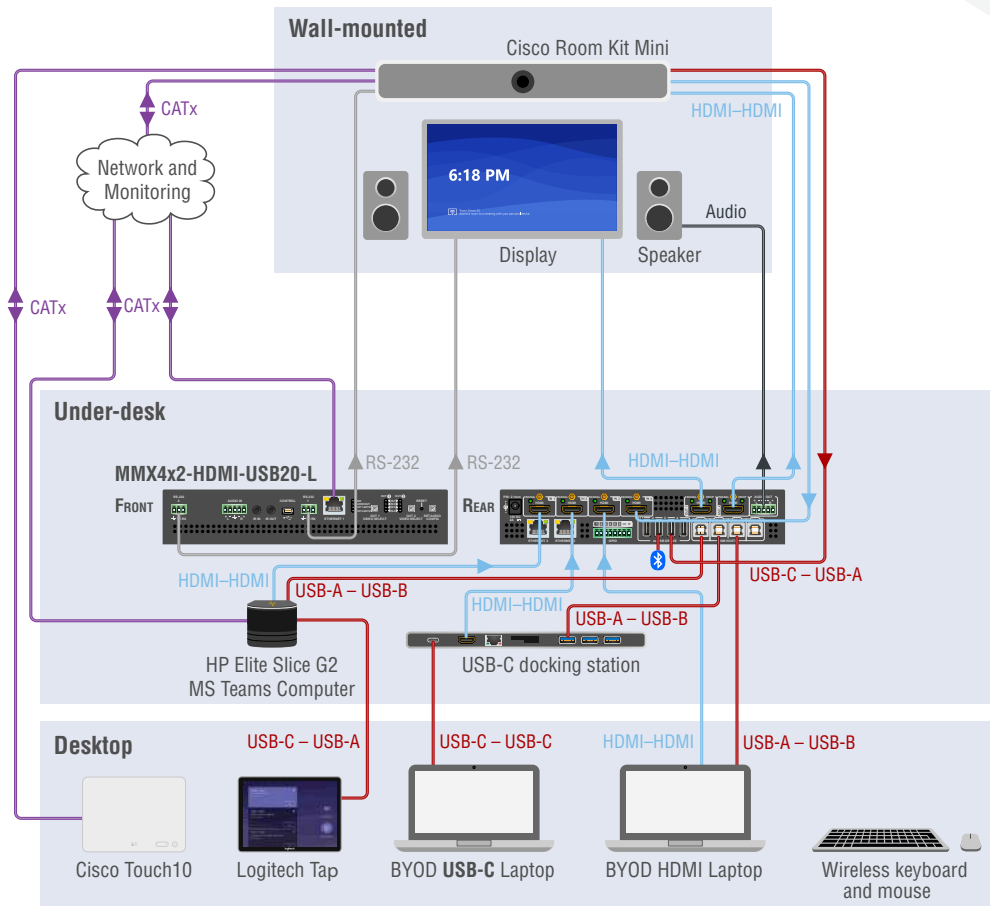

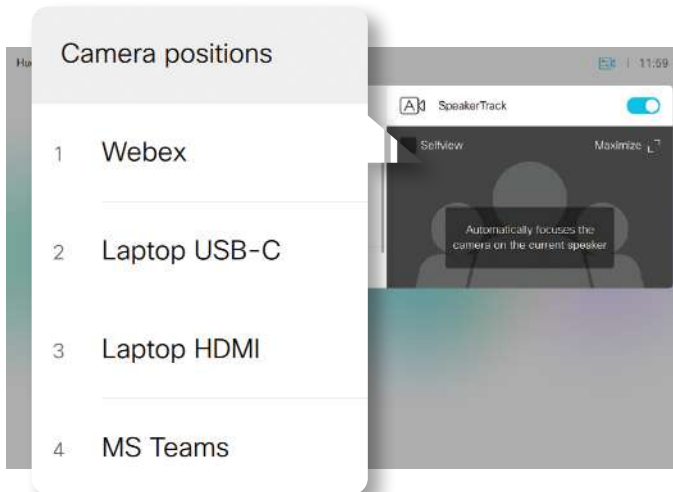

The Camera Selector Icon on the top right corner of the screen provides access to the Camera Selector Menu.

In the Camera Selector Menu users can choose from a list of pre-defined and per-configured camera options.

Once the required camera is selected, the Lightware matrix sets up the system to be immediately ready for collaboration on the chosen VC platform.



When the Webex RoomKit Mini is utilized as a USB camera, the 'Do-not-disturb' screen is displayed on the Touch10 to advise users about the current status.

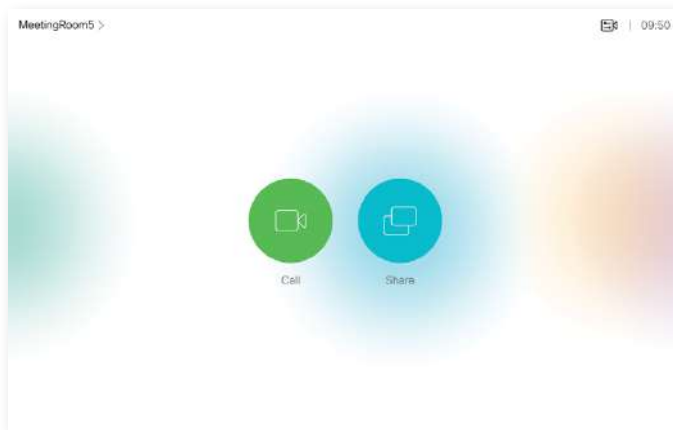

Upon tapping the Touch10, users are presented with the Main Screen in Normal Mode where they can either initiate a call using the Cisco Webex platform or enter the Share Menu to choose from additional input options.



The desired input device can also be chosen inside the Share Screen Menu where all available options are displayed.

The currently active input device is highlighted in green and its content is displayed on the room's main screen.

Dual Screen Application with Wireless Presenter

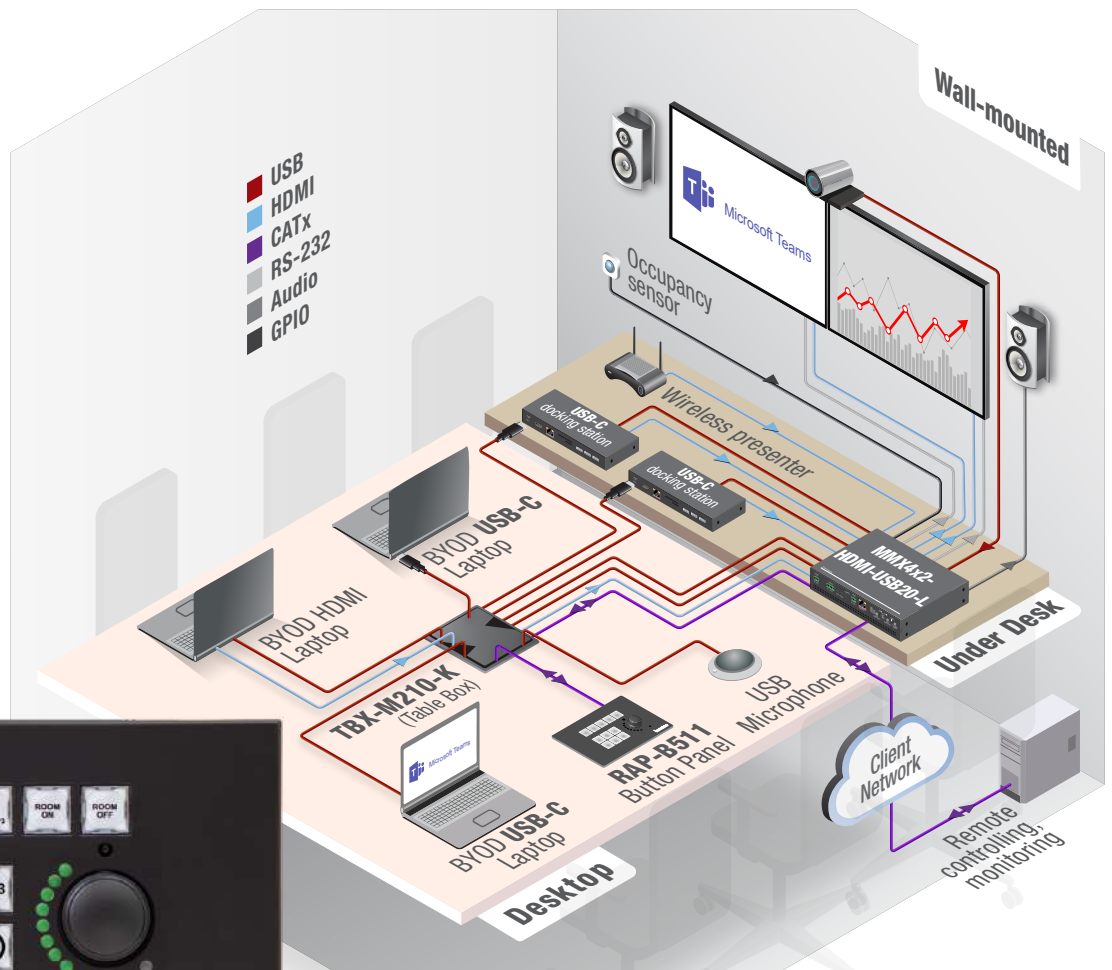
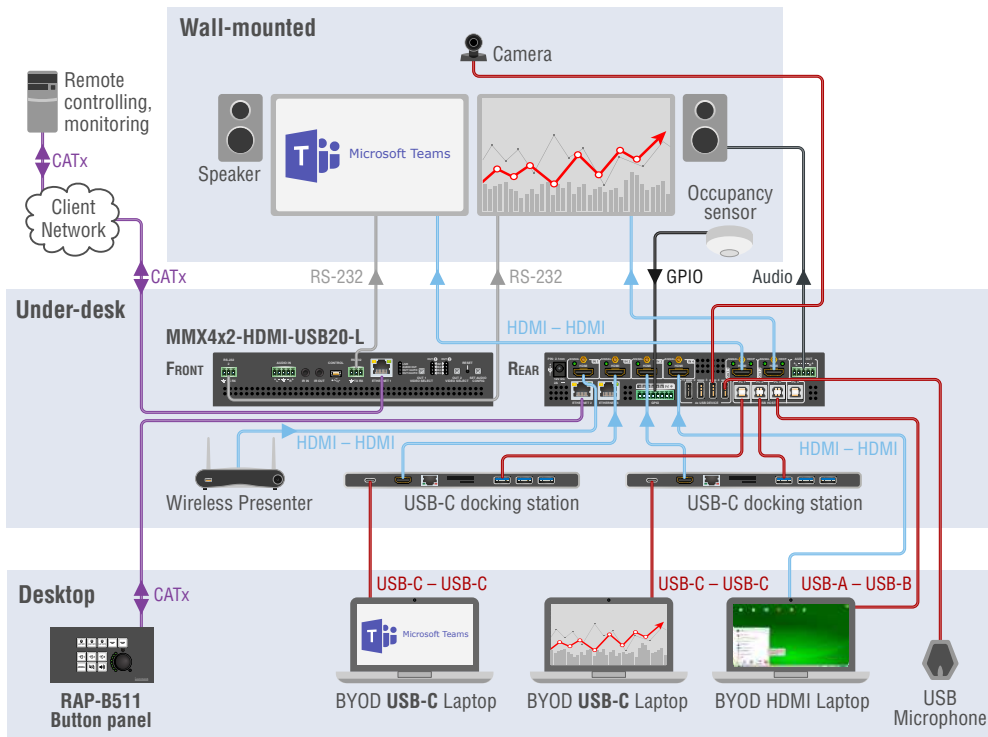

RAP-B511
Button Panel



MMX4x2-HDMI-USB20-L

MMX4x2-HDMI-USB20-L Port Diagram

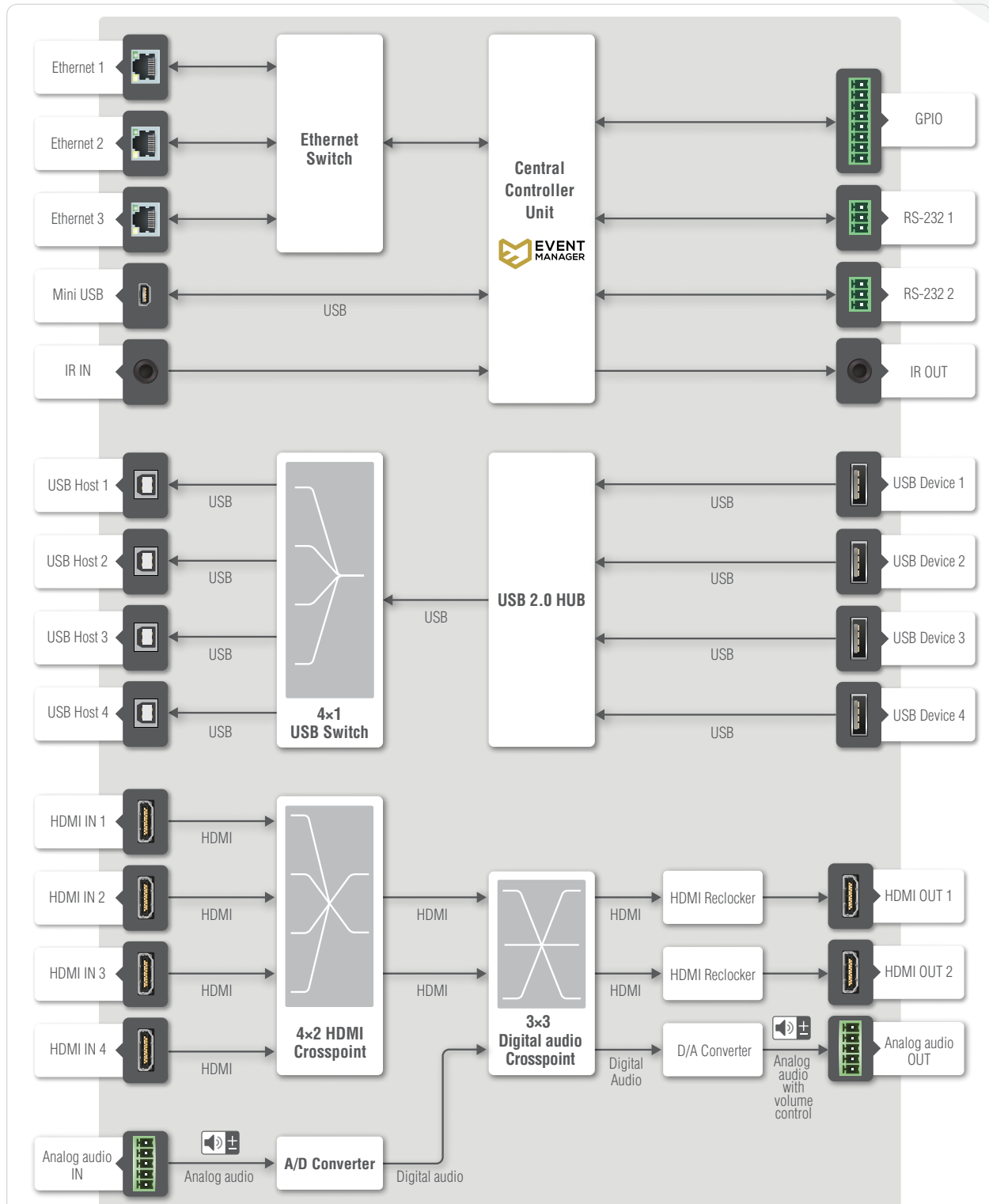



MMX8x8-HDMI-A-USB20 is an integrator-friendly, 8x8 matrix switcher for HDMI video and USB2.0 peripherals.

It has eight HDMI inputs and eight independent HDMI outputs, as well as a USB 2.0 layer that provides the switching of four external USB peripherals (such as webcam, speakerphone, multitouch display, etc.) to four independent computers or laptops. The 'Power Switch Delay' feature allows sinks and displays to detect any changes in the source signal, by cutting power off between the camera and the device for 2 seconds.

The MMX8x8-HDMI-4K-A-USB20 offers 4+2 balanced, bi-directional, 5-pole Phoenix audio ports for embedding and de-embedding audio signals. Unique USB functions allow seamless integration in Unified Communication and small Video Conference rooms. The "USB 5V Host Detect" function recognizes when a USB cable is connected and performs condition triggering for the Event Manager. For example, switch USB devices to the last connected USB laptop if configured accordingly. The "USB 5V PWR Switch" turns ON or OFF peripherals' 5Volt over the USB cable.

One of the USB-A type connectors is capable to power connected devices with 1000mAh at 5V, and therefore allows remote charging for certain devices, such as the Huddly Go and Huddly IQ cameras, that require at least 900mAh.

"USB Disconnect" helps Cisco Room Kit Mini and Touch 10 control unit to switch between Webcam and Webex video conferencing operation modes. It also solves the problem when Cisco Touch 10 gets locked in USB webcam operation and touch buttons become unavailable.

MMX8x8-HDMI-A-USB20 and built-in Event Manager automation makes the meeting room easy, intuitive and hassle-free: it detects powered computers, turns on the screen and camera, and prepares for the next call. Based on the specific configuration it allows auto-switch for USB and video signals. In other cases USB may not follow video, according to the application.

The MMX8x8-HDMI-A-USB20 seamlessly integrates with Cisco Rooms, and also offers users unprecedented flexibility to utilize the Cisco Webex Room kits as a USB camera if they prefer to use a 3rd party video conference platform.

Features

- Multiple USB 2.0 connectivity for any type of USB devices (Camera, speakerphone, touch monitor, USB-HID devices etc...)
- USB-C Source Support (With external adaptors)

- USB 2.0 Host switching layer for external USB 2.0 peripherals (Camera; Touch sensor; Speakerphone, etc.)
- 4 x USB 2.0 Device peripherals
- 4 x USB 2.0 Host computers
- USB Host switching is compatible with Windows, MacOS and any other operating system
- "Host5vSense" triggers Event Manager
- "Device5vEnable" function turns ON or OFF peripherals' 5 V USB power
- "HostSelect 0" disconnects Cisco Room Kit Mini's webcam
- USB-C Laptop Support (With external adaptors)
- Separate USB 2.0 Host switching layer for multiple USB hosts and USB devices
- Cisco VC room integration compatibility
- Advanced control feature pack for 3rd party video conference collaboration
- Audio embedding and de-embedding
- 5-pole Phoenix balanced analog audio connectors
- Advanced EDID Management
- Supports HDMI 4K signal formats (4K UHD @30Hz RGB 4:4:4 or @60Hz YUV 4:2:0, up to 9 Gbps)
- Command injection on RS-232 and IR ports
- Built-in Event Manager automation feature
- No signal latency, zero frame delay

Applications

- Meeting and conference rooms
- Huddle Rooms with Soft VC

Connectors

Digital video inputs:	8 x HDMI connector
Digital video outputs:	8 x HDMI connector
Balanced audio I/O ports:	6 x 5-pole Phoenix (Euroblock) connector
Ethernet:	3 x RJ45
USB device:	4 x USB-A
USB power:	1 x 1000mA & 3 x 500mA
USB host:	4 x USB-B
USB control:	mini-USB-B connector
Control:	6 x GPIO, 8-pole Phoenix (Euroblock)
IR in and out:	3.5 mm jack
Serial port:	2 x RS-232 Serial Port
Serial/IR configurable port:	2 x 2-pole Phoenix connector
Power:	Locking DC connector (2.1 / 5.5 mm)

MMX8x8-HDMI-4K-A-USB20

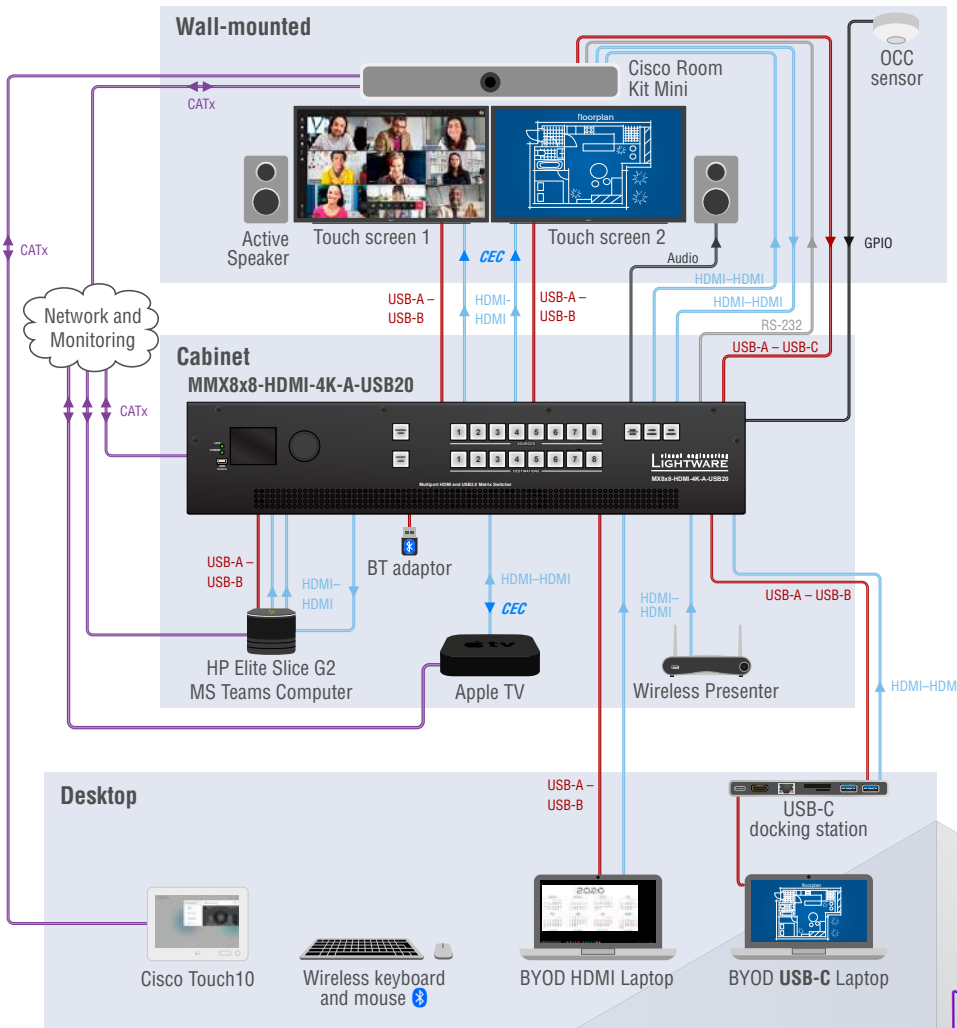

Small Room Application

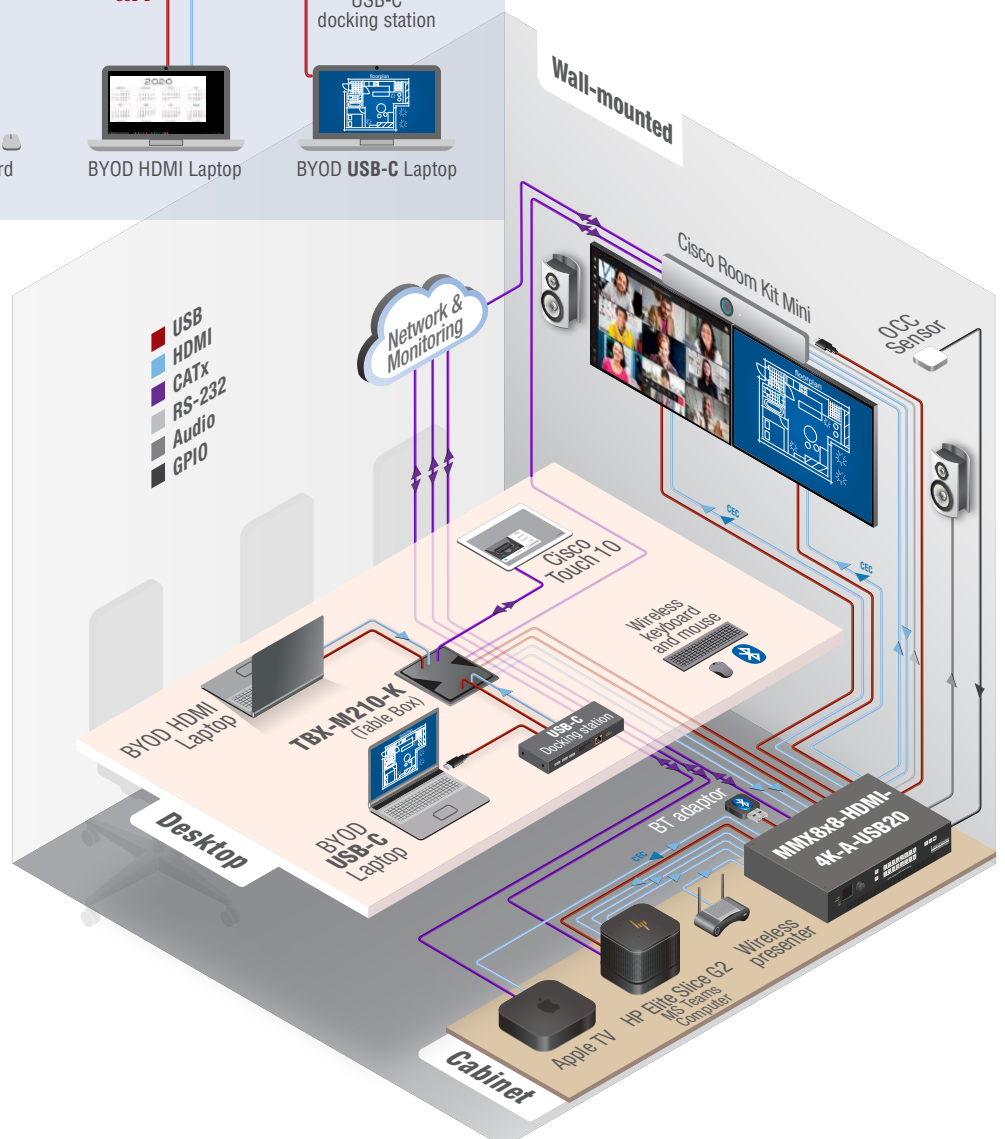

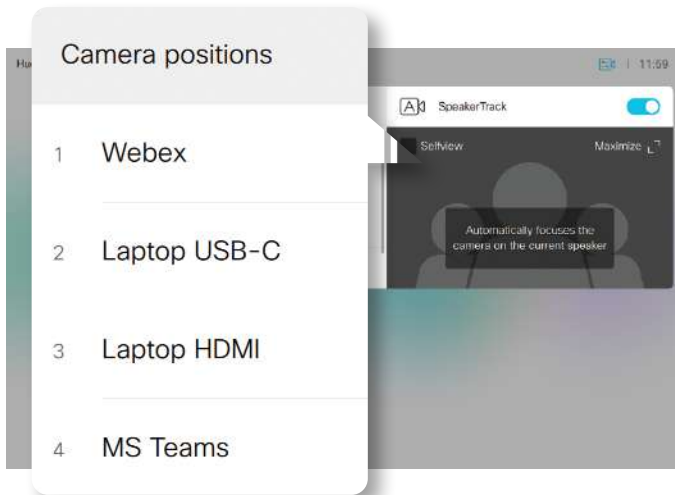

The Camera Selector Icon on the top right corner of the screen provides access to the Camera Selector Menu.

In the Camera Selector Menu users can choose from a list of pre-defined and per-configured camera options.

Once the required camera is selected, the Lightware matrix sets up the system to be immediately ready for collaboration on the chosen VC platform.

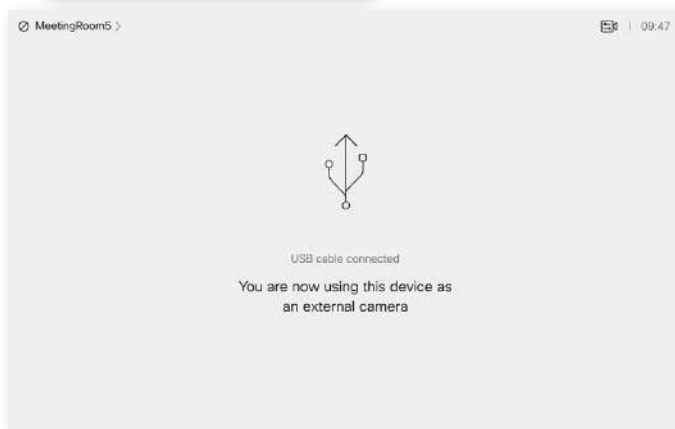

When the Webex RoomKit Mini is utilized as a USB camera, the 'Do-not-disturb' screen is displayed on the Touch10 to advise users about the current status.

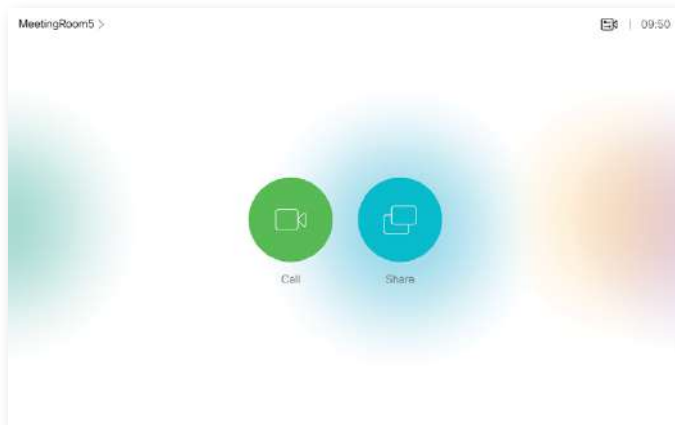

Upon tapping the Touch10, users are presented with the Main Screen in Normal Mode where they can either initiate a call using the Cisco Webex platform or enter the Share Menu to choose from additional input options.



The desired input device can also be chosen inside the Share Screen Menu where all available options are displayed.

The currently active input device is highlighted in green and its content is displayed on the room's main screen.

MMX8x8-HDMI-4K-A-USB20

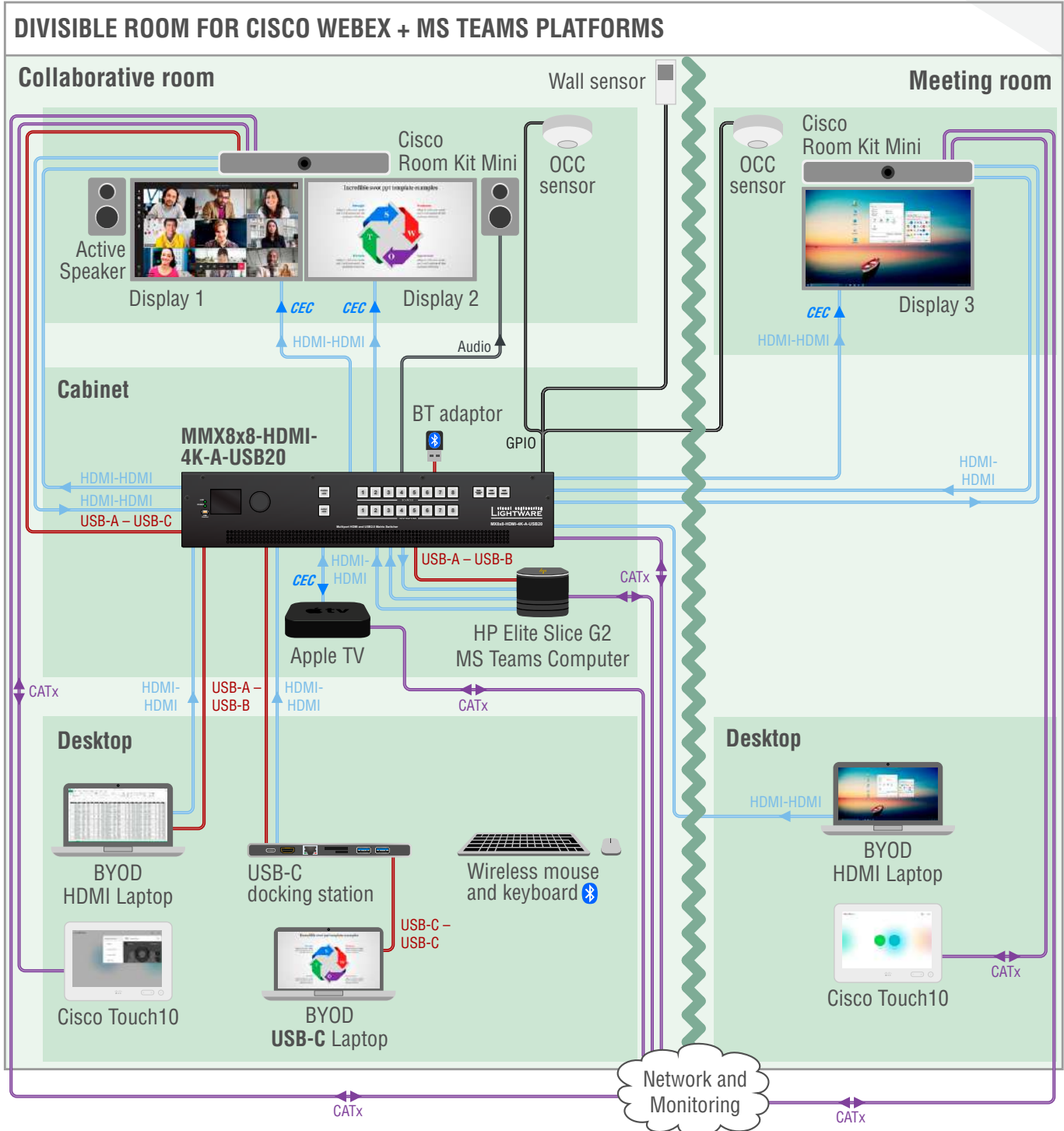

Divisible Room for Cisco Webex + MS Teams Platforms

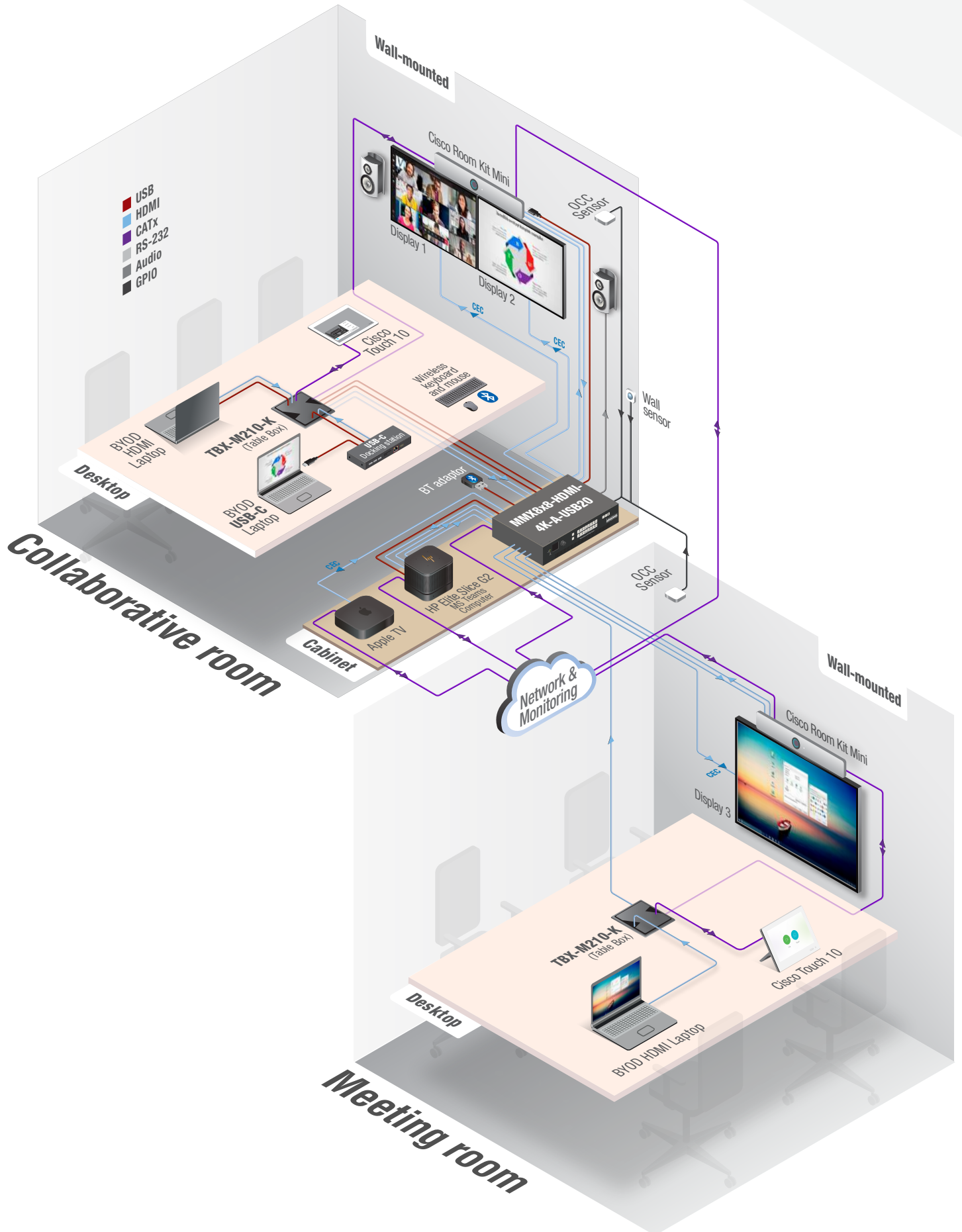

MMX8x8-HDMI-4K-A-USB20

DIVISIBLE ROOM WITH TOUCH SCREENS

Collaborative room

Meeting room

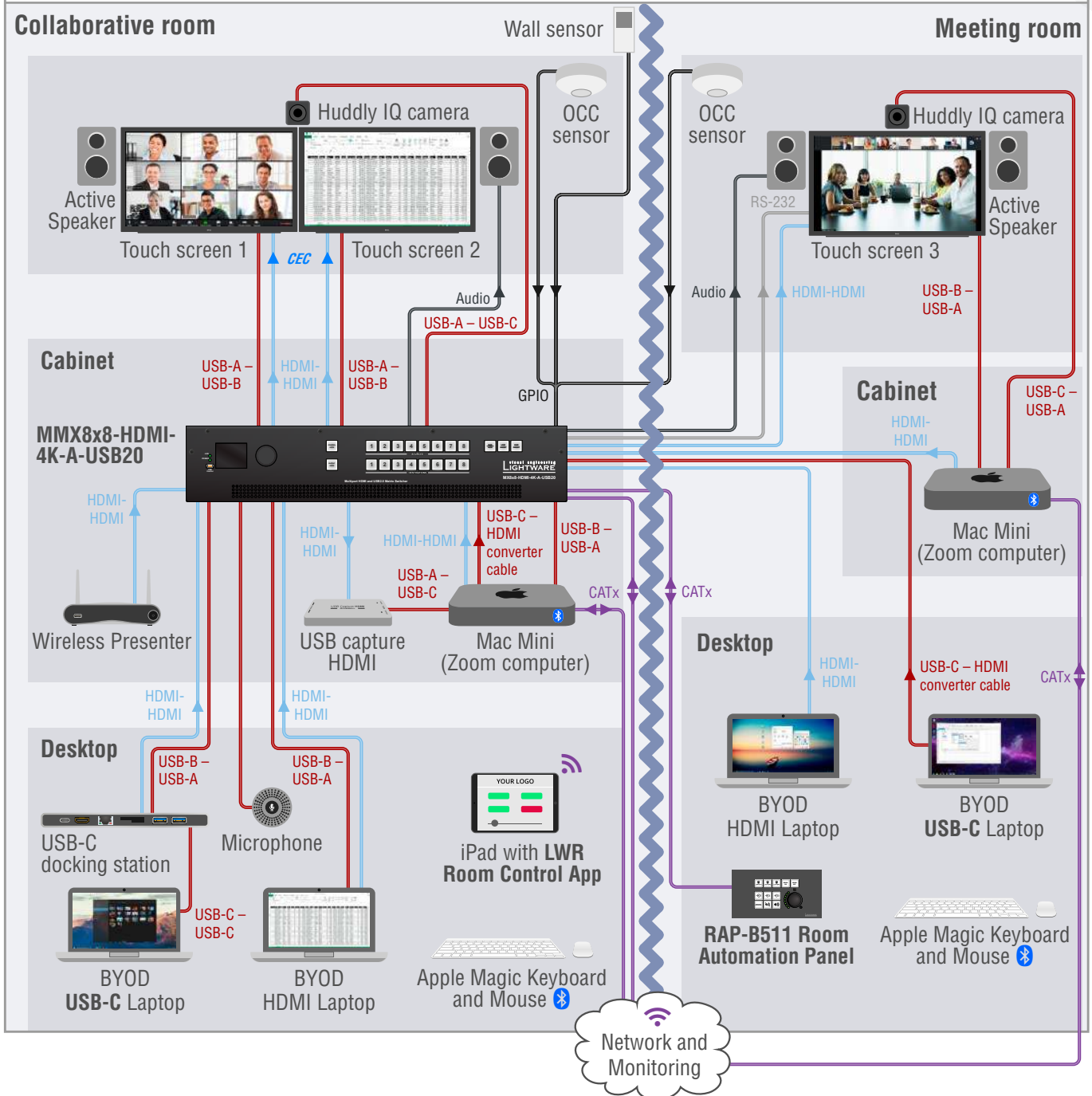

Divisible Room with Touch Screens

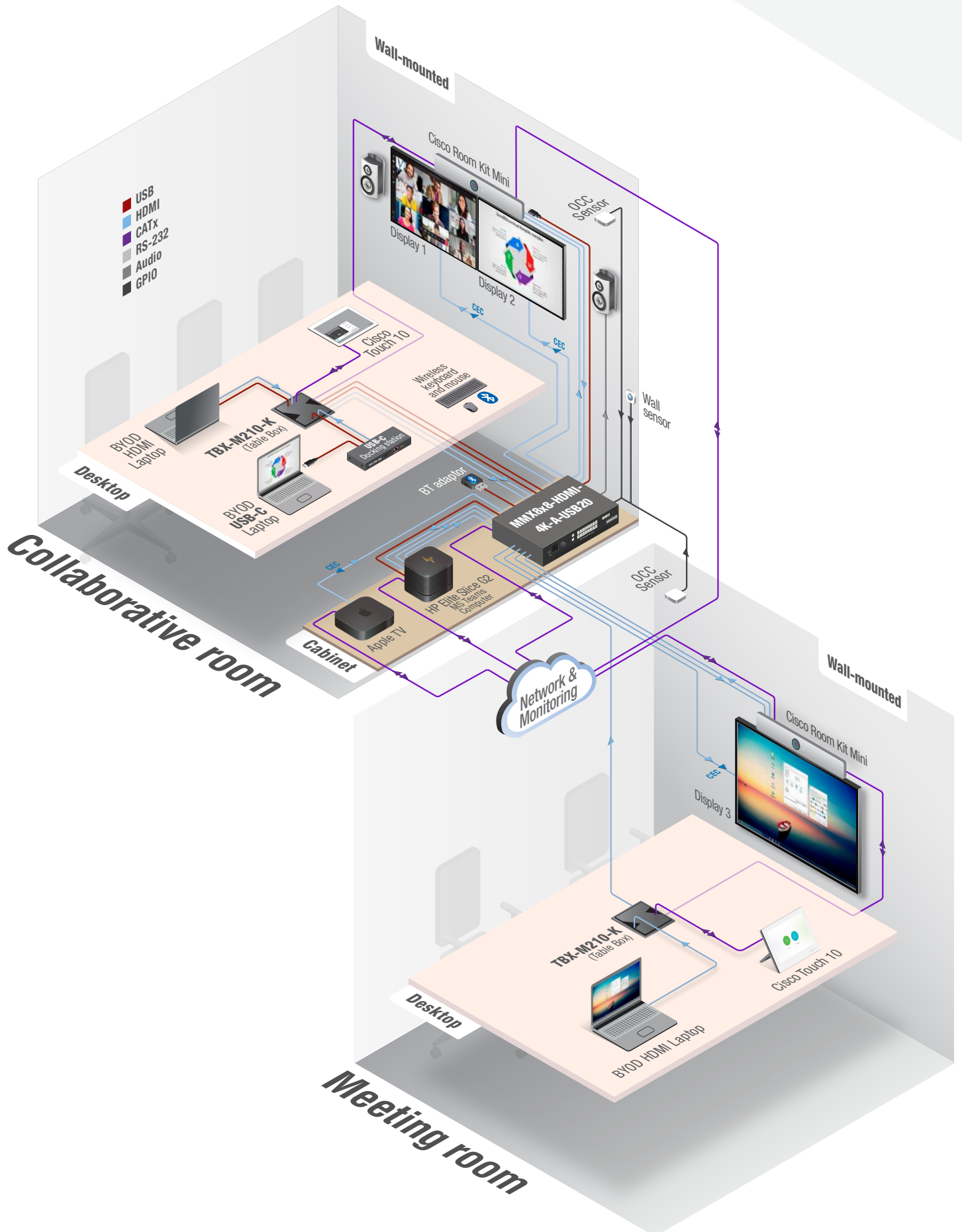

MMX8x8-HDMI-4K-A-USB20

MMX8x8-HDMI-4K-A-USB20 Port Diagram

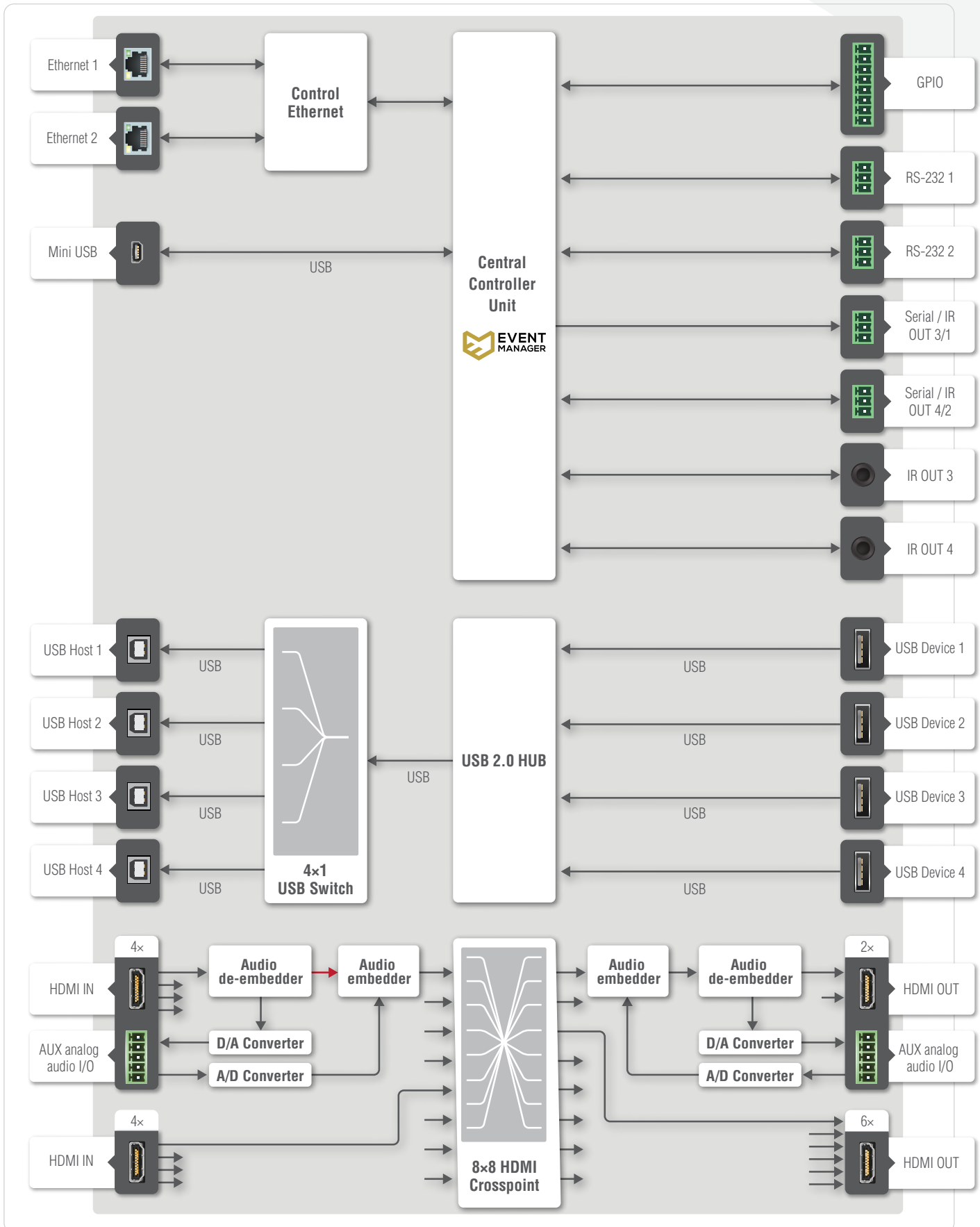

Lightware Headquarters

Peterdy 15, Budapest H-1071, Hungary
Tel: +36 1 255 3800
sales@lightware.com | support@lightware.com | www.lightware.com

Lightware Visual Engineering Australia & New Zealand

Unit 18, Leighton Industrial area, 22 Leighton Place, Hornsby, Sydney, NSW, 2077
Tel : +(02) 9476 8850 | sales.anz@lightware.com | support.anz@lightware.com

Lightware Visual Engineering Benelux

1218 EB Hilversum, Krekelmeent 38
Tel: +31 35 631 3295 | sales.nl@lightware.com | support.nl@lightware.com

Lightware Visual Engineering China

Sailuo No. 1, Room 510, 435 Baiziwan Xili Chao Yang District, Beijing, P. R. China 100124
Tel: +86 010-5712 7558 | sales.china@lightware.com | support.china@lightware.com

Lightware Deutschland GmbH

Otto Hahn Straße 13b, 85521 Riemerling, Germany
Tel (North): +49 (175) 361 5541 | Tel (South): +49 (0) 171 3232 466 | sales.de@lightware.com

Lightware Visual Engineering Iberia

C/San Bernardo, 107, 28015 Madrid, Spain
Mob: +34 652 99 70 53 | sales.iberia@lightware.com | support.iberia@lightware.com

Lightware Visual Engineering India

No-1AAC-214, G Floor, East of NGEF Layout, Kasturinagar, Bangalore - 560043, India
Tel: 91 984 5555 4847 | sales.india@lightware.com | support.india@lightware.com

Lightware Visual Engineering Italy & Malta

Via Mons. Bagnoli, 49 67051 Avezzano (AQ)
Tel: +39 086 345 1738 | italy@lightware.com | support.italy@lightware.com

Lightware Visual Engineering Latin America

Carrera 83 # 32B-181 Medellin - Colombia South America
Tel: +573 01323 6831 | carlos.otero@lightware.com

Lightware Visual Engineering Middle East

P.O. Box 410595, Techno Point 223, Silicon Oasis, Dubai, UAE
Tel: +971 502449964 | sales.me@lightware.com | support.me@lightware.com

Lightware Visual Engineering Nordics

c/o Barnö, Frigångsgatan 12, 413 01 Gothenburg, Sweden
Tel: +46 708 409999 | sales.nordics@lightware.com | support.nordics@lightware.com

Lightware Visual Engineering North America

40 Engelwood Drive Suite C, Lake Orion, MI 48359 USA
Tel: +1 888 587 5587 | sales.na@lightware.com | support.na@lightware.com

Lightware Visual Engineering Singapore & Southeast Asia

351 Jalan Besar, Reliance Building, #02-01, Singapore 208988
Tel: +65 6957 3800 | sales.sea@lightware.com | support.sea@lightware.com

Lightware Visual Engineering UK & Ireland

Dunley Hill Court, Ranmore, Dorking, Surrey, RH5 6SX
Tel: +44(0) 1483 28 13 10 | sales.uk@lightware.com | support.uk@lightware.com