



PRESSURA™ ROOM PRESSURE MONITOR MODEL RPM10 AND RPM20

OPERATION AND SERVICE MANUAL

P/N 6006644, REVISION M
APRIL 2020



START SEEING THE BENEFITS OF REGISTERING TODAY!

Thank you for your TSI instrument purchase. Occasionally, TSI releases information on software updates, product enhancements and new products. By registering your instrument, TSI will be able to send this important information to you.

<http://register.tsi.com>

As part of the registration process, you will be asked for your comments on TSI products and services. TSI's customer feedback program gives customers like you a way to tell us how we are doing.



UNDERSTANDING, ACCELERATED

TSI Incorporated - Visit our website www.tsi.com for more information.

USA	Tel: +1 800 874 2811	India	Tel: +91 80 67877200
UK	Tel: +44 149 4 459200	China	Tel: +86 10 8219 7688
France	Tel: +33 1 41 19 21 99	Singapore	Tel: +65 6595 6388
Germany	Tel: +49 241 523030		

PRESSURA™

ROOM PRESSURE CONTROLLER

MODEL RPM10 AND RPM20

OPERATION AND SERVICE MANUAL

P/N 6006644, REVISION M
APRIL 2020

U.S. AND CANADA

Sales & Customer Service:
(800) 680-1220 / (651) 490-2860
Fax:
(651) 490-3824

SHIP/MAIL TO:

TSI Incorporated
ATTN: Customer Service
500 Cardigan Road
Shoreview, MN 55126
USA

OTHER COUNTRIES

Sales & Customer Service:
(001 651) 490-2860
Fax:
(001 651) 490-3824

E-MAIL

customer.service@tsi.com

WEB SITE

www.tsi.com



WARNING

These Instruments **must** be used in the manner described in this manual. Failure to follow all of the procedures described in this manual can result in serious injury or death. There are no user-serviceable parts inside the instrument. Refer all repairs to a qualified factory-authorized technician.

Part number 6006644 / Rev M / April 2020

Limitation of Warranty and Liability (effective April 2014)

(For country-specific terms and conditions outside of the USA, please visit www.tsi.com.)

Seller warrants the goods, excluding software, sold hereunder, under normal use and service as described in the operator's manual, to be free from defects in workmanship and material for **24 months**, or if less, the length of time specified in the operator's manual, from the date of shipment to the customer. This warranty period is inclusive of any statutory warranty. This limited warranty is subject to the following exclusions and exceptions:

- a. Hot-wire or hot-film sensors used with research anemometers, and certain other components when indicated in specifications, are warranted for 90 days from the date of shipment;
- b. Pumps are warranted for hours of operation as set forth in product or operator's manuals;
- c. Parts repaired or replaced as a result of repair services are warranted to be free from defects in workmanship and material, under normal use, for 90 days from the date of shipment;
- d. Seller does not provide any warranty on finished goods manufactured by others or on any fuses, batteries or other consumable materials. Only the original manufacturer's warranty applies;
- e. This warranty does not cover calibration requirements, and seller warrants only that the instrument or product is properly calibrated at the time of its manufacture. Instruments returned for calibration are not covered by this warranty;
- f. This warranty is **VOID** if the instrument is opened by anyone other than a factory authorized service center with the one exception where requirements set forth in the manual allow an operator to replace consumables or perform recommended cleaning;
- g. This warranty is **VOID** if the product has been misused, neglected, subjected to accidental or intentional damage, or is not properly installed, maintained, or cleaned according to the requirements of the manual. Unless specifically authorized in a separate writing by Seller, Seller makes no warranty with respect to, and shall have no liability in connection with, goods which are incorporated into other products or equipment, or which are modified by any person other than Seller.

The foregoing is **IN LIEU OF** all other warranties and is subject to the **LIMITATIONS** stated herein. **NO OTHER EXPRESS OR IMPLIED WARRANTY OF FITNESS FOR PARTICULAR PURPOSE OR MERCHANTABILITY IS MADE. WITH RESPECT TO SELLER'S BREACH OF THE IMPLIED WARRANTY AGAINST INFRINGEMENT, SAID WARRANTY IS LIMITED TO CLAIMS OF DIRECT INFRINGEMENT AND EXCLUDES CLAIMS OF CONTRIBUTORY OR INDUCED INFRINGEMENTS. BUYER'S EXCLUSIVE REMEDY SHALL BE THE RETURN OF THE PURCHASE PRICE DISCOUNTED FOR REASONABLE WEAR AND TEAR OR AT SELLER'S OPTION REPLACEMENT OF THE GOODS WITH NON-INFRINGEMENT GOODS.**

TO THE EXTENT PERMITTED BY LAW, THE EXCLUSIVE REMEDY OF THE USER OR BUYER, AND THE LIMIT OF SELLER'S LIABILITY FOR ANY AND ALL LOSSES, INJURIES, OR DAMAGES CONCERNING THE GOODS (INCLUDING CLAIMS BASED ON CONTRACT, NEGLIGENCE, TORT, STRICT LIABILITY OR OTHERWISE) SHALL BE THE RETURN OF GOODS TO SELLER AND THE REFUND OF THE PURCHASE PRICE, OR, AT THE OPTION OF SELLER, THE REPAIR OR REPLACEMENT OF THE GOODS. IN THE CASE OF SOFTWARE, SELLER WILL REPAIR OR REPLACE DEFECTIVE SOFTWARE OR IF UNABLE TO DO SO, WILL REFUND THE PURCHASE PRICE OF THE SOFTWARE. IN NO EVENT SHALL SELLER BE LIABLE FOR LOST PROFITS, BUSINESS INTERRUPTION, OR ANY SPECIAL, INDIRECT, CONSEQUENTIAL OR INCIDENTAL DAMAGES. SELLER SHALL NOT BE RESPONSIBLE FOR INSTALLATION, DISMANTLING OR REINSTALLATION COSTS OR CHARGES. No Action, regardless of form, may be brought against Seller more than 12 months after a cause of action has accrued. The goods returned under warranty to Seller's factory shall be at Buyer's risk of loss, and will be returned, if at all, at Seller's risk of loss.

Buyer and all users are deemed to have accepted this LIMITATION OF WARRANTY AND LIABILITY, which contains the complete and exclusive limited warranty of Seller. This LIMITATION OF WARRANTY AND LIABILITY may not be amended, modified or its terms waived, except by writing signed by an Officer of Seller.

Service Policy

Knowing that inoperative or defective instruments are as detrimental to TSI as they are to our customers, our service policy is designed to give prompt attention to any problems. If any malfunction is discovered, please contact your nearest sales office or representative, or call TSI's Customer Service department at (800) 680-1220 or (651) 490-2860.

Trademarks

TSI and TSI logo are registered trademarks of TSI Incorporated. PresSura is a trademark of TSI Incorporated. BACnet is a registered trademark of ASHRAE. Modbus is a registered trademark of Modicon, Inc. Lon Works is a registered trademark of Echelon® Corporation. IBM is a registered trademark of International Business Machines Corporation.

CONTENTS

HOW TO USE THIS MANUAL.....	1
Safety Information	1
Description of Caution Symbol.....	1
Access Code / Passcode	1
PART ONE	3
User Basics	3
The Instrument	3
Useful User Information.....	3
Operator Panel	3
Display Screen	4
Room Indicator Colors.....	4
Operator Keys	4
USB Port	5
Alarms.....	5
Visual Alarm	5
Audible Alarms	5
Alarm Relays	6
Before Calling TSI	6
PART TWO.....	7
Technical Section	7
Software Programming.....	8
Changing Room Mode	8
Entering Menus	9
Menus and Menu Items.....	9
Entering Data	9
Programming Example.....	10
Menu and Menu Items.....	12
Configure Menu.....	14
ALARM CONSTRAINTS	28
Alarm Config Menu.....	30
Interface Menu	31
Diagnostics Menu.....	37
Calibration	67
Room Pressure Calibration	67
Flow Calibration.....	68
Maintenance and Repair Parts.....	71
System Component Inspection	71
Pressure Sensor Cleaning	72
Display Screen Cleaning.....	72
Replacement Parts.....	72
Troubleshooting Section.....	72
Hardware Test.....	73
Troubleshooting Chart.....	75

APPENDIX A	79
Specifications*	79
APPENDIX B	81
Network Communications.....	81
Modbus® Communications	81
Unique to TSI	81
Network Points RAM Variables	82
XRAM Variables	83
RPM10 Variable List.....	83
RPM20 Variable List.....	85
RPM20 Variable List.....	88
RPM20 Variable List.....	89
LonWorks® Object	91
Node Object Network Variables	91
Room Pressure Monitor Object Network Variables	91
Description of LON SNVTs	92
Model RPM10 and RPM20 BACnet® MS/TP Protocol Implementation Conformance Statement.....	93
BACnet® MS/TP Object Set.....	96
APPENDIX C	111
Wiring Information	111
Back Panel Wiring	111
APPENDIX D	127
Access Codes / Passcode.....	127

How to Use This Manual

The Operation and Service Manual describes how to operate, configure, calibrate, maintain and troubleshoot the Model RPM10 and RPM20 Room Monitors. The manual is divided into two parts. [Part one](#) describes the unit and how to interface with the device. This section should be read by users, facilities staff, and anyone who requires a basic understanding of how the device operates.

[Part two](#) describes the technical aspects of the product which include operation, configuration, calibration, maintenance and troubleshooting. Part two should be read by personnel programming or maintaining the unit.

TSI recommends thoroughly reading this manual before changing any software items.

NOTE: This operation and service manual assumes that the monitor has been properly installed. Refer to the Installation Instructions if there is any question as to whether the monitor has been installed properly.

Safety Information

This section gives instructions to promote safe and proper handling of Model RPM10 and RPM20 Room Monitors.

There are no user-serviceable parts inside the instrument. Opening the instrument case will void the warranty. Refer all service of the unit to a qualified technician.

Description of Caution Symbol



CAUTION
<p>Caution indicates:</p> <ul style="list-style-type: none">• Equipment may be damaged if procedures are not followed.• Improper settings may result in loss of containment.• Important information about unit operation.

Access Code / Passcode

Model RPM10 and RPM20 Room Monitors have access codes to limit unauthorized access to the room mode or complete menu system. The access codes can be turned on or off through the Passcode menu item. When the units ship from TSI, they are configured with the access code off. Refer to Appendix D, [Passcode](#), for instructions on entering the access code.

(This page intentionally left blank)

Part One

User Basics

This section is designed to provide a brief but thorough overview of the product installed. These few pages explain the purpose (The Instrument) and the operation (Useful user information, Operator panel, Alarms) of the product. Technical product information is available in Part Two of the manual.

The Instrument

The Model RPM10 and RPM20 Monitors are designed to measure and report room pressure differential in health-care facilities and other critical environments. They also can measure other parameters, such as supply flow, exhaust flow, relative humidity, and room temperature.

Useful User Information

The display of the monitor is colored gray, green, or red. Green indicates the room pressure differential and other configured measurements are adequate. The display turns red to indicate alarm status when the room pressure differential or another configured measurement has risen above or dropped below a safe level. The display provides additional information depending on the configuration of the unit. Gray indicates that the room is in no isolation mode and will not alarm if room pressure differential is not maintained.

Operator Panel

The Model RPM10 and RPM20 Room Monitors are easy to use. Normal vs. alarm condition and room modes are always shown on the display. In addition, the displayed can be configured to show the room pressure differential or all measurements. Specific details about the front panel display and controls are described on the following pages. The front panel, shown in Figure 1 and Figure 2 identifies the important features on the display:

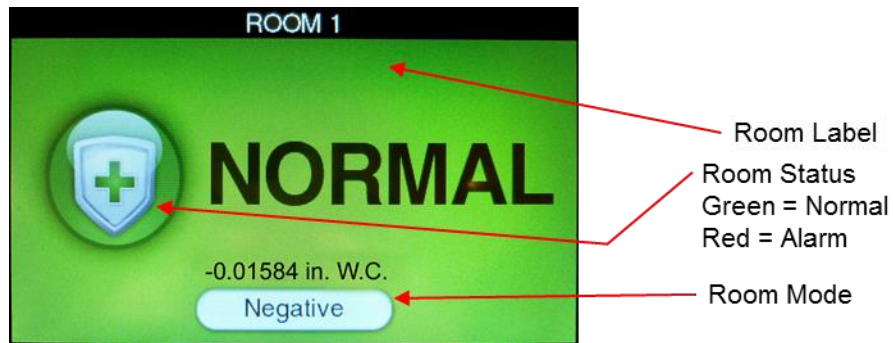

Figure 1. Single Room Screen

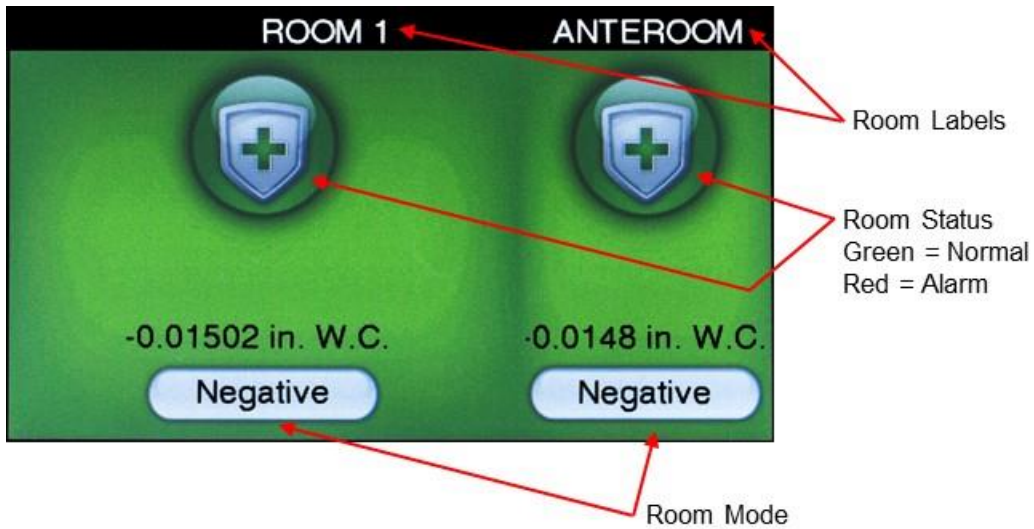

Figure 2. Two Room Screen

Display Screen

The LCD display is highly configurable and can display various critical information including pressure differential, flow rate, alarm status, menu options, and error messages. In addition, the LCD display is used for programming the unit. When programming the unit, the display will show menus, menu items, and current value of the menu item, depending on the specific programming function being performed.

Room Indicator Colors

Green	The screen icon is colored green (NORMAL) when the room pressure and/or other configured measurements are adequate. This light indicates the room is operating safely. If a set point cannot be maintained or an alarm limit has been reached, the green light turns off and the red alarm light turns on.
Red	The room icon is colored red (ALARM) when the room pressure and/or other configured measurements are not within alarm limits. This light indicates the room is not operating safely. The display screen will also indicate the type of alarm or an emergency message.
Gray	The room icon is colored gray to indicate No Isolation mode. In No Isolation mode the Model RPM10 and RPM20 will not alarm.

Operator Keys

The following keys appear on the display of the Model RPM10 and RPM20 room monitor:



MUTE key

The **MUTE** key silences an audible alarm. The alarm remains silent until the MUTE TIME value has been reached or the unit returns to control set point.



ACKNOWLEDGE key

The **ACKNOWLEDGE** key clears alarms when the Model RPM10 and RPM20 have been set latched alarms under the **ALARM RESET** item.

USB Port

There is a USB port on the case. This USB port can be used with TSI's Configuration Software.

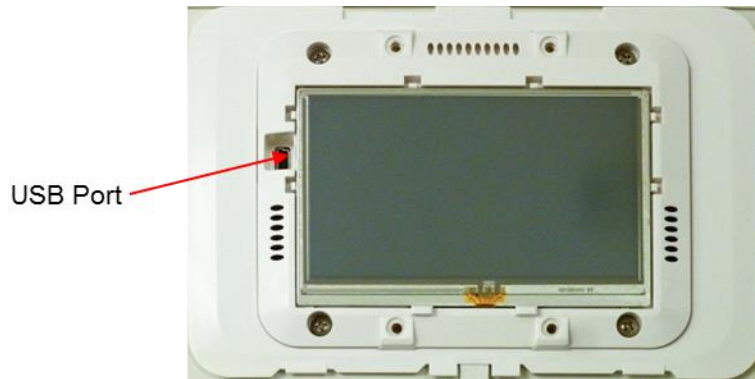

Figure 3. USB Port Location

Alarms

The Model RPM10 and RPM20 monitors have visual (red light) and audible alarms to inform you of changing room conditions. The alarm levels (set points) are determined by facilities staff, which could be Engineering, Industrial Hygiene, or a facilities group depending on how the safety staff is organized.

The audible and visual alarms will activate whenever the field configured alarm level is reached. The alarms will activate if the room pressure differential is low or inadequate, high or too great, or when the airflow is too low or too high (need optional flow device installed). When the room is operating safely, no alarms will sound.

Example: The low alarm is preset to activate when the room pressure differential falls below -0.01 in. W.C. (closer to neutral). When the room pressure drops to -0.005 in. W.C., for example, the audible and visual alarms activate. The alarms turn off (when set to unlatched) when the unit returns to the safe range, which is defined as 0.001 in. W.C. greater than alarm set point (-0.01 in. W.C.).

Visual Alarm

The display of the monitor turns red to indicate an alarm condition. The icon turns continuously red for all alarm conditions.

Audible Alarms

The audible alarm is continuously on in all low and high alarm conditions. The audible alarm can be silenced by pressing the  key.

If the audible alarm has been muted, the alarm is silenced for a configurable period of time (see menu item **MUTE TIME**) or the measurement returns to the safe range. The safe range is 0.001 in. W.C. (50 cfm) above the low alarm set point and 0.001 in. W.C. (50 cfm) below the high alarm set point.

The audible and visual alarms can be programmed to either automatically turn off when the unit returns to the safe range or to stay in alarm until the  key is pressed (See menu item **ALARM RESET**).

Alarm Relays

The PresSura monitors feature 2 alarm relays. The alarm relays can be field configured to either open or close to indicate an alarm condition, although they will close on loss of power.

Relay 1 functions as the low alarm relay, and will activate after the alarm delay for low pressure, low flow, low temperature and low RH alarms. Relay 1 will trigger without waiting for the alarm delay to indicate a LOM alarm, or low pressure drop across a venturi valve, if a flow input is configured for venturi valves.

Relay 2 is field-configurable to function as a high alarm relay or to indicate the room status. Refer to the **Relay 2 Out** item in the **Alarm Config** menu for details on this operation.

Before Calling TSI

This manual should answer most questions and resolve most problems you may encounter. If you need assistance or further explanation, contact your local TSI representative or TSI. TSI is committed to providing high quality products backed by outstanding service.

Please have the following information available prior to contacting your authorized TSI Manufacturer's Representative or TSI:

- Model number of unit* RPM10 and RPM20
- Type of room pressure sensor (TSI Through-the-wall sensor or pressure transducer)
- Software revision level*
- Facility where unit is installed

* Can be determined by entering the **Diagnostics** menu.

Due to the different configurations of the Model RPM10 and RPM20 monitor available, the above information is needed to accurately answer your questions.

For the name of your local TSI representative or to talk to TSI service personnel, please call TSI at (800) 680-1220 (U.S. and Canada) or (001 651) 490-2860 (other countries).

Prior to shipping any components to TSI for service or repair, please utilize our convenient Service Request Form, which is available online at tsi.com/service.

Part Two

Technical Section

The PresSura™ Room Pressure Monitor is ready to use after being properly installed and configured. The TSI through-the-wall sensor is factory calibrated, as are most pressure transducers. Figure 4 shows the Digital Interface Module (DIM) which is programmed with a default configuration that can be easily modified to fit your application.

The technical section is separated into five parts that cover all aspects of the unit. Each section is written as independently as possible to minimize flipping back and forth through the manual for an answer.

The [Software Programming](#) section explains the programming keys on the DIM. In addition, the programming sequence is described, which is the same regardless of the menu item being changed. At the end of this section is an example of how to program the DIM.

The [Menu and Menu Items](#) section lists all of the software items available to program and change. The items are grouped by menu which means all set points are in one menu, control signal items in another, etc. The menu items and all related information is provided including; programming name, description of menu item, range of programmable values, and how the unit shipped from the factory (default value).

The [Calibration](#) section describes the required procedure to calibrate the controller. This section explains how to compare the controller's reading to a portable thermal anemometer and then adjust the span to establish an accurate calibration. This section also describes how to zero a TSI flow station transducer (if installed).

The [Maintenance and Repair Parts](#) section covers all routine maintenance of equipment, along with a list of repair parts.

The [Troubleshooting](#) section is split into two areas: mechanical operation of the unit and system performance. Many external variables will affect how the unit functions so it is critical to first determine if the system is having mechanical problems—i.e., no display on unit, alarms do not function, , etc. If no mechanical problems exist, look for performance problems (i.e., does not seem to read correctly, display fluctuates, etc.). The first step is to determine that the system is mechanically operating correctly, followed by modifying the configuration to eliminate the performance problems.



Figure 4. PresSura Room Pressure Monitor

Software Programming

Programming the PresSura Model RPM10/RPM20 monitor is quick and easy if the proper keystroke procedure is followed. The programming keys are defined first, followed by the required keystroke procedure. At the end of this section is a programming example.

NOTE: It is important to note that the unit is always operating when programming. When a menu item value is changed, the new value takes effect *immediately* after saving the change, not when the unit returns to normal operating mode.

This section covers programming the instrument through the keypad and display. If programming through network communications (see [Appendix B](#)), use the host computer's procedure. The changes take place immediately upon saving data in the instrument.

Changing Room Mode

1. Press the **Room Mode** button for the room on the touchscreen.

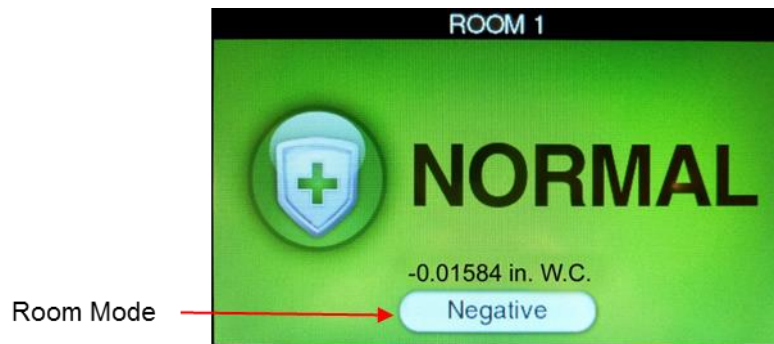

Figure 5. Main Running Screen

2. Select the desired room mode by pressing on the desired room mode button at the bottom of the screen.

NOTE: If a room mode is not selected, the PresSura monitor will return to the main running screen after a short delay.

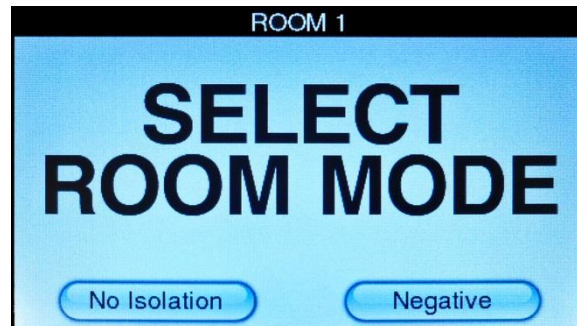

Figure 6. Room Mode Selection Screen

Entering Menus

Swipe across the display, from the top right corner to the bottom left corner, to access the menu system.

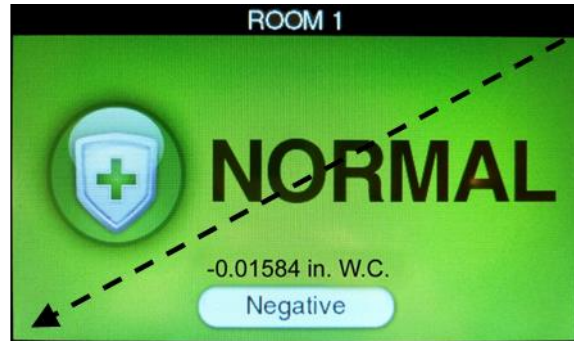

Figure 7. Swipe to access menu system

Menus and Menu Items

After accessing a menu, the screen will change to show the items associated with that menu. Refer to the Menu and Menu Items section for a list of the menus and their associated items.

Entering Data

After entering a menu item, the Model RPM10/RPM20 monitor display will change to select items. Some items have pre-defined choices selected through a drop-down menu; others allow numeric setpoints. Not all menus will be available on all models.

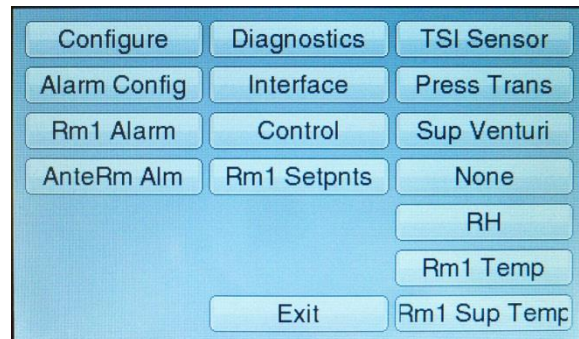

Figure 8. Menu System

Drop-Down Selection

It is easy to view available choices and make a selection from drop-down items. Touch the item displayed in the drop-down box to view all available options. Then, touch the item desired. Touch the **Save** button to save your selection and exit the item or touch the **Cancel** button to exit the item without saving.



Figure 9. Using a Drop-Down Selection

Numeric Setpoints

It is easy to enter new numeric setpoints on the PresSura Model RPM10/RPM20 monitor. On a numeric setpoint screen, the current setpoint is displayed in a box at the top left of the screen.

- Use the numeric keypad to enter a new setpoint.
- The value entered must be between the min and max listed on-screen.
- The measurement units are displayed as units. The <- button deletes the last digit.
- The **Clr** button clears the entire setpoint.
- The **Save** button saves your selection and exits the item.
- The **Cancel** button exits the item without saving changes.

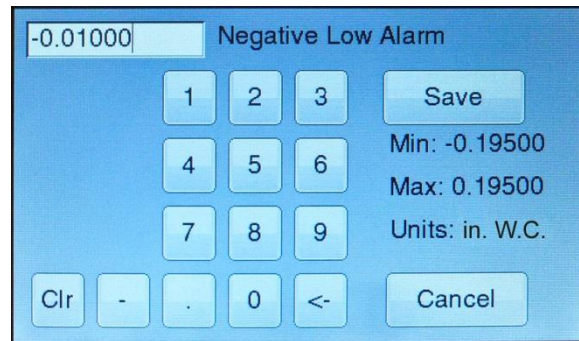
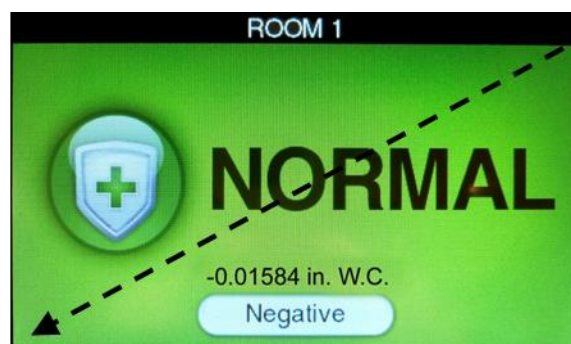
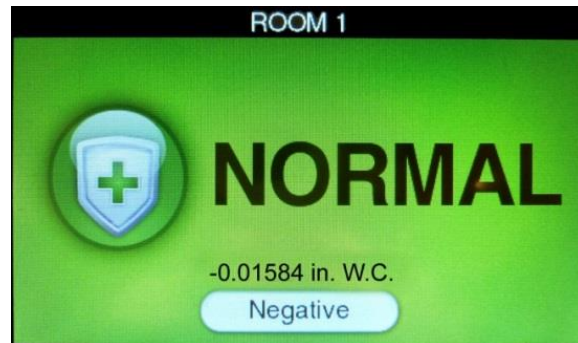

Figure 10. Entering Numeric Setpoints

Programming Example

The following example demonstrates the keystroke sequence. In this example the negative low alarm set point for Room 1 will be changed from -0.01000 in. W.C. to -0.01300 in. W.C.

- 1 Unit is in normal operation.
- 2 Swipe from the top right corner to the bottom left corner to access the menu system.



- 3 The menu screen is displayed.

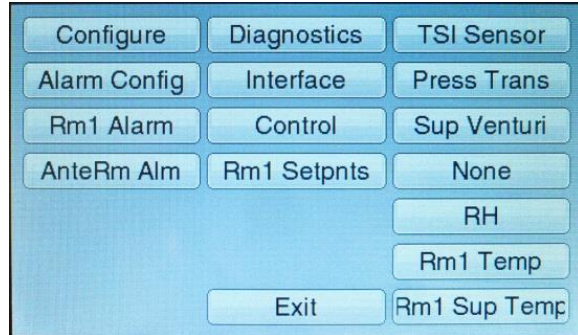

- 4 Select the **Rm1 Alarm** menu.

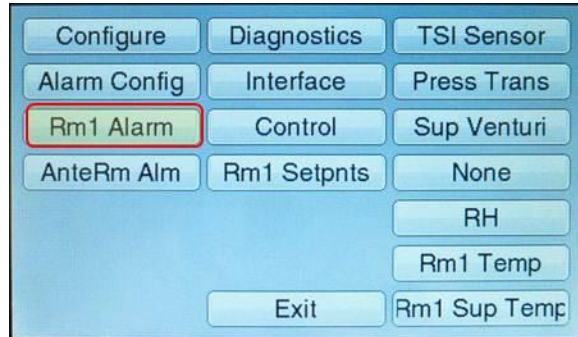

- 5 Select the **Neg Low Alm** item.



- 6 Enter the new setpoint of -0.01300 in. W.C. **Save** the new setting.

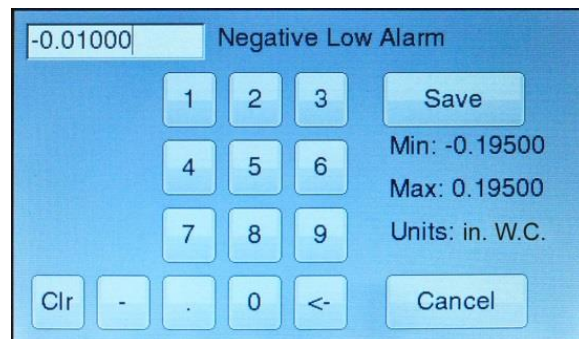

- 7 Touch the **Exit** button in the Rm1 Alarm menu and again in the main menu to return to the main running screen.

Menu and Menu Items

The PresSura Model RPM10 and RPM20 monitors are very versatile devices which can be configured to meet your specific application. This section lists all of the menu items available to program and change (except diagnostics menu). Changing items is accomplished by using the touchscreen or through communications with the Building Automation System. If you are unfamiliar with the keystroke procedure please see [Software Programming](#) section for a detailed explanation. This section provides the following information:

- Complete list of menus and all menu items.
- Gives the menu or programming name.
- Defines each menu item's function; what it does, how it does it, etc.
- Gives the range of values that can be programmed.
- Gives default item value (how it shipped from factory).

The menus covered in this section are divided into groups of related items to ease programming. As an example all set points are in one menu, alarm information in another, etc. The manual follows the menus as programmed in the controller. The menu items are always grouped by menu and then listed in menu item order, not alphabetical order.

Figure 11 and Figure 12 show the PresSura Model RPM10 and RPM20 monitor menu items.

Configure	Rm1 Alarm	Diagnostics	Alarm Config
# of Rooms	Room Mode	View Inputs	Alarm Reset
Language	Neg Low Alm	View Outputs	Audible Alm
Press Modes	Neg Hi Alm	Relay Outputs	Alarm Delay
Rm1 Label	Pos Low Alm	Analog Outpt	Mute Time
Display Meas	Pos Hi Alm	Touch Cal	Door Delay
Display Avg	Exh Low Alm	Reset	Relay 2 Out
Units	Sup Low Alm		Relay 1 Dir
Passcode	Alarm Enable		Relay 2 Dir
Num Format	ACH Duct		
Input 1	Room 1 Vol		
Input 2			
Input 3			
Input 4			
Input 5			
Input 6			
Input 7			
Interface	Input 1 Configure	Input 2 Configure	Input 3 Configure
Comm Type	<i>See menu for items.</i>	<i>See menu for items.</i>	<i>See menu for items.</i>
Address			
MAC ID			
Baud Rate			
Nurse Address			
Baud Rate			
BACnet Data			
Stop Bits			
AO1 Sig Type			
AO2 Sig Type			
AO2 Sig Rnge			
AO2 Out Type			
AO3 Sig Type			
Input 4 Configure	Input 5 Configure	Input 6 Configure	Input 7 Configure
<i>See menu for items.</i>	<i>See menu for items.</i>	<i>See menu for items.</i>	<i>See menu for items.</i>

Figure 11. Menu Items – Model RPM10 Monitor



Configure	Rm1 Alarm	AnteRm Alarm	Rm2 Alarm
# of Rooms Language Press Modes Rm1 Label AnteRm Label Rm2 Label Display Meas Display Avg Units Passcode Num Format Input 1 Input 2 Input 3 Input 4 Input 5 Input 6 Input 7	Room Mode Neg Low Alm Neg Hi Alm Pos Low Alm Pos Hi Alm Exh Low Alm Sup Low Alm Temp Low Alm Temp Hi Alm ACH Duct Room1 Vol RH Low Alm RH High Alm Alarm Enable	Room Mode Neg Low Alm Neg Hi Alm Pos Low Alm Pos Hi Alm Alarm Enable	Room Mode Neg Low Alm Neg Hi Alm Pos Low Alm Pos Hi Alm Alarm Enable
Alarm Config	Diagnostics	Interface	Input 1 Configure
Alarm Reset Audible Alm Alarm Delay Mute Time Door Delay Relay 2 Out Relay 1 Dir Relay 2 Dir	View Inputs View Outputs Relay Outputs Analog Outpt Touch Cal Reset	Comm Type LON Address MAC ID Baud Rate Nurse Address AO1 Sig Type AO2 Sig Type AO2 Sig Rnge AO2 Out Type AO3 Sig Type AO3 Sig Rnge AO3 Out Type	<i>See menu for items.</i>
Input 2 Configure	Input 3 Configure	Input 4 Configure	Input 5 Configure
<i>See menu for items.</i>	<i>See menu for items.</i>	<i>See menu for items.</i>	<i>See menu for items.</i>
Input6 Configure	Input 7 Configure		
<i>See menu for items.</i>	<i>See menu for items.</i>		

Figure 12. Menu Items – Model RPM20 Monitor



Configure Menu

MENU ITEM Monitor/ Controller	SOFTWARE NAME	ITEM DESCRIPTION	ITEM RANGE	DEFAULT VALUE						
Number of Rooms Monitored <i>RPM10 and RPM20</i>	# of Rooms	The # of Rooms item selects the number of rooms the Model RPM10 and RPM20 monitor will monitor and control.	RPM10: 1 Room RPM20: 1 Room, 1 Room with Anteroom, 2 Rooms with Anteroom	1 Room						
Language on Main Display <i>RPM10 and RPM20</i>	Language	The Language item selects the language of text on the main running display.	English, Dutch	English						
Number of Pressure Mode Selections <i>RPM10 and RPM20</i>	Press Modes	<p>The Press Modes item determines the room modes available for selection when the user presses the Room Mode button on the main running screen.</p> <table border="1"> <thead> <tr> <th>Press Mode</th> <th>Room Mode Selections on Screen</th> </tr> </thead> <tbody> <tr> <td>2 Buttons</td> <td>Positive / No Isolation <i>Or</i> Negative / No Isolation (based on Room Mode item in respective Alarm menu)</td> </tr> <tr> <td>3 Buttons</td> <td>Negative / No Isolation / Positive</td> </tr> </tbody> </table> <p> WARNING</p> <p>Codes and Standards in the U.S. and many other areas of the world do not allow a room to be switched from Positive to Negative Isolation. Consult local authorities before setting Press Modes to 3 Buttons.</p>	Press Mode	Room Mode Selections on Screen	2 Buttons	Positive / No Isolation <i>Or</i> Negative / No Isolation (based on Room Mode item in respective Alarm menu)	3 Buttons	Negative / No Isolation / Positive	2 Buttons, 3 Buttons	2 Buttons
Press Mode	Room Mode Selections on Screen									
2 Buttons	Positive / No Isolation <i>Or</i> Negative / No Isolation (based on Room Mode item in respective Alarm menu)									
3 Buttons	Negative / No Isolation / Positive									
Label for Room 1 <i>RPM10 and RPM20</i>	Rm1 Label	The Rm1 Label item allows the user to set the room number or other designator for room 1.	13 characters of text	ROOM 1						



Configure Menu

MENU ITEM Monitor/ Controller	SOFTWARE NAME	ITEM DESCRIPTION	ITEM RANGE	DEFAULT VALUE
Label for Room 2 <i>RPM20</i>	Rm2 Label 	The Rm2 Label item allows the user to set the room number or other designator for room 2. NOTE: Rm2 Label is only active if the # of Rooms item is set to 2 Rooms with Anteroom .	13 characters of text	ROOM 2
Label for Anteroom <i>RPM20</i>	AnteRm Label 	The AnteRm Label item allows the user to set the room number or other designator for the anteroom. NOTE: AnteRm Label is only active if the # of Rooms item is set to 1 Room with Anteroom or 2 Rooms with Anteroom .	13 characters of text	ANTEROOM
Measurements Displayed <i>RPM10 and RPM20</i>	Display Meas 	The Display Meas item selects which measurements will be presented on the display during normal operating mode. Use the Units item to choose the units of measure: ROOM STATUS displays the room mode as negative, positive or no isolation. ROOM PRESSURE displays the room mode and the current measurement of room pressure differential. ALL displays the room mode and all currently connected measurements. Only functions when # of Rooms is set to 1 Room. NOTE: Measurements will still enable alarms if not on the display. The measurement will not appear on the display.	Room Status, Room Pressure, All	Room Status
Display Average <i>RPM10 and RPM20</i>	Display Avg	The Display Avg item selects the display's running average period. The display-averaging period is the length of time the face velocity has been averaged before being displayed. The Display Avg item value may be set between 0.5 and 40 seconds. The higher the averaging value, the more stable the display.	1, 2, 3, 5, 10, 20, or 40 seconds	20 seconds

Configure Menu

MENU ITEM Monitor/ Controller	SOFTWARE NAME	ITEM DESCRIPTION	ITEM RANGE	DEFAULT VALUE
Display Units <i>RPM10 and RPM20</i>	Units	The Units item selects the unit of measure that the monitor displays all values (except calibration span). These units display for all menu items setpoints, alarms, flows, etc.	in. W.C., cfm, F Pa, l/s, C Pa, cmh, C	in. W.C., cfm
Configure INPUT1 <i>RPM10 and RPM20</i>	Input 1 	The Input 1 item selects the desired input type for Input1, the room pressure sensor for Room 1. Go to the Input 1 menu to adjust parameters such as sensor range associated with Input1.	TSI Sensor, Pressure Transducer	TSI Sensor
Configure INPUT2 <i>RPM20</i>	Input 2 	The Input 2 item selects the desired input type for Input2, the room pressure sensor for the AnteRm. Go to the Input2 menu to adjust parameters such as sensor range associated with Input2. The Input 2 item is only active if the # of Rooms item is set to 1 ROOM WITH ANTEROOM . The Input 2 item is not functional on the Model RPM10 Monitor. It is only active on the Model RPM20 Monitor.	RPM20: TSI Sensor, Pressure Transducer, None RPM20-CC: Particle Channel A, None	None
Configure INPUT3 <i>RPM10 and RPM20</i>	Input 3 	The Input 3 item selects the desired input type for Input3. Go to the Input 3 menu to adjust parameters such as sensor range associated with Input3. The Model RPM10 Monitor cannot be set to TSI Sensor or Pressure Transducer. Input 3 can only be set to TSI Sensor or Pressure Transduce if the # of Rooms item is set to 2 Rooms with Anteroom.	RPM10: Supply Pressure Flow Supply Linear Flow, Supply Venturi Flow, Supply Switch, None RPM20: Supply Pressure Flow Supply Linear Flow, Supply Venturi Flow, Supply Switch TSI Sensor, Pressure Transducer, None	None

Configure Menu

MENU ITEM Monitor/ Controller	SOFTWARE NAME	ITEM DESCRIPTION	ITEM RANGE	DEFAULT VALUE
Configure INPUT4 <i>RPM10 and RPM20</i>	Input 4 	The Input 4 item selects the desired input type for Input4. Go to the Input 4 menu to adjust parameters such as sensor range associated with Input4.	RPM10: None, Room1 Door Switch, Room 1 Occupancy Sensor RPM20: None, Room1 Door Switch, Room 1 Occupancy Sensor RPM20-CC: None, Room1 Door Switch, Room 1 Occupancy Sensor, Particle Channel B	None
Configure INPUT5 <i>RPM10 and RPM20</i>	Input 5 	The Input 5 item selects the desired input type for Input5. Go to the Input 5 menu to adjust parameters such as sensor range associated with Input5. The Model RPM10 Monitor cannot be set to Relative Humidity Sensor.	RPM10: None, Room1 Key Switch RPM20: None, Room1 Key Switch, Relative Humidity Sensor	None
Configure INPUT6 <i>RPM20</i>	Input 6 	The Input 6 item selects the desired input type for Input6. Go to the Input 6 menu to adjust parameters such as sensor range associated with Input6. The Input 6 item is not functional on the Model RPM10 Monitor. It is only active on the Model RPM20 Monitor.	None, Room1 Temp Sensor, Room1 Door Switch, Room 2 Occupancy Sensor, Room 2 Door Switch	None

Configure Menu

MENU ITEM Monitor/ Controller	SOFTWARE NAME	ITEM DESCRIPTION	ITEM RANGE	DEFAULT VALUE
Configure INPUT7 <i>RPM10 and RPM20</i>	Input 7 	<p>The Input 7 item selects the desired input type for Input7.</p> <p>Go to the Input 7 menu to adjust parameters such as sensor range associated with Input7.</p> <p>Input 7 can only be set to Room 2 Key Switch if the # of Rooms item is set to 2 Rooms With Anteroom.</p> <p>The Model RPM10 Monitor cannot be set to Room 2 Key Switch.</p>	<p>RPM10: Exhaust Pressure Flow, Exhaust Linear Flow, Exhaust Venturi Flow, Exhaust Switch, None</p> <p>RPM20: Exhaust Pressure Flow, Exhaust Linear Flow, Exhaust Venturi Flow, Exhaust Switch, Room 2 Key Switch, None</p> <p>RPM20-CC: Exhaust Pressure Flow, Exhaust Linear Flow, Exhaust Venturi Flow, Exhaust Switch, Room 2 Key Switch, Particle Status, None</p>	None
Number Format <i>RPM10 and RPM20</i>	Num Format	The Num Format menu item selects the way that numbers are displayed.	Period Comma	Period

Configure Menu

MENU ITEM Monitor/ Controller	SOFTWARE NAME	ITEM DESCRIPTION	ITEM RANGE	DEFAULT VALUE	
Enable Access Codes <i>RPM10 and RPM20</i>	Passcode	The Passcode item selects whether an access code (pass code) is required to enter the menu items. The Passcode item prevents unauthorized access to a menu. If the Passcode item is:	Off Room Mode Menus All Set Room Mode Passcode Set Menu Passcode	Menus	
		OFF			No code is required to enter the room mode or menu screens.
		ROOM MODE			Access code is required to enter the room mode screens but not the menu screens.
		MENUS			Access code is required to enter the menu screens but not the room mode screens.
		ALL			Access code is required to enter the room mode and menu screens.
		SET ROOM MODE PASSCODE			Change passcode to select ROOM MODE .
		SET MENU PASSCODE			Change passcode to enter Menu system. Contact TSI to recover a lost password.

Rm1 Alarm Menu

MENU ITEM	SOFTWARE NAME	ITEM DESCRIPTION	ITEM RANGE	DEFAULT VALUE
Mode of Room 1 <i>RPM10 and RPM20</i>	Room Mode	The Room Mode item selects the room pressure direction. This item enables all related alarms, for pressure direction selected. NOTE: No Isolation Room Mode can be selected from the main running screen.	Positive Negative	Negative

Rm1 Alarm Menu

MENU ITEM	SOFTWARE NAME	ITEM DESCRIPTION	ITEM RANGE	DEFAULT VALUE
Room 1 Alarm Enable <i>RPM10 and RPM20</i>	Alarm Enable	The Alarm Enable item enables the low and high alarm functions. When this item is entered, the monitor will show buttons for Low Alarms and High Alarms. Press the button to toggle between enabling and disabling the alarms. NOTE: The Alarm Enable item enables or disables pressure, flow, temperature and humidity alarms.	Enabled Disabled	Low Alarms Enabled High Alarms Disabled
Room 1 Negative Low Alarm <i>RPM10 and RPM20</i>	Neg Low Alm	The Neg Low Alm item sets the negative low pressure alarm setpoint. A low alarm condition is defined as when the magnitude of the room pressure falls below the Neg Low Alm setpoint. This item is active when the TSI key switch is in negative room pressure position or when NEGATIVE is selected in ROOM MODE item. However, it is always accessible through the menu system.	-0.19500 in. W.C. to +0.19500 in. W.C. (TSI Sensor) -1.0 in. W.C. to 1.0 in. W.C. (Pressure Transducer) NOTE Neg Low Alm cannot be set more negative than the Neg Hi Alm	-0.01000 in. W.C.
Room 1 Negative High Alarm <i>RPM10 and RPM20</i>	Neg Hi Alm	The Neg Hi Alm item sets the negative high pressure alarm setpoint. A high alarm condition is defined as when the room is more negative than the Neg Hi Alm setpoint. This item is active when the TSI key switch is in negative room pressure position or when NEGATIVE is selected in ROOM MODE item. However, it is always accessible through the menu system.	--0.19500 in. W.C. to +0.19500 in. W.C. (TSI Sensor) -1.0 in. W.C. to 1.0 in. W.C. (Pressure Transducer) NOTE Neg Hi Alm cannot be set less negative than the Neg Lo Alm	-0.10000 in. W.C.

Rm1 Alarm Menu

MENU ITEM	SOFTWARE NAME	ITEM DESCRIPTION	ITEM RANGE	DEFAULT VALUE
Room 1 Positive Low Alarm <i>RPM10 and RPM20</i>	Pos Low Alm	<p>The Pos Low Alm item sets the positive low pressure alarm setpoint. A low alarm condition is defined as when the room is less positive than the Pos Low Alm setpoint.</p> <p>This item is active when the TSI key switch is in positive room pressure position or when POSITIVE is selected in ROOM MODE item. However, it is always accessible through the menu system.</p>	<p>-0.19500 in. W.C. to +0.19500 in. W.C. (TSI Sensor)</p> <p>-1.0 in. W.C. to 1.0 in. W.C. (Pressure Transducer)</p> <p>NOTE</p> <p>Pos Low Alm cannot be set more positive than the Pos Hi Alm</p>	+0.01000 in. W.C.
Room 1 Positive High Alarm <i>RPM10 and RPM20</i>	Pos Hi Alm	<p>The Pos Hi Alm item sets the positive high pressure alarm setpoint. A high alarm condition is defined as when the magnitude of the room pressure rises above the Pos Hi Alm setpoint.</p> <p>This item is active when the TSI key switch is in positive room pressure position or when POSITIVE is selected in ROOM MODE item. However, it is always accessible through the menu system.</p>	<p>-0.19500 in. W.C. to +0.19500 in. W.C. (TSI Sensor)</p> <p>-1.0 in. W.C. to 1.0 in. W.C. (Pressure Transducer)</p> <p>NOTE</p> <p>Pos Hi Alm cannot be set less positive than the Pos Lo Alm</p>	+0.10000 in. W.C.
Room 1 Low Exhaust Flow Alarm <i>RPM10 and RPM20</i>	Exh Low Alm	<p>The Exh Low Alm item sets the minimum exhaust flow alarm setpoint. A minimum flow alarm is defined as when the exhaust flow is less than the Exh Low Alm setpoint.</p>	0 to 30,000 cfm	0 cfm
Room 1 Low Supply Flow Alarm <i>RPM10 and RPM20</i>	Sup Low Alm	<p>The Sup Low Alm item sets the minimum supply flow alarm setpoint. A minimum flow alarm is defined as when the supply flow is less than the Sup Low Alm setpoint.</p>	0 to 30,000 cfm	0 cfm

Rm1 Alarm Menu

MENU ITEM	SOFTWARE NAME	ITEM DESCRIPTION	ITEM RANGE	DEFAULT VALUE						
Room 1 Low Room Temperature Alarm <i>RPM20</i>	Temp Low Alm	The Temp Low Alm item sets the minimum room temperature alarm setpoint.	50 to 100°F NOTE Temp Low Alm cannot be set greater than the Temp Hi Alm	50°F						
High Room Temperature Alarm <i>RPM20</i>	Temp Hi Alm	The Temp Hi Alm item sets the maximum room temperature alarm setpoint.	50 to 100°F NOTE Temp Hi Alm cannot be set less than the Temp Low Alm	100°F						
Low Relative Humidity Alarm <i>RPM20</i>	RH Low Alm	The RH Low Alm item sets the minimum relative humidity alarm setpoint.	0 to 100% NOTE RH Low Alm cannot be set greater than the RH Hi Alm	0%						
High Relative Humidity Alarm <i>RPM20</i>	RH Hi Alm	The RH Hi Alm item sets the maximum relative humidity alarm setpoint.	0 to 100% NOTE RH Hi Alm cannot be set less than the RH Low Alm	100%						
Duct for Air Changes per Hour Calculation <i>RPM10 and RPM20</i>	ACH Duct	The ACH Duct item sets the duct to be used for ACH calculations: <table border="1" data-bbox="730 1263 1419 1421"> <tr> <td>SUPPLY</td> <td>Is normally used for positive rooms.</td> </tr> <tr> <td>EXHAUST</td> <td>Is normally used for negative rooms.</td> </tr> <tr> <td>OFF</td> <td>Is used if the ACH calculation is not desired.</td> </tr> </table>	SUPPLY	Is normally used for positive rooms.	EXHAUST	Is normally used for negative rooms.	OFF	Is used if the ACH calculation is not desired.	OFF SUPPLY EXHAUST	OFF
SUPPLY	Is normally used for positive rooms.									
EXHAUST	Is normally used for negative rooms.									
OFF	Is used if the ACH calculation is not desired.									

Rm1 Alarm Menu

MENU ITEM	SOFTWARE NAME	ITEM DESCRIPTION	ITEM RANGE	DEFAULT VALUE
Room Volume <i>RPM10 and RPM20</i>	Room1 Vol	The Room1 Vol item sets the room volume for the ACH calculation.	0 to 99,999 ft ³	0 ft ³

AnteRm Alarm Menu

MENU ITEM	SOFTWARE NAME	ITEM DESCRIPTION	ITEM RANGE	DEFAULT VALUE
Mode of Anteroom <i>RPM20</i>	Room Mode	The Room Mode item selects the room pressure direction. This item enables all related alarms, for pressure direction selected. Selecting ROOM1 means that the Room Mode will follow the Room Mode of Room 1. NOTE: No Isolation Room Mode can be selected from the main running screen.	Positive Negative Room1	Negative
Anteroom Alarm Enable <i>RPM20</i>	Alarm Enable	The Alarm Enable item enables the low and high alarm functions. When this item is entered, the monitor will show buttons for Low Alarms and High Alarms. Press the button to toggle between enabling and disabling the alarms.	Enabled Disabled	Low Alarms: Enabled High Alarms: Disabled
Anteroom Negative Low Alarm <i>RPM20</i>	Neg Low Alm	The Neg Low Alm item sets the negative low pressure alarm setpoint. A low alarm condition is defined as when the magnitude of the room pressure falls below the Neg Low Alm setpoint. This item is active when the TSI key switch is in negative room pressure position or when NEGATIVE is selected in ROOM MODE item. However, it is always accessible through the menu system.	-0.19500 in. W.C. to +0.19500 in. W.C. (TSI Sensor) -1.0 in. W.C. to 1.0 in. W.C. (Pressure Transducer) NOTE Neg Low Alm cannot be set more negative than the Neg Hi Alm	-0.01000 in. W.C.

AnteRm Alarm Menu

MENU ITEM	SOFTWARE NAME	ITEM DESCRIPTION	ITEM RANGE	DEFAULT VALUE
Anteroom Negative High Alarm <i>RPM20</i>	Neg Hi Alm	<p>The Neg Hi Alm item sets the negative high pressure alarm setpoint. A high alarm condition is defined as when the room is more negative than the Neg Hi Alm setpoint.</p> <p>This item is active when the TSI key switch is in negative room pressure position or when NEGATIVE is selected in ROOM MODE item. However, it is always accessible through the menu system.</p>	<p>-0.19500 in. W.C. to +0.19500 in. W.C. (TSI Sensor) -1.0 in. W.C. to 1.0 in. W.C. (Pressure Transducer)</p> <p>NOTE Neg Hi Alm cannot be set less negative than the Neg Lo Alm</p>	-0.10000 in. W.C.
Anteroom Positive Low Alarm <i>RPM20</i>	Pos Low Alm	<p>The Pos Low Alm item sets the positive low pressure alarm setpoint. A low alarm condition is defined as when the room is less positive than the Pos Low Alm setpoint.</p> <p>This item is active when the TSI key switch is in positive room pressure position or when POSITIVE is selected in ROOM MODE item. However, it is always accessible through the menu system.</p>	<p>-0.19500 in. W.C. to +0.19500 in. W.C. (TSI Sensor) -1.0 in. W.C. to 1.0 in. W.C. (Pressure Transducer)</p> <p>NOTE Pos Low Alm cannot be set more positive than the Pos Hi Alm</p>	0.01000 in. W.C.

AnteRm Alarm Menu

MENU ITEM	SOFTWARE NAME	ITEM DESCRIPTION	ITEM RANGE	DEFAULT VALUE
Anteroom Positive High Alarm <i>RPM20</i>	Pos Hi Alm	<p>The Pos Hi Alm item sets the positive high pressure alarm setpoint. A high alarm condition is defined as when the magnitude of the room pressure rises above the Pos Hi Alm setpoint.</p> <p>This item is active when the TSI key switch is in positive room pressure position or when POSITIVE is selected in ROOM MODE item. However, it is always accessible through the menu system.</p>	<p>-0.19500 in. W.C. to +0.19500 in. W.C. (TSI Sensor)</p> <p>-1.0 in. W.C. to 1.0 in. W.C. (Pressure Transducer)</p> <p>NOTE Pos Hi Alm cannot be set less positive than the Pos Lo Alm</p>	0.10000 in. W.C.

Rm2 Alarm Menu

MENU ITEM	SOFTWARE NAME	ITEM DESCRIPTION	ITEM RANGE	DEFAULT VALUE
Mode of Room 2 <i>RPM20</i>	Room Mode	<p>The Room Mode item selects the room pressure direction. This item enables all related alarms, for pressure direction selected. Selecting ROOM1 means that the Room Mode will follow the Room Mode of Room 1.</p> <p>NOTE: No Isolation Room Mode can be selected from the main running screen.</p>	Positive Negative Room1	Negative
Room 2 Alarm Enable <i>RPM20</i>	Alarm Enable	The Alarm Enable item enables the low and high alarm functions. When this item is entered, the monitor will show buttons for Low Alarms and High Alarms. Press the button to toggle between enabling and disabling the alarms.	Enabled Disabled	Low Alarms Enabled High Alarms Disabled

Rm2 Alarm Menu

MENU ITEM	SOFTWARE NAME	ITEM DESCRIPTION	ITEM RANGE	DEFAULT VALUE
Room 2 Negative Low Alarm <i>RPM20</i>	Neg Low Alm	<p>The Neg Low Alm item sets the negative low pressure alarm setpoint. A low alarm condition is defined as when the magnitude of the room pressure falls below the Neg Low Alm setpoint.</p> <p>This item is enabled when the TSI key switch is in negative room pressure position or when NEGATIVE is selected in Room Mode item.</p>	<p>-0.19500 in. W.C. to +0.19500 in. W.C. (TSI Sensor)</p> <p>-1.0 in. W.C. to 1.0 in. W.C. (Pressure Transducer)</p> <p>NOTE</p> <p>Neg Low Alm cannot be set more negative than the Neg Hi Alm</p>	-0.01000 in. W.C.
Room 2 Negative High Alarm <i>RPM20</i>	Neg Hi Alm	<p>The Neg Hi Alm item sets the negative high pressure alarm setpoint. A high alarm condition is defined as when the room is more negative than the Neg Hi Alm setpoint.</p> <p>This item is enabled when the TSI key switch is in negative room pressure position or when NEGATIVE is selected in Room Mode item.</p>	<p>-0.19500 in. W.C. to +0.19500 in. W.C. (TSI Sensor)</p> <p>-1.0 in. W.C. to 1.0 in. W.C. (Pressure Transducer)</p> <p>NOTE</p> <p>Neg Hi Alm cannot be set less negative than the Neg Lo Alm</p>	-0.10000 in. W.C.

Rm2 Alarm Menu

MENU ITEM	SOFTWARE NAME	ITEM DESCRIPTION	ITEM RANGE	DEFAULT VALUE
Room 2 Positive Low Alarm <i>RPM20</i>	Pos Low Alm	<p>The Pos Low Alm item sets the positive low pressure alarm setpoint. A low alarm condition is defined as when the room is less positive than the Pos Low Alm setpoint.</p> <p>This item is enabled when the TSI key switch is in positive room pressure position or when POSITIVE is selected in Room Mode item.</p>	<p>-0.19500 in. W.C. to +0.19500 in. W.C. (TSI Sensor)</p> <p>-1.0 in. W.C. to 1.0 in. W.C. (Pressure Transducer)</p> <p>NOTE</p> <p>Pos Low Alm cannot be set more positive than the Pos Hi Alm</p>	0.01000 in. W.C.
Room 2 Positive High Alarm <i>RPM20</i>	Pos Hi Alm	<p>The Pos Hi Alm item sets the positive high pressure alarm setpoint. A high alarm condition is defined as when the magnitude of the room pressure rises above the Pos Hi Alm setpoint.</p> <p>This item is enabled when the TSI key switch is in positive room pressure position or when POSITIVE is selected in Room Mode item.</p>	<p>-0.19500 in. W.C. to +0.19500 in. W.C. (TSI Sensor)</p> <p>-1.0 in. W.C. to 1.0 in. W.C. (Pressure Transducer)</p> <p>NOTE</p> <p>Pos Hi Alm cannot be set less than positive the Pos Lo Alm</p>	0.10000 in. W.C.

ALARM CONSTRAINTS

There are a number of constraints that prohibit you from incorrectly adjusting the set points. These are as follows:

1. Room mode. The positive pressure alarms are only active when positive control is selected. Negative pressure alarms are only active when negative control is selected. In no isolation mode all alarms are turned off.
2. The PresSura monitor is programmed with deadbands between alarm setpoints to prevent the controller from cycling between high and low alarms due to normal fluctuations. Setpoint deadbands are:
 - Pressure = 0.001 in. W.C.
 - Flow = 50 cfm
 - Temperature = 1°F
 - Relative Humidity = 1%
 - Position = 1% Open

Example: The control **NEG LOW ALM** is set at -0.01 in. W.C. The **NEG HI ALM** cannot be set less negative than -0.011 in. W.C.

3. Alarms do not terminate until the room pressure slightly exceeds the alarm setpoint.
4. The **ALARM RESET** item selects how the alarms will terminate when the controller returns to the safe range. The pressure and flow alarms all terminate the same; they are either latched or unlatched. If unlatched is selected the alarms automatically turn off when the value slightly exceeds the alarm setpoint. If latched is selected, the alarms will not terminate until the pressure or flow exceeds the alarm setpoint *and* the  key is pressed.
5. There is a programmable **ALARM DELAY** that determines how long to delay before activating the alarms. This delay affects all alarms, pressure and flow.
6. The **MUTE TIME** item temporarily turns the audible alarm off for all pressure and flow alarms.

7. The display can only show one alarm message. Therefore, the monitor has an alarm priority system, with the highest priority alarm being displayed. If multiple alarms exist, the lower priority alarms will not display until after the highest priority alarm has been eliminated. The alarm priority is as follows:

- Room 1 pressure sensor – low alarm
- Room 1 pressure sensor – high alarm
- Room 1 – minimum exhaust flow
- Room 1 – minimum supply flow
- Room 1 – temperature alarms
- Room 1 – relative humidity alarms
- Room 1 – supply venturi (low static pressure) alarm
- Room 1 – exhaust venturi (low static pressure) alarm
- Anteroom pressure sensor – low alarm
- Anteroom pressure sensor – high alarm
- Room 2 pressure sensor – low alarm
- Room 2 pressure sensor – high alarm
- Room 1 – supply airflow-proving switch
- Room 1 – exhaust airflow-proving switch

8. The low and high alarms are absolute values. The chart below shows how the values must be programmed in order to operate correctly.

-1.0 in. W.C. Min Transducer Reading (maximum negative)		+1.0 in. W.C. Max Transducer Reading (maximum positive)	
High	Low	Low	High
Negative	Negative	Positive	Positive
Alarm	Alarm	Alarm	Alarm

The value of each setpoint or alarm is unimportant (except for small dead band) in graph above. It is important to understand that the high alarm is a greater negative (positive) value than the low alarm.

Alarm Config Menu

MENU ITEM	SOFTWARE NAME	ITEM DESCRIPTION	ITEM RANGE	DEFAULT VALUE
Alarm Reset <i>RPM10 and RPM20</i>	Alarm Reset	<p>The Alarm Reset item selects how the alarms terminate after the unit returns to control set point. The Alarm Reset affects the audible alarm, visual alarm, and relay output, which means all are latched or unlatched.</p> <p>LATCHED requires the staff to press the  key to clear alarms.</p> <p>UNLATCHED (alarm follow) automatically resets the alarm when the room pressure is:</p> <ul style="list-style-type: none"> • 0.001 in. W.C. ft/min greater than the low alarm set point, or 0.001 in. W.C. below the high alarm set point • 50 cfm greater than the low alarm setpoint for flow alarms • 0.3 °F for temperature • 0.5% RH 	Latched, Unlatched	Unlatched
Enable Sound <i>RPM10 and RPM20</i>	Audible Alm	The Audible Alm item enables the beeper on the PresSura monitor.	On, Off	Off
Alarm Delay <i>RPM10 and RPM20</i>	Alarm Delay	The Alarm Delay item sets the period of time the room pressure differential, flow or temperature must be above the high alarm set point or below the low alarm set point before the controller enters alarm mode. Use the Alarm Delay function to avoid momentary, nuisance alarms.	20 to 600 seconds	20 seconds
Door Delay <i>RPM10 and RPM20</i>	Door Delay	<p>The Door Delay item sets the period of time the room pressure differential, flow or temperature must be above the high alarm set point or below the low alarm set point before the monitor enters alarm mode when the door is open. Use the Door Delay function to avoid momentary, nuisance alarms.</p> <p>NOTE: Input4 Config or Input6 Config must be set to DOOR SWITCH for the Door Delay to take effect. Door Delay can be configured even if Input 4 or Input 6 is not set to DOOR SWITCH.</p>	20 to 600 seconds	60 seconds





Alarm Config Menu

MENU ITEM	SOFTWARE NAME	ITEM DESCRIPTION	ITEM RANGE	DEFAULT VALUE
Mute Timeout <i>RPM10 and RPM20</i>	Mute Time	The Mute Time item sets the length of time the audible alarm will be silenced if the mute button is pressed. The Mute Time can be set from 1 to 60 minutes.	1 to 60 Minutes	5 Minutes
Relay2 Output Signal <i>RPM10 and RPM20</i>	Relay 2 Out	The Relay 2 Out item sets desired alarm output to be used with Relay 2. If set to:		High Alarm Negative Room Positive Room
		HIGH ALARM	The PresSura monitor will activate the relay if a high alarm condition exists.	
		NEGATIVE ROOM	The PresSura monitor will activate the relay when the mode for room 1 is negative.	
		POSITIVE ROOM	The PresSura monitor will activate the relay when the mode for room 1 is positive.	
Relay 2 Output Direction	Relay 2 Dir	The Relay 2 Dir item sets desired signal output to be used with Relay 2. If Relay 2 Out is set to HIGH ALARM. If Relay 2 Out is set to NEGATIVE ROOM or POSITIVE ROOM:	OK = OPEN OK = CLOSED NO ISO = OPEN NO ISO = CLOSED	OK = OPEN NO ISO = OPEN

Interface Menu

MENU ITEM	SOFTWARE NAME	ITEM DESCRIPTION	ITEM RANGE	DEFAULT VALUE
Network Communications Protocol <i>RPM10 and RPM20</i>	Comm Type 	The Comm Type item selects the communications protocol used to interface with the building management system. NOTE: LON can only be selected on Model RPM20 monitors with LONworks. Modbus® and BACnet® will only appear on Model RPM20 monitors without LON and on all Model RPM10 monitors.	RPM10: Modbus® BACnet® RPM20: Modbus® BACnet® LON	Modbus

Interface Menu

MENU ITEM	SOFTWARE NAME	ITEM DESCRIPTION	ITEM RANGE	DEFAULT VALUE
Network Address <i>RPM10 and RPM20</i>	Address 	The Address item sets the main network address of the room pressure monitor. Each unit on the network must have its own unique address. NOTE: The Address item is only functional when Comm Type is set to Modbus or BACnet . NOTE: Changes to the Address may take up to 1 minute to take effect when using BACnet® communications.	Modbus: 1 to 247 BACnet: 1 to 128	128
MAC ID <i>RPM10 and RPM20</i>	MAC ID 	The MAC ID item is the Device ID of the unit for BACnet® communications. NOTE: The MAC ID item is only functional when Comm Type is set to BACnet . NOTE: Changes to the MAC ID may take up to 1 minute to take effect when using BACnet® communications.	1 to 4,194,302	606
Baud Rate <i>RPM10 and RPM20</i>	Baud Rate 	The Baud Rate item sets the communication speed of the PresSura monitor when using Modbus or BACnet® communications. NOTE: Changes to the Baud Rate may take up to 1 minute to take effect when using BACnet® communications. Baud Rate is not configurable when Comm Type is set to Modbus.	Modbus: 9600 BACnet: 9600, 19200, 38400, 76800, AutoBaud	Modbus: 9600 BACnet: AutoBaud

Interface Menu

MENU ITEM	SOFTWARE NAME	ITEM DESCRIPTION	ITEM RANGE	DEFAULT VALUE
Network Address for Nurse's Station <i>RPM10 and RPM20</i>	Nurse Address	<p>The Nurse Address item sets the main network address of the room pressure monitor when communicating with the Nurse's Station Monitor. Each unit on the network must have its own unique address.</p> <p>NOTE: PresSura Model RPM10 and RPM20 monitors will have rooms displayed on the Nurse's Station Monitor in order of the Nurse Address. The PresSura monitor with the lowest Nurse Address will be displayed at the top-left of the Nurse's Station Monitor screen. If a PresSura monitor is configured for more than 1 room, then the rooms will be displayed on the Nurse's Station in order of Room 1, Room 2, and Anteroom.</p>	1 to 8	1
LON Configuration <i>RPM20</i>	LON	<p>When the SERVICE PIN option is selected, the Model RPM20 sends a broadcast message containing its Neuron ID and program ID. This is required to install the Model RPM20 on the LonWorks® network, or to reinstall the Model RPM20 after using the GO UNCONFIGURED command.</p> <p>Selecting the GO UNCONFIGURED option resets the Model RPM20 monitor's authentication key. This is required in the event a foreign network tool inadvertently acquires a Model RPM20 and installs it with network management authentication. The Model RPM20 monitor's owner will then be unable to reclaim the Model RPM20 over the network.</p> <p>NOTE: The LON item is only functional when Comm Type is set to LON.</p>	Service Pin Go Unconfigured	N/A

Interface Menu

MENU ITEM	SOFTWARE NAME	ITEM DESCRIPTION	ITEM RANGE	DEFAULT VALUE
BACnet Inputs (When using BACnet) <i>RPM10 and RPM20</i>	BACnet Data	The BACnet Data item allows for select inputs to be read over BACnet® instead of being wired to the RPM10 or RPM20. Selecting the button “ ON ” will allow that specific device input to be written to the RPMx and displayed on the touchscreen. NOTE: The BACnet data item only applies when BACnet® is used. NOTE: The RPM10 allows the Supply Flow and Exhaust Flow to be written over BACnet®. The RPM20 allows the Supply Flow, Exhaust Flow, Room Temperature, and Relative Humidity to be written over BACnet®.	ON or OFF	OFF
Stop Bits (When using Modbus) <i>RPM10 and RPM20</i>	Stop Bits	The Stop Bits items select the number of stop bits used in Modbus communication.	1 or 2	1
Analog Output Signal Type <i>RPM10 and RPM20</i>	AO1 Sig Type	The AO1 Sig Type item selects the measurement that the analog output signal will represent.	None AnteRoom Pressure	None
Analog Output Signal Type <i>RPM10 and RPM20</i>	AO2 Sig Type	The AO2 Sig Type item selects the measurement that the analog output signal will represent.	Room 1 Pressure Exhaust Flow None	None
Analog Output Signal <i>RPM10 and RPM20</i>	AO2 Out Type	The AO2 Out Type item selects the analog output (not control output signal).	0 to 10 VDC 4-20 mA	0 to 10 VDC

Interface Menu

MENU ITEM	SOFTWARE NAME	ITEM DESCRIPTION	ITEM RANGE	DEFAULT VALUE															
Analog Output Full Scale <i>RPM10 and RPM20</i>	AO2 Sig Rnge	The AO2 Sig Rnge item selects the full scale range that the analog output signal will represent. If the room pressure sensor is set to:	PRESSURE: -1.00 in. W.C. to +1.00 in. W.C. FLOW: 0 to 30,000 CFM	PRESSURE: 0.10 in. W.C. FLOW: 1000 CFM															
		<table border="1"> <thead> <tr> <th>AO2 SIGNAL TYPE (SENSOR)</th> <th>0 V / 4 mA</th> <th>10 V / 20 mA</th> </tr> </thead> <tbody> <tr> <td>ROOM 1 PRESSURE (TSI)</td> <td>- AO2 Sig Rnge</td> <td>+ AO2 Sig Rnge</td> </tr> <tr> <td>ROOM 1 PRESSURE (PRESSURE TRANSDUCER; SENSOR MIN=0)</td> <td>0</td> <td>AO2 Sig Rnge</td> </tr> <tr> <td>ROOM 1 PRESSURE (PRESSURE TRANSDUCER; SENSOR MIN≠0)</td> <td>- AO2 Sig Rnge</td> <td>+ AO2 Sig Rnge</td> </tr> <tr> <td>EXHAUST FLOW</td> <td>0</td> <td>AO2 Sig Rnge</td> </tr> </tbody> </table>			AO2 SIGNAL TYPE (SENSOR)	0 V / 4 mA	10 V / 20 mA	ROOM 1 PRESSURE (TSI)	- AO2 Sig Rnge	+ AO2 Sig Rnge	ROOM 1 PRESSURE (PRESSURE TRANSDUCER; SENSOR MIN=0)	0	AO2 Sig Rnge	ROOM 1 PRESSURE (PRESSURE TRANSDUCER; SENSOR MIN≠0)	- AO2 Sig Rnge	+ AO2 Sig Rnge	EXHAUST FLOW	0	AO2 Sig Rnge
		AO2 SIGNAL TYPE (SENSOR)			0 V / 4 mA	10 V / 20 mA													
		ROOM 1 PRESSURE (TSI)			- AO2 Sig Rnge	+ AO2 Sig Rnge													
		ROOM 1 PRESSURE (PRESSURE TRANSDUCER; SENSOR MIN=0)			0	AO2 Sig Rnge													
		ROOM 1 PRESSURE (PRESSURE TRANSDUCER; SENSOR MIN≠0)			- AO2 Sig Rnge	+ AO2 Sig Rnge													
EXHAUST FLOW	0	AO2 Sig Rnge																	
	NOTE: Do <i>not</i> set AO2 Sig Rnge to a value greater than the sensor input.																		
Analog Output Signal Type <i>RPM20</i>	AO3 Sig Type	The AO3 Sig Type item selects the measurement that the analog output signal will represent.	Room 2 PressureSupply Flow Exhaust Flow None	None															
Analog Output Signal <i>RPM20</i>	AO3 Out Type	The AO3 Out Type item selects the analog output (not control output signal).	0 to 10 VDC or 4-20 mA	0 to 10 VDC															

Diagnostics Menu

MENU ITEM	SOFTWARE NAME	ITEM DESCRIPTION
View Measurement Inputs <i>RPM10 and RPM20</i>	View Inputs	The View Inputs item allows the user to view the measurements for all 7 inputs on one screen.
View Output Signals <i>RPM10 and RPM20</i>	View Outputs	The View Outputs item allows the user to view the current output signals, in units of V or mA.
Control Relay Outputs <i>RPM10 and RPM20</i>	Relay Outputs	The Relay Outputs item allows the user to view and manually control the 2 relay outputs.
Manually Adjust Analog Outputs <i>RPM10 and RPM20</i>	Analog Outpt	The Analog Outpt item allows the user to manually control the Analog Outputs.
Recalibrate Touchscreen <i>RPM10 and RPM20</i>	Touch Cal 	The Touch Cal item starts the touchscreen recalibration process. While recalibrating the touchscreen, the PresSura monitor will direct the user to touch the screen in various places. NOTE: Recalibrating the touchscreen is best accomplished using a stylus, pen, or similar object.
Reset to Default <i>RPM10 and RPM20</i>	Reset	The Reset item resets all parameters to factory default.

Input1 Config Menu

TSI Sensor

MENU ITEM	SOFTWARE NAME	ITEM DESCRIPTION	ITEM RANGE	DEFAULT VALUE
Set Sensor Zero Calibration <i>RPM10 and RPM20</i>	Sensor Zero	The Sensor Zero item is used to re-zero the TSI Sensor zero calibration point.	None	Unit is factory calibrated and should not need adjustment.
Set Sensor Span Calibration <i>RPM10 and RPM20</i>	Sensor Span	The Sensor Span item is used to match or calibrate the PresSura TSI sensor to the average room pressure velocity as measured by a portable air velocity meter.	None	Unit is factory calibrated and should not need adjustment.
Set Sensor Elevation <i>RPM10 and RPM20</i>	Elevation	The Elevation item is used to enter the elevation of the sensor above sea level. The pressure value needs to be corrected due to changes in air density at different elevations. While this number can be entered in increments of 1 foot, the density adjustments are in 1,000 foot increments. For example, if the PresSura will interpret Elevation settings between 0 and 999 feet as 0 feet, settings between 1000 and 1999 feet as 1000 feet, etc.	0 to 10,000 feet above sea level	0
Reset Calibration <i>RPM10 and RPM20</i>	Reset Cal	The Reset Cal item is used to return to the factory default calibration, undoing field calibration adjustments. When this menu item is entered, the monitor will prompt the user to verify that they want to do this by displaying the message "Are You Sure." Entering YES resets the Sensor Zero , Sensor Span and Elevation items to defaults. Entering NO will cancel the reset.	None	N/A

Input1 Config Menu

TSI Sensor

MENU ITEM	SOFTWARE NAME	ITEM DESCRIPTION	ITEM RANGE	DEFAULT VALUE	
Check Sensor Status	Check Status	The Check Status item is used to check the communication status of the sensor. After pressing the button, the PresSura unit will respond with:	None	N/A	
		COMM ERROR			DIM cannot communicate with sensor. Check all wiring and the pressure sensor address.
		SENS ERROR			Physical damage to pressure sensor circuitry. Unit is <i>not</i> field-repairable. Send to TSI for repair.
		CAL ERROR			Calibration data lost. Send to TSI for calibration.
		DATA ERROR			Problem with sensor EEPROM, field calibration or analog output. Check all data configured and confirm unit is functioning correctly.

Input1 Config Menu

Press Trans

MENU ITEM	SOFTWARE NAME	ITEM DESCRIPTION	ITEM RANGE	DEFAULT VALUE
Set Minimum Sensor Pressure Output <i>RPM10 and RPM20</i>	Sensor Min	The Sensor Min item is used to set the minimum reading of a pressure transducer used to measure room pressure differential. For example, if the pressure transducer has a range of -0.25 in. W.C. to +0.25 in. W.C. (-62.5 to +62.5 Pa), the Sensor Min should be set to -0.25 in. W.C. (-62.5 Pa).	-1.00 to +1.00 in. W.C.	0
Set Maximum Sensor Pressure Output <i>RPM10 and RPM20</i>	Sensor Max	The Sensor Max item is used to set the maximum reading of a pressure transducer used to measure room pressure differential. For example, if the pressure transducer has a range of -0.25 in. W.C. to +0.25 in. W.C. (-62.5 to +62.5 Pa), the Sensor Max should be set to +0.25 in. W.C. (+62.5 Pa).	-1.00 to +1.00 in. W.C.	0

Input1 Config Menu

Press Trans

MENU ITEM	SOFTWARE NAME	ITEM DESCRIPTION	ITEM RANGE	DEFAULT VALUE
Set Minimum Sensor Voltage Output <i>RPM10 and RPM20</i>	Signal Min	The Signal Min item is used to set the minimum output signal when a pressure transducer is used to measure room pressure differential.	0 to 5 V	0 V
Set Maximum Sensor Voltage Output <i>RPM10 and RPM20</i>	Signal Max	The Signal Max item is used to set the maximum output signal when a pressure transducer is used to measure room pressure differential.	1 to 10 V	10 V
Set Sensor Zero Calibration <i>RPM10 and RPM20</i>	Sensor Zero	The Sensor Zero item is used to re-zero the pressure transducer zero calibration point.	None	N/A
Reset Calibration <i>RPM10 and RPM20</i>	Reset Cal	The Reset Cal item is used to return to the factory default calibration, undoing any field calibration adjustments. When this menu item is entered, the monitor will prompt the user to verify that they want to do this by displaying the message "Are You Sure." Entering YES resets the Sensor Zero factor for this sensor to defaults. Entering NO will cancel the reset.	None	N/A

Input2 Config Menu

TSI Sensor

MENU ITEM	SOFTWARE NAME	ITEM DESCRIPTION	ITEM RANGE	DEFAULT VALUE
Set Sensor Zero Calibration <i>RPM20</i>	Sensor Zero	The Sensor Span item is used to re-zero the TSI Sensor zero calibration point.	None	Unit is factory calibrated and should not need adjustment.
Set Sensor Span Calibration <i>RPM20</i>	Sensor Span	The Sensor Span item is used to match or calibrate the PresSura monitor TSI sensor to the average room pressure velocity as measured by a portable air velocity meter.	None	Unit is factory calibrated and should not need adjustment.
Set Sensor Elevation <i>RPM20</i>	Elevation	<p>The Elevation item is used to enter the elevation of the sensor above sea level. The pressure value needs to be corrected due to changes in air density at different elevations.</p> <p>While this number can be entered in increments of 1 foot, the density adjustments are in 1,000 foot increments. For example, if the PresSura monitor will interpret Elevation settings between 0 and 999 feet as 0 feet, settings between 1000 and 1999 feet as 1000 feet, etc.</p>	0 to 10,000 feet above sea level	0
Reset Calibration <i>RPM20</i>	Reset Cal	The Reset Cal item is used to return to the factory default calibration, undoing field calibration adjustments. When this menu item is entered, the controller will prompt the user to verify that they want to do this by displaying the message "Reset Settings to Factory Default?" Entering YES resets the Sensor Zero , Sensor Span and Elevation items to defaults. Entering NO will cancel the reset.	None	N/A

Input2 Config Menu

TSI Sensor

MENU ITEM	SOFTWARE NAME	ITEM DESCRIPTION	ITEM RANGE	DEFAULT VALUE								
Check Sensor Status <i>RPM20</i>	Check Status	<p>The Check Status item is used to check the communication status of the sensor. After pressing the button, the PresSura unit will respond with:</p> <table border="1" data-bbox="720 428 1421 862"> <tr> <td data-bbox="720 428 957 537">COMM ERROR</td> <td data-bbox="957 428 1421 537">DIM cannot communicate with sensor. Check all wiring and the pressure sensor address.</td> </tr> <tr> <td data-bbox="720 537 957 646">SENS ERROR</td> <td data-bbox="957 537 1421 646">Physical damage to pressure sensor circuitry. Unit is not field-repairable. Send to TSI for repair.</td> </tr> <tr> <td data-bbox="720 646 957 724">CAL ERROR</td> <td data-bbox="957 646 1421 724">Calibration data lost. Send to TSI for calibration.</td> </tr> <tr> <td data-bbox="720 724 957 862">DATA ERROR</td> <td data-bbox="957 724 1421 862">Problem with sensor EEPROM, field calibration or analog output. Check all data configured and confirm unit is functioning correctly.</td> </tr> </table>	COMM ERROR	DIM cannot communicate with sensor. Check all wiring and the pressure sensor address.	SENS ERROR	Physical damage to pressure sensor circuitry. Unit is not field-repairable. Send to TSI for repair.	CAL ERROR	Calibration data lost. Send to TSI for calibration.	DATA ERROR	Problem with sensor EEPROM, field calibration or analog output. Check all data configured and confirm unit is functioning correctly.	None	N/A
COMM ERROR	DIM cannot communicate with sensor. Check all wiring and the pressure sensor address.											
SENS ERROR	Physical damage to pressure sensor circuitry. Unit is not field-repairable. Send to TSI for repair.											
CAL ERROR	Calibration data lost. Send to TSI for calibration.											
DATA ERROR	Problem with sensor EEPROM, field calibration or analog output. Check all data configured and confirm unit is functioning correctly.											

(continued on next page)

Input2 Config Menu

Press Trans

MENU ITEM	SOFTWARE NAME	ITEM DESCRIPTION	ITEM RANGE	DEFAULT VALUE
Set Minimum Sensor Pressure Output <i>RPM20</i>	Sensor Min	The Sensor Min item is used to set the minimum reading of a pressure transducer used to measure room pressure differential. For example, if the pressure transducer has a range of -0.25 in. W.C. to +0.25 in. W.C. (-62.5 to +62.5 Pa), the Sensor Min should be set to -0.25 in. W.C. (-62.5 Pa).	-1.00 to +1.00 in. W.C.	0
Set Maximum Sensor Pressure Output <i>RPM20</i>	Sensor Max	The Sensor Max item is used to set the maximum reading of a pressure transducer used to measure room pressure differential. For example, if the pressure transducer has a range of -0.25 in. W.C. to +0.25 in. W.C. (-62.5 to +62.5 Pa), the Sensor Max should be set to +0.25 in. W.C. (+62.5 Pa).	-1.00 to +1.00 in. W.C.	0
Set Minimum Sensor Voltage Output <i>RPM20</i>	Signal Min	The Signal Min item is used to set the minimum output signal when a pressure transducer is used to measure room pressure differential.	0 to 5 V	0 V
Set Maximum Sensor Voltage Output <i>RPM20</i>	Signal Max	The Signal Max item is used to set the maximum output signal when a pressure transducer is used to measure room pressure differential.	1 to 10 V	10 V
Set Sensor Zero Calibration <i>RPM20</i>	Sensor Zero	The Sensor Zero item is used to re-zero the pressure transducer zero calibration point.	None	N/A
Reset Calibration <i>RPM20</i>	Reset Cal	The Reset Cal item is used to return to the factory default calibration, undoing field calibration adjustments. When this menu item is entered, the controller will prompt the user to verify that they want to do this by displaying the message "Reset Settings to Factory Default?" Entering YES resets the Sensor Zero item to defaults. Entering NO will cancel the reset.	None	N/A

Input2 Config Menu

Particle A

MENU ITEM	SOFTWARE NAME	ITEM DESCRIPTION	ITEM RANGE	DEFAULT VALUE
Input Scale <i>RPM20-CC</i>	Scale	The Scale item sets the particle range scale of the analog input. The Scale must match the scale of the analog output from the AeroTrak Remote with Pump Particle Counter. TSI recommends using the Log scale to see the full range of particle concentrations with good resolution.	Linear 100 Linear 1,000 Linear 10,000 Linear 100,000 Linear 1,000,000 Linear 10,000,000 Linear 100,000,000 Linear 1,000,000,000 Log	Linear 100
Minimum Particle Size Measured <i>RPM20-CC</i>	Ptcl Size	The Ptcl Size item sets the minimum particle size of Particle Channel A. The Ptcl Size must match the selected size on the AeroTrak Remote with Pump Particle Counter.	0.0 to 10.0 μm	0.0 μm
Resistance <i>RPM20-CC</i>	Resistance	The Resistance item sets the resistance of the resistor used to convert the 4-20 mA output from the AeroTrak Remote with Pump Particle Counter to a 2-10VDC signal at the Model RPM20-CC. TSI recommends a nominal 500 Ω resistor.	0 to 1000 Ω	500 Ω
Update Time of Particle Counter <i>RPM20-CC</i>	Sample time	The Sample Time item sets the update speed of the particle measurement. The Sample Time must match the selected sample time on the AeroTrak Remote with Pump Particle Counter.	1 to 600 sec	60 sec
High Alarm Setpoint <i>RPM20-CC</i>	High Alarm	The High Alarm item sets the particle concentration alarm setpoint for Particle Channel A.	0 to 1,000,000,000 / ft^3 (0 to 3531466752 / m^3)	0

Input2 Config Menu

Particle A

MENU ITEM	SOFTWARE NAME	ITEM DESCRIPTION	ITEM RANGE	DEFAULT VALUE
Particle Channel A Alarm Enable <i>RPM20-CC</i>	Alarm Enable	The Alarm Enable item enables the high particle concentration alarm function. Select ON for the monitor to alarm if the particle concentration is above the High Alarm setpoint. Select OFF to measure the particle concentration without alarming.	ON, OFF	ON
Alarm Delay Strategy <i>RPM20-CC</i>	Strategy	The Strategy item chooses the delay strategy to avoid nuisance alarms. Consecutive Readings requires a selectable number of readings above the High Alarm setpoint to create an alarm condition. SPC creates an alarm based on a high frequency of readings (such as 3 of the last 10) above the High Alarm setpoint.	Consecutive Readings SPC	Consecutive Readings
Number of Readings to Enter Alarm State <i>RPM20-CC</i>	# Consecutive	The # Consecutive item sets the number of readings above the High Alarm setpoint to create an alarm condition. # Consecutive is only active if the Strategy is set to Consecutive Readings.	1 to 60	1
Number of Readings to Exit Alarm State <i>RPM20-CC</i>	Exit Readings	The Exit Reading item sets the number of readings below the High Alarm setpoint to clear an alarm condition. Exit Readings is only active if the Strategy is set to Consecutive Readings.	1 to 10	1
Number of Readings to Enter Alarm State <i>RPM20-CC</i>	Frequency	The Frequency item sets the number of readings above the High Alarm setpoint to enter an alarm condition. Frequency is only active if the Strategy is set to SPC. For example, if the monitor should alarm if 3 of the last 10 readings are above the High Alarm setpoint, set the Frequency to 3 and the Period to 10.	1 to 60	1

Input2 Config Menu

Particle A

MENU ITEM	SOFTWARE NAME	ITEM DESCRIPTION	ITEM RANGE	DEFAULT VALUE
Number of Readings to be Examined for Alarm State <i>RPM20-CC</i>	Period	The Period item sets the number of samples to check against the High Alarm setpoint. Period is only active if the Strategy is set to SPC. For example, if the monitor should alarm if 3 of the last 10 readings are above the High Alarm setpoint, set the Frequency to 3 and the Period to 10.	1 to 60	1

(continued on next page)

Input3 Config Menu

Sup Pres Flow

MENU ITEM	SOFTWARE NAME	ITEM DESCRIPTION	ITEM RANGE	DEFAULT VALUE
Set Flow Station Zero Calibration <i>RPM10 and RPM20</i>	Sensor Zero	The Sensor Zero item is used to re-zero the pressure transducer zero calibration point.	NONE	
Set Maximum Sensor Pressure Output <i>RPM10 and RPM20</i>	Sensor Max	The Sensor Max item is used to set the maximum reading of a flow station and pressure transducer used to measure supply air flow. For example, if the pressure transducer has a range of 0 in. W.C. to +0.25 in. W.C. (0 to +62.5 Pa), the Sensor Max should be set to +0.25 in. W.C. (+62.5 Pa).	0 to 1.00 in. W.C.	1.00 in. W.C.
Set Minimum Sensor Voltage Output <i>RPM10 and RPM20</i>	Signal Min	The Signal Min item is used to set the minimum output signal when a flow station and pressure transducer is used to supply flow.	0 to 10 V	0 V
Set Maximum Sensor Voltage Output <i>RPM10 and RPM20</i>	Signal Max	The Signal Max item is used to set the maximum output signal when a flow station and pressure transducer is used to measure supply flow.	1 to 10 V	10 V
Flow Station Low Calibration <i>RPM10 and RPM20</i>	Low Cal	The Low Cal menu item enters the Low Cal Submenu.	See Flow Calibration	
Flow Station High Calibration <i>RPM10 and RPM20</i>	High Cal	The High Cal menu item enters the High Cal Submenu.	See Flow Calibration	

Input3 Config Menu

Sup Pres Flow

MENU ITEM	SOFTWARE NAME	ITEM DESCRIPTION	ITEM RANGE	DEFAULT VALUE
Reset Calibration <i>RPM10 and RPM20</i>	Reset Cal	The Reset Cal item is used to return to the factory default calibration, undoing any field calibration adjustments. When this menu item is entered, the controller will prompt the user to verify that they want to do this by displaying the message “Reset Settings to Factory Default?” Entering YES resets the Low Cal , High Cal and K-Factor factors for this sensor to defaults. Entering NO will cancel the reset.	None	N/A

(continued on next page)

Input3 Config Menu

Sup Lin Flow

MENU ITEM	SOFTWARE NAME	ITEM DESCRIPTION	ITEM RANGE	DEFAULT VALUE
Set Flow Station Duct Area <i>RPM10 and RPM20</i>	Duct Area	<p>The Duct Area item is used to program the cross sectional area of the duct where the flow station is mounted. Since the flow station is used to measure duct velocity, the Duct Area is necessary to calculate the duct air flow.</p> <p>NOTE: The DIM DOES NOT compute duct area. The area must be first calculated and then entered into the unit.</p> <p>Use the following equations to calculate the duct area (in ft²).</p> <p>For round ducts</p> $\text{Duct Area} = \frac{3.14 * \left[\frac{\text{duct diameter (in inches)}}{2} \right]^2}{144}$ <p>For rectangular ducts</p> $\text{Duct Area} = \frac{[\text{width (in inches)} * \text{height (in inches)}]}{144}$ <p style="text-align: center;">WARNING</p> <p>If the proper Duct Area is not programmed into the Model RPM10 and RPM20, the flow measurement will be incorrect. Thus, all the other information that uses the flow measurement, such as the flow alarms, will also be incorrect.</p>	0 to 50.00 ft ² (0 to 4.6450 m ²)	0.00 ft ² (0.0000 m ²)
Set Flow K-Factor Adjustment <i>RPM10 and RPM20</i>	K-Factor	<p>The K-Factor menu item sets the “K” factor for the flow signal. The flow signal is multiplied by the K-Factor so that the flow measurement matches the actual flow, determined with a pitot tube traverse or other reference measurement.</p> <p>NOTE: K-Factor modifies the entire range of the calibrated flow, not just a single point.</p>	0.01 to 10.00	1.00

Input3 Config Menu

Sup Lin Flow

MENU ITEM	SOFTWARE NAME	ITEM DESCRIPTION	ITEM RANGE	DEFAULT VALUE
Set Maximum Sensor Output <i>RPM10 and RPM20</i>	Sensor Max	The Sensor Max item is used to set the maximum reading of a flow station used to measure supply air flow. The Sensor Max item has increments of 1000 ft/min.	0 to 10,000 ft/min	0
Set Minimum Sensor Voltage Output <i>RPM10 and RPM20</i>	Signal Min	The Signal Min item is used to set the minimum output signal when a flow station and pressure transducer is used to supply air flow.	0 to 10 V	0 V
Set Maximum Sensor Voltage Output <i>RPM10 and RPM20</i>	Signal Max	The Signal Max item is used to set the maximum output signal when a flow station and pressure transducer is used to supply air flow.	1 to 10 V	10 V
Reset Calibration <i>RPM10 and RPM20</i>	Reset Cal	The Reset Cal item is used to return to the factory default calibration, undoing any field calibration adjustments. When this menu item is entered, the controller will prompt the user to verify that they want to do this by displaying the message "Reset Settings to Factory Default?" Entering YES resets the K-Factor for this sensor to defaults. Entering NO will cancel the reset.	None	N/A

Input3 Config Menu

Sup Venturi

MENU ITEM	SOFTWARE NAME	ITEM DESCRIPTION	ITEM RANGE	DEFAULT VALUE
Minimum Flow <i>RPM10 and RPM20</i>	Min Flow	<p>The Min Flow item sets the flow rate through the venturi valve when it is fully closed. The display will indicate a volumetric flow rate. Adjust the displayed value to match the flow through the venturi valve.</p> <p>NOTE: The flow information can be obtained from the label on the TSI Venturi Valve or by closing the venturi valve using the Flow Control item in the DIAGNOSTICS menu and performing a pitot tube traverse of the duct.</p> <p>The Min Flow menu item must be completed before moving on to the Max Flow menu item.</p>	0 to 10000 cfm	0 cfm
Maximum Flow <i>RPM10 and RPM20</i>	Max Flow	<p>The Max Flow item sets the flow rate through the venturi valve when it is fully open. The display will indicate a volumetric flow rate. Adjust the displayed value to match the flow through the venturi valve.</p> <p>NOTE: The flow information can be obtained from the label on the TSI Venturi Valve or by closing the venturi valve using the Flow Control item in the DIAGNOSTICS menu and performing a pitot tube traverse of the duct.</p> <p>The Min Flow menu item must be completed before moving on to the Max Flow menu item.</p>	0 to 10000 cfm	0 cfm
Set Flow K-Factor Adjustment <i>RPM10 and RPM20</i>	K-Factor	<p>The K-Factor menu item sets the “K” factor for the flow signal. The flow signal is multiplied by the K-Factor so that the flow measurement matches the actual flow, determined with a pitot tube traverse or other reference measurement.</p> <p>NOTE: K-Factor modifies the entire range of the calibrated flow, not just a single point.</p>	0.01 to 10.00	1.00

Input3 Config Menu

Sup Venturi

MENU ITEM	SOFTWARE NAME	ITEM DESCRIPTION	ITEM RANGE	DEFAULT VALUE
Reset Calibration <i>RPM10 and RPM20</i>	Reset Cal	The Reset Cal item is used to return to the factory default calibration, undoing any field calibration adjustments. When this menu item is entered, the controller will prompt the user to verify that they want to do this by displaying the message “Reset Settings to Factory Default?” Entering YES resets the K-Factor factor for this sensor to defaults. Entering NO will cancel the reset.	None	N/A

Input3 Config Menu

Supply Switch

MENU ITEM	SOFTWARE NAME	ITEM DESCRIPTION	ITEM RANGE	DEFAULT VALUE
Low Flow Alarm Signal <i>RPM10 and RPM20</i>	Low Flow Sig	The Low Flow Sig item sets the signal the Model RPM10 or RPM20 Room Pressure Monitor will receive to indicate a low supply flow condition.	Open, Closed	Closed

Input3 Config Menu

TSI Sensor

MENU ITEM	SOFTWARE NAME	ITEM DESCRIPTION	ITEM RANGE	DEFAULT VALUE
Set Sensor Zero Calibration <i>RPM20</i>	Sensor Zero	The Sensor Span item is used to re-zero the TSI Sensor zero calibration point.	None	Unit is factory calibrated and should not need adjustment.
Set Sensor Span Calibration <i>RPM20</i>	Sensor Span	The Sensor Span item is used to match or calibrate the PresSura monitor TSI sensor to the average room pressure velocity as measured by a portable air velocity meter.	None	Unit is factory calibrated and should not need adjustment.

Input3 Config Menu

TSI Sensor

MENU ITEM	SOFTWARE NAME	ITEM DESCRIPTION	ITEM RANGE	DEFAULT VALUE								
Set Sensor Elevation <i>RPM20</i>	Elevation	<p>The Elevation item is used to enter the elevation of the sensor above sea level. The pressure value needs to be corrected due to changes in air density at different elevations.</p> <p>While this number can be entered in increments of 1 foot, the density adjustments are in 1,000 foot increments. For example, if the PresSura monitor will interpret Elevation settings between 0 and 999 feet as 0 feet, settings between 1000 and 1999 feet as 1000 feet, etc.</p>	0 to 10,000 feet above sea level	0								
Reset Calibration <i>RPM20</i>	Reset Cal	The Reset Cal item is used to return to the factory default calibration, undoing field calibration adjustments. When this menu item is entered, the controller will prompt the user to verify that they want to do this by displaying the message "Reset Settings to Factory Default?" Entering YES resets the Sensor Zero , Sensor Span and Elevation items to defaults. Entering NO will cancel the reset.	None	N/A								
Check Sensor Status <i>RPM20</i>	Check Status	<p>The Check Status item is used to check the communication status of the sensor. After pressing the button, the PresSura unit will respond with:</p> <table border="1"> <tbody> <tr> <td>COMM ERROR</td> <td>DIM cannot communicate with sensor. Check all wiring and the pressure sensor address.</td> </tr> <tr> <td>SENS ERROR</td> <td>Physical damage to pressure sensor circuitry. Unit is not field-repairable. Send to TSI for repair.</td> </tr> <tr> <td>CAL ERROR</td> <td>Calibration data lost. Send to TSI for calibration.</td> </tr> <tr> <td>DATA ERROR</td> <td>Problem with sensor EEPROM, field calibration or analog output. Check all data configured and confirm unit is functioning correctly.</td> </tr> </tbody> </table>	COMM ERROR	DIM cannot communicate with sensor. Check all wiring and the pressure sensor address.	SENS ERROR	Physical damage to pressure sensor circuitry. Unit is not field-repairable. Send to TSI for repair.	CAL ERROR	Calibration data lost. Send to TSI for calibration.	DATA ERROR	Problem with sensor EEPROM, field calibration or analog output. Check all data configured and confirm unit is functioning correctly.	None	N/A
COMM ERROR	DIM cannot communicate with sensor. Check all wiring and the pressure sensor address.											
SENS ERROR	Physical damage to pressure sensor circuitry. Unit is not field-repairable. Send to TSI for repair.											
CAL ERROR	Calibration data lost. Send to TSI for calibration.											
DATA ERROR	Problem with sensor EEPROM, field calibration or analog output. Check all data configured and confirm unit is functioning correctly.											

Input3 Config Menu

Press Trans

MENU ITEM	SOFTWARE NAME	ITEM DESCRIPTION	ITEM RANGE	DEFAULT VALUE
Set Minimum Sensor Pressure Output <i>RPM20</i>	Sensor Min	The Sensor Min item is used to set the minimum reading of a pressure transducer used to measure room pressure differential. For example, if the pressure transducer has a range of -0.25 in. W.C. to +0.25 in. W.C. (-62.5 to +62.5 Pa), the Sensor Min should be set to -0.25 in. W.C. (-62.5 Pa).	-1.00 to +1.00 in. W.C.	0
Set Maximum Sensor Pressure Output <i>RPM20</i>	Sensor Max	The Sensor Max item is used to set the maximum reading of a pressure transducer used to measure room pressure differential. For example, if the pressure transducer has a range of -0.25 in. W.C. to +0.25 in. W.C. (-62.5 to +62.5 Pa), the Sensor Max should be set to +0.25 in. W.C. (+62.5 Pa).	-1.00 to +1.00 in. W.C.	0
Set Minimum Sensor Voltage Output <i>RPM20</i>	Signal Min	The Signal Min item is used to set the minimum output signal when a pressure transducer is used to measure room pressure differential.	0 to 5 V	0 V
Set Maximum Sensor Voltage Output <i>RPM20</i>	Signal Max	The Signal Max item is used to set the maximum output signal when a pressure transducer is used to measure room pressure differential.	1 to 10 V	10 V
Set Sensor Zero Calibration <i>RPM20</i>	Sensor Zero	The Sensor Zero item is used to re-zero the pressure transducer zero calibration point.	None	N/A
Reset Calibration <i>RPM20</i>	Reset Cal	The Reset Cal item is used to return to the factory default calibration, undoing field calibration adjustments. When this menu item is entered, the controller will prompt the user to verify that they want to do this by displaying the message "Reset Settings to Factory Default?" Entering YES resets the Sensor Zero item to defaults. Entering NO will cancel the reset.	None	N/A

Input4 Config Menu

Rm1 Dr Sw

MENU ITEM	SOFTWARE NAME	ITEM DESCRIPTION	ITEM RANGE	DEFAULT VALUE
Signal to Indicate Open Door <i>RPM10 and RPM20</i>	Dr Open Sig	The Dr Open Sig item sets the signal the Model RPM10 or RPM20 Room Pressure Controller will receive to indicate a door is open.	Open, Closed	Closed

Input4 Config Menu

Rm1 Occ Sen

MENU ITEM	SOFTWARE NAME	ITEM DESCRIPTION	ITEM RANGE	DEFAULT VALUE
Room Unoccupied Signal <i>RPM10 and RPM20</i>	Unocc Sig	The Unocc Sig item is used to set the signal that indicates the room is unoccupied.	Open, Closed	Closed

Input4 Config Menu

Particle B

MENU ITEM	SOFTWARE NAME	ITEM DESCRIPTION	ITEM RANGE	DEFAULT VALUE
Input Scale <i>RPM20-CC</i>	Scale	The Scale item sets the particle range scale of the analog input. The Scale must match the scale of the analog output from the AeroTrak Remote with Pump Particle Counter. TSI recommends using the Log scale to see the full range of particle concentrations with good resolution.	Linear 100 Linear 1,000 Linear 10,000 Linear 100,000 Linear 1,000,000 Linear 10,000,000 Linear 100,000,000 Linear 1,000,000,000 Log	Linear 100
Minimum Particle Size Measured <i>RPM20-CC</i>	Ptcl Size	The Ptcl Size item sets the minimum particle size of Particle Channel B. The Ptcl Size must match the selected size on the AeroTrak Remote with Pump Particle Counter.	0.0 to 10.0 μm	0.0 μm
Resistance <i>RPM20-CC</i>	Resistance	The Resistance item sets the resistance of the resistor used to convert the 4-20 mA output from the AeroTrak Remote with Pump Particle Counter to a 2-10 VDC signal at the Model RPM20-CC. TSI recommends a nominal 500 Ω resistor.	0 to 1000 Ω	500 Ω
Update Time of Particle Counter <i>RPM20-CC</i>	Sample time	The Sample Time item sets the update speed of the particle measurement. The Sample Time must match the selected sample time on the AeroTrak Remote with Pump Particle Counter.	1 to 600 sec	60 sec
High Alarm Setpoint <i>RPM20-CC</i>	High Alarm	The High Alarm item sets the particle concentration alarm setpoint for Particle Channel B.	0 to 1,000,000,000 / ft^3 (0 to 3531466752 / m^3)	0
Particle Channel B Alarm Enable <i>RPM20-CC</i>	Alarm Enable	The Alarm Enable item enables the high particle concentration alarm function. Select ON for the monitor to alarm if the particle concentration is above the High Alarm setpoint. Select OFF to measure the particle concentration without alarming.	ON, OFF	ON

Input4 Config Menu

Particle B

MENU ITEM	SOFTWARE NAME	ITEM DESCRIPTION	ITEM RANGE	DEFAULT VALUE
Alarm Delay Strategy <i>RPM20-CC</i>	Strategy	The Strategy item chooses the delay strategy to avoid nuisance alarms. Consecutive Readings requires a selectable number of readings above the High Alarm setpoint to create an alarm condition. SPC creates an alarm based on a high frequency of readings (such as 3 of the last 10) above the High Alarm setpoint.	Consecutive Readings SPC	Consecutive Readings
Number of Readings to Enter Alarm State <i>RPM20-CC</i>	# Consecutive	The # Consecutive item sets the number of readings above the High Alarm setpoint to create an alarm condition. # Consecutive is only active if the Strategy is set to Consecutive Readings.	1 to 60	1
Number of Readings to Exit Alarm State <i>RPM20-CC</i>	Exit Readings	The Exit Reading item sets the number of readings below the High Alarm setpoint to clear an alarm condition. Exit Readings is only active if the Strategy is set to Consecutive Readings.	1 to 10	1
Number of Readings to Enter Alarm State <i>RPM20-CC</i>	Frequency	The Frequency item sets the number of readings above the High Alarm setpoint to enter an alarm condition. Frequency is only active if the Strategy is set to SPC. For example, if the monitor should alarm if 3 of the last 10 readings are above the High Alarm setpoint, set the Frequency to 3 and the Period to 10.	1 to 60	1
Number of Readings to be Examined for Alarm State <i>RPM20-CC</i>	Period	The Period item sets the number of samples to check against the High Alarm setpoint. Period is only active if the Strategy is set to SPC. For example, if the monitor should alarm if 3 of the last 10 readings are above the High Alarm setpoint, set the Frequency to 3 and the Period to 10.	1 to 60	1

Input5 Config Menu

Rm1 Key Switch

ITEM DESCRIPTION
The Model RPM10 or RPM20 will display a message “Nothing to Configure” when Input 5 is set to Rm1 Key Switch and the user enters the Input5 Config menu.

Input5 Config Menu

RH

MENU ITEM	SOFTWARE NAME	ITEM DESCRIPTION	ITEM RANGE	DEFAULT VALUE
Set Minimum Sensor Output <i>RPM20</i>	Sensor Min	The Sensor Min item is used to set the minimum reading of the relative humidity sensor.	0 to 100% RH	0% RH
Set Maximum Sensor Output <i>RPM20</i>	Sensor Max	The Sensor Max item is used to set the maximum reading of the relative humidity sensor.	0 to 100% RH	100% RH
Set Minimum Sensor Voltage Output <i>RPM20</i>	Signal Min	The Signal Min item is used to set the minimum output signal of the relative humidity sensor.	0 to 10 V	0 V
Set Maximum Sensor Voltage Output <i>RPM20</i>	Signal Max	The Signal Max item is used to set the maximum output signal of the relative humidity sensor.	1 to 10 V	10 V
Adjust Sensor Calibration <i>RPM20</i>	Sensor Span	The Sensor Span item is used to adjust the calibration of the relative humidity sensor. The Sensor Span is an offset adjustment and can only be adjusted by $\pm 10\%$ RH.	-10% to +10% RH	0% RH
Reset Calibration <i>RPM20</i>	Reset Cal	The Reset Cal item is used to return to the factory default calibration, undoing any field calibration adjustments. When this menu item is entered, the controller will prompt the user to verify that they want to do this by displaying the message “Reset Settings to Factory Default?” Entering YES resets the Sensor Span factor for this sensor to defaults. Entering NO will cancel the reset.	None	N/A

Input6 Config Menu

Rm1 Temp

MENU ITEM	SOFTWARE NAME	ITEM DESCRIPTION	ITEM RANGE	DEFAULT VALUE
Adjust Sensor Calibration <i>RPM20</i>	Sensor Span	The Sensor Span item is used to adjust the calibration of the temperature sensor.	-10°F to +10°F	0°F
Reset Calibration <i>RPM20</i>	Reset Cal	The Reset Cal item is used to return to the factory default calibration, undoing any field calibration adjustments. When this menu item is entered, the controller will prompt the user to verify that they want to do this by displaying the message "Reset Settings to Factory Default?" Entering YES resets the Sensor Span factor for this sensor to defaults. Entering NO will cancel the reset.	None	N/A

Input6 Config Menu

Rm2 Occ Sen

MENU ITEM	SOFTWARE NAME	ITEM DESCRIPTION	ITEM RANGE	DEFAULT VALUE
Signal to Indicate Room Unoccupied <i>RPM20</i>	Unocc Sig	The Unocc Sig item is used to set the signal that indicates the room is unoccupied.	Open, Closed	Closed

Input6 Config Menu

Rm2 Dr Sw

MENU ITEM	SOFTWARE NAME	ITEM DESCRIPTION	ITEM RANGE	DEFAULT VALUE
Signal to Indicate Open Door <i>RPM20</i>	Dr Open Sig	The Dr Open Sig item sets the signal the Model RPM20 Room Pressure Monitor will receive to indicate a door is open.	Open, Closed	Closed

Input7 Config Menu

Exh Pres Flow

MENU ITEM	SOFTWARE NAME	ITEM DESCRIPTION	ITEM RANGE	DEFAULT VALUE
Set Flow Station Duct Area <i>RPM 10 and RPM20</i>	Duct Area	<p>The Duct Area item is used to program the cross sectional area of the duct where the flow station is mounted. Since the flow station is used to measure duct velocity, the Duct Area is necessary to calculate the duct air flow.</p> <p>NOTE: The DIM DOES NOT compute duct area. The area must be first calculated and then entered into the unit. Use the following equations to calculate the duct area (in ft²).</p> <p>For round ducts</p> $Duct\ Area = \frac{3.14 * \left[\frac{duct\ diameter\ (in\ inches)}{2} \right]^2}{144}$ <p>For rectangular ducts</p> $Duct\ Area = \frac{width\ (in\ inches) * height\ (in\ inches)}{144}$ <p style="text-align: center;">WARNING</p> <p>If the proper Duct Area is not programmed into the Model RPM10 and RPM20, the flow measurement will be incorrect. Thus, all the other information that uses the flow measurement, such as the flow alarms, will also be incorrect.</p>	0 to 50.00 ft ² (0 to 4.6450 m ²)	0.00 ft ² (0.0000 m ²)
Set Flow K-Factor Adjustment <i>RPM 10 and RPM20</i>	K-Factor	<p>The K-Factor menu item sets the “K” factor for the flow signal. The flow signal is multiplied by the K-Factor so that the flow measurement matches the actual flow, determined with a pitot tube traverse or other reference measurement.</p> <p>NOTE: K-Factor modifies the entire range of the calibrated flow, not just a single point.</p>	0.01 to 10.00	1.00
Set Flow Station Zero Calibration <i>RPM 10 and RPM20</i>	Sensor Zero	The Sensor Zero item is used to re-zero the pressure transducer zero calibration point.	NONE	

Input7 Config Menu

Exh Pres Flow

MENU ITEM	SOFTWARE NAME	ITEM DESCRIPTION	ITEM RANGE	DEFAULT VALUE
Set Maximum Sensor Pressure Output <i>RPM10 and RPM20</i>	Sensor Max	The Sensor Max item is used to set the maximum reading of a flow station and pressure transducer used to measure exhaust air flow. For example, if the pressure transducer has a range of 0 in. W.C. to +0.25 in. W.C. 0 to +62.5 Pa), the Sensor Max should be set to +0.25 in. W.C. (+62.5 Pa).	0 to +1.00 in. W.C.	1.00 in. W.C.
Set Minimum Sensor Voltage Output <i>RPM10 and RPM20</i>	Signal Min	The Signal Min item is used to set the minimum output signal when a flow station and pressure transducer is used to measure exhaust flow	0 to 10 V	0 V
Set Maximum Sensor Voltage Output <i>RPM10 and RPM20</i>	Signal Max	The Signal Max item is used to set the maximum output signal when a flow station and pressure transducer is used to measure exhaust flow.	1 to 10 V	10 V
Flow Station Low Calibration <i>RPM10 and RPM20</i>	Low Cal	The Low Cal menu item enters the Low Cal Submenu.	See Flow Calibration	
Flow Station High Calibration <i>RPM10 and RPM20</i>	High Cal	The High Cal menu item enters the High Cal Submenu.	See Flow Calibration	
Reset Calibration <i>RPM10 and RPM20</i>	Reset Cal	The Reset Cal item is used to return to the factory default calibration, undoing any field calibration adjustments. When this menu item is entered, the controller will prompt the user to verify that they want to do this by displaying the message "Reset Settings to Factory Default?" Entering YES resets the Low Cal , High Cal and K-Factor factors for this sensor to defaults. Entering NO will cancel the reset.	None	N/A

Input7 Config Menu

Exh Lin Flow

MENU ITEM	SOFTWARE NAME	ITEM DESCRIPTION	ITEM RANGE	DEFAULT VALUE
Set Flow Station Duct Area <i>RPM10 and RPM20</i>	Duct Area	<p>The Duct Area item is used to program the cross sectional area of the duct where the flow station is mounted. Since the flow station is used to measure duct velocity, the Duct Area is necessary to calculate the duct air flow.</p> <p>NOTE: The DIM DOES NOT compute duct area. The area must be first calculated and then entered into the unit.</p> <p>Use the following equations to calculate the duct area (in ft²).</p> <p>For round ducts</p> $Duct\ Area = \frac{3.14 * \left[\frac{duct\ diameter\ (in\ inches)}{2} \right]^2}{144}$ <p>For rectangular ducts</p> $Duct\ Area = \frac{[width\ (in\ inches) * height\ (in\ inches)]}{144}$ <p> WARNING</p> <p>If the proper Duct Area is not programmed into the Model RPM10 and RPM20, the flow measurement will be incorrect. Thus, all the other information that uses the flow measurement, such as the flow alarms, will also be incorrect.</p>	0 to 50.00 ft ² (0 to 4.6450 m ²)	0.00 ft ² (0.0000 m ²)
Set Flow K-Factor Adjustment <i>RPM10 and RPM20</i>	K-Factor	<p>The K-Factor menu item sets the “K” factor for the flow signal. The flow signal is multiplied by the K-Factor so that the flow measurement matches the actual flow, determined with a pitot tube traverse or other reference measurement.</p> <p>NOTE: K-Factor modifies the entire range of the calibrated flow, not just a single point.</p>	0.01 to 10.00	1.00

Input7 Config Menu

Exh Lin Flow

MENU ITEM	SOFTWARE NAME	ITEM DESCRIPTION	ITEM RANGE	DEFAULT VALUE
Set Maximum Sensor Output <i>RPM10 and RPM20</i>	Sensor Max	The Sensor Max item is used to set the maximum reading of a flow station used to measure exhaust air flow. The Sensor Max item has increments of 1000 ft/min.	0 to 10,000 ft/min	0
Set Minimum Sensor Voltage Output <i>RPM10 and RPM20</i>	Signal Min	The Signal Min item is used to set the minimum output signal when a flow station and pressure transducer is used to measure exhaust air flow	0 to 10 V	0 V
Set Maximum Sensor Voltage Output <i>RPM10 and RPM20</i>	Signal Max	The Signal Max item is used to set the maximum output signal when a flow station and pressure transducer is used to measure exhaust air flow.	1 to 10 V	10 V
Reset Calibration <i>RPM10 and RPM20</i>	Reset Cal	The Reset Cal item is used to return to the factory default calibration, undoing any field calibration adjustments. When this menu item is entered, the controller will prompt the user to verify that they want to do this by displaying the message "Reset Settings to Factory Default?" Entering YES resets the K-Factor factor for this sensor to defaults. Entering NO will cancel the reset.	None	N/A

Input7 Config Menu

Exh Venturi

MENU ITEM	SOFTWARE NAME	ITEM DESCRIPTION	ITEM RANGE	DEFAULT VALUE
Minimum Flow <i>RPM10 and RPM20</i>	Min Flow	<p>The Min Flow item sets the flow rate through the venturi valve when it is fully closed. The display will indicate a volumetric flow rate. Adjust the displayed value to match the flow through the venturi valve.</p> <p>NOTE: The flow information can be obtained from the label on the TSI Venturi Valve or by closing the venturi valve using the Flow Control item in the DIAGNOSTICS menu and performing a pitot tube traverse of the duct.</p> <p>The Min Flow menu item must be completed before moving on to the Max Flow menu item.</p>	0 to 10000 cfm	0 cfm
Maximum Flow <i>RPM10 and RPM20</i>	Max Flow	<p>The Max Flow item sets the flow rate through the venturi valve when it is fully open. The display will indicate a volumetric flow rate. Adjust the displayed value to match the flow through the venturi valve.</p> <p>NOTE: The flow information can be obtained from the label on the TSI Venturi Valve or by closing the venturi valve using the Flow Control item in the DIAGNOSTICS menu and performing a pitot tube traverse of the duct.</p> <p>The Min Flow menu item must be completed before moving on to the Max Flow menu item.</p>	0 to 10000 cfm	0 cfm
Set Flow K-Factor Adjustment <i>RPM10 and RPM20</i>	K-Factor	<p>The K-Factor menu item sets the “K” factor for the flow signal. The flow signal is multiplied by the K-Factor so that the flow measurement matches the actual flow, determined with a pitot tube traverse or other reference measurement.</p> <p>NOTE: K-Factor modifies the entire range of the calibrated flow, not just a single point.</p>	0.01 to 10.00	1.00

Input7 Config Menu

Exh Venturi

MENU ITEM	SOFTWARE NAME	ITEM DESCRIPTION	ITEM RANGE	DEFAULT VALUE
Reset Calibration <i>RPM10 and RPM20</i>	Reset Cal	The Reset Cal item is used to return to the factory default calibration, undoing any field calibration adjustments. When this menu item is entered, the controller will prompt the user to verify that they want to do this by displaying the message “Reset Settings to Factory Default?” Entering YES resets the K-Factor factor for this sensor to defaults. Entering NO will cancel the reset.	None	N/A

Input7 Config Menu

Exh Switch

MENU ITEM	SOFTWARE NAME	ITEM DESCRIPTION	ITEM RANGE	DEFAULT VALUE
Low Flow alarm Signal <i>RPM10 and RPM20</i>	Low Flow Sig	The Low Flow Sig item sets the signal the Model RPM10 and RPM20 Room Pressure Controller will receive to indicate a low exhaust flow condition.	Open, Closed	Close

Input7 Config Menu

Room 2 Key Switch

ITEM DESCRIPTION				
The Model RPM20 will display a message “Nothing to Configure” when Input 7 is set to Room 2 Key Switch and the user enters the Input7 Config menu.				

Input7 Config Menu

Particle Status

MENU ITEM	SOFTWARE NAME	ITEM DESCRIPTION	ITEM RANGE	DEFAULT VALUE
Resistance <i>RPM20-CC</i>	Resistance	The Resistance item sets the resistance of the resistor used to convert the 4-20 mA output from the AeroTrak Remote with Pump Particle Counter to a 2-10 VDC signal at the Model RPM20-CC. TSI recommends a nominal 500Ω resistor.	450 to 550 Ω	500 Ω

Calibration

The calibration section explains how to calibrate the controller and how to zero a TSI flow station pressure transducer (optional). The Model RPM10/RPM20 Monitor will warn the user with a display message if it has not been calibrated.

NOTE: This section assumes that the appropriate sensor has been correctly installed. Inaccurate readings may be detected if sensor is not installed correctly. Review the Installation Instructions and verify that the sensor is installed correctly (usually only a problem on initial set up).

Reference measurements, such as from a Portable Air Velocity Meter like the TSI VelociCalc® Model 9565 or a capture hood like the Alnor® Balometer® Model EBT731, are required to calibrate the PresSura monitors.

	<p style="text-align: center;">WARNING</p> <p>The monitor is disabled during calibration. Alarms will not function to warn of unsafe conditions.</p>
---	---

To begin the calibration process, enter the appropriate **INPUT# CONFIGURE** menu (see [Software Programming](#) if not familiar with keystroke procedure).

Room Pressure Calibration

Room pressure can be measured using either a TSI through-the-wall sensor or a pressure transducer.

TSI (Through-the-Wall) Sensor Calibration

NOTE: The TSI through-the-wall sensor is calibrated at the factory and does not normally need adjustment when installed.

1. Select **SENSOR SPAN** item.
2. Position a thermal anemometer or other instrument configured to measure air velocity in the door opening to obtain a velocity reading. Take a measurement of the air velocity entering/exiting the door.
3. Input the reference measurement from step 3 into the PresSura monitor.
4. Save the reading and exit the menu system.

Pressure Transducer Calibration

NOTE: This calibration process is to configure the PresSura monitor to match the reading from the pressure transducer. If the pressure transducer itself needs to be calibrated, refer to the instructions that come with the pressure transducer.

1. Write down the output signal range and pressure range of the pressure transducer. As an example for these instructions, we will assume the pressure transducer has an output signal range of 0 to 10V and a pressure range of -0.25 to +0.25 in. W.C.
2. Select the **SENSOR MIN** item and enter the minimum pressure range of the transducer. In this example, you would enter -0.25 in. W.C.
3. Select the **SENSOR MAX** item and enter the maximum pressure range of the transducer. In this example, you would enter +0.25 in. W.C.
4. Select the **SIGNAL MIN** item and enter the minimum output signal of the transducer. In this example, you would enter 0 V.

5. Select the **SIGNAL MAX** item and enter the maximum output signal of the transducer. In this example, you would enter 10 V.
6. To zero the pressure transducer:
 - a. Mark the high pressure tubing going to the high port of the transducer.
 - b. Remove the tubing from the high and low ports of the transducer.
 - c. Enter the **PRESSURE ZERO** item on the PresSura monitor.
 - d. Reconnect tubing to the high and low ports of the pressure transducer, using the mark to connect the high pressure tubing to the high port.

Flow Calibration

Flow can be measured using a Pressure Flow Station, Linear Flow Station, or Venturi valve with feedback

Pressure Flow Station Calibration

NOTE: Flow stations are optional and may not be installed in your system.

1. Set **DUCT AREA** item to the duct area where the flow is measured.
2. To Zero the flow station:
 - a. Mark the high pressure tubing going to the high port of the transducer.
 - b. Remove the tubing from the high and low ports of the transducer.
 - c. Enter the **Sensor Zero** item on the PresSura monitor.
 - d. Reconnect tubing to the high and low ports of the pressure transducer, using the mark to connect the high pressure tubing to the high port.
3. Enter the **LOW CAL** item to perform the low flow calibration submenu with the following items:

VOLTAGE INPUT	Current voltage from pressure transducer
UNCALIBRATED FLOW	Current flow rate
ZERO VOLTAGE	Voltage from pressure transducer during Flow Station Pressure Transducer Zero
CALIBRATED FLOW	Input actual flow as measured with reference instrument here

- a. Adjust the flow to its minimum volume. Observe the **VOLTAGE INPUT** displayed on the screen, or use a voltmeter to read the voltage at the pressure input terminals on the back of the controller.
- b. Slowly increase the flow until the **VOLTAGE INPUT** (pressure transducer output) shows the first noticeable increase in voltage from the minimum flow. A general rule-of-thumb is that the voltage change should occur with the damper between approximately 10% to 30% open.
- c. For reference only, the **UNCALIBRATED FLOW** item will display the default measured flow based on the current settings of the flow station (duct area, etc.).
- d. Determine the actual flow with a duct traverse or other reference measurement.
- e. Enter the actual flow measurement under the **CALIBRATED FLOW** menu item.
- f. Press the **Save** key to save the flow data.
- g. The low flow calibration is complete.

4. Enter the **HIGH CAL** item to perform the high flow calibration submenu with the following items:

VOLTAGE INPUT	Current voltage from pressure transducer
UNCALIBRATED FLOW	Current flow rate
ZERO VOLTAGE	Voltage from pressure transducer during Flow Station Pressure Transducer Zero
CALIBRATED FLOW	Input actual flow as measured with reference instrument here

- a. Adjust the flow to its maximum volume. Observe the **VOLTAGE INPUT** displayed on the screen, or use a voltmeter to read the voltage at the pressure input terminals on the back of the controller.
- b. Slowly decrease the flow until the **VOLTAGE INPUT** (pressure transducer output) shows the first noticeable decrease in voltage from the minimum flow.
- c. For reference only, the **UNCALIBRATED FLOW** item will display the default measured flow based on the current settings of the flow station (duct area, etc.).
- d. Determine the actual flow with a duct traverse or other reference measurement.
- e. Enter the actual flow measurement under the **CALIBRATED FLOW** menu item.
- f. Press the **Save** key to save the flow data.
- g. The high flow calibration is complete.

NOTE: Use **Balance Flow** to verify flow station calibration and adjust the **K-FACTOR**.

Linear Flow Station Calibration

NOTE: Flow stations are optional and may not be installed in your system.

1. Set **DUCT AREA** to the duct area at the linear flow station location.
2. Set **SENSOR MAX** to match the range of the linear flow station used.
3. Set **SIGNAL MIN** to match the minimum voltage output (0 to 10 V) of the linear flow station used. This is typically 0 V.
4. Set **SIGNAL MAX** to match the maximum voltage output (0 to 10 V) of the linear flow station used. This is typically 10 V.
5. Linear flow station calibration should be complete. Exit the menu.

NOTE: Use **Balance Flow** to verify flow station calibration and adjust the **K-FACTOR**.

Venturi with Feedback Calibration

NOTE: LOM Venturi Valves are optional and may not be installed in your system.

1. Obtain the venturi valve minimum and maximum flow, either by reading the label on the venturi valve or by performing duct traverses when the venturi valve is fully closed and fully opened.
2. Set **MIN FLOW** to the minimum venturi valve flow.
3. Set **MAX FLOW** to the maximum venturi valve flow.
4. Venturi with Feedback calibration is now complete. Exit the menu.

NOTE: Use **Balance Flow** to verify Venturi with Feedback calibration and adjust the **K-FACTOR**.

Supply/Exhaust Switch Calibration



NOTE: Flow switches are optional and may not be installed in your system. Flow switches do not actually measure the flow, but are designed to provide an open or closed signal to indicate the presence or absence of flow.

1. Set the **LOW FLOW SIG** to match the low flow indication from the switch. **OPEN** means the switch will open to indicate low flow. **CLOSED** means the switch will close to indicate low flow.

Door Switch Configuration



NOTE: Door switches are optional and may not be installed in your system.

1. Set the **DR OPEN SIGN** to match the door open indication from the switch. **OPEN** means the switch will open to indicate the door is open. **CLOSED** means the switch will close to indicate the door is open.

Temperature Sensor Configuration



NOTE: Temperature sensors are optional and may not be installed in your system.

1. Adjust the **SENSOR SPAN** so the displayed temperature matches a reference measurement. Use the **RESET CAL** item to reset the **SENSOR SPAN** back to the factory default.

Relative Humidity Sensor Configuration



NOTE: Relative Humidity sensors are optional and may not be installed in your system.

1. Set the **SENSOR MIN** to the minimum reading of the relative humidity sensor. This is usually 0%.
2. Set the **SENSOR MAX** to the maximum reading of the relative humidity sensor. This is usually 100%.
3. Set the **SIGNAL MIN** to the minimum output voltage of the relative humidity sensor. This is usually 0 V.
4. Set the **SIGNAL MAX** to the maximum output voltage of the relative humidity sensor. This is usually 10 V.
5. Adjust the **SENSOR SPAN** so the displayed relative humidity matches a reference measurement.

Use the **RESET CAL** item to reset the **SENSOR SPAN** back to the factory default.

Occupancy Sensor Configuration



NOTE: Occupancy switches are optional and may not be installed in your system.

1. Set the **UNOCC SIG** to match the occupancy indication from the switch. **OPEN** means the switch will open to indicate the room is unoccupied. **CLOSED** means the switch will close to indicate the room is unoccupied.

Maintenance and Repair Parts

The Model RPM10 and RPM20 PresSura Room Pressure Monitors require minimal maintenance. Periodic inspections of system components as well as an occasional pressure sensor cleaning are all that are needed to ensure that the PresSura monitor is operating properly.

System Component Inspection

It is recommended that the pressure sensor be periodically inspected for accumulation of contaminants. The frequency of these inspections is dependent upon the quality of the air being drawn across the sensor. Quite simply, if the air is dirty, the sensors require more frequent inspection and cleaning.

Visually inspect the pressure sensor by sliding open the sensor housing door (Figure 13). The air flow orifice should be free of obstructions. The small ceramic coated sensors protruding from the orifice wall should be white and free of accumulated debris.

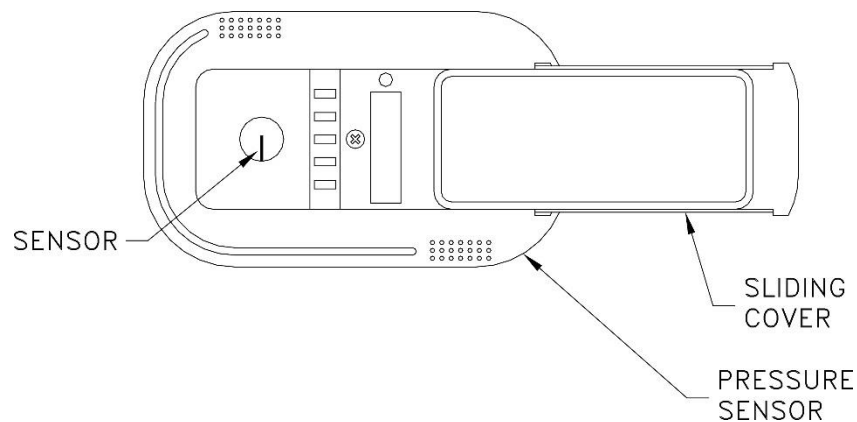



Figure 13: Pressure sensor door slid open

Periodically inspect the other system components for proper performance and physical signs of excessive wear.

Pressure Sensor Cleaning

Accumulations of dust or dirt can be removed with a dry soft-bristled brush (such as an artist's brush). If necessary, water, alcohol, acetone, or trichlorethane may be used as a solvent to remove other contaminants.

Use extreme care when cleaning the velocity sensors. The ceramic sensor may break if excessive pressure is applied, if sensor is scraped to remove contaminants, or if the cleaning apparatus abruptly impacts the sensor.

WARNING	
	<p>If you are using a liquid to clean the sensor, turn off power to the RPM10 / RPM20 PresSura Monitor.</p> <p>DO NOT use compressed air to clean the velocity sensors.</p> <p>DO NOT attempt to scrape contaminants from the velocity sensors. The velocity sensors are quite durable; however, scraping may cause mechanical damage and possibly break the sensor. Mechanical damage due to scraping voids the pressure sensor warranty.</p>

Display Screen Cleaning

Accumulations of dust or dirt can be removed with a dry soft cloth. If necessary, Isopropyl, or Ethyl Alcohol may be used to remove other contaminants.

Replacement Parts

All components of the Room Pressure Monitor system are field replaceable. Contact TSI or your nearest TSI Manufacturer's Representative for replacement part pricing and delivery.

Part Number	Description
Found on back of unit	Model RPM10/RPM20 PresSura Room Pressure Monitor
800243	Pressure Sensor
800248	Sensor Cable
800414	Transformer Cable

Troubleshooting Section

The Model RPM10 and RPM20 Room Pressure Monitors are designed to be trouble free. However, installation problems or interaction with other HVAC components may cause system problems. The system is easy to troubleshoot if an organized approach to evaluate the system is taken. Troubleshooting is broken down into hardware (mechanical) and software problems. Hardware problems deal with the physical installation of the device. Hardware problems include wiring problems, incorrectly installed equipment, and add-ons or non-TSI equipment. Software problems include control problems, configuration problems, or interaction problems with the HVAC system.

The hardware test described in this section determines that all TSI mechanical components are functioning correctly. The hardware test requires the diagnostics menu items to be accessed. If you are unfamiliar with the controller menus, see [Software Programming](#) for keystroke procedure. Troubleshooting the majority of problems is usually quick if the hardware test is followed.

Software and hardware problems are covered in the troubleshooting chart. Pick the problem that most closely resembles your problem and review the possible symptoms and corrective action. Software or system performance problems can and are affected by the supply air system, exhaust air system, or physical configuration of the room. Separating TSI system problems from the laboratory HVAC system can sometimes be difficult. TSI recommends confirming all hardware is operating correctly before troubleshooting software problems.

Hardware Test

Three tests need to be performed in order to determine all hardware is functioning correctly. The tests are broken down into:

- Confirming wiring is correct.
- Confirming physical installation is correct.
- Verifying mechanical components.

Confirming wiring is correct

The most common problem with installed hardware equipment is incorrect wiring. This problem usually exists on initial installation, or when modifications to the system take place. The wiring should be very closely checked to verify it *exactly* matches the wiring diagram. Wiring diagrams are located in [Appendix C](#) of this manual. Wiring associated with non-TSI components should be closely checked for correct installation. If non-TSI components are installed, consider disconnecting them for testing purposes.

Confirming physical installation is correct

All of the hardware components need to be installed properly. Review the installation instructions and verify components are installed properly at the correct location. This is easily done when the wiring is checked.

Verifying mechanical components

Verifying all TSI components are operating correctly requires following a simple procedure. The fastest procedure to confirm all equipment is operating is to first test the Digital Interface Module (DIM), and then go into the diagnostic menu to test each component.



NOTE: These tests require power to the units, so if unit has no power, refer to hardware troubleshooting chart to eliminate power problem.

Test – Analog Outputs

Enter the **Analog Outpt** item in the Diagnostics menu to manually manipulate the analog outputs.

- Touch the **Output 1**, **Output 2**, **Output 3** button to manually set the output signal.

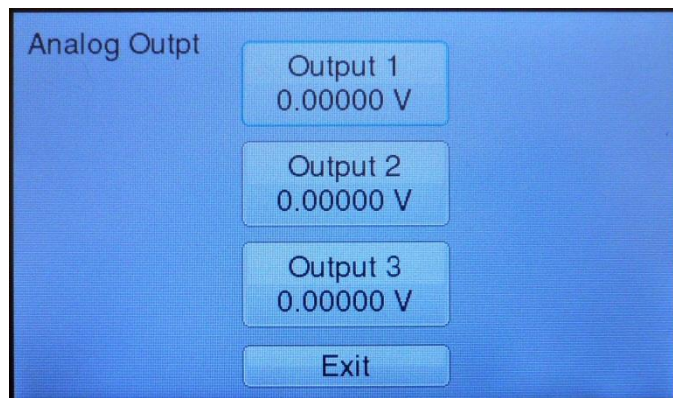

Figure 14. Analog Outputs screen in Diagnostics menu

Test – Relay Outputs

Enter the **Relay Outputs** item in the Diagnostics menu to manually manipulate the relay outputs.

- Touch the **Relay 1 Toggle** or **Relay 2 Toggle** button to manually open or close the relay.



Figure 15. Relay Outputs screen in Diagnostics menu

Test - View Inputs

Enter the **View Inputs** item to view all inputs with real-time updates.

- The Model RPM10/RPM20 monitor will display “Unconfigured” for any inputs that have not been configured. Go to the **Configure** menu to configure these inputs appropriately.

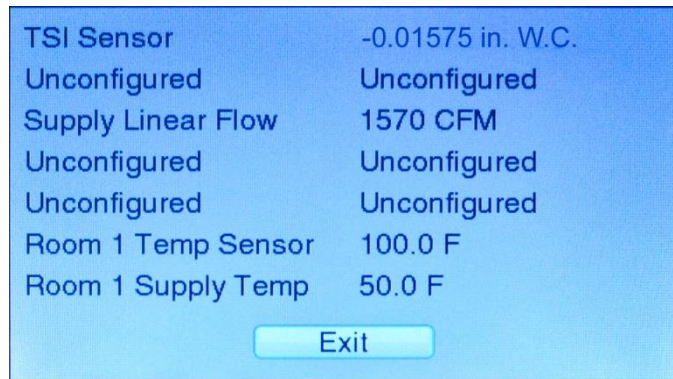

Figure 16. View Inputs screen in Diagnostics menu

Test - View Outputs

Enter the **View Outputs** item to view all output signals with real-time updates.

- If the monitor passes each of the tests, the mechanical piece parts are all functioning correctly.

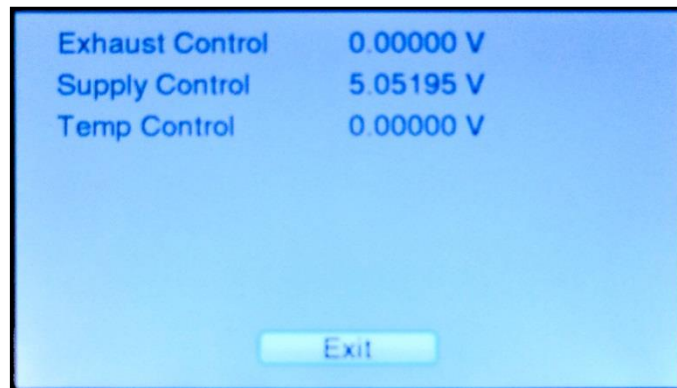

Figure 17. View Outputs screen in Diagnostics menu

Troubleshooting Chart

Symptom	Possible Cause	Corrective Action
Display is blank.	Fuse is blown.	Measure voltage at pins 1 and 2 on DIM 2-pin connector. The voltage should nominally be 24 VAC. If correct voltage is measured, internal DIM fuse is probably blown. Unplug 2-pin connector from DIM for 2 minutes. The internal fuse will automatically reset. Plug unit back in and check display. If display is still blank, check all wiring, etc. Verify circuit breaker is on. Verify transformer primary measures 110 VAC. Verify transformer secondary measures 24 to 30 VAC.
	DIM is defective.	If proper voltage is found between pins 1 and 2 of the DIM, all wiring has been checked, fuses have been reset, and screen is still blank, the DIM is probably defective. Replace DIM.
Cannot access menu		Slide finger across the screen diagonally from upper right to lower left corner.
Need to display model number and firmware revision	--	Enter the DIAGNOSTICS menu.
Measurements in Diagnostics mode read "Not Configure"	Inputs not configured.	Enter the Configure menu to appropriately configure inputs.
Sensor does not calibrate.	Incorrect pressure sensor address.	Rm1 pressure sensor must have address of 1. Anteroom sensor must have address of 2. Rm2 sensor must have address of 3. Check pressure sensor DIP switches 5 & 6 and verify address is correct (7 to 12 must be OFF). 
Sensor communications not working.		Check SENSOR STAT item in diagnostics menu. If NORMAL is displayed, sensor is okay. If COMM ERROR is displayed, check wiring, pressure sensor address, and that DIP switch 1 & 2 are ON (Figure 18).

Figure 18: Pressure Sensor DIP Switch

Symptom	Possible Cause	Corrective Action
Pressure sensor red LED is blinking (Figure 18).	Problem with sensor (slow uniform blink).	Check SENSOR STAT and confirm NORMAL is displayed. If ERROR is displayed, correct error.
	Communication (fast burst of non-uniform blinking).	Unit is communicating with DIM. This is normal.
	Red LED is constantly on or blinks every 5 seconds.	This is normal when no problems exist or when no communication is occurring.
DIM always displays 0.200 in. W.C.	Incorrect pressure sensor output.	Pressure sensor must be set for 0 to 10 volt output, not 4-20 mA (do not confuse this output with DIM analog output). Check pressure sensor DIP switch 3 and make sure it is OFF (see Figure 18).
DIM displays opposite pressure signal.	Sensor direction is incorrect.	Pressure sensor must have DIP switch correctly set for proper sign display. Verify DIP switch 4 is ON when sensor is mounted in isolation room (controlled space), and OFF when sensor is mounted in reference space (see Figure 18).
Positive/negative/neutral key switch does not work.	Incorrect wiring.	Verify wiring is correct between key switch and DIM.
	Inputs not configured for key switch	Go to Configure menu, Input 5 item (for Room 1 key switch) or Input 7 item (for Room 2 key switch). Verify item is set to Room 1 Key Switch or Room 2 Key Switch.
	Defective switch / defective DIM.	Go into DIAGNOSTICS menu, VIEW INPUTS item. Key Switch inputs should read negative in negative position, positive in positive position, and no isolation in neutral position. If display changes correctly, switch and switch input is good. If display does not change: Disconnect key switch wires from Input 4, pins 17 & 18 for Room 1, or Input 7, pins 23 and 24 for Room 2. Measure the resistance of the switch: <ul style="list-style-type: none"> Negative position should be open (infinite). Neutral position should read approximately 273 kOhms. Positive position should be closed (short). If room mode is correct and resistance check is good, DIM key input is probably defective. Replace DIM.

Symptom	Possible Cause	Corrective Action
DIM does not respond to network communications.	Network protocol is incorrect.	Go into INTERFACE menu, COMM TYPE item. The protocol must match host system. Select correct interface.
	Incorrect network address.	The network address at the building automation system and at the DIM must match. The network address must be unique for each DIM.
	Incorrect MAC ID (BACnet MS/TP only)	The MAC ID and network address at the building automation system and at the DIM must match. The MAC ID and network Address must be unique for each DIM.
	Incorrect baud rate (BACnet MS/TP only)	The baud rate of the building automation system and the DIM must match. Reset the BAUD RATE item in the Interface menu to match the building automation system.
DIM does not respond to network communications. (continued)	Incorrect polarity.	Verify and/or change polarity of RS-485 A and B wires.
	Incompatible software.	Data sent to DIM may be in form that the monitor cannot recognize.
	LonWorks® board not installed.	Contact factory for further assistance.
	Bad LonWorks® board.	Contact factory for assistance.
	Foreign network acquired monitor. (LonWorks® only)	Go into Interface menu, LON item. Select GO UNCONFIG option, press the SELECT key. Return to the LON item, select the SERVICE PIN option and press the SELECT key. Selecting GO UNCONFIG will reset the PresSura monitor's authentication key, allowing the SERVICE PIN to install or reclaim the PresSura monitor to the LonWorks® network.
Alarm relays do not work.	Alarms are turned off.	Enter the Rm1 Alarm, AnteRm Alarm or Rm2 Alarm menu. Verify that the Alarm Enable item is set to enable the high or low alarms as desired.
	Incorrect wiring.	Check the wiring from DIM relay output to the device that is connected to the relays.
	Relay may be defective.	Disconnect the wiring (terminals 9 to 12) from relay contacts. Go into DIAGNOSTICS menu, Relay Outputs item. Connect an ohm-meter to relay terminals to verify contact open and closes. Press the Relay1 Toggle or Relay 2 Toggle button to manually trip the relay. <ul style="list-style-type: none"> If relay responds (contact opens and closes), the device connected is incompatible or defective. If relay does not respond, relay is defective (may be caused by incompatible device). Replace DIM.

Symptom	Possible Cause	Corrective Action
Displayed room pressure or flow wildly fluctuating.	Supply air is affecting the sensor.	Check location of supply air diffusers. They should be located as far from the pressure sensor as is realistic, 10 feet preferred with 6 feet minimum. Supply diffuser terminal throw velocity must be less than 10 ft/min at the sensor. Relocate supply or exhaust as needed.
	Display averaging is very short.	Lengthen the time constant by entering the CONFIGURATION menu, DISPLAY AVG item, and increase the average time.
	Monitor needs calibration.	Calibrate monitor.
Analog output does not work properly.	Monitor is connected to incompatible equipment.	Enter the DIAGNOSTICS menu, Analog Outpt item. Use Output 1, Output 2 or Output 3 button to adjust the output. Change the output value while measuring the output with a multimeter. If the voltage (current) changes, the monitor is functioning properly. If the voltage (current) does not change, disconnect the analog out device and repeat the above procedure. If voltage now changes, the monitor is good, and the external device is defective. If no change occurs, DIM is defective.
Displayed velocity does not match measured velocity.	Pressure sensor is dirty.	See Maintenance and Repair Parts .
	Monitor is not calibrated.	See Calibration .
Monitor does not communicate with TSI Configuration Software.	Defective cable.	Replace cable with TSI P/N 700036.
Audible alarm is sounding intermittently	Configuration settings lost (single beep every 2 seconds)	Replace monitor.
	Calibration settings lost (double beep every 2 seconds)	Replace monitor.
	Configuration and calibration settings lost (double beep every second)	Replace monitor.

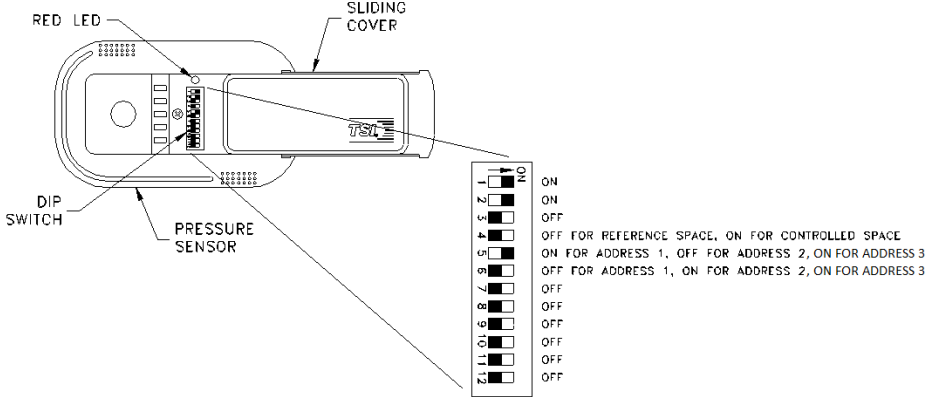
Appendix A

Specifications*

Digital Interface Module	
Display	
Range	-0.20000 to +0.20000 in. W.C. (-50 to +50 Pa): TSI Sensor -1.00 to +1.00 in. W.C. (-250 to +250 Pa): Pressure Transducer
Resolution	5% of reading or 0.00001 in. W.C. (0.0025 Pa): TSI Sensor 5% of reading or 0.001 in. W.C. (0.25 Pa): Pressure Transducer
Low Alarm Range	-0.19500 to +0.19500 in. W.C.; TSI Sensor -1.00 to +1.00 in. W.C. (-250 to +250 Pa): Pressure Transducer 0 to 10,000 cfm (0 to 4,720 l/s, 0 to 16,990 m ³ /hr)
High Alarm Range	80 to 1,000 ft/min (0.41 to 5.08 m/s) 0 to 10,000 cfm (0 to 4,720 l/s, 0 to 16,990 m ³ /hr)
Communications Protocols.....	Modbus® RTU 9600 baud BACnet® MS/TP 76.8k, 38.4k, 19.2k, 9600 baud LonWorks® (Optional)
Operating Temperature	32 to 120°F (0 to 50°C)
Input Power.....	24 VAC, 50/60 Hz 15 to 40 VDC 5 Watt maximum (50 VA with TSI Actuator)
Dimensions	7.0 in x 4.875 in x 1.75 in (17.8 cm x 12.4 cm x 4.4 cm) 0.625 in (1.6 cm) protrusion
Weight.....	14 oz. (0.40 kg)
Velocity Sensor	
Inputs—Seven (7) Total	
Input 1.....	TSI Sensor or Pressure Transducer (0 to 10 VDC)
Input 2.....	TSI Sensor or Pressure Transducer (0 to 10 VDC)
Input 3.....	Supply Flow, TSI Sensor or Pressure Transducer (0 to 10 VDC)
Input 4.....	Door Switch or Occupancy Sensor (Relay In)
Input 5.....	Room 1 Key Switch (Relay In) or RH (0 to 10 VDC)
Input 6.....	Room 2 Door Switch or Occupancy Sensor (Relay In) Room 1 Temperature (1000 Ω Platinum RTD)
Input 7.....	Room 2 Key Switch (Relay In) Exhaust Flow (0 to 10 VDC) Supply Air Temperature (1000 Ω Platinum RTD)

Outputs—Three (3)Total	
Output 1	None
Output 2	Room 1 Pressure Out, Exhaust Flow Out (0 to 10 VDC / 4-20 mA)
Output 3	Room 2 Pressure Out, Exhaust Flow Out, Supply Flow Out (0 to 10 VDC / 4-20 mA)
Alarm Contacts	Relay1: Low Alarm Relay 2: High Alarm or Room Mode SPST, 60 W max 2A @ 30 VDC Nominal Contacts field-configurable to open or close in alarm condition. Contacts close on loss of power.
TSI Through-the-Wall Sensor	
Temperature Compensation Range.....	55 to 95°F
Power Dissipation	0.16 watts at 0 in. W.C., 0.20 watts at 0.00088 in. W.C.
Dimensions (D x H)	5.58 in. x 3.34 in. x 1.94 in. (84.8 x 141.7 x 49.3 mm)
Weight.....	0.2 lb.

**Specifications are subject to change without notice.*

Appendix B

Network Communications

Network communications are available on the PresSura room monitors. The PresSura room monitors can communicate with a building management system through Modbus[®], LonWorks[®] or BACnet[®] MS/TP protocols. Please refer to the appropriate section below for more detailed information.

Modbus[®] Communications

Modbus[®] communications are installed in the PresSura room monitors. This document provides the technical information needed to communicate between the host DDC system and the PresSura room monitors. This document assumes the programmer is familiar with Modbus[®] protocol. Further technical assistance is available from TSI if your question is related to TSI interfacing to a DDC system. If you need further information regarding Modbus[®] programming in general, please contact:

Modicon Incorporated (a division of Schneider-Electric)
One High Street
North Andover, MA 01845
Phone (800) 468-5342

The Modbus[®] protocol utilizes the RTU format for data transfer and Error Checking. Check the Modicon Modbus[®] Protocol Reference Guide (PI-Mbus-300) for more information on CRC generation and message structures.

The messages are sent at 9600 baud with 1 start bit, 8 data bits, and 1 or 2 stop bits. Do **not** use the parity bit. The system is set up as a master slave network. The TSI units act as slaves and respond to messages when their correct address is polled.

Blocks of data can be read from each device. Using a block format will speed up the time for the data transfer. The size of the blocks is limited to 255 bytes. This means the maximum message length that can be transferred is 255 bytes. The typical response time of the device is around 0.05 seconds with a maximum of 0.1 seconds.

Unique to TSI

The list of variable addresses shown below skips some numbers in the sequence due to internal PresSura room monitors functions. This information is not useful to the DDC system and is therefore deleted. Skipping numbers in the sequence will not cause any communication problems. If a variable is not used by the particular PresSura room monitors, it will be reported with a value of -1.

All variables are outputted in English units: ft/min, and cfm. If the DDC system is to display different units, the DDC system needs to make the conversion.

Network Points RAM Variables

RAM variables use the Modbus command **04 Read Input Registers**. RAM variables are read only variables that correspond to what is shown on Digital Interface Module (DIM) display. TSI offers a number of different models, so if a feature is **not** available on a unit, the variable is set to 0.

Variable Name	Variable Address	Information Provided to Master System	Integer DDC system receives
Room 1 Pressure	0	Room 1 Pressure	Displayed in in. W.C. Host DDC system must divide value by 10,000 to report pressure correctly
Supply Flow	1	Supply Flow Rate	Displayed in CFM.
ACH	2	Air Changes per Hour	Displayed in number per hour. Host DDC system must divide value by 10 to report ACH correctly.
RH (RPM20 only)	3	Relative Humidity	Displayed in %RH
Temperature (RPM20 only)	4	Temperature for Room 1	Displayed in °F Host DDC system must divide value by 10 to report temperature correctly
Exhaust Flow	6	Exhaust Flow Rate	Displayed in CFM.
Room 1 Door Status	7	Room 1 Door Status	1 Door Closed (Normal) 2 Door Open
Anteroom Pressure (RPM20 only)	8	Anteroom Pressure	Displayed in in. W.C. Host DDC system must divide value by 10,000 to report pressure correctly
Room 2 Pressure (RPM20 only)	10	Room 2 Pressure	Displayed in in. W.C. Host DDC system must divide value by 10,000 to report pressure correctly
Room 2 Door Status (RPM20 only)	12	Room 2 Door Status	1 Door Closed (Normal) 2 Door Open
Room 1 Occupancy	13	Room 1 Occupancy	1 Occupied (Normal) 2 Unoccupied
Room 2 Occupancy (RPM20 only)	15	Room 2 Occupancy	1 Occupied (Normal) 2 Unoccupied

EXAMPLE of **04 Read Input Registers** function format
This example reads variable addresses 0 (Pressure).

QUERY

Field Name	Example # 2 (Hex)
Slave Address	01
Function	04
Starting Address Hi	00
Starting Address Lo	00
No. of Points Hi	00
No. of Points Lo	01
Error Check (CRC)	--

RESPONSE

Field Name	Example # 1 (Hex)
Slave Address	01
Function	04
Byte Count	02
Data Hi Addr0	00
Data Lo Addr0	64 (0.00100 in. W.C.)

Modbus Communications (continued)

XRAM Variables

These variables can be *read* using Modbus® command **03 Read Holding Registers**. They can be *written* to using Modbus® command **06 Write Single Register**. Many of these variables are the same “menu items” that are configured from the monitor keypad. The calibration and control items are not accessible from the DDC system. This is for safety reasons since each room is individually setup for maximum performance.

RPM10 Variable List

Variable Name	Variable Address	Read/Write	Integer DDC system receives
Number of Rooms	0	Read	1 1 Room
Devices Controlled	1	Read	1 None
Measurements Displayed	2	Read/Write	1 Room Status 2 Room Status and Pressure 3 All Measurements
Display Average	3	Read	1 1 second 2 2 seconds 3 3 seconds 4 5 seconds 5 10 seconds 6 20 seconds 7 40 seconds
Units	4	Read/Write	1 in. W.C., cfm, F 2 Pa, lps, C 3 Pa, m ³ /hr, C
Access Codes	5	Read/Write	1 Off 2 Room Mode 3 Menus 4 Room Mode and Menus
Relay 2 Configuration	6	Read	1 High Alarm 2 Negative Room Mode 3 Positive Room Mode
Input 1 Configuration	7	Read	1 TSI Sensor 2 Pressure Transducer
Input 2 Configuration	8	Read	4 None
Input 3 Configuration	9	Read	1 Supply Pressure Flow 2 Supply Linear Flow 3 Supply Venturi 4 Supply Switch 7 None
Input 4 Configuration	10	Read	1 Room 1 Door Switch 2 Room 1 Occupancy Sensor 3 None
Input 5 Configuration	11	Read	1 Room 1 Key Switch 3 None
Input 6 Configuration	12	Read	6 None

RPM10 Variable List

Variable Name	Variable Address	Read/Write	Integer DDC system receives
Input 7 Configuration	13	Read	2 Exhaust Pressure Flow 3 Exhaust Linear Flow 4 Exhaust Venturi 5 Exhaust Switch 8 None
Room 1 Mode	14	Read/Write	1 Positive 2 Negative 3 No Isolation
Room 1 Low Alarm Enable	15	Read/Write	1 Disabled 2 Enabled
Room 1 High Alarm Enable	16	Read/Write	1 Disabled 2 Enabled
Room 1 Negative Low Alarm Setpoint	17	Read/Write	Displayed in in. W.C. Host DDC system must divide value by 10,000 to report pressure correctly
Room 1 Negative High Alarm Setpoint	18	Read/Write	Displayed in in. W.C. Host DDC system must divide value by 10,000 to report pressure correctly
Room 1 Positive Low Alarm Setpoint	19	Read/Write	Displayed in in. W.C. Host DDC system must divide value by 10,000 to report pressure correctly
Room 1 Positive High Alarm Setpoint	20	Read/Write	Displayed in in. W.C. Host DDC system must divide value by 10,000 to report pressure correctly
Low Exhaust Alarm	21	Read/Write	Displayed in cfm
Low Supply Alarm	22	Read/Write	Displayed in cfm
Alarm Reset	61	Read/Write	1 Latched 2 Unlatched
Audible Alarm Enable	62	Read/Write	1 On 2 Off
Alarm Delay	63	Read/Write	Displayed in seconds
Mute Timeout	64	Read/Write	Displayed in minutes
Door Delay	65	Read/Write	Displayed in seconds
Modbus Address	66	Read	
Output 1 Signal Type	67	Read	1 None
Output 2 Signal Type	71	Read	1 None 2 Room 1 Pressure Output 3 Room 1 Exhaust Flow Output
Output 2 Range	72	Read	If Pressure: Displayed in in. W.C. Host DDC system must divide value by 10,000 to report pressure correctly If Flow: Displayed in cfm
Output 2 Signal	73	Read	1 4-20 mA 2 0 to10 VDC
Output 2 Value	74	Read	0 to 100%

Modbus Communications (continued)

RPM10 Variable List

Variable Name	Variable Address	Read/Write	Integer DDC system receives
Output 3 Signal Type	75	Read	1 None
Output 3 Range	76	Read	If Pressure: Displayed in in. W.C. Host DDC system must divide value by 10,000 to report pressure correctly If Flow: Displayed in cfm
Output 3 Signal	77	Read	1 4-20 mA 2 0 to 10 VDC
Output 3 Value	78	Read	0 to 100%
Status Index	79	Read	1 Normal 2 Room 1 Negative Low Alarm 3 Room 1 Negative High Alarm 4 Room 1 Positive Low Alarm 5 Room 1 Positive High Alarm 6 Low Exhaust Alarm 7 Low Supply Alarm 2 Data Error 0
Room 1 Label	80 to 86	Read	
Room 2 Label	87 to 93	Read	
Anteroom Label	94 to 100	Read	

RPM20 Variable List

Variable Name	Variable Address	Read/Write	Integer DDC system receives
Number of Rooms	0	Read	1 1 Room 2 1 Room 3 2 Rooms with Anteroom
Devices Controlled	1	Read	1 None
Measurements Displayed	2	Read/Write	1 Room Status 2 Room Status and Pressure 3 All Measurements
Display Average	3	Read	1 1 second 2 2 seconds 3 3 seconds 4 5 seconds 5 10 seconds 6 20 seconds 7 40 seconds
Units	4	Read/Write	1 in. W.C., cfm, F 2 Pa, lps, C 3 Pa, m ³ /hr, C
Access Codes	5	Read/Write	1 Off 2 Room Mode 3 Menus 4 Room Mode and Menus

RPM20 Variable List

Variable Name	Variable Address	Read/Write	Integer DDC system receives
Relay 2 Configuration	6	Read	1 High Alarm 2 Negative Room Mode 3 Positive Room Mode
Input 1 Configuration	7	Read	1 TSI Sensor 2 Pressure Transducer
Input 2 Configuration	8	Read	1 TSI Sensor 2 Pressure Transducer 4 None
Input 3 Configuration	9	Read	1 Supply Pressure Flow 2 Supply Linear Flow 3 Supply Venturi 4 Supply Switch 5 TSI Sensor 6 Pressure Transducer 7 None
Input 4 Configuration	10	Read	1 Room 1 Door Switch 2 Room 1 Occupancy Sensor 3 None
Input 5 Configuration	11	Read	1 Room 1 Key Switch 2 Relative Humidity 3 None
Input 6 Configuration	12	Read	1 Room 1 Temperature 3 Room 2 Occupancy Sensor 4 Room 2 Door Switch 6 None
Input 7 Configuration	13	Read	2 Exhaust Pressure Flow 3 Exhaust Linear Flow 4 Exhaust Venturi 5 Exhaust Switch 6 Room 2 Key Switch 8 None
Room 1 Mode	14	Read/Write	1 Positive 2 Negative 3 No Isolation
Room 1 Low Alarm Enable	15	Read/Write	1 Disabled 2 Enabled
Room 1 High Alarm Enable	16	Read/Write	1 Disabled 2 Enabled
Room 1 Negative Low Alarm Setpoint	17	Read/Write	Displayed in in. W.C. Host DDC system must divide value by 10,000 to report pressure correctly
Room 1 Negative High Alarm Setpoint	18	Read/Write	Displayed in in. W.C. Host DDC system must divide value by 10,000 to report pressure correctly
Room 1 Positive Low Alarm Setpoint	19	Read/Write	Displayed in in. W.C. Host DDC system must divide value by 10,000 to report pressure correctly

Modbus Communications (continued)

RPM20 Variable List

Variable Name	Variable Address	Read/Write	Integer DDC system receives
Room 1 Positive High Alarm Setpoint	20	Read/Write	Displayed in in. W.C. Host DDC system must divide value by 10,000 to report pressure correctly
Low Exhaust Alarm	21	Read/Write	Displayed in cfm
Low Supply Alarm	22	Read/Write	Displayed in cfm
Room 1 Low Temperature Alarm	23	Read/Write	Displayed in °F Host DDC system must divide value by 10 to report temperature correctly
Room 1 High Temperature Alarm	24	Read/Write	Displayed in °F Host DDC system must divide value by 10 to report temperature correctly
Room 1 Low RH Alarm	25	Read/Write	Displayed in %RH
Room 1 High RH Alarm	26	Read/Write	Displayed in %RH
Anteroom Mode	47	Read/Write	1 Positive 2 Negative 3 No Isolation 6 Anteroom not configured
Anteroom Low Alarm Enable	48	Read/Write	1 Disabled 2 Enabled
Anteroom High Alarm Enable	49	Read/Write	1 Disabled 2 Enabled
Anteroom Negative Low Alarm Setpoint	50	Read/Write	Displayed in in. W.C. Host DDC system must divide value by 10,000 to report pressure correctly
Anteroom Negative High Alarm Setpoint	51	Read/Write	Displayed in in. W.C. Host DDC system must divide value by 10,000 to report pressure correctly
Anteroom Positive Low Alarm Setpoint	52	Read/Write	Displayed in in. W.C. Host DDC system must divide value by 10,000 to report pressure correctly
Anteroom Positive High Alarm Setpoint	53	Read/Write	Displayed in in. W.C. Host DDC system must divide value by 10,000 to report pressure correctly
Room 2 Mode	54	Read/Write	1 Positive 2 Negative 3 No Isolation 6 Room 2 not configured
Room 2 Low Alarm Enable	55	Read/Write	1 Disabled 2 Enabled
Room 2 High Alarm Enable	56	Read/Write	1 Disabled 2 Enabled

RPM20 Variable List

Variable Name	Variable Address	Read/Write	Integer DDC system receives
Room 2 Negative Low Alarm Setpoint	57	Read/Write	Displayed in in. W.C. Host DDC system must divide value by 10,000 to report pressure correctly
Room 2 Negative High Alarm Setpoint	58	Read/Write	Displayed in in. W.C. Host DDC system must divide value by 10,000 to report pressure correctly
Room 2 Positive Low Alarm Setpoint	59	Read/Write	Displayed in in. W.C. Host DDC system must divide value by 10,000 to report pressure correctly
Room 2 Positive High Alarm Setpoint	60	Read/Write	Displayed in in. W.C. Host DDC system must divide value by 10,000 to report pressure correctly
Alarm Reset	61	Read/Write	1 Latched 2 Unlatched
Audible Alarm Enable	62	Read/Write	1 On 2 Off
Alarm Delay	63	Read/Write	Displayed in seconds
Mute Timeout	64	Read/Write	Displayed in minutes
Door Delay	65	Read/Write	Displayed in seconds
Modbus Address	66	Read	
Output 1 Signal Type	67	Read	1 None 2 Room 1 Pressure (RPM20)
Output 1 Range	68	Read	Displayed in in. W.C. Host DDC system must divide value by 10,000 to report pressure correctly
Output 1 Signal	69	Read	1 4-20 mA 2 0 to 10 VDC
Output 1 Value	70	Read	0 to 100%
Output 2 Signal Type	71	Read	1 None 2 Room 1 Pressure Output 3 Room 1 Exhaust Flow Output
Output 2 Range	72	Read	If Pressure: Displayed in in. W.C. Host DDC system must divide value by 10,000 to report pressure correctly If Flow: Displayed in cfm
Output 2 Signal	73	Read	1 4-20 mA 2 0 to 10 VDC
Output 2 Value	74	Read	0 to 100%
Output 3 Signal Type	75	Read	1 None 2 Room 1 Supply Flow Output (RPM20) 3 Room 1 Exhaust Flow Output (RPM20) 4 Room 2 Pressure Output (RPM20)
Output 3 Range	76	Read	If Pressure: Displayed in in. W.C. Host DDC system must divide value by 10,000 to report pressure correctly If Flow: Displayed in cfm

Modbus Communications (continued)

RPM20 Variable List

Variable Name	Variable Address	Read/Write	Integer DDC system receives
Output 3 Signal	77	Read	4-20 mA 0 to 10 VDC
Output 3 Value	78	Read	0 to 100%
Status Index	79	Read	1 Normal 2 Room 1 Negative Low Alarm 3 Room 1 Negative High Alarm 4 Room 1 Positive Low Alarm 5 Room 1 Positive High Alarm 6 Low Exhaust Alarm 7 Low Supply Alarm 8 Low Temperature Alarm 9 High Temperature Alarm 10 Low RH Alarm 11 High RH Alarm 12 Anteroom Negative Low Alarm 13 Anteroom Negative High Alarm 14 Anteroom Positive Low Alarm 15 Anteroom Positive High Alarm 16 Room 2 Negative Low Alarm 17 Room 2 Negative High Alarm 18 Room 2 Positive Low Alarm 19 Room 2 Positive High Alarm 20 Data Error
Room 1 Label	80 to 86	Read	
Room 2 Label	87 to 93	Read	
Anteroom Label	94 to 100	Read	

EXAMPLE of 06 Write Single Register function format:

This example changes the normal low face velocity alarm set point to 60 ft/min.

QUERY		RESPONSE	
Field Name	(Hex)	Field Name	(Hex)
Slave Address	01	Slave Address	01
Function	06	Function	06
Starting Address Hi	00	Starting Address Hi	00
Starting Address Lo	16	Starting Address Lo	16
Data Value (High)	00	Error Check (CRC)	--
Data Value (Low)	3C		
Error Check (CRC)	--		

EXAMPLE of **03 Read Holding Registers** function format:
 This example reads the face velocity and current face velocity set point.

QUERY		RESPONSE	
Field Name	(Hex)	Field Name	(Hex)
Slave Address	01	Slave Address	01
Function	03	Function	03
Starting Address Hi	00	Byte Count	04
Starting Address Lo	00	Data Hi	00
No. Of Registers Hi	00	Data Lo	64 (100 ft/min)
No. Of Registers Lo	02	Data Hi	00
Error Check (CRC)	--	Data Lo	64 (100 ft/min)
		Error Check (CRC)	

LonWorks® Object

The Model RPM20-LON supports LonWorks communications. Contact TSI if you have a model RPM20 without LonWorks and you need LonWorks communications.

Node Object Network Variables

SNVT Number	Bit	Description	SNVT Name	SNVT Type
0			nciLocation	SCPTLocation
1			nciOutlnHt	SCTPalrmInbT
2			nciIndex	SCPTdevMajVer
3			nciVersion	SCPTdvMinVer
4			nviRequest	SNVT_obj_request
5			nviTimeSet	SNVT_time_stamp
6			nvoStatus	SNVT_obj_status
7			nvoAlarm	SNVT_alarm

Room Pressure Monitor Object Network Variables

SNVT Number	Bit	Description	SNVT Name	SNVT Type
17		Room Mode	nviRoomMode	SNVT_char_ascii
18		Room 1 Pressure Differential	nvoRm1Press	SNVT_press_f
19		Anteroom Pressure Differential	nvoAntePress	SNVT_press_f
20		Room 2 Pressure Differential	nvoRm2Press	SNVT_press_f
21		Supply Flow	nvoSupplyFlow	SNVT_flow
22		Exhaust Flow	nvoExhaustFlow	SNVT_flow
23		Room Temperature	nvoTempMeas	SNVT_temp_p
24		Relative Humidity	nvoRHMeas	SNVT_lev_percent
25		Status	nvoUnitState	SNVT_state
	1	Room 1 Low Pressure Alarm		
	2	Room 1 High Pressure Alarm		
	3	Anteroom Low Pressure Alarm		
	4	Anteroom High Pressure Alarm		
	5	Low Exhaust Flow Alarm		
	6	Low Supply Flow Alarm		
	7	Low Room Temperature Alarm		
	8	High Room Temperature Alarm		
	9	Low Relative Humidity Alarm		
	10	High Relative Humidity Alarm		
26		Door Mode	nvoDoorMode	SNVT_char_ascii
27		Room 1 Mode	nvoRoomMode	SNVT_char_ascii
28		Number of Rooms	nvoNumRooms	SNVT_char_ascii

SNVT Number	Bit	Description	SNVT Name	SNVT Type
8		Maximum Time Without Sending Update	nciMaxSendTime	SCPTmaxSendTime
9		Minimum Time Before Sending Update	nciMinSendTime	SCPTminSendTime
10		Room 1 Pressure Minimum Update Change	nciSndDeltaP1	SCPTsndDelta
11		Anteroom Pressure Minimum Update Change	nciSndDeltaP2	SCPTsndDelta
12		Room 2 Pressure Minimum Update Change	nciSndDeltaP2	SCPTsndDelta
13		Exhaust Flow Minimum Update Change	nciSndDeltaF11	SCPTsndDelta
14		Supply Flow Minimum Update Change	nciSndDeltaF12	SCPTsndDelta
15		Room Temperature Minimum Update Change	nciSndDeltaT1	SCPTsndDelta
16		Relative Humidity Minimum Update Change	nciSndDeltaRH	SCPTsndDelta

Description of LON SNVTs

SNVT	Command Supported	Action
nviRoomMode	0	Negative Mode
nvoRoomMode	1	Positive Mode
	2	No Isolation Mode

SNVT	Value Sent / Received	Action
nviRequest object_request	CLEAR_ALARM	Clears alarm (See SNVT nvoAlarm)

Model RPM10 and RPM20 BACnet® MS/TP Protocol Implementation Conformance Statement

Date: February 1, 2019
Vendor Name: TSI Incorporated
Product Name: PresSura Room Monitor
Product Model Number: RPM10 and RPM20
Applications Software Version: 1.0
Firmware Revision: 1.21
BACnet Protocol Revision: Version 1, Rev 8

Product Description:

TSI's PresSura monitors are designed to maintain the room pressure differential of isolation rooms, operating rooms and other critical environments. These models are capable of acting as a stand-alone devices or as part of a building automation system via BACnet® MS/TP protocol.

BACnet Standardized Device Profile (Annex L):

- BACnet Operator Workstation (B-OWS)
- BACnet Building Controller (B-BC)
- BACnet Advanced Application Controller (B-AAC)
- BACnet Application Specific Controller (B-ASC)
- BACnet Smart Sensor (B-SS)
- BACnet Smart Actuator (B-SA)

All BACnet Interoperability Building Blocks Supported (Annex K):

Application Service	Designation
Data Sharing – ReadProperty - B	DS-RP-B
Data Sharing – WriteProperty - B	DS-WP-B
Data Sharing – ReadPropertyMultiple - B	DS-RPM-B
Device Management – Dynamic Device Binding - B	DM-DDB-B
Device Management – Dynamic Object Binding - B	DM-DOB-B
Device Management – DeviceCommunicationsControl - B	DM-DCC-B
Device Management – ReinitializeDevice - B	DM-RD-B

Segmentation Capability:

- Segmented requests supported Window Size: 480
- Segmented responses supported Window Size: 480

Standard Object Types Supported:

Analog Input Object

- Dynamically Create: Yes No
- Dynamically Delete: Yes No
- Optional Properties: Reliability
- Writable properties: Present_Value when Out_Of_Service is true,
Out_Of_Service
- Proprietary Properties: None
- Property Range Restrictions: None
- Data Type: Real

Analog Value Object

Dynamically Create: Yes No
Dynamically Delete: Yes No
Optional Properties: Reliability
Writable properties: Present_Value, Out_Of_Service
Proprietary Properties: None
Property Range Restrictions: None
Data Type: Real

Binary Input Object

Dynamically Create: Yes No
Dynamically Delete: Yes No
Optional Properties: Reliability, Active_Text, Inactive_Text
Writable properties: Present_Value when Out_Of_Service is true, Out_Of_Service
Proprietary Properties: None
Property Range Restrictions: None
Data Type: Enumerated

Binary Value Object

Dynamically Create: Yes No
Dynamically Delete: Yes No
Optional Properties: Reliability, Active_Text, Inactive_Text
Writable properties: Present_Value, Out_Of_Service
Proprietary Properties: None
Property Range Restrictions: None
Data Type: Enumerated

Device Object

Dynamically Create: Yes No
Dynamically Delete: Yes No
Optional Properties: Max_Master, Max_Info_Frames
Writable properties: Max_Master
Proprietary Properties: None
Property Range Restrictions: None
Data Type: Unsigned Int

Multistate Input Object

Dynamically Create: Yes No
Dynamically Delete: Yes No
Optional Properties: Reliability, State_Text
Writable properties: Present_Value when Out_Of_Service is true, Out_Of_Service
Proprietary Properties: None
Property Range Restrictions: None
Data Type: Unsigned Int

Multistate Value Object

Dynamically Create: Yes No
Dynamically Delete: Yes No
Optional Properties: Reliability, State_Text
Writable properties: Present_Value, Out_Of_Service
Proprietary Properties: None
Property Range Restrictions: None
Data Type: Unsigned Int

Data Link Layer Options:

- BACnet IP, (Annex J)
- BACnet IP, (Annex J), Foreign Device
- ISO 8802-3, Ethernet (Clause 7)
- ANSI/ATA 878.1, 2.5 Mb. ARCNET (Clause 8)
- ANSI/ATA 878.1, RS-485 ARCNET (Clause 8), baud rate(s) _____
- MS/TP master (Clause 9), baud rate(s): 9600, 19200, 38400, 76800
- MS/TP slave (Clause 9), baud rate(s): _____
- Point-To-Point, EIA 232 (Clause 10), baud rate(s): _____
- Point-To-Point, modem, (Clause 10), baud rate(s): _____
- LonTalk, (Clause 11), medium: _____
- Other: _____

Device Address Binding:

Is static device binding supported? Yes No

Networking Options:

- Router, Clause 6 - List all routing configurations, e.g., ARCNET-Ethernet, Ethernet-MS/TP, etc.
- Annex H, BACnet Tunneling Router over IP
- BACnet/IP Broadcast Management Device (BBMD)
Does the BBMD support registrations by Foreign Devices? Yes No

Character Sets Supported:

Indicating support for multiple character sets does not imply that they can all be supported simultaneously.

- ANSI X3.4
- IBM®/Microsoft® DBCS
- ISO 8859-1
- ISO 10646 (UCS-2)
- ISO 10646 (UCS-4)
- JIS C 6226

BACnet® MS/TP Object Set

RPM10 PresSura Monitor

Object Type	Device Instance	*Units	Description	Writable		Notes and Range
				Object	Value	
Analog Input	1	in. W.C., Pa	Room1 Pressure	Y		
Analog Input	2	cfm, l/s, m ³ /hr	Supply Flow Rate			
Analog Input	3		Air Changes Per Hour			
Analog Input	6	cfm, l/s, m ³ /hr	Exhaust Flow Rate			
Analog Input	10		Room 1 Label	Y		Writing to Object name will change Rm1 Label item. Room 1 Label object has not applicable in. W.C. units. Updating Room 1 Label Object name will not affect other Room 1 Object names.
Analog Value	1	in. W.C., Pa	Room 1 Neg Low Alarm		Y	-0.19500 to +0.19500 in. W.C.: TSI Sensor -1.0 to +1.0 in. W.C.: Pressure Transducer
Analog Value	2	in. W.C., Pa	Room 1 Neg High Alarm		Y	-0.19500 to +0.19500 in. W.C.: TSI Sensor -1.0 to +1.0 in. W.C.: Pressure Transducer
Analog Value	3	in. W.C., Pa	Room 1 Pos Low Alarm		Y	-0.19500 to +0.19500 in. W.C.: TSI Sensor -1.0 to +1.0 in. W.C.: Pressure Transducer
Analog Value	4	in. W.C., Pa	Room 1 Pos High Alarm		Y	-0.19500 to +0.19500 in. W.C.: TSI Sensor -1.0 to +1.0 in. W.C.: Pressure Transducer
Analog Value	5	cfm, l/s, m ³ /hr	Room 1 Low Exhaust Alarm		Y	0 to 30,000 cfm
Analog Value	11	ft ³ , m ³	Room 1 Volume		Y	0 to 20,000
Analog Value	39		Alarm Delay		Y	20 to 600 seconds
Analog Value	40		Mute Timeout		Y	1 to 60 minutes
Analog Value	41		Door Delay		Y	20 to 600 seconds
Analog Value	42		Address		Y	1 to 127
Analog Value	43		MAC ID (Device ID)		Y	0 to 4,194,302
Analog Value	55	cfm, l/s, m ³ /hr	Supply Flow over BACnet		Y	0 to 10,000 cfm
Analog Value	58	cfm, l/s, m ³ /hr	Exhaust Flow over BACnet		Y	0 to 10,000 cfm
Binary Input	1		Room 1 Door Switch			0 Door Closed (Normal) 1 Door Open
Binary Input	4		Room 1 Occupancy			0 Occupied (Normal) 1 Unoccupied

RPM10 PresSura Monitor

Object Type	Device Instance	*Units	Description	Writable		Notes and Range
				Object	Value	
Binary Value	1		Room 1 High Alarm			0 Disable 1 Enable
Binary Value	2		Room 1 Low Alarm			0 Disable 1 Enable
Binary Value	9		Supply Flow over BACnet Enable		Y	0 Disable 1 Enable
Binary Value	12		Exhaust Flow over BACnet Enable		Y	0 Disable 1 Enable
Multi-State Value	3		Passcode Enable		Y	1 No Password 2 Room Mode Password 3 Menu Password 4 Menu & Room Mode Passwords
Multi-State Value	4		Input 1 Configuration			1 TSI Sensor 2 Pressure Transducer
Multi-State Value	5		Input 2 Configuration			4 None
Multi-State Value	6		Input 3 Configuration			1 Supply Pressure Flow 2 Supply Linear Flow 3 Supply Venturi Flow 4 Supply Switch 7 None
Multi-State Value	7		Input 4 Configuration			1 Room 1 Door Switch 2 Room 1 Occupancy Sensor 3 None
Multi-State Value	8		Input 5 Configuration			1 Room 1 Key Switch 3 None
Multi-State Value	9		Input 6 Configuration			6 None
Multi-State Value	10		Input 7 Configuration			2 Exhaust Pressure Flow 3 Exhaust Linear Flow 4 Exhaust Venturi Flow 5 Exhaust Switch 8 None
Multi-State Value	11		Room 1 Mode		Y	1 Positive 2 Negative 3 No Isolation

RPM10 PresSura Monitor

Object Type	Device Instance	*Units	Description	Writable		Notes and Range
				Object	Value	
Multi-State Value	12		ACH Duct		Y	1 Supply 2 Exhaust 3 Off
Multi-State Value	16		Status Index			1 Normal 2 Room 1 Negative Low Alarm 3 Room 1 Negative High Alarm 4 Room 1 Positive Low Alarm 5 Room 1 Positive High Alarm 6 Low Exhaust Alarm 7 Low Supply Alarm 20 Data Error
Multi-State Value	17		Device Type			3 RPM10
Multi-State Value	18		Units Value		Y	1 in. W.C., cfm 2 Pa, lps 3 Pa, m ³ /hr

*The units are based on the value of the Units Value object. When the Units Value is set to 1, the units are in English form. When the Units Value is set to 2 or 3, the units are metric. English is the default value.

RPM20 PresSura Monitor

Object Type	Device Instance	*Units	Description	Writable		Notes and Range
				Object	Value	
Analog Input	1	in. W.C., Pa	Room1 Pressure	Y		
Analog Input	2	cfm, l/s, m ³ /hr	Supply Flow Rate			
Analog Input	3		Air Changes Per Hour			
Analog Input	4	% RH	Relative Humidity			
Analog Input	5	°F, °C	Room Temperature			
Analog Input	6	cfm, l/s, m ³ /hr	Exhaust Flow Rate			
Analog Input	7	in. W.C., Pa	Anteroom Pressure	Y		1 Room with Anteroom or 2 Room with Anteroom configurations only
Analog Input	8	in. W.C., Pa	Room 2 Pressure	Y		2 Room with Anteroom configuration only

RPM20 PresSura Monitor

Object Type	Device Instance	*Units	Description	Writable		Notes and Range
				Object	Value	
Analog Input	10		Room 1 Label	Y		Writing to Object name will change Rm1 Label item. Room 1 Label object has not applicable in. W.C. units. Updating Room 1 Label Object name will not affect other Room 1 Object names.
Analog Input	11		Anteroom Label	Y		Writing to Object name will change AnteRm Label item. Anteroom Label object has not applicable in. W.C. units. Updating Anteroom Label Object name will not affect other Anteroom Object names.
Analog Input	12		Room 2 Label	Y		Writing to Object name will change Rm2 Label item. Room 2 Label object has not applicable in. W.C. units. Updating Room 2 Label Object name will not affect other Room 2 Object names.
Analog Value	1	in. W.C., Pa	Room 1 Neg Low Alarm		Y	-0.19500 to +0.19500 in. W.C.: TSI Sensor -1.0 to +1.0 in. W.C.: Pressure Transducer
Analog Value	2	in. W.C., Pa	Room 1 Neg High Alarm		Y	-0.19500 to +0.19500 in. W.C.: TSI Sensor -1.0 to +1.0 in. W.C.: Pressure Transducer.
Analog Value	3	in. W.C., Pa	Room 1 Pos Low Alarm		Y	-0.19500 to +0.19500 in. W.C.: TSI Sensor -1.0 to +1.0 in. W.C.: Pressure Transducer
Analog Value	4	in. W.C., Pa	Room 1 Pos High Alarm		Y	-0.19500 to +0.19500 in. W.C.: TSI Sensor -1.0 to +1.0 in. W.C.: Pressure Transducer
Analog Value	5	cfm, l/s, m ³ /hr	Room 1 Low Exhaust Alarm		Y	0 to 30,000 cfm
Analog Value	6	cfm, l/s, m ³ /hr	Room 1 Low Supply Alarm		Y	0 to 30,000 cfm
Analog Value	7	°F, °C	Room 1 Low Temperature Alarm		Y	50 to 100 °F
Analog Value	8	°F, °C	Room 1 High Temperature Alarm		Y	50 to 100 °F
Analog Value	9	% RH	Room 1 Low RH Alarm		Y	0 to 100

RPM20 PresSura Monitor

Object Type	Device Instance	*Units	Description	Writable		Notes and Range
				Object	Value	
Analog Value	10	% RH	Room 1 High RH Alarm		Y	0 to 100
Analog Value	11	ft ³ , m ³	Room 1 Volume		Y	0 to 20,000
Analog Value	31	in. W.C., Pa	Anteroom Neg Low Alarm		Y	-0.19500 to +0.19500 in. W.C.: TSI Sensor -1.0 to +1.0 in. W.C.: Pressure Transducer 1 Room with Anteroom or 2 Room with Anteroom configurations only
Analog Value	32	in. W.C., Pa	Anteroom Neg High Alarm		Y	-0.19500 to +0.19500 in. W.C.: TSI Sensor -1.0 to +1.0 in. W.C.: Pressure Transducer 1 Room with Anteroom or 2 Room with Anteroom configurations only
Analog Value	33	in. W.C., Pa	Anteroom Pos Low Alarm		Y	-0.19500 to +0.19500 in. W.C.: TSI Sensor -1.0 to +1.0 in. W.C.: Pressure Transducer 1 Room with Anteroom or 2 Room with Anteroom configurations only
Analog Value	34	in. W.C., Pa	Anteroom Pos High Alarm		Y	-0.19500 to +0.19500 in. W.C.: TSI Sensor -1.0 to +1.0 in. W.C.: Pressure Transducer 1 Room with Anteroom or 2 Room with Anteroom configurations only
Analog Value	35	in. W.C., Pa	Room 2 Neg Low Alarm		Y	-0.19500 to +0.19500 in. W.C.: TSI Sensor -1.0 to +1.0 in. W.C.: Pressure Transducer 2 Room with Anteroom configuration only
Analog Value	36	in. W.C., Pa	Room 2 Neg High Alarm		Y	-0.19500 to +0.19500 in. W.C.: TSI Sensor -1.0 to +1.0 in. W.C.: Pressure Transducer 2 Room with Anteroom configuration only
Analog Value	37	in. W.C., Pa	Room 2 Pos Low Alarm		Y	-0.19500 to +0.19500 in. W.C.: TSI Sensor -1.0 to +1.0 in. W.C.: Pressure Transducer 2 Room with Anteroom configuration only
Analog Value	38	in. W.C., Pa	Room 2 Pos High Alarm		Y	-0.19500 to +0.19500 in. W.C.: TSI Sensor -1.0 to +1.0 in. W.C.: Pressure Transducer 2 Room with Anteroom configuration only
Analog Value	39		Alarm Delay		Y	20 to 600 seconds
Analog Value	40		Mute Timeout		Y	1 to 60 minutes
Analog Value	41		Door Delay		Y	20 to 600 seconds
Analog Value	42		Address		Y	1 to 127
Analog Value	43		MAC ID (Device ID)		Y	0 to 4,194,302

RPM20 PresSura Monitor

Object Type	Device Instance	*Units	Description	Writable		Notes and Range
				Object	Value	
Analog Value	55	cfm, l/s, m ³ /hr	Supply Flow over BACnet		Y	0 to 10,000 cfm
Analog Value	56	% RH	Relative Humidity over BACnet		Y	0 to 100%
Analog Value	57	°F, °C	Room 1 Temperature over BACnet		Y	50 to 85 °F
Analog Value	58	cfm, l/s, m ³ /hr	Exhaust Flow over BACnet		Y	0 to 10,000 cfm
Binary Input	1		Room 1 Door Switch			0 Door Closed (Normal) 1 Door Open
Binary Input	3		Room 2 Door Switch			0 Door Closed (Normal) 1 Door Open
Binary Input	4		Room 1 Occupancy			0 Occupied (Normal) 1 Unoccupied
Binary Input	6		Room 2 Occupancy			0 Occupied (Normal) 1 Unoccupied
Binary Value	1		Room 1 High Alarm		Y	0 Disable 1 Enable
Binary Value	2		Room 1 Low Alarm		Y	0 Disable 1 Enable
Binary Value	3		Anteroom High Alarm		Y	0 Disable 1 Enable
Binary Value	4		Anteroom Low Alarm		Y	0 Disable 1 Enable
Binary Value	5		Room 2 High Alarm		Y	0 Disable 1 Enable
Binary Value	6		Room 2 Low Alarm		Y	0 Disable 1 Enable
Binary Value	9		Supply Flow over BACnet Enable		Y	0 Disable 1 Enable
Binary Value	10		Relative Humidity over BACnet Enable		Y	0 Disable 1 Enable
Binary Value	11		Room 1 Temperature over BACnet Enable		Y	0 Disable 1 Enable

RPM20 PresSura Monitor

Object Type	Device Instance	*Units	Description	Writable		Notes and Range
				Object	Value	
Binary Value	12		Exhaust Flow over BACnet Enable		Y	0 Disable 1 Enable
Multi-State Value	1		Number of Rooms			1 1 Room 2 1 Room with Anteroom 3 2 Rooms with Anteroom
Multi-State Value	3		Passcode Enable		Y	1 No Password 2 Room Mode Password 3 Menu Password 4 Menu & Room Mode Passwords
Multi-State Value	4		Input 1 Configuration			1 TSI Sensor 2 Pressure Transducer
Multi-State Value	5		Input 2 Configuration			1 TSI Sensor 2 Pressure Transducer 4 None
Multi-State Value	6		Input 3 Configuration			1 Supply Pressure Flow 2 Supply Linear Flow 3 Supply Venturi Flow 4 Supply Switch 5 TSI Sensor 6 Pressure Transducer 7 None
Multi-State Value	7		Input 4 Configuration			1 Room 1 Door Switch 2 Room 1 Occupancy Sensor 3 None
Multi-State Value	8		Input 5 Configuration			1 Room 1 Key Switch 2 Room 1 Relative Humidity 3 None
Multi-State Value	9		Input 6 Configuration			1 Room 1 Temp Sensor 3 Room 2 Occupancy Sensor 4 Room 2 Door Switch 6 None
Multi-State Value	10		Input 7 Configuration			2 Exhaust Pressure Flow 3 Exhaust Linear Flow 4 Exhaust Venturi Flow 5 Exhaust Switch 6 Room 2 Key Switch 8 None

RPM20 PresSura Monitor

Object Type	Device Instance	*Units	Description	Writable		Notes and Range
				Object	Value	
Multi-State Value	11		Room 1 Mode		Y	1 Positive 2 Negative 3 No Isolation
Multi-State Value	12		ACH Duct		Y	1 Supply 2 Exhaust 3 Off
Multi-State Value	14		Anteroom Mode		Y	1 Positive 2 Negative 3 No Isolation
Multi-State Value	15		Room 2 Mode		Y	1 Positive 2 Negative 3 No Isolation
Multi-State Value	16		Status Index			1 Normal 2 Room 1 Negative Low Alarm 3 Room 1 Negative High Alarm 4 Room 1 Positive Low Alarm 5 Room 1 Positive High Alarm 6 Low Exhaust Flow Alarm 7 Low Supply Flow Alarm 8 Low Temperature Alarm 9 High Temperature Alarm 10 Low RH Alarm 11 High RH Alarm 12 Anteroom Negative Low Alarm 13 Anteroom Negative High Alarm 14 Anteroom Positive Low Alarm 15 Anteroom Positive High Alarm 16 Room 2 Negative Low Alarm 17 Room 2 Negative High Alarm 18 Room 2 Positive Low Alarm 19 Room 2 Positive High Alarm 20 Data Error
Multi-State Value	17		Device Type			2 RPM20
Multi-State Value	18		Units Value		Y	1 in. W.C., cfm, F 2 Pa, lps, C 3 Pa, m ³ /hr, C

*The units are based on the value of the Units Value object. When the Units Value is set to 1, the units are in English form. When the Units Value is set to 2 or 3, the units are metric. English is the default value.

RPM20-CC PresSura Monitor

Object Type	Device Instance	*Units	Description	Writable		Notes and Range
				Object	Value	
Analog Input	1	in. W.C., Pa	Room1 Pressure	Y		
Analog Input	2	cfm, l/s, m ³ /hr	Supply Flow Rate			
Analog Input	3		Air Changes Per Hour			
Analog Input	4	% RH	Relative Humidity			
Analog Input	5	°F, °C	Room Temperature			
Analog Input	6	cfm, l/s, m ³ /hr	Exhaust Flow Rate			
Analog Input	7	in. W.C., Pa	Anteroom Pressure	Y		1 Room with Anteroom or 2 Room with Anteroom configurations only
Analog Input	8	in. W.C., Pa	Room 2 Pressure	Y		2 Room with Anteroom configuration only
Analog Input	10		Room 1 Label	Y		Writing to Object name will change Rm1 Label item. Room 1 Label object has not applicable in. W.C. units. Updating <i>Room 1 Label</i> Object name will not affect other Room 1 Object names.
Analog Input	11		Anteroom Label	Y		Writing to Object name will change AnteRm Label item. Anteroom Label object has not applicable in. W.C. units. Updating <i>Anteroom Label</i> Object name will not affect other Anteroom Object names.
Analog Input	12		Room 2 Label	Y		Writing to Object name will change Rm2 Label item. Room 2 Label object has not applicable in. W.C. units. Updating <i>Room 2 Label</i> Object name will not affect other Room 2 Object names.
Analog Input	16	Ft ³ , m ³	Particle Channel A Counts			0 to 1E+09
Analog Input	17	Ft ³ , m ³	Particle Channel B Counts			0 to 1E+09
Analog Value	1	in. W.C., Pa	Room 1 Neg Low Alarm		Y	-0.19500 to +0.19500 in. W.C.: TSI Sensor -1.0 to +1.0 in. W.C.: Pressure Transducer

RPM20-CC PresSura Monitor

Object Type	Device Instance	*Units	Description	Writable		Notes and Range
				Object	Value	
Analog Value	2	in. W.C., Pa	Room 1 Neg High Alarm		Y	-0.19500 to +0.19500 in. W.C.: TSI Sensor -1.0 to +1.0 in. W.C.: Pressure Transducer
Analog Value	3	in. W.C., Pa	Room 1 Pos Low Alarm		Y	-0.19500 to +0.19500 in. W.C.: TSI Sensor -1.0 to +1.0 in. W.C.: Pressure Transducer
Analog Value	4	in. W.C., Pa	Room 1 Pos High Alarm		Y	-0.19500 to +0.19500 in. W.C.: TSI Sensor -1.0 to +1.0 in. W.C.: Pressure Transducer
Analog Value	5	cfm, l/s, m ³ /hr	Room 1 Low Exhaust Alarm		Y	0 to 30,000 cfm
Analog Value	6	cfm, l/s, m ³ /hr	Room 1 Low Supply Alarm		Y	0 to 30,000 cfm
Analog Value	7	°F, °C	Room 1 Low Temperature Alarm		Y	50 to 100 °F
Analog Value	8	°F, °C	Room 1 High Temperature Alarm		Y	50 to 100 °F
Analog Value	9	% RH	Room 1 Low RH Alarm		Y	0 to 100
Analog Value	10	% RH	Room 1 High RH Alarm		Y	0 to 100
Analog Value	11	ft ³ , m ³	Room 1 Volume		Y	0 to 20,000
Analog Value	19		Particle Alarm Status			1 No Signal 2 Normal 3 Laser Alarm 4 Flow Alarm 5 Flow and Laser Alarm
Analog Value	20		Particle Alarm Strategy		Y	1 Consecutive 2 SPC
Analog Value	31	in. W.C., Pa	Anteroom Neg Low Alarm		Y	-0.19500 to +0.19500 in. W.C.: TSI Sensor -1.0 to +1.0 in. W.C.: Pressure Transducer 1 Room with Anteroom or 2 Room with Anteroom configurations only
Analog Value	32	in. W.C., Pa	Anteroom Neg High Alarm		Y	-0.19500 to +0.19500 in. W.C.: TSI Sensor -1.0 to +1.0 in. W.C.: Pressure Transducer 1 Room with Anteroom or 2 Room with Anteroom configurations only

RPM20-CC PresSura Monitor

Object Type	Device Instance	*Units	Description	Writable		Notes and Range
				Object	Value	
Analog Value	33	in. W.C., Pa	Anteroom Pos Low Alarm		Y	-0.19500 to +0.19500 in. W.C.: TSI Sensor -1.0 to +1.0 in. W.C.: Pressure Transducer 1 Room with Anteroom or 2 Room with Anteroom configurations only
Analog Value	34	in. W.C., Pa	Anteroom Pos High Alarm		Y	-0.19500 to +0.19500 in. W.C.: TSI Sensor -1.0 to +1.0 in. W.C.: Pressure Transducer 1 Room with Anteroom or 2 Room with Anteroom configurations only
Analog Value	35	in. W.C., Pa	Room 2 Neg Low Alarm		Y	-0.19500 to +0.19500 in. W.C.: TSI Sensor -1.0 to +1.0 in. W.C.: Pressure Transducer 2 Room with Anteroom configuration only
Analog Value	36	in. W.C., Pa	Room 2 Neg High Alarm		Y	-0.19500 to +0.19500 in. W.C.: TSI Sensor -1.0 to +1.0 in. W.C.: Pressure Transducer 2 Room with Anteroom configuration only
Analog Value	37	in. W.C., Pa	Room 2 Pos Low Alarm		Y	-0.19500 to +0.19500 in. W.C.: TSI Sensor -1.0 to +1.0 in. W.C.: Pressure Transducer 2 Room with Anteroom configuration only
Analog Value	38	in. W.C., Pa	Room 2 Pos High Alarm		Y	-0.19500 to +0.19500 in. W.C.: TSI Sensor -1.0 to +1.0 in. W.C.: Pressure Transducer 2 Room with Anteroom configuration only
Analog Value	39		Alarm Delay		Y	20 to 600 seconds
Analog Value	40		Mute Timeout		Y	1 to 60 minutes
Analog Value	41		Door Delay		Y	20 to 600 seconds
Analog Value	42		Address		Y	1 to 127
Analog Value	43		MAC ID (Device ID)		Y	0 to 4,194,302
Analog Value	46	#	Particle Alarm Consecutive Readings		Y	1 to 60
Analog Value	47	#	Particle Alarm Exit Readings		Y	1 to 10
Analog Value	48	#	Particle Alarm Frequency		Y	1 to 60
Analog Value	49	#	Particle Alarm Period		Y	1 to 60
Analog Value	52	Ft ³ , m ³	Particle A High Alarm Setpoint		Y	0 to 1E+09

RPM20-CC PresSura Monitor

Object Type	Device Instance	*Units	Description	Writable		Notes and Range
				Object	Value	
Analog Value	54	Ft ³ , m ³	Particle B High Alarm Setpoint		Y	0 to 1E+09
Analog Value	55	cfm, l/s, m ³ /hr	Supply Flow over BACnet		Y	0 to 10,000 cfm
Analog Value	56	% RH	Relative Humidity over BACnet		Y	0 to 100%
Analog Value	57	°F, °C	Room 1 Temperature over BACnet		Y	50 to 85 °F
Analog Value	58	cfm, l/s, m ³ /hr	Exhaust Flow over BACnet		Y	0 to 10,000 cfm
Binary Input	1		Room 1 Door Switch			0 Door Closed (Normal) 1 Door Open
Binary Input	3		Room 2 Door Switch			0 Door Closed (Normal) 1 Door Open
Binary Input	4		Room 1 Occupancy			0 Occupied (Normal) 1 Unoccupied
Binary Input	6		Room 2 Occupancy			0 Occupied (Normal) 1 Unoccupied
Binary Value	1		Room 1 High Alarm		Y	0 Disable 1 Enable
Binary Value	2		Room 1 Low Alarm		Y	0 Disable 1 Enable
Binary Value	3		Anteroom High Alarm		Y	0 Disable 1 Enable
Binary Value	4		Anteroom Low Alarm		Y	0 Disable 1 Enable
Binary Value	5		Room 2 High Alarm		Y	0 Disable 1 Enable
Binary Value	6		Room 2 Low Alarm		Y	0 Disable 1 Enable
Binary Value	7		Particle A High Alarm		Y	0 Disable 1 Enable
Binary Value	8		Particle B High Alarm		Y	0 Disable 1 Enable
Binary Value	9		Supply Flow over BACnet Enable		Y	0 Disable 1 Enable

RPM20-CC PresSura Monitor

Object Type	Device Instance	*Units	Description	Writable		Notes and Range
				Object	Value	
Binary Value	10		Relative Humidity over BACnet Enable		Y	0 Disable 1 Enable
Binary Value	11		Room 1 Temperature over BACnet Enable		Y	0 Disable 1 Enable
Binary Value	12		Exhaust Flow over BACnet Enable		Y	0 Disable 1 Enable
Multi-State Value	1		Number of Rooms			1 1 Room 2 1 Room with Anteroom 3 2 Rooms with Anteroom
Multi-State Value	3		Passcode Enable		Y	1 No Password 2 Room Mode Password 3 Menu Password 4 Menu & Room Mode Passwords
Multi-State Value	4		Input 1 Configuration			1 TSI Sensor 2 Pressure Transducer
Multi-State Value	5		Input 2 Configuration			1 TSI Sensor 2 Pressure Transducer 4 Particle Channel A 5 None
Multi-State Value	6		Input 3 Configuration			1 Supply Pressure Flow 2 Supply Linear Flow 3 Supply Venturi Flow 4 Supply Switch 5 TSI Sensor 6 Pressure Transducer 7 None
Multi-State Value	7		Input 4 Configuration			1 Room 1 Door Switch 2 Room 1 Occupancy Sensor 3 Particle Channel B 4 None
Multi-State Value	8		Input 5 Configuration			1 Room 1 Key Switch 2 Room 1 Relative Humidity 3 None
Multi-State Value	9		Input 6 Configuration			1 Room 1 Temp Sensor 3 Room 2 Occupancy Sensor 4 Room 2 Door Switch 6 None

RPM20-CC PresSura Monitor

Object Type	Device Instance	*Units	Description	Writable		Notes and Range
				Object	Value	
Multi-State Value	10		Input 7 Configuration			2 Exhaust Pressure Flow 3 Exhaust Linear Flow 4 Exhaust Venturi Flow 5 Exhaust Switch 6 Room 2 Key Switch 8 Particle Status 9 None
Multi-State Value	11		Room 1 Mode		Y	1 Positive 2 Negative 3 No Isolation
Multi-State Value	12		ACH Duct		Y	1 Supply 2 Exhaust 3 Off
Multi-State Value	14		Anteroom Mode		Y	1 Positive 2 Negative 3 No Isolation
Multi-State Value	15		Room 2 Mode		Y	1 Positive 2 Negative 3 No Isolation

RPM20-CC PresSura Monitor

Object Type	Device Instance	*Units	Description	Writable		Notes and Range
				Object	Value	
Multi-State Value	16		Status Index			1 Normal 2 Room 1 Negative Low Alarm 3 Room 1 Negative High Alarm 4 Room 1 Positive Low Alarm 5 Room 1 Positive High Alarm 6 Low Exhaust Flow Alarm 7 Low Supply Flow Alarm 8 Low Temperature Alarm 9 High Temperature Alarm 10 Low RH Alarm 11 High RH Alarm 12 Anteroom Negative Low Alarm 13 Anteroom Negative High Alarm 14 Anteroom Positive Low Alarm 15 Anteroom Positive High Alarm 16 Room 2 Negative Low Alarm 17 Room 2 Negative High Alarm 18 Room 2 Positive Low Alarm 19 Room 2 Positive High Alarm 20 Data Error
Multi-State Value	17		Device Type			2 RPM20
Multi-State Value	18		Units Value		Y	1 in. W.C., cfm, F 2 Pa, lps, C 3 Pa, m ³ /hr, C

Appendix C

Wiring Information

Back Panel Wiring

PIN #	Input / Output / Comm	Signal	Description
1, 2	Input	24 VAC/DC	Power in Digital Interface Module (DIM).
3, 4	Output	24 V	Power for TSI Pressure Sensors 24 VAC
5, 6	Input	0 to 10 VDC	Input 1
7, 8	Comm	RS-485	Communications between DIM and TSI Pressure Sensors
9, 10	Output	Open / Closed	Relay 1 Output (Low Alarm)
11, 12	Output	Open / Closed	Relay 2 Output (High Alarm or Room Mode)
13, 14	Input	0 to 10 VDC	Input 2
15, 16	Input	0 to 10 VDC Open / Closed	Input 3
17, 18	Input	Open / Closed	Input 4
19, 20	Input	0 to 10 VDC Resistance	Input 5
21, 22	Input	Resistance Open / Closed	Input 6
23, 24	Input	0 to 10 VDC Resistance	Input 7
25, 26	Output	0 to 10 VDC	Analog Out 1
27, 28	Output	0 to 10 VDC 4-20 mA	Analog Out 2
29, 30	Output	0 to 10 VDC 4-20 mA	Analog Out 3
31, 32, 33	Comm	RS-485	Nurse Station Display 31: B 32: A 33: Ref
34, 35, 36	Comm	Modbus / BACnet MS/TP / LON	BAS Communications 34: B 35: A 36: Ref (Modbus / BACnet MS/TP only)

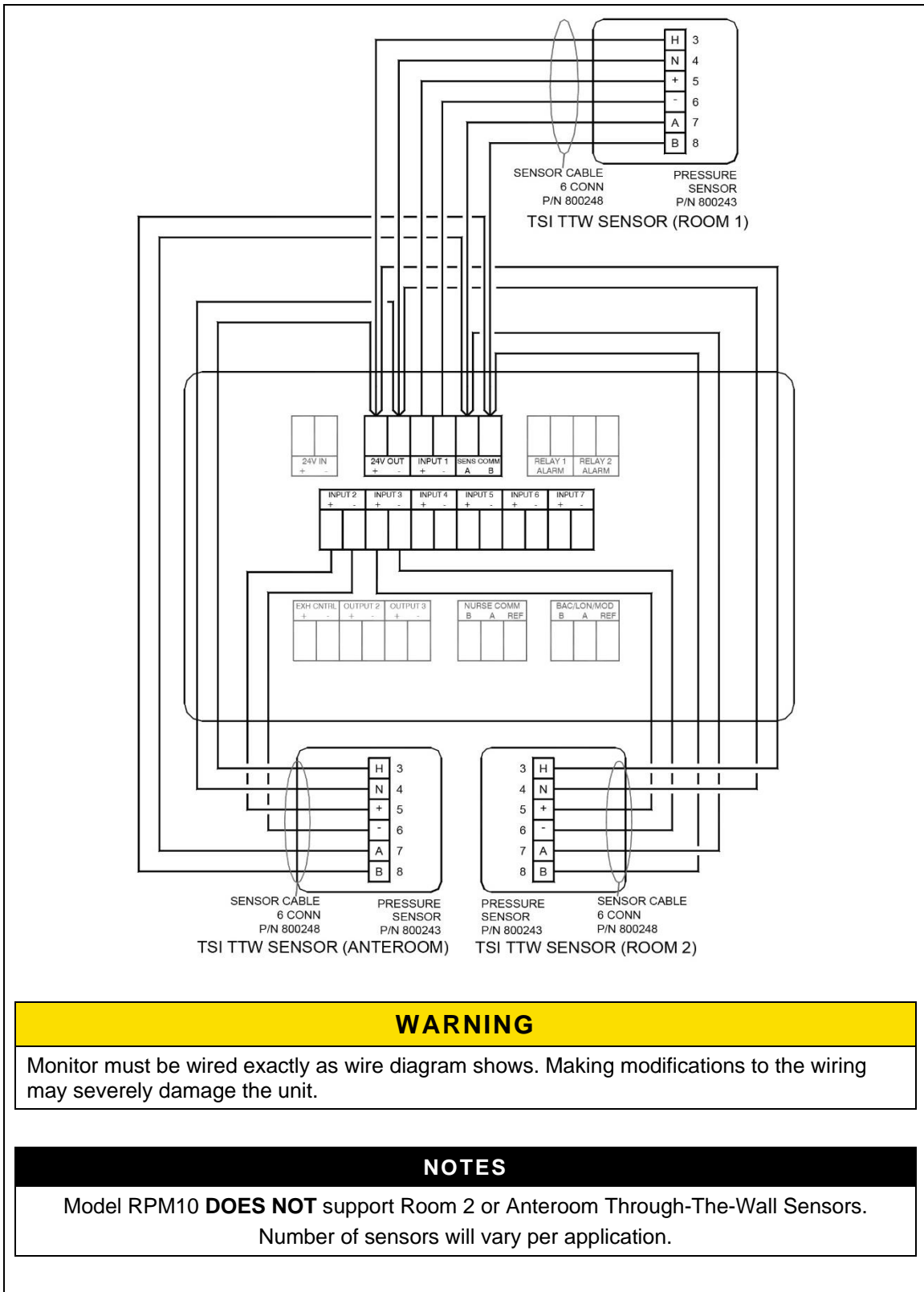
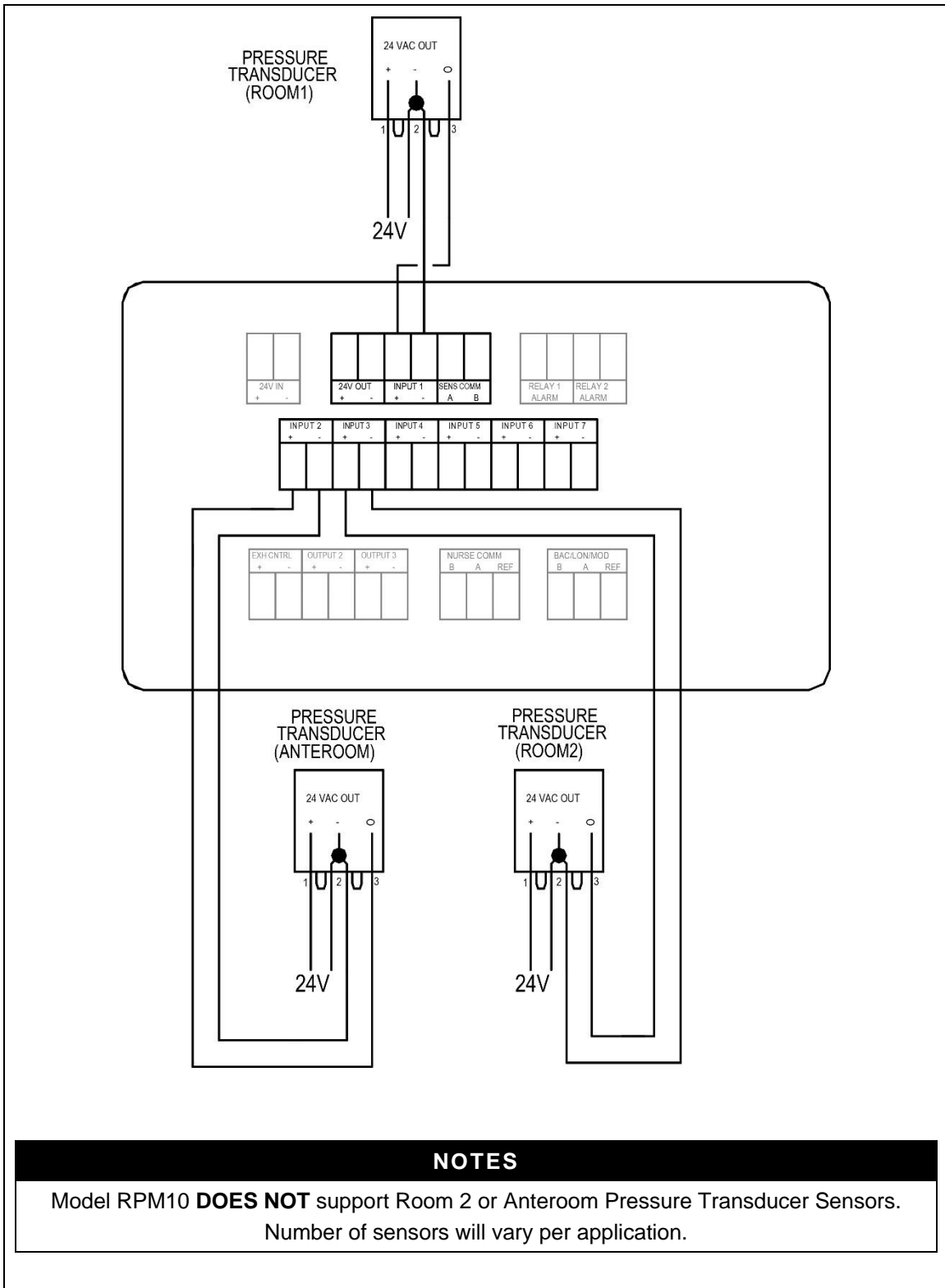

Figure 19: Wiring Diagram –Through-The-Wall Sensors Wiring to Model RPM10/RPM20



NOTES

Model RPM10 **DOES NOT** support Room 2 or Anteroom Pressure Transducer Sensors.
Number of sensors will vary per application.

Figure 20. Pressure Transducer Sensors Wiring to Model RPM10/RPM20

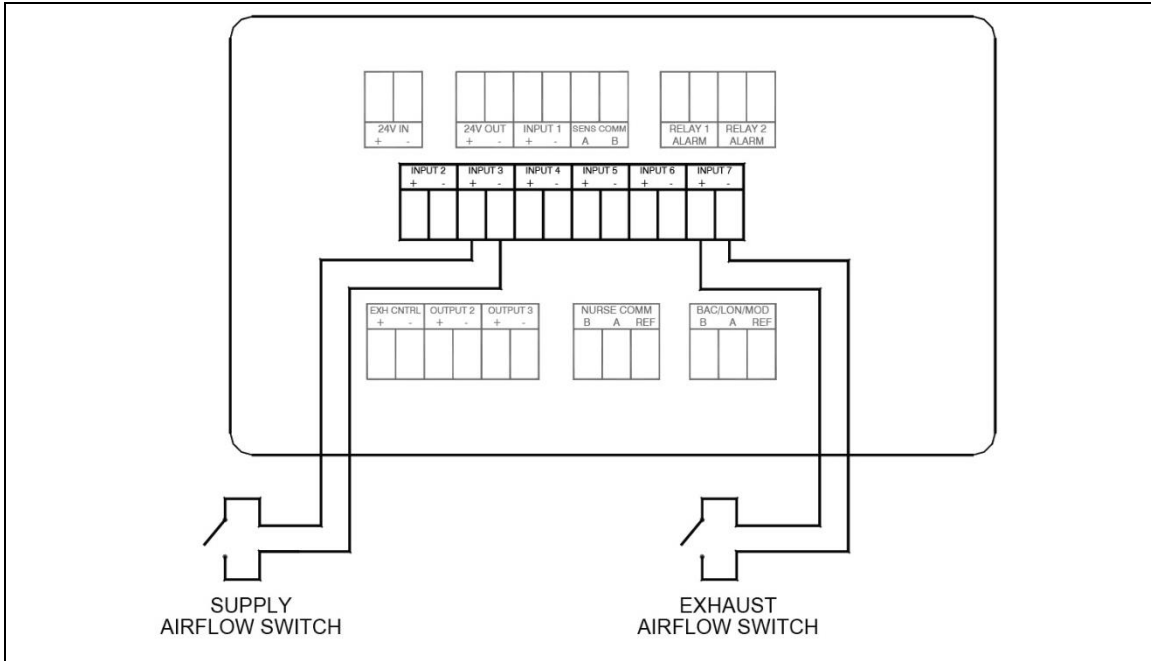

Figure 21. Optional Supply / Exhaust Flow Switch Wiring to Model RPM10/RPM20

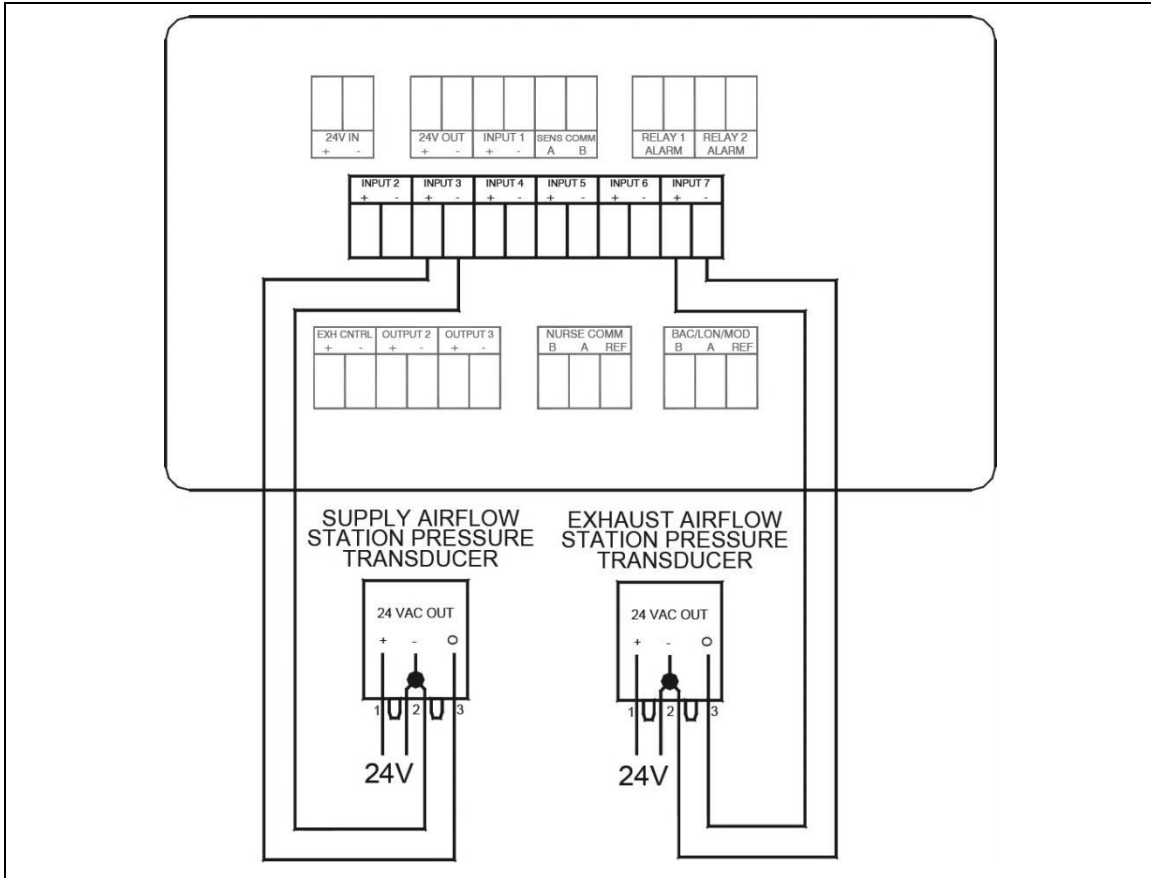

Figure 22. Optional Supply/Exhaust Pressure-Based Flow Station Wiring to Model RPM10/RPM20

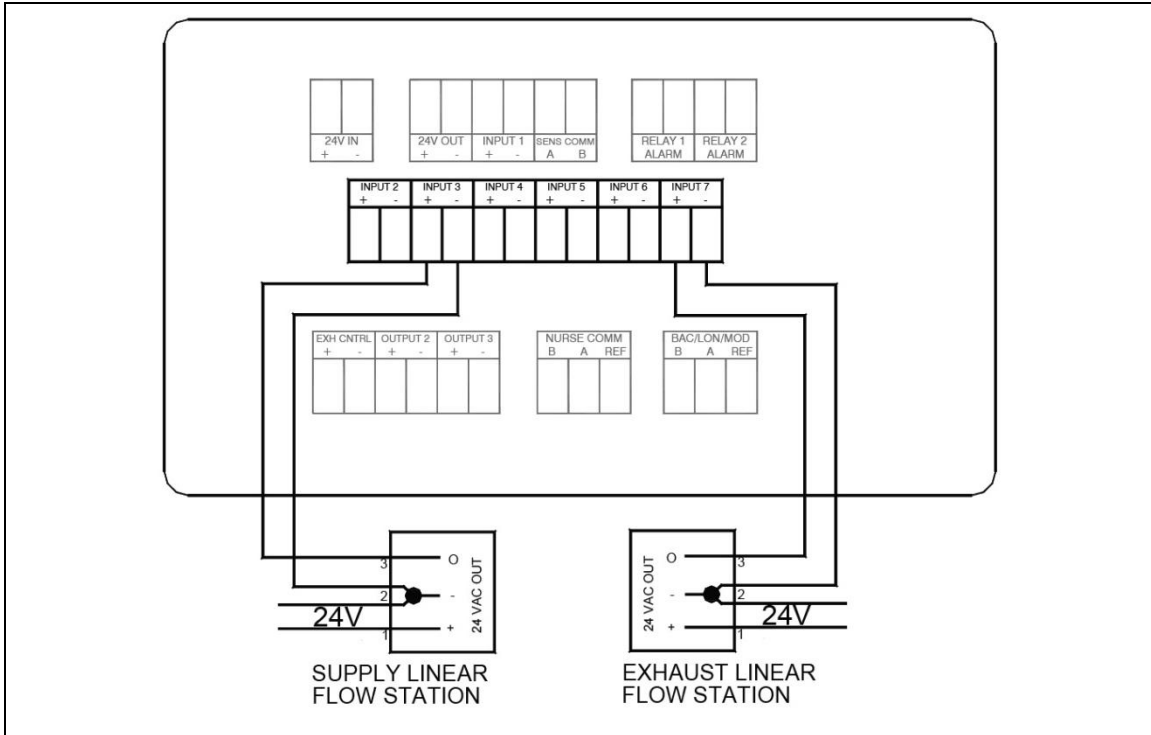

Figure 23. Optional Supply/Exhaust Linear Flow Station Wiring to Model RPM10/RPM20

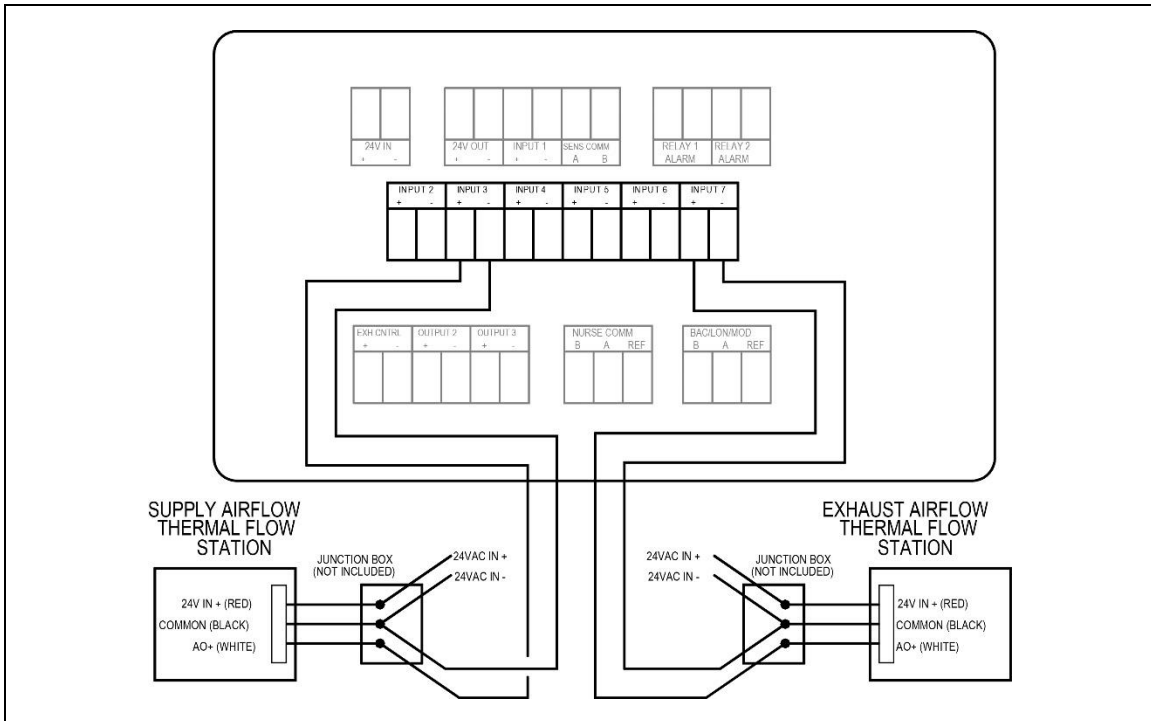

Figure 24. Optional Supply/Exhaust Thermal Flow Station Wiring to Model RPM10/RPM20

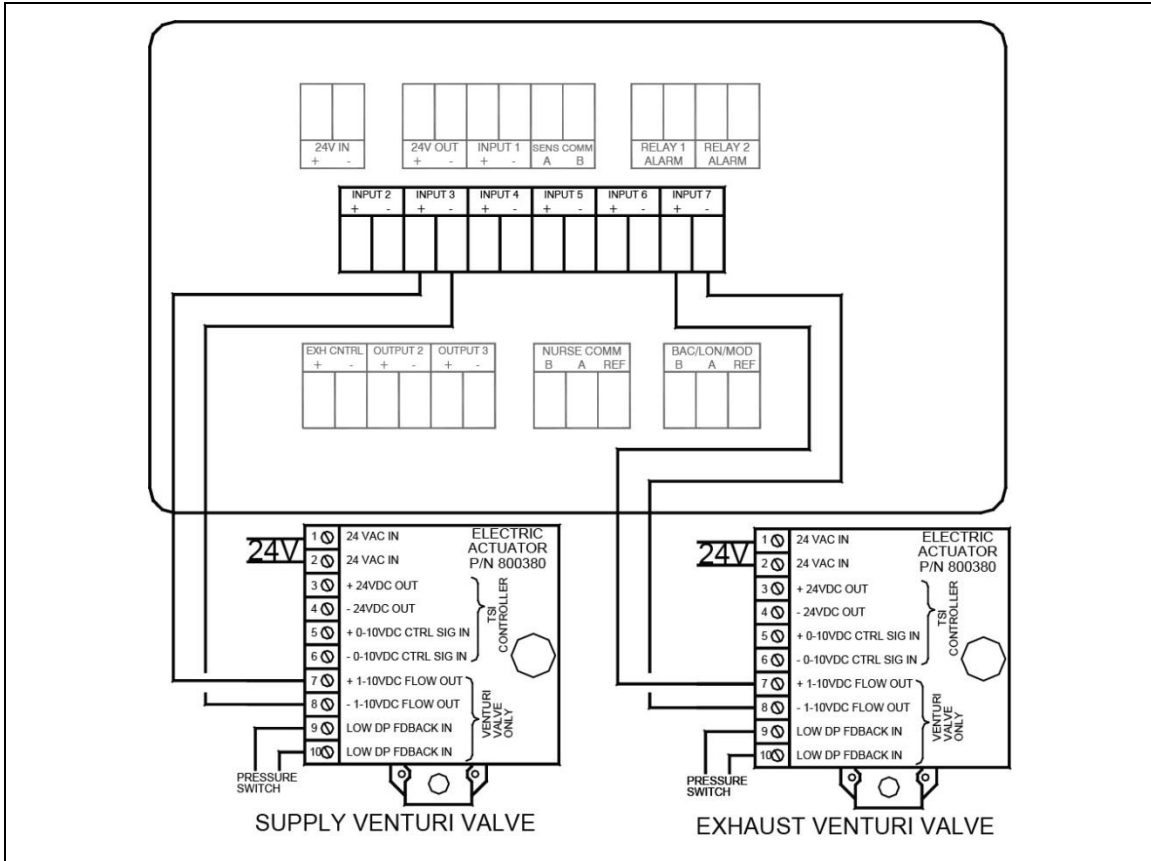

Figure 25. Optional Supply/Exhaust Venturi Valve Wiring to Model RPM10/RPM20

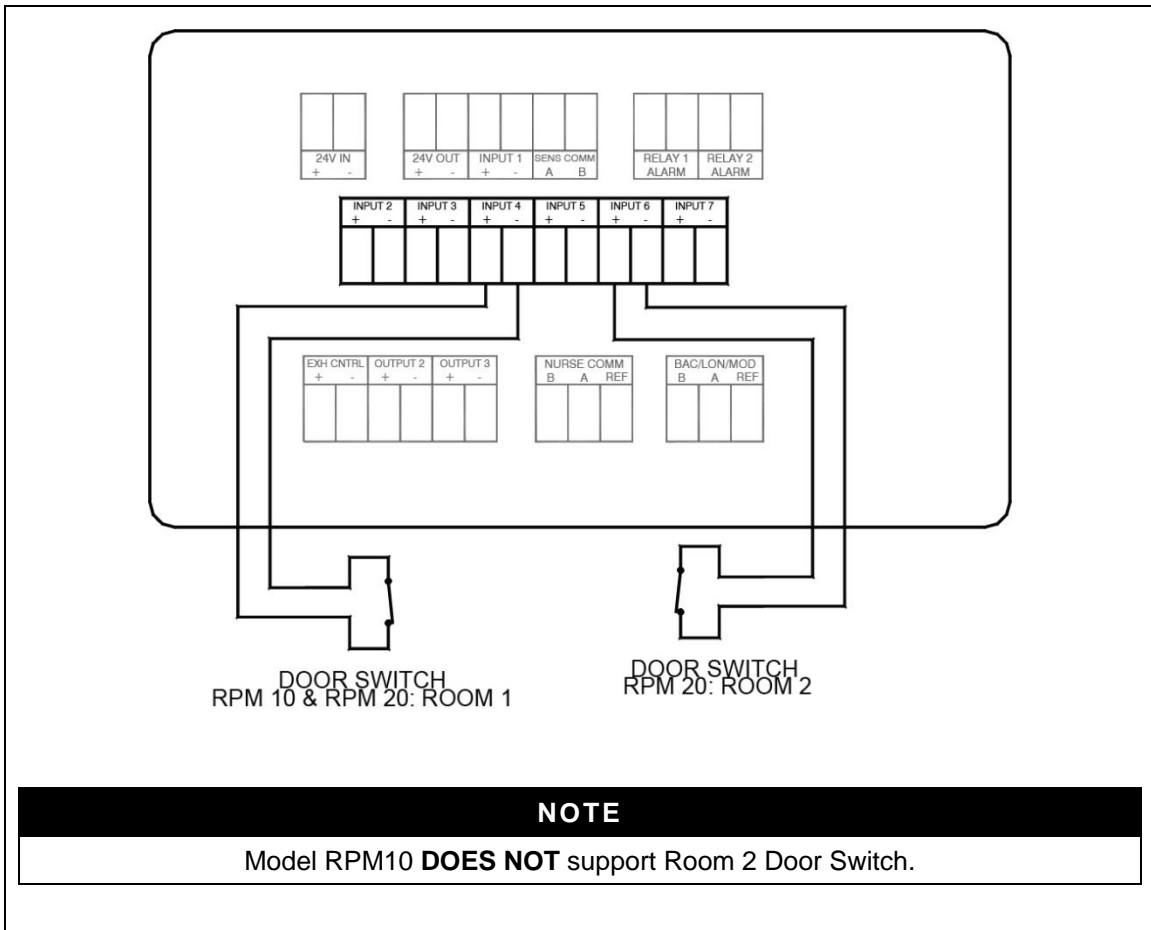

Figure 26. Optional Door Switch Wiring to Model RPM10/RPM20

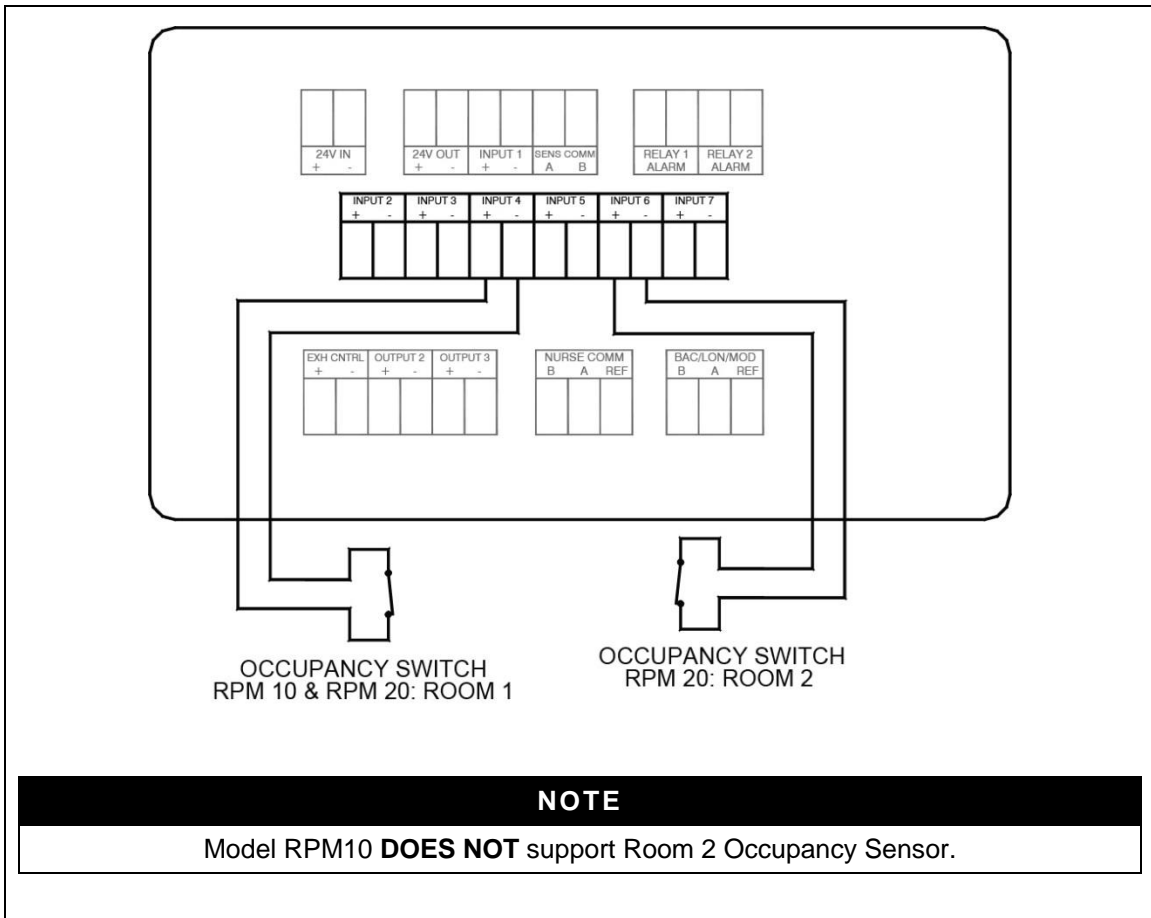

Figure 27. Optional Occupancy Sensor Wiring to Model RPM10/RPM20

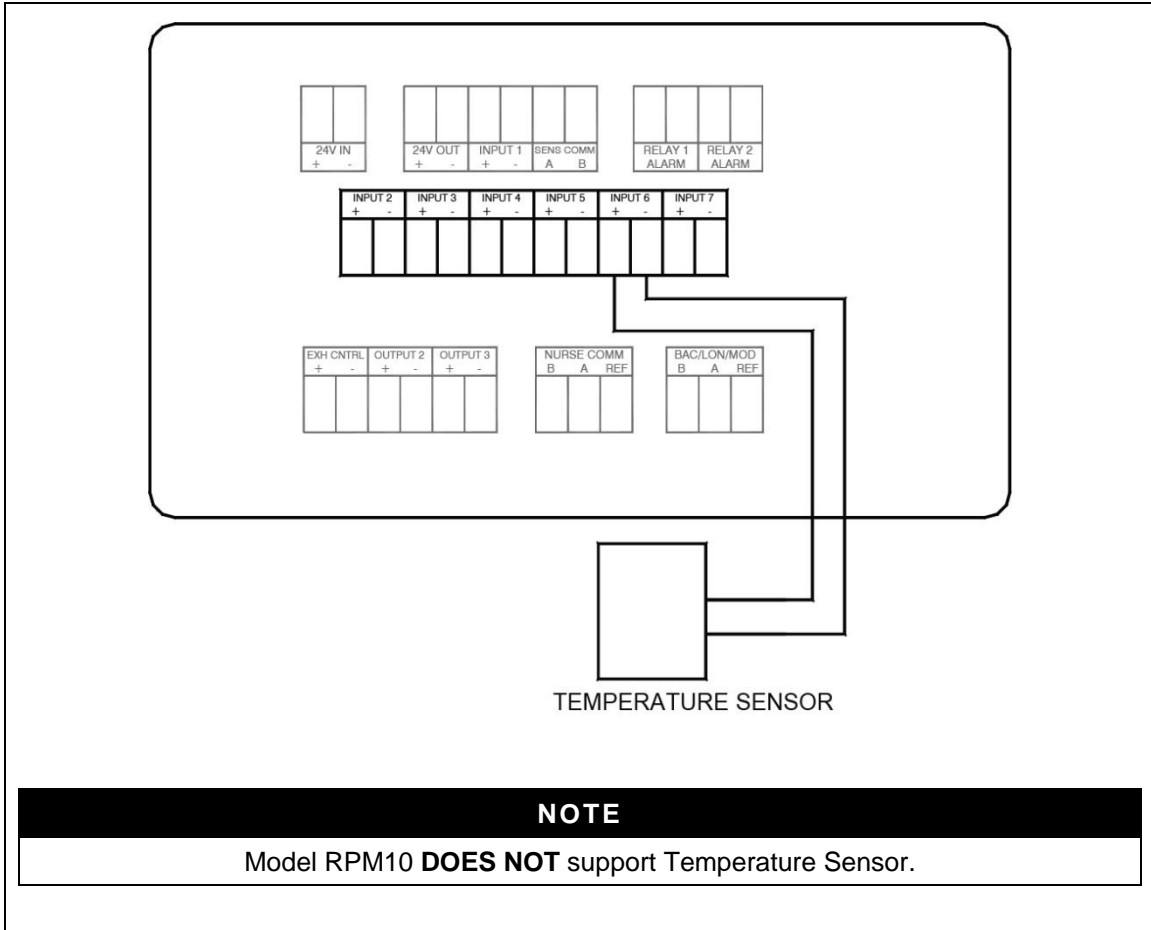

Figure 28. Optional Temperature Sensor Wiring to Model RPM20

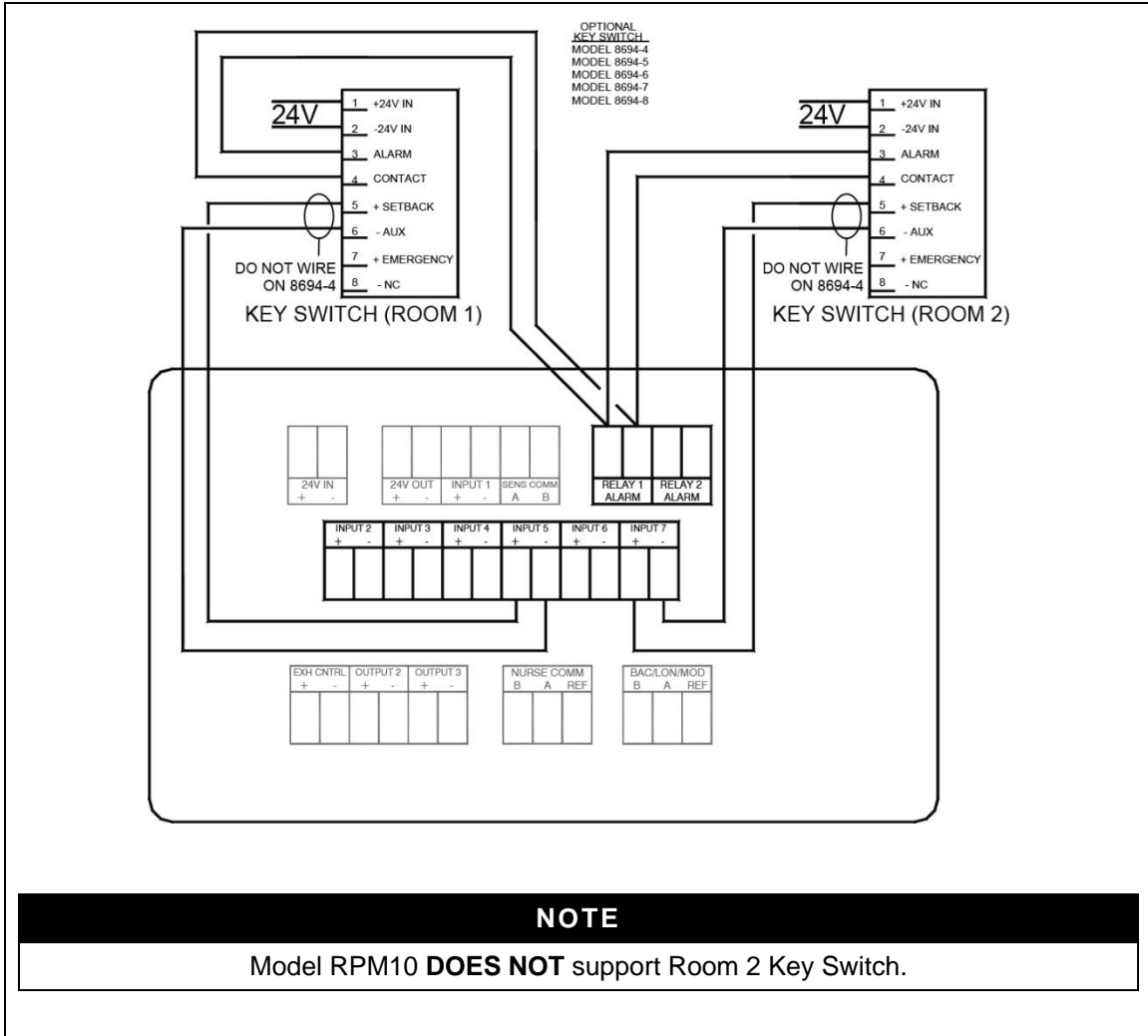

Figure 29. Optional Key Switch Wiring to Model RPM10/RPM20

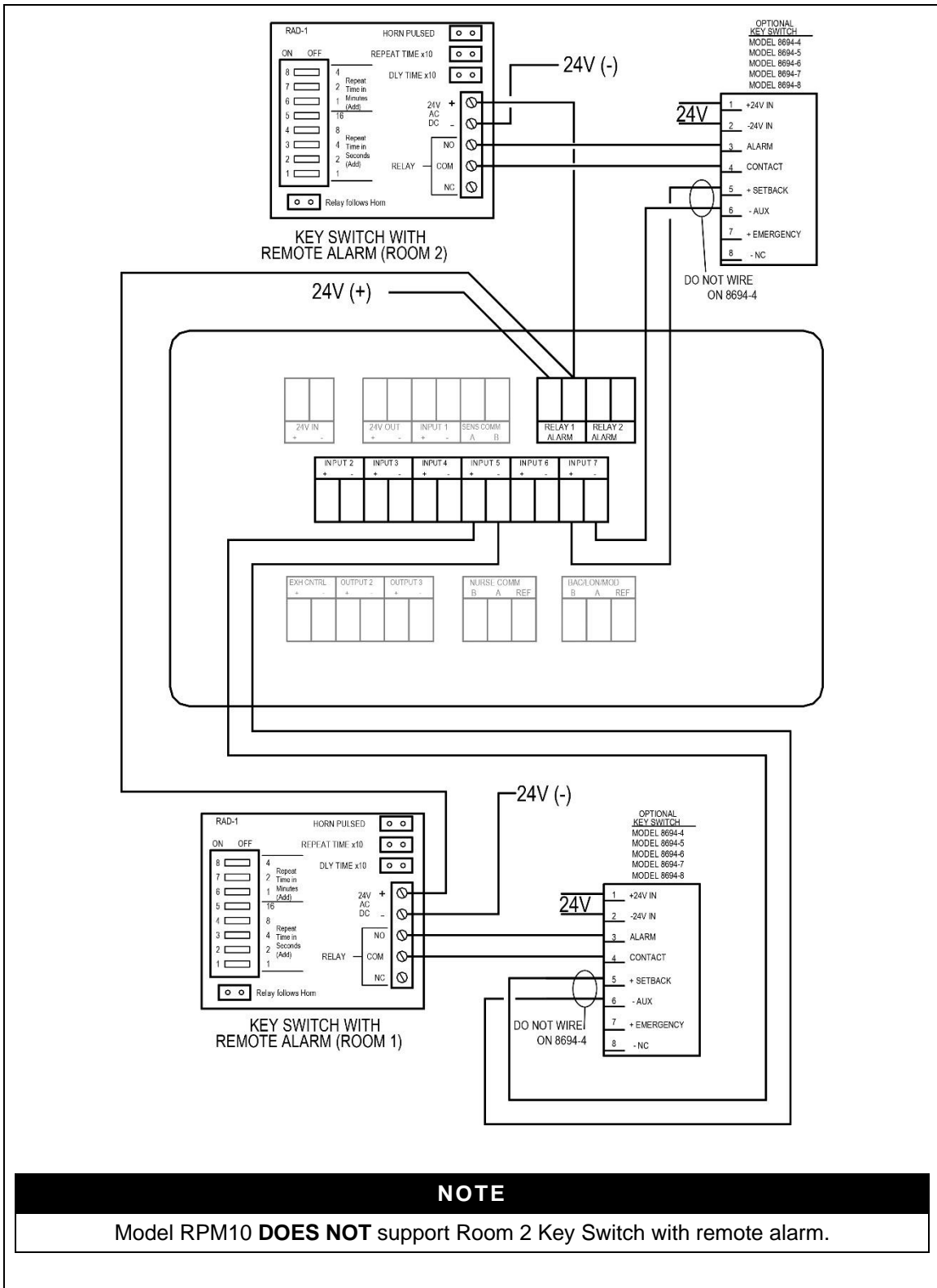

Figure 30. Optional Key Switch with Remote Alarm Wiring to Model RPM10/RPM20

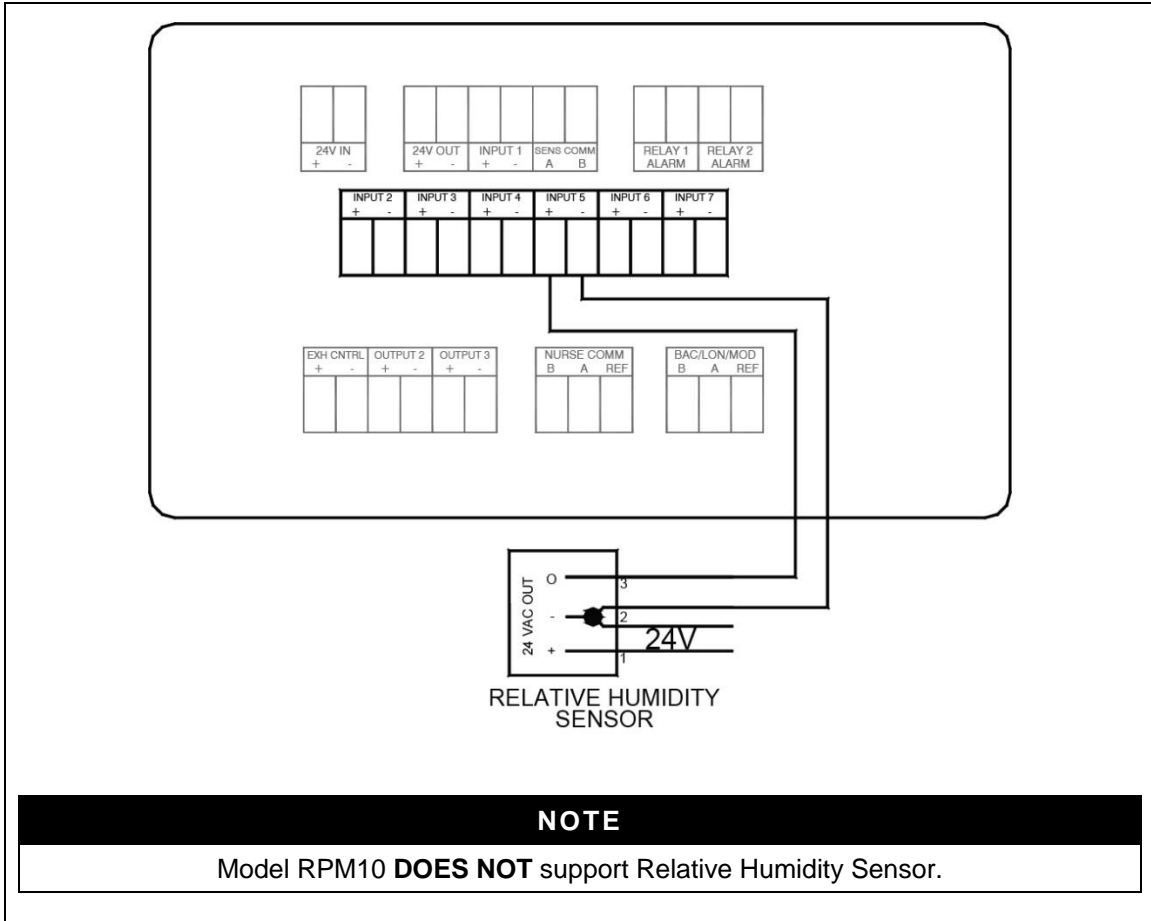

Figure 31. Optional Relative Humidity Sensor Wiring to Model RPM20

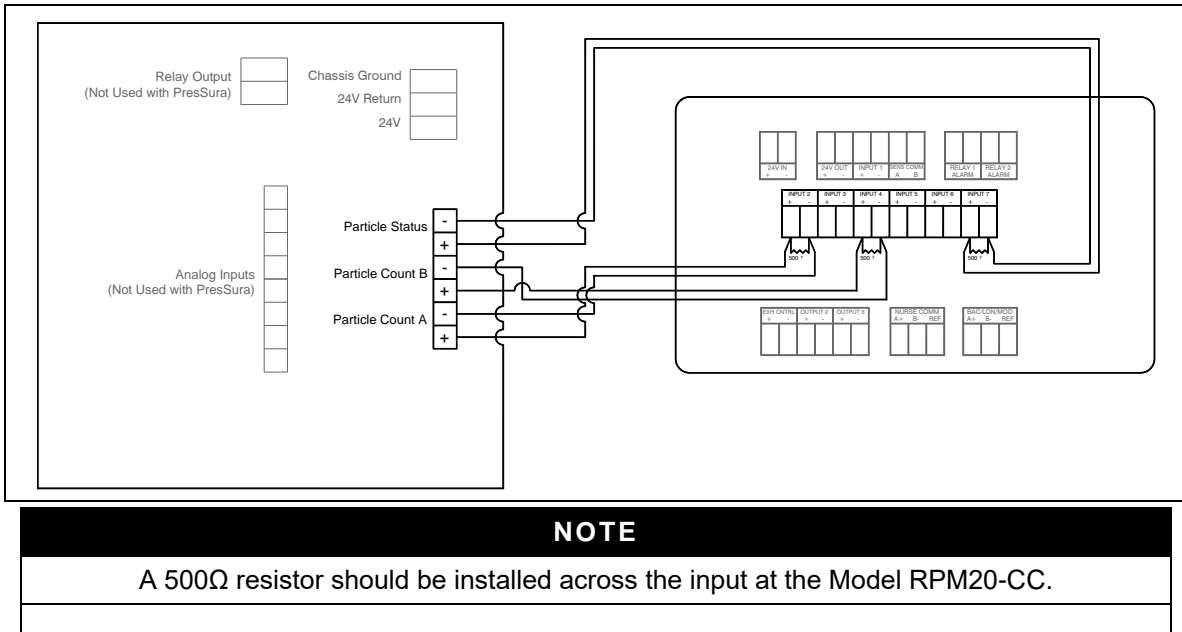

Figure 32. Remote with Pump Particle Counter wiring to Model RPM20-CC

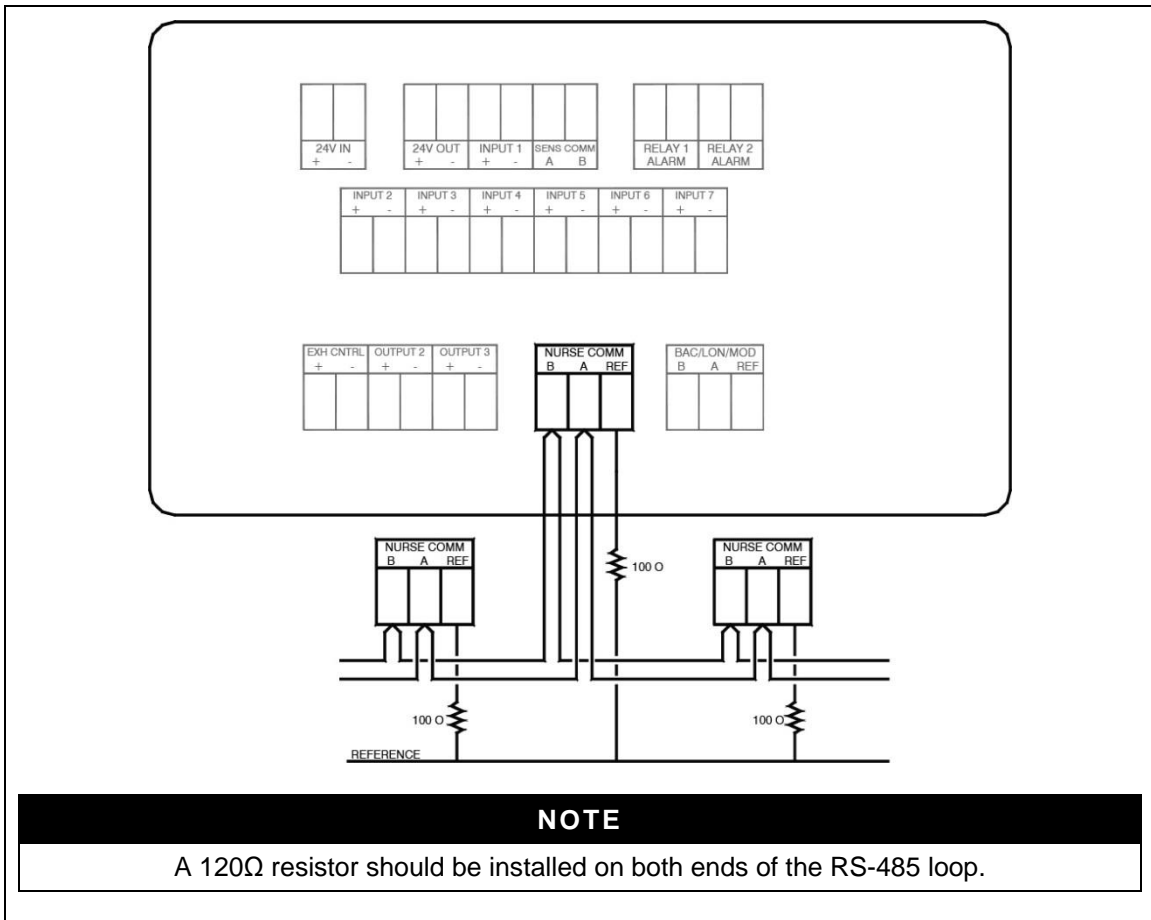
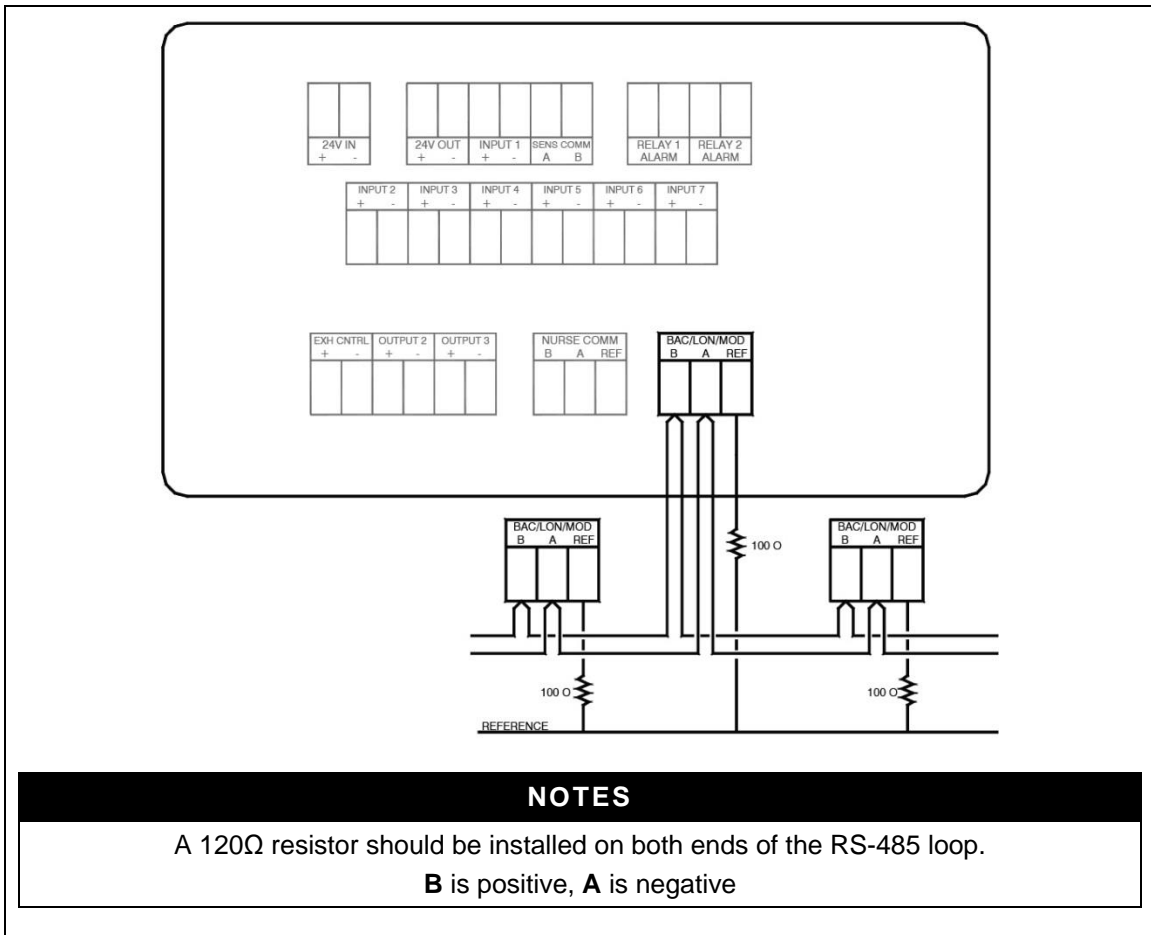

Figure 33. Optional Nurses Station Communications Wiring to Model RPM10/RPM20



NOTES

A 120Ω resistor should be installed on both ends of the RS-485 loop.
B is positive, **A** is negative

Figure 34. Optional Modbus and BACnet MS/TP Communications Wiring to Model RPM10/RPM20

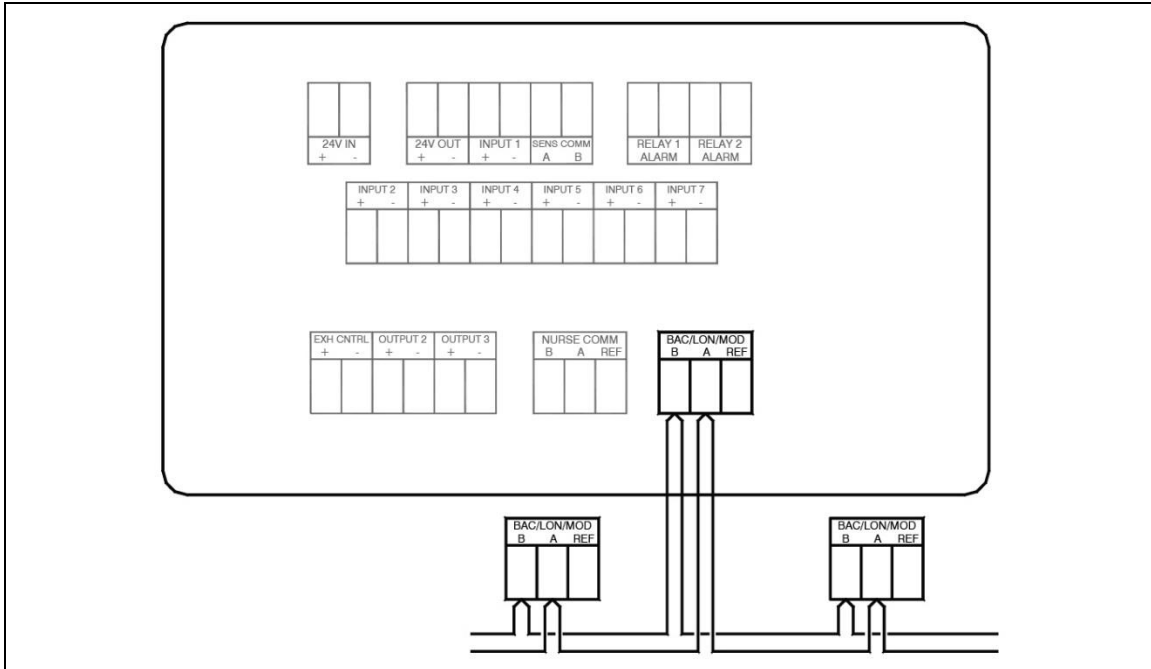

Figure 35. Optional LONworks Communications Wiring to Model RPM20-LON

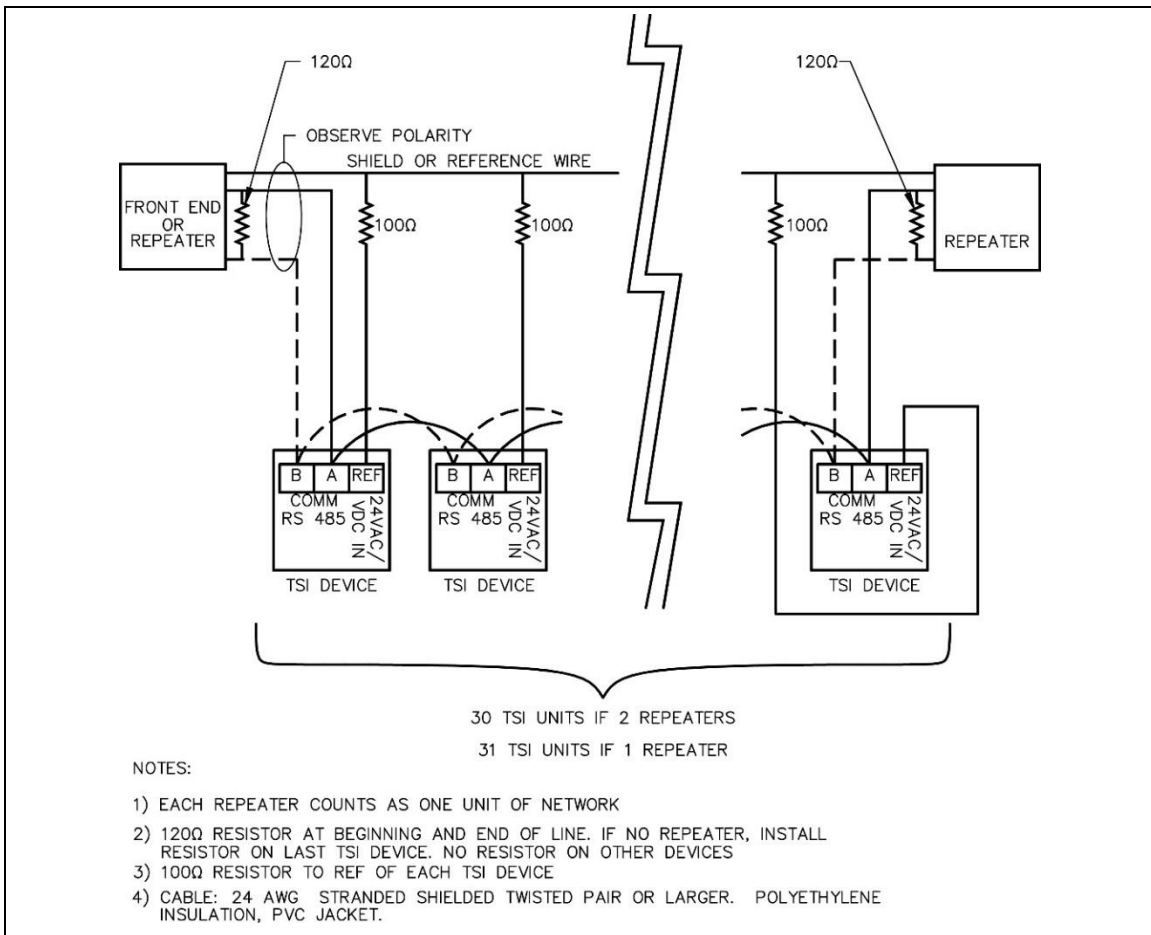

Figure 36. Proper Communication Wiring Diagram

(This page intentionally left blank)

Appendix D

Access Codes / Passcode

The Model RPM10 and RPM20 Room Monitors may prompt you to enter an access code to change the room mode or to enter the menu system. The access code screen is shown in figure below. To enter the access code, type in the 4-digit passcode shown below and press **Save**.

The PresSura room monitors and controllers feature two levels of passcode access:

- To change the **room mode**, use the passcode **0317**.
- To access the **menu** system, use the passcode **2887**.



NOTE

ROOM MODE and **MENU** passcodes may have been changed. Contact TSI to recover a lost passcode.



Figure 37. Access Code Screen

(This page intentionally left blank)



UNDERSTANDING, ACCELERATED

TSI Incorporated – Visit our website www.tsi.com for more information.

USA	Tel: +1 800 680 1220	India	Tel: +91 80 67877200
UK	Tel: +44 149 4 459200	China	Tel: +86 10 8219 7688
France	Tel: +33 1 41 19 21 99	Singapore	Tel: +65 6595 6388
Germany	Tel: +49 241 523030		

P/N 6006644 Rev. M

©2020 TSI Incorporated

Printed in U.S.A.

