

1 YEAR
WARRANTY



User's Guide



Shop online at

omega.com[®]

Ω OMEGA[®]

omega.com

e-mail: info@omega.com

*For latest product manuals:
omegamanual.info*

ISO 9001
CERTIFIED
CORPORATE QUALITY

STAMFORD, CT

ISO 9001
CERTIFIED
CORPORATE QUALITY

MANCHESTER, UK

MADE IN TAIWAN

HH376

Data Logger, RTD Thermometer



OMEGAnet® Online Service omega.com	Internet e-mail info@omega.com
---	---

Servicing North America:

U.S.A.:
ISO 9001 Certified
Omega Engineering, Inc., One Omega Drive, P.O. Box 4047
Stamford, CT 06907-0047
Toll-Free: 1-800-826-6342
FAX: (203) 359-7700
Tel: (203) 359-1660
e-mail: info@omega.com

Canada:
976 Bergar
Laval (Quebec), H7L 5A1 Canada
Toll-Free: 1-800-826-6342
FAX: (514) 856-6886
TEL: (514) 856-6928
e-mail: info@omega.ca

For immediate technical or application assistance:

U.S.A. and Canada: Sales Service: 1-800-826-6342/1-800-TC-OMEGA®
Customer Service: 1-800-622-2378/1-800-622-BEST®
Engineering Service: 1-800-872-9436/1-800-USA-WHEN®

**Mexico/
Latin America** En Español: 001 (203) 359-7803 FAX: 001 (203) 359-7807
info@omega.com.mx e-mail: espanol@omega.com

Servicing Europe:

Benelux: Managed by the United Kingdom Office
Toll-Free: 0800 099 3344 TEL: +31 20 347 21 21
FAX: +31 20 643 46 43 e-mail: sales@omegaeng.nl

Czech Republic: Frystatska 184
733 01 Karviná, Czech Republic
Toll-Free: 0800-1-66342 TEL: +420-59-6311899
FAX: +420-59-6311114 e-mail: info@omegashop.cz

France: Managed by the United Kingdom Office
Toll-Free: 0800 466 342 TEL: +33 (0) 161 37 29 00
FAX: +33 (0) 130 57 54 27 e-mail: sales@omega.fr

Germany/Austria: Daimlerstrasse 26
D-75392 Deckenpfronn, Germany
Toll-Free: 0800 6397678 TEL: +49 (0) 7056 9398-0
FAX: +49 (0) 7056 9398-29 e-mail: info@omega.de

United Kingdom: OMEGA Engineering Ltd.
ISO 9001 Certified One Omega Drive, River Bend Technology Centre, Northbank
Irlam, Manchester M44 5BD United Kingdom
Toll-Free: 0800-488-488 TEL: +44 (0) 161 777-6611
FAX: +44 (0) 161 777-6622 e-mail: sales@omega.co.uk

It is the policy of OMEGA Engineering, Inc. to comply with all worldwide safety and EMC/EMI regulations that apply. OMEGA is constantly pursuing certification of its products to the European New Approach Directives. OMEGA will add the CE mark to every appropriate device upon certification.

The information contained in this document is believed to be correct, but OMEGA accepts no liability for any errors it contains, and reserves the right to alter specifications without notice.

WARNING: These products are not designed for use in, and should not be used for, human applications.

CONTENTS

TITLE	PAGE
1. Introduction	1
2. Specifications	1
3. Symbol Definition and Button Location	2
4. Operation Instructions	3
4.1 Power-Up.....	3
4.2 Connection the Temperature Probe.....	3
4.3 Selecting the Temperature Scale.....	3
4.4 Data-Hold Operation.....	3
4.5 Back light Operation.....	3
4.6 Relative Operation.....	3
4.7 Record Operation.....	3
4.8 MAX/MIN Operation.....	3
4.9 Auto Power Off.....	4
4.10 Low Battery Condition.....	4
5. Temperature Measurement	4
6. Setting the Time	5
7. Changing the Logging Interval	5
8. Clearing Memory	5
9. Temperature Meter Calibration Setup	6
10. Communicating with a PC	7
Testlink HH376 Software.....	7
11. Power Preparation	11
12. Maintenance	11
13. Temperature Probe	11

1. INSTRUCTION

This instrument is a digital thermometer for use with platinum-type temperature sensor. Temperature indication follows IEC751 temperature table for PT-type sensor.

2. SPECIFICATIONS

Numerical Display: 5 digital liquid crystal displays

Measurement Range: -100°C ~ 400°C; -148°F ~ 752°F

Resolution: 0.01°C; 0.02°F;

Sensor types:

Platinum resistance temperature sensor for pt-100 4 wires.

ALPHA=0.00385

Environmental:

- Operating Temperature and Humidity:
0°C ~50°C (32°F ~ 122°F) ; 0 ~ 80% RH
- Storage Temperature:
-10°C to 60°C (14°F ~ 140°F); 0 ~ 80% RH
- Altitude up to 2000 meters.

Accuracy: at (23 ± 5°C)

Range	Accuracy
-100°C ~ 400°C	±(0.05% reading + 0.1°C)
-148°F ~ 752°F	±(0.05% reading + 0.2°F)

Temperature Coefficient:

For ambient temperatures from 0°C ~ 18°C and 28°C ~ 50°C, for each °C ambient below 18°C or above 28°C add the following tolerance into the accuracy spec.

0.005% of reading + 0.01°C (0.005% of reading + 0.02°F)

Note:

The basic accuracy Specification does not include the error of the probe please refer to the probe accuracy specification for additional details.

Sample Rate: 2 times per second

Dimension: 185 x 65 x 36 mm(meter only)

Weight: 360g Approx.

Power requirement:

9V Battery;

AC adapter: 9V DC(7~10V Max.)/20mA Min (Plug Diameter: 3.5mmx1.35mm)

Battery Life: Approx. 100hours

Standard Accessory:

Pt-100 Probe(class A), Instruction manual, 9V Battery, windows software, carrying case, USB cable.

Optional Accessories: AC Adaptor, HH300-Adaptor & RS232 Cable, HH300-Cable.

3. SYMBOL DEFINITION & BUTTON LOCATION

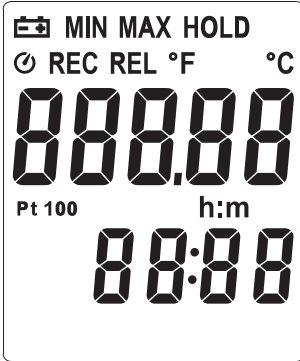

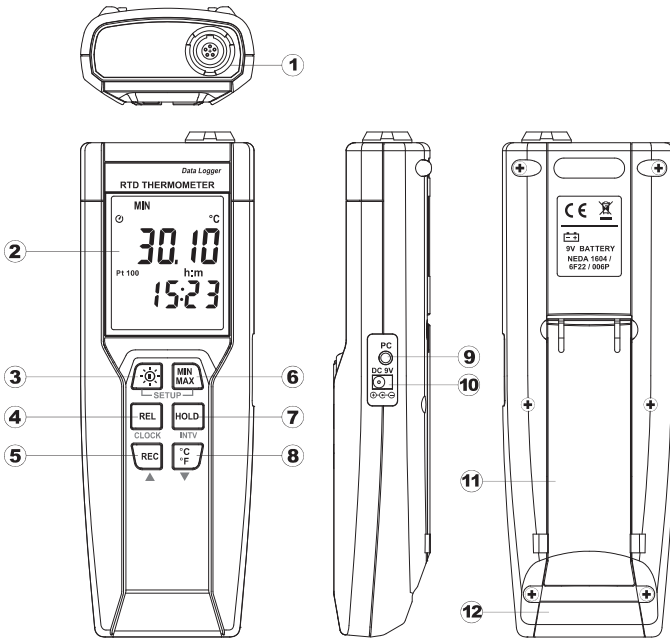

	: The Battery is not sufficient for proper operation.
MIN	: The Minimum value is now being displayed
MAX	: The Maximum value is now being displayed
HOLD	: This indicates that the display data is being hold.
	: This indicates Auto Power Off is enabled.
REC	: Readings are being logged.
REL	: The reading is now under Relative Mode.
°C °F	: Centigrade and Fahrenheit indication.
-	: This indicates that the minus temperature is sensed.
h:m	: hours; minute



- | | |
|--|------------------------------------|
| ① Pt type temperature sensor connector | ⑦ HOLD button |
| ② LCD display | ⑧ °C , °F control button |
| ③ Power ON/OFF and Back light button | ⑨ PC Interface |
| ④ Relative readout button | ⑩ External DC 9V power supply jack |
| ⑤ REC button | ⑪ Tilt stand |
| ⑥ MAX MIN control button | ⑫ Battery Compartment |

4. OPERATION INSTRUCTIONS

4.1 Power-Up

Press the “” key to turn **ON** the thermometer and Press and hold “” buttons for 3 seconds to **OFF**.

4.2 Connection the Temperature Pprobe

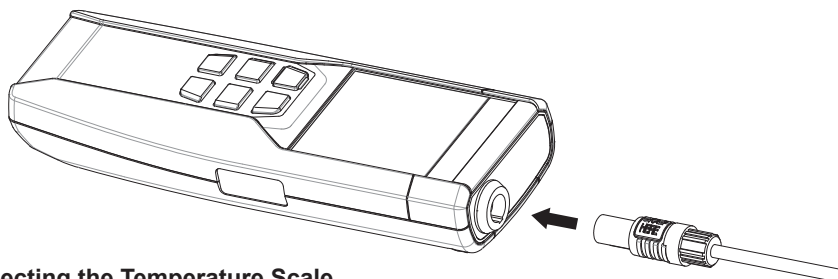

For measurement, plug the temperature probe into the input connectors.





4.3 Selecting the Temperature Scale



When the meter is first powered on, the default scale setting is set at Celsius (°C) scale. The user may change it to Fahrenheit (°F) by pressing  button and vice versa to Celsius and change the default scale.

4.4 Data-Hold Operation



The user may hold the present reading and keep it on the display by pressing the  button. When the hold data is no longer needed, one may release the data-hold operation by pressing  button again.

When the meter is under Data Hold operation, the  ,  and  button are disabled.

4.5 Back light Operation:

Press the  button will turn the back light on and Pressing it once again will it turn off. The meter will turn the back light off if there is no push  button for 30 seconds.

4.6 Relative Operation:

When one presses the  button, the meter will memorize the present reading and the difference between the new reading and the memorized data will be shown on the display. Press the  button again to exit the Relative operation.

4.7 Record Operation:

Starting and Stopping Logging Setup, memory clear, and PC communications are inaccessible during logging.

Set the logging interval. (See “Changing the Logging Interval.”)







Press  button to start logging. The display shows “REC”.

Press  button again to stop logging.

4.8 MAX/MIN Operation:

When one presses the  button the meter will enter the MAXMIN mode. Under this mode the maximum value, minimum value is kept in the memory simultaneously and updated with every new data.

When the **MAX** symbol is displayed, the Maximum reading is shown on the display.

Press  button again, then the **MIN** symbol is on the display and also the minimum reading.
 Press  button again, **MAX** and **MIN** will blink together. This means that all these data is updated in the memory and the reading is the present temperature.
 One may press  to circulate the display mode among these options.
 When the meter is under MAXMIN operation,  and  button is disabled.
 To exit the MAX/MIN mode, one may press and hold  button for two seconds.

4.9 Auto Power Off:

By default, when the meter is powered on, it is under auto power off mode. The meter will power itself off after 30 minutes if there is no key operation.
 One may press and hold  button and then power on the meter: there will be two successive beeps to indicate that the auto power off is disabled.

4.10 Low Battery Condition:

The temperature meter low battery indication shows as follows:

	Low battery. Replace the batteries.
---	-------------------------------------

5. TEMPERATURE MEASUREMENT

5.1 Correct Measurement Method:

The temperature sensor is located at the end of the metal sheath of the sheath type TEMPERATURE PROBE. To accurately test internal temperature insert the probe into the item you want to measure to a distance of at least 15 times the diameter of the sheath.

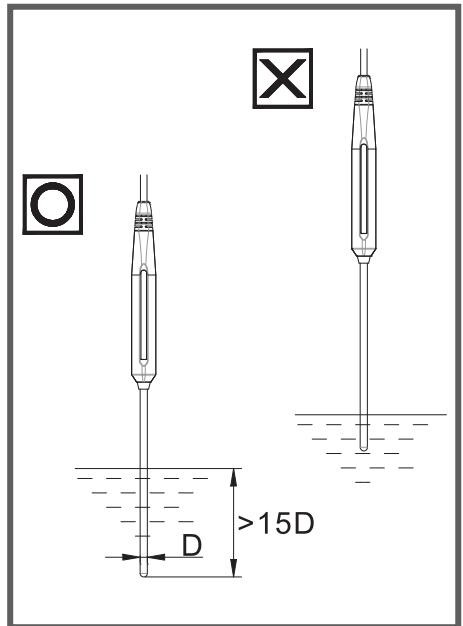

5.2 Connector Configuration:

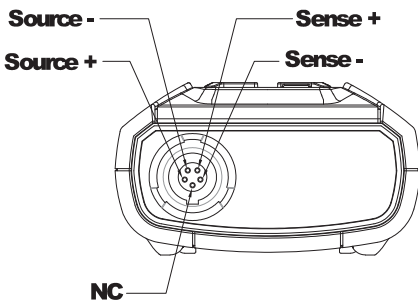

6. SETTING THE TIME

- 6.1** Press and hold $\left[\begin{smallmatrix} \text{MIN} \\ \text{MAX} \end{smallmatrix} \right]$ button and then power on the meter to enter setup mode.
- 6.2** Press $\left[\text{REL} \right]$ button to enter Time setting mode. The right two digits blink.
- 6.3** Press $\left[\text{REC} \right]$ or $\left[\begin{smallmatrix} \text{°C} \\ \text{°F} \end{smallmatrix} \right]$ button until the display shows the correct **year**, and then press $\left[\text{REL} \right]$ button to select. The left two digits blink.
- 6.4** Press $\left[\text{REC} \right]$ or $\left[\begin{smallmatrix} \text{°C} \\ \text{°F} \end{smallmatrix} \right]$ button until the display shows the correct **month**, and then press $\left[\text{REL} \right]$ button to select. The right two digits blink.
- 6.5** Press $\left[\text{REC} \right]$ or $\left[\begin{smallmatrix} \text{°C} \\ \text{°F} \end{smallmatrix} \right]$ button until the display shows the correct **day**, and then press $\left[\text{REL} \right]$ button to select. The left two digits blink.
- 6.6** Press $\left[\text{REC} \right]$ or $\left[\begin{smallmatrix} \text{°C} \\ \text{°F} \end{smallmatrix} \right]$ button until the display shows the correct **hour** (24-hour format), and then press $\left[\text{REL} \right]$ button to select. The right two digits blink.
- 6.7** Press $\left[\text{REC} \right]$ or $\left[\begin{smallmatrix} \text{°C} \\ \text{°F} \end{smallmatrix} \right]$ button until the display shows the correct **minutes**, and then press $\left[\text{REC} \right]$ button to store the time in memory.

Note:

Holding down “REC” or “°C/°F” causes the number to change more quickly.

7. CHANGING THE LOGGING INTERVAL

The logging interval determines how often the thermometer stores logged readings in memory.

- 7.1** Press and hold $\left[\begin{smallmatrix} \text{MIN} \\ \text{MAX} \end{smallmatrix} \right]$ button and then power on the meter to enter setup mode.
- 7.2** Press $\left[\text{HOLD} \right]$ button to enter Interval setting mode. The left two digits blink.
- 7.3** Press $\left[\text{REC} \right]$ or $\left[\begin{smallmatrix} \text{°C} \\ \text{°F} \end{smallmatrix} \right]$ button until the display shows the correct **hour** (24-hour format), and then press $\left[\text{REL} \right]$ button to select. The right two digits blink.
- 7.4** Press $\left[\text{REC} \right]$ or $\left[\begin{smallmatrix} \text{°C} \\ \text{°F} \end{smallmatrix} \right]$ button until the display shows the correct **minutes**, and then press $\left[\text{REL} \right]$ button to store the time in memory.

Note:

Holding down “REC” or “°C/°F” causes the number to change more quickly.

8. CLEARING MEMORY

When memory is full, **REC** appears and blinks on the display and logging stops.

You can clear memory in the next power on of the meter by entering the clear memory mode.

Press and hold $\left[\text{REC} \right]$ button and then power on the meter to enter clear memory mode to delete logged readings from memory. The display shows the number from 5 and decreases to 0.

9. TEMPERATURE METER CALIBRATION SETUP

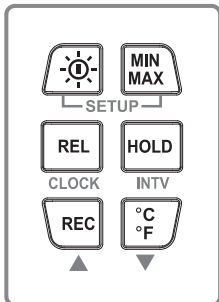

Below table diagram shows each button function when user enters into the calibration mode.

Note:

**Turn the Power “OFF” before attempting SETUP.
Setup mode is cancelled during below procedure if “POWER”
button is pressed.**

9.1 Temperature Calibration

Place the temperature probe in a known, stable temperature environment. Allow the readings to stabilize. In Setup, change the offset until the display reading matches the calibration temperature.

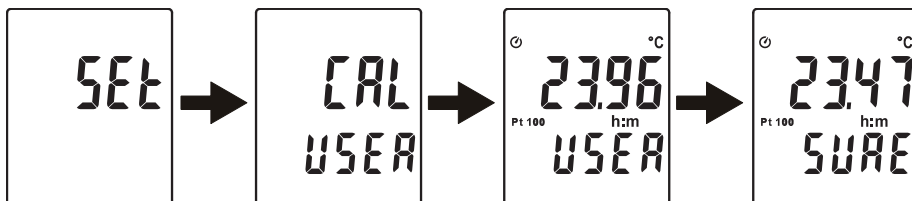

Press and hold **REL** + **HOLD** buttons and then power on the meter to enter setup mode.

Press **°C/°F** button to enter calibration mode. (in 3 seconds)

Press **HOLD** button to enter calibration mode. (in 3 seconds)

Press **REC** or **°C/°F** button to confirm present Temperature value.

Press **HOLD** button twice to confirm selection.

Note: To abort during the process, press **⊖** button to exit calibration mode.

9.2 Recall Default factory setting value

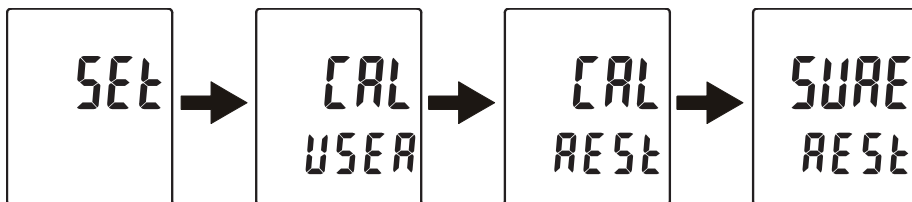

Press and hold **REL** + **HOLD** buttons and then power on the meter to enter setup mode.

Press **°C/°F** button to enter calibration mode. (in 3 seconds)

Press **MIN/MAX** button to enter recall mode. (in 3 seconds)

Press  button to confirm revert back to "Default factory setting value"

Press  button to confirm selection.

Note: To abort during the process, press  button to exit calibration mode.

10. COMMUNICATION WITH A PC

You can transfer the contents of the temperature's memory to a PC using **SE376** software. The communication requires USB or RS-232 serial connection.

TESTLINK SE-376 SOFTWARE

(1) The SE-376 package contains:

- 80mm CD
- Custom designed USB cable for HH376

(2) System Required:

Windows NT 4.0/ NT2000/ XP/ VISTA/ Windows 7

(3) Minimum Hardware Required:

- PC or NoteBook with Pentium 800MHz or higher, 128 MB RAM
- At least 50 MB hard disk space available to install SE376
- Recommended screen resolution 800X600 or above

(4) Install SE-376:

1. We recommend closing all other applications before installing SE376.
2. Insert setup CD disk to CD disk drive.
3. Choose the Start button on the Taskbar and select Run.
4. Type E:\SETUP and choose OK, the program will copy SE376.exe (executable file) and help file to your hard disk (default path is c:\program files\SE376).

(5) Main menu and buttons:

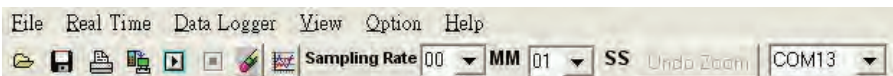

Open - Retrieve files from the disk



Save - Save the present data to the disk



Print - Send data in the present table to the printer



Pause - Stop data recording



Run - Start data recording



Output To Graph - Send tabular data to another graph



New - Reset all the data

Option - Setup dialog to set attributions of graph. (You can also double click on the graph.)

Sampling Rate - Time interval between each data to be recorded. If you want to change it, move mouse cursor to the digit you want to change and click, then input the new sampling rate. The change will be effective immediately. It will keep up to 5000 data points, when data points exceed this limit, the oldest 100 points will be replaced sequentially.

(6) Real Time Graph:

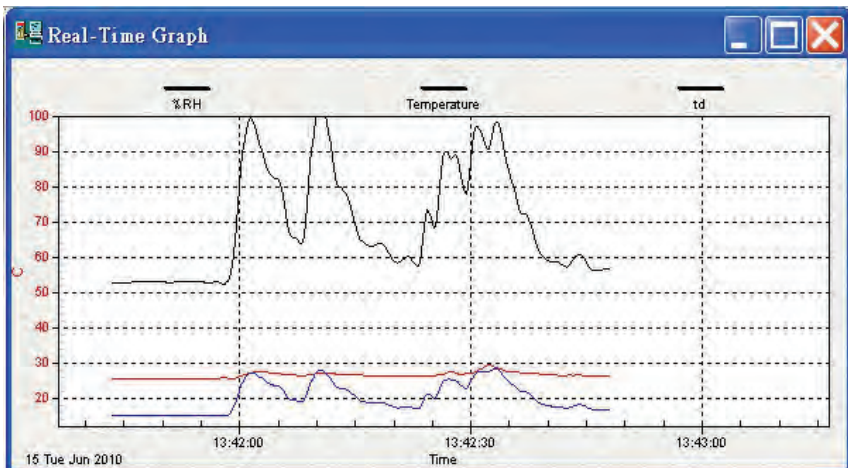

You can Zoom this graph by using mouse:

To Zoom:

1. Press and hold the Shift key
2. Press the left mouse button and drag the cursor to select the new extents
3. Release the mouse button

To Undo the Zoom:

Press the Alt+U key or click Undo Zoom button

Note: Zooming method is not allowed in Real Time Graph Window.

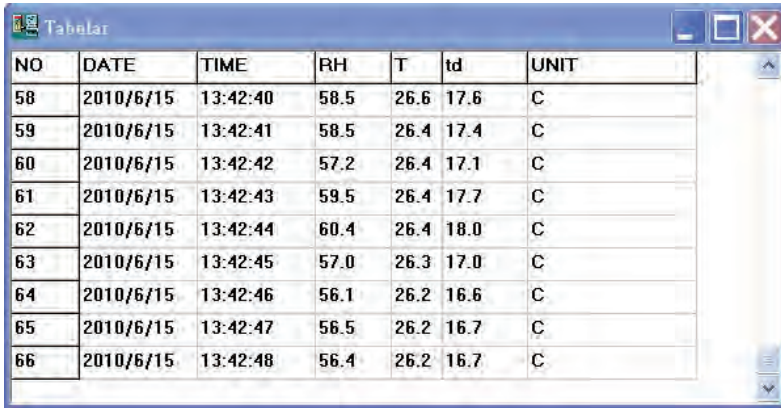
(7) Tabular:

NO	DATE	TIME	RH	T	td	UNIT
58	2010/6/15	13:42:40	58.5	26.6	17.6	C
59	2010/6/15	13:42:41	58.5	26.4	17.4	C
60	2010/6/15	13:42:42	57.2	26.4	17.1	C
61	2010/6/15	13:42:43	59.5	26.4	17.7	C
62	2010/6/15	13:42:44	60.4	26.4	18.0	C
63	2010/6/15	13:42:45	57.0	26.3	17.0	C
64	2010/6/15	13:42:46	56.1	26.2	16.6	C
65	2010/6/15	13:42:47	56.5	26.2	16.7	C
66	2010/6/15	13:42:48	56.4	26.2	16.7	C

The Tabular window can be used to record real time data in a table format. The maximum number of records that the Tabular window can keep will be dependent on availability of memory and hard disk space of the connected computer.

(8) Data Logger

When you have the thermometer connected to a computer, select "Load Data" to start loading the recorded data from the thermometer. There will be a progress indicator to show the loading progress.

If error occurs, just click "Load Data" again.

After the data has been successfully loaded to a computer, the left side window will show how many data sets were loaded and their detailed information (start date, start time, recording rate, and record numbers).

For example:



Set	DATE	TIME	Rate	Nums
1	2010/5/7	下午 07:42:18	08:33	1
2	2010/5/7	下午 07:55:39	20:59	1
3	2010/6/25	下午 01:37:57	20:59	1
4	2010/6/25	下午 01:38:01	20:59	1
5	2010/6/25	下午 01:38:03	20:59	1
6	2010/6/25	下午 01:38:05	20:59	1
7	2010/6/25	下午 01:38:07	20:59	1
8	2010/6/25	下午 01:38:14	20:59	1
9	2010/6/25	下午 01:38:17	20:59	1
10	2010/6/25	下午 01:38:30	20:59	1
11	2010/6/25	下午 01:38:32	20:59	1

SE376 will transfer the first data set to graph and tabular on the right side window once you finish loading recorded data from the thermometer. You can click on any data set to show its graph and tabular on the right side window.

You can choose a rectangle area on the graph to zoom in for detail.

The vertical dash line in the graph will match the highlight row in the tabular. When clicking on another row in the tabular, the vertical dash line will move to the corresponding position to match the time.

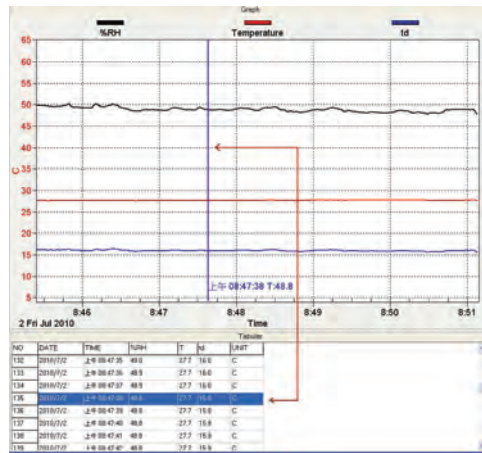

(9) Frequently Asked Question:

Q: I have connected thermometer to computer serial port and turned thermometer on, but it still shows "NO CONNECTION" ?

A: This could be caused if all serial ports are occupied by other applications. Close all applications, restart your computer, and run SE376 again.

Q: In TABULAR window, I saved a file. Can I use EXCEL to open this file?

A: If the decimal separator is comma (,) in your area, you cannot use CSV file because CSV file uses comma to separate data. This will cause confusion (for example 23,6,C,24,6,C).

However, you can use TXT files instead. It uses tab to separate the data.

(For example: 23.6 C 24.6 C) can be accepted in EXCEL.

Q: How to uninstall SE376?

A: Uninstall SE376 by launching the Add/Remove Programs applet out of the Control Panel, highlighting the SE376, and clicking on the Add/Remove... button, this will remove the SE376 folder and files from your computer.

11. POWER PREPARATION

11.1 Battery Loading

Remove the battery cover on the back and insert one 9V battery.

11.2 Battery Replacement

When the battery voltage drops below the operating voltage, Low battery indicator  will appear. Replace with 9 Volt battery immediately to ensure the unit functions properly.

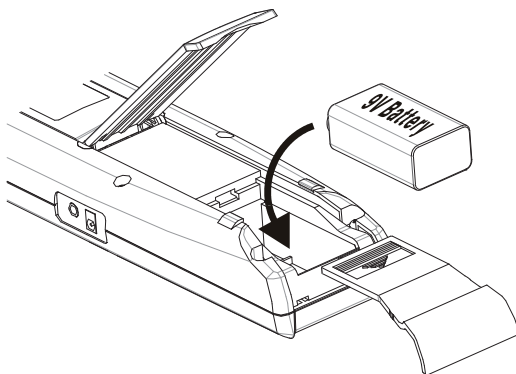

11.3 AC Adapter Connection

When the AC adapter is used, insert the plugs of the adapter into the DC9V connector on the side panel.

Note:

When the AC adapter is connected while a battery is installed, the unit will be powered from the adapter (the AC adapter has priority).

12. Maintenance

Cleaning

In order to ensure the accuracy of the thermometer for a longer period of time you should have Omega recalibrate it once a year.

Clean the device and the window of the display with a clean, lint-free, antistatic and dry cleaning cloth.

⚠ *Do not use cleaning agents that contain carbon or benzenes, alcohol or anything similar to clean the product since these substances damage the surface of the measuring instrument. Moreover, these fumes are hazardous to health and explosive. Do not use tools with sharp edges, screwdrivers, metal brushes or anything similar to clean the device.*

13. Temperature Probe

13.1 Piercing type temperature probe Model # HH376-RP.

Model HH376-RP

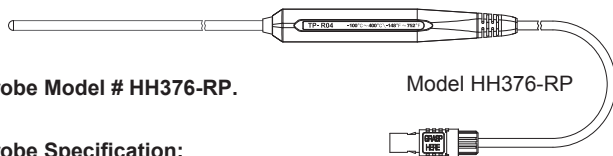

13.2 Piercing type temperature probe Specification:

Sensor Type	Platinum resistance thermometer sensor Pt 100 (4 wires)
Accuracy	IEC751, class A (t: measurement temperature)
Measurement Range	-100 to 400°C
Temperature Sensor Dimensions	Approx. Ø5.0mm (Ø0.2")
Temperature Sensor Length	Approx. 230mm (9.05")
Cable Length	Approx. 1500mm (59.0")

WARRANTY/DISCLAIMER

OMEGA ENGINEERING, INC. warrants this unit to be free of defects in materials and workmanship for a period of **13 months** from date of purchase. OMEGA's WARRANTY adds an additional one (1) month grace period to the normal **one (1) year product warranty** to cover handling and shipping time. This ensures that OMEGA's customers receive maximum coverage on each product.

If the unit malfunctions, it must be returned to the factory for evaluation. OMEGA's Customer Service Department will issue an Authorized Return (AR) number immediately upon phone or written request. Upon examination by OMEGA, if the unit is found to be defective, it will be repaired or replaced at no charge. OMEGA's WARRANTY does not apply to defects resulting from any action of the purchaser, including but not limited to mishandling, improper interfacing, operation outside of design limits, improper repair, or unauthorized modification. This WARRANTY is VOID if the unit shows evidence of having been tampered with or shows evidence of having been damaged as a result of excessive corrosion; or current, heat, moisture or vibration; improper specification; misapplication; misuse or other operating conditions outside of OMEGA's control. Components in which wear is not warranted, include but are not limited to contact points, fuses, and triacs.

OMEGA is pleased to offer suggestions on the use of its various products. However, OMEGA neither assumes responsibility for any omissions or errors nor assumes liability for any damages that result from the use of its products in accordance with information provided by OMEGA, either verbal or written. OMEGA warrants only that the parts manufactured by the company will be as specified and free of defects. OMEGA MAKES NO OTHER WARRANTIES OR REPRESENTATIONS OF ANY KIND WHATSOEVER, EXPRESSED OR IMPLIED, EXCEPT THAT OF TITLE, AND ALL IMPLIED WARRANTIES INCLUDING ANY WARRANTY OF MERCHANTABILITY AND FITNESS FOR A PARTICULAR PURPOSE ARE HEREBY DISCLAIMED. LIMITATION OF LIABILITY: The remedies of purchaser set forth herein are exclusive, and the total liability of OMEGA with respect to this order, whether based on contract, warranty, negligence, indemnification, strict liability or otherwise, shall not exceed the purchase price of the component upon which liability is based. In no event shall OMEGA be liable for consequential, incidental or special damages.

CONDITIONS: Equipment sold by OMEGA is not intended to be used, nor shall it be used: (1) as a "Basic Component" under 10 CFR 21 (NRC), used in or with any nuclear installation or activity; or (2) in medical applications or used on humans. Should any Product(s) be used in or with any nuclear installation or activity, medical application, used on humans, or misused in any way, OMEGA assumes no responsibility as set forth in our basic WARRANTY/DISCLAIMER language, and, additionally, purchaser will indemnify OMEGA and hold OMEGA harmless from any liability or damage whatsoever arising out of the use of the Product(s) in such a manner.

RETURN REQUESTS/INQUIRIES

Direct all warranty and repair requests/inquiries to the OMEGA Customer Service Department. BEFORE RETURNING ANY PRODUCT(S) TO OMEGA, PURCHASER MUST OBTAIN AN AUTHORIZED RETURN (AR) NUMBER FROM OMEGA'S CUSTOMER SERVICE DEPARTMENT (IN ORDER TO AVOID PROCESSING DELAYS). The assigned AR number should then be marked on the outside of the return package and on any correspondence.

The purchaser is responsible for shipping charges, freight, insurance and proper packaging to prevent breakage in transit.

FOR **WARRANTY** RETURNS, please have the following information available BEFORE contacting OMEGA:

1. Purchase Order number under which the product was PURCHASED,
2. Model and serial number of the product under warranty, and
3. Repair instructions and/or specific problems relative to the product.

FOR **NON-WARRANTY** REPAIRS, consult OMEGA for current repair charges. Have the following information available BEFORE contacting OMEGA:

1. Purchase Order number to cover the COST of the repair,
2. Model and serial number of the product, and
3. Repair instructions and/or specific problems relative to the product.

OMEGA's policy is to make running changes, not model changes, whenever an improvement is possible. This affords our customers the latest in technology and engineering.

OMEGA is a registered trademark of OMEGA ENGINEERING, INC.

© Copyright 2010 OMEGA ENGINEERING, INC. All rights reserved. This document may not be copied, photocopied, reproduced, translated, or reduced to any electronic medium or machine-readable form, in whole or in part, without the prior written consent of OMEGA ENGINEERING, INC.

Where Do I Find Everything I Need for Process Measurement and Control?

OMEGA...Of Course!

Shop online at omega.comSM

TEMPERATURE

- ☑ Thermocouple, RTD & Thermistor Probes, Connectors, Panels & Assemblies
- ☑ Wire: Thermocouple, RTD & Thermistor
- ☑ Calibrators & Ice Point References
- ☑ Recorders, Controllers & Process Monitors
- ☑ Infrared Pyrometers

PRESSURE, STRAIN AND FORCE

- ☑ Transducers & Strain Gages
- ☑ Load Cells & Pressure Gages
- ☑ Displacement Transducers
- ☑ Instrumentation & Accessories

FLOW/LEVEL

- ☑ Rotameters, Gas Mass Flowmeters & Flow Computers
- ☑ Air Velocity Indicators
- ☑ Turbine/Paddlewheel Systems
- ☑ Totalizers & Batch Controllers

pH/CONDUCTIVITY

- ☑ pH Electrodes, Testers & Accessories
- ☑ Benchtop/Laboratory Meters
- ☑ Controllers, Calibrators, Simulators & Pumps
- ☑ Industrial pH & Conductivity Equipment

DATA ACQUISITION

- ☑ Data Acquisition & Engineering Software
- ☑ Communications-Based Acquisition Systems
- ☑ Plug-in Cards for Apple, IBM & Compatibles
- ☑ Data Logging Systems
- ☑ Recorders, Printers & Plotters

HEATERS

- ☑ Heating Cable
- ☑ Cartridge & Strip Heaters
- ☑ Immersion & Band Heaters
- ☑ Flexible Heaters
- ☑ Laboratory Heaters

ENVIRONMENTAL

MONITORING AND CONTROL

- ☑ Metering & Control Instrumentation
- ☑ Refractometers
- ☑ Pumps & Tubing
- ☑ Air, Soil & Water Monitors
- ☑ Industrial Water & Wastewater Treatment
- ☑ pH, Conductivity & Dissolved Oxygen Instruments