



U

RX-V2065

AV Receiver

OWNER'S MANUAL

IMPORTANT SAFETY INSTRUCTIONS

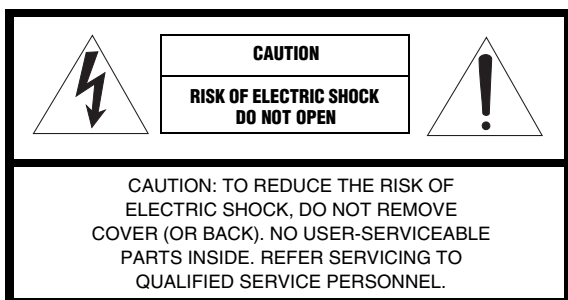

• Explanation of Graphical Symbols



The lightning flash with arrowhead symbol, within an equilateral triangle, is intended to alert you to the presence of uninsulated “dangerous voltage” within the product’s enclosure that may be of sufficient magnitude to constitute a risk of electric shock to persons.



The exclamation point within an equilateral triangle is intended to alert you to the presence of important operating and maintenance (servicing) instructions in the literature accompanying the appliance.

- 1 Read these instructions.
- 2 Keep these instructions.
- 3 Heed all warnings.
- 4 Follow all instructions.
- 5 Do not use this apparatus near water.
- 6 Clean only with dry cloth.

- 7 Do not block any ventilation openings. Install in accordance with the manufacturer’s instructions.
- 8 Do not install near any heat sources such as radiators, heat registers, stoves, or other apparatus (including amplifiers) that produce heat.
- 9 Do not defeat the safety purpose of the polarized or grounding-type plug. A polarized plug has two blades with one wider than the other. A grounding type plug has two blades and a third grounding prong. The wide blade or the third prong are provided for your safety. If the provided plug does not fit into your outlet, consult an electrician for replacement of the obsolete outlet.
- 10 Protect the power cord from being walked on or pinched particularly at plugs, convenience receptacles, and the point where they exit from the apparatus.
- 11 Only use attachments/accessories specified by the manufacturer.
- 12 Use only with the cart, stand, tripod, bracket, or table specified by the manufacturer, or sold with the apparatus. When a cart is used, use caution when moving the cart/apparatus combination to avoid injury from tip-over.
- 13 Unplug this apparatus during lightning storms or when unused for long periods of time.
- 14 Refer all servicing to qualified service personnel. Servicing is required when the apparatus has been damaged in any way, such as power-supply cord or plug is damaged, liquid has been spilled or objects have fallen into the apparatus, the apparatus has been exposed to rain or moisture, does not operate normally, or has been dropped.



FCC INFORMATION (for US customers)

1 IMPORTANT NOTICE: DO NOT MODIFY THIS UNIT!

This product, when installed as indicated in the instructions contained in this manual, meets FCC requirements. Modifications not expressly approved by Yamaha may void your authority, granted by the FCC, to use the product.

- 2 **IMPORTANT:** When connecting this product to accessories and/or another product use only high quality shielded cables. Cable/s supplied with this product **MUST** be used. Follow all installation instructions. Failure to follow instructions could void your FCC authorization to use this product in the USA.

- 3 **NOTE:** This product has been tested and found to comply with the requirements listed in FCC Regulations, Part 15 for Class “B” digital devices. Compliance with these requirements provides a reasonable level of assurance that your use of this product in a residential environment will not result in harmful interference with other electronic devices.

This equipment generates/uses radio frequencies and, if not installed and used according to the instructions found in the users manual, may cause interference harmful to the operation of other electronic devices.

Compliance with FCC regulations does not guarantee that interference will not occur in all installations. If this product is found to be the source of interference, which can be determined by turning the unit “OFF” and “ON”, please try to eliminate the problem by using one of the following measures:

Relocate either this product or the device that is being affected by the interference.

Utilize power outlets that are on different branch (circuit breaker or fuse) circuits or install AC line filter/s.

In the case of radio or TV interference, relocate/reorient the antenna. If the antenna lead-in is 300 ohm ribbon lead, change the lead-in to coaxial type cable.

If these corrective measures do not produce satisfactory results, please contact the local retailer authorized to distribute this type of product. If you can not locate the appropriate retailer, please contact Yamaha Electronics Corp., U.S.A. 6660 Orangethorpe Ave, Buena Park, CA 90620.

The above statements apply **ONLY** to those products distributed by Yamaha Corporation of America or its subsidiaries.

Caution: Read this before operating your unit.

- 1 To assure the finest performance, please read this manual carefully. Keep it in a safe place for future reference.
- 2 Install this sound system in a well ventilated, cool, dry, clean place – away from direct sunlight, heat sources, vibration, dust, moisture, and/or cold. Allow ventilation space of at least 30 cm on the top, 20 cm on the left and right, and 20 cm on the back of this unit.
- 3 Locate this unit away from other electrical appliances, motors, or transformers to avoid humming sounds.
- 4 Do not expose this unit to sudden temperature changes from cold to hot, and do not locate this unit in an environment with high humidity (i.e. a room with a humidifier) to prevent condensation inside this unit, which may cause an electrical shock, fire, damage to this unit, and/or personal injury.
- 5 Avoid installing this unit where foreign objects may fall onto this unit and/or this unit may be exposed to liquid dripping or splashing. On the top of this unit, do not place:
 - Other components, as they may cause damage and/or discoloration on the surface of this unit.
 - Burning objects (i.e. candles), as they may cause fire, damage to this unit, and/or personal injury.
 - Containers with liquid in them, as they may fall and liquid may cause electrical shock to the user and/or damage to this unit.
- 6 Do not cover this unit with a newspaper, tablecloth, curtain, etc. in order not to obstruct heat radiation. If the temperature inside this unit rises, it may cause fire, damage to this unit, and/or personal injury.
- 7 Do not plug in this unit to a wall outlet until all connections are complete.
- 8 Do not operate this unit upside-down. It may overheat, possibly causing damage.
- 9 Do not use force on switches, knobs and/or cords.
- 10 When disconnecting the power cable from the wall outlet, grasp the plug; do not pull the cable.
- 11 Do not clean this unit with chemical solvents; this might damage the finish. Use a clean, dry cloth.
- 12 Only voltage specified on this unit must be used. Using this unit with a higher voltage than specified is dangerous and may cause fire, damage to this unit, and/or personal injury. Yamaha will not be held responsible for any damage resulting from use of this unit with a voltage other than specified.
- 13 To prevent damage by lightning, keep the power cord and outdoor antennas disconnected from a wall outlet or the unit during a lightning storm.
- 14 Do not attempt to modify or fix this unit. Contact qualified Yamaha service personnel when any service is needed. The cabinet should never be opened for any reasons.
- 15 When not planning to use this unit for long periods of time (i.e. vacation), disconnect the AC power plug from the wall outlet.
- 16 Install this unit near the AC outlet and where the AC power plug can be reached easily.

- 17 Be sure to read the “Troubleshooting” section on common operating errors before concluding that this unit is faulty.
- 18 Before moving this unit, press **ⓁMAIN ZONE ON/OFF** to set this unit to the standby mode, and disconnect the AC power plug from the wall outlet in the main room.
- 19 **VOLTAGE SELECTOR** (Asia and General models only)
The **VOLTAGE SELECTOR** on the rear panel of this unit must be set for your local main voltage **BEFORE** plugging into the AC wall outlet. Voltages are:
 - AC 110/120/220/230-240 V, 50/60 Hz (General model)
 -AC 220/230-240 V, 50/60 Hz (Asia model)
- 20 The batteries shall not be exposed to excessive heat such as sunshine, fire or like.
- 21 Excessive sound pressure from earphones and headphones can cause hearing loss.

WARNING

TO REDUCE THE RISK OF FIRE OR ELECTRIC SHOCK, DO NOT EXPOSE THIS UNIT TO RAIN OR MOISTURE.

As long as this unit is connected to the AC wall outlet, it is not disconnected from the AC power source even if you turn off this unit by **ⓁMAIN ZONE ON/OFF**. In this state, this unit is designed to consume a very small quantity of power.

FOR CANADIAN CUSTOMERS

To prevent electric shock, match wide blade of plug to wide slot and fully insert.
This Class B digital apparatus complies with Canadian ICES-003.

POUR LES CONSOMMATEURS CANADIENS

Pour éviter les chocs électriques, introduire la lame la plus large de la fiche dans la borne correspondante de la prise et pousser jusqu’au fond.
Cet appareil numérique de la classe B est conforme à la norme NMB-003 du Canada.

IMPORTANT

Please record the serial number of this unit in the space below.

MODEL:

Serial No.:

The serial number is located on the rear of the unit.
Retain this Owner’s Manual in a safe place for future reference.

■ Notes on remote controls and batteries

- Do not spill water or other liquids on the remote control.
- Do not drop the remote control.
- Do not leave or store the remote control in the following conditions:
 - places of high humidity, such as near a bath
 - places of high temperatures, such as near a heater or stove
 - places of extremely low temperatures
 - dusty places
- Insert the battery according to the polarity markings (+ and -).
- Change all batteries if you notice the following conditions:
 - the operation range of the remote control narrows
 - the transmit indicator does not flash or is dim
- If the batteries run out, immediately remove them from the remote control to prevent an explosion or acid leak.
- If you find leaking batteries, discard the batteries immediately, taking care not to touch the leaked material. If the leaked material comes into contact with your skin or gets into your eyes or mouth, rinse it away immediately and consult a doctor. Clean the battery compartment thoroughly before installing new batteries.
- Do not use old batteries together with new ones. This may shorten the life of the new batteries or cause old batteries to leak.
- Do not use different types of batteries (such as alkaline and manganese batteries) together. Specification of batteries may be different even though they look the same.
- Before inserting new batteries, wipe the compartment clean.
- If the remote control is without batteries for more than 2 minutes, or if exhausted batteries remain in the remote control, the contents of the memory may be cleared. In such a case, install new batteries and set the remote control code.
- Dispose of batteries according to your regional regulations.

COMPLIANCE INFORMATION STATEMENT (DECLARATION OF CONFORMITY PROCEDURE)

Responsible Party:	Yamaha Electronics Corporation, U.S.A.	• This device complies with Part 15 of the FCC Rules.
Address:	6660 Orangethorpe Avenue Buena Park, CA 90620	• Operation is subject to the following conditions: <ul style="list-style-type: none">– This device may not cause harmful interference.– This device must accept any interference received including interference that may cause undesired operation.
Telephone:	714-522-9105	See the Troubleshooting section at the end of this manual if interference to radio reception is suspected.
Fax:	714-670-0108	
Type of Equipment:	AV Receiver	
Model Name:	RX-V2065	

We Want You Listening For A Lifetime



Yamaha and the Electronic Industries Association's Consumer Electronics Group want you to get the most out of your equipment by playing it at a safe level. One that lets the sound come through loud and clear without annoying blaring or distortion – and, most importantly, without affecting your sensitive hearing. Since hearing damage from loud sounds is often undetectable until it is too late, Yamaha and the Electronic Industries Association's Consumer Electronics Group recommend you to avoid prolonged exposure from excessive volume levels.

Contents

INTRODUCTION

Features	2
About this manual	3
Supplied accessories	3
Part names and functions	4
Front panel.....	4
Rear panel.....	5
Front panel display.....	6
Remote control.....	6
Simplified remote control.....	8
Quick start guide	9

PREPARATION

Connections	10
Placing speakers.....	10
Connecting speakers.....	11
Information on jacks and cable plugs.....	13
Connecting a TV monitor or projector.....	14
Connecting other components.....	16
Connecting a Yamaha iPod universal dock or Bluetooth™ wireless audio receiver.....	18
Connecting to the network.....	19
Connecting a USB storage device.....	19
Using the VIDEO AUX jacks.....	19
Connecting the FM and AM antennas.....	20
Connecting the power cable.....	20
Turning this unit on and off.....	20
Optimizing the speaker setting for your listening room (YPAO)	21
Using Auto Setup.....	21
When an error message is displayed during measurement.....	23
When a warning message is displayed after measurement.....	23

BASIC OPERATION

Playback	24
Basic procedure.....	24
Using the SCENE function.....	24
Selecting a source on the GUI screen.....	25
Muting audio output.....	25
Adjusting high/low frequency sounds (tone control).....	25
Enjoying pure hi-fi sound.....	25
Using your headphones.....	26
Changing information on the front panel display.....	26
Enjoying the sound field programs	27
Selecting sound field programs.....	27
Enjoying unprocessed input sources (Straight decode mode).....	30
Enjoying sound field programs without surround speakers (Virtual CINEMA DSP).....	30
Enjoy sound field programs with headphones (SILENT CINEMA™).....	30
Using CINEMA DSP 3D mode.....	30
FM/AM tuning	31
Tuning in to the desired FM/AM station (Frequency tuning).....	31
Registering FM/AM stations and tuning in (Preset tuning).....	31
Using HD Radio™ features (U.S.A. model only)	33
Selecting HD Radio™ audio programs.....	33
Using the iTunes Tagging feature.....	33
Displaying HD Radio™ information.....	34
XM® Satellite Radio tuning (U.S.A. model only)	35
Connecting XM Mini-Tuner Home Dock.....	35
Activating XM Satellite Radio.....	35
XM Satellite Radio® operations.....	36

Registering XM Satellite Radio channels.....	37
Displaying the XM Satellite Radio™ information.....	38
SIRIUS Satellite Radio™ tuning (U.S.A. model only)	39
Connecting the SiriusConnect™ tuner.....	39
Activating SIRIUS Satellite Radio™ subscription.....	39
SIRIUS Satellite Radio™ operations.....	39
Registering SIRIUS Satellite Radio™ channels.....	41
Setting the Parental Lock.....	42
Displaying the SIRIUS Satellite Radio™ information.....	43
Using iPod™	44
Controlling iPod™.....	44
Using Bluetooth™ components	46
Pairing the Bluetooth™ wireless audio receiver and your Bluetooth component.....	46
Playback of the Bluetooth™ component.....	46
Using USB storage devices	47
Playback of the USB storage device.....	47
Using PC servers	48
Windows Media Player 11 setup.....	48
Playback of PC music contents.....	48
Using the Internet Radio feature	50
Listening to Internet Radio.....	50
Using the Rhapsody® service (U.S.A. model only)	51
Account setup for Rhapsody®.....	51
Playback of Rhapsody® contents.....	51
Other functions	53
Selecting the HDMI OUT jack.....	53
Using the HDMI™ control function.....	53
Using the sleep timer.....	53

ADVANCED OPERATION

Setting the option menu for each input source (Option menu)	54
Option menu items.....	54
Selecting a video signal to be output during an audio reproduction.....	56
Operating various settings for this unit (Setup menu)	57
Basic operation of the Setup menu.....	59
Using multi-zone configuration	69
Connecting Zone2/3.....	69
Controlling Zone2/3.....	71
Controlling other components with the remote control	72
Setting remote control codes.....	72
Resetting all remote control codes.....	72
Advanced setup	73

APPENDIX

Troubleshooting	75
Glossary	88
Sound field program information	91
Information on HDMI™	92
Specifications	93
Index	94

(at the end of this manual)

Information about software	i
List of remote control codes	iii

INTRODUCTION

Features

■ Built-in 7-channel power amplifier

- Minimum RMS Output Power (20 Hz to 20 kHz, 0.08% THD, 8 Ω)
- FRONT L/R: 130 W + 130 W
- CENTER: 130 W
- SURROUND L/R: 130 W + 130 W
- SURROUND BACK L/R: 130 W + 130 W

■ Speaker/Preout outputs

- Speaker terminals (7-channel), extra speaker terminals (2-channel for presence or Zone2, 2-channel for Zone3), preout jacks (7.1-channel)

■ Input/Output terminals

Input terminals

- HDMI input x 5 (rear x 4, front V-AUX x 1)
- Audio/Visual input
 - [Audio] Digital input (coaxial) x 2, digital input (optical) x 2, analog input x 3 (rear x 2, front V-AUX x 1)
 - [Video] Component video x 2, Video x 5 (rear x 4, front V-AUX x 1)
- Audio input (analog) x 2
- Phono input (analog) x 1
- Multi-channel audio input (7.1-channel)
- DOCK terminal to connect a Yamaha iPod universal dock (such as YDS-11, sold separately) or Bluetooth wireless audio receiver (such as YBA-10, sold separately)
- USB port to connect a USB storage device
- NETWORK port to connect a PC or access the Internet Radio and Rhapsody® (U.S.A. model only) via LAN

Output terminals

- Monitor output
 - [Audio/Video] HDMI x 2
 - [Video] Component video x 1, Video x 1
- Audio/Visual output
 - [Audio] Analog x 1
 - [Video] Video x 1
- Audio output
 - Digital (optical) x 1, Analog x 1
- Zone2/3 output
 - Analog x 2

Other terminals

- Remote input x 1, Remote output x 1
- Trigger output x 2

■ Proprietary Yamaha technology for the creation of sound fields

- CINEMA DSP 3D
- Compressed Music Enhancer mode
- Virtual CINEMA DSP
- SILENT CINEMA

■ Digital audio decoders

- Dolby TrueHD, Dolby Digital Plus decoder
- DTS-HD Master Audio, DTS-HD High Resolution Audio, DTS Express
- Dolby Digital/Dolby Digital EX decoder
- DTS, DTS 96/24 decoder, DTS-ES Matrix 6.1, DTS-ES Discrete 6.1
- Dolby Pro Logic/Dolby Pro Logic II/Dolby Pro Logic IIx decoder
- DSD decoder
- DTS NEO:6 decoder
- Neural Surround decoder (U.S.A. model only)

■ Radio tuners

- HD Radio digital broadcast reception capability (U.S.A. model only)
- XM Satellite Radio tuning capability, using XM Mini-Tuner and Home Dock, sold separately (U.S.A. model only)
- SIRIUS Satellite Radio tuning capability, using SiriusConnect tuner, sold separately (U.S.A. model only)

■ HDMI™ (High-Definition Multimedia Interface)

- HDMI interface for standard, enhanced or high-definition video as well as multi-channel digital audio.
 - Automatic audio and video synchronization (lip sync) information capability
 - Deep Color video signal (30/36 bit) transmission
 - “x.v.Color” video signal transmission capability
 - High refresh rate and high resolution video signals
 - High definition digital audio format signals capability
- Analog to analog and HDMI digital video up-conversion (video ↔ component video → HDMI) capability for monitor out
- Analog video input up-scaling for HDMI digital video output 480i(576i) or 480p(576p) → 720p, 1080i or 1080p
- HDMI control function supported
- Dual HDMI output (possible to select individual or simultaneous output)

■ Automatic speaker setup features

- “YPAO” (Yamaha Parametric Room Acoustic Optimizer) for automatically optimizing speaker outputs suitable for listening environments.

■ Other features

- 192-kHz/24-bit D/A converter
- GUI (graphic user interface) menus to optimize this unit to suit individual audiovisual system
- iPod, USB and PC file browsing
- Album art display capability
- Pure Direct mode for pure hi-fi sound for all sources
- Adaptive dynamic range controlling capability
- SCENE function for changing input sources and sound field programs with one key
- Bi-amplification connection capability
- Multi-zone function (Zone2/3)
- DHCP automatic or manual network configuration
- iTunes Tagging function (U.S.A. model only)

About this manual

- Some operations can be performed by using either the keys on the front panel or the ones on the remote control. In case the key names differ between the front panel and the remote control, the key name on the remote control is given in parentheses.
- This manual is printed prior to production. Design and specifications are subject to change in part as a result of improvements, etc. In case of differences between the manual and product, the product has priority.
- For better viewing, we increase the size of characters used in example screen images in this manual. Therefore the size ratio of characters to other objects (such as icons) may be different from that of the actual display image.
- “**MAIN ZONE ON/OFF**” or “**HDMI 1**” (example) indicates the name of the parts on the front panel or the remote control. Refer to the attached sheet or “Part names and functions” (page 4) for the information about each position of the parts.
- ⓘ indicates the page describing the related information.
- ✎ indicates a tip for your operation.



Manufactured under license from Dolby Laboratories.
Dolby, Pro Logic and the double-D symbol are trademarks of Dolby Laboratories



Manufactured under license under U.S. Patent No's:
5,451,942;5,956,674;5,974,380;5,978,762;6,226,616;6,487,535 &
other U.S. and worldwide patents issued & pending. DTS is a
registered trademark and the DTS logos, Symbol, DTS-HD and DTS-
HD Master Audio are trademark of DTS, Inc. © 1996-2007 DTS, Inc.
All Rights Reserved.



Neural Surround™ name and related logos are trademarks owned
by Neural Audio Corporation.

iPod™

“iPod” is a trademark of Apple Inc., registered in the U.S. and other
countries.



Fraunhofer Institut
Integrierte Schaltungen

MPEG Layer-3 audio coding technology licensed from
Fraunhofer IIS and Thomson.



This receiver supports network connections.

Bluetooth™

Bluetooth is a registered trademark of Bluetooth SIG and is used by
Yamaha in accordance with a license agreement.



“HDMI”, the “HDMI” logo and “High-Definition Multimedia
Interface” are trademarks, or registered trademarks of HDMI
Licensing LLC.

x.v.Color

“x.v.Color” is a trademark of Sony Corporation.



“SILENT CINEMA” is a trademark of Yamaha Corporation.



SIRIUS, XM and all related marks and logos are trademarks of Sirius
XM Radio Inc. and its subsidiaries. All rights reserved. **Service not
available in Alaska and Hawaii.**

HD Radio

HD Radio™ Technology Manufactured Under License From iBiquity
Digital Corp. U.S. and Foreign Patents. HD Radio™ and the HD
Radio logo are proprietary trademarks of iBiquity Digital Corp.



Rhapsody and the Rhapsody logo are registered trademarks of
RealNetworks, Inc.

Supplied accessories

Check that you received all of the following parts.

- Remote control (page 6)
- Simplified remote control (page 8)
- Batteries (2) (AAA, R03, UM-4) (page 6)
- Power cable (page 20)
- Optimizer microphone (page 21)
- AM loop antenna (page 20)
- Indoor FM antenna (page 20)
- VIDEO AUX input cover (page 19)

Part names and functions

Front panel

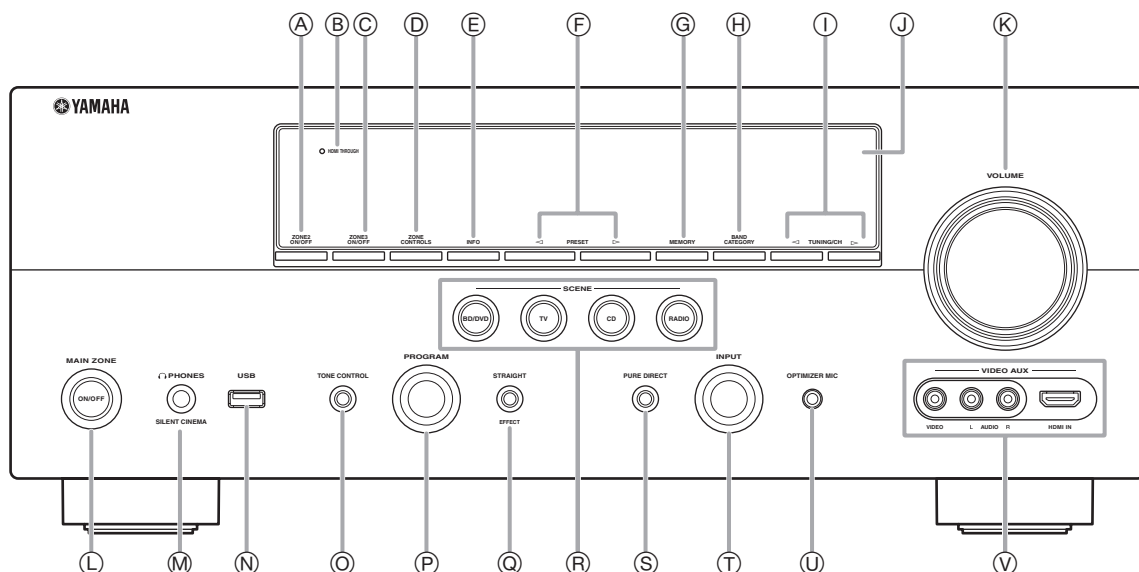

- A ZONE2 ON/OFF**
Switches Zone2 on and off (page 71).
- B HDMI THROUGH**
Lights up in the following cases while this unit is on standby.
- when the HDMI control function is on
 - when the HDMI signal standby-through function is currently working
- C ZONE3 ON/OFF**
Switches Zone3 on and off (page 71).
- D ZONE CONTROLS**
Selects a zone to control with the main amplifier operations (page 71).
- E INFO**
Changes information (input, DSP program, audio decoder, etc) displayed on the front panel display (page 26).
- F PRESET** ◀ / ▶
Selects an FM/AM preset station (page 32) or an XM/SIRIUS preset channel (pages 37 and 41).
- G MEMORY**
Registers FM/AM stations as preset stations (page 32) or XM/SIRIUS channels as preset channels (pages 37 and 41).
- H BAND (CATEGORY)**
Change the tuner bands between FM and AM.
Select a channel category for a XM/SIRIUS.
- I TUNING/CH** ◀ / ▶
Changes FM/AM frequencies or XM/SIRIUS tuner channels.
- J Front panel display**
Displays information on this unit (page 6).
- K VOLUME control**
Controls the volume of this unit (page 24).
- L MAIN ZONE ON/OFF**
Turns this unit on and off (page 20).
- M PHONES jack**
For plugging headphones (page 26).
- N USB port**
For connecting a USB memory device or USB portable audio player (page 19)
- O TONE CONTROL**
Adjusts high-frequency/low-frequency output of speakers (page 25).
- P PROGRAM selector**
Changes sound field programs (page 27).
- Q STRAIGHT**
Toggles between the selected sound field program and straight decode mode (page 30).
- R SCENE**
Switches between linked sets of input sources and sound field programs (page 24).
- S PURE DIRECT**
Changes mode to Pure Direct mode (page 25). This key lights up when Pure Direct mode is on.
- T INPUT selector**
Selects an input source (page 24).
- U OPTIMIZER MIC jack**
For connecting the supplied optimizer microphone and adjusting output characteristics of speakers (page 21).
- V VIDEO AUX jacks**
For connecting a game console, camcorder or digital camera to either the HDMI IN jack or analog AUDIO/VIDEO jacks (page 19).

Rear panel

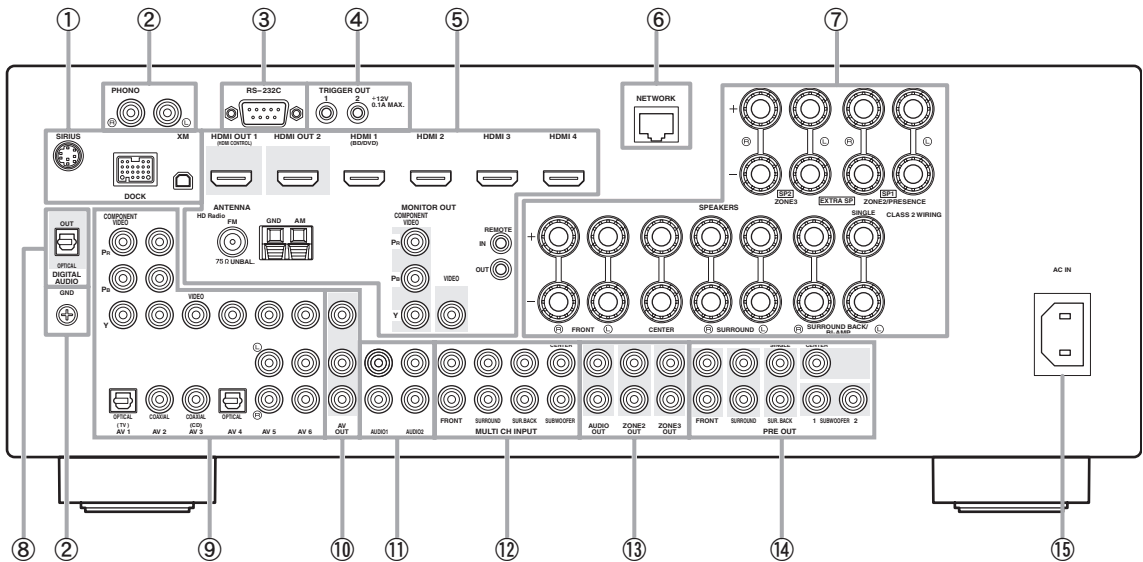

- ① **SIRIUS jack**
For connecting a SiriusConnect tuner (sold separately) (page 39).
- DOCK terminal**
For connecting an optional Yamaha iPod universal dock (YDS-11) or Bluetooth wireless audio receiver (YBA-10) (page 18).
- XM jack**
For connecting XM Mini-Tuner in XM Mini-Tuner Home Dock (sold separately) (page 35).
- ② **PHONO jacks**
For connecting a turntable (page 16).
- GND terminal**
For connecting a turntable to reduce noise in the signal (page 16).
- ③ **RS-232C terminal**
Control expansion terminal for factory use only. Consult your dealer for details.
- ④ **TRIGGER OUT 1/2 jacks**
For connecting an external terminal with a trigger input terminal to operate it linked with operation of this unit. Consult your dealer for details.
- ⑤ **HDMI OUT 1/2 jacks**
For connecting HDMI-compatible video monitors (page 14).
- HDMI 1-4 jacks**
For connecting external components for HDMI inputs 1-4 (page 16).
- ANTENNA terminals**
For connecting supplied FM and AM antennas (page 20).
- MONITOR OUT jacks**
Outputs visual signals from this unit to a video monitor, such as a TV (page 14).
- REMOTE IN/OUT jacks**
For connecting an external component that supports the remote control function (page 18).
- ⑥ **NETWORK port**
For connecting to the network (page 19).
- ⑦ **SPEAKERS terminals**
For connecting front, center, surround and surround back speakers (page 11). Connect the presence speakers (page 11) or the speakers for Zone2/3 (page 70) to EXTRA SP terminals.
- ⑧ **DIGITAL AUDIO jack**
Outputs audio signals from a selected digital audio input source to an external component (page 16).
- ⑨ **AV 1-6 jacks**
For connecting external components for audio/visual inputs 1-6 (page 16).
- ⑩ **AV OUT jacks**
Outputs audio/visual signals from a selected analog input source to an external component (page 16).
- ⑪ **AUDIO 1/2 jacks**
For connecting external components for audio inputs 1-2 (page 16).
- ⑫ **MULTI CH INPUT jacks**
For connecting a player that supports a multi-channel output (page 18).
- ⑬ **AUDIO OUT jacks**
Outputs audio signals from a selected analog input source to an external component (page 16).
- ZONE2/3 OUT jacks**
Output sound of this unit to an external amplifier set in a different zone (page 69).
- ⑭ **PRE OUT jacks**
Outputs multi-channel signals from up to 7.1 channels to an external amplifier (page 18).
- ⑮ **AC IN**
For connecting the supplied power cable (page 20).

Front panel display

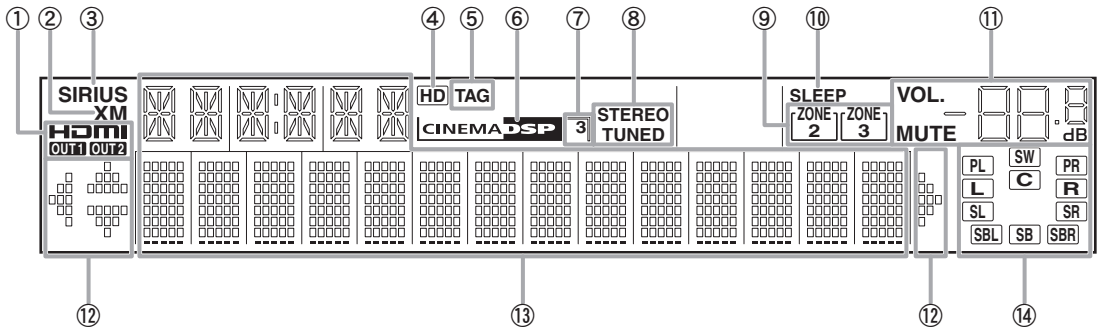

① HDMI indicator

Lights up during normal communication when HDMI is selected as an input source.

OUT 1/OUT 2 indicators

The respective indicator lights up when HDMI signals are output from the HDMI OUT 1/2 jacks.

② XM indicator

Lights up when an XM tuner is selected as an input source.

③ SIRIUS indicator

Lights up when a SiriusConnect tuner is selected as an input source.

④ HD indicator

Lights up when this unit is tuned into the HD Radio reception band (page 33).

⑤ TAG indicator

Lights up when the selected HR Radio program (or song being played) supports the iTunes Tagging feature (page 33).

⑥ CINEMA DSP indicator

Lights up when a sound field program that uses CINEMA DSP is selected.

⑦ CINEMA DSP 3D indicator

Lights up when CINEMA DSP 3D is activated.

⑧ Tuner indicator

Lights up during receiving radio broadcast signals from an FM/AM station (page 31).

⑨ ZONE2/ZONE3 indicator

Lights up when Zone2 or Zone3 is turned on.

⑩ SLEEP indicator

Lights up when the sleep timer is activated (page 53).

⑪ MUTE indicator

Flashes when audio is muted.

VOLUME indicator

Displays volume levels.

⑫ Cursor indicators

Light up if corresponding cursors on the remote control are available for operations.

⑬ Multi information display

Displays menu items and settings for the current operation.

⑭ Speaker indicators

Indicate speaker terminals from which signals are currently output.

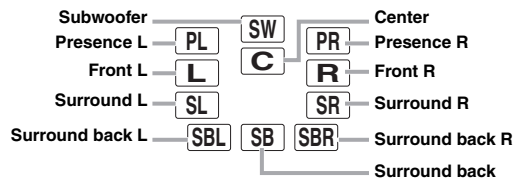

Remote control

Note

• Before installing batteries or using the remote control, make sure that you read “Notes on remote controls and batteries” in the “Caution” section.

■ Installing batteries

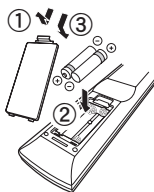

- ① Take off the battery compartment cover.
- ② Insert the two supplied batteries (AAA, R03, UM-4) according to the polarity markings (+ and -) on the inside of the battery compartment.
- ③ Snap the battery compartment cover back into the place.

■ Operation range

The remote control transmits a directional infrared ray. Be sure to aim the remote control directly at the remote control sensor on this unit during operation.

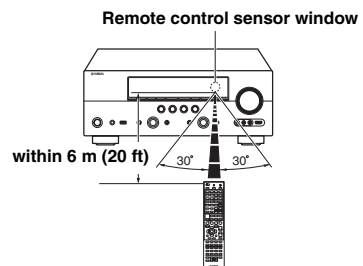

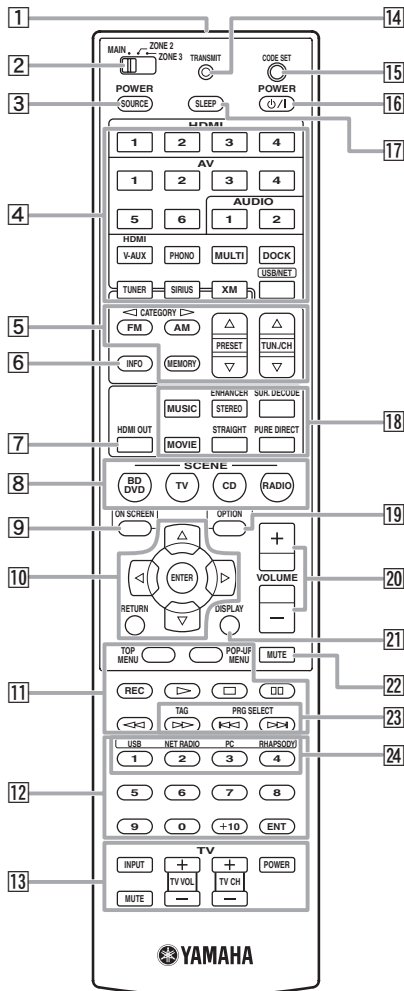

- 1 Remote control signal transmitter**
Transmits infrared signals.
- 2 Zone selection switch**
Switches amplifiers (main, Zone2 or Zone3) to be operated by the remote control (page 71).
- 3 SOURCE POWER**
Switches an external component on and off.
- 4 Input selection keys**
HDMI 1-4 Selects HDMI inputs 1 through 4.
AV 1-6 Selects AV inputs 1 through 6.
AUDIO 1/2 Selects AUDIO inputs 1 and 2.
V-AUX Selects a signal input from the VIDEO AUX jacks.
PHONO Selects a signal input from the PHONO jacks.
MULTI Selects a signal input from the MULTI CH INPUT jacks.
DOCK Selects a Yamaha iPod universal dock/Bluetooth wireless audio receiver connected to the DOCK terminal.
TUNER Selects the FM/AM tuner.
SIRIUS Selects a SiriusConnect tuner as an input source.
XM Selects an XM tuner as an input source.
USB/NET Selects a USB device or a signal input via network (selected by **24 Sub-input selection keys**).

- 5 Tuner keys**
FM/AM (CATEGORY </>) Switches a band between FM and AM. Select a channel category for XM/SIRIUS.
MEMORY PRESET Δ / ∇ Presets radio stations. Selects a preset station.
TUN./CH Δ / ∇ Changes FM/AM frequencies or XM/SIRIUS tuner channels.
- 6 INFO**
Changes the information shown on the front panel display (page 26).
- 7 HDMI OUT**
Switches the HDMI OUT jacks to output HDMI signals (page 53).
- 8 SCENE**
Switches between linked sets of input sources and sound field programs (page 24).
- 9 ON SCREEN**
Displays the GUI screen (page 25).
- 10 Cursors $\Delta / \nabla / < / >$** Select menu items or change settings.
- ENTER RETURN**
Confirms a selected item. Returns to the previous screen or ends the menu display.
- 11 External component operation keys**
Operate recording, playback etc. of external components (page 72).
- 12 Numeric keys**
Enter numbers.
- 13 TV control keys**
Enables operations of a TV or a projector (page 72).
- 14 TRANSMIT**
Lights up when a signal is output from the remote control.
- 15 CODE SET**
Sets remote control codes for external component operations (page 72).
- 16 POWER**
Switches this unit on and standby (page 20).
- 17 SLEEP**
Switches the sleep timer operations (page 53).
- 18 Sound selection keys**
Selects sound field programs (page 27).
- 19 OPTION**
Displays the Option menu (page 54).
- 20 VOLUME +/-**
Adjust the volume of this unit (page 24).
- 21 DISPLAY**
Displays the play information on the video monitor. When an iPod is connected: Changes the operation mode of the iPod connected to the Yamaha iPod universal dock (page 44).
- 22 MUTE**
Turns the mute function on and off (page 25).
- 23 HD Radio keys**
TAG Stores "tag" data to the iPod or internal memory of this unit (page 33).
PRG SELECT Selects an HD Radio audio program (page 33).
- 24 Sub-input selection keys**
Selects USB, NET RADIO, PC or Rhapsody when "USB/NET" is selected as the input source.

Simplified remote control

Use the supplied simplified remote control to make basic controls of this unit. Keys on the simplified remote control function as well as the identical keys on the main remote control (page 6).

Note

- Before using the simplified remote control or replacing the battery, make sure that you read “Notes on remote controls and batteries” in the “Caution” section.

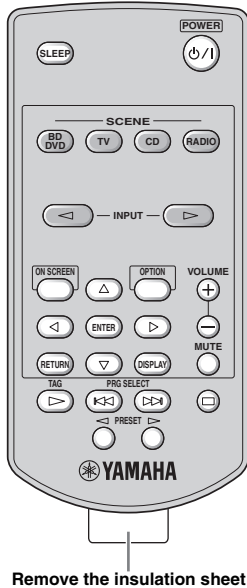

Remove the insulation sheet

■ Replacing the battery of the simplified remote control

Change the battery when the operation range of the simplified remote control decreases.

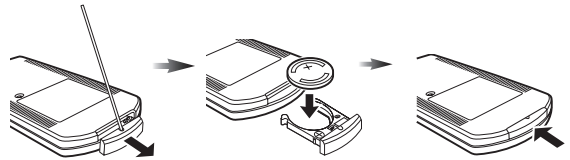

Use a straight pin to remove the cover.

Replace the battery with a new CR2025 battery.

Close the cover.



- To select an input source, press INPUT ◀/▶ repeatedly.
- The printings “TAG” and “PRG SELECT” are for U.S.A. model.

■ Setting the controlling zone

Follow the procedure below to select an amplifier (main, Zone2 or Zone3) to be operated by the simplified remote control (page 71).

Zone to select	Procedure
Main	Press and hold ▷ (right of ENTER) and BD/DVD for more than 3 seconds.
Zone2	Press and hold ▷ (right of ENTER) and TV for more than 3 seconds.
Zone3	Press and hold ▷ (right of ENTER) and CD for more than 3 seconds.

■ Setting the remote control ID

Follow the procedure below to set the remote control ID of the simplified remote control. For details about remote control ID, see page 74.

Zone to select	Procedure
ID1	Press and hold ◀ (left of ENTER) and BD/DVD for more than 3 seconds.
ID2	Press and hold ◀ (left of ENTER) and TV for more than 3 seconds.

Quick start guide

When you use this product for the first time, perform setup following the steps below. See the related pages for details on operations and settings.

Step 1: Prepare items for setup

Prepare speakers, DVD player, cables, and other items necessary for setup.

For example, prepare the following items for setting up a 7.1-channel sound system.

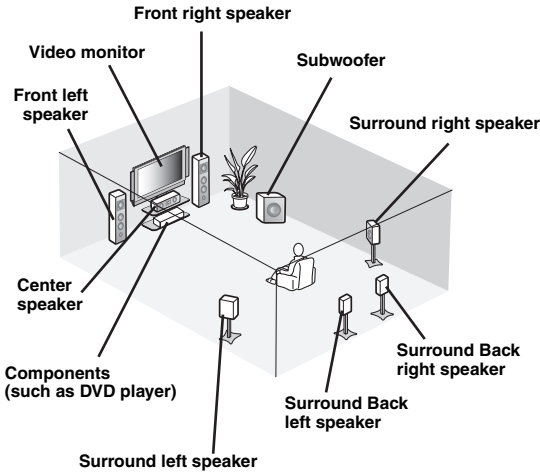

Requirements		qty.
Speakers	Front speaker	2
	Center speaker	1
	Surround speaker	2
	Surround back speaker	2
Active subwoofer		1
Speaker cable		7
Subwoofer cable		1
Reproduction component such as DVD player		1
Video monitor such as TV		1
Video cable or HDMI cable		2
Audio cable		2

- The priority of the requirement of other speakers is as follows:
 - 1 Two surround speakers
 - 2 One center speaker
 - 3 One (or two) surround back speaker(s)
- Video and audio cables are unnecessary if you use HDMI cables.

Step 2: Set up your speakers

Place your speakers in the room and connect them to this unit.

- Placing speakers ☞ P. 10
- Connecting speakers ☞ P. 11



- This unit has a YPAO (Yamaha Parametric Room Acoustic Optimizer) that automatically optimizes this unit based on room acoustic characteristics (audio characteristics of the speakers, speaker positions, and room acoustics, etc.). You can enjoy good balanced sound without special knowledge by using the YPAO technology (☞ P. 21).

Step 3: Connect your components

Connect your TV, DVD player, or other components.

- Connecting a TV monitor or projector ☞ P. 14
- Connecting other components ☞ P. 16
- Connecting a multi-format player or an external decoder ☞ P. 18
- Connecting an external amplifier ☞ P. 18
- Connecting a USB storage device ☞ P. 19
- Connecting a Yamaha iPod universal dock or Bluetooth wireless audio receiver ☞ P. 18
- Connecting to the network ☞ P. 19
- Connecting the FM and AM antennas ☞ P. 20
- Connecting an XM Mini-Tuner Home Dock ☞ P. 35
- Connecting a SiriusConnect tuner ☞ P. 39

Step 4: Turn on the power

Connect the power cable and turn on this unit.

- Connecting the power cable ☞ P. 20
- Turning this unit on and off ☞ P. 20

Step 5: Select the input source and start playback

Select the component connected in step 3 as an input source and start playback.

- Basic procedure ☞ P. 24
- Selecting sound field programs ☞ P. 27



- This unit supports the SCENE function (page 24) that changes the input source and sound field program at one time. Four scenes are preset for different purposes for Blu-ray disc, DVD and CD, and you can select from a scene from those just by pressing a remote control key.

PREPARATION

Connections

Placing speakers

This unit supports up to 7.1-channel surround. We recommend the following speaker layout in order to obtain the optimum surround effect.

7.1-channel speaker layout

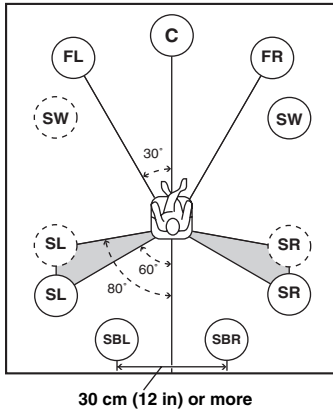

6.1-channel speaker layout

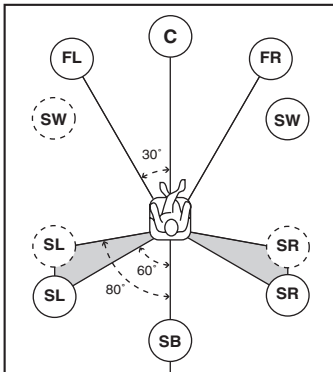

5.1-channel speaker layout

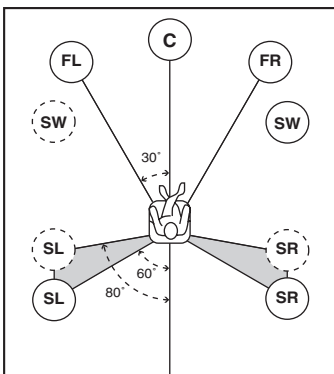

Speaker channels

■ Front left and right speakers (FL and FR)

The front speakers are used for the front channel sounds (stereo sound) and effect sounds. Place these speakers at an equal distance from the ideal listening position. Adjust the height of the TV or screen so that about 1/4 of the screen from the bottom is aligned with the tweeters of the front speakers.

■ Center speaker (C)

The center speaker is for the center channel sounds (dialog, vocals, etc.). Place it halfway between the left and right speakers. When using a TV, place the speaker just above or just under the center of the TV with the front surfaces of the TV and the speaker aligned. When using a screen, place it just under the center of the screen.

■ Surround left and right speakers (SL and SR)

The surround speakers are used for effect and surround sounds. Place them at the rear left and rear right facing the listening position. To obtain a natural sound flow in the 5.1-channel speaker layout, place them slightly further back than in the 7.1-channel speaker layout.

■ Surround back left and right speakers (SBL and SBR) / Surround back speaker (SB)

The surround back left and right speakers are used for rear effect sounds. Place them at the rear of the room facing the listening position at least 30 cm (1 ft) away from each other, ideally at the same distance as that between the front left and right speakers.

In the 6.1-channel speaker layout, surround back left and right channel sound signals are mixed down and output from the single surround back speaker.

In the 5.1-channel speaker layout, surround back left and right channel sound signals are output from the surround left and right speakers.

■ Subwoofer (SW)

The subwoofer speaker is used for bass sounds and low-frequency effect (LFE) sounds included in Dolby Digital and DTS signals. Use a subwoofer with a built-in amplifier, such as the Yamaha Active Servo Processing Subwoofer System. Place it exterior to the front left and right speakers facing slightly inward to reduce reflections from a wall.

■ Presence left and right speakers (PL and PR)

The presence speakers supplement the sound from the front speakers with extra ambient effects produced by the sound field programs (page 27). We recommend that you use the presence speakers especially for the CINEMA DSP sound field programs. To use the presence speakers, connect the speakers to SP1 terminals and then set “Extra Speaker Assignment” to “Presence” (page 60).

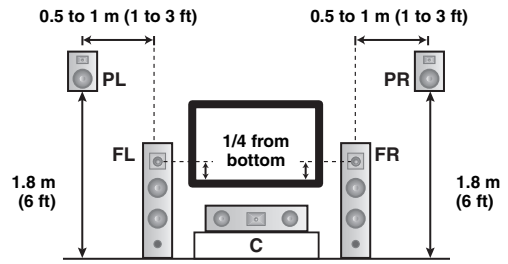

Connecting speakers

Connect your speakers to the respective terminals according to your speaker layout. The following illustration shows how to connect speakers for 7.1-channel speaker layout.



- You can connect Zone2/3 speakers to the EXTRA SP (SP1/SP2) terminals (page 70).
- You can connect up to two subwoofers. When two subwoofers are connected, the same sound is output from them.

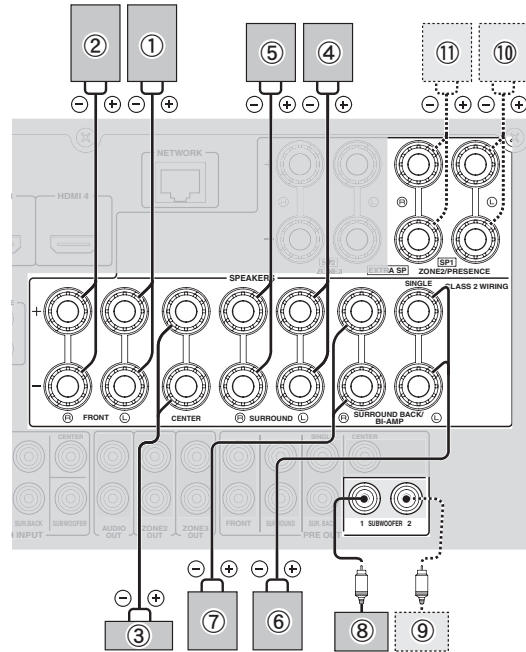
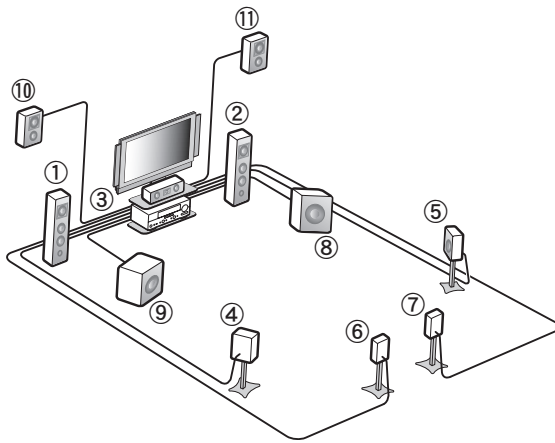

Speakers	Jacks on this unit	7.1-channel	6.1-channel	5.1-channel
① Front left	FRONT (L)	✓	✓	✓
② Front right	FRONT (R)	✓	✓	✓
③ Center	CENTER	✓	✓	✓
④ Surround left	SURROUND (L)	✓	✓	✓
⑤ Surround right	SURROUND (R)	✓	✓	✓
⑥ Surround back left (Surround back for 6.1-channel)	SURROUND BACK (L) (SINGLE)	✓	✓	
⑦ Surround back right	SURROUND BACK (R)	✓		
⑧ Subwoofer 1	SUBWOOFER 1	✓	✓	✓
⑨ Subwoofer 2	SUBWOOFER 2	Option	Option	Option
⑩ Presence left	SP1 (L)	Option	Option	Option
⑪ Presence right	SP1 (R)	Option	Option	Option

Caution

- A speaker cable is a pair of insulated cables running side by side in general. One of the cables is colored differently or striped to indicate a polarity. Connect one end of the colored/striped cable to the “+” (red) terminal of this unit and the other end to that of your speaker, and connect one end of the other cable to the “-” (black) terminal of this unit and the other end to that of your speaker.
- Before connecting the speakers, be sure to disconnect the power cable.
- Do not let the bare speaker wires touch each other or any metal part of this unit. This could damage this unit and/or speakers. If the circuit shorts out, “CHECK SP WIRES!” appears on the front panel display when this unit is turned on.
- If images on the monitor (CRT) are distorted, place the speakers away from the video monitor.
- Use speakers with an impedance of 6-ohm or larger. Set speaker impedance in the advanced setup menu before connecting the speakers (page 73). You can also use 4-ohm speakers as the front speakers when you set “SP IMP.” to “6ΩMIN”.

■ **Connecting speaker cables**

- 1 Remove approximately 10 mm (0.4 in) of insulation from the end of each speaker cable and then twist bare wires of the cable together so that they will not cause a short circuits.**

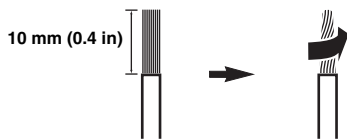

- 2 Loosen the knob, insert the twisted bare wires into the hole and then tighten the knob.**

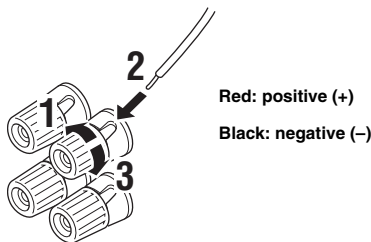

Connecting the banana plug (Except Korea, U.K., Europe, Russia and Asia models)

Tighten the knob and then insert the banana plug into the end of the terminal.

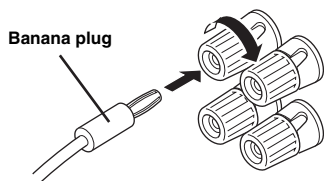

■ **Using bi-amplification connections**

If you do not connect surround back speakers, you can use the SURROUND BACK/BI-AMP jacks to make bi-amplification connections to one speaker system which supports bi-amplification connection as shown below. To activate the connections, set “BI-AMP” to “ON” in the advanced setup menu (page 73).

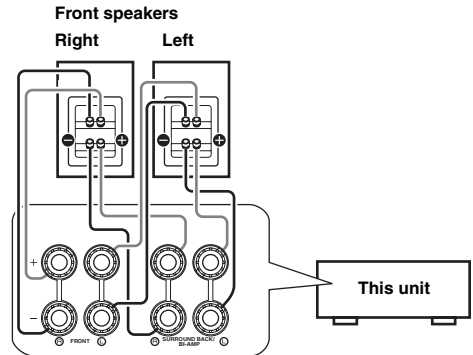

Caution

Before making bi-amplification connections, remove any brackets or cables that connect a woofer with a tweeter. Refer to the instruction manuals of speakers for details.

When not making bi-amplification connections, make sure that the brackets or cables are connected before connecting the speaker cables.

Note

- You cannot use surround back speakers or extra speakers (presence and Zone2 speakers) when bi-amplification connections are made.

Information on jacks and cable plugs

This unit has the following input and output jacks. Use jacks and cables appropriate for components that you are connecting.

Audio jacks

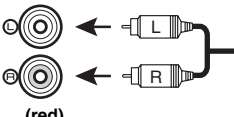
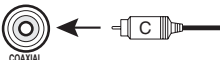
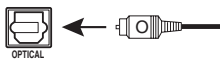
Jack and cables	Description
Analog audio jacks (white)  (red)	To transmit conventional analog stereo audio signals. Use stereo pin cables.
COAXIAL jacks (orange)  COAXIAL	To transmit coaxial digital audio signals. Use pin cables.
OPTICAL jacks  OPTICAL	To transmit optical digital audio signals. Use optical fiber cables.

Video jacks

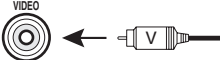
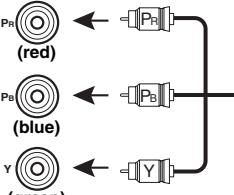
Jack and cables	Description
VIDEO jacks  (yellow)	To transmit conventional composite video signals. Use pin cables.
COMPONENT VIDEO jacks COMPONENT VIDEO  (red) (blue) (green)	To transmit component video signals that include luminance (Y), chrominance blue (PB) and chrominance red (PR) components. Use component video cables.

Video/audio jacks

Jack and cables	Description
HDMI jacks  HDMI	To transmit digital video and digital audio signals. Use HDMI cables.



- We recommend that you use a commercially available 19-pin HDMI cable no longer than 5 meters (16 feet) with the HDMI logo printed on it.
- Use a conversion cable (HDMI jack ↔ DVI-D jack) to connect this unit to other DVI components.
- You can check the potential problem about the HDMI connection (page 55).

Connecting a TV monitor or projector

According to the types of video input jacks available on your video monitor (such as a TV or projector), choose one of the connection methods as shown below. When you connect video players such as a DVD player to this unit with an HDMI connection, connect your video monitor to this unit with an HDMI connection.

Note

- Make sure that this unit and other components are unplugged from the AC wall outlets.

■ If your video monitor has an HDMI input jack

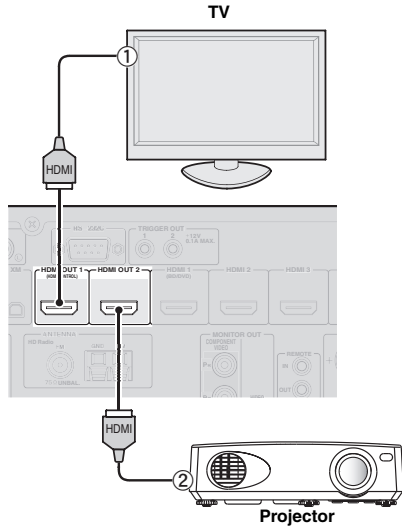

Jacks on components	Jacks on this unit
① HDMI input	HDMI OUT 1
② HDMI input	HDMI OUT 2



- This unit is equipped with two HDMI OUT jacks. You can select the active HDMI OUT jack(s) by pressing **[Z] HDMI OUT** (page 53).
- This unit supports the HDMI control function (page 53). If your TV supports the HDMI control function, connect the TV to the HDMI OUT 1 jack to control this unit with the remote control of your TV.

■ If your video monitor does not have HDMI input jacks but component video input jacks

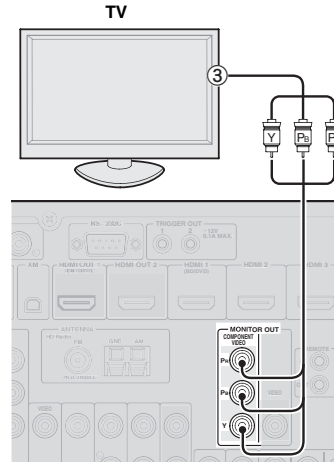

Jacks on components	Jacks on this unit
③ Component video output	MONITOR OUT (COMPONENT VIDEO)

■ If your video monitor has neither HDMI nor component video input jacks

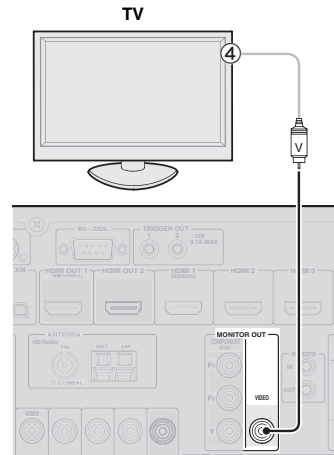

Jacks on components	Jacks on this unit
④ Video input (composite)	MONITOR OUT (VIDEO)

Outputting TV sounds from this unit

To output sound of a TV from this unit, make connection between one of the AV 1-6 jacks of this unit and an audio output jack of the TV.

If the TV supports an optical digital output, we recommend that you use the AV 1 jack. Connecting to the AV 1 jack allows you to switch an input source to the AV 1 jack with a just a single key operation using the SCENE function (page 24).

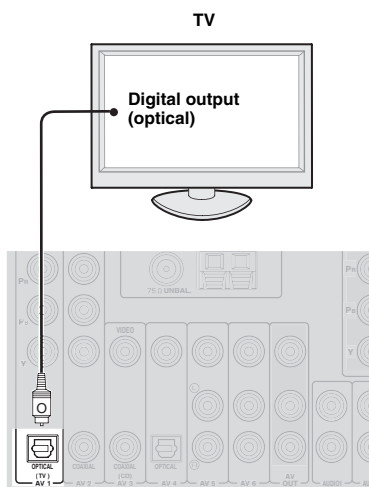

Connecting other components

This unit has input and output terminals for respective input and output sources. You can reproduce sound and movies from input sources selected with the front panel display or remote control.

Note

- Make sure that this unit and other components are unplugged from the AC wall outlets.

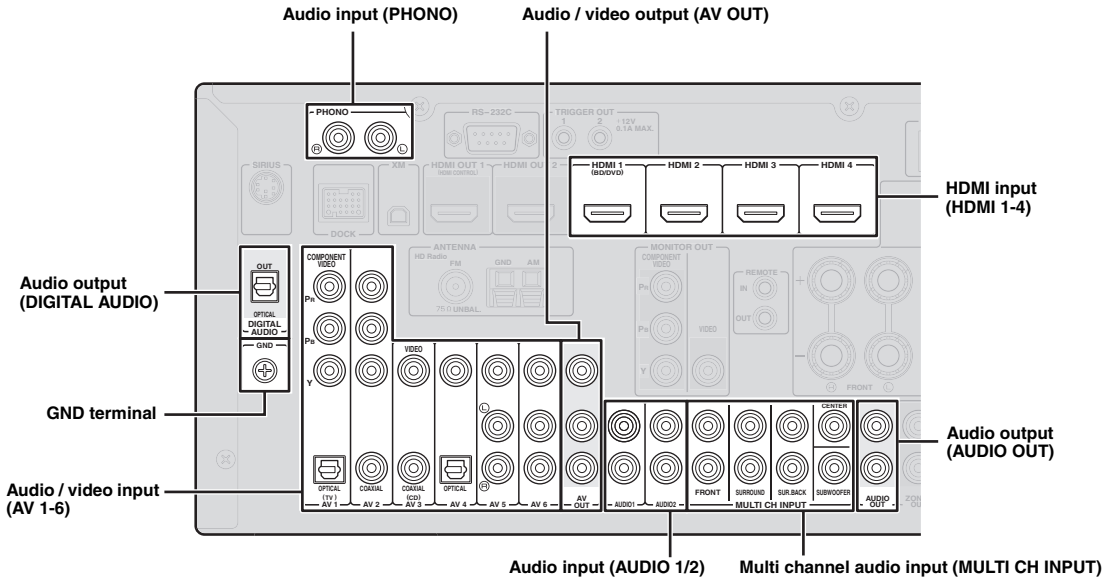

■ Audio and video player / Set-top box

External component	Signal	Output jacks on components	Input jacks on this unit	
External component with HDMI output	Audio/Video	HDMI output	HDMI 1 (BD/DVD)	
			HDMI 2	
			HDMI 3	
			HDMI 4	
External component with component video output	Audio	Optical digital output	AV 1 (TV)	OPTICAL
		Component video output		COMPONENT VIDEO
	Video	Coaxial digital output	AV 2	COAXIAL
		Component video output		COMPONENT VIDEO
External component with composite video output	Audio	Coaxial digital output	AV 3 (CD)	COAXIAL
		Composite output		VIDEO
	Video	Optical digital output	AV 4	OPTICAL
		Composite output		VIDEO
	Audio	Analog audio output	AV 5	Analog audio
		Composite output		VIDEO
Video	Analog audio output	AV 6	Analog audio	
	Composite output		VIDEO	



- Input jacks in parentheses indicate the jacks to which the SCENE function (page 24) is assigned by the initial factory settings. To use the SCENE function with the initial factory settings, connect external components that support the SCENE function to these jacks.
- You can change the name of the input source displayed on the front panel display as necessary (page 64).
- See page 69 on how to use the ZONE2/3 OUT jacks.
- When you connect an external component with analog audio and component video (or composite) output jacks, connect the analog audio output to the AUDIO 1 or AUDIO 2 jacks of this unit while making a video connection (component video or composite). Then select the video to be output when “AUDIO 1” or “AUDIO 2” is selected as the input source (page 56).

■ Audio player

External component	Output jacks on components	Input jacks on this unit	
External component with optical digital output	Optical digital output	AV 1 (TV)	OPTICAL
		AV 4	OPTICAL
External component with coaxial digital output	Coaxial digital output	AV 2	COAXIAL
		AV 3 (CD)	COAXIAL
External component with analog audio output	Analog audio output	AV 5	Analog audio
		AV 6	Analog audio
		AUDIO 1	Analog audio
		AUDIO 2	Analog audio
Turntable	Analog audio output	PHONO	Analog audio



- If your CD player has a coaxial digital output jack, connect it to the AV3 jack of this unit. In this case, you can use the SCENE function (page 24) with the initial factory settings.
- When connecting a turntable with a low-output MC cartridge to the PHONO jacks, use an in-line boosting transformer or MC-head amplifier.
- Connect your turntable to the GND terminal of this unit to reduce noise in the signal.

About audio/video output jacks

When using the AV OUT jacks: connect these jacks to composite video and analog audio input jacks of an external component.

When using the AUDIO OUT jacks: connect these jacks to analog audio input jacks of an external component.

When using the DIGITAL AUDIO (OPTICAL OUT) jack: connect this jack to optical digital input jack of an external component.

■ Internal signal flow

Video signal flow

This unit automatically converts input video signals and outputs the signals to the HDMI OUT jacks and MONITOR OUT (COMPONENT VIDEO and VIDEO) jacks (video conversion).

Note

- The AV OUT (composite video) jack only outputs video signals input to the composite video input jacks.

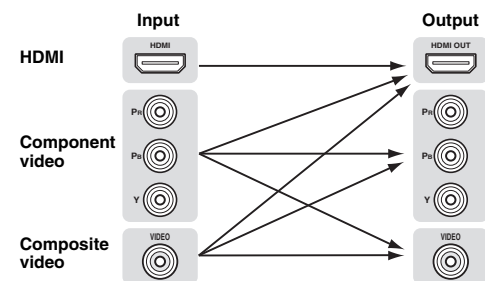

Audio signal flow

Notes

- Audio signals input to the HDMI input jacks are output from either the speaker terminals or HDMI OUT 1/2 jacks depending on the “Audio Output” setting (page 62).
- The DIGITAL AUDIO (OPTICAL OUT) jack outputs digital audio signals only when signals are input to the optical or coaxial optical input jacks and corresponding input source is selected.

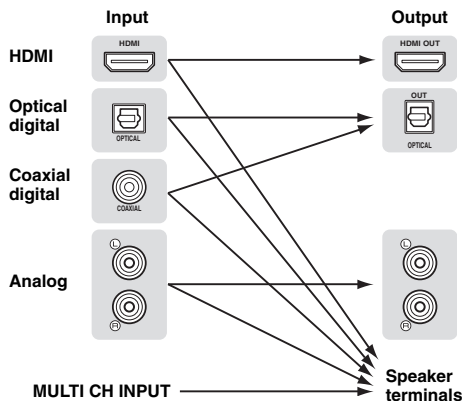

■ Connecting a multi-format player or an external decoder

This unit is equipped with 8 additional input jacks (Front L/R, Center, Surround L/R, Surround Back L/R and Subwoofer) for analog multi-channel input from a multi-format player, external decoder, etc.

Notes

- When you select “MULTI CH” as the input source, the digital sound field processor is automatically disabled.
- Since this unit does not redirect signals input at the MULTI CH INPUT jacks to accommodate for missing speakers, connect at least a 5.1-channel speaker system when using this feature.
- You can specify a video signal to be output during a multi-channel audio reproduction (page 56). If your DVD player has analog multi-channel output jacks, connect them to the MULTI CH INPUT jacks while making a video connection (component video or composite).

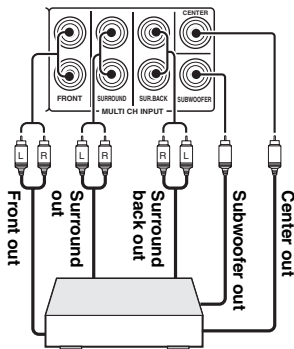

Multi-format player or external decoder (7.1-channel output)

■ Connecting an external amplifier

If you want to use another amplifier, connect an external amplifier to the PRE OUT jacks. Each PRE OUT jack outputs the same channel signals as the corresponding speaker terminals.

Note

- When you make connections to the PRE OUT jacks, do not make any connections to the speaker terminals.

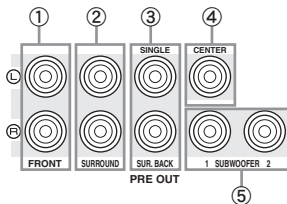

- FRONT PRE OUT jacks**
Front channel output jacks.
 - SURROUND PRE OUT jacks**
Surround channel output jacks.
 - SUR. BACK PRE OUT jacks**
Surround back output jacks. When you only connect one external amplifier for the surround back channel, connect it to the left SUR. BACK (SINGLE) jack.
- To output surround back channel signals at these jacks, set “Surround Speaker” to any parameter except “None” (page 60).
- CENTER PRE OUT jack**
Center channel output jack.

- SUBWOOFER PRE OUT 1/2 jack**
Connect a subwoofer with a built-in amplifier.

■ Transmitting/receiving remote control signals

When the components have the capability of the transmission of the remote control signals, connect the REMOTE IN and REMOTE OUT jacks to the remote control input and output jack with the monaural analog mini cable as follows.

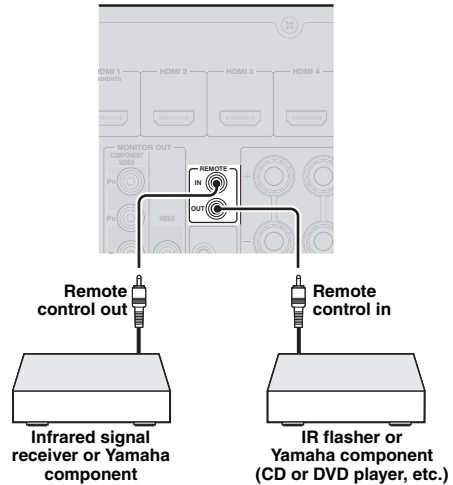

- If connecting a Yamaha component that supports the SCENE control signal reception to the REMOTE OUT jack of this unit, you can start playback on the Yamaha component by using the SCENE function (page 24).
- If connecting a component other than Yamaha products to the REMOTE OUT jack of this unit, set “SCENE IR” to “OFF” in the advanced setup menu (page 73).

Connecting a Yamaha iPod universal dock or Bluetooth™ wireless audio receiver

This unit has the DOCK terminal, to which you can connect a Yamaha iPod universal dock (YDS-11, sold separately) or a Bluetooth wireless audio receiver (YBA-10, sold separately). You can play an iPod or a Bluetooth component with this unit by connecting it to the DOCK terminal.

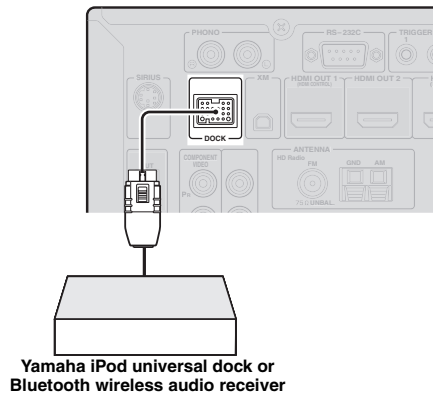

Connecting to the network

To connect this unit to your network, plug one end of a network cable (CAT-5 or higher straight cable) into the NETWORK port of this unit, and plug the other end into one of the LAN ports on your router that supports the DHCP (Dynamic Host Configuration Protocol) server function. To enjoy Internet Radio or music files saved on your PC, each device must be connected properly in the network.

Note

- Use an STP (shielded twisted pair) cable (commercially available) to connect a network hub or router and this unit.
- If the DHCP server function on your router is disabled, you need to configure the network settings manually (page 64).

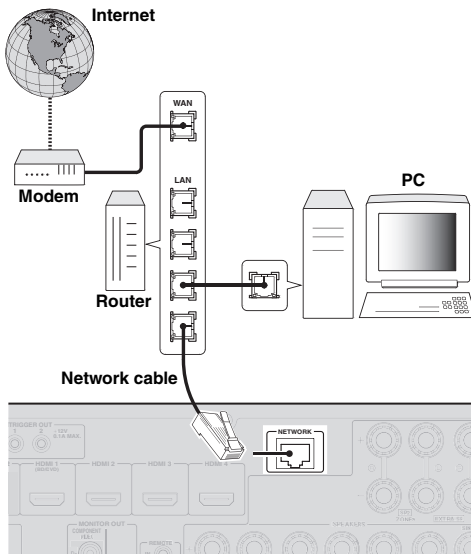

Connecting a USB storage device

Connect a USB memory device or USB portable audio player to the USB port on the front panel of this unit. For information about USB storage devices supported by this unit, see page 47.

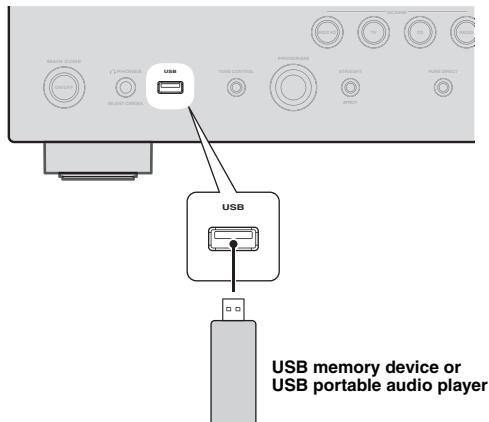

Using the VIDEO AUX jacks

Use either the HDMI IN jack or analog AUDIO/VIDEO jacks on the front panel to connect a game console, camcorder or digital camera to this unit. Be sure to turn down the volume of this unit and other components before making connections.

Note

- When signals are input to the HDMI IN and analog input jacks (AUDIO L/R and VIDEO) at the same time, the HDMI connection has a priority.

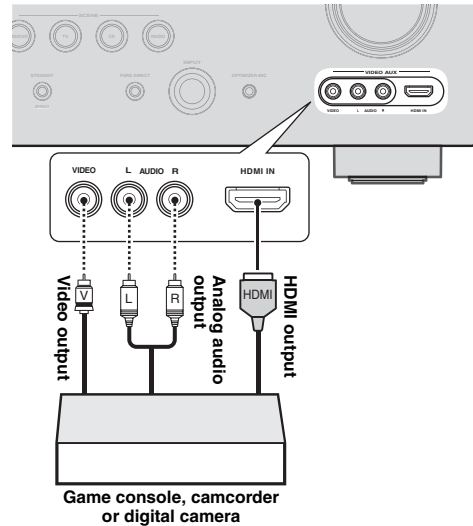

Note

- To protect against dust, attach the supplied VIDEO AUX input cover to the VIDEO AUX jacks when you do not use the jacks. To remove the cover, push the right section of it.

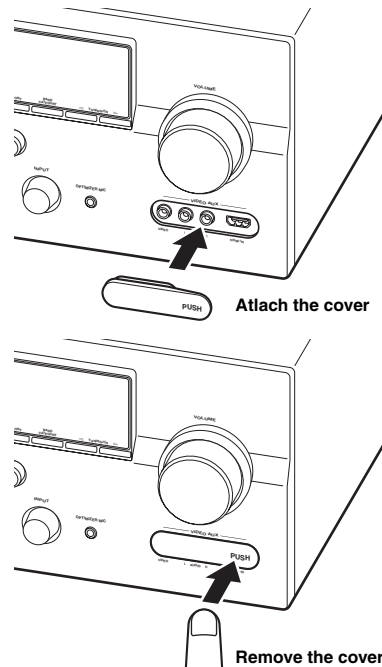

Connecting the FM and AM antennas

An indoor FM antenna and an AM loop antenna are supplied with this unit. Connect these antennas properly to the respective jacks.

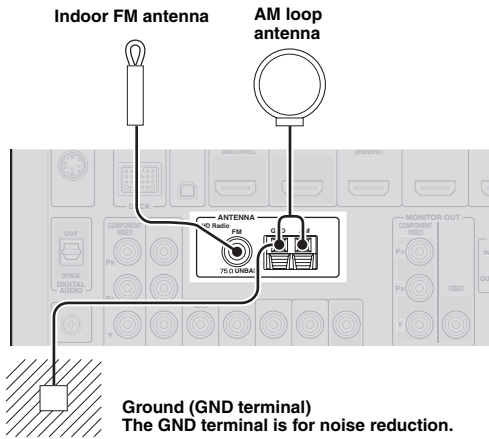

- The supplied antennas are normally sensitive enough to obtain good reception.
- Position the AM loop antenna away from this unit.
- If you cannot get good reception, we recommend that you use an outdoor antenna. For details, consult the nearest authorized Yamaha dealer or service center.
- Always use the AM loop antenna even when the outdoor antenna is connected.

Assembling the AM loop antenna

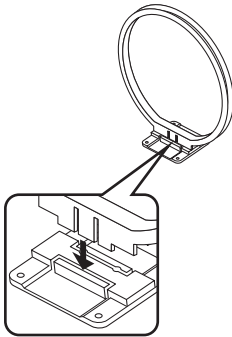

Connecting the AM loop antenna

The wires of the AM loop antenna have no polarity. You can connect either wire to the AM terminal and the other to the GND terminal.

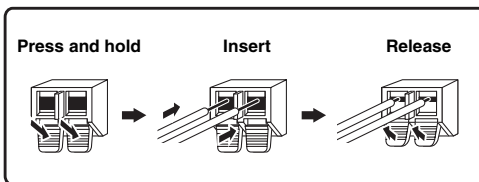

Connecting the power cable

After all connections are complete, plug the supplied power cable into the AC inlet and then plug it into an AC wall outlet.

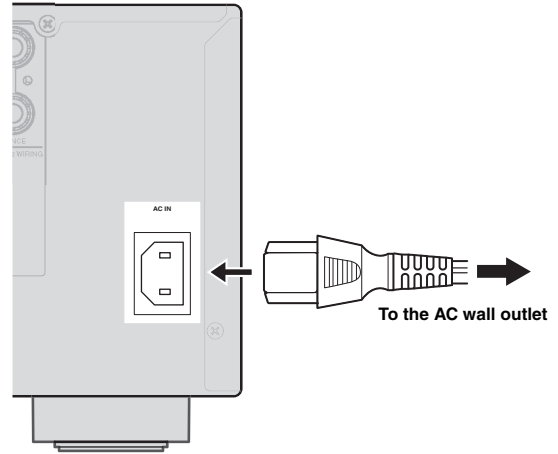

Turning this unit on and off

- 1 Press **MAIN ZONE ON/OFF** on the front panel (or **POWER** on the remote control) to turn on this unit.
- 2 Press **MAIN ZONE ON/OFF** (or **POWER**) again to turn off this unit (standby mode).



- The unit needs a few seconds until ready to play back.
- You can also turn on this unit by pressing **SCENE** (or **SCENE**).
- This unit consumes a small amount of electricity even in the standby mode. We recommend disconnecting the power cable from the AC wall outlet.

Caution

Do not unplug this unit while it is turned on. Doing so may damage this unit or cause the settings of this unit to be saved incorrectly.

Optimizing the speaker setting for your listening room (YPAO)

This unit has a Yamaha Parametric Acoustic Optimizer (YPAO). With the YPAO, this unit automatically adjusts the output characteristics of your speakers based on speaker position, speaker performance, and the acoustic characteristics of the room. We recommend that you first adjust the output characteristics with the YPAO when you use this unit.

Caution

- Be advised that it is normal for loud test tones to be output during the “Auto Setup” procedure. Do not allow small children to enter the room during the procedure.
- To achieve the best results, make sure the room is as quiet as possible while the “Auto Setup” procedure is in progress. If there is too much ambient noise, the results may not be satisfactory.



- You can manually adjust the output characteristics of your speakers with “Manual Setup” in the Setup menu (page 59).

Using Auto Setup

1 Check the following points.

Before starting the automatic setup, check the following.

- All speakers and subwoofer are connected properly.
- Headphones are disconnected from this unit.
- The video monitor is connected properly.
- This unit and the video monitor are turned on.
- This unit is selected as the video input source of the video monitor.
- The connected subwoofer is turned on and the volume level is set to about half way (or slightly less).
- The crossover frequency controls of the connected subwoofer are set to the maximum.

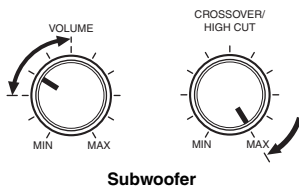

2 Connect the supplied optimizer microphone to the **OPTIMIZER MIC** jack on the front panel.

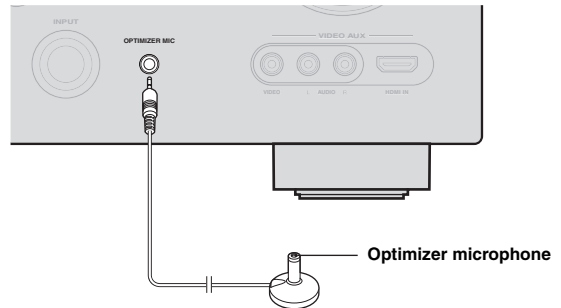

“MIC ON. View GUI MENU” appears on the front panel display.

The GUI screen appears on the video monitor.

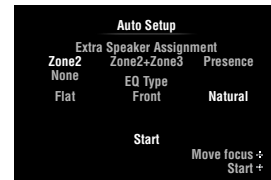

- You can bring up the above menu screen from the Setup menu (page 59).

3 Place the optimizer microphone at your normal listening position on a flat level surface with the omni-directional microphone heading upward.

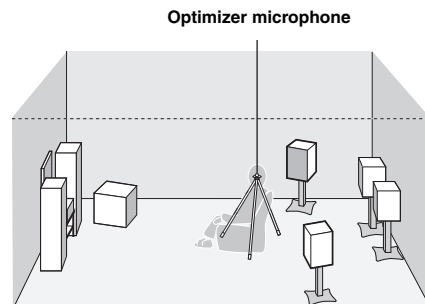

- It is recommended that you use a tripod or something similar to fix the optimizer microphone at the same height as your ears would be when seated in your listening position. You can fix the optimizer microphone to the tripod with the attaching screw of the tripod.

- 4** When the speakers are connected to EXTRA SP terminals, press **[10]Cursor** Δ repeatedly to select “Extra Speaker Assignment” and then press **[10]Cursor** \leftarrow/\rightarrow to select how to use EXTRA SP terminals from “Zone2”, “Zone2+Zone3”, “Presence” or “None”.

If this unit does not work when you press **[10]Cursor**, press **[9]ON SCREEN** once and then operate this unit.

- 5** To select sound characteristics for adjustment, press **[10]Cursor** ∇ to select “EQ Type” and then press **[10]Cursor** \leftarrow/\rightarrow .

If this unit does not work when you press **[10]Cursor**, press **[9]ON SCREEN** once and then operate this unit.

This unit has a parametric equalizer that adjusts the output levels for each frequency range. The equalizer is adjusted to produce a cohesive sound field based on automatically measured speaker characteristics. In “EQ Type”, you can select the following parametric equalizer characteristics suitable for the desired sound characteristics.

Flat

This adjusts each speaker to obtain the same characteristics. Select this if your speakers have similar qualities.

Front

This adjusts each speaker to obtain the same characteristics as the front left and right speakers. Select this if your front left and right speakers have significantly better qualities than the other speakers.

Natural

This adjusts all speakers to achieve natural sound. Select this if sounds in the high frequency range seem too strong when “EQ Type” is set to “Flat”.

- 6** Press **[10]Cursor** ∇ to select “Start” and then press **[10]ENTER** to start the setup procedure.

A countdown starts and a measurement starts in 10 seconds. A loud test tone is output during measurement.

Notes

- During the automatic setup procedure, do not perform any operation on this unit.
- Press **[10]Cursor** Δ to cancel the automatic setup procedure.

Measurement takes about 3 minutes. To obtain precise results, stay where you will not disturb the measurement, such as to the side of or behind the speakers or outside the room.

When measurement is successfully completed, “YPAO Complete” appears on the front panel display and the measurement result appears on the GUI screen.

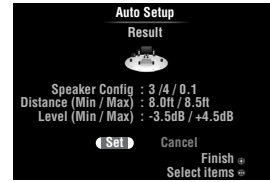

Speaker Config

Displays the number of speakers connected to this unit in the following order:

Total of Front and Center/Total of Surround and Surround Back/Subwoofer

Distance (Min / Max)

Displays the speaker distance from the listening position in the following order:

Closest speaker distance/Farthest speaker distance

Level (Min / Max)

Displays the speaker output levels in the following order:

Lowest speaker output level/Highest speaker output level

Notes

- If “Error” appears on the GUI screen during “Auto Setup”, measurement is canceled and the type of error is displayed. For details, see “When an error message is displayed during measurement” (page 23).
- If problems occur during measurement, “Check xx warning(s)” (xx indicates the number of warnings) appears in red. For details, see “When a warning message is displayed after measurement” (page 23).

- 7** Press **[10]ENTER** to confirm the settings.

To cancel the operation, press **[10]Cursor** \leftarrow/\rightarrow to select “Cancel” and press **[10]ENTER**.

The speaker characteristics are adjusted according to measurement results.

When the following screen appears, remove the optimizer microphone. “Auto Setup” is now complete.



The optimizer microphone is sensitive to heat. Store it in a cool place and away from direct sunlight after measurement. Do not leave it in a place where it will be subjected to high temperatures such as on an AV component.

Notes

- If you do not want to apply the measurement results, select “Cancel”.
- Perform “Auto Setup” again if you change the number or positions of speakers.

When an error message is displayed during measurement

If an error is detected during measurement, the measurement is canceled and “Error” appears on the GUI screen. Check the error and solve the problem. For details on each error message, see page 86.

Press **[10]Cursor** ∇ once, press **[10]Cursor** $\triangleleft / \triangleright$ to select “Retry” or “Exit” and then press **[10]ENTER**.

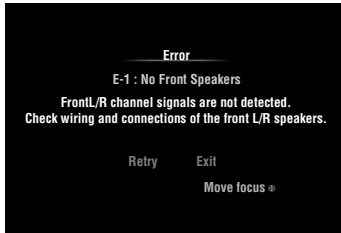

Retry

Performs “Auto Setup” again.

Exit

Terminates the measurement and “Auto Setup”.



- When “E-5:NOISY” appears, you can continue measurement. To continue measurement, select “Proceed”. However, we recommend that you solve the problem first and then perform measurement again.

When a warning message is displayed after measurement

If a problem occurs during measurement, “Check xx warning(s)” appears on the GUI screen. Check the warning and solve the problem. For details on each warning message, see page 87.



- Optimization will not be performed while a warning message is displayed. We recommend that you solve the problem and perform “Auto Setup” again.

1 Press **[10]Cursor** ∇ / \triangle to select “Check xx warning(s)” and then press **[10]ENTER**.

Details of the warning message are displayed. If there are multiple warning messages, you can display the next message using **[10]Cursor** \triangleright .

2 To return to the top result display, press **[10]ENTER** again.

BASIC OPERATION

Playback

Basic procedure

1 Turn on external components (TV, DVD player, etc.) connected to this unit.

2 Rotate the **ⓂINPUT selector (or press **Ⓜ**Input selection key) to select an input source.**

If you press **Ⓜ**USB/NET on the remote control, press **Ⓜ**Sub-input selection key to select a sub-input source.

The name of the selected input source is displayed for a few seconds.

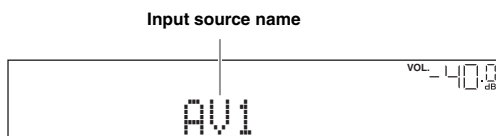

- If you connect two video monitors to the HDMI OUT jacks of this unit, press **Ⓜ**HDMI OUT repeatedly to select the active video monitor(s) (page 53).
- You can also select an input source from the GUI screen (page 25).
- You can change the input source name displayed on the front panel display or GUI screen as necessary (page 64).

3 Play the external component that you have selected as the source input, or select a radio station on the tuner.

Refer to the operating instructions of the external component for details on playback. For selecting radio stations or playback of an iPod, Bluetooth component, USB storage device or network contents using this unit, see the following.

- FM/AM radio tuning (page 31)
- iPod playback (page 44)
- Bluetooth component playback (page 46)
- USB storage device playback (page 47)
- Internet Radio playback (page 50)
- PC playback (page 48)
- Rhapsody® playback (page 51)

4 Turn the **ⓂVOLUME control (or press **Ⓜ**VOLUME +/-) to adjust the volume.**

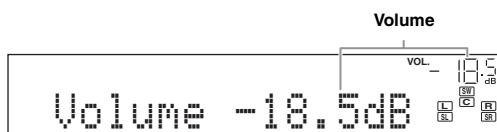

Note

When you play back a DTS-CD, noise may be output in some conditions, which may cause a speaker malfunction. Make sure that the volume is set to low before starting playback. If noise is output, do the following.

1) When only noise is output

If a DTS bitstream signal is not properly input to this unit, only noise is output. Connect the playback component to this unit by digital connection and play back the DTS-CD. If the condition is not improved, the problem may result from the playback component. Consult the manufacturer of the playback component.

2) When noise is output during playback or skip operation
Before playing back the DTS-CD, display the Option menu after selecting the input source and set "Decoder Mode" to "DTS" (page 54).

Using the SCENE function

This unit has a SCENE function that allows you to change input sources and sound field programs with one key. Four scenes are available for different usages, such as playing movies or music. The following input sources and sound field programs are provided as the initial factory settings.

Keys	Input source	Sound field program
BD/DVD	HDMI 1	Straight
TV	AV 1	Straight
CD	AV 3	Straight
RADIO	TUNER	7ch Enhancer



- When this unit is on standby, you can turn on this unit by pressing **Ⓜ**SCENE (or **Ⓜ**SCENE).
- If you connect a Yamaha DVD/CD player that has the capability of the SCENE control signals to the REMOTE OUT jack of this unit, you can start playback on the player by using the SCENE function.

Selecting a SCENE

Press **Ⓜ**SCENE (or **Ⓜ**SCENE).



- You can also select a SCENE from the GUI screen (page 25).

Registering input source/sound field program to SCENE

Select the desired input source/sound field program and then press and hold **Ⓜ**SCENE (or **Ⓜ**SCENE) to edit until "SET Complete" appears on the front panel display.



- If you change the input source setting, register the remote control code of an external component to the input source (page 72).

Switching remotely controlled external components linked to scene selections

You can operate an external component with the remote control of this unit by setting a remote control code for the external component for each input source. Setting remote control codes for desired input sources allows you to switch between external components linked to scene selections.

- 1 Register the remote control code of an external component to the desired input source (page 72).

Note

- This feature is not available for TUNER, SIRIUS and XM input sources.

- 2 While holding down the desired **[8] SCENE** key, press and hold the **[4] Input selection key** to which you registered a remote control code in step 1.

From now on the external component can be remotely controllable just by selecting a scene.

Selecting a source on the GUI screen

- 1 Press **[9] ON SCREEN** on the remote control. The GUI screen appears on the video monitor.



- 2 Use **[10] Cursor** Δ / ∇ repeatedly to switch the page and **[10] Cursor** \leftarrow / \rightarrow repeatedly to select the desired source.

Category	Source
Select Scene	BD/DVD, TV, CD, RADIO
Select Input	HDMI1-4, V-AUX, PHONO, MULTI CH, DOCK, AV1-6, AUDIO1/2, USB, NET RADIO, PC, Rhapsody, TUNER, SIRIUS, XM



- If an input source you want to select is available in "Select Scene", you can select the desired input source and sound field program at once.

- 3 Press **[10] ENTER**.

Muting audio output

- 1 Press **[22] MUTE** on the remote control to mute the audio output.
- 2 Press **[22] MUTE** again to resume audio output.

Adjusting high/low frequency sounds (tone control)

You can adjust the balance of the high frequency range (Treble) and low frequency range (Bass) of sounds output from the front left and right speakers to obtain desired tone.

- 1 Press **[C] TONE CONTROL** on the front panel repeatedly to select "Treble" or "Bass".

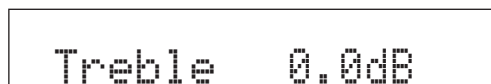

- 2 Rotate the **[P] PROGRAM** selector to adjust the frequency range.

Control range: -10.0 dB to +10.0 dB

The display returns to the previous screen automatically in few seconds.

Note

- The tone control settings are not effective when this unit is in the Pure Direct mode or "MULTI CH" is selected as an input source.

Enjoying pure hi-fi sound

Use Pure Direct mode to enjoy the pure high fidelity sound of the selected source. When Pure Direct mode is activated, this unit plays back the selected source with the least circuitry.

Press **[S] PURE DIRECT** (or **[18] PURE DIRECT**) to turn the Pure Direct mode on or off.

[S] PURE DIRECT lights up when you set Pure Direct mode on.

The following features are disabled in the Pure Direct mode.

- sound field program, tone control
- display and operation of the Option menu and Setup menu
- multi-zone function



- The front panel display automatically turns off while this unit in the Pure Direct mode.

Using your headphones

Plug your headphones in the **PHONES** jack on the front panel.

When you select a sound field program while using the headphones, the mode is automatically set to SILENT CINEMA mode.

Notes

- When you connect headphones, no signals are output at the speaker terminals.
- When multi-channel signals are processed, sounds in all channels are divided to left and right channels. When "MULTI CH" is selected as the input source, only front L/R sounds are output from the headphones.

Changing information on the front panel display

Press **INFO** (or **INFO**) repeatedly.

Available information differs depending on the selected input source.

For example, if you select HDMI1 input and display "DSP Program", the following screen appears on the front panel display.



Input source	Information
HDMI1-4	Input
AV1-6	DSP Program
AUDIO1/2	Audio Decoder
V-AUX	
PHONO	
iPod (DOCK) (simple remote mode)	
BLUETOOTH (DOCK)	
MULTI CH	Input
TUNER	Frequency, DSP Program, Audio Decoder
	(for HD Radio information) Call Sign*, Category*, Artist / Song*, Album*, Tag Info, DSP Program, Audio Decoder, Frequency
SIRIUS	Channel, Category, Artist / Song, Composer, Antenna, DSP Program, Audio Decoder
XM	Channel, Category, Artist / Song, Antenna, DSP Program, Audio Decoder

Input source	Information
iPod (DOCK) (menu browse mode)	(on play information display) DSP Program, Audio Decoder, Song, Artist, Album
USB (USB/NET)	
PC (USB/NET)	(on GUI screen) List
Rhapsody (USB/NET)	(on play information screen) DSP Program, Audio Decoder, Song, Artist (or Artist / Channel if channel name is available), Album
	(on GUI screen) List
NET RADIO (USB/NET)	(on play information display) DSP Program, Audio Decoder, Station Name
	(on GUI screen) List

Note

- Information marked with "*" is not available when analog HD Radio station is selected.

Enjoying the sound field programs

This unit is also equipped with a Yamaha digital sound field processing (DSP) chip. You can enjoy multi-channel sounds for almost all input sources using various sound field programs stored on the chip and a variety of surround decoders.

Selecting sound field programs

■ Selecting a sound field program on the front panel

Rotate the **PROGRAM** selector to select a desired sound field program.

■ Selecting a sound field program with the remote control

Perform the following operations depending on the category of the sound field programs.

- Sound field programs for movies/TV programs..... Press **MOVIE** repeatedly.
- Sound field programs for music Press **MUSIC** repeatedly.
- Stereo reproduction Press **STEREO** repeatedly.
- Multi-channel stereo reproduction Press **STEREO** repeatedly.
- Compressed music enhancer Press **STEREO** repeatedly.
- Surround decoder Press **SUR.DECODE** repeatedly.

For example, if you select “Sci-Fi”, the following screen appears on the front panel display.

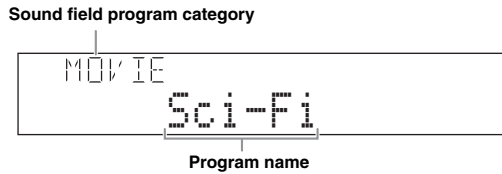

Notes

- Sound field programs are stored for each input source. When you change the input source, the sound field program previously selected for that input source is applied again.
- When you play back DTS Express sources or audio signals with sampling frequency of higher than 96 kHz, the straight decode mode (page 30) is automatically selected.
- When you play back Dolby TrueHD sources with CINEMA DSP, another program may be automatically selected in specific cases.
- When you play back DTS-HD sources with CINEMA DSP, the DTS decoder is automatically selected.

Sound field program descriptions

This unit provides sound field programs for multiple categories including music, movies and stereo reproduction. Select a sound field program based on your listening preference, not merely on the name of the program, etc.



- You can check what speakers are currently outputting signals with the speaker indicators on the front panel display (page 6).
- Each program can adjust sound field elements (sound field parameters). For details, see page 65.
- **CINEMA DSP** in the table indicates the sound field program with CINEMA DSP (page 91).

For movie/TV program sources (MOVIE) **CINEMA DSP**

Program	Descriptions
Standard	This program creates a sound field emphasizing the surrounding feeling without disturbing the original acoustic positioning of multi-channel audio such as Dolby Digital and DTS. It has been designed with the concept of “an ideal movie theater”, in which the audience is surrounded by beautiful reverberations from the left, right and rear.
Spectacle	This program represents the spectacular feeling of large-scale movie productions. It reproduces a broad theater sound field matching the cinemascope and wider-screen movies with an excellent dynamic range from very small to extremely large sound.
Sci-Fi	This program clearly reproduces the finely elaborated sound design of the latest science fiction and special effects-featuring movies. You can enjoy a variety of cinematographically created virtual spaces reproduced with clear separation between dialog, sound effects and background music.
Adventure	This program is ideal for precisely reproducing the sound design of action and adventure movies. The sound field restrains reverberations but puts emphasis on reproducing a powerful space expanded widely to the left and right. The reproduced depth is also restrained relatively to ensure the separation between audio channels and the clarity of the sound.

Program	Descriptions
Drama	This sound field features stable reverberations that match a wide range of movie genres from serious dramas to musicals and comedies. The reverberations are modest but offer an optimum 3D feeling, reproducing effects tones and background music softly but cubically around clear words and center positioning in a way that does not fatigue the listener even after long hours of viewing.
Mono Movie	This program is provided for reproducing monaural video sources such as a classic movie in an atmosphere of a good old movie theater. The program produces the optimum expansion and reverberation to the original audio to create a comfortable space with a certain sound depth.
Sports	This program allows the listeners to enjoy stereo sport broadcasts and studio variety programs with enriched live feeling. In sports broadcasts, the voices of the commentator and sportscaster are positioned clearly at the center while the atmosphere of the stadium expands in an optimum space to offer the listeners with a feeling of presence in the stadium.
Action Game	This sound field has been suitable for action games such as car racing and FPS games. It uses the reflection data that limits the effects range per channel in order to offer a powerful playing environment with a being-there feeling by enhancing various effects tones while maintaining a clear sense of directions.
Roleplaying Game	This sound field has been suitable for role-playing and adventure games. It combines the sound field effects for movies and the sound field designs for “Action Game” to represent the depth and 3D feeling of the field during play, while offering movie-like surround effects in the movie scenes in the game.

For audio music sources (MUSIC)



Program	Descriptions
Hall in Munich	This sound field simulates a concert hall with approximately 2500 seats in Munich, using stylish wood for the interior finishing as normal standards for European concert halls. Fine, beautiful reverberations spread richly, creating a calming atmosphere. The listener’s virtual seat is at the center left of the arena.
Hall in Vienna	This is an approximately 1700-seated, middle-sized concert hall with a shoebox shape that is traditional in Vienna. Pillars and ornate carvings create extremely complex reflections from all around the audience, producing a very full, rich sound.
Chamber	This program creates a relatively wide space with a high ceiling like an audience hall in a palace. It offers pleasant reverberations that are suitable for courtly music and chamber music.
Cellar Club	This program simulates a live house with a low ceiling and homey atmosphere. A realistic, live sound field features powerful sound as if the listener is in a row in front of a small stage.
The Roxy Theatre	This is the sound field of a rock music live house in Los Angeles, with approximately 460 seats. The listener’s virtual seat is at the center left of the hall.
The Bottom Line	This is the sound field at stage front in The Bottom Line, that was a famous New York jazz club once. The floor can seat 300 people to the left and right in a sound field offering real and vibrant sound.
Music Video	This sound field offers an image of a concert hall for live performance of pop, rock and jazz music. The listener can indulge oneself in a hot live space thanks to the presence sound field that emphasizes the vividness of vocals and solo play and the beat of rhythm instruments, and to the surround sound field that reproduces the space of a big live hall.

For stereo reproduction (STEREO)

Program	Descriptions
2ch Stereo	Use this program to mix down multi-channel sources to 2 channels.



- When multi-channel signals are input, they are downmixed to 2 channels and output from the front left and right speakers.

For multi-channel stereo reproduction (STEREO)

Program	Descriptions
7ch Stereo	Use this program to output sound from all speakers. When you play back multi-channel sources, this unit downmixes the source to 2 channels and then outputs the sound from all speakers. This program creates a larger sound field and is ideal for background music at parties, etc.

Compressed Music Enhancer (ENHANCER)

Program	Descriptions
Straight Enhancer	Use this program to enhance the sound nearest to the original depth and width of the 2-channel or multi-channel compression artifacts.
7ch Enhancer	Use this program to play back compression artifacts in 7-channel stereo.

Surround decode mode (SUR. DECODE)

Select this program to playback sources with selected decoders. You can playback 2-channel sources on multi-channels.

Decoder	Descriptions
Pro Logic	Dolby Pro Logic decoder suitable for all kinds of sources.
PLIIx Movie / PLII Movie	Dolby Pro Logic IIX (or Dolby Pro Logic II) decoder suitable for movies. If your listening environment is as follows, you cannot select the Dolby Pro Logic IIX decoder. <ul style="list-style-type: none"> • When the surround back speakers are not connected • When headphones are connected
PLIIx Music / PLII Music	Dolby Pro Logic IIX (or Dolby Pro Logic II) decoder suitable for music. If your listening environment is as follows, you cannot select the Dolby Pro Logic IIX decoder. <ul style="list-style-type: none"> • When the surround back speakers are not connected • When headphones are connected
PLIIx Game / PLII Game	Dolby Pro Logic IIX (or Dolby Pro Logic II) decoder suitable for games. If your listening environment is as follows, you cannot select the Dolby Pro Logic IIX decoder. <ul style="list-style-type: none"> • When the surround back speakers are not connected • When headphones are connected
Neo:6 Cinema	DTS decoder suitable for movies.
Neo:6 Music	DTS decoder suitable for music.
Neural Sur. (U.S.A. model only)	Neural Surround processing for any sources. The Neural Surround decoder supports PCM (sampling rate of 96 kHz or lower), Dolby Digital, DTS Digital Surround (except for DTS 96/24), DSD and analog 2-channel input sources. When Neural Surround-incompatible signals are being input while the Neural Surround decoder is selected, multi-channel sources are decoded straight into the appropriate channels without any additional effect processing and the Neural Surround-incompatible PCM signals are reproduced in stereo. The Neural Surround decoder is especially suitable for the XM HD Surround program of XM Satellite Radio.



- An input source is played back in straight decode mode (page 30) when "MULTI CH" is selected as the input source.

Enjoying unprocessed input sources (Straight decode mode)

In straight decode mode, sounds are reproduced without sound field effect. 2-channel stereo sources are output from only the front left and right speakers. Multi-channel input sources are decoded straight into the appropriate channels and multi-channel sounds are reproduced without a sound field effect.

1 To enable straight decode mode, press
Ⓞ**STRAIGHT** (or **18****STRAIGHT**).
“Straight” appears on the front panel display.

2 To cancel straight decode mode, press
Ⓞ**STRAIGHT** (or **18****STRAIGHT**) again.
A sound field program name appears on the front panel display, and sound is reproduced with that sound field effect.

Enjoying sound field programs without surround speakers (Virtual CINEMA DSP)

Virtual CINEMA DSP allows you to enjoy DSP sound field surround effects even without any surround speakers by using virtual surround speakers. You can even enjoy Virtual CINEMA DSP using a minimal two-speaker system that does not include a center speaker. When “Surround Speaker” in the Setup menu is set to “None” (page 60), this unit operates in Virtual CINEMA DSP mode.

Note

- Virtual CINEMA DSP is not available in the following conditions even if you set “Surround Speaker” to “None” (page 60).
 - headphone plug is connected to the PHONES jack.
 - 7ch Stereo of the field sound program is selected.
 - Pure Direct mode or straight decode mode is used.

Enjoy sound field programs with headphones (SILENT CINEMA™)

SILENT CINEMA allows you to enjoy multi-channel sources with your headphones. SILENT CINEMA mode is automatically selected when you connect the headphone plug to the PHONES jack.

Note

- SILENT CINEMA mode is not available in the following conditions.
 - 2ch Stereo of the sound field program is selected.
 - Pure Direct mode or straight decode mode is selected.

Using CINEMA DSP 3D mode

CINEMA DSP 3D mode creates the intensive and accurate stereoscopic sound field in the listening room. To use this unit in CINEMA DSP 3D mode, presence speakers are required. Connect the presence speakers to the SP1 terminals, perform the following settings and then select a CINEMA DSP related sound field program.

- Disconnect the headphones from the PHONES jack.
- Set “Extra Speaker Assignment” to “Presence” (page 60).
- Set “3D DSP” to “On” (page 66).

When the sound field program runs in CINEMA DSP 3D mode, the 3D indicator on the front panel display lights up.

FM/AM tuning

The FM/AM tuner of this unit provides the following two modes for tuning.

■ Frequency tuning mode

You can tune in to a desired FM/AM station by searching or specifying its frequency.

■ Preset tuning mode

You can preset the frequencies of FM/AM stations by registering them to specific numbers, and later just select those numbers to tune in.

Note

- Adjust the FM/AM antennas connected to this unit for the best reception.

Tuning in to the desired FM/AM station (Frequency tuning)

- 1 Rotate the **① INPUT** selector (or press **④ TUNER**) to select “TUNER” as the input source.
- 2 Press **Ⓜ BAND** (or **⑤ FM** or **⑤ AM**) to select a band.
- 3 Press **① TUNING/CH** $\triangleleft / \triangleright$ (or **⑤ TUN./CH** \triangle / ∇) to specify the frequency.
The TUNED indicator on the front panel display lights up when the tuner is tuned in to a station. The STEREO indicator also lights up if the program being broadcasted is in stereo.



The frequency changes in the following manner according to how you press **① TUNING/CH** $\triangleleft / \triangleright$ (or **⑤ TUN./CH** \triangle / ∇).

When you press the key more than 1 second

The tuner searches the frequency of a station that is detectable around the current frequency. This is effective when the tuner can receive strong signals without any interference. Once the search starts, release the key. When you keep holding the key, the search continues even when a station is detected. This is useful when you want to tune in to a specific station.

When you press and release the key

The tuner increases or decreases the frequency in steps. Use this method when the tuner cannot receive strong signals and stations are skipped during the search.



- You can switch between stereo and monaural for FM broadcast in the Option menu (page 55).
- (U.S.A. model only)
When tuning in to an HD Radio station, the HD indicator lights up. See page 33 for details about the HD Radio features.

- 4 To tune in by direct frequency tuning, press **⑫ Numeric keys** to enter the frequency of the station.

Enter only integers. For example, if you want to set the frequency to 88.9 MHz, enter “889”.

Notes

- When you press **⑫ Numeric keys** during preset tuning, a preset number is selected. Set tuning mode to frequency tuning mode using **① TUNING/CH** $\triangleleft / \triangleright$ (or **⑤ TUN./CH** \triangle / ∇) prior to the operation.
- “Wrong Station!” appears on the front panel display when you enter a frequency that is out of receivable range. Make sure that the entered frequency is correct.

Registering FM/AM stations and tuning in (Preset tuning)

You can register up to 40 FM/AM stations (Preset).

Registering stations by automatic station preset

The tuner automatically detects FM stations with strong signals and registers up to 40 stations. To register AM stations, use manual station preset.

(U.S.A. model only)

You can register up to 40 FM HD Radio, AM HD Radio and analog FM radio stations with strong signals.

Note

- (U.S.A. model only)
If you register an FM HD Radio station with this feature, only the main audio program of the station (HD1) will be stored. To store other audio program, preset the station manually.

- 1 Rotate the **① INPUT** selector (or press **④ TUNER**) to select “TUNER” as the input source.
- 2 Press **⑩ OPTION** on the remote control.
The Option menu for “TUNER” is displayed (page 54).
- 3 Select “Auto Preset” and then press **⑩ ENTER**.

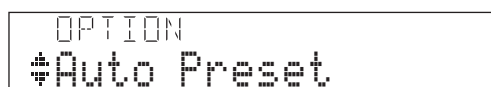

Automatic station preset starts about 5 seconds later from the lowest frequency upwards.



- You can select the preset number at which the preset starts by pressing **[5]PRESET Δ / ▽** or **[10]Cursor Δ / ▽** while “READY” is displayed on the front panel display.
- To cancel registration, press **[10]RETURN**.

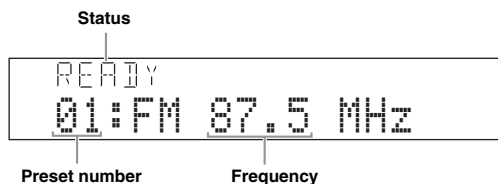

During the automatic station preset, “MEMORY” appears in the front panel display each time a station is registered.

When registration is complete, “FINISH” appears and then the display returns to the Option menu. To return the display to the original state, press **[19]OPTION**.

Registering stations by manual station preset

You can manually register FM stations with weak signals or AM stations.

1 Tune in to the desired station (page 31).



- (U.S.A. model only)
To register a sub-audio program of the HD Radio station (HD2 to HD8), press **[23]PRG SELECT** to select the desired audio program.

2 Press **[6]MEMORY** (or **[5]MEMORY**).

“Manual Preset” appears on the front panel display, followed soon by the preset number to which the station will be registered.



- By holding down **[6]MEMORY** (or **[5]MEMORY**) for more than 2 seconds, you can skip the following steps and automatically register the selected station to an empty preset number (next to the lastly-registered preset number).

3 Press **[6]PRESET </>** (or **[5]PRESET Δ / ▽**) to select the preset number to which the station will be registered.

When you select a preset number to which no station is registered, “Empty” appears. When you select a preset number to which any station has been already registered, the frequency of the station is displayed.

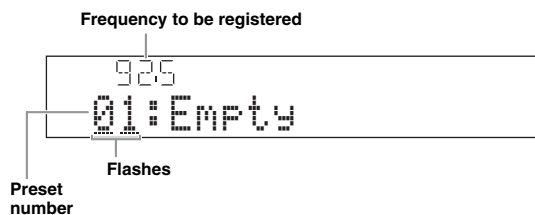

- You can also select a preset number using the **[12]Numeric keys**.

4 Press **[6]MEMORY** (or **[5]MEMORY**).

When registration is complete, the display returns to the original state.



- To cancel registration, press **[10]RETURN** or leave this unit without any operations for about 30 seconds.

Calling a preset station (Preset tuning)

You can call preset stations registered by automatic station preset or manual station preset.

Press **[6]PRESET </>** (or **[5]PRESET Δ / ▽**) to select a preset number.



- Preset numbers to which no stations are registered are skipped.
- “No Presets” or “No Presets in Memory” is displayed if no stations are registered.
- You can directly select a preset number by pressing **[12]Numeric keys** while calling a preset station. “Empty” appears on the display if you enter a preset number to which no station is registered. “Wrong Num.” appears if you enter an invalid number.
- When you press **[12]Numeric keys** during normal tuning, a frequency is entered. Set tuning mode to preset tuning mode using **[6]PRESET </>** (or **[5]PRESET Δ / ▽**) prior to the operation.
- (U.S.A. model only)
This unit may take a little time to call a sub-audio program of an HD Radio station.

Clearing preset stations

1 Rotate the **[1]INPUT** selector (or press **[4]TUNER**) to select “TUNER” as the input source.

2 Press **[19]OPTION** on the remote control.

The Option menu for “TUNER” is displayed (page 54).

3 Press **[10]Cursor Δ / ▽** to select “Clear Preset” and then press **[10]ENTER**.

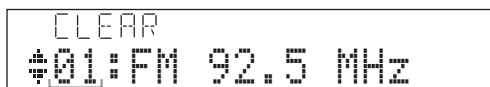

Preset number



- To cancel the operation and return to the Option menu, press **[10]RETURN**.

4 Press **[10]Cursor Δ / ▽** to select a preset number to reset and then press **[10]ENTER**.

The preset station registered to the selected preset number is cleared. To clear the registration of multiple preset numbers, repeat step 4.

5 To exit the Option menu, press **[19]OPTION**.

Using HD Radio™ features (U.S.A. model only)

HD Radio technology is a new technology that enables FM and AM radio stations to broadcast programs digitally. Digital broadcasting provides listeners with radically improved audio quality and reception as well as new data services. Furthermore, supplemental program services allow listeners to select from up to 8 HD Radio programs multicast on a single FM HD Radio channel. For further information on HD Radio technology, visit “<http://www.hdradio.com/>”. This unit is equipped with an HD Radio reception feature, facilitating CD quality FM broadcasts as well as analog FM stereo quality AM broadcasts. In addition, this unit can receive both audio and data (such as song titles, artist names, program types, and comments) from all HD Radio programs (HD1 to HD8).

Notes

- The tuning method for HD Radio stations are same as analog FM/AM radio stations; however, you only tune into the analog part of a hybrid HD Radio station while this unit is in the monaural tuning mode (page 55).
- This unit is capable of receiving both hybrid and all-digital HD Radio station signals. However, this unit may not automatically receive all-digital FM station signals and the automatic tuning operation may stop. In this case, enter the frequency of the desired all-digital FM HD Radio station directly by using the **[Numeric keys]** (page 31).

Selecting HD Radio™ audio programs

The HD indicator lights up in the front panel display when this unit is tuned into an HD Radio reception band. In this state, you can select the desired audio program if the selected FM HD Radio station provides multiple audio programs (up to 8).

■ When multiple audio programs are provided

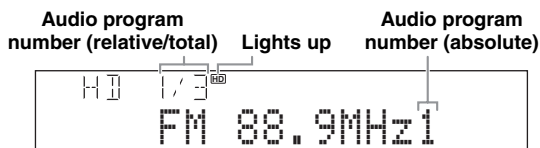

Press **[PRG SELECT]** **[<< / >>]** on the remote control repeatedly to select the desired audio program.



- You can also select audio program using **[Numeric keys]** (1-8) and **[ENT]** when this unit is in the automatic or manual tuning mode. In case you select an audio program currently not available, “HDx Off” (“x” indicates the program number) appears.

Notes

- When reception for an audio program ceases, the HD indicator disappears from the front panel display and HD1 is automatically selected after approximately 20 seconds.
- Some audio programs may not contain data programs depending on the broadcasting station and the time period.

■ When only one audio program is provided

If this unit is tuned into an FM HD Radio station including only one audio program or an AM HD Radio station, you cannot select audio programs.

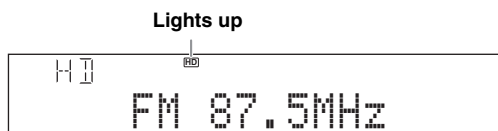

■ Behavior of the display

This unit automatically shows the HD Radio information (call sign, etc) on the front panel display after 3 seconds. You can switch HD Radio information to be displayed (page 34).

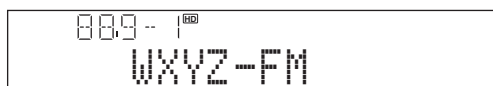

Using the iTunes Tagging feature

This unit is equipped with the iTunes Tagging feature that enables HD Radio listeners to “tag” songs for subsequent preview and purchase on iTunes. For details on the iTunes Tagging feature, visit “<http://www.hdradio.com/>”.

1 Tune into an HD Radio station and select HD Radio audio program (if available).

If the selected HD Radio program (or song being played) supports the iTunes Tagging feature, the TAG indicator lights up in the front panel display and “TAG” appears on the GUI screen.



2 While a song you want to tag is being played back, press **[TAG]** on the remote control.

If a song is tagged, “StorageSuccess” and the number of stored iTunes Tagging information files (up to 50) appear in the front panel display.

Notes

- “Insufficient Data” appears in the front panel display and GUI screen if tagging is not available.
- If a status message or an error message appears on the front panel display or the GUI screen, see “iTunes Tagging” (page 80).



- This unit transmits the “tag” data to the iPod if an iPod that supports iTunes Tagging feature is stationed in the Yamaha iPod universal dock (YDS-11, sold separately) connected to the DOCK terminal of this unit. Otherwise, this unit stores the “tag” data (up to 50) in the internal memory and will transmit it next time your iPod is stationed.

Displaying HD Radio™ information

Use this feature to display the HD Radio information in the front panel display or on the GUI screen.

Note

- If a status message or an error message appears on the front panel display or GUI screen, see “HD Radio Reception” (page 79).

■ Front panel display

Press **ⓔ**INFO (or **ⓖ**INFO) repeatedly to toggle the following HD Radio information display modes.

Call Sign
Call sign, frequency, audio program number (absolute)



Category
Program category, frequency, audio program number (absolute)



Artist / Song
Artist name, song title, frequency, audio program number (absolute)



Album
Album title, frequency, audio program number (absolute)



Tag Info
The number of iTunes Tagging information files stored in the internal memory, frequency, audio program number (absolute)



DSP Program
Current sound field program (page 27), frequency, audio program number (absolute)

Audio Decoder
Current audio decoder (page 29), frequency, audio program number (absolute)



Frequency
Frequency, audio program number (absolute), audio program number (relative/total)



Back to “Call Sign”

Display example (Call Sign)

88.9 - 1 ^{HD}
WXYZ-FM

■ GUI screen

Press **Ⓚ**DISPLAY on the remote control to turn on or off the information display.

The following information is displayed on the GUI screen.

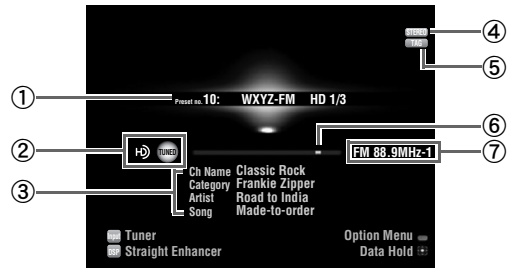

- 1 Preset number, call sign, audio program number (relative/total)
- 2 HD Radio icon, TUNED icon
- 3 Program category, artist name, song title, album title
- 4 STEREO icon
- 5 TAG icon
- 6 Frequency indication gauge
- 7 Band, frequency, audio program



- To hold or release the displayed information, press **Ⓚ**ENTER. While it is held, the “HOLD” icon appears on the GUI screen.

XM® Satellite Radio tuning (U.S.A. model only)

Listening to Satellite Radio

To listen to Satellite Radio, you'll need to connect either a SIRIUS or XM Satellite Radio tuner (sold separately) to your satellite-ready receiver. Satellite Radio is available to residents of the US (except Alaska and Hawaii).

Satellite Radio delivers a variety of commercial-free music from categories ranging from Pop, Rock, Country, R&B, Dance, Jazz, Classical and many more plus coverage of all the top professional and college sports including play by play games from select leagues and teams. Additional programming includes expert sports talk, uncensored entertainment, comedy, family programming, local traffic and weather and news from your most trusted sources.

Whether you purchase a SIRIUS or XM tuner, you'll need to activate and subscribe to begin enjoying the service. Easy to follow installation and setup instructions are provided with the satellite tuners. Whichever service you choose, there are a variety of programming packages available, including the option of adding "The Best of SIRIUS" programming to your XM tuner or "The Best of XM" programming to your SIRIUS tuner, enabling you to enjoy the most popular programming among both services. The "Best of" packages are not available to SIRIUS or XM Canada subscribers at this time. Family friendly packages are also available to restrict channels featuring content that may be inappropriate for children.

To subscribe to XM, U.S. customers should visit xmradio.com or call 1-800-XMRADIO (1-800-967-2346).

To subscribe to SIRIUS, U.S. customers can call 1-888-539-SIRI (1-888-539-7474) or visit sirius.com (US).

SIRIUS XM Radio Legal

SIRIUS, XM and all related marks and logos are trademarks of Sirius XM Radio Inc. and its subsidiaries. All other marks and logos are the property of their respective owners. All rights reserved. SIRIUS and XM subscriptions sold separately. Taxes and a one-time activation fee may apply. XM tuners and home docks or SIRIUS tuners (each sold separately) are required to receive the SIRIUS or XM satellite radio service. All programming and fees subject to change. It is prohibited to copy, decompile, disassemble, reverse engineer, hack, manipulate or otherwise make available any technology or software incorporated in receivers compatible with the SIRIUS or XM Satellite Radio Systems. **Service not available in Alaska and Hawaii.**

Connecting XM Mini-Tuner Home Dock

Connect XM Mini-Tuner and XM Mini-Tuner Home Dock (sold separately) to the XM jack on the rear panel of this unit. For details, see the operating instructions provided with the XM Mini-Tuner Home Dock.

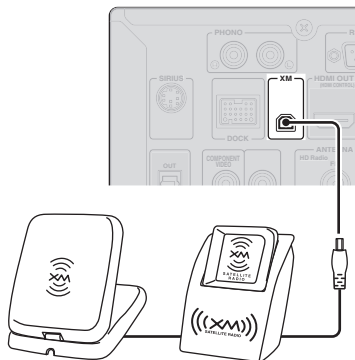

XM Mini-Tuner and XM Mini-Tuner Home Dock (sold separately)



- To ensure optimal reception of the XM Satellite Radio signals, the XM Mini-Tuner Home Dock must be placed at or near a southerly facing window with no obstacles in the path to the sky. You can mount it indoors or outdoors. Use the "Antenna" information on the front panel display or on the GUI screen (page 38) to check the antenna reception level and adjust the orientation of the antenna.

Note

- If "CHECK ANTENNA", "CHECK XM TUNER" or "NO SIGNAL" appears on the front panel display, the connection and setting of the antenna, XM Mini-Tuner Home Dock, or XM Mini-Tuner may not be correct.

Activating XM Satellite Radio

Once you have installed the XM Mini-Tuner Home Dock, inserted the XM Mini-Tuner, connected the XM Mini-Tuner Home Dock to your XM Ready® home audio system, and installed the antenna, you are ready to subscribe and begin receiving XM programming. There are three places to find your eight character XM Radio ID: on the XM Mini-Tuner, on the XM Mini-Tuner package, and on XM Channel 0. Record the XM Radio ID in the following eight squares for reference.

□	□	□	□	□	□	□	□
---	---	---	---	---	---	---	---

Note

- The XM Radio ID does not use the letters "I", "O", "S" or "F". Activate your XM Satellite Radio service in the U.S. online at <http://activate.xmradio.com/> or call 1-800-XM-RADIO (1-800-967-2346). You will need a major credit card. XM will send a signal from the satellites to activate the full channel lineup. Activation normally takes 10 to 15 minutes, but during peak busy periods you may need to keep your XM Ready home audio system on for up to an hour. When you can access the full lineup on your XM Ready home audio system you are done.

XM Satellite Radio® operations

1 Rotate the **INPUT** selector (or press **XM**) to select “XM” as the input source.

The XM Satellite Radio information (such as channel number, channel name, category, artist name, or song title) for the currently selected channel appears on the front panel display and GUI screen (page 38).

Search mode



Channel number Channel name



- When you select “XM” as the input source, this unit automatically recalls the previously selected channel.

Note

- If a status message or an error message appears on the front panel display or on the GUI screen, see “XM Satellite Radio” (page 80).

2 Search for a channel by using one of the XM Satellite Radio search modes.

- To select a channel from the all channel list, see “All Channel Search mode” on this page.
- To select a channel by category, see “Category Search mode” on this page.
- To select the desired channel directly by entering the channel number, see “Direct number access” on this page.
- To select a channel from the preset channels, see “Calling a preset channel (Preset Search mode)” (page 37).



- You can display the XM Satellite Radio information on the front panel display or on the GUI screen (page 38).
- You can set the XM Satellite Radio preset channels (page 37).

All Channel Search mode

Press **TUNING/CH** $\triangleleft/\triangleright$ (or **TUN./CH** \triangle/∇) repeatedly to search for a channel within all channels.

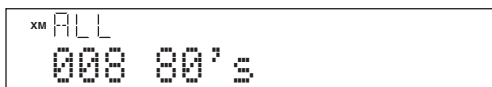

- You can search for a channel quickly by holding down **TUNING/CH** $\triangleleft/\triangleright$ (or **TUN./CH** \triangle/∇).
- You can skip channels to the previous or next category by pressing **CATEGORY** (or **CATEGORY** $\triangleleft/\triangleright$).

Category Search mode

1 Press **CATEGORY** (or **CATEGORY** $\triangleleft/\triangleright$) to select the channel category.

“CAT” is displayed on the front panel display during the channel category selection. When you select the category, the first channel in the category is selected.

Category search mode The first channel in the category



Category name

Note

- If you do not operate within 10 seconds, the category search mode returns to “ALL” (All Channel Search).

2 While “CAT” is displayed on the front panel display, press **TUNING/CH** $\triangleleft/\triangleright$ (or **TUN./CH** \triangle/∇) repeatedly to search for a channel within the selected channel category.



- You can search for a channel quickly by pressing and holding **TUNING/CH** $\triangleleft/\triangleright$ (or **TUN./CH** \triangle/∇).

Note

- This unit skips the channels when this unit is in the All Channel Search mode or Category Search mode in the following cases (it is not malfunction of this unit):
 - the channel is out of service.
 - you do not subscribe to the channel.

Direct number access

In the All Channel Search mode or Category search mode, press the **Numeric keys** to enter the desired three-digit channel number.

For example, to enter the number 123, press the **Numeric keys** as “1”, “2” and “3”.



- To display the Radio ID number displayed on the front panel display, select channel “0”.
- To enter a one-digit or two-digit channel number, press the **Numeric keys** on the remote control and then press **ENT** to confirm the input number.
- Instead of pressing **ENT** to tune into the channel immediately, you can wait a few seconds until this unit confirms the entered channel number.
- If no key is pressed within a few seconds after you enter a one-digit or two-digit number, this unit automatically confirms the entered channel number.
- If the selected channel is not available, an advisory message may appear. For details, see “XM Satellite Radio” (page 80).

Registering XM Satellite Radio channels

You can use this feature to store up to 40 XM Satellite Radio channels. You can then recall any preset channel easily by selecting the preset channel as described in “Calling a preset channel (Preset Search mode)” on this page.

Registering preset channels

1 Search a channel you want to set as a preset channel in one of the XM Satellite Radio search modes.

For details, see “XM Satellite Radio operations” (page 36).

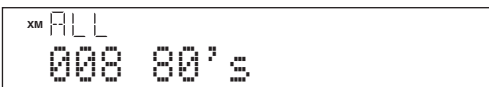

2 Press **MEMORY** (or **MEMORY**).

The indicator on the front panel display changes as follows.

Currently registered channel number
(or “----” if empty)



Preset number to which new channel number is registered

Channel number to be registered



- By holding down **MEMORY** (or **MEMORY**) for more than 2 seconds, you can skip the following steps and automatically register the selected channel to an empty preset number (next to the lastly-registered preset number).
- To cancel the preset operation, press **RETURN**.

3 Press **PRESET** **</>** (or **PRESET** **Δ/∇**) to select the stored preset station number.



- You can also select a preset number using the **Numeric keys**.
- If you select a preset number being used (currently registered channel number appears next to the preset number), the current preset channel will be overwritten.

4 Press **MEMORY** (or **MEMORY**).

Calling a preset channel (Preset Search mode)

Prior to selecting a preset channel in the Preset Search mode, you must preset XM channels. For details, see “Registering preset channels” on this page.

Preset channel number



Press **PRESET** **</>** (or **PRESET** **Δ/∇**) repeatedly to change the preset channel number (1 to 40).



- You can directly select a preset number by pressing a **Numeric key** while calling a preset channel.

Clearing preset channels

You can clear the assignments of preset XM Satellite Radio channels.

1 Press **OPTION** on the remote control.
The Option menu for “XM” is displayed.

2 Press **Cursor** **Δ/∇** repeatedly to select “Clear Preset” and then press **ENTER**.

3 Press **Cursor** **Δ/∇** to select the preset station number that you want to clear.

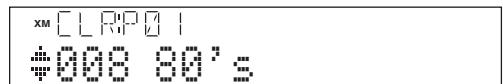

4 Press **ENTER** to execute the clearing of the selected preset channel.

To clear the registration of multiple preset numbers, repeat steps 3 and 4.

5 To exit the Option menu, press **OPTION**.

Displaying the XM Satellite Radio™ information

Use this feature to display the XM Satellite Radio information on the front panel display or on the GUI screen.

Note

- If a status message or an error message appears on the front panel display or GUI screen, see “XM Satellite Radio” (page 80).

■ Front panel display

Press **Ⓔ INFO** (or **Ⓕ INFO**) repeatedly to toggle the following XM Satellite Radio information display modes.

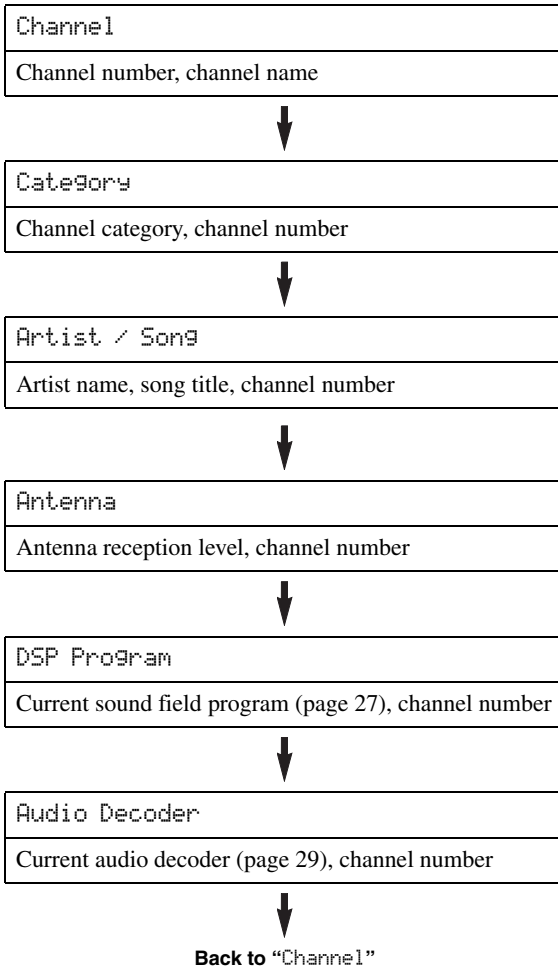

Display example (Antenna)



- You can configure the scroll setting of the front panel display with “Front Panel Display Scroll” in the Setup menu (page 63).
- If the XM Satellite Radio information contains a character that cannot be recognized by this unit, the character will be displayed with a space.
- When an information is unavailable, “—” appears.

■ GUI screen

Press **Ⓔ DISPLAY** on the remote control to turn on or off the information display.

The following information is displayed on the GUI screen.

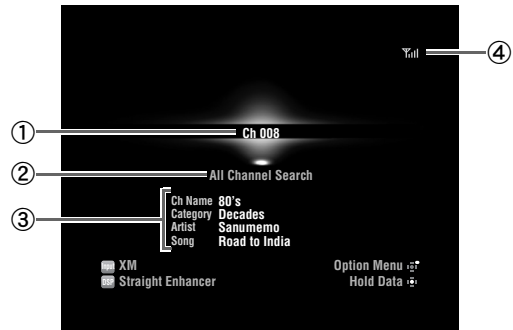

- ① Channel number
- ② Search mode (page 36)
- ③ Channel name, channel category, artist name, song title
- ④ Antenna reception level



- To hold or release the displayed information, press **Ⓔ ENTER**. While it is held, the “HOLD” icon appears on the GUI screen.

SIRIUS Satellite Radio™ tuning (U.S.A. model only)

Connecting the SiriusConnect™ tuner

Connect the SiriusConnect tuner (sold separately) to the SIRIUS jack on the rear panel of this unit. For details, see the operating instructions provided with the SiriusConnect tuner.

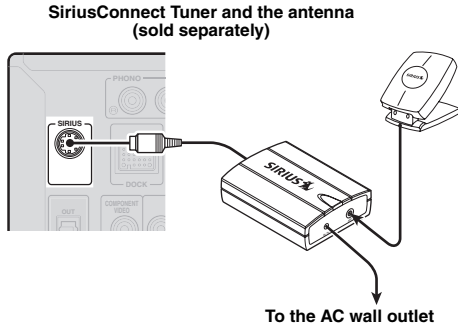

- To ensure optimal reception of the SIRIUS Satellite Radio signals, the antenna of the SiriusConnect tuner must be placed at or near a window with no obstacles in the path to the sky. The orientation of the antenna for the best reception differs depending on the area. Refer to the instruction manuals supplied with the SiriusConnect tuner for the installation of the antenna. You can mount it indoors or outdoors.
- Use the “Antenna” information in the front panel or “SIRIUS Information” screen on the GUI screen (page 43) to check the antenna reception level and adjust the orientation of the antenna.
- You need to connect the SiriusConnect tuner to the AC wall outlet.

Notes

- If “CHECK SR TUNER” or “ANTENNA ERROR” appears on the front panel display, the connection of the SiriusConnect tuner or antenna is incorrect. In such cases, check the connection of the SiriusConnect tuner and the antenna.
- If “NOT SUPPORTED” appears on the front panel display, this unit does not support the connected SiriusConnect tuner.

Activating SIRIUS Satellite Radio™ subscription

Before using the SIRIUS Satellite Radio feature, you need to activate your SIRIUS Satellite Radio subscription. To activate the subscription you need the Sirius ID which is uniquely assigned to the SiriusConnect tuner. Sirius ID is 12-digit number and it appears on the package of the SiriusConnect tuner, on the label of the SiriusConnect tuner, and when you tune into the SIRIUS Satellite Radio channel “0” (see below).

Displaying the Sirius ID of your SiriusConnect tuner

- 1 Rotate the **INPUT** selector (or press **SIRIUS**) to select “SIRIUS” as the input source.
- 2 Press **0** and then **ENT** to display the Sirius ID of your SiriusConnect tuner. “000 Sirius ID” and “xxxxxxxxxxxx” (“xxxxxxxxxxxx” indicates the 12-digit Sirius ID of your SiriusConnect tuner) appears alternately on the front panel display. Write the Sirius ID below.
ID: _____

- 3 Contact SIRIUS Satellite Radio to activate your subscription.

SIRIUS Satellite Radio online information

Contact for activation

URL: <https://activate.siriusradio.com/>

Phone: 1-888-539-SIRIUS (1-888-539-7474)



- Status messages appear on the front panel display or GUI screen during the activation. For details, see “SIRIUS Satellite Radio” (page 81). Once the activation is finished, “SUB UPDATED” appears.

SIRIUS Satellite Radio™ operations

- 1 Rotate the **INPUT** selector (or press **SIRIUS**) to select “SIRIUS” as the input source.

The SIRIUS indicator lights up on the front panel display and the SIRIUS Satellite Radio information (such as channel number, channel name, category, artist name, or song title) for the currently selected channel appears on the front panel display.

Search mode



Channel number Channel name



- When you select “SIRIUS” as the input source, this unit automatically recalls the previously selected channel.

Notes

- When you have not activated your subscription yet, you can only select “184” or “000”.
- If a status message or an error message appears on the front panel display or on the GUI screen, see “SIRIUS Satellite Radio” (page 81).

2 Search for a channel by using one of the SIRIUS Satellite Radio search modes.

- To select a channel from the all channel list, see “All Channel Search mode” on this page.
- To select a channel by category, see “Category Search mode” on this page.
- To select the desired channel directly by entering the channel number, see “Direct number access” on this page.
- To select a channel from the preset channels, see “Calling a preset channel (Preset Search mode)” (page 41).



- You can display the SIRIUS Satellite Radio information on the front panel display or on the GUI screen (page 43).
- If you tune into a channel that you do not subscribe, “CALL SIRIUS” (on the front panel display) and “CALL 888-539-SIRIUS TO SUBSCRIBE” (on the GUI screen) appear.
- You can set the SIRIUS Satellite Radio preset channels (page 41).

■ All Channel Search mode

Press **⓪ TUNING/CH** </> (or **Ⓜ TUN./CH** Δ / ∇) repeatedly to search for a channel within all channels.



- You can search for a channel quickly by holding down **⓪ TUNING/CH** </> (or **Ⓜ TUN./CH** Δ / ∇).
- You can skip channels to the previous or next category by pressing **Ⓜ CATEGORY** (or **Ⓜ CATEGORY** </>).

■ Category Search mode

1 Press **Ⓜ CATEGORY** (or **Ⓜ CATEGORY** </>) to select the channel category.

“CAT” is displayed on the front panel display during channel category selection. When you select the category, the first channel in the category is selected.

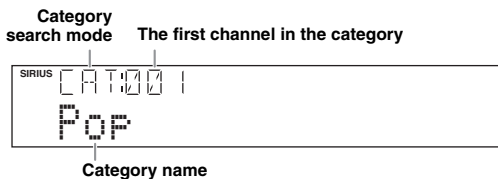

Note

- If you do not operate within 10 seconds, the category search mode returns to “ALL” (All Channel Search).

2 While “CAT” is displayed on the front panel display, press **⓪ TUNING/CH** </> (or **Ⓜ TUN./CH** Δ / ∇) repeatedly to search for a channel within the selected channel category.



- You can search for a channel quickly by pressing and holding **⓪ TUNING/CH** </> (or **Ⓜ TUN./CH** Δ / ∇).

Note

- This unit skips the channels when this unit is in the All Channel Search mode or Category Search mode in the following cases (it is not malfunction of this unit):
 - the channel is locked (page 42).
 - the channel is out of service.
 - you do not subscribe to the channel.

■ Direct number access

In the All Channel Search mode or Category search mode, press the **Ⓜ Numeric keys** to enter the desired three-digit channel number.

For example, to enter the number 123, press the **Ⓜ Numeric keys** as “1”, “2” and “3”.



- To display the Sirius ID number displayed on the front panel display, select channel “0”.
- To enter a one-digit or two-digit channel number, press the **Ⓜ Numeric keys** on the remote control and then press **Ⓜ ENT** to confirm the input number.
- Instead of pressing **Ⓜ ENT** to tune into the channel immediately, you can wait a few seconds until this unit confirms the entered channel number.
- If no key is pressed within a few seconds after you enter a one-digit or two-digit number, this unit automatically confirms the entered channel number.
- If the selected channel is locked, “PIN: ___” appears on the front panel display. Enter the four-digit Parental Lock code number by using the **Ⓜ Numeric keys** or press **Ⓜ ENT** to cancel (page 42).
- If the selected channel is not available, an advisory message may appear. For details, see “SIRIUS Satellite Radio” (page 81).

Registering SIRIUS Satellite Radio™ channels

You can use this feature to store up to 40 SIRIUS Satellite Radio channels. You can then recall any preset channel easily by selecting the preset channel group and number as described in “Calling a preset channel (Preset Search mode)” on this page.

Registering preset channels

1 Search a channel you want to set as a preset channel in one of the SIRIUS Satellite Radio search modes.

For details, see “SIRIUS Satellite Radio operations” (page 39).

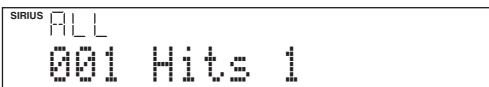

2 Press **MEMORY** (or **MEMORY**).

The indicator on the front panel display changes as follows.

Currently registered channel number
(or “----” if empty)



Preset number to which new channel number is registered

Channel number to be registered



- By holding down **MEMORY** (or **MEMORY**) for more than 2 seconds, you can skip the following steps and automatically register the selected channel to an empty preset number (next to the lastly-registered preset number).
- To cancel the preset operation, press **RETURN**.

3 Press **PRESET** </> (or **PRESET** Δ/∇) to select the stored preset station number.



- You can also select a preset number using the **Numeric keys**.
- If you select a preset number being used (currently registered channel number appears next to the preset number), the current preset channel will be overwritten.

4 Press **MEMORY** (or **MEMORY**).

Calling a preset channel (Preset Search mode)

Prior to selecting a preset channel in the Preset Search mode, you must preset SIRIUS channels. For details, see “Registering preset channels” on this page.



Press **PRESET** </> (or **PRESET** Δ/∇) repeatedly to change the preset channel number (1 to 40).

Clearing preset channels

You can clear the assignments of preset SIRIUS Satellite Radio channels.

1 Press **OPTION** on the remote control.
The Option menu for “SIRIUS” is displayed.

2 Press **Cursor** Δ/∇ repeatedly to select “Clear Preset” and then press **ENTER**.

3 Press **Cursor** Δ/∇ to select the preset station number that you want to clear.

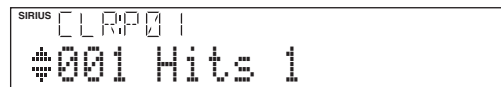

4 Press **ENTER** to execute the clearing of the selected preset channel.

To clear the registration of multiple preset numbers, repeat steps 3 and 4.

5 To exit the Option menu, press **OPTION**.

Setting the Parental Lock

You can use the Parental Lock feature to limit the access to the desired SIRIUS Satellite channels. This unit automatically skips the locked channels when this unit is in the All Channel Search mode or Category Search mode and you search a channel by pressing **[1] TUNING/CH** $\triangleleft/\triangleright$ (or **[5] TUN./CH** \triangle/∇).

Setting the code number and the locking channels

Use this feature to set the Parental Lock code number (PIN) and select the channels to be locked.

- Press **[9] OPTION** on the remote control. The Option menu for “SIRIUS” is displayed.
- Press **[10] Cursor** \triangle/∇ repeatedly to select “Parental Lock” and then press **[10] ENTER**.
- Use **[10] Cursor** $\triangleleft/\triangleright$ (to select a digit to edit) and **[10] Cursor** \triangle/∇ (to select a number) to enter the desired 4-digit code number. If you have entered a code number before, enter the same code number.

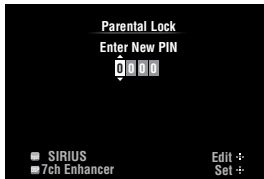

The entered code number is needed for tuning in the channel or unlocking the channel. Write it down below.
Code number: _____

- Press **[10] ENTER**. The confirmation screen appears.
- Press **[10] ENTER** again to confirm the code number. “OK” and then the SIRIUS Satellite Radio channel list appears.

Note

- If a code number is already registered and you enter the different number, “Wrong” appears and the screen returns to step 3. Enter the correct code number.
- If you forget the Parental lock code or want to change it, reset it using “SR PIN” (page 73).

- Press **[10] Cursor** $\triangleleft/\triangleright$ to select the category of a channel you want to lock.

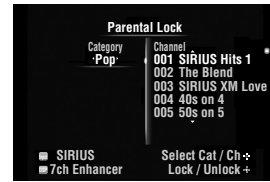

- Press **[10] Cursor** \triangle/∇ to select a channel you want to lock.

Notes

- You can also select a channel by using **[5] CATEGORY** $\triangleleft/\triangleright$ or **[5] TUN./CH** \triangle/∇ .
- While the SIRIUS Satellite Radio channel list screen is displayed, sound of the selected channel is output even the channel is locked.

- Press **[10] ENTER** to lock the selected channel.

A check mark appears next to the locked channel on the GUI screen. You can toggle channel lock and unlock as you press **[10] ENTER**.

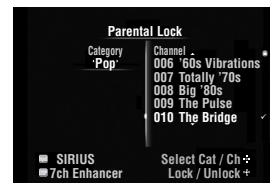

- Repeat steps 6 through 8 to lock all the desired channels.

- Press **[10] RETURN** repeatedly to exit the “Parental Lock” screen.

This unit is tuned into the last channel you select in the “Parental Lock” screen. If the channel is locked, this unit is tuned into “184 Weather/Emergency” or “000 Sirius ID”.

Tuning into the locked channels

Tune into the channel with direct number access (page 40) or Preset Search mode (page 41). When you tune into the locked channel, “LOCKED” appears on the front panel display and GUI screen, followed by the following message. Enter the set Parental lock code by using the **[12] Numeric keys**. To cancel this operation, press **[12] ENT**.



Note

- If an incorrect number is entered, “Wrong” appears on the front panel display or the GUI screen and this unit is tuned into the previously selected channel.

Displaying the SIRIUS Satellite Radio™ information

Use this feature to display the SIRIUS Satellite Radio information on the front panel display or on the GUI screen.

Note

- If a status message or an error message appears on the front panel display or GUI screen, see “SIRIUS Satellite Radio” (page 81).

■ Front panel display

Press **ⓂINFO** (or **ⓂINFO**) repeatedly to toggle the following SIRIUS Satellite Radio information display modes.

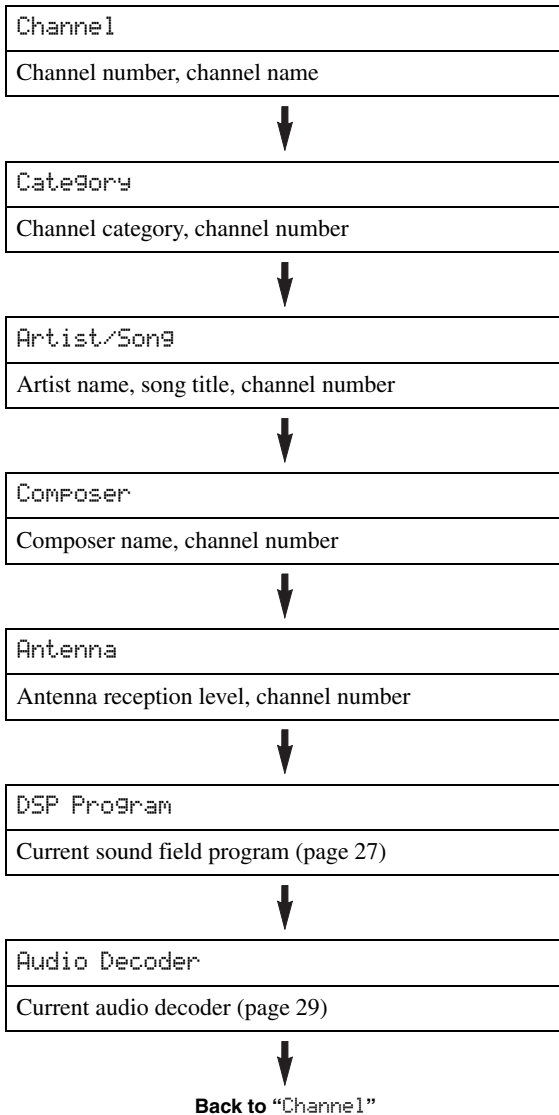

Display example (Antenna)



- You can configure the scroll setting of the front panel display with “Front Panel Display Scroll” in the Setup menu (page 63).
- If the SIRIUS Satellite Radio information contains a character that cannot be recognized by this unit, the character will be displayed with a space.
- When the antenna of the SiriusConnect tuner cannot receive the signals, “ACQUIRING” appears on the front panel display.
- When an information is unavailable, “—” appears.

■ GUI screen

Press **ⓂDISPLAY** on the remote control to turn on or off the information display.

The following information is displayed on the GUI screen.

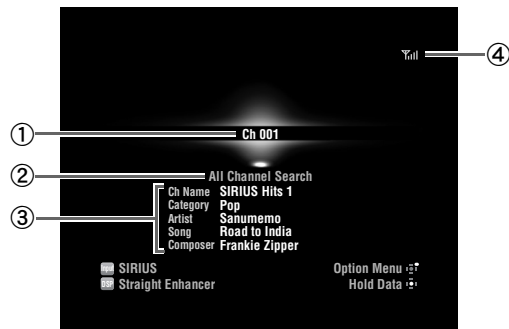

- ① Channel number
- ② Search mode (page 40)
- ③ Channel name, channel category, artist name, song title, composer name
- ④ Antenna reception level



- To hold or release the displayed information, press **ⓂENTER**. While it is held, the “HOLD” icon appears on the GUI screen..

Using iPod™

Once you have stationed your iPod in a Yamaha iPod universal dock (such as the YDS-11, sold separately) connected to the DOCK terminal on the rear panel of this unit (page 18), you can enjoy playback of your iPod using the supplied remote control or the menu displayed on the GUI screen. You can also use the Compressed Music Enhancer mode of this unit to improve the sound quality of the compression artifacts (such as MP3 format) stored on your iPod (page 29).



Notes

- iPod touch, iPod (Click and Wheel including iPod classic), iPod nano, and iPod mini are supported.
 - Some features may not be compatible depending on the model or the software version of your iPod.
 - Some features may not be available depending on the model of Yamaha iPod universal dock. The following sections describe the procedure when using the YDS-11.
-  • Once the connection between your iPod and this unit is complete, “iPod connected” appears on the front panel display.
- For a complete list of status messages that appear on the front panel display and GUI screen, see “iPod” (page 83).
- (U.S.A. model only)
Once the connection between an iPod that supports iTunes Tagging feature and this unit is complete, this unit transmits iTunes Tagging information to the iPod (page 33).

Controlling iPod™

You can control your iPod when you set it in the iPod universal dock and switch the input source to DOCK. The operations of your iPod can be done with the aid of the video display (menu browse mode) or without it (simple remote mode).

When you connect your iPod to this unit, you can perform the following operations with the remote control.

Key	Function
ENTER	Subsequent menu
△	Menu up
 ▽	Menu down
◀	Previous menu
▶	Subsequent menu
▶	Play (Menu browse mode) Play/Pause (Simple remote mode)
□	Stop
⏸	Pause (Menu browse mode) Play/Pause (Simple remote mode)
 ◀◀	Search backward (Press and hold)
▶▶	Search forward (Press and hold)
⏮	Skip backward
⏭	Skip forward
 DISPLAY	Switch between Menu browse mode and Simple remote mode

Controlling iPod in simple remote mode

You can perform basic iPod operations (play, stop, skip, etc.) using the supplied remote control without displaying the menu on the GUI screen. You can also directly control your iPod in this mode.

Controlling iPod in menu browse mode

You can browse song or video files stored on your iPod using the GUI screen. You cannot directly control your iPod in this mode.

-  • “_” (underscore) is displayed for characters that this unit cannot display.

1 Rotate the  INPUT selector (or press  DOCK) to select “iPod” (DOCK) as the input source.

2 Press  DISPLAY on the remote control.

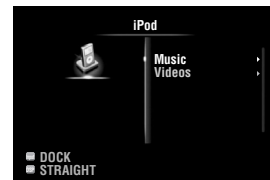



3 Press  Cursor △ / ▽ to select “Music” or “Videos” and then press  Cursor ▶.

- Select “Music” to browse music files.
- Select “Videos” to browse video files.

Note

- The “Videos” menu does not appear unless the both your iPod and Yamaha iPod universal dock support the video browsing feature.

4 Press  Cursor △ / ▽ / ◀ / ▶ to select a menu item and then press  ENTER to start playback.

■ Play information display

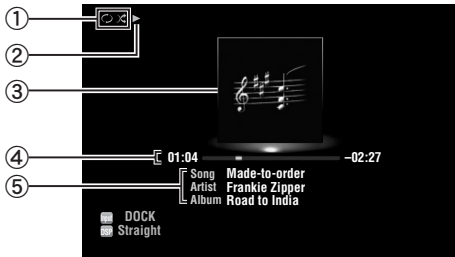

- ① Shuffle and repeat icons
- ② ► (playback), || (pausing), ►► (search forward) and ◀◀ (search backward)
- ③ Album art (image of CD jacket, etc)
- ④ Elapsed time, progress bar, remaining time
- ⑤ Song title, artist name, album title



- You can switch the information displayed on the front panel display by pressing **ⓈINFO** (or **ⓈINFO**).
- Album arts are available only when the file contains image data.

■ Shuffle/repeat playback

When controlling iPod in simple remote mode, operate the iPod directly to set the shuffle and repeat playback.

- 1 Press **ⓈDISPLAY** to switch to menu browse mode while “DOCK” is selected as the input source.**

- 2 Press **ⓈOPTION** on the remote control.**
The Option menu for “iPod” is displayed (page 54).

- 3 Press **ⓈCursor** **▲** / **▼** to select “Shuffle” or “Repeat”, press **ⓈENTER** and then press **ⓈCursor** **◀** / **▶** to select the desired playback style.**

Shuffle:

 - Select “Off” if you do not want to play back in random order.
 - Select “Songs” to play back songs in random order.
 - Select “Albums” to play back albums in random order.

Repeat:

 - Select “Off” if you do not want to play back repeatedly.
 - Select “One” to repeat each song.
 - Select “All” to repeat all songs.

- 4 To exit the Option menu, press **ⓈOPTION**.**

Using Bluetooth™ components

You can connect a Yamaha Bluetooth wireless audio receiver (such as YBA-10, sold separately) to the DOCK terminal of this unit and enjoy the music contents stored in your Bluetooth component (such as a portable music player) without wiring between this unit and the Bluetooth component.

Note

- This unit supports A2DP (Advanced Audio Distribution Profile) of the Bluetooth profile.
- For a complete list of status messages that appear on the front panel display and GUI screen, see “Bluetooth™” (page 83).

About “Pairing”

Pairing (registration of the Bluetooth devices) must be performed when making Bluetooth connections between the Yamaha Bluetooth wireless audio receiver and your Bluetooth components for the first time. Once pairing is complete, you can select one of the Bluetooth components to connect to the Yamaha Bluetooth wireless audio receiver for playback.



- Yamaha Bluetooth wireless audio receiver YBA-10 can be paired with up to eight Bluetooth components. If ninth pairing data is registered, the pairing data for the component least recently used is cleared.

Pairing the Bluetooth™ wireless audio receiver and your Bluetooth component



- If the pairing data has been cleared from the Bluetooth wireless audio receiver or your Bluetooth component, you need to perform pairing again.
- For details on operations on your Bluetooth component, refer to the operating instruction of it.

To ensure security, a time limit of 8 minutes is set for the pairing operation. You are recommended to read and fully understand all the instructions before starting.

1 Rotate the **Ⓘ** INPUT selector (or press **4** DOCK) to select “BLUETOOTH” (DOCK) as the input source.

2 Turn on the Bluetooth component you want to pair with and set it to pairing mode.

3 Press **19** OPTION on the remote control. The Option menu for “BLUETOOTH” is displayed (page 54).

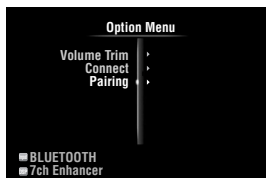

4 Press **10** Cursor ∇ to select “Pairing” and then press **10** ENTER. “Searching” appears and the pairing operation starts.



- To cancel pairing, press **10** RETURN.
- You can also start pairing operation by holding down **Ⓢ** MEMORY on the front panel.

5 Make sure the Bluetooth component recognizes the Bluetooth wireless audio receiver.

If the Bluetooth component detects the Bluetooth wireless audio receiver, “YBA-10 YAMAHA” (example) appears in the Bluetooth device list.

6 Select the Bluetooth wireless audio receiver in the Bluetooth device list, and enter a pass key “0000” into the Bluetooth component.

When pairing is complete, “Completed” appears on the front panel display.

Playback of the Bluetooth™ component

1 Rotate the **Ⓘ** INPUT selector (or press **4** DOCK) to select “BLUETOOTH” (DOCK) as the input source.

2 Press **19** OPTION on the remote control.

3 Press **10** Cursor ∇ to select “Connect” and then press **10** ENTER.

The Bluetooth connection is established between the Bluetooth wireless audio receiver and your Bluetooth component connected last time.



- If the Bluetooth wireless audio receiver cannot find the Bluetooth component connected last time, “Not found” appears on the front panel display.
- To disconnect the Bluetooth wireless audio receiver from the Bluetooth component currently connected, select “Disconnect” and then press **10** ENTER or perform a disconnect operation on the Bluetooth component.
- To make a connection between the Bluetooth wireless audio receiver and another Bluetooth component (already paired), perform a connect operation on the Bluetooth component while no Bluetooth connection is established on the Bluetooth wireless audio receiver.

4 Start playback of the Bluetooth component.

5 To exit the Option menu, press **19** OPTION.

Using USB storage devices

You can enjoy playback of WAV (PCM format only), MP3, WMA, MPEG-4 AAC and FLAC files stored on your USB memory device or USB portable player connected to the USB port on the front panel of this unit. This unit supports USB mass storage class devices (FAT 16 or FAT 32 format, except USB HDDs).

Notes

- You can play back only the files stored in the first partition.
- Some files may not be playable depending on models and types of USB storage devices.
- For a complete list of status messages that appear on the front panel display and GUI screen, see “USB and network” (page 84).

Playback of the USB storage device

1 Connect your USB storage device to the **(N) USB port on the front panel (page 19).**

2 Rotate the **(1) INPUT selector (or press (4) USB/NET and then (24) USB)** to select “USB” as the input source.

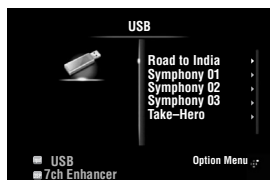

If you have connected the USB storage device to this unit before, playback of the music file played at the last time automatically starts.

3 Press **(10) Cursor** Δ / ∇ / \leftarrow / \rightarrow to select a music file to play back.

- To select a file or folder, press **(10) Cursor** Δ / ∇ .
- To confirm the selection, press **(10) Cursor** \rightarrow or **(10) ENTER**.
- To return to the previous menu, press **(10) Cursor** \leftarrow .

4 Press **(10) ENTER** to start playback.

You can also perform the following operations with the remote control.

Key	Function
\triangleright	Play
\square	Stop
(11) $\triangleright\triangleright$	Skip forward during playback
$\triangleleft\triangleleft$	Skip backward during playback

Play information display

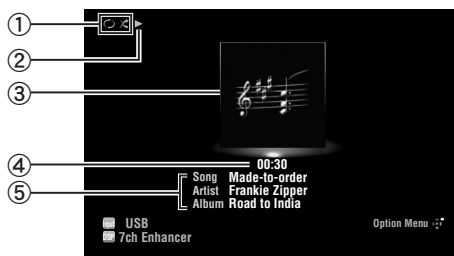

- ① Shuffle and repeat icons
- ② \blacktriangleright (playback)
- ③ Album art (image of CD jacket, etc)
- ④ Elapsed time
- ⑤ Song title, artist name, album title



- You can switch the information displayed on the front panel display by pressing **(E) INFO** (or **(6) INFO**) (page 26).
- Album arts are available only when the file contains image data.

Shuffle/repeat playback



- These settings are also reflected in playback of PC and Rhapsody® contents.

1 Press **(19) OPTION** on the remote control while “USB” is selected as the input source. The Option menu for “USB” is displayed (page 54).

2 Press **(10) Cursor** Δ / ∇ to select “Shuffle” or “Repeat”, press **(10) ENTER** and then press **(10) Cursor** \leftarrow / \rightarrow to select the desired playback style.

Shuffle:

- Select “Off” if you do not want to play back in random order.
- Select “On” to play back music files in random order.

Repeat:

- Select “Off” if you do not want to play back repeatedly.
- Select “One” to repeat each music file.
- Select “All” to repeat all music files in the folder.

3 To exit the Option menu, press **(19) OPTION**.

Using PC servers

You can enjoy playback of audio files stored on PCs connected to this unit via your network. To play back audio files on your PC, you need to install Windows Media Player 11 on the PC and configure the media sharing setting of Windows Media Player 11.

Note

- If you do not use a DHCP server, configure the network parameters (IP address, etc) of this unit manually (page 64)

Windows Media Player 11 setup

1 Install Windows Media Player 11 on your PC.

You can download the installer of Windows Media Player 11 from the Microsoft website, or use the upgrade function of the installed Microsoft Windows Media Player.

2 Turn on your PC then allow media sharing.

Activate Windows Media Player 11 first, enable the media sharing and then select this unit as a device to which the media is shared.

Note

- If the operating system (OS) of your PC is Windows Vista, Windows Media Player 11 is pre-installed (except some products).
- Some security software installed on your PC (anti-virus software, firewall software, etc.) may block the access of this unit to your PC. In such cases, configure the security software appropriately.
- You can connect this unit to up to 16 PC servers, and each server must be connected to the same subnet as this unit.

Playback of PC music contents



- For a complete list of status messages that appear on the front panel display and GUI screen, see “USB and network” (page 84).

1 Rotate the **INPUT** selector (or press **4** **USB/NET** and then **24** **PC**) to select “PC” as the input source.

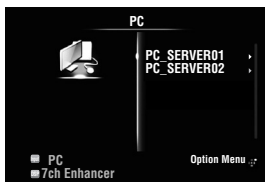

2 Press **10** **Cursor** Δ / ∇ / \leftarrow / \rightarrow to select a PC server and music file to play back.

- To select a PC server, folder or file, press **10** **Cursor** Δ / ∇ .
- To confirm the selection, press **10** **Cursor** \rightarrow or **10** **ENTER**.
- To return to the previous menu, press **10** **Cursor** \leftarrow .



- To update the PC server list displayed in the GUI screen, press **19** **OPTION**, press **10** **Cursor** Δ / ∇ to select “Refresh” and then press **10** **ENTER**. To exit the Option menu, press **19** **OPTION**.

3 Press **10** **ENTER** to start playback.

You can also perform the following operations with the remote control.

Key	Function
\triangleright	Play
\square	Stop
11 $\triangleright \triangleright$	Skip forward during playback
$\triangleleft \triangleleft$	Skip backward during playback

■ Play information display

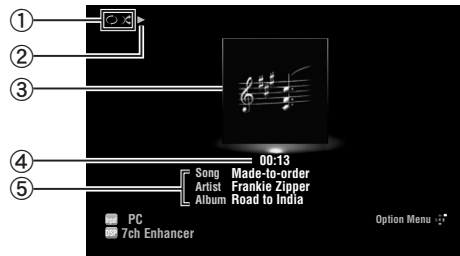

- 1 Shuffle and repeat icons
- 2 \triangleright (playback)
- 3 Album art (image of CD jacket, etc)
- 4 Elapsed time
- 5 Song title, artist name, album title



- You can switch the information displayed on the front panel display by pressing **6** **INFO** (or **6** **INFO**) (page 26).
- Album arts are available only when the file contains image data.

Shuffle/repeat playback



- These settings are also reflected in playback of USB and Rhapsody® contents.

- 1 Press **[F10]OPTION** on the remote control while “PC” is selected as the input source. The Option menu for “PC” is displayed (page 54).
- 2 Press **[F10]Cursor** Δ / ∇ to select “Shuffle” or “Repeat”, press **[F10]ENTER** and then press **[F10]Cursor** \triangleleft / \triangleright to select the desired playback style.

Shuffle:

 - Select “Off” if you do not want to play back in random order.
 - Select “On” to play back music files in random order.

Repeat:

 - Select “Off” if you do not want to play back repeatedly.
 - Select “One” to repeat each music file.
 - Select “All” to repeat all music files in the folder.
- 3 To exit the Option menu, press **[F10]OPTION**.

Using the Internet Radio feature

You can listen to Internet Radio stations using the vTuner Internet Radio station database service particularly customized for this unit, providing a database of over 2000 radio stations. Also, you can store your favorite stations with bookmarks.

Note

- To use this feature, your network must be connected to the Internet.
- A narrowband Internet connection (i.e. 56K modem, ISDN) will not provide satisfactory results, and a broadband connection is strongly recommended (i.e. a cable modem, an xDSL modem, etc.). For detailed information, consult with your ISP.
- If you do not use a DHCP server, configure the network parameters (IP address, etc) of this unit manually (page 64)
- Some security devices (such as firewall) may block the access of this unit to Internet Radio stations. In such cases, configure the security settings appropriately.
- This service may be discontinued without notice.
- Some Internet Radio stations may not be played

Listening to Internet Radio



- For a complete list of status messages that appear on the front panel display and GUI screen, see “USB and network” (page 84).

- 1 Rotate the **INPUT** selector (or press **4** **USB/NET** and then **24** **NET RADIO**) to select “NET RADIO” as the input source.



- 2 Press **10** **Cursor** **Δ** / **∇** / **◀** / **▶** to select an item to play back.
 - To select an item, press **10** **Cursor** **Δ** / **∇**.
 - To confirm the selection, press **10** **Cursor** **▶** or **10** **ENTER**.
 - To return to the previous menu, press **10** **Cursor** **◀**.

- 3 Press **10** **ENTER** to start playback.

You can also perform the following operations with the remote control.

Key	Function
11	Play
	Stop

Play information display

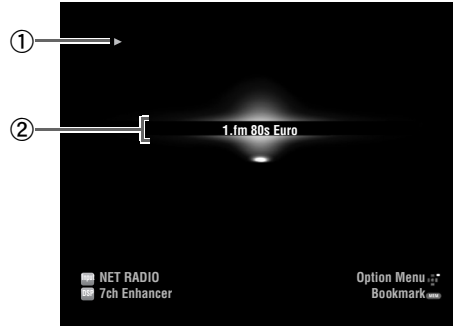

- 1 (playback)
- 2 Station name



- You can switch the information displayed on the front panel display by pressing **6** **INFO** (or **6** **INFO**) (page 26).

Storing your favorite Internet Radio stations with bookmarks

- 1 Select the desired Internet Radio station.

- 2 Press **5** **MEMORY**.

The selected Internet Radio station is added to the “Bookmarks” list in “NET RADIO”.



- To remove stations from the “Bookmarks” list, select the station under “Bookmarks” and then press **5** **MEMORY**.
- You can also register your favorite Internet Radio stations on this unit by accessing the website with the web browser on your PC. To use this feature, you need the vTuner ID of this unit (page 65) and your e-mail address to create your personal account. For details, refer to the help information on the website. URL: <http://yradio.vtuner.com/>

Using the Rhapsody® service (U.S.A. model only)

Prohibition

It is strictly prohibited to modify, reproduce, reverse-engineer or use this unit and/or built-in software for use other than audiovisual purposes.

The Rhapsody® service is the power behind the Rhapsody® Media Player (the Rhapsody® player software that you can download to your computer). Rhapsody® service supplies the music, keeps My Library up to date, provides you with Rhapsody® channels, the Playlist Central online community, and manages your downloads. Your software connects to Rhapsody® service through the internet. Because your account information and Rhapsody® content are on servers instead of any individual computer, your music is infinitely portable. Much of what you see in the Display area comes from Rhapsody® service. What you can do with Rhapsody® service depends on your subscription. You can use Rhapsody® service for free, or get even more from a paid membership. The Rhapsody® service also brings you Rhapsody® Online, a streamlined, internet version of Rhapsody® that you can access from almost anywhere. Just sign in to your Rhapsody® account to start letting the Rhapsody® service work for you. For more information, <http://www.rhapsody.com/>

Account setup for Rhapsody®

When you select “Rhapsody” for the first time, the account setup screen appears. Set up your Rhapsody® account to start using the Rhapsody® service on this unit.



- You can view the account information or edit your Rhapsody® account later with “Rhapsody Information” in the Setup menu (page 65).
- For a complete list of status messages that appear on the front panel display and GUI screen, see “USB and network” (page 84).

1 Rotate the \odot INPUT selector (or press $\boxed{4}$ USB/NET and then $\boxed{24}$ RHAPSODY) to select “Rhapsody” as the input source.

2 Press $\boxed{10}$ Cursor Δ / ∇ to select “Sign In to your account” and then press $\boxed{10}$ ENTER.

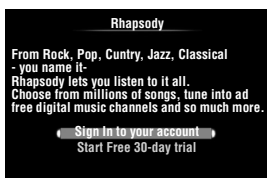

- To subscribe to the Rhapsody® service using 30-day free trial, select “Start Free 30-day trial” in step 2 and then read the description on the GUI screen. If you accept the terms and conditions, select “Yes” to get started. In this case, you do not need to follow steps 3 and 4.

3 Use $\boxed{10}$ Cursor Δ / ∇ / \triangleleft / \triangleright and $\boxed{10}$ ENTER to enter your user name and password (up to 64 characters each) and then select “OK” .



“Please wait” appears followed by the confirmation screen.

4 Press $\boxed{10}$ ENTER.

Playback of Rhapsody® contents



- For a complete list of status messages that appear on the front panel display and GUI screen, see “USB and network” (page 84).

1 Rotate the \odot INPUT selector (or press $\boxed{4}$ USB/NET and then $\boxed{24}$ RHAPSODY) to select “Rhapsody” as the input source.



- If the remaining term of your free trial account is less than seven days, the number of remaining days is displayed in the GUI screen. To proceed to step 2 (with the free trial service), press $\boxed{10}$ ENTER. To sign up for Rhapsody®, see “Rhapsody Information” (page 65).

2 Press $\boxed{10}$ Cursor Δ / ∇ / \triangleleft / \triangleright to select an item to play back.

- To select an item, folder or file, press $\boxed{10}$ Cursor Δ / ∇ .
- To confirm the selection, press $\boxed{10}$ Cursor \triangleright or $\boxed{10}$ ENTER.
- To return to the previous menu, press $\boxed{10}$ Cursor \triangleleft .

Rhapsody Music Guide	Select a track from the lists organized by category (artist, album, etc).
Rhapsody Channels	Select a network radio channel from the lists of the channels provided by Rhapsody®.
Search	Use the software keyboard to search the desired item (artist, album, etc) by keyword.
My Library	Select a track from items (artist, album, etc) added to “My Library” .

3 Press **[ENTER]** to start playback.

You can also perform the following operations with the remote control.

Key	Function
[▶]	Play
[□]	Stop (pause for “Rhapsody Channels”)
[⏸]	Pause (unavailable for “Rhapsody Channels”)
[⏭]	Skip forward
[⏮]	Skip backward (unavailable for “Rhapsody Channels”)



- To play back the currently selected item (track, album, channel or playlist) directly, press **[POP-UP MENU]**, press **[Cursor Δ / ▽]** to select “Play” and then press **[ENTER]**.
- To display the track list of the album that contains the currently selected track, press **[POP-UP MENU]**, press **[Cursor Δ / ▽]** to select “Show Album Page” and then press **[ENTER]**. (This menu is not available when you have selected a track from the track list of an album).

■ Play information display



- Shuffle and repeat icons
- ▶ (playback)
- Album art (image of CD jacket, etc) or channel logo
- Elapsed time, progress bar, total time
- Song title, artist name, album title



- You can switch the information displayed on the front panel display by pressing **[INFO]** (or **[INFO]**) (page 26).
- Album arts or channel logos are available only when the selected service provides image data.

Adding your favorite Rhapsody® items to “My Library”

1 Select the desired Rhapsody® item.

2 Press **[POP-UP MENU]**.

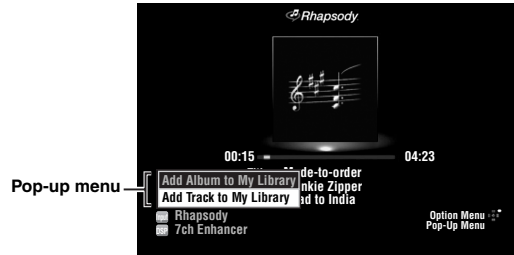

- Available pop-up menu items vary depending on the menu level or selected item.

3 Press **[Cursor Δ / ▽]** to select the desired operation and then press **[ENTER]**.

- Select “Add Track to My Library” to add the currently selected track to “My Library”.
- Select “Add Album to My Library” to add the currently selected album to “My Library”.
- Select “Add Channel to My Library” to add the currently selected channel to “My Library”.

4 To exit the pop-up menu, press **[POP-UP MENU]**.



- To remove items from “My Library”, select the item under “My Library”, press **[POP-UP MENU]**, press **[Cursor Δ / ▽]** to select “Remove from My Library” and then press **[ENTER]**.

Shuffle/repeat playback



- These settings are also reflected in playback of USB and PC contents.

1 Press **[OPTION]** on the remote control while “Rhapsody” is selected as the input source.

2 Press **[Cursor Δ / ▽]** to select “Shuffle” or “Repeat”, press **[ENTER]** and then press **[Cursor < / >]** to select the desired playback style.

Shuffle:

- Select “Off” if you do not want to play back in random order.
- Select “On” to play back songs in the selected list in random order.

Repeat:

- Select “Off” if you do not want to play back repeatedly.
- Select “One” to repeat each song.
- Select “All” to repeat all songs in the selected list.

3 To exit the Option menu, press **[OPTION]**.

Other functions

Selecting the HDMI OUT jack

Use this feature to select the HDMI OUT jack(s) to output the input signals.

Press **[7]** **HDMI OUT** repeatedly to select the active HDMI OUT jack(s).



HDMI OUT 1+2	Outputs the signals from both the HDMI OUT 1 and HDMI OUT 2 jacks simultaneously.
HDMI OUT 1	Outputs the signals from the HDMI OUT 1 jack.
HDMI OUT 2	Outputs the signals from the HDMI OUT 2 jack.
HDMI OFF	Not to output any signals from the HDMI OUT jacks. Select this setting when you do not use the video monitor connected to one of the HDMI OUT jacks.



- This unit automatically activates the HDMI OUT 1 jack when receiving an HDMI control signal through the HDMI OUT 1 jack while the HDMI OUT 1 jack is not selected.

Using the HDMI™ control function

You can operate the following functions of this unit with the remote control of your TV when the TV (HDMI control function supported) is connected to the HDMI OUT 1 jack of this unit.

- Turning on this unit or to the standby (conjunction with TV)
- Adjusting the volume
- Selecting a device to reproduce TV sounds (this unit or TV)



- Even if your TV supports the HDMI control function, some functions may not be available. For details, refer to the manual supplied with your TV.
- If you connect this unit and Blu-ray player or DVD player (HDMI control function supported) with HDMI, you can also control those devices with the HDMI control function. For details, refer to the manual supplied with each device.
- We suggest that you use products (TV, Blu-ray/DVD player, etc.) from the same manufacturer.
- The HDMI control-compatible components include Panasonic VIERA Link compatible TV, DVD player/recorder and Blu-ray Disc player.

(Steps 1 through 3 are required for the HDMI control function setup.)

1 Turn on all devices connected to this unit with HDMI.

2 Enable the HDMI control function on each device.

For this unit, set “HDMI Control” to “On” (page 62).
For external devices, refer to the manual supplied with each device.

3 Turn off the TV and then turn on it again.

(Steps 4 through 6 are required for making the TV learn linked devices. If the connections or devices are switched, you need to carry out these steps again.)

4 Select this unit as the input source of the TV.

5 Turn on the HDMI control device (Blu-ray or DVD player) connected to this unit.

6 Select the HDMI control device (Blu-ray or DVD player) as the input source of this unit to check the video input.

7 Check if the HDMI control function works (turn on this unit or adjust the volume level using the remote control of the TV).

Note

- In case the HDMI control function does not work, check the followings. Also, turning off (unplug) and turning on (plug) the TV may be effective.
 - The TV is connected to the HDMI OUT 1 jack of this unit.
 - “HDMI Control” is set to “On” on this unit.
 - The HDMI control function is enabled on the TV.



- This unit automatically selects the TV scene (page 24) when you select this unit as the device to reproduce TV sounds using the remote control of your TV. That is, if you connect an audio output jack of your TV to the AV 1 (OPTICAL) jack of this unit, you can enjoy TV sounds with the specified sound field program soon.

Using the sleep timer

The sleep timer is useful if you want to go to sleep while this unit is playing or recording a source.

Press **[17]** **SLEEP** repeatedly to select the amount of time.

The sleep timer setting changes as follows.

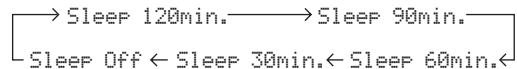

If the sleep timer is set, the SLEEP indicator on the front panel display lights up.

To disable the sleep timer, select “Sleep Off”.

ADVANCED OPERATION

Setting the option menu for each input source (Option menu)

The Option menu allows users to configure various settings for each input source and reflect corresponding settings automatically when an input source is switched. Also, you can view the signal information for certain input sources. The procedure for setting the Option menu items is described below.

- 1 Rotate the **INPUT** selector (or press **4** **Input selection key**) to select the desired input source.

If you press **4** **USB/NET** on the remote control, press **2** **Sub-input selection key** to select a sub-input source.

- 2 Press **19** **OPTION** on the remote control.

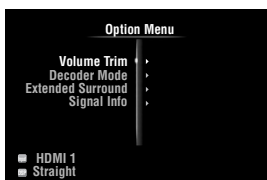

- 3 Press **10** **Cursor** Δ / ∇ to select the desired menu item and then press **10** **ENTER**.

- 4 Press **10** **Cursor** Δ / ∇ / \leftarrow / \rightarrow to select the desired setting and then press **10** **ENTER**.

- 5 To exit the Option menu, press **19** **OPTION**. To return to the previous menu, press **10** **RETURN**.

Note

- In case **10** **Cursor** Δ / ∇ / \leftarrow / \rightarrow or other keys do not work after closing the Option menu, press **4** **Input selection key** to select the current input source again.

Option menu items

The following menu items are provided for each input source.

Input source	Menu items
HDMI1-4 AV1-4 V-AUX*1	Volume Trim, Decoder Mode, Extended Surround, Signal Info
AV5-6 PHONO	Volume Trim
AUDIO1/2 MULTI CH	Volume Trim, Video Out
iPod (DOCK)*2	Volume Trim, Shuffle, Repeat
NET RADIO (USB/NET)	Volume Trim, Signal Info
USB (USB/NET) Rhapsody (USB/NET)	Volume Trim, Signal Info, Shuffle, Repeat
PC (USB/NET)	Volume Trim, Signal Info, Shuffle, Repeat, Refresh

Input source	Menu items
BLUETOOTH (DOCK)	Volume Trim, Connect/Disconnect, Pairing
TUNER	Volume Trim, Audio Mode, Auto Preset, Clear Preset
SIRIUS	Volume Trim, Clear Preset, Parental Lock
XM	Volume Trim, Clear Preset

Notes

- *1 Only "Volume Trim" is available when no external device is connected to the HDMI IN jack.
- *2 "Shuffle" and "Repeat" are not available during the simple remote mode.

Details of the menu items are as follows. The configuration will be reflected to the input source currently selected.



- The default settings are marked with "**".

Volume Trim

Input source: All
Adjustable range: -6.0dB to 0.0dB* to +6.0dB (in 0.5 dB steps)

Reduces any change in volume when switching input sources by correcting volume differences between input sources.

Decoder Mode

Input source: HDMI1-4, AV1-4, V-AUX

Choices: Auto*, DTS

Selects DTS digital audio signals for reproduction.

Auto Automatically selects audio input signals.

DTS Selects DTS signals only. Other input signals are not reproduced.

Extended Surround

Input source: HDMI1-4, AV1-4, V-AUX

Choices: Auto*, PLIIxMovie, PLIIxMusic, EX/ES, Off

Selects whether to reproduce multi-channel (or 2-channel) input signals in 6.1- or 7.1-channel when surround back speakers are used.

Auto Automatically selects the most suitable decoder if a flag for reproducing surround back channel is present, and reproduces the signals in 6.1- or 7.1-channel.

- PLIIx Movie Always reproduces signals in 7.1-channel using the PLIIxMovie decoder whether or not surround back channel signals are contained. You can select this parameter when two surround back speakers are connected.
- PLIIx Music Always reproduces signals in 6.1- or 7.1-channel using the PLIIxMusic decoder whether or not surround back channel signals are contained. You can select this parameter when one or two surround back speakers are connected.
- EX/ES Automatically selects the most suitable decoder for input signals whether or not the flag for reproducing surround back channel is present, and always reproduces signals in 6.1-channel.
- Off Always reproduces original signals whether or not the flag for reproducing surround back channel is present.

Signal Info

Input source: HDMI1-4, AV1-4, V-AUX, USB (USB/NET), NET RADIO (USB/NET), PC (USB/NET), Rhapsody (USB/NET)

Displays information on audio and video signals on the GUI screen and front panel display. You can change items to be displayed using **Cursor** / .

• Audio information

Format	Format of digital audio signals.
Channel	The number of input signal channels (front/surround/LFE). For example, if input signal channels are 3 front channels, 2 surrounds and LFE, “3/2/0.1” is displayed. If a channel that cannot be expressed as the above, a total number of channels such as “5.1ch” may be displayed.
Sampling Frequency	The sampling frequency per second in analog-to-digital conversion.
Bitrate	The bit rate of input signal per second.

Notes

- “No Signal” is displayed when no signals are input and “---” is displayed when signals that this unit cannot recognize are input.
- The bit rate may vary during playback.

• Video information

Video In	Format and resolution of video input signal.
Video Out	Format and resolution of video output signal.
Message	Error messages about HDMI signals and HDMI components. See the following for details of the error messages.

- HDMI error message (appears only when an error has occurred)

HDCP Error	HDCP authentication failed.
Device Over	The number of HDMI components connected is over the limit.
Out of Res.	The connected monitor is not compatible with the video input signal.

Audio Mode

Input source: TUNER

Choices: Auto*, Mono

Sets FM (or HD Radio) broadcasting receiving mode.

- Auto Receives in stereo mode by priority.
- Mono Receives in monaural mode. You can get a better reception in monaural mode.

Note

- (U.S.A. model only)
Select “Auto” to tune into HD Radio stations. When “Mono” is selected, you can tune into analog stations only.

Auto Preset

Input source: TUNER

Automatically detects FM radio stations and registers them as preset stations (page 31).



- (U.S.A. model only)
Automatically detects FM and AM HD Radio stations and analog FM radio stations and registers them as preset stations.

Clear Preset

Input source: TUNER, XM, SIRIUS

Clears preset station (TUNER: page 32, XM: page 37, SIRIUS: page 41).

Parental Lock

Input source: SIRIUS

Set the Parental Lock (page 42).

Shuffle

Input source: iPod (DOCK), USB (USB/NET), PC (USB/NET), Rhapsody (USB/NET)

Choices: iPod (DOCK): Off*, Songs, Albums
USB (USB/NET), PC (USB/NET), Rhapsody (USB/NET): Off*, On

Changes the shuffle playback style.



- This setting is shared among the USB/NET sub-input sources (USB, PC and Rhapsody). For example, the playback style configured for “USB” is also reflected in “PC” and “Rhapsody”.

Repeat

Input source: iPod (DOCK), USB (USB/NET), PC (USB/NET), Rhapsody (USB/NET)

Choices: Off*, One, All

Changes the repeat playback style.



- This setting is shared among the USB/NET sub-input sources (USB, PC and Rhapsody). For example, the playback style configured for “USB” is also reflected in “PC” and “Rhapsody”.

Refresh

Input source: PC (USB/NET)

Updates the PC server list displayed in the GUI screen (page 48).

Connect / Disconnect

Input source: BLUETOOTH (DOCK)

Connects to or disconnects from a Bluetooth component (page 46).

Pairing

Input source: BLUETOOTH (DOCK)

Performs pairing of this unit and a Bluetooth component (page 46).

Video Out

Input source: AUDIO 1/2, MULTI CH

Choices: AV1 to AV6, Off*

Specifies a video signal to be output during an audio reproduction. For details, see “Selecting a video signal to be output during an audio reproduction” on this page.

Selecting a video signal to be output during an audio reproduction

This function enables this unit to output video signals when “AUDIO 1”, “AUDIO 2” or “MULTI CH” is selected as the input source. Follow the procedure below to select the video to be output during an audio reproduction.

- 1 Rotate the \odot INPUT selector (or press $\boxed{4}$ Input selection keys) to select “AUDIO 1”, “AUDIO 2” or “MULTI CH” as the input source.**
- 2 Press $\boxed{19}$ OPTION on the remote control.**
The Option menu for the selected input source is displayed.
- 3 Press $\boxed{10}$ Cursor Δ / ∇ to select “Video Out” and then press $\boxed{10}$ ENTER.**



- 4 Press $\boxed{10}$ Cursor $\triangleleft / \triangleright$ to select a video input jack to be used during an audio reproduction.**
 - AV1-2 (COMPONENT VIDEO)
 - AV3-6 (VIDEO)
 - Off (no video output)
- 5 To exit the Option menu, press $\boxed{19}$ OPTION.**

Operating various settings for this unit (Setup menu)

You can call the Setup menu using the remote control and change the settings of various menus. For details, read “Basic operation of the Setup menu” first, and see the respective pages.

Menu/Submenu	Function	Page
Speaker Setup	Sets items for speakers.	59
Auto Setup (YPAO)	Automatically adjusts output characteristics of speakers.	59
Manual Setup	Manually adjusts output characteristics of speakers.	59
Speaker Configuration	Sets speaker configurations, such as connection status of speaker and a size of the connected speaker (sound reproduction capacity), suitable for the listening environment.	59
Speaker Level	Separately adjusts volume of each speaker.	61
Speaker Distance	Adjusts timing at which each speaker outputs sound based on distances between speakers and the listening position.	61
Equalizer	Selects an equalizer that adjusts speaker output characteristics.	61
Test Tone	Generates test tones.	61
Sound Setup	Sets various items for sound outputs.	62
Dynamic Range	Adjusts dynamic ranges of speakers and headphones.	62
Lipsync	Adjusts delay in output timing between video signals and audio signals.	62
HDMI OUT1	Fine adjusts the delay time of automatic lipsync applied when only the HDMI OUT 1 jack is used or when both the HDMI OUT 1 and HDMI OUT 2 jacks are used.	62
HDMI OUT2	Fine adjusts the delay time of automatic lipsync applied when only the HDMI OUT 2 jack is used.	62
ANALOG MONITOR OUT	Adjusts the delay time applied when only the analog MONITOR OUT (COMPONENT VIDEO or VIDEO) jacks are used.	62

Menu/Submenu	Function	Page
Function Setup	Sets various items for HDMI and display.	62
HDMI	Sets various items for input sources.	62
HDMI Control	Selects on or off of the HDMI control function when a component that supports the HDMI control function is connected to the HDMI OUT 1 jack of this unit.	62
Standby Through	Selects on or off of output of HDMI signals input from the HDMI 1-4 jacks or HDMI IN (VIDEO AUX) jack to the active HDMI OUT jack(s) when this unit is on standby.	62
Audio Output	Selects this unit or a component connected to the HDMI OUT 1 jack of this unit for reproducing sound signals.	62
Resolution	Sets resolution of the HDMI output that is converted from analogy visual input signals.	63
Aspect	Set an aspect ratio of images reproduced by HDMI signals converted from analog video input signals.	63
Display	Sets items for a video monitor or the front panel display.	63
Dimmer	Sets brightness of the front panel display.	63
Front Panel Display Scroll	Selects the way to display characters on the front panel display.	63
GUI Position	Adjusts top and bottom positions of the GUI screen displayed on the video monitor.	63
Volume	Sets items for volumes.	63
Adaptive DRC	Adjusts the dynamic range (difference between the maximum volume and the minimum volume) in conjunction with the volume level.	63
Max Volume	Sets the maximum volume level so that the volume will not be accidentally increased.	64
Initial Volume	Sets the volume at the time this unit is turned on.	64
Input Rename	Changes input source names to be displayed on the GUI screen or the front panel display.	64
Zone	Sets the maximum volume level and initial volume level of Zone2/3.	64
Zone2 Max Volume	Sets the maximum volume level of Zone2.	64
Zone2 Initial Volume	Sets the volume level of Zone2 applied when this unit is turned on.	64
Zone3 Max Volume	Sets the maximum volume level of Zone3.	64
Zone3 Initial Volume	Sets the volume level of Zone3 applied when this unit is turned on.	64
Network	Sets items for network features.	64
IP Address	Sets the network parameters (IP address, etc) manually.	64
MAC Address Filter	Sets MAC address filter to restrict access to this unit via LAN.	64
Network Standby	Selects whether or not to accept the commands via network when this unit is on standby.	65
Information	Displays network information.	65
Rhapsody Information	Sets your Rhapsody® account.	65
Account Status	Displays the registration status of your Rhapsody® account.	65
Sign In	Registers your Rhapsody® account.	65
Rhapsody Free Trial	Subscribes to the Rhapsody® service using 30-day free trial.	65
Remove Account	Removes your Rhapsody® account.	65
DSP Parameter	Sets parameters for the sound field programs.	65
Memory Guard	Protects some settings against accidental alteration.	68

Basic operation of the Setup menu

The Setup menu screen appears on both the GUI screen and front panel display.

GUI screen

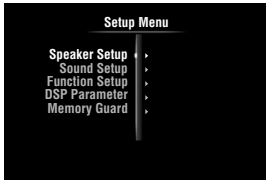

Front panel display



In this section, procedures of setting menus using the video monitor are described.

- 1 Press [ON SCREEN] on the remote control.**
The GUI screen appears on the video monitor.
- 2 Press [Cursor] to select "Setup" and then press [ENTER].**
The Setup menu appears on the video monitor.
- 3 Press [Cursor] to select the desired menu then press [ENTER].**
Items of the selected menu are displayed.

Example (Function Setup)

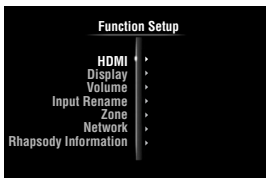

- To return to the previous menu, press [RETURN].

- 4 If necessary, press [Cursor] to select the desired submenu then press [ENTER].**

Example (Volume)

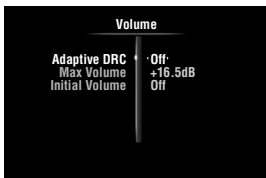

- 5 Press [Cursor] to select an item to edit and then press [Cursor] to change the setting.**

Some items in "Manual Setup" of "Speaker Setup" take up a full screen. To display other items in "Manual Setup", press [Cursor].

Example (Speaker Configuration)

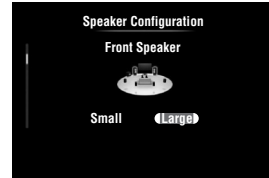

- To configure other items, repeat step 5.

- 6 To turn off the GUI screen, press [ON SCREEN].**

Note

- In case [Cursor] or other keys do not work after closing the Setup menu, press [Input selection key] to select the current input source again.

Speaker Setup

You can set various items for speakers. Two kinds of adjustments are available. One is "Auto Setup" (YPAO) for automatic adjustment and another is "Manual Setup" for manual adjustment.



- The default settings are marked with "*".

Auto Setup

Automatically adjusts output characteristics of speakers to obtain optimum balance for the output sound based on positions and performances of the speakers and acoustic characteristics of the room, which are automatically measured. For details on operations, see page 21.

Manual Setup

Adjusts output characteristics of speakers based on manually set parameters.

After "Auto Setup" (YPAO) is performed, you can check automatically adjusted parameters in the "Manual Setup" menu. Fine adjust the parameters for your preference if necessary.

Speaker Configuration

Sets speaker configurations, such as connection status of speaker and a size of the connected speaker (sound reproduction capacity), suitable for the listening environment.



- The speaker configuration includes items for defining a speaker size: "Large" or "Small". "Large" and "Small" refer to speakers with woofer diameters 16 cm or larger and smaller than 16 cm, respectively.

Extra Speaker Assignment

Choices: Zone2*, Zone2 + Zone3, Presence, None

Selects the application for the EXTRA SP (SP1/SP2) terminals.

- Zone2 Assigns the SP1 terminals for Zone2 speakers and disables the SP2 terminals.
- Zone2 + Zone3 Assigns the SP1 terminals for Zone2 speakers and SP2 terminals for Zone3 speakers.
- Presence Assigns the SP1 terminals for presence speakers and disables the SP2 terminals.
- None Disables the EXTRA SP (SP1/SP2) terminals.

Note

- When setting "Extra Speaker Assignment" to "Zone2" or "Presence", surround back channel signals for main unit are separately output from other channels.
- When setting "Extra Speaker Assignment" to "Zone2 + Zone3", surround and surround back channel signals for main unit are separately output from other channels.

LFE / Bass Out

Choices: Subwoofer, Front, Both*

Selects speaker(s) for outputting low-frequency components of the LFE (low-frequency effect sound) channel or other channels. The output status is as follows.

LFE channel signals

Parameter	Subwoofer	Front speakers	Other speakers
Subwoofer	Output	Not output	Not output
Front	Not output	Output	Not output
Both	Output	Not output	Not output

Low-frequency components of other channel signals

Parameter	Subwoofer	Front speakers	Other speakers
Subwoofer	[1]	[2]	[2]
Front	Not output	[3]	[2]
Both	[3]	[4]	[2]

- [1] Outputs low-frequency components of the channel of speaker, the size of which is set to "Small".
- [2] Outputs low-frequency components when the sizes of speakers are set to "Large".
- [3] Outputs low-frequency components of the front left and right channels and the channel of speaker, the size of which is set to "Small".
- [4] Outputs low-frequency components of the front left and right channels.

Front Speaker

Choices: Small, Large*

Sets the sizes of front left and right speakers.

- Small Select this when small speakers are connected. Low-frequency components of the front left and right channels are output from a subwoofer.

- Large Select this when large speakers are connected.

Note

- If "LFE / Bass Out" is set to "Front", "Front Speaker" automatically switches to "Large" even when it is set to "Small".

Center Speaker

Choices: None, Small*, Large

Sets the size of center speaker.

- None Select this when no center speaker is connected. Center channel signals are spread to front left and right speakers.
- Small Select this when a small center speaker is connected. Low-frequency components of center channel are output from a subwoofer. If a subwoofer is not connected they are output from front speakers.
- Large Select this when a large center speaker is connected.

Surround Speaker

Choices: None, Small*, Large

Sets sizes of left and right surround speakers.

- None Select this when no surround speakers are connected. Surround channel signals are spread to front left and right speakers. "Surround Back Speaker" automatically switches to "None" when this is selected.
- Small Select this when small surround speakers are connected. Low-frequency components of surround channels are output from a subwoofer. If a subwoofer is not connected they are output from front speakers.
- Large Select this when large surround speakers are connected.



- When "None" is selected, the sound field programs automatically enter the Virtual CINEMA DSP mode.

Surround Back Speaker

Choices: None, Large x 1, Small x 1, Large x 2, Small x 2*

Sets sizes of left and right surround back speakers.

- None Select this when no surround back speaker are connected. Surround back channel signals are output from the surround L/R speakers and subwoofer. If the subwoofer is disabled, they are output from the surround L/R speakers and front speakers.
- Large x 1 Select this when one large surround back speaker is connected.
- Small x 1 Select this when one small surround back speaker is connected.
- Large x 2 Select this when two large surround back speakers are connected.
- Small x 2 Select this when two small surround back speakers are connected.



- When "Surround Back Speaker" is set to "None", "PLIIx Movie", "PLIIx Music" and "PLIIx Game" of the surround decode mode (page 29) are not available.

Bass Crossover Frequency

Choices: 40Hz, 60Hz, 80Hz*, 90Hz, 100Hz, 110Hz, 120Hz, 160Hz, 200Hz

Sets the lower limit of the low-frequency component output from a speaker with a size set to "Small" (Small x 1, Small x 2) Sound with a frequency below that limit is output from a subwoofer or front speakers. If your subwoofer has a volume control or a crossover frequency control, set the volume to half or the crossover frequency at the maximum.

Subwoofer Phase

Choices: Normal*, Reverse

Sets the phase of your subwoofer if bass sounds are lacking or unclear.

- Normal** Select this not to change the phase of your subwoofer.
- Reverse** Select this to reverse the phase of your subwoofer.

Speaker Level

Adjustable range: -10.0dB to +10.0dB (0.5dB step)

Defaults: 0dB (FR.L, FR.R, SWFR, PR.L, PR.R)
-1.0dB (CNTR, SUR.L, SUR.R, SBL, SBR)

Separately adjusts volume of each speaker so that the sounds from speakers are at the same volume at the listening position. Items to be displayed vary depending on the number of speakers connected.



- When only one surround back speaker is connected, "SB" appears instead of "SBL" and "SBR".
- You can adjust the volume listening to test tones when you set "Test Tone" to "On" (on this page).
- If your subwoofer has a volume control or a crossover frequency control, set the volume to half or the crossover frequency at the maximum.

Speaker Distance

Adjusts timing at which each speaker outputs sound so that sounds from speakers reach the listening position at the same time. Set unit (Unit) first and set the distance of each speaker.

Unit

Choices: feet (ft)*, meters (m)

- feet (ft)** Displays the speaker distance in feet.
- meters (m)** Displays the speaker distance in meters.

FR.L / FR.R / CNTR / SUR.L / SUR.R / SBL / SBR / SWFR / PR.L / PR.R

Adjustable range: 0.30m to 24.00m (1.0ft to 80.0ft)

Defaults: 3.00m (10.0ft) (FR.L, FR.R, SWFR, PR.L, PR.R)
2.60m (8.5ft) (CNTR)
2.40m (8.0ft) (SUR.L, SUR.R, SBL, SBR)



- Available items differ depending on the "Speaker Configuration" settings (page 59).
- When only one surround back speaker is connected, "SB" appears instead of "SBL" and "SBR".

Equalizer

Adjusts sound quality and tone using a parametric graphic equalizer.

EQ Type Select

Choices: Auto PEQ, GEQ*, Off

Selects an equalizer type.

- Auto PEQ** Uses a parametric equalizer selected in "Auto Setup". Characteristics of the currently used parametric equalizer are displayed below "Auto PEQ".
- GEQ** Uses a graphic equalizer. Press **[10]ENTER** to adjust the characteristics of the graphic equalizer.
- Off** Not use a graphic equalizer.

GEQ

Channels Front Left, Front Right, Center, Surround Left, Surround Right, Surround Back Left, Surround Back Right

Choices: 63Hz, 160Hz, 400Hz, 1kHz, 2.5kHz, 6.3kHz, 16kHz

Adjustable range: -6.0dB to 0dB* to +6.0dB (0.5dB step)

Adjusts sound quality of each speaker using a graphic equalizer. The graphic equalizer of this unit can adjust signal levels in 7 frequency ranges.

To adjust the signal level within each range, press **[10]Cursor** < / > to select the desired speaker while "Channel" is selected, press **[10]Cursor** Δ / ▽ to select the desired frequency band and then press **[10]Cursor** < / > to adjust the signal level.

Test Tone

Choices: Off*, On

Switches between on and off of an oscillator that generates test tones. When "On" is selected, you can adjust the settings of "Manual Setup" while listening to a test tone.

- Off** Not generate test tones.
- On** Generates test tones.

Sound Setup

You can set various items for sound outputs.

■ Dynamic Range

Choices: Min/Auto, STD, Max*

Selects the dynamic range adjustment method for reproducing bitstream signals.

Min/Auto	(Min) Sets the dynamic range suitable for low volume or a quiet environment, such as at night, for bitstream signals except for Dolby TrueHD signals. (Auto) Adjusts the dynamic range for Dolby TrueHD signals based on input signal information.
STD	Sets the standard dynamic range recommended for regular home use.
Max	Outputs sound without adjusting the dynamic range of the input signals.

■ Lipsync

Adjusts delay between video output and audio output. This unit automatically adjusts the delay (automatic lipsync) when a TV that supports the automatic lipsync is connected to the HDMI OUT 1 or HDMI OUT 2 jack of this unit and HDMI signals are output only from the corresponding HDMI OUT jack.

HDMI OUT1

Adjustable range: 0* to 240ms (1 ms step)

Displays the delay time adjusted by automatic lipsync for HDMI signals output from the HDMI OUT 1 jack. To fine adjust the delay time, set an offset time in the "Offset" field. This offset time is also applied to the signals output from the HDMI OUT 2 jack when both the HDMI OUT 1 and HDMI OUT 2 jacks are active.

HDMI OUT2

Adjustable range: 0* to 240ms (1 ms step)

Displays the delay time adjusted by automatic lipsync for HDMI signals output from the HDMI OUT 2 jack. To fine adjust the delay time, set an offset time in the "Offset" field.

ANALOG MONITOR OUT

Adjustable range: 0* to 240ms (1 ms step)

Adjusts the delay time applied when only the analog MONITOR OUT (COMPONENT VIDEO or VIDEO) jacks are used.

Function Setup

You can set various items for HDMI and display.

HDMI

You can set items for HDMI.

■ HDMI Control

Choices: On, Off*

Selects on or off of the HDMI control function when a component that supports the HDMI control function is connected to the HDMI OUT 1 jack of this unit. When this parameter is set to "On", this unit output signals input from the HDMI 1-4 jacks or HDMI IN (VIDEO AUX) jack to the video monitor even when this unit is on standby.

On	Enables the HDMI control function.
Off	Disables the HDMI control function.



- The **HDMI THROUGH** indicator lights up in the following cases while this unit is on standby.
 - when the HDMI control function is on
 - when the HDMI signal standby-through function is currently working
- When "HDMI Control" is set to "On", this unit consumes 1 to 3 watts of power depending on a condition of an HDMI signal passing through this unit.

■ Standby Through

Choices: On, Off*

Selects on or off of output of HDMI signals input from the HDMI 1-4 jacks or HDMI IN (VIDEO AUX) jack to the active HDMI OUT jack(s) when this unit is on standby. When this parameter is set to "On", this unit output signals input from the HDMI 1-4 jacks or HDMI IN (VIDEO AUX) jack to the video monitor(s) even when this unit is on standby.

On	Outputs the HDMI signals to the active HDMI OUT jack(s)
Off	Not output the HDMI signals to the HDMI OUT 1/2 jacks.



- This parameter is not available when "HDMI Control" is set to "On".
- To enable HDMI signal standby-through output, any one of the input sources connected to the HDMI 1-4 jacks or HDMI IN (VIDEO AUX) jack must be selected before switching to standby.
- When "Standby Through" is set to "On", the **HDMI THROUGH** indicator lights up. In this state, the amount of power consumption in the standby mode increases.

■ Audio Output

Choices: Amplifier*, TV, Amplifier + TV

Selects this unit or a component connected to the HDMI OUT 1 jack of this unit for reproducing sound signals input from the HDMI 1-4 jacks or HDMI IN (VIDEO AUX) jack.

Amplifier	Outputs HDMI sound signals from the speakers connected to this unit.
-----------	--

TV Outputs HDMI sound signals from the speakers of a TV connected to the HDMI OUT 1/2 jacks of this unit. Sound output from the speakers connected to this unit is muted.

Amplifier + TV Outputs HDMI sound signals from the speakers connected to this unit and the speakers of a TV connected HDMI OUT 1/2 jacks of this unit.

Note

- Signal formats of audio and visual signals output from this unit to the TV vary depending on specifications of the monitor.



- This parameter is not available when "HDMI Control" is set to "On".

Resolution

Choices: Through*, 480p(576p), 720p, 1080i, 1080p

Upscales the resolution of HDMI output that is converted from analog video input signals and output from the HDMI OUT 1/2 jacks.

Notes

- Resolution of the HDMI output converted from 720p or 1080i analog video signals cannot be upscaled.
- When a video monitor is connected to one of the HDMI OUT 1/2 jacks and the corresponding HDMI OUT jack is selected (page 53), this unit automatically detects a resolution that the monitor supports. An asterisk (*) appears on the left of detected resolution.
- When a video monitor is connected to both of the HDMI OUT 1/2 jacks and "HDMI OUT 1+2" is selected (page 53), this unit automatically selects a resolution depending on the lower-resolution monitor.
- If this unit cannot detect the resolution that the monitor supports, set "MON.CHK" in the advanced setup menu to "SKIP" (page 73) and try again.

Aspect

Choices: Through*, 16:9, Smart Zoom

Sets a horizontal to vertical ratio (aspect ratio) of images reproduced by HDMI signals output from the HDMI OUT 1/2 jacks when the HDMI signals are converted from analog video input signals by a video conversion function.

Through Outputs the video signals without changing the aspect ratio.

16:9 Outputs the video signals that displays 4:3 images on a 16:9 TV with black bands on the right and left sides of the TV screen.

Smart Zoom Outputs the video signals that displays 4:3 images on a 16:9 TV by stretching right and left of images to fit on the TV screen.

Notes

- You cannot change the aspect ratio of the screen when "Resolution" is set to "Through".
- This setting is not effective for inputs with the aspect ratio other than 4:3.
- You cannot obtain an effect of the aspect ratio when visual signals are input from the HDMI 1-4 jacks or HDMI IN (VIDEO AUX) jack or when 720p, 1080i or 1080p signals are input.

Display

You can set items for a video monitor and the front panel display.

Dimmer

Adjustable range: -4 to 0*

Sets brightness of the front panel display. As the value is lowered, the brightness of the front panel display is darkened.

Note

- The brightness of display does not become bright in Pure Direct mode even if the value is increased.

Front Panel Display Scroll

Choices: Continuous*, Once

Selects the way to scroll the screen when a total number of characters exceed a display area of the front panel display.

Continuous Repeatedly displays all characters by scrolling.

Once Displays all characters by scrolling once, halts scrolling and then displays first 14 characters.

GUI Position

Adjustable range: -5 to 0* to +5 (vertical/horizontal direction)

Adjusts the position of the GUI screen displayed on the video monitor. To move the screen up (or to the right), set this value larger. To move the screen down (or to the left), set this value smaller.

Volume

You can set items for volumes.

Adaptive DRC

Choices: Auto, Off*

Adjust the dynamic range in conjunction with the volume level. This feature is useful when you are listening at lower volumes or at night. When this function is enabled, the dynamic range is adjusted as follows.

When the volume level is low: narrow the dynamic range
When the volume level is high: widen the dynamic range

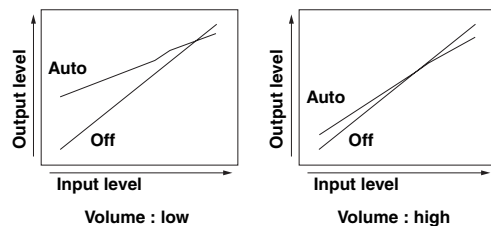

Auto Adjusts the dynamic range automatically.
Off Not adjust the dynamic range automatically.



- This setting is also effective for headphones.

■ Max Volume

Adjustable range: -30.0dB to +15.0dB, +16.5dB* (5.0 dB step)
Sets the maximum volume level so that the volume will not be accidentally increased. For example, you can adjust the volume between -80.0 dB and -5.0 dB (or Mute) when you set this parameter to "-5.0dB". The volume increases to the maximum level when this parameter is set to +16.5 dB (default).

■ Initial Volume

Adjustable range: Off*, Mute, -80.0dB to +16.5dB (0.5 dB step)
Sets the volume at the time this unit is turned on. When this parameter is set to "Off", the volume level used when this unit was set to standby is applied.

Note

- When you set "Max Volume" and "Initial Volume" the setting of "Max Volume" becomes effective. For example, when you set "Max Volume" to "-30.0dB" and "Init. Volume" to "0.0dB", the volume is automatically set to "-30.0dB" at the next time this unit is turned on.

Input Rename

Changes input source names to be displayed on the front panel display.

Selecting a name to be displayed from templates

Press **[F10]Cursor** Δ / ∇ to select the input source name to edit and then press **[F10]Cursor** \triangleleft / \triangleright to select a new name from the templates (Blu-ray, DVD, SetTopBox, etc.).

Entering an original name

Press **[F10]Cursor** Δ / ∇ to select the input source name to edit and then press **[F10]ENTER**. Enter up to 9 characters by selecting one character at a time with the following key operations.

- [F10]Cursor** \triangleleft / \triangleright Selects a character to edit.
- [F10]Cursor** Δ / ∇ Selects a character to enter.
- [F10]ENTER** Enters a selected character.

The following characters are available for input.
A to Z, 0 to 9, a to z, symbols (#, *, -, +, etc.) and space

Zone

Sets the maximum volume level and initial volume level of Zone2/3.



- The menu items for Zone2 are available only when "Extra Speaker Assignment" is set to "Zone2" or "Zone2 + Zone3" (page 60).
- The menu items for Zone3 are available only when "Extra Speaker Assignment" is set to "Zone2 + Zone3" (page 60).

■ Zone2/3 Max Volume

Adjustable range: -30.0dB to +15.0dB, +16.5dB* (5.0 dB step)
Sets the maximum volume level of Zone2/3, so that the volume will not be accidentally increased. For example, you can adjust the volume between -80.0 dB and -5.0 dB when you set this parameter to "-5.0dB".

■ Zone2/3 Initial Volume

Adjustable range: Off*, Mute, -80.0dB to +16.5dB (0.5 dB step)
Use this feature to set the volume level of Zone2/3 when the power of Zone2/3 unit is turned on. When this parameter is set to "Off", the volume level used at the time when the Zone2/3 unit was set to standby is applied.

Note

- The "Zone2 Max Volume" or "Zone3 Max Volume" setting takes priority over the "Zone2 Initial Volume" or "Zone3 Initial Volume" setting. For example, if you set "Zone2 Max Volume" to "-30.0dB" and "Zone2 Initial Volume" to "0.0dB", the volume is automatically set to "-30.0dB" at the next time the Zone2 unit is turned on.

Network

You can set items for network features.

■ IP Address

Sets the network parameters (IP address, etc).

DHCP

Choices: On*, Off

Select whether or not this unit obtain the network parameters (IP address, subnet mask, default gateway, primary DNS server and secondary DNS server) from the DHCP server of the connected network.

- On Select this setting when this unit can obtain the network parameters from the DHCP server of the connected network.
- Off Select this setting when you set the network parameters manually.

IP Address

Use this parameter to specify the IP address assigned to this unit. This value must not be the same as the one used for other devices in the target network.

Subnet Mask

Use this parameter to specify the subnet mask value assigned to this unit.

Default Gateway

Use this parameter to specify the IP address of the default gateway.

DNS Server (P) / DNS Server (S)

Use this parameter to specify the IP address of the primary and secondary DNS (Domain Name System) servers.



- If you have only one DNS address, enter the DNS address in "DNS Server (P)". If you have two or more DNS addresses, enter one of them in "DNS Server (P)" and another in "DNS Server (S)".

■ MAC Address Filter

Sets MAC address filter to restrict access to this unit via LAN.

MAC Address Filter

Choices: Off*, On

Select whether or not to use the MAC address filter function.

- Off Disables the MAC address filter function.

On Permit access to this unit only from network devices with the specified MAC addresses.

MAC Address 1-10

Specify MAC addresses of network devices that are permitted to access to this unit when “MAC Address Filter” is set to “On”.

Network Standby

Choices: Off*, On

Selects whether or not to accept the commands via network when this unit is on standby.

Off Not accept the commands via network.

On Accept the commands via network.



- When “Network Standby” is set to “On”, the amount of power consumption in the standby mode increases.

Information

Displays the network parameters (IP address, etc.) or vTuner ID assigned to this unit.

Rhapsody Information

You can set your Rhapsody® account.

For information about the Rhapsody® service and how to play back Rhapsody® contents, see “Using the Rhapsody® service” (page 51).

Account Status

Displays the registration status of your Rhapsody® account. If “Not Available” appears, check the network settings.

Sign In

Use this menu to register your Rhapsody® account with your user name and password provided by Rhapsody®. To start registration, follow steps 3 and 4 in “Account setup for Rhapsody®”(page 51).

If an error message appears (page 84), confirm your user name and password and then try again.

Rhapsody Free Trial

Use this menu to subscribe to the Rhapsody® service using 30-day free trial. To subscribe to the free-trial service, read the description on the GUI screen and then select “Yes” if you accept the terms and conditions. If you have subscribed to the free trial service, the remaining service days and account number (required for receiving Rhapsody® support) appear on the GUI screen.

Remove Account

Removes your Rhapsody® account.

DSP Parameter

Although the field sound programs would satisfy you as they are with the default parameters, you can arrange sound effect or decoders suitable for acoustical conditions of sources or rooms by setting the parameters.

- 1 Press **10**Cursor Δ / ∇ to select “DSP Parameter” and then press **10**ENTER.

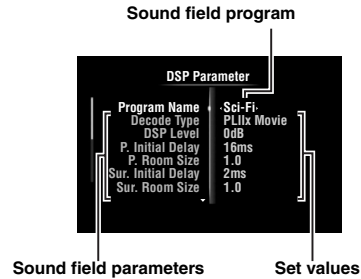

- 2 Press **10**Cursor Δ / ∇ to select “Program Name” and then press **10**Cursor \leftarrow / \rightarrow to select a sound field program to edit.

- 3 Press **10**Cursor Δ / ∇ to select a parameter to edit and then press **10**Cursor \leftarrow / \rightarrow to change the setting.



- Repeat steps 2 and 3 to change other sound field program parameters.

To initialize the parameters of the selected sound field program, press **10**Cursor ∇ repeatedly to select “Initialize” and then press **10**Cursor \rightarrow . Then, press **10**Cursor \rightarrow again to execute the initialization or **10**Cursor \leftarrow to cancel it.

CINEMA DSP basic parameters

DSP Level

Adjustable range: -6dB to 0dB* to +3dB

Fine adjusts an effect level (level of the sound field effect to be added). You can adjust the level of the sound field effect while checking sound levels. Adjust “DSP Level” as follows.

- The effect sound is too soft.
→Increase the effect level.
- There are no differences between effects of the sound field programs.
- The sound is dull.
- The sound field effect is added too much.
→Reduce the effect level.

Dialogue Lift

Choices: 0* to 5

Use this feature to adjust the vertical position of the dialogues in movies. The ideal position of the dialogues is at the center of the video monitor screen.

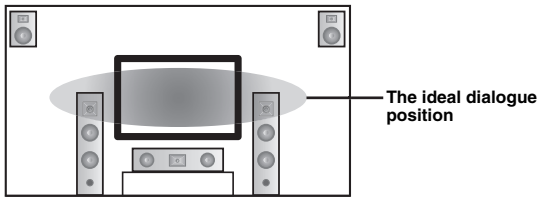

If the dialogues are heard at the lower position of the video monitor screen, increase the value of "Dialogue Lift".

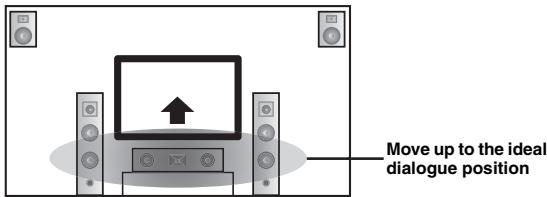

When the value is set to zero, the position is at the lowest. The position gets higher as you increase the value.

Notes

- This setting is available only when "Extra Speaker Assignment" is set to "Presence" (page 60).
- You cannot move the dialogue position down from the initial dialogue position.

3D DSP

Choices: On*, Off

When CINEMA DSP 3D is enabled, sets whether to use sound field programs in 3D mode.

Note

- This setting is available only when "Extra Speaker Assignment" is set to "Presence" (page 60).

Sound field parameters for advanced configurations

Parameters for adjusting early-reflected sound

Initial Delay / P. Initial Delay / Sur. Initial Delay / Sur. Back Initial Delay

Adjustable range: 1 to 99ms (Initial Delay / P. Initial Delay), 1 to 49ms (Sur. Initial Delay / Sur. Back Initial Delay)

Adjusts attenuation characteristics of early-reflected sound. You can create a lively sound field (with a high reverberant sound level) as you increase the value, and a dead sound field (with a low reverberant sound level) as you decrease the value. Creating either a lively sound field or a dead sound field in an actual music hall is determined by the acoustic absorption characteristics of reflection surfaces. A dead sound field is created when the attenuation time is short while a lively sound field is created when the attenuation time is long.

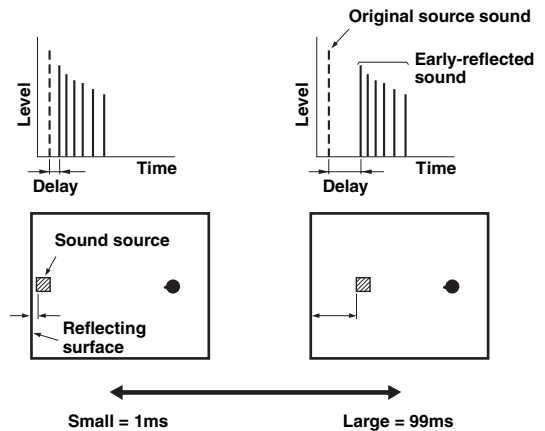

- We recommend that you adjust the size of corresponding sound field when you adjust the delay time.

Parameters for specifying room size

Room Size / P. Room Size / Sur. Room Size / Sur. Back Room Size

Adjustable range: 0.1 to 2.0

Produces different senses of sound expansion according to room sizes specified. In a large size room such as a music hall, the duration from when reflected sound is heard until when the next reflected sound is heard is long. Thus, different senses of sound expansion can be created by changing the duration. 1.0 is the original room size. When this parameter is set to 2.0, each side of the room is defined as twice larger than the original room size.

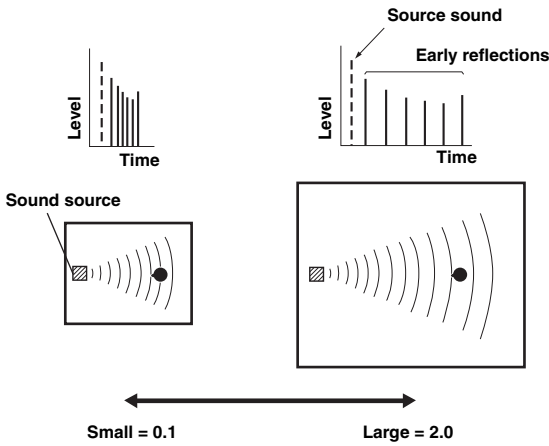

Parameters for defining attenuation characteristics of early-reflected sound

Liveness / P. Liveness / Sur. Liveness / Sur. Back Liveness

Adjustable range: 0 to 10

Adjusts the attenuation of reflected sound. You can create a lively sound field (with a high reverberant sound level) as you increase the value, and a dead sound field (with a low reverberant sound level) as you decrease the value. Creating either a lively sound field or a dead sound field in an actual music hall is determined by the acoustic absorption characteristics of reflection surfaces. A dead sound field is created when the attenuation time is short while a lively sound field is created when the attenuation time is long.

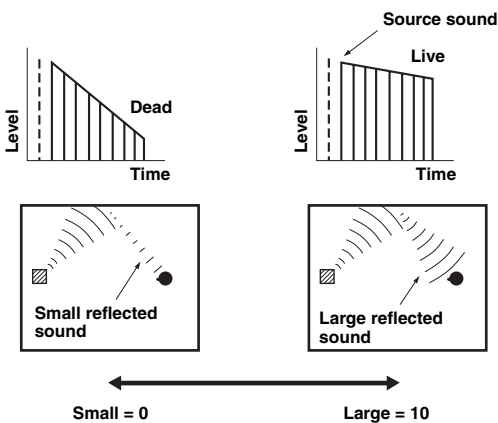

Parameters for adjusting reverberant sound

Reverb Time

Adjustable range: 1.0 to 5.0s

Reverb Time parameter adjusts the attenuation time of the rear reverberant sound based on the time that about 1kHz reverberant sound takes for 60dB of attenuation.

Reverberant sound attenuates faster as you decrease the value. Reverb Time adjustment allows you to create a natural reverberant sound, by setting the attenuation time longer for a sound source or room with less echo, or shorter for a sound source or room with more echo.

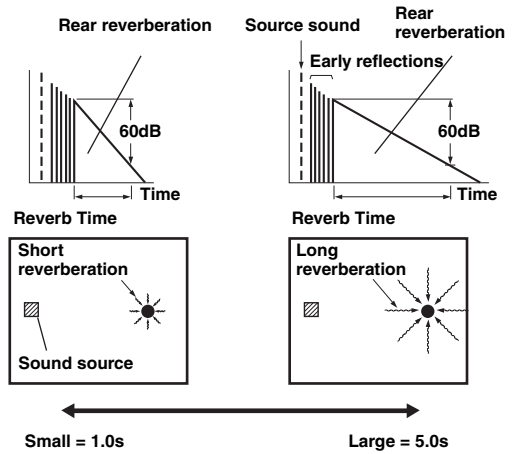

Reverb Delay

Adjustable range: 0 to 250ms

Reverb Delay parameter adjusts the time difference between the beginning of the direct sound and the beginning of the reverberation sound. The larger the value, the later the reverberation sound begins. Increasing the value of Reverb Delay allows you to create a reverberant sound in a wider area for the same Reverb Time.

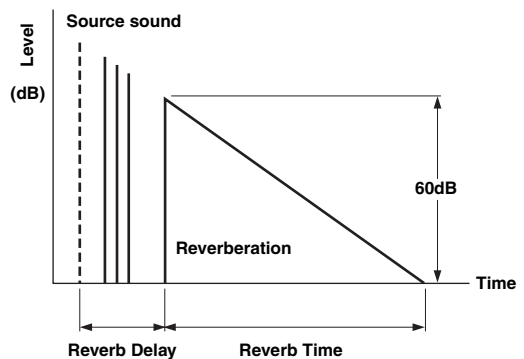

Reverb Level

Adjustable range: 0 to 100%

Reverb Level parameter adjusts the reverberation sound level. Increasing the value of Reverb Level makes the reverberation sound level higher, which allows you to create more echo.

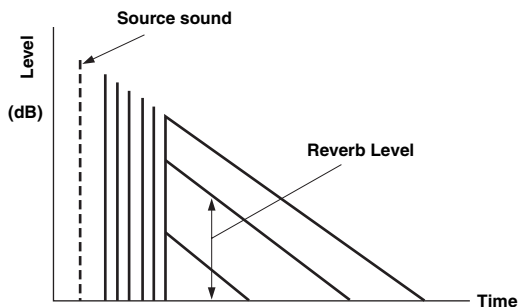

Parameters for certain sound field programs

Parameter for MOVIE sound field programs

Decode Type

Choices: PLIIx Movie (PLII Movie), Neo:6 Cinema

Selects the decoder type for use with the MOVIE sound field programs.

Note

- You cannot select a decoder for the following MOVIE sound field programs.
 - Mono Movie
 - Sports
 - Action Game
 - Roleplaying Game

Parameter for 2ch Stereo

Direct

Choices: Auto*, Off

Automatically bypasses the DSP circuit and tone control circuit when an analog sound source is selected as the input source. You can enjoy a higher quality sound.

Auto Outputs sound by bypassing the DSP circuit and tone control circuit when the “Bass” and “Treble” tone controls are both set to 0 dB.

Off Do not bypass the DSP circuit and tone control.

Parameters for 7ch Stereo

Center Level / Surround L Level / Surround R Level / Surround Back Level / Presence L Level / Presence R Level

Adjustable range: 0 to 100%

Adjusts the volume of the center, surround L/R, surround back and presence L/R channels in the 7ch Stereo program. The available parameters differ depending on the setting of the speakers.

Parameter for Straight Enhancer and 7ch Enhancer

Effect Level

Choices: High*, Low

Adjusts the Compressed Music Enhancer effect level. When the high-frequency signals of the source is emphasized too much, set the effect level to “Low”. To reduce the effect, set this parameter to “Low”.

Decoder parameters

You can customize decoder effects by setting the following parameters. For details about the types of decoders, see “Surround decode mode” (page 29).

Parameter for PLIIx Music and PLII Music

Panorama

Choices: Off*, On

Adjusts the soundscape of the front sound field. Sends stereo signals to the surround speakers as well as the front speakers for a wraparound effect.

Dimension

Adjustable range: –3 to STD* to +3

Adjusts the difference in level between the front sound field and the surround sound field. You can adjust the difference in level created by the software being played back to obtain the preferred sound balance. The surround sound gets stronger as you make the value more negative and the front sound gets stronger as you make the value more positive.

Center Width

Adjustable range: 0 to 3* to 7

You can spread the center sound toward left and right according to your preference. Set this parameter to 0 for outputting the center sound from the center speaker only, or to 7 for outputting it from the front left/right speaker.

Parameter for Neo:6 Music

Center Image

Adjustable range: 0.0 to 0.3* to 1.0

Adjusts the front left and right channel output relative to the center channel to make the center channel more or less dominant as necessary.

Memory Guard

Choices: Off*, On

Protects the Setup menu settings against accidental alteration.

Off Not protect settings.

On Protects the Setup menu settings (except for “Decode Type” in “DSP Parameter” and “Memory Guard”).

Note

- When this parameter is switched to “On”, “ ” appears at the top left corner of the Setup menu screen.

Using multi-zone configuration

This unit allows you to configure a multi-zone audio system. This feature allows you to set this unit to reproduce separate input sources in the main zone, second zone (Zone2) and third zone (Zone3). You can control this unit from the second zone or third zone using the supplied remote control.

Only analog signal can be sent to the second and third zones. If you want to output sounds to Zone2/3, connect an external component to the AV5-6 or AUDIO1-2 jacks (by analog connection). For example, if you want to output sound from an HDMI DVD player to the second zone, you must connect the HDMI DVD player to this unit by both HDMI and analog connections.

Connecting Zone2/3

You need the following additional equipment to use the multi-zone functions of this unit:

- An infrared signal receiver in the second zone and/or third zone.
- An infrared signal emitter in the main zone. This emitter transmits infrared signals from the remote control to a CD player or a DVD player, etc. in the main zone via the infrared signal receiver in the second zone and/or third zone.
- An amplifier and speakers in the second zone and/or third zone.



- Since there are many possible ways to connect and use this unit in a multi-zone configuration, we recommend that you consult with your nearest authorized Yamaha dealer or service center about the Zone2/3 connections that best meet your requirements.
- Some Yamaha models can be directly connected to the REMOTE jacks of this unit. You may not need use an infrared signal emitter for these products. Up to 6 components can be connected using monaural analog mini cables or via an IR flashers. For details about connections, see “Transmitting/receiving remote control signals” (page 18).

Using external amplifiers

Connect an amplifier/receiver in the second zone and/or third zone and other components to this unit as follows.

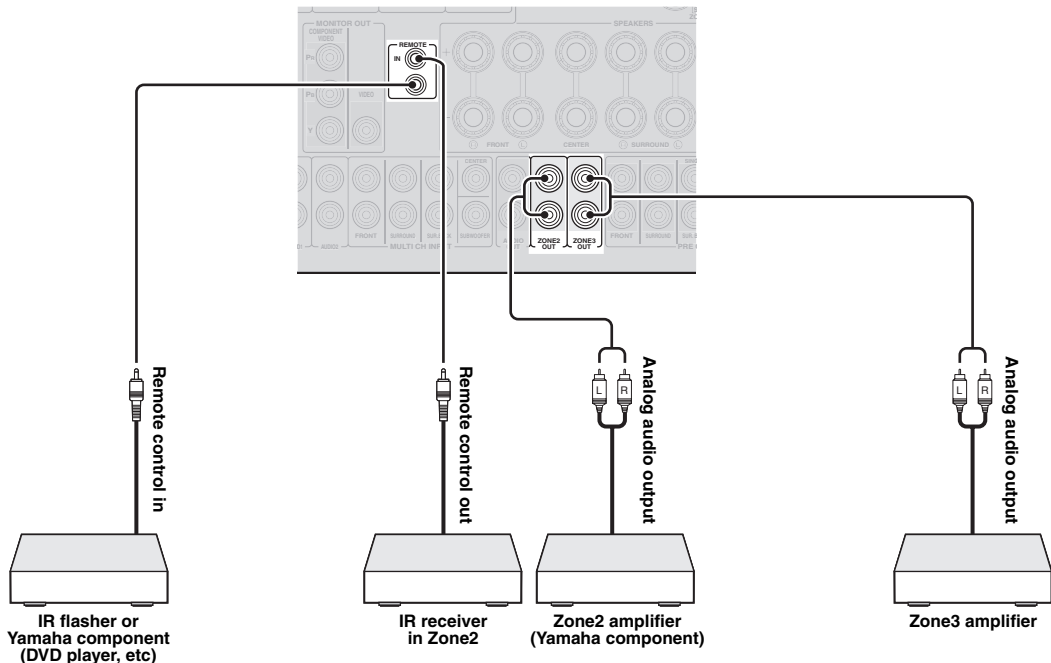

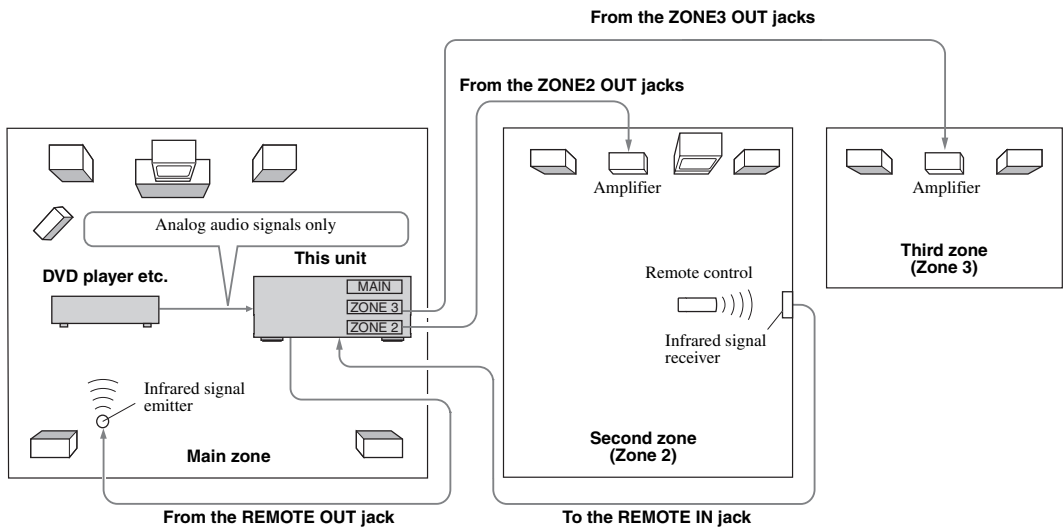

Using the internal amplifiers of this unit

Important safety notice

The EXTRA SP terminals of this unit should not be connected to a Passive Loudspeaker Selector Box or more than one loudspeaker per channel. Connection to a Passive Loudspeaker Selector Box or multiple speakers per channel could create an abnormally low impedance load resulting in amplifier damage. See this owner's manual for correct usage. Compliance with minimum speaker impedance information for all channels must be maintained at all times. This information is found on the back panel of your unit.

If you want to use one internal amplifier of this unit

Connect the Zone 2 speakers directly to the SP1 terminals and then set "Extra Speaker Assignment" to "Zone2" (page 60)

If you want to use two internal amplifiers of this unit

Connect the Zone 2 and Zone 3 speakers directly to the SP1 and SP2 terminals and then set "Extra Speaker Assignment" to "Zone2 + Zone3" (page 60).

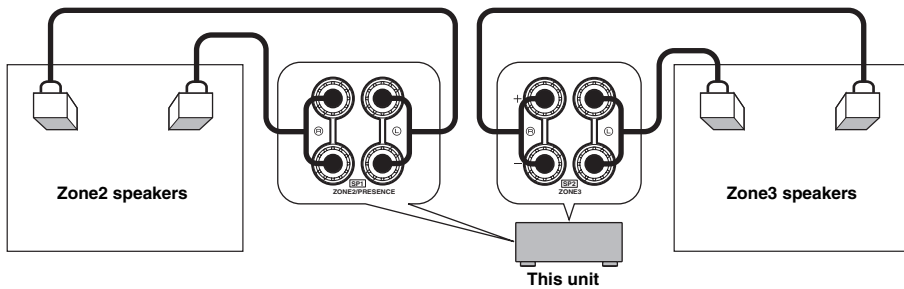

- You can use the speakers connected to EXTRA SP (SP1/SP2) terminals as the front speaker system of another zone.
- When you use the internal amplifiers for the Zone2/3 speakers, you can adjust the volume level and set the initial volume and maximum volume of the Zone2/3 speakers (page 64).

Controlling Zone2/3

You can select and control Zone2/3 by using the control keys on the front panel or on the remote control. The available operations are as follows:

- Selecting the input source.
- Tuning into the desired station (when “TUNER” is selected as the input source)
- Tuning into the desired channel (when “XM” or “SIRIUS” is selected as the input source) (U.S.A. model only)
- Adjusting the volume of Zone2/3 (when Zone2/3 speakers are connected to the EXTRA SP terminals).

Switching to the Zone2/3 operation mode

Before controlling Zone2/3 by using the control keys on the front panel or on the remote control, follow the procedure below to switch this unit to the Zone2/3 operation mode.

- **To control Zone2/3 by using the front panel control keys**

Press **Ⓧ** **ZONE CONTROLS** repeatedly to select the zone you want to control while the target zone is turned on.

The zone indicator flashes on the front panel display for approximately 10 seconds.

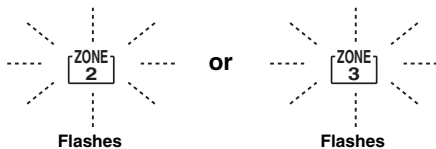

Note

- Complete each step while the zone indicator is flashing on the front panel display. Otherwise, the Zone2 or Zone3 operation mode is automatically canceled and this unit returns to the main zone operation mode.

- **To control Zone2/3 by using the remote control**

Switch **Ⓧ** **Zone selection switch** to “ZONE2” or “ZONE3” position.

Operations in the Zone2/3 operation mode

- **Turning on or set Zone2 to standby**

Press **Ⓧ** **ZONE2 ON/OFF** (or **Ⓧ** **POWER**).

- **Turning on or set Zone3 to standby**

Press **Ⓧ** **ZONE3 ON/OFF** (or **Ⓧ** **POWER**).

- **Operating Zone2/3**

Rotate the **Ⓧ** **INPUT selector** (or press **Ⓧ** **Input selection key**) to select the desired input source.

If you press **Ⓧ** **USB/NET** on the remote control, press **Ⓧ** **Sub-input selection key** to select a sub-input source.

- Select “AV5”, “AV6”, “AUDIO1”, “AUDIO2” or “PHONO” to listen to the input source in the selected zone.
- Select “DOCK” to use the iPod features (page 44) or Bluetooth features (page 46) in the selected zone.
- Select “TUNER” to use the FM/AM radio features (page 31) in the selected zone.
- Select “SIRIUS” to use the SIRIUS Satellite Radio features (page 39) in the selected zone.
- Select “XM” to use the XM Satellite Radio features (page 35) in the selected zone.
- Select “USB” to use the USB features (page 47) in the selected zone.
- Select “NET RADIO” to use the Internet Radio features (page 50) in the selected zone.
- Select “PC” to use the PC features (page 48) in the selected zone.
- Select “Rhapsody” to use the Rhapsody® features (page 51) in the selected zone.

Note

- The sub-input source (USB, NET RADIO, PC and Rhapsody) for “USB/NET” is shared among all zones (main, Zone2 and Zone3). You cannot select different sub-input source for each zone.

Controlling other components with the remote control

You can control external components for a selected input source with the remote control. The keys available for controlling external components are as follows:

3 SOURCE POWER

Turns on and off an external component.

10 Cursor, ENTER, RETURN

Operates the menus of external components.

11 External component operation keys

Function as a recording or playback key of an external component, or a menu display key.

12 Numeric keys

Function as numeric keys of an external component.

13 TV control keys

INPUT Switches visual inputs of TV

MUTE Mutes audio of TV

TV VOL +/- Controls the volume of TV

TV CH +/- Switches channels of TV

POWER Turns on and off TV

21 DISPLAY

Switches between the screens of external components.



- You can use **13 TV control keys** to control your TV regardless of a selected input source if a remote control code for your TV is assigned to **4 AV1**, **4 AV4** or **4 PHONO** (in the order of descending priorities).
- You need to set the remote control code first to control external components.
- The remote control keys for controlling external components are available only when the external components have corresponding control keys.

The following remote control codes are assigned to input sources as factory default settings.

Default remote control code settings

Input source	Category	Manufacturer	Default code
[HDMI 1]	Blu-ray Disc	Yamaha	2018
[HDMI 2]	—	—	—
[HDMI 3]	—	—	—
[HDMI 4]	—	—	—
[AV 1]	—	—	—
[AV 2]	—	—	—
[AV 3]	CD	Yamaha	5013
[AV 4]	—	—	—
[AV 5]	—	—	—
[AV 6]	—	—	—
[AUDIO 1]	—	—	—
[AUDIO 2]	—	—	—
[V-AUX]	—	—	—
[PHONO]	—	—	—
[MULTI]	—	—	—
[DOCK]	DOCK	Yamaha	5011 (fixed)

Input source	Category	Manufacturer	Default code
[TUNER]	Tuner	Yamaha	5007 (fixed)
[SIRIUS]	Tuner	Yamaha	5017 (fixed)
[XM]	Tuner	Yamaha	5009 (fixed)
[USB/NET]	—	Yamaha	— (fixed)

“—” indicates no assignment



- An external component controlled by the remote control is automatically selected according to selection of the scenes (page 24).

Setting remote control codes

You can control other components by setting the appropriate remote control codes. For a complete list of available remote control codes, refer to “List of remote control codes” at the end of this manual.

You should perform each step within 1 minute after the previous step.

1 Press 15 CODE SET on the remote control using a pointed object such as the tip of a ballpoint pen.

14 TRANSMIT blinks twice.

2 Press the desired 4 Input selection key.

To use **13 TV control keys** to control your TV, assign a remote control code for your TV to **4 AV1**, **4 AV4** or **4 PHONO**.

3 Press 12 Numeric keys to enter a remote control code.

Once the remote control code is registered, **14 TRANSMIT** blinks twice. If it fails, **14 TRANSMIT** blinks six times. Repeat from step 1.

Resetting all remote control codes

You can reset all remote control codes to the factory default settings.

1 Press 15 CODE SET on the remote control using a pointed object such as a tip of a ballpoint pen.

14 TRANSMIT blinks twice.

2 Press 9 ON SCREEN.

3 Press 12 Numeric keys to enter “9981”.

Once the initialization is complete, **14 TRANSMIT** blinks twice. If it fails, **14 TRANSMIT** blinks six times. Repeat from step 1.

Advanced setup

In the advanced setup menu, you can set basic operations of this unit, such as on and off of a bi-amp connection, or initialize user settings.

1 Set this unit to standby.

2 While holding down **Ⓞ**STRAIGHT on the front panel, press **Ⓛ**MAIN ZONE ON/OFF.

Keep holding down **Ⓞ**STRAIGHT until “ADVANCED SETUP” appears on the front panel display.

ADVANCED SETUP

3 Rotate the **Ⓟ**PROGRAM selector to select the parameter you want to change.

The default setting are marked with “*”.



- Set values are placed in XXX of the following parameters on an actual display screen.

SP IMP. -XXX

Choices: 6ΩMIN, 8ΩMIN*

Selects output impedance of this unit according to connected speakers. When you connect 4-ohm speakers to the FRONT speaker terminals, set “SP IMP.” to “6ΩMIN”.

RS232C STBY -X

Choices: Y (Yes)*, N (No)

Selects whether or not to transmit data via the RS-232C terminal when this unit is in the standby mode.

REMOTE ID -XXX

Choices: ID1*, ID2

Sets a remote control ID. When using multiple Yamaha AV receivers, you can operate them with a single remote control by setting the receiver IDs to the same setting.

SR PIN -XXX

Choices: RESET, CANCEL*

Resets Parental lock cord when using SIRIUS Satellite tuner.

BI AMP - XXX

Choices: ON, OFF*

Switches on and off of bi-amp connection of main speakers. For bi-amp connection, see page 12.

SCENE IR -XXX

Choices: ON*, OFF

Selects whether or not to transmit the control signals to an external component connected to the REMOTE OUT jack on this unit when BD/DVD or CD SCENE function is selected.

MON. CHK - XXXX

Choices: YES*, SKIP

Adds upscaling limitation on output signals to a video monitor connected to this unit via the HDMI OUT jack.

INIT-XXXXXXXXXX

Choices: DSP PARAM, VIDEO, NETWORK, ALL, CANCEL*

Initializes various settings stored in this unit. You can select an initialization method from the following.

DSP PARAM: All parameters of sound field programs

VIDEO Video conversion settings (resolution/aspect) in the Setup menu and the GUI display position

NETWORK Network settings in the Setup menu

ALL All

CANCEL Cancellation of initialization

USB FirmUpdate

NET FirmUpdate

Updates the firmware of this unit. For details on how to update the firmware, refer to information supplied with updates.

Notes

- Do not use this feature unless you need to update the firmware.
- Be sure to read information supplied with updates before updating the firmware.

VERXXX.XXX.XXX

Displays the firmware of this unit.

4 Press **Ⓞ**STRAIGHT repeatedly to change the selected parameter setting.

To change other settings, repeat steps 3 and 4.

5 Press **Ⓚ**MAIN ZONE ON/OFF to set this unit to standby.

The settings you made are reflected next time you turn on this unit.

Setting a remote control ID

Two IDs are provided for the remote control of this unit. If another Yamaha amplifier is in the same room, setting a different remote control ID to this unit prevents unwanted operation of the other amplifier.

“ID1” is set for both the main unit and remote control by default. If you have changed the remote control ID, make sure that you select the same ID for the main unit in the the advanced setup menu.



- For details on how to set the remote control ID of the simplified remote control, see page 8.

1 Press [15]CODE SET on the remote control using a pointed object such as the tip of a ballpoint pen.

[14]TRANSMIT blinks twice.

2 Press [9]ON SCREEN.

3 Enter the desired remote control ID code.

To switch to ID1, press [12]Numeric keys to enter “5019”.

To switch to ID2, press [12]Numeric keys to enter “5020”.

Once the remote control code is registered,

[14]TRANSMIT blinks twice.

If it fails, [14]TRANSMIT blinks six times. Repeat from step 1.



- If you initialize the settings of this unit, “REMOTE ID” (remote control code of this unit) is set to “ID1”.

APPENDIX

Troubleshooting

Refer to the table below when this unit does not function properly. If the problem you are experiencing is not listed below or if the instruction below does not help, turn off this unit, disconnect the power cable, and contact the nearest authorized Yamaha dealer or service center.

General

Problem	Cause	Remedy	See page
This unit does not operate properly.	The internal microcomputer is frozen due to an external electric shock (such as lightning or excessive static electricity) or by a drop in power supply voltage.	Disconnect the power cable from the AC wall outlet, wait about 30 seconds and then plug it in again.	—
This unit suddenly enters the standby mode	The internal temperature is too high and the overheat protection circuitry has been activated.	Wait about 1 hour for this unit to cool down and then turn it back on.	—
	The protection circuitry has been activated because of a short circuit, etc.	Check that the speaker impedance setting is correct. Check that the speaker wires are not touching each other and then turn this unit back on.	73 —
	The sleep timer has turned off this unit.	Turn on this unit and play the source again.	—
This unit fails to turn on or enters the standby mode soon after the power is turned on.	The power cable is not connected or the plug is not completely inserted.	Connect the power cable properly to an AC wall outlet.	20
	The speaker impedance setting is incorrect.	Set the speaker impedance to match your speakers.	73
	(When this unit is turned back on and “CHECK SP WIRES!” is displayed.) The protection circuitry has been activated because this unit was turned on while a speaker cable was shorted.	Make sure that all speaker cables between this unit and speakers are connected properly.	11
This unit cannot be turned off.	The internal microcomputer is frozen due to an external electric shock (such as lightning or excessive static electricity) or by a drop in power supply voltage.	Disconnect the power cable from the AC wall outlet, wait about 30 seconds and then plug it in again.	—

Problem	Cause	Remedy	See page
No picture.	An appropriate video input is not selected on the video monitor.	Select an appropriate video input on the video monitor.	—
	An appropriate HDMI OUT jack is not selected.	Select the HDMI OUT jack which your video monitor is connected.	53
	The external video component is connected to one of the HDMI 1-4 jacks or HDMI IN (VIDEO AUX) jack while your video monitor is connected to the MONITOR OUT (COMPONENT VIDEO or VIDEO) jacks.	Connect the external video component to the video input jacks other than the HDMI 1-4 jacks or connect the video monitor to one of the HDMI OUT jacks or HDMI IN (VIDEO AUX) jack.	14, 16
	This unit outputs the video signals not supported by the video monitor connected to one of the HDMI OUT jacks.	Displays the advanced setup menu and select “VIDEO” in “INIT” to reset the video parameters.	73
		Displays the advanced setup menu and set “MON.CHK” to “YES”.	73
	Video signals are input from a game console while your video monitor is connected to one of the HDMI OUT jacks.	Connect the video monitor to the MONITOR OUT (COMPONENT VIDEO) jacks.	14
Non-standard video signals are input.	Connect the video monitor to the MONITOR OUT (COMPONENT VIDEO or VIDEO) jacks.	14	
The picture is disturbed.	The video software is copy-protected.		
No sound.	Incorrect input or output cable connections.	Connect the cables properly. If the problem persists, the cables may be defective.	16
	No appropriate input source has been selected.	Rotate the Ⓘ INPUT selector (or press Ⓛ Input selection key) to select the desired input source.	24
	Speaker connections are not secure.	Secure the connections.	11
	The volume is turned down or muted.	Turn up the volume.	24
	Signals this unit cannot reproduce are being input from a source component, such as a CD-ROM.	Display “Signal Info” in the Option menu and check the input signal format. If “No Signal” is displayed, check if the playback component is properly connected to this unit (or a proper input source is selected). If “___” is displayed, the input signal in that format cannot be reproduced by this unit.	—
		The HDMI components connected to this unit do not support the HDCP copy protection standards.	Connect HDMI components that support the HDCP copy protection standards.
	“Audio Output” in “HDMI” is set to “TV”.	Set “Audio Output” (Function Setup → HDMI → Audio Output) to the other setting.	62
	A proper audio decoder is not selected.	Display the Option menu and set “Decoder Mode” to “Auto”.	54
Only the center speaker outputs substantial sound.	When a monaural source sound field program is applied, sound of all channels are output from the center speaker for some surround decoders.	Try another sound field program.	27
	The playback component or speakers are not connected properly.	Connect the cables properly. If the problem persists, the cables may be defective.	12, 16

Problem	Cause	Remedy	See page
No sound is output from a specific speaker.	Output from that speaker is disabled.	Check the Speaker indicators on the front panel display. If the corresponding indicator is turned off, try the following. 1) Change the input source to another one. 2) With the selected sound field program, sound is not output from that speaker. Select another sound field program. 3) "None" may have been selected for that speaker on this unit. Display "Speaker Setup" in the "Setup" menu and enables output of that speaker.	6, 24, 27, 59
	The volume of that speaker is set to minimum in "Speaker Setup" in the "Setup" menu.	Display "Speaker Setup" in the "Setup" menu and adjust the volume (Manual Setup → Speaker Level).	61
	This unit is in the straight decode mode.	Press ⓄSTRAIGHT (or 18STRAIGHT) to turn off the straight decode mode.	30
	Sound may not be output from certain channels depending on input sources or sound field programs.	Try another sound field program.	27
	The speaker is malfunction.	Check the speaker indicators on the front panel display. If the corresponding indicator lights up, connect another speaker and check if sound is output. If sound is not output, this unit may be malfunction.	—
No sound is heard from the subwoofer.	"LFE / Bass Out" is set to "Front" and a Dolby Digital, DTS or AAC signals is being played.	Set "LFE / Bass Out" to "Subwoofer" or "Both".	60
	"LFE / Bass Out" is set to "Subwoofer" or "Front" and a 2-channel source is being played.	Set "LFE / Bass Out" to "Both".	60
	The source does not contain low frequency signals.		
No sound is heard from the surround back speakers.	"Extended Surround" in the Option menu is set to "Off", or an input signal does not contain a surround back flag with "Extended Surround" set to "Auto".	Set "Extended Surround" other than "Off" or "Auto".	54
The audio input sources cannot be played in the desired digital audio signal format.	The connected component is not set to output the desired digital audio signals.	Set the playback component properly referring to its operating instructions.	—
Multi-channel playback is not available.	The connected component is set to output 2-ch or PCM signals.	Set the playback component properly referring to its operating instructions.	—
	"Audio Output" is set to "Amplifier + TV".	Set "Audio Output" to "Amplifier".	62

Problem	Cause	Remedy	See page
Noise/hum noise is heard.	Incorrect cable connection.	Connect the audio cables properly. If the problem persists, the cables may be defective.	—
	A DTS-CD is being played back.	1) When only noise is output If a DTS bitstream signal is not properly input to this unit, only noise is output. Connect the playback component to this unit by digital connection and play back the DTS-CD. If the condition is not improved, the problem may result from the playback component. Consult the manufacturer of the playback component. 2) When noise is output during playback or skip operation Before playing back the DTS-CD, display the Option menu after selecting the input source and set “Decoder Mode” to “DTS”.	16, 54
The volume level cannot be increased, or the sound is distorted.	The component connected to the AUDIO 1/2 jacks of this unit is turned off.	Turn on the power of the component.	72
“Memory Guard!” is displayed and the setting cannot be changed.	“Memory Guard” in “Set Menu” is set to “On”.	Set “Memory Guard” to “Off”.	68
There is noise interference from digital or radio frequency equipment.	This unit is too close to other digital or radio frequency equipment.	Move this unit further away from such equipment.	—

HDMI™

Problem	Cause	Remedy	See page
No picture or sound.	The number of the connected HDMI components is over the limit.	Disconnect some of the HDMI components.	—
	The connected HDMI component does not support high-bandwidth digital copyright protection (HDCP).	Connect an HDMI component that supports HDCP.	92

Tuner (FM/AM)

	Problem	Cause	Remedy	See page
FM	FM stereo reception is noisy.	You are too far from the station transmitter or the input from the antenna is weak.	Check the antenna connections.	20
			Replace the outdoor antenna with a more sensitive multi-element antenna.	—
			Switch to monaural mode.	55
FM	There is distortion, and clear reception cannot be obtained even with a good FM antenna.	There is multi-path interference.	Adjust the antenna height or orientation, or place it in a different location.	—
AM	The desired station cannot be tuned into with the automatic tuning method.	You are in an area far from a station or an input from the antenna is weak.	Replace an outdoor antenna with more sensitive multi element antenna.	—
			Tune in manually or by direct frequency tuning.	31
AM	The desired station cannot be tuned into with the automatic tuning method.	The signal is weak or the antenna connections are loose.	Adjust the AM loop antenna orientation.	20
			Use the manual tuning method.	31
AM	There are continuous crackling and hissing noises.	Supplied AM loop antenna is not connected.	Connect the AM loop antenna correctly even if you use an outdoor antenna.	20
		The noises may be caused by lightning, fluorescent lamps, motors, thermostats and other electrical equipment.	It is difficult to completely eliminate noise, but it can be reduced by installing and properly grounding an outdoor AM antenna.	20
	There are buzzing and whining noises.	A TV set is being used nearby.	Move this unit away from the TV set.	—

HD Radio™ Reception (U.S.A. model only)

	Problem	Cause	Remedy	See page
	This unit cannot receive the HD Radio signals of the selected radio station.	The radio station provides analog FM/AM radio service only.	Select other radio stations that provides the HD Radio service.	33
		The signal is too weak.	Adjust the antenna position.	—
			Use a high-quality FM/AM antenna.	—
		“Audio Mode” in the Option menu is set to “Mono”.	Set “Audio Mode” to “Auto”.	55
	This unit cannot select other audio programs than the main program.	The radio station provides one audio program only.		
	HD Radio information does not appear.	The radio station does not provide the information.		

iTunes Tagging (U.S.A. model only)

Problem	Cause	Remedy	See page
Tag data cannot be transferred to your iPod when it is station in the Yamaha iPod universal dock (YDS-10).	“YDS-10” does not support tag file transfer.	Use “YDS-11” to transfer tag data from this unit to your iPod.	—
Status message	Cause	Remedy	See page
Insufficient Data	Tag data is not saved because of invalid data.	The selected HR Radio program (or song being played) does not support the iTunes Tagging feature.	—
Tag Already Stored	Tag data for the same content has been already saved.		
Tag Storage full	Tag data cannot be stored because the internal memory of this unit is full.	Station your iPod in the Yamaha iPod universal dock (YDS-11) connected to the DOCK terminal of this unit.	—
iPod full Tags cannot be stored	Tag data cannot be stored on your iPod because the HDD space of your iPod is full.	Delete unnecessary data from your iPod to make room and try again.	—
Transferring Failed	Tag data cannot be transferred to your iPod.	Check if the iPod is stationed in the Yamaha iPod universal dock (YDS-11) properly.	—
Storing Tag	Tag data is being stored in the internal memory of this unit.		
Transferring	Tag data is being transferred to your iPod.		
Tag(s)Sent	Tag data has been transferred to your iPod.		

XM Satellite Radio (U.S.A. model only)

If an operation takes longer than usual or an error occurs, one of the following messages may appear on the GUI screen. In this case, read the cause and follow the corresponding remedies.

Status message	Cause	Remedy	See page
CHECK XM TUNER	The XM Mini-Tuner is not installed in the XM Mini-Tuner Home Dock or the XM Mini-Tuner Home Dock is not connected to this unit.	Confirm the XM Mini-Tuner is fully seated in the dock and check the XM Mini-Tuner Home Dock cable is connected to this unit.	35
CHECK ANTENNA	The XM antenna is not connected to the XM Mini-Tuner Home Dock or the XM antenna cable has become damaged.	Check that the XM antenna is securely connected to the XM Mini-Tuner Home Dock and check the antenna cable for damage. Replace the XM antenna if the cable is damaged.	35
LOADING XM	The XM Mini-Tuner is acquiring audio or program information from the XM satellite signal. This message can also occur in weak XM signal conditions. Note that this unit may not respond to some operations while this message is displayed.	This message should disappear in a few seconds in good signal conditions. If you see this message often, reposition the XM antenna to get better signal reception. Use the “Antenna” information on the front panel display or XM information on the GUI screen to check the antenna reception level.	38

Status message	Cause	Remedy	See page
NO SIGNAL	The XM Mini-Tuner is not receiving the XM satellite signal. Something may be blocking the XM antenna's view of the satellites or the antenna is not properly aimed.	Check for antenna obstructions and reposition the XM antenna to get better signal reception. Use the "Antenna" information on the front panel display or XM information on the GUI screen to check the antenna reception level. See instructions supplied with the XM Mini-Tuner and Dock for antenna installation information.	38
CHANNEL OFF AIR	The XM channel you selected is not currently broadcasting.	Check back at a later time; in the meantime, select another channel.	—
CHANNEL NOT AUTHORIZED	You may be attempting to tune to an XM channel that is blocked or that you cannot receive with your XM subscription package.	Consult the latest channel guide at http://www.xmradio.com/ for the current list of channels. For information on receiving this channel, visit http://www.xmradio.com/ or contact XM Satellite Radio at 1-800-967-2346.	—
CHANNEL NOT AVAILABLE	The selected channel is not available. The channel may have been reassigned to a different channel number. This message may occur initially with a new XM Mini-Tuner or an XM Mini-Tuner that has not received XM's signal for an extended period.	Consult the latest channel guide at http://www.xmradio.com/ for the current list of channels. For cases of a new XM Mini-Tuner or an XM Mini-Tuner that has not received XM's signal for an extended period, allow the XM Mini-Tuner to receive the XM satellite signal for at least 5 minutes and then try to select the channel again.	—
----	No artist name or song title is available for this selection.	No action required.	—

SIRIUS Satellite Radio (U.S.A. model only)

If an operation takes longer than usual or an error occurs, one of the following messages may appear on the GUI screen. In this case, read the cause and follow the corresponding remedies.

Status message	Cause	Remedy	See page
ANTENNA ERROR	The antenna is not connected to the SiriusConnect tuner properly.	Check the connection of the antenna and SiriusConnect tuner.	39
SIRIUS LOADING	This unit is communicating with the SiriusConnect tuner.	The message disappears normally within several tens of seconds.	—
CHECK SIRIUS TUNER	The SiriusConnect tuner is not connected to the SIRIUS jack of this unit correctly.	Check the connection of the SiriusConnect tuner and this unit.	39
	The SiriusConnect tuner is not connected to the AC wall outlet.	Connect the power cable of the SiriusConnect tuner to the AC wall outlet.	39
NOT SUPPORTED	This unit does not support the connected SIRIUS Satellite Radio tuner.	Connect the SiriusConnect tuner that this unit supports,	39
ACQUIRING SIGNAL	The signal is too weak.	Adjust the orientation of the antenna of the SiriusConnect tuner. Use the "Antenna" information on the front panel display or SIRIUS information on the GUI screen to check the antenna reception level.	43
UPDATING	The SiriusConnect tuner is updating the channel list.	Wait until the updating is complete.	—
	The period of the subscription is end.	Contact SIRIUS Satellite Radio to renew the subscription.	39
F/W UPDATING	The SiriusConnect tuner is updating the firmware.	Wait until the updating is complete.	—

Status message	Cause	Remedy	See page
CALL 888-539-SIRIUS TO SUBSCRIBE	The selected channel is not subscribed.	Contact SIRIUS Satellite Radio to subscribe the selected channel. URL: https://activate.siriusradio.com/ Phone: 1-888-539-SIRIUS (1-888-539-7474)	39
		Select another channel.	39
SUBSCRIPTION UPDATED	The subscription information is updated.		
INVALID CHANNEL	The selected channel is currently out of service.	Select another channel.	39
Not Available	The operation you made is not available.		

Remote control

Problem	Cause	Remedy	See page	
The remote control does not work or function properly.	Wrong distance or angle.	The remote control will function within a maximum range of 6 m (20 ft) and no more than 30 degrees offaxis from the front panel.	6	
	Direct sunlight or lighting (from an inverter type of fluorescent lamp, strobe light, etc.) is striking the remote control sensor of this unit.	Adjust the lighting angle or reposition this unit.	—	
	The batteries are weak.	Replace all batteries.	6, 8	
	The remote control ID of the remote control and this unit do not match.	Match the remote control ID of this unit and the remote control.	74	
	The remote control code is not correctly set.	Set the remote control code correctly using “List of remote control codes” at the end of this manual.		72
		Try setting another code of the same manufacturer using “List of remote control codes” at the end of this manual.		72
		If this unit does not work when you press Cursor , do the following. When the key does not work during DVD disc menu operation: press the Input selection keys on the remote control again. When the key does not work during Option menu or Setup menu operation: press the key applicable for the current menu operation again.		—
	Even if the remote control code is correctly set, there are some models that do not respond to the remote control.			

iPod™

Note

- In case of a transmission error without a status message appearing on the front panel display and GUI screen, check the connection of your iPod (page 18).

Status message	Cause	Remedy	See page
Loading...	This unit is in the middle of recognizing the connection with your iPod.		
	This unit is in the middle of acquiring song lists from your iPod.		
Connect error	There is a problem with the signal path from your iPod to this unit.	Turn off this unit and reconnect the Yamaha iPod universal dock to the DOCK terminal of this unit.	18
		Remove your iPod in the Yamaha iPod universal dock and then place it back in the dock.	44
Unknown iPod	The iPod being used is not supported by this unit.	Use an iPod supported by this unit.	—
iPod Connected	Your iPod is properly placed in the Yamaha iPod universal dock.		
Disconnected	Your iPod is removed from the Yamaha iPod universal dock.		44
Unable to play	This unit cannot play back the songs currently stored on your iPod.	Check that the songs currently stored on your iPod are playable.	—

Bluetooth™

Status message	Cause	Remedy	See page
Searching...	The Bluetooth wireless audio receiver and the Bluetooth component are in the middle of the pairing.		
	The Bluetooth wireless audio receiver and the Bluetooth component are in the middle of establishing the connection.		
Completed	The pairing is completed.		
Canceled	The pairing is canceled.		
BT Connected	The connection between the Yamaha Bluetooth wireless audio receiver and the Bluetooth component is established.		
Disconnected	The Bluetooth component is disconnected from the Yamaha Bluetooth wireless audio receiver.		
Not Found	No Bluetooth components are found during a pairing process.	Pairing must be performed on the both this unit and your Bluetooth component at the same time. Check whether your Bluetooth component is set to the pairing mode and then try again.	46
		Check whether your Bluetooth component is turned on and then try again.	46
		Locate your Bluetooth component within 10 meters (33 feet) of this unit and then try again.	46

USB and network

Problem	Cause	Remedy	See page
The music files and folders in the USB storage device cannot be browsed.	The music files and folders are stored the locations other than the FAT area.	Place the music files and folders in the FAT area.	—
	You are attempting to browse directory hierarchies of over 8 levels or a directory with more than 500 files.	Modify the data structure on your USB storage device.	—
	This unit cannot recognize some characters used in the file name or folder name.	Edit the file name or folder name using a PC and then try again.	—
The USB storage device cannot be recognized.	The USB storage device is not compatible with mass storage class (except USB HDDs).	Use a USB storage device that is compatible with mass storage class (except USB HDDs).	—
	This unit does not recognize the USB storage device properly.	Turn this unit off and then turn on again.	20
The PC server/ Internet Radio/ Rhapsody® does not function properly.	The network cable is not connected properly.	Connect the network cable properly.	19
	The IP address is not set properly.	Set the DHCP server function of the router to ON. Alternately, perform manual configuration according to the current operating environment.	64
The music on the PC server cannot be played back.	The PC does not have Windows Media Player 11 installed on it.	Install Windows Media Player 11 on the PC.	—
	The music is recorded in a format that cannot be played on this unit. This unit cannot play music formats other than WAV (PCM format only), MP3, WMA, MPEG-4 AAC or FLAC. Also note some music files cannot be played regardless of the file formats.	Play music recorded in a format that this unit is compatible with.	—
Internet Radio stations cannot be played.	The firewall of the network device is activated. Internet Radio stations can only be played when the signal pass through the port designated by the individual radio stations. The port number varies from station to station.	Check the firewall setting of the network device.	—
	Connection to the Internet is not available.	Check the configuration of the network device and contact your Internet service provider.	—
Skip forward operation becomes not available during playback of a Rhapsody® channel.	Skip forward works up to 30 times every 3 hours during playback of a Rhapsody® channel.		—
Status message	Cause	Remedy	See page
USB Connected	Your USB storage device is connected.		—
USB Disconnected	Your USB storage device has been disconnected from the USB port of this unit.	Check the connection between this unit and your USB storage device.	—

Status message	Cause	Remedy	See page
Access Error (ACCESS ERROR)	This unit cannot access your USB storage device.	Try another USB storage device.	—
	There is a problem with the signal path from your USB storage device to this unit.	Turn off this unit and reconnect your USB storage device to the USB port of this unit.	19, 20
		Try resetting your USB storage device.	—
	This unit cannot connect to the data server due to network error, etc.	Check the network settings and contact your Internet service provider.	64
Access Denied	The PC you are attempting to connect has denied connection.	Configure the sharing setting of Windows Media Player 11 and select this unit as a device to which music contents are shared.	48
Unable to play	This unit cannot play back the songs currently stored on your PC.	Make sure Windows Media Player 11 is installed on your PC.	—
		Play music recorded in a format that this unit is compatible with (WAV (PCM format only), MP3, WMA, MPEG-4 AAC or FLAC).	—
License unavailable	You are attempting to play back expired digital rights management (DRM) encrypted content.	Select a file that is not protected by DRM	—
	Windows Media Player 11 does not acquire the digital rights management (DRM) license for the file.	Acquire the license to play back the file on Windows Media Player 11.	—
LOGIN OK	You have successfully logged into the Rhapsody® account.		
LOGIN FAILED	Your attempt to log in to the Rhapsody® account failed because of an incorrect user name.	Retry with the correct user name.	51
WRONG PASSWORD	Your attempt to log in to the Rhapsody® account failed because of an incorrect password.	Retry with the correct password.	51
x days left	Your trial account will be expired in x days.	Sign up for Rhapsody® to use the service continuously. For more information, http://www.rhapsody.com/yamaha/go	65
Your account has expired	Your account has already expired.	Sign up for Rhapsody® to use the service continuously. For more information, http://www.rhapsody.com/yamaha/go	65
No Contents	No Rhapsody® items match your search keyword.	Retry with another keyword.	51
	No Rhapsody® items exist in “My Library”.	Add your favorite Rhapsody® items to “My Library”.	52
Skip Limit Reached	Skip forward works up to 30 times every 3 hours during playback of a Rhapsody® channel.	It will be resumed in 3 hours or after once you stop the playback.	51

Auto Setup (YPAO)

Notes

- If an error or warning message appears, resolve the problem and then run “Auto Setup” again.
- Warning message “W-2” or “W-3” indicates that the adjusted settings may not be optimal.
- Depending on the speakers, warning message “W-1” may appear even if the speaker connections are correct.
- If error message “E-10” occurs repeatedly, contact a qualified Yamaha service center.

Before Auto Setup

Error message	Cause	Remedy	See page
Connect MIC!	Optimizer microphone is not connected.	Connect the supplied optimizer microphone to the OPTIMIZER MIC jack on the front panel.	21
Unplug HP!	Headphones are connected.	Unplug the headphones.	—
Memory Guard!	The parameters of this unit are protected.	Set “Memory Guard” to “Off”.	68

During Auto Setup

Error message	Cause	Remedy	See page
E-1:NO FRONT SP	Front L/R channel signals are not detected.	Check the front L/R speaker connections.	11
E-2:NO SUR. SP	Only a signal from one of the surround channels are detected.	Check the surround L/R speaker connections.	11
E-3:NO PRNS SP	Only signals from one of the presence L/R channels are detected.	Check the presence L/R speaker connections.	11
E-4:SBR->SBL	Only right surround back channel signal is detected.	If you connect only one surround back speaker, connect it to the left SUR.BACK (SINGLE) jack.	11
E-5:NOISY	Measurement cannot be performed accurately due to loud ambient noise.	Try running “Auto Setup” in a quiet environment. Turn off noisy electric equipment like air conditioners or move them away from the optimizer microphone.	— —
E-6:CHECK SUR.	Surround back speakers are connected, though surround L/R speakers are not.	When using surround back speakers, you need to connect surround L/R speakers.	11
E-7:NO MIC	The optimizer microphone was unplugged during the “Auto Setup” procedure.	Do not touch the optimizer microphone during “Auto Setup”.	21
E-8:NO SIGNAL	The optimizer microphone does not detect test tones.	Check whether the microphone is properly placed. Check whether the speakers are properly placed and connected. The optimizer microphone or OPTIMIZER MIC jack may be defective. Contact the nearest Yamaha dealer or service center.	21 10, 11 —
E-9:USER CANCEL	“Auto Setup” was canceled due to an inappropriate user operation.	Run “Auto Setup” again.	21
E-10:INTERNAL ERROR	An internal error occurred.	Run “Auto Setup” again.	21

After Auto Setup

Error message	Cause	Remedy	See page
W-1:OUT OF PHASE	Speaker polarity is not correct. This message may appear depending on the speakers even when the speakers are connected correctly.	Check the polarities (+, -) of the displayed speaker. If they are correct, the speakers work properly even when this message is displayed.	12
W-2:OVER 24m (80ft)	The distance between the speaker and the listening position is over 24 m (80 ft).	Bring the speaker within 24 m (80 ft.) area around the listening position.	—
W-3:LEVEL ERROR	The difference of volume level among speakers is excessive.	Recheck the speaker positions and make sure all speakers are placed in a similar environment.	—
		Check the polarities (+, -) of the speakers.	12
		We recommended that you use speakers with the same or similar specifications.	—
		Adjust the output volume of the subwoofer.	—
W-4:CHECK PRNS	Presence speakers were not detected during measurement with “Extra Speaker Assignment” set to “Presence”.	Check the presence speaker connections and perform measurement again. If presence speakers are not connected, set the “Extra Speaker Assignment” to other than “Presence”.	11, 60

■ Audio and video synchronization (lip sync)

Lip sync, an abbreviation for lip synchronization, is a technical term that involves both a problem and a capability of maintaining audio and video signals synchronized during post-production and transmission. Whereas the audio and video latency requires complex end-user adjustments, HDMI version 1.3 incorporates an automatic audio and video syncing capability that allows devices to perform this synchronization automatically and accurately without user interaction.

■ Bi-amplification connection

A bi-amplification connection uses two amplifiers for a speaker. One amplifier is connected to the woofer section of a loudspeaker while the other is connected to the combined mid and tweeter section. With this arrangement each amplifier operates over a restricted frequency range. This restricted range presents each amplifier with a much simpler job and each amplifier is less likely to influence the sound in some way.

■ Component video signal

With the component video signal system, the video signal is separated into the Y signal for the luminance and the PB and PR signals for the chrominance. Color can be reproduced more faithfully with this system because each of these signals is independent. The component signal is also called the “color difference signal” because the luminance signal is subtracted from the color signal. A monitor with component input jacks is required in order to output component signals.

■ Composite video signal

With the composite video signal system, the video signal is composed of three basic elements of a video picture: color, brightness and synchronization data. A composite video jack on a video component transmits these three elements combined.

■ Deep Color

Deep Color refers to the use of various color depths in displays, up from the 24-bit depths in previous versions of the HDMI specification. This extra bit depth allows HDTVs and other displays go from millions of colors to billions of colors and eliminate on-screen color banding for smooth tonal transitions and subtle gradations between colors. The increased contrast ratio can represent many times more shades of gray between black and white. Also Deep Color increases the number of available colors within the boundaries defined by the RGB or YCbCr color space.

■ Dolby Digital

Dolby Digital is a digital surround sound system that gives you completely independent multi-channel audio. With 3 front channels (front L/R and center), and 2 surround stereo channels, Dolby Digital provides 5 full-range audio channels. With an additional channel especially for bass effects, called LFE (Low Frequency Effect), the system has a total of 5.1-channels (LFE is counted as 0.1 channel). By using 2-channel stereo for the surround speakers, more accurate moving sound effects and surround sound environment are possible than with Dolby Surround. The wide dynamic range from maximum to minimum volume reproduced by the 5 full-range channels and the precise sound orientation generated using digital sound processing provide listeners with unprecedented excitement and realism. With this unit, any sound environment from monaural up to a 5.1-channel configuration can be freely selected for your enjoyment.

■ Dolby Digital Surround EX

Dolby Digital EX creates 6 full-bandwidth output channels from 5.1-channel sources.

For the best results, Dolby Digital EX should be used with movie sound tracks recorded with Dolby Digital Surround EX. With this additional channel, you can experience more dynamic and realistic moving sound especially with scenes with “fly-over” and “fly-around” effects.

■ Dolby Digital Plus

Dolby Digital Plus is an advanced audio technology developed for high-definition programming and media including HD broadcasts, and Blu-ray Disc. Selected as an optional audio standard for Blu-ray Disc, this technology delivers multichannel sound with discrete channel output. Supporting bitrates up to 6.0 Mbps, Dolby Digital Plus can carry up to 7.1 discrete audio channels simultaneously. Supported by HDMI version 1.3 and designed for the optical disc players and AV receivers/amplifiers of the future, Dolby Digital Plus also remains fully compatible with the existing multichannel audio systems that incorporate Dolby Digital.

■ Dolby Pro Logic II

Dolby Pro Logic II is an improved technique used to decode vast numbers of existing Dolby Surround sources. This new technology enables a discrete 5-channel playback with 2 front left and right channels, 1 center channel, and 2 surround left and right channels instead of only 1 surround channel for conventional Pro Logic technology. There are three modes available: “Music mode” for music sources, “Movie mode” for movie sources and “Game mode” for game sources.

■ Dolby Pro Logic IIx

Dolby Pro Logic IIx is a new technology enabling discrete multichannel playback from 2-channel or multi-channel sources. There are three modes available: “Music mode” for music sources, “Movie mode” for movie sources (for 2-channel sources only) and “Game mode” for game sources.

■ Dolby Surround

Dolby Surround is widely used with nearly all video tapes and laser discs, and in many TV and cable broadcasts as well. Dolby Surround uses a 4-channel analog recording system to reproduce realistic and dynamic sound effects: 2 front left and right channels (stereo), a center channel for dialog (monaural), and a surround channel for special sound effects (monaural). The surround channel reproduces sound within a narrow frequency range. The Dolby Pro Logic decoder built into this unit employs a digital signal processing system that automatically stabilizes the volume on each channel to enhance moving sound effects and directionality.

■ Dolby TrueHD

Dolby TrueHD is an advanced lossless audio technology developed for high-definition disc-based media including Blu-ray Disc. Selected as an optional audio standard for Blu-ray Disc, this technology delivers sound that is bit-for-bit identical to the studio master, offering a high-definition home theater experience. Supporting bitrates up to 18.0 Mbps, Dolby TrueHD can carry up to 8 discrete channels of 24-bit/96 kHz audio simultaneously. Dolby TrueHD also remains fully compatible with the existing multichannel audio systems and retains the metadata capability of Dolby Digital, allowing dialog normalization and dynamic range control.

■ DSD

Direct Stream Digital (DSD) technology stores audio signals on digital storage media, such as Super Audio CDs. Using DSD, signals are stored as single bit values at a high-frequency sampling rate of 2.8224 MHz, while noise shaping and oversampling are used to reduce distortion, a common occurrence with very high quantization of audio signals. Due to the high sampling rate, better audio quality can be achieved than that offered by the PCM format used for normal audio CDs. The frequency is equal to or higher than 100 kHz and the dynamic range is 120 dB. This unit can transmit or receive DSD signals input from the HDMI jack.

■ DTS 96/24

DTS 96/24 offers an unprecedented level of audio quality for multi-channel sound on DVD video, and is fully backward-compatible with all DTS decoders. “96” refers to a 96 kHz sampling rate compared to the typical 48 kHz sampling rate. “24” refers to 24-bit word length. DTS 96/24 offers sound quality transparent to the original 96/24 master, and 96/24 5.1-channel sound with full-quality full-motion video for music programs and motion picture soundtracks on DVD video.

■ DTS Digital Surround

DTS digital surround was developed to replace the analog soundtracks of movies with a 5.1-channel digital sound track, and is now rapidly gaining popularity in movie theaters around the world. DTS, Inc. has developed a home theater system so that you can enjoy the depth of sound and natural spatial representation of DTS digital surround in your home. This system produces practically distortion-free 6-channel sound (technically, front left and right, center, surround left and right, and LFE 0.1 (subwoofer) channels for a total of 5.1 channels). This unit incorporates a DTS-ES decoder that enables 6.1-channel reproduction by adding the surround back channel to the existing 5.1-channel format.

■ DTS Express

This is an audio format for next-generation optical discs such as Blu-ray discs. It uses optimized low bit rate signals for network streaming. In the case of a Blu-ray disc, this format is used with secondary audio, enabling you to enjoy the commentary of the movie producer via the Internet while playing the main program.

■ DTS-HD High Resolution Audio

DTS-HD High Resolution Audio is a high resolution audio technology developed for high-definition disc-based media including Blu-ray Disc. Selected as an optional audio standard for Blu-ray Disc, this technology delivers sound that is virtually indistinguishable from the original, offering a high-definition home theater experience. Supporting bitrates up to 6.0 Mbps for Blu-ray Disc, DTS-HD High Resolution Audio can carry up to 7.1 discrete channels of 24-bit/96 kHz audio simultaneously.

DTS-HD High Resolution Audio also remains fully compatible with the existing multichannel audio systems that incorporate DTS Digital Surround.

■ DTS-HD Master Audio

DTS-HD Master Audio is an advanced lossless audio technology developed for high-definition disc-based media including Blu-ray Disc. Selected as an optional audio standard for Blu-ray Disc, this technology delivers sound that is bit-for-bit identical to the studio master, offering a high-definition home theater experience. Supporting bitrates up to 24.5 Mbps for Blu-ray Disc, DTS-HD Master Audio can carry up to 7.1 discrete channels of 24-bit/96 kHz audio simultaneously. Supported by HDMI version 1.3 and designed for the optical disc players and AV receivers/amplifiers of the future, DTS-HD Master Audio also remains fully compatible with the existing multichannel audio systems that incorporate DTS Digital Surround.

■ FLAC

This is a file format for lossless audio data compression. FLAC is inferior to lossy compression formats in compression rate but provides higher audio quality.

■ HDMI

HDMI (High-Definition Multimedia Interface) is the first industry-supported, uncompressed, all-digital audio/video interface. Providing an interface between any source (such as a set-top box or AV receiver) and an audio/video monitor (such as a digital television), HDMI supports standard, enhanced or high-definition video as well as multi-channel digital audio using a single cable. HDMI transmits all ATSC HDTV standards and supports 8-channel digital audio, with bandwidth to spare to accommodate future enhancements and requirements.

When used in combination with HDCP (High-bandwidth Digital Content Protection), HDMI provides a secure audio/video interface that meets the security requirements of content providers and system operators. For further information on HDMI, visit the HDMI website at “<http://www.hdmi.org/>”.

■ LFE 0.1 channel

This channel reproduces low-frequency signals. The frequency range of this channel is from 20 Hz to 120 Hz. This channel is counted as 0.1 because it only enforces a low-frequency range compared to the full-range reproduced by the other 5/6 channels in Dolby Digital or DTS 5.1/6.1-channel systems.

■ MP3

One of the audio compression methods used by MPEG. It employs the irreversible compression method, which achieves a high compression rate by thinning out the data of hardly audible part to the human ears. It is said to be capable of compressing the data quantity by about 1/11 (128 kbps) while maintaining a similar audio quality to music CD.

■ MPEG-4 AAC

An MPEG-4 audio standard. As it allows compression of data at a bit rate lower than that of MPEG-2 AAC, it is used among others for mobile telephones, portable audio players and other low-capacity devices requiring high sound quality.

In addition to the above types of devices, MPEG-4 AAC is also used to distribute contents on the Internet, and as such is supported by computers, media servers and many other devices.

■ Neural Surround

Neural Surround represents the latest advancement in surround technology and has been adopted by XM Satellite Radio for digital radio broadcast of surround recordings and live events in surround sound. Neural Surround employs psychoacoustic frequency domain processing which allows delivery of a more detailed sound stage with superior channel separation and localization of audio elements. System playback is scalable from 5.1 to 7.1 multi-channel surround playback.

■ Neo:6

Neo:6 decodes the conventional 2-channel sources for 6-channel playback by the specific decoder. It enables playback with the full-range channels with higher separation just like digital discrete signal playback. There are two modes available: “Music mode” for music sources and “Cinema mode” for movie sources.

■ PCM (Linear PCM)

Linear PCM is a signal format under which an analog audio signal is digitized, recorded and transmitted without using any compression. This is used as a method of recording CDs and DVD audio. The PCM system uses a technique for sampling the size of the analog signal per very small unit of time. Standing for “Pulse Code Modulation”, the analog signal is encoded as pulses and then modulated for recording.

■ Sampling frequency and number of quantized bits

When digitizing an analog audio signal, the number of times the signal is sampled per second is called the sampling frequency, while the degree of fineness when converting the sound level into a numeric value is called the number of quantized bits. The range of rates that can be played back is determined based on the sampling rate, while the dynamic range representing the sound level difference is determined by the number of quantized bits. In principle, the higher the sampling frequency, the wider the range of frequencies that can be played back, and the higher the number of quantized bits, the more finely the sound level can be reproduced.

■ WAV

Windows standard audio file format, which defines the method of recording the digital data obtained by converting audio signals. It does not specify the compression (coding) method so a desired compression method can be used with it. By default, it is compatible with the PCM method (no compression) and some compression methods including the ADPCM method.

■ WMA

An audio compression method developed by Microsoft Corporation. It employs the irreversible compression method, which achieves a high compression rate by thinning out the data of hardly audible part to the human ears. It is said to be capable of compressing the data quantity by about 1/22 (64 kbps) while maintaining a similar audio quality to music CD.

■ “x.v.Color”

A color space standard supported by HDMI version 1.3. It is a more extensive color space than sRGB, and allows the expression of colors that could not be expressed before. While remaining compatible with the color gamut of sRGB standards, “x.v.Color” expands the color space and can thus produce more vivid, natural images. It is particularly effective for still pictures and computer graphics.

Sound field program information

■ Elements of a sound field

What really creates the rich, full tones of a live instrument are the multiple reflections from the walls of the room. In addition to making the sound live, these reflections enable us to tell where the player is situated as well as the size and shape of the room in which we are sitting. There are two distinct types of sound reflections that combine to make up the sound field in addition to the direct sound coming straight to our ears from the player's instrument.

Early reflections

Reflected sounds reach our ears extremely rapidly (50 ms to 100 ms after the direct sound), after reflecting from one surface only (for example, from a wall or the ceiling). Early reflections actually add clarity to the direct sound.

Reverberations

These are caused by reflections from more than one surface (for example, from the walls, and/or the ceiling) so numerous that they merge together to form a continuous sonic afterglow. They are nondirectional and lessen the clarity of the direct sound.

Direct sound, early reflections and subsequent reverberations taken together help us to determine the subjective size and shape of the room, and it is this information that the digital sound field processor reproduces in order to create sound fields.

If you could create the appropriate early reflections and subsequent reverberations in your listening room, you would be able to create your own listening environment.

The acoustics in your room could be changed to those of a concert hall, a dance floor, or a room with virtually any size at all. This ability to create sound fields at will is exactly what Yamaha has done with the digital sound field processor.

■ CINEMA DSP

Since the Dolby Surround and DTS systems were originally designed for use in movie theaters, their effect is best felt in a theater having many speakers designed for acoustic effects. Since home conditions, such as room size, wall material, number of speakers, and so on, can differ so widely, it is inevitable that there are differences in the sound heard.

Based on a wealth of actually measured data, Yamaha CINEMA DSP provides the audiovisual experience of a movie theater in the listening room of your own home by using the Yamaha original sound field technology combined with various digital audio systems.

■ CINEMA DSP 3D

The actually measured sound field data contain the information of the height of the sound images. CINEMA DSP 3D feature achieves the reproduction of the accurate height of the sound images so that it creates the accurate and intensive stereoscopic sound fields in a listening room.

■ SILENT CINEMA

Yamaha has developed a natural, realistic sound effect DSP algorithm for headphones. Parameters for headphones have been set for each sound field so that accurate representations of all the sound field programs can be enjoyed on headphones.

■ Virtual CINEMA DSP

Yamaha has developed a Virtual CINEMA DSP algorithm that allows you to enjoy DSP sound field surround effects even without any surround speakers by using virtual surround speakers. It is even possible to enjoy Virtual CINEMA DSP using a minimal two-speaker system that does not include a center speaker.

■ Compressed Music Enhancer

The Compressed Music Enhancer feature of this unit enhances your listening experience by regenerating the missing harmonics in a compression artifact. As a result, flattened complexity due to the loss of high-frequency fidelity as well as lack of bass due to the loss of low-frequency bass is compensated, providing improved performance of the overall sound system.

Information on HDMI™

■ HDMI signal compatibility

Audio signals

Audio signal types	Audio signal formats	Compatible media
2ch Linear PCM	2ch, 32 to 192 kHz, 16/20/24 bit	CD, DVD-Video, DVD-Audio, etc.
Multi-ch Linear PCM	8ch, 32 to 192 kHz, 16/20/24 bit	DVD-Audio, Blu-ray Disc, HD DVD, etc.
DSD	2/5.1ch, 2.8224 MHz, 1 bit	SA-CD, etc.
Bitstream	Dolby Digital, DTS	DVD-Video, etc.
Bitstream (High definition audio)	Dolby TrueHD, Dolby Digital Plus, DTS-HD Master Audio, DTS-HD High Resolution Audio, DTS Express	Blu-ray Disc, HD DVD, etc.



- If the input source component can decode the bitstream audio signals of audio commentaries, you can play back the audio sources with the audio commentaries mixed down by using the following connections:
 - multi-channel analog audio input (page 18)
 - digital input (OPTICAL or COAXIAL)
- Refer to the supplied instruction manuals of the input source component, and set the component appropriately.

Notes

- When CPPM copy-protected DVD-Audio is played back, video and audio signals may not be output depending on the type of the DVD player.
- This unit is not compatible with HDCP-incompatible HDMI or DVI components.
- To decode audio bitstream signals on this unit, set the input source component appropriately so that the component outputs the bitstream audio signals directly (does not decode the bitstream signals on the component). Refer to the supplied instruction manuals for details.
- This unit is not compatible with the audio commentary features (for example, the special audio contents downloaded via Internet) of Blu-ray Disc or HD DVD. This unit does not play back the audio commentaries of the Blu-ray Disc or HD DVD contents.

Video signals

This unit is compatible with the video signals of the following resolutions:

- 480i/60 Hz
- 576i/50 Hz
- 480p/60 Hz
- 576p/50 Hz
- 720p/60 Hz, 50 Hz
- 1080i/60 Hz, 50 Hz
- 1080p/60 Hz, 50 Hz, 24 Hz

Specifications

AUDIO SECTION

- Minimum RMS Output Power for Front, Center, Surround, Surround back
20 Hz to 20 kHz, 0.08% THD, 8 Ω 130 W
- Dynamic Power (IHF)
Front Speakers 8/6/4/2 Ω 160/200/260/330 W
- Maximum Useful Output Power (JEITA)
[General, China, Korea, Australia and Asia models]
1 kHz, 10% THD, 8 Ω 175 W
- Maximum Output Power [U.K., Europe and Russia models]
1 kHz, 0.7% THD, 4 Ω 180 W
- Dynamic Headroom [U.S.A. and Canada models]
8 Ω 0.9 dB
- IEC Output Power [U.K., Europe and Russia models]
Front Speakers 1 kHz, 0.08% THD, 8 Ω 130 W
- Damping Factor (IHF)
Front Speakers, 20 Hz to 20 kHz, 8 Ω 100 or more
- Input Sensitivity/Input Impedance
PHONO 3.5 mV/47 kΩ
AV5, etc. 200 mV/47 kΩ
- Maximum Input Voltage
PHONO (1 kHz, 0.1% THD) 60 mV or more
AV5, etc. (1 kHz, 0.5% THD) 2.3 V or more
- Rated Output Voltage/Output Impedance
AUDIO OUT 200 mV/1.2 kΩ
PRE OUT 1.0 V/1.2 kΩ
SUBWOOFER (2ch Stereo, Front Speaker: Small)
..... 1.0 V/1.2 kΩ
ZONE2/3 OUT 200 mV/1.4 kΩ
- Headphone Jack Rated Output/Impedance
AV5, etc. (1 kHz, 50 mV, 8 Ω) 100 mV/470 Ω
- Frequency Response
AV5 to FRONT 10 Hz to 100 kHz, +0/-3 dB
- RIAA Equalization Deviation
PHONO 0 ± 0.5 dB
- Total Harmonic Distortion
PHONO to AUDIO OUT
(20 Hz to 20 kHz, 1 V) 0.02% or less
AV5, etc. to FRONT, Pure Direct
(20 Hz to 20 kHz, 50 W, 8 Ω) 0.06% or less
- Signal to Noise Ratio (IHF-A Network)
PHONO Input Shorted (5.0 mV to AUDIO OUT)
[U.S.A., Canada, General and China models] 86 dB or more
[Other models] 81 dB or more
AV5, etc. Input Shorted (250 mV to Front Speakers)
..... 100 dB or more
- Residual Noise (IHF-A Network)
Front Speakers 150 μV or less
- Channel Separation (1 kHz/10 kHz)
PHONO (Input Shorted) 60 dB/55 dB or more
AV5, etc. (5.1 kΩ shortened) 60 dB/45 dB or more
- Volume Control Mute / -80 dB to +16.5 dB
- Tone Control (Front Speakers)
Bass Boost/Cut ±10 dB at 50 Hz
Bass Turnover Frequency 350 Hz
Treble Boost/Cut ±10 dB at 20 kHz
Treble Turnover Frequency 3.5 kHz
- Filter Characteristics (fc=40/60/80/90/100/110/120/160/200 Hz)
H.P.F. (Front, Center, Surround, Surround back: Small)
..... 12 dB/oct.
L.P.F. (Subwoofer) 24 dB/oct.

VIDEO SECTION

- Video Signal Type (Gray Back)
[U.S.A., Canada, General and Korea models] NTSC
[Other models] PAL
- Video Signal Type (Video Conversion) NTSC/PAL
- Signal Level
Composite 1 Vp-p/75 Ω
S-video [U.K., Europe and Russia models]
..... 1 Vp-p/75 Ω (Y), 0.286 Vp-p/75 Ω (C)
Component 1 Vp-p/75 Ω (Y), 0.7 Vp-p/75 Ω (Cb/Cr)
- Maximum Input Level (Video Conversion: Off)
..... 1.5 Vp-p or more
- Signal to Noise Ratio 50 dB or more
- Frequency Response [MONITOR OUT]
Component (Video Conversion: Off)
..... 5 Hz to 60 MHz, -3 dB

FM SECTION

- Tuning Range
[U.S.A. and Canada models] 87.5 to 107.9 MHz
[General and Asia models] 87.5/87.50 to 108.0/108.00 MHz
[Other models] 87.50 to 108.00 MHz
- 50 dB Quieting Sensitivity (IHF)
Mono 3.0 μV (20.8 dBf)
- Signal to Noise Ratio (IHF)
Mono/Stereo 74 dB/70 dB
HD [U.S.A. model] 80 dB
- Harmonic Distortion (1 kHz)
Mono/Stereo 0.3/0.3%
HD [U.S.A. model] 0.03%
- Antenna Input (unbalanced) 75 Ω

AM SECTION

- Tuning Range
[U.S.A. and Canada models] 530 to 1710 kHz
[General and Asia models] 530/531 to 1710/1611 kHz
[Other models] 531 to 1611 kHz

GENERAL

- Power Supply
[U.S.A. and Canada models] AC 120 V, 60 Hz
[General model] AC 110/120/220/230-240 V, 50/60 Hz
[China model] AC 220 V, 50 Hz
[Korea model] AC 220 V, 60 Hz
[Australia model] AC 240 V, 50 Hz
[U.K., Europe and Russia models] AC 230 V, 50 Hz
[Asia model] AC 220/230-240 V, 50/60 Hz
- Power Consumption
[U.S.A. and Canada models] 450 W/560 VA
[Other models] 450 W
- Standby Power Consumption (reference data)
(HDMI Control/Standby Through/Network Standby: Off,
RS232C STBY: No) 0.2 W or less
(HDMI Control/Standby Through/Network Standby: On)
No Repeat 5.6 W or less
Repeat 10.6 W or less
- Maximum Power Consumption
[General and Asia models] 680 W
- Dimensions (W x H x D) 435 x 171 x 365 mm
(17-1/8 x 6-3/4 x 14-3/8 in)
- Weight 12.4 kg (27.4 lbs)

* Specifications are subject to change without notice.

Index

■ Numerics

2ch Stereo, sound field program	28
5.1-channel speaker layout	10
6.1-channel speaker layout	10
7.1-channel speaker layout	10
7ch Enhancer, sound field program	29
7ch Stereo, sound field program	29

■ A

AC IN, rear panel	5
Account Status, Rhapsody Information, Function Setup	65
Action Game, sound field program	28
Adaptive DRC, Volume, Function Setup	63
Adjusting high frequency sound	25
Adjusting low frequency sound	25
Advanced setup	73
Adventure, sound field program	27
All Channel Search mode, SIRIUS Satellite Radio	40
All Channel Search mode, XM Satellite Radio	36
AM antenna connection	20
AM tuning	31
Analog audio jack	13
ANALOG MONITOR OUT, Lipsync, Sound Setup	62
ANTENNA terminal, rear panel	5
Aspect, HDMI, Function Setup	63
AUDIO 1/2 jack, rear panel	5
Audio and video player connection	16
Audio jack	13
Audio Mode, Option menu	55
AUDIO OUT jack, rear panel	5
Audio Output, HDMI, Function Setup	62
Audio player connection	17
Audio program, HD Radio	33
Auto Preset, Option menu	55
Auto Setup (YPAO), troubleshooting	86
Auto Setup, Speaker Setup	59
Automatic setup	21
AV 1-6 jack, rear panel	5
AV OUT jack, rear panel	5

■ B

BAND (CATEGORY), front panel	4
Bass Crossover Frequency, Manual Setup, Speaker Setup	61
BI AMP, advanced setup	73
Bi-amplification connection	12
Bluetooth component playback	46
Bluetooth wireless audio receiver connection	18
Bluetooth, troubleshooting	83

■ C

Category Search mode, SIRIUS Satellite Radio	40
Category Search mode, XM Satellite Radio	36
Cellar Club, sound field program	28
Center Image, DSP Parameter	68
Center Level, DSP Parameter	68
Center speaker	10
Center Speaker, Manual Setup, Speaker Setup	60
Center Width, DSP Parameter	68
Chamber, sound field program	28
Changing information on the front panel display	26
CINEMA DSP 3D	30
CINEMA DSP 3D indicator, front panel display	6
CINEMA DSP indicator, front panel display	6
Clear Preset, Option menu	55
COAXIAL jack	13
CODE SET, remote control	7

COMPONENT VIDEO jack	13
Connect, Option menu	56
Connecting AM antenna	20
Connecting audio and video player	16
Connecting audio player	17
Connecting Bluetooth wireless audio receiver	18
Connecting external amplifier	18
Connecting external decoder	18
Connecting FM antenna	20
Connecting iPod universal dock	18
Connecting multi-format player	18
Connecting power cable	20
Connecting projector	14
Connecting set-top box	16
Connecting SiriusConnect tuner	39
Connecting speaker	11
Connecting speaker cable	12
Connecting to network	19
Connecting TV monitor	14
Connecting USB storage device	19
Connecting XM Mini-Tuner Home Dock	35
Connecting Zone2	69
Connecting Zone3	69
Connections	10
Controlling other component, remote control	72
Controlling Zone2	71
Controlling Zone3	71
Cursor indicator, front panel display	6
Cursor Δ/∇ / \leftarrow/\rightarrow , remote control	7

■ D

Decode Type, DSP Parameter	68
Decoder Mode, Option menu	54
Dialogue Lift, DSP Parameter	66
DIGITAL AUDIO jack, rear panel	5
Dimension, DSP Parameter	68
Dimmer, Display, Function Setup	63
Direct number access, SIRIUS Satellite Radio	40
Direct number access, XM Satellite Radio	36
Direct, DSP Parameter	68
Disconnect, Option menu	56
Display, Function Setup	63
DISPLAY, remote control	7
DOCK terminal, rear panel	5
Drama, sound field program	28
DSP Level, DSP Parameter	65
DSP Parameter, Setup menu	65
Dynamic Range, Sound Setup	62

■ E

Effect Level, DSP Parameter	68
ENTER, remote control	7
EQ Type Select, Manual Setup, Speaker Setup	61
Equalizer, Manual Setup, Speaker Setup	61
Extended Surround, Option menu	54
External amplifier connection	18
External component operation key, remote control	7
Extra Speaker Assignment, Manual Setup, Speaker Setup	60

■ F

FM antenna connection	20
FM tuning	31
Frequency tuning	31
Front left speaker	10
Front panel	4
Front panel display	6
Front Panel Display Scroll, Display, Function Setup	63
Front panel display, front panel	4
Front Speaker, Manual Setup, Speaker Setup	60
Function Setup, Setup menu	62

■ G

General, troubleshooting	75
GEQ, Manual Setup, Speaker Setup	61
GND terminal, rear panel	5
GUI Position, Display, Function Setup	63

■ H

Hall in Munich, sound field program	28
Hall in Vienna, sound field program	28
HD indicator, front panel display	6
HD Radio	33
HD Radio audio program	33
HD Radio key, remote control	7
HD Radio reception, troubleshooting	79
HDMI 1-4 jack, rear panel	5
HDMI control	53
HDMI Control, HDMI, Function Setup	62
HDMI indicator, front panel display	6
HDMI information	92
HDMI jack	13
HDMI OUT 1/2 jack, rear panel	5
HDMI OUT jack, select	53
HDMI OUT, remote control	7
HDMI OUT1, Lipsync, Sound Setup	62
HDMI OUT2, Lipsync, Sound Setup	62
HDMI THROUGH, front panel	4
HDMI, Function Setup	62
HDMI, troubleshooting	78
Headphones, use	26
Hi-fi sound playback	25
High frequency sound adjustment	25

■ I

INFO, front panel	4
INFO, remote control	7
Information, Network, Function Setup	65
INIT, advanced setup	73
Initial Delay, DSP Parameter	66
Initial Volume, Volume, Function Setup	64
Input Rename, Function Setup	64
Input selection key, remote control	7
INPUT selector, front panel	4
Installing batteries, remote control	6
Internal signal flow	17
Internet Radio content playback	50
IP Address, Network, Function Setup	64
iPod playback	44
iPod universal dock connection	18
iPod, troubleshooting	83
iTunes Tagging, HD Radio	33
iTunes Tagging, troubleshooting	80

■ L

LFE / Bass Out, Manual Setup, Speaker Setup	60
Lipsync, Sound Setup	62
Liveness, DSP Parameter	67
Low frequency sound adjustment	25

■ M

MAC Address Filter, Network, Function Setup	64
MAIN ZONE ON/OFF, front panel	4
Manual Setup, Speaker Setup	59
Max Volume, Volume, Function Setup	64
Memory Guard, Setup menu	68
MEMORY, front panel	4
MON.CHK, advanced setup	73
MONITOR OUT jack, rear panel	5
Mono Movie, sound field program	28
MULTI CH INPUT jack, rear panel	5
Multi information display, front panel display	6
Multi-format player connection	18
Multi-zone configuration	69
Music Video, sound field program	28
MUTE indicator, front panel display	6
MUTE, remote control	7

- Muting audio output25
- N**
- Neo:6 Cinema, sound field program29
- Neo:6 Music, sound field program29
- NET FirmUpdate, advanced setup73
- Network connection19
- NETWORK port, rear panel5
- Network Standby, Network,
Function Setup65
- Network, Function Setup64
- Network, trouble shooting84
- Neural Sur., sound field program29
- Numeric key, remote control7
- O**
- ON SCREEN, remote control7
- Operation range, remote control6
- OPTICAL jack13
- OPTIMIZER MIC jack, front panel4
- Option menu54
- OPTION, remote control7
- OUT 1/OUT 2 indicator,
front panel display6
- P**
- P. Initial Delay, DSP Parameter66
- P. Liveness, DSP Parameter67
- P. Room Size, DSP Parameter66
- Pairing Bluetooth component46
- Pairing, Option menu56
- Panorama, DSP Parameter68
- Parental Lock, Option menu55
- PC music content playback48
- PHONES jack, front panel4
- PHONO jack, rear panel5
- Placing speaker10
- PLII Game, sound field program29
- PLII Movie, sound field program29
- PLIIX Game, sound field program29
- PLIIX Movie, sound field program29
- PLIIX Music, sound field program29
- Power cable connection20
- POWER, remote control7
- PRE OUT jack, rear panel5
- Presence L Level, DSP Parameter68
- Presence left speaker11
- Presence R Level, DSP Parameter68
- Presence right speaker11
- PRESET <I/O>, front panel4
- Preset Search mode,
SIRIUS Satellite Radio41
- Preset Search mode,
XM Satellite Radio37
- Preset tuning31
- Pro Logic, sound field program29
- PROGRAM selector, front panel4
- Projector connection14
- PURE DIRECT, front panel4
- R**
- Rear panel5
- Receiving remote control signal18
- Refresh, Option menu56
- Registering SIRIUS Satellite Radio
channel41
- Registering XM Satellite Radio channel37
- Remote control6
- Remote control code resetting72
- Remote control code setting72
- Remote control ID setting74
- Remote control signal transmitter, remote
control7
- Remote control, troubleshooting82
- REMOTE ID, advanced setup73
- REMOTE IN/OUT jack, rear panel5
- Remove Account, Rhapsody Information,
Function Setup65
- Repeat, Option menu55
- Replacing the battery,
simplified remote control8
- Resetting remote control code72
- Resolution, HDMI, Function Setup63
- RETURN, remote control7
- Reverb Delay, DSP Parameter67
- Reverb Level, DSP Parameter68
- Reverb Time, DSP Parameter67
- Rhapsody content playback51
- Rhapsody Free Trial, Rhapsody Information,
Function Setup65
- Rhapsody Information, Function Setup65
- Roleplaying Game, sound field program28
- Room Size, DSP Parameter66
- RS232C STBY, advanced setup73
- RS-232C terminal, rear panel5
- S**
- SCENE function24
- SCENE IR, advanced setup73
- SCENE, front panel4
- SCENE, remote control7
- Sci-Fi, sound field program27
- Selecting HDMI OUT jack53
- Selecting source on GUI screen25
- Selection SCENE24
- Setting Parental Lock,
SIRIUS Satellite Radio42
- Setting remote control code72
- Setting remote control ID74
- Set-top box connection16
- Setup menu57
- Setup menu, basic operation59
- Shuffle, Option menu55
- Sign In, Rhapsody Information,
Function Setup65
- Signal Info, Option menu55
- SILENT CINEMA30
- Simplified remote control8
- SIRIUS indicator, front panel display6
- SIRIUS jack, rear panel5
- SIRIUS Satellite Radio tuning39
- SIRIUS Satellite Radio, troubleshooting81
- SiriusConnect tuner connection39
- SLEEP indicator, front panel display6
- Sleep timer53
- SLEEP, remote control7
- Sound field program27
- Sound selection key, remote control7
- Sound Setup, Setup menu62
- SOURCE POWER, remote control7
- Source selection, GUI screen25
- SP IMP., advanced setup73
- Speaker cable connection12
- Speaker Configuration, Manual Setup,
Speaker Setup59
- Speaker connection11
- Speaker Distance, Manual Setup,
Speaker Setup61
- Speaker indicator, front panel display6
- Speaker layout10
- Speaker Level, Manual Setup,
Speaker Setup61
- Speaker placement10
- Speaker Setup, Setup menu59
- SPEAKERS terminal, rear panel5
- Specifications93
- Spectacle, sound field program27
- Sports, sound field program28
- SR PIN, advanced setup73
- Standard, sound field program27
- Standby Through, HDMI, Function Setup62
- Straight decode mode30
- Straight Enhancer, sound field program29
- STRAIGHT, front panel4
- Sub-input selection key, remote control7
- Subwoofer10
- Subwoofer Phase, Manual Setup,
Speaker Setup61
- Sur. Back Initial Delay, DSP Parameter66
- Sur. Back Liveness, DSP Parameter67
- Sur. Back Room Size, DSP Parameter66
- Sur. Initial Delay, DSP Parameter66
- Sur. Liveness, DSP Parameter67
- Sur. Room Size, DSP Parameter66
- Surround back left speaker10
- Surround Back Level, DSP Parameter68
- Surround back right speaker10
- Surround back speaker10
- Surround Back Speaker, Manual Setup,
Speaker Setup60
- Surround L Level, DSP Parameter68
- Surround left speaker10
- Surround R Level, DSP Parameter68
- Surround right speaker10
- Surround Speaker, Manual Setup,
Speaker Setup60
- T**
- TAG indicator, front panel display6
- Test Tone, Manual Setup, Speaker Setup61
- The Bottom Line, sound field program28
- The Roxy Theatre, sound field program28
- Tone control25
- TONE CONTROL, front panel4
- TRANSMIT, remote control7
- Transmitting remote control signal18
- TRIGGER OUT 1/2 jack, rear panel5
- Tuner (FM/AM), troubleshooting79
- Tuner indicator, front panel display6
- Tuner key, remote control7
- Tuning, AM31
- Tuning, FM31
- TUNING/CH <I/O>4
- Turning off20
- Turning on20
- TV control key, remote control7
- TV monitor connection14
- U**
- Unit, Manual Setup, Speaker Setup61
- USB FirmUpdate, advanced setup73
- USB port, front panel4
- USB storage device connection19
- USB storage device playback47
- USB, troubleshooting84
- V**
- VER, advanced setup73
- VIDEO AUX jack, front panel4
- VIDEO jack13
- Video jack13
- Video Out, Option menu56
- Video/audio jack13
- Virtual CINEMA DSP30
- VOLUME +/-, remote control7
- VOLUME control, front panel4
- VOLUME indicator, front panel display6
- Volume Trim, Option menu54
- Volume, Function Setup63
- X**
- XM indicator, front panel display6
- XM jack, rear panel5
- XM Mini-Tuner Home Dock connection35
- XM Satellite Radio tuning35
- XM Satellite Radio, troubleshooting80
- Y**
- YPAO21
- Z**
- ZONE CONTROLS, front panel4
- Zone selection switch, remote control7
- Zone, Function Setup64
- Zone2 connection69
- Zone2 Initial Volume, Zone,
Function Setup64
- Zone2 Max Volume, Zone,
Function Setup64
- ZONE2 ON/OFF, front panel4

ZONE2/3 OUT jack, rear panel 5
ZONE2/ZONE3 indicator,
front panel display 6
Zone3 connection 69
Zone3 Initial Volume, Zone,
Function Setup 64
Zone3 Max Volume, Zone,
Function Setup 64
ZONE3 ON/OFF, front panel 4

“**Ⓛ MAIN ZONE ON/OFF**” or
“**Ⓜ HDMI**” (example) indicates
the name of the parts on the front
panel or the remote control. Refer
to “Part names and functions” on
page 4.

Information about software

This product uses the following free software.

For information (copyright, etc) about each software, read the original sentences stated below.

About curl

COPYRIGHT AND PERMISSION NOTICE

Copyright (c) 1996 - 2007, Daniel Stenberg, <daniel@haxx.se>.

All rights reserved. Permission to use, copy, modify, and distribute this software for any purpose with or without fee is hereby granted, provided that the above copyright notice and this permission notice appear in all copies.

THE SOFTWARE IS PROVIDED "AS IS", WITHOUT WARRANTY OF ANY KIND, EXPRESS OR IMPLIED, INCLUDING BUT NOT LIMITED TO THE WARRANTIES OF MERCHANTABILITY, FITNESS FOR A PARTICULAR PURPOSE AND NONINFRINGEMENT OF THIRD PARTY RIGHTS. IN NO EVENT SHALL THE AUTHORS OR COPYRIGHT HOLDERS BE LIABLE FOR ANY CLAIM, DAMAGES OR OTHER LIABILITY, WHETHER IN AN ACTION OF CONTRACT, TORT OR OTHERWISE, ARISING FROM, OUT OF OR IN CONNECTION WITH THE SOFTWARE OR THE USE OR OTHER DEALINGS IN THE SOFTWARE.

Except as contained in this notice, the name of a copyright holder shall not be used in advertising or otherwise to promote the sale, use or other dealings in this Software without prior written authorization of the copyright holder.

Copyright (c) 1995, 1996, 1997, 1998, 1999 Kungliga Tekniska Högskolan (Royal Institute of Technology, Stockholm, Sweden).

Copyright (c) 2004 - 2007 Daniel Stenberg
All rights reserved.

Redistribution and use in source and binary forms, with or without modification, are permitted provided that the following conditions are met:

- 1 Redistributions of source code must retain the above copyright notice, this list of conditions and the following disclaimer.
- 2 Redistributions in binary form must reproduce the above copyright notice, this list of conditions and the following disclaimer in the documentation and/or other materials provided with the distribution.
- 3 Neither the name of the Institute nor the names of its contributors may be used to endorse or promote products derived from this software without specific prior written permission.

THIS SOFTWARE IS PROVIDED BY THE INSTITUTE AND CONTRIBUTORS "AS IS" AND ANY EXPRESS OR IMPLIED WARRANTIES, INCLUDING, BUT NOT LIMITED TO, THE IMPLIED WARRANTIES OF MERCHANTABILITY AND FITNESS FOR A PARTICULAR PURPOSE ARE DISCLAIMED. IN NO EVENT SHALL THE INSTITUTE OR CONTRIBUTORS BE LIABLE FOR ANY DIRECT, INDIRECT, INCIDENTAL, SPECIAL, EXEMPLARY, OR CONSEQUENTIAL DAMAGES (INCLUDING, BUT NOT LIMITED TO, PROCUREMENT OF SUBSTITUTE GOODS OR SERVICES; LOSS OF USE, DATA, OR PROFITS; OR BUSINESS INTERRUPTION) HOWEVER CAUSED AND ON ANY THEORY OF LIABILITY, WHETHER IN CONTRACT, STRICT LIABILITY, OR TORT (INCLUDING NEGLIGENCE OR OTHERWISE) ARISING IN ANY WAY OUT OF THE USE OF THIS SOFTWARE, EVEN IF ADVISED OF THE POSSIBILITY OF SUCH DAMAGE.

About Iwip

Copyright (c) 2001, 2002 Swedish Institute of Computer Science.

Copyright (c) 2001-2004 Leon Woestenberg <leon.woestenberg@gmx.net>

Copyright (c) 2001-2004 Axon Digital Design B.V., The Netherlands.
All rights reserved.

Redistribution and use in source and binary forms, with or without modification, are permitted provided that the following conditions are met:

- 1 Redistributions of source code must retain the above copyright notice, this list of conditions and the following disclaimer.
- 2 Redistributions in binary form must reproduce the above copyright notice, this list of conditions and the following disclaimer in the documentation and/or other materials provided with the distribution.
- 3 The name of the author may not be used to endorse or promote products derived from this software without specific prior written permission.

THIS SOFTWARE IS PROVIDED BY THE AUTHOR "AS IS" AND ANY EXPRESS OR IMPLIED WARRANTIES, INCLUDING, BUT NOT LIMITED TO, THE IMPLIED WARRANTIES OF MERCHANTABILITY AND FITNESS FOR A PARTICULAR PURPOSE ARE DISCLAIMED. IN NO EVENT SHALL THE AUTHOR BE LIABLE FOR ANY DIRECT, INDIRECT, INCIDENTAL, SPECIAL, EXEMPLARY, OR CONSEQUENTIAL DAMAGES (INCLUDING, BUT NOT LIMITED TO, PROCUREMENT OF SUBSTITUTE GOODS OR SERVICES; LOSS OF USE, DATA, OR PROFITS; OR BUSINESS INTERRUPTION) HOWEVER CAUSED AND ON ANY THEORY OF LIABILITY, WHETHER IN CONTRACT, STRICT LIABILITY, OR TORT (INCLUDING NEGLIGENCE OR OTHERWISE) ARISING IN ANY WAY OUT OF THE USE OF THIS SOFTWARE, EVEN IF ADVISED OF THE POSSIBILITY OF SUCH DAMAGE.

Copyright (c) 2002 CITEL Technologies Ltd. All rights reserved.

Redistribution and use in source and binary forms, with or without modification, are permitted provided that the following conditions are met:

- 1 Redistributions of source code must retain the above copyright notice, this list of conditions and the following disclaimer.
- 2 Redistributions in binary form must reproduce the above copyright notice, this list of conditions and the following disclaimer in the documentation and/or other materials provided with the distribution.
- 3 Neither the name of CITEL Technologies Ltd nor the names of its contributors may be used to endorse or promote products derived from this software without specific prior written permission.

THIS SOFTWARE IS PROVIDED BY CITEL TECHNOLOGIES AND CONTRIBUTORS "AS IS" AND ANY EXPRESS OR IMPLIED WARRANTIES, INCLUDING, BUT NOT LIMITED TO, THE IMPLIED WARRANTIES OF MERCHANTABILITY AND FITNESS FOR A PARTICULAR PURPOSE ARE DISCLAIMED. IN NO EVENT SHALL CITEL TECHNOLOGIES OR CONTRIBUTORS BE LIABLE FOR ANY DIRECT, INDIRECT, INCIDENTAL, SPECIAL, EXEMPLARY, OR CONSEQUENTIAL DAMAGES (INCLUDING, BUT NOT LIMITED TO, PROCUREMENT OF SUBSTITUTE GOODS OR SERVICES; LOSS OF USE, DATA, OR PROFITS; OR BUSINESS INTERRUPTION) HOWEVER CAUSED AND ON ANY THEORY OF LIABILITY, WHETHER IN CONTRACT, STRICT LIABILITY, OR TORT (INCLUDING NEGLIGENCE OR OTHERWISE) ARISING IN ANY WAY OUT OF THE USE OF THIS SOFTWARE, EVEN IF ADVISED OF THE POSSIBILITY OF SUCH DAMAGE.

Copyright (c) 2003 by Marc Boucher, Services Informatiques (MBSI) inc.

Copyright (c) 1997, 1998 by Global Election Systems Inc. All rights reserved.

Copyright (c) 2001 by Cognizant Pty Ltd.

The authors hereby grant permission to use, copy, modify, distribute, and license this software and its documentation for any purpose, provided that existing copyright notices are retained in all copies and that this notice and the following disclaimer are included verbatim in any distributions. No written agreement, license, or royalty fee is required for any of the authorized uses.

THIS SOFTWARE IS PROVIDED BY THE CONTRIBUTORS "AS IS" AND ANY EXPRESS OR IMPLIED WARRANTIES, INCLUDING, BUT NOT LIMITED TO, THE IMPLIED WARRANTIES OF MERCHANTABILITY AND FITNESS FOR A PARTICULAR PURPOSE ARE DISCLAIMED. IN NO EVENT SHALL THE CONTRIBUTORS BE LIABLE FOR ANY DIRECT, INDIRECT, INCIDENTAL, SPECIAL, EXEMPLARY, OR CONSEQUENTIAL DAMAGES (INCLUDING, BUT NOT LIMITED TO, PROCUREMENT OF SUBSTITUTE GOODS OR SERVICES; LOSS OF USE, DATA, OR PROFITS; OR BUSINESS INTERRUPTION) HOWEVER CAUSED AND ON ANY THEORY OF LIABILITY, WHETHER IN CONTRACT, STRICT LIABILITY, OR TORT (INCLUDING NEGLIGENCE OR OTHERWISE) ARISING IN ANY WAY OUT OF THE USE OF THIS SOFTWARE, EVEN IF ADVISED OF THE POSSIBILITY OF SUCH DAMAGE.

Copyright (c) 1993, 1994 The Australian National University. All rights reserved.

Redistribution and use in source and binary forms are permitted provided that the above copyright notice and this paragraph are duplicated in all such forms and that any documentation, advertising materials, and other materials related to such distribution and use acknowledge that the software was developed by the Australian National University. The name of the University may not be used to endorse or promote products derived from this software without specific prior written permission.

THIS SOFTWARE IS PROVIDED "AS IS" AND WITHOUT ANY EXPRESS OR IMPLIED WARRANTIES, INCLUDING, WITHOUT LIMITATION, THE IMPLIED WARRANTIES OF MERCHANTABILITY AND FITNESS FOR A PARTICULAR PURPOSE.

Copyright (c) 1989 Carnegie Mellon University. All rights reserved.

Redistribution and use in source and binary forms are permitted provided that the above copyright notice and this paragraph are duplicated in all such forms and that any documentation, advertising materials, and other materials related to such distribution and use acknowledge that the software was developed by Carnegie Mellon University. The name of the University may not be used to endorse or promote products derived from this software without specific prior written permission.

THIS SOFTWARE IS PROVIDED "AS IS" AND WITHOUT ANY EXPRESS OR IMPLIED WARRANTIES, INCLUDING, WITHOUT LIMITATION, THE IMPLIED WARRANTIES OF MERCHANTABILITY AND FITNESS FOR A PARTICULAR PURPOSE.

Copyright (c) 1991 Gregory M. Christy. All rights reserved.

Redistribution and use in source and binary forms are permitted provided that the above copyright notice and this paragraph are duplicated in all such forms and that any documentation, advertising materials, and other materials related to such distribution and use acknowledge that the software was developed by Gregory M. Christy. The name of the author may not be used to endorse or promote products derived from this software without specific prior written permission.

THIS SOFTWARE IS PROVIDED "AS IS" AND WITHOUT ANY EXPRESS OR IMPLIED WARRANTIES, INCLUDING, WITHOUT LIMITATION, THE IMPLIED WARRANTIES OF MERCHANTABILITY AND FITNESS FOR A PARTICULAR PURPOSE.

Copyright (c) 1995 Eric Rosenquist, Strata Software Limited. <http://www.strataware.com/> All rights reserved.

Redistribution and use in source and binary forms are permitted provided that the above copyright notice and this paragraph are duplicated in all such forms and that any documentation, advertising materials, and other materials related to such distribution and use acknowledge that the software was developed by Eric Rosenquist. The name of the author may not be used to endorse or promote products derived from this software without specific prior written permission.

THIS SOFTWARE IS PROVIDED "AS IS" AND WITHOUT ANY EXPRESS OR IMPLIED WARRANTIES, INCLUDING, WITHOUT LIMITATION, THE IMPLIED WARRANTIES OF MERCHANTABILITY AND FITNESS FOR A PARTICULAR PURPOSE.

Copyright (C) 1990, RSA Data Security, Inc. All rights reserved.

License to copy and use this software is granted provided that it is identified as the "RSA Data Security, Inc. MD5 Message-Digest Algorithm" in all material mentioning or referencing this software or this function.

License is also granted to make and use derivative works provided that such works are identified as "derived from the RSA Data Security, Inc. MD5 Message-Digest Algorithm" in all material mentioning or referencing the derived work. RSA Data Security, Inc. makes no representations concerning either the merchantability of this software or the suitability of this software for any particular purpose. It is provided "AS IS" without express or implied warranty of any kind.

These notices must be retained in any copies of any part of this documentation and/or software.

Copyright (c) 1989 Regents of the University of California. All rights reserved.

Redistribution and use in source and binary forms are permitted provided that the above copyright notice and this paragraph are duplicated in all such forms and that any documentation, advertising materials, and other materials related to such distribution and use acknowledge that the software was developed by the University of California, Berkeley. The name of the University may not be used to endorse or promote products derived from this software without specific prior written permission.

THIS SOFTWARE IS PROVIDED "AS IS" AND WITHOUT ANY EXPRESS OR IMPLIED WARRANTIES, INCLUDING, WITHOUT LIMITATION, THE IMPLIED WARRANTIES OF MERCHANTABILITY AND FITNESS FOR A PARTICULAR PURPOSE.

About OpenSSL

LICENSE ISSUES

The OpenSSL toolkit stays under a dual license, i.e. both the conditions of the OpenSSL License and the original SSLeay license apply to the toolkit. See below for the actual license texts. Actually both licenses are BSD-style Open Source licenses. In case of any license issues related to OpenSSL, please contact openssl-core@openssl.org.

OpenSSL License

Copyright (c) 1998-2007 The OpenSSL Project. All rights reserved.

Redistribution and use in source and binary forms, with or without modification, are permitted provided that the following conditions are met:

- 1 Redistributions of source code must retain the above copyright notice, this list of conditions and the following disclaimer.
- 2 Redistributions in binary form must reproduce the above copyright notice, this list of conditions and the following disclaimer in the documentation and/or other materials provided with the distribution.
- 3 All advertising materials mentioning features or use of this software must display the following acknowledgment:
"This product includes software developed by the OpenSSL Project for use in the OpenSSL Toolkit. (<http://www.openssl.org/>)"
- 4 The names "OpenSSL Toolkit" and "OpenSSL Project" must not be used to endorse or promote products derived from this software without prior written permission. For written permission, please contact openssl-core@openssl.org.
- 5 Products derived from this software may not be called "OpenSSL" nor may "OpenSSL" appear in their names without prior written permission of the OpenSSL Project.
- 6 Redistributions of any form whatsoever must retain the following acknowledgment:
"This product includes software developed by the OpenSSL Project for use in the OpenSSL Toolkit (<http://www.openssl.org/>)"

THIS SOFTWARE IS PROVIDED BY THE OPENSSL PROJECT "AS IS" AND ANY EXPRESSED OR IMPLIED WARRANTIES, INCLUDING, BUT NOT LIMITED TO, THE IMPLIED WARRANTIES OF MERCHANTABILITY AND FITNESS FOR A PARTICULAR PURPOSE ARE DISCLAIMED. IN NO EVENT SHALL THE OPENSSL PROJECT OR ITS CONTRIBUTORS BE LIABLE FOR ANY DIRECT, INDIRECT, INCIDENTAL, SPECIAL, EXEMPLARY, OR CONSEQUENTIAL DAMAGES (INCLUDING, BUT NOT LIMITED TO, PROCUREMENT OF SUBSTITUTE GOODS OR SERVICES; LOSS OF USE, DATA, OR PROFITS; OR BUSINESS INTERRUPTION) HOWEVER CAUSED AND ON ANY THEORY OF LIABILITY, WHETHER IN CONTRACT, STRICT LIABILITY, OR TORT (INCLUDING NEGLIGENCE OR OTHERWISE) ARISING IN ANY WAY OUT OF THE USE OF THIS SOFTWARE, EVEN IF ADVISED OF THE POSSIBILITY OF SUCH DAMAGE.

This product includes cryptographic software written by Eric Young (ey@cryptsoft.com). This product includes software written by Tim Hudson (tjh@cryptsoft.com).

Original SSLeay License
Copyright (C) 1995-1998 Eric Young (ey@cryptsoft.com)
All rights reserved.

This package is an SSL implementation written by Eric Young (ey@cryptsoft.com). The implementation was written so as to conform with Netscapes SSL.

This library is free for commercial and non-commercial use as long as the following conditions are adhered to. The following conditions apply to all code found in this distribution, be it the RC4, RSA, lhash, DES, etc., code; not just the SSL code. The SSL documentation included with this distribution is covered by the same copyright terms except that the holder is Tim Hudson (tjh@cryptsoft.com).

Copyright remains Eric Young's, and as such any Copyright notices in the code are not to be removed. If this package is used in a product, Eric Young should be given attribution as the author of the parts of the library used. This can be in the form of a textual message at program startup or in documentation (online or textual) provided with the package.

Redistribution and use in source and binary forms, with or without modification, are permitted provided that the following conditions are met:

- 1 Redistributions of source code must retain the copyright notice, this list of conditions and the following disclaimer.
- 2 Redistributions in binary form must reproduce the above copyright notice, this list of conditions and the following disclaimer in the documentation and/or other materials provided with the distribution.
- 3 All advertising materials mentioning features or use of this software must display the following acknowledgement:
"This product includes cryptographic software written by Eric Young (ey@cryptsoft.com)"
The word 'cryptographic' can be left out if the routines from the library being used are not cryptographic related :-).
- 4 If you include any Windows specific code (or a derivative thereof) from the apps directory (application code) you must include an acknowledgement:
"This product includes software written by Tim Hudson (tjh@cryptsoft.com)"

THIS SOFTWARE IS PROVIDED BY ERIC YOUNG "AS IS" AND ANY EXPRESS OR IMPLIED WARRANTIES, INCLUDING, BUT NOT LIMITED TO, THE IMPLIED WARRANTIES OF MERCHANTABILITY AND FITNESS FOR A PARTICULAR PURPOSE ARE DISCLAIMED. IN NO EVENT SHALL THE AUTHOR OR CONTRIBUTORS BE LIABLE FOR ANY DIRECT, INDIRECT, INCIDENTAL, SPECIAL, EXEMPLARY, OR CONSEQUENTIAL DAMAGES (INCLUDING, BUT NOT LIMITED TO, PROCUREMENT OF SUBSTITUTE GOODS OR SERVICES; LOSS OF USE, DATA, OR PROFITS; OR BUSINESS INTERRUPTION) HOWEVER CAUSED AND ON ANY THEORY OF LIABILITY, WHETHER IN CONTRACT, STRICT LIABILITY, OR TORT (INCLUDING NEGLIGENCE OR OTHERWISE) ARISING IN ANY WAY OUT OF THE USE OF THIS SOFTWARE, EVEN IF ADVISED OF THE POSSIBILITY OF SUCH DAMAGE.

The licence and distribution terms for any publically available version or derivative of this code cannot be changed, i.e. this code cannot simply be copied and put under another distribution licence [including the GNU Public Licence.]

About FLAC codec library

Copyright (C) 2000,2001,2002,2003,2004 Josh Coalsen

Redistribution and use in source and binary forms, with or without modification, are permitted provided that the following conditions are met:

- Redistributions of source code must retain the above copyright notice, this list of conditions and the following disclaimer.
- Redistributions in binary form must reproduce the above copyright notice, this list of conditions and the following disclaimer in the documentation and/or other materials provided with the distribution.
- Neither the name of the Xiph.org Foundation nor the names of its contributors may be used to endorse or promote products derived from this software without specific prior written permission.

THIS SOFTWARE IS PROVIDED BY THE COPYRIGHT HOLDERS AND CONTRIBUTORS "AS IS" AND ANY EXPRESS OR IMPLIED WARRANTIES, INCLUDING, BUT NOT LIMITED TO, THE IMPLIED WARRANTIES OF MERCHANTABILITY AND FITNESS FOR A PARTICULAR PURPOSE ARE DISCLAIMED. IN NO EVENT SHALL THE FOUNDATION OR CONTRIBUTORS BE LIABLE FOR ANY DIRECT, INDIRECT, INCIDENTAL, SPECIAL, EXEMPLARY, OR CONSEQUENTIAL DAMAGES (INCLUDING, BUT NOT LIMITED TO, PROCUREMENT OF SUBSTITUTE GOODS OR SERVICES; LOSS OF USE, DATA, OR PROFITS; OR BUSINESS INTERRUPTION) HOWEVER CAUSED AND ON ANY THEORY OF LIABILITY, WHETHER IN CONTRACT, STRICT LIABILITY, OR TORT (INCLUDING NEGLIGENCE OR OTHERWISE) ARISING IN ANY WAY OUT OF THE USE OF THIS SOFTWARE, EVEN IF ADVISED OF THE POSSIBILITY OF SUCH DAMAGE.

About Vorbis library

Copyright (c) 2001, Xiphophorus

Redistribution and use in source and binary forms, with or without modification, are permitted provided that the following conditions are met:

- Redistributions of source code must retain the above copyright notice, this list of conditions and the following disclaimer.
- Redistributions in binary form must reproduce the above copyright notice, this list of conditions and the following disclaimer in the documentation and/or other materials provided with the distribution.
- Neither the name of the Xiphophorus nor the names of its contributors may be used to endorse or promote products derived from this software without specific prior written permission.

THIS SOFTWARE IS PROVIDED BY THE COPYRIGHT HOLDERS AND CONTRIBUTORS "AS IS" AND ANY EXPRESS OR IMPLIED WARRANTIES, INCLUDING, BUT NOT LIMITED TO, THE IMPLIED WARRANTIES OF MERCHANTABILITY AND FITNESS FOR A PARTICULAR PURPOSE ARE DISCLAIMED. IN NO EVENT SHALL THE REGENTS OR CONTRIBUTORS BE LIABLE FOR ANY DIRECT, INDIRECT, INCIDENTAL, SPECIAL, EXEMPLARY, OR CONSEQUENTIAL DAMAGES (INCLUDING, BUT NOT LIMITED TO, PROCUREMENT OF SUBSTITUTE GOODS OR SERVICES; LOSS OF USE, DATA, OR PROFITS; OR BUSINESS INTERRUPTION) HOWEVER CAUSED AND ON ANY THEORY OF LIABILITY, WHETHER IN CONTRACT, STRICT LIABILITY, OR TORT (INCLUDING NEGLIGENCE OR OTHERWISE) ARISING IN ANY WAY OUT OF THE USE OF THIS SOFTWARE, EVEN IF ADVISED OF THE POSSIBILITY OF SUCH DAMAGE.

Notice for Windows Media DRM

The Certified For Windows Vista logo, Windows Media and the Windows logo are trademarks or registered trademarks of Microsoft Corporation in the United States and/or other countries.

Content providers are using the digital rights management technology for Windows Media contained in this device (WMDRM) to protect the integrity of their content (Secure Content) so that their intellectual property, including copyright, in such content is not misappropriated.

This device uses WM-DRM software to play Secure Content (WM-DRM Software).

If the security of the WM-DRM Software in this device has been compromised, owners of Secure Content (Secure Content Owners) may request that Microsoft revoke the WM-DRM Software's right to acquire new licenses to copy, display and/or play Secure Content. Revocation does not alter the WMDRM Software's ability to play unprotected content. A list of revoked WM-DRM Software is sent to your device whenever you download a license for Secure Content from the Internet or from a PC. Microsoft may, in conjunction with such license, also download revocation list onto your device on behalf of Secure Content Owners.

List of remote control codes

TV		Ausind		Clatronic		Durabrand	
A.R. Systems	0274	Autovox	0249, 0257, 0259, 0260, 0328		0243, 0249, 0259, 0260, 0261, 0262, 0268, 0269, 0273, 0274, 0328	Dux	0077, 0097, 0133, 0225
Acme	0260	Aventura	0097			Dwin	0271
Acura	0261, 0273	Awa	0327, 0328	CMS	0327	Dynatron	0224
ADC	0259	Axion	0206	CMS Hightec	0328	Dynex	0268, 0271, 0274
Admiral	0100, 0224, 0257, 0258, 0259, 0264, 0265	Baird	0328	Coby	0151	Elbe	0181, 0182
Advent	0204	Bang & Olufsen	0230, 0257	Colortyme	0072, 0090		0243, 0250, 0274, 0328
Adventura	0107	Basic Line	0261, 0262, 0268, 0273, 0274, 0328	Commercial Solutions	0071	Elcit	0257
Adyson	0260, 0327, 0328	Bastide	0260, 0328	Concerto	0072, 0090	Electa	0270
Agashi	0327, 0328	Baur	0271, 0274	Concorde	0261, 0273	ELECTRO TECH	0261
Agazi	0259	Bazin	0328	Condor	0243, 0260, 0268, 0269, 0273, 0274, 0327	Electroband	0057, 0101
Aiko	0260, 0261, 0273, 0274, 0327, 0328	Beko	0243, 0269, 0274, 0282, 0351, 0357, 0372, 0380			Electrograph	0226
Aim	0274	Belcor	0090	Contec	0225, 0260, 0261, 0266, 0273, 0327	Electrohome	0072, 0090, 0101, 0102
Aiwa	0028, 0297	Bell & Howell	0065, 0100	Contec/Cony	0094, 0104	Element	0180
Akai	0063, 0096, 0101, 0205, 0231, 0261, 0262, 0268, 0271, 0273, 0274, 0327, 0328	Benq	0051, 0160, 0315	Continental Edison	0267	Elin	0260, 0268, 0271, 0273, 0274, 0327
Akiba	0262, 0274	Beon	0268, 0271, 0274			Elite	0262, 0268, 0274
Akura	0259, 0262, 0273, 0274	Best	0243	Cosmel	0261, 0273	Elman	0263
Alaron	0327	Bestar	0243, 0268, 0274	Craig	0104, 0225	Elta	0261, 0273, 0327
Alba	0243, 0260, 0261, 0262, 0266, 0269, 0271, 0273, 0274, 0294, 0300, 0327	Binatone	0260, 0328	Crosley	0088, 0119, 0249, 0257	Emerson	0065, 0072, 0077, 0082, 0085, 0090, 0094, 0095, 0097, 0104, 0105, 0119, 0225, 0243, 0257, 0274
Albatron	0222	Blue Sky	0262, 0274			Emprex	0200
Alcyon	0249	Blue Star	0270	Crown	0104, 0225, 0243, 0249, 0261, 0268, 0269, 0271, 0273, 0274	Envision	0072, 0090, 0096
Alleron	0105	Boots	0260, 0328			Epson	0156, 0201, 0309
Allorgan	0328	BPL	0270, 0274	CS Electronics	0260, 0262, 0327	Erres	0268, 0271, 0274
Allstar	0268, 0274	Bradford	0104, 0225	CTC Clatronic	0263	ESA	0097
America Action	0225	Brandt	0267, 0272	CTX	0159	ESC	0328
AMOi	0326	Brilliant	0228	Curtis Mathes	0065, 0071, 0072, 0085, 0088, 0090, 0096, 0099, 0224	Etron	0261
Amplivision	0243, 0260, 0275, 0328	Brinkmann	0274			Eurofeel	0328
Amstrad	0259, 0261, 0262, 0273, 0274	Briovega	0257, 0268, 0271, 0274	CXC	0104, 0225	Euro-Feel	0259
Amtron	0104			Cybertron	0262	Euroline	0271
Anam	0225, 0261	Britannia	0260, 0327, 0328	Cytron	0202	Euroman	0243, 0327, 0328
Anam National	0102, 0104	Brockwood	0090	Daewoo	0072, 0085, 0090, 0103, 0119, 0245, 0260, 0261, 0268, 0273, 0274, 0281, 0285, 0303, 0321, 0327, 0328, 0344, 0361, 0387	Euromann	0259, 0260, 0268, 0274
Anglo	0261, 0273	Broksonic	0063, 0225			Europhon	0260, 0263, 0268, 0274, 0327, 0328
Anitech	0249, 0259, 0261, 0273, 0274	Bruns	0257	Dainichi	0262, 0327	Expert	0275
Ansonic	0243, 0250, 0261, 0263, 0273, 0274	BTC	0262	Dansai	0259, 0268, 0271, 0274, 0327, 0328	Exquisit	0274
AOC	0072, 0090, 0096, 0103	Bush	0261, 0262, 0264, 0266, 0268, 0270, 0271, 0273, 0274, 0282, 0286, 0294, 0300, 0328, 0329, 0351, 0388, 0394, 0413	Daytron	0243, 0271	Fenner	0261, 0273
Apex	0061, 0117, 0139	Capsonic	0259	Dantax	0243, 0271	Ferguson	0267, 0271, 0272
Arcam	0327, 0328	Carena	0274	Dawa	0274	Fidelity	0260, 0264, 0274, 0327
Arcam Delta	0260	Carnivale	0096	De Graaf	0072, 0085, 0090, 0264	Filsai	0328
Aristona	0268, 0271, 0274	Carrefour	0266	Decca	0260, 0268, 0271, 0274, 0328	Finlandia	0264
Arthur Martin	0275	Carver	0088	Dell	0167, 0195	Finlux	0249, 0257, 0260, 0263, 0268, 0271, 0274, 0328
ASA	0257, 0265	Cascade	0261, 0273, 0274	Denver	0308, 0312	FIRST LINE	0260, 0261, 0268
Asberg	0249, 0268, 0274	Casio	0317	Desmet	0268, 0271, 0274	Firstline	0273, 0274, 0327, 0328
Astra	0261	Cathay	0268, 0271, 0274	Diamant	0274	Fisher	0065, 0243, 0257, 0260, 0266, 0269, 0328
Asuka	0259, 0260, 0262, 0327, 0328	CCE	0229, 0328	Diamond	0327	Flint	0268, 0274
Atlantic	0260, 0268, 0271, 0274, 0327	Celebrity	0057, 0101	DiamondVision	0213, 0221	Formenti	0249, 0257, 0258, 0260, 0271, 0327
Atori	0261, 0273	Celera	0117	Dimensia	0099	Formenti/Phoenix	0327
Auchan	0275	Centurion	0268, 0271, 0274	Disney	0137	Fortress	0257, 0258
Audiosonic	0243, 0260, 0261, 0262, 0268, 0271, 0274, 0328	Century	0257	Dixi	0261, 0268, 0271, 0273, 0274, 0328	Fraba	0243, 0274
AudioTon	0243, 0260, 0328	CGE	0243, 0249	Dream Vision	0415, 0416	Friac	0243
Audiovox	0104, 0144, 0225	Changhong	0117	Dual	0260, 0274, 0328	Frontech	0259, 0261, 0264, 0265, 0273, 0328
		Chimei	0323	Dual-Tec	0260, 0261	Fujitsu	0023, 0024, 0025, 0105, 0328
		Chimline	0261, 0273	Dumont	0076, 0090, 0108, 0257, 0260, 0263, 0328	Fujitsu General	0328
		Citizen	0072, 0085, 0090, 0096, 0104				
		City	0261, 0273				
		Clarion	0225				
		Clarivox	0271				

Fujitsu Siemens	0425, 0426, 0427, 0428, 0429	Hinari	0261, 0262, 0266, 0268, 0271, 0273, 0274	Kaisui	0260, 0261, 0262, 0270, 0273, 0274, 0327, 0328	Magnavox	0072, 0088, 0090, 0091, 0095, 0096, 0098, 0114, 0115, 0129, 0134, 0176, 0178, 0189, 0210
Funai	0033, 0034, 0035, 0036, 0037, 0097, 0104, 0105, 0225, 0259	Hisawa	0262, 0270, 0275	Kamosonic	0260		0259, 0261
Futuretech	0104, 0225	Hisense	0006, 0014, 0015, 0016, 0042, 0072, 0090, 0094, 0173, 0254, 0255, 0256, 0260, 0264, 0265, 0266, 0274, 0285, 0300, 0319, 0328, 0348, 0349, 0385, 0402, 0410	Kamp	0260, 0327	Magnum	0100
Galaxi	0269, 0274	Hitachi	0006, 0014, 0015, 0016, 0042, 0072, 0090, 0094, 0173, 0254, 0255, 0256, 0260, 0264, 0265, 0266, 0274, 0285, 0300, 0319, 0328, 0348, 0349, 0385, 0402, 0410	Kapsch	0265	Majestic	0259
Galaxis	0243, 0274			Karcher	0243, 0260, 0261, 0271, 0274	Mandor	0259, 0260, 0268, 0271, 0274, 0328
Gateway	0163, 0226, 0227			Kawasho	0072, 0090, 0101, 0327	Manesth	0271, 0274, 0328
GBC	0261, 0266, 0273			KEC	0225	Marantz	0072, 0088, 0090, 0096, 0158, 0268, 0271, 0274
GE	0069, 0071, 0072, 0073, 0077, 0090, 0099, 0102, 0106, 0112, 0131	Hornlyphon	0268, 0274	Kendo	0243, 0263, 0264, 0274	Marelli	0257
Geant Casino	0275	Hoshi	0262	Kenwood	0072, 0090, 0096	Mark	0268, 0271, 0273, 0274, 0327, 0328
GEC	0260, 0265, 0268, 0271, 0274, 0328	Huanyu	0260, 0327	KIC	0328		
Geloso	0261, 0264, 0273	Hygashi	0260, 0327, 0328	Kingsley	0260, 0327	Masuda	0328
General Technic	0261, 0273	Hyper	0260, 0261, 0273, 0327, 0328	KLH	0117	Matsui	0260, 0261, 0264, 0266, 0268, 0271, 0273, 0274, 0328, 0405
Genexxa	0262, 0265, 0268, 0274	Hypson	0259, 0260, 0268, 0270, 0271, 0274, 0275, 0328	Kloss Novabeam	0104, 0107		
GFM	0177, 0210			Kneissel	0243, 0250, 0274	Matsushita	0067
Giant	0328	Hyundai	0223	Kolster	0268, 0274	Maxent	0193, 0226
Gibraltar	0076, 0090, 0096, 0108	Iberia	0274	Konka	0262	Mediator	0268, 0271, 0274
GoldHand	0327	ICE	0259, 0260, 0261, 0262, 0268, 0273, 0274, 0327, 0328	Korpel	0268, 0271, 0274	Medion	0259, 0261, 0274
Goldline	0274			Korting	0243, 0257	Megapower	0222
GoldStar	0072, 0077, 0085, 0090, 0094, 0096, 0103, 0243, 0260, 0261, 0264, 0268, 0271, 0273, 0274, 0327, 0328	ICeS	0327	Kosmos	0274	Megatron	0072, 0077
		Ilo	0198, 0203	Koyoda	0261	MElectronic	0273, 0274, 0327, 0328
		IMA	0104	KTV	0085, 0096, 0104, 0225, 0229, 0260, 0328		
		Imperial	0243, 0249, 0265, 0268, 0269, 0274	Kyoto	0327, 0328	Melvox	0275
		Indiana	0268, 0271, 0274	Lasat	0243	Memorex	0065, 0072, 0077, 0100, 0103, 0133, 0219, 0261, 0273
Goodmans	0164, 0259, 0261, 0266, 0268, 0271, 0273, 0274, 0322, 0328, 0395, 0399, 0412	Infinity	0088	Lenco	0261, 0273	Memphis	0261, 0273
		InFocus	0168, 0277, 0313, 0397, 0430	Lenoir	0260, 0261, 0273	Mercury	0273, 0274
		Ingelen	0265	Leyco	0259, 0268, 0271, 0274	Metz	0257
Gorenje	0243, 0269	Initial	0203	LG	0016, 0038, 0039, 0077, 0103, 0145, 0222, 0243, 0246, 0253, 0260, 0261, 0264, 0268, 0271, 0273, 0274, 0282, 0290, 0299, 0316, 0327, 0328, 0351, 0359, 0367, 0382, 0384, 0389, 0396	MGA	0072, 0077, 0090, 0096, 0103
GPM	0262	Inno Hit	0249, 0260, 0261, 0262, 0268, 0271, 0273, 0274, 0328	LG/GoldStar	0246	Micromaxx	0259, 0261
GPX	0211	Innovation	0259, 0261	Liesenk	0271	Microstar	0259, 0261
Gradiente	0162	Insignia	0182, 0188, 0190, 0209	Liesenkotter	0274	Midland	0069, 0071, 0073, 0076, 0085, 0106, 0108
Graetz	0265	Inteq	0076	Life	0259, 0261		0108
Granada	0249, 0260, 0264, 0266, 0268, 0271, 0274, 0275, 0328	Interactive	0243	Lifetec	0259, 0261, 0273, 0274	Minerva	0249
Grandin	0261, 0262, 0270, 0271	Interbuy	0261, 0273	Lloyds	0273	Minoka	0268, 0274
Gronic	0328	Interfunk	0243, 0257, 0265, 0268, 0271, 0274	Loewe	0243, 0250, 0274, 0280, 0306, 0347	Mintek	0203
Grundig	0242, 0243, 0249, 0274, 0356	International	0327	Loewe Opta	0257, 0268, 0271	Mitsubishi	0006, 0015, 0016, 0048, 0072, 0077, 0090, 0103, 0196, 0224, 0257, 0266, 0268, 0274, 0298, 0371
Grunpy	0104, 0105, 0225	Intervision	0243, 0259, 0260, 0263, 0274, 0328	Logik	0100	Mivar	0243, 0249, 0250, 0260, 0327, 0328
Haier	0187, 0207	Irradio	0249, 0261, 0262, 0268, 0271, 0273, 0274	Luma	0264, 0271, 0273, 0274	Monivision	0222
Halifax	0259, 0260, 0327, 0328			Lumatron	0264, 0268, 0271, 0274, 0328	Montgomery Ward	0100
Hallmark	0072, 0077, 0090	Isukai	0262, 0274	Lux May	0268	Motion	0249
Hampton	0260, 0327, 0328	ITC	0260, 0328	Luxman	0072, 0090	Motorola	0102, 0224
Hanseatic	0243, 0250, 0260, 0261, 0266, 0268, 0271, 0273, 0274, 0328	ITS	0262, 0268, 0270, 0274, 0327	Luxor	0260, 0264, 0328	MTC	0072, 0090, 0096, 0103, 0243, 0327
Hantarex	0261, 0273, 0274	ITT	0261, 0265	LXI	0061, 0065, 0071, 0072, 0073, 0077, 0088, 0099	Multi System	0271
Hantor	0274	ITV	0261, 0271, 0274			Multitech	0104, 0225, 0229, 0243, 0260, 0261, 0263, 0264, 0266, 0271, 0273, 0274, 0327, 0328
Harman/Kardon	0088	Janeil	0107	M Electronic	0260, 0261, 0265, 0267, 0268, 0271	Murphy	0260, 0327
Harvard	0104, 0225	JBL	0088	MAG	0050	NAD	0061, 0072, 0077
Harwood	0273, 0274	JC Penney	0072, 0073, 0085, 0090, 0099, 0103, 0106	Magnadyne	0257, 0263, 0271	Naonis	0264
Havermy	0224	Jensen	0057, 0101	Magnafon	0249, 0260, 0263, 0327	NEC	0026, 0053, 0072, 0090, 0096, 0102, 0103, 0266, 0328
HCM	0259, 0260, 0261, 0270, 0273, 0274, 0328	JVC	0017, 0018, 0019, 0092, 0093, 0094, 0106, 0251, 0252, 0266, 0268, 0293, 0360, 0379				
Hema	0273, 0328						
Hewlett Packard	0146						
Higashi	0327						
HiLine	0274						

Neckermann	0243, 0257, 0260, 0264, 0268, 0269, 0271, 0274, 0328		0114, 0135, 0143, 0176, 0178, 0189, 0210, 0212, 0232, 0233, 0257, 0260, 0268, 0271, 0274, 0278, 0287, 0301, 0302, 0307, 0311, 0314, 0330, 0331, 0333, 0337, 0338, 0339, 0341, 0343, 0345, 0355, 0363, 0365, 0377, 0378, 0381, 0383, 0406, 0409, 0414	RCA	0071, 0072, 0073, 0074, 0075, 0090, 0099, 0102, 0103, 0109, 0120, 0179, 0218	SEI-Sinudyne	0257, 0263, 0265 0264, 0265, 0266 0261, 0273 0273 0327	
NEI	0268, 0271, 0274					Sencora	0261, 0273	
Net-TV	0226					Sentra	0273	
Neufunk	0273, 0274					Serino	0327	
New Tech	0261, 0268					Sharp	0009, 0010, 0011, 0072, 0080, 0081, 0082, 0083, 0085, 0090, 0094, 0110, 0148, 0183, 0216, 0224, 0247, 0248, 0258, 0266, 0288, 0304, 0324, 0325, 0340, 0358, 0362, 0369, 0386, 0392, 0398, 0400, 0401, 0403	
New World	0262							
NewTech	0273, 0274, 0328							
Nicamagic	0260, 0327							
Nikkai	0259, 0260, 0262, 0268, 0271, 0273, 0274, 0327, 0328							
Nikko	0072, 0077, 0096							
Noblisko	0249, 0260, 0263, 0327	Philips Magnavox Phoenix	0089, 0114, 0115 0243, 0257, 0268, 0271, 0274, 0327	Rhapsody R-Line Roadstar	0243, 0250, 0257 0327 0268, 0271, 0274 0259, 0261, 0262, 0273			
Nokia	0265					Sheng Chia	0224	
Norcent	0155	Phonola	0257, 0268, 0271, 0274, 0327	Robotron	0257	Shogun	0090	
Nordic	0328					Siarem	0257, 0263, 0274	
Nordmende	0257, 0265, 0267, 0268	Pilot Pioneer	0085, 0090, 0096 0012, 0013, 0072, 0090, 0243, 0265, 0267, 0268, 0271, 0274, 0408	Rowa Royal Lux RTF	0327, 0328 0243 0257	Sierra	0268, 0274	
Nordvision	0271					Siesta	0243	
Novatronic	0274					Signature	0100	
Oceanic	0265, 0275					Silva	0327	
Okano	0243, 0269, 0274	Plantron	0259, 0268, 0273, 0274	Saisho	0259, 0260, 0261, 0273, 0328	Silver	0266	
Olevia	0052, 0140, 0149, 0154, 0157	Playsonic Polaroid	0328 0117, 0152, 0184, 0220			Singer	0257, 0263, 0275	
ONCEAS	0260					Sinudyne	0257, 0263, 0271, 0274	
Onwa	0104, 0225					Skantic	0265	
Opera	0274	Poppy	0261, 0273	Sambers	0249, 0263	Solavox	0265	
Oppo	0208	Portland	0072, 0085, 0090, 0103	Sampo	0072, 0085, 0090, 0096, 0226	Sonitron	0243, 0328	
Optimus	0065, 0067					Sonoko	0259, 0260, 0261, 0268, 0271, 0273, 0274, 0328	
Optoma	0194	Prandoni-Prince	0249, 0264	Samsung	0029, 0030, 0031, 0032, 0044, 0045, 0046, 0047, 0072, 0077, 0084, 0085, 0086, 0087, 0090, 0094, 0096, 0103, 0118, 0217, 0229, 0235, 0236, 0237, 0243, 0259, 0260, 0261, 0268, 0269, 0271, 0273, 0274, 0284, 0295, 0327, 0328, 0336, 0346, 0390, 0407			
Optonica	0224	Precision	0260, 0328			Sonolor	0265, 0275	
Orbit	0268, 0274	Prima	0161, 0207, 0261, 0265, 0273			Sontec	0243, 0268, 0271, 0274	
Orion	0121, 0192, 0261, 0268, 0271, 0273, 0274, 0282, 0329	Princeton Prism Profex	0222 0069, 0106 0261, 0273			Sony	0041, 0057, 0058, 0059, 0060, 0101, 0116, 0125, 0126, 0127, 0142, 0169, 0170, 0171, 0172, 0174, 0234, 0261, 0266, 0276, 0289, 0292, 0393, 0411 0262, 0263	
Orline	0274	Proline	0268, 0274					
Osaki	0259, 0260, 0262, 0274, 0328	Proscan	0071, 0073, 0099					
Oso	0262	Prosonic	0243, 0260, 0271, 0274, 0327, 0328					
Otto Versand	0258, 0260, 0266, 0268, 0270, 0271, 0274, 0328	Protech	0259, 0260, 0261, 0263, 0268, 0271, 0328	Sandra	0260, 0327, 0328	Sound & Vision	0072, 0077, 0090, 0104, 0105, 0225 0268, 0271, 0274 0097	
Pael	0260, 0327							
Palladium	0243, 0260, 0269, 0274, 0328	Proton	0072, 0077, 0090, 0094	Sansui	0063, 0121, 0268, 0274	Soundesign	0268, 0271, 0274 0097	
Palsonic	0328							
Panama	0259, 0260, 0261, 0273, 0274, 0327, 0328	Protron PROVIEW Provision	0150 0050, 0164 0271, 0274	Sanyo	0020, 0021, 0022, 0049, 0065, 0090, 0141, 0191, 0243, 0250, 0260, 0266, 0273, 0291, 0327, 0328, 0370, 0373, 0391	Soundwave	0268, 0271, 0274 0097	
Panasonic	0006, 0007, 0066, 0067, 0068, 0069, 0070, 0102, 0106, 0113, 0147, 0215, 0241, 0265, 0274, 0279, 0310, 0332, 0334, 0368, 0374	Pulsar Pye Pymi Quandra Vision Quasar	0076, 0090, 0108 0268, 0271, 0274, 0296, 0338 0261, 0273 0275 0067, 0069, 0102, 0106	SBR Sceptre Schaub Lorenz Schneider	0271, 0274 0166, 0185 0265 0260, 0262, 0268, 0271, 0274, 0287, 0300, 0328, 0364, 0366	Squareview SSS Standard	0090, 0104, 0225 0260, 0261, 0262, 0268, 0273, 0274, 0328	
Panavision	0274	Quelle	0259, 0260, 0268, 0271, 0274, 0328			Starlite	0104, 0225, 0271, 0273, 0274	
Pathe Cinema	0243, 0250, 0260, 0275, 0327	Questa	0266			Stenway	0270	
Pausa	0261, 0273	Radialva	0274			Stern	0264, 0265	
Penney	0061, 0069, 0071, 0077, 0096	RadioShack	0065, 0071, 0077, 0096, 0225, 0274	Scotch Scott	0072, 0077 0072, 0077, 0090, 0094, 0104, 0105, 0199, 0225	Strato	0273, 0274	
Perdio	0274, 0327					Stylandia	0328	
Perfekt	0274	RadioShack/Realistic	0072, 0085, 0090, 0094, 0099, 0104			Sunkai	0261	
Philco	0072, 0088, 0090, 0091, 0094, 0096, 0102, 0103, 0243, 0249, 0257, 0274	Radiola	0268, 0271, 0274, 0328	Sears	0061, 0065, 0071, 0072, 0073, 0077, 0088, 0090, 0097, 0099, 0105	Sunstar	0273, 0274	
Philharmonic	0260, 0328	Radiomarelli	0257, 0274			Sunwood	0261, 0268, 0273, 0274	
Philips	0040, 0088, 0089, 0090, 0091, 0094, 0098, 0099, 0102,	Radiotone	0243, 0268, 0273, 0274	SEG	0259, 0260, 0263, 0266, 0271, 0273, 0274, 0300, 0327, 0328	Supra	0261, 0273	
		Rank	0266			Supre-Macy	0107	
						Supreme	0057, 0101	
						Susumu	0262	
						Sutron	0261, 0273	
						SVA	0197	
						Sydney	0260, 0327, 0328	
				SEI	0274			

Sylvania	0072, 0088, 0089, 0090, 0091, 0095, 0096, 0097, 0098, 0175, 0177, 0210	Triumph	0274	Adventura	1023	Dumont	1072, 1078
Symphonic	0097, 0104, 0108, 0133, 0210, 0225	Uher	0243, 0249, 0265, 0268, 0274	Adyson	1090	Durabrand	1032
Syntax	0149	Ultravox	0257, 0260, 0263, 0274, 0327	Aiwa	1023, 1072, 1073, 1074	Dynatech	1023
Syntax-Brilliant	0149	Unic Line	0274	Akai	1071, 1073	Echostar	1064
Sysline	0271	United	0271	Akiba	1079, 1090	Elbe	1091
Sytong	0327	Universum	0243, 0249, 0259, 0268, 0269, 0271, 0274, 0328	Akura	1073, 1079, 1090	Elcatech	1090
Tandy	0224, 0258, 0260, 0262, 0265, 0328	Univox	0274	Alba	1074, 1075, 1076, 1079, 1090, 1091	Electrohome	1021
Tashiko	0260, 0264, 0266, 0327, 0328	Vector Research	0096	Alienware	1066	Electrohome	1021
Tatung	0102, 0227, 0260, 0268, 0271, 0274, 0328	Vestel	0264, 0265, 0268, 0269, 0271, 0274, 0328	Ambassador	1076	Elsay	1090
TCM	0259, 0261	Vexa	0261, 0271, 0273, 0274	American High	1022	Elta	1079, 1090, 1091
Teac	0274, 0328	Victor	0093, 0266, 0268	Amstrad	1072, 1090, 1091	Emerson	1021, 1022, 1023, 1070, 1090
Tec	0260, 0261, 0273, 0328	VIDEOLÓGIC	0327	Anitech	1079, 1090	ESC	1075, 1091
Technics	0067, 0069, 0106	Videologique	0260, 0262, 0327, 0328	Apex	1010	Etzuko	1079, 1090
TechniSat	0320, 0417, 0418, 0419	VideoSystem	0268, 0274	ASA	1077, 1078	Expressvu	1064
Techwood	0069, 0072, 0090, 0106	Videotechnic	0327, 0328	Asha	1020	Ferguson	1073
TEDELEX	0328	Vidikron	0088	Asuka	1072, 1077, 1078, 1079, 1090	Fidelity	1072, 1090
Teknika	0072, 0085, 0088, 0090, 0094, 0100, 0103, 0104, 0105, 0225	Vidtech	0072, 0077, 0090, 0103	Audio Dynamics	1018	Finlandia	1078
Teleavia	0267	Viewsonic	0153, 0186, 0226, 0318	Audiosonic	1091	Finlux	1072, 1073, 1078
Telecor	0274, 0328	Viking	0107	Audiovox	1021	Firstline	1074, 1077, 1079, 1090
Telefunken	0267, 0268, 0272, 0274	Viore	0198	Baird	1072, 1073, 1075, 1091	Fisher	1019
Telegazi	0274	Visiola	0260, 0327	Bang & Olufsen	1067	Flint	1074
Telemeister	0274	Vision	0268, 0274, 0328	Basic Line	1074, 1075, 1076, 1079, 1090, 1091	Formenti/Phoenix	1078
Telesonic	0274	Vizio	0090, 0136, 0160, 0227, 0420, 0421, 0422, 0423, 0424	Baur	1078	Frontech	1076
Telestar	0274	Vortec	0268, 0271, 0274	Beaumarck	1020	Fuji	1022
Teletech	0261, 0271, 0273, 0274	Voxson	0249, 0257, 0264, 0265, 0268, 0274	Bell & Howell	1019	Fujitsu	1072
Teleton	0260, 0328	Waltham	0260, 0274, 0328	Bestar	1075, 1076, 1091	Funai	1023, 1072
Televideon	0327	Wards	0072, 0077, 0088, 0090, 0091, 0096, 0098, 0099, 0100, 0103, 0105	Black Panther Line	1075, 1091	Galaxy	1072
Televiso	0275	Watson	0268, 0271, 0274	Blaupunkt	1078	Garrard	1023
Tensai	0261, 0262, 0268, 0273, 0274, 0328	Watt Radio	0260, 0263, 0327	Bondstec	1076, 1090	Gateway	1066
Tesmet	0268	Waycon	0061	Broksonic	1054	GBC	1076, 1079
Tevion	0259, 0261	Wega	0257, 0266, 0274	Bush	1074, 1075, 1079, 1090, 1091, 1097, 1099, 1109, 1139	GE	1020, 1022
Textet	0260, 0273, 0327, 0328	Wegavox	0273	Calix	1021	GEC	1078
Thomson	0238, 0239, 0240, 0260, 0267, 0268, 0272, 0274, 0335	Weltblick	0268, 0271, 0274, 0328	Candle	1020, 1021	Geloso	1079
Thorn	0072, 0077, 0090	Westinghouse	0057, 0138, 0142	Canon	1022	General	1076
TNCi	0076	White Westinghouse	0008, 0119, 0260, 0263, 0271, 0274, 0327	Cathay	1091	General Technic	1074
Tokai	0268, 0274, 0328	Wincom	0055, 0056	Catron	1076	GOI	1064
Tokyo	0260, 0327	Xrypton	0274	CGE	1072, 1073	GoldHand	1079, 1090
Tomashi	0270	Yamaha	0000, 0001, 0002, 0003, 0004, 0005, 00103	Cimline	1074, 1079, 1090	Goldstar	1018, 1021, 1072, 1077
Toshiba	0027, 0043, 0053, 0054, 0061, 0062, 0063, 0064, 0065, 0122, 0123, 0124, 0128, 0130, 0132, 0139, 0214, 0244, 0266, 0283, 0305, 0328, 0329, 0342, 0350, 0352, 0353, 0354, 0375, 0404	Yamishi	0274, 0328	CineVision	1058	Goodmans	1072, 1075, 1076, 1077, 1079, 1090, 1091
Totevision	0085	Yokan	0274	Citizen	1020, 1021	Gradiente	1023
Towada	0265, 0328	Yoko	0243, 0259, 0260, 0261, 0262, 0268, 0271, 0273, 0274, 0327, 0328	Clatronic	1076, 1090	Graetz	1073
Trakton	0328	Zenith	0076, 0077, 0078, 0079, 0090, 0100, 0108, 0111	Colortyme	1018	Granada	1078
Trans Continens	0274, 0328	Zorx	0262	Condor	1075, 1076, 1091	Grandin	1072, 1075, 1076, 1077, 1079, 1090, 1091
Transtec	0327	Zanussi	0264, 0328	Craig	1020, 1021	Grundig	1078, 1079
Trident	0328	Zenith	0076, 0077, 0078, 0079, 0090, 0100, 0108, 0111	Crown	1075, 1076, 1079, 1090, 1091	Hanseatic	1077, 1078, 1091
		VCR		Curtis Mathes	1018, 1020, 1022	Harley Davidson	1023
		ABS	1066	Cybernex	1020	Harman/Kardon	1018
				CyberPower	1066	Harwood	1090
				Daewoo	1023, 1075, 1076, 1091, 1116, 1141	HCM	1079, 1090
				Dansai	1079, 1090, 1091	Headquarter	1019
				Dantax	1074	Hewlett Packard	1066
				Daytron	1075, 1091	Hinari	1074, 1079, 1090, 1091
				DBX	1018	Hisawa	1074
				De Graaf	1078	Hitachi	1072, 1073, 1078, 1089, 1108, 1124
				Decca	1072, 1073, 1078	HNS	1060
				Dell	1066	Howard Computers	1066
				Denko	1090	HP	1066
				DiamondVision	1050	HTS	1064
				DigiFusion	1092	Hughes	1035, 1040, 1061
				DIRECTV	1035, 1038, 1040, 1059, 1060, 1061, 1065	Hughes Network Systems	1038, 1060
				Dish Network	1064	Humax	1035, 1060, 1094
				Dishpro	1064	Hush	1066
				Dual	1073, 1078, 1091	Hypson	1074, 1079, 1090, 1091

iBUYPOWER	1066	Multitech	1020, 1023, 1072,	Ricavision	1066	Telefunken	1073
Impego	1076		1076, 1078, 1079,	Roadstar	1075, 1077, 1079,	Teletech	1090, 1091
Imperial	1072		1090		1090, 1091	Tenosal	1079, 1090
Inno Hit	1075, 1076, 1078,	Murphy	1072	Royal	1090	Tensai	1072, 1077, 1079,
	1079, 1090, 1091	NEC	1018, 1019, 1073	Runco	1032		1090
Innovation	1074	Neckermann	1073, 1078	Saba	1073	Tevion	1074
Instant Replay	1022	NEI	1078	Saisho	1074, 1079	Thomson	1073, 1087
Interbuy	1077, 1090	Nesco	1079, 1090	Samsung	1006, 1020, 1038,	Thorn	1073
Interfunk	1078	Nikkai	1076, 1090, 1091		1040, 1046, 1060,	Tivo	1035, 1036, 1037,
Intervision	1072, 1091	Nikko	1021		1080, 1107, 1110,		1039, 1040, 1060,
Irradio	1077, 1079, 1090	Niveus Media	1066		1112, 1121, 1123,		1061, 1062
ITT	1073	Noblex	1020		1140, 1142	TMK	1020
ITV	1075, 1077, 1091	Nokia	1073, 1091	Samurai	1076, 1090	Tokai	1077, 1079, 1090
JC Penney	1018, 1019, 1020,	Nordmende	1073	Sanky	1032	Tonsai	1079
	1021, 1022	Northgate	1066	Sansui	1033, 1056, 1069,	Toshiba	1004, 1005, 1034,
JCL	1022	Oceanic	1072, 1073		1073		1051, 1063, 1066,
JVC	1011, 1012, 1013,	Okano	1074, 1090, 1091	Sanyo	1019, 1020, 1114		1073, 1078, 1086,
	1014, 1015, 1016,	Olympus	1022	Saville	1091		1099, 1102, 1119,
	1017, 1018, 1019,	Optimus	1021	SBR	1078		1144
	1028, 1035, 1064,	Orion	1033, 1069, 1074,	Schaub Lorenz	1072, 1073	Totevision	1020, 1021
	1073, 1085, 1117,		1097, 1139	Schneider	1072, 1074, 1075,	Touch	1066
	1130, 1131, 1133,	Orson	1072		1076, 1077, 1078,	Towada	1079, 1090
	1134, 1135, 1136	Osaki	1072, 1077, 1079,		1079, 1090, 1091	Towika	1079, 1090
Kaisui	1079, 1090		1090	Sears	1019, 1021, 1022	TVA	1076
Karcher	1078	Otto Versand	1078	SEG	1079, 1090, 1091	Uher	1077
Kendo	1074, 1075, 1076,	Palladium	1073, 1077, 1079,	SEI-Sinudyne	1078	UltimateTV	1065
	1090		1090	Seleco	1073	Ultravox	1091
Kenwood	1018, 1019, 1073	Panasonic	1007, 1008, 1009,	Sentra	1076, 1090	Unitech	1020
Kodak	1021, 1022		1022, 1026, 1042,	Sentron	1079, 1090	United Quick Star	1075, 1091
Korpel	1079, 1090		1043, 1068, 1082,	Sharp	1031, 1045, 1057,	Universum	1072, 1077, 1078
Kyoto	1090		1101, 1126, 1132		1081, 1115, 1137	Vector Research	1018
Lenco	1075	Pathe Marconi	1073	Shintom	1079, 1090	Video Concepts	1018
Leyco	1079, 1090	Perdio	1072	Shivaki	1077	Videon	1074
LG	1021, 1053, 1072,	Philco	1022, 1090	Shogun	1020	Videosonic	1020
	1077, 1088, 1100,	Philips	1022, 1030, 1035,	Siemens	1077	Viewsonic	1066
	1106, 1125, 1143		1038, 1039, 1040,	Silva	1077	Voodoo	1066
Lifetec	1074		1044, 1055, 1060,	Silver	1091	Wards	1020, 1021, 1022,
Linksys	1066		1078, 1084, 1095,	Singer	1022		1023
Lloyd's	1023		1096, 1104, 1105,	Sinudyne	1078	Weltblick	1077
Loewe Opta	1077, 1078		1111, 1113, 1122,	Solavox	1076	XR-1000	1022, 1023
Logik	1079, 1090		1124, 1127, 1128,	Sonic Blue	1041, 1068	Yamaha	1018, 1019
Lumatron	1075, 1091		1129	Sonneclair	1090	Yamishi	1079, 1090
Luxor	1090	Philips Magnavox	1030	Sonoko	1075, 1091	Yokan	1079, 1090
LXI	1021	Phonola	1078	Sontec	1077	Yoko	1076, 1077, 1079,
M Electronic	1072	Pilot	1021	Sony	1000, 1001, 1002,		1090
Magnavox	1022, 1032, 1044,	Pioneer	1078, 1118		1003, 1024, 1027,	Zenith	1032
	1070	Polaroid	1010, 1049		1036, 1062, 1066,	ZT Group	1066
Magnin	1021	Portland	1075, 1076, 1091		1083, 1098, 1103,		
Manesth	1079, 1090	Prinz	1072		1138	DVD	
Marantz	1018, 1019, 1022,	Profex	1079	Stack	1066	4Kus	2097
	1078	Proline	1072	Stack 9	1066	Accurian	2220
Mark	1091	Proscan	1065	Standard	1075, 1091	Advent	2169, 2201
Marta	1021	Prosonic	1074, 1091	Stern	1091	AEG	2312
Matsui	1074, 1077	Pulsar	1032	STS	1022	Airis	2318
Matsushita	1022	Pye	1052, 1078	Sunkai	1074	Aiwa	2272
Media Center PC	1066	Quarter	1019	Sunstar	1072	Akai	2170, 2195, 2225,
Mediator	1078	Quartz	1019	Suntronic	1072		2227
Medion	1074	Quasar	1022	Sunwood	1079, 1090	Akura	2310
MEI	1022	Quelle	1072, 1078	Superscan	1070	Alba	2018, 2232, 2247,
Memorex	1019, 1020, 1021,	Radialva	1090	Sylvania	1022, 1023, 1044,		2259, 2264
	1022, 1023, 1032,	RadioShack	1021		1052, 1070	Alco	2199
	1048, 1069, 1072,	RadioShack/Realistic		Symphonic	1023, 1044, 1090	Alize	2315
	1077		1019, 1020, 1021,	Systemax	1066	Allegro	2215
Memphis	1079, 1090		1022, 1023	Tagar Systems	1066	Amitech	2312
MGN Technology	1020	Radiola	1078	Taisho	1074	Amphion MediaWorks	
Micromaxx	1074	Radix	1021	Tandberg	1091		2145
Microsoft	1066	Randex	1021	Tandy	1019	AMW	2145, 2313
Microstar	1074	RCA	1020, 1022, 1025,	Tashiko	1021, 1072	Apex	2044, 2045, 2046,
Migros	1072		1035, 1040, 1047,	Tatung	1072, 1073, 1078		2047, 2076, 2208,
Mind	1066		1060, 1065	TCM	1074, 1093, 1120		2209
Mitsubishi	1029, 1072, 1078	Realistic	1019, 1020, 1021,	Teac	1023, 1091	Apple	2163
Motorola	1022		1022, 1023	Tec	1076, 1090, 1091	Arrgo	2216
MTC	1020	ReplayTV	1041, 1068	Technics	1022	Asono	2318
		Rex	1073	Teknika	1021, 1022, 1023	Aspire	2140, 2202
		RFT	1076, 1078, 1090	Teleavia	1073	Astar	2162

ATACOM	2318	Enzer	2302	LG	2080, 2107, 2115,	2252, 2256, 2260,
Audiovox	2111, 2199	Epson	2165		2116, 2141, 2188,	2268, 2282, 2332,
Avious	2317	ESA	2219		2211, 2215, 2237,	2333, 2343, 2344,
Awa	2313	Finlux	2304, 2312, 2317		2239, 2285, 2293,	2345, 2367, 2371,
Axion	2171	Fintec	2299		2295, 2348, 2370	2373, 2380, 2382,
Bang & Olufsen	2210	Fisher	2212	Life	2228	2385
Baze	2317	Funai	2219	Lifetec	2228	Phonotrend 2317
BBK	2318	Gateway	2097	Limit	2305	Pioneer 2012, 2013, 2014,
Bellagio	2313	GE	2079, 2206, 2209	Liquid Video	2204	2063, 2064, 2065,
Best Buy	2309	Gericom	2269	Liteon	2097, 2121, 2220	2066, 2067, 2113,
Blaupunkt	2209	GFM	2176	Loewe	2274	2134, 2207, 2230,
Blue Parade	2207	Giec	2300	LogicLab	2305	2236, 2265, 2266,
Boghe	2300	Global Solutions	2305	Magnavox	2075, 2096, 2178,	2267, 2297, 2322,
Brainwave	2312	Global Sphere	2305		2180, 2196, 2205,	2351, 2352, 2353,
Brandt	2198, 2238	Go Video	2135, 2215		2219, 2308	2354, 2355, 2356,
Broksonic	2192, 2195	Goodmans	2247, 2289, 2298,	Magnex	2317	2357, 2358, 2359,
Bush	2018, 2060, 2248,		2300, 2308, 2330,	Majestic	2314	2377
	2264, 2301, 2308,		2369	Marantz	2282	Pointer 2312
	2317, 2350, 2368	GPX	2177	Marquant	2312	Polaroid 2047, 2133, 2185
California Audio Labs		Gradiente	2197	Matsui	2198, 2296	Portland 2312
		Graetz	2302	McIntosh	2149	Powerpoint 2313
Cambridge Audio	2304	Greenhill	2209	Mecotek	2312	Prima 2174
CAT	2306, 2307	Grundig	2271	Medion	2228	Proceed 2208
CAVS	2146	Grunkel	2312, 2316	Memorex	2078, 2184, 2195	Proscan 2206
Centrum	2307	GVG	2299	MiCO	2300, 2304	Prosonic 2299, 2314
CGV	2304, 2312	H&B	2308	Micromaxx	2228	Prottron 2152
Changhong	2222	H_her	2318	Microsoft	2206	Provision 2308
Cinetec	2313	Haaz	2304, 2305	Microstar	2228	Pye 2194
CineVision	2191, 2215	Haier	2172	Minoka	2312	Qwestar 2198
Clatronic	2308, 2317	Harman/Kardon	2125, 2213	Minowa	2317	Raite 2302
Coby	2077, 2124, 2314	HiMAX	2309	Mintek	2167, 2209	RCA 2058, 2059, 2071,
Conia	2301	Hitachi	2008, 2033, 2108,	Mitsubishi	2081	2079, 2183, 2199,
Continental Edison			2302, 2309, 2320,	Mizuda	2308, 2309	2206, 2207, 2209
			2366	Monyka	2302	2310, 2312, 2314
Crown	2312	Hiteker	2208	Mustek	2232	RedStar 2203
C-Tech	2305	Home Tech Industries		Mx Onda	2304	Regent 2203
Curtis Mathes	2217		2318	Mystral	2316	Reoc 2305
CVG	2299	Hyundai	2316	Naiko	2312	Rimax 2315
CyberHome	2048, 2068, 2216,	Ilo	2167	Nesa	2209	Rio 2215
	2233, 2258	Initial	2167, 2209	Neufunk	2302	Roadstar 2281, 2308
Cytron	2166	Innovation	2228	Nevir	2312	Ronin 2313
Daenyx	2313	Insignia	2080, 2175, 2219	Next Base	2221	Rotel 2153
Daewoo	2083, 2215, 2280,	Integra	2207	Nexxtech	2161	Rowa 2200, 2301
	2299, 2312, 2313,	Irradio	2103	NU-TEC	2301	Rowsonic 2307
	2326, 2376	iSymphony	2164	Onkyo	2205, 2290	Saba 2198, 2238
Daewoo International		JBL	2213	Oopla	2097	Sabaki 2305
		JVC	2049, 2050, 2051,	Oppo	2150, 2173	Saivod 2312
Dalton	2311		2052, 2053, 2054,	Optim	2303	Sampo 2223
Dansai	2303, 2312		2055, 2056, 2057,	Optimus	2230	Samsung 2031, 2032, 2033,
Daytek	2145, 2234, 2313		2070, 2242, 2261,	Orava	2308	2034, 2035, 2082,
Dayton	2313		2275, 2276, 2277,	Orbit	2313	2127, 2137, 2138,
DEC	2308		2278, 2339, 2340,	Orion	2027, 2060	2154, 2182, 2197,
Decca	2312		2341, 2342, 2386,	Oritron	2198, 2204	2283, 2319, 2325,
Denon	2105, 2147, 2197,		2387, 2389, 2390,	P&B	2308	2346, 2347, 2349,
	2286		2391	Pacific	2305	2372, 2381
Denver	2288, 2308, 2310,	Jwin	2148	Panasonic	2015, 2016, 2017,	Sansui 2027, 2195, 2304,
	2314	Kansai	2314		2036, 2037, 2038,	2305, 2312
Denzel	2302	Kawasaki	2199		2039, 2040, 2041,	Sanyo 2139, 2195, 2212,
Desay	2159	Kennex	2312		2042, 2043, 2074,	2374
Diamond	2304, 2305	Kenwood	2123, 2197, 2270		2089, 2104, 2108,	ScanMagic 2232
DiamondVision	2179, 2186	KeyPlug	2312		2112, 2120, 2131,	Schaub Lorenz 2312
Disney	2078, 2088	Kiiro	2312		2132, 2197, 2205,	Schneider 2226
DK Digital	2257	Kingavon	2308		2244, 2245, 2246,	Scientific Labs 2305
Dmtech	2226	Kiss	2302		2253, 2254, 2255,	Scott 2243, 2311
Dual	2302	KLH	2199, 2209		2292, 2321, 2324,	Seeltech 2318
Durabrand	2218	Koda	2308		2327, 2328, 2329,	SEG 2240, 2302, 2305,
DVX	2305	Koss	2095, 2198, 2204		2331, 2383, 2388	2313
Easy Home	2309	KXD	2309	Parasound	2151	Sharp 2009, 2010, 2084,
Eclipse	2304	Landel	2221	peeKTON	2318	2122, 2142, 2143,
E-Dem	2318	Lasonic	2214	Philips	2026, 2061, 2062,	2144, 2181, 2190,
Electrohome	2312	Lawson	2305		2075, 2090, 2094,	2228, 2262, 2375
Elin	2312	Lecson	2303		2096, 2097, 2103,	Shinsonic 2167
Elta	2263, 2312, 2315	Lenco	2308, 2312, 2317		2110, 2126, 2180,	Sigmatek 2309, 2318
Emerson	2196, 2211, 2219	Lenoxx	2203, 2218		2193, 2205, 2231,	Silva 2310
Enterprise	2211				2235, 2241, 2251,	Singer 2304, 2305
						Skymaster 2279, 2305

The letters in circles and the numbers in squares correspond to those in the Owner's Manual.

■ Front panel

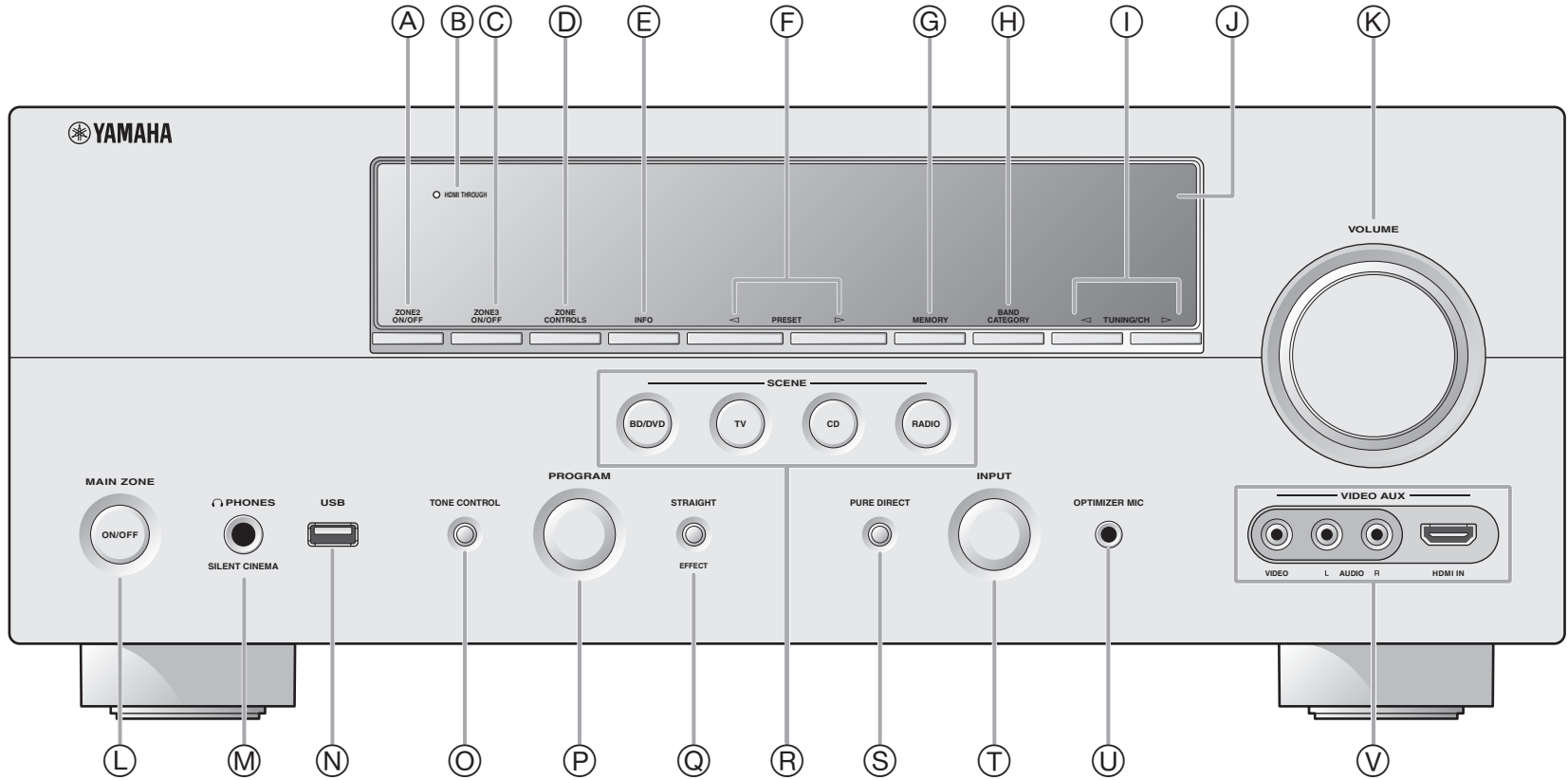

Remote control

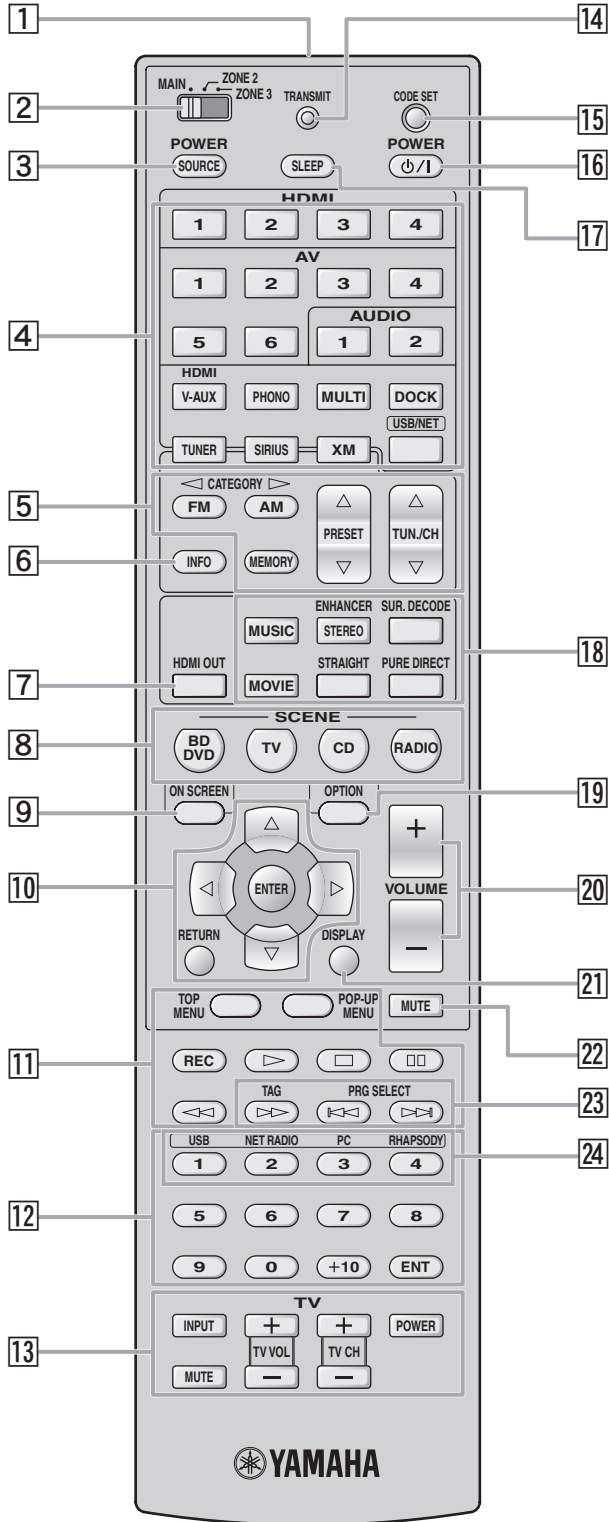

Viewmaster	3045	Condor	4074, 4090, 4137	Fuba	4074, 4083, 4090,	Lasat	4074, 4088, 4090,
Vision	3045	Connexions	4074, 4092		4092, 4093, 4101,		4100, 4133, 4134,
Visiopass	3051, 3054, 3055	Conrad	4074, 4133, 4136,		4133		4137
Vortex View	3045		4137	Galaxis	4074, 4087, 4090,	Lasonic	4062
Wittenberg	3048	Conrad Electronic	4137, 4139		4091, 4096, 4098,	Lenco	4074, 4083, 4099,
Zenith	3035, 3040, 3046	Contec	4096		4133, 4140		4133, 4137, 4139
Zentek	3044	Coolsat	4050	GE	4015, 4016, 4061,	Leng	4095
<hr/>							
Sattelite							
AB Sat	4138, 4139	Cosat	4098	General Instrument	4027, 4065	Lennox	4098
AccessHD	4058	Coship	4063			Lenson	4136
ADB	4142	Crown	4089	GMI	4089	Lexus	4103
AGS	4138	Daeryung	4092	GOI	4039	LG	4053, 4057, 4099
Akai	4101, 4103	Daewoo	4107, 4139	Goldbox	4135	Lifesat	4074, 4090, 4134,
Alba	4083, 4084, 4085,	DDC	4085	GoldStar	4099		4139
	4086, 4108, 4139	Delega	4085	Goodmans	4079, 4080, 4084	Lifetec	4090
Aldes	4085, 4087, 4088	Dew	4096	Goodmind	4061	Lorenzen	4137
Allsat	4098, 4101, 4103	Diamond	4097	Grandin	4077	Lorraine	4099
Allsonic	4074, 4087, 4090	Digiality	4137	Grothusen	4083, 4099	Lupus	4074, 4090
Alltech	4139	Digital Stream	4059	Grundig	4084, 4086, 4093,	Luxor	4136
Alpha	4103	DIRECTV	4017, 4018, 4020,		4113, 4129, 4136,	Lyonnaise	4102
Alpha Digital	4058		4021, 4022, 4024,	Hänsel & Gretel	4140	Macab	4102
Alphastar	4031		4037, 4038, 4040,	Hantor	4137	Magnavox	4045, 4055
Amitronica	4139		4041, 4043, 4045,	Hanuri	4083, 4095	Manata	4077, 4138, 4139
Amstrad	4089, 4113, 4136,		4057, 4106, 4143,		4088	Manhattan	4084, 4088, 4098,
	4139		4144, 4145, 4146,	Hauptpauge	4126		4138
Anglo	4139		4147, 4148, 4149,	Heliocom	4137	Marantz	4101
Ankaro	4074, 4087, 4090,		4150, 4151, 4152,	Hinari	4085	Mascom	4088
	4139	Discoverer	4153, 4154, 4155,	Hirschmann	4074, 4093, 4128,	Maspro	4084, 4139
			4156, 4157		4136, 4137, 4138,	Matsui	4138
Anttron	4083, 4086	Discovery	4138	Hisawa	4095	Max	4137
Apollo	4083	Diseqc	4138	Hisense	4066	Mediabox	4135
Armstrong	4089, 4103	Dish Network	4011, 4012, 4013,	Hitachi	4032, 4084, 4149,	Mediamarkt	4089
Artec	4054		4014, 4019, 4039,		4153	Mediasat	4091, 4135, 4136
Asat	4101, 4103		4064	Homecast	4005, 4006, 4007	Medion	4074, 4090, 4139
ASLF	4139	Dishpro	4039, 4064	Houston	4098	Medison	4139
Astacom	4138	Distrisat	4103	HTS	4039	Mega	4101, 4103
Astra	4089, 4091, 4100,	Ditrisat	4098	Hughes	4018, 4022, 4144,	Memorex	4045
	4137, 4139	DNT	4092, 4101, 4103		4146, 4150, 4152	Metronic	4077, 4078, 4083,
Astro	4074, 4086, 4088,	Drake	4026	Hughes Network Systems			4086, 4087, 4088,
	4090, 4093, 4135,	DStv	4140		4021	Metz	4139
	4136, 4137	Dune	4074	Humax	4051, 4075, 4076,	Micro electronic	4136, 4137, 4139
AudioTon	4086, 4098	Echostar	4011, 4019, 4039,		4110	Micro Technology	4139
Aurora	4140		4064, 4092, 4139	Huth	4087, 4089, 4094,	MicroGem	4056
Austar	4140	Einhell	4083, 4087, 4089,		4095, 4096, 4098,	Micromaxx	4074, 4090
Axiel	4138		4136, 4139		4137, 4141	Microstar	4090
Axis	4074, 4090, 4091,	Elap	4138, 4139	Hypson	4077	Microtec	4139
	4096	Elekta	4088	Ilo	4066	Minerva	4093
Best	4074, 4090	Elsat	4139	Imex	4077	Mitsubishi	4084, 4093, 4152
Blaupunkt	4093	Elta	4074, 4083, 4090,	Innovation	4090	Mitsumi	4100
Blue Sky	4139		4098, 4101, 4103	Insignia	4057	Morgan's	4089, 4100, 4101,
Boca	4089, 4100, 4105,	Emanon	4083	Intertronic	4089		4103, 4139
	4139	Emme Esse	4074, 4090	Intervision	4098, 4137	Motorola	4008, 4009, 4010,
Boston	4138	Engel	4139	ITT Nokia	4084		4065
Brain Wave	4095	Ep Sat	4084	Jerrold	4065	Multichoice	4140
Broadcast	4094	EURIEULT	4077	Johansson	4095	Multitec	4134
Broco	4139	Eurodec	4102	JOK	4138	Muratto	4099
BSkyB	4113, 4123	Europa	4103, 4136, 4137	JSR	4098	Mysat	4139
BT	4138	Europhon	4137	JVC	4011, 4019, 4039,	Navex	4095
Bubu Sat	4139	Eurosat	4089		4079	Neuhaus	4091, 4098, 4136,
Bush	4084, 4127	Eurosky	4074, 4089, 4090,	Kamm	4139		4137, 4139
Cambridge	4136		4133, 4136, 4137	Kathrein	4093, 4101, 4103,	Neusat	4139
Canal Satellite	4135	Eurostar	4089, 4133, 4137		4109, 4112, 4120,	Next Level	4065
Canal+	4135	Eutelsat	4139		4133, 4138, 4139	NextWave	4141
CaptiveWorks	4049	Exator	4083, 4086	Kathrein Eurostar	4133	Nikko	4089, 4139
Channel Master	4060, 4085	Expressvu	4039	Klap	4138	Nokia	4084, 4122
Chaparral	4025	Fenner	4074, 4134, 4139	Konig	4137	Nordmende	4083, 4084, 4085,
CHEROKEE	4138	Ferguson	4084, 4102, 4132	Kosmos	4099		4088, 4102
Chess	4134, 4139	Fidelity	4136	KR	4086	Nova	4140
CityCom	4084, 4133, 4137	Finlandia	4084	Kreiselmeyer	4093	Novis	4095
Clatronic	4095	Finlux	4084	K-SAT	4139	Oceanic	4097
CNT	4088	FinnSat	4096, 4102	Kyostar	4083	Octagon	4083, 4086, 4096
Comag	4000, 4001, 4002,	Flair Mate	4139	L&S Electronic	4074	Okano	4089
	4003, 4004	Foxtel	4140			Optex	4098
Commlink	4087	Freecom	4083, 4099, 4136			Optus	4135, 4140, 4141
Comtech	4096	FTEmaximal	4074, 4139				

Orbitech	4083, 4134, 4135, 4136	Satcom	4094, 4137	Tivax	4058
OSat	4086	Satec	4139	Tivo	4150
Otto Versand	4093	Satelco	4074	Tokai	4103
Pace	4084, 4093, 4113, 4121, 4125, 4138	Satford	4094	Tonna	4084, 4094, 4098, 4136, 4139
Pacific	4097	Satmaster	4094	Toshiba	4144, 4152, 4153
Packsat	4138	Satplus	4134	Triad	4099
Palcom	4085	Schneider	4090, 4134, 4138	Triasat	4136
Palladium	4089, 4136	Schwaiger	4097, 4134, 4137	Triax	4093, 4133, 4136, 4139
Palsat	4134, 4136	SCS	4133	Turnsat	4139
Panasat	4140	Seemann	4089, 4091, 4092	Tvonics	4132
Panasonic	4043, 4044, 4046, 4084, 4113, 4118, 4143, 4148	SEG	4074, 4083, 4090, 4095	Twiner	4077, 4139
Panda	4084, 4137	Seleco	4098	UEC	4140
Pansat	4047	Servi Sat	4077, 4139	Uher	4134
Patriot	4138	Siemens	4093	UltimateTV	4020
Paysat	4045	Silva	4099	Uniden	4029, 4045
PCT	4060	Skantin	4139	Unisat	4089, 4096, 4103
Philco	4055	Skardin	4091	Unitor	4095
Philips	4021, 4022, 4045, 4084, 4101, 4103, 4111, 4115, 4135, 4138, 4150, 4152, 4153, 4155, 4156	Skinsat	4136	Universum	4093, 4133, 4137
Phoenix	4096	SKR	4139	US Digital	4066
Phonotrend	4084, 4087, 4098	Sky master	4067, 4068, 4087, 4134, 4139	Variosat	4093
Pioneer	4124, 4135	Sky max	4101, 4103	Vega	4074
Polsat	4102	SkySat	4134, 4136, 4137, 4139	Ventana	4101, 4103
Predki	4095	Skyvision	4098	Viewsat	4048
Premiere	4098, 4135	SM Electronic	4134, 4139	Visiosat	4095, 4098, 4138, 4139
Priesner	4089	Smart	4133, 4139	Voom	4065
Primestar	4030	Sony	4017, 4020, 4135	Vortec	4083
Profile	4138	SR	4089, 4100	Welltech	4134
Promax	4084	Star Choice	4065	WeTeKom	4134, 4136
Prosat	4085, 4087	Starland	4139	Wevasat	4084
Proscan	4015, 4016, 4040, 4151	Starring	4095	Wewa	4084
Protek	4097	Start Trak	4083	Winersat	4095
Proton	4066	Strong	4074, 4083, 4086, 4090, 4099, 4140	Wisi	4084, 4092, 4093, 4136, 4137
Provision	4088	STS	4033	Woorisat	4088
Quadral	4074, 4085, 4087, 4090, 4138	STVI	4077	Worldsat	4138
Quelle	4093, 4133, 4137	Sumida	4089	Xrypton	4074
Quiero	4102	Sunny Sound	4074	XSat	4139
RadioShack	4065	Sunsat	4139	Zehnder	4074, 4088, 4090, 4131, 4133
Radiola	4101, 4103	Sunstar	4074, 4089, 4100	Zenith	4052, 4057, 4145
Radix	4092, 4119	Supermax	4141	Zodiac	4086
Rainbow	4086	Tandberg	4102		
RCA	4015, 4016, 4034, 4035, 4036, 4037, 4038, 4040, 4151, 4157	Tandy	4086		
Realistic	4028	Tantec	4084		
Redpoint	4091	TCM	4090		
Redstar	4074, 4090	Techniland	4094		
RFT	4087, 4101, 4103	TechniSat	4071, 4072, 4073, 4092, 4103, 4116, 4117, 4134, 4135, 4136		
Roadstar	4139	Technology	4140		
Roch	4077	Technosat	4141		
Rover	4074, 4139	Technowelt	4137		
Saba	4088, 4133, 4137, 4138	Teco	4089, 4100		
Sabre	4084	Telanor	4085		
Sagem	4069, 4102	Telasat	4133, 4137		
Sakura	4096	Telecom	4139		
Samsung	4018, 4021, 4023, 4041, 4042, 4081, 4082, 4083, 4114, 4150, 4154	Telefunken	4067, 4083, 4138		
SAT	4085, 4136	Teleka	4086, 4089, 4092, 4136, 4137		
Sat Cruiser	4141	Telemaster	4088		
Sat Partner	4083, 4086, 4088, 4095, 4099, 4136	Telesat	4137		
Sat Team	4139	Telestar	4134, 4135, 4136		
		Televcs	4084, 4136		
		Telewire	4098		
		Tempo	4141		
		Tevion	4090, 4139		
		Thomson	4070, 4084, 4102, 4104, 4130, 4133, 4135, 4137, 4138, 4139		
		Thorens	4097		
		Thorn	4084		

CD

Yamaha 5000, 5013

CD Recoder

Yamaha 5001

MD

Yamaha 5002, 5003, 5004

Tape

Yamaha 5005, 5006

Tuner

Yamaha 5007, 5008, 5009,
5010, 5014, 5015,
5016, 5017, 5018

USB

Yamaha 5012, 5021

DOCK

Yamaha 5011, 5022

LD

Yamaha 2002

