

Century
INSTRUCTIONS FOR USE



CE
0086

WARNING

To avoid injury, always read this *Instructions for Use* and accompanying documents before using the product.



Mandatory to read the *Instructions for Use*

Design Policy and Copyright

® and ™ are trademarks belonging to the ArjoHuntleigh group of companies.

© ArjoHuntleigh AB 2014.

As our policy is one of continuous improvement, we reserve the right to modify designs without prior notice. The content of this publication may not be copied either whole or in part without the consent of ArjoHuntleigh AB.

Contents

Foreword	4
Intended Use	5
Safety Instructions	6
Preparations	7
Parts Designation	8
Control Panel	10
Buttons and Displays	10
Product Description/Functions	12
Drain Control Knob	12
Auto Fill Function	12
Shampoo/Body Wash and Bath Oil/ArjoSound™	12
Water Conditioner	12
Scalding Protection	13
Patient Shower	13
Disinfection Unit	14
Hydromassage™ System	15
Hydrosound® System	17
Bathe Patient	19
Cleaning and Disinfection Instructions	21
Care and Preventive Maintenance	29
Troubleshooting	33
Technical Specifications	37
Labels	40
Approvals and List of Standards	42
Electromagnetic Compatibility	43
Parts and Accessories	46
ArjoHuntleigh Addresses	Last Page

Foreword

Thank you for purchasing ArjoHuntleigh Equipment

Your Century™ bath is part of a world-wide family of quality products designed especially for efficient patient hygiene and good ergonomics for the caregiver.

Please contact us if you have any questions about the operation or maintenance of your *Century* bath.

Please read this Instructions for Use thoroughly!

Please read this *Instructions for Use (IFU)* in its entirety before using your *Century* bath. Information in this *IFU* is crucial to the proper operation and maintenance of the equipment, will help protect your product, and ensure that the equipment performs to your satisfaction. Some of the information in this *IFU* is important for your safety and must be read and understood to help prevent possible injury.

Unauthorized modifications on any ArjoHuntleigh equipment may affect its safety. ArjoHuntleigh will not be held responsible for any accidents, incidents or lack of performance that occur as a result of any unauthorized modification to its products.

Service and Support

A routine service must be performed on your *Century* every year by qualified personnel to maintain safety and reliability of the equipment. See section *Care and Preventive Maintenance on page 29*.

If you require further information, please contact ArjoHuntleigh for comprehensive support and service programs to maximize the long-term safety, reliability and value of the product.

Contact ArjoHuntleigh for replacement parts. The contact information is found on the last page of this *IFU*.

Definitions in this *IFU*

WARNING

Means:
Safety warning. Failure to understand and obey this warning may result in injury to you or to others.

CAUTION

Means:
Failure to follow these instructions may cause damage to all or parts of the system or equipment.

NOTE

Means:
This is important information for the correct use of this system or equipment.



Means:
The name and address of the manufacturer.

Intended Use

This bath is intended for assisted bathing and showering of adult residents in hospital and care facilities. *Century* must be used by appropriately trained caregivers with adequate knowledge of the care environment, its common practices and procedures, and in accordance with the guidelines in this *Instructions for use*.

The bath should only be used for the purpose specified in this *Instructions for Use*. Any other use is prohibited.

Resident Assessment

We recommend that facilities establish regular assessment routines. Caregivers should assess each resident according to the following criteria prior to use:

- The resident's weight should not exceed 160 kg / 353 lbs (Max Patient Weight)
- Active and semi-active residents (i.e. able to sit upright self supported on the side of the bed or toilet) can use the bath. Correct transfer equipment shall be used if needed.
- The resident should have the ability to understand and respond to instructions, or have limited physical capacity to move, to ensure a safe position during the bathing procedure.
- Hydrosound should not be used by pregnant women.

If the resident does not meet these criteria an alternative equipment/system shall be used.

Indication for Use

To relieve pain and itching and as an aid in the healing process of inflamed and traumatized tissue and it serves as a setting for removal of contaminated tissue.

Installation & Service Requirements

The equipment must be installed by appropriately trained personnel according to the *Assembly and Installation Instructions* which can only be superseded by local code.

Expected Lifetime

The expected life of the *Century* is unless otherwise stated ten (10) years, if subject to preventive maintenance being carried out in accordance with the instruction for *Care and Preventive Maintenance on page 29*.

Safety Instructions

WARNING

To avoid hair entrapments under water, always install the *Hydromassage* system suction cover before use.

WARNING

To avoid falling, make sure the patient always remains in a seated position.

WARNING

To avoid explosion or fire, never use the equipment in oxygen rich environment, in presence of heat source or flammable anaesthetic gases.

WARNING

To avoid entrapment or pinching of genitals, make sure there is enough clearance during movement over the tub edge, toilet, bedpan or other furniture.

WARNING

To avoid the device from tipping and the patient from falling, do not use the equipment on floor with recessed drains, holes or slopes exceeding a ratio of 1:50 (1.15°).

WARNING

To avoid falling during transfer, always make sure that the brakes are applied on all equipment being used.

WARNING

To avoid entrapment, make sure to keep the patient's hair, arms and feet close to the body and use designated grab supports during any movement.

WARNING

To prevent cross-contamination, always follow the disinfection instructions in this *IFU*.

WARNING

To avoid falling, make sure that the patient is positioned correctly and that the safety belt is being used, properly fastened and tightened.

WARNING

To avoid electric shock, never use other electrical equipment near this device.

WARNING

To avoid injury, make sure that the patient is not left unattended at any time.

CAUTION

Do not use the *Hydrosound* system for more than 15 minutes at a time with a 15 minute stop in between.

Safety Practice

For a safe bath and to avoid injuries, make sure the patient is sitting firmly and facing the control panel.

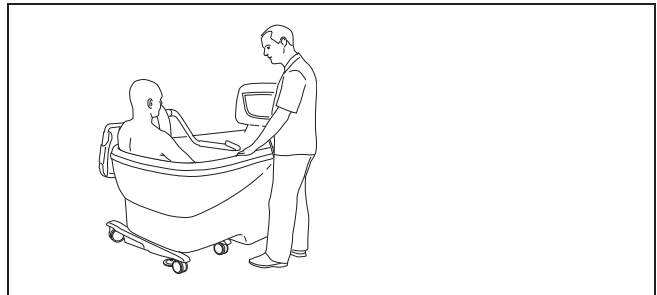

Preparations

Site Preparations

Prior to the installation of the *Century* bath, the floor and walls within the required area must be finished.

Material: The floor should be water sealed, made of a slip resistant material and free of bumps.

Floor Slope: When using a floor drain, the slope towards the drain should not exceed 1:50 (1.15°).

Floor attachments: The floor construction must be suitable for anchoring the equipment bolts.

Actions Before First Use

(8 steps)

- 1 Make sure the bath has been installed according to the *Assembly and Installation Instructions*.
- 2 Check all parts of the product are supplied. Compare with section *Parts Designation on page 8*. If any part is missing or damaged - do NOT use the product.
- 3 Read this *IFU*.
- 4 Disinfect the product according to section *Cleaning and Disinfection Instructions on page 21*.
- 5 Perform a functionality test according to section *Care and Preventive Maintenance on page 29*.
- 6 Choose a designated area, where the *IFU* should be kept and is easily accessible at all times.

7 **WARNING**

To prevent scalding, make sure that the water mixer has been calibrated. Confirm that responsible organization has established calibration routines.

Make sure the thermostatic mixer has been calibrated by an ArjoHuntleigh service technician according to the *Assembly and Installation Instructions*.

- 8 Make sure to have a rescue plan ready in case of a patient emergency.

Actions Before Every Use

(5 steps)

- 1 Check that all parts are in place. Compare to section *Parts Designation on page 8*.
- 2 Check bath and accessories for damage.
- 3 If any part is missing or damaged - do NOT use the product!
- 4 Check the liquid level of disinfection bottle.

5 **WARNING**

To prevent cross-contamination, always follow the disinfection instructions in this *Instructions for Use*.

Before every use, make sure the *Century* bath is cleaned and disinfected according to section *Cleaning and Disinfection Instructions on page 21*.

NOTE

If you have any questions, please contact your local ArjoHuntleigh representative for support and service. The contact information (ArjoHuntleigh addresses) is listed on the last page of this *IFU*.

Parts Designation

- 1 Bathtub 
 - 2 Leg
 - 3 Foot
 - 4 Control panel
 - 5 Outlet for bathtub filling
 - 6 Patient shower handle
 - 7 Popup-drain
 - 8 Sensors
 - 9 Surface overflow outlet and drain manoeuvring knob
 - 10 Dispenser for Bath oil or Arjo Sound Water Conditioner (for *Hydrosound* system) (optional)
 - 11 Shampoo dispenser (optional)
 - 12 Disinfectant spray handle (behind door) (optional)
 - 13 Flow meter (optional)
 - 14 Storage container area, left; Disinfectant
 - 15 Storage container area, right; Shampoo and Bath Oil
- Hydromassage™ system (optional)**
- 16 Treatment hose with nozzle
 - 17 Suction inlet screen
 - 18 *Hydrosound* system outlet
 - 19 Water flow and Air mix control
- Hydrosound® system (optional)**
- 20 *Hydrosound* system transducing plate
 - 21 LED
 - 22 Intensity knob



Type B Applied part.
Degree of Protection - Electrical shock

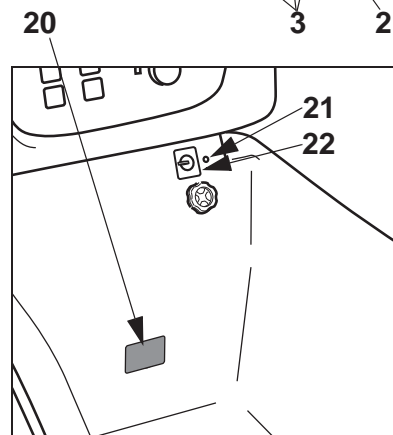
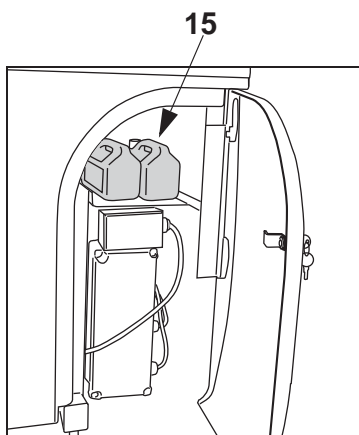
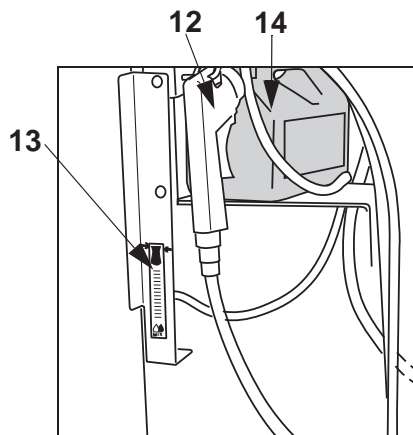
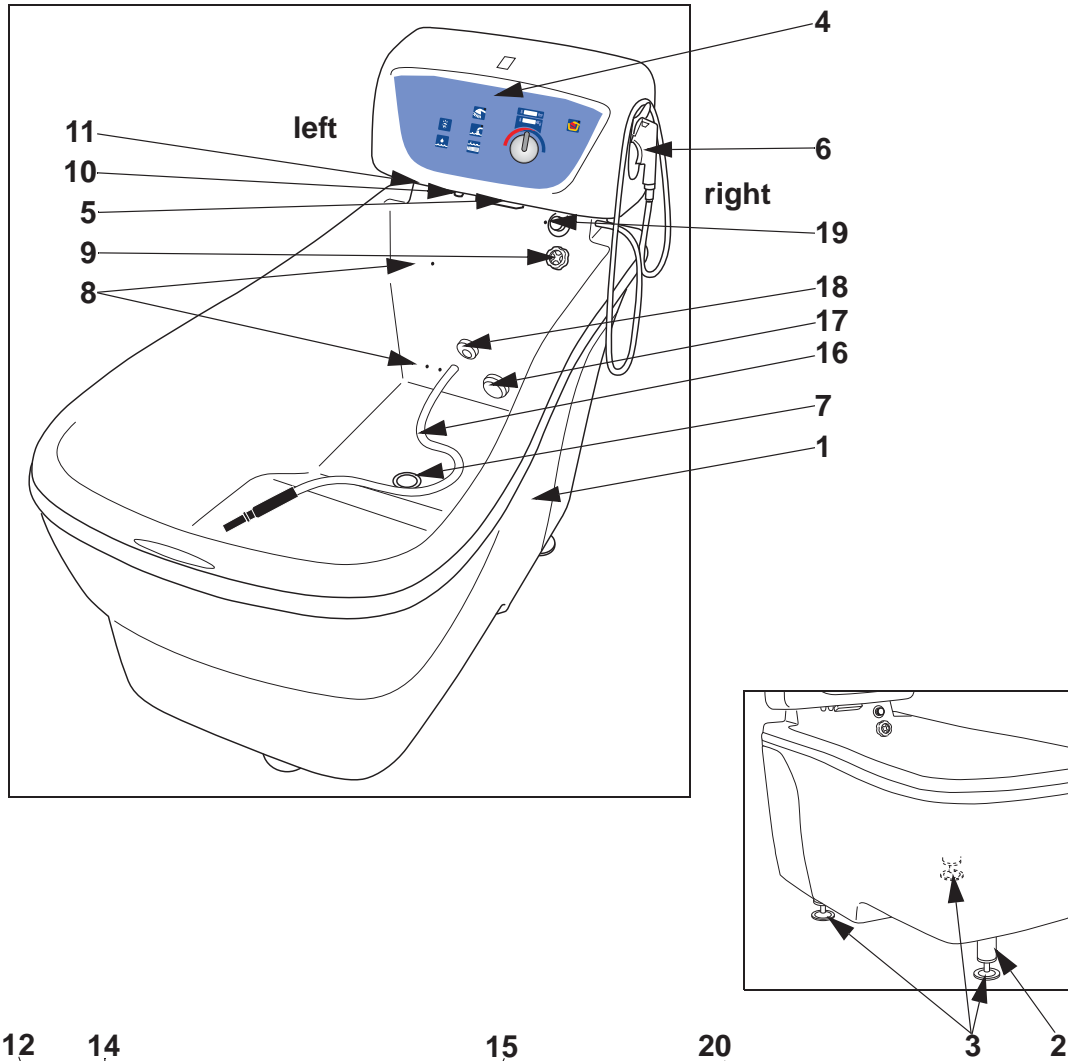

Control Panel

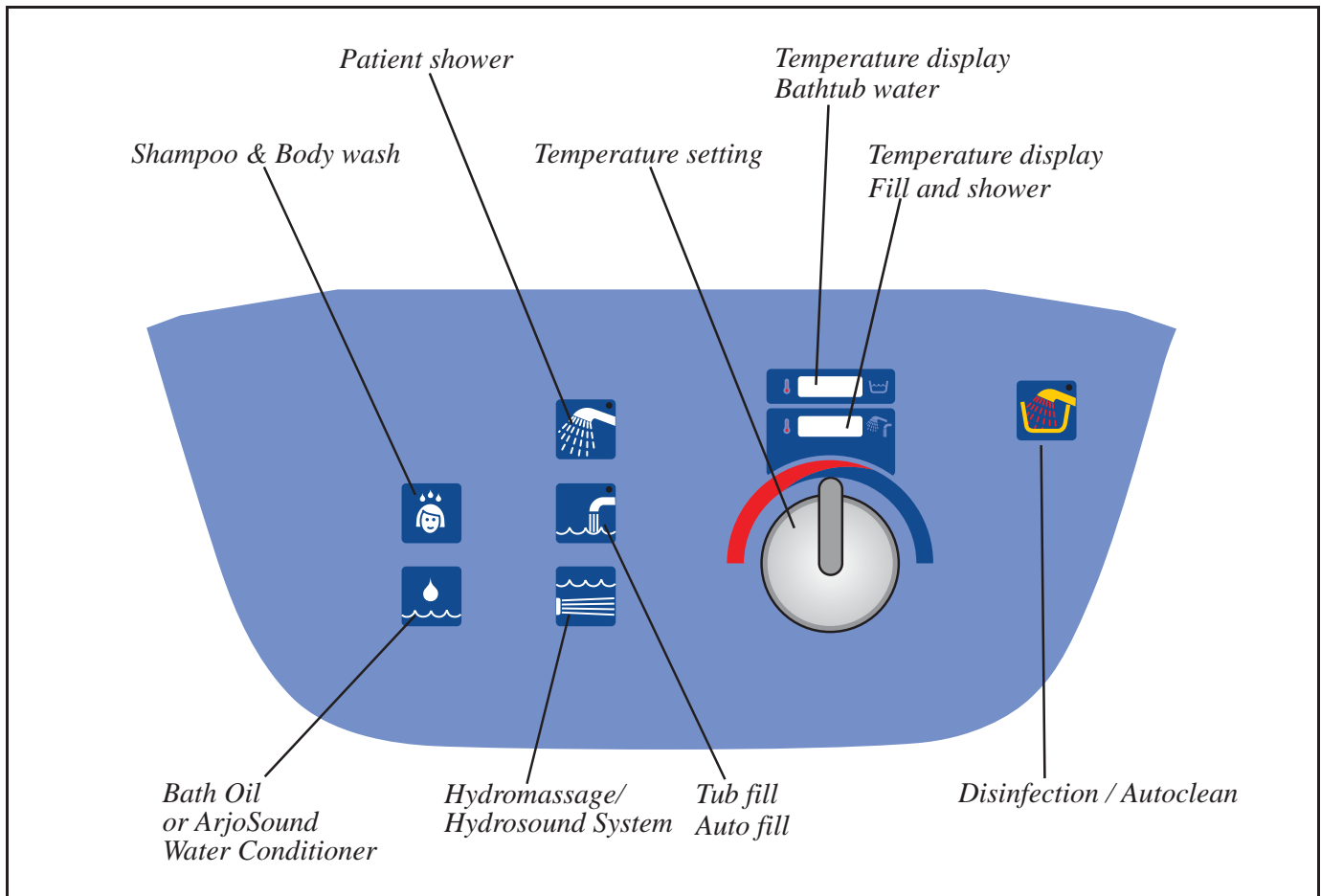

Buttons and Displays



Shampoo & Body Wash Button

Press the Shampoo & Body Wash button to dispense shampoo or body wash from corresponding outlet



Tub Filling/Auto Fill Button

(2 steps)

- 1 Press the Tub Fill/Auto Fill button to fill the bathtub. The auto fill function will automatically stop to fill at a preset level. The LED is lit while the bathtub is being filled.
- 2 Press the Tub Fill/Auto Fill button again to manually stop to fill.



Patient Shower Button

(2 steps)

- 1 Press the Patient Shower button to start the shower.
- 2 Press the Patient Shower button again to stop the shower.

The LED lights up when active. The shower function automatically shuts off after 15 minutes. Press the Patient Shower button to restart.



Bath Oil/ArjoSound™ Water Conditioner Button

Press the Bath Oil/*ArjoSound* water conditioner button to dispense Bath Oil/*ArjoSound* water conditioner from corresponding outlet.

Baths equipped with *Hydrosound* system have *ArjoSound* water conditioner instead of Bath Oil.

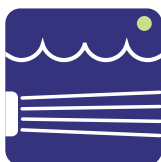

Hydromassage™ / Hydrosound® System Button (optional)

(2 steps)

The bath is either equipped with *Hydromassage* or *Hydrosound* system.

- 1 Press the *Hydromassage/Hydrosound* system button to start hydromassage (built-in jets) or hydrosound (low frequency ultra sound).
- 2 Press the *Hydromassage/Hydrosound* system button again to stop hydromassage/hydrosound.

LED lights up green when active. The *Hydromassage/Hydrosound* system will automatically shut itself off after 15 minutes. After completion, wait 15 minutes before the *Hydromassage/Hydrosound* system can be restarted.



Disinfection/Autoclean Button (Optional)

Press the Disinfection/Autoclean button to activate disinfection unit.

LED lights up when active. Button only works when there is no water in the bathtub and no other functions are activated.



Temperature Display – Bathtub Water

The digital display shows the current water temperature in the bathtub.



Temperature Display – Filling and Shower

The digital display shows the current water temperature in the outlet for bathtub filling or the shower.

Product Description/Functions

Fig. 1

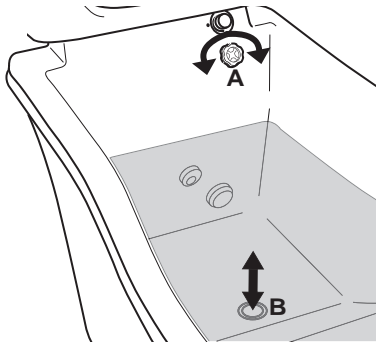

Drain Control Knob

Turn the drain control knob (A) to open or close the bathtub drainage plug (B). (See Fig. 1)

- Turn **Clockwise** to **open**.
- Turn **Counter Clockwise** to **close**.

The drain control knob is equipped with a built-in surface overflow outlet to prevent water to overflow the bathtub.

Fig. 2

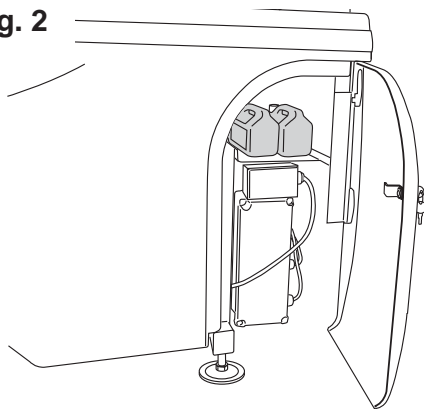

Auto Fill Function (2 steps)

The bath system is equipped with an auto fill function, which fills the bathtub to a preset water level. For adjustments or assistance, call your ArjoHuntleigh Service Department.

- 1 To start to fill the bathtub, press the Tub Fill/Auto Fill button.
- 2 To manually stop the fill, press the Tub Fill/Auto Fill button again.

LED lights up when active.

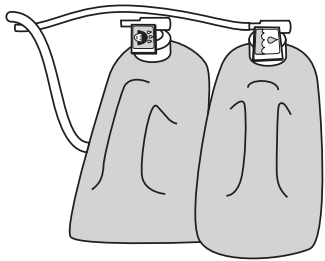
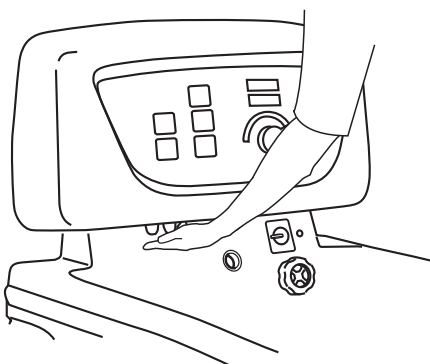

Fig. 3



Shampoo/Body Wash and Bath Oil/ ArjoSound™ Water Conditioner

Bottles with Shampoo/Body Wash and Bath Oil/*ArjoSound* water conditioner are placed behind a door on the right side of the panel. The bottles should be mounted, sufficiently filled and connected to their corresponding hose and bottle connection. (See Fig. 2)

- Press the Shampoo/Body Wash button while holding your hand under the dispenser outlet. Dosage will continue as long as the button is pressed. (See Fig. 3)
- Press the Bath Oil/*ArjoSound* water conditioner button to dispense directly into the bath water.

When your bath system is equipped with *Hydrosound* system, the Bath Oil is replaced with *ArjoSound* water conditioner.

Scalding Protection

Century bath is equipped with an electric scalding protection to reach a maximum safety for the patient. The function is used during filling, showering and cleaning.

The scalding protection is activated when the water temperature gets too high. If the bathtub water reaches 45 °C (113 °F) or above, the electronic scalding protection shuts off the water after 10 s, both LEDs on the Disinfection/Autoclean button and the Patient Shower button flash for a short time.

WARNING

To prevent scalding if the scalding protection is activated, remove the patient from the bath immediately in a safe manner.

Reset the scalding protection (5 steps)

- 1 Make sure both LEDs on the Disinfection/Autoclean button and the Patient Shower button have stopped flashing.
- 2 Turn the knob on the thermostatic mixer to COLD.
- 3 Press the Tub Filling button until the display shows 30-35 °C (86-95 °F).
- 4 Press the Patient Shower button. Lift off the shower handle, direct it away from yourself down into the bathtub. Press the trigger on the shower handle.
- 5 Allow a few seconds for the water to reach correct temperature.

Patient Shower

(7 steps)

- 1 The patient shower is on the right side of the panel. (See Fig. 4)
- 2 Press the Patient Shower button on the control panel.

The green LED indicates when the patient shower is activated.

NOTE

The shower handle and the fill function cannot be activate at the same time.

- 3 Lift off the shower handle, direct it down into the bathtub. Press the trigger on the shower handle. (See Fig. 5)

Continue with the steps on the next page.

Fig. 4

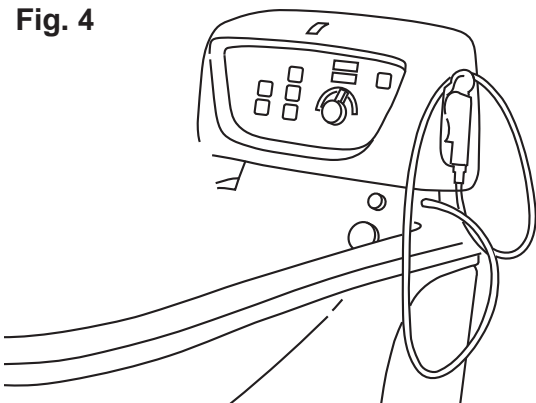
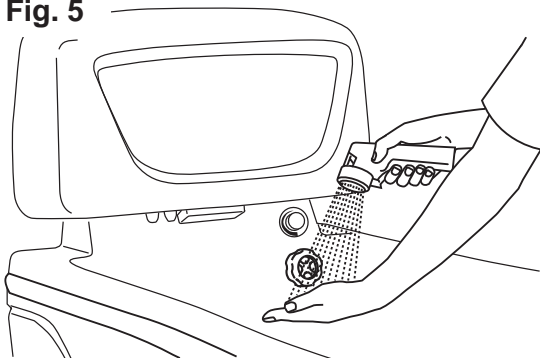
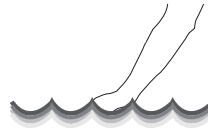

Fig. 5



4

WARNING



To prevent scalding, always check the water temperature with your naked hand before directing the water on the patient. Do not use gloves as it may insulate to the extent that the water temperature can be misjudged. Point the flow of the water away from the patient.

Direct the water stream away from the patient and allow a few seconds for the water to reach desired temperature. If desired, adjust the water temperature by using the knob on the panel.

- 5 Place your hand in the water stream to make sure the water temperature feels comfortable before the water stream is directed on the patient.

To get continuous water flow without having to hold in the trigger:

- 6 Press the shower handle trigger and push in the Lock button on the side. The water will continue to flow without having to press the trigger. (See Fig. 6)
- 7 Release the lock by pressing the handle trigger and the Lock button will pop out by itself.

Fig. 6

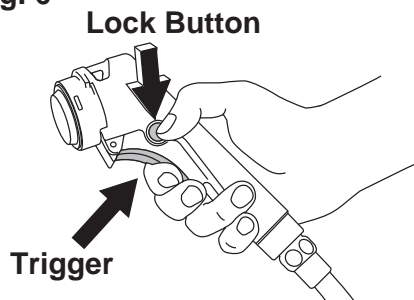
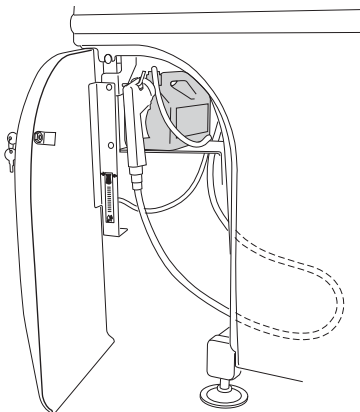

Fig. 7



Disinfection Unit

The bath has a built-in disinfection unit. The disinfection bottles are placed behind a door on the left side of the panel together with a disinfection spray handle and a flow meter. The flow meter shows the liquid mix ratio between disinfectant and water. The disinfectant bottle cap is adjustable and regulates the disinfectant/water ratio. (See Fig. 7)

For further cleaning and disinfection instructions, see section *Cleaning and Disinfection Instructions on page 21.*

Hydromassage™ System

Fig. 1

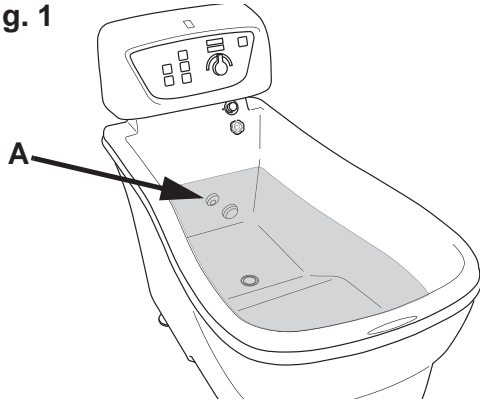

WARNING

To avoid hair entrapments under water, always install the *Hydromassage* system suction cover before use.

Use the Hydromassage™ System (5 Steps)

- 1 Before the hydromassage starts, fill the bathtub over the *Hydromassage* system outlet (A), according to section *Bathe Patient* on page 19. (See Fig. 1)
- 2 Press the *Hydromassage* system button on the control panel to start the *Hydromassage* system built-in jet.

The default runtime is 15 minutes after which the hydromassage will automatically end. Wait 15 minutes to restart.

- The hydromassage can be stopped at any time, during the 15 minutes of runtime, by pressing the *Hydromassage* system button.
- Always turn the *Hydromassage* system off when the treatment has finished.

- 3 Adjust the water flow with the knob on the upper right side of the bathtub.

- Start at a low intensity by turning the knob counter clockwise.
- Increased the water flow intensity by turning the knob clockwise. (See Fig. 2)

- 4 Adjust the water-jet direction by turning the *Hydromassage* system outlet. (See Fig. 3)

- Remove the adjustable *Hydromassage* system nozzle, by pulling it out, if you want the jet to cover a wider area (See Fig. 4)

- 5 When finished the hydromassage, turn the *Hydromassage* system off by pressing the *Hydromassage* system button.

Fig. 2

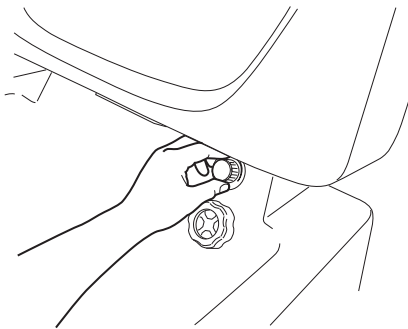

Decrease
intensity

Increase
intensity

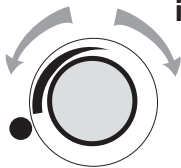

Fig. 3

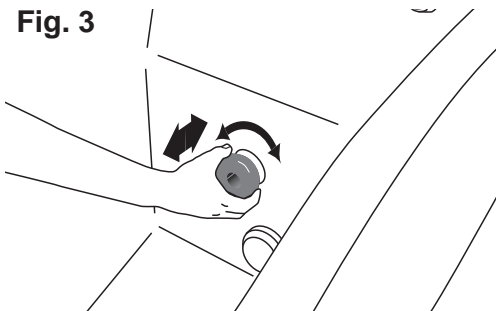
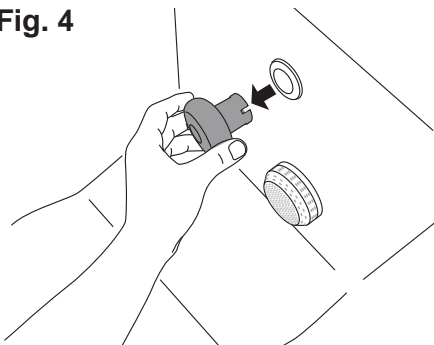

Fig. 4



Hydromassage with Treatment Hose (7 optional steps)

NOTE

If hydromassage is active, stop it by pressing the *Hydromassage* system button on the control panel before connecting the treatment hose.

Fig. 1

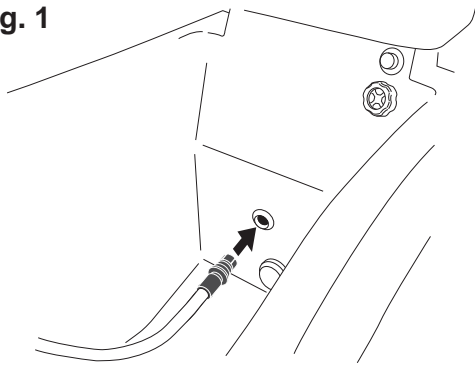

Fig. 2

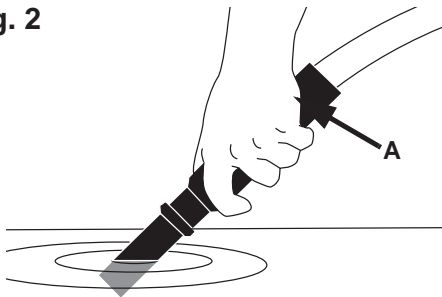

Fig. 3

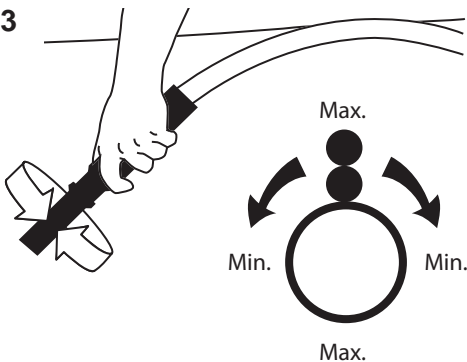
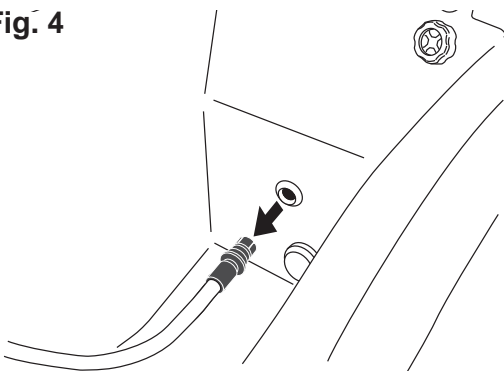

Fig. 4



- 1 Remove the *Hydromassage* system nozzle by pulling it out.
- 2 Connect the treatment hose to the quick coupling in the bathtub. (See Fig. 1)

The treatment hose and the built-in jet within the bathtub cannot be used simultaneously.
- 3 Direct the treatment hose nozzle into the water. Make sure the air inlet (A) is above the water surface. (See Fig. 2)
- 4 Press the *Hydromassage* system button on the control panel to start the hydromassage from the treatment hose.
 - The treatment automatically ends after 15 minutes. Press the *Hydromassage* system button to manually stop the treatment.
- 5 To adjust the jet stream intensity, turn the outermost part of the treatment hose nozzle. (See Fig. 3)
 - When the two dots on the nozzle are aligned, the jet stream is at its most intensity.
 - When turning the nozzle 90°, the jet stream intensity decreases.
 - When turning the nozzle 90° more, the jet stream intensity increases and so on.
- 6 When the local treatment is finished, press the *Hydromassage* system button on the control panel to turn it off.
- 7 Remove the treatment hose from the quick coupling device by pushing in the hose while pulling the hose bracket back simultaneously. (See Fig. 4)

Hydrosound® System

ArjoHuntleigh Hydrosound® system is a method of cleaning patients by means of low frequency, low intensity ultra sound. Working together with water, it is an effective and skin friendly method of cleaning the skin.

The amount of time and intensity setting used for *Hydrosound* system cleaning is a matter of choice consistent with the degree of patient cleanliness required and patient comfort. The longer time of exposure and the greater intensity setting, the more efficient cleaning.

For patients experiencing *Hydrosound* system cleaning for the first time, it is recommended that the intensity is set at the lower levels before using the higher intensity settings.

Fig. 1

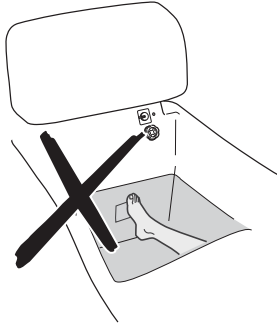

WARNING

To avoid burns, avoid continuous contact with *Hydrosound* system transducer plate while in operation. (See Fig. 1)

WARNING

To avoid injury, never use the *Hydrosound* system function when pregnant.

Fig. 2

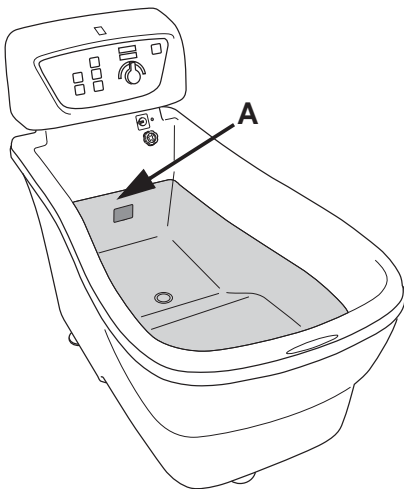

Use the Hydrosound® System (7 steps)

- 1 Before the *Hydrosound* system starts, fill the bath according to section *Bathe Patient* on page 19.
- 2 Press the *ArjoSound* water conditioner button on the control panel during the filling process. Check the conditioner mixes into the water.

CAUTION

Do not use bath oils and skin conditioners other than *ArjoSound* water conditioner together with the *Hydrosound* system as they may inhibit the ultra sound pressure waves.

- 3 Make sure the water level covers the top of the *Hydrosound* system transducer plate (A). (See Fig. 2)
- 4 Press the *Hydrosound* system button on the control panel.

The default hydrosound runtime is 15 minutes. After completion, wait 15 minutes before the *Hydrosound* system can be restarted.

Continue with the steps on the next page.

Fig. 3

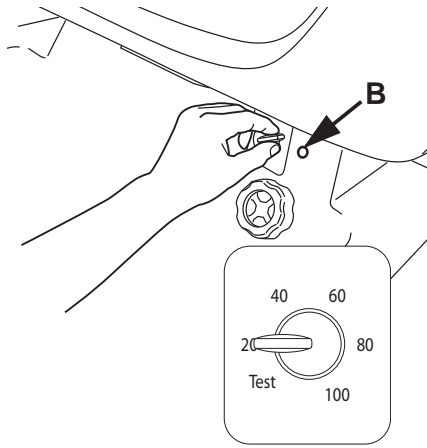

Fig. 4



Fig. 5



- 5 It is possible to select different intensity levels by turning the knob on the upper right side of the bathtub. (See Fig. 3)
- The intensity is increased by turning the intensity knob clockwise.
 - The levels 20, 40, 60, 80 or 100 (mW/cm²) and Test can be chosen step by step.
 - The LED (B) will show a steady green light and a buzzing sound will be heard when any active level is selected.
 - The buzzing sound will increase with each higher level.

6 **WARNING**

To avoid damage to hearing, make sure to keep the patient's head above the water when using the *Hydrosound* system.

Bathe the patient with *Hydrosound* system activated. (See Fig. 4)

- 7 Raise the patient out of the water and shower the patient thoroughly to remove loosened particles from the skin. (See Fig. 5)

Bathe Patient

Fig. 1

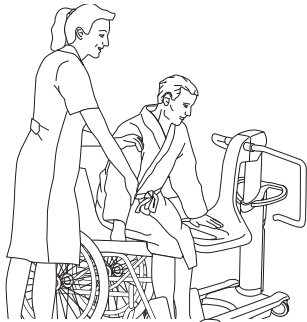

Fig. 2



Fig. 3

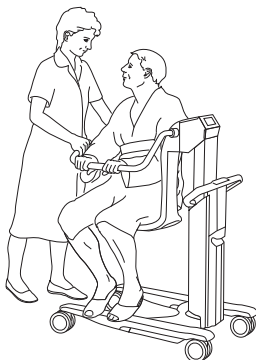
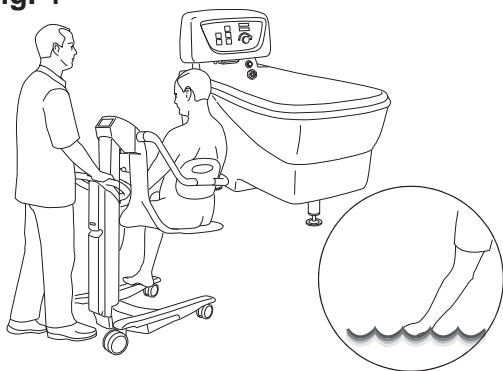

Fig. 4



Transfer and Bathe the Patient (14 steps)

- 1 Close the drainage plug by turning the drain control knob counter clockwise.
- 2 Press the Tub Fill button to fill the bathtub

3 **WARNING**

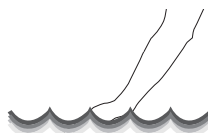

To prevent scalding, always check the water temperature with your naked hand before directing the water on the patient. Do not use gloves as it may insulate to the extent that the water temperature can be misjudged. Point the flow of the water away from the patient.

Press the Tub Fill button to manually stop the Auto fill function, when desired level is reached.

4 **WARNING**

To avoid entrapment, make sure to keep the patient's hair, arms and feet close to the body and use designated grab supports during any movement.

Sitting patient may be lifted without effort from their bed or wheelchair by using the *Alenti* or *Calypso* lift hygiene chair. See corresponding equipment *IFU*. (See Fig. 1-3).

- 5 Check the bath water temperature with your bare hand before the patient enters the water. (See Fig. 4)

Continue with the steps on the next page.

Fig. 5



Fig. 6



Fig. 7

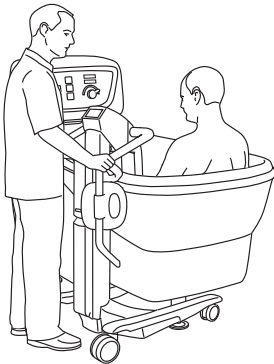

Fig. 8



6 Position the lift hygiene chair next to the end of the bath.

7 **WARNING**

To avoid entrapment or pinching of genitals, make sure there is enough clearance during movement over the tub edge, toilet, bedpan or other furniture.

Raise the lift hygiene chair to a position where it is clear from the edge of the bath and move the patient over. (See Fig. 5)

8 **WARNING**

To avoid entrapment of the patient's or caregiver's legs or feet, make sure that they are kept clear of all obstacles.

Position the lift hygiene chair in the middle of the bath and lower the lift as far as possible. (See Fig. 6)

9 If desired and if the patient is capable, rotate the back rest out of the way, this allows the patient to recline against the back of the bathtub. (See Fig. 7)

10 **WARNING**

To avoid injury, make sure that the patient is not left unattended at any time.

Bathe the patient.

11 After the bath, let the water run out of the bath and sit the patient up. Position the back rest against the patient's back. Raise the lift hygiene chair to a convenient working height and then start showering the patient. (See Fig. 8)

12 Dry the patient, as well as the underside of the seat, to prevent water from dripping on to the floor.

13 Raise the lift hygiene chair, and pull it away from the end of the bath. Help the patient to move their legs over the edge of the bath.

14 When moving the patient straight from the bath to the bed, put a bath towel on the bed under the lift hygiene chair's seat to avoid making the bed wet. Check the patient is thoroughly dry.

Cleaning and Disinfection Instructions

ArjoHuntleigh Disinfectant

For optimal performance use only ArjoHuntleigh Disinfectant.

For any questions regarding proper disinfection procedure or for liquid product ordering information (see section *Parts and Accessories on page 46*), contact ArjoHuntleigh Customer Service. Disinfection will minimize cross-contamination and removing tissue residue.

WARNING

To prevent cross-contamination, always follow the disinfection instructions in this IFU.

WARNING

To avoid eye or skin irritation, never disinfect in the presence of a patient.

NOTE

The disinfection process can only be started when all other functions are turned off.

Disinfectant spray

The spray handle is placed behind the access door on the left side of the panel and has a trigger handle.

WARNING

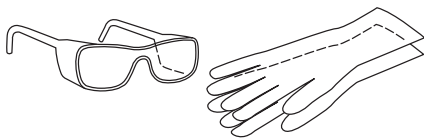

To avoid eye and skin damage, always use protective glasses and gloves. If contact occurs rinse with plenty of water. If eyes or skin becomes irritated, contact a physician. Always read the material safety data sheet of the disinfectant.

NOTE

Make sure that the disinfection hose, when not in use, is placed to the right behind the cover.

General

We strongly recommend that you follow the cleaning and disinfection instructions when disinfecting the bathtub, see section *Clean and Disinfect with Disinfection Spray Handle or Spray Bottle on page 24*.

If you are not sure about the effect on the bath system while using certain disinfectants or need to order more disinfectant, please contact your nearest ArjoHuntleigh office for further information.

- When using bath water additives, make sure the additives are fully dissolved in water before adding it to the filled bathtub. After bathing with bath additives the bathtub must be thoroughly rinsed with clean water.
- For daily disinfection we recommend Arjo Clean (Arjo Cen-Kleen IV), especially developed for use with ArjoHuntleigh Bath Systems, in order to avoid scratches in the plastic surface.
- In the dispenser system it is recommended to only use: Arjo Care, Arjo Oil or for *Hydrosound* system: *ArjoSound* water conditioner. In the US and Canada use Arjo Cen-Care II, Arjo Cen-Sol II or for *Hydrosound* system: *ArjoSound* water conditioner.

CAUTION

Do not use the following substances in the bath: Iodine, bromide, methylene blue, potassium permanganate etc. (Discoloration) Chlorine, heavy-metal chlorides, petroleum based solvents, trichlorethylene, phenol based disinfectants or similar solvents that can damage the plastic surface.

Accessories for Cleaning and Disinfection

- Protective glasses
- Protective gloves
- Spray bottle with disinfectant or disinfection spray handle
- Spray bottle with water or shower handle
- Cloths – wet and dry
- Disposable towels
- Soft bristled brush
- Long handled soft bristled brush

Microbiological Formation Prevention

In order to enhance the on-site curative actions (chlorine or thermal shock), which do not guarantee a reduction of the contamination long term, make sure to follow the instructions below.

Installation precautions

In order to limit the growth of bacterial flora, it is necessary to take action at four levels:

- Avoid stagnating water and make sure proper water circulation;
- Take precautions against the formation of scale and corrosion based on the water quality;
- Maintain a high water temperature all the way from the hot water dispenser to the different distribution pipes;
- Mix hot and cold water as close as possible to the point of use.

Use

- Make sure the water circulates in the bath and the shower on a daily basis *even if the bathtub is not used*; and particular to make sure to remove any water that may be left in the hose.
- Before every use, make sure the product is clean and disinfected.

Do not forget to contact ArjoHuntleigh for the annual Preventive Maintenance visit.

Fig. 1

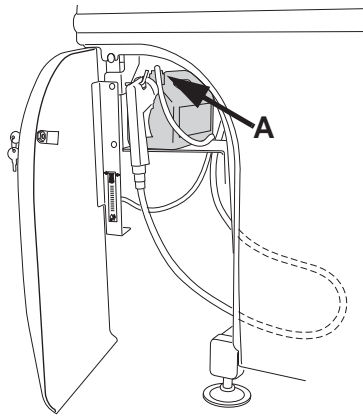

Replace Disinfectant Bottle

(10 steps)

- 1 Put on protective glasses and gloves.
- 2 Open the access door on the left side of the panel.
(See Fig. 1)
- 3 Disconnect the suction part (A) from the disinfectant bottle.
- 4 Discard the old bottle and replace with a new ArjoHuntleigh Disinfectant bottle.
- 5 Connect the suction part (A) to the new bottle.
- 6 Grab the disinfectant spray handle, and direct it against the bottom of the bathtub.
- 7 Press the Disinfection button on the control panel. The LED lights when the disinfection is activated.
- 8 Adjust water temperature so it reaches approximately 25 °C (77 °F) to eliminate disinfectant fumes.
- 9 Spray disinfectant in the bathtub, keeping an eye on the flow meter so it is in accordance with the setting range due to the mix ration table below. (See Fig. 2)
- 10 If necessary, adjust the bottle cap by hand to get correct mix ratio. (See Fig. 3)

Fig. 2

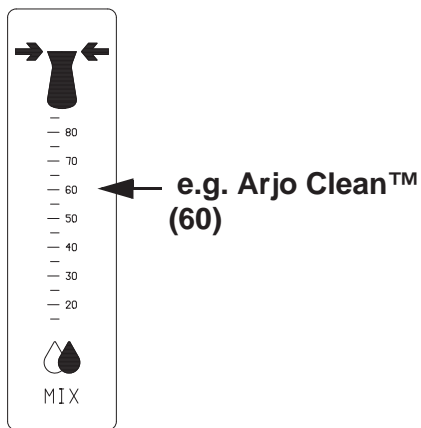
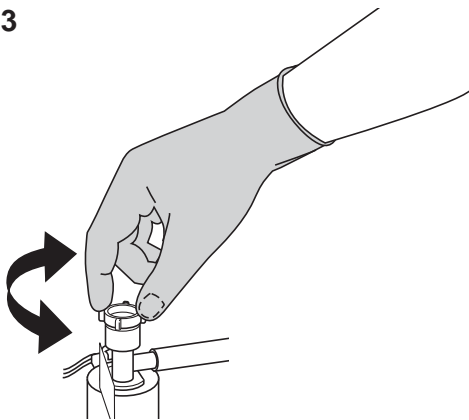

Fig. 3



Disinfectant	Flow Meter Mix Ratio
General Purpose Disinfectant	30
Arjo Clean™	60
Arjo Disinfectant Cleanser IV	30
Cen-Kleen IV™	30

Clean and Disinfect with Disinfection Spray Handle or Spray Bottle

(Still Bath and Hydrosound® System) (42 steps)

Before every use, make sure that the bath system is clean and disinfected. This procedure cleans and disinfects the bath system.

Fig. 1

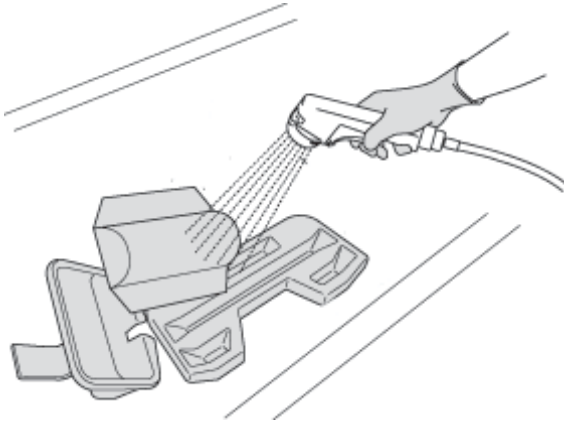

Remove visual residue (Step 1-6 of 42)

- 1 Check the level of disinfectant in the disinfectant bottle.
- 2 Make sure all functions are turned off.
- 3 Open drain to empty the bathtub from any left over water.
- 4 Detach and place accessories (if applicable) such as pillow, foot support and toiletry tray at the bottom of the bathtub.
- 5 Press the Patient Shower button on the control panel.
- 6 Shower and rinse the bathtub and accessories in the bottom of the bathtub with water to remove visible residue. Turn the accessories and rinse again. (See Fig. 1)

Clean (Step 7-26 of 42)

Fig. 2

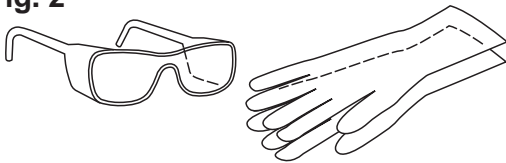

- 7 Put on protective gloves and protective glasses. (See Fig. 2)
- 8 Open the access door on the left side of the panel and lift out the disinfection spray handle or use a disinfection spray bottle.
- 9 For disinfection spray handle only: Direct the disinfectant spray towards the bottom of the bathtub and press the Disinfection button on the control panel.
- 10 For disinfection spray handle only: Adjust water temperature so it reaches approximately 25 °C (77 °F) to eliminate disinfectant fumes.
- 11 Spray disinfectant in the bathtub, keeping an eye on the flow meter so it is in accordance with the setting range according to the mix ration table in section *Replace Disinfectant Bottle* on page 23. (See Fig. 3)
- 12 Spray disinfectant in the drain.
- 13 Scrub the drain with a long handled brush.
- 14 Close the drain.
- 15 Spray disinfectant on all internal bathtub surfaces and the accessories at the bottom of the bathtub. Pay attention to knobs and sensors attached to the bathtub surface such as drain control knob and surface overflow outlet.

Fig. 3

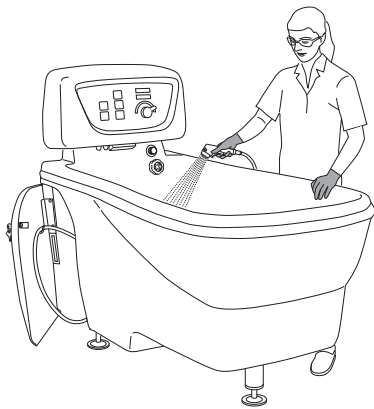

Continue with the steps on the next page.

Fig. 4

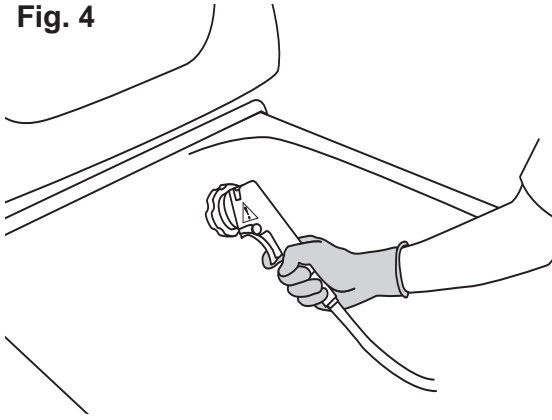
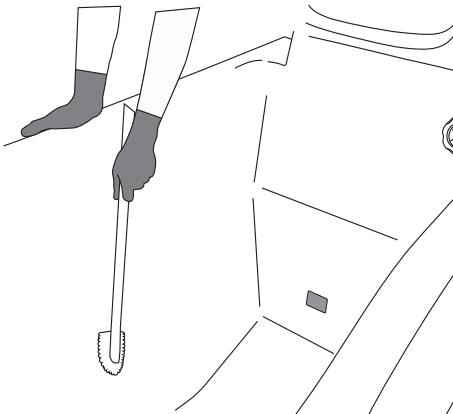

Fig. 5



16 Spray disinfectant into the surface overflow outlet.
(See Fig. 4)

17 For disinfection spray handle only: Press the Disinfectant button on the control panel to turn it off, and place the disinfectant spray handle back behind the access door.

18 **CAUTION**
Never use green or brown Scotch-Brite nor steel wool on the bath as it may scratch the surface.

Scrub the surface of the bathtub, loose parts and accessories with a soft bristle brush or cloth (to remove any deposits e.g. skin flakes). Scrub thoroughly, especially on handles and hand control. (See Fig. 5)

19 Open the drain.

20 Press the Patient Shower button on the control panel.

21 Rinse all parts clean with plenty of water having a temperature of approximately 25 °C (77 °F), using the shower handle, to remove disinfectant.

22 Soak a cloth in disinfectant.

23 Wipe all other contact areas with the cloth, such as the outside of the bath (particularly behind the head), sensors and hand control.

24 Wet a new cloth with water and remove all traces of disinfectant on contact areas. The cloth should occasionally be rinsed in running water.

25 Examine bathtub and accessories to make sure that all of the disinfectant is removed. Repeat rinse if needed.

26 Examine bathtub and accessories for visible damage.

For Century bath with Hydromassage system, go to section Clean and Disinfect Hydromassage™ System with Automatic Disinfection on page 27, after that proceed with Disinfect (Step 27-42 of 42) on page 26.

Continue with the steps on the next page.

Disinfect (Step 27-42 of 42)

- 27 Open the access door on the left side of the panel and lift out the disinfection spray handle or use a disinfection spray bottle.
- 28 For disinfection spray handle only: Direct the disinfectant spray towards the bottom of the bathtub and press the Disinfection button on the control panel.
- 29 Close the drain.
- 30 For disinfection spray handle only: Adjust water temperature so it reaches approximately 25 °C (77 °F) to eliminate disinfectant fumes.

Fig. 5

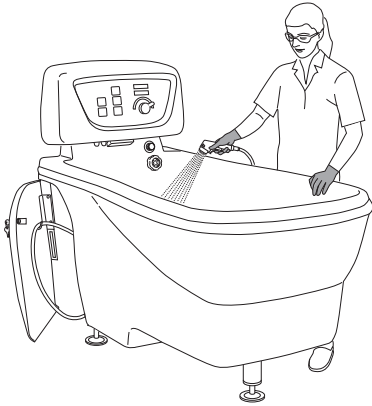

- 31 Spray disinfectant on all internal bathtub surfaces and accessories at the bottom of the bathtub. Turn the accessories and spray on the other side. Pay attention to knobs and sensors attached to the bathtub surface such as drain control knob and surface overflow outlet. **(See Fig. 5)**

After using the disinfectant for a period of time, it will stop automatically. The system will be locked for a predefined time, basically as long as the LED on the Disinfection button is lit. This is a predefined time frame and is there to ensure disinfectant contact time.

- 32 For disinfection spray handle only: Press the Disinfection button on the control panel to turn it off, and place the disinfectant spray handle back behind the access door.
- 33 Allow an appropriate contact time of the disinfectant according to the instructions on the bottle.
- 34 Open the drain.
- 35 Press the Patient Shower button on the control panel.
- 36 Rinse all parts clean with plenty of water having a temperature of approximately 25 °C (77 °F) using the shower handle, to remove disinfectant.
- 37 Soak a cloth in disinfectant.
- 38 Wipe all other contact areas such as the outside of the bathtub (particularly behind the head), sensors and hand control with the cloth.
- 39 Allow an appropriate contact time of the disinfectant according to the instructions on the bottle.

Continue with the steps on the next page.

- 40 Wet a new cloth with water and remove all traces of disinfectant on contact areas. The cloth should occasionally be rinsed in running water when removing disinfectant.
- 41 Leave to air dry.
- 42 Attach any accessories.

NOTE

Let the pillow dry with the suction cups upwards.

Fig. 1

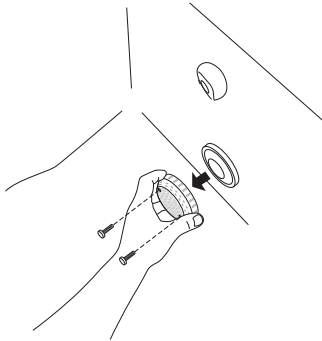

Fig. 2

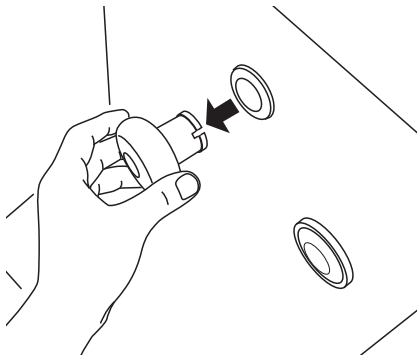
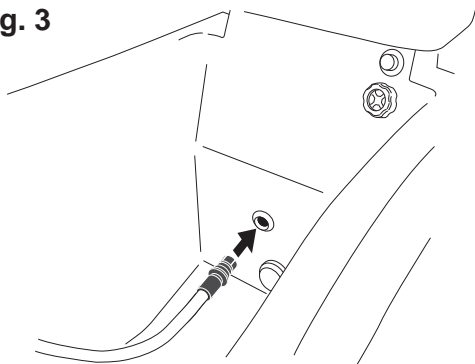

Fig. 3



Clean and Disinfect Hydromassage™ System with Automatic Disinfection (15 steps)

This procedure is a complement when cleaning the bath system, see section *Clean and Disinfect with Disinfection Spray Handle or Spray Bottle* on page 24.

To ensure proper disinfection, the *Hydromassage* system is automatically disinfected. The treatment hose is an accessory. If you do not have a treatment hose, skip such cleaning instructions.

NOTE

Look at the flow meter and make sure there is an appropriate mixture of disinfectant liquid to the water, according to section *Replace Disinfectant Bottle* on page 23.

- 1 Check the level of disinfectant.
- 2 Open the drain.
- 3 Remove the suction inlet screen and clean it separately. **(See Fig. 1)**
- 4 For treatment hose only: pull out the *Hydromassage* system nozzle and clean it separately. **(See Fig. 2)**
- 5 For treatment hose only: Insert the treatment hose in the *Hydromassage* system outlet. **(See Fig. 3)**
- 6 Press the Disinfection button on the control panel to start the automatic disinfection cycle. Disinfectant is flushed through the *Hydromassage* system nozzle/treatment hose. The disinfection cycle ends with the *Hydromassage* system being rinsed with water.
- 7 For treatment hose only: When the disinfectant cycle is completed, remove the treatment hose and let it hang dry on the holder. Place the *Hydromassage* system nozzle back into the *Hydromassage* system outlet.

Continue with the steps on the next page.

Fig. 4

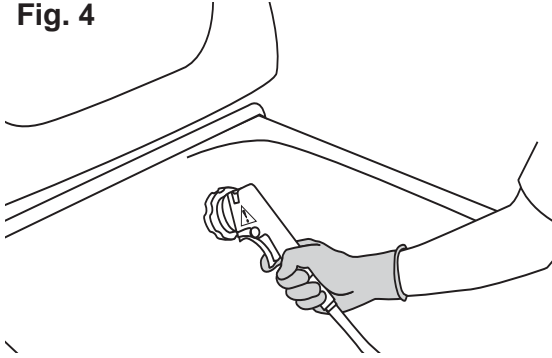

- 8 Open the access door on the left side of the panel and lift out the disinfection spray handle or use a disinfection spray bottle.
- 9 For disinfection spray handle only: Direct the disinfectant spray towards the bottom of the bathtub and press the Disinfection button on the control panel.
- 10 Spray disinfectant into the surface overflow outlet.
(See Fig. 4)
- 11 For disinfection spray handle only: Press the Disinfection button on the control panel to turn it off, and place the disinfectant spray handle back behind the access door.
- 12 Let the disinfectant act according to the time printed on disinfectant bottle.
- 13 When disinfection is completed, reassemble the suction inlet screen.
- 14 Press the Patient Shower button on the control panel.
- 15 Rinse all treated parts clean with plenty of water having a temperature of approximately 25 °C (77 °F) using the shower handle, to remove disinfectant.

NOTE

Continue with remaining disinfection instructions according to section *Disinfect (Step 27-42 of 42)* on page 26.

Care and Preventive Maintenance

The *Century* bath is subject to wear and tear, and the following maintenance instructions must be performed, when specified, to make sure the equipment remains within its original manufacturing specification.

WARNING

To avoid malfunction resulting in injury, make sure to conduct regular inspections and follow the recommended maintenance schedule. In some cases due to heavy use of the product and exposure to aggressive environment more frequent inspections should be carried out. Local regulations and standards may be more stringent than the recommended maintenance schedule.

Preventive Maintenance Schedule

CAREGIVER OBLIGATIONS Action/Check	Between Patients	Every Day	Every Week	Every Month	Every Year
Clean and Disinfect	X				
Check liquid levels		X			
Visually check all exposed parts			X		
Visually check hoses, pipes and connections			X		
Perform functionality test			X		
Hydrosound system functionality test			X		
Check and clean shower head				X	
Check and clean filters, incoming water				X	
Exercise the thermostat mixer				X	
Yearly checks by qualified personnel only					X
Check electrical installation (to be performed by authorized electrician)	Intervals according to local requirements				

WARNING

To avoid injury to both the patient and the caregiver, never modify the equipment or use incompatible parts.

Caregiver Obligations

Caregiver obligations shall be carried out by personnel with sufficient *Century* bath knowledge following the instructions in this *IFU*.

If the product deviates from normal (function or in appearance) immediately contact your local ArjoHuntleigh Service for support.

Between Patients

- **Clean and disinfect:**

Before every use, make sure the *Century* bath is cleaned and disinfected according to section *Cleaning and Disinfection Instructions on page 21*.

Every Day

Check liquid levels: Check liquid levels in the bottles of disinfectant, shampoo and bath oil (*ArjoSound* water conditioner).

Every Week

- **Visually check all exposed parts (2 steps):** Especially where personal contact is made by either the patient or the caregiver.

- 1 Make sure no cracks or sharp edges have developed that could cause the patient or caregiver injury or become unhygienic and can cause cross-contamination. Any use of chlorine, alcohol may damage the bathtub and cause cracks. If there is such damage, contact qualified personnel.

- 2 Check all screws are tightened.

- **Visually check hoses, pipes and connections:** Visually inspect for leaks of any kind by looking underneath the bathtub and behind the panel.
- **Perform functionality test:** Test all panel and disinfection functions. With the water on, check the shower handle for damage
- **Hydrosound system functionality test (2 steps):** If the bath is equipped with *Hydrosound* system, perform a self test to check that the ultra sound intensity levels are correct.

- 1 To perform a self test, start the *Hydrosound* system from the control panel.

- 2 Turn the intensity knob to **Test**.

The *Hydrosound* system has successfully passed the self test if the LED (A) shows a steady yellow light. A flashing yellow light indicates a problem, contact qualified personnel.

(See Fig. 1)

Fig. 1

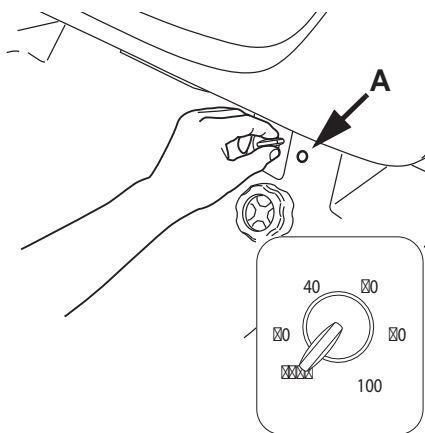
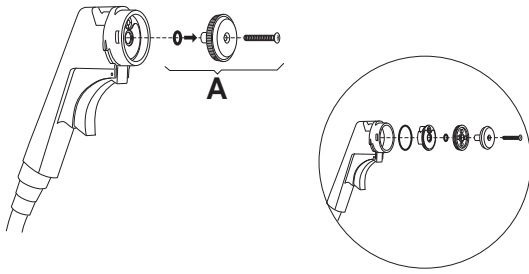

Fig. 1



Every Month

- **Check and clean the shower head (5 steps):** Remove and clean the strainers in the shower head.

- 1 Loosen the screw. (See Fig. 1)
- 2 Remove all loose parts (A) according to the illustration.
- 3 Clean all parts carefully.
- 4 Reassemble the shower head. The parts (A) must be assembled before these are set back into the handle. (See Fig. 1)
- 5 Tighten the screw carefully.

- **Check and clean filters, incoming water (5 steps):** A rinsing valve with a filter is mounted on each of the two water supply hoses found under the front cover. The filter in the cold and hot water valves should be cleaned according to the following procedure.

Fig. 2

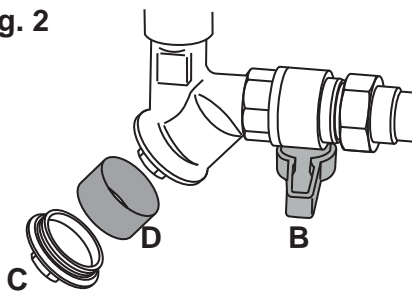

WARNING

Pressurised system and risk of scalding. Make sure that the valve (B) is closed before removing the cap (C), this is especially important for the hot water valve.

- 1 Close the valves (B). The handles (red for hot water and blue for cold) should be in a cross position. (See Fig. 2)
 - 2 Remove the cap (C) with a wrench.
 - 3 Pull out the filter (D) and clean it carefully in water.
 - 4 Reassemble.
 - 5 Open the valves (B).
- **Exercise the thermostat mixer:** Turn the temperature control back and forth over the whole temperature range with water on. This is particularly important in areas with hard water.

Yearly Checks by Qualified Personnel Only

The *Century* bath must be serviced once a year in accordance with the *Maintenance and Repair Manual*.

To make sure that you have problem-free and safe operation, it is recommended to have regular scheduled services with calibration of the thermostatic mixers by a trained technician. Significant changes/modifications in local water supply may require re-calibration of the thermostatic mixing valve.

Contact your local ArjoHuntleigh service representative to sign for a service agreement.

WARNING

To avoid injury and/or unsafe product, the maintenance activities must be carried out at the correct frequency by qualified personnel using correct tools, parts and knowledge of procedures. Qualified personnel must have documented training in maintenance of this device.

NOTE

All Caregiver Obligations are to be checked when performing the Qualified Personnel Service. For details, see separate service instructions.

Troubleshooting

NOTE

Before starting the troubleshooting check: Power supply, Water supply and the LEDs on control panel. If the problem can not be solved with the problem solving actions below, please contact an ArjoHuntleigh authorized technician.

General Problems

PROBLEM	ACTION
<p>The water is too hot or cold when filling the bath or showering.</p>	<ul style="list-style-type: none"> • Inlet supply reversed (hot supply to cold supply). • No hot water reaching the mixer. • Check strainer and inlet/outlet fittings for blockage, according to section <i>Care and Preventive Maintenance</i> on page 29. <div style="border: 1px solid black; padding: 5px; margin: 10px 0;"> <p>WARNING</p> <p>Pressurised system and risk of scalding. Make sure that the valve (B) is closed before removing the cap, this is especially important for the hot water valve.</p> </div> <ul style="list-style-type: none"> • Installation conditions continuously outside operating parameters - contact qualified personnel.
<p>Auto fill function will not stop to fill when the water level reaches to the sensors.</p>	<ul style="list-style-type: none"> • The preset filling level can be up to approximately 5cm above the sensor. • Sensors need cleaning because of collected residue build up. See section <i>Cleaning and Disinfection Instructions</i> on page 21. • Contact qualified personnel.
<p>Low or bad flow in shower handle.</p>	<ul style="list-style-type: none"> • Check and clean the shower handle head. See section <i>Care and Preventive Maintenance</i> on page 29. • Check and clean the incoming water filters. See section <i>Care and Preventive Maintenance</i> on page 29. • Contact qualified personnel.
<p>Low or bad flow from filling spout.</p>	<ul style="list-style-type: none"> • Check incoming water valves and pipes. • Check and clean incoming water filters. See section <i>Care and Preventive Maintenance</i> on page 29. • Contact qualified personnel.
<p>Water on the floor</p>	<ul style="list-style-type: none"> • Check for leakage from water inlet pipes and bathtub drainage. • Turn off the electrical supply and water supply.

PROBLEM	ACTION
Water temperature fluctuates.	<ul style="list-style-type: none"> • Probably caused by supply temperature fluctuation. • In order to feel if any hot water is coming in, feel the incoming hot water line to see if hot. • Check and clean the incoming water filters. See <i>Care and Preventive Maintenance on page 29</i>. • Contact qualified personnel.
Maximum temperature too hot or cold.	Contact qualified personnel.
Hydromassage/Hydrosound function stops working.	<ul style="list-style-type: none"> • The function Automatically stops after 15 minutes. • Check the <i>Hydrosound</i> system LED, a yellow flash indicates that a problem has occurred. • If the function stops before 15 minutes - contact qualified personnel.
Water not draining.	<ul style="list-style-type: none"> • Check bath plug and adjust the centre screw if necessary. • Contact service engineer.
Water draining during bathing.	<ul style="list-style-type: none"> • Check bath plug and adjust the centre screw if necessary. • Check the sealing on the bath plug. • Contact qualified personnel.
No foam build up while scrubbing the disinfectant in the bath.	<ul style="list-style-type: none"> • Check the disinfectant flow meter value correspond to <i>Replace Disinfectant Bottle on page 23</i>. • Check level in the disinfection container, replace if low. • Contact qualified personnel.
Not possible to adjust correct value on disinfectant flow meter.	<ul style="list-style-type: none"> • Check level in the disinfection container, replace if low, see <i>Replace Disinfectant Bottle on page 23</i>. • Contact qualified personnel.

Control Panel Problems

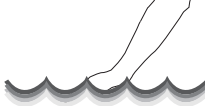
PROBLEM	ACTION
No shampoo, body wash, bath oil/ <i>ArjoSound</i> water conditioner emerges from the dispenser when pressing the Shampoo & Body Wash or Bath Oil/ <i>ArjoSound</i> water conditioner button.	<ul style="list-style-type: none"> • Check power supply and fuses. • Check level in Shampoo/Bath oil container. • Contact qualified personnel.
Main power failure.	<ul style="list-style-type: none"> • Check power supply and fuses. • Contact qualified personnel.
Temperature display read-out failure.	<div style="border: 1px solid black; padding: 10px; margin-bottom: 10px;"> <p>WARNING</p>  <p>To prevent scalding, always check the water temperature with your naked hand before directing the water on the patient. Do not use gloves as it may insulate to the extent that the water temperature can be misjudged. Point the flow of the water away from the patient.</p> </div> <ul style="list-style-type: none"> • Check power supply and fuses. • Contact qualified personnel.
No reaction when pressing a button on control panel.	<ul style="list-style-type: none"> • Check power supply and fuses. • Make sure that no other function is activated. • If the shower and disinfection LED are flashing, the scalding protection is activated, see <i>Scalding Protection on page 13</i>. • Contact qualified personnel.
Disinfection does not start when pressing Disinfection button.	<ul style="list-style-type: none"> • Check power supply and fuses. • Make sure the bathtub is empty of water. • Make sure shower, fill or <i>Hydrosound</i> system is not activated. • Check level in the disinfection container, replace if low. <i>Replace Disinfectant Bottle on page 23</i>. • Contact qualified personnel.

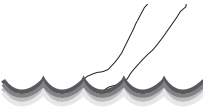
PROBLEM	ACTION
Hydromassage/Hydrosound function does not start.	<ul style="list-style-type: none"> • Check power supply and fuses. • Make sure that no other function is activated. • Make sure that the water level is above the top level sensor in the bathtub. • Check the <i>Hydrosound</i> system LED, a yellow flash indicates that a problem has occurred. • Contact qualified personnel.
Both LEDs at the Disinfection/Autoclean button and the Patient Shower button are flashing.	<div style="border: 1px solid black; padding: 10px; margin-bottom: 10px;"> <p>WARNING</p>  <p>To prevent scalding, always check the water temperature with your naked hand before directing the water on the patient. Do not use gloves as it may insulate to the extent that the water temperature can be misjudged. Point the flow of the water away from the patient.</p> </div> <ul style="list-style-type: none"> • Scalding protection is activated. See <i>Scalding Protection on page 13</i>. • Contact qualified personnel.

Technical Specifications

Technical Data: Still Bath, Hydrosound® System & Hydromassage™ System

NOTE

All drainage, water and electrical installation work should be carried out by qualified personnel, in accordance with local and national regulations.

Market	Voltage	Frequency	Fuse (slow blow)	Power consumption
Europe	230/240 V single phase AC	50 Hz	6 A	maximum 700 VA
North America	120 V single phase AC	60 Hz	10 A	maximum 700 VA
Japan	100 V single phase AC	50/60 Hz	10 A	maximum 700 VA

General

Power supply cord: replaced by qualified personnel

The unit must be continuously powered and connected to a separate fuse with a ground fault circuit interrupter.

Fuses according to EN60898.

Main switch must be placed close to the bathtub and be visible for the user.

Power supply is activated via the main switch.

The unit must be permanently connected to the mains when used in USA and Canada. All electrical installations must comply with the US National Electrical Code and the Canadian Electrical Code respectively.

Pollution degree 2

Thermometer

Range 10-50 °C (50-122 °F)

Accuracy +/-1 °C (1.8 °F)

Resolution 0.1 °C (0.18 °F)

Loading

SWL (Safe Working Load, patient + water) 380 kg (838 lbs)

Maximum patient weight 182 kg (401 lbs)

Maximum floor loading/foot pad 482 kg / 0.4 m²

Maximum floor pressure 0.5 N/mm²

Water Drainage

Minimum drainage capacity 100 l/minute

Sound Levels (LwA, maximum)	
Sound level at hydromassage	76 dBA
Sound level at bathtub filling	80 dBA

Water Supply	
Cold water	G3/4" male (customers connection)
Warm water	G3/4" male (customers connection)
Connect with shut off valves between unit and supply net	Minimum through Ø 16 mm
Maximum static pressure	6 bar (600 kPa, 87 psi)
Minimum operating pressure (all markets)	2 bar (200 kPa, 29 psi)
Minimum flow	25 l/minute (50 l/minute CW+WW)
CW temperature	2–20 °C (36–68 °F)
WW temperature	60–80 °C (140–176 °F)

Operating Conditions	
Ambient temperature	10–40 °C (50–104 °F)
Relative humidity	30–95% Rh
Atmospheric pressure	800–1060 hPa

Transport and Storage	
Ambient temperature	-20 °C to 70 °C (-4 °F to 158 °F)
Relative humidity	10% - 80% at 20 °C (68 °F)
Atmospheric pressure	500–1100 hPa

Mains Disconnection Device	
Permanently installed in wall. Visible and accessible all times	
Mains transient voltage	4 kV*
Creepage distance	3 mm*
Air clearance	1.8 mm*
Direction of movement	Up and down, right and left, clockwise and counterclockwise
* If local regulations are higher, these must be met.	

WARNING

To avoid injury, always follow the allowed combinations listed in this *IFU*. No other combinations are allowed.

Allowed Combinations	
ArjoHuntleigh Lift	Model
Alenti	All models
Calypso	All models
ArjoHuntleigh Upgrade Kit	Article Number
Upgrade dispensing system	ARC0310
Level sensitivity kit	8543134

Recycling	
Package	Wood, corrugated cardboard and plastic recyclable.
The bath	Electric, steel and plastic parts shall be separated and recycled according to WEEE.

Disposal of Century Bath	
Bathtub	The device is marked with the WEEE symbol to indicate that it is electronic equipment covered by the Directive 2012/19/EU on waste electrical and electronic equipment. In European countries the crossed out wheeled-bin WEEE symbol reminds you that all the electrical and electronic products, batteries and accumulators must be taken to separate collection at end of their working life. This requirement applies in the European Union. Do not dispose these products as unsorted municipal waste. You can return your device and accessories to ArjoHuntleigh or you can contact your local authorities for advice on disposal.

WARNING

To avoid electric shock, make sure the equipment is connected to:

- **Continuously powered supply mains with protective earth.**
- **Separate fuse and ground fault circuit interrupter (GFCI)**
- **A mains disconnection device**
- **Equipotential bonding point**



All installations must be in accordance with local codes and regulations.





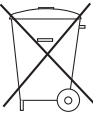

Labels

Label Explanation

Identification Label	States the product identification; serial number, year and month of manufacturing. For example, 1402XXXXX where “14” states manufacturing year, “02” states manufacturing month and “XXXXX” states serial number.
Data Label	States technical performance and requirements, for example classified safety standard and input voltage.
Water Connection Label	States the minimum/maximum temperature and pressure requirement of inlet water.

Symbol Explanation

SWL	Safe Working Load
VA	Maximum power
IP X4	Protection class - Protection against splashing water.
Maximum 15 minutes “ON” and minimum 15 minutes “OFF”	Continuous operation with <i>Hydrosound</i> system intermittent loading
V ~ Hz	Voltage and AC frequency
Class I	Insulation class
	Type B Applied part: protection against electrical shock in accordance with IEC 60601-1.
	Read the <i>IFU</i> before use.
	Name and address of the manufacturer.
	Separate electrical and electronic components for recycling in accordance with the European Directive 2012/19/EU (WEEE).

	Manufacturing date.
4ML5	Certificate control number for UL
	Label for equipotential connection point (bonding lug).
	CE marking in accordance with the Medical Devices Directive 93/42/EEC. The equipment has been EMC-tested and fulfils all requirements according to IEC 60601-1-2. Electric safety according to EN 60601-1. Refer to Notified Body: BSI.
	Classified by Underwriters Laboratories Inc. with respect to electric shock, fire, mechanical hazards and other specified hazards only in accordance with: UL 2601-1 and CAN/CSA - C 22.2 No 601.1-M90. UL marking (US-models 120 V-60 Hz)
	Warning! Hot surface! Label located at the <i>Hydrosound</i> system plate.
	Recognized by Underwriters Laboratories Inc. with respect to electric shock, fire, mechanical hazards and other specified hazards only in accordance with UL 60601-1 and CAN/CSA - C 22.2 No 601.1-M90.

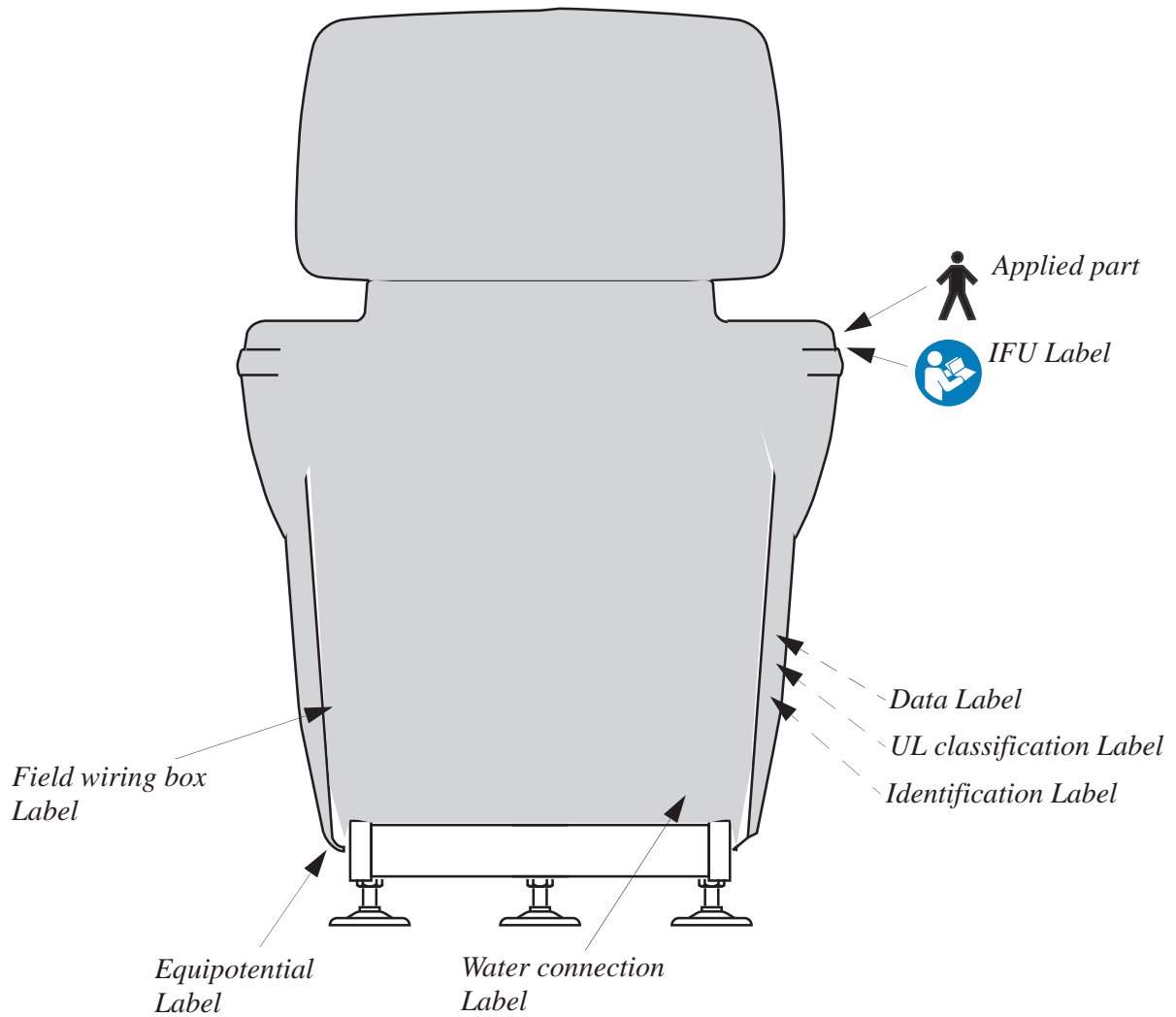
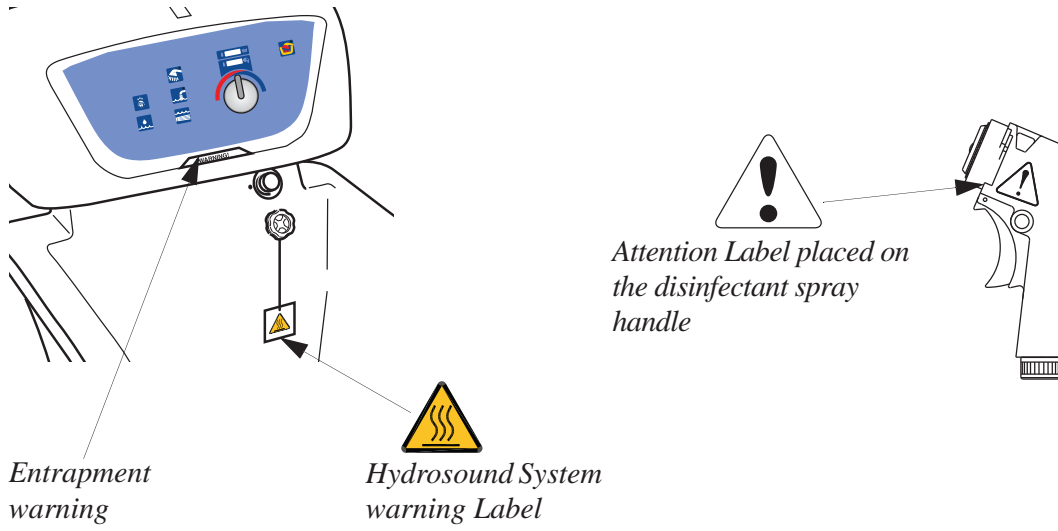

Approvals and List of Standards

Plumbing Approval

Standard	Description
ANSI, Z124.1.2–2005	Plastic Bathtub and Shower Units
ANSI/ASME, A112.19.8–1987	Suction Fittings
ANSI/ASME, 1001–2008	Atmospheric Type Vacuum Breakers
ANSI/ASME, 1014–1989	Backflow Prevention Devices for Hand-Held Showers
ANSI/ASME, 1016–2005	Automatic Compensating Valves for Individual Showers and Bathtub/Shower Combinations
ANSI/ASME, 1056–2001	Spill Resistant Vacuum Breakers
CAN/CSA, B45.0–02	Plumbing Fixtures
CAN/CSA, B45.5–02	Plastic Plumbing Fixtures

Electric and Electromagnetic Approval

Standard	Description
ANSI/AAMI ES60601–1 (2005)	Medical Electrical Equipment, Part 1: General Requirements for Basic Safety and Essential Performance
ANSI/AAMI/IEC 60601–1–2	Medical Electrical Equipment, Part 1–2: General Requirements for Basic Safety and Essential Performance Collateral Standard: Electromagnetic Compatibility – Requirements and Tests
CAN/CSA– C22.2 No. 60601– 1 (2008)	Medical Electrical Equipment, Part 1: General Requirements for Basic Safety and Essential Performance
CAN/CSA– C22.2 No. 60601–1–2 (2008)	Medical Electrical Equipment, Part 1–2: General Requirements for Basic Safety and Essential Performance Collateral Standard: Electromagnetic Compatibility – Requirements and Tests
UL 60601–1	Medical Electrical Equipment, Part 1: General Requirements
CAN/CSA– C22.2 No. 601.1	Medical Electrical Equipment, Part 1: General Requirements

Electromagnetic Compatibility

Medical electrical equipment needs special precautions regarding EMC (Electromagnetic compatibility) and needs to be used according to the EMC information below.

The *Century* bath is intended for the use in the electromagnetic environment specified below. The customer or the user of the *Century* bath should assure that it is used in such an environment.

WARNING

Stacking or placing other electrical equipment next to this device is not recommended, it can interfere with the equipment's operation and safety. Portable and mobile radio-frequency (RF) communications equipment can interfere with this equipment operation and safety.

WARNING

The equipment may cause radio interference or may disrupt the operation of nearby equipment. It may be necessary to take action, such as reorienting, relocating the equipment or shielding the location.

Guidance and Manufacturer's Declaration – Electromagnetic Emissions		
Emissions test	Compliance	Electromagnetic Environment – Guidance
RF emissions CISPR 11	Group 1	The <i>Century</i> bath uses RF energy only for its internal function. Therefore, its RF emissions are very low and are not likely to cause any interference in nearby electronic equipment.
RF emissions CISPR 11	Class B	The <i>Century</i> bath is suitable for use in all establishments, those directly connected to the public low-voltage power supply network that supplies buildings used for domestic purposes.
Harmonic emission IEC 61000-3-2	Class A	
Voltage fluctuations/flicker emission IEC 61000-3-3	Complies	

Guidance and Manufacturer's Declaration – Electromagnetic Immunity			
Emissions test	IEC 60601 test level	Compliance	Electromagnetic environment – guidance
Electrostatic discharge (ESD) IEC 61000-4-2	6 kV Contact 8kV air	6 kV Contact 8kV air	Floors should be wood, concrete or ceramic tile. If floors are covered with synthetic material, the relative humidity should be at least 30%.
Electrical fast transient/burst IEC 61000-4-4	+/- 2 kV for power supply lines +/- 1 kV for input/output lines	+/- 2 kV for power supply lines +/- 1 kV for input/output lines	Mains power supply should be that of a typical or hospital environment.
Surge IEC 61000-4-5	+/- 1 kV line(s) to line(s) +/- 2 kV line(s) to earth	+/- 1 kV differential mode +/- 2 kV common mode	
Voltage dips, short interruptions and voltage variations on power supply input lines IEC 61000-4-11	<5% U_t (>95% dip in U_t) for 0.5 cycle 40% U_t (60% dip in U_t) for 5 cycle 70% U_t (30% dip in U_t) for 25 cycle <5% U_t (>95% dip in U_t) for 5 s	<5% U_t (>95% dip in U_t) for 0.5 cycle 40% U_t (60% dip in U_t) for 5 cycle 70% U_t (30% dip in U_t) for 25 cycle <5% U_t (>95% dip in U_t) for 5 s	
Power frequency (50/60 Hz) Magnetic field IEC 61000-4-8	3 A/m	0.3 A/m	If functional disturbance occurs on the <i>Century</i> bath it may be necessary to install magnetic shielding. The power frequency magnetic field should be measured prior to installation to assure that it is sufficiently low.
NOTE U_T is the a.c. mains voltage prior to application of the test level.			

Guidance and manufacturer's declaration – electromagnetic immunity			
Immunity test	IEC 60601 test level	Compliance level	Electromagnetic environment – guidance
Conducted RF IEC 61000-4-6	3 Vrms 150 MHz to 80 MHz outside ISM bands 10 Vrms 150 MHz to 80 MHz outside ISM ^{c)} bands	1 Vrms	Portable and mobile RF communications equipment should be used no closer to any part of the <i>Century</i> bath, including cables, than 1 meter if the transmitters output power rating exceeds 1 W Field strengths from fixed RF transmitters, as determined by an electromagnetic site survey, a) Should be less than the compliance level in each frequency range. b) Interference may occur in the vicinity of equipment marked with the following symbol: 
Radiated RF IEC 61000-4-3	10 Vrms 80 MHz to 2.5 GHz	10 Vrms 80 MHz to 2.5 GHz	
NOTE 1 At 80 MHz and 800 MHz, the higher frequency range applies.			
NOTE 2 These guidelines may not apply in all situations. Electromagnetic propagation is affected by absorption and reflection from structures, objects and people.			
<p>a) Field strengths from fixed transmitters, such as base stations for radio (cellular/cordless) telephones and land mobile radios, amateur radio, AM and FM radio broadcast cannot be predicted theoretically with accuracy. To assess the electromagnetic environment due to fixed RF transmitters, an electromagnetic site survey should be considered. If the measured field strengths in the location in which the <i>Century</i> bath is used exceeds the applicable RF compliance level above, the <i>Century</i> bath should be observed to verify normal operation. If abnormal performance is observed, additional measures may be necessary.</p> <p>b) Over the frequency range 150 kHz to 80 MHz, field strengths should be less than 1 V/m.</p> <p>c) The ISM (industrial, scientific and medical) bands between 150 kHz and 80 MHz are 6.765 MHz to 6.795 MHz; 13.553 MHz to 13.567 MHz to 27.283 MHz; and 40.66 MHz to 40.70 MHz.</p> <p>d) The compliance level in the ISM frequency bands between 1510 kHz and 80 MHz and in the frequency range 80 MHz to 2.5 GHz are intended to decrease the likelihood that mobile/portable communications equipment could cause interference if it is inadvertently brought into patient areas. For this reason, an additional factor of 10/3 has been incorporated into the formulae used in the calculating the recommended separation distance for transmitters in these frequency ranges.</p>			
Recommended separation distance between portable and mobile RF communications equipment and the <i>Century</i> bath.			
The <i>Century</i> bath is intended for use in an electromagnetic environment in which radiated RF disturbance are controlled. The customer or the user of the <i>Century</i> bath can help prevent electromagnetic interference by maintaining a minimum distance between portable and mobile RF communications equipment (transmitters) and the <i>Century</i> bath by maintaining a distance of not less than 1 meter to any part of the <i>Century</i> bath, including cables, if the transmitters output power rating exceeds 1 W.			

Parts and Accessories

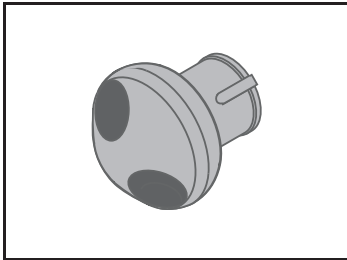

8341958
Dual Hydromassage
Nozzle

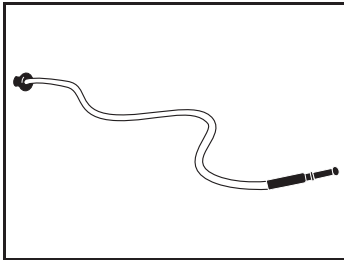

ARA0500-03
Hydromassage
Treatment Hose

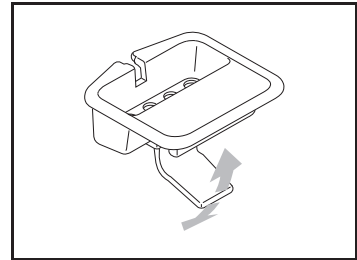

ARA0007-01
Tray
(for bath utensils)

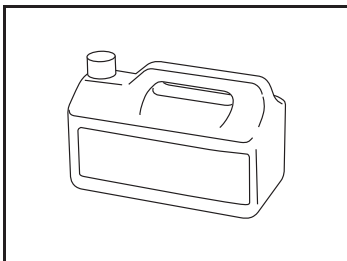

For Disinfectant contact
your local representative

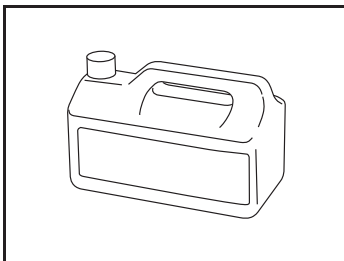

SRB1000
ArjoSound™
Water Conditioner
(for Hydrosound System)
2 X 2 Litre bottles

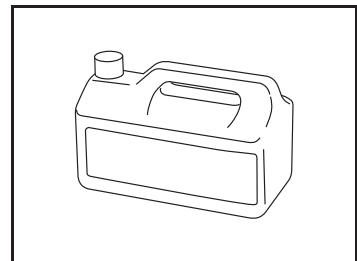

SRB5000
Arjo Care™
(Shampoo, Body Wash)
4 X 2 Litre bottles

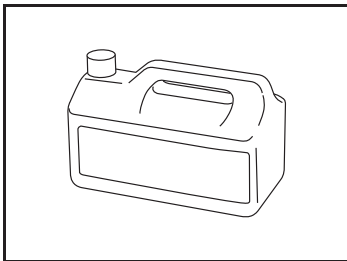

SRB4000
Arjo Oil™ (Bath Oil)
2 X 2 Litre bottles

ArjoHuntleigh Addresses

AUSTRALIA

ArjoHuntleigh Pty Ltd
78, Forsyth Street
O'Connor
AU-6163 Western Australia
Tel: +61 89337 4111
Free: +1 800 072 040
Fax: + 61 89337 9077

BELGIQUE / BELGIË

ArjoHuntleigh NV/SA
Evenbroekveld 16
BE-9420 ERPE-MERE
Tél/Tel: +32 (0) 53 60 73 80
Fax: +32 (0) 53 60 73 81
E-mail: info@arjohuntleigh.be

BRASIL

Maquet do Brasil
Equipamentos Médicos Ltda
Rua Tenente Alberto Spicciati, 200
Barra Funda, 01140-130
SÃO PAULO, SP - BRASIL
Fone: +55 (11) 2608-7400
Fax: +55 (11) 2608-7410

CANADA

ArjoHuntleigh
90 Matheson Boulevard West
Suite 300
CA-MISSISSAUGA, ON, L5R 3R3
Tel/Tél: +1 905 238 7880
Free: +1 800 665 4831 Institutional
Free: +1 800 868 0441 Home Care
Fax: +1 905 238 7881
E-mail: info.canada@arjohuntleigh.com

ČESKÁ REPUBLIKA

ArjoHuntleigh s.r.o.
Hlinky 118
CZ-603 00 BRNO
Tel: +420 549 254 252
Fax: +420 541 213 550

DANMARK

ArjoHuntleigh A/S
Vassingerødvej 52
DK-3540 LYNGBÆK
Tel: +45 49 13 84 86
Fax: +45 49 13 84 87
E-mail:
dk_kundeservice@arjohuntleigh.com

DEUTSCHLAND

ArjoHuntleigh GmbH
Peter-Sander-Strasse 10
DE-55252 MAINZ-KASTEL
Tel: +49 (0) 6134 186 0
Fax: +49 (0) 6134 186 160
E-mail: info-de@arjohuntleigh.com

ESPAÑA

ArjoHuntleigh Ibérica S.L.
Ctra. de Rubí, 88 1ª planta - A1
08173 Sant Cugat del Vallés
ES- BARCELONA 08173
Tel: +34 93 583 11 20
Fax: +34 93 583 11 22
E-mail: info.es@arjohuntleigh.com

FRANCE

ArjoHuntleigh SAS
2 Avenue Alcide de Gasperi
CS 70133
FR-59436 RONCQ CEDEX
Tél: +33 (0) 3 20 28 13 13
Fax: +33 (0) 3 20 28 13 14
E-mail: info.france@arjohuntleigh.com

HONG KONG

ArjoHuntleigh (Hong Kong) Ltd
1510-17, 15/F, Tower 2
Kowloon Commerce Centre
51 Kwai Cheong Road
Kwai Chung
HONG KONG
Tel: +852 2207 6363
Fax: +852 2207 6368

INTERNATIONAL

ArjoHuntleigh International Ltd
ArjoHuntleigh House
Houghton Hall Park
Houghton Regis
UK-DUNSTABLE LU5 5XF
Tel: +44 (0) 1582 745 800
Fax: +44 (0) 1582 745 866
E-mail:
international@arjohuntleigh.com

ITALIA

ArjoHuntleigh S.p.A.
Via di Tor Vergata 432
IT-00133 ROMA
Tel: +39 (0) 6 87426211
Fax: +39 (0) 6 87426222
E-mail: Italy.promo@arjohuntleigh.com

NEDERLAND

ArjoHuntleigh Nederland BV
Biezenwei 21
4004 MB TIEL
Postbus 6116
4000 HC TIEL
Tel: +31 (0) 344 64 08 00
Fax: +31 (0) 344 64 08 85
E-mail: info.nl@arjohuntleigh.com

NEW ZEALAND

ArjoHuntleigh Ltd
41 Vestey Drive
Mount Wellington
NZ-AUCKLAND 1060
Tel: +64 (0) 9 573 5344
Free Call: 0800 000 151
Fax: +64 (0) 9 573 5384
E-mail: nz.info@ArjoHuntleigh.com

NORGE

ArjoHuntleigh Norway AS
Olaf Helsets vei 5
N-0694 OSLO
Tel: +47 22 08 00 50
Faks: +47 22 08 00 51
E-mail:
no.kundeservice@arjohuntleigh.com

ÖSTERREICH

ArjoHuntleigh GmbH
Dörrstrasse 85
AT-6020 INNSBRUCK
Tel: +43 (0) 512 204 160 0
Fax: +43 (0) 512 204 160 75

POLSKA

ArjoHuntleigh Polska Sp. z o.o.
ul. Ks Piotra Wawrzyniaka 2
PL-62-052 KOMORNIKI (Poznan)
Tel: +48 61 662 15 50
Fax: +48 61 662 15 90
E-mail: arjo@arjohuntleigh.com

PORTUGAL

ArjoHuntleigh em Portugal
MAQUET Portugal, Lda. (Distribuidor Exclusivo)
Rua Poeta Bocage n.º 2 - 2G
PT-1600-233 Lisboa
Tel: +351 214 189 815
Fax: +351 214 177 413
E-mail: Portugal@arjohuntleigh.com

SUISSE / SCHWEIZ

ArjoHuntleigh AG
Fabrikstrasse 8
Postfach
CH-4614 HÄGENDORF
Tél/Tel: +41 (0) 61 337 97 77
Fax: +41 (0) 61 311 97 42

SUOMI

Oy Vestek AB
Martinkuja 4
FI-02270 ESPOO
Puh: +358 9 8870 120
E-mail: info@vestek.fi

SVERIGE

ARJO Scandinavia AB
Hans Michelsensgatan 10
SE-211 20 MALMÖ
Tel: +46 (0) 10 494 7760
Fax: +46 (0) 10 494 7761
E-mail: kundservice@arjohuntleigh.com

UNITED KINGDOM

ArjoHuntleigh UK
ArjoHuntleigh House
Houghton Hall Park
Houghton Regis
UK-DUNSTABLE LU5 5XF
Tel: +44 (0) 1582 745 700
Fax: +44 (0) 1582 745 745
E-mail: sales.admin@arjohuntleigh.com

USA

ArjoHuntleigh Inc.
2349 W Lake Street Suite 250
US-Addison, IL 60101
Tel: +1 630 307 2756
Free: +1 800 323 1245 Institutional
Free: +1 800 868 0441 Home Care
Fax: +1 630 307 6195
E-mail: us.info@arjohuntleigh.com

ARJOHUNTLEIGH

GETINGE GROUP

GETINGE GROUP is a leading global provider of products and systems that contribute to quality enhancement and cost efficiency within healthcare and life sciences. We operate under the three brands of ArjoHuntleigh, GETINGE and MAQUET. ArjoHuntleigh focuses on patient mobility and wound management solutions. GETINGE provides solutions for infection control within healthcare and contamination prevention within life sciences. MAQUET specializes in solutions, therapies and products for surgical interventions and intensive care.

www.ArjoHuntleigh.com

 ArjoHuntleigh AB
Hans Michelsensgatan 10
211 20 Malmö
Sweden