

Rear Seat Entertainment System

Owner's manual

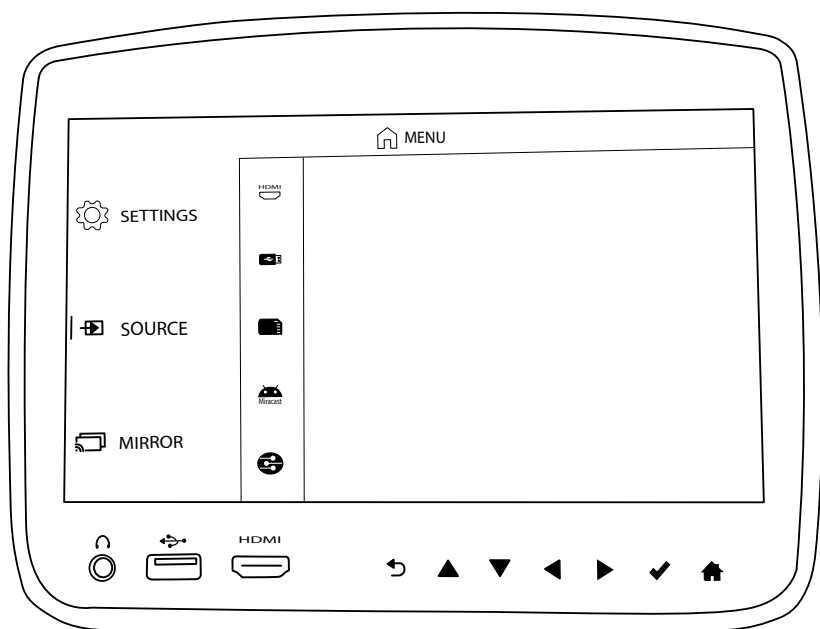

Contents

Welcome	4
Control Description – EVO 5	6
Control Description – EVO 0	7
Remote Control Operation	8
General Operating Instructions	10
Playing a DVD	10
Navigating Menus	12
Playback Controls	13
Context Menu (Viewing Content)	13
USB / SD Card	14
HDMI	17
Mirroring Screens	17
Miracast	18
SmartStream	18
Slingplayer	19
Settings	20
Mobile Application	23
Troubleshooting	27
Specifications	28
Compliance Information	29

© 2017 VoxxHirschmann Corporation. All rights reserved.

This manual, or any portion thereof, may not be reproduced without the express written permission of VoxxHirschman Corporation.

Design and specifications subject to change without notice.

Welcome

Thank you for purchasing the Rear Seat Entertainment System with built-in DVD player. Before operating the system, read this manual thoroughly and retain it for future reference.

Important Notice

It is unlawful in most jurisdictions for a person to drive a motor vehicle which is equipped with a television viewer or screen that is located in the motor vehicle at any point forward of the back of the driver's seat, or that is visible, directly or indirectly, to the driver while operating the vehicle. The monitors should never be installed where they will be visible, directly or indirectly, by the operator of the motor vehicle. If your vehicle is equipped with a wireless rear seat audio system or any other wireless infrared device, make sure it is powered off when operating the Rear Seat Entertainment System. If both systems are powered on at the same time, the two systems may obstruct each other, possibly creating undesirable audio interference through the wireless headphones

Safety Precaution

For safety reasons, when changing video discs, it is recommended that the vehicle is not in motion, and that you do not allow children to unfasten safety belts to make any adjustments to the system. System adjustments can be accomplished using the remote control unit, while safety belts remain fastened. Enjoy your entertainment system but remember that safety of all passengers remains the number one priority. Direct eye contact from protruding HDMI cables and or USB memory sticks may result in injury during an accident. To prevent eye injury, disconnect all HDMI cables and USB memory sticks when not in use.

Warnings

- Do not use any harsh solvents or chemicals when cleaning the unit.
- Do not use any abrasive cleaners that may scratch the screen. Use only a lightly dampened lint free cloth to wipe the screen if it is dirty.
- Do not put pressure on the screen.

Product Features

EVO 5

- 8-inch Color TFT-LCD Panel (1024x600) with 16:9 aspect ratio
- Built-in Top-Loading DVD Player
- USB 2.0, SD Card, and MHL-compatible HDMI Ports
- 3.5mm Stereo Headphone Output
- Power and Eject Buttons on Top of Monitor
- 7 Function Capacitive Touch Buttons
- 11 Function Remote Control
- Infrared Transmitter for IR Wireless Headphones
- Remote Sensor on the Front Panel
- IP remote control capability (using optional mobile app)
- Monitor screen sharing
- Miracast wireless display capability
- Media streaming

EVO 0

- 8-inch Color TFT-LCD Panel (1024x600) with 16:9 aspect ratio
- 3.5mm Stereo Headphone Output
- Infrared Transmitter for IR Wireless Headphones
- Remote Sensor on the Front Panel
- 11 Function Remote Control
- Top Power Button
- 7 Function Capacitive Touch Buttons
- IP remote control capability (using optional mobile app)
- Monitor screen sharing

Caution

Be sure to run the vehicle engine while using the system. Using this system without running the engine can result in battery drain. To avoid the risk of battery drain, please remember to turn off the system when the vehicle is not in use. Do not touch the inner pins of the jacks on the front panel. Electrostatic discharge may cause permanent damage to the system.

Accessories

Wireless Headphones

Each monitor includes a built-in dual channel infrared transmitter for use with wireless headphones. The wireless headphones must be used within a direct line of sight from the screen. Infrared transmission, like visible light, travels only in a straight line.

How to Use the Wireless Headphones

When wearing the headphones, make sure to observe the “Left” and “Right” labels. The headphones must be oriented correctly in order to receive the audio signal. Press the power button located on the right side headphone. To switch between channel “A” (Driver’s side) and channel “B” (Passenger side), slide the selector switch located on the right side. Volume can be adjusted by rotating the wheel on the outside of the channel select button. The headphones are designed to automatically turn off after approximately 3 minutes of no activity to help prevent battery drain. If the headphones are not going to be used for an extended amount of time it is recommended to remove the batteries to prevent damage of the headphones due to battery corrosion.

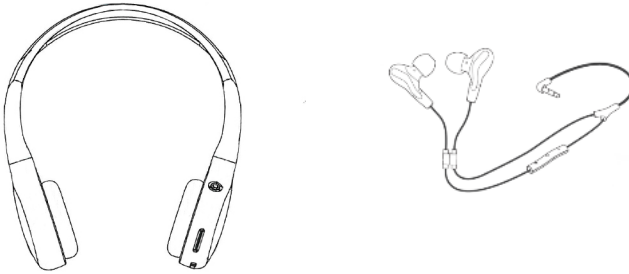

Wired Headphones

The System will allow you to use your personal headphones to listen to audio content. There are 3.5mm stereo headphone output jacks located on the front panel of each monitor which can be used with most standard stereo headphones.

Control Description of the Front Panel - EVO 5

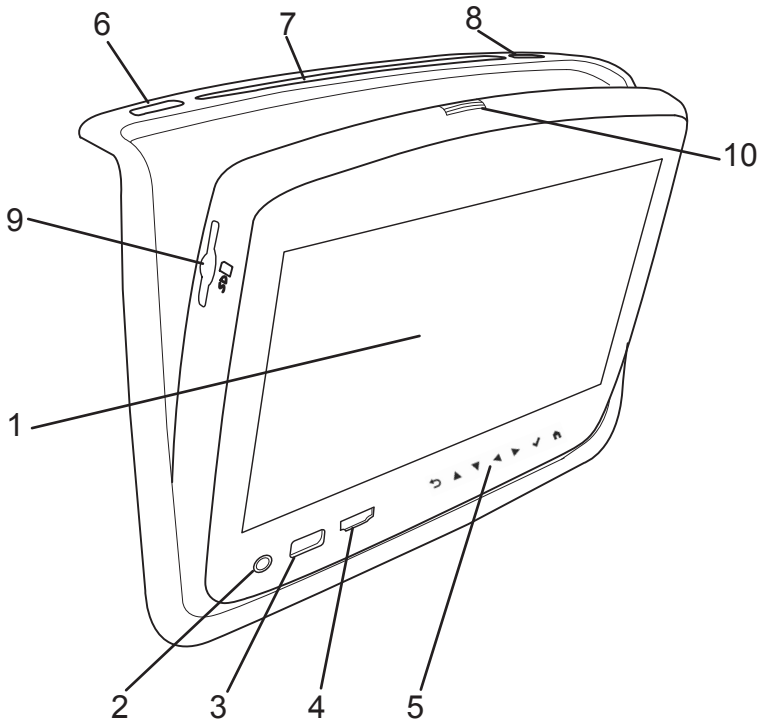

1. **8-inch TFT LCD Panel.**
2. **Headphone Output Jack.** Connect wired headphones using a 3.5 mm stereo connector
3. **USB Port.** You can play music, images, and videos stored on most USB devices.
4. **MHL-Compatible HDMI Port.** Connect an external audio/video source using a MHL or HDMI connector.
5. **Capacitive Touch Buttons.** Directional arrows, Enter, Return, and Home functions can be accessed via these touch buttons on the front panel.
6. **Eject Button.** This button ejects the disc from the DVD loader.
7. **Disc Compartment Slot.** Insert DVDs and Data Discs to view content.
8. **Power Button.** This button will turn the monitor on and off.
9. **SD Card Slot** Insert full size SD Card into the slot located on the left side of the monitor when opened to view content.
10. **Latch Release.** Pressing this will release the latch and allow you to adjust the viewing angle.

Control Description of the Front Panel - EVO 0

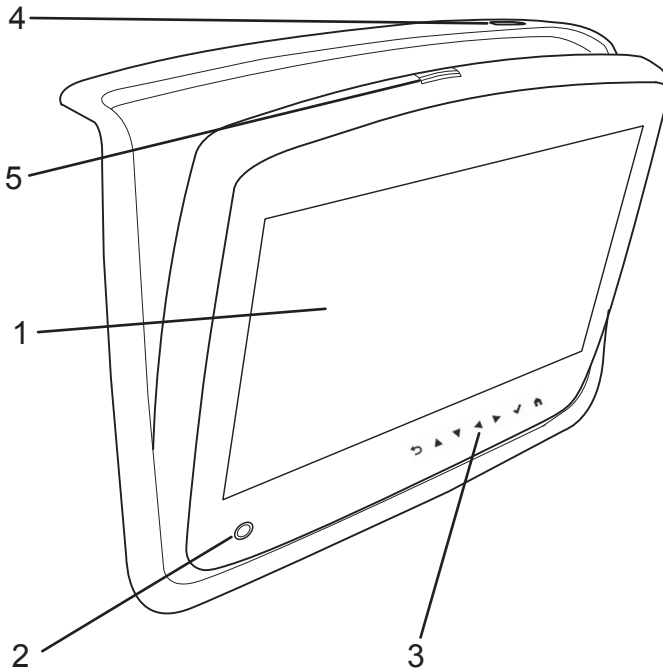

1. **8-inch TFT LCD Panel.**
2. **Headphone Output Jack.** Connect wired headphones using a 3.5 mm stereo connector
3. **Capacitive Touch Buttons.** Directional arrows, Enter, Return, and Home functions can be accessed via these touch buttons on the front panel.
4. **Power Button.** This button will turn the monitor on and off.
5. **Latch Release.** Pressing this will release the latch and allow you to adjust the viewing angle.

Remote Control Operation

Installing or Replacing the Battery

1. On the rear of the remote control, use a coin to turn the battery cover slightly counterclockwise and remove the battery cover.



2. Install one "CR2032" battery as shown. Make sure that proper polarity (+ or -) is observed. The Positive (+) side of the battery should be facing upwards.



3. Place the cover back and turn it clockwise until it locks into place.



The remote control is only designed to operate this device. It is not a universal remote control and will not operate any other device.

Warning/Caution on using batteries

- Always ensure that the battery is inserted with the positive and negative terminals in the correct direction as shown in the battery compartment.
- If the remote control fails to function, replace the battery before seeking repairs at the dealer.
- Keep batteries out of the reach of children. Should the battery be swallowed, immediately consult a doctor. When disposing of used batteries, please comply with governmental regulations or environmental public institution rules that apply in your country/area.
- Remove the battery if the remote control is not used for a month or longer to avoid corrosion and damage to the remote control.

Remote Control Operation (continued)

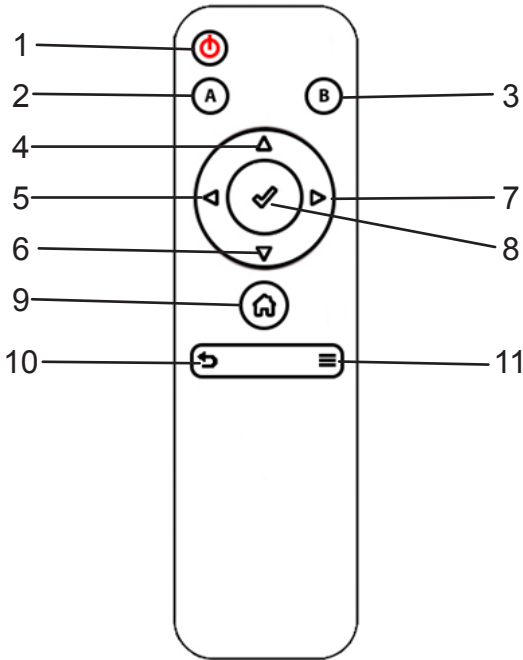

1. **POWER** Press this button to turn the monitor on and off.
2. **A** Press this button to operate monitor A.
3. **B** Press this button to operate monitor B.
4. **UP** Press this button to navigate up when displaying a menu or file list.
5. **LEFT** Press this button to navigate left when displaying a menu or file list.
6. **DOWN** Press this button to navigate down when displaying a menu or file list.
7. **RIGHT** Press this button to navigate right when displaying a menu or file list.
8. **SELECT** Press this button to make a selection or begin playback of the media.
9. **HOME** Press this button to return to the home screen.
10. **BACK** Press this button to go back to the previous screen.
11. **CONTEXT MENU** Press the button to go to the open the context menu options (when available).

General Operating Instructions

Turning the monitor ON or OFF

It may be necessary to wait approximately 10-15 seconds after starting the vehicle before turning the unit on. Press the "Power" button on the top panel or the remote control to turn the monitor on or off. When the unit is powered on, the panel buttons will illuminate.

Once the monitor has been turned on and is displaying a picture, you can optimize the picture quality by pivoting the screen to adjust the viewing angle.

It is recommended to turn the monitor off when not in use.

DVD - Basic Overview

To get the most use out of each DVD, make sure you read this section completely.

Regional Coding:

Both the DVD player and discs are coded by region. These regional codes must match in order for the disc to play. The system is preset to the region code designated for your area by order of the DVD Copy Control Association. Other regions may not be played in this system.

Types of Discs your monitor will play:

Before you load a disc, make sure that it is compatible with the player.

- DVD-Video: DVD contains video.
- DVD +/- R: DVD contains video.
- CD-DA: CD contains audio.

Known Incompatible Discs:

Note that the following discs CANNOT be used with this system:

- Optical disc- CD-1
- CD-ROM
- DVD-ROM
- Mini disc
- CDG (audio only, not graphics)

(List is not all inclusive and subject to change without notice).

To Load and Play a Disc:

Press the "Power" button to turn the system on. Place the disc about halfway into the disc compartment slot, with the disc's label facing the rear of the vehicle. The unit will pull the disc in the rest of the way. Do NOT insert the disc at an angle or force the disc in. The disc must be inserted straight into the player. The DVD will automatically play on each monitor if there is no content already playing. You may also select "DVD" from the source menu to begin DVD playback mode.

To mirror DVD content on the other monitor, see section in this manual titled "Screen Mirroring".

Some discs may start at the root menu, where playback must be selected to start a movie. Use the remote control or capacitive buttons to navigate through the DVD menu and play the movie.

General Operating Instructions

Notes on Discs:

- To keep a disc clean, do not touch its surface. Handle the disc by its edge.
- Keep your discs in their cases or sleeves when not in use. Also, do not subject disc to heat/high temperature. Avoid leaving them in a parked vehicle or on a dashboard/rear tray.
- Do not attach labels, or use discs with sticky ink/ residue. Such discs may stop spinning when used, causing a malfunction, or may ruin the disc.



Labels may also cause an inability to eject a disc (due to a label or sticker peeling off and jamming the disc mechanism) or the inability to read data correctly (i.e., playback skipping, or no playback) due to heat shrinking of a sticker or label causing a disc to warp.

- Before playing, clean the discs with a commercially available cleaning cloth. Wipe each disc from the center out. Do not use solvents such as benzene, thinner, commercially available cleaners, or antistatic spray intended for analog discs.
- Use only normal, circular discs. If you insert irregular, non-round shaped discs they may not play properly or jam in the DVD player causing damage.

Notes on Media Compatibility:

This system is compatible with the following media formats. Please note:

- The text information of some audio and video files may not be correctly displayed.
- There may be a slight delay before playback of files using an SD card or USB flash drive with complex folder hierarchies.
- Some audio, video, and image files may be incompatible with this system due to file characteristics, file format, recording software used, directory structure, and/or the type of audio/video encoding used.

	Format	Extension	Video Codecs
Audio	AAC	.m4a, .aac	
	DTS	.dts	
	FLAC	.flac	
	MPEG	.mp1, .mp2, .mp3	
	OGG	.ogg	
	WAV	.wav	
	WMA	.wma	
Video	ASF	.wmv	H.264, MPEG-2 Part 2, WMV
	AVI	.avi	H.264, MPEG-2 Part 2, Xvid, WMV
	MP4	.mp4, .m4v, .m4a	H.264, MPEG-2 Part 2, MPEG-4 Part 2, WMV
	Matroska	.mkv, .mka, .mks	H.264, MPEG-2 Part 2, MPEG-4 Part 2, WMV
	MPEG	.mpg, .mp3g, .vob, .m2ts	H.264, MPEG-2 Part 2, MPEG-4 Part 2
Image	BMP	.bmp	
	GIF	.gif	
	JPEG	.jpg, .jpeg	
	PNG	.png	
	TIFF	.tiff, .tif	
	WebP	.webp	

General Operating Instructions

Navigating Menus

The “Home” screen can be accessed at any time by pressing the “Home” button on the remote control, or the capacitive touch buttons found on the front display of the rear seat entertainment unit.

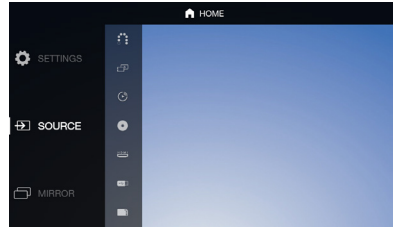

The main menu is located on the far left side of the screen and allows users to select a source, change settings, and mirror the monitor. The menu options will change with each selection.

To the right of the main menu is a preview menu, which gives a preview of the highlighted option in the main menu.

Pressing the “Up” and “Down” buttons will scroll through the options in each menu. The current selection always remains highlighted in the center of the menu when scrolling up and down. Pressing the “Select” or “Right” buttons when there is an item highlighted on the menu will select the highlighted menu item. Pressing the “Back” or “Left” buttons will move back one level in the menu.

In the top left corner of the screen there is a navigation history, which shows the navigational path of the current menu. For example, from the Home > Source menu > DVD source.

Playing a DVD

Insert a disc into the top slot of the unit with the label facing the rear of the vehicle. If the disc is supported and there is no content already playing, the DVD will automatically begin playing on the monitor(s).

When a disc is inserted, the DVD will automatically begin playing on each monitor only if there is no content already playing. The DVD will not interrupt playback on that monitor but will automatically play on the other monitor, if it is not in use.

If the disc is already inserted before powering on the rear seat entertainment system, DVD playback can be accessed by selecting SOURCE from the Home screen then selecting DVD from the source menu.

General Operating Instructions

Playback Controls

Playback Controls allow for navigation and adjustment of video and music content. Options includes:

- Previous/Next Chapter or Track
- Rewind/Fast-Forward
- Play/Pause
- Volume
- Shuffle/Repeat
- Night Mode toggle
- Eject (DVD-only)

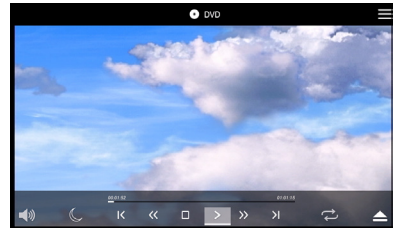

Available options will be different depending on the type of content being played.

To initiate the Playback Controls menu, press the “Select” button on the remote. Use the “Left” and “Right” buttons to navigate the menu, moving left and right. Use the “Select” button to select the highlighted option.

The Playback Controls menu will disappear after approximately 5 seconds of no user input.

Rewind and Fast-Forward each have 4 speeds: 2x, 4x, 8x, and 16x. When selecting Rewind/Fast-Forward, the speed is displayed in the top right corner of the screen. To change the speed, press “Select” on Rewind/Fast-Forward again and the new speed will be displayed.

Selecting “Stop” from the Playback Controls will stop the movie and return you to the main screen.

Context Menu (Viewing Content)

Pressing the “Context Menu” button on the remote while viewing content will bring up the context menu on the right side of the screen (when available).

When a video is playing, the context menu provides extra options to adjust the display, audio, aspect ratio, and subtitle settings if they are available.

Pressing the “Select” button will select or toggle the highlighted item from the menu. Pressing the “Back” button will navigate to the previous option.

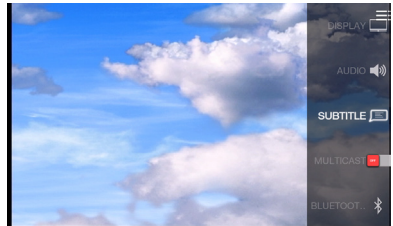

To close the context menu, press the “Context Menu” button on the remote while it is open.

Display Adjustments (from the Context Menu)

Display settings can be found in the Context Menu under “Display” while a video is playing. These settings can be adjusted by selecting the setting, then pressing the “Up” and “Down” buttons.

Pressing the “Select” or “Back” buttons will save changes to the display settings.

These settings can also be adjusted from the “Display” menu found under “Settings”.

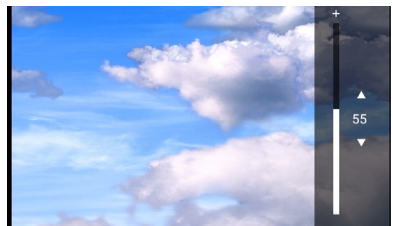

General Operating Instructions

Volume Adjustment

Volume can be adjusted by pressing the “Up” and “Down” buttons at any time a video is playing, or by selecting the volume icon in the Playback Controls menu. Then, press “Up” or “Down” to adjust the volume.



NOTE: The “Maximum Wired Volume” setting in the “Settings” menu will control ONLY volume functions of the wired headphones via the 3.5mm jack on the front of the monitor.

USB/SD Card

Operations for accessing files and content stored on a SD Card, or a USB Drive are identical and can be used by selecting “SD Card” or “USB” from the “Source” menu, respectively.

NOTE: When initially loading a storage device with a large library of content, there may be a delay before the full library will load.

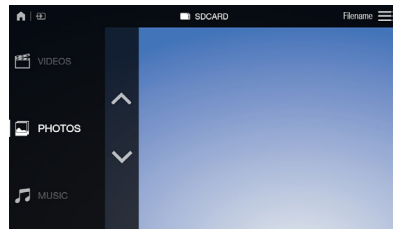

Basic Video Navigation

When entering the SD Card or USB menu, the contents from the storage device will be categorized by media type. The three media types available are “Music”, “Videos”, and “Photos”. Highlighting each option will show a preview of the available files of that media type on the device. After selecting a media type, you may navigate through the content and select the desired file.

Alphabetical Search Bar

The Alphabetical Search Bar is a tool that can be used to quickly scroll through and navigate a library of content.

After selecting “Music” or “Videos” as a media type, the Alphabetical Search Bar is available by pressing “Left” on the remote control. Then press “Up” or “Down” and highlight the desired letter. Pressing “Select” or “Right” on a letter will move to and highlight the first item that starts with that letter in your library.

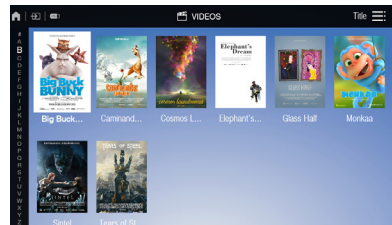

General Operating Instructions

Navigating Content

When a media item is highlighted, the artwork is enlarged and there is a white border around the icon. The highlighted item's available metadata (video title, artist, track name, rating, genre, etc.) will be displayed in the information bar that appears at the bottom of the screen (if available).

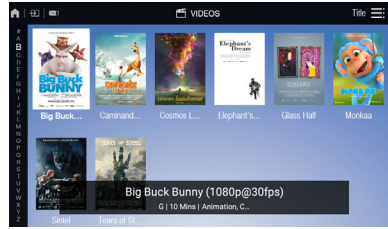

Context Menu (Navigating Content)

Pressing the “Context Menu” button while navigating any content (music, videos, or photos) will display the Context Menu from the right side of the screen. The Context Menu offers advanced options such as searching, sorting, and changing the page view.

Selecting “Page View” gives the option to change the view of the displayed content to allow for easy navigation. For Audio and Video, there are two different views available to choose from: Grid, and List. Grid view is the default option.

Grid View

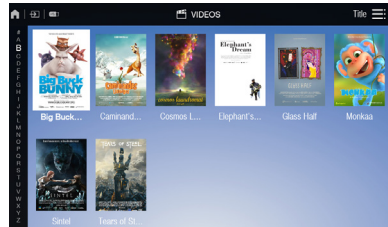

List View

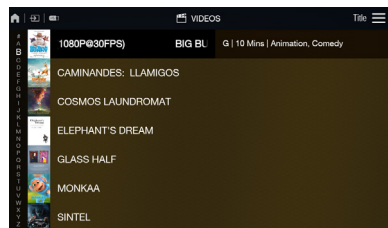

General Operating Instructions

Navigating Music

Navigating through a music library is identical to navigating through the video library. Features such as the “Alphabetical Search Bar,” “Information Bar,” and “Context Menu” are available.

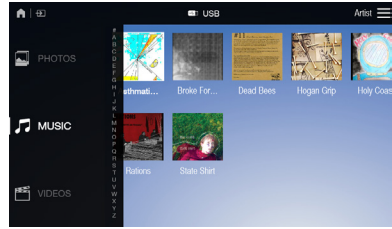

The default sorting option for music is “Artist”. Selecting an artist will then sort by “Album” and will display all available albums by that artist in your music library. There is also an option to “Play All” albums from the selected artist.

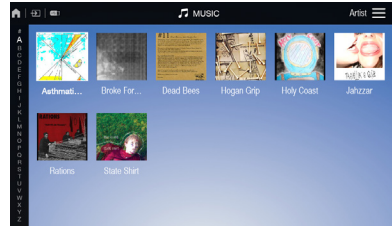

Selecting an album will display the songs in the album. Use the “Up” and “Down” buttons to move the cursor through the songs. Pressing “Select” will begin playing the selected track.

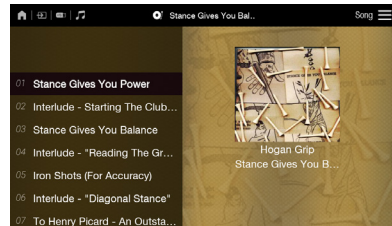

Pressing the right arrow will navigate to the “Now Playing” screen. The “Now Playing” screen contains Playback Controls including Previous/Next Track, Rewind/Fast-Forward, Play/Pause, Shuffle, Repeat, Volume adjustment, and Night mode.

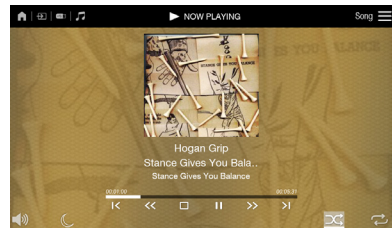

Pressing “Back” will return to the “Song Select” screen. The audio will continue to play while navigating back to the Artist select page. During playback, the system will return to the “Now Playing” screen after 15 seconds has passed with no user input.

General Operating Instructions

Navigating Photos

Navigating Photos is similar to navigating “Music” and “Video”. Use the “Left”, “Right”, “Up”, and “Down” buttons to select a photo.

Selecting the “Photos” media type from the USB or SD Card source will display any available images from the storage device.

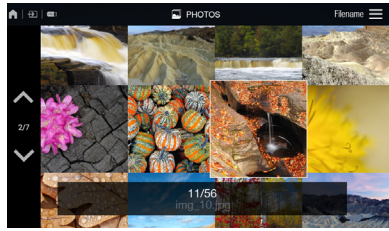

In “Photos” there are “Page Selector” arrows that allow for quick navigation of a large library of photos, press the “Left” button to access. Once “photos” is selected, use the “Up” and “Down” buttons to quickly browse through the photos. After finding the desired page, press “Select” or “Right” to begin highlighting individual photos.

While navigating a Photo library, pressing the “Context Menu” button will open the context menu, allowing for additional options such as “Search”, “Sorting”, and “Page View”. You can additionally select Overview, Slideshow, and Full Screen, Grid, and List as more viewing options.

HDMI Source

The HDMI Source will display content coming into the system through the HDMI port located on the front of the monitor. Many modern devices contain HDMI outputs, enabling audio and video to be sent to a separate device.

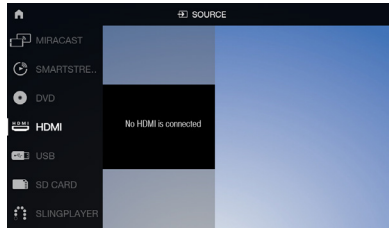

To access the HDMI source, select “Source” from the Home Screen and navigate to the “HDMI” option in the menu. When highlighting “HDMI” you will see a preview of the HDMI input in the preview screen to the right.

Pressing the “Back” button will return to the source menu.

NOTE: HDMI devices are independantly controlled devices and must be controlled from the source device. You will not be able to control playback on the HDMI device from the monitor.

Mirroring Screens

Selecting “Mirror” from the home menu will copy the screen of the opposite monitor onto the selected monitor. This feature is used to display the same content on both monitors.

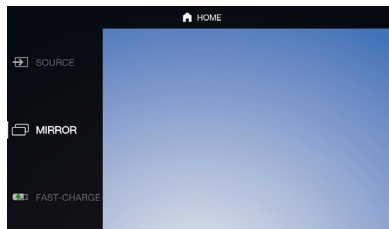

General Operating Instructions

Miracast™

Miracast™ is a technology used to wirelessly mirror content from a supported mobile device to a separate monitor.

Selecting “Miracast™” from the “Source” menu will bring up a “Ready to Connect” screen, which provides instructions for connecting a mobile device to the screen. This screen must be active to be able to connect your mobile device to the monitor.

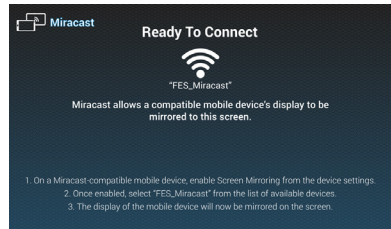

SmartStream

The “SmartStream” source allows for content that is stored on a mobile device to be wirelessly streamed to each of the monitors.

To stream content from a mobile device, select the “SmartStream” source from the “Source” menu. A “Ready to Connect” screen will be visible once selected. From the mobile device’s WiFi settings, connect to the wireless access point displayed on the “Ready to Connect” screen. The default password is “123456789” via the “WiFi Settings” menu if desired.

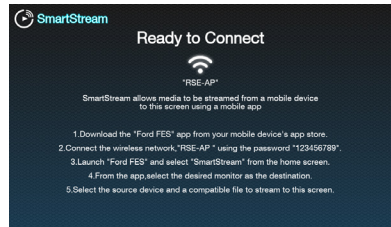

Once connected, launch the Mobile Application and select “SmartStream” to begin sending content to play. Next, select a monitor to stream to by selecting with Monitor “A” or Monitor “B” from the list. Note: A monitor will only appear as a streaming destination if the “SmartStream” source is selected from the monitor. Next, select a source to browse content from. Any devices that are connected to the wireless access point and using the mobile app in the vehicle will be available to be browsed.

After selecting a source device, navigate through the folders and select any supported file to stream to the monitor. Once the file is selected, it will begin playing/displaying on the selected monitor. Playback Controls are available from the “Now Playing” screen in the app as well as from the on-screen Playback Controls on the monitor (using the remote).

Note: DRM protected content may not be available to stream wirelessly. To play DRM content on the RSE, a HDMI/MHL adapter for your device may be required. Ensure you are using an OEM branded (Apple, Samsung, etc.) adapter. Generic adapters may not function properly with your device.

General Operating Instructions

Slingplayer™

Note: An active internet connection is required for the Slingplayer to function. See the WiFi section on page 21 of this manual to access the “Client Mode” and connect to an internet source.

The first use of Slingplayer will prompt you to enter your Slingplayer login credentials. Using the remote control to navigate the on-screen keyboard, enter the e-mail address and password associated with your Slingplayer account.

Once logged into your account, the main Slingplayer menu page will be displayed. You have 3 options to choose from:

- The “Connect” button allows the user to watch live television from their Slingbox.
- The “Settings” button allows a user to change settings of the Slingplayer application.
- The “Help” button gives the user information on how to properly use the Slingplayer application.

Connect for Video Stream.

Pressing the “Select” button on the remote control will bring up the navigational menu that will display two sets of Menu Control Bars.

The Upper Menu Control Bar will display the type of controls you would like to use. Pressing “Select” on the remote control will access that type of control. Pressing the “Back” button on the remote control will hide the menus and return to the live stream.

These options would include:

- Main
- DVR
- Directional Pad
- Number
- Miscellaneous

Accessing the Program Guide

Pressing the “Context Menu” button on the remote control will display the program guide. You can use the directional arrows on the remote control to navigate through the programs available, and pressing the “Select” button will tune to that channel.

Pressing either the “Back” or “Context Menu” button on the remote control will exit the Program Guide.

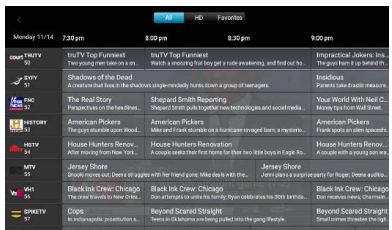
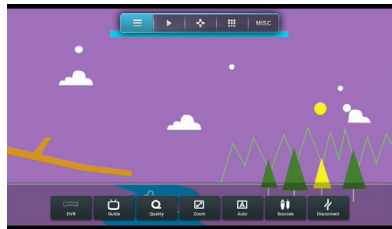
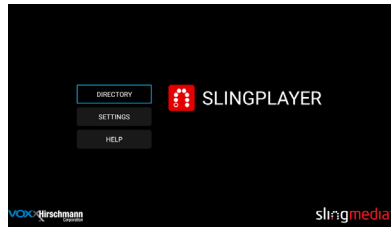
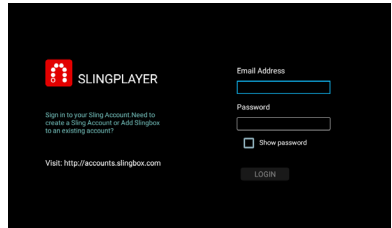
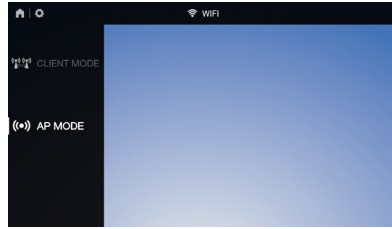

General Operating Instructions

Exiting Slingplayer

There are 2 ways to exit the Slingplayer application. Either pressing the “Home” button, or pressing the “Back” button while on the main screen will display the “Main Menu” page. Pressing “Back” again will exit the application.

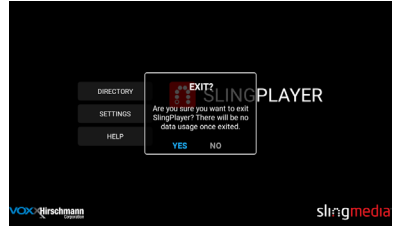

When exiting the application, you will be prompted with a confirmation box. “Are you sure you want to exit Slingplayer? There will be no data usage once exited”. Selecting “Yes” will return you to the “Home” screen of the Entertainment System. Selecting “No” will return to the stream.

Settings

When entering the “Settings” menu from the Home screen, there are many available options to be detailed in the following pages.

Audio

The Audio settings menu allows for adjusting audio settings such as maximum wired volume, and Bluetooth® audio routing of the system. “Maximum Wired Volume” will limit the maximum volume of the wired headphones via the 3.5mm headphone jack.

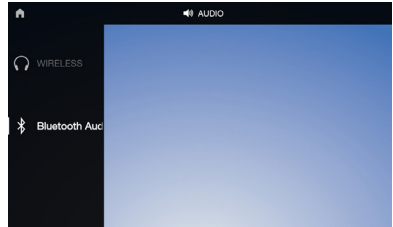

Bluetooth®

Bluetooth® connection settings can be accessed in the “Settings” menu and is used to pair the system to send audio from a monitor to the vehicle’s audio system, when desired.

After selecting “Bluetooth®”, turn Bluetooth® on by highlighting the “Status” button and pressing “Select”. You will see the button turn green to indicate that Bluetooth has been turned on.

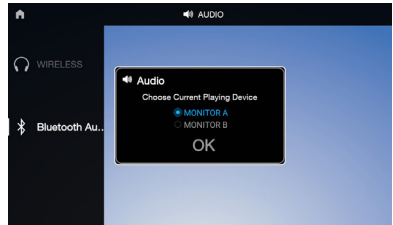

When Bluetooth® is on, the RSE system will search for discoverable devices. To pair a device, make sure the device is in Bluetooth® Discovery Mode (read the device’s manual for instructions). Once discovered by the system, the device’s name will appear under “Available Devices”.

Navigate down to the list and select the intended device to pair with the system. Enter the PIN number provided by the device if applicable. Once pairing is complete, there will be a message indicating a successful pairing. The system will also remember the last paired device and automatically connect to the device when Bluetooth® is turned on.

Read Back

Read Back is a text-to-speech aid, and activated through the “Settings” menu. When enabled, the RSE will read the text items displayed on the screen to you through the audio system. You can enable/disable this feature, adjust the speech volume, and the speech speed settings by selecting this item from the “Settings” menu.

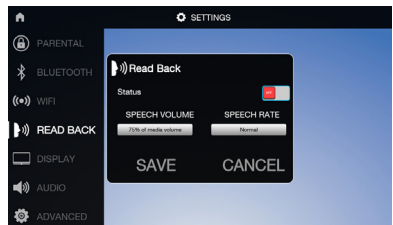

General Operating Instructions

WiFi

The WiFi settings menu allows for changing the name (SSID) and password of the wireless access point as well as toggling Client Mode.

In the Access Point Mode settings, a user is able to change the default SSID (network name) and password for the wireless access point.

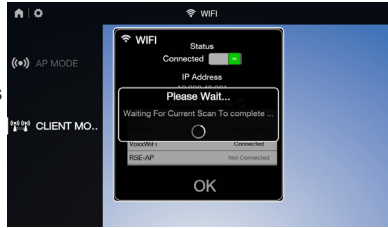

Client Mode allows the system to connect to another wireless access point. This is useful for features that require Internet access, such as “Slingplayer”. To use Client Mode, enter the “WiFi” settings menu and select “Client Mode”. Turn on the “Status” switch at the top of the menu by highlighting it and pressing “Select”. The switch will turn green when on. Once on, the system will begin searching for available wireless access points and display them under “Available Devices”. Navigate down to this list, highlight, and select the network. Enter the password for the network (if necessary) and the system will connect. Once connected, the system will automatically connect to the last connected network until Client Mode is disabled, as long as it is available and the credentials have not changed.

NOTE: Using client mode will use data from the selected WiFi access point. Use with care when using with mobile data plans.

Language

The system language can be changed to any one of the seven available languages. These languages include: English, Spanish, French, Arabic, Simplified and Traditional Chinese, and Hebrew. The “Language” menu is located in the “Advanced” menu under “Settings”.

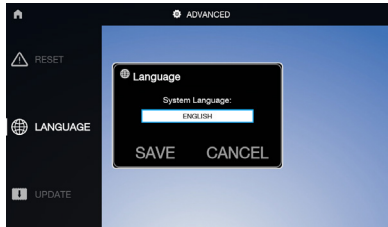

To change the language, highlight and select the current language and a drop-down list will appear containing the available languages. Navigate down the list and select the intended language. Next, there will be a prompt, select “Yes” to verify the change. The system will reboot to apply the changes.

Display

The “Display” settings are similar to the settings found in the “Context Menu” when viewing video content and can be accessed from the “Settings” menu. These settings include Backlight, Brightness, Contrast, and Tint.

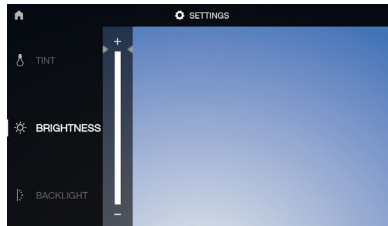

To adjust, select one of the settings from the menu then use the “Up” and “Down” buttons to control the level of adjustment. Each setting has a range of 0 to 100 and can be adjusted in increments of 5.

Reset

This will reset every item and option in the RSE back to all factory defaults. Any user options and customizations will be lost and reset back to factory default settings.

General Operating Instructions

Customize

Changing the Background Image:

The “Background” setting allows a user to change the background image on each monitor. To change the background image, select “Background” from the “Customize” option in the “Settings” menu. Next, select a source for the image (USB, SD Card, or Local.)

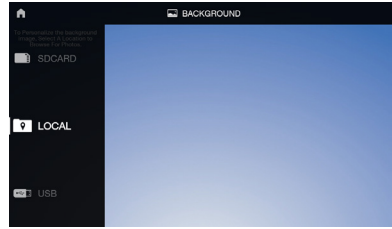

Select a source then navigate and select the image for the background. A prompt will confirm the change; select “Yes” to continue. Once complete, press the “Home” button to view the change. Each monitor can have a separate background image.

Note: The “Local” setting contains up to the last 10 background images that have been used.

Parental Controls

Parental controls give the ability to lock DVD content with certain ratings. The Ratings menu provides the ability to toggle between locked and unlocked based on the selected discrimination level, ranging from 1 (most restrictive) to 8 (least restrictive). See Page 26 for detailed rating settings. The default setting for Parental Controls is “off”.

A password will need to be created to access parental controls. When entering “Parental Controls” for the first time, you will be prompted to set up a password to be used to set the ratings. Use the “Up” and “Down” buttons on the remote control to change the numbers, pressing “Select” to confirm. The system will then prompt you to verify the password for confirmation.

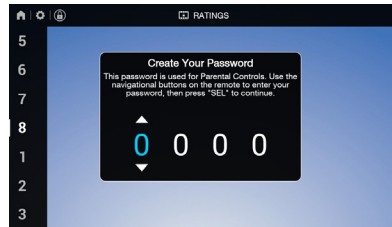

Write this password down in a secure place. You will need this password to access “Parental Controls” in the future to make any changes to the settings.

Performing a Factory Reset on the system will reset the Parental Controls to default settings (off).

Fast-Charge

Fast-Charge is a feature available from the main menu screen. This will allow you to charge some compatible devices more quickly. Enabling the Fast-Charge mode will disable the USB port from reading data or content from USB drives or other devices. When Fast-Charge is active, the icon on the main menu screen turns green.

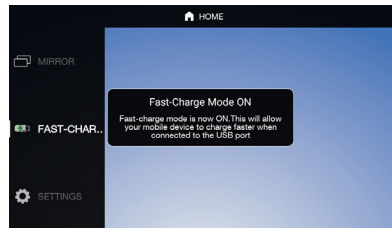

When selecting “USB” as the content source, the Fast-Charge feature is automatically disabled.

General Operating Instructions

Mobile Application

Mobile App Remote Control

The Mobile App Remote Control is available via the mobile application. This remote control duplicates all of the functionality of the included remote control through your device. To use the Mobile App Remote Control, enable Wi-Fi on your device and connect to the Rear Seat Entertainment System's Wi-Fi Network. Then open the mobile application and select the "Remote Control" function from the home screen in the mobile application.

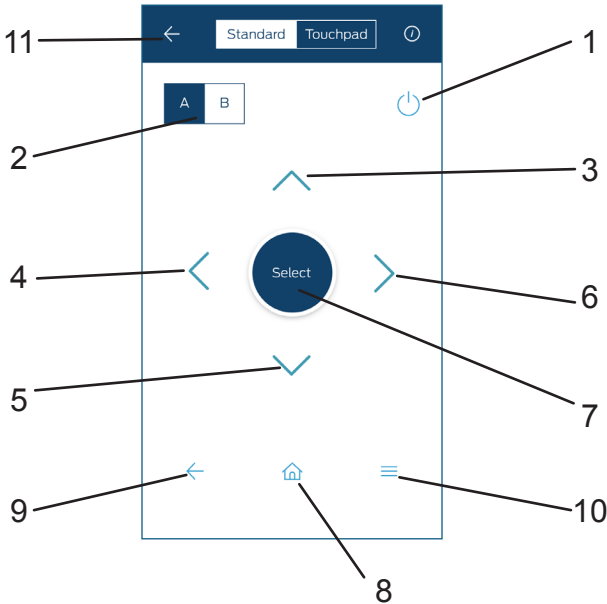

1. **POWER** Press this button to turn the monitor on and off.
2. **A-B** Press this button to switch between operating monitor "A" or monitor "B".
3. **UP** Press this button to navigate up when displaying a menu or file list.
4. **LEFT** Press this button to navigate left when displaying a menu or file list.
5. **DOWN** Press this button to navigate down when displaying a menu or file list.
6. **RIGHT** Press this button to navigate right when displaying a menu or file list.
7. **SELECT** Press this button to make a selection or begin playback of the media.
8. **HOME** Press this button to return to the home screen.
9. **BACK** Press this button to go back to the previous screen.
10. **CONTEXT MENU** Press the button to go to the open the context menu options (when available).
11. **APP BACK** Returns to the main menu of the mobile application.

There is a toggle on the top of the screen to access "Touchpad" mode. This mode will allow swipe, drag, and tap gestures to navigate the RSE menus instead of the directional arrows on the standard remote control mode.

General Operating Instructions

SmartStream

The SmartStream feature of the mobile application allows you to wirelessly stream content from your mobile device to the RSE. To connect the device, the RSE needs to be on the “SmartStream” source, located in the “Source” menu.

1. Open the mobile application, and select “SmartStream” from the home screen.

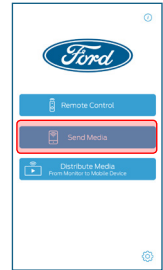

2. Select the device where you want to view the content.

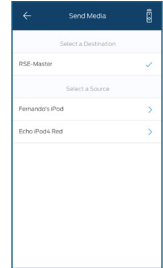

3. Select the device which contains the content you wish to stream.

4. Navigate through the stored content until you locate and select the file you wish to stream. The content should automatically begin to play on the device selected in step 2.

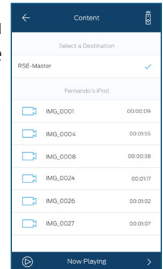

You can control the content from the “Now Playing” screen in the mobile application, or from the remote control for the RSE.

Note for iOS Devices: In order for content to be available on iOS devices, video, music, and photo files must be transferred to the mobile application through iTunes.

To transfer video files onto your iOS device for SmartStream playback:

1. Connect your mobile device to a computer and launch iTunes.

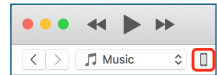

2. In iTunes, click on the device button that should appear after connecting your device to the computer.

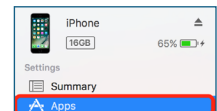

3. Under the “Settings” dropdown, select “Apps”.

4. In the main iTunes window, scroll down to reveal “File Sharing” and select the “Ford Play” app.

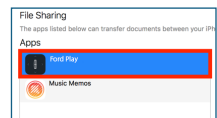

General Operating Instructions

MultiCast

MultiCast is a feature that allows you to select content that is currently playing on the RSE and mirror it to your mobile device.

1. Select “MultiCast” from the home stream of the mobile application.

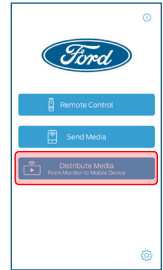

2. When content is currently playing on the RSE, you will be able to view and select the monitor you wish to stream to your mobile device.



3. Once selected, the content will start to display on the mobile device. Volume is controlled from your mobile device, not the RSE.



Note: MultiCast is not available from the HDMI or SlingPlayer sources.

Note: To access MultiCast in the DVD source, you must press the “Context” button on the remote control and scroll down and turn on the “MultiCast” option to enable the function to be available in DVD mode. This must be performed each time you wish to use MultiCast for the DVD source.

General Operating Instructions

This owner’s manual can be accessed by opening the “Settings” button at the bottom of the mobile application’s home screen. Tutorial screens can be accessed in the mobile application by pressing the “Information” button in the upper right hand corner of the mobile application’s home screen.

DVD Parental Rating Levels						
Level	Country					
	USA	Mexico	Canada (Québec)	Canada (Other)	United Arab Emirates	Brazil
1	G	A	G	G	G	L
2						10
3	PG	B	13+	PG	PG13	12
4	PG13				PG15	14
5	R	B-15	16+	14A	15+	16
6						
7	NC17	C	18+	18A	18+	18
8		D		R		

Note: Setting a Parental Rating Level will allow DVDs with that rating (and lower) to be played by the system. All ratings that are of a higher Parental Rating Level will not be allowed until unlocked.

Troubleshooting

Symptom	Remedy
Monitor does not power on.	<ul style="list-style-type: none"> Verify the vehicle is in the ON/RUN or ACC position. Verify the battery is installed in the remote control and fresh. Verify the fuse located in-line is good.
Remote control does not function.	<ul style="list-style-type: none"> Verify that the battery in the remote control is fresh. Verify that the remote sensor lens is not obstructed.
Monitor frozen - does not respond	<ul style="list-style-type: none"> Try to reset the monitor. This is done by pressing and holding the power button on the top of the monitor for at least 5 seconds. The monitor should shut off and restart, same as cycling the ignition key off, then back on.
Disc will not play.	<ul style="list-style-type: none"> Insert the disc with label side facing the rear of the vehicle. Check if the disc is defective by trying another disc. Check the type of disc being played. This unit only plays DVD (Single, Dual Layer), DVD-R/+R, DVD+R Dual layer, DVD-RW/+RW, CD, CD-R, and CD-RW. Both the unit and DVD discs are coded by region. If the region codes don't match, the DVD can't be played.
Disc plays, but stops intermittently.	<ul style="list-style-type: none"> The disc may be dirty and need cleaning. Condensation may have formed inside the unit. Remove the disc and allow unit to dry out. The disc may be scratched too badly to play.
No picture.	<ul style="list-style-type: none"> Check that the signal source is connected. Check the menu source setting. Match your monitor mode with the source correctly.
Distorted picture.	<ul style="list-style-type: none"> Check the disc for fingerprints and clean with a soft cloth, wiping from center to edge.
Cannot advance through a DVD movie.	<ul style="list-style-type: none"> You cannot advance through the opening credits and warning information that appears at the beginning of DVDs because the disc is programmed to prohibit these actions. Some discs may not allow this function. Try another disc.
No sound or distorted sound.	<ul style="list-style-type: none"> Make sure that the external media device is connected properly, and all cables are securely inserted into the appropriate jacks. Verify that the batteries in the headphones are fresh. If you are using the wireless headphones, make sure you turn on the power and select the correct monitor (A or B). Verify the volume is turned up on headphones. Verify nothing is blocking the path between the monitor IR sensor and headphones. When placing the headphones on your head, make sure to observe the Left and Right orientation. The headphones must be oriented correctly (facing forward) in order to receive the audio signal.
Monitor feels warm.	<ul style="list-style-type: none"> When the monitor is in use for a long period of time, the surface will be warm. This is normal.
Player does not respond to all commands during playback.	<ul style="list-style-type: none"> Some operations are not permitted by the DVD. Refer to the specific instructions included with the DVD for more information.
A Parental Setting message is displayed, prohibiting movie playback.	<ul style="list-style-type: none"> Using the remote control, enter your 4-digit Parental Password and then press Enter. Refer to "Parental Controls" section for more details.

Specifications

LCD Backlight	LED
Resolution	1024x3(RGB) x 600 TFT LCD Panel
DVD Mechanism	Slot-In Loader
Supported Disc	DVD (Single, Dual Layer), DVD-R/+R, DVD+R Dual layer, DVD-RW/+RW, CD, CD-R, CD-RW
Sources	USB, SD Card, HDMI, DVD, Miracast™, SmartStream, Slingplayer™.
I/O Ports	3.5mm Headphone Jack, SD card, USB port, HDMI
Frequency Response	20Hz ~20kHz
Headphone (Audio Out)	IR headphones (included), Wired headphones (not included)
Video Display System	NTSC/PAL
HDMI Compliant	Version 1.4
Wireless Audio	Dual channel infrared audio transmitter, supports stereo headphone operation (reception: 0.9 m; 80°, 1.8 m; 50°)
Wi-Fi	802.11b/g/n 2412 MHz - 2462 MHz Ant. 1 802.11b 802.11g 802.11n HT20 802.11n HT40 MIMO Ant. 1+2 802.11n HT20
Wi-Fi Modulation	802.11b : DSSS (DBPSK / DQPSK / CCK) 802.11g/n : OFDM (BPSK / QPSK / 16QAM / 64QAM)
Bluetooth BR/EDR	TX/RX Frequency - 2402 MHz - 2480 MHz Channels - 79 Bluetooth BR (1Mbps) : GFSK Modulation Bluetooth EDR (2Mbps) : $\pi/4$ -DQPSK Modulation Bluetooth EDR (3Mbps) : 8-DPSK Modulation
Bluetooth LE	TX/RX Frequency - 2402 MHz - 2480 MHz Channels - 40 Carrier Frequency of Each Channel : (37 hopping + 3 Adversiting channel) Type of Modulation : Bluetooth LE : GFSK

Compliance Information

FCC Notice

This device has been tested and found to comply with the limits for a Class B digital device, pursuant to part 15 of the FCC Rules. These limits are designed to provide reasonable protection against harmful interference in a residential installation. This device generates, uses, and can radiate radio frequency energy, and if not installed and used in accordance with the instructions, may cause harmful interference to radio communications. However, there is no guarantee that interference will not occur in a particular installation. If this device does cause unacceptable interference to radio or television reception, which can be determined by turning the device off and on, the user is encouraged to try to correct the interference by one or more of the following measures:

- Reorient or relocate the receiving antenna.
- Increase the separation between the device and receiver.
- Connect the device into an outlet on a circuit different from that to which the receiver is connected.
- Consult your dealer or an experienced radio/TV technician for help.

FCC Warning:

To assure continued FCC compliance, the user must use the provided grounded power supply cord and the shielded video interface cable with bonded ferrite cores. Also, any unauthorized change or modifications to this device would void the user's authority to operate this device.



ITE Notice:

This Class B digital apparatus complies with Canadian ICES-003.

Cet Appareil numérique de la classe B est conforme à la norme NMB-003 du Canada.

This device complies with Industry Canada license-exempt RSS standard(s). Operation is subject to the following two conditions: (1) this device may not cause interference, and (2) this device must accept any interference, including interference that may cause undesired operation of the device.

Le présent appareil est conforme aux CNR d'Industrie Canada applicables aux appareils radio exempts de licence. L'exploitation est autorisée aux deux conditions suivantes : (1) l'appareil ne doit pas produire de rouillage, et (2) l'utilisateur de l'appareil doit accepter tout brouillage radioélectrique subi, même si le brouillage est susceptible d'en compromettre le fonctionnement.

This device and its antenna(s) must not be co-located or operation in conjunction with any other antenna or transmitter. Under Industry Canada regulations, this radio transmitter may only operate using an antenna of a type and maximum (or lesser) gain approved for the transmitter by Industry Canada. To reduce potential radio interference to other users, the antenna type and its gain should be so chosen that the equivalent isotropically radiated power (e.i.r.p.) is not more than that necessary for successful communication.

Compliance Information

WEEE Notice

Disposal of Old Electrical & Electronic Equipment (Applicable in the European Union and other European countries with separate collection systems)

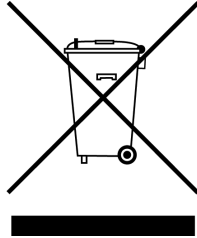

This symbol on the product or on its packaging indicates that device shall not be treated as household waste. Instead it shall be handed over to the applicable collection point for the recycling of electrical and electronic equipment. By ensuring this device is disposed of correctly, you will help prevent potential negative consequences for the environment and human health, which could otherwise be caused by inappropriate waste handling of this device. The recycling of materials will help to conserve natural resources. For more detailed information about recycling of this device, please contact your local city office, your household waste disposal service or the shop where you purchased the device. Applicable accessory: remote control.

Macrovision Notice

This product incorporates copyright protection technology that is protected by method claims of certain U.S. patents and other intellectual property rights owned by Macrovision Corporation and other rights owners. Use of this copyright protection technology must be authorized by Macrovision Corporation, and is intended for home and other limited viewing uses only unless otherwise authorized by Macrovision Corporation. Reverse engineering or disassembly is prohibited.

Dolby Audio

Manufactured under license from Dolby Laboratories.

Dolby and the double-D symbol are registered trademarks of Dolby Laboratories.



The Bluetooth® word mark and logos are registered trademarks owned by Bluetooth SIG, Inc. And any use of such marks is under license. Other trademarks and trade names are those of their respective owners.



