



REFRIGERATOR

BOTTOM MOUNT FREEZER

BASIC : RFG298AA

MODEL NAME : RFG298AARS
RFG298AABP
RFG298AAWP
RFG298AAPN

MODEL CODE : RFG298AARS/XAA
RFG298AABP/XAA
RFG298AAWP/XAA
RFG298AAPN/XAA

SERVICE *Manual*

REFRIGERATOR



RFG298AA

CONTENTS

- 1. PRECAUTIONS(SAFETY WARNINGS) · 4
- 2. PRODUCT SPECIFICATIONS · · · · · 8
- 3. DISASSEMBLY AND REASSEMBLY · 26
- 4. TROUBLESHOOTING · · · · · 52
- 5. EXPLODED VIEW & PARTS LIST · · 101
- 6. PCB DIAGRAM · · · · · 124
- 7. WIRING DIAGRAM · · · · · 129
- 8. SCHEMATIC DIAGRAM · · · · · 130

For the latest parts information, Please access to our service web site
(● North America : <http://service.samsungportal.com>)



WARNING

IMPORTANT SAFETY NOTICE

The service guide is for service men with adequate backgrounds of electrical, electronic, and mechanical experience. Any attempt to repair a major appliance may result in personal injury and property damage. The manufacturer or dealer cannot be responsible for the interpretation of this information.

SAMSUNG ELECTRONICS AMERICA, INC.

Technical Service Guide

Copyright ©2008

All rights reserved. This service guide may not be reproduced in whole or in part in any form without written permission from the SAMSUNG ELECTRONICS Company.

Contents

1. Precautions(Safety Warnings)	4
2. Product Specifications	8
2-1) Introduction of main function	9
2-2) Specifications	11
2-3) Interior Views	12
2-4) Model Specification	13
2-5) Model Specification & Specification Chart	14
2-6) Dimensions of Refrigerator (Inches)	17
2-7) Optional Material Specification	18
2-8) Refrigerant Route in Refrigeration cycle	19
2-9) Cooling Air Circulation	25
3. Disassembly and Reassembly	26
3-1) PRECAUTION	27
3-2) Refrigerator Door	28
3-3) Door Handle Freezer	30
3-4) Refrigerator Light	31
3-5) Cover-display & water-dispenser	31
3-6) Water-dispenser	32
3-7) Glass Shelf	33
3-8) Foldable Glass Shelf	34
3-9) Vegetable & Fruit Drawers Shelf	34
3-10) Cool Select Pantry	35
3-11) Water Tank	36
3-12) Motor Damper	38
3-13) Water Filter (Disassembly)	38
3-14) Water Filter (Reassembly)	39
3-15) Gallon Door Bin	39
3-16) Vertical Hinged Section	40
3-17) Evaporator Cover In Refrigerator	41
3-18) Evaporator In Refrigerator	42
3-19) Freezer Door	43
3-20) Pull Out Drawer	44
3-21) Ice-Maker	45
3-22) Freezer Light	46
3-23) Door Switch In Freezer	46
3-24) Evaporator Cover In Freezer	47
3-25) Evaporator In Freezer	47
3-26) Machine Compartment	48
3-27) Electric Box	51
4. TROUBLESHOOTING	52
4-1) Function for failure diagnosis	53
4-1-1. Test mode (manual operation / manual defrost function)	53
4-1-2. Display function of Communication error	54
4-1-3. Self-diagnostic function	55
4-1-4. Display function of Load condition	58
4-1-5. Exhibition mode setting function	59
4-1-6. Option setting function	60
4-1-7. Option TABLE	62
4-2) Diagnostic method according to the trouble symptom(Flow Chart)	64
4-2-1. If the trouble is detected by self-diagnosis (F, R, C - FAN)	65
4-2-2. If FAN does not operate	76
4-2-3. If ICE Room Fan does not operate	77
4-2-4. If Ice Maker does not operate	78
4-2-5. If ICE MAKER(F) does not operate	79

Contents

4-2-6. If defrost does not operate (F,R DEF Heater)	80
4-2-7. If Power is not supplied	81
4-2-8. If compressor does not operate	82
4-2-9. When alarm sounds continuously without stop(related with buzzer sound)	84
4-2-10. If Panel PCB does not work normally	86
4-2-11. If Pantry Panel PCB is not working normally	87
4-2-12. When refrigerator ROOM Lamp does not light up	88
4-2-13. If ICE Water is not supplied	90
4-2-14. If Cubed or Crushed Ice is not supplied	92
4-2-15. If Cover Ice Route Motor(Geard Motor) is not working normally	93
4-2-16. If Photosynthetic LED Lamp does not work properly	94
4-2-17. If Inverter PCB Power is not supplied	95
4-2-18. If compressor does not operate	96
4-2-19. LED blinking frequency depending on protecting functions	97
Spm internal diode voltage	98
Inverter controller board connector location	99
Inverter pcb circuit diagram	100
5. Exploded View & PARTS LIST	101
5-1) Freezer	102
5-2) Refrigerator	106
5-3) Cabinet	112
5-4) Disassembly of Freeze Door	116
5-5) Disassembly of Refrigerator DoorLeft	118
5-6) Disassembly of Refrigerator Door Right	122
6. PCB DIAGRAM	124
6-1) PCB Layout with part position	126
6-2) PCB Layout with part position (SMPS Board)	128
6-3) Connector Layout with part position (Main Board)	127
6-4) Connector Layout with part position (SMPS Board)	128
7. WIRING DIAGRAM	129
7-1) Model : RFG298**	129
8. SCHEMATIC DIAGRAM	130
8-1) Whole block diagram	130
8-1-1. MODEL : RFG298**	130
8-1-2. MODEL : RFG23***	131
8-2) CIRCUIT DIAGRAM	132
8-2-1. Main	132
8-2-2. INVERTER	133

1. PRECAUTIONS(SAFETY WARNINGS)

- Unplug the appliance before the changing or repairing the electric parts.
→ Be careful the electric shock.
- When exchanging the parts, use the correct parts.
→ Check the model name, rating voltage, rating current, running temperature symbols.
- When troubleshooting, connect firmly the types of harness.
→ Make not to be separated when some power is imposed.
- Check the traces of water infiltration at the electric parts.
→ If there is a trace of water infiltration, exchange or tape the parts.
- Check the assemble status of parts after troubleshooting.
→ It must be in the same assembled state when compared with the state before disassembly.
- Check the use circumstance of refrigerator.
→ If the refrigerator is installed at the place that is damp or wet, or status of installation is unstable, change the installation place.
- Ground the refrigerator properly
→ Particularly, Be sure to earth when there is a risk of an electric leakage by humidity or wetness.
- Do not use multi plugs in a plug socket at the same time.
Check if the power cord and socket is damaged, pressed, squeezed, or fired.
→ If the plug or plug socket is damaged, repair or exchange it immediately.
- Do not allow consumers to repair the appliance by themselves.
- Do not store other materials except the foods.
→ Drugs or scientific materials : difficult to keep precise temperature.
→ The inflammables(alcohol, benzene, ether, LP gas, butane gas etc.): have risk of explosion.

PRECAUTIONS(SAFETY WARNINGS)

Read all instructions before repairing the product and follow the instructions in order to prevent danger or property damage.
 Plug out and remove all the items in refrigerator prior to repair.

CAUTION/WARNING SYMBOLS DISPLAYED



Warning

Indicates that a danger of death or serious injury exists.



Caution

Indicates that a risk of personal injury or material damage exists.

SYMBOLS



means "Prohibited".



means "Do not disassemble".



means "No contact".



means "Warning or Caution".



means "Unplug the unit before performing service"



means "Earth or Ground".



Warning & Caution

Plug out to exchange the interior lamp.

- It may cause electric shock.



Unplug

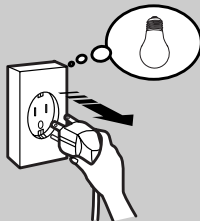

Use the rated components on the replacement.

- Check the correct model, rated voltage, rated current, operating temperature and so on.



Rated components



On repair, make sure that the wires such as harness are bundled tightly.

- Bundle tightly wires in order not to be detached by the external force and then not to be wetted.

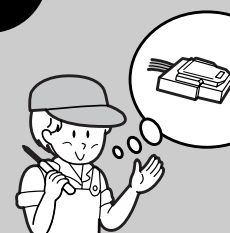

On repair, remove completely dust or other things of housing parts, harness parts, and check parts.

- Cleaning may prevent the possible fire by tracking or short.

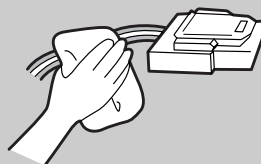

After repair, check the assembled state of components.

- It must be in the same assembled state when compared with the state before disassembly.

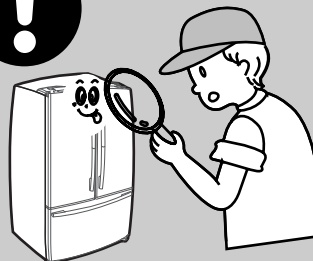

Check if there is any trace indicating the permeation of water.

- If there is that kind of trace, change the related components or do the necessary treatment such as taping using the insulating tape.

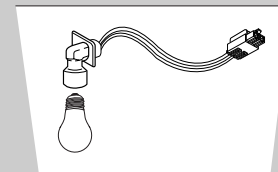

PRECAUTIONS(SAFETY WARNINGS)

* Please let users know following warnings & cautions in detail.



Warning & Caution

Do not allow users to put bottles or kinds of glass in the freezer.

● Freezing of the contents may inflict a wound.

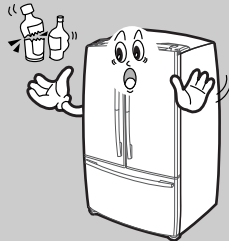

Do not allow users to store narrow and lengthy bottles or foods in a small multi-purpose room.

● It may hurt you when refrigerator door is opened and closed resulting in falling stuff down.



Do not allow users to store pharmaceutical products, scientific materials, etc., in the refrigerator.

● The products which need precise temperature control should not be stored in the refrigerator.



Do not allow users to plug several appliances into the same power receptacle.

● May cause abnormal generation of heat or fire.



Prohibition

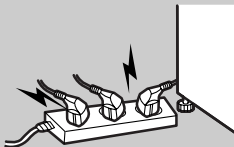

Do not allow users to disassemble, repair or alter.

● It may cause fire or abnormal operation which leads to injury.



Do not disassemble

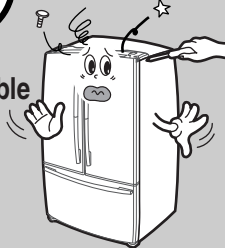

Do not allow users to bend the power cord with excessive force or do not have the power cord pressed by heavy article.

● May cause fire.

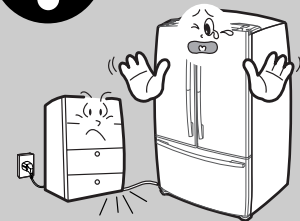

Do not allow users to store articles on the product.

● Opening or closing the door may cause things to fall down, which may cause injury.



Prohibition

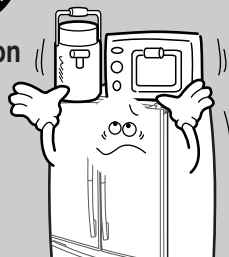

Do not allow users to install the refrigerator in the wet place or the place where water splashes.

● Deterioration of insulation of electric parts may cause electric shock or fire.

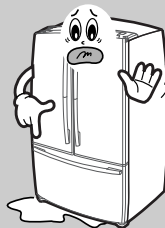

Make sure of the earth.

● Be sure the product is properly grounded.



Earth

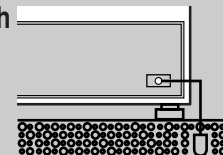

PRECAUTIONS(SAFETY WARNINGS)

FLOORING

For proper installation, this refrigerator must be placed on a level surface of hard material that is the same height as the rest of the flooring. This surface should be strong enough to support a fully loaded refrigerator, or approximately 660lbs(299kg).

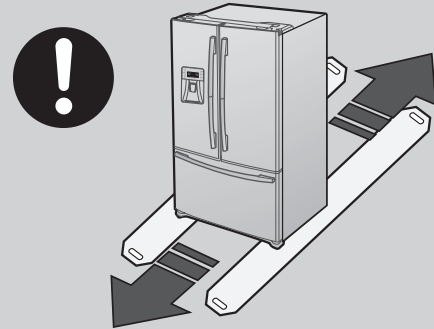

MOVING

Protect the finish of the flooring. Cut a large section of the cardboard carton and place under the refrigerator where you are working. When moving, be sure to pull the unit straight out and push back in straight.

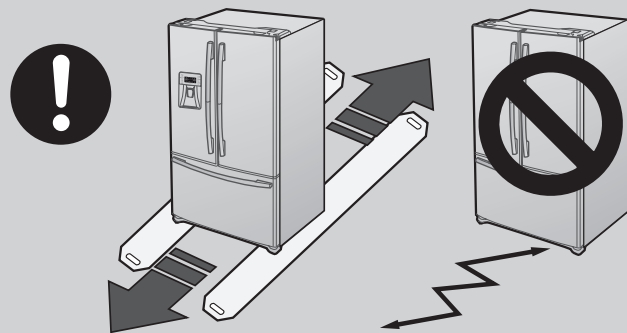







2. PRODUCT SPECIFICATIONS

2-1) INTRODUCTION OF MAIN FUNCTION	9
2-2) SPECIFICATIONS	11
2-3) INTERIOR VIEWS	12
2-4) MODEL SPECIFICATION	13
2-5) MODEL SPECIFICATION & SPECIFICATION CHART	14
2-6) DIMENSIONS OF REFRIGERATOR (INCHES)	17
2-7) OPTIONAL MATERIAL SPECIFICATION	18
2-8) REFRIGERANT ROUTE IN REFRIGERATION CYCLE	19
2-9) COOLING AIR CIRCULATION	25



2. PRODUCT SPECIFICATIONS

2-1) Introduction of Main Function

- A newly developed SAMSUNG bottom mount freezer in 2008 has the following characteristics.

	<p>Surround Multi Flow</p> <ul style="list-style-type: none"> ● Uniform cooling for each shelf and even in corner in fresh food compartment by centerpositioned fan and duct with multiple flow effluences.
	<p>Twin Cooling System</p> <ul style="list-style-type: none"> ● The refrigerator and the freezer have two evaporators. Given this independent system, the freezer and the refrigerator are cooled individually as required and are, therefore, more efficient. Food odor from the refrigerator does not affect food in the freezer due to separate air flow circulation.
	<p>Electronic control from outside of Pantry Cover</p> <ul style="list-style-type: none"> ● Adjustable temperature control ((around 41°F (5°C) : Deli / around 38°F (3°C) : Fresh / around 34°F (1°C) Chilled) Temperature control from outside of the Pantry : user friendly design helps keep foods fresh for longer
	<p>16" Pizza Corner</p> <ul style="list-style-type: none"> ● Can be used for 16" pizza if the flap is turned up
	<p>Ice and Water Dispenser</p> <ul style="list-style-type: none"> ● The ice and water dispenser provides ice and cold water at any time.
	<p>Secure Auto Close Door System</p> <ul style="list-style-type: none"> ● Secure Auto Close Door System ● Cool tight doors ● Energy saving ● Preventing sweat on fridge doors
	<p>Easy Handle System</p> <ul style="list-style-type: none"> ● Ez-open Freezer Door ● Ergonomic Door Design

PRODUCT SPECIFICATIONS

	<p>Easy Handle</p> <ul style="list-style-type: none">• The freezer door is more user-friendly. So, it comes as much convenient.
	<p>Drawer</p> <ul style="list-style-type: none">• The dimension of the right-side drawer is 6:4 (H x W) with the shelf being raised. So, the right-side drawer can be pulled out with the left door closed.
	<p>Dual Ice Maker</p> <ul style="list-style-type: none">• 9 cubes ice-Maker(Refrigerator)• 7 cubes ice-Maker(Freezer)

PRODUCT SPECIFICATIONS

2-2) Specifications

ELECTRICAL SPECIFICATIONS

Defrost Control From 24 to 32 hrs
 Thermo Bimetal Protector140°F(60°C)(off) 104°F(40°C)(on)
 Defrost Thermistor(502AT) 50°F(10°C)(off)
 Electrical Rating AC115V 60Hz 11.6 Amps
 Maximum Current Leakage 0.25 mA
 Maximum Ground Path Resistance 0.1 Ohm
 Energy Consumption 550KWh/year

NO LOAD PERFORMANCE

Ambient Temperature 70°F(21°C) 90°F(32°C)
 Refrigerator, °F 34°F(1°C)~46°F(8°C) 34°F(1°C)~46°F(8°C)
 Freezer, °F -8°F(-22°C)~-8°F(-13°C) -8°F(-22°C)~-8°F(-13°C)
 Run Time, % < 40 < 60

REFRIGERATION SYSTEM

Refrigerant Charge (R134a) 5.64 oz(160g)
 Compressor(BK190C-L2C)1314 Btu/hr(0.385kw)
 Compressor oil Freol α 15c
 R Capillary tube(Dia, Length) 0.032 " ,118 " (0.82mm,3500mm)
 F Capillary tube(Dia, Length) 0.032 " ,118 " (0.82mm,3500mm)

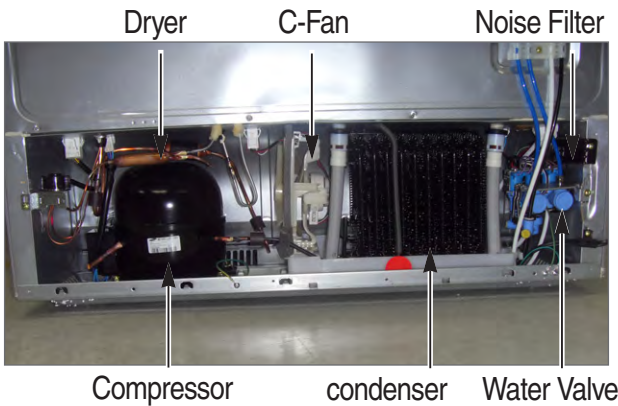

Refrigerator

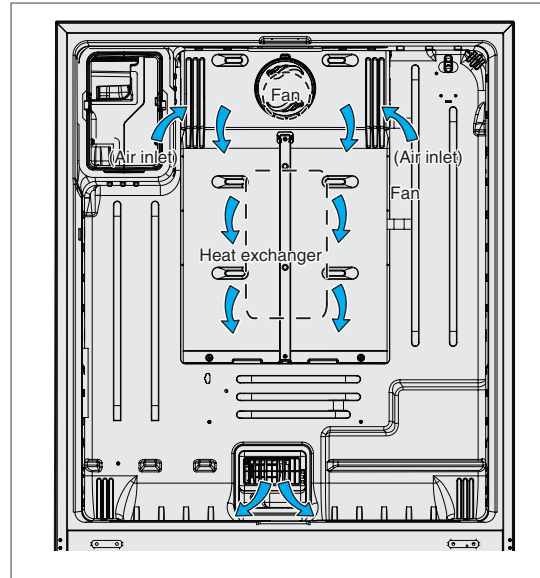

Freezer

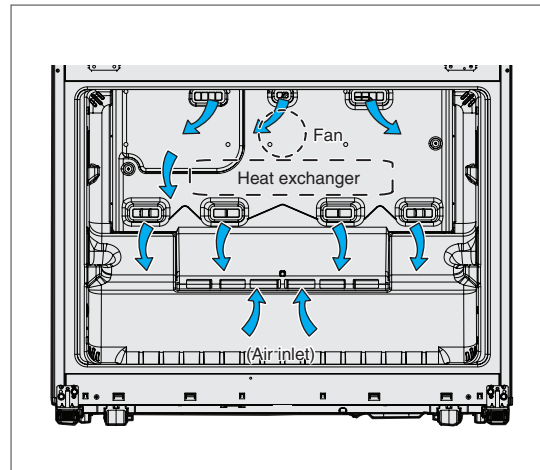

INSTALLATION

Clearance must be provided for air circulation

AT TOP 1 " (25mm)
 AT SIDES 1 " (25mm)
 AT REAR 2 " (50mm)



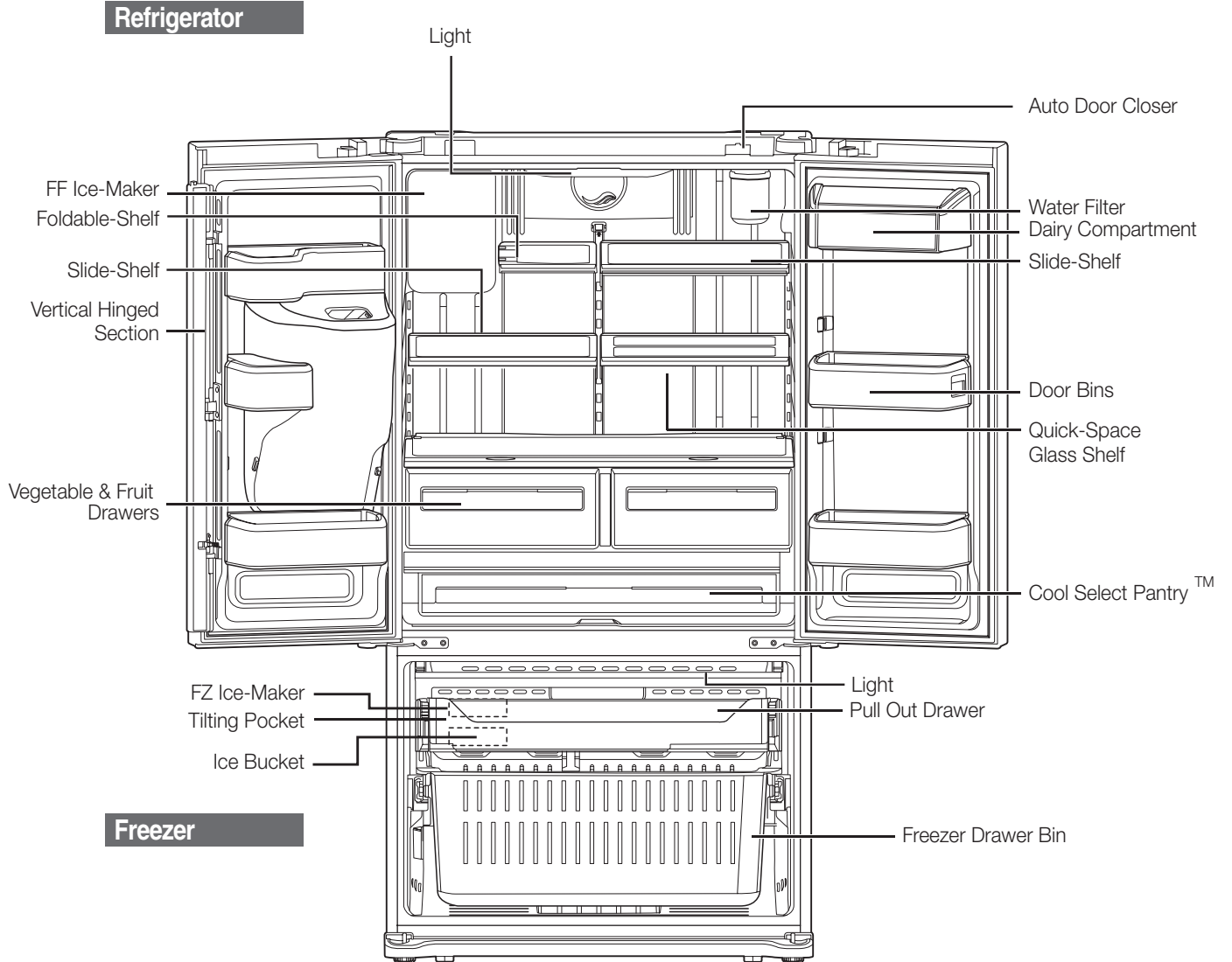

PRODUCT SPECIFICATIONS

2-3) Interior Views



PRODUCT SPECIFICATIONS

2-4) Model Specification

ITEM		SPEC	SAMSUNG		MAYTAG	LG	
			RFG298AA	RFG297AA	MFI2568AES	LFX25960ST	
Appearance							
Product Zone		Cooling Tech	Twin Cooling	Twin Cooling	Mono Cooling	Mono Cooling	
		Door Shape	Contour	Contour	Contour	Contour	
		Special Room	Cool Select Pantry	Cool Select Pantry	Pantry	Pantry	
Performance	Cooling Speed(Min)	F-Room	250 ↓	231.2	199.2	246	224
		R-Room	250 ↓	209.3	197.3	575	232
	89.6°F (32°C)	F-Room	-26.0 ↓	-27.8	-28.1	-27.2	-28.8
		R-Room	2.0 ↓	1.7	0.7	1.6	-1.8
	89.6°F (32°C)	F-Room	-18.0 ↓	-22	-21.5	-20.9	-22.5
		R-Room	5.0 ↓	2	1.3	5.9	0.8
	Temperature Distribution (Fridge)	F-Room	2.0 ↓	0.2	0.2	0.6	1.3
		R-Room	2.0 ↓	0.4	0.3	1.1	0.5
Running Rate	N-N	80% ↓	68.4	62.5	60.7	56.5	
Noise	Sound power level	46dB ↓	45	41	47	41.7	
	Sound Pressure level	45dB ↓	43.8	38.6	48.2	40.1	

PRODUCT SPECIFICATIONS

2-5) Model Specification & Specification Chart

ITEM	Model		RFG298AA
			Ice & Water Dispenser with Pantry
External size	W		35 3/4 inch (908mm)
	D	On Cabinet	29 1/8 inch (740mm)
		W/O Handle	32 7/8 inch (836mm)
		With Handle	35 3/4 inch (905mm)
	H	W/O Hinge Cap	68 3/4 inch (1743mm)
		With Hinge Cap	69 3/4 Inch (1773mm)
Net Capacity	Total		28.5 Cu.ft (807.1 l)
	Freezer		9.0 Cu.ft(254.9 l)
	Refrigerator		19.5 Cu.ft(552.2 l)
Efficiency of Volume			55.4%
Weight	Set		328.5 Pounds (149kg)
	Packing		359.3 Pounds (163kg)
Packing	Width		38 5/8 Inch (980mm)
	Depth		39 3/8 Inch (1001mm)
	Height		75 5/8 Inch (1923mm)
Compressor			Reciprocate
Rated Frequency and Frequency			AC 115V/60Hz
Refrigerant			R 134a
Foaming Agent			C-Pentane
Refrigerant Input Amount			5.64 oz (160g)
Type Refrigerator			Indirect Cooling Method Refrigerator
Motor Rated Consumption Power			165W
Electric Heater Rated Consumption Power			380W

COLOR			
	Cabinet (Both Side)	Door	Molding
Black	All Black	Empire Black	I Black
Real STS	Noble STS	Versailles Stainless	Creamy STS
White	Snow White	Snow White	Snow White
Platinum STS	Noble STS	Stainless Platinum	Creamy STS

PRODUCT SPECIFICATIONS

Items		Specification				
Model		RFG298AA				
Components for Freezer	Compressor	Model	BK190C-L2C			
		Starting type	BLDC			
		Oil Charge	FREOL α - 15c			
	Evaporator	Freezer	SPLIT FIN TYPE			
		Refrigerator	SPLIT FIN TYPE			
	Condenser		Forced and Natural Convection Type			
	Dryer		Molecular shieve XH-9			
	Capillary tube(Dia x Length)		R: 0.032" x 118" (0.82mm x 3500mm) / F: 0.032" x 118" (0.82mm x 3500mm)			
Refrigerant		R134a				
Room Temperature Sensor Components	Freezer	Model	Temperature Selection	ON(°F)	OFF(°F)	
		THERMISTOR (F-SENSOR) 502AT	-14°F(-26°C)	-11°F(-24°C)	-17°F(-27°C)	
			-2°F(-19°C)	1°F(-17°C)	-5°F(-21°C)	
	8°F(-13°C)	11°F(-12°C)	5°F(-15°C)			
	Refrigerator	Model	Temperature Selection	ON(°F)	OFF(°F)	
		THERMISTOR (R-SENSOR) 502AT	34°F(1°C)	36°F(2°C)	32°F(0°C)	
38°F(3°C)			40°F(4°C)	36°F(2°C)		
46°F(8°C)	48°F(9°C)	44°F(7°C)				
Defrost Related Components	Defrost Cycle	First Defrost Cycle (Concurrent defrost of F and R)		6hr \pm 10min		
		Defrost Cycle(FRE)		12~22hr(vary according to the conditions used)		
		Defrost Cycle(REF)		6~11hr(vary according to the conditions used)		
		Pause time		12 \pm 1min		
	Defrost Sensor	F Defrost-Sensor	Model	THERMISTOR (502AT)		
			SPEC	5.0 $\kappa\Omega$ at 77°F(25°C)		
		R Defrost-Sensor	Model	THERMISTOR (502AT)		
			SPEC	5.0 $\kappa\Omega$ at 77°F(25°C)		
	Bimetal	F Bimetal-thermo Protector	Rated	AC 125V 10A		
			Operating temperature	Off : 140°F(60°C) / On : 104°F(40°C)		
R Bimetal-thermo Protector		Rated	AC 125V 10A			
		Operating temperature	Off : 140°F(60°C) / On : 104°F(40°C)			

PRODUCT SPECIFICATIONS

Items		Specification	
Model		RFG298AA	
Electric Components	Defrost Heater(FRE)	Heated at F Defrost AC 115V, 240W	
	Defrost Heater(REF)	Heated at R Defrost AC115V, 120W	
	DISPENSER Heater	Interlock with French Heater AC115V, 1.6W	
	FRENCH Heater	- AC115V, 8W	
	ICE Duct Heater	Interlock with Defrost Heater (FRE) AC115V, 4W	
	Water Tank Heater	- DC 12V, 2W	
	Water Pipe Heater	- DC 12V, 2W	
	Bimetal thermo for Preventing Overheating of Refrigerator Lamp		AC125V 6A / AC250V 3A Off: 140°F(60°C)/ On : 104°F(40°C)
	Over Load Relay	Model	4TM445PHBYY-82
		Temp.ON	156.2± 16.2°F (69± 9°C)
		Temp.OFF	257± 9°F (125± 5°C)
	Rated Voltage		AC 115V/ 60Hz
	Motor-BLDC(FRE)		DC12V / DREP5020LC
	Motor BLDC(ICE ROOM)		DC12V / DREP5020LB
	Motor-BLDC(REF)		DC12V / DREP5020LC
	Motor-BLDC(CIRCUIT)		DC12V / DRCP5030LA
	Motor-DAMPER(PANTRY)		DC12V / NSBY001TD1
	Lamp(FRE)		AC 120V / 60W(1EA)
	Lamp LED (REF)		DC 12V / 720mA
	Lamp LED (VEG)		DC 12V / 60mA
	Door Switch	FRE	AC 125V 1.5A (1EA)
		REF	DC200V 1.5A / MS-406-SS-01(2EA)
		REF(ICE ROOM)	125V/5A, EMB816
Power Cord		AC125V 15A	
Earth Screw		BSBN (BRASS SCREW)	

PRODUCT SPECIFICATIONS

2-6)Dimensions of Refrigerator (Inches)

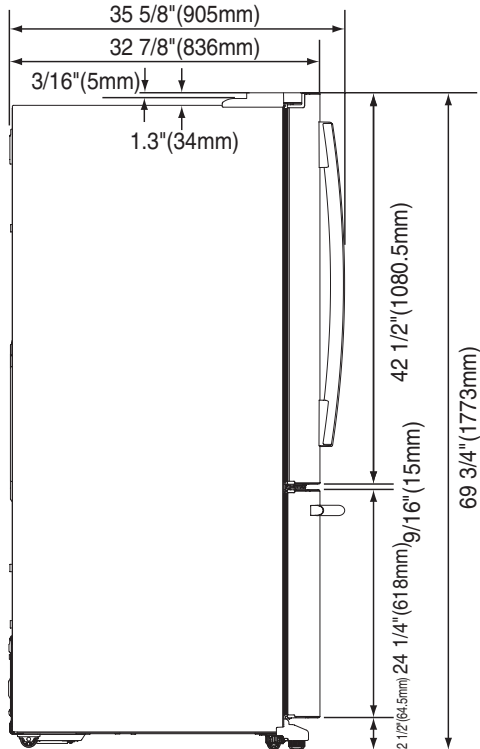
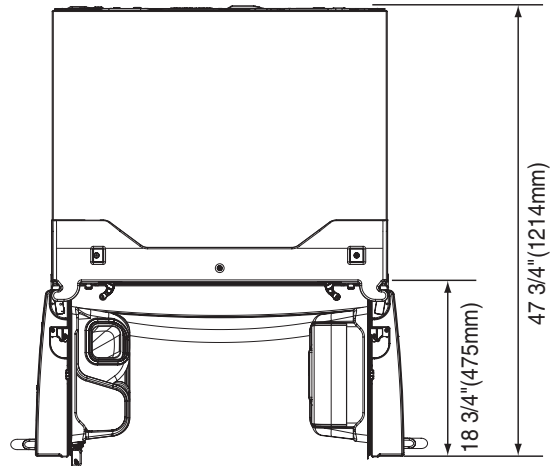
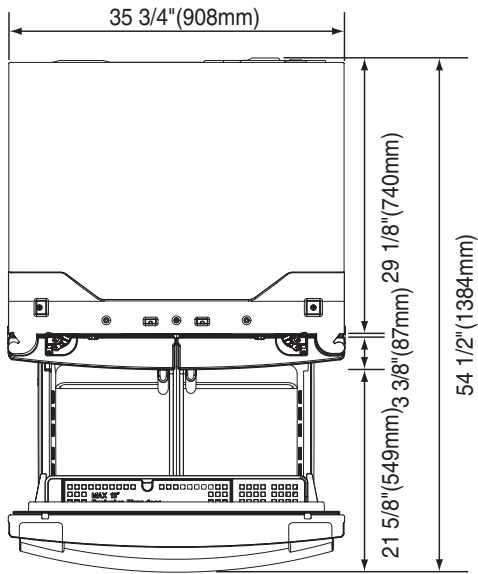

PRODUCT SPECIFICATIONS

2-7) Optional Material Specification

	Part Name	Part Code	AMOUNT
	<p>FILTER WATER-ASSY</p>	<p>DA29-00003B</p>	<p>1</p>
	<p>ASSY-PACKING SUB</p>	<p>DA99-00240S</p>	<p>1</p>
	<p>INCANDESCENT LAMP</p>	<p>4713-001223</p>	<p>1</p>
	<p>LED LAMP</p>	<p>DA96-00329A</p>	<p>1</p>

PRODUCT SPECIFICATIONS

2-8) Refrigerant Route in Refrigeration cycle

1. Compressor → Sub-condenser → Hot Pipe → Back Cluster Pipe → Dryer → R Capillary Tube → Refrigerator Evaporator → Freezer Evaporator → Suction Pipe → Compressor
2. Compressor → Sub-condenser → Hot Pipe → Back Cluster Pipe → Dryer → F Capillary Tube → Freezer Evaporator → Suction Pipe → Compressor

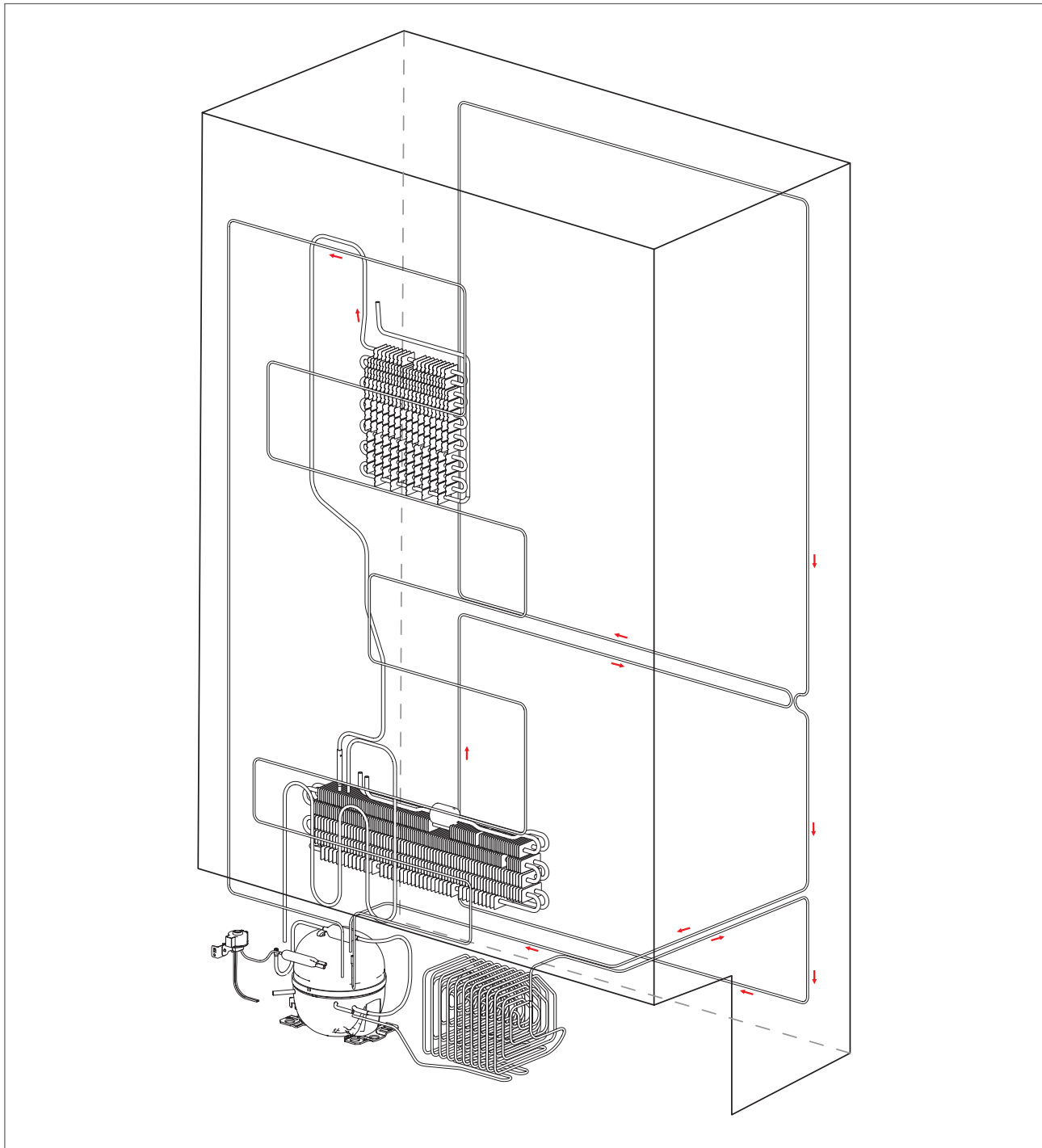

PRODUCT SPECIFICATIONS

2-8-1. PRINCIPLE OF FREEZEER

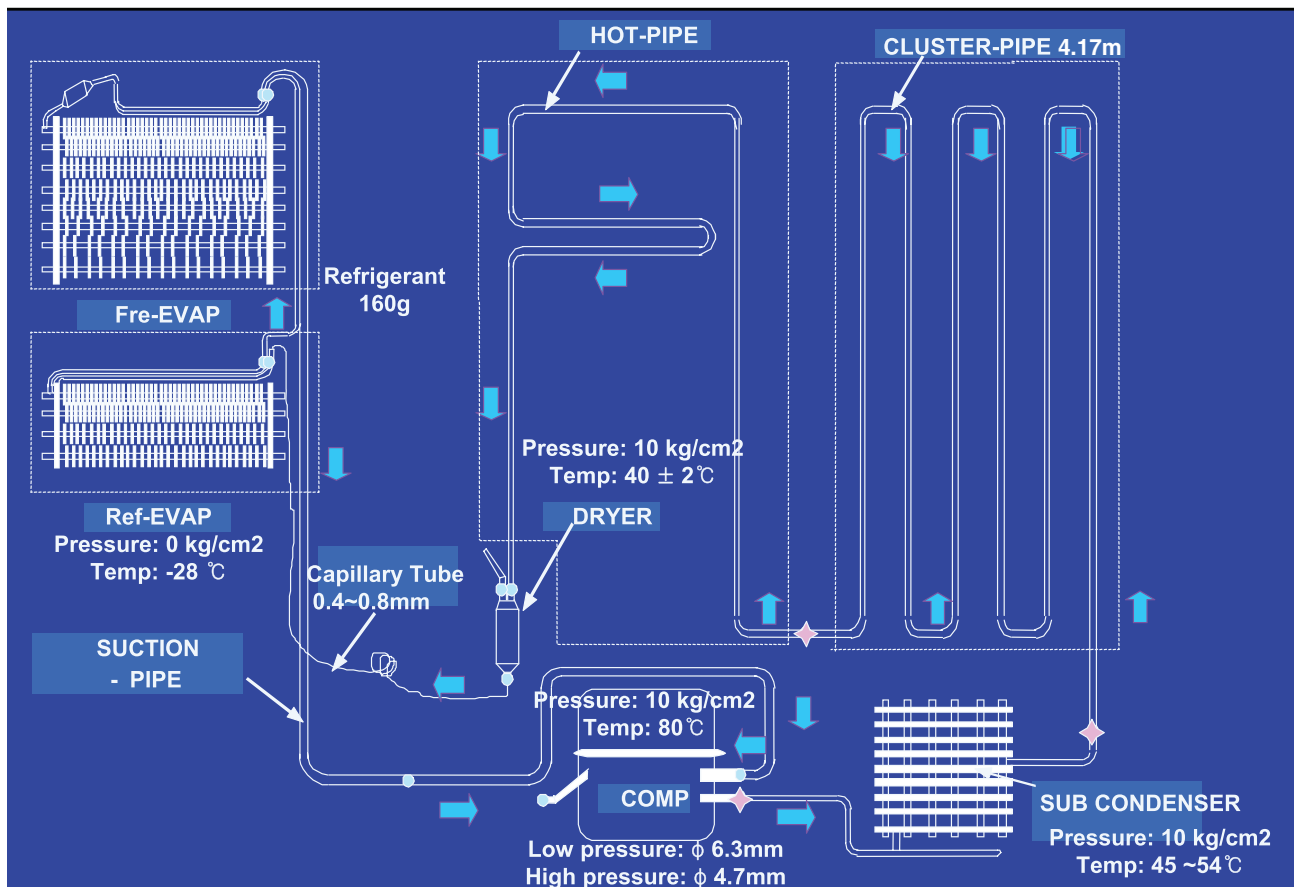
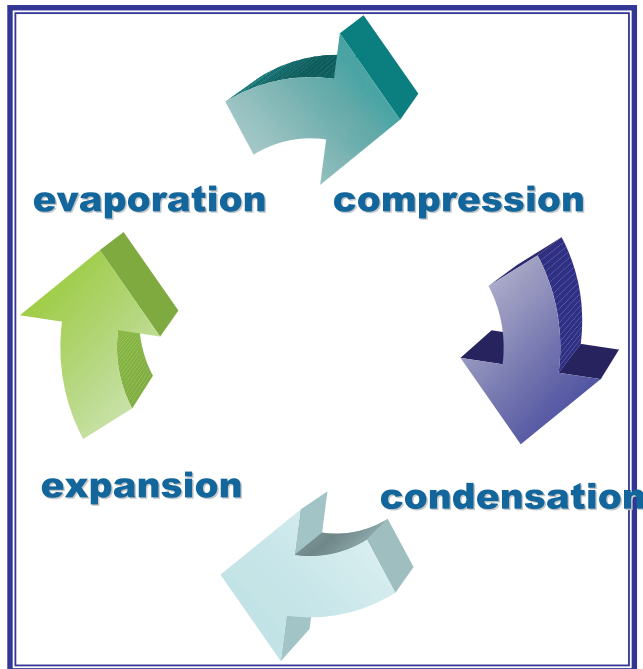

PRODUCT SPECIFICATIONS

2-8-2. Operation theory of refrigeration cycle components

■ Condenser

1) Role: A device which radiates heat to the outside (water/air) to make liquid state for the high temperature / high pressure gas refrigerant discharged from compressor

2) Types

A. Air-cooling Type : Condense air by circulating naturally or manually.

1) Natural Convection Type : Used for the household refrigerator which has small condensing capacity.

2) Manual Convection Type : Circulate air manually by FAN-Motor (Large capacity)

B. Water-cooling Type : Make cooling water pass through the pipe in the condenser (Large capacity)

※ Location

① CLUSTER heat-radiating type : All Pipes effective for radiating heat are formed in the right/left, and front side of refrigerator with hard urethanes and radiate heat through the whole surfaces of cabinet to ambient air.

② Install the condenser on the outside of the product. (An old model)

③ Make them cluster at the lower part of product and radiate heat manually by fan.

☞ Radiate condensed potential heat up to liquefy completely and make change the state without changing the gas temperature itself.

※ Pipe thickness

① Low pressure: 6.3mm ② High pressure : 4.7mm ③ Capillary : About 0.4-0.8mm

※ Condenser length (Based on 300 l) : 26.5 M

① Assistance : 5 M ② HOT-PIPE: 6.6 M ③ CLUSTER-PIPE: 4.17 M

■ Capillary

1. Role: A device which makes low temperature and pressure refrigerant by reducing the pressure the normal temperature / high pressure liquid refrigerant condensed from condenser, and supply it to the evaporator.

A. To evaporate more lower temperature in case of evaporation.

B. It flows to the evaporator without back flowing to condenser, if compressor stops, and the difference of pressure between high pressure and low pressure is small so it is easy to operate the compressor again.

2. Outline

A. Thickness : About 0.4-0.8mm

B. Length : It is changeable to low temperature and pressure (10-5Pa) depends on the 2M of thin and long copper pipe wall resistance.

2-8-3. Operation theory of refrigeration cycle components

■ Evaporator

1. Role: As the low pressure liquid refrigerant flowed from capillary absorbs heat inside of the refrigerator, it becomes low pressure gas and refrigerate the foods.
2. Theory: The low pressure refrigerant flowed to evaporator operates cooling which takes ambient evaporated potential heat with maintaining the evaporation up to evaporate completely.
3. Types of Evaporator
 - A. ROLL-BOND Evaporator → Direct Cooling ONE-DOOR Type
 - ☞ Rolled and adhere the 2 aluminum plate and then make refrigerant passage.
 - B. PIN-PIPE Type → Indirect cooling TWO-DOOR Type
 - ☞ a small aluminum plate on the aluminum pipe to increase the cooling effect.

■ Compressor

1. Role: It operates same as pump which pull out the subterranean water. It inhales the low temperature and pressure refrigerant gas (flowed out) from evaporator and make high temperature and pressure refrigerant liquid in the compressor and send it to the condenser.
2. Type of Condenser
 - a. Back-and-forth motion type: A method that piston makes back-and-forth motion through shaft and cylinder of motor rotation and compresses. ※ Used for household refrigerant
 - b. Rotary Type: A method that inhales the refrigerant gas through the gap between the outside of rotor electric attached on the shaft and the inside of cylinder and compresses.
 - c. Centrifugal Type
3. Please insert the explanation of inverter comp operation theory.

■ Dryer

1. Role: Absorb the moisture from the refrigerant that refrigeration cycle circulates and eliminate the foreign substance.
2. Structure: If even some moisture is included refrigerant is impossible to circulate by freezing the small capillary outlet, so silica gel or molecular sieve is (included and) sealed to absorb the internal moisture, and install a minute net to eliminate the foreign substance.

2-8-4. Operation theory of refrigeration cycle components

※ .Influence of moisture

- ① Moisture precipitation – Blocked by ice
- ② Refrigerant and reaction
- ③ Life reduction of oil
- ④ Acceleration of oxidization
- ⑤ Copper plating phenomenon
- ⑥ Gas dissolution by the interaction of synthetic insulating material (insulator)

※ .Influence of foreign substance

- ① Increase of condensed temperature.
- ② Increase of temperature.
- ③ Decrease of cooling efficiency
- ④ Shorten the life by friction between oil and foreign substance in the compressor.

■ Accumulator

1. Role : To send a pure refrigerant gas to compressor by removing completely the refrigerant liquid from evaporator.

※ If a refrigerant liquid go into the compressor, overload is occurred.

PRODUCT SPECIFICATIONS

2-8-5. Refrigeration Cycle Type

TDM Cycle

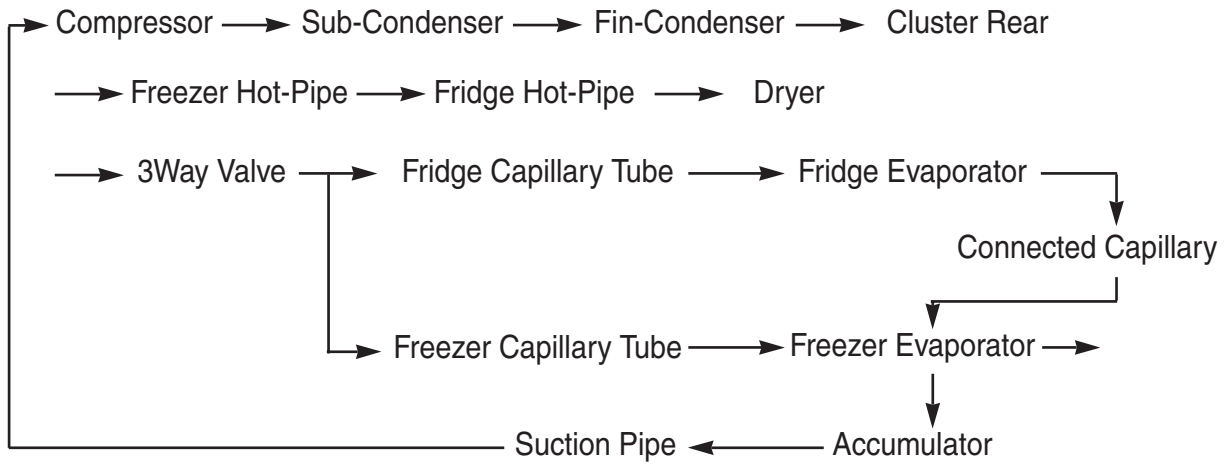

HM Cycle

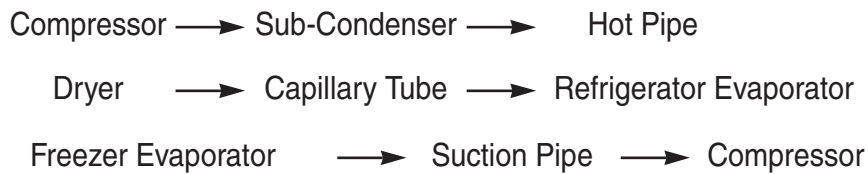

PRODUCT SPECIFICATIONS

2-9) Cooling Air Circulation

Refrigerator

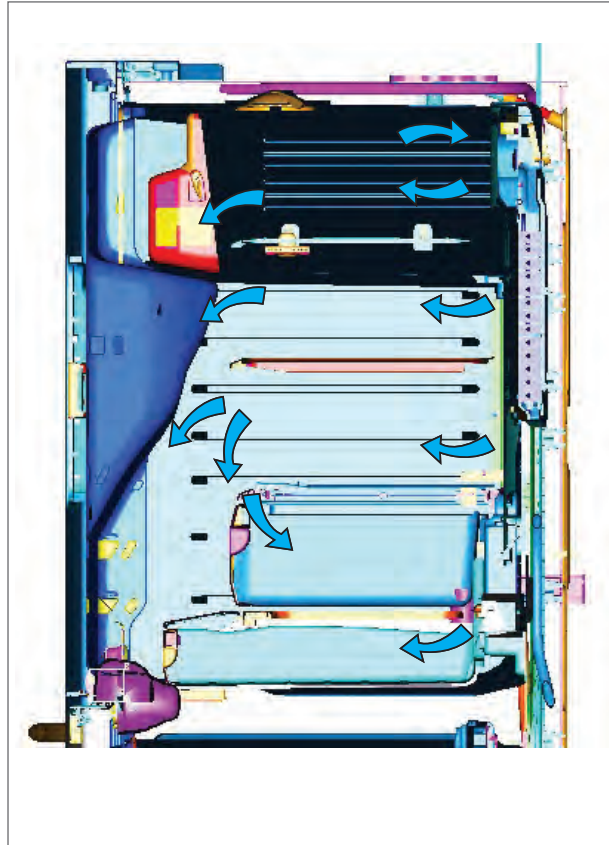

Freezer

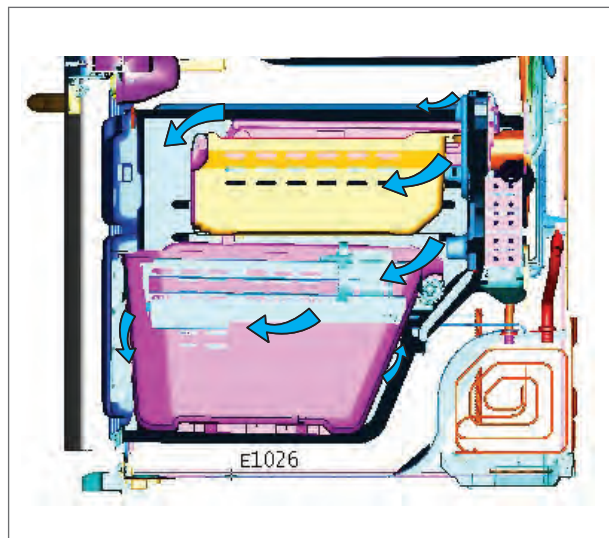

3. DISASSEMBLY AND REASSEMBLY





3-1) PRECAUTION	27
3-2) REFRIGERATOR DOOR	28
3-3) DOOR HANDLE FREEZER	30
3-4) REFRIGERATOR LIGHT	31
3-5) COVER-DISPLAY & WATER-DISPENSER	31
3-6) WATER-DISPENSER	32
3-7) GLASS SHELF	33
3-8) FOLDABLE GLASS SHELF	34
3-9) VEGETABLE & FRUIT DRAWERS SHELF	34
3-10) COOL SELECT PANTRY	35
3-11) WATER TANK	36
3-12) MOTOR DAMPER	38
3-13) WATER FILTER (DISASSEMBLY)	38
3-14) WATER FILTER (REASSEMBLY)	39
3-15) GALLON DOOR BIN	39
3-16) VERTICAL HINGED SECTION	40
3-17) EVAPORATOR COVER IN REFRIGERATOR	41
3-18) EVAPORATOR IN REFRIGERATOR	42
3-19) FREEZER DOOR	43
3-20) PULL OUT DRAWER	44
3-21) ICE-MAKER	45
3-22) FREEZER LIGHT	46
3-23) DOOR SWITCH IN FREEZER	46
3-24) EVAPORATOR COVER IN FREEZER	47
3-25) EVAPORATOR IN FREEZER	47
3-26) MACHINE COMPARTMENT	48
3-27) ELECTRIC BOX	51

DISASSEMBLY AND REASSEMBLY

3-1) PRECAUTION

- Unplug the refrigerator before cleaning and making repairs.
- Do not disassemble or repair the refrigerator by yourself.
 - It may cause risk of causing a fire, malfunction and/or personal injury.
- Remove any foreign matter or dust from the power plug pins.
 - Otherwise there is a risk of fire.
- Do not use a cord that shows cracks or abrasion damage along its length or at either end.
- Do not plug several appliances into the same multiple power board. The refrigerator should always be plugged into its own individual electrical which has a voltage rating that matched the rating plate.
 - This provides the best performance and also prevents overloading house wiring circuits, which could cause a fire hazard from overheated wires.
- Do not install the refrigerator in a damp place or place where it may come in contact with water.
 - Deteriorated insulation of electrical parts may cause an electric shock or fire.
- The refrigerator must be grounded.
 - You must ground the refrigerator to prevent any power leakages or electric shocks caused by current leakage from the refrigerator.
- Do not put bottles or glass containers in the freezer.
 - When the contents freeze, the glass may break and cause personal injury.
- Do not store volatile or flammable substances in the refrigerator.
 - The storage of benzene, thinner, alcohol, ether, LP gas and other such products may cause explosions.

- Required Tools

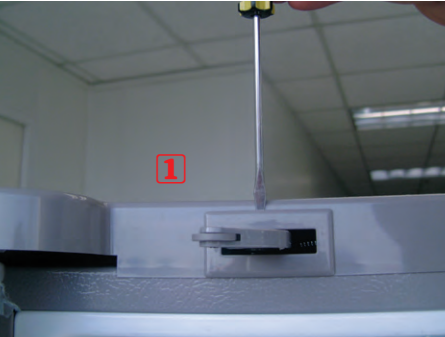

IMAGE	ITEM	USE
	Phillips Head Driver	Use for assembling and disassembling of screw
	Flat Head Driver	Use for assembling and disassembling of HomeBar, Dispenser, Deli Cartessen Box, Main PBA etc...
	Hex Wrench \varnothing 2mm	Use for assembling and disassembling of Handle
	Socket Wrench \varnothing 10mm	Use for assembling and disassembling of Door Hinge

- Water whitening phenomenon

All water provided to refrigerators flows through the core filter which is an alkaline water filter. In this process, the pressure in the water that has flowed out of the filter gets increased, and massive oxygen and nitrogen become saturated. When this water flows out in the air, the pressure plummets and the oxygen and nitrogen get supersaturated so that they turn into gas bubbles. The water could look misty due to these oxygen bubbles. It is not because dust or chemicals, just a few seconds later, it will be clean again.

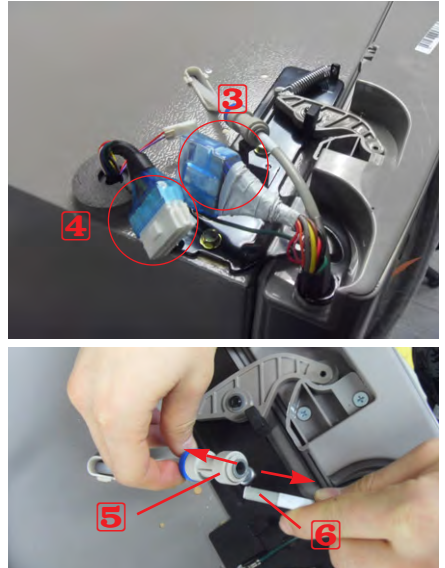
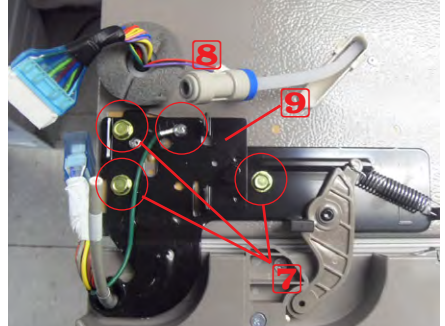

DISASSEMBLY AND REASSEMBLY

3-2) Refrigerator Door

Part Name	How To Do	Descriptive Picture
<p style="text-align: center;">Refrigerator Door</p>	<p>1. With the door opened, remove the Top Table cap(1) with a Flat head screwdriver, and close the door.</p>	
	<p>2. Remove the 3 screws holding down the Top Table and remove the Top Table(2).</p>	
	<p>3. Disconnect the electrical connector(3) above the upper right door hinge and the 3 electrical connectors(4) above the upper left door hinge. Disconnect the fastener in tube fitting(5) and the water tube(6) by pulling the tube fitting (5) apart as shown in the picture.</p>	
	<p>4. Remove the 3 hex head bolts(7) attached to the upper left and right door hinges with a Wrench(10mm). With a Philips head screwdriver, remove the ground screw(8) attached to the upper left and right door hinges. Remove the upper left and right door hinges(9).</p>	

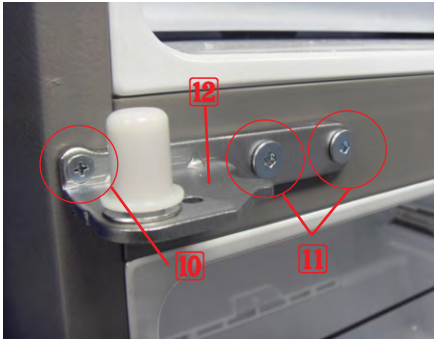



DISASSEMBLY AND REASSEMBLY

Part Name	How To Do	Descriptive Picture
Refrigerator Door	5. Lift the door straightly up to remove.	
	6. With a Philips head screwdriver, remove the two screws (10) attached to the lower left and right door hinges. With a wrench(10mm), remove the 2 flat head screws (11) attached to the lower left and right door hinges. Remove the lower left and right door hinges (12).	

Part Name	How To Do	Descriptive Picture
COVER VINYL	1. Using a wrench, unscrew the two screws. And disassemble the door handle.	
	2. Remove the cover vinyl of door.	

DISASSEMBLY AND REASSEMBLY

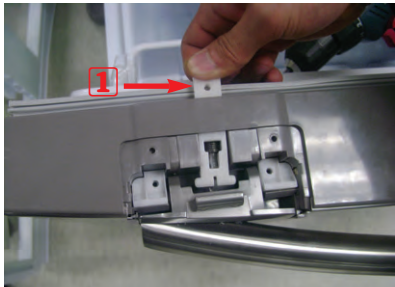
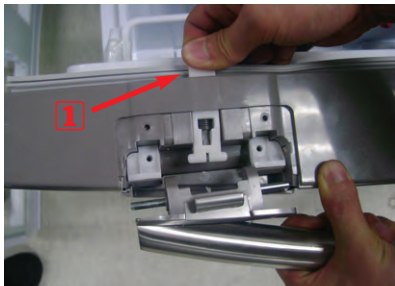
3-3) Door Handle Freezer

Part Name	How To Do	Descriptive Picture
<p>Door Handle Freezer</p>	<p>1. Remove the Cap Door with a flat-blade(-) screwdriver.</p>	
	<p>2. Remove 4 screws</p>	
	<p>3. Lift up the handle to have the Slider Handle Fre(1) pushed back.</p>	
	<p>4. After having the Slider Handle Fre(1) pushed back, screw up at the hole.</p>	
	<p>5. Remove the door handle by lifting it up.</p>	

DISASSEMBLY AND REASSEMBLY

3-4) Refrigerator Light

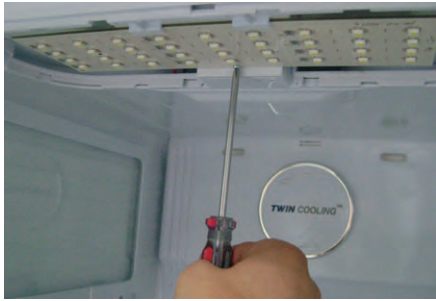
Part Name	How To Do	Descriptive Picture
Refrigerator Light	1. Remove the lamp cover by pulling it down as pushing the rear of lamp cover.	
	2. Remove the screw. And separate the LED panel.	

3-5) Cover-Display & Water-Dispenser

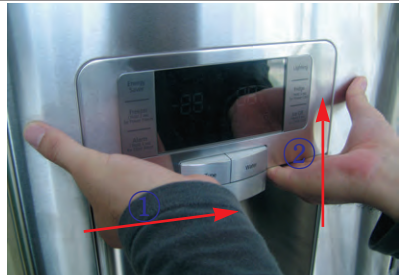
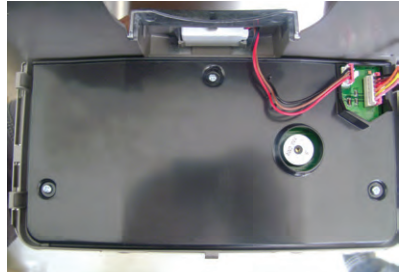
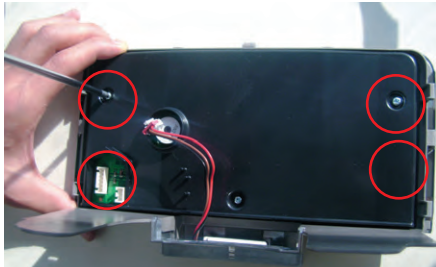

Part Name	How To Do	Descriptive Picture
Cover-Display	1. Remove the display cover by pushing it to the right side and pulling it up.	
	2. Disengage the housing connect of display cover.	
	3. Remove 4 screws of cover-display.	

DISASSEMBLY AND REASSEMBLY

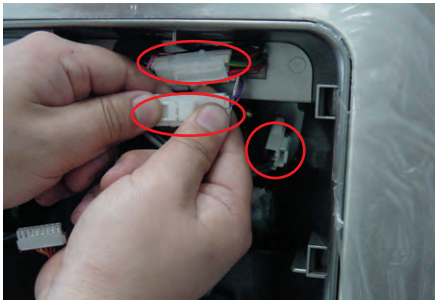
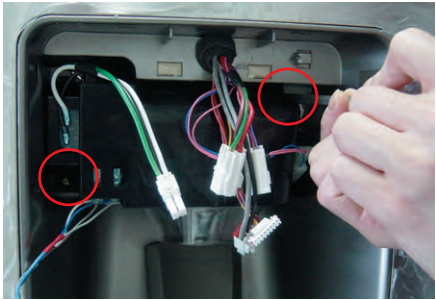
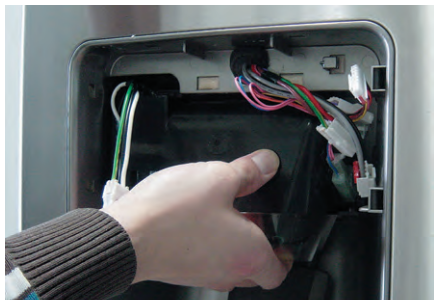
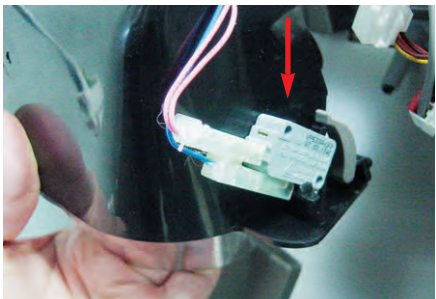
3-6) Water-Dispenser

Part Name	How To Do	Descriptive Picture
Water-Dispenser	1. Disengage the 3 Housing Connectors.	
	2. Remove 2 screws of the Case Ice Route Assy.	
	3. Pull the Case Ice Route Assy.	
	4. Push the hook and remove the Micro Switch.	

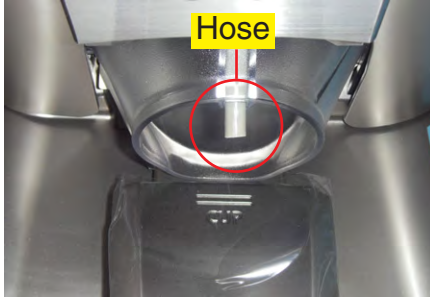
DISASSEMBLY AND REASSEMBLY

Part Name	How To Do	Descriptive Picture
Water-Dispenser	<p>1. Assembly shall be in order from the disassembly. Case-Ice and Route shall be assembled inside of hose. Otherwise, assemble cannot be accomplished.</p>	
	<p>2. When assembling Cover-Display, first insert it from leftside and then assemble to rightside. Otherwise, the hook can be broken.</p>	

3-7) Glass Shelf



Part Name	How To Do	Descriptive Picture
Glass Shelf	<p>Remove the shelf by lifting the front part of the shelf up and pulling it out.</p>	



DISASSEMBLY AND REASSEMBLY

3-8) Foldable Glass Shelf

Part Name	How To Do	Descriptive Picture
Foldable Glass Shelf	Remove 2 screws of the Foldable Glass Shelf	





3-9) Vegetable & Fruit Drawers Shelf

Part Name	How To Do	Descriptive Picture
Vegetable & Fruit Drawers Shelf	1. Remove the vegetable & fruit drawer by pulling the roller part and lifting it up.	
	2. Remove the vegetable & fruit drawer shelf by pulling it out. (Refer to the picture)	

Part Name	How To Do	Descriptive Picture
Vegetable & Fruit LED LAMP	1. Remove 1 screw	
	2. Disengage the housing connector.	



DISASSEMBLY AND REASSEMBLY

3-10) Cool Select Pantry





Part Name	How To Do	Descriptive Picture
Cool Select Pantry	1. Remove the cool select pantry by pulling the roller part and lifting it up.	
Cool Select Pantry Cover	1. Remove the cool select pantry cover by lifting the central part of the cover while pushing it to the left.	
Cool Select Pantry Shelf	1. Remove the cool select pantry shelf by lifting the front part of the shelf while pulling it.	
Cool Select Pantry Rail	1. Remove the cool select pantry rail by unscrewing the 3 screws and pulling the rail.	
	2. Disconnect the housing connector from the internal rail part. (Refer to the picture)	

DISASSEMBLY AND REASSEMBLY

3-11) Water Tank

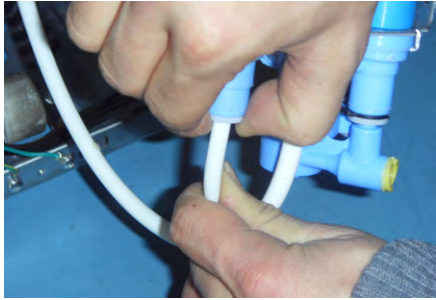

Part Name	How To Do	Descriptive Picture
Water Tank	<p>The Water Tank is located in the lower part of the fridge. Before disassembling the Water Tank take out shelves and drawers and pantry located in front of the Water Tank.</p> <p>1. Remove 2 screws of the Water Tank cover.</p>	
	<p>2. Disengage the housing connector.</p>	
	<p>3. Remove the 1 screws attached to the Water Tank Heater. Remove the Water Tank heater. Remove the Water Tank cover.</p>	

DISASSEMBLY AND REASSEMBLY

Part Name	How To Do	Descriptive Picture
<p>Water Tank</p>	<p>One Water Tube is located in the machine compartment of the refrigerator. Before disassembling the Water Tube, take out the compressor cover.</p> <p>5. Remove the water valve fixed by the screw.</p>	
	<p>6. Disconnect the water tube by pushing the tube fitting apart as shown in the picture.</p>	
	<p>The other Water Tube is located in the Top Table of the refrigerator. Before disassembling the Water Tube, take out the Top table.</p> <p>7. Remove the cap tube fitting with a flat head screwdriver.</p>	
	<p>8. Disconnect the Water Tube by pushing the tube fitting apart as shown in the picture.</p>	
	<p>9. Remove the Water Tank by pulling the Water Tube.</p>	

DISASSEMBLY AND REASSEMBLY

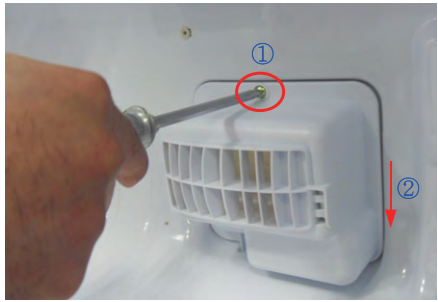
3-12) Motor Damper



Part Name	How To Do	Descriptive Picture
Motor Damper	1. Remove the cool select pantry. Remove the screw of motor damper part and then push the motor damper down.	
	2. Disengage 2 housing connectors from the rear motor damper. (Refer to the picture)	

3-13) Water Filter (Disassembly)

Part Name	How To Do	Descriptive Picture
Water Filter	<ol style="list-style-type: none">1. Remove the shelf by lifting the front plane of the shelf up and pulling it out.2. Remove the water filter by turning it clockwise. (Refer to the picture)	

DISASSEMBLY AND REASSEMBLY

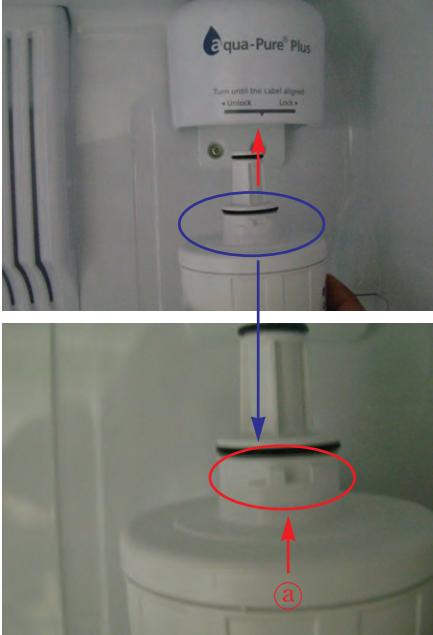
3-14) Water Filter (Reassembly)



Part Name	How To Do	Descriptive Picture
<p style="text-align: center;">Water Filter</p>	<p>1. Place the part of (a) arrow (that is indicating in the picture) in the middle of the front filter cover and push it up.</p>	
	<p>2. Turn the water filter counterclockwise until central horizontal line of filter cover and both ends of water filter label are aligned. (Refer to the picture.)</p>	

3-15) Gallon Door Bin

Part Name	How To Do	Descriptive Picture
<p style="text-align: center;">Gallon Door Bin</p>	<p>1. Remove the gallon door bin by lifting it up. (Refer to the picture)</p>	



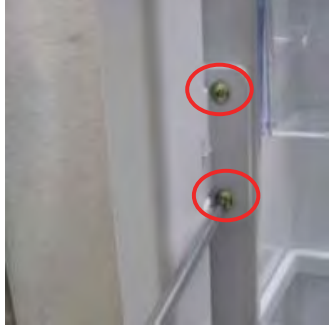

DISASSEMBLY AND REASSEMBLY

3-16) Vertical Hinged Section

Part Name	How To Do	Descriptive Picture
Vertical Hinged Section	1. Remove 2 screw cap parts with a flat-blade(-) screwdriver. (Refer to the picture)	
	2. Unscrew 2 screws.	
	3. Disengage the internal housing connector of the vertical hinge.	
	4. Remove the vertical hinged section by lifting the vertical hinge up. (Refer to the picture)	





DISASSEMBLY AND REASSEMBLY

3-17) Evaporator Cover In Refrigerator

Part Name	How To Do	Descriptive Picture
<p>Evaporator Cover In Refrigerator</p>	<p>1. Remove the angle cap with a flat-blade screwdriver. (Refer to the picture)</p>	
	<p>2. Unscrew 4 screws.</p>	
	<p>3. Remove the the lower part of angle mid by pulling it out and pushing it down. (Refer to the picture)</p>	
	<p>4. Remove the hook by pulling it from the lower part and pushing the cover down. (Refer to the picture)</p>	
	<p>5. Disconnect the housing connector of the rear plane. (Refer to the picture)</p>	



DISASSEMBLY AND REASSEMBLY

3-18) Evaporator In Refrigerator

Part Name	How To Do	Descriptive Picture
Evaporator In Refrigerator	1. Remove the the housing cover by pushing both lateral sides of the housing cover and pulling it out. (Refer to the picture)	
	2. Disconnect the housing connector part. (Refer to the picture)	
	3. Unscrew 2 screws.	
	4. Remove the evaporator by lifting the bottom side of it up and pulling it out. (Refer to the picture)	

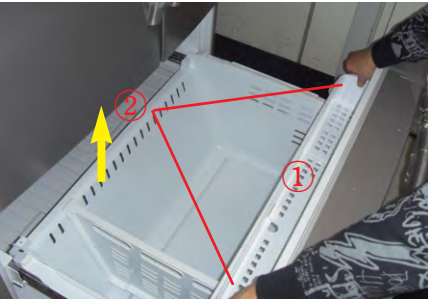

DISASSEMBLY AND REASSEMBLY

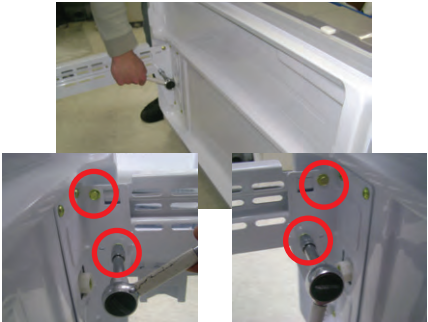
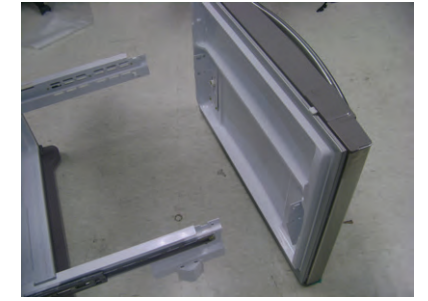
3-19) Freezer Door

Part Name	How To Do	Descriptive Picture
Freezer Door	1. Pull the drawer open to full extension.	
	2. Remove the tilting Pocket(①) by pulling the both brackets(②) upward at the same time.	
	3. Take out the lower basket(③) by lifting the basket up from rail system.	
	4. Unscrew 4 bolts. (2 bolts each on the both sides)	
	5. Lifting up the freezer door, remove the freezer door from the rail.	





DISASSEMBLY AND REASSEMBLY

3-20) Pull Out Drawer

Part Name	How To Do	Descriptive Picture
Door Handle Freezer	1. Slide the drawer in as much as possible.	
	2. Lift the drawer up.	
	3. Remove the pull out drawer by lifting the bottom part of drawer bin and pulling it out.	

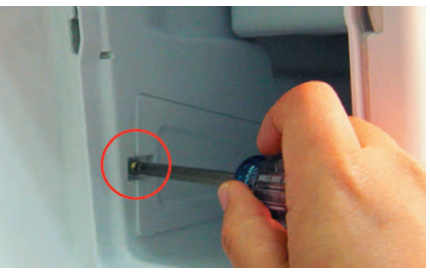
DISASSEMBLY AND REASSEMBLY

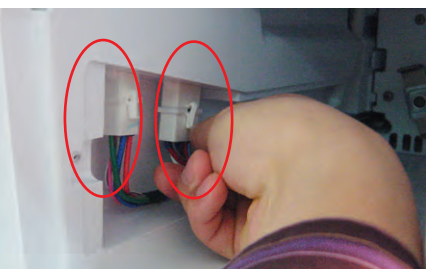
3-21) Ice-Maker

Part Name	How To Do	Descriptive Picture
<p>Ice Maker</p>	<p>1. Pull the lever forward and take out the ice bucket.</p>	
	<p>2. Remove 1 screw of the Cover.</p>	
	<p>3. Disassemble the cover with a flat-blade(-) screwdriver and pull it out.</p>	
	<p>4. Disengage the 2 housing connectors.</p>	
	<p>5. Push the hook and pull the Ice-Maker out.</p>	
	<p>6. To disassemble, push the tab and pull the Case-Auger and the motor out.</p>	

DISASSEMBLY AND REASSEMBLY

3-22) Freezer Light

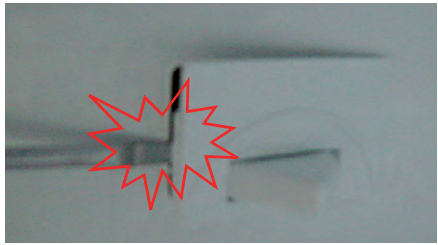
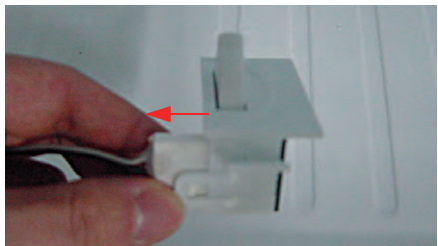

Part Name	How To Do	Descriptive Picture
Freezer Light	1. Remove the light by pulling the light cover down while pushing the rear plane of light cover.	

3-23) Door Switch In Freezer



Part Name	How To Do	Descriptive Picture
Door Switch In Freezer	1. Remove the freezer drawer bin by using a flat-blade(-) screwdriver.(Refer to the picture)	
	2. Disconnect the housing connector part.	

DISASSEMBLY AND REASSEMBLY

3-24) Evaporator Cover In Freezer





Part Name	How To Do	Descriptive Picture
Evaporator Cover In Freezer	1. Remove the freezer door and freezer drawer by pulling out the drawer and then unscrewing 2 screws.	
	2. Lift up the evaporator cover.	
	3. Disengage the 3 housing connectors and remove the evaporator cover.	

3-25) Evaporator In Freezer



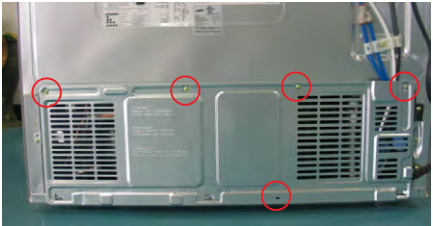
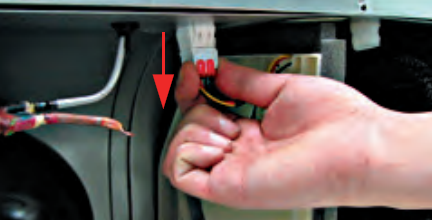

Part Name	How To Do	Descriptive Picture
Evaporator In Freezer	1. Remove the housing cover by pushing both lateral sides of housing cover part and pulling it out. Remove the housing connector part.	
	2. Remove the evaporator by pulling the lower part of the evaporator while lifting it up.	

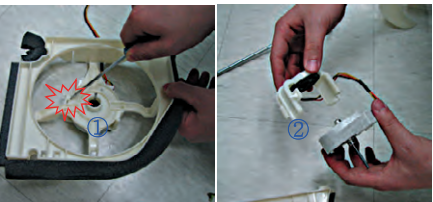
DISASSEMBLY AND REASSEMBLY

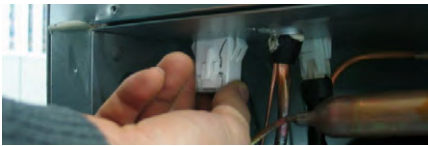

3-26) Machine Compartment

Part Name	How To Do	Descriptive Picture
<p>Motor Fan</p>	<p>1. Unscrew 5 screws of cover compressor.</p>	
	<p>2. Disengage the housing connector. (Refer to the picture)</p>	
	<p>3. Remove the hooker of support circuit motor by lifting the hooker up and pulling it out.</p>	
	<p>4. Remove the screw with a flat-blade screwdriver. (Refer to the picture)</p>	
	<p>5. Remove the motor fan by pulling the fan out while grasping the motor part. (Refer to the picture)</p>	
	<p>6. Unscrew 2 screws fixed in the motor.</p>	
	<p>7. Remove the hook of the motor cover with a flat-blade (-) screwdriver and then remove the motor.</p>	

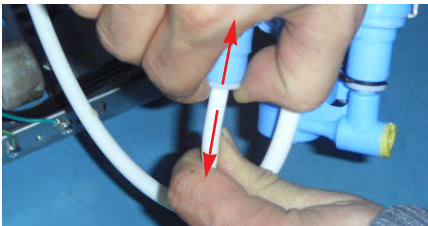
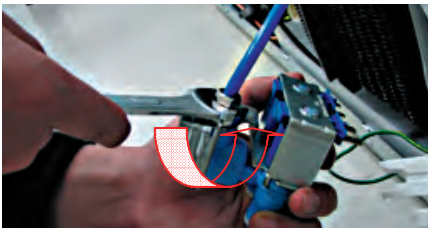
DISASSEMBLY AND REASSEMBLY



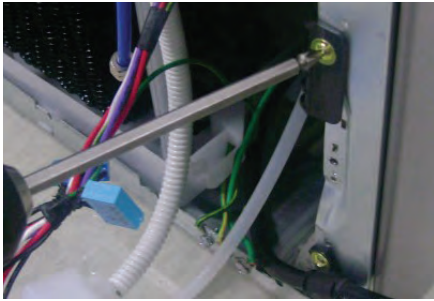
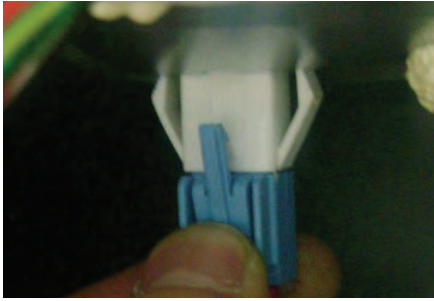
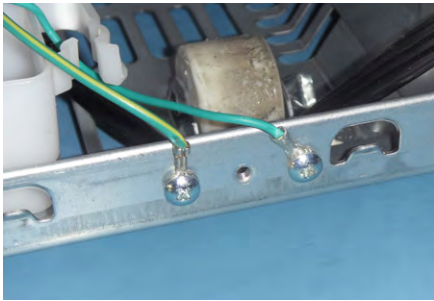

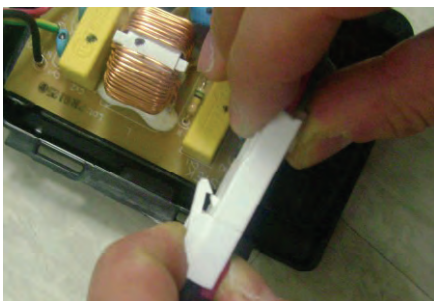
Part Name	How To Do	Descriptive Picture
<p>Relay O/L</p>	<p>1. Disengage the housing connector.</p>	
	<p>2. Remove Cover Relay.</p>	
	<p>3. Remove the relay O/L with a flat-blade screwdriver. (Refer to the picture)</p>	
<p>Water Valve</p>	<p>1. Unscrew the screw which is fixing the Water Valve.</p>	
	<p>2. Disassembling the fixer hose which is fixing the four hoses like a picture.</p>	
	<p>3. Remove 2 water hose parts while pushing the upper part of ①. (Refer to the picture)</p>	
	<p>4. Remove the hose connected by the nut with a wrench(8mm).</p>	

DISASSEMBLY AND REASSEMBLY

Part Name	How To Do	Descriptive Picture
Power Cord & Noise Filter	1. Unscrew 2 screws.	
	2. Disengage the housing connector.	
	3. Unscrew 2 earth screws.	
	4. Remove the cover by pushing the hook up using a flat-blade(-) screwdriver. (Refer to the picture)	
	5. Disengage the housing connector to separate the power cord and noise filter.	

DISASSEMBLY AND REASSEMBLY

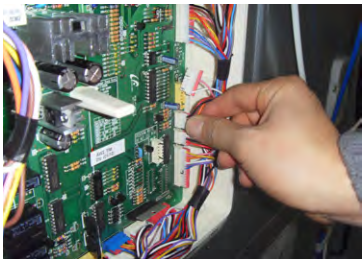
3-27) Electric Box

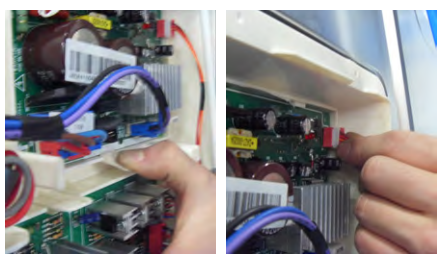
Part Name	How To Do	Descriptive Picture
<p>PBA Main</p>	<p>1. Pull the refrigerator forward to have enough space to work at the rear side of the appliance.</p>	
	<p>2. Unscrew 2 screws of the PCB cover.</p>	
	<p>3. Disengage all housing connectors from the main PCB.</p>	
	<p>4. Remove the main PCB by lifting the upper part of the hook up. (Refer to the picture)</p>	
<p>PBA SMPS</p>	<p>1. Remove the cover PCB and then disengage the housing connector connected with main PCB. Remove the SMPS PCB by pushing the lower part of the hook down.</p>	

4. TROUBLESHOOTING

4-1) FUNCTION FOR FAILURE DIAGNOSIS	53
4-1-1. TEST MODE (MANUAL OPERATION / MANUAL DEFROST FUNCTION)	53
4-1-2. DISPLAY FUNCTION OF COMMUNICATION ERROR	54
4-1-3. SELF-DIAGNOSTIC FUNCTION	55
4-1-4. DISPLAY FUNCTION OF LOAD CONDITION	58
4-1-5. EXHIBITION MODE SETTING FUNCTION	59
4-1-6. OPTION SETTING FUNCTION	60
4-1-7. OPTION TABLE	62
4-2) DIAGNOSTIC METHOD ACCORDING TO THE TROUBLE SYMPTOM(FLOW CHART)	64
4-2-1. IF THE TROUBLE IS DETECTED BY SELF-DIAGNOSIS	65
4-2-2. IF FAN DOES NOT OPERATE(F, R, C - FAN)	76
4-2-3. IF ICE ROOM FAN DOES NOT OPERATE	77
4-2-4. IF ICE MAKER DOES NOT OPERATE	78
4-2-5. IF DEFROST DOES NOT OPERATE	79
4-2-6. IF DEFROST DOES NOT OPERATE (F,R DEF HEATER)	80
4-2-7. IF POWER IS NOT SUPPLIED	81
4-2-8. IF COMPRESSOR DOES NOT OPERATE	82
4-2-9. WHEN ALARM SOUNDS CONTINUOUSLY WITHOUT STOP(RELATED WITH BUZZER SOUND)	84
4-2-10. IF PANTRY PANEL PCB IS NOT WORKING NORMALLY	86
4-2-11. IF PANTRY PANEL PCB IS NOT WORKING NORMALLY	87
4-2-12. WHEN REFRIGERATOR ROOM LAMP DOES NOT LIGHT UP	88
4-2-13. IF ICE WATER IS NOT SUPPLIED	90
4-2-14. IF CUBED OR CRUSHED ICE IS NOT SUPPLIED	92
4-2-15. IF COVER ICE ROUTE MOTOR(GEARD MOTOR) IS NOT WORKING NORMALLY	93
4-2-16. IF PHOTOSYNTHETIC LED LAMP DOES NOT WORK PROPERLY	94
4-2-17. IF INVERTER PCB POWER IS NOT SUPPLIED	95
4-2-18. IF COMPRESSOR DOES NOT OPERATE	96
4-2-19. LED BLINKING FREQUENCY DEPENDING ON PROTECTING FUNCTIONS	97
SPM INTERNAL DIODE VOLTAGE	98
INVERTER CONTROLLER BOARD CONNECTOR LOCATION	99
INVERTER PCB CIRCUIT DIAGRAM	100

TROUBLESHOOTING

4-1) Function for failure diagnosis

4-1-1. Test mode (manual operation / manual defrost function)

- If Energy Saver Key + Fridge Key on the front of panel are pressed simultaneously for 8 seconds , it will be changed to the test mode and all displays on the front of panel will be off.
- If any key on the front of panel is pressed within 15 seconds after the test mode, it will be operated as below sequence :
manual operation(Freezer compartment 1) → manual operation(Freezer compartment 2) → manual operation(Freezer compartment 3) → manual defrost of fresh food and freezer compartments(Fd) → Cancel(Display all off).
- If any key on the front of panel is not pressed within 15 seconds after the test mode, the test mode will be canceled and it will be returned to previous mode.
- If the test mode is canceled, Recommend the power off and reactivate the refrigerator.

1) Manual operation function

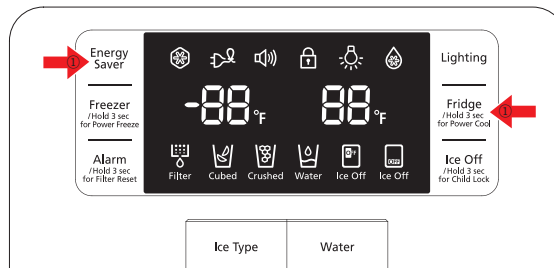

- ① If Energy Saver Key + Fridge Key are pressed simultaneously for 8 seconds, (displays are all off)

It will be changed to the test mode (manual operation) by pressing any key

- 1-1) If any key is pressed once in test mode, blinks "FF-1" on the display and it indicates the refrigerator has entered the manual operation. At this moment, buzzer beeps as an alarm.
- 1-2) If any key is pressed once at the manual operation1 status, FF-2 will be displayed. And if any key is pressed one more time, FF-3 will be displayed. FF-2 and FF-3 means manual operation2 and 3 separately. These 3 functions operate with different RPM of COMP.
- 1-3) If manual operation is selected, compressor will run at once without 7 minutes delay in any mode. If the refrigerator is on the defrost cycle at the moment, defrost will be finished and manual operation will begin.
(Be careful if manual operation get started at the moment of compressor off, over load could be occurred.)

Compulsion working 1 : 3600RPM

Compulsion working 2 : 2450RPM

Compulsion working 3 : 2200RPM

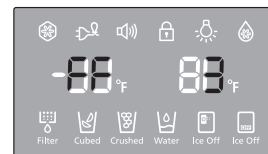
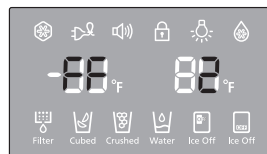
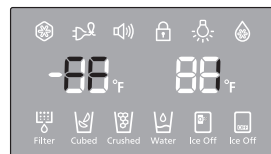

- 1-4) If manual operation works, compressor & f-fan operate continuously for 24 hours and fresh food compartment will be controlled by the setting temperature.
- 1-5) When the manual operation runs, setting temperature will be selected automatically as below: freezer compartment -8°F.(-22°C), fresh food compartment 32°F(1°C).
- 1-6) During manual operation, Power Freeze & Power Cool function will not be worked.
If a function is selected, the power function icon of the selected function will be off automatically after 10 seconds.
- 1-7) Manual operation can be canceled by turning on the appliance after power off(reset) or choosing the step 3) test cancel mode.
- 1-8) Alarm(0.25 sec ON/ 0.75 sec OFF) will beep continuously until manual operation is completed and there is no function to make the sound stop.

TROUBLESHOOTING

2) Simultaneous manual defrost(fresh food and freezer compartments) function

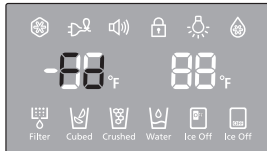

2-1) If any key is pressed one more time during manual operation(fresh food compartment), "Fd" shows in the display and then manual operation will be canceled at once and fresh food and freezer compartment will be defrosted.

2-2) At this moment, alarm beeps for 3 seconds (0.1 sec ON/ 1 sec OFF) during manual defrost function of fresh food and freezer compartment.

3) Test cancel mode

3-1) During the simultaneous defrosting of fresh food and freezer compartments simultaneously, if the display panel change to the test mode and test button is pressed one more time, defrosting of fresh food and freezer compartments will be canceled at the same time and will return to the normal operation. Or, all test functions will be canceled by turning main power OFF and ON.

4-1-2. Display function of Communication error

1) Display function when Panel ↔ MAIN MICOM communication has error

1-1) If there is no answer for 10 seconds after the panel micom received the requirement of communication, "Pc - Er" display on the panel PCB will be ON/OFF alternately until the communication error is canceled. (0.5 sec ALL ON, 0.5 sec ALL OFF alternately)

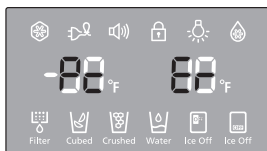

1-2) "Pc - E" display on the Pantry Room Display will be ON/OFF alternately until the communication error is canceled. (0.5 sec ALL ON, 1.5 sec ALL OFF alternately)

2) Display function when Panel ↔ MAIN MICOM OPTION has error

2-1) "OP - Er" code is repeatedly ON/OFF until Option error settles down.

TROUBLESHOOTING

4-1-3. Self-diagnostic function

1) Self-diagnostic function in the Initial power ON

- 1-1) Micom operates self-diagnostic function to check the temperature sensor condition within 1 second when the refrigerator turned On initially.
- 1-2) If bad sensor is detected by the self-diagnostic function, the applicable display LED will blink for 0.5 sec.
At this moment, there is no beep sound.(Refer to self-diagnostic CHECK LIST)
- 1-3) Self-diagnostic button is recognized only when the error is displayed by the bad sensor. Display does not operate normally but temperature control will be controlled by the emergency operation.
- 1-4) When the error is detected by self-diagnosis, the error can be canceled automatically if all troubled sensors are corrected or Self-diagnostic function key (Energy Saver Key + Lighting Key) are pressed simultaneously for 8 seconds.
(Return to normal display mode)

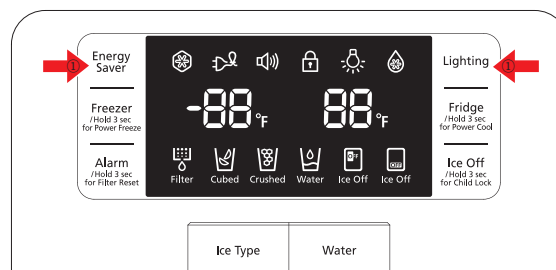

- ① If Energy Saver Key + Lighting Key are pressed simultaneously for 8 seconds, the error mode by self-diagnosis will be canceled.

2) Self-diagnostic function during normal operation

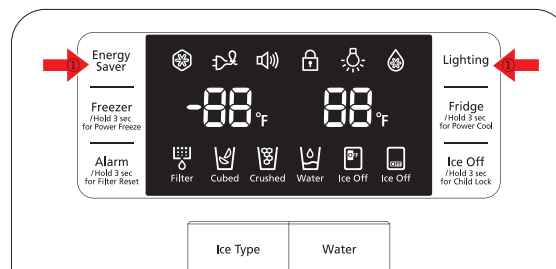

- ① If Energy Saver Key + Lighting Key are pressed simultaneously for 8 seconds, the error mode by self-diagnosis will be canceled.

- 2-1) If Energy Saver Key + Lighting Key are pressed simultaneously for 6 seconds during normal operation, the temperature setting display will operate for 2 seconds (ON/OFF 0.5sec each).
If Energy Saver Key + Lighting Key are pressed simultaneously for 8 seconds (including above 2 seconds), self-diagnostic function will be selected.
- 2-2) At this moment, self-diagnostic function will be returned with buzzer sound 'ding-dong'.
If there is an error, display of error will be operated for 30 seconds and then return to normal condition whether problem is corrected or not.
(Refer to self-diagnosis CHECK LIST)
- 2-3) Input by button is not accepted during self-diagnostic function.

TROUBLESHOOTING

* Self-diagnosis CHECK LIST

NO	Trouble item	Display LED	Trouble contents
1	Ice Maker Sensor Error(R)	R-1-(a)	Senser system in ICE MAKER(R) errors
2	R-Sensor Error	R-1-(b)	Sensor system in FF compartment errors
3	R-DEF-Sensor Error	R-1-(c)	Defrost Sensor system in FF compartment errors
4	R-FAN Error	R-1-(d)	Fan motor system in FF compartment errors
5	Ice Maker operation Error(R)	R-1-(e)	ICE MAKER(R) operation system error
6	R-DEF, Heater Error	R-1-(g)	Defrost system in FF compartment errors
7	Ambient-Sensor Error	F-1-(a)	Snesor external system errors
8	F-Sensor Error	F-1-(b)	Sensor system in FZ compartment error
9	F-DEF-Sensor Error	F-1-(c)	Defrost Sensor system in FZ compartment errors
10	F-FAN Error	F-1-(d)	Fan motor system in FZ compartment errors
11	C-FAN Error	F-1-(e)	Fan motor system in machinery room errors
12	Ice Room-Sensor Error	F-1-(f)	Sensor system in ICE ROOM errors
13	F-DEF.-Heater Error	F-1-(g)	Defrost system in FZ compartment errors
14	Ice Room FAN Error	F-10-(b)	Fan motor system in ICE ROOM errors
15	Pantry-Damper-Heater Error	R-10-(a)	Damper Heater open/wire connection errors
16	Pantry-Sensor Error	R-10-(b)	Sensor system in Pantry Room errors
17	Panel↔Main Micom Error	F-10-(g)	Communication between Panel MAIN MICOM error
18	Water Tank-Heater Error	R-10-(g)	Water Tank Heater open/wire connection errors
19	Ice Maker Sensor Error(F)	R-10-(d)	Senser system in ICE MAKER(R) errors
20	Ice Maker operation Error(F)	R-10-(e)	ICE MAKER(F) operation system error

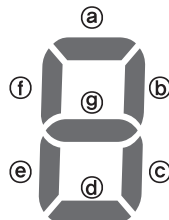
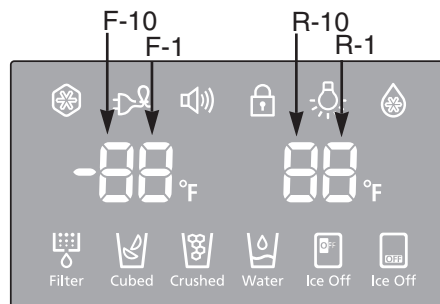

TROUBLESHOOTING

* Self-diagnostics check list

LED	Item	Trouble contents	Diagnostic method
R-1-Ⓐ	Ice Maker(R) Sensor Error	Display error : separation of sensor housing part, contact error, disconnection, short circuit	The voltage of MAIN PCB CN30 #7↔CN76 #1:shall be between 4.5V~1.0V
R-10-Ⓓ	Ice Maker(F) Sensor Error		The voltage of MAIN PCB CN90 #8 ↔#4: shall be between 4.5V~1.0V
R-1-Ⓑ	R-Sensor Error	Display error of detecting temperature of sensor: more than 149°F (+65°C) or less than -58°F (-50°C)	The voltage of MAIN PCB CN30#6↔CN76#1:shall be between 4.5V~1.0V
R-1-Ⓒ	R-DEF-Sensor Error		The voltage of MAIN PCB CN30#8↔CN76#1:shall be between 4.5V~1.0V
R-1-Ⓓ	R-FAN Error	Display error during operation of applicable fan motor : Feed Back signal line contact error, separation of motor wire, motor error	Voltage of MAIN PCB CN76-4 Orange ↔ 1 Gray shall be between 7V~12V
R-1-Ⓔ	Ice Maker(R) operation Error	Display error : ice making kit is harvested more than 3 times and level error ** Apply to the applicable Ice Maker model.	After replacing ice maker, check the operation by turning the appliance ON again.
R-10-Ⓔ	Ice Maker(F) operation Error	ice making kit is harvested more than 3 times and level error ** Apply to the applicable Ice Maker model.	After replacing ice maker, check the operation by turning the appliance ON again.
R-1-Ⓕ	R-DEF. Error	Display error : separation of fresh food compartment defrost heater housing part, contact error, disconnection, short circuit or temperature fuse error. Display error : the defrosting does not finish though fresh food compartment defrost is heating continuously for more than 80 minutes.	After separating MAIN PCB CN70,CN71 from PCB, the resistance value between CN70 White ↔ CN71 Orange shall be 110(441) ohm ± 7%. (Resistant value is varied by the input power) 0 Ohm : heater short, ∞ Ohm : wire / bimetal Open.
F-1-Ⓐ	Ambient-Sensor Error	Display error : sensor housing separation, contact error, disconnection, short circuit	The voltage of MAIN PCB CN31#1↔#4 : shall be between 4.5V~1.0V.
F-1-Ⓑ	F-Sensor Error		The voltage of MAIN PCB CN30#3↔CN76#1:shall be between 4.5V~1.0V
F-1-Ⓒ	F-DEF-Sensor Error	Display error by detecting temperature of sensor: more than 149°F (+65°C) or less than -58°F (-50°C)	The voltage of MAIN PCB CN30#4↔CN76#1:shall be between 4.5V~1.0V
F-1-Ⓓ	F-FAN Error	Display error during operation of applicable fan motor : Feed Back signal line contact error, motor wire separation, motor error	Voltage of MAIN PCB CN76-3 Yellow ↔ 1 Gray shall be between 7V~12V.
F-1-Ⓔ	C-FAN Error	Display error during operation of applicable fan motor : Feed Back signal line contact error, motor wire separation, motor error	Voltage of MAIN PCB CN76-5 Sky-blue ↔ 1 Gray shall be between 7V~12V.
F-1-Ⓕ	Ice Room Sensor Error	Display error : sensor housing separation,contact error, disconnection, short circuit. Display error by detecting temperature of sensor: more than 149°F (+65°C) or less than -58°F (-50°C)	The voltage of MAIN PCB CN31#3↔CN76#1:shall be between 4.5V~1.0V
F-1-Ⓖ	F-DEF. Error	Display error : separation of freezer compartment defrost heater housing part , contact error, disconnection, short circuit or temperature fuse error. Display error : the defrosting does not finish though fresh food compartment defrost is heating continuously for more than 70 minutes.	After separating MAIN PCB CN70,CN71 from PCB, resistant value between CN70 brown ↔ CN71 Orange shall be 55(220) ohm ± 7%. (Resistant value is varied by input power) 0 Ohm : heater short, ∞ Ohm : wire / bimetal Open.
F-10-Ⓑ	Ice Room-FAN Error	Display error during operation of applicable fan motor : Feed Back signal line contact error, motor wire separation, motor error	Voltage of MAIN PCB CN76-2 Black ↔ CN76-1 Gray : shall be between 6V~12V.
R-10-Ⓐ	Pantry-Damper-Heater Error	Display error when open error is detected by damper heater : separation of Damper Heater housing part, contact error, disconnection, short circuit	After separating MAIN PCB CN91from PCB, the resistant value between Black ↔ brown wire shall be 145 ohm ± 7%. 0 Ohm : heater short, ∞ Ohm : wire / bimetal Open.
R-10-Ⓑ	Pantry-Sensor Error	Display error : separation of sensor housing, contact error, disconnection, short circuit. Display error by detecting temperature of sensor: more than 149°F (+65°C) or less than -58°F (-50°C)	The voltage of MAIN PCB CN30#9 ↔ CN76#1 : shall be between 4.5V~1.0V.
R-10-Ⓒ	Water Tank-Heater Error	Display error when open error is detected by Water Tank Heater : separation of Water Tank Heater housing part,contact error, disconnection, short circuit	After separating MAIN PCB CN79 from PCB, the resistant value between pink ↔ white wire shall be 72 ohm ± 7%. Check : 0 Ohm → heater short, ∞ Ohm → wire / bimetal Open.
F-10-Ⓒ	Panel↔Main communication Error	Display "Pc - Er" in the panel with alarm : MICOM MAIN PANEL communication error oP-Er is displayed when the Option is not equivalent with the right value.	Actually, If there is not a problem, it is desirable to replace Main and Panel PCB With the oscilloscope after a cable problem confirming.

TROUBLESHOOTING

4-1-4. Display function of Load condition

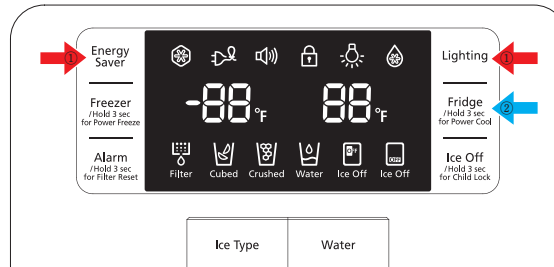

- ① If Energy Saver Key + Lighting key are pressed simultaneously for 6 seconds, ALL ON/OFF will blink with 0.5 interval for 2 seconds.
 - ② If take the finger off from above keys and press Fridge, load condition mode will be started.
- 1) If Power Energy Saver Key + Lighting key are pressed simultaneously for 6 seconds during normal operation, the temperature setting display of fresh food and freezer compartments will blink ALL ON/OFF with 0.5 for 2 seconds.
 - 2) At this moment, If Fridge Key after Energy Saver Key + Lighting Key is pressed, load condition display mode will be returned with alarm. At LED all on state, only load condition display will blink ON/OFF with 0.5 seconds interval.
 - 3) Load condition display mode shows the load that micom signal is outputting. However, It means that micom signal is outputting, it does not mean whether load is operating or not. That is to say that though load operation is displayed, load could not be operated by actual load error or PCB relay error etc. (This function would be applied at A/S.)
 - 4) Load condition display function will maintain for 30 seconds and then normal condition will be returned automatically.
 - 5) Load condition display is as below.

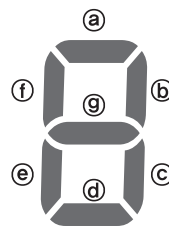
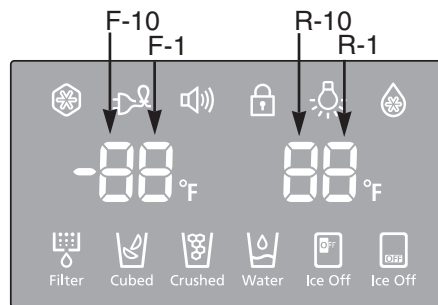

TROUBLESHOOTING

* Load mode Check list

Display LED	Display contents	Operation contents
R-1-a	R-FAN High	When FF compartment FAN operates with high speed, applicable LED ON
R-1-b	R-FAN Low	When FF compartment FAN operates with low speed, applicable LED ON
R-1-c	R-DEF Heater	When FF compartment defrost heater operates, LED ON
R-1-d	Start Mode	When refrigerator is plugged initially, LED ON
R-1-e	Overload condition	When ambient temperature is more than 93°F (34°C), LED ON
R-1-f	Low temperature condition	When ambient temperature is less than 72°F (22°C), LED ON
F-1-e, f ALL LED Off	Normal Condition	When ambient temperature is between 73°F (23°C) and 91°F (33°C)
R1-g	Exhibition Mode	LED ON at the display mode.
F-1-a	COMP.	When COMP operates, applicable LED ON.
F-1-b	F-FAN High	When FZ compartment FAN operates with high speed, applicable LED ON.
F-1-c	F-FAN Low	When FZ compartment FAN operates with low speed, applicable LED ON.
F-1-d	F-DEF Heater	When FZ compartment defrost heater operates, LED ON
R-10-e	C-FAN High	When compressor FAN operates with high speed, applicable LED ON.
R-10-f	C-FAN Low	When compressor FAN operates with low speed, applicable LED ON.
F-1-g	Dispenser Heater	When Dispenser Heater operates, applicable LED ON.
F-10-a	Water Tank Heater	When Water Tank Heater operates, applicable LED ON.
F-10-d	Ice Room-FAN High	When Ice Room-FAN operates with high speed, applicable LED ON.
F-10-e	Ice Room-FAN Low	When Ice Room-FAN operates with low speed, applicable LED ON.
R-10-g	French Heater	When French heater operates, applicable LED ON
R-10-a	Pantry Room Damper Open	When damper open, applicable LED ON
F-10-b	F-Valve Open	When the F-valve open, LED ON
R-10-b	R-Valve Open	When the R-valve open, LED ON

4-1-5. Exhibition mode setting function

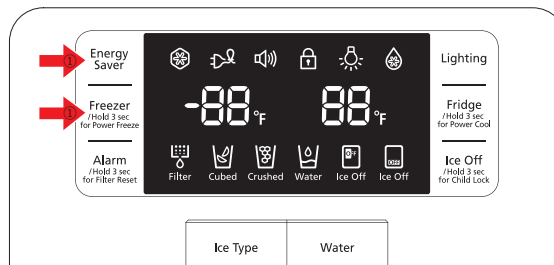

- ① If Energy Saver Key + Freezer Key are pressed for 3 seconds, Exhibition mode will be started.
- 1) If Energy Saver Key + Freezer are pressed simultaneously for 3 seconds during normal operation, Exhibition mode will be started with buzzer sound(ding-dong).
 - 2) If above Energy Saver Key + Freezer Key are pressed one more time, Exhibition mode will be canceled.
 - 3) If Exhibition mode is selected, blinks "OF-OF" on the temperature setting display of . The panel and it indicates the refrigerator has entered the Cooling Off mode.
 - 4) During Exhibition mode, if fresh food and freezer compartments sensors are higher than 149°F (65°C). Exhibition will be canceled automatically and freezing operation will be returned.
(There is no buzzer sound when the Exhibition mode is canceled by the temperature.)
 - 5) Operation contents of Exhibition Mode
 - Display, Fan motor and etc operate normally, not to operate compressor only.
 - Defrost is not operated. (including french heater)
 - Display function of the initial real temperature is finished.
 - Under the condition of Exhibition mode, Exhibition mode will be operated when Power On after Power OFF.

TROUBLESHOOTING

4-1-6. Option setting function

- If Freezer Key+ lighting Key are pressed simultaneously for 12 seconds during normal operation, fresh food and freezer compartments temperature display will be changed to option setting mode.

KEY operation method for changing to option mode

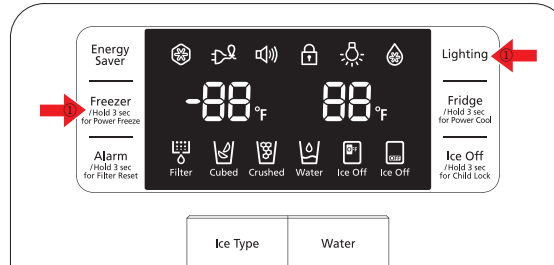

- ① If Freezer Key+ lighting Key are pressed simultaneously for 12 seconds, option setting mode will be started.

KEY control method after converting to option mode

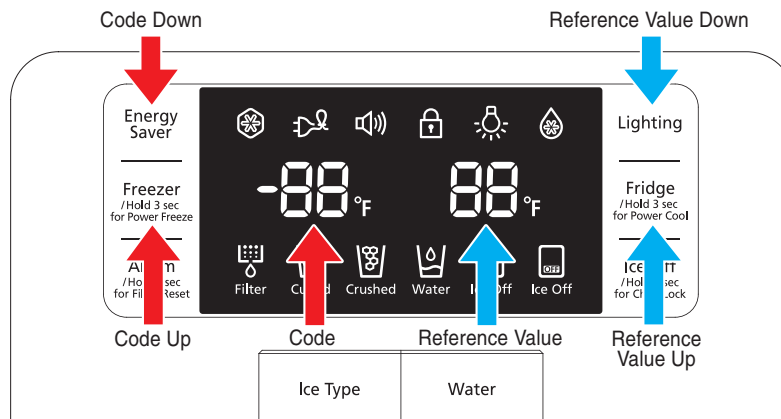

* Key control in option mode

Energy Saver Key	Code Down key
Freezer Key	Code Up key
Lighting key	Reference Value down key
Fridge key	Reference Value Up key

- If the display changes to option setting mode, all displays will be off except freezer and fridge compartments temperature display as below.
(Fresh food and freezer compartments case will be explained only because all options are operated with the same method according to the option table.)

TROUBLESHOOTING

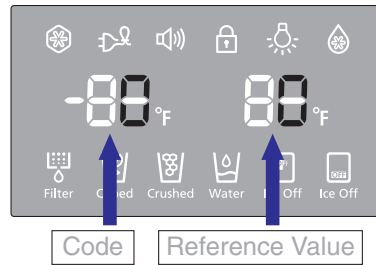

- 1) For example, if you want to change freezer compartment standard temperature to -4°F (-2°C) by operating option, do as below. This function is for changing the standard temperature. In -2°F (-19°C) of current temperature of freezer compartment, if you make the temperature lower to -4°F (-2°C) by the option, the standard temperature would be controlled -6°F (-21°C). Therefore, if you change the setting of temperature option to -2°F (-19°C) on the panel, the appliance will be operated with -6°F (-21°C). It means that standard temperature is controlled -4°F (-2°C) less than setting temperature in the display.



NOTE

Basically, all the data in option has cleared from the factory. Therefore, almost all setting value are "0". But, some setting values could be changed for the purpose of improving performance. You need to check the product manual and/or specification.

- 2) After changing to the option mode, fresh food compartment "0", freezer compartment "0" will be displayed. (Basically fresh food compartment "0", freezer "0" would be set at shipping process, but setting value could be changed for the purpose of improving product at mass producing process.)
- If fresh food compartment "0" shows only, temperature reference value of freezer compartment will be set and current freezer compartment temperature code will be displayed on the freezer temperature display.
- 3) If freezer compartment "4" is set as below freezer compartment code after fresh food compartment "0" is set, standard temperature of freezer compartment will be lower than -4°F (-2.0°C). (Refer to the picture "changing the freezer compartment temperature")

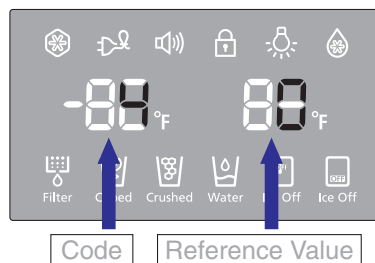

: If you wait for 20 seconds after completing the setting, MICOM will save the setting value to the EEPROM and normal display will be returned and the option setting mode will be canceled.

- 4) Option changing method as above is the same as all RFG29** model.
- 5) By the same method as above, it is possible to control the fresh food compartment temperature, water supply, ice-maker harvest temperature/time, defrost return time, hysteresis by temperature, notch gap by temperature etc.
- 6) Option function is set in the EEPROM at shipping process in the factory. You would better not to change the option of your own. Completing the setting is that option function return to normal display after 20 seconds. Do not turn off the appliance before returning to the normal display mode.



NOTE

Option setting function exists in the other items. We will skip the explanation of the other functions by the option because it is associated with refrigerator control function and is not needed at SERVICE. (Please do not set the other options except above SERVICE Manual.)

TROUBLESHOOTING

4-1-7. Option TABLE

1) Temperature changing table of freezer compartment

Set item	Freezer Temp Shift
MODEL	RFG29*****
Reference Value	Fridge Room 7-SEG
	0

Setting value	Temp. compensation
0	0°F(0.0°C)
1	-1°F(-0.5°C)
2	-2°F(-1.0°C)
3	-3°F(-1.5°C)
4	-4°F(-2.0°C)
5	-5°F(-2.5°C)
6	-6°F(-3.0°C)
7	-7°F(-3.5°C)
8	+1°F(+0.5°C)
9	+2°F(+1.0°C)
10	+3°F(+1.5°C)
11	+4°F(+2.0°C)
12	+5°F(+2.5°C)
13	+6°F(+3.0°C)
14	+7°F(+3.5°C)
15	+8°F(+4.0°C)

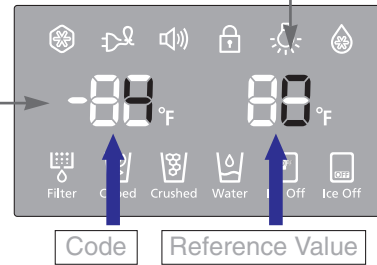

ex) If you want to change the freezer standard temperature to -4°F (-2°C)

2) Temperature changing table of fresh food compartment

Set item	Freezer Temp Shift
MODEL	RFG29*****
Reference Value	Fridge Room 7-SEG
	1

Setting value	Temp. compensation
0	0°F(0.0°C)
1	-1°F(-0.5°C)
2	-2°F(-1.0°C)
3	-3°F(-1.5°C)
4	-4°F(-2.0°C)
5	-5°F(-2.5°C)
6	-6°F(-3.0°C)
7	-7°F(-3.5°C)
8	+1°F(+0.5°C)
9	+2°F(+1.0°C)
10	+3°F(+1.5°C)
11	+4°F(+2.0°C)
12	+5°F(+2.5°C)
13	+6°F(+3.0°C)
14	+7°F(+3.5°C)
15	+8°F(+4.0°C)

ex) If you want to change the freezer compartment standard temperature to 4°F (2°C)

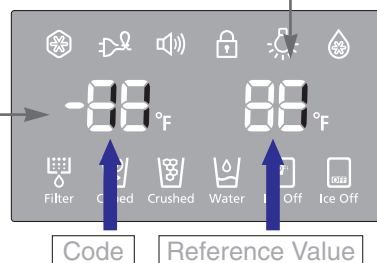

TROUBLESHOOTING

3) Temperature changing table of ICE ROOM compartment .

Set item	ICE ROOM Temp shift
MODEL	RFG29*****
Reference Value	Fridge Room 7-SEG
	20

Setting value	Temp. compensation
FZ compartment Code	
0	8.6°F(-13°C)
1	6.8°F(-14°C)
2	5°F(-15°C)
3	3.2°F(-16°C)
4	1.4°F(-17°C)
5	-0.4°F(-18°C)
6	-2.2°F(-19°C)
7	10.4°F(-12°C)

ex) If you want to change the freezer compartment standard temperature to 10.4°F(-12°C).

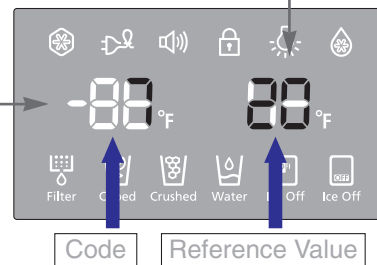

4) Temperature changing table of Pantry Room compartment

- Could change the temperature of Pantry Room in fresh food compartment.

Set item	PANTRY ROOM Temp shift
MODEL	RFG29*****
Reference Value	Fridge Room 7-SEG
	33

Setting value	Temp. compensation
FZ compartment Code	
0	0°F(0.0°C)
1	-1°F(-0.5°C)
2	-2°F(-1.0°C)
3	-3°F(-1.5°C)
4	-4°F(-2.0°C)
5	-5°F(-2.5°C)
6	-6°F(-3.0°C)
7	-7°F(-3.5°C)
8	+1°F(+0.5°C)
9	+2°F(+1.0°C)
10	+3°F(+1.5°C)
11	+4°F(+2.0°C)
12	+5°F(+2.5°C)
13	+6°F(+3.0°C)
14	+7°F(+3.5°C)
15	+8°F(+4.0°C)

ex) If you want to change the freezer compartment standard temperature to 4°F(2°C).

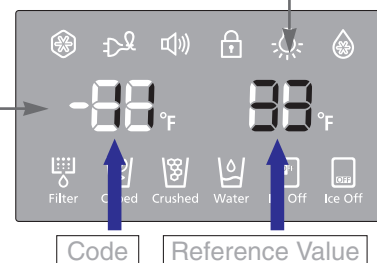

TROUBLESHOOTING

4-2) Diagnostic method according to the trouble symptom(Flow Chart)

DATA1.Temperature table

Resistance value and MICOM port voltage of sensor according to the temperature.

SENSOR CHIP : PX41C, 502AT// 103**(ICE MAKER SENSOR(MOLD))//FULL UP ,20K ohm used.

(The survey of resistance is nearly twice than below data.)

°C	°F	Voltage	Resistance	°C	°F	Voltage	Resistance	°C	°F	Voltage	Resistance
-50	-58	4.694	153319	-5	23	3.107	16419	40	104	1.153	2997
-49	-56.2	4.677	144794	-4	24.8	3.057	15731	41	105.8	1.124	2899
-48	-54.4	4.659	136798	-3	26.6	3.006	15076	42	107.6	1.095	2805
-47	-52.6	4.641	129294	-2	28.4	2.955	14452	43	109.4	1.068	2714
-46	-50.8	4.622	122248	-1	30.2	2.904	13857	44	111.2	1.040	2627
-45	-49	4.602	115631	0	32	2.853	13290	45	113	1.014	2543
-44	-47.2	4.581	109413	1	33.8	2.802	12749	46	114.8	0.988	2462
-43	-45.4	4.560	103569	2	35.6	2.751	12233	47	116.6	0.963	2384
-42	-43.6	4.537	98073	3	37.4	2.700	11741	48	118.4	0.938	2309
-41	-41.8	4.514	92903	4	39.2	2.649	11271	49	120.2	0.914	2237
-40	-40	4.490	88037	5	41	2.599	10823	50	122	0.891	2167
-39	-38.2	4.465	83456	6	42.8	2.548	10395	51	123.8	0.868	2100
-38	-36.4	4.439	79142	7	44.6	2.498	9986	52	125.6	0.846	2036
-37	-34.6	4.412	75077	8	46.4	2.449	9596	53	127.4	0.824	1973
-36	-32.8	4.385	71246	9	48.2	2.399	9223	54	129.2	0.803	1913
-35	-31	4.356	67634	10	50	2.350	8867	55	131	0.783	1855
-34	-29.2	4.326	64227	11	51.8	2.301	8526	56	132.8	0.762	1799
-33	-27.4	4.296	61012	12	53.6	2.253	8200	57	134.6	0.743	1745
-32	-25.6	4.264	57977	13	55.4	2.205	7888	58	136.4	0.724	1693
-31	-23.8	4.232	55112	14	57.2	2.158	7590	59	138.2	0.706	1642
-30	-22	4.199	52406	15	59	2.111	7305	60	140	0.688	1594
-29	-20.2	4.165	49848	16	60.8	2.064	7032	61	141.8	0.670	1547
-28	-18.4	4.129	47431	17	62.6	2.019	6771	62	143.6	0.653	1502
-27	-16.6	4.093	45146	18	64.4	1.974	6521	63	145.4	0.636	1458
-26	-14.8	4.056	42984	19	66.2	1.929	6281	64	147.2	0.620	1416
-25	-13	4.018	40938	20	68	1.885	6052	65	149	0.604	1375
-24	-11.2	3.980	39002	21	69.8	1.842	5832	66	150.8	0.589	1335
-23	-9.4	3.940	37169	22	71.6	1.799	5621	67	152.6	0.574	1297
-22	-7.6	3.899	35433	23	73.4	1.757	5419	68	154.4	0.560	1260
-21	-5.8	3.858	33788	24	75.2	1.716	5225	69	156.2	0.546	1225
-20	-4	3.816	32230	25	77	1.675	5039	70	158	0.532	1190
-19	-2.2	3.773	30752	26	78.8	1.636	4861	71	159.8	0.519	1157
-18	-0.4	3.729	29350	27	80.6	1.596	4690	72	161.6	0.506	1125
-17	1.4	3.685	28021	28	82.4	1.558	4526	73	163.4	0.493	1093
-16	3.2	3.640	26760	29	84.2	1.520	4369	74	165.2	0.481	1063
-15	5	3.594	25562	30	86	1.483	4218	75	167	0.469	1034
-14	6.8	3.548	24425	31	87.8	1.447	4072	76	168.8	0.457	1006
-13	8.6	3.501	23345	32	89.6	1.412	3933	77	170.6	0.446	978
-12	10.4	3.453	22320	33	91.4	1.377	3799	78	172.4	0.435	952
-11	12.2	3.405	21345	34	93.2	1.343	3670	79	174.2	0.424	926
-10	14	3.356	20418	35	95	1.309	3547	80	176	0.414	902
-9	15.8	3.307	19537	36	96.8	1.277	3428	81	177.8	0.404	877
-8	17.6	3.258	18698	37	98.6	1.253	3344	82	179.6	0.394	854
-7	19.4	3.208	17901	38	100.4	1.213	3204	83	181.4	0.384	832
-6	21.2	3.158	17142	39	102.2	1.183	3098	84	183.2	0.375	810

TROUBLESHOOTING

4-2-1. If the trouble is detected by self-diagnosis

- The error of sensor will be displayed on the front of display.
When the error of sensor is detected at initial power ON, the appliance will operated by the emergency mode and display of abnormal sensor part will blink.
- The appliance will not stop operating when the error of sensor is detected during operation of the appliance.
But normal freezing might be not operated if the appliance is operated by the emergency operation mode. You would better to check the appliance according to the self-diagnosis of the manual.

1) If ICE Maker(R) Sensor has troubled

ERROR Code



DATA1.
Temperature table

** Measuring point of resistance value according to Sensor **
ICE MAKER(R) : CN30#7 ↔ #4 measuring resistance value
** 0 Ω : Short trouble / ∞ Ω : Open trouble

Refer to circuit diagram in the manual

Sensor MICOM/Connector number	
ICE Maker(R)	Connector CN30-"7"(Brown) and REG1 HEAT-SINK PCB common Ground Voltage measured between 4.6V ~ 0.6V.

Measuring voltage of IC01 MICOM #75, CN30-"7"(Brown) and REG1, HEAT SINK from PCB typical Ground part are similar.
→ Check the measure on the SENSOR MARKING #4(R312) due to the SMD MICOM

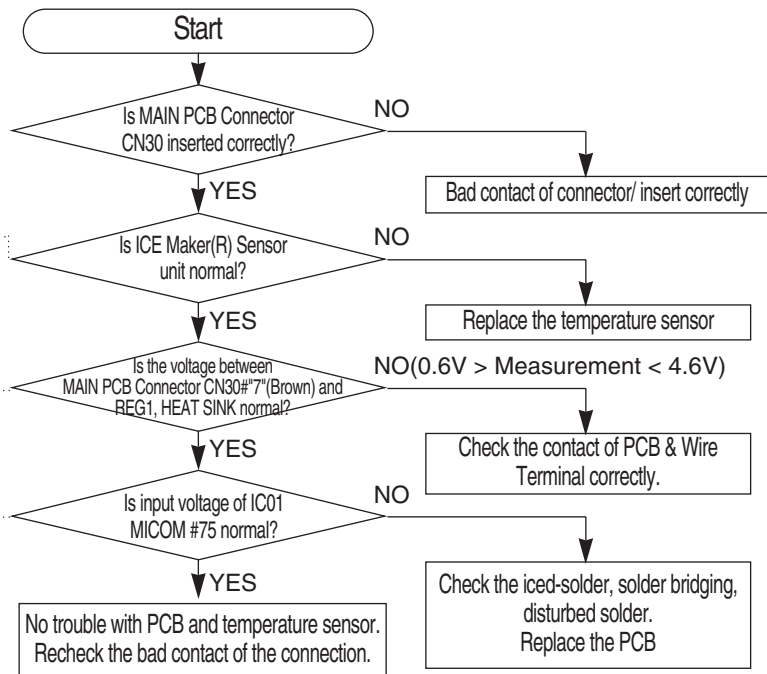

- ☞ Checking Method of ICE MAKER(R) Sensor resistance CN30 #7(Brown) ↔ CN76 #1(Gray)
- Compare the temperature table after the measure.



- ☞ Checking method of ICE Maker(R) Sensor voltage
- Measure the voltage of Sensor Check Point #4(IC01 MICOM #75) or CN30#7(Brown) ↔ REG1, HEAT SINK.
- Compare the temperature table after the measure. Measuring voltage of CN30#4(Brown) ↔ REG1, HEAT SINK are below.



typical PCB Ground
REG1 HEAT-SINK



TROUBLESHOOTING

2) If ICE Maker(F) Sensor has troubled

ERROR Code



※ This refrigerator has Dual Ice Maker, so controlled two Ice Makers.

DATA1.
Temperature table

** Measuring point of resistance value according to Sensor **
ICE MAKER(F) : CN90 #3 or #8 ↔ #4 measuring resistance value
** 0 Ω : Short trouble / ∞ Ω : Open trouble

Refer to circuit diagram in the manual

Sensor MICOM/Connector number	
ICE Maker(F)	Connector CN90-#4(White) and REG1 HEAT-SINK PCB common Ground
Voltage measured between 4.6V ~ 0.6V.	

Measuring voltage of IC01 MICOM #78, CN90#4(White) and REG1, HEAT SINK from PCB typical Ground part are similar.
→ Check the measure on the SENSOR MARKING #9(R901) due to the SMD MICOM.

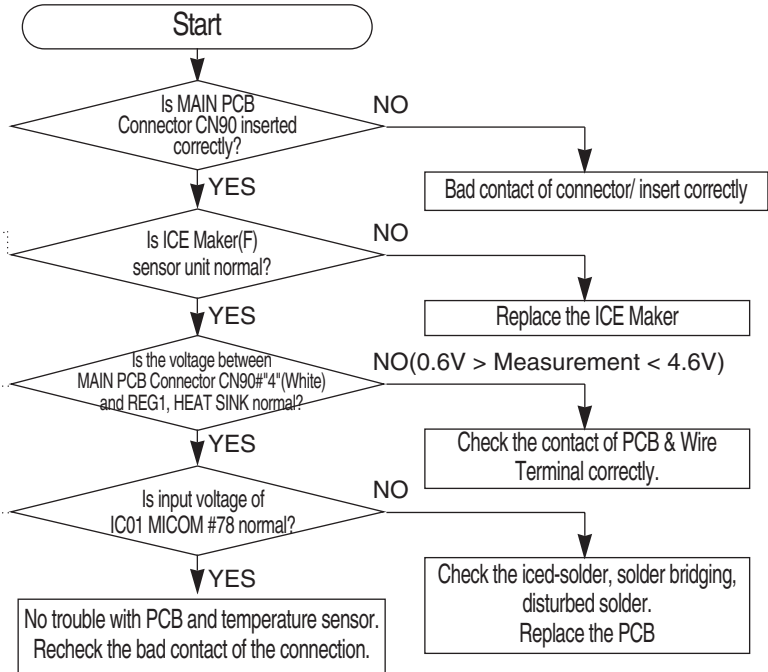

☞ Checking Method of ICE MAKER(R) Sensor resistance CN90 #3(white) or #8(Sky_blue) ↔ #4(White)
- Compare the temperature table after the measure.

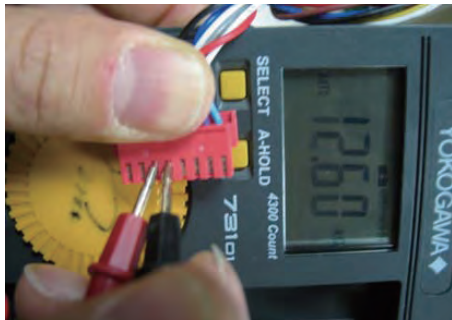

☞ Checking method of ICE Maker(F) Sensor voltage
- Measure the voltage of Sensor Check Point #9(IC01 MICOM #78) or CN90#4(white) ↔ REG1, HEAT SINK.
- Compare the temperature table after the measure.
- Measuring voltage of CN90#4(White) ↔ REG1, HEAT SINK are below.



typical PCB Ground
REG1 HEAT-SINK

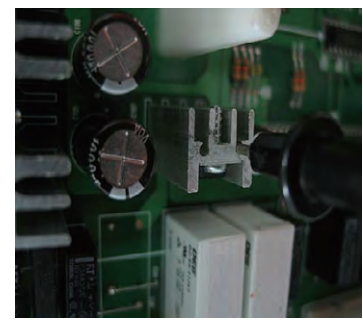

TROUBLESHOOTING

3) If R Sensor has trouble

ERROR Code



DATA1.
Temperature table

** Measuring point of resistance value according to Sensor **
 R : CN30#6 ↔ CN76#1 measuring resistance value
 ** 0 Ω : Short trouble / ∞ Ω : Open trouble

Refer to circuit diagram in the manual

Sensor MICOM/Connector number	
R	Connector CN30#6(White) to REG1 HEAT-SINK PCB typical Ground Voltage measured between 4.6V ~ 0.6V.

Measuring voltage IC01 MICOM #76, CN30#6(White) and REG1, HEAT SINK from PCB typical Ground part are similar.
 → Check the measure on the SENSOR MARKING #3(R311) due to the SMD MICOM

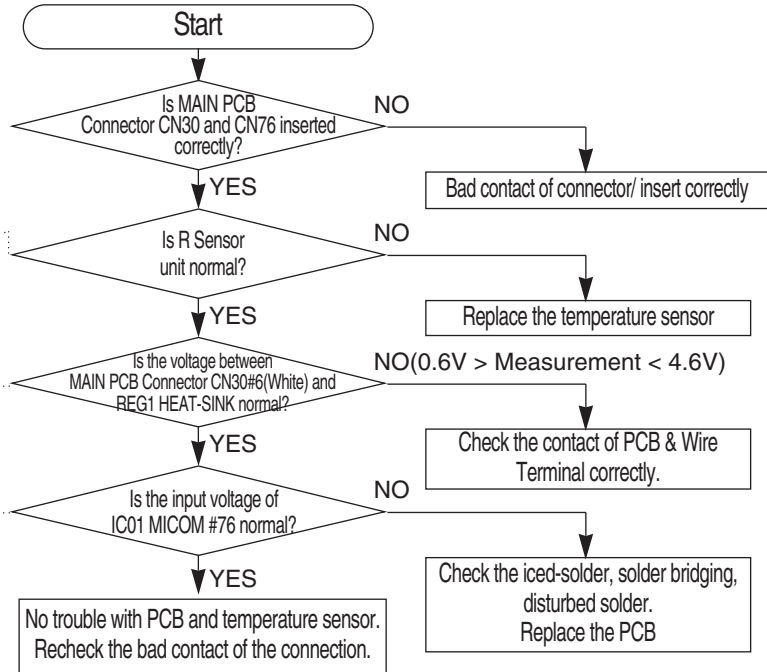

☞ Checking method of R Sensor resistance
 CN30#6(White) ↔ CN76#1(Grey) Compare the temperature table after measurement.



☞ Checking method of R Sensor resistance
 - Measure the voltage of Sensor Check Point #3(IC01 MICOM #76) on PCB or CN30#6(White) ↔ REG1, HEAT SINK
 - Compare the temperature table after measurement.
 - Measuring voltage of CN30#6(White) ↔REG1, HEAT SINK are as below.

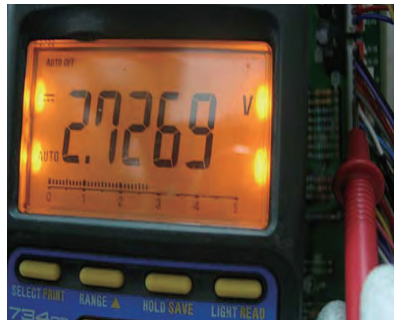

Typical PCB Ground
 REG1, HEAT SINK

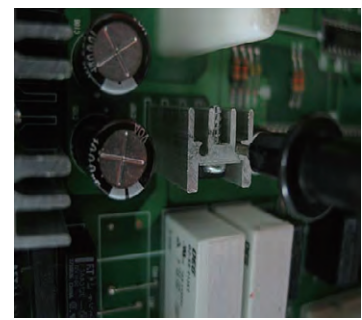

TROUBLESHOOTING

4) If R DEF Sensor has trouble

ERROR Code



DATA1.
Temperature table

** Measuring point of resistance value according to Sensor **
R-DEF : CN30#8 ↔ CN76#1 measuring resistance value
** 0 Ω : Short trouble / ∞ Ω : Open trouble

Refer to circuit diagram in the manual

Sensor MICOM/Connector Number	
R DEF	Connector CN30-8*(Sky-blue) and REG1, HEAT SINK PCB common Ground Voltage measured between 4.6V ~ 0.6V.

Measuring voltage of IC01 MICOM #74, CN30#8(Sky-blue) and REG1, HEAT SINK from PCB typical Ground part are similar.
→ Check the measure on the SENSOR MARKING #5(R313) due to the SMD MICOM

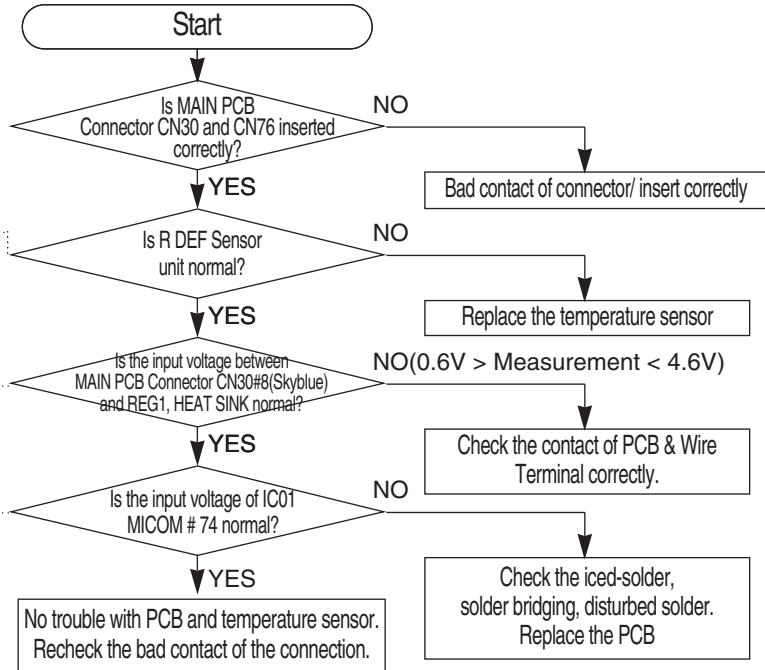

☞ Checking method of R Sensor resistance
CN30#8(Sky-blue) ↔ CN76#1(Grey)
- Compare the temperature table after measurement.



☞ Checking method of R DEF Sensor resistance
- Measure the voltage of Sensor Check Point #5(IC01 MICOM #74) on PCB or CN30#8(Sky-blue)→REG1, HEAT SINK
- Compare the temperature table after measurement.
Measuring voltage of CN30#8(Sky-blue) ↔ REG1, HEAT SINK are as below.

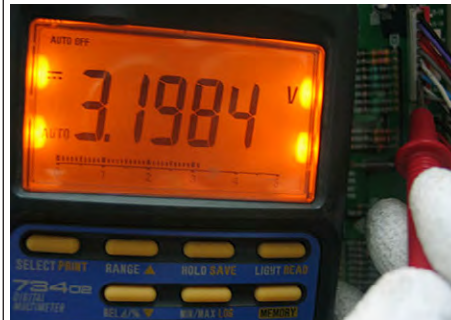

Typical PCB Ground
REG1, HEAT SINK

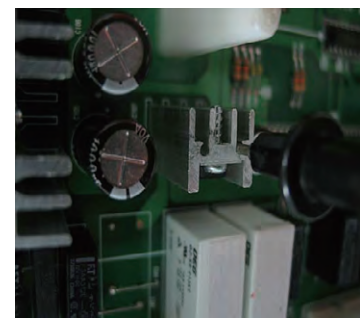

TROUBLESHOOTING

5) If Ambient Sensor has trouble

ERROR Code



DATA1.
Temperature table

** Measuring point of resistance value according to Sensor **
 Ambient : CN31#1 ↔ #4 measuring resistance value
 ** Placed in the right top table of upper hinge.
 ** 0 Ω : Short trouble / ∞ Ω : Open trouble

Refer to circuit diagram in the manual

Sensor MICOM/Connector number	
Ambient	Connector CN31#1(Yellow) to REG1, HEAT-SINK PCB typical Ground Voltage measured between 4.6V ~ 0.6V.

Measuring voltage of IC01 MICOM #72, CN31#1(Yellow) and REG1, HEAT SINK from PCB typical Ground part are similar.
 → Check the measure on the SENSOR MARKING #7(R307) due to the SMD MICOM

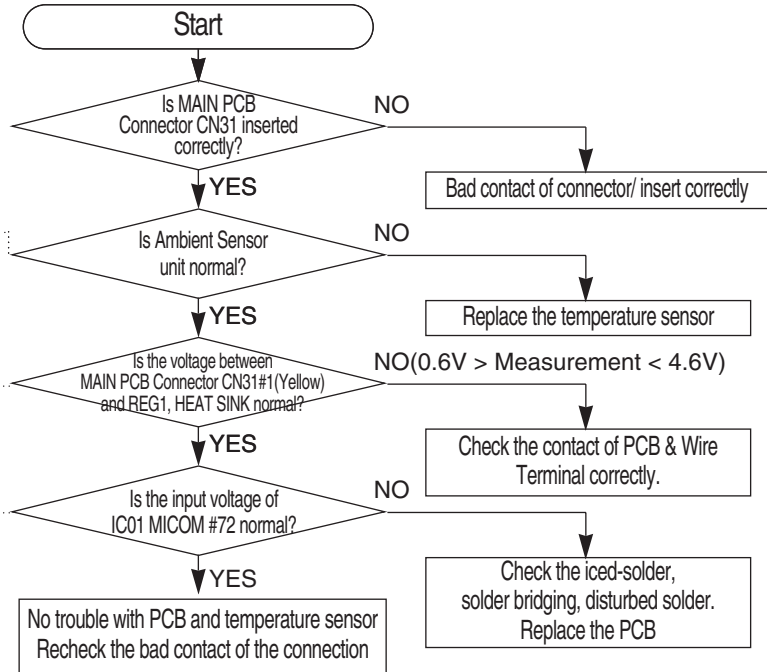

☞ Checking method of Ambient Sensor resistance
 CN31#1(Yellow) ↔ #4(Yellow)
 - Compare the temperature table after measurement.



☞ Checking method of Ambient Sensor voltage
 - Measure the voltage of Sensor Check Point #7(IC01 MICOM #72) on PCB or CN31#1(Yellow) ↔ REG1, HEAT SINK
 - Compare the temperature table after measurement.
 Measuring voltage of CN31#1(Yellow) ↔ REG1, HEAT SINK are as below

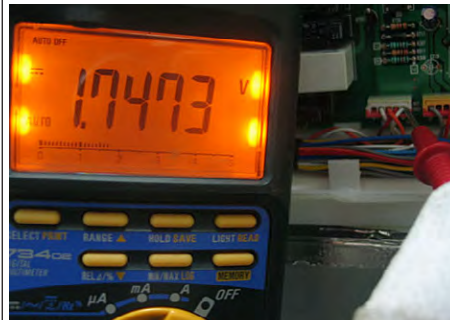

Typical PCB Ground
 REG1 Heater Sink



TROUBLESHOOTING

6) If F Sensor has trouble

ERROR Code



DATA1.
Temperature table

** Measuring point of resistance value according to Sensor ***
 F : CN30#3 ↔ CN76#1 measuring resistance value
 ** 0 Ω : Short trouble / ∞ Ω : Open trouble

Refer to circuit diagram in the manual

Sensor MICOM/Connector number	
F	Connector CN30#3(Red) to REG1, HEAT SINK PCB typical Ground Voltage measured between 4.6V ~ 0.6V.

Measuring voltage of IC01 MICOM #81, CN30#3(Red) and REG1, HEAT SINK from PCB typical Ground part are similar.
 → Check the measure on the SENSOR MARKING #1 (R309) due to the SMD MICOM

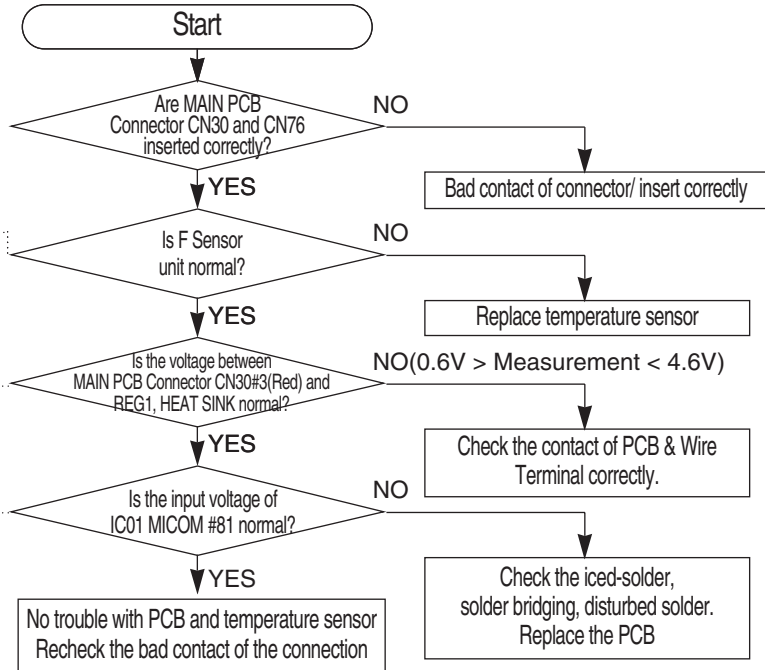

☞ Checking method of F Sensor resistance
 CN30#3(Red) ↔ CN76#1(Gray)
 - Compare the temperature table after measurement.



☞ Checking method of F Sensor voltage
 - Measure the voltage of Sensor Check Point #1(IC01 MICOM #81) on PCB or CN30#3(Red) ↔ REG1, HEAT SINK
 - Compare the temperature table after measurement.
 Measuring voltage of CN30#3(Red) ↔ REG1, HEAT SINK are as

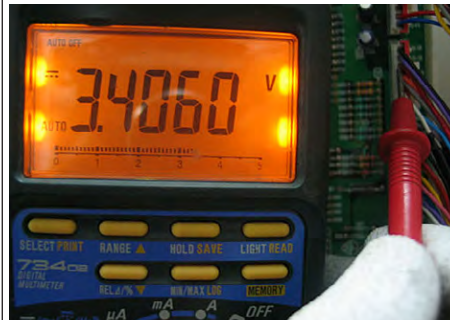

Typical PCB Ground
 REG1 Heater Sink

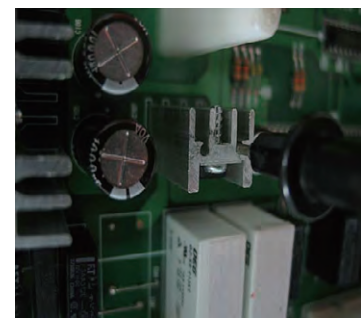

TROUBLESHOOTING

7) If F DEF Sensor has trouble

ERROR Code



DATA1.
Temperature table

** Measuring point of resistance value according to Sensor **
 F-DEF : CN30#4 ↔ CN76#1 measuring resistance value
 ** 0 Ω : Short trouble / ∞ Ω : Open trouble

Refer to circuit diagram in the manual

Sensor MICOM/Connector number	
F DEF	Connector CN30#4(Orange) to REG1, HEAT SINK PCB typical Ground Voltage measured between 4.6V ~ 0.6V.

Measuring voltage of IC01 MICOM #77, CN30#4(Orange) and REG1, HEAT SINK from PCB typical Ground part are similar.
 → Check the measure on the SENSOR MARKING #2(R310) due to the SMD MICOM

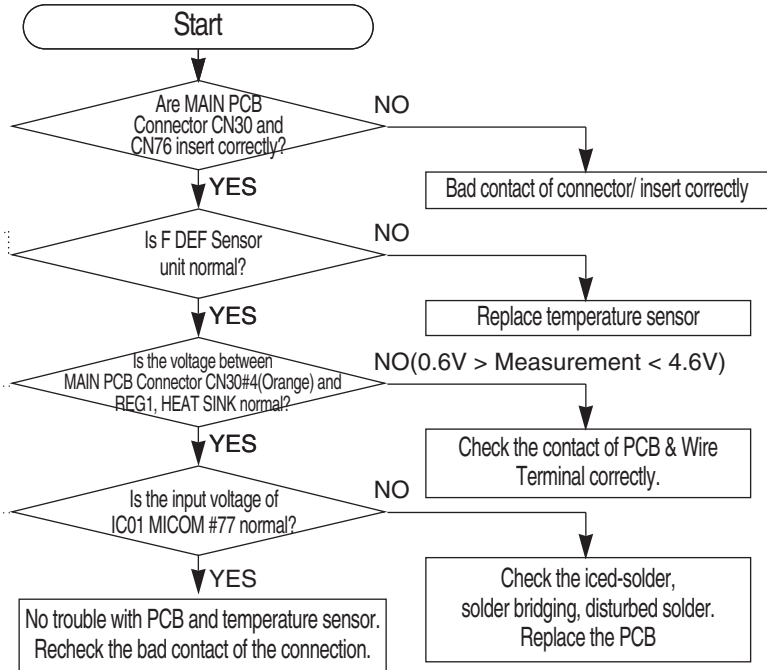

- ☞ Checking method of F DEF Sensor resistance
 CN30#4(Orange) ↔ CN76#1(Grey)
 - Compare the temperature table after measurement.

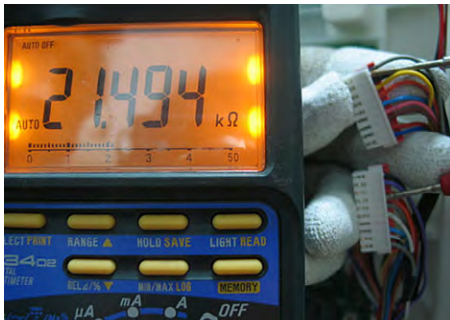

- ☞ Checking method of F DEF Sensor voltage
 - Measure the voltage of Sensor Check Point #2(IC01 MICOM #77) on PCB or CN30#4(Orange) ↔ REG1, HEAT SINK
 - Compare the temperature table after measurement.
 Measuring voltage of CN30#4(Orange) ↔ REG1, HEAT SINK are

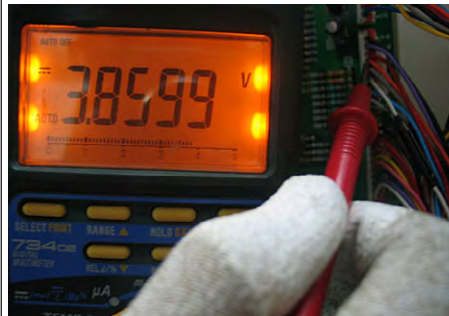

Typical PCB Ground
 REG1, Heater Sink

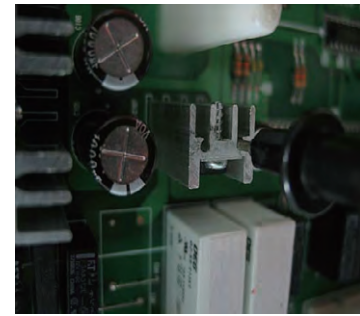

TROUBLESHOOTING

8) If Ice Room Sensor has trouble

ERROR Code



DATA1.
Temperature table

** Measuring point of resistance value according to Sensor **
 Ambient : CN32#3 ↔ CN76#1 Measure the resistance value
 ** 0 Ω : Short trouble / ∞ Ω : Open trouble

Refer to the circuit diagram in this manual

Sensor MICOM/Connector number	
Ice Room	Connector CN31-"3"(Orange) and REG1, HEAT SINK from typical PCB Ground Voltage measured between 4.6V ~ 0.6V.

Measuring voltage of IC01 MICOM #71, CN31-"3"(Orange) and REG1, HEAT SINK from typical PCB Ground are similar.
 → Check the measure on the SENSOR MARKING #8(R308) due to the SMD MICOM

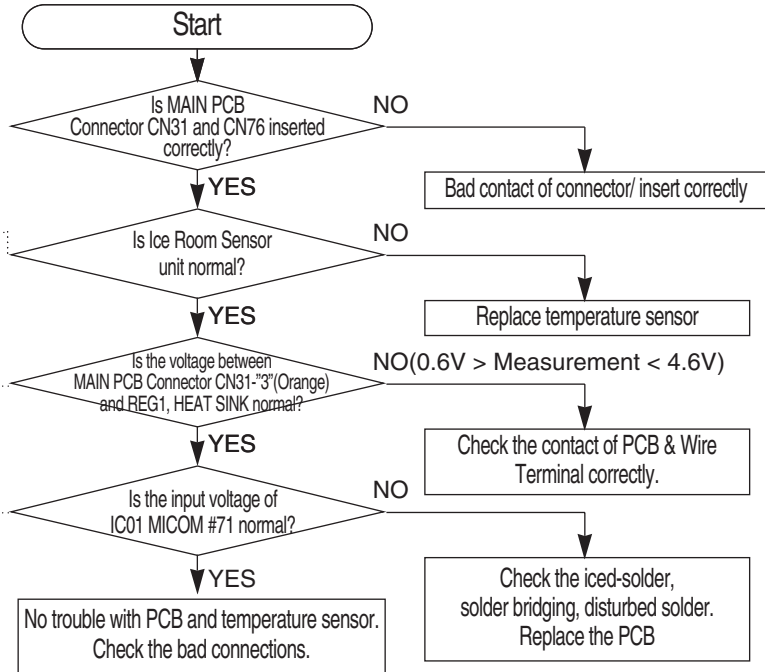

☞ Checking Method of Ice Room Sensor voltage
 CN31-"3"(Orange) ↔ CN76-"1" (Gray)
 - Compare with the temperature table after measurement.

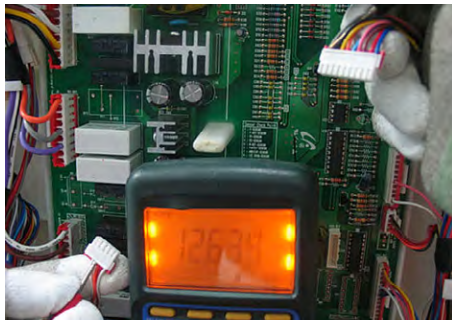

☞ Checking Method of Ice Room Sensor Voltage
 - Measure the voltage of sensor checking point #8(IC01 MICOM #71) on PCB or CN31-"3" (Orange) ↔ REG1, HEAT SINK
 - Compare with the temperature table after measurement.
 Measured voltage of CN31-"3" (Orange) ↔ REG1, HEAT SINK are as below

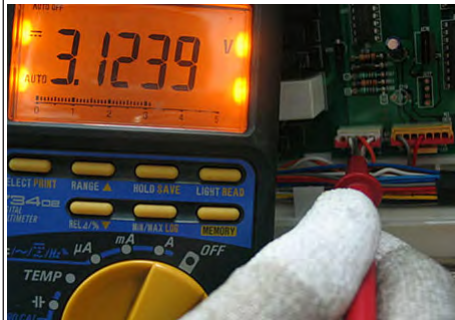

Typical PCB Ground
 REG1, HEAT SINK

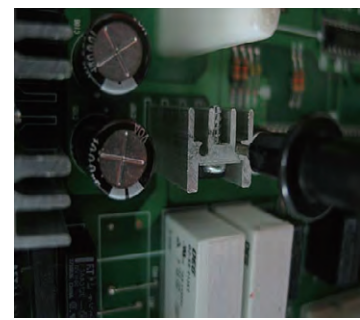

TROUBLESHOOTING

9) If Pantry Sensor has trouble

ERROR Code



DATA1.
Temperature table

** Measuring point of resistance value according to Sensor **
 Pantry : CN30#9 ↔ CN76 #1 measuring resistance value
 ** 0 Ω : Short trouble / ∞ Ω : Open trouble

Refer to circuit diagram in the manual

Sensor MICOM/Connector number	
Pantry	Connector CN30#9(White-black) to REG1 HEAT SINK PCB typical Ground Voltage measured between 4.6V ~ 0.6V.

Measuring voltage of IC01 MICOM #73, CN30#9(White-black) and REG1, HEAT SINK from PCB typical Ground part are similar.
 → Check the measure on the SENSOR MARKING #6(R314) due to the SMD MICOM

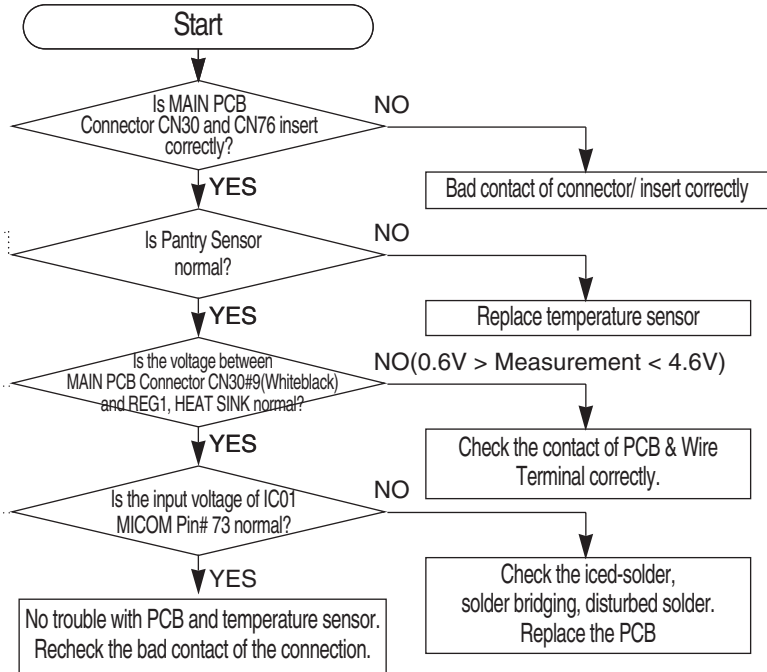

- ☞ Checking method of Pantry Sensor resistance
CN30#9(White-black) ↔ CN76#1(Grey)
- Compare the temperature table after measurement.



- ☞ Checking method of Pantry Sensor voltage
- Measuring voltage of Sensor Check Point #6(IC01 MICOM #73) on PCB or CN30#9(White-black) ↔ REG1, HEAT SINK
- Compare the temperature table after measurement.
- Measuring voltage of CN30#9(white-black)→REG1, HEAT SINK are

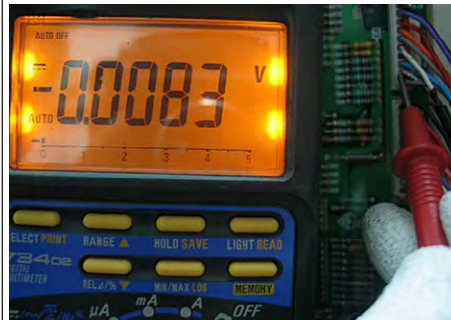

Typical PCB Ground
REG1 Heater Sink

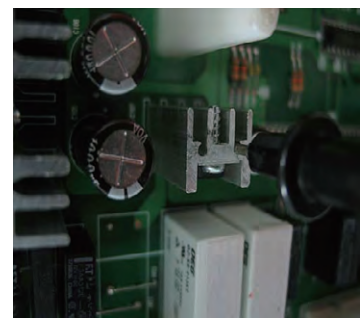

TROUBLESHOOTING

10) If Pantry Room Damper Heater has trouble

ERROR Code

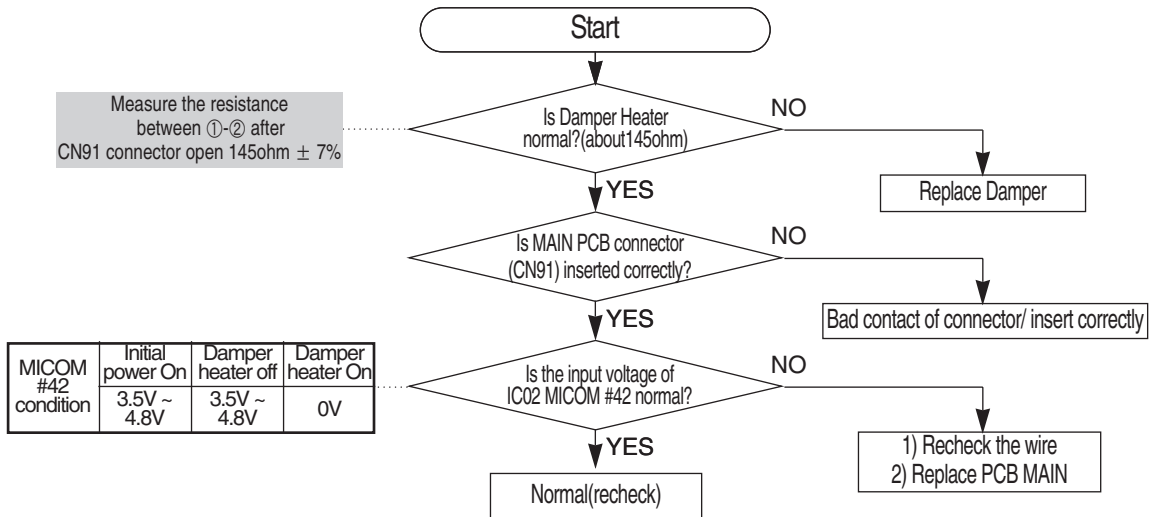

※ It could changed HEATER capacity by operation.

☞ Checking method of Pantry Room Damper resistance CN91#1(Black) ↔ #2(Brown)
 ** ∞ Ω : Open(wire disconnection, heater disconnection) trouble / 0 Ω : Short trouble



TROUBLESHOOTING

11) If Tank Water Heater has trouble

ERROR Code

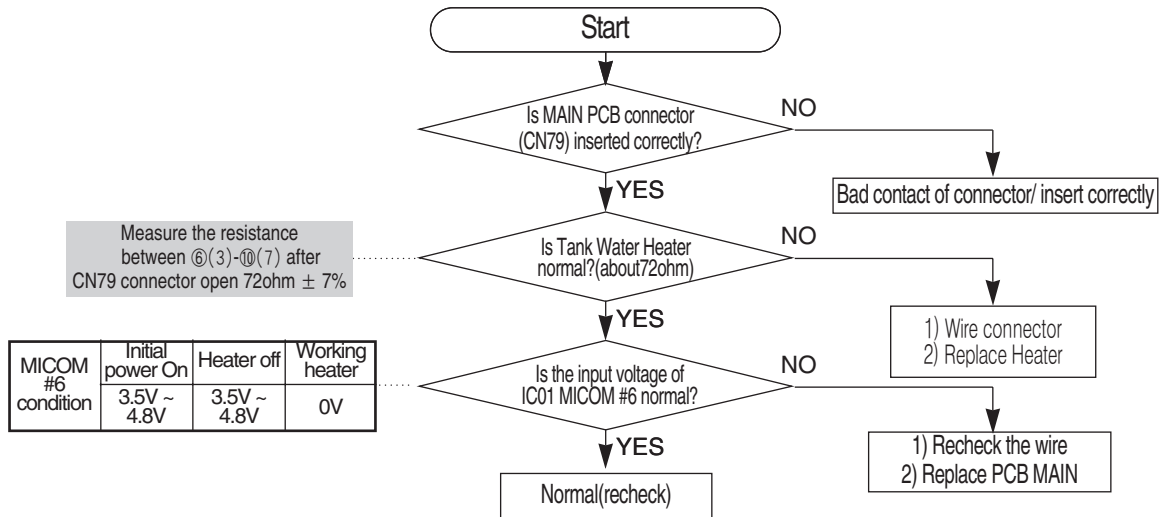

※ It could changed HEATER capacity by operation

☞ Checking method of Tank Water Heater resistance CN79#6(Pink) ↔ #10(White)
 ** ∞ Ω : Open(wire disconnection, heater disconnection) trouble / 0 Ω : Short trouble



TROUBLESHOOTING

4-2-2. IF FAN does not operate(F, R, C - FAN)

- The refrigerator of this model has BLDC FAN motor. BLDC motor is driven by DC 7~12V.
- On the normal condition of COMP ON, it operates together with F-FAN motor.
If door is opened and closed once at a high ambient temperature, it will be operated after 1 minute delay.
Therefore, you are advised not to taken it for an error.
- If there is a trouble, you should select the self-diagnostic function to check the trouble before power off.

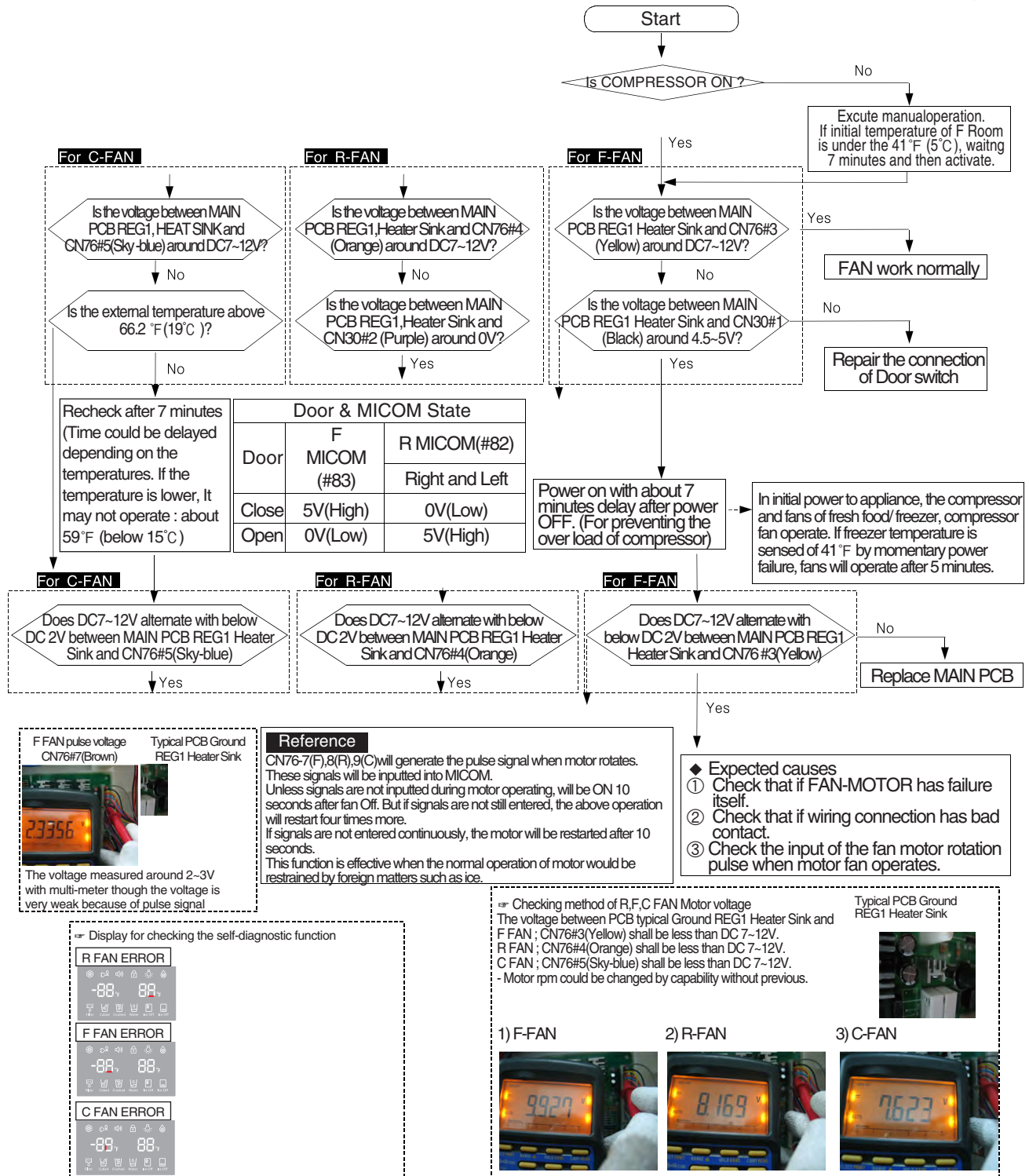

TROUBLESHOOTING

4-2-3. If ICE Room Fan does not operate

- This refrigerator has BLDC FAN motor. BLDC motor is driven by DC7~12V.
- When COMP ON, normally operates with F-FAN motor.
- If there is any trouble, you should select the self-diagnostic function to check the trouble before power off.

- When pressing the ICE TEST S/W for a certain period of time (over 1.5sec), the function is accomplished. After beginning of TEST mode, Ice maker heater turns on for initial 2 minutes, if the ice making temperature is below 0°C.
- If it exceeds 0°C, Ice maker heater turns on for initial 30 seconds.
- After Ice maker heater turns on for 30 seconds, it turns off and then Ice maker motor turns on.
- As the Ice maker motor turns on, TEST MODE COUNT operates. (6 minutes count)

Condition

- Ambient temperature : 32°C/75%
- Notch : 2°F/38°F (-19.0°C/3.3°C)
- Initial full of ice bucket capacity : 794 g, 58ea

Ice Room control temperature	
Ice ON	8.6°F (-13°C)
Ice OFF	26.6°F (-3°C)

Reference

CN76 #6 will generate the pulse signal when motor rotates. These signals will be input into MICOM. Unless signals are not input during motor operating, will be ON 10seconds after fan OFF. But if signals are not still taken, the above operation will be retried four times more. If signals are not taken continuously, the motor will be restarted after 10 minutes. This function is against the case that motor movement would be restrained by foreign matters like ice.

FAN pulse voltage CN76-6(Pink) Typical PCB Ground REG1 Heater Sink

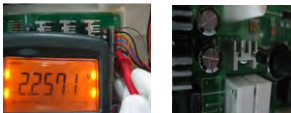

The voltage is variable due to pulse signal but measured about 2~3V with the Multi-Meter.

Display for checking the self-diagnostic function

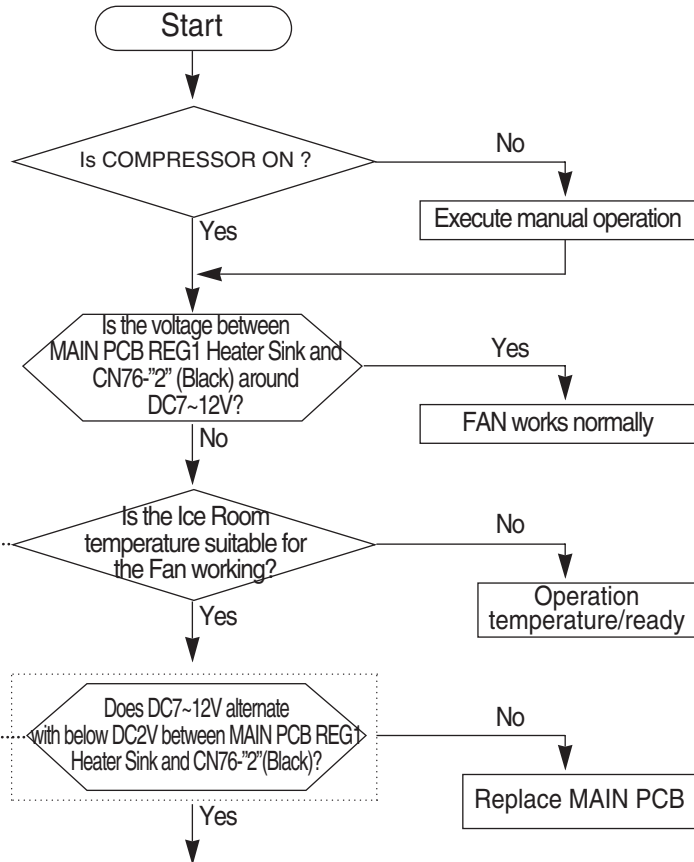

- ◆ Predicted Cause
- ① FAN-MOTOR troubles itself
 - ② Bad wiring connections.
 - ③ Wrong Input of the fan motor rotation pulse

☞ Checking method of Ice Room FAN Motor Voltage with the voltage between typical PCB Ground REG1 Heater Sink and Ice Room FAN ; CN76-2(BLack) shall be less than DC 6~12V.
- Additional check if resistance values are different after measurement.

1) Ice Room - FAN

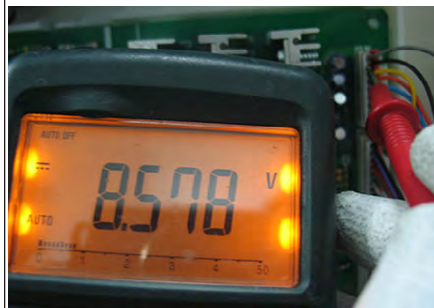

Typical PCB Ground REG1 Heater Sink



TROUBLESHOOTING

4-2-4. If Ice Maker does not operate

1. Water is automatically supplied to the Ice Maker depending on temperature & time condition and Ice Maker Dispenses cubed or crushed ice.
2. Power is applied to the one end of wires. Be careful when disassembling and shall refer to its exploded diagram in any case.
3. Ice Maker operation shall be checked after pressing the Ice Maker testing switch.
(Freezer Ice Maker) It is not possible to check when the power is disengaged.
4. We recommend that TWO PEOPLE check the PCB and Ice Maker because they are located at front and rear side each.
5. Be careful! The Ice Maker Heater can cause personal injury like burn.
6. Ice maker could operate not only genuine rotate but also reverse rotate, so it is not out of order that reverse rotate.

Displays ERROR Code



MICOM(IC02) Operation Status		
#05 (Test Switch)	Operation 5V	Ready 0V

MICOM(IC01) Operation Status				
	Ready	Rotation	Before Complete	Returning
#111 (Blade Ice Scoop)	0V	4.9V	4.9V	0V
#38 (Guide Ice Full)	0V	0V	4.9V	0V

State of Ice maker operation	
Levelness sensing	→ water supply
→ Motor reverse rotate	→ return to normal
→ return to normal	→ normality

Operating Condition when motor rotates Operating Status of Micom(IC01)

	Ready	Operation
Motor Load (#56)	0V	5V
Heater Load (#57)	0V	5V
Heater Load (#67)	0V	5V

Heater operates differently according to the conditions.
Test Mode operation will be 30 sec.

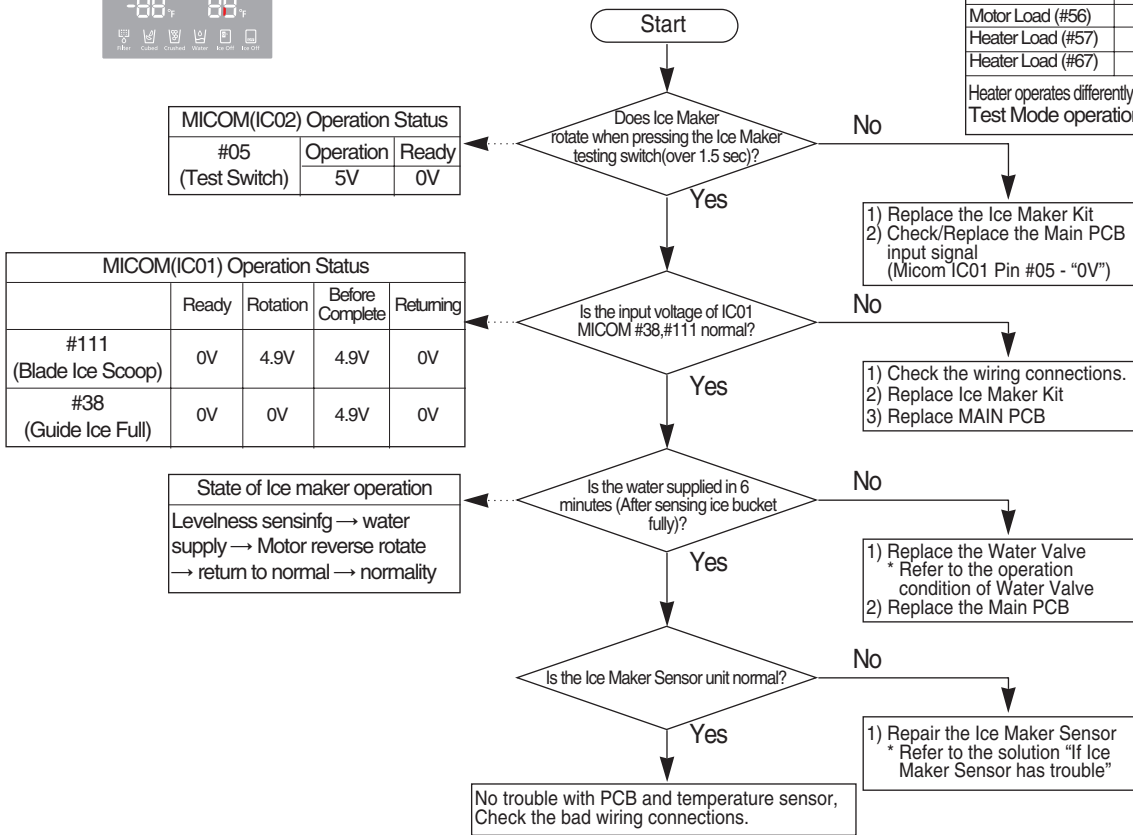

☞ Checking Method of ICE Maker Voltage

With typical PCB Ground REG1 Heater Sink and
1) Test Switch operation (press selected) : CN75-"5" (Black) shall be DC 0V.
Test Switch ready ; CN75-"5" (Black) shall be less than DC 5V.

a) Test Switch operating
- When the refrigerator operate, the voltage is 0V.

b) Test Switch ready



Typical PCB Ground
REG1 Heater Sink



☞ Checking Method of ICE Maker Voltage

With typical PCB Ground REG1 Heater Sink and
2) IC01 MICOM #111 voltage ; Ready(0V) → Rotate (4.9V) → Before complete(4.9V) → Return(0V)
* MICOM #111 voltage is same as Connector CN50-"11"(Sky-Blue)
3) IC02 MICOM #38 voltage ; Ready(0V) → Rotate (0V) → Before complete(4.9V) → Return(0V)
* MICOM #38 voltage is same as Connector CN90-"6"(Blue)

☞ Check the ICE Maker Heater & Motor Resistance

1) Measuring the Ice Maker Heater resistance values

CN70-"11"(Gray) -"1"(Black)



Resistance value : 91(365)Ohm ± 10%

2) Measuring the Ice Maker Motor resistance values

CW: 13P-"11"(White) and CN70-"9"(Red)
CCW: 13P-"13"(Pink) and CN70-"9"(Red)



Resistance value : 200KOhm ± 30%

TROUBLESHOOTING

4-2-5. If ICE MAKER(F) does not operate

1. Water is automatically supplied to the Ice Maker depending on temperature & time condition and Ice Maker Dispenses cubed or crushed ice.
2. Power is applied to the one end of wires. Be careful when disassembling and shall refer to its exploded diagram in any case.
3. Ice Maker operation shall be checked after pressing the Ice Maker testing switch.
(Freezer Ice Maker) It is not possible to check when the power is disengaged.
4. We recommend that TWO PEOPLE check the PCB and Ice Maker because they are located at front and rear side each.

ERROR Code

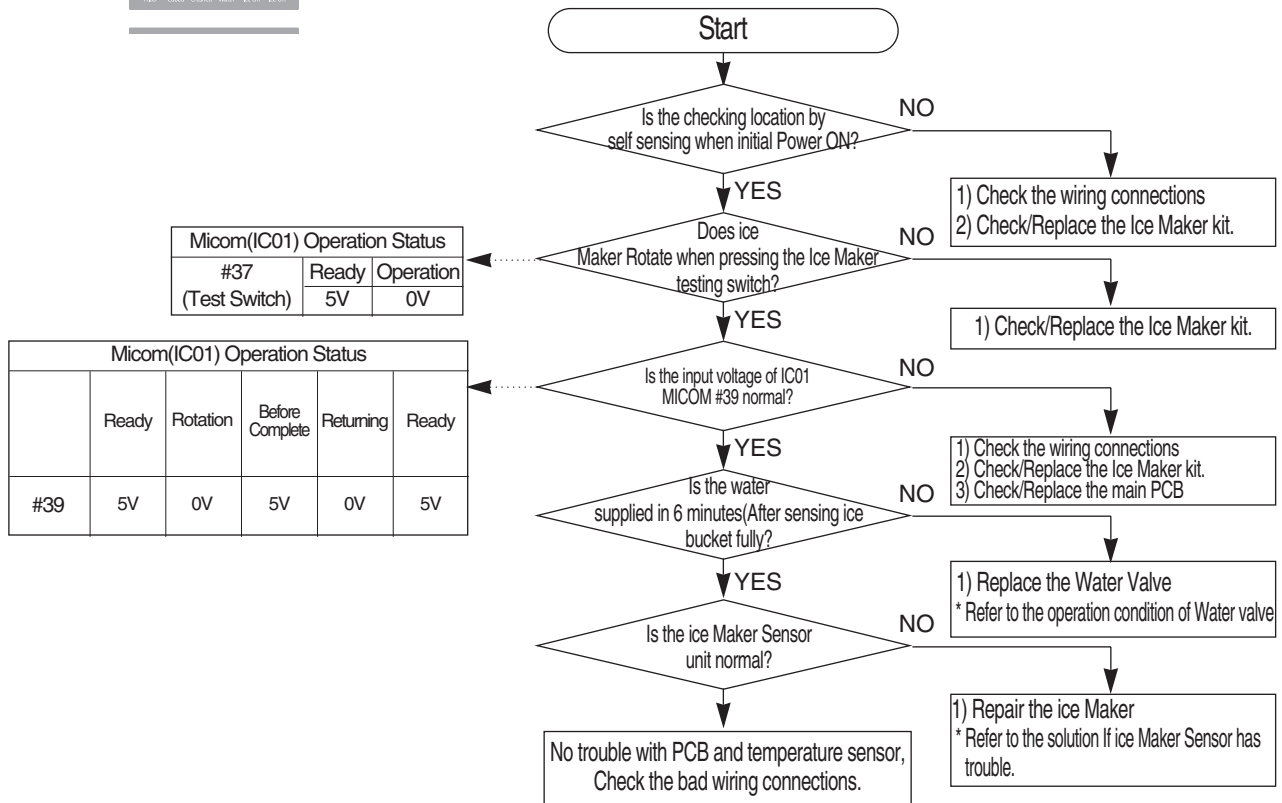

☞ Checking Method of ICE Maker Voltage With typical PCB Ground REG1 Heater Sink and

- 1) Test Switch operation (press selected) ; CN90-"5"(Gray) shall be DC 0V.
Test Switch ready ; CN90-"5"(Gray) Shall be less than DC 5V.

1) Test Switch operating



1) Test Switch ready



typical PCB Ground
REG1 HEAT-SINK



☞ Checking Method of ICE Maker Voltage With typical PCB Ground REG1 Heater Sink and

- 2) IC01 MICOM #39 voltage ; Ready(0V) → Rotate(0V) → Before complete(5V) → Return(0V) → Ready(5V)
* MICOM #39 voltage is same as Connector CN90-"7"(Purple)

TROUBLESHOOTING

4-2-6. If defrost does not operate (F,R DEF Heater)

- If defrost has trouble, select the self-diagnostic function to detect the error of defrost heater before Power Off. (Check the function with the self-diagnostic function)

R DEF ERROR



F DEF ERROR



****Measuring point of resistance value according to heater****
 F-DEF(Ice Duct parallel) : CN70#7(Brown) ↔ CN71#9 (Orange) measuring resistance value(55 ohm ± 7%)
 R-DEF : CN70#5(White) ↔ CN71#9(Orange) measuring resistance value(110 ohm ± 7%)
**** 0 Ω : Short trouble / ∞ Ω : Open(bimetal, heater) trouble**

****Measuring point of resistance value according to sensor****
 F-DEF : CN30#4 ↔ CN76#1 measuring resistance value
 R-DEF : CN30#8 ↔ CN76#1 measuring resistance value
**** 0 Ω : Short trouble / ∞ Ω : Open trouble**

Resistance value of sensor according to temperature		If you need the temperature with detail, refer to DATA1. temperature table
86°F(30°C)	4.22kΩ	
68°F(20°C)	6.05kΩ	
50°F(10°C)	8.87kΩ	
32°F(0°C)	13.29kΩ	
14°F(-10°C)	20.42kΩ	
-4°F(-20°C)	32.23kΩ	
-22°F(-30°C)	52.41kΩ	

****Measuring point of resistance value according to sensor****
 F-DEF : CN30#4 ↔ CN76#1 measuring resistance value
 R-DEF : CN30#8 ↔ CN76#1 measuring resistance value
**** 0V : Short trouble / 5V : Open trouble**

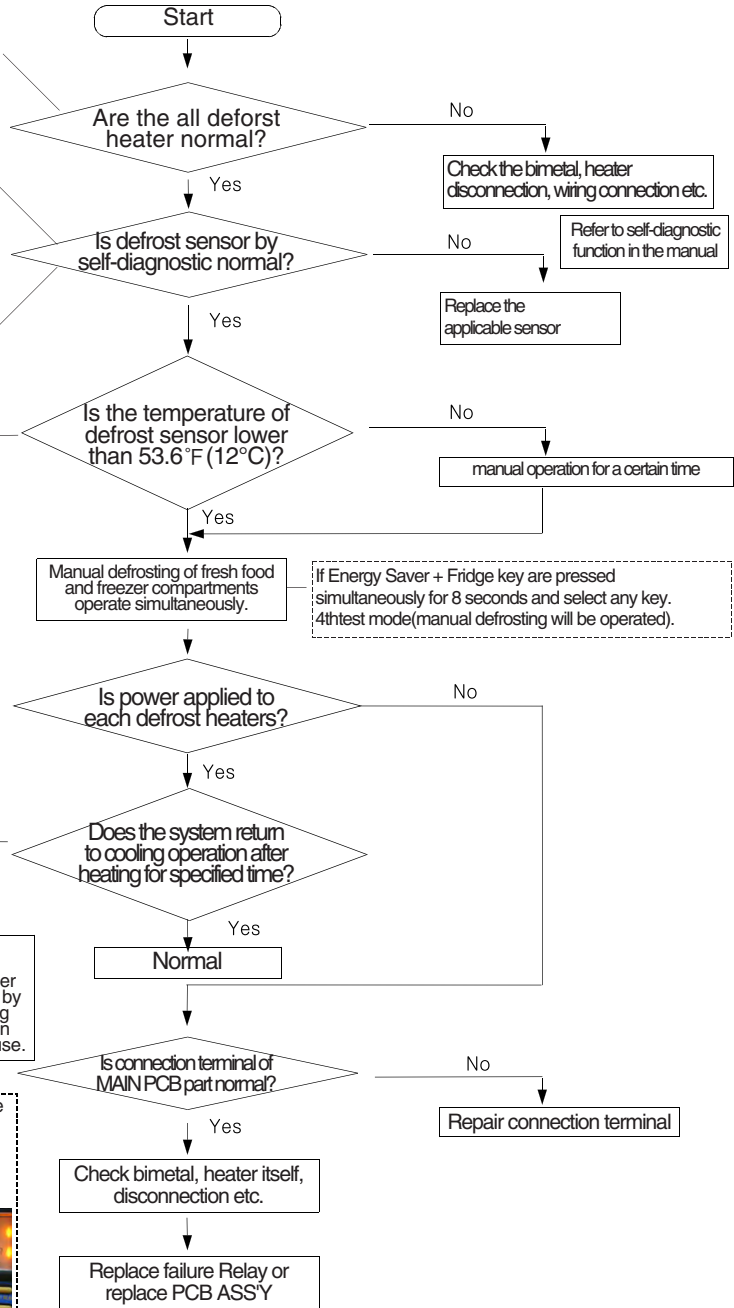

☞ Checking method of F,R DEF Heater resistance value
 F DEF : CN70#7(Brown) ↔ CN71#9(Orange)
 R DEF : CN70#5(White) ↔ CN71#9(Orange)
 Recheck if resistance values are different after the test

1) F DEF Heater 2) R DEF Heater

TROUBLESHOOTING

4-2-7. If Power is not supplied

Caution

At the power of main PCB, the AC115V power and a high-voltage over DC 170V are occurred. Please take care of yourself during repair and measurement.

- Refer to the function and reference parts in the manual when check the MAIN PCB

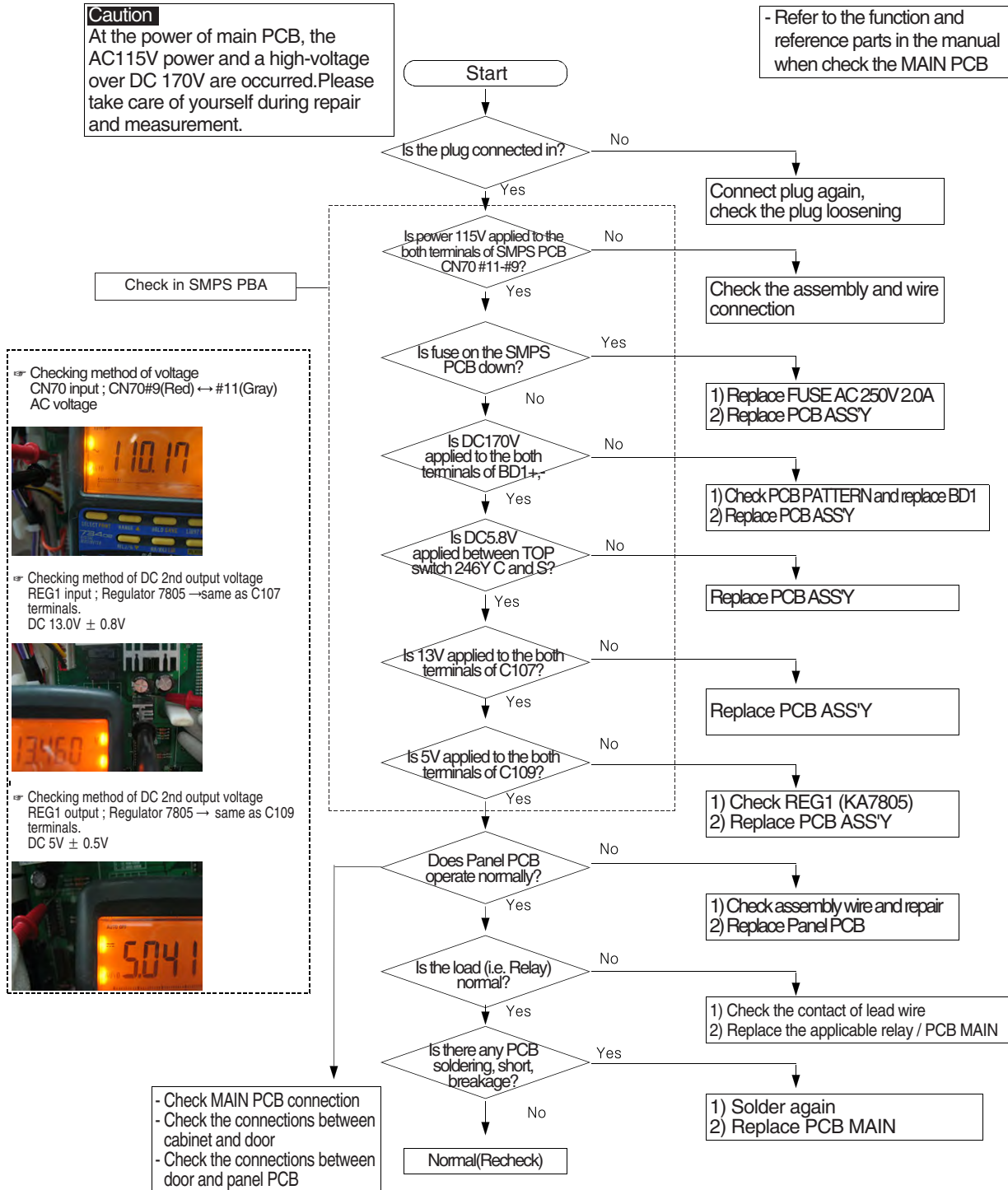

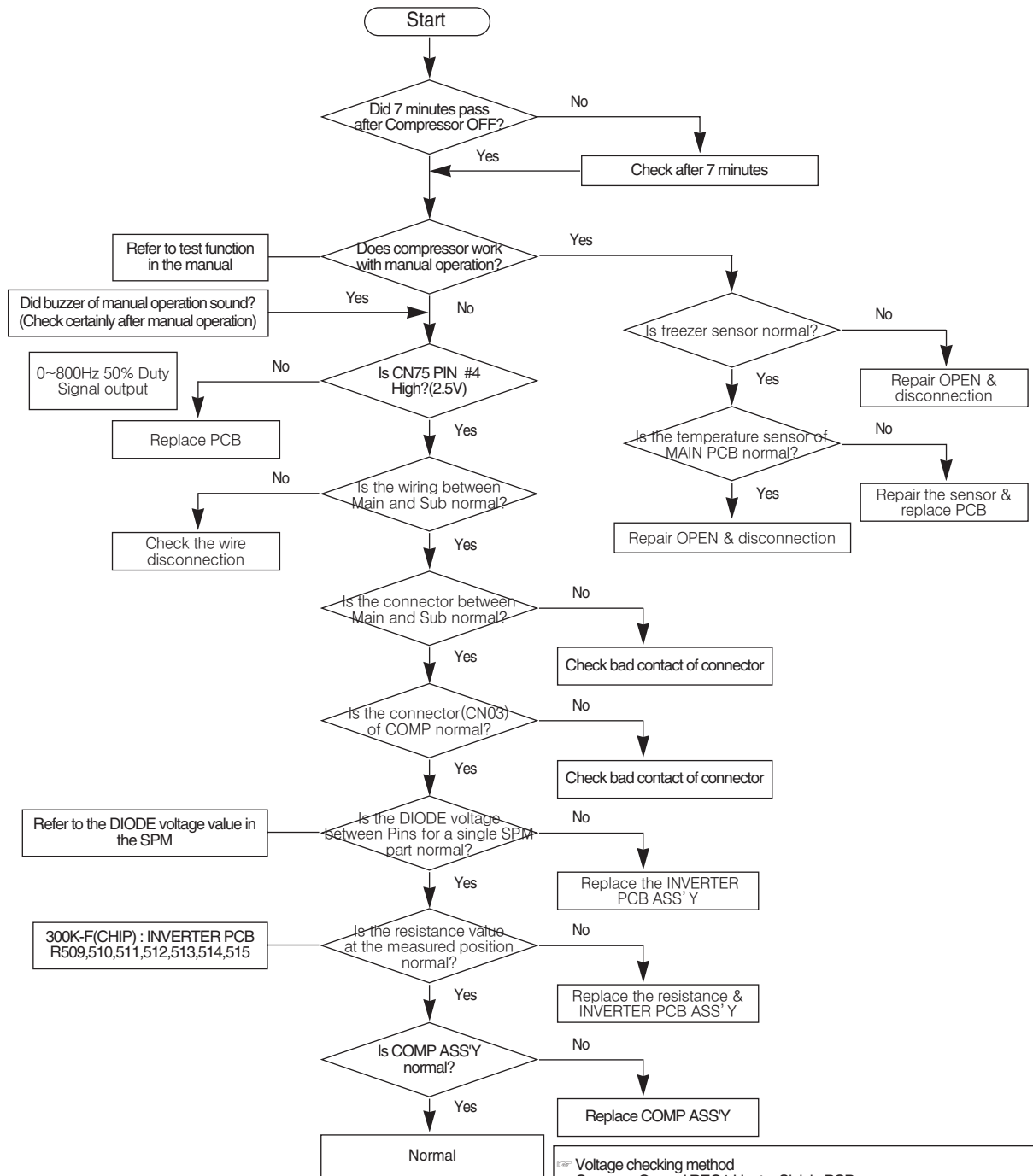

TROUBLESHOOTING

4-2-8. If compressor does not operate

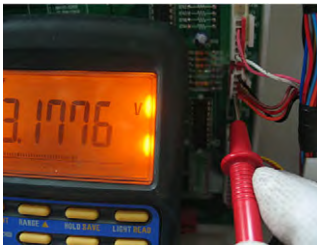

Voltage checking method
 Common Ground REG1 Heater Sink in PCB and 1) IC01 MICOM #4 ; Square wave voltage → 3V measured after MULTI TEST IC01 MICOM #4, COMP operates

Common PCB Ground REG1 Heater Sink

SPM FREEWHEELING DIODE VOLTAGE VALUE

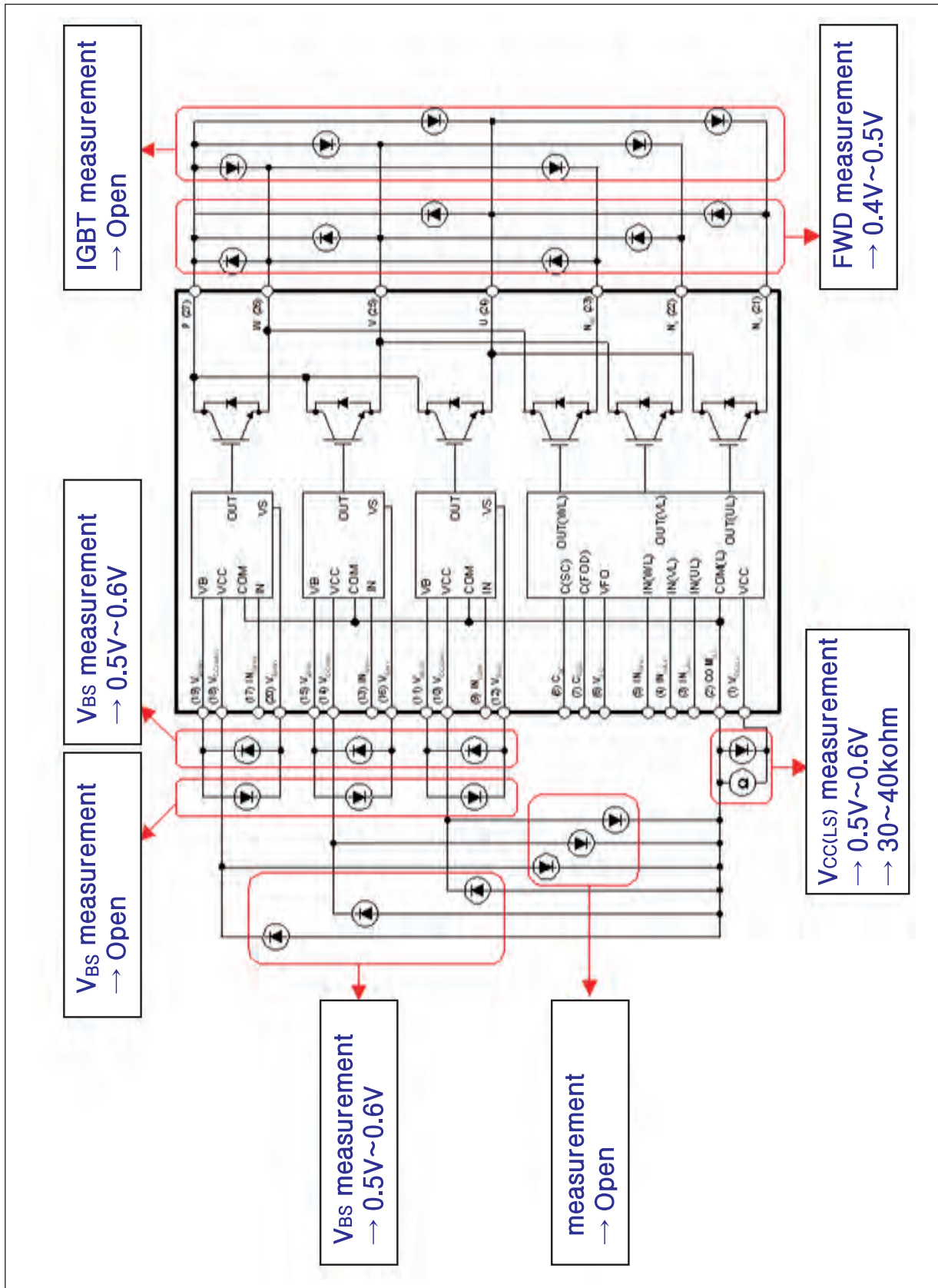

TROUBLESHOOTING

4-2-9. When alarm sounds continuously without stop(related with buzzer sound)

① If 'ding-dong'sound continuously

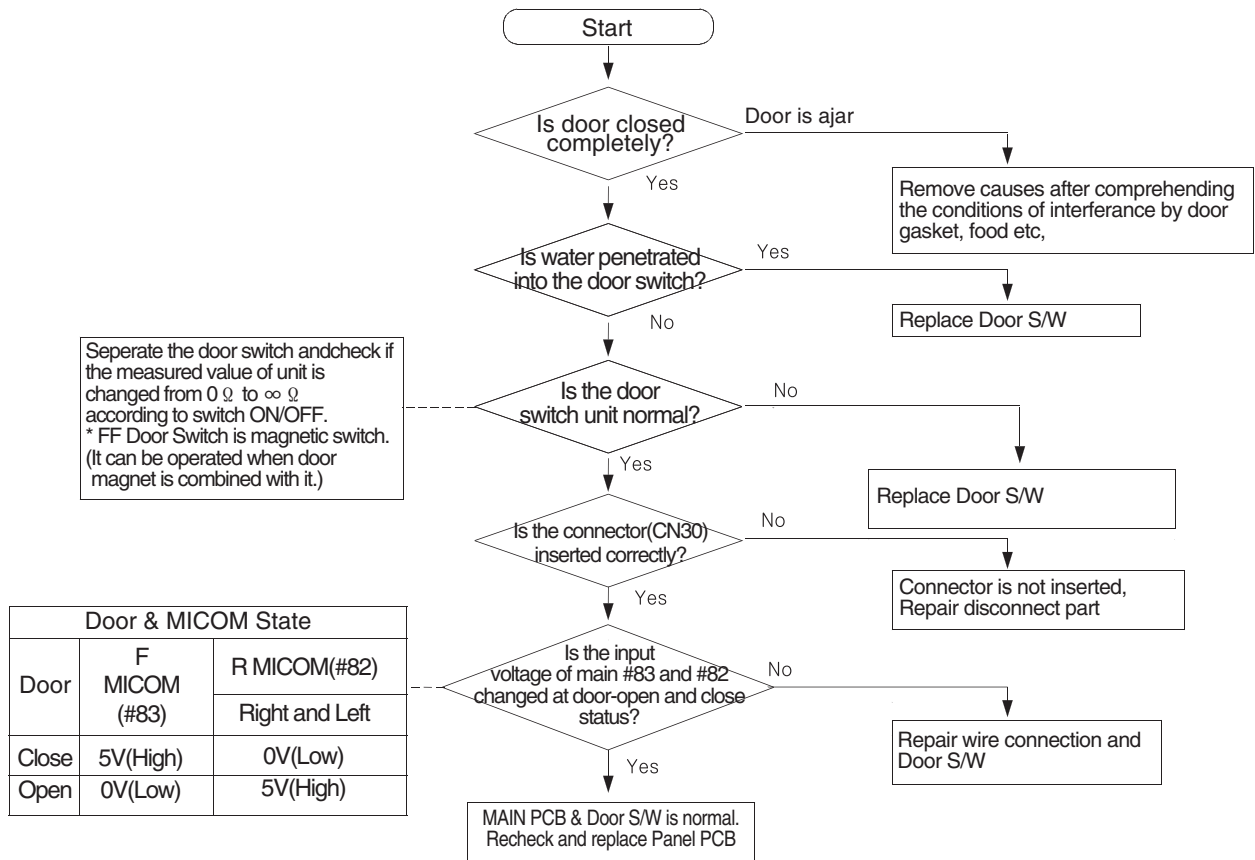

② If 'beep-beep' sounds continuously

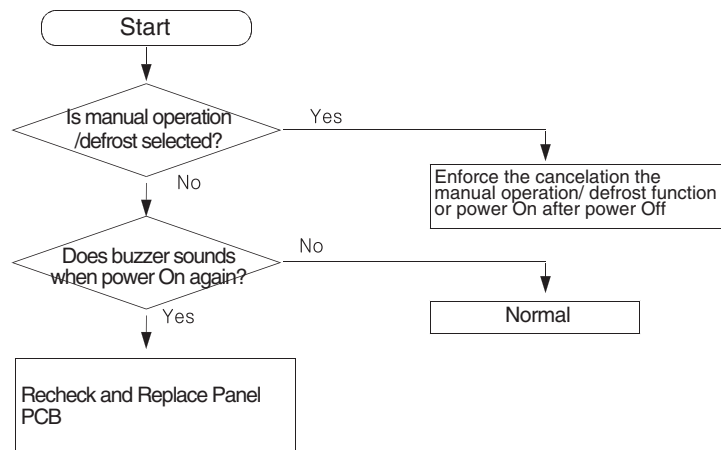

TROUBLESHOOTING

③ If buzzer does not sound

Buzzer is installed on the panel PCB in this model.

If buzzer does not sound even though the button is pressed, manual operation is started and door is opened, it should separate panel PCB and check the breakage of buzzer and bad soldering.

It is very hard to repair the panel PCB because it consists of SMD assemblies.

It is recommended to replace PCB assembly when the failure associated with panel is occurred except the minor error such as switch pressing error, surface peeling off and so on.

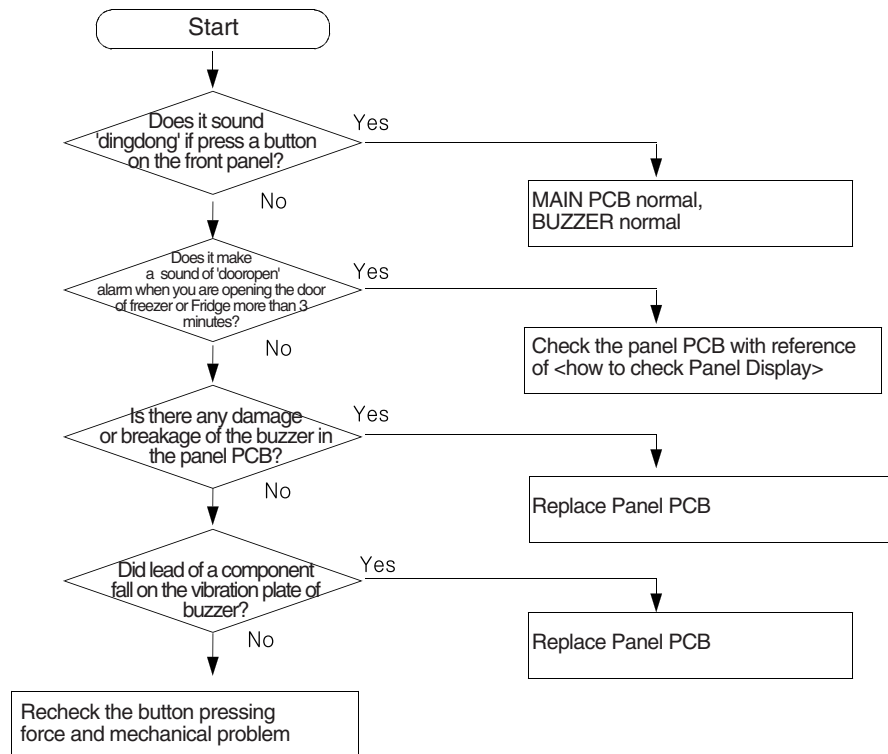

TROUBLESHOOTING

4-2-10. If Panel PCB does not work normally

① When lighting of Panel PCB is disabled or only some LED Lamp are disabled

Be careful to repair because display of this model is installed in the MICOM of internal PCB. It is recommended to replace PCB MAIN after checking except specified solder touch.

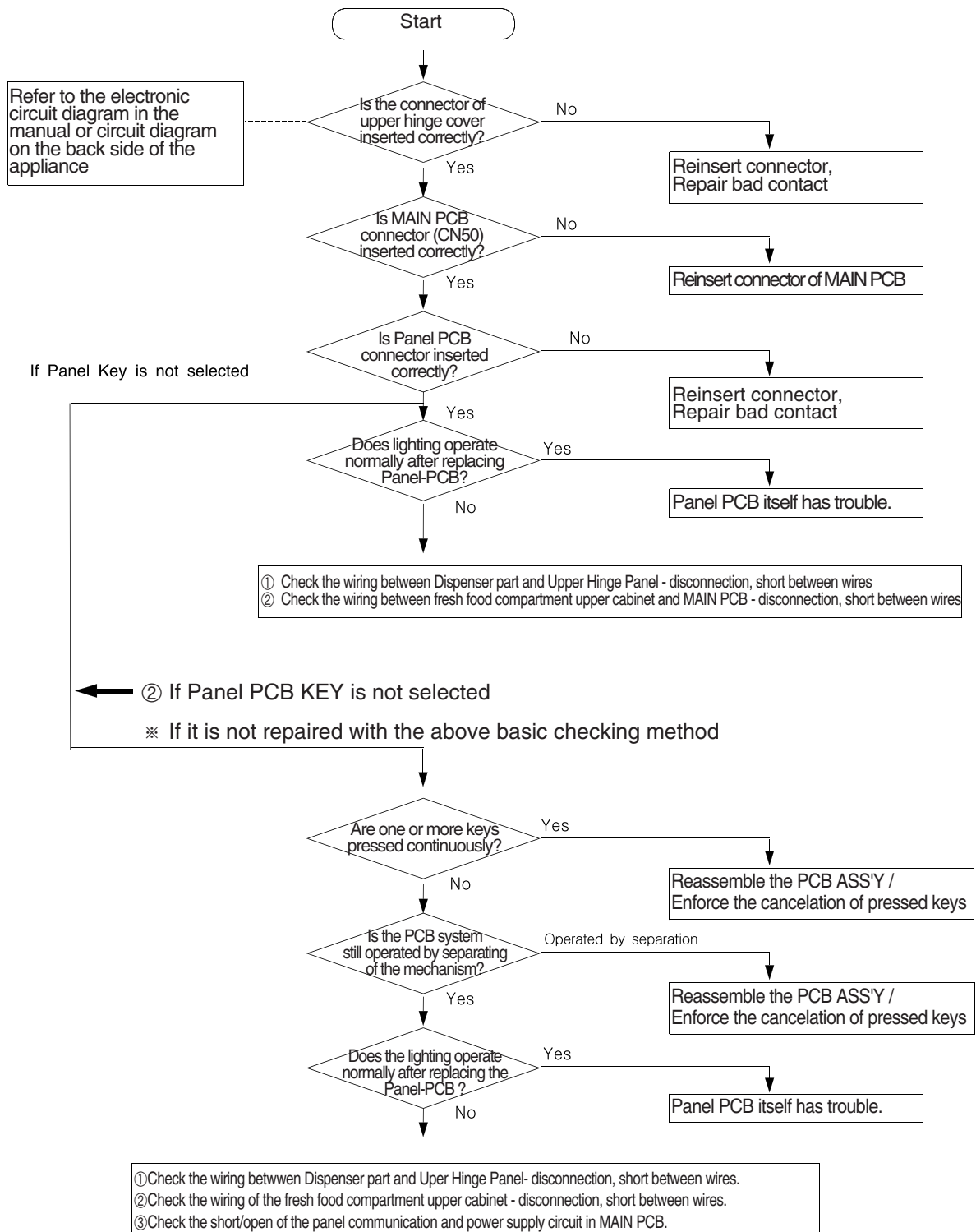

TROUBLESHOOTING

4-2-11. If Pantry Panel PCB is not working normally

You should check the display after door opening because the display of this model operates only when the fresh food compartment door is opened.

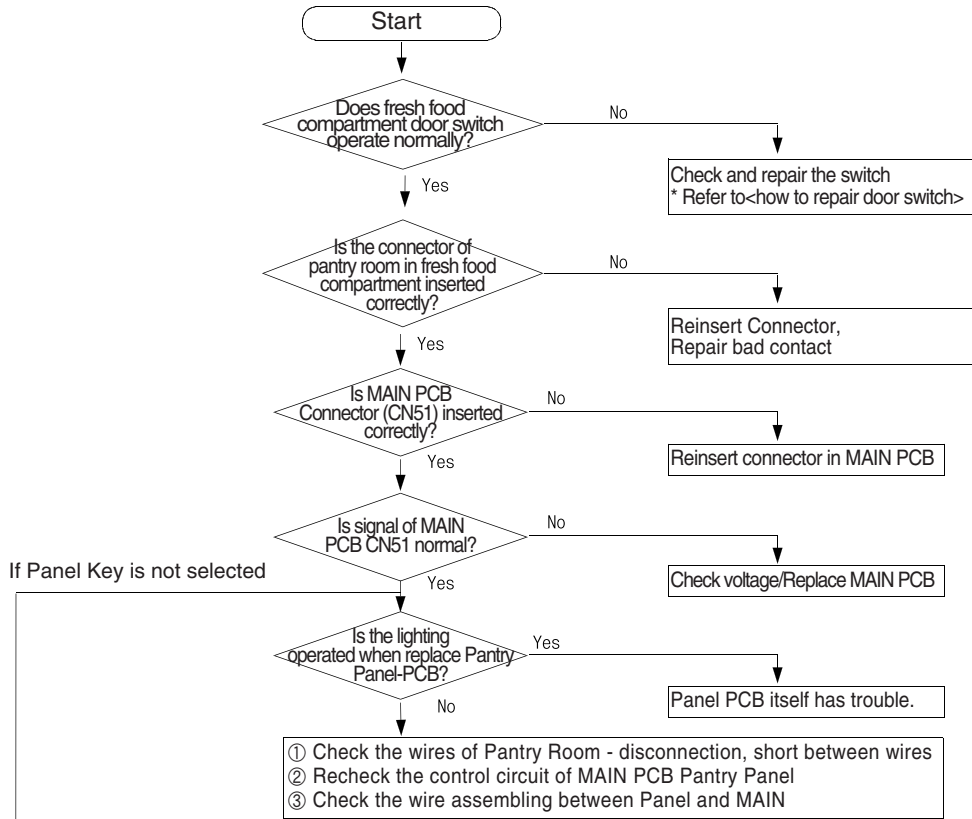

Typical PCB Ground REG1 Heater Sink



← ② If Panel PCB Key is not selected

※ If it is not repaired with the above basic checking method

☞ Checking method of voltage Based on PCB typical Ground REG1 Heater Sink

1) Key voltage ; CN51#6"(Purple)

1) selected (operating) (0V) 2) normal (about 5.0V ± 0.5V)

2) LED part voltage ; CN51-"1"(Yellow), "2"(Pink), "3"(Orange) → Voltage of CN51 is same as IC50 #14, #13, #12 voltage.

- Display On (0.7V ± 0.5V) - Display Off (11V ± 1V)

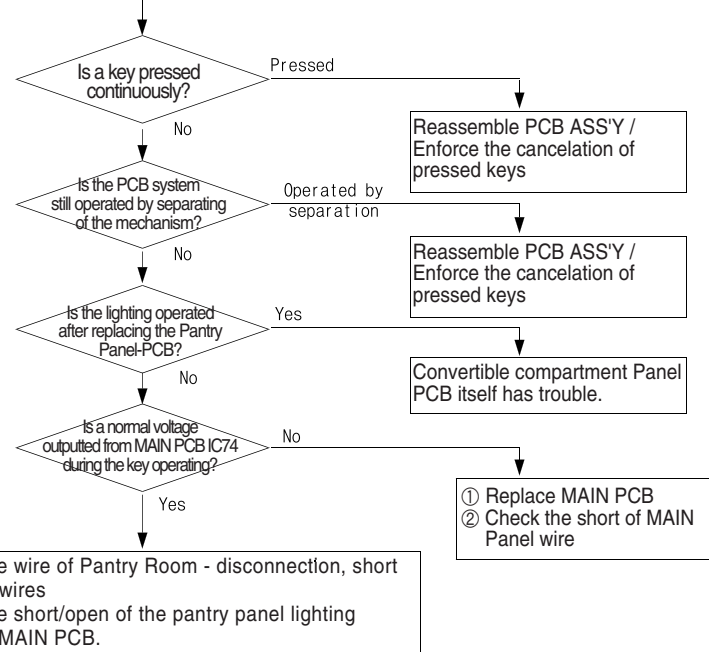

TROUBLESHOOTING

4-2-12. When refrigerator ROOM Lamp does not light up

1. When you replace the lamp of freezer, please power OFF to avoid an electric shock.
2. Please keep in mind you could get burnt by the excessive heating of an incandescent light bulb.
3. Bimetal is installed in the refrigerator LAMP. Check that if LAMP may be turned OFF by bimetal.

1) AC Lamp (Option)

※ We only explain about Fresh Food compartment in this page.
Because it is possible to repair the other room lamps with the same method.

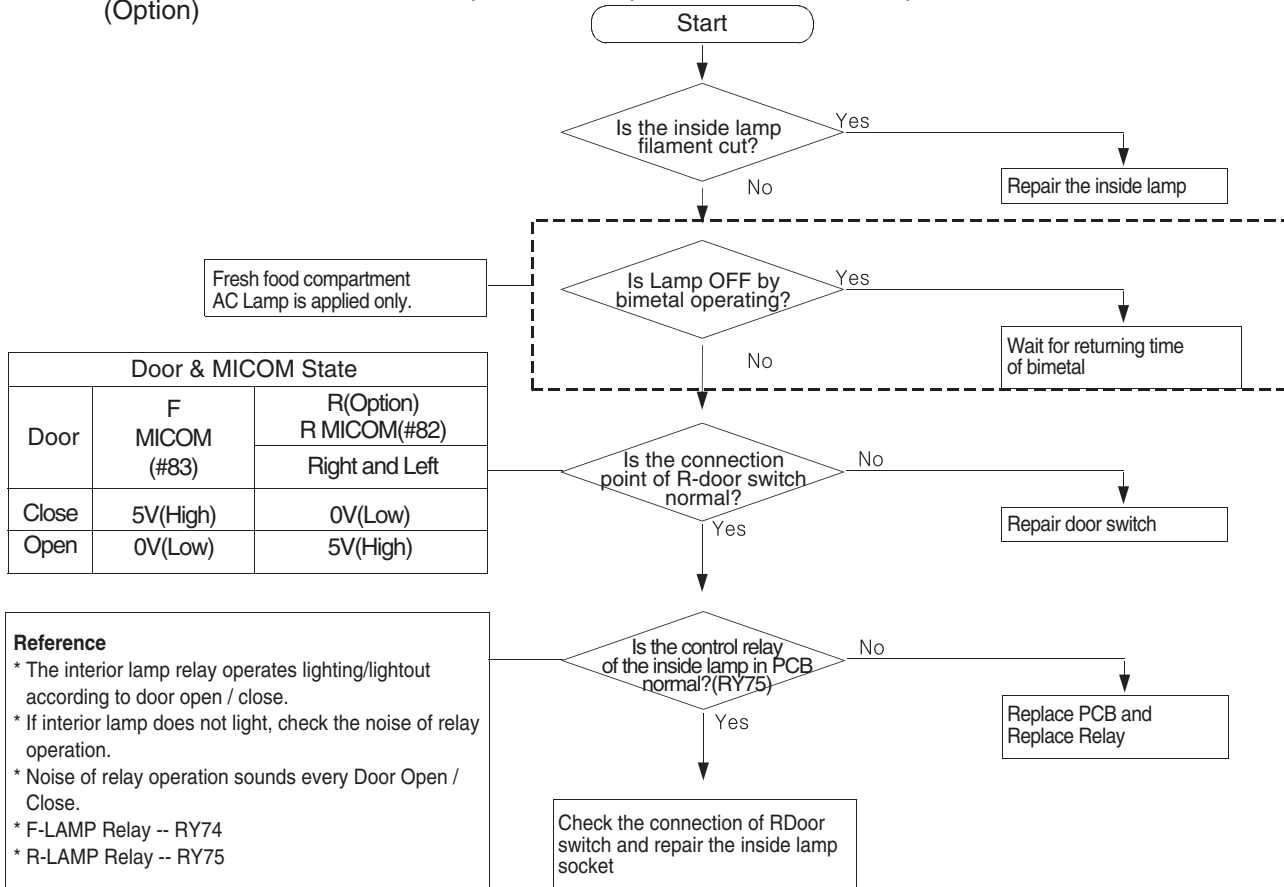

Reference

If the door is opened, the contact of door switch will be opened and MICOM will get applied 5V to finally sense Open.
If 5V has been sensed over three minutes afterwards, Door-Open alarm will sound 'Ding-Dong' for 10 seconds in a one minutes cycle.
For that reason, if the door switch has failure, the refrigerator can make a "Ding-Dong" sound with oneminute cycle. Please note the step for its service.

☞ When measure lamp resistance to the Wire
→ Resistance can be changed by Lamp input voltage.
(Actual measurement is below, it can be changed by performance)

Wire color changed from the following picture



☞ Fresh food compartment lamp
CN70#9 (Red) ↔ CN71#1 (Blue);
10Ohm ± 5%
Lamp ; 60W + 60W

☞ Freezer compartment lamp
CN70#9 (Red) ↔ CN71#3 (Gray);
15Ohm ± 5%
Lamp ; 60W

☞ Checking method of Door Switch voltage

- Measuring voltage of CN30#2(Purple), CN30#1(black) and REG1, HEAT SINK from PCB typical Ground part
→ See the R DOOR Switch at the following picture.

CLOSE



OPEN



Typical PCB Ground REG1 Heater Sink



TROUBLESHOOTING

1) LED Lamp (Option)

When controlling the refrigerator light with Regulator(12V) : LED LAMP
 → Applying only to the FF compartment.

* If the Vegetable Lamp does not work properly, check the FF compartment LED Lamp because it is connected with the FF compartment LED Lamp in parallel. Refer to the circuit diagram to repair.

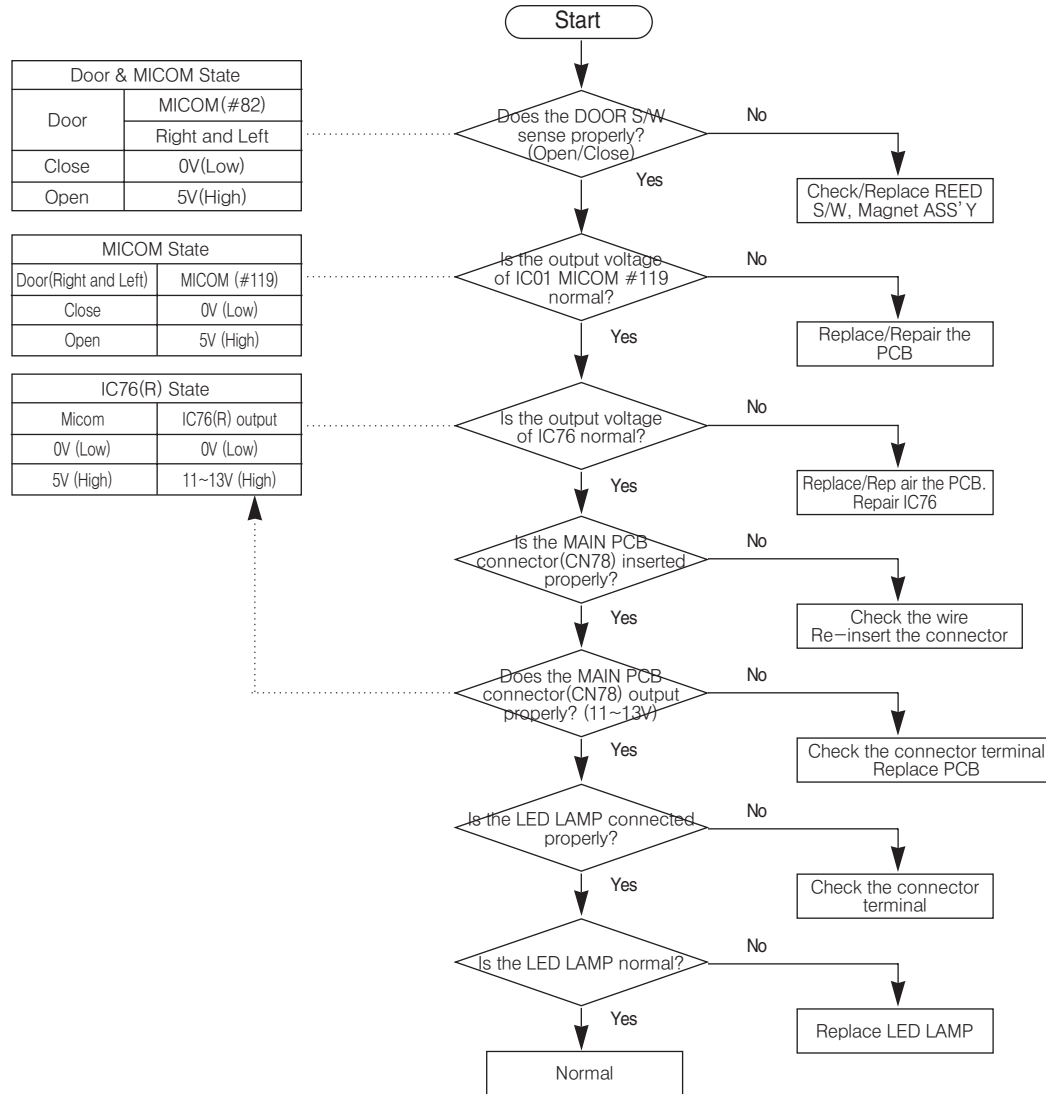

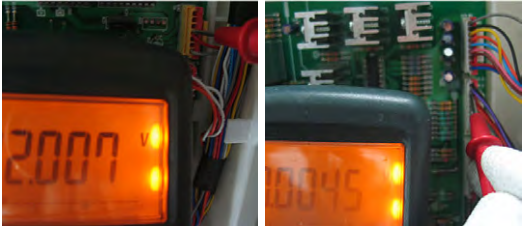

☞ Output Voltage Checking Method
 - Common Ground REG1 Heater Sink in PCB and
 1) 1) Measuring IC76 voltage (CN78-#4(Red) / R ROOM LED)

LED Lamp ON LED Lamp OFF

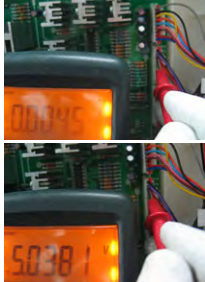

☞ Door Switch voltage Checking Method
 - Measuring common Ground REG1 Heater Sink in PCB and CN30-2 (Purple) (R Door Switch)

Typical PCB Ground REG1 Heater Sink

TROUBLESHOOTING

4-2-13. If ICE Water is not supplied

1. Please shut the water supplying prior to repair.
2. Power is applied to the one end of wires. Be careful when disassembling not to get an electric shock.

1) Fridge Ice Water Valve

Typical PCB Ground REG1 Heater Sink



- ☞ Checking method of voltage Based on PCB typical Ground REG1 Heater Sink
- 1) Check the voltage of IC73#4(same voltage as IC01 #54)
- ICE Water valve operating (about $5V \pm 0.5V$)



- Based on PCB typical Ground REG1 Heater Sink
- 2) IC73 #15 voltage
- ICE Water valve Waiting (about $13V \pm 0.8V$)
 - ICE Water valve operating (about $0.7V \pm 0.5V$)



- 3) Check the voltage of Fridge Ice Water Valve operating(AC voltage)
- => For checking the Relay RY78 operating.
CN73 and CN74 combined and use same connector(13p)
CN70#9(Red) ↔ 13P#7(Purple)
- ICE Water valve waiting (about AC 0V)



- ICE Water valve operating (about AC $115V \pm 20\%$)

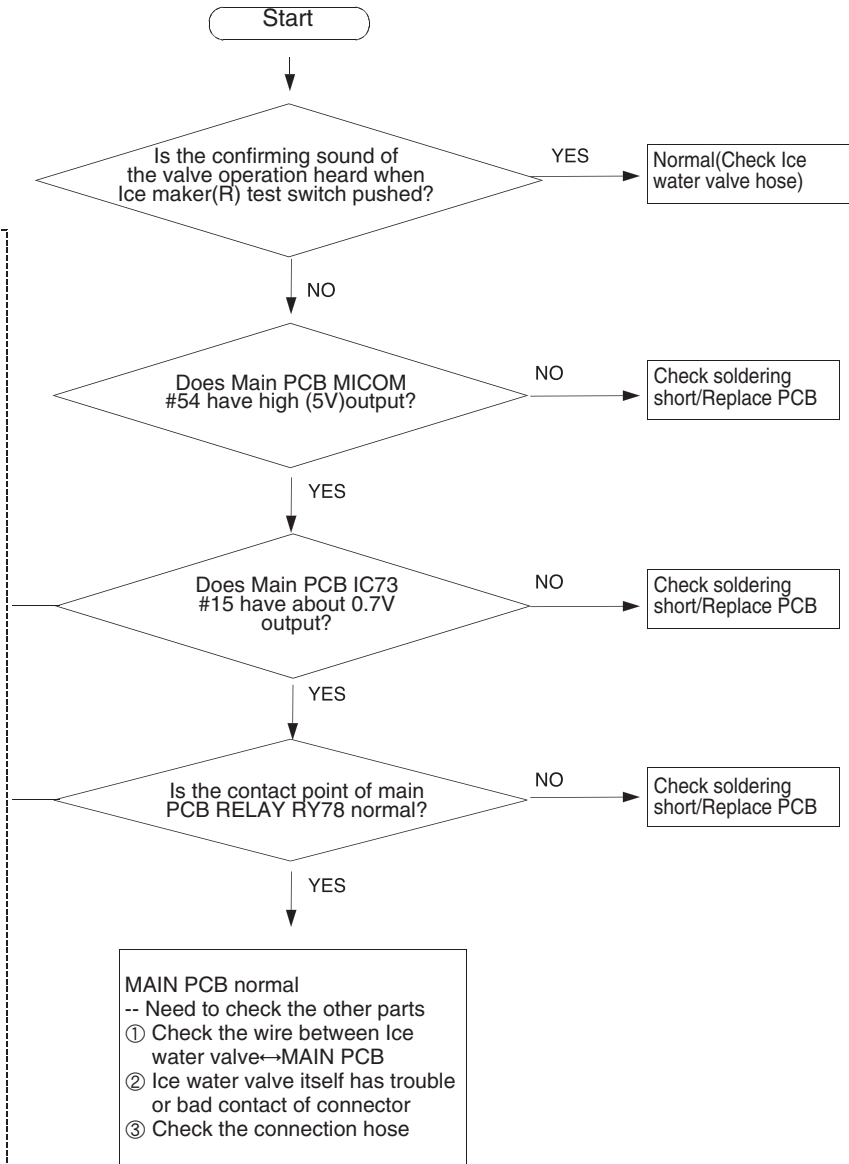

TROUBLESHOOTING

2) Freeze Ice Water valve(Dual Ice Maker)

Typical PCB Ground REG1 Heater Sink



☞ Checking method of voltage Based on PCB typical Ground REG1 Heater Sink
 1) Check the voltage of IC72#1(same voltage as IC01#58)
 - ICE Water valve operating (about $5V \pm 0.5V$)



Based on PCB typical Ground REG1 Heater Sink
 2) IC72 #18 voltage
 - ICE Water valve Waiting (about $13V \pm 0.8V$)
 - ICE Water valve operating (about $0.7V \pm 0.5V$)



3) Check the voltage of Fridge Ice Water Valve operating(AC voltage)
 => For checking the Relay RY76
 CN70-9"(Red) ↔ CN72-5"(Brown)
 - ICE Water valve waiting (about AC 0V)



- ICE Water valve operating (about AC $115V \pm 20\%$)

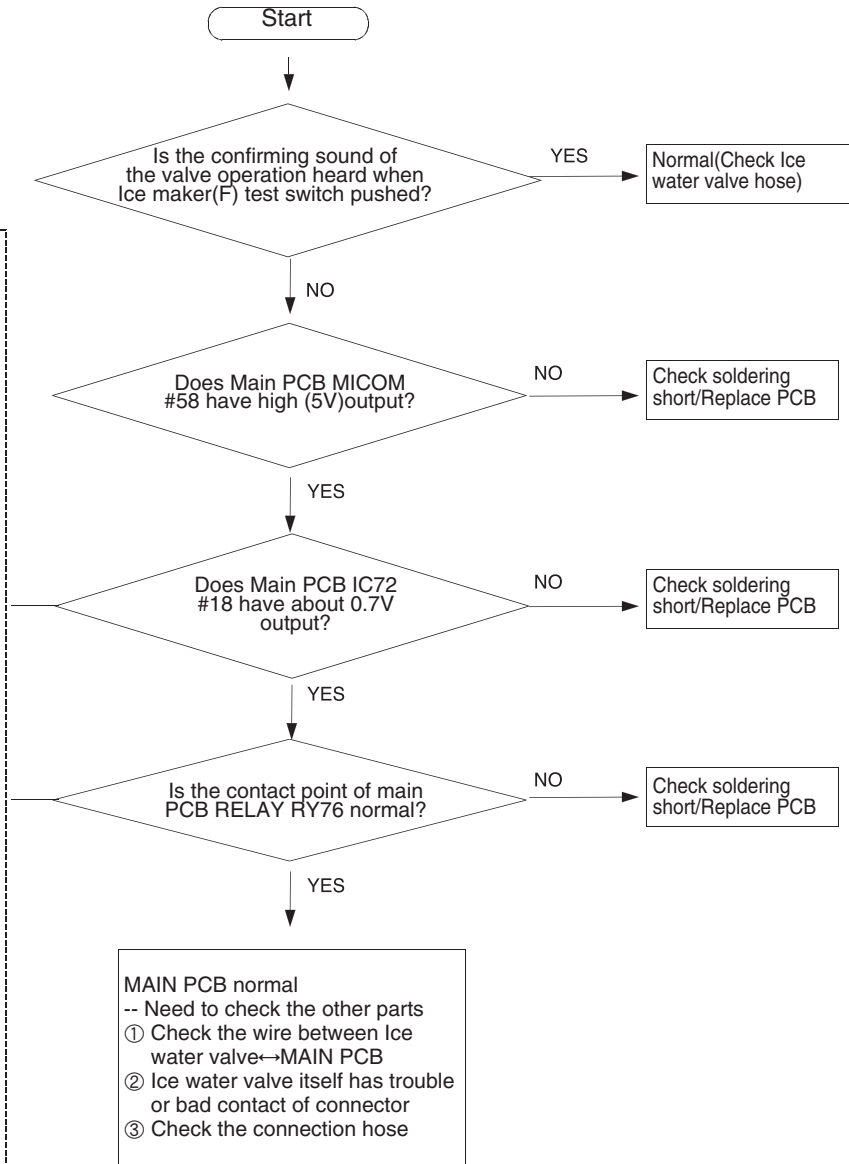

TROUBLESHOOTING

4-2-14. If Cubed or Crushed Ice is not supplied

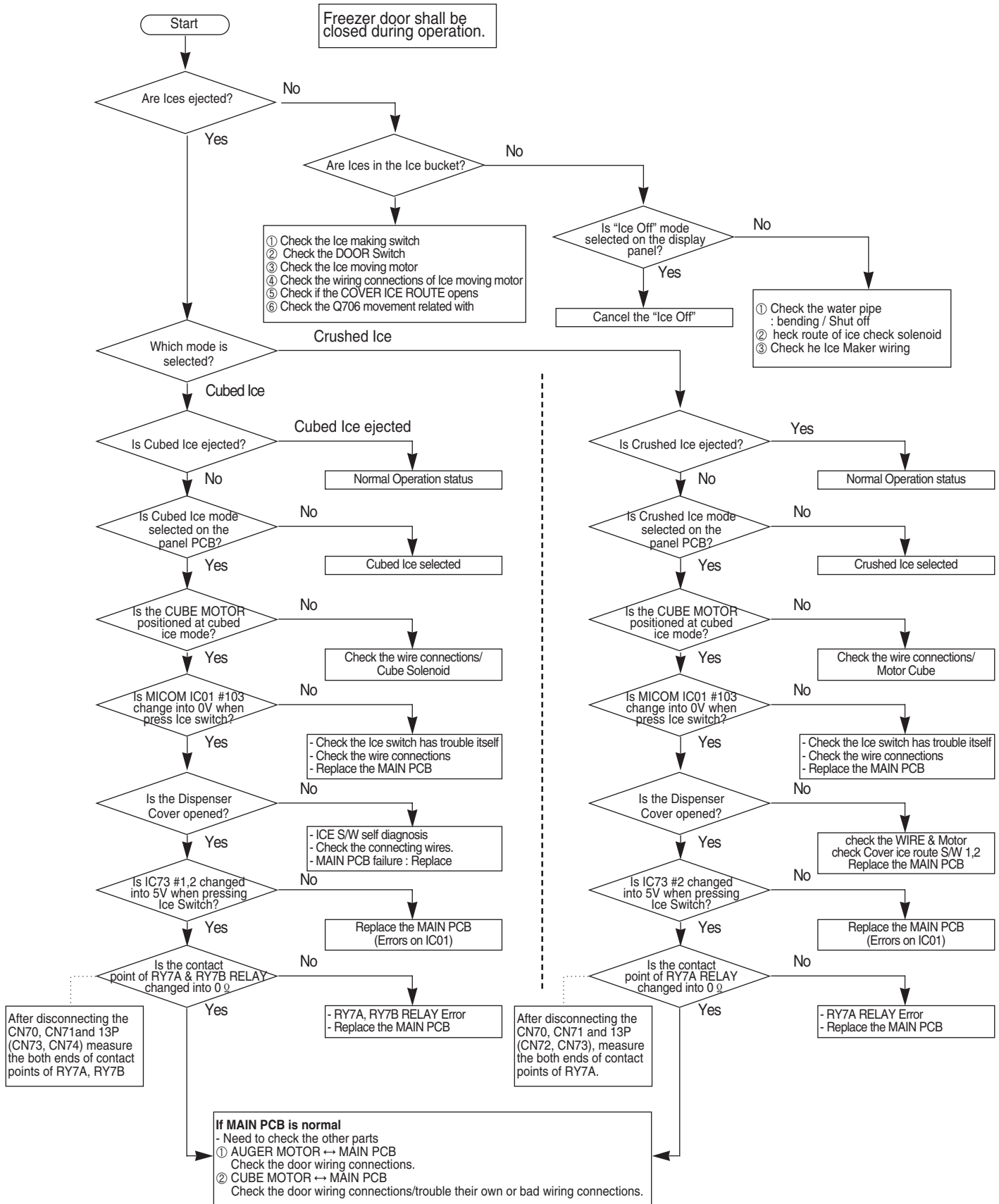

TROUBLESHOOTING

4-2-15. If Cover Ice Route Motor(Geard Motor) is not working normally

Caution

1. When replacing the Cover Ice Motor, pull out the plug to avoid an electric shock.
2. Be careful! When disassemble the Cover Ice Motor, spring can jumped out and may cause personal injury.
3. Motor will rotate continuously when the Motor Switch is not sensed.

☞ Checking Method of Cover Ice Route Motor Resistance
 (Make sure to work after Power Off)
 The Resistance is variable according to the input voltage.
 CN73 and CN74 combined and use same connector(13P)
 CN70#9(RED) ↔ 13P#9(Blue)
 ** 0 Ω : Short trouble / ∞ Ω : Open trouble

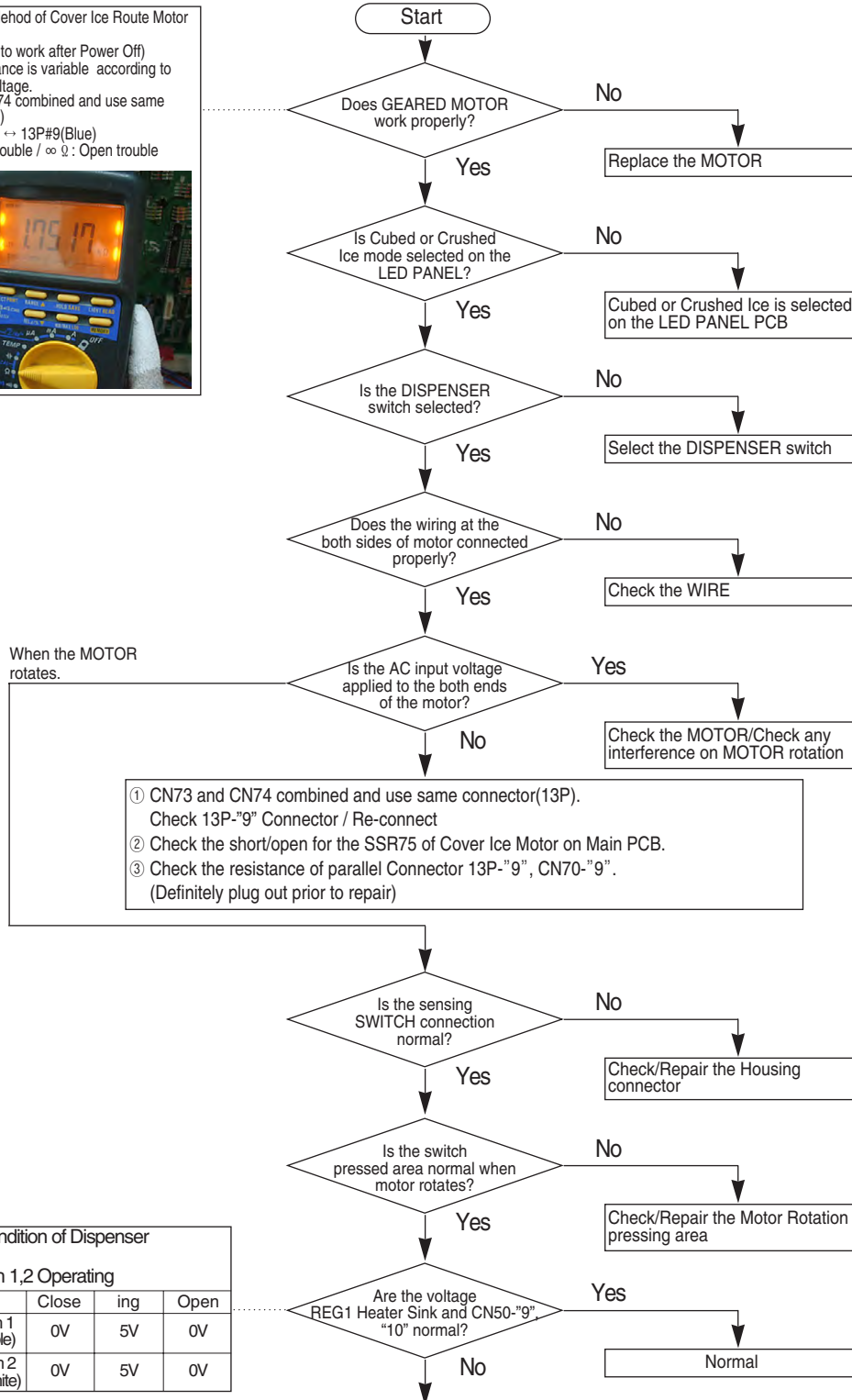
Operating Condition of Dispenser
 Open/Close
 CN50 - Switch 1,2 Operating

	Close	ing	Open
Ice Route Switch 1 CN50 - '9' (Purple)	0V	5V	0V
Ice Route Switch 2 CN50 - '10' (White)	0V	5V	0V

- ① Main PCB - Check the wire OPEN/SHORT between the Cover Ice Motor Rotation sensing switches.
- ② Check the Short of Cover Ice Motor Control Circuit SSR75 in the MAIN PCB.
- ③ Replace the MAIN PCB or the Dispenser Cover Motor.

TROUBLESHOOTING

4-2-16. If Photosynthetic LED Lamp does not work properly

Sears model Option

* Please check the Power prior to repair, even though DC power does not cause electric shock.
This lamp operates related to COMP operation, please check the COMP first.

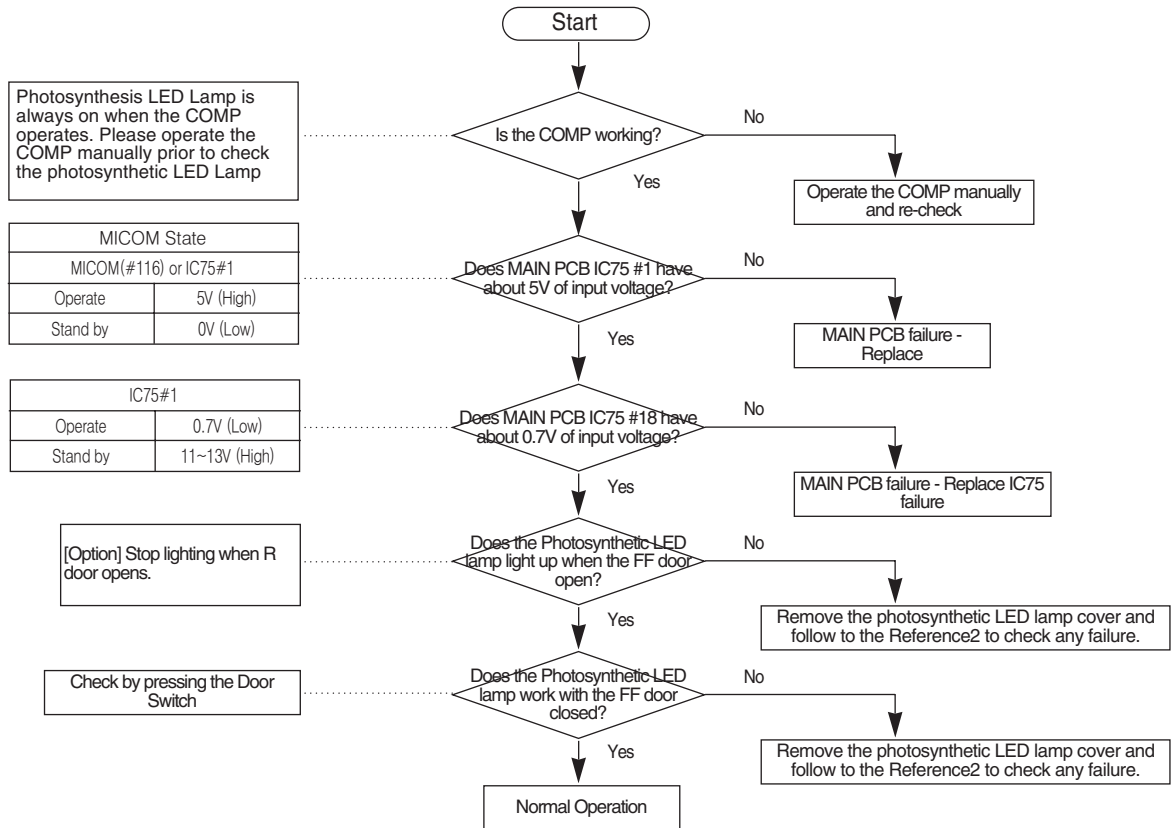

Reference 2

Remove the Photosynthetic LED lamp cover from the rear wall of Veg. Pan and connect battery to check the lamp operation.
1) Contact + of 9V battery onto #1 and - of 9V battery onto #3. Check whether LED light up. When the battery contacting time is longer, LED can be broken. Please contact it momentarily and just check the lighting.
- If LED doesn't light up, you are recommended to replace the whole photosynthetic LED ASS'Y.



TROUBLESHOOTING

4-2-17. If Inverter PCB Power is not supplied

Caution

At the INVERTER PCB Power, AC 110V/220V power and over DC 300V of high-voltage are applied. Please take care of yourself when repair and measure.

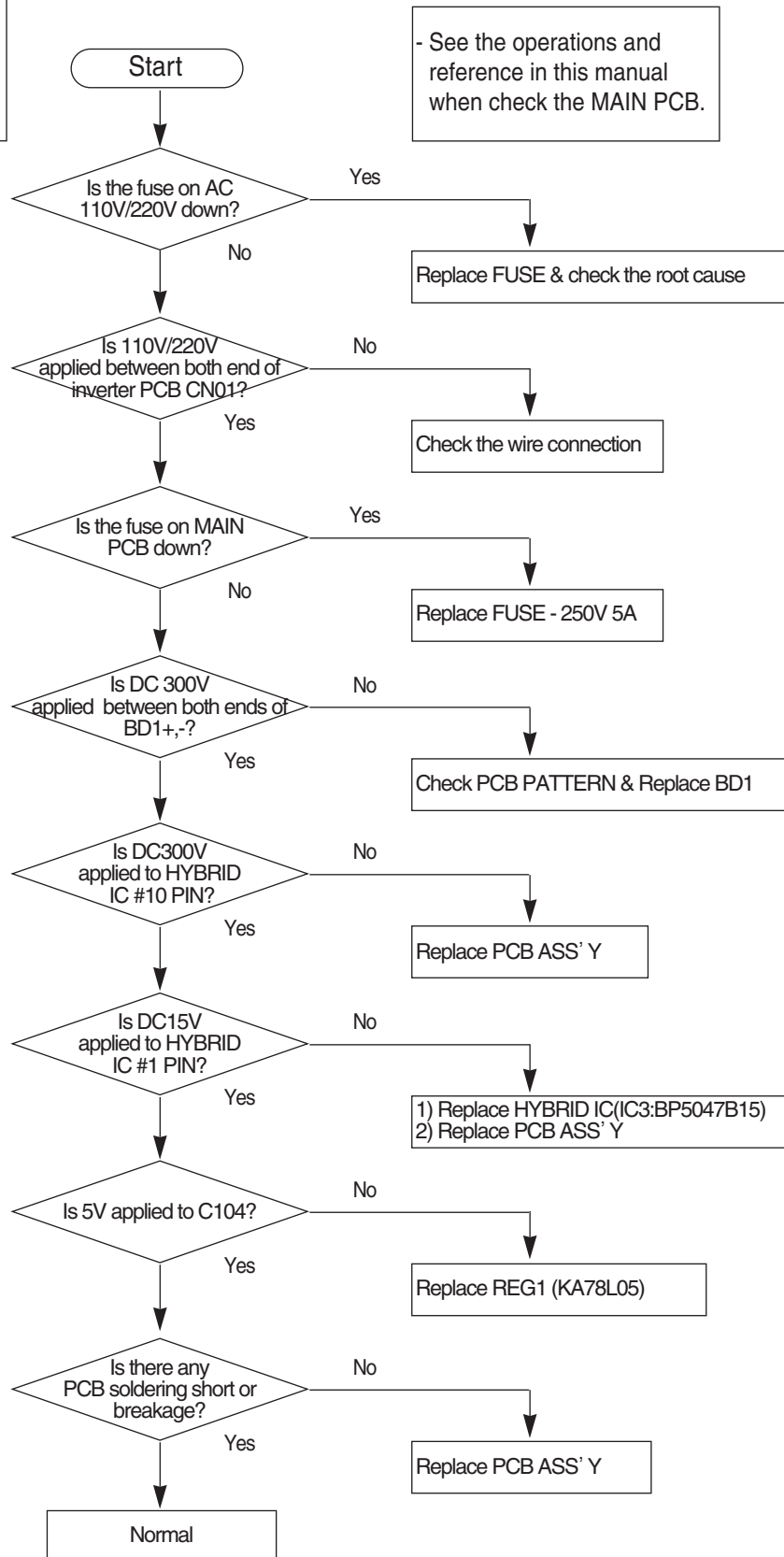

TROUBLESHOOTING

4-2-18. If compressor does not operate

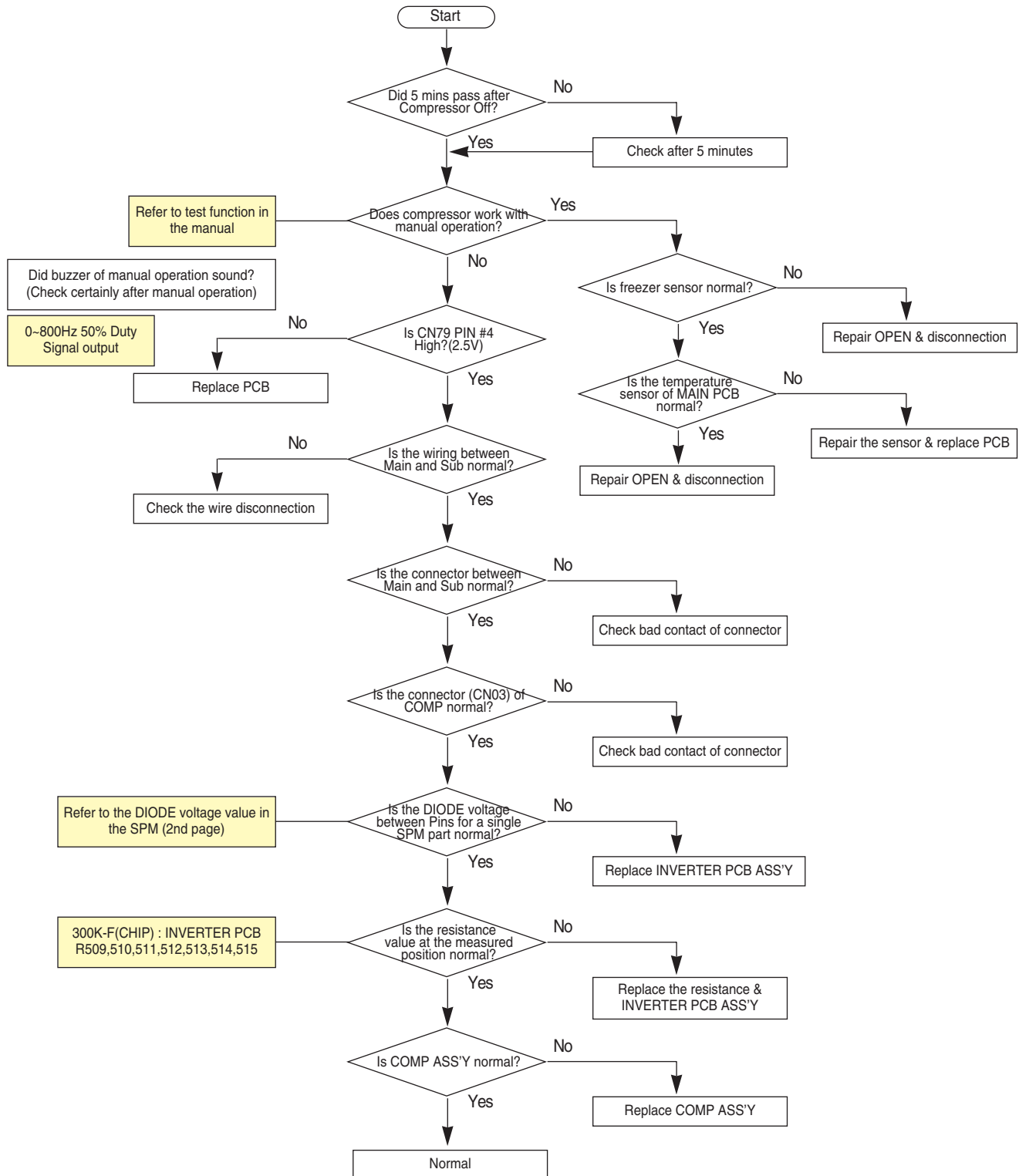







TROUBLESHOOTING

4-2-19. LED blinking frequency depending on protecting functions

If Failure Condition is detected during compressor is operating, immediately stop Compressor operating and stand by 5 minutes. During this 5 minutes, RPM command signal is not available. It means, even if available RPM command signal is applied to the compressor, it does not work and keep standing by.

Blinking time is 1 second and dwell time is 2 seconds.

LED Blinking Frequency	Protecting Functions	Remarks
	Normal Operation	N/A
	Starting Failure	Check the Inverter PCB.
	SPM Fault	Check the Inverter PCB, COMP, Cycle.
	Detecting Position Failure	Check the COMP, Cycle, Inverter PCB.
	Motor Locked / Over RPM	Check the COMP.
	Under Voltage	Check the Input Voltage.
	Over Voltage	Check the Input Voltage.

LED blinking frequency depending on protecting functions

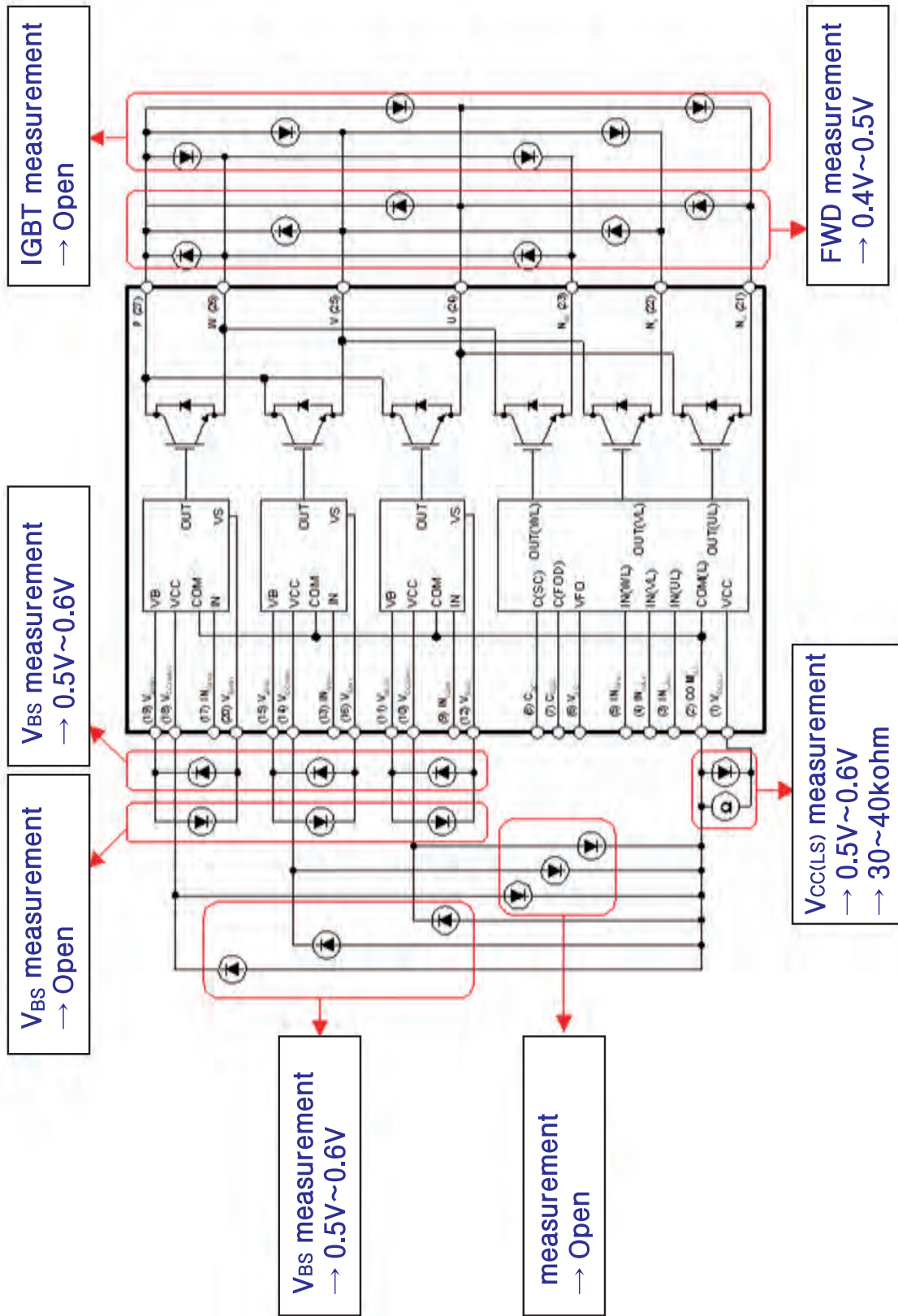

TROUBLESHOOTING

INVERTER CONTROLLER BOARD Connector Location

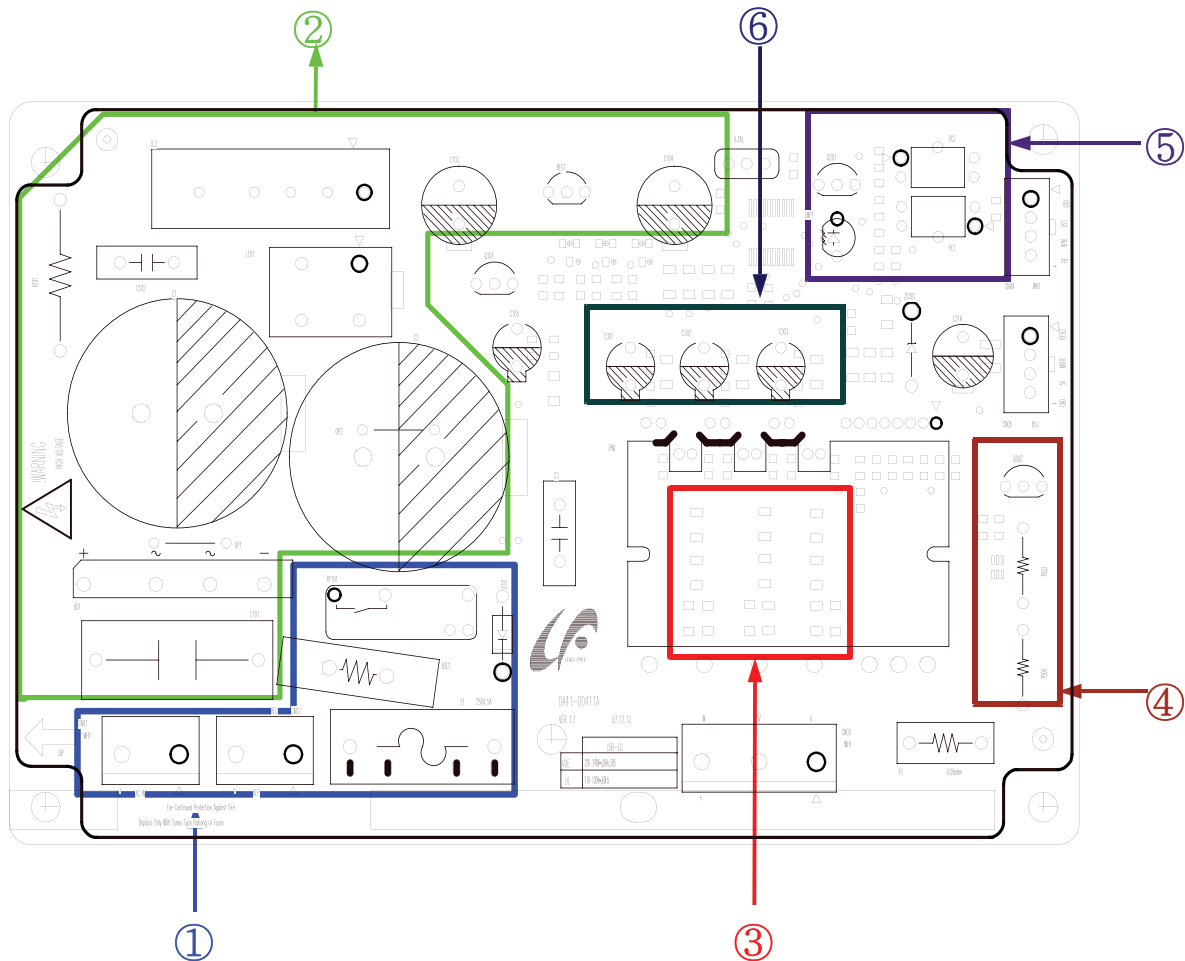

1. Inrush Current protecting area : It prevents an instant inrush of current generated in condenser when plug in.
2. PCB Power Source : Power source (HYBRID IC). It supplied DC15V and 5V to MICOM.
3. Location sensing resistance area : It senses motor location through the current detected.
4. Current sensing area : It senses the current from the SHUNT resistance and controls PWM DUTY.
5. COMP operating SIGNAL area : It receives COMP operating signal from MAIN PCB and conduct it.
6. BOOTSTRAP live part : Charging circuit that 1GBT of SPM can On/Off securely.

TROUBLESHOOTING

INVERTER PCB Circuit Diagram

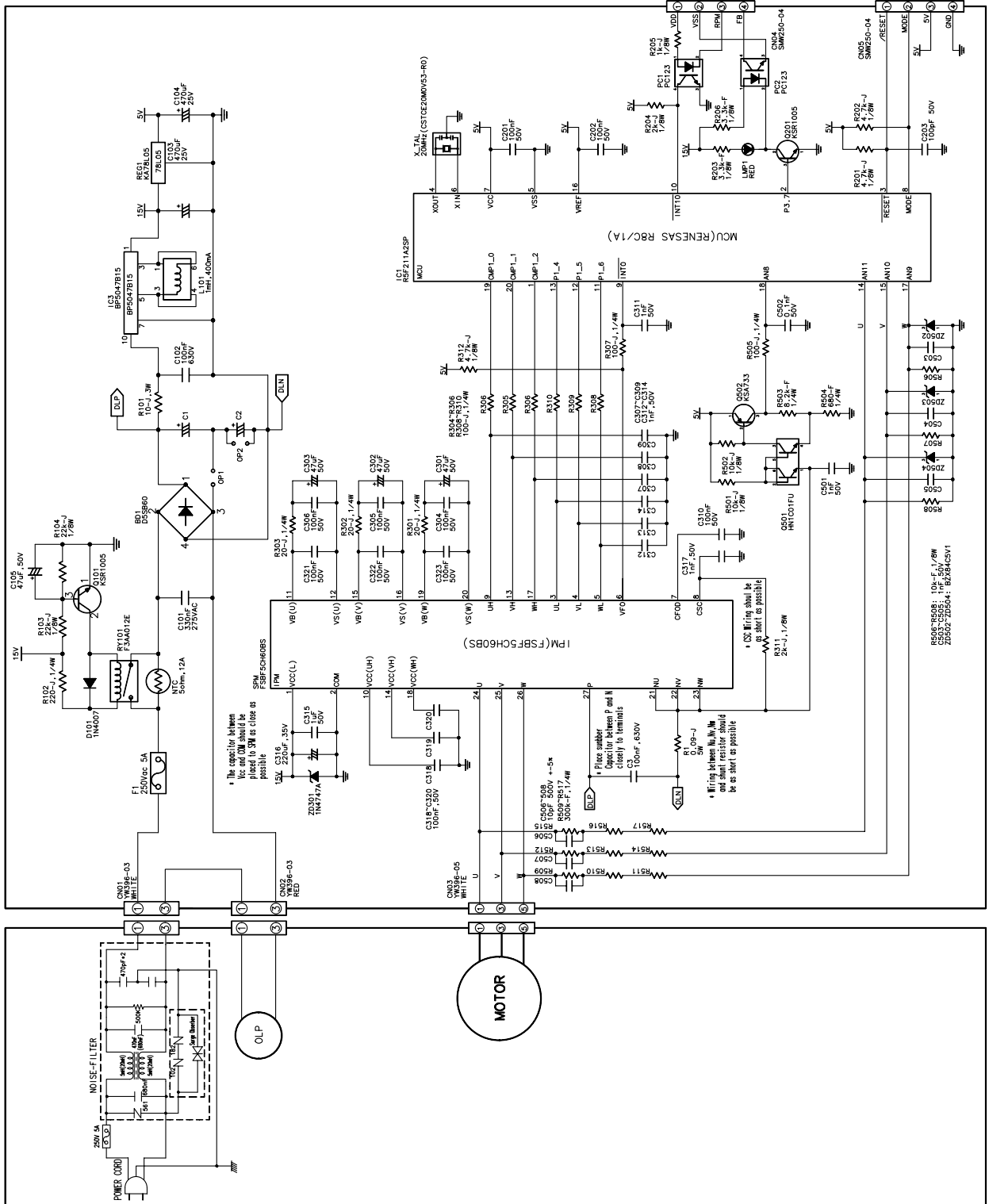

5 . EXPLODED VIEW& PARTS LIST

5-1) FREEZER	102
5-2) REFRIGERATOR	106
5-3) CABINET	112
5-4) DISASSEMBLY OF FREEZER DOOR	116
5-5) DISASSEMBLY OF REFRIGERATOR DOOR LEFT	118
5-6) DISASSEMBLY OF REFRIGERATOR DOOR RIGHT	122

EXPLODED VIEW & PARTS LIST

■ Parts List of Freezer

NO	CODE-NO	PART NAME	SPEC	QUAN TITY	REMARK
1	DA96-00462B	ASSY EVAP-FRE	AW-PJT(08),115V/240W	1	RF011
1-1	6501-000123	CABLE TIE	DACT-140,-,3.6,146,WHT(NTR),NYLON	2	RH705
1-3	DA32-10105B	SENSOR TEMP	-,,-,-,-,-,TEMP CAP TYPE,-,-	1	RS126
1-4	DA47-00243C	THERMO BIMETAL-PROTECTOR	AW-PJT(R),BT-121-M, PW-5M1N,125 / 250V,10 / 5A,60℃,40℃,-,-,100μ,-,-	1	RI074
1-5	DA47-00244B	HEATER-METAL SHEATH	-,AW-PJT,-,120W,-,115V,110.2Ω,-,-,R-ROOM	1	RF205
1-6	DA59-00361A	EVAP-FRE ICE	-,PIN,-,115V,-,-,-,AW-PJT,-	1	
1-7	DA60-90005A	RIVET-AVEX	AL,D3.2,L9.83,-,-	2	RS724
1-8	DA61-02901A	FIXER-SENSOR EVAP	CORE-PJT,PP,-,NTR,-	1	RI157
1-9	DA61-03644A	PLATE-EVAP HEATER	AW-PJT,AL,T0.7,-,-,-,-	1	RF170
1-10	DA61-04225A	PLATE-DRAIN FRE	AW2-PJT,GALVANUME,T0.3,-,-,-,-	1	RF026
2	DA63-02902B	COVER-FIXER HOUSING V	NEXT-PJT,GALVA,T0.3,W31,L42,-,-,-,-	2	RI222
3	DA63-04296A	COVER LAMP-FRE	AW2,PC,-,-,-,-,-,Transparent,-	1	RF031
4	4713-001223	LAMP-INCANDESCENT	120V,500mA,60W,-,-,-,47x84mm	1	RI081
5	DA97-07638A	ASSY TRAY-FRE UPP	AW2 TIM,COOL WHITE,Extended	1	RI242
5-1	DA61-04154A	FIXER-ROLLER TRAY FRE UPP	AW-PJT,POM,1.8,NATURAL,-	2	RF155
5-2	DA63-05038A	TRAY-FRE UPP	AW2 TIM,ABS,COOL WHITE(SC-02740R),Extended	1	RI064
5-3	DA63-04252B	COVER-TRAY FRE UPP A	AW2,ABS,-,-,-,-,-,COOL WHITE,-	1	RI064
5-4	DA63-04253A	COVER-TRAY FRE UPP B	AW2,GPPS,-,-,-,-,-,-	1	RI062
5-5	DA61-05300A	CASE-ICE CUBE	AW2 TIM,PP,COOL WHITE(SC-02740R),Extended	1	RM012
5-6	DA66-00554A	ROLLER-TRAY FRE UPP	AW-PJT,POM,42.2,-,NATURAL,-,PVC COATING	2	RF151
5-7	DA66-10104A	ROLLER-FRE	POM,-,-,D22,-,-,-	1	RW648
5-8	DA61-05185A	GUIDE-TRAY FRE UPP R	AW2 CD,PA+ABS,COOL WHITE(SC-02740R)	1	
5-9	DA61-05186A	GUIDE-TRAY FRE UPP L	AW2 CD,PA+ABS,COOL WHITE(SC-02740R)	1	
6	DA61-04260A	RAIL-FRE UPP L	AW2,ABS,-,-,-,-,COOL WHITE,-	1	RF191
7	DA61-04259A	RAIL-FRE UPP R	AW2,ABS,-,-,-,-,COOL WHITE,-	1	RF192
8	DA63-03414A	COVER-RAIL LOW L	AW-PJT,ABS,-,-,-,-,-,COOL WHITE,-	1	RI223
9	DA97-06626A	ASSY RAIL-SLIDE LOW L	AW2-PJT,-,-,-,-,-,STS430	1	RI171
9-1	DA34-00047A	SWITCH PRESSURE	AW-PJT,-,-,-,-,-,PP,COOL WHITE	1	RO151
9-2	DA61-03154A	FIXER-GEAR	AW-PJT,POM,-,NTR,-	1	RI170
9-3	DA61-04437A	HANGER-RAIL LOW L	AW-PJT,SECC1,T1.6,COOL WHITE,-,-,Powder Coating	1	RD094
9-4	DA61-03158A	RAIL-SLIDE LOW L	AW-PJT,STS430,-,-,-,-,-	1	
9-5	DA61-03285A	HANGER-RIVET	AW-PJT,BSW2,-,-,-,-,-	3	RI184
9-6	DA66-00436A	GEAR-L	AW-PJT,POM,-,-,-,NTR,-,-	1	RI242
10	DA66-00437B	SHAFT-GEAR	AW2,SM25C,715.1,-,-,-,BLACK Electro-deposition Coating	1	RI244
11	DA67-00859C	CAP-DOOR HANDLE	CORE,ABS,-,-,-,-,INOX,SC-06034R	1	RD059
12	DA97-06625A	ASSY RAIL-SLIDE LOW R	AW2-PJT,-,-,-,-,-,STS430	1	RI173
12-1	DA61-03154A	FIXER-GEAR	AW-PJT,POM,-,NTR,-	1	RI170
12-2	DA61-04439A	HANGER-RAIL LOW R	AW-PJT,SECC1,T1.6,COOL WHITE,-,-,Powder Coating	1	RD095
12-3	DA61-03285A	HANGER-RIVET	AW-PJT,BSW2,-,-,-,-,-	3	
12-4	DA61-03333A	RAIL-SLIDE LOW R	AW-PJT,STS430,-,-,-,-,-	1	RI185
12-5	DA66-00435A	GEAR-R	AW-PJT,POM,-,-,-,NTR,-,-	1	RI243
13	DA63-03415A	COVER-RAIL LOW R	AW-PJT,ABS,-,-,-,-,-,COOL WHITE,-	1	RI224
14	DA34-10120E	SWITCH DOOR-F	-,slide,-,250V,-,0.5A,-,-,-,-,-,cool white,-,-,-	1	RF041
15	DA61-04253A	GUIDE-DRAWER BOX	AW2,PP,2.8,-,-,WHITE,-	1	RI218
16	DA97-06276B	ASSY TRAY-DRAWER BOX	AW2 TIM,COOL WHITE,Extended Box	1	RI227
16-1	6002-001122	SCREW-TAPPING	FH,-,1,M4,L14,ZPC(WHT),SWRCH18A	2	RS059
16-2	DA61-03160A	REINF-DRAWER BOX	AW-PJT,SHP1,T2.0,BLACK	2	RI181
16-3	DA63-04251A	TRAY-DRAWER BOX	AW2,PP,-,-,-,-,-,COOL WHITE,-	1	RI237
16-4	DA63-04313A	GROMMET-TRAY DRAWER BOX	AW2,SILICON,-,-,-,-,-,WHT,-	2	RF152
16-5	DA61_05459A	RAIL-FRE UPP R	AW2,ABS,-,-,-,-,COOL WHITE,-	1	
16-6	DA61-04260A	RAIL-FRE UPP L	AW2,ABS,-,-,-,-,COOL WHITE,-	1	RF191
17	DA97-07656A	ASSY COVER EVAP-FRE ICE	AW2-TIM(115V),TWIN I/M	1	RF150

EXPLODED VIEW & PARTS LIST

5-2) Refrigerator



EXPLODED VIEW & PARTS LIST

■ Parts List of Refrigerator

NO	CODE-NO	PART NAME	SPEC	QUAN TITY	REMARK
1	DA96-00461C	ASSY EVAP-REF	NW2-PJT,PIN,-,115V/240W,-,-,-	1	RI016
1-1	6501-000123	CABLE TIE	DACT-140,-,3.6,146,WHT(NTR),NYLON	2	RH705
1-2	DA32-10105B	SENSOR TEMP	,-,-,-,-,-,TEMP CAP TYPE,-,-	1	RS126
1-3	DA47-00243C	THERMO BIMETAL-PROTECTOR	AW-PJT(R),BT-121-M,PW-5M1N,125 / 250V,10 / 5A,60℃,40℃,-,-,100μ,-,-	1	RI074
1-4	DA47-00244B	HEATER-METAL SHEATH	-AW-PJT,-,120W,-,115V,110.2Ω,-,-,R-ROOM	1	RF205
1-5	DA59-00357B	EVAP REF	,-,-,-,-,-,AW-PJT,-	1	RI016
1-6	DA60-90005A	RIVET-AVEX	AL,D3.2,L9.83,-,-	2	RS724
1-7	DA61-03644A	PLATE-EVAP HEATER	AW-PJT,AL,T0.7,-,-,-,-	1	RF170
1-8	DA61-03683A	FIXER-SENSER	AW-PJT,PP,-,NTR,FH-44N	1	RM017
1-9	DA61-04148A	PLATE-DRAIN REF	AW-PJT(08),GALVNUME,T0.3,-,-,-,-	1	RF026
2	DA63-02902B	COVER-FIXER HOUSING V	NEXT-PJT,GALVA,T0.3,W31,L42,-,-,-,-	2	RI222
3	DA97-06323C	ASSY COVER-EVAP REF	AW2-PJT,TWIN COOLING,BLDC,non waterproof housing	1	RI008
3-1	6002-001122	SCREW-TAPPING	FH,+,-,1,M4,L14,ZPC(WHT),SWRCH18A	2	RS059
3-2	6002-001122	SCREW-TAPPING	FH,+,-,1,M4,L14,ZPC(WHT),SWRCH18A	2	RS059
3-3	DA31-00124A	FAN-AX100W4CC-T1	,-,TD-PJT,ABS,-,-	1	RI085
3-4	DA31-00146B	MOTOR BLDC	DRCP5030LA,1560,-,DC12V,230mA,-,-,2.7W,ATOP,-,-,-,-,-	1	RI089
3-5	DA32-10105B	SENSOR TEMP	,-,-,-,-,-,TEMP CAP TYPE,-,-	1	RS126
3-6	DA61-03181A	CASE-MOTOR REF	AW-PJT,BUBBLE PP,-,-,-,NTR,-	1	RF121
3-7	DA61-03182A	GUIDE-INS EVAP REF	AW-PJT,ABS,-,-,-,NTR,-	1	RI210
3-8	DA61-03186A	PLATE-INS EVAP REF	AW-PJT,GALVNUME,T0.4,-,-,-,-	1	RI141
3-9	DA61-03599A	PLATE-HOUSING REF	AW-PJT,GALVALUME,T0.3,-,-,-,-	1	RI307
3-10	DA61-20128A	SPRING ETC-FAN	,-,STS304,P17.8,-,OD1.0,-,-,-,-,-,FD	1	RW716
3-11	DA62-01383A	INSULATION-EVAP SUB	AW-PJT,FOAM-PS,-,-,-,-,-,-	1	RI232
3-12	DA62-01423A	INSULATION-EVAP DUCT	AW-PJT,FOAM-PS,T20,W44.5,L45,-,-,-,-	2	RI236
3-13	DA62-01804A	INSULATION-EVAP REF	AW2-PJT,FOAM-PS,-,-,-,-,-,33 MAGNIFICATION	1	RI231
3-14	DA62-01805A	INSULATION-EVAP REAR	AW2-PJT,FOAM-PS,-,-,-,-,-,33 MAGNIFICATION	1	RI233
3-15	DA63-01146A	GROMMET-MOTOR,REAR	A-TOP,NBR,-,-,-,ID6.5,OD42,BLK,BLDC	2	RO138
3-16	DA63-01808A	GROMMET-MOTOR,FRONT	BLDC,NBR,BLACK,-,-,-,-,-,H20	1	RO137
3-17	DA63-01809A	COVER MOTOR-BLDC	BLDC-NEW,PP,NTR,-,-,-,-,-,BJ-730	1	RF083
3-18	DA63-04218A	COVER-EVAP REF	AW2-PJT,PP,-,-,-,-,-,COOL-WHITE(SC-02740R)-	1	RI008
3-19	DA63-40167A	GROMMET-COVER CHIL	SILICON,T3.0,L16,BLACK	1	RI087
3-20	DA64-02065A	TRIM-COVER EVAP REF	AW-PJT,ABS,-,-,-,COOL WHITE,-	1	RI241
3-21	DA39-00060K	WIRE HARNESS-MOTOR	A-TOP,-,-,-,-,-,35151-0410,N0090-9204,-,BLDC,-,-,-,-,R,F-FAN	1	RF028
4	DA97-06409A	ASSY CASE LAMP-REF	AW2-PJT,-,-,-,-,-,LED	1	RI246
4-1	6003-001136	SCREW-TAPTYPE	BH,+,-,B,M4,L8,ZPC(WHT),SWRCH18A,-	6	
4-2	DA61-04318A	CASE LAMP-REF	AW2,ABS,-,-,-,COOL WHITE,-	1	
4-3	DA96-00398A	ASSY-LAMP_LED	AW-PJT,ROOM LAMP_LED	1	RW960
4-4	6501-000123	CABLE TIE	DACT-140,-,3.6,146,WHT(NTR),NYLON	2	RH705
5	DA63-04326A	COVER LAMP-REF	AW2(LED),PC,-,-,-,-,-,Transparent,-	1	RI078
6	DA61-04329A	ANGLE-SHELF REF SIDE R	AW2(PANTRY),SECC1,T2.0,-,-,COOL WHITE,Powder Coating	1	RI301
7	DA97-06372A	ASSY-ANGLE SHELF REF MID	AW2,-,-,-	1	RI288
8	DA67-01688A	CAP-ANGLE	AW-PJT,TALC PP,-,-,-,COOL WHITE,-	1	RI298
9	DA97-06394A	ASSY SHELF-REF MID	AW2,-	2	RI040
9-1	DA67-01927A	SHELF-INSERT REF SLIDE	AW2,PP+GLASS,-,-,-,COOL WHITE,INSERT	1	
9-2	DA91-02722A	ASSY HANGER-SHELF SLIDE	AW2,-,COOL WHITE,-,-	1	
10	DA97-06329A	ASSY COVER-VEG REF	AW2-PJT,-,-,-,-,-,-	1	RI449
10-1	6002-001122	SCREW-TAPPING	FH,+,-,1,M4,L14,ZPC(WHT),SWRCH18A	2	RS059
10-2	DA01-00400E	GLASS-COVER VEG	789°338,T3.2,1° PRINT	1	
10-3	DA61-03166A	FIXER-COVER VEG	AW,TALC PP,-,COOL WHITE,-	2	RI208
10-4	DA61-04292A	REINF-COVER VEG	AW2-PJT,SHP1,T2.9,-,-,-,-	1	RI209
10-5	DA63-04281A	COVER-VEG REF	AW2-PJT,HIPS,-,-,-,-,-,COOL-WHITE(SC-02740R)-	1	RI010
10-6	DA64-00817A	KNOB-HUMIDITY	QUEEN,ABS,-,-,-,-,-,-	2	RQ611

EXPLODED VIEW & PARTS LIST

■ Parts List of Refrigerator

NO	CODE-NO	PART NAME	SPEC	QUAN TITY	REMARK
10-7	DA66-00438A	LEVER-HUMIDITY	AW,HIPS,,,,,COOL WHITE,-	2	RD023
10-8	DA66-10104A	ROLLER-FRE	POM,;,D22,;,;	1	RW648
11	DA97-04839A	ASSY RAIL-VEG L	AW-PJT,;,;,;,;	1	RI028
11-1	DA61-03172A	RAIL-VEG L	AW,TALC PP,;,;,COOL WHITE,-	1	RI028
11-2	DA66-10104A	ROLLER-FRE	POM,;,D22,;,;	1	RW648
12	DA97-04840A	ASSY RAIL-VEG R	AW-PJT,;,;,;,;	1	RI029
12-1	DA61-03177A	RAIL-VEG R	AW,TALC PP,;,;,COOL WHITE,-	1	RI029
12-2	DA66-10104A	ROLLER-FRE	POM,;,D22,;,;	1	RW648
13	DA97-06330A	ASSY CASE-VEG REF L	AW2-PJT,;,;,;,;	1	RI291
13-1	DA61-04293A	CASE-VEG REF L	AW2-PJT,SAN,;,;,NTR,-	1	RI359
13-2	DA61-04294A	SUPPORT-TRIM VEG R	AW2-PJT,HIPS,;,;,COOL-WHITE(SC-02740R),-	1	
13-3	DA61-04295A	SUPPORT-TRIM VEG L	AW2-PJT,HIPS,;,;,COOL-WHITE(SC-02740R),-	1	
13-4	DA63-04282A	COVER-VEG FRONT L	AW2-PJT,SAN,;,;,;,COOL-WHITE(SC-02740R),-	1	RI355
13-5	DA63-04283A	COVER-VEG TRIM L	AW2-PJT,SAN,;,;,;,COOL-WHITE(SC-02740R),-	1	RI354
13-6	DA66-10104A	ROLLER-FRE	POM,;,D22,;,;	1	RW648
13-7	DA71-20145A	FIXER-ROLLER	,PA,--	2	RH029
14	DA97-06332A	ASSY CASE-VEG REF R	AW2-PJT,;,;,;,;	1	RI290
14-1	DA61-04294A	SUPPORT-TRIM VEG R	AW2-PJT,HIPS,;,;,COOL-WHITE(SC-02740R),-	1	
14-2	DA61-04295A	SUPPORT-TRIM VEG L	AW2-PJT,HIPS,;,;,COOL-WHITE(SC-02740R),-	1	
14-3	DA61-04296A	CASE-VEG REF R	AW2-PJT,SAN,;,;,NTR,-	1	RI360
14-4	DA63-04284A	COVER-VEG FRONT R	AW2-PJT,SAN,;,;,;,COOL-WHITE(SC-02740R),-	1	RI357
14-5	DA63-04285A	COVER-VEG TRIM R	AW2-PJT,HIPS,;,;,;,COOL-WHITE(SC-02740R),-	1	RI356
14-6	DA66-10104A	ROLLER-FRE	POM,;,D22,;,;	1	RW648
14-7	DA71-20145A	FIXER-ROLLER	,PA,--	2	RH029
15	DA97-06333A	ASSY PARTITION-VEG	AW2-PJT,;,;,;,;	1	RI289
15-1	DA63-04286A	COVER-PARTITION VEG	AW2-PJT,SAN,;,;,;,NTR,-	1	
15-2	DA67-02007A	PARTITION-VEG	AW2-PJT,HIPS,COOL-WHITE(SC-02740R)	1	RI321
16	DA97-07129C	ASSY COVER TWATER	AW2,ASSY,;,;,;,;	1	
16-1	6002-001122	SCREW-TAPPING	FH,+,1,M4,L14,ZPC(WHT),SWRCH18A	2	RS059
16-2	DA47-00295A	HEATER-WATER TANK	,AW-PJT(09),P-CORD,2W,-,12V,72.0 ohm,--	1	RI045
16-3	DA63-04889A	COVER-TANK WATER	AW2,PP,;,;,;,COOL WHITE,BJ730,SC-02740R	1	RI350
16-4	DA63-04674A	COVER-HEATER WATER TANK	AW-PJT,PP,;,;,;,NATURAL,WATER DRIBBLE	1	RM036
16-5	DA97-07150A	ASSY TANK WATER	AW,ASSY,;,;,;,;	1	RI043
17	DA97-06327A	ASSY COVER-SLIDE PANTRY	AW2-PJT,;,;,;,;	1	RI192
17-1	DA63-04279A	COVER-SLIDE PANTRY B	AW2-PJT,HIPS,;,;,;,COOL-WHITE(SC-02740R),-	1	RI200
17-2	DA63-04280A	COVER-SLIDE PANTRY A	AW2-PJT,HIPS,;,;,;,COOL-WHITE(SC-02740R),-	1	RI199
17-3	DA63-40167A	GROMMET-COVER CHIL	SILICON,T3.0,L16,BLACK	1	RI087
17-4	DA66-10104A	ROLLER-FRE	POM,;,D22,;,;	1	RW648
18	DA97-06328A	ASSY SHELF-PANTRY	AW2-PJT,-	1	RI195
18-1	DA61-03174A	REINF-SHELF PANTRY	AW-PJT,SECC1,T1.2,Black	1	RI204
18-2	DA64-02235A	WINDOW-SHELF PANTRY	AW-PJT BEST,GPPS,2.5,--NTR,-	2	
18-3	DA67-02006A	SHELF-PANTRY	AW2-PJT,HIPS,;,;,COOL-WHITE(SC-02740R),-	1	RI205
19	DA97-06324B	ASSY COVER-MOTOR DAMPER	AW2-PJT,COOL-WHITE,0.5W	1	RI292
19-1	DA31-00071F	MOTOR DC-DAMPER	NSBY001TH1,DC12V,MAX 60mA,AW2-CD	1	RI168
19-2	DA32-00006R	SENSOR TEMP-PANTRY	PX-41C, 502AT,AW-PJT,-40-110℃,5V,--PANTRY SENSOR,YEL,200MM	1	RI270
19-3	DA62-01380A	INSULATION-MOTOR DC DAMPER	AW-PJT,FOAM-PS,;,;,NTR,--	1	RI228
19-4	DA63-04274A	COVER-MOTOR DC DAMPER	AW2-PJT,PP,;,;,;,COOL-WHITE(SC-02740R),-	1	RF037
20	DA61-04285A	GUIDE-FRENCH	AW2-PJT,PC-ABS,;,;,COOL-WHITE(SC-02740R),-	1	RI211
21	DA63-04150B	COVER-FILTER	AW,HIPS,-,96.0,73.6,--COOL WHITE,1° SILK PRINTING	1	RI068
22	DA97-06317E	ASSY CASE-FILTER	AW2 CD,OUTLET(BLACK)	1	RI006
23	DA97-06399A	ASSY COVER-RAIL PANTRY L	AW2,;,;,;,;	1	RI190
23-1	6002-001122	SCREW-TAPPING	FH,+,1,M4,L14,ZPC(WHT),SWRCH18A	2	RS059

EXPLODED VIEW & PARTS LIST

■ Parts List of Refrigerator

NO	CODE-NO	PART NAME	SPEC	QUANTITY	REMARK
23-2	DA63-04277A	COVER-RAIL PANTRY L	AW2-PJT,HIPS,,,,,COOL-WHITE(SC-02740R),-	1	RI197
23-3	DA97-06447B	ASSY RAIL-SLIDE PANTRY L	AW2,,,,,STS	1	RI285
24	DA97-06325A	ASSY CASE-PANTRY	AW2-PJT,,,,,-	1	RI189
24-1	DA61-04284A	CASE-PANTRY	AW2-PJT,HIPS,,,,,COOL-WHITE(SC-02740R),-	1	RI196
24-2	DA61-04288A	SUPPORT-TRIM PANTRY R	AW2-PJT,HIPS,,,,,COOL-WHITE(SC-02740R),-	1	
24-3	DA61-04289A	SUPPORT-TRIM PANTRY L	AW2-PJT,HIPS,,,,,COOL-WHITE(SC-02740R),-	1	
24-4	DA63-04275A	COVER-PANTRY FRONT	AW2-PJT,SAN,,,,,NTR,-	1	
24-5	DA63-04276A	COVER-PANTRY TRIM	AW2-PJT,HIPS,,,,,COOL-WHITE(SC-02740R),-	1	
24-6	DA66-00580A	ROLLER-PANTRY	AW2-PJT,POM,-,NTR,-	2	RI299
24-7	DA61-04290A	GUIDE-PANTRY	AW2-PJT,TALC PP,,,,,COOL-WHITE(SC-02740R),-	1	RI201
25	DA97-06401A	ASSY COVER-RAIL PANTRY R	AW2,,,,,,-	1	RI191
25-1	6002-001122	SCREW-TAPPING	FH,+,1,M4,L14,ZPC(WHT),SWRCH18A	2	RS059
25-2	6002-001122	SCREW-TAPPING	FH,+,1,M4,L14,ZPC(WHT),SWRCH18A	2	RS059
25-3	DA41-00423C	PBA PANEL-PANTRY	AW-PJT,PANTRY ROOM BLUE WIN,FR-1,96*14.6*1.6T,WINE ZONE BLUE,12V,-	1	RO052
25-4	DA63-04278A	COVER-RAIL PANTRY R	AW2-PJT,HIPS,,,,,COOL-WHITE(SC-02740R),-	1	RI198
25-5	DA64-02578A	INLAY-CONTROL PANEL	AW2,PC,T0.3,,,,-	1	RF163
25-6	DA97-06448B	ASSY RAIL-SLIDE PANTRY R	AW2,,,,,STS	1	RI284
26	DA29-00003G	FILTER WATER-ASSY	-,ATOP,-,D81, H143,-,NSF42, 53,-	1	RI070
27	DA97-06392B	ASSY SHELF-INSERT REF FOLD	AW2-PJT,SCREW	1	RI287
27-1	DA61-03571A	HINGE-SHELF-BODY-UPP	AW-PJT,PBT,-,40,75,-,-	2	RI306
27-2	6002-001122	SCREW-TAPPING	FH,+,1,M4,L14,ZPC(WHT),SWRCH18A	2	RS059
27-3	DA67-02013A	SHELF-INSERT REF FOLD	AW2,ABS,-,-,COOL WHITE,-	1	
27-4	DA97-05251B	ASSY HINGE-SHELF	AW-PJT,-,40,75,COOL-WHT,-,PC,FOLDER SHELF SUB ASSY	2	RI294
28	DA97-06416A	ASSY SHELF-QUICK SPACE	AW2,-	1	RI286
28-1	DA01-00465A	GLASS-SHELF QUICK SPACE FRONT	377*197.6,T3.2,-	1	
28-2	DA01-00466A	GLASS-SHELF QUICK SPACE REAR	354.5*198.1,T3.2,-	1	
28-3	DA67-02011A	SHELF-QUICK SPACE FRONT	AW2,ABS,-,-,COOL WHITE,-	1	
28-4	DA67-02012A	SHELF-QUICK SPACE REAR	AW2,ABS,-,-,COOL WHITE,-	1	
28-5	DA91-02721A	ASSY HANGER-QUICK SPACE	AW2,-,COOL WHITE,-	1	RI296
28-6	6002-001122	SCREW-TAPPING	FH,+,1,M4,L14,ZPC(WHT),SWRCH18A	2	RS059
29	DA61-04330A	ANGLE-SHELF REF SIDE L	AW2(PANTRY),SECC1,T2.0,-,COOL WHITE,Powder Coating	1	RI300
30	DA97-05239E	ASSY TRAY-ICE BUCKET	AW-PJT,-,90,490,WHT,AW-BEST	1	RF004
30-1	DA63-03687A	COVER-ICE BUCKET A	AW-PJT,HIPS,T2.5,,,,,WHT,187*266*120	1	
30-2	DA62-01475A	INSULATION-COVER ICE BUCKET	AW-PJT,EPS,40,182,261,WHT,-,-	1	
30-3	DA63-03737A	GASKET-COVER ICE BUCKET	AW-PJT,SILICONE,1.0,-,730,GRAY,-,OD5.0	1	RM037
30-4	DA63-03686A	COVER-CRUSHER	AW-PJT,HIPS,T3,,,,,WHT,140*140*55	1	RF035
30-5	DA62-01569A	INSULATION-COVER ICE BUCKET-SUB	AW-PJT,EPS,20,30,115,WHT,-,-	1	
30-6	DA61-03505A	GUIDE-CRUSHER	AW-PJT,HIPS,T3,-,-,WHT,48*96*60	1	RM028
30-7	DA66-00476A	LEVER-ICE BUCKET B	AW-PJT,ABS,13,40,67,-,WHT,-	1	
30-8	DA61-03506A	SPRING ETC-COVER BUCKET	AW-PJT,STS304,*1.2,ID 9.6,OD12,-,25,-,-	1	
30-9	DA66-00477A	LEVER-ICE BUCKET C	AW-PJT,ABS,13,40,115,-,WHT,-	1	
30-10	DA63-03688A	COVER-ICE BUCKET B	AW-PJT,HIPS,T2,,,,,WHT,181*266*40	1	
30-11	DA66-00475A	LEVER-ICE BUCKET A	AW-PJT,ABS,T2.0,-,-,WHT,15*50*11	1	
30-12	DA67-01719A	CAP-LEVER ICE BUCKET	AW-PJT,ABS,T1.0,-,-,WHT,ø 9.8*6	2	RI297
30-13	DA65-00055A	CLAMPER CORE-HELIX	AW,STS304,-,OD 8,-	1	RF104
30-14	DA63-03689A	TRAY-ICE BUCKET	AW-PJT,HIPS,T2.5,,,,,WHT,138*165*410	1	RM012
30-15	DA61-20124D	SPRING ETC-DISPENSER	AW-BEST-GE-OEM,STS304,0.9,,,,,9,,,,	1	RM039
30-16	DA66-00478A	LEVER-CUBE	AW-PJT,MSWR10,*4.5,-,L550,-,-	1	RF145
31	DA97-07365A	ASSY ICE MAKER	TIM(AW2)-PJT,29Cu.ft.DUAL ICE MAKER,Y	1	RM001
32	DA97-05246G	ASSY CASE-AUGER MOTOR	AW2,115V/60Hz	1	RF034
32-1	DA61-03517A	CASE-AUGER MOTOR	AW-PJT,HIPS(HR-1360),,-,NTR,-	1	RF034
32-2	DA31-00105G	MOTOR GEARED-AUGER	ISG3240SSI-1,18RPM,127Kgf.cm,192:1,110-127V 60Hz,2.3A,-,4OT,-	1	RF039

EXPLODED VIEW & PARTS LIST

5-3) Cabinet

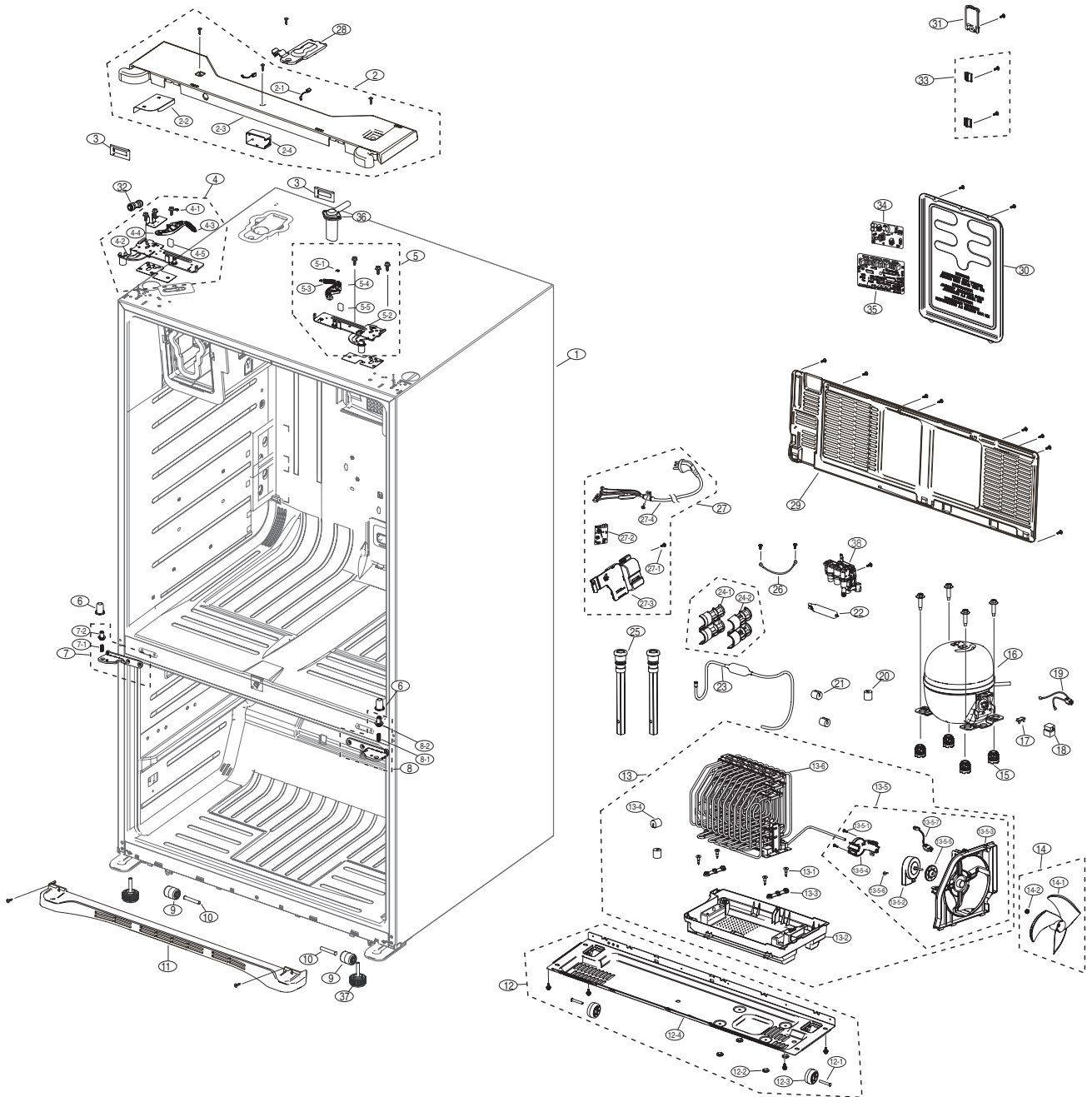

EXPLODED VIEW & PARTS LIST

■ Parts List of Cabinet

NO	CODE-NO	PART NAME	SPEC	QUAN TITY	REMARK
1	DA90-05305A	ASSY CABINET FORM	TM(AW2)-PJT,29Cu.ft,DUAL ICE MAKER,RS/PN	1	
2	DA97-07571A	ASSY TOP-TABLE	AW2 CD,RS	1	
2-1	DA34-00043B	SWITCH REED-ASSY	200VDC,0.5A,MDCG-4 type	2	RO150
2-2	DA61-03678A	PLATE-TOP TABLE	AW-PJT,SGCC,T0.3,64.5,125,AW-BEST	1	RO159
2-3	DA64-02917A	TOP TABLE	AW2 CD,ABS,CREAMY STS	1	RO008
2-4	DA61-05274A	PLATE-DOOR SWITCH	AW2 CD,SGCC,T0.4,;;,NC	1	
3	DA67-02304A	CAP-TOP TABLE	AW2 CD,ABS,;;,CREAMY STS,-	2	RO184
4	DA97-07822F	ASSY HINGE-UPP L	AW2 CD,T2.9,CREMMY STS,BEST	1	RO041
4-1	DA60-00162A	FASTENER-RING	AW-PJT,STS304,ID5,T0.5,;OD11,BLACK,;-	1	RO152
4-2	DA61-03239A	HINGE-UPP L	AW-PJT,SHP1,T2.9,;;,;;	1	RO129
4-3	DA61-03301C	SPRING ETC-AUTO CLOSE	AW-PJT,HSWR,1.4,9.2,12,;17 3/4,;;,;;	1	RE084
4-4	DA97-04903B	ASSY LEVER-AUTO CLOSE	AW-PJT,;;,;;,CREAMY STS,-	1	RO172
4-5	DA63-03673A	GROMMET-LEVER	AW-PJT,NBR,;;,;;,BLACK,-	1	RO170
5	DA97-04875G	ASSY HINGE UPP-R	AW2,;;,;Creamy-STS,SHIM DELETE	1	RO042
5-1	DA60-00162A	FASTENER-RING	AW-PJT,STS304,ID5,T0.5,;OD11,BLACK,;-	1	RO152
5-2	DA61-03240A	HINGE-UPP R	AW-PJT,SHP1,T2.9,;;,;;	1	RO128
5-3	DA61-03301C	SPRING ETC-AUTO CLOSE	AW-PJT,HSWR,1.4,9.2,12,;17 3/4,;;,;;	1	RE084
5-4	DA97-04903B	ASSY LEVER-AUTO CLOSE	AW-PJT,;;,;;,CREAMY STS,-	1	RO172
5-5	DA63-03673A	GROMMET-LEVER	AW-PJT,NBR,;;,;;,BLACK,-	1	RO170
6	DA63-02905A	GROMMET HINGE-MID,R	NEXT,POM,T2.0,;;,;WHITE,-	2	RO163
7	DA97-07514A	ASSY HINGE MID-L	AW2 CD-PJT,T4.5,;;,Ni-Cr Plated,;-	1	RO122
7-1	6004-001082	SCREW-SET	;-HT,;M4,L4,PASS,STS304,;-FP	2	RS030
7-2	DA61-04916D	HINGE-MID L	AW2,SHP1,T4.5,Ni-Cr+Cu Plating,Heat Treatment,SNC2	1	RO122
8	DA97-07515A	ASSY HINGE MID-R	AW2 CD-PJT,T4.5,;;,Ni-Cr Plated,;-	1	RO123
8-1	6004-001082	SCREW-SET	;-HT,;M4,L4,PASS,STS304,;-FP	2	RS030
8-2	DA61-04917D	HINGE-MID R	AW2,SHP1,T4.5,Ni-Cr+Cu Plating,Heat Treatment,SNC2	1	RO123
9	DA61-04702A	CASTER-FRONT	AW-PJT,PP,;35,NTR,35,PP+TPE	2	RH009
10	DA61-01920A	CASTER-RIVET	(ZPC2),MSWR10,OD8.0,L54,;;	2	RH012
11	DA63-04975A	COVER-LEG FRONT	AW2 CD,PP,T2.5,;;,;CREAMY STS,-	1	RO003
12	DA97-07547A	ASSY CHASSIS-COMP	AW2-CD,;;,;;,PP+TPE CASTER	1	RO002
12-1	DA66-00649A	SHAFT-CASTER	AW-PJT,MSWR10,L46,OD8.2,;-ZPC2	2	RX039
12-2	DA61-01867A	BRACKET-COMP	A-TOP,SGHC,T2.0,;;,;;	4	RW083
12-3	DA61-04703A	CASTER-REAR	AW-PJT,PP,;35,NTR,35,PP+TPE	2	RH011
12-4	DA64-02902A	CHASSIS COMP	AW2 CD,SBHG1,T1.4,;;,;;	1	RO002
13	DA97-07756D	ASSY TRAY-DRAIN WATER	AW2-PJT	1	RH003
13-1	6009-001475	SCREW-SPECIAL	FH,;M5,L25(15.5),PASS,STS304,1,-	2	RQ747
13-2	DA63-05084A	TRAY-DRAIN WATER	AW2-PJT,PP,NTR	1	RH003
13-3	DA63-40128A	GROMMET-SUB COND	;-NBR,;;,;;,DARK-GRAY	2	RH022
13-4	DA63-40171B	GROMMET-SUCT PIPE A	;-NBR,OD20,ID4,L20,;;,Brown,-	1	RW413
13-5	DA97-07754C	ASSY SUPPORT-CIRCUIT MOTOR	AW2-PJT	1	RO132
13-5-1	6003-000333	SCREW-TAPTYPE	RH,;2S,M3,L10,ZPC(WHT),SWRCH18A,-	1	
13-5-2	DA31-00146B	MOTOR BLDC	DRCP5030LA,1560,;DC12V,230mA,;-2.7W,ATOP,;;,;;	1	RI089
13-5-3	DA61-05357B	SUPPORT-CIRCUIT MOTOR	AW2,PP,NTR	1	RF033
13-5-4	DA61-02355B	BRACKET-CIRCUIT MOTOR	ABS,NEXT,;;,;NTR,-	1	RH039
13-5-5	DA63-01146A	GROMMET-MOTOR,REAR	A-TOP,NBR,;;,;ID6.5,OD42,BLK,BLDC	2	RO138
13-5-6	DA63-40167A	GROMMET-COVER CHIL	SILICON,T3.0,L16,BLACK	1	RI087
13-5-7	DA96-00042P	ASSY-HARNESS MOTOR	AW2,C-FAN	1	RI133
13-6	DA97-05093B	ASSY PIPE-SPIRAL COND	AW2-PJT	1	RW002
14	DA31-00010D	FAN-ASSY	;-ET,ZIPEL,ASSY,;UNIT,;150	1	RH713
14-1	DA31-00015C	FAN-TURBO	;-ET-PJT,ABS+GLASS FIBE,;-GR-4010	1	RH713
14-2	DA61-20128A	SPRING ETC-FAN	;-STS304,P17.8,;OD1.0,;;,;;,FD	1	RW716
15	DA63-02017A	GROMMET COMP	QUEEN,EPDM,BLACK	4	

EXPLODED VIEW & PARTS LIST

5-4) Disassembly of Freezer Door

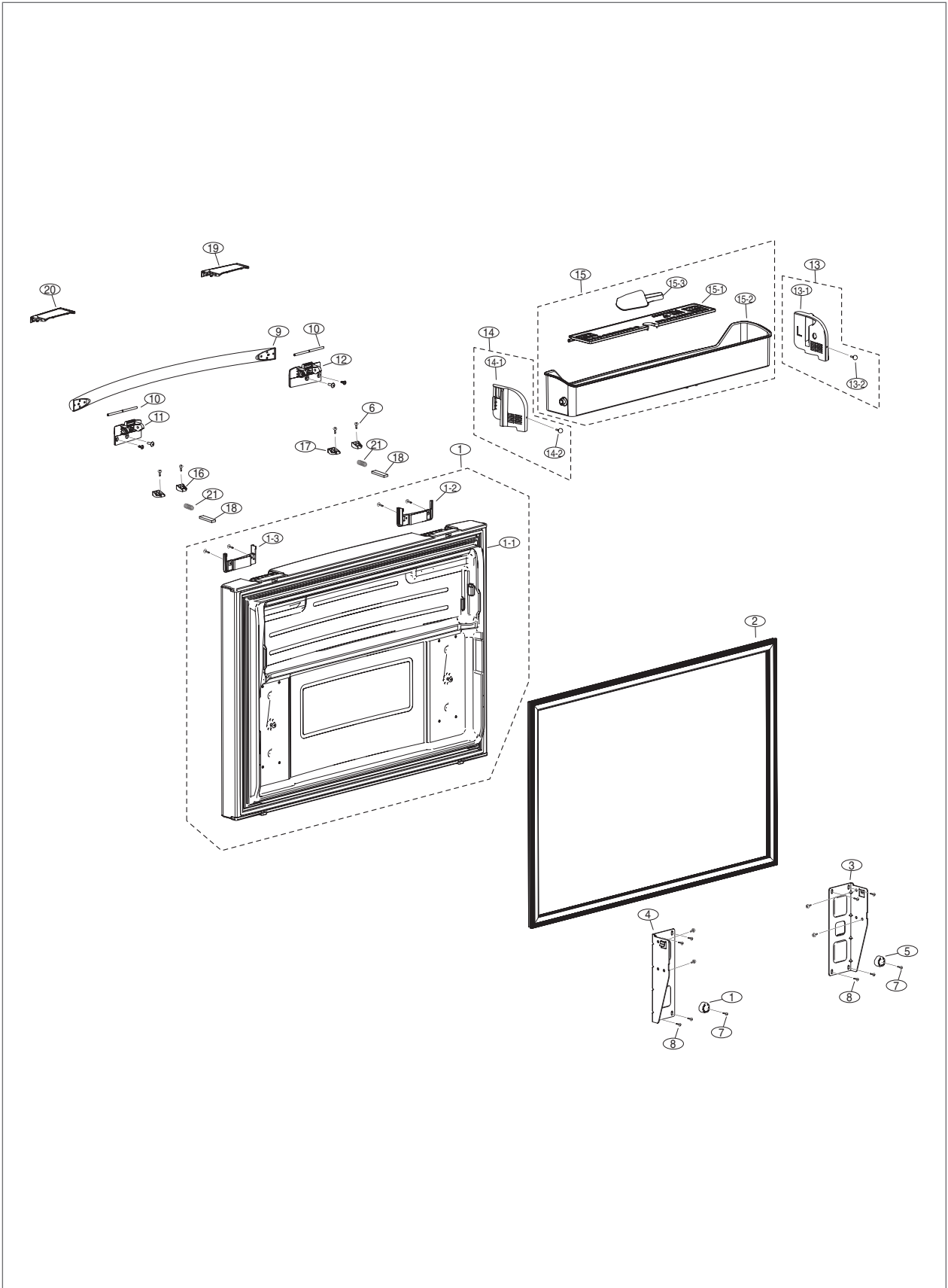

EXPLODED VIEW & PARTS LIST

5-5) Disassembly of Refrigerator Door Left

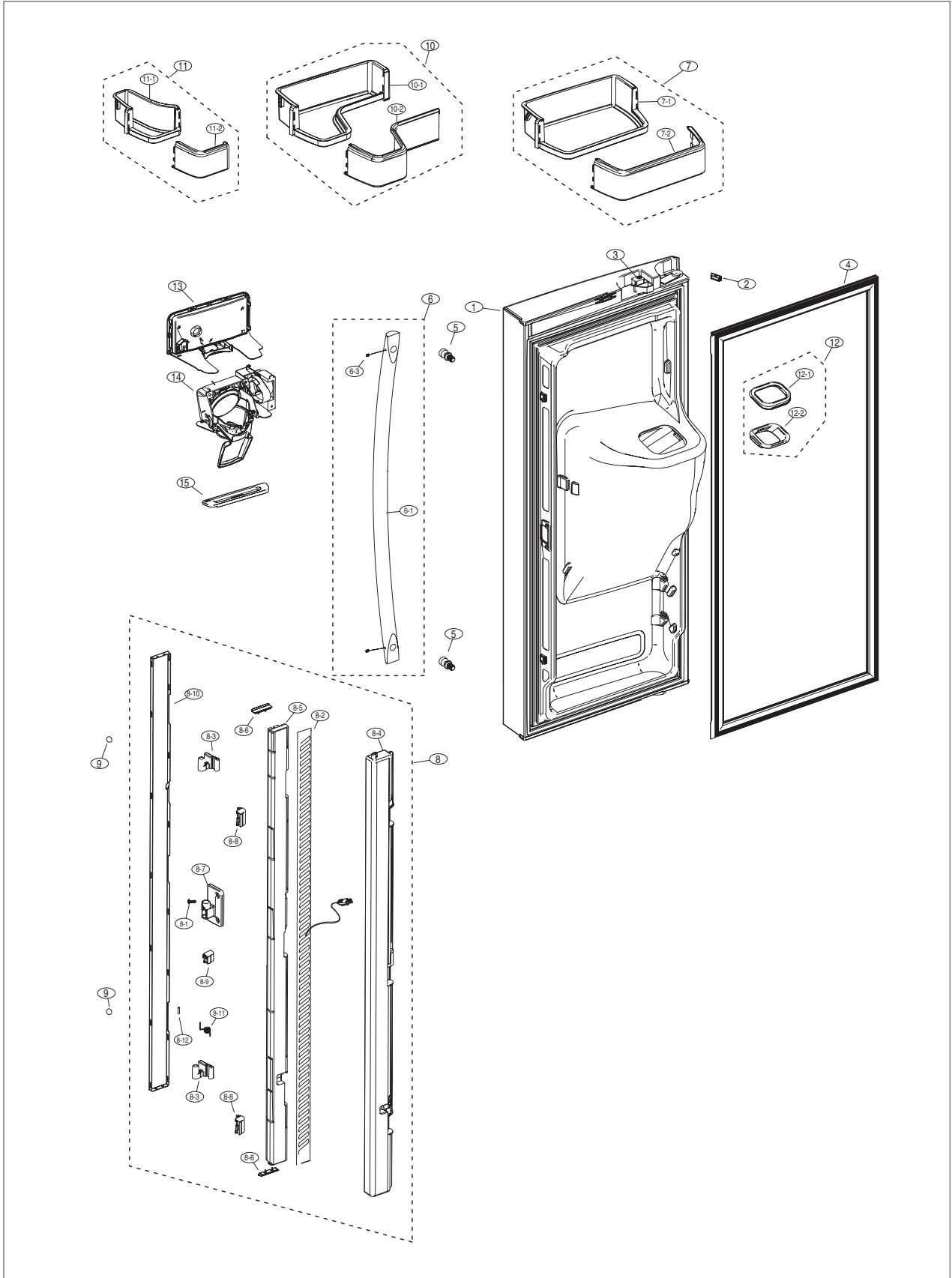

EXPLODED VIEW & PARTS LIST

5-6) Disassembly of Refrigerator Door Right

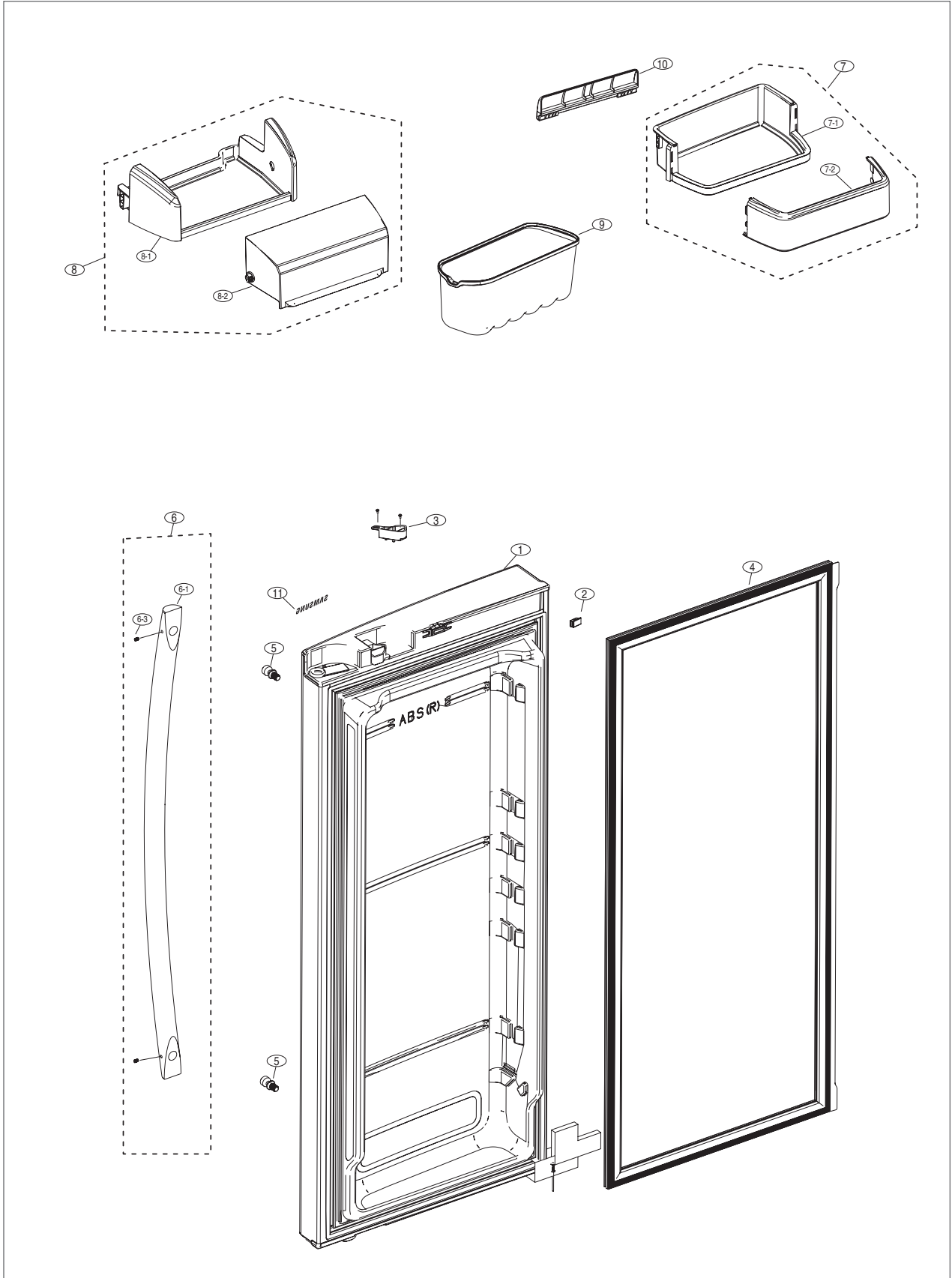

6. PCB DIAGRAM

6-1) PCB LAYOUT WITH PART POSITION	125
6-2) PCB LAYOUT WITH PART POSITION (SMPS BOARD)	126
6-3) CONNECTOR LAYOUT WITH PART POSITION (MAIN BOARD)	127
6-4) CONNECTOR LAYOUT WITH PART POSITION (SMPS BOARD)	128

6-1) PCB Layout with part position

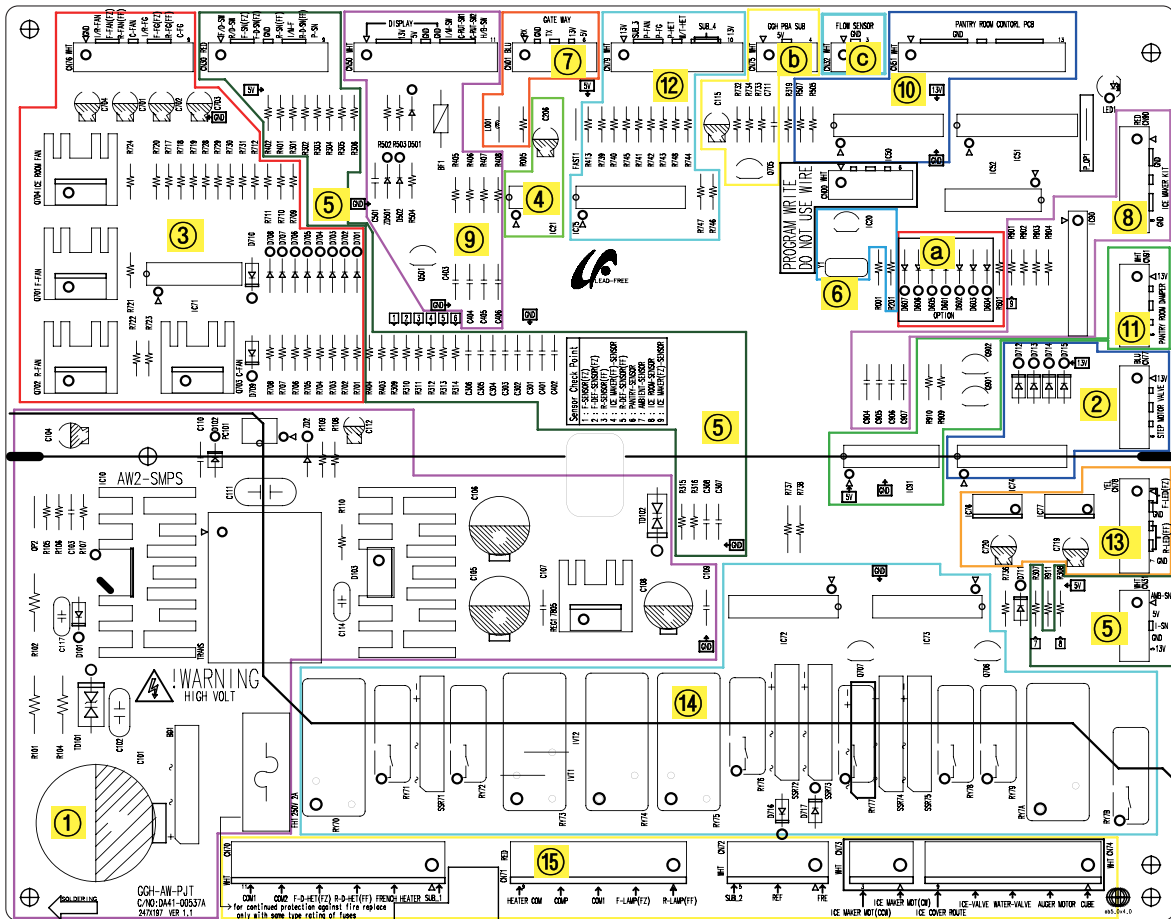

1. DC13V, 5V, GND supplied from SMPS PCB
2. Circuit for controlling Step-Valve (3-Way Valve) * Option
3. FAN MOTOR control part : To supply the power from 8.3V ~ 12V according to the motor types. (F,R,C,ICE)
4. EEPROM : Save and record every kinds of data.
5. Transmit inputted signals from every sensor into MICOM after eliminate the noise.
6. Micom : control the refrigerator Ceramic resonator : generate the basic frequency of Micom operation.
Reset IC : make Micom reset if input voltage of Micom is detected less than the specified voltage
7. PLC input/output
 - PLC (Power Line communication) * Option(PLC module is not inserted unless specified occasion)
8. Operate ICE-MAKER, supply power to MOTOR, and sense the variation of switch.
9. Main Micom ↔ Panel Micom serial communication circuit
 - Dispenser option input part (Water & Cover Ice route switch)
10. Pantry room display control part : display LED, detect KEY state.
11. Control Pantry room damper & Damper heater
12. Water Tank Heater Controls (also controls other options)
13. LED LAMP Control Circuit (F, R LAMP)
14. Relay parts that controls AC load and receives Micom operating signal through Sink IC.
15. Connector with AC load
 - a. Diode option setting area
 - b. Inverter COMP controlling signal
 - c. Flow Sensor. sensing part

6-2) PCB Layout with part position (SMPS Board)

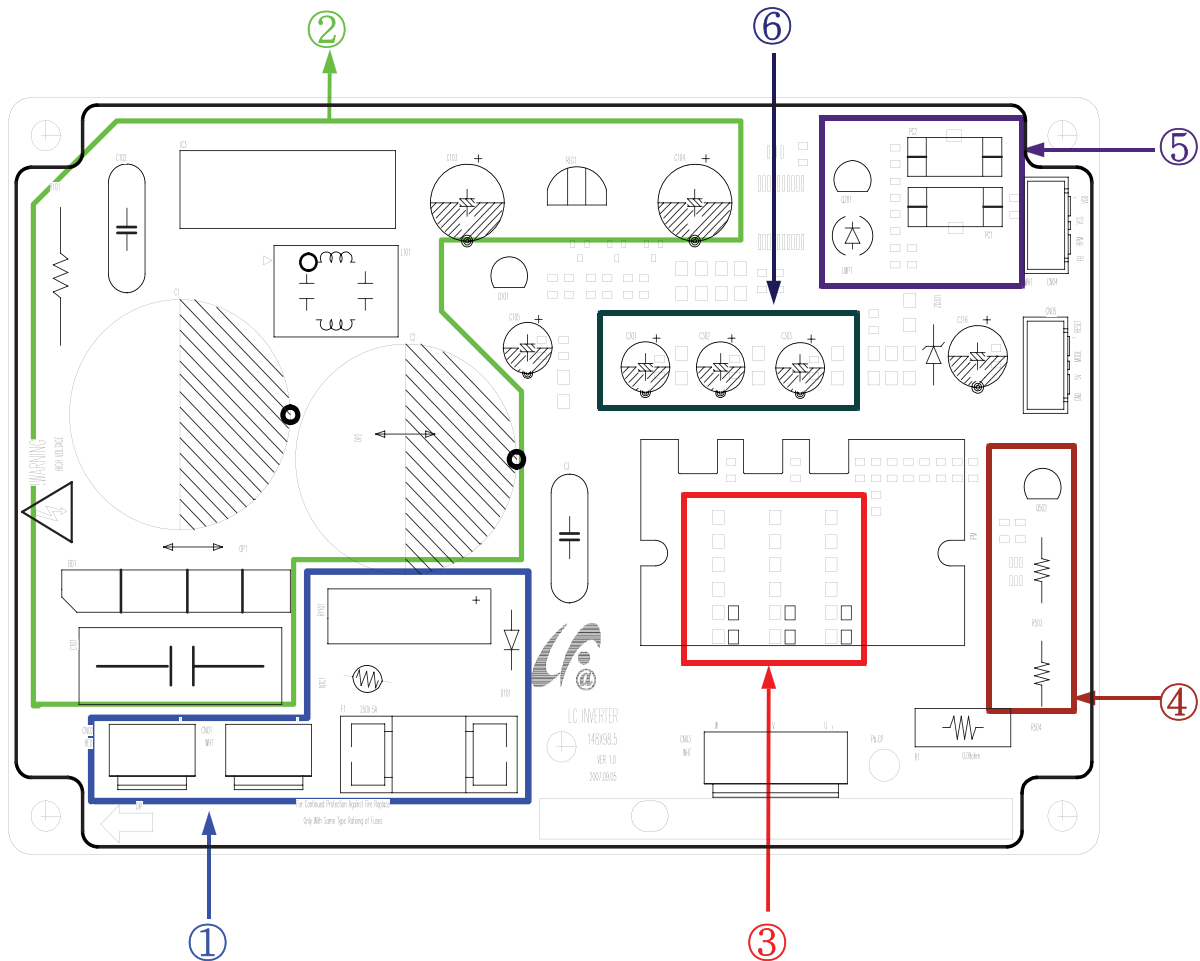

1. Inrush current protecting area : It prevents an instant inrush of current generated in condenser when plug in.
2. PCB Power Bus : power bus (Hybrid IC). It supplies DC15V and 5V to MICOM.
3. Location detecting resistance area : It detects motor location through the current detected.
4. Current detecting area : It detects the current from the SHUNT resistance and controls PWM DUTY.
5. COMP operating Signal area : It receives COMP operating signal from Main PCB and conduct it.
6. BOOTSTRAP live part : Charging circuit that 1GBT of SPM can On/Off securely.

PCB DIAGRAM

6-3) Connector Layout with part position (Main Board)

6-3-1. RFG298**

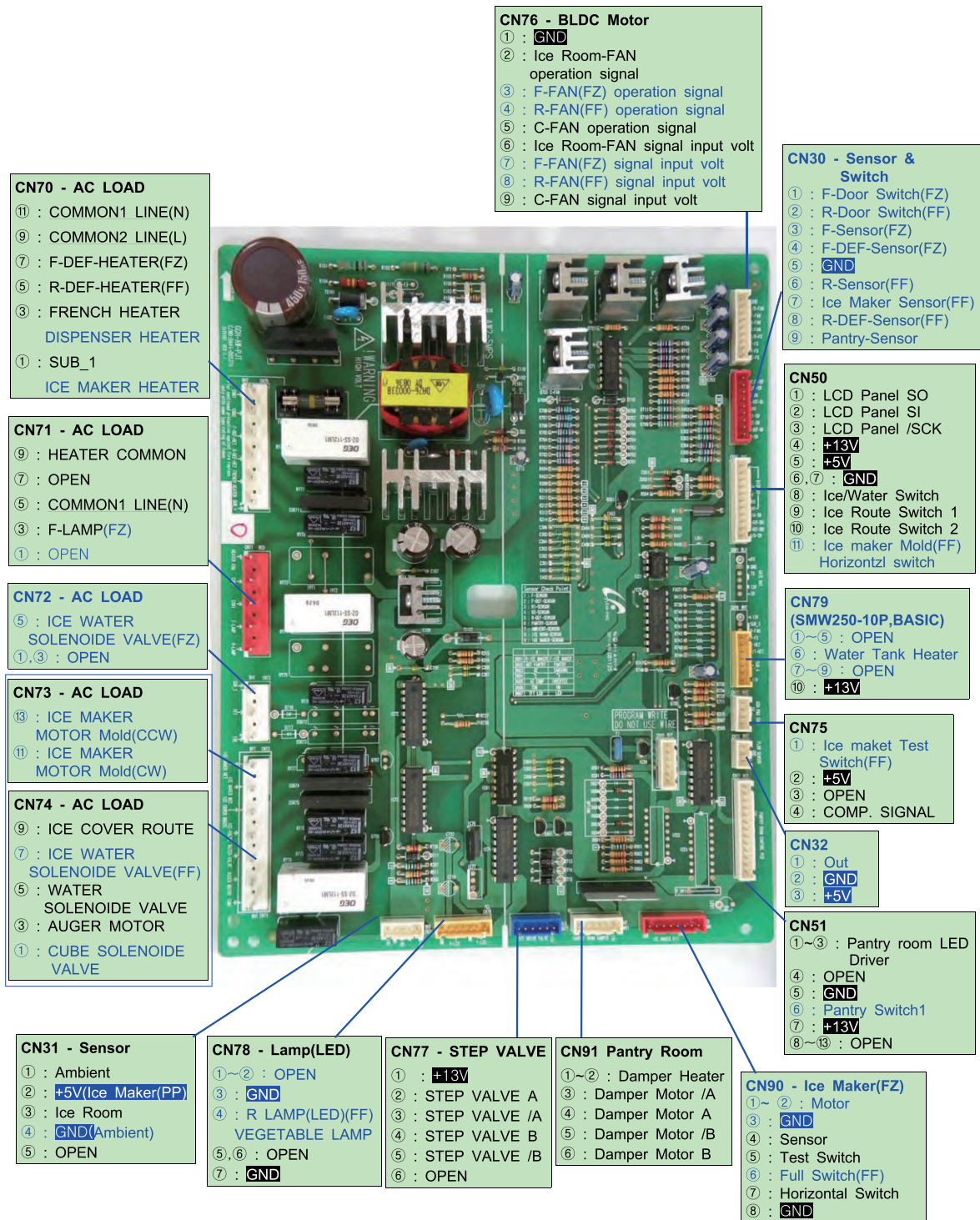

PCB DIAGRAM

6-4) Connector Layout with part position (SMPS Board)

6-4-1. RFG29**AA**

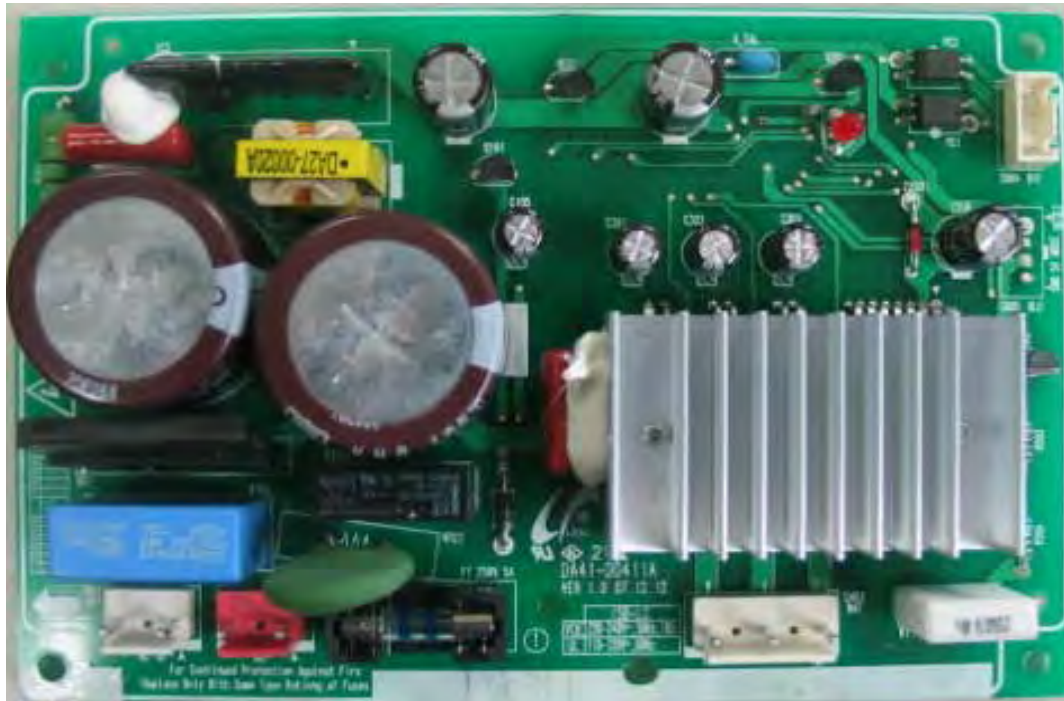

- ①VDD
- ②VSS
- ③RPM
- ④FB

POWER(110V)
OLP

- ①U
- ②V
- ③W

7. WIRING DIAGRAM

7-1) Model : RFG298**

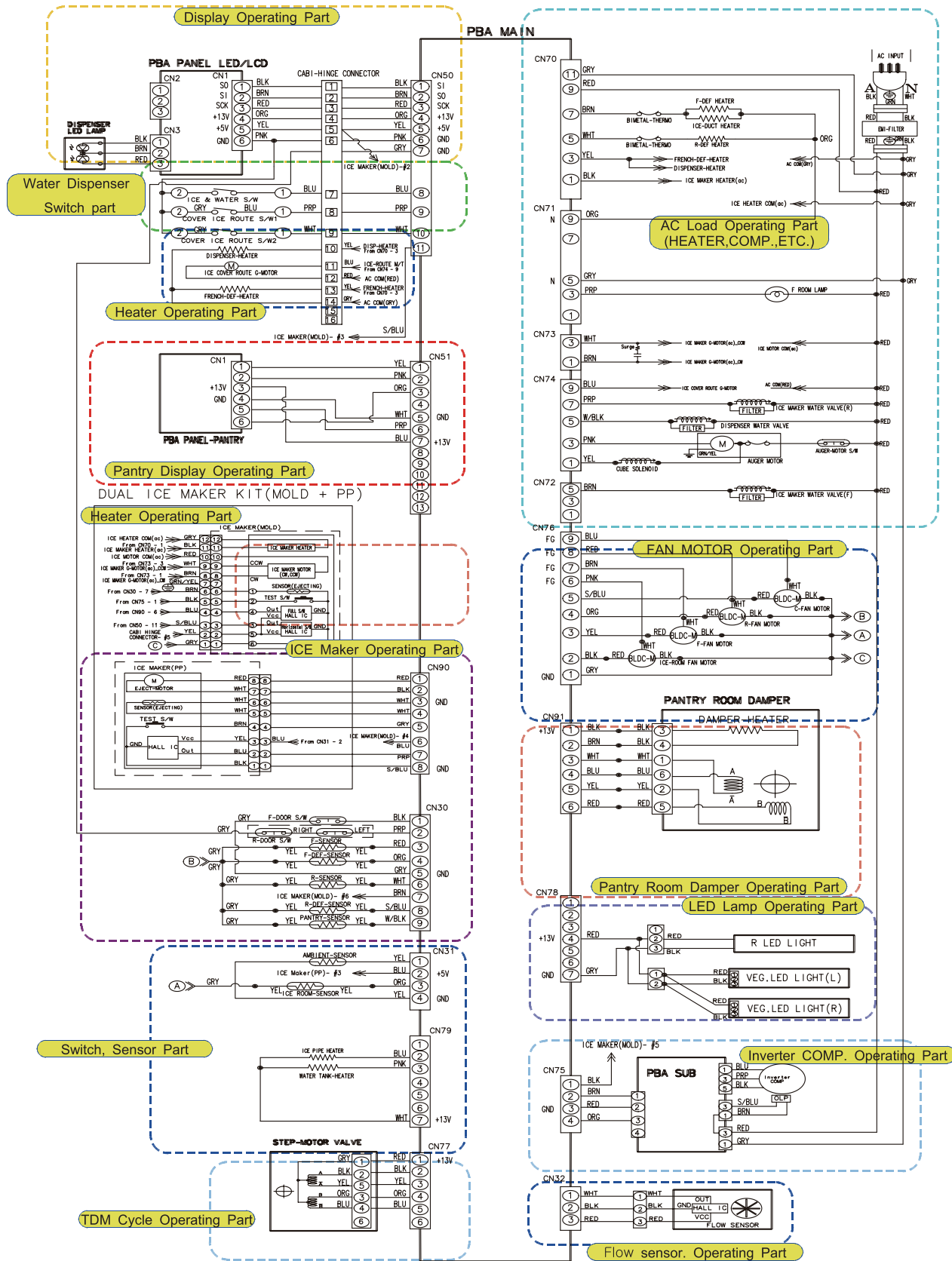

8. SCHEMATIC DIAGRAM

8-1) Whole block diagram

8-1-2. MODEL : RFG298**

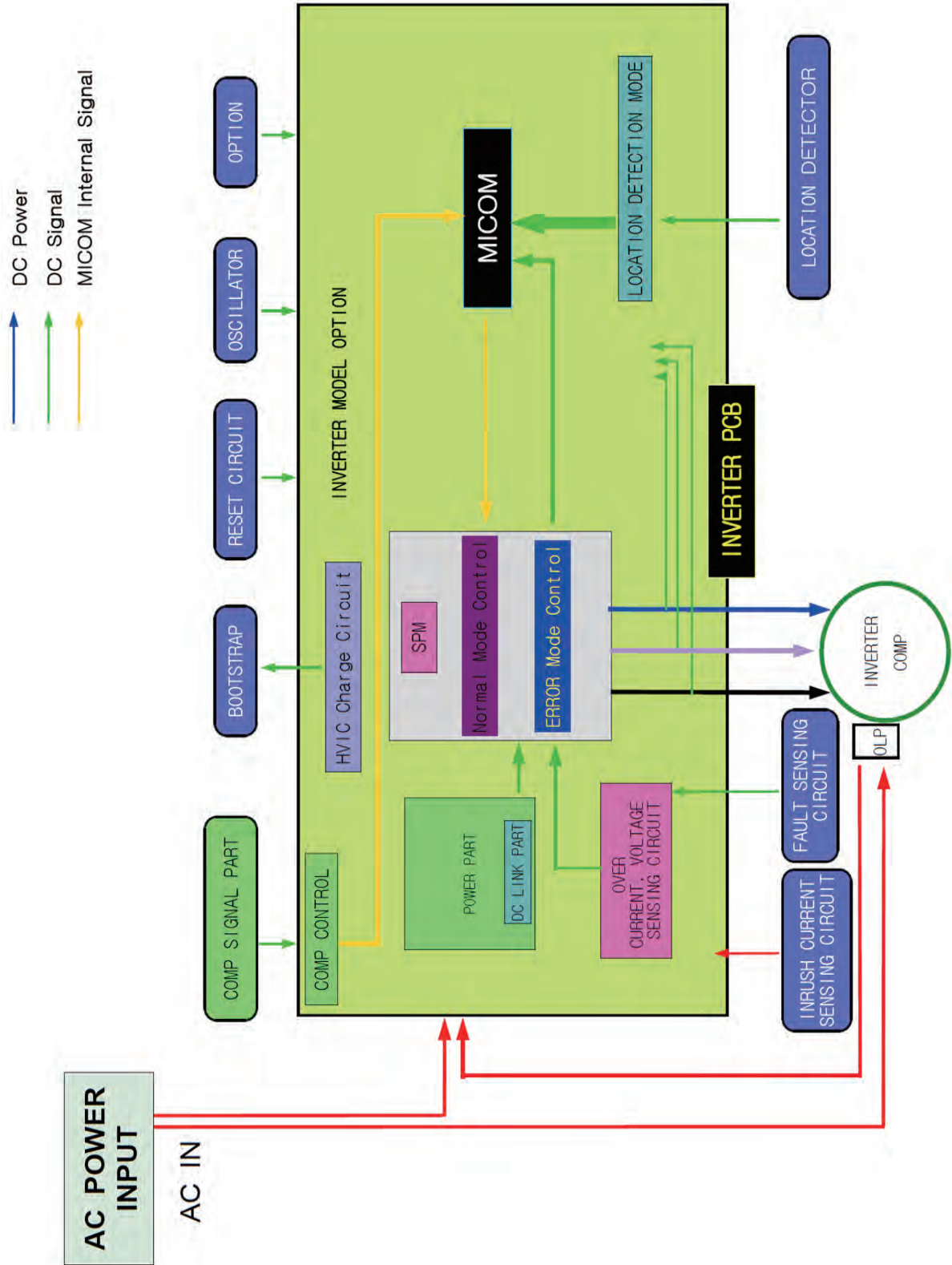

SCHEMATIC DIAGRAM

8-2) CIRCUIT DIAGRAM

8-2-1. Main

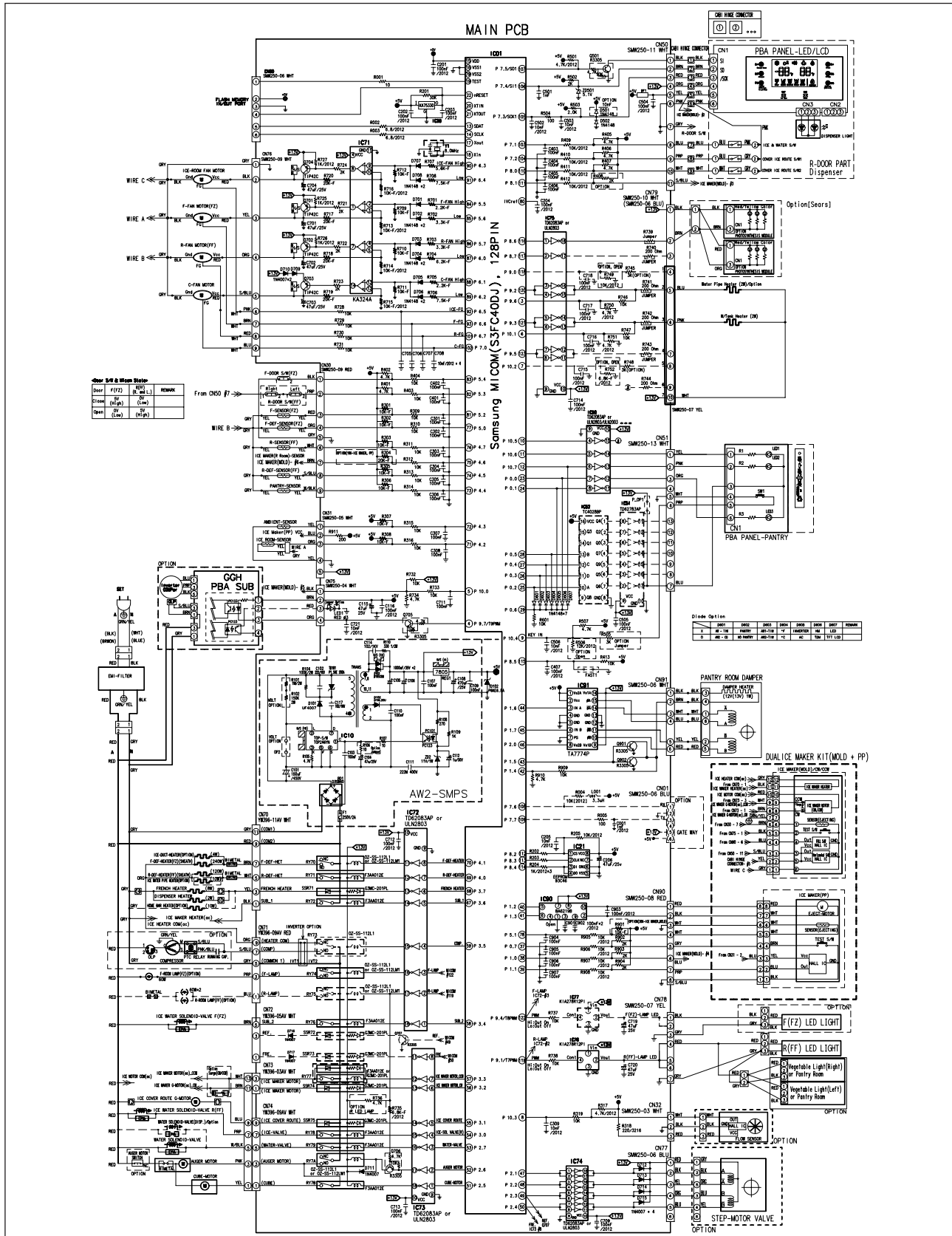

SCHEMATIC DIAGRAM

8-2) CIRCUIT DIAGRAM

8-2-2. INVERTER

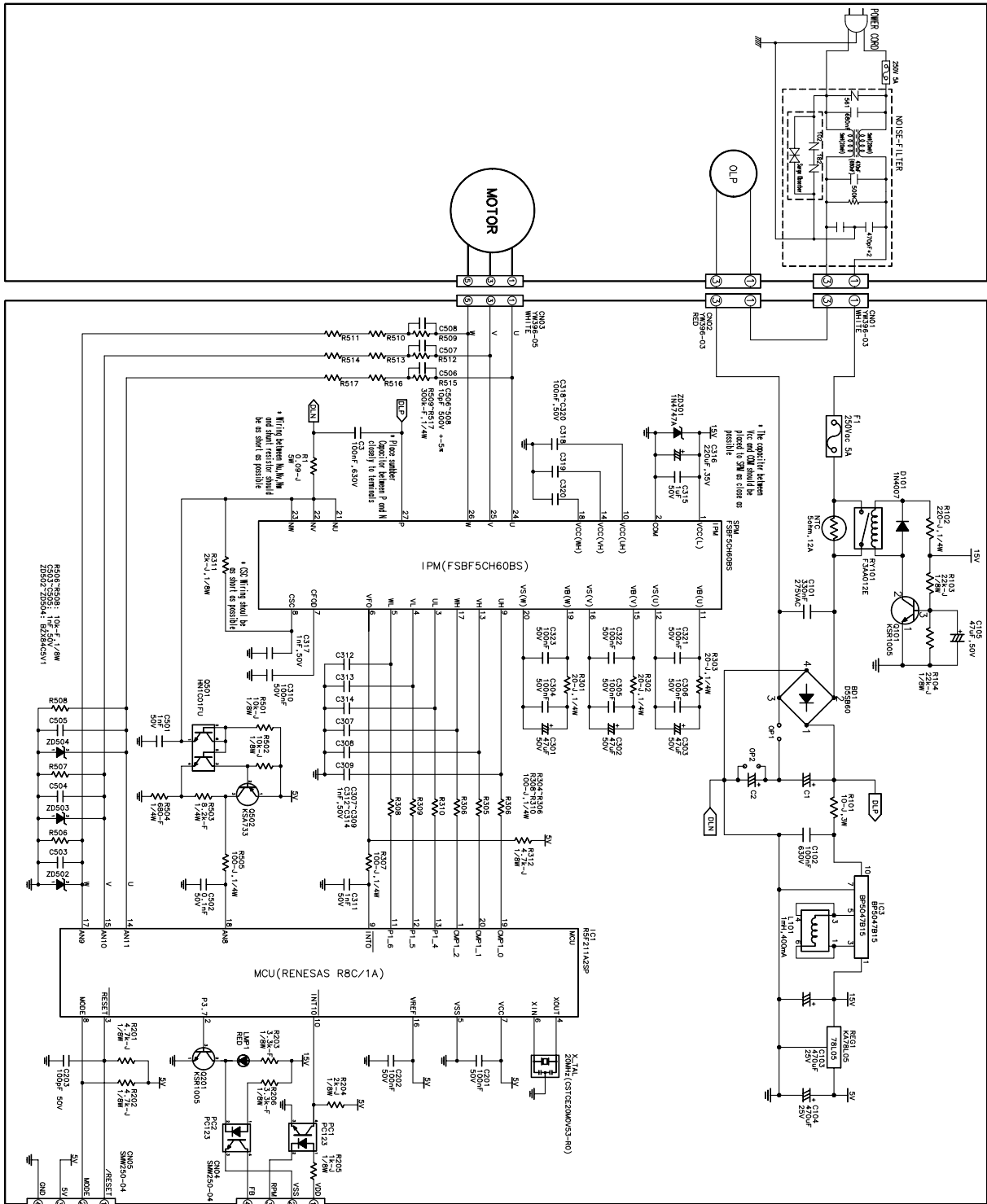



272, Oseon-Dong, Gwangsan-Gu,
Gwangju-City, Korea, 506-253
TEL : 82-62-950-6193, 6896
FAX : 82-62-950-6829

- This Service Manual is a property of Samsung Electronics Co., Ltd.
Any unauthorized use of Manual can be punished under applicable
International or domestic law.