

ABB

4|11

The corporate
technical journal

review

Making seawater drinkable with desalination 6

Growing smart solutions with irrigation 11

Staying in control with remote metering 23

Saving water is saving energy 39

Water



Power and productivity
for a better world™



The water cycle is often cited as an example of a self-sustaining and self-replenishing natural phenomenon. Yet the ready availability of clean water is not to be taken for granted. This issue of *ABB Review* looks at ABB's contribution to the water supply.

The front cover shows the skyline of Singapore with the Marina Barrage pump house in the foreground. This massive project, using ABB motors, protects low-lying parts of the city from flooding while meeting one sixth of the city-state's water needs. The inside front cover shows another pumping station, Toshka in Egypt.



Water supply and conservation

- 6 Getting fresh water from the sea**
ABB's variable speed drives turn the wheels of desalination technology
 - 11 Downloading the cloud**
The Spanish experience of smart irrigation with Neptuno
 - 17 Managing water use responsibly**
ABB technology helps the process industries achieve sustainable water use
-

Water control and distribution

- 23 AquaMaster 3™**
Remote water metering with Internet delivery of water-leakage management
 - 29 Every drop counts**
Increasing the efficiency of water distribution
 - 34 Introducing Symphony™ Plus**
Total plant automation for the power generation and water industries
 - 36 ABB service in water**
Provision of eBOP service to world's largest covered wastewater treatment plant
-

Water and efficiency

- 39 Water of life**
Sustainability and energy efficiency in the water industry
 - 44 Clever pumping**
ABB all-in-one drives make the water industry's pumps intelligent
-

Technology focus

- 48 Submarine link**
Submarine HVAC power cable to the floating oil and gas platform at Gjøa
 - 55 The frugal manufacturer**
Part 2, Analyzing industry's commitment to improvement
 - 60 ServicePro 3.0, global best practices**
Maximizing ABB service efficiency worldwide
-

Index 2011

- 61 Index 2011**
The year at a glance

Water, element of life



Claes Ryttoft
Chief Technology Officer
ABB Ltd.

Dear Reader,

Without water, there would be no life on Earth. It is maybe less obvious to what extent the functioning of our society is dependent on water: Whereas physicians may advise us to consume 2.5 liters every day, our real water footprint exceeds this by several orders of magnitude. This starts with our nutrition – thousands of liters are required to grow the food one person consumes in a day. In fact agriculture accounts for more than 70 percent of all freshwater consumed. Looking at the broader economy, our reliance on water is greater still. 20 to 25 percent of total freshwater consumption is accounted for by industry.

As the world's population continues to rise, the pressure on water sources is increasing. The problem is exacerbated by the unequal geographic distribution of water and by climate change. This issue of *ABB Review* is dedicated to this challenge and ABB's contribution to the sustainable use of water.

Starting with the supply side, we look at desalination technology, permitting freshwater to be won from the sea. This method of obtaining water requires a very energy efficient process to be viable.

Rising demand is not being met by new sources alone. Efficiency in distribution and usage presents considerable potential for loss reduction. ABB offers instrumentation solutions permitting the accurate measurement and remote monitoring of water flow. One major challenge facing water networks is the loss of water through leakages. Besides the wasted water, leakages are a waste of the energy used to process and transport the

water up to that point. Water-management systems from ABB can quantify and locate leakages, thus supporting maintenance crews or providing early warnings of developing problems. Leakage losses can be further reduced by controlling pumps to avoid pressure peaks.

On the consumption side, we show how control systems can improve efficiency, reduce losses and improve the flow of information in agricultural and industrial applications.

Not directly related to water supply, but connected to water in a broader sense, we also look at a submarine cable installed to supply power to a floating oil and gas platform. Besides the depth and length of the cable, one major challenge was the dynamic section rising from the seabed to the platform, which must follow all movements of the sea and platform, even under extreme weather conditions.

I trust that the reading of this edition of *ABB Review* will provide you fresh insights into the fascinating world of water and make you more aware of the numerous ways in which ABB can contribute.

Enjoy your reading

A handwritten signature in blue ink that reads "Claes Ryttoft". The signature is fluid and cursive, with the first letters of the first and last names being capitalized and prominent.

Claes Ryttoft
Chief Technology Officer
ABB Ltd.





Getting fresh water from the sea

ABB's variable speed drives turn the wheels of desalination technology

MATTHEW WONG – “Water, water everywhere, nor any drop to drink”. How the Ancient Mariner would have marveled at today's technology that can extract the cleanest of drinking water from the briniest of seawater through the wonders of desalination. Overall though, electricity is still the key cost component of desalinated water and, depending on the desalination technology used, it can represent more than 30 percent of the operational costs.

As a result, energy efficiency and lifecycle cost optimization are among the most important challenges for both developers and plant owners. ABB offers a comprehensive range of advanced technology for the desalination industry which enhances plant performance, efficiency and reliability. A prominent member of this range which is very suitable for use in desalination is the variable speed drive.



The logical place to look for new fresh-water supplies is to our oceans and seas; desalination technology can unlock the abundance of water available there.

Title picture

Desalination is still an energy-hungry activity. How can variable speed drives help reduce energy usage and costs?

Although water covers over 70 percent of the earth's surface, 97.5 percent of it is sea water. Whilst much of the remaining 2.5 percent of fresh water, is unobtainable, demand for it is increasing daily, driven by a complex combination of geophysical, geopolitical and demographic factors. The logical place to look, then, for new water supplies is to our oceans and seas. Desalination technology can unlock the almost unlimited abundance of water available there by removing salts and other minerals to make the water suitable for human use.

Currently, the most popular desalination methods are thermal and membrane desalination. The former principally uses multi-stage flash (MSF) and multiple-effect distillation (MED) methods, the latter reverse osmosis (RO) → 1. The cost of transforming sea water into fresh water is one of the main factors in deciding which method to use, but these three common desalination methods are still all considered to be energy intensive.

Other technologies, too, have been commercialized for desalination. For example, forward osmosis, which is also an osmotic process using a membrane to separate the dissolved solutes from the water; and the Passarell process which uses a vacuum to enable the sea water to vaporize at a lower temperature. Other desalination methodologies such as geothermal desalination, nanotube membrane desalination, biomimetic membranes, low-temperature thermal desalination (LTTD) are in the development phase.

Reverse osmosis

When a power station is near the desalination plant, either MSF or MED is usually used, as these methods can utilize the thermal energy produced by the

power station. Occasionally, hybrid designs which combine two or more desalination methods will be adopted. In the absence of a convenient power plant,

Electricity is still the key cost component of desalinated water. Because the pump power required varies with the cube of the speed, even a small reduction in speed can make a big difference in energy use.

the lower-energy RO → 2 is usually the preferred choice.

In normal osmosis, the solvent naturally moves from an area of low solute concentration through a membrane to an area of high solute concentration. This natural tendency to equalize solute concentrations on each side of the mem-

1 The three main desalination processes

Multi-stage flash (MSF).

Used in large applications, MSF is a multistage distilling method whereby the seawater is heated and the ambient pressure lowered so the water "flashes" into steam. Each stage is held at a lower pressure to the previous one.

Multiple-effect distillation (MED).

MED gets its name from the fact that more than one boiling chamber or "effect" is used to produce distilled water. Used in medium-sized applications, seawater is boiled in a sequence of effects, each held at a lower pressure than the one before. Vapor from one series is subsequently used to heat the next. Only the first vessel (at the highest pressure) requires an external heat source.

Reverse osmosis (RO):

Brackish water or seawater is pumped at high pressure through a permeable membrane in a closed vessel. Concentrated brine remains on one side of the membrane and potable water on the other side. Historically RO technology has been used in small and medium-sized plants. Because it is considered the most cost-effective desalination solution, RO methodology is used in large applications today

2 Reverse osmosis. Pressure forces water molecules through the membrane, leaving contaminants on the other side to be flushed to drain

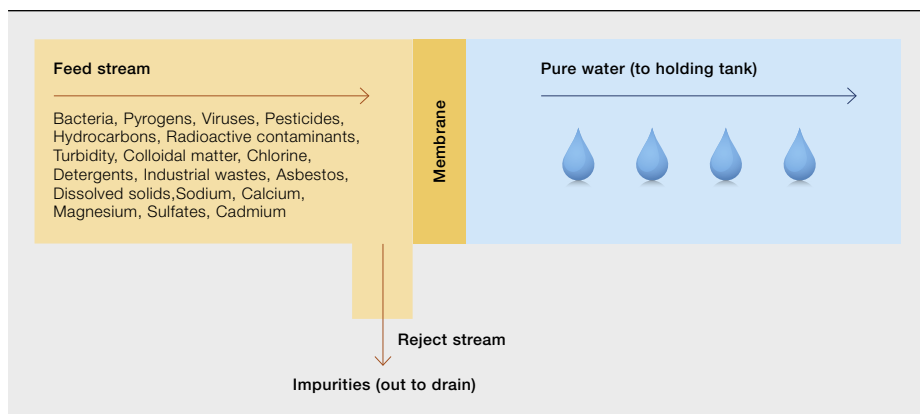

brane generates osmotic pressure. Applying an external pressure to reverse the natural flow of pure solvent is reverse osmosis. For drinking water, the pressure forces only the water molecules through the membrane, resulting in clean water on the other side. Different pressures are applied depending on which dissolved contaminants are present.

Membrane pressurization and VSDs

During the RO process startup, a precisely-controlled pressurization of the membrane system is essential as the membrane must be pushed gently but firmly against its support. This ensures no elements are damaged and that the ideal conditions prevail for water production at the correct flow and pressure.

Since variable pressure needs to be applied for both startup and production, a direct-on-line starter can be used to start the pumps and run the motor at full speed. Then, by throttling a valve, the required water pressure can be achieved. This method serves the purpose but it creates mechanical stress, such as vibration and hammering on the pipeline and valves, and wastes energy.

It is far better to use a variable speed drive (VSD) → 3.

With a VSD, instead of using a valve to control flow or pressure the motor speed itself can simply be adjusted to achieve the desired output flow or pump pressure.

And, because the pump power required varies with the cube of the speed, even a small reduction in speed can make a big difference in energy use.

Using VSDs will not only help to save energy and enhance reliability through reduced mechanical stress, but will also improve process performance: a VSD is able to match the pump output flow or pressure directly to the process requirements, and small variations can also be corrected more rapidly by a VSD compared to other control means.

Stopping harmonics

While the VSD helps to save energy and improve reliability and control, precautions must be taken against the harmonics it can generate. Harmonics will cause distortion of the electrical waveform and, if left unmanaged, can cause problems such as overheating of cables, motors and transformers; electronic display and light flicker; and nuisance tripping of electrical protection devices. One way to solve the harmonics issue is to connect an active harmonics filter (AHF) to where the major harmonics occur. ABB's AHF solution uses the power quality filter (PQF) which monitors the line current in real time and processes the measured harmonics as digital signals in a high-speed multi-DSP (digital signal processor). The multi-DSP, in turn, drives IGBT power modules with pulse width modulated (PWM) signals, causing them to inject currents of exactly opposite phase to the harmonics into the components involved, thus eliminating that order of harmonics.

Lower cost

The motor driving the pump can be either low voltage (LV) or medium voltage (MV) depending on the pump power rating. The latest member of the MV VSD family, the ACS2000, lowers the cost of ownership as it is not necessary to use an

The active front end (AFE) design of the ACS2000 eliminates the need for a special phase-shift transformer.



expensive and specialized transformer at the input of the MV VSD to lower the harmonics generated by the VSD. The active front end (AFE) design of the ACS2000 eliminates the need for such a special phase-shift transformer.

When it comes to operation and maintenance, the ACS2000 has excellent availability and reliability due to its low parts count and, thus, extended mean time between failures (MTBF). With its modular design, it also has an impressive mean time to repair (MTTR) as its drawer design concept enables quick component replacement and thus minimizes downtime → 4.

For the low-voltage VSD → 5, the Low Harmonics Drive family offers a unique harmonics solution that is incorporated into the drive and that fulfils harmonics requirements without external filtering devices or multi-pulse transformer arrangements.

Power factor

During operation, the pump motor will generate reactive power that can cause an undesirable drop in the electrical power factor. A capacitor bank is usually used to correct for such a drop. However,

a VSD already has an internal capacitor bank and this may be exploited to eliminate power factor drops or to reduce the size of the external capacitor bank that is required to do so.

Membrane maintenance

Pushing the solution through the membrane is the most energy-hungry activity in a reverse osmosis desalination plant. One of the factors which affect the pres-

The VSD's internal capacitor bank may be exploited to eliminate power factor drops or to reduce the size of the external capacitor bank that is required to do so.

sure, and therefore the energy, required to accomplish this is the cleanliness of the membrane. When the membrane be-

gins to foul, more pressure is required to achieve the same production rate, and the pressure is only adjustable within an allowed range. Thus, membrane maintenance is crucial.

Cleaning is generally done by flushing, chemical cleaning or replacement, the appropriate intervals being determined by the degree of membrane fouling. This rate is affected by water temperature, concentration, flow rate, recovery rate, etc. Usually, maintenance is carried out at the fixed intervals recommended by the membrane manufacturers or when the pressure drop between feed and reject streams goes out of range. Such regimes can lead to premature cleaning, resulting in overconsumption of chemicals and excess production loss, or belated cleaning, resulting in permanent fouling which may damage the membrane.

ABB's Optimax Membrane Performance module, which won the "Water/Energy Nexus" award at the H₂O Water Awards 2010, can help to overcome the drawbacks of current approaches. One module of the Optimax, Membrane Performance Monitoring, displays the membrane performance, factoring in the hydrodynamics of membrane fouling,



and provides advice for maintenance measures and recommended due dates so that the intervention can be planned and production disruption minimized. It also provides information as to how successful the cleaning was.

The other module of the Optimax is Membrane Optimization, which uses the results from the Performance Monitoring module as a basis to calculate the optimal operational conditions given the operational and physical constraints. As the fouling rate dynamics depend on the operational set-points such as feed flow and feed pressure, these are also factored in to the calculation so as to increase productivity levels as well as to optimize the fouling rate. The optimization can be run regularly and can be

MNS iS is one integrated MCC system configurable for all possible customer specifications.

implemented for open-loop or closed-loop operation. By applying the optimization function, it is possible to reduce the gap between the actual and optimal set-points; productivity increases of two percent are achievable.

Increased productivity is not the only benefit: the when-needed cleaning approach reduces chemical usage and thus operation costs; lowering the risk of membrane damage minimizes unbudgeted membrane replacement; and maintenance



outages can be better planned, thus increasing plant availability.

The intelligent MCC

A large proportion of the equipment in desalination plants is controlled by motor control centers (MCC). To better manage operation and maintenance, operators need more information such as how long units have been operating, what is their operating condition, etc. Traditionally, this extra data required more meters, transmitters and devices and, of course, a mass of cables leading to the control room. However, now ABB's MNS iS, the first integrated Low Voltage MCC system, will help solve this. MNS iS is a single integrated MCC system configurable for all possible customer specifications – from conventional right up to very sophisticated intelligent motor control system requirements. MNS iS makes modifications of control and protection functions possible at any time and at any stage of the complete project lifecycle. It provides much-needed flexibility for engineers, system integrators and end users. A very few standard motor starter variants are needed for a complete plant.

The MCC also provides condition monitoring such as: motor overcurrent; cable and terminal temperatures; MCC drawer reinsertion count - which may require performing some drawer maintenance; and so on. All this information facilitates pre-

dictive rather than reactive maintenance and helps reduce unplanned downtime.

Outlook

Overall, electricity is still the key cost component of desalinated water and, depending on the chosen desalination technology, can represent more than 30 percent of the operational costs. As a result, energy efficiency and lifecycle cost optimization are among the most important challenges for both developers and plant owners. ABB offers advanced technology for the desalination industry with a comprehensive range of proven products as well as the technology ownership behind these which allow ABB to play a role in enhancing the plant performance, efficiency and reliability. As a provider of instrumentation, control and electrical (ICE) solutions, ABB is able to provide complete engineered packages with the benefits of a single interface that saves time, reduces cost and manages risk.

As demand for fresh water increases, conservation and efficient usage are areas where we can maximize the utility of the water we already have. Cheaper and less energy-intensive desalination is the key to unlocking the vast reserves of water in our seas and oceans and thus massively expanding the freshwater supply.

Matthew Wong

Power System Division

Singapore

matthew.wong@sg.abb.com



Downloading the cloud

The Spanish experience of smart irrigation with Neptuno

ENRIQUE MONSALVE, LUIS LLORENTE – Despite being one of the most abundant substances on Earth, only a tiny percent of water is directly usable by humans [1]. In less than 50 years water has gone from being considered inexhaustible and cheap to being seen as a scarce resource that must be husbanded and carefully distributed. The United Nations has proclaimed 2005–2015 as the International Decade of actions in "Water for life" [2] and have included in their Millennium Development Goals [3] halving the number of people without regular access to drinking water

by 2015 and developing sustainable sources. At the same time, more than 70 percent of the fresh water consumed worldwide is dedicated to agriculture (up to 95 percent in some developing countries), followed by industry (22 percent) and domestic (8 percent) [4]. Therefore, policies linked to agriculture's use and modernization have a large, direct impact on the development and optimization of the use of water. The Neptune system provides support in achieving this goal while increasing the crop yield and improving the standard of living of the farmer.



World population has increased from 2,500 million people in 1950 to 7,000 million today and projections expect a further increase of 2,000 million by the year 2030 [5]. This means that mankind will need to produce more food, 80 percent of the production which will require irrigation. Although each person consumes from two to five liters of water per day, an average of 3,000 liters are required to produce the food a person eats daily [6]. And this figure increases every year as the consumption of meat and vegetables increases while that of cereals decreases. However, the availability of water for agriculture is limited by the increasing demand in other sectors where the price is higher (industry and households), the degradation and distribution of water resources and the need to achieve environmental sustainability. All these issues force a production increase which must be achieved through infrastructure policies, the increase of irrigated areas (that multiplies production by two or four [1]), the modernization of agriculture and the technifi-

cation of farmers. This is where automation and irrigation play a major role.

Specific aspects of irrigation automation

The automation of irrigation in the agricultural sector faces some very particular challenges since the control elements are usually outdoors, in extreme weather conditions, located in areas with ground and heavy machinery movement, highly distributed geographically and without access to a continuous power supply. Thus, solutions used in other sectors are not usable here (eg, communication cable or locally configurable and programmable equipment).

Irrigators, or their associations, seldom have enough knowledge or resources to maintain an automation system. Often their facilities do not have the minimum conditions to support a control system with 24 hour availability. This makes the local SCADA a problematic issue in these projects.

On the other hand, to achieve the best results with the control system, the need to have specific infrastructures owned and maintained by the end user must be avoided; a narrow-band or private radio

communication is usually not an ideal solution. Similarly, a classic SCADA solution, where the operation of the system depends on local servers, does not seem the most appropriate or the most maintainable solution in such environments. With this in mind, ABB developed a specific solution for irrigation.

First approach, Neptune irrigation solution

The basic Neptune solution for irrigation is made up of remote terminal units (RTUs), the SCADA and communications.

Control elements are usually outdoors, in extreme weather conditions, in areas with ground and heavy machinery movement and without access to a continuous power supply.

Neptune RTUs are designed to manage irrigation information and control signals in environments without electricity and so are powered with rechargeable batteries (recharged by a small solar panel, hydro turbines or other means) or with special lithium ion batteries. The hardware is designed to minimize energy needs. The irrigation valves are activated

Title picture

Increased food production requires a modernization of agriculture and a technification of farms.

2 Neptune solution scheme, including ABB GPRS network and remote access

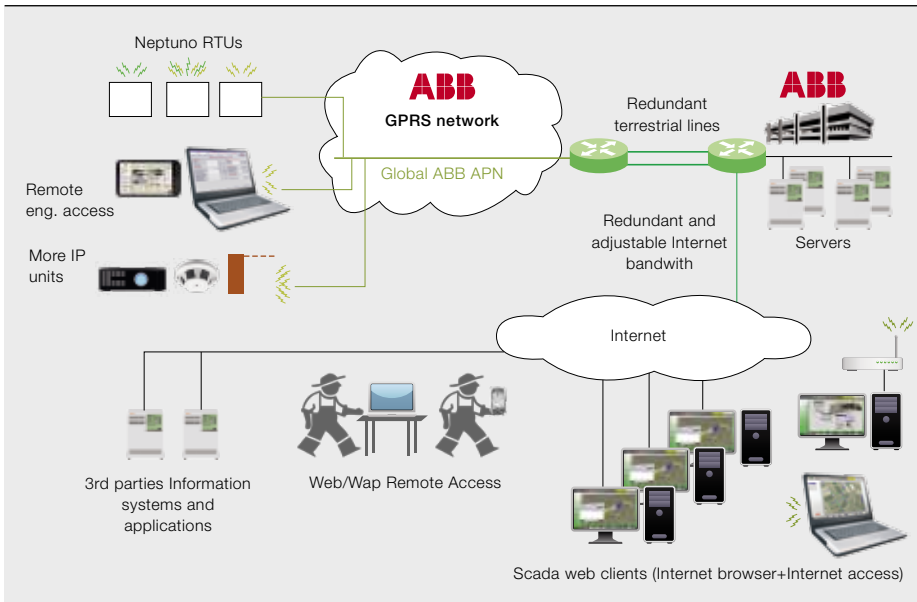

The SCADA Neptune not only displays RTU status, alarms, events, reports and historical data, but it also communicates via SMS and email and allows users remote internet access.

through pulses and with intelligent management of water meter and other existing signals, be they digital (intrusion . . .), or analog (pressure, humidity, etc) readings. Communication using GPRS modems (data on mobile phone) allows the installer to place the RTUs anywhere and change their location or quantity without having to create, modify or maintain a proprietary communication infrastructure → 1. The only requirement is to have adequate mobile operator coverage. The unit can be controlled, configured and reprogrammed (firmware upgrade) remotely.

The Neptune protocol minimizes network traffic (bytes) and allows adjustment of communications energy consumption to be the minimum necessary in each case. The RTU can be configured to have its communications normally off, activating them only when one of the preselected events or alarms occurs, such as at a given time (eg, pre-specified minutes, hours or days), at a pulse from the meter, the beginning or end of an irrigation program, when the analog input reaches a given value, etc. Thus the RTUs control the irrigation autonomously (up to four irrigation programs, delimited by time and/or volume, per day of the week) dating and recording all events or alarms. When any of the preselected events occur, the unit instantly activates the modem, communicates all the stored information to the SCADA, receives the SCADA information and/or instructions and shuts down communications. This

way energy needs and communications are reduced to the minimum. The unit can be configured to be permanently connected, or in a mixed mode (asleep for a certain time and online for the rest), and the mode of operation can be modified at any time, individually, for each unit.

ABB's GPRS network use a private APN (access point network), secured by IPSec, that can't be accessed from the outside and with a configuration that allows users to assign a fixed IP address to each remote within the network → 2. This way the information is secured and, at the same time, the amount of communications and the transmission time is reduced.

The use of GPRS provides flexibility and immediate availability while maintenance of the network and security are the responsibility of the mobile operators and the cost has been reduced in recent years. Although the client can contract the communications themselves (Neptune system is open) ABB has reached agreements with global mobile operators to offer lower prices and a level of support that would normally be beyond the reach of customers. Thanks to these agreements ABB can offer complete maintenance support of the project, from the field to the central system.



The Neptuno system has evolved into CSIS that enables access to the SCADA interface through standard web technologies, using the SaaS concept. The customer does not need to have or maintain any specific infrastructure.

The Neptuno SCADA is able to manage the reception of signals, events and alarms and to control the transmission of communications and orders to and from the RTU asynchronously. In addition to displaying the status of the RTU, managing orders, alarms, events, reports and historical data the SCADA Neptuno can send alerts via email or SMS warning when certain events occur. SCADA Neptuno also has mobile engineering stations that can connect to the remote units from any location.

Second approach, the farmer in charge

All of the RTUs can be controlled and monitored from the SCADA, but in some irrigation communities this is not enough because the farmer wants to personally determine irrigation for his crop. To accomplish this, the Neptuno system has integrated a secure web and wap access allowing the farmer to monitor and modify irrigation from anywhere with internet access, including PCs, smartphones or even mobile phones which only have wap facilities → 3 and 8. Each user has a name and password that grants access to a series of RTUs with a certain level of authorization, eg, visualize, actuate, etc. This way the farmers are no longer forced to go to their plots to open and close valves, adjust the irrigation to changing climatic conditions or when the water is cheaper (usually the cost of water depends of the time of day it's used). Instead, they can manage all of these choices in a comfortable way and from a distance. This not only optimizes the use and cost of water, but increases

the crop yield and improves farmers' quality of life.

The RTUs can also be used for the control of water distribution networks or even pumping stations. For this reason the remote access is also very useful for irrigation communities' maintenance personnel, since they can control everything from anywhere with a mobile phone without needing to carry engineering stations. Cameras and any other IP elements can be integrated into the user interfaces.

Third approach, evolution of Neptuno to CSIS

Unfortunately, irrigation communities often do not have the appropriate facilities and maintenance personnel for a control system to work properly. Additionally, the initial investment needed for such systems prevent many communities from accessing its advantages and consequently improving their competitiveness.

To address these problems the Neptuno system has evolved into the centralized smart irrigation system (CSIS) that enables access to the SCADA interface through standard web technologies, using the SaaS (software as a service) concept. This way, ABB has all the necessary core elements such as software, servers, communications, power systems, cooling etc. Equally ABB takes care of operation and permanent upgrades and maintenance, offering services both to integrators such as engineering companies, and to farmers.

5 CSIS system user reports

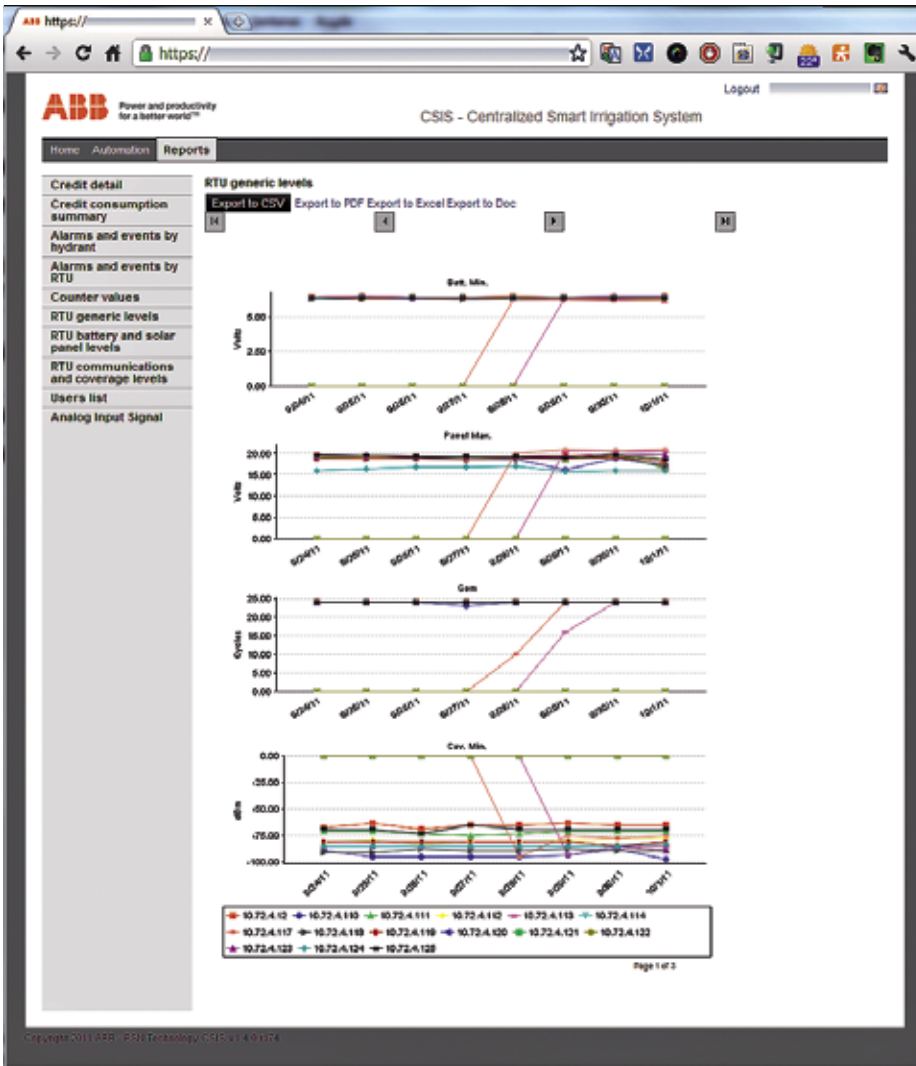

The user can see his system from any internet browser and, thanks to the technology employed, his view will be the same as if the system was installed locally → 4 and → 5.

This approach achieves many of the user's objectives:

- Dramatic reduction of the initial investment (only the RTUs), so it is affordable for communities of any size and even for individual users.
- Increased availability of the system through using better equipment, redundancy and facilities that would not be economically viable in the traditional solution.
- Secure access from anywhere. Internet access, even at low-bandwidth, and an internet browser are enough to use the system.
- Access to fixes and new features of the system from the moment they are published.
- The client does not require computer specialists or maintenance personnel.

- There are no specific infrastructures or facilities required for the project.
- It minimizes the resources needed by the customer.
- Costs are distributed over time and are adjustable according to needs.

CSIS and sustainability

Each CSIS project in an irrigation community uses equipment in the 'Cloud' which replaces the on-site need for servers, communications equipment and auxiliary equipment, such as UPS and air conditioning, etc. This implies savings in energy expenditure and, therefore, reduced emissions of greenhouse gases. In this way, the CSIS approach can achieve major improvements in sustainability. This saving can be seen by comparing the annual energy consumption of a SCADA and a CSIS system with the same number of remote units. The consumption figures for a system with 1,000 remote units can be seen in table → 6.

The consumption of CSIS is lower because the auxiliary systems and even the servers are shared with other users or applications. Savings are even more evident if the total consumption of several SCADA projects are compared with the equivalent in CSIS. Taking an existing installed base of 15,000 Neptuno RTUs and dividing it into projects each comprised of 1,000 RTUs, the figures shown in → 7 are obtained.

While the consumption of a classic system increases proportionally with the number of projects, the CSIS consumption remains almost unchanged.

Since the system can be monitored and controlled from anywhere at any time, the farmer has to travel to his crop less frequently, thus reducing his carbon footprint.

Spanish experience, the customer's opinion

ABB started implementation of Neptuno systems in Spain, where there are now many and varied references, with projects ranging from the few dozens to thousands of RTUs. Though insufficient

Since the system is controlled and monitored from anywhere at any time, the number of times a farmer has to go to his crop is reduced, so another decrease in greenhouse gas emissions is achieved.

time has elapsed to realize all of Neptuno's advantages, some communities of irrigators have drawn interesting preliminary conclusions: water savings of between 15 and 40 percent; 10 to 25 percent saving in electrical consumption; and 20 percent higher crop productivity. Further, because in Spain peak

6 Consumption figures for a system with 1000 RTUs

	Energy consumption/yr	Equivalent CO ₂ emissions saved/yr
1× SCADA system (1000 Neptuno RTUs)	21 MWh	3 Tn
1× CSIS system (1000 Neptuno RTUs)	10 MWh	1,5 Tn

7 Results from an installed base of 15,000 RTUs

	Energy consumption/yr	Equivalent CO ₂ emissions saved/yr
15× SCADA system (1000 RTUs per SCADA)	315 MWh	45 Tn
1× CSIS system (15000 RTUs)	10 MWh	1,5 Tn

8 24/7 access saves water, power and emissions



Communities of irrigators and farmers value very much the ability to control their crop irrigation from anywhere and at any time.

rate electricity is four times more expensive than off-peak, moving irrigation to off-peak hours can reduce the electricity bill more than the actual reduction in consumption does.

In the irrigators' community of Canal del Zújar, with 11,122 plots in a vast 210 km² belt of prime agricultural land, the cost of electricity was around 2.6 million Euros annually and they used more than 100,000,000 m³ of water a year. While not all the farmers have started to take advantage of the system, the irrigators' community is saving around 300,000 Euros annually in electricity and over 20 percent in water. These savings are expected to increase as more farmers start to use the system. At the same time, their maintenance personnel are driving 20,000 km less per year.

The irrigator community of Lorca, in the Murcia area, with 8,500 irrigators distributed across 125 km², has so far benefited from a saving of around 700,000 Euros just from reducing the quantity of water used.

In addition, the communities of irrigators and farmers value very much the ability to control their crop irrigation from anywhere and at any time. This allows them to reduce the number of trips to their fields, thereby also saving on fuel and the depreciation of their vehicles → 8. Though it depends on the size and physical structure, users estimate a saving of around 100 km a year per square kilometer of land just for the maintenance personnel, on top of which must be added that of their own irrigators.

In summary, ABB systems have allowed irrigators to reduce the costs of production, minimize the use of water, get the most from cultivation without having to worry about the remote control system and achieve a better quality of life. The SaaS approach of the Neptuno system

puts this solution in the hands of more irrigators, has reduced maintenance and operating costs as well as the need for local infrastructure and technical people, and at the same time, continues to contribute to the sustainability of irrigation.

Enrique Monsalve

Luis Llorente

ABB Power Systems, PSNM Network Management
Madrid, Spain

enrique.monsalve@es.abb.com

luis.llorente@es.abb.com

References

- [1] Food and Agriculture Organization of the United Nations (FAO). Water at a Glance. 2003
- [2] United Nations International decade for action. Water for life. 2005–2015. <http://www.un.org/waterforlifedecade/>
- [3] United Nations Summit on the Millennium Development Goals. <http://www.un.org/millenniumgoals/>
- [4] The 3rd United Nations World Water Development Report: Water in a Changing World (WWDR-3) 2009
- [5] United Nations Press Release POP/952, 13 March 2007
- [6] The 2nd United Nations World Water Development Report: Water, a shared responsibility (WWDR-2) 2006



Managing water use responsibly

ABB technology helps the process industries achieve sustainable water use

NUNZIO BONAVIDA, ROB TERRELL – Tantalizingly, 97.5 percent of the world's vast surface water volume is salt water and, of the remaining 2.5 percent present as fresh water, only 0.6 percent is available for ecosystems and human use [1]. Whereas some areas have an abundance of this most essential of resources, most do not. Further, the UN reports that, over the last century, water use has been growing at more than twice the rate of population increase [2]. This makes it all the more important to exploit this natural

resource prudently and to be conscientious in reducing use. Industry, globally, accounts for 20–25 percent of water use, but this rises to some 60 percent in developed countries. It is in industry, therefore, that we should look to improve water management. With its wide range of innovative water management products and approaches, ABB can do much to help – leading the drive towards sustainability and accruing real economic benefits for the water user at the same time.

1 Global water distribution

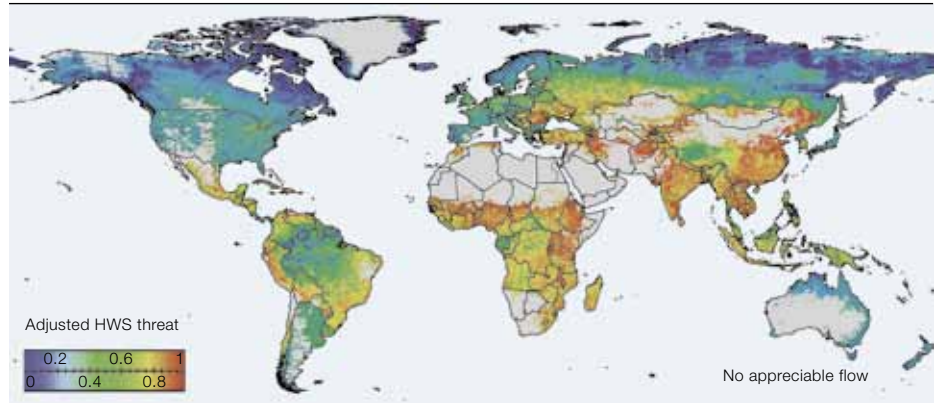

2 A typical water scheme in an industrial plant

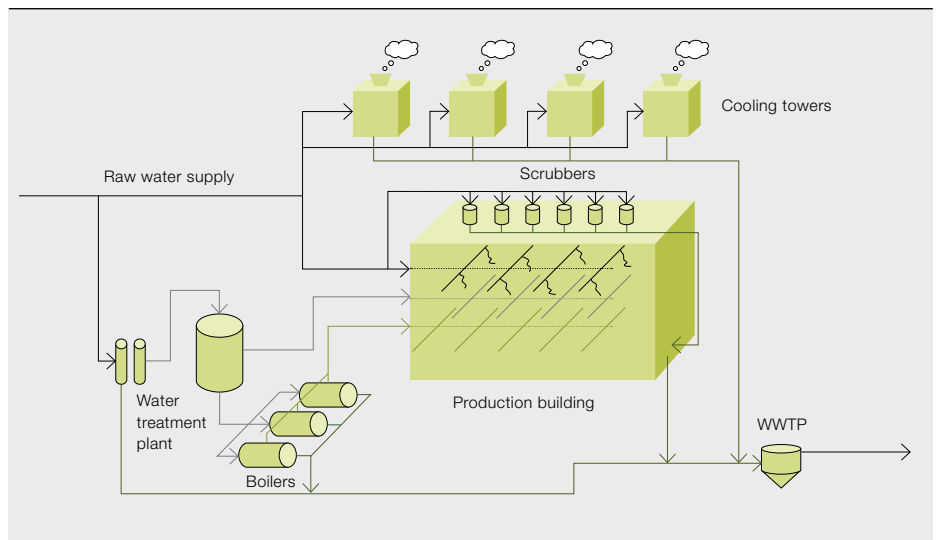

Unfortunately, rain seldom falls in the right place in the right quantities → 1 and transporting water is expensive; it is estimated that California uses seven percent of its electricity just moving water around. Sometimes it is cheaper to look for alternative sources nearby or to purify water locally, but this is no panacea either: the World Business Council for Sustainable Development has estimated, for example, that it costs the same to desalinate 1 m³ of sea water as it does to pump it over 350 km (horizontally) [3].

Water use and sustainability

According to the World Bank, agriculture accounts for over 70 percent of worldwide water use, with industrial use at 22 percent and domestic at 8 percent. And this consumption is increasing.

Of these users, industry offers the most promising short-term reduction opportunity:

- It is focused in specific locations and supported by measurement and control systems.

- It is contaminant-tolerant, with the possible exception of the food and drink sector.
- It is inherently receptive to high-technology solutions.

The major industrial use of water is for energy transfer, eg heating, cooling or as steam to drive turbines. But it is also used as a reaction medium, as a carrier, for product formulation, for cleaning and so on → 2.

Unfortunately, in most cases these processes are designed and operated in the certain knowledge that water is cheap and plentiful. This practice has developed for a number of reasons: the low cost of water compared to its value and its ready availability; the perceived high cost and complexity of treating water; and the often mistaken

belief that water reuse would have a detrimental impact on production.

If the efficient use of water in industry is to be voluntarily adopted, rather than driven by legislation, taxation, pricing policy or supply rationing, water reuse / recycle practices and technologies must be able to address these concerns. The practices must be easy to manage, the

Water use has been growing at more than twice the rate of population increase in the last century.

technologies used must be non-intrusive and the net present value (NPV) must be positive to compete with other demands for investment.

Title picture

Water. With demand rising faster than supply, what can ABB do to help industry manage this most essential of resources?

Water reuse/recycle principles

The ideal factory would reuse all water. This closed-cycle situation, however, can usually only be achieved by using excessive energy to evaporate off excess water, thus generating solids which have to be disposed of.

It is better to view water use reduction as a journey to be taken in steps which are both environmentally and economically sustainable. Water reuse/recycle should be pre-eminent in plant design; retrofitting infrastructure later is usually troublesome and expensive.

Wastewater could, of course, simply be fed back to the start of the process, displacing the fresh water supply. Inevitably though, the water quality would be inadequate without expensive treatment – and such treatment might produce water “too good” for some lower-grade tasks. A more acceptable solution is a distributed water reuse/recycle system where any available “waste” water can be recovered and reused (without treatment) or recycled (reused after essential treatment), thus ensuring that critical duties, ie those requiring specific water qualities, can be protected. This principle is known as Distributed Effluent Treatment (or DET). This results in a number of “water recovery units” being installed at key locations around the plant to improve overall water efficiency without putting the process at risk → 3.

But what is the best way to do this to satisfy the competing demands of cost, water demand, plant operability and environmental compliance?

Suitable treatment technologies

First of all, where possible, the water will be reused for lower grade duties without any treatment. Otherwise, a minimum treatment is performed to make the water suitable for its new duty and, if feasible, to recover raw material for reuse in the process. Examples of suitable technologies include:

- Media filtration units or hydrocyclones to remove suspended solids
- Activated carbon to remove organic contaminants and oxidants such as chlorine
- High efficiency flotation devices to remove free oil
- Membrane filtration including microfiltration and nanofiltration for the

3 A typical water scheme in an industrial plant

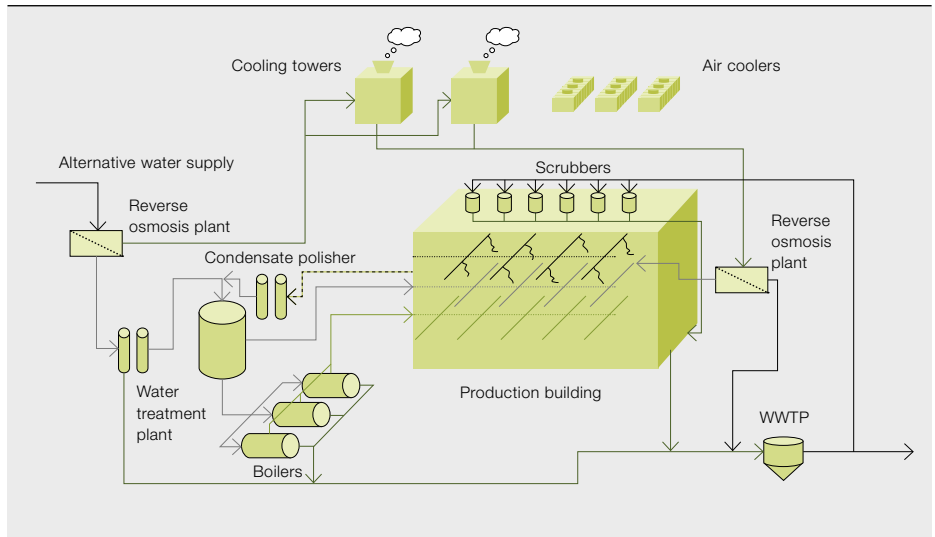

- removal of fine particles, colloidal material and microbiological organisms
- Membrane processes including nanofiltration and reverse osmosis to remove dissolved salts

The critical role of measurement and monitoring

As better water management practices are introduced, contaminants will no longer be lost to drain but will be transferred into a “receiving process” and may create scaling or corrosion problems there. Proper specification and close monitoring of the scheme is therefore essential. This will require the installation of flowmeters and on-line instruments to measure critical contaminants, with the data being collected centrally and processed to allow real time control. Typical measurements required will include pH, conductivity and temperature, but there will also be a need for specific instruments for parameters such as total organic carbon, redox potential and adenosine triphosphate (for the measurement of microbiological activity).

Establishing a reuse/recycle methodology

Before any equipment can be specified, it is critical to understand the total water flow and composition, and the quality required by the receiving duty. Also, as reuse/recycle is introduced it will inevitably influence these. It is therefore essential that any scheme is implemented in a logical, progressive manner, starting at the “clean water” end and progressing through to the “dirty water” end. This

Proper specification and close monitoring of any water reuse/recycle scheme is essential.

4 Any water reuse/recycle scheme should be developed via a logical hierarchy of activities

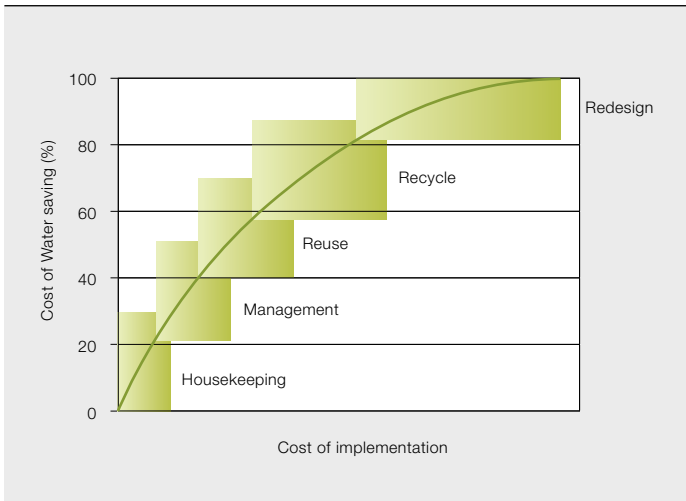

Activity	Potential Savings
1. Establish a verifiable water balance	-
2. Housekeeping / waste minimization through a program of tackling leaks and unmanaged water losses	20 to 30 %
3. Improved management of existing water systems, including process water usage and utilities	20 to 30 %
4. Reuse of water into tolerant "lower grade" duties	10 to 20 %
5. Recycle of water after treatment into tolerant "higher grade" duties	10 to 20 %
6. Redesign the system to eliminate the use of water where possible. (Generally only applicable to new systems).	10 to 20 %

Factors other than simply water cost usually decide water reuse/recycle project viability.

leads to a logical hierarchy of activities from which typical savings can be deduced → 4, although these will depend on the starting point.

The best implementation of a water recycling/conservation policy will be a combination of good management of the existing water systems, direct reuse of water for lower grade duties, where possible, and the introduction of appropriate recycle technologies.

This process needs to be underpinned by a sound and consistent methodology which can predict the impact of changes on the water quality at any point in the network. This is essential to have confidence that the reduction in water consumption will not adversely affect the process or utility operations through corrosion, scale formation, microbiological growth or the build-up of trace contaminants, result in breaches in compliance for discharges from the plant or entail excessive costs.

Will it be economically viable?

Factors other than mere water cost usually decide reuse/recycle projects' viability:

- Increased availability of water for future plant expansion
- Reduced wastewater disposal costs and opportunity for product and raw material recovery
- Meeting discharge consents reliably
- Simpler technology for wastewater treatment
- Greater wastewater treatment plant capacity giving longer residence times and greater operating stability

- Reduced capital for wastewater treatment plant expansion due to lower flow
- Improved company image
- Continued license to operate, etc

Real life examples can bring the real benefits of water reuse/recycle to life.

Real life examples

There is a growing list of reported examples of improved water consumption, including:

- Power utilities using only tertiary treated sewage as make-up
- Large chemical plants and industrial complexes being supplied only with tertiary treated sewage for all their duties
- The pulp and paper industry reducing water consumption by a factor of more than 20 over the last 30 years
- Individual fine chemicals plants reducing their net water consumption by over 60 percent
- The brewing industry as a whole driving its specific water consumption down by over 30 percent through efficiency measures

Drivers for these improvements were, typically, threat of local water shortage, industry peer pressure to be seen to be responsible and environmentally-aware and, and perhaps more significant, simple economic benefit.

How can ABB help? Case studies

ABB has a wide offering of products, solutions and services to help its customers improve their water management practices. The products include top-



quality instrumentation and analyzers able to improve the clarification of raw water or to properly manage a water network safely, as well as state-of-the-art integrated control and electrical systems. Water-specific solutions extend from specialized turn-key ultrafiltration units for pulp and paper plants to EPC contracts for large oil and gas installations. The range may best be illustrated by some examples.

A consultancy case study in steel

A steel plant planned a significant production increase over a period of five years. Although the plant was already an efficient water user compared to its peers, preliminary calculations indicated that there was insufficient water supply available to support this increase. The constraints included future abstraction permits, physical limitations in abstraction, and uncontrolled water usage. A study was carried out by ABB to address three major questions:

- How much extra water was required to achieve a production rate
- What would be the best way to achieve an increase, taking into account cost, timing, reliability and likelihood of success?
- How much production would these measures support and what would need to be done to achieve even higher production rates?

The current water supply, distribution, demand, recycle and discharge on the site were reviewed and the limited information available used to develop a “predicted usage” model to estimate the water demand for different production rates,

based on current operating practices. Each aspect of the water system was considered in turn to identify ways in which this water demand could be met or, alternatively, ways in which the demand could be reduced.

The study identified several relatively cheap and simple ways of achieving the first production target through the implementation of a number of minor projects to improve control and remove bottlenecks in the supply and distribution systems.

The study showed that to achieve sustained production rate increases in excess of 30 percent would require major investment to either

- develop the existing river water pumping station, including the distribution system to the site, which would require the renegotiation of the abstraction permit, or
- develop a new major supply to the site

The use of piecemeal improvements, while still required to sustain the increased production rates, would be insufficient to meet the higher water demands reliably. The study further concluded that even the present production rate was not sustainable due to weaknesses in the present pumping and dis-

tribution arrangements and seasonal variations in water availability and quality. The impact of seasonal variations would be even greater at higher production rates.

Oily water case study

New oil wells typically produce three barrels of water per barrel of oil, this rising to as many as 12 barrels as fields become marginal. This problematic and often highly saline water has to be treated appropriately before it can be re-injected, discharged or used for agricultural purposes. The disposal of produced water, as it is called, in the oil and gas sector is a growing challenge. [4]

Between 2000 and 2006 ABB built water de-oiling plants in three different locations in North Africa for a leading oil and gas company before being selected in 2007 to perform both operation and “full service” activities for four water de-oiling plants for a period of five years.

ABB has developed an innovative approach to treat high-salinity, oily water which is recognized in two different patents and which presents some appealing features, including:

- Can be adapted to treat oily water with high salinity
- Is not dependent on the temperature or pH of the wastewater
- Has full flexibility of flow (0 to 100 percent of max inlet water flow)
- Improves energy efficiency by minimizing the number of pumps through the use of gravity flow

The study identified several relatively cheap and simple ways of achieving the production target with number of minor projects to improve control and remove bottlenecks in the supply and distribution.

Additionally, it has a small footprint (35 by 80 meters), it can be easily managed by local operators and it utilizes chemicals which can be produced on site from easily available, cheap, base ingredients, a feature which is highly advantageous in

desert areas. It can be built on skids and transported to site for final installation and commissioning [5].

Compared with existing technologies for treating produced water, the ABB solution has proved more effective, not only in terms of process results but in critical areas like cost, energy efficiency, footprint, speed of installation and ease of operation. The process has exceeded the customer's specifications for hydrocarbon content and suspended solid concentration in the outlet water by 7 and 55 times respectively. This is a huge improvement over current alternative methods, and this treatment method is believed to be the only one that meets the rigorous requirements of proposed European legislation on produced water.

EPC case study

The sheer scale of ABB's involvement in water treatment can be gauged from the El Merk oil and gas development in Algeria. Here, the ABB-led consortium comprising Sarpi of Algeria and Petrojet of Egypt is responsible for the off-site facilities. The contract awarded in 2009 has an overall value of 650 MUSD and is one of

The process has exceeded the customer's specifications for hydrocarbon content and suspended solid concentration in the outlet water by 7 and 55 times respectively.

the largest EPC contracts in ABB's history [6]. ABB is responsible for the design, procurement, transportation, construction, commissioning and start-up of:

- Ten field gathering stations
- Six gas distribution manifolds
- The complete material supply for 120 wells and the hooking up of the first 80 for production in 2012
- The 719 km of pipelines and process piping across all the production fields.

ABB's scope of supply includes critical water systems for injection into the wells, the flowlines for production, gas lift, dilution water and water supply, the trunk lines for oil and gas condensate, gas injection and water injection, and the process piping. Other equipment supplied

The sheer scale of ABB's involvement in water treatment can be gauged from the El Merk oil and gas fields.

by ABB related to water systems includes 20-odd water pumps and filters and 210 km of water pipelines¹.

Construction, involving up to 6,000 local and foreign personnel is currently underway and first oil should flow in March 2012.

Summary

Most current examples of industrial water management are largely driven by water shortage, but some industry sectors have already demonstrated that such management also has net positive economic benefits. Progress is not technology-limited but is often hindered by water's relative cheapness, a mistaken perception of water's abundance and by lack of understanding of the opportunities.

But a progressive methodology coupled with economic acuity can lead to significant water consumption savings and a positive payback, leaving the enterprise better placed to withstand future pressures and demonstrating a responsible approach to this valuable, limited resource.

ABB already plays a significant role in this market and is well placed to lead the drive towards more sustainable and more responsible industrial water use.

Nunzio Bonavita

Process Automation Division
ABB SpA
Genoa, Italy
nunzio.bonavita@it.abb.com

Rob Terrell

Process Automation Division
ABB Ltd
Daresbury, UK
rob.terrell@gb.abb.com

Footnote

- 1 For further information on the El Merk project, please see "In the depths of the desert" on pages 20–24 of *ABB Review 2/2011*.

References

- [1] UN Water Statistics, <http://www.unwater.org/statistics.html>
- [2] UNESCO "World Water Assessment Programme", http://www.unesco.org/water/wwap/facts_figures/index.shtml
- [3] World Business Council for Sustainable Development "Water, Energy and Climate Change", March 2009
- [4] US Department of Energy (DOE) "A White Paper Describing Produced Water from Production of Crude Oil, Natural Gas, and Coal Bed Methane", W-31-109-Eng-38, 2004
- [5] *ABB Review* (June 2011) "Untroubled waters – a flexible, compact and efficient solution for oil and water separation technology"
- [6] S. Casati "In the depths of the desert", *Industrial Plants*, May 2011



AquaMaster 3™

Remote water metering with Internet delivery
of water leakage management

RAY KEECH, BRIAN HAYES, TERRY MIZZI – Much attention is given to the conservation of our precious natural resources. Clean water is, literally, the most vital of these. Whereas extending the supply of water is a key task, it is also of great importance to combat leaks in existing water infrastructure. Indeed, some tens of percent are lost in a typical water supply network, and this trend is increasing in many cases. The hidden and often remote nature of much of the

water supply infrastructure makes leak detection particularly difficult. As a direct response to this challenge and to customers' requirements to conserve drinking water, ABB developed and commercialized an exciting new product for the water industry. The new enhanced flow meter, AquaMaster 3™, which delivers measurement data from remote locations directly to customers via the Internet, heralds a new era in water leakage management.

tromagnetic devices on large pipes such as district mains; applying them to revenue-collecting situations was then novel. It is telling that many tens of thousands of AquaMasters are now sold annually.

However, ABB's customers are now interested in more than the flowmeter itself – they want the flowrate data, delivered to them as part of their management information system. The third generation of this meter, the new AquaMaster 3, now raises the bar and delivers just this.

AquaMaster benefits

Water companies have been making do with an accuracy of ± 2 percent. But now the ABB AquaMaster electromagnetic meter provides them with an accuracy of ± 0.5 percent. For pipe sizes above DN100 (4 inch), the meter can pay for itself in under a month by simply measuring and charging the water more accurately. For example, exchanging a mechanical DN150 (6 inch) flow meter, accurate to within ± 2 percent, to an AquaMaster would give the operator around US\$4730 additional revenue. As a consequence many customers are switching to AquaMaster, even in sizes as small as DN40 (1.5 inch).

Further savings and increased revenue come from the maximum and minimum flow rates that can be measured by an electromagnetic meter: the AquaMaster enables previously unrecordable minimal night flow rates to be properly metered, which would double the estimated extra earnings potential to US\$9,000 per year.

In addition to the headline improvement in accuracy, AquaMaster has many other benefits, inherent in electromagnetic measurement technologies:

- The meter uses the Faraday Principle, which allows it to be constructed with no moving parts thus eliminating the need for routine maintenance.
- Lower installation costs because the end user does not need valves to isolate the meter during maintenance and replacement. Also the possibility of being submerged in water or buried under a busy road without chambers further reduces whole life cost.

- The lack of moving parts also means that meter accuracy will not deteriorate through wear, unlike a mechanical meter.
- Today's AquaMaster meters boast an ISO-certified and Measuring Instruments Directive compliant turndown ratio of 1,000:1, thus ensuring accurate readings at both high and low flows.
- A novel hydraulic contour of the meter also makes it far less sensitive to hydraulic disturbances up- or downstream, even if the meter is positioned, for instance, near a bend or a valve.

AquaMaster 3 – pressure and power options

This variant of the AquaMaster family offers a range of attractive options. For example, as flow measurement often also involves pressure sensing, then this is included as an integrated AquaMaster option. Power source flexibility is provided too: The AquaMaster 3 can optionally exploit several renewable energy sources, such as wind and solar. Traditional battery and mains power units are, of course, still available. On-board, 21-day backup is standard.

Data logging options

Data logging is another common requirement, so the AquaMaster family offers the option of logging the flow rate and pressure every 15 minutes. The digital connection between the flow measure-

Water use has increased six-fold over the last century, more than twice the rate of population growth.

In a growing number of cases, limited freshwater resources are a major constraint on sustainable development and, worldwide, the availability of drinking water per capita is inadequate and shrinking. All of this throws a harsh spotlight on the 10–20 percent leakage loss in many water networks.

The AquaMaster is a product that is on the cutting edge of technology with features and applications that are unique within the water conservation and distribution market and which goes a long way to help utilities address this water leakage loss.

ABB first introduced the AquaMaster flowmeter in 1999. It has come a long way from its basic idea of applying electromagnetic technology to a market dominated by mechanical flow meters. Before, water companies only used elec-

Title picture

Water: every drop lost through leakage is one too many. But how do you detect leakage in a water system that is, for the most part, buried or far away? ABB's new AquaMaster 3 helps solve the problem.

Water use has increased six-fold over the last century, more than twice the rate of population growth.

ment and the data logger allows high resolution data to be logged at a rate not possible with traditional solutions. This is very significant: traditional external data logger pulses are captured over the logging interval, but due to upper frequency limitations on the flow meter only a limited number of pulses can be counted in the log interval. So for a meter with a large turndown ratio, it is not uncommon to get measurement or “quantisation” errors of around ± 10 percent or more, the data being very stepped or “quantised” as a consequence. AquaMaster, with its

1 Leak Detection: Step testing using 15 min data logging

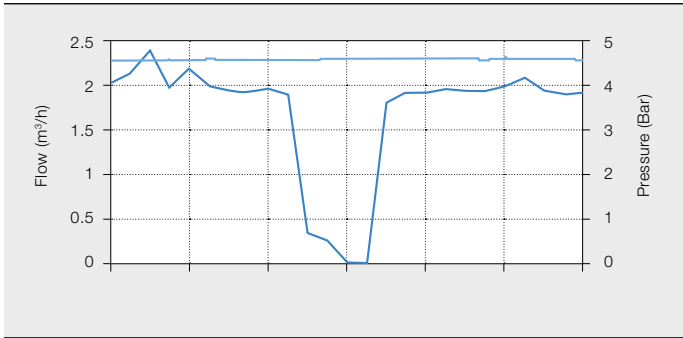

2 Leak Detection: Step testing using 1 min data logging

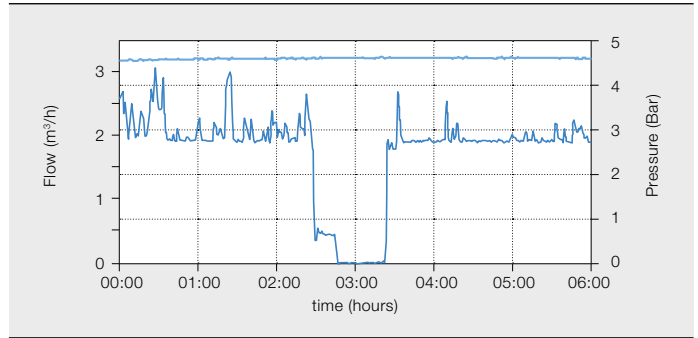

3 Block diagram: Internet based AquaMaster data

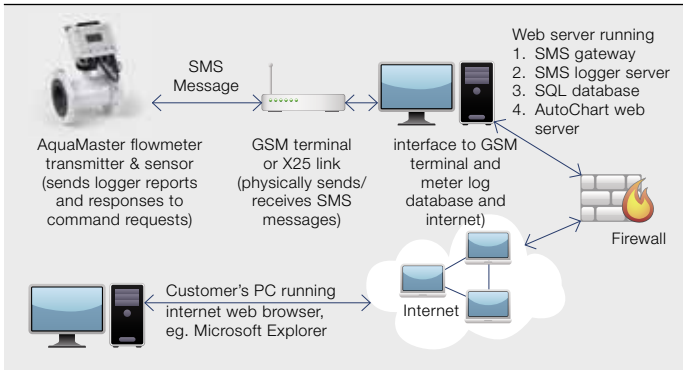

4 AquaMaster SMS data handling to any database or client

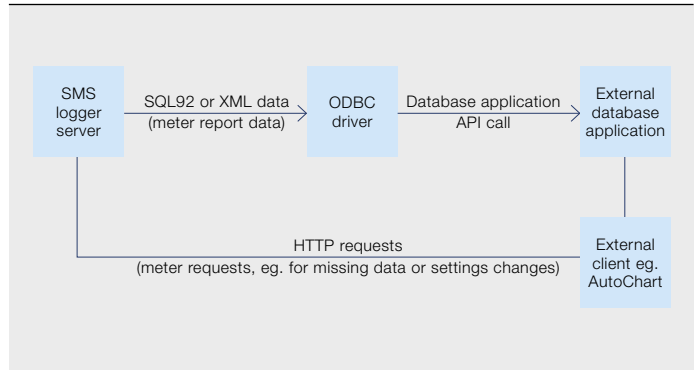

digital connection to the data logger, reduces quantisation-associated errors to negligible levels. In addition, AquaMaster offers very high speed, very high resolution logging up to an interval of 15 seconds on a second channel. This is invaluable for capturing transients during network step testing.

Data logging and leak location

Within water networks, step testing is a well-established technique for localising water loss in a zoned distribution system. It requires the establishment of zones where water can be supplied through a single meter after all boundaries and circulation valves have been closed. Closure of a valve isolates a specific section of the zone. A large drop in flow indicates a leak within that section.

The benefit of AquaMaster 3 in such step testing is best illustrated by comparison of → 1, on a traditional 15 min log interval with → 2, captured in great detail from the second channel one minute log.

In this step test, one zone valve was closed at 02:30, with a further zone valve closed at around 02:40. From the one minute log, the zone with a significant leak was clearly identifiable from the sudden drop in flow, with a second

smaller leak within the second zone. The magnitude of the leak in the two zones is very significant, at around 2m³/hr.

Step testing with AquaMaster 3 is far simpler, cheaper and faster than with established methods. It no longer requires a skilled technician or external step test data logger. It just takes a person to close a valve at specific pre-agreed times. Also, any disruption to water consumers is minimised by restricting the time a valve needs to be closed to only a few minutes. Later, the high resolution log data can be downloaded and analysed to identify the source of the water leak. This step testing process is significantly enhanced by the use of radio communication to obtain meter data, which leads us to ABB's latest AquaMaster 3 with SMS.

AquaMaster 3 with SMS

Traditionally, data is logged external to the flow measurement and recovered by someone travelling to site to download it, or, sometimes, to retrieve the entire logger. This procedure is being increasingly replaced by radio retrieval techniques and so the ABB AquaMaster 3 meters now have a GSM SMS radio option and exploit the SMS text messaging feature. Flow and pressure data infor-

Customers want flowrate data, delivered to them as part of their management information system.

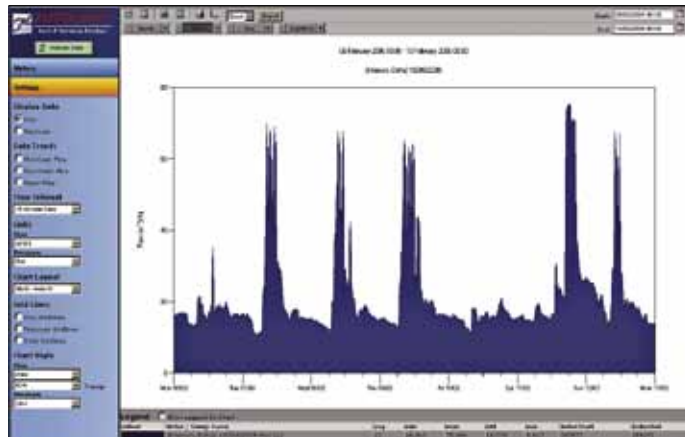
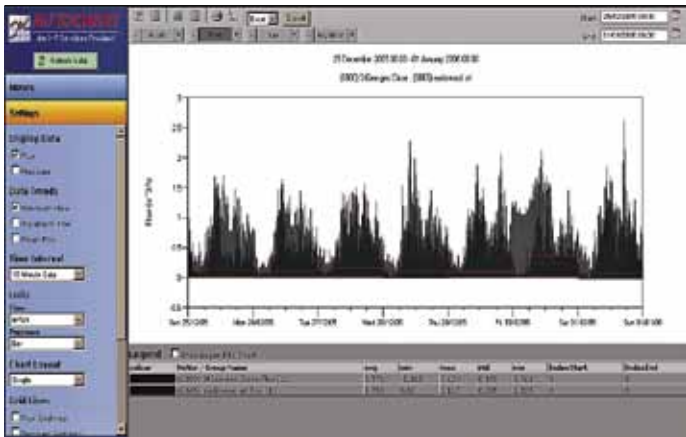

The meter pays for itself within less than a month simply by measuring and charging the water more accurately.

mation, as well as fault and tamper alarms, are sent automatically, typically once per day to conserve power in the case of battery/renewable powered AquaMaster units.

The AquaMaster 3 also responds to SMS text messages sent to it, such as configuration changes or requests for specific data. Internally, up to three months of data is stored.

Delivering measurement data to the customer

Measuring and logging flow and pressure are only part of the equation: getting the collected data onto the customer’s computer, management information or leakage management system is the other part. Discussions with key global customers showed that they could be partitioned into two groups with different requirements:

- Customers with an existing infrastructure and established water management system.
- Greenfield customers who have measurement requirements but no back office system to handle the measured data.

To address both customers’ needs, ABB devised a solution based on delivering remote meter data via SMS text messages to virtually any database, using industry standard programming mechanisms. ABB’s SMS Logger Server software delivers the data seamlessly into databases such as Oracle, SQL Server, MS Access etc, solving the data delivery issue for group one. For the latter group there are a couple of options:

- The customer can easily install any supported database and use the SMS

- Logger Server software from ABB combined with third party software to manage and display the flow data.
- As above but use a web server to deliver the data via the Internet.

ABB ZeeChart is a web-based presentation system that enables data from equipment such as flow and pressure sensors to be viewed and analyzed quickly and easily. Use of the ABB ZeeChart software to process SMS data sent from an internet-enabled AquaMaster is best illustrated by reference to → 3: SMS data is received, either on an SMS engine connected to a PC via an SMS Gateway provided by ABB, or, alternatively, for high numbers of meters, an X25 link direct from the SMS service provider.

Encryption

In some applications, security of information is critical. To protect the data from eavesdropping, AquaMaster SMS encodes the flow data with a dual-key encryption system. The encryption algorithm, based on a well-known public domain technique, is currently believed to be uncrackable. Every AquaMaster in the world has a unique, hash-encoded, service password which changes every time it is being used, thus protecting the first security key. Received SMS logger data messages are deciphered by a Windows DLL provided by ABB, with the second key for unscrambling the coded message provided by the secure ABB SMS Logger Server application. With this two-key encryption procedure the customers can have total confidence in the security of the data delivered by their AquaMaster SMS flow meters.

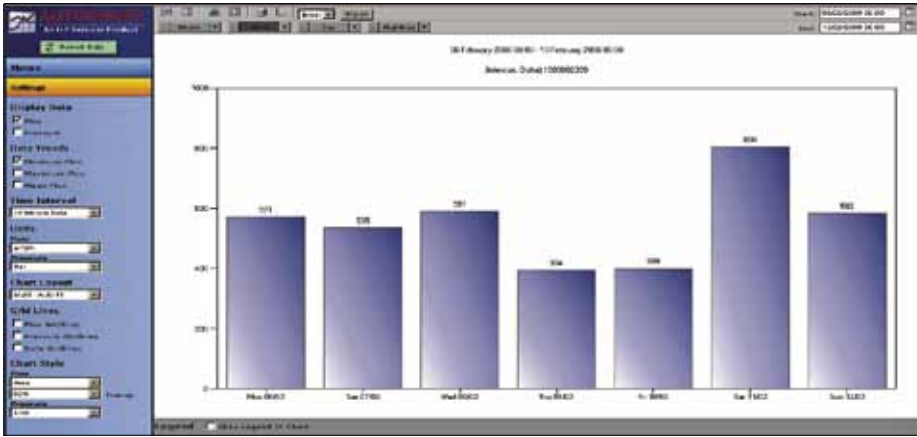

Database population

Processing of the SMS data by the ABB server application is best illustrated by reference to → 4. The application handles all incoming and outgoing AquaMaster SMS messages and delivers the data to a database. To make the system as universal as possible it uses Industry standard SQL 92 database queries; these are supported by virtually all existing databases. For newer, platform-independent databases, the ABB server supports an XML-based scheme. Connection to the database is via Industry standard Open Database Connectivity (ODBC). Queries from the customer client to the flow meters use HTTP requests. All this means it is very simple to deliver AquaMaster data to virtually any database.

Auto configuration

One of key design objectives was to make the system as easy as possible to configure and setup: the designers achieved a self-configuring implementation where any number of AquaMaster SMS flow meters can be connected with zero configuration of the ABB SMS Logger Server application. All a customer is

sands of AquaMasters this has immediate time and cost saving benefits.

Measurement data via Internet

This section describes a case study where real data was delivered via Internet to a customer.

A Web server implementation on ABB ZeeChart was used in this case. This utilizes an SQL Server database combined with the ABB SMS Logger Server Application. Being Internet-based, the information is made available worldwide to any registered user. No special software is required on the customer's PC, just a web browser and an Internet connection. ABB ZeeChart delivers information from the customer's AquaMaster flow meters, either singly or as a group, with data available in an easy-to-use graphical or tabular presentation format. An example of a typical diurnal pattern for two meters is shown in → 5. The customer is interested in the unusual daily consumption on Friday 30th December.

With Internet access it is possible not only for the water utility to see the consumption profiles and revenue information but, if so enabled, the same data may be accessed by the consumer. Such a strategy opens up major possibilities for management of water usage and

detection of leaks. For instance, one user recently identified an abnormal usage of water that was caused by continuous automatic urinal flushing. A consumption reduction of over 30 percent

was achieved by fitting simple motion detectors for controlled flushing. A similar example metering a hotel water feed is shown in → 6.

AquaMaster 3 with SMS is also unique in that the volume totals from the instrument index register are also sent by SMS text message. In ZeeChart these are displayed with the profile information and can also be displayed as daily consumption as in → 7. In effect, by combining AquaMaster 3 SMS™ with ZeeChart ABB is now able to offer customers the equivalent of a human meter reader visiting the flowmeter every day to note the totaliser reading on the display – but done automatically and over the internet.

The challenge

When the first AquaMaster meters hit the market in 2001, they were totally unique. Now, a decade later, ABB has raised the bar in providing a total measurement data delivery solution for remote metering for both existing customer information systems and for greenfield installations.

But staying ahead of the competition for the next few years will mean listening to what customers want and continuing the vigorous process of innovation that has already brought the AquaMaster this far.

Getting the collected data onto the customer's leakage management system is the other half of the equation.

required to do is to enter the phone number of the server into the field-located AquaMaster SMS flow meter. Its daily data set will then automatically be delivered. On larger scale systems with thou-

sands of AquaMasters this has immediate time and cost saving benefits.

Ray Keech

Terry Mizzi

ABB Measurement Products

Stonehouse, UK

ray.keech@gb.abb.com

terry.mizzi@gb.abb.com

Brian Hayes

ABB Measurement Products

Warminster PA, USA

brian.hayes@us.abb.com





Every drop counts

Increasing the efficiency of water distribution

FREDERIK BLANK, MARKUS GAUDER – Drinking water is a precious but scarce commodity, and is not equally distributed on our planet. With rising world population, water withdrawals are predicted to increase by 50 percent by 2025 in developing countries and 18 percent in developed countries, according to the UN's GEO-4 report. Shortages are further exacerbated by climatic change. One part of the solution lies in implementing new sources of water, treatment capability and in transporting water over longer distances. Another contribution lies in addressing the significant losses that occur in its transport and distribution. The World Bank estimated that leakages account for 32 billion cubic meters in 2006. Particularly in water distribution, losses of up to 50 percent were found to occur in some regions and countries. Reducing losses is not just about saving water but also about saving energy as every drop lost is also a waste of the energy invested in its treatment and transportation (and thus has a price in terms of CO₂ emissions). ABB has developed an integrated water-management solution to reduce these losses in different ways. It supports maintenance by helping locate leaks, but also reduces the volumes lost by optimizing pump pressures, and saves energy and energy costs by scheduling pump operations.

Leaks in water supply networks can be attributed to a variety of causes. Besides ageing pipelines, high pressures are among the main causes for water losses as pressure peaks not only increase water loss at existing damage points, but also cause additional leaks.

an unnecessarily high energy consumption (and thus CO₂ emissions). Improvements in water supply efficiency can be achieved by the following measures:

- Leakage management
- Pressure management
- Energy management

Water supply networks are often operated at unnecessarily high pressures to ensure supply at critical points, eg, parts of the network at high altitudes. Inadequate working points for pumps lead to

Title picture

Water is a precious commodity that is not equally distributed across the planet. The environmental sustainability of water supplies can be raised by tackling wastage of both water and energy (the title picture of this article shows the skyline of Dubai).

1 Building blocks of a comprehensive leakage management strategy

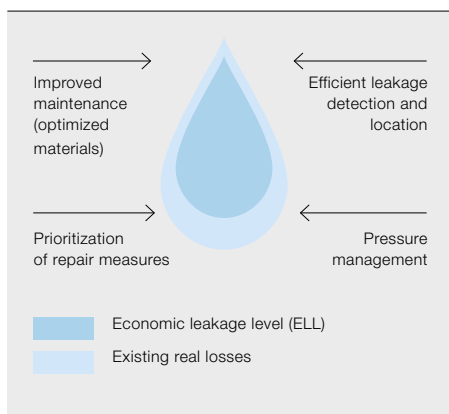

Leakage management

A comprehensive leakage management strategy must generally consider different aspects. Active leakage management aims at minimizing both the occurrence of new damages and existing leakage flows by optimized pressure management. Passive leakage management detects and locates additional leaks at an early stage and thus supports maintenance planning. The latter thus focuses on the relatively small leakage flows occurring in the background rather than larger pipe bursts that can be identified and located relatively quickly due to their obvious impact. It is estimated that only 10 percent of the water losses in well-monitored and controlled networks are caused by larger pipe burst whereas the largest part of the losses are due to the many smaller leaks that are difficult to identify and locate.

Reducing the real water losses to an economically acceptable level – the so-called economic level of leakage (ELL) –

Pressure peaks not only increase water loss at existing damage points, but also cause additional leaks.

requires targeted and coordinated measures in the following four functional areas:

- (1) leakage detection and location
- (2) pressure management
- (3) improved system maintenance, eg, by using optimized materials, and
- (4) prioritization and implementation of repair measures → 1.

2 Sequence flow of a measurement signal with a leak

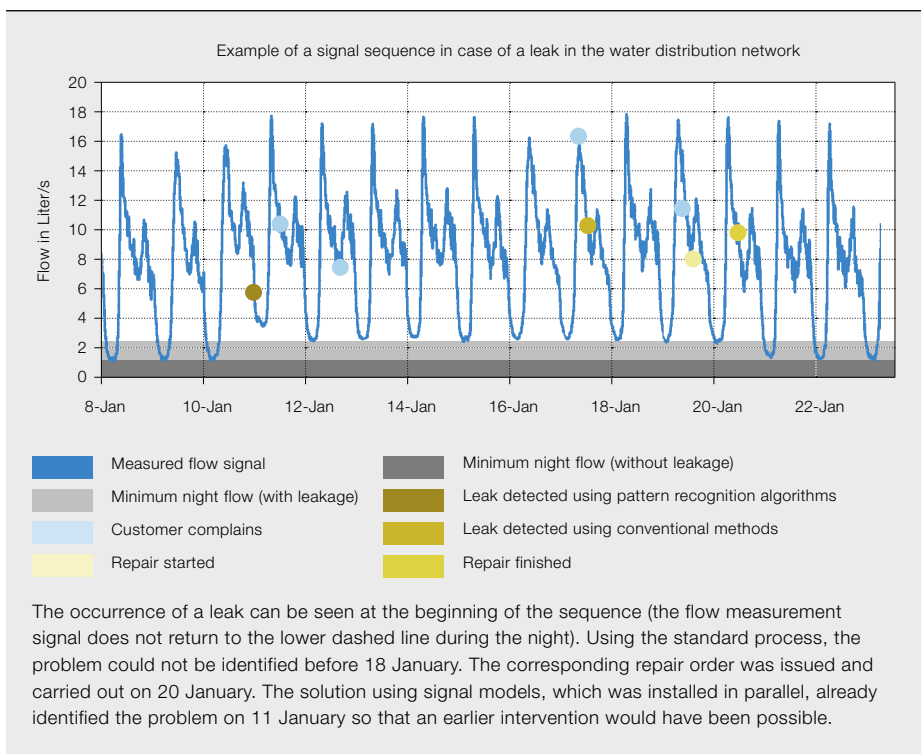

A complete elimination of water losses is not feasible from a practical and above all from an economic point of view. The absolute minimum requirement, however, should be that losses are reduced to an economically acceptable level.

In leakage management, distribution networks are subdivided into so-called leakage or pressure-management zones, with an appropriate leakage detection and evaluation as well as pressure regulation being implemented in every zone.

An approach followed by ABB builds on a continuous analysis of flow and pressure data. Using pattern recognition techniques, neuro-fuzzy and statistical methods, models are generated that predict the signal values that can be expected as a result of activity on the network

(such as valve settings and pumping). If measured values (or sequences of values over a longer period) deviate from these predictions, an alarm is generated. The use of self-learning methods allows the solution to regularly adapt to the operational changes in the supply network.

If additional data including maintenance information, customer feedback (eg, telephone calls) and weather data are made available to the system, these can also be taken into account in the analysis. The consideration of such additional data can increase the error detection rate and further narrow down the geographic area to be considered when searching for a damaged section. The on-site search can then use appropriate (eg, acoustic) leakage detection devices in a targeted and hence more efficient manner.

This approach allows changes to be recognized very quickly and permits a proactive planning of maintenance measures. Overall, problems can be dealt with before the customer supply is actually affected. The approach requires neither extensive modeling of the water supply network nor assumptions regarding the configuration. The system runs automatically and trains itself continuously → 2.

On the basis of hydraulic network models, a fault-tree analysis, and correlating current and historic data, a risk indicator can be calculated for each individual pipe segment. This value indicates the probability that the identified leak has occurred in a particular pipe segment and evaluates the leak's potential impact on the supply. This data helps narrow

3 Decision support system showing a likelihood/impact map

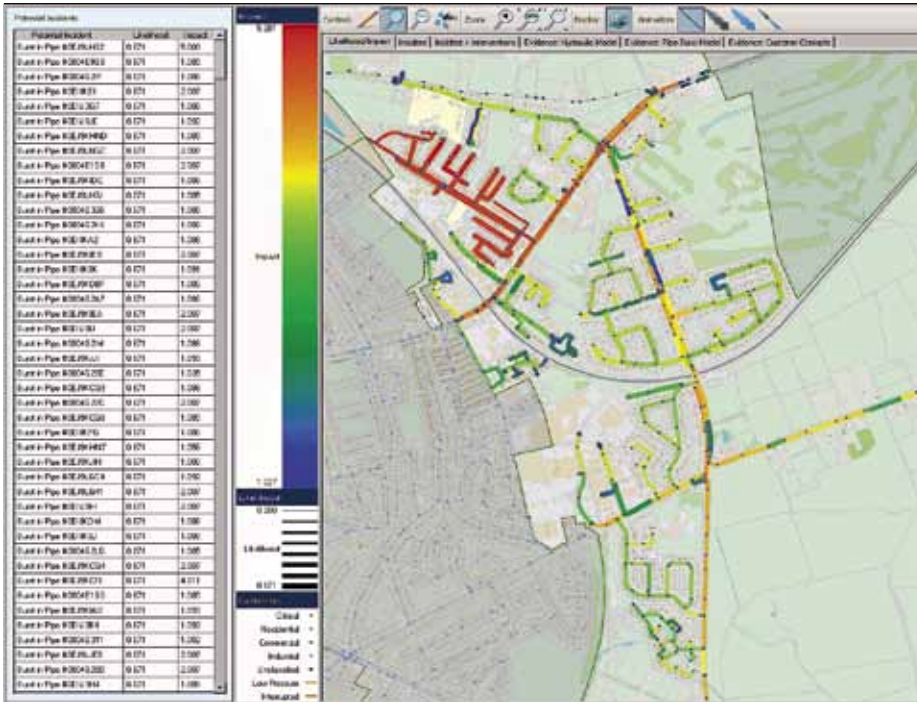

Color coding and line thickness are used as indicators of likelihood and impact of a leak.
Source: Exeter University, UK

4 Cascading management zones with the corresponding pressure control elements (actuators)

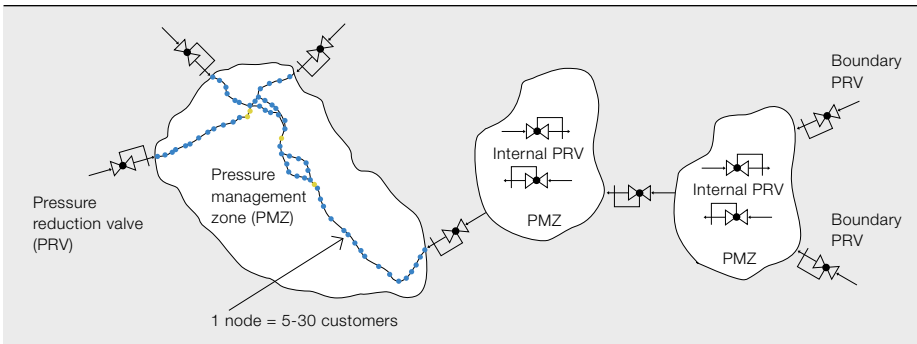

A characteristic feature of the management zones are multiple inlet and outlet points allowing systematic control of the pressure within the respective zone.

down the location of the leak and can be used to prioritize maintenance activities → 3.

Pressure management

The pressure management zones discussed above are usually controlled by means of pumps or control valves → 4. The ABB pressure-management solution uses a hydraulic model of the zones to be optimized and a prediction of the consumption at the various nodes. Mathematical optimization methods are used to calculate the optimum pressure at reference valves and pumps for a future time horizon (eg, the next 24 hours).

Operational requirements such as ensuring the minimum required pressure at the highest point of the pressure management zone are taken into account by the formulation of mathematical constraints. The reference values are then implemented on each actuator (pump or valve).

Previous pressure management systems rely on a simple local control of the pressure control elements based on pre-determined approaches, possibly varying over 24 hours or being flow-controlled. If the water consumption curves change only very little from one day to the next, the time- or flow-based control schemes configured in the valve remain valid

5 Energy accounts for a large part of water costs

Drivers	Energy's share of operating costs
Pump stations	up to 60 %
Desalination plants	up to 40 %
Water treatment plants	up to 45 %
Wastewater treatment plants	up to 50 %

The largest part of the energy used in water-supply networks is consumed by pumps. Energy accounts for 40 to 60 per cent of the operating costs.

6 Schematic representation of the inputs and outputs of the energy management solution

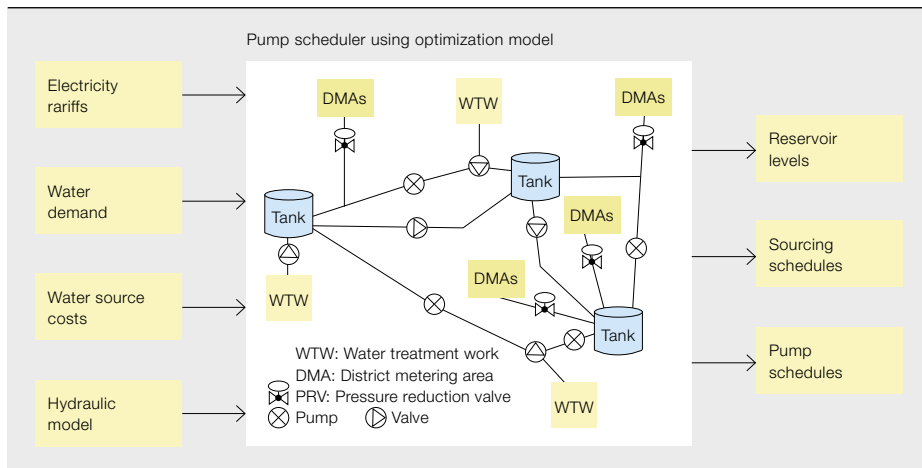

throughout the defined 24 hour time period. In this context it should be noted that this type of pressure control is mainly suitable for pressure management zones with only one inlet.

The situation is different when the water consumption curves vary from day to day, when multiple actuators are involved in controlling the pressure within the zone or when strong interactions with other pressure management zones exist. In such cases, the pressure reference values must be adapted to the respective operating situation. In such a system, the pressure management is implemented on two levels: Besides the local control, a higher-level reference value generation for the individual actuators is required in order to define the optimum pressure reference values. In addition to the reduction of water losses caused by leaks, this strategy helps prevent water hammering and oscillations in the water network. The higher-level pressure control is based on appropriate simulation models, consumption predictions and real-time data provided via the control system.

The higher-level pressure control is integrated in the control system and has access to its functions and data inventory. This does not only allow the result of the higher-level pressure control to be forwarded directly to the connected actuators but also its visualization as a trend or in an integrated geographic information system (GIS). In addition, the pressure reference values can be generated in real-time taking into account the current condition of the system.

Energy management

The largest part of the energy used in water-supply networks is consumed by pumps. Energy accounts for 40 to 60 percent of the operating costs (considered over a period of 20 years) → 5. ABB's pump optimization solution thus seeks to deliver savings in terms of both energy and cost.

As input parameters it uses a hydraulic model of the water supply network and pump characteristics (efficiency curves) as well as current and predicted (over a period of 24 hours) water consumption data and power tariffs. From this it cre-

The pump schedules are generated by cyclic calculations and are continuously updated in the information management system.

ates a pump schedule containing detailed information for a future time horizon defining which pump is to be operated when and at which operating points. It defines not only the start-up and shut-down points of the pumps but also their speeds (when variable speed pumps are used). The optimization seeks to operate the pumps as close to their maximum energy efficiency points as possible. At the same time, the filling of

reservoirs is no longer based on such rigid rules as "if reservoir level too low, switch on pump 1". Instead, the optimization algorithm takes into account the entire optimization horizon of, eg, 24 hours and seeks to fill the reservoirs when the electricity costs are low.

The pump schedules are generated by cyclic calculations and are continuously updated in the information management system. The integration of the scheduling solution into the control-system environment allows the generated schedules to be applied directly and immediately. Before they are applied, the results can be visualized, for example in the form of trends → 6.

A critical aspect of pump scheduling is the computing time required to calculate optimum pump schedules. To reduce this time and make sure that the results are delivered within a reasonable time-frame, ABB has developed a model simplifier that can automatically reduce the hydraulic model to the essential elements without compromising the required model accuracy or falsifying the hydraulic results. While other solutions on the market require special models that have to be adapted and adjusted to changing network structures, the simplifier developed by ABB automatically processes hydraulic simulation models that can be changed, adapted and calibrated directly by the operator.

The aspect of integration

The applications mentioned above already exist and are being used by water suppliers in different variants. However, these software solutions and IT systems have mostly evolved over time and consist of partly incompatible and not-fully integrated components, preventing optimal data and information flow. The previous sections have shown that the topics of leakage management, pressure management and energy management are closely interlinked, influence each other and are partially based on the same data.

The integration of the aforementioned modules and additional applications in a control system-based user environment enables further efficiency gains. Here, ABB pursues the approach of an integrated water management system which enables a modular structure and the

7 Example implementation of the integrated water management approach

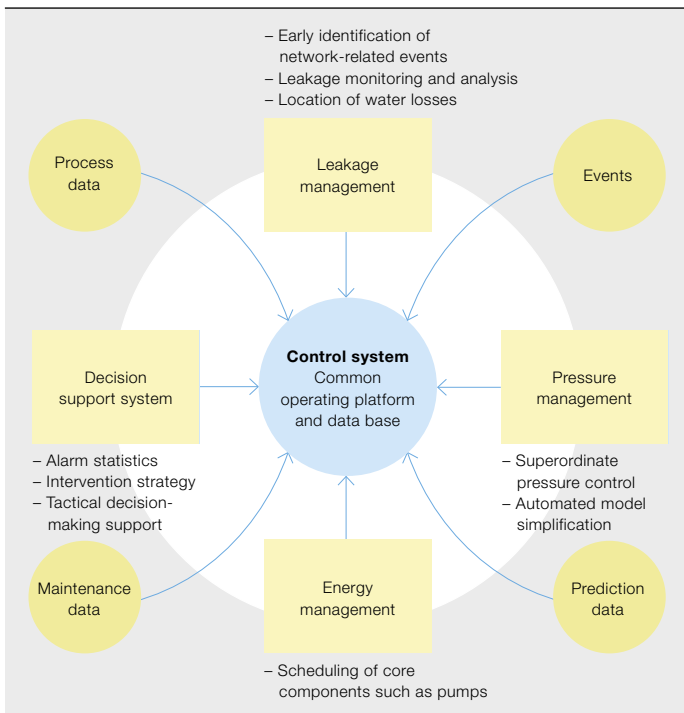

combination of the solution approaches described above.

A schematic representation of the integrated water management approach including its core components is shown in → 7. The system is characterized by a

ABB has developed a model simplifier that can automatically reduce the hydraulic model to the essential elements without compromising the required model accuracy or falsifying the hydraulic results.

comprehensive, near real-time view on the water supply network, a common user guidance based on a GIS, and the linking of individual applications on the basis of a common data base. Any information, be it of technical or commercial nature, can be retrieved in a context-related and processed form, allowing a detailed view on the condition of the supply network.

Visualization

Depending on the objectives, an adapted representation of relevant data and information may be necessary. Besides visualizations such as process graphics, which are provided by control systems as standard, the integration of a GIS into the control system environment provides significant added value. GISs are very common among water suppliers, and are used, among other purposes, for planning and network control. From the GIS, the functions of the control system can be accessed in an object- and context-dependent way, while the control system is supplemented by GIS-typical functions such as zooming, panning and decluttering. Temporal and spatial data can also be represented in the same view → 8.

A comprehensive solution

Value-added applications such as those presented above support a sustainable and efficient operation of water supply networks. The application of real-time simulation and optimization contribute to

8 The geographic information system (GIS) is fully integrated in ABB's control system



making network operation manageable in complex network topologies. Pressure management and pump scheduling are two important examples. The use of technologies, for example from the area of statistical signal analysis, allows early identification of changes in the network operation and facilitates intervention before customers become affected by a lack of pressure or even the interruption of their water supply. In the area of visualization, the integration of a geographic information system into the control system environment allows a combined representation of geographic and time-based data (such as process data, alarms or simulation results) in real-time and hence a deeper insight into the current state of the network. The approach described in this article supports the development towards a sustainable and efficient operation of water supply networks.

Frederik Blank

Markus Gauder

ABB Power Systems

Mannheim, Germany

frederik.blank@de.abb.com

markus.gauder@de.abb.com

Introducing Symphony™ Plus

Total plant automation for the power generation and water industries

MARK BITTO – Symphony™ Plus is the latest generation of ABB's hugely successful Symphony family of control systems. It is designed specifically to meet the present and future needs of the power generation and water industries.



Originally introduced in 1980, the Symphony family has gone through several stages of evolution over the years. Through ABB's "Evolution without obsolescence" life-cycle policy, each generation builds on and enhances its predecessors, adding new technologies and new functionalities that improve plant performance while protecting the customer's previous control-system investments.

There are now more than 6,000 systems installed worldwide, making Symphony one of the largest installed bases of any process automation system in the world. Symphony Plus opens a new era of total plant automation that is simple, scalable, seamless and secure → 1.

Defining great performance

Symphony Plus balances performance objectives such as asset availability, operational reliability and production efficiency with business goals such as asset life extension, carbon reduction and regulatory compliance → 2.

In so doing, it provides plant owners with an essential tool for achieving sustainable profitable growth. Its defining features include the following:

Total plant automation

Symphony Plus provides users with a comprehensive view of the plant by integrating data from all plant areas and systems, including turbine control, electrical balance of plant, and remote SCADA systems. Through its open architecture, Symphony Plus seamlessly consolidates and rationalizes plant data to improve operator response to changing conditions, thereby improving plant safety and uptime.

Transforms data into actionable business decisions

Information is the key to successful business performance. Historical, process and business data are collected from across the plant and stored securely. Symphony Plus presents pertinent, easy-to-understand information in intuitive desktop displays to all levels of the organization.

Unified engineering workbench

Time to production is the measure of engineering efficiency. Symphony Plus' engineering environment, S+ Engineering, is an integrated engineering tool with the functionality to engineer, configure, administrate, secure, commission and maintain any Symphony Plus component – from field devices, electrical devices, control and I/O to operator workplace and gateway configuration.

Embedded ABB know-how

Each Symphony Plus solution builds on ABB's more than 125 years of power and water expertise, combining in-depth process knowledge with extensive electrical and automation know-how to provide a best-in-class solution for each plant requirement.

Single control and I/O platform

Symphony Plus provides total plant automation from a single control and I/O platform that encompasses dedicated interface modules and devices for all turbine types, OEMs and sizes, as well as an

1 Symphony™ Plus at a glance

Simple

Symphony Plus is easily adapted to meet the broad spectrum of plant configurations and applications in the power and water industries.

Scalable

Symphony Plus' unique system architecture provides flexible and scalable configurations, from the small and server-less to large multi-system, multi-server architectures.

Seamless

Symphony Plus enables the seamless integration of field devices, process and turbine automation systems, electrical and SCADA systems, and business and maintenance systems.

Secure

Symphony Plus provides users with a secure and reliable control environment with built-in security features that prevent unauthorized control system access.

2 Symphony Plus system architecture

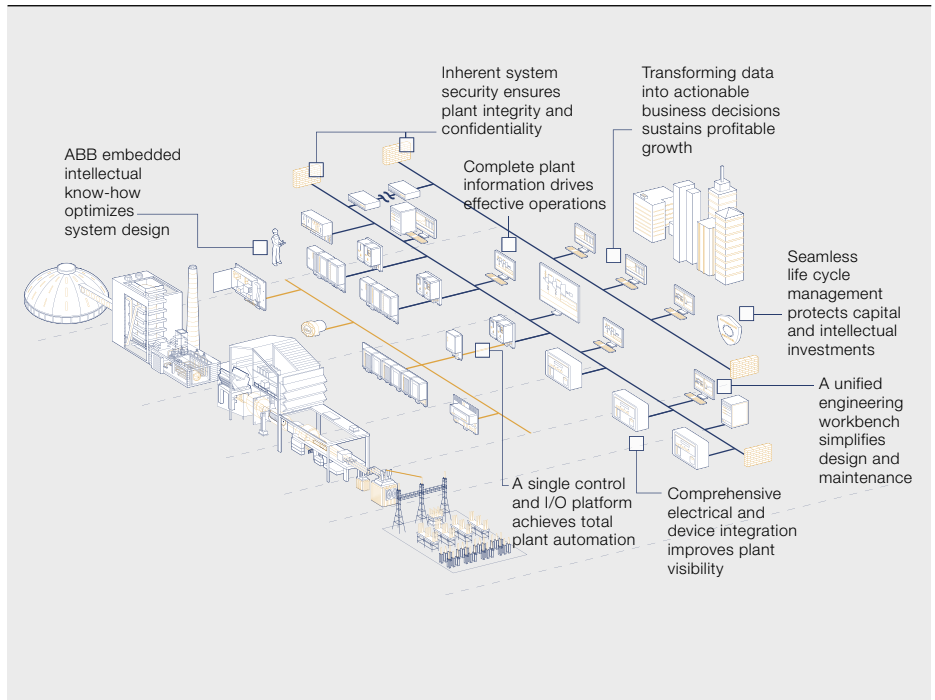

unparalleled selection of combustion instruments.

Electrical and device integration

Symphony Plus provides process and electrical control from a single platform. Using open-standard protocols such as IEC 61850 and Modbus TCP, Symphony Plus integrates electrical devices with process control and plant operations. It provides full integration of just about every type of device, and enables the monitoring and management of all plant assets at all levels of the plant.

Inherent system security

ABB understands the need to maintain a secure, reliable control environment while expending minimal time and effort.

In addition to the many security features built into Symphony Plus, ABB actively participates in several major control system security standards committees.

The guidance provided by these committees is designed to increase the integrity and confidentiality of all system functions and help prevent unauthorized control system access.

Seamless life-cycle management

Evolution and investment protection are the cornerstones of ABB's product life cycle strategy. The company's "Evolution without obsolescence" policy helps cus-

tomers find a balance between upgrading with new technologies and maximizing the return on asset investments already made. Plant owners have the ability to extend the useful life of their systems through evolution and avoid the costly and high-risk rip-and-replace approach.

to commissioning, operation and decommissioning.

With unparalleled process, application and technology expertise, ABB is uniquely positioned to support changing needs and industry requirements.

To learn more about Symphony Plus contact your local ABB sales office or download a brochure at: www.abb.com/powergeneration

There are now more than 6,000 systems installed worldwide, making Symphony one of the largest installed bases of any process automation system in the world.

Life-cycle services

ABB offers a complete portfolio of services, from repairs and spare parts to Full Service® contracts and complete plant upgrades and equipment retrofits. ABB services are available to enhance every phase of the plant life cycle, from first concept and front-end engineering

Mark Bitto

ABB Power Systems, Power Generation
Wickliffe, OH, United States
mark.bitto@us.abb.com



ABB service in water

Provision of eBOP service to world's largest covered wastewater treatment plant

JOSEPH QUEK – The award-winning Changi water reclamation plant (CWRP) in Singapore is the world's largest covered wastewater treatment plant. This exceptional construction is equipped with a wide range of ABB products. ABB have now been awarded a complete service package at Changi and thus will continue to contribute engineering know-how to what is regarded as one of the world's most innovative and visionary water projects.



The Changi water reclamation plant → 1 is one of the largest water reclamation facilities in the world. The CWRP and Deep Tunnel Sewerage System (DTSS) in Singapore will collect, treat and purify every drop of waste water produced by the city-state over the next 100 years, replacing all existing local plants in Singapore. Located at the eastern edge of Singapore, the plant is mainly underground and is built in a stacked arrangement, thus occupying a land area less than one third of a conventional layout. The plant produces clean water to the highest international standards, suitable for deep sea discharge in the Straits of Singapore. On the rooftop, CWRP incorporates the fifth operational facility (NEWater) in Singapore capable of reclaiming potable water which is fit for human consumption or for high-requirement industrial use.

The project was crowned the Water Project of the Year at the prestigious Global Water Awards 2009 in Switzerland.

Title picture

The Changi Water Reclamation Plant is fed by a mammoth 48-km tunnel sewer running up to 55 metres below ground. The picture shows just some of the pipework which handles the huge inflow.

Powering Singapore's water superhighway

Amounting to a project cost of US\$3 billion, the CWRP uses the most advanced technology available to treat two-thirds of the 1.3 million cubic meters of wastewater Singapore generates daily. The plant is being extended to a daily maximum capacity of 2,400,000 cubic meters – sufficient to accommodate the entire needs of Singapore.

Building the CWRP threw up many technological challenges and ABB played a prominent role in its construction by providing advanced power and automation expertise and products such as high-efficiency motors and medium-voltage drives that enable critical parts of the process to operate at the highest levels of energy efficiency and reliability. In fact, throughout the entire Changi water treatment process ABB products and systems power, monitor, measure and speed-control crucial process equipment in the liquid and solids treatment modules, sludge drying systems, centrifuges and turbine generators, and effluent pumping station.

Water service to CWRP

ABB is no stranger to the global water industry, having supplied electrical, automation and service solutions for more than five decades. It has one of the largest installed bases in this industry, as well as market and technology leadership in power and automation technologies, unrivalled application know-how

The three-year, \$2 million service contract is for the electrical Balance of Plant (eBop) which will help ensure reliable and efficient operations of CWRP.

2 The service package covers such items as motors and drives, distribution boards, transformers, switchgear, and so on



and process expertise in all application areas of the water cycle. These include water transfer systems, distribution and irrigation networks, pumping stations, desalination plants, as well as urban and industrial wastewater treatment and re-use plants.

A key driver for ABB is to deliver energy efficient and lifecycle cost-optimized solutions. And the company's worldwide service capability and lifecycle manage-

ment expertise enables plants to keep running optimally throughout their entire operational life.

With its wide range of products, systems and services, ABB follows the whole lifecycle of Changi Water Reclamation Plant, from engineering to construction to, now, service and maintenance. ABB supports CWRP in identifying the best solutions for their specific needs, including maintenance and asset optimization.

The service contract from the Public Utilities Board, valued at just under US\$2 million, is a three-year service and main-

tenance agreement for the electrical Balance of Plant (eBop) which will help ensure reliable and efficient operations of CWRP. The service package includes the vital maintenance of critical

equipment such as 21 units of medium-voltage, high-efficiency motors and water-cooled, medium-voltage drives that power and control the huge pumps at exceptional levels of energy efficiency. Also covered are high-voltage distribution boards and transformers; medium-voltage switchgear, motors and drives; both low- and medium-voltage transformers; and low-voltage switchboards, switchgear, motors and drives → 2.

Under the service contract, ABB provides, 24/7, certified standby engineers and response to site within four hours for critical equipment. A key engineer is

assigned to support the CWRP and internally coordinate various service groups to establish a single contact point. Through this contact, ABB helps CWRP to plan and execute regular maintenance.

Other value-added aspects of this full service contract include providing Parts Online Access, maintaining the failure log book and supplying basic training and refreshers for ABB equipment operation. With ABB's Logistic Center Asia (LCA) located in Singapore, local, fast response on spare parts is available, thus allowing CWRP to minimize their spare parts inventory. Last but not least, and viewed by the customer as very important, are the local drive service workshops and Motor service workshops led by ABB factory certified personnel.

Key success factors in service

Despite the wide range of ABB equipment involved in the service contract, the customer perceives just one ABB entity. This exceptionally easy interface makes it simple for CWRP to run and maintain their equipment. The CWRP maintenance team has peace of mind as ABB personnel will always be there to support and resolve any of their issues in all the critical equipment. For full clarity, the customer has easy access to ABB's sales and service engineers via a clear and simple contact chart.

Changi Water Reclamation Plant has recognized how ABB's service can help increase the reliability and efficiency of their operations:

"We thank ABB for the service provided so far, and also for assigning proficient and efficient engineers to support CWRP. ABB engineers have been very responsive, accommodating and helpful to our maintenance team. For that, we are very grateful and appreciate their efforts and diligence in keeping our critical equipment in good working order," complimented Mr. Lim Swee Sen of Public Utilities Board.

Joseph Quek

ABB DM Service Sales & Marketing
Singapore
joseph.quek@sg.abb.com

Despite the wide range of ABB equipment involved in the service contract, the customer perceives just one ABB entity.

ment expertise enables plants to keep running optimally throughout their entire operational life.

After the Changi Water Reclamation Plant went into full operation in June 2009, ABB were following up with the customer when it was noticed that he had a demand for a complete service package. The customer had contact with various ABB departments regarding service requirements so ABB co-ordinated a response across several of its divisions and created a single comprehensive service contract offering.



Water of life

Sustainability and energy efficiency in the water industry

DAVID PRIDGEON, WERNER JANIK, MARKUS GAUDER, SENTHILMURUGAN SUBBIAH, NAVEEN BHUTANI – Water shortages pose an immediate threat in terms of health issues and economic development. The threat is developing at an alarming rate due to growing demand. According to the United Nations [1], there are already 700 million people distributed across 43 countries facing a water shortage. Projections show dramatic changes over the next 15 years such that almost two thirds of the world's population are expected to live in water stressed countries by 2025 → 1 → 2 [2]. This equates to a 50 percent consumption increase by 2025 in

developing countries and 18 per cent in developed countries, according to the UN's GEO-4 report. Traditionally the passive collection of rain water from rivers and reservoirs and the use of artesian wells have met the water demand in populated areas but the effects of population growth, greater urbanization and climate change are increasing the need for artificial desalination and advanced wastewater treatments. As energy plays a key role in production, transfer, distribution and treatment of water and wastewater, it is necessary to optimize its usage to increase the level of sustainability and to minimize specific costs.

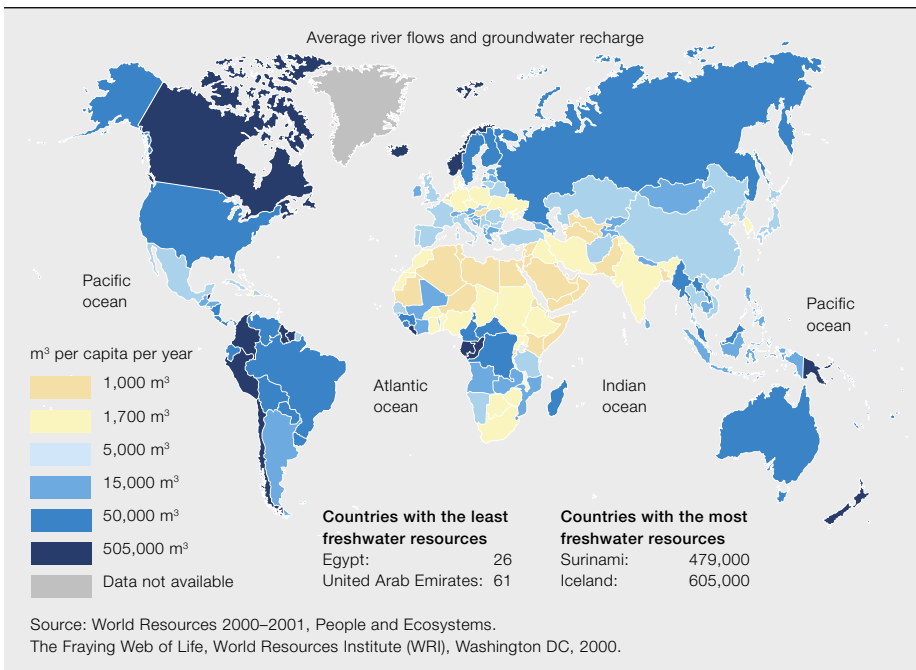

To secure future water supplies a tremendous investment in water infrastructure is required, either by rehabilitating deteriorating systems and plants or by extending the infrastructure by building new facilities. Depending on the region, these investments will occur in various water and wastewater applications. They include, for example, pumping stations for water transfer schemes, desalination, municipal and industrial water treatment, re-use and recycling, water distribution, municipal and industrial wastewater treatment and irrigation schemes for agriculture.

Such investments should not focus purely on the hardware of the infrastructure but should also encompass its operation and maintenance. A common factor in all the water and wastewater applications referred to above is that they are all very energy intensive processes → 3. Overall, tighter water quality standards, water stress and scarcity are drivers for more energy intensive technologies for tertiary or advanced wastewater treatment. In addition, in a growing number of countries, there are direct or indirect govern-

ment incentives to reduce energy consumption.

This article looks at the energy efficiency aspects of the water supply, whereas the accompanying article “Managing water use responsibly” on pages 17-23 of this edition of *ABB Review* looks at the aspect of saving water itself. As these articles show, the topics are closely inter-related and the optimization of water networks must consider both aspects rather than one at the expense of the other.

Energy efficiency assessment

In order to achieve a higher level of energy efficiency, the complete application process needs to be taken into consideration to capture all opportunities for efficiency improvements and then to properly prioritize these opportunities. While for green field systems the optimization aspects may well be covered during the design phase, for plants and systems already in operation, the identification of improvement opportunities is a much more challenging exercise which requires a structured methodology for execution. Optimization of energy consumption can be achieved by following different reduction strategies including the optimization of the mechanical system, electrical system, the

controls as well as implementing energy recovery or cogeneration measures.

An example of such an approach is the ABB concept of industrial energy efficiency (IEE). With this methodology, the focus is not only on individual items of equipment but on the overall system, considering the process and the site organization as well as the consumption of utilities. This concept of IEE employs a staged approach

Enormous energy savings can be achieved by controlling the discharge pressure and flow by varying their speed rather than using throttle valves.

covering an opportunity identification phase, a master plan phase designed to assess and prioritize identified improvement opportunities and, in conclusion, the implementation phase. The execution is a joint effort by ABB and the client, involving experts from different disciplines.

Opportunity identification

During this phase the efficiency of existing utility systems is assessed and improvements that can be achieved from process control, equipment modification or alternative energy efficient technologies are identified. Available data such as around consumption or flow conditions as well as

Title picture

In many parts of the world, water is a scarce commodity. How can its future supply be assured in the face of growing demand and climate change?

site assessments are considered as inputs for the analysis. Additionally, monitoring and targeting as well as the assessment of behaviors and practices relating to energy efficiency are part of the phase.

During opportunity identification, a critical analysis of process components in use is made. Asking, for instance:

- Is it required to run the process equipment at all?
- Can it be run for fewer hours, e.g., part time versus full time use?
- Can the process or equipment achieve the same results at a lower flow capacity?

Answers to such questions deliver a first indication of possible energy efficiency optimization potentials.

As an example, taking a closer look at the biological process of a wastewater treatment plant, the following general opportunities should be analyzed in more detail as according to experience, energy efficiency improvement potentials are connected with these:

- Optimizing sludge recirculation.
- Optimizing sequence of disc aerators.
- Reduction of sludge age.
- Implementing, or modification of, advanced controls.
- Changing the selected aerator type or optimization of aerators.

The analysis and implementation of energy efficiency measures in a treatment process needs always to consider that there is an inherent risk that reducing energy consumption may adversely affect the operation of the biological process, eg, by reducing the amount of oxygen available for the digestion process. The selection of measures should therefore be carefully taken and consider the possible impacts on the process and its operation.

The master plan

During the phase of master plan development, the set of selected energy saving opportunities is developed into an implementation plan. For each of the opportunities, the key aspects for implementation are considered. The master plan development phase uses alignment and prioritization workshops with the customers to define elements such as the magnitude of energy savings and the investment range or constraints. The plan is developed based on the assessment of the opportunities in terms of:

2 Illustration of projected levels of freshwater in 2025

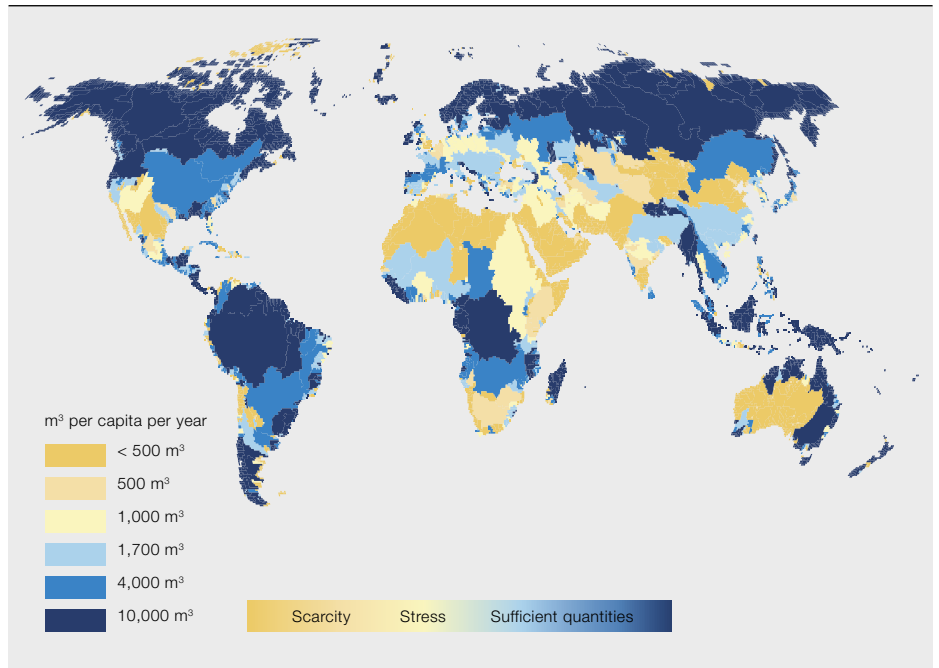

- The technical feasibility and data confidence of the energy saving opportunity.
- The business impact and development requirements of the energy saving opportunity.
- The timescale to implement the energy saving opportunity, including budget and site availability.
- The estimated time to achieve a complete return on investment.

As part of this phase, projects are separated into two tiers:

- Tier 1 describes those opportunities selected for immediate development towards implementation.
- Tier 2 gives opportunities that require further information prior to selection and development.

While for tier 1, opportunities project specifications are generated, for tier 2 opportunities a summary is created to enable the confirmation of the project.

The implementation phase

Implementation measures follow the outcomes of the master plan. For implementation measures, the implementation team set-up is driven by the nature of the projects themselves and the in-house capabilities of the client's organization.

Energy efficiency in different applications

Looking at pumping stations for instance, one of the potentials for major energy savings is associated with flow and pressure control. Control can be achieved using

Alignment and prioritization workshops with the customer define elements such as the magnitude of energy savings and the investment range or constraints.

3 Comparison of energy consumption in various treatment processes

	Percentage of required energy expenditure for pump operation	Percentage of operational expenditure for energy
Pumping Station Applications	80	50 to 60
Water treatment	75	40 to 50
Wastewater treatment	main energy consumption due to aeration and solids handling	40 to 50
Desalination	Varies according to process employed	20 to 40

4 Comparative energy usage for flow control schemes

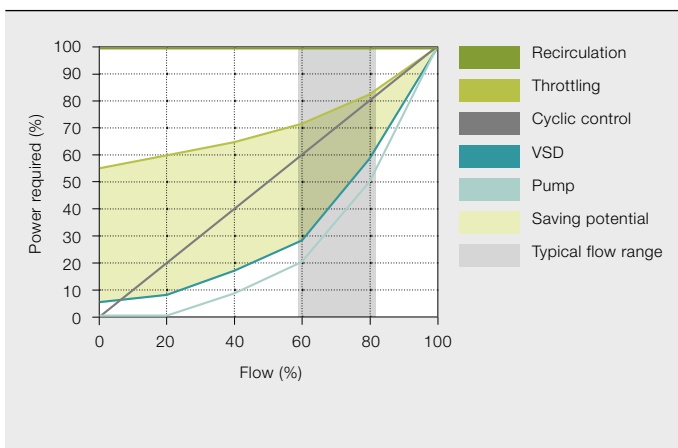

5 Different flow and pressure control solutions

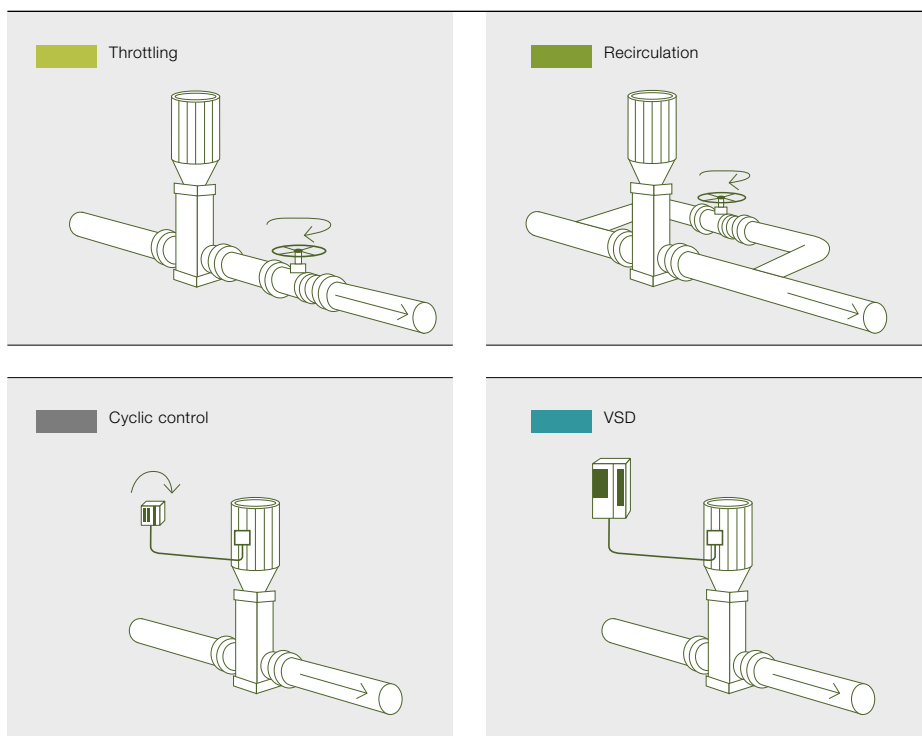

either a mechanical or an electrical solution. In many cases, pumps are operated at partial loads and thus enormous energy savings can be achieved by controlling the discharge pressure and flow by varying their speed rather than using throttle valves for mechanical control → 4 → 5.

Pump affinity laws

1. Flow is proportional to pump speed
2. Pressure is proportional to the square of pump speed
3. Power is proportional to the cube of pump speed

Such mechanical fixed speed solutions can be compared to adjusting the speed of a car by braking while keeping the foot

on the gas, resulting in energy wastage and worn out equipment. The more elegant and energy efficient solution is to use variable frequency drives, allowing changes in production volume by adapting the motor speed. Such an approach can be compared to reducing the speed by taking the foot off the gas and switching to a lower gear.

For pumps with a relatively low static head the majority of the pump discharge head is required to overcome the friction loss in the pipe. By reducing the speed with a variable speed drive (VSD) to reduce the flow, the head is reduced as well. This will result in operating the pumps at its best efficiency point (BEP)

over the operating speed range of the drive with the clear advantages of achieved energy savings, decreased of CO₂ emissions and minimized operating costs as well as a fast and precise process control. VSDs can also act as soft starters, reducing stress on the network, motors and pumps. During the start up process, VSDs progressively increase the motor speed and smoothly accelerate the load to its rated speed. A single variable speed drive can be used to start several pumps in sequence. The soft start feature eliminates high starting currents and voltage dips which can cause process trips, therefore maintenance costs are reduced and the lifetime of the system equipment extended. In case the demand for water is reduced, VSDs slowly reduce the speed of the pumps, avoiding water hammer and ensuring a minimum water velocity in the system.

Taking a measured approach with PEMS

When it comes to energy efficiency and related improvement measures, a key challenge is always about the definition of a baseline in order to determine and evaluate the achieved improvements. In the case of pump systems, measuring the efficiency of a pump gives a more detailed insight and thus allows much better assessment and benchmarking of the equipment. The pump efficiency monitoring system (PEMS) is an ABB solution that allows the determination of the efficiency of a pump in real time and thus to get condition based information. PEMS applies thermodynamic principles for efficiency calculation and only requires as inputs pressure and temperature measurements on the suction and delivery side of the pump. If the electrical power

6 Typical example of evaluation of identified opportunities

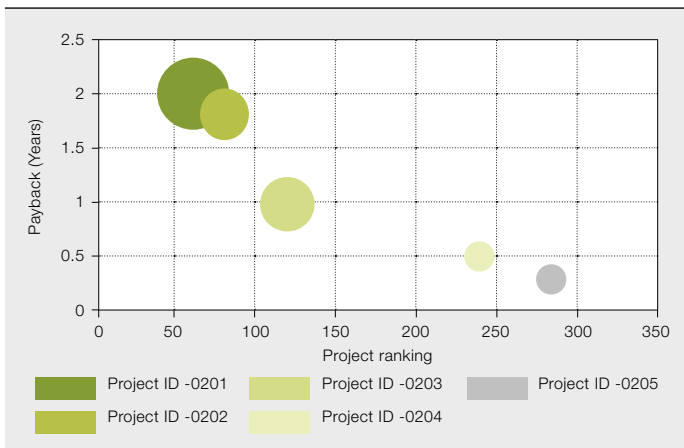

is measured as well, the flow values can also be derived from this method. PEMS can not only be used for benchmarking activities but also provides reduced operational costs when operating the system with the highest efficiency. In addition, the plant availability can be increased by implementing optimized maintenance schedules. Taking a look at the broader picture is fundamental to developing a comprehensive strategy. The obvious potentials might not be the ones that deliver the highest benefits.

Economic aspects

As the methodology already implies, it is usually applied to existing plants. As a rule of thumb, for all plants to be considered for an energy assessment, the requirements such as follows should guide the selection process:

- Plants should have a remaining plant lifetime of at least 10 years. If the lifetime is too short there will not be enough time left to sufficiently enjoy the savings.
- The unit energy cost of plant operations should be above medium level compared to the global average. Energy costs which are too low may lead to the conclusion that the saved energy does not have sufficient value to be economically attractive.

However it is clear that among all of the opportunities identified, only those which have an attractive return on investment will be shortlisted. The payback graph shows a typical example of such an evaluation → 6. The opportunity ranking gives information as to how quickly and simply an opportunity can be installed (high value means simple and quick installation), the

bubble sizes are proportional to the value of savings per year, and most importantly it gives information on expected return on investment. The projects in focus have a payback period of less than three years.

Typically the amount of potential opportunities which are economically attractive and which are shortlisted for implementation will provide on average 5 to 10 percent of improvement in energy efficiency in total. Those savings do not only provide cost reduction in terms of energy saved or production increases, they also provide savings in CO₂ emissions → 7. Savings in CO₂ emissions can be calculated as equivalent to energy consump-

Mechanical fixed speed solutions can be compared to adjusting the speed of a car by braking while keeping the foot on the gas.

tion, where applicable carbon credit trading might support investment for energy savings. Results in the area of the grey segment in → 7 can always be expected and would also lead to significant plant performance improvements in terms of energy savings.

ABB is increasingly looking at improving the energy efficiency of water applications including desalination processes and is thus stepping into the service busi-

7 Annual savings related to energy efficiency improvement and tonnes of CO₂ saved in relation to site energy use

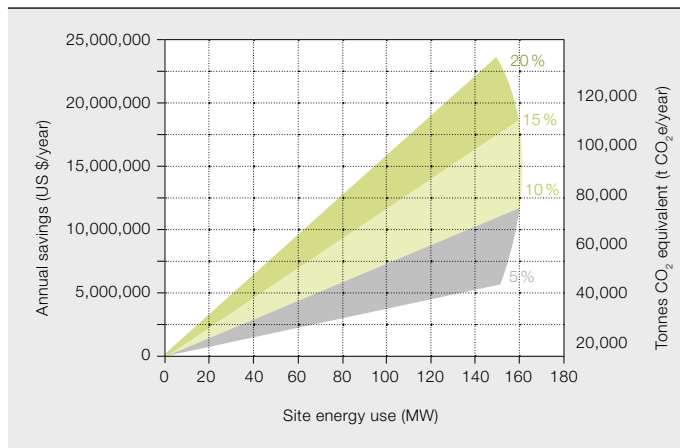

ness for energy efficiency assessments in general and carbon footprint assessments specifically. This allows to tap underlying opportunities through improved sustainability and better compliance at marketplace in the water industry. Using ABB's extensive R&D experience an extensive set of different solutions is available to improve energy efficiency in water and wastewater applications and thus to deliver advanced solutions.

David Pridgeon

ABB Power Systems, Transmission Substations
Stone city, Great Britain
david.pridgeon@gb.abb.com

Werner Janik

ABB Power Systems, Power Generation
Mannheim, Germany
werner.janik@de.abb.com

Markus Gauder

ABB Global Water Industry Segment Initiative
Mannheim, Germany
markus.gauder@de.abb.com

Senthilmurugan Subbiah

ABB Global Water Industry Segment Initiative
Bangalore India
senthilmurugan.s@in.abb.com

Naveen Bhutani

ABB Corporate Research
Bangalore, India
naveen.bhtani@in.abb.com

References

- [1] www.un.org/waterforlifedecade/scarcity.html
- [2] World Resources 2000-2001, People and Ecosystems: The fraying web of life, World Resources Institute (WRI), Washington DC, 2000.



Clever pumping

ABB all-in-one drives make the water industry's pumps intelligent

Title picture

Moving water around might seem a rather humdrum, routine task. This is deceptive: today's water industry is turning to advanced technology, such as the ABB ACQ810 Variable Speed Drive, shown here, to reduce cost of ownership and lessen climate impact.

SANNA-KAISA EHANTO – Climate change, increasing water demands due to global urbanisation, and the legal obligations of the EU's Water Framework Directive are all making the water sector an attractive arena for technologies that can help reduce costs and contribute to reducing the effects of climate change. It is against this backdrop that the demand for intelligent process control equipment is surging throughout the water industry. Variable speed drive (VSD) manufacturers are in the vanguard of these developments. The functionality being demanded from VSDs is manifold and includes enhanced connectivity, reduced energy consumption, minimized downtime and features that intelligently react to, as well as prevent, real problems, preferably before they cause damage.

1 Summary of VSD's benefits at various operating points of the motor

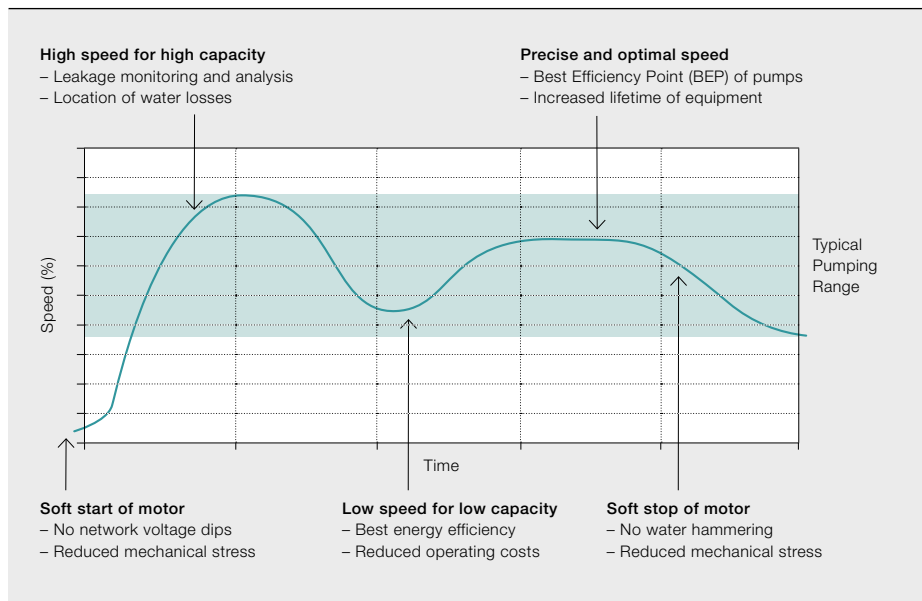

The growing use of VSDs, particularly intelligent drives for pump control, represents a major departure from the standard operating practice of using control valves to vary fluid flow. With its low energy usage and low maintenance outlay, the total lifecycle cost of a VSD-controlled pumping system can be significantly less than traditional pump technology. Other VSD benefits include smoother start-ups and production changes, more precise control during continuous operation, and faster diagnosis of potential system problems before product quality or process operation is negatively affected.

The emergence of intelligent pumps is a critical step forward in the evolution of process management. With embedded intelligence, VSDs can provide pump control, pump condition monitoring, protection and traditional energy saving benefits → 1.

Pump cleaning

Consider, for instance, the anti-jam or anti-ragging function now found in several VSDs. A long standing problem suffered by water companies is that of “ragging”, the fouling of pump impellers which consumes thousands of hours of maintenance time in sewage pumping

stations and wastewater treatment plants around the world. Manually clearing the problem is a costly and unpleasant task requiring a maintenance team and frequently a crane. Downtime may, extend to several days, during which time the back-up systems are under additional pressure. A total system failure can result in effluent leakage, which has environment and human health implications as well as clean-up costs and legislation issues.

The anti-jam function prevents pumps and pipes from clogging by initiating a sequence of forward and reverse runs of the pump to clean the impeller.

Severn Trent Water (STW) in the UK is one of the early adopters of this technology and they have saved thousands of Euros annually on pump maintenance as a result. The company installed four submersible foul pumps at its Worcester Water Treatment Works, pumping raw sewage from a new foul well but experienced a number

of blockages in the foul pumps, caused by rags sticking to the impeller. ABB suggested the installation of its anti-jam software. Taking minutes to complete, the cleaning cycle removes the debris from around the pump volute, preventing it from entering the pump and blocking it

when the pump ramps up from zero to its nominal operating speed.

Following installation, STW has not experienced a single blockage of the foul pumps.

Dedicated drives for pumps

But it is not just by unclogging impellers that the latest intelligent drive technology can enhance a pump’s lifecycle. In fact, ABB has identified several pump-specific requirements and bundled them all into one product which it calls the ABB industrial drive module for water and wastewater applications – ACQ810.

The idea of application-specific drives is something which IMS Research, a leading supplier of market research, has identified as a growing trend. With such drives, the user can reduce their total

Following installation, STW has not experienced a single blockage of the foul pumps.

cost through shorter start-up times, lower integration costs and improved machine productivity. IMS Research estimates that low voltage AC drive shipments to the global water and wastewater market will grow from \$448 million in 2010 to \$760 million in 2014.

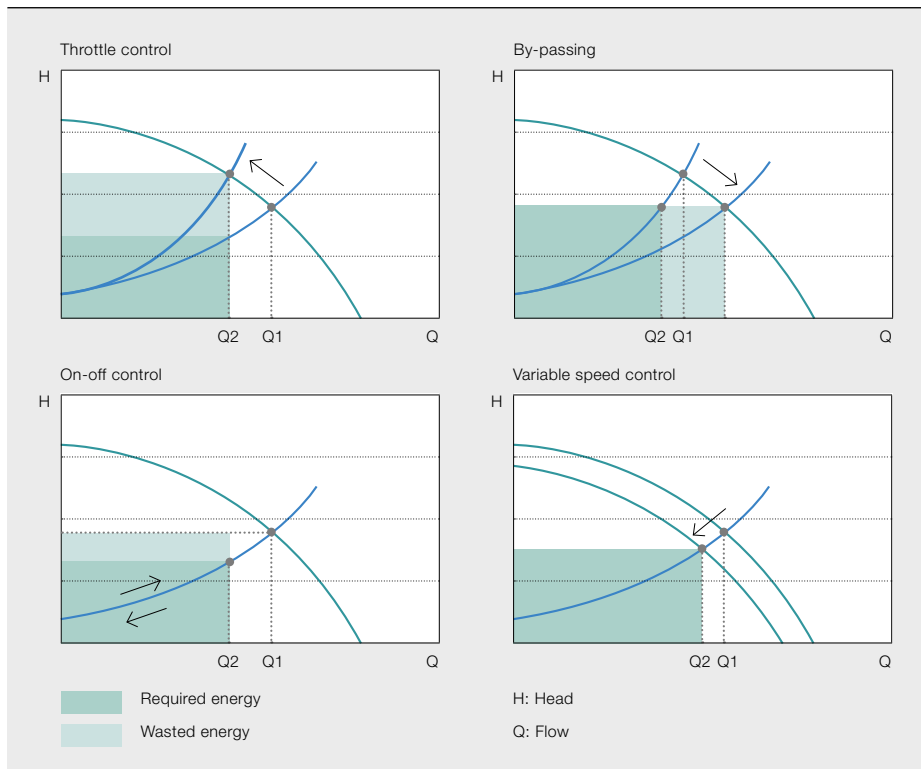

Energy saving and maintenance cost reductions remain at the heart of using VSDs on pumping systems.

“It is for these reasons that ABB has specially designed a drive to meet the demanding needs of squared torque pump control, for single and multi-pump systems,” says Johanna Johansson, product manager for the drive. “Pumps are by far the biggest application area for variable speed drives. And all these pumps have specific requirements from flow calculation through to level control, all of which can be solved using the latest software now available. The drives’ pump-specific functions decrease the lifecycle cost of the pumping systems, helping to save time and money, boost energy efficiency and reduce carbon dioxide emissions.”

Typical of the applications which can now benefit from intelligent pump control are water pumping stations, many of which demand, in addition to the anti-jam feature mentioned above, also level control and pump priority functions.

Level control

Level control is designed to control the filling or emptying of storage tanks containing wastewater or storm water contaminated with dirt, gravel, litter and other debris. The function seeks to prevent sediment build-up on the tank walls by randomly varying the surface level within a preset range. Additionally, aggressive,

fast-ramp starting creates a flush effect, thereby preventing blockages, while minimizing energy consumption by running pumps within a favorable operating area.

Pump priority

Pump priority schedules pump operation to enable maintenance planning. It is intended for systems where the consumption rate varies with demand. For example, the drive can be programmed to operate higher capacity pumps during the daytime and smaller units at night. This allows for better maintenance planning and can boost energy efficiency by operating pumps closer to their best efficiency point.

Energy saving

Energy saving lies at the heart of VSD use in pumping systems.

In general, the lifecycle costs of a pump system depend on the power range and its in-service lifetime. However, typical costs for pump systems between 50 to 100kW will be incurred through energy usage (between 70–80 percent) and maintenance (20–30 percent).

Over a 20-year period, the combined energy and maintenance costs may exceed 10 times the initial pump purchase price. These operating costs can be dramatically reduced through efficiency improvements.

Two common causes of pump system efficiency loss are pump over-sizing and throttled valves. Poor pump performance can result in downtime, collateral damage to equipment and high maintenance costs.

In VSD-controlled pumping systems it is also possible to run the pump at higher than nominal rotational speeds. Normally, the motor is designed so that it enables operation in the area of higher power range. This makes it possible to run the same VSD-controlled pump in a higher power range area compared to an on-off controlled pump. This mode of operation enables a pump with a smaller power rating to be used, which also reduces initial investment cost. This is valid for situations in which peak flows occur every now and then → 2.

The energy-saving benefits of VSDs are well documented, with savings typically from 20 to 60 percent readily achievable in speed-controlled pump applications. Now, as part of the added intelligence within a drive, manufacturers are including features such as an energy optimizer, which improves the total energy efficiency of the pumping system.

Tracking this entire energy saving is possible through inbuilt energy counters that show how much energy has been used and saved in kWh, currency (\$ or €) or volume of CO₂ emissions.

Pressure and flow control

Using VSDs to control pressure and flow improves flow management, minimizes maintenance and reduces electrical energy requirements.

A pressure boosting station, for example, feeds water directly into the distribution system and seeks to maintain a constant pressure in the pipes. With smooth VSD control there are no pressure shocks causing noise, erosion or leakage in the pipeline.

Intelligent VSDs also increase uptime: Parallel drives enable the system to run with 100 percent redundancy. If a defect occurs in one of the pumps, motors or drives, the others will continue operation without any interruption. Pump stations are sometimes located remotely and service activities might take some time. With redundancy, the pump station operation is trouble-free with minimized downtime.

Further, the running time of the pumps can be controlled with the pump priority function (see earlier) to ensure that wear and tear on all pumps is the same.

Where several parallel pumps are operated together and the required flow rate

of the pumps needed. This function provides the most energy-efficient way to operate parallel pumps.

Sleep and boost

Another pressure-related function is that of sleep and boost.

Traditionally, standard PID control may allow a pump to operate at undesirably low speeds for prolonged periods of time. This can cause mechanical issues with certain pump types and in general wastes energy, since most pumps do not generate significant flow at low speeds.

A sleep and boost function, however, lets the drive go to “sleep”, meaning that the drive output will shut off and the pump will stop. This is suitable for clean water pumping systems during night time when water consumption falls. If the system pressure drops below a defined level, this function detects slow rotation and runs the pump to boost the pressure in the pipeline or water level in the tank prior to shutdown. This extends the pump’s sleep time and therefore saves energy. The pressure is continuously monitored and pumping restarts when the pressure falls below the minimum level. It also avoids unnecessary starting and stopping and helps to flush the pipelines.

Flow calculation

Another feature now built into drives is flow calculation. This function provides the drive with a flow meter routine that enables the pumped volume to be monitored by the VSD, without any additional components. This is a useful feature in systems where data about the total flow during a specific time period is needed.

Remote monitoring

ABB drives can connect to all the major automation systems via an Ethernet connection or GSM wireless network. This

is achieved with a dedicated gateway concept between the fieldbus systems and the drives. A remote monitoring module gives simple access to the drive

via the Internet, communicating via a standard web browser. The user can set up a virtual monitoring room wherever there is a PC with an Internet connection or via a simple dial-up modem connection. This enables remote monitoring, configuration, diagnostics and, when needed, control.

Remote monitoring provides easy access to pumping systems, even in faraway locations, thereby avoiding unnecessary site visits and saving time. Through the use of Ethernet adapters, process data, logs and event messages concerning pumped volumes, tank levels, and other operating conditions can be sent independently.

Summary

ABB’s industrial drive module for water and wastewater applications can significantly enhance a pump’s lifecycle. With up to 60 percent energy savings possible along with reduced carbon dioxide emissions and payback on investment often within two years, the future for the intelligent variable speed drive is certainly looking bright.

The energy-saving benefits of VSDs are well documented, with 20–60 percent savings readily achievable.

is variable, a function called multi-pump control maintains stable process conditions optimizing the speed and number

via the Internet, communicating via a standard web browser. The user can set up a virtual monitoring room wherever

Sanna-Kaisa Ehanto

ABB Drives

Helsinki, Finland

sanna-kaisa.ehanto@fi.abb.com



Submarine link

Submarine HVAC cable to the floating oil and gas platform at Gjøa

ERIK ERIKSSON, MARC JEROENSE, MAGNUS LARSSON-HOFFSTEIN, CLAES SONESSON, KNUT-ARIL FARNES (STATOIL), ROLF OVE RÅD (STATOIL), KARL ATLE STENEVIK (STATOIL) – Oil and gas exploration is increasingly advancing into areas that are challenging to access geographically. The Gjøa installation, located off the Norwegian coast is a floating oil and gas platform in 380m deep water. To power the platform, a 98km long 123kV AC cable was laid from shore at depths of up to 540m. One of the greatest challenges, and one which made Gjøa the first of its type, is the dynamic section of the cable that rises up from the sea floor to the floating platform. This must accommodate extreme environmental conditions and the platform's movement.

Title picture

The submarine cable on the drum of the cable-laying vessel.



The Gjøa platform is located west of the Sognefjord in Norway, about 100 km north-west of Mongstad. The platform was developed and built by Statoil and is currently operated by GDF SUEZ E&P Norge AS. Gas and oil produced by this floating platform are transported by pipelines to Mongstad and also to St. Fergus in Scotland.

It was initially intended to meet Gjøa's power needs with a gas turbine power plant. In order to reduce greenhouse gas emission, it was instead decided to import electric power from a shore connection at Mongstad (the Norwegian energy mix has a high proportion of hydro-power). The platform's electrical consumption is estimated at 40 MW peak and 25 to 30 MW average.

Characteristics of the Gjøa cable link

The link consists of a 98.5 km static cable on the sea bed and a 1.5 km dynamic cable rising upwards to the floating platform → 2. The dynamic cable must allow for the platform's horizontal and vertical movement, including a lateral radius of 75 m. To accommodate the additional length the cable requires for this, its lower part is lifted using 73 equidistant buoyancy units → 7 in what is called a lazy wave configuration → 2.

Design of the cable

An important part of the design process of the dynamic cable involved determining its fatigue life. This process had three main components → 3.

- Global analysis
- Local analysis
- Fatigue testing

Global analysis

The mechanical load on the dynamic cable depends on several parameters, including the motion of the platform, water currents, marine growth and the cable's configuration → 2.

The cable's response to translation, force, curvature etc. is analyzed by modeling it as a one-dimensional string using global properties such as weight, diameter, axial, bending and torsional stiffness. The configuration is optimized in an iterative procedure, selecting, for example, the position, size and number of buoyancy units.

The axial force and curvature of the cable were analyzed under extreme environmental conditions. An example of a typical extreme condition is a 100-year wave combined with a 10-year water current. The curvature and axial forces must remain within the design limits even under such conditions.

This analysis was accompanied by an interference analysis evaluating the possibility of collisions with neighboring risers and subsea infrastructure. Such occurrences are not permissible under any conditions.

Local analysis and lifetime estimation

A dynamic cable is a complex structure. It contains different components and diverse materials. In general there are several ways of modeling the cable on a local level. Common methods include finite element modeling and analytical models. In the case of Gjøa, a conservative analytical model was used.

The strain in fatigue-critical components was calculated to be able to determine the lifetime of the cable, and is depen-

The project brought together knowledge and skills from two industries that are normally largely separate: the oil and gas industry and the high voltage cable industry.

dent on several factors, including curvature and friction between helical components.

Based on this analysis, the lifetime was calculated using the method of linear damage accumulation in the identified fatigue-critical components. The calcu-

2 Factors affecting the mechanical load on the dynamic cable

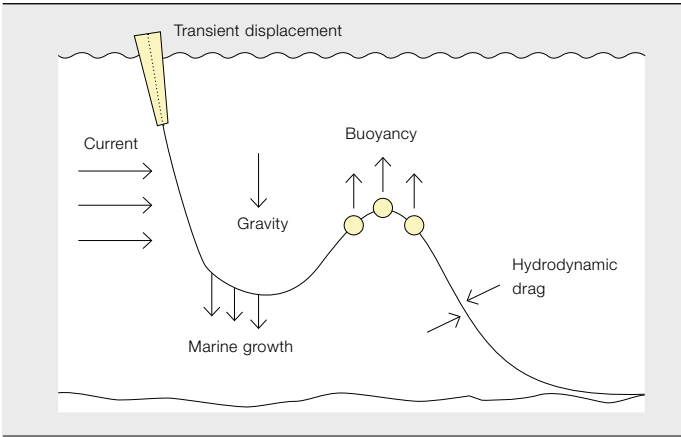

4 The cable submerged



lated lifetime of the cable exceeded 35 years with a safety factor of six.

Fatigue testing

The objective of the fatigue testing is to establish a Wöhler diagram (or S-N curve – a curve plotting cyclic stress against failure) of the identified fatigue-critical component. Emphasis was placed on the radial water barrier (the cable's welded copper sheath).

Components of the cable system

Bending stiffener

The severest loads to which the cable is subjected in terms of axial force and curvature occur at its upper end. An 8 m long stiffener was mounted here → 10.

Static cable

The static cable is a three-phase, 115 kV cable using 240 mm² solid copper conductors. The conductors are enclosed in a lead sheath preventing water ingress. Lead was chosen (rather than copper as in the dynamic cable) as the sheath does



A flex test simulates the fatigue the cable will be subjected to during its lifetime by applying increased bending stresses over a shorter time.

not have to withstand recurrent mechanical forces. A bedding of semi-conducting tape is located underneath the sheath to prevent longitudinal water ingress (it is semi-conducting to even out charging currents in the lead). A polyethylene sheath covers the metallic sheath to pro-

3 Conceptual layout of foundation in order to determine fatigue life

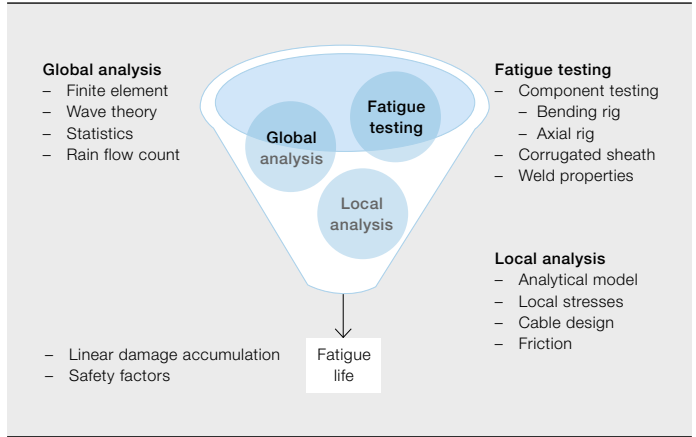

- Global analysis**
- Finite element
 - Wave theory
 - Statistics
 - Rain flow count
- Linear damage accumulation
- Safety factors

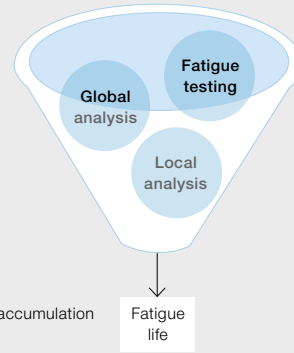

- Fatigue testing**
- Component testing
 - Bending rig
 - Axial rig
 - Corrugated sheath
 - Weld properties
- Local analysis**
- Analytical model
 - Local stresses
 - Cable design
 - Friction

tect it mechanically. A fiber-optical cable with 48 fibers is placed in the interstice of the three core conductors. The armor consists of two layers of galvanized-steel wires. The layers are wrapped in opposing directions to achieve a torsion-free yet strong structure, and are separated by bedding tape. The wires are covered with a bitumen compound to protect them against corrosion. The outer cover consists of two layers of polypropylene yarn, the inner one is impregnated with bitumen compound.

Dynamic cable

The dynamic cable → 5 is a three-phase, 115 kV cable with 300 mm² conductors. The sheath is of corrugated copper, TIG¹ welded, and double armored to prevent water ingress and withstand mechanical fatigue during its design life time of 35 years plus with a safety factor of six. The sheath is also capable of handling phase to earth fault currents. The conductors are stranded and compacted in accordance with IEC 60228. The

conductor section of the dynamic cable is larger compared to that of the static cable as the dynamic cable is thermally limited inside the stiffener at its upper end. The conductors are longitudinally wa-

ter-sealed using a polymer compound. An optical-fiber cable with 46 single-mode fibers and two multi-mode fibers is located in one of the interstices. The multi-mode fibers can be used to monitor the temperature of the dynamic cable. To increase the weight/diameter ratio,

6 The cable tensioner (on board the laying vessel)



7 One of the buoyancy units used in the lazy wave configuration → 2



two lead rods are also placed in two of the interstices of the dynamic cable. A polyethylene sheath covers the galvanized wires and protects them from abrasion.

Repair joint

Should the dynamic section be damaged, it is most likely to be replaced in its entirety. For the longer static section, a repair joint was included in the cable's scope of delivery. The electrical part of the repair joint consists of three pre-molded rubber bodies, one for each phase, each covered by hermetically sealed casings. There is also one fiber optical cable joint and an outer common rigid casing for mechanical protection and to transmit the mechanical loads.

Flexible joint

The flexible joint connects the dynamic and static cables. It consists of:

- Three flexible molded core joints, one for each phase, each covered by a lead sheath soldered to the original metallic sheath of the cables
- One fiber-optical cable joint
- Armoring

Qualification

Various tests were performed as part of the qualification process. These include Electra 171 and IEC 60840. As this type of test is well known, this article will look at the less common flex test.

A flex test simulates the fatigue the cable will be subjected to during its lifetime by applying increased bending stresses over a shorter time. Two million cycles were applied on the full-scale dynamic submarine cable under constant axial load. The loads applied were calculated

on the basis of the global analysis discussed above. The loads occurring at the top end of the cable are more severe than at the lower end.

A test rig was used to test a length of cable. The bending stiffener and hang-off were attached to the test section for the purpose of this test. The sample was installed horizontally in a rig, with the end that would normally be at the top being attached to a rocking head that flexed the cable. The other end was connected to the 500 kN servo-hydraulic tension actuator. Before and after the flex test the cable cores were measured electrically (partial discharge and conductor resistance) revealing that no degradation had taken place. The cable cores were also inspected visually and application of a penetration fluid confirmed there were no cracks in the copper sheath.

Sea trials

As the cable was to be installed with a new cable laying vessel and laying system, a sea trial was performed before the actual cable laying. The trial included the following:

- Verification of methods for installation of vortex-induced vibration (VIV) suppressors, buoyancy units and handling of the stiff cable end (a stiff tube on the cable simulated the bending stiffener and hang-off).
- Verification of cable-laying in deep water under relevant conditions (for North Sea in early spring).

The trials went well, with only slight modifications on some mechanical parts of the laying system being needed. The sea trial was also a valuable training opportunity for the cable-laying crew.

The trials went well, with only slight modifications on some mechanical parts of the laying system being needed.

Footnote

- 1 TIG: tungsten inert gas

8 The cable-laying vessel in Mongstad, where the cable connects to the shore



9 The Gjøa platform with the cable being pulled aboard.



The Gjøa project combined innovative development with rigorous engineering in an environment that leaves no space for error or mistakes.

Cable laying vessel

The cable was transported and installed using the cable-laying vessel North Ocean 102 (the ship has a loading capacity of 5,800 tonnes). The entire cable (including static and dynamic sections) was laid in one length.

The cable was loaded onto a rotating drum → 8. To be able to lay the cable at a significant wave height of 4 m, a heave compensated chute (HCC) was developed for the project. The HCC reduces the dynamic tension during laying. The vessel was also equipped with two 120 ton tensioners → 6. The bending stiffener and the pre-installed hang-off body which were mounted on the cable before loading were stored on top of the carousel.

During loading, temporary terminations were mounted on the dynamic cable end on board the vessel. To test the complete cable after laying, each phase of the cable was terminated into a gas insulated (GIS) chamber.

Cable laying

The total route length of the cable was 98 km from Mongstad beach → 8 to the Gjøa platform → 9. The cable-laying work presented a number of challenge, including:

- The shore landing of the cable at Mongstad.

- Laying the cable down the steep underwater cliff at Mongstad including VIV suppression strakes.
- Routing of cable through an exposed area of sea.
- Laying cable at a water depth up to 540 m.
- Continuous touchdown monitoring during cable laying using underwater ROV (remotely operated vehicle).
- Safe handling and unloading of bending stiffener, pre-installed pull-in and hang-off body.
- Installation of 73 permanent buoyancy modules for the "lazy wave".
- Storage of dynamic cable end including buoyancy modules, bending stiffener, pre-installed pull-in head and hang-off body on the seabed.

An underwater cliff, about 0.3 km from Mongstad, was so steep that the cable had to be suspended with considerable free spans. To reduce the risk of vortex induced vibration VIV, suppression strakes² were mounted on it. Free spans were also eliminated by rock dumping.

After laying the dynamic cable end (including the buoyancy modules), the bending stiffener and the pull-in head and hang-off body were temporarily placed on the sea bed for approximately three months before the pull-in operation.



Tests during and after laying

All optical fibers at the end of the cable were fusion-spliced to form separate loops. This permitted continuous OTDR³ measurement during cable-laying. The OTDR measurement was performed from the Mongstad substation.

An electrical test was performed immediately after the positioning of the flexible transition joint on the seabed and installation of the buoyancy modules.

The total route length of the cable was 98 km from Mongstad beach to the Gjøa platform.

Pull-in operation and top side joints

Before the pull-in operation, the stored cable was raised from the seabed and the pull-in head was secured to the platform pull-in winch wire. The pre-installed hang-off body was then raised to the hang-off table on the platform and the cable secured → 9.

Following the pull-in operation, the armored wires on the dynamic cable were removed and the phase cables and opti-

cal cables connected. The screens of the phases and the sheath of the optical cable were connected to an earthing bar.

A successful delivery

The Gjøa project combined innovative development with rigorous engineering in an environment that leaves no space for error or mistakes. It represents the first ever connection of a power cable to a floating platform. The project brought together knowledge and skills from two industries that are normally largely separate: the oil and gas industry and the high voltage cable industry. The resulting product is an energy supply reducing overall carbon dioxide emissions.

This article is a shortened version of a paper presented at JICABLE11 in Paris in June 2011 Paris by the same authors under the title "HVAC Power Transmission to the Gjøa Platform". A similar paper was published at CIGRE 2010.

Erik Eriksson

Marc Jeroense

Magnus Larsson-Hoffstein

Claes Sonesson

ABB AB, High Voltage Cables
Karlskrona, Sweden

claes.sonesson@se.abb.com

erik.x.eriksson@se.abb.com

magnus.larsson-hoffstein@se.abb.com

marc.jeroense@se.abb.com

Knut-Aril Farnes

Rolf Ove Råd

Karl Atle Stenevik

Statoil AS, Stavanger, (Norway)

kafa@statoil.com

rora@statoil.com

katst@statoil.com

Footnotes

2 A strake is an aerodynamic (or in this case hydrodynamic) surface that improves airflow.

3 OTDR: optical time-domain reflectometer



The frugal manufacturer

Part 2, Analyzing industry's commitment to improvement

CHRISTOPHER WATTS – Energy, so our physics books tell us, is the ability to do work, and work is at the heart of all industrial production. In view of the environmental impacts of its energy footprint and the rising price of energy, industry is having to re-assess its energy usage and seek to produce more with less. Part two of this three-part article investigates why commitment to energy efficiency in industry remains weak despite the broad acknowledgement of its value.

In issue 3/2011 of *ABB Review*, the first part of this series of articles discussed the importance of energy efficiency to industry → 2. The findings were based on a survey commissioned by ABB and performed by the Economist Intelligence Unit → 1. While most industry managers appear to appreciate the importance of energy efficiency in securing long-term financial performance, relatively few are practicing the discipline, and low levels of energy-efficiency remain the norm. Only 40 percent of survey respondents say they have invested in capital, plant and equipment to improve energy efficiency within the past three years. Respondents who have done so are more likely to be in developing economies, where 49 percent have invested in equipment to improve energy efficiency, versus 34 percent in developed regions. North America trails clearly in this respect, with only 21 percent of respondents saying their firms have invested in equipment over the past three years to improve energy efficiency.

Looking beyond investments in plant and equipment, and focusing on energy efficiency practices, the situation remains poor – but slightly less so. 46 percent of firms do not have a company-wide energy management system in place to track and optimize energy use, according to survey results; 50 percent do have such systems; the rest say they don't know. Among relatively small firms in the survey sample (annual revenues under \$1 billion), a clear majority, 55 percent, have no energy management system. These findings are all the more surprising

Forty-six percent of firms do not have a company-wide energy management system in place to track and optimize energy use.

given that experts consider various kinds of energy management systems to be highly cost-effective → 3.

At one level, an energy management system may refer to an organizational framework to actively take control of corporate energy use – as, for example, the new ISO 50001 standard, due in the sec-

Title picture

The importance of measures to increase energy efficiency is broadly recognized in industry. In many sectors, however, the implementation is lagging behind. The title illustration shows the mechanical hoist drum at Totten mine, Sudbury, Ontario, Canada, which is equipped with energy-efficient drives from ABB.

1 The frugal manufacturer



This series of articles presents the findings of a report commissioned by ABB and researched and written by the Economist Intelligence Unit. The survey collected input from 348 senior industry executives, mostly in North America, Asia-Pacific, and Western Europe, asking them about their plans to invest in improving energy efficiency in production processes, the issues they face as they consider these investments, and the factors that are likely to influence industrial energy efficiency in the coming years. In addition to the online survey, the study conducted 15 in-depth interviews with senior business executives, policy makers, and other experts in industrial energy efficiency.

2 Summary of part 1 :Industry leaders recognize the importance of energy efficiency



The frugal manufacturer

Part 1: Using energy sparingly

The first part of the series, “The frugal manufacturer: Using energy sparingly”, was published in the previous edition of the *ABB Review* (see pages 7–12 of issue 3/2011). The findings of the first part include:

- 88 percent of respondents say industrial energy efficiency will be a critical success factor for their business in the coming two decades.
- 72 percent “agree strongly” or “agree somewhat” that energy efficiency is a critical success factor for manufacturers today.
- 59 percent say that in making the financial and business case for investments in efficiency, the energy price is one of the biggest factors.
- 26 percent see improving their company’s image as another reason to invest in energy efficiency.

3 Do you have a company-wide system in place to track and optimize energy use?

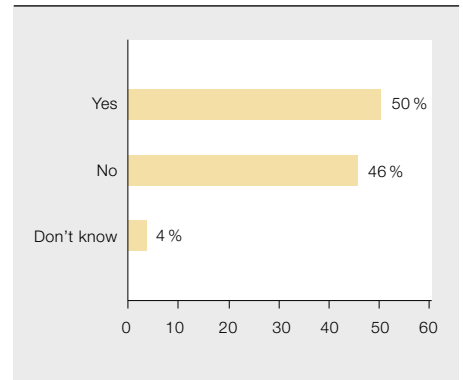

Only 48 percent of firms regularly report progress on improving energy efficiency at either plant level, business unit level, or group level.

ond half of 2011, will set out → 4. “Energy efficiency is not complicated,” insists Doug May, VP of Energy and Climate Change at the Dow Chemical company. “It just takes discipline, and it takes a commitment to measuring it, looking for the opportunities, having the behavior and the organization in place to identify them and address them.”

At another level, an energy management setup may include systems of software, switches, and controls. Considering, for example, the case of Bayer MaterialScience, which supplies plastics and other materials to customers such as car manufacturers. The firm has introduced plant analytics that enable it to reduce variation in its product quality and allow the plant to run closer to its “boilerplate” capacity. The system cost some \$700,000, with an expected payback period of less than one year. “Such investments are not very big,” says Hans-Joachim Leimkühler, Director of Process Design at Bayer Technology Services, which acts as an in-house counsel for Bayer MaterialScience. “But the results are sometimes very considerable.”

Further evidence of industry’s hesitance to take control of energy efficiency emerges in the survey. Just 34 percent of companies have conducted an energy audit across the entire company or group. McCallion of EBRD highlights the role energy audits can play in measuring and managing energy use: “An energy audit is the key driver for companies to realize not just which technical measures to pursue, but what the financial benefits of those technical measures are,” he says. “It’s how you end up with investments that have internal rates of return in excess of 100 percent. You need to look to energy audits to unlock [these projects].”

Given industry’s apparent weak commitment to gauging its energy use and striving to manage its energy needs, it comes perhaps as little surprise that fewer than half of firms (48 percent) regularly report progress on improving energy efficiency at either plant level, business unit level, or group level → 5.

In a further indication of industry’s lack of emphasis on core energy efficiency, survey findings show that companies are far

4 ISO 50001 — a new energy management standard

Since 2008, the International Organization for Standardization, a Geneva-based group that establishes operating norms for business, government and society, has been compiling an international energy management standard — ISO 50001. The standard is due to launch in the second half of 2011.

What can companies expect? ISO 50001 will provide a framework to help them plan and manage their energy use. Rather than setting out technical requirements, the standard will set out the procedures and practices that constitute a sound energy management system.

Among other areas, ISO 50001 will cover the following:

- Making better use of existing energy-consuming assets
- Benchmarking
- Measuring
- Documenting and reporting energy intensity improvements

- Transparency and communication in the management of energy resources
- Energy management best practices
- Assessing and prioritizing the implementation of new energy-efficient technologies
- Promoting energy efficiency throughout the supply chain
- Energy management improvements in the context of carbon dioxide emissions reduction projects.

ISO 50001 is likely to be particularly appealing for those organizations that already operate according to the ISO 9001 quality management standard. Experts say the new energy management standard may be worthwhile for any organization with large energy bills — say, over \$500,000 a year. In time, the ISO hopes that this new standard will have a positive impact on the way in which up to 60 percent of the world's energy is used.

5 Does your company regularly report its progress on improving energy efficiency?

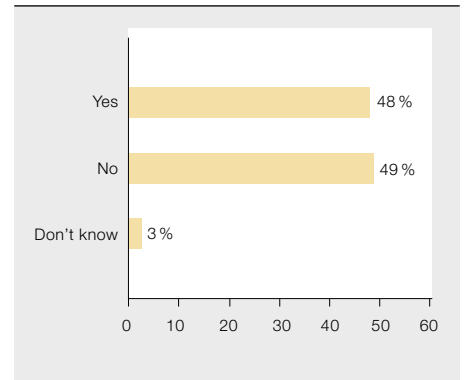

more likely to have undertaken measures to drive energy efficiency in areas other than their core manufacturing processes. Asked in which specific areas their companies have undertaken measures in the past three years to improve energy efficiency, 67 percent of respondents say lighting systems, 48 percent air conditioning, 45 percent heating and 42 percent water use. Just 40 percent have taken energy efficiency measures relating to plant and equipment in their factories → 6.

A question of funding

What holds companies back from making a stronger commitment to energy efficiency improvements in their core production processes? When asked to name the two most significant obstacles to investment in energy efficiency, 42 percent of executives point to a “lack of a clear-cut financial case for energy efficiency investments,” more than any other obstacle → 7. The next biggest barrier, highlighted by 28 percent of respondents, is “lack of funds.” In some cases, particularly in high-growth markets, group management is torn between allocating capital to expand capacity, and committing funds to increase energy efficiency. This point is illustrated by L. Rajasekar, Executive President of UltraTech Cement, which is doubling its production capacity every 10 years. “[Market] capacity continues to grow, so

we also have to grow,” he says. “If we don’t grow, then we don’t maintain our market share.”

Interviews with industry executives reveal a number of practices that help their companies to overcome some of the financial barriers to investment. The 3M group, for example, allocates capital to each of the six business units; from there, points out Steve Schultz, Global Manager of Corporate Energy at 3M, “they determine what their best opportunities are. It may be growth, and it may be margin improvement.” Furthermore, as plant managers at the firm make a financial case for investment, they can make use of 3M’s corporate-wide energy projects database. Says Schultz: “That database allows us to share information from facility to facility, so that one facility can learn from another facility what worked, and sometimes also what didn’t work.”

There are other ways to make the financial investment case more compelling. For example, measures to improve the efficiency of existing equipment can be

all the more cost-effective if undertaken as part of normal capital investment and plant maintenance cycles, to reduce production downtime. “Timing and coordination with operations is absolutely critical in our business,” notes May of Dow, whose plants run day and night. “The economics really get impacted if you’re bringing down the equipment just to implement the project.” And as top man-

Measures to improve the efficiency of existing equipment can be all the more cost-effective if undertaken as part of normal capital investment and plant maintenance cycles.

agement become increasingly aware of the importance of some “softer” benefits of energy efficiency for long-term growth, it may be that these benefits add weight to the financial case. Says Ian Gilmour, Safety, Health and Environment and Manufacturing Manager at Orica, an Australian chemicals manufacturer: “The other way I argue it is: Image, reputation, and benefit to society. And I have a board that listens to that argument.”

6 With regard to which of the following has your organization undertaken measures within the past three years to improve energy efficiency? Select all that apply

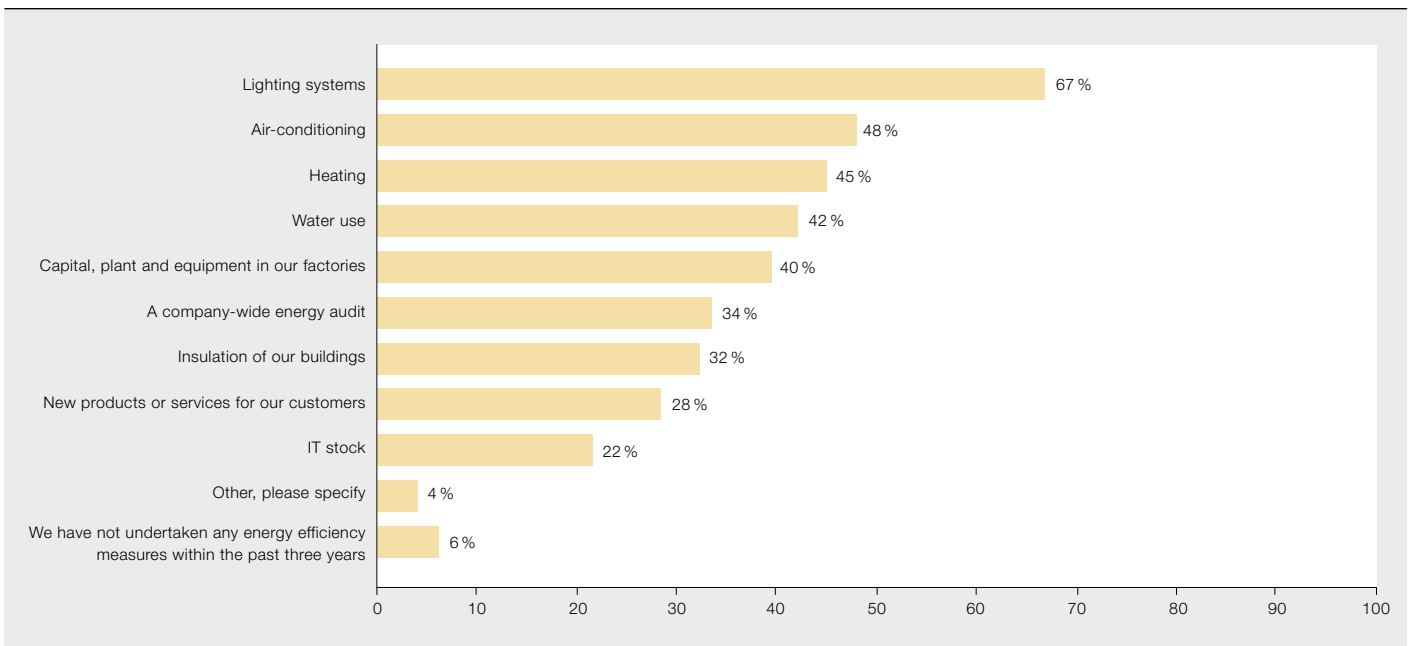

The general lack of information about energy options is compounded, perhaps, by the widespread difficulty in benchmarking plant efficiency levels across geographic regions and industry segments.

Benchmarking alternatives

Financial barriers are not the only issue holding back investments in energy efficiency. One of the challenges in putting together a sound investment case, and securing funding, for efficiency improvements lies in what some managers say is a lack of information about energy options. This is the third most significant barrier, flagged by 27 percent of respondents. One notable variance in the survey results is that, in the Asia-Pacific region, 37 percent of respondents highlight the issue of inadequate information—considerably more than the proportion of managers there that blame lack of funds (24 percent).

Meanwhile, among smaller firms, the proportion of managers who say that lack of information is a barrier is higher than the sample average, at 32 percent. BEE Director General Ajay Mathur illustrates the effects of inadequate specialist information: “There can be a problem of ‘I’m going to get this new technology, will it work?’ The guy who comes to the door says, ‘Put this widget in, and your energy consumption will drop by half.’ Will it? Or will the plant stop? So the perceived risk of new technologies is something that constrains the early adoption of energy efficient technologies.” Furthermore, in making assessments such as these, it must be taken into account that smaller companies have fewer resources available to manage energy efficiency: In

17 percent of smaller firms, responsibility for energy efficiency rests with a dedicated energy efficiency manager, in contrast to 24 percent at larger firms → 8.

In India, BEE has a dedicated program to provide information on industrial efficiency to small and medium enterprises (SMEs). The body’s director general, Mathur, says many of India’s SMEs are organized in geographic and sector-based clusters. “We are bringing in state-of-the-art engineering knowledge through consultants who go into these plants and see what is possible,” he says. The consultants discuss the options in seminars with equipment vendors, plant managers, and lenders, before a project is implemented. Later, others in the cluster can see the investment in action, and if they want to do the same, “the business case is already proven – there’s somebody who’s doing it,” says Mathur. BEE is rolling out this model in 25 SME clusters nationwide.

The general lack of information about energy options is compounded, perhaps, by the widespread difficulty in benchmarking plant efficiency levels across geographic regions and industry segments. For some manufacturing processes, reliable benchmarks are available: “In ammonia and ammonium nitrate, there’s a worldwide conference where everybody will share data,” says Safety, Health and Environment and

7 What, if any, are the main barriers to investment in industrial energy efficiency in your organization? Select up to two

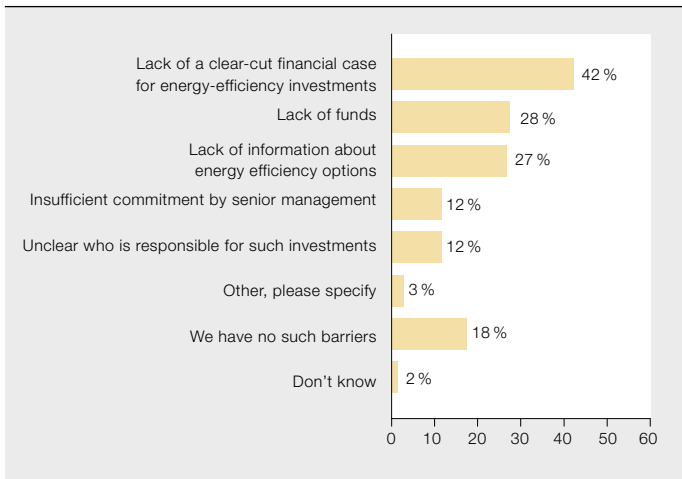

8 Who has formal responsibility for energy efficiency in your organization?

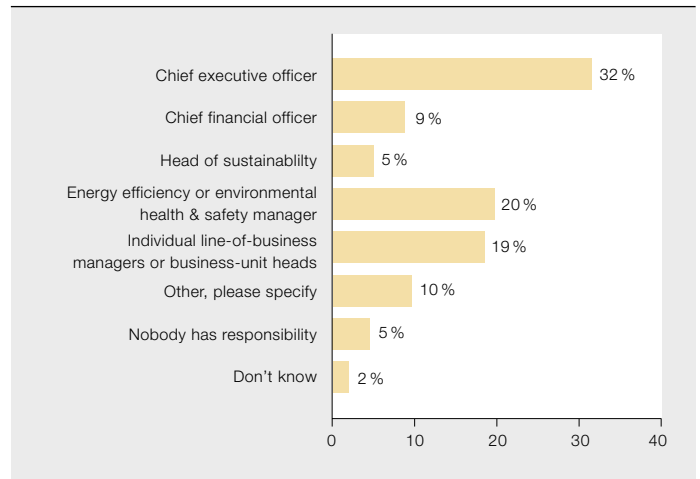

Manufacturing Manager, Ian Gilmour, of Orica (Australia). “We all know what plants everybody else has got, and what kinds of efficiencies they get. It’s all published data,” he says. But in many cases, benchmarking remains a challenge. “The diversity of manufacturing processes and product mixes varies so much from plant to plant, that it becomes almost impossible to benchmark against either

efficiency performance with its prior-year performance, to track continuous improvement; other companies are benchmarking not their energy use, but rather the way they manage energy – a practice that ISO 50001 is likely to reinforce.

Many companies cite a lack of cash or a need to prioritize investment in expanding manufacturing capacity as the reason for deferring efficiency investments.

Yet other companies show how it is possible to overcome these obstacles. For a start, there are many simple, low-cost projects with short payback periods that not only

Some companies are benchmarking not their energy use, but rather the way they manage energy – a practice that ISO 50001 is likely to reinforce.

a domestic or even global competitor,” points out the ACEEE’s Associate Director R. Neal Elliott. It comes as no surprise that 77 percent of survey respondents agree that “industries need clearer benchmarks for what constitutes energy efficiency” in their sectors.

Still, in the general absence of reliable benchmarks, industry is using a variety of other yardsticks to measure their energy efficiency, and efficiency gains. Hans-Joachim Leimkühler, the process design director at Bayer Technology Services, provides one example: “We cannot compare Plant A with Plant B. So we compare Plant A actual with Plant A optimal,” a level that is arrived at through workshops with plant staff. Some companies are comparing a plant’s energy

efficiency performance with its prior-year performance, to track continuous improvement; other companies are benchmarking not their energy use, but rather the way they manage energy – a practice that ISO 50001 is likely to reinforce.

This article is the second of three parts of the report, *The frugal manufacturer: Using energy sparingly*. The report was researched and written by the Economist Intelligence Unit and commissioned by ABB. The third and final part of this series, to be published in a forthcoming issue of *ABB Review*, will focus on regulatory aspects of energy efficiency.

The Economist Intelligence Unit bears sole responsibility for the content of the report. The findings and views expressed in the report do not necessarily reflect the views of the sponsor.

For further information on energy efficiency of industry, utilities, buildings and transportation please visit www.abb.com/energyefficiency

The Economist Intelligence Unit would like to thank all survey respondents, as well as executives cited in the report.

Christopher Watts (author)
Aviva Freudmann (editor)
 The Economist Intelligence Unit

Please address enquiries to
Mark Curtis
mark.curtis@ch.abb.com
 ABB Corporate Communication
 Zurich, Switzerland

ServicePro 3.0: global best practices

Maximizing ABB service efficiency worldwide

VINCE WILLIAMSON – With the ServicePro 3.0 Service Management System, ABB expanded the resources and capabilities applied for global best practices for automation and process services.

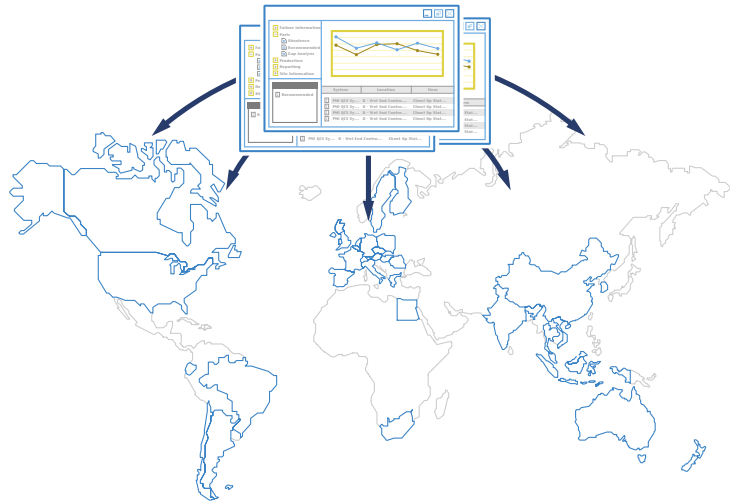

ServicePro 3.0 is a global service management system for ABB service engineers and ABB customers. It can be used to monitor and plan service for control systems, drives and other automation equipment in any industry that uses ABB process automation. Included are key performance measurements to determine the effectiveness of service activities and to assist in parts inventory and system lifecycle management. ServicePro 3.0 provides standard and customizable reports offering real-time awareness. This provides ABB customers with the information necessary to manage service proactively, thereby enabling enhanced process automation efficiency.

The ServicePro 3.0 Service Management System

- Gathers, synchronizes and disseminates best service practices from and to ABB process automation customers worldwide.
- Helps to increase proactive service activities to reduce costs and improve productivity.
- Monitors parts use to keep inventories stocked with needed items and reduce unnecessary emergency shipping expenses.
- Maintains institutional knowledge to deliver continuity and assure success.

- Provides data to evaluate process automation reliability and efficiency in a single facility or across multiple facilities in an enterprise.

The unique foundation of the ServicePro 3.0 Service Management System is a globally synchronized database that ensures users have the latest information for service practices, parts and lifecycle information.

ServicePro 3.0 provides ABB customers with the information necessary to manage service proactively, thereby enabling enhanced process automation efficiency.

ServicePro 3.0 comprises five components that help service engineers and ABB customers to improve the maintenance and performance of ABB process automation

- *Report Management* provides configurable reporting for visibility and accountability needed to manage service activities
- *Maintenance Management* collects and deploys best automation and process service practices and guides planning, scheduling and execution
- *Parts Management* tracks and manages parts related to equipment being serviced, including lifecycle status, parts kitting, part orders and inventories
- *Optimization Management* ensures that system and process improvements are sustained and enhanced
- *Contract Management* manages service resources, identifies the strongest performance areas and compares performance service across several sites.

ServicePro 3.0 is designed for ABB automation and ABB-automated processes, and can also be used to manage service for all critical equipment, independent of manufacturer or process.

For additional information on the ServicePro 3.0 Service Management System, contact Vince Williamson, Product Manager, ServicePro, Tel: (in the U.S.A.) 614-818-6533, or via email: vince.williamson@us.abb.com.

Innovation



- 6 Innovation highlights**
The 11 best innovations for 2011
- 12 CLEEN innovations**
How collaboration is supporting ABB's research and development work
- 18 The smart eVolution**
eVD4 brings simplicity and reliability to medium-voltage distribution networks
- 24 A seismic switch**
Certified switchgear for nuclear power plants is providing a critical link in the chain
- 29 Driving value**
Sophisticated ring-gear mill drives from ABB (Part 1)
- 36 Onshore and onboard**
Looking at the shoreside and shipside technologies and the case for standardization in shore-to-ship power
- 41 The five-level converter**
ANPC-5L technology and the ACS 2000 drive
- 47 Harvest time**
Harvesting energy to create truly autonomous devices for industrial processes
- 52 Spark-free safety**
Synchronous and induction motors and generators with guaranteed spark-free operation
- 56 Motoring ahead**
Synchronous motors controlled by variable-speed drives are bringing higher efficiencies to many industrial applications
- 63 The other alternative fuel**
Energy efficiency is a critical part of a sustainable energy policy for many power plants
- 68 Surviving a strike**
ABB helps distribution transformers survive rapid voltage transients
- 73 Sharing values**
ABB is implementing the first commercial installation of IEC 61850-9-2 process-bus technology
- 78 The results are in**
ABB Review readership survey

Oil and gas



- 6 Oil and gas**
The energy we love to hate
- 15 Energy trends**
Interview with University of Texas Professor Scott W. Tinker, state geologist of Texas and Director of the Bureau of Economic Geology
- 20 In the depths of the desert**
The challenges of building oil and gas infrastructure in a remote and inhospitable part of the Sahara Desert
- 25 Fuel from integration**
Integrated solutions for coal bed methane projects
- 29 A new housing trend**
Customized electrical houses are now being delivered with fully integrated electrical and automation systems
- 33 Untroubled waters**
A flexible, compact and efficient solution for oil and water separation technology
- 39 Testing large ASDs**
Testing adjustable speed drive systems which are bringing new levels of efficiency to oil and gas customers
- 45 Wise warnings**
Turning process data into useful business insight using ABB's online MS2
- 50 Remote inspection and intervention**
Remote robotics at work in harsh oil and gas environments
- 56 A mine of efficiency**
ABB is helping extend the life of the massive Aitik copper mine by making it more efficient
- 63 Harmonizing drives**
The driving force behind ABB's common drives architecture
- 67 Substation retrofit**
Retrofitting Sils substation with IEC 61850 technology
- 71 Speedy protection**
ABB surge arresters for rail applications at formula-one speed and beyond
- 74 Smooth operation**
Sophisticated ring-gear mill drives from ABB (Part 2)

Technology matters



- 6 The frugal manufacturer**
Part 1, Using energy sparingly
- 13 Efficiency with usability**
ABB's all new string inverter for photovoltaic systems
- 19 On-line protection**
Next generation teleprotection solutions
- 26 Power on tap**
A pumped storage solution to meet energy and tariff demand
- 32 Intelligent application**
Applying intelligent equipment to bring increased benefits to power distributors and consumers
- 41 Software architectures that last**
Intelligent software architectures create value and safeguard product investments in the short, medium and long term
- 51 Smarter recovery**
Integrated Operations ñ Enabling safe and profitable operation of remote and mature assets
- 58 Model-based emission monitoring**
PEMS: a monitoring system that uses artificial intelligence to reduce environmental impact
- 64 Efficient power harvesting**
Low-power design of ABB's FieldKey wireless adapter

Water



- 6 Getting fresh water from the sea**
ABB variable speed drives turn the wheels of desalination technology
- 11 Downloading the cloud**
The Spanish experience of smart irrigation with Neptuno
- 17 Managing water use responsibly**
ABB technology helps the process industries achieve sustainable water use
- 23 AquaMaster 3™**
Remote water metering with Internet delivery of water-leakage management
- 29 Every drop counts**
Increasing the efficiency of water distribution
- 34 Introducing Symphony™ Plus**
Total plant automation for the power generation and water industries
- 36 ABB service in water**
Provision of eBOP service to world's largest covered wastewater treatment plant
- 39 Water of life**
Sustainability and energy efficiency in the water industry
- 44 Clever pumping**
ABB all-in-one drives make the water industry's pumps intelligent
- 48 Submarine link**
Submarine HVAC power cable to the floating oil and gas platform at Gjøa
- 55 The frugal manufacturer**
Part 2, Analyzing industry's commitment to improvement
- 60 ServicePro 3.0, global best practices**
Maximizing ABB service efficiency worldwide
- 61 Index 2011**

Editorial Board

Claes Ryttoft

Chief Technology Officer
Group R&D and Technology

Clarissa Haller

Head of Corporate Communications

Ron Popper

Head of Corporate Responsibility

Eero Jaaskela

Head of Group Account Management

Andreas Moglestue

Chief Editor, *ABB Review*
andreas.moglestue@ch.abb.com

Publisher

ABB Review is published by ABB Group R&D and Technology.

ABB Technology Ltd.

ABB Review

Affolternstrasse 44

CH-8050 Zürich

Switzerland

ABB Review is published four times a year in English, French, German, Spanish, Chinese and Russian. *ABB Review* is free of charge to those with an interest in ABB's technology and objectives. For a subscription, please contact your nearest ABB representative or subscribe online at www.abb.com/abbreview

Partial reprints or reproductions are permitted subject to full acknowledgement. Complete reprints require the publisher's written consent.

Publisher and copyright ©2011

ABB Technology Ltd.

Zürich/Switzerland

Printer

Vorarlberger Verlagsanstalt GmbH

AT-6850 Dornbirn/Austria

Layout

DAVILLA AG

Zürich/Switzerland

Disclaimer

The information contained herein reflects the views of the authors and is for informational purposes only. Readers should not act upon the information contained herein without seeking professional advice. We make publications available with the understanding that the authors are not rendering technical or other professional advice or opinions on specific facts or matters and assume no liability whatsoever in connection with their use. The companies of the ABB Group do not make any warranty or guarantee, or promise, expressed or implied, concerning the content or accuracy of the views expressed herein.

ISSN: 1013-3119

www.abb.com/abbreview



Preview 1112

Innovation at large

Innovation is the lifeblood of progress. In ABB's research centers across the globe, more than 6,000 scientists and engineers are creating the technologies that will shape the world of tomorrow. In addition to this, ABB collaborates with about 70 universities worldwide, sharing its knowledge with tomorrow's researchers while permitting them to contribute to exciting developments of today.

Every year, the first edition of the year is dedicated to innovation. Its articles look at individual innovations while the overall spirit of the journal is dedicated to innovation itself.

Some of the articles will look at recent or approaching product launches for products selected because of their ground-breaking and innovative nature. Others will look in a broader sense at leading edge technologies and developments.



Efficient solutions for the water cycle. A world where every drop counts.

Water is an essential resource for our ecosystems and a key factor for productivity. With over 50 years of experience and presence in more than 100 countries worldwide, ABB has been providing products, solutions and services for water plants and networks. ABB's complete portfolio along with specific water process know-how, allows you to fit your needs for efficient power and automation solutions, meeting the rising demand for water production, transportation, distribution and treatment, using less energy. www.abb.com/water