

Apple® II Plus/IIe Troubleshooting & Repair Guide

Robert C. Brenner

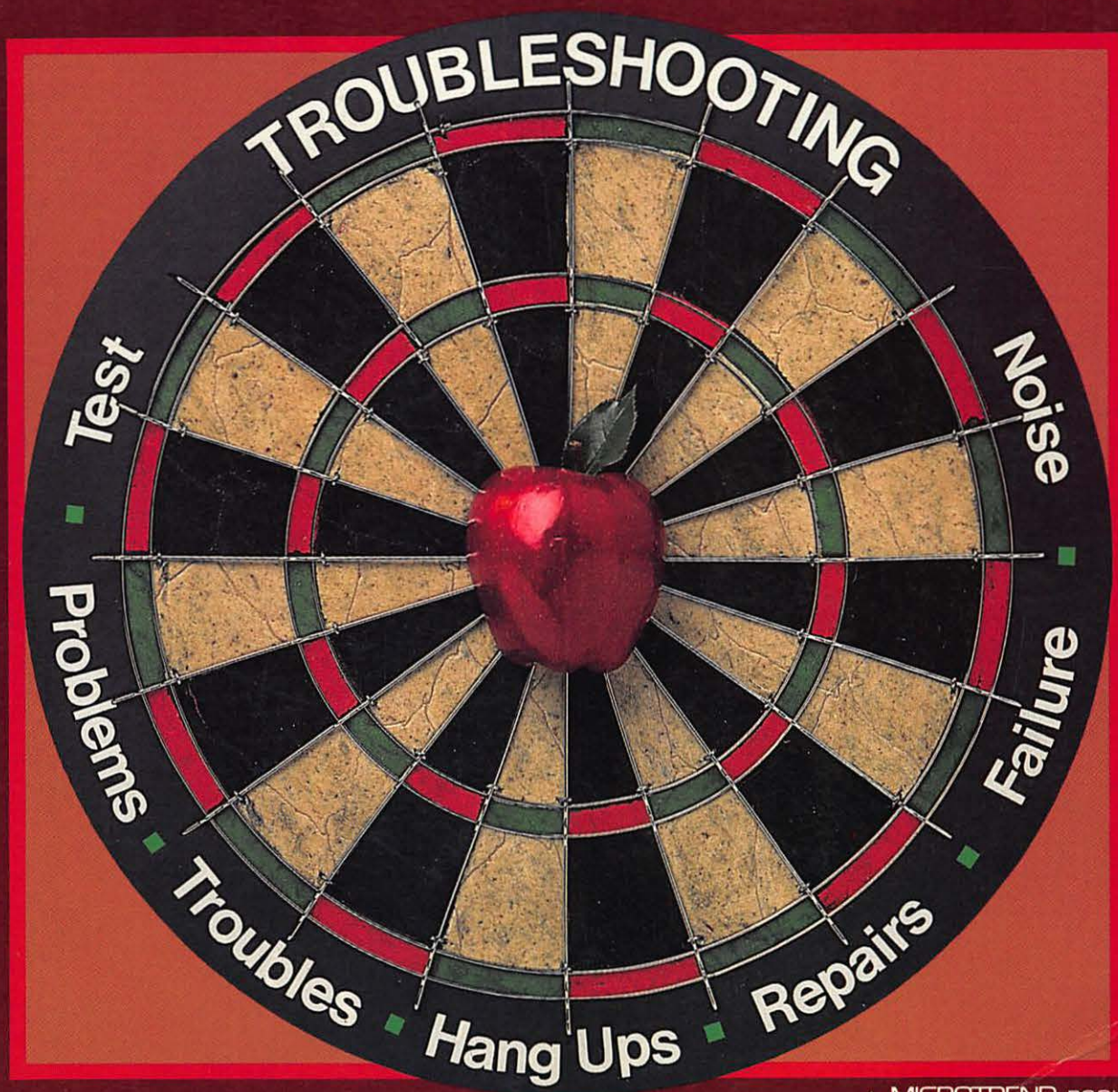

A MICROTREND BOOK

The Apple® II Plus/IIe Troubleshooting & Repair Guide



Robert Brenner is a retired Naval officer with distinguished service in submarines and in engineering duty officer billets. He has a graduate degree in electrical engineering from the Naval Postgraduate School in Monterey, California. He also has a graduate degree in management from the University of Southern California. Mr. Brenner is a specialist in microelectronic applications and is an avid computer enthusiast. He is married to the former Carol Ann Berry of East Detroit, Michigan. The Brennens have four children and reside in San Diego, California.

The Apple[®] II Plus/IIe
Troubleshooting &
Repair Guide

by

Robert C. Brenner

Dale Berggren

Howard W. Sams & Co., Inc.

A Publishing Subsidiary of **ITT**

4300 West 62nd Street, Indianapolis, Indiana 46268

© 1984 by Robert C. Brenner

FIRST EDITION
FIRST PRINTING – 1984

All rights reserved. No part of this book shall be reproduced, stored in a retrieval system, or transmitted by any means, electronic, mechanical, photocopying, recording, or otherwise, without written permission from the publisher. No patent liability is assumed with respect to the use of the information contained herein. While every precaution has been taken in the preparation of this book, the publisher assumes no responsibility for errors or omissions. Neither is any liability assumed for damages resulting from the use of the information contained herein.

International Standard Book Number: 0-672-22353-8
Library of Congress Catalog Card Number: 84-71058

Edited by: *Microtrend, Inc.*

Printed in the United States of America.

Acknowledgments

I wish to thank the following people, whose efforts and guidance made this manual possible.

Diane Berry Long for providing valuable assistance in preparing the many drawings and block diagrams in this book.

Jerome Mosley, Professional Photographer, San Diego, California for providing excellent close-up photographs of the Apple circuitry.

Dawn, DeeDee, Laura and Veronica Brenner for giving many hours of their free time to help collate, mark, and package the manuscript copies of this manual.

The staff of Microtrend for their professional guidance and support in structuring and editing the book.

Trademarks

Apple, Apple II, Apple II Plus, Apple IIe, and Applesoft are registered trademarks of Apple Computer, Inc.

CP/M is a registered trademark of Digital Research.

Warranty Warning

Warning: Opening or otherwise modifying the Apple IIe computer may void any manufacturer's warranty on the product.

Dedication

This book is dedicated to my son, Dan, a doggone good tech and an inspiration to me during the many hours of research and preparation.

Contents

INTRODUCTION	13
Why an Apple Repair Manual?	13
How to Use This Manual	14
CHAPTER 1 – BASIC TROUBLESHOOTING	17
Introduction to Troubleshooting	17
Steps to Successful Troubleshooting	17
Looking at the Components	18
Component Recognition	18
Component Failures	23
How Disk Drives Fail	23
How Displays Fail	24
Other Failures	24
The Most Common Failure	25
How to Localize Failures	25
If You Must Use a Service Center	31
Safety Precautions During Troubleshooting and Repair	32
Special Handling	33
Repair Parts	33

CHAPTER 2 – THE APPLE II PLUS DESCRIBED	35
Overview	35
Structure	36
CHAPTER 3 – APPLE II PLUS OPERATIONS	43
The Basic Parts of Your Apple II Plus	43
How Each Part Works	43
Chip Location Scheme	44
Memory Design	44
RAM Memory Used During DOS Boot	46
Physical Location of RAM Addresses on the Motherboard ..	46
Where BASIC Programs are Stored	47
Bus Structure	47
Clock Timing	48
The Power Supply	49
Video Display	49
Cassette Input and Output	50
The Disk II Drive	51
Keyboard Operation	52
Speaker	53
The Game Input and Output	54
How the System Works	56
Apple II Revisions	58
Software Structure	59
Summary	60
CHAPTER 4 – SPECIFIC TROUBLESHOOTING AND REPAIR, APPLE II PLUS	61
Troubleshooting Index	62
Start-up Problems	62
Run Problems	74
Display Problems	81
Keyboard Problems	99
Other Input/Output Problems	106
Summary	114
CHAPTER 5 – APPLE IIe DESCRIBED	115
Overview	115
Structure	115

CHAPTER 6 – APPLE IIe OPERATIONS	123
The Basic Parts of Your Apple IIe	123
How Each Part Works	123
Chip Location Scheme	124
Apple IIe Custom Chips	125
Memory Design	125
RAM Used During DOS Boot	126
Physical Location of RAM Addresses on the Motherboard ..	126
Where BASIC Programs Are Stored	127
Bus Structure	127
Clock Timing	129
The Power Supply	130
Video Display	130
Cassette Input and Output	131
The Disk II Drive	132
Keyboard Operation	132
Speaker	133
The Game Input and Output	134
How the System Works	137
Software Structure	138
Summary	139
CHAPTER 7 – SPECIFIC TROUBLESHOOTING AND REPAIR, APPLE IIe	141
Troubleshooting Index	142
Start-up Problems	142
Run Problems	152
Display Problems	158
Keyboard Problems	170
Other Input/Output Problems	175
Summary	184
CHAPTER 8 – ROUTINE PREVENTIVE MAINTENANCE ..	185
Contributors to System Failure	186
Noise Interference	189
Where Does Interference Come From?	190
Noise Interference Countermeasures	190
Power-Line Problems	194
Preventing Power-Line Problems	195

Corrosion	197
Corrosion Prevention	198
Magnetism	199
PMs for Floppy Disks	199
PMs for Disk Drives	201
Hard Disk Maintenance	209
Display Screens and Eye Problems	209
Using Heat to Spot Troubles	210
Summary	212

CHAPTER 9 – ADVANCED TROUBLESHOOTING

Tools of the Trade	213
Components and How They Fail	219
Using Tools to Find Failed Components	221
Other Troubleshooting Techniques	223
Testing Capacitors	224
Testing Diodes	225
Testing Transistors	225
Removing Solder	227
Soldering Tips	228
Recommended Troubleshooting and Repair Equipment	229
Spare Parts	230
Summary	230

APPENDIX	231
GLOSSARY	243
BIBLIOGRAPHY	245
INDEX	249

Introduction

WHY AN APPLE REPAIR MANUAL?

This book is written and dedicated to all the others who have experienced long, anxious hours waiting for a computer or peripheral device to be fixed and then almost had a coronary when the repair bill was presented.

I am, like yourself, one of the 100 million computer users in this country. When I purchased my first real computer, an Apple II, I was so elated I hardly slept a wink the first night. It wasn't long before my machine was dancing and twirling (figuratively, of course) as it produced tons of code and useful hard-copy reports, articles, and various analysis documents.

And then, one day, the dreaded event happened — the Apple broke down. I could scarcely contain my frustration. The *key*, the doggone “A” key stopped working!

My machine was out of warranty. With tenderness, I lifted it and carried it down to my “friendly” computer store.

“My Apple is sick.”

“Too bad. What seems to be the problem?”

“Key won't work.”

“Oh? Well, we can take care of that for you.”

“Great! When can I get it back all better?”

“How about a week from Wednesday . . . late afternoon?”

My heart sank. A week from Wednesday? Eight days just to fix a sick “A” key? Reluctantly, I handed over my cherished Apple to the technical service person. Sadly, I turned and left.

The next eight days were rough — for me *and* my family. From the third day on, one of us called the store's computer service center every day to determine the status of the repair and to try to get the work expedited.

On the appointed day my whole family escorted me to the store. I was like a kid at Christmas. There on the counter was my machine, all neat, clean looking, and fixed. I was back in computer heaven. My Apple was coming home.

And then I got the bill. “Wait a minute! This bill says fifty-four dollars and twenty-three cents!”

“Yes, it does.”

“To fix *one key*?”

“Well, the key actually cost less than five dollars. The rest is labor.”

“But, but . . .” I was stuttering and stammering as I paid the bill, and they escorted me and my Apple out to the car. Although I was indeed happy to have my

computer back, I never forgot that day and *that bill*. I knew there had to be a less expensive way. Most computers don't often have major failures. Most problems come from the breakdown of simple chips (those little black plastic, centipede-looking things) or other easy-to-spot components. And with a little training, just about anyone could make most repairs.

A plan began to develop. Why not repair my own equipment and then pay myself for the labor costs? I began to read, study, research, and test various troubleshooting techniques. I spent the next year preparing myself.

And then it happened again. Right in the middle of typing out a college report using my word processor program, the machine suddenly stopped. It quit printing and refused to access the disk where the report was stored.

The report was due the next morning. Here was my first real opportunity to test my knowledge of repairing our Apple. To my delight, I was able to troubleshoot and repair our computer in less than an hour. And most of that time was spent running down to the electronic parts store to buy a chip. The total cost for the repair — 82 cents plus tax. Probable savings — forty-five dollars. I was convinced. We were all delighted. My research was paying off.

It wasn't long before our friends who also owned Apples heard about my success and began calling on me to help fix their machines too. Another idea began to develop. Rather than spend my life running from one friend's repair to another friend's repair (you'll never know how many friends you have until you can fix a computer), I decided to write a book and let everyone save on their own repairs.

This is the result. In the two years it took to complete this manual, each step, each troubleshooting idea was tested and verified.

HOW TO USE THIS MANUAL

This manual is structured to make it quick and easy for either the novice or the experienced technician to locate and correct most computer failures.

The first chapter introduces troubleshooting and repair. In easy-to-understand terms, it proceeds step by step through the diagnostic techniques (called troubleshooting) for microcomputer hardware. Chapter 1 covers methods taught the best service technicians and includes numerous useful hints used by practicing electronic repair persons.

Chapter 2 describes just what constitutes an Apple

II system. The chapter begins with a definition and specification overview, followed by a discussion of system structure.

In Chapter 3 the operation of the Apple II is explored from both an internal and an external perspective. This chapter describes what happens inside the machine when power is applied and explains what events you should observe as the system powers up. Each of the major subsystems of an Apple II Plus is discussed, and numerous drawings are included to help you understand.

Chapter 4 describes specific hardware malfunctions (failures) that can happen to the Apple II Plus. The main focus of the book, Apple-specific failure diagnosis and repair, begins in this chapter. The chapter starts with a trouble symptom index table that guides you quickly to the page that treats a specific problem. Malfunctions are organized by computer subsystem. Each type of failure is analyzed to the chip level with ample drawings, including a picture layout of the board on which the failure is most probably located. Chips are highlighted for easy identification.

Chapters 5, 6, and 7 are specific to the Apple IIe. In Chapter 5 we describe the Apple IIe and delve into what makes this machine so great.

Chapter 6 begins the detailed discussion of how the Apple IIe operates. Again, ample drawings are provided to help you understand the system.

Then, in Chapter 7, we address troubleshooting and repair questions specific to the Apple IIe. Chapter 7 is organized the same way as Chapter 4. A quick reference at the beginning of the chapter makes your diagnostic search easier. Drawings and a chip layout chart help you understand why a particular chip could cause a specific problem and where the chip can be found in the Apple IIe.

A good repair manual should not just help locate and correct computer failures; it should also provide guidance in preventing further failures. Chapter 8 provides valuable periodic preventive maintenance (PM) suggestions to help maintain a healthy system. This chapter covers such subjects as maintenance of disks and disk drives, electrical and magnetic interference, and recommended cleaning techniques. This chapter also includes a preventive maintenance schedule which you can use to keep the system in peak operating condition and extend its "on-line" life.

By the time you've mastered Chapters 1 through 8, you should be able to troubleshoot and repair 95 percent of all Apple II Plus or Apple IIe computer failures. Chapter 9 was written for those who wish to go after the remaining 5 percent of malfunctions. In this chapter you'll become familiar with the tools of the repair tech-

nician's trade—logic probes, logic pulsers, current tracers, oscilloscopes, logic analyzers, and signature analyzers. The chapter even provides guidance in developing some of your own diagnostic tools, both hardware and software.

The Appendix provides a wealth of backup information. It includes step-by-step disassembly and reassembly instructions, conversion tables, specification data sheets, and system configuration record and repair sheets.

A reference section, a glossary, and a lengthy index complete the manual.

This book is a detailed troubleshooting and repair document. It is not a treatise on basic computer theory or a discussion of chip operation, registers, busses, and logic gates. It is an all “meat and potatoes” manual to enable the computer user to repair his or her own machine in those 95 percent of circumstances where knowledge and a good reference are enough to find and repair a failure.

Using this manual, you should be able to isolate and correct most Apple failures. This book has brought me much success in my own troubleshooting, and I trust it will do the same for you.

CHAPTER 1

Basic Troubleshooting

Like automobiles, computers break down after lots of use. Some break down sooner than others. Finding what broke can be easy or difficult, depending on your understanding of how to analyze a problem, identify the failed part, and step toward the correct repair. This chapter will show you how to find problems in your Apple in the shortest amount of time.

INTRODUCTION TO TROUBLESHOOTING

Imagine for a moment that you're in the midst of printing a lengthy analysis report when suddenly the printer halts, the screen display goes blank, and your Apple ceases to function. What do you do? What failed?

This chapter is devoted to a subject we often wish we could pass off or ignore — trouble. Trouble is like a flat tire: no one wants one, but when it occurs we all wish we could fix it quickly and get the experience behind us. Knowledge and action are required to overcome trouble.

You know from reading the owner's manual that came with your computer that it's a digital machine; it operates in binary, where every condition is either true (logic 1) or false (logic 0).

A digital computer like the Apple generally doesn't break down slowly, with graceful degradation. If it fails, it's usually with a hard, consistent failure. In addition, the digital devices that make up your Apple function within strict rules of logic. The most effective way to respond to a failure in these devices is to think the problem through just as the machine operates — logically. Understand what should happen and compare the “shoulds,” one by one, with what is really happening.

An interesting deductive technique called *troubleshooting* is particularly appropriate for solving digital equipment failure problems. Troubleshooting could be a really frustrating experience if you were left to struggle through the process by yourself without a good guide. This book provides you with techniques for quick and easy troubleshooting and repair.

STEPS TO SUCCESSFUL TROUBLESHOOTING

Effective and efficient troubleshooting requires gathering clues and applying deductive reasoning to isolate the problem. Once you know the cause of the problem, you can follow a process of analyzing, testing, and substituting good components for each suspected bad

component to find the particular part that has failed.

The use of special test equipment such as logic probes and logic clips can speed the analysis, but, for most failures, good old brain power can suffice quite well. Once the problem has been isolated to a particular group of chips, deductive analysis changes to intelligent trial-and-error replacement. Reducing the number of suspected chips to just a few and using intelligent substitution is the fastest way to identify the faulty device in the least amount of time.

In general, you can follow these “Apple Optimum” steps to success when your computer fails:

1. Don't panic.
2. Observe the conditions.
3. Use your senses.
4. Retry.
5. Document.
6. Assume one problem.
7. Diagnose to a section (fault identification).
8. Localize to a stage (fault localization).
9. Isolate to a failed part (fault isolation).
10. Repair.
11. Test and verify.

The following pages discuss the steps to troubleshooting success in detail.

LOOKING AT THE COMPONENTS

Every computer is composed of functional sections as shown in Fig. 1-1. Any of these sections can fail.

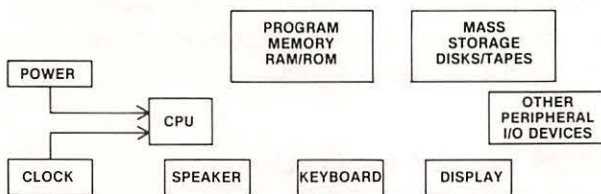

Fig. 1-1. The functional parts of the Apple II computer.

When something goes wrong, the first step is to determine whether the trouble results from a failure or just a loose connection or human error. Once you're sure a failure has occurred, the next step is to determine which functional section of the system is not operat-

ing — disk drive, keyboard, display, or some other part.

Then, step by step, break each section up into stages and try to track the trouble to a single component. If a display isn't working, for example, the problem could be in the display monitor itself, in the video cable, or in the video circuitry of the Apple computer. Each of these can be considered a stage of the video display functional section.

Next, to troubleshoot your computer, you need to understand what your Apple is all about physically and how it interacts with the other parts of the system.

COMPONENT RECOGNITION

What's an Apple II made of? Let's take a look.

That strong housing or case with the built-in keyboard is made of high-strength, flame-retardant molded plastic — an improved material called Cylolac KJW from Borg-Warner Chemicals, Inc. in Parkersburg, West Virginia. The case is not likely to fail under normal use.

Make sure the power is off and open the lid on your Apple computer. Inside the case opening, you'll notice a long silver-or-gold-colored rectangular box at the left. This is the switching power supply. It delivers all the necessary voltages to the rest of the computer via some wires that come out of the keyboard end of the supply and connect through a plug to a large green board. Touch the top case of the power supply, and then carefully remove the power plug from the back of the computer.

The large green board with many components mounted on it in the main part of your Apple is called the “main printed circuit board,” or simply the “motherboard.” Also inside the case you'll see a small speaker. Notice that the power supply, the speaker, and the motherboard are all attached to a metal baseplate. Let's concentrate on the motherboard since this is where most failures occur.

Fig. 1-2 compares the Apple II Plus and Apple IIe motherboards.

The motherboard is made of fiberglass and has lots of colorful devices mounted on it — sockets, connectors, and wire traces embedded into the board, integrated circuits (or chips), resistors, capacitors, transistors, and (for the IIe) light-emitting diodes (or LEDs). Fig. 1-3 shows the types of devices that you will find mounted on the motherboard. The numbers indicated in the figure are the actual identification numbers of components on the Apple II Plus motherboard.

A matrix of letters and numbers are used to locate

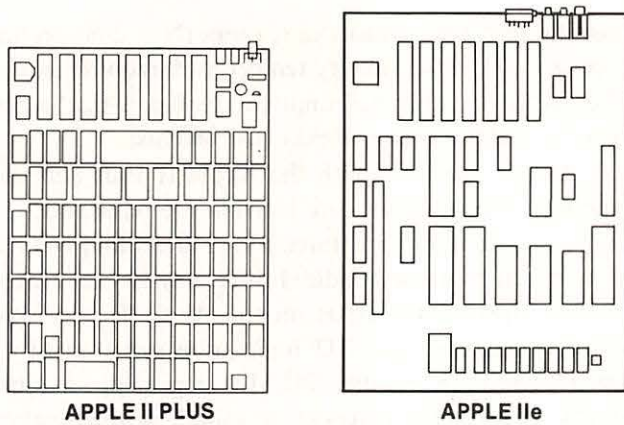

Fig. 1-2. A comparison of the Apple II Plus and Apple IIe main circuit boards (motherboards).

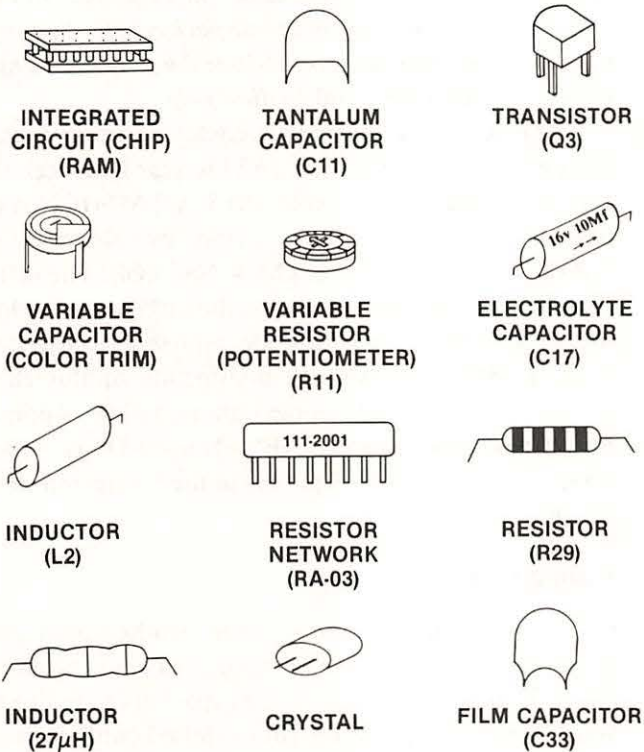

Fig. 1-3. Components found on Apple II motherboards.

tors (or vacuum tubes, the predecessors of transistors), and cause the computer to work logically. The Apple II is a *Von Neumann machine*: it works in Binary digITs (bits); all conditions are either ON (logic 1) or OFF (logic 0), and all operations occur in sequence. Dr. John Von Neumann first described his idea of a binary computer at a conference in 1945 at the Moore School of Electrical Engineering.

There are five sizes of chips on your motherboard: 8-pin, 14-pin, 16-pin, 24-pin, and 40-pin. The Apple IIe also has two 40-pin custom chips. Apple Computer Company placed these chips in sockets, so repair is quick and easy with no unsoldering and soldering.

Notice how each chip has a notch or groove at one end as shown in Fig. 1-4. This notch marks the end of the chip where pin 1 can be found. Pin 1 is to the left of the groove as you look down upon the top of the chip with the groove pointed away from you. The pins are numbered counterclockwise starting from pin 1, so that the highest-numbered pin is directly across from pin 1. As you'll learn later, in chip replacement, you must insert the new chip into the socket with pin 1 in the right place.

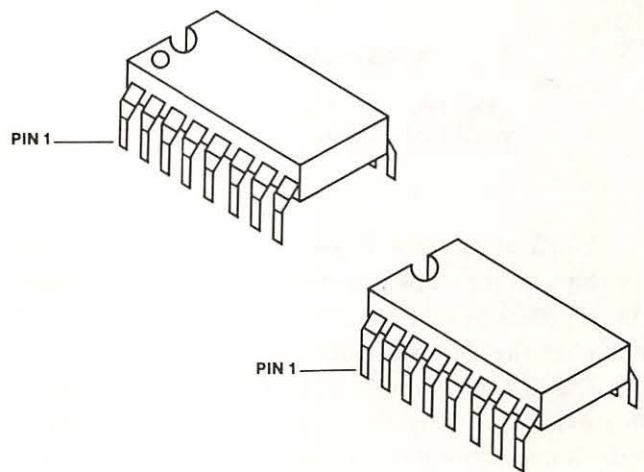

Fig. 1-4. Identification of pin 1 on a chip.

devices on the motherboard. Rows are marked with letter designations, and columns are marked with number designations. Thus, A-8 would refer to a device located at the intersection of row A, column 8.

Chips

Those black-case, centipede-looking things are the chips. They serve the function of hundreds of transis-

Chips have special markings that tell a lot about what's inside. Look at the printing on the top of the chips on your Apple's motherboard. First, you'll notice that many different companies make chips, and that many of these companies are outside the United States — Japan, Malaysia, Indonesia, and El Salvador, for example. Some companies place their logo on the chip. Some of the logos represented in your Apple chips are shown in Fig. 1-5.











	<u>COMPANY</u>
	ADVANCED MICRO DEVICES
	AMERICAN MICROSYSTEMS
	FAIRCHILD
	HARRIS
	HITACHI
	MONOLITHIC MEMORIES
	MOTOROLA
	NATIONAL SEMICONDUCTOR
	OKI JAPAN
	STANDARD MICROSYSTEMS
	SYNERTEK
	TEXAS INSTRUMENTS

Fig. 1-5. A sampling of the logos you'll find on chips in your Apple II.

You'll also notice letter-number combinations on the chips. Some chips have two sets of letter-numbers. One set identifies the type of device, and the other set tells when the chip was made.

The first, or primary, set of letter-numbers is called the *manufacturer's type number* or *manufacturer's device code*. It appears in three sections as shown in Fig. 1-6.

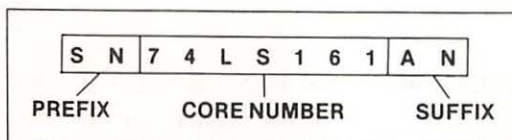

Fig. 1-6. The manufacturer's device code for a 74LS161 chip.

The prefix ("SN" in SN74LS161AN) is usually used to identify the manufacturer, although sometimes it is used to identify the device family (also associated with a

manufacturer) or a temperature range (N = commercial temperatures, S = military temperature requirements). The prefix is sometimes omitted. In Fig. 1-6, the SN represents the company Texas Instruments.

All the chips on both the Apple II Plus and the Apple IIe motherboards are listed in the Appendix.

The core number is three to six digits long with a letter or letters in the middle. It indicates the basic logic family. Most of the chips on the Apple II are 74xx series, which represents TTL logic (transistor-transistor-logic). The core number 74LS161 represents a 4-bit binary counter. The letters in the middle of the number describe particulars about the logic used in the chip such as speed or power. In Fig. 1-6, the LS stands for *low power schottky*, a particular type of TTL logic design.

The suffix represents the package type or temperature range. Usually it describes the package type. In Fig. 1-6, the AN denotes a *dual in-line package (DIP)*, a type of chip. Other package types include the *flatpacks*, *single in-line package (SIP)*, and *leadless chip*.

The second letter-number combination on a chip represents the manufacturer and the year and week the chip was made. For example, the UA/LM741CN is an *operational amplifier chip* made by Signetics or National (UA = Signetics, LM = National). The suffix CN refers to DIP packaging, and the 8108 printed below the manufacturer's device code represents the eighth week in 1981, the date of manufacture of this chip. Likewise, the chip in the upper right part of the Apple II Plus motherboard marked NE558N and 8114 is a *quad timer* manufactured by Signetics in the fourteenth week of 1981.

Capacitors

In addition to chips, your motherboard has mounted on it a number of devices called capacitors. Fig. 1-7 shows what some of the capacitors look like so you can pick them out on your motherboard. Capacitors come in four varieties: (1) electrolytic, (2) tantalum, (3) film, and (4) variable. Your Apple boards have some of each type.

Capacitors are measured in fractions of farads. You'll see values listed in " μ F" for microfarads and "p" for picofarads. *Micro* means "to the sixth decimal place" or .000001 (one millionth) and *pico* means "to the twelfth decimal place" or .000000000001 (one trillionth). Thus .022 microfarads means .00000022 farads and 47 picofarads means 47 trillionths of a farad.

Capacitor (cap) value identification is one of the most challenging tasks you can encounter because most companies like to use their own identification standards.

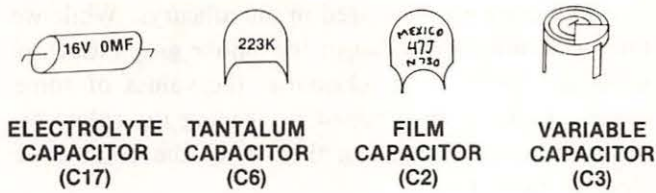

Fig. 1-7. Four types of capacitors found on Apple II motherboards.

On the side of C17 in your Apple II Plus, you'll find the numbers "16 V" and "10 μ F." This means that C17 is a ten-microfarad capacitor and is rated at 16 volts.

On the side of another cap, C6, is printed "223 K." The first two digits (22) represent the significant figures. The last number (3) represents how many zeroes to add after the first two numbers to get the true value in picofarads. Thus 223 represents 22,000 picofarads, which is the same as .022 microfarads.

The 47 picofarads capacitor, C2, is not much easier to decode. On the side of C2 you will see the word "Mexico." Under Mexico there are two letter-number sets: the first, "47 J," represents 47 picofarads (the J represents a tolerance of 5 percent). Beneath the 47 J is "N 750," which refers to the capacitance effect under changes in operating temperature.

The *color trim adjust* (C3 on your Apple II Plus) is a variable tuning capacitor that can be varied between 5 and 50 picofarads. You won't be able to see the values stamped on this capacitor. The capacitor is so small that printing the variable capacitance on the side of it is impractical. The value was probably printed on the side of the bag in which the capacitor was shipped to Apple.

Resistors

Fig. 1-8 shows the three types of resistors found in the Apple circuitry.



Fig. 1-8. Three types of resistors found in the Apple circuitry.

Resistors are used to restrict or limit the flow of electrical current through the board's circuitry. One type of resistor is the cylindrical wire-wound device shown in Fig. 1-8A. The value of resistance is given in ohms, and

can be determined by comparing the color bands with the colors in Table 1-1.

Table 1-1. Color Codes for Wirewound Resistors

Color	Digit	Multiplier
Black	0	1
Brown	1	10
Red	2	100
Orange	3	1000
Yellow	4	10000
Green	5	100000
Blue	6	1000000
Violet	7	
Gray	8	
White	9	
Gold $\pm 5\%$ tolerance		
Silver $\pm 10\%$ tolerance		

For example, R10 (over by the video jack at the top right of the Apple II Plus board) has the color code red-violet-black-silver. The first two bands describe the primary number. The third band represents the number of zeroes to add to the primary number. The last band is the tolerance value, or how close to the color band value the actual value must be. As Table 1-1 shows, the red band stands for 2, the violet for 7, and the black for 0, or no zeroes after the 27. Thus, by using Table 1-1, R10's value can be found to be 27 ohms. This matches the value given on Apple's schematic of the II Plus. The silver band represents a 10 percent tolerance value. (This means the actual resistance value can be plus or minus 10 percent away from the 27-ohm designation.)

Fig. 1-8B shows a variable resistor like the one labelled R11 at location J-14 on the motherboard. Resistor R11 is used to fine tune the video output going to your monitor. Its resistance can be varied between 0 ohms and 200 ohms. The value of a variable resistor is stamped on the side or top of the device.

A recently developed electronic device, the resistor network (shown in Fig. 1-8C) is actually a group of resistors built into a single in-line package (SIP) or a dual in-line package (DIP). Several SIP resistor networks are mounted on the board. These resistors are designated "RAXX."

The resistance designation of network resistors is printed on the side of the package. The RAXX devices

are marked 1000-111. The 1000 refers to the resistance (1K ohms). The 111 refers to a manufacturer's type number which is not of interest here.

Inductors

Fig. 1-9 shows two types of inductors found on the Apple II Plus motherboard. Near C2 at location H-14 is a green and color-banded inductor labelled "L1" (Fig. 1-9A). The other type of inductor is smoke gray in color and doesn't have markings (Fig. 1-9B). The part of the motherboard just below several of these unmarked inductors is labelled "L4, L5, L3."

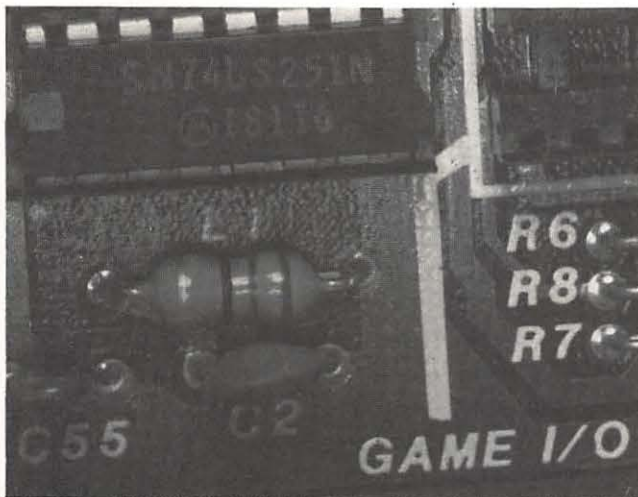

A. Inductor L1.

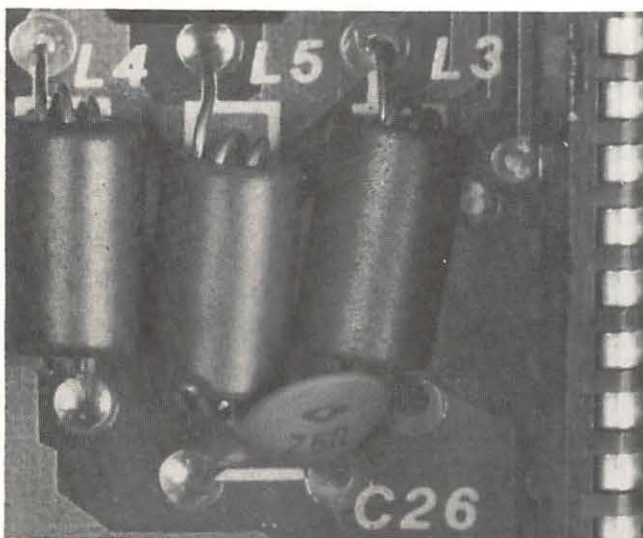

B. Unmarked inductors L3, L4, and L5.

Fig. 1-9. Two types of inductors found on the Apple II Plus motherboard.

Inductors are measured in microhenrys. While we must determine the value of the smoke gray inductors using the labels on a schematic, the values of some inductors can be determined by reading the colors on the device and comparing them with the color code chart in Table 1-1.

Diodes

Diodes are tiny, usually glass devices shaped like resistors. They are marked with printing on the side. There are several diodes on the motherboard. The key to determining if the device in question is a diode or something else is the label on the side. The "1Nxxxx" label denotes a diode. Look at CR1 at location J-14 on the Apple II Plus motherboard — it's right next to the 74LS74 by slot 7. CR1 is a diode. It is a 1N914 (although you'll have a dickens of a time reading the 1N914 on the side). CR1 is in the circuitry for the speaker output.

Transistors

The half-moon-shaped devices on the motherboard are *transistors*. The key to recognizing a transistor is its "2Nxxxx" designator. Fig. 1-10 is a drawing of transistor Q3 at J-14 on your Apple II Plus motherboard. On the side of it is printed "2N3904." The "2Nxxxx" label tells us it's a transistor. We can look up this transistor in a parts catalog and find that the 3904 transistor is a general purpose device. It sells for about 35 cents.

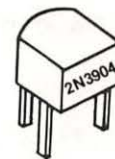

Fig. 1-10. A 2N3904 transistor, Q3.

When you check the electronic parts catalogs, you'll find lists of these devices with prices that will pleasantly amaze you. Since 95 percent of microcomputer failures are chip failures, introducing the capacitors, the resistors, the inductors, the diodes, and the transistors serves only to familiarize you with what is on your Apple motherboard. These devices are soldered into the board and can be replaced only by those experienced in repair. Chip replacement is probably as far as you'll want to go in computer repair. Usually you'll let a repair technician replace the soldered-in components.

COMPONENT FAILURES

While the use of troubleshooting equipment makes it easier to analyze and isolate different computer problems, many failures can be found without expensive equipment. In fact, troubleshooting and repair can be relatively simple if you understand how electronic components fail.

Failures generally occur in the circuits that are used or stressed the most. These include the RAM and ROM memory chips, the 6502 CPU, and the input/output (I/O) chips between the motherboard and the disk drive. The CPU is a highly reliable device and doesn't fail very often. Most failures involve the other chips. Except for the ROM chips, which are programmed by Apple Computer Company, these other chips are standard, off-the-shelf devices and are so common they've earned the nickname "jelly beans" — inexpensive, easy-to-replace products.

Transistors and diodes fail by disconnecting inside, which causes an open or break in the circuitry, or by having their output short. Either kind of failure causes total loss of signal.

Capacitors and inductors fail when they short internally or when one of the leads disconnects, causing an open. Again there is a loss of signal.

Resistors can absorb too much current and actually bake in the circuit. The result is usually an open circuit with shorting during the "melt-down." All of the devices mentioned so far are solid state. They are constructed of materials (metals, plastics, oxide, etc.) that change as the components age or are subjected to severe temperatures or high voltages. Such a change can cause the device and the circuit or system to behave strangely. Fortunately, Apple motherboards are not "subjected" to high voltages. But they do get pretty hot, and this will affect the operation of the components. When we use our computers we place the circuitry, and especially the chips, under a lot of stress. First they heat up when we turn on and use our computers. Then they cool down when we turn the machine off. They heat up when we turn the machine on again. This hot-cold-hot effect causes circuits to fail sooner. The thermal stress can cause a break in the connection of a wire leading from inside the chip to a pin, producing an "open" circuit, which requires chip replacement.

Even if there is no break in the chip or lead connection, after exposure to high voltages or temperatures the operating characteristics of a device can change. A chip may work intermittently or simply refuse to work at all. An output can become stuck at "1" or stuck at "0," no

matter what the input signal is. Theoretically, a wearout failure like this won't occur until after several hundred years of use, but we shorten the life span of the chips by placing them in high-temperature, high-voltage, or power-cycling environments that cause them to fail sooner.

Other problems occur outside the chip — between the chip leads and the support structure pins which connect the device to the rest of the computer through the socket. Such failures include inputs or outputs shorted to ground, pins shorted to the +5-volt supply, pins shorted together, open pins, and connectors with intermittent defects. Most commonly, trouble results from opens or shorts to ground. Chips fail far more often than diodes or transistors, because the chips that are the same size as single (discrete) diodes or transistors contain many tiny circuits that produce more heat and therefore more thermal wear.

Chapter 8, "Routine Preventive Maintenance," tells more about heat effects. If you keep your computer cool and clean, it should work well for many years.

HOW DISK DRIVES FAIL

Disk drives give us the ability to save and load software at almost unbelievable speeds. These "boxes" are some of the most complex collections of electronics and mechanical hardware ever constructed. Thousands of tiny magnetic signals are stored on each disk that is placed into one of these drives. We expect disk drives to save all of our programs and data accurately and quickly and to accurately load the information back into our Apple with not a single lost number or letter.

And they do. Disk drives will give you months of faultless service if you do your part, operating them carefully and providing tuning and periodic cleaning.

But sometimes we forget. We operate our drives as someone nearby puffs on a cigarette, tapping ashes onto a tray at the side of the drive. We smile as we jam a disk into the drive and then slam the drive door closed.

And then one day, that horrible DISK ERROR message appears and the drive "gives up the ghost." Now what? What kinds of failures can occur with disk drives?

First, disk drive failure can be caused by the well-motivated troubleshooter moving the disk controller card inside the Apple with power applied. This can "fry" from one to three chips on a circuit card in the drive.

Another kind of failure is a change in the drive rotation speed, which affects the reading and writing of information on the disks. The speed is adjusted for approximately 300 revolutions per minute. As the speed

varies from this optimum, disk read and write errors begin to occur.

Rough handling in disk insertion and removal can cause misalignment of the read head. Misalignment is not an easy thing to fix. It usually requires special software and alignment tools.

HOW DISPLAYS FAIL

Most of us don't anticipate failure of a display monitor. But why not? Monitors are like television sets. And you know from experience that sooner or later your TV will develop a problem and need repair.

Part of the reason displays still fail is that displays are the only new electronic device that still uses a vacuum tube. The cathode ray tube (CRT) is the screen you look at when you work with your computer. It displays video information. The CRT is probably the only modern electronic component that is guaranteed to wear out.

The letters and numbers you see on your screen are displayed there by electrons striking the back side of the screen. The electron streams get weaker as the CRT ages.

You can correct some of the effects of age, but others require a service center, since it's better not to open up the display unit and expose yourself to those dangerous high voltages.

Here are some possible video display failures:

Short inside the CRT – can result in a “hum” noise and a bar across the screen, very poor contrast, a bright beam on the screen, or even diagonal lines on the screen.

Open or disconnect inside the CRT – no characters are displayed on the screen.

Bright “bloomy” letters; poor intensity control – caused by tube age. The center of the CRT has worn so that you can get normal brightness with the intensity turned down as far as possible, but black is really black, and grey shades are poor or not displayed.

Screen edge won't display; picture fuzzy – a deposit has formed on the inside of the screen causing reduced brightness and fuzzy display. The deposit is thicker at the outer edge of the CRT.

No picture – brightness and intensity controls have no effect.

Marginal performance – display monitor performance is less than optimal. Monitors, like computers, printers, and other electronic equipment, are affected by dust and dirt. These pollutants coat the components inside the chassis and cause heat to build up. And you know (now) what heat can do to your equipment.

In general, CRT failures cannot be corrected by anyone other than a trained service technician. The voltages inside the chassis of your monitor reach as high as 25,000 volts. These levels can be lethal if you make a mistake.

The only adjustments you should attempt are those that can be accomplished from outside the chassis. If you see holes in the back of the chassis for alignment, you'd be better off keeping out of these, too; but if you feel experimental, be sure you use a *plastic* alignment tool (it looks like a thin pen with screwdriver-shaped ends).

OTHER FAILURES

Some people simply have a knack for fouling up the works every time they try to “repair” something. These folks should take up reading instead of repair. Other failures can be caused by overzealous or under-trained repair technicians.

In the following list are some repair-generated “failures”:

Devices “blown-up” in handling – occurs when someone picks up ROM, CPU, MMU, or IOU chips without first touching the top of the power supply case or otherwise grounding any static electricity that a person might be carrying.

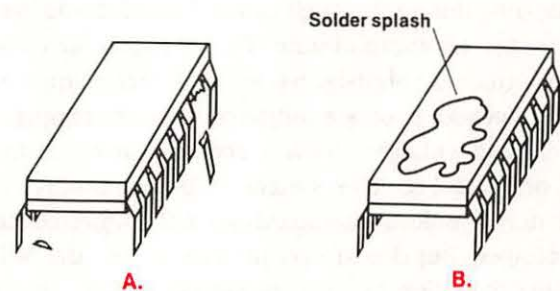

Fig. 1-11. Failures can be caused by overzealous or undertrained repair people.

Bent or broken pins – watch the way you put those chips in. You can only straighten those pins so many times before they break off completely (Fig. 1-11A).

Solder “splashes” – caused by dropping tiny balls of solder from the end of the soldering right on top of the board, shorting out some of the circuit (Fig. 1-11B).

Liquid “fry” – occurs when someone holds or sets a liquid on top of or too close to the computer and then accidentally spills the liquid into the top of the keyboard

while the computer is running. It's a real mess to clean up, and you also get to replace lots of components.

Component failure by asphyxiation—caused by blocking the Apple vent openings or stuffing your computer with interface boards that produce lots of heat without installing a cooling fan. It “kills” components.

The interface that doesn't—can be caused by improper connection of cables. Plugging cables in with the alignment one pin off blows lots of chips. If cable connectors are badly corroded, no signal can get through the cable.

RFI wipeout—ribbon cables don't have much protection from radio frequency interference or magnetic fields produced around high voltage machines or even power cords. Printers may print garbage or not at all if the ribbon cable connecting the computer to the printer runs alongside or through a loop in a power cord.

So much for “other failures.” If it can be done, someone has probably done it.

THE MOST COMMON FAILURE

By far the greatest number of Apple II computer breakdowns are caused by “experimenters” or troubleshooters who forget to turn off the power before touching anything inside the machine case. Many, *many* people have reached into their Apple and pulled out or put in a peripheral interface card without turning off the power. Much to their chagrin, they hear the agonizing “psst” and realize they just put 12 volts across the wrong pin and shorted out part of a circuit (and part of their checkbook).

As shown in Fig. 1-12, the short is caused by raising one end or corner of a peripheral interface card, placing the connectors across one another on an angle and putting the wrong voltage on the wrong pin. Chip burnout is the result.

CAUTION: Never insert or remove a peripheral card without first turning off the power to the computer, removing the lid, touching the top of the power supply case, and then reaching around in back of the Apple and pulling the power plug out of the back of the computer.

HOW TO LOCALIZE FAILURES

O.K., you're convinced that computer parts are pretty good, but they *can* fail. How do we locate the failure?

There are three ways to localize failures, or find out which computer part is broken: (1) the hardware

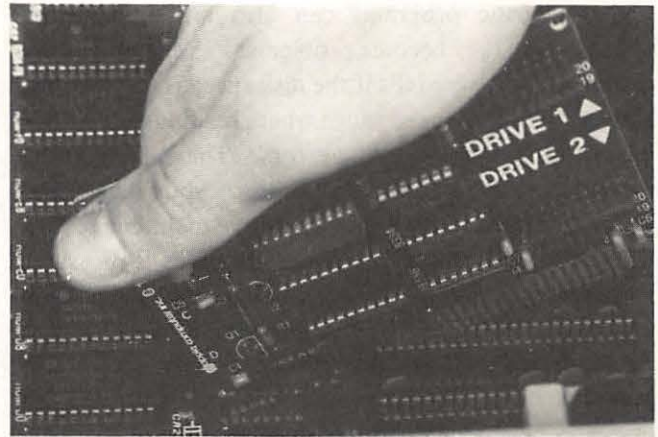

Fig. 1-12. Failure is commonly caused by trying to insert or remove an interface card with the computer power still on.

approach, (2) the software approach, and (3) the Apple-Easy approach.

Hardware Approach

In the hardware approach, we use troubleshooting tools to measure voltage (logic) levels in the circuitry of the Apple. These tools include the logic probe, the logic pulser, the current probe, the oscilloscope, the multimeter, the logic analyzer, and the signature analyzer.

This approach requires some knowledge of electronics and test equipment. It is usually used as a last resort, so we'll save the hardware approach for Chapter 9, “Advanced Troubleshooting.”

Software Approach

The software approach is a troubleshooting method used widely by Apple repair technicians. As long as the disk drive will boot up properly, we can often find the failure using diagnostic software.

Watching strange things happen to your computer system can be frustrating. Often you can't be sure immediately if *you* caused those weird characters on the screen or if your Apple is sick. It's better not to start taking the system apart for failure analysis if the machine isn't really broken.

There is a way to gain confidence that the system is healthy and that the errors are probably in the software program you're trying to run. If the error is repeatable and the system drive still boots up, you can insert a diagnostic disk into your Apple system and run a series of programs that test the condition of the computer. These self-test routines can give you a 95 percent or greater confidence indicator that your Apple is working properly and that you need to check your software.

Diagnostic programs can also indicate possible faults before they become problems. For example, some diagnostic software tells if the disk speed is too fast, too slow, or within a speed range where reading and writing data can occur without errors. These diagnostics measure the mechanical operation of your disk drives and are helpful in periodic preventive maintenance.

The effectiveness of self-test packages is measured by the level of confidence one can have that the component identified as bad by the software is indeed faulty. Some diagnostics are advertised as only 60 percent accurate; other companies say that their software test packages have an 85 percent confidence factor.

Most minicomputer diagnostics only identify faults to the board or module level. That's because customers in the large companies that own most minicomputers usually depend on the computer manufacturer's field service representatives for repair support. In this case, the diagnostic is used as an improved user interface. The user can relay diagnostic test results to the computer service center so that the troubleshooting visits from field service technicians can be performed more quickly. Fortunately, most of the Apple microcomputer diagnostics can call out faults to the chip level (especially faults in memory).

Several companies provide diagnostic programs for Apple II's. These programs test main memory, system read-only memory (ROM), the CPU, the monitor, the game port, the keyboard, the disk drive speed, and some peripherals.

The most common diagnostic programs check the system random-access memory (RAM) and some of the input/output. Some routines check the operation of the CPU itself, but these usually locate only minor errors. It's difficult for a CPU like the 6502 to run a test on itself. Most diagnostics assume that the CPU is working properly.

Some memory diagnostics test to see if the computer is properly setting and clearing individual bits in memory and also if store or write operations are affecting more than one memory address location at one time.

The main memory tests assume the CPU is fine and go on to do some pretty fancy tests on the RAM. This form of testing finds out if test data can be correctly loaded into one and only one location in memory. If a "storage error" occurs — that is, the test data stored is not the same as the test data — a message is printed on your screen. If the correct data gets stored but into several different memory locations at the same time, an "addressing error" has occurred and this too is noted on your screen.

There are many algorithms (routines) for testing memories. Here is a list of the most common memory tests:

Common Memory Tests

- Simple store and read
- Sequential numbers test
- Rotating bit test
- Walking bit test
- Dual address test
- Butterfield test
- Sum test

A **simple store and read test** stores a known value in every location in a selected block of memory. Then it reads the contents of each location to ensure that the value was correctly stored. It is a quick and easy rough test.

A **sequential numbers test** involves storing all the binary number combinations for an 8-bit word sequentially into a block of 256 memory locations. Then it starts at the first address location and reads out the data word stored, comparing it to the value that should be there. If the data is correct, the routine displays the words "all O.K." and the test moves on to the second location. If an error is found, the program displays an "error" symbol on the screen and the test starts over at the next (third) address location. The test repeats until you reset your system.

A better memory test, the **rotating bit test** checks each address location to see if a binary bit stored in any one of the eight positions in a binary 8-bit data word will falsely set another bit in the same word.

This test starts by loading the binary number 0000 0001 in the lowest RAM address. The contents of this address are then read back out and verified. If the 0000 0001 was correctly stored, the bit is shifted left one place to 0000 0010 and the test is repeated. After the set bit (the "1") is shifted through all the binary combinations, stored in that same address location, read out, and verified, the entire test starts over at the next memory address location.

The **walking bit test** improves on the rotating bit test slightly. All eight bits in a starting location are set to 0, or "cleared." Then the first bit is set to "1" (0000 0001) as in the rotating bit test. The program tests all seven other bits to see if they have changed from 0 to 1. Then the second bit position is set to 1 and all other positions to 0 (0000 0010). Again all seven other bit positions are tested. This process walks through each bit in that memory location, setting each bit to 1 and testing all seven other positions.

Next, the values are all reversed; all the cleared bits are set to "1" and the set bits are cleared to "0," and the entire process begins once more, but now as a rotating zero test.

This test is quite time consuming. Apparently, it can take over 13 hours to check a 16K-byte area of RAM. And it can take over 52 hours to test 32K-bytes of memory!

A **dual-address test** provides a more thorough addressing check. Starting with the lowest memory address in a selected block of memory, the program stores all zeroes into the area (clears it to zero). It then stores all ones (1111 1111) into the first location and checks all other locations to see if any other memory address falsely received any ones. If all other locations are still "zero-loaded," the test location is cleared (written into with all zeroes) and the test shifts to the next higher address, storing all ones in this location and then testing all other memory locations. This test repeats until the program reaches the end of the selected memory area.

A man named Jim Butterfield wrote a program that is a variation of the dual-address test and is in the public domain. In the **Butterfield test** program, all ones are stored in every location of the selected memory area. Then all zeroes are stored in every third address location starting with the first address. The algorithm then checks the contents of every memory address to make sure the values have been stored correctly.

Next, the program shifts the position of the "all zeroes" word twice using the second and then third locations in the memory as starting points.

After the three-pass test using zeroes in a memory field of all ones, the bits are reversed and all ones are stored in every third location of an all zeroes memory field.

If an error is found, the program stops and the address of the error is displayed. If no error is detected, the program ends and the top address plus one is displayed on the monitor.

The **sum test** is probably the most sophisticated memory diagnostic test. It generates a unique data word for storing in each location of memory to be checked. The data word is the sum of the two bytes that comprise that memory address. (Recall that it takes 16 bits to address 64K bytes of memory; 16 bits is two 8-bit bytes.) Since each succeeding address is one location higher, the value stored increases and each value is unique to an address.

The algorithm then checks for correct value stor-

age. If an error is found, the program displays the error and its location on the screen.

This diagnostic test is also time consuming. It's a good idea to run these types of dual-address tests on small blocks of memory rather than testing all of the RAM. It has been determined that the testing time quadruples for each doubling of the amount of memory tested.

Self-Diagnosis

There is a trend toward building diagnostic capability into peripheral equipment like printers and plotters. There is also a strong incentive to place diagnostics in CRT displays, disk drives, and even new personal computers, because so many of these devices are being sold.

Disk drives and printers function both electronically and mechanically. The electronic controller portion of these machines can contain their own diagnostics and indeed, many controllers now do some form of self diagnosis each time the system is powered up. These tests check for faults in the electronics.

Mechanical components are inherently less reliable than electronics, so peripherals containing mechanical parts need diagnostics that regularly check their internal operation. Most of the conditions monitored are operator related; for example, "paper out" or "ribbon out." Disk drive diagnostics measure mechanical parameters like speed and head alignment. We'll cover disk speed adjustments and head alignment in Chapter 8, "Routine Periodic Maintenance."

Table 1-2 describes four of five diagnostic programs you can purchase.

Table 1-2. Commercially Available Diagnostic Programs for Disk Drives

Diagnostic	Source*
APTEST	Apple PugetSound Program Library Exchange (A.P.P.L.E.) Club (to members only)
Diagnostics II	Supersoft (CP/M Systems)
Master Diagnostics	Nikrom Technical Products
XPS-Diagnostic II or IIe	XPS, Inc.

* The addresses of the manufacturers can be found in the reference section at the rear of the manual.

A fifth diagnostic program is found on some of the copy programs being marketed today. This program, Locksmith 4.x or 5.x, provides a disk speed test. All of these “canned” diagnostic packages use some version of the seven test algorithms described above. Each diagnostic program is a valuable addition to your “troubleshooting toolbox,” but no software diagnostic can help if your system won’t boot or display. The message is: “There are many ways to skin a computer cat. Know them all.”

Apple-Easy Approach

Usually when a chip comes to the end of its useful life, a catastrophic failure occurs — it cooks itself internally. While your eye can’t always see the chip defect, you can find the problem without much effort. (But, don’t think that every time your Apple quits working, you’ve just had a catastrophic failure.) In most cases, the use of the Troubleshooting Index will enable you to locate and correct the trouble quickly; but for those problems that are not as easy to identify, let’s refer again to our guidelines for success.

1. **Don’t panic.** You now have a manual that will help.
2. **Observe.** What conditions existed at the time of failure? What actions were in progress? What program was running? What was on the display screen?
3. **Sense.** Is there any odor present from overheated components? Does any part of the system feel overly hot?
4. **Retry.** If the power light isn’t on, check the power plug and the power cord. Is the plug snug in the back of the computer? Is the other end of the power cord plugged into a wall socket? Is the wall socket working? If any of these isn’t right, correct the problem and try again.

If your problem involves the display, the printer, or other I/O peripheral equipment connected to your Apple by cable, make sure the power to the system is off, disconnect the power plug from the computer, and then reseat all the connector cables associated with the failure. Cables have a habit of working loose if they aren’t clamped down. Once you’ve checked the cable connections, reconnect the power plug, power up, and retry.

If a disk didn’t boot (get read in and acted on by the disk drive), try the disk in another Apple II Plus or IIe computer. Or, try booting a copy of another program disk. I like to use a copy of the System Master since I can always recopy again on the same disk if the data stored on it is changed or erased.

If it still won’t work and you have a second disk drive, reconfigure your system so the second drive is now Drive 1 (connect the second drive’s ribbon cable to the “Drive 1” output of the controller card that connects your disk drives to the Apple through the interface slot — slot 6, inside). Try to boot the disk again. Try to boot up another program disk copy. These are two ways to isolate a boot problem to software or a drive.

5. **Write.** Document all that you see and sense. Write down all the conditions that you observed at the time of failure. Write down what conditions exist now that failure has occurred.

What is it not doing?

What is being displayed?

What is still operating?

Is power still indicated on each part of the system?

6. **Assume one problem.** In digital circuitry, the likelihood of multiple simultaneous failures is low. Usually, a single chip malfunctions, causing one or more symptoms.

7. **Diagnose to section.** Analyze and decide what section or division of the machine failed. Is it the display, the input or output, the keyboard, or the memory? You can troubleshoot to a failed section by knowing how your Apple operates and what the component parts do, inspecting inside and out, and observing symptoms.

8. **Consult the symptom index.** Chapters 4 and 7 include indexes of the most common troubles with the Apple II Plus and IIe, respectively. If the symptoms that you see match a problem described in the “Troubleshooting Index,” turn to the referenced page and follow the instructions under “Troubleshooting Procedure.”

CAUTION: Any time you open the top of the computer, ensure the power is off, and touch the top of the power supply case to ground any stray static electricity.

9. **Localize to a stage.** Turn off the power to the Apple (the power light on the keyboard should be off). Open the top of the computer, touch the case of the power supply, and then remove the power cord plug from the back of your computer. This procedure guarantees that the power is off. Disconnect all the equipment (peripheral hardware) connected to your Apple, including the disk controller card and the disk drive by removing the peripheral cards (boards). Reconnect the monitor to the computer and power up both the computer and the monitor. Press RESET. You will hear a speaker “beep” and see an “Apple II” screen message.

If the beep and message display do not occur, refer to symptom “Won’t boot, Power light on, Drive doesn’t

whir” in Chapter 4 or 7 on “Specific Troubleshooting and Repair.”

If you did hear the beep and see the display, turn off the power (remember to open the lid, touch the power supply case, and then pull the power cord plug out of the back of the power supply) and reconnect the disk controller card and disk drive to the Apple.

Try booting a *copy* of the System Master disk. If this action is unsuccessful, refer to “Troubleshooting Index” symptom “System won’t boot – power light on, beeps, screen displays ‘Apple][,’ drive keeps running.”

CAUTION: Beware of static electricity. Always ground yourself by touching the power supply case before touching anything inside the Apple case.

If the boot action is good, turn off the power, open the lid, touch the power supply case, pull the power plug out from the back socket, and reinstall the peripheral cards (boards) one at a time. Each time you reinstall a board, plug in the power cord, put on the lid, and turn on the computer, booting up the same disk. Power down after each successful test and reinsert and test each board until the system fails. You then know that the last board installed is bad. If no boards are found to cause the failure, you probably had some corrosion on a board’s connector pins and just pulling out and reinserting the board cleaned the contacts enough to restore operation.

However, if the system is still inoperative with all the boards removed, move on to the next step.

10. Isolate to failed part. Following the procedures in Chapter 4 or 7 on “Specific Troubleshooting and Repair,” substitute chips known to be good, one at a time. After each substitution, reassemble the system enough to power up and test the repair. This process is very likely to locate the trouble.

Many things get in the way of proper system operation. Chips have a tendency to work themselves out of their sockets under normal operation. A loose chip could be your whole problem. “Loose chips sink MIPS” (MIPS stands for millions of instructions per second – a measure of computer capability).

Chip replacement may look easy, but there are some pitfalls you should be aware of. Those fragile pins on your chips bend easily, and it doesn’t take very many straightening actions to break a pin completely off.

Sometimes a problem is caused by noise. Not audible noise, but electrical noise, the kind that produces “static” on your radio. This noise also affects computers. Noise in the computer system can cause data to be lost or wrong data to be stored or displayed.

NOTE: To avoid noise problems, keep cables clear and away from power cords, especially coiled power cords.

And it’s appropriate to add, don’t try out your new drill set next to your computer while computing the effects of your recent pay raise. Your calculations might prove unbelievable.

Sooner or later you’re going to be confronted with those once-in-a-while failures called “intermittents.” These can be really frustrating.

Unlike a hard (constant) failure, an intermittent problem shows up randomly, or only at certain times (usually when you expect it least). Intermittent failures are difficult to handle using standard troubleshooting methods.

Since intermittent failures can be caused by shock, vibration, or temperature change, these conditions can be used to find and correct them. Here are some helpful hints regarding intermittent failures:

CAUTION: The following steps are conducted with the cover lid removed and with the computer operating. Be careful not to short out any connectors or pin leads. Use only a nonmetallic or wood object to probe components inside an energized Apple computer.

- a. Check, clean, and reseal all connector boards and cable plugs.
- b. Tap gently at specific components on the suspected board using a nonmetallic rod or screwdriver.
- c. Heat the suspected area with an infrared lamp or hair dryer. Don’t overheat it.
- d. Spray canned coolant on a suspect component. A component that fails intermittently can sometimes be found with this technique used by service technicians. Several companies sell pressurized cans of coolant spray that have long plastic extender nozzles for pinpoint application on top of a suspect chip. By cooling the device, turning on the computer, and operating the system, you can identify chips on the verge of total failure. The system works for a few moments until the chip heats back up and starts causing problems again.
- e. After you’ve found the area where the problem is located, use a strong light and a magnifying glass to look for small cracks in the wiring or solder connections.

If the problem is a marginal chip, replace the pesky rascal. Be sure your replacement chip is of the same logic family as the original (i.e., replace 74LS74 with another 74LS74).

A large section of Chapter 8 is devoted to identifying and solving the intermittent problem. For now, let's say that good cleaning, pin and board reseating, and inside-the-case temperature control will prevent the occurrence of most random failures.

The final method for fault isolation to a component is signal tracing. This technique will be covered in the advanced troubleshooting chapter.

11. **Repair.** A disassembly and reassembly guide is located in the Appendix.

It takes a little practice before you can remove a chip without it jumping out of the socket, flipping in midair, and sticking you right in the thumb or index finger with that double row of toothlike pins. Fortunately there are several devices that make the job much easier. These are the tiny screwdriver, or "tweaker," and the IC extractor tool. Fig. 1-13 shows how each tool can aid in removing stubborn chips from their sockets.

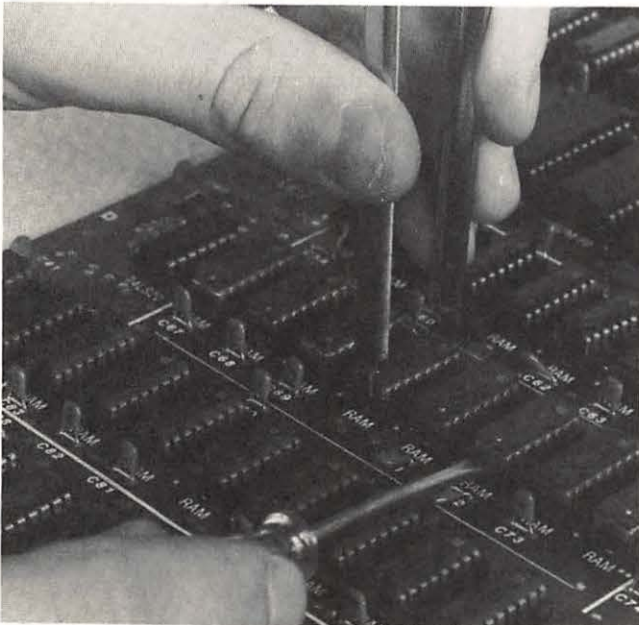

Fig. 1-13. Removing chips from your Apple II motherboard.

Getting the chip out is only part of the repair challenge. Now you have to put the new chip in the socket. Here's how to do it:

- a. Line up the pin-1 end (with the notch or dot)

with pin 1 on the socket. (Notice how all the other chips around this socket are mounted.)

- b. Place the chip over the socket, lining up one row of pins with its socket holes, as shown in Fig. 1-14.

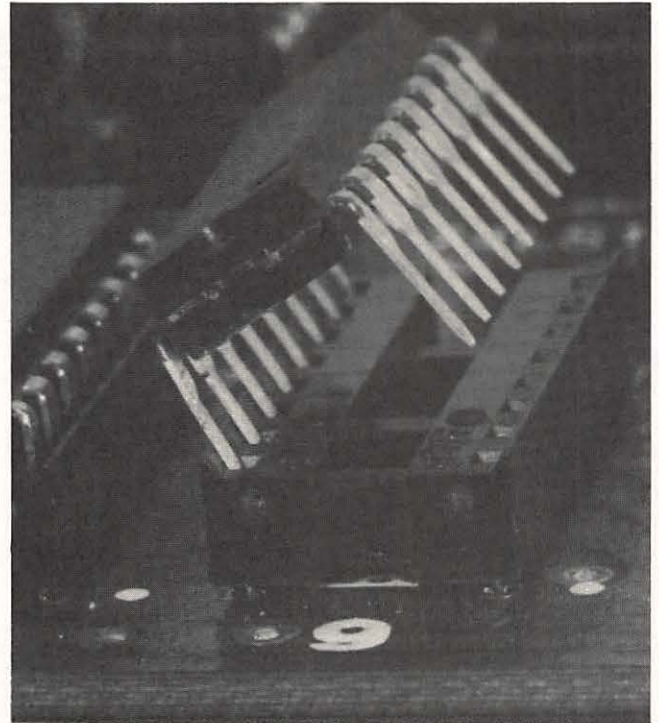

Fig. 1-14. Place the chip over the socket as shown.

- c. With the chip at a slight angle, press down gently, causing the row of pins in contact with the socket to bend slightly, which lets the other row of pins slip easily into their sockets, as shown in Fig. 1-15.
- d. Press the top of the chip down firmly to seat the chip completely into the socket. **Be careful not to flex the board too much.** If necessary, support the motherboard with the fingers of your other hand as you press the chip into place.

Now, that wasn't too bad was it? Well, there is something else. It is pretty easy to made mistakes in chip replacement. Here's where Murphy is hiding:

- Make sure you don't put the chip in backwards. The notch or dot marking the pin-1 end of the chip is intended to help you correctly line up pin 1 on the chip with pin 1 on the socket.

- Don't offset the chip over the socket by one pin as shown in Fig. 1-16.
- Don't force the chip down so one of the pins actually hangs out over the socket or is bent up under the chip.

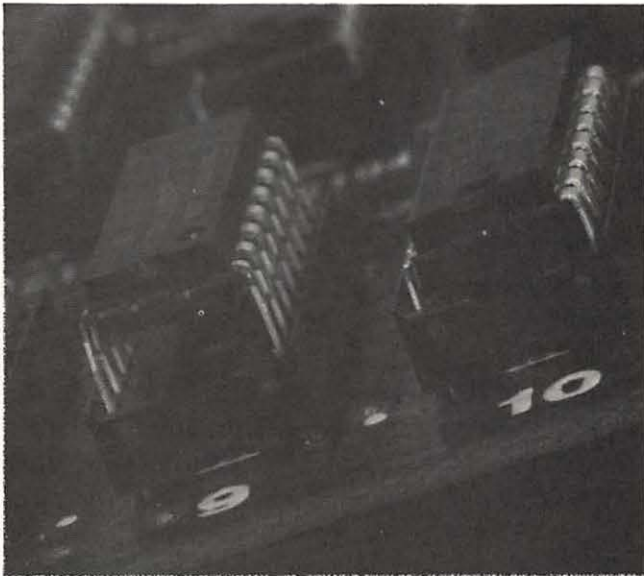

Fig. 1-15. Once each row of pins has been started into the socket, you can press down gently to complete the chip insertion.

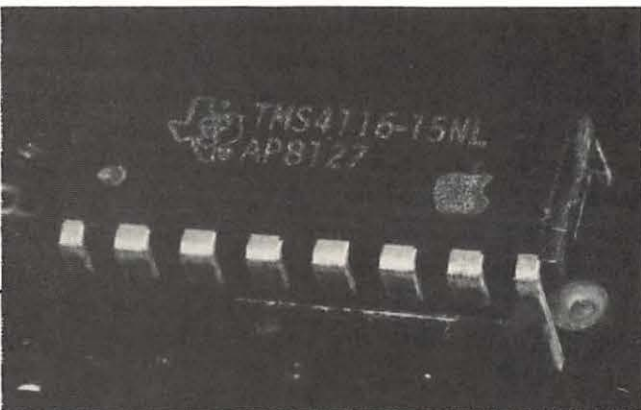

Fig. 1-16. Be careful you don't offset the chip by one pin.

12. **Test and verify.** This is an important step. We need to know that all is now well with the system. After booting up and testing, using a copy of your System Master disk, run the same program that was in the machine at the time of failure.

NOTE: It's a good idea to log the repair action in a record book to develop a history of the maintenance

conducted on the machine. Sample record sheets are included at the back of this book.

If these troubleshooting steps still don't help you find the failed component, you have two choices: either take the machine to a service repair center; or break out (or borrow) some test equipment, open the schematics, and start hunting for the failed or malfunctioning stage. Try signal tracing with a logic probe and a logic clip. Use an oscilloscope and a digital voltmeter (DVM) to test the discrete components such as transistors, capacitors, and resistors. Connect a logic analyzer or signature analyzer to the system and step through the circuitry. Make voltage and resistance tests to locate the bad part. Test hardware and advanced troubleshooting methods are discussed in Chapter 9.

IF YOU MUST USE A SERVICE CENTER

Before you disassemble your system and take it down to the repair shop (if that's your alternative), there are some things that you can do to minimize your expense. Before you call for help, step through the following list:

Repair Service Checklist

1. What is affected?
2. Is the problem in software?
3. Was it caused by operator error?
4. Is it an intermittent failure?
5. Describe the problem in writing.
6. Ask for recommendations.
7. Log the serial numbers of your system components.
8. Request an estimate.
9. Ask for a repair listing.
10. Is the repair covered by warranty?
11. Test the system before accepting the repair.

This checklist is a handy guide and should be used both before and after the service center repair. Each step is expanded here for clarity.

1. Find out if the problem is "catastrophic" and affects the operation of everything. If it affects only a part of the system (such as a disk drive),

you may be able to take just the drive in for service center repair.

2. Be certain the problem isn't in the software. Try to run a program that you know is good.
3. Be certain the problem wasn't caused by operator error. Try a different operation that uses the same hardware or function.
4. If your problem is intermittent, and you take it in for repair, it could take quite a while (at quite a fee) for the problem to occur, be found, and be fixed. You may just want to live with the problem until the intermittent becomes permanent (a hard failure). At least then you will have something concrete to troubleshoot. Intermittents are discussed further in Chapter 8, "Routine Preventive Maintenance."
5. Write down a complete description of the problem.
 - What was the system doing at the time of failure?
 - What were you doing at the time of failure?
 - What is the system doing now?
 - What isn't it doing now?
6. Call your local users group and ask for recommendations of some good, reasonable service centers.
7. Jot down the serial numbers of all the peripherals and boards you'll be turning over for repair.
8. Request an estimate of time and charges.
9. Ask to have a detailed listing of what was repaired or replaced including a breakout of charges.
10. Make sure the work and parts are warranted for at least 90 days.
11. Test run the system before taking it out of the shop.

SAFETY PRECAUTIONS DURING TROUBLESHOOTING AND REPAIR

As with all devices that use or operate on electrical power, you must observe certain precautions to prevent damage to yourself or your Apple system.

Recommended Safety Precautions

- Keep out of the display chassis.
- Stay out of the power supply.
- Turn the power off, open the lid, touch the power supply, and pull the plug.
- Handle diskettes carefully.
- Don't cycle the power quickly.
- Use a power strip to apply power to all components at once (except for hard disk drives).
- Keep liquids away from the computer.
- Handle components with care.

Observing these precautions can save you time, money, and frustration. Each point is expanded here for your benefit.

Keep out of the display monitor chassis. The voltages inside your monitor or television are dangerous, and only trained technicians should ever open a display unit for repair. Voltages as high as 25,000 volts hide in there, so stay out!

Don't open up your Apple power supply. These circuits convert the 115-volt line power in your home or office to the 5-12 volts used by the motherboard. That 115-volt electricity can be lethal! This manual does not discuss power supply troubleshooting and repair other than whole (unopened) supply replacement.

Always turn the power off, open the lid, touch the power supply case, and then pull out the power cord before touching anything inside. Many failures are caused by people who don't follow this rule.

Handle your diskettes carefully. Don't write on a label once it is attached to the disk jacket. Don't lay disks on a dusty, dirty surface. Keep cigarette ash away from your disks and your computer system. Don't touch the disk surface. Don't try to see how flexible a floppy disk is. Don't set your disks on or in front of a TV or color monitor.

Don't cycle the power on and off quickly. Wait 7 to 10 seconds to let the capacitors discharge fully and the circuits to return to a stable (quiescent) condition.

Use a power strip. This saves wear and tear on the Apple ON/OFF switch. Most power strips also have a built-in overload protection for voltage spikes. Voltage spikes can harm your computer system.

Keep liquids away from the keyboard. I once had the opportunity to help a friend who's son had spilled a soda on the keyboard. It's amazing how sticky soda becomes after frying components all over the inside of the computer.

Handle components with care. Don't let chips lie around; the pins will get bent. Watch out for static electricity — chips may need “special handling.”

SPECIAL HANDLING

Some logic devices require extra care when you touch or handle them. With TTL (74xxxx series) chips you have no problem removing or inserting these devices. But the metal oxide semiconductor (MOS) chip family (MOS, CMOS, NMOS, etc.) need some extra care since these chips are more susceptible to static electricity than TTL chips. There are some 74HCxx chips being sold today that are CMOS, but these aren't currently used in the Apple computer.

Don't be afraid to touch the chips in your computer. Most guides for handling MOS chips lean far toward the supersafe zone and sometimes cause more problems than they prevent. These chips can be damaged by the static charge you can build up by scuffing your feet across a carpet; so be sure to ground yourself by touching the power supply case before you reach for a chip inside the Apple chassis. In addition, conductive foam is available for storing or transporting MOS-type chips. This foam prevents static electrical charge from getting into the chip.

The MOS chips in your Apple II Plus are:

- The 6502 CPU.
- The ROM chips.

In your Apple IIe there are also some MOS-type chips:

- The 6502 CPU.
- The ROM chips.
- The MMU chip.
- The IOU chip.

Additional precautions should be observed when you use test equipment with your Apple computer. These will be covered in Chapter 9, “Advanced Troubleshooting.”

REPAIR PARTS

Finding that a trouble really exists is only part of the problem. You must locate the specific chip (if the

software doesn't) and then make the repair. This too, can be somewhat challenging. But Apple provides a telephone number you can call to order parts directly:

Apple End User Support Center Numbers

Area 1 (408) 745-6731:

Alaska	Northern Nevada
Arizona	Oregon
Colorado	Utah
Idaho	Washington
Montana	Western Nebraska
New Mexico	Western Texas
Northern California	Wyoming

Area 2 (714) 549-4229:

Hawaii	Southern Nevada
Southern California	

Area 3 (214) 245-0228:

Arkansas	Missouri
Eastern Nebraska	Oklahoma
Iowa	Southern Illinois
Kansas	Texas
Louisiana	

Area 4 (617) 481-8101:

Connecticut	New Hampshire
Delaware	New Jersey
Eastern Pennsylvania	New York
Maine	Rhode Island
Massachusetts	Vermont

Area 5 (704) 527-6170:

Alabama	Mississippi
District of Columbia	North Carolina
Florida	South Carolina
Georgia	Tennessee
Maryland	Virginia

Area 6 (312) 577-4102:

Indiana	Ohio
Kentucky	South Dakota
Michigan	Western Pennsylvania
Minnesota	West Virginia
North Dakota	Wisconsin
Northern Illinois	

There are other sources for Apple repair parts. Your local Radio Shack store carries most of the 7400 series chips. In fact, just about any electronic parts store will have a supply of 7400 series chips. You can make a list of the spare parts you'd like to have on hand from the listing in the Appendix.

The custom Apple chips — ROM, MMU, IOU —

are proprietary to Apple and I recommend you buy *all* of these custom chips directly from Apple or from your local Apple repair center. Chips for my Apple II motherboard are generally easy to locate and are also inexpensive.

The trade magazines sometimes advertise inexpensive packages of Apple II repair parts. As the Appendix indicates, some Apple IIe chips can be replaced only by a board swap-out, or board exchange. The exchange price may seem high, but you do get a new board, and

the kind of failure that necessitates this action does not occur very often. In fact, it occurs very infrequently.

So there you have it. In this introductory chapter on troubleshooting, you've learned the troubleshooting steps to success, how to recognize the components inside the Apple, how components, disks and displays fail, and various methods for finding failures in your computer system. The next chapter reviews the Apple II Plus and moves on toward the Apple-specific troubleshooting and repair that is the primary focus of this repair manual.

The Apple II Plus Described

Chapter 1 explored the basics of troubleshooting, and you learned how you can quickly locate and repair computer failures. Chapter 2 focuses on the Apple II Plus computer. This chapter is primarily for the novice; most new expressions are explained in easy-to-understand terms. Examples reinforce key points. Experienced users will find this chapter a helpful review, and Chapter 3, “Apple II Plus Operations,” will probably be new material for everyone.

OVERVIEW

One of the most popular microcomputers sold, the Apple II was born in the days of electronic kits, when microcomputers were the toys and tools of the technicians and hobbyists who were comfortable handling electronic components and building computer projects. In this 1977 environment, the newly introduced Apple Computer with its compact construction, superior graphics, sound, easy set-up, and extensive expandability gained instant recognition as the “Cadillac” of personal computers. Over a million Apple IIs have been sold and several major revisions have occurred since its introduction.

Its modular construction gives easy access to the circuitry — the top of the computer pops off inviting a

look inside. (This presents a temptation to touch the inside of the machine even when power is applied.)

While most computer manufacturers build their machines so that their own upgrade hardware can be added on, Apple designed-in eight expansion slots with so much flexibility that several hundred companies were created, successfully building and selling custom interfaces or peripherals for the Apple II. There are over 30,000 software programs for this machine, and more appear on the market each month. In fact, Apple Computer sells a prototype card that allows you to design your own custom computer interfaces.

The first Apple IIs came with Integer BASIC in permanent memory (ROM), but this meant only whole numbers could be used to write programs, which limited their usefulness, especially for doing division problems. So the Apple company cleverly changed the built-in language to a version of Microsoft BASIC called Applesoft BASIC, that works with integers *and* fractions (the “real numbers”). This change created the Apple II Plus, as described in Fig. 2-1.

The appearance of the Apple II Plus system, shown in Fig. 2-2, with its sleek lines, clean, creamy white case, and multicolored apple with the bite mark, is the trademark of a company that has made history in the micro-computer revolution.

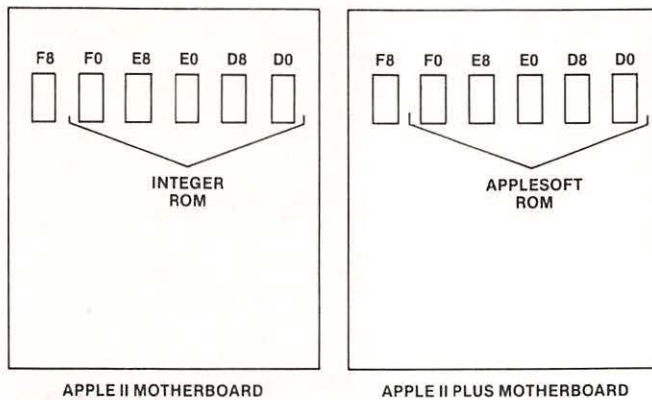

Fig. 2-1. Changing the ROM created the Apple II Plus.

Your Apple II was designed for flexibility, so the many different kinds of input and output devices available — display screens, mass storage devices, and printers, for example — easily attach to it.



Fig 2-2. The Apple II Plus.
(Courtesy of Apple Computer, Inc.)

STRUCTURE

The Apple II Plus is really a single-board computer in a molded case, or chassis. It weighs just 11 pounds, and uses less power to operate than a 100-watt light bulb. (A hair dryer uses 1,200 watts!)

Your Apple has a typewriter-style keyboard mounted in the case, with a space bar and 52 keys that can

generate 91 characters, including uppercase letters, numerals, punctuation marks, and other symbols. You can get about 15 more characters by doing certain things to the system. Pressing a key generates an uppercase character on the screen. Some keys can produce several characters — one character by pressing the key alone and another character by pressing SHIFT along with the key. A lot of us like to write, program, or even play games using both uppercase and lowercase letters, so add-on interface boards were designed to give the computer the ability to generate both types of characters. Some companies are selling these uppercase and lowercase peripherals, which have the ability to display 80 characters to the screen line.

Fig. 2-3 shows the connections at the back of your Apple II Plus computer.

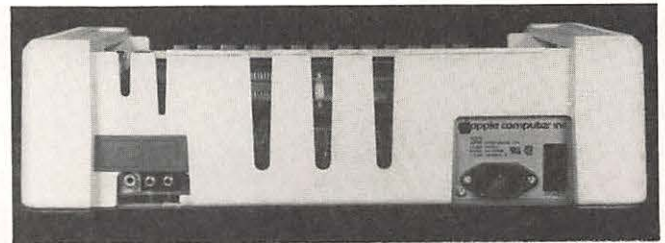

Fig. 2-3. The connections at the rear of the Apple II Plus computer.

Moving from left to right, notice the Video Output connection, the Cassette Output, the Cassette Input, and on the far right, the 115-volt Power-In plug connection.

With the power plug pulled out of the wall, grasp the back of the Apple II cover with both hands and pop off the top of the computer. Look inside and compare what you see with Fig. 2-4.

That big, flat, green thing with all those tiny components is the main part of the Apple. It's called a "printed circuit board," "main board," or "motherboard." Mounted on this board are tiny, black integrated circuits or chips that make up the most important parts of the machine, the Central Processing Unit (CPU), also known as the microprocessor or simply processor, with its memory and a host of other chips that assist the CPU in moving information around, in and out of the motherboard.

Looking at the motherboard from the keyboard end toward the back, you'll see eight connector slots. These slots are where you plug in those peripheral cards that increase the capability of your computer system. Over on the far left is slot 0. This is where the expanded

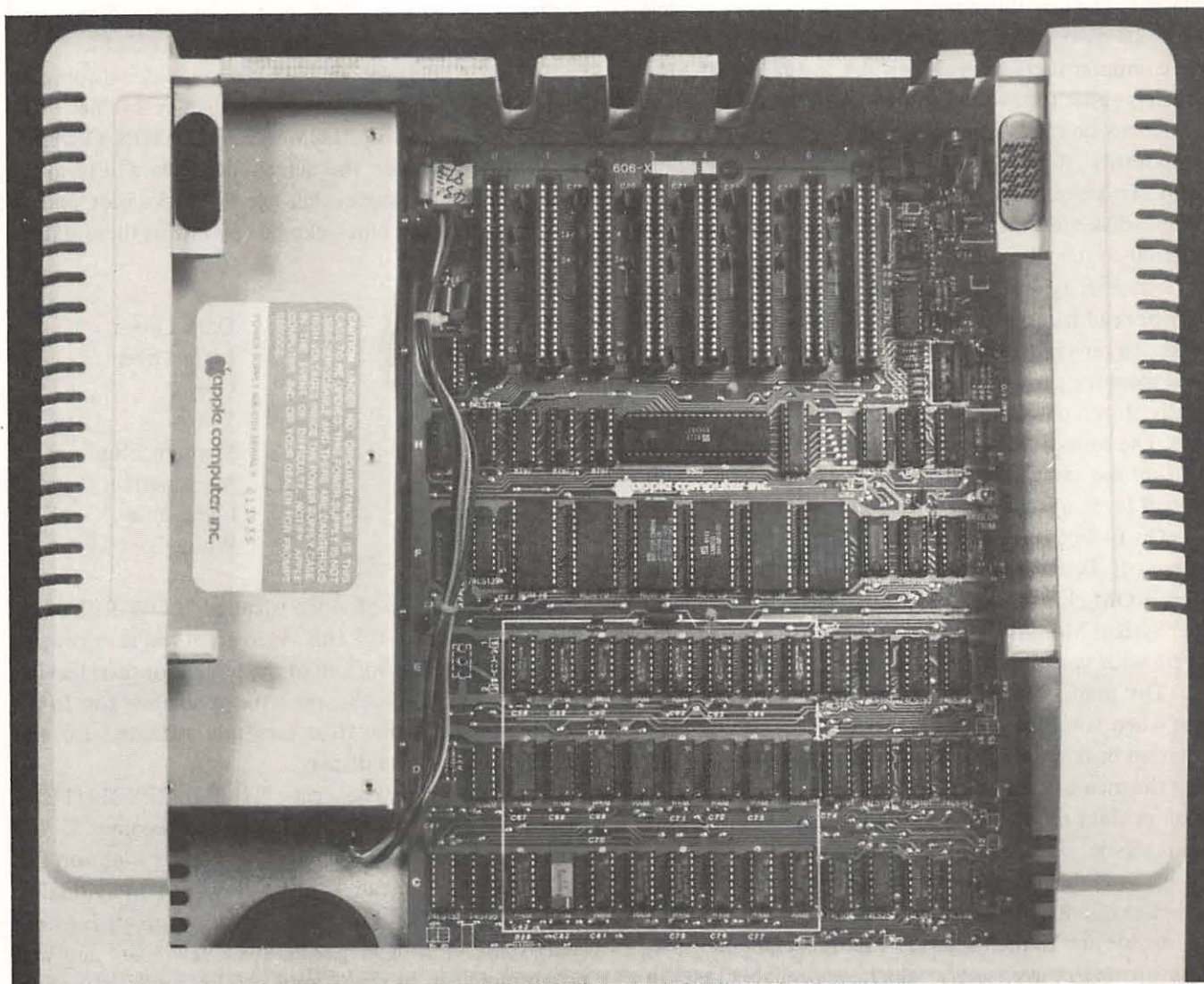

Fig. 2-4. Looking down inside the Apple II Plus computer.

memory (language or RAM) card goes. It can increase the on-line Random Access Memory (RAM) from 48K (approximately 48 thousand characters) to 64K or higher. Some companies sell 256K boards that plug in here. Printers usually connect with a cable to a card in slot 1. Slot 6 is where you plug in your Disk Controller card. Actually, the Disk Controller card can be plugged in any slot except slot 0. Each Disk Controller card can handle two disk drives, and more controller cards can be installed. In fact, up to 14 disk drives can be connected to your Apple II Plus at any one time. The rest of the slots (other than slot 0 and slot 6) can be used to connect many other devices to your computer, including modems, voice recognition and voice generation boards, big fancy displays, and even additional printers. I have

both a dot matrix printer and a daisy wheel printer connected to my Apple II Plus.

There are five sizes of chips on the motherboard — 8-pin, 14-pin, 16-pin, 24-pin, and the 40-pin 6502 CPU. That big chip sitting horizontal on the board is the brain of the Apple II — the central processing unit. The CPU in your Apple is called a 6502. (Some of the CPUs used in other computers are the 8080, Z80, and 6800.) Everything that happens inside the computer does so under the control of the CPU chip.

Looking below the 6502, you'll see a neat array of 24 chips in three rows of eight, marked off with a white line. These are the random access memory (RAM) chips. They provide 48K of on-board memory. The "K" stands for the number 1024. The number of K in RAM

relates to the way the computer handles binary numbers (base 2). Two raised to the sixteenth power is 65,536. We computer users call this 64K ($64 \times 1024 = 65,536$), which is easier to say than 65,536. RAM memory can be written to or read from. RAM is where programs are temporarily stored when you're writing or running them. To store information for a long time, you'll use floppy diskettes, hard disks, or audio cassette tapes external to the computer.

Another type of memory on the motherboard can only be read from. Just above the RAM you'll see a row of six larger chips called Read Only Memory (ROM). This memory can only be read. Information is permanently stored or written in these chips during manufacture. The chips hold programs that make your computer start-up the same way each time you switch the power on and let you write your own software code.

On five of these ROM chips, Apple has stored the Applesoft BASIC language program. Stored on the other ROM chip is a machine language program called the "System Monitor" that lets you control and communicate with your machine from the keyboard.

The main difference between RAM and ROM is that when you turn off the power to the computer, the program or data in RAM disappears (the power voltage kept the memory active). That's why you store your program or data on a disk or cassette before you turn off the machine. The programs in ROM are always there, always available when your Apple is on. You can't erase or write over ROM programs as you can over RAM.

Inside and to the far left is a shiny rectangular box, the *switching power supply*, which very reliably takes in electrical power from the cord you plugged into the wall socket and converts it to the four different voltages necessary to make your computer system function properly. The electrical cord plugs into the back of this power supply just to the left of the power ON/OFF rocker switch.

The Apple generates video signals and makes them available at several places on the motherboard — at a connector on the rear and at a pin on the main printed circuit board inside. These video signals cause text on the display to be 40 columns wide and 24 lines high.

Probably you will use a computer monitor connected to what engineers call an RCA jack (the video connection) on the rear of the Apple II Plus for video display. If you want to use your television as a display device, you'll need to add an RF (radio frequency) modulator to the computer. It will convert the video signal produced by the computer to a signal the television can "understand" and use. The monitor or television can be

either a color or a black and white unit. Green and amber monochrome monitors are also available.

Your Apple produces five types of video display. In the "TEXT" mode the screen can display 24 lines of 40 characters across. In "LOW RESOLUTION GRAPHICS" (lo res) mode the screen becomes a display of small, bright rectangles that are 40 blocks wide and 48 blocks high. Each block can be any one of these sixteen colors:

Black	Dark Green
Brown	Light Green
Magenta	Grey 2
Orange	Yellow
Dark Blue	Medium Blue
Grey 1	Aquamarine
Purple	Light Blue
Pink	White

The third type of video is called "LOW RESOLUTION WITH TEXT." This video gives you four rows (8 blocks high) at the bottom of the screen for text, leaving 40 rows by 40 blocks per row available for lo-res graphics. The same 16 colors are available for the graphics part of the display.

Fourth, you can get "HIGH RESOLUTION GRAPHICS" (hi res) where the screen becomes 53,760 dots or pixels (picture elements), 280 pixels wide and 192 pixels high. You can control each dot individually, making it bright or dark. That fancy picture of Einstein that Apple used in magazine ads a few years ago was programmed in hi res Graphics. This mode is used in many graphic adventure games. In hi res you can display only six colors:

Black	Green
White	Red
Violet	Blue

The last form of video is a modification of hi res called "HIGH RESOLUTION WITH TEXT." In this video mode, the bottom of the display screen becomes a four-line text window just as it does in LO RES WITH TEXT. The same six hi-res "colors" are available for HI RES GRAPHICS WITH TEXT.

Under the chassis top and close to the keyboard is a small (2-inch) 8-ohm speaker which you can use to make all sorts of sounds, including the familiar beep, arcade sounds, music, and even crude speech.

Also located on the motherboard and near the right rear is a socket called the *Game I/O* (for input/output)

Connector. This socket is a unique window to the computer. Out of this socket the computer sends voltage levels, or signals, which are generated by programs. This means a program can address a certain memory location and affect the voltage (or logic) level at one of these output-socket pins. On another output pin you can cause a short (one-half microsecond) strobe pulse to occur under software control.

A total of seven INPUTS to the Apple are on your Game I/O Connector. Three of these inputs are called flags and can be read by a program. Usually these are connected to push-button inputs for games. For example, when you depress the push button on your game paddle or joystick, you are sending a logic level signal or voltage into your Apple II through the Game I/O socket pin called PB0. There are also four voltage inputs which can vary between 0 and +5 volts. These are called analog or paddle inputs. The rotary knob on each of your game paddles connects to one of these inputs through a variable resistor (attached to the knob).

Besides game paddles and joysticks, a keypad or other custom devices can be attached to your computer through the Game I/O Connector. The Game I/O Connector can be used for computer control and monitoring of laboratory experiments, for example, or to control your landscape watering.

At the back of the computer are two connections for a cassette interface. When the first Apple was built, disk drives were very expensive, so a decision was made to give the first Apple users the ability to use standard audio cassette recorders as mass storage devices.

Using cassette tapes provides cheap mass storage, but saving or loading these programs with them is painfully slow and frustrating. The Apple II can be sensitive to the volume control setting on the cassette player, and using the tape requires close attention to the tape counter to locate the beginning and end of files quickly. Most users who started out with these recorders soon shifted to a floppy disk drive storage device for the speed, reliability, and simplicity of operation, and because most of the programs that we wanted to buy were sold on floppy disks.

One reason you might want to consider using a cassette as a mass storage medium is for archive, or backup, storage. Many more files or pages of information can be stored on a good audio cassette tape than can be stored on a floppy disk. In fact, one type of archive

storage for hard disks is a cassette video tape, just like that used to tape your favorite TV shows. Corvus, a hard disk manufacturer, uses a system called the Mirror to backup hard disk files on video tape.

Fig. 2-5 shows the proper way to install an Apple II disk drive. Notice that the disk interface card (Controller Card) is plugged into slot 6.

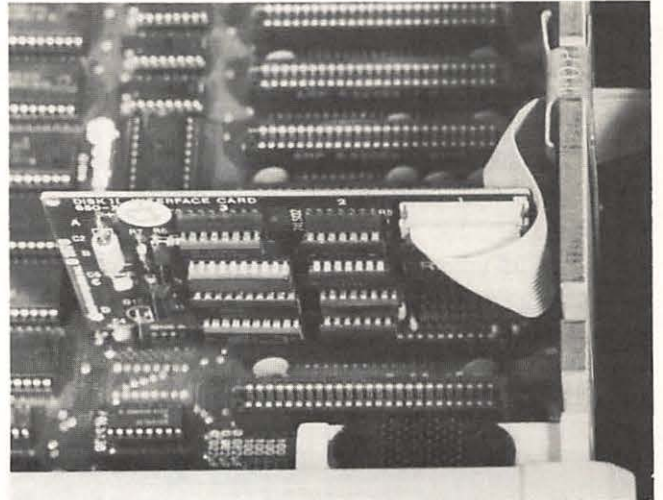

Fig. 2-5. Be sure power is off before installing your Disk Controller Card.

A disk drive lets you store and retrieve information on flexible magnetic disks called *minidiskettes* or *floppy disks*. Since disk drives are an important part of your Apple II system, we'll have lots to say about disk drives in Chapter 4, "Specific Troubleshooting and Repair," and in Chapter 8, "Routine Preventive Maintenance."

Proper connection of a monitor display unit is described in Fig. 2-6. While we won't cover internal repair of the monitor in this manual, you will be exposed to a number of easy-to-correct display problems.

A "basic" Apple II Plus system is shown in Fig. 2-7. Since it has a built-in speaker, this is the minimum configuration for the Apple II Plus. Without the display, or the keyboard, or a storage device such as the cassette recorder/player, your computer is so limited it can't really be called a system.

In Fig. 2-8, you see the "standard" Apple II Plus configuration. The cassette recorder/player has been replaced with a floppy disk drive, and a printer has been added to provide a "hard copy" output.

Small business users generally configure a system as shown in Fig. 2-9. The additional 16K Language or RAM card brings the total RAM to 64K (although only 60K is usable).

The 80-column card and the CP/M card let you use WordStar, a popular word processor program, and other useful 80 column software packages. The two disk drives let you use larger software programs that actually need more than one disk drive to run.

Flexibility is the key, as Fig. 2-10 shows. The Apple II Plus is known world-wide for its ability to have many interfaces.

This has been a quick overview of the Apple II Plus. Chapter 3 discusses how the computer works. If Chapter 3 gets too technical, don't worry, the troubleshooting and maintenance chapters can be used without really understanding how the machine operates. The technical detail is provided so it will be here when you're ready for it.

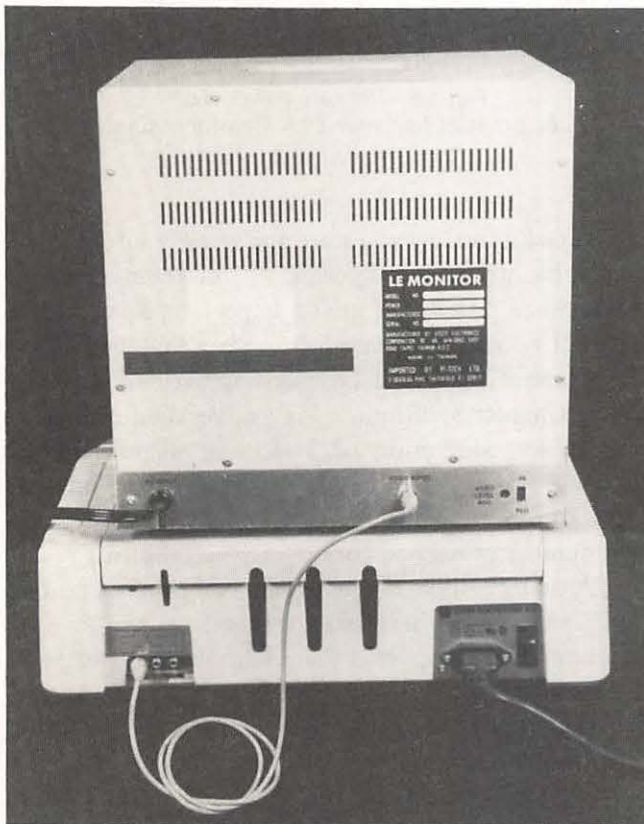

Fig. 2-6. Monitor display units are very easy to connect to your Apple II Plus.

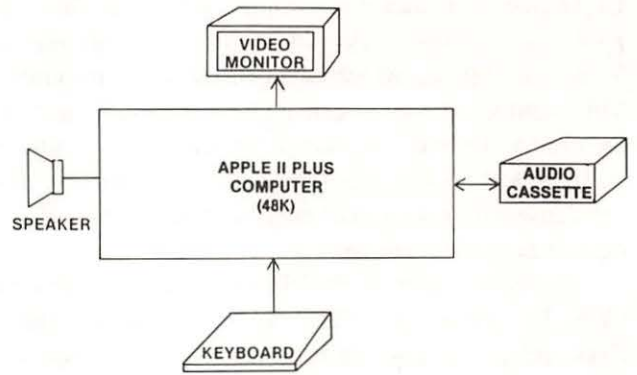

Fig. 2-7. The "basic" Apple II Plus system.

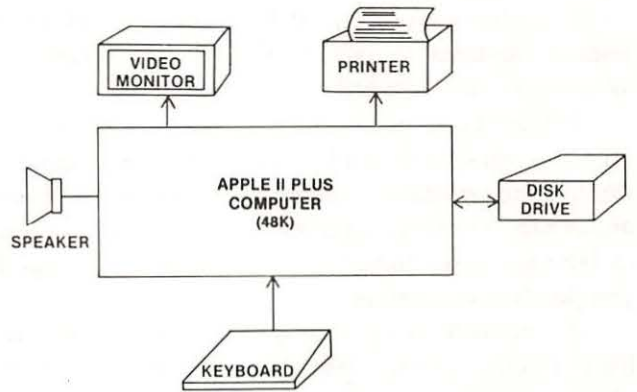

Fig. 2-8. The "standard" Apple II Plus system.

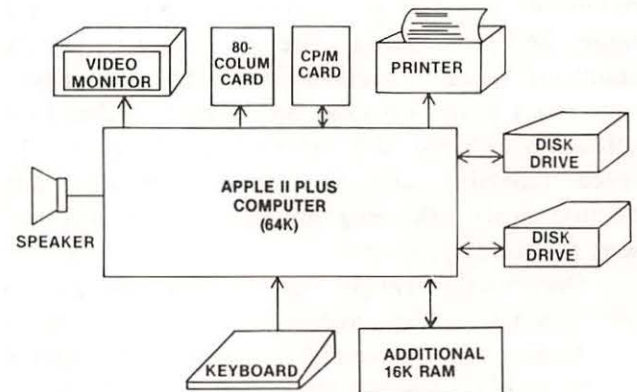

Fig. 2-9. A typical small business Apple II Plus system.

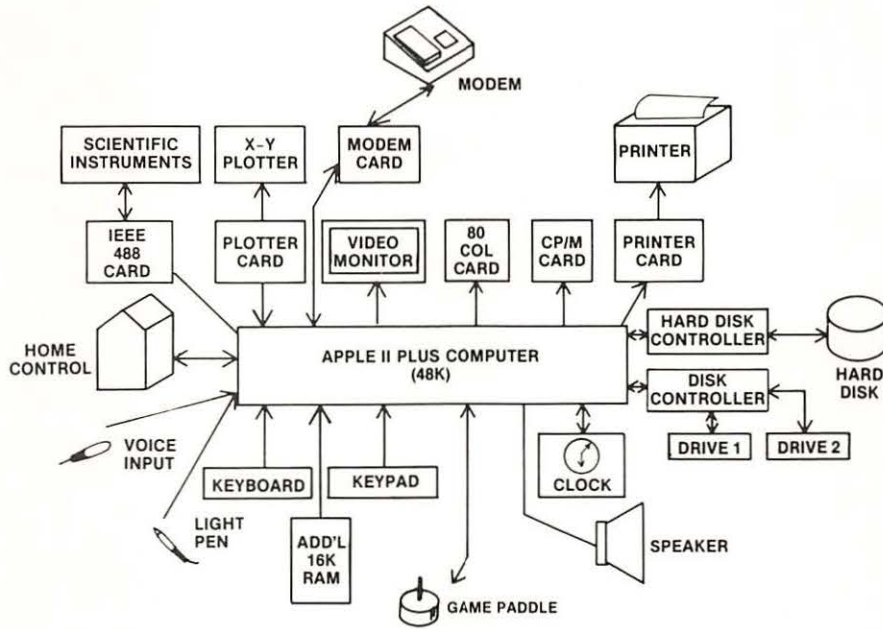

Fig. 2-10. The flexibility of your Apple II Plus computer.

Apple II Plus Operations

In Chapter 2, you read a descriptive overview of the Apple II Plus computer. Next we'll explore how your Apple works.

THE BASIC PARTS OF YOUR APPLE II PLUS

Whether it's a tiny single-chip microcomputer, an Apple II Plus, or a room-size mainframe, every computer has five basic parts:

- An arithmetic logic unit
- A memory unit
- An input unit
- An output unit
- A control unit

These parts are associated as shown in Fig. 3-1.

HOW EACH PART WORKS

Math and number crunching (arithmetic) occur in the **arithmetic logic unit (ALU)**. All the adding, sub-

tracting, multiplying, dividing, comparing, and so on goes on there.

The **memory unit** is used to store programs, calculations, and results. As shown in Fig. 3-2, this unit is composed of two types of memory – RAM (random access memory) which can be read from and written to, and ROM (read only memory) which can only be read from. RAM is sometimes called “main memory.”

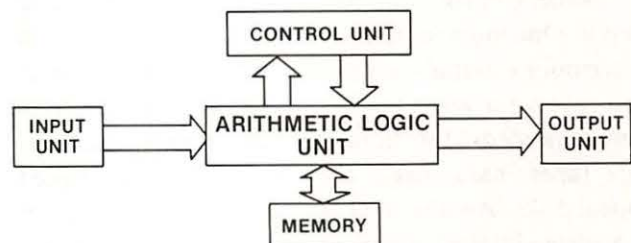

Fig. 3-1. The five basic parts of the Apple II Plus.

When you turn off power to your Apple II Plus, whatever you had stored in RAM is lost unless you saved it on a disk first. The program in ROM is placed there by Apple during manufacturing. Since the program (software) is in a device (hardware), we call this “firmware.”

The **input unit** lets you enter information into the computer. It is a way for you to “talk” to your Apple.

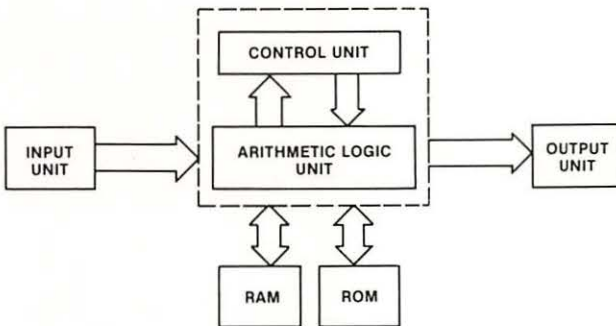

Fig. 3-2. The memory is composed of RAM and ROM.

This communication is called the “man-to-machine” interface. You can communicate with your computer through your keyboard, a light pen that reacts as you touch a spot on the screen, a special pen and a graphics tablet, an electronic mouse that moves your cursor about the screen as you roll the mouse on your desktop, or a voice recognition board and a microphone.

An **output unit** gets information from the computer to you. We call this the “machine-to-man” interface. It lets the Apple “talk” to you. A television or monitor screen is the most commonly used “machine-to-man” interface. You can also use a printer to produce *hard copy* (paper output). Other ways for your Apple to communicate include turning on motors and lights, making music and arcade sounds, and even “talking” in your own language through a speech synthesizer board and a speaker.

Some computer devices are for both input and output. One input/output (I/O) device includes a form of memory external to the computer — “mass storage.” You save your programs to mass storage and retrieve them as needed. Mass storage includes floppy disks, cassette tapes, hard disks, and the recently announced optical disks. Another I/O device is the modem (*modulator-demodulator*) which you use to send or receive information through your telephone line.

Input/output devices are called peripherals. They can be built into your computer, as your speaker is, or connected to your Apple II Plus through printed circuit cards called *interfaces* that plug into *slots* — those long sockets on your Apple motherboard.

Everything your Apple does is directed by the control unit. This unit interprets computer instructions and initiates the actions that cause the Apple II circuits to do certain tasks.

The control unit and the arithmetic logic unit are combined into a single chip called the *central processing*

unit, or CPU. As shown in Fig. 3-3, the CPU on your Apple II Plus motherboard is a 6502 microprocessor.

Your Apple’s 6502 CPU looks into memory, fetches an instruction from that location, interprets the instruction, performs the action the instruction requires (e.g., adding two numbers), and then moves on to process the next instruction. Unless the next instruction directs the 6502 to a particular memory location to carry out the instruction stored there, the CPU will move from one instruction to the next instruction in sequential memory locations (one step after the other). Perhaps the most important difference between your stepping through a program (sequence of instructions) and your Apple doing the stepping is that the Apple can handle about 500,000 of these steps each second.

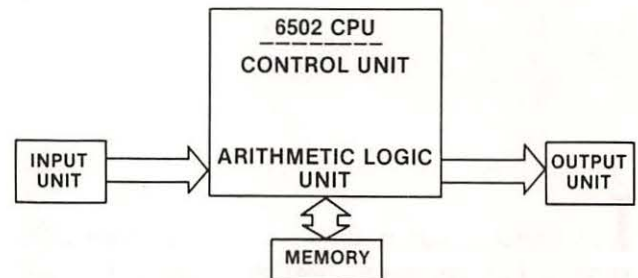

Fig. 3-3. The control unit and arithmetic logic unit are included as part of the 6502 central processing unit (CPU).

CHIP LOCATION SCHEME

When Apple designed the Apple II Plus motherboard, they took a number of steps to make the board easy to install and easy to troubleshoot. As shown in Fig. 3-4, Apple designers divided the board into an XY matrix where rows are marked off with letters from A to K, and columns are labelled from 1 to 14. This allows you to locate any component on the board by its row and column. Thus, the keyboard connector can be located at A7 (row A, column 7), the CPU can be found at K6-K9, and so on.

In the pages that follow, all motherboard chips being discussed will be identified by the chip type (e.g., 74LS74), name (e.g., D-Latch), and location (e.g., B10). A list of all the chips used in your Apple II Plus can be found in the Appendix.

MEMORY DESIGN

Your Apple II Plus comes with 48K of RAM memory. Since the 6502 CPU can address 65,536 loca-

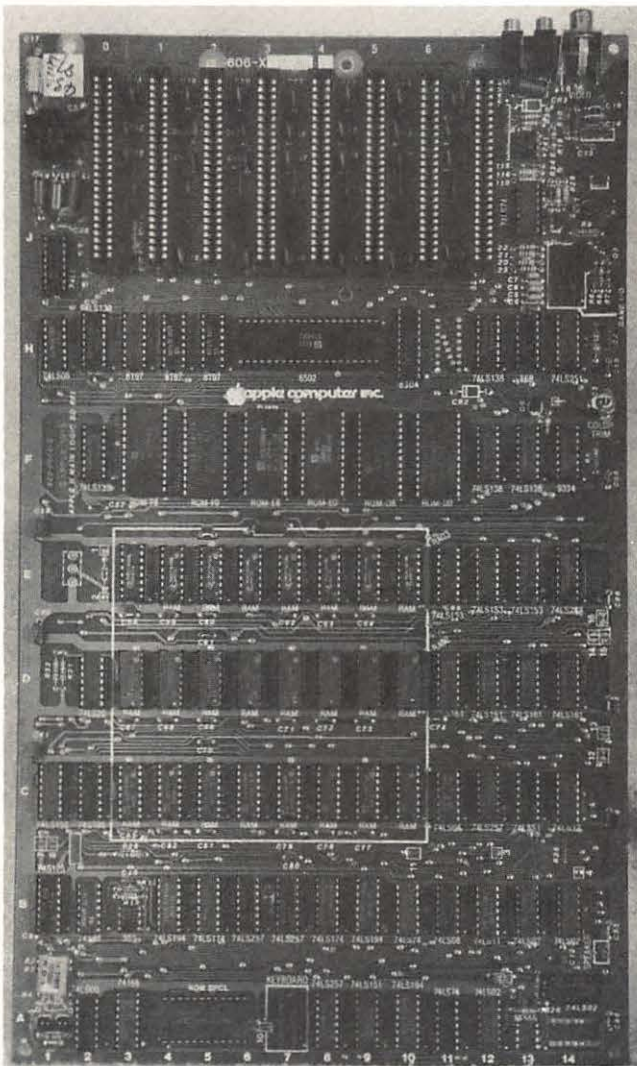

Fig. 3-4. The Apple II Plus motherboard, with location designations.

tions (64K), you've probably installed a Language card or RAM card in slot 0 to expand your system to a full 64K. Several companies sell interface boards that expand the addressable memory to 128K or more. A technique known as "memory management" is used to address more than 64K of RAM.

Your 64K address space is separated into areas for RAM, ROM, and the input/output. Input and output ports have unique memory addresses — that is, the I/O is *memory-mapped*. For example, to place a logic HIGH (+5 volts) on the line going to the speaker (causing it to click), you address location 49200 (\$C030 in hexadecimal). Addressing location 64477 (\$FBDD in hex) will cause the speaker to make a bell sound. The map of memory allocation for your computer is shown in Fig. 3-5. For convenience, a decimal to hexadecimal conversion table is included in the Appendix.

THE MEMORY MAP

FFFF	ROM (12K)		
D000			
CFFF	I/O ROM (2K)		
C800			
C7FF	I/O (2K)		
C000			
BFFF		(Free RAM)	BFFF 6000
		(Hi-Res Graphics)	5FFF 2000
		(Free RAM)	1FFF 0C00
		(Text & Lo Res Graphics)	0BFF
		(Text & Lo Res Graphics)	0800 07FF
		(Used by System)	0400 03FF
0000	RAM (48K)		0000

Fig. 3-5. The memory allocation map for the Apple II Plus.

The top 12K of memory (\$C800-\$FFFF) is reserved for system ROM with 2K of ROM and 2K of RAM just below it (\$C000-\$CFFF) reserved for I/O addressing. From hex address \$BFFF down to \$0000 is RAM memory space. Some of this memory is reserved for text, graphics, and system functions.

The ROM part of memory is further allocated as shown in Fig. 3-6. This figure shows the map current to newer Apple II Plus machines and does not reflect those machines that have Integer BASIC in ROM. For further information, I'd suggest you review page 72 of Apple's *The Dos Manual*.

ROM STORAGE

FFFF	(Autostart ROM)
F800	"
F7FF	(Applesoft BASIC)
	"
D000	"

Fig. 3-6. The allocation of ROM memory for the Apple II Plus.

To translate these addresses to physical ROM chips, the upper-left ROM chip is for the upper 2K of ROM memory (board location F3). The lowest ROM address (\$D000) then would be found on the rightmost ROM chip at motherboard location F11.

RAM USED DURING DOS BOOT

Every type of computer uses a unique software package to control the way it communicates with peripheral equipment and other software programs. This package is called an *operating system*. Some of the operating systems in use in microcomputers today are DOS, MS-DOS, TRS-DOS, RTX, CP/M, CP/M-86, etc.

On the Apple II Plus, your operating system is called DOS, for *disk operating system*. You load this control program into the Apple's RAM memory by *booting* the system up with a disk containing DOS. The DOS is loaded into several areas in RAM and eventually locates in the top 10.5K of memory.

Fig. 3-7 is a memory map of the areas of RAM that are overwritten during the boot process to load DOS.

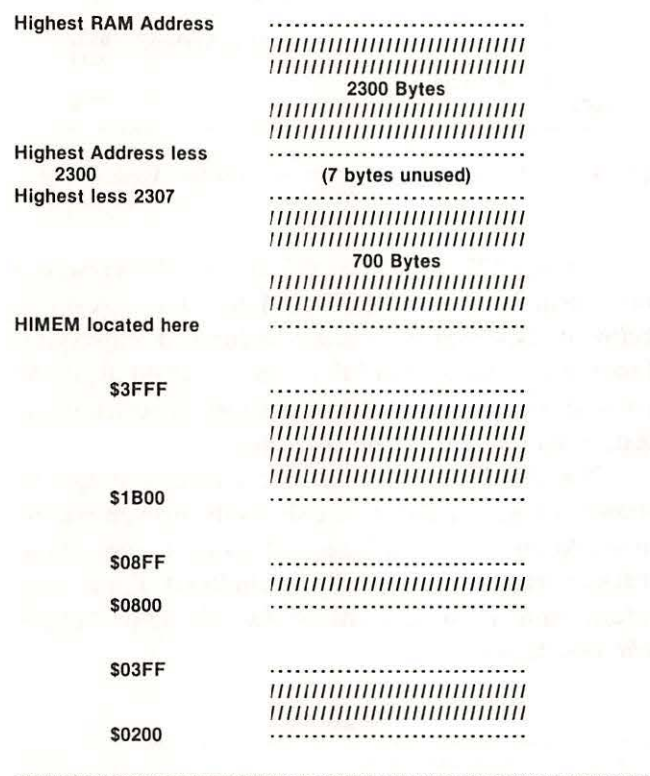

Fig. 3-7. The parts of RAM used when DOS is loaded during the boot process.

Sometimes neophyte programmers forget where DOS is stored and inadvertently write programs that store different values in the DOS-reserved area. This changes the values in DOS, which causes trouble—usually at the most inopportune time. To offer some protection from this hazard, Apple added two utility commands to the programming language, Applesoft

BASIC. LOMEM and HIMEM establish the lowest and highest address in memory. The memory space between these two values is used to store program variables and data.

PHYSICAL LOCATION OF RAM ADDRESSES ON THE MOTHERBOARD

Let's relate the RAM memory addresses to the chips on your Apple's motherboard. As shown in Fig. 3-8, there are three rows of RAM memory mounted on the motherboard—at locations C3-C10, D3-D10, and E3-E10. Each row is eight chips wide and holds 16K of memory. The leftmost chip is for the *LSB*, or *least significant bit*, of the binary eight-bit word. The rightmost bit, therefore, is for the *MSB* (*most significant bit*). The row of chips closest to the keyboard is for the lowest 16K of addresses beginning with \$0000. The next row back is for the second 16K of memory (\$4000-\$7FFF) and the last row is for addresses \$8000 through \$BFFF (the upper 16K of 48K in RAM). Addresses \$C000 through \$FFFF are in ROM, although the Language card or RAM card from Microsoft gives the user another 16K (approximately) of RAM memory to use.

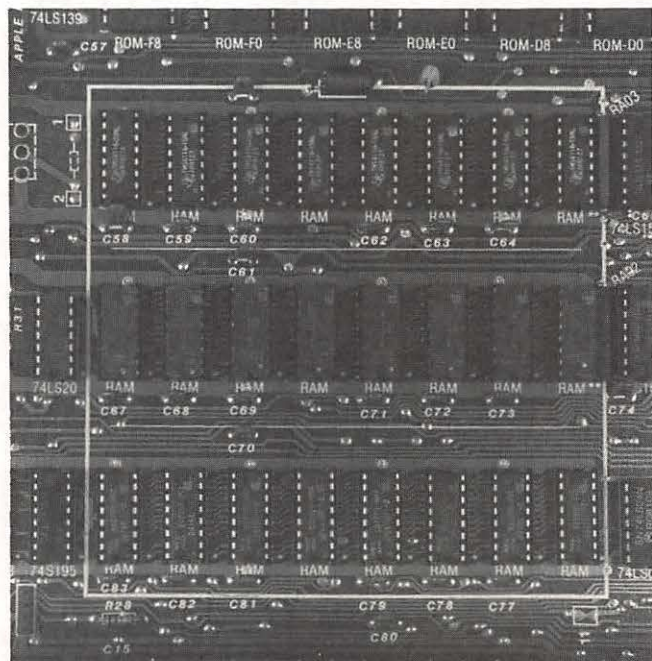

WHERE BASIC PROGRAMS ARE STORED

Except for Applesoft BASIC, interpreters for high-level languages are loaded into your Apple's RAM memory. The Applesoft BASIC interpreter is stored in ROM. When you write programs in the high-level language Applesoft BASIC, the program code (source code) is stored as hex symbols in RAM beginning at address \$0801. Roger Wagner, well-known author and expert on 6502 assembly language, gives an excellent overview of BASIC program location and code interpretation in an article entitled "Assembly Lines" in the January 1982 issue of *Softalk* magazine.

Should your simple programs appear to load correctly, but not run, the problem could be a bad memory chip in the BASIC program storage area. It could also be a problem you cause yourself by inadvertently storing data values in the midst of the BASIC program storage area.*

BUS STRUCTURE

Control signals, addresses, and data are shared between the CPU and the rest of the Apple system over tiny parallel lines, or traces, on the motherboard called *busses*, as shown in Fig. 3-9.

A bus is like a roadway over which the 6502 CPU communicates with other components (peripherals like disk drives) and the real world (motors, lights, sensors, etc.). Your Apple II has three different busses in its design:

- The data bus
- The address bus
- The control bus

Each trace on each bus has a voltage on it (approximately 0 volts or +5 volts) which represents a logic level (0 or 1).

* I once did this. When the program refused to RUN and I listed it on the screen, I found that the contents of two addresses had been changed from this:

```
830 PRINT:INPUT"WOULD YOU LIKE A PRINTOUT? ";P$
835 IF P$="Y" OR P$="YES" THEN 5800
```

to this:

```
65442 SPEED =
60096 MID$ MID$ MID$ MID$ MID$ MID$ SPEED = PLOT X
TAB(MID$ MID$ * = MID$ 'A VTAB
```

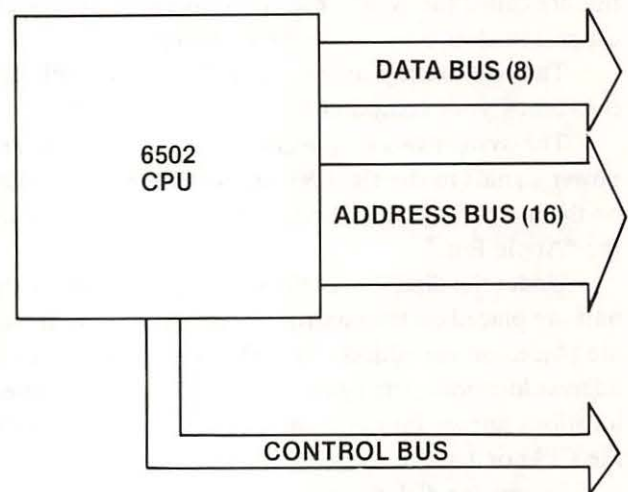

Fig. 3-9. The Apple II Plus bus structure.

The **data bus** and the **address bus** are the primary busses. Information on the data bus can travel either to or from the CPU (it is bidirectional). Addresses come from the CPU (unidirectional) on the address bus.

The Apple II Plus is called an "8-bit machine" which means that a data word is eight bits long. Therefore, the data bus has eight bits that, when taken together, represent a data word or "byte." Because the data bus is bidirectional, it requires a signal to control the direction of data flow. This signal is sent via the control bus, a set of traces or lines on which special voltage signals are placed to enable or disable certain parts of the circuitry.

The largest (widest) bus in the Apple carries the addresses the CPU accesses for program instructions or data. The address bus is 16 bits wide, enabling it to address up to 64K of memory locations. (Two to the 16th power is 65,536, called 64K.) These 16 logic levels collectively represent unique address locations in memory or in the Apple II Plus I/O.

The **control bus** is composed of special signal lines used to enable or disable certain parts of the circuitry.

Together, the address bus, data bus, and control

It was impossible to delete these two program lines because their numbers were beyond those my Apple would accept for line numbers. And I certainly didn't want to erase 80 percent of my 500-line program! To save my work, I followed Wagner's guidance, located the bad values in RAM, and rewrote the correct line number values over the bad data. I didn't touch the command instructions which appear after the line numbers because I only wanted to be able to list the two bad lines. After listing that section of the program, I simply deleted the two bad lines and rewrote those two lines of code. What a life saver!!

bus are called the *system bus*. It lies beneath those eight expansion slots on your Apple motherboard.

The relationship of the system bus to the CPU and the rest of your computer is shown in Fig. 3-10.

The system bus is interconnected with timing and power signals to the eight 50-pin expansion I/O sockets on the motherboard. The system bus is sometimes called the "Apple Bus."

Under the direction of the CPU, special control signals are placed on the control bus and unique addresses are placed on the address bus. The control signals open address locations, letting the information stored in these locations appear on the data bus, which is acted on by the CPU or I/O.

Except for disk drive access signals, all data moves through the CPU and all addresses are generated and placed on the address bus by the CPU.

Each of the I/O ports, or windows through which information passes, has its own address. This is called *memory-mapped I/O*. Other CPU chips such as the 8080 and the Z80 use special instructions or commands to access the I/O ports. In the Apple, you simply address a certain memory location in your computer to access the computer's ports.

So many peripherals have been developed for the Apple II that sometimes the Apple itself becomes the

peripheral for the equipment connected to it. As shown in Fig. 3-11, you can really "stuff" your computer with a lot of special interface cards. This expansion capability is a trademark of the Apple II Plus and Apple IIe computers.

You have quite a bit of choice in connecting devices and capabilities to your Apple. Recall that slot 0 is reserved for memory expansion and slot 6 for disk drive interfacing. The other slots are unassigned, giving you plenty of flexibility in your system design. However, over the years, some pseudostandards have developed as programmers have generated software based on interface cards for certain devices, such as printers and modems, being inserted in certain slots.

Fig. 3-12 describes the most common uses for some of the Apple II Plus I/O expansion slots.

If you're using "canned" (that is, commercially available) software, you will find that most programs conform to the assignments listed in Fig. 3-12.

CLOCK TIMING

Information processing is made possible in those tiny chips by several clock signals that pulse throughout your Apple. A crystal oscillator on the Apple motherboard produces a 14.318 MHz *master oscillator signal* from which all other clock signals are derived.

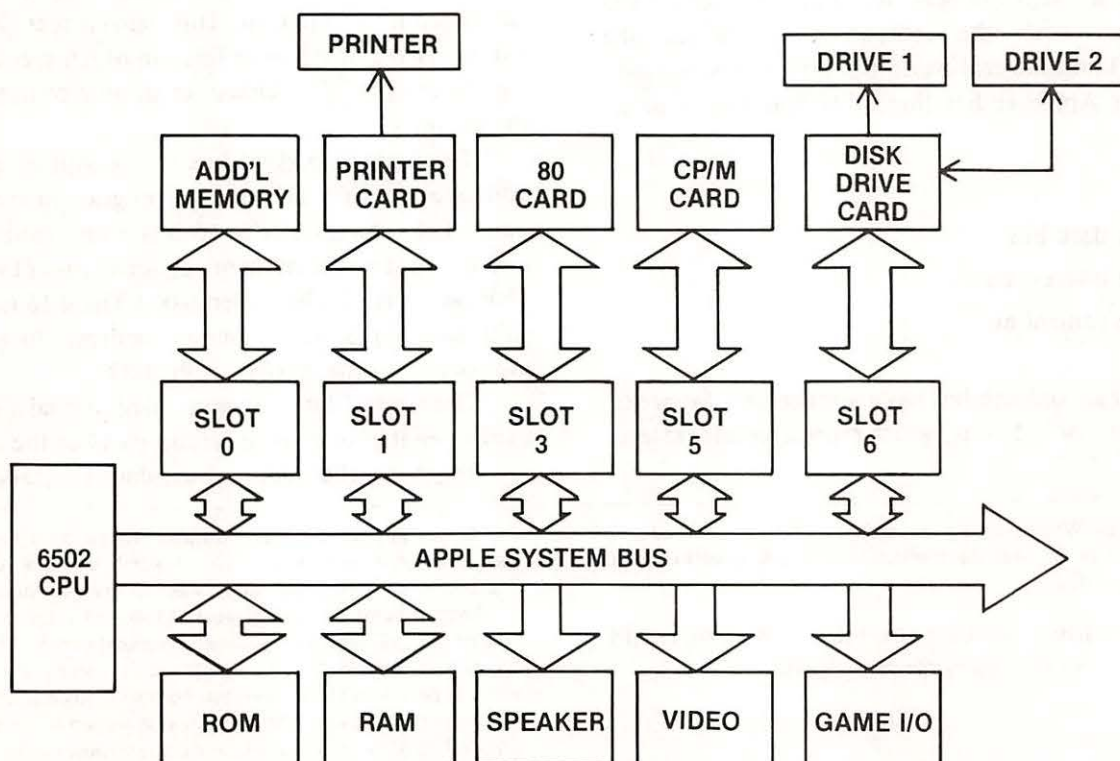

Fig. 3-10. The Apple II Plus system bus.

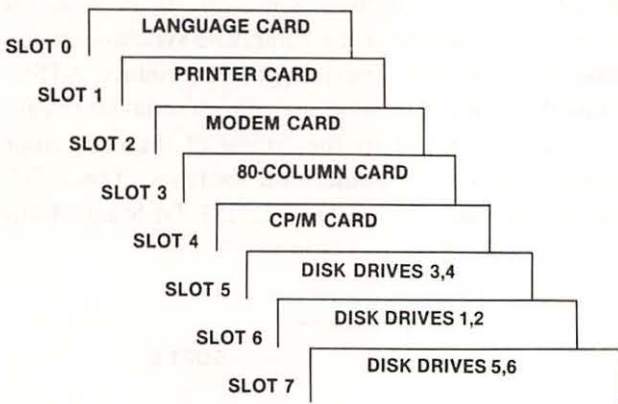

Fig. 3-11. The Apple II Plus slots, "stuffed."

SLOT	COMMON USE
SLOT 0	16K RAM CARD: 16K LANGUAGE CARD
SLOT 1	PRINTER INTERFACE CARD
SLOT 2	
SLOT 3	80-COLUMN CARD
SLOT 4	
SLOT 5	CP/M CARD
SLOT 6	DISK DRIVES 1 AND 2
SLOT 7	

Fig. 3-12. Common uses for the Apple's expansion slots.

The 14.318 MHz clock pulses are divided in half to 7.159 MHz as an intermediate timing signal called "7M." From this signal, four other frequency clocks are generated:

- A 3.580 MHz color reference for the video circuitry;
- A 2.000 MHz general purpose timing signal, "Q3";
- A 1.023 MHz Phase 0 System Clock, $\Phi 0$;
- A 1.023 MHz Phase 1 System Clock, $\Phi 1$."

The **Q3**, **phase 0**, **phase 1**, and **color reference** signals are available on the I/O socket peripheral connector. These signals are derived as shown in the schematic in Fig. 3-13.

Should your machine behave erratically, a sick clock may be your problem. (Another could be the 6502 CPU itself.) We'll learn more about this in Chapter 4.

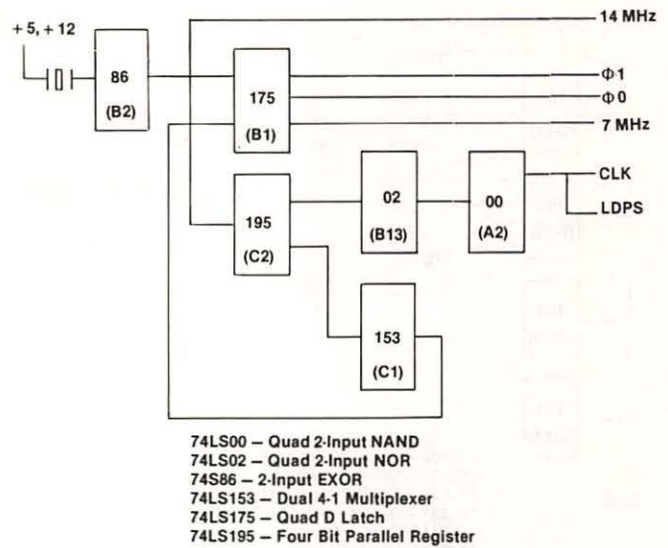

74LS00 – Quad 2-Input NAND
 74LS02 – Quad 2-Input NOR
 74LS86 – 2-Input EXOR
 74LS153 – Dual 4-1 Multiplexer
 74LS175 – Quad D Latch
 74LS195 – Four Bit Parallel Register

Fig. 3-13. Clock timing circuitry.

THE POWER SUPPLY

As described on pages 92 and 93 of your *Apple II Reference Manual*, a switching power supply provides four voltages to the Apple circuitry: +5.0 volts, +11.8 volts, -12.0 volts, and -5.2 volts. The maximum power consumption is a fantastic 79 watts (less than your 100-watt room lamp). Because switching power supplies rarely fail and because this manual avoids getting you in or around high-voltage circuits, I won't discuss troubleshooting the power supply. It's best to leave power supply problems to an experienced repair technician. For those readers who fall into the "experienced technician" category, a schematic can be found on page 93 of the *Apple II Reference Manual*.

VIDEO DISPLAY

A positive, composite, NTSC-compatible video signal is produced and made available at three locations on your Apple: a standard RCA phono connector on the rear of the chassis; a Molex 4-pin Auxiliary Video Output connector near the rear of the motherboard; and a single wire-wrap pin below the Auxiliary Video Output connector. This signal is generated by the circuitry shown in Fig. 3-14 and described on pages 96 and 97 of your *Apple II Reference Manual*.

Note that all the synchronization and timing signals derive from a chain of 74LS161 counters. These counters generate 15 synchronization signals which are sent to the RAM address multiplexer (MUX) which converts

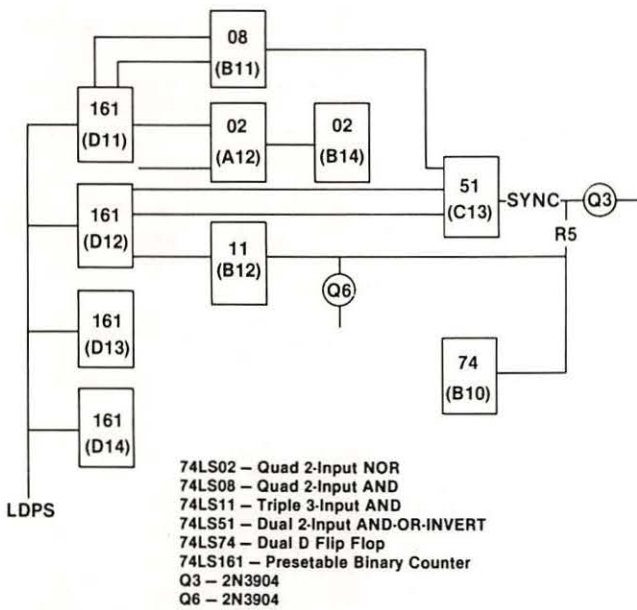

Fig. 3-14. Video display circuitry.

the signals into RAM addresses, depending on the positions of the video-display soft switches. (A soft switch is an electronic device that acts like a two-position switch under software control. Addressing a certain memory location can cause the switch to shift from on to off, or from Text Mode to Graphics Mode.) The MUX passes the addresses to RAM and latches hold the video data, which is then rerouted to the video generation circuit. Screen memory map scrambling is accomplished by the 74LS283 4-bit Full Adder.

If the screen area addressed is to receive a text character, the video generator routes part of the data word to a 2513 Character Generator that outputs to a 74166 8-bit Parallel-Serial Shift Register, producing a serial stream of bits representing dots on the screen. This bit stream is routed to an exclusive-OR gate, which produces inverse and flashing characters if certain data-flag conditions are met. The text bit stream then goes on the video selector/multiplexer.

If the computer is programmed for graphics mode, the RAM data is provided to two 74LS194 shift registers which send two serial bit streams to the video selector/multiplexer. On the way, a 74LS257 MUX selects between color and hi-res graphic displays, and acts to delay the serialized hi-res bit stream if hi-res is chosen. This delay action produces the six colors available in hi-res graphics.

The two data streams are mixed in the video selector/MUX according to the settings of the video soft switches. The 74LS194 4-bit Shift Register and the

74LS151 8-input Multiplexer select one of the input bit streams for mixing with the composite synchronization signal and the color burst signal to produce NTSC-compatible video at the outputs. Which serial bit stream is used is determined by the setting of the text, color graphics, or hi-res graphics soft switches. These soft switches are decoded by the 74LS257 Tri-State Multiplexer shown in Fig. 3-15 below.

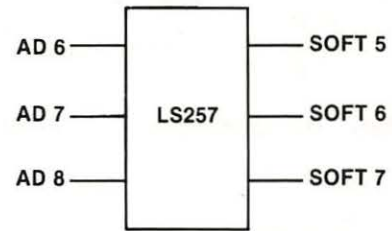

Fig. 3-15. Addresses are used to produce software switches.

The color-burst signal comes from the circuit shown in Fig. 3-16. The signal is conditioned by the resistor-inductor-capacitor network for optimum tint. Capacitor C3 can be trimmed to yield the best tint for color output. Resistor R27 and transistor Q6 disable the color-burst signal during text display.

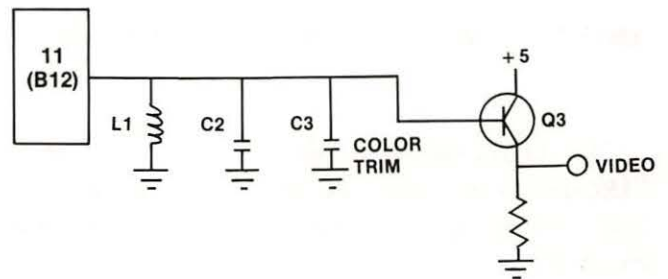

Fig. 3-16. The color-burst circuitry.

The video signal out of the RCA connector can be adjusted. The tip of the RCA phono jack input is connected to the video output signal through a 200-ohm potentiometer (variable resistor, or *pot*) which can be adjusted to vary the output voltage between 0 and 1 volt for best video signal level.

CASSETTE INPUT AND OUTPUT

The simple circuit in Fig. 3-17 enables you to store programs and data on a standard audio cassette tape.

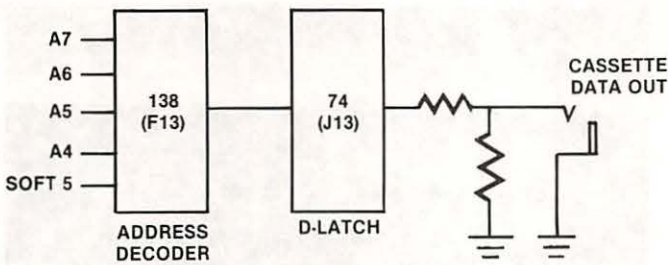

Fig. 3-17. The cassette output circuit.

A cable can be connected from the OUT connector (a miniature phone jack) on the back of your computer to the microphone input of your cassette tape recorder. Each time your program addresses location \$C020 (49,184, or -16,352 in decimal), the address decoder 74LS138 at board location F13 puts a signal on the input to D-Latch 74LS74 chip at J13, causing the output of this flip-flop circuit to toggle, producing a voltage at the Cassette Data Out connector that shifts between 0 volts and 25 millivolts. These are the same voltages produced by the microphone when it is connected to your recorder.

By referencing the \$C020 soft switch repeatedly, a tone can be produced which can be varied in pitch and duration to represent data. Your *System Monitor* (a program permanently stored in ROM) has a routine built into it that can encode programs and data so they can be saved on tape. Again, this is a soft switch. It doesn't matter what's stored in location \$C020. Addressing location \$C020 with READ instructions is all that it takes to produce the desired result.

Fig. 3-18 shows the circuitry used to bring information into your Apple from a cassette tape. This circuitry receives a 1-volt signal (peak-to-peak) from your cassette recorder's earphone jack through a cable connected from your recorder to the Cassette Data IN phone jack on the back of your Apple. The input cassette data is multiplexed through the 74LS251 eight-input multiplexer at location H14. The output is placed directly on the high-bit line of the data bus (DA7). The System Monitor has a built-in routine that reads the DA7 bit and rebuilds the data as 8-bit data words.

THE DISK II DRIVE

The Apple Disk II drive is designed to enable you to easily and quickly store and retrieve information using 5¼-inch floppy disks. The disk mechanism is housed in a 3⅞ × 6⅙ × 8¾-inch beige case as shown in Fig. 3-19.

Power for operating the drive is supplied from the Apple II Plus via a ribbon cable connected to a disk

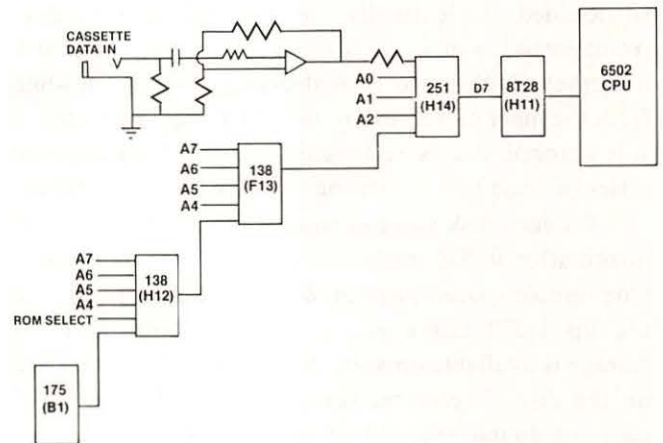

Fig. 3-18. The cassette input circuit.



Fig. 3-19. The Disk II is the drive most commonly used with the Apple II Plus computer.

controller card plugged into one of the Apple expansion slots (usually slot 6). The major cause of Apple II Plus system failures is the insertion or removal of this controller card with power applied. The Disk II (or another manufacturer's drive) is probably the most important peripheral connected to your computer. It's the primary mass storage device used by Apple owners all over the world.

The 35-track cam-positioned drive rotates at 300 rpm to write or read data on a thin mylar disk with a coating of magnetic oxide particles. The disk starts as a .003-inch-thick polyester disk, which is then coated with about .0001-inch of iron oxide. The disk is called a "floppy" because it is thin and quite flexible.

The disk (or diskette) used in your Disk II is a

single-sided, single-density platter whose surface is electromagnetically divided into 35 tracks or rings. The disk is further divided into 16 wedge-shaped sectors leading from the inner center hole to the outer edge. Each disk is soft sectored; that is, sectors are marked off by a special series of code bits written on the disk by your Apple.

On each disk you can store about 140,000 bytes of information in 560 track-sector areas of 256 bytes each. One double-spaced page on 8½- by 11-inch paper can use up 1,670 characters, or bytes. About 126K of storage is available on your disks if you also have DOS on the disk. Therefore, you can store a little over 75 pages of double-spaced text on one disk.

KEYBOARD OPERATION

What happens when you depress a character key on your Apple keyboard? Right! You see a character displayed on your monitor screen. But what causes that particular character to be displayed?

Look at your computer keyboard. That remarkable input device has 52 built-in keys. Forty-six keys generate specific characters. The other six keys are CTRL, ESC, REPT, RESET, RETURN, and SHIFT. The ESC (Escape) and RETURN keys are handled by your keyboard electronics just as character keys are.

Apple II keyboards are single- or double-printed circuit board devices that connect to the motherboard through a 16-conductor ribbon cable that plugs into a socket at motherboard location A7. The older single-board keyboards use a National MM5740-AAE encoder chip. This encoder is uppercase only and is no longer made, so you can expect trouble in finding a replacement if you have the single-board version.

Newer Apple II Plus keyboards use two boards — one for the keys and another for the encoder circuitry. The two-board version uses the AY-5-3600 encoder chip, custom made by General Instrument for Apple Computer. The AY-5-3600 interprets signals generated by pressing the keys to produce the correct characters or special function codes.

In both versions, the keys are an integral part of an XY matrix of wires, where each key is on a crossover point of an X row and a Y column. Since the majority of us have the double-board version, I'll discuss this type of keyboard in this manual. The single-board version works essentially the same way. The two-piece keyboard is shown in Fig. 3-20.

Notice that the electronics board is mounted piggy-back on the bottom of the keyboard. A pin-socket

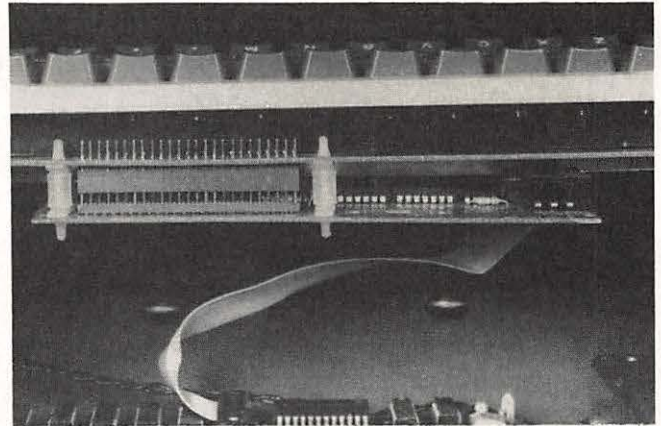

Fig. 3-20. Photo of the two-piece Apple II Plus keyboard.

arrangement connects the two boards electrically. That short ribbon cable shown in the photo above routes the key information to your Apple II motherboard.

Fig. 3-21 is a simplified schematic of the keyboard circuitry.

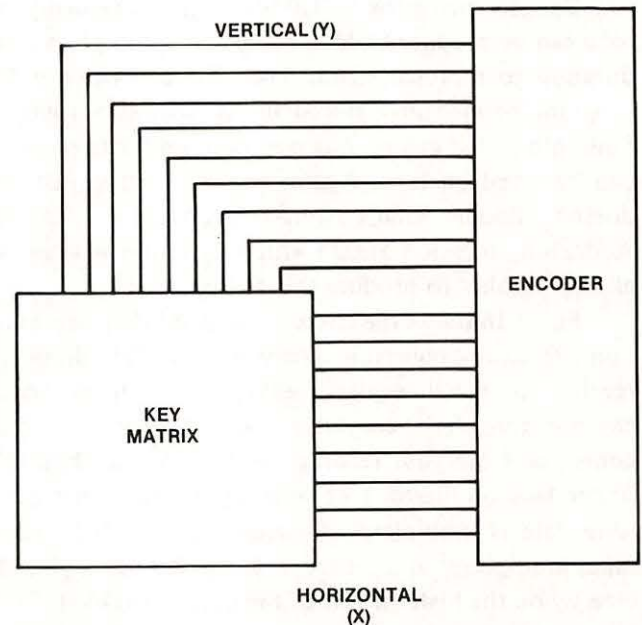

Fig. 3-21. Keyboard circuitry.

Apple chose a keyboard with an encoder chip that produces a 7-bit code to represent the character selected by your finger action. The encoder is essentially a counter circuit with a built-in ROM which contains the ASCII (American Standard Code for Information Interchange) character set. Each time you press a character key, the circuitry converts this action into an ASCII code. The ASCII code for your Apple II Plus is listed in the

Appendix. Your push-button action also generates a short strobe pulse that sets a 74LS74 D-Latch, pushing a 25-microsecond (μ s) pulse out the keyboard ribbon cable.

When the encoder senses a character key action, it looks at the CTRL and SHIFT keys to see if they have also been pressed (indicating that an uppercase symbol or special function is intended).

One of the problems with mechanical switches such as keys is that they don't close cleanly. Electronically, they bounce several times before solid contact is achieved. This bouncing can produce noise spikes that could be interpreted as valid signals, causing such effects as four or five repeated characters to occur on one key action. To counter this, a capacitor is connected between pin 31 of the encoder chip and ground. This capacitor produces an 8 millisecond (ms) delay before the key action is encoded and the strobe pulse is generated.

If you held the REPT (Repeat) key down while a character key was pressed, the 555 Timer would produce a series of pulses (at a 15 Hz rate) which pass through the 74LS00 OR gate to generate additional strobe pulses.

When you depress the RESET key, whatever your Apple was doing stops and a prompt appears at the lower left corner of your screen.

The ESC (Escape) key generates a unique ASCII code (27) and the strobe pulse. Your SPACE bar generates the ASCII code 32. RETURN generates ASCII code 13. Again, the strobe pulse signal is generated with each key action.

The ASCII code and the strobe signal pass out through the ribbon cable and onto your Apple II Plus motherboard through the connector socket at motherboard location A7, as shown in Fig. 3-22. Once these signals reach the motherboard, they sit on the input to the two 74LS257 Data Multiplexers. These devices place either keyboard data or memory data on the data bus under control of a RAM select (RAM SEL) and a

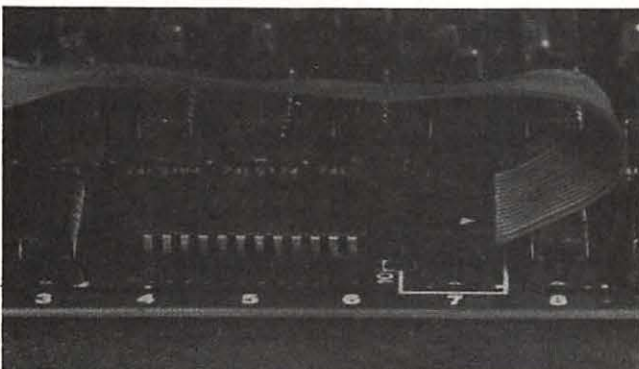

Fig. 3-22. The Apple II Plus keyboard cable plugs into a socket on the motherboard at location A7.

keyboard (KBD) signal. The RAM SEL signal is used to *enable* the two chips (to let them operate). The KBD signal is used to select which input (keyboard or memory data) will be passed through to the data bus.

When the program you are running (the System Monitor if you are just starting) gets to a command requiring keyboard entry, the program checks to see if a keyboard strobe pulse has occurred, setting the output of the 74LS74 D-Latch at location B10 to HIGH. This output HIGH puts a logic 1 on data bit 7 (D7). When this bit is HIGH, the program reads data bits D0 through D6, interprets these as a character, and then addresses \$C010, generating a CLR STB pulse out of the 74LS138 decoder at F13. The CLR STB signal resets the 74LS74 D-Latch at B10 back to a LOW output, and the system is ready for another key to be pressed.

SPEAKER

Fig. 3-23 indicates how your speaker is able to make sounds. As shown, the speaker is software controlled. Whenever your program addresses location \$C030 (49,200 or -16,336 in decimal), the output of the D-latch 74LS74 at board location J13 changes state. If the output was high, it goes low; if it was low, it goes high. Each change is amplified by transistor/amplifier Q-4 to move the cone of the speaker in or out, producing an audible click. By varying how often and how fast you cause these clicks, your Apple can produce arcade sounds, music, and even crude speech.

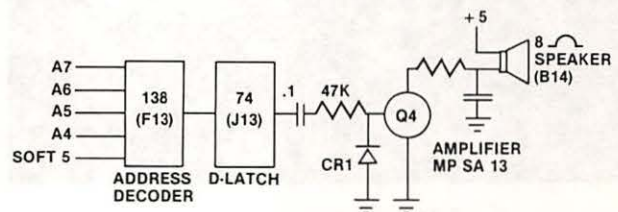

Fig. 3-23. Speaker circuitry.

A peek to address \$C030 activates the circuit. This soft switch doesn't care what's stored at \$C030, just addressing this location produces the clicks (hence the sounds). You can program this with $Y = \text{PEEK}(-16336)$. The address decoder 74LS138 at board location F13 decodes the address, enabling its output to toggle the 74LS74 latch at J13.

The range of frequencies that you can generate depends on how you program your machine. If you

write your program in Applesoft BASIC, the highest frequency you can produce is about 72 Hz. If you write in Integer BASIC, you can generate frequencies up to 256 Hz. By programming in machine language, you can cover the audio band (300 to 3000 Hz).

Your Apple's Monitor ROM has a program routine stored in it that, when addressed (called by your program), clicks the speaker at a 1 KHz frequency for a tenth of a second. This is the familiar "beep" sound that is produced when you boot up, get an error (e.g., SYNTAX ERROR), or type Control-G. It's called the Apple "bell."

THE GAME INPUT AND OUTPUT

One of the most versatile, yet least used, I/O ports on your Apple is the Game I/O socket shown in Fig. 3-24.

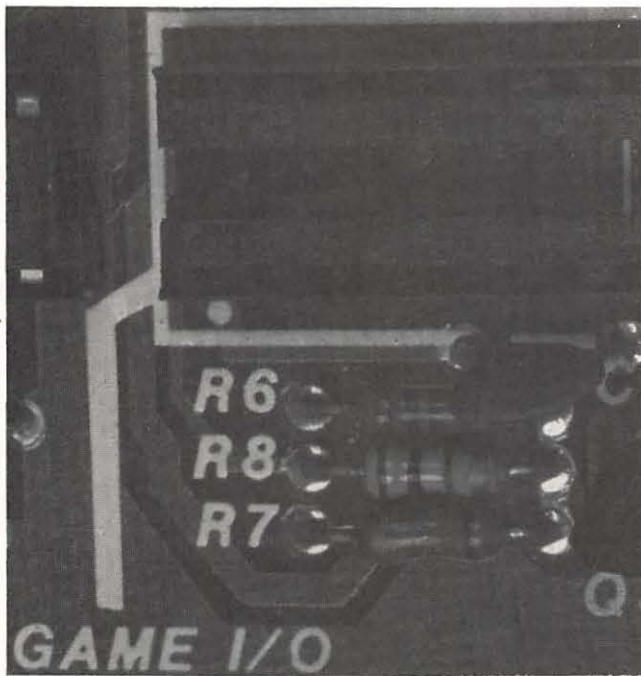
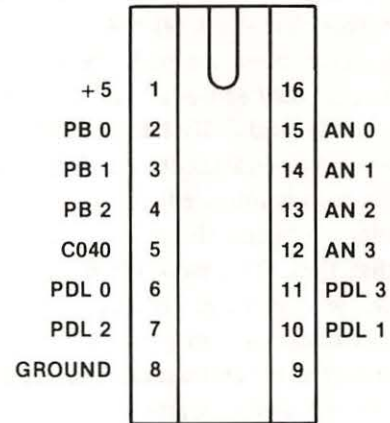

Fig. 3-24. The Game I/O socket on the Apple II Plus motherboard.

Most of us have used this window to our Apple for connecting game paddles or joysticks and have enjoyed hours of arcade-type games. But as you'll learn shortly, we've barely used its capability.

This I/O port lets you easily interface devices to your machine. As shown in Fig. 3-25, the port has three digital inputs, four analog inputs, four digital outputs, and one pulse or strobe output.



PIN	SIGNAL	DESCRIPTION
1	+ 5 VOLTS	CHIP POWER SOURCE
2,3,4	PB0,PB1,PB2	DIGITAL INPUTS, USUALLY PUSH-BUTTON
5	C040 STROBE	A 1/2-MICROSECOND ACTIVE L PULSE (0 VOLTS ACTIVE) TRIGGERED BY ADDRESSING LOCATION \$C040
6,7,10,11	PDL 0 - PDL 3	GAME CONTROLLER INPUTS, VARYING VOLTAGE BETWEEN AND + 5 VOLTS
8	GROUND	SYSTEM GROUND
9,16	(NOT CONNECTED)	
15,14,13,12	AN0 - AN3	DIGITAL OUTPUTS

Fig. 3-25. Game I/O socket signal assignments.

The three digital-switch or push-button inputs and the four analog or paddle inputs are placed on the high-bit signal (D7) of the data bus as shown in Fig. 3-26.

The cassette data input works the same way. This is significant (as shown in Fig. 3-27) since only data bit D7 contains information in this kind of communication with the CPU.

Now, a 1 in position D7 (bit 8 on the bus) makes the binary number 1xxxxxxx equal 128 or more. A 0 in this position results in a value less than 128 (127 or lower). Therefore, the information gained from interpreting D7 is that either the value is 128 or greater, or the value is 127 or less. This is enough information for a program to recognize as valid data.

Digital Inputs

The three single-bit inputs - PB0, PB1, and PB2 - were designed for game paddle push buttons. Generally these buttons are connected as shown in Fig. 3-28.

The state or logic level (HIGH=1, or +5 volts; LOW=0, or 0 volts) can be read by addressing the appropriate location, as shown in Fig. 3-29.

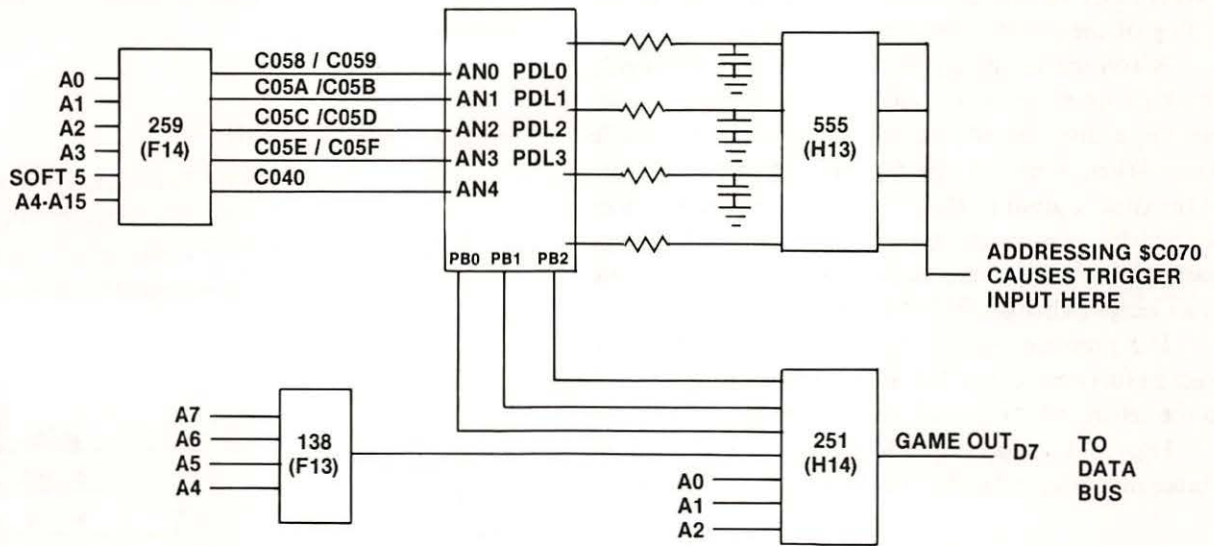

Fig. 3-26. Game I/O input circuitry.

D7	D6	D5	D4	D3	D2	D1	D0
1	X	X	X	X	X	X	X
0	X	X	X	X	X	X	X

X = DOESN'T MATTER

Fig. 3-27. Only bit 8 (D7) contains the information.

Analog Inputs

Each of the four analog inputs – PDL0, PDL1, PDL2, and PDL3 – can be connected to +5 volts inside the Apple through a 150K ohm potentiometer (variable resistor or “pot”) as shown in Fig. 3-30. Connecting a potentiometer input to the +5 volt power source lets you vary the voltage on that analog input between 0 and +5 volts by varying the resistance of the pot.

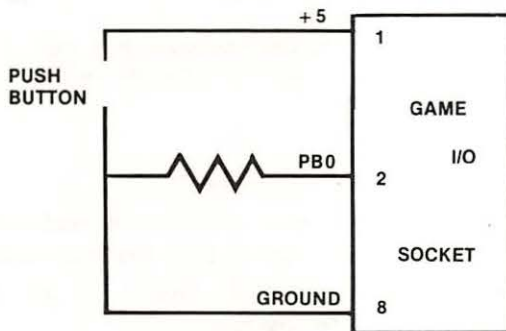

Fig. 3-28. Push-button PB0 in a hand controller connects to the Game I/O socket as shown.

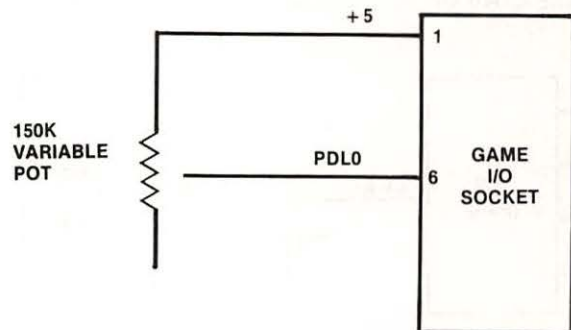

Fig. 3-30. Circuit showing how paddle PDL0 connects to the Game I/O socket.

PUSH BUTTON	ADDRESS	
	HEX	DECIMAL
PB0	\$C061	49249 –16287
PB1	\$C062	49250 –16286
PB2	\$C063	49251 –16285

Fig. 3-29. Addressing scheme for reading the state of a push-button input.

The value of resistance set on the 150K-ohm pot in each game paddle is part of a timing circuit composed of the 150K-ohm pot, a resistor, a capacitor, and a part of the 558 Quad Timer. The 558 is simply four 555 timers together in one chip package. When the 558 is triggered by addressing \$C070, all four outputs from it are set HIGH and the timing circuit begins to count down. This

level remains HIGH for a time period determined by the setting of the potentiometer for each paddle.

A routine in the System Monitor can repeatedly check to see if the timer output is still HIGH. It does this by reading the address for the appropriate paddle input. When it does so, the data bus DA7 bit is the state of the timer output (a HIGH, or 1, as long as the timer is counting down). A counter in the program keeps track of how many times the timer is checked before the timer output changes to LOW, or 0.

The program then stops counting, with the value reached (between 0 and 255) being directly proportional to the setting of the paddle potentiometer.

Fig. 3-31 shows the addressing scheme used to enable this unique “analog-by-digital-means” circuit.

ADDRESS		PURPOSE
HEX	DECIMAL	
\$C070	49264 – 16272	TRIGGER TIMERS, INITIATE COUNTING
\$C064	49252 – 16284	ENABLE PDL 0 TO BE READ
\$C065	49253 – 16283	ENABLE PDL 1 TO BE READ
\$C066	49254 – 16282	ENABLE PDL 2 TO BE READ
\$C067	49255 – 16281	ENABLE PDL 3 TO BE READ

Fig. 3-31. Addressing scheme for enabling the paddle circuitry.

C040 Strobe Output

The C040 strobe circuit is shown in Fig. 3-32.

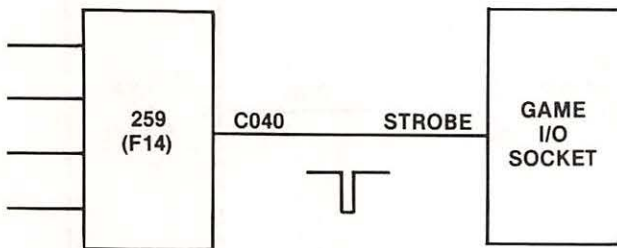

Fig. 3-32. The C040 strobe pulse is generated by placing the hexadecimal value \$C040 on the address bus, which places this address on the input to the 74LS259 at location F14.

On pin 5 is a normally HIGH (–5 volts) signal that can be pulsed LOW for 1/2 microsecond by addressing location \$C040 (49,216 or –16,320 in decimal). Writing to this address generates two strobe pulses. Reading this address causes a single strobe pulse on pin 5 of the socket. Since the address is active on the address bus for

1/2 microsecond, the strobe pulse is active for the same amount of time.

Annunciator Outputs

The four handy annunciator outputs shown in Fig. 3-33 act as flip-flops or latches. Each of these outputs can be toggled on or off by soft-switch addresses. As shown in Fig. 3-34, there is a separate address for each output ON or OFF.

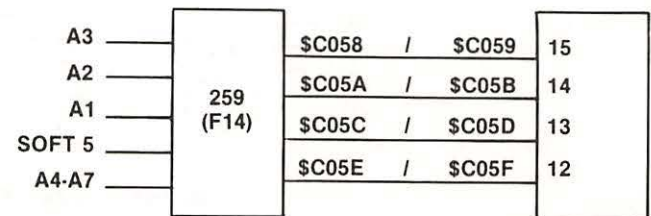

Fig. 3-33. Out of the 74LS259 at F14 come soft switches for controlling the four annunciator outputs.

ANNUNCIATOR	ON ADDRESS	OFF ADDRESS
0	\$C058	\$C059
1	\$C05A	\$C05B
2	\$C05C	\$C05D
3	\$C05E	\$C05F

Fig. 3-34. Each annunciator output can be toggled by placing a certain address on the address bus.

The ON position places +5 volts on that output pin; OFF places 0 volts on the pin. The level remains until the opposite activation address is accessed, changing the state of the output.

HOW THE SYSTEM WORKS

You slip a System Master disk into Drive 1, close the door, and flick the power switch ON. Immediately your Apple system surges into action. The screen flashes and prints out the familiar “APPLE] [.”

Your disk drive whirs as the computer boots itself up – pulls DOS (Integer BASIC is also loaded if a language card or a RAM card is installed) off the floppy disk. After a few moments, the drive stops and your screen settles down with the display shown in Fig. 3-35.

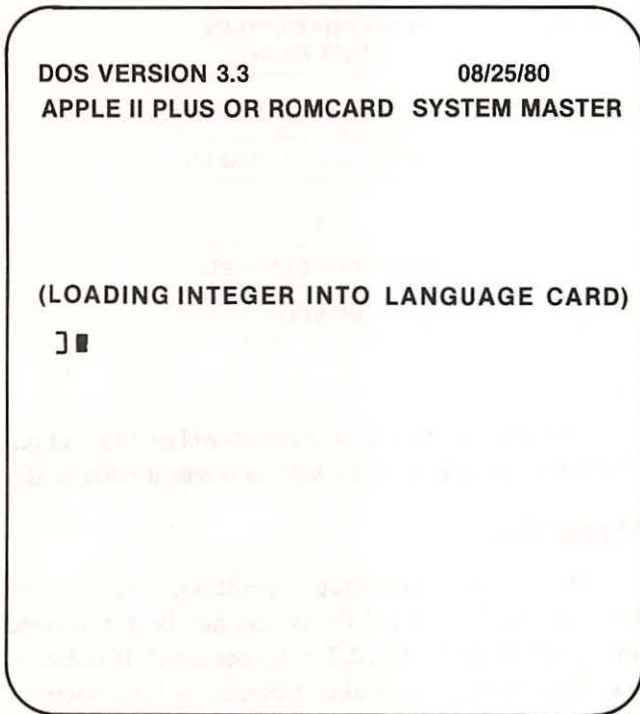
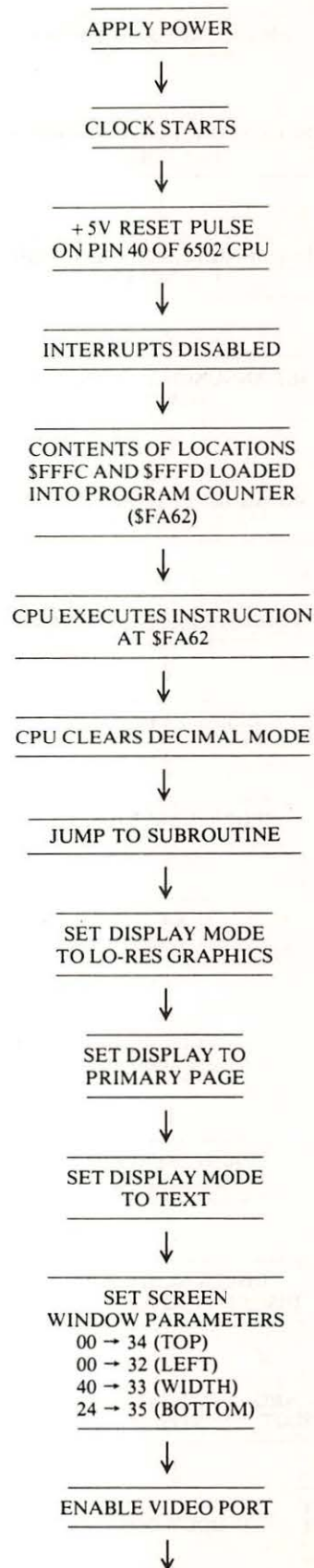

Fig. 3-35. The display after proper DOS boot.

Cold Boot

What does it mean to “boot up” a disk? When you first apply power to your Apple II Plus, the switching power supply puts out +5 volts to the RESET pin of your 6502 CPU. This signal starts the boot-up routine. It’s called a *cold boot* because the system was not energized before the boot. The word “boot” comes from “bootstrap” – pulling one up by one’s own bootstrap. The system is being reset and initialized with all the start-up conditions necessary to operate and enable the man-machine communication interface. The bootstrap in your Apple II Plus is the System Monitor, a machine language program that, in this case, acts as a program-starting program, so to speak.

The following is a flowchart of the actions that occur in your Apple from the time you turn on the power.



(Continued)

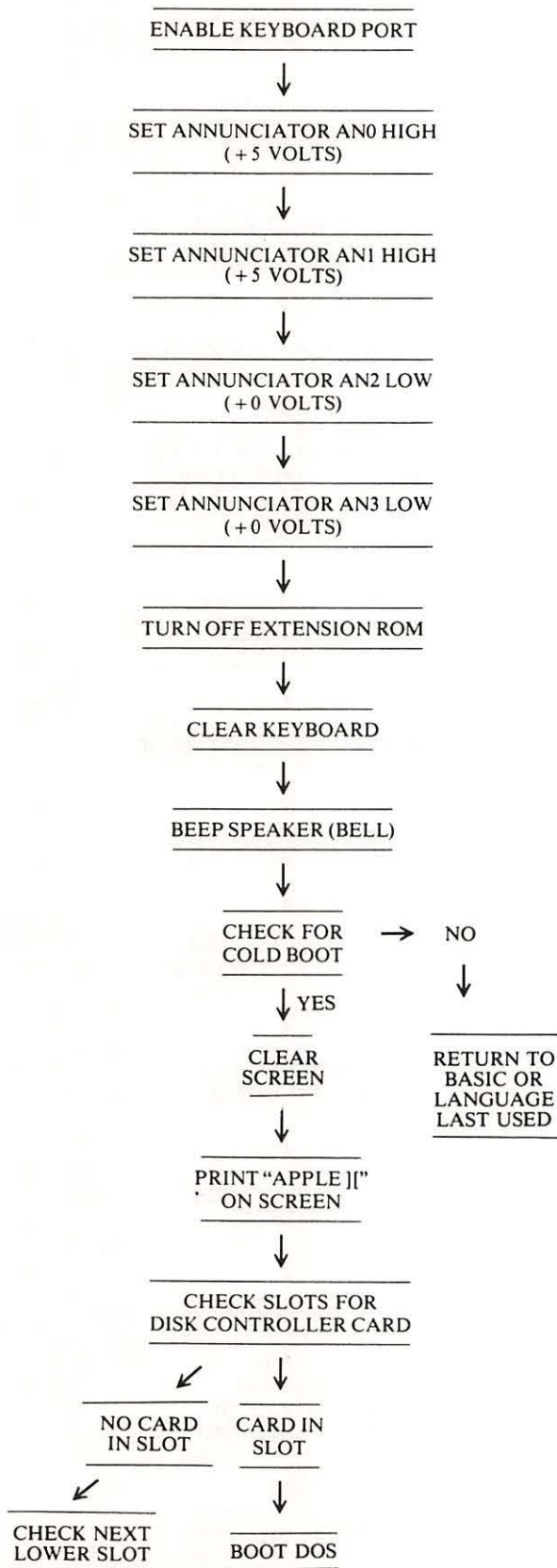

(Continued)

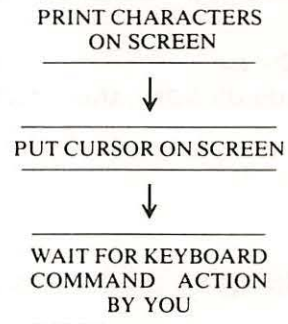

The rest is up to you. The system will sit and wait until your interaction with the keyboard tells it what to do.

Warm Boot

During the bootstrap operation, the System Monitor checks to see if the system had been energized and used before the RESET pulse occurred. If indeed it was powered up, the speaker is beeped and the system is placed in BASIC language with the Applesoft prompt printed on the lower left part of the screen.

Typing PR#6 will cause your Apple II Plus to load DOS from the disk in Drive 1 (Drive 1 is connected to the controller card in slot 6).

APPLE II REVISIONS

Your Apple II is much improved over the short-lived Apple I of 1977. The cover case has been redesigned so it doesn't pull off the keyboard when the cover is removed. The BASIC interpretive language included with the system has been expanded from the 5K BASIC in the Apple I. And the application package library for your Apple II has grown to many thousands of programs.

Four major revisions have occurred to the Apple II since it first appeared on the market in 1977. Actually, more than four have occurred, but six of the revisions are collectively called Revision 1. The major revisions are:

- Rev 0
- Rev 1
- Rev 7
- RFI

While there are a number of improvements at each revision, the major changes are as follows:

Revision 0 systems included the first-version motherboards sold in the Apple II. They were limited to four

hi-res colors (black, green, violet, and white), and the colors generated by the video circuitry placed an annoying fringe tint on the edges of the screen characters. No RESET pulse was generated on initial power up, so users had to press the RESET key to start the System Monitor program unless a disk controller card was installed which had its own RESET-on-power-up circuitry built-in. The Rev 0 boards also lacked the auxiliary video pin and the 50 Hz video option. These boards used jumpers for memory configuration.

With **Rev 1** came improved color capabilities. The 16-pin jumpers for memory configuration were retained. Some of the Rev 0 boards had experienced problems adjusting the cassette input for proper READ operation, so the gain circuitry for CASSETTE DATA IN was improved with Rev 1. Blue and orange colors were added to the hi-res color capability. An auxiliary video pin and 50 Hz video capability were also added to the Rev 1 boards.

Televisions were still being used for display devices in the early days of this decade, and while Rev 1 improved the fringe tint problem so prevalent in the Rev 0 boards, the Apple company made another improvement on its **Rev 7** boards. Newer chips were used on the data bus, reducing the chip count slightly.

One of the persistent problems associated with the Apple II has been noise interference from board-generated radio frequencies. These RFI signals have frustrated many computer owners who mistakenly placed their computer systems too close to the TV. It's fine if the TV is the display for the Apple II, but operating the computer and trying to watch a TV program at the same time caused "snow" and diagonal lines on many an owner's set. To address the RFI problem, the Apple company introduced a major system upgrade in 1981. This **RFI** revision included a redesign of the motherboard — relocating power and ground traces, adding isolation components, and shielding the chassis case. The circuit functions remained the same.

Remember, none of these revisions made an Apple II into an Apple II Plus. The II Plus came about when Apple replaced the Integer BASIC ROMs with Applesoft BASIC ROMs. The firmware used makes all the difference.

SOFTWARE STRUCTURE

Three types of software are supplied with your disk drive Apple II Plus computer system:

1. System Monitor

2. Applesoft BASIC (high-level language)
3. Disk operating system (DOS)

The **System Monitor** lets you initialize your computer and enables it to receive keyboard entries and generate a screen display. The System Monitor resides in the ROM chip at F8.

Each Apple II Plus comes complete with the **high-level language Applesoft BASIC** stored in ROM. BASIC is an interpretive language. Each instruction is read, interpreted, converted to machine language code, and acted upon before the next instruction is read, and so on. With a compiled language like FORTRAN, *all* the instructions are read, interpreted, and converted into machine language before being acted upon. While compiled-language programs run faster than interpreted-language programs, BASIC is simple to learn, making the programs easy to write. And many youthful entrepreneurs have become millionaires writing useful software in BASIC.

The third ingredient for a complete software system is the operating system. Your Apple II Plus **disk operating system (DOS)** handles reading and writing disk-stored information and lets you format disks, copy disks, and even catalog the programs or files you've saved.

Apple's DOS was first known as DOS 3.2. It worked with 13-sector disks. Soon Apple engineers discovered that they could gain about 20 percent more storage space on the disks by formatting and using 16 sectors, so DOS 3.3 was born. But the Apple people didn't forget the users of DOS 3.2 software when they started marketing DOS 3.3 with the Disk II drive. They included two ways to boot your system using DOS 3.2 disks with the DOS 3.3 package. One way is the BASIC disk; the other is the BOOT13 program on the DOS 3.3 System Master disk.

Today, an even more improved disk operating system is available. ProDOS (or XDOS) has the same function as DOS 3.3, but works faster and has more capability.

ProDOS has the UNIX-like hierarchical file structure common to the Apple III operating system SOS (Sophisticated Operating System), so it makes possible data transfers between the two machines. ProDOS won't support Integer BASIC, but it will work with any size disks, including hard disk drives of up to 32 megabytes. And this new operating system doesn't require any new hardware. It performs fine with the Disk II controller card that works with DOS 3.3.

Each month you'll see more commercial software

written for ProDOS systems. It's a giant step forward for Apple II users who want Apple III capabilities.

SUMMARY

In this chapter you've learned what a basic computer is made of and how your Apple II Plus works,

from a hardware standpoint. You saw that memory, I/O, and the CPU all perform vital functions in this computer system. You learned what happens inside the Apple II Plus when you turn power on. And you learned that several kinds of software are required to make your Apple a functioning system.

Specific Troubleshooting and Repair, Apple II Plus

Chapter 4 is an Apple-specific troubleshooting and repair guide focusing on a large variety of computer failures. The section is divided into five parts. The parts are as follows:

1. Start-up problems
2. Run problems
3. Display problems
4. Keyboard problems
5. Other input/output (I/O) problems

Each fault can be associated with one of these areas. The key index to problems of these five general types follows these introductory pages. By letting your “fingers do the walking” through the Troubleshooting Index, you can quickly locate the page where your particular problem is addressed.

Part 1 covers all symptoms that can occur at the time you turn the power on, or at start up, including no power available, no boot up of the disk, and no beep/no display problems.

Part 2 discusses all symptoms that can occur after initial boot up, such as faulty disk read or write, bad memory, program lock-up, and reset, or keyboard command, problems.

Part 3 addresses difficulties associated with the display portion of the computer; for example, no display, no text mode, no hi-res or no lo-res, video synchronization failures, cursor and character faults, bad graphics, and others.

Keyboard problems are detailed in Part 4. This section covers such faults as bad key operation, key top pop-off, and others.

Part 5 encompasses all the other input and output problems, including speaker faults, cassette I/O failures, game paddle problems, and peripheral slot malfunctions.

Each part is subdivided into unique failures and provides symptom, problem, possible cause, and repair action or page reference for each circumstance. This data is followed with step-by-step troubleshooting instructions, illustrated with applicable schematic drawings and a chip location layout diagram to make replacement easy.

As you use this guide, you will find many useful hints for both troubleshooting and repair. Be especially alert to the cautions since further system degradation can occur if you do not follow those procedures exactly as listed.

If any step seems too complex, stop where you are and seek help from a service center technician. You

should be able to find and correct most problems, but occasionally a component such as a resistor, capacitor, or inductor fails. Finding these failures requires advanced troubleshooting techniques, and this book does not assume you have these skills. If you'd like to try the advanced methods, refer to Chapter 9 for guidance, and observe good troubleshooting procedures.

TROUBLESHOOTING INDEX

- 1. Start-up problems – system won't boot 62
- 2. Run problems 74
- 3. Display problems – no display 81
- 4. Keyboard problems 99
- 5. Other Input/Output problems 106

1. START-UP PROBLEMS

Symptom Category	Page
System won't boot	
No power light, no beep, drive won't run	62
Power light on, no beep, drive won't run	
No message, no beep	63
Message, no beep	64
No message, beep	65
Garbage on screen	67
Power light on, beeps, screen	
displays "APPLE]["	69
Drive won't run	69
Drive keeps running	70
Drive runs then stops	71
Power light on, beeps, no display,	
drive whirs then stops	72

NOTE: If booting won't work, the Apple DOS manual suggests you reread the manual. You can probably deduce the problem faster by noting the conditions of the machine at the time of "failure" and following the logical troubleshooting steps outlined in this chapter.

A number of things can cause the computer to boot improperly or not to boot at all: wrong diskette in the drive, no operating system on the diskette, cables loose, controller card not fully seated, disk drive failure, memory chip bad, no clock pulses, or even a forgotten unplugged power cord.

To find the problem, select the category above that best describes the symptoms and turn to the appropriate page for a step-by-step troubleshooting guide.

SYMPTOM: System won't boot – no power light, no beep, drive won't run

Problem	Possible cause	Repair action
No power	Power cord not plugged in Power supply faulty	Plug in cord Replace

Troubleshooting Procedure

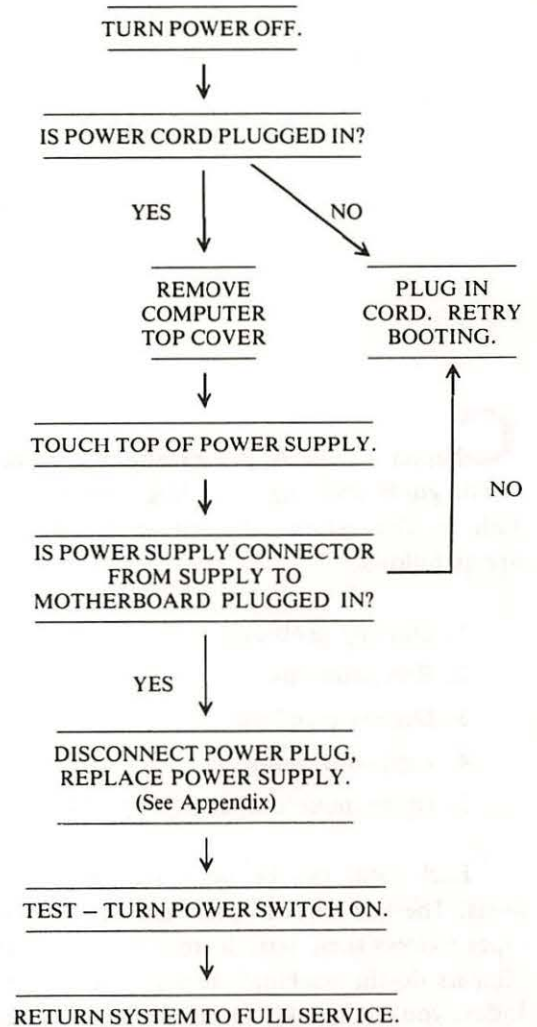

Circuitry Affected

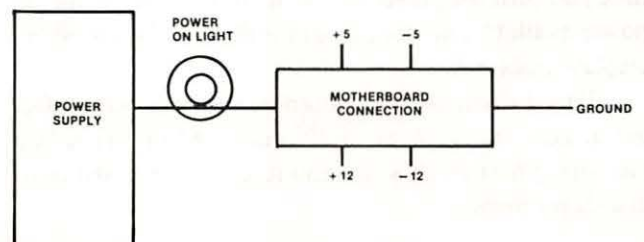

Fig. 4-1. Simplified power supply circuitry.

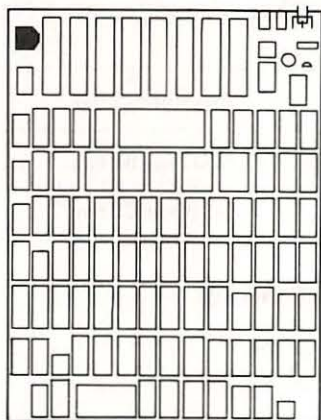
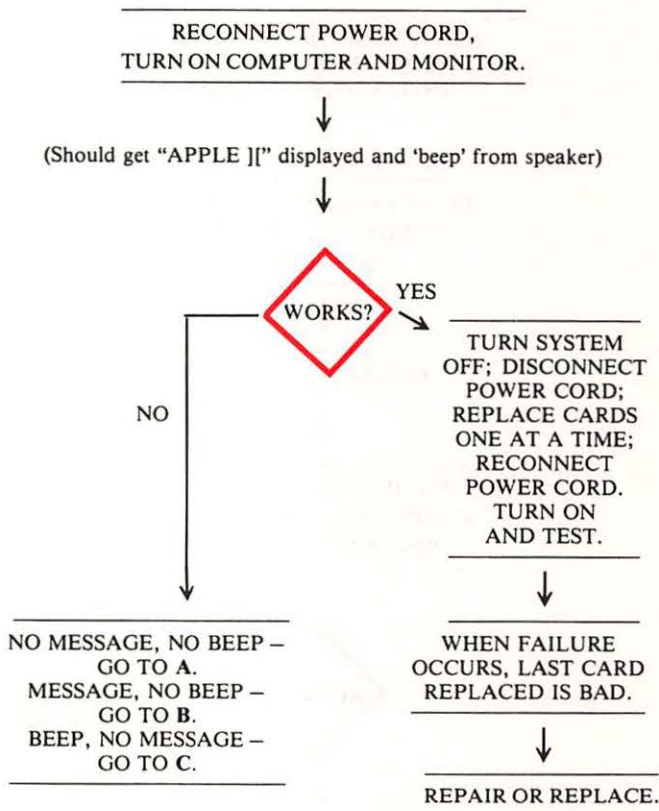
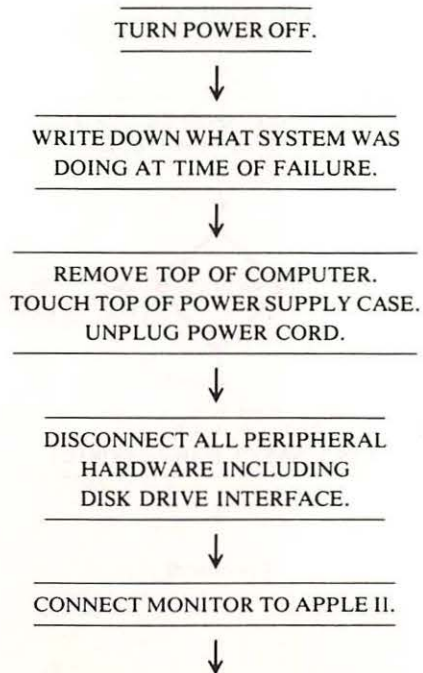

Fig. 4-2. Physical location guide.

SYMPTOM: System won't boot — power light on, no beep, drive won't run

Problem	Possible cause	Repair action
No clock	74S86 at B2 bad 74S195 at C2 bad 74LS153 at C1 bad 74S175 at B1 bad 74LS00 at A2 bad 74LS02 at B13 bad Bad crystal	Replace and test Replace and test Replace and test Replace and test Replace and test Replace and test Replace and test

Troubleshooting Procedure



A: SYMPTOM: No message, no beep

Problem	Possible cause	Repair action
No LPDS clock for video circuits	74S86 at B2 bad	Replace and test
No phase 0 clock for speaker circuit	74S86 at B2 bad	Replace and test
No clock pulses on motherboard	74S86 at B2 bad	Replace and test

Reference Drawings

- Fig. 4-3, p. 66
- Fig. 4-5, p. 67
- Fig. 4-7, p. 67

Troubleshooting Procedure

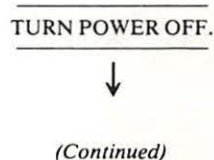

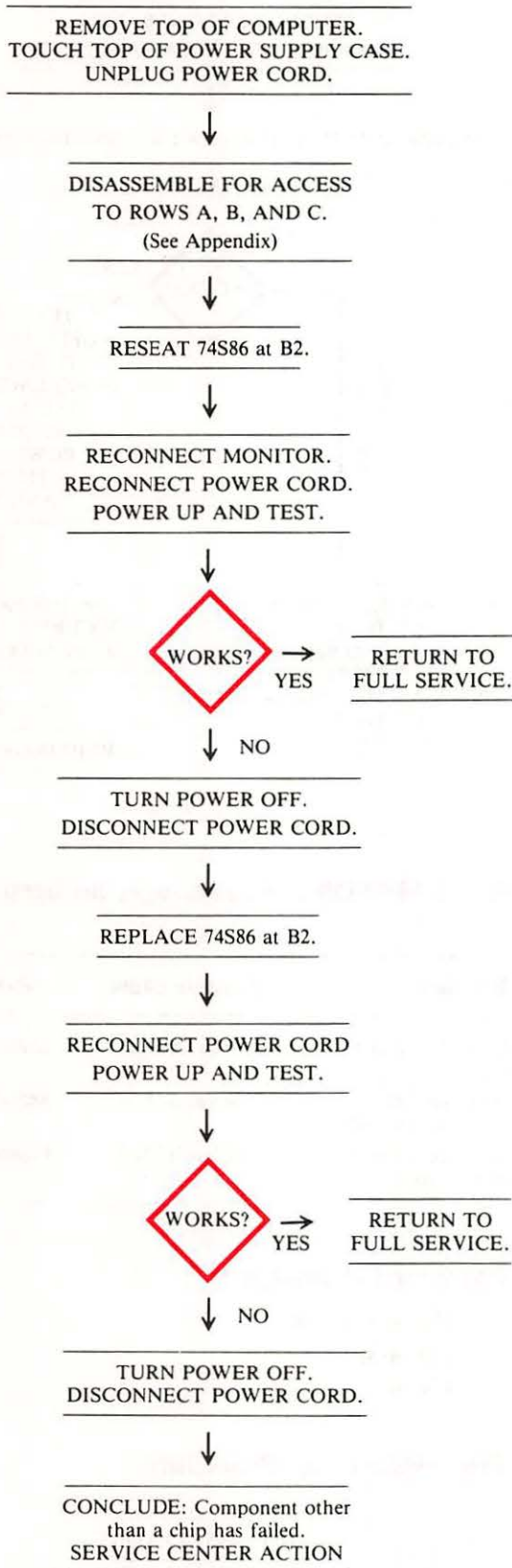

B: SYMPTOM: Message, no beep

Problem	Possible cause	Repair action
No phase 0, phase 1, or 7 MHz clock signals	74S175 at B1 bad 74LS153 at C1 bad 74S195 at C2 bad	Replace and test Replace and test Replace and test

Reference Drawings

Fig. 4-3, p. 66

Fig. 4-7, p. 67

Troubleshooting Procedure

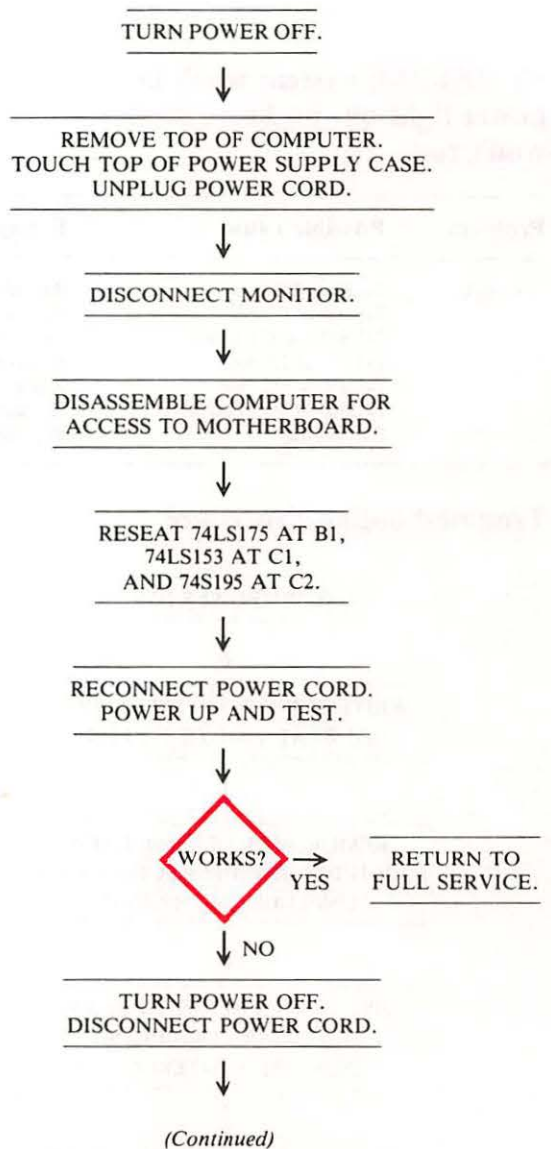

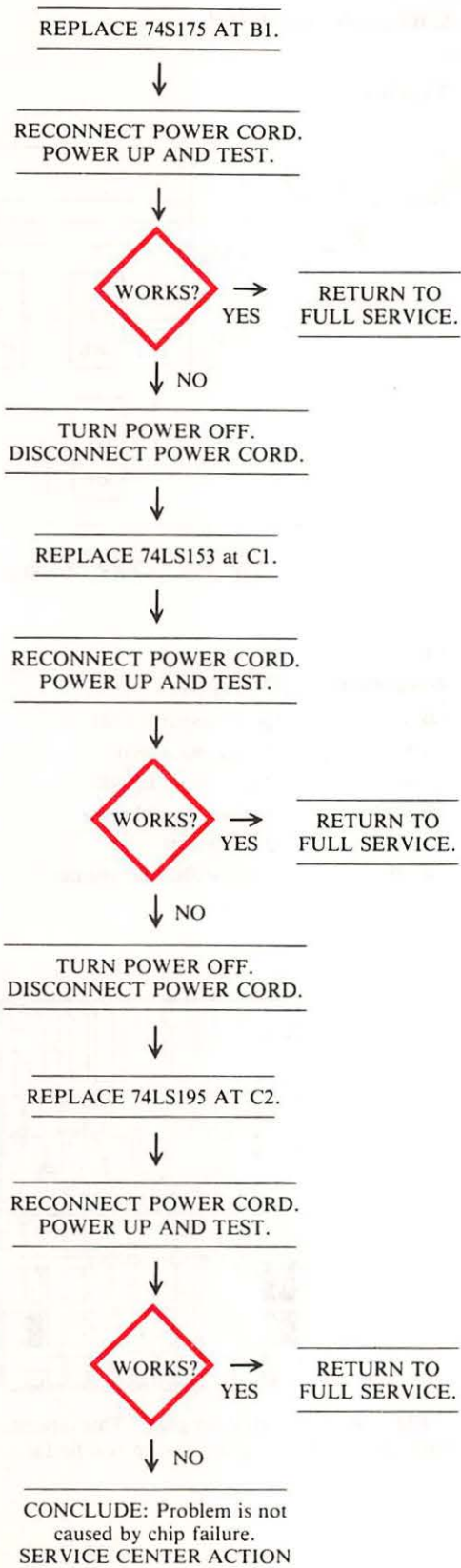

C: SYMPTOM: No message, beep

Problem	Possible cause	Repair action
Phase 0 clock good, but no LPDS signal for video circuits.	74LS00 at A2 bad 74LS02 at B13 bad 74S195 at C2 bad	Replace and test Replace and test Replace and test

Reference Drawings

Fig. 4-3, p. 66
Fig. 4-5, p. 67

Troubleshooting Procedure

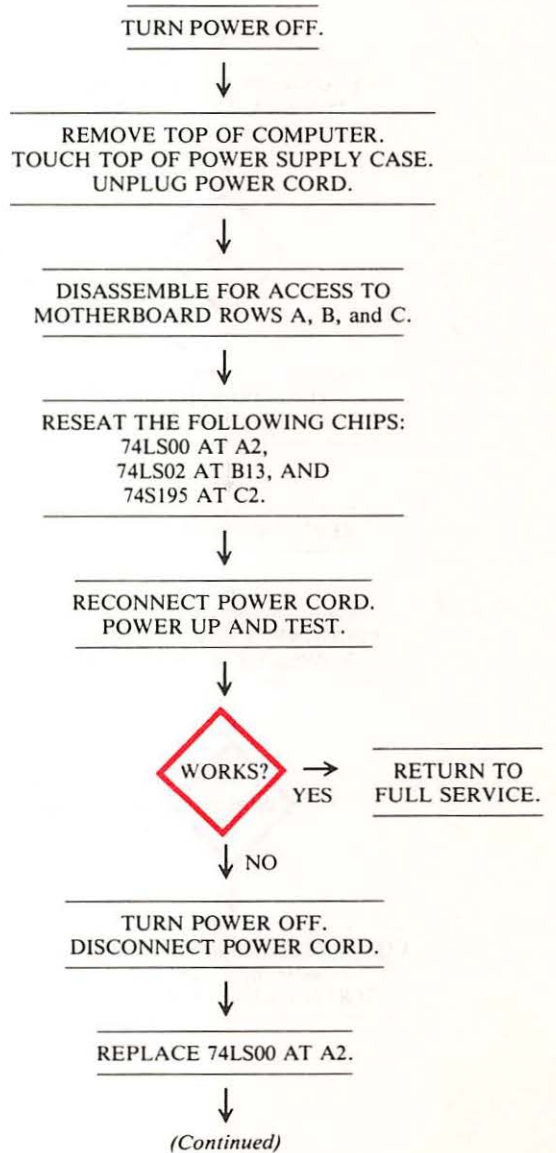

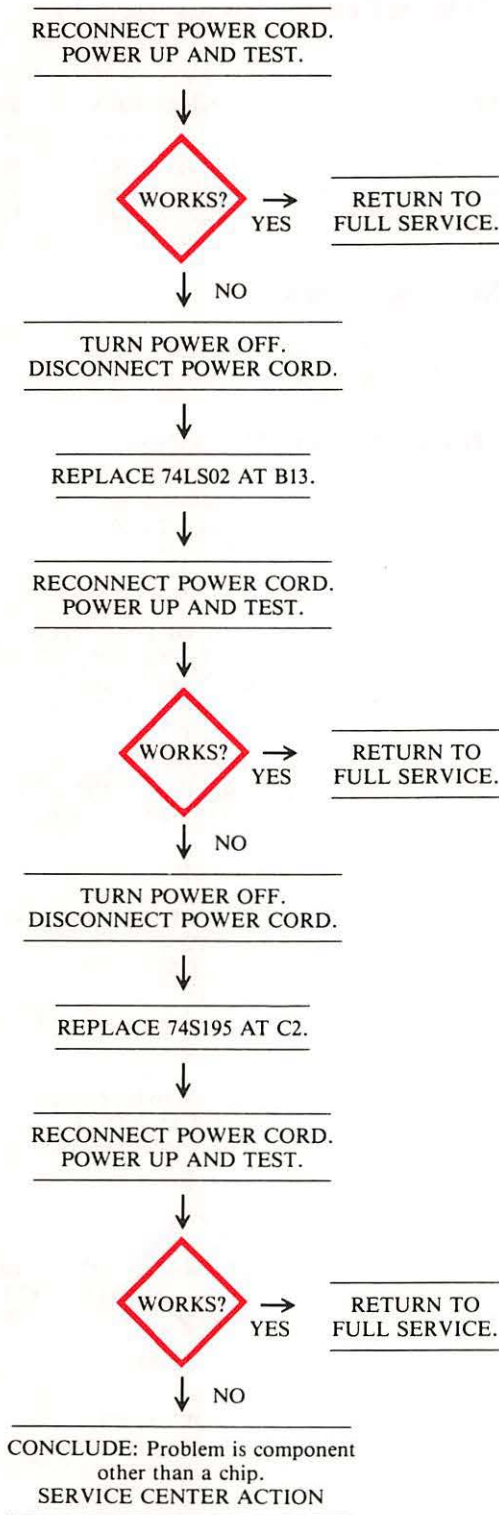

Circuitry Affected

Clock Circuitry

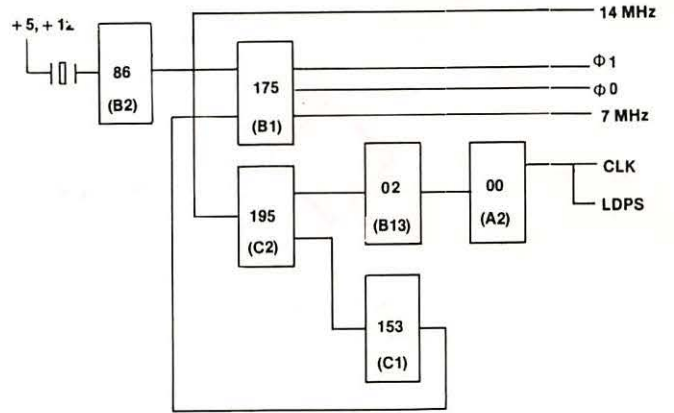

Fig. 4-3. Clock circuitry.

Chip designation	Description	Location
74LS00	Quad 2-input NAND	A2
74LS02	Quad 2-input NOR	B13
74S86	Quad 2-input EXOR	B2
74LS153	Dual 4-1 multiplexer	C1
74LS175	Quad D-latch	B1
74S195	4-bit parallel shift register	C2

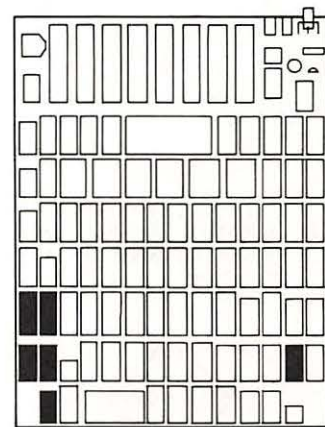

Fig. 4-4. Chip location guide. This represents the Apple motherboard and is a guide to help you find the chips of interest.

Video Circuitry

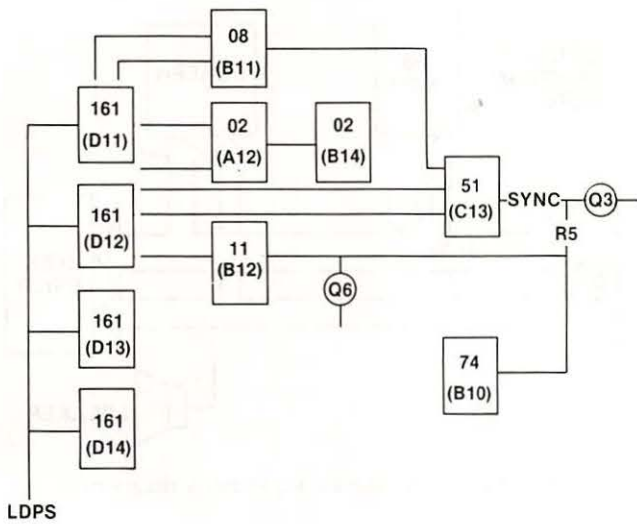

Fig 4-5. Video circuitry.

Chip designation	Description	Location
74LS02 (2)	Quad 2-input NOR	A12 B14
74LS08	Quad 2-input AND	B11
74LS11	Triple 3-input AND	B12
74S51	Dual 2-input AND-OR-Invert	C13
72LS74	Dual D flip-flop	B10
74LS161 (4)	Presetable binary counter	D11 D12 D13 D14
Q3	2N3904	J14
Q6	2N3904	J14

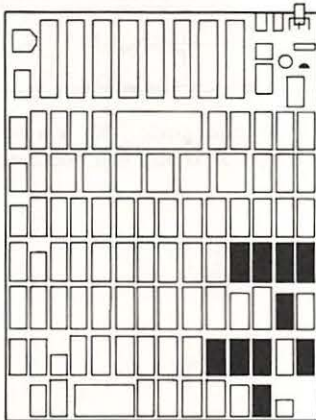

Fig. 4-6. Chip location guide. This represents the Apple motherboard and is a guide to help you find the chips of interest.

Beep Circuitry

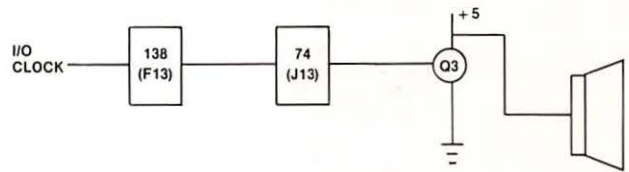

Fig. 4-7. Beep circuitry.

Chip designation	Description	Location
74LS74	Dual D flip-flop	J13
74LS138	3 to 8 decoder	F13
Q4	MPSA13 transistor	J14

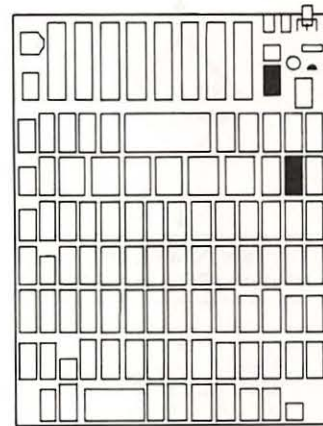

Fig. 4-8. Chip location guide. This represents the Apple motherboard and is a guide to help you find the chips of interest.

SYMPTOM: System won't boot — power light on, no beep, drive won't run, garbage on screen

Problem	Possible cause	Repair action
Autostart ROM not working	Bad F8 ROM	Replace F8 ROM at location F8
CPU not activating ROM	Bad 6502	Replace 6502 CPU at location H7

Troubleshooting Procedure

TURN POWER OFF.



(Continued)

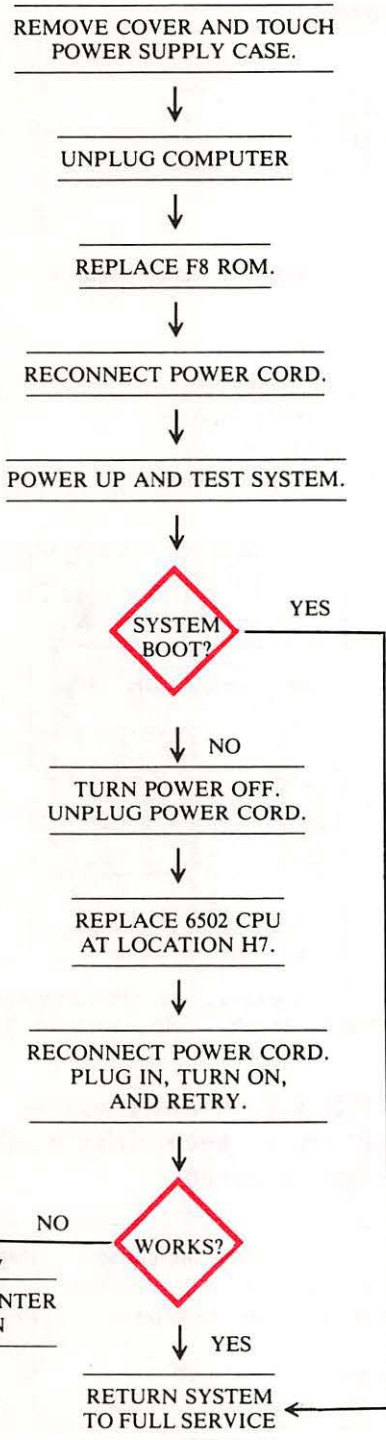

Circuitry Affected

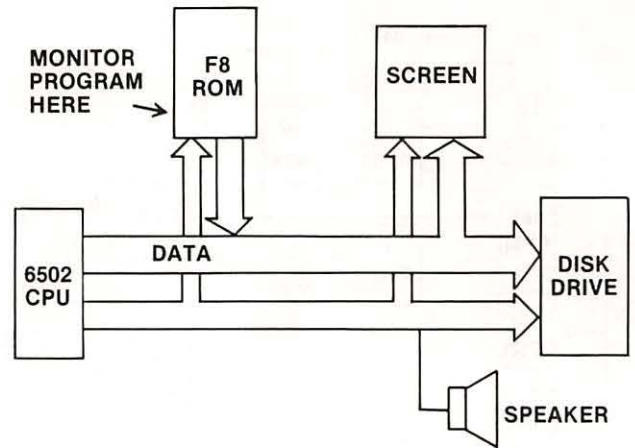

Fig. 4-9. CPU and F8 ROM block diagram.

Chip designation	Description	Location
F8 ROM	Read only memory	F3
6502 CPU	Central processing unit	H7

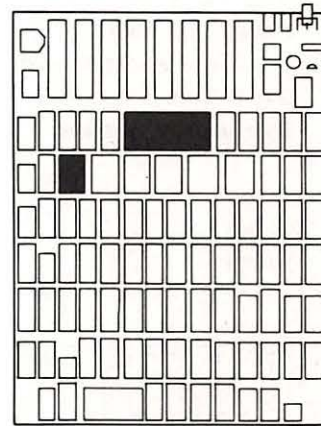
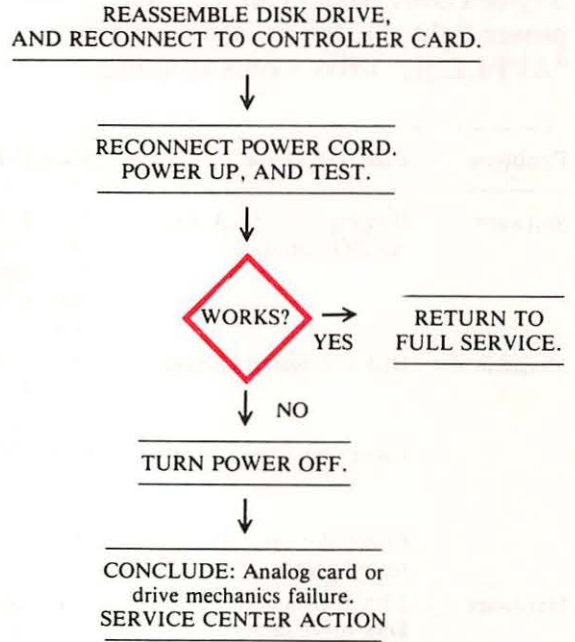
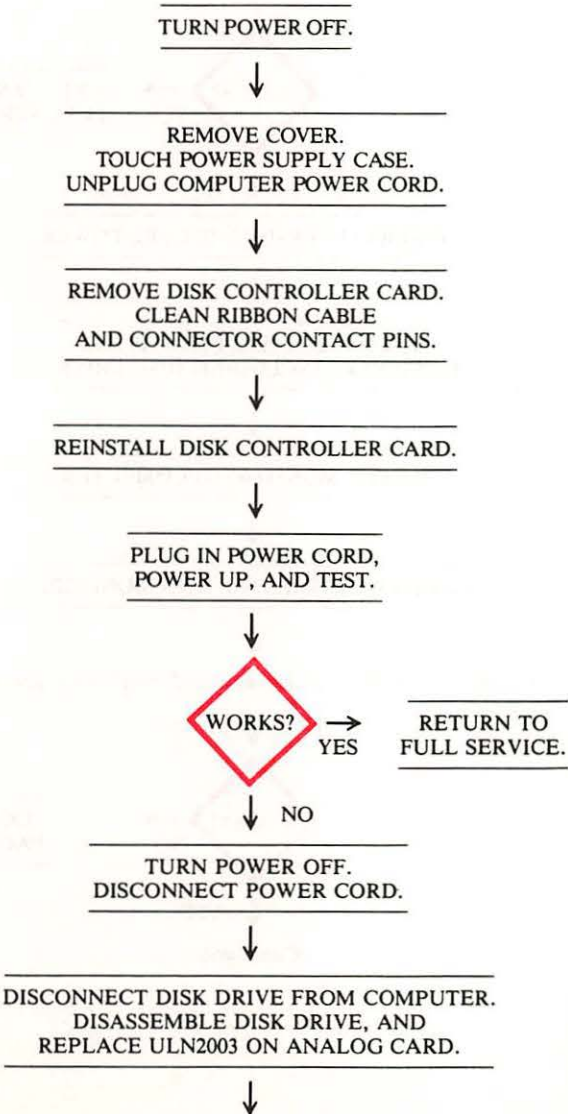

Fig. 4-10. Chip location guide. This represents the Apple motherboard and is a guide to help you find the chips of interest.

SYMPTOM: System won't boot — power light on, beeps, screen displays "APPLE II," drive won't run

Problem	Possible cause	Repair action
Disk boot signal bad	Corrosion on connector pins	Clean connector pins
Disk boot signal missing	Bad ribbon cable	Clean or replace cable
	Bad ULN2003 on analog card	Replace ULN2003
	Bad regulator circuit on analog card	Replace analog card
	Bad stepper motor or drive mechanism	Take to service center

Troubleshooting Procedure



Circuitry Affected

Chip designation	Description	Location
ULN2003	7-channel input driver	Analog card

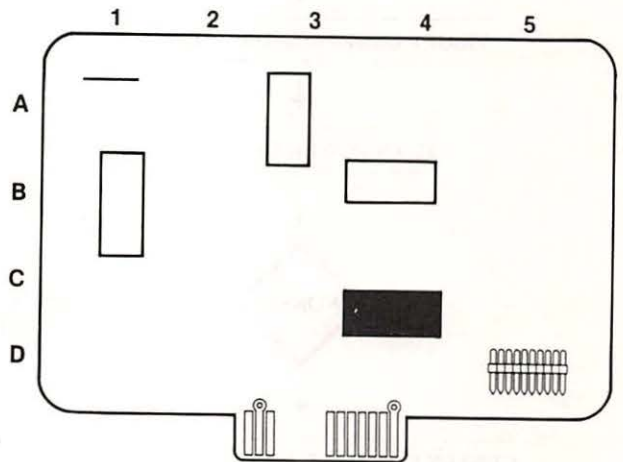
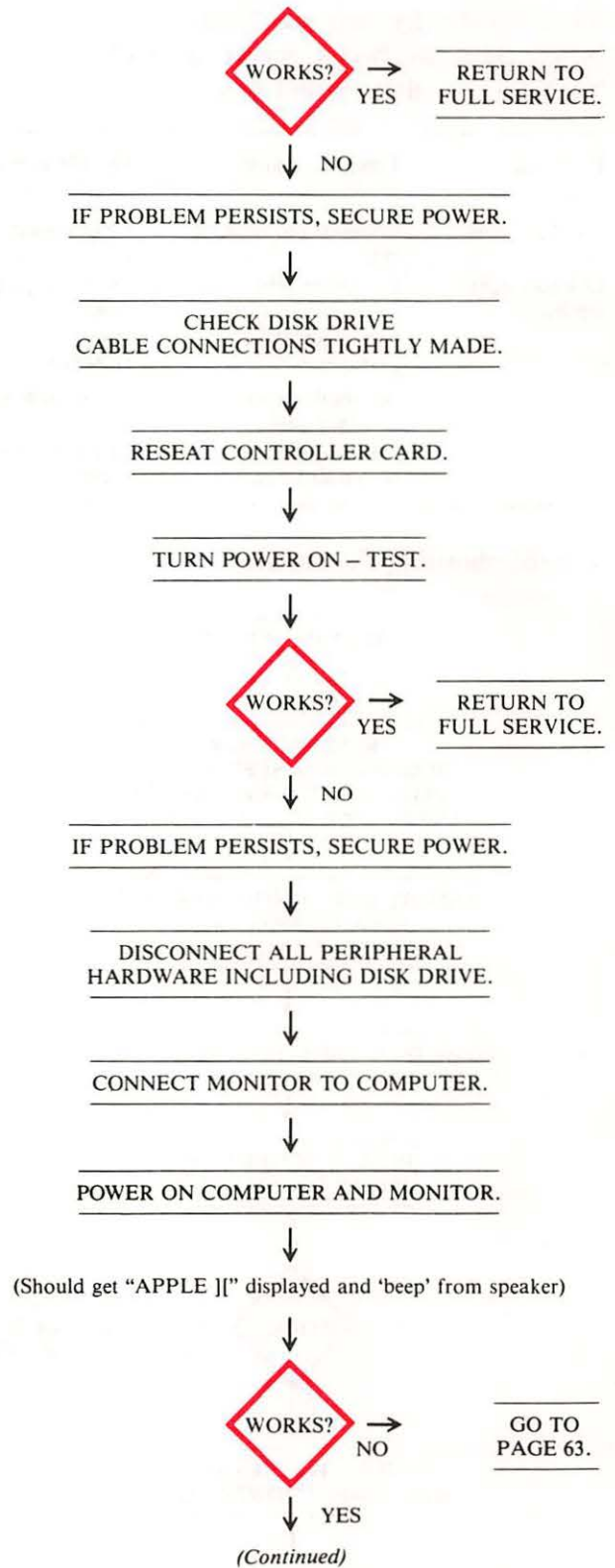
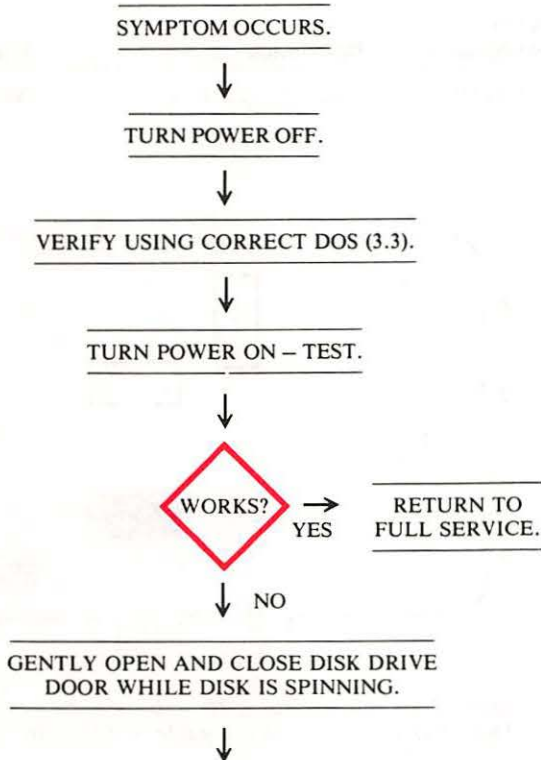

Fig. 4-11. Chip location guide. This represents the Apple Disk II analog card and is a guide to easy chip location.

SYMPTOM: System won't boot – power light on, beeps, screen displays "APPLE][," drive keeps running

Problem	Possible cause	Repair action
Software	Booting 3.2 on 3.3 system No DOS on disk	Boot with 3.3 DOS; boot up with copy of System Master first
Mechanical	Disk not seated properly	Slowly open and close drive door
	Cable connection loose	Check all cable connections (firmly made?) Reseat card
Hardware	Controller card not seated properly	Reseat card
	Disk I/O faulty Disk drive faulty	See page 74 See page 74

Troubleshooting Procedure



CONCLUDE – Problem is in one of 3 areas:
 1. Disk controller card
 2. Motherboard circuitry
 3. Disk drive electronics

↓

GO TO PAGE 74. DRIVE NOT READING.

SYMPTOM: System won't boot – power light on, beeps, screen displays "APPLE II," drive runs then stops

Problem	Possible cause	Repair action
DOS not being loaded into RAM	Bad DOS on disk	Try another disk
	Bad disk	Try another disk
	Bad RAM chip on motherboard	Replace and test
	Bad RAM chip on language card	Replace and test

Troubleshooting Procedure

TURN POWER OFF.

↓

WRITE DOWN WHAT SYSTEM WAS DOING AT TIME OF FAILURE.

↓

TRY TO BOOT ANOTHER DOS DISK

↓

WORKS? → YES → RETURN TO FULL SERVICE.

↓ NO

TURN POWER OFF.

↓

REMOVE TOP OF COMPUTER. TOUCH TOP OF POWER SUPPLY CASE. UNPLUG POWER CORD.

↓

DISCONNECT ALL PERIPHERAL HARDWARE INCLUDING DISK DRIVE INTERFACE

↓

CONNECT MONITOR TO APPLE II.

↓

RECONNECT POWER CORD. TURN ON COMPUTER AND MONITOR.

↓

(Should get "APPLE II" displayed and 'beep' from speaker)

↓

WORKS? → YES → TURN SYSTEM OFF. DISCONNECT POWER CORD. REPLACE CARDS ONE AT A TIME.

↓ NO

ONE CHIP AT A TIME, SWAP BOTTOM ROW (ROW C) OF RAM CHIPS WITH ROW D RAM CHIPS.

↓

TURN POWER ON – TEST.

↓

WHEN FAILURE OCCURS, LAST CHIP REPLACED IN ROW C IS BAD.

↓

TURN ON POWER, TEST.

↓

WHEN FAILURE OCCURS, LAST CARD REPLACED IS BAD.

↓

REPAIR OR REPLACE.

Circuitry Affected

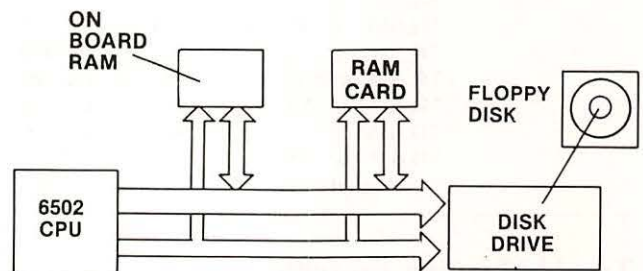

Fig. 4-12. Circuitry affected.

Chip designation	Description	Location
2116	16K X 1-bit RAM memory chip	ROW C, D, E

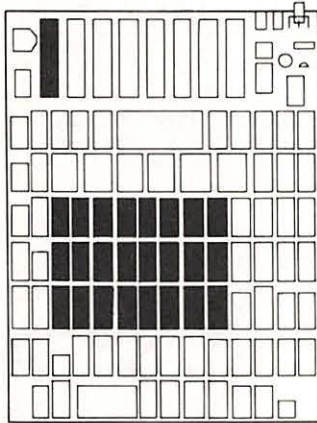
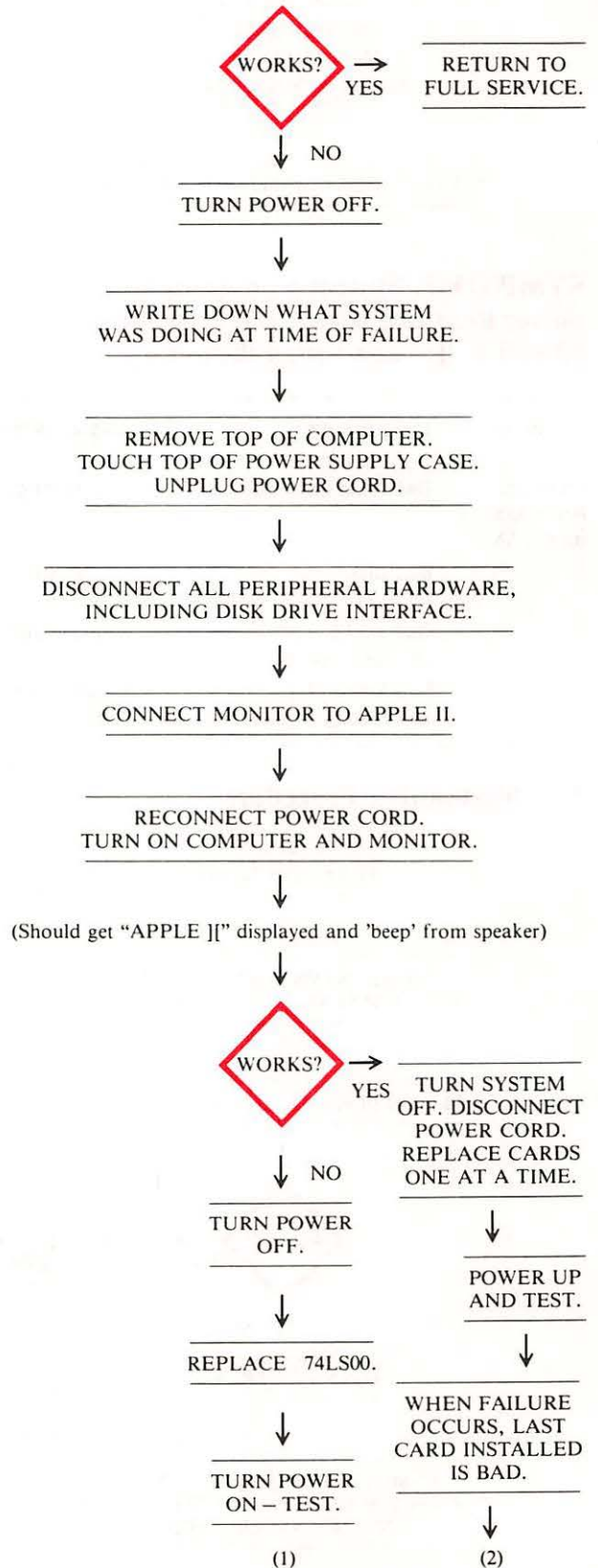
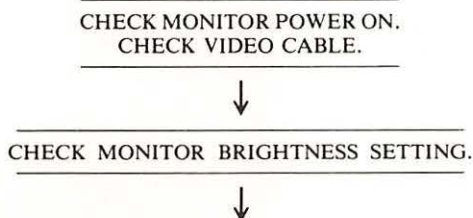

Fig. 4-13. Chip location guide. This represents the Apple motherboard and is a guide to help you find the chips of interest.

SYMPTOM: System won't boot — power light on, beeps, no display, drive whirs then stops.

Problem	Possible cause	Repair action
No Video	Video cable bad	Replace and test
Out signal	Video connector bad	Replace and test
Video signal too low	Monitor brightness control set too low	Readjust brightness
No clock pulse getting to video circuits	74LS00 at A2 bad 74LS02 at B13 bad 74S195 at C2 bad	Replace and test Replace and test Replace and test
Video circuit component bad	74LS04 at C11 bad 74LS161 at D11 bad 74LS161 at D12 bad 74LS161 at D13 bad 74LS161 at D14 bad 74LS74 at B10 bad 74LS151 at A9 bad 74LS194 at A10 bad 74LS257 at A8 bad 74S86 at B2 bad	Replace and test Replace and test Replace and test Replace and test Replace and test Replace and test Replace and test Replace and test Replace and test

Troubleshooting Procedure



(Continued)

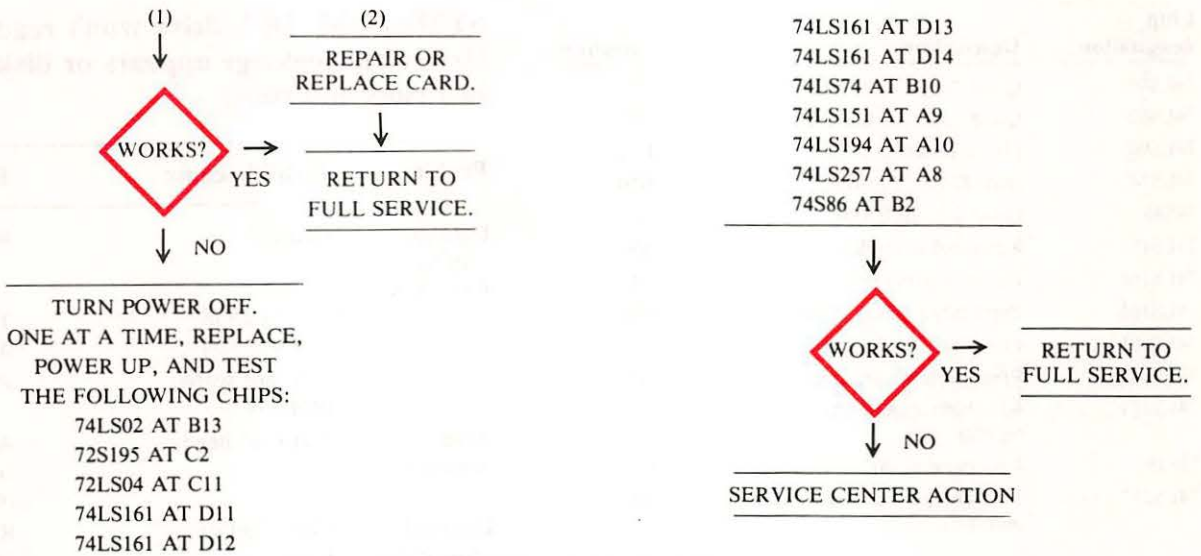

Circuitry Affected

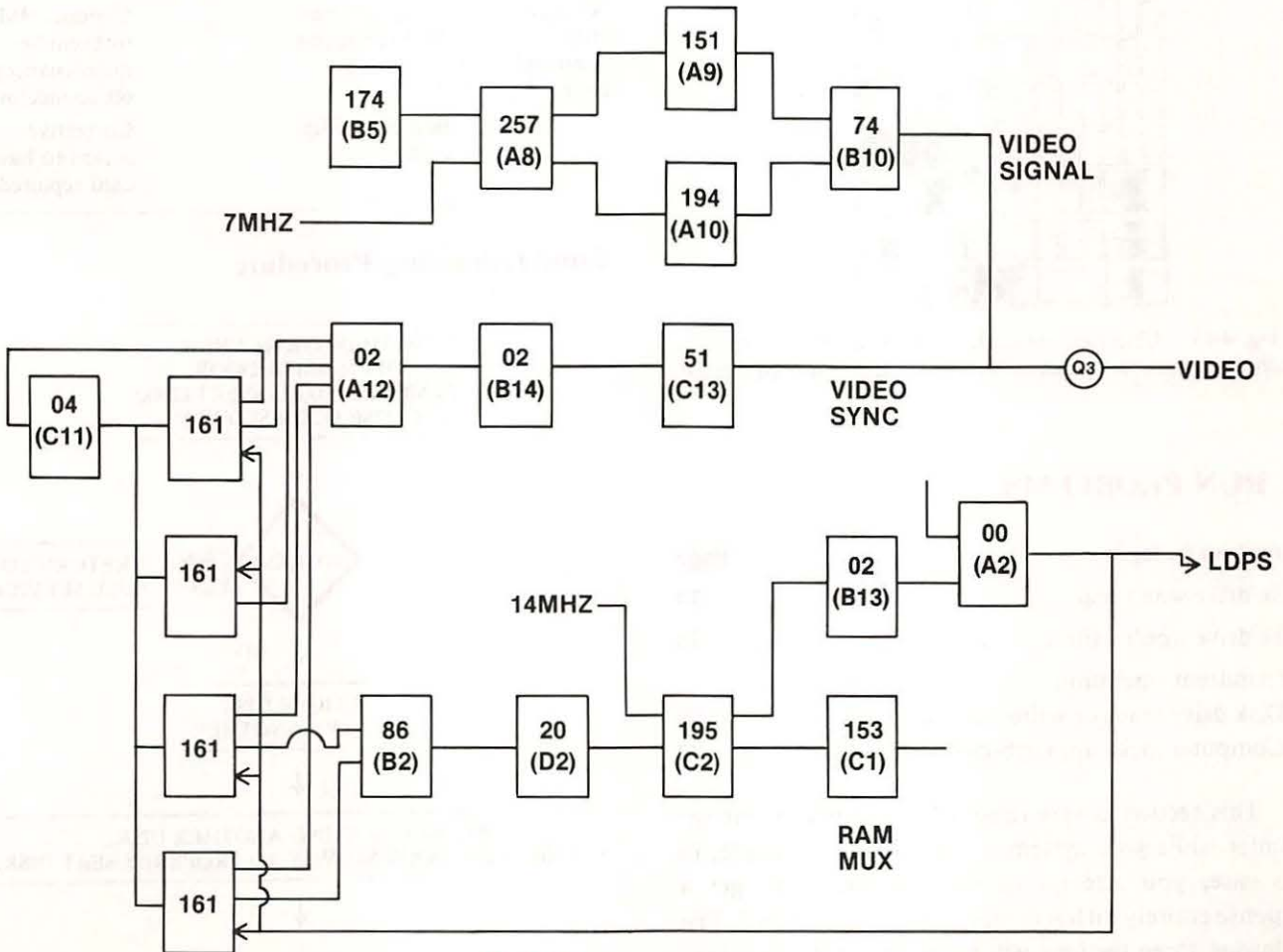

Fig. 4-14. Circuitry affected.

Chip designation	Description	Location
74LS00	Quad 2-input NAND gate	A2
74LS02	Quad 2-input NOR gate	B13
74LS04	Hex inverter	C11
74LS74	Dual D-type flip-flop	B10
74S86	Quad 2-input EXOR	B2
74LS151	8-channel multiplexer	A9
74LS161	Presetable binary counter	D11
74LS161	Presetable binary counter	D12
74LS161	Presetable binary counter	D13
74LS161	Presetable binary counter	D14
74LS194	4-bit bidirectional shift register	A10
74S195	4-bit parallel shift register	C2
74LS257	Tri-state quad 2-input multiplexer	A8

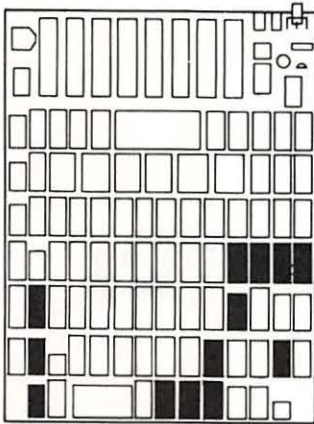

Fig. 4-15. Chip location guide. This represents the Apple motherboard and is a guide to help you find the chips of interest.

2. RUN PROBLEMS

Symptom Category	Page
Disk drive won't read	74
Disk drive won't write	76
Intermittent operation	
Disk drive reads or writes intermittently	78
Computer locks up, keyboard won't work	79

This section covers those problems you might encounter while your system is running. For example, in this case, you attempt to do something and get a response entirely different from what you expected. The following three sections will cover broad malfunctions such as display failure, keyboard failure, and input/output failure (although these may also occur during the time your program is running merrily along).

SYMPTOM: Disk drive won't read (I/O error message appears or disk just runs and runs)

Problem	Possible cause	Repair action
Data not coming from disk	Bad disk	Replace disk
	Wrong DOS (3.2 not 3.3)	Try another disk
Read head not reading	Disk not seated properly	Reseat disk
	Bad read head	Ask service center to replace head
Data not coming out of drive	Cable bad or loose	Reseat or replace
	Bad chip on drive analog card	Replace and test
No data from controller card	Corrosion on card connector	Conduct PM (preventive maintenance) on connector
	Bad controller card	Corrective action to have card repaired

Troubleshooting Procedure

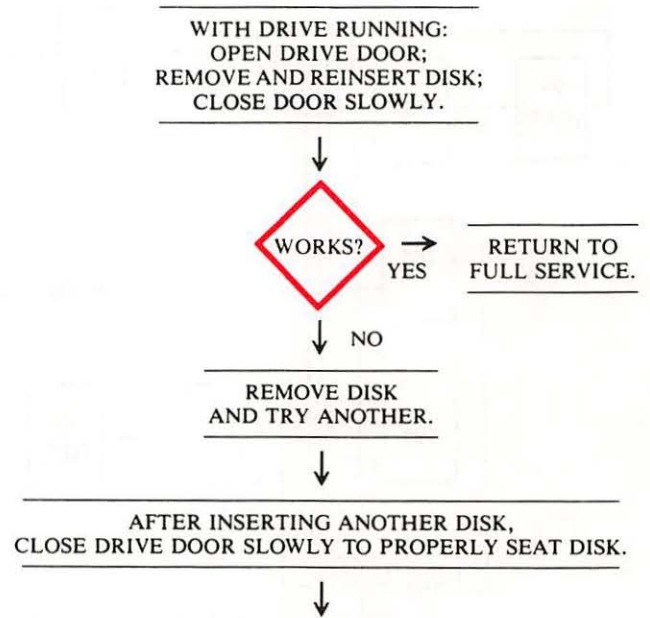

(Continued)

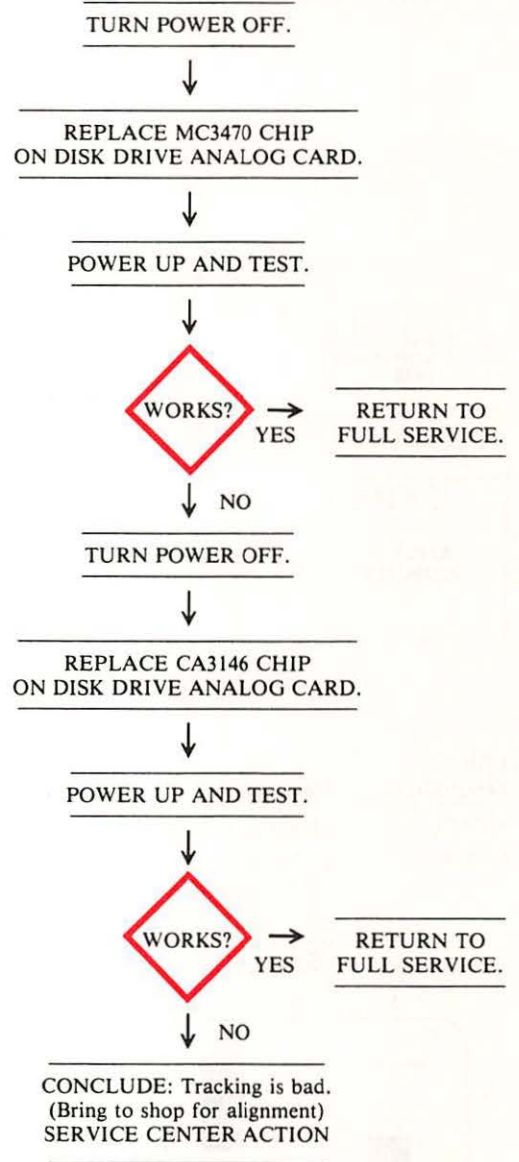
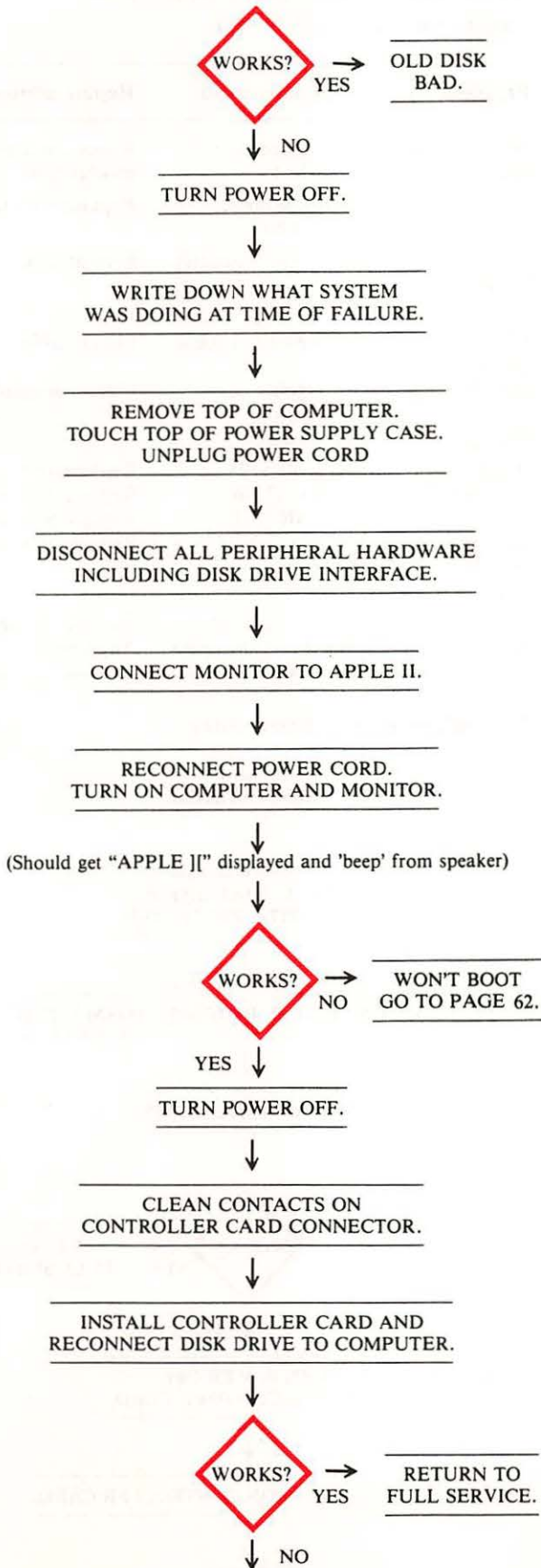

Circuitry Affected

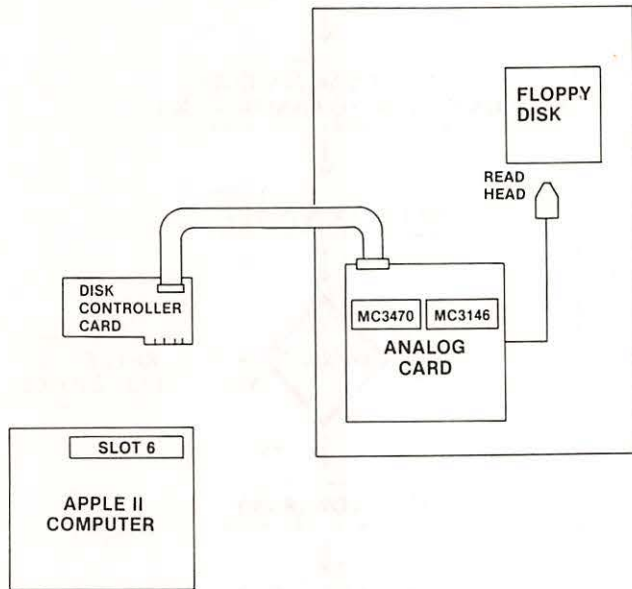

Fig. 4-16. Circuitry affected.

Chip designation	Description	Location
MC3470	Floppy disk read amplifier	Analog card
CA3146	Differential pair and three NPN transistors	Analog card

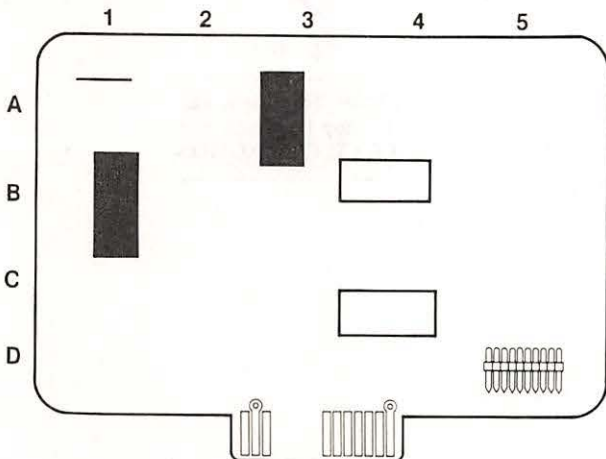
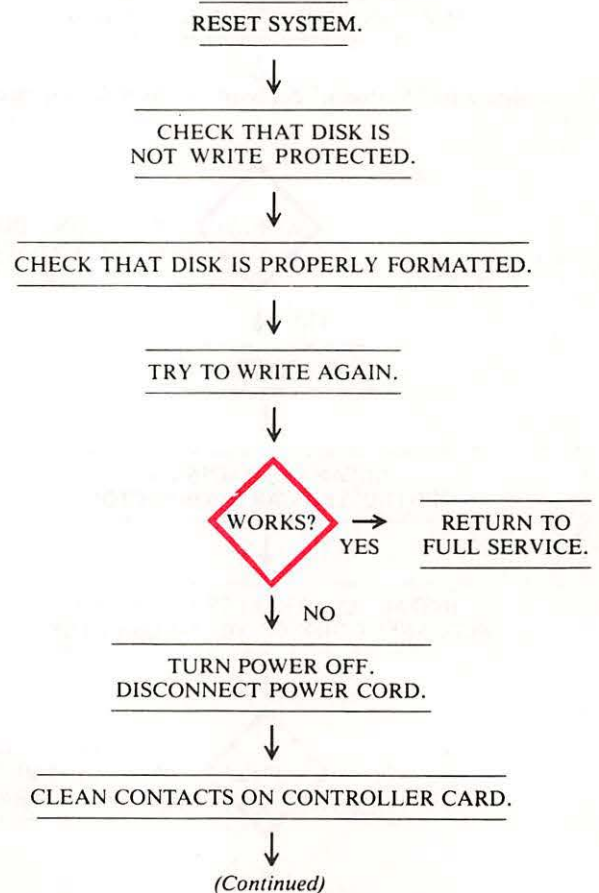

Fig. 4-17. Analog card chip location guide. This represents the Apple Disk II analog card and is a guide to help you find the chips of interest.

SYMPTOM: Disk drive won't write (read functions properly)

Problem	Possible cause	Repair action
Disk is write protected	Write-protect tab installed	Remove write-protect tab
	Write-protect switch bad	Replace switch
Drive can't tell where to write	Disk not formatted	Format disk
Write signals not getting to drive electronics	Cable bad or loose	Check cable
	Controller card connectors corroded	Clean connectors
Drive electronic signals improper on analog card	Bad 74LS125	Replace and test
	Bad CA3146	Replace and test
	Bad MC3470	Replace and test
	Bad ULN2003	Replace and test
Drive mechanics bad	Bad write head	Replace and test
	Bad head alignment	Align head

Troubleshooting Procedure



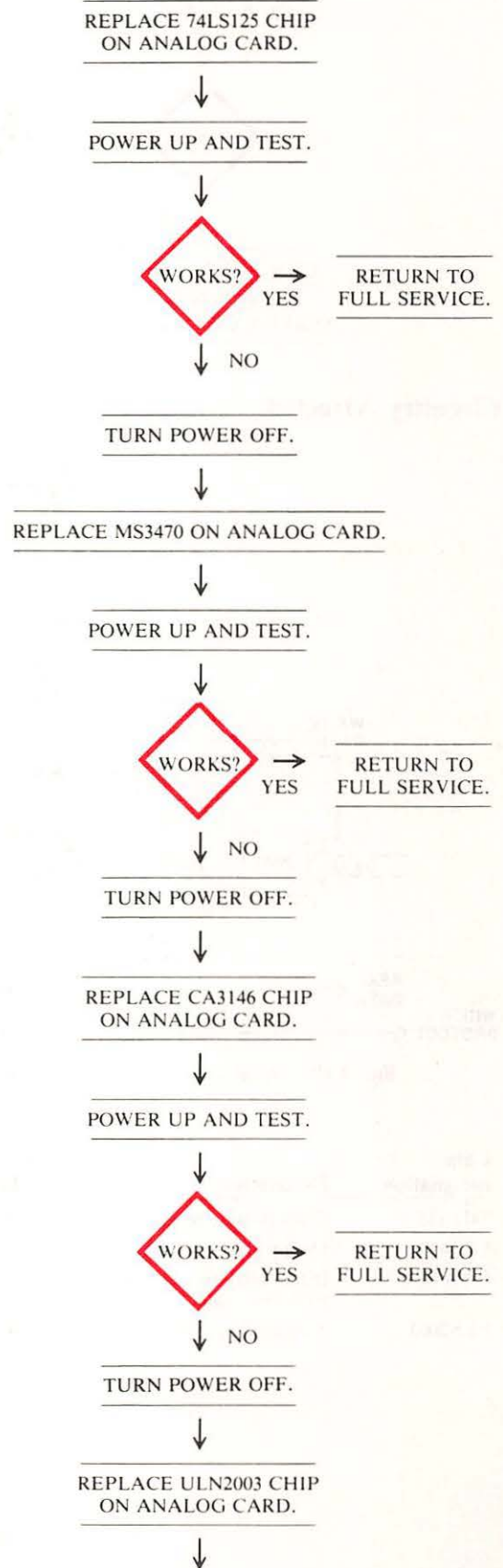
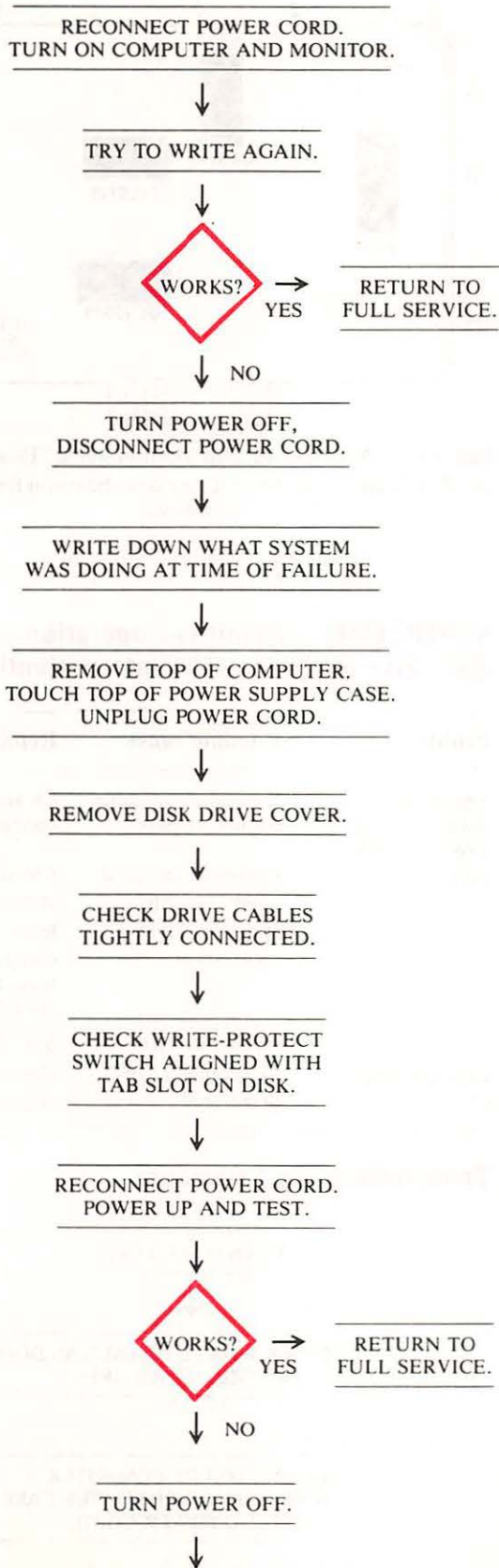

(Continued)

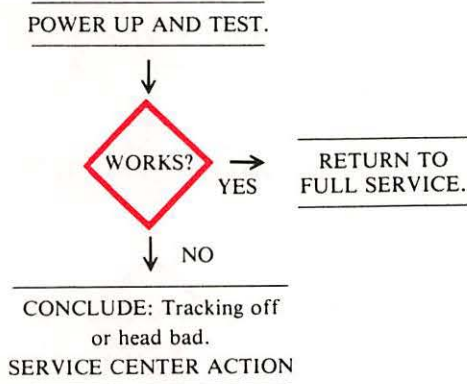

Circuitry Affected

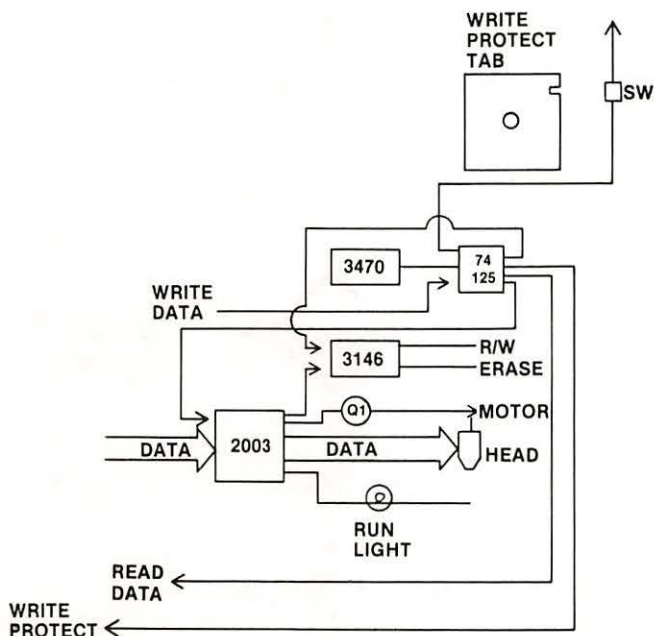

Fig. 4-18. Analog card circuitry affected.

Chip designation	Description	Location
74LS125	Quad tri-state buffer	Analog card
MC3470	Floppy disk read amplifier	Analog card
CA3146	Differential pair and three NPN transistors	Analog card
ULN2003	7-channel input driver	Analog card

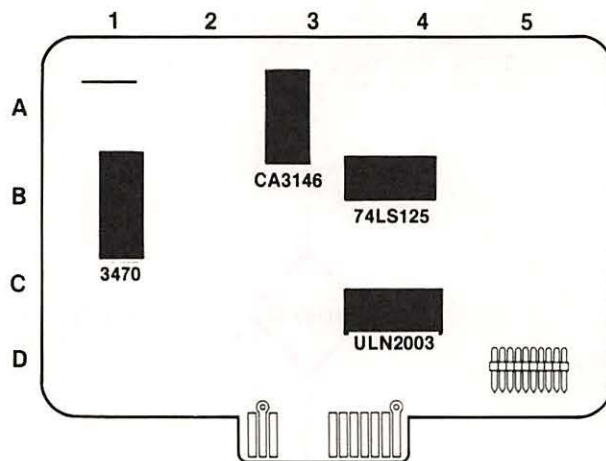
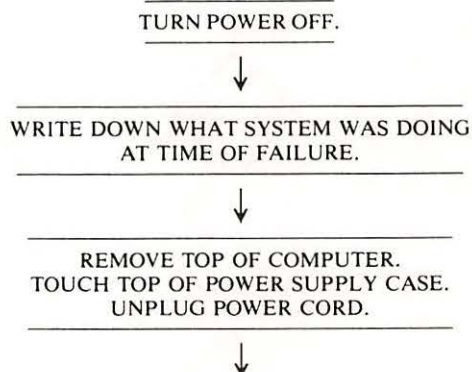

Fig. 4-19. Analog card chip location guide. This represents the Disk II analog card and is a guide to help you find the chips of interest.

SYMPTOM: Intermittent operation – disk drive reads or writes intermittently

Problem	Possible cause	Repair action
Signals not always getting into controller card	Corrosion on cable connector pins	Clean cable connector pins
	Corrosion on card connector pins	Clean card connector pins
	Heat-sensitive component	Install fan; component troubleshooting—see Chapter 9
Disk tracking off	Noise interference	See Chapter 8
	Misalignment of drive head	Correct alignment

Troubleshooting Procedure



(Continued)

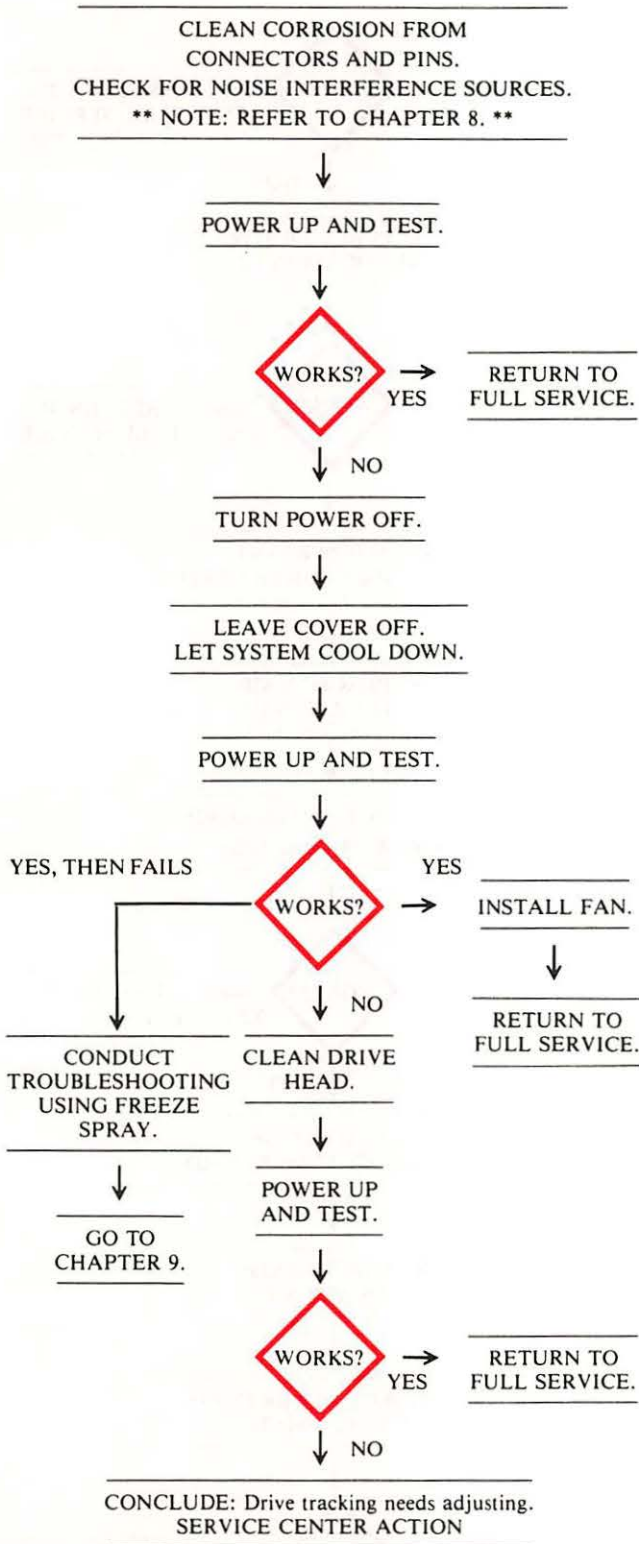

Circuitry Affected

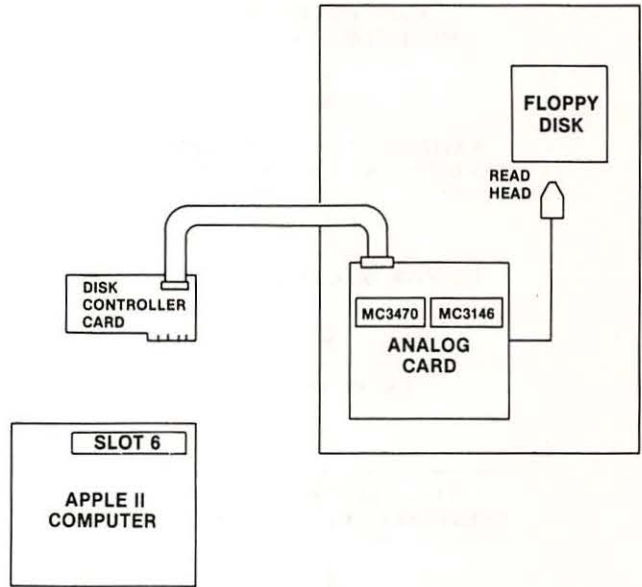
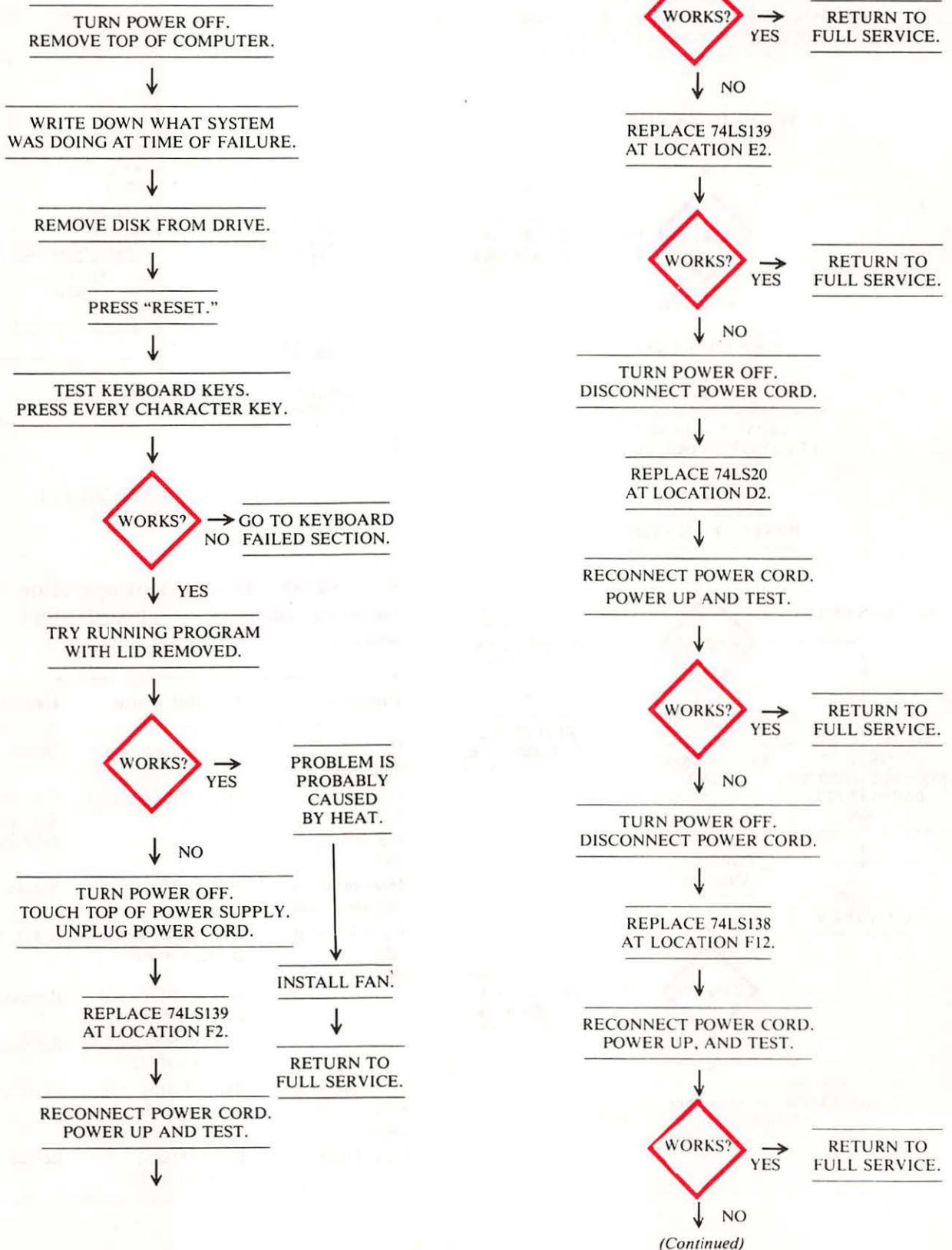

Fig. 4-20. Circuitry affected.

SYMPTOM: Intermittent operation — computer locks up, keyboard won't work

Problem	Possible cause	Repair action
Programming lock-out	Error in program	Debug program.
No output from keyboard circuitry	Failure in keyboard circuitry	Go to "Bad Key Action", page 101.
Heat problem on motherboard	Bad RAM chip	Replace and test
No RAM chip select signal	Bad 74LS139 chip at location F2	Replace and test
	Bad 74LS139 chip at location E2	Replace and test
	Bad 74LS20 chip at location D2	Replace and test
No ROM chip select signal	Bad 74LS138 chip at location F12	Replace and test
CPU failure	Bad 6502 chip at location H7	Replace and test

Troubleshooting Procedure



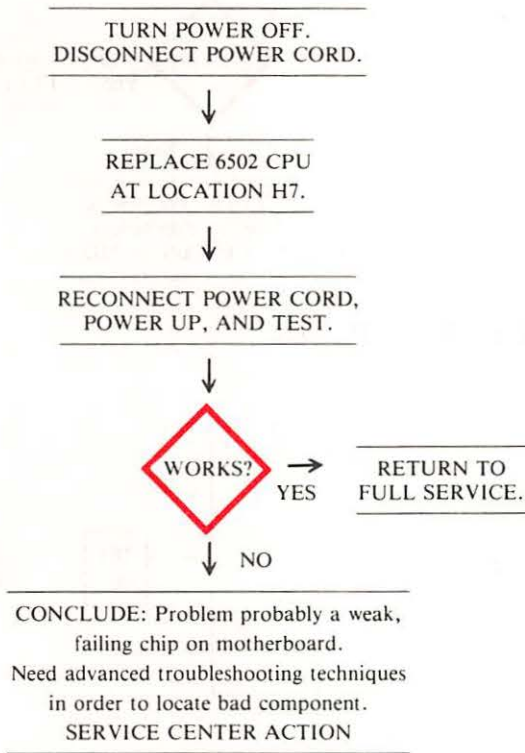

Chip designation	Description	Location
6502A	Central processing unit	H7
74LS20	Dual 4-input NAND	D2
74LS138	Expandable 3/8 decoder	F12
74LS139	Expandable 2/4 decoder	E2, F2

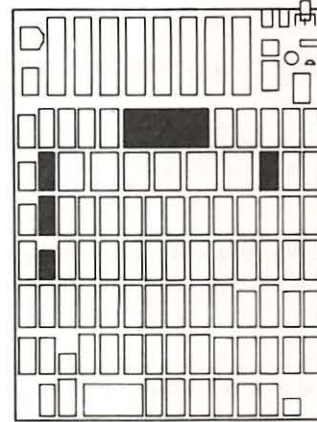

Fig. 4-22. Chip location guide. This represents the Apple motherboard and is a guide to help you find the chips of interest.

Circuitry Affected

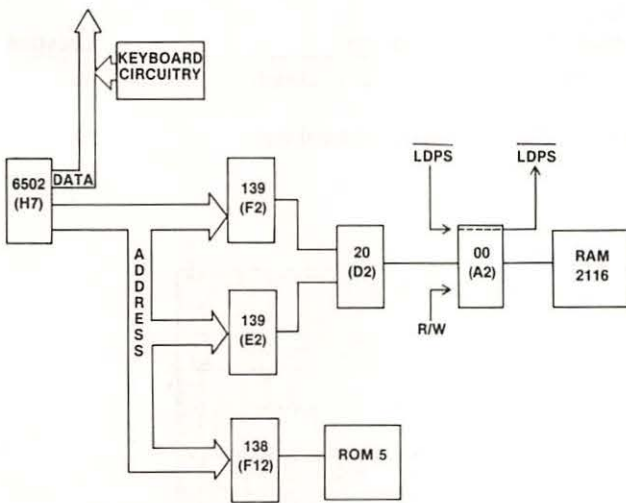

Fig. 4-21. Circuitry affected.

3. DISPLAY PROBLEMS

Symptom Category	Page
No display	
Screen all white	82
No video	83
Screen blank	86
No color	88
No vertical synchronization	89
No horizontal synchronization	90
Bad cursor or no cursor	92
Bad inverse or flash	93
No text	94
Video	
Wrong characters	96
Annoying color tint on fringe	96
Bad graphics	
No hi-res or lo-res graphics; text OK	97
No hi-res graphics; lo-res and text OK	98

SYMPTOM: No display – screen all white

Problem	Possible cause	Repair action
7F or FF hex latched in chip	Bad 74LS194 at B4 Bad 74LS194 at B9	Replace and test Replace and test

Troubleshooting Procedure

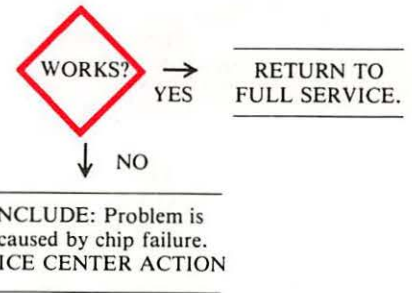
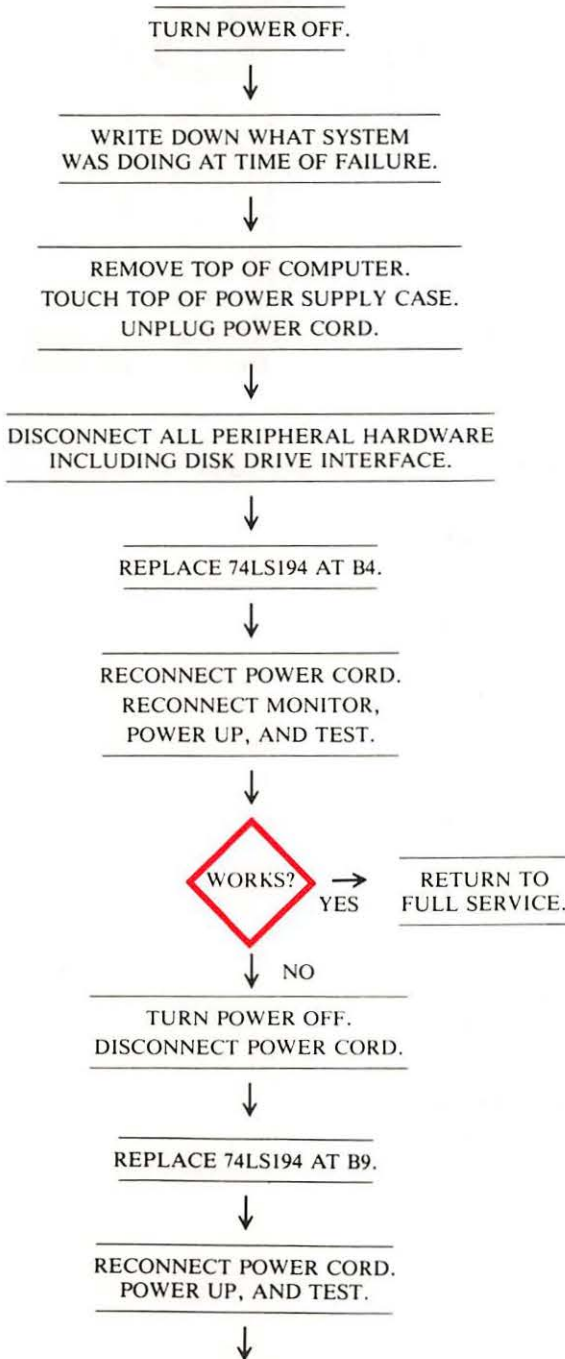

Circuitry Affected

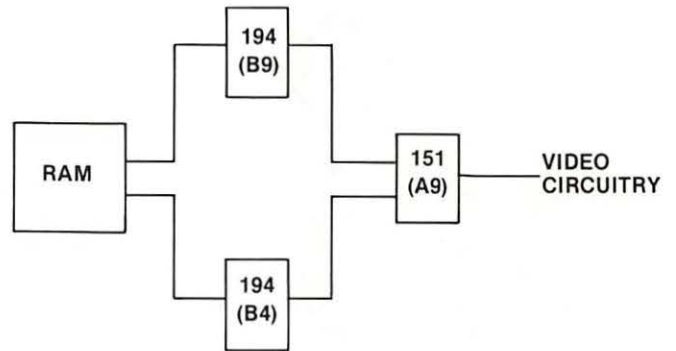

Fig. 4-23. Circuitry affected.

Chip designation	Description	Location
74LS194	4-bit bidirectional shift register	B4
74LS194	4-bit bidirectional shift register	B9

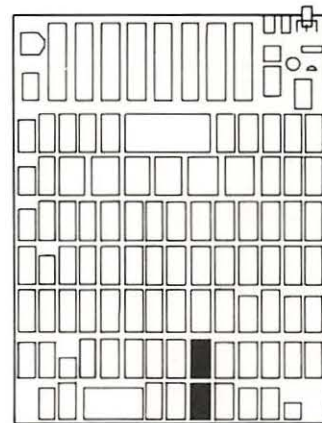
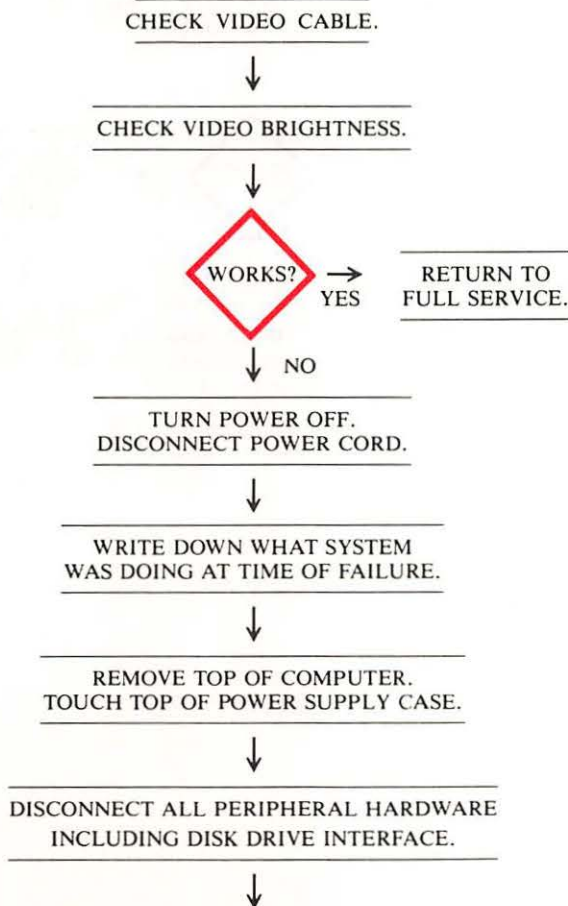

Fig. 4-24. Chip location guide. This represents the Apple motherboard and is a guide to help you find the chips of interest.

SYMPTOM: No display – no video

Problem	Possible cause	Repair action
No video into monitor	Bad cable replace	Reseat or
Video signal too small	Brightness out of adjustment Bad monitor	Adjust brightness Check and replace if necessary
No video signal being generated	Bad 74LS195 at C2 Bad 74LS02 at B13 Bad 74LS00 at A2 Bad 74LS161 at D11-D14 Bad 74LS04 at C11 Bad 74LS74 at B10 Bad 74LS151 at A9 Bad 74LS194 at A10 Bad 74LS257 at A8 Bad 74S86 at B2 Bad M3904 (Q3) at J14 Bad 74LS51 at C13	Replace and test Replace and test Replace and test Replace and test Replace and test Replace and test Replace and test Replace and test Replace and test Replace and test Replace and test (soldering) Replace and test

Troubleshooting Procedure



CONNECT MONITOR TO APPLE II.

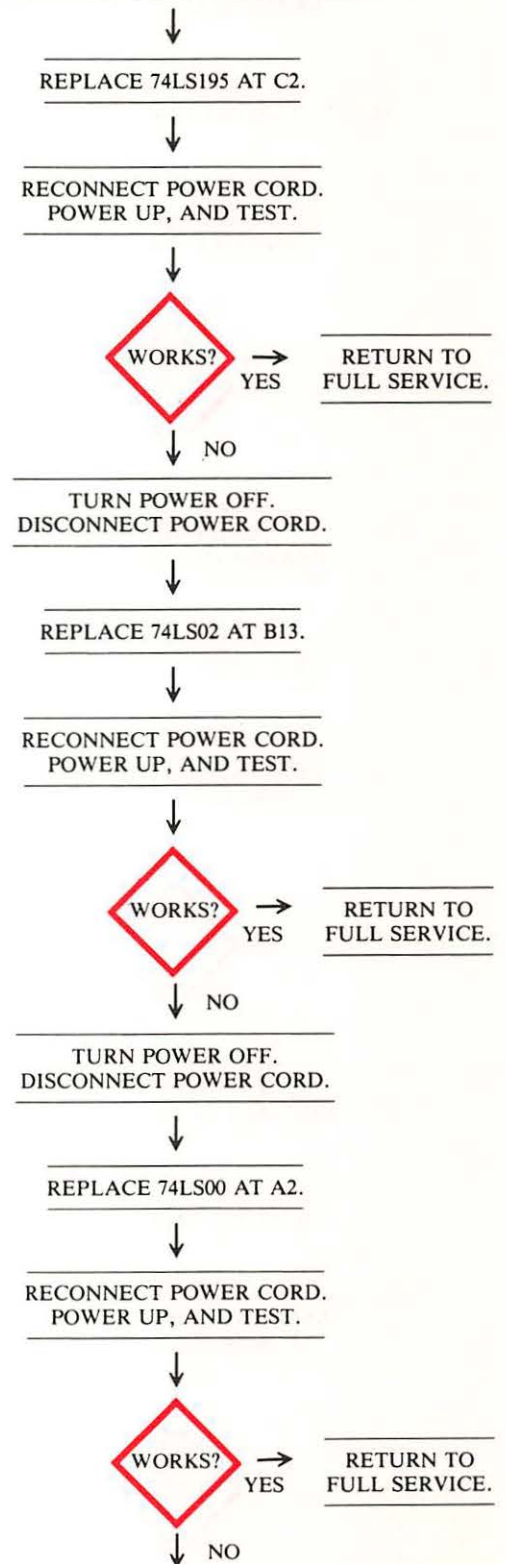

(Continued)

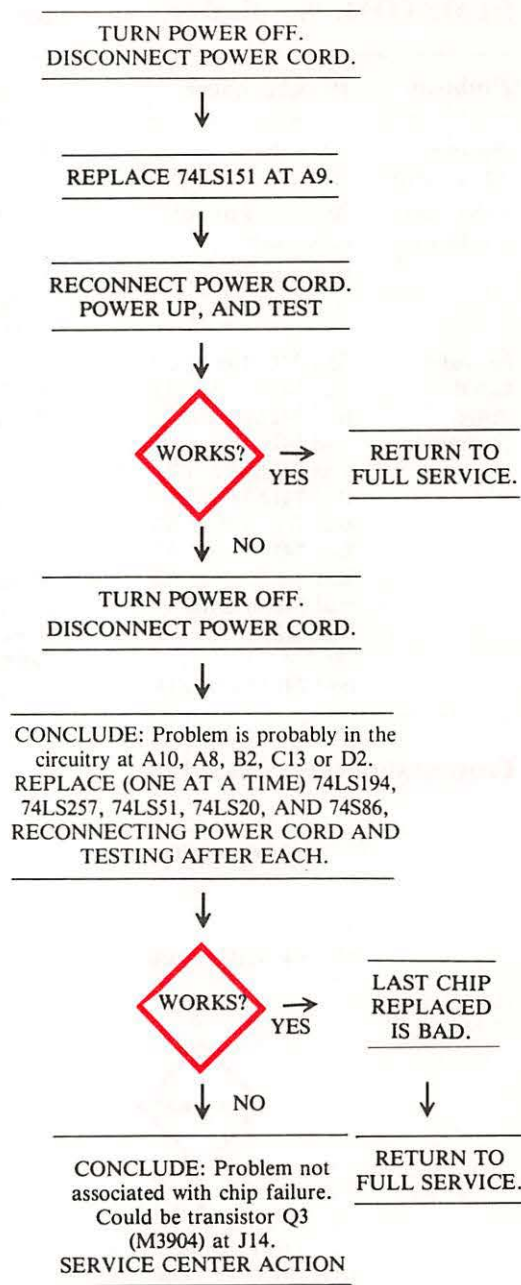
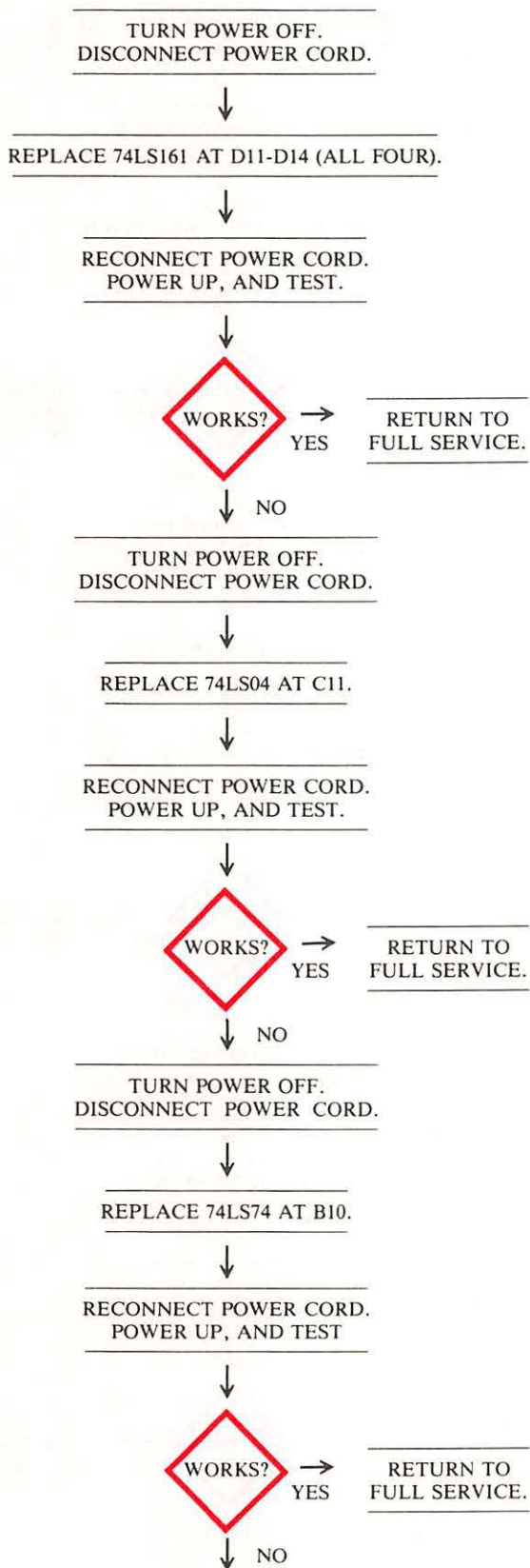

Circuitry Affected

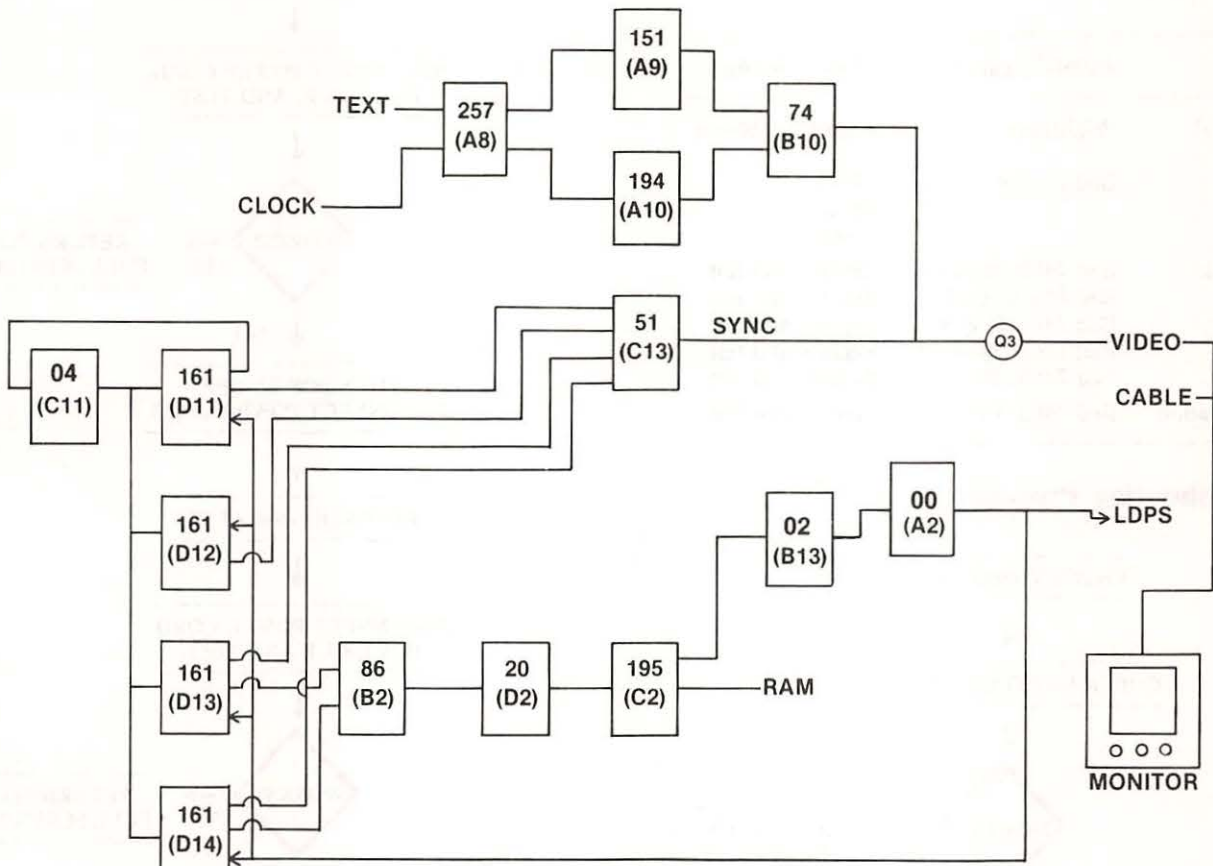

Fig. 4-25. Circuitry affected.

Chip designation	Description	Location
M3904	General-purpose transistor	J14
74LS00	Quad 2-input NAND	A2
74LS02	Quad 2-input NOR	B13
74LS04	Hex inverter	C11
74LS20	Dual 4-input NAND	D2
74LS51	2-input AND-OR-Invert gate	C13
74LS74	Dual D-type flip-flop	B10
74S86	Quad 2-input EXOR	B2
74LS151	8-channel multiplexer	A9
74LS161	Presetable binary counter	D11-D14
74LS194	4-bit bidirectional shift register	A10
74LS195	4-bit parallel shift register	C2
74LS257	Tri-state quad 2-input multiplexer	A8

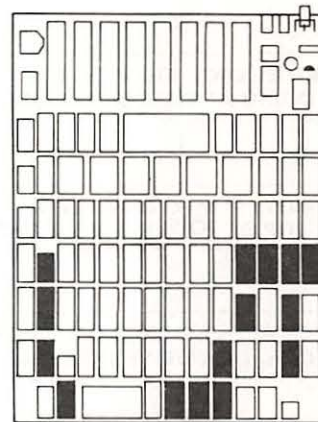
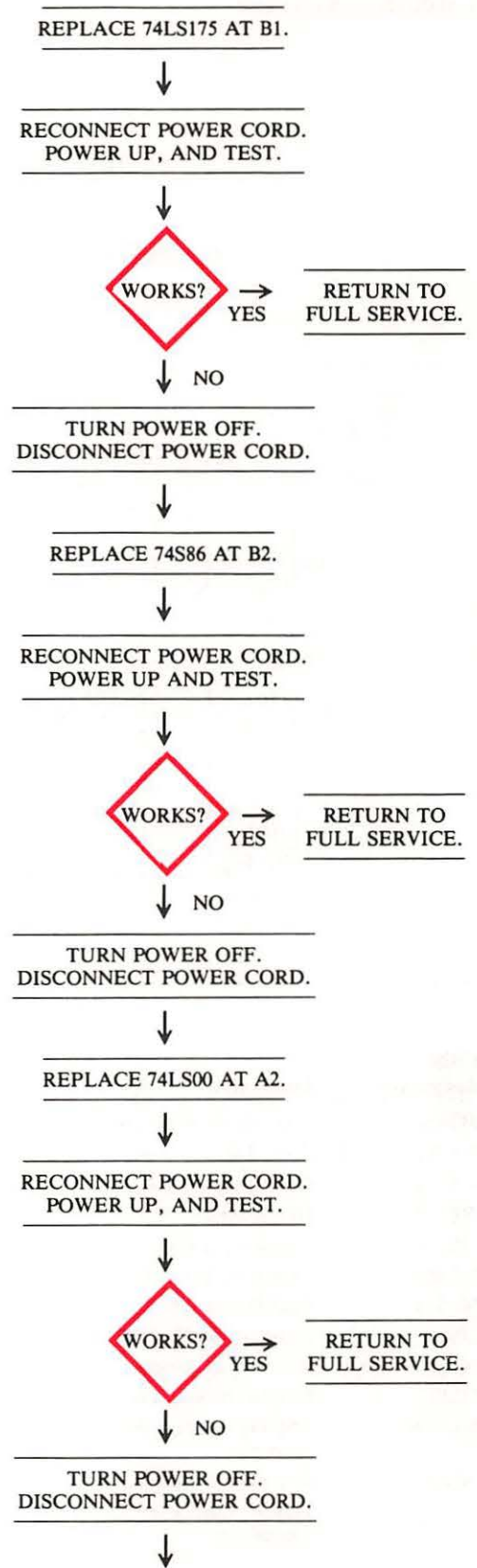
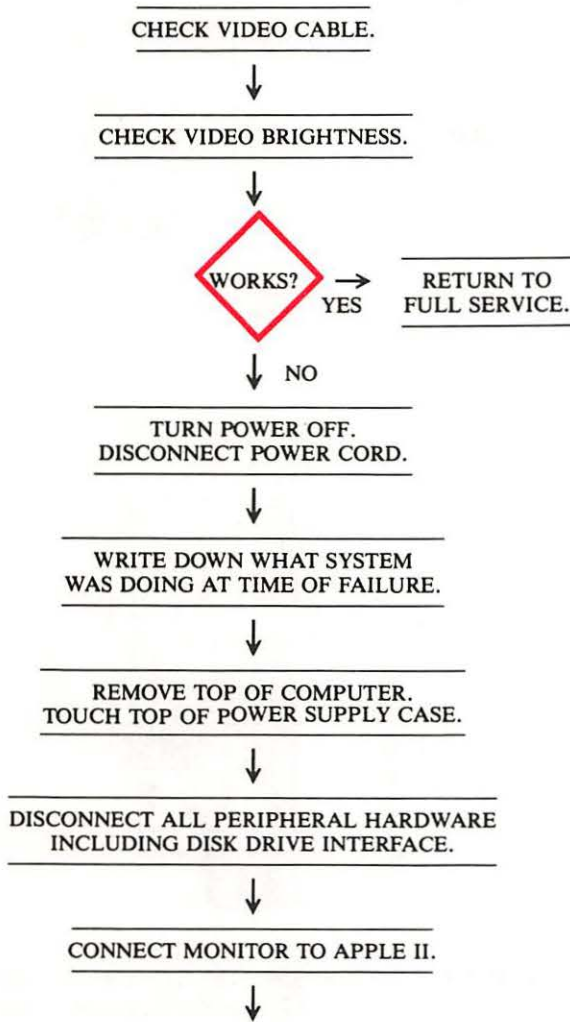

Fig. 4-26. Chip location guide. This represents the Apple motherboard and is a guide to help you find the chips of interest.

SYMPTOM: No display – screen blank

Problem	Possible cause	Repair action
Video signal too small	Brightness	Adjust brightness
	Bad monitor	Check and replace if necessary
Video clock circuitry not working correctly	Bad 74LS175 at B1	Replace and test
	Bad 74S86 at B2	Replace and test
	Bad 74LS00 at A2	Replace and test
	Bad 74LS153 at C1	Replace and test
Synchronization	Bad 74LS195 at C2	Replace and test
	Bad 74LS51 at C13	Replace and test

Troubleshooting Procedure



(Continued)

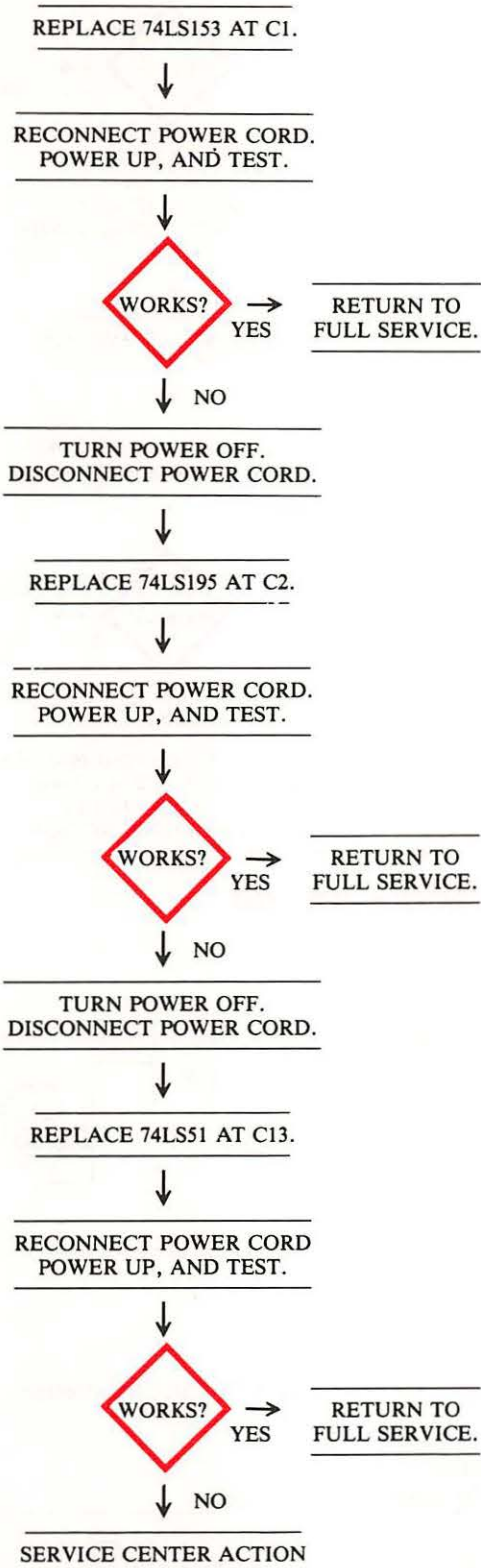

Circuitry Affected

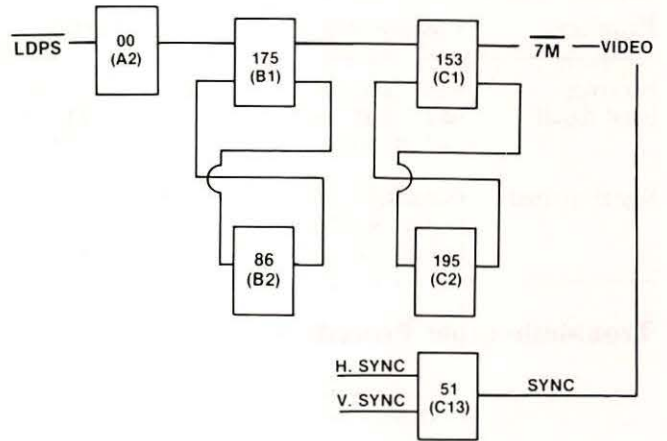

Fig. 4-27. Circuitry affected.

Chip designation	Description	Location
74LS00	Quad 2-input NAND	A2
74LS51	2-input AND-OR-Invert gate	C13
74S86	Quad 2-input EXOR	B2
74LS153	Dual 4/1 multiplexer	C1
74LS175	Quad D flip-flop	B1
74LS195	4-bit parallel shift register	C2

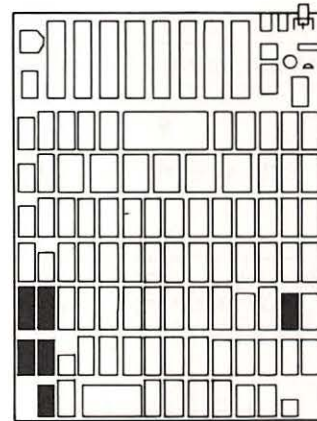
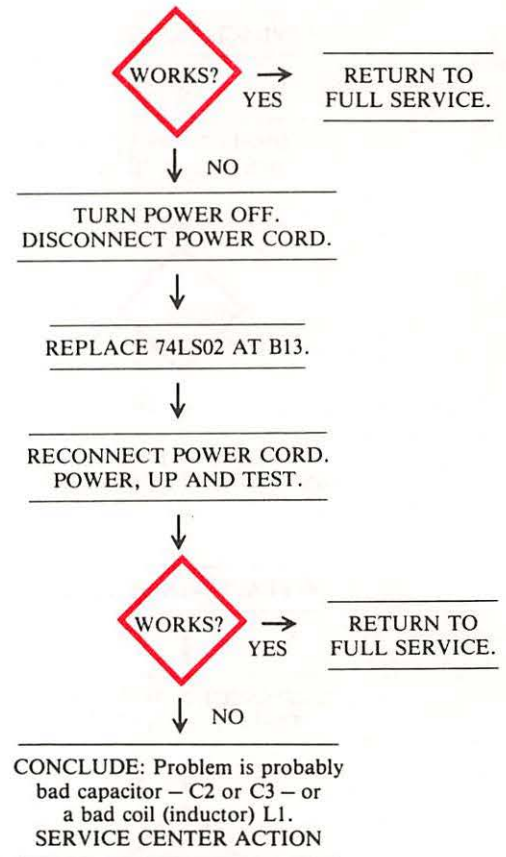
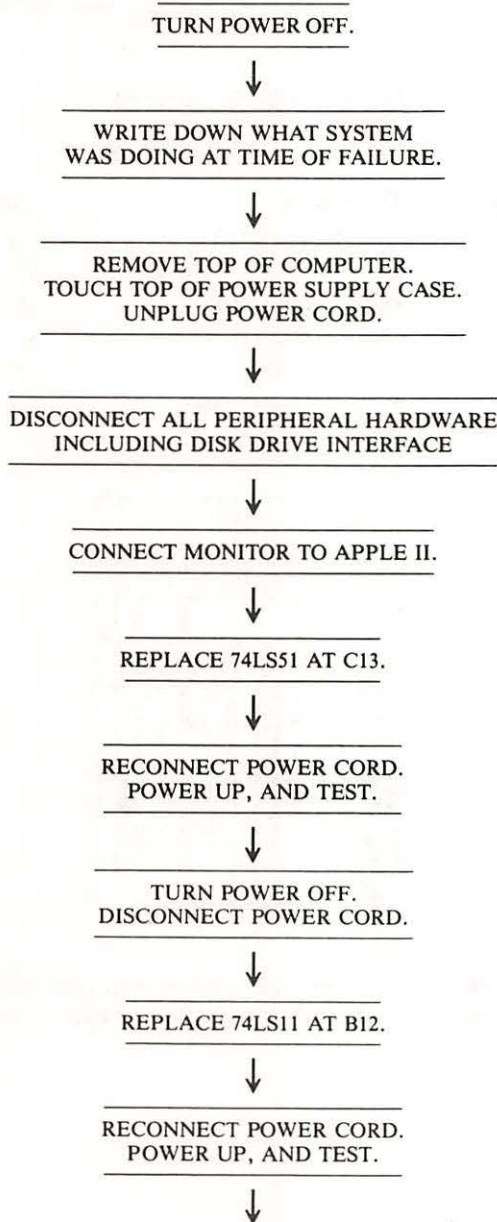

Fig. 4-28. Chip location guide. This represents the Apple motherboard and is a guide to help you find the chips of interest.

SYMPTOM: No color

Problem	Possible cause	Repair action
No color burst signal	Bad 74LS51 at C13	Replace and test
	Bad 74LS11 at B12	Replace and test
	Bad 74LS02 at B13	Replace and test
Signal shorted	Capacitor C2 shorted Capacitor C3 shorted Inductor L1 Bad	Replace 2 Replace C3 Replace L1

Troubleshooting Procedure



Circuitry Affected

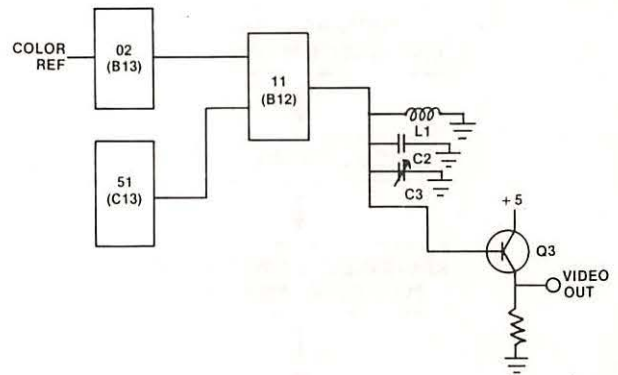

Fig. 4-29. Circuitry affected.

Chip designation	Description	Location
74LS02	Quad 2-input NOR gate	B13
74LS11	Triple 3-input AND gate	B12
74LS51	Dual 2-input AND-OR-Invert gate	C13

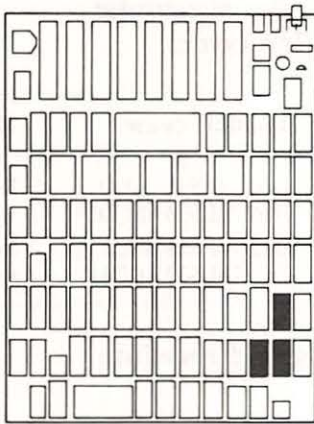
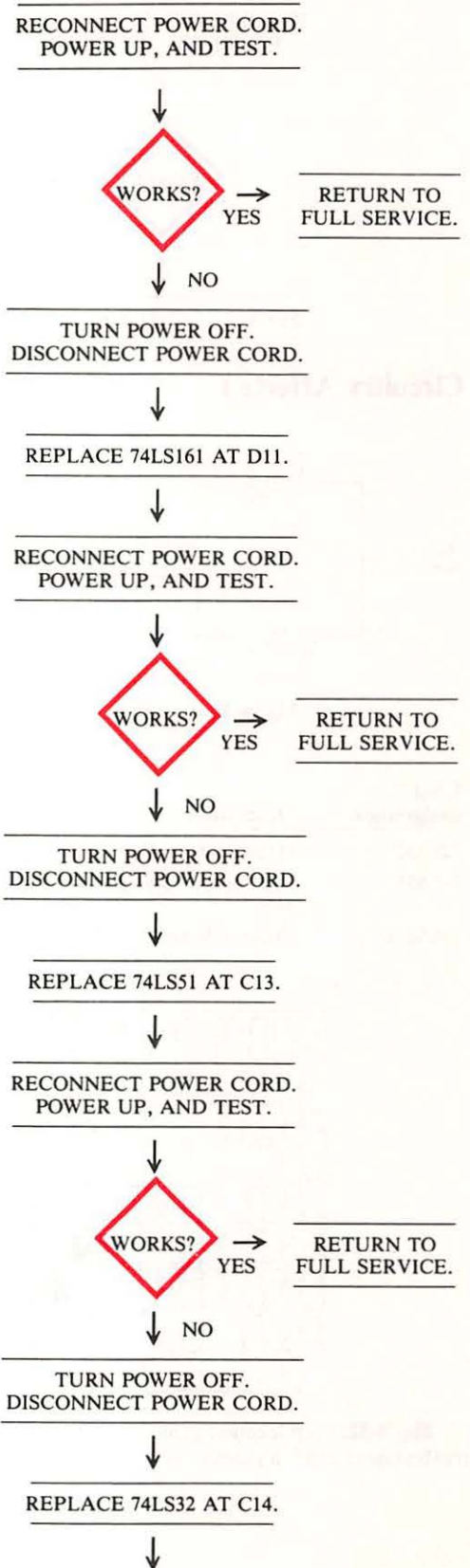
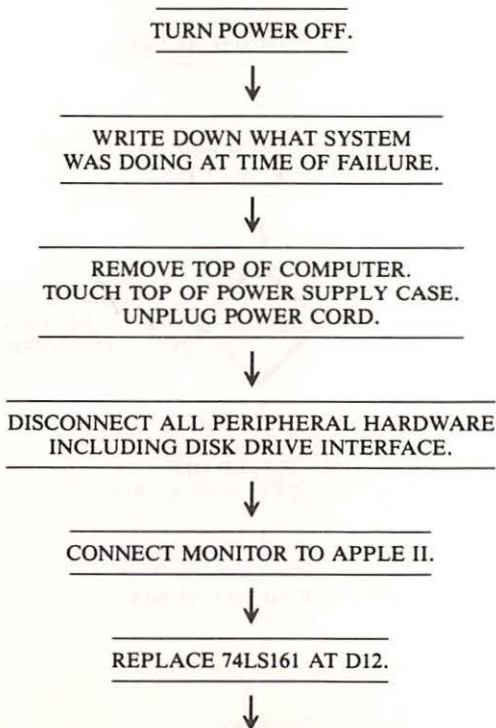

Fig. 4-30. Chip location guide. This represents the Apple motherboard and is a guide to help you find the chips of interest.

SYMPTOM: No vertical synchronization (sync)

Problem	Possible cause	Repair action
No sync being sent	Bad 74LS161 at D12	Replace and test
	Bad 74LS161 at D11	Replace and test
Sync not being accessed	Bad 74LS51 at C13	Replace and test
	Bad 74LS32 at C14	Replace and test

Troubleshooting Procedure



(Continued)

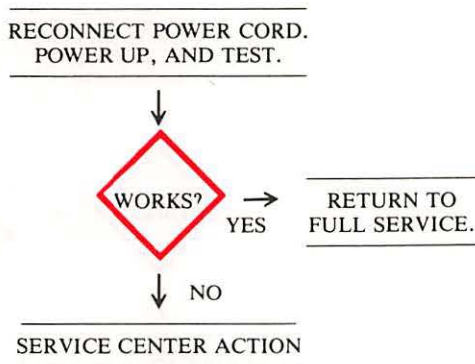

Circuitry Affected

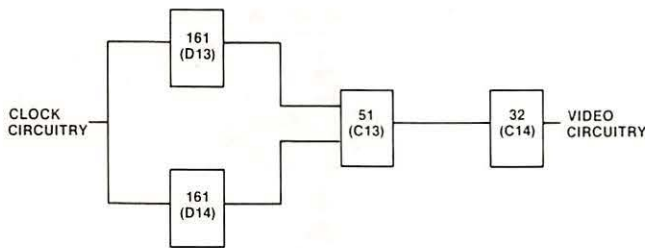

Fig. 4-31. Circuitry affected.

Chip designation	Description	Location
72LS32	Quad 2-input OR gate	C14
74LS51	Dual 2-input AND-OR-Invert gate	C13
74LS161	Presettable binary counter	D11, D12

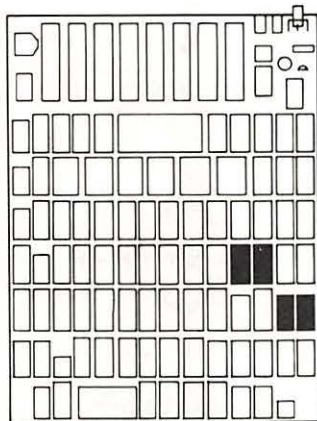
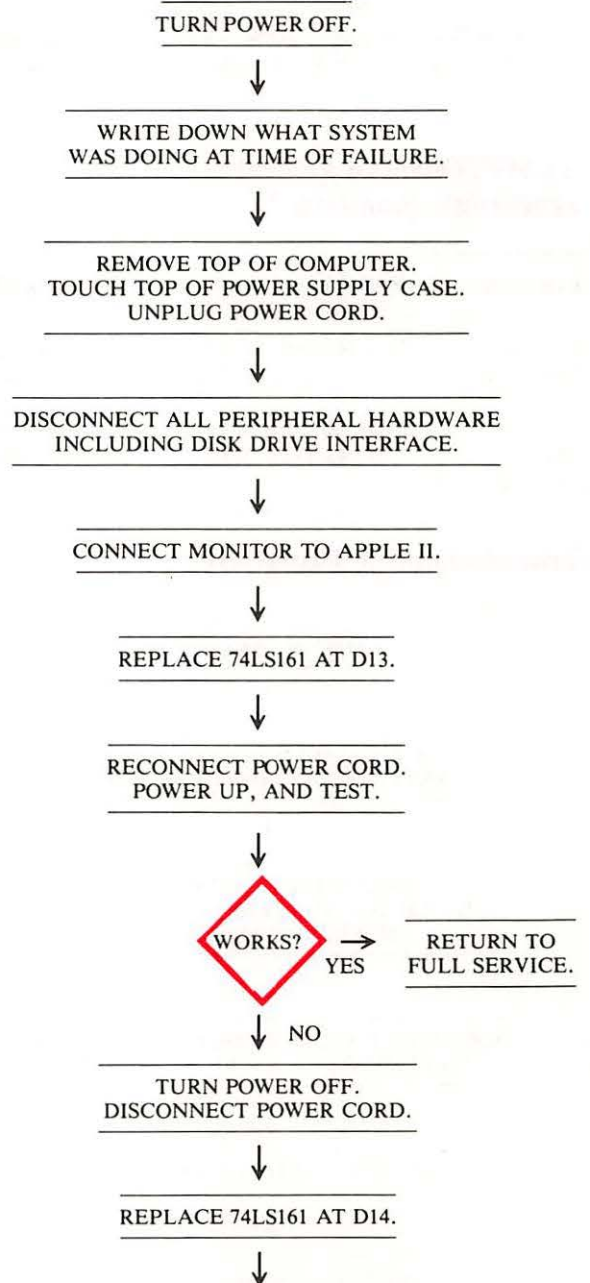

Fig. 4-32. Chip location guide. This represents the Apple motherboard and is a guide to help you find the chips of interest.

SYMPTOM: No horizontal synchronization (sync)

Problem	Possible cause	Repair action
No sync signal	Bad 74LS161 at D13 Bad 74LS161 at D14	Replace and test Replace and test
Sync not being accessed	Bad 74LS51 at C13 Bad 74LS32 at C14	Replace and test Replace and test

Troubleshooting Procedure



(Continued)

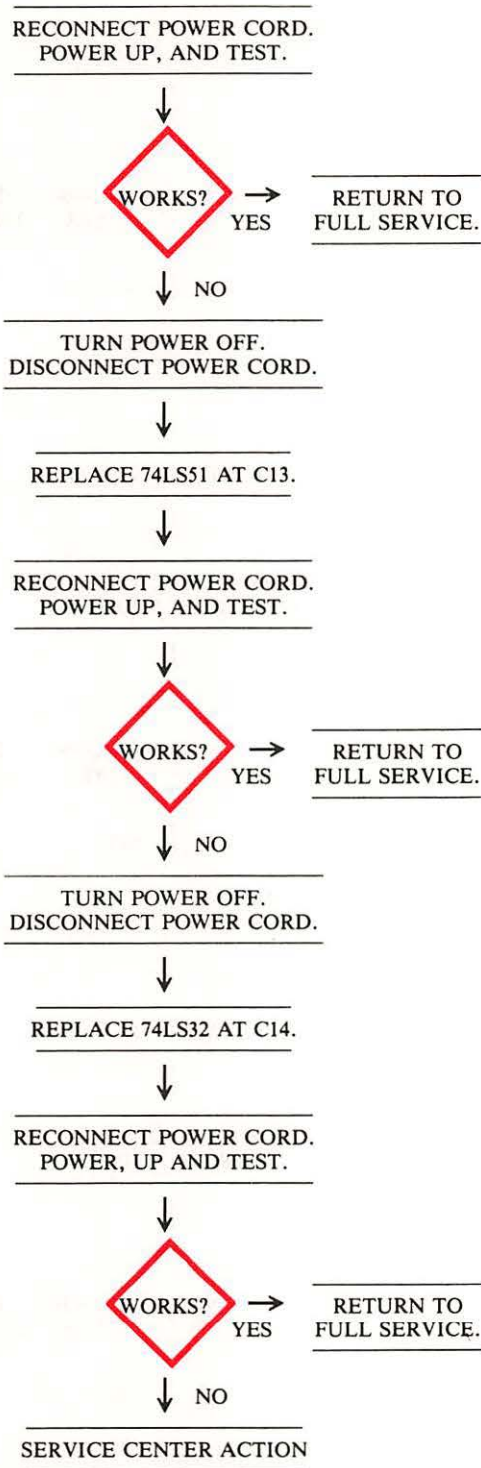

Circuitry Affected

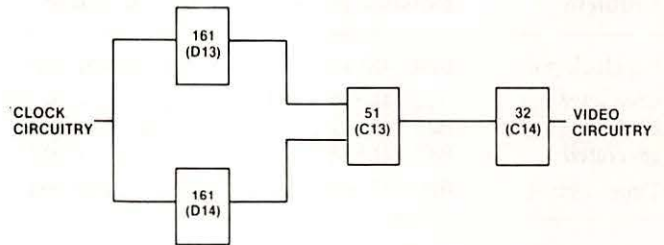

Fig. 4-33. Circuitry affected.

Chip designation	Description	Location
74LS32	Quad 2-input OR gate	C14
72LS51	Dual 2-input AND-OR-Invert gate	C13
74LS161	Presetable binary counter	D13, D14

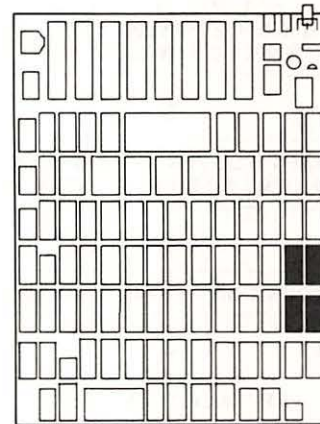
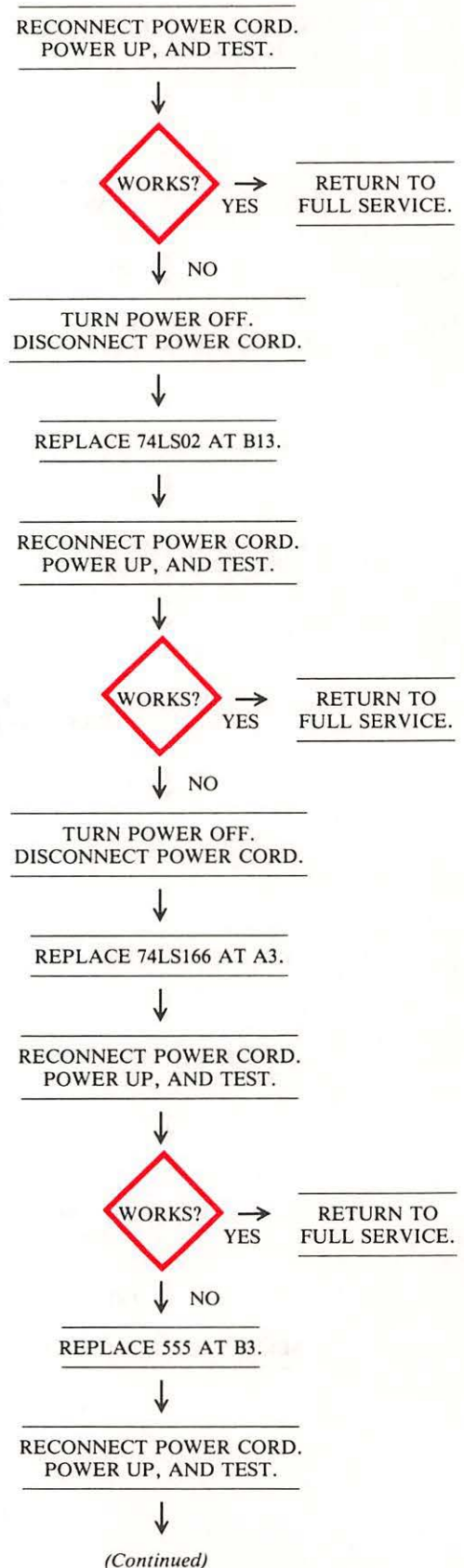
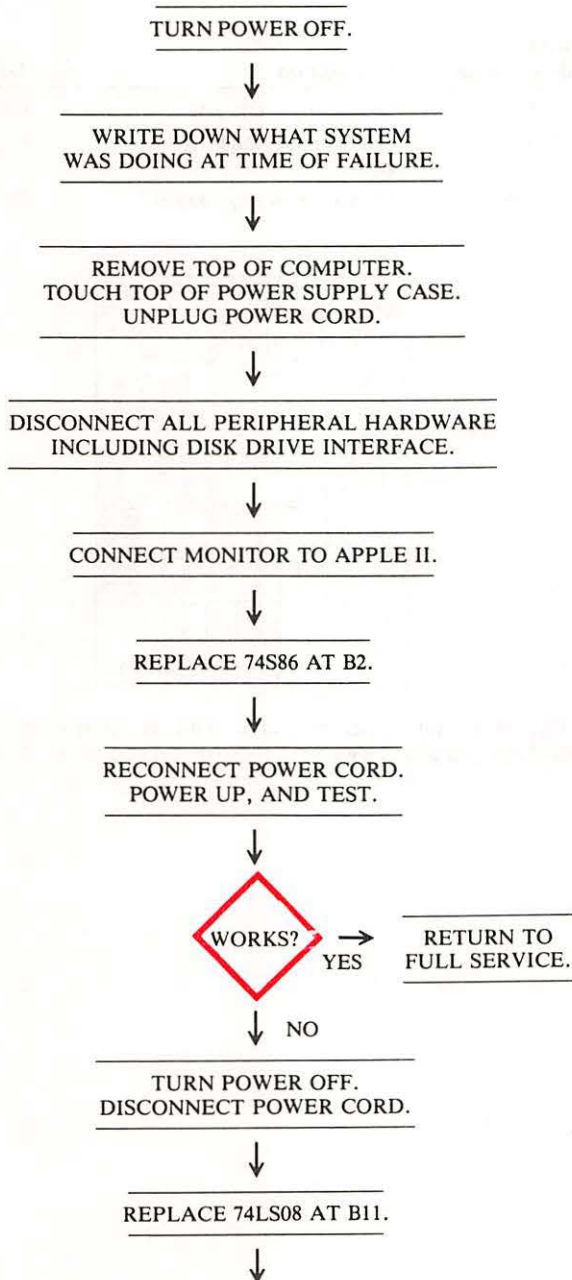

Fig. 4-34. Chip location guide. This represents the Apple motherboard and is a guide to help you find the chips of interest.

SYMPTOM: Bad or no cursor

Problem	Possible cause	Repair action
No clock pulse	Bad 74S86 at B2	Replace and test
Character not being generated	Bad 74LS08 at B11	Replace and test
	Bad 74LS02 at B13	Replace and test
Timer circuit	Bad 74LS166 at A3	Replace and test
	Bad 555 timer at B3	Replace and test

Troubleshooting Procedure



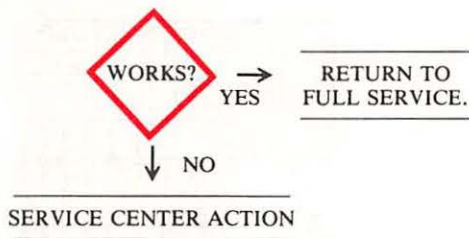

SYMPTOM: Bad inverse or flash

Problem	Possible cause	Repair action
Mode not being selected Timer circuit	Bad 74LS02 at B13	Replace and test
	Bad 74LS08 at B11	Replace and test
	Bad 555 timer at B3	Replace and test

Circuitry Affected

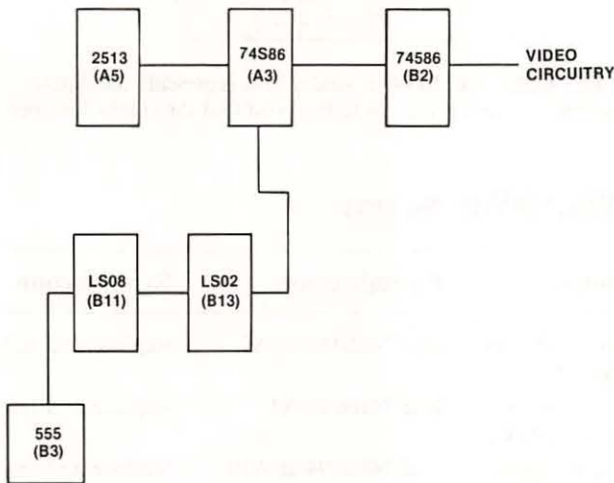

Fig. 4-35. Circuitry affected.

Chip designation	Description	Location
555	Timer	B3
74LS02	Quad 2-input NOR gate	B13
74LS08	Quad 2-input AND gate	B11
74S86	Quad 2-input XOR gate	B2
74LS166	8-bit serial-to-parallel shift register	A3

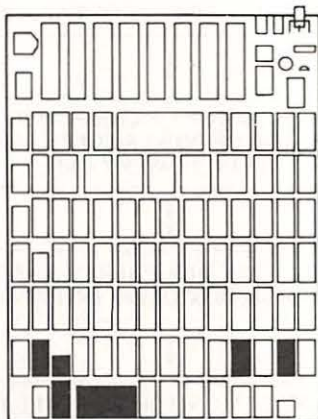
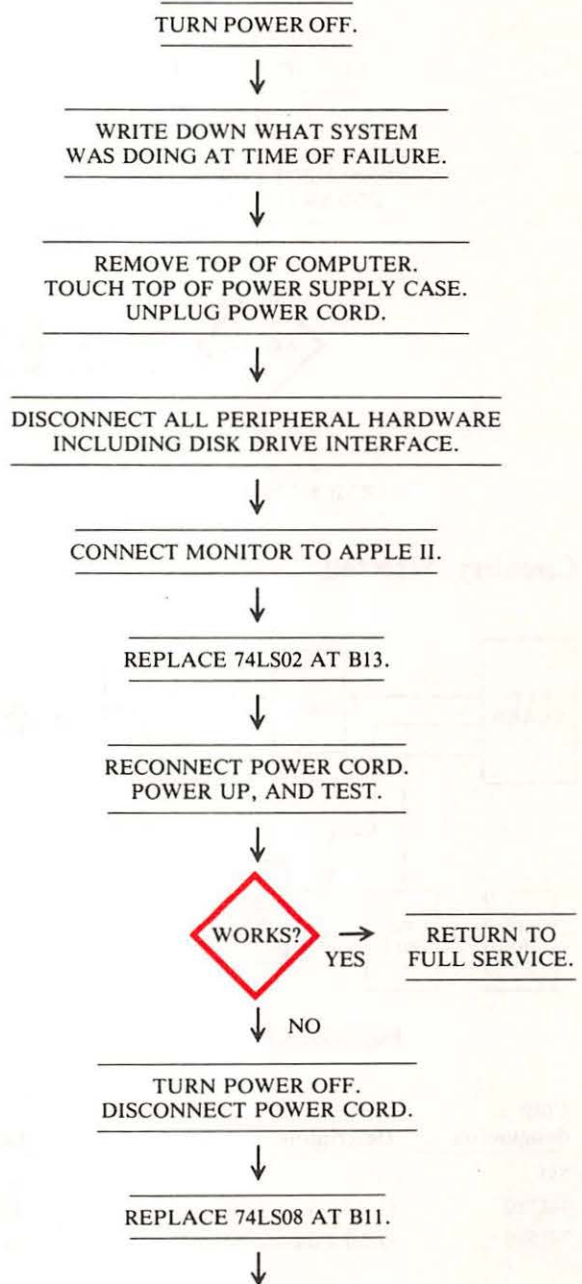

Fig. 4-36. Chip location guide. This represents the Apple motherboard and is a guide to help you find the chips of interest.

Troubleshooting Procedure



(Continued)

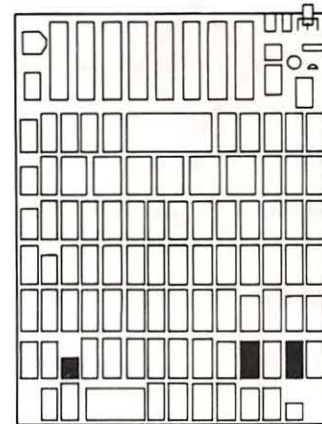
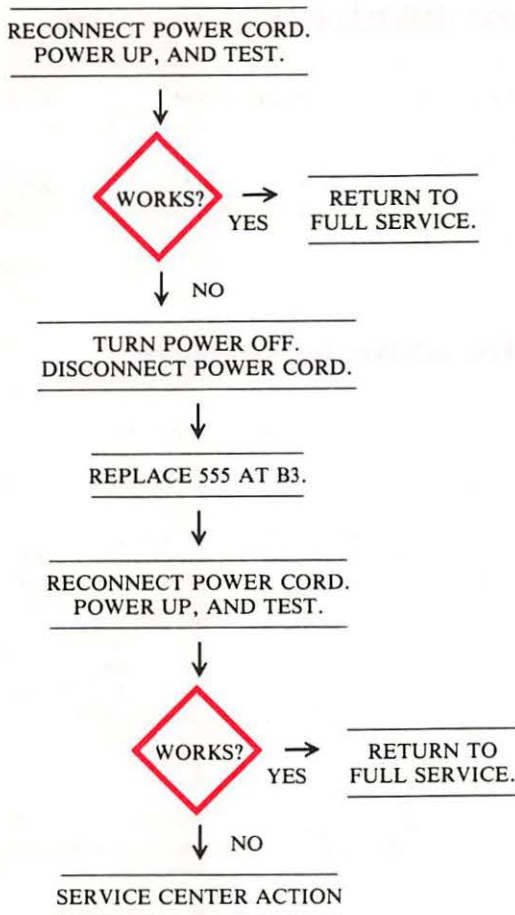

Fig. 4-38. Chip location guide. This represents the Apple motherboard and is a guide to help you find the chips of interest.

SYMPTOM: No text

Problem	Possible cause	Repair action
Text mode not selected	Bad 74LS151 at A9	Replace and test
Text mode not being received	Bad 74166 at A3	Replace and test
Text mode not being latched	Bad 74LS194 at A10	Replace and test
No clock pulse	Bad 74S86 at B2	Replace and test
No text being generated	Bad 2513 ROM at A5 Bad 74LS257 at A8	Replace and test Replace and test

Circuitry Affected

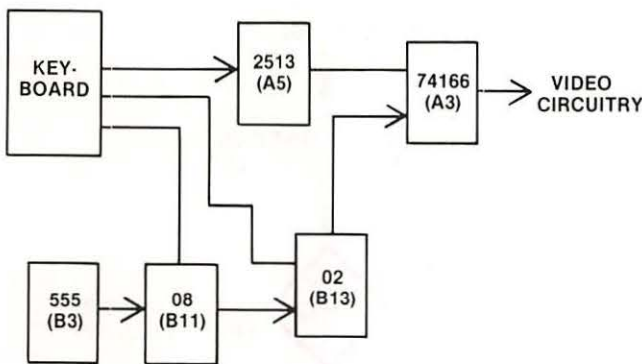
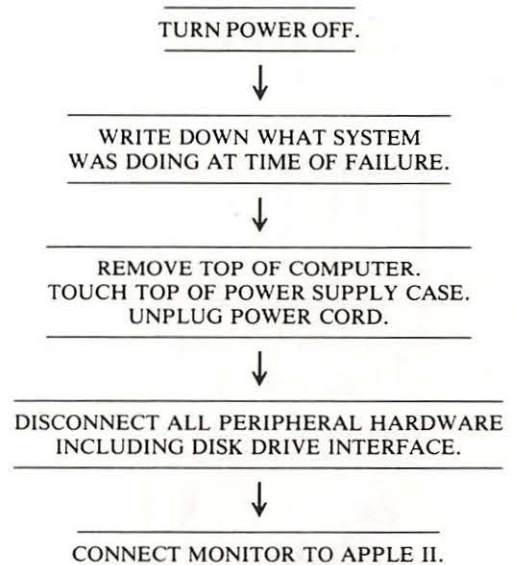

Fig. 4-37. Circuitry affected.

Chip designation	Description	Location
555	Timer	B3
74LS02	Quad 2-input NOR gate	B13
74LS08	Quad 2-input AND gate	B11

Troubleshooting Procedure



(Continued)

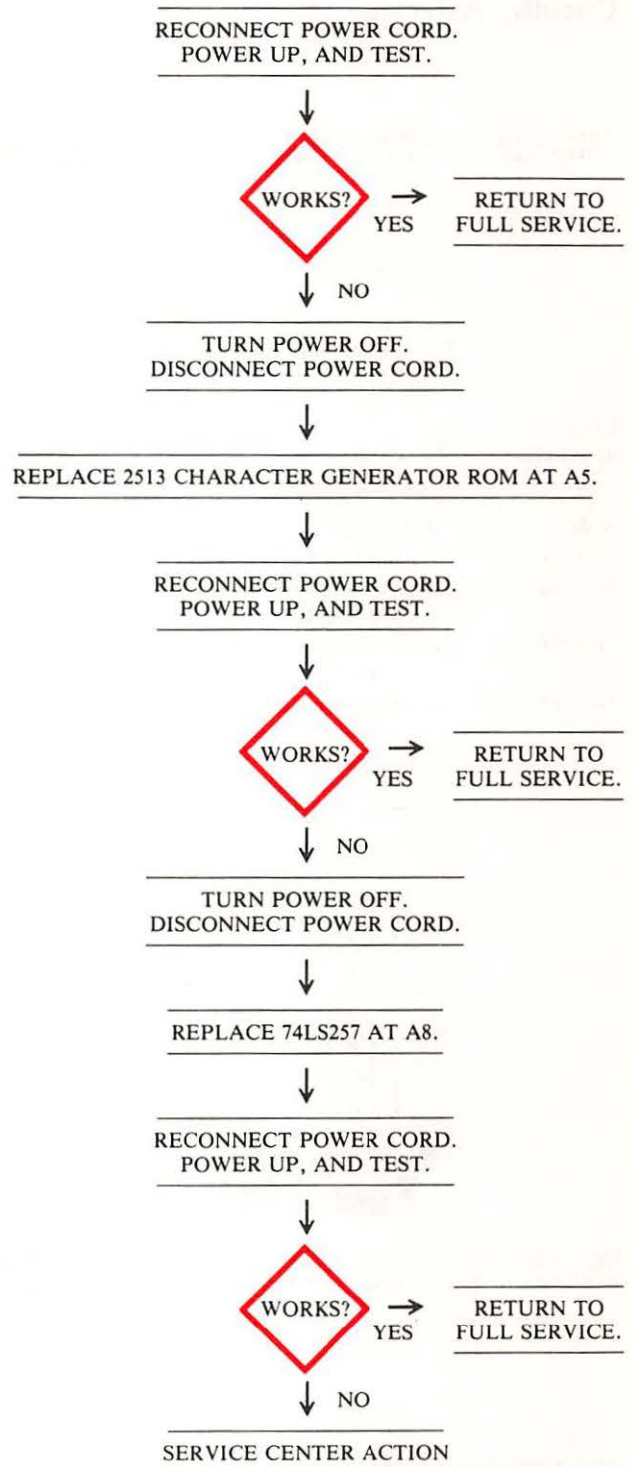
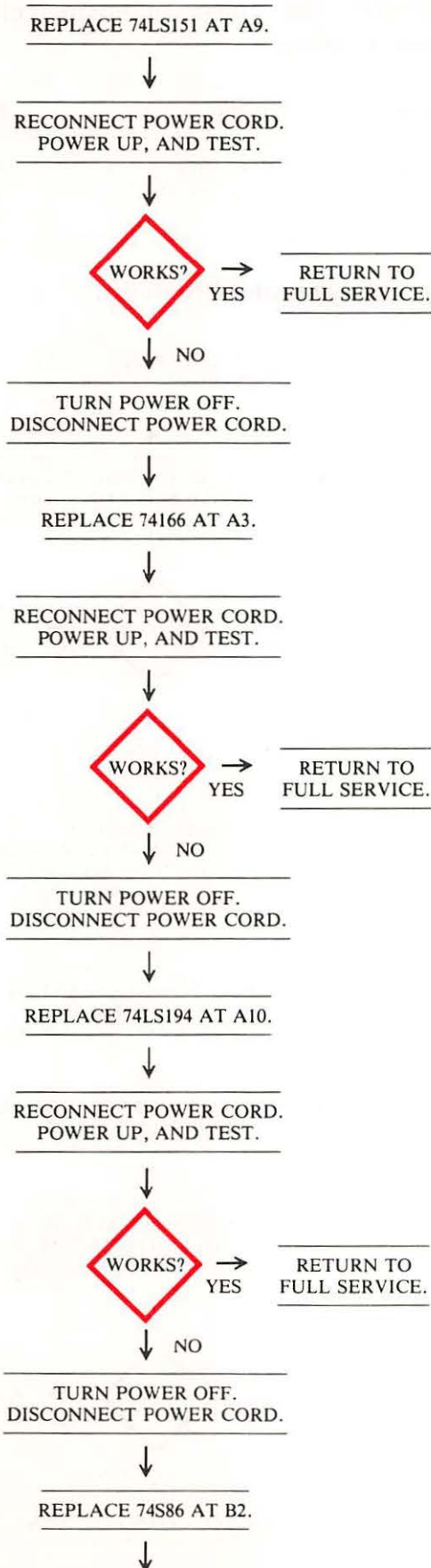

Circuitry Affected

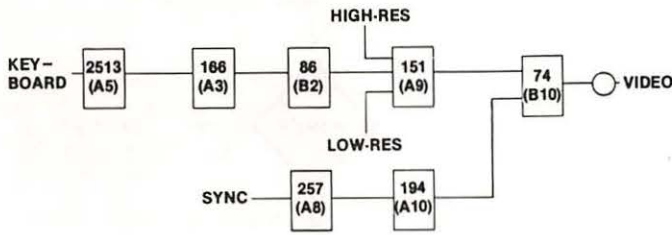

Fig. 4-39. Circuitry affected.

Chip designation	Description	Location
2513	Character generator ROM	A5
74S86	Quad 2-input XOR gate	B2
74LS151	8-channel multiplexer	A9
74LS166	8-bit serial-to-parallel shift register	A3
74LS194	4-bit bidirectional shift register	A10
74LS257	Tri-state quad 2-input multiplexer	A8

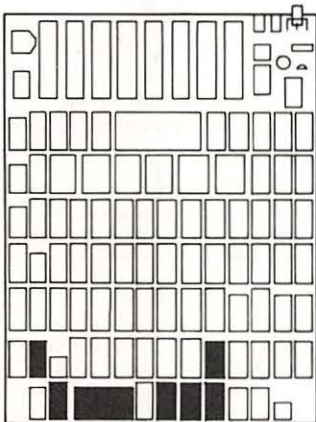

Fig. 4-40. Chip location guide. This represents the Apple motherboard and is a guide to help you find the chips of interest.

SYMPTOM: Video – wrong characters

Problem	Possible cause	Repair action
		Refer to “Part 4, Keyboard Problems; Bad key action – prints wrong characters.”

SYMPTOM: Video – annoying color tint on fringe

Problem	Possible cause	Repair action
Color signal imbalance	Color trim at location F14/H14	Adjust color trim variable capacitor

Troubleshooting Procedure

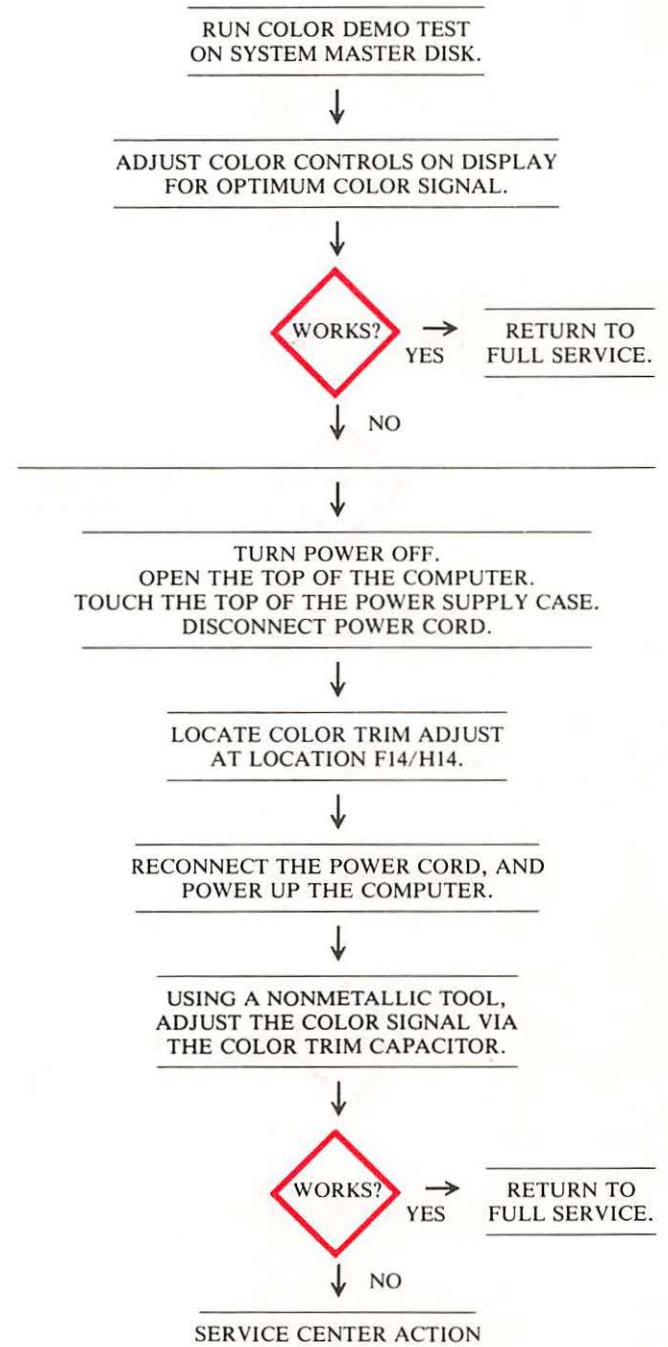

Circuitry Affected

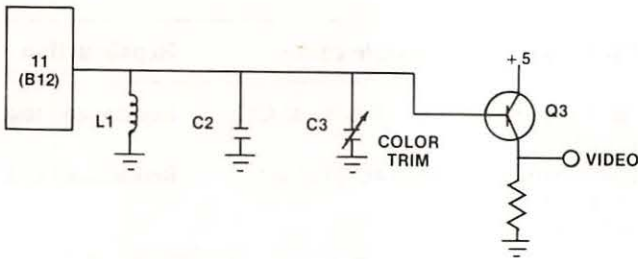

Fig. 4-41. Circuitry affected.

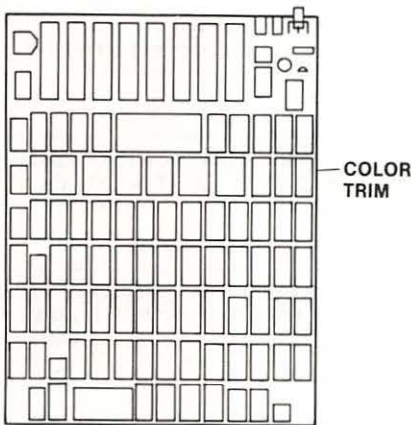
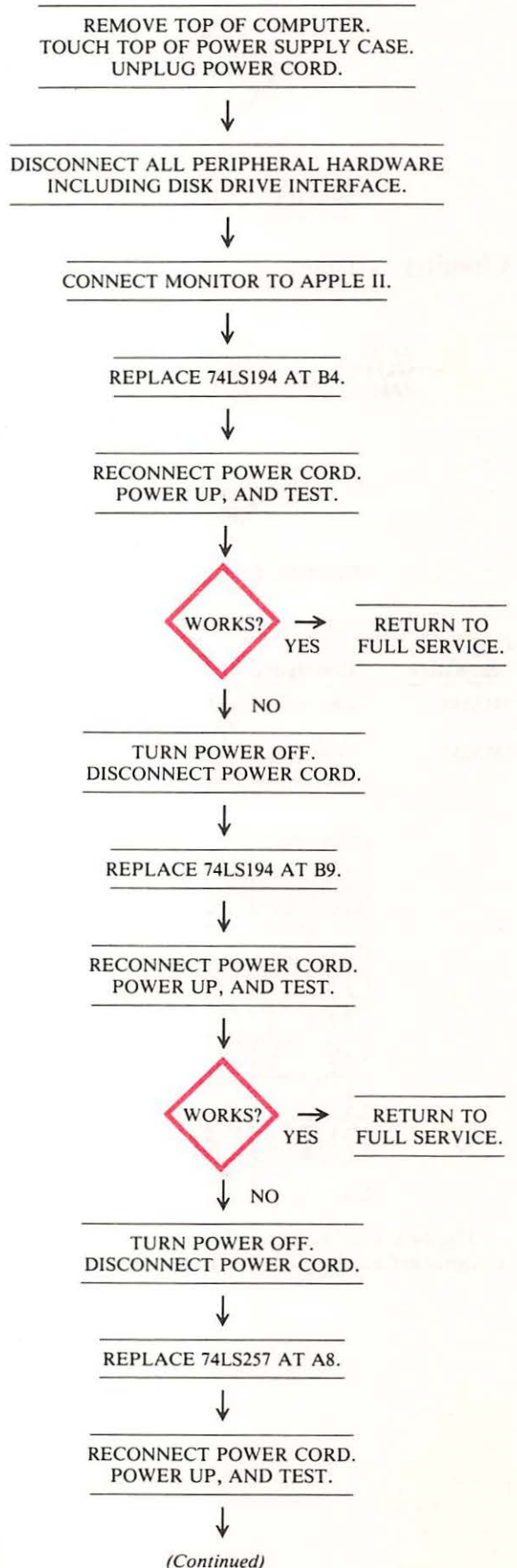
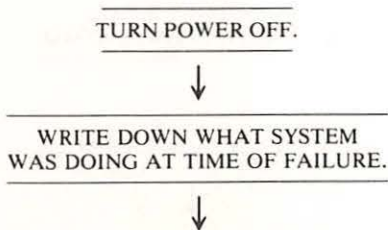

Fig. 4-42. Chip location guide. This represents the Apple motherboard and is a guide to help you find the color trim variable capacitor.

SYMPTOM: Bad graphics – no hi-res or lo-res graphics; text OK

Problem	Possible cause	Repair action
No hi-res or lo-res pixels produced	Bad 74LS194 at B4 Bad 74LS194 at B9	Replace and test Replace and test
No hi-res or lo-res activated	Bad 74LS257 at A8	Replace and test

Troubleshooting Procedure



(Continued)

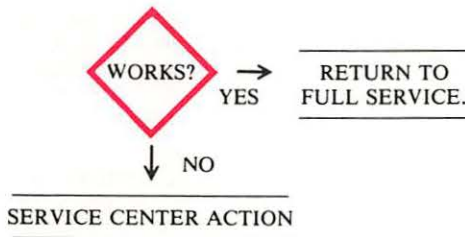

Circuitry Affected

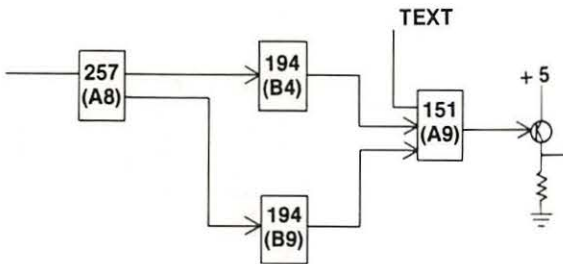

Fig. 4-43. Circuitry affected.

Chip designation	Description	Location
74LS194	4-bit bidirectional shift register	B4, B9
74LS257	Tri-state quad 2-input multiplexer	A8

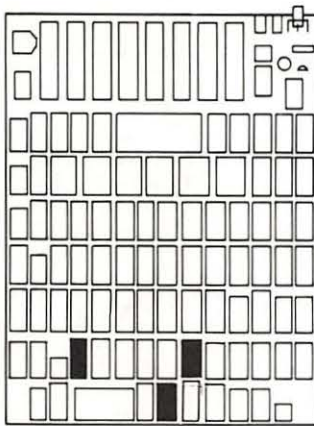
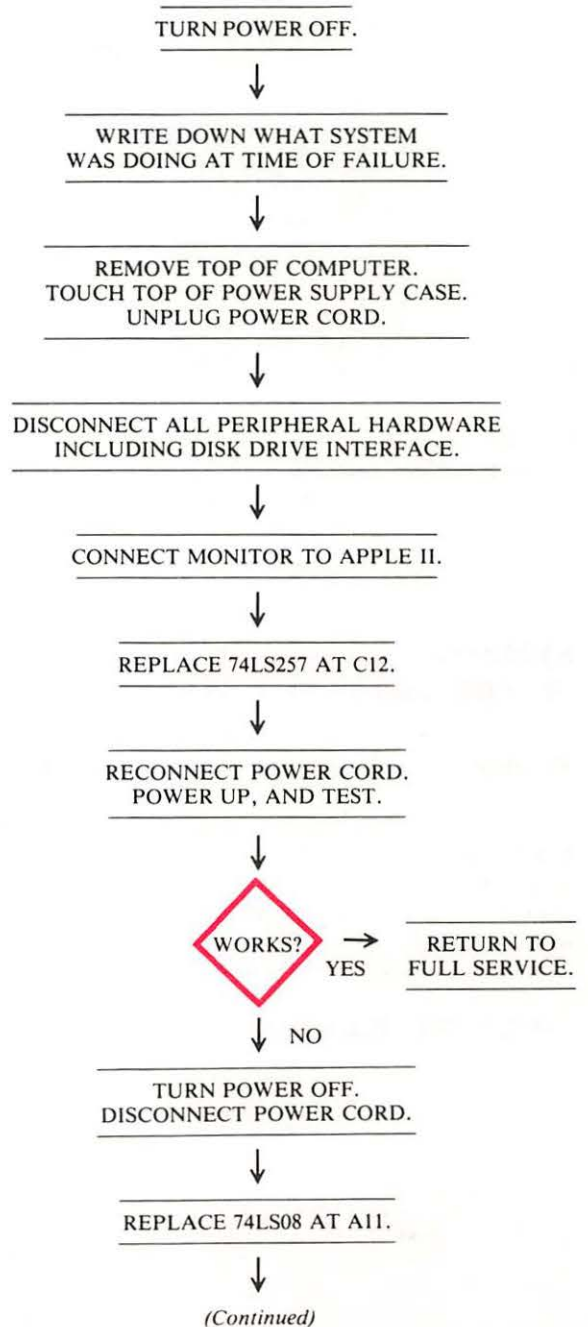

Fig. 4-44. Chip location guide. This represents the Apple motherboard and is a guide to help you find the chips of interest.

SYMPTOM: Bad graphics – no hi-res graphics; lo-res and text OK

Problem	Possible cause	Repair action
Hi-res signal stuck low	Bad 74LS257 at C12	Replace and test
Page 2 signal stuck in text or lo-res	Bad 74LS08 at A11	Replace and test

Troubleshooting Procedure



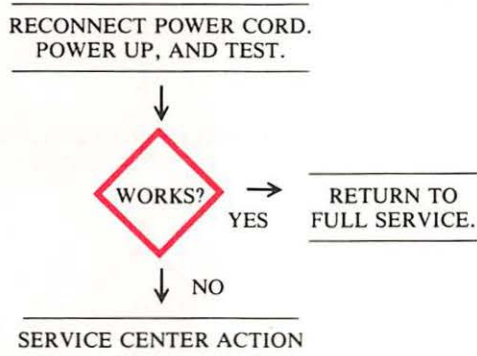

Circuitry Affected

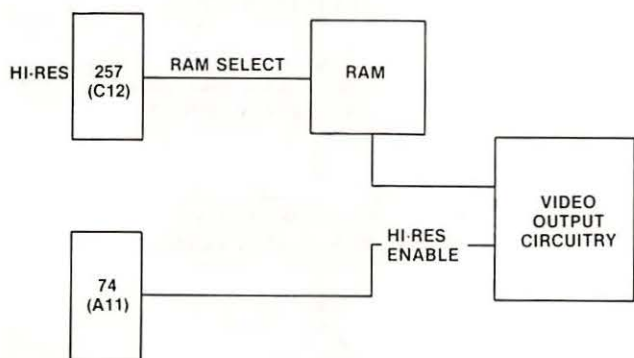

Fig. 4-45. Circuitry affected.

Chip designation	Description	Location
74LS08	Quad 2-input AND gate	A11
74LS257	Tri-state quad 2-input multiplexer	C12

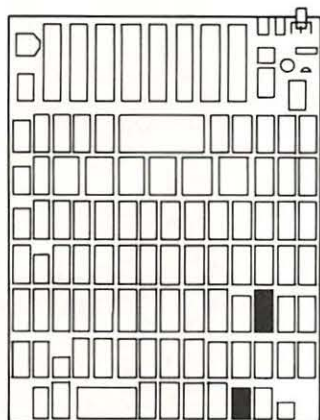

Fig. 4-46. Chip location guide. This represents the Apple motherboard and is a guide to help you find the chips of interest.

4. KEYBOARD PROBLEMS

Symptom Category	Page
Bad key action	
No keys or only some keys respond	99
Prints wrong characters	101
Unwanted repeat	103
Repeat key won't work	104
Key top pops off	105

The keyboard is your line of communication with the computer. Its operation is vital to your successful use of the machine. This section is devoted to the most common key and keyboard problems.

SYMPTOM: Bad key action – no keys or only some keys respond

Problem	Possible cause	Repair action
No key contact	Bad key	Replace key
Signal not reaching motherboard	Bad or loose cable	Reseat or replace cable
No character being generated	Bad 2513 at A5	Replace and test
No signal	Bad 74LS138 at location F13	Replace and test

Troubleshooting Procedure

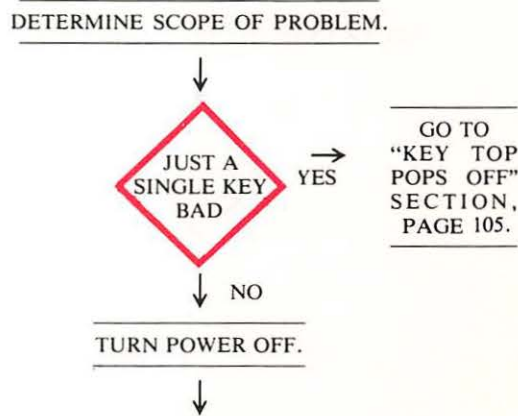

(Continued)

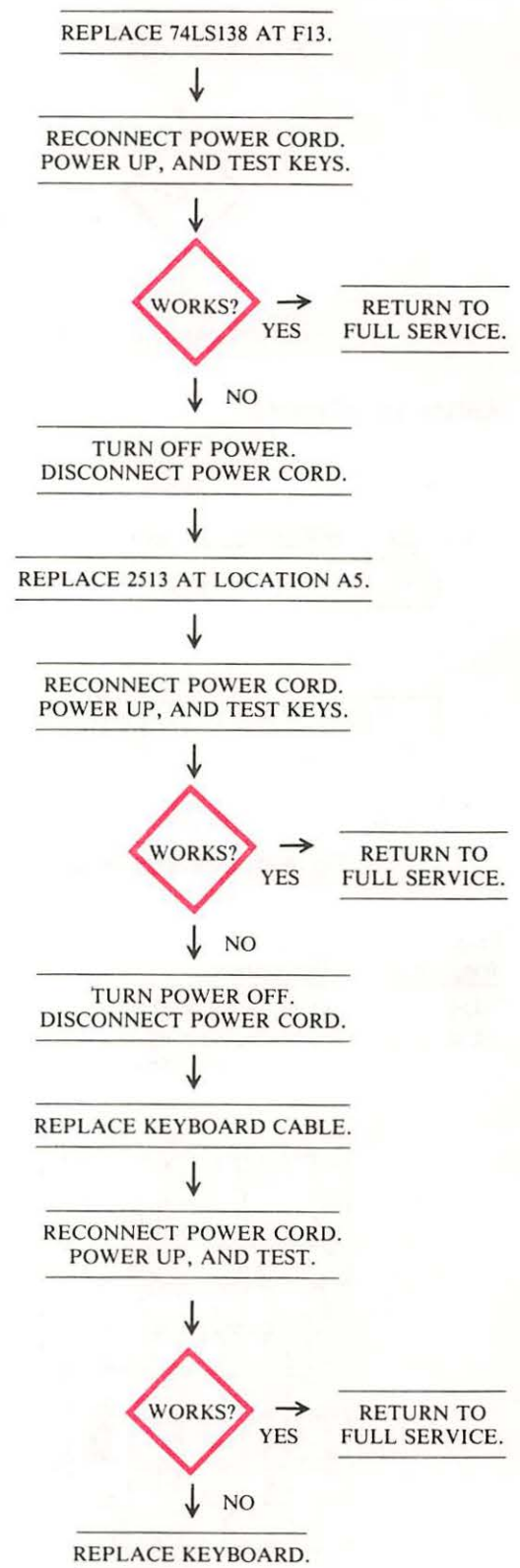
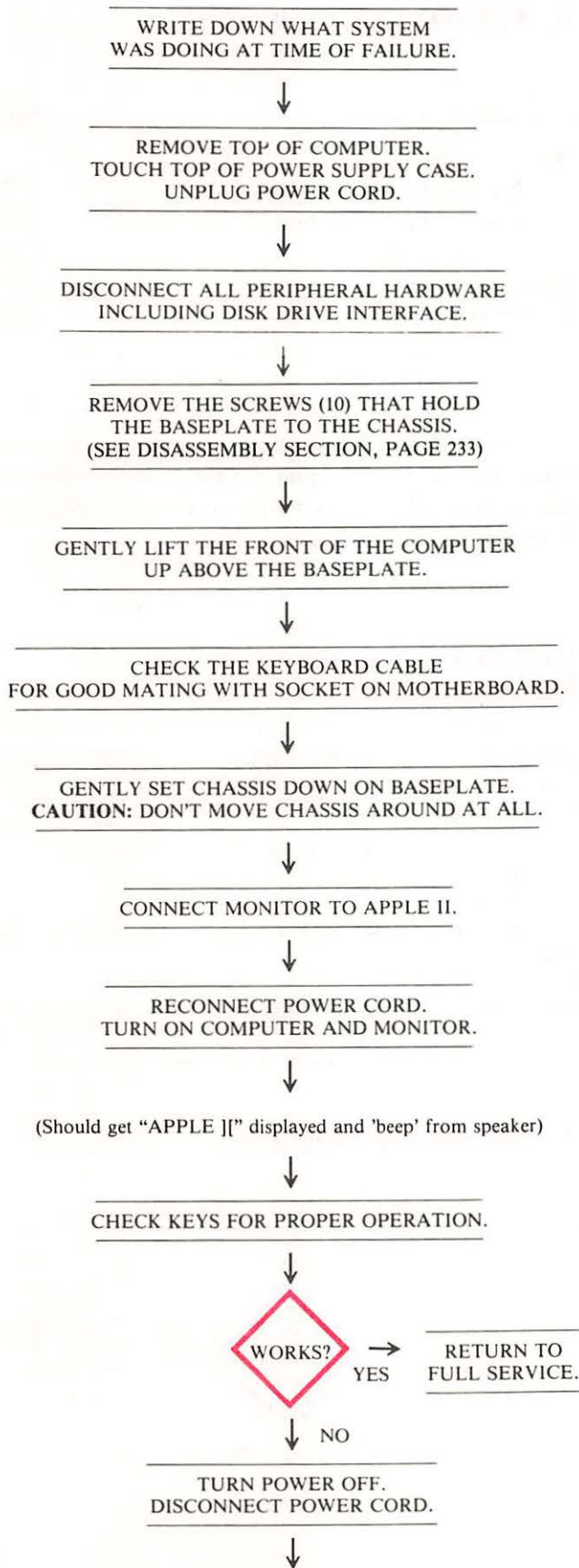

Circuitry Affected

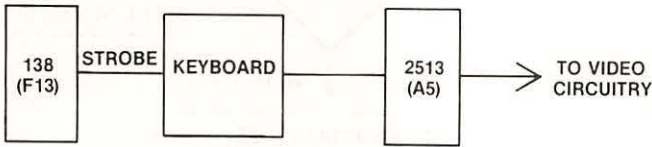
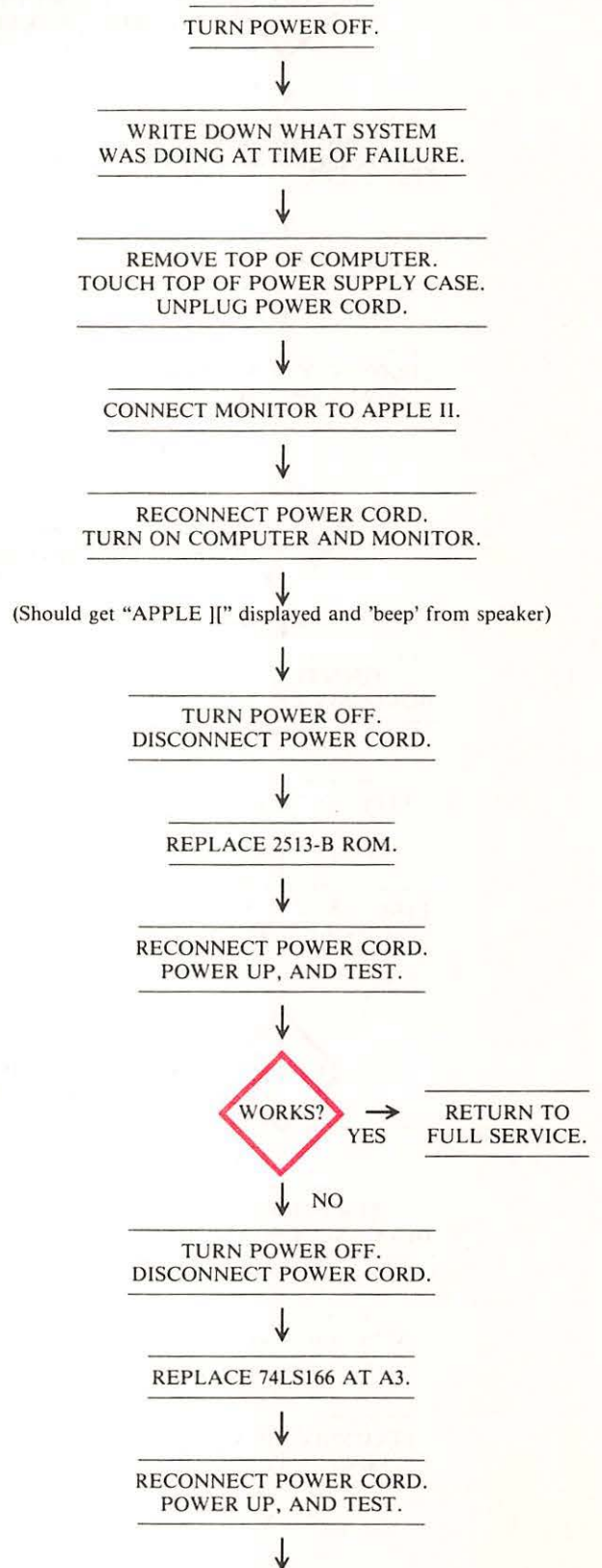

Fig. 4-47. Circuitry affected.

Troubleshooting Procedure



Chip designation	Description	Location
2513	Character generator ROM	A5
74LS138	Expandable 3/8 decoder	F13

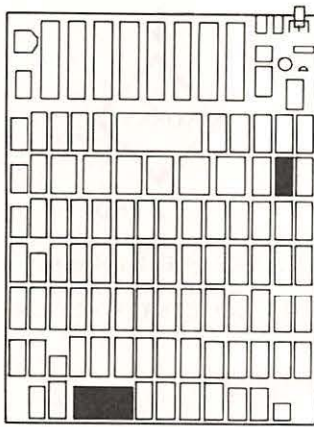
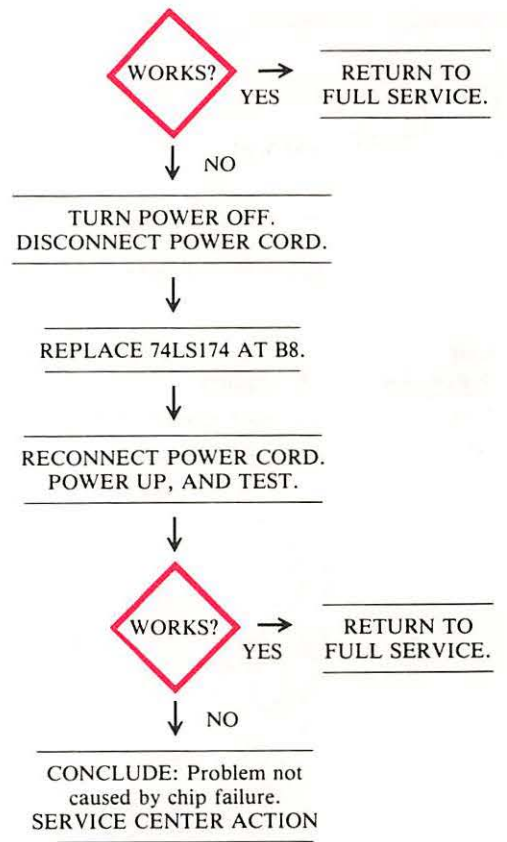
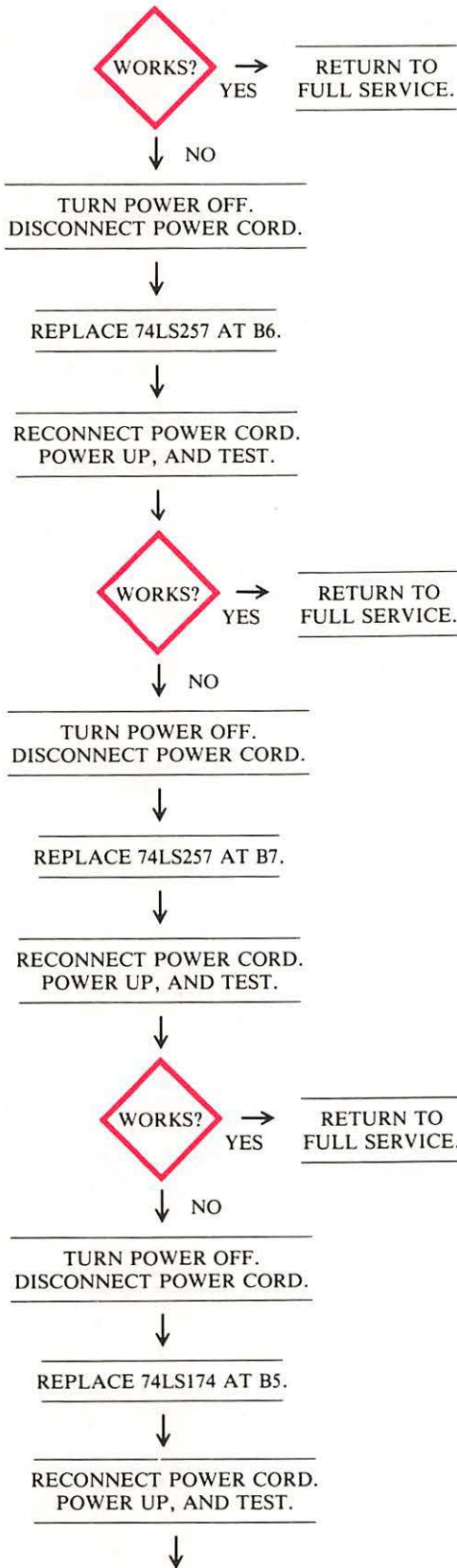

Fig. 4-48. Chip location guide. This represents the Apple motherboard and is a guide to help you find the chips of interest.

SYMPTOM: Bad key action – prints wrong characters

Problem	Possible cause	Repair action
Characters not generated properly	Bad 2513 ROM at location A5	Replace and test
Character data blocked	Bad 74166 at A3 Bad 74LS257 at B6 Bad 74LS257 at B7	Replace and test Replace and test Replace and test
Low byte of data hung up high or low	Bad 74LS174 at B5	Replace and test
High byte of data hung up high or low	Bad 74LS174 at B8	Replace and test

(Continued)



Circuitry Affected

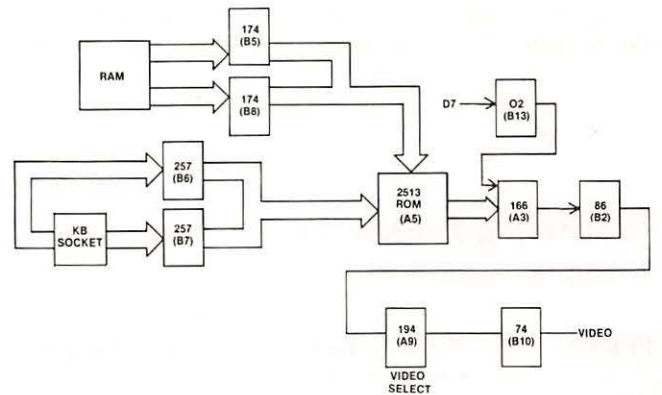

Fig. 4-49. Circuitry affected.

Chip designation	Description	Location
2316-B	Character generator ROM	A5
74166	8-bit serial-in-parallel-out shift register	A3
74LS174	Hex D flip-flop	B5, B8
74LS257	Tri-state quad 2-input multiplexer	B6, B7

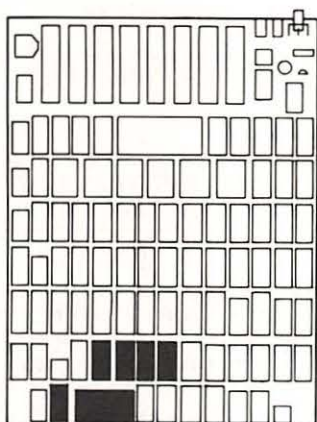
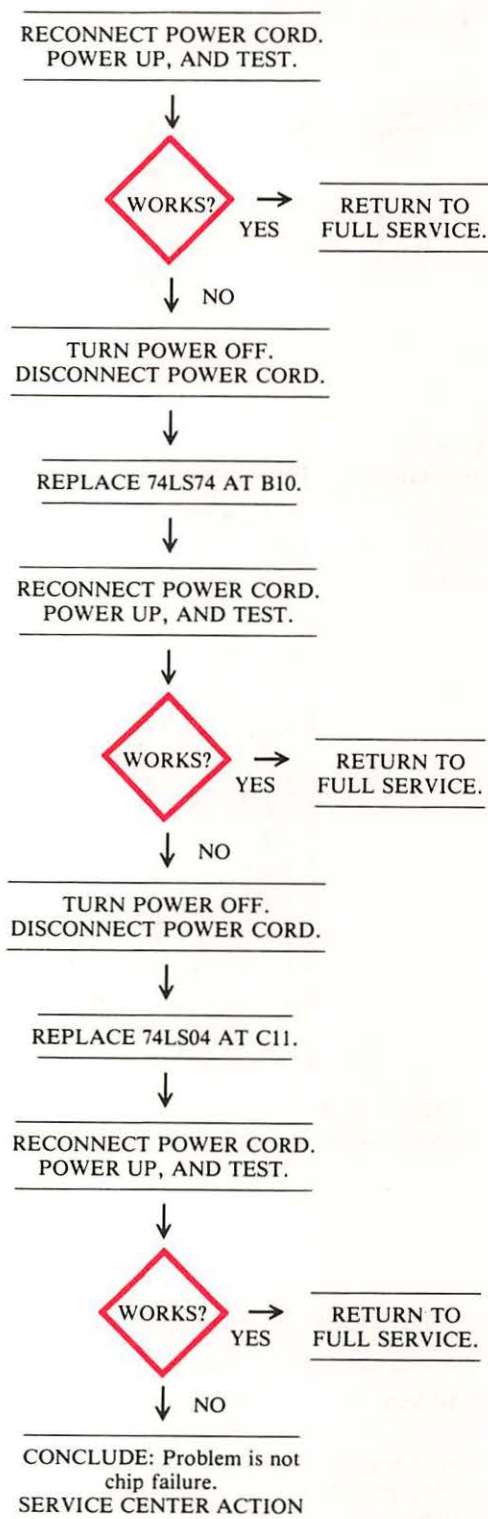
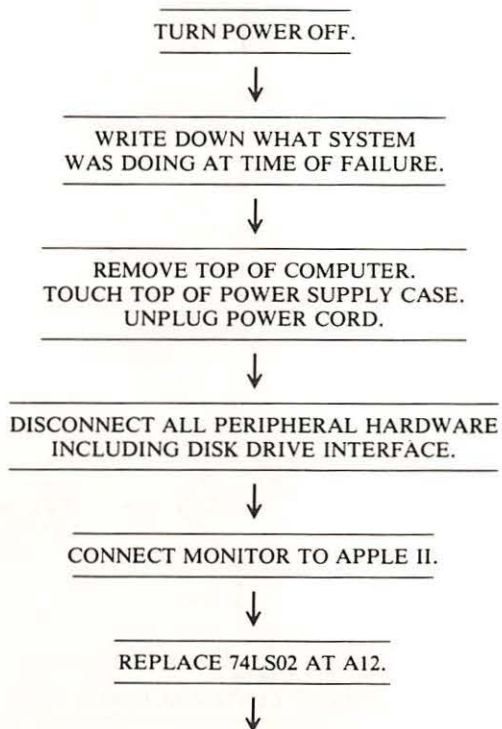

Fig. 4-50. Chip location guide. This represents the Apple motherboard and is a guide to help you find the chips of interest.

SYMPTOM: Bad key action – unwanted repeat

Problem	Possible cause	Repair action
Keybounce	Bad 74LS74 at B10	Replace and test
	Bad 74LS02 at A12	Replace and test
	Bad 74LS04 at C11	Replace and test

Troubleshooting Procedure



Circuitry Affected

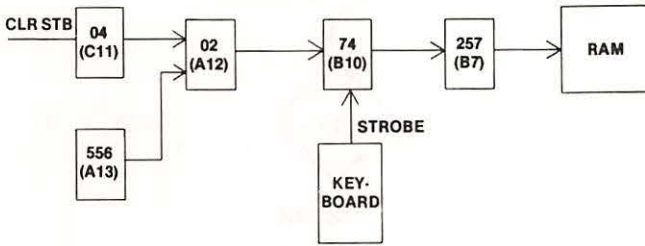

Fig. 4-51. Circuitry affected.

Chip designation	Description	Location
74LS02	Quad 2-input NOR	A12
74LS04	Hex inverter	C11
74LS74	Dual D-type flip-flop	B10

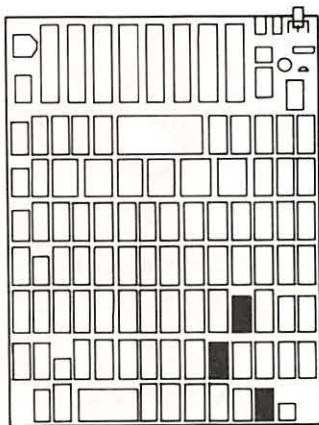
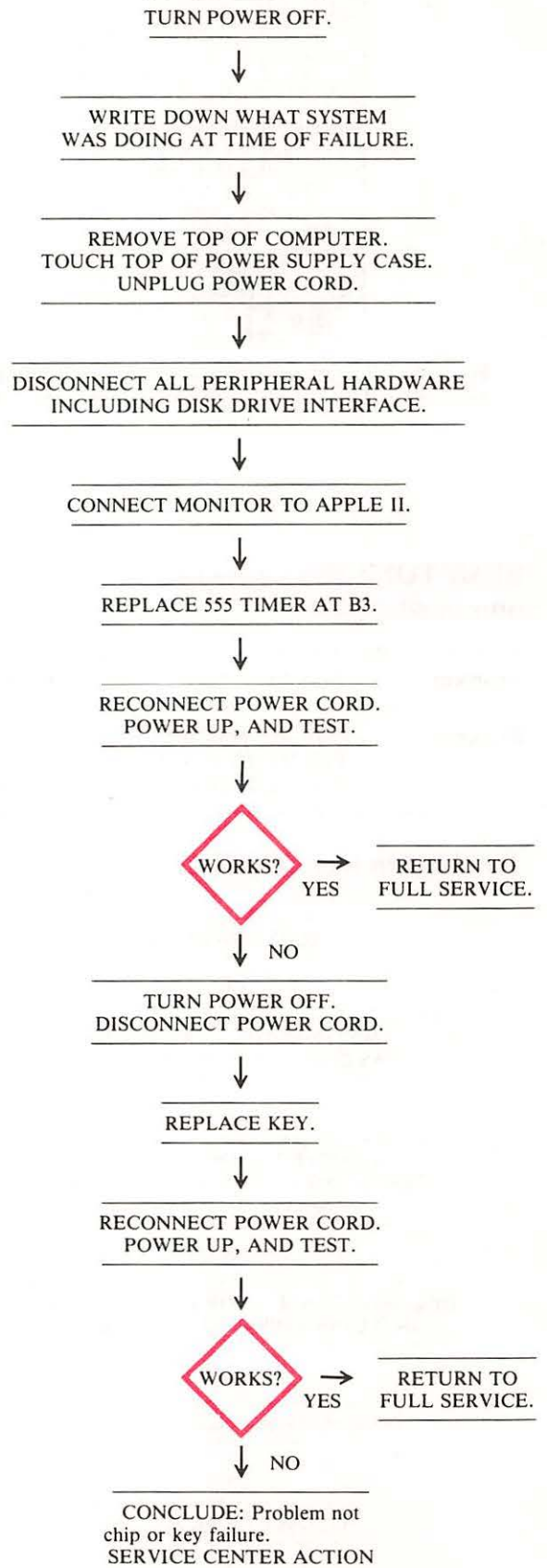

Fig. 4-52. Chip location guide. This represents the Apple motherboard and is a guide to help you find the chips of interest.

SYMPTOM: Repeat key won't work

Problem	Possible cause	Repair action
Repeat key not making proper contact	Bad key	Replace key
Repeat timing circuit failure	Bad 555 at B3	Replace and test

Troubleshooting Procedure



Circuitry Affected

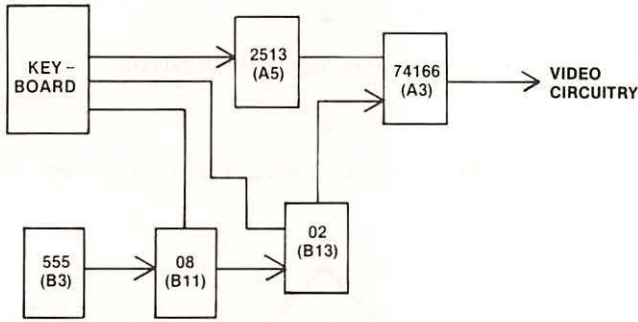

Fig. 4-53. Circuitry affected.

Chip designation	Description	Location
555	Timer	B3

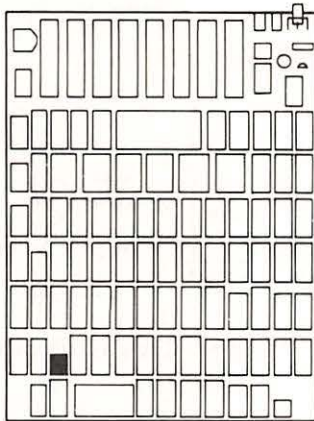
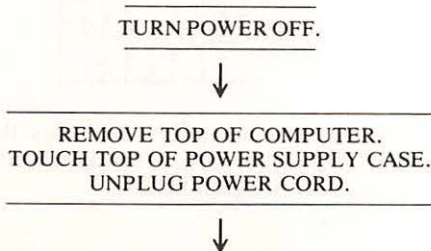

Fig. 4-54. Chip location guide. This represents the Apple motherboard and is a guide to help you find the 555 timer.

SYMPTOM: Key top pops off*

Problem	Possible cause	Repair action
Key top loose	Excessive use	Replace key
	Mishandling	Put top back on
	Bad key	Replace key

Troubleshooting Procedure



DISCONNECT ALL PERIPHERAL HARDWARE INCLUDING DISK DRIVE INTERFACE.

TAKE CORRECTIVE ACTION TO REPLACE KEY TOP AS SHOWN IN FIG. 4-55 OR FIG. 4-56.

*Applies to all keys on the Apple II Plus keyboard.

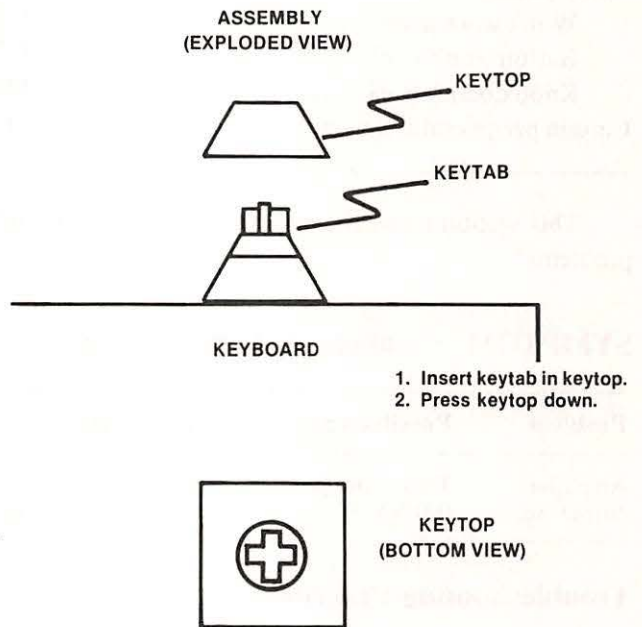

Fig. 4-55. Character key top replacement.

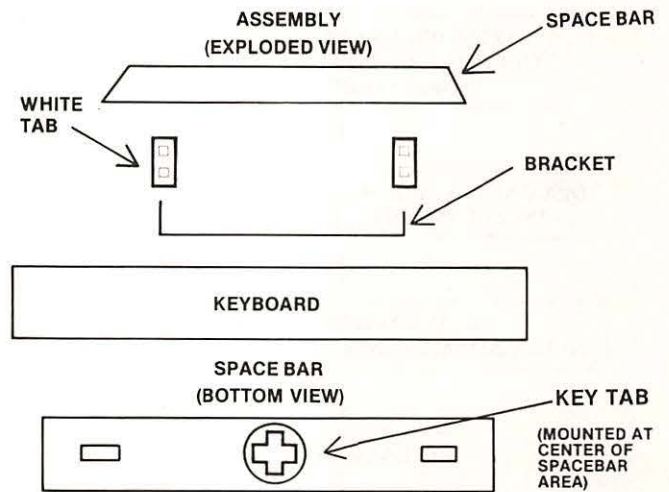

Fig. 4-56. Space bar key top replacement.

5. OTHER INPUT/OUTPUT PROBLEMS

Symptom Category	Page
Speaker	
Volume too low	106
Won't click	107
Cassette	
Can't load data	108
Can't write data	109
Game paddle	
Won't work at all	110
Button won't work	112
Knob doesn't work correctly	112
Card in peripheral slot won't work	113

This section treats the most common input/output problems.

SYMPTOM: Speaker – volume too low

Problem	Possible cause	Repair action
Amplifier output weak	Transistor Q4 (MP SA 13) marginal	Replace and test (requires soldering)

Troubleshooting Procedure

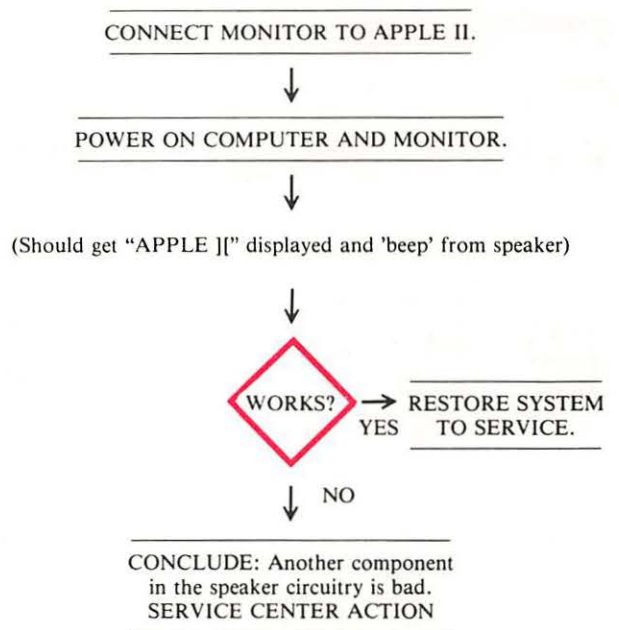
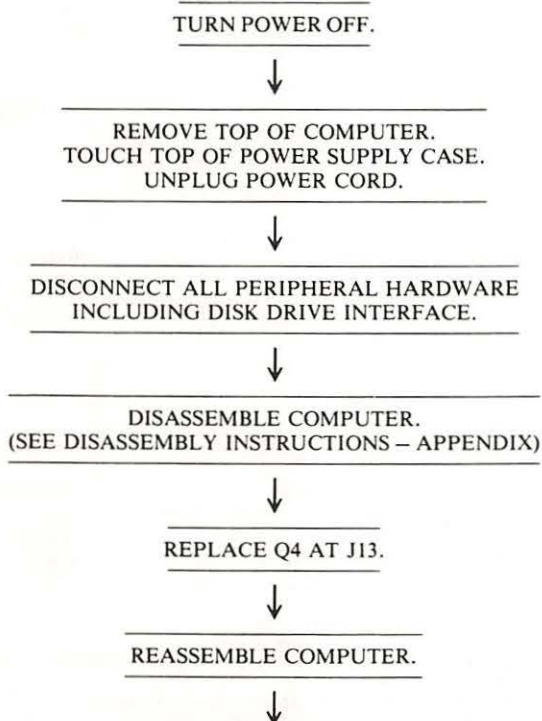

Circuitry Affected

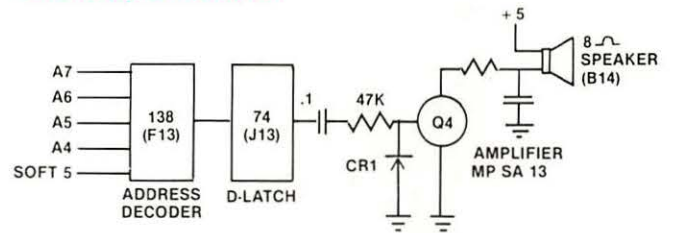

Fig. 4-57. Circuitry affected.

Chip designation	Description	Location
MPSA13	Transistor amplifier	J13

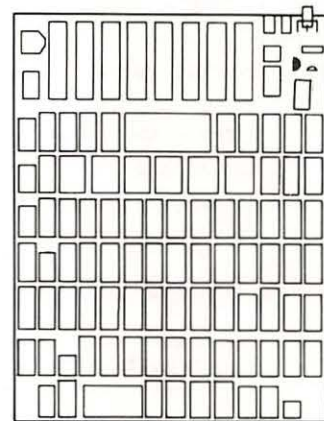
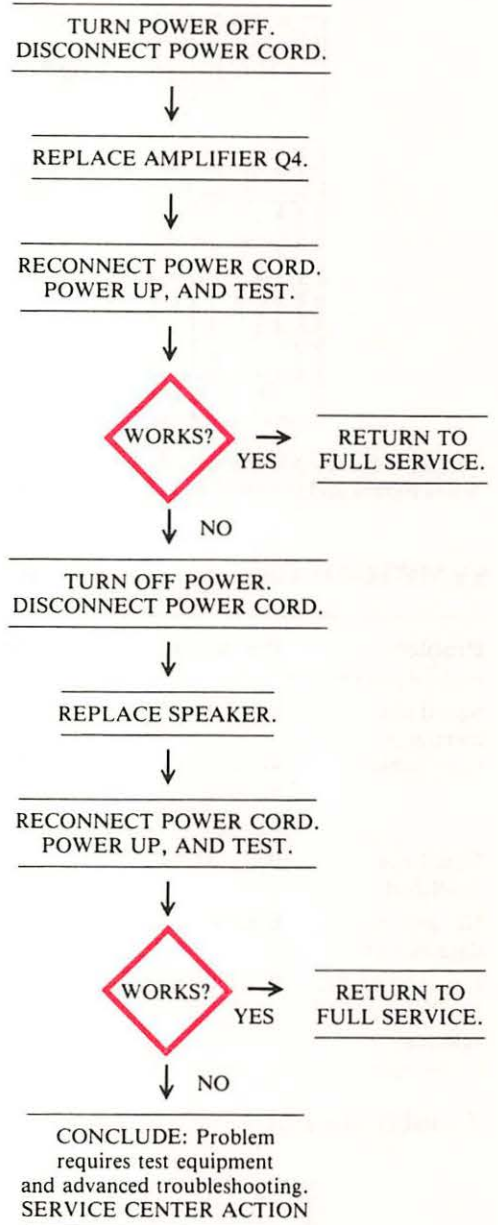
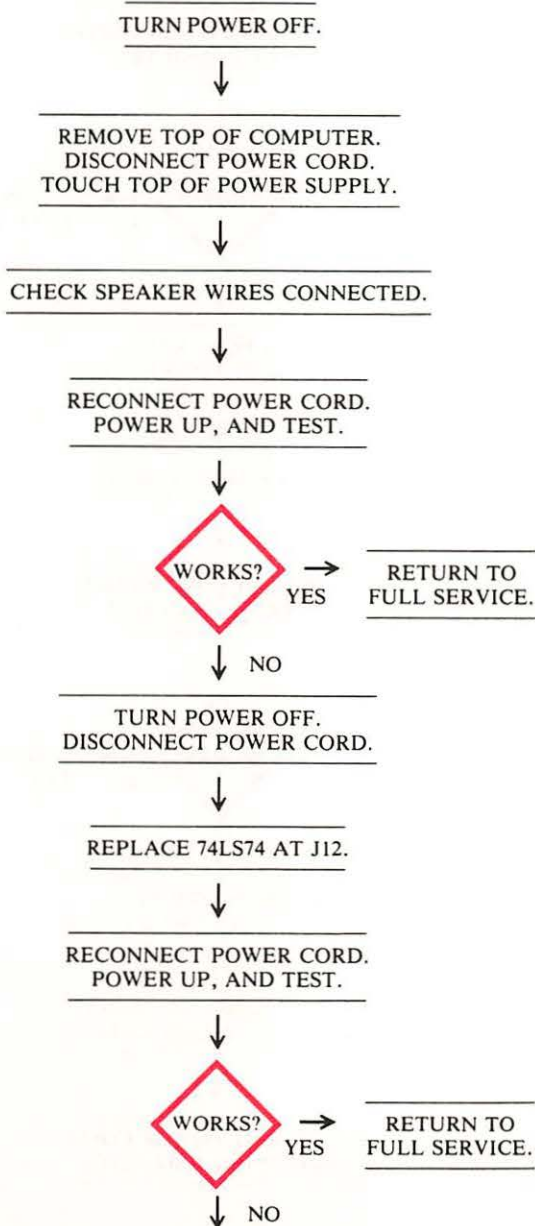

Fig. 4-58. Chip location guide. This represents the Apple motherboard and is a guide to help you find the MPSA13 transistor amplifier.

SYMPTOM: Speaker – won't click

Problem	Possible cause	Repair action
Speaker cone won't respond	Bad speaker	Replace speaker
No signal from amplifier to speaker	Speaker wires disconnected	Reconnect wires
	Bad MPSA13 at location J13	Replace and test (requires soldering)
	Bad 74LS74 at location J12	Replace and test

Troubleshooting Procedure



Circuitry Affected

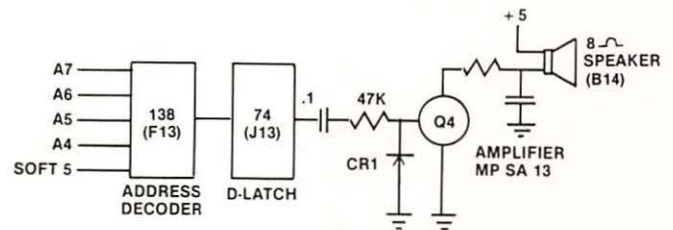

Fig. 4-59. Circuitry affected.

Chip designation	Description	Location
MPSA13	Transistor amplifier	J12
74LS74	D-latch flip-flop	J12

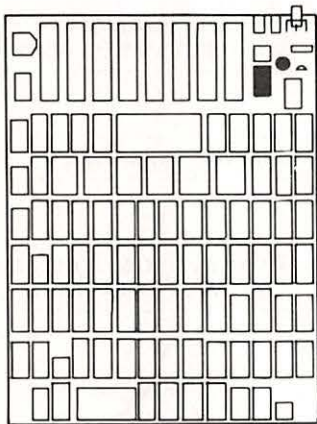
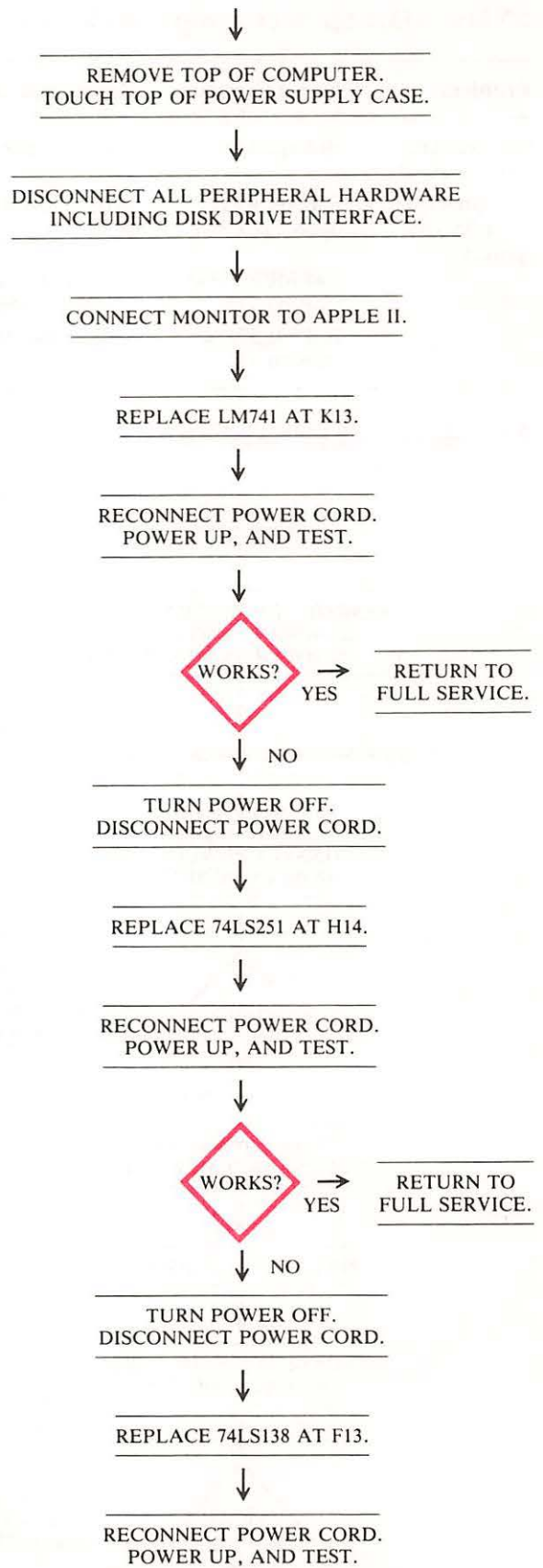
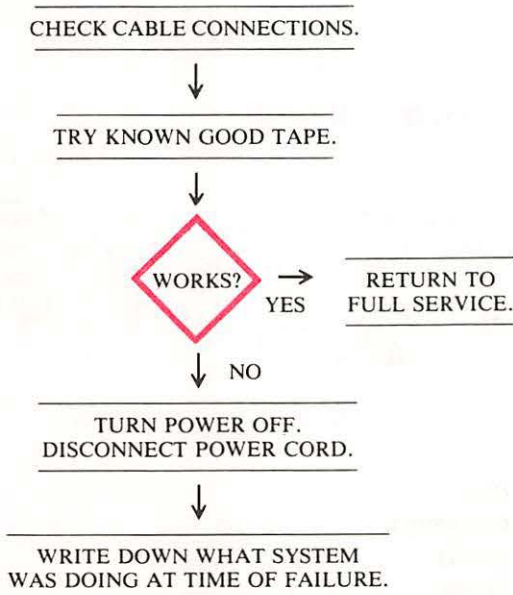

Fig. 4-60. Chip location guide. This represents the Apple motherboard and is a guide to help you find the chips of interest.

SYMPTOM: Cassette – can't load data

Problem	Possible cause	Repair action
Signal not coming in from cable	Bad cable	Replace cable
	Volume not set properly	Adjust tape recorder volume
	No signal on tape	Replace bad tape
Signal not amplified	Bad LM741 at K13	Replace and test
No data to data bus D7	Bad 74LS251 at H14	Replace and test
Cassette DATA IN port not selected	Bad 74LS138 at F13	Replace and test

Troubleshooting Procedure



(Continued)

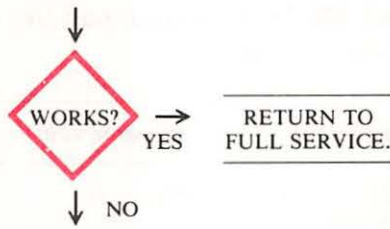

CONCLUDE: Problem is not caused by chip failure.
SERVICE CENTER ACTION

Tape not working	Bad tape	Replace
Signal not being sent	Bad 74LS74 at J13	Replace and test
Cassette DATA OUT not being selected	Bad 74LS138 at F13	Replace and test

Circuitry Affected

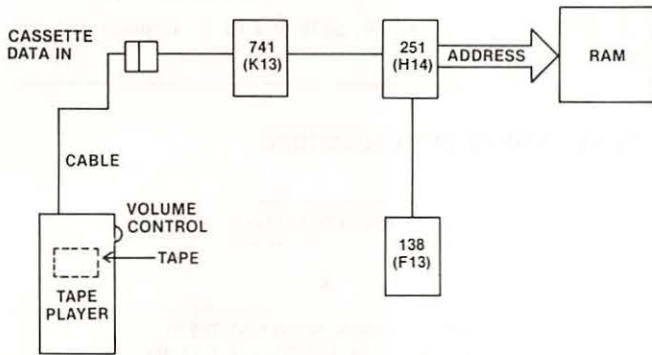

Fig. 4-61. Circuitry affected.

Chip designation	Description	Location
LM741	Operational amplifier	K12
74LS138	Expandable 3/8 decoder	F13
74LS251	Tri-state 8-input multiplexer	H14

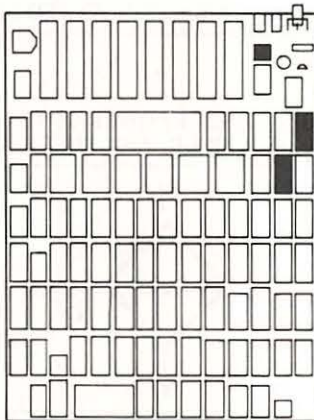

Fig. 4-62. Chip location guide. This represents the Apple motherboard and is a guide to help you find the chips of interest.

SYMPTOM: Cassette – can't write data to tape

Problem	Possible cause	Repair action
No signal to tape	Bad cable connection	Reconnect or replace cable

Troubleshooting Procedure

CHECK CABLE CONNECTIONS.

TRY KNOWN GOOD TAPE.

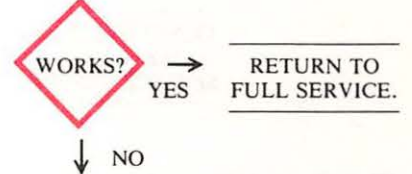

TURN POWER OFF.
DISCONNECT POWER CORD.

WRITE DOWN WHAT SYSTEM
WAS DOING AT TIME OF FAILURE.

REMOVE TOP OF COMPUTER.
TOUCH TOP OF POWER SUPPLY CASE.

DISCONNECT ALL PERIPHERAL HARDWARE
INCLUDING DISK DRIVE INTERFACE.

REPLACE 74LS74 AT J13.

RECONNECT POWER CORD.
POWER UP AND TEST.

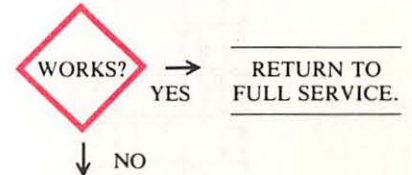

(Continued)

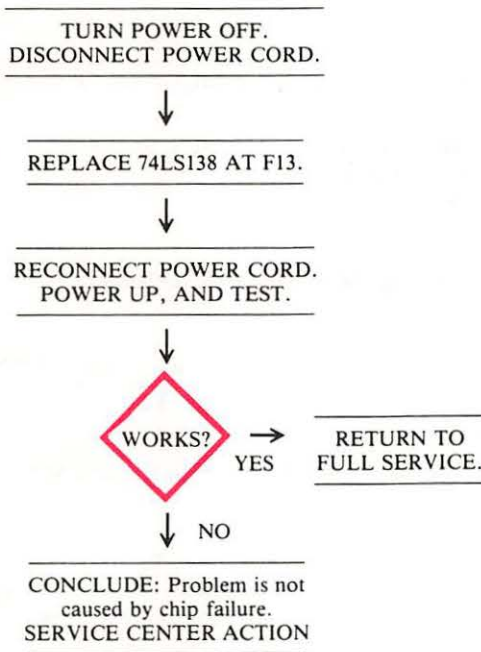

Circuitry Affected

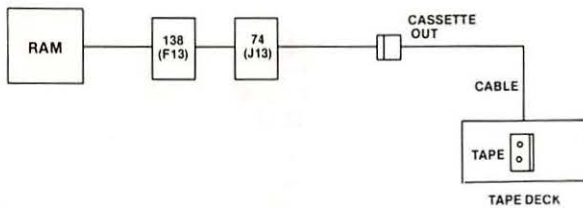

Fig. 4-63. Circuitry affected.

Chip designation	Description	Location
74LS74	D-latch flip-flop	J13
74LS138	Expandable 3/8 decoder	F13

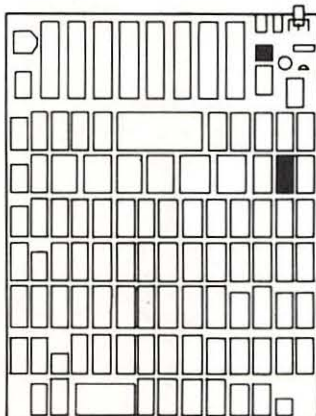
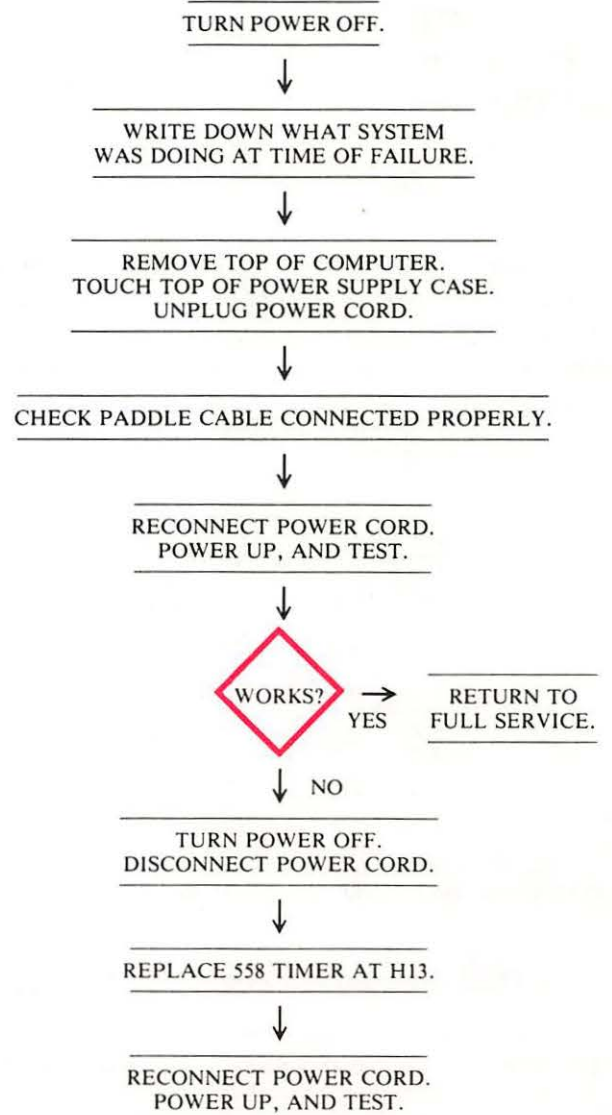

Fig. 4-64. Chip location guide. This represents the Apple motherboard and is a guide to help you find the chips of interest.

SYMPTOM: Game paddle – won't work at all

Problem	Possible cause	Repair action
Signals not getting to paddle	Bad cable Bad 558 Timer at location H13	Replace cable Replace and test
Game port not being accessed	Bad 74LS259/N9334 at location F14	Replace and test
Signal not put on data bus D7	Bad 74LS251 at location H14	Replace and test
No strobe to paddle	Bad 74LS138 at F13	Replace and test

Troubleshooting Procedure



(Continued)

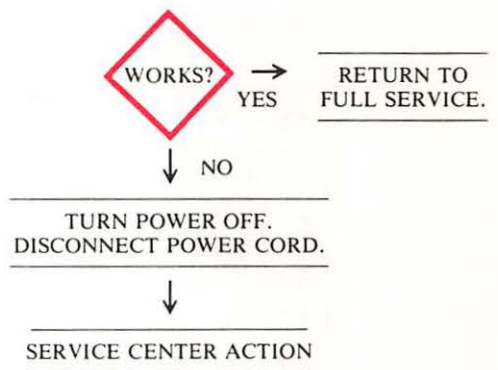
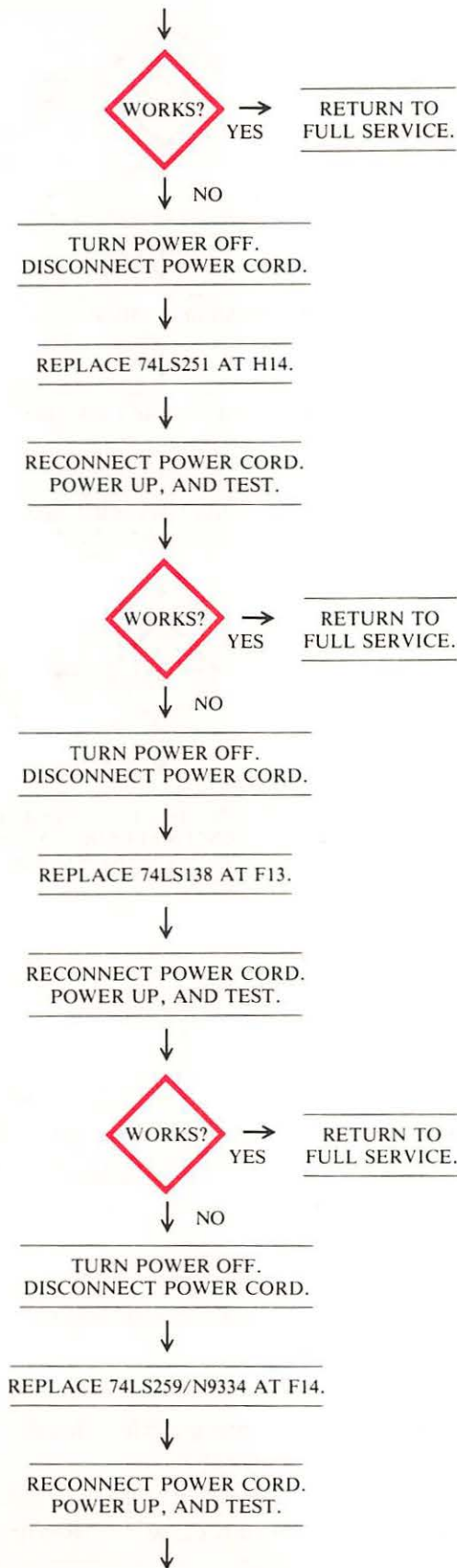

Circuitry Affected

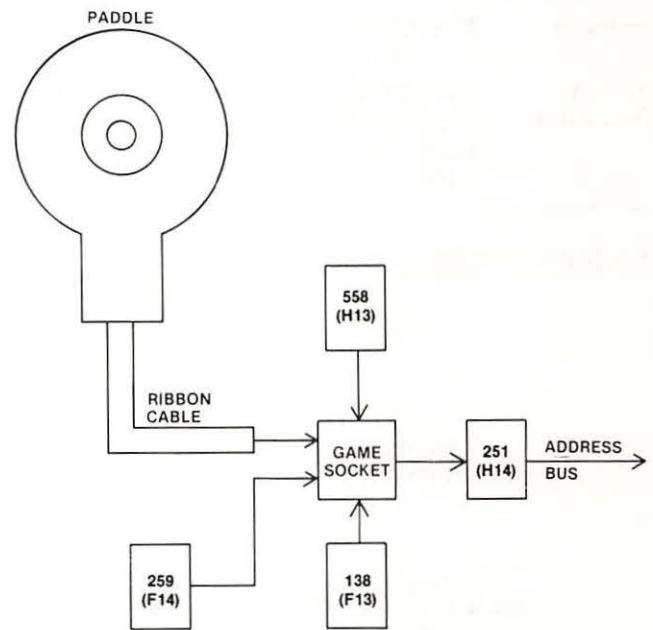

Fig. 4-65. Circuitry affected.

Chip designation	Description	Location
558	Quad timer	H13
74LS138	Expandable 3/8 decoder	F13
74LS251	Tri-state 8-input multiplexer	H14
74LS259/N9334	8-bit addressable latch	F14

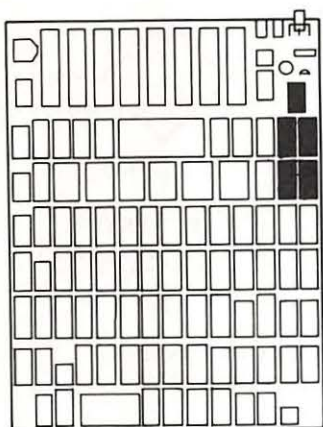
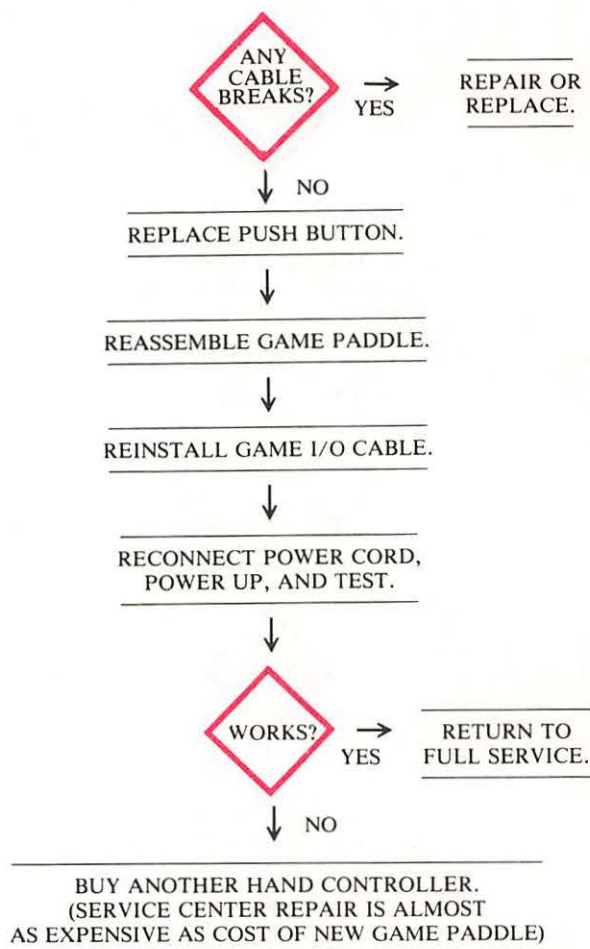
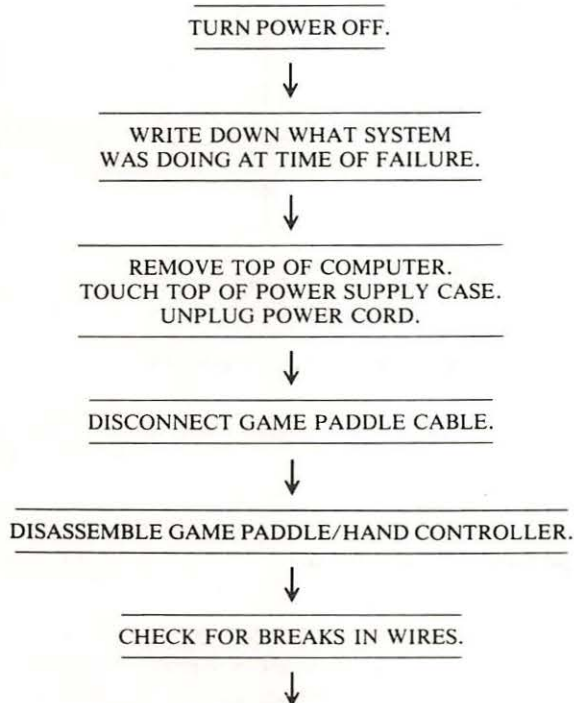

Fig. 4-66. Chip location guide. This represents the Apple motherboard and is a guide to help you find the chips of interest.

SYMPTOM: Game paddle – button won't work

Problem	Possible cause	Repair action
No signal from button	Bad pushbutton in game paddle	Replace pushbutton
	Broken wire in cable	Repair wire (requires soldering)

Troubleshooting Procedure



Circuitry Affected

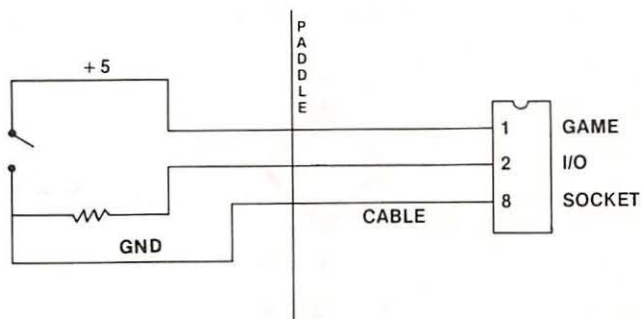

Fig. 4-67. Circuitry affected.

SYMPTOM: Game paddle – knob doesn't work correctly

Problem	Possible cause	Repair action
Resistance incorrect	Bad potentiometer in hand controller	Replace pot (requires soldering)

Signal not getting to computer Broken wire in hand controller or cable Repair or replace (requires soldering)

PURCHASE ANOTHER GAME PADDLE.
(SERVICE CENTER REPAIR IS ALMOST AS EXPENSIVE AS COST OF NEW GAME PADDLES)

Troubleshooting Procedure

Circuitry Affected

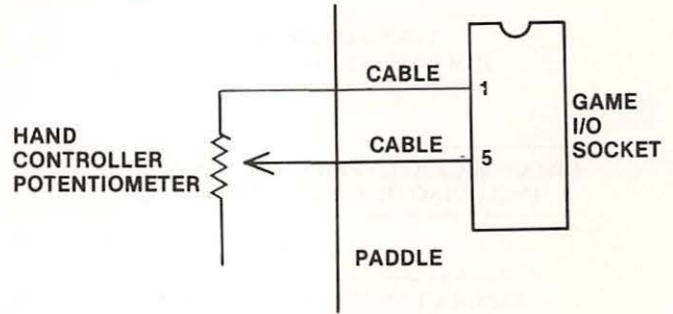
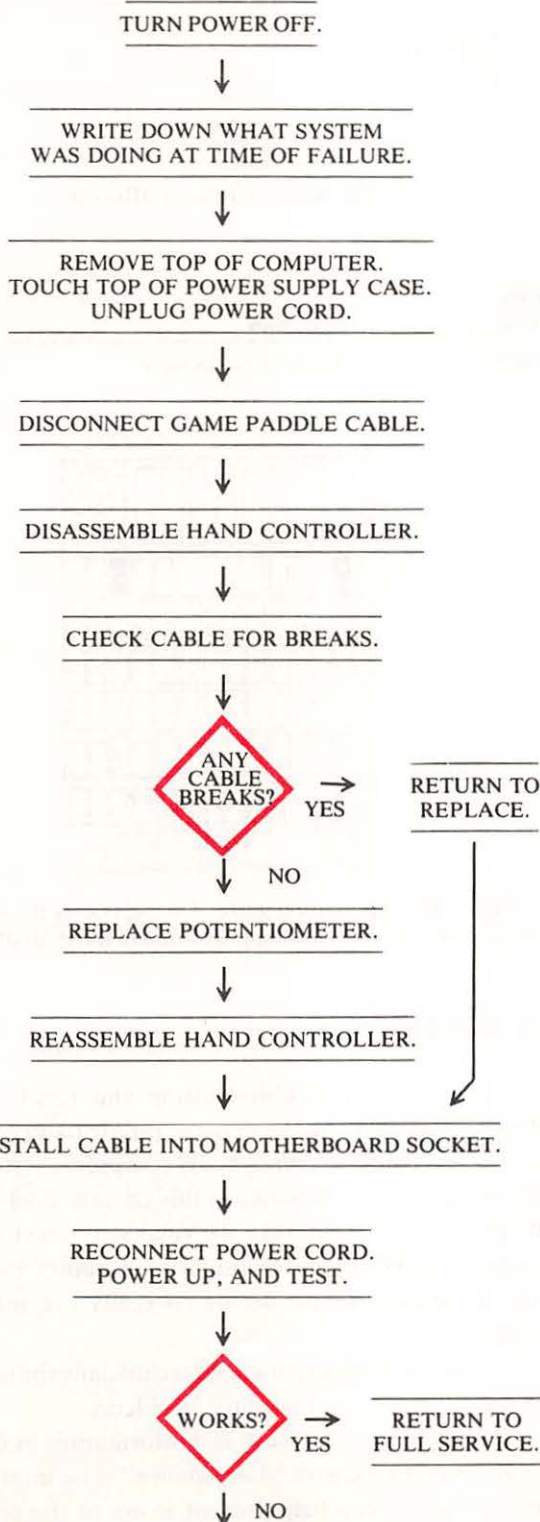
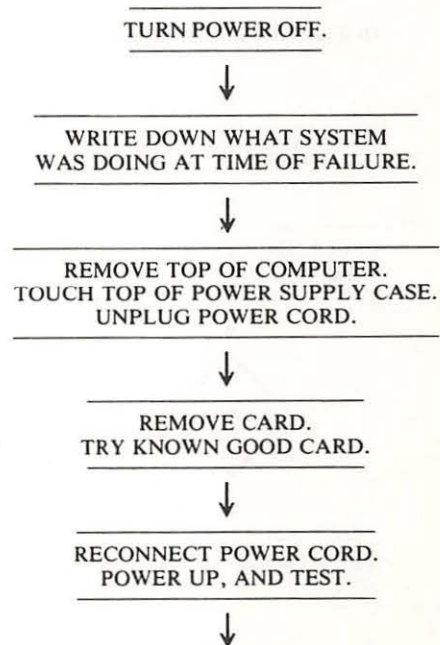

Fig. 4-68. Circuitry affected.

SYMPTOM: Card in peripheral slot won't work

Problem	Possible cause	Repair action
Slot not being accessed	Bad 74LS138 at H2 Bad 74LS138 at H12	Replace and test Replace and test
Bad card	Bad component on peripheral card	Repair or replace

Troubleshooting Procedure



(Continued)

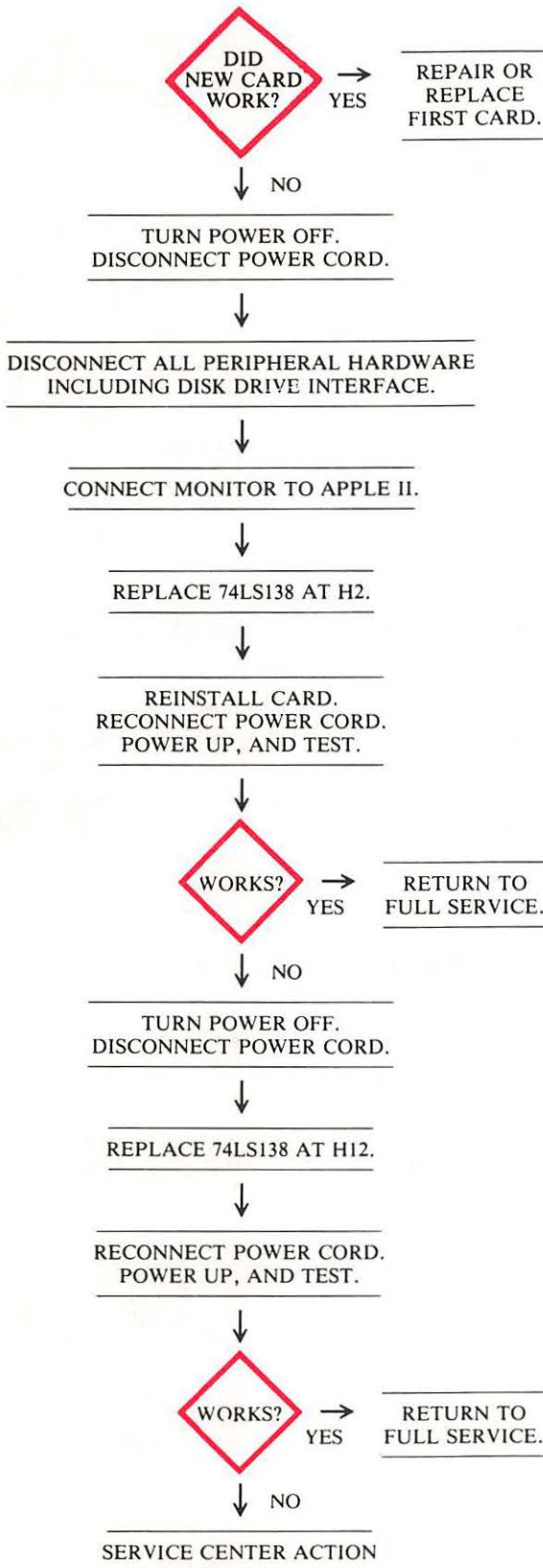

Circuitry Affected

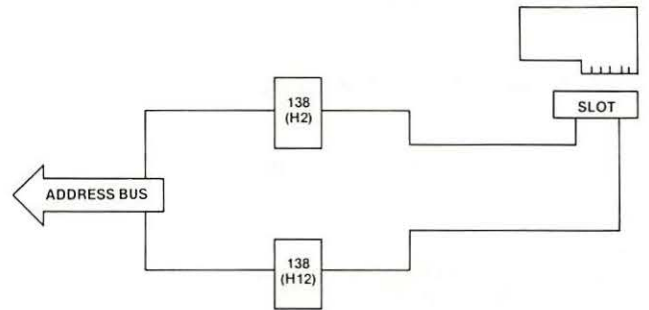

Fig. 4-69. Circuitry affected.

Chip designation	Description	Location
74LS138	Expandable 3/8 decoder	H2, H12

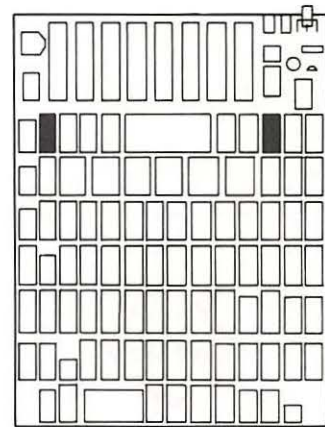

Fig. 4-70. Chip location guide. This represents the Apple motherboard and is a guide to help you find the chips of interest.

SUMMARY

This detailed troubleshooting and repair chapter has covered most of the general problems experienced by owners (and repairers) of computer systems. If following one of the guides in this chapter doesn't solve the problem, you can take the final step (service center action) yourself if you feel qualified. Chapter 9 will provide assistance if you decide to really dig into your machines.

Caution: Only experienced technicians should work on power supply and monitor problems.

Don't forget to absorb the information in Chapter 8, "Routine Preventive Maintenance." The information provided there can help prevent many of the problems analyzed for repair in this chapter.

Apple IIe Described

Chapters 2 through 4 dealt with the Apple II Plus and the problems you might experience over its years of operation. Chapter 5 begins the part of the manual dedicated to the Apple IIe Computer, a machine that outperforms even the Apple II Plus.

OVERVIEW

In January 1983, Apple Computer Company introduced a remarkable new improved Apple II computer, the Apple IIe. Maintaining its compatibility with the Apple II, correcting some deficiencies of the Apple II Plus, and incorporating many of the good features of its competitors, the “IIe” has become a key product in the company’s continued success.

The Apple IIe has an expanded keyboard with more characters than the Apple II Plus. Both uppercase and lowercase are standard features of the Apple IIe, and 64K RAM is the baseline. The Apple IIe has a completely redesigned main printed circuit board (motherboard) with fewer components and cooler operation. Yet this new machine is 99 percent compatible with existing Apple II Plus software.

The same modular construction with a top that pops off gives easy access to the expansion slots inside.

And Applesoft BASIC is provided as the “built-in” high level language. The “e” in “IIe” stands for “enhanced,” and indeed it is.

STRUCTURE

The typical Apple IIe system is shown in Fig. 5-1. The Apple IIe is really a single-board computer housed in a molded plastic case. It weighs 12 pounds and uses less power to operate than a single 100-watt light bulb. In fact, the typical power consumption is only 11 watts. Compare this with an electric hair dryer that uses 1,200 watts of power!

The built-in typewriter shown in Fig. 5-2 has a full 63-key keyboard that can generate all 128 characters in the American Standard Code for Information Interchange (ASCII), including uppercase and lowercase. In addition to up, down, right, and left arrow keys, the keyboard has special keys such as Caps Lock, Delete, and two keys – Open-Apple and Closed-Apple – for special functions or as substitutes for game-paddle buttons.

Pressing CTRL, Open-Apple, and RESET all at the same time causes the computer to restart the system without turning the power off and then back on. The



Fig. 5-1. The Apple IIe System. (Apple Computer, Inc.)

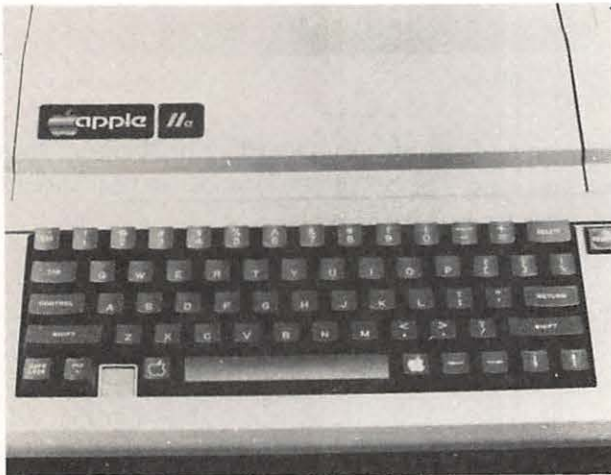

Fig. 5-2. The Apple IIe keyboard. (Apple Computer, Inc.)

Open-Apple key is connected internally as an alternate Paddle 0 (PB0) push button.

Pressing CTRL, Closed-Apple, and RESET together causes the computer to run a self-test program to check its memory and circuitry. Patterns are displayed on your monitor screen as the 20-second test is running. If the computer passes the test, the message "KERNEL OK" is displayed on your screen.

The full ASCII character set accessible on your Apple IIe keyboard includes 26 lowercase characters, 26 uppercase characters, 10 numbers, 34 special characters (such as / , . () [] and so on), and 32 control characters (e.g., pressing the CTRL and C keys together generates a special control character for "cancel"). Six of the

control characters are for moving the cursor on your screen.

Holding any key down for more than a second causes the character to repeat automatically.

The Apple IIe keyboard is like the Apple III keyboard. The keys are "dished" slightly (concave top surfaces) and look much like those on the IBM Selectric. Another nice feature is the tiny bumps on the "D" and "K" keys to help the user locate the "home keys" to aid in proper finger placement.

Fig. 5-3 shows the connections at the back of your Apple IIe computer. From left to right, notice the Video Output connection, the Cassette Data Output, the Cassette Data Input, the 9-pin D-connector for game paddles or a joystick, and, on the far right, the 115-volt Power-In plug connection and the ON/OFF power switch.

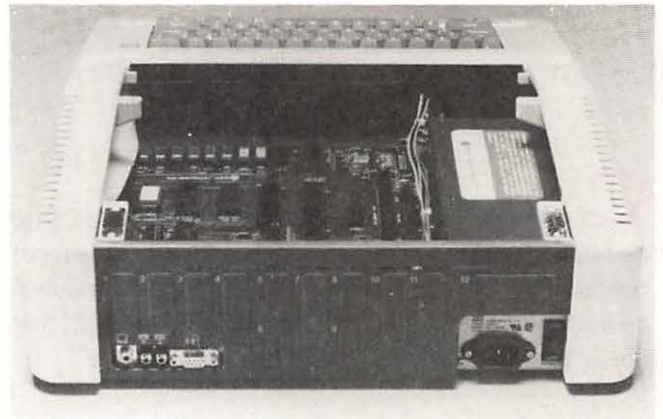

Fig. 5-3. The rear panel connections of the Apple IIe computer.

Notice also the 12 access ports, or slots, covered with plastic snap plugs. These allow you to connect two-way sockets to interface peripheral cards to the external devices; short cables connect between the card and the inside of the socket, and a longer cable connects between the outside of the socket and the external device. By keeping the access ports closed, the plastic snap plugs minimize dust entry. They also reduce the amount of electronic noise (radio frequency interference) generated on the main circuit board that gets outside to affect your television set.

Peripheral devices requiring 25-pin D-connectors can use slots 5, 8, 11, and 12 for entry to peripheral cards inside the Apple IIe. Devices with 19-pin connectors can use slots 1 and 4. Slots 6, 7, 9, and 10 provide access to the computer if 9- or fewer-pin connectors are used. Apple has included a diagram on the back panel showing which slot each particular device should use.

Facing your Apple IIe's keyboard, you'll see two plastic grip tabs extending beyond the back of the computer's top cover. Make sure the power to your Apple IIe is turned off. Then grasp these grips with both hands and pop the lid up, sliding it back off the computer. Look inside and compare what you see with the components identified in Fig. 5-4.

That big, flat, green thing with all those tiny components is a "printed circuit board," the "main board," or "motherboard" of the Apple IIe. Mounted on this board are tiny, black integrated circuits, or chips, that make up the most important part of the machine—the Central Processing Unit (CPU), "microprocessor," or simply "processor," with its Memory Management Unit (MMU),

Input/Output Unit (IOU), memory, and a host of other chips that help the CPU move information around, into, and out of the motherboard.

The Apple II Plus has a little over a hundred chips, or integrated circuits (ICs), on its motherboard. The Apple IIe uses only 31 chips to perform the same functions as the II Plus, plus some the II Plus can do only with extra peripheral cards.

Looking from the keyboard end of the motherboard back toward the rear chassis, you'll see seven 50-pin connector slots. An eighth, slightly longer slot is on the left side of the board. These slots provide expansion capability for your Apple IIe. Unlike the II Plus, the Apple IIe has the language or RAM card designed

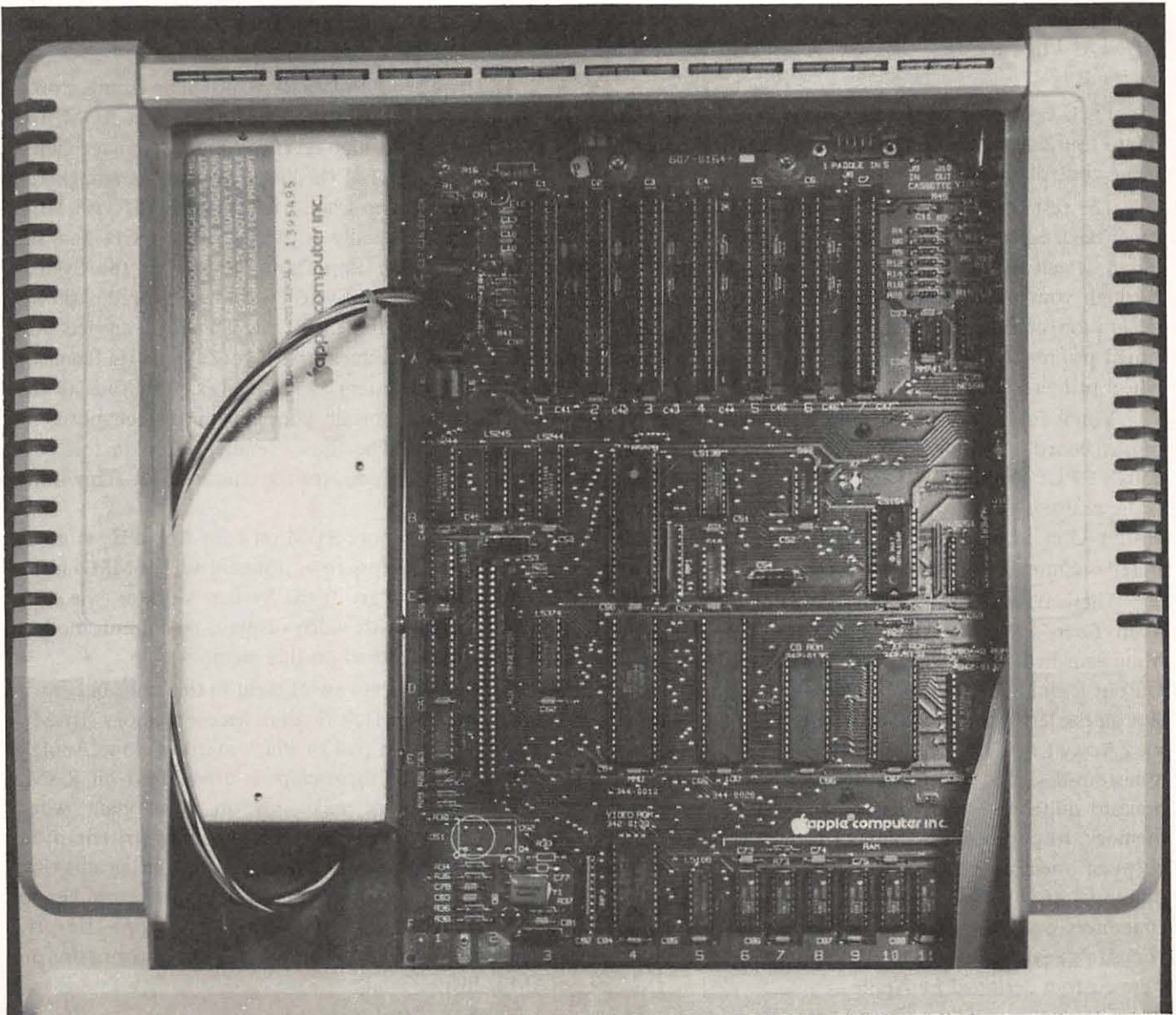

Fig. 5-4. An inside look at the Apple IIe computer.

into the motherboard circuitry, eliminating the requirement for slot 0. This freed a slot, so the IIe designers made it a 60-pin eighth, or auxiliary, slot and brought some different signals to it that weren't easily accessible on the Apple II Plus. Apple Computer sells 80-column cards with or without 64K bytes of additional RAM that plug into this eighth slot. In addition, since a lot of Apple II software recognizes slot 3 as the location for the 80-column card, Apple designed this eighth slot to respond to PR#3, just as slot 3 does. Apple II 80-column cards that don't require extra connections on the main board can be installed in slot 3 of the IIe. It's important not to install cards in both the auxiliary eighth slot and slot 3 since slot 3 will not be recognized; instead, only the auxiliary slot will be active.

Printers still connect to slot 1 as they do in the Apple II Plus; the first disk controller card still plugs into slot 6.

Each controller card can handle two disk drives. Up to four disk drives can be connected to the Apple IIe using controller cards in slots 4 and 6.

The rest of the slots can be used to connect many other devices, including a modem (modulator-demodulator), which allows you to send and receive information through your phone lines, voice recognition and voice generation boards, elaborate displays, and even additional printers. (I have both a dot matrix and a daisy wheel printer connected to my Apple computer.)

You'll find four sizes of chips on your Apple IIe motherboard — 14-pin, 16-pin, 24-pin, and the 40-pin 6502B CPU. That big, long chip sitting just below slot 2 is the brain of your Apple IIe — the 6502B Central Processing Unit. Everything that happens inside your computer is controlled by this chip.

There are three other special chips on your Apple's main board. Just below the 6502B is the Memory Management Unit (MMU), and to its right, the Input/Output Unit (IOU). Finally, outside the large auxiliary slot on the left side of the motherboard is the Programmed Array Logic (PAL) integrated circuit. The MMU is a custom-designed device that enables the Apple IIe to operate quite well with more than 64K of on-board memory. Its purpose is to manage the movement of data between memories inside your machine. The IOU develops the video signals necessary to display characters on your screen. It's circuitry also controls your IIe's keyboard. Both the MMU and the IOU chips were custom designed by Apple.

The PAL device generates timing and control signals. PAL chips are like programmable memories.

They are constructed of OR logic gates and one-time programmable AND gates. These devices can be configured for many different functions. PAL devices operate very fast and don't use much power. This means they run cooler than the five to seven chips that each of them replaces. Using PALs is one way Apple was able to reduce the number of chips on the Apple IIe motherboard. PALs are permanently written on (configured) during manufacture.

Just to the right of your Apple's IOU chip are two chips slightly smaller than the IOU, and a third chip that is smaller yet. These three devices make up part of the read only memory (ROM) of your computer. ROM chips can only be read from. You can't write any information to a ROM. Like the MMU and the IOU chip, your IIe's ROM is also configured or programmed during manufacture.

The two larger ROMs have special programs stored in them (we call this "firmware"). The first ROM, the CD ROM, holds a high-level computer language called "Applesoft BASIC." This is a popular language for writing your own programs. Applesoft BASIC is a large program, and actually is stored on the CD and EF ROMs. The other important program is the System Monitor. Most of the System Monitor is stored in the second ROM chip, the EF ROM. This program lets you control and communicate with your Apple IIe from the keyboard. The System Monitor also establishes all the initial conditions inside your machine when power is first turned on. The third, smaller ROM in this row stores the ASCII codes for the character set. This is the keyboard ROM.

There's one more ROM on your Apple IIe motherboard. On the bottom row, just beneath the MMU is the 4K video ROM. Part of the System Monitor, the software that deals with video display, 80-column modes, and self tests is stored on this memory chip.

Sitting in a neat row of eight in this bottom row of chips is the Apple IIe's random access memory (RAM). This is the scratch pad or blackboard of your Apple's memory. Each of these chips is a 64K-by-1-bit RAM, so eight of them make up the 8-bit data word memory. RAM chips can be read from or written to. In these eight chips, you temporarily store programs that you write or load from your disks. Just remember to save your work before you turn your Apple IIe off, because once power is turned off, any information in RAM is lost.

Another 64K of RAM is available on a handy 80-column card sold by Apple. It lets you expand your

system so that a “standard” Apple IIe configuration (with 80 columns) has 128K RAM.

A welcome improvement over the Apple II Plus is that tiny red LED (light emitting diode) bulb in the upper left corner of the Apple’s motherboard. This LED lights whenever you apply power to the system (turn the power on). Many Apple II Plus owners mistakenly burned out chips in their disk drive interface circuitry when they forgot power was on as they tried to insert or remove the disk controller card. The “psst” sound told them they were too late to prevent shorting connector pins on the interface card as it was being jockeyed out of the expansion slot socket. The red LED in the Apple IIe adds an internal visual support to the power ON light on the keyboard. Check the LED to make sure all power to your computer is off before you do anything inside the case.

The other LED, next to the power ON LED, was used by Apple during manufacturing tests for quality control. It can also be used by service center technicians who have access to special Apple IIe diagnostics.

Just to the left of these LEDs is a long, shiny rectangular box that faithfully takes in electrical power from that cord you plugged into the wall socket and converts it to the voltages necessary to make your computer system function properly. This box is called a *switching power supply*, and it is very reliable. This manual doesn’t discuss repairing this power supply because extensive training is required to conduct repairs in high voltage circuits. The electrical cord plugs into the back of this power supply just to the left of the ON/OFF rocker switch.

On the right of your Apple IIe motherboard you’ll notice the keyboard ribbon cable leading down from beneath the keyboard to a connector on the main board. Unlike the Apple II Plus, the Apple IIe keyboard has no electronic circuits mounted on it. All the keyboard electronics for the IIe are located on the motherboard.

To the left of the keyboard ribbon-cable connection is another special built-in feature of the Apple IIe — an 11-pin numeric keypad connector. Apple Computer sells a keypad that plugs in here.

The video of the Apple IIe also shows improvement over the Apple II Plus. The system comes with both uppercase and lowercase character displays. With an 80-column card installed, you can get 24 rows of 40 characters or 24 rows of 80 characters in Text mode depending on how you set some software (programmable) switches.

A number of display options are available to you under software control. Simply by addressing (or having

your program address) certain memory locations, you can cause the screen to display text, graphics, or both. Your Apple IIe generates special video signals to achieve these display options and makes them available at several places on the motherboard.

One such location is at a connector on the rear of the computer. The video signal that comes out here is correct for driving a display monitor. This video output jack is also where 80-column text signals come on their way to your monitor if you have an 80-column board plugged into the auxiliary slot. Video output from this jack can produce either 40-column or 80-column text, 24 lines high.

You can use the video output located on the board just above the 16-pin Game I/O socket to connect an RF modulator to convert the Apple video signal to one suitable for television. These video signals cause text to be displayed 40 columns wide and 24 lines high in both uppercase and lowercase.

Both the monitor and the television can be color or black and white units. Monitors are also available that display characters in green or amber. For any 80-column work, you must use a monitor to get an easily readable display.

There are five types of video displays available on your Apple. First, *Text* mode can display 24 lines of 40 or 80 columns across. Second, *low resolution graphics*, or simply *lo res* produces small, bright rectangles on a screen 40 blocks wide and 48 blocks high. Each block can be any one of the 16 colors listed:

Black	Dark green	Brown	Light green
Magenta	Grey 1	Orange	Yellow
Dark blue	Medium blue	Grey 2	Aquamarine
Purple	Light blue	Pink	White

The third type of video is called *low resolution with text*. This video gives you four rows (eight blocks high) for text at the bottom of the screen. This leaves 40 rows by 40 blocks per row available for lo-res graphics. The same 16 colors are available for the graphics part of the display.

Fourth, you can get *high resolution graphics (hi-res)*. The screen becomes 53,760 dots, or pixels (picture elements), 280 pixels wide and 192 pixels high. You can control each dot, making it bright or dark. That fancy picture of Einstein that Apple used in magazine ads a few years ago was programmed in hi-res graphics. In hi-res, you can display only these six colors:

Black	Green
White	Red
Violet	Blue

The last form of video is a modification of hi-res called *high resolution with text*. In this video mode, the bottom of the display screen becomes a four-line text window as it does in low-res-with-text mode. This leaves 280 columns by 160 rows of pixels for the graphics. The same six hi-res colors are available for hi-res graphics with text. This is the mode used by many of the graphics adventure games available for Apple computers.

Under the chassis top and close to the keyboard is a small (2 inch) 8-ohm speaker, which you can use to make all sorts of sounds, including the familiar beep, arcade sounds, music, and even crude speech.

Also located on the motherboard near the right rear and on the rear of the computer are two sockets, each called a Game I/O (for Input/Output) connector. The socket on the rear of your Apple IIe is a 9-pin connector used for connecting hand controllers for games. The 16-pin connector inside, on the motherboard, is for connecting Apple II Plus game controllers. These sockets are unique windows to the computer. Programs running in the computer can send signals (variations in voltage levels) out of these sockets. This means you can address a certain memory location and affect the voltage (or logic) level at one of these output socket pins. On another output pin you can cause a short, 1/2-microsecond strobe pulse to occur under software control.

There are seven INPUTS to the Apple on each Game I/O connector. Three of these inputs are called flags, and they can be read by a program. Usually these are connected as push-button inputs for games. For example, when you depress the push button on your game paddle or joystick, you send a logic level voltage signal into your Apple IIe through the Game I/O socket pin called PB0. There are also four voltage inputs, called analog or paddle inputs that can vary between 0 and +5 volts. The rotary knob on each of your game paddles connects to one of these inputs through a variable resistor (attached to the knob) and the game paddle cable.

Besides game paddles and joysticks, your Game I/O connectors can be used to connect other custom devices to your computer. The Game I/O connector can be used for computer control and monitoring of laboratory tests such as the control of a landscape watering experiment.

At the back of the computer are two connections for a cassette interface. When the first Apple was built, disk drives were very expensive, so the first Apple users

were given the option of using standard audio cassette recorders as mass storage devices.

Using cassette tapes is a cheap way to provide mass storage for your programs, but saving or loading these programs with a cassette tape recorder is slow and frustrating because of the rewinding and the close attention to the tape counter required to locate the beginnings and endings of files. Most Apple II users who start out with these recorders soon shift to a floppy disk drive storage device for its speed, reliability, and simplicity of operation, and because many more programs are available on disk than on tape.

One reason you might want to consider using a cassette as a mass storage medium is for archive or backup storage. Many more files or pages of information can be stored on a good audio cassette tape than can be stored on a floppy disk. In fact, one type of archive storage for hard disks is a cassette video tape. Corvus, a hard disk manufacturer, uses a system called the Mirror to back up hard disk files on video tape.

Fig. 5-5 shows the proper way to install an Apple IIe disk drive. Notice that the disk interface card (controller card) is plugged into slot 6.

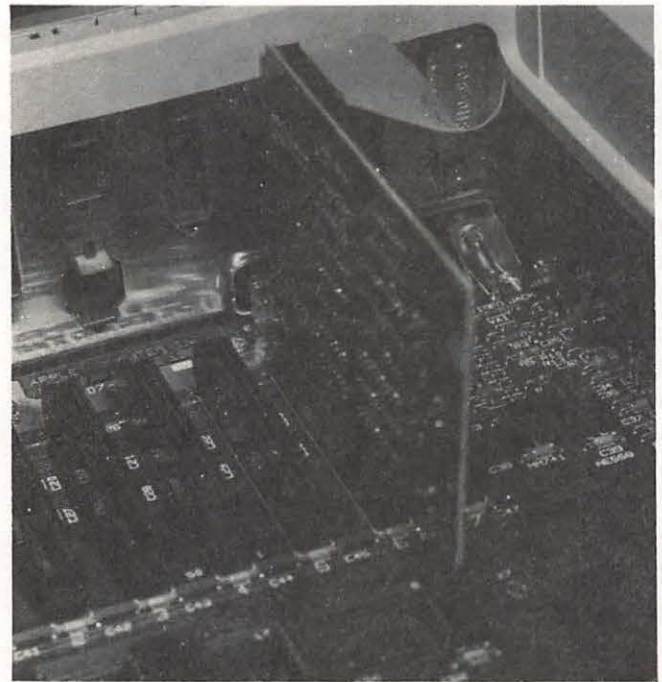

Fig. 5-5. The Disk II installed.

Your disk drive lets you store and retrieve information on flexible magnetic disks called *minidiskettes*, or *floppy disks*. Disk drives are an important part of your Apple IIe system. Chapter 7, "Specific Troubleshooting

and Repair,” and Chapter 8, “Routine Preventive Maintenance” contain extensive information on disk drives.

Proper connection of a monitor display unit is illustrated in Fig. 5-6. Although this manual doesn’t cover internal repair of monitors, you will be exposed to a number of display problems that are easy to correct.

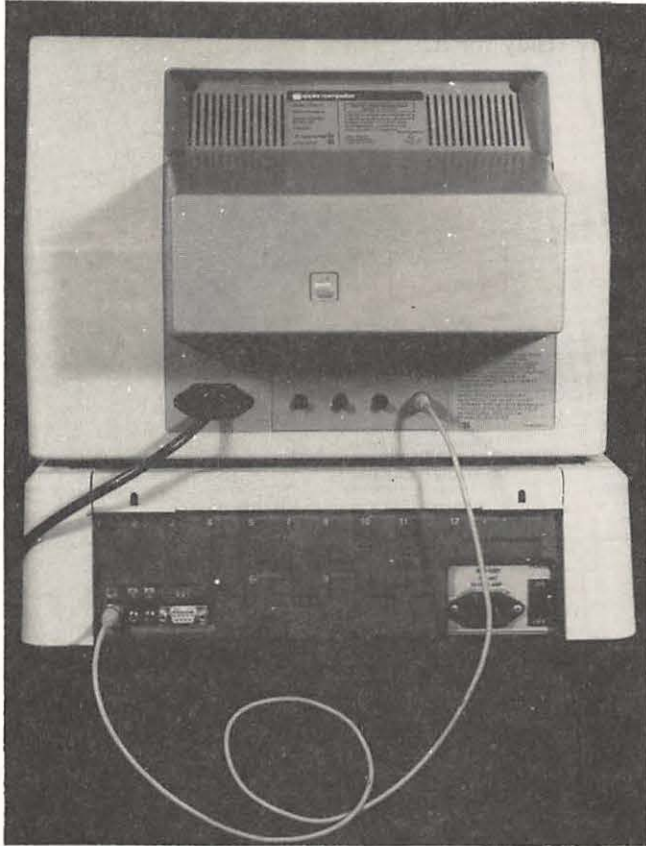

Fig. 5-6. Installing a monitor display is easy.

A properly connected Apple IIe system can provide fun, relaxation, and valuable help in your work.

A “basic” Apple IIe system is shown in Fig. 5-7. With the built-in speaker, this is the minimum configuration for the Apple IIe. Without the display, keyboard, or cassette recorder/player, your computer would be so limited it couldn’t really be called a system.

In Fig. 5-8, you see the “standard” Apple IIe configuration. The cassette recorder/player has been replaced with a floppy disk drive, and a printer has been added to provide hard copy, or printed output.

Small business users generally configure a system as shown in Fig. 5-9. Connecting an optional 80-column card with memory brings the total RAM to 128K.

The 80-column card and the CP/M card let you use

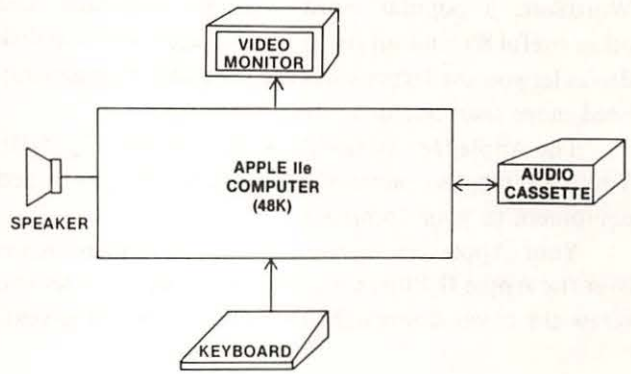

Fig. 5-7. The “basic” Apple IIe computer system.

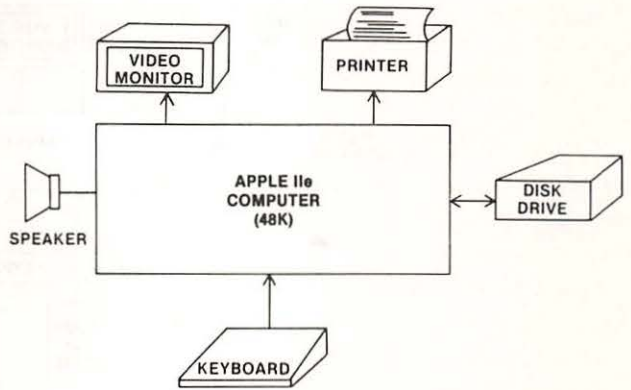

Fig. 5-8. The “standard” Apple IIe computer system.

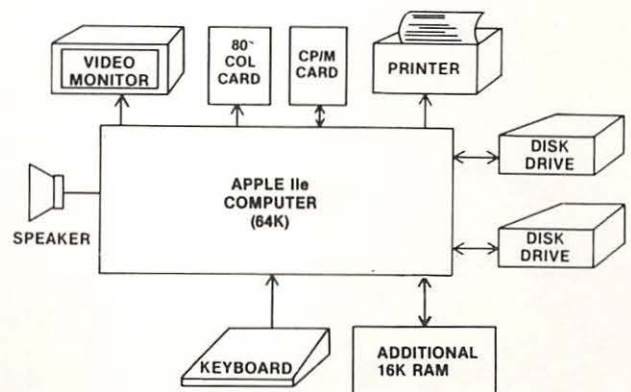

Fig. 5-9. A typical small business Apple IIe computer system.

WordStar, a popular word processor program, and other useful 80-column software packages. The two disk drives let you use larger software programs that actually need more than one disk drive to run.

The Apple IIe's flexibility is illustrated in Fig. 5-10. You can connect almost any electrically controlled equipment to your computer.

Your Apple IIe shows many more improvements over the Apple II Plus, such as holes in the lid to let you screw the cover down tight to prevent your three-year-

old from "modifying" your motherboard with his new toy hammer. These improvements make your Apple easier to use, maintain, and repair.

This has been a quick overview of the Apple IIe. Chapter 6 discusses how the computer works. If Chapter 6 gets too technical, don't worry — you can use the troubleshooting and maintenance steps in Chapter 7 without really understanding how the machine operates. The technical detail is provided so it will be here when you're ready for it.

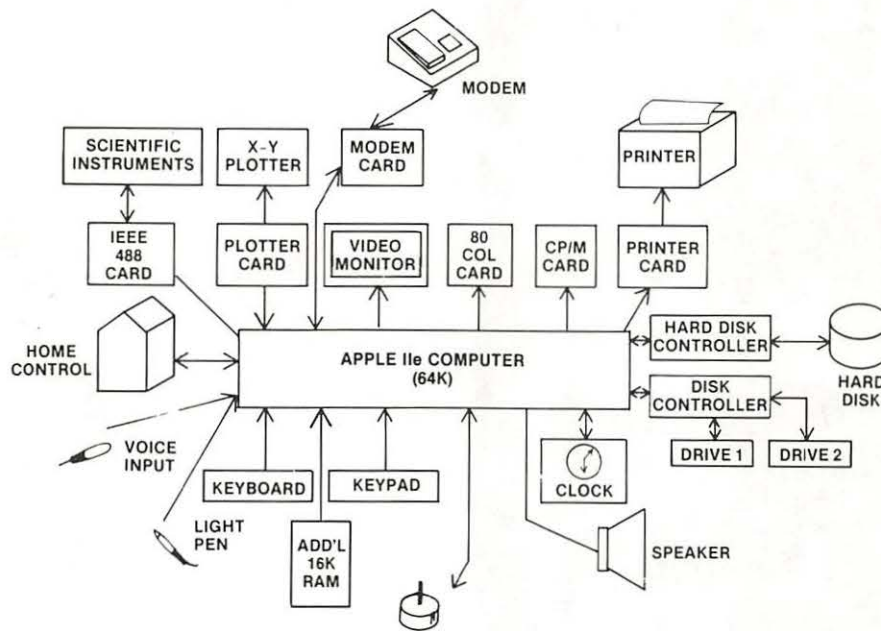

Fig. 5-10. The flexibility built into your Apple IIe.

Apple IIe Operations

In Chapter 5, you read a descriptive overview of the Apple IIe computer. This chapter explores how the Apple IIe works.

THE BASIC PARTS OF YOUR APPLE IIe

Whether it's a tiny, single-chip micro, an Apple IIe, or a room-size main frame, every computer has five basic parts:

- an arithmetic logic unit
- a memory unit
- an input unit
- an output unit
- a control unit

These parts are associated as shown in Fig. 6-1.

HOW EACH PART WORKS

Math and number crunching (arithmetic) occur in the **arithmetic logic unit (ALU)**. All the adding, subtracting, multiplying, dividing, comparing, and other manipulations are done by the ALU.

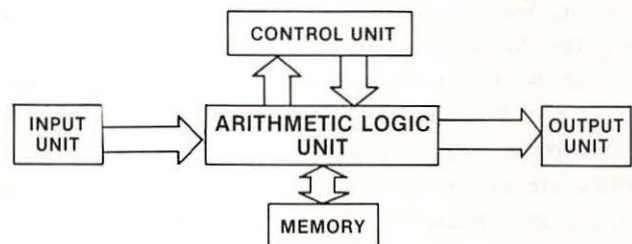

Fig. 6-1. The five parts of your Apple IIe computer.

The **memory unit** is used to store programs, calculations, and results. As shown in Fig. 6-2, this unit includes two types of memory – RAM (random access memory), which can be read from and written to, and ROM (read only memory), which can be read from but not written to. RAM is sometimes called *main memory*.

When you turn off power to your Apple IIe, whatever you had stored in RAM is lost unless you first saved it on a disk. The program in ROM is placed there by Apple during manufacturing. Since the program (software) is in a device (hardware), we call this “firmware.”

The **input unit** lets you enter information into the computer. It is a way for you to “talk” to your Apple.

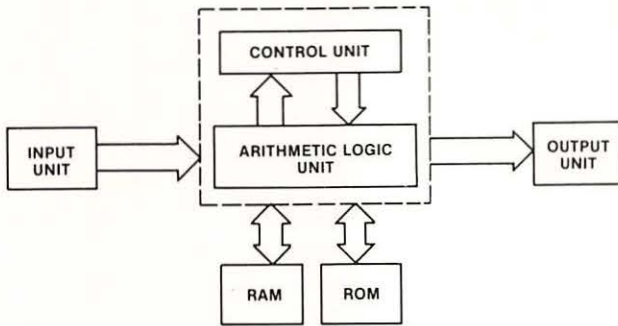

Fig. 6-2. The main memory is composed of RAM and ROM.

This communication is called the “man-to-machine” interface. You can communicate with your computer through your keyboard, a light pen that reacts as you touch a spot on the screen, a special pen and a graphics tablet, a mouse that moves your cursor about the screen as you roll the mouse on your desktop, or a voice recognition board and a microphone.

An **output unit** gets information from the computer to you. We call this the “machine-to-man” interface. It lets the Apple “talk” to you. A television or monitor screen is the most commonly used machine-to-man interface. You can also use a printer to produce *hard copy* (paper output). Other ways for your Apple to communicate include turning on motors and lights, making music and arcade sounds, and even “talking” in your own language with a speech synthesizer board and a speaker.

Some computer devices are for both input and output. One input/output (I/O) device includes a form of memory external to the computer — “mass storage.” You save your programs to mass storage and retrieve them as needed. Mass storage includes floppy disks, cassette tapes, hard disks, and the recently announced optical disks. Another I/O device is the *modem* (*modulator-demodulator*) which you use to send or receive information through your telephone line.

Input/output devices are called *peripherals*. They can be built into your computer, as your speaker is, or connected to your Apple IIe through printed circuit cards called *interfaces* that plug into slots — those long sockets on your Apple motherboard.

Everything your Apple does is directed by the **control unit**. This unit interprets computer instructions and initiates the signals that cause the Apple IIe circuits to do certain tasks.

The control unit and the **arithmetic logic unit** are

combined into a single chip called the *central processing unit*, or *CPU*. As shown in Fig. 6-3, the CPU on your Apple IIe motherboard is a 6502B microprocessor. This is a faster version of the 6502. The 6502B is an 8-bit microprocessor (8 bits comprise a data word) with 16 bits of address capability (you can directly address over 65,000 memory locations).

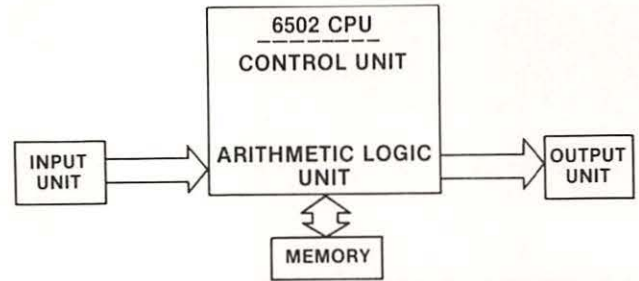

Fig. 6-3. The control unit and arithmetic logic unit are combined in the 6502B central processing unit (CPU).

Your Apple’s 6502B CPU looks into memory, fetches an instruction from that location, interprets the instruction, performs the actions the instruction requires (e.g., adding two numbers), and then moves on to process the next instruction. Unless the next instruction directs the 6502B to a particular memory location to carry out the instruction stored there, the CPU will move from one instruction to the next instruction in sequential memory locations (one step after the other). Perhaps the most important difference between your stepping through a program (sequence of instructions) and your Apple’s doing the stepping is that the Apple can handle about 500,000 of these steps each second.

CHIP LOCATION SCHEME

When Apple designed the new Apple IIe motherboard, they took a number of steps to make the board easy to install and easy to troubleshoot. As shown in Fig. 6-4, Apple designers continued their successful board layout from Apple II Plus days and divided the board into an XY matrix, with rows marked off with letters from A to F, and columns labelled from 1 to 14. This allows you to locate any component on the board by its row and column. Thus, the game I/O connector can be located at A14 (row A, column 14), the CPU can be found at C4, and so on.

In the pages that follow, all motherboard chips being discussed will be identified by the chip type (e.g.,

74LS10), name (e.g., triple 3-input NAND gate), and location (e.g., B5). A list of all the chips used in your Apple IIe can be found in the Appendix.

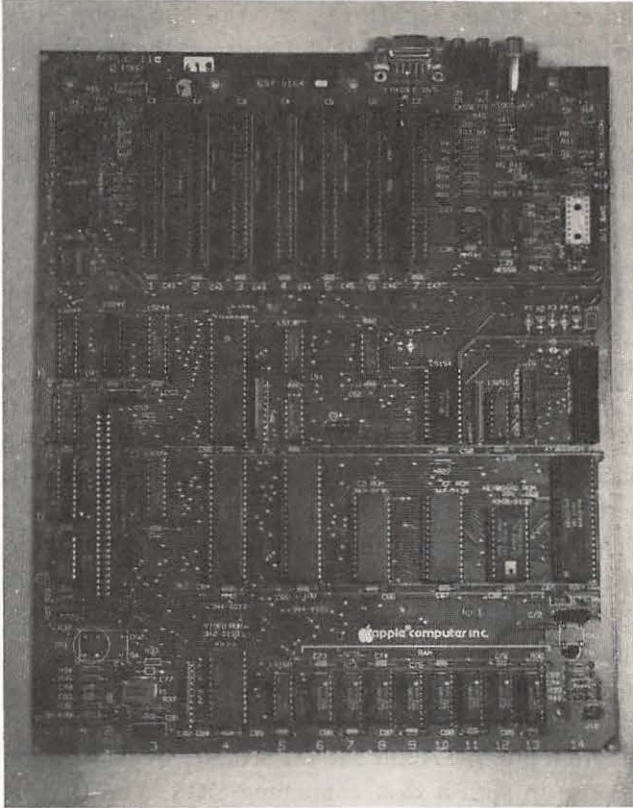

Fig. 6-4. The Apple IIe motherboard.

APPLE IIe CUSTOM CHIPS

Three custom chips are designed into your Apple IIe system to support the 6502B CPU. The *memory management unit (MMU)* and the *input-output unit (IOU)* work together to generate the multiplexed addresses for memory interaction and data transfer. The 40-pin MMU implements ten addressable switches, called “soft switches,” and multiplexed or interleaved addresses for reading and writing memory. Multiplexing or interleaving is a way to send blocks of information (data words or address words) sequentially, one after the other, on a single line or wire. The 40-pin IOU implements nine more soft switches, including video mode signals necessary to enable display on your monitor. It also uses a built-in chain of counters to generate unique display addresses which are multiplexed for display data transfer. The third custom chip is a 20-pin PAL16R8 *programmed array logic* device, which

generates timing and other control signals. The PAL controls memory row and column addressing.

Your Apple IIe uses a two-phase clock system to achieve faster operation than is possible with a single 1.023 MHz clock. The two clock signals oppose one another. Thus, when one signal is logic HIGH, the other is logic LOW. During the first phase the CPU reads or writes to RAM. During the second phase the display memory is accessed. Interleaving these two clock signals in this way doubles the RAM access rate. Two different circuits access memory — one during the CPU cycle and the other during the display cycle. Multiplexing or interleaving the memory and display addresses is controlled by the MMU.

MEMORY DESIGN

Your Apple IIe comes with 64K of RAM. Since the 6502B CPU can address 65,536 locations (called 64K), you’ve probably wondered how your computer can have much more than 64K of memory being addressed and used as you operate your system. All the RAM, ROM, and additional memory cards are allocated the same 64K address space. Your machine switches parts of the memory in your Apple system into and out of the same address space using a technique called “bank-switching.” Memory addresses from \$D000 to \$FFFF (12K) are shared by your Apple IIe’s RAM and ROM. In fact, 4K of the RAM is also bank switched. Switching between RAM and ROM or between parts of RAM is achieved by addressing certain memory locations activating soft switches.

You can install an 80-column text card into your IIe and get not only 40- or 80-column displays, but also added memory. This card adds 64K of auxiliary RAM (1K of this is used to provide the 80-column display) and expands the addressable memory to 128K or more using memory management techniques. Auxiliary memory is switched in and out using two soft switch addresses.

Your 64K address space is separated into areas for RAM, ROM, and input and output. Input and output ports have unique memory addresses — that is, the I/O is *memory-mapped*. For example, to place a logic HIGH (+5 volts) on the line going to the speaker (causing it to click), you address location 49200 (\$C030 in hexadecimal). Addressing location 64477 (\$FBDD in hex) will cause the speaker to make a bell sound. The map of memory allocation for your computer is shown in Fig. 6-5. For convenience, a decimal to hexadecimal conversion table is included in the Appendix.

FFFF	ROM (12K) / BANK SWITCHED RAM		
D000 CFFF			
C800	ROM (2K)		
C7FF		(BUILT-IN SELF TEST)	\$C7FF \$C400
	I/O		
		(BUILT-IN SELF TEST)	\$C2FF \$C100
C000	RAM (48K)		
BFFF		(FREE RAM)	\$BFFF \$6000
		(HI-RES GRAPHICS)	\$5FFF \$2000
		(FREE RAM)	\$1FFF \$0C00
		(TEXT & LO-RES GRAPHICS)	\$0BFF \$0800
		(TEXT & LO-RES GRAPHICS)	\$07FF \$0400
0000		(USED BY SYSTEM)	\$03FF \$0000

Fig. 6-5. The Apple IIe memory allocation map.

\$FFFF	(MONITOR PROGRAM)
\$F000	
\$EFFF	(APPLESOFT BASIC INTERPRETER)
\$E000	
\$DFFF	(APPLESOFT BASIC INTERPRETER)
\$D000	
\$CFFF	(80 COLUMN DISPLAY SOFTWARE)
\$C800	
\$C7FF	(BUILT-IN SELF TEST)
\$C400	
\$C3FF	(80 COLUMN DISPLAY SOFTWARE)
\$C300	
\$C2FF	(BUILT-IN SELF TEST)
\$C100	
\$C0FF	(SPECIAL MONITOR FUNCTIONS,
\$C000	SOFT SWITCHES)

Fig. 6-6. ROM allocation.

The top 12K of memory (\$D000-\$FFFF) is reserved for ROM with 4K just below it (\$C000-\$CFFF) reserved for I/O addressing. From hex address \$BFFF down to \$0000 is RAM memory space. Some of this memory is reserved for text, graphics, and system functions.

The ROM part of memory is further allocated as shown in Fig. 6-6. These addresses can be translated to physical ROM chips. The ROM chip at board location D7 is called the CD, or *diagnostic ROM*. It handles addresses \$C100 to \$DFFF, covering the Apple IIe's built-in, self-test routines and part of the Applesoft BASIC interpreter. The ROM just to the right of this, at location D10, is the EF, or *Monitor ROM*, chip. This ROM occupies address space \$E000 to \$FFFF and handles monitor subroutines and the rest of Applesoft BASIC.

RAM USED DURING DOS BOOT

Every type of computer uses a unique software package to control the way it communicates with peripheral equipment and other software programs. This package is called an *operating system*. Some of the operating systems in use in microcomputers today are DOS, PRO-DOS, MS-DOS, TRS-DOS, RTX, CP/M, and CP/M-86.

On the Apple IIe, your operating system is called *DOS*, for *disk operating system*. You load this control program into the Apple's RAM memory by *booting* the system up with a disk containing DOS. The DOS is loaded into several areas in RAM and eventually locates in the top 10.5K of memory.

Fig. 6-7 is a memory map of the areas of RAM that are overwritten during the boot process to load DOS.

Sometimes neophyte programmers forget where DOS is stored and inadvertently write programs that store different values in the DOS-reserved area. This changes the values in DOS, which causes trouble—usually at the most inopportune time.

PHYSICAL LOCATION OF RAM ADDRESSES ON THE MOTHERBOARD

Let's relate the RAM to the physical chips on your Apple's motherboard. As shown in Fig. 6-8, a single row of RAM is mounted on the motherboard. This row is eight chips wide and holds 64K of memory. Each chip is a 64K-by-1-bit device. The leftmost chip is for the LSB, or least significant bit, of the binary 8-bit word. The rightmost bit therefore is for the MSB (most significant bit).

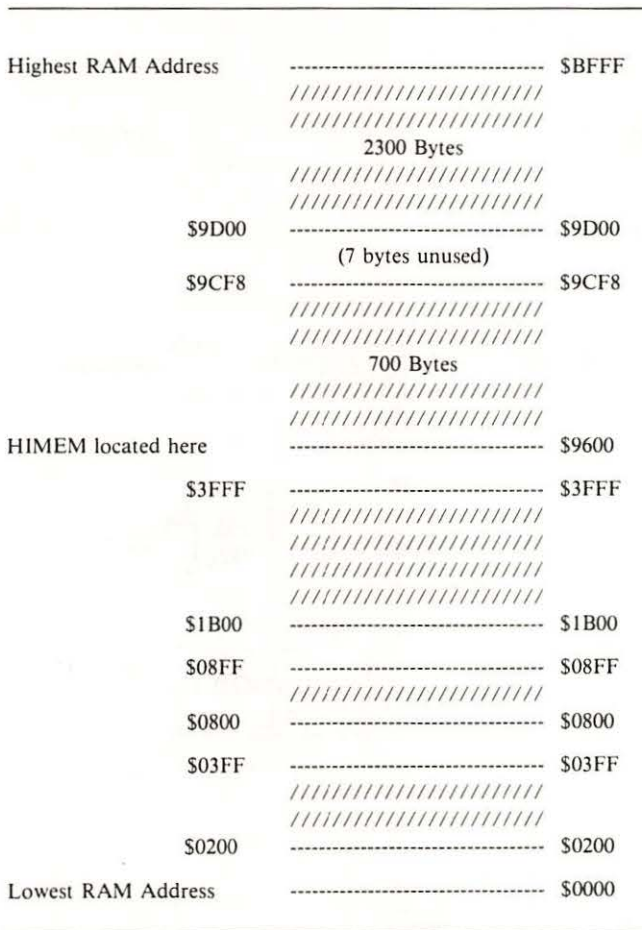

Fig. 6-7. RAM used during the DOS boot process.

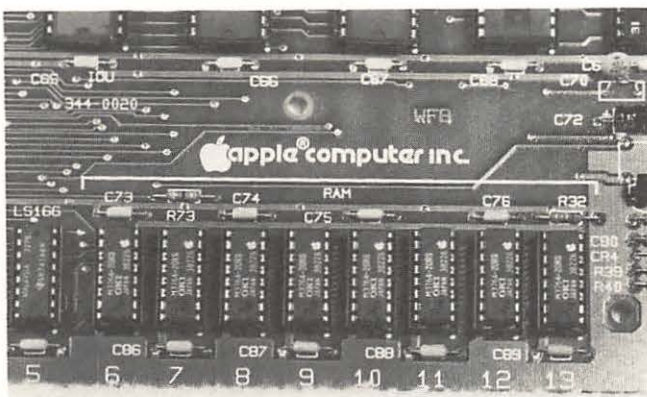

Fig. 6-8. The single row of RAM chips on your Apple IIe motherboard.

WHERE BASIC PROGRAMS ARE STORED

Except for Applesoft BASIC, high-level languages are loaded into your Apple's RAM. The interpreter program for Applesoft BASIC is stored in ROM. When

you write programs in the high-level language Applesoft BASIC, the program code (source code) is stored as hex symbols in RAM beginning at address \$0801. Roger Wagner, well-known author and expert on 6502 assembly language, gives an excellent overview of BASIC program location and code interpretation in an article entitled "Assembly Lines" in the January, 1982, issue of *Softalk* magazine.

BUS STRUCTURE

Control signals, addresses, and data are shared between the CPU and the rest of the Apple system over tiny parallel lines, or traces, on the motherboard called *busses* as shown in Fig. 6-9.

A bus is like a roadway over which the 6502B CPU communicates with other components (peripherals such as disk drives) and the real world (motors, lights, sensors, etc.). Your Apple IIe has an advanced bus design with all data and address output lines fully buffered for protection. The Apple IIe busses include:

- data bus
- address bus
- control bus
- multiplexed address bus
- video data bus

Each trace on each bus has a voltage on it (approximately 0 volts or +5 volts) which represents a logic level (0 or 1).

The **data bus** and the **address bus** are the primary busses. Data bus words are identified as MD0-MD7. The address bus is identified by bits A0-A15. Information on the data bus can travel either to or from the CPU (it's bidirectional). Addresses travel from the CPU out along the address bus (unidirectional) on a one-way path.

The Apple IIe is called an "8-bit machine" because a data word is eight bits wide. Therefore, the data bus has eight bits that represent a data word or byte. Because the data bus is bidirectional, it requires a signal to control the direction of data flow. This signal is part of the **control bus** — a set of traces, or lines, on which special voltage signals are placed to enable or disable certain parts of the circuitry.

The largest (widest) bus in the Apple carries the addresses the CPU accesses for program instructions or data. The address bus is 16 bits wide, enabling it to address up to 64K of memory locations. (2 to the 16th power is 65,536, called 64K). These 16 logic levels col-

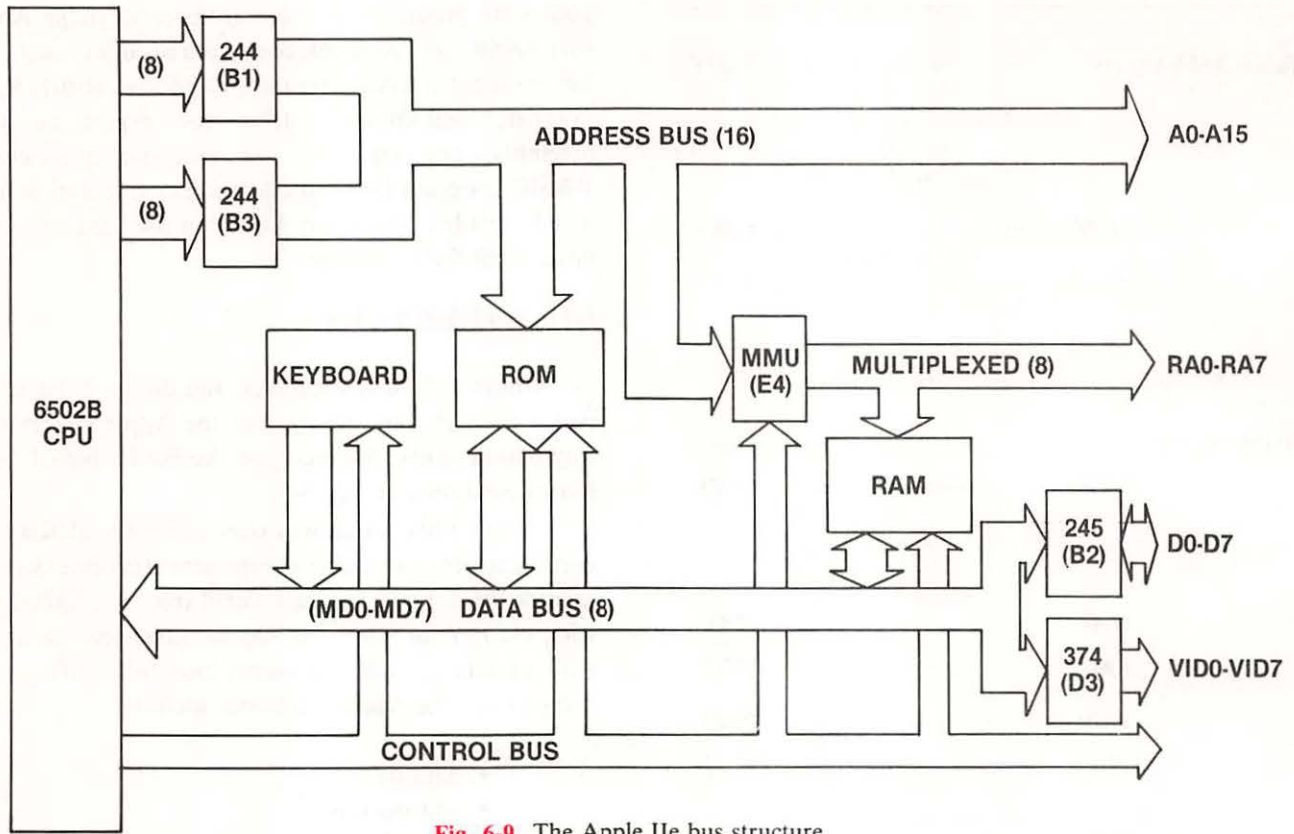

Fig. 6-9. The Apple IIe bus structure.

lectively represent unique address locations in memory or I/O in the Apple IIe.

The complete Apple IIe bus structure is described in Fig. 6-10. Notice that the address bus is directly connected to the ROM (permanent memory), but is applied to the RAM memory as two 8-bit sequential address words since the RAM chips can only receive eight address bits at a time. To achieve this, the MMU receives the 16 bits of the primary address bus and then multiplexes these 16 bits as two 8-bit sequences to the RAM memory chips. This **multiplexed address bus** is identified as RA0-RA7.

Since the outputs are fully buffered, the address bus passes through two 74LS244 chips at locations B1 and B3 before being applied to any other circuitry as A0-A15. The memory data bus MD0-MD7 is buffered by a 74LS245 at location B2 before becoming the **buffered data bus D0-D7**. The video data ia also buffered by 74LS374 at D3 before becoming the **video data bus VID0-VID7**.

Under the direction of the CPU, special control signals are placed on the control bus and unique addresses are placed on the address bus. The control signals open the address locations, letting the informa-

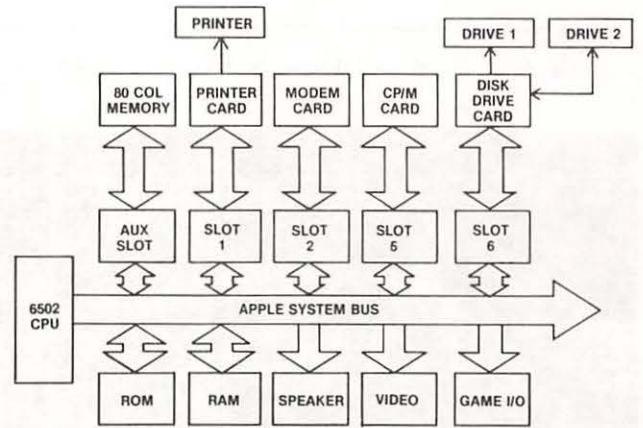

Fig. 6-10. The Apple IIe bus structure with peripherals.

tion stored in these locations appear on the data bus, which is acted on by the CPU or I/O.

Together, the address bus, the data bus, and the control bus are called the *system bus*. The system bus lies beneath those seven expansion slots on your Apple IIe motherboard.

Besides the address bus, the data bus, and the control bus, the 50-pin system bus includes timing and power signals. It is accessible on seven 50-pin I/O

sockets mounted at the rear of the motherboard. Another name for this 50-pin arrangement is the "Apple Bus."

Except for disk drive access signals, all data moves through the CPU and all addresses are generated and placed on the address bus by the CPU.

Each of the I/O ports, or windows through which information passes, has its own address. This is called *memory-mapped I/O*. Other CPU chips, such as the 8080 and the Z80, use special instructions or commands to access the I/O ports. In the Apple, you simply address a certain memory location in your computer to access the computer's ports.

So many peripherals have been developed for the Apple II (compatible with your Apple IIe) that sometimes the Apple itself becomes the peripheral for the equipment connected to it. As shown in Fig. 6-11, you can really "stuff" your computer with a lot of special interface cards.

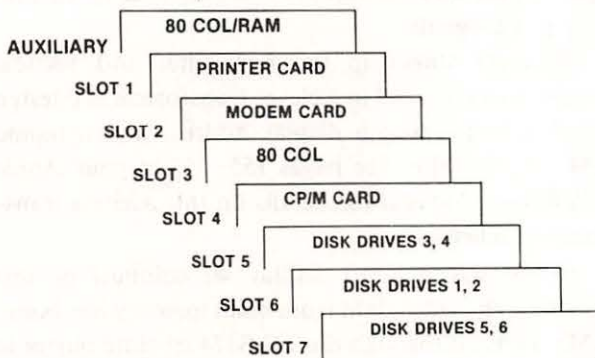

Fig. 6-11. The Apple IIe expansion slots "stuffed".

This expansion capability is a trademark of the Apple IIe computer.

You have quite a bit of choice in connecting devices and capabilities to your Apple. You don't need slot 0 for memory expansion since this expansion capability is built into your Apple IIe in the 60-pin auxiliary slot (used also for 80-column display). Slot 6 is still reserved for disk drive interfacing. The rest of the slots are unassigned, giving you plenty of flexibility in your system design. However, over the years, some pseudo-standards have developed as programmers have generated software based on interface cards for certain devices, such as printers and modems, being inserted in certain slots. If you're using "canned" (that is, commercially available) software, you will find that most programs conform to the assignments listed in Fig. 6-12.

SLOT	COMMON USE
AUXILIARY SLOT	80 COL & RAM EXPANSION
SLOT 1	PRINTER INTERFACE CARD
SLOT 2	
SLOT 3	
SLOT 4	
SLOT 5	CP/M CARD/GRAPHICS TABLET
SLOT 6	DISK DRIVES 1, 2
SLOT 7	

Fig. 6-12. The most common uses for some of your Apple IIe expansion slots.

CLOCK TIMING

Information processing is made possible in those tiny chips by several clock signals that pulse throughout your Apple. A crystal oscillator on the Apple motherboard produces a 14.318 MHz *master oscillator signal* from which all other clock signals are derived.

The 14.318 MHz clock pulses are divided in half to produce a 7.159 MHz intermediate timing signal called "7M." From this signal, four other clock frequencies are generated:

- A 3.580 MHz color reference for the video circuitry
- A 2.000 MHz general-purpose timing signal, "Q3"
- A 1.023 MHz phase 0 system clock
- A 1.023 MHz phase 1 system clock

The Q3, phase 0, phase 1, and color reference signals are available on the I/O socket peripheral connector. These same signals plus the 14.3 MHz master clock signal are available on the auxiliary slot connector. These signals are derived as shown in the schematic in Fig. 6-13.

Should your machine behave erratically, a sick clock may be your problem. (Another could be the 6502B CPU itself.) We'll learn more about this in Chapter 7.

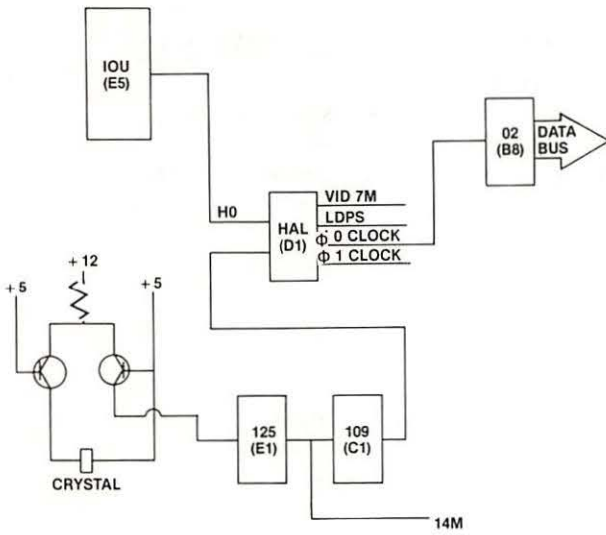

Fig. 6-13. Clock timing circuitry.

THE POWER SUPPLY

As described on pages 138 and 139 of your *Apple IIe Reference Manual*, a switching power supply provides four voltages to the Apple circuitry: +5.0 volts, +11.8 volts, -12.0 volts, and -5.2 volts. The maximum power consumption is a fantastic 80 watts (less than your 100-watt room lamp). Because power supplies rarely fail and because this manual avoids getting you in or around high-voltage circuits, I won't discuss troubleshooting the power supply. It is best to leave power supply problems to an experienced repair technician. For those readers who fall into the "experienced technician" category, the schematic on page 93 of the *Apple II Reference Manual* also applies to the Apple IIe power supply. (No such schematic is to be found in the *Apple IIe Reference Manual*.)

VIDEO DISPLAY

A positive, composite, NTSC-compatible video signal is produced and made available at two locations on your Apple IIe: a standard RCA phono jack connector on the rear of the chassis, and a Molex 4-pin auxiliary video output connector near the rear on the motherboard. This signal is generated by the circuitry shown in Fig. 6-14 and described on page 163 of your *Apple IIe Reference Manual*.

Note that the synchronization and timing signals derive from a chain of counters inside the IOU. A seven-stage binary counter cycles from 0 to 63 with a double count at zero to develop the horizontal blanking signal, the horizontal synchronization (sync) pulse, the color burst signal, and part of the display address. When the horizontal counter reaches a maximum of 65, it activates a nine-stage vertical counter that clocks from 0 to 262. This counter generates the 192 scan lines in your Apple display and the vertical blanking and synchronization pulse signals.

Different stages in the horizontal and vertical counters are combined in a clever transformation design technique to produce a display address and dynamic RAM refresh pulse. See pages 155-157 in your *Apple IIe Reference Manual* for details on this address transformation scheme.

If the screen is to display 40 columns of text characters, the video data from main memory (on-board RAM) is passed through the 74LS374 tri-state buffer at location D3 during clock phase 0 out onto the video data bus as VID0-VID7. The two higher bits (VID6 and VID7) are passed to the IOU at location E5, where they are used to select between the primary and alternate character sets stored in the 2732 Character Generator

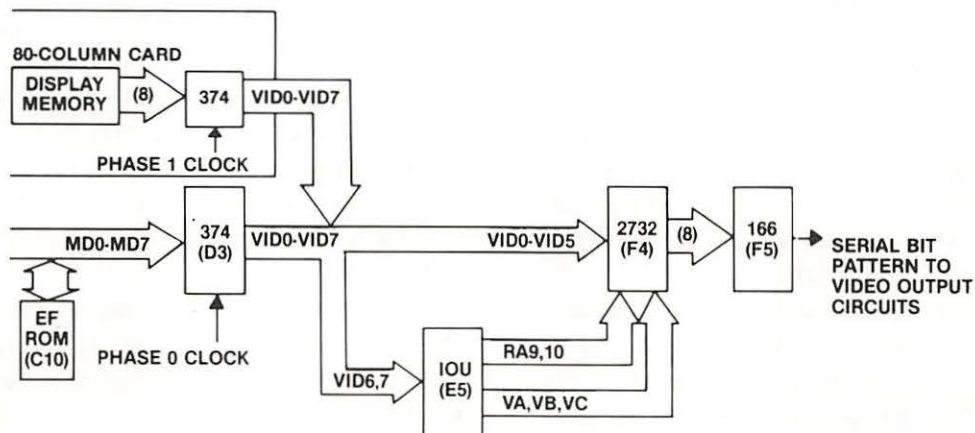

Fig. 6-14. Video display circuitry.

ROM. The IOU outputs two bits (RA9 and RA10) to tell the 2732 ROM which character set to display.

Since each character is made of eight rows of seven dots each, the vertical counters in the IOU output the bit code from vertical counter bits VA, VB, and VC to the 2732 ROM to enable each specific row of the dot pattern. The dot pattern for each row is converted to a serial bit stream and shifted into the video output circuits at 7 MHz.

For 80-column displays, the RAM on your Apple IIe's motherboard outputs an 8-bit data word through the 74LS374 buffer at D3 onto the video data bus during phase 0, just as in the 40-column mode, but then the display memory on your 80-column card outputs VID0-VID7 through its own 74LS374 buffer during phase 1 clock active. This effectively doubles the processing speed, since the clocks phase 0 and phase 1 are simply the inverse of each other. Each becomes active HIGH (+5 volts) during one system clock cycle. To get the 80 columns out in time, the serial bit stream from the 74166 parallel to the serial shift register is clocked into the video output circuitry at 14 MHz. The stream of bits represents dots on the screen.

If lo-res graphics is the mode desired and programmed, the RAM data (MD0-MD7) is provided to the 74LS374 tri-state buffer at D3, which produces the 8-bit video data bus word, just as it does for text. Again, the two high-order bits, VID6 and VID7, are used by the IOU to produce the video mode signals (in this case H0, HIRES', and VC) used by the 2732 character generator ROM to produce the bit patterns to be displayed. The signal VC causes the ROM to divide the eight display lines (discussed earlier for a text character) into two groups of four lines each. Half of the 8-bit data word for each row determines the color to be displayed. The lo-res display is a grid 40 blocks wide and 48 blocks high and can be in any combination of up to 16 colors.

The bit pattern is passed to the 74166 chip, where the parallel signal is converted to serial and clocked out of the 74166 into the video output circuitry. Now, however, the video signal is acted on by a 3.58 MHz clock signal that passes through the NTSC video jack into your monitor. The monitor uses this 3.58 MHz signal as a reference to generate its own 3.58 MHz color signal.

Should hi-res be commanded, the character generator ROM reproduces the video display data. In hi-res, any of six colors are produced on a display grid 280 dots wide and 192 dots high by the interaction of the video bit pattern and the 3.58 MHz clock signal generated inside your monitor display unit. As in lo-res, the Apple IIe's

3.58 MHz clock signal is used to develop the clocked bursts of video output. The full set of hi-res colors is produced by selectively delaying some of the video signals. The PAL chip reacts to the logic level of the D7 input to the 74166 shift register to cause the delay. If D7 is high, timing signals LDPS' and VID7M are delayed by half a dot, producing two more colors. Your Apple IIe uses software to achieve color compensation.

The color burst signal comes from the IOU as shown in Fig. 6-15. The signal is conditioned by the resistor-inductor-capacitor network for optimum tint.

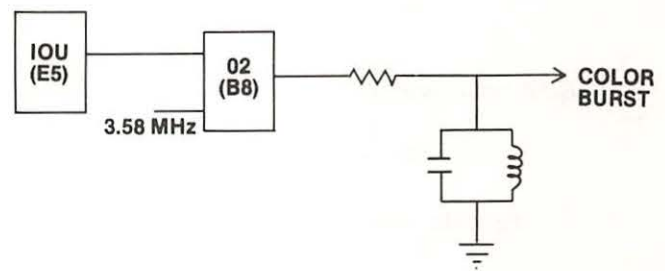

Fig. 6-15. Color burst circuitry.

CASSETTE INPUT AND OUTPUT

The simple circuit in Fig. 6-16 enables you to store programs and data on a standard audio cassette tape.

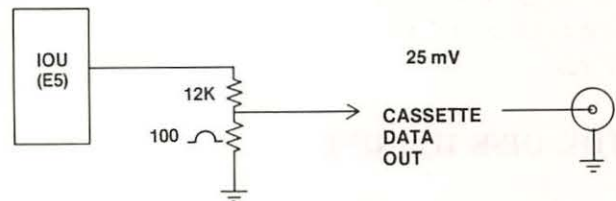

Fig. 6-16. Cassette output circuitry.

A cable can be connected from the OUT connector (a miniature phone jack) on the back of your computer to the microphone input of your cassette tape recorder. Each time your program addresses location \$C020 (49184 or -16352 in decimal), the IOU outputs a toggled signal through the resistor voltage divider network, R6 and R9, producing a voltage at the Cassette Data OUT connector that shifts between 0 volts and 25 millivolts. These are the same voltages produced by the microphone when it is connected to your recorder.

By referencing the \$C020 soft switch repeatedly, a tone can be produced which can be varied in pitch and duration to represent data. Your *System Monitor* (a

program permanently stored in ROM) has a routine built into it that can encode programs and data so they can be saved on tape. Again, this is a soft switch. It doesn't matter what's stored in location \$C020. Addressing location \$C020 with READ instructions is all that it takes to produce the desired result.

Fig. 6-17 shows the circuitry used to bring information into your Apple from a cassette tape.

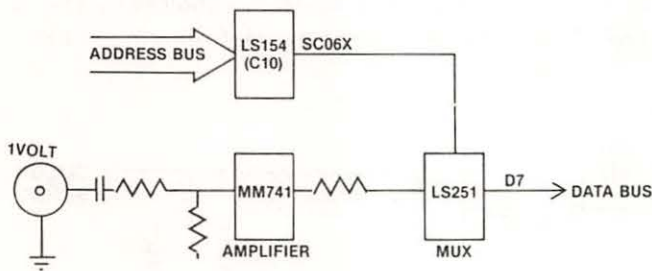

Fig. 6-17. Cassette input circuitry.

This circuitry receives a 1-volt signal (peak-to-peak) from your cassette recorder's earphone jack through a cable connected from your recorder to the Cassette Data IN phone jack on the back of your Apple. The input cassette data is amplified by the 741 operational amplifier at location A11 and then multiplexed through the 74LS251 eight-input multiplexer at location C12. The output is placed directly on the high-bit line of the data bus (D7). The System Monitor has a built-in routine that reads the D7 bit and rebuilds the data as 8-bit data words.

THE DISK II DRIVE

The Apple Disk II drive is designed to enable you to easily and quickly store and retrieve information using 5¼-inch floppy disks. The disk mechanism is housed in a 3⅞ × 6-3/16 × 8¾-inch beige case as shown in Fig. 6-18.

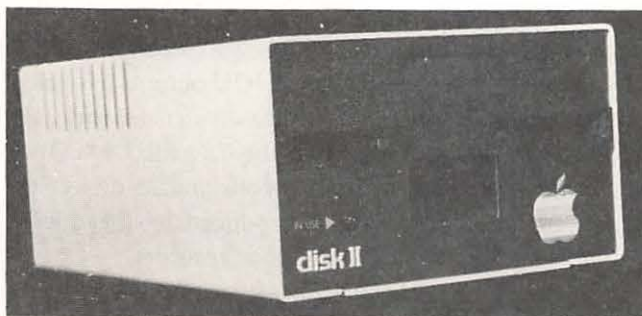

Fig. 6-18. The Apple IIe Disk II drive.

Power for operating the drive is supplied from the Apple IIe via a ribbon cable connected to a disk controller card plugged into one of your Apple expansion slots (usually slot 6). The major cause of Apple II system failures is the insertion or removal of this controller card with power applied. Therefore, Apple Computer installed a red LED light inside your Apple IIe to let you know visually when power is applied to your IIe's motherboard.

The Disk II (or another manufacturer's drive) is probably the most important peripheral connected to your computer. It's the primary mass storage device used by Apple owners all over the world.

The 35-track cam-positioned drive rotates at 300 rpm to write or read data on a thin mylar disk with a magnetic coating of oxide particles. The disk starts life as a .003-inch-thick polyester wafer, which is then coated with about .0001-inch of iron oxide. The disk is called a "floppy" because it is thin and quite flexible.

The disk (or diskette) used in your Disk II drive is a single-sided, single-density platter whose surface is electromagnetically divided into 35 tracks or rings. The disk is further divided into 16 rectangular sectors leading from the inner center hole to the outer edge. Each disk is soft sectored; that is, sectors are marked off by a special series of code bits written on the disk by your Apple.

On each disk you can store about 140,000 bytes of information in 560 track-sector areas of 256 bytes each. One double-spaced page on 8½- by 11-inch paper can use up 1,670 characters or bytes. About 126K of storage is available on your disks if you also have DOS on the disk. Therefore, you can store a little over 75 pages of double-spaced text on one disk.

KEYBOARD OPERATION

What happens when you depress a character key on your Apple keyboard? Right! You see a character displayed on your monitor screen. But what causes that particular character to be displayed on your screen?

Look at your computer keyboard. That remarkable input device has 63 built-in keys and has a feel much like the Apple III keyboard. Besides keys standard to electric typewriters like the IBM Selectric, your Apple IIe keyboard includes some special keys. The Open Apple, and the Closed Apple keys are used to perform special computer functions, such as starting a self-test program. They are also connected to the push-button (SW0, SW1) game inputs. The other keys are CTRL, ESC, REPT, four arrow keys, and a RESET key.

Apple Computer provides special keyboards for computer users in other countries.

The Apple IIe keyboard is a big improvement over the keyboards used on the original Apple II and the Apple II Plus computers. The keyboard itself is simply a matrix array of momentary contact push-button switches. Each time you depress a key, you close a switch at a crossover point of an X row and a Y column on the matrix. The signal thus generated passes through a ribbon cable into a keyboard connector on the motherboard. All of the electronic circuitry for the keyboard is on the motherboard, including the AY3600 keyboard decoder and a 2316 character generator ROM. The AY3600 produces the correct characters or special function codes.

Fig. 6-19 is a simplified schematic of the keyboard circuitry. The AY 3600 keyboard decoder at location E14 has a built-in counter that continuously monitors the keyboard matrix to see whether any key has been depressed. It produces a 5-bit output that is passed to the 2716 keyboard ROM at location E12, where the code is interpreted to generate the American Standard Code for Information Interchange (ASCII) for that character. Each time you press a character key, the circuitry converts this action into one of 128 ASCII codes. See the Appendix for a listing of the ASCII code for your Apple IIe.

When the encoder senses a character key action, it looks at the CTRL and SHIFT keys to see if they have also been pressed (indicating that an uppercase symbol or special function is intended).

One of the problems with mechanical switches such as keys is that they don't close cleanly. Electronically, they "bounce" several times before solid contact is achieved. This bouncing can produce noise spikes that could be interpreted as valid signals, causing such effects as four or five repeated characters to occur on one key action. To counter this, a capacitor is connected between pin 31 of the encoder chip and ground. This

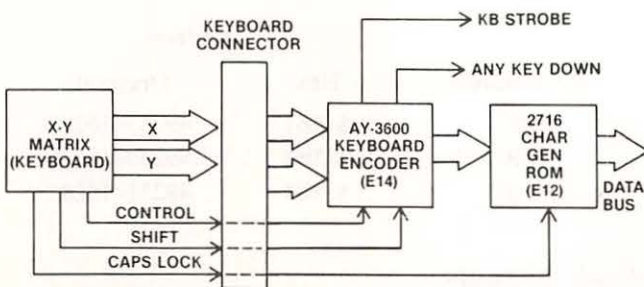

Fig. 6-19. The Apple IIe keyboard circuitry.

capacitor produces an 8 ms delay before the key action is encoded and a strobe pulse is generated.

All the character keys on your IIe keyboard have automatic repeat capability. If you hold the REPT (Repeat) key down while a character key is pressed, a timer in the AY-3600 will produce a series of pulses that generate additional key character strobe pulses.

When you depress the RESET key, whatever your Apple was doing stops and a prompt appears at the lower left corner of your screen.

The ESC (Escape) key generates a unique ASCII code (27) and a key strobe pulse. Your space bar generates the ASCII code 32. RETURN generates ASCII code 13.

Once these signals become ASCII code, they are placed on the data bus as MD0-MD6 where they are acted on by the CPU and IOU for storage, output, or display.

When the program you are running (the System Monitor if you are just starting) gets to a command requiring keyboard entry, the program checks to see if a keyboard strobe pulse (KSTRB) has occurred at the input to the IOU chip at location E5. The IOU causes the CPU to read data bits MD0 through MD6 as a character.

SPEAKER

Fig. 6-20 describes how your speaker is able to make sounds. As shown, the speaker is software controlled. Whenever your program addresses location \$C030 (49,200 or -16,336 in decimal), the output of the IOU at board location E5 changes state. If the output was high, it goes low; if it was low, it goes high. Each change is amplified by transistor Q5 (MPSA13) to move the cone of the speaker in or out, producing an audible click. By varying how often and how fast you cause

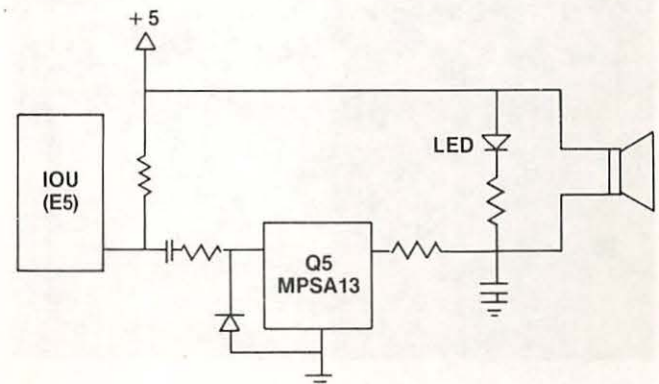

Fig. 6-20. Speaker output circuitry.

these clicks, your Apple can produce arcade sounds, music, and even crude speech.

A peek to address \$C030 activates the circuit. It doesn't matter what's stored at \$C030 – just addressing this location produces the clicks (hence the sounds). You can program this with Y=PEEK (-16336).

The range of frequencies you can generate depends on how you program your machine. If you write your program in Applesoft BASIC, the highest frequency you can produce is about 72 Hz. If you write in Integer BASIC, you can generate frequencies up to 256 Hz. By programming in machine language, you can cover the audio band (300 to 3000 Hz).

Your Apple's Monitor ROM has a program routine stored in it that, when addressed (called by your program), clicks the speaker at a 1 KHz frequency for a tenth of a second. This is the familiar "beep" sound that is produced when you boot up, get an error (e.g., SYNTAX ERROR), or type Control-G. It's called the Apple "bell."

THE GAME INPUT AND OUTPUT

One of the most versatile, yet least used, I/O ports on your Apple is the Game I/O socket. It's actually two ports, as shown in Fig. 6-21.

You have probably used this window to the Apple for connecting game paddles or joysticks and have

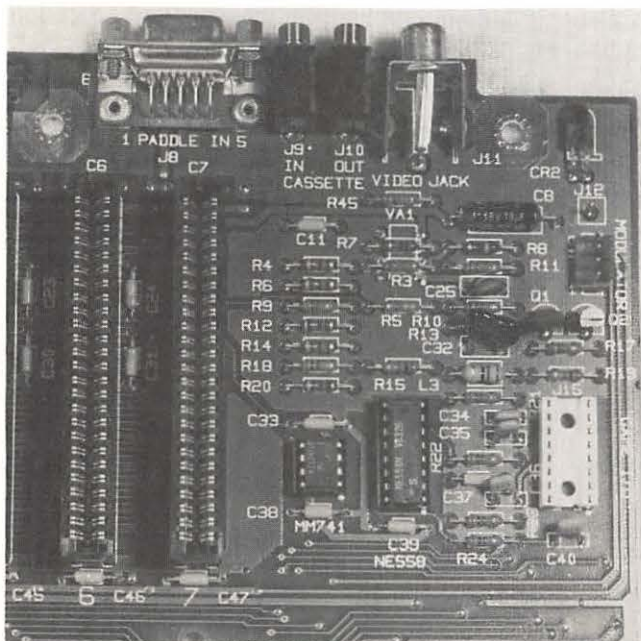

Fig. 6-21. Photo depicts the relationship between the two Game I/O sockets.

enjoyed hours of arcade-type games. But as you'll learn shortly, you've barely used its capability.

The two game ports, or I/O connections, are available for interfacing game paddles, joysticks, or experiments to your Apple IIe. On the 9-pin DB-9 connector at the rear of your machine, you can access the four paddle in/outs and three switch or push-button inputs. Inside your computer, on the motherboard, is a 16-pin socket to which you can connect the Apple II Plus-type hand controllers. This socket gives you access to all the same signals as the DB-9 connector, plus four annunciator outputs. These I/O ports let you easily interface devices to your machine. The relationship between the two game ports is shown in Fig. 6-22.

The three digital-switch or push-button inputs and the four analog or paddle inputs are placed on the high bit (D7) of the data bus as shown in Fig. 6-23.

The cassette data input works the same way. This is significant, since only bit D7 contains information in this kind of communication with the CPU (see Fig. 6-24).

Now, a 1 in position D7 (bit 8 on the bus) makes the binary number 1 xxxxxxx equal 128 or more. An 0 in this position results in a value less than 128 (127 or lower). Therefore, the information gained from interpreting D7 is either that the value is 128 or greater, or the value is 127 or less. This is enough information for a program to recognize that actual data is being sent.

Digital Inputs

The three single-bit inputs – PB0, PB1, and PB2 – were designed for game paddle push-buttons. Generally these buttons are connected as shown in Fig. 6-25.

The state or logic level (HIGH = 11, or +5 volts; LOW = 0, or 0 volts) can be read by addressing the appropriate location as shown in Table 6-1.

Table 6-1. Addressing Scheme for Reading

	Address	
Push Button	Hex	Decimal
PB0	\$C061	49249-16287
PB1	\$C062	49250-16286
PB2	\$C063	49251-16285

Analog Inputs

The four analog inputs – PDL0, PDL1, PDL2, and PDL3 – can be connected to +5 volts through a

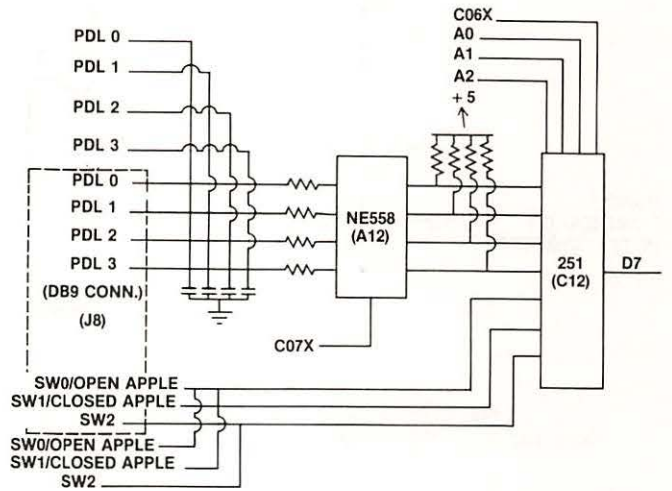
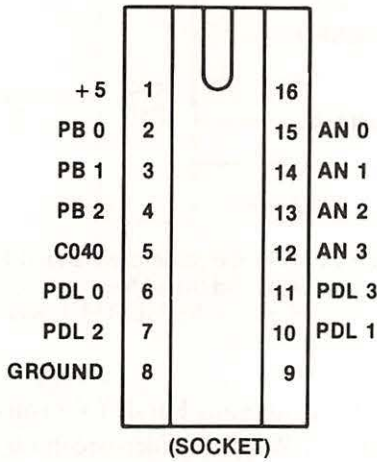
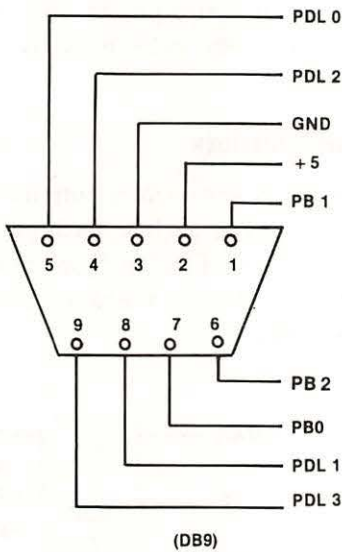

Fig. 6-23. The Game I/O input circuitry.



D7	D6	D5	D4	D3	D2	D0
1	X		X		X X	X
0	X		X		X X	X

X = DON'T CARE

Fig. 6-24. Only bit 8 (D7) contains the information.

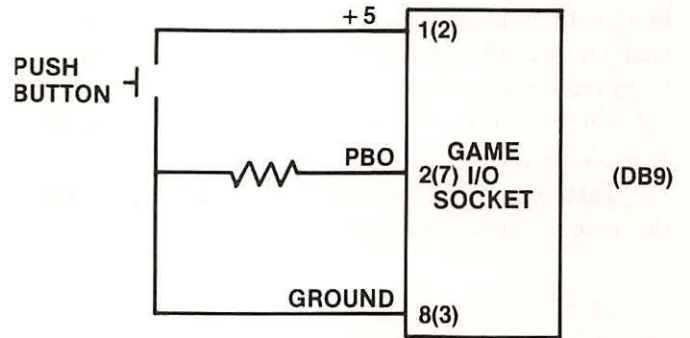

Fig. 6-25. Push button PB0 in a hand controller connects to the Game I/O socket as shown.

IN	DB9 CONNECTOR	SIGNAL	DESCRIPTION
1	11	+5 VOLTS	CHIP POWER SOURCE
2,3,4	7,1,6	PB0,PB1, PB2	DIGITAL INPUTS, USUALLY PUSH-BUTTON
5	-	C040 STROBE	A 1/2 MICROSECOND ACTIVE LOW PULSE (0 VOLTS ACTIVE) TRIGGERED BY ADDRESSING LOCATION \$C040
6,7,10,11	5,8,4,9	PDL 0 - PDL 3	GAME CONTROLLER INPUTS, VARYING VOLTAGE BETWEEN 0 AND +5 VOLTS
9,16,16	3	GROUND (NOT CONNECTED)	SYSTEM GROUND
15,14,13,12	-	AN0-AN3 DIGITAL OUTPUTS	

Fig. 6-22. Game I/O pin assignments.

150K ohm potentiometer (variable resistor), or “pot,” as shown in Fig. 6-26.

The value of resistance set on the 150K-ohm pot in one game paddle is part of a timing circuit composed of the 150K-ohm pot, a resistor, a capacitor, and a part of the 558 quad timer at location A12. The 558 is simply four 555 timers together in one chip package. When the 558 is triggered by addressing \$C070, all four outputs from it are set HIGH and the timing circuit begins to count down. This level remains HIGH for a time period

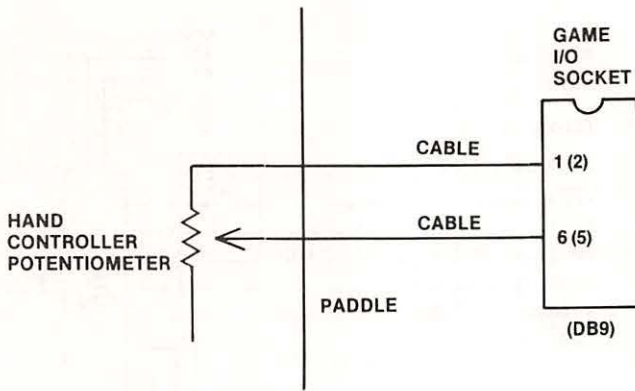

Fig. 6-26. Circuit diagram showing how paddle PDL0 connects to the Game I/O socket.

determined by the setting of the potentiometer for each paddle.

A routine in the System Monitor can repeatedly check to see if the timer output is still HIGH. It does this by reading the address for the appropriate paddle input. When it does so, the 74LS251 8-input multiplexer at C12 places information on D7 of the data bus. The logic level of this bit represents the state of the timer output. This bit is HIGH, or 1, as long as the timer is counting down. A counter in the program keeps track of how many times the timer is checked before its output changes to LOW, or 0. When a 0 is read, the program stops counting, with the value reached (between 0 and 255) directly proportional to the setting of the paddle potentiometer.

Table 6-2 shows the addressing scheme to enable this unique “analog-by-digital-means” circuit.

Table 6-2. Addressing Scheme for Enabling the Paddle Circuitry

Address		Purpose
Hex	Decimal	
\$C070	49264-16272	Trigger Timers, initiate counting
\$C064	49252-16284	Enable PDL 0 TO BE read
\$C065	49253-16283	Enable PDL 1 TO BE read
\$C066	49254-16282	Enable PDL 2 TO BE read
\$C067	49255-16281	Enable PDL 3 TO BE read

C040 Strobe Output

The C040 strobe circuit is shown in Fig. 6-27.

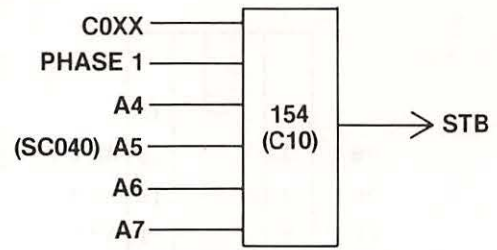

Fig. 6-27. The C040 Strobe pulse is generated by placing the hexadecimal value \$C040 on the address bus, which places this address on the input to the 74LS154 at location C10.

On pin 5 is a normally HIGH (+5 volts) signal that can be pulsed LOW for 1/2 microsecond by addressing location \$C040 (49216 or -16320 in decimal). Writing to this address generates two strobe pulses. Reading this address causes the 74LS154 decoder at C10 to generate a single strobe pulse to pin 5 of the motherboard socket. Since the address is active on the address bus for 1/2 microsecond, the strobe pulse is active for the same amount of time.

Annunciator Outputs

The four handy annunciator outputs shown in Fig. 6-28 act as flip-flops or latches. Each of these outputs can be toggled ON or OFF by soft switch addresses. As shown in Table 6-3, there is a separate address for each output ON or OFF.

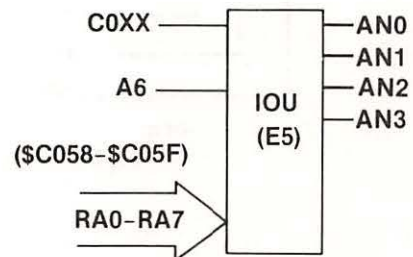

Fig. 6-28. Each of the annunciator outputs shown can be toggled ON or OFF by the addresses listed in Table 6-3.

Table 6-3. Addresses Used to Toggle Each Annunciator Output

Annunciator	ON Address	OFF Address
0	\$C058	\$C059
1	\$C05A	\$C05B
2	\$C05C	\$C05D
3	\$C05E	\$C05F

The ON position places +5 volts on that output pin; OFF places 0 volts on the pin. The level remains until the opposite activation address is accessed, changing the state of the output.

HOW THE SYSTEM WORKS

You slip a System Master disk into drive 1, close the door, and flick the power switch ON. Immediately your Apple system surges into action. The screen flashes and prints out the familiar "APPLE][".

Your disk drive whirs as the computer boots itself up — pulls DOS and Integer BASIC off the floppy disk. After a few moments, the drive stops and your screen settles down with the display shown in Fig. 6-29.

APPLE][

DOS VERSION 3.3 SYSTEM MASTER

JANUARY 1, 1983

COPYRIGHT APPLE COMPUTER, INC. 1980, 1982

BE SURE CAPS LOCK IS DOWN

]⏏

Fig. 6-29. The display after proper DOS boot.

Cold Boot

What does it mean to "boot up" a disk? When you first apply power to your Apple IIe, the switching power supply puts out +5 volts to the RESET pin of your 6502B CPU. This signal starts the boot-up routine. It's called a *cold boot* because the system was not energized before the boot. The word "boot" comes from "bootstrap" — pulling one up by one's own bootstrap. The system is being reset and initialized with all the start-up conditions necessary to operate and enable the man-machine communication interface. The bootstrap in your Apple IIe is the System Monitor, a machine language program that, in this case, acts as a program-starting program so to speak.

The following flowchart shows the actions that occur in your Apple from the time you turn on the power.

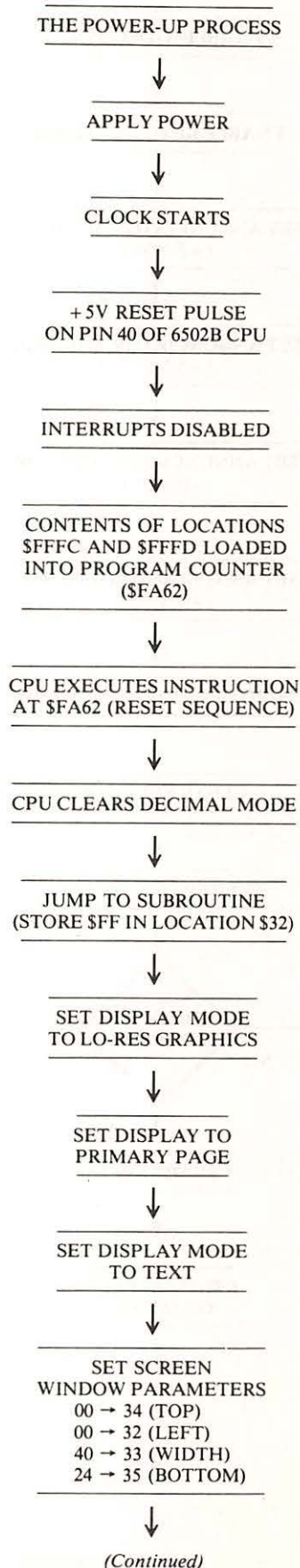

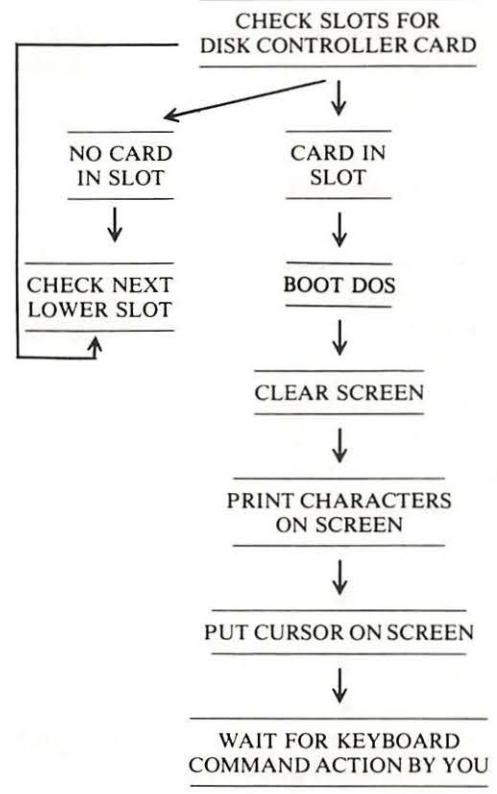
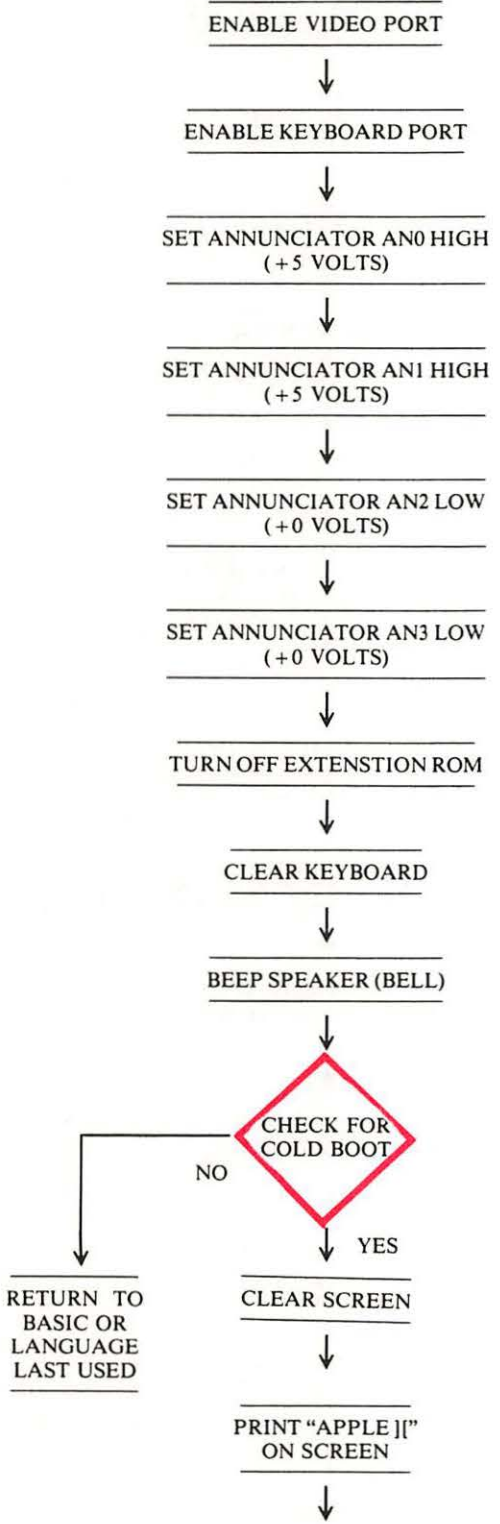

The rest is up to you. The system will sit and wait until your interaction with the keyboard tells it what to do.

Warm Boot

During the bootstrap operation, the System Monitor checks to see if the system had been energized and used before the RESET pulse occurred. If indeed it was powered up, the speaker is beeped and the system is placed in BASIC language with the Applesoft prompt printed on the lower left part of the screen.

Typing PR#6 will cause your Apple IIe to load DOS from the disk in drive 1 (drive 1 is connected to the controller card in slot 6).

SOFTWARE STRUCTURE

Three types of software are supplied with your disk drive Apple IIe computer system:

- System Monitor
- BASIC high-level language
- Disk operating system (DOS)

The System Monitor lets you initialize your computer and enables it to receive keyboard entries and generate a screen display. The System Monitor resides in the EF ROM.

Each Apple IIe comes complete with the high-level language Applesoft BASIC stored in ROM. BASIC is an interpretive language. Each instruction is read, interpreted, converted to machine language code, and acted upon before the next instruction is read, and so on. With a compiled language such as FORTRAN, *all* the instructions are read, interpreted, and converted into machine language before being acted upon. While compiled-language programs run faster than interpreted-language programs, BASIC is simple to learn, making the programs easy to write. And many youthful entrepreneurs have become millionaires writing useful software in BASIC.

The third ingredient for a complete software system is the operating system. Your Apple IIe disk operating system (DOS) handles reading and writing disk-stored information and lets you format disks, copy disks, and even catalog the programs or files you've saved.

Apple's DOS was first known as DOS 3.2. It worked with 13-sector disks. Soon Apple engineers discovered that they could gain about 20 percent more storage space on the disks by formatting and using 16 sectors, so DOS 3.3 was born. But the Apple people didn't forget the users of DOS 3.2 software when they started marketing DOS 3.3 with the Disk II drive. They

included two ways to boot your system to DOS 3.2 disks with the DOS 3.3 package. One way is the BASIC disk; the other is the BOOT13 program on the DOS 3.3 System Master Disk. New Disk II drives include only the BOOT13 program on the System Master Disk.

Today, an even more improved disk operating system is available. ProDOS (or XDOS) has the same function as DOS 3.3, but works faster and has more capability.

ProDOS has the UNIX-like hierarchical file structure common to the Apple III operating system SOS (Sophisticated Operating System), so it makes possible data transfers between the two machines. ProDOS won't support Integer BASIC, but it will work with any size disks, including hard disk drives up to 32 megabytes. And this new operating system doesn't require any new hardware. It works fine with the Disk II controller card that works with DOS 3.3.

Each month you'll see more commercial software written for ProDOS systems. It's a giant step forward for Apple II users who want Apple III capabilities.

SUMMARY

In this chapter you've learned what a basic computer is made of, and how your Apple IIe works from a hardware standpoint. You saw that memory, I/O, and the CPU all perform vital functions in this computer system. You learned what happens inside the Apple IIe when you turn power on. And you learned that several kinds of software are required to make your Apple a functioning system.

Specific Troubleshooting and Repair, Apple IIe

Chapter 7 is an Apple-specific troubleshooting and repair guide covering a wide variety of computer failures. The chapter is divided into five parts:

1. Start-up problems
2. Run problems
3. Display problems
4. Keyboard problems
5. Other input/output (I/O) problems

Each fault can be associated with one of these areas. The key index to problems of these five general types follows these introductory remarks. By letting your “fingers do the walking” through the Troubleshooting Index, you can quickly locate the page where your particular problem is addressed.

Part 1 of this chapter covers all symptoms that can occur at the time you turn the power on, or at start up — including no power available, no boot up of the disk, and no beep/no display problems.

Part 2 discusses all symptoms that can occur after initial boot up, such as faulty disk read or write, bad memory, program lock-up, and reset, or keyboard command, problems.

Part 3 addresses difficulties associated with the display portion of the computer; for example, no display, no text mode, no hi-res or no lo-res, video synchronization failures, cursor and character faults, bad graphics, and others.

Keyboard problems are detailed in Part 4. This section covers such faults as bad key operation, key top pop-off, and others.

Part 5 encompasses all the other input and output problems, including speaker faults, cassette I/O failures, game paddle problems, and peripheral slot malfunctions.

Each part is subdivided into unique failures and provides symptom, problem, possible cause, and repair action or page reference for each circumstance. This data is followed by step-by-step troubleshooting instructions illustrated with applicable schematic drawings and a chip location layout diagram to make replacement easy.

As you use this manual, you will find many useful hints for both troubleshooting and repair. Be especially alert to the cautions since further system degradation can occur if you do not follow those procedures exactly as listed.

If any step seems too complex, stop where you are

and seek help from a service center technician. You should be able to find and correct most problems, but occasionally a component such as a resistor, capacitor, or inductor fails. Finding these failures requires advanced troubleshooting techniques, and this book does not assume you have these skills. If you'd like to try the advanced methods, refer to Chapter 9 for guidance, and observe good troubleshooting procedures.

TROUBLESHOOTING INDEX

1. Start-Up Problems – System won't boot 142
2. Run Problems – Disk drive won't read/write . 152
3. Display Problems 158
4. Keyboard Problems 170
5. Other Input/Output Problems 175

1. START-UP PROBLEMS

Symptom Category	Page
System won't boot	
No power light, no beep, drive won't run	142
Power light on, no beep, drive won't run	
No message, no beep	143
Message, no beep	144
Garbage on screen	146
Power light on, beeps, screen displays "Apple II"	
Drive won't run	147
Drive keeps running	148
Drive runs and then stops	149
Power light on, beeps, no display,	
drive whirs then stops	150

NOTE: If booting won't work, the Apple DOS manual suggests you reread the manual. You can probably deduce the problem faster by noting the conditions of the machine at time of "failure" and following the logical troubleshooting steps outlined in this chapter.

A number of things can cause the computer to boot improperly or not to boot at all: wrong diskette in the drive, no operating system on the diskette, cables loose, controller card not fully seated, disk drive failure, memory chip bad, no clock pulses, or even a forgotten unplugged power cord.

To find the problem, select the category above that best describes the symptoms and turn to the appropriate page for a step-by-step troubleshooting guide.

SYMPTOM: System won't boot – no power light, no beep, drive won't run

Problem	Possible cause	Repair action
No power	Power cord not plugged in	Plug in cord
	Power supply faulty	Replace and test

Troubleshooting Procedure

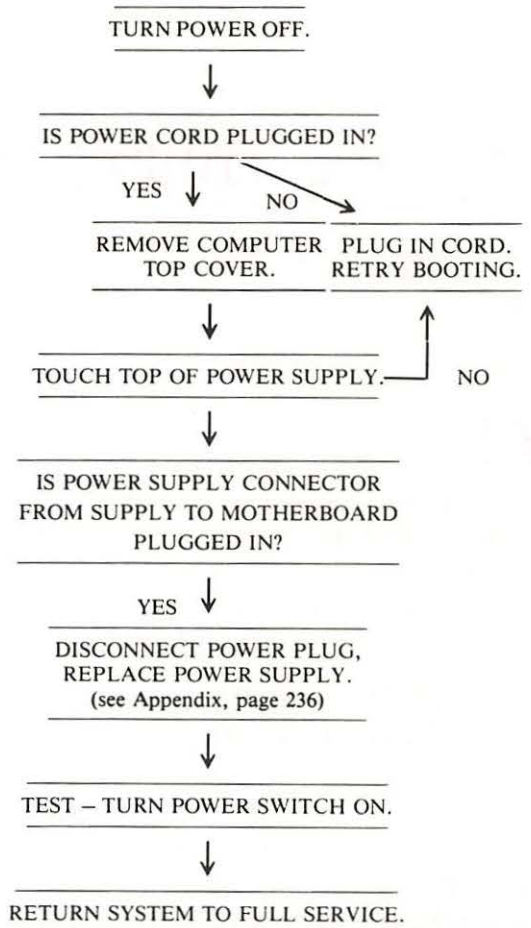

Circuitry Affected

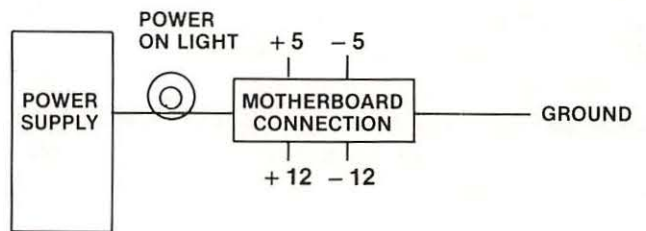

Fig. 7-1. Power supply circuitry.

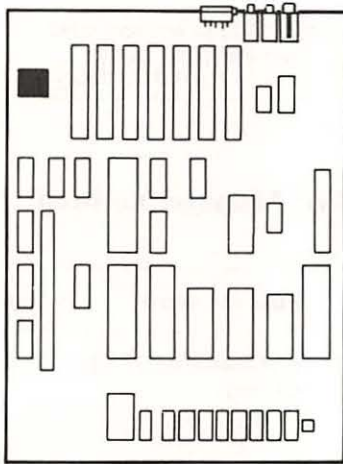
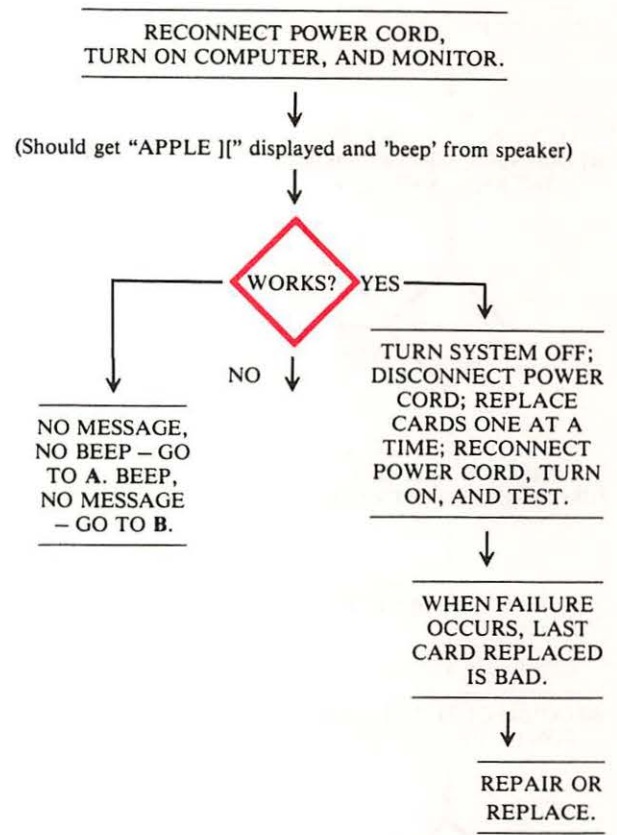
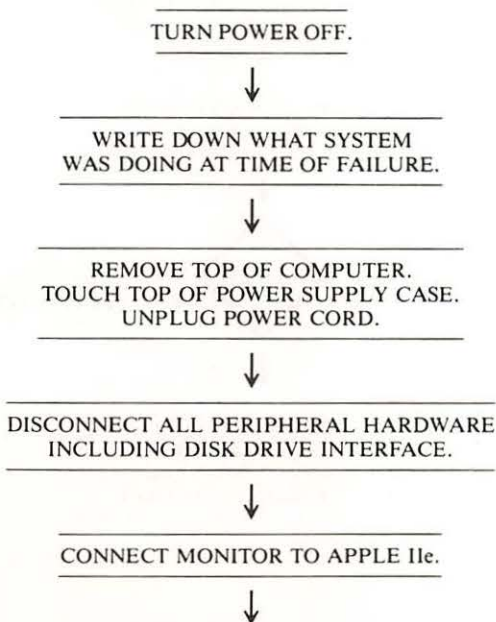

Fig. 7-2. Physical location guide.

SYMPTOM: System won't boot – power light on, no beep, drive won't run

Problem	Possible cause	Repair action
No clock	74LS125 at E1 bad	Replace and test
	74F109 at C1 bad	Replace and test
	74S02 at B8 bad	Replace and test
	PAL 8323T at D1 bad	Replace and test
	IOU at E5 bad	Replace and test
	2N4258 (Q6) bad	Replace and test
	2N4258 (Q4) bad	Replace and test
	Bad crystal	Replace and test

Troubleshooting Procedure



A: SYMPTOM: No message, no beep

Problem	Possible cause	Repair action
No LPDS clock for video circuits	74S02 at B8 bad	Replace and test
	74F1009 at C1 bad	Replace and test
No clock pulses on motherboard	PAL 8323T at D1 bad	Replace and test

Reference Drawings

- Fig. 7-3, p. 145
- Fig. 7-5, p. 145

Troubleshooting Procedure

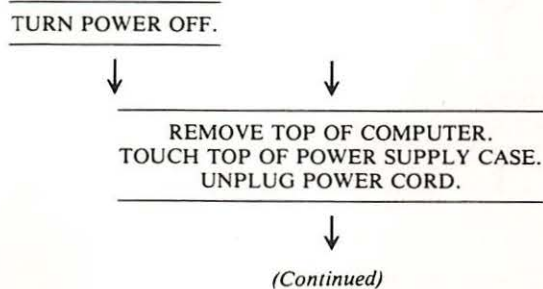

REPLACE PAL 8323T AT D1.



RECONNECT MONITOR.
RECONNECT POWER CORD,
POWER UP, AND TEST.



YES →

RETURN TO FULL SERVICE.

NO ↓

TURN POWER OFF.
DISCONNECT POWER CORD.



REPLACE 74F109 AT C1.



RECONNECT POWER CORD,
POWER UP, AND TEST.



YES →

RETURN TO FULL SERVICE.

NO ↓

TURN POWER OFF.
DISCONNECT POWER CORD.



REPLACE 74S02 AT B8.



RECONNECT POWER CORD,
POWER UP, AND TEST.



YES →

RETURN TO FULL SERVICE.

NO ↓

TURN POWER OFF.
DISCONNECT POWER CORD.



CONCLUDE: Component other than a chip has failed.
SERVICE CENTER ACTION

B. SYMPTOM: Message, no beep

Problem	Possible cause	Repair action
Phase 0, but no LDPS, clock to speaker circuit	PAL 16R8/8323T at D1 bad	Replace and test

Reference Drawings

Fig. 7-3, p. 145

Fig. 7-5, p. 145

Troubleshooting Procedure

TURN POWER OFF.



REMOVE TOP OF COMPUTER.
TOUCH TOP OF POWER SUPPLY CASE.
UNPLUG POWER CORD.



REPLACE PAL 16R8/8323T AT D1.



RECONNECT POWER CORD,
POWER UP, AND TEST.



YES →

RETURN TO FULL SERVICE.

NO ↓

CONCLUDE: Problem is component other than a chip, possibly transistor Q4, Q6, or crystal.
SERVICE CENTER ACTION

Circuitry Affected

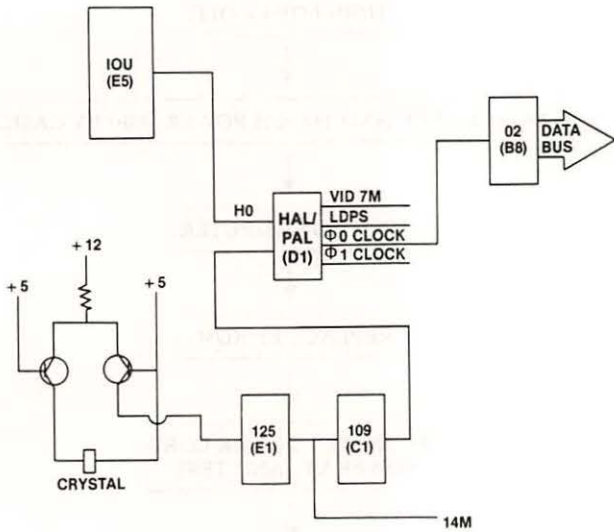

Fig. 7-3 Clock circuitry.

Video Circuitry

Chip designation	Description	Location
74S02	Quad 2-input NOR	B8
74LS10	Triple 3-input NAND	C5
74166	8-bit parallel-serial shift register	F5
74LS374	Tri-state buffer	D3
2732	Character generator ROM	F4
IOU	Input/output unit	E5

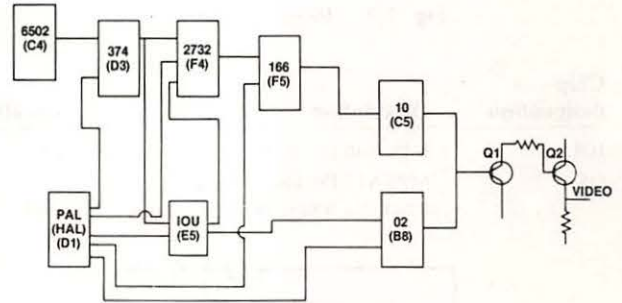

Fig. 7-5. Video circuitry.

Chip designation	Description	Location
PAL 16R8 /8323T	Programmed array logic	D1
2N4258 (2)	Transistors Q4, Q6	Lower left of motherboard
Crystal	14.31818 MHz oscillator	Lower left of motherboard

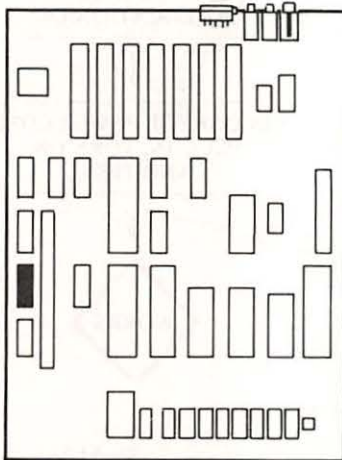

Fig. 7-4. Chip location guide. This represents the Apple motherboard and is a guide to help you find the components of interest.

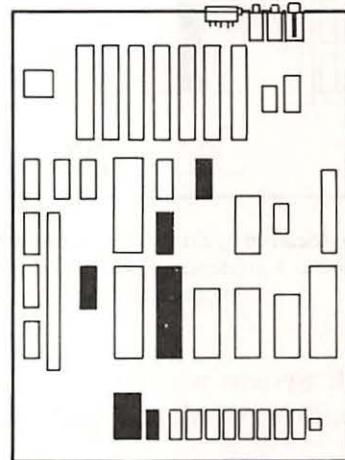

Fig. 7-6. Chip location guide. This represents the Apple motherboard and is a guide to help you find the chips of interest.

Beep Circuitry

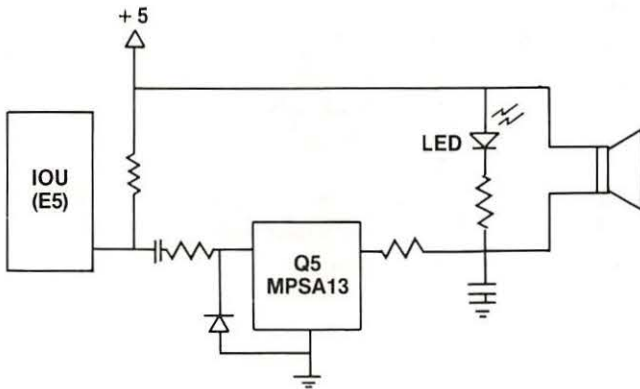

Fig. 7-7. Beep circuitry.

Chip designation	Description	Location
IOU	Input/output unit	E5
Q5	MPSA13 Darlington pair transistor amplifier	A14

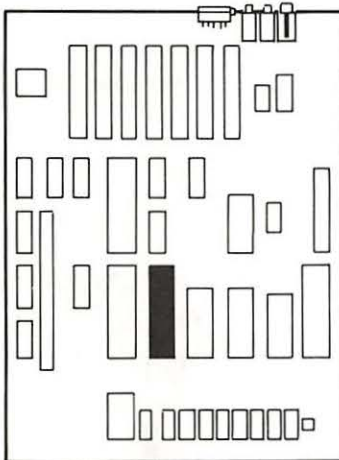
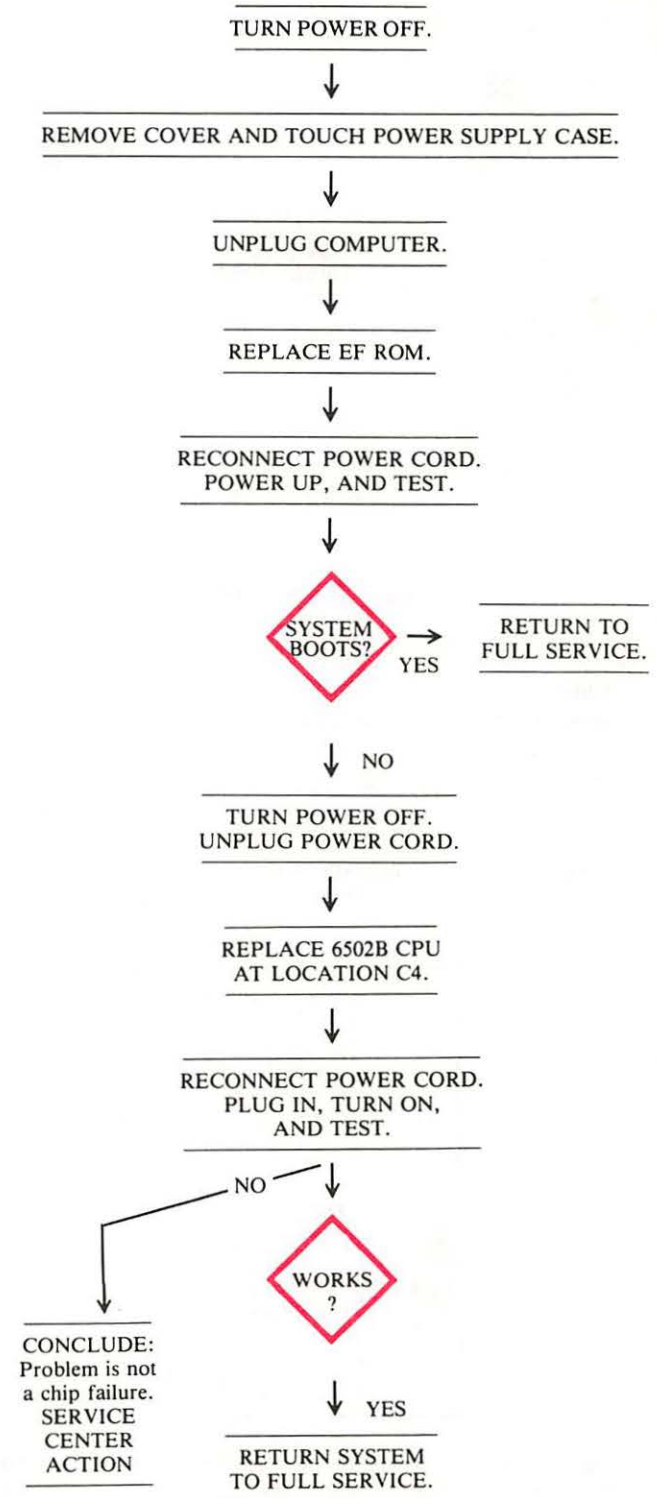

Fig. 7-8. Chip location guide. This represents the Apple motherboard and is a guide to help you find the components of interest.

SYMPTOM: System won't boot – power light on, no beep, drive won't run, garbage on screen

Problem	Possible cause	Repair action
Monitor ROM not working	Bad EF ROM at E10	Replace and test
CPU not activating ROM	Bad 6502B at C4	Replace and test

Troubleshooting Procedure



Circuitry Affected

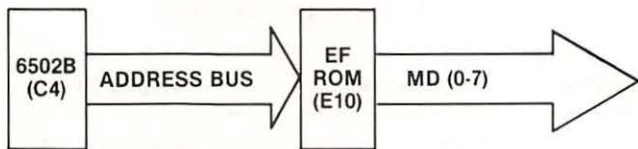

Fig. 7-9. EF ROM and 6502B circuitry .

Troubleshooting Procedure

TURN POWER OFF.
↓
REMOVE COVER.
TOUCH POWER SUPPLY CASE.
UNPLUG COMPUTER POWER CORD.

↓
REMOVE ALL CARDS
AND PERIPHERAL DEVICES.

↓
CLEAN CARD CONNECTOR PINS.

↓
REPLACE DISK CONTROLLER CARD.

↓
RECONNECT MONITOR AND DISK DRIVE.

↓
PLUG IN POWER CORD,
TURN ON, AND TEST.

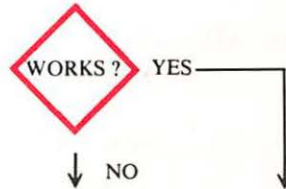

TURN OFF
COMPUTER.
DISCONNECT
POWER CORD.

REPLACE OTHER
CARDS AND
RETURN SYSTEM
TO FULL SERVICE.

↓
REPLACE RIBBON CABLE.

↓
RECONNECT POWER CORD,
POWER UP, AND TEST.

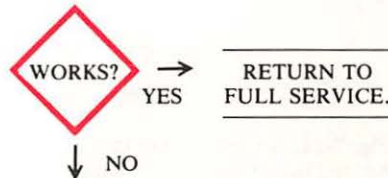

(Continued)

Chip designation	Description	Location
EF ROM	Monitor read-only memory	E10
6502B CPU	Central processing unit	C4

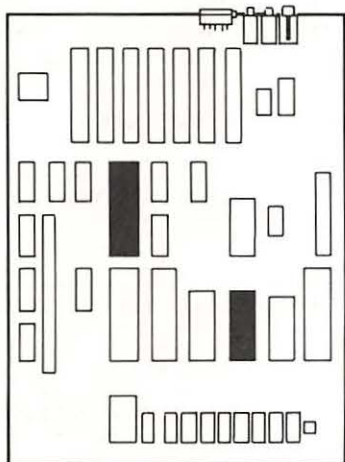
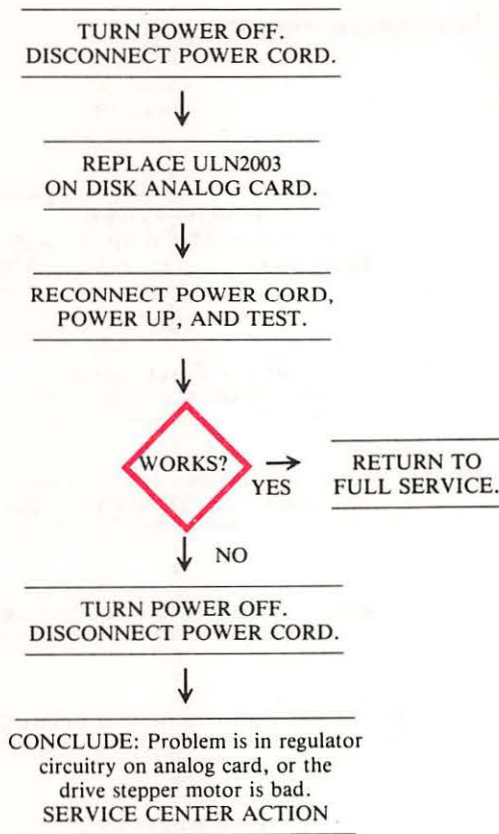

Fig. 7-10. Chip location guide. This represents the Apple motherboard and is a guide to help you find the chips of interest.

SYMPTOM: System won't boot – power light on, beeps, screen displays "APPLE][", drive won't run

Problem	Possible cause	Repair action
Disk boot signal bad	Corrosion on connector pins	Clean connector pins
Disk boot signal missing	Bad ribbon cable	Clean or replace cable
	Bad ULN2003 on analog card	Replace ULN2003
	Bad regulator circuit on analog card	Replace analog card
	Bad stepper motor or drive mechanism	Bring to service center



SYMPTOM: System won't boot – power light on, beeps, screen displays "APPLE][," drive keeps running

Problem	Possible cause	Repair action
Software	Booting 3.2 on 3.3 system	Boot with 3.3 DOS
	No DOS on disk	Boot with System Master first
Mechanical	Disk not seated properly	Slowly open and close drive door
	Cable connection loose	Check all cable connections tight
Hardware	Controller card seating	Reseat card
	Disk I/O faulty	See page 152
	Disk drive faulty	See page 152

Troubleshooting Procedure

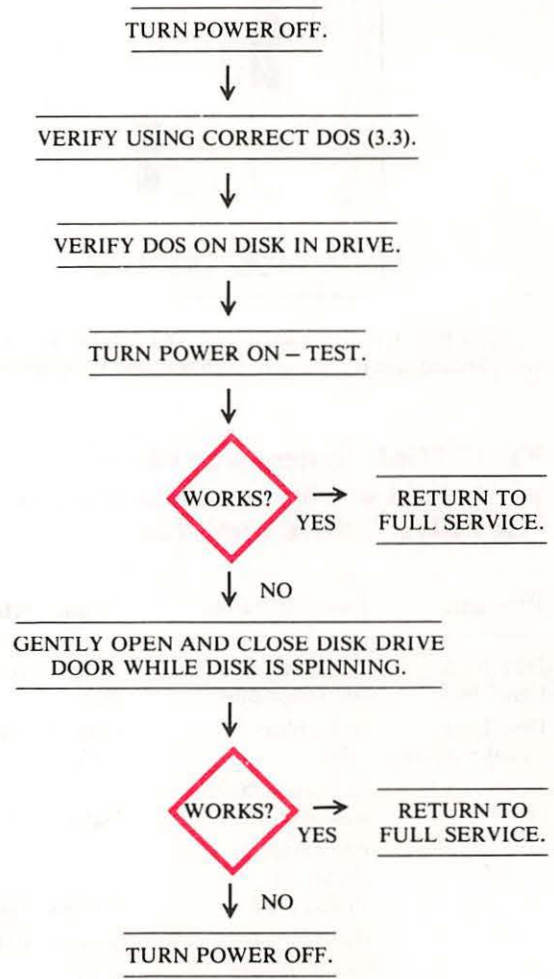

Circuitry Affected

Chip designation	Description	Location
ULN2003	7-channel input driver	Analog card

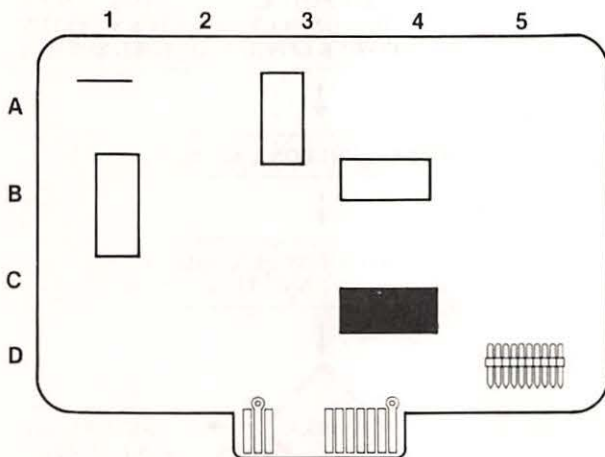

Fig. 7-11. Analog card chip location guide. This represents the Apple Disk II analog card and is a guide to help you find the chip of interest.

(Continued)

CHECK DISK DRIVE CABLE CONNECTIONS TO BE SURE THEY'RE TIGHTLY MADE.



RESEAT CONTROLLER CARD.



TURN POWER ON – TEST.



RETURN TO FULL SERVICE.



TURN POWER OFF.



DISCONNECT ALL PERIPHERAL HARDWARE INCLUDING DISK DRIVE.



CONNECT MONITOR TO COMPUTER.



POWER ON COMPUTER AND MONITOR.



(Should get "APPLE][]" displayed and 'beep' from speaker)

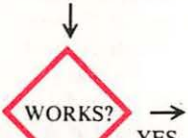

GO TO PAGE 143 SYMPTOM – SYSTEM WON'T BOOT

CONCLUDE: Problem is in one of 3 areas:
1. Disk controller card
2. Motherboard circuitry
3. Disk drive electronics



DRIVE NOT READING. GO TO PAGE 152.

SYMPTOM: System won't boot – power light on, beeps, screen displays "APPLE][," drive runs and then stops

Problem	Possible cause	Repair action
DOS not being loaded in RAM	Bad DOS on disk	Try another disk
	Bad disk	Try another disk
	Bad RAM chip on motherboard	Replace and test

Troubleshooting Procedure

TURN POWER OFF.



WRITE DOWN WHAT SYSTEM WAS DOING AT TIME OF FAILURE.



TRY TO BOOT ANOTHER DOS DISK.



RETURN TO FULL SERVICE.



TURN POWER OFF.



REMOVE TOP OF COMPUTER. TOUCH TOP OF POWER SUPPLY CASE. UNPLUG POWER CORD.



DISCONNECT ALL PERIPHERAL HARDWARE INCLUDING DISK DRIVE INTERFACE.



CONNECT MONITOR TO APPLE IIe.



RECONNECT POWER CORD. TURN ON COMPUTER AND MONITOR.



(Should get "APPLE][]" displayed and 'beep' from speaker)



(Continued)

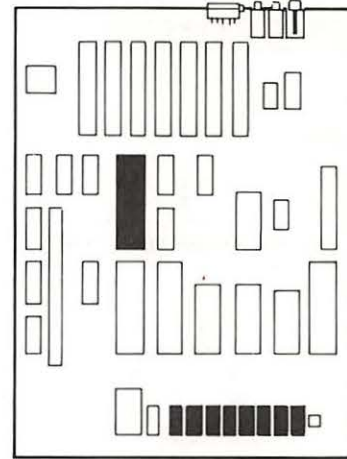
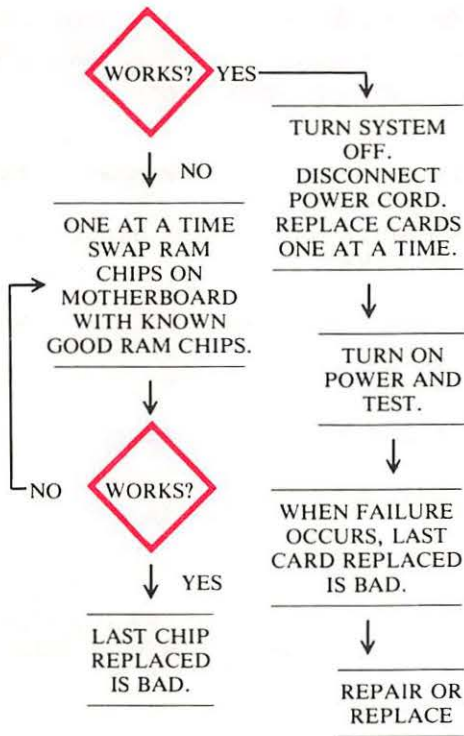

Fig. 7-13. Chip location guide. This represents the Apple motherboard and is a guide to help you find the chips of interest.

SYMPTOM: System won't boot — power light on, beeps, no display, drive whirs and then stops

Circuitry Affected

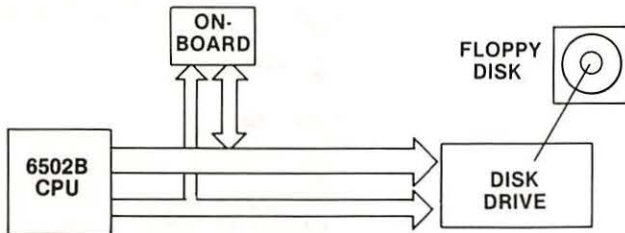
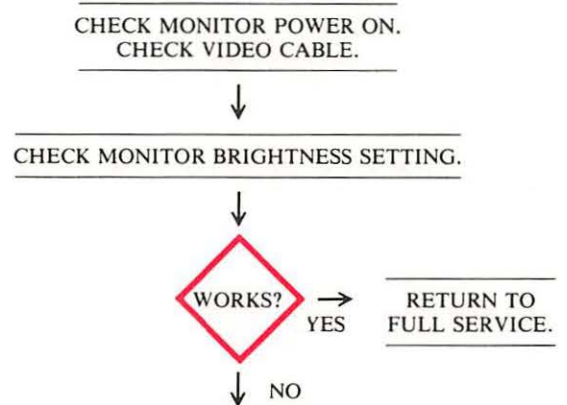

Fig. 7-12. Circuitry affected.

Problem	Possible cause	Repair action
No VIDEO OUT signal	Video cable bad Video connector bad	Replace and test Replace and test
Video signal too low	Monitor brightness control set too low	Readjust brightness
Video circuit component bad	74LS02 at B8 bad	Replace and test
	74LS10 at C5 bad	Replace and test
	74LS166 at F5 bad	Replace and test
	74LS374 at D3 bad	Replace and test
	IOU at E5 bad	Replace and test
	2732 ROM at F4 bad	Replace and test
	2N3904 (Q2) at A14 bad	Replace and test
	2N3906 (Q1) at A14 bad	Replace and test

Chip designation	Description	Location
6664	64K × 1-bit RAM chip	Bottom row

Troubleshooting Procedure



(Continued)

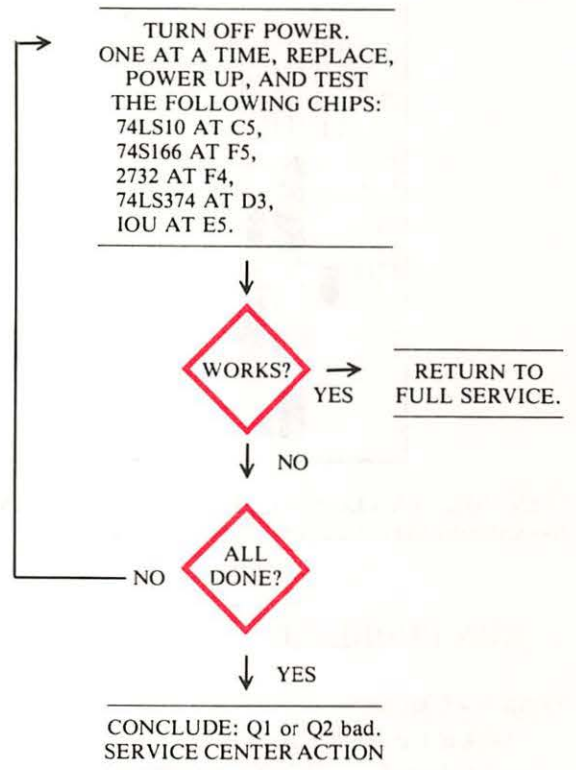
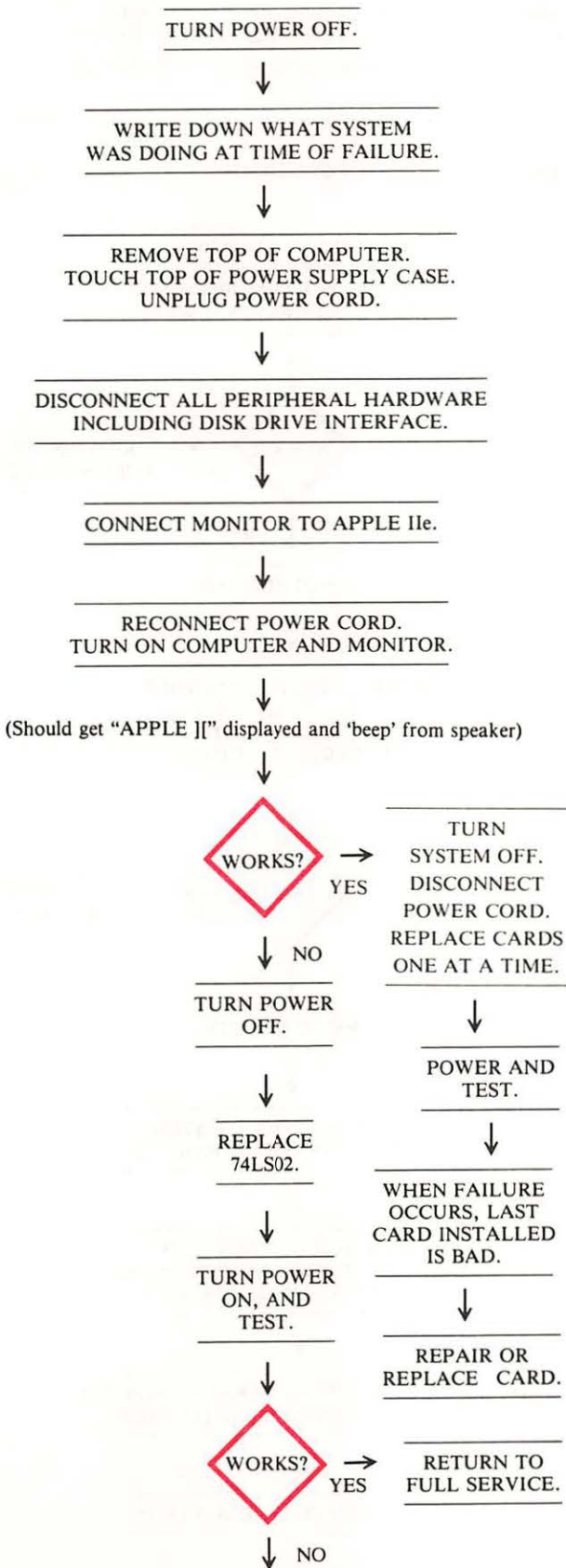

Circuitry Affected

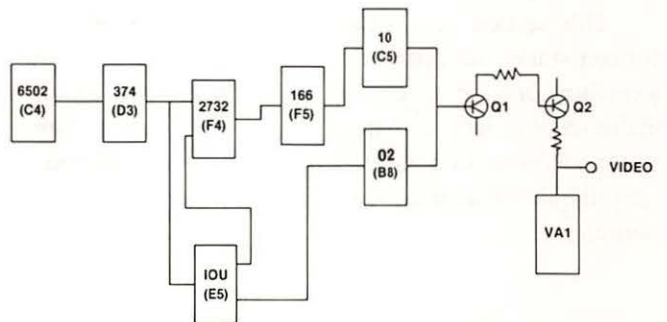

Fig. 7-14. Circuitry affected.

Chip designation	Description	Location
74LS02	Quad 2-input NOR gate	B8
74LS10	Triple 3-input NAND	C5
74LS166	8-Bit parallel-serial shift register	F5
74LS374	Tri-state buffer	D3
IOU	Input Output Unit	E5
2732	Character generator ROM	F4

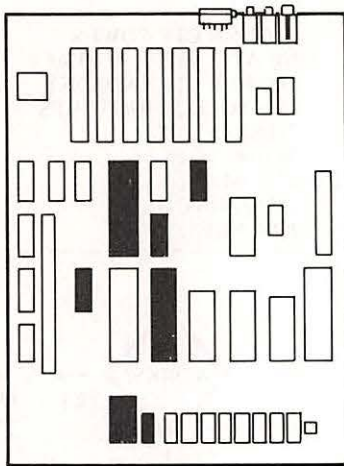

Fig. 7-15. Chip location guide. This represents the Apple motherboard and is a guide to help you find the chips of interest.

No data from controller card	Corrosion on card connector	Conduct PMs on connector
	Bad controller card	Replace card.

Troubleshooting Procedure

WITH DRIVE RUNNING:
OPEN DRIVE DOOR,
REMOVE AND REINSERT DISK,
THEN CLOSE DOOR SLOWLY.



YES → RETURN TO FULL SERVICE.

NO ↓

TRY ANOTHER DISK.



AFTER INSERTING ANOTHER DISK, CLOSE DRIVE DOOR SLOWLY TO PROPERLY SEAT DISK.



YES → OLD DISK WAS BAD.

NO ↓

TURN POWER OFF.



WRITE DOWN WHAT SYSTEM WAS DOING AT TIME OF FAILURE.



REMOVE TOP OF COMPUTER. TOUCH TOP OF POWER SUPPLY CASE. UNPLUG POWER CORD.



DISCONNECT ALL PERIPHERAL HARDWARE INCLUDING DISK DRIVE INTERFACE.



CONNECT MONITOR TO APPLE IIe.



(Continued)

2. RUN PROBLEMS

Symptom Category	Page
Disk drive won't read	152
Disk drive won't write	154
Intermittent operation	156
Disk drive reads or writes intermittently	156
Computer locks up, keyboard won't work	157

This section covers those problems you might encounter while your system is running – you attempt to do something and get an entirely different response. Broad malfunctions such as display failure, keyboard failure, and input/output failures will be treated in later sections, although they may occur during the time your program is running.

SYMPTOM: Disk drive won't read (get I/O error or disk just runs and runs)

Problem	Possible cause	Repair action
Data not coming from disk	Bad disk	Replace disk
	Wrong DOS (3.2 not 3.3)	Try another disk
	Disk not seated properly	Reseat disk
Read head not reading	Bad read head	Service center replace head
Data not coming out of drive	Cable bad or loose	Reseat or replace
	Bad chip on drive analog card	Replace and test

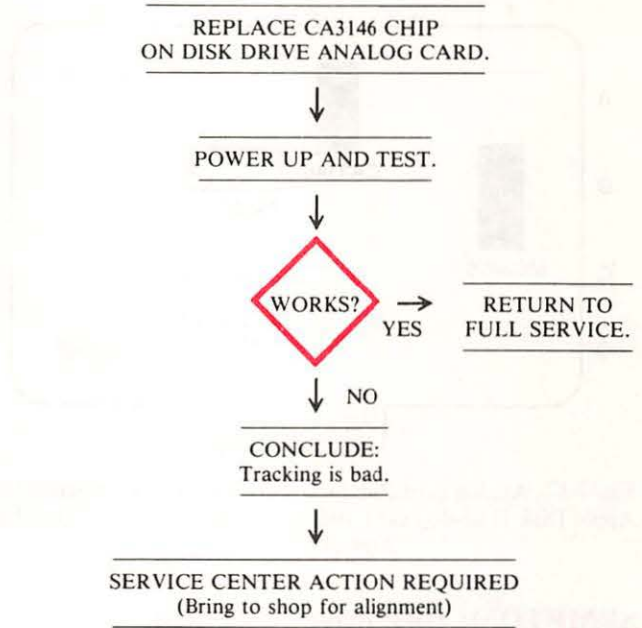
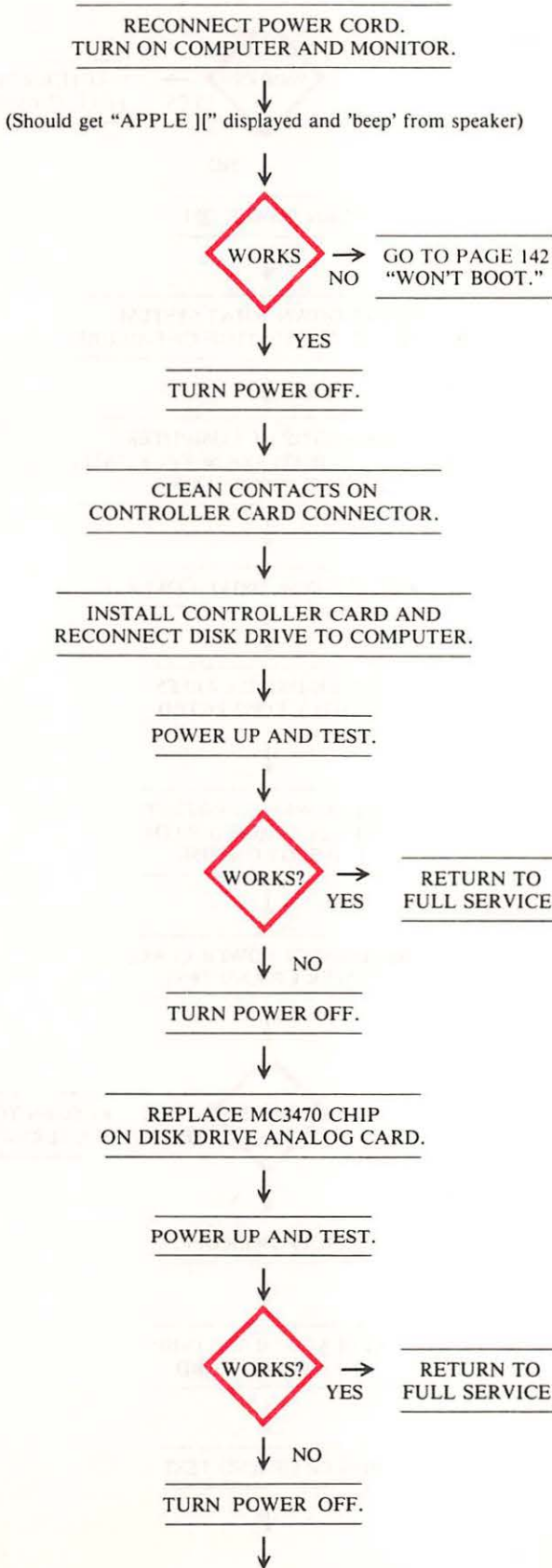

Circuitry Affected

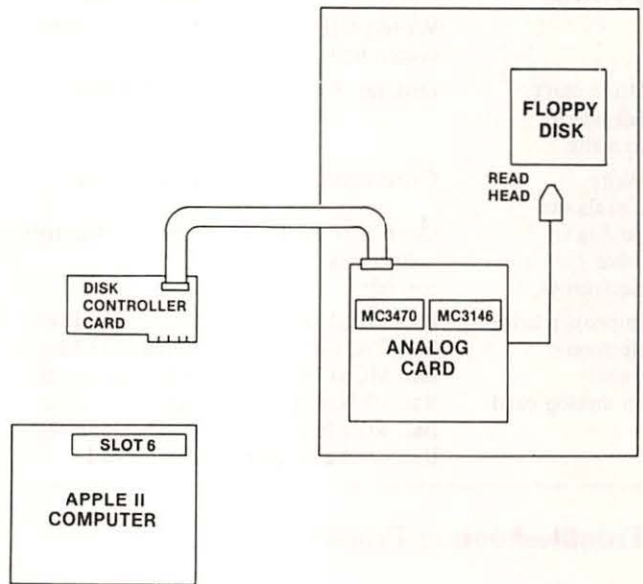

Fig. 7-16. Circuitry affected.

Chip designation	Description	Location
MC3470	Floppy disk read amplifier	Analog card
CA3146	Differential pair and three NPN transistors	Analog card

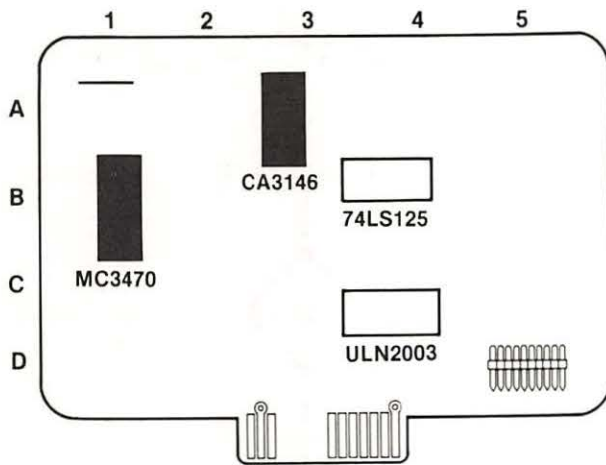
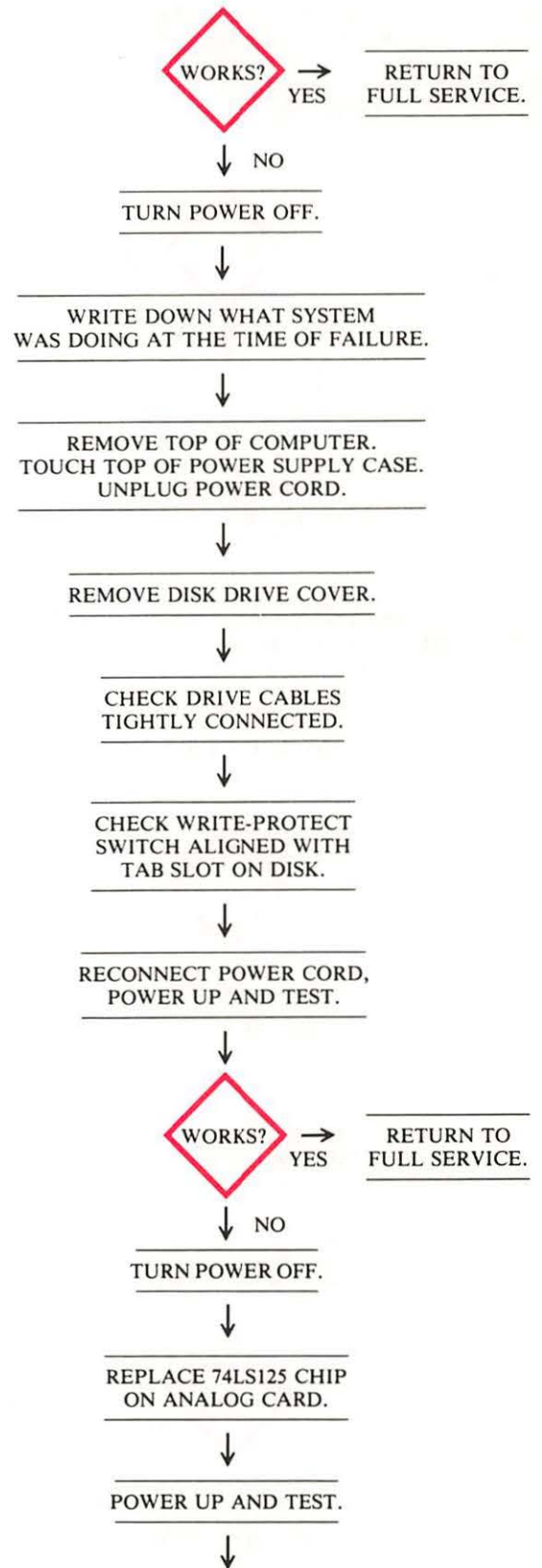
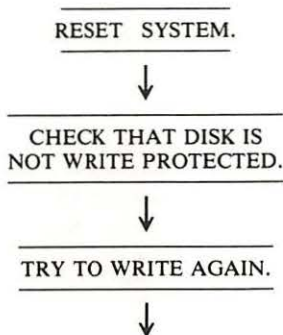

Fig. 7-17. Analog card chip location guide. This represents the Apple Disk II analog card and is a guide to help you find the chips of interest.

SYMPTOM: Disk drive won't write (read is OK)

Problem	Possible cause	Repair action
Disk write protected	Write-protect tab installed	Remove write-protect tab
	Write-protect switch bad	Replace switch
Drive can't tell where to write	Disk not formatted	Format disk
Write signals not getting to drive electronics	Cable bad or loose	Check cable
	Controller card connectors corroded	Clean connectors
Improper drive electronic signals on analog card	Bad 74LS125	Replace and test
	Bad CA3146	Replace and test
	Bad MC3470	Replace and test
	Bad ULN2003	Replace and test
	Bad write head Bad head alignment	Replace and test Align head

Troubleshooting Procedure



(Continued)

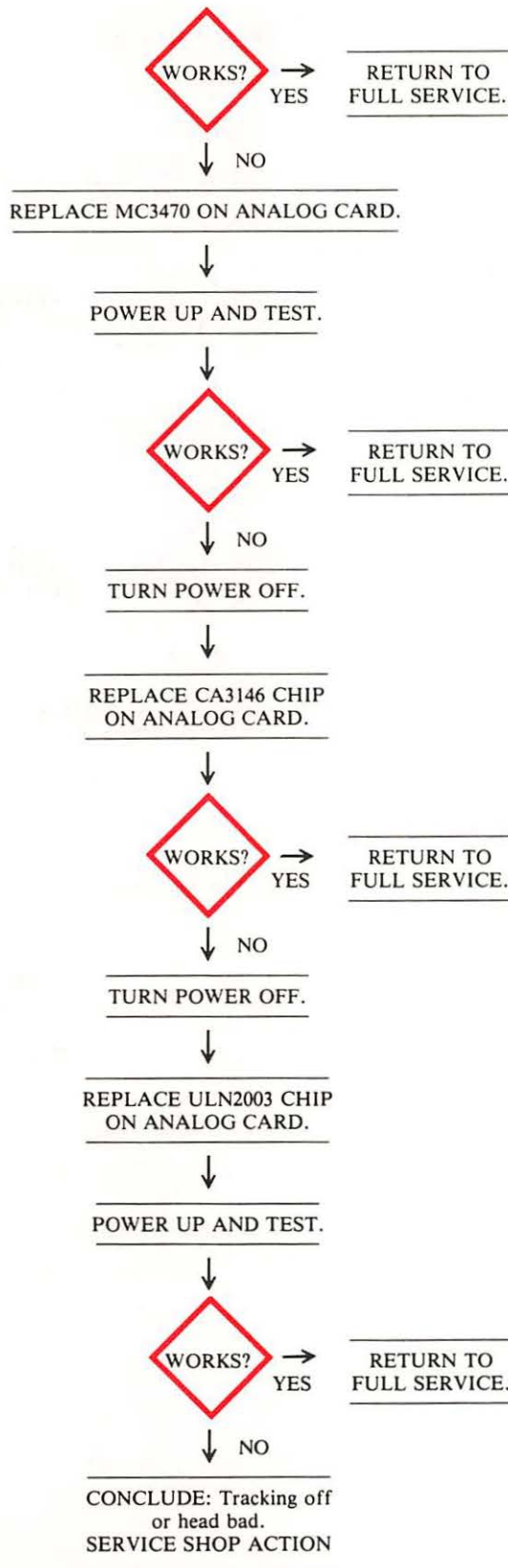

Circuitry Affected

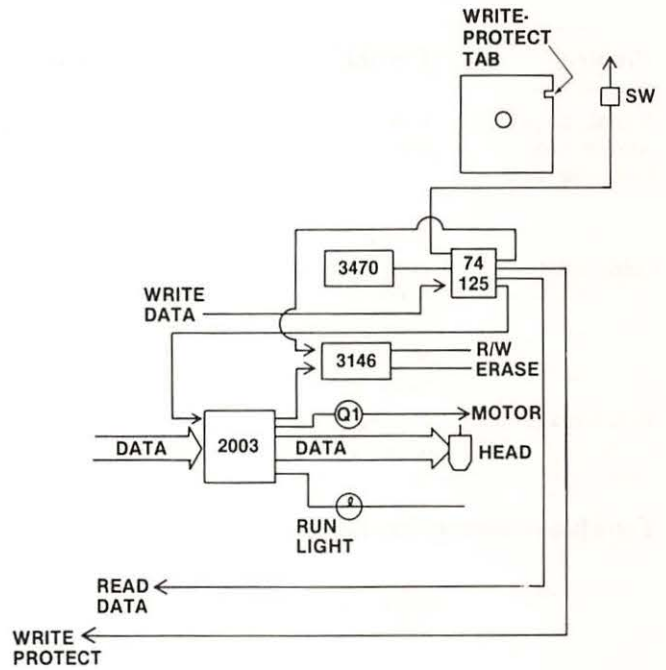

Fig. 7-18. Analog card circuitry affected.

Chip designation	Description	Location
74LS125	Quad 3-state buffer	Analog card
MC3470	Floppy disk read amplifier	Analog card
CA3146	Differential pair and three NPN transistors	Analog card
ULN2003	7-channel input driver	Analog card

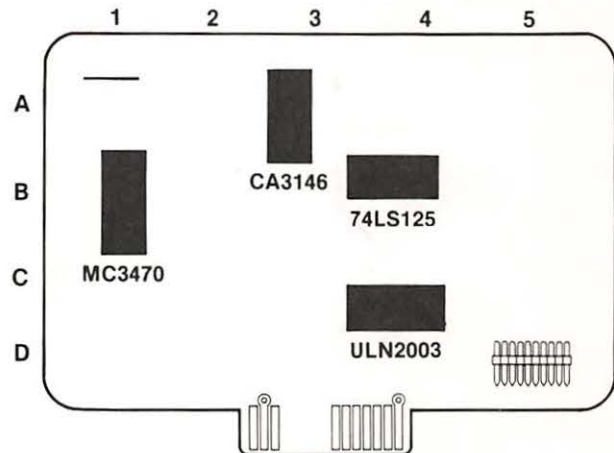
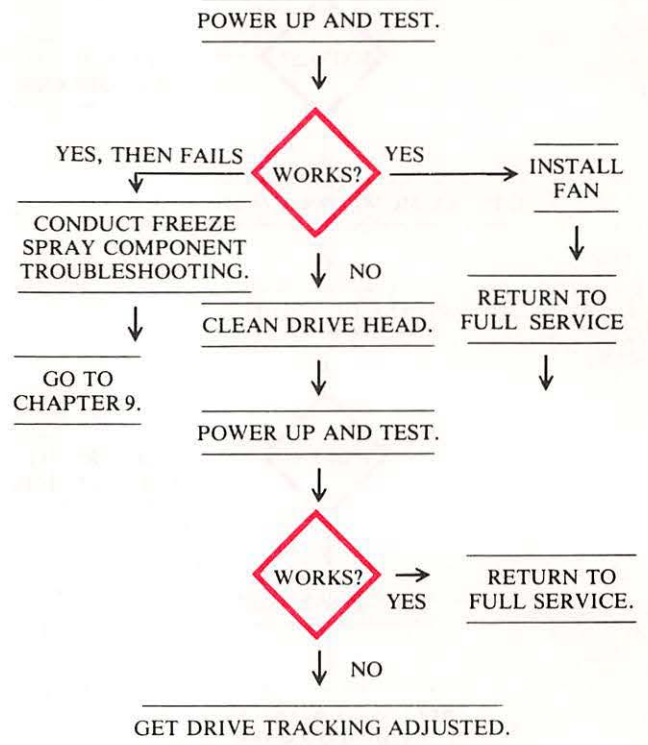
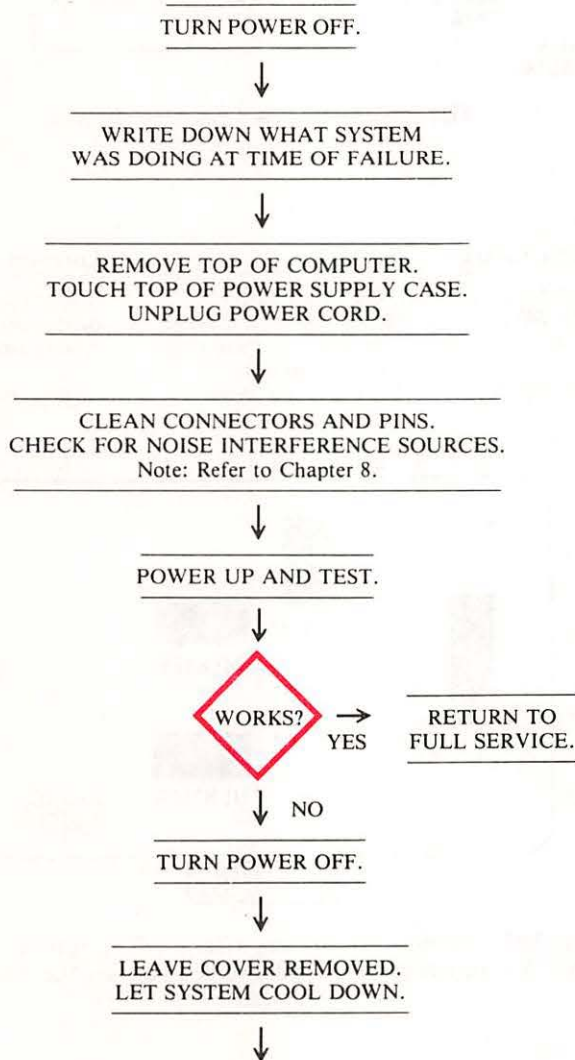

Fig. 7-19. Analog card circuitry affected. This represents the Disk II analog card and is a guide to help you find the chips of interest.

SYMPTOM: Intermittent operation – disk drive reads or writes intermittently

Problem	Possible cause	Repair action
Signals not always getting into controller card	Corrosion on cable connector	Clean cable connector pins
Component	Corrosion on connector pins	Clean connector pins
	Heat-sensitive component troubleshooting; see Chapter 9.	Install fan;
Disk tracking off	Noise interference	See Chapter 8
	Misalignment of drive head	Corrective alignment

Troubleshooting Procedure



Circuitry Affected

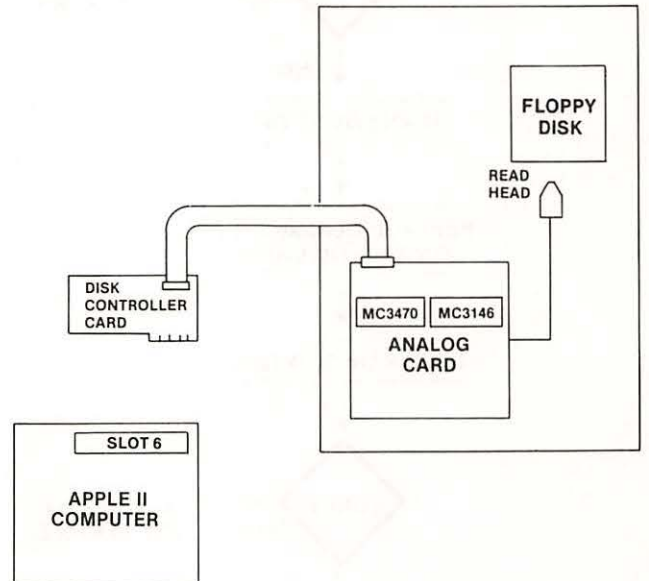
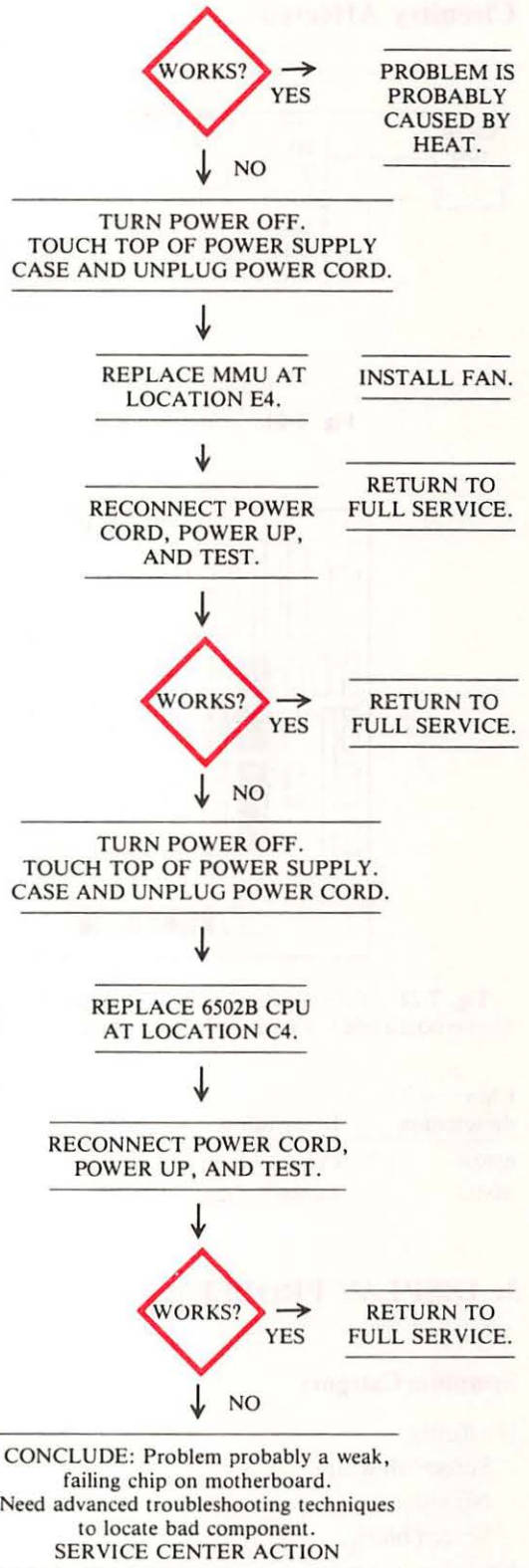
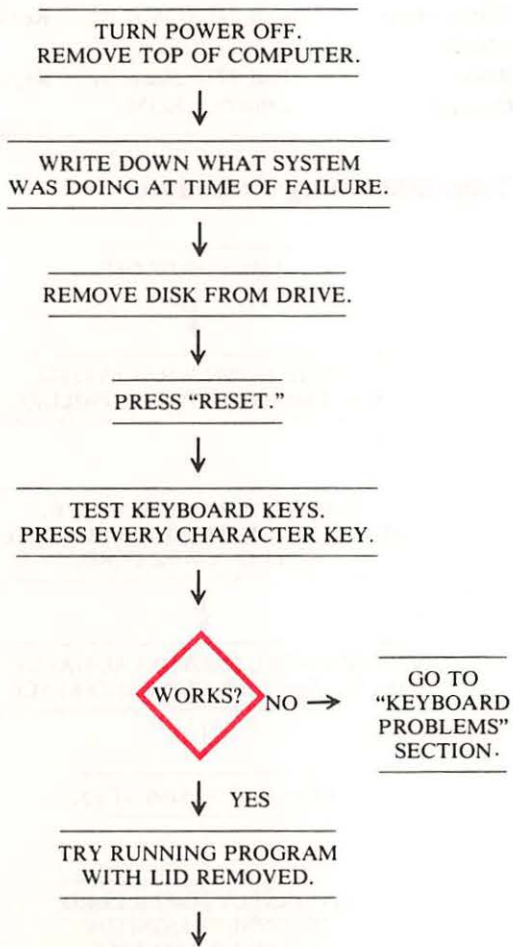

Fig. 7-20. Circuitry affected.

SYMPTOM: Intermittent operation – computer locks up, keyboard won't work

Problem	Possible cause	Repair action
Programming lock-out	Error in program	Debug program
No output from keyboard circuitry	Failure in keyboard circuitry	Go to "Keyboard Problems" section, p.170
Heat problems on motherboard	Bad RAM chip	Replace and test
Bad MMU chip	Bad MMU chip	Replace and test
CPU failure	Bad 6502B chip at location C4	Replace and test

Troubleshooting Procedure



Circuitry Affected

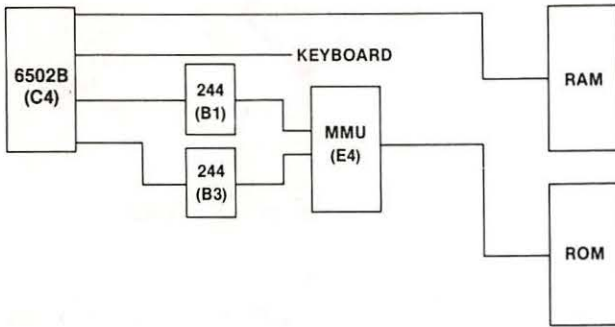

Fig. 7-21. Circuitry affected.

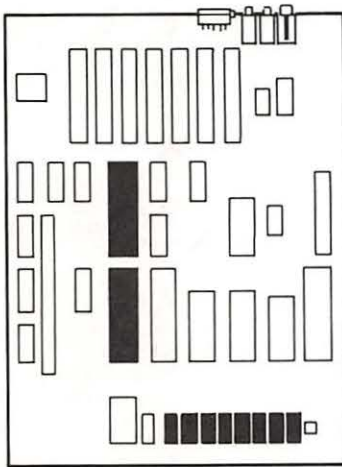

Fig. 7-22. Chip location guide. This represents the Apple motherboard and is a guide to help you find the chips of interest.

Chip designation	Description	Location
6502B	Central processing unit	C4
MMU	Memory management unit	E4

3. DISPLAY PROBLEMS

Symptom Category	Page
No display	
Screen all white	158
No video	159
Screen black	162
No color	163
No synchronization	164
Bad cursor or no cursor	165
Bad inverse or flash	165

No text	166
Video	
Wrong characters	167
Bad color	167
Bad graphics	
No hi-res or lo-res graphics; text OK	168
No hi-res graphics, lo-res and text OK	169

This section covers a wide selection of display problems experienced by Apple owners.

SYMPTOM: No display – screen all white

Problem	Possible cause	Repair action
Shift register latch-up	Bad 74LS166 at F5	Replace and test
ROM data hung up	Bad 2732 character generator ROM	Replace and test

Troubleshooting Procedure

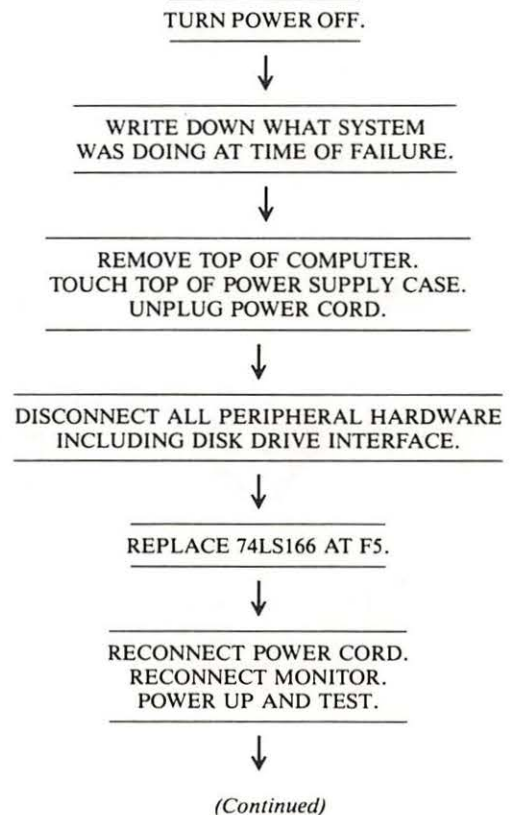

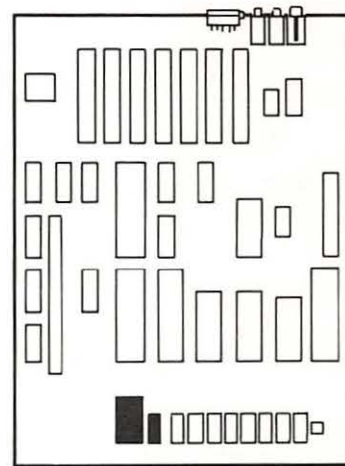
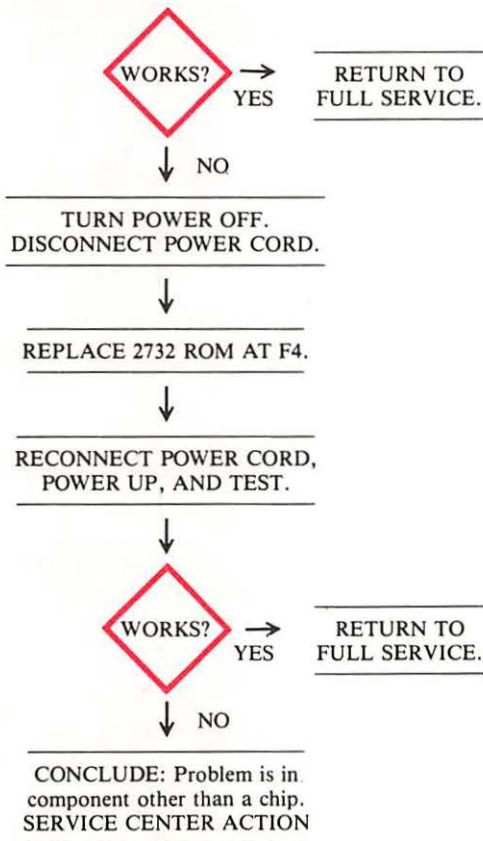

Fig. 7-24. Chip location guide. This represents the Apple motherboard and is a guide to help you find the chips of interest.

SYMPTOM: No display – no video

Problem	Possible cause	Repair action
No video into monitor	Bad cable	Reseat or replace
Video signal too small	Brightness	Adjust brightness
	Bad monitor	Check and replace if necessary
No video signal at output	Bad 74LS02 at B8	Replace and test
	Bad 2N3906 at A14	Replace and test
	Bad 2N3904 at A14	Replace and test
No serial video data	Bad 74LS10 at C5	Replace and test
	Bad 74LS166 at F5	Replace and test
No video generated	Bad 2732 ROM at F4	Replace and test
No data on video bus	Bad 74LS374 at D3	Replace and test
No synchronization pulse	Bad IOU at E5	Replace and test
No clock	Bad PAL 16R8 at D1	Replace and test

Circuitry Affected

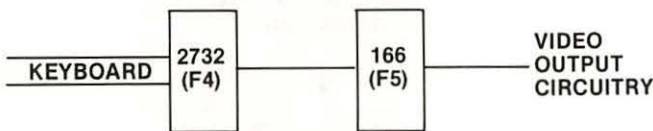
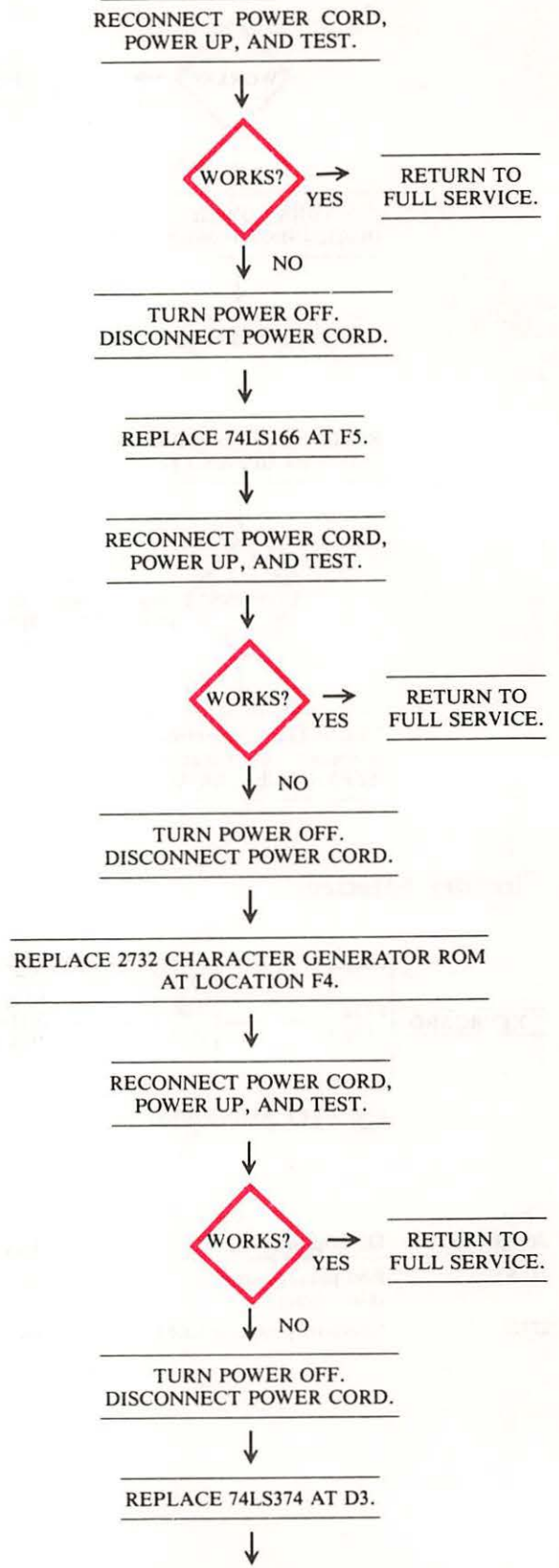
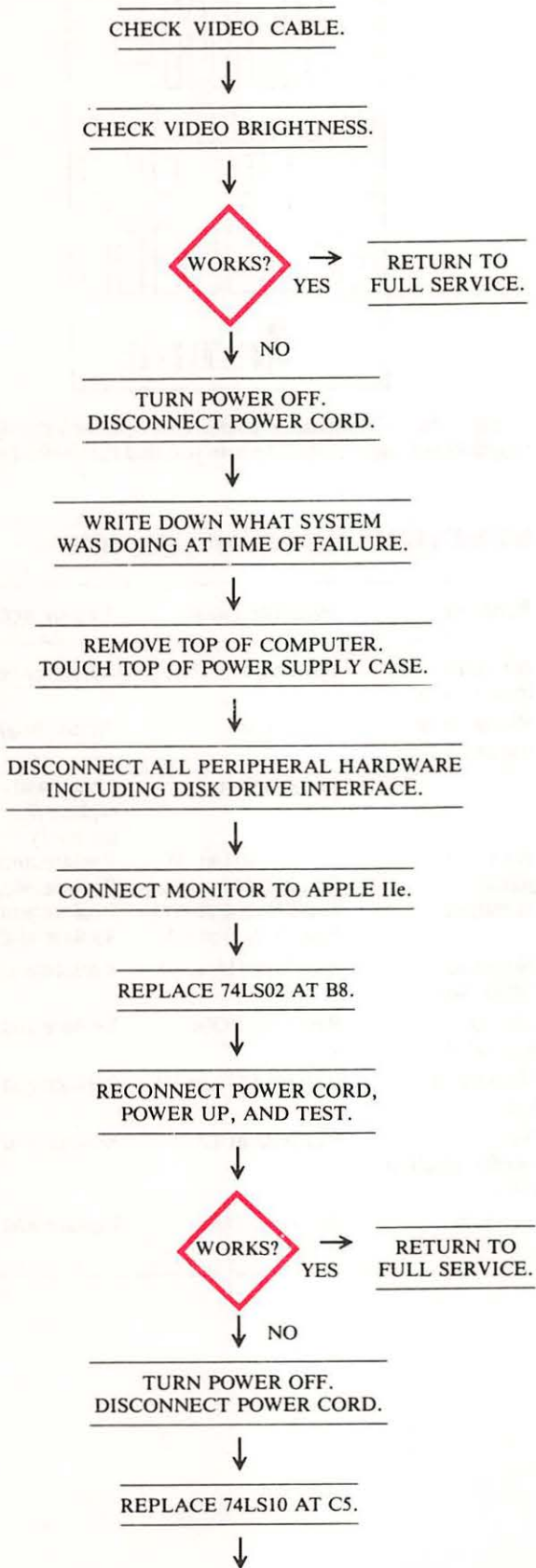

Fig. 7-23 Circuitry affected.

Chip designation	Description	Location
74LS166	8-bit parallel-serial shift register	F5
2732	Character generator ROM	F4

Troubleshooting Procedure



(Continued)

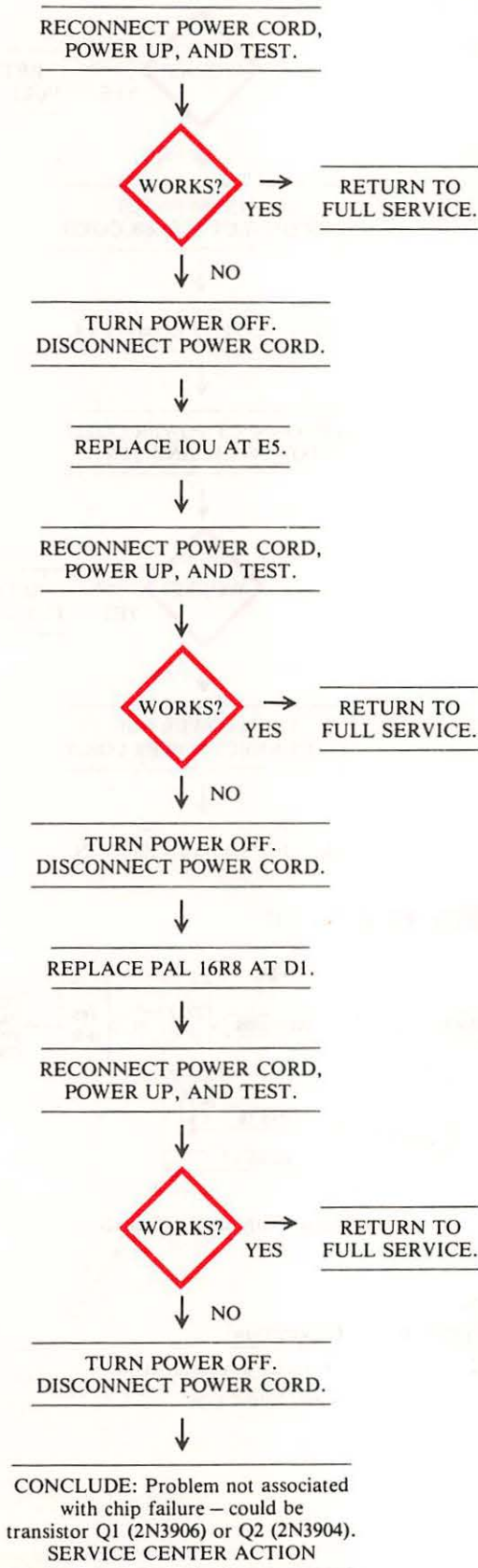

Circuitry Affected

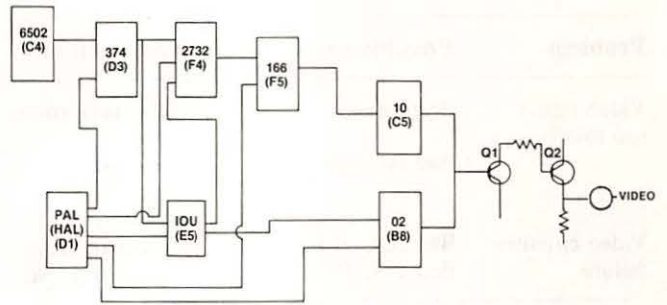

Fig. 7-25. Circuitry affected.

Chip designation	Description	Location
2732	Character generator ROM	F4
74LS02	Quad 2-input NOR	B8
74LS10	Triple 3-input NAND	C5
74LS166	8-bit parallel-serial shift register	F5
74LS374	Tri-state buffer	D3
IOU	Input/output unit	E5
PAL 16R8	Programmed array logic	D1
Q1	2N3906 transistor	A14
Q2	2N3904 transistor	A14

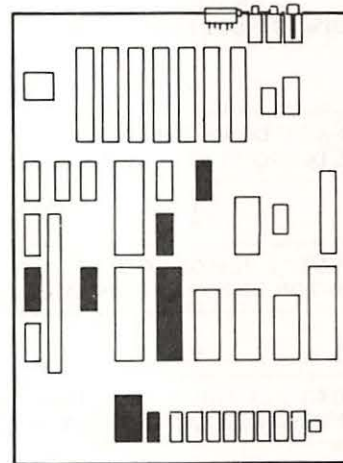
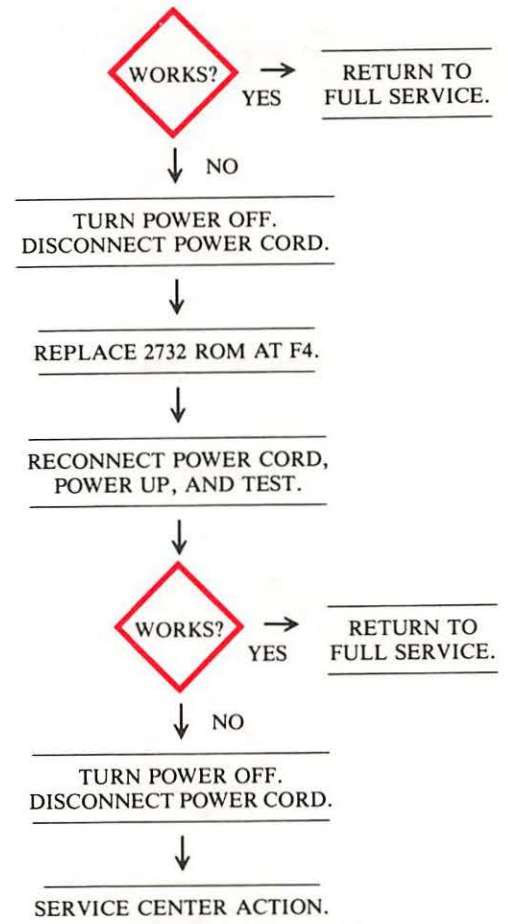
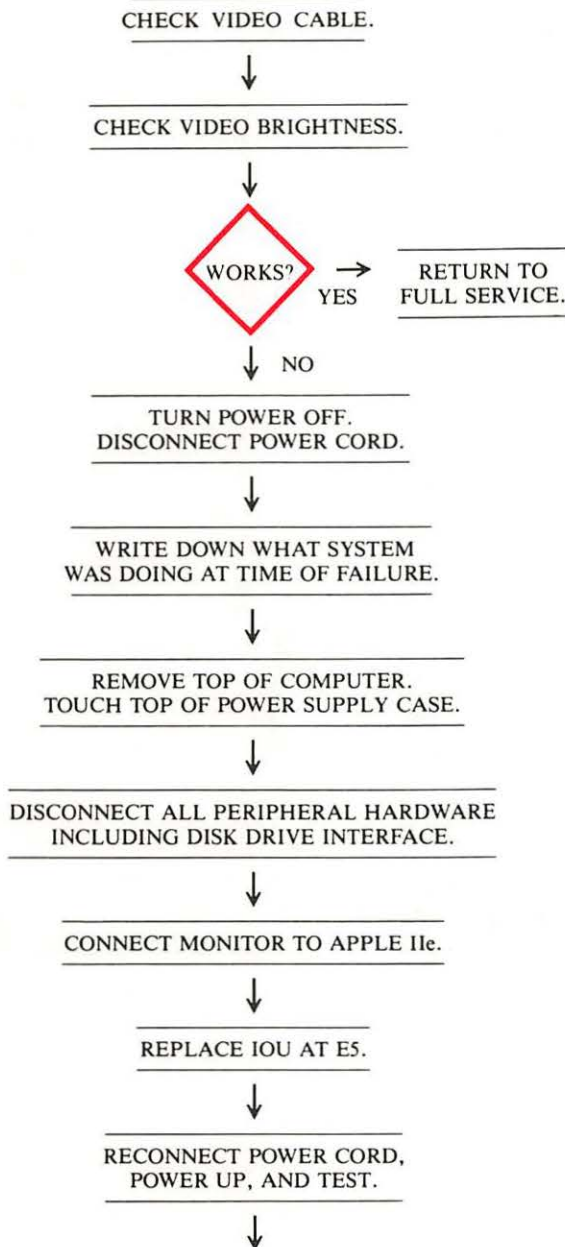

Fig. 7-26. Chip location guide. This represents the Apple motherboard and is a guide to help you find the chips of interest.

SYMPTOM: No display – screen black

Problem	Possible cause	Repair action
Video signal too small	Brightness	Adjust brightness.
	Bad monitor	Check and replace if necessary.
Video circuitry failure	Bad IOU at E5	Replace and test.
	Bad 2732 ROM at F4	Replace and test.

Troubleshooting Procedure



Circuitry Affected

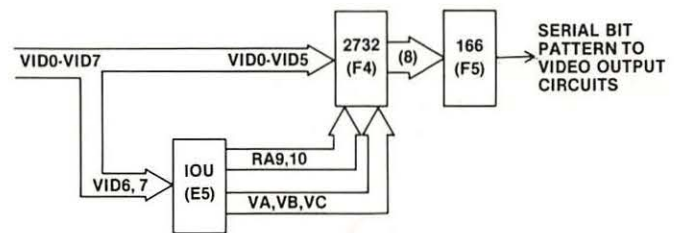

Fig. 7-27. Circuitry affected.

Chip designation	Description	Location
2732	Character generator ROM	F4
IOU	Input/output unit	E5

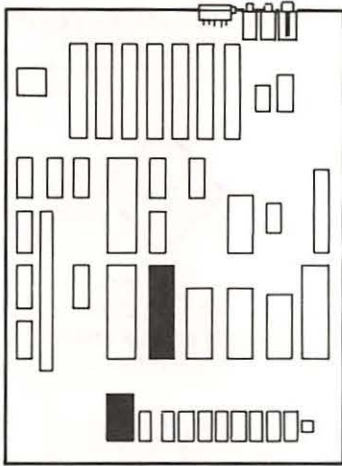
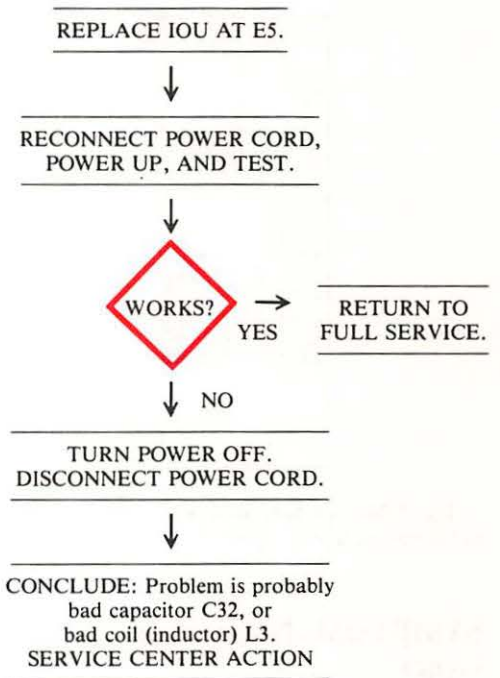
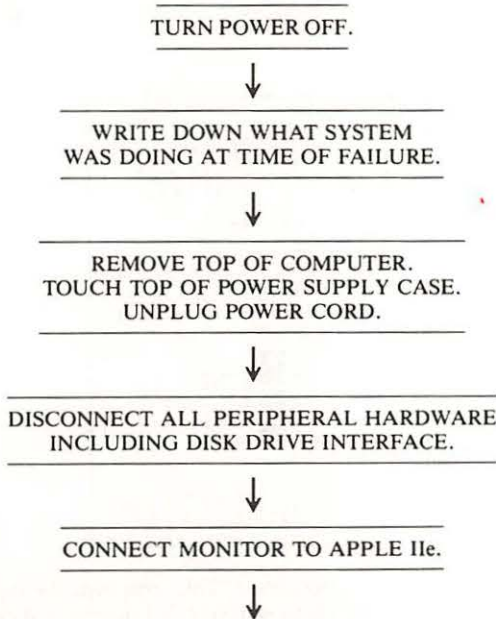

Fig. 7-28. Chip location guide. This represents the Apple motherboard and is a guide to help you find the chips of interest.

SYMPTOM: No color

Problem	Possible cause	Repair action
No color burst signal	Bad IOU at E5	Replace and test
Signal shorted	Capacitor C32 shorted	Replace C32 (requires soldering)
	Inductor L3 Bad	Replace L3 (requires soldering)

Troubleshooting Procedure



Circuitry Affected

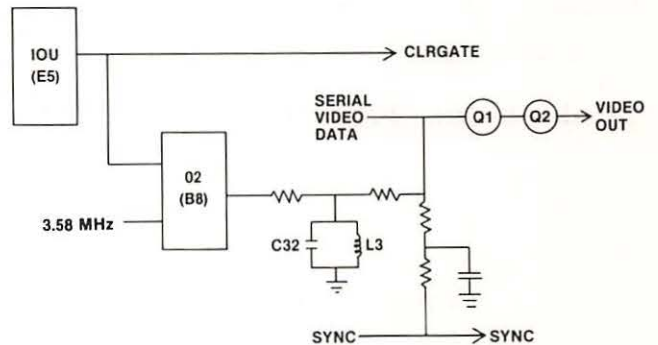

Fig. 7-29. Circuitry affected.

Chip designation	Description	Location
IOU	Input/output unit	E5

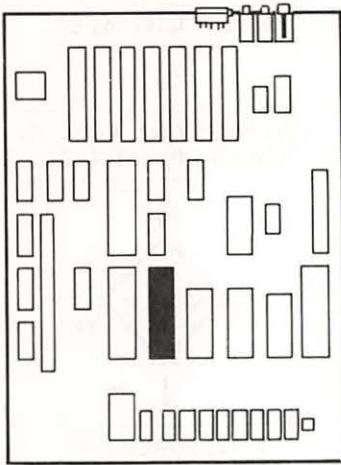
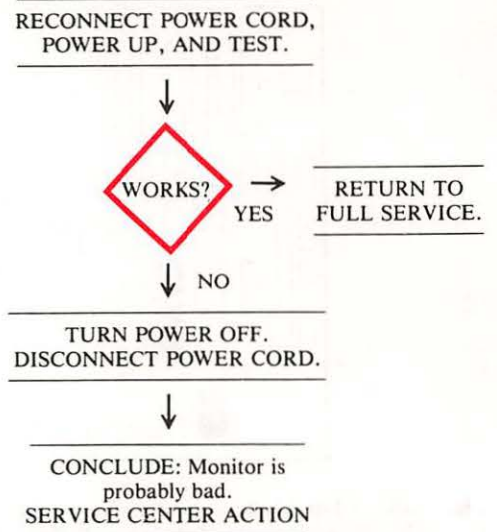
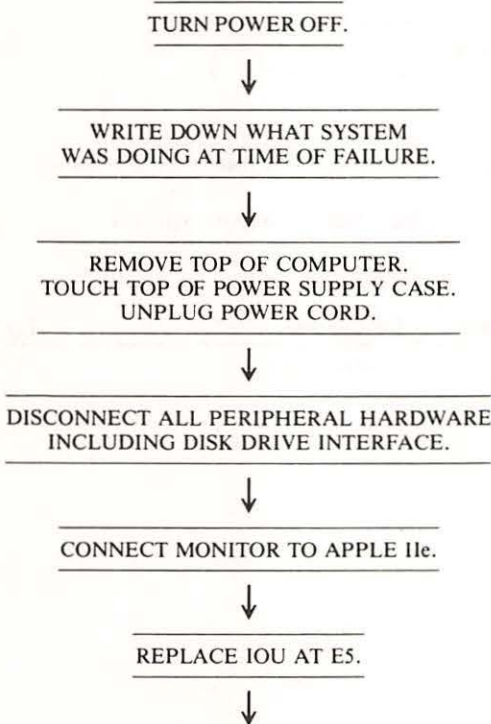

Fig. 7-30. Chip location guide. This represents the Apple motherboard and is a guide to help you find the chips of interest.

SYMPTOM: No synchronization (sync)

Problem	Possible cause	Repair action
No sync	Bad IOU at E5 Bad monitor	Replace and test Service center action

Troubleshooting Procedure



Circuitry Affected

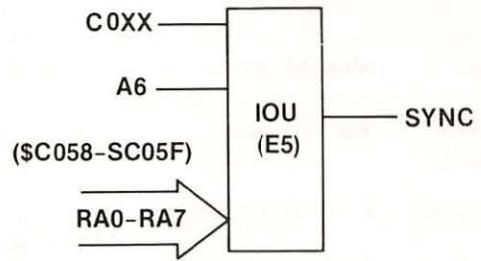

Fig. 7-31. Circuitry affected.

Chip designation	Description	Location
IOU	Input/output unit	E5

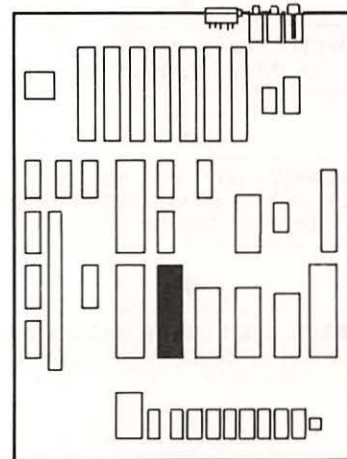
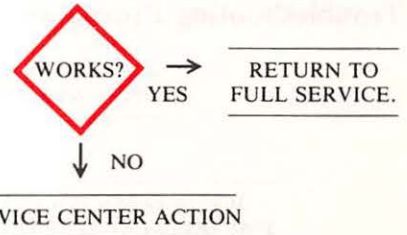
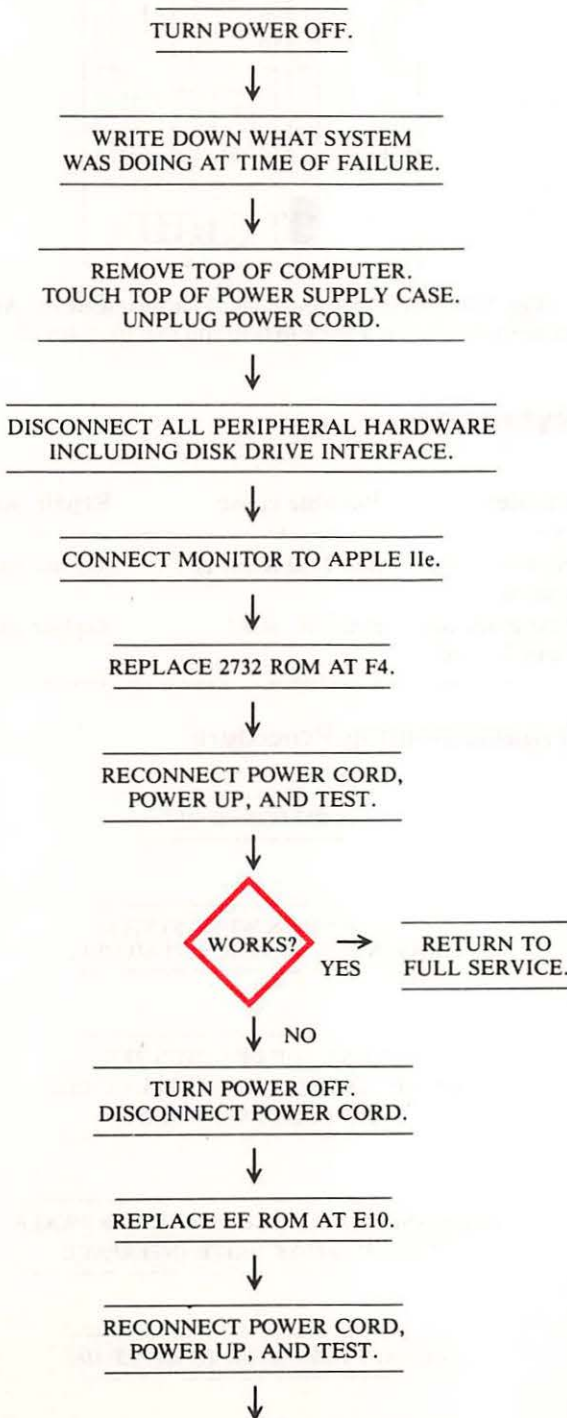

Fig. 7-32. Chip location guide. This represents the Apple motherboard and is a guide to help you find the chips of interest.

SYMPTOM: Bad cursor or no cursor

Problem	Possible cause	Repair action
Character not being generated	Bad EF ROM at E10 Bad 2732 ROM at F4	Replace and test Replace and test

Troubleshooting Procedure



Circuitry Affected

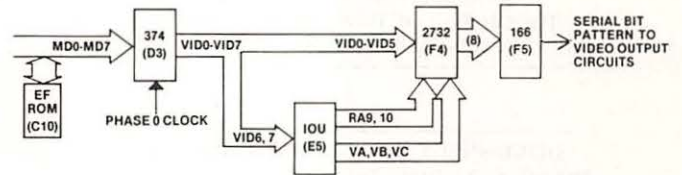

Fig. 7-33. Circuitry affected.

Chip designation	Description	Location
2732	Character generator ROM	F4
EF ROM	Monitor ROM	E10

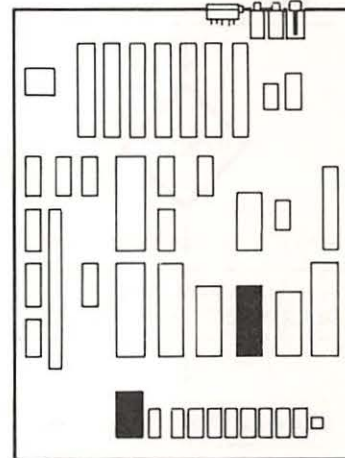
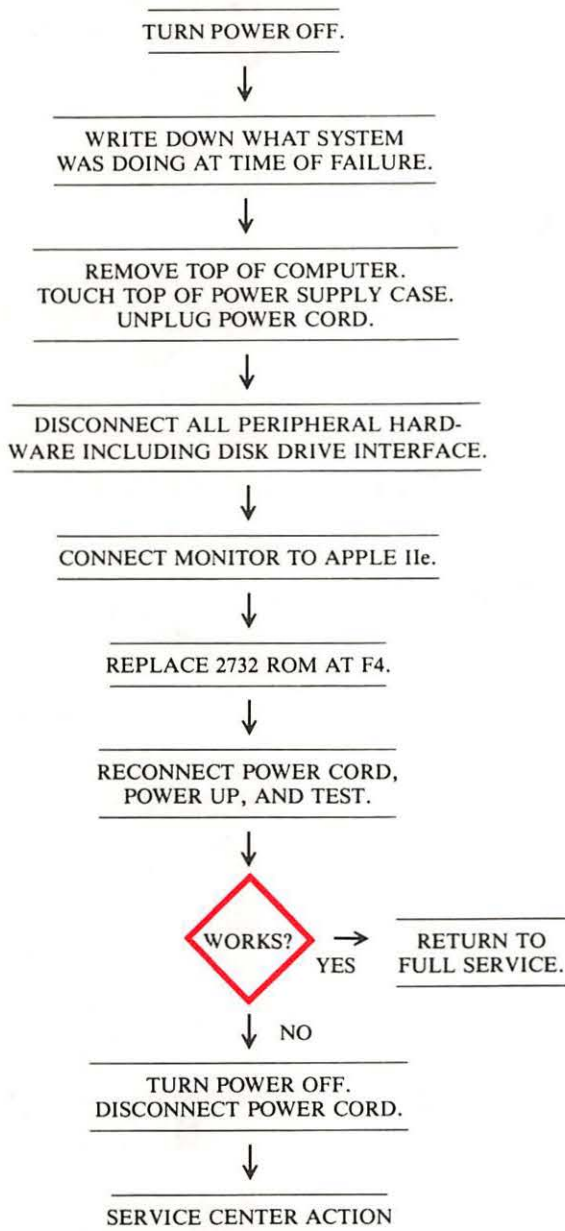

Fig. 7-34. Chip location guide. This represents the Apple motherboard and is a guide to help you find the chips of interest.

SYMPTOM: Bad inverse or flash

Problem	Possible cause	Repair action
Mode not being selected, timer malfunction	Bad 2732 character generator ROM at F4	Replace and test

Troubleshooting Procedure



Circuitry Affected

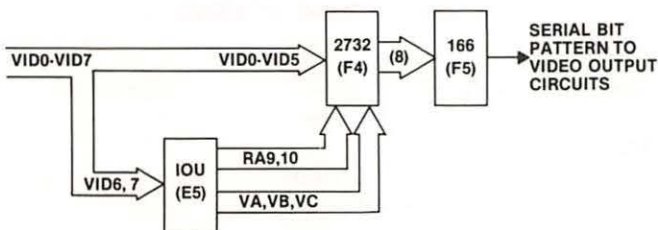

Fig. 7-35. Circuitry affected

Chip designation	Description	Location
2732	Character generator ROM	F4

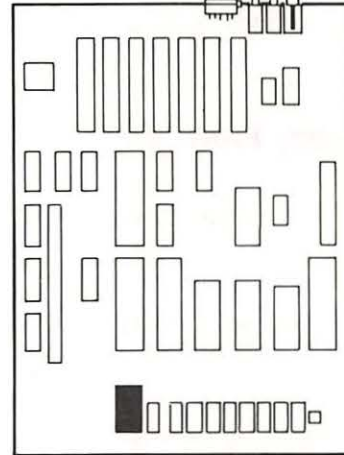
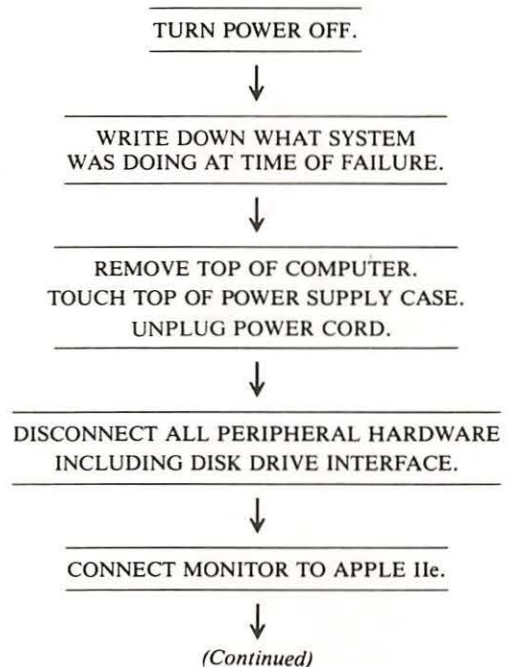

Fig. 7-36. Chip location guide. This represents the Apple motherboard and is a guide to help you find the chips of interest.

SYMPTOM: No text

Problem	Possible cause	Repair action
No text being generated	Bad 2732 ROM at F4	Replace and test
Text mode not being latched	Bad IOU at E5	Replace and test

Troubleshooting Procedure



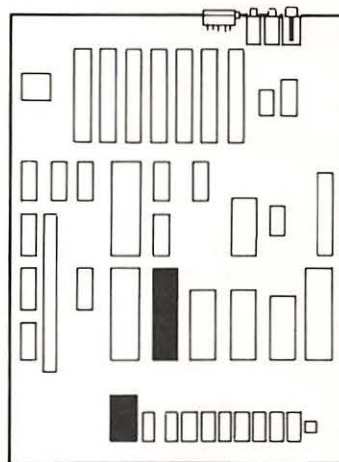
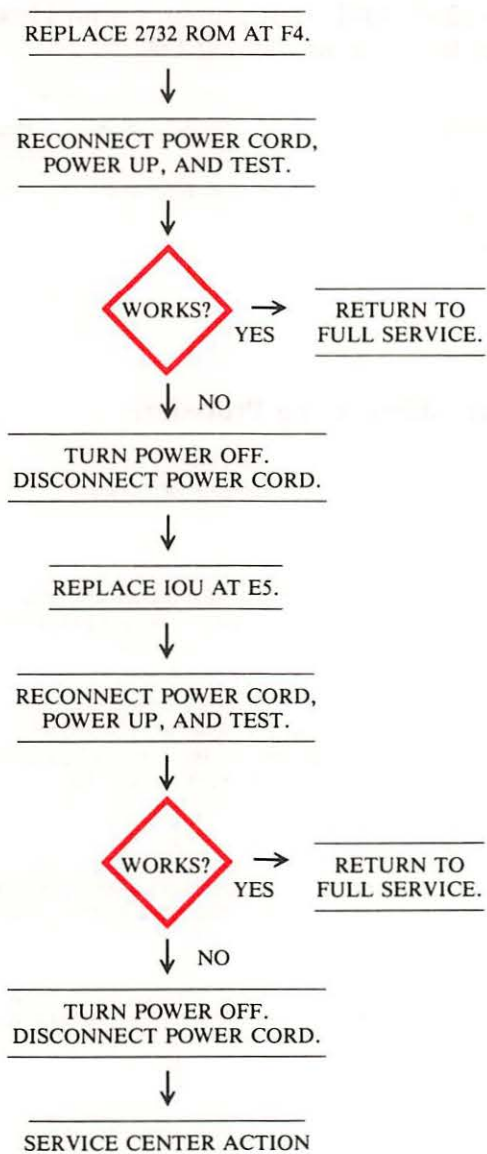

Fig. 7-38. Chip location guide. This represents the Apple motherboard and is a guide to help you find the chips of interest.

SYMPTOM: Video – wrong characters

Problem	Possible cause	Repair action
Refer to "Part 4, Keyboard Problems; Bad key action – prints wrong characters," pg. 172		

SYMPTOM: Video – bad color

Problem	Possible cause	Repair action
Pin 5 latch-up of VID7 signal	Bad HAL at D1	Replace and test

Troubleshooting Procedure

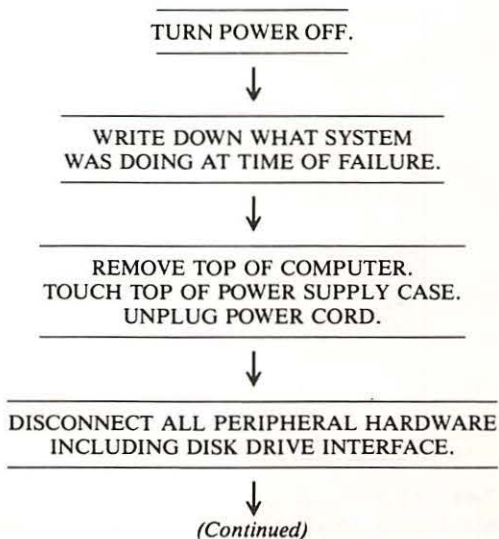

Circuitry Affected

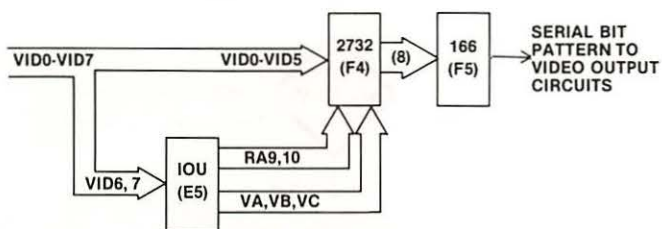
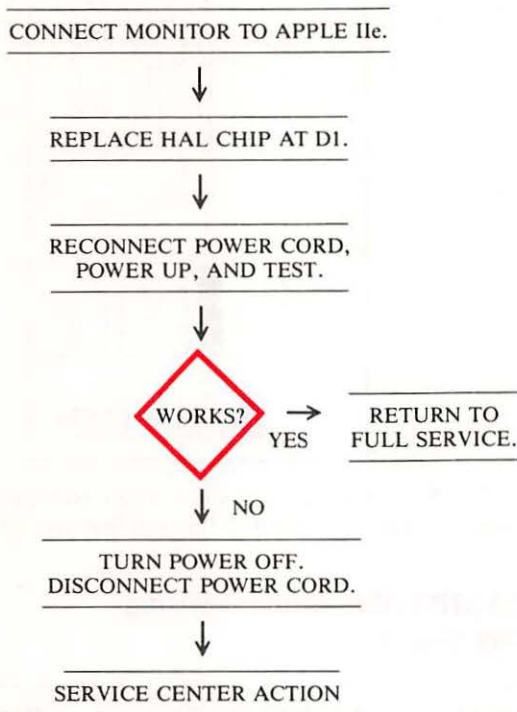

Fig. 7-37. Circuitry affected

Chip designation	Description	Location
2732	Character generator ROM	F4
IOU	Input/output unit	E5



Circuitry Affected

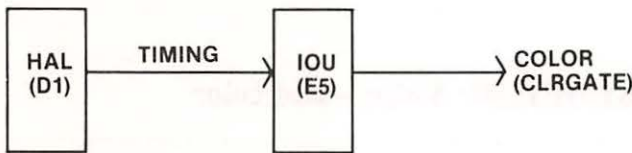

Fig. 7-39. Circuitry affected.

Chip designation	Description	Location
16R8 HAL/PAL	Programmed array logic	D1

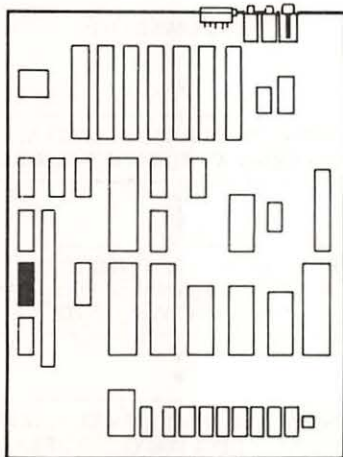
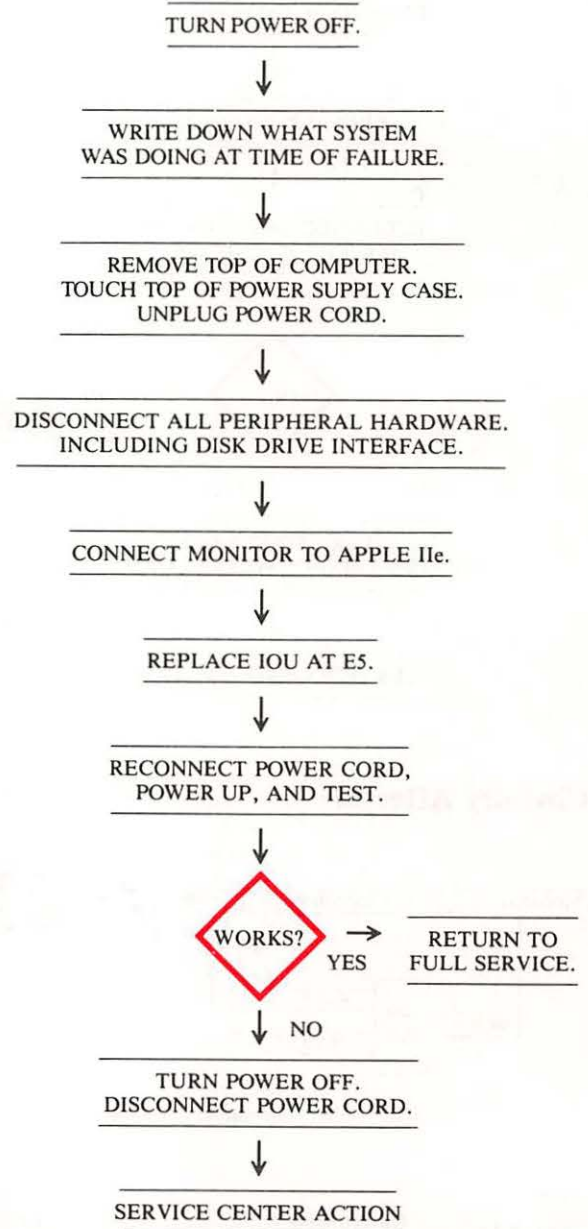

Fig. 7-40. Chip location guide. This represents the Apple motherboard and is a guide to help you find the HAL/PAL chip.

SYMPTOM: Bad graphics — no hi-res or lo-res graphics; text OK

Problem	Possible cause	Repair action
No hi-res or lo-res pixels produced. No hi-res or lo-res activated	Bad IOU at E5	Replace and test

Troubleshooting Procedure



Circuitry Affected

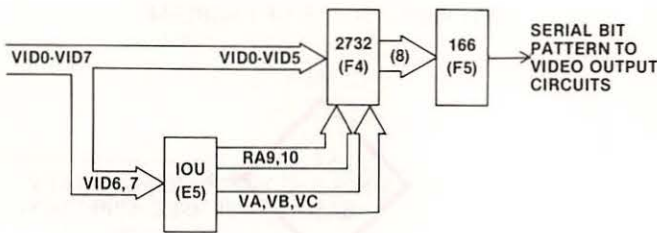

Fig. 7-41. Circuitry affected.

Chip designation	Description	Location
IOU	Input/output unit	E5

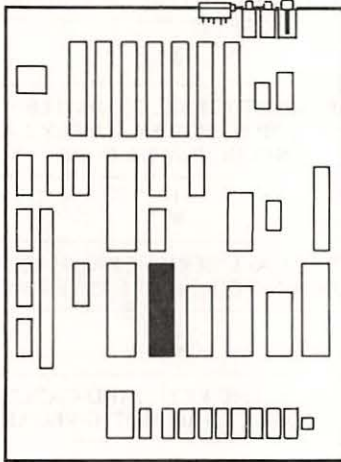
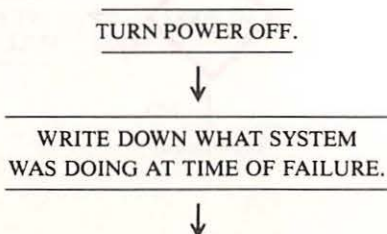

Fig. 7-42. Chip location guide. This represents the Apple motherboard and is a guide to help you find the IOU chip.

SYMPTOM: Bad graphics – no hi-res graphics; lo-res and text OK

Problem	Possible cause	Repair action
Hi-res signal stuck Low; Page 2 signal stuck in text or lo-res mode	Bad IOU at E5	Replace and test

Troubleshooting Procedure



REMOVE TOP OF COMPUTER.
TOUCH TOP OF POWER SUPPLY CASE.
UNPLUG POWER CORD.

DISCONNECT ALL PERIPHERAL HARDWARE
INCLUDING DISK DRIVE INTERFACE.

CONNECT MONITOR TO APPLE IIe.

REPLACE IOU AT E5.

RECONNECT POWER CORD,
POWER UP, AND TEST.

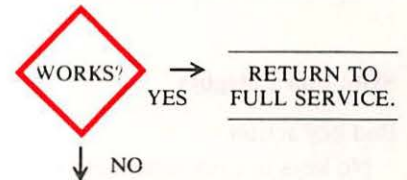

TURN POWER OFF.
DISCONNECT POWER CORD.

SERVICE CENTER ACTION

Circuitry Affected

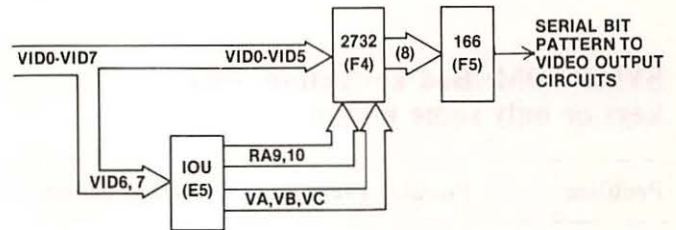

Fig. 7-43. Circuitry affected.

Chip designation	Description	Location
IOU	Input/output unit	E5

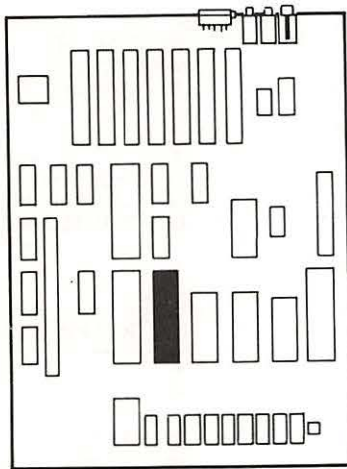

Fig. 7-44. Chip location guide. This represents the Apple motherboard and is a guide to help you find the IOU chip.

4. KEYBOARD PROBLEMS

Symptom Category	Page
Bad key action	
No keys or only some keys work	170
Prints wrong characters	172
Unwanted repeat	173
Repeat key won't work	174
Key top pops off	175

The keyboard is a window into the computer. Its proper operation is important to successful use of the machine. This section covers the most common key and keyboard problems.

SYMPTOM: Bad key action – no keys or only some keys work

Problem	Possible cause	Repair action
No key contact	Bad key	Replace key
Signal not reaching motherboard	Bad or loose cable	Reseat or replace cable
No character being generated	Bad AY3600 at E14 Bad 2716 ROM at E12	Replace and test cable Replace and test

Troubleshooting Procedure

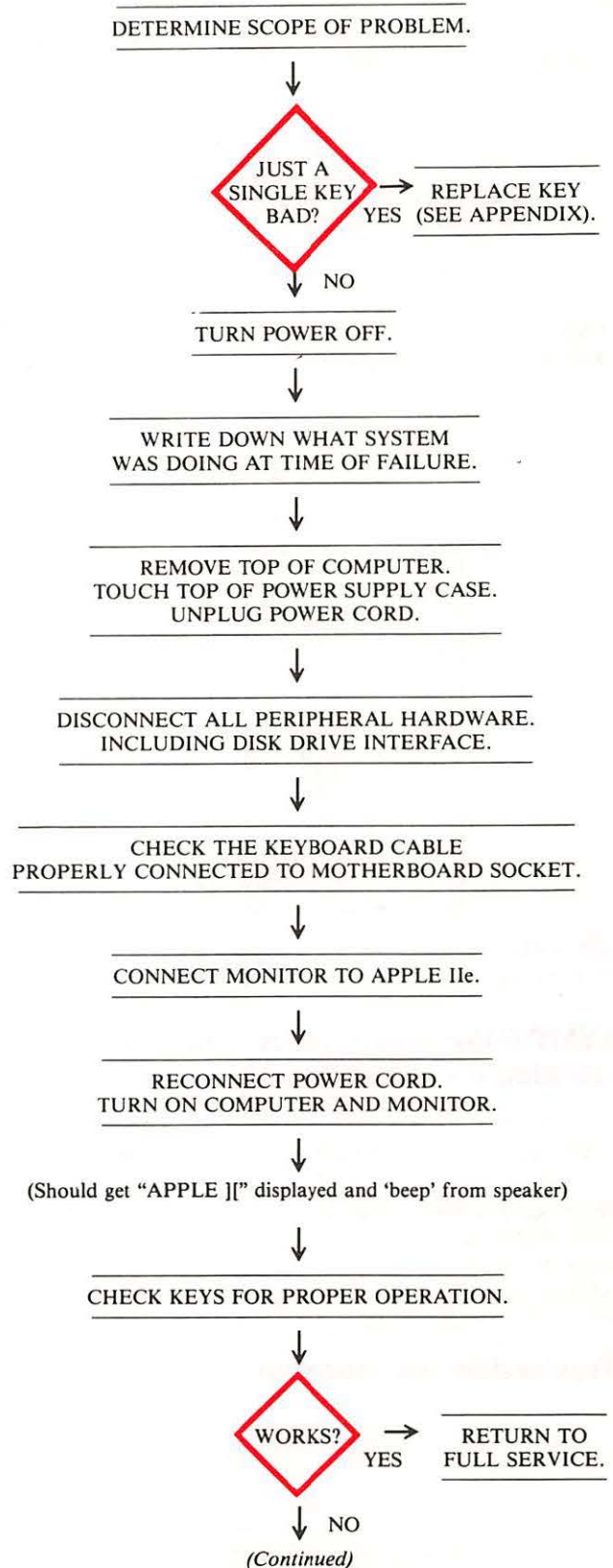

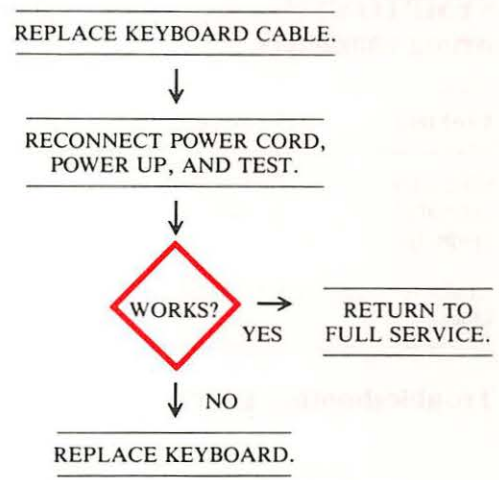
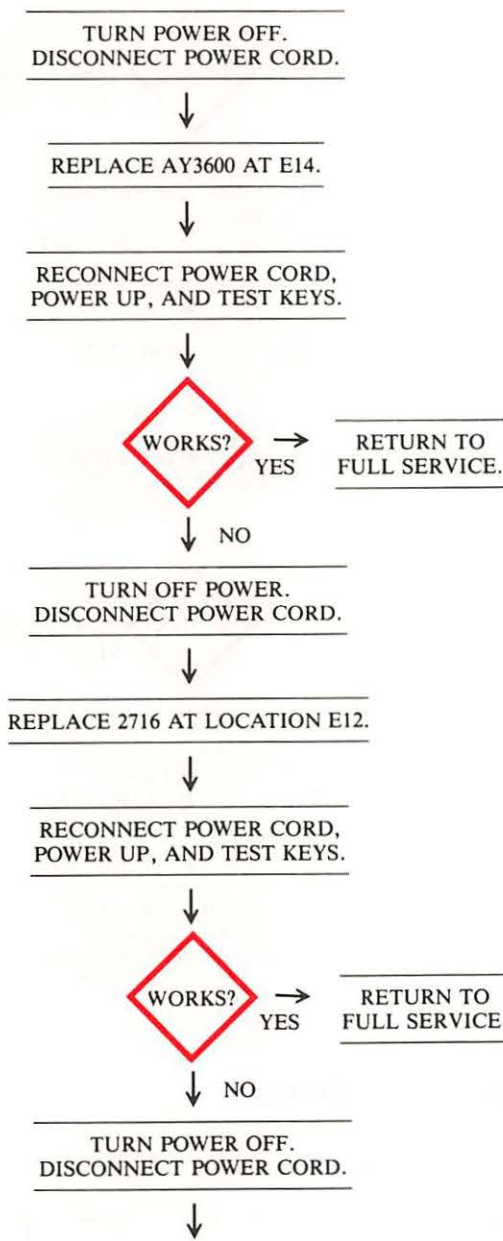

Chip designation	Description	Location
2716	Character generator ROM	E12
AY3600	Keyboard decoder	E14

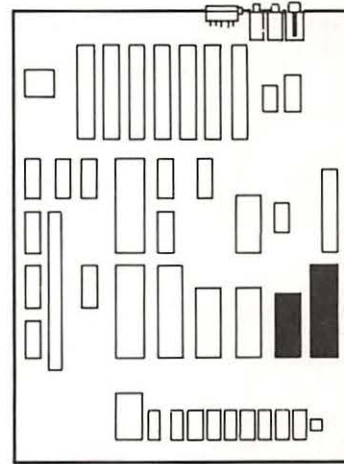

Fig. 7-46. Chip location guide. This represents the Apple motherboard and is a guide to help you find the chips of interest.

Circuitry Affected

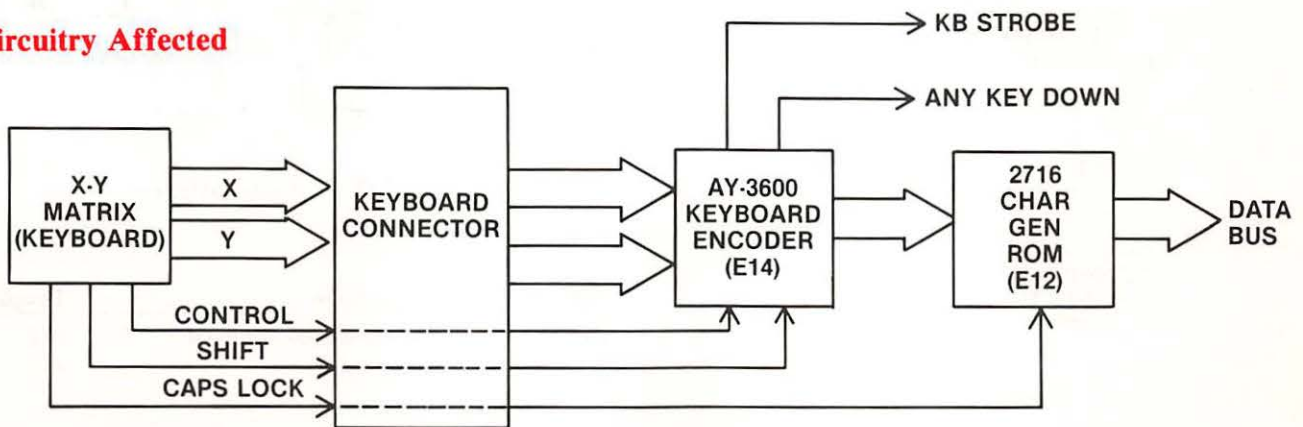
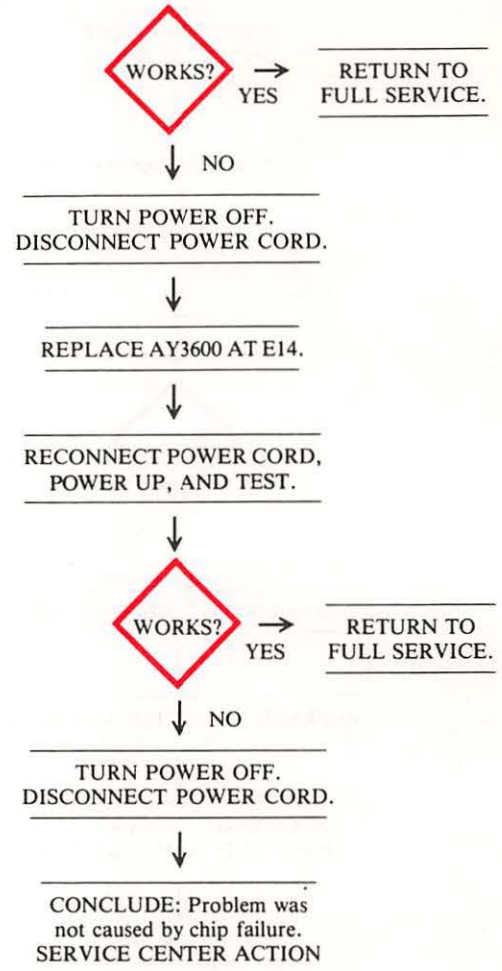
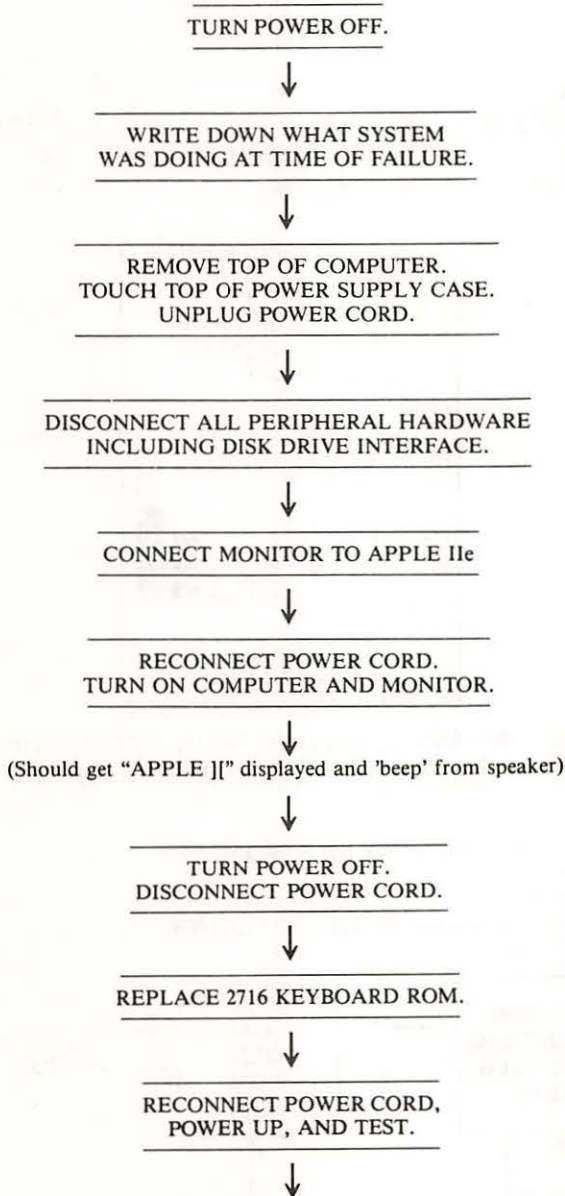

Fig. 7-45. Circuitry affected.

SYMPTOM: Bad key action — prints wrong characters

Problem	Possible cause	Repair action
Characters not generated properly	Bad 2716 ROM at location E12	Replace and test
Character data blocked	Bad AY3600 at E14	Replace and test

Troubleshooting Procedure



Circuitry Affected

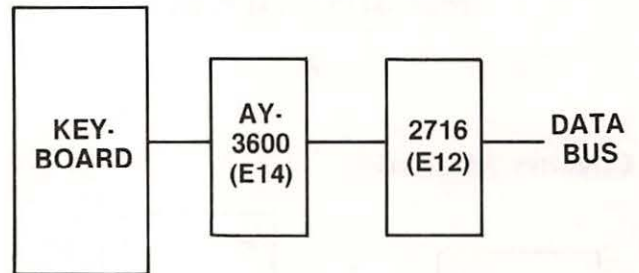

Fig. 7-47. Circuitry affected.

Chip designation	Description	Location
2716	Character generator ROM	E12
AY3600	Keyboard decoder	E14

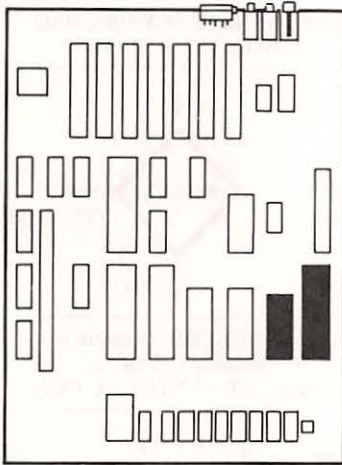
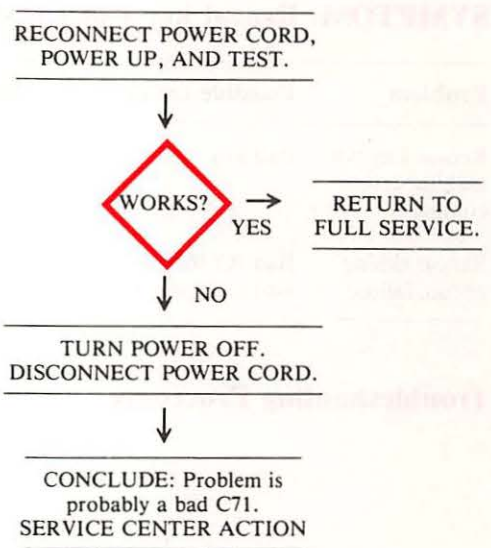

Fig. 7-48. Chip location guide. This represents the Apple motherboard and is a guide to help you find the chips of interest.



SYMPTOM: Bad key action – unwanted repeat

Problem	Possible cause	Repair action
Keybounce	Bad AY3600 at E14 Bad capacitor C71	Replace and test Replace C71 (requires soldering)

Troubleshooting Procedure

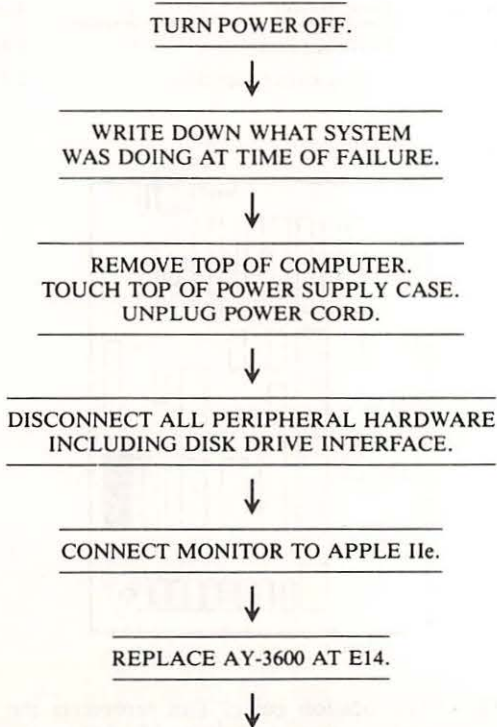

Circuitry Affected

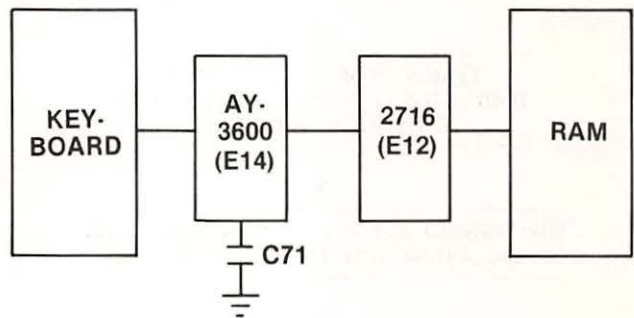

Fig. 7-49. Circuitry affected.

Chip designation	Description	Location
AY3600	Keyboard decoder	E14
C71	Debounce capacitor	E14

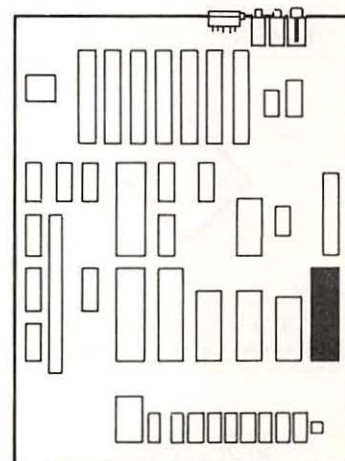
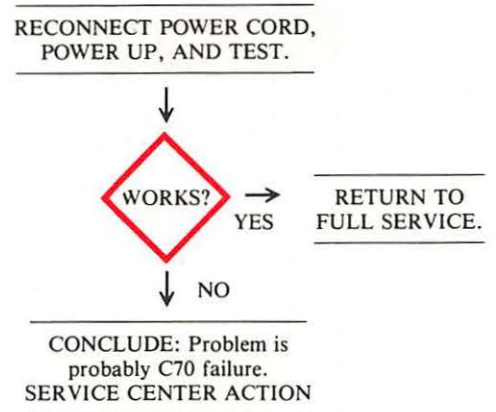
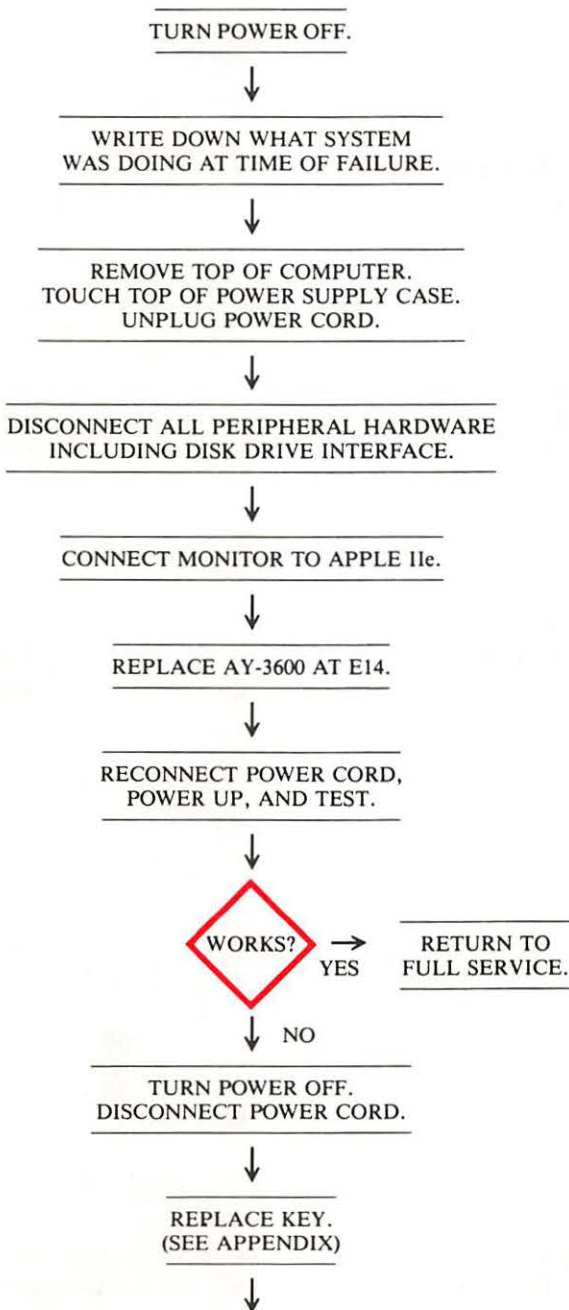

Fig. 7-50. Chip location guide. This represents the Apple motherboard and is a guide to help you find the components of interest.

SYMPTOM: Repeat key won't work

Problem	Possible cause	Repair action
Repeat key not making proper contact	Bad key	Replace key
Repeat timing circuit failure	Bad AY3600 at E14 Bad capacitor C70	Replace and test Replace and test

Troubleshooting Procedure



Circuitry Affected

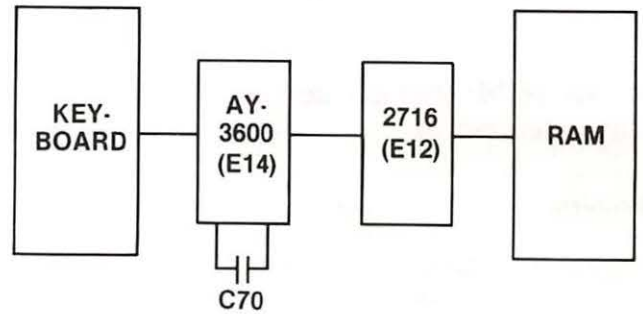

Fig. 7-51. Circuitry affected.

Chip designation	Description	Location
AY3600	Keyboard decoder	E14
C70	Timing circuit capacitor	E14

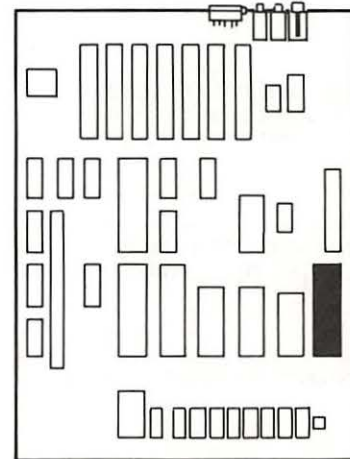

Fig. 7-52. Chip location guide. This represents the Apple motherboard and is a guide to help you find the components of interest.

SYMPTOM: Key top pops off

Problem	Possible cause	Repair action
Key top loose	Excessive use	Replace key
	Mishandling	Put top back on.
	Bad key	Replace key

NOTE: The above applies to all keys on the Apple IIe keyboard.

Troubleshooting Procedure

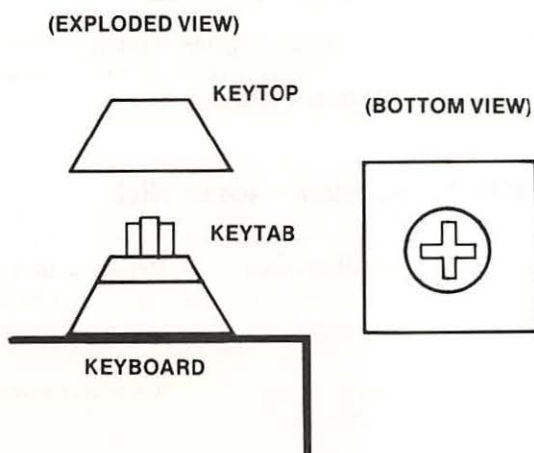
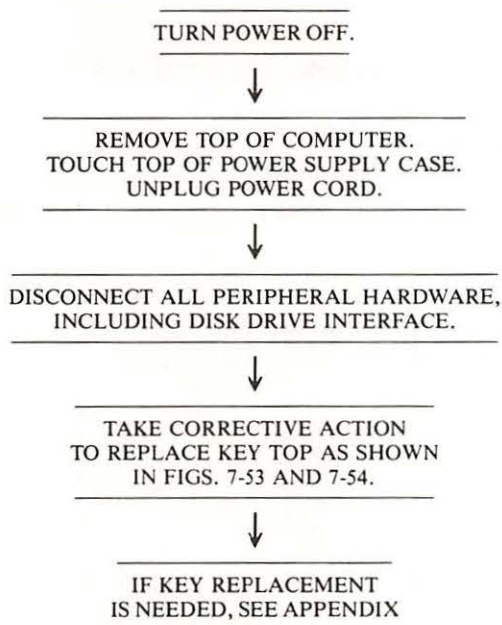

- 1) INSERT KEYTAB IN KEYTOP
- 2) PRESS KEYTOP DOWN

Fig. 7-53. Character key top replacement

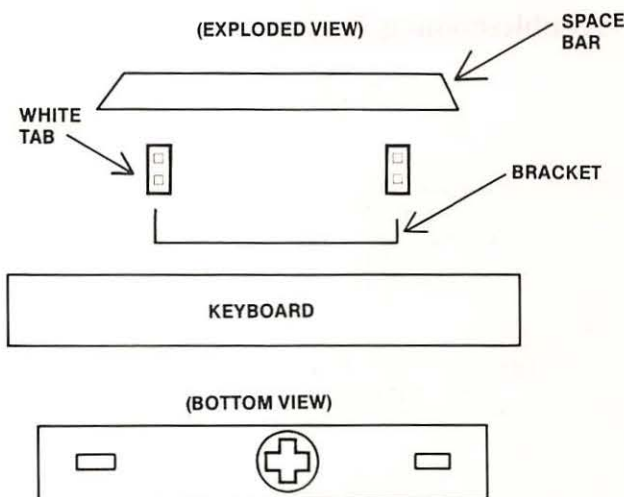

- 1) FIRST INSERT WHITE TABS IN SPACE BAR
- 2) THEN INSERT BRACKET ENDS IN HOLE ON WHITE TABS WHILE THE BRACKET IS STILL IN KEYBOARD
- 3) INSERT OTHER END OF WHITE TABS IN SLOTS IN KEYBOARD
- 4) THIS MAY TAKE PATIENCE, SELF CONTROL, AND SKILL

Fig. 7-54. Space bar key top replacement

5. OTHER INPUT/OUTPUT PROBLEMS

Symptom Category	Page
Speaker	
Volume too low	175
Won't click	176
Cassette	
Can't load data	178
Can't write data	179
Game paddle	
Won't work at all	180
Button won't work	181
Knob doesn't work correctly	182
Card in peripheral slot won't work	183

This section is a compilation of the most common problems experienced in the input/output category.

SYMPTOM: Speaker – volume too low

Problem	Possible cause	Repair action
Amplifier output weak	Transistor Q5 (MPSA13) marginal	Replace and test (requires soldering)

Troubleshooting Procedure

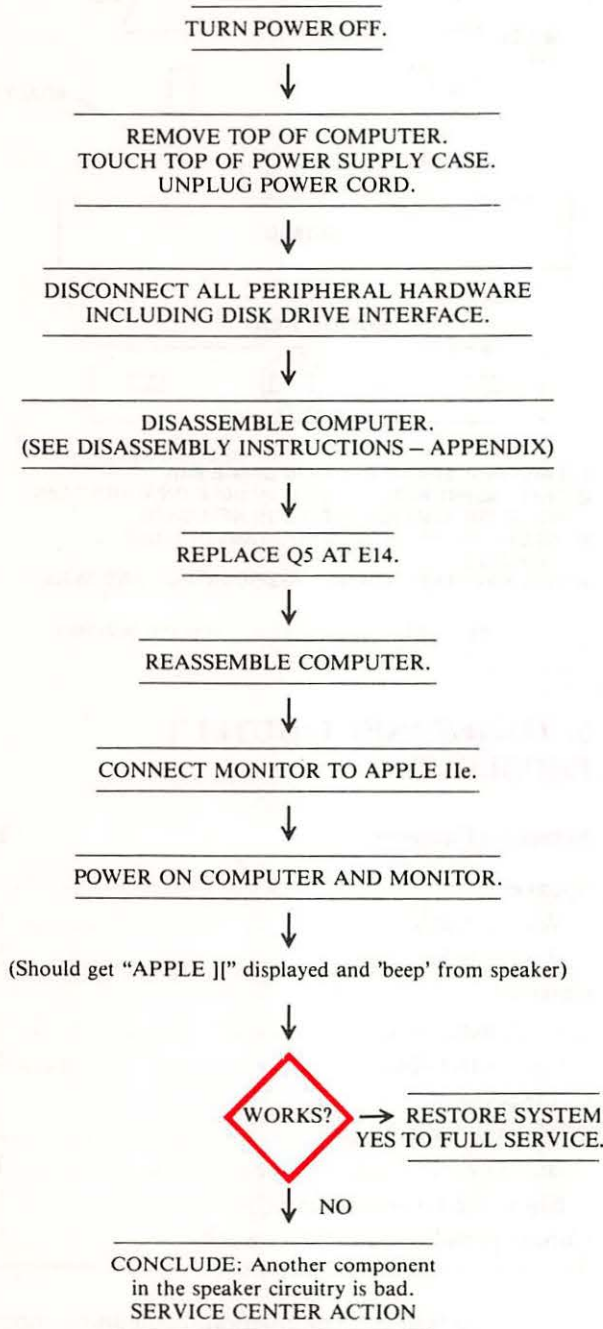

Circuitry Affected

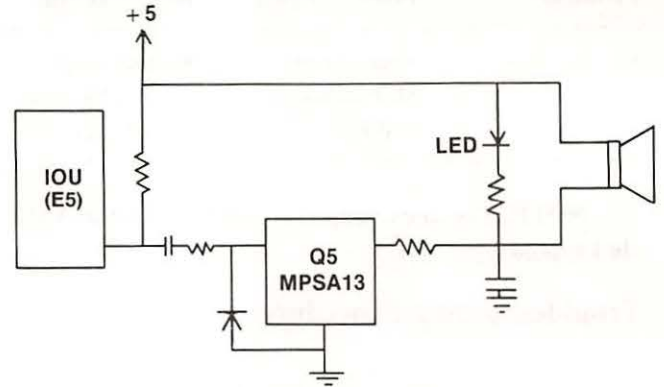

Fig. 7-55. Circuitry affected.

Component designation	Description	Location
MPSA13	Transistor amplifier	E14

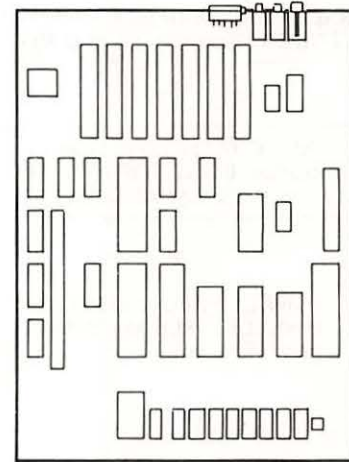
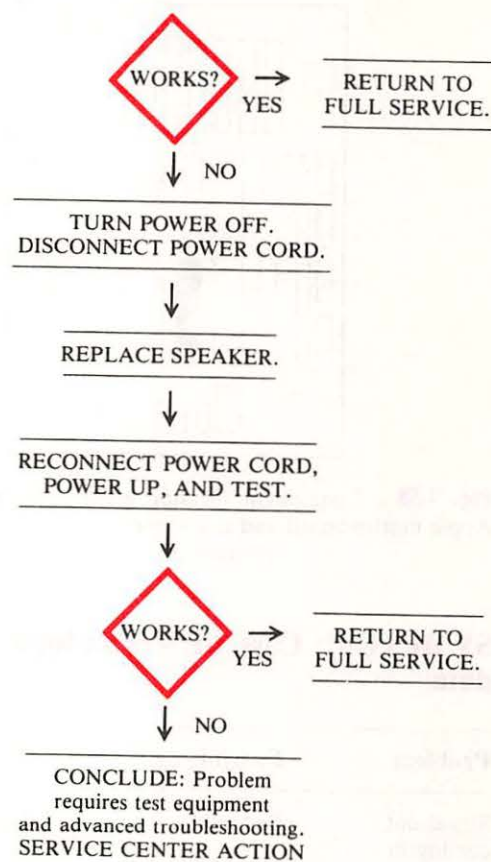
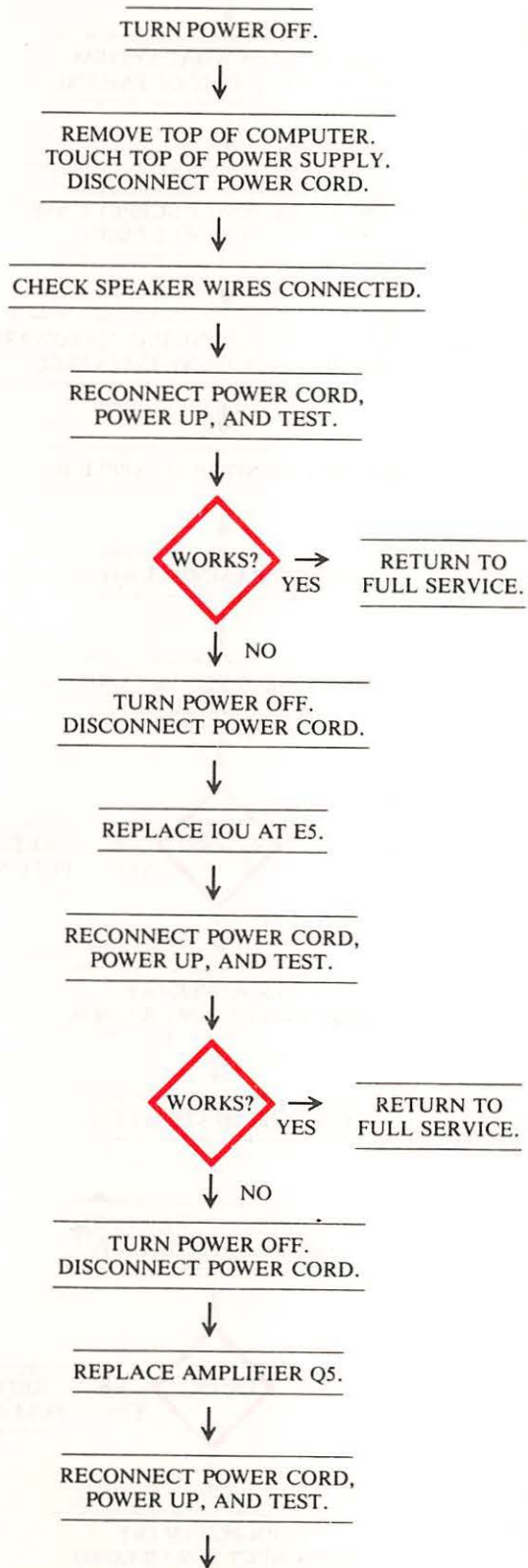

Fig. 7-56. Component location guide. This represents the Apple motherboard and is a guide to help you find the component of interest.

SYMPTOM: Speaker – won't click

Problem	Possible cause	Repair action
Speaker cone won't respond	Bad speaker	Replace speaker
No signal from amplifier to speaker	Speaker wires disconnected	Reconnect wires
	Bad MPSA13 (Q5) at location E14	Replace and test (requires soldering)
	Bad IOU at E5	Replace and test

Troubleshooting Procedure



Circuitry Affected

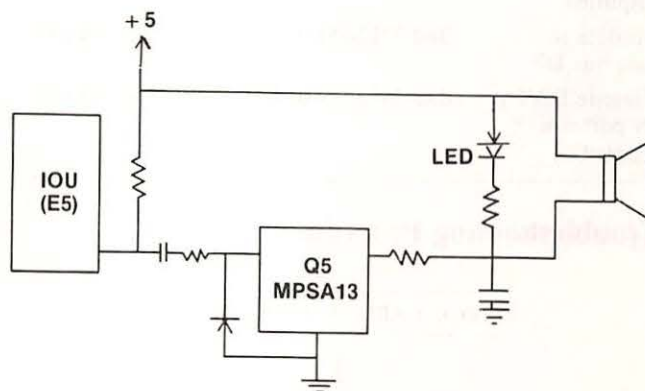

Fig. 7-57. Circuitry affected.

Component designation	Description	Location
MPSA13	Transistor amplifier, Q5	E14
IOU	Input/output unit	E5

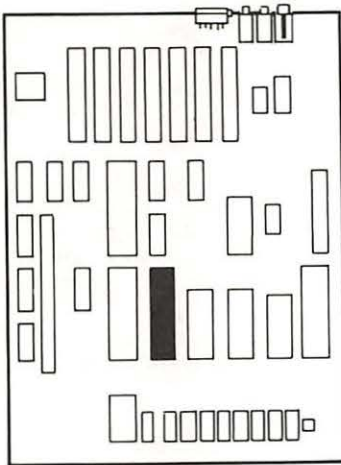
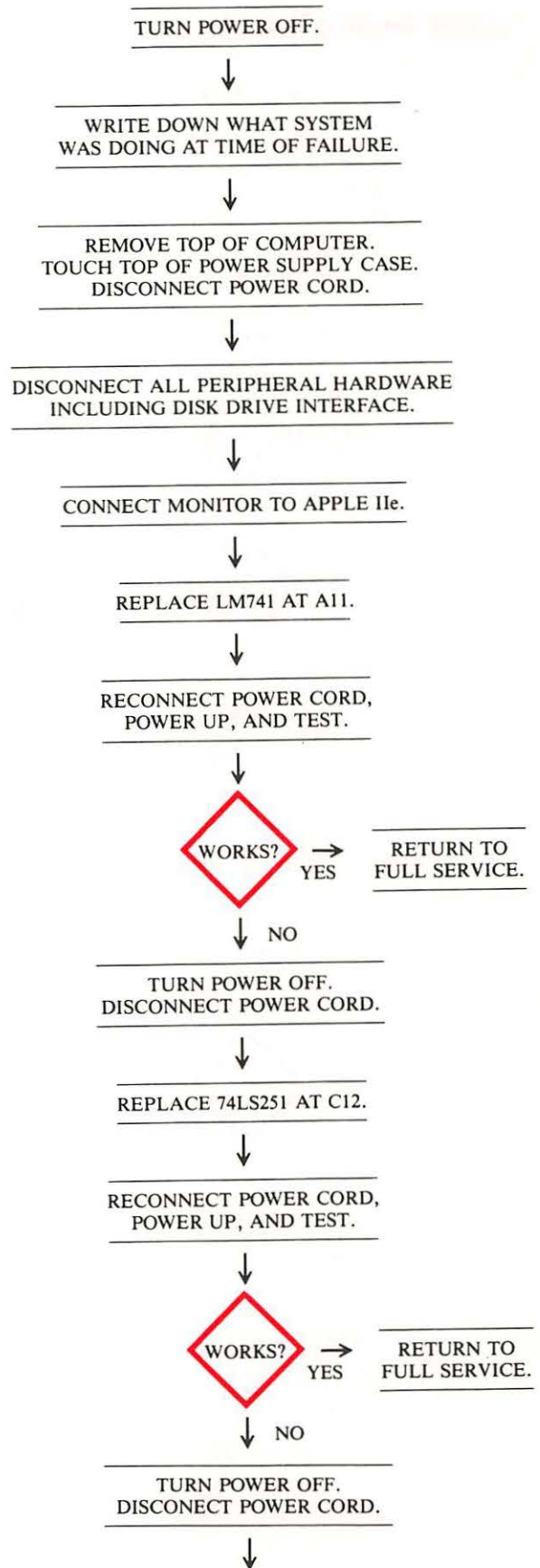
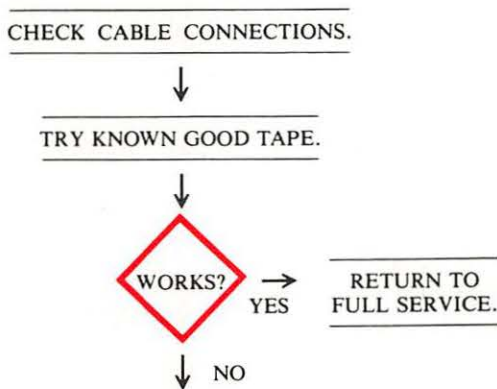

Fig. 7-58. Component location guide. This represents the Apple motherboard and is a guide to help you find the components of interest.

SYMPTOM: Cassette – can't load data

Problem	Possible cause	Repair action
Signal not coming in from cable	Bad cable	Replace cable
	Volume not set properly	Adjust tape recorder volume
	No signal on tape	Replace bad tape
Signal not amplified	Bad LM741 at A11	Replace and test
No data to data bus D7	Bad 74LS251 at C12	Replace and test
Cassette DATA IN port not selected	Bad 74LS154 at C10	Replace and test

Troubleshooting Procedure



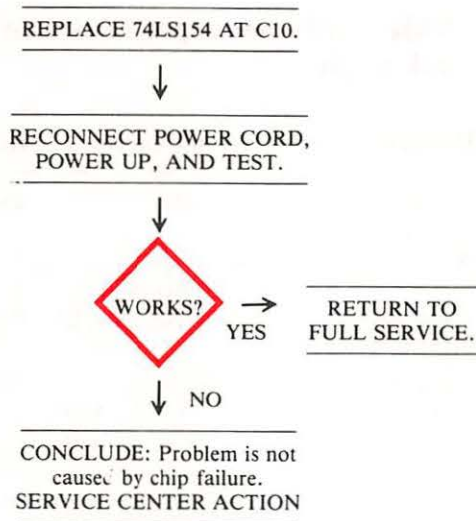

SYMPTOM: Cassette – can't write data

Problem	Possible cause	Repair action
No signal to tape	Bad cable connection	Reconnect or replace cable
Tape not working	Bad tape	Replace tape
Signal not being sent	Bad IOU at E5	Replace and test

Troubleshooting Procedure

Circuitry Affected

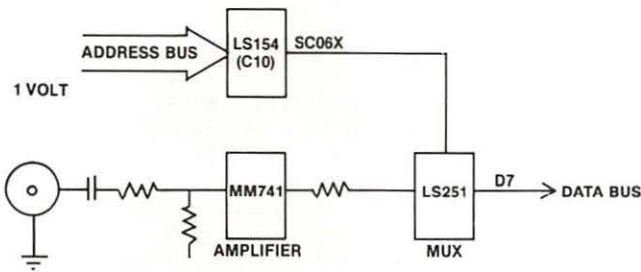

Fig. 7-59. Circuitry affected.

Chip designation	Description	Location
LM741	Operational amplifier	A11
74LS154	1/16 decoder – demultiplexer	C10
74LS251	Tri-state 8-input multiplexer	C12

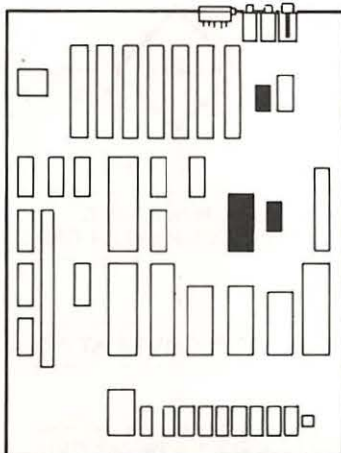
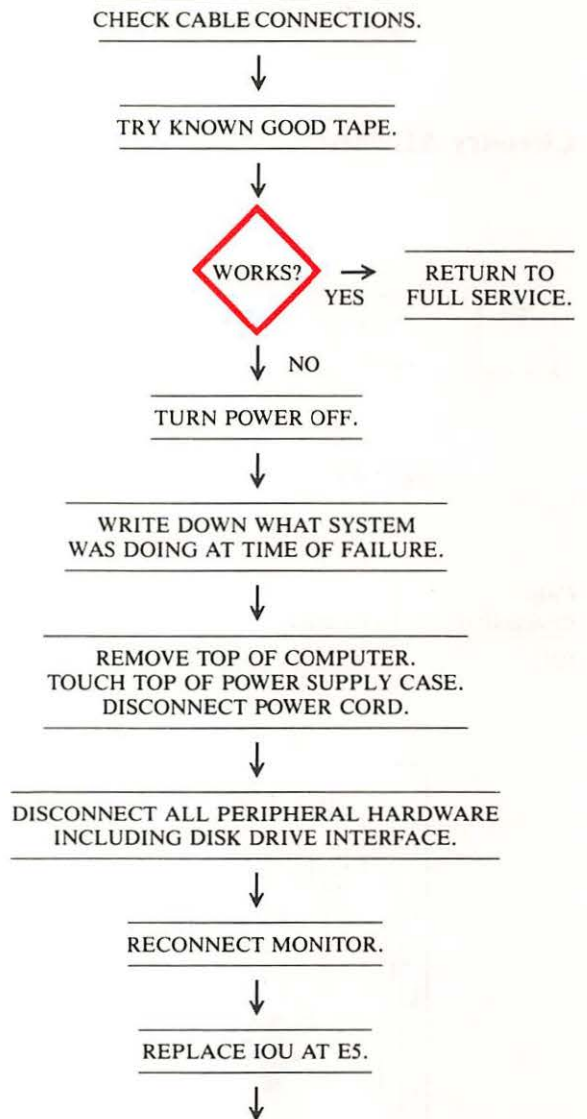
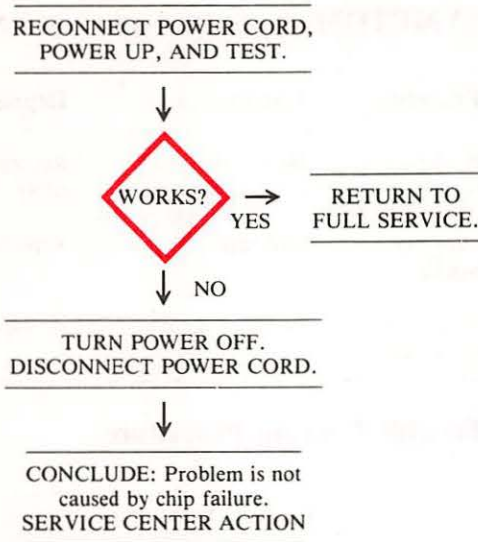

Fig. 7-60. Chip location guide. This represents the Apple motherboard and is a guide to help you find the chips of interest.



(Continued)



SYMPTOM: Game paddle – won't work at all

Problem	Possible cause	Repair action
Signals not getting to Apple IIe	Bad cable Bad 558 timer at location A12	Replace cable Replace and test.
Game port not being accessed	Bad 74LS251 at C12	Replace and test
Signal not put on data bus D7	Bad 74LS251 at location C12	Replace and test
No strobe to paddle	Bad 74LS154 at C10	Replace and test

Troubleshooting Procedure

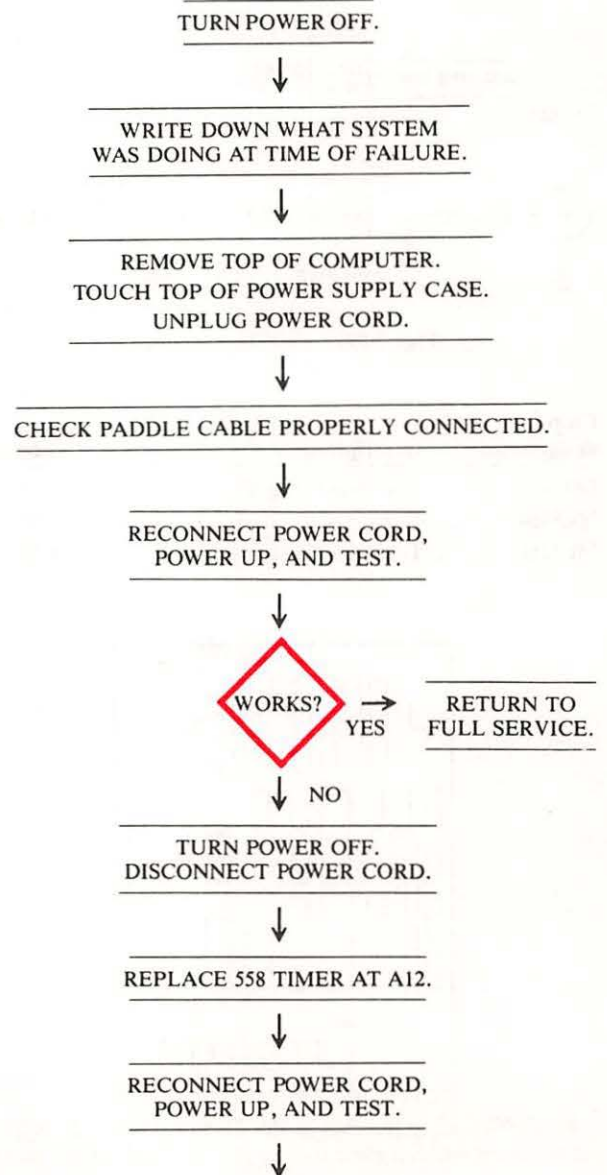

Circuitry Affected

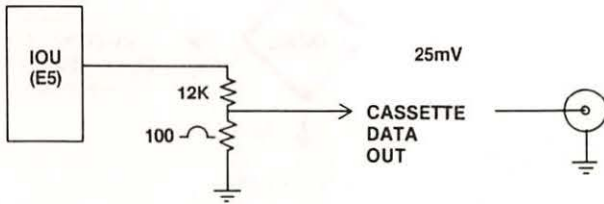

Fig. 7-61. Circuitry affected.

Chip designation	Description	Location
IOU	Input/output unit	E5

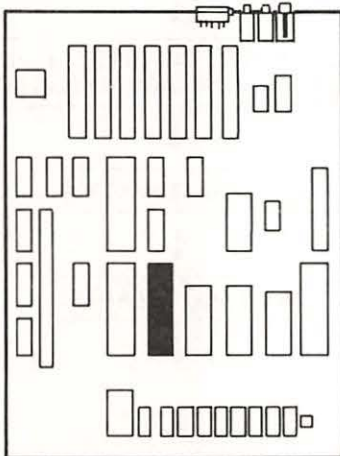
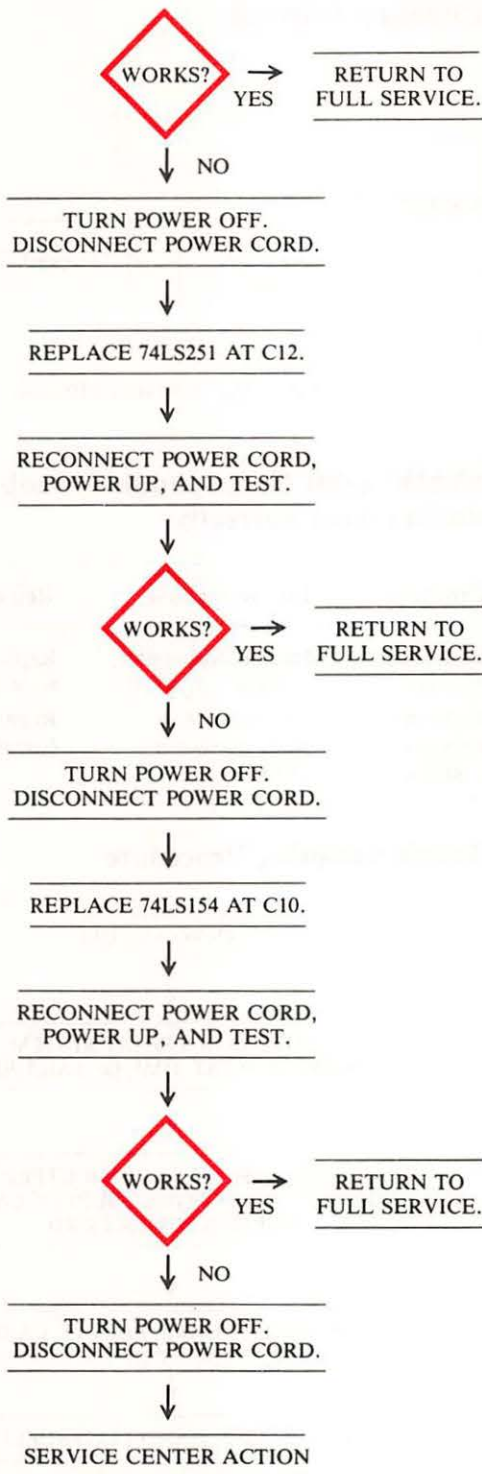

Fig. 7-62. Chip location guide. This represents the Apple motherboard and is a guide to help you find the IOU chip.



Circuitry Affected

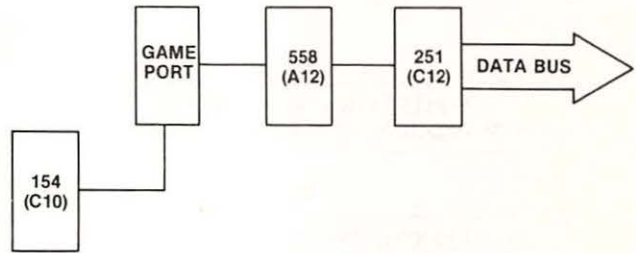

Fig. 7-63. Circuitry affected.

Chip designation	Description	Location
NE558	Quad timer	A12
74LS154	1/16 decoder/demultiplexer	C10
74LS251	Tri-state 8-input multiplexer	C12

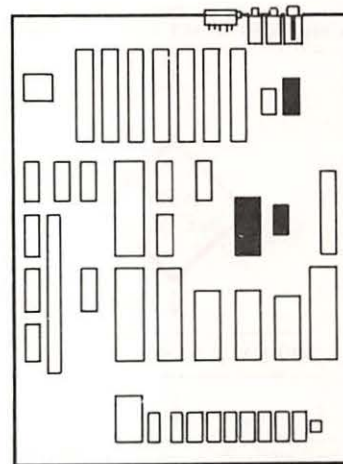
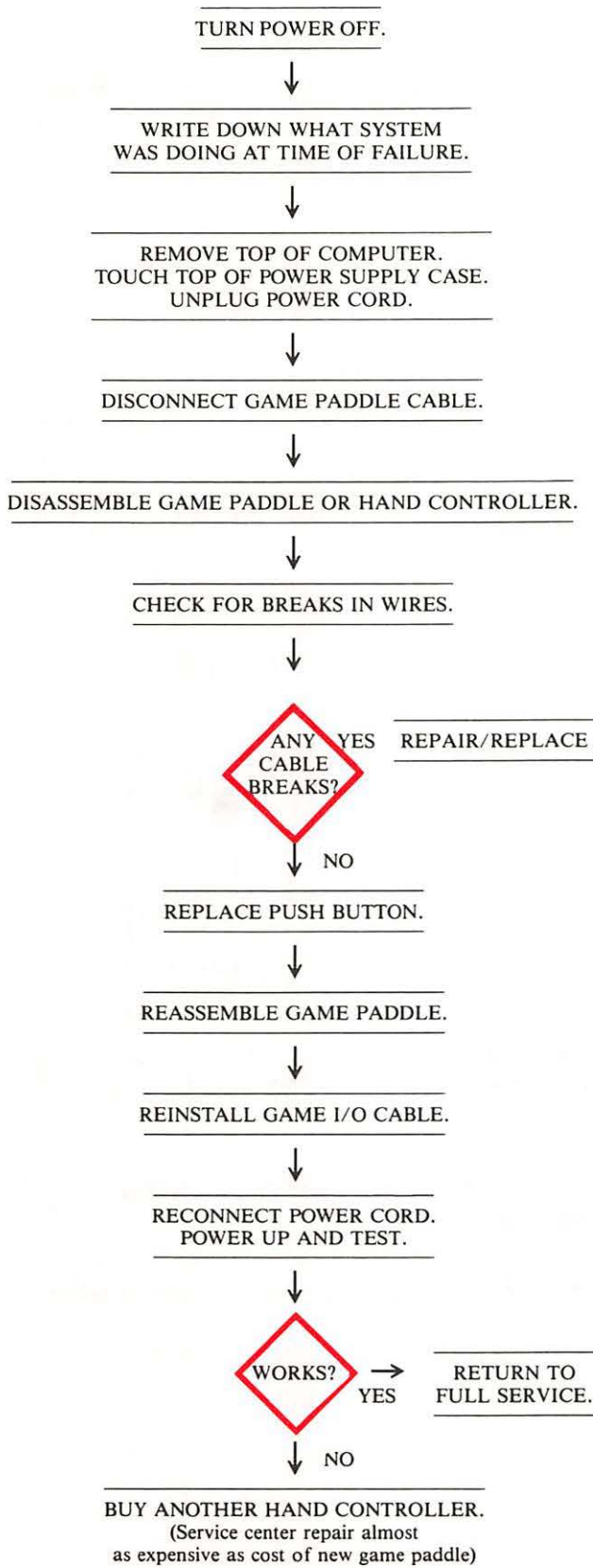

Fig. 7-64. Chip location guide. This represents the Apple motherboard and is a guide to help you find the chips of interest.

SYMPTOM: Game paddle – button won't work

Problem	Possible cause	Repair action
No signal from button	Bad push button in game paddle	Replace push button
	Broken wire in cable	Repair wire (requires soldering)

Troubleshooting Procedure



Circuitry Affected

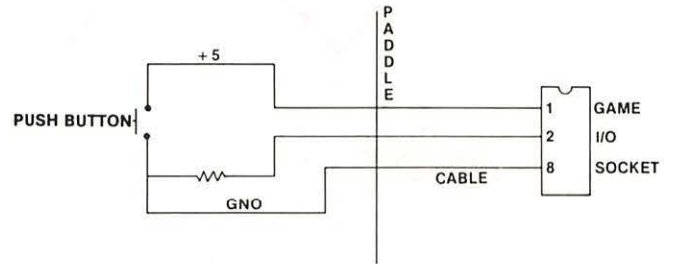
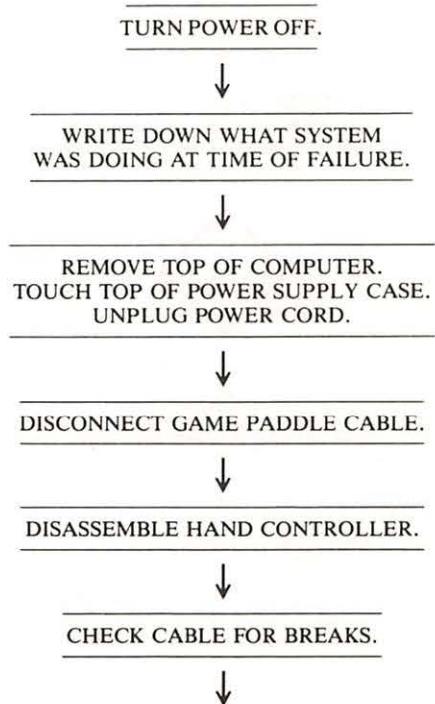

Fig. 7-65. Circuitry affected.

SYMPTOM: Game paddle – knob doesn't work correctly

Problem	Possible cause	Repair action
Resistance incorrect	Bad potentiometer in hand controller	Replace pot (requires soldering)
Signal not getting to computer	Broken wire in hand controller or cable	Repair or replace (requires soldering)

Troubleshooting Procedure



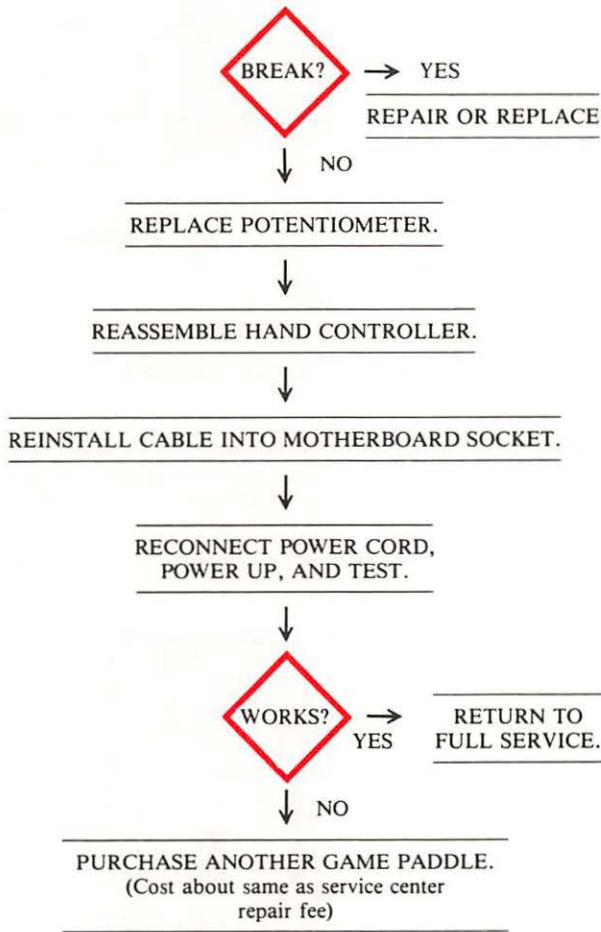

Circuitry Affected

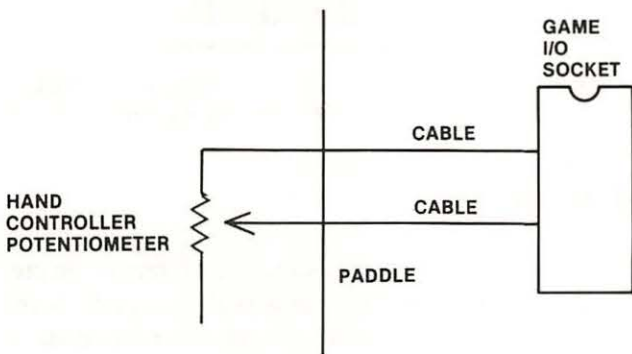

Fig. 7-66. Circuitry affected.

SYMPTOM: Card in peripheral slot won't work

Problem	Possible cause	Repair action
Slot not being accessed	Bad 74LS138 at B5 Bad 74LS154 at C10 Bad 74LS10 at C5	Replace and test Replace and test Replace and test

Bad card Bad component on peripheral card Repair or replace

Troubleshooting Procedure

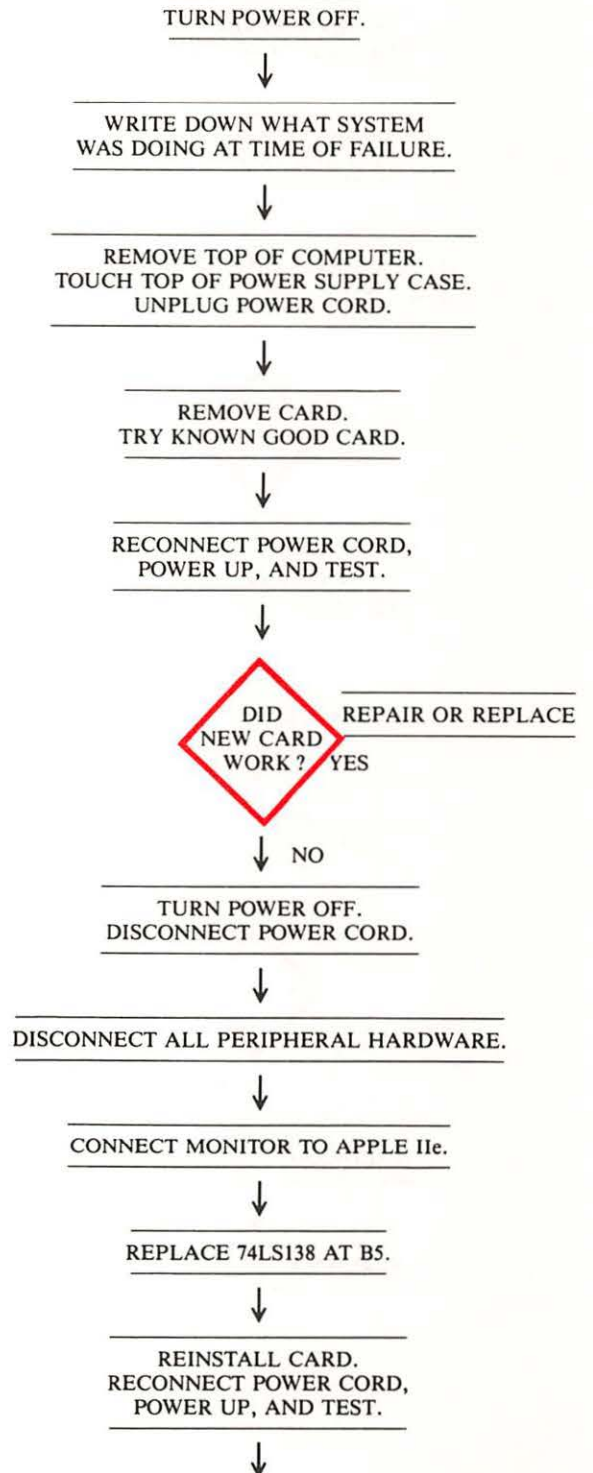

(Continued)

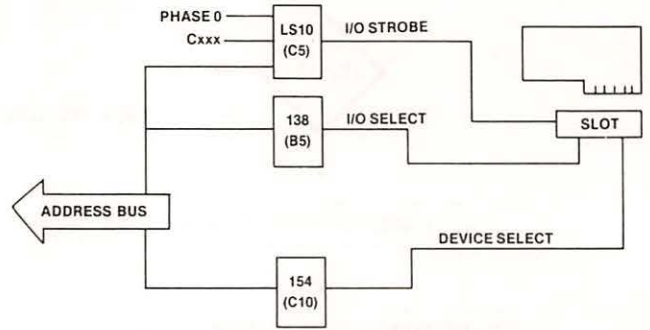
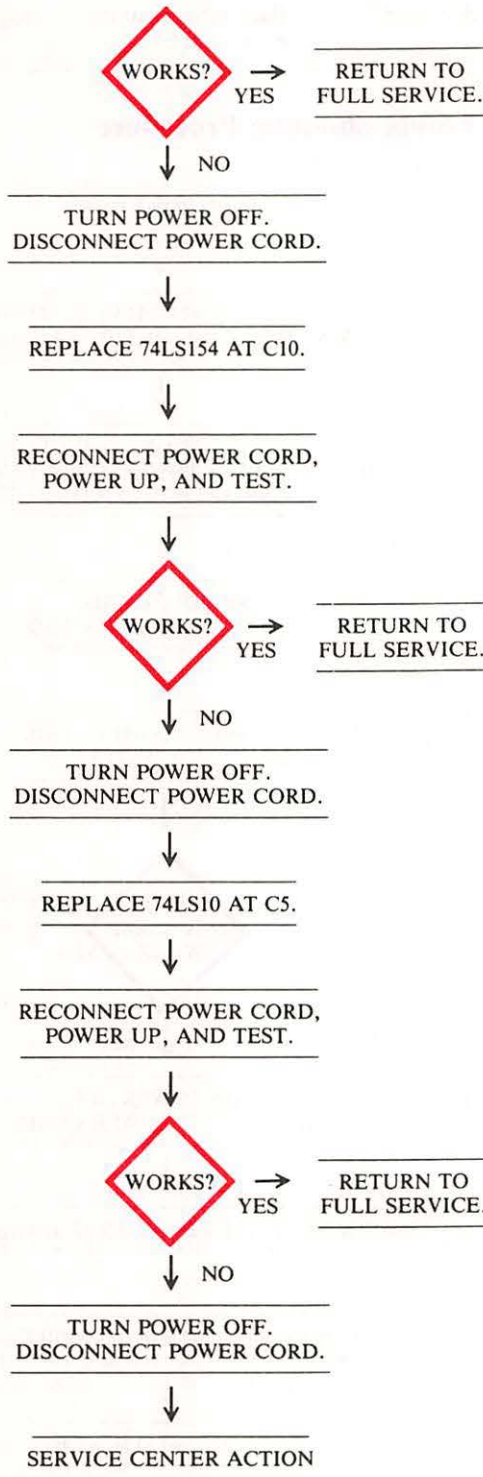

Fig. 7-67. Circuitry affected.

Chip designation	Description	Location
74LS10	Triple 3-input NAND gate	C5
74LS138	Expandable 3/8 decoder	B5
74LS154	1/16 decoder/demultiplexer	C10

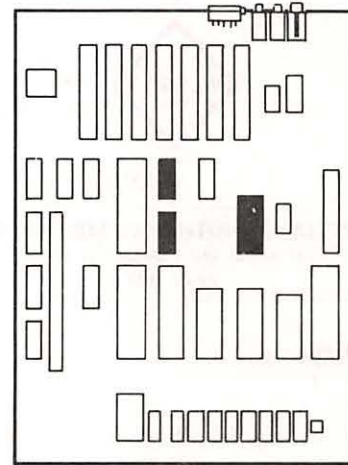

Fig. 7-68. Chip location guide. This represents the Apple motherboard and is a guide to help you find the chips of interest.

SUMMARY

This detailed troubleshooting and repair chapter has covered most of the general problems encountered by owners (and repairers) of computer systems. If following one of the guides in this chapter doesn't solve the problem, you can take the final step (listed as Service Center Action) yourself if you feel qualified. Chapter 9 will provide assistance if you decide to really dig into your machine.

CAUTION: Only experienced technicians should work on power supply and monitor problems.

Don't forget to absorb the information in Chapter 8, "Routine Preventive Maintenance." The information provided there can help prevent many of the problems analyzed for repair in this chapter.

Routine Preventive Maintenance

In Chapters 4 and 7 we stepped through detailed troubleshooting and corrective maintenance of the Apple II Plus and Apple IIe. Chapter 8 discusses another type of maintenance, one that is intended not to *fix* a problem but rather to prevent a problem from ever happening. Preventive maintenance is in every way as important as corrective maintenance. In this chapter you'll learn what factors damage your computer and cause it to fail, and what you can do to prevent these failures.

Often, the price you pay to buy your computer system is actually a small part of the overall system cost. The life-cycle cost of the equipment can be much larger than the initial purchase investment. This total cost increases dramatically as the costs for software, books, magazine subscriptions, those extra interface boards, disks, and service center repair charges are added in. Service costs can grow to 10 to 50 percent of your system cost.

Occasionally we find a repair expense that exceeds the value of the equipment that is broken. It's when we look at high repair costs that terms like *mean time between failures (MTBF)* and *mean time to repair (MTTR)* become important. While your Apple has an excellent reliability track record, the way you operate your machine and the environment in which you place it

become important to that MTBF number. Another factor to consider is that those "bargain" interfaces and peripherals that you bought at such a low cost probably have a less than excellent reliability record. You get what you pay for.

Your Apple computer is sturdy and fast, and it performs work easily and accurately. Under most operating conditions, Apples are indeed very reliable machines. But, like other machines, they wear out and fail.

As your experience with computers grows and the computer becomes more and more essential in your home and business, your need for uninterrupted computer power increases. The power of the computer can be seen in the impact it has on us when it breaks down. If you have to take your computer to a repair shop, you can expect your machine to be gone for one to three weeks, although most problems can be fixed within a day.

Most large companies take steps to protect their huge computer and data processing investment. Accidents and unnecessary failures cost thousands of dollars in lost business. A small business, with a single microcomputer, two disk drives, and a printer, faces just as catastrophic a loss by system failure, yet most don't take steps to prevent such failures.

Computers don't burn out. They wear out or are

forced out by human error or adverse operating conditions. If you misuse your computer or don't protect it from the environmental elements, *you* can be the cause of its failure.

A few moments of care can result in many more hours of good, consistent performance. We call this care *preventive maintenance*, or just *PM*. Just as you periodically check the oil and water in your car's engine, and lubricate, wash, and wax the body to keep it running right, so you should care for and protect your computer.

Futurists today feel that there are three major kinds of items each of us will purchase in our lifetime — a house, a car, and (now) a computer. Each is a major investment. Each deserves to receive good care. You can get good, reliable operation from your computer for many months, if not years, if you provide timely and proper maintenance to keep the system in peak condition.

CONTRIBUTORS TO SYSTEM FAILURE

Proper PM begins with an understanding of what we are fighting. Six factors can influence the performance of your Apple computer (not including the disk-eating dog or the floppy-bending baby):

- Excessive temperature
- Dust build-up
- Noise interference
- Power-line problems
- Corrosion
- Magnetic fields

Each acts to cause computer breakdown. This chapter tells how to successfully battle these enemies of reliable performance.

Heat

As you learned earlier, the chips and other devices in your computer are sensitive to high temperatures. During normal operation, your Apple generates heat that is generally tolerable to the circuitry. Usually, leaving your Apple on for long periods won't hurt it because the slots and air vents let enough of the heat dissipate to the outside of the case. As long as the components on the motherboard are not too hot to touch, the amount of heat being produced should not cause any damage. However, heat can become a problem when you begin

adding interface boards. The power supply has plenty of voltage margin and is protected against overload, but with increased power demand it also produces more heat. The design of the Apple case, with the motherboard lying flat, provides an open space for hot air to rise, but the air has a tendency to hang over the board rather than moving out through the vents. Adding interface cards into the slots further restricts any natural convection air flow, and the components get even warmer. And the power supply heats up more as it pumps out even more current to power the stacks of interface cards. The cards, the power supply, and the motherboard all give off heat, and the inside temperatures soar.

In the Apple II Plus with a disk controller card, a language card, a printer interface card, an 80-column card, and a CP/M card, heat can become a problem. The biggest source of heat is the CP/M card, which can get downright warm. If you put any more than three boards in the Apple II Plus, you should install a cooling fan. The Apple IIe has less of a tendency to overheat, primarily because the IIe uses fewer and cooler chips on the motherboard.

Excessive heat within a component causes premature aging and failure. The heat produced during operation is not uniform across the device, but appears at specific locations on the chip (generally at the input/output connectors where the leads meet the chip itself). The usual effects of heating and cooling are to break down the contacts or junctions in the chip or other device, causing open circuit failure. The RAM chips are the components most affected by heat. When hot, these devices can produce intermittent "soft errors," with loss of or incorrect data. This effect is known as "thermal wipeout," and is a chronic problem in loaded systems that aren't externally cooled. The continual heating and cooling action during normal operation also causes the chips to work themselves out of their sockets.

Heat can also contribute to disk failure. Disks, those inexpensive yet extremely valuable platters, act just like your stereo records when exposed to heat, especially the heat of the sun. If you leave your disks sitting in a hot car, you can be sure some warpage will occur. If the thin disk warps too much, you will lose whatever information you stored on that floppy. You could try to set it flat in the sun and hope to "warp" it back into shape, but the success rate for this "repair" isn't very high.

The following suggestions should help in preventing heat-related failures:

- Reseat the chips every 6 months (earlier if intermittent failures occur).
- Install a cooling fan if the system has three or more cards installed.
- Keep the cooling vents clear.
- Keep your system dust free inside and outside. Do your PMs (preventive maintenance actions) regularly.
- Keep your disks in a cool, dry location.

Cold

The effect of cold on computers is an interesting subject. The U.S. government is funding work on super-fast computers that operate supercold. Electronic components operate quite well in cold temperatures, but mechanical components have trouble functioning when the temperature drops. Take disk drives, for example. The operating range for a standard floppy disk drive is approximately 40 degrees F to 115 degrees F. At the low end, mechanical sluggishness occurs, with an increased possibility of erratic data storage and retrieval. The floppy disk itself can become brittle as it gets cold.

The rule of thumb for cold temperatures is to let the system warm up to room temperature (stabilize) before turning on the power. If the temperature is comfortable for you, it's fine for the system.

Dust and Other Particles

Just like flies at a picnic, dust seems to descend on computer equipment. Interestingly, the dust is attracted to the display monitor in the same manner as it is to a television screen. If the dust is not cleaned from the screen, it will build up, and eventually someone will rub it and mar the screen surface.

The static electric charge that builds up in the computer and the display monitor attracts dust and dirt. That's why large computer systems are kept in cool, clean computer rooms. They require special air conditioning and dust-free spaces because the large equipment generates more heat and is just as susceptible to failures caused by dust build-up.

Dust and dirt build-up insulate the circuit devices and prevent the release of the heat generated during normal operation. If the devices can't dissipate this heat, the inside temperature rises higher than normal, causing the chips and other components to wear out even faster. Dust is a major contributor to memory chip failure. Dust seems to be attracted to heat. Have you ever noticed that dust builds up on light bulbs in your lamps or

on the tops of stereos and televisions more than it does on cooler objects? The dust particles are charged and are attracted to the magnetic field around electrical equipment. Your computer system problems increase in direct proportion to the increase in dust build-up.

Mechanical devices such as printers and disk drives fail more often than solid-state electronic devices because mechanical and electromechanical devices have moving parts that get dirty easily, causing overheating and earlier failure. Look inside your printer and you'll see the kinds of dirt and dust that are collecting. Paper sheds tiny particles as it moves through the printer. These particles become insulators to prevent the heat generated during normal operation from escaping off the equipment and into the air.

Disk drives have more dust-related problems than printers because they are designed with read/write heads that operate on or slightly above the diskette. The space between the head and the disk is small. When the head rides on the disk surface, dust and dirt can cause major problems (see Fig. 8-1).

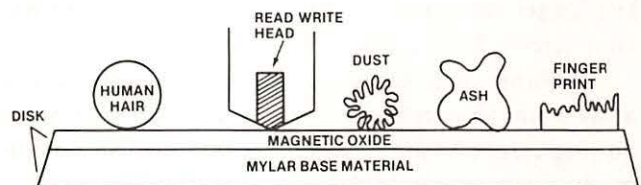

Fig. 8-1. Because the read head rides on the surface of the disk, any small piece of foreign material can cause problems.

Foreign particles such as dirt, smoke, ash, and tiny fibers can cause catastrophic problems in diskette jackets and in disk drives themselves. The air we breathe is full of airborne particles, but most of these are too small even to be seen, let alone to become a problem. The larger particles in the air cause computer system problems. Cigarette ash, for example, can settle on a disk surface and move from track to track inside the disk jacket, causing loss of data.

Inside the vinyl jacket surrounding each of your disks is a special lining that traps dirt and dust as the disk spins in the drive. This doesn't mean you can get careless about dust and dirt. Dirt on a disk can be swept off by the drive read/write head and can gouge out a path on the disk surface, or it can stick on the head and cause other disks to be gouged. The dirt can also cause the head itself to corrode and wear out.

Smoke from cigarettes and cigars can coat the internal surfaces of the disk drive with a gummy soot

that not only can produce data transfer errors, but can also interfere with the mechanical operation, further increasing the wear on the drive. Tobacco is also believed to cause rapid oxidation on pins and connectors, increasing the likelihood of intermittent errors. Most computer centers and computer rooms are off-limits for smoking.

Dust build-up can be controlled. Thoroughly cleaning your computer area every week will do much to keep your system in top condition. Dirt and dust can be removed from the equipment housings using a damp cloth lightly coated with mild soap. Be careful you don't wet or moisten the electronic components.

After washing the surface, I rewipe the outside of the equipment with a soft cloth dampened with a mixture of one part liquid fabric softener to three parts water. The chemical makeup of some liquid softeners is almost the same as antistatic chemical spray. Wiping the case and screen helps to keep static charges from attracting dust to the screen and tops of the hardware. The fabric softener is antimagnetic and prevents the attraction of dust. The chemicals in this inexpensive solution last longer than some antistatic sprays and help make your screens less susceptible to scratching.

Another quite successful technique is blowing dust away from the screen with a pressurized can of antistatic dusting spray, as shown in Fig. 8-2. Using this kind of product means you don't have to wipe your equipment off first. Wiping a screen should be done carefully, because you could scratch the screen if some hard dust or dirt particles are on the screen or your cloth.

The following are some manufacturer-recommended cleaning methods:

- Use one part fabric softener to three parts water to clean your screen.
- Use mild soap and water with a soft cloth for drying.
- Use a window cleaner spray. (NOTE: Although the monitor literature from several manufacturers recommends this, be careful. Common household aerosol sprays, solvents, polishes, or cleaning agents may damage your monitor cabinet and screen. The safest cleaning solution is mild soap and water.
- Another way to keep dust off is to use an anti-static spray.



Fig. 8-2. An antistatic spray for computer equipment. (Courtesy of Falcon Safety Products, Inc.)

Associated with cleaning advice, each manufacture also includes an important safety precaution:

CAUTION: Make sure the power is off and the plug(s) pulled out of the power socket(s). Use a damp cloth. Don't let any liquid run or get into your equipment.

You can use a long plastic nozzle on the end of your vacuum hose to reach in and around everything inside the hardware. Dust and small particles can be cleaned off the circuit board inside your Apple using a soft brush. Be careful you don't damage any of the parts. Brush lightly.

Another control measure is the use of dust covers. You may not have an air-conditioned, air-purified room in which to use your Apple, so dust covers become of paramount importance. Plastic covers, made static-free with an anti-static aerosol or by wiping the surface with the fabric softener-water mixture, will provide good dust protection for your system.

Here is a summary of ways to counter dust in your Apple system.:

- Use dust covers.
- Keep windows closed.
- No smoking near your Apple system.
- No crumb-producing foods near the computer.
- No liquids on *any* equipment.
- Don't touch the surface of any floppy disk.
- Vacuum the system and the area weekly.
- Clean your monitor screen with static-reducing material.

NOISE INTERFERENCE

Your Apple computer and its peripherals are sensitive to interference noise, which can affect the proper operation or transfer of information. But what is noise, and where does it come from? How can you get rid of it?

Noise can be described as those unexpected or undesired random changes in voltage, current, data, or sound. Noise is sometimes called "static." It can be a sudden pulse of energy, a continuous hum in the speaker, or a garbled display of characters.

Three types of noise cause problems: noise that affects you, the user (acoustic), noise that affects your Apple system, and noise that affects other electronic equipment. Acoustic noise includes, for example, the crying of a baby, the blare of an overpowered stereo, and the loud consistent tap-tapping of a computer printer. Noise that affects the computer and other equipment can be radiated, conducted, or received. It takes the form of electromagnetic radiation (EMR). EMR noise can be further classified as low- or high-frequency radiation, as shown in Fig. 8-3.

If the noise occurs in the 1 Hz to 10 kHz range, it is called *electromagnetic interference (EMI)*. If it occurs at a frequency above 10 kHz, it is called *radio frequency interference (RFI)*. RFI can occur in two forms: conducted RFI and radiated RFI.

If the RFI is fed back from the Apple through the power cord to the high voltage AC power line, it is classified as *conducted RFI*. In this case, the power line acts as an antenna, radiating the noise interference.

When your Apple system and its cabling transmit noise, this noise source is called *radiated RFI*.

EMI has three primary components:

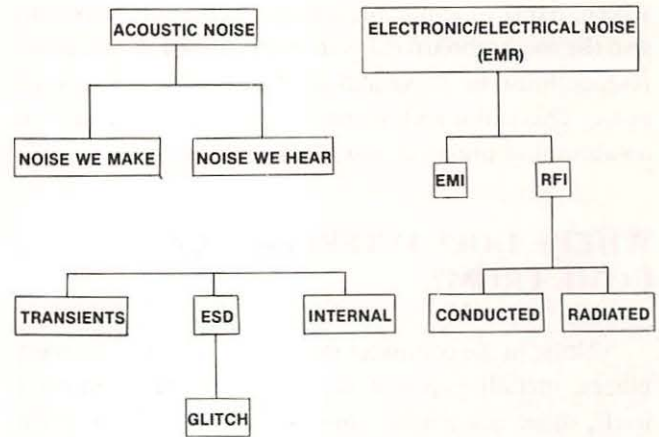

EMR – Electromagnetic radiation
 EMI – Electromagnetic interference
 RFI – Radio frequency interference
 ESD – Electrostatic discharge

Fig. 8-3. The various forms of noise that affect computer equipment.

- Transient EMI
- Internal EMI
- Electrostatic discharge (ESD)

Transients include the undesirable response in electrical equipment when simply turning a device on or off causes a large voltage pulse, or "spike," to occur and go smashing through the circuitry. Power line transients and electrostatic discharge from the human body are the two most severe forms of externally generated EMI.

Internal EMI is the noise generated within and by the chips and other motherboard devices. With current microelectronic designs, internal noise levels are so low that other factors such as connections and the length of leads have become the main source of noise in printed circuits. Internal noise *does* become a problem when the components are excessively heated or when the chips begin to fail.

The last form of EMI, the **electrostatic discharge (ESD)**, is the same as the effect you get from walking across a carpet and then getting shocked upon touching a metal doorknob. ESD can cause the notorious "glitch" in electronic circuits.

All these types of noise interference can produce undesirable or damaging effects in your Apple systems. They can cause programs to stop in the middle of an operation, garbage to be read from or written to disks, garble to appear on the screen, cursors to freeze, diagonal lines to appear on the television or monitor

screen, paper to jam in the printer, memory to wipe out, and the motherboard chips to be destroyed. Noise interference must be prevented by reducing or eliminating noise. This is not an insurmountable challenge, but it is a substantial practical and analytical task.

WHERE DOES INTERFERENCE COME FROM?

Noise in the computer system can originate in many places, including power supplies, fans, the computer itself, other equipment, connectors, cables, fluorescent lights, lightning, and electrostatic discharge. The use of high-powered components in switching power supplies has led to widespread problems with noise being conducted back into the power lines. Switching power supplies have been found to generate EMI in the 10–100 KHz frequency range.

Noise can even be passed or coupled to nearby equipment that's on a totally different circuit and not physically connected to your system. If two wires lie next to each other, one can pick up signals coupled across from the other. This is known as "crosstalk." Just 10 volts of electricity on one wire will cause a measurable (0.25 volts) on the other wire. Imagine how much crosstalk there could be if the voltage were increased to 100 volts. The induced voltage on the other wire would be 2.5 volts, which is enough to change information in a stream of data being sent through that second wire.

Everything has some capacitance associated with it. Some typical capacitance values are shown in Table 8-1. Engineers have found that even 0.1 pF of capacitance can produce 5-volt spikes in digital circuits such as those found in the Apple II Plus and Apple IIe.

Table 8-1. Typical Capacitance Values

Source	Capacitance
People	700.0 pF
A ½ watt resistor	1.5 pF
Connector (pin-to-pin)	2.0 pF

Power-line noise can feed into the computer circuits whenever it exceeds the blocking limits of the power supply. Nearby high voltage machinery such as stamping mills, saws, air-conditioning units, or clothes dryers can produce strong magnetic fields in the area around them and their power cords.

Cables that vibrate and move in a magnetic field

can also cause problems. Relays and motors can produce high voltage transients when they are turned on or off. And televisions and radios can be affected by noise coming from the computer system.

Any digital circuit that uses a clock signal will emit or radiate interference off the cables connected to that circuit. The Apple II CPU operates at a clock speed slightly over 1 MHz – inside the frequency range of radio and television signals. (Recall that RFI covers *all* noise that occurs at frequencies above 10 KHz.) If the Apple system were not designed to correct for this type of RFI, the CPU broadcast transmissions would interfere with the normal operation of nearby radios and televisions.

NOTE: Televisions on cable service would not be affected because the shielded cable allows only the cable TV program signals to get into the TV antenna input.

Finally, EMI can come from industrial, medical and scientific equipment, electric motors, home appliances, drills, saws, and tool speed controls.

It's important to understand noise and how it can be generated. Our computer systems must be able to operate without causing interference with other nearby electronic equipment. They must be able to function without radiating noise; and they must be able to function even in an environment that includes noise being introduced from outside sources.

NOISE INTERFERENCE COUNTERMEASURES

The most effective approach to noise reduction is prevention. If you can't prevent noise, you can at least take steps to minimize its impact.

Five methods for dealing with noise are shown in Fig. 8-4. Usually, the approach taken is a combination of these methods, although filtering and shielding are the most widely used ways to protect electronic equipment. Filtering involves the use of capacitors and inductors. There are many kinds of filters that respond to voltage, current, and frequency. For example, one kind of filter prevents high-frequency voltage spikes from leaking out of a switching power supply into the circuitry being supported.

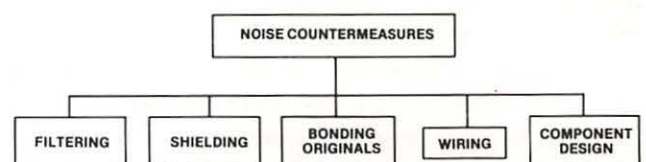

Fig. 8-4. Five ways to counter noise interference.

The following paragraphs present countermeasures used to prevent the various forms of noise interference.

Audible Noise

Most microcomputer systems don't generate enough audible noise to require acoustic shielding or enclosure. The normal busy office can generate about 80 dB of noise. The noisiest part of a computer system is the printer. Most printers don't exceed 70 dB of noise, but the type of noise (tap-tap printing) can become so irritating that many companies purchase insulated sound-trapping enclosures that fit over the printers and cut the noise output in half. If you have installed a cooling fan in your Apple, it can be another source of audible computer system noise.

Some computer users place acoustic sound-absorbing foam around their computer system area to achieve a quieter operating place. Acoustic pads placed under disk drives and printers can significantly reduce noise.

Electromagnetic Interference (EMI)

This is an unplanned, extraneous electrical signal that affects the performance of your Apple computer system. It can cause memory errors and data file destruction. It can appear as power supply drift, voltage ripple, unplanned logic signals, or circuit crosstalk.

While circuit designers try to minimize EMI, it is a natural by-product of aging components, bad solder joints, damaged or corroded connector contacts, and loose connections. It is also produced when a burst of electromagnetic or electrostatic energy is conducted or induced through the circuitry. An externally produced EMI can enter the Apple through the cabling or openings in the case. Sometimes it will enter by static discharge through the case of the disk drive.

The Apple case is made of injection molded plastic. It is lightweight, durable, and rustproof. While these are good qualities, plastic does have some disadvantages. Plastic isn't as strong as metal, and unlike metal, plastic doesn't conduct electricity, so it provides no protection against EMI/RFI and even ESD noise.

The FCC has established specifications that computer equipment must meet regarding the amount of radiated noise allowed to exit the chassis. The FCC places any devices that conduct or radiate EMI of frequencies above 10 KHz into one of two categories:

Class A — Industrial computing devices sold for use in commercial, business, and industrial environments, and not sold to the general public.

Class B — Consumer computing devices used in commercial, business, and industrial applications plus personal computers and their associated peripherals.

Your Apple is considered a Class B consumer computing device, and the EMI emitted is strictly regulated as shown in Table 8-2.

Table 8-2. EMI Requirements for Class B Equipment

Frequency (MHz)	Distance (meters)	EMI Field Strength (microvolt/meter)
30-88	3	100
88-216	3	150
216-1000	3	200

Both conducted and radiated EMI are regulated. Conducted EMI in frequencies between 450 kHz and 30 MHz must be reduced by 48 dB for levels above 1 microvolt. Radiated EMI must be reduced by at least 46 dB, measured three meters away from the source.

To meet these requirements, Apple Computer installed strips of metal shielding inside the Apple II computers. While this brought the EMI within limits, EMI still leaks out of the APPLE II Plus, since it gets out anywhere there is an opening on the chassis — the slots at the rear of the chassis, the vent holes, and even the power and keyboard key holes on top of the case.

The Apple IIe is better designed to control EMI leakage. Baffles cover the openings intended for cable connectors. These work quite well as long as you don't remove them and then leave the opening uncovered. The Apple II molded plastic chassis could be improved by the addition of "modifiers" of aluminum alloy flakes or fibers to provide EMI shielding, static charge dissipation, and resistive heat conduction in the case. The improved electrical and thermal properties of the chassis to shield against EMI could eliminate the need for painting or metal spraying to provide protection. The resistive heat conduction would mean that the temperatures generated inside the Apple could be dissipated through the case, greatly aiding in component longevity.

Apple engineers have employed most of the following techniques to reduce EMI/RFI:

- Use decoupling capacitors (0.01 μF to 0.1 μF).
- Carefully lay out components.
- Keep traces as short as possible.
- Minimize transistor-transistor-logic (TTL) since it tends to generate current spikes when switching logic states.
- Shield sensitive circuits.
- Reduce noise sources.
- Use fewer components.
- Carefully route wires.
- Use a shielded cabinet with minimal openings.

Cables are a source of EMI and RFI. Both the internal cables and those external cables leading to your monitor, printer, and disk drives can radiate interference.

How can you improve on Apple's efforts to counteract EMI? Since you won't be changing the circuit board design, you can reduce EMI interference in two ways: (a) prevent it from reaching the motherboard and interface card circuits, and (b) keep it contained within shielded enclosures. To do this, use shielding, grounded cables, filters, and transient absorbers.

Metal enclosures make the best shields. Notice that your switching power supply, a high source of EMI, is enclosed in a metal can. The greater the shield thickness, the better the shield affect. While the plastic computer case is easy for Apple to shape, it's transparent to EMI, so Apple added shielding inside the case. You can improve on the shielding by sealing *all* openings that aren't being used. Compressible gaskets can be used to close slot holes. Metal honeycomb ventilation screens can be used over the cooling vent.

Use shielded cables. A shield is a conductive coat or envelope placed around a conductor wire or group of wires to provide a barrier to electromagnetic interference. Ground the shields. Did you hook those ground clips on your disk drive cables to the side of the Apple II Plus slot? If not, do so.

Some connectors can be purchased with built-in filter pins to reduce radiated EMI around connectors. Other EMI-reduction devices include the ferrite "shield beads" which are placed on power supply leads and connections to ground or between stages on the circuit board.

Electrostatic Discharge (ESD)

It sometimes appears that a wizard with a weird sense of humor secretly loads into every computer a

program that intermittently produces random errors, or glitches, to drive users wild. Chasing and catching the elusive phantom glitch is a challenge even for experienced repair technicians using expensive and complex troubleshooting equipment, but you can learn more about this intermittent problem and how to prevent it from affecting your computer operation.

Glitches are electrical disturbances of short duration but often of long enough duration to cause problems in digital circuitry. They are often the result of an electrostatic discharge (ESD), one of the most severe sources of EMI.

People and objects such as chairs and desks can accumulate a substantial electrical charge or potential. The human body can accumulate static charges up to 25,000 volts. It is not unusual to build up and carry charges of 500 to 15,000 volts. Charged objects or people can then discharge (quickly get rid of the voltage) to a grounded surface through another object or person. Remember the times you dragged your feet across the carpet and then shocked your friend, brother, or sister? This electrical charge is static. It can even discharge through your computer, and when it does, all sorts of undesirable things can occur. If a program is running and a computer user carrying a large potential of electrical charge touches a key on the keyboard, the arc of discharge will find the shortest route to ground, usually through the RAM or CPU, and the program will bomb to a halt, data bits "falling away" everywhere. The screen can go wild and display weird characters. Sensitive components can be damaged or destroyed. Even a charge of only 3 volts is enough to create an erroneous bit in most logic circuits.

Electrostatic charges can be of any voltage. The following is a list of some of the sources of ESD glitches:

- People in motion
- Missing covers and gaskets
- Overheated components
- Circuit lines too close
- Improper grounding
- Poor solder connection
- Poorly shielded cables
- Low humidity
- Improperly installed shields

We know that static occurs when two objects are rubbed together. Your movement walking while wearing wool or polyester slacks can cause a tremendous

charge of electricity to build up on your body. When this charge reaches 10,000 volts, it is likely to discharge on any grounded metal part.

Litton Systems, Inc. has developed the "triboelectric series" chart shown in Table 8-3. Cotton is the reference material since it absorbs moisture readily and can easily become conductive. If any material on the list above cotton is rubbed with any material on the list below cotton, the item listed above will give up electrons and become positively charged. The item listed below cotton will absorb electrons causing it to become negatively charged.

Table 8-3. The Litton Systems, Inc. Triboelectric Series

Air
Your hand
Asbestos
Rabbit fur
Glass
Your hair
Nylon
Wool
Fur
Lead
Silk
Aluminum
Paper
Cotton
Steel
Wood
Hard rubber
Nickel, copper
Brass, silver
Gold, platinum
Acetate, rayon
Polyester
Polyurethane
Polyvinyl chloride
Silicon
Teflon

The two oppositely charged materials will tend to cling together. If they are separated, a static charge difference occurs. If teflon is rubbed in your hands, a large electrostatic charge is built up. The farther apart the materials are listed in Table 8-4, the larger the charge that can build up. Notice that your hair is listed above

cotton. Hard rubber is below cotton. Paper is listed just above cotton. Have you ever pulled a rubber or plastic comb through your hair and then used the comb to pick up pieces of paper just like having a magnet? This is electrostatic charge in action.

Our problem occurs when this charge builds and becomes quite large. Just walking across a carpet can generate over a thousand volts of charge. If the humidity is low and it is drier in the room, the charge can be substantially higher. (When the relative humidity is 50 percent or higher, static charges generally don't accumulate.) A built-up static charge will readily arc to any grounded metal, such as a disk drive chassis.

An ESD release on your disk drive case won't hurt you, but it can be very damaging to your electronics. The discharge pulse drives through the case to the read/write head and then on to the analog card circuitry where it can burn out some of the chips. Even if no components are "fried," the damage that is done by this overvoltage spike accumulates and starts to degrade the functioning of some circuit board components. Sooner or later the chip(s) fail completely.

If your computer occasionally gets the "shock treatment" or pulls the old "disappearing data" trick on you, there are some things you can do. The following list offers some specific solutions to ESD problems.

- Use antistatic spray on your rugs, carpets, and computer equipment. The antistatic spray applied with a soft cloth works both as a static reducer and control measure.
- Install a static-free carpet in your computer area.
- Install an antistatic floor mat beneath your computer chair. (This is the most popular solution.)
- Mop hard floors with an antistatic solution. The antistatic floor finish works well, but this is really an expensive solution and more suited for electronics manufacturing facilities. Most antistatic floor finishes work for up to six months.
- Install a conductive table top.
- Install a humidifier to keep humidity above 50 percent.
- Use static-free table mats.
- Keep chips in conductive foam (that black styrofoam-looking material).

- Touch a grounded metal object (power supply case) before touching anything else inside computer.
- Touch a grounded metal object (desk lamp, door handle) before touching the computer.
- Attach a ground wire from beneath one of the screws under your disk drive to a grounded screw on the Apple II chassis to bring both to the same ground potential.

You can defeat ESD glitches by paying attention to static charge in and about the computer system. By making static charge elimination a part of your preventive maintenance program, you take one more step to extending the longevity of your computer system.

Radio Frequency Interference (RFI)

Radio frequency interference noise is much the same as EMI except it occurs at higher frequencies (above 10 KHz). RFI is what causes five other garage doors on your street to open when you operate your new automatic garage door opener. You'd really rather it didn't work like that.

Although RFI isn't a health hazard, it's controlled just as EMI is. FCC Rule, Part 15, Subpart J states that any digital product that generates timing signals or pulses at rates greater than 10 kHz must comply with FCC regulations. In fact, Class B devices like the Apple computer are tested over a range of 30 to 1,000 MHz to ensure their emissions fall below maximum field strength limits. The computer is also limited in the amount of emission that it can feed back along the power lines (250 micro volts). The same chart that applies to EMI field strength radiation also applies to RFI.

The only sure way to completely block RFI emissions is to completely enclose your computer system in a shield. This is impractical, but there are other solutions to minimize or reduce the emission of RFI.

The Apple IIe enjoys some major improvements over the II Plus in handling RFI. The smaller component count on the IIe reduces the number of sources for RFI and improves the system operation. Reliability improves in direct proportion to RFI improvements.

There are some actions that you can take yourself to improve your system's RFI condition.

- Locate your computer system at least six feet away from any TV.
- Reposition the outside TV antenna if interference occurs.

- Use a directional outdoor TV antenna.
- Subscribe to cable TV.
- Connect traps or line filters on your TV.
- Replace the antenna twin-lead wire with 75-ohm coaxial cable.

With current computer designs, and FCC direction, the RFI emissions are so low that interfering with your neighbor's TV set is no longer a problem.

POWER-LINE PROBLEMS

Probably the most important environmental factor for your computer system is good, clean power. If you depend on your local utility to supply this power in steady, reliable consistency, you may be disappointed.

While room lighting systems can tolerate line voltage problems that momentarily dim the lights when a large power-hungry machine is switched on, computer systems cannot. Your Apple computer, like most electronic computers today, is more sensitive to power-line disturbances than other electrical equipment. Even well-designed machines such as your Apple II are affected by the quality of power provided. Under-voltage or over-voltage puts severe stress on computer components. The effect is to accelerate the conditions under which a device gradually weakens, becomes marginal, and finally wears out.

As shown in Fig. 8-5, there are four types of power-line problems that cause concern.

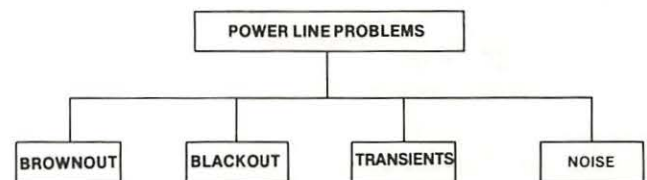

Fig. 8-5. The four types of power-line problems.

Brownouts

Brownouts are those planned (and sometimes unplanned) voltage sags, when less voltage is available to drive your Apple power supply, display CRT, and printer motor. Brownouts are far more common than you may realize.

Voltage dips are common if you operate your computer near some large electrical equipment such as air conditioners or arc welders. Your line voltage can be

drawn down as much as 20 percent by the heavy momentary drain caused when this equipment is turned on.

Now your Apple II should still work with line voltages that drop and remain 20 percent below the 110 volt rating. But if the supply voltage gets *too* low, the regulators in your power supply won't be able to pump adequate power into your motherboard, and data can get garbled. During brownouts, computer systems can operate intermittently, overheat, or simply shut down and lock up.

By the way, your power supply can handle a voltage "brown-up" (increased line voltage), providing proper power to your circuit, but the power supply regulators will generate a lot more heat as they handle the extra incoming voltage level.

Blackout

Power-line blackout, a total loss of line voltage, can be caused by storms and lightning. It can be caused by vehicles accidentally knocking down power lines or even by improper switching action by a power station operator.

When power is lost, whatever you had in RAM is gone. If you are writing to the disk when power fails, you will have only a partial save — the information that was still in RAM and not yet copied over to your disk is lost. If you know a power outage is planned, postpone using your computer. If the weather turns bad and thunder is echoing across the sky, don't turn your computer on. If a blackout occurs or if you see lightning, turn your machine off and pull the plug(s) until the storm passes.

And when the power goes out, *be careful*. While the room lights are out and you're muttering under your breath as you feel around for a flashlight, remember what is sure to happen when power is restored — a tremendous voltage spike will be produced as lights and motors go back on all over the neighborhood. This could damage your Apple system. *Always unplug your computer system when a blackout occurs*. Wait until power has been restored for a few minutes, then turn your system back on. Don't test your power supply filters on these kinds of spikes.

Transients

Other than electrostatic discharge, power-line transients are the most devastating form of noise interference in computer circuits. Transients are large, potentially damaging spikes of voltage or current that are generated in the power lines feeding electrical power to your community. Spikes can be caused by lightning striking a power line somewhere, utility company equipment

failure, or the on/off switching action common to using any electrical tool or appliance.

Most of these spikes are small and are barely noticeable, but some voltage spikes as large as 1,700 volts have been measured in home wiring. Residential areas experience more large spike transients than commercial areas. The line filters in your Apple power supply will protect your system from most high-voltage transients, but occasionally a spike overcomes the power supply protection and gets to the logic circuitry. The general effect is erased or altered data, but if the spike is too large, sensitive circuit devices can be destroyed.

Your Apple II power supply is normally not affected by the transients generated by on or off switching actions. These actions can produce a short-lived spike that is five times normal line voltage.

Spikes are not all generated outside your Apple. When you save a file by typing "SAVE" and the file name and depressing RETURN, activating your disk drive, the start-up of your drive produces a voltage spike inside your computer. Apple engineers have placed capacitors in strategic locations on the motherboard and in the disk drive electronics to carry spikes harmlessly away to ground, preventing component damage. If any part of the spike reaches the circuit components, the devices are stressed and can become marginal.

PREVENTING POWER-LINE PROBLEMS

If you live in an area where power outages or brownouts are common, or where electrical storms occur when you aren't ready, or if your computer system occasionally hangs up, you need protection. There are two kinds of approaches to preventing power-line problems. You can condition the power being supplied, or you can provide an auxiliary, or backup, power source as shown in Fig. 8-6. The various forms of power-line conditioners include the isolator, the regulator, and the filter.

Power Line Conditioner	Backup Power Supply
ISOLATOR	UPS
REGULATOR	
FILTER	

Fig. 8-6. The two basic ways to prevent power line problems.

Isolators provide protection from voltage and current surges and include transient suppressors, surge protectors, and isolation devices. These devices can keep line voltage at a proper level even when the line supply is 25 percent over normal. Some surge protectors can filter out high-frequency spikes but cannot respond to slow, low-frequency transients. One form of surge protector is called a *metal oxide varistor (MOV)*, a form of diode that will clamp the line voltage at a certain level, preventing over-voltage spikes from getting into your system. These devices are installed across the power-line wires leading into your computer. The December 1983 issue of *Byte* magazine has a good article on installation of MOV devices, should you be interested in installing them. Isolators cannot provide protection against brownout or complete loss of electrical power.

Regulators act to maintain the line voltage within prescribed limits. They are essential if line voltage varies more than 10 percent at the computer, but they don't provide protection against voltage spikes and blackout.

Filters remove noise from the input power line. They short EMI/RFI signals to ground and remove high-frequency signals from the low-frequency 60 Hz power line. Power-line filters work best when they are located immediately next to or at the front end of the power supply. Filters don't stop spikes. Nor are they effective during low- or high-voltage conditions.

When power availability is in question, an auxiliary power source is a necessity. Two choices are available: an uninterruptible power supply (UPS), and a portable generator.

The UPS is used to store energy when line power is present and deliver that power to the computer when a blackout occurs. These power supplies can cost between \$300 and \$15,000, but they are a dependable source of auxiliary power. A UPS is composed of a motor, a generator, and a battery. The motor is driven by power from the utility line while local power is available. The motor turns a generator which produces electricity to charge a battery. When local line power is lost, the battery turns the generator to produce AC electricity that can be used by the computer.

As shown in Fig. 8-7, there are four types of UPS equipment that can be used to power your computer system.

A **continuous-service UPS** changes the AC line voltage to DC to charge a set of batteries. When power is lost, the batteries operate an inverter which changes the DC battery power back to AC to run your computer.

Portable and fixed **motor generators** are powered

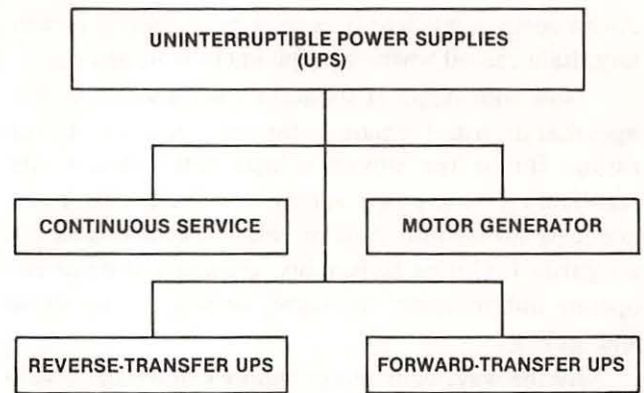

Fig. 8-7. The four types of UPS equipment.

by electricity, gasoline, or diesel motors. The generator is turned by the motor and supplies a regulated AC voltage to operate your computer system (and probably many other appliances and lights in your house or business). These devices are often used as emergency backup power for hospitals, police departments, and radio stations. Generators can be expensive, but they can provide backup power throughout the period line power is not available.

A **forward-transfer UPS** supplies power to your computer system only when line power is lost. It is the classic UPS, in which the line power drives a motor that rotates a generator that charges a battery (or set of batteries). When line power is lost, the batteries take over and provide AC power to the computer through an inverter.

A **reverse-transfer UPS** provides power to the computer from a battery most of the time, and switches to line power only if the UPS fails, or is turned off.

Some UPS equipment provides much more than just a power source. One company markets a UPS that provides protection not only against total power loss, but also against power transients, under- and over-voltage fluctuations, brownouts, and dirty (noisy) lines. Most UPS devices can switch to battery power very quickly. One UPS makes the transfer from primary power to battery power in about 4 milliseconds.

Once the transfer occurs, the next important consideration is the length of time the back-up will be able to provide power. Some units will keep your computer system running long enough to save what you had in RAM and to conduct a normal system shutdown. A unit from Topaz Inc. in San Diego, California can provide up to an hour of reliable AC power. It sells for about \$800.

How important is a UPS and the time it can provide power? If you are in an area that gets frequent power outages, consider this: what effect would losing

power at the time you were updating your disk directory have on your system? Likely, you'd lose your directory and not be able to retrieve whatever you had on your disk. The problem can be much worse when you connect a hard disk into your system. If a power outage occurs when the hard disk is activated or even simply powered up, there is no way for you to conduct a normal power-down sequence. If your hard disk requires the read/write heads to be in a certain position, you can't achieve this unless you have a UPS that switches in instantaneously. Failure to properly position the heads can cause drive damage as well as loss of valuable data.

You have some choices. What level of insurance do you need? Can you manage adequately without standby power — making backup copies of all your data, and saving to disk often during computer operation? Power-line protection can prevent damage, expensive data loss, and unnecessary down-time.

When selecting a power line conditioner or a back-up power supply, consider these parameters:

1. Power line conditioner
 - Speed of response in handling voltage spikes
 - Ability to filter out high-frequency noise
 - Ability to handle repeated transients
 - Amount of line power it can handle
 - Range of input voltages it will handle for clean power out
 - Multiple outlets to handle several devices
2. Backup power supply
 - Total back-up power required
 - Time to switch to standby power
 - Length of time back-up will provide power
 - Availability of built-in line conditioning
 - Availability of under- and over-voltage protection
 - Battery life cycle

To determine how much backup power you may require, add the amperage ratings on the label plates of all your Apple system equipment (computer, display monitor, printer, drives, plotters, etc.) and multiply by 120. The result is the approximate wattage, or power, you will require to operate the entire system. Since the larger the amount of power required, the higher your cost, you may want to consider only the power required to operate the basic system (computer, monitor, and disk drives). You can leave the other peripheral equip-

ment plugged into your standard wall socket and let these fail off when power is lost. If you do this, don't forget to turn these machines off and unplug the power cords before power is restored to prevent a big transient from damaging them.

How much power protection to provide is up to you. Many computer users are able to get along quite well with unprotected systems. Others prefer to operate their systems knowing that unseen environmental upheavals won't affect access to their Apple system.

CORROSION

The metal connector pins on cables, interface cards, and chip pins are subject to corrosion, a chemical change in which the metal plating of the pins and sockets is gradually eaten away. Corrosion can be very damaging.

There are three types of corrosion that can affect the Apple system:

- Direct oxidation by chemicals
- Atmospheric corrosion
- Galvanic electrical corrosion

Direct Oxidation

In **direct oxidation** a chemical corrosion occurs. A film of oxide forms on the metal surface, reducing the pin's contact with the socket. At high temperatures this oxidation process accelerates. The metal is slowly worn away as the electrical contact surface is converted to an oxide and the oxide crumbles.

Atmospheric Corrosion

Chemicals in the air attack the metals in computer system circuitry, causing pitting and a "rust" build-up. In the early stages of this corrosion, sulfur compounds in the atmosphere are converted to tiny droplets of sulfuric acid that lie on the surface of our connector pins. This acid eats away the metal, causing pits to form.

In the early stages of **atmospheric corrosion**, the contacts can be wiped clean, restoring the metal brightness. But if the sulfuric acid is allowed to remain, the long exposure converts the acid to a sulfate layer that can no longer be wiped away.

The effect is to reduce electrical contact between the pins and their sockets. A layer of discolored rust that prevents any contact between the pins and their sockets causes an open circuit, and can be located. It's

the in-between stage when the “almost-open” condition exists that produces those horrible intermittent failures that can be so hard to find.

Near the ocean the presence of salt spray or increased levels of chlorides can cause severe pitting of some metals.

Galvanic Corrosion

In **galvanic corrosion**, a tiny crack or hole in the metal plating on a pin or connector lets an electrolyte such as salt (sodium chloride) in moisture penetrate between the metal plating and the underlying base metal.

A kind of battery forms, with a tiny electric current flowing between the two dissimilar metals. The plating surface becomes scaly and rough as the plating is slowly eroded away. The corrosive action is concentrated on the underlying metal exposed at the breaks in the scale since this is where the galvanic battery exists.

The effect is the same as for the other forms of corrosion — the electrical contact between the pin and the socket decreases, causing intermittent problems, until the scale is so complete the electrical circuit is broken and signals are blocked entirely.

You can actually cause this corrosive action to start if you handle your connectors and boards improperly. The *wrong* way to handle interface cards is demonstrated in Fig. 8-8.

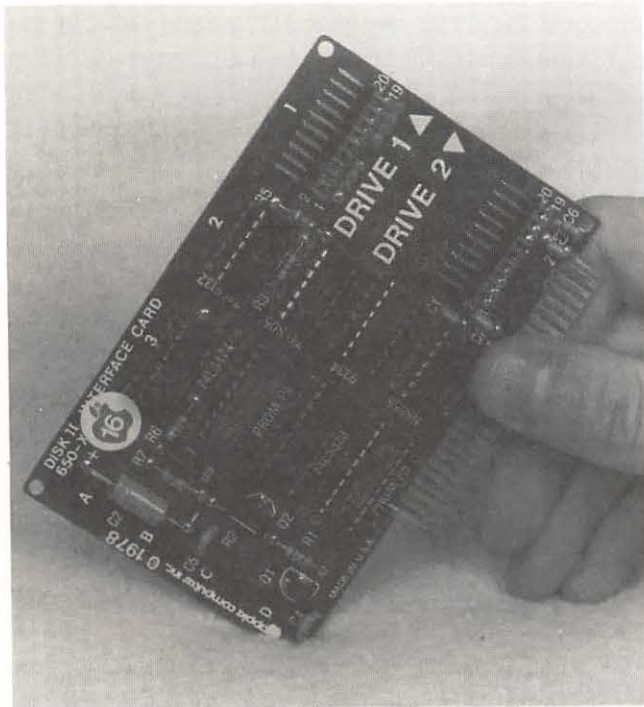

Fig. 8-8. Handling an interface card the *wrong* way can cause corrosion to occur.

NOTE: Never touch contacts with your fingers. The oils on your fingers contain enough sodium chloride to begin oxidation action on those pins.

CORROSION PREVENTION

While metal gates and cars can be spray painted to prevent rust (oxidation), this is not an option for preventing corrosion on circuit pins and connectors. The best preventive action is cleaning. By keeping the contacts clean, you can deter oxidation build-up and prevent the occurrence of intermittent glitches.

You can clean the pins on your chips by reseating the chips periodically. Chips have a habit of working up out of the sockets after extended use. Turning off all the power and carefully pushing these devices back down into their sockets will act to clean the pin surface, restoring (or ensuring) good electrical contact.

CAUTION: Always turn off the power and touch the power supply before touching anything inside the Apple II case.

Since the Apple motherboard is not fully supported from below, be especially careful not to overbend or overflex the board; this can cause tiny cracks (open lines) in the circuitry.

Oxidation of the finger contacts on peripheral circuit boards such as the disk controller card and the RAM card can be cleaned off with emery cloth, a soft rubber eraser, a solvent wipe, or a contact cleaner spray.

CAUTION: When rubbing to clean contacts, always rub along the pin (lengthwise). Rubbing lengthwise on the pins prevents accidentally pulling a pin contact up off the board.

If you use emery cloth, be careful not to grind away the metal plating itself. If you use a rubber eraser, keep eraser dust away from the computer.

Solvent wipes are available as part of cleaning kits sold by many computer supply companies. These wipes can clean and then lubricate the contact surface with a film that helps seal out atmospheric corrosion without interfering with signal flow. Most solvent wipes are individually wrapped in small packages much like the hand towelettes you get in some restaurants or on some airplane flights.

Spraying the pins with a contact cleaner spray (available at most electronic parts stores) is also an effective corrosion preventive. Contact cleaner wipes and spray are the best methods for removing an oxidation layer.

There is a trade-off between preventing corrosion and preventing electrostatic discharge, because corro-

sive action is reduced with a reduction in the relative humidity, but ESD increases.

Electronics manufacturers are aware of the effects of corrosion, and most connectors are made of a combination of metals that resist corrosion but are good conductors of electrical signals. You can choose the type of connectors to use for your cables. You can buy cables and connectors with tin alloy plating on the pins or with a thin gold plating. You can imagine which type is more expensive. Although you will pay more for the gold-plated connectors, they can be "worth their weight in gold," because they provide superior contact reliability. Gold-plated contacts don't wear out as tin alloy surfaces do, but even the tin surfaces take a long time to wear away, so a sound, consistent cleaning program can really help.

One final note on the subject of corrosion: high temperatures will increase the corrosive action in your Apple system. It helps to keep your computer tuned up and running cool.

MAGNETISM

The effects of magnetism are especially important in disks and disk drives, since these two parts of the Apple computer system are designed to operate on magnetic principles.

Each floppy disk is coated with a magnetic oxide with millions of tiny pole magnets randomly positioned on its surface. As the drive write head passes over the disk surface, a magnetic force is induced in the head by the disk drive electronics, causing the pole magnets on the disk surface to line up according to the digital information being converted to voltage pulses in the head. This is "good" magnetism.

The voltages used in monitors and television receivers produce strong magnetic fields. These can be bad. If you accidentally place one of your disks in the field, the tiny pole magnets on your disk's tracks can change their alignment. Then when your disk drive tries to read the disk, the head cannot understand or can misinterpret the information on the disk, and you get garbage, or UNABLE TO READ errors.

Magnetic flux is caused by the presence of a high (115 V) voltage in computer display monitors and televisions. A color television produces the strongest magnetic flux, but high-voltage areas of monitors, printers, telephones, and even power strips can be sources of offensive flux and can cause intermittent data loss. The strength of the flux field depends on the strength of the

voltage, which can fluctuate depending on the amount of power being required by the equipment.

The moral is: keep your diskettes, and even your information cables, away from power sources.

PMs FOR FLOPPY DISKS

Two valuable components in any Apple system are the mass storage devices (disks) and the disk drives. Most Apple systems use 5¼-inch floppy disks as the mass storage medium. Technically they are called "diskettes" to differentiate them from the "disks" used in 8-inch drives, but the terms "floppy" and "disk" are so commonly used with the 5¼-inch diskettes that the term "disk" will suffice. Since disks and disk drives are such critical components in computer systems, it makes sense to do all you can to protect and maintain them.

The read/write head in your Apple disk drive rides on the most vulnerable part of the mass storage system, the floppy disk. Floppy disks are made of mylar or polyethylene terephthalate and coated with a magnetic iron (ferric) oxide. As shown in Fig. 8-9, the oxide-coated mylar disk or "cookie" is placed in a protective polyvinyl-chloride jacket.

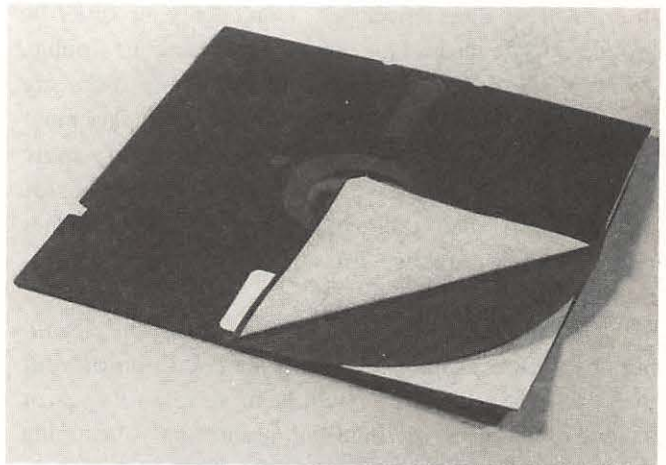

Fig. 8-9. A floppy disk with the jacket lining exposed.

Now disks are pretty sturdy things, but they are sensitive to magnetic and electrical fields, high temperature, low temperature, pressure, bending, and dust. Dust and little airborne fibers are particularly bad for your disks. With the drive read/write head riding on the surface of the disk, any tiny piece of "junk" lying on your disk looks like a huge boulder to the head. A piece of your own hair (assuming you still have some after

your last computer failure experience) is about 40 microns (.0015748 inch) thick. A hair is a huge obstruction to the disk drive head. Even dust and fingerprints on the disk surface cause obstacles to the even movement of the disk under the head. To protect the disk medium, and the head, each disk jacket is lined inside with a dust catching synthetic fiber. As the disk is rotated inside the drive at a whopping 300 rpm, dust and other particles that may have slipped inside the jacket or settled on the disk are quickly swept off the disk by the liner material. But a build-up of too many particles can overload this protective system.

Another substance that is harmful to disks and disk drives is tobacco smoke. The tars and nicotine that filter up into the air from the ends of cigarettes and cigars (or out of the lungs of smokers) can settle on your computer system. These sticky chemicals form a gummy ash build-up on any exposed surface — including your disks and your disk drives. This material gums up the drive, eats into the read/write head, and scratches the surface of your disks. The effect is similar to taking a metal file to your favorite record album. Avoid smoking or allowing smoking in your computer area. If you can't do this, then clean your system more often.

Disks are further protected by the paper storage envelopes, or sleeves, into which the square disk jackets are inserted. Use these envelopes. Don't let your disks lie around outside the envelope inviting dust and dirt trouble.

Not all disks are created equal. Some disks are manufactured to better standards and with thicker magnetic oxide coatings. Naturally, these disks are more expensive. Less-expensive disks have thinner oxide coatings and shed their oxide layers easily, further reducing their effective life. Compare disk specifications before you buy.

Depending on the quality of your disks, the cleanliness of your computer area, and the condition of your disk drive, your disk life could be as short as a week or as long as 17 years, or 70 million revolutions. Assuming the quality, cleanliness, and condition factors are favorable, disk life is estimated on actual rotations while the disk read/write head is in contact with the disk surface, rather than on total time of existence.

As the drive head rides the disk's oxide surface, it causes tiny bits of oxide to rub off the disk. Most of these loose oxide particles are caught and held by the liner, but some of the oxide sticks to the head. Gradually an oxide layer builds up. This oxide layer has two effects on system operation: (a) it makes the head less sensitive to reading and writing data, and; (b) it causes an abrasive action on the disk surface. As the oxide

layer builds up, it becomes ragged. This roughness scratches even more oxide off the disk, until the oxide on the disk surface is too thin to support data storage. When oxide is missing from the surface, "drop-outs" or spots occur, where data can no longer be stored. Then the disk fails to read or write properly, and it becomes useless.

Keeping this oxide layer from building on the read/write head will help extend the life of your disks. The better disks are less likely to spin off oxide particles, so the head stays cleaner longer, and the disks last longer.

NOTE: Disks make different sounds in the disk drive, depending on the type of liner used. Some types of liners provide more wiping action than others. Although the disk may sound like coarse sandpaper when it spins in the drive, that doesn't mean the disk surface or the drive is being harmed. A louder disk may actually be doing a better job than a quieter disk.

Toward Longer Disk Life

Here is a summary of what you can do to help extend disk life.

1. Buy name-brand disks. Avoid "bargain" disks. The \$7 disk should last seven times as long as the \$1.50 disk.
2. Never touch the disk surface.
3. Never slam the disk-door closed on a disk. You could press the disk-drive centering hardware into the disk surface instead of the disk hole.
4. Store disks in their protective jackets.
5. Never write on a label that's on a disk. Ball point pens and pencils can cause indentations in the disk surface. Mark the label first, and then put the label on the disk jacket.
6. Store disks in a cool, clean place.
7. Back up everything.
8. Store working disks and backup disks in different places.
9. Don't lay disks in the sun. They warp just as stereo records do.
10. Never allow smoking near your disks or your drive. Smoke lets tars settle on the disk surface (and inside your drive), gumming up the works.
11. Never set disks by monitors or televisions. The magnetic fields can erase data.

12. Avoid placing disks near vacuum cleaners or large motors. Even freezers and refrigerators have compressor motors that can alter data on your disks.
13. Don't bend or fold disks.
14. Store disks vertically. Storing disks horizontally can cause the disk to bind in the jacket, preventing proper speed of rotation, causing scratching of the disk surface, and resulting in intermittent failure.
15. Don't put disks through airport x-ray machines. Hand them to the security guard for inspection, and have them bypass the x-ray inspection process.

Flipping the Floppy

Before we get into PMs for disk drives, let's clear up a few misconceptions about disk use in a single-sided disk drive system. Many people believe that you can flip your disk over, cut an additional write-protect slot into the jacket, and then use the flip side of the disk to store more programs and data. They contend that using the back side of a disk in a single-sided drive system won't cause any problems with either the disk or the drive. Some reputable magazines and Apple user groups support this idea. Disk drive manufacturers strongly disagree. Who is correct?

When the door is closed on a single-sided disk drive, a pressure pad comes in contact with the disk, pushing it against the drive read/write head, which rides on the bottom of the inserted disk. The drive motor rotates the disk in only one direction, at a speed of 300 rpm. As the disk wears, tiny bits of oxide come off the disk and get swept up and held by the liner inside the disk jacket, or build up on the drive read/write head. Some oxide even builds up on the pressure pads.

Disk manufacturers test both sides of a disk, and if one side fails they often place the defective side in the disk jacket so that only the good side is exposed when the platter is marketed as a single-sided disk.

The disk jacket liner, catching up most of the oxides, dust, and dirt that gets on the disk surface, functions the same way as a lint brush being used on a dark wool suit. Brushing in one direction removes the lint and hair, but brushing in the opposite direction, wipes the collected lint back onto the suit. The same thing happens with disks in lined jackets. As the drive spins the disk in one direction, the lint, dust, and whatever else is on the disk surface is wiped up by the liner. If the disk is turned over and rotated in the

opposite direction, the "junk" collected by the liner gets wiped off and back onto the disk. The excess dirt in the liner scratches more oxide off the disk. You begin to experience "drop-outs" in the areas of the disk that no longer have enough oxide left to store digital information. Your head gets dirty even faster, and the pressure pad build-up increases.

Even the act of cutting an additional write-protect notch in the disk jacket causes problems. The polyvinylchloride jacket material shatters when cut, producing tiny shards of polyvinyl chloride that can scratch the disk surface and add to the material collected by the liner.

Another problem occurs with the pressure pads themselves. When you flip your disk, you are placing the "good" side of your disk in contact with the rough, oxide layers built up on the pads. Rotation of the disk now causes scratches on that side of your disk.

One last additional hazard caused by writing data on both sides of a disk is the potential for magnetic field "bleed through" from writing on one side of the disk and having the magnetic field created affect the data stored on the opposite side of the disk. This can cause alteration of data and even loss of files.

The evidence seems clear. You can use both sides of a disk, but you do so at a risk.

PMs FOR DISK DRIVES

What kinds of PM are there for disk drives? If you own a \$100-million-a-year company using hundreds of disk drives, you could plan for and purchase a \$50,000 disk drive tester that tests four drives at a time using dual microprocessors. But you probably don't. So how can you test and maintain your own disk drive(s) without this expensive equipment?

Disk drive manufacturers' representatives insist that "officially" there isn't any PM required for disk drives, but — they describe head cleaning as the only routine maintenance that *could* be done by a novice, although even this is not officially recommended. Why not? Suppose you were a disk drive manufacturer with lots of repair and testing facilities. Would you be inclined to recommend owner-conducted maintenance that would make your drives last years longer before repair was required? The repair business is *big business*. The less maintenance you do, the sooner your system will start giving read/write errors and the more work you will provide for repair companies.

Here are some facts:

1. Head cleaning is a PM you can do. Head cleaning diskettes of various kinds are available. The "wet" diskette kind works with a cleaning solvent.
2. Heads need cleaning to remove the oxides from your disks that build up on the leading edge of the head (the side facing the direction of disk rotation), as shown in Fig. 8-10.

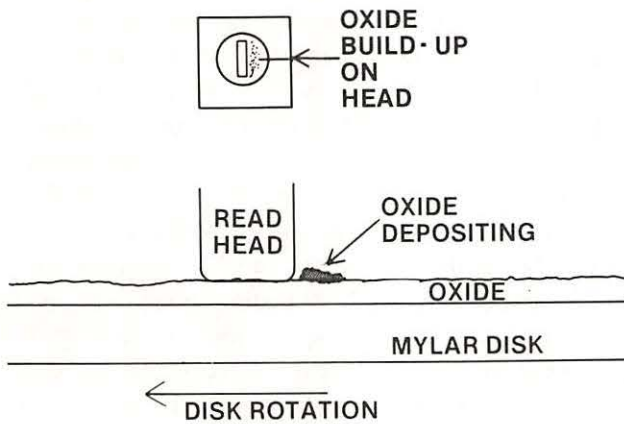

Fig. 8-10. Oxides get wiped off the disk surface and build up on the head surface.

3. Some head cleaners are abrasive and can damage the head if they are used for too long. If you buy this type of cleaner, you must use the cleaner just long enough to remove the oxide build-up, but not long enough to damage the head.
4. New nonabrasive head cleaners are being marketed. Two examples are Verbatim's Data-life head-cleaning kit, and Innovative Computer Products' Perfect Data head-cleaning kit. Both products use fabric-covered disks which are dampened with a cleaning solvent. With the one kit, you sprinkle cleaning solvent on the disk fabric and then insert the disk into your drive for spinning-action head cleaning. The disk can be used as many as 13 times. The other kit has cleaning disks that are predampened and individually sealed. You use a cleaning disk once and then throw it away, using another the next time. Both of these products work well.
5. Since any cleaning disk works by rubbing action and chemical action between the disk fabric and the drive head, there is a potential for abrasion to occur. So you must be careful not to leave the

disk spinning in the drive for too long. A cleaning disk can be allowed to spin in a disk drive for 30 seconds with no apparent damage. With most cleaning disk kits, 45 seconds is too long to keep the cleaning solvent in contact with the drive head.

6. Drive heads can also be cleaned with alcohol and a cotton swab wrapped in a lint-free material (see Fig. 8-11). With manual alcohol and swab cleaning, you could accidentally scrub the pressure pads by mistake, causing more problems than you're preventing. But, if you're careful, manual cleaning can be effective.

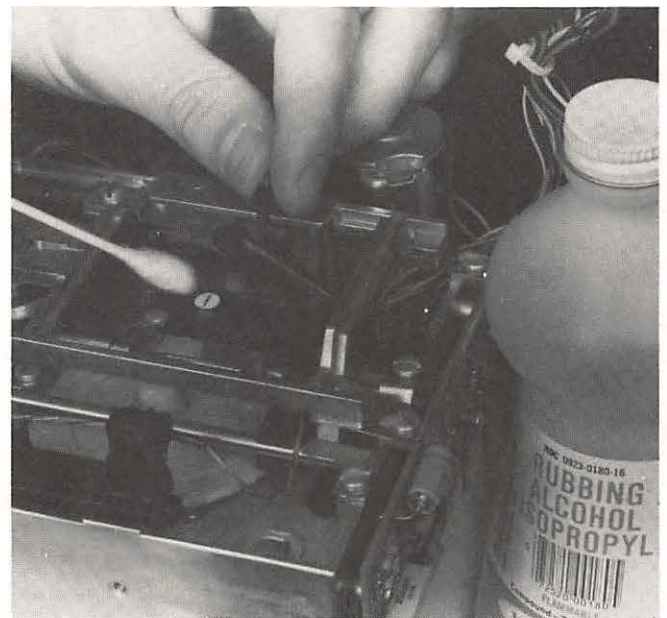

Fig. 8-11. This way to clean your read head is dangerous unless you wrap the cotton swab with a lint-free material.

Special cleaning material such as cellular-foam swabs and chamois leather cloth are good materials to use for manual head cleaning. Or you can use a piece of bed sheet wrapped around the cotton swab. Uncovered cotton swabs are dangerous because the cotton fibers can catch or pull away and lie in the drive or on the head, becoming cotton logs on a disk-surface highway, waiting to get swept into the drive head that rides on the surface of the disk. These fibers can also catch on the ferrite chip in the middle of the ceramic head, loosening it

from its mounting and ruining the head. Surgical isopropyl alcohol or methanol can be used as the cleaning solvent. The solvent used must not leave a residue when it evaporates, so most other alcohol solvents should be avoided. You can also use typewriter cleaner or trichloroethane. In all cases use plenty of ventilation and make sure the solvent has evaporated before you operate the drive.

7. How often the head must be cleaned depends on how much the drive is used and what type of diskettes are used. A high-quality diskette is good for about three million passes, or rotations, against a read/write head before enough oxide is worn off so that the head needs cleaning. The "bargain" disks are good for one tenth the rotational life. This means that instead of 167 hours of access time, you might get 16 hours or less before the head gets caked with oxide or your disk surface gets too worn to write to or read from. Now you know why your bargain disks don't seem to last very long.

A useful rule of thumb for head cleaning is to clean the read/write head after every 40 hours of disk operation. This means clean after 40 hours of rotational life if you're using standard disks. You could clean more often or even wait until you start getting read/write errors and then replace or clean the head.
8. Keeping the drive door closed unless you are inserting or removing a disk will help keep dust and dirt out. It also prevents unwelcome visitors (insects and even mice) from climbing into the drive.

Cleaning the Drive Head Using a Cleaning Disk

Follow these steps:

1. Make sure the power to the computer is turned off.
2. Dampen the cleaning disk with the solvent supplied with the disk.
3. Insert the dampened cleaning disk in the drive.
4. Close the drive door.
5. Turn on the power to the computer. The system will try to boot DOS, but since DOS isn't on the cleaning disk, the disk will simply

spin in the drive, cleaning as it whirs along.

6. After 20 or 30 seconds, turn off your computer, open the drive door, and remove the disk.
7. Let the drive read/write head dry thoroughly before you operate the system.

Manually Cleaning the Drive Head

You will need a Phillips head screwdriver, a protective pad, and adequate lighting.

1. Turn power to the computer off.
2. Open the computer cover and touch the power supply case.
3. Pull the power plug out of the rear of the Apple chassis.
4. Disconnect the disk drive cable from the controller card in slot 6.
5. Close the disk drive door.
6. Turn the disk drive over on a protective pad such as a clean towel or a clean, lint-free surface.
7. Remove the four black Phillips head screws holding the cover tight, as shown in Fig. 8-12.

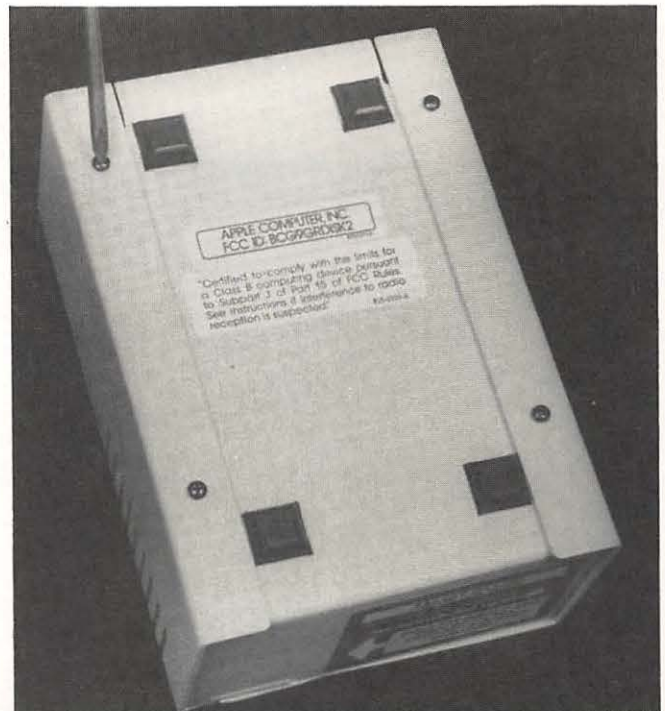

Fig. 8-12. Remove the black screws holding the disk drive cover on the drive mechanism.

8. Gently slide the drive case cover back off the drive mechanism as shown in Fig. 8-13.

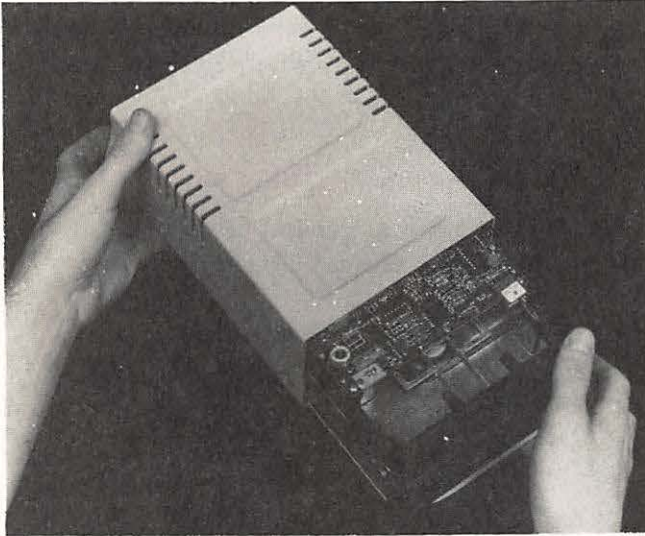

Fig. 8-13. Gently slide the drive case cover off the drive mechanism.

NOTE: The cover fits snugly, so you may have to wiggle it gently to get it off.

9. Set the cover aside.
10. Set the disk drive right side up.
11. Remove the analog card as shown in Fig. 8-14.

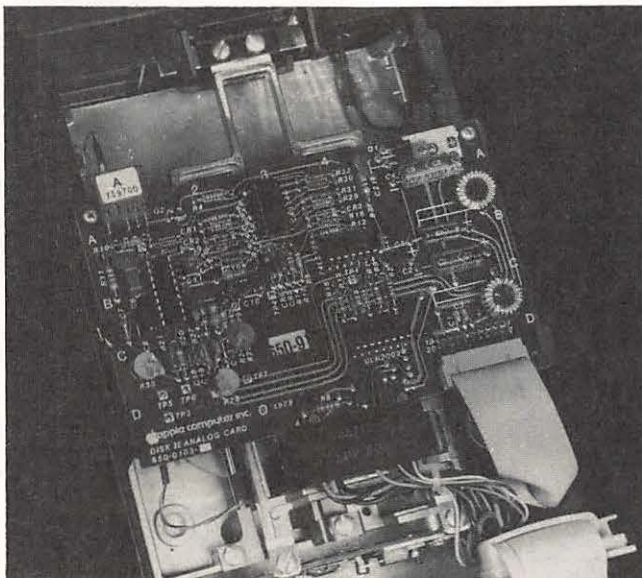

Fig. 8-14. The Disk II analog card.

12. Disconnect the 4-pin plug at location (A).
13. Disconnect the ribbon cable at location (B).
14. Disconnect the black cable plug at location (C).
15. Remove the two silver Phillips head screws securing the front end of the analog card.
16. Gently slip the printed circuit analog card toward the front of the disk drive past the two black plastic hold-downs at (D) and (E).
17. Remove the analog card and set it aside.
18. Carefully lift the black head load arm as shown in Fig. 8-15 and look for discoloration (build-up) on the surface of the pad or on the read/write head below.

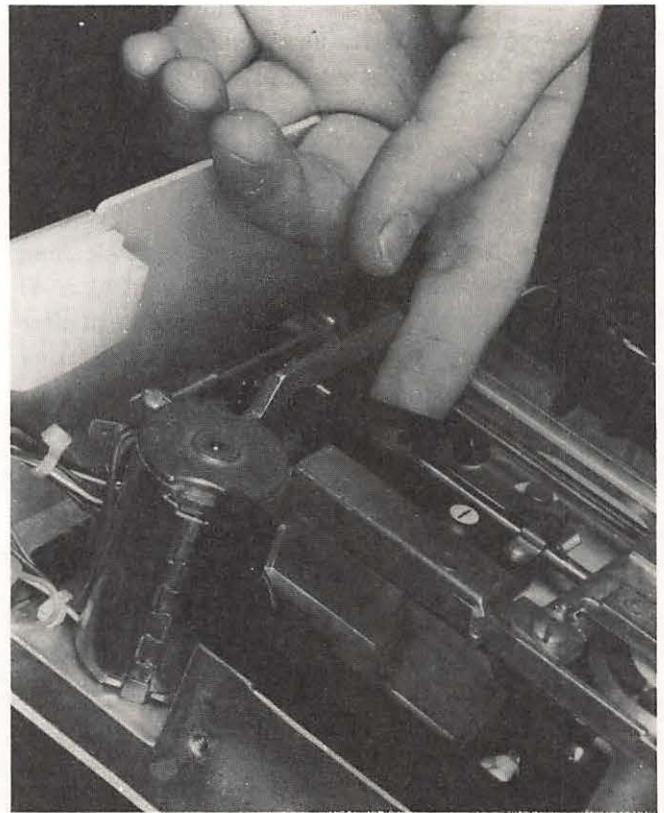

Fig. 8-15. Carefully lift the head load arm to expose the read head below.

19. Using a wrapped cotton swab dampened with cleaning solvent, gently rub the head and the pad.
20. Let the surfaces dry completely before reassembling.
21. Notice the cam disk below and to the side of the head. If this cam is beige, you're lucky. The

drives that have dark brown cams can have lots of problems; the hole in the top of the cam was sometimes drilled off center, causing these disk drives to intermittently fail to read or write properly.

22. When the head and pressure pad are dry, reinstall the analog card as follows: (a) gently slip the card beneath the two black plastic hold-downs, moving the card from the front to the rear of the drive; (b) center the card over the two Phillips head screw holes; (c) reinstall the two Phillips head screws; and (d) reinstall the three cable plugs at (A), (B), and (C).

CAUTION: You can damage the drive electronics if you attach the cable incorrectly. Cable plugs (A) and (C) are keyed so you can connect them in only one way. Cable plug (B) has an arrow on one end of the plastic connector plug that should be pointing up when the plug is reinstalled, as shown in Fig. 8-16. The cable should feed up away from the connector as shown in Fig. 8-16. Make sure all the pins are correctly matched with the holes in the plug.

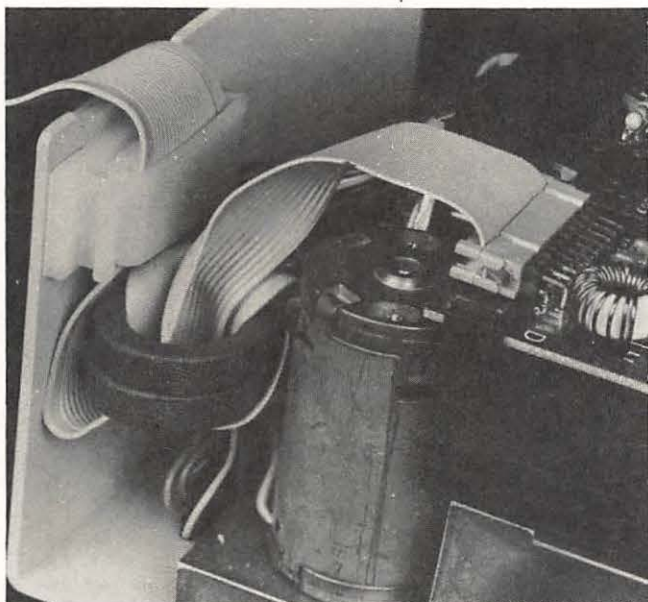

Fig. 8-16. Cable plugs are keyed, but be careful to install them correctly.

23. Reinstall the cover from the rear (cable end) to the front, being careful not to tear the black paper covering the vent holes.
24. Replace the four black Phillips head screws in the base of the cover.

25. Turn the drive over and reconnect the drive ribbon cable to the controller card in slot 6.
26. Reconnect the Apple II power cord plug.
27. Replace the computer lid.
28. Place a *copy* of the System Master disk in the cleaned drive. Have you waited until all the surfaces are dry?
29. Close the drive door.
30. Turn on the Apple and test operate the drive.
31. Restore the system to full operation.

Disk Drive Head-Cleaning Interval

Cleaning your drive head is like changing the oil in your car. You change the oil when you feel you've driven enough miles or when the oil looks dirty. Some software manufacturers recommend cleaning heads every other week. Some repair technicians say clean every six months. Others suggest you don't clean the heads until the disk drive makes mistakes trying to read or write data. Table 8-4 provides some rules of thumb.

Table 8-4. Rules of Thumb for Cleaning the Disk Drive.

System Usage	Cleaning Interval
Over six hours each day	Weekly
Daily	Monthly
Light to moderate	Twice monthly
Occasionally	Every six months

If you live in an area that gets a lot of smog, you may want to clean the heads more often. In any case, it won't hurt for you to clean at least annually. If you begin to get read/write errors, check your operational time log to see if PMs are due. Some recommended operational log sheets are included in the Appendix.

Disk Speed Tests

A somewhat more detailed — yet handy — PM is checking and, if necessary, adjusting the disk drive speed. Variation in speed is caused by normal mechanical drive wear or by excessive moving and reconnecting of drives.

Just as automobile engines need periodic checkups and engine retuning, disk drives benefit from correctly adjusting the drive motor speed. Your Apple disk drives rotate at 300 rpm and work with soft-sectored disks; that is, the computer software identifies the beginning and end of each of the 16 sectors on each of the 35 tracks (DOS 3.3). No timing holes are used, as with

hard-sectored disks. Using soft-sectored disks makes the speed of rotation critical to accurate synchronization of the software with the signals stored on the disk. If the speed is off by only 10 rpm (about 3 percent), the drive may not be able to correctly read the disk.

Should the speed be incorrect, the data will be written in the wrong location on the disk. The next time you access that area on the track again, the computer will hang up and give you an I/O ERROR message. While disk speeds between 291 rpm and 309 rpm should be acceptable for read/write operation, speeds outside this range can cause intermittent or disastrous results. If the speed becomes slower than 270 rpm or faster than 309 rpm, any write action will erase the synchronization timing marks on the disk, making it useless unless you reinitialize the disk (wiping out the data you had stored).

There are two ways to tune up your drive speed. You can adjust the speed using a disk speed test program or a standard room lamp. Both techniques require your removing the disk cover.

Disk Drive Disassembly

You will need a Phillips head screwdriver, a jeweler's screwdriver, and a protective pad.

NOTE: If any of this seems difficult, have a repair service shop do the speed adjustment.

1. Turn off the power to your Apple computer.
2. Open the computer lid and touch the power supply case.
3. Pull the power cord plug out.
4. Disconnect the drive ribbon cable from the disk controller card as shown in Fig. 8-17.
5. Lay the disk drive upside down on the protective pad.
6. Remove the four Phillips head screws as shown in Fig. 8-18.
7. Gently slide the drive cover housing backwards off the drive mechanism as shown in Fig. 8-19. The cover fits snugly so you may have to wiggle it gently to slide it off.
8. Set the cover aside.
9. Reconnect the drive cable to the controller card.
10. Locate the speed adjustment control potentiometer as shown in Fig. 8-20.

You are now ready to adjust the drive speed.

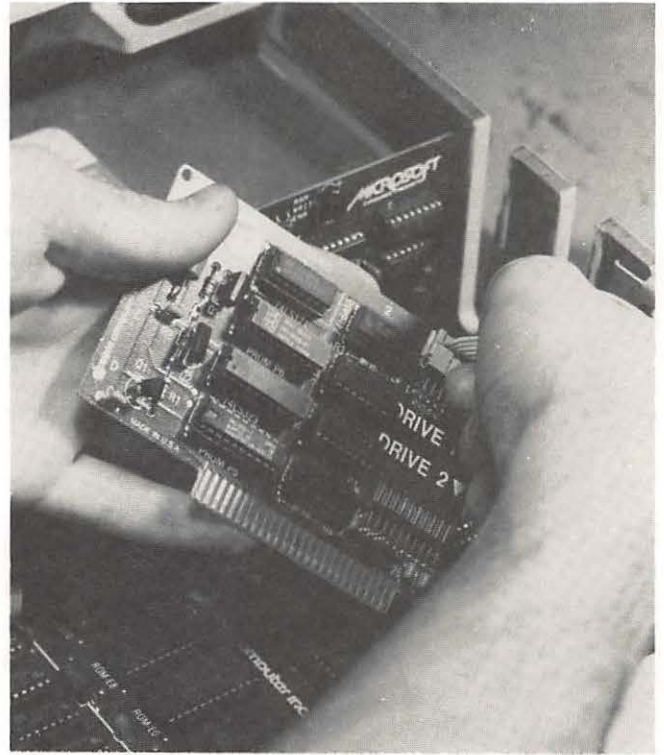

Fig. 8-17. Disconnect the ribbon cable from the disk controller card.

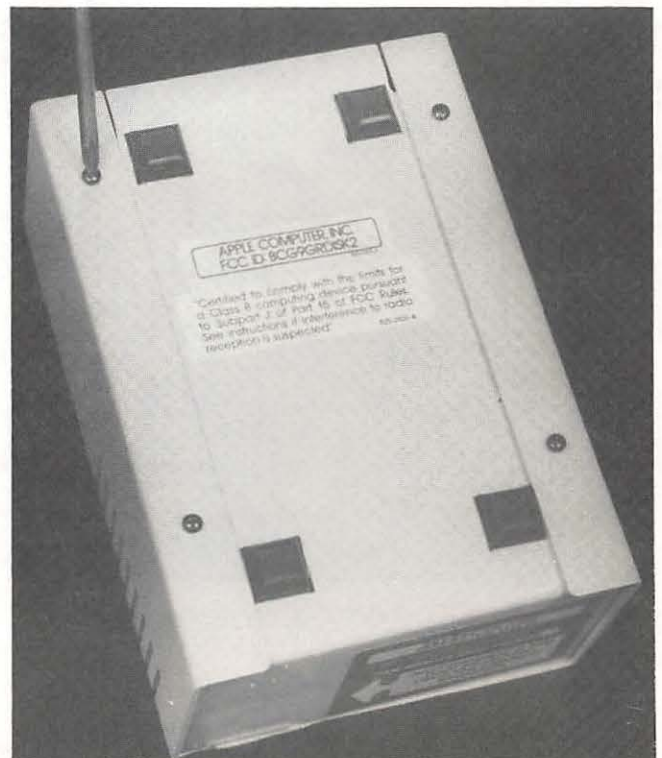

Fig. 8-18. Remove the four Phillips head screws.



Fig. 8-19. Gently slide the drive cover housing back off the drive mechanism.

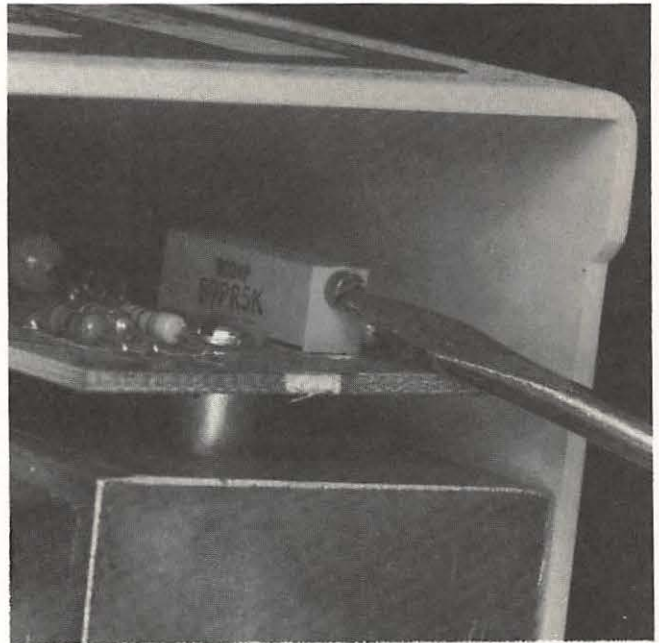
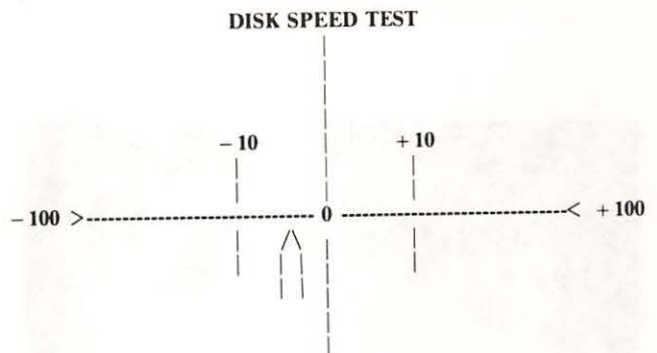

Fig. 8-20. The screw driver is inserted in the speed adjustment potentiometer.

A Disk Speed Program

1. Reconnect the power cord to the computer.
2. Replace the Apple case lid.
3. Insert the disk containing the disk speed test program in the drive to be adjusted.
4. Close the disk drive door.
5. Turn on the power to the Apple computer.
6. Observe disk boot-up in the drive.
7. Most speed test programs display a graduated scale of the sort shown in Fig. 8-21. Using a jeweler's screwdriver, slowly turn the speed control adjustment pot screw until the speed display shows the actual rpm close to the ZERO reference or 300 RPM point. (The best position is just under or to the left of the reference. This allows for creep as the system wears.)
8. Remove the disk.
9. Turn off the power to the Apple.
10. Pull the power cord plug.
11. Disconnect the disk drive ribbon cable from the controller card.
12. Reassemble the drive. Be careful to slide the



(CURRENT SPEED SETTING = -4)
ESC(APE TO STOP TEST

Fig. 8-21. Sample disk speed test screen display.

cover on from the rear with the vents toward the back (cable end) of the drive mechanism. Make sure the paper covering the vent slots doesn't get jammed and torn.

13. Replace the four Phillips head screws in the cover.
14. Turn the drive over and reconnect the ribbon cable to the controller card in slot 6.
15. Reconnect the Apple II power cord plug.

16. Replace the computer cover lid.
17. Turn on the computer and test operate the drive.
18. Restore the system to full operation.

Using a Tuning Lamp

1. With the cover removed, set the drive upside down on the protective pad.
2. Remove the four silver Phillips head screws on the baseplate as shown in Fig. 8-22.
3. Remove the baseplate from the drive mechanism.
4. Locate the timing marks on the strobe disk as shown in Fig. 8-23. The outer circle of markings is used for 60 Hz electrical systems common in the United States. The inner circle of strobe markings is used with 50 Hz line power such as is found in Europe.

Using a strobe disk for speed adjustment is amazingly simple, and very accurate. If you

place the strobe disk in the light of an ordinary room lamp, and cause the disk to spin, you will notice that the strobe disk marks slowly rotate in one direction or another, depending on whether the disk speed is fast or slow. This action is much like the effect seen on movie film when stagecoach wheels seem to be rotating in the opposite direction to the movement of the coach. The wheels are rotating at a different speed than the film is moving through the projector so you see this strange effect. The marks on the strobe disk are spaced so they appear stationary when the rotational speed is exactly 300 rpm.

5. Place a lighted lamp near the drive.
6. Reconnect the ribbon cable to the controller card.
7. Reconnect the Apple power cord plug.
8. Insert a blank, uninitialized disk in the drive and close the drive door.
9. Turn on the Apple and observe the strobe wheel as the disk spins in the drive.

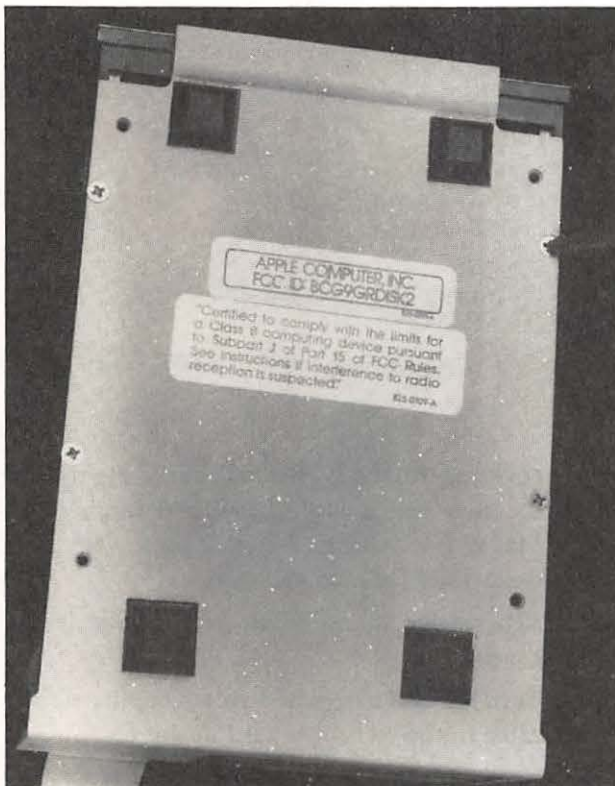

Fig. 8-22. Remove the four silver screws from the baseplate.

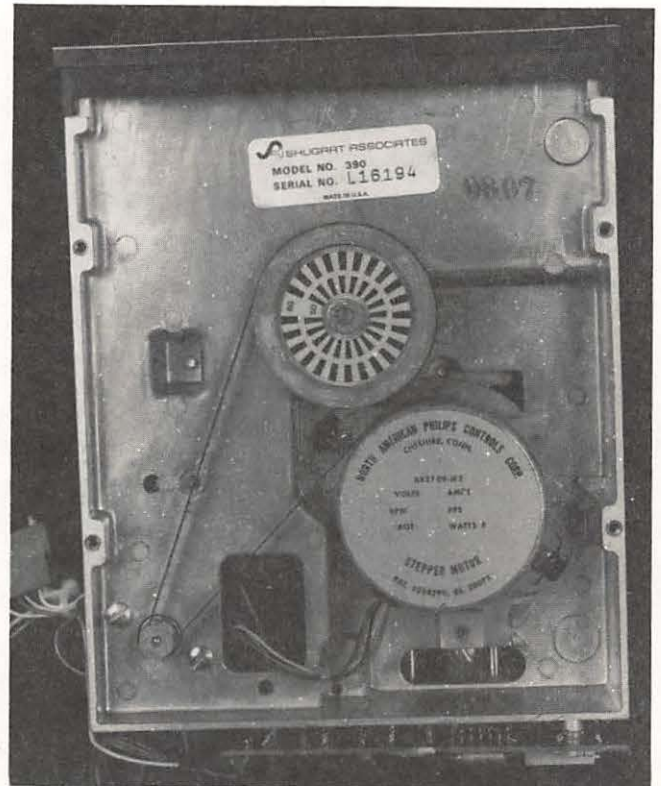

Fig. 8-23. The two circles of timing marks are clearly shown on the strobe disk.

10. Using a jeweler's screwdriver, adjust the speed control pot until the strobe disk seems to be sitting still.
11. Turn off the computer power.
12. Remove the disk.
13. Pull the Apple power cord plug.
14. Disconnect the disk drive cable from the controller card.
15. Reinstall the drive baseplate (use the four silver Phillips head screws).
16. Slide the cover on from the rear (vents toward rear), being careful not to jam or tear the black paper over the vents.
17. Reinstall the four black Phillips head screws in the cover.
18. Turn the drive over, right side up.
19. Reconnect the drive cable on the controller card.
20. Reconnect the power cord plug.
21. Replace the computer lid on your Apple.
22. Operationally test the system.
23. Restore the system to full service.

Disk Drive Alignment

This procedure is *not* recommended for the novice. The alignment adjustments in your Apple drive set the positioning of the read/write head correctly over the tracks on the disk, adjust the disk stop guide, or adjust the collet hub that fits in the hole in your disks. These procedures require special equipment, including a dual-trace oscilloscope, special alignment disks, and various disk alignment tools usually available only to Apple repair people.

If speed adjustment and cleaning don't clear up any read/write problems you may have had, bite the bullet and take your drive into a service center for maintenance.

The most critical alignment adjustment is the read/write head alignment or tracking. Some programs require very accurate alignment of the head over the track. The State of the Art General Ledger program has been known to require very accurate tracking. PFS:FILE is another program for which head alignment is critical. If the program loads fine but won't read data and the disk just spins, you may have a track alignment problem.

If you have to replace the analog card in the drive, you should have the tracking checked. Each card is tuned for the drive, and a new card could affect the head tracking.

Alignment should be checked every year. The easiest way to accomplish this is to format two disks on two different drives whose speeds have been verified to be correct. Save some programs on each disk using the same drive on which formatting was done. Read and write each disk with its drive to make sure the individual drives work satisfactorily. Then switch disks and see if each disk works properly in the alternate drive. If one drive reads correctly while the other can't find the data or reads out "garbage," you know you have alignment problems.

HARD DISK MAINTENANCE

Since hard disks are sealed in dust-tight enclosures, the only PM you can do on these devices is exterior cleaning and proper location to minimize noise interference problems. Improperly connecting Apple IIe floppy disk drive cables has been known to generate so much RFI that Corvus hard disk units over six feet away have failed to operate correctly. If you have the Apple IIe, be careful how you connect the disk drive cable clamps at the rear of the computer chassis.

DISPLAY SCREENS AND EYE PROBLEMS

This subject has been bantered about for 15 years as hobbyists, military and civilian radar operators, and, currently, word processing operators struggle for answers to some nagging questions. Will long periods of staring at the face of a CRT screen damage the eyes? Is the radiation emitted by the CRT tube dangerous to the user.

Let's take these questions in reverse order. First, a CRT that makes characters and shapes on its screen by sending streams of electrons toward a phosphor-coated surface (the back or inside of the screen) *does* produce radiation. Two types of radiation are produced. Light-radiation, which becomes the characters we look at, and low-level X-ray radiation.

The United States government has placed limits on the amount of X-radiation that can be allowed to escape out the face of a CRT. This limit is 0.5 milliroentgens per hour measured about 2 inches out from the screen. Manufacturers of CRTs added strontium and lead to the glass panels in televisions and monitors to eliminate almost all X-radiation escaping out the front of a display. Many intense tests were conducted by government and civilian organizations to determine how much radiation is emitted by video display terminals. The results were very encouraging. There was no evidence of

damaging radiation coming out of any of the displays tested. Measuring instruments recorded more radiation in the sunlight than in the CRT display light. The overwhelming conclusion by these researchers is that radiation from video displays doesn't threaten our vision.

We do have a separate problem that needs our attention. Older screens display harsh white letters. Looking at a high-contrast screen of letters and numbers for a long time can cause eye fatigue, headaches, and neck and back strain.

Eye fatigue can result from looking at those bright white letters and numbers on a dark black background screen. New CRT phosphors allow the use of green, and now amber, displays, significantly reducing eyestrain problems.

Room light reflections were also linked to eyestrain, so recommendations were made that display terminal users work in a well-lighted room and use nonreflective screens applied to their CRT display screens.

Neck and back strain, and even some emotional problems, have been related to long periods of using a display screen. These issues are being resolved by redesigning the operator station or desk, and even the room itself. Poorly designed desks and poor working environments affect the output produced by display terminal operators. In addition, managers sometimes fail to apply good work practices for people "stuck" on a console for hours on end.

To solve workers' problems, new displays are being designed and work concepts are being revised. There are more display monitors that can tilt and swivel to improve user comfort. More computers are being introduced with detachable keyboards. Monitor height positions are becoming adjustable. Glare-reducing screens have become standard in new displays. Room lighting is being redesigned for optimum display-screen viewing. Work conditions are being modified to include frequent rest breaks, and training classes are being conducted to educate management and employees in the proper use of video terminals. Business has made great strides in reducing user problems.

You can learn from these experiences and act to reduce the probability of your own eye, neck, or back strain.

- Use a hard-back chair instead of a soft, "cushy," slouch-producing recliner.
- Take frequent, short rest breaks.
- Take a moment to stretch. Develop some simple

physical exercises to move unused muscles.

- Move away from your computer system for a few minutes each hour. This gives the eyes a rest and can often clear the brain for the arrival of another great idea.
- Keep the room well lighted, but not harshly bright. Try a desk lamp; an incandescent bulb shining on your work and keyboard area from the side works. You can also keep an overhead light on for background lighting and to cut glare.
- Set your display unit at a height that feels comfortable for viewing. You'll know if it's correct after a few hours at the keyboard. Adjust the display height as necessary.
- Avoid using a color television or color monitor for word processing or database applications. These displays are good for games and graphic displays, but they can produce eyestrain if you looked at them for long periods, as you will when working with word processing or database software.
- Have your eyes examined at least annually (every six months is better). If you wear glasses, the doctor can prescribe lightly tinted lenses (light blue or light green), which help to reduce eye strain.
- Increase your intake of foods high in vitamin A (carrots and squash, for example — the "yellow" foods).
- Keep your equipment clean and in good operating condition.

There are over 10 million video display units in use today, and twice this many are expected to be in use within two years. As prices come down, perhaps it's time to consider trading in that old, clunky black and white display for a new \$100 green or amber unit that will better serve you.

USING HEAT TO SPOT TROUBLES

Thermal Imaging

There is a new troubleshooting and preventive maintenance technique that uses the temperature of the components to determine the condition of the system, much as a mother takes the temperature of her child to

see if the child is ill. This technique is called “thermal imaging” or “thermography” and is proving to be a remarkably accurate preventive maintenance tool.

Imagine having an infrared picture taken of your Apple motherboard, new and shiny and operating on a certain program. Comparing this to a second photo taken a year later when the system has started acting “flaky” shows you a new “hot spot” right in the middle of the board’s RAM, indicating that one of the memory chips is about to give out. Replacing this one chip will bring the system back up to peak operating potential.

Standard photography produces images or pictures from visible light; thermal imaging produces pictures from the invisible heat coming up off the surface of objects. It’s a cost-effective maintenance procedure in many large industrial plants.

Several companies sell expensive thermograph machines that produce heat images or “heat maps” in vivid color on high resolution red-green-blue (RGB) monitors. These units can measure temperatures all over a printed circuit board with a sensitivity of 0.1 degree C over a temperature range of 0–200 degrees. If any board has an area on it with a temperature outside specific limits, a computer comparison of the suspected board temperature image with normal board baseline temperatures will immediately point out the fault. These faults can be shorts, opens, and even marginally defective components. These thermograph units can even diagnose failures in high-density circuit boards—all without touching the board. Unfortunately, these machines cost thousands of dollars. But there’s an alternative.

If you own a 35 mm camera, you could try your own thermal imaging using infrared (IR), heat-sensitive film. Either color or black and white should work. A good black and white candidate is Kodak HIE-135-36, ASA-25 IR film. Color IR film is about 50 percent more expensive. A special filter (Wratten Number 87, 88A, or 89B) makes the picture more effective.

With your Apple open and running a simple program (AppleVision on your System Master disk works fine, since it continuously repeats), let the computer warm up for about two minutes to let the components reach operating temperatures. Then take a picture of the motherboard. Background light won’t matter, because the film is sensitive to heat, not light. Take several shots.

Then periodically, every six months for example, or when the system starts acting up, take another series of pictures with the same program running in the computer. A comparison of the before and after pictures will quite likely point out where your system is wearing out or has failed already.

Heat-Sensitive Liquid Crystal

Another useful technique for finding potential or actual troublespots in your computer is the use of liquid crystals (LCs). These organic compounds are derived from cholesterol and react to changes in temperature by changing color.

This visual method for testing and evaluating your Apple circuit boards is available as a laminate (pressed layer) film or as a liquid solution. The liquid solution is recommended for circuit boards. The temperature range for measurement can be specified in increments of 1 to 50 degrees C within an operating range up to 150 degrees C.

Two types of these liquid crystals are available today—the *temperature limited liquid crystal (TL-LC)*, which returns to its original shade upon cooling, and the *recording temperature limit liquid crystal (RTL-LC)*, which remains an ash-grey color until you brush or rub it, causing the original shade to return.

The nondrying opaque liquid is applied by brushing it directly on the surface of solder joints, chips, other circuit board components, and connectors. The solution has a very high resistance, so it won’t short out anything on the board.

When the Apple is energized, the heat generated as the circuits function causes the liquid crystal solution to change color according to the temperature sensed by the solution. Hot spots turn indigo blue, cooling to blue, turquoise, green, through yellow and orange, to red and finally gray.

This LC solution is useful for testing printed circuit components for failing chips, solder shorts, and even solder connection bonds that are breaking apart. The completeness of a bond can be detected by the color changes during normal operation; air in the bond cools more slowly than the surrounding metal. A dark surface shows the color changes best so the manufacturer adds black dye to the LC solution.

Typically the surface to be tested is first cleaned of all oils and dirt, since these contaminants will give incorrect color readings. Then it is dried, and the LC solution is brushed or sprayed onto the components and board, leaving a thin, even coat. When the circuit is powered up, the rainbows of colors pinpoint the hot spots on the board or components. If the heat generated at one place on the board doesn’t follow the normal circuit heat-up pattern, a failure in that component area can be predicted. On connectors, excessive heat generation indicates a poor connection.

When the test is complete, the solution can be

wiped off with a lint-free cloth. The solution won't short out or contaminate the circuit board or the components.

A testing kit including sheets of film, different temperature-range liquid solutions, an aerosol can of black paint, applicator brushes, a sprayer, and solvent for surface and sprayer cleaning is available from Liquid Crystal Applications, Inc. in Clark, New Jersey for about \$250.

SUMMARY

This chapter has covered every aspect of routine preventive maintenance to keep your Apple system in

peak operating condition. It discussed six major contributors to computer system failures: excessive temperature, dust build-up, noise interference, power-line problems, corrosion, and magnetic fields. For each of these factors, one or more preventive countermeasures was presented. You learned that floppy disks are uniquely constructed to be protected from dust and dirt, discovered how disks and disk drive read heads can be damaged, and, most important, learned how to extend the life of disks and disk drive systems. You learned that display-screen-caused eye, neck, and back strain can be prevented. Finally, you learned two interesting ways to use heat for locating potential or existing circuit failures.

Advanced Troubleshooting

In earlier chapters you learned the basic techniques for troubleshooting most Apple failures. You found there are eleven “Apple Optimum” steps to successful fault identification and correction. You learned how to recognize the various components of your computer, and you discovered four ways to find failures:

1. The hardware approach
2. The software approach
3. Self diagnosis
4. The Apple-Easy approach

In the hardware approach, you use troubleshooting tools such as logic probes and logic pulsers to step through a circuit. This requires test equipment and some knowledge of digital electronics.

The software approach is a troubleshooting method used widely by Apple repair technicians (out in the retail stores). As long as the disk drive boots up properly, diagnostic software is effective at finding chip failures.

The Apple-Easy approach uses the troubleshooting guides in Chapters 4 and 7 to quickly pinpoint potential chip failures. If you conclude that the problem is not a chip and you still want to locate the failed part, you can use the techniques discussed in this chapter to test the rest of the components in the suspected failure area.

In this chapter you will learn the advanced techniques. You’ll be introduced to the repair technician’s “tools of the trade.” Like other parts of this manual, this chapter is full of “meat and potatoes” information to help you keep your Apple system in peak operating condition.

TOOLS OF THE TRADE

When the problem can’t be solved using flowcharts and pictures, repair technicians reach for help — they reach for their “tools.” These tools are not only the tiny screwdrivers (tweakers), the diagonal cutters (dykes), and the soldering pencil, they also include electronic test equipment — the various measurement meters (VOM, DVM, DMM), logic probes, logic pulsers, current tracers, clips, oscilloscopes, and logic and signature analyzers.

Meter

Electronic measurement equipment has improved a great deal over the years, markedly improving your ability to test and locate circuit troubles. Twenty years ago, a meter called a *VOM* (*volt-ohm-milliammeter*) was used to measure the three parameters of an electric circuit — voltage, resistance, and current (Fig. 9-1). Then

came the *VTVM* (*vacuum-tube-voltmeter*). It wasn't long before electric circuits made room for electronic circuits, replacing analog with digital, and new meters appeared for troubleshooting using some of this new capability in their design. The *DVM* (*digital voltmeter*) and *DMM* (*digital multimeter*) quickly became the preferred measurement devices for digital technicians because they offered capabilities better suited for electronic circuit testing, including increased accuracy. These meters have characteristically high input impedances (resistances), so they don't load down or draw down a digital circuit to the point that voltages and currents are far lower than those found in analog circuits.



Fig. 9-1. A volt-ohm-milliammeter (VOM) and a digital voltmeter (DVM).

Two changes affected the types of tools used in troubleshooting and repair. First, vacuum tubes were replaced by solid-state devices such as transistors and the integrated circuit (IC), or chip. Second, circuits themselves became smaller with more components packed compactly into less board area. One need only compare the early radios and televisions (standing 4 feet tall and weighing 40 pounds) with the wrist radios and now the wrist televisions of today to recognize that electronic circuits are smaller, more complex, and more difficult for test-probe access.

Electronic advances always lead to electronic opportunities, and clever test equipment designers soon came up with devices that allowed digital circuit testing without fear of inaccurate readings caused by circuit overload, or circuit failure caused by bulky test probes shorting two pins or wires on a packed printed circuit board.

Logic Clip

One digital circuit testing device is the *logic clip* and is shown in Fig. 9-2. This handy tool fits over an IC and has exposed pins at the top. Measuring or monitoring probes or tiny clips can be attached to the pins to determine the logic level on any pin of the device under test.

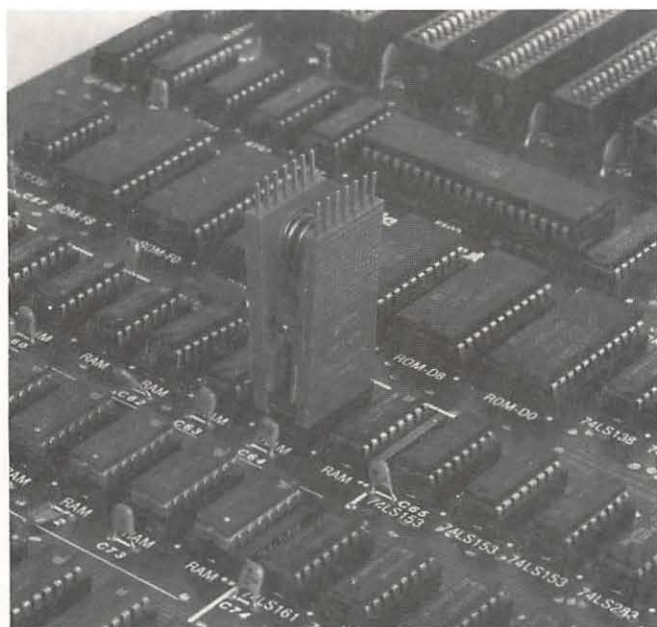

Fig. 9-2. A popular type of logic clip. (Pomona Electronics Division of International Telephone and Telegraph Corporation)

Another type of logic clip has a built-in monitoring capability. Instead of exposed pins, the top of the clip is lined with two rows of *light emitting diodes (LEDs)* which continuously display the logic condition of each pin on the chip. The LEDs are turned on (indicating a logic 1) by power from the circuit under test. All the pins are electrically buffered so the clip doesn't load down the circuit being tested.

CAUTION: When using a logic clip, turn power to the circuit off, attach the clip, and then turn power on. (This helps prevent accidentally shorting out the chip.)

Logic clips can be obtained in several varieties — to work with almost all logic families, including TTL and CMOS — and in voltages up to 30 volts DC.

To use the clip, squeeze the top (LED) end to spread the pin contacts, and slip the clip over the top of the chip to be tested. When power is applied to the circuit, the LEDs will indicate the logic level at each pin on the chip.

Logic clips can be used on ICs with up to 16 pins, or 80 percent of the ICs on your Apple II Plus motherboard.

Logic Probe

When you want to really “get into” your circuit, you can use a logic probe. A blown chip can’t be repaired, but the logic probe can tell you which chip has failed so you can replace it.

The logic probe shown in Fig. 9-3 is the most widely used tool for this kind of analysis. It can’t do many of the things complex test equipment such as logic analyzers can do; however, the high frequency of chip failures in electronic circuits, the simplicity of the probe, and the ability to rapidly troubleshoot in an energized circuit make this tool ideal for 90 percent of your fault isolation needs.

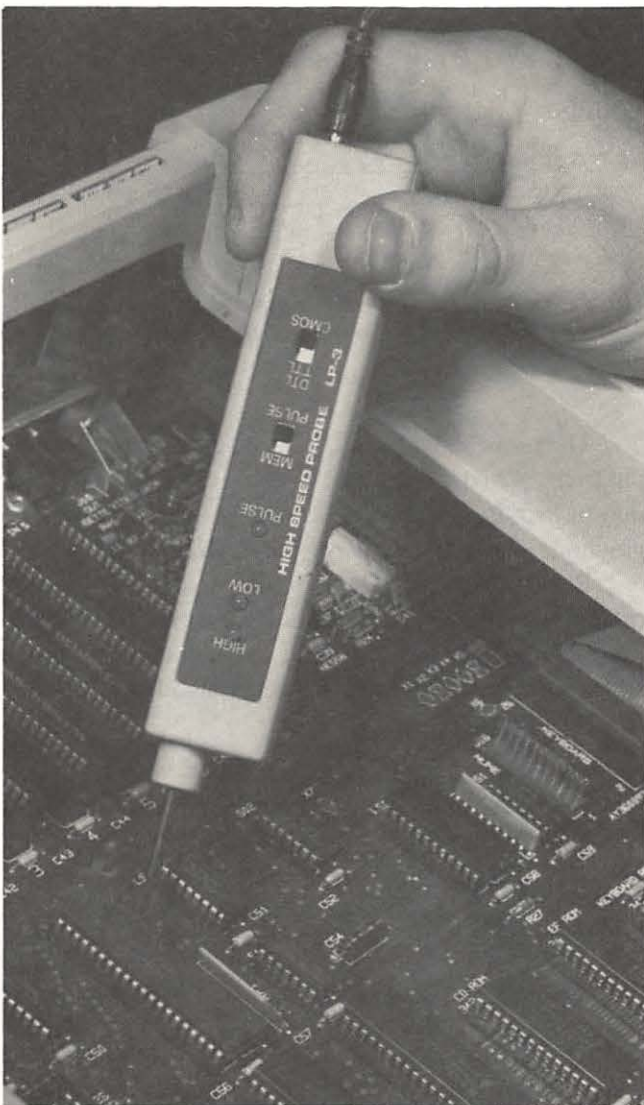

Fig. 9-3. The logic probe is the most widely used tool for circuit board analysis.

When the tiny tip of the probe is placed against a pin on a suspected bad chip, a test point, or even a trace on a circuit board, an indicator light near the tip of the probe tells you the logic state (level) at that point. The metal tip on most logic probes sold today is protected against damage from accidentally touching a source of higher voltage (up to 120 volts AC for 30 seconds) than that of logic gates (+ 5 volts).

Some probes have two lights built in near their tips — one for logic HIGH and the other for logic LOW. The better probes can also tell you whether the test point has a pulsing signal present. They can also store a short pulse burst to tell you if a glitch or spike has occurred at that point. If you’re planning to buy a logic probe, be sure it will work with the logic families you plan to analyze.

The ability to touch a point with the probe tip and directly determine the condition at the point for diagnostic analysis, and the ability to store pulses, make this device easy to use and universally accepted as the proper diagnostic tool for all but the most complex digital troubleshooting. Other tools force you to attach the measurement probe and then look away at some display to read the condition. The logic probe displays the condition near the tip of the probe itself.

The logic probe in Fig. 9-3 provides four indications:

- Lamp OFF for logic LOW (logic 0)
- Lamp ON bright for HIGH (logic 1)
- Lamp DIM for floating or tri-state
- Lamp flashing for pulsing signals

Power for the probe comes from a clip attached to a voltage point on the circuit under test. Another clip attaches to ground, providing improved sensitivity and noise immunity.

Probes are ideal for finding short-duration, low-frequency pulses difficult to see on an oscilloscope, but more often they’re used to quickly locate gates whose output is hung, or locked, in a HIGH or LOW condition.

A useful method of circuit analysis with the probe is to start at the center of the suspect circuit and check for the presence of a signal. (This of course assumes you have and can use a schematic of the circuit.) Move backward or forward toward the failed output as shown in Fig. 9-4. It doesn’t take long to find the faulty chip whose output isn’t changing.

The only limitation of logic probes is their inability to monitor more than one line.

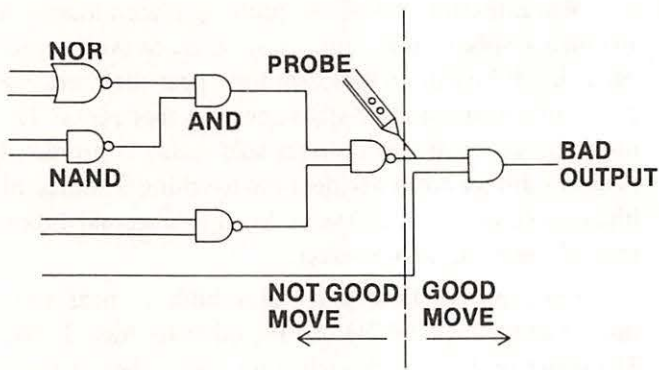

Fig. 9-4. Circuit analysis starting at the center of a suspect circuit.

Logic Pulser

If the circuit under test doesn't have a pulsing or changing signal, you can inject controlled pulses into the circuit using a logic pulser (Fig. 9-5). These handy devices are portable logic generators.

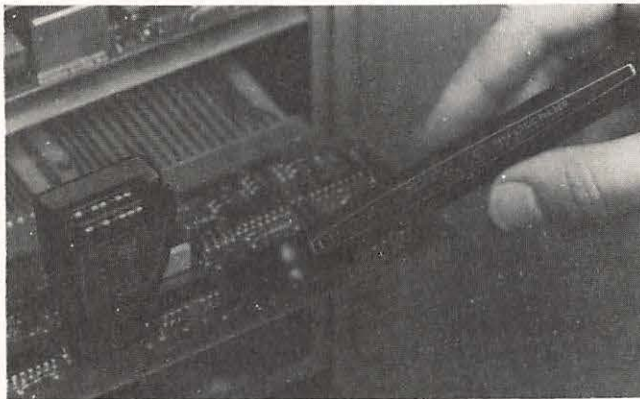

Fig. 9-5. A logic pulser can be used to inject a signal into a circuit.

When activated by a push button or slide switch, the pulser will sense the logic level at the point touched by the tip and automatically generate a pulse or series of pulses of the opposite logic level. The pulses can be seen on an LED lamp built into the handle of the pulser.

The ability to introduce a changing signal into a circuit without unsoldering or cutting wires makes the logic pulser an ideal companion to the logic probe and logic clip. These two tools used together permit step-by-step stimulus/response evaluation of sections of a circuit.

Fig. 9-6 shows several ways to test logic gates using the probe and pulser. Assume the output of the NAND gate remains HIGH. Testing inputs 1, 2, and 3, you find them all HIGH. This condition should cause the AND

gate output to go HIGH, producing a LOW out of the NAND gate. Something is wrong. Placing a probe at the AND gate output, you discover the level is LOW. It should be HIGH. Now, which gate is bad?

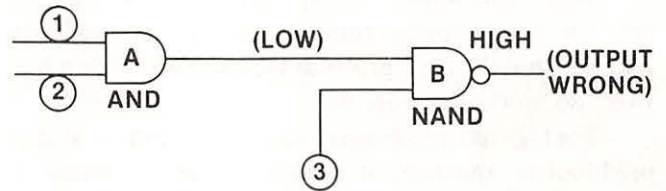

Fig. 9-6. There are several ways to test logic gates.

To find out, place the probe on the NAND (gate B) output and the pulser on the AND (gate A) output (NAND gate input), as shown in Fig. 9-7. Pulse this line.

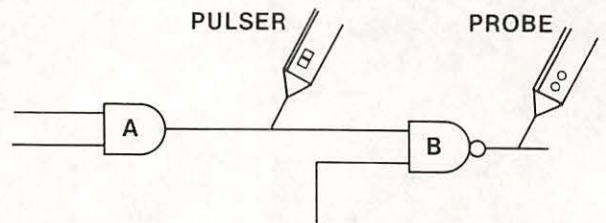

Fig. 9-7. Place the probe on the NAND gate output and the pulser on the AND gate output.

The probe should blink, indicating a change at the input to the NAND. If it doesn't blink a change, the NAND may be bad. But what if the LOW was caused by a short to ground at the AND output or the NAND input?

Place the probe and the pulser on the AND output trace as shown in Fig. 9-8, and pulse this line. If the pulse blinks, the NAND is bad; its input changed state, so its output should have changed state also.

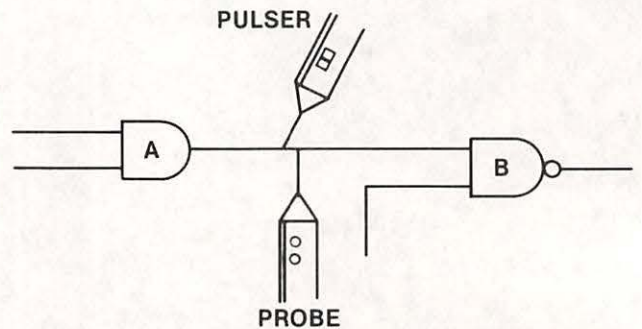

Fig. 9-8. Place the probe and the pulser on the AND gate output.

If the probe doesn't blink, you know this line is shorted to ground. One way you can determine which chip is shorted is by touching the chip case. A shorted chip gets pretty hot, while a chip hung at one level seems to be normal but just won't change state.

Current Tracer

A fourth handy troubleshooting aid is the *current tracer probe*. This portable device lets you precisely locate shorts on your Apple motherboard (or peripheral card). The current tracer senses the magnetic field produced by the flow of electrical current in the circuitry. The logic pulser can be used to generate a pulsing signal that will make the current tracer LED blink, indicating the presence of current.

If you set the tip of the tracer on a printed circuit line and slide the tracer along the line, an LED in the tip end of the tracer will pulse as long as there is a current present. When you slide past a shorted point, the lamp will go dim or out, and you've found the short.

Fig. 9-9 shows an easy way to determine which gate has the short to ground in a logic circuit. Assume gate B has a shorted input. Place the pulser and the tracer midway between the two gates. Adjust the LED in the current tracer so that it just lights. Pulse the line as you place the tracer on the output of A and then on the input to B. The gate with the short to ground will pulse brightly because most of the current will ground there. Therefore, the input to B causes the tracer lamp to pulse brightly, while the A side of the line doesn't cause the LED to light. Following the LED light with your tracer will lead you to where the current is going.

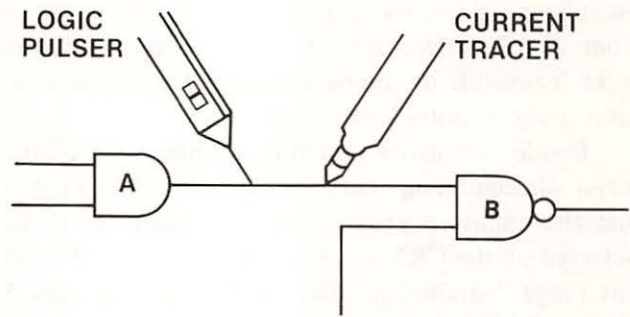

Fig. 9-9. Following the LED light with your tracer will lead you to the short.

markets an in-circuit component tester that's actually a cathode ray tube that can display signals up to 50 mHz. It displays the voltage versus current characteristics for virtually all circuit components including capacitors, diodes, integrated circuits, resistors, and transistors. With their tester, the condition of the component under test is determined by the shape of the CRT display. Using this test machine, you can easily pick out open circuits, shorts, leaky diodes, leaky transistors, and marginal ICs. The tool is valuable because it can test a wide selection of components while they're still mounted in the circuit.

For do-it-yourselfers, Gilbert Marosi of Micro Power Systems in Santa Clara, California has written an interesting article for the May 26, 1983 issue of *EDN* magazine. Marosi's article deals with constructing an IC tester using an Apple II as an integral part of the test system.

Oscilloscope

The *oscilloscope* has been with us for years, although recent advances in the state of the art have added a great many capabilities to the instrument.

Simply put, an oscilloscope is an electronic display device that draws a graph of signal voltage amplitude versus time or frequency on a CRT screen. A scope is used to analyze the quality and characteristic of an electronic signal, using a probe that touches a test point in a circuit. It is also used as a measuring device to determine the voltage level of certain signals.

Scopes come in all sizes, shapes, and capabilities. Prices vary between \$500 and \$20,000. Some scopes use a single test probe for displaying and analyzing a single trace signal. Others have two probes and display two different signals (dual trace) at the same time. As many as eight traces can be analyzed at the same time on some oscilloscopes. In fact, the November 17, 1983 issue of *Electronic Products* magazine described the newest in

IC Tester

Advanced troubleshooting equipment is becoming very sophisticated (and expensive). Today, you can buy equipment that tests almost every chip in your system for between \$1,000 and \$2,000. For \$10,000 you can even conduct your tests from a remote location.

Micro Sciences, Inc. in Dallas, Texas makes an IC tester that can test over a hundred 7400 TTL and 4000 CMOS series devices. Options for this tester include RAM and ROM tests.

Microtek Lab in Gardena, California makes a tester that can do complete functional pin tests of all 900 devices in the 54/74 TTL series chips. This test tool displays the condition of the chip under test on a liquid crystal display (LCD). It uses LEDs to signal Go/No Go test results.

VuData Corporation in San Diego, California

oscilloscope technology, a seven-color digital scope from Test & Measurement Systems Company. Colors make it possible to compare signals at different locations in the circuitry very rapidly.

Besides sensitivity and trace display, one of the major distinguishing characteristics of oscilloscopes is that they allow a great range of frequencies to be observed on the CRT screen as frozen images. We call this range "bandwidth." Bandwidths vary between 5 MHz and 300 MHz, and price is proportional to frequency.

Oscilloscopes are useful tools for freezing an analog or varying signal and displaying this static waveform on the face of a CRT screen covered with a measurement grid. While it is time consuming to learn how to use an oscilloscope, the analytical rewards are substantial. Not only can you measure voltage amplitudes and frequencies of test signals, you can also measure delay times, and signal rise and fall times, and even locate the intermittent glitch.

Some scopes have built-in memories to let the machine store a signal of interest for future evaluation.

If you're not trying to set the world on fire as a system designer, you can probably get along fine with a dual trace, 25-30 MHz scope. Investment in an oscilloscope is not cost effective if you intend to use it only for analyzing your Apple motherboard while troubleshooting a component failure. You'd be better off saving the money and spending a comparatively small portion of it to have a service center fix your machine.

The nice thing about dual trace, quad trace, and even eight trace is the ability to look at different signal paths or different signals simultaneously. For example, you could look at the input and output of a gate and actually see and be able to measure the delay time for the signal passing from input to output of the chip. Another useful technique is simultaneously displaying all or parts of the data bus, or part of the address bus to see what the logic level is (HIGH = +5 V, LOW = 0 V) and what binary number it represents.

Logic Analyzer

A companion device to the oscilloscope, the *logic analyzer* is a multichannel oscilloscope with a memory. It captures and stores a number of digital signals, letting you view the signals simultaneously. If each signal is a bit on the data bus, you can see the entire data bus at one time. This means you can analyze the logic level for each bit on the bus for any instant in time. The bus signals are frozen for your display and analysis. The

ability to freeze a single event or data pattern so you can determine the information present on a digital bus at any moment in time is a distinct advantage for troubleshooting.

Logic analyzers, like oscilloscopes, cost between \$500 and \$20,000. And, again like the scopes, logic analyzers work at frequencies from 2 MHz up to 200 MHz.

These analyzers can display many signals (channels of input) simultaneously. Arium Corporation in Anaheim, California recently announced an analyzer that handles 32 channels of input data at frequencies up to 100 MHz. Nicolet offers a 48-channel, 200 MHz analyzer with built-in microcomputer and dual, double-density floppy disk drives. Each channel has associated with it a probe clip for connecting to some test point in the circuitry. Fortunately, the clip probes are tiny and easy to install.

A sampling of the capabilities currently available in logic analyzers reveals one configuration that provides 104 channels at 25 MHz, another with 32 channels at 100 MHz, and yet another with 16 channels at 330 MHz. Another configuration has 8 channels of input and can operate at 600 MHz! (Recall that your Apple II clock is 1.023 MHz.)

Northwest Instrument Systems, Inc. of Beaverton, Oregon is marketing an add-on device for your Apple II that converts the computer into an interactive logic analyzer. Called an *interactive state analyzer (ISA)*, this system combines the CRT and keyboard of the Apple II with the electronics of the analyzer to produce a real-time analysis tool for troubleshooting 8- and 16-bit designs.

Where would logic analyzers be useful? One place is in debugging software. You can read the data in machine code and trace its flow through the circuit. You could analyze the input and output of memory simultaneously for locating a bad RAM chip. Or you could uncover intermittent glitches, those phantom spikes that can raise havoc with your system. There are many more uses for logic analyzers, including analysis of disk I/O operation.

The logic analyzer has been called the oscilloscope of the digital domain. It can be a valuable tool for the software or hardware designer. But for the home or small business computer owner who simply wants to fix his or her own computer when it fails, the logic analyzer is expensive overkill.

Signature Analyzer

Logic probes can be effective in detecting logic levels and pulses at single points. Oscilloscopes can ex-

tend the number of points to be monitored even though the data pulses all tend to look alike. And logic analyzers extend the number of test points even further to include buses the size of the data and address buses. However, as the sophistication and capability of the measurement device increases, so does the expertise required to operate the test tool. Logic analyzers, in particular, can be very capable but they can also be difficult to understand and operate. The *signature analyzer* was developed to allow easy detection of hardware failures.

Signature analysis is a comparison method of troubleshooting. It works by running a diagnostic program in the system being tested, and evaluating a coded signal at specific test points in the circuitry. If the coded signal matches the code observed when the system was running properly, the malfunction is not in that part of the circuitry. When a test point signature fails to match the baseline correct code, this indicates that you have located the faulty area. Then you can probe backwards or forwards from this point to isolate and locate the component that has failed.

The first codes were developed by Hewlett-Packard and with slight modification are still being used today. The key to the success of this test technique is in the signature code. It is a 16- or 24-bit repeatable value that represents a stream of data passing a test point during an interval of time. This known stream of data, when sampled at different places on a good circuit board by a signature analyzer, produces a unique 16- or 24-bit code at each test point.

These codes can be documented or stored in a PROM (Programmable Read Only Memory) and recalled later for comparison during troubleshooting. The PROM then becomes a custom memory module containing every signature sampled from a properly working system that was being stimulated or pulsed with a known data stream.

Signature analysis has not been a popular troubleshooting tool because it takes a lot of time to identify the test points or nodes, probe the nodes, produce a signature, and then document the code. Once this task is completed, however, the task of locating a failure becomes a breeze. And the introduction of PROM modules has made the setup task much easier. More improvements in this analysis technique can be expected in the near future.

One analyzer on the market uses a mode called "backtrace" to prompt the troubleshooter through a series of test points, guiding the tester to trace bad signatures back to the failed part.

The investment for a signature analyzer is between \$400 and \$10,000. Signature analysis uses a simple,

nontechnical approach to troubleshooting so even untrained people can use the equipment and the technique.

COMPONENTS AND HOW THEY FAIL

While the use of troubleshooting equipment makes the analysis and isolation of computer problems much easier, many failures can be found without expensive equipment. In fact, an understanding of how electronic components fail can make troubleshooting and repair relatively simple.

Other than for operator error, failures generally occur in the circuits that are used or stressed the most. This includes the RAM and ROM chips, the 6502 CPU, and the I/O chips between the motherboard and the disk drive. The CPU is a highly reliable device and doesn't fail very often. Most failures involve the other chips. Except for the ROMs, which are preprogrammed by Apple Computer Company, these other chips are standard off-the-shelf devices and are so common they're called "plain vanillas" or "jelly beans" — inexpensive easy-to-replace products. There are other components on your Apple's motherboard which may someday require replacement. These require soldering and are not as easy to replace.

Now that you understand what kinds of tools are available, let's look at the kinds of components you'll be analyzing in your troubleshooting efforts and how these components can fail.

Integrated Circuits — Chips

A chip or integrated circuit is constructed out of silicon with some other tiny particles of metal (impurities) embedded in specific positions in the silicon. By positioning the metals in certain ways, tiny transistors can be formed. Applying a voltage to certain places on the chip allows the device to invert a voltage level (+5 volts, logic 1, to 0 volts, logic 0), and enables all sorts of logic gates (AND, NAND, OR, NOR, etc.) to function. It turns out that these chips can be made with silicon/metal junctions so tiny that today thousands of transistors can be placed on one chip. A memory chip the size of a fingernail can hold over 470,000 transistors.

The problem for chip manufacturers is how to get voltages and signals in and off such a tiny chip. Very thin wires are used as inputs and outputs to the chip. These wires are glued or bonded to tiny pads on the chip. The other end of each wire is bonded to a larger pad on a supporting material (the big part of what we

call the integrated circuit as shown in Fig. 9-10). The supporting structure includes the pins we plug into the sockets on our printed circuit boards.

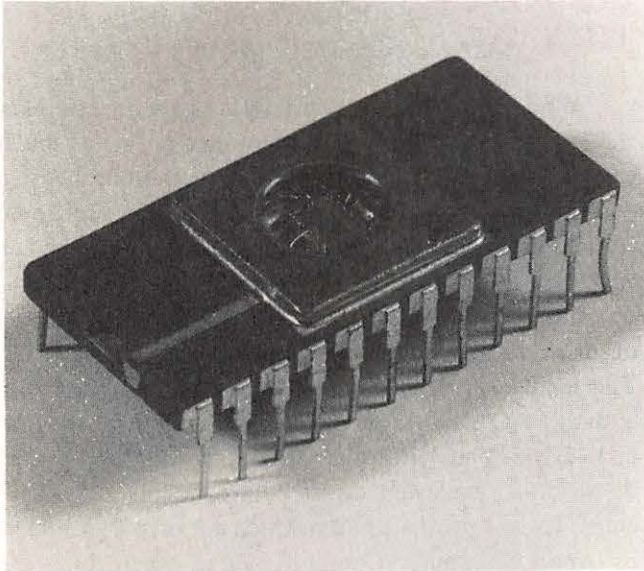

Fig. 9-10. The tiny leads from the chip to the pins of the chip package can be seen clearly in this photo.

These tiny silicon and metal chips are placed in environments that really put them under a lot of stress. First they heat up when you use your computer. Then they cool down when you turn off your machine. Then they heat up again. This hot-cold-hot effect is called "thermal stress." It affects those tiny strands of wire, or leads, going between the chip and the supporting structure, which includes the large pins that are inserted into sockets. After a period of time, the thermal stress can cause the bonding of the wire lead to break away from the pad on the chip. This disconnect causes an input or output to become an "open" circuit, and chip replacement is required.

Another failure in these chips is caused by a phenomenon called "metal migration." The chip can be compared to an ocean of atoms. Some tiny particles of metal float about in this sea, migrating in directions perpendicular to electrical current flowing through the chip. Problems occur when these metal particles begin to collect in parts of the chip. If they concentrate in the middle of one of those microelectronic transistors, they cause the transistor to operate differently or not at all. If the resistance of these collected metals gets high enough, it causes the device to operate intermittently or to simply refuse to work. Since a transistor is part of a logic gate, the gate malfunctions and the output may

become "stuck at 1" or "stuck at 0," no matter what the input signal is. Theoretically, a wearout failure won't occur until after several hundred years of use. We shorten the lifespan of our chips by placing them in high temperature, high voltage, or power cycling environments. These cause the devices to fail sooner.

Other problems occur outside the chip, between the chip leads and the support structure pin leads called the device inputs or outputs.

These types of failures include: inputs or outputs shorted to ground, pins shorted to the +5 volt supply, pins shorted together, open pins, and connectors with intermittent defects. The most common problems (assuming power is available) are opens or shorts to ground. Under normal use, chips finally fail with an input or output shorted to ground.

Capacitors

An understanding of the way a standard capacitor is constructed will aid in your understanding of how these devices fail.

In Chapter 1, you discovered that there are several types of capacitors on the Apple motherboard. The capacitor is constructed of two separated plates. A voltage is placed across the plates and, for a short instant, current flows across the gap. But soon electrons build up on one plate and cause the current flow to stop. The capacitor is then considered charged to some voltage potential. Capacitors are used to store charge and to filter unwanted signal spikes (sharp, quick peaks of voltage) to ground.

The electrolytic capacitor is constructed as shown in Fig. 9-11. Two aluminum foils or plates are separated by a layer of porous paper soaked with electrolyte, a conductive liquid. On one plate (the positive plate) a thin layer of aluminum oxide is deposited. This is called the dielectric. A capacitor has an anode (the positive plate), and a cathode (the electrolyte). Electrons build up on one plate causing it to become so negative that it prevents further current flow (remember that electrons have a negative charge).

Another type of capacitor is the "film" capacitor. It is constructed of alternating layers of aluminum foil and a plastic (usually polystyrene) insulation. The metal foil acts as the plates and the plastic insulation acts as the dielectric between the plates. A film capacitor is shown in Fig. 9-12. Film capacitors are coated with epoxy and have tinned-copper leads.

Capacitors fail open or shorted depending on the operating conditions and on their age.

Electrolytic capacitors are especially susceptible to

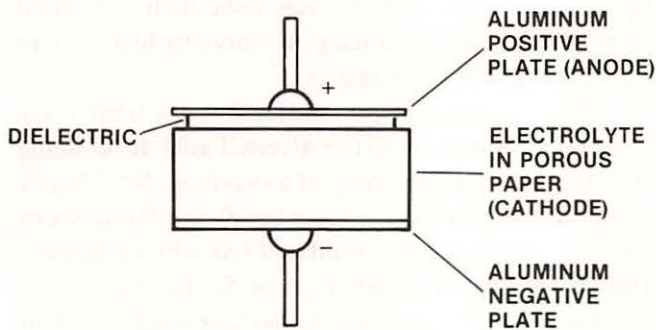

Fig. 9-11. The electrolytic capacitor.



Fig. 9-12. The film capacitor.

the aging process. One effect of aging is drying out of the electrolyte insulator. The capacitance value increases, and circuit performance decreases. Finally the capacitance value drops dramatically as the plates fold toward each other, and shorting of the plates can occur.

Another kind of failure occurs when some of the dielectric oxide dissolves into the moist electrolyte, causing the thickness of the dielectric to shrink. This deforming usually occurs when the electrolytic capacitor sits for a long time without voltage applied. In this case, the capacitance value increases but a high leakage of electrons occurs across the plates, making the capacitor useless.

The leads of the capacitor can physically detach from its plate causing an open in the circuit.

Also, the plates can short together when a large area of one plate is stripped of its dielectric oxide layer by the application of too much voltage.

Like resistors, however, capacitors in our Apple digital logic circuitry will seldom fail. It takes a failure in the power supply to "fry" a capacitor on your Apple motherboard. And while excessive temperatures can also damage capacitors, they damage other components more.

Resistors

These current-limiting, voltage-dropping devices are quite reliable and should function properly for the life of your computer. However, the same factors that shorten the useful life of the chips also act to reduce the operational life of these resistors. High temperatures, high voltage, and power cycling all affect the materials

of which the resistors are made. These stresses cause breaks in the carbon, resistive paste, or resistive layers producing an open conduction path in the circuit. Excessively high voltages can produce electrical current so large that it actually chars resistors to burnt ash. This is rare, especially in a digital circuit where the highest voltage seen is 12 volts (usually 5 volts) and the currents are very tiny indeed (milliamps).

Resistor failures are almost always associated with catastrophic failure of some other circuit component. Resistor failures, when they occur, are usually located in printer electronics rather than in the Apple II computer.

Inductors

Inductors are used in tuning circuits. Their function is to keep the current flow at a constant level.

As you learned earlier in the manual, there is a small inductor in the color-tuning circuitry on your motherboard. These devices are constructed of a coil of insulated wire. Inductor failure occurs very seldom, but it can happen. Wires can be shorted if the inductor or coil is subjected to high temperature or high voltage.

Diodes and Transistors

The diodes and transistors on your Apple motherboard are made of solid material and act much alike. In fact, the transistor can be considered as partly constructed of two diodes.

Diodes are one-way valves for electric current, allowing current flow in only one direction. Diodes are usually made of either silicon or germanium. They are used in power supplies as rectifiers and in some circuits to maintain a constant voltage level. Other diodes are made of gallium arsenide and react by giving off light when biased in a certain way. These are called light emitting diodes or LEDs.

Transistors are used in various places in your computer circuitry as amplifiers or electronic switches.

Diodes and transistors fail in the same ways and for the same reasons as chips, but chips fail far more often than diodes or transistors. One reason is that there are many more tiny transistors on a chip the same size as a single (discrete) diode or transistor. This produces more heat and hence more thermal wear in the chip.

USING TOOLS TO FIND FAILED COMPONENTS

Most chips on the Apple motherboard are TTL (Transistor-Transistor-Logic). If you know the logic

gates in a chip to be tested (NAND, NOR, OR, AND, etc.), you can test for opens or shorts by applying a known logic level to the inputs while monitoring the output. For example, if you were to place a slowly pulsing +5 volt to 0 volt signal on the input to the AND gate in Fig. 9-13, with both inputs shorted, you should see the output voltage level change (pulse) along with the input. Whenever the input is a logic "1," the output becomes a logic "1" (between +5 volts and +2.4 volts).

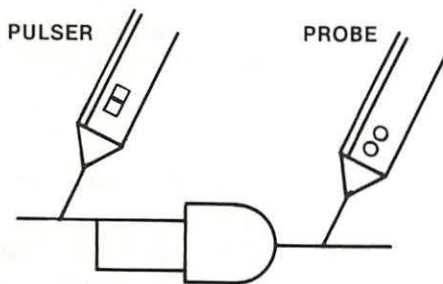

Fig. 9-13. Pulsing the input should cause a change in the output as noted on the logic probe.

The tool you use on the input is a logic pulser. The monitor tool on the output is a logic probe. The pulser places a cyclical logic level on the input to the device and the probe measures the presence or absence of a logic signal on the output of the chip.

If the input to the AND gate becomes shorted to ground, the pulser cannot cause the gate to react to its signal and the output remains at a logic 0 or low (about 0 volts). Even if just one of the inputs shorts to ground, the output cannot change and remains at a logic 0.

A short to the gate supply voltage (+5 volts) will have the effect of qualifying or enabling one input to the gate all the time. This means that each time the other input receives a logic "1," the input set is correct and causes the output to change to a logic "1" even though only one input signal was actually correct. This produces incorrect circuit operation and strange results. This is the kind of problem that shows up in memory circuits. Only one of the inputs to a particular gate is shorted or opened. Whenever this gate is used, the resulting output may or may not be correct — a difficult problem to trace down.

Shorting an input pin to +5 volts can have potentially disastrous results. When the previous gate tries to deliver a logic "0" or low, a huge current is produced which usually causes catastrophic failure of the driving chip. The same result occurs when the input pin is shorted to ground and the previous gate tries to deliver a

logic "1" or high. The +5-volt logic high is shorted directly to ground, producing an unusually high current with equally disastrous results.

Open connections prevent logic levels from being transferred and prevent the affected gate from being able to respond. If one input of a two-input NAND gate is open at the input, as shown in Fig. 9-14, all but one of the four possible input combinations will be correct. This means that with this type of failure, the system could operate correctly most of the time when only half of the inputs are good. The failure would be intermittent.

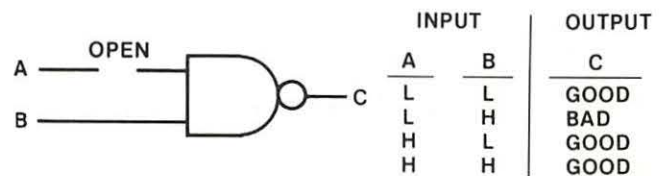

Fig. 9-14. An open at the input to a NAND gate is only a problem in one of four logic state cases.

As shown in Fig. 9-15, if the device being tested is a NOR logic gate, the output would be a logic "1" or "high" only when both inputs are at logic "0" or "low." Should one of the inputs become open, it would float to logic "1" and cause none of the input conditions to produce a logic "1" or "high" output. Thus, the output would be low all the time — just as though the output were shorted to ground.

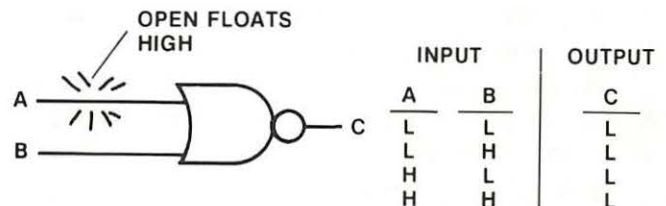

Fig. 9-15. An open at the input to a NOR gate will prevent the output from ever changing state or going HIGH.

If the chip has an open pin at its output, it cannot deliver any logic "1" or "0" to the next gate. You can measure a voltage at the input to the next gate since it is providing the potential, a logic "1" or "high" level (something around +4 volts). The key here is that any time an input to a TTL gate opens (a condition we call "floating"), the gate will act as though a logic "1" were constantly applied to that input. The voltage on this floating input will drift between the high supply voltage

of +5 volts and a level somewhere between a valid "high" and a valid "low" (about 1.5 volts). (A valid "high" is usually above +2.4 volts; a valid "low" is below +0.4 volts.)

A voltmeter reading of about +1.7 volts at the output pin of a gate on a chip is a clue that the output is floating open and the voltage is actually being provided by the next chip or following gate.

All these kinds of failures can be located using a logic pulser and a logic probe with backup from a VTVM for voltage measurement.

Since the Apple motherboard is flexible at certain points, a user who is replacing chips or depressing the board without supporting it from beneath could cause a break to occur, opening a trace on the circuit board. A hairline crack such as this is often difficult to find, but looking at the board with a magnifying glass and a strong light (I use a magnifying lamp) can sometimes reveal a suspected failure. A resistance test can be conducted with a VOM or VTVM by placing a probe at either side of the suspected bad trace, as shown in Fig. 9-16, and observing whether a zero ohm reading is measured. Another way to ascertain if an open trace is present is to compare the logic states at either end of the trace.

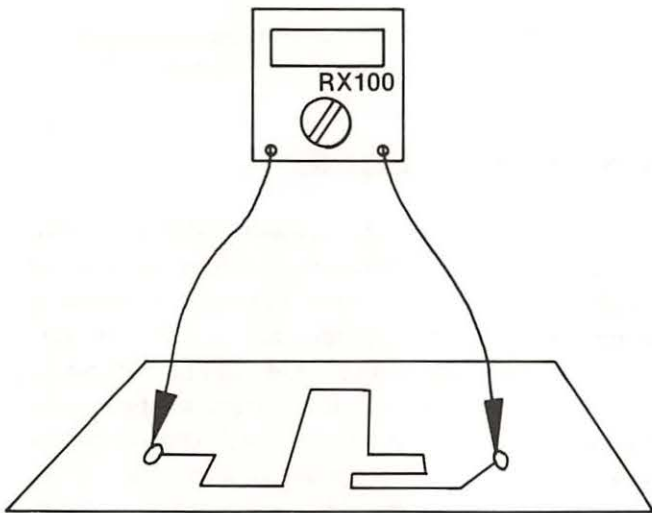

Fig. 9-16. A trace can be tested for an open using an ohmmeter to test the logic states at either end of the trace.

An important fact to keep in mind when testing for individual shorted or open gates in the Apple motherboard circuitry is that more than one gate may use the same input or output lines to or from another gate. This is called "fan-in" or "fan-out." When studying the gate circuitry, remember, the failure could be located at the

other end of the board. One long trace from it to the chip you are looking at may be shorted or open at that end. Use of the schematics in your *Apple II Reference Manual* will be of value here.

OTHER TROUBLESHOOTING TECHNIQUES

There are some interesting tricks you can use to aid in finding chip failures.

Use Your Senses

Look, smell, and feel. Sometimes failed components become discolored or develop bubbles or charred spots. Blown devices can produce some distinctive smells – the smell of a ruptured electrolytic capacitor, for example. Finally, shorted chips can get really hot. By using a "calibrated finger," you can pick out the hot spots on your board.

Heat It, Cool It

Heating and cooling is a fast technique for locating the cause of intermittent failures. Frequently, as an aging device warms up under normal operation, it becomes marginal and then intermittently quits working. If you heat the area where a suspected bad chip is located until the intermittent failures begin, and then methodically cool each device with a short blast of canned coolant spray, you can quickly cause a marginally defective chip to function again. By alternately heating, cooling, heating, and cooling, you can pinpoint the trouble in short order.

You can heat the area with a hair dryer or a focused warm-air blower designed for electronic testing. Be careful using this technique since the thermal stress you place on the chips being tested can shorten the life of good components. A 1- or 2-second spray of freeze coolant is all you should ever need to get a heat-sensitive component working again.

Most coolant sprays come with a focus applicator tube. Use this to pinpoint the spray. And avoid spraying electrolytic capacitors, because the spray soaks into the cap, destroying the electrolyte in some aluminum capacitors. Also, be careful not to spray your own skin. You could get a severe frost burn.

Piggybacking

Fig. 9-17 shows another way you can chase down intermittents caused by a break in a chip bond (wire) in-

side the chip housing that allows good contact only when the chip is cool.

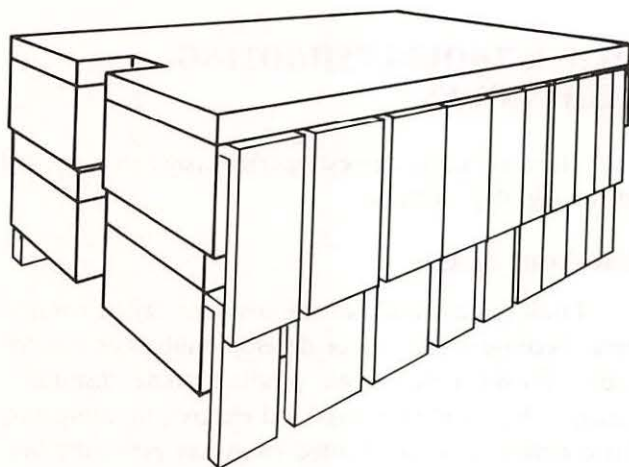

Fig. 9-17. Some IC failures can be found by piggybacking a good device over the top of a suspect device.

Place a good chip over the top of a suspected chip and energize the circuitry. You may need to squeeze the pins of the good chip in slightly so they make good contact with the pins of the suspect device.

If the intermittent failure is caused by an open connection, the new chip will react to input data and cause its output to act accordingly. Use your stock of spare parts as your piggyback source.

The Easter Egg Approach

Quite often we can quickly locate a fault to a couple of chips but need further testing to determine which chip is the culprit.

When time is of essence, take an "Easter Egg" approach. Just as youngsters used to pick up and examine Easter eggs one at a time to see if their name was marked on any, returning those not identified as "theirs" back to where it was located, you can try replacing the chips one at a time to determine if the chip replaced was causing the problem. You have a 50-50 chance of selecting the right chip the first time. If it didn't work, replace the other chip.

If the chips involved are inexpensive "jelly beans" (7400 series TTL), why not replace them both? For thirty cents more, go ahead and splurge. If the problem's gone, but you're still curious, you can always go back later and test each chip individually.

Microvolt Measuring a Piece of Wire

If you have a meter with microvolt sensitivity and have isolated a "stuck low" problem to two chips, you can try the technique shown in Fig. 9-18. Measure the voltage drop between input pin 1 of gate B and output pin 3 of gate A. Now this means measuring the opposite ends of the same trace or piece of wire! You're interested in determining which end of that trace is more negative. The end nearest a bad chip will be more negative because the defective chip will short the trace voltage to ground, causing this point to be more negative than at pin 3.

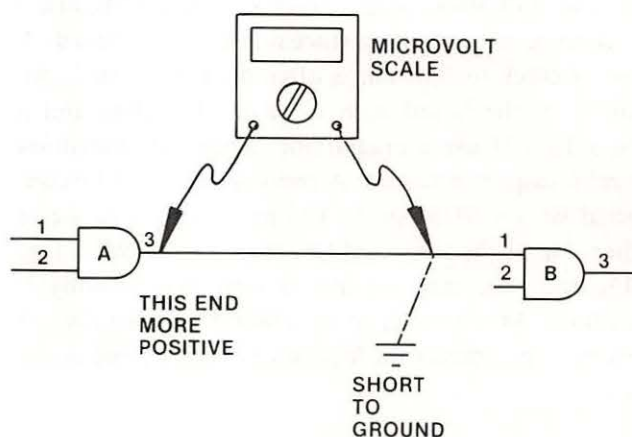

Fig. 9-18. A short circuit that is sinking current can be found using a meter with microvolt sensitivity.

TESTING CAPACITORS

How do you check out a capacitor that you believe has failed? If the device has shorted, resulting in severe leakage of current, you can spot this easily by placing an ohmmeter across the capacitor and reading the resistance. At first you'll notice a low reading because the capacitor acts as a short until it charges; but then, if the capacitor is working properly, it will charge and the resistance will rise to a nominally high value. If the device is shorted, the initial low resistance reading continues and the capacitor won't charge.

Should the component be open, you'll not see the instantaneous short at T0 the moment charge starts to build. An open circuit has infinite resistance. An in-circuit capacitance tester is helpful here.

Total failure as a short or open is pretty easy to find. But how about the device whose leakage depends on temperature or whose dielectric has weakened, changing the capacitance value? To test this capacitor requires a different level of analysis.

Capacitance Measuring

If you have an ohmmeter whose face has the number 10 in the middle of the scale, you can easily use it to approximate the capacitance of a device using the time constant formula $T=RC$, where the time in seconds for a capacitor to charge to 63.2 percent of supply voltage is equal to the resistance in ohms times the capacitance in farads. Using a $22\ \mu\text{F}$ (22 microfarad or .000022 farad), capacitor and a 1M ohm (1,000,000 ohm) resistor, the charge time for one time constant is $.000022 \times 1,000,000 = 22$ seconds.

Transposing the formula to read:

$$C = T/R,$$

we can determine the value of capacitance by knowing the resistance and counting the seconds required for the charge to cause the ohmmeter needle to reach 63.2 percent of full scale (infinite resistance). This point is at about 17 on the meter's scale.

To do this, disconnect one end of a capacitor from the circuit, turn on your meter, and let it warm up for a minute. Zero adjust the ohms scale reading. Then estimate the ohms scale multiplier needed to let the capacitor charge in some acceptable time period. For microfarad capacitors use the $\times 100\text{K}$ scale because this will let the capacitor charge in less than a minute. The 17 on the scale represents 1.7 M ohms on the $\times 100\text{K}$ scale.

Short a low-ohm-value resistor across the two capacitor leads for several seconds to thoroughly drain off any charge. Then connect the meter's ground lead to the negative side of the capacitor (either side if the capacitor is not an electrolytic), and touch the positive meter probe to the other side of the capacitor. Using a stop watch to count seconds and tenths of a second, watch the face of the ohmmeter as the capacitor charges, moving the resistance needle up. When the needle gets to 17 on the scale, stop the clock and read the time. This will give you the value of capacitance in microfarads.

This technique will give you a close enough approximation of the capacitance value to determine if the device is good or should be replaced.

Replacing Capacitors

Always try to use a capacitor of the same type and value as the one being replaced. Keep the leads as short as possible and solder the capacitor into the solder connector holes with the proper iron. The solder process should not exceed 1.5 seconds per lead or heat damage to the component may result.

A good technique to use is to tin the capacitor leads just before poking them through the circuit board holes. This speeds the solder bond process.

TESTING DIODES

If you have a digital multimeter (DMM) with a diode test capability, you can quickly determine whether a suspect diode is bad or good. Placing the meter on the ohmmeter setting and the probes across the diode causes the meter to apply a low current through the diode if the diode is forward biased. The voltage drop across a diode is normally 0.2–0.3 volt for germanium diodes and 0.6–0.7 volt for silicon diodes. Reversing the leads should result in no current flow, so a higher voltage reading should be observed. A low voltage reading when biasing the diode in either direction indicates that the device is leaking or shorted. A high voltage reading in both directions indicates the diode bond has opened. In either case, replace the diode immediately.

In-circuit tests of diodes can also be performed using the ohmmeter to check the resistance across a diode in both directions. With one polarity of the meter probes, you should get a reading different from that obtained when the probes are reversed – not just a few ohms different but several hundred ohms different. For example, in the forward-biased direction you could read 50–80 ohms; in the reverse biased direction, 300K ohms. This difference in readings is called DE, for “diode effect,” and is useful for evaluating transistors. When diode readings in both directions show low resistance, you can be sure the leaky short is present.

TESTING TRANSISTORS

It's no fun to desolder a transistor to test it for failure, then finding it good, solder it or a new device back into the circuit board.

Fortunately, there is a way to determine the quality of silicon transistors without removing them from the circuit. In 90 percent of the tests this procedure will accurately determine whether a device is bad.

As shown in Fig. 9-19, transistors operate the same way as a configuration of diodes. PNP and NPN transistors have opposite-facing diodes. The transistor functions by biasing certain pins and applying a signal to one of the leads (usually base) while taking an output off the collector or emitter.

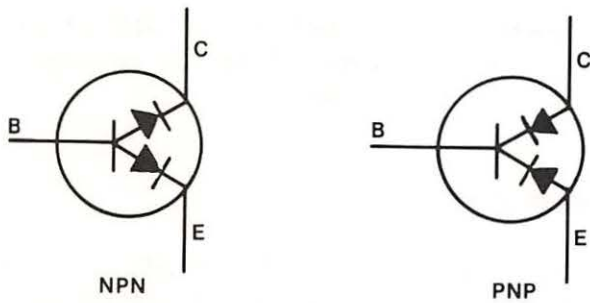

Fig. 9-19. Transistors act like a pair of diodes.

These tests apply to both PNP and NPN transistors. If an ohmmeter is placed between the collector and emitter (C-E), as shown in Fig. 9-20, it effectively bridges a two-diode combination in which the diodes are opposing. You should get a high resistance reading with the leads applied both ways. (It's possible to wire the transistor in a circuit, which makes the transistor collector-emitter junction act like a single diode. In this case you could get DE. Both results are O.K.)

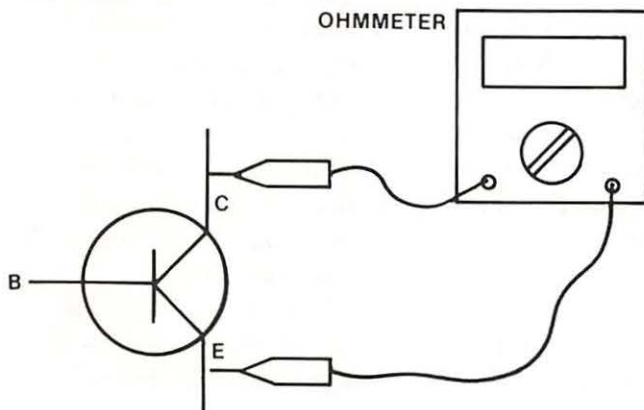

Fig. 9-20. A transistor can be tested using an ohmmeter placed across the collector-to-emitter junction.

Typical C-E resistance readings for germanium transistors are as follows:

- Forward biased = 80 ohms
- Reverse biased = 8,000 ohms (8K)

For silicon transistors you might read:

- Forward biased = 22 M ohms
- Reverse biased = 190 M ohms

The high/low ratio is evident and is about the same for both types.

Place the probes across the collector-to-base junction leads. Reverse the probes. You should observe a

low reading in one case and a high reading with the test probe leads reversed (the diode effect).

Try the same technique on the base-to-emitter junction leads. Look for the DE (Fig. 9-21). If DE is not present in all the above steps, you can be certain the transistor is bad and needs replacing.

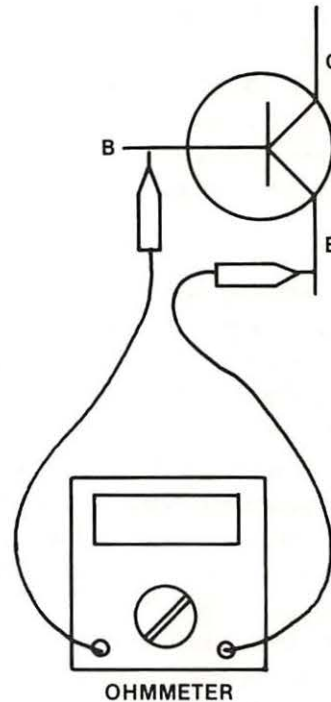

Fig. 9-21. Check the base-to-emitter junction for diode action.

Another way to evaluate a transistor is to measure the bias voltage from base to emitter (B-E) on an energized circuit. Confirm the correct supply voltage first; power supply problems have been known to trick troubleshooters into thinking a certain component has failed.

The B-E forward bias for silicon transistors should be between 0.6 and 0.7 volt DC. If the reading is below 0.5 volt, replace the diode – the diode junction is leaking too much current. If the reading is almost a volt, the junction is probably open and again the device should be replaced.

B-E Voltage (Forward biased)	Action
0.6-0.7 V	Good, keep
0.5	Replace
0.9	Replace

Although in some isolated cases some other failure could cause the low reading, the most common cause of

low bias voltage is failure in the transistor itself.

If the previous tests are inconclusive, there is something else you can try. Measure the voltage across the collector-to-emitter (C-E) junction. If the reading is the same as the source supply (+5 volts for Q3 on the Apple II Plus motherboard) and you notice on the schematic that there's plenty of resistance in the collector/base circuit, the junction is probably open. Replace the device.

If your reading is close to 0 volts, take a small length of wire and short the base to the emitter, removing all the transistor bias. The C-E meter reading should instantly rise. If it doesn't, the transistor is shorting internally and should be replaced. If C-E voltage does rise, it suggests a failure in the bias circuitry — perhaps a leaky coupling capacitor.

REMOVING SOLDER

We used to call them “solder suckers” — those hand-held vacuum pumps with the spring-driven plunger to pull the hot, melted solder off a connector (Fig. 9-22). The process involves heating the old solder until it melts, placing the spring-propelled vacuum pump in the hot solder, then quickly removing the soldering iron while releasing the vacuum pump's spring, sucking the solder up into a storage chamber in the pump.



Fig. 9-22. The spring-driven plunger in the solder vacuum pump is used to pull hot solder off a connection.

This technique works fine until you try to use it around CMOS chips. Some vacuum pumps produce static electricity, and by now you know what that can do to MOS or CMOS chips.

A safer way to remove solder is to touch the solder with the end of a strip of braided copper. Then heat the braid just a short distance from the solder (Fig. 9-23). The copper braid heats quickly, transferring the heat to the solder, which melts and is drawn into the braid by capillary action. Then, cut off the solder-soaked part of the braid and throw it away.

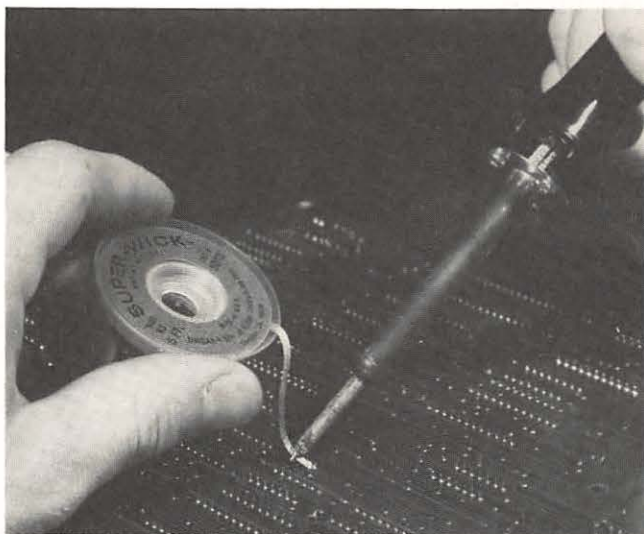

Fig. 9-23. Use of solder wick is another way to remove solder from a connection.

If any solder remains in the circuit board hole, heat the solder and push a toothpick into the hole as the solder cools. The toothpick will keep the hole open so you can easily insert another wire lead for resoldering.

Another way to remove the residual solder blocking a hole is to drill out the hole with a tiny drill bit. Be sure to remove any debris, filings, or pieces of solder before energizing the circuit board. Use a magnifying glass to confirm that nothing unwanted remains on the board.

Be careful not to overheat the board during the solder-removal process. Excessive heat can cause part of the circuitry to come away from the board. It can also damage good components nearby.

If you remove the solder from a component and a lead is still stuck on some residual solder, take a pair of needle-nose pliers and pinch the lead as you gently wiggle it to break it loose from the solder bond.

Sometimes tightly soldered chips need replacing. The pins of these chips are bonded to the circuit board by a process called wave soldering. Wave soldering produces an exceptionally good bond without the added manufacturing expense of a socket. This process helps keep the fabrication costs down, but it makes it more difficult for you to replace the chip.

One effective way to remove wave-soldered chips is to cut the chip leads or pins on the component side and remove the bad chip. Then remove the pieces of pin sticking through the board using a soldering iron and solder braid or a vacuum pump.

Some special tools are available to help you remove soldered components. Fig. 9-24 shows a desoldering tip that fits over all the leads of a chip or dual-in-line package (DIP) socket. Fig. 9-25 is a photograph of a spring-loaded dual-in-line extractor tool. By attaching this device to the chip and then applying the DIP tip shown in Fig. 9-24 to the soldered connections on the opposite side of the board, you can easily remove a complete chip all at one time. Press the load button downward and engage the clips, causing the extractor to place an upward spring pressure on the chip. When the solder on the reverse side melts enough, the chip will pop up and off the board.

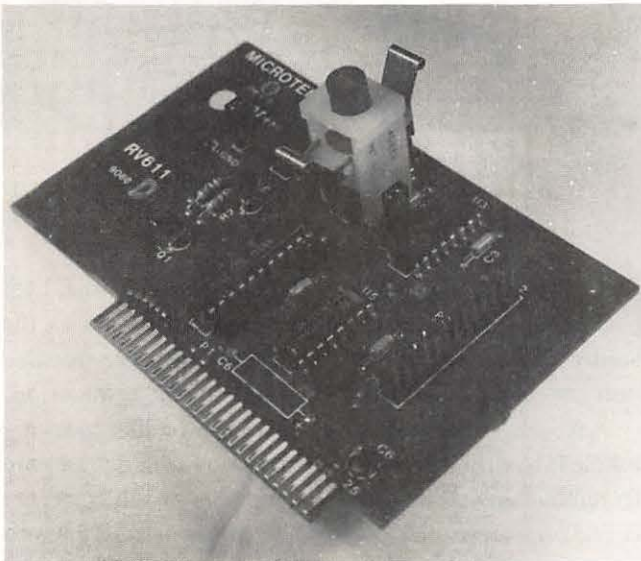

Fig. 9-24. A desoldering tip for removing chips that are soldered to the circuit board.

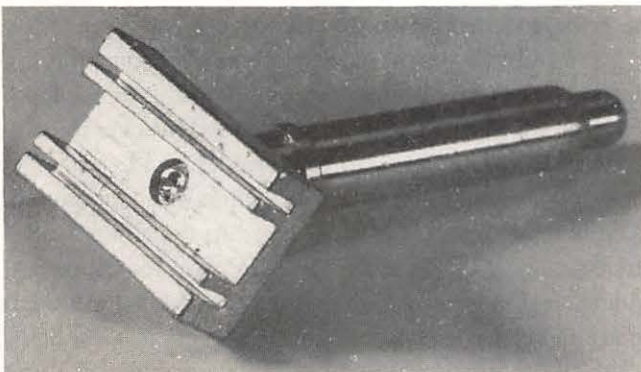

Fig. 9-25. A spring-loaded dual-in-line extractor tool.

When you replace a chip that was soldered to the printed circuit board, always solder in a socket and then plug the replacement chip into this socket. This will make future replacements a lot easier. Be careful to maintain the correct pin 1 alignment.

SOLDERING TIPS

No pun intended. Hand soldering is the most misunderstood and most often abused function in electronics repair. Not only do many people use poor soldering techniques, but they also use the wrong soldering irons.

Solder isn't simply a band-aid adhesive making two metals stick together. It actually melts and combines with the metals to form a consistent electrical as well as mechanical connection. Time and temperature are critical in this process. The typical hand solder job should be accomplished in 1.5 seconds or less if the soldering iron and tip are properly selected and then properly maintained.

The nominal solder melting temperature is 361 degrees F. Metal combination between the solder and the metals being joined occurs at temperatures between 500 and 600 degrees F.

Most soldering jobs join the metals copper and tin, but both of these metals are easily oxidized. Poor or no solder connections are made if the surfaces to be connected are covered by contaminants such as oils, dirt, or even smog, so be sure to use solder with a good cleaning flux. The flux prepares the surfaces for best solder metalization. The flux melts first and flows over the metal surfaces removing oxidation and other contaminants. Then the metal heats so that the solder melts and flows, producing a good, shallow bond.

The key to successful soldering is in the soldering iron tip. Most people selecting their first soldering iron jump right into a low-wattage iron, but this is a mistake. Instead, pick an iron whose tip operating temperature is suited for the circuit board you're to repair. If the tip temperature is too low, the tip sticks to the surface being soldered. If it's too high, it damages the board surface. The ideal working temperature for soldering on your computer's circuit board is between 600 and 700 degrees F.

The soldering iron tip is used to transfer the heat generated in the iron out to the soldering surface. The iron should heat the tip quickly, and the tip should be as large as possible yet slightly smaller than any soldering pad on the board.

Tips are made of the same material as some of the contacts you're soldering — copper. Copper quickly

conducts heat, but it dissolves in contact with tin. Solder is made of tin and lead. To keep the tin from destroying the copper tip, manufacturers plate a thin layer of iron over the tip. The hot iron (now you know where the term “iron” came from) still melts the solder, but now the tip lasts longer. The iron melts above 820 degrees F, so if the heat produced by the iron stays below 700 degrees F, the solder melts but not the iron plating.

The disadvantages of the iron plating are that it doesn't conduct heat as well as copper, and it oxidizes rapidly. To counteract this, you can melt a thin coat of solder over the tip. This is called “tinning.” This solder layer helps the soldering iron heat quickly and also prevents oxidation.

The tip of an old soldering iron is usually black or dirty-brown with oxidation. And it doesn't conduct heat very well. These “burned-out” tips can be cleaned with fine emery cloth and then can be retinned and used.

Wiping the hot tip with a wet sponge just before returning the iron to its holder is a mistake. This removes the protective coating, exposing the tip surface to atmospheric oxidation. It's much better to add some fresh solder to the tip instead. Keep your iron well tinned.

Fig. 9-26 shows the proper way to solder a socket or connector lead. Place the tip of the iron on one side of the lead and the solder on the other side. As the solder pad heats, the tin/lead solder melts and flows evenly over the wire and the pad. Keep the solder shallow and relatively even. Large solder balls or mounds invite “cold solder joints,” where contact is only partially made. These are a potential cause of intermittent failure.

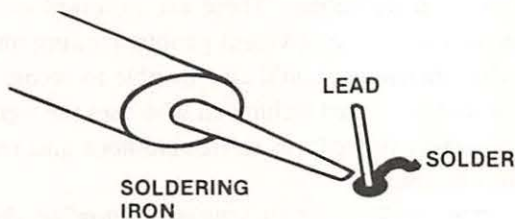

Fig. 9-26. Place the soldering iron on the opposite side of the lead from the solder.

Good soldering takes patience, knowledge, and the right tools — a temperature-controlled soldering iron whose tip temperature is maintained in the 500–600 degree F range for optimum soldering effect.

Before You Solder It In

A useful thing to do before you solder in a replacement part is to test the device in the circuit. Simply

insert the chip or other device into the solder holes and wedge each lead in its hole with a toothpick. Then energize the circuit and test. After proper function is assured, remove the toothpicks and solder the component into the board.

Circuit Board Repair

Repairing damaged circuit boards is a lucrative business, and several companies have developed around this activity. For some board failures, you can repair your own circuitry and save some money.

Before soldering in new components, check over the board for any broken traces or pads lifting off the board. If a trace is open and is starting to lift away from the board surface, jumper across the broken spot from one component solder pad to another pad. Use solid #18 or #20 wire tinned at both ends before soldering.

If a pad or trace lifts free, replace it with an adhesive-backed pad or trace overlapping the damaged area. Scrape the coating off the pad or both ends of the trace so the new pad or trace can be soldered firmly to the existing pad or trace. Remove all excess solder and redrill any lead hole that has become covered or plugged with residual solder.

RECOMMENDED TROUBLESHOOTING AND REPAIR EQUIPMENT

If you're planning to tackle failures that usually require service center support, you can minimize your investment costs and yet optimize your chance of success by carefully selecting your equipment and tools.

First, get a set of good screwdrivers — both flat head and Phillips head. Get a wide selection of sizes — from the tiny “tweakers” to an 8-inch flat head. You might also find a set of jeweler's screwdrivers quite helpful.

Then get several sizes of long-nose or needle-nose pliers. Get several sizes of diagonal cutters or “dykes” for cutting wire and pins. A good low-wattage soldering iron whose tip temperature is automatically controlled is a must if you intend to replace nonsocketed components. A simple 3½ digit DVM or DMM is useful for test measurements. Another handy tool is the logic probe.

If you can afford it, get a 15–25 MHz oscilloscope with dual trace and a time-base range of 200 nanoseconds to a half second. Select a scope with a vertical sensitivity of 10 millivolts per division or better.

Below is an approximate price list for troubleshooting and repair equipment.

Screwdrivers – 12	\$ 15.00
Pliers	15.00
4½” short nose	
5¾” long nose	
Diagonal cutters	10.00
4½” flush	
4½” midget	
DMM (3½ digit)	80.00
Logic probe	83.00
Logic pulser	85.00
Current tracer	200.00
Logic clip	80.00
Oscilloscope	1200.00
Logic analyzer	1100.00

You can get by quite nicely for less than \$500 using the probe, pulser, tracer, and DMM as your primary equipment. Prices vary from one manufacturer to another.

SPARE PARTS

Because of the cost involved, you will probably want to maintain a minimal stock of repair parts; yet you want to be able to fix your machine quickly when it breaks down. Since the Apple II Plus is no longer being manufactured, spare parts for the machine can become a critical issue.

The optimal backup would include one each of every type of chip on your Apple’s motherboard. For the II Plus, this represents an investment of \$60 to \$100 in 80 chips. For about the same cost, you can get 24 chips for a IIe. Currently, Apple is providing only their custom chips – the MMU, IOU, and PAL – on a board exchange. The total chip count for the Apple II Plus and

the Apple IIe is higher than the number of chips you need as spares because many duplicate chips are used on the motherboard (e.g., you only need 1 of the RAM chips as a spare). Your largest expense in chips will be for the ROMs, MMU, and IOU chips.

Several companies are marketing spare parts packages with schematics, diagnostic tests, and one each of the chips for the Apple II Plus.

In the Appendix you’ll find a listing of each chip in your computer, including its designation, name, and location.

SUMMARY

There are four possible ways to optimize your computer system’s operational life:

1. Buy a highly reliable computer with a good track record of performance.
2. Buy a good on-site repair contract.
3. Buy a second identical computer to use as a backup during repair of the first.
4. Become a knowledgeable repair technician yourself.

Armed with the knowledge in this manual, you’ll be able to spot downright poor troubleshooting – the “tech” using a bare cotton swab with low-grade alcohol, “cleaning” a disk drive read head, the repair person wiping his or her soldering iron on a wet sponge just before putting it in its holder. These are mistakes of poorly trained (or poorly motivated) people working on someone else’s machine. You’ll also be able to recognize the sharp, highly trained technician who uses the right tools and the right procedures to troubleshoot and repair in minimum time.

Then you’ll smile to yourself, knowing that you were smart enough to buy this book and do your own repair the right way – the Apple Optimum way.

Appendix

	PAGE
Apple II Plus Data Sheet	231
Apple II Plus Chip Information Chart	232
Apple II Plus Disassembly Instructions	232
Apple II Plus Reassembly Instructions	233
Apple IIe Data Sheet	234
Apple IIe Chip Information Chart	234
Apple IIe Disassembly Instructions	235
Apple IIe Reassembly Instructions	236
Disk II Disassembly Instructions	236
Power Supply Replacement	236
Equipment History Record	237
(Sample) Equipment History Record	237
Record of Configuration Changes	237
(Sample) Record of Configuration Changes	237
System Description	238
(Sample) System Description	238
Operational Log Sheet	238
Routine Preventive Maintenance	238
Summary of Cautions and Notes	239
ASCII Code Chart	240
Hexadecimal to Decimal Conversion Chart	241

APPLE II PLUS DATA SHEET

Computer: Apple II Plus

Manufacturer: Apple Computer, Inc.
20525 Mariani Avenue
Cupertino, CA 95014

Size: 4.5" × 18" × 15.5"

Weight: 11 lb

Power Required: 79 watts (maximum)

CPU: Synertek 6502

Data Word Size: 8 bits

CPU Clock Speed: 1.023 MHz

Memory Size: 48K (expandable to 64K)

Mass Storage Capability: Up to 14 Apple Disk II
drives (usual configura-
tion – 2 Disk II drives)

Keyboard Size: 52 keys
91 character codes

Text Display: 40 uppercase characters
24 lines

Graphics Capability: Low resolution – 40 × 48 blocks
High resolution
– 192 × 280 pixels

Color Capability: Low Resolution – 16 colors
 High Resolution – 6 colors

Input/Output:
 Cassette Input Cassette Output
 3 one-bit digital inputs 4 “annunciator” outputs
 4 analog inputs ½-microsecond strobe output
 Built-in speaker
 NTSC-compatible, positive composite color video
 8 expansion slots

Languages: Applesoft BASIC provided
 (Numerous languages commercially available)

74LS257	A8,B6, B7,C12	00.76	Tri-state quad 2- input multiplexer
74LS259	F14,J1	01.38	8-Bit addressable latch
74LS283	E14	00.83	4-Bit binary adder
NE555	A13,B3	00.41	Timer
MC741	K12	00.75	Operational amplifier
4116	C3-C10	02.00	16K x 1-bit RAM
4116	D3-D10	02.00	16K x 1-bit RAM
4116	E3-E10	02.00	16K x 1-bit RAM
6502	H7	07.00	8-Bit microprocessor
8T28	H10,H11	01.50	4-Bit parallel bus transceiver
8T97	H3,H4,H5	01.25	Tri-state hex buffer
9334	F14	01.40	8-Bit addressable latch

APPLE II PLUS CHIP INFORMATION CHART

Integrated Circuit	Location	Approximate Price (dollars)	Description
74LS00	A2	00.39	Quad 2-input NAND
74LS02	A12,B13,B14	00.39	Quad 2-input NOR
74LS04	C11	00.41	Hex Inverter
74LS08	B11,H1	00.41	Quad 2-input AND
74LS11	B12	00.40	Triple 3-input AND
74LS20	D2	00.39	Dual 4-input NAND
74LS32	C14	00.43	Quad 2-input OR
74LS51	C13	00.39	Dual 2-input AND-OR-Inv
74LS74	A11,B10,J12	00.46	Dual D Flip-flop
74S86	B2	00.67	Quad 2-input EXOR
74LS125	Analog Card	00.56	Tri-state quad buffer
74LS138	F12,F13, H2,H13	00.66	Expandable 3/8 decoder
74LS139	E2,F2	00.66	Expandable 2/4 decoder
74LS151	A9	00.68	8-Channel multiplexer
74LS153	C1,E11, E12,E13	00.64	Dual 4-1 multiplexer
74LS161	D11,D12, D13,D14	00.86	Presetable binary counter
74LS166	A3	00.92	8-Bit serial parallel shift register
74LS174	B5,B8	00.70	Hex D Flip-flop
74LS175	B1	00.70	Quad latch
74LS194	A10,B4,B9	00.86	4-Bit bidirectional shift register
74LS195	C2	00.83	4-Bit parallel shift register
74LS251	H14	01.10	Tri-state 8-input multiplexer

D0 ROM	F11	14.00	Read only memory
D8 ROM	F9	14.00	Read only memory
E0 ROM	F8	14.00	Read only memory
E8 ROM	F6	14.00	Read only memory
F0 ROM	F5	14.00	Read only memory
F8 ROM	F3	14.00	Read only memory

AVAILABLE ONLY FROM

ULN2003	Analog card	APPLE	7-Channel input driver
2513	A5	APPLE	Character generator ROM
LM3146	Analog card	APPLE	Transistor array
MC3470	Analog card	APPLE	Floppy disk read amplifier

APPLE II PLUS DISASSEMBLY INSTRUCTIONS

These procedures apply to those repairs that require access to the complete Apple II Plus motherboard. There may be slight differences between various versions of the computer, but the procedures are essentially the same.

Motherboard Access

Tools and Equipment Required

- #2 Phillips head screwdriver
- Uncluttered workspace
- Container to hold screws until reassembly

Procedure for Motherboard Access

1. Turn the power off.
2. Grasp the rear top corners of the lid and pull up to disconnect the hold-downs. Remove the lid.

3. Touch the power supply case. Unplug the power cord from the rear of the computer.
4. Disconnect all peripheral equipment, including cables.
5. Resting the keyboard on a roll of paper or conductive foam rubber, lay the computer upside down on an uncluttered work surface.
6. Refer to Fig. A-1. Remove the six silver-colored, flat-head screws from the outside edges of the baseplate.
7. Refer to Fig. A-1. Remove the four black, round-head screws and lockwashers from the keyboard end of the baseplate.
8. Hold the baseplate to the Apple chassis and turn the computer rightside up with the keyboard facing you.
9. Lift the front of the case a few inches to expose the keyboard cable, plugged snugly into the keyboard connector socket on the motherboard.
10. Using a small, nonmagnetic screwdriver, gently rock the keyboard connector out of the socket.

Note: If you don't use a screwdriver or chip extractor tool to assist you, be ready to get a pin or two stuck into your fingers as the connector pops free.

11. Lift the case housing up off the base and set it aside. The motherboard is now fully exposed.

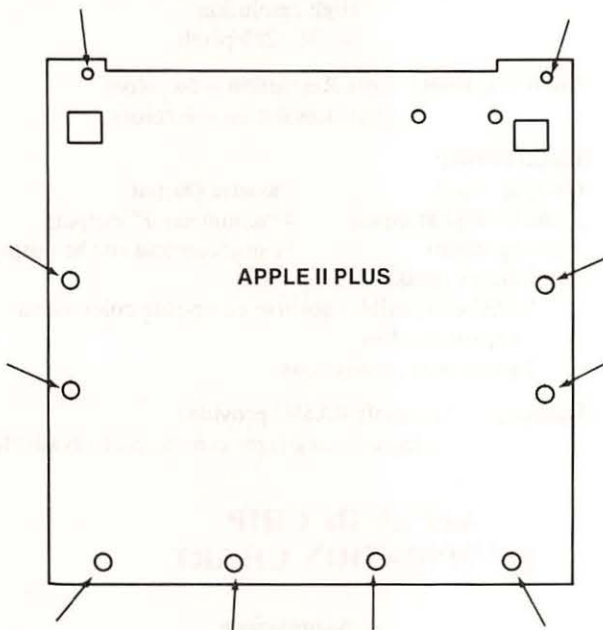

Fig. A-1. Apple II Plus Bottom Plate.

Motherboard Removal

If you are planning to repair the motherboard or replace soldered components, follow these steps:

Tools and Equipment Required

- Needlenose (long-nose) pliers
- 5/16" nutdriver

Procedure for Removing Motherboard

1. Follow steps 1 through 11 under "Procedure for Motherboard Access."
2. Unplug the speaker connector at location B14.
3. Remove the power supply plug by pinching the front and sides of the plug while pulling up on the plug.
4. Remove the 5/16" nut and lockwasher in the middle of the motherboard at the top line of the RAM box.
5. Use the needlenose pliers to pinch the sides of the six plastic standoffs. Start in the corners. As each standoff is released the motherboard is freed a little more.
6. Lift the motherboard off the baseplate.

Keyboard Removal

For repair or replacement of the Apple II Plus keyboard.

Tools and Equipment Required

- Screwdriver

Procedure for Removing Keyboard

1. Follow steps 1 through 10 under Motherboard Access.
2. Place the Apple chassis or housing upside down with the keyboard resting on a support pad.
3. Remove the four screws and lockwashers from each corner of the keyboard.
4. Lift the keyboard up out of the housing.

APPLE II PLUS REASSEMBLY INSTRUCTIONS

Now that the repair is complete, follow these steps to put your system back together.

Reinstalling the Motherboard

1. Align the motherboard over the six standoffs, and gently press it into place.
2. Install the washer, then the nut in the middle of the board at the top line of the RAM section.
3. Reconnect the power supply plug at the top left of the motherboard.
4. Reconnect the speaker to the jack at location B14.
5. Lower the Apple II case gently over the baseplate with the motherboard installed.
6. Lift the front of the case a few inches and reinstall

the keyboard cable connector in the socket at location A7.

CAUTION: Be certain you line pin 1 of the plug with pin 1 of the connector socket.

7. Hold the baseplate to the Apple chassis and turn the computer upside down, resting the keyboard on a support pad.
8. Confirm the tab at the back of the baseplate is in the slot in the housing.
9. Install the four black lockwashers and round-head screws in keyboard end of the baseplate.
10. Install the six silver, flat-head screws into the outside edges of the baseplate. All holes in the baseplate should now be covered.
11. Turn the computer rightside up.
12. Reconnect the power cord, energize, and test.
13. Reconnect the peripheral cards and return the system to full operation.
14. Fill out your Equipment History Record.

Reinstalling the Keyboard

1. Gently align the keyboard over the four securing holes in the computer case.
2. Reinstall the four screws and lockwashers to hold the keyboard to the case.
3. Turn the Apple case or housing rightside up and place it over the baseplate.
4. Lift the front of the case a few inches and reinstall the keyboard cable connector in the socket at location A7.

CAUTION: Be certain you line pin 1 of the plug with pin 1 of the connector socket.

5. Hold the baseplate to the Apple chassis and turn the computer upside down, resting the keyboard on a support pad.
6. Confirm the tab at the back of the baseplate is in the slot in the housing.
7. Install the four black lockwashers and round-head screws in the keyboard end of the baseplate.
8. Install the six silver, flat-head screws into the outside edges of the baseplate. All holes in the baseplate should now be covered.
9. Turn the computer rightside up.
10. Reconnect the power cord, energize, and test.
11. Reinstall the peripheral cards and return the system to full operation.
12. Fill out your Equipment History Record.

APPLE IIe DATA SHEET

Computer: Apple IIe

Manufacturer: Apple Computer, Inc.
20525 Mariani Avenue
Cupertino, CA 95014

Size: 4.5" × 18" × 5.5"

Weight: 10 lb

Power Required: 80 watts (maximum)

CPU: Synertek 6502B

Data Word Size: 8 bits

CPU Clock Speed: 1.023 MHz

Memory Size: 64K

Mass Storage Capability: Up to 4 Apple Disk II drives (usual configuration – 2 Disk II drives)

Keyboard Size: 63 keys
128 character codes

Text Display: 40 uppercase characters
24 lines

Graphics Capability: Low resolution – 40 × 48 blocks
High resolution
– 192 × 280 pixels

Color Capability: Low Resolution – 16 colors
High Resolution – 6 colors

Input/Output:

Cassette Input	Cassette Output
3 one-bit digital inputs	4 "annunciator" outputs
4 analog inputs	½-microsecond strobe output
Built-in speaker	
NTSC-compatible, positive composite color video	
8 expansion slots	
2 game port connections	

Languages: Applesoft BASIC provided
(Numerous languages commercially available)

APPLE IIe CHIP INFORMATION CHART

Integrated Circuit	Location	Approximate Price (dollars)	Description
74LS02	B8	00.39	Quad 2-input NOR
74S10	C5	00.39	Triple 3-input NAND
74S109	C1	00.67	Dual JK flip-flop
74LS125	E1	00.56	Tri-state quad buffer
74LS138	B5	00.66	Expandable 3/8 decoder

74LS154	C10	01.40	4-16 decoder or demultiplexer
74LS166	F5	00.92	8-bit serial in, parallel out shift register
74LS244	B1,B3	01.40	Tri-state octal line driver
74LS245	B2	01.42	Tri-state octal bus receiver
74LS251	C11	01.10	Tri-state 8-input multiplexer
74LS374	D3	01.53	Tri-state octal D flip-flop
NE558	A12	01.10	Quad 555 timer
MC741	A11	00.75	Operational amplifier
ULN2003	Analog card	APPLE	7-channel input driver
LM3146	Analog card	APPLE	Transistor array
MC3470	Analog card	APPLE	Floppy disk read amplifier
MC3764	F6 – F13	20.00	64K × 1-bit RAM
6502B	B4	14.00	8-bit microprocessor
KB ROM	D12	08.00	Keyboard ROM
VID ROM	F4	12.00	Video ROM
CD ROM	D10	20.00	Applesoft ROM
EF ROM	D8	20.00	Monitor ROM
HAL	D1	56.00	Programmed array logic (board exchange – through APPLE only)
IOU	D6	56.00	Input-output unit (board exchange – through APPLE only)
MMU	D4	56.00	Memory management unit (board exchange – through APPLE only)
AY3600	D14	16.00	Keyboard decoder

APPLE IIe DISASSEMBLY INSTRUCTIONS

These procedures apply to those repairs that require access to the complete Apple IIe motherboard.

Tools and Equipment Required

- #2 Phillips-head screwdriver
- Uncluttered workspace
- Container to hold screws until reassembly

Procedure for Motherboard Access

1. Turn the power off.
 2. Grasp the rear top corners of the lid and pull up to disconnect the hold-downs. Remove the lid.
 3. Touch the power supply case. Unplug the power cord from the rear of the computer.
 4. Disconnect all peripheral equipment including cables.
 5. Resting the keyboard on a roll of paper or conductive foam rubber, lay the computer upside down on an uncluttered work surface.
 6. Refer to Fig. A-2. Remove the six black round-head screws from the outside edges of the baseplate.
 7. Refer to Fig. A-2. Remove the four black, round-head screws from the keyboard end of the baseplate.
- Note:** Newer Apple IIe chassis have only three screws in the keyboard area of the baseplate.
8. Hold the baseplate to the Apple chassis and turn the computer rightside up with the keyboard facing you.
 9. Remove the two screws in the left and right upper corners of the back panel. (You won't find these two screws on the newer machines.)
 10. Press down slightly on the thin, metal back panel to free it from the bar across the rear top of the case. Lift the case housing up off the base and set it aside.

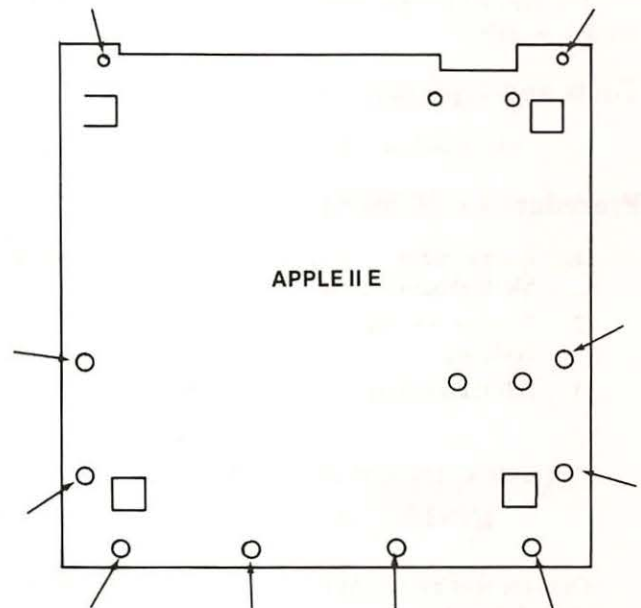

Fig. A-2. Apple IIe Bottom Plate.

MOTHERBOARD REMOVAL

If you are planning to repair the motherboard or replace soldered components, follow these steps:

Tools and Equipment Required

- Needlenose (long-nose) pliers
- 5/16" nutdriver

Procedure for Removing Motherboard

1. Follow steps 1 through 10 under "Procedure for Motherboard Access."
2. Unplug the speaker connector at location J14.
3. Unplug the power supply connector by pinching the front and sides of the plug while pulling up on the plug.
4. Disconnect the keyboard cable from the motherboard.
5. Remove the four screws at the back of the motherboard just above the seven expansion slots.
6. Use the needlenose pliers to pinch the sides of the six plastic standoffs. Start in the corners. As each standoff is released, the motherboard is freed a little more.
7. Lift the motherboard off the baseplate.

KEYBOARD REMOVAL

For repair or replacement of the Apple IIe keyboard, procede as follows:

Tools and Equipment Required

- Phillips-head screwdriver

Procedure for Removing Keyboard

1. Follow steps 1 through 10 of "Procedures for Motherboard Access."
2. Remove the four screws from each corner of the keyboard.
3. Lift the keyboard up off the keyboard stand.

APPLE IIe REASSEMBLY INSTRUCTIONS

Once the repair is complete, follow these steps to put your system back together.

Reinstalling the Motherboard

1. Align the motherboard over the six standoffs and gently press the board into place.
2. Install the four screws at the rear of the motherboard.
3. Reconnect the power supply plug at the top left of the motherboard.
4. Reconnect the speaker to the jack at location J14.

5. Reconnect the keyboard cable to the motherboard.

Caution: Be certain you line pin 1 of the plug with pin 1 of the connector socket.

6. Lower the Apple IIe case gently over the baseplate with the motherboard installed. Realign the backpanel with the bar at the top of the computer housing.

Caution: Be sure the outer keyboard keys and the RESET key are not binding in the housing key holes.

7. Grasp the baseplate and the case firmly and turn the computer upside down with the keyboard resting on a support cushion or pad.
8. Install the four black lockwashers and round-head screws in the keyboard end of the baseplate. (Newer Apple IIes have only three screws here.)
9. Install the six black, round-head screws into the outside edges of the baseplate. All holes in the baseplate should now be covered.
10. Turn the computer rightside up.
11. Replace the two screws in the left and right upper corners of the back panel (older IIe models).
12. Reconnect the power cord, energize, and test the system.
13. Reinstall the peripheral cards and return the system to full operation.
14. Fill out your Equipment History Record.

Reinstalling the Keyboard

1. Gently align the keyboard over the four securing holes in the computer case.
2. Reinstall the four screws to hold the keyboard to the case.
3. Replace the IIe chassis case as indicated in steps 5 through 14 in "Reinstalling the Motherboard."

DISK II DISASSEMBLY AND REASSEMBLY INSTRUCTIONS

(These procedures are covered in Chapter 8, "Routine Preventive Maintenance," page 185).

POWER SUPPLY REPLACEMENT

The following procedure is for removing and replacing the Apple II power supply.

Tools and Equipment Required

- Phillips-head screwdriver

Power Supply Removal Procedure

1. Remove the Apple II Plus or IIe chassis case as

described in steps 1 through 11 of "Apple II Plus Disassembly Instructions," or steps 1 through 10 of "Apple IIe Disassembly Instructions."

2. Disconnect the power supply power plug connected to the motherboard.
3. Set the baseplate on its side, with the power supply closest to the work surface.
4. Remove the four small, black screws holding the power supply to the baseplate.

Note: Be sure to steady the power supply case while removing these screws.

5. Lift the power supply away from the baseplate.

Power Supply Reinstallation Procedure

1. Set the baseplate on its side with the power supply holes closest to the bottom or work surface.
2. Align the power supply case with the holes in the baseplate.
3. Reinstall the four screws that secure the power supply case to the baseplate.
4. Set the baseplate down in normal position.
5. Reconnect the power supply connector plug to the motherboard.
6. Reinstall the computer housing as described in steps 1 through 13 of "Apple II Plus Reassembly Instructions," or steps 1 through 14 of "Apple IIe Reassembly Instructions."
7. Fill out your Equipment History Record.

EQUIPMENT HISTORY RECORD

Name of Unit	Model	Serial Number	Card Number
--------------	-------	---------------	-------------

Manufacturer _____ Date Installed _____

Date	Nature of trouble	Cause of failure, description work done	Name of part	Circuit symbol

(SAMPLE) EQUIPMENT HISTORY RECORD

Name of Unit	Model	Serial Number	Card Number
Apple Computer	Apple II Plus	A2S199500	1

Manufacturer Apple Computer Date Installed July 15, 1984

Date	Nature of trouble	Cause of failure, description work done	Name of part	Circuit symbol
1984				
08/22	Wouldn't boot	No clock signal	LS125	A6
09/01	PMs	Cleaned	—	—
10/01	PMs	Cleaned	—	—

RECORD OF CONFIGURATION CHANGES

Name of Equipment	Serial Number	Model	Date Installed	Card Number
-------------------	---------------	-------	----------------	-------------

Number	Title of Change	Date of Change
--------	-----------------	----------------

(SAMPLE) RECORD OF CONFIGURATION CHANGES

Name of Equipment	Serial Number	Model	Date Installed	Card Number
Apple Computer	A2S199500	II Plus	07/15/84	1

Number	Title of Change	Date of Change
1	Added 16K language card	07/20/84
2	Shift key modification for WordStar	08/05/84

SYSTEM DESCRIPTION

Hardware:

System: Model: Serial Number:

Memory Size: Type Serial Number

Disk Drives:

Printer:

Display:

Modem:

Software:

Operating System: Languages: Data Management Tools: Applications Software:

Communications software:

(SAMPLE) SYSTEM DESCRIPTION

Hardware:

System: Apple Computer Model: Apple II Plus Serial Number: A2S199500

Memory Size: 64K

	Type	Serial Number
Disk Drives:	Disk II	308386
	Disk II	311390
Printer:	Epson MX-100	348584
	Typrinter 221	1901
Display:	NEC 12" green	112200
	Amdek 19" color	75450
Modem:	D.C. Hayes 300 baud	11271

Software:

Operating System:	Languages:	Data Management Tools:	Applications Software:
DOS 3.3	Applesoft PASCAL Integer BASIC	VisiCalc dBase II PFS:File	Home Finance Apple Plot WordStar

Communications software: ASCII Express

OPERATIONAL LOG SHEET

Equipment Title: Serial Number:

Configuration:

DATE ON OFF DATE ON OFF DATE ON OFF

ROUTINE PREVENTIVE MAINTENANCE

Preventive maintenance, or PM, is one of the least used techniques for operational cost reduction, yet the savings that result can be substantial. If the equipment doesn't fail, you can't evaluate the bottom-line savings in conducting proper PM. But after your first mind-boggling repair bill, the fact will sink in: You might have prevented this failure by doing some easy, routine maintenance.

Someone once said, "Time is money." Failure to take the time to do routine preventive maintenance can indeed cost money. Do your PMs!

Many manufacturers are not sure what optimum PM should be. Some companies prefer you don't do any PMs. (The effect is to cause more equipment repair by their service people.) Among those who recommend PMs, there is great variation in recommended PM schedules for similar hardware (e.g., disk drives).

The listing that follows is a consensus of recommendations of manufacturers, dealers, and users and the author's own experience.

Optimal PM Schedule

Note: Modify the schedule below if intermittents occur frequently.

Daily

- Log operational time.
- Estimate disk drive "run-light-on" time.
- Estimate printer "printing" time.
- Estimate computer "power on" time.
- Monitor humidity (a measure of static electricity).

Weekly

- Clean computer system work area.
 - Pick up all loose trash, reshelve scattered books, restore magazines, toss out old printed paper, toss those "bad" disks you've been saving, wipe down hardware with anti-static, dust-absorbing cloth, wipe desk and bench space with antistatic cloth, and vacuum shelves, desk, and floor.
- Clean equipment housings and cases.
 - Wipe chassis with antistatic cloth, "wash" with lightly soaped damp cloth.

Clean display screens.

Use antistatic "dust-off" type spray or damp cloth of antistatic solution. Clean drive read head (after 10 hours of "run-light-on" use).

Monthly

Some manufacturers recommend that you demagnetize the drive read head (after 40 hours "run-light-on" use).

Clean inside computer.

Turn power off, open lid, touch power supply case. Use soft brush and long narrow vacuum cleaner hose nozzle (it helps to spray the nozzle with antistatic first).

Clean inside printer.

Use same technique as for cleaning inside computer.

Check ventilation filters in equipment. Replace if cleaning is not practical (filter becomes worn or badly soiled).

Check connector contacts.

Look for signs of corrosion, pitting, or discoloration. Clean if necessary. The corrosion-removing wipes that also coat the surface with a lubricating coating to protect it from atmospheric corrosion is strongly recommended.

Every Other Month

Reseat chips on motherboard (Apple II Plus only).

Reconnect cable and connector plugs.

This removes corrosion buildup.

Apply antistatic treatment to computer work area.

See Chapter 8 for details.

Clean inside printer.

Use nonmagnetic, plastic vacuum hose nozzle and soft camel hair brush. Spray or wipe nozzle with antistatic spray or solution first.

Every Six Months

Replace vent filters.

Only if you have filters. None are standard in the Apple II computer.

Check disk drive speed.

Speed test programs are advertised in Apple computer publications. Remember the room light, strobe mark test (see Chapter 8).

Check head alignment.

Do this only if you suspect a disk problem.

Clean connector contacts.

If you haven't done this during earlier inspection checks, conduct this PM now. Do this PM more often if your computer system is used in a smoggy part of the country or near salt air.

Clean disk drive read head.

If you use your system daily, your drive heads may need cleaning about now, but this depends very much on the kind and quality of disks you use.

Conduct printer routine inspection.

Do this every six months or 500,000 lines of print. Check the tightness of the screws and connectors. Conduct a printer self test as described in the printer owner's manual.

Annually

Take routine maintenance infrared photo (optional).

(Only if you're into this form of PM or troubleshooting).

SUMMARY OF CAUTIONS AND NOTES

The following is a listing of the CAUTION and NOTE statements used in this troubleshooting and repair manual. They are repeated here so you can review them quickly. It's a good idea to review them periodically.

Never insert or remove a peripheral card without first turning off the power to the computer, removing the lid, touching the top of the power supply case, and then reaching around in back of the Apple and pulling the power plug out of the back of the computer.

Any time you open the top of the computer, ensure the power is off, and touch the top of the power supply case to ground any stray static electricity.

Beware of static electricity. Always ground yourself by touching the power supply case before touching anything inside the Apple case.

For any procedures conducted with the cover lid removed and with the computer operating, be careful not to short out any connectors or pin leads. Use only a nonmetallic or wood object inside an energized Apple computer.

Keep out of display chassis.

Stay out of power supply.

Use a power strip. Plug the Apple II and all peripherals (except a hard disk drive) into a switch-controlled strip.

Keep liquids away from computer.

Handle components with care.

When cleaning, make *sure* the power is off and the plug(s) pulled out of the power socket(s). Use a damp cloth. Don't let any liquid run or get into your equipment.

When rubbing to clean contacts, always rub along the pin (lengthwise).

When using a logic clip, turn the power to the circuit off, attach the clip, then turn the power on. This helps prevent accidentally shorting out the chip.

In the event of a lightning storm, unplug your entire system.

Don't use power tools near your computer while it's operating.

Apple optimum steps to success:

1. Don't panic.
2. Observe the conditions.
3. Use your senses.
4. Retry.
5. Document.
6. Assume one problem.
7. Diagnose to a section.
8. Localize to a stage.

9. Isolate to a failed part.

10. Repair.

11. Test and verify.

Keep cables clear and away from power cords, especially coiled power cords.

Be careful not to flex the motherboard or other boards too much.

It's a good idea to log the repair action in a record book to develop a history of the maintenance conducted on the machine (see page 237 for sample equipment history records).

Don't wait for lightning to strike before you protect your computer system investment from electrical surges.

Always unplug your computer system when blackout occurs.

Never touch contacts with your fingers.

Keep your diskettes, and even your information cables away from power sources.

You can damage the disk drive electronics if you attach the cable incorrectly (see your disk drive owner's manual).

Handle diskettes carefully. Don't lay the disks around. Keep the disks in protective jackets. Don't touch the disk surface with your fingers. Keep the disks out of the hot sun.

Don't use both sides of your disks in a single-sided drive.

To extend disk life:

Buy name brand disks.

Never touch the disk surface.

Never slam the disk door closed on a disk.

Store disks in their protective jackets.

Never write on a label that's already on a disk.

Store disks in a cool, clean place.

Back up all data disks.

Store working disks and backup disks in different places.

Never allow smoking near your disks or your drive.

Never set disks near monitors or televisions.

Avoid placing disks near vacuum cleaners and large motors.

Don't bend or fold disks.

Don't put disks through airport X-ray machines.

Clean the read/write heads every 40 hours of disk operation.

Provide adequate ventilation when cleaning read heads with solvent.

Make sure the solvent evaporates before you operate the drive.

If speed adjustment seems difficult (see Chapter 5), have a repair service shop do it.

ASCII CODE CHART

Hexa- decimal	ASCII	Hexa- decimal	ASCII	Hexa- decimal	ASCII
00	^@ (Null)	2B	+	56	V
01	^A	2C	,	57	W
02	^B	2D	-	58	X
03	^C	2E	.	59	Y
04	^D	2F	/	5A	Z
05	^E	30	0	5B	[
06	^F	31	1	5C	\
07	^G (Bell)	32	2	5D]
08	^H (Backspace)	33	3	5E	^
09	^I (Tab)	34	4	5F	_
0A	^J (Linefeed)	35	5	60	¸
0B	^K	36	6	61	a
0C	^L	37	7	62	b
0D	^M	38	8	63	c
0E	^N	39	9	64	d
0F	^O	3A	:	65	e
10	^P	3B	;	66	f
11	^Q	3C	<	67	g
12	^R	3D	=	68	h
13	^S	3E	>	69	i
14	^T	3F	?	6A	j
15	^U	40	@	6B	k
16	^V	41	A	6C	l
17	^W	42	B	6D	m
18	^X	43	C	6E	n
19	^Y	44	D	6F	o
1A	^Z	45	E	70	p
1B	^[(Escape)	46	F	71	q
1C	^\	47	G	72	r
1D]	48	H	73	s
1E	~	49	I	74	t
1F	^_	4A	J	75	u
20	Space	4B	K	76	v
21	!	4C	L	77	w
22	"	4D	M	78	x
23	#	4E	N	79	y
24	\$	4F	O	7A	z
25	%	50	P	7B	{
26	&	51	Q	7C	
27	'	52	R	7D	}
28	(53	S	7E	~
29)	54	T	7F	Delete
2A	*	55	U		

(The symbol ^ represents a control character.)

HEXADECIMAL TO DECIMAL CONVERSION CHART

Hex	Dec	Hex	Dec	Hex	Dec	Hex	Dec	Hex	Dec	Hex	Dec	Hex	Dec	Hex	Dec
\$00	00	\$20	32	\$40	64	\$60	96	\$80	128	\$A0	160	\$C0	192	\$E0	224
\$01	01	\$21	33	\$41	65	\$61	97	\$81	129	\$A1	161	\$C1	193	\$E1	225
\$02	02	\$22	34	\$42	66	\$62	98	\$82	130	\$A2	162	\$C2	194	\$E2	226
\$03	03	\$23	35	\$43	67	\$63	99	\$83	131	\$A3	163	\$C3	195	\$E3	227
\$04	04	\$24	36	\$44	68	\$64	100	\$84	132	\$A4	164	\$C4	196	\$E4	228
\$05	05	\$25	37	\$45	69	\$65	101	\$85	133	\$A5	165	\$C5	197	\$E5	229
\$06	06	\$26	38	\$46	70	\$66	102	\$86	134	\$A6	166	\$C6	198	\$E6	230
\$07	07	\$27	39	\$47	71	\$67	103	\$87	135	\$A7	167	\$C7	199	\$E7	231
\$08	08	\$28	40	\$48	72	\$68	104	\$88	136	\$A8	168	\$C8	200	\$E8	232
\$09	09	\$29	41	\$49	73	\$69	105	\$89	137	\$A9	169	\$C9	201	\$E9	233
\$0A	10	\$2A	42	\$4A	74	\$6A	106	\$8A	138	\$AA	170	\$CA	202	\$EA	234
\$0B	11	\$2B	43	\$4B	75	\$6B	107	\$8B	139	\$AB	171	\$CB	203	\$EB	235
\$0C	12	\$2C	44	\$4C	76	\$6C	108	\$8C	140	\$AC	172	\$CC	204	\$EC	236
\$0D	13	\$2D	45	\$4D	77	\$6D	109	\$8D	141	\$AD	173	\$CD	205	\$ED	237
\$0E	14	\$2E	46	\$4E	78	\$6E	110	\$8E	142	\$AE	174	\$CE	206	\$EE	238
\$0F	15	\$2F	47	\$4F	79	\$6F	111	\$8F	143	\$AF	175	\$CF	207	\$EF	239
\$10	16	\$30	48	\$50	80	\$70	112	\$90	144	\$B0	176	\$D0	208	\$F0	240
\$11	17	\$31	49	\$51	81	\$71	113	\$91	145	\$B1	177	\$D1	209	\$F1	241
\$12	18	\$32	50	\$52	82	\$72	114	\$92	146	\$B2	178	\$D2	210	\$F2	242
\$13	19	\$33	51	\$53	83	\$73	115	\$93	147	\$B3	179	\$D3	211	\$F3	243
\$14	20	\$34	52	\$54	84	\$74	116	\$94	148	\$B4	180	\$D4	212	\$F4	244
\$15	21	\$35	53	\$55	85	\$75	117	\$95	149	\$B5	181	\$D5	213	\$F5	245
\$16	22	\$36	54	\$56	86	\$76	118	\$96	150	\$B6	182	\$D6	214	\$F6	246
\$17	23	\$37	55	\$57	87	\$77	119	\$97	151	\$B7	183	\$D7	215	\$F7	247
\$18	24	\$38	56	\$58	88	\$78	120	\$98	152	\$B8	184	\$D8	216	\$F8	248
\$19	25	\$39	57	\$59	89	\$79	121	\$99	153	\$B9	185	\$D9	217	\$F9	249
\$1A	26	\$3A	58	\$5A	90	\$7A	122	\$9A	154	\$BA	186	\$DA	218	\$FA	250
\$1B	27	\$3B	59	\$5B	91	\$7B	123	\$9B	155	\$BB	187	\$DB	219	\$FB	251
\$1C	28	\$3C	60	\$5C	92	\$7C	124	\$9C	156	\$BC	188	\$DC	220	\$FC	252
\$1D	29	\$3D	61	\$5D	93	\$7D	125	\$9D	157	\$BD	189	\$DD	221	\$FD	253
\$1E	30	\$3E	62	\$5E	94	\$7E	126	\$9E	158	\$BE	190	\$DE	222	\$FE	254
\$1F	31	\$3F	63	\$5F	95	\$7F	127	\$9F	159	\$BF	191	\$DF	223	\$FF	255

Glossary

A

- Address** A number that represents a unique location in Apple II memory.
- Address bus** The collection of 16 wires over which the memory address is sent by the CPU to the memory or I/O device.
- AND** A logic gate used in the Apple computer; the output is HIGH (or logic 1) if and only if all inputs are also HIGH.
- ASCII** A code (American Standard Code for Information Interchange) representing the character symbols possible for specific hexadecimal codes.
- Applesoft** The form of BASIC high level language permanently stored in Apple ROM.
- Auxiliary slot** A special 60-pin slot on the Apple IIe motherboard designed for an 80-column text or extended 80-column text card.

B

- BASIC** An easy-to-learn high-level language. BASIC stands for *Beginner's All-purpose Symbolic Instruction Code*.
- Bit** A Binary digIT which is the basic unit used to form the address and data words in your Apple.
- Blackout** The total loss of electrical power.
- Bootstrap** A process by which a short loader program loads itself into memory and then loads a longer program. The program, in effect, "pulls itself up by its bootstrap."
- Brownout** A deliberate reduction in the electrical line voltage supplied to you; usually caused by excessive electrical demand on the electric utility or insufficient power generation capability.

- Bus** A collection of wires over which data words travel. For example, in the Apple the bus can be the 8 wires that transfer the data word, or the 16 wires that transfer the address word.
- Byte** The size of a data word in the Apple. A byte is eight bits wide and represents a numerical value between 0 and 255 (decimal).

C

- Chip** An integrated circuit; a silicon device mounted on a plastic support package. Often the complete package is called a chip.
- Clock** A consistent, periodic signal used to step logic information through a computer circuit.
- Cold start** The process of initializing the startup conditions in your Apple computer. The cold start process assumes no previous activity in the computer; all registers in the machine are set to initial conditions.
- CPU** Central processing unit; the area in which the primary logic decisions are made and arithmetic manipulations are done. The CPU in your Apple II is called a 6502.
- CRT** Cathode ray tube. The display screen on which you observe the characters and graphics output by the Apple II.
- Cursor** The display symbol that indicates the position in which the next character will appear.

D

- Data** Computer information such as numbers, letters, or special symbols.
- Data bus** The collection of wires or traces over which the

8-bit data word travels in your Apple computer.

Disk The magnetic medium on which you store computer data.

Display The device on which visual information is presented in light images by the computer.

F

Firmware Programs that are stored in hardware such as a ROM.

Flip-flop An electronic device (chip/IC) that holds a given logic state until acted on by a signal on a certain input pin, at which time the opposite logic state is expressed.

H

Hardware The physical components of a computer system. The computer itself, the printer, the monitor display unit, and so on.

Head The electromagnetic material through which your disks are written on or read from.

Hexadecimal The numbering system based on 16 digits, in which the digits above 9 are A, B, C, D, E, and F. Each hexadecimal number can be represented as a 4-bit code.

I

IC The integrated circuit, a kind of microelectronic device, that is the building block of the computer; also called a "chip," although technically, the chip is the material on which the IC is mounted.

I/O The input/output media through which the computer sends and receives information to and from the outside world (i.e., disk drives, keyboard, display unit, etc.).

K

K Stands for kilo; in computer applications equal to 1024; the symbol used to represent the size of memory in your Apple. The term 64K actually means 65,536.

M

Motherboard The large printed circuit board in the Apple II on which most of the electronic devices are mounted; the primary or main board in your computer. All other boards receive control signals or information from the motherboard.

N

Noise The electrical interference that results from the presence of an electrical field in the vicinity of electrical signals from such equipment as data busses, TV, or radio.

P

Pin The small metal connection that protrudes down from an IC, or the finger of a circuit trace on the edge of a peripheral card.

R

RAM Random access memory; memory that can be read from or written to by the Apple computer's CPU.

ROM Read only memory; memory with information permanently stored in its solid material. The information cannot be changed by the user.

S

6502 The microprocessor in the Apple II Plus.

6502B An improved microprocessor found in the Apple IIe.

Software The programs that determine or control the actions of the computer.

Spike A short, high-intensity burst of electrical energy that, if not bypassed (or shorted) to ground, can cause damage to electronic components.

Surge A temporary increase in electrical voltage lasting long enough to be noticed on a meter.

T

Transient A brief fluctuation in voltage; shorter than a surge; smaller in magnitude than a spike.

Troubleshoot To systematically locate a computer hardware failure. Software failures are found by systematic debugging.

W

Warm start The process of restarting the computer without reloading the operating system. The warm start process returns the user to the program language last used (e.g., Applesoft BASIC).

Bibliography

BIBLIOGRAPHY

- Anderson, Garry J. "Designer's Guide to the CMOS STD Bus." *Electronic Products*, November 17, 1983, pp. 81-87.
- Apple IIe 80-Column Text Card Manual*. Cupertino, California: Apple Computer Co., 1982.
- Apple IIe Owner's Manual*. Cupertino, California: Apple Computer Co., 1983.
- Apple IIe Reference Manual*. Cupertino, California: Apple Computer Co., 1982.
- Apple IIe Reference Manual Addendum: Monitor ROM Listings*. Cupertino, California: Apple Computer Co., 1982.
- Apple II Reference Manual*. Cupertino, California: Apple Computer Co., 1981.
- APTEST. Renton, Washington: A.P.P.L.E., 1983.
- Archibald, Dale. "The Making of the Magnetic Media for Micros." *Softalk*, February 1982, pp. 160-164.
- Babcoke, Carl. "Practical Information About Testing and Replacing Capacitors." *Electronic Servicing*, July 1970, pp. 28-37.
- Babcoke, Carl. "Quick Testing of Transistors." *Electronic Servicing*, November 1970, pp. 26-33.
- Babcoke, Carl. "Simple Servicing Tips." *Electronic Servicing & Technology*, July 1983, pp. 44-49.
- Baker, Alan, and Mielke, Neal. "Detecting Quality and Reliability Defects in EPROMs." *Electronic Test*, November 1983, pp. 56-62.
- Barden, William, Jr. "Getting Your Micro Repaired." *Popular Computing*, May 1983, pp. 54-58.
- Bayer, Barry D. "Fix Your Disks." *Apple Orchard*, February 1983, pp. 59-62.
- Belt, Forest. "1-2-3-4 Servicing Simplifies Industrial Electronic Maintenance." *Electronic Servicing*, September 1979, pp. 21-27.
- Benyo, Richard. "Singing the Praises of Dustcovers." *Popular Computing*, April 1983, p. 165.
- Bethune, Robert W. "Getting Along With Cassette Storage." *Popular Computing*, June 1983, pp. 190-192.
- Brawley, Harry E., Jr. "Keep Your Cool." *Call A.P.P.L.E.*, May 1982, pp. 57-61.
- Brunelle, Robert. "Meeting the New Radio Interference Standards." *Digital Design*, November 1982, pp. 36-38.
- Bulkeley, William M. "Originators of BASIC Computer Language Seek to Profit From Success of Their Work." *Wall Street Journal*, November 15, 1983, p. 38.
- Caffrey, Morgan P. "The New Apple IIe." *Apple Orchard*, February 1983, pp. 12-28.
- "Choosing and Using the Proper Soldering Iron." *Electronic Servicing & Technology*, December 1981, pp. 36-39.
- Choudhury, Margaret A. "Heat Shows Its Colors for Testing." *Electronic Packaging & Production*, May 1983, pp. 120-121.
- Crosby, Mark L. "Singin' the Disk I/O Blues." *Apple Orchard*, Winter 1981/82, pp. 63-68.
- Cunningham, John E. "Troubleshooting Digital Equipment." *Electronic Servicing*, September 1980, pp. 18-21.
- Dale, Alan. "1-2-3-4 Servicing." *Electronic Servicing*, December 1970, pp. 26-30.
- Dash, Glen. "Understanding EMI Test Methods Eases Product Acceptance." *EDN*, May 1983, pp. 183-192.

- Davis, Dwight B. "Diagnostics Improve as Computer Systems Proliferate." *Mini-Micro Systems*, August 1982, pp. 115-123.
- Davis, Dwight B. "Manufacturers Work Out Last RFI Kinks as Final FCC Deadline Approaches." *Mini-Micro Systems*, September 1983, pp. 127-138.
- Deavenport, Joe E. "EMI Susceptibility Testing of Computer Systems." *Computer Design*, March 1980, pp. 145-149.
- DIAGNOSTIC II. Champaign, Illinois: Supersoft, Inc., 1983.
- Engel, George M. "Line Cleaner - A Construction Project." *In Cider*, August 1983, pp. 108-110.
- Frank, Dr. Arthur L. "Survey: Eyestrain." *Government Computer News*, December 1983, pp. 26-30.
- Freedman, David H. "Designing the Right Enclosure." *Mini-Micro Systems*, August 1983, pp. 229-242.
- Friedman, Herb. "Choosing the Right Floppy Disk." *Computers and Programming*, September/October 1981, pp. 29-31, 70.
- Gayler, Winston D. *The Apple II Circuit Description*. Indianapolis, Indiana: Howard W. Sams & Co., Inc., 1983.
- Goldblatt, Robert C. "How Computers Can Test Their Own Memories." *Computer Design*, July 1976, pp. 125-129.
- Goodman, Robert. "An Ounce of Prevention." *Electronic Servicing & Technology*, May 1983, pp. 24-39.
- Green, Richard. "A Simple Write Protect Indicator for the Apple II." *In Cider*, December 1983, pp. 100, 101.
- Grolle, Carl G. *Electronic Technician's Handbook of Time-Savers and Shortcuts*. West Nyack, New York: Parker Publishing Company, Inc., 1974.
- Halperin, Stephen A. "Guarding Against Electrostatic Discharge." *Mini-Micro Systems*, August 1983, pp. 257, 258.
- Hancock, Earle. "A Man of Letters." *In Cider*, December 1983, pp. 172-174.
- Hancock, Earle. "Do-It-Yourself Disk Drive Repair." *In Cider*, November 1983, pp. 32-34.
- Harwood, Robert. "Diagnostic and Utility Software." *Personal Computing*, October 1981, pp. 47-54, 166-169.
- Hogan, Thom. "We're Not in Kansas Anymore." *The Portable Companion*, June/July 1982, pp. 11-14.
- Kaminer, David A. "What to Do When Your System Crashes." *Popular Computing*, April 1983, pp. 154-156.
- Kotelly, George V. "Video Display Terminals: Help or Hazard?" *Mini-Micro Systems*, November 1983, p. 7.
- Lemons, Wayne. "Streamlined Tests for Transistors." *Electronic Servicing*, August 1977, pp. 34-39.
- Leona, Matteo, and Hancock, Earle. "Apple Repair and Care." *In Cider*, July 1983, pp. 120-123.
- Lesser, Hartley G. "Apple IIe . . . Worth the Wait?" *In Cider*, March 1983, pp. 58-69.
- Lewis, Gordon. "Disks, Drives, and Dirt." *Pro/Files*, September/October 1983, pp. 59-61.
- Lieberman, David. "Data Input Alternatives." *Electronic Products*, June 6, 1983, pp. 47-55.
- Lieberman, David. "The Clean Connection." *Nibble*, vol. 2, no. 8, 1981, pp. 159-165.
- Lipson, Neil D. "Diagnosing and Repairing Your Apple II." *Apple Orchard*, February 1983, pp. 34-35.
- Little, M. Andre. "System Security." *In Cider*, December 1983, pp. 117-121.
- Little, Tom. "Ins and Outs." *Call A.P.P.L.E.*, June 1982, pp. 24-35.
- Little, Tom. "Ins and Outs." *Call A.P.P.L.E.*, June 1982, pp. 19-26.
- Littlefield, Patti. "What to Try Before Taking Your Microcomputer Into the Repair Department." *Educational Computer Magazine*, May-June 1983, p. 73.
- Mann, Timothy J. "Disk Cleaner." *In Cider*, October 1983, pp. 166-168.
- Mardiguian, Michael, and White, Donald R. J. "Electrostatic Discharge, What It Is and How to Control It." *Electronic Products*, September 30, 1983, pp. 111-115.
- Margolis, Art. *Troubleshooting & Repairing Personal Computers*. Blue Ridge Summit, Pennsylvania: Tab Books, Inc., 1983.
- "MASTER DIAGNOSTICS." Nikrom Technical Products, Inc., 1983.
- Mazur, Jeffrey. "Boarding the Apple Bus, Part 1." *Softalk*, January 1982, pp. 144-150.
- Mazur, Jeffrey. "Hard Talk." *Softalk*, October 1982, pp. 192-199.
- Mazur, Jeffrey. "Hard Talk." *Softalk*, December 1982, pp. 275-279.
- Mazur, Jeffrey. "Hard Talk." *Softalk*, April 1983, pp. 56-62.
- Mazur, Jeffrey. "Hard Talk." *Softalk*, May 1983, pp. 91-98.
- McCain, John. "Spikes: Pesky Voltage Transients and How to Minimize Their Effects." *Byte*, November 1977, pp. 54-56.
- McClain, Larry. "Servicing Your System: Be Prepared." *Personal Computing*, September 1982, pp. 50-55, 148-154.
- McDermott, Jim. "EMI Shielding and Protective Components." *EDN*, September 5, 1979, pp. 165-176.
- Miller, Beth. "Microsystem Reliability Testing." *Electronic Test*, November 1983, pp. 48-54.
- Milner, Edward J. "Fast Memory Test Checks Individual Bits." *EDN*, October 13, 1983, pp. 222-229.
- Moore, Robin. "Apple's Enhanced Computer, The Apple IIe." *Byte*, February 1983, pp. 68-86.
- Mossberg, Sandy. "Apple IIe Cast of Characters." *Nibble*, Vol. 4, no. 6, 1983, pp. 179-182.
- Olivieri, Peter. "Mind Your Business." *Softalk*, June 1983, pp. 207-212.
- Pearlman, Dara. "Coping With Static Electricity." *Popular Computing*, January 1984, pp. 150-155.
- Poole, Lon, McNiff, Martin, and Cook, Steven. *Apple II User's Guide*. Berkeley, California: Osborne/McGraw Hill, 1981.
- Radding, Alan. "When Your Computer Breaks Down." *Popular Computing*, May 1983, pp. 196-198.
- Rampil, Ira. "A Floppy Disk Tutorial." *Byte*, December 1977, pp. 24-25.
- Rechsteiner, Emil B. "Keeping Power Clean and Steady." *Mini-Micro Systems*, August 1983, pp. 245-252.
- Riccio, Ronald. "How to Avoid Damage When Repairing PC Boards." *Electronic Servicing & Technology*, February 1983, pp. 38-42.
- Rich, Alan. "Understanding EMI-Type Noise." *Electronics Test*, May 1983, pp. 34-46.
- Robinson, J. B. *Modern Digital Troubleshooting*. Redmond, Washington: Data I/O Corporation, 1983.

- Root, Jock. "Everyone's Guide to Assembly Language." *Softalk*, July 1983, pp. 111-112.
- Santoni, Andy. "Probes and Test Cells Simplify EMI Testing." *EDN*, September 5, 1979, pp. 51-54.
- Schilling, Robert, Jr. "Hardware Diagnostics for the Home." *Popular Computing*, August 1983, pp. 204-210.
- Schatz, Gerald, S. "Video Terminals Do Not Threaten Vision, Concludes National Research Council." *The IEEE Institute*, September 1983, pp. 1, 5.
- Scovern, John L. "No Corrosion with Antistat." *Circuits Manufacturing*, January 1983, pp. 51-53.
- Segal, Hillel. "Apple II Plus, Solid Performance and Low Price." *Interface Age*, October 1981, pp. 60-62.
- Shafer, Kurt. "Diverse UPS Technologies Provide Design Alternatives." *Digital Design*, June 1983, pp. 81-96.
- Shaffer, Richard A. "Electronic Interference Rises Causing Havoc in Many Fields." *Wall Street Journal*, November 18, 1983, p. 31.
- Sloop, Joe. "Troubleshooting Logic Systems Logically." *Electronic Servicing & Technology*, July 1983, pp. 26-37.
- Snyder, E. J. "Engineering for EMI Compliance." *Mini-Micro Systems*, August 1983, pp. 254-255.
- The DOS Manual*. Cupertino, California: Apple Computer, Inc., 1981.
- Tommervik, Al. "Apple IIe: The Difference." *Softalk*, February 1983, pp. 118-127, 142.
- Updegraff, Stephen W. "Better Than Gold - Substrate Coating Surpasses Gold in Hi-Rel Connectors." *Circuits Manufacturing*, December 1983, pp. 54-59.
- Victor, Jesse, "Low Noise Topologies, Innovative Designs to be Spotlighted at Powercon 9." *EDN*, June 9, 1982, pp. 75-84.
- Wagner, Roger. "Everyone's Guide to Assembly Language." *Softalk*, January 1982, pp. 37-42.
- Weishaar, Tom. "DOSTalk." *Softalk*, November 1983, pp. 259-262.
- Whitaker, Lewis A. "Maintenance Alternatives for Personal Computers." *Byte*, June 1982, pp. 452-459.
- Wiles, James, P., and Stewart, George. "What Happens When the Lights Go Out?" *Popular Computing*, August 1982, pp. 97-102.
- XPS - DIAGNOSTIC II OR IIe*. Carlisle, Pennsylvania: XPS, Inc., 1983.

Index

Page references directed towards the Apple II Plus are in italics.
Page references directed towards the Apple IIe are in bold face.
General references are in standard type.

A

- Apple Computers, Inc., 35, 115
- Apple-Easy repair approach, 28-31, 213
 - assume one problem, 18, 28
 - consult symptom index, 18, 28
 - diagnose to section, 18, 28
 - diagnostic steps, 18, 28-31
 - don't panic, 18, 28
 - isolate to failed part, 18, 29-30
 - localize to a stage, 18, 28-29
 - observe, 18, 28
 - power off, 18
 - repair, 18, 30-31
 - retry, 18, 28
 - sense, 18, 28
 - static electricity, 29
 - test and verify, 18, 31
 - write, 18, 28
- Applesoft BASIC, 35, 38, 46, 59, 115, 139, 243
 - storage area, 47, 118, 127, 139
- ASCII code, 52, 53, 115, 116, 133, 243
 - chart, 240
 - storage area, 118

B

- BASIC, 58, 59, 139, 243
 - program location, 47, 127
- Boot, 46, 56-58, 126, 137-138, 243
 - cold, 57, 137, 243
 - warm, 58, 138, 244

- Boot failures, 62-63, 67-74, 142-143
 - no power light, no beep, drive won't run, 62-63, 142-143
 - power light on, beeps, no display, drive whirs then stops, 72-74, 150-152
 - power light on, beeps, screen displays "Apple II," drive keeps running, 70-71, 148-149
 - power light on, beeps, screen displays "Apple II," drive runs then stops, 71-72, 149-150
 - power light on, beeps, screen displays "Apple II," drive won't run, 69, 147-148
 - power light on, no beep, drive won't run, 63, 143
 - power light on, no beep, drive won't run, garbage on screen, 67-68, 146-147
- Bus structure, 47-48, 127-129, 243
 - address bus, 47, 127, 243
 - control bus, 47, 127
 - data bus, 47, 127, 243-244
 - multiplexed address bus, 128
 - revisions, 59
 - system bus, 48, 128
 - video data bus, 128, 131

C

- Capacitor failures, 23, 220-221, 224-225
 - aging, 220-221
 - capacitance measuring, 225
 - circuit open, 221
 - dielectric oxide dissolution, 221
 - repairing, 22, 31
 - replacement, 225
 - testing, 224-225
- Capacitors, 20-21
 - color trim adjust, 21
 - construction, 220
 - electrolytic, 20, 220

- farads, 20
 - film, 20, 220
 - tantalum, 20
 - value identification, 20-21
 - variable, 20
 - Cassette storage device, 39, 120
 - back-up storage, 39, 120
 - drawbacks, 39, 120
 - input/output, 50-51, 55, 116, 132, 134, 135
 - soft switch, 51
 - tapes, 44, 124
 - Cassette storage device failures, 61, 108-110, 141, 178-180
 - can't load data, 108-109, 178-179
 - can't write data to tape, 109-110, 179-180
 - Cathode ray tube; *see* CRT
 - Central Processing Unit; *see* CPU
 - Chip failures, 23, 219-224
 - corrosion prevention, 198
 - dust, 187
 - easter egg approach, 224
 - heating/cooling, 223
 - heat-sensitive liquid crystal testing, 211
 - IC tester, 217
 - leads, 220
 - logic clip, 214-215, 222
 - logic probe, 215-216, 222
 - mental migration, 220
 - microvolt measuring, 224
 - piggybacking, 223-224
 - replacement, 22, 29, 30-31
 - resistance test, 223
 - sense tests, 223
 - thermal stress, 186, 187, 220
 - TTL testing, 221-223
 - VTVM (vacuum-tube-voltmeter), 223
 - Chips, 19-20, 36, 117, 214, 243
 - handling of, 33
 - information chart, 232, 234-235
 - internal EMI and, 189, 190
 - letter-number combinations, 20
 - markings, 19-20
 - pin 1 identification, 19
 - sizes, 19, 37, 118
 - socket placement, 19
 - Von Neumann machine, 19
 - Circuitry repairs, 229
 - logic probe, 215-216
 - logic pulser, 216-217
 - self-test program, 116
 - Clock-timing, 48-49, 125, 129, 243
 - color reference signal, 49, 129
 - failures, 49, 129
 - master oscillator signal, 48, 129
 - phase/signal, 49, 129, 130
 - phase O signal, 49, 129, 130
 - Q3 signal, 49, 129
 - Components; *see* specific device, e.g. Motherboard
 - Computer parts, 43, 123, 221-222
 - arithmetic logic unit (ALU), 43, 123
 - control unit, 43, 44, 123, 124
 - input unit, 43-44, 123-124
 - memory unit, 43, 123
 - output unit, 43, 44, 123, 124
 - Configuration changes record, 237
 - Corrosion, 186, 197-199
 - atmospheric corrosion, 197-198
 - direct oxidation, 197
 - galvanic corrosion, 197, 198
 - prevention, 198-199
 - CPU, 36, 37, 117, 118, 124, 243
 - bus structures, 47-48, 127-129
 - failures, 23
 - functions of, 44, 124
 - input/output unit (IOU), 118, 125
 - program array logic (PAL), 118, 125
 - RFI and, 190
 - CRT, 24, 209-210, 243
 - body strain, 210
 - eye fatigue, 210
 - light radiation, 209
 - x-radiation, 209-210
 - see also* Display monitor
- D**
- Digital computer, 17
 - Diodes, 22
 - Digital multimeter (DMM) testing, 225
 - diode effect (DE), 225
 - failures, 23, 221
 - identification of, 22
 - in-circuit tests, 225
 - repairing, 22
 - see also* LED
 - Disk; *see* Floppy disk
 - Disk drive, 23
 - disk controller card, 37, 118
 - installation, 39
 - see also* Disk drive head
 - see also* Disk II drive
 - Disk drive head, 202-205, 244
 - cleaning disk, 203
 - cleaning dos and don'ts, 202-203
 - cleaning intervals, 205
 - cleaning materials, 202-203
 - manual cleaning, 203-205
 - read head misalignment, 24
 - Disk drive failures, 23-24, 74-79, 152-156
 - acoustic noise, 191
 - alignment, 209
 - booting repair, 28
 - cold temperature, 187
 - controller card movement, 23
 - disassembly instructions, 206
 - dust problems, 187
 - magnetism prevention, 199
 - prevention maintenance, 201-209
 - reads or writes intermittently, 78-79, 156
 - rotation speed alteration, 23, 206
 - self-diagnostics, 27
 - speed program, 207-208
 - speed test, 28, 205-209
 - tuning lamp, 208-209
 - won't read, 74-76, 152-154
 - won't write, 76-78, 154-155
 - Disk operating system; *see* DOS
 - Disk II drive, 51, 120, 132
 - failures, 51, 132
 - installing, 120, 132
 - power supply reinstallation, 236
 - power supply removal, 235
 - storage capacity, 52
 - see also* Disk drive
 - Display monitor, 38, 44, 49-50, 119, 124, 130-131, 244
 - character generator, 50
 - connection of, 39, 116, 121
 - high-resolution graphics, 38, 119-120, 131
 - high-resolution with text, 38, 120
 - low-resolution graphics mode, 38, 119, 131
 - low-resolution with text, 38, 119
 - RCA jack, 38, 130
 - RF modulator, 38
 - safety precautions, 32
 - screen memory map scrambling, 50
 - serial bit stream, 50

shift registers, 50
 soft switches, 49
 static electricity, 187
 television, 38
 text mode, 38, 119
see also CRT
see also Video signal
 Display monitor failures, 24, 61, 81-99, 141, 158-170
 bad graphics — no hi-res graphics; lo-res and text ok, 98-99, 169-170
 bad graphics — no hi-res or lo-res graphics; text ok, 97-98, 168-169
 bad inverse or flash, 93-94, 165-166
 bad or no cursor, 92-93, 165
 CRT aging, 24
 CRT short, 24
 dust, 187
 fuzzy picture, 24
 no characters, 24
 no color, 88-89, 163-164
 no display — no video, 83-84, 159-161
 no display — screen all white, 82, 158-159
 no display — screen blank, 86-87, 162-163
 no horizontal synchronization, 90-91
 no picture, 24
 no synchronization, 164
 no text, 94-96, 166-167
 no vertical synchronization, 89-90
 preventive maintenance, 188-189
 repairing, 24, 28
 thermal stress, 24
 video — annoying color tint on fringe, 96-97
 video — wrong characters, 96, 167-168
 DOS, 46, 59-60, 126, 138-139
 development of, 59, 138-139
 loading, 46
 storage area, 46

E

Equipment history record sheet, 237
 Expansion slots, 35

F

Failure locating; *see specific approach*, e.g. Apple Easy
 Failures, 23, 61-62, 141-142
 asphyxiation, 25
 cables, 25
 device handling, 24
 high-voltage exposure, 23
 liquid spillage, 24-25, 32
 pin breakage, 24
 power on, 25
 power-cycling environments, 23
 repair generated, 24
 solder splashes, 24
 thermal stress, 23
 wearout, 23
 see also specific devices
 see also specific type, e.g. Start-up problems
 Floppy disks, 39, 44, 51-52, 120, 124, 132, 244
 age span, 200
 both side use, 201
 cold temperature, 187
 construction of, 199
 dust problems, 187, 200
 magnetism prevention, 199
 oxide layer build-up, 200
 preventive maintenance, 299-201
 proper handling, 30, 187, 189, 200, 239-240

 smoke problems, 200
 sounds, 200
 thermal stress, 186
 FORTRAN, 59, 139

G

Game I/O connector, 38-39, 54-56, 120, 134-137
 analog inputs, 55-56, 120, 134-136
 annunciator outputs, 56, 134, 136-137
 arcade games, 54, 115, 116, 134
 C040 strobe output, 56, 136
 device attaching, 39
 digital inputs, 54-55, 134
 flag inputs, 39, 120
 voltage input, 39, 120
 Game paddle failures, 61, 110-113, 141, 180-183
 button won't work, 112, 181-182
 knob doesn't work correctly, 112-113, 182-183
 won't work, 110-111, 180-181

H

Hard copy; *see* Printer
 Hard disk, 44, 124
 preventive maintenance, 209
 Hardware casing, 18, 36, 115
 preventive maintenance, 188-189
 revisions, 58
 Hardware repair approach, 25, 213
 Hexadecimal, 244
 decimal conversion chart, 241

I

Inductors, 22
 failures, 23, 221
 green, 11, 22
 microhenry values, 22
 repairing, 22
 smoke gray, 22
 Input/output devices; *see* I/O devices
 Input/output unit, 118, 125, 130
 soft switches, 125
 Integer BASIC, 35, 59, 139
 Integrated circuit; *see* Chip
 I/O devices, 244
 attachment of, 36, 44, 116
 expansion slots, 48
 memory-mapped addresses, 45, 48, 129
 see also specific device
 I/O devices failures, 23, 61, 106-114, 175-184
 card in peripheral slot won't work, 113-114, 183-184
 repairing, 28
 see also specific device
 IOU; *see* Input/output unit

K

Keyboard, 36, 44, 52-53, 115, 124, 132-133
 automatic key repeat, 116, 133
 double circuit board, 52
 encoder circuitry, 52, 133
 keys, 52, 115, 116, 132
 motherboard location, 53, 133
 reinstallation, 233-234, 236
 removal, 233, 236
 ribbon-cable connection, 119
 single-circuit board, 52

strobe pulse, 52-53, 133
 Keyboard failures, 61, 99-105, 141, 170-175
 bad key action — no keys or only some keys respond, 99-101, 170-171
 bad key action — prints wrong characters, 101-103, 172-173
 bad key action — unwanted repeat, 103-104, 173
 key top pops off, 105, 175
 repeat key won't work, 104-105, 174
 won't work, 79-81, 157-158
 Keypad, 119

L

LED, 119, 132, 221
 in current tracer probes, 217
 in IC testers, 217
 in logic clips, 218
 in logic pulsers, 216
 see also Diodes
 Light emitting diode; *see* LED
 Light pen, 44, 124

M

Main memory; *see* RAM
 Main printed circuit board; *see* Motherboard
 Maintenance; *see* Preventive maintenance
 Memory, 26
 HIMEN, 46
 LOMEN, 46
 self-test program, 116
 Memory design, 44-45, 125-126
 bank-switching, 125
 memory map, 45, 125-126
 Memory management, 45
 Memory management unit, 118, 125, 128
 soft switches, 125
 Minidiskettes; *see* Floppy disks
 MMU; *see* Memory management unit
 Monitor; *see* Display monitor
 Metal oxide semiconductor; *see* MOS
 Modem, 44, 118, 124
 Modular construction, 35
 MOS, 33
 Motherboard, 18-22, 36, 115, 117, 244
 access to, 232, 235
 chip location scheme, 18-19, 44, 124
 current tracer probe, 217
 internal EMI and, 189
 mounted devices, 18
 reinstallation, 233-234, 236-237
 removal, 233, 236
 revisions, 58-59
 testing, 223
 thermal imaging, 211
 thermal stress, 23, 186
 see also specific device, e.g. Chips

N

Noise interference, 29, 186, 189-193, 244
 acoustic noise, 189, 191
 capacitance, 190
 countermeasures, 190-193
 cross talk, 190
 EMI (electromagnetic interference), 189, 191-192
 EMR (electromagnetic radiation) noise, 189
 ESD (electrostatic discharge), 189, 192-193
 ESD countermeasures, 193-194
 glitches, 192
 internal EMI (electromagnetic interference), 189

radiated RFI (radio frequency interference), 189
 RFI (radio frequency interference), 189, 192, 193
 RFI (radio frequency interference), 59
 sources of, 190
 transient EMI (electromagnetic interference), 189
 triboelectric series, 193

O

Operating system, 46, 126
 Optical disk, 44, 124

P

PAL, 118, 125
 Peripherals; *see* I/O devices
 PM; *see* Preventive Maintenance
 Power, 25, 115, 116
 failure repair, 28
 safety precautions, 32
 Power-line disturbances, 186, 193-197
 back-up power, 197
 blackout, 195, 243
 brownouts, 194-195, 243
 brown-up, 195
 conditioners, 197
 continuous-service UPS, 196
 countermeasures, 195-197
 filters, 195, 196
 forward-transfer UPS, 196
 Isolators, 195, 196
 metal oxide varistor (MOV), 196
 motor generators, 196
 regulators, 195-196
 reverse-transfer UPS, 196
 spike transients, 195, 244
 uninterruptible power supply (UPS), 195, 196-197
 Power strip, 32
 Power supply; *see* switching power supply
 Preventive maintenance, 185-212
 annual routines, 239
 cold temperatures, 186, 187
 cooling fan, 186, 191
 corrosion; *see* Corrosion
 daily routines, 238
 dust covers, 188
 dust problems, 186, 187-189
 every other month routines, 239
 every six month routines, 239
 heat sensitive liquid crystal (LC), 211-212
 magnetic flux, 199
 magnetism, 186, 199
 mean time between failures (MTBF), 185
 mean time to repair (MTTR), 185
 monthly routines, 239
 noise problems; *see* Noise interference
 power-line problems; *see* Power-lines
 recording temperature limit liquid crystal (RTL-LC), 211
 smoking, 188-189
 static electricity, 188
 temperature limited liquid crystal (TL-LC), 211
 thermal imaging, 210-211
 thermal stress, 186-187
 weekly routines, 238-239
 see also specific devices
 Printer, 44, 124
 acoustic noise, 191
 connector card, 37, 118
 dust problems, 187
 repairing, 28
 ProDos, 59-60, 139
 Programmed array logic; *see* PAL

R

- RAM, 43, 115, 118-119, 123, 131, 244
 - blackouts and, 195
 - DOS boot and, 46, 126
 - expansion card, 36-37, 45, 46, 118, 119, 125
 - failures, 23
 - least significant bit (LSB), 46, 127
 - memory, 37-38, 44, 126
 - most significant bit (MSB), 46, 127
 - motherboard memory address, 46, 126-127
 - MUX, 49-50
 - ROM and, 38
 - thermal wipeout, 186
 - Random Access Memory; *see* RAM
- Read Only Memory; *see* ROM
- Repair parts, 33-34
 - Apple repair center, 33, 34
 - electronic parts stores, 33
 - spare parts, 230
 - trade magazines, 34
- Repair service checklist, 31-32
- Resistance test, 31
- Resistors, 21-22
 - color bands, 21
 - electric current restriction, 21
 - failures, 23, 221
 - network, 21-22
 - repairing, 22, 31
 - variable, 21
 - wire-wound, 21
- Revision 1, 59
- Revision RF1, 59
- Revision 7, 59
- Revision 0, 58-59
- ROM, 43, 118, 123, 244
 - CD ROM, 118, 126
 - diagnostic ROM, *see* CD ROM
 - EF ROM, 118, 126
 - failures, 23
 - 4K video ROM, 118
 - keyboard ROM, 118
 - memory, 38, 45, 126
 - monitor ROM, *see* EF ROM
 - motherboard memory address, 46
 - RAM and, 38
- Run problems, 61, 74-81, 141, 152-158
 - computer locks up, keyboard won't work, 79-81, 157-158
 - disk drive disorders; *see* Disk drive failures
- Rust; *see* Corrosion

S

- Safety precautions, 32-33, 239
- Soft switches, 49, 51, 53, 131
- Software programs, 35, 39, 122, 244
 - debugging, 218
 - run problems, 46
 - see also* specific program
- Software repair approach, 25-27, 213
 - Butterfield test, 26, 27
 - diagnostic disk tests, 25-26
 - diagnostic program checks, 26
 - dual-address test, 26, 27
 - memory diagnostic tests, 26
 - rotating bit test, 26
 - sequential numbers test, 26
 - simple store and read test, 26
 - sum test, 26, 27
 - walking bit test, 26-27
- Soldering, 227-229
 - heat-sensitive liquid crystal testing, 211
 - removing solder, 227-228

- solder suckers, 227
- technique, 228-229
- tools, 228
- Solid state devices, 23
- Speaker, 18, 38, 53-54, 120, 133-134
 - beep sound, 54, 134
 - click variations, 53, 134
 - frequency, 53-54, 134
 - soft switch, 53
- Speaker failures, 61, 106-108, 141, 175-178
 - volume too low, 106, 175-176
 - won't click, 107-108, 176-178
- Start-up problems, 61, 62-74, 141, 142-152
 - boot disorders, *see* Boot failures
 - message, no beep, 64-65
 - no message, beep, 65-67, 144-146
 - no message, no beep, 63-64, 143-144
 - Static electricity; *see* Noise interference
- Switching power supply, 18, 38, 119, 130
 - internal EMI and, 190
 - power consumption, 49, 130
 - repairing, 49, 130, 184
 - voltages, 49
- System description sheet, 238
- System monitor, 38, 51, 59, 131, 139
 - ROM chip location, 59, 118, 139

T

- Test equipment; *see* Tools
- Tools, 23, 213-219
 - current tracer probe, 25, 217
 - DMM (digital multimeter), 214
 - DVM (digital voltmeter), 31, 214
 - IC tester, 30, 217
 - ISA (interactive state analyzer), 218
 - logic analyzer, 25, 31, 218
 - logic clips, 18, 31, 214-215
 - logic probes, 18, 25, 31, 215-216
 - logic pulser, 25, 216-217
 - oscilloscope, 25, 31, 217-218
 - recommended equipment, 229-230
 - signature analyzer, 25, 31, 218-219
 - tweaker, 30, 213
 - VOM (volt-ohm-millimeter), 213
 - VTVM (vacuum-tube-voltmeter), 214
- Transistors, 22, 214
 - failures, 23, 221
 - identification of, 22
 - removing solder, 227-228
 - repairing, 22, 31
 - testing, 225-227

V

- Vacuum tubes, 214
- Video display; *see* Display monitor
- Video signals, 38, 119, 130
 - color-burst signal, 50, 131
 - counters, 49, 130
 - display address, 130
 - horizontal blanking signal, 130
 - horizontal synchronization pulse, 130
 - Molex 4-pin auxiliary video output connector, 49, 130
 - RCA phono connector, 49, 50, 130
 - single wire-wrap pin, 49
- Voltage test, 31

X

- XDOS, 59-60, 139

Apple[®] II Plus/IIe Troubleshooting & Repair Guide

The *Apple II Plus/IIe Troubleshooting & Repair Guide* will help you keep your microcomputer in top operating condition. This book will guide you step by step through the complexities of making simple repairs to your Apple II Plus/IIe.

- Learn to fix it yourself
- Basic and advanced chapters
- Make most repairs with few or no tools
- Worth many times its cost in repair savings alone
- Quickly zero in on a malfunctioning component
- Easy to understand circuit diagrams
- Contains schematics, block diagrams, and photos
- . . . and much more.

These and many other features are explained in an easy to read, easy to understand style that makes learning an interesting and rewarding investment of precious time.

The *Apple II Plus/IIe Troubleshooting & Repair Guide* will teach even a computer novice how to feel comfortable with the complex world of electronic troubleshooting. The fully illustrated *Apple II Plus/IIe Troubleshooting & Repair Guide* is highly recommended reading for anyone who uses an Apple II Plus or Apple IIe.

Howard W. Sams & Co., Inc.

A Publishing Subsidiary of **ITT**

4300 West 62nd Street, Indianapolis, Indiana 46268 U.S.A.

\$19.95/22353

ISBN: 0-672-22353-8