



# Sideline® Series Electric Fireplace Heater **OWNER'S MANUAL**



**28" / 36" / 40" / 45" / 50" / 60" / 72" / 84" / 100"**

**Sideline® Series Recessed Electric Fireplace**

**AC 110-120V    60Hz    1500W**

Model #: 80004 / 80011 / 80013 / 80014 / 80015 / 80025 / 80027 / 80028 / 80029 / 80032 / 80043



**800.215.1990**



**sales@thpus.com**



**touchstonehomeproducts.com**



## TABLE OF CONTENTS

### 3 General Information

- CSA Approval Listing Information
- Fireplace Specifications
- Dimensional Drawings

- 80028 Sideline® 28" Dimensions
- 80014 Sideline® 36" Dimensions
- 80027 Sideline® 40" Dimensions
- 80025 Sideline® 45" Dimensions
- 80004 Sideline® 50" Dimensions
- 80029 Sideline® 50" White Dimensions
- 80013 Sideline® 50" Steel Dimensions
- 80011 Sideline® 60" Dimensions
- 80015 Sideline® 72" Dimensions
- 80043 Sideline® 84" Dimensions
- 80032 Sideline® 100" Dimensions

### 15 Unpacking Your Fireplace

- **Parts and Hardware**
  - A. Tools Required
  - B. What's in the Box
- **Unpacking and Setup**
  - A. Unpacking Instructions
- **Wiring**
  - A. Testing the Fireplace Prior to Installation
  - B. 3-Prong Outlet Installation
  - C. Hard Wire Connection

### 18 Installation

- **WARNINGS**
- **Choosing Installation Location**
- **Removing the Rubber Feet**
- **Removing the Glass Panel**
- **Removing the Steel Panel**  
(80013 Sideline Steel only)
- **Recessed Installation**
  - A. Crystal Ember Installation
  - B. Fire Log Installation
- **Wall Mounted Installation**

### 27 Operating Your Fireplace

- **Power**
- **Methods of Operation**
  - A. Control Panel
  - B. Remote Control Functions
- **Remote Control Operation**
- **Replacing Remote Control Battery**
- **Temperature Limiting Control**

### 29 Care and Maintenance

- **Cleaning**
- **Maintenance**

### 30 Warranty

## Important Safety Information Warning

- **THIS FIREPLACE IS HOT WHEN IN OPERATION AND CAN CAUSE INJURY**
- Ensure clearances to combustibles are maintained when building a mantel or shelves above the fireplace. Elevated temperatures on the wall or in the air above the fireplace can cause melting, discoloration or damage to the decorations, a TV or other electronic components.
- Do not operate fireplace before reading and understanding operating instructions. Failure to operate fireplace according to operating instructions could cause fire or injury.
- Risk of injury. This fireplace is HOT when in operation and heating element is ON. Power to the fireplace should be turned OFF and the fireplace allowed to cool before servicing. To disconnect power to the fireplace, turn controls to OFF, then remove plug from outlet.
- Do not install damaged, incomplete, or substitute components.
- Young children should be carefully supervised when they are in same room with fireplace. Toddlers, young children and others may be susceptible to accidental injury. A physical barrier is recommended if there are at-risk individuals in the house.
- Clothing and other flammable material should not be placed on or near the fireplace.
- Due to high temperatures, the fireplace should be located out of traffic and away from furniture and draperies.
- It is imperative that the control compartments, circulating blower, and its passageway to the fireplace are kept clean.
- Under no circumstances should this fireplace be modified.
- Do not use the fireplace if any part has been under water.
- Do not operate the fireplace with the glass panel removed, cracked or broken.
- Keep the packaging material out of the reach of children. As with all plastic bags, these are not toys and should be kept away from children and infants.
- Servicing should only be done while the fireplace is disconnected from the power.
- Do not operate this fireplace with a damaged cord or plug, after the fireplace malfunctions, has been dropped, or damaged in any manner.
- Do not use outdoors.
- Never locate fireplace where it may fall into a bathtub or other water container.
- Do not run the cord under carpeting. Do not cover cord with throw rugs, runners, or the like.
- Connect to a properly grounded outlet or hard wire connection only.
- Do not insert foreign objects into any ventilation or exhaust opening as this may cause an electric shock, fire, or damage to the fireplace.
- To prevent a possible fire, do not block the air intakes or exhaust in any manner. Do not use on soft surfaces, like a carpet, where openings may be blocked.



# CSA Approval Listing Information

This fireplace has been tested in accordance with the CSA Standards for fixed and location-dedicated electric room appliances in the United States and Canada. If you need assistance during installation, please contact our technical support department at **800-215-1990**.

**Note: This fireplace must be electrically wired and grounded in accordance with local codes or, in the absence of local codes, with National Electric Code ANSI/NFPA 70-latest edition in the United States or the Canadian Electric Code, CSA C22.1 in Canada.**

## Fireplace Specifications

Model Number	80028	80014	80027	80025	80004
Description	Sideline® 28	Sideline® 36	Sideline® 40	Sideline® 45	Sideline® 50
Voltage	120v AC	120v AC	120v AC	120v AC	120v AC
Watts	Max 1100W	Max 1500W	Max 1500W	Max 1500W	Max 1500W
Amps	12 AMP	12 AMP	12 AMP	12 AMP	12 AMP
Fireplace Width	28"	36"	40"	45"	50"
Fireplace Height	16 1/2"	21 1/2"	21 1/2"	21 1/2"	21 1/2"
Fireplace Depth	5 1/2"	5 1/2"	5 1/2"	5 1/2"	5 1/2"
Net Weight	25 lb	38 lb	41 lb	55 lb	60 lb
Gross Weight	33 lb	47 lb	49 lb	59 lb	65 lb

Model Number	80029	80013	80011	80015	80043
Description	Sideline® 50 White	Sideline® 50 Steel	Sideline® 60	Sideline® 72	Sideline® 84
Voltage	120v AC	120v AC	120v AC	120v AC	120v AC
Watts	Max 1500W	Max 1500W	Max 1500W	Max 1500W	Max 1500W
Amps	12 AMP	12 AMP	12 AMP	12 AMP	12 AMP
Fireplace Width	50"	50"	60"	72"	84"
Fireplace Height	21 1/2"	21 3/8"	21 1/2"	21 1/2"	21 1/2"
Fireplace Depth	5 1/2"	5 1/2"	5 1/2"	5 1/2"	5 1/2"
Net Weight	60 lb	60 lb	70 lb	110 lb	125 lb
Gross Weight	65 lb	65 lb	78 lb	150 lb	160 lb

Model Number	80032
Description	Sideline® 100
Voltage	120v AC
Watts	Max 1500W
Amps	12 AMP
Fireplace Width	100"
Fireplace Height	21 1/2"
Fireplace Depth	5 1/2"
Net Weight	150 lb
Gross Weight	175 lb

# Sideline® 28” Recessed Fireplace | PN: 80028

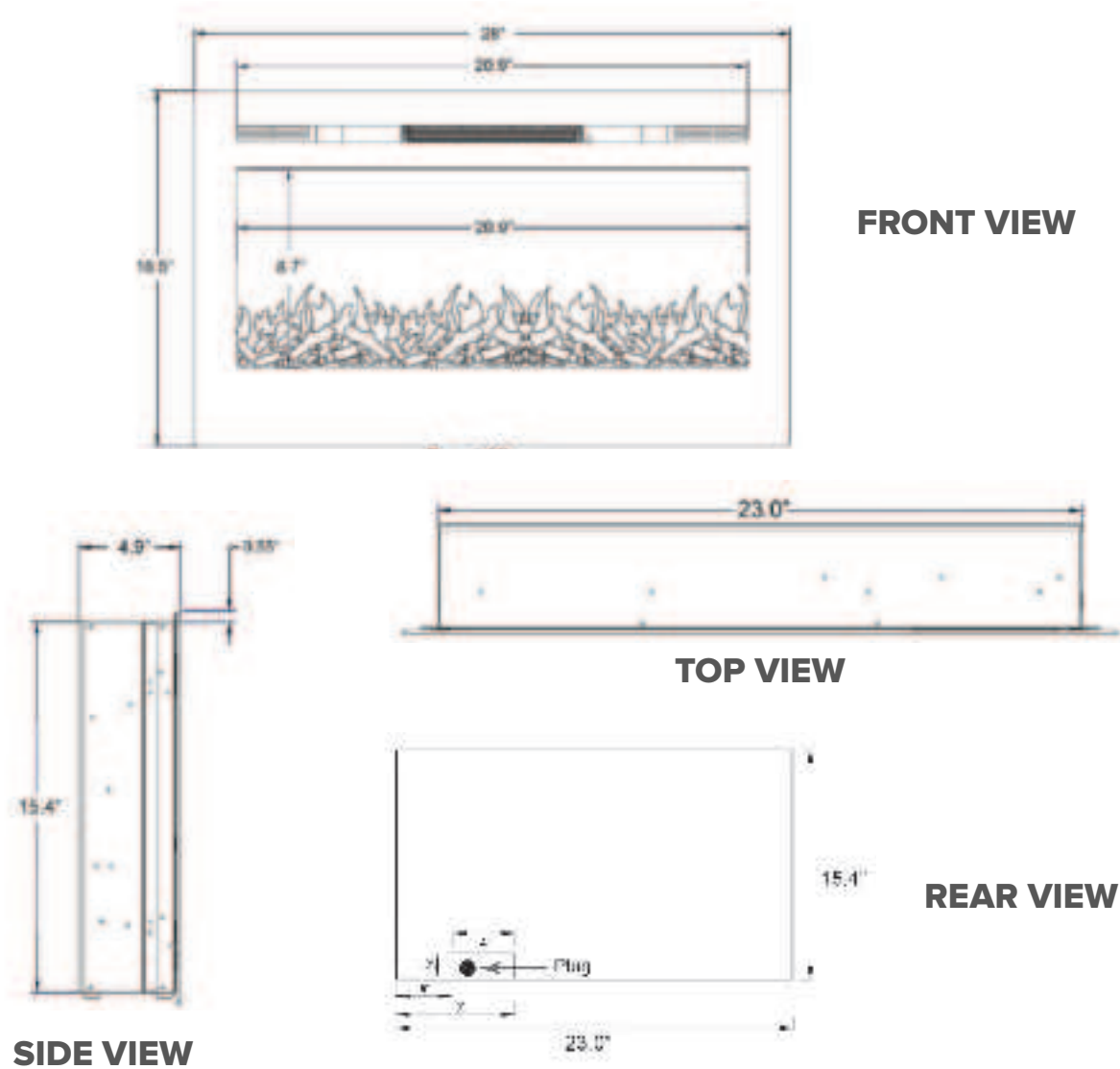

## 80028 - Sideline 28” Recessed Fireplace

### FEATURES

- 2 heat settings (high and low)
- Designed for recessed mounting in wall
- Remote control for heat and flame setting (batteries not included)
- Dual mode, operates with or without heat for only flame effect
- Built in timer mode for shut off in 30 minutes to 7.5 hours
- Faux Fire Log and Glass Crystal Media Options
- Ships with fire log secured in place. To use glass crystal media, simply unscrew and remove the log.

### SPECIFICATIONS

- Frame color: Black
- Watts: 1100
- BTU's: 3753
- Room Coverage: 400 ft
- Voltage: 120v
- Amps: 12
- Rough Opening: 23 1/4"W x 15 3/4"H x 5 1/2"D

Note: the Sideline 28 is not hard wire compatible.





## Sideline® 36" Recessed Fireplace | PN: 80014

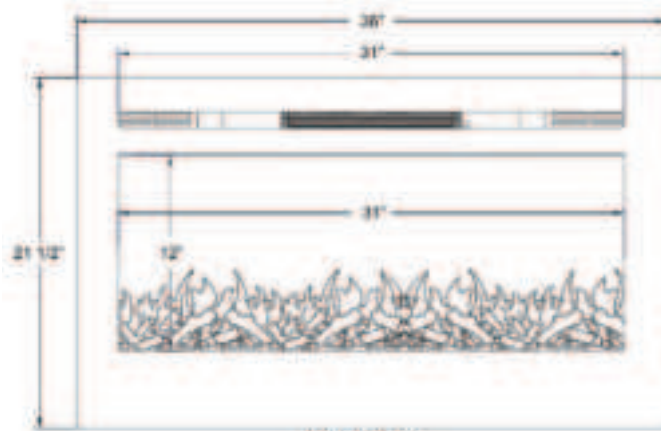

**FRONT VIEW**



**SIDE VIEW**

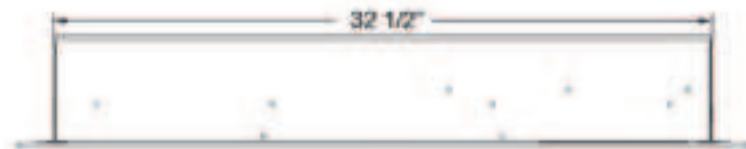

**TOP VIEW**

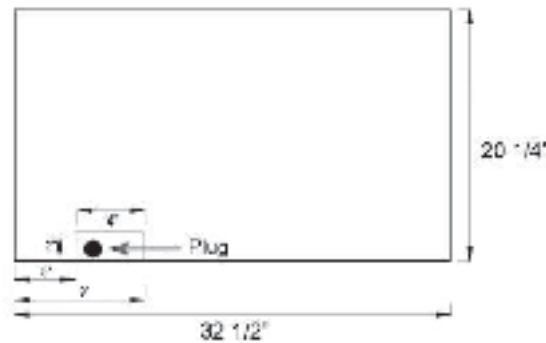

**REAR VIEW**

### 80014 - Sideline 36" Recessed Fireplace

#### FEATURES

- 2 heat settings (high and low)
- Designed for recessed mounting in wall
- Remote control for heat and flame setting (batteries not included)
- Dual mode, operates with or without heat for only flame effect
- Built in timer mode for shut off in 30 minutes to 7.5 hours
- Faux Fire Log and Glass Crystal Media Options

#### SPECIFICATIONS

- Frame color: Black
- Watts: 1500
- BTU's: 5000
- Room Coverage: 400 ft
- Voltage: 120v
- Amps: 12
- Rough Opening: 32 3/4"W x 20 1/2"H x 5 3/4"D

# Sideline® 40" Recessed Fireplace | PN: 80027

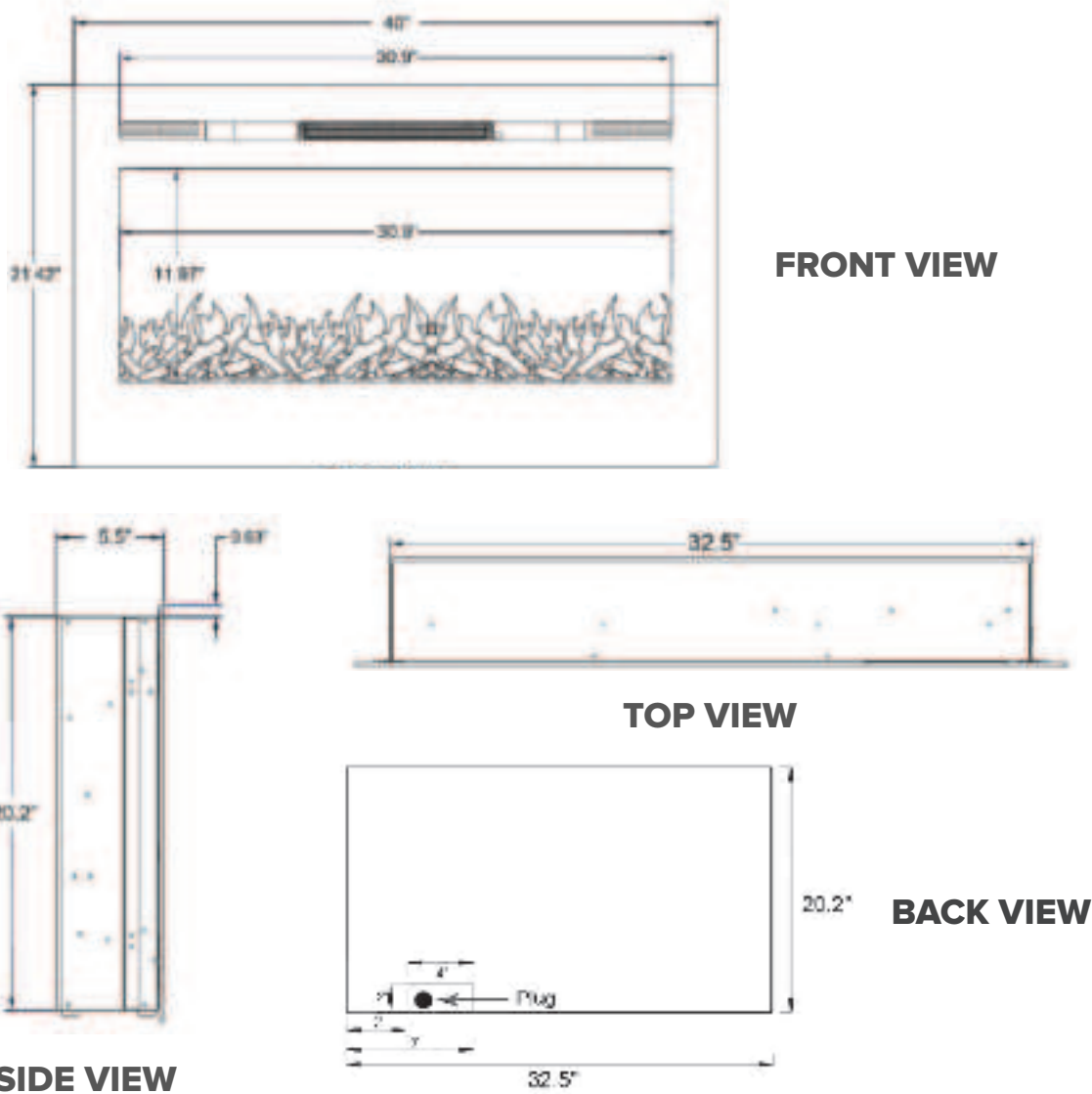

## 80027 - Sideline 40" Recessed Fireplace

### FEATURES

- 2 heat settings (high and low)
- Designed for recessed mounting in wall
- Remote control for heat and flame setting (batteries not included)
- Dual mode, operates with or without heat for only flame effect
- Built in timer mode for shut off in 30 minutes to 7.5 hours
- Faux Fire Log and Glass Crystal Media Options

### SPECIFICATIONS

- Frame color: Black
- Watts: 1500
- BTU's: 5000
- Room Coverage: 400 ft
- Voltage: 110v - 120v
- Amps: 12
- Rough Opening: 32 3/4"W x 20 1/2"H x 5 3/4"D



# Sideline® 45" Recessed Fireplace | PN: 80025

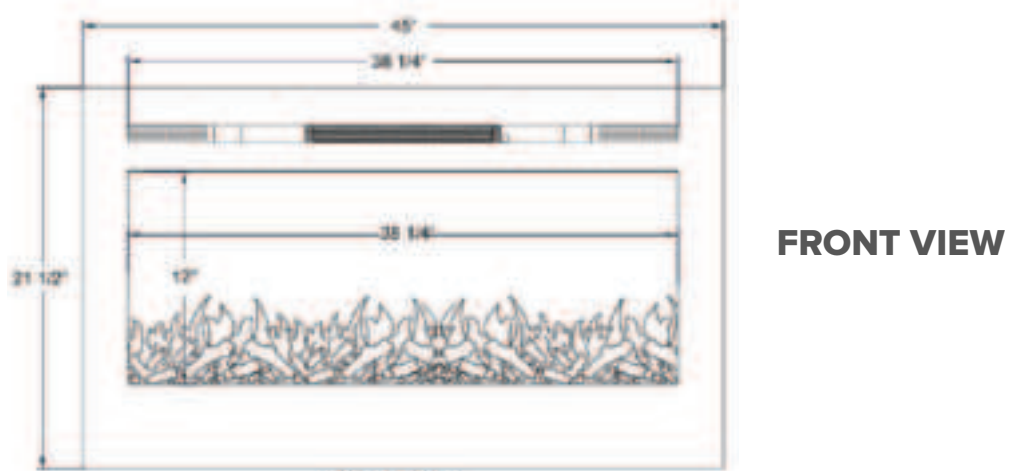

**FRONT VIEW**

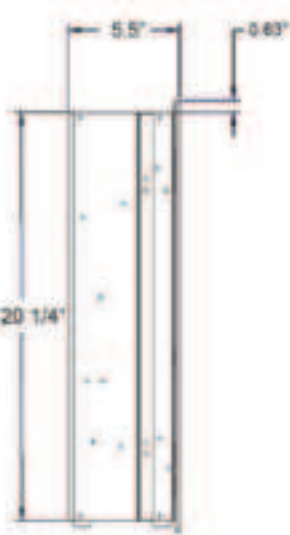

**SIDE VIEW**

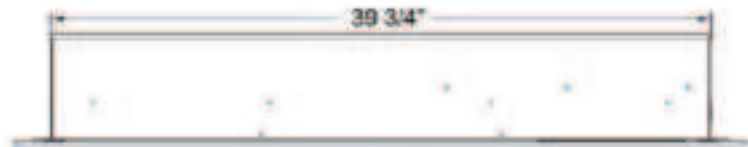

**TOP VIEW**

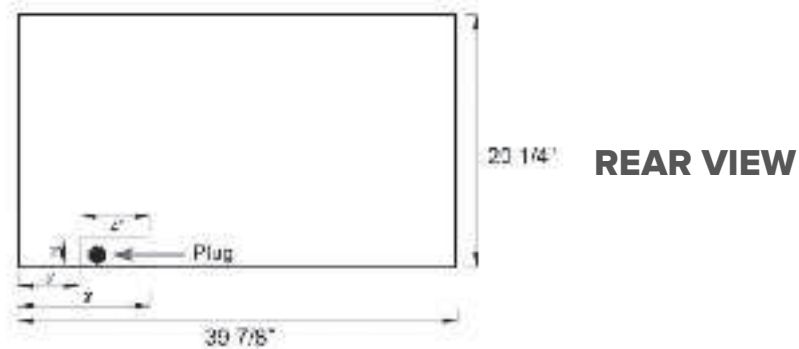

**REAR VIEW**

## 80025 - Sideline 45" Recessed Fireplace

### FEATURES

- 2 heat settings (high and low)
- Designed for recessed mounting in wall
- Remote control for heat and flame setting (batteries not included)
- Dual mode, operates with or without heat for only flame effect
- Built in timer mode for shut off in 30 minutes to 7.5 hours
- Faux Fire Log and Glass Crystal Media Options

### SPECIFICATIONS

- Frame color: Black
- Watts: 1500
- BTU's: 5000
- Room Coverage: 400 ft
- Voltage: 120v
- Amps: 12
- Rough Opening: 40 1/8"W x 20 1/2"H x 5 3/4"D



**Sideline® 50" Recessed Fireplace | PN: 80004 / 80029**

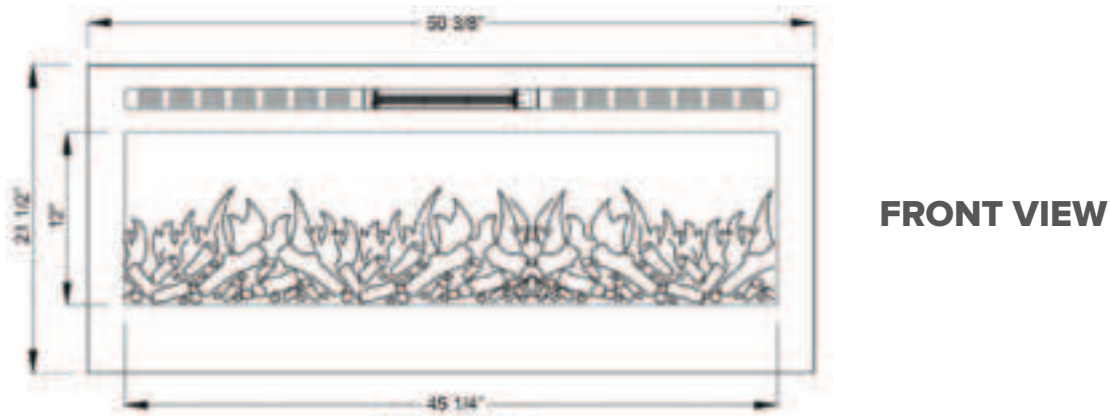

**FRONT VIEW**



**SIDE VIEW**

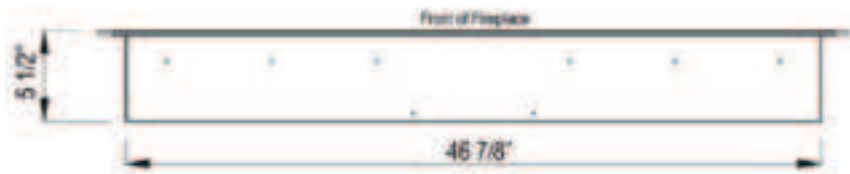

**TOP VIEW**

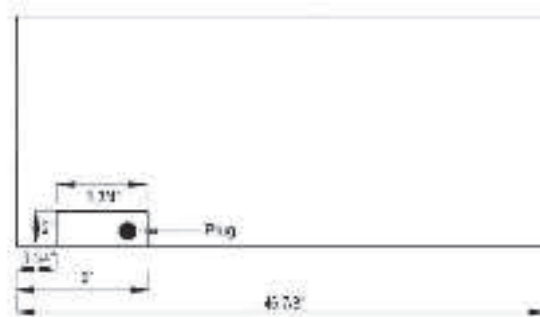

**REAR VIEW**

**80004 - Sideline 50" Recessed Fireplace - Black**  
**80029 - Sideline 50" Recessed Fireplace - White**

**FEATURES**

- 2 heat settings (high and low)
- Designed for recessed mounting in wall
- Remote control for heat and flame setting (batteries not included)
- Dual mode, operates with or without heat for only flame effect
- Built in timer mode for shut off in 30 minutes to 7.5 hours
- Faux Fire Log and Glass Crystal Media Options

**SPECIFICATIONS**

- Frame color: 80004 - Black / 80029 - White
- Watts: 1500
- BTU's: 5000
- Room Coverage: 400 ft
- Voltage: 110v - 120v
- Amps: 12
- Rough Opening: 47 1/8"W x 20 1/2"H x 5 3/4"W



# Sideline® Steel 50" Recessed Fireplace | PN: 80013

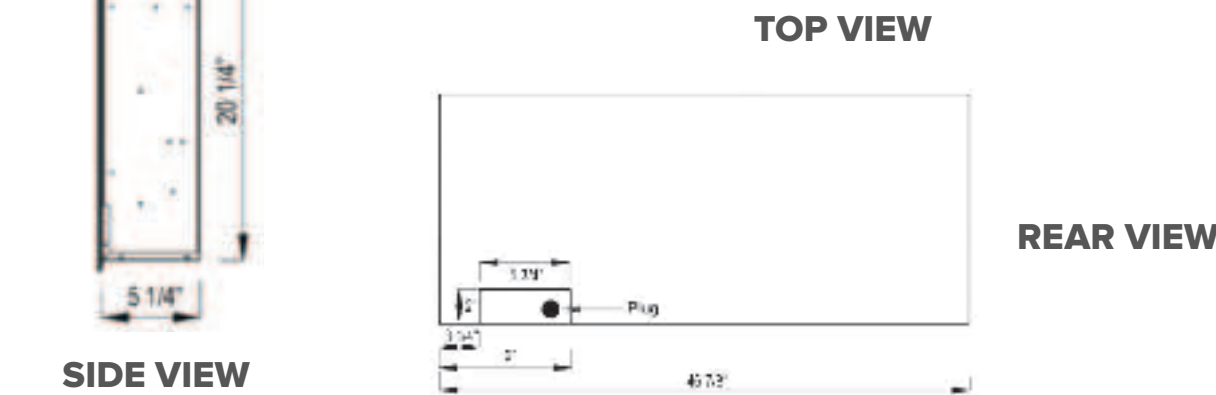
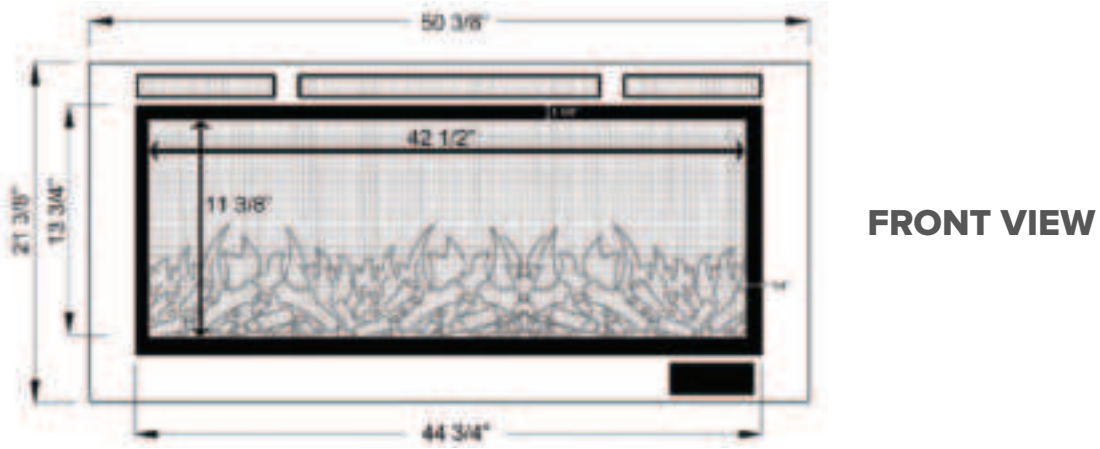

## 80013 - Sideline Steel 50" Recessed Fireplace

### FEATURES

- 2 heat settings (high and low)
- Designed for recessed mounting in wall
- Remote control for heat and flame setting (batteries not included)
- Dual mode, operates with or without heat for only flame effect
- Built in timer mode for shut off in 30 minutes to 7.5 hours
- Faux Fire Log and Glass Crystal Media Options

### SPECIFICATIONS

- Frame color: Black
- Watts: 1500
- BTU's: 5000
- Room Coverage: 400 ft
- Voltage: 110v - 120v
- Amps: 12
- Rough Opening: 47 1/8"W x 20 1/2"H x 5 3/4"W

# Sideline® 60" Recessed Fireplace | PN: 80011

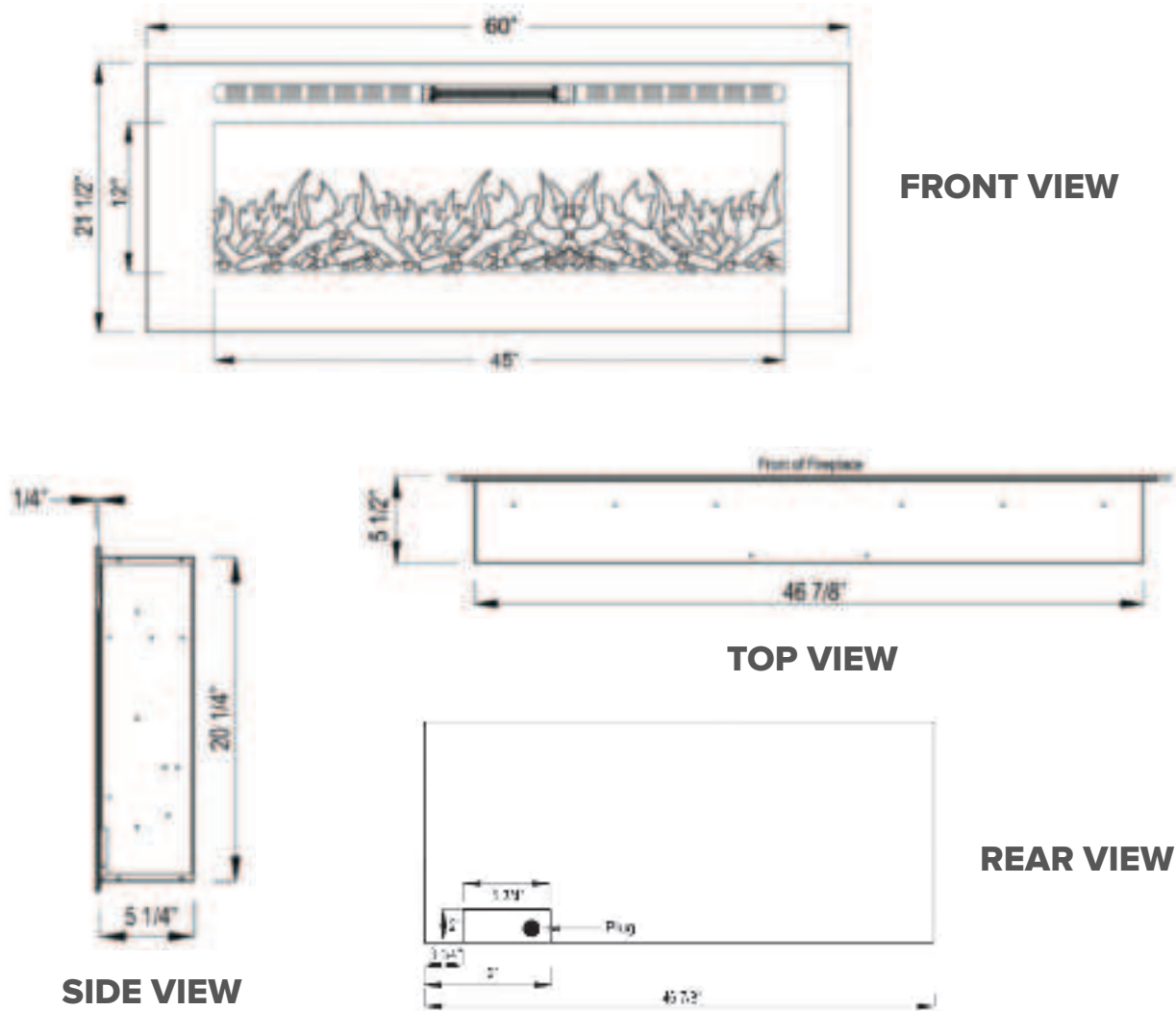

## 80011 - Sideline 60" Recessed Fireplace - Black

### FEATURES

- 2 heat settings (high and low)
- Designed for recessed mounting in wall
- Remote control for heat and flame setting (batteries not included)
- Dual mode, operates with or without heat for only flame effect
- Built in timer mode for shut off in 30 minutes to 7.5 hours
- Faux Fire Log and Glass Crystal Media Options

### SPECIFICATIONS

- Frame color: Black
- Watts: 1500
- BTU's: 5000
- Room Coverage: 400 ft
- Voltage: 110v - 120v
- Amps: 12
- Rough Opening: 47 1/8"W x 20 1/2"H x 5 3/4"W



## Sideline® 72” Recessed Fireplace | PN: 80015

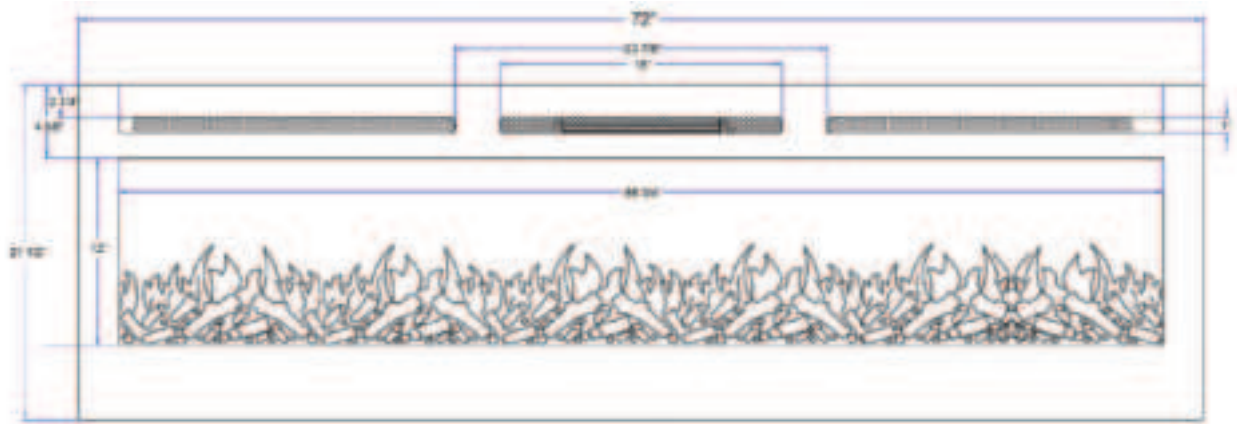

**FRONT VIEW**



**SIDE VIEW**



**TOP VIEW**

### 80015 - Sideline 72” Recessed Fireplace

#### FEATURES

- 2 heat settings (high and low)
- Designed for recessed mounting in wall
- Remote control for heat and flame setting (batteries not included)
- Dual mode, operates with or without heat for only flame effect
- Built in timer mode for shut off in 30 minutes to 7.5 hours
- Faux Fire Log and Glass Crystal Media Options

#### SPECIFICATIONS

- Frame color: Black
- Watts: 1500
- BTU's: 5000
- Room Coverage: 400 ft
- Voltage: 110v - 120v
- Amps: 12
- Rough Opening: 68 3/4”W x 20 1/2”H x 5 3/4”D

# Sideline® 84” Recessed Fireplace | PN: 80043

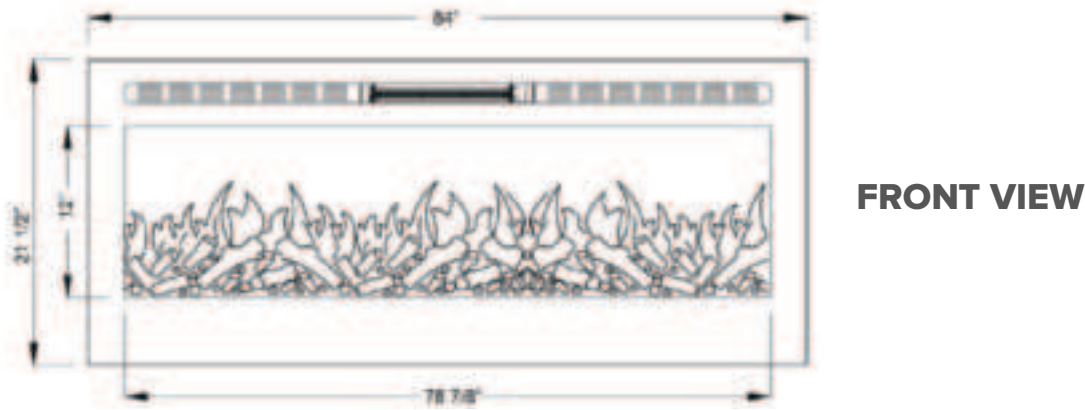

**FRONT VIEW**



**SIDE VIEW**

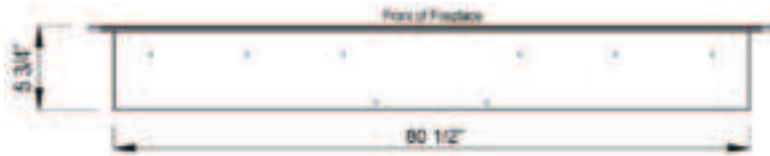

**TOP VIEW**

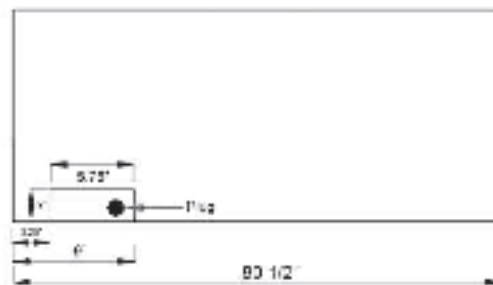

**BACK VIEW**

## 80043 - Sideline 84” Recessed Fireplace

### FEATURES

- 2 heat settings (high and low)
- Designed for recessed mounting in wall
- Remote control for heat and flame setting (batteries not included)
- Dual mode, operates with or without heat for only flame effect
- Built in timer mode for shut off in 30 minutes to 7.5 hours
- Faux Fire Log and Glass Crystal Media Options

### SPECIFICATIONS

- Frame color: Black
- Watts: 1500
- BTU's: 5000
- Room Coverage: 400 ft
- Voltage: 110v - 120v
- Amps: 12
- Rough Opening: 80 3/4”W x 20 1/2”H x 5 3/4”D





# Sideline® 100" Recessed Fireplace | PN: 80032

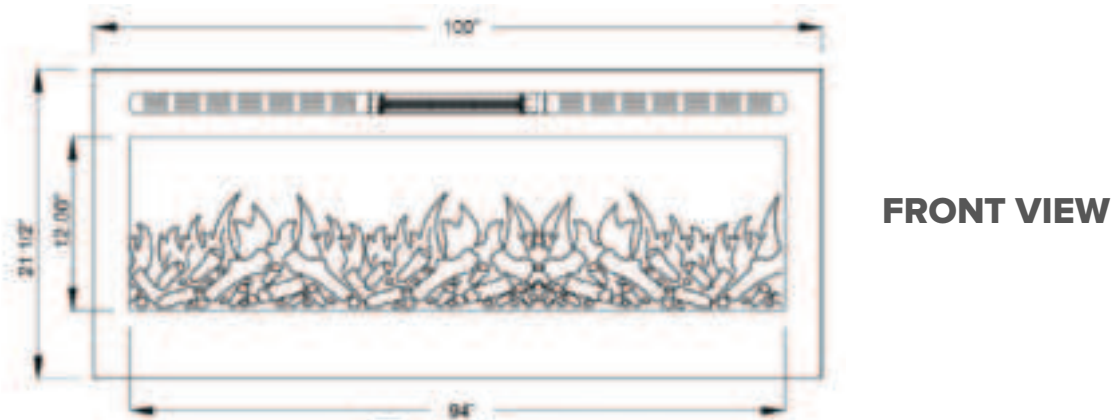

**FRONT VIEW**



**SIDE VIEW**



**TOP VIEW**

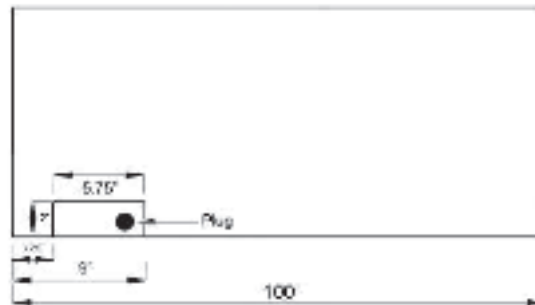

**REAR VIEW**

## 80032 - Sideline 100" Recessed Fireplace

### FEATURES

- 2 heat settings (high and low)
- Designed for recessed mounting in wall
- Remote control for heat and flame setting (batteries not included)
- Dual mode, operates with or without heat for only flame effect
- Built in timer mode for shut off in 30 minutes to 7.5 hours
- Faux Fire Log and Glass Crystal Media Options

### SPECIFICATIONS

- Frame color: Black
- Watts: 1500
- BTU's: 5000
- Room Coverage: 400 ft
- Voltage: 110v-120v
- Amps: 12
- Rough Opening: 96 3/4"W x 20 1/2"H x 5 3/4"D

# Unpacking Your Fireplace

## Parts and Hardware

### Tools Required

- Phillips screwdriver
- Stud finder
- Level
- Tape measure
- Electric drill
- 1/4" wood drill bit

### What's in the Box



Fireplace - 1



Wood Screws - 6



Drywall Anchors - 6  
(Wall mount install use)



Wall Bracket\* - 1  
(Wall mount install use)

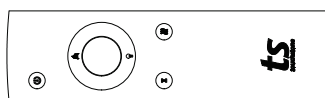

Remote Control - 1



Metal Bracket - 2



Fire Log - 1



Crystal Embers - 1 Bag



Plastic Tray\* - 1

## Unpacking and Setup

### Unpacking Instructions:

- Remove all parts and hardware from the carton and place them on a clean, soft, dry surface. Check the parts list to make sure no parts are missing. If parts are missing, please contact technical support at **800-215-1990** for replacement.

**NOTE: Dispose of plastic bag, as it may cause choking hazard with young children.  
Do not let children play with plastic bag.**

\* Delivered installed

The Sideline® series recessed fireplace can either be plugged into a grounded 3-prong outlet or hard wire connection. Note, the Sideline 28 is not hard wire compatible.

## Testing the Fireplace Prior to Installation

- Before installing the fireplace, test the fireplace to make sure that it operates properly.
- Plug fireplace into approved outlet and power on fireplace. Once fireplace is tested, continue with installation.
- If you have any problems, please contact technical support at **800-215-1990**.

## 3-prong Outlet Installation

- Only use this fireplace on a 120V AC, 15-Amp grounded circuit. Never overload the circuit. If this fireplace trips the circuit breaker, unplug all other appliances on the same circuit before the next use. Avoid plugging other appliances into the same circuit as this fireplace.
- Always check the fireplace plug and connections before each use.
- Never plug this fireplace into an outlet that is cracked or has any loose wires or connections. Plugging this fireplace into a faulty outlet could result in the outlet overheating or catching fire.
- Make sure this plug fits securely into the outlet. Faulty wall outlet connections or loose plugs can cause the outlet to overheat. If the outlet or faceplate is hot, discontinue use immediately and have a qualified electrician inspect and/or replace the faulty outlet.
- The power cord supplied with the heater has three prongs: two flat blades (live and neutral) and one round pin (ground). If a 3-slot receptacle is not available, an adapter **MUST** be used. The adapter **MUST** be **properly grounded** to the outlet box (see figure below).

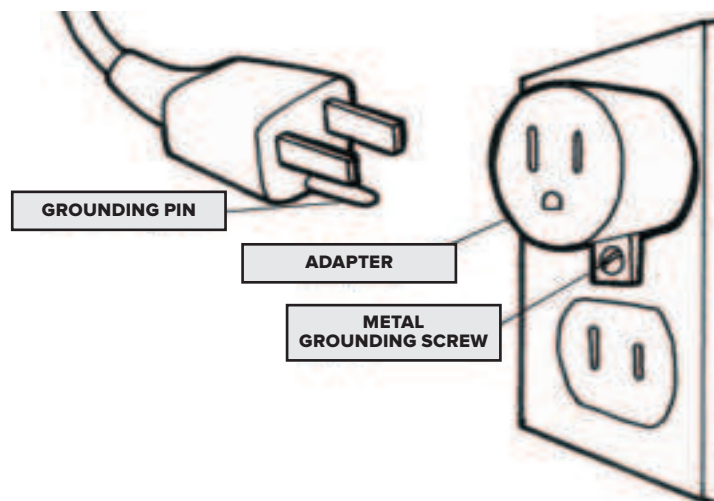

**NOTE: Adapter NOT INCLUDED**

## Hard Wire Connection

If it is necessary to hard wire this appliance, a qualified electrician must remove the cord connection, and wire the appliance directly to the household wiring. **Note, the Sideline 28 is not hard wire compatible.**

This appliance must be electrically connected and grounded in accordance with local codes, if hard wired. In the absence of local codes, use the current ANSI/NFPA 70 NATIONAL ELECTRICAL CODE in the United States or the current CSA C22.1 CANADIAN ELECTRICAL CODE in Canada.

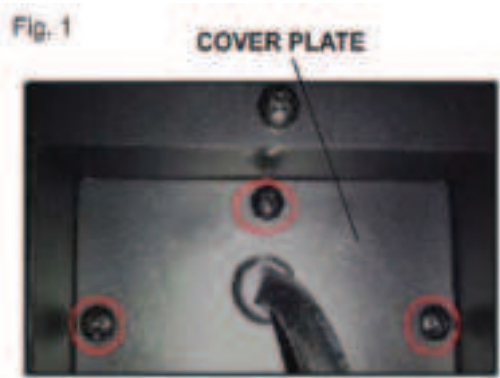

- A.** Remove the cover plate from the right side bottom of the appliance by removing the three screws, as shown above. Save screws for Installation of new cover plate.
- B.** Remove the wire connectors from the power cord. Keep power cord, in case needed in future.
- C.** Remove the power cable and wires from the cover plate. Thread your wiring through the hole in the cover plate for connecting to the wires in the Sideline® fireplace.
- D.** Using the wire connectors, connect the ground green wires (G), the common white wires (N) together, then the hot black wires (L) and then the refer to Figure 3.
- E.** Reinstall the cover plate using the three screws, as shown in Figure 1.

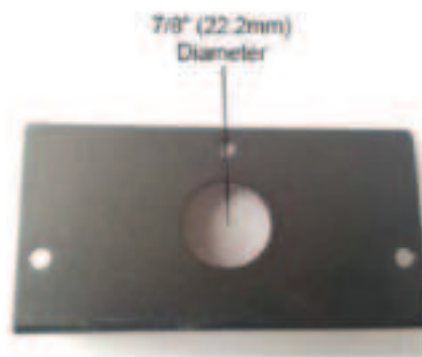
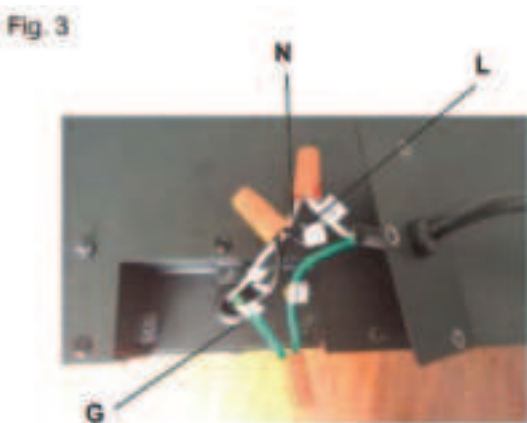

## WARNINGS

- Keep materials, such as furniture, pillows, bedding, papers, clothes, and curtains at least 36” away from the front of the fireplace.
- Never install the fireplace where it may fall into a bathtub or other body of water.
- Wear safety gloves and safety glasses for protection during installation. Broken glass may cause injury or harm.
- Prevent contact with loose insulation. Do not install the fireplace against a vapor barrier or exposed insulation.
- Do not expose the fireplace to the elements (rain, etc.).



For more detailed instructions, visit our website or Touchstone Home Products YouTube channel for the product support videos.

## Choosing Wall Location

- Measure wall location to ensure that fireplace will fit on desired wall location.
- Minimum clearances (measurements taken from front of glass panel):

<b>Bottom of Fireplace to Floor:</b>	6”	<b>Top of Fireplace:</b>	8” to mantel
<b>Sides of Fireplace:</b>	6”	<b>Top of Fireplace:</b>	8” to TV
<b>Back of Fireplace:</b>	0”	<b>Top of Fireplace:</b>	8” to ceiling

- Select a location that is not prone to moisture and is located at least 36” away from materials such as curtains, drapes, furniture, or bedding.
- See Safety Information on pages 3 for warnings about safe placement, safe installation, and proper use of this product.

## Removing the Rubber Feet

- For in-wall, recessed installations, the rubber feet on the bottom of the fireplace are removeable.
- To remove, use a Philips-head screwdriver to remove the four rubber feet on the bottom of the fireplace as shown below

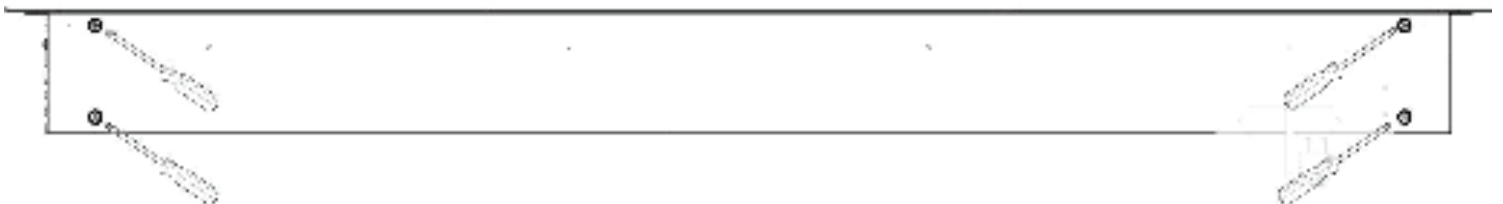



## REMOVING THE GLASS PANEL

Prior to installation, remove the glass panel. Please remove glass panel as per instructions below:

### Instructions

1. There are 2 screws in the top vent opening, one on the far left and one on the far right. Remove both screws from the glass panel.

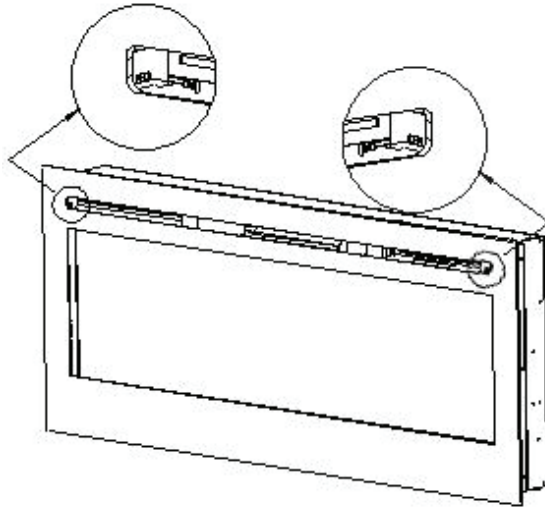

2. After removing screws, lift glass panel UP and STRAIGHT OUT toward you to remove from fireplace. Place glass panel in a soft, dry place.

**CAUTION: It is recommended that 2 people remove the glass panel to minimize chance of breakage.**

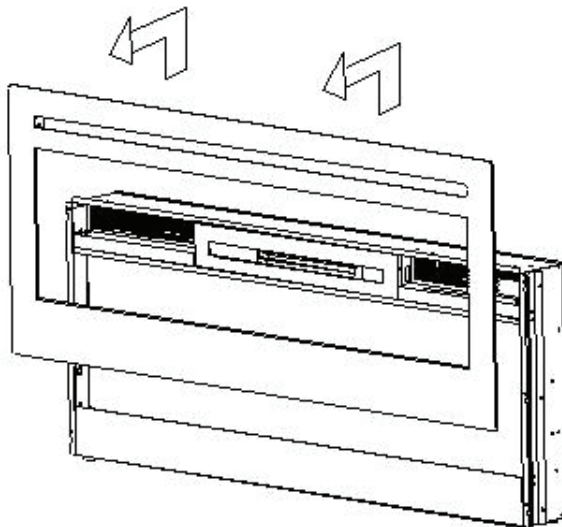

## REMOVING THE STEEL PANEL (80013 SIDELINE STEEL ONLY)

Prior to installation, remove the front panel from your 80013 Sideline Steel Fireplace. Please remove front panel as per instructions below:

### Instructions

1. There are 2 screws securing the front panel to the firebox, one on the far left and one on the far right. Remove both screws from the front panel.

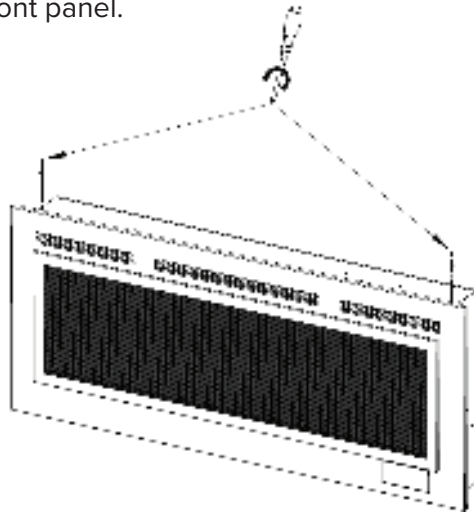

**CAUTION:** These screws are for shipping purposes only. They will not be reinstalled when installation is complete.

2. After removing screws, lift glass panel UP and STRAIGHT OUT toward you to remove from fireplace. Place front panel in a soft, dry place.

**CAUTION:** It is recommended that 2 people remove the front panel to minimize chance of breakage.

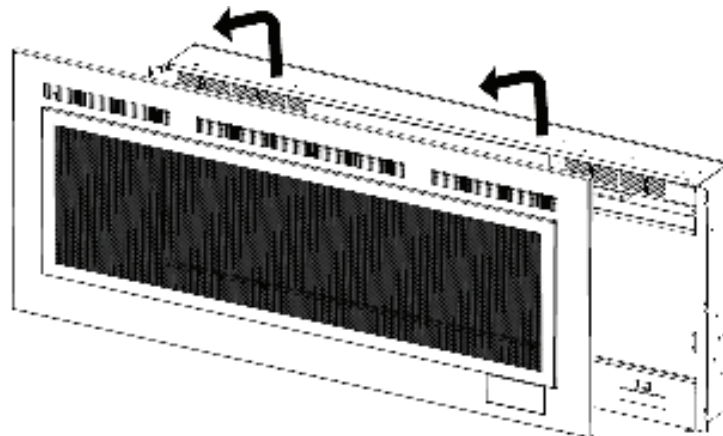

## RECESSED INSTALLATION

- Due to many different finish materials used on walls, it is highly recommended that you consult a professional before you install this fireplace in the wall.
- Select a location that is not prone to moisture and is located at least 36" away from materials such as curtains, drapes, furniture or bedding.
- In order to avoid the possibility of exposed insulation or vapor barrier coming in contact with the fireplace, it is recommended that the walls of the fireplace enclosure be "finished" (ie. Sheetrock, drywall, etc) as you would finish any other outside wall of your home. This will ensure that clearance to combustibles is maintained within the wall cavity.
- Never install fireplace into load-bearing walls. When recessing fireplace in a wall, recess into non-load bearing walls ONLY!

### Instructions:

1. Choose a location in the wall to install fireplace.
2. Create opening in the wall that is no more than 1/4" larger than metal firebox portion of fireplace. The rough opening dimensions for the wall opening is listed in the table on the right.

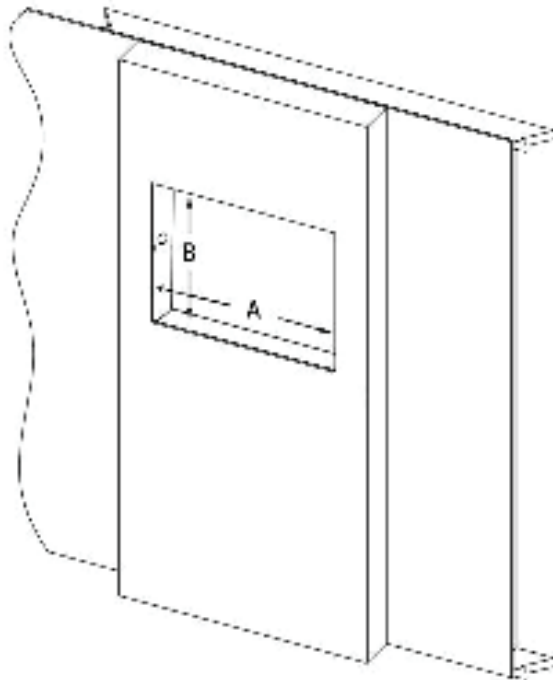

### Firebox Dimensions

MODEL	WIDTH	HEIGHT	DEPTH
<b>80004</b>	46 7/8"	20 1/4"	5 1/4"
<b>80011</b>	46 7/8"	20 1/4"	5 1/4"
<b>80013</b>	46 7/8"	20 1/4"	5 1/4"
<b>80014</b>	32 1/2"	20 1/4"	5 1/4"
<b>80015</b>	68 3/8"	20 1/4"	5 1/4"
<b>80025</b>	39 7/8"	20 1/4"	5 1/4"
<b>80027</b>	32 1/2"	20 1/4"	5 1/4"
<b>80028</b>	23"	15 1/2"	5"
<b>80029</b>	46 7/8"	20 1/4"	5 1/4"
<b>80032</b>	96 1/2"	20 1/4"	5 1/4"
<b>80043</b>	80 1/2"	20 1/4"	5 1/4"

### Rough Opening Dimensions

MODEL	A (WIDTH)	B (HEIGHT)	C (DEPTH)
<b>80004</b>	47 1/8"	20 1/2"	5 3/4"
<b>80011</b>	47 1/8"	20 1/2"	5 3/4"
<b>80013</b>	47 1/8"	20 1/2"	5 3/4"
<b>80014</b>	32 3/4"	20 1/2"	5 3/4"
<b>80015</b>	68 7/8"	20 1/2"	5 3/4"
<b>80025</b>	40 1/8"	20 1/2"	5 3/4"
<b>80027</b>	32 3/4"	20 1/2"	5 3/4"
<b>80028</b>	23 1/4"	15 3/4"	5 1/2"
<b>80029</b>	47 1/8"	20 1/2"	5 3/4"
<b>80032</b>	96 3/4"	20 1/2"	5 3/4"
<b>80043</b>	80 3/4"	20 1/2"	5 3/4"

## RECESSED INSTALLATION - Continued

1. With the help of a second person, insert fireplace into wall opening and secure with mounting screws provided.

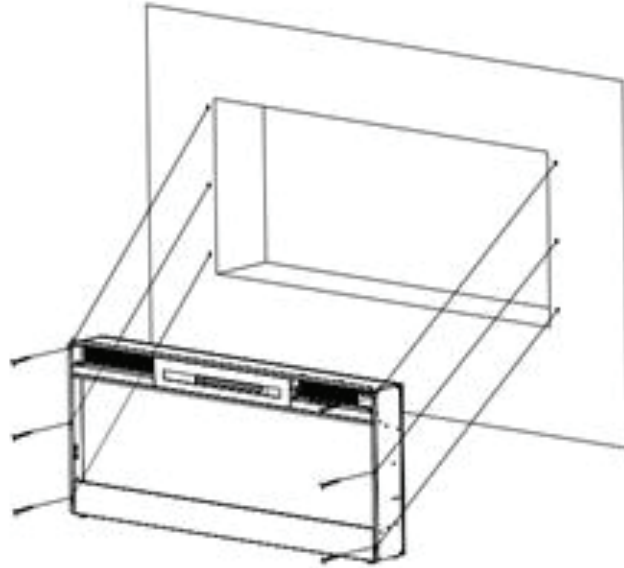

2. Once the fireplace is installed in the wall, place crystal embers or fire log in the firebox.

### A. Crystal Ember Installation

1. Carefully, place crystal embers on plastic strip as illustrated in the picture to the right. Apply an even layer from side to side.



**Note, the Sideline 28 ships with the log secured in place. Simply unscrew the log on either side to remove and replace with crystal embers.**

**RECESSED INSTALLATION - Continued****A. Fire Log Installation**

1. Place fire log in fireplace as illustrated below. Note, the Sideline 28 ships with the log fastened in place.



3. Once completed installing crystal embers or fire log, reinstall glass panel. The hooks on the back of the glass panels fit into the slots on the side of the firebox. Once in the slots, the glass panel goes down and locks into place. Once in place, reinstall 2 locking screws to hold glass securely in place.

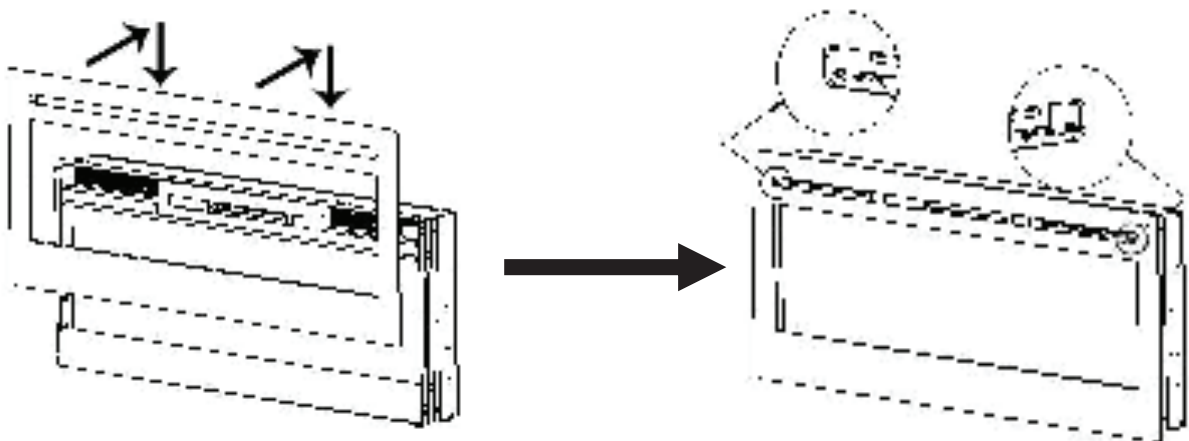



## WALL MOUNTED INSTALLATION

- Due to many different finish materials used on walls, it is highly recommended that you consult a professional before you install this fireplace on the wall.
- Select a location that is not prone to moisture and is located at least 36" away from materials such as curtains, drapes, furniture or bedding.

### Instructions

1. With glass panel removed (see p.19 for instructions on removing glass panel), have two people hold the fireplace against the wall to determine the final location.
2. Place the unit face down on a soft, non-abrasive surface. Remove the bracket from the back of the unit by removing the screws holding the bracket to the back of the fireplace.

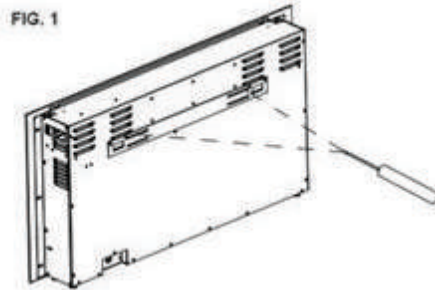

**80004 / 80011 / 80014 / 80025 / 80027 / 80013 / 80029 / 80028** - Wall Bracket Removal (1 bracket)

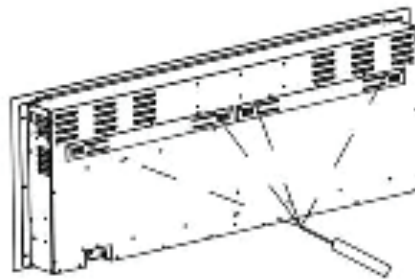

**80015 / 80032 / 80043** - Wall Bracket Removal (2 brackets)

### WALL MOUNTED INSTALLATION - Continued

3. Mark location of bracket on wall and then mount the bracket to the wall using the supplied screws and dry wall anchors. The hooks in the bracket **MUST** be pointed away from the wall, upward, and level.

**Note: Mount bracket to at least 2 studs. If 2 studs cannot be used, ensure that the supplied dry wall anchors are used to affix the bracket to the wall and the bracket is adequately secured before moving to the next step.**

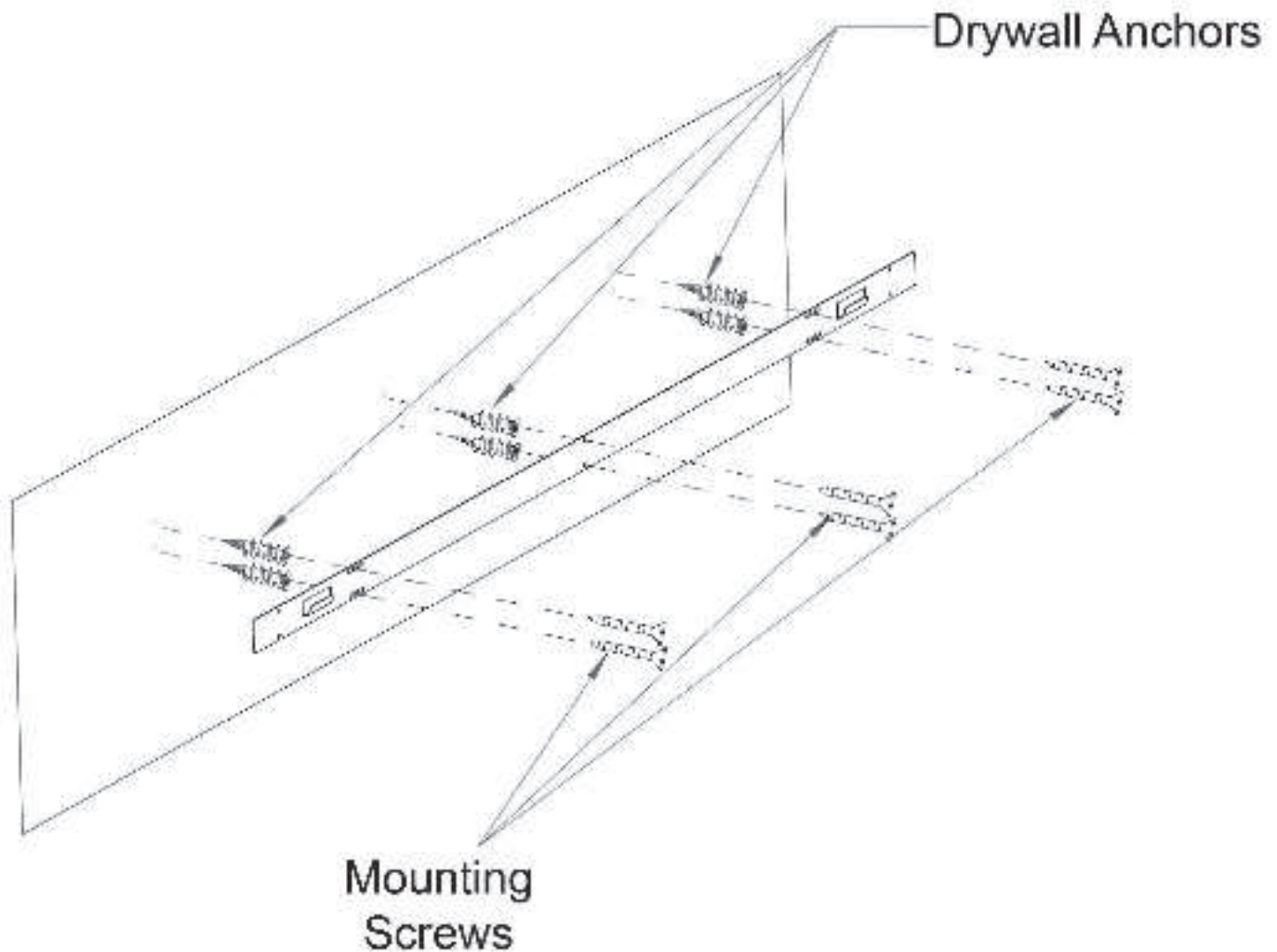

## WALL MOUNTED INSTALLATION - Continued

4. With the wall mounting bracket installed, have 2 people lift the fireplace up and insert the 2 hooks on the bracket into the back of the fireplace. The 2 hooks on the mounting bracket will line up with the 2 holes on the back of the fireplace. Once aligned, the hooks will insert into the holes in the back of the fireplace and lock in the down position.

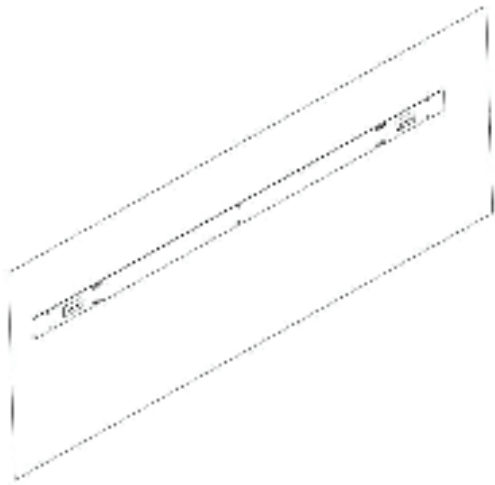

Mounting bracket installed on wall

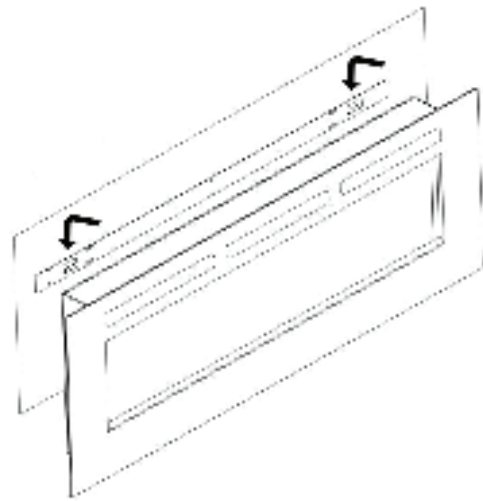

Hang fireplace on mounting bracket hooks

5. Check the fireplace for stability, ensuring that the bracket will not pull free from the wall. Once satisfied, install crystal embers/fire log and reinstall glass panel.

# Operating Your Fireplace

Once the fireplace has been plugged into a grounded outlet, the fireplace is now ready for operation. Ensure that the house circuit breakers for the power supply are turned on.





## Power

Plug the power cable into a 110v 15 amp grounded outlet. Make sure the outlet is in good condition and that the plug is not loose. **NEVER** exceed the maximum amperage for the circuit. **DO NOT** plug other appliances into the same circuit.

## Methods of Operation

This electric fireplace can be operated by the CONTROL PANEL, located in the upper right vent in the front glass panel, or by the REMOTE CONTROL. The operation and functions of both methods are the same.

### Control Panel and Remote Control Functions

BUTTON	FUNCTION	ACTION & INDICATION
 <b>POWER</b>	<p><b>ON:</b> Enables control panel functions and remote control. Turns on the flame effect.</p> <p><b>OFF:</b> Disables control panel functions and remove control. Turns off the flame effect.</p>	<p>1. <b>Press once.</b> Indicator light turns on. Power turns on. All functions enabled.</p> <p>2. <b>Press again.</b> Flame effect turns off. Unit goes to standby. All functions turn off.</p>
 <b>TIMER</b>	<p><b>TIMER Button:</b> Control time settings to turn off fireplace at selected time.</p> <p>Settings range from 0.5 hours to 7.5 hours.</p>	<p>1. <b>Press once.</b> Indicator light turns on. Timer is set to 0.5 hours.</p> <p>2. <b>Press again until desired setting is reached.</b> Indicator lights show setting.</p>
 <b>FLAME</b>	<p><b>FLAME Button:</b> Makes flame effects dimmer or brighter.</p> <p><b>NOTE:</b> Flame effect stays on until power button is turned off. Flame effect must be on for heater to turn on.</p>	<p>1. <b>Press once</b> to change the flame brightness.</p> <p>2. <b>Press again</b> until desired setting is reached.</p>
 <b>COLOR</b>	<p><b>COLOR Button:</b> Changes the color of the flame.</p>	<p>1. <b>Press once</b> to change the color of the flame.</p> <p>2. <b>Press again</b> until desired setting is reached.</p>
 <b>HEATER</b>	<p><b>HEATER Button:</b> Turns heater on and off.</p> <p><b>NOTE:</b> The heater only works when the flame effect is on. To prevent overheating, the heater fan will blow cool air for 8-10 seconds before the heater turns on, and after the heater turns off.</p>	<p>1. <b>Press once.</b> Indicator lights up. Fan blows cool air for 10 seconds and 750W heater turns on and blows warm air.</p> <p>2. <b>Press again:</b> Indicator lights up. 1500W heater turns on and blows hot air.</p> <p>3. <b>Press again.</b> Heater turns off.</p>



# Operating Your Fireplace

## Remote Control Operation

- This remote control uses 2 AAA batteries (not included).
- To improve operation of the remote control, aim the remote control at the front of the fireplace. **DO NOT PRESS the buttons too quickly.** Give the unit time to respond to each command.
- **NOTICE: NEVER** dispose of batteries in fire. Failure to observe this precaution **may result in an explosion.** Dispose of batteries at your local hazardous material processing center.

## Temperature Limiting Control

This heater is equipped with a Temperature Limiting Control. Should the heater reach an unsafe temperature, the heater will automatically **TURN OFF**. To reset, please do the following:

1. Unplug the power cord from the outlet.
2. Turn ON/OFF switch on the CONTROL PANEL to OFF. Wait 5 minutes for fireplace to cool down.
3. Inspect the fireplace to make sure no vents are blocked or clogged with dust or lint.  
If they are, use a vacuum to clean the vent areas.
4. With the POWER switch in the OFF position, plug the power cord back into the outlet.
5. If the problem continues, have your outlet and wiring inspected by a professional.  
If the outlet is OK, please contact our customer support department at **800-215-1990**.

## CLEANING

- ALWAYS turn the heater OFF and unplug the power cord from the outlet before cleaning.
- NEVER immerse in water or spray with water. Doing so could result in electric shock, fire, or personal injury.

### **Metal:**

- Buff using a soft cloth, slightly dampened with citrus oil-based product.
- DO NOT use brass polish or household cleaners, as these products will damage the metal trim.

### **Glass:**

- Use a good quality glass cleaner sprayed onto a cloth or towel. Dry thoroughly with a paper towel or lint-free cloth.
- NEVER use abrasive cleansers, liquid sprays, or any cleaner that could scratch the surface.

### **Vents:**

- Use a vacuum or duster to remove dust and dirt from the heater and vent areas.

### **Plastic:**

- Wipe gently with a slightly damp cloth and a mild solution of dish soap and warm water.
- NEVER use abrasive cleansers, liquid sprays, or any cleaner that could scratch the surface.

## MAINTENANCE

- RISK OF ELECTRIC SHOCK! DO NOT OPEN any panels.
- ALWAYS turn the heater OFF and unplug the power cord from the outlet before cleaning, performing maintenance, or moving the fireplace. Failure to do so could result in electric shock, fire, or personal injury.

### **Electrical and Moving Parts:**

- The fan motors are lubricated at the factory and will not require lubrication.
- Electrical components are integrated in the fireplace and are not serviceable by the customer.

### **Storage:**

- Store fireplace in a clean, dry place when not in use.



## Warranty

Touchstone Home Products, Inc warrants our electric fireplaces to be free of defects in material and workmanship for one year from date of purchase. Touchstone will repair or replace any fireplace or fireplace part that is deemed defective or becomes defective during normal use within one year after the date of purchase.

Electrical components, such as fan motor, heater motor, control board, remote control, and control panel are covered under warranty for one year from date of purchase. Touchstone Home Products will provide replacement parts free of charge during the first year of the warranty.

Replacement parts and fireplace units are covered under a 90-day warranty or the remainder of the original one year manufacturer's warranty from original date of purchase, whichever is greater.

Touchstone Home Products, Inc does not warrant its products against damage caused by third parties.

Touchstone Home Products, Inc does not cover damages caused by misuse, alterations, accident, lack of maintenance, abuse or neglect. Parts installed from other manufacturers will void this warranty.

The warranty does not cover paint scratches, cosmetic blemishes, dents, corrosion, or other normal wear and tear associated with the fireplace. Damage to fireplace or other components due to water, weather damage, long periods of dampness, condensation, damaging chemicals or cleaners are not covered under warranty.

This warranty does not cover breakage of fireplace glass panel.

Touchstone Home Products will not be responsible for installation, labor, or any other expenses related to the reinstallation of a warranted part, and such expenses are not covered under warranty.

Extended warranty coverage for the fireplace is available by contacting Touchstone Home Products, Inc. directly at **1-800-215-1990**.





**Touchstone® TV Lift Mechanisms**



**Touchstone® TV Lift Cabinets**

Visit our website to see the full Touchstone® product line.



## **Questions? We are here to help.**

You can reach our team by phone, email or live chat. You may also fill out the contact form on our website and we will respond to your inquiry.



Visit our website or Touchstone Home Products YouTube Channel for detailed product support videos.

## **Showroom / Mailing Address:**



TOUCHSTONE HOME PRODUCTS, INC.  
208 Philips Road, Exton, PA 19341



**CALL US FIRST!  
DO NOT RETURN TO STORE.**



For immediate help with assembly, product information or if your product arrives damaged, call our toll free number or email us at [customerservice@thpus.com](mailto:customerservice@thpus.com). Our staff is ready to provide assistance.

 <b>WARNING</b>	<b>Read and understand</b> this entire owner's manual, including <b>all safety information, before plugging in or using</b> this product. Failure to do so could result in <b>fire, electric shock, or serious personal injury</b> .
 <b>CAUTION</b>	<b>Keep this owner's manual</b> for future reference. If you sell or give this product away, <b>make sure this manual accompanies this product</b> .

FEB 2021



**800.215.1990**



**sales@thpus.com**



**touchstonehomeproducts.com**