

Thermo Scientific Dionex UltiMate 3000 Series

Autosamplers WPS-3000PL (RS) and WPS-3000FC

Operating Instructions (Original Operating Instructions)



Revision: 1.6

Date: September 2013

© 2013 Thermo Fisher Scientific Inc.

Doc No. 4828.2050



Declaration of Conformity

(Original Declaration of Conformity)

Product: Thermo Scientific Dionex UltiMate 3000 - Autosampler

Types: **WPS-3000TBPL**
WPS-3000PL RS and **WPS-3000TPL RS**
WPS-3000TFC and **WPS-3000TBFC**

Dionex Softron GmbH herewith declares conformity of the above products with the respective requirements of the following regulations:

- Low-Voltage Directive 2006/95/EC
- EMC Directive 2004/108/EC

The electrical safety of the products was evaluated based on the following standard:

- DIN EN 61010-1:2010
Safety requirements for electrical equipment for measurement, control and laboratory use, Part 1: General Requirements

The Electromagnetic Compatibility (EMC) of the products was evaluated based on the following standard:

- DIN EN 61326:2006
Electrical equipment for measurement, control and laboratory use
EMC Requirements

This declaration is issued for the manufacturer

Dionex Softron GmbH
Part of Thermo Fisher Scientific Inc.
Dornierstraße 4
D-82110 Germering

by the Managing Director, Rüdiger Obst, and
the Vice President HPLC, Fraser McLeod.

September 2, 2013

Table of Contents

1	Introduction.....	1
1.1	How to Use This Manual	1
1.2	Safety	3
1.2.1	Symbols on the Instrument and in the Manual	3
1.2.2	Safety Precautions	5
1.2.3	Consignes de Sécurité.....	9
1.3	Intended Use	13
1.4	Federal Communications Commission (FCC) Note.....	15
2	Overview.....	17
2.1	Unit Description.....	17
2.2	Operating Principle	18
2.3	Autosampler Configurations	19
2.3.1	Overview	19
2.3.2	Biocompatible Autosamplers	20
2.3.3	Autosamplers with Sample Thermostating	21
2.3.4	Autosamplers for Fraction Collection	21
2.3.5	Proper Syringe, Buffer Tubing, and Sample Loop Combinations	22
2.4	Interior Components	23
2.4.1	WPS-3000(T)PL (RS) and WPS-3000TBPL	23
2.4.2	WPS-3000TFC and WPS-3000TBFC	25
2.5	Front Panel Elements	27
2.6	Rear Panel	28
2.6.1	Power Switch.....	29
2.6.2	Fuse Holder	29
2.6.3	USB Connector.....	29
2.6.4	Digital I/O Ports	29
2.7	Carousel, Sample Racks, Vials, and Well Plates.....	30
2.8	Compartment Lights	33
2.9	Fluidic Connections	33
2.10	Leak Sensor.....	33
2.11	Injection Valve.....	34
2.12	Chromeleon Software	35
2.13	System Wellness and Predictive Performance.....	36
3	Installation.....	37
3.1	Facility Requirements	37
3.2	Unpacking	37
3.3	Positioning the Autosampler in the UltiMate 3000 System	39
3.4	Connecting the Autosampler	40
3.4.1	General Information	40
3.4.2	Connecting the USB Cable.....	40
3.4.3	Connecting the Power Cord.....	41
3.4.4	Connecting the Digital I/O	42

3.5	Setting Up the Autosampler in Chromeleon	44
3.5.1	Loading the USB Driver for the Autosampler	44
3.5.2	Installing the Autosampler	46
3.5.3	Configuring the Autosampler	47
3.6	Setting Up the Autosampler in DCMSLink	52
4	Preparation for Operation	53
4.1	Overview of Actions	53
4.2	Tips and Precautions for Connecting Capillaries	55
4.3	Installing the Wash Liquid Reservoir	56
4.3.1	Connecting the Wash Liquid Lines for Online Degassing	56
4.3.2	Connecting the Wash Liquid Bottle	57
4.4	Connections on the Syringe Valve	59
4.5	Connecting the Drain Tube	60
4.6	Removing Air Bubbles from the Syringe (Priming)	60
4.7	Installing and Loading the Sample Rack	62
4.8	Loading the 5-Position Holders	64
4.9	Equilibrating the System	65
5	Operation and Maintenance	67
5.1	Power-Up	67
5.2	Status Screen	68
5.3	Sample Positions	69
5.4	Operation with Chromeleon	71
5.4.1	Connecting to Chromeleon	71
5.4.2	Direct Control	72
5.4.3	Automated Control	74
5.5	Display Screens (Function Keys and Menus)	77
5.5.1	Showing the Function Keys	77
5.5.2	Autosampler Menus	78
5.6	Operational Settings	85
5.6.1	Setting the Injection Mode	85
5.6.2	Synchronizing the Inject Command with the Pump Strokes	88
5.6.3	Turning On Sample Thermostatting	88
5.6.4	Changing the Carousel Configuration	89
5.6.5	Setting the Injection Parameters and Starting the Injection	90
5.6.6	Turning On Leak Detection	91
5.6.7	Adjusting the Screen Brightness or Contrast	91
5.6.8	Recommendations for Operation	92
5.7	Special Chromeleon Functions	93
5.7.1	Predictive Performance	93
5.7.2	Defining the Needle Height and Puncture Depth	95
5.7.3	Moving the Tray before Drawing the Sample (Tray Shake)	96
5.7.4	Operational Qualification and Performance Qualification	97
5.7.5	Automatic Tray Test	97
5.7.6	Automatic Sample Container Detection	97
5.7.7	User-Defined Programs	98

5.8	Shutting Down the Autosampler.....	99
5.9	Routine and Preventive Maintenance	101
6	Troubleshooting	103
6.1	Overview.....	103
6.2	Messages on the Front Panel Display	104
7	Service.....	109
7.1	General Notes and Safety Precautions.....	109
7.2	Leak Sensor.....	111
7.3	Replacing the Syringe.....	112
7.4	Replacing the Buffer Tubing	115
7.5	Needle Pair.....	117
7.5.1	Checking the Position of the Needle Pair.....	118
7.5.2	Washing the Needle.....	119
7.5.3	Replacing the Needle.....	120
7.5.4	Replacing the Puncturer.....	122
7.6	Replacing the Sample Loop.....	123
7.7	Injection Valve and Fractionation Valve.....	124
7.7.1	Cleaning the Valve	125
7.7.2	Disassembling the Valve	125
7.7.3	Reassembling the Valve	127
7.8	Replacing the Main Power Fuses.....	129
7.9	Updating the Autosampler Firmware	130
8	Autosampler-Specific Information.....	133
8.1	Operating Principle (WPS-3000PL (RS)).....	133
8.2	Autosamplers for Fraction Collection.....	135
8.2.1	WPS-3000FC.....	135
8.2.2	Autosamplers with Micro Fraction Collection (MFC) Option.....	143
8.3	Biocompatible Autosamplers.....	144
8.4	Injection Methods	148
8.4.1	Full-Loop Injections	148
8.4.2	Partial-Loop Injections	151
8.4.3	Microliter Pick-Up.....	153
8.4.4	Low Dispersion Mode	156
9	Technical Information.....	159
10	Accessories, Consumables and Spare Parts	161
10.1	Standard Accessories	161
10.2	Optional Accessories	167
10.2.1	WPS-3000(T)PL (RS) Nano/Cap.....	167
10.2.2	WPS-3000TBPL Nano/Cap.....	169
10.2.3	WPS-3000TBPL Analytical	171
10.2.4	WPS-3000TFC	172
10.2.5	WPS-3000TBFC.....	174

10.3 Consumables and Spare Parts	176
11 Index.....	183

1 Introduction

1.1 How to Use This Manual

The layout of this manual is designed to provide quick reference to the sections of interest to the reader. However, in order to obtain a full understanding of your Thermo Scientific™ Dionex™ autosampler, Thermo Fisher Scientific recommends that you review the manual thoroughly before beginning operation.

Almost all descriptions in this manual apply to the following autosamplers of the UltiMate™ 3000 autosampler series:

- WPS-3000PL (RS) (Including “T” model with sample thermostating)
- WPS-3000TBPL Analytical
- WPS-3000TFC
- WPS-3000TBFC

The following conventions apply to the descriptions throughout this manual:

- The term "the autosampler" or "the device" is used throughout the manual. If some detail applies to only one autosampler model or one version, the model or version is identified by name.
- If not otherwise stated, the descriptions for the
 - ◆ WPS-3000PL (RS) autosamplers apply also to the versions with sample thermostating option (WPS-3000TPL RS).
 - ◆ Viper™ capillary connections apply also to the nanoViper™ and possible other Viper capillary connections. Parts made of nanoViper are made of PEEK-sheathed fused silica, if not otherwise stated.
- The device configuration may vary, for example, the autosampler may be equipped with a thermostatted carousel; therefore, not all descriptions necessarily apply to your particular instrument.
- It may happen that the representation of a component in this manual is different from the real component. However, this does not influence the descriptions.
- The descriptions in this manual refer to firmware version 4.13 and Chromeleon™ 6.80 Service Release 13. If you want to operate the autosampler with Chromeleon 7, note the information on page 35.

This manual is provided "as is". Every effort has been made to supply complete and accurate information and all technical specifications have been developed with the utmost care. The information contained in this manual should not be construed as a commitment by Thermo Fisher Scientific. Thermo Fisher Scientific assumes no responsibility for any errors that may appear in this document that is believed to be complete and accurate at the time of publication and, in no event, shall Thermo Fisher Scientific be liable for incidental or consequential damages in connection with or arising from the use of this document. We appreciate your help in eliminating any errors that may appear in this document.

All rights reserved, including those for photomechanical reproduction and storage on electronic media. No part of this publication may be copied or distributed, transmitted, transcribed, stored in a retrieval system, or transmitted into any human or computer language, in any form or by any means, electronic, mechanical, magnetic, manual, or otherwise, or disclosed to third parties without the express written permission of Thermo Fisher Scientific Inc.

Trademarks

Analyst is a registered trademark of AB Sciex.

Compass and Hystar are trademarks of Bruker Daltonics.

Empower is a trademark of Waters Corp.

PEEK is a trademark of Victrex PLC.

PEEKsil is a trademark of SGE Incorporated.

Cheminert is a registered trademark of Valco Instruments Co., Inc.

Windows and Windows Vista are registered trademarks of Microsoft Corp.







All other trademarks are property of Thermo Fisher Scientific Inc. and its subsidiaries.

1.2 Safety





The CE Mark label and cTUVus Mark safety label on the instrument indicate that the instrument is in compliance with the related standards.

1.2.1 Symbols on the Instrument and in the Manual

The table below shows the symbols used on the instrument:

Symbol	Description
	Alternating current—Courant alternatif
	Power supply is on (–) — L'instrument est mis sous tension (–) and Power supply is off (O)— L'instrument est mis hors tension (O)
	Pinch point hazard—Risque de pincement
	Refer to the operating instructions to prevent risk of harm to the operator and to protect the instrument against damage. Référez-vous à ce manuel pour éviter tout risque de blessure à l'opérateur et/ou protéger l'instrument contre tout dommage.
	Label according to the "Measures for Administration of the Pollution Control of Electronic Information Products" (China RoHS) guideline Étiquette "Measures for Administration of the Pollution Control of Electronic Information Products" (China RoHS)
	WEEE (Waste Electrical and Electronic Equipment) label—For more information, refer to the WEEE Information section in the "Installation and Qualification Documents for Chromatography Instruments" binder. Étiquette DEEE (Déchets d'Équipements Électriques et Electroniques) —Pour plus d'informations, référez-vous au chapitre WEEE Information dans le classeur "Installation and Qualification Documents for Chromatography Instruments".

At various points throughout the manual, messages of particular importance are indicated by certain symbols:

-  **Tip:** Indicates general information, as well as information intended to optimize the performance of the instrument.
-  **Important:** Indicates that failure to take note of the accompanying information could cause wrong results or may result in damage to the instrument.
-  **Important:** Indique que ne pas tenir compte de l'information jointe peut conduire à de faux résultat ou endommager l'instrument.
-  **Warning:** Indicates that failure to take note of the accompanying information may result in personal injury.
-  **Avertissement:** Indique que ne pas tenir compte de l'information jointe peut entraîner des blessures corporelles.

1.2.2 Safety Precautions

When working with analytical instrumentation, you must know the potential hazards of using chemical solvents.

 **Tip:** Before initial operation of the autosampler, make yourself familiar with the contents of this manual.

For the safety precautions in French, see page 9.

 **Warning:** All users of the device must observe the following safety precautions and all additional safety precautions in this manual to avoid the possibility of personal injury or damage to the device when operating the device or carrying out any maintenance or service procedures.

Observe any warning labels on the device and refer to the related sections in these *Operating Instructions*.

- **Protective equipment**

When performing any work on or near the HPLC system, wear personal protective equipment (protective clothing, safety gloves, safety glasses) as required by the hazard of the mobile phase and sample. For information about the proper handling of a particular substance and for advice on specific hazards, refer to the material safety data sheet for the substance you are using. Observe the guidelines of Good Laboratory Practice (GLP).

An eyewash facility and a sink should be close to the device. If any substance splashes on the eyes or skin, wash the affected area and seek medical attention.

- **Hazardous substances**

Many organic solvents, mobile phases and samples are harmful to health. Be sure that you know the toxic and infectious properties of all substances that you are using. You may not know the toxic or infectious properties of many substances that you are using. If you have any doubt about a substance, treat it as if it contains a potentially harmful substance. For advice on the proper handling of a particular substance, refer to the Safety Data Sheet (SDS) of the manufacturer. Observe the guidelines of Good Laboratory Practice (GLP).

Dispose of waste substance in an environmentally safe manner that is consistent with all local regulations. Do not allow flammable, toxic, and/or infectious substances to accumulate. Follow a regulated, approved waste disposal program. Never dispose of flammable, toxic, and/or infectious substances through the municipal sewage system.

- **Hazardous gases**

Install the HPLC system in a well-ventilated laboratory. If the mobile phase or sample includes volatile or flammable solvents, do not allow them to enter the workspace. If the mobile phase or sample includes volatile or flammable solvents, avoid open flames and sparks.

- **Electrostatic discharge**

Discharge of electrostatic energy may lead to sparking and can constitute a fire hazard. This effect is particularly pronounced in insulating capillaries and with non-conductive solvents (for example, pure acetonitrile).

Take appropriate measures to prevent the generation of static electricity near the HPLC system. For example, make sure that the air humidity level in the laboratory is sufficiently high and provide proper ventilation, wear anti-static clothing or shoes, prevent accumulation of air bubbles in waste lines, and use grounded waste containers. Use only non-conductive capillaries to direct solvents into the waste container. With electrically conductive capillaries, make sure that they are properly grounded.

IMPORTANT WPS-3000TFC and WPS-3000TBFC SAFETY INSTRUCTIONS!

The WPS-3000TFC and WPS-3000TBFC autosamplers have been designed ONLY for the multidimensional separation of biomolecules with aqueous and polar organic mobile phases, for example methanol, that are commonly used in reversed-phase (RP) liquid chromatography.

HENCE, NEVER OPERATE THESE AUTOSAMPLERS WITH NON-CONDUCTIVE AND NON-POLAR NORMAL-PHASE (NP) ELUENTS! DOING SO COULD RESULT IN FIRE AND / OR EXPLOSION HAZARD!

Note that a normal-phase upgrade kit (part no. 6820.0060) is available ONLY for the WPS-3000TFC autosampler (part no. 5824.0020). Use normal-phase eluents ONLY with the WPS-3000TFC autosampler after the autosampler has been modified with this normal-phase kit. OPERATING THE AUTOSAMPLER WITHOUT THE APPROPRIATE KIT CAN RESULT IN FIRE AND / OR EXPLOSION HAZARD!

Do NOT perform normal-phase applications without a proper grounding protection for the needle. Nonconductive, non-polar normal-phase eluents, for example hexane, can lead to a build-up of electrostatic charges on an ungrounded valve and needle. THE ELECTROSTATIC DISCHARGE CAN CREATE A FIRE AND / OR EXPLOSION HAZARD.

The WPS-3000TBFC autosampler (part no. 5825.0020) may NOT be used for normal-phase applications. There is no upgrade kit available for this autosampler type. NEVER use this autosampler type with NP eluents! DOING SO CAN RESULT IN FIRE AND / OR EXPLOSION HAZARD! The WPS-3000TBFC autosampler may be used for reversed-phase chromatography ONLY.

- **Self-ignition of solvents**

Do not use solvents for which the self-ignition temperature is below 150 °C. In case of leakage, these solvents may self-ignite on a hot surface.

- **Capillaries, capillary connections, open connections**
 - ◆ Capillaries, especially non-metallic capillaries may burst, slip out of their fittings or may not be screwed in. This may result in substances spraying out of the open connections.
 - ◆ In an UltiMate 3000 system, some components are made of PEEK™. This polymer has superb chemical resistance to most organic solvents. However, it tends to swell when in contact with trichloromethane (CHCl₃), dimethyl sulfoxide (DMSO), or tetrahydrofuran (THF). In addition, it is attacked by concentrated acids, such as, sulfuric acid and nitric acid or a mixture of hexane, ethyl acetate, and methanol. In both cases, capillaries may start leaking or they can burst. Swelling or attack by concentrated acids is not a problem with brief flushing procedures.
 - ◆ Do not use tubing that is stressed, bent, kinked, or damaged.
 - ◆ Capillary connections can be contaminated by harmful substances or harmful substances can escape from open connections.
 - ◆ Always wear safety glasses when handling fused silica tubing, for example, during installation or when cutting capillaries to the length.
- Disconnect the autosampler from all power sources before removing the panels. When the panels are removed, dangerous electrical connections will be exposed. The enclosure must be opened only by Thermo Fisher Scientific service personnel.
- Always replace blown fuses with original spare part fuses authorized by Thermo Fisher Scientific.
- Replace faulty communication cables.
- Replace faulty power cords. Never use a power cord other than the power cords provided for the device.
- Use only the original spare parts and accessories authorized for the device by Thermo Fisher Scientific.
- The autosampler is primed with 2-propanol. During initial operation of the autosampler, make sure that the solvents used are miscible with 2-propanol. Otherwise, follow the appropriate intermediate steps.
- When operating the HPLC system, always set a lower pressure limit for the pump. This prevents damage resulting from leakage or from running the pump dry.
- A team effort is required to lift or move the autosampler. The autosampler is too heavy and/or bulky for one person alone to lift or move safely.
- When lifting or moving the autosampler, always lift by the bottom or sides of the unit, with the front panel being closed. This is to avoid damage to the instrument.
- The open front panel door is not designed to carry weight. Do not place any heavy objects on the open front panel door; this may damage the door.
- After operation, rinse out buffers and solutions that form peroxides.

- Before switching from buffer to organic solution, rinse the analytical system thoroughly with deionized or HPLC grade water.
- When switching to another solvent, ensure that the new solvent is miscible with the one contained in the HPLC system. If the solvents are not miscible, the system can be damaged, for example, by flocculation.
- If a leak occurs, turn off the autosampler immediately, stop the pump flow, and remedy the situation.
- Use only standard solvents (HPLC grade) and buffers that are compatible with all parts that may be exposed to solvents.
- Avoid looking directly into the autosampler light LED and do not use light focusing instruments for viewing the light beam. The high luminosity of the lamp can be harmful to the eyes.
- To avoid personal injury, do not reach inside the sample compartment during a running analysis.
- Do not switch the valve of the WPS-3000(T)PL RS dry. Damage to the valves could result.
- Before interrupting operation for several days or more or when preparing the autosampler for transport, observe the precautions for shutting down the instrument (→ page 99).
- Do not use the autosampler in ways other than those described in these *Operating Instructions*.
- Keep the operating instructions near the device to be available for quick reference.

1.2.3 Consignes de Sécurité

Si vous utilisez d'instrumentation analytique, vous devez connaître les risques d'utilisation de produit chimiques.

 **Veillez noter:** Avant de commencer à utiliser l'instrument, assurez-vous que vous vous êtes familiarisés avec le contenu de ce manuel.

 **Avertissement:** Toutes les personnes utilisant l'instrument doivent observer les consignes de sécurité suivantes et dans les autres chapitres de ce manuel pour éviter une mise en danger de sa personne ou de dommage à l'instrument pendant l'utilisation et des opérations de maintenance ou service de l'instrument.

Observez les étiquettes d'avertissement sur l'instrument et référez-vous aux sections correspondantes dans ce mode d'emploi.

- **Equipment de protection**

Pour tous les travaux sur le système HPLC ou à proximité, portez l'équipement de protection personnel (vêtements de protection, gant de sécurité, lunettes de protection) qui correspond aux risque découlant de la phase mobile et/ou de l'échantillon. Pour les informations sur la manipulation correcte des composés et des recommandations pour les situations de risque spécifiques, veuillez consulter la fiche de données de sécurité des substances que vous utilisez. Veuillez respecter des directives des Bonnes Pratiques de Laboratoire (BPL).

Une installation permettant de se laver les yeux ainsi qu'un lavabo doivent se trouver à proximité du système. Si une substance, quelle qu'elle soit, entre en contact avec vos yeux ou votre peau, rincez abondamment la zone affectée à l'eau, puis.

- **Substances dangereuses**

De nombreux solvants organiques, phases mobiles et échantillons sont nuisibles à la santé. Informez-vous de propriétés toxicologiques et infectieuses de toutes les substances que vous utilisez. Les propriétés toxicologiques et infectieuses de nombreuses substances peuvent être mal connues. Au moindre doute concernant une substance, traitez-la comme s'il contenait une substance potentiellement dangereuse. Pour des instructions comment utiliser correctement des composés particuliers, veuillez consulter à la fiche de données des sécurités du fabricant respectif. Veuillez respecter des directives des Bonnes Pratiques de Laboratoire (BPL).

Débarrassez-vous de tous les déchets de substances de manière écologique, conformément à la réglementation en vigueur au niveau local. Empêchez impérativement l'accumulation de solvants inflammables, toxiques et/ou infectieux. Suivez un programme d'élimination des déchets règlementé et approuvé. Ne jetez jamais de solvants inflammables, toxiques et/ou infectieux dans le système municipal d'évacuation des eaux usées.

- **Gaz dangereux**

Installez le système HPLC dans un laboratoire bien ventilé. Si la phase mobile ou l'échantillon contient des solvants volatils ou inflammables, vous devez assurer qu'ils ne pénètrent dans l'espace de travail. Si la phase mobile ou l'échantillon contient des solvants volatils ou inflammables, évitez les flammes nues et les sources d'étincelles à proximité.

- **Décharge électrostatique**

Décharge électrostatique peut provoquer la formation d'étincelles et peut présenter un risque d'incendie. Veuillez noter que des solvants fluides dans les capillaires peuvent se charger automatiquement. Cet effet se peut produire particulièrement forte dans les capillaires isolants et avec des solvants non-conducteurs (par exemple, l'acetonitrile pur).

Prenez des mesures appropriées pour éviter les charges électrostatiques à proximité du système HPLC. Par exemple, s'assurez qu'il y a une humidité de l'air suffisante et une ventilation adéquate dans le laboratoire, portez des vêtements ou équipement de protection antistatique, évitez l'accumulation de bulles d'air dans les lignes de déchets et utilisez des réservoirs à déchets mis à la terre.

Utilisez uniquement des capillaires non-conducteurs pour diriger solvants au réservoir de déchets. Capillaires électriquement conducteur devrait être mis à la terre.

**CONSIGNES DE SECURITE IMPORTANTES POUR LES PASSEURS
D'ECHANTILLONS WPS-3000TFC ET WPS-3000TBFC!**

Les passeurs d'échantillons WPS-3000TFC et WPS-3000TBFC ont été EXCLUSIVEMENT développés pour la séparation multidimensionnelle de biomolécules avec les phases mobiles aqueuses et organiques polaires, par exemple méthanol, qui sont utilisés couramment en chromatographie en phase inverse.

N'UTILISEZ JAMAIS CES PASSEURS D'ECHANTILLONS AVEC DES SOLVANTS DE LA PHASE NORMALE, NON-CONDUCTEURS ET NON-POLAIRES! NE PAS RESPECTER CES RECOMMANDATIONS PEUT PRESENTER UN RISQUE D'INCENDIE ET/OU D'EXPLOSION!

Notez que le kit d'évolution pour applications en phase normale (référence 6820.0060) est disponible EXCLUSIVEMENT pour le passeur d'échantillons WPS-3000TFC (référence 5824.0020). Utilisez les solvants de type phase normale UNIQUEMENT avec le passeur d'échantillons WPS-3000TFC modifié à l'aide du kit "phase normale".
L'UTILISATION DU PASSEUR D'ECHANTILLONS SANS LE KIT APPROPRIE PEUT PRESENTER UN RISQUE D'INCENDIE ET/OU D'EXPLOSION!

N'effectuez pas d'applications en phase normale sans vous être assuré que votre aiguille est proprement isolée et mise à la terre. Les solvants de la phase normale, non-conducteurs et non-polaires, par exemple hexane, peuvent entraîner une accumulation de charges électrostatiques sur les vannes ou l'aiguille en l'absence de mise à la terre. **NE DECHARGE ELECTROSTATIQUE PEUT REPRESENTER UN RISQUE D'INCENDIE ET/OU D'EXPLOSION.**

Le passeur d'échantillons WPS-3000TBFC (référence 5825.0020) NE doit PAS être utilisé pour des applications en phase normale. Un kit d'évolution pour applications en phase normale n'est pas disponible pour ce passeur d'échantillons. N'utilisez JAMAIS ce passeur d'échantillons avec des solvants pour phase normale! NE PAS RESPECTER CES RECOMMANDATIONS PEUT CONDUIRE A UN RISQUE D'INCENDIE ET/OU D'EXPLOSION! Le passeur d'échantillons WPS-3000TBFC doit être utilisé EXCLUSIVEMENT en chromatographie en phase inverse.

- **Inflammation spontanée des solvants**

N'utilisez aucun solvants avec une température d'auto-inflammabilité inférieure à 150° C. Si une fuite se produit, ces solvants peuvent s'auto-enflammer au contact d'une surface chaude.

- **Capillaires, connecteur capillaires, connexions ouvertes**

- ◆ Des capillaires, en particulier les capillaires non-métalliques, pourraient fendre ou glisser des connecteurs ou ne peuvent pas être vissés. Ceci peut en résulter aussi que des substances pourraient jaillir des connexions ouvertes.
 - ◆ Dans un système UltiMate 3000, certaines composantes sont en PEEK. Bien que ce polymère présente une excellente résistance chimique à la plupart des solvants organiques, il a tendance à gonfler lorsqu'il est en contact prolongé avec du chloroforme (CHCl₃), du diméthyle sulfoxide (DMSO) ou du tetrahydrofuran (THF). De plus, il est attaqué par des acides concentrés tels que l'acide sulfurique et l'acide nitrique ou d'un composé du hexane, éthyle acétate et méthanol. Ceci peut causer des capillaires de fuite ou risquer des capillaires d'éclater. Ces acides peuvent cependant être utilisés dans le cadre de procédures de nettoyage, à condition que l'exposition soit brève.
 - ◆ N'utilisez pas de capillaires écrasés, pliés, abimés ou endommagés.
 - ◆ Les connecteurs capillaires pour pourrait être contaminé par des substances dangereuses ou des substances dangereuses pourrait sortir des connexions ouvertes.
 - ◆ Portez des lunettes de protection lorsque vous manipulez des capillaires en silice fondue (pendant l'installation, découpe, etc.).
- Quand les capots de protection de l'appareil sont démontés, vous êtes exposés à des connexions électriques sous haute tension deviennent accessibles. Débranchez l'instrument de toute source d'alimentation électrique avant de retirer les capots. Ne démontez les capots de protection que si cela est explicitement demandé au cours de ces instructions. Les capots de protection devraient être démontés uniquement par le personnel de service de Thermo Fisher Scientific.
 - Remplacez toujours les fusibles grillés par des fusibles de rechange autorisés par Thermo Fisher Scientific.
 - Remplacez les câbles de communication défectueux.
 - Remplacez les cordons d'alimentation électrique défectueux. Utilisez uniquement les cordons d'alimentation électrique spécifique à l'instrument.

- Utilisez seulement des pièces de rechange originales et des accessoires autorisés par Thermo Fisher Scientific.
- Le passeur d'échantillon est stocké sous 2-Propanol. Au cours démarrage du passeur d'échantillon, assurez-vous que les solvants utilisés soient miscibles avec le 2-Propanol. Sinon, suivez les étapes intermédiaires appropriées.
- Réglez toujours une limite de pression minimum pour la pompe HPLC. Ceci prévient les dommages résultant de fuites ou de long-terme fonctionnement à sec de la pompe.
- Lorsque vous soulevez ou l'instrument, tenez-le toujours par le dessous ou par les côtés de l'unité. Soulever l'instrument par la partie avant inférieure ou par le panneau avant peut endommager la porte.
- Ne placez aucun objet lourd sur la porte ouverte du panneau avant. Ceci pourrait endommager la porte.
- Après utilisation, purgez le système des tampons et des susceptibles de former des peroxydes.
- Lorsque vous passez d'une solution saline à un solvant organique, effectuez un rinçage intermédiaire du système HPLC à l'eau dé-ionisée ou qualité HPLC.
- Lorsque vous passez à un autre solvant, assurez-vous que le nouveau solvant soit miscible avec celui qui se trouve dans la pompe. Dans le cas contraire, la pompe peut être endommagée; par exemple, par des floculations!
- Si une fuite se produit, arrêtez immédiatement l'instrument, stoppez le débit de la pompe et remédiez au problème.
- Utilisez uniquement des solvants (qualité HPLC) et des solutions salines compatibles avec les matériaux exposés phase mobiles.
- Afin d'éviter des blessures corporelles, ne mettez pas la main à l'intérieur du compartiment à échantillons lorsqu'une analyse est en cours.
- Ne faites pas fonctionner le vanne du WPS-3000(T)PL RS à sec. Il peut en résulter des dommages aux vannes.
- Ne regardez jamais directement la DEL pour l'éclairage intérieur et ne regardez pas du faisceau lumineux par des instruments qui focalisent le rayon lumineux. L'intensité lumineuse de la lampe peut être nocif pour les yeux.
- Avant d'interrompre le fonctionnement pendant plusieurs jours ou plus, observez les précautions figurant en page 99.
- N'utilisez pas l'instrument de manière autre que celles décrites dans ce manuel.
- Conservez ce manuel à proximité de l'instrument pour pouvoir le consulter facilement.

1.3 Intended Use

For Research Use Only. Not for use in diagnostic procedures. The device is designed to be operated only by qualified and authorized personnel. All users must know the hazards presented by the device and the used substances.

The autosampler is designed for laboratory research use in high-performance liquid chromatography (HPLC) and ultra-high performance liquid chromatography (UHPLC) applications. It is part of the UltiMate 3000 system, but can also be used with other HPLC systems if adequate control inputs and outputs are available. A PC with USB port is required.

The autosampler can be operated with the Chromeleon Chromatography Management System. Being part of the UltiMate 3000 system, the autosampler can also be operated with other data systems, such as

- Xcalibur™, Compass™/HyStar™ or Analyst®. Installation of the DCMS^{Link} (Thermo Scientific Dionex Chromatography Mass Spectrometry Link) software is required in addition to the installation of the data system.
- Empower™. Installation of the Thermo Scientific Dionex Instrument Integration Software is required in addition to the installation of the data system.

For more information, contact the Thermo Fisher Scientific sales organization for Dionex HPLC Products.

Observe the following for using the autosampler:

- The WPS-3000TFC and WPS-3000TBFC autosamplers have been designed for the multidimensional separation of biomolecules with aqueous and polar organic mobile phases, for example methanol, that are commonly used in reversed-phase (RP) liquid chromatography. For normal-phase (NP) applications, observe the safety instructions for the WPS-3000TFC and WPS-3000TBFC autosamplers on page 6. For the safety instructions in French, see page 10.
- The autosampler must be operated only with accessories and spare parts recommended by Thermo Fisher Scientific (→ page 161) and within the technical specifications (→ page 130).
- Use only standard solvents (HPLC grade, better LC-MS grade (0.2 µm, filtered)) and buffers, compatible with the flow path materials. If water from water purification systems that are not properly maintained is used, polymeric contamination may seriously damage the column and may rapidly block solvent filters. Note the special properties of the solvents such as viscosity, boiling point, UV absorption (UV/VIS detector), refractive index (refractive index detector), and dissolved gas (degasser).

- *Stainless steel autosampler versions only*
Buffer concentration: Typically up to 1 mol/L (< 0.1 mol/L chloride ions).
- Also observe the information about the solvent compatibility of the other UltiMate 3000 system modules. For more information, refer to the Operating Instructions for the modules.

If there is any question regarding appropriate usage, contact Thermo Fisher Scientific before proceeding.



Warning:

If the device is used in a manner not specified by Thermo Fisher Scientific, the protection provided by the device could be impaired. Thermo Fisher Scientific assumes no responsibility and will not be liable for operator injury and/or instrument damage. Whenever it is likely that the protection is impaired, the instrument must be disconnected from all power sources and be secured against any intended operation.



Avertissement:

Si l'instrument est utilisé de façon non spécifiée par Thermo Fisher Scientific, la protection prévue par l'instrument pourrait être altérée. Thermo Fisher Scientific n'assume aucune responsabilité et ne sera pas responsable des blessures de l'opérateur et/ou des dommages de l'instrument. Si la protection de l'instrument n'est pas garanti à tout moment, débranchez l'instrument de toutes les sources d'alimentation électrique et assurez-vous que l'instrument n'est pas utilisé involontairement.

1.4 Federal Communications Commission (FCC) Note

This equipment has been tested and found to comply with the limits for a Class A digital device, pursuant to part 15 of the U.S. FCC Rules. These limits are designed to provide reasonable protection against harmful interference when the equipment is operated in a commercial environment. This equipment generates, uses, and can radiate radio frequency energy and, if not installed and used in accordance with the instruction manual, may cause harmful interference to radio communications. Operation of this equipment in a residential area is likely to cause harmful interference, in which case the user will be required to correct the interference at his expense.

2 Overview

2.1 Unit Description

The autosampler is a high-quality injection module designed for HPLC analysis as part of an UltiMate 3000 system. The module was developed especially for HPLC applications, offering high availability and reproducibility, even with lowest injection volumes. The design has been optimized for minimum dead volume and maximum efficiency.

- The carousel can handle any combination of different vial sizes, well plates, and deep well plates (→ page 30), which can be used in the same autosampling sequence.
- It is possible to execute full-loop injections, partial-loop injections, and microliter pick-up injections. "Low Dispersion" injection control is supported for full-loop and partial-loop injections to optimize the injection profile (→ page 148).
- A separate puncturing needle (puncturer) pierces the vial cap/septum or plate seal prior to injection, allowing the protected insertion of fused silica capillaries down to the bottom of the vial or well. In this way, even lowest sample volumes can be processed with zero sample loss.
- The autosampler can be fully controlled by the Chromeleon Chromatography Management System, allowing you to randomly access samples, use several standards per analysis sequence, or set variable injection volumes and numbers of replicates for each sample.
- Various safety and monitoring features are provided for optimum system performance and reliability (→ page 35).
- The autosampler is designed for easy access to the fluidic components, allowing fast and reliable maintenance while the instrument remains in the UltiMate 3000 system stack.
- All parts that may be exposed to solvents are made of materials that provide optimum resistance to the most commonly used solvents and buffer solutions.
- The autosampler is available also as biocompatible autosampler (→ page 20) and/or with integrated temperature control for sample cooling and/or heating (→ page 21). In addition, autosampler versions are available for fraction collection (→ page 21).
- A transparent front cover is available as an option (part no. 6820.1427). The front cover allows you to close the sample compartment, e.g., to prevent dust or other particles from entering.

2.2 Operating Principle

The autosampler uses the pulled-loop injection principle and supports full-loop injections, partial-loop injections, and microliter pick-up injections. "Low Dispersion" injection control is supported for full-loop and partial-loop injections to optimize the injection profile.

The schematics in section 8 (→ page 133) illustrate how the autosamplers operate. This section also provides detailed information about the injection methods.

Find the following information ...	On page ...
Operating principle WPS-3000PL (RS)	133
Operating principle WPS-3000FC	135
Injection methods	148
- Full-loop injections	148
- Partial-loop injections	151
- Microliter pickup	153
- Low dispersion mode	156

2.3 Autosampler Configurations

2.3.1 Overview

The autosampler is available in the configurations indicated in the table. For information about the components that are available as an option, see page 167.

WPS-3000PL RS	Part No.
WPS-3000PL RS Nano/Cap (without sample thermostating option), including - 2.4 µL needle - 25 µL syringe - 50 µL buffer tubing - 1µL sample loop - 2-position, 6-port injection valve suitable for pressures < 90 MPa (12500 psi)	5826.0010
WPS-3000TPL RS Nano/Cap, same as WPS-3000PL RS Nano/Cap, however, with sample thermostating	5826.0020
For biocompatible applications with WPS-3000(T)PL RS autosamplers, the PAEK Modification Kit is available. The kit includes all components required to modify the standard non-biocompatible fluidics of a WPS-3000(T)PL RS autosampler to a biocompatible version. For further information and installation of the kit, contact the Thermo Fisher Scientific Service for Dionex HPLC Products.	

WPS-3000PL	Part No.
WPS-3000PL Nano/Cap (without sample thermostating option), including - 2.4 µL needle - 25 µL syringe - 50 µL buffer tubing - 1µL sample loop - 2-position, 6-port injection valve suitable for pressures < 34 MPa (5000 psi)	---
WPS-3000TPL Nano/Cap, same as WPS-3000PL Nano/Cap, however, with sample thermostating	---
WPS-3000TBPL Nano/Cap (biocompatible autosampler), same as WPS-3000PL Nano/Cap, however, with sample thermostating	---

WPS-3000TBPL Analytical	Part No.
WPS-3000TBPL Analytical (biocompatible autosampler), including - 15 µL needle - 100 µL syringe - 500 µL buffer tubing - 50 µL sample loop - 2-position, 6-port injection valve suitable for pressures < 34 MPa (5000 psi) - sample thermostating	5823.0020

WPS-3000FC	Part No.
WPS-3000TFC - 15 µL needle - 250 µL syringe - 500 µL buffer tubing - 50 µL sample loop - 2-position, 6-port injection valve suitable for pressures < 34 MPa (5000 psi) - 2-position, 6-port fractionation valve suitable for pressures < 3,4 MPa (500 psi) - sample thermostating option	5824.0020
WPS-3000TBFC, same as WPS-3000TFC, however, biocompatible autosampler	5825.0020
Both autosampler versions can be optimized for nano and cap applications (→ page 141). The WPS-3000FC with stainless steel fluidics can optionally be equipped with a 90 MPa/13050 psi valve for RSLC applications.	
A normal-phase upgrade kit (part no. 6820.0060) is available only for the WPS-3000TFC autosampler (part no. 5824.0020). Use normal-phase eluents only with the WPS-3000TFC autosampler after the autosampler has been modified with this normal-phase kit. For normal-phase (NP) applications, observe the safety instructions for the WPS-3000TFC and WPS-3000TBFC autosamplers on page 6. For the safety instructions in French, see page 10.	

2.3.2 Biocompatible Autosamplers

Almost all descriptions of the standard autosamplers apply also to the biocompatible versions. If some detail applies to only one version, the version will be identified.

In any case, note the differences on the injection valve and the connected components (→ page 144).

2.3.3 Autosamplers with Sample Thermostatting

The autosampler is available also with temperature control for sample thermostating. The autosampler is equipped with electronic Peltier elements that cool or heat the cooling liquid, which in turn cools the carousel and all its components to the desired temperature. This patented technology allows precise equalization of the sample temperature.

The autosampler with sample thermostating option allows sample cooling by max. 22 °C from the ambient temperature. The lower temperature limit is +4 °C. In addition, the samples can be warmed to max. +45 °C.

Additional supplies, such as cooling water or compressed air are not required.

Observe the following:

- To remove any condensing water that collects in the carousel, a waste line (drain tubing) can be connected to bottom right port (rear port) underneath the autosampler. The thermostatted autosampler is equipped with active condensing water drainage (via a pump).
- The drain tube must remain below the drain port. Otherwise, the liquid may flow back into the interior and cause damage to the autosampler.
- In case of increased humidity and formation of condensing water, Thermo Fisher Scientific recommends cleaning the carousel regularly to prevent impurities in the tray. Also, the transparent front cover (part no. 6820.1419) may help minimizing the formation of condensing water.

2.3.4 Autosamplers for Fraction Collection

The following options are available for fraction collection:

- **WPS-3000TFC**
The autosampler is fitted with a 2-position, 6-port injection valve and a 2-position, 6-port fractionation valve. For information about the operating principle and about special operational settings, see section 8.2.1 (→ page 136).
For normal-phase applications with the WPS-3000TFC autosampler, a normal-phase upgrade kit is available (part no. 6820.0060). For further information, see section 8.2.1.5 (→ page 142). For normal-phase (NP) applications, observe the safety instructions for the WPS-3000TFC and WPS-3000TBFC autosamplers on page 6. For the safety instructions in French, see page 10.
- **WPS-3000(T)PL RS, WPS-3000(T)PL Nano/Cap, and WPS-3000TBPL Nano/Cap**
For these autosamplers, the standard 2-position, 6-port injection valve can be replaced with a 2-position, 8-port switching valve for fraction collection (→ page 143).

2.3.5 Proper Syringe, Buffer Tubing, and Sample Loop Combinations

The following table provides information about the recommended combinations of syringe, sample loop, and buffer tubing.

Autosampler	Syringe	Buffer Tubing	Sample Loop
WPS-3000PL RS Nano/Cap, WPS-TPL RS Nano/Cap, WPS-3000(T)PL Nano/Cap and WPS-3000TBPL Nano/Cap	25 µL 100 µL 250 µL ¹	50 µL 500 µL 500 µL	1 µL, 5 µL, 10 µL, 20 µL 5 µL, 10 µL, 20 µL, 50 µL 50 µL, 125 µL
WPS-3000TBPL Analytical	100 µL 250 µL	500 µL 1000 µL	5 µL, 10 µL, 20 µL, 50 µL 250 µL ²
WPS-3000TFC, WPS-3000TBFC	25 µL ³ 100 µL 250 µL 250 µL	50 µL 500 µL 500 µL 1000 µL	1 µL, 5 µL, 10 µL, 20 µL 5 µL, 10 µL, 20 µL, 50 µL 50 µL, 125 µL 250 µL

¹ Upgrade kits are available for the 250 µL syringe (part no. 6820.0031 and 6821.0031 for the biocompatible version). They include the recommended buffer tubing and sample loop (125 µL).

² Due to the material of the 250 µL sample loop, the offset of the injector linearity can be up to 11.0 µL for this combination.

³ Nano/Cap Modification Kits are available for the WPS-3000TFC (part no. 6824.0030) and WPS-3000TBFC (part no. 6825.0030). They include the recommended parts for Nano/Cap configuration.

For information about the part numbers, refer to sections 10.2 (→ page 167) and 10.3 (→ page 176).

2.4 Interior Components

2.4.1 WPS-3000(T)PL (RS) and WPS-3000TBPL

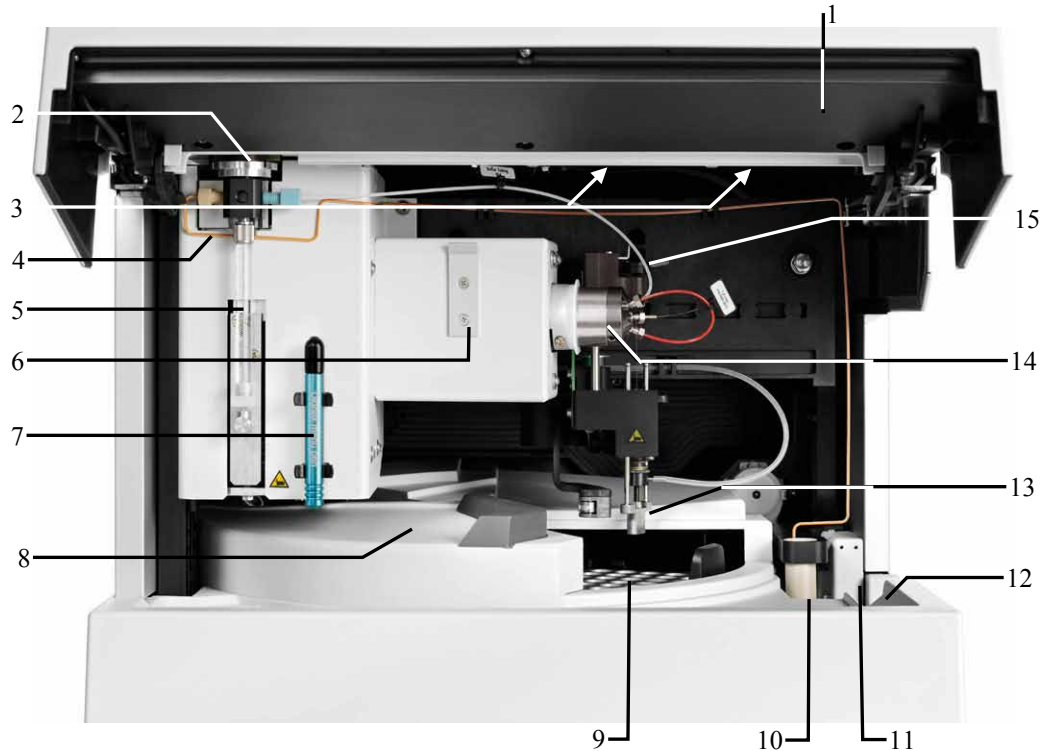

Fig. 1: Interior view (here WPS-3000PL RS)

No.	Description
1	Front panel (tilted upward)
2	Syringe valve (→ page 59)
3	Compartment lights (here hidden by the front panel (→ page 33))
4	Tubing from syringe valve to wash port (wash port supply)
5	Syringe
6	Wash liquid reservoir (for 125 mL of wash liquid; → page 56)
7	Menu pen
8	Movable cover for the carousel For manual access to the samples in the carousel, grasp and move the cover at the black bar to the left. To close the carousel, move the cover to the right until contact is established to the needle arm. The needle arm will open and close the cover automatically for sampling.
9	Rack (well plate or vials) For a detailed view of the carousel, see Fig. 2 (→ page 24).
10	Wash port The wash port is in a tray in which liquid leaks are collected. The drain port on the bottom right of autosampler discharges the liquid from the wash port (→ page 60).

No.	Description
11	Leak sensor
12	Drip tray
13	Needle pair, comprising the puncturer and the needle, with sensor for plate and vial detection
14	Injection valve with sample loop (→ page 34)
15	Buffer tubing



Fig. 2: Carousel view

No.	Description
1	Well plate or sample rack
2	Holder for 5 10-mL reagent and/or transport vials. Three holders, which are included in the shipment, can be installed in the carousel.

For further information about sample racks, see page 30.

2.4.2 WPS-3000TFC and WPS-3000TBFC

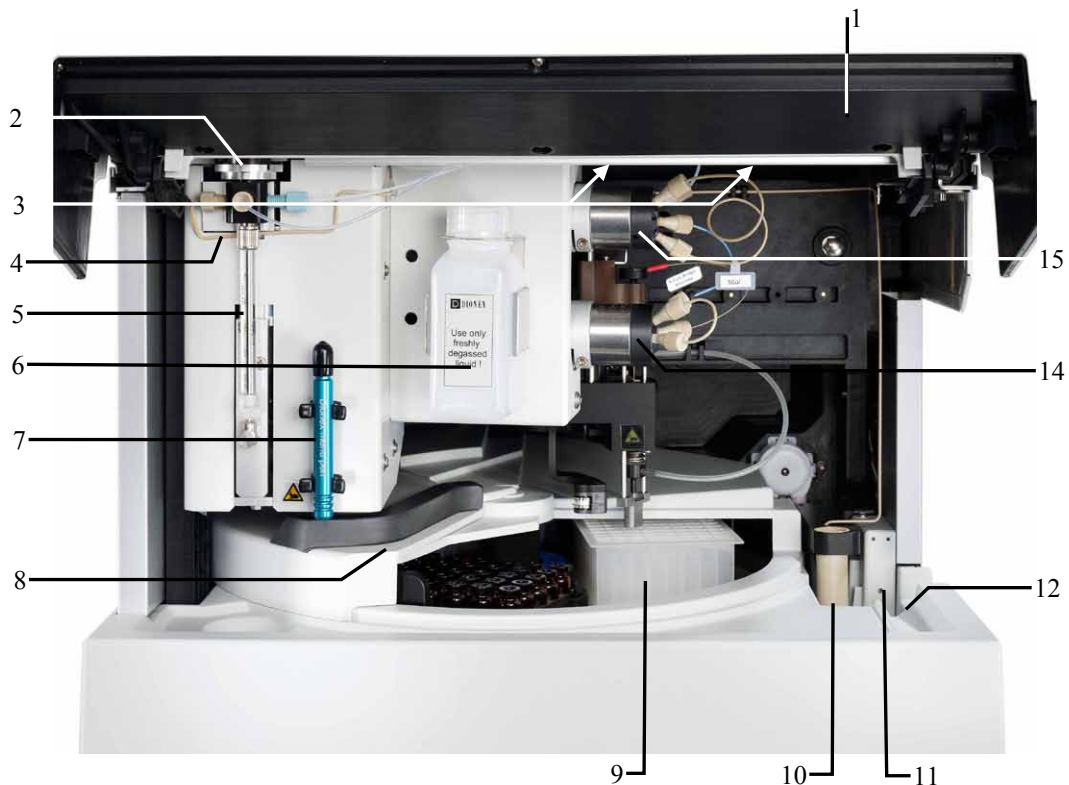

Fig. 3: Interior view (here WPS-3000TFC)

No.	Description
1	Front panel (tilted upward)
2	Syringe valve (→ page 59)
3	Compartment lights (here hidden by the front panel (→ page 33))
4	Tubing from syringe valve to wash port (wash port supply)
5	Syringe
6	Wash liquid reservoir (for 125 mL of wash liquid; → page 56)
7	Menu pen
8	Movable cover for the carousel For manual access to the samples in the carousel, grasp and move the cover at the black bar to the left. To close the carousel, move the cover to the right until contact is established to the needle arm. The needle arm will open and close the cover automatically for sampling.
9	Rack (well plate or vials) For a detailed view of the carousel, see Fig. 2 (→ page 24).
10	Wash port The wash port is in a tray in which liquid leaks are collected. The drain port on the bottom right of autosampler discharges the liquid from the wash port (→ page 60).
11	Leak sensor
12	Drip tray

No.	Description
13	Needle pair, comprising the puncturer and the needle, with sensor for plate and vial detection
14	Fractionation valve
15	Injection valve with sample loop (→ page 34)

2.5 Front Panel Elements



Fig. 4: Front panel view (here WPS-3000TBFC)

No.	Front Panel Element	Description
1	Display	Shows information about the autosampler, for example: <ul style="list-style-type: none"> - General information upon power-up (→ page 67) - Status screen (→ page 68) - Various functions and menus (→ page 77) - Messages (→ page 103)
2	Standby button	Switches the autosampler to Standby mode (the LED is lighted). To cancel Standby mode and resume operation, press the Standby button again (the LED is not lighted). Note: To allow the autosampler to change the mode, press the Standby button for at least 1second.
3	LEDs	
	Power	The LED is blue when the autosampler is turned on.
	Connected	The LED is green when the autosampler is controlled by Chromeleon.
	Status	The LED is red when an error has been detected. The related message appears on the display. Autosamplers with sample thermostating: The LED is yellow when the target temperature has not yet been reached. Otherwise, the LED is green.

2.6 Rear Panel



Fig. 5: Rear panel view (here WPS-3000TPL)

No.	Description
1	Power switch
2	Fuse holder (→ page 29)
3	Main power receptacle (→ page 41)
4	Type label
5	USB 1.1 port for connection to the server PC (→ page 29)
6	USB hub (3 USB 1.1 ports) Depending on the UltiMate 3000 system configuration, for connection of one UltiMate 3000 system module each or for connection of one USB hub each (→ page 29)
7	Digital I/O ports for communication with external devices under Chromeleon (→ page 29)
8	<i>Autosampler with sample thermostating only</i> Cooling fans

2.6.1 Power Switch

The power switch on the rear panel is the main power switch for the autosampler. Turn on the power switch before initial operation of the autosampler and leave it on. For routine on/off control, use the standby button on the front of the autosampler (→ page 23). Press and hold the button for one second to allow the autosampler to change the mode. Turn off the main power switch when instructed to do so, for example, before performing a service procedure or when interrupting operation for longer periods (one week or more). In this case, also observe the precautions on page 99.

2.6.2 Fuse Holder

The fuse holder contains two slow-blow fuses, depending on the autosampler model rated at 2 A, 250 V (autosampler *without* sample thermostating) or 4 A, 250 V (autosamplers *with* sample thermostating). For information about how to change the fuses, see page 129.

2.6.3 USB Connector

The Chromeleon Chromatography Management System can use a USB connection to control the autosampler. Data is transferred digitally via the appropriate USB cable (→ page 40). To ensure trouble-free operation, use only the cables shipped with the autosampler.

The internal USB hub (→ Fig. 5, no. 6) allows you to connect three other instruments in the UltiMate 3000 product line or three external USB hubs to the autosampler.

 **Important:** Thermo Fisher Scientific recommends using these USB ports for connections to Dionex instruments only. Thermo Fisher Scientific cannot guarantee correct functioning if instruments from other manufacturers are connected.

 **Important:** Thermo Fisher Scientific recommande d'utiliser les ports USB uniquement pour les raccordements aux instruments Dionex. Thermo Fisher Scientific ne peut garantir le bon fonctionnement si les instruments d'autres fabricants sont raccordés.

For information about how to connect the autosampler to the Chromeleon computer, see section 3.4.1 (→ page 40).

2.6.4 Digital I/O Ports

The 6-pin Mini-DIN ports on the rear panel can be used in Chromeleon to exchange digital signals with external devices. To connect an external device to the autosampler, use a 6-pin Mini-DIN signal cable (part no. 6000.1004). For information about how to connect the digital I/O, see page 42.

2.7 Carousel, Sample Racks, Vials, and Well Plates

The carousel has three segments (red, green, and blue) and can handle any combination of three different sample racks (trays). For information about how to install a sample rack, see page 62.



Fig. 6: Examples for sample racks (trays)

The following rack types are available:

Sample Rack for	Vial/Tube Size	Part No.
40 vials	1.8 mL or 2 mL	6820.4070
40 vials (<i>conical</i>)	1.1 mL	6820.4087
40 vials (Eppendorf)	0.5 mL	6820.4096
40 vials (Eppendorf)	1.5 mL	6820.4094
10 vials (<i>cylindrical</i>)	10 mL	6820.4086
22 vials (<i>cylindrical</i>)	4 mL	6820.4084
72 vials (<i>cylindrical</i>)	1.2 mL	6820.4090
72 vials (<i>cylindrical</i>)	0.3 mL	6820.4091
72 micro-dialysis vials	0.3 mL	6820.4097

If you are using well plates, the well plates, too, must be placed on a suitable sample rack. The following rack types are available for well plates:

Sample Rack for	Part No.
Normal well plates (12 - 24 mm high)	6820.4070, 6820.4086, 6820.4087, 6820.4090, or 6820.4091
Deep-well plates (34 - 46 mm high)	6820.4079
Deep well plates (20 - 32 mm high)	6820.4089
Deep-well plates (30 - 36 mm high)	6820.4083
Low well PCR plates (8 - 12 mm high)	6820.4070, 6820.4086, 6820.4087, 6820.4090 or 6820.4091 In addition, an adapter (part. no. 6820.4088) is required.

In addition, three 5-position holders for 10-mL vials, such as reagent vials, are installed in the carousel (→ page 64).

For information about the vials and (deep) well plates recommended by Thermo Fisher Scientific and the required minimum and maximum container heights, see the table below. The part number always refers to the packing unit. Unless otherwise stated, the packing unit is 1 unit. For more information, contact the Thermo Fisher Scientific sales organization for Dionex HPLC Products.

Sample Container (Min. - Max. Heights)	Description	Part No.
Vials (31 - 43 mm)	Cylindrical vial up to 1.8 mL (O.D. < 12 mm) e.g. 250 µL vials (1000 vials) Caps and seals for 250 µL vials for 40-position rack (part no. 6820.4070)	6820.0029 6820.0028
1.1 mL vials (31 - 43 mm)	Conical vial Crimp cap and slotted silicone/PTFE septum for 40-position rack (part no. 6820.4087)	6000.0077 6000.0076
1.1 mL vials (31 - 43 mm)	Conical vial Screw cap Silicone seal for 40-position rack (part no. 6820.4087)	6000.0078 6000.0057 6000.0058
1.2 mL vials (31 - 43 mm)	Cylindrical vial Crimp cap Septum (silicone/PTFE, slotted) for 72-position rack (part no. 6820.4090)	6000.0062 6000.0064 6000.0061
1.8 mL vials (31 - 43 mm)	Cylindrical vial Crimp cap and septum for 40-position rack (part no. 6820.4070)	6000.0072 6000.0071
2.0 mL vials (31 - 43 mm)	Cylindrical vial Screw cap Silicone seal for 40-position rack (part no. 6820.4070)	6000.0060 6000.0057 6000.0058

Sample Container (Min. - Max. Heights)	Description	Part No.
4 mL vials (36 - 48 mm)	4 mL vial Screw cap Silicone/PTFE septum for 22-position rack (part no. 6820.4084)	6000.0074 6000.0073 6000.0075
10 mL vial (38 - 50 mm)	Cylindrical vial with cap and seal for 5-position holder (part no. 6820.4073)	6820.0023
1.5 mL Eppendorf tubes	Eppendorf vials without caps or with caps when marked or specified as piercable; for example, Eppendorf Standard Micro Test Tube 3810 for 40-position Eppendorf rack (part no. 6820.4094)	Not available from Thermo Scientific
0.5 mL Eppendorf tubes	Eppendorf vials without caps or with caps when marked or specified as piercable; for 40-position Eppendorf rack (part no. 6820.4096)	Not available from Thermo Scientific
Normal well plate (12 - 24 mm)	96 wells 384 wells <i>Note:</i> Install these well plates on one of the appropriate racks listed on page 30. Sealing cap for 96-well plate Sealing cap for 384-well plate	6820.4100 6820.4110 6820.4102 6820.4112
Deep-well plate (34 - 46 mm)	96 wells Sealing cap for 96-well plate 384 wells 24 wells <i>Note:</i> For all deep well plates, a special support rack is required (part no. 6820.4079). Do <i>not</i> install these deep well plates on a support rack other than this special rack. For the 24 deep well plates, an adapter for the vial pusher must be installed (part no. 6820.2402).	6820.4101 6820.4102 Contact Thermo Scientific. Contact Thermo Scientific.

Observe the following:

- Using septa other than those mentioned above may block the capillaries or affect chromatographic results.
- Eppendorf vials *must* be uncapped.
- If you want to use *uncapped* 10 mL vials, installation of the vial pusher adapter is recommended (part no. 6820.2402). When the adapter is installed, the automatic tray test *must* be disabled (→ page 97).
- If you want to use sample containers other than those mentioned above, observe the required minimum and maximum heights.

2.8 Compartment Lights

Two lights are installed on the inside front panel to illuminate the sample compartment during autosampler operation. To avoid personal injury when you reach inside the sample compartment, the lights signal needle arm movement. Before the needle arm moves to a different position, the lights turn off and on again.

This function is enabled by default. In Chromeleon, set **TrayIllumination** to **Off** if your samples are sensitive to light.

2.9 Fluidic Connections

The front panel tilts upward (→ page 23) to provide easy access to the fluidic connections in the autosampler. The open cover locks in the topmost position.

 **Important:** The open front panel is not designed to carry weight. Therefore, you should not place any objects on the open front panel door.

For the fluidic connections, use only the capillaries shipped with the autosampler and original Dionex spare capillaries.

Reuse used fittings with steel ferrules only for the same capillary connection. This is to avoid increased dead volume. nanoViper capillaries can be repeatedly reused for different capillary connections.

 **Important:** Ne placez aucun objet sur la porte ouverte du panneau avant. Ceci peut endommager la porte.

Utilisez uniquement les capillaires fournis avec le passeur d'échantillon et les capillaires de rechange d'origine Dionex.

La réutilisation des raccords et férules en acier n'est possible que pour la connexion capillaire d'origine, afin d'éviter l'apparition de volumes morts. La réutilisation des raccords nanoViper pour des autres connexions capillaire est possible.

2.10 Leak Sensor

A leak sensor is installed inside the autosampler. If liquid collects in the drip tray, the leak sensor reports a leak, and the **Status** LED on the front panel door is red. In addition, a message appears on the front panel display and in Chromeleon and a beep alerts you, depending on the leak sensor mode setting (→ page 83).

When the leak sensor reports a leak, eliminate the cause for the leakage and dry the leak sensor (→ page 111). If the sensor is not dry, the **Status** LED remains red. To remove the message from the display, select **Clear** on the navigation bar (→ page 80).

2.11 Injection Valve

The autosampler is equipped with *one* 2-position, 6-port Cheminert® injection valve. The injection valve is suitable for the following pressures.

Injection valve	Material	Maximum pressure	Description
WPS-3000PL RS	SST	90 MPa (13050 psi)	1/16", 0.25 mm, 50°C
WPS-3000PL, WPS-3000TFC	SST	35 MPa (5000 psi)	1/16", 0.25 mm, 75°C
WPS-3000TBPL, WPS-3000TBFC	PAEK	35 MPa (5000 psi)	1/16", 0.25 mm, 50°C

The injection valve has two operating positions: **Load** and **Inject**. While the valve is in the **Load** position, sample is drawn by the syringe, through the needle, into the sample loop. When the injection valve is switched into the **Inject** position, the solvent flow is directed from the sample loop through the high-pressure flow path to the column.

The components are connected to the valve as follows:

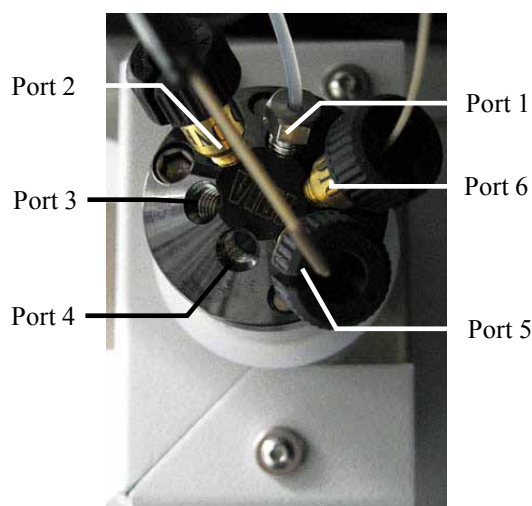

Fig. 7: Connections on the injection valve (here WPS-3000PL RS)

Port	Connect the ...	Port	Connect the ...
1	Syringe/buffer tubing	4	Column
2	Sample loop	5	Sample loop
3	Pump	6	Needle

When you operate a biocompatible autosampler, observe the instructions for connecting the capillaries to the injection valve (→ page 144).

The WPS-3000TFC has *two* 2-position, 6-port switching valves: injection valve and fractionation valve. For information about the fractionation valve, see section 8.2.1.2 (→ page 137).

2.12 Chromeleon Software

The autosampler can be controlled by the Chromeleon Chromatography Management System. To control the autosampler, an appropriate Chromeleon version and a **Timebase Class 1** Chromeleon license are required. For the WPS-3000TFC, a fraction collection license is required in addition to the **Timebase Class 1** license (→ page 139).

Two modes of software control are available:

- *Direct Control*
With direct control, you select operating parameters and commands in the **Commands** (F8) dialog box or on a control panel. Direct commands are executed as soon as they are entered. For more information about direct control, see page 72.
- *Automated Control*
With automated control, you create a program (or PGM File). This is a list of control commands, executed in chronological order, for automated operation of the autosampler. Programs can be created automatically with the help of a software wizard or manually by editing an existing program. For more information about automated control, see page 74.

 **Tip:** All software details in this manual refer to *Chromeleon 6.80*.

If you want to operate the autosampler with Chromeleon 7, refer to the following documents for information about how to perform the related processes in Chromeleon 7 (all documents are included in the Chromeleon 7 shipment)

- *Chromeleon 7 Help*—provides extensive information and comprehensive reference material for all aspects of the software.
- *Quick Start Guide*—describes the main elements of the user interface and guides you step-by-step through the most important workflows.
- *Reference Card*—provides a concise overview of the most important workflows.
- *Installation Guide*—provides basic information about module installation and configuration. For specific information about how a certain module, refer to the Chromeleon 7 Instrument Configuration Manager Help.

Please also note the following:

- Chromeleon 7 terminology is different from the terminology used in Chromeleon 6.80. For details, refer to the 'Glossary - Chromeleon 7.0,' which is available in the Documents folder of your Chromeleon 7.0 installation.
- Chromeleon 7 may not yet support all functions supported in Chromeleon 6.80.

2.13 System Wellness and Predictive Performance

The autosampler supports several system wellness and reliability features that can help you detect small problems before they turn into big ones:

- Internal monitoring of all mechanical operations
- Automatic self-test upon power-up
- Automatic needle overload protection (puncturer)
- Automatic plate and vial detection (→ page 97)
- Leak sensor (→ page 111)
- Monitoring of the cooling performance by three temperature sensors

When an error is detected, the **Status** LED on the front panel is red and a message appears on the front panel display (→ page 104).

When the autosampler is operated with Chromeleon, additional functions for estimating the lifetime of consumables and monitoring and recording service and (re)qualification information (= predictive performance) are available (→ page 93).

3 Installation

3.1 Facility Requirements

The installation site must meet the following requirements:

- The main power switch and the main power receptacle are on the rear panel. Make sure that
 - ◆ Free and unrestricted access to the main power switch is ensured at all times.
 - ◆ The power cord of the device can be easily reached and disconnected from the power line at all times. Provide sufficient space behind the device to unplug the cable.
- Make sure that the installation site meets the power and environmental specifications listed in the Technical Information section (→ page 159).
- Install the instrument in the laboratory on a stable surface that is free of vibrations.
- Make sure that the surface is resistant to solvents.
- Avoid locations with extreme changes in temperature (such as direct sunlight or drafts) and high humidity.
- Allow sufficient clearance behind and on the sides of the autosampler for power connections and ventilation.

3.2 Unpacking

All electrical and mechanical components of the autosampler are carefully tested before the instrument is shipped from the factory. After unpacking, please inspect the instrument for any signs of mechanical damage that might have occurred during transit.

i **Tips:** Immediately report any shipping damage to both, the incoming carrier and Thermo Fisher Scientific. Shipping insurance will compensate for the damage only if reported immediately.

Keep the original shipping container and the packing material. They provide excellent protection for the instrument in case of future transit. Shipping the unit in any other packaging automatically voids the product warranty.

1. Place the shipping container on the floor and remove the white accessories kit and the power cord. All moving parts of the rotary unit (racks, well plates) and the wash liquid reservoir are shipped in a separate box.

2. Grasp the autosampler by the sides. Slowly and carefully, pull the instrument out of the shipping container and place it on a stable surface.

⚠ Important: A team effort is required to lift or move the autosampler. The autosampler is too heavy and/or bulky for one person alone to lift or move safely.

To prevent the unit from falling, lift the unit by the sides. Do not lift the autosampler by the packing material. When lifting or moving the autosampler, always lift by the bottom or sides of the unit.

⚠ Important: Vous ne devriez pas soulever le passeur d'échantillon seul. Le passeur d'échantillon est trop lourd et trop encombrant pour une seule personne.

Lorsque vous soulevez ou déplacez le passeur d'échantillon, soulevez toujours par le bas ou les côtés, avec le panneau avant fermé afin de ne pas endommager l'instrument. Lorsque vous soulevez ou déplacez le passeur d'échantillon, soulevez toujours par le bas ou les côtés.

3. Remove the foam spacers, and then remove the polythene packaging.
4. Remove the foam inserts that protect the autosampler during shipment.
 - ◆ Tilt the front panel upward and remove the two foam inserts that secure the front panel.
 - ◆ A foam insert secures the needle arm and carousel cover, and serves as the shipping container for the preformed capillary from the pump to the autosampler. Remove the foam insert and capillary.
5. Before connecting the autosampler to the power supply, wait approximately 4 hours to allow the instrument to come to room temperature and to allow any condensation that might have occurred during shipping to evaporate. After 4 hours, check the autosampler; if condensation still exists, allow the autosampler to continue to warm up (without connecting it to the power source) until the condensation is completely gone.

3.3 Positioning the Autosampler in the UltiMate 3000 System

If the autosampler is part of an UltiMate 3000 system, Thermo Fisher Scientific recommends stacking the individual modules, for example, as shown in Fig. 8. The arrangement of the system modules depends on the application.



Fig. 8: Example for an UltiMate 3000 RSLCnano system

Apart from the Solvent Rack, all modules of the UltiMate 3000 system can be connected separately to the computer. However, Thermo Fisher Scientific recommends interconnecting all modules, and then connecting the system to the Chromeleon computer via only one connection. If the system includes a DAD-3000(RS) or MWD-3000(RS), you can use *only* the hub on the detector for the connection. If the system includes a VWD-3x00(RS), use the hub on the pump.

3.4 Connecting the Autosampler

3.4.1 General Information

If you want to operate the autosampler with Chromeleon

Verify that Chromeleon is installed on the computer and that the license code is entered *before* you connect the autosampler to the USB port on the Chromeleon computer and turn on the autosampler power. Only if you install Chromeleon first, the USB driver for the autosampler is automatically loaded and the Windows[®] operating system can detect the autosampler when the power is turned on.

3.4.2 Connecting the USB Cable

Connect the autosampler to the Chromeleon computer via the USB ports on the rear panel (→ Fig. 5, page 28). To do so, select one of the following alternatives:

- Connect the autosampler directly to the USB port on the computer.
- Connect the autosampler to the internal USB port on another module in the UltiMate 3000 system that is connected to the computer.

 **Tip:** For detailed information about how to interconnect the individual modules for nano and cap HPLC applications, see further documentation:

- ◆ WPS-3000(T)PL RS: the *Operating Instructions* for the UltiMate 3000 NCS Nano Cap System
 - ◆ WPS-3000(T)PL, WPS-3000TBPL Nano/Cap: the UltiMate 3000 Proteomics MDLC System Manual.
 - ◆ WPS-3000TBPL Analytical: the *Operating Instructions* for the UltiMate 3000 pump.
- Connect the autosampler to computer via an external USB hub.

The following cables are available:

Cable	Part No.
USB cable, type A to type B High Speed USB 2.0 (cable length: 5m)	6035.9035 (shipped with the autosampler)
USB cable, type A to type B High Speed USB 2.0 (cable length: 5m)	6911.0002

 **Tip:** The USB standard limits the USB cable length to 5 meters. Each USB device can be separated from the PC or next USB hub by no more than 5 meters.

3.4.3 Connecting the Power Cord

Use the power cord shipped with the autosampler to connect the instrument to the main power source. Connect the power cord from the main power receptacle on the rear panel to the power source that is connected to a true ground. No adjustment is required to adapt the line voltage to local voltage requirements.



Warning:

Never use a power cord other than the power cords provided for the device.

Do not use multiple sockets or extension cords. Using defective multiple sockets or extension cords may cause personal injury or damage to the device.



Avertissement: Utilisez uniquement les cordons d'alimentation électrique spécifique à l'instrument.

N'utilisez pas des blocs multiprise ou des câbles prolongateurs. Cela pourrait entraîner des blessures corporelles ou endommager l'instrument.

3.4.4 Connecting the Digital I/O

To connect an external device to the digital I/O ports on the rear panel (→ Fig. 5, page 28), use the 6-pin mini-DIN cable (part no. 6000.1004).

1. Plug the 6-pin connector of the mini-DIN cable into the **Digital I/O port 1 (2, 3, or 4)**.
2. For each relay output or digital input to be used, connect the appropriate signal wire and ground wire to the corresponding connectors on the external device (→ documentation provided with the external device).
3. When configuring the autosampler in the Chromeleon **Server Configuration** program (→ page 44), make the following settings:
 - ◆ On the **Relays** page, select the corresponding relay output (→ page 51).
 - ◆ On the **Inputs** page, select the corresponding digital input (→ page 51).

The port numbering on the rear panel corresponds to the numbering of the relays and digital inputs in Chromeleon.

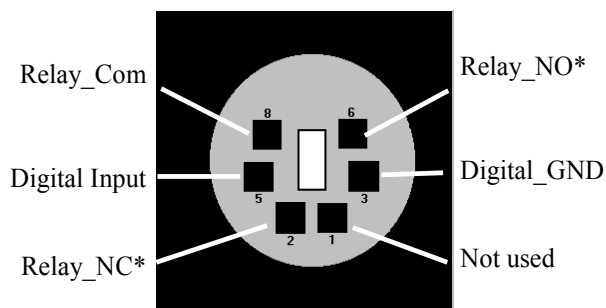

COM is the common contact for NO and NC. If the relay is not activated or if the autosampler is turned off, the connection is between COM and NC. If the relay is activated, the connection is between COM and NO.

* NO = normally open contact; NC = normally closed contact

Fig. 9: Digital I/O (view from the rear)

	Description
Digital Input ↔ Digital GND	0 to +5V
Relay_Com ↔ Relay_NO (or Relay_NC)	Switching voltage: 100V DC; switching current: 0.25 A Carry current: 0.5 A; Switching capacity: 3W Contact resistance: max. 200 mΩ

Fig. 10: Digital I/O

The table lists the functions assigned to the connector pins. It also provides information about the core colors and core labels for each pin:

Pin	Signal Name	Signal Level	Core Color	Core Label
1	Not used		pink	Analog High
2	Relay_NC	Max. 100VDC/0.25A/3W	gray	Analog Low
3	Digital_GND	0V	green	Digital GND
5	Digital Input	0 to +5V	yellow	Digital Input
6	Relay_NO	Max. 100VDC/0.25A/3W	brown	Digital Output
8	Relay_COM	Max. 100VDC/0.25A/3W	white	Dig./Out (GND)
			black	Shield

Fig. 11: Pin assignment (6-pin Mini-DIN port and cable)

Inject Synchronization with a Mass Spectrometer

Relay 4 is used by the autosampler to send an injection response signal. A typical application is that the autosampler automatically provides a start signal to a mass spectrometer. In this case, connect the mass spectrometer to the Digital I/O port 4. It is *not* required to enable Relay_4 in the Chromeleon Server Configuration. The duration of the provided signal can be defined in the Chromeleon **Commands** dialog box:

1. Press F8 or click **Command** on the **Control** menu.
2. Click the plus sign beside **Sampler**.
3. Select **Relay4Enabled**.
4. Select a duration between 1 s (**1sec_InjectOut**) and 10 s (**10sec_InjectOut**) from the list.
5. Click **Execute** and close the dialog box.

If you do *not* want to start the mass spectrometer *immediately* after the injection, you can configure another relay to provide the start signal manually. The relay must be enabled in the Chromeleon Server Configuration, and the corresponding Relay On/Off commands must be included in the program.

i **Tip:** If you do not want to use relay 4 for inject synchronization, you can enable relay 4 for user-defined control under Chromeleon by setting the **Relay4Enabled** property in Chromeleon to **Yes**.

3.5 Setting Up the Autosampler in Chromeleon

This section provides brief instructions for setting up Chromeleon. For details about any of these steps, see the *Chromeleon Help*.

 **Tip:** When the autosampler is connected to the Chromeleon computer, verify that the Chromeleon software is installed *before* turning on the autosampler power for the first time. Only then, the Windows operating system will detect the autosampler automatically when the autosampler power is turned on.

3.5.1 Loading the USB Driver for the Autosampler

1. Turn on the computer power, if it is not already on.
2. Under Windows[®] Vista[®], Windows[®] XP, Windows[®] 7 or Windows[®] Server 2008, log on as a
 - ◆ local administrator if the computer is a local computer.
 - ◆ user with local computer administrator privileges if the computer is a network computer.
3. Open the Chromeleon **Server Monitor** program by double-clicking the Chromeleon Server Monitor icon  on the Windows taskbar.

If the Server Monitor icon is not on the taskbar, click **Start** on the taskbar, point to **Programs** (or **All Programs**, depending on the operating system), point to **Chromeleon**, and then click **Server Monitor**.

4. Click **Start** to start the server.
5. Click **Close** to close the Server Monitor window. The Server Monitor icon  appears on the taskbar.

 **Tip:** Clicking the **Quit Monitor** button quits (exits) the Server Monitor program, but does not stop the server. To stop the server, click **Stop**.

6. Turn on the main power switch on the rear panel of the autosampler.

7. *Windows Vista, Windows 7, and Windows Server 2008*

will automatically detect the new autosampler and perform the USB installation.

If Windows fails to detect the autosampler and launches a wizard instead, this indicates that you connected the autosampler to the computer and turned on the power for the first time *before* you installed Chromeleon. To resolve the problem:

- a) Click **Cancel** to exit the wizard.
- b) Turn off the autosampler and unplug the USB cable from the computer.
- c) Install Chromeleon.
- d) Reconnect the USB cable to the computer and turn on the power to the autosampler. Windows will now detect the autosampler and install the USB software for the autosampler automatically.

Windows XP

will automatically detect the new autosampler and launch the **Found New Hardware Wizard**, which guides you through the USB installation. Select the following options:

- a) If asked whether Windows can connect to Windows Update to search for software, select **No, not this time**.
- b) Accept the default option (**Install the software automatically**) and click **Next>**.
- c) Click **Finish** when the wizard reports that the software for the autosampler has been installed.

If Windows fails to detect the autosampler and a message box asks for a USB configuration file (cmwdmusb.inf), this indicates that you connected the autosampler to the computer and turned on the power for the first time *before* you installed Chromeleon.

To resolve the problem:

- a) Click **Cancel** in the Windows message box.
- b) Turn off the autosampler and unplug the USB cable from the computer.
- c) Install Chromeleon.
- d) Reconnect the USB cable to the computer and turn on the power to the autosampler. Windows will now automatically detect the autosampler and launch the **Found New Hardware Wizard**.

3.5.2 Installing the Autosampler

After the USB software for the autosampler has been installed (→ page 44), install and configure the autosampler in Chromeleon:

1. Start the Chromeleon **Server Monitor** if it is not already running (→ page 44).
2. Start the Chromeleon **Server Configuration** program by clicking **Start** on the taskbar. Point to **Programs** (or **All Programs**, depending on the operating system), point to **Chromeleon**, and then click **Server Configuration**.
3. If necessary, click the plus sign beside the server name to display the items underneath.
4. Select the timebase to which the autosampler will be assigned, or create a new timebase (on the **Edit** menu, click **Add Timebase**).
5. Open the **Add device to timebase** dialog box. To do so, click **Add Device** on the **Edit** menu or right-click the timebase and click **Add Device** on the menu.
6. On the **Manufacturers** list, click **Dionex HPLC: UltiMate 3000** and on the **Devices** list, click **WPS-3000(RS) Autosampler**.
7. A wizard guides you through the installation. Chromeleon connects to the autosampler and transfers the settings from the instrument firmware to Chromeleon, setting the options on the wizard pages accordingly.
8. On each wizard page, verify that the settings are correct and select additional settings if needed. For a description of the wizard pages, see section 3.5.3.1 (→ page 47).
9. Click **Finish** to complete the installation of the autosampler.
10. On the **File** menu, click **Save Installation** and then close the Server Configuration program.

3.5.3 Configuring the Autosampler

3.5.3.1 Initial Installation

During the installation, Chromeleon connects to the autosampler and transfers the settings from the instrument firmware to Chromeleon, setting the options on the wizard pages accordingly. Verify that the default settings are correct and make additional settings if needed. You may as well reopen the configuration pages later again to change the settings (→ page 51).

i **Tip:** Changing the settings for a specific application in the **Commands** dialog box, in a program file (PGM), or on a control panel, will not change the default settings on the configuration pages.

For additional information about a page, click **Help**.

General Page

Define the general instrument parameters.

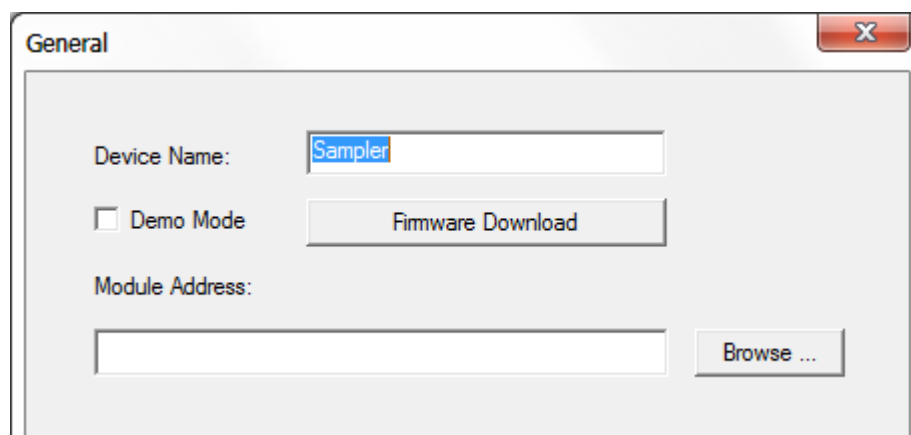

Fig. 12: General page

- **Device Name**
The name used to identify the autosampler the installation environment and in the Chromeleon client program. To control the autosampler with the existing control panels, accept the default name. If you enter a different name, you may have to re-link the controls on the control panels and edit the device name in the program files.
- **Demo Mode**
Verify that the check box is cleared. In the Demo Mode, Chromeleon simulates the functions of the autosampler. If the Demo Mode is enabled, the **Module Address** box will be unavailable. If you exit this page without having entered a module address, the Demo Mode will be enabled automatically.
- **Module Address**
To enter the module address of the autosampler, click **Browse** and then double-click the autosampler that you want to use. The address is automatically entered in the **Module Address** box.

- **Firmware Download**

Clicking this button updates the autosampler firmware with the version available in Chromeleon. (The button appears dimmed if the Demo Mode is enabled.) The autosampler is shipped with the most recent firmware version. If a firmware update is ever required, follow the steps in section 7.9 (→ page 130).

When you leave the **General** page during initial installation of the autosampler (with the Demo Mode being disabled), Chromeleon attempts to connect to the autosampler and to retrieve the settings from the autosampler firmware, and then sets the options on the corresponding pages of the installation wizard accordingly. Confirm the related message with **OK**.

Sharing Page

The timebase in which the autosampler is installed is selected by default. However, the autosampler can be shared by two timebases. From the list of available timebases, select the timebase that will share the autosampler. In the Server Configuration program, the autosampler appears in both timebases so that both timebases can excise commands on the autosampler.

Segments / Pump Link Page

This page indicates which sample containers are installed in the red, green, and blue segments. If the UltiMate 3000 system includes an UltiMate 3000 series low-pressure gradient pump, you can link the autosampler to the pump. Thermo Fisher Scientific recommends always specifying a pump because this setting allows synchronizing the injection command of the autosampler with the strokes of a low-pressure gradient pump. Synchronization ensures that all injections are performed at the same phase of the pump cycle, considerably enhancing considerably the retention time precision with gradient applications.

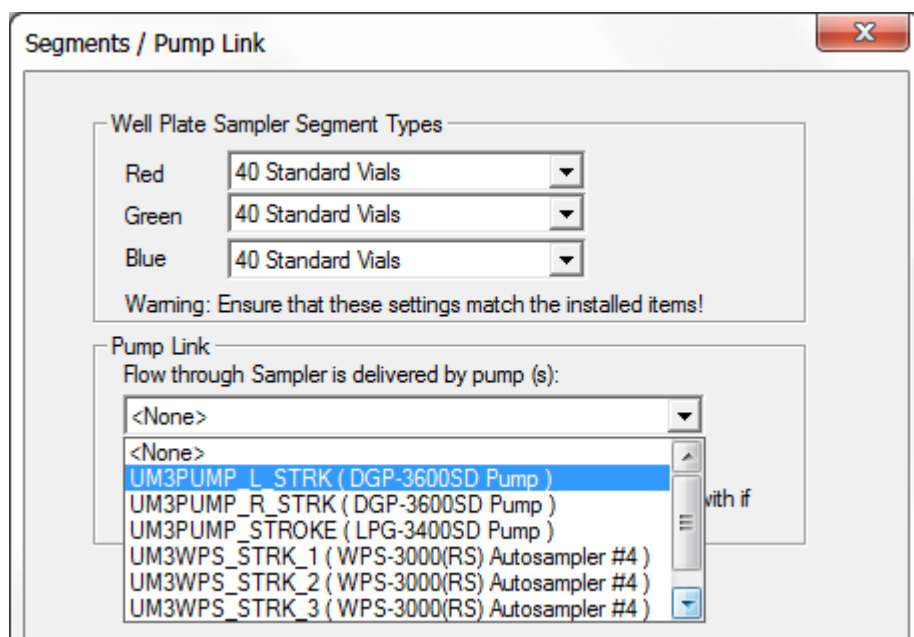

*Fig. 13: Segments / Pump Link page
(here: when the UltiMate 3000 system includes a DGP-3600 pump)*

- **Well Plate Sampler Segment Types**
The section shows which sample containers are installed in the red, green, and blue segments (default setting). Verify that the settings match the installed sample containers. If you later install different sample containers, you have to adapt the settings in Chromeleon accordingly (→ page 89).
- **Pump Link**
Select the pump to which the autosampler is linked on the **Flow through sampler is delivered by pump(s)** list. The list shows all pumps that are installed in the timebase.
 - ◆ *If the UltiMate 3000 system includes a DGP-3600 pump or an NCS-3500 Nano/Cap System*
Select **UM3PUMP_L_STRK** to link the autosampler to the left pump. To link the autosampler to the right pump, select **UM3PUMP_R_STRK**.
 - ◆ *If the UltiMate 3000 system includes a pump other than a DGP-3600*
Select **UM3PUMP_STROKE**.
 - ◆ *If you do not want to link the autosampler to a pump*
Select **<None>**.

Only when the autosampler is linked to a DGP-3600, LPG-3400, or NCS-3500 on this page, synchronization of the injection command with the strokes of the pump will be available. In the Chromeleon Client program, you can then set whether you want to use synchronization and you can select a different pump if necessary (→ page 88).

Options Page

This page shows the autosampler configuration. Verify that the selected options match the installed hardware. Change the settings if necessary and make additional settings as required.

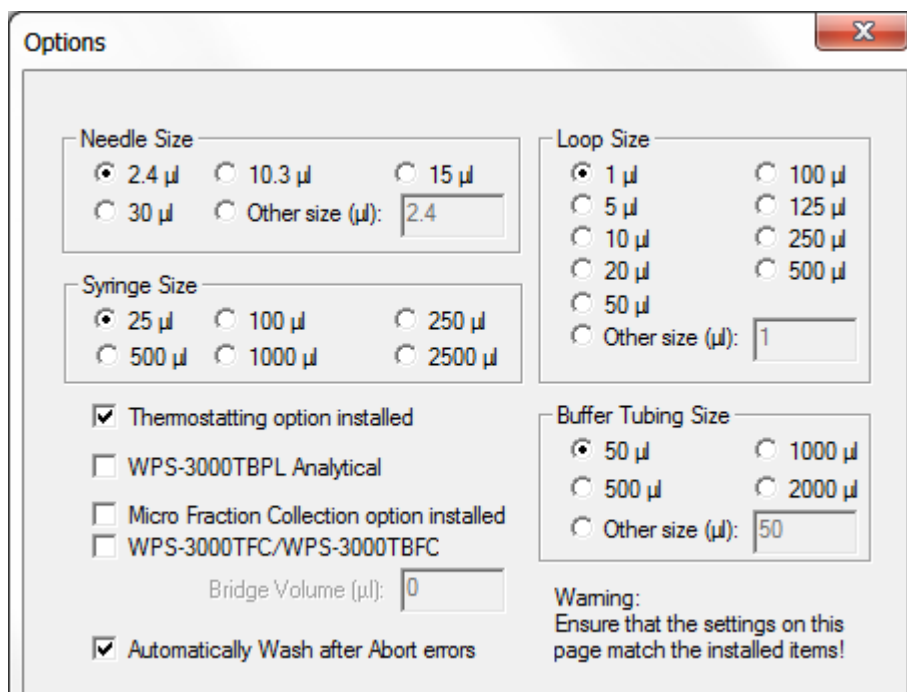



Fig. 14: Options page

- **Needle Size, Syringe Size, Loop Size and Buffer Tubing Size**
Indicate the size of the installed needle, syringe, loop and buffer tubing.
- **Thermostatting option installed**
When the autosampler supports sample thermostatting, verify that the check box is selected.
- **WPS-3000TBPL Analytical**
Verify that the check box is selected if you are operating a WPS-3000TBPL Analytical (biocompatible autosampler for analytical HPLC applications).
If this check box is cleared, some of the functions for analytical systems may not be available and problems may occur during Operational Qualification.
- **Micro Fraction Collection option installed**
Select this check box if the autosampler has the Micro Fraction Collection installed, that is, if the standard 6-port injection valve has been replaced with an 8-port valve for fraction collection. Do *not* select this check box if a WPS-3000(T)FC is installed.
- **WPS-3000FC/WPS-3000TFC**
Verify that the check box is selected if you are operating a WPS-3000TFC. Do *not* select this check box if the Micro Fraction Collection option is installed.

BridgeVolume (µL)

If a capillary connects the two valves in the WPS-3000TFC for fraction collection, the volume of the capillary *must* be indicated in the **BridgeVolume** box. Therefore, verify that the value in the **BridgeVolume** box matches the value indicated on the label of the capillary (6.2 µL for analytical and 1 µL for nano applications respectively).

If the **BridgeVolume** is not set to the correct value, injection errors may occur.

 **Tip:** Keep in mind that you *have to* adapt the value in the **BridgeVolume** box if you install a bridge capillary with a different volume or if you use the autosampler for an application for which the two valves are *not* connected (in this case, set the volume to 0).

- **Automatically Wash after Abort errors**
The check box is selected by default. Accept this setting to have Chromeleon automatically perform a wash cycle when an abort error occurred.

Each time the autosampler is connected in Chromeleon, the settings on the **Segments / Pump Link** and **Options** pages are compared to the instrument configuration reported by the autosampler upon connect. If the instrument configuration and the settings in Chromeleon do not match, the autosampler is disconnected in Chromeleon and a message appears in the Audit Trail. Check and match the settings if necessary by clicking either **Retrieve configuration from module** or **Send configuration to module** on the **General** page (→ page 47).

Relays Page

The **Relays** page lists all available relays (Relay_1 to Relay_4). Select a check box to enable the corresponding relay. If a check box is cleared, the relay will not be available in Chromeleon. To change the relay name or timebase assignment, double-click the relay name (or press the **F2** button) and make the changes in the **Devices Configuration** dialog box.

i **Tip:** Relay 4 is used by the autosampler to send and injection response signal. A typical application is that the autosampler automatically provides a start signal to a mass spectrometer (→ page 43). Therefore, if you need to use a relay to be controlled by Chromeleon, choose a different relay. If you want to use relay 4, you will have enable relay 4 by setting the **Relay4Enabled** property in Chromeleon to **Yes**.

Inputs Page

The **Inputs** page lists all available remote inputs (Input_1 to Input_4). Select a check box to enable the corresponding remote input. If a check box is cleared, the input will not be available in Chromeleon. To change the input name or timebase assignment, double-click the input name (or press the **F2** button) and make the changes in the **Devices Configuration** dialog box.

3.5.3.2 Changing the Configuration Properties

To change the default configuration settings, reopen the configuration pages.

1. Start the **Server Configuration** program (→ page 46).
2. Right-click the autosampler in the timebase and select **Properties** on the menu.
3. Change the settings as needed. For a description of the wizard pages, see section 3.5.3.1 (→ page 47).

Note that Chromeleon provides two more buttons on the **General** page. They allow you to match the configuration of the autosampler with the settings in Chromeleon.

Button	Description
Retrieve configuration from module	Click this button to transfer the current autosampler configuration to Chromeleon. The settings on the Segments / Pump Link and Options pages will be updated accordingly. This is necessary only if you connect a different autosampler or if automatic matching was not performed correctly when the wizard was started.
Send configuration to module	Click this button to transfer the settings from the Chromeleon Segments / Pump Link and Options pages to the autosampler.

In addition to the pages provided during the initial installation of the autosampler, Chromeleon provides an **Error Levels** page. This page classifies the severity of any errors that occur. It is generally not necessary to change the default settings.

4. To save the changed configuration, click **Save** on the **File** menu and then close the **Server Configuration** program.

3.6 Setting Up the Autosampler in DCMSLink

To set up the autosampler in DCMSLink, refer to *DCMSLink Installation Guide*, which is provided on the DCMSLink DVD in the *Additional Documents\DCMSLink User Documents* folder.

1. Install and configure the DCMSLink software (→ *DCMSLink Installation Guide*).
2. Open the Chromeleon **Server Configuration** program (→ *DCMSLink Installation Guide*).
3. In the **Server Configuration** program, add the autosampler to the timebase. Follow the appropriate steps in section 3.5.2 (→ page 46).
4. Configure the autosampler as described in section 3.5.3 (→ page 47).

For more information about DCMSLink, refer to the *DCMSLink Quick Start Guide*, which is also provided on the DCMSLink DVD and to *DCMSLink Help*.

4 Preparation for Operation

4.1 Overview of Actions

⚠ Important: The autosampler is filled with 2-propanol when being shipped from the factory. During initial operation of the autosampler, make sure that the solvents used are miscible. Otherwise, use an appropriate intermediate solvent.

When connecting capillaries, make sure that the connectors are free from contaminants. Even minute particles may cause damage to the system.

To prevent damage to the 13050 psi valve, make sure that you do not switch the valves dry when operating the WPS-3000(T)PL RS.

⚠ Important: Le passeur d'échantillon est stocké sous 2-Propanol. Au cours du démarrage du passeur d'échantillon, assurez-vous que les solvants utilisés soient miscibles avec le 2-Propanol. Sinon, suivez les étapes intermédiaires appropriées.

Lorsque vous connectez les capillaires, assurez-vous que les raccords sont exempts de contaminants. Même d'infimes particules peuvent endommager le système.

Ne faites pas fonctionner la vanne du WPS-3000(T)PL RS (13050 psi/ 900 bar) à sec. Il peut en résulter des dommages à la vanne.

After you have unpacked, positioned and connected the autosampler as described in sections 3.1 through 3.5 (→ page 37 and following pages), prepare the autosampler for operation. Follow the sequence of steps below:

1. Establish the fluidic connections to the pump and flow manager/column compartment or column. The fluidic connections depend on your application.

For detailed information about the fluidic connections for nano and cap HPLC applications, see further documentation:

- ◆ WPS-3000(T)PL RS: the *Standard Applications* manual for the UltiMate 3000 RSLCnano system.
- ◆ WPS-3000(T)PL, WPS-3000TBPL Nano/Cap: the *UltiMate 3000 Proteomics MDLC System Manual*.
- ◆ *All autosamplers*
Observe the instructions for connecting the capillaries to the injection valve in section 4.2 (→ page 55).
- ◆ *Biocompatible autosamplers*
Observe the instructions for connecting the capillaries to the injection valve in section 8.3 (→ page 144).

2. Check the connections on the injection valve (→ page 34) and/or injection valve and fractionation valve (→ page 135).

⚠ Important: It is important that the contents of the sample loop be transported to the column in back flush mode (→ page 133). Therefore, make sure that you do not interchange the pump and column connections on the injection valve.

⚠ Important: Il est important que le contenu de la boucle d'échantillonnage soit transporté jusqu'à la colonne en mode rétrobalayage (backflush; → page 133). Par conséquent, assurez-vous de ne pas intervertir les raccordements de la pompe et de la colonne sur la vanne d'injection.

3. Install and fill the wash liquid reservoir (→ page 56).
4. Check the connections on the syringe valve (→ page 59).
5. Connect drain tubing (→ page 60).
6. *If you want to operate the autosampler with Chromeleon*
Install the autosampler in Chromeleon if it is not already set up (→ page 44).
Autosamplers for fraction collection
Install the **Fraction Collection** driver in Chromeleon (→ page 139).
7. Turn on the autosampler (→ page 67).
8. Prime the syringe (→ page 60).
9. Install and load the sample racks (→ page 62).
10. Load the 5-position vial holders for the 10 mL vials if applicable (→ page 64).
11. Verify that the needle pair descends correctly into the wash port (→ page 118).
12. *Autosamplers with sample thermostating option only*
Turn on and set the temperature for sample thermostating if applicable (→ page 88).
13. Check and change the leak alarm mode if necessary (→ page 91).
14. Adjust the brightness and contrast of the front panel display if necessary (→ page 91).
15. Before using the autosampler for sample analysis, equilibrate the entire system (→ page 65).

4.2 Tips and Precautions for Connecting Capillaries

When connecting capillaries to the autosampler, observe the following general precautions:

- Observe the precautionary statements for capillaries and capillary connections in section 1.2.2 (→ page 5).
- When you connect capillaries, make sure that the connectors are free from contaminants. Even minute particles may cause damage to the system.
- Different fitting systems are used in an UltiMate 3000 system. Therefore, install the capillaries and fittings only at the positions for which they are intended.
- Use only the capillaries shipped with the autosampler and original Dionex spare capillaries.
- Use Viper capillary connections whenever possible, observing the information in the instructions shipped with the capillary.
- Depending on the fitting connection, also observe the following:
 - ◆ *Viper fitting connections*

Loosen and tighten Viper fitting connections *only* by the black knurled screw and *only* with your hand (do *not* use tools). The knurled screw can easily be removed and reattached to the capillary at any time.

First, tighten the screw hand-tight. If you observe leakage on the connection, tighten the screw a little further. If leakage continues, remove the capillary, carefully clean the capillary ends by using a cloth or tissue wetted with isopropanol, and reinstall the capillary. If the connection continues to leak, replace the Viper capillary.

Capillaries with Viper fitting connections can be reused also for a different connection.
 - ◆ *Conventional fitting connections (non-Viper)*

Do not overtighten these fitting connections. If you observe leakage on the connection, tighten a little further.

If leakage still exists, first consider cleaning the connection port with a cleaning rod (part no. 6040.0006). Replace the capillary and/or fitting if this does not eliminate the problem.

Reuse used fittings and ferrules only for the same capillary connection. This is to avoid increased dead volume or damage to the system and leakage.

Observe the instructions for connecting capillaries in biocompatible autosamplers in section 8.3

4.3 Installing the Wash Liquid Reservoir

Thermo Fisher Scientific recommends that you degas the wash liquid on a continuous basis. If the UltiMate 3000 system includes an LPG-3400 pump or an appropriate SRD-3x00 Solvent Rack, you can degas the wash liquid online via the degasser of the pump or solvent rack.

4.3.1 Connecting the Wash Liquid Lines for Online Degassing

Select one of the following alternatives:

- If a free degassing channel is available, connect the wash liquid line directly to the degasser (see below). In this case, the wash liquid can be any appropriate liquid.
- If a free degassing channel is not available, connect the wash liquid line to the degasser via the UltiMate 3000 system pump (→ page 57). In this case, one of the solvents delivered by the pump must also be an appropriate wash liquid.

All parts required for connecting the wash liquid line are provided in the Online Degas Wash kit, which is included in the accessories kit for the autosampler.

i Tip: To speed up the priming process, you may want to use a 100 μ L syringe instead of the 25 μ L syringe. However, this may reduce the precision and accuracy of the injection.

To connect the wash liquid lines directly to the degasser

1. Fill a reservoir with an appropriate wash liquid.
2. First, prepare and install the wash liquid line in the wash liquid reservoir, and then, connect the free end of the tube to the degasser inlet. (The procedure is identical to connecting the solvent lines. For details, see *Connecting the Solvent Reservoirs* in the operating instructions for the pump or solvent rack.)
3. Place the wash liquid reservoir in the tray of the solvent rack.
4. Connect the long tube from the Online Degas Wash kit to the syringe valve (→ Fig. 17, page 59).
5. Use a capillary cutting tool to cut the free end of the tube to the appropriate length for your application. Make sure to cut square.
6. Connect the free end of the wash liquid line to the degasser outlet. Use the knurled nut and fitting from the Online Degas Wash kit for the connection.
7. Prime the syringe until all air bubbles are gone (→ page 60).

To connect the wash liquid lines to the degasser via the UltiMate 3000 system pump

1. Fill the wash liquid reservoir with an appropriate wash liquid.
2. First, prepare and install the wash liquid line in the wash liquid reservoir. Then, connect the free end of the tube to the degasser inlet. (The procedure is identical to connecting the solvent lines. For details, see *Connecting the Solvent Reservoirs* in the operating instructions for the pump or solvent rack.)
3. Place the wash liquid reservoir in the tray of the solvent rack.
4. Connect the long tube from the Online Degas Wash kit to the syringe valve (→ Fig. 17, page 59).
5. Connect the free end of the tube with the Tee piece from the Online Degas Wash kit.
6. Disconnect the tube from the degasser outlet to the pump on the proportioning valve (or pump inlet, depending on the pump type), and reconnect the tube to the Tee piece.
7. Connect the Tee piece to the proportioning valve or pump inlet, using the short tube from the Online Degas Wash kit.

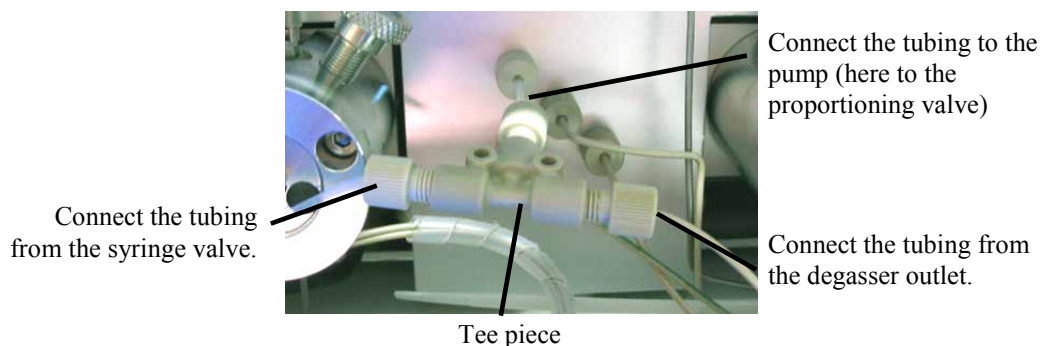

Fig. 15: Example for connecting the wash liquid via the pump

8. Prime the syringe until all air bubbles are gone (→ page 60).

4.3.2 Connecting the Wash Liquid Bottle

A 125 mL wash liquid reservoir is shipped with the autosampler. Follow the steps below to connect the reservoir:

1. Fill the reservoir with an appropriate wash liquid. Before using the wash liquid, degas it either in an ultrasonic bath or on a continuous basis with a vacuum filtration device.

i Tip: For best results with isocratic separations, Thermo Fisher Scientific recommends using a wash liquid that contains the mobile phase (without any salt or modifiers). For best results with gradients, Thermo Fisher Scientific recommends using a wash liquid that corresponds to the start gradient (without any salt or modifiers). It is not recommended to use pure methanol as a wash liquid.

2. Verify that the wash liquid line is installed in the wash liquid reservoir, through the opening in the reservoir cap. Verify also that the tube descends into the reservoir deep enough (preferably to the bottom). (To do so, hold the bottle up to the light.)
3. Connect the other end of wash liquid line to the syringe valve (→ Fig. 17, page 59).

i Tip: To prevent air from entering the system, verify that the tube is completely filled with the wash liquid before you connect the tube to the syringe valve. To fill the tube with the liquid, squeeze the bottle. While doing so, cover the ventilation hole in the bottle with your thumb. Pressure builds up in the bottle, thus filling the tube with the liquid.

4. Insert the assembly of wash liquid bottle and holding clip into the holder that is available in the sample compartment. Make sure that the holding clip locks in place.

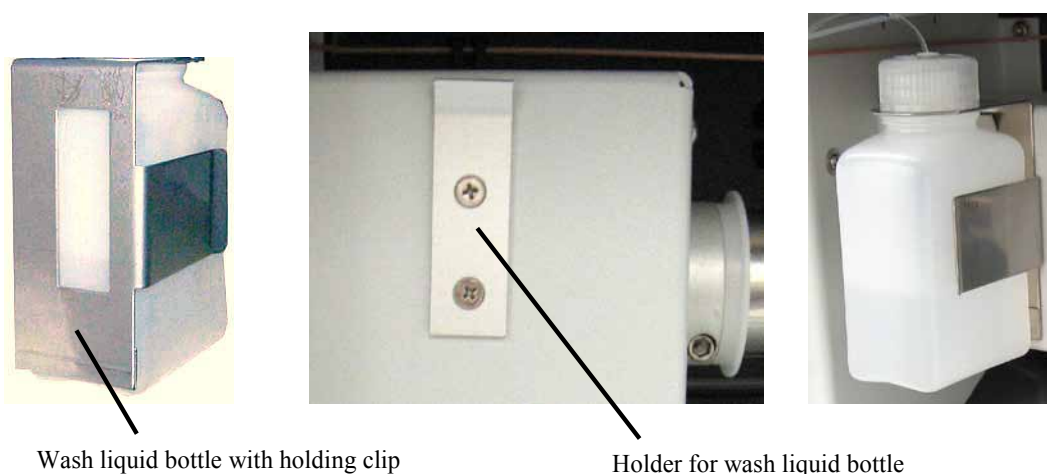

Fig. 16: Installing the wash liquid reservoir in the autosampler

5. Prime the syringe until all air bubbles are gone (→ page 60).

To refill the liquid reservoir or to exchange the wash liquid, hold the reservoir including the holding clip and push both parts vertically toward the top. The holding clip disengages. Remove the reservoir including the holding clip from the autosampler.

i Tip: If more wash liquid is required for your application, you may as well connect a longer tube (with flanged end for the valve fitting) and place a larger reservoir beside the autosampler. To fill this tube, you may have to repeat the flushing procedure several times.

4.4 Connections on the Syringe Valve

On the syringe valve, verify that the buffer tubing, syringe, syringe waste tubing and wash liquid tubing are properly connected. If necessary, retighten the connections.

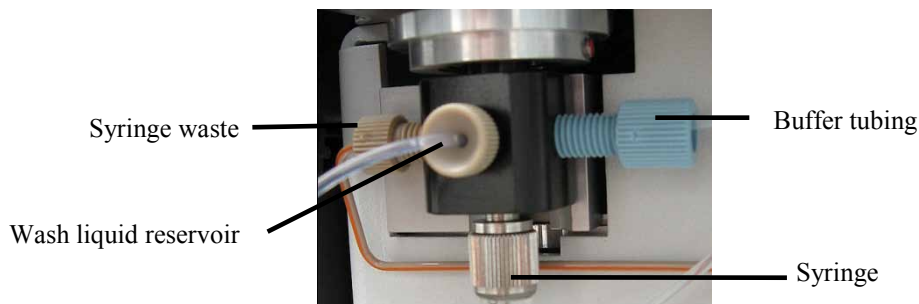

Fig. 17: Connections on the syringe valve

If you retightened the syringe or wash liquid connection, prime the syringe to remove air bubbles trapped in the syringe, syringe valve, and wash liquid lines (→ page 60).

If you retightened the buffer tubing, perform a wash cycle to remove also air bubbles trapped in the buffer tubing. Perform the wash cycle either from the front panel display—show the function keys and select **Wash** (→ page 69) or select **Wash** on the **Control** menu (→ page 81)—or via the **Wash** command in Chromeleon.

4.5 Connecting the Drain Tube

To discharge liquid leaks and waste, the autosampler has two or three drain ports at the bottom right of the instrument (depending on the autosampler version).

- The autosampler without sample thermostating option has *two* drain ports. The syringe waste, wash waste, and liquid leaks are routed inside the autosampler to the drain ports.
- The autosampler with sample thermostating option has *three* drain ports. The syringe waste, wash waste, and liquid leaks are routed inside the autosampler to the front ports. Condensing water that collects in the carousel is routed to the rear port.

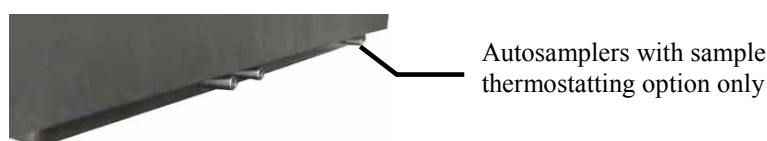

Fig. 18: Drain ports

Direct liquid leaks to waste via the drain system of the UltiMate 3000 system, using the components from the drain kit. The kit is shipped with the pump of the UltiMate 3000 system and can be ordered separately (part no. 6040.0005). The kit includes all required components and detailed installation instructions.

4.6 Removing Air Bubbles from the Syringe (Priming)

Air bubbles in the syringe may affect the measurement results considerably. To prime the syringe and remove air bubbles trapped in the syringe, select one of the following alternatives:

- Prime the syringe from Chromeleon.
- Prime the syringe from the front panel display.

During the prime cycle, all capillaries and tubing connected to the syringe valve are filled and flushed with the wash liquid.

To prime the syringe from Chromeleon

1. In Chromeleon, open the **Commands** dialog box (→ page 72).
2. Under **Sampler**, click **PrimeSyringeNumber**. Enter how often the syringe is filled and emptied during the prime cycle.
3. Execute the **PrimeSyringe** command until the air is completely removed from the syringe (no air bubbles to be seen). Use degassed wash liquid if necessary.
4. If you cannot remove the air from the syringe, see the **Troubleshooting Tip** below.

To prime the syringe from the front panel display

1. Show the function keys and select **Prime** (→ page 77).
2. Prime the syringe until the air is removed completely (no air bubbles to be seen). Use degassed wash liquid if necessary.
3. If you cannot remove the air from the syringe, see the **Troubleshooting Tip** below.

Troubleshooting Tip

1. Remove the syringe (→ page 112).
2. Fill a beaker with wash liquid or a mixture of isopropanol and water (50:50). Hold the syringe into the beaker (syringe input toward the bottom of the beaker).
3. With the plunger completely in the syringe, move the syringe quickly several times to remove gas bubbles that might have gathered at the syringe inlet. If necessary, quickly draw and expel the liquid (several times) until the syringe is free of air.
4. Reinstall the syringe (→ page 112). When connecting the syringe to the syringe valve, make sure that a liquid film covers the syringe inlet. This prevents air from reentering the syringe.
5. Perform a wash cycle either via the **Wash** command in Chromeleon or from the front panel display. To do so, show the function keys and select **Wash** or select **Wash** on the **Control** menu.

4.7 Installing and Loading the Sample Rack

The autosampler is designed to enable easy sample loading. Follow the steps below to install a sample rack. The installation procedure is similar for all rack types.

STOP Warning: To avoid personal injury, do not reach inside the sample compartment during a running analysis.

STOP Avertissement: Afin d'éviter des blessures corporelles, ne mettez pas la main à l'intérieur du compartiment à échantillons lorsqu'une analyse est en cours.

1. Move the carousel cover to the utmost left.
2. Rotate the segment of interest (red, green, or blue) to the front. To do so, select one of the following alternatives:
 - ◆ Manually turn the carousel until the segment is in front.
 - ◆ Show the function keys and select **Rotate** until the segment is in front.
 - ◆ On the **Control** menu, select **Rotate**, and then select **R**, **G**, or **B**.
 - ◆ In Chromeleon, open the **Commands** dialog box, select **InitiateChangeVial**, and then click **BlueTray** (**GreenTray** or **RedTray**) on the **Tray** list..
3. *If you want to use a well plate*
Install the well plate onto the vial rack, aligning the well plate on position A1. Press the well plate onto the vial rack until it locks into position (→ Fig. 19).

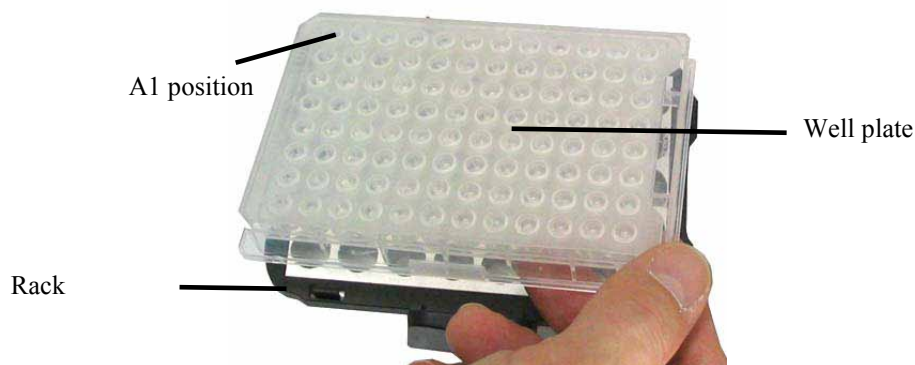

Fig. 19: Installing a well plate on a rack

4. Insert the vial rack (or the rack with well plate) in the carousel as shown in the image. Make sure that the pins on the carousel bottom lock in the rack bottom.

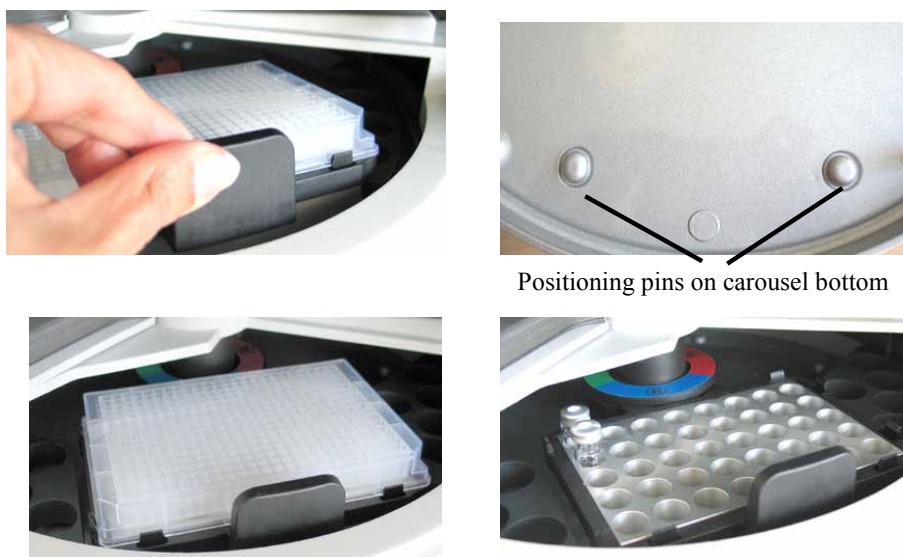

Fig. 20: Top: Inserting a sample rack (here with well plate)
Bottom: Carousel view (left: rack with well plate; right: rack with vials)

As a standard, holders for 10 mL vials, such as reagent vials, are installed at three positions in the carousel. If you operate the carousel *as an exception without* these holders, be sure to align the positioning bracket of the tray with the right end of the segment color.

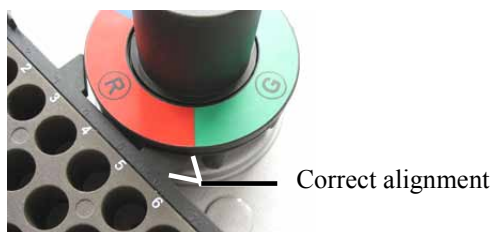

Fig. 21: Sample rack alignment

5. Load the tray with the appropriate vials if applicable (→ page 30).
6. Move the carousel cover back to the utmost right until contact is established to the needle arm.
7. *When the autosampler is operated with Chromeleon*
 - a) In Chromeleon, check and change the sample container settings for the three segments if necessary (→ page 89). The needle might be damaged if the installed sample containers do not match the settings in Chromeleon.
 - b) Adapt the **SampleHeight** if necessary (→ page 95).

4.8 Loading the 5-Position Holders

When the autosampler is shipped, 5-position vial holders for 10 mL reagent and/or transport vials installed at three positions in the carousel. Load the holders with the appropriate vials (→ page 30).



Warning: To avoid personal injury, do not reach inside the sample compartment during a running analysis.



Avertissement: Afin d'éviter des blessures corporelles, ne mettez pas la main à l'intérieur du compartiment à échantillons lorsqu'une analyse est en cours.



Tip: As an alternative, you can install 2 mL vials in the 5-position holders by using adapters (part no. 6820.4092). Set the value of **SampleHeightOffset_T = 9mm** to prevent needle damage while the adapter is used.

1. Move the carousel cover to the utmost left.
2. Rotate the segment of interest (red, green, or blue) to the front. Select one of the following alternatives:
 - ◆ Manually turn the carousel until the segment is in front.
 - ◆ Show the function keys and select **Rotate** until the holder is in front.
 - ◆ On the **Control** menu, select **Rotate**, and then select **R**, **G**, or **B**.
 - ◆ In Chromeleon, open the **Commands** dialog box, select **InitiateChangeVial**, and then click **BlueVials** (**GreenVials** or **RedVials**) on the **Tray** list.
3. Load the holder with appropriate 10 mL vials (→ page 30).
4. Move the carousel cover back to the utmost right until contact is established to the needle arm.
5. *If the autosampler is operated with Chromeleon*
In the **Commands** dialog box (→ page 72), select and adapt the **TransLiquidHeight** if necessary (→ page 95).

When loading the vial holder, install vials of the same type in all five positions.

4.9 Equilibrating the System

Before using the autosampler for sample analysis, equilibrate the UltiMate 3000 system:

1. Pump the starting solvent through the entire system until the system is free of any other liquid composition.
2. Heat or cool all temperature-controlled devices, such as the column oven, to the temperature required for the application.
3. Set the detector wavelengths and turn on the lamps. (Wavelength calibration is performed automatically.)
4. Monitor the pump pressure and verify that the reading is correct for the application and is stable.
5. Monitor the detector signal and verify that the baseline signal is at the expected reading for your application and is stable.

Perform system equilibration in Chromeleon or select the required commands and parameters on the front panel menus of the instruments.

To equilibrate the system from Chromeleon

- Select and perform the operating commands and parameters from the **Commands** dialog box (→ page 72) or from the control panels (→ page 73).
- Create and run an equilibration program to automate the process (→ page 74).

 **Tip:** For the WPS-3000TBPL Analytical, the **SmartStartup** wizard is available. With SmartStartup, the different modules of the UltiMate 3000 system are turned on automatically and in a controlled manner. For the autosampler with sample thermostating, for example, the carousel and all its components are heated or cooled to the desired temperature. In addition, SmartStartup can purge the pump of the HPLC system automatically, flush the column, and perform system equilibration. Important module parameters are monitored. For more information, see the *Chromeleon Help*.

To equilibrate the system from the front panel menus

Select and perform the operating commands and parameters on the front panel menus of the instruments. For information about the autosampler menus, see section 5.5.2 (→ page 78). For information about the menus of other system modules, see operating instructions for the module.

5 Operation and Maintenance

The autosampler can be controlled by the Chromeleon Chromatography Management System. For details, see section 5.4 (→ page 71).

In addition, function keys and menus are available on the front panel display to facilitate operation during, for example, initial installation of the autosampler, diagnostics, and maintenance. They allow you to perform certain actions directly from the autosampler display:

- Performing certain functions (rotating the carousel)
- Executing certain commands (wash, approaching service positions)
- Setting parameters (leak sensor mode, target temperature for sample thermostating)
- Viewing diagnostic information
- Viewing and changing the autosampler configuration

For details, see section 5.5 (→ page 77).

5.1 Power-Up

To start the autosampler for the first time, turn on the main power switch on the rear panel of the autosampler. The following sequence of events occurs when the autosampler is powered up:

- For a short time, general information about the autosampler appears on the front panel display: device type, serial number, boot loader and firmware versions.
- The autosampler runs a series of internal tests. During these self-diagnostics, all of the main components are checked. When testing is complete and has been successful, the initial screen changes to the status screen (→ page 68).
- If an error is detected, the autosampler is not ready for analysis. The **Status** LED on the front panel is red and a message appears on the front panel display. If the autosampler is operated with Chromeleon, the message is logged also in the Chromeleon Audit Trail. Turn off the autosampler, take appropriate remedial action (→ page 103), and turn on the autosampler again.

For routine operation, leave the main power switch on. For routine on/off control, use the standby button on the front of the autosampler (→ page 23). Press and hold the button for one second to allow the autosampler to change the mode. Turn the main power switch off when instructed to do so, for example, before performing a service procedure.

5.2 Status Screen

If the self-test was successful, the initial screen changes to the status screen.

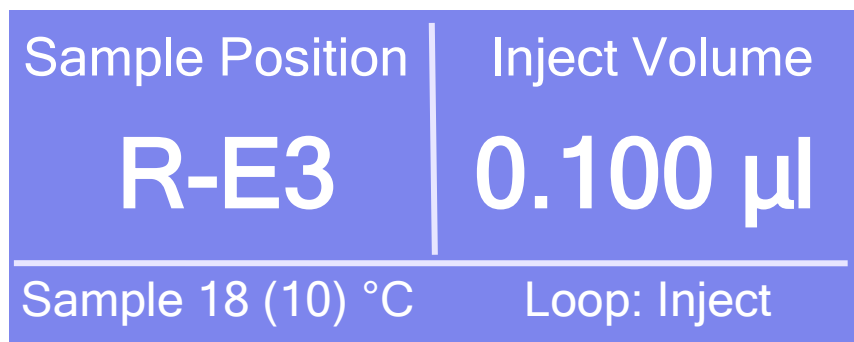

Fig. 22: Status screen

The status screen shows the following information:

- Sample position
For information about the sample position, see page 69.
- Injection volume
- *Autosamplers with sample thermostating only*
Actual temperature and target temperature (in brackets) for sample thermostating
- Valve position (Loop: Inject or Load)

You can adapt the screen brightness and contrast to your requirements if necessary (→ page 91).

5.3 Sample Positions

The segments in the carousel are color-coded R for red, G for green, and B for blue. This information is part of the sample position.

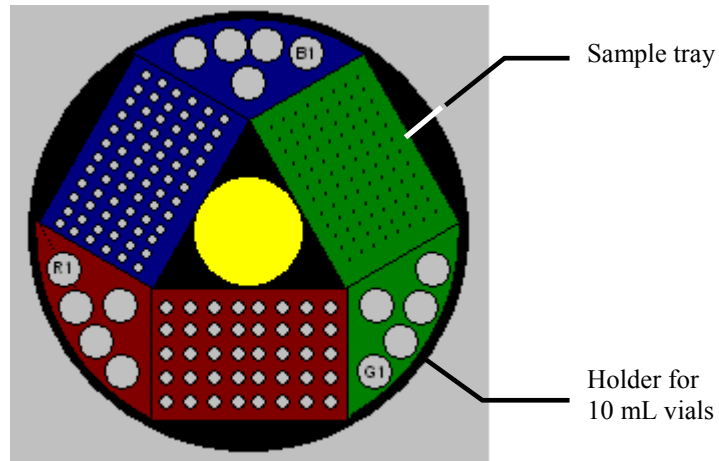

Fig. 23: Sample position (here: rack preview from Chromeleon)

For details about the vial positions on a tray, see below. For information about the positions of the 5-position vial holder, see page 70.

i Tip: The autosampler supports automatic detection of vials and well plates (→ page 97).

Sample positions for vials and (deep) well plates

The character defining the segment that holds the sample container comes first (R, G, or B), followed by a letter and a digit, as in a system of coordinates. The letters specify the individual rows from the inner to the outer row. The digits specify the position of the sample in the row. The numbering is from the left to the right.

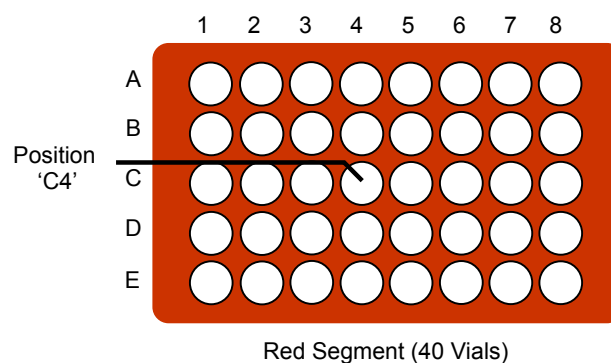

Fig. 24: Example for sample numbering (here: 40-vial rack)

Example

Sample position R-C4 (RC4 in Chromeleon) indicates that the vial is in the

- red segment (R)
- third row (C) in the segment
- fourth hole from the left (4) in the row

Positions of the 5-Position Vial Holder

For the reagent and/or transport vials, the character defining the segment that holds the vial (R, G, or B) comes first, followed by a digit (1-5).

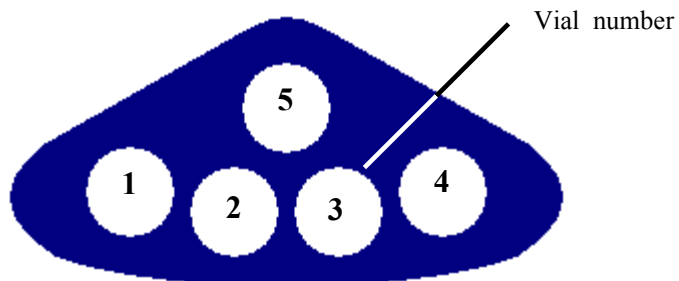

Fig. 25: Positions in the 5-position holder

Example

Position B3 indicates that the vial is in the

- blue segment (B)
- third hole (3)

5.4 Operation with Chromeleon

Before you begin, verify that

1. The Chromeleon software is installed on the computer and the license code is entered.
2. The autosampler is connected to the Chromeleon computer via a USB connection.

 **Tip:** Verify that Chromeleon is installed on the computer and that the license code is entered *before* you connect the autosampler to the USB port on the Chromeleon computer and turn on the autosampler power. Only then, the USB driver for the autosampler is automatically loaded and the Windows operating system can detect the autosampler when the power is turned on.

3. The autosampler is set up in Chromeleon, as described in section 3.5 (→ page 44).

Before you can operate the autosampler with Chromeleon, you have to connect the timebase in which the autosampler is installed to the Chromeleon client program (→ section 5.4.1).

Two modes of software control are available:

- Direct control with the parameters and commands in the **Commands** dialog box (F8 box) or on a control panel (→ page 72)
- Automated control with a control program (PGM) (→ page 74)

5.4.1 Connecting to Chromeleon

1. Start the Chromeleon **Server Monitor** if it is not already running (→ page 44).

2. Start the Chromeleon client by clicking the Chromeleon icon  on the desktop.

If the Chromeleon icon is not on the desktop, click **Start** on the taskbar, point to **Programs** (or **All Programs**, depending on the operating system), point to **Chromeleon**, and then click **Chromeleon**.

3. Connect the Chromeleon client to the timebase in which the autosampler is installed. For details about how to do this from the **Commands** dialog box, see page 72. For details about how to do this on a control panel, see page 73.

When the autosampler is correctly connected to Chromeleon:

- The **Connected** LED on the front panel is green.
- Front panel input is disabled. However, it is still possible to rotate the carousel via the **Rotate** key.
- Functions for estimating the lifetime of consumables and monitoring and recording service and (re)qualification information are provided (→ page 93).
- The **Standby** button on the front panel remains active.

Before turning off the autosampler by the main power switch, always **disconnect** the module in Chromeleon.

5.4.2 Direct Control

With direct control, you select operating parameters and commands in the **Commands** (F8) dialog box. Direct commands are executed as soon as they are entered. For routine operation, most parameters and commands are also available on a control panel.

To open the Commands dialog box

1. Open a control panel (any panel is possible). To open a control panel, open the Chromeleon Browser and double-click a control panel in the **Dionex Templates/Panels** folder.
2. Connect the control panel to the timebase in which the autosampler is installed. On the **Control** menu, select **Connect to Timebase**, and then select the timebase on the **Timebase** tab. For information about the **Timebase** dialog, click **Help**.

 **Tip:** The **Control** menu is visible only when a control panel is already open.

3. Press the F8 key or select **Command** on the **Control** menu..
4. To see the parameters and commands that are available for the autosampler, click the plus sign beside **Sampler**.

The commands and parameters available in the dialog box vary, depending on the

- ◆ Chromeleon version
- ◆ options selected in the **Properties** dialog for the autosampler (→ page 47)
- ◆ display filter level (**Normal**, **Advanced**, or **Expert**)

5. Change the display filter level if necessary. Right-click in the commands list and select the filter level on the menu.

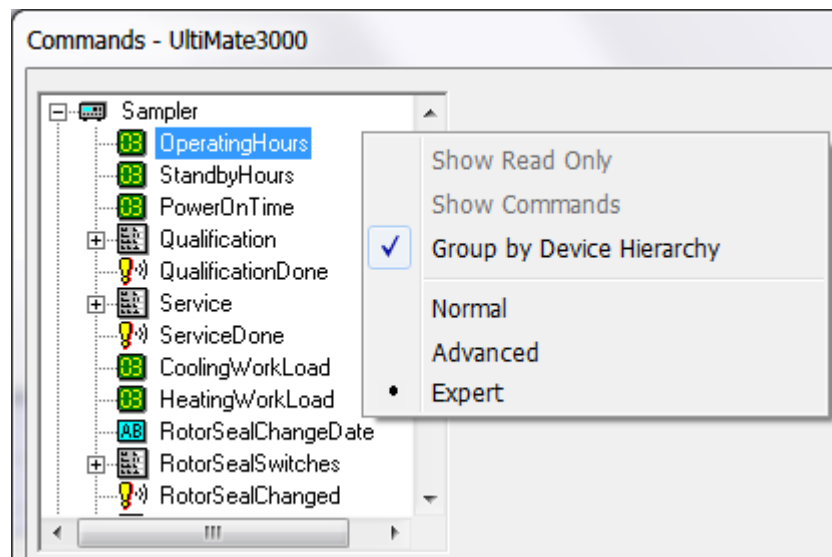

Fig. 26: Commands dialog box

6. Verify that the autosampler is connected to Chromeleon. If it is not, select **Connect** to connect the autosampler.

For a list of the commands and properties that are supported for the autosampler, see the *Chromeleon Help*. In addition to the autosampler commands and parameters, the **Commands** dialog box provides access to all of the commands and parameters available for all devices that are installed in the selected timebase.

To open a control panel

1. On the **View** menu, click **Default Panel Tabset** or click the corresponding icon on the toolbar , and then connect to the Chromeleon server.

Chromeleon creates centralized control panels, called panel tabsets (→ Fig. 27, page 74), for all timebases available on the Chromeleon server. A panel tabset provides control panels for the individual instruments in a timebase and, in addition, one or more panels for performing system-wide functions, for example, creating and running sequences. For more information about panel tabsets, see the *Chromeleon Help*.

2. On the **Panel Tabset** for your timebase, click the **Sampler** page (→ Fig. 27).
3. Verify that the autosampler is connected to Chromeleon (the LED next to the **Connect** button is green). If it is not, click **Connect**.

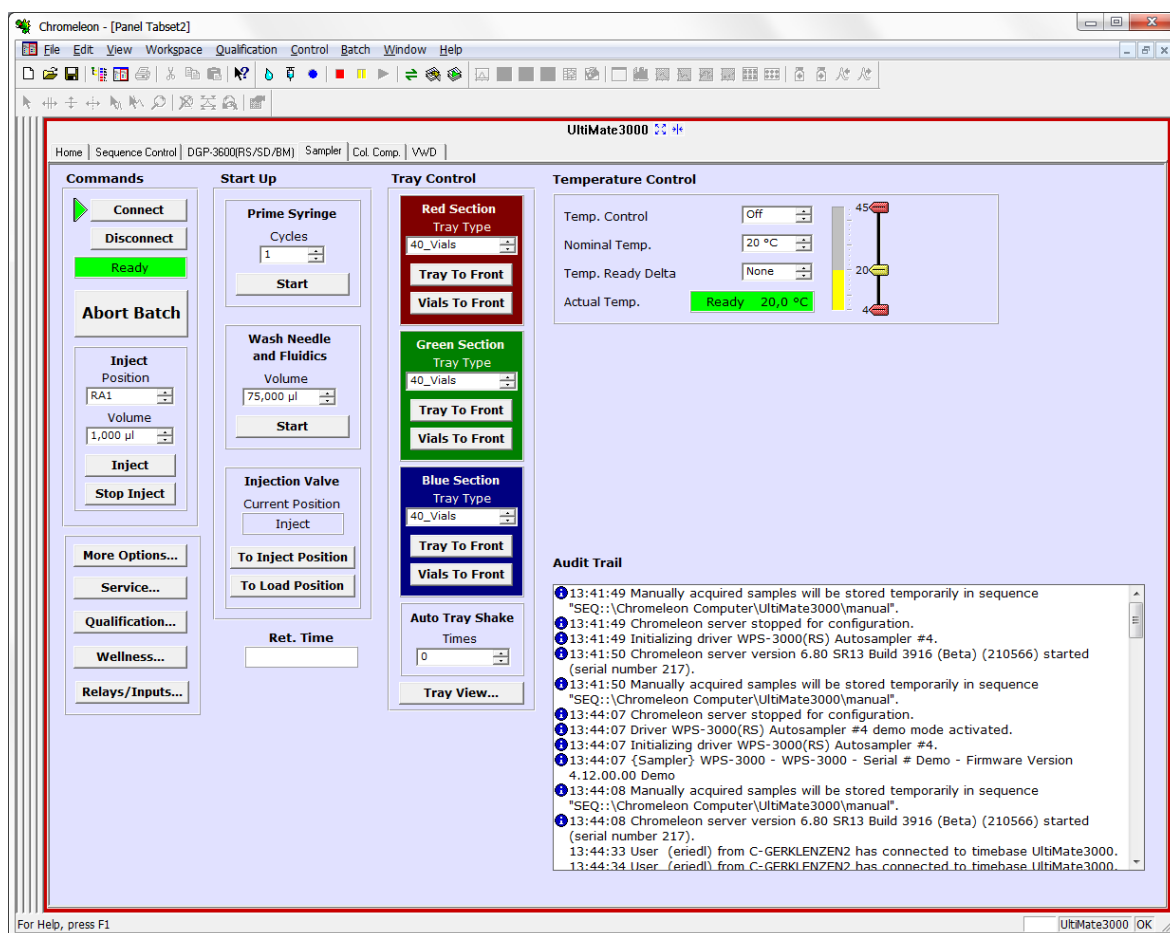

Fig. 27: Autosampler Control Panel on the Panel Tabset

The control panel provides access to the operating parameters and commands required for routine operation of the autosampler. Additional functions are available in the **Commands** dialog box. To open the **Commands** box from the panel tabset, select **Command** on the **Control** menu.

5.4.3 Automated Control

With automated control, you create a program file (PGM) for automated operation of the autosampler. Programs can be created automatically with the help of a software wizard or manually by editing an existing program.

In addition to programs for sample analysis, you can also create programs for special purposes, for example, programs for sample preparation (→ page 98), programs to automate system shutdown (→ page 100), or programs to ensure that the system automatically restarts operation as desired after a power failure. For more information about these programs, see the *Chromeleon Help*.

To create a program with the Program Wizard

1. On the **File** menu, select **New**, and then select **Program File**.

The wizard guides you through program creation. On each wizard page, make the desired settings or accept the default values. For additional information about a page, click **Help**.

2. After you finish the wizard, Chromeleon automatically creates the corresponding program.
3. To start the program, follow the steps on page 76.

To create a program manually

1. Open an existing program.

Select and double-click the program you want to open.

—or—

On the **File** menu, select **Open**. In the dialog box, select **Program** on the **Object of Type** list and select the program.

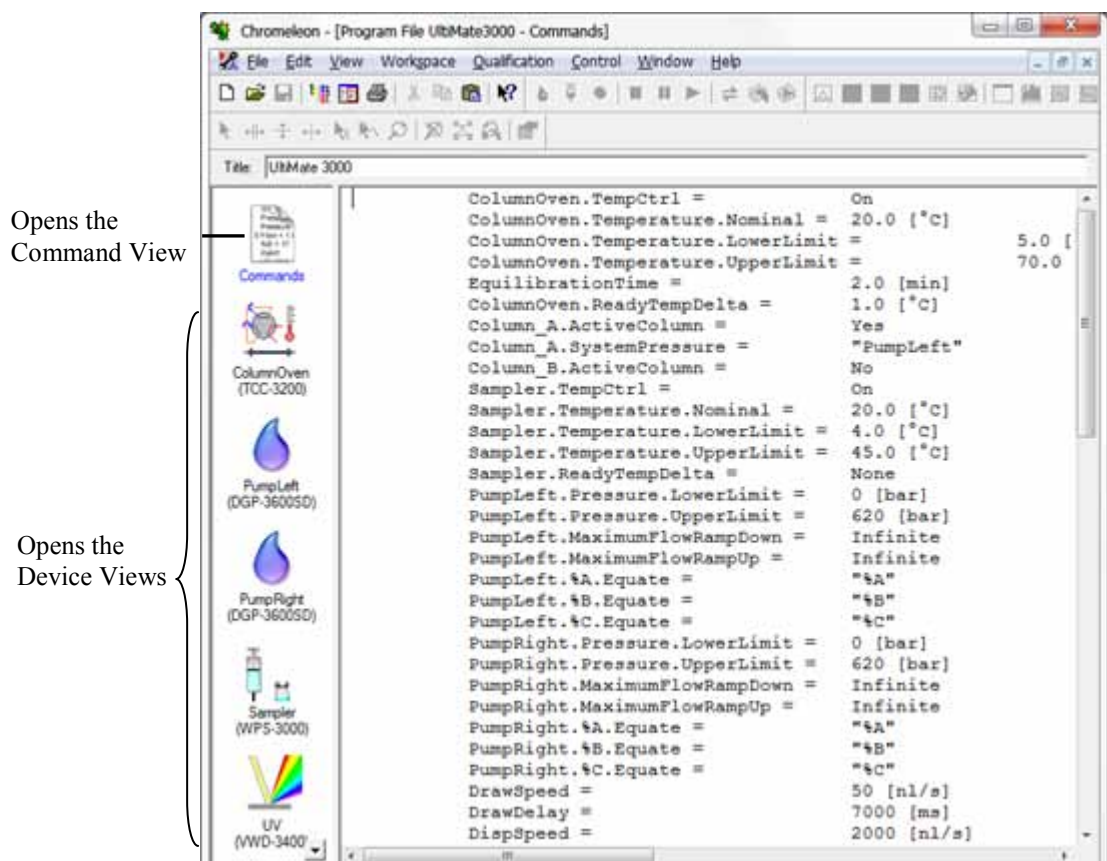

Fig. 28: Chromeleon program file (here: program shown in the Commands view)

2. Change the settings in the program as desired.

The easiest way to edit a program is to do this in the Device Views (→ Fig. 28). Click a device icon and change the settings on the device pages. Editing the program in the Device Views ensures correct command syntax.

If you cannot edit a certain parameter in the Device View, click **Commands** to open the Commands View. The Commands View shows the entire program, listing the control commands in chronological order. Edit the parameter of interest or enter a new parameter. For more information, see the *Chromeleon Help*.

3. To start the program, follow the steps below.

To start a program

Program for sample analysis

1. Create a sample list (sequence). A sequence must include the program and a method for evaluating the sample data (for example, for peak identification, area determination, and amount determination).
2. Assign the program and method to each sample on the list.
3. Add the sequence to the batch and start the batch.

For information about each of the above steps, see the *Chromeleon Help*.

Other programs

Add the program to the batch and start the batch.

5.5 Display Screens (Function Keys and Menus)

Via the function keys and menus that are available on the front panel display, you can make several settings or execute certain commands directly from the autosampler. For general information about the function keys, see section 5.5.1. For information about each menu, see section 5.5.2 (→ page 78).

5.5.1 Showing the Function Keys

Four white spots on the front panel mark the positions of four function keys: **Menu**, **Rotate**, **Wash**, and **Prime**. To show the keys, select the position of the utmost left dot on the front panel display with the menu pen (part no. 6300.0100). The menu pen is included in the autosampler shipment.



Fig. 29: Showing the soft key menus

The function keys replace the information in the bottom line of the status screen. If no key is selected, the bottom line of the status screen is restored after about 5 seconds.

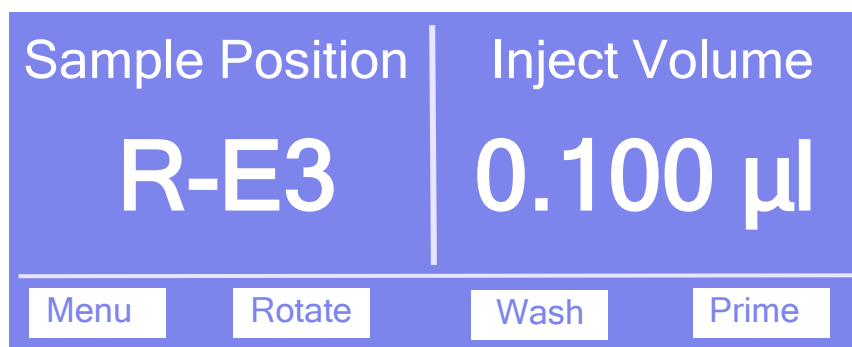

Fig. 30: Function keys

To ...	Select ...
Open the Main menu (→ page 80).	Menu
Rotate the carousel to the next segment. The needle withdraws from the vial (microtiter plate) first if necessary.	Rotate
Start a wash cycle. In the wash port, the needle is rinsed from the outside with the wash liquid and dried with air from the membrane pump afterward. The wash volume is the volume specified under Wash on the Control menu (→ page 81).	Wash

To ...	Select ...
Remove air bubbles from the syringe valve and syringe. During the prime cycle, liquid is drawn and dispensed several times. For more information about how to prime the syringe, see section 4.6 (→ page 60).	Prime

Front panel input is disabled while the autosampler is connected in Chromeleon. However, it is still possible to rotate the carousel via the **Rotate** key.

5.5.2 Autosampler Menus

Fig. 31 shows an overview of the autosampler menus. For information about the general menu layout and structure, see page 79. For information about the commands and parameters that are supported by the menus, see sections 5.5.2.2 through 5.5.2.6 (→ page 80 and following pages):

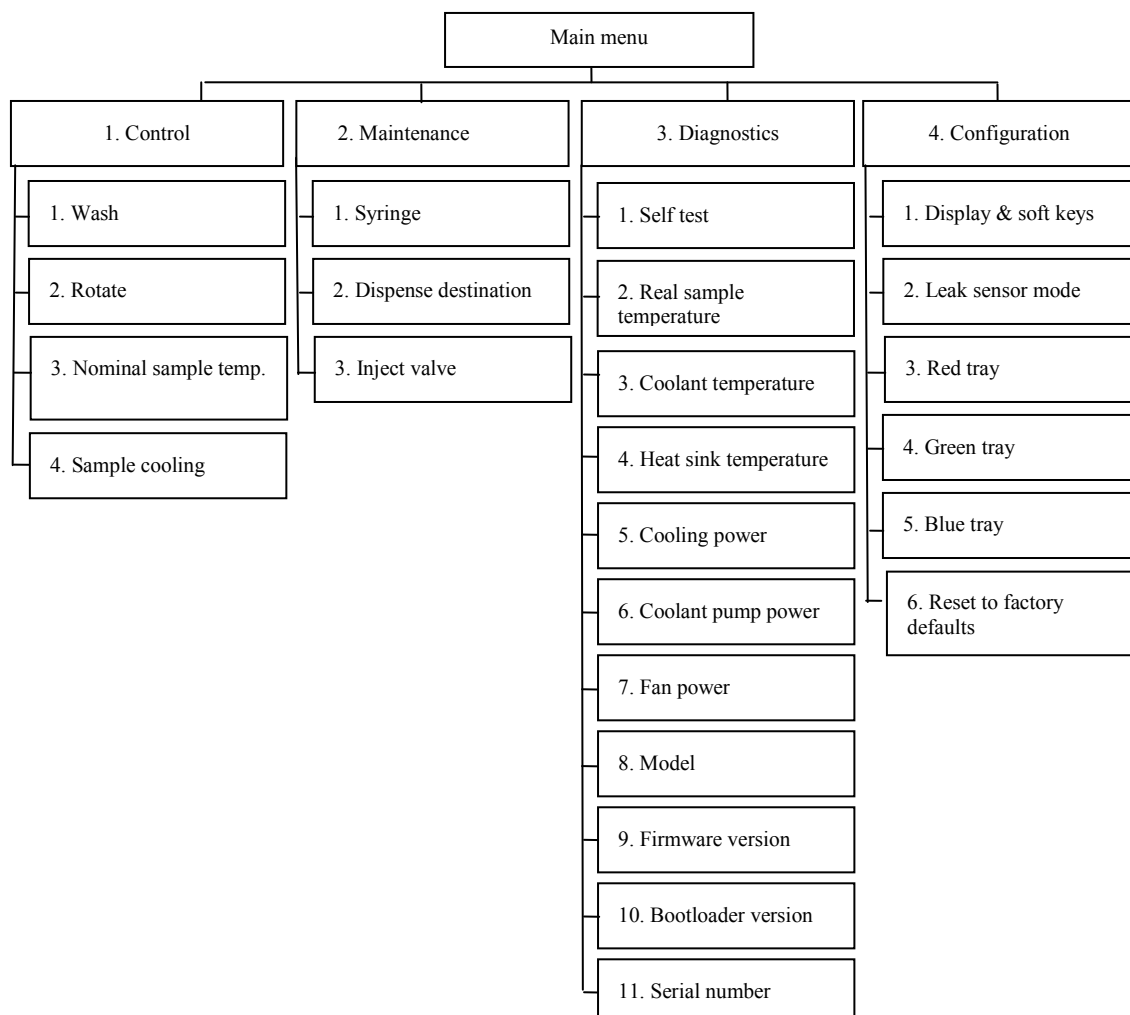

Fig. 31: Menu structure (here: WPS-3000TPL)

5.5.2.1 General Menu Layout and Structure

In general, the menu layout is as follows:

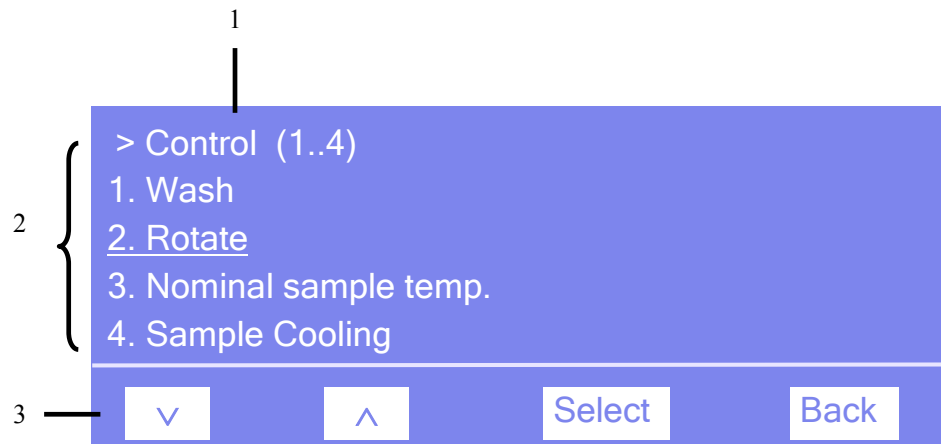

Fig. 32: Menu layout (here: Control menu)

No.	Description
1	Reports the menu name and the number of items on the menu list.
2	The menu items appear on a list and are numbered consecutively. The selected item is underlined.
3	Navigation bar

Select an item with the arrow up or down key—the selected item is underlined. Confirm your selection with **Select**. **Back** returns you to the previous menu level.

The selected menu item or parameter determines which keys appear on the navigation bar:

To ...	Select...
Return to the previous entry on a list. If the list contains 5 or more items, you can use the arrow up key to scroll up through the list, after reaching the first line (→ Key autorepeat , page 83).	^
Increment numerical values.	^
Proceed to the next entry on a list. If the list contains 5 or more items, you can use the arrow down key to scroll down through the list, after reaching the forth line (→ Key autorepeat , page 83).	∨
Proceed to the next figure in a number. Any decimal point is skipped.	>
Confirm the selection and activate the box if applicable. If an item is read-only, the Select key will not be available.	Select
Return to the previous menu level.	Back
Perform the command.	Execute
Confirm the selection or input.	OK
Cancel the action and restore the last value.	Cancel
Note: Depending on the selected option, specific keys may replace these general keys.	

If an error is found, one or more messages appear on the front panel display. In this case, the **Prev**, **Next**, and **Clear** keys appear on the navigation bar.

To ...	Select ...
Return to the previous message.	Prev
Proceed to the next message.	Next
Remove the message from the display.	Clear

5.5.2.2 Main Menu

The **Main** menu provides top-level access to the menu structure. To open the **Main** menu, show the function keys and select **Menu**.

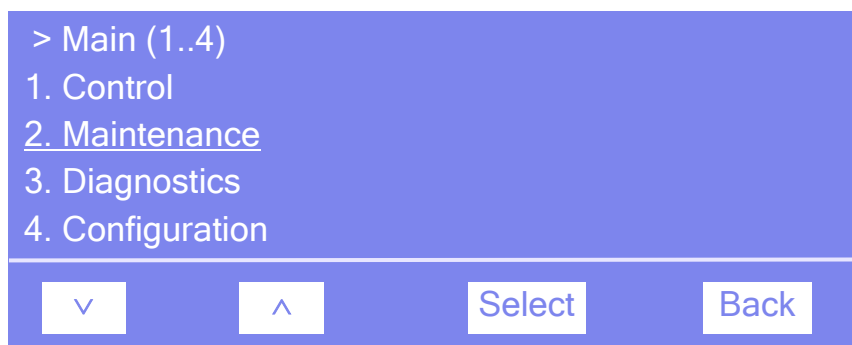

Fig. 33: Main menu

For information about the menus, see the following sections:

- Control Menu (→ page 81)
- Maintenance Menu (→ page 82)
- Diagnostics Menu (→ page 83)
- Configuration Menu (→ page 84)

5.5.2.3 Control Menu

On the **Control** menu, you can specify the wash volume, start different wash cycles, and rotate the carousel to move the segment of interest to the front.

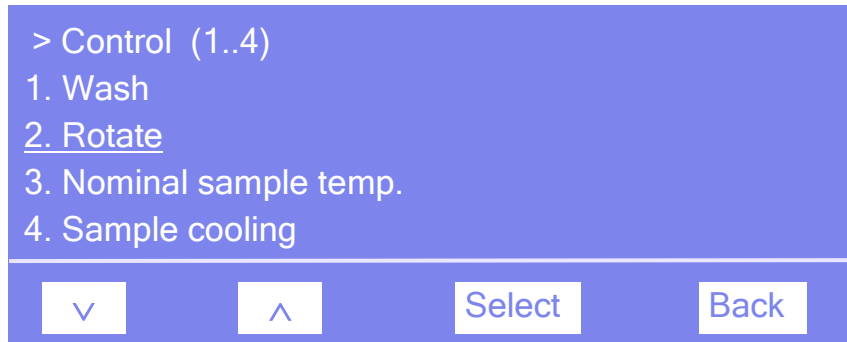

Fig. 34: Control menu (here WPS-3000TPL)

To ...	Select ...
Specify the wash volume and start the wash cycle. The needle is rinsed from the outside (in the wash port) with the wash liquid and dried with air from the membrane pump afterward.	Wash
Select a segment (R = red, G = green, B = blue) and move it to the front. The vial tray and the 5-position holder of this segment are alternately moved to the front. The needle is withdrawn from the vial or well first if necessary.	Rotate
Set the temperature for sample thermostating.	Nominal sample temp.
Turn sample thermostating on or off.	Sample cooling

5.5.2.4 Maintenance Menu

On the **Maintenance** menu, you can make the settings required for the maintenance procedures and/or perform the related commands:

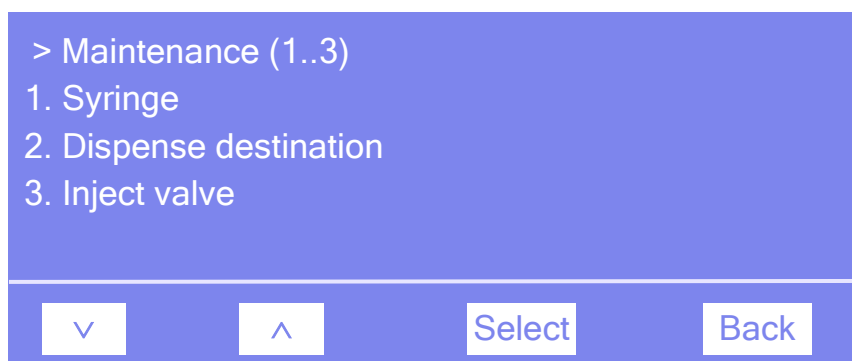

Fig. 35: Maintenance menu

To ...	Select ...
Move the syringe up or down and show the volume that is actually in the syringe.	Syringe
Set the position to which the wash liquid is directed.	Dispense destination
Switch the injection valve into the selected position (Inject or Load).	Inject valve

5.5.2.5 Diagnostics Menu

The **Diagnostics** menu provides information for diagnostics purposes (read-only) and allows you to make the related settings and/or perform commands:

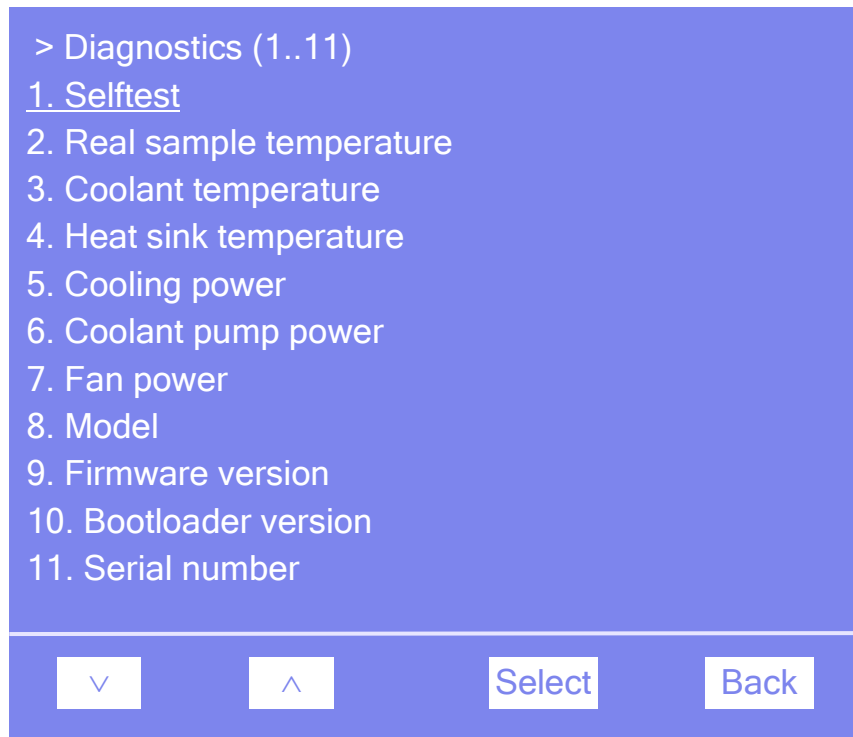

Fig. 36: Diagnostics menu (here WPS-3000TPL)

To ...	Select ...
Perform a self test. If an error or mechanical fault is detected, the Status LED on the front panel is red and a message appears on the front panel display	Selftest
See the current sample temperature.	Real sample temperature
See the coolant temperature.	Coolant temperature
See the heat sink temperature.	Heat sink temperature
See the load of cooling power (in per cent).	Cooling power
See the load of the cooling pump (in per cent).	Coolant pump power
See the load of the fan (in per cent).	Fan power
See the autosampler model.	Model
See which firmware version is installed.	Firmware version
See the bootloader version.	Bootloader version
See the serial number of the autosampler.	Serial number

5.5.2.6 Configuration Menu

The **Configuration** menu provides information about the autosampler configuration and allows you to make the required settings or change the settings.

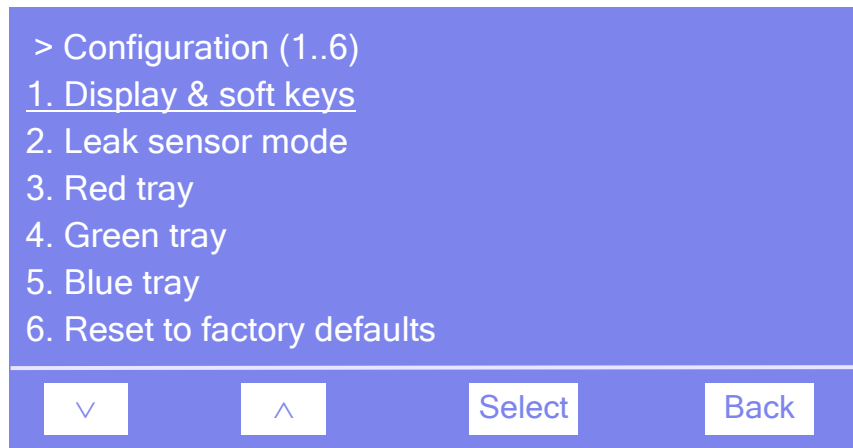

Fig. 37: Configuration menu

To ...	Select ...
<p>Set the display and function key parameters:</p> <p>Brightness—sets the screen brightness. The input is in per cent.</p> <p>Contrast—sets the screen contrast. The input is in per cent.</p> <p>Key sound—sets whether an acoustic beep sounds when you select a function key: On—yes or Off—no.</p> <p>Key autorepeat— sets whether the keystroke is automatically repeated when you remain on the key for a longer period, for example, to change a value quickly (On = yes or Off = no).</p>	Display & soft keys
<p>Set whether leak detection is performed and how you are alerted in case of an alarm:</p> <p>Enabled—enables leak detection. When a leak is detected, a message appears on the front panel display and a beep sounds.</p> <p>Silent—enables leak detection. When a leak is detected, a message appears on the front panel display, but no beep sounds.</p> <p>Disabled—disables leak detection.</p>	Leak sensor mode
<p>Set which sample containers are installed in the related segment.</p>	Red (Green, Blue) tray
<p>Restore the factory settings.</p> <p>In the Reset to factory defaults? dialog box, select OK to confirm the restore or select Cancel to keep your settings.</p>	Reset to factory defaults

5.6 Operational Settings

This section provides information for settings and functions that should be observed when operating the autosamplers.

To learn more about...	See page...
Setting the Injection Mode	See below.
Synchronizing the Inject Command with the Pump Strokes	88
Turning On Sample Thermostating	88
Changing the Carousel Configuration	89
Setting the Injection Parameters and Starting the Injection	90
Turning On Leak Detection	91
Adjusting the Screen Brightness or Contrast	91
Recommendations for Operation	92

5.6.1 Setting the Injection Mode

The autosampler supports the full-loop, partial-loop, and microliter pick-up injection modes. In addition, Chromeleon allows programming a user-defined sample preparation and injection procedure. Select the injection mode in Chromeleon. To set the injection mode, follow the steps below. The required parameters are also available in the Commands dialog box and on the control panel for the autosampler.

1. Open the **Program Wizard** (→ page 74).
2. On the **Sampler Options** page, select the injection mode from the **Inject Mode** list. Select **UserProg**, **Partial**, **FullLoop**, or **ulPickUp**.

Full-loop injections provide maximum reproducibility as the sample loop is completely filled with sample. The injection volume corresponds to the sample loop volume. The required amount of sample is

$$\text{FlushVolume} + \text{LoopVolume} \times \text{LoopOverfill}$$

For subsequent injections from the same sample container (if **RinseBetweenReinjections** = **No**):

$$\text{FlushVolume2} + \text{LoopVolume} \times \text{LoopOverfill}$$

For information about the injection process (distribution of the liquids and switching sequence), see page 148.

With **Partial-loop injections**, less sample is required as the sample loop is filled with sample only partially. In addition, the injection volume is freely selectable and variable without the need of installing a sample loop with a different volume. The required amount of sample is

$$\text{FlushVolume} + \text{InjectionVolume}$$

For subsequent injections from the same sample container:

FlushVolume2 + InjectionVolume

For information about the injection process (distribution of the liquids and switching sequence), see page 151.

With **Microliter pick-up**, the loop volume is injected completely, but contains only partly sample volume. The sample plug is transported into the loop, sandwiched by a plug of transport liquid whose volume is the FlushVolume. That is why the TransportVial should contain solvent of the start gradient. There is zero sample loss and maximum accuracy but slightly diminished reproducibility.

For information about the injection process (distribution of the liquids and switching sequence), see page 153.

For details about User-defined injection programs, see section 5.7.7 (→ page 98).

Parameter	Description
FlushVolume	Sets the flush volume for the needle. Smaller flush volumes than the default volume can be programmed, but not smaller than the volume of the injection needle. Smaller flush volumes may result in decreased accuracy. For the WPS-3000FC, the flush volume must be equal to or larger than the needle volume + the bridge volume.
FlushVolume2 (for full-loop and partial-loop injections only)	Sets the flush volume for the needle for subsequent injections from the same vial. The default setting is 2 µL. Condition: RinseBetweenReinjections must be set to No .
Volume	Sets the injection volume. For full-loop injections, Volume should be the volume of the sample loop.
LoopOverfill (for full-loop injections only)	Determines the volume that is drawn through the loop prior to injection. The default factor is 2, which means that the loop is flushed once and then filled.

3. The parameters listed in the table are preset to default values. The default values are optimized for water as solvent. If you use a different solvent, check and change the parameters as required by your application.

Parameter	Description	Default Values for WPS-3000	
		PL, T(B)PL	TBPL Analytical, T(B)FC
DispSpeed	Sets the speed of the syringe used for dispensing the sample.	2000 nL/s	20 µL/s
DrawSpeed*	Sets the speed of the syringe used for drawing the sample.	50 nL/s	3 µL/s
DrawDelay	Sets the time that the needle remains in the vial after drawing the sample.	5 s	3 s
WashSpeed	Sets the speed of the syringe for the wash cycle.	4000 nL/s	20 µL/s
WasteSpeed	Sets the speed of the syringe used for expelling liquid to the waste.	4000 nL/s	32µL/s

* Higher value is possible, depending on the gas content of the sample and the injection mode.

5.6.2 Synchronizing the Inject Command with the Pump Strokes

Only when the UltiMate 3000 system includes a DGP-3600 or LPG-3400

Synchronization of the injection command with the strokes of the pump will be available only when you linked the autosampler to a DGP-3600 or LPG-3400 pump in the Chromeleon **Server Configuration** program (→ page 49). Synchronization ensures that all injections are performed at the same phase of the pump cycle, and thus help enhancing considerably the retention time precision with gradient applications.

In the **Commands** dialog box, in a program, or on the control panel for the autosampler (under **More Options**), you can then set whether you want or do not want to use synchronization, and you can select a different pump if necessary.

- Set **SyncWithPump** to **Off** if you do not want to use synchronization.
- **Pump Device** shows the name of the pump with which synchronization will be performed. If you want to use a different pump, type the name of the pump in the box. (Use the name specified for the pump in the Server Configuration program.) Verify that **SyncWithPump** is set to **On**.

5.6.3 Turning On Sample Thermostatting

Autosamplers with Sample Thermostatting Option only

You can turn sample thermostatting on and off and set the desired temperature in Chromeleon or on the front panel display.

To turn on sample thermostatting from Chromeleon

1. In Chromeleon, open the **Commands** dialog box (→ page 72).
2. Select **Temperature**, and then select **Nominal** and enter the desired temperature. Entering a temperature sets **TempCtrl** to **On** if it is not yet on.

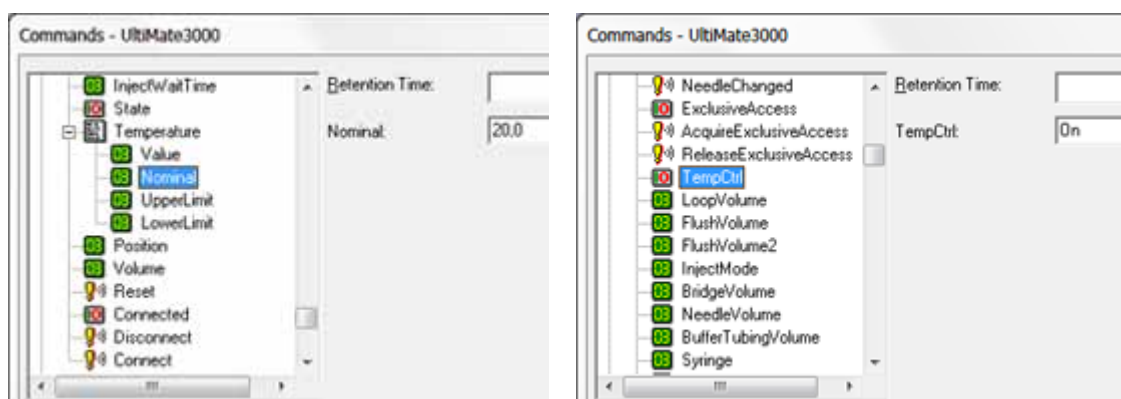

Fig. 38: Turning on sample thermostatting

Set **TempCtrl** to **Off** if you do not want to use sample thermostating for a certain application.

If you want to enable thermostating later again, set **TempCtrl** to **On**. When you change the temperature setting under **Nominal**, Chromeleon sets **TempCtrl** automatically **On** again.

To turn on sample thermostating from the front panel display

1. On the front panel display, select the **Control** menu (→ page 81).
2. Select **Nominal sample temperature** and enter the desired temperature.
3. To turn on sample thermostating, select **SampleCooling** and **On**.

Set **SampleCooling** to **Off** if you want to work without sample thermostating.

5.6.4 Changing the Carousel Configuration

During initial installation of the autosampler in Chromeleon, the standard configuration of the carousel is specified on the **Segments / Pump Link** page in the Chromeleon **Server Configuration** program. If you later install different sample containers, you have to adapt the settings in Chromeleon accordingly:

- *If you want to adapt the standard configuration*
Adapt the settings on the **Segments / Pump Link** page in the Chromeleon Server Configuration program (→ page 48).
- *If you do not want to change the standard configuration, you can adapt the settings in the Chromeleon Client program.*

Select one of the following alternatives:

- ◆ Open the **Commands** dialog box, select **RedTray**, **GreenTray**, or **BlueTray**, and click the new sample containers on the input list.
- ◆ Open the control panel for the autosampler. Under **Red Section**, **Green Section**, or **Blue Section**, click the new sample containers on the **Tray Type** list.

If the settings in Chromeleon do not match the installed sample containers, the needle may be damaged. To prevent this, you can activate the automatic tray test (→ page 97).

5.6.5 Setting the Injection Parameters and Starting the Injection

You can perform an injection from Chromeleon either manually or as part of a program. The autosampler reports to Chromeleon when injection is complete.

Manual Injection

 **Tip:** First, verify that the desired injection mode is set (→ page 85).

Select one of the following alternatives to enter the injection parameters and start injection:

- **Commands** dialog box
Select **Inject**, click **Position** and enter the sample position, click **Volume** and enter the volume for the injection, and then click **Execute** to start the process.
- Control panel for the autosampler
Under **Inject**, enter the sample position and volume for the injection and click **Inject** to start the process.
- **Control** menu or **Online** taskbar
The Control menu and the Online taskbar are available only when a control panel is open and connected to the timebase in which the autosampler is installed.
Select **Inject** on the **Control** menu or click the **Inject** icon  on the **Online** taskbar. Enter the sample position and injection volume in the dialog box and click **OK** to start the injection.

Program-controlled Injection

To perform an injection via a program, the program must include the following line

```
0.000 Inject
```

indicating that the inject command is executed at the retention time of 0.000 minutes. When you create the program with the Program Wizard (→ page 74), the **Inject** command is included automatically.

Specify the sample position and volume for the injection in the sequence and start the program (→ page 76).

5.6.6 Turning On Leak Detection

You can activate and deactivate leak detection in Chromeleon or on the autosampler display. The running analysis will *not* be aborted when the leak sensor reports a leak

To turn on leak detection in Chromeleon

1. In Chromeleon, open the **Commands** dialog box for the autosampler (→ page 72).
2. Under **LeakSensorMode**, select **Enabled** or **Silent**.

Enabled—activates leak detection. When the leak sensor reports a leak

- ◆ the **Status** LED on the autosampler display changes to red.
- ◆ a message appears in Chromeleon and on the autosampler display.
- ◆ a beep sounds.

Silent—activates leak detection. When the leak sensor reports a leak

- ◆ the **Status** LED on the autosampler display changes to red.
- ◆ a message appears in Chromeleon and on the autosampler display (no beep sounds).

Disabled deactivates leak detection.

To turn on leak detection on the autosampler display

1. Show the function keys and select **Menu** (→ page 77).
2. Select the **Configuration** menu and select **Leak sensor mode** (→ page 84).
3. Select **Enabled** or **Silent**. (For details about these settings, see above.) **Disabled** deactivates leak detection.

5.6.7 Adjusting the Screen Brightness or Contrast

You can adjust the screen brightness or screen contrast to your requirements from Chromeleon or on the front panel display.

- In Chromeleon, open the **Commands** dialog box for the autosampler (→ page 72). Select **Brightness** and change the value for the screen brightness and/or select **Contrast** and change the value for the screen contrast as appropriate.
- On the autosampler menu, select the **Configuration** menu and select **Display & soft keys** (→ page 83). Select **Brightness** and change the value for the screen brightness and/or select **Contrast** and change the value for the screen contrast as appropriate.

5.6.8 Recommendations for Operation

Perform the following actions at regular intervals, especially after longer periods of autosampler inactivity:

- Check whether air bubbles are present in the syringe and prime the syringe if applicable (→ page 60).
- Perform a wash cycle for the buffer loop.
To do so, perform the **Wash** command in Chromeleon. As an alternative, show the function keys on the front panel display and select **Wash** (→ page 77) or select **Wash** on the **Control** menu (→ page 81). Thermo Fisher Scientific recommends that the wash volume be at least twice the buffer loop volume. It might be necessary to fill the syringe more than once.
- Inspect the needle for indications of wear and/or damage at regular intervals. This is especially important for fused silica or PEEK needles.

5.7 Special Chromeleon Functions

This section provides a short overview of some special functions that Chromeleon supports for the autosampler.

To learn more about...	See page...
Predictive Performance	See below.
Defining the Needle Height and Puncture Depth	95
Moving the Tray before Drawing the Sample (TrayShake)	96
Operational Qualification and Performance Qualification	97
Automatic Tray Test	97
Automatic Sample Container Detection	97
User-Defined Programs	98

All of these functions are available in the **Commands** dialog box (unless otherwise noted). In addition, some functions are available also on the control panel for the autosampler. For additional information about a function, see the *Chromeleon Help*.

5.7.1 Predictive Performance

Predictive Performance provides various functions for estimating the lifetime of consumables and monitoring and recording service and (re)qualification information.

Commands Dialog Box

Open the **Commands** dialog box (→ page 72) and enter the limits for the predictive performance parameters. For a complete list of available commands and parameters, see the *Chromeleon Help*. To keep the predictive performance information up-to-date, Thermo Fisher Scientific recommends the following actions:

After you have...	Perform the following command...
Replaced the rotor seal	RotorSealChanged
Replaced the syringe	SyringeChanged
Serviced the autosampler (for example, annual maintenance)	ServiceDone
Performed instrument qualification	QualificationDone

These commands reset the related counters and update the information when the action was performed.

Control Panel

On the control panel for the autosampler (→ page 73), click **Wellness**, **Qualification**, and **Service** to see the related predictive performance commands and parameters on separate panels. On these panels, you can enter the limits and reset the counters. In addition, wellness bars provide visual indicators of qualification and service periods (Chromeleon 6.80 and later).

The color-coding of the wellness bars provides information about the status:

Color	Description
Green	OK.
Yellow	The value will soon reach the specified limit and/or the related component needs servicing or should be replaced soon.
Orange	(Only for monitoring Qualification properties) The value has reached the specified limit. However, a Grace Period has been specified during which the component may still be operated.
Red	The value has reached the specified limit or the specified grace period has expired. Replacement, servicing, or qualification of the component is overdue. The component can no longer be operated and it is not possible to start a batch.

In addition, a message appears in the Chromeleon Audit Trail when a limit has been reached.

5.7.2 Defining the Needle Height and Puncture Depth

The **SampleHeight** parameter allows you to specify the distance (in mm) between the outer bottom of the sample container (well plate, deep-well plate, or vial) and the tip of the needle. This value defines how deep the needle descends into the container for sampling. The needle height for the reagent and/or transport vials is set in the same way via the **TransLiquidHeight** parameter. When setting the needle height, observe the information on page 96.

The **PunctureDepth** parameter sets how deep the puncturer descends into the sample container (well-plate, deep-well plate, or vial), as measured from the top of the sample container. The puncture depth for the reagent and/or transport vials is set in the same way via the **TransVialPunctureDepth**. When setting the puncture depth, observe the information on page 96.

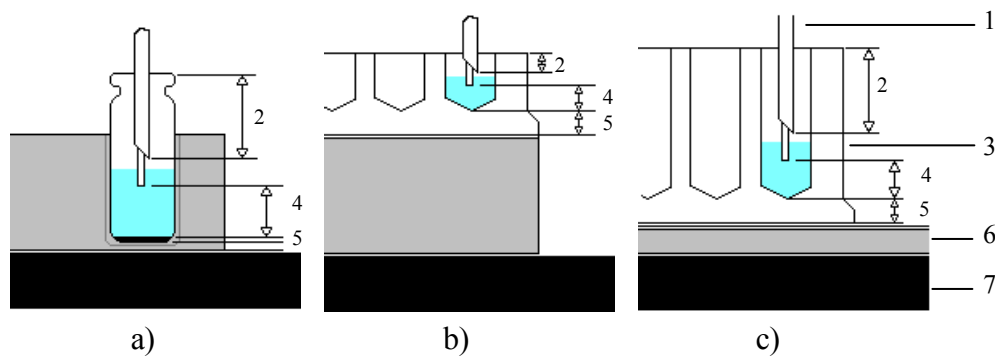

Fig. 39: Defining the needle height and puncture depth
a) for a standard vial
b) for a standard 96-well plate
c) for a deep-well plate

No.	Description
1	Needle pair (puncturer and needle)
2	PunctureDepth, TransVialPunctureDepth
3	Sample container
4	Distance between the tip of the needle and the bottom of the sample container, as measured from interior (SampleHeight/TransLiquidHeight)
5	Offset value for the bottom height (SampleHeightOffset_XX)
6	Tray
7	Carousel

When setting the sample height, observe the following:

- You should *not* set **SampleHeight** to '0' when a sample container is installed. When the parameter is set to '0', the needle touches the bottom of the container. The tip of the needle is fragile and may be damaged.
- If you want to sample only *once* from a container, select the **SampleHeight** value in such a way that the needle is lowered into the container only as deep as required; thus, minimizing sample carry-over.
- If you want to sample *several* times from the same container, select the **SampleHeight** value in such a way that the needle is lowered as deep as possible into the container, that is, as close as possible to the container bottom, allowing you to sample the volume almost completely.
- Use the **SampleHeightOffset_XX** parameter to prevent the needle from touching the bottom of the sample container even if the **SampleHeight** is set to 0 mm. Enter the bottom height for the currently used sample container. This offset will be taken into account when the needle descends. By default, **SampleHeightOffset_XX** is set to 0.
- If the **TransLiquidHeight** is set to a small value, you may have to increase the **TransVialPunctureDepth** to allow the needle to descend to the bottom of the transport vial.

When setting the puncture depth, observe the following:

- Select the puncture depth in such a way that the puncturer is lowered into the sample container as deep as required to pierce the septum but not that deep that contact is established to the sample.
- If the value is selected too low, the puncturer will not pierce the septum of the sample container. Thus, the needle cannot enter the vial and may be damaged.
- For most HPLC vials, a puncture depth of 8 mm will be sufficient to pierce the septum.

5.7.3 Moving the Tray before Drawing the Sample (Tray Shake)

Chromleon supports tray shake to allow re-homogenization of the sample, especially after longer idle times. The tray is moved rapidly one or more times to mix the analyte thoroughly before the sample is drawn. This avoids changes in the peak area due to local changes in the concentration of the analyte in the sample container.

The function is disabled by default (**AutoTrayShakeTimes** = 0). Enter a value to specify how often the tray is shaken before the sample is drawn.

5.7.4 Operational Qualification and Performance Qualification

Operational Qualification and Performance Qualification allow you to check and document the performance of the HPLC system. All materials required for performing qualification and detailed instructions are available on request.

5.7.5 Automatic Tray Test

This function is disabled by default. To enable this function, set **EnableTrayTest** in Chromeleon to **Enabled**.

The automatic tray test checks whether the sample container installed in the segment from which the next injection shall be performed matches the configuration settings. If this is not the case, the needle may be damaged. The test is performed once per segment whenever the first injection is performed from a segment after manual interference.

5.7.6 Automatic Sample Container Detection

The vial pusher is fitted with a sensor for automatic plate and vial detection monitoring.

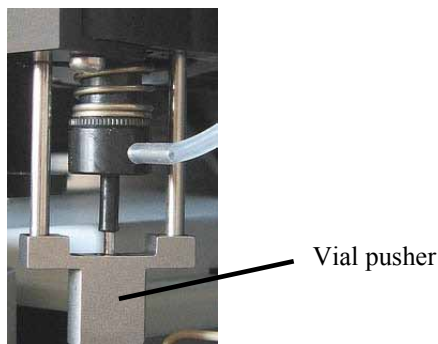

Fig. 40: Vial pusher

The sensor checks whether the vial pusher descends onto a vial or well plate. If no sample container is present at the specified position, a message appears on the front panel display and in the Chromeleon Audit Trail.

i **Tip:** An adapter must be installed on the vial pusher for use with 24 deep well plates (part no. 6820.2402). If this adapter is installed, the automatic tray test must not be enabled (→ section 5.7.5).

5.7.7 User-Defined Programs

5.7.7.1 Creating a User-Defined Program

The Program Wizard in Chromeleon assists you not only in creating programs for sample analysis but also in creating user-defined programs, for example, to specify the single steps for sample preparation.

1. Open the **Program Wizard** (→ page 74).
2. On the **Sampler Options** page, select **User Prog** from the **Inject Mode** list.

The screenshot shows the 'Program Wizard: Sampler Options' dialog box. The 'Inject Mode' dropdown menu is open, with 'UserProg' selected. Other options in the menu are 'Partial', 'FullLoop', and 'ulPickUp'. To the right of the menu is a 'To:' dropdown menu with 'RA1' selected. Below these are several input fields with their respective ranges:

Field	Value	Range
Inject Mode	UserProg	
Transport Vials (ulPickUp)		
Transport Vial Capacity	Unlimited	[0...99999]
Transport Liquid Height	5,000	[0,000...30,000 mm]
Transport Vial Puncture Depth	5,000	[0,000...11,000 mm]
Flush Volume (FullLoop/Partial)	2,400	[2,400...10000,000 µl]
Flush Volume 2	2,000	[0,000...10000,000 µl]
Loop Overfill	2,000	[1,000...10,000]

Fig. 41: User-defined program

3. On the next page of the wizard, specify the desired sample preparation steps.

The **Inject** command in the sample analysis program starts the user-defined program. The chromatographic run is on hold until the `UDPInjectMarker` command is given in the user-defined program.

For more information about user-defined programs and for program examples, see the *Chromeleon Help*.

i Tip: The sample preparation commands (Udp commands) are also available in the **Commands** dialog box.

5.7.7.2 Specifying Relative Sample Positions

Chromeleon allows you to specify sample positions relative to the position of another sample, for example, for the vial to be used for sample preparation (PrepVial).

The relative position can be in a different row of the sample rack, in a different segment of the carousel, or a certain number of vials away from the current vial.

The *Chromeleon Help* provides more information about how to enter relative sample positions in a program and tells you what you should observe when doing so.

5.8 Shutting Down the Autosampler

Please observe the following precautions before interrupting the operation for more than one week or before shipping the autosampler:

- Rinse out any solvents. If a buffer is used as a part of the mobile phase, flush the system with several volumes of methanol/water (50:50) before it is shut down. This will prevent salt build-up inside the unit.
- Fill the autosampler with methanol or a similar alcohol, such as 2-propanol or ethanol. If the solvents in the autosampler are not miscible with water, use an appropriate intermediate solvent.
- If you want to move or ship the autosampler, you have to
 - ◆ Remove the movable parts of the carousel (sample racks, vials, well plates) and the wash liquid reservoir, if installed.
 - ◆ Secure the needle arm and carousel cover with the foam insert as described in the packing instructions.

 **Important:** *This is a must!* First, move the needle and needle arm into the correct position (needle on the right and needle out of the wash port) by either pressing the **Standby** button on the front of the autosampler or performing the **Standby** command in Chromeleon. Then, turn off the autosampler and secure the needle arm. This is to avoid damage to the needle.

 **Important:** *C'est à doit!* Afin d'éviter tout dommage à l'aiguille, prenez soin de parquer l'aiguille en position haute avant d'installer le bloc de mousse, en utilisant le bouton **Stand-by** du panneau de commande du passeur ou le command Standby dans Chromeleon.

- Ship the unit only in the original shipping container and observe the packing instructions. If the original shipping container is not available, appropriate shipping containers and packing material can be ordered from the Thermo Fisher Scientific sales organization for Dionex HPLC products. The packing instructions are included in the "Installation and Qualification Documents for Chromatography Instruments" binder and are available upon request.

Shipping the unit in any other packaging automatically voids the warranty.

If you are running Chromeleon, you can set the autosampler and HPLC system into the standby mode or run a shutdown program (→ page 100).

Standby Program

A standby program sets the HPLC system into standby mode. The application can be reactivated very quickly afterward. The main program steps:

- The pump flow is automatically reduced at the end of the program.
- The temperature of all temperature-controlled modules in the system is reduced.

Shutdown Program

A shutdown program automates shutdown of the HPLC system. The main program steps are:

- The pump flow is automatically stopped at the end of the program.
- Certain system components and functions are turned off (for example, detector lamps, temperature control).

To create a standby or shutdown program

Select one of the following alternatives:

- Select and perform the operating commands and parameters from the **Commands** dialog box (→ page 72).
- Create and run a corresponding program to automate the process (→ page 74).

i **Tip:** Chromeleon supports SmartShutdown for the WPS-3000TBPL Analytical in an analytical UltiMate 3000 system. If you have to interrupt system operation, use the **SmartShutdown** wizard to create a program to set the HPLC system into standby mode or to automate system shutdown. For more information, see the *Chromeleon Help*.

5.9 Routine and Preventive Maintenance

The autosampler is made of high-quality components and materials to minimize maintenance requirements. All surfaces are well resistant to weak acids, alkali, and organic solvents. Nevertheless, immediately wipe up all liquids spilled onto the autosampler surface, using lint-free cloth or paper. If surfaces are exposed for longer periods, these liquids can cause damage.

Perform the maintenance procedures listed below at regular intervals to ensure optimum performance and maximum uptime of the autosampler. The exact maintenance schedule for the autosampler will depend on a number of factors.

Frequency	What you should do...
Daily	Before you start operating the autosampler, inspect the fluid lines for air bubbles and degas the wash liquid.
	Check the fluid lines for any signs of leakage.
	Check the fluidic connections for any signs of salt deposits.
	When using buffer solutions, flush the system thoroughly after use with a solvent that does not contain buffers or salts.
Periodically	Inspect the tubing for possible damage, such as cracks, nicks, cuts, or blockage.
	Inspect the carousel and remove any deposits using a cloth or paper. To do so, remove the sample racks and the 5-position vial holders if necessary. This inspection is especially important for the autosampler with sample thermostating, as a clean carousel enhances the cooling performance.
	Check the drain tubes connected to the drain ports on the bottom right of the autosampler (→ page 60). Verify that the tubing is unclogged and is routed below the drain port(s). Check the volume of the liquid in the waste container and empty as needed.
Annually	Inspect and replace the following components if necessary: <ul style="list-style-type: none"> - Connections on the switching valves (→ page 59 and/or page 135). - Connections on the syringe valve (→ page 59) - Needle (→ page 120) - Puncturer (→ page 122) - Rotor seal and stator (→ page 124)
	Have a Thermo Fisher Scientific service representative check the autosampler once a year to prevent, for example, contamination and excessive wear.

i **Tip:** Chromeleon supports predictive performance to estimate the lifetime of consumables (→ page 93).

6 Troubleshooting

6.1 Overview

The following features help you to identify and eliminate the source for problems that may occur during the operation of the autosampler or an UltiMate 3000 system.

Status Indicators

The status indicators on the front panel display provide a quick visual check of the operational status of the autosampler. They indicate whether the autosampler is turned on, connected in Chromeleon, and operating properly (→ page 23).

Error Messages

If a fault or mechanical error is detected during the operation of the autosampler, an error message is generated on the user interface. Check the Messages on the Front Panel Display section (→ page 104) for a short description of possible causes along with recommended courses of action. If the autosampler is operated by Chromeleon, the error is also logged in the Chromeleon Audit Trail.

 **Tip:** For information about common operating problems that might occur with the UltiMate 3000 RSLCnano system, see the operating instructions for the NCS Nano Cap System.

For information about common operating problems that might occur with the UltiMate 3000 system with Flow Manager for nano and cap HPLC applications, see the UltiMate 3000 Proteomics MDLC system manual.

For information about common operating problems that might occur with the UltiMate 3000 system for analytical HPLC applications, see the *Operating Instructions* for the other system modules.

If you are unable to eliminate a problem following the instructions given here, contact Thermo Fisher Scientific Service.

6.2 Messages on the Front Panel Display

Each time a fault or error occurs during the operation of the autosampler, the **Status** LED on the front panel is red and a message appears on the front panel display. In this case, the **Prev**, **Next**, and **Clear** keys appear on the navigation bar.

To ...	Select ...
Return to the previous message.	Prev
Proceed to the next message.	Next
Remove the message from the display.	Clear

These keys are active also when the autosampler is connected in Chromeleon.

When the autosampler is operated with Chromeleon

- The message is also displayed in the Chromeleon Audit Trail. Some of the messages in the table are identical for the different drives. In the Chromeleon Audit Trail, these messages start with the drive to which the message relates: Carousel, syringe drive, needle drive, or horizontal drive. Therefore, in the table, these messages are listed as: (Drive): message.
- Messages on the front panel display can be removed also via the **ClearDisplayError** command in Chromeleon.

The following table lists autosampler-related messages along with appropriate remedial actions. In addition to the messages in the table, other messages may appear. In this case, note the exact wording of the message and contact Thermo Fisher Scientific Service if you are unable to eliminate the problem.

Message	Remedial action
24V power failure.	Turn the autosampler off and on again by pressing the power switch on the rear of the autosampler or perform a self test.
(Drive): End point not reached.	Turn the autosampler off and on again by pressing the power switch on the rear of the autosampler or perform a self test.
(Drive): Error updating motor controller firmware.	Turn the autosampler off and on again by pressing the power switch on the rear of the autosampler or perform a self test.
(Drive): Home position not found.	Turn the autosampler off and on again by pressing the power switch on the rear of the autosampler or perform a self test.
(Drive): Home sensor malfunction.	Turn the autosampler off and on again by pressing the power switch on the rear of the autosampler or perform a self test.
(Drive): Needle sensor malfunction.	Turn the autosampler off and on again by pressing the power switch on the rear of the autosampler or perform a self test.
(Drive): No communication.	Turn the autosampler off and on again by pressing the power switch on the rear of the autosampler or perform a self test.

Message	Remedial action
(Drive): Not initialized.	Turn the autosampler off and on again by pressing the power switch on the rear of the autosampler or perform a self test.
(Drive): Not ready.	Turn the autosampler off and on again by pressing the power switch on the rear of the autosampler or perform a self test.
(Drive): Obstruction detected.	The vial pusher may be obstructed or the needle may be obstructed when descending into the vial. Remove the obstruction. The needle descends onto the rim of the vial and does not enter the septum. In Chromeleon, check whether the settings on the Segments / Pump Link page (→ page 48) match the sample container actually used in the autosampler.
(Drive): Stop condition at start.	Turn the autosampler off and on again by pressing the power switch on the rear of the autosampler or perform a self test.
A self test is required.	A self test must be performed. The autosampler will not be ready for operation until the self test is successful. Turn the autosampler off and on again by pressing the power switch on the rear of the autosampler or perform a self test. If a fault or mechanical failure is detected during the self test, a message appears in the Audit Trail.
Buffer loop is too full.	The buffer loop contains too much liquid. Empty the buffer loop via the Wash soft key (→ page 77) or the Wash command on the Control menu (→ page 81).
Carousel temperature sensor malfunction.	Turn the autosampler off and on again by pressing the power switch on the rear of the autosampler or perform a self test.
Command input overflow.	Perform a driver and/or firmware update.
Command queue overflow.	The user-defined program is too long. Shorten the program.
Command syntax error.	Perform a driver and/or firmware update.
Command was aborted.	The command was aborted by the user. Perform the command again if necessary.
Coolant temperature sensor malfunction.	Turn the autosampler off and on again by pressing the power switch on the rear of the autosampler or perform a self test.
Cooling system overheated.	Verify that the ventilation slots are not obstructed. Turn the autosampler off and on again by pressing the power switch on the rear of the autosampler or perform a self test.
Device is off.	The autosampler power has been turned off (standby). Turn the autosampler on by pressing the standby key on the autosampler or via the related command in Chromeleon.
DVC position error.	Verify that the injection valve is not blocked.
DVC (+ additional text) —or— Error updating I2C controller firmware.	Turn the autosampler off and on again by pressing the power switch on the rear of the autosampler and retry. Reinstall the firmware or perform a firmware update if necessary.
EEprom serialization error.	Perform a firmware update.

Message	Remedial action
Heat sink temperature sensor malfunction.	Turn the autosampler off and on again by pressing the power switch on the rear of the autosampler or perform a self test.
Illegal command parameter.	Perform a driver and/or firmware update.
Illegal syringe speed.	The specified syringe speed is not allowed. Change the syringe speed.
Illegal value.	Perform a driver and/or firmware update.
Inject volume must be equal to loop volume.	The injection volume exceeds or is below the sample loop volume. (The message occurs only for full-loop injection mode.) Change the injection volume.
Internal update. nn% finished. Do not interrupt. (nn = value)	An internal update is performed. The percentage reports the degree of completion. Wait until the update is complete.
Invalid mix target.	The target specified for the mix operation is not allowed. Specify a valid target (using the following commands in Chromeleon: UdpDraw > From and/or UdpDispense > To).
Leak detected.	The leak sensor has detected a leak. Find and eliminate the leak. Dry the leak sensor and the tray (→ section 7.2, page 111).
Motor switching valve malfunction.	Turn the autosampler off and on again by pressing the power switch on the rear of the autosampler or perform a self test.
Motor switching valve timeout.	Turn the autosampler off and on again by pressing the power switch on the rear of the autosampler or perform a self test.
Needle home position not found.	Turn the autosampler off and on again by pressing the power switch on the rear of the autosampler or perform a self test.
Needle home sensor malfunction.	Turn the autosampler off and on again by pressing the power switch on the rear of the autosampler or perform a self test.
Needle malfunction.	Turn the autosampler off and on again by pressing the power switch on the rear of the autosampler or perform a self test.
Out of transport liquid.	The transport vials are empty. Refill the transport vials, and then set the TransportVialUsecount counter in Chromeleon to zero.
Property is protected.	An attempt was made to change a protected property. Some properties are read-only and cannot be changed by the user.
Property is read only.	An attempt was made to change a read-only property. Some properties are read-only and cannot be changed by the user.
Reagent vial not found.	There is no reagent vial at the specified position. Place a reagent vial at the specified position or specify a different position.
Remote control not enabled.	The connection to the autosampler was disconnected in Chromeleon. Reestablish the connection ("Connect"). Perform a driver and/or firmware update.
Sample height out of reach.	The needle does not descend deep enough into the sample container to draw the liquid. If possible, increase the setting for the puncture depth in Chromeleon (= PunctureDepth for sample containers and/or TransVialPunctureDepth for reagent and transport vials). Else, refill the sample container or change the needle height setting (→ page 95). Verify that the SampleHeightOffset_XX is set to zero.

Message	Remedial action
Syntax error.	Perform a driver and/or firmware update.
Syringe is not empty.	The syringe is not empty at the beginning of the injection. Turn the autosampler off and on again by pressing the power switch on the rear of the autosampler or perform a self test.
Syringe is too empty.	The volume to be dispensed is larger than the volume that was previously drawn. Change the program (volume to be dispensed \leq drawn volume).
Syringe is too full.	The volume to be dispensed is larger than the volume that was previously drawn. Change the program (volume to be dispensed \leq drawn volume).
Syringe valve malfunction.	Check the syringe valve.
Temperature difference too large. Probable coolant circuit malfunctions.	Close the carousel cover. Turn the autosampler off and on again by pressing the power switch on the rear of the autosampler or perform a self test.
The device is busy.	The autosampler is already executing another command. Wait until the autosampler has executed the command and retry.
The volume is too large.	The volume to be drawn is larger than the volume that the syringe or buffer loop can hold. Change the volume.
Transport liquid vial not found.	There is no transport vial at the specified position. Place a transport vial at the specified position or specify a different position.
Unknown command.	Perform a driver and/or firmware update.
Unknown property.	Perform a driver and/or firmware update.
Unknown vial position.	The specified position does not exist in the current configuration. Check the specified position. Check and change the segment settings if necessary (\rightarrow Segments / Pump Link , page 48).
USB interface is not ready.	The USB connection could not be established. Check the USB connection. Exchange defective USB cables if necessary.
Vial not found.	There is no sample container present at the specified position. Place a sample container at the specified position or specify a different position. This message appears also if the test for sample container detector is disabled (\rightarrow page 97), and your sample containers do not meet the minimum height requirements (\rightarrow page 30). Thermo Fisher Scientific recommends using the sample containers listed on page 30. The specified segment type is wrong. Check and correct the segment settings if necessary (\rightarrow Segments / Pump Link , page 48).
Vial pusher malfunction.	Turn the autosampler off and on again by pressing the power switch on the rear of the autosampler or perform a self test.
Wrong tray type detected.	Automatic tray detection recognized that the sample containers specified on the Segments / Pump Link tab page in Chromeleon do not match the sample containers actually installed. On the Segments / Pump Link tab in Chromeleon, check and correct the segment settings if necessary (\rightarrow page 48). Verify that your sample containers meet the minimum height requirements (\rightarrow page 30). Thermo Fisher Scientific recommends using the sample containers listed on page 30.

If communication between Chromeleon and the autosampler cannot be established, related error messages may appear in the Chromeleon audit trail, also. Refer to the table below for the most important error messages, along with possible causes and the corresponding remedial actions. (The number 1610103 in the table below is the serial number of the instrument.)

Message	Remedial Action
WPS-3000PL@USB-01610103 - Device not found on the USB.	The USB connection between the autosampler and the Chromeleon server may be interrupted. Check the USB connection. The power supply to the autosampler may be interrupted. Check the power supply connection of the autosampler.
Error opening WPS-3000PL@USB-01610103 – The System cannot find the file specified	The USB connection between the autosampler and the Chromeleon server may be interrupted. Check the USB connection. The power supply to the autosampler may be interrupted. Check the power supply connection of the autosampler.
Error issuing control request to WPS-3000PL@USB-01610103	The USB connection between the autosampler and the Chromeleon server may be interrupted. Check the USB connection. The power supply to the autosampler may be interrupted. Check the power supply connection of the autosampler. Remove the autosampler specified in the message from the server configuration or else, select a different autosampler from the list of available autosamplers in the server configuration program (via Properties/Browse)..
Error reading from WPS-3000PL@USB-01610103 Data error (cyclic redundancy check)	Check the USB connection. The connection to the next hub must not exceed 5 m. The overall connection length, including the hub connections must not exceed 30 m (→ page 40). Replace any defective USB cable or hub.
Error reading from WPS-3000PL@USB-01610103	The USB connection between the autosampler and the Chromeleon server may be interrupted. Check the USB connection. The power supply to the autosampler may be interrupted. Check the power supply connection of the autosampler.

7 Service

7.1 General Notes and Safety Precautions

The following sections describe all procedures for the autosampler that the user may perform. All other maintenance and service procedures must be performed only by Thermo Fisher Scientific service personnel.

 **Warning:** The fluid components of the device may be filled with solvents that are harmful to health. In the same way, harmful substances may be present at the wetted parts. Wear appropriate personal protective equipment. Rinse the fluid components with an appropriate solvent to remove harmful substances.

For information about the proper handling of a particular substance and for advice on specific hazards, refer to the material safety data sheet for the substance you are using. Observe the guidelines of Good Laboratory Practice (GLP).

 **Avertissement:** Les composants fluidiques de l'instrument peuvent être remplis de solvants nocifs. De la même, des substances nocives peuvent être présents sur les pièces en contact avec le fluide. Portez l'équipement de protection personnel approprié. Rincez les composants fluidiques avec un solvant approprié afin d'éliminer les substances nocives.

Pour les informations sur la manipulation correcte des substances et des recommandations pour les situations de risque spécifiques, veuillez consulter la fiche de données de sécurité des substances que vous utilisez. Veuillez respecter des directives des Bonnes Pratiques de Laboratoire (BPL).

Before starting maintenance or service procedures, observe the following precautions:

- For all service and repair procedures, observe all precautionary statements provided in these operating instructions.
- Do not operate the autosampler when the enclosure is open.
- When performing maintenance or repair work on the fluid components, always move the syringe and/or needle in the appropriate position via the related commands on the front panel display or in Chromeleon. (Follow the instructions in the sections for the individual components.) In all cases, do not place any objects under the syringe plunger to avoid damage to the syringe and instrument.
- Use only the original spare parts authorized for the device by Thermo Fisher Scientific.

- Before returning any instrument for repair, contact Thermo Fisher Scientific Service for Dionex HPLC Products. An RMA (Return Material Authorization) number is required to track your instrument. Always use the original shipping container and observe the packing instructions (available on request) when shipping the autosampler. Shipping the instrument in anything other than the original packaging voids the warranty.

If the original shipping container is not available, appropriate shipping containers and packing material can be ordered from the Thermo Fisher Scientific sales organization for Dionex HPLC products. The packing instructions are included in the "Installation and Qualification Documents for Chromatography Instruments" binder and are available upon request.

For instructions on shutting down the autosampler, see page 99.

7.2 Leak Sensor

When the leak sensor reports a leak, eliminate the cause for the leakage and dry the leak sensor. Find and eliminate the leak, and then dry the sensor (wear appropriate protective clothing).

To find and eliminate the leak, follow the steps below wearing appropriate protective clothing:

1. Turn off the autosampler.
2. Inspect the autosampler for signs of leakage. Tighten or replace leaking connections.
3. Wipe up all liquid and dry the leak sensor. To do so, use a cloth or tissue to absorb any liquid that has accumulated in the tray.

 **Important:** Make sure that you do not bend or damage the sensor.



 **Important:** Assurez-vous que vous ne tordez, ni n'endommagez le capteur.



Fig. 42: Drying the leak sensor

4. Allow the sensor to adjust to the ambient temperature for a few minutes.
5. Turn on the autosampler.
6. If no error is reported after turning on the autosampler, operation can be resumed.

 **Tip:** If the sensor is not dry, the **Status** LED remains red. If a message appeared on the front panel display, select **Clear** on the navigation bar to remove the message from the display (→ page 80).

7.3 Replacing the Syringe

Description	Part No.
<i>WPS-3000(T)PL (RS) Nano/Cap and WPS-3000TBPL Nano/Cap</i> 25 µL syringe	6822.0001
<i>WPS-3000TBPL Analytical</i> 100 µL syringe	6822.0002
<i>WPS-3000T(B)FC</i> 250 µL syringe	6822.0003
For information about any syringes that are available as an option, see section 10.2 (→ page 167).	

1. Move the syringe down.
Perform the **InitiateChangeSyringe** command in Chromeleon —or—select the **Maintenance** menu on the front panel display, and then select **Syringe** and **Down**.
2. Tilt the front panel upward.
3. Unscrew the syringe plunger mounting screw with an open-end wrench, size 8, and then remove the screw manually. Keep the screw for the installation of the new syringe.

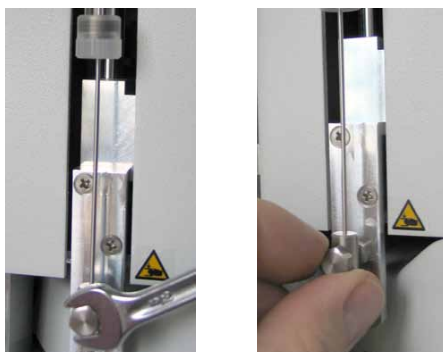

Fig. 43: Disconnecting the syringe on the plunger

4. Unscrew and remove the syringe from the syringe valve.



Fig. 44: Removing the syringe from the syringe valve

5. Verify that the gasket in the syringe valve is still in place, for example, by looking into the lower bore with a mirror. If the gasket was lost or damaged, install a new gasket before connecting the new syringe. A new gasket is shipped with the replacement syringe, but is also available as a separate part (part no. 6822.0009 for 5 gaskets).

⚠ Important: Be sure that only one gasket is installed in the syringe valve. If you install two or more gaskets, the valve will be damaged.

⚠ Important: Vérifiez que seulement un joint est installé dans la valve de seringue. Si vous installez deux joints la seringue risque d'être endommagée.

6. To remove the air from the new syringe, fill the syringe, using a plastic syringe, or follow the steps below:
 - a) Fill a beaker with wash liquid or a mixture of isopropanol and water (50:50).
 - b) Place the threaded end of the syringe into the beaker.
 - c) Push the plunger completely into the syringe body and move the syringe several times rapidly to dislodge any air bubbles that might have gathered at the syringe inlet.
 - d) Fill the syringe several times completely. Push the plunger up and pull down rapidly with short movements to dislodge the bubbles.
7. Fill the new syringe completely.
8. Orient the syringe with the threaded end toward the top and position the syringe under the valve.
9. While holding the syringe vertically, push a small amount of liquid out the top to make sure that no air is present, and then screw the syringe into the valve.

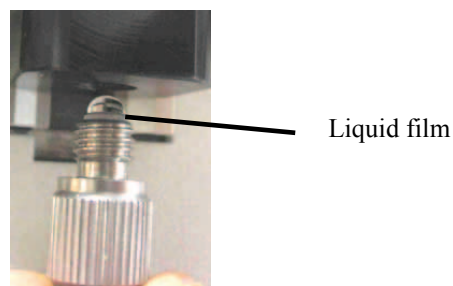



Fig. 45: Liquid film covering the syringe inlet

10. Align the syringe plunger. Manually turn in the mounting screw, and then tighten the screw slightly more than hand-tight with the open-end wrench.
11. Tilt the front panel downward.

12. Move the syringe up.
Perform the **TerminateChangeSyringe** command in Chromeleon—*or*—select the **Maintenance** menu on the front panel display, and then select **Syringe and Up**.

 **Important:** Before executing either command, verify that the syringe is installed correctly. If it is not, moving the syringe plunger up may cause damage to the syringe.

 **Important:** Avant d'exécuter n'importe quelle commande, vérifiez que la seringue est installée correctement sinon la seringue risque d'être endommagée au cours du déplacement du piston.

13. Flush the new syringe several times as described in section 4.6 (→ page 60). Air in the syringe has a strong effect on the measurement results. Therefore, make sure that there is no air in the syringe before you start your analysis.

 **Tips:** When the size of the new syringe is different from the size of the syringe you replaced, verify that

- ◆ The syringe size selected on the **Options** page (→ page 49) for the auto-sampler in the **Server Configuration** program matches the installed syringe. If it does not, change the setting and transfer the new configuration from Chromeleon to the autosampler, by clicking **Send configuration to module** on the **General** page (→ page 47).
- ◆ You have installed an appropriate sample loop and buffer tubing (→ page 22).

After you have replaced the syringe, perform the **SyringeChanged** command in Chromeleon to update the related service information.

7.4 Replacing the Buffer Tubing

Description	Part No.
<i>WPS-3000(T)PL (RS) Nano/Cap</i> 50 µL buffer tubing	6820.0019
<i>WPS-3000TBPL Nano/Cap</i> 50 µL buffer tubing	6821.0019
<i>WPS-3000TFC</i> 500 µL buffer tubing	6820.0020
<i>WPS-3000TBPL Analytical and WPS-3000TBFC</i> 500 µL buffer tubing	6821.0020
For information about any buffer tubing that is available as an option, see section 10.2 (→ page 167).	

1. Tilt the front panel upward.
2. Disconnect the buffer tubing from the syringe valve.

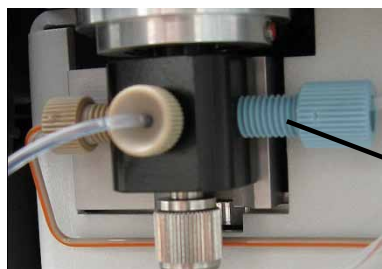

Disconnect the buffer tubing from the syringe valve.

Fig. 46: Buffer tubing on the syringe valve

3. Disconnect the buffer tubing from the injection valve (port 1).
4. Follow the steps below to connect new buffer tubing. This is to avoid that air enters the system during the installation.
 - a) Perform a wash cycle via **Wash** on the **Control** menu (→ page 81) or the related Chromeleon commands (**WashVolume** and **Wash**). Thermo Fisher Scientific recommends that the wash volume be at least twice the buffer loop volume. Install the new buffer tubing while the wash cycle is running.
 - b) Install the new buffer tubing to the syringe valve when the wash liquid comes out of the syringe valve.
 - c) Install the buffer tubing on the injection valve when the wash liquid comes out of the buffer tubing. This is to prevent air from entering the tubing.
5. Observe the tips on the next page.

- i** **Tips:** When the size of the new buffer tubing is different from the size of the buffer tubing you replaced, verify that
- ◆ The buffer tubing volume selected on the **Options** page (→ page 49) for the autosampler in the Server Configuration program matches the installed buffer tubing. If it does not, change the setting and transfer the new configuration from Chromeleon to the autosampler, by clicking **Send configuration to module** on the **General** page (→ page 47).
 - ◆ You have installed also an appropriate sample loop and syringe (→ page 22).

7.5 Needle Pair

The needle pair consists of the puncturer and the needle.

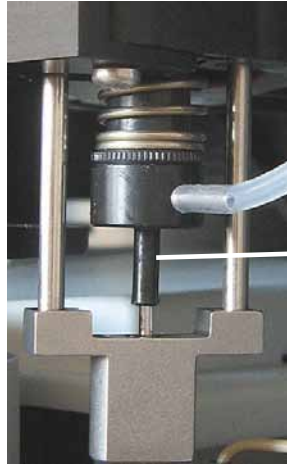

Puncturer with needle inside

Fig. 47: Needle pair

- **Puncturer**
The puncturer is a hollow steel needle in which the needle is located. The puncturer pierces the septum/seal of the sample container before the needle enters the container. For information about how to replace the puncturer, see section 7.5.4 (→ page 122).
- **Needle**
The needle that is located inside the puncturer transports the sample to the sample loop. For information about how to replace the needle and about the capillaries that may be installed as an option, see section 7.5.3 (→ page 120).

7.5.1 Checking the Position of the Needle Pair

Follow the steps below to check whether the needle pair descends correctly into the wash port (→ Fig. 57, page 133):

i **Tip:** You should perform this check before you operate the autosampler for the first time.

1. Open the fastener to release the needle. This is to avoid that the needle is bend if the needle pair does not descend correctly into the wash port.

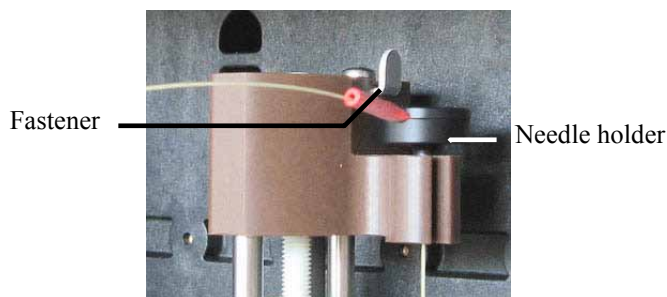

Fig. 48: Needle fastener

2. Perform a wash cycle (→ page 119).

i **Tip:** Make sure that the wash liquid reservoir is filled with wash liquid.

3. At the end of the wash cycle, observe how the needle pair descends into the wash port. The needle should descend correctly into the port (→ Fig. 49) while the needle holder should remain in the position shown in Fig. 48.



Fig. 49: Fused silica needle in wash port

If the needle touches the wash port (for example, the needle holder is higher), the needle pair is not positioned correctly and should be realigned. In this case, contact Service.

4. Be sure that the needle is properly fastened.

7.5.2 Washing the Needle

The needle is rinsed from the outside (in the wash port) with the wash liquid and then dried with air from the membrane pump. There are two ways how to wash the needle:

From Chromeleon

1. In Chromeleon, open the **Commands** dialog box.
2. Under **Sampler**, click **WashVolume**. Enter the wash volume to be used for the wash cycle.
3. Click **WashSpeed** and enter the syringe speed for the wash cycle.
4. Click **InjectValveToInject** or **InjectValveToLoad** to switch the injection valve into the desired position for the wash cycle. With **InjectValveToLoad**, the wash cycle also includes the sample loop.
5. Perform the **Wash** command.

From the front panel display

- Show the function keys and select **Wash**. The wash volume is the volume specified under **Wash** on the **Control** menu.
- Select the **Control** menu, and then select **Wash**. Enter the wash volume and start the wash cycle.

7.5.3 Replacing the Needle

STOP Warning: The needle is very sharp. Be careful not to injure yourself when replacing the needle.

STOP Avertissement: L'aiguille est très coupante. Veuillez à ne pas vous blesser lorsque vous remplacez l'aiguille.

Description	Part No.
<i>WPS-3000(T)PL (RS) Nano/Cap and WPS-3000TPL Nano/Cap</i> 2.4 µL needle, fused silica, nanoViper, black sleeve	6820.3010
<i>WPS-3000TBPL Analytical and WPS-3000TBFC</i> 15 µL needle, PEEK, Viper, red sleeve	6820.3025
<i>WPS-3000TFC</i> 15 µL needle, fused silica, nanoViper, blue sleeve	6820.3115
For information about any needles that are available as an option, see section 10.2 (→ page 167).	

1. Open the fastener to release the needle.

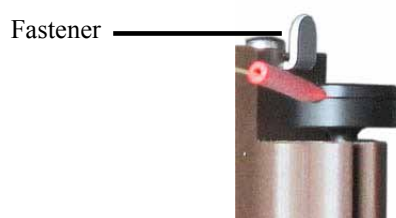

Fig. 50: Needle fastener

2. In Chromeleon, perform the **PuncturerDownNeedleDown** command to move the puncturer and the needle downward.
3. Disconnect the needle from the injection valve or fractionation valve (port 6).

4. Remove the needle from the needle holder and withdraw the needle from the puncturer, pulling it toward the top.

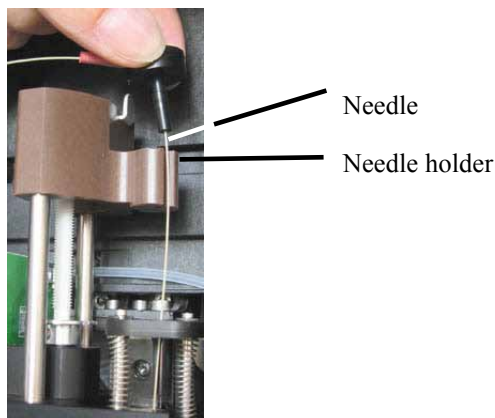

Fig. 51: Removing the needle

5. Carefully insert the new needle into the puncturer (→ Fig. 51).
6. Install the needle in the holder (→ Fig. 51).
7. Connect the needle to the injection valve (→ Fig. 7, page 34).
8. Lock the needle by closing the fastener (→ Fig. 50).
9. In Chromeleon, perform the **PuncturerUpNeedleUp** command to move the puncturer and the needle upward.
10. Perform the **SelfTest** command in Chromeleon—or—select the **Diagnostics** menu on the front panel display, and then select **Selftest**.

i **Tip:** When the size of the new needle is different from the size of the needle you replaced, verify that the needle size selected on the **Options** page (→ page 49) for the autosampler in the **Server Configuration** program matches the installed needle. If it does not, change the setting and transfer the new configuration from Chromeleon to the autosampler, by clicking **Send configuration to module** on the **General** page (→ page 47).

7.5.4 Replacing the Puncturer

STOP Warning: The puncturer is very sharp. Be careful not to injure yourself when replacing the puncturer.

STOP Avertissement: Le puncturer est très coupantes. Veillez à ne pas vous blesser lorsque vous remplacez le puncturer.

Description	Part No.
Puncturer	6820.2400

1. Remove the needle as described in section 7.5.3 (→ page 120).
2. Loosen the screw that attaches the puncturer, using the open-end wrench (part no. 6000.0051) from the accessories kit for the autosampler or a slotted-head box wrench (size 1/4").

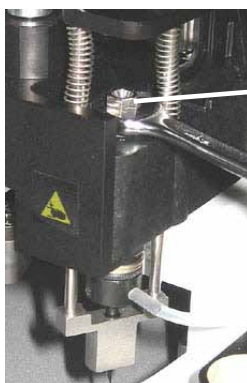

Loosen the screw that attaches the puncturer.

Fig. 52: Hexagon socket head screw attaching the puncturer

3. In Chromeleon, perform the **PuncturerUpNeedleUp** command to move the puncturer and needle up.
4. Remove the screw and the puncturer toward the top.



Fig. 53: Removing the puncturer

5. Install the new puncturer.
6. Tighten the hexagon socket head screw, using the hex key from the accessory kit for the autosampler.
7. Reinstall the needle as described in section 7.5.3.
8. Perform the **SelfTest** command in Chromeleon—or—select the **Diagnostics** menu on the front panel display, and then select **Selftest**.

7.6 Replacing the Sample Loop

Description	Part No.
<i>WPS-3000 (T)PL (RS) Nano/Cap and WPS-3000TBPL Nano/Cap</i> 1 µL sample loop, nanoViper, fused silica/PEEK sheathed	6826.2401
<i>WPS-3000TFC</i> 50 µL sample loop, SST	6824.0019
<i>WPS-3000TBPL Analytical and WPS-3000TBFC</i> 50 µL sample loop, PEEK	6823.0019
For information about any sample loops that are available as an option, see section 10.2 (→ page 167).	

1. Disconnect the sample loop from the injection valve.
2. To switch the injection valve into the **Load** position, perform the **InjectValveToLoad** command in Chromeleon—or—select the **Maintenance** menu on the front panel display, and then select **Inject valve**.
3. Perform a wash cycle (→ page 119), with the wash volume being set to a minimum of 200 µL or the volume of the sample loop. To avoid that air enters the system during the installation, install the new sample loop while the wash cycle is running.
4. Connect the sample loop to port 2 on the injection valve when the wash liquid starts leaving this port.
5. Connect the sample loop to port 5 on the injection valve when the wash liquid starts leaving the sample loop.

-  **Tip:** When the size of the new sample loop is different from the size of the sample loop you replaced, verify that
- ◆ the sample loop volume selected on the **Options** page (→ page 49) for the autosampler in the Server Configuration program matches the installed sample loop. If it does not, change the setting and transfer the new configuration from Chromeleon to the autosampler, by clicking **Send configuration to module** on the **General** page (→ page 47).
 - ◆ you have also installed an appropriate buffer tubing and syringe (→ page 22).

7.7 Injection Valve and Fractionation Valve

⚠ Important: To prevent damage to the 13050 psi valve, make sure that you do not switch the valves dry when operating the WPS-3000(T)PL RS.

⚠ Important: Ne faites pas fonctionner le vanne du WPS-3000(T)PL RS (13050 psi/ 900 bar) à sec. Il peut en résulter des dommages à la vanne.

📄 Tip: Wear disposable gloves when maintaining the valve to avoid any contamination of the surfaces.

Two parts of the valve, the rotor and the stator, are subject to wear. The degree of wear depends on the application. Both parts can be replaced independently from each other.

Valves (2 positions, 6 ports, 1/16")	Part No.
<i>WPS-3000(T)PL RS</i> Rotor, SST (13050 psi) Stator, SST (13050 psi)	6826.0013 6826.0012
<i>WPS-3000(T)PL Nano/Cap</i> Rotor, SST Stator, SST	6820.0014 6820.0012
<i>WPS-3000TBPL Nano/Cap and Analytical</i> Rotor, PAEK Stator, PAEK Stator, titanium	6820.0035 6820.0034 6820.0049
<i>WPS-3000TFC</i> Rotor injection valve/fractionation valve, SST Stator injection valve/fractionation valve, SST	6820.0014 6820.0012
<i>WPS-3000TBFC</i> Rotor injection valve/fractionation valve, PAEK Stator injection valve/fractionation valve, PAEK Stator injection valve, titanium	6820.0035 6820.0034 6820.0049

Fractionation valve (2 positions, 6 ports, 1/32")*	Part No.
<i>WPS-3000TBFC</i> Rotor, PAEK Stator, PAEK	6720.0109 6720.0108

*For use with a nano LC system with tandem operation only.

Fractionation valves (2 positions, 8 ports, 1/16")	Part No.
<i>WPS-3000(T)PL (RS) with Micro Fraction Collection Option</i> Rotor, SST Stator, SST	6820.0054 6820.0053
<i>WPS-3000(T)BPL with Micro Fraction Collection Option</i> Rotor, PAEK Stator, PAEK	6821.0054 6821.0053

7.7.1 Cleaning the Valve

Maintenance requirements are kept to a minimum. In most instances, it will be sufficient to clean the valve by flushing all lines with an appropriate solvent. The nature of the solvent to be used depends on the sample(s) and the mobile phase(s) that are used. Use a common solvent such as methanol or acetonitrile or an 80/20 mixture of methanol or acetonitrile and water.

7.7.2 Disassembling the Valve

To disassemble a 1/16" valve

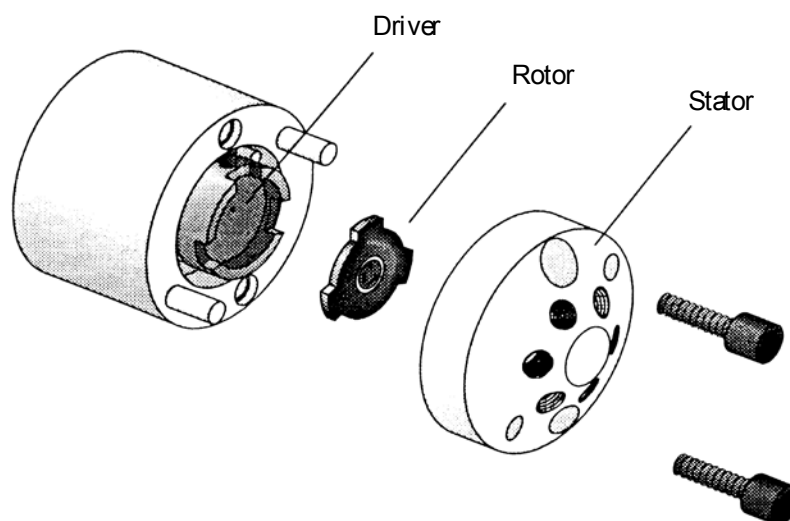

Fig. 54: Exploded view of the 1/16" valve

1. Use a 9/64" hex driver to remove the socket head screws that secure the stator to the valve. Loosen the screws alternately, loosening each screw by only half a turn at a time to avoid that the stator gets jammed.
2. Remove the stator from the valve body. To ensure that the sealing surface of the cap is not damaged, rest it on its outer face. If the tubing is still attached, leave it suspended by the tubing.

3. Gently pry the rotor away from the driver with your fingers or a small screwdriver.
4. Examine the rotor and stator sealing surfaces for scratches:
 - ◆ If scratches are visible to the naked eye, the rotor/stator must be replaced.
 - ◆ If no scratches are visible, clean all parts thoroughly with an appropriate solvent. Take care that no surfaces are scratched while you are cleaning the components. (The most common problem in the use of the valve with HPLC is the formation of buffer crystals, which are usually water-soluble.) After cleaning, it is not necessary to dry the rotor.

To disassemble a 1/32" valve

1. Use a 9/64" hex driver to remove the socket head screws that secure the cap and the stator to the valve. Loosen the screws alternately, loosening each screw by only half a turn at a time to avoid that the stator gets jammed.

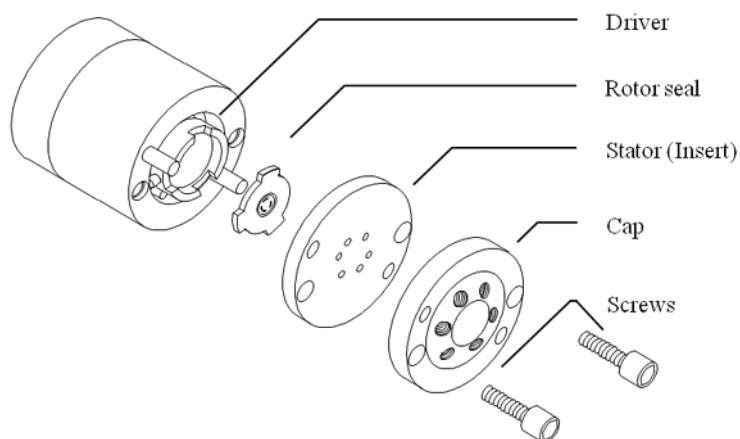

Fig. 55: Exploded view of the 1/32" valve

2. Remove the cap. The cap has one polished sealing surface on the bottom and the stator has sealing surfaces on its top and bottom. To make sure that the sealing surfaces are not damaged, rest the cap on its top face.
3. Remove the stator and rest it on a clean soft surface.
4. Gently pry the rotor away from the driver with your fingers or a small screwdriver.
5. Examine the rotor and stator sealing surfaces for scratches:
 - ◆ If scratches are visible to the naked eye, the rotor/stator must be replaced.
 - ◆ If no scratches are visible, clean all parts thoroughly with an appropriate solvent. Take care that no surfaces are scratched while you are cleaning the components. (The most common problem in the use of the valve with HPLC is the formation of buffer crystals, which are usually water-soluble.) After cleaning, it is not necessary to dry the rotor.

7.7.3 Reassembling the Valve

i **Tip:** To avoid any contamination of the surfaces, clean all parts with isopropanol and use disposable gloves when reassembling the valve.

To reassemble a 1/16" valve

1. Insert the rotor in the driver, making sure that the rotor sealing surface with its engraved flow passages is facing out. The pattern is asymmetrical to prevent improper placement.
2. Reinstall the stator. Insert the two socket head screws and tighten them gently until both are snug. Do not overtighten the screws. They simply hold the assembly together and do not affect the sealing force, which is automatically set as the screws close the cap against the valve body.
3. Test the valve by pressurizing the system. If the valve does not hold pressure, return the valve for repair.
4. *After replacing the rotor*
After you have replaced the rotor, perform the **RotorSealChanged** command in Chromeleon to update the related service information.
5. Observe the notes after reassembly of the valve on the following page.

To reassemble a 1/32" valve

1. Insert the rotor in the driver, making sure that the rotor sealing surface with its engraved flow passages is facing out. The pattern is asymmetrical to prevent improper placement.
2. Reinstall the stator, making sure that the top side faces out. The two sides can be distinguished by the fact that the bottom has smaller holes and the top has larger conical holes.
3. Reinstall the cap. Insert the two socket head screws and tighten them gently until both are snug. Do not overtighten the screws. They simply hold the assembly together and do not affect the sealing force, which is automatically set as the screws close the cap against the valve body.
4. Test the valve by pressurizing the system. If the valve does not hold pressure, return the valve for repair.
5. *After replacing the rotor*
After you have replaced the rotor, perform the **RotorSealChanged** command in Chromeleon to update the related service information.
6. Observe the notes after reassembly of the valve on the following page.

After reassembling the valve

Observe the following when reconnecting capillaries on the valve:

- When you operate a biocompatible autosampler, observe the instructions in section 8.3 (→ page 144).
- To connect the capillaries to the valve, install only the ferrules and fitting screws recommended by the valve manufacturer, observing the manufacturer's installation instructions.

7.8 Replacing the Main Power Fuses

STOP Warning: Turn off the autosampler. Disconnect the power cord from its source.

STOP Avertissement: Avant de remplacer les fusibles, arrêtez le passeur d'échantillon. Assurez-vous de bien débrancher le cordon d'alimentation de la source secteur.

1. Remove the fuse holder, using a small screwdriver.

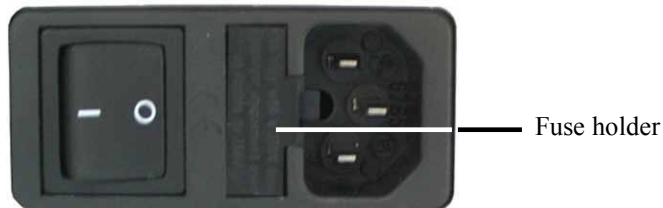

Fig. 56: Fuse holder

2. Replace the fuses with fuses of the appropriate rating.

STOP Warning: Always install two fuses. Use only the fuses indicated in the following table.

STOP Avertissement: Installez toujours deux nouveaux fusibles. Utilisez uniquement les fusibles indiqués ci-dessous.

Description	Part No.
Autosamplers without sample thermostating: Fuse, 2 A, slow-blow, 5 x 20 mm	Included in WPS Fuses Kit (part no. 6820.0026). For information about which fuses are contained in the kit, see section 10.3 (→ page 176).
Autosamplers with sample thermostating: Fuse, 4A, slow-blow, 5 x 20 mm	

3. Reinstall the fuse holder.
4. Reconnect the power cord to its source. Turn on the autosampler.

7.9 Updating the Autosampler Firmware

The autosampler is shipped with the most recent firmware version. The autosampler firmware is also included in Chromeleon.

To check which firmware version is installed in the autosampler and which version is included in Chromeleon:

- *Firmware version installed in the autosampler*
 - Turn on the autosampler via the main power switch on the rear panel to see general information autosampler, including the firmware version, on the front panel display.
 - On the **Main** menu, select **Diagnostics** (→ page 83), and then select **Firmware version**.
- *Firmware version in Chromeleon*

In the Windows Explorer, locate the **IQReport.log** file in the **IQ** folder of your Chromeleon installation. In the file, search for UM3_WPS.hex.

 **Tip:** When updating the firmware via Chromeleon, this information will also be provided during the download.

Whenever a new firmware version is released for the autosampler, the new version will be provided with the next Chromeleon Service Pack release and described in the related release notes.

The new firmware will *not* be downloaded automatically to the autosampler when you install a Chromeleon Service Pack. To update the firmware in the autosampler, follow the steps below:

 **Important:** To ensure that the download is successful, make sure that the communication between the autosampler and Chromeleon is *not* interrupted during the download, and do *not* turn off the autosampler.

 **Important:** Au cours du téléchargement, assurez-vous que la communication entre l'instrument et Chromeleon n'est pas interrompue et n'arrêtez pas l'instrument. Ceci peut entraîner des dysfonctionnements de l'instrument.

1. Before you begin verify that:
 - ◆ The autosampler is connected in Chromeleon.
 - ◆ The Chromeleon server is in *running idle* mode. All processes on the Chromeleon server PC and in Chromeleon have been stopped.
2. Start the **Server Configuration** program (→ page 46).
3. Right-click the autosampler in the timebase and select **Properties** on the menu.

4. On the **General** page (→ page 47), click **Firmware Download**. A message displays the firmware version that is currently installed in the autosampler and the version that will be downloaded from Chromeleon.

i **Tip:** If the autosampler comes with a newer firmware than the version included in Chromeleon, do *not* downgrade the firmware. Older firmware may be incompatible with new hardware revisions.

5. Click **Yes** to start the download. (Click **No** to cancel the action.)

The download can take several minutes. The download is complete when **Download completed successfully** appears in the Messages Server window in the Chromeleon Server Configuration program. The message appears also in the Chromeleon Audit Trail.

If the download was not successful, the related messages appear in the Audit Trail. In this case, turn off the autosampler. Turn on the autosampler again and repeat the above steps. If the download fails again, contact Service.

i **Tip:** When the download from Chromeleon is complete, an internal download may be required in the autosampler. If this is the case, you can monitor the progress on the autosampler display. Do *not* turn off the autosampler until the internal download is complete, too.

8 Autosampler-Specific Information

8.1 Operating Principle (WPS-3000PL (RS))

The picture below illustrates how the WPS-3000PL operates:

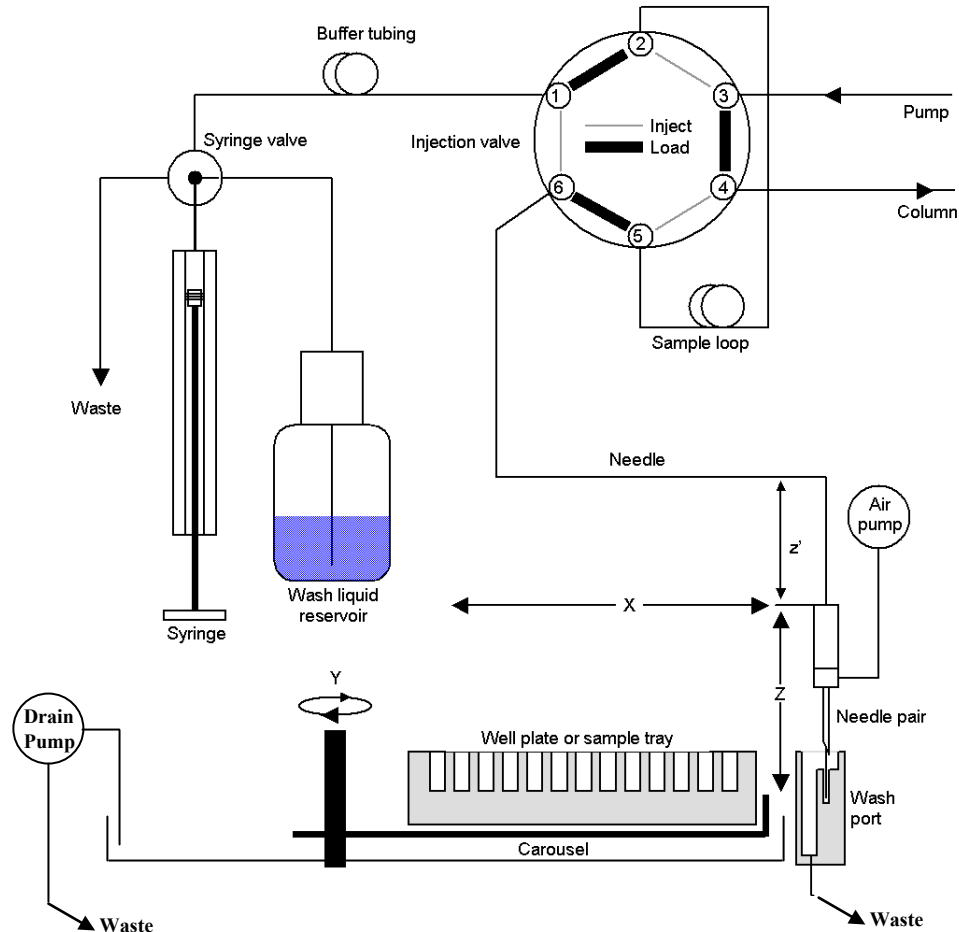

Fig. 57: Operating principle

The autosampler uses the pulled-loop injection principle: While the injection valve is in the **Inject** position, the syringe aspirates sample from the vial into the buffer tubing, thus, filling the entire needle with sample. Then, the injection valve is switched into the **Load** position. The sample is drawn by the syringe through the needle and placed in the sample loop. Afterward, the injection valve is switched into the **Inject** position, directing the solvent flow from the sample loop through the high-pressure flow path to the column.

The sample is transported onto the column in back flush mode: In the **Load** position, the sample is drawn into the sample loop toward the syringe. In the **Inject** position, the sample flow is in the opposite direction.

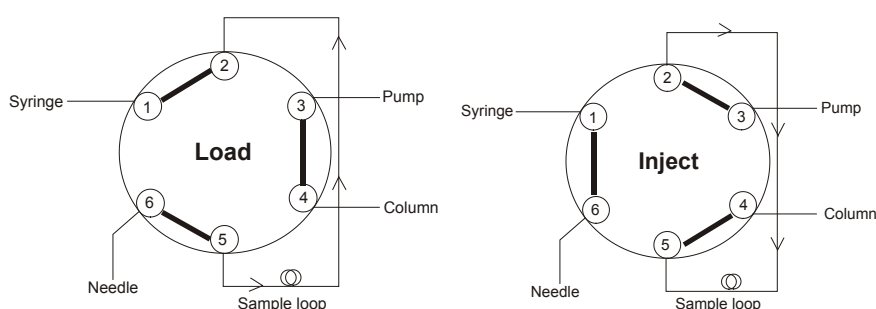

Fig. 58: Back flush mode

The autosampler includes the following fluid components:

Component	Description
Injection valve and sample loop	Sample is directed through the injection valve and sample loop to the mobile phase.
Needle pair	The needle pair includes the puncturer and the needle. The puncturer pierces the cap/septum of the vial or the seal of the well prior to the injection. The needle is used to draw the sample.
Wash port	In the wash port, the needle can be rinsed from both the inside and outside.
Carousel	The carousel holds the well plates and/or racks.
Syringe	The syringe aspirates sample from the well or vial into the sample loop.
Buffer tubing	To prevent contamination of the syringe by the sample, buffer tubing is installed between the injection valve and syringe.
Wash liquid	The wash liquid is used both to remove residual sample from the buffer tubing and needle and to rinse the buffer tubing and needle.
Air pump	The air pump is used to dry the outside of the needle.
X, Z, and z'	Indicates the directions in which the needle pair can move.
Y	Indicates the direction in which the carousel can move.

For information about the supported injection methods, see section 8.4 (→ page 148).

Almost any function is available in Chromeleon in a User-Defined Program (UDP) (→ page 98).

8.2 Autosamplers for Fraction Collection

8.2.1 WPS-3000FC

The WPS-3000FC has *two* 2-position, 6-port switching valves, one injection valve, and one fractionation valve. With this configuration, injection, fraction collection, and re-injection can be fully automated on one system.

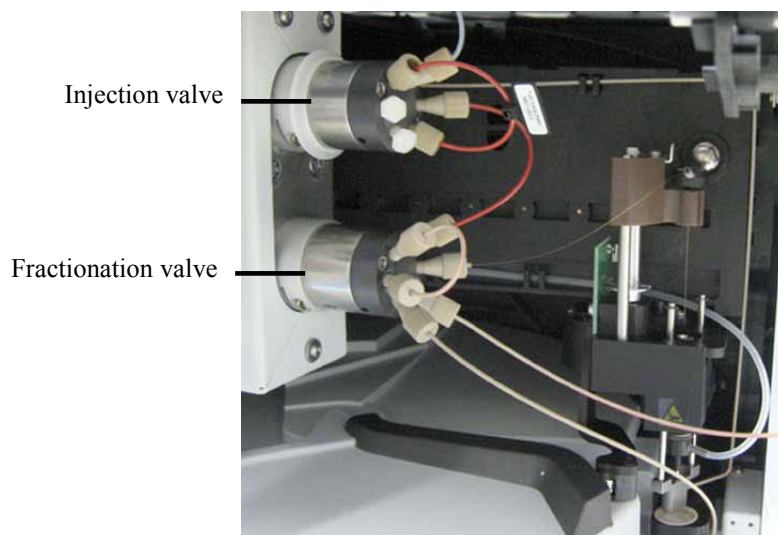

Fig. 59: WPS-3000TFC (here biocompatible configuration)

For information about the operating principle of the autosampler, see section 8.2.1.1 (→ page 136).

The autosampler is available also as biocompatible autosampler version. When you operate the biocompatible autosampler, observe the instructions for connecting the capillaries to the injection and fractionation valves (→ page 144). The biocompatible fractionation valve can be replaced by a 0.1 mm bore (1/32") valve (part no. 6825.0020).

The injection valve can be replaced by a 13050 psi valve. Please contact Service for installation of the valve.

Modification Kits

Normal-Phase Kit for WPS-3000TFC Autosampler

A normal-phase upgrade kit is available to modify a WPS-3000TFC autosampler for normal-phase applications. For information about the kit, see section 8.2.1.5 (→ page 142).

Nano/Cap Modification Kit for Nano/Cap Applications

In addition, modification kits are available to optimize the autosampler configuration for nano/cap applications (→ page 141).

8.2.1.1 Operating Principle

The picture below illustrates how the WPS-3000FC operates:

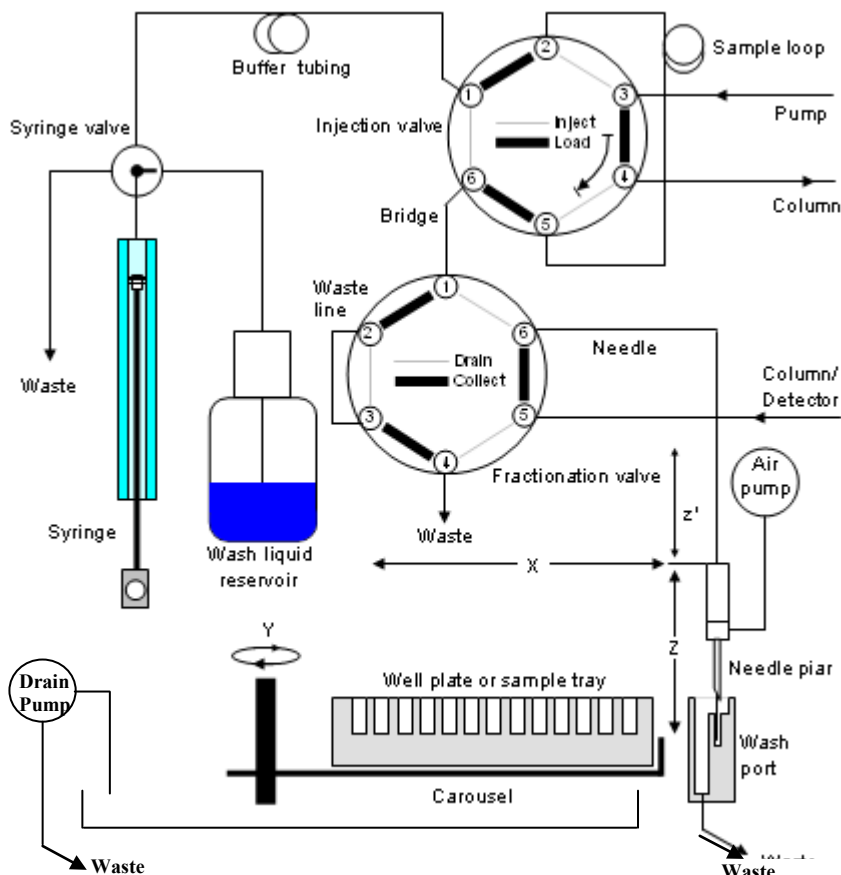

Fig. 60: Operating principle

The autosampler uses the pulled-loop injection principle: While the injection valve is in the **Inject** position and the fractionation valve is in the **Drain** position, the syringe aspirates sample from the sample container into the buffer tubing, thus, filling the entire needle and the capillary between the two valves (bridge) with sample. Then, the injection valve is switched into the **Load** position. The sample is drawn by the syringe through the needle and bridge, and placed in the sample loop. Afterward, the injection valve is switched into the **Inject** position, directing the solvent flow from the sample loop through the high-pressure flow path to the column.

The sample is transported onto the column in back flush mode: In the **Load** position, the sample is drawn into the sample loop toward the syringe. In the **Inject** position, the sample flow is in the opposite direction.

After the injection has been performed, the fractionation valve can be switched into the **Collect** position. While the valve is in this position, fractions can be collected through the needle and into the sample containers.

The autosampler includes the following fluid components:

Component	Description
Injection valve and sample loop	Sample is directed through the injection valve and sample loop to the mobile phase.
Fractionation valve	When the fractionation valve is switched into the Collect position after the injection has been performed, fractions can be collected through the needle and into the sample containers.
Bridge	Capillary that connects the injection valve and the fractionation valve.
Needle pair	The needle pair includes the puncturer and the needle. The puncturer pierces the cap/septum of the vial or the seal of the well prior to the injection. The needle is used to draw the sample.
Wash port	In the wash port, the needle can be rinsed from both the inside and outside.
Carousel	The carousel holds the well plates and/or racks.
Syringe	The syringe aspirates sample from the well or vial into the sample loop.
Buffer tubing	To prevent contamination of the syringe by the sample, buffer tubing is installed between the injection valve and syringe.
Wash liquid	The wash liquid is used both to remove residual sample from the buffer tubing and needle and to rinse the buffer tubing and needle.
Air pump	The air pump is used to dry the outside of the needle.
X, Z, and z'	Indicates the directions in which the needle pair can move.
Y	Indicates the direction in which the carousel can move.

For information about the supported injection methods, see section 8.4 (→ page 148).

Almost any function is available in Chromeleon in a User-Defined Program (UDP) (→ page 98).

8.2.1.2 Injection Valve and Fractionation Valve

The autosampler is equipped with one 2-position, 6-port injection valve and one 2-position, 6-port fractionation valve. The fractionation valve is suitable for the following pressures (for details about the injection valve, see page 34):

Fractionation valve	Material	Maximum pressure	Description
WPS-3000TFC	SST	3.5 MPa (500 psi)	1/16", 0.25 mm, 75°C
WPS-3000TBFC	PAEK	3.5 MPa (500 psi)	1/16", 0.25 mm, 50°C
WPS-3000TBFC (available as an option)	PAEK	35 MPa (5000 psi)	1/32", 0.1 mm, 50°C

Each valve has two operating positions. These are **Load** and **Inject** for the injection valve and **Collect** and **Drain** for the fractionation valve.

An injection can be performed only when the injection valve is in the **Load** position and the fractionation valve is in the **Drain** position. The sample is drawn by the syringe, through the needle and bridge, into the sample loop. When the injection valve is switched into the **Inject** position, the solvent flow is directed from the sample loop through the high-pressure flow path to the column.

After the injection has been performed, the fractionation valve can be switched into the **Collect** position. In this position, fractions can be collected through the needle and into the sample containers.

The components are connected to the valve as follows:

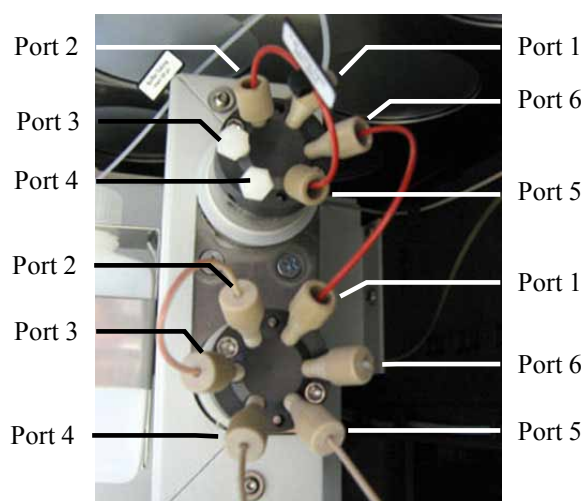

Fig. 61: Connections on the injection valve and fractionation valve

Injection Valve		Fractionation Valve	
Port	Connect the ...	Port	Connect the ...
1	Syringe/buffer tubing	1	Capillary between the valves (bridge)
2	Sample loop	2	Waste line
3	Pump	3	Waste line
4	Column	4	Waste
5	Sample loop	5	Column/detector
6	Capillary between the valves (bridge)	6	Needle

When you operate a biocompatible autosampler, observe the instructions for connecting the capillaries to the injection and fractionation valves (→ page 144).

8.2.1.3 Tips for Operation

Observe the following before you start operating the autosampler:

- Fraction collection is currently not supported in Chromeleon 7.1 or later.
- For operating the autosampler with Chromeleon, Chromeleon 6.80 Service Release 6 (or higher) and the following licenses are required:

- ◆ **Timebase Class 1**

- ◆ **Fraction Collection** (part no. 5960.0038)

for *basic* fraction collection, with wizard-based program setup and fraction reporting.

—or—

- ◆ **Extended Fraction Collection** (part no. 5960.0039)

for *advanced* fraction collection. The **Extended Fraction Collection** license includes the **Fraction Collection** license. In addition, it supports functions for advanced fraction collection, such as automatic sample purification via the associated post-acquisition steps, color-coded sample and fraction tracking, and sophisticated fractionation algorithms with peak shoulder detection.

For more information about the licenses, contact the Thermo Fisher Scientific sales organization.

- Verify that the **WPS-3000FC/WPS-3000TFC** check box is selected on the **Options** page (→ page 49) in the **Properties** dialog for the autosampler and that **BridgeVolume** is set to the correct value

The **BridgeVolume** is the volume of the capillary that connects the injection valve and the fractionation valve. Be sure that the value matches the value indicated on the capillary label. If the **BridgeVolume** is not correct, injection errors may occur.

 **Tip:** Keep in mind that you *have to* adapt the value in the **BridgeVolume** box if you install a bridge capillary with a different volume or if you use the autosampler for an application for which the two valves are *not* connected (in this case, set the volume to 0).

- To make the functions for fraction collection available in Chromeleon, install the **Fraction Collection** driver in addition to the autosampler:
 - a) Install the driver in the timebase in which the autosampler is installed. Installation is similar to the installation of the autosampler (→ page 46).
 - b) On the **Manufacturers** list, click **Generic** and on the **Devices** list, click **Fraction Collection**.

The **General** page shows the device name used to identify the driver the installation environment and in the Chromeleon client program and the maximum number of detection channels. Check and change the settings if necessary. If you want to use existing control panels, accept the default name.
 - c) Click **Ok** to complete the installation of the autosampler.
 - d) On the **File** menu, click **Save Installation** and then close the **Server Configuration** program.

- Chromeleon 6.80 SR10 improves the support of fraction collection by the Program Wizard and adds special panels. When creating a program with the wizard, Chromeleon writes all lines of the program required for fraction collection – manual editing is not required. Two additional wizard pages offer options for the first fraction position, the meandering scheme, an airdry option, and the options for fraction tubes.
 - ◆ Fraction programs are tray-specific. If you change the sampler tray configuration, also change the tray type on the **Collector - General Options** page of the PGM Editor.
 - ◆ Parameters that are related to the tray layout, fractionation scheme, or numbering of fractions must not be changed during the entire batch.

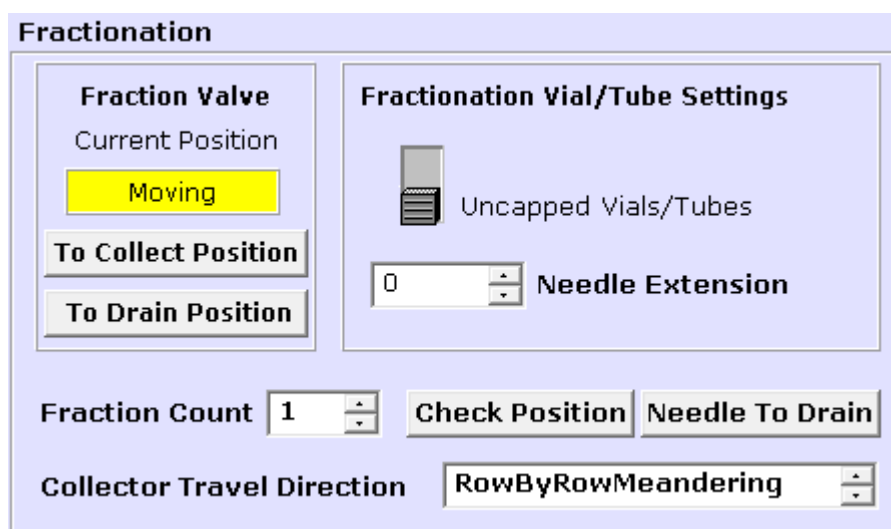

Fig. 62: Fractionation section on WPS-3000FC control panel

For more information about fraction collection and for a list of commands and properties for the autosampler, see the *Chromeleon Help*.

8.2.1.4 Optimizing the Autosampler for Nano/Cap Applications

Both autosampler versions can be optimized for applications in nano and cap LC.

Description	Part No.
Nano/Cap modification kit for WPS-3000TFC, including - 2.4 µL needle (fused silica, nanoViper) - 25 µL syringe - 50 µL buffer loop - 1 µL sample loop, nanoViper - 1 µL bridge (PEEKsil™) <i>Optional sample loops (nanoViper):</i> 5 µL 10 µL 20 µL	6824.0030 6826.2405 6826.2410 6826.2420
Nano/Cap modification kit for WPS-3000TBFC, including - 2.4 µL needle (fused silica, nanoViper) - 25 µL syringe - 50 µL buffer loop - 1 µL sample loop, nanoViper - 1 µL bridge (PEEKsil, biocompatible) <i>Optional sample loops (nanoViper):</i> 5 µL 10 µL 20 µL	6825.0030 6826.2405 6826.2410 6826.2420

Install the components from the modification kit, following the steps in the related service sections (→ section 7, page 109 and following pages, and section 8.2.1.6, page 142).

8.2.1.5 Optimizing the WPS-3000TFC for Normal-Phase Applications

A normal-phase upgrade kit (part no. 6820.0060) is available **only** for the WPS-3000TFC autosampler (part no. 5824.0020). Use normal-phase eluents **only** with the WPS-3000TFC autosampler after the autosampler has been modified with this normal-phase kit.

Warning

For normal-phase (NP) applications, observe the safety instructions for the WPS-3000TFC and WPS-3000TBFC autosamplers on page 6. For the safety instructions in French, see page 10.

Description	Part No.
Normal Phase Kit, including 1 needle, 15 µL, SST, Viper (200 µm x 0.5 mm (I.D. x O.D.)), with grounding cable 1 capillary, Viper (SST, 0.18 x 250 mm (I.D. x L), for use as a 6.4 µL bridge) 1 hexagon socket wrench (size 2 mm) 1 washer and 1 retaining washer	6820.0060

8.2.1.6 Service

The Service section describes all procedures for the autosampler (→ page 109 and following pages). For the WPS-3000TFC, the capillary connecting the injection valve and fraction valve (bridge) can also be replaced.

Description	Part No.
<i>Bridge (PEEK, volume: 6.2 µL) for</i> WPS-3000TFC	6824.0016
WPS-3000TBFC	6825.0016
<i>Bridge (PEEKsil, volume: 1 µL) for</i> WPS-3000TFC, optimized for nano/cap applications	6824.0015
WPS-3000TBFC, optimized for nano/cap applications	6825.0015

Remove the capillary from both port 6 on the injection valve and port 1 on the fractionation valve. Keep in mind that you have to adapt the **BridgeVolume** in the **Properties** dialog for the autosampler (→ page 49) when the volume of the new bridge is different from the volume of the bridge you replaced. If the bridge volume is not correct, injection errors may occur.

8.2.2 Autosamplers with Micro Fraction Collection (MFC) Option

For the WPS-3000(T)PL and WPS-3000TBPL Nano/Cap autosamplers, a 2-position, 8-port valve is available as Micro Fraction Collection (MFC) option. With this option, the injection, fractionation, and re-injection can be fully automated on one single system.

The autosampler is equipped with *one* 2-position, 8-port injection valve. The valve is suitable for the following pressures:

Valve	Material	Maximum pressure	Description
WPS-3000PL with MFC	SST	35 MPa (5000 psi)	1/16", 0.25 mm, 75°C
WPS-3000BPL with MFC	PAEK	35 MPa (5000 psi)	1/16", 0.25 mm, 50°C

 **Important:** The WPS-3000(T)PL and WPS-3000TBPL nano/cap autosampler equipped with the MFC option must **not** be used for normal-phase applications.

 **Important:** Le passeur d'échantillons WPS-3000(T)PL et WPS-3000TBPL nano/cap équipés de l'option de l'recueil de fractions (MFC) ne doit pas être utilisé pour des applications en phase normale.

For detailed information about this option, see the accompanying documents *Micro-Fraction Collection Option for the UltiMate 3000 Series Nano/Cap Autosampler*

- *Installation Instructions*, providing detailed installation and qualification instructions
- *Operating Instructions*, providing detailed operating instructions, Chromeleon program files, and examples

8.3 Biocompatible Autosamplers

This section refers to biocompatible autosamplers that are fitted with a PAEK injection valve (injection valve and fractionation valve, respectively).

The components connected to the valve (buffer tubing, needle, sample loop, column, and capillaries) are made of PEEKsil, PEEK, PTFE, or fused silica. As PAEK valves have deeper connection ports (→ Fig. 63), make sure the fitting is seated firmly in the port for a zero dead volume connection when conventional fittings are used. Note that this is not required for nanoViper or Viper fittings, which are dead-volume free by design.

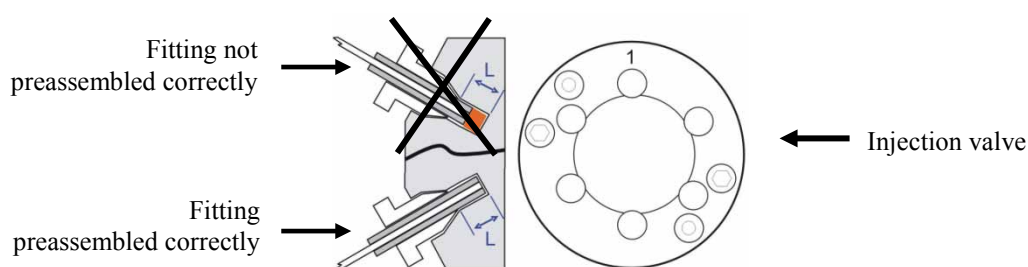

Fig. 63: Capillary connection on the injection valve

To avoid damage to the valve or the connected components, use the preassembly tool to establish the fitting connection. The preassembly tool is included in the application kit (WPS-3000TBPL Nano/Cap) or shipped with the instrument (WPS-3000TBPL Analytical and WPS-3000TBFC). To order the tool separately, use part no. 6000.0065.

⚠ Important: Do not use a stainless steel nut and/or ferrule to connect the components to the PAEK valve. To avoid damage to the valve, use only the supplied capillaries and fittings, as well as original Dionex spare parts.

⚠ Important: N'utilisez jamais de vis et/ou fêrures métalliques pour les connexions sur une vanne biocompatible en PAEK. Afin d'éviter tout dommage à la vanne, utilisez seulement les capillaires et raccords fournis, ainsi que des pièces d'origine Dionex.

Follow the steps below to connect the components to the biocompatible injection valve. The steps refer to the connection of a nano column, but are similar for the other components.

1. To establish a zero dead volume fitting connection between the column and the injection valve, a finger-tight nut, ferrule, and sleeve are required. Slide the finger-tight nut and the ferrule onto the sleeve as shown in Fig. 64.

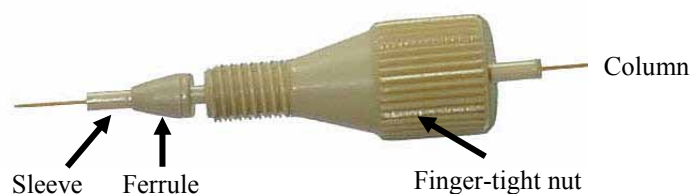

Fig. 64: Fitting connection

2. Insert the sleeve with the nut and the finger-tight nut in a port on the preassembly tool and tighten the nut by two or three manual turns.



Fig. 65: Preassembly tool

- ⚠ Important:** To avoid damage to the biocompatible injection valve, neither preassemble the fitting connection on the valve nor use any tool to tighten the finger-tight nut.
- ⚠ Important:** Afin d'éviter tout dommage à la vanne d'injection biocompatible, ne l'utilisez jamais pour le pré-sertissage des raccords, et n'utilisez aucun outil pour visser les raccords à serrage manuel.
3. Push the sleeve all the way into the port. It is essential for a zero dead volume connection that the assembly seats firmly.



Fig. 66: Preassembling the fitting connection

4. Tighten the nut in the port until it is finger-tight.
 5. Carefully turn the nut an additional 1/4 turn (90°) past the point at which the ferrule starts to grab the sleeve.
- 📘 Tip:** Thermo Fisher Scientific cannot provide a torque specification because the force required to tighten the nut can vary due to the friction between nut and the thread, as well as the composition and wall thickness of the component to be connected.

6. Remove the preassembled fitting from the tool and inspect the fitting. When you gently pull the ferrule, the ferrule should not easily move on the sleeve. If the ferrule sleeve moves laterally (→ Fig. 67), re-insert the fitting into the preassembly tool and tighten it an additional 1/8 turn past finger-tight.



Fig. 67: Inspecting the fitting

7. Remove and re-inspect the fitting. Repeat the previous step if necessary.
8. Insert the column (or the fused silica capillary) all the way through the sleeve until it extends the sleeve.

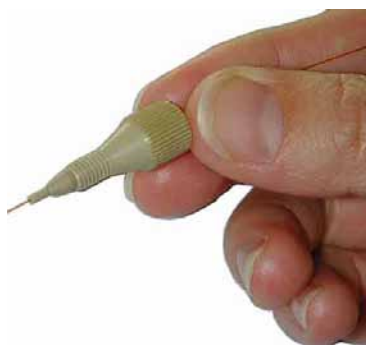

Fig. 68: Inserting the column

9. Pull the column back and install the preassembled fitting with the column to the appropriate port on the switching valve. Make certain that the column does not extend the sleeve when installing it into the port.

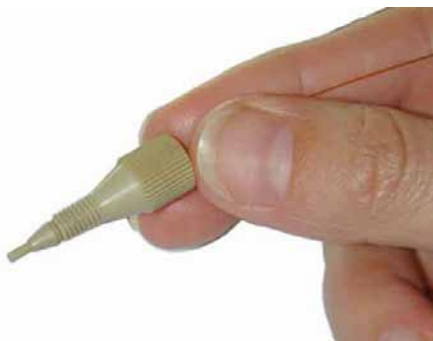

Fig. 69: Pulling the column back

10. Tighten the nut finger-tight. While tightening, push the column and the sleeve carefully into the valve to make certain that the column inlet enters all the way to the bottom of the valve port and to avoid the formation of dead volumes.
11. Tighten the nut additional 1/4 turn past finger-tight.
12. Start flow delivery and check for leakage. In case of any leakage, stop flow delivery and remove the fitting. Repeat steps 8 through 11.

i Tip: For the WPS-3000TBPL, the application kits for the biocompatible UltiMate 3000 system include long hex style nuts (→ Fig. 70; part no. 6721.0017). You may use these nuts instead of the finger-tight fittings. Follow the above steps and then connect the hex nut to the appropriate port on the injection valve. Tighten the nut with a 1/4" wrench.



Fig. 70: Long hex style nut

8.4 Injection Methods

The autosampler supports the following injection methods. For information about how to select the injection method in Chromeleon, see page 85. For information about *user-defined* injection programs, see page 98 and the *Chromeleon Help*.

The following sections describe the injections methods for the WPS-3000PL.

8.4.1 Full-Loop Injections

Full-loop injections provide maximum reproducibility (RSD < 0.4% for 1- μ L injections) but they are less accurate; the injected amount is determined by the loop volume. The sample consumption is:

For the first injection:

$$\text{FlushVolume} + \text{LoopVolume} \times \text{LoopOverflow}$$

Example:

$$5.0 \mu\text{L} + 5.0 \mu\text{L} \times 2 = 15 \mu\text{L}$$

For additional injections from the same sample container:

$$\text{FlushVolume2} + \text{LoopVolume} \times \text{LoopOverflow}$$

Example:

$$2.4 \mu\text{L} + 5.0 \mu\text{L} \times 2 = 12.4 \mu\text{L}$$

i Tip: For the fused silica needle, the flush volume should be at least 5.0 μ L. If the samples are highly viscous, it may be necessary to increase the flush volume and reduce the syringe speed for better accuracy.

The switching sequence for a standard full-loop injection is given below. In addition, the autosampler supports optimization of the injection profile (\rightarrow page 156).

When the sequence starts, the valve is in the INJECT position (\rightarrow Fig. 71). The puncturer has pierced the seal/septum of the sample container and the needle is in the container.

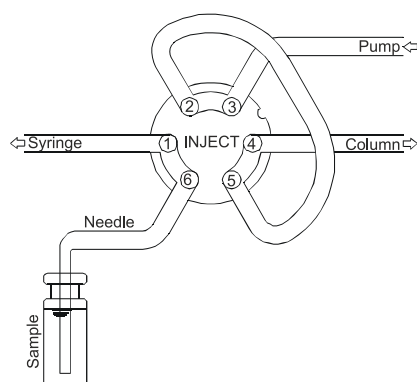

Fig. 71: INJECT position

The syringe draws the programmed FlushVolume from the sample container; thus, removing any residual wash liquid by filling the needle with sample (→ Fig. 72).

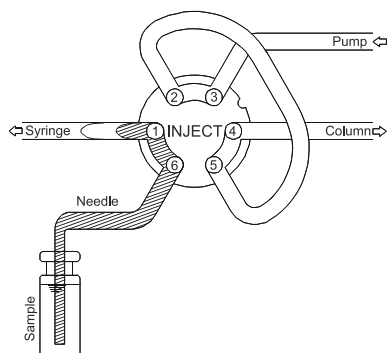

Fig. 72: Drawing sample into the needle

When the injection valve is set to the LOAD position (→ Fig. 73), a "sharp" sample front is placed at the inlet of the sample loop.

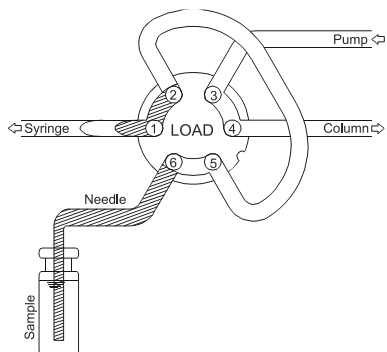

Fig. 73: LOAD position

For full-loop injections, the sample loop is quantitatively filled by transporting the LoopOverfill factor times the loop volume through the loop (→ Fig. 74).

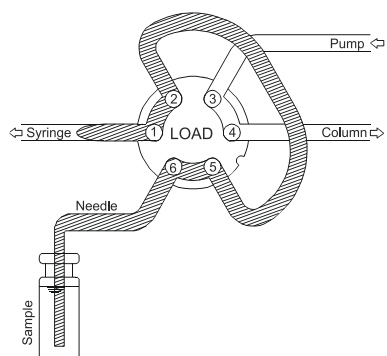

Fig. 74: Transporting the loop volume through the sample loop

The injection valve is set to the INJECT position (→ Fig. 75). The sample loop becomes part of the mobile phase flow path; the sample is transported to the column and the analysis time starts.

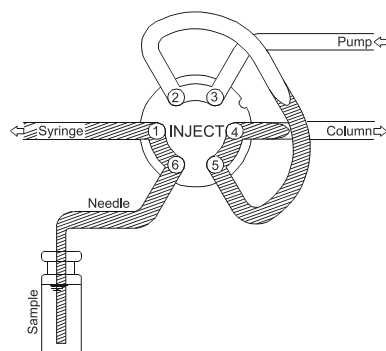

Fig. 75: INJECT position

The following picture illustrates the distribution of the liquids for a full-loop injection shortly before the injection is performed (and when a Wash was performed before):

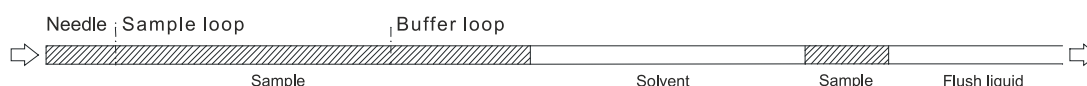

Fig. 76: Full-loop injection

i Tips: If only one injection is performed from each sample container or if a wash cycle has to be performed after each injection, the needle withdraws from the container directly after the injection (and is washed immediately if a wash cycle has been programmed). After the analysis time is completed, a new sample is started.

If more than one injection is performed from the same sample container without a wash cycle, the programmed FlushVolume2 is used. If the total amount of sample drawn from the sample container for the next injection exceeds the total volume of the buffer tubing, a Wash operation is performed before the next injection. The next sample then starts with the programmed FlushVolume.

FlushVolume2 can be smaller than FlushVolume. Thermo Fisher Scientific recommends always setting the value at least equal or larger than the needle volume.

8.4.2 Partial-Loop Injections

Partial-loop injections provide maximum accuracy. (Please keep in mind that the accuracy depends on syringe accuracy.) For injection volumes > 200 nL, the reproducibility is better than 1% RSD. Thermo Fisher Scientific recommends programming a flush volume of 5.0 µL. Smaller flush volumes can be programmed, but this may result in decreased performance. For maximum reproducibility and accuracy, use a 25 µL syringe and a 1 µL sample loop to avoid loss of accuracy due to expansion of the loop content when switching from INJECT to LOAD position prior to sample loading. When working with high pressure (2900 psi/200 bar), this loss may be up to 0.025 µL for a 5 µL loop.

The minimum required amount of sample in partial-loop injection mode is

For the first injection:

$$\text{FlushVolume} + \text{Injection Volume}$$

Example:

$$5.0 \mu\text{L} + 2.5 \mu\text{L} = 7.5 \mu\text{L}$$

For additional injections from the same sample container:

$$\text{FlushVolume2} + \text{Injection Volume}$$

Example:

$$2.4 \mu\text{L} + 2.5 \mu\text{L} = 4.9 \mu\text{L}$$

If a wash cycle is performed between injections, the sample loss always corresponds to the FlushVolume. For zero sample loss, use the microliter pick-up mode.

The switching sequence for a standard partial-loop injection is given below. In addition, the autosampler supports optimization of the injection profile (→ page 156).

The first three steps are identical to those for full-loop injections (→ page 148).

For partial-loop injections, the sample loop is filled by transporting the programmed injection volume into the sample loop (→ Fig. 77).

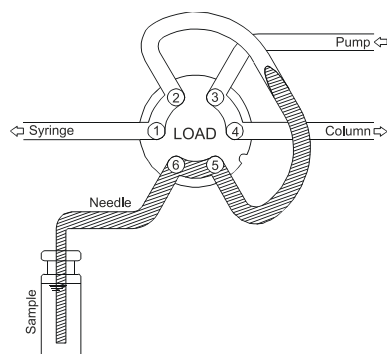

Fig. 77: Partially filling the sample loop with the desired injection volume

i Tip: You are free to choose the sample volume. However, if the injection volume exceeds 50% of the sample loop volume, the linearity will decrease considerably. In this case, Chromeleon issues a Warning. Chromeleon issues an Error if the injection volume is 100% of the sample loop volume.

The injection valve is set to the INJECT position (→ Fig. 78). The sample loop becomes part of the mobile phase flow path; the sample is now transported to the column and the analysis time starts.

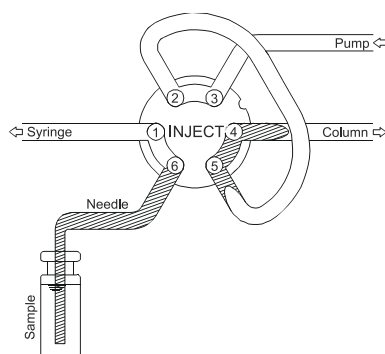

Fig. 78: INJECT position

The following picture illustrates the distribution of the liquids for a partial-loop injection:



Fig. 79: Partial-loop injection

i Tips: If only one injection is performed from each sample container or if a wash cycle has to be performed after each injection, the needle withdraws from the container directly after the injection (and is washed immediately if a wash cycle has been programmed). After the analysis time is completed, a new sample is started.

If more than one injection is performed from the same sample container without a wash cycle, the programmed FlushVolume2 is used. If the total amount of sample drawn from the sample container for the next injection exceeds the total volume of the buffer tubing, a Wash operation is performed before the next injection. The next sample then starts with the programmed FlushVolume.

FlushVolume2 can be smaller than FlushVolume. Thermo Fisher Scientific recommends always setting the value equal or larger than the needle volume.

8.4.3 Microliter Pick-Up

Microliter pick-up means zero sample loss and maximum accuracy but slightly diminished reproducibility. Use a 25 µL syringe and a 10 µL sample loop for optimum accuracy and reproducibility. The sample plug is transported into the loop, sandwiched by a plug of transport liquid whose volume is the FlushVolume.

To ensure the accuracy of the microliter pickup, there is a maximum amount of sample that can be injected. This maximum is based on the loop and needle volumes and can be calculated as follows:

$$0.5 \times (\text{LoopVolume} - 3 \times \text{NeedleVolume})$$

For a 20 µL loop and 2.4 µL needle, a maximum amount of 6.4 µL can be injected completely. If a higher injection volume is specified, a warning will appear in Chromeleon. The specified volume will be drawn, but the sample will not be injected completely and the accuracy will be slightly diminished.

For an example of a user-defined programs using microliter pick-up, see the *Chromeleon Help*.

The switching sequence for microliter pick-up is as follows:

When the sequence starts, the valve is in the INJECT position (→ Fig. 80). The puncturer has pierced the septum of the transport vial and the needle is in the transport vial.

i **Tip:** Thermo Fisher Scientific recommends using the mobile phase as the transport liquid for microliter pick-up injections. This is to avoid that an extra peak appears in the chromatogram for the transport liquid.

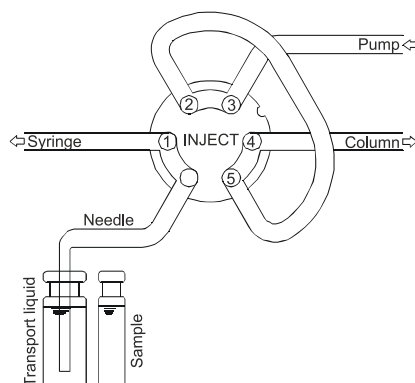

Fig. 80: INJECT position

For the first injection after a wash cycle or after emptying the buffer tubing, the syringe draws the transport liquid from the transport vial; thus, removing any residual wash liquid by filling the needle with transport liquid (→ Fig. 81).

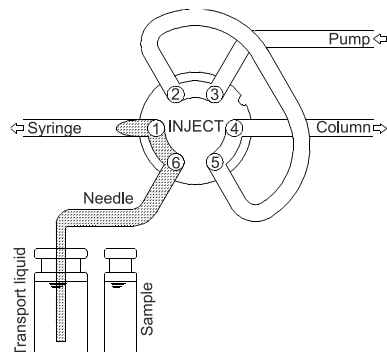

Fig. 81: Drawing transport liquid

The needle leaves the transport vial and moves into the sample container. The injection valve is set to the LOAD position (→ Fig. 82).

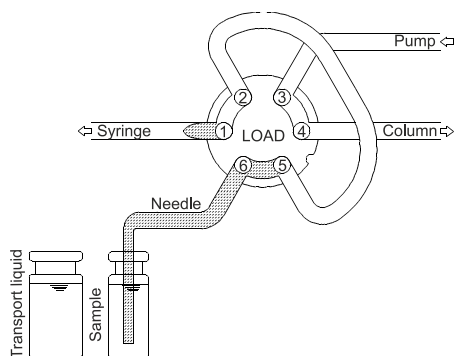

Fig. 82: LOAD position

The programmed injection volume is drawn from the sample container (→ Fig. 83).

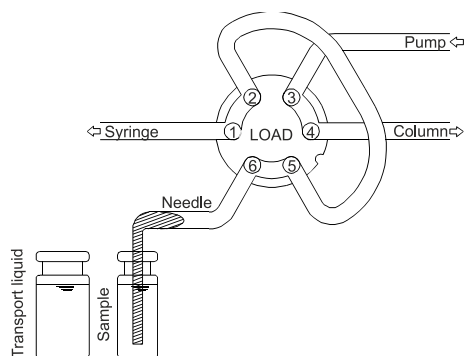

Fig. 83: Drawing the sample volume

The needle moves back to the transport vial (→ Fig. 84). The sample is quantitatively transported into the loop, with transport liquid (mobile phase) from the transport vial.

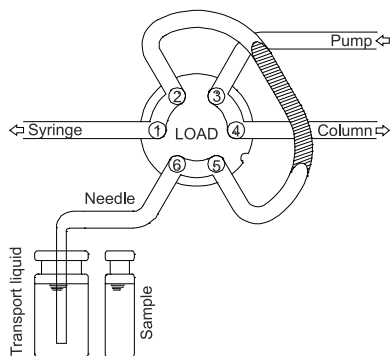

Fig. 84: Transporting sample into the sample loop

The injection valve is set to the INJECT position (→ Fig. 85). The sample loop becomes part of the mobile phase flow path; the sample is transported to the column and the analysis time starts.

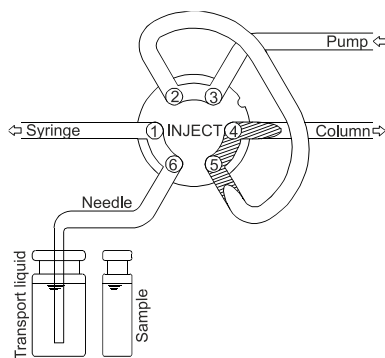

Fig. 85: INJECT position

The following picture illustrates the distribution of the liquids for microliter pick-up:

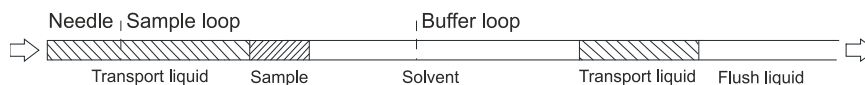

Fig. 86: Microliter pick-up

i Tip: If a wash cycle is performed after the injection or if the liquid in the buffer tubing has been directed to the wash port, the entire sequence is repeated, including drawing transport liquid at the beginning of the sequence. In all other cases, this step is omitted.

8.4.4 Low Dispersion Mode

To optimize the injection profile, the autosampler supports **Low Dispersion** injection control for full-loop and partial-loop injections. The corresponding properties are available in Chromeleon.

i **Tip:** Low dispersion mode can be used in user-defined programs (UDP), also.

The injection valve is set back to the LOAD position after a calculated time; the tailing part of the sample plug is cut off. This allows you to optimize the injection profile and thus, to improve the reproducibility.

The following parameters are important:

- **LowDispersionFlow:**

This value is the flow rate with which the sample is flushed out of the sample loop.

i **Tip:** If the flow rate is set to 0.00 $\mu\text{l}/\text{min}$, a standard injection is performed.

- **LowDispersionFactor (L.D. factor):**

The **LowDispersionFactor** determines the amount of sample volume that is cut off when the injection valve is set back. A value of 1.0 corresponds to the volume of the sample plug. If the value is greater than (less than) 1.0, the injection valve is set back after the volume is greater than (less than) the sample volume that has been transferred through the sample loop. The valid range is 0.01 to 100. For example, if the value is 1.2, the valve is set back when 120 % of the value of the sample plug has been transferred. The injection profile for various values is shown in Fig. 87.

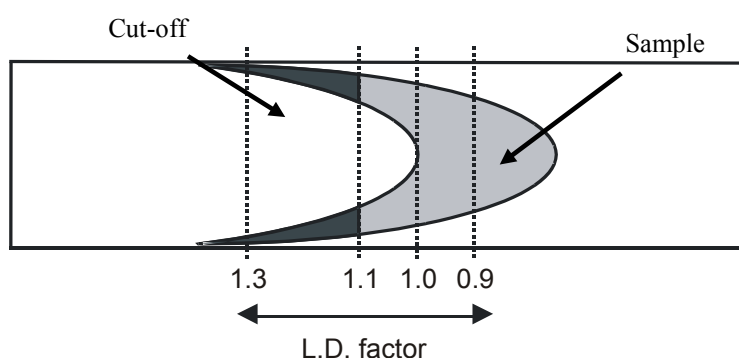

Fig. 87: Low Dispersion injection profiles

The formula for calculating the time after which the injection valve is set back to the LOAD position is as follows:

$$S_t = (f) (V_1) (60)/F$$

where: S_t = Switching time (sec)

f = L.D. factor (Low Dispersion factor)

V_1 = Injection volume (μL)

F = LowDispersionFlow ($\mu\text{L}/\text{min}$)

For example, if the injection volume V_1 is 1 μL , the flow rate F is 5 μL , and the L.D. factor f is 1.1, the valve switching time S_t will be 13.2 sec.

i **Tips:** With these conditions, the sample loop will be flushed with the wash liquid as well, which may result in injection problems, such as lack of proper peak resolution. Thermo Fisher Scientific recommends using the mobile phase (typically mobile phase A) as the wash liquid.

The switching time (S_t) must be at least 10 s. If the calculated switching time is less than this limit, it will be redefined to 10 s.

9 Technical Information

	WPS-3000(T)PL (RS)/ WPS-3000TBPL Nano/Cap	WPS-3000TBPL Analytical/ WPS-3000T(B)FC
Sample capacity	Dependent on the carousel configuration:	
Vials	216 x 0.3 mL vials, 120 x 1.1 mL conical vials, 216 x 1.2 mL vials, 120 x 1.8 mL or 2.0 mL vials, 66 x 4 mL vials, 30 x 10 mL vials and/or 120 x 0.5 mL or 1.5 mL Eppendorf tubes (capped and pierced) + 15 x 10 mL vials	
Well plates	3 x 96 or 3 x 384 normal or deep well plates 3 x 24 deep well plates, 3 x 384 low well PCR plates + 15 x 10 mL vials	
Injection methods	Full-loop and partial-loop injections (both also with Low Dispersion mode) Microliter pick-up Freely programmable user defined injection methods	
Injection technique	Needle in needle, with programmable needle wash	
Needle wash	Active external	
Carry-over	< 0.02% for caffeine with external wash	
Minimum sample required	1 µL out of 1 µL (microliter pick-up)	
Injection volume Settable range: Recommended range:	0.001 - 20 µL 20 nL - 20 µL	0.01 - 250 µL 0.1 - 250 µL
Fractionation Modes	n. a.	WPS-3000T(B)FC only: time slices, peak signal, manual and external trigger
Injection volume precision	RSD < 0.4% for 1 µL full-loop injections RSD < 1% for 200 nL partial-loop injections	RSD < 0.25% for 5 µL full-loop injections RSD < 0.3% for 5 µL and 20 µL partial-loop injections
Linearity	Corr. Coeff. > 0.9995, at 100 nL to 500 nL partial-loop injections, caffeine in water	Corr. Coeff. > 0.9999 RSD < 0.5 % at 5 - 30 µL (caffeine in water), Offset < 2.0 µL (500 µL buffer tubing), < 11.0 µL (1000 µL buffer tubing)
Injection cycle time	< 30 seconds for 1 µL full-loop injection	< 60 seconds for 5 µL full-loop injections < 90 seconds for 5 µL partial-loop injections

	WPS-3000(T)PL (RS)/ WPS-3000TBPL Nano/Cap	WPS-3000TBPL Analytical/ WPS-3000T(B)FC
WPS-3000TPL (RS), TBPL and TBFC Sample thermostating Sample temperature accuracy	4 to 45 °C, max. 22 °C below ambient ±2 °C at a setpoint of 10 °C at ambient temperatures of ≤25 °C and ≤50% relative humidity	
Control	All functions software controlled via USB 1.1 Integrated USB 1.1 hub with 3 free USB connectors	
I/O interfaces	4 digital inputs, 4 programmable relay outputs	
User input/display	LCD-indicating system parameters Standby button 3 LEDs for status monitoring (Power, Connected, Status) 4 soft keys for operation during initial installation and maintenance	
Safety features	Leak sensor, automatic plate/vial recognition, needle overload protection (puncturer), internal monitoring of all mechanical operations, Autosampler with sample thermostating: Monitoring of the function and cooling performance by 3 temperature sensors	
GLP features	In Chromeleon: Full support of automatic equipment qualification (AutoQ™) and Wellness monitoring All system parameters are recorded in Chromeleon audit trail.	
Wetted parts In sample flow path In wash liquid flow path	PEEK, PAEK, PEEKsil, fused silica, stainless steel PCTFE, ETFE, ECTFE, PTFE, glass	PEEK, PAEK, stainless steel (WPS-3000TFC) PCTFE, ETFE, ECTFE, PTFE, glass
Power requirements	100–120 V, 60 Hz; 200–240 V, 50 Hz; max. 150 VA (WPS-3000PL), max. 320 VA (WPS-3000TPL/WPS-3000TFC)	
Emission sound pressure level	Typically < 65 dB(A) in 1 m-distance	
Environmental conditions	Range of use: Indoor use Temperature: 10 to 35 °C (50 to 95 °F) Air humidity: 80% relative humidity, non-condensing Overvoltage category: II Pollution degree: 2	
Dimensions (h × w × d)	36 x 42 x 51 cm (14.2 x 16.5 x 20 inch)	
Weight	WPS-3000PL (RS): 19 kg (42 lb) WPS-3000TPL (RS): 24 kg (53 lb) WPS-3000TBPL Nano/Cap: 24 kg (53 lb)	WPS-3000TBPL Analytical: 24 kg (53 lb) WPS-3000T(B)FC: 25 kg (55 lb)

Technical information: September 2013.

All technical specifications are subject to change without notice.

10 Accessories, Consumables and Spare Parts

Accessories, spare parts, and consumables for the autosampler are always maintained at the latest technical standard. Therefore, part numbers are subject to alteration. However, updated parts will always be compatible with the parts they replace.

10.1 Standard Accessories

The following accessories are shipped with the autosampler. (The list is subject to change without notice). Some parts listed below are included in one of the spare part kits. For information about these kits, refer to section 10.3 (→ page 176).

The part number always refers to the packing unit. Unless otherwise stated, the packing unit is 1 unit. For more information, contact the Thermo Fisher Scientific sales organization for Dionex HPLC Products.

Description	Part No.	Quantity in the accessories kit
WPS-3000PL RS, WPS-3000TPL RS accessories kit, including:		
Online degas wash kit (includes all tubes and fittings required to connect the wash liquid for online degassing)	6820.2450	1
Fuse, 2 A, slow-blow (5 x 20 mm)	Included in 6820.0026	2
Fuse, 4 A, slow-blow (5 x 20 mm)	Included in 6820.0026	2
Fuse, 10 A, slow-blow, 250V (6.3 x 32 mm)	Included in 6820.0026	1
Hex key (size 9/64")	6000.0053	1
Open-end wrench (size 1/4 x 5/16")	6000.0051	1
Tubing (ECTFE, 0.75 mm ID, 600 mm long)	6820.0011	1
2.4 µL needle (fused silica, nanoViper, 100 µm ID)	6820.3010	1
Sample loop (20 µL, nanoViper)	6826.2420	1
Rack (for 40 vials, O.D. < 12 mm) and normal well plate (12 - 24 mm high)	6820.4070	3
10 mL transport vials with cap and seal	Included in 6820.0023	16
Wash liquid reservoir	Included in 6820.4075	1
Normal 96 well plate	6820.4100	1
Sealing cap for (deep) well plate (96 wells)	6820.4102	1
Polypropylene vials (250 µL)	Included in 6820.0029	10
Caps for 250 µL polypropylene vials	Included in 6820.0028	10
USB cable, type A to type B, USB 2.0, 1 m	6035.9035	1

Description	Part No.	Quantity in the accessories kit
WPS-3000PL, and WPS-3000TPL Nano/Cap accessories kit, including:		
Online degas wash kit (includes all tubes and fittings required to connect the wash liquid for online degassing)	6820.2450	1
Fuse, 2 A, slow-blow (5 x 20 mm)	Included in 6820.0026	2
Fuse, 4 A, slow-blow (5 x 20 mm)	Included in 6820.0026	2
Fuse, 10 A, slow-blow, 250V (6.3 x 32 mm)	Included in 6820.0026	1
Hex key (size 9/64")	6000.0053	1
Open-end wrench (size 1/4 x 5/16")	6000.0051	1
Tubing (ECTFE, 0.75 mm ID, 600 mm long)	6820.0011	1
2.4 µL needle (fused silica, nanoViper, 100 µm ID)	6820.3010	1
Sample loop (20 µL, nanoViper)	6826.2420	1
Rack (for 40 vials, O.D. < 12 mm) and normal well plate (12 - 24 mm high)	6820.4070	3
10 mL transport vials with cap and seal	Included in 6820.0023	16
Wash liquid reservoir	Included in 6820.4075	1
Normal 96 well plate	6820.4100	1
Sealing cap for (deep) well plate (96 wells)	6820.4102	1
Polypropylene vials (250 µL)	Included in 6820.0029	10
Caps for 250 µL polypropylene vials	Included in 6820.0028	10
USB cable, type A to type B, USB 2.0, 1 m	6035.9035	1

Description	Part No.	Quantity in the accessories kit
WPS-3000TBPL Nano/Cap (biocompatible autosampler) accessories kit, including:		
Online degas wash kit (includes all tubes and fittings required to connect the wash liquid for online degassing)	6820.2450	1
Fuse, 2 A, slow-blow (5 x 20 mm)	Included in 6820.0026	2
Fuse, 4 A, slow-blow (5 x 20 mm)	Included in 6820.0026	2
Fuse, 10 A, slow-blow, 250V (6.3 x 32 mm)	Included in 6820.0026	1
Hex key (size 9/64")	6000.0053	1
Open-end wrench (size 1/4 x 5/16")	6000.0051	1
Tubing (ECTFE, 0.75 mm ID, 600 mm long)	6820.0011	1
2.4 µL needle (fused silica, nanoViper, 100 µm ID)	6820.3010	1
Sample loop (20 µL, PEEKsil)	6821.0018	1
Rack (for 40 vials, O.D. < 12 mm)	6820.4070	3
10 mL transport vials with cap and seal	Included in 6820.0023	16
Wash liquid reservoir	Included in 6820.4075	1
Normal 96 well plate	6820.4100	1
Sealing cap for (deep) well plate (96 wells)	6820.4102	1
Polypropylene vials (250 µL)	Included in 6820.0029	10
Caps for 250 µL polypropylene vials	Included in 6820.0028	10
USB cable, type A to type B, USB 2.0, 1 m	6035.9035	1

Description	Part No.	Quantity in the accessories kit
WPS-3000TBPL Analytical (biocompatible autosampler) accessories kit, including:		
Online degas wash kit (includes all tubes and fittings required to connect the wash liquid for online degassing)	6820.2450	1
Fuse, 2 A, slow-blow (5 x 20 mm)	Included in 6820.0026	2
Fuse, 4 A, slow-blow (5 x 20 mm)	Included in 6820.0026	2
Fuse, 10 A, slow-blow, 250V (6.3 x 32 mm)	Included in 6820.0026	1
Hex key (size 9/64")	6000.0053	1
Open-end wrench (size 1/4 x 5/16")	6000.0051	1
Tool for preassembling biocompatible fittings	6000.0065	1
Tubing (ECTFE, 0.75 mm ID, 600 mm long)	6820.0011	1
Capillary (PEEK, OD x ID: 1/16" x 0.25 mm) WPS - TCC	6251.6001	2 m
One-piece fitting (PEEK, 1/16", 15 mm)	6266.0024	2
15 µL needle (PEEK, Viper, 250 µm ID)	6820.3025	1
Sample loop (250 µL, PEEK)	6823.0020	1
Finger-tight fitting screw (PEEK, 1/16", with ferrule) for connecting capillaries to the injection valve	6823.0010	2
Buffer tubing (1000 µL, PEEK/PTFE)	6821.0022	1
Syringe (250 µl)	6822.0003	1
Rack (for 40 vials, O.D. < 12 mm)	6820.4070	3
10 mL transport vials with cap and seal	Included in 6820.0023	16
Vials, 1.8 mL (brown)	Included in 6000.0072	10
Caps for 1.8 mL vials (with septum)	Included in 6000.0071	10
Vials, 2.0 mL (brown)	Included in 6000.0060	10
Caps (white) for 2.0 mL vials	6000.0057	10
Septum for 2.0 mL vials (silicone, red)	6000.0058	10
Wash liquid reservoir	Included in 6820.4075	1
Normal 96 well plate	6820.4100	1
Sealing cap for (deep) well plate (96 wells)	6820.4102	1
USB cable, type A to type B, USB 2.0, 1 m	6035.9035	1

Description	Part No.	Quantity in the accessories kit
WPS-3000TFC accessories kit, including:		
Online degas wash kit (includes all tubes and fittings required to connect the wash liquid for online degassing)	6820.2450	1
Fuse, 2 A, slow-blow (5 x 20 mm)	Included in 6820.0026	2
Fuse, 4 A, slow-blow (5 x 20 mm)	Included in 6820.0026	2
Fuse, 10 A, slow-blow, 250V (6.3 x 32 mm)	Included in 6820.0026	1
Tubing (ECTFE, 0.75 mm ID, 600 mm long)	6820.0011	1
15 µL needle (fused silica, nanoViper, 250 µm ID)	6820.3115	1
Sample loop (250 µL, SST)	6824.0020	1
Buffer tubing (1000 µL, SST/PTFE)	6820.0056	1
Rack (for 40 vials, O.D. < 12 mm) and normal well plate (12 - 24 mm high)	6820.4070	3
10 mL transport vials with cap and seal	Included in 6820.0023	16
Wash liquid reservoir	Included in 6820.4075	1
Vials, 1.8 mL (brown)	Included in 6000.0072	10
Caps for 1.8 mL vials (with septum)	Included in 6000.0071	10
Vials, 2.0 mL (brown)	Included in 6000.0060	10
Caps (white) for 2.0 mL vials	6000.0057	10
Septum for 2.0 mL vials (silicone, red)	6000.0058	10
Normal 96 well plate	6820.4100	1
Deep-well plate (34 - 46 mm high, 96 wells)	6820.4101	1
Support rack for deep-well plates (34 - 46 mm high)	6820.4079	1
Sealing cap for (deep) well plate (96 wells)	6820.4102	2
USB cable, type A to type B, USB 2.0, 1 m	6035.9035	1

Description	Part No.	Quantity in the accessories kit
WPS-3000TBFC accessories kit, including:		
Online degas wash kit (includes all tubes and fittings required to connect the wash liquid for online degassing)	6820.2450	1
Fuse, 2 A, slow-blow (5 x 20 mm)	Included in 6820.0026	2
Fuse, 4 A, slow-blow (5 x 20 mm)	Included in 6820.0026	2
Fuse, 10 A, slow-blow, 250V (6.3 x 32 mm)	Included in 6820.0026	1
Tool for preassembling biocompatible fittings	6000.0065	1
Tubing (ECTFE, 0.75 mm ID, 600 mm long)	6820.0011	1
Capillary (PEEK, OD x ID: 1/16" x 0.25 mm) from WPS - TCC and/or from pump to WPS	6251.6001	2 m
One-piece fitting (PEEK, 1/16", 15 mm)	6266.0024	2
15 µL needle (PEEK, Viper, 250 µm ID)	6820.3025	1
Sample loop (250 µL, PEEK)	6823.0020	1
Finger-tight fitting screw (PEEK, 1/16", with ferrule) for connecting capillaries to the injection valve	6823.0010	2
Buffer tubing (1000 µL, PEEK/PTFE)	6821.0022	1
Rack (for 40 vials, O.D. < 12 mm)	6820.4070	3
10 mL transport vials with cap and seal	Included in 6820.0023	16
1.8 mL vials (brown)	Included in 6000.0072	10
Vial caps for 1.8 mL vials (with septum)	Included in 6000.0071	10
Wash liquid reservoir	Included in 6820.4075	1
Normal 96 well plate	6820.4100	1
Deep-well plate (34 - 46 mm high, 96 wells)	6820.4101	1
Support rack for deep-well plates (34 - 46 mm high)	6820.4079	1
Sealing cap for (deep) well plate (96 wells)	6820.4102	1
USB cable, type A to type B, USB 2.0, 1 m	6035.9035	1

10.2 Optional Accessories

10.2.1 WPS-3000(T)PL (RS) Nano/Cap

Optional Accessory	Part No.	Remarks
Automated Off-Line 2DLC Solution	6820.0050	Micro Fraction Collection Option plus Chromeleon Timebase Class 1 and Extended Fraction Collection licenses
<i>Buffer tubing, SST/PTFE</i> 500 µL	6820.0020	Make sure that you have also installed an appropriate sample loop and syringe (→ page 22).
Drain kit for UltiMate 3000 systems	6040.0005	The kit includes all components required for system drainage and detailed installation instructions.
Extended Fraction Collection License	5960.0039	Additional Chromeleon license required for <i>advanced</i> fraction collection (→ page 139). This license includes the Fraction Collection license.
Fraction Collection License	5960.0038	Additional Chromeleon license required for <i>basic</i> fraction collection (→ page 139).
Front cover (transparent)	6820.1427	Closes the sample compartment to prevent dust and other particles from entering.
Micro Fraction Collection Option	6820.0051	Hardware extension (8-port valve) for fraction collection (no software license included).
<i>Needles</i> 3.5 µL, PEEK, Viper; 127 µm ID 15 µL, PEEK, Viper; 250 µm ID; for analytical purposes 15 µL, fused silica, nanoViper; 250 µm ID; for analytical purposes	6820.3023 6820.3025 6820.3115	
PAEK Modification Kit <i>Optional accessories for biocompatible applications with upgraded WPS-3000(T)PL (RS) Nano/Cap:</i> <i>Sample loops (PEEK)</i> 5 µL 10 µL 20 µL 50 µL, for analytical applications 125 µL, for analytical applications	Contact Service. 6823.0016 6823.0017 6823.0018 6823.0019 6821.0032	Kit for modifying the standard non-biocompatible fluidics of a WPS-3000(T)PL RS autosampler to a biocompatible version.

Optional Accessory	Part No.	Remarks
<i>Syringe bio upgrade kit, including</i> Syringe, 250 µL Needle, 15 µL, fused silica, nanoViper Buffer tubing, 500 µL, PEEK/PTFE Sample loop, 125 µL, PEEK <i>Buffer tubing, PEEK/PTFE</i> 50 µL 500 µL	6821.0031 6821.0019 6821.0020	For optional use after the autosampler has been modified with the PAEK Modification Kit.
<i>Sample loop, nanoViper (fused silica/PEEK sheathed)</i> 1 µL 5 µL 10 µL 20 µL 50 µL 125 µL, for analytical applications	6826.2401 6826.2405 6826.2410 6826.2420 6826.2450 6826.2412	Make sure that you have also installed appropriate buffer tubing and an appropriate syringe (→ page 22).
Signal cable (6-pin Mini-DIN)	6000.1004	To connect an external device.
Syringe upgrade kit, including Syringe, 250 µL Needle, 15 µL, fused silica, nanoViper Buffer tubing, 500 µL, SST/PTFE Sample loop, 125 µL, nanoViper	6820.0031	Kit for upgrading the autosampler for use with a 250 µL syringe
<i>Syringes</i> 100 µL 250 µL, for analytical applications	6822.0002 6822.0003	Make sure that you have also installed appropriate buffer tubing and an appropriate sample loop (→ page 22).

10.2.2 WPS-3000TBPL Nano/Cap

Optional Accessory	Part No.	Remarks
Automated Off-Line 2DLC Solution (biocompatible)	6821.0050	Micro Fraction Collection Option plus Chromeleon Timebase Class 1 and Extended Fraction Collection licenses
<i>Buffer tubing, PEEK/PTFE</i> 500 µL	6821.0020	Make sure that you have also installed an appropriate sample loop and syringe (→ page 22).
Drain kit for UltiMate 3000 systems	6040.0005	The kit includes all components required for system drainage and detailed installation instructions.
Extended Fraction Collection License	5960.0039	Additional Chromeleon license required for <i>advanced</i> fraction collection (→ page 139). This license includes the Fraction Collection license.
Fraction Collection License	5960.0038	Additional Chromeleon license required for <i>basic</i> fraction collection (→ page 139).
Front cover (transparent)	6820.1427	Closes the sample compartment to prevent dust and other particles from entering.
Micro Fraction Collection Option (biocompatible)	6821.0051	Hardware extension (8-port valve) for fraction collection (no software license included).
<i>Needles</i> 15 µL, PEEK, Viper; 250 µm ID; for analytical purposes 15 µL, fused silica, nanoViper; 250 µm ID; for analytical purposes	6820.3025 6820.3115	
<i>Sample loops, nanoViper (fused silica/PEEK sheathed)</i> 1 µL 5 µL 10 µL 20 µL 50 µL, for analytical applications 125 µL, for analytical applications <i>Sample loops, PEEK</i> 5 µL 10 µL 20 µL 50 µL 125 µL	6826.2401 6826.2405 6826.2410 6826.2420 6826.2450 6826.2412 6823.0016 6823.0017 6823.0018 6823.0019 6821.0032	Make sure that you have also installed appropriate buffer tubing and an appropriate syringe (→ page 22).

Optional Accessory	Part No.	Remarks
Signal cable (6-pin Mini-DIN)	6000.1004	To connect an external device.
Syringe bio upgrade kit, including Syringe, 250 μ L Needle, 15 μ L, fused silica, nanoViper Buffer tubing, 500 μ L, PEEK/PTFE Sample loop, 125 μ L, PEEK	6821.0031	Kit for upgrading the biocompatible autosampler for use with a 250 μ L syringe
<i>Syringes</i> 100 μ L 250 μ L, for analytical applications	6822.0002 6822.0003	Make sure that you have also installed appropriate buffer tubing and an appropriate sample loop (\rightarrow page 22).

10.2.3 WPS-3000TBPL Analytical

Optional Accessory	Part No.	Remarks
Buffer tubing, PEEK/PTFE 1000 µL	6821.0022	Make sure that you have also installed an appropriate sample loop and syringe (→ page 22).
Drain kit for UltiMate 3000 systems	6040.0005	The kit includes all components required for system drainage and detailed installation instructions.
Front cover (transparent)	6820.1427	Closes the sample compartment to prevent dust and other particles from entering.
Needles 3.5 µL, PEEK, Viper; 127 µm ID 15 µL, fused silica, nanoViper; 250 µm ID	6820.3023 6820.3115	
Sample loops, nanoViper (fused silica/PEEK sheathed) 50 µL 125 µL Sample loops, PEEK 5 µL 10 µL 20 µL 50 µL 125 µL 250 µL	6826.2450 6826.2412 6823.0016 6823.0017 6823.0018 6823.0019 6821.0032 6823.0020	Make sure that you have also installed appropriate buffer tubing and an appropriate syringe (→ page 22). The 5, 10 and 20 µL loops are designed for Full Loop injections of the respective volume.
Signal cable (6-pin Mini-DIN)	6000.1004	To connect an external device.
Syringe, 250 µL	6822.0003	Make sure that you have also installed appropriate buffer tubing and an appropriate sample loop (→ page 22).

10.2.4 WPS-3000TFC

Optional Accessory	Part No.	Remarks
Buffer tubing, SST/PTFE 1000 µL	6820.0056	Make sure that you have also installed an appropriate sample loop and syringe (→ page 22).
Drain kit for UltiMate 3000 systems	6040.0005	The kit includes all components required for system drainage and detailed installation instructions.
Extended Fraction Collection License	5960.0039	Additional Chromeleon license required for <i>advanced</i> fraction collection (→ page 139). This license includes the Fraction Collection license.
Fraction Collection License	5960.0038	Additional Chromeleon license required for <i>basic</i> fraction collection (→ page 139).
Front cover (transparent)	6820.1427	Closes the sample compartment to prevent dust and other particles from entering.
Nano/cap modification kit, including - 2.4 µL needle (fused silica, nanoViper) - 25 µL syringe - 50 µL buffer tubing, SST/PTFE - 1 µL sample loop, nanoViper - 1 µL bridge (PEEKsil)	6824.0030	Install the components from the modification kit, following the steps in the related service sections (→ section 7, page 109 and following pages, and section 8.2.1.6, page 142).
<i>Optional accessories for nano/cap applications:</i> <i>Sample loops, nanoViper (fused silica/PEEK sheathed)</i> 1 µL 5 µL 10 µL 20 µL	6826.2401 6826.2405 6826.2410 6826.2420	
<i>Syringe</i> 25 µL	6822.0001	
<i>Buffer tubing, SST/PTFE</i> 50 µL	6820.0019	
<i>Needles</i> 2.4 µL, fused silica, nanoViper; 100 µm ID 3.5 µL, PEEK, Viper; 127 µm ID	6820.3010 6820.3023	
<i>Needle</i> 15 µL, PEEK, Viper; 250 µm ID	6820.3025	

Optional Accessory	Part No.	Remarks
Normal Phase Kit for WPS-3000TFC, including - 15 µL needle, SST, Viper - 6.4 µL bridge, SST, Viper - Hexagon socket wrench (size 2 mm) - 1 washer - 1 retaining washer	6820.0060	For normal-phase applications with the WPS-3000TFC autosampler. The kit includes all components required to ground the needle, the injection valve and the fractionation valve for normal-phase applications.
<i>Sample loops, nanoViper (fused Silica/PEEK sheathed)</i> 50 µL 125 µL <i>Sample loop, SST</i> 250 µL	6826.2450 6826.2412 6824.0020	Make sure that you have also installed appropriate buffer tubing and an appropriate syringe (→ page 22).
Signal cable (6-pin Mini-DIN)	6000.1004	To connect an external device.
Syringe, 100 µL	6822.0002	Make sure that you have also installed appropriate buffer tubing and an appropriate sample loop (→ page 22).

Optional Accessory	Part No.	Remarks
<i>Sample loops, nanoViper (fused silica/PEEK sheathed)</i> 50 µL 125 µL <i>Sample loops, PEEK</i> 5 µL 10 µL 20 µL 50 µL 125 µL 250 µL	6826.2450 6826.2412 6823.0016 6823.0017 6823.0018 6823.0019 6821.0032 6823.0020	Make sure that you have also installed appropriate buffer tubing and an appropriate syringe (→ page 22).
Signal cable (6-pin Mini-DIN)	6000.1004	To connect an external device.
Syringe, 100 µL	6822.0002	Make sure that you have also installed appropriate buffer tubing and an appropriate sample loop (→ page 22).

10.3 Consumables and Spare Parts

The part number always refers to the packing unit. Unless otherwise stated, the packing unit is 1 unit. For more information, contact the Thermo Fisher Scientific sales organization for Dionex HPLC Products.

Description	Part No.
Adapter for 2 mL vials in 10 mL transport vial holder	6820.4092
Adapter for low well PCR plates with a height of 8 - 12 mm	6820.4088
Adapter for vial pusher, for use with 24 deep well plates	6820.2402
Bridge (PEEK, volume: 6,2 µL) for WPS-3000TFC WPS-3000TBFC	6824.0016 6825.0016
Bridge (PEEKsil, volume: 1µL) for WPS-3000TFC WPS-3000TBFC	6824.0015 6825.0015
Bridge for WPS-3000TFC for normal-phase applications (capillary, Viper, SST, volume 6.4 µL, 0.18 x 250 mm (I.D. x L)) Included in the Normal Phase Kit (part no. 6820.0060). For details on the kit, see section 10.2.4 (→ page 172).	6040.2385
<i>Buffer tubing, PEEK/PTFE, for WPS-3000(T)PL (RS) Nano/Cap, upgraded with PAEK modification kit</i> 50 µL 500 µL	6821.0019 6821.0020
<i>Buffer tubing, PEEK/PTFE, for WPS-3000TBFC</i> 500 µL 1000 µL	6821.0020 6821.0022
<i>Buffer tubing, PEEK/PTFE, for WPS-3000TBFC, optimized for nano/cap applications</i> 50 µL	6821.0019
<i>Buffer tubing, PEEK/PTFE, for WPS-3000TBPL Analytical</i> 500 µL 1000 µL	6821.0020 6821.0022
<i>Buffer tubing, PEEK/PTFE, for WPS-3000TBPL Nano/Cap</i> 50 µL 500 µL, for analytical applications	6821.0019 6821.0020
<i>Buffer tubing, SST/PTFE, for WPS-3000(T)PL (RS) Nano/Cap</i> 50 µL 500 µL	6820.0019 6820.0020
<i>Buffer tubing, SST/PTFE, for WPS-3000TFC</i> 500 µL 1000 µL	6820.0020 6820.0056
<i>Buffer tubing, SST/PTFE, for WPS-3000TFC, optimized for nano/cap applications</i> 50 µL	6820.0019
Capillary (long) from loading pump to autosampler, biocompatible devices (130 µm ID x 75 cm, PEEK), including the appropriate fitting connections	6721.0032

Description	Part No.
Capillary (long) from loading pump to autosampler, standard devices (130 µm ID x 75 cm, PEEK), including the appropriate fitting connections	6720.0032
Capillary (PEEK, OD x ID: 1/16" x 0.25 mm) from WPS-3000TBPL Analytical/WPS-3000TFC to column thermostat and/or from pump to WPS-3000TBPL Analytical	6251.6001
Capillary (short) from loading pump to autosampler standard devices (130 µm ID x 60 cm, PEEK), including the appropriate fitting connections	6720.0031
Capillary (short) from loading pump to autosampler, biocompatible devices (130 µm ID x 60 cm, PEEK), including the appropriate fitting connections	6721.0031
Capillary from loading pump to autosampler (130 µm ID x 45 cm, PEEK), including appropriate fitting connections, standard devices	6720.0057
Capillary from loading pump to autosampler (130 µm ID x 45 cm, PEEK), including appropriate fitting connections, biocompatible devices	6721.0057
Capillary from pump to WPS-3000TFC (Viper, SST, 0.18 mm x 550 mm ID x L)	6040.2355
Capillary from WPS-3000TFC to TCC-3000 (Viper, SST, 0.13 mm x 350 mm ID x L)	6040.2335
Capillary union (1/16", zero dead volume)	6720.0039
Drain kit for UltiMate 3000 systems	6040.0005
Ferrule (1/16", SST316, 10 pieces)	6720.0017
Ferrules and Fittings kit (SR/FS-7), including: 6 fitting screws (FS-7, 1/16", stainless steel) 6 ferrules (SR-7, 1/16", stainless steel)	6822.0012
Finger-tight fitting screw (PEEK, 1/16") for connecting capillaries to the injection valve of the WPS-3000TBPL Analytical	6823.0010
Fitting screw (PEEK, 1/16", 15 mm)	6266.0024
Front cover (transparent)	6820.1427
Fuses Kit, including: 2 A fuse, slow-blow, 5 x 20 mm (10 fuses) 4 A fuse, slow-blow, 5 x 20 mm (10 fuses) 10 A fuse, slow-blow, 250V, 6.3 x 32 mm (5 fuses)	6820.0026
Gasket for syringe/injection valve (5 gaskets)	6822.0009
Hex key (size 9/64")	6000.0053
Menu pen	6300.0100
<i>Needle for WPS-3000(T)PL (RS) Nano/Cap</i> 2.4 µL, fused silica, nanoViper; 100 µm ID 3.5 µL, PEEK, Viper; 127 µm ID 15 µL, PEEK, Viper; 250 µm ID; for analytical purposes 15 µL, fused silica, nanoViper; 250 µm ID; for analytical purposes	6820.3010 6820.3023 6820.3025 6820.3115
<i>Needle for WPS-3000T(B)FC, optimized for nano/cap applications</i> 2.4 µL, fused silica, nanoViper; 100 µm ID 3.5 µL, PEEK, Viper; 127 µm ID	6820.3010 6820.3023

Description	Part No.
<i>Needle for WPS-3000TBFC</i> 15 µL, PEEK, Viper; 250 µm ID 15 µL, fused silica, nanoViper; 250 µm ID	6820.3025 6820.3115
<i>Needle for WPS-3000TBPL Analytical</i> 3.5 µL, PEEK, Viper; 127 µm ID 15 µL, PEEK, Viper; 250 µm ID 15 µL, fused silica, nanoViper; 250 µm ID	6820.3023 6820.3025 6820.3115
<i>Needle for WPS-3000TBPL Nano/Cap</i> 2.4 µL, fused silica, nanoViper; 100 µm ID 15 µL, PEEK, Viper; 250 µm ID; for analytical purposes 15 µL, fused silica, nanoViper; 250 µm ID; for analytical purposes	6820.3010 6820.3025 6820.3115
<i>Needle for WPS-3000TFC</i> 15 µL, PEEK, Viper; 250 µm ID 15 µL, fused silica, nanoViper; 250 µm ID 15 µL, SST, Viper; 200 µm ID; for normal-phase applications Included in the Normal Phase Kit (part no. 6820.0060). For details on the kit, see section 10.2.4 (→ page 172).	6820.3025 6820.3115 ---
Normal Phase Kit for WPS-3000TFC Autosampler For normal-phase applications with the WPS-3000TFC autosampler. The kit includes all components required to ground the needle, the injection valve and the fractionation valve for normal-phase applications. For details on the content of the kit, see page 172.	6820.0060
Nut (1/16", standard, SS316, 10 pieces)	754.ZN1S6
Nut (1/16", standard, SST, 10 pieces)	6720.0018
Online degas wash kit (The kit includes all tubes and fittings required to connect the wash liquid for online degassing.)	6820.2450
Open-end wrench (size 1/4 x 5/16")	6000.0051
Power cord, Australia, China	6000.1060
Power cord, Denmark	6000.1070
Power cord, EU	6000.1000
Power cord, India/SA	6000.1090
Power cord, Italy	6000.1040
Power cord, Japan	6000.1050
Power cord, Switzerland	6000.1030
Power cord, UK	6000.1020
Power cord, US	6000.1001
Puncturer	6820.2400
Rack for 10 <i>cylindrical</i> 10 mL vials	6820.4086
Rack for 22 <i>cylindrical</i> 4 mL vials	6820.4084
Rack for 40 <i>conical</i> 1.2 mL vials	6820.4087
Rack for 40 vials, O.D. < 12 mm	6820.4070

Description	Part No.
Rack for 40 x 0.5 mL Eppendorf tubes	6820.4096
Rack for 40 x 1.5 mL Eppendorf tubes	6820.4094
Rack for 72 <i>cylindrical</i> 0.3 mL vials	6820.4091
Rack for 72 <i>cylindrical</i> 1.2 mL vials	6820.4090
Rack for 72 microdialysis vials	6820.4097
Rotor for 2-position, 6-port valve Standard valve 13050 psi valve Biocompatible valve	6820.0014 6826.0013 6820.0035
Rotor for 2-position, 8-port valve (Micro Fraction Collection Option) Standard valve Biocompatible valve	6820.0054 6821.0054
<i>Sample loop for WPS-3000(T)PL (RS) Nano/Cap, nanoViper (fused silica/PEEK sheathed)</i> 1 µL 5 µL 10 µL 20 µL 50 µL 125 µL, for analytical applications	6826.2401 6826.2405 6826.2410 6826.2420 6826.2450 6826.2412
<i>Sample loop for WPS-3000(T)PL (RS) Nano/Cap, upgraded with PAEK Upgrade Kit</i> 5 µL, PEEK 10 µL, PEEK 20 µL, PEEK 50 µL, PEEK, for analytical applications 125 µL, PEEK, for analytical applications	6823.0016 6823.0017 6823.0018 6823.0019 6821.0032
<i>Sample loop for WPS-3000TBFC</i> <i>Sample loops, nanoViper (fused silica/PEEK sheathed)</i> 50 µL 125 µL <i>Sample loops, PEEK</i> 5 µL 10 µL 20 µL 50 µL 125 µL 250 µL	6826.2450 6826.2412 6823.0016 6823.0017 6823.0018 6823.0019 6821.0032 6823.0020

Description	Part No.
<p><i>Sample loop for WPS-3000TBPL Analytical</i></p> <p><i>Sample loops, nanoViper (fused silica/PEEK sheathed)</i></p> <p>50 µL</p> <p>125 µL</p> <p><i>Sample loops, PEEK</i></p> <p>5 µL</p> <p>10 µL</p> <p>20 µL</p> <p>50 µL</p> <p>125 µL</p> <p>250 µL</p>	<p></p> <p>6826.2450</p> <p>6826.2412</p> <p></p> <p>6823.0016</p> <p>6823.0017</p> <p>6823.0018</p> <p>6823.0019</p> <p>6821.0032</p> <p>6823.0020</p>
<p><i>Sample loop for WPS-3000TBPL Nano/Cap</i></p> <p><i>Sample loops, nanoViper (fused silica/PEEK sheathed)</i></p> <p>1 µL</p> <p>5 µL</p> <p>10 µL</p> <p>20 µL</p> <p>50 µL, for analytical applications</p> <p>125 µL, for analytical applications</p> <p><i>Sample loops, PEEK</i></p> <p>5 µL</p> <p>10 µL</p> <p>20 µL</p> <p>50 µL</p> <p>125 µL</p>	<p></p> <p>6826.2401</p> <p>6826.2405</p> <p>6826.2410</p> <p>6826.2420</p> <p>6826.2450</p> <p>6826.2412</p> <p></p> <p>6823.0016</p> <p>6823.0017</p> <p>6823.0018</p> <p>6823.0019</p> <p>6821.0032</p>
<p><i>Sample loop for WPS-3000TFC</i></p> <p><i>Sample loops, nanoViper (fused silica/PEEK sheathed)</i></p> <p></p> <p>50 µL</p> <p>125 µL</p> <p><i>Sample loops, PEEK</i></p> <p>50 µL</p> <p>250 µL</p>	<p></p> <p></p> <p></p> <p>6826.2450</p> <p>6826.2412</p> <p></p> <p>6824.0019</p> <p>6824.0020</p>
<p><i>Sample loop for WPS-3000TFC and WPS-3000TBFC, optimized for nano/cap applications, nanoViper (fused silica/PEEK sheathed)</i></p> <p>1 µL</p> <p>5 µL</p> <p>10 µL</p> <p>20 µL</p>	<p></p> <p>6826.2401</p> <p>6826.2405</p> <p>6826.2410</p> <p>6826.2420</p>
<p>Signal cable (6-pin Mini-DIN)</p>	<p>6000.1004</p>

Description	Part No.
Stator for 2-position, 6-port valve Standard valve (stainless steel) 13050 psi valve (stainless steel) Biocompatible valve (PAEK stator) Biocompatible valve (Titanium stator)* The titanium stator cannot be used with the fractionation valve.	6820.0012 6826.0012 6820.0034 6820.0049
Stator for 2-position, 8-port valve (Micro Fraction Collection Option) Standard valve (stainless steel) Biocompatible valve	6820.0053 6821.0053
Support rack for deep-well plates 20 - 32 mm high	6820.4089
Support rack for deep-well plates 30 - 36 mm high	6820.4083
Support rack for deep-well plates 34 - 46 mm high	6820.4079
Syringe bio upgrade kit (250 µL, biocompatible version) for WPS-3000(T)PL (RS) Nano/Cap and WPS-3000TBPL Nano/Cap, including Syringe, 250 µL Needle, 15 µL, fused silica, nanoViper Buffer tubing, 500 µL, PEEK/PTFE Sample loop, 125 µL, PEEK	6821.0031
Syringe upgrade kit (250 µL) for WPS-3000(T)PL (RS) Nano/Cap, including Syringe, 250 µL Needle, 15 µL, fused silica, nanoViper Buffer tubing, 500 µL, SST/PTFE Sample loop, 125 µL, nanoViper	6820.0031
<i>Syringes for WPS-3000(T)PL (RS) Nano/Cap and WPS-3000TBPL Nano/Cap</i> 25µL 100 µL 250 µL, for analytical applications	6822.0001 6822.0002 6822.0003
<i>Syringes for WPS-3000TBPL Analytical</i> 100 µL 250 µL	6822.0002 6822.0003
<i>Syringes for WPS-3000TFC and WPS-3000TBFC</i> 100 µL 250 µL <i>Optimized for nano/cap applications</i> 25µL	6822.0002 6822.0003 6822.0001
Tool for preassembling biocompatible fittings	6000.0065
Transport vial (10 mL vial, cylindrical), including cap and seal (5 vials)	6820.0023
Transport vial holder	6820.4073
Tubing from wash liquid reservoir to syringe valve (ECTFE, 0.75 mm ID, 600 mm long)	6820.0011
USB cable, type A to type B, USB 2.0, cable length: 1 m	6035.9035
USB cable, type A to type B, USB 2.0, cable length: 5 m	6911.0002
Vial (1.1 mL, conical; for crimp caps; 500 vials)	6000.0077

Description	Part No.
Vial (1.1 mL, <i>conical</i> ; for screw caps; 500 vials)	6000.0078
Vial (1.2 mL, <i>cylindrical</i> ; 500 vials)	6000.0062
Vial (1.8 mL, brown; 100 vials)	6000.0072
Vial (10 mL vial, <i>cylindrical</i>), including cap and seal (5 vials)	6820.0023
Vial (2 mL, amber; 500 vials)	6000.0060
Vial (250 µL, <i>cylindrical</i> , polypropylene with glass insert; 100 vials)	6820.0027
Vial (250 µL, <i>cylindrical</i> , polypropylene; 1000 vials)	6820.0029
Vial (4 mL, amber; 100 vials)	6000.0074
Vial caps (crimp caps) for 4 mL vials (100 caps)	6000.0073
Vial caps (white) for 2 mL vials (500 screw caps)	6000.0057
Vial caps for 1.1 mL vials (crimp cap with silicone septum, 1000 caps)	6000.0076
Vial caps for 1.2 mL vials (crimp cap; 1000 caps)	6000.0064
Vial caps for 1.2 mL vials (crimp cap with slotted silicone/PTFE septum; 500 caps)	6000.0061
Vial caps for 1.8 mL vials (crimp cap with septum, 100 caps)	6000.0071
Vial caps for 250 µL polypropylene vials (100 caps)	6820.0046
Vial caps for 250 µL polypropylene vials (1000 caps)	6820.0028
Vial septum for 2 mL vials (silicone, red, 500 septa)	6000.0058
Vial septum for 4 mL vials (silicone/PTFE, 500 septa)	6000.0075
Wash liquid reservoir for WPS-3000PL autosampler (2 reservoirs), including: reservoir holder and tubing	6820.4075
Well plate (384-deep well plate)	Contact Thermo Scientific
Well plate (96-deep well plate)	6820.4101
Well plate (normal, 384 wells)	6820.4110
Well plate (normal, 96 wells)	6820.4100
Well plate sealing cap for (deep) well plate (96 wells)	6820.4102
Well plate sealing cap for normal 384-well plate	6820.4112
Wrench (box wrench, slotted head, size ¼") for puncturer and fitting installation	6000.0052

11 Index

A	
Accessories	
Optional	167
Standard	161
Air Bubbles	60
Automatic Vial Detection	97
Autosampler-Specific Information	133
B	
Back	79
Back Flush Mode	133, 136
Batch	76
Biocompatible Autosamplers	20, 144
Buffer Tubing	22, 115
C	
Cancel	79
Capillaries	
Biocompatible Fittings	144
Standard Connections	55
Viper Connections	55
Carousel	30
Change Configuration)	89
Tray Shake	96
Tray Test	97
Chromleon	35, 71
Automated Control	74
Autosampler Configuration	47
Autosampler Installation	46
Connect	71
Direct Control	72
Installation Program	44
License	35
Load USB Driver	44
Predictive Performance	93
Program Wizard	75
Server Configuration Program	44, 46
Server Monitor	44, 46
Special Functions	93
Chromleon Dialog Boxes	
Error Levels	51
General	47
Inputs	51
Options	49
Relays	51
Segments / Pump Link	48
Sharing	48
Commands (Dialog Box)	72
Commands (Display)	77
Compartment Lights	33
Configuration Menu	84
Configurations	19
Connection	
Chromleon Computer	40
USB	40
Connections	
Capillaries	55
Degasser	56
Digital I/O	42
Fluidic	33
Power	41
Rear Panel	28
Syringe Valve	59
Wash Liquid	56
Control (Automated)	71, 74
Control (Direct)	71, 72
Control Menu	81
Control Panel	73
Coolant Temperature	83
Cooling Power	83
Cooling Pump Power	83
D	
DCMSLink	52
Degasser	56
Degassing	56
Detection (Vial, Plate)	69
Device View	76
Digital I/O	29, 42
Dispense Destination	82
DispenseSpeed	87
Display	77
Display & soft keys	84
DispSpeed	87
DrawDelay	87
DrawSpeed	87
E	
Equilibration	65
Error Levels (Dialog Box)	51
Error Messages	103, 104
Execute	79
F	
Fan Power	83
Firmware Download	130
Firmware Update	130
Fluidic Connections	33
Flushing (Syringe)	60
FlushVolume	87
Found New Hardware Wizard	45
Fraction Collection	21, 135
Fractionation Valve (WPS-3000FC)	124, 137
Front Panel Display	
Function Key	77
Screen Brightness	91
Screen Contrast	91
Soft Keys	77
Status Screen	68

Full-Loop Injections	148	Instrument Shut Down.....	99
Function Key	77	Intended Use.....	13
Arrow down	79		
Arrow right	79	L	
Arrow up	79	Leak Sensor	33, 91, 111
Back	79	Leak Sensor Mode.....	84, 91
Cancel	79	Lights.....	33
Clear	80, 104	LoopOverfill.....	87
Execute.....	79	Low Dispersion	156
Menu	77		
Next.....	80, 104	M	
Ok	79	Main Menu	80
Prev	80, 104	Maintenance	
Prime.....	78	Intervals	101
Rotate.....	77	Shut Down	99
Select.....	79	Maintenance Menu.....	82
Wash	77	Menus	77, 78
Fuse Holder.....	29	Configuration.....	84
Fuse Replacement.....	129	Control.....	81
		Main.....	80
G		Maintenance	82
General (Dialog Box)	47	Micro Fraction Collection Option	143
General Design	23	Microliter Pick-up Injections.....	153
		Module Address	47
H			
Heat Sink Temperature	83	N	
Height Requirements (Sample Container).....	31	Needle (Replace)	120
		Needle Height.....	95
I		Needle Pair	117
Inject.....	90	Needle Pair Position	118
Inject Command	90	Needle Wash	119
Inject Synchronization	48, 88	Nominal Sample Temperature.....	81
Inject Valve.....	82	Normal-Phase Applications (WPS-3000FC).....	6
Injection Methods		Normal-Phase Kit (WPS-3000TFC).....	142
Full-Loop	148		
Low Dispersion	156	O	
Microliter Pick-up.....	153	Ok.....	79
Partial-Loop	151	Online Degassing	56
Injection Mode.....	85	Operating Instructions	1
Injection Parameters	90	Operating Principle	
Injection Valve	34, 124	WPS-3000FC.....	136
WPC-3000TFC	137	WPS-3000PL.....	133
WPS-3000PL	34	Operation	
Inputs (Chromleon Dialog).....	51	Chromleon	71
Installation		Function Key	77
Connection	40	Power-Up.....	67
Connections (Rear Panel).....	28	Recommendations	92
in Chromleon.....	44	Safety Precautions	5
in DCMSLink	52	Safety Symbols	3
Needle	120	Soft Key Menus	77
Power Connection.....	41	User Interface	67
Puncturer.....	122	Operation Principle.....	18
Racks.....	62, 69	Operational Qualification	97
Reagent Vials.....	64	Operational Settings	85
Transport Vials	64	Optional Accessories	
Well plates	62, 69	WPS-3000(T)PL.....	167
		WPS-3000TBFC.....	174

WPS-3000TBPL	169
WPS-3000TBPL Analytical.....	171
WPS-3000TFC.....	172
Options (Dialog Box).....	49

P

Packing Instructions.....	110
Panel Tabset.....	73
Partial-Loop Injections	151
Performance Qualification.....	97
Plate Detection.....	69
Power Connection.....	41
Power Switch.....	29
Power-Up.....	67
Predictive Performance.....	93
Preparation.....	53
Connecting Capillaries	55
Equilibration	65
Flushing the Syringe	60
General.....	53
Reagent Vials.....	64
Syringe Valve.....	59
Transport Vials.....	64
Wash Liquid.....	56
Priming the Syringe	60
Program (Sample Preparation).....	98
Program (User-Defined)	98
Program Creation.....	74
Program Start.....	76
Program Wizard.....	75
Pump Link	48
PunctureDepth	95
Puncturer.....	122

R

Racks	
Install	62
Load	62
Reagent Vials	
Positioning	64
Sample Position	69
Real Temperature.....	83
Rear Panel.....	29
Rear Panel Connections	28
Rear Panel Connector	29, 40
Relative Sample Position	98
Relays (Chromleon Dialog)	51
Replacement	
Buffer Tubing.....	115
Fuses	129
Needle	120
Sample Loop.....	123
Syringe.....	112
Reset to Factory Defaults.....	84
RMA Number	110

S

Safety Information.....	3
Safety Precautions	5, 109
Safety Symbols.....	3
Sample Container	62, 89
Sample Cooling	81
Sample Loop.....	22, 123
Sample Position.....	69, 98
Sample Preparation Program.....	98
Sample Rack.....	30
Sample Thermostating.....	88
Sample Tray	
Automatic Detection.....	97
Needle Height	95
SampleHeight	95
Scope of Supply.....	37
Screen Brightness.....	91
Screen Contrast.....	91
Segments / Pump Link (Dialog Box).....	48
Select	79
Self Test.....	83
Server Configuration Program.....	46
Server Monitor	46
Service	
Buffer Tubing	115
Firmware Update	130
Fractionation Valve	124
Fuse Replacement.....	129
General Notes	109
Injection Valve	124
Leak Sensor	111
Needle.....	120
Puncturer.....	122
Safety Precautions	109
Sample Loop.....	123
Syringe.....	112
Valve Cleaning	125
Valve Disassembly	125
Valve Reassembly	127
Wash Needle.....	119
Sharing (Dialog Box)	48
Shut Down.....	99
Shutdown Program	100
Soft Key.....	77
Soft Keys	77, 78
Software Control	35, 71
Solvents	13
Spare Parts.....	176
Specification.....	159
Standby Program	100
Startup (Equilibration).....	65
Status Screen	68
Sync Inject.....	88
Synchronization (Inject)	48, 88
Syringe	22, 82, 112
Syringe Flushing.....	60
Syringe Priming.....	60

Syringe Valve	59
System Wellness	36

T

Technical Information	159
Temperature Control	21
TransLiquidHeight	95
Transport Vials	
Positioning	64
Sample Position	69
TransVialPunctureDepth	95
Tray	30, 84
Tray (Sample Position)	69
Tray Shake	96
Tray Test	97
Troubleshooting	103
Error Messages	104
LED Flashing	27

U

Unit Description	17
Biocompatible Autosamplers	20, 144
Configurations	19
General Design	23
Operating Principle	133, 136
Overview	17
Principle of Operation	18
Temperature Control	21
Unpacking	37
USB	29, 40
User Information	15
User Interface	67

V

Valve	
Cleaning	125

Disassembly	125
Reassembly	127
Version Info	83
Vial	30
Automatic Detection	97
Recommendation	31
Vial Detection	69
Vial Rack	30
Vial Tray	30
Viper Capillaries	55
Volume	87

W

Wash	81, 119
Wash Liquid	56
WashSpeed	87
WasteSpeed	87
Well Plates	30
Install	62
Needle Height	95
Recommendation	31
Sample Position	69
Wellness	36
WPS-3000FC	135
Fractionation Valve	137
Injection Valve	137
Nano/Cap Applications	141
Normal-Phase Applications	6, 142
Normal-Phase Kit	142
Operating Principle	136
Service	142
Tips for Operation	139
WPS-3000PL	
Injection Valve	34
Micro Fraction Collection Option	143
Operating Principle	133