

**1 YEAR**  
WARRANTY

# **Ω OMEGA™** **User's Guide**

Shop online at  
**omega.com**

e-mail: [info@omega.com](mailto:info@omega.com)  
For latest product manuals:  
[www.omegamanual.info](http://www.omegamanual.info)



**LD320, LD620, LD621, LD630, LD650 Series**  
**DISPLACEMENT TRANSDUCERS**



omega.com info@omega.com

**Servicing North America:**

**U.S.A.  
Headquarters:**

Omega Engineering, Inc.  
Toll-Free: 1-800-826-6342 (USA & Canada only)  
Customer Service: 1-800-622-2378 (USA & Canada only)  
Engineering Service: 1-800-872-9436 (USA & Canada only)  
Tel: (203) 359-1660 Fax: (203) 359-7700  
e-mail: info@omega.com

**For Other Locations Visit [omega.com/worldwide](http://omega.com/worldwide)**

## Index

**Section Title**

- 1.0 Introduction .
- 2.0 Installation
- 2.1 Mounting the Transducer .
- 2.2 Cores
- 2.3 Carriers
- 2.3.1 Guided Carriers
- 2.3.2 Ball Tips
- 2.3.3 Springs
- 2.3.4 Universal Joints
- 2.3.5 Thread Mount Option
- 3.0 Electrical Interfaces
- 3.1 Standard LVDT
- 3.2 4-20MA
- 3.3 DC Voltage
- 3.4 Digital
- 4.0 Conditioning
- 5.0 Marking

# 1.0: Introduction

Omega's new LD320, LD620, LD621, LD630 range of displacement transducers forms a wide range of transducers offering measurement ranges from  $\pm 2.5$  mm to  $\pm 150$  mm. The LD320, LD620, LD621, LD630 offers the advantage of a shorter body than traditional displacement transducers. Furthermore, four electrical output types are provided; these are standard LVDT, 4-20 mA, isolated DC voltage and digital outputs.

All models in the LD320, LD620, LD621, LD630 can be configured with guided or unguided core for frictionless operation. The wide bore to core clearance of the LD320, LD620, LD621, LD630 makes installation and alignment a very easy process. The guided versions are provided with polymer bearings for high rigidity and are available with special tips, universal joint fittings and return springs. The universal joints are useful in applications where lever movements induce variations in the motion straightness.

The rugged construction of the LD320, LD620, LD621, LD630 and the options of IP65 and IP67 rating makes these transducers a cost-effective product suitable for use in harsh environments.

## GENERAL SPECIFICATION

Storage Temperature	LVDT Variants	-40 °C to +120 °C
	4-20 mA, DC and Digital Variants	-20 °C to +85 °C
Operating Temperature	LVDT Variants	-40 °C to +120 °C
	4-20 mA and DC Variants	0 °C to +65 °C
	Digital variants (Transducer only)	-40 °C to +120 C
Linearity	0.2% FSO	

For full specification please refer to the Product Datasheet or catalog.

## Typical Mechanical Configurations

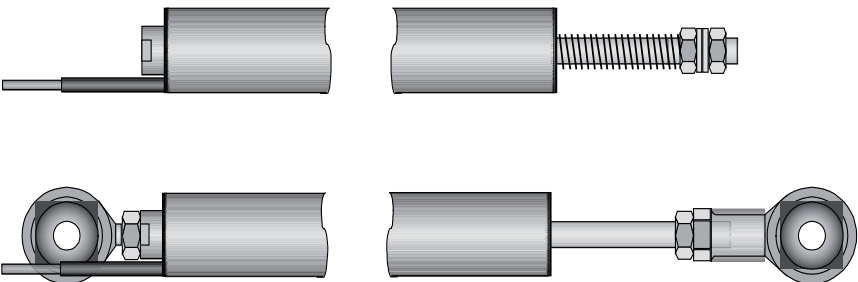

## 2.0: Installation

### 2.1: Mounting the Transducer

LVDT based transducers are a reliable and proven technology that is well established in all areas of manufacturing and control industries. The majority of the associated problems experienced with their application and use are totally avoidable, particularly if sufficient thought is given during the initial design stages of equipment to the positioning and clamping methods employed for these feedback elements.

LVDT's, being of inductive nature, are susceptible to some degree to the influence of magnetic fields.

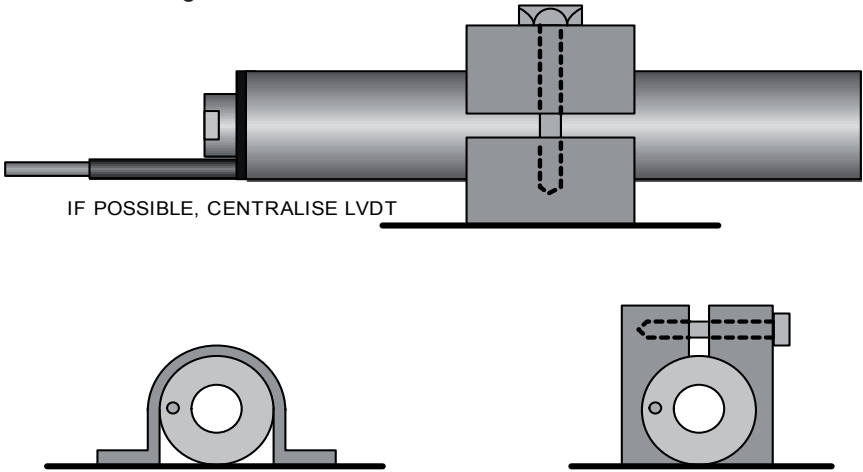

The LD320, LD620, LD621, LD630, LD650, transducers contain an integral magnetic screen that reduces these effects. However, the transducer should be positioned well away from electric motors, relays and permanent magnets. If this is not possible checks should be made on the influence of such items.

Clamping of the coil assembly should be carefully considered. Some example methods are shown below. Ideally the body of the transducers should be clamped centrally in a pinch or yoke type clamp, manufactured from a low conductivity, non-magnetic material.

Irrespective of clamping method, care must be taken not to over-tighten retaining screws as distortion of the body may prove damaging to the integrity of the transducer and adversely affect the geometry of the installation.

If the LVDT is to be mounted on equipment subject to high "g" then, dependent on the direction of these forces, it may be advantageous to consider end to end clamping in preference to over body clamping.

For Universal Joint fittings maximum tightening torque on the ball = 2.5 Nm.

## 2.0: Installation (continued)

### 2.2: Cores

The standard core supplied is a  $\varnothing 6.35$  mm Core with M4 x 0.7 x 12 mm female thread at both ends for mounting onto a carrier. The magnetic core has been manufactured to achieve optimum performance and any subsequent handling of the core which results in stress being imparted will render the calibration void. This includes over-tightening of the core during installation onto its carrier. Hand tightening and retention by means of a suitable thread locking anaerobic retainer is the recommended procedure.

### 2.3: Carriers

A standard length carrier is available for each model of transducer, manufactured from 316 stainless steel and incorporating an M4 x 0.7 x 10 mm long male thread for attachment to the standard core and an M6 x 1.0 x 17 mm male thread for attachment to the fixture.

#### 2.3.1: Guided Carriers

**Mounting:** Normal mounting methods apply (see Installation). Careful consideration should be given to alignment; the carrier must be able to move freely within the transducer core. Side force should be kept to a minimal level.

**Maintenance:** Check for free movement of the carrier when in the vertical plane. The polymer guide bearing is maintenance free.

#### 2.3.2: Ball Tips

This option is for use with the Guided Carrier and is attached via an adapter fitted to the threaded end of the core carrier. Side forces that may exert undue pressure and flex the carrier must be avoided.

#### 2.3.3: Springs

A spring may be fitted externally in conjunction with a guided carrier and also with a ball tip.

#### 2.3.4: Universal Joints

**Mounting:** All LD320, LD620, LD621, LD630 transducers up to 300 mm total measurement range ( $\pm 150$  mm) may be mounted in any axis; it is recommended that the rear rod end bearing (near cable exit) is mounted on the static component. (The larger transducers, because of the increase in weight, may exhibit bowing of the carrier and therefore mounting in the horizontal plane should either be avoided or additional support given to the body. This option is used with the guided core.)

**Maintenance:** Periodic inspection of locking screws and nuts etc. is advisable depending upon the Customer's application. Rod end bearings should be able to move freely and have minimal side play.

# 2.0: Installation (continued)

## 2.3.5: Thread Mount Option - LD650 Series



2 Mounting Nuts 1/2"-  
20 UNF-2A

# 3.0: Electrical Interfaces

## 3.1: Standard LVDT

The LD320, LVDT output transducer is designed to operate with an excitation voltage of  $3 \pm 1$  V rms, an excitation frequency of  $5 \pm 0.5$  kHz into a 100 k $\Omega$  load as detailed below. Operation in different configurations may mean the optimum performance is degraded.

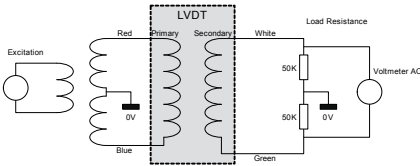

### Standard LVDT Connector 5 pin 240° DIN

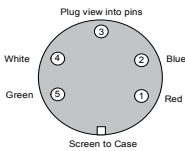

The LD320 range of LVDT transducers operate on the principal that movement of a core inside the transducer body is detected by a differential change in output on two secondary coils, the primary coil(s) being energized by an appropriate AC excitation signal. With the core in a central position, the coupling from the primary to each secondary is equal and opposite and therefore cancel out, thus the resultant output voltage is zero. As the core is displaced further into one secondary, its voltage increases proportionally and the other secondary voltage decreases hence the output changes in magnitude and phase in proportion to movement in either direction from null.

The red and white connections are in phase for inward movement (i.e. towards the cable end).

The output signal depends on both core movement and energization voltage and is expressed as a sensitivity in  $mV_{output} / V_{energizing} / mm$  travel.

## 3.2: 4-20 MA

The LD630 and LD650 are configured as a two wire 4-20 mA loop device, the transducer provides a current between 4 mA (fully out) and 20 mA (fully in). The transducer requires an excitation voltage between 10 VDC and 30 VDC.

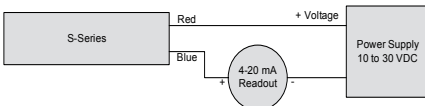

Note: 4-20 mA products are designed to operate with a maximum loop resistance of 600  $\Omega$ .

# 3.0: Electrical Interfaces (continued)

## 3.3: DC Voltage

The LD620 and LD621 can be configured to provide a DC voltage output as shown below;

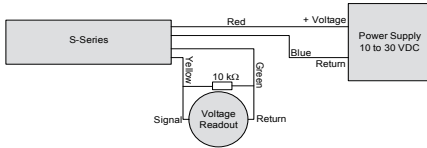

Measurement Range	Output	Output
0-d mm		0-10 VDC
-d/2 to +d/2 mm	-5 VDC to +5 VDC	

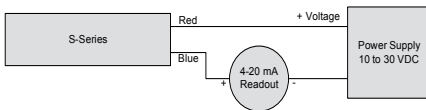

The transducer requires an excitation voltage between 10 VDC and 30 VDC.

The transducer output is electrically isolated from the input supply. Note: to achieve calibrated accuracy the load must be 10 kΩ between Yellow and Green,

## 3.4: DIGITAL

Digital versions of the LD640 transducers are supplied with an integral PIE module.

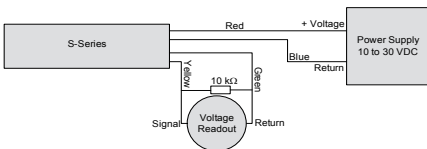

This module is fully compatible with LDN232. For details see Digital Probe User Leaflet.



## 4.0: Conditioning

The 4-20 mA and DC output version of the transducer require no signal conditioning other than being connected to an appropriate receiver such as a voltmeter, A/D converter or current meter.

LVDT transducers usually require the signal to be conditioned either by end user amplifiers or with Omega conditioning circuits. Information on these products can be obtained from original supplier.

## 5.0: Marking

Products with integrated electronics are CE marked.  
Digital probes are CE marked.

## WARRANTY/DISCLAIMER

OMEGA ENGINEERING, INC. warrants this unit to be free of defects in materials and workmanship for a period of 13 months from date of purchase. OMEGA's WARRANTY adds an additional one (1) month grace period to the normal one (1) year product warranty to cover handling and shipping time. This ensures that OMEGA's customers receive maximum coverage on each product.

If the unit malfunctions, it must be returned to the factory for evaluation. OMEGA's Customer Service Department will issue an Authorized Return (AR) number immediately upon phone or written request. Upon examination by OMEGA, if the unit is found to be defective, it will be repaired or replaced at no charge. OMEGA's WARRANTY does not apply to defects resulting from any action of the purchaser, including but not limited to mishandling, improper interfacing, operation outside of design limits, improper repair, or unauthorized modification. This WARRANTY is VOID if the unit shows evidence of having been tampered with or shows evidence of having been damaged as a result of excessive corrosion; or current, heat, moisture or vibration; improper specification; misapplication; misuse or other operating conditions outside of OMEGA's control. Components in which wear is not warranted, include but are not limited to contact points, fuses, and triacs.

OMEGA is pleased to offer suggestions on the use of its various products. However, OMEGA neither assumes responsibility for any omissions or errors nor assumes liability for any damages that result from the use of its products in accordance with information provided by OMEGA, either verbal or written. OMEGA warrants only that the parts manufactured by the company will be as specified and free of defects. OMEGA MAKES NO OTHER WARRANTIES OR REPRESENTATIONS OF ANY KIND WHATSOEVER, EXPRESSED OR IMPLIED, EXCEPT THAT OF TITLE, AND ALL IMPLIED WARRANTIES INCLUDING ANY WARRANTY OF MERCHANTABILITY AND FITNESS FOR A PARTICULAR PURPOSE ARE HEREBY DISCLAIMED. LIMITATION OF LIABILITY: The remedies of purchaser set forth herein are exclusive, and the total liability of OMEGA with respect to this order, whether based on contract, warranty, negligence, indemnification, strict liability or otherwise, shall not exceed the purchase price of the component upon which liability is based. In no event shall OMEGA be liable for consequential, incidental or special damages.

CONDITIONS: Equipment sold by OMEGA is not intended to be used, nor shall it be used: (1) as a "Basic Component" under 10 CFR 21 (NRC), used in or with any nuclear installation or activity; or (2) in medical applications or used on humans. Should any Product(s) be used in or with any nuclear installation or activity, medical application, used on humans, or misused in any way, OMEGA assumes no responsibility as set forth in our basic WARRANTY / DISCLAIMER language, and, additionally, purchaser will indemnify OMEGA and hold OMEGA harmless from any liability or damage whatsoever arising out of the use of the Product(s) in such a manner.

## RETURN REQUESTS/INQUIRIES

Direct all warranty and repair requests/inquiries to the OMEGA Customer Service Department. BEFORE RETURNING ANY PRODUCT(S) TO OMEGA, PURCHASER MUST OBTAIN AN AUTHORIZED RETURN (AR) NUMBER FROM OMEGA'S CUSTOMER SERVICE DEPARTMENT (IN ORDER TO AVOID PROCESSING DELAYS). The assigned AR number should then be marked on the outside of the return package and on any correspondence.

The purchaser is responsible for shipping charges, freight, insurance and proper packaging to prevent breakage in transit.

FOR WARRANTY RETURNS, please have the following information available BEFORE contacting OMEGA:

1. Purchase Order number under which the product was PURCHASED,
2. Model and serial number of the product under warranty, and
3. Repair instructions and/or specific problems relative to the product.

FOR NON-WARRANTY REPAIRS, consult OMEGA for current repair charges. Have the following information available BEFORE contacting OMEGA:

1. Purchase Order number to cover the COST of the repair,
2. Model and serial number of the product, and
3. Repair instructions and/or specific problems relative to the product.

OMEGA's policy is to make running changes, not model changes, whenever an improvement is possible. This affords our customers the latest in technology and engineering.

OMEGA is a trademark of OMEGA ENGINEERING, INC.

© Copyright 2017 OMEGA ENGINEERING, INC. All rights reserved. This document may not be copied, photocopied, reproduced, translated, or reduced to any electronic medium or machine-readable form, in whole or in part, without the prior written consent of OMEGA ENGINEERING, INC.

# Where Do I Find Everything I Need for Process Measurement and Control? **OMEGA...Of Course!**

Shop online at [omega.com](http://omega.com)

## **TEMPERATURE**

- M** Thermocouple, RTD & Thermistor Probes, Connectors, Panels & Assemblies
- M** Wire: Thermocouple, RTD & Thermistor
- M** Calibrators & Ice Point References
- M** Recorders, Controllers & Process Monitors
- M** Infrared Pyrometers

## **PRESSURE, STRAIN AND FORCE**

- M** Transducers & Strain Gages
- M** Load Cells & Pressure Gages
- M** Displacement Transducers
- M** Instrumentation & Accessories

## **FLOW/LEVEL**

- M** Rotameters, Gas Mass Flowmeters & Flow Computers
- M** Air Velocity Indicators
- M** Turbine/Paddlewheel Systems
- M** Totalizers & Batch Controllers

## **pH/CONDUCTIVITY**

- M** pH Electrodes, Testers & Accessories
- M** Benchtop/Laboratory Meters
- M** Controllers, Calibrators, Simulators & Pumps
- M** Industrial pH & Conductivity Equipment

## **DATA ACQUISITION**

- M** Communications-Based Acquisition Systems
- M** Data Logging Systems
- M** Wireless Sensors, Transmitters, & Receivers
- M** Signal Conditioners
- M** Data Acquisition Software

## **HEATERS**

- M** Heating Cable
- M** Cartridge & Strip Heaters
- M** Immersion & Band Heaters
- M** Flexible Heaters
- M** Laboratory Heaters

## **ENVIRONMENTAL MONITORING AND CONTROL**

- M** Metering & Control Instrumentation
- M** Refractometers
- M** Pumps & Tubing
- M** Air, Soil & Water Monitors
- M** Industrial Water & Wastewater Treatment
- M** pH, Conductivity & Dissolved Oxygen Instruments