

Table of Contents

Introduction	2
Instrument Cluster	6
Driving	8
Roadside Emergencies	16
Cleaning	18
Maintenance and Specifications	20
Scheduled Maintenance Guide	69
Index	94

All rights reserved. Reproduction by any means, electronic or mechanical including photocopying, recording or by any information storage and retrieval system or translation in whole or part is not permitted without written authorization from Ford Motor Company. Ford may change the contents without notice and without incurring obligation.

Copyright © 2010 Ford Motor Company

1

Introduction

POWER STROKE DIESEL ENGINE

Your new diesel engine will feel, drive and function somewhat differently than a gasoline engine. Therefore it is very important that you read and thoroughly familiarize yourself and others operating the vehicle with this guide. **A special procedure for turning off the diesel engine is in the *Driving* chapter. It is important to read and understand this material in order to maintain the best service life for your engine.**

This guide will acquaint you with the Power Stroke diesel engine. It provides recommendations on engine care and operating procedures. For complete vehicle information, also refer to the *Owner's Guide* included with the vehicle. It also describes equipment and gives specifications for equipment that was in effect when this guide was approved for printing, and should be considered a permanent part of the vehicle.

Some aftermarket products may cause severe engine/transmission and/or exhaust system damage; refer to the *Warranty Guide* for more information. **Your vehicle's powertrain control systems can detect and store information about vehicle modifications that increase horsepower and torque output such as whether or not performance-enhancing powertrain components commonly referred to as "performance chips" have been used. This information cannot be erased and will stay in the system's memory even if the modification is removed. The information can be retrieved by Ford Motor Company, Ford of Canada, and service and repair facilities when servicing your vehicle. This information may be used to determine if repairs will be covered by warranty.**

Ford may discontinue models or change specifications without any notice and without incurring obligations.

Important notice

Ford vehicles are suitable for producing ambulances only if equipped with the Ford ambulance preparation package. In addition, Ford urges ambulance manufacturers to follow the recommendation of the *Ford Incomplete Vehicle Manual*, *Ford Truck Body Builder's Layout Book* (and pertinent supplements) and the *Qualified Vehicle Modifiers Guidelines*. Using a Ford vehicle without the Ford ambulance preparation package to produce an ambulance voids the Ford warranty and could result in elevated underbody temperatures, fuel overpressurization and the risk of fuel expulsion and fires. To determine whether the vehicle is equipped with the Ford ambulance preparation package, inspect the information plate on the driver's side door pillar. Contact the manufacturer of your vehicle to determine whether the ambulance manufacturer's followed Ford's recommendations.

2

Introduction



WARNINGS

Throughout this guide, you will find warnings identified by the symbol . Warnings remind you to be especially careful to reduce the risk of personal injury.

NEW VEHICLE BREAK-IN

Your vehicle does not need an extensive break-in. Try not to drive continuously at the same speed for the first 1,000 miles (1,600 km) of new vehicle operation. Vary your speed to allow parts to adjust themselves to other parts.

Drive your new vehicle at least 500 miles (800 km) before towing a trailer. Make sure you use the specified engine oil by checking the engine oil specification chart under *Engine oil* in the *Maintenance and Specifications* chapter.

Do not add friction modifier compounds or special break-in oils during the first few thousand miles (kilometers) of operation, since these additives may prevent piston ring seating. See *Engine oil* in the *Maintenance and Specifications* chapter of this supplement for more information on oil usage.

DIESEL ENGINE INFORMATION

The diesel engine fuel system is a pressurized two-stage filtration system and consists of:

- a frame-mounted diesel fuel conditioner module (DFCM) / primary filter with an electric fuel pump and water drain,
- an engine-mounted secondary fuel filter,
- a fuel injector for each cylinder (8 total),
- a high-pressure fuel pump,
- a high-pressure fuel rail for each cylinder bank (2 total) and
- numerous high-pressure pipes from the high-pressure pump to the rails, and rails to the injectors.

The DFCM acts as a primary fuel filter/water separator which removes both water and impurities from the fuel. The engine mounted filter filters finer impurities from the diesel fuel. The engine-mounted fuel filter and the DFCM filter should be changed at the recommended service interval or when indicated by the message center **LOW FUEL PRESSURE** message. Refer to the *scheduled maintenance information* in this supplement for more information.



Introduction

The DFCM should be drained at regular intervals or when indicated by the message center message and water in fuel indicator light. See *Fuel filter/water separator* in the *Maintenance and Specifications* chapter.

The fuel injection system is controlled through the powertrain control module (PCM).

Fuel is drawn from the fuel tank by a frame-mounted electric fuel pump located inside the DFCM and provides pressurized fuel to the engine. The fuel pump contains a pressure relief valve for overpressure protection in the event of restricted flow.

Engine protection mode

Ford diesel engines are equipped with engine protection and emission control systems. These systems monitor critical temperatures and pressures, and modify engine operation accordingly. These features are intended to modify engine performance characteristics. If these modified engine performance characteristics persist for an extended period or the service engine soon  or powertrain malfunction/reduced power/electronic throttle control light  is illuminated, seek service from your authorized dealer.

Lubrication system

It is important to change the engine oil at the recommended service intervals to maintain oil viscosity. Extending the oil and filter change interval beyond the recommended interval can negatively affect engine performance, fuel economy and engine life. Refer to *Engine oil* in the *Maintenance and Specifications* chapter.

Fast start glow plug system

The diesel engine glow system consists of:

- eight glow plugs (one per cylinder)
- the glow plug control module (GPCM)
- engine coolant temperature (ECT) sensor
- barometric pressure (BARO) sensor
- environmental temperature sensor

Introduction

The glow plug system is electronically controlled by the PCM and GPCM. The GPCM energizes the glow plugs immediately after the ignition is turned on and kept on as determined by the GPCM using the ECT, BARO and environmental temperature sensor. The required time for the glow plugs to be energized decreases as the coolant temperature, barometric pressure and environmental temperature increase.



Engine and secondary cooling system

The cooling system contains an engine cooling loop to cool the engine and a secondary cooling loop to cool the transmission, exhaust gas recirculation (EGR), charge air and fuel. The coolant serves three primary purposes: to provide heat transfer, freeze point protection, and corrosion protection using additives.

Vehicles with diesel engines typically are used to carry heavy loads and accumulate mileage rapidly. These two factors may cause the additives in the coolant to “wear out” in a shorter time. Refer to the *Special operating conditions* section for more information about coolant additives and coolant change intervals. Operating the engine with insufficient coolant and/or coolant additive can cause severe engine damage.

Selective catalytic reduction (SCR) system

Your vehicle is equipped with a selective catalytic reduction (SCR) system to help reduce emission levels of oxides of nitrogen from the exhaust of the diesel engine. This system relies on the use of diesel exhaust fluid (DEF) which must be replenished at certain intervals. Failure to maintain proper DEF levels or if the DEF becomes contaminated will result in vehicle speed limitations and/or result in the vehicle entering an idle-only mode. See *Selective catalytic reduction (SCR) system* in the *Maintenance and Specifications* chapter for more information.

Speed control (if equipped)

If vehicle speed goes outside a predetermined range from the set speed, the RES (Resume) function will not reset vehicle speed. Vehicle speed will need to be reset with the SET +/- button after reaching desired speed using accelerator pedal.

Instrument Cluster

WARNING LIGHTS

Base cluster with standard measure shown; metric and optional similar

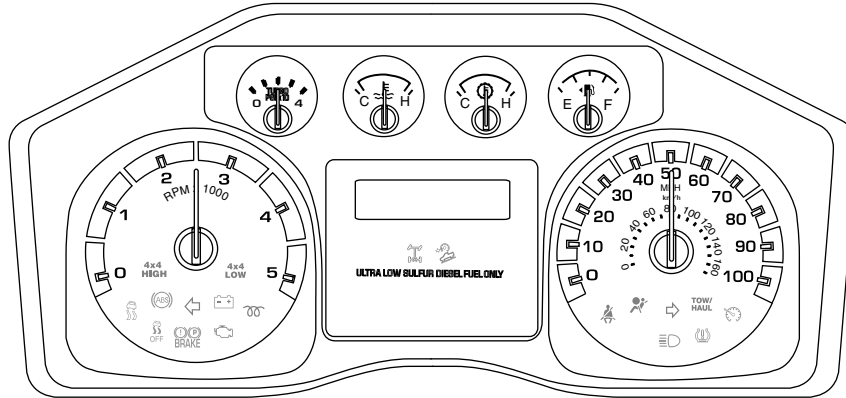

Note: Some warning lights are reconfigurable telltale (RTT) indicator lights and will illuminate in the message center display and function the same as the other warning lights.

Glow plug pre-heat indicator:



With the key in the on position, this light will illuminate if glow plug heat is necessary as a starting aid. Wait until the light goes off before starting. Refer to *Cold weather starting* in the *Driving* chapter of this supplement. After the engine starts, the light should turn off. The light should always illuminate at least momentarily when the engine is cold and the ignition is turned to on.

Instrument Cluster

Water in fuel:

During refueling, it is possible for water-contaminated diesel fuel to be pumped into your tank. Your vehicle's fuel system is equipped with a fuel filter/water separator to remove water from the fuel. The water in fuel light will illuminate when the DFCM has a significant quantity of water in it.



If the light illuminates when the engine is running, stop the vehicle as soon as safely possible, shut off the engine, then drain the DFCM. Refer to *Fuel filter/water separator* in the *Maintenance and Specifications* chapter of this supplement for the drain procedure. Allowing water to stay in the system could result in extensive damage to, or failure of, the fuel injection system.

Note: Air will enter into the fuel system if the DFCM is drained while the system is running. The engine will not operate properly if air enters the system.



WARNING: Do not drain the DFCM while the engine is running. Fuel may ignite if the separator is drained while the engine is running or the vehicle is moving.

Low/contaminated diesel exhaust fluid:

With the key in the on position, this light will illuminate if the exhaust fluid is contaminated and/or low. See *Diesel exhaust fluid* in the *Maintenance and Specifications* chapter for more information.



GAUGES

Engine boost gauge:

Indicates the amount of manifold air pressure in the engine.



Driving

STARTING THE ENGINE

Read all starting instructions carefully before you start your vehicle.

For temperatures below 32°F (0°C), the use of the correct grade engine oil is essential for proper operation. Refer to *Engine oil specifications* in the *Maintenance and Specifications* chapter for more information.

Your vehicle may be equipped with a cold weather starting strategy that prevents severe engine damage by assisting in engine lubrication warm-up. In extremely cold ambient temperatures, this strategy activates and prevents the accelerator pedal from being used for 30 seconds after starting the vehicle. By not allowing the accelerator pedal to be used, the engine oil is allowed to properly lubricate the bearings preventing engine damage due to lack of proper lubrication. After the 30 second warm-up period, the accelerator pedal will be operational again as long as the pedal is not being pressed when the 30 second time limit expires. When starting the engine in extremely cold temperatures (-15°F [-26°C]), it is recommended to allow the engine to idle for several minutes before driving the vehicle.

Ensure the gearshift lever is in P (Park) and the parking brake is fully set before you turn the key. Do not press the accelerator during starting.

Engine-driven cooling fan (fan clutch)

Your vehicle is equipped with an engine driven cooling fan drive (also called a fan clutch). This fan drive changes the fan speed to match the vehicle's changing cooling air flow requirements. Fan speed, fan noise level and fuel consumption all will increase based on the driving conditions that include trailer towing, hill climbing, heavy loads, high speed and high ambient temperature, individually or in combination.

The fan drive is designed to provide the minimum fan speed (and resulting minimum fan noise and fuel consumption) required to meet the ever changing vehicle cooling air flow requirements. You will hear the amount of fan noise increasing and decreasing as the engine power requirements and vehicle driving conditions change as you drive. This is to be expected as being normal to the operation of your vehicle. High levels of fan noise might also be heard when your engine is first started, and should normally decrease after driving for a short time.

Driving

If the vehicle's speed is limited or the vehicle has entered an idle-only mode

If the vehicle's speed is limited or in an idle-only mode, the SCR system may be limiting the vehicle's functions due to low or contaminated diesel exhaust fluid (DEF). Check the DEF. See *Selective catalytic reduction (SCR) system* in the *Maintenance and Specifications* chapter for more information.

Cold weather starting

It is recommended that the engine block heater be used for starting when the temperature is -10°F (-23°C) or colder. Refer to *Engine block heater (if equipped)* in the *Driving* chapter of the *Owner's Guide*.

When operating in cold weather, use Motorcraft® cetane improvers or non alcohol-based cetane improvers from a reputable manufacturer.

Do not crank the engine for more than 10 seconds as starter damage may occur. If the engine fails to start, turn the key to 3 (off) and wait 30 seconds before trying again.



WARNING: Do not use starting fluid, such as ether, in the air intake system (see air filter decal). Such fluid could cause immediate explosive damage to the engine and possible personal injury.



WARNING: Do not add gasoline, gasohol or alcohol to diesel fuel. This practice creates a serious fire hazard and causes engine performance problems.

1. Turn the key to on without turning the key to start. **Do not start the engine** until the glow-plug pre-heat indicator  turns off.

2. When the glow plug pre-heat indicator turns off, turn the key to start, then release the key as soon as the engine starts. The glow plugs



may remain on for a period of time after engine start. If the engine is not started before the glow plug activation time ends, the glow plugs will need to be reset by turning the key to off.

3. After the engine starts, **allow it to idle for about 15 seconds**. This is to protect the engine. Do not increase engine speed until the oil pressure gauge indicates normal pressure.

Driving

ENGINE IDLE SHUTDOWN (IF EQUIPPED)

Your vehicle may be equipped with an engine idle shutdown system. This system will automatically shut down your engine when it has been idling in P (Park) or N (Neutral) for five minutes (parking brake set) or 15 minutes (parking brake not set). When the engine idle shutdown process has started:

- A chime will sound and the message center will display **ENGINE TURNS OFF IN 30** (seconds) and start counting down.
- The 5 or 15 minute timer can be restarted by changing the position of the accelerator pedal, brake pedal or the park brake within the final 30 seconds.
- When the timer reaches zero, the engine shuts down and the message center will display **ENGINE TURNED OFF**.
- One minute after the engine has shut down, the electrical system will simulate key off, even though the ignition is still in the on position, initiating normal accessory delay period.
- The ignition must be moved to the off position to reset the system before restarting the vehicle.

Note: The engine idle shutdown idle timer will not start if:

- The engine is operating in power take-off (PTO) mode.
- The engine coolant temperature is below 60°F (16°C).
- The exhaust emission control device (DPF) is regenerating.

STOPPING THE ENGINE

Turn the ignition to the off position.

To prolong engine life (especially after extended high speed, high ambient temperature, or high GVW/GCW operation), it is recommended that a hot engine be idled for 3-5 minutes which will allow the turbocharged engine to cool down.

COLD WEATHER OPERATION

Changing to a lighter grade engine oil also makes starting easier under these conditions. Refer to *Engine oil specifications* in the *Maintenance and Specifications* chapter of this supplement.

Diesel fuel is adjusted seasonally for cold temperatures. Diesel fuel which has not been properly formulated for the ambient conditions may form wax crystals which can clog the fuel filters. At temperatures below 20°F (-7°C), if the engine starts, stalls after a short time, and then will not

10

Driving

restart, the fuel filter(s) may be clogged. For best results in cold weather, use a diesel fuel which has been formulated for the ambient conditions. If you have been using biodiesel, you may need to use a fuel with lower biodiesel content, try another brand, or discontinue using biodiesel.

Your vehicle is equipped with a diesel fuel conditioner module (DFCM) which recirculates fuel from the engine to help prevent fuel filter clogging. Your vehicle is also equipped with a bypass relief valve, located in the fuel tank pick-up boot, which provides fuel flow to the engine if the fuel pickup should become plugged. To allow the bypass valve to function and avoid engine fuel starvation during cold weather operation of 32°F (0°C) or below, it is recommended that the fuel level in your tank should not be allowed to drop below ¼ full. This will help prevent air from entering the fuel system and stalling the engine.

Your vehicle is equipped with a an SCR system which uses diesel exhaust fluid (DEF) to operate properly. DEF must be replenished at certain intervals. When filling the vehicle's DEF tank in cold weather, special care must be taken to prevent damage to the DEF tank. For proper cold weather fill procedure, see *Selective Catalytic Reduction (SCR) System* in the *Maintenance and Specifications* chapter.

In cold weather below 32°F (0°C), the engine will slowly increase to a higher idle speed if left idling in P (Park). As the engine warms-up, the engine sound level will decrease due to the activation of PCM-controlled sound reduction features.

If your vehicle is operated in a heavy snow storm or blowing snow conditions, the engine air induction may become partially clogged with snow and/or ice. If this occurs, the engine may experience a significant reduction in power output. At the earliest opportunity, clear all the snow and/or ice away from inside the air filter assembly. Remove the air cleaner cover and the pleated paper filter, leaving the foam filter in and remove any snow or ice. Ensure the foam filter is installed correctly in place. Remove any debris, snow and/or ice on the foam filter by brushing the surface with soft brush. Do not use water, solvents, or a hard brush for cleaning the foam filter.

In order to operate the engine in temperatures of 32°F (0°C) or lower, read the following instructions:

- Make sure that the batteries are of sufficient size and are fully charged. Check other electrical components to make sure they are in optimum condition.
- Use the proper coolant solution at the concentration recommended to protect the engine against damage from freezing.

Driving

- Try to keep the fuel tank full as much as possible at the end of operation to prevent condensation in the fuel system.
- Make sure you use proper cold weather engine oil and that it is at its proper level. Also, if necessary, make sure to follow the engine oil and filter change schedule found under the *Special operating conditions* section listed in the *scheduled maintenance information*.
- At temperatures of -10°F (-23°C) or below, it is recommended that you use an engine block heater to improve cold engine starting.
- If operating in arctic temperatures of -20°F (-29°C) or lower, consult your truck dealer for information about special cold weather equipment and precautions.

Note: Idling in cold weather will not heat the engine to its normal operating temperature. Long periods of idling, especially in cold weather, can cause a buildup of deposits which can cause engine damage.

The following cold weather idling guidelines are recommended:

- Use Motorcraft® cetane improvers or non alcohol-based cetane improvers from a reputable manufacturer.
- Maintain the engine cooling system properly.
- Avoid shutting the engine down after an extensive idling period. Drive the vehicle for several miles with the engine at normal operating temperatures under a moderate load.
- Consider using an engine block heater.
- For extended idle times use an approved idle speed increase device.

Winter operating tips for Arctic operation -20°F (-29°C) and below

The following information is provided as a guideline only, and is not intended to be the only source of possible solutions in resolving extreme cold temperature issues.

Starting aids:

The use of the factory engine block heater (if equipped) (refer to *Engine block heater* in the *Driving* chapter of the *Owner's Guide*) will assist in engine starting in extreme cold ambient temperatures.



WARNING: Do not use starting fluid, such as ether, in the air intake system (see air filter decal). Such fluid could cause immediate explosive damage to the engine and possible personal injury.

Idle control:

- Your vehicle may have a factory option for a stationary elevated idle control (SEIC) through dash-mounted upfitter switches will allow the operator to elevate the idle rpm for extended idle periods, as well as aftermarket equipment such as PTO operation. This feature must be configured even if ordered from the factory. See your authorized dealer for required upfitting.

Operation in snow and rain

Vehicle operation in heavy snowfall or extreme rain conditions may feed excessive amounts of snow/water into the air intake system. This could plug/soak the air filter with snow and may cause the engine to lose power and possibly shut down.

The following actions are recommended after operating the vehicle up to 200 miles (320 km) in snowfall or extreme rain:

- **Snow:** At the earliest opportunity, open the hood and clear all the snow and ice from the air filter housing inlet (do not remove the foam filter) and reset the air filter restriction gauge.

Note: Removal of the foam filter degrades vehicle performance during snow and hot weather conditions.

- **Extreme rain:** The air filter will dry after about 15–30 minutes at highway speeds. At the earliest opportunity, open the hood and reset the air filter restriction gauge.

Refer to *Air filter and restriction gauge* in the *Maintenance and Specifications* chapter of this supplement for more information.

Operation in standing water

Ingestion of water into the diesel engine can result in immediate and severe damage to the engine. If driving through water, slow down to avoid splashing water into the intake. If the engine stalls, and ingestion of water into the engine is suspected, do not try to restart the engine. Consult your dealer for service immediately.

Engine block heater (if equipped)

Refer to the *Driving* chapter in the *Owner's Guide*.

Driving

Rapid heat supplemental heating system (if equipped)

The optional rapid heat feature is an electrically powered device that is designed to provide supplemental heat during engine warm up. For maximum effectiveness mid to low blower speed is recommended during initial warm up. When operating in automatic mode (when equipped) the climate control unit will determine the appropriate blower speed for existing conditions.

Note: Additional aftermarket electrical loads operated during engine warm up may impact the performance of the rapid heat supplemental heater.

DUAL FUEL TANK SELECTOR CONTROL (IF EQUIPPED)

If your vehicle is equipped with dual fuel tanks, you will have a selector control, located to the right of the steering wheel, which allows you to draw fuel from either tank. Your fuel gauge and the DTE (distance to empty) will display the amount of fuel in the currently selected tank.

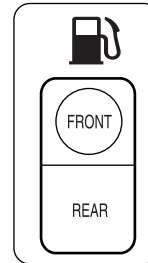

ENGINE-EXHAUST BRAKING

This feature increases engine braking at higher engine speeds to provide better grade descent control with less brake and transmission wear and tear.

This feature is integrated with the tow/haul mode feature. When tow/haul mode is switched on, the engine-exhaust braking feature will also be active. For more information on tow/haul, see *Automatic transmission operation* in the *Owner Guide*.

Driving

TRAILER TOWING

Refer to your *Owner's Guide* for full details on towing a trailer.

Trailer towing tables

Vehicle type	Rear axle ratio	Maximum GCWR - lb (kg)
F-250/F-350 Single Rear Wheel (SRW)	3.31/3.55/3.73	23500 (10659)
F-350 Dual Rear Wheel (DRW) Chassis Cab	3.73/4.10	24500 (11113)
F-350 Dual Rear Wheel (DRW) Pick-up	3.73	30000 (13608)
F-450 Chassis Cab	4.10	26000 (11793)
	4.30	30000 (13608)*
F-450 Pick-up	4.30	33000 (14969)
F-550 (17500/18000 lb GVWR)	4.10/4.88	26000 (11793)
F-550 (19000/19500 lb GVWR)	4.30/4.88	35000 (15875)*
* Requires optional GCWR package		

Roadside Emergencies

FUEL PUMP SHUT-OFF SWITCH

This device stops the electric fuel pump from sending fuel to the engine when your vehicle has had a substantial jolt.

After an accident, if the engine cranks but does not start, this switch may have been activated.

This switch is located on the passenger's side of the instrument panel. Open the front passenger door and remove the small access panel

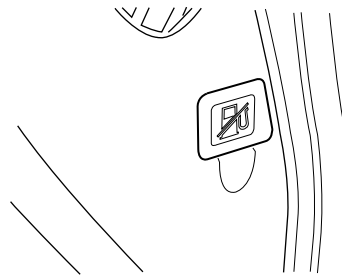

The switch has a red button on top of it.

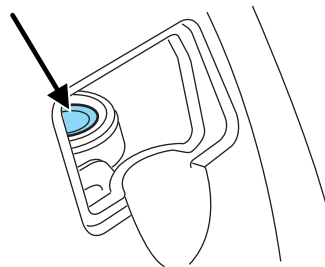

To reset the switch:

1. Turn the ignition off.
2. Check the fuel system for leaks.
3. If no leaks are apparent, reset the switch by pushing in on the reset button.
4. Turn the ignition on.
5. Wait a few seconds and return the key to off.
6. Make another check for leaks.

Roadside Emergencies

JUMP STARTING YOUR VEHICLE

The 6.7 diesel engine can be jump started using the same procedure as a gasoline engine. Use the primary battery (battery located on the passenger side) for any jump starting procedure and refer to your *Owner's Guide* for the proper method of jump starting.

RUNNING OUT OF DEF (DIESEL EXHAUST FLUID)

If your vehicle runs out of DEF, it will enter into a speed limited mode and can also enter into an idle-only mode. Normal vehicle operation will not resume until DEF is refilled. See the *Selective Catalytic Reduction (SCR) System* section in the *Maintenance and Specifications* chapter for more information.

Contact roadside assistance for help in finding a retailer that sells DEF. See the *Customer Assistance* chapter in the *Owner's Guide* for more information.

Cleaning

ENGINE

Engines are more efficient when they are clean because grease and dirt buildup keep the engine warmer than normal. When washing:

- Take care when using a power washer to clean the engine. The high-pressure fluid could penetrate the sealed parts and cause damage.
- Do not spray a hot engine with cold water to avoid cracking the engine block or other engine components.
- Spray Motorcraft® Engine Shampoo and Degreaser (ZC-20) on all parts that require cleaning and pressure rinse clean.
- Never wash or rinse the engine while it is running; water in the running engine may cause internal damage.
- Cover the highlighted areas to prevent water damage when cleaning the engine.

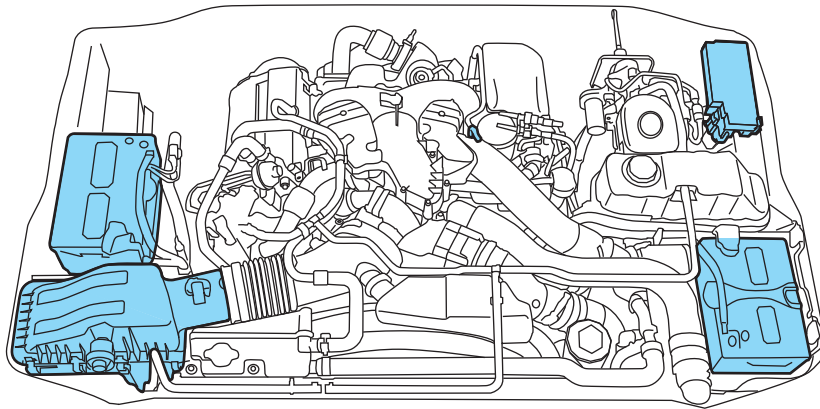

Cleaning

EXHAUST

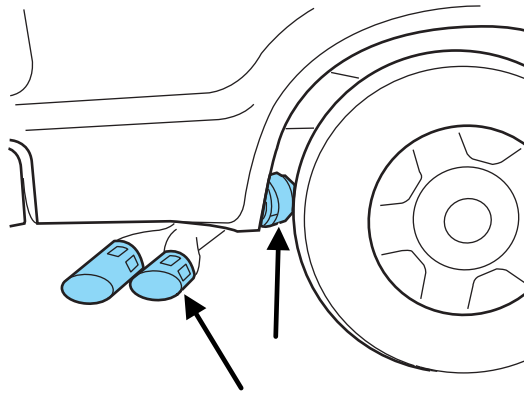

The visible holes in each leg of the twin tip and the holes under the shield just inboard of the right rear tire(s) are functional. The holes need to be kept clear of mud/debris or foreign material to maintain proper function of the exhaust system. Clean and remove debris or foreign material if present as needed. Spraying with a hose during regular washing of vehicle should help keep holes clean and clear of debris or foreign material.

! **WARNING:** Failure to maintain the functional holes, in the tailpipe section of the exhaust, clean and free of debris or foreign material may result in the holes becoming blocked or plugged. Do not modify or remove the tail-pipe section. Blocked or plugged holes or removal/modification of the system could result in elevated exhaust gas temperatures which may result in vehicle/property damage or personal injury

! **WARNING:** The normal operating temperature of the exhaust system is very high. Never work around or attempt to repair any part of the exhaust system until it has cooled. Use special care when working around the diesel oxidation catalytic converter and/or the diesel particulate filter (DPF). The diesel oxidation catalytic converter and/or the DPF heats up to a high temperature after only a short period of engine operation and can stay hot even after the engine is turned off. Failure to follow these instructions may result in personal injury.

Maintenance and Specifications

IDENTIFYING COMPONENTS IN THE ENGINE COMPARTMENT

F-Super Duty

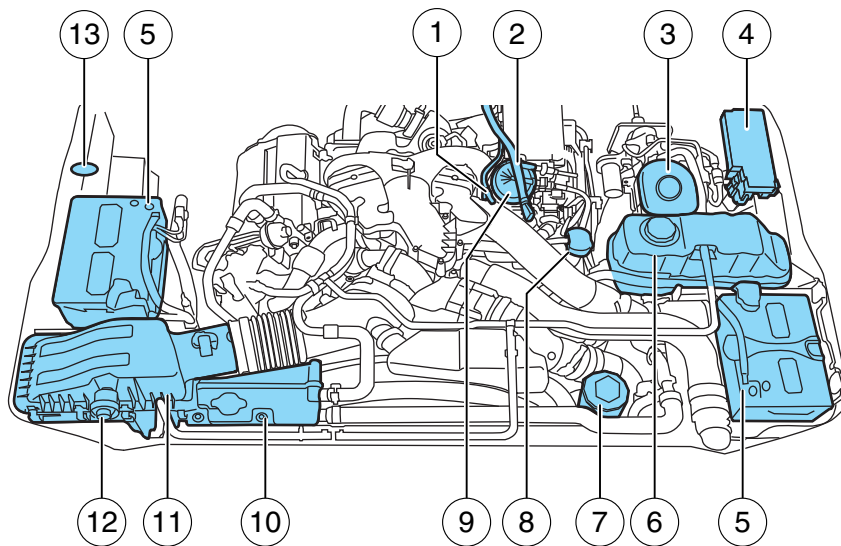

1. Engine oil dipstick
 2. Automatic transmission dipstick
 3. Brake fluid reservoir
 4. Power distribution box
 5. Batteries
 6. Engine cooling system coolant reservoir (primary high-temperature cooling system)
 7. Power steering fluid reservoir
 8. Engine oil fill
 9. Engine-mounted fuel filter assembly
 10. Secondary cooling system coolant reservoir
 11. Air filter assembly
 12. Air filter restriction gauge
 13. Windshield washer fluid reservoir
- 20

Maintenance and Specifications

SCHEDULED MAINTENANCE

The scheduled maintenance services in the *scheduled maintenance information* of this supplement are required because they are considered essential to the life and performance of your vehicle.

Use only recommended fuel, lubricants, fluids and service parts conforming to Ford specifications. Motorcraft® parts are designed and built for best performance in your vehicle.

FUEL REQUIREMENTS - CHOOSING THE RIGHT FUEL: VEHICLES OPERATED WHERE ULTRA LOW SULFUR DIESEL FUEL IS REQUIRED (UNITED STATES/CANADA/PUERTO RICO/U.S. VIRGIN ISLANDS AND OTHER LOCALES)

Use only Ultra Low Sulfur (15 ppm Sulfur Maximum) number 1-D or 2-D diesel fuel (also known as ULSD) in your 6.7L diesel engine. The engine and exhaust system were designed to only use this fuel. Look for the **ULTRA-LOW SULFUR HIGHWAY DIESEL FUEL (15 ppm Sulfur Maximum)** label on fuel pumps when purchasing your fuel.

Using low sulfur diesel fuel (16-500 ppm) or high sulfur diesel fuel (greater than 500 ppm) in a diesel engine designed to use only Ultra Low Sulfur Diesel fuel will cause certain emission components to malfunction which may also cause the service engine soon  light to illuminate indicating an emissions-related concern.

Diesel fuel is adjusted seasonally for cold temperature. For best results at temperatures below 20°F (-7°C), it is recommended to use a diesel fuel which has been seasonally adjusted for the ambient conditions. See *Cold weather operation* in the *Driving* chapter of this supplement.

FUEL REQUIREMENTS - CHOOSING THE RIGHT FUEL: VEHICLES OPERATED WHERE ULTRA LOW SULFUR DIESEL FUEL IS NOT REQUIRED

For the engine to operate reliably on low sulfur or high sulfur diesel fuel, the engine must be a high sulfur configured engine or a ULSD fuel-configured engine that has been retrofitted for high sulfur diesel fuel use.

Maintenance and Specifications

Use only a diesel engine that has been configured for use with high sulfur diesel fuel in markets with diesel fuel that has sulfur content greater than 15 ppm. Using low sulfur diesel fuel (16–500 ppm) or high sulfur diesel fuel (greater than 500 ppm) in a diesel engine designed to use only Ultra Low Sulfur Diesel fuel may result in damage to engine emission control devices and the aftertreatment system, potentially rendering the vehicle inoperable. Engine damage from using the improper type of fuel is not covered under your warranty.

Vehicles with engines configured for use with high sulfur diesel fuel will only be made available for sale in countries where ULSD fuel is generally not available or mandated by the government. Vehicles originally sold in a ULSD fuel market that are subsequently exported to non-ULSD fuel markets will need to be retrofitted (at the customer's expense) in order to be reliably operated on non-ULSD fuel.

Diesel fuel is adjusted seasonally for cold temperature. For best results at temperatures below 20°F (-7°C), it is recommended to use a diesel fuel which has been seasonally adjusted for the ambient temperature. See *Cold weather operation* in the *Driving* chapter of this supplement.

BIODIESEL

This vehicle may be operated on diesel fuels containing up to 20% biodiesel, also known as B20.

To help achieve acceptable engine performance and durability when using biodiesel in your vehicle:

- Confirm the biodiesel content of the fuel to be B20 (20% biodiesel) or less
- Only use biodiesel fuel of good quality that complies with industry standards
- Follow the recommended service maintenance intervals section in the *Schedule Maintenance* chapter.
- Do not store biodiesel fuel in the fuel tank for more than 1 month
- Consider changing brands or reducing biodiesel content if you have cold temperature fuel gelling issues or a frequent **LOW FUEL PRESSURE** message appearing.
- Do not use raw oils, fats or waste cooking greases

Maintenance and Specifications

Use of biodiesel in concentrations greater than 20% may cause damage to your vehicle, including engine and/or exhaust after-treatment hardware (exhaust catalyst and particulate filter) failures. Concentrations greater than 20% can also cause fuel filter restrictions that may result in a lack of power and / or damage to fuel system components, including fuel pump and fuel injector failures.

5W-40 or 15W-40 oil is recommended for fuels with greater than 5% biodiesel (B5). Refer to the *Special operating conditions* section under the *Schedule Maintenance* chapter for more information about oil change intervals and other maintenance when operating on biodiesel.

Look for a label on the fuel pump to confirm the amount of biodiesel contained in a diesel fuel. Biodiesel content is often indicated with the letter “B” followed by the percent of biodiesel in the fuel. For example, B20 indicates a fuel containing 20% biodiesel. Ask the service station attendant to confirm the biodiesel content of a diesel fuel if you do not see a label on the fuel pump.

Biodiesel fuels degrade more easily than diesel fuels not containing biodiesel and should not be stored in the fuel tank for more than 1 month. If your vehicle will be parked or stored for more than 1 month, then your vehicle fuel tank should be emptied of biodiesel fuel, filled with a pure petroleum-based diesel fuel, and run for a minimum of 30 minutes.

Note: Degraded or oxidized biodiesel can damage fuel system seals and plastics and corrode steel parts.

During cold weather, if you have problems operating on biodiesel, you may need to use a diesel fuel with lower biodiesel content, try another brand, or discontinue the use of biodiesel.

Biodiesel fuel is a product that has been converted from renewable fuel sources, including vegetable oil, animal fat and cooking oil. Raw or refined vegetable oil, animal fat, cooking oil or recycled greases should **NOT** be used.



WARNING: Do not use home heating oil, agricultural fuel or any diesel fuel not intended for highway use. Damage to the fuel injection system, engine and exhaust catalyst can occur if an improper fuel is used. Do not add gasoline, gasohol or alcohol to diesel fuel. This practice creates a serious fire hazard and engine performance problems.

Maintenance and Specifications

Fuel quality

It should not be necessary to add any aftermarket additives to your fuel tank if you use a properly formulated diesel fuel that meets either the ASTM D975 diesel or the ASTM D7467 B6-B20 biodiesel industry specifications. Outside of North America, use fuels meeting EN590 or equivalent local market standard. Aftermarket additives can damage the injector system or engine. Repairs to correct the effects of using an aftermarket product in your fuel may not be covered by your warranty.

Many of the world's automakers approved the World-wide Fuel Charter that recommends diesel fuel specifications to provide improved performance and emission control system protection for your vehicle. Diesel fuel that meets the World-wide Fuel Charter should be used when available. Ask your fuel supplier about fuel that meets the World-wide Fuel Charter.

Do not blend used engine oil with diesel fuel under any circumstances. Blending used oil with the fuel will significantly increase your vehicle's exhaust emissions and reduce engine life due to increased internal wear.

Diesel fuel conditioner

Additives that will improve fuel cetane numbers may be used to verify/enhance fuel quality. Use Motorcraft® or an equivalent cetane booster & performance improver as listed in the *Maintenance product specifications and capacities* section in this chapter. The customer warranty may be void from using additives that do not meet or exceed Ford specifications.

Do not use alcohol based additives to correct fuel gelling. This may result in damage to the fuel injectors/system. Use Motorcraft® or an equivalent anti-gel & performance improver as listed in the *Maintenance product specifications and capacities* section in this chapter. The customer warranty may be void from using additives that do not meet or exceed Ford specifications.

Note: These ultra-low sulfur formulations are designed to meet the emissions standards for the 6.7L engine and is backward compatible as well (i.e., can be used in Ford 7.3L, 6.9L, 6.4L and 6.0L diesel engines in Ford vehicles).

Fueling tips

Truck stops have pumps and nozzles designed for larger, heavy-duty trucks. When refueling at truck stops: if the nozzle shuts off repeatedly when refueling, wait 5–10 seconds; then use a slower rate of flow (don't depress the nozzle trigger as far).

24

Maintenance and Specifications

If air is allowed to enter the fuel system (during fuel filter change or if you run out of fuel) the engine will purge the trapped air as it runs. To purge the air sooner: prior to engine start, prime system by turning the key to on for 30 seconds then to off. Repeat this several times. The engine may run rough and produce white smoke while air is in the system. This is normal and should correct itself in a short time.

An engine that suddenly becomes noisy or operates poorly after a fuel fill could be using substandard fuel (i.e., high water content, low cetane rating or gasoline in the fuel). Diesel fuel should be purchased from a reputable station which sells a large amount of diesel fuel.

Care should be taken whenever diesel fuel is stored. Use only clean, approved containers which will prevent the entry of dirt or water.

Diesel fuel must not be stored in a galvanized container. The fuel will dissolve the zinc in a galvanized container. The zinc will then remain in the solution until it is run through the engine where it will be deposited in the fuel injectors causing expensive-to-repair damage.

Diesel fuel dispensing nozzle fill rate

This truck is equipped with a fuel fill pipe which is able to accept fuel up to 20 gallons per minute from a 1½ fuel dispensing nozzle. Pumping fuel at greater flow rates may result in premature nozzle shut-off or spitback.

Fuel filler cap

Your fuel tank filler cap has an indexed design with a 1/4 turn on/off feature.

When fueling your vehicle:

1. Turn the engine off.
2. Carefully turn the filler cap counterclockwise until it spins off.
3. Pull to remove the cap from the fuel filler pipe.
4. To install the cap, align the tabs on the cap with the notches on the filler pipe.
5. Turn the filler cap clockwise 1/4 of a turn until it clicks at least once.

If you must replace the fuel filler cap, replace it with a fuel filler cap that is designed for your vehicle. The vehicle warranty may be void for any damage to the fuel tank or fuel system if the correct genuine Ford or Motorcraft® fuel filler cap is not used.

Maintenance and Specifications



WARNING: The fuel system may be under pressure. If the fuel filler cap is venting vapor or if you hear a hissing sound, wait until it stops before completely removing the fuel filler cap. Otherwise, fuel may spray out and injure you or others.



WARNING: If you do not use the proper fuel filler cap, excessive pressure or vacuum in the fuel tank may damage the fuel system or cause the fuel cap to disengage in a collision, which may result in possible personal injury.

Selective Catalytic Reduction (SCR) System

Your vehicle is equipped with a selective catalytic reduction (SCR) system to help reduce emission levels of oxides of nitrogen from the exhaust of the diesel engine. The system automatically injects diesel exhaust fluid (DEF) into the exhaust system to enable proper SCR function.

Importance of maintaining the DEF level

In order for the SCR system to operate properly, the DEF level must be maintained. Generally, the DEF tank should be filled during the oil change service interval. See the *scheduled maintenance information* in this supplement for more information. However, certain conditions or driving styles, such as trailer towing or fast rates of acceleration, will require the refilling of the DEF tank more often.

The engine control unit will monitor the amount of fluid available in the DEF tank. Running a system check in the message center will indicate whether the DEF level is ok or if it is less than 1/2 full. A message will automatically be displayed in the message center when the DEF level is low and needs to be refilled. When you see this message you should refill your tank. See *Message center* in the *Instrument Cluster* chapter of your *Owner's Guide* for message center functions. For instructions on refilling your DEF tank, see *Filling the DEF tank* later in this section.

Maintenance and Specifications

DEF warning messages and vehicle operations

 **WARNING:** Diesel Exhaust Fluid (DEF) must be refilled when low or replaced when contaminated or the vehicle speed will be speed limited to 55 mph (89 km/h) and then 50 mph (80 km/h). In these conditions, drive with caution and refill DEF immediately. If the DEF becomes empty or contaminated fluid is not replaced, the vehicle will become limited to idle speed only once stopped. In these conditions, be cautious where you stop the vehicle because you may not be able to drive long distances and will not be able to maintain highway speeds until DEF is refilled or replaced.

Your vehicle's message center will display a series of messages regarding the amount of DEF available. A systems check will display messages indicating the amount of DEF available (OK or under ½ full) or will produce a warning message that displays the mileage (kilometers) remaining as the fluid in the DEF tank nears empty. For more information on warning messages, see the *Message center* section in the *Instrument Cluster* chapter of your *Owner's Guide*.

As the DEF level nears empty, the DEF warning symbol will be displayed and chimes will sound with the messages starting at 300 miles (483 km) remaining before DEF is depleted. The warning symbol and messages will continue until the DEF tank is refilled.



Continued driving without refilling will result in the following actions as required by the California Air Resources Board (CARB) and /or U.S. Environmental Protection Agency (EPA):

- Within a certain number of miles (kilometers) to empty, speed will be limited upon vehicle restart. Prior to this occurring a message will appear in the message center.
- Further vehicle operation without refilling your DEF tank will cause the engine to enter an idle-only condition. This will only occur upon vehicle refueling and will be indicated by a message in the message center indicating required actions to resume normal operation. It is required to add a minimum of 0.5 gallons (1.9L) of DEF to the tank to exit the idle-only condition, but the vehicle will still be in the speed limiting mode until the tank is refilled.

Maintenance and Specifications

For either vehicle speed limiting or idle-only condition, normal vehicle operation will resume when the DEF tank is refilled.

Note: When filling the DEF tank from empty, there may be a short delay before detecting the increased level of DEF. This must occur before full power is returned.

Maintenance and Specifications

Low DEF Warnings and Actions — Instrument Cluster Messages (Optional message center messages shown, base message center messages similar)			
Distance/DEF Level or Action	Cluster Message	Customer Requested Actions	Vehicle Actions
Full Tank	Exhaust Fluid Level OK	Drive normally	None
Below ½ Tank	Exhaust Fluid Under ½ Full	Drive normally	None
800 Miles (1287 km)	Exhaust Fluid Range 800 miles (1287 km)	Refill exhaust fluid	None
300 Miles (483 km)	Exhaust Fluid Range 300 miles (483 km)	Refill exhaust fluid	None
99 Miles (159 km)	In 99 Miles (159 km) Speed Limited to 55 MPH (89 km/h) Exhaust Fluid Empty	Refill exhaust fluid	None
0 Miles (0 km)	Speed Limited to 55 MPH (89 km/h) Max Upon Restart Exhaust Fluid Empty	Refill exhaust fluid	None

Maintenance and Specifications

Low DEF Warnings and Actions — Instrument Cluster Messages (Optional message center messages shown, base message center messages similar)			
Distance/DEF Level or Action	Cluster Message	Customer Requested Actions	Vehicle Actions
Restart	Speed Limited To 55 MPH (89 km/h) Exhaust Fluid empty	Refill exhaust fluid	Speed is limited to 55 MPH. (89 km/h)
In 200 Miles (322 km) after vehicle reaches 0 mile (0 km) DEF range	Speed Limited to 50 MPH (80 km/h) Exhaust Fluid Empty	Refill exhaust fluid	On vehicle restart, speed is limited to 50 MPH (80 km/h). (No action taken until vehicle is refueled)
Restart	Speed Limited To 50 MPH (80 km/h) Exhaust Fluid Empty	Refill exhaust fluid	
In 300 Miles (483 km) after vehicle reaches 0 mile (0 km) DEF range	Engine Idled Upon Refuel Exhaust Fluid Empty	Refill exhaust fluid	None
Diesel Tank Fill	Engine Idled-See Owner's Manual Exhaust Fluid Empty	Refill exhaust fluid	Engine limited to idle ONLY (No action taken until vehicle is refueled)

Maintenance and Specifications

Filling the DEF tank

Your vehicle is equipped with a DEF tank with a blue-capped filler port located next to the diesel fuel fill inlet. The tank can be filled using a nozzle at a DEF filling station (similar to fuel fill) or using a DEF bottle with a spout. Motorcraft® DEF bottles are recommended as they are designed to be spill proof and will stop the flow of DEF when the tank is full. Other aftermarket bottles can be used, but they should have a seal on the spout and an internal vent tube to achieve best fill performance and prevent overfilling. Overfilling your DEF tank can cause damage to the tank. For DEF capacity, see *Maintenance product specifications and capacities* in this chapter.

Note: Do not put DEF in the fuel tank. This can cause engine damage not covered by your vehicle's warranty.

Note: Immediately wipe away any DEF that has spilled on painted surfaces with water and a damp cloth to prevent damage to the paint. You can purchase DEF at your authorized dealer, most highway truck stops or you can contact roadside assistance for help in finding a retailer that sells DEF. See the *Customer Assistance* chapter in the *Owner's Guide* for more information. In addition, there is a government website locator for DEF at the following web address that can be used to find the nearest location to purchase DEF: <http://www.afdc.energy.gov/afdc/locator/def>.

Use only DEF certified by the American Petroleum Institute (API) such as Motorcraft® DEF or equivalent meeting Ford specification WSS-M99C130-A and/or ISO 22241. Look for API certification trademark shown here.

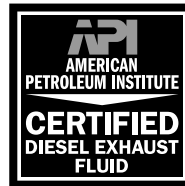

Repairs resulting from the use of non-certified DEF products may not be covered by your vehicle's warranty.

Maintaining the purity of DEF is important to avoid malfunctions in the SCR system.

If DEF is removed from the tank for repair work, etc., the same DEF must not be used to refill the tank as its purity is no longer guaranteed.



WARNING: Make sure that DEF does not come into contact with eyes, skin or clothing. Should DEF contact your eyes, flush them with plenty of water and contact a physician. Clean affected skin with soap and water. If DEF is swallowed, drink plenty of water and contact a physician immediately.

Maintenance and Specifications

 **WARNING:** Refill DEF in a well-ventilated area. When opening the cap on the DEF tank or bottle containing DEF, ammonia vapors may escape. The vapors can be irritating to skin, eyes and mucous membranes. Inhaling ammonia vapors can cause burning to the eyes, throat and nose and cause coughing and watery eyes.

To fill the DEF tank, see your authorized dealer or do the following (before filling the DEF tank in cold climates, see *Filling the DEF tank in cold climates* later in this section):

- **DEF bottle fill with spout:**

The following procedure applies to Motorcraft® DEF or similar DEF bottles; for other brands or bottle types, refer to the instructions on the bottle label.

1. Remove the cap from the DEF container. Remove the spout from the bottle and insert the straw end into the bottle. Ensure that the arrow above the nut is aligned with the bottle handle and the small tube end extends into the far corner of the bottle. Twist the spout nut on the container until it is tight.

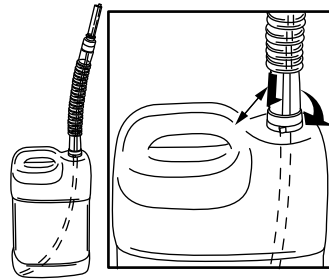

2. Open the DEF filler port on the vehicle by turning the blue cap counterclockwise.

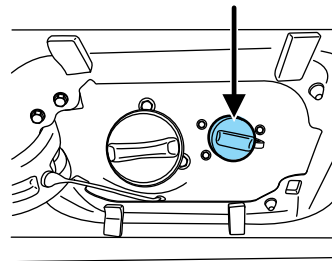

Maintenance and Specifications

3. Lift and hold the DEF container, without tipping, and insert the spout into the DEF filler port until the small black seal on the spout is completely seated into the DEF filler port.

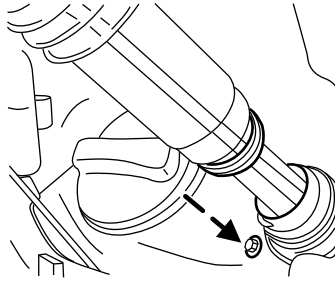

4A. While filling, the fluid level in the bottle will continually drop.

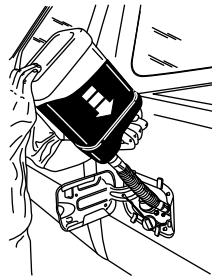

4B. When the DEF tank is full, the fluid level in the bottle will stop dropping, indicating the fluid has stopped flowing.

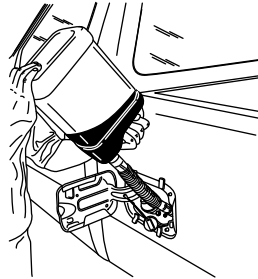

Maintenance and Specifications

5. Once the level in the DEF bottle has stopped dropping, return the container to the vertical position slightly below the DEF filler port and let any DEF drain out of the spout. **DO NOT** try to continue to add DEF to the tank by shaking or repositioning the container to induce flow. This may cause spilling and overflow the tank. Overflowing the DEF tank can cause damage to the tank.

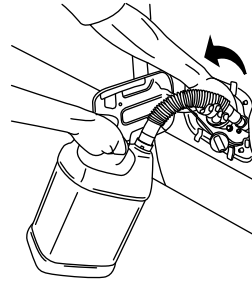

6. Once the spout has drained, remove the spout from the DEF filler port and install the blue cap on the DEF filler port.

7. Remove the spout from the DEF container and install the cap back on the bottle.

8. If the container is empty, discard the empty container and spout, or recycle if possible. If there is some DEF left in the container, retain it and the spout for later use. Store the spout to ensure it is kept clean.

9. Wipe away any DEF that has spilled on painted surfaces with water and a damp cloth.

- **DEF filling station nozzle fill:**

Filling the DEF tank using a nozzle is similar to a normal fuel fill. The nozzle will shut off automatically when the tank is full. Do not continue to fill the tank as this may cause spilling and overflow the tank which can cause damage.

Note: Some filling station nozzles may prevent filling of your DEF tank due to a magnetic mechanism in the nozzle. This is not a problem with your vehicle. To refill your tank either locate another filling station or use a bottle to refill the tank.

Filling the DEF tank in cold climates

DEF will freeze below 12°F (-11°C); however, your vehicle is equipped with an automatic preheating system which allows the DEF system to operate below 12°F (-11°C). When the vehicle is not in operation for an extended period of time with temperatures at or below 12°F (-11°C), the DEF tank could freeze. If the tank is **OVERFILLED** and freezes, it could be damaged, therefore **DO NOT OVERFILL**.

Maintenance and Specifications

To prevent overfilling of the DEF tank when filling with a bottle, Ford recommends using Motorcraft® DEF. Additionally, if the message center indicates **EXHAUST FLUID UNDER 1/2 FULL**, you should only add a MAXIMUM of 2 gallons (6.7L) of DEF to the tank to prevent freeze damage due to overfilling. If the message center indicates **EXHAUST FLUID LEVEL OK**, do not add DEF.

Contaminated DEF

SCR systems are sensitive to contamination of the DEF. USE ONLY API or ISO 22241 CERTIFIED DIESEL EXHAUST FLUID. If the system becomes contaminated, the DEF light will illuminate and contaminated exhaust fluid messages will appear in the message center.



Continued driving without replacing DEF will result in the following actions as required by the California Air Resources Board (CARB) and /or U.S. Environmental Protection Agency (EPA):

- Within a certain number of miles (kilometers) to empty, speed will be limited upon restart. Prior to this occurring a message will appear in the message center.
- Further vehicle operation without replacing contaminated DEF will cause the engine to enter an idle-only condition. This will only occur upon vehicle refueling and will be indicated by a message in the message center indicating required actions to resume normal operation.

For either vehicle speed limiting or idle-only condition, normal vehicle operation will resume when the contaminated system is repaired. **To service a contaminated SCR system, see your authorized dealer. DEF guidelines and information**

- Use only DEF that carries the trademark: American Petroleum Institute (API) certified DEF or ISO 22241.
- Do not put DEF in the diesel fuel tank.
- Do not overfill the DEF tank.
- Do not re-use the DEF container or nozzle once it is emptied.
- Avoid spilling DEF on painted surfaces, carpeting or plastic components. Immediately wipe away any DEF that has spilled with a damp cloth and water. If it has already crystallized, use warm water and a sponge.

Maintenance and Specifications

- Store DEF out of direct sunlight and in temperatures between 23°F (-5°C) — 68°F (20°C).
- DEF will freeze below 12°F (-11°C).
- Do not store DEF bottle in vehicle. If it leaks it could cause damage to interior components or release an ammonia odor inside the vehicle.
- DEF is non-flammable, non-toxic, colorless and water-soluble liquid.
- Do not dilute DEF with water or any other liquid.
- An ammonia odor may be smelled when the cap is removed or during refill. Refill DEF in a well ventilated area.

Typical Diesel Exhaust Fluid (DEF) Usage

The charts below illustrate *approximate* DEF usage for the given distances traveled under various driving conditions and when using the PTO. Your usage may vary depending on: driving style, trailer towing, loaded vehicle weight, weather, idle time, PTO usage, etc.

Pick-up (3.31 axle ratio)			
Driving style	Trailer towing / aggressive or city driving	Normal driving	Steady highway driving
DEF usage	4100 miles (6598 km) – 7100 miles (11426 km)	7100 miles (11426 km) – 9600 miles (15450 km)	9600 miles (15450 km) – 10000 miles (16093 km) +
Pick-up (3.55 axle ratio)			
Driving style	Trailer towing / aggressive or city driving	Normal driving	Steady highway driving
DEF usage	2800 miles (4506 km) – 5800 miles (9334 km)	5800 miles (9334 km) – 8100 miles (13036 km)	8100 miles (13036 km) – 9700 miles (15611 km)

Maintenance and Specifications

Pick-up (3.73 axle ratio)			
Driving style	Trailer towing / aggressive or city driving	Normal driving	Steady highway driving
DEF usage	2050 miles (3299 km) – 5050 miles (8127 km)	5050 miles (8127 km) – 7300 miles (11748 km)	7300 miles (11748 km) – 8900 miles (14323 km)
Pick-up (4.30 axle ratio)			
Driving style	Trailer towing / aggressive or city driving	Normal driving	Steady highway driving
DEF usage	1100 miles (1770 km) – 4100 miles (6598 km)	4100 miles (6598 km) – 6300 miles (10139 km)	6300 miles (10139 km) – 7900 miles (12714 km)
Chassis cab (non-PTO)			
Driving style	Trailer towing / aggressive or city driving	Normal driving	Steady highway driving
DEF usage	1700 miles (2736 km) – 4700 miles (7564 km)	4700 miles (7564 km) – 7800 miles (12553 km)	7800 miles (12553 km) – 9300 miles (14967 km)
Chassis cab (with PTO)			
PTO usage	< - - - Cont. PTO usage — Min. PTO usage - - - >		
DEF usage	0 miles (0 km) — 7800 miles (12553 km)		

FUEL FILTER/WATER SEPARATOR

Diesel Fuel Conditioner Module (DFCM)

The vehicle is equipped with a diesel fuel conditioning module (DFCM) located on the frame-rail under the driver-side floorboard near the transmission

Maintenance and Specifications

Water should be drained from the module assembly whenever the warning light comes on and the message center directs you to drain the water separator. This will occur when approximately 0.32 pints (150 ml) of water accumulates in the module. If water level is allowed to exceed this level, the water may be passed through to the engine and may cause fuel injection equipment damage.



Draining the DFCM

1. Stop the vehicle and **shut off** the engine.

 **WARNING:** The vehicle must be stopped with the engine off when draining the DFCM. Fuel may ignite if the separator is drained while the engine is running or vehicle is moving.

Note: Air will enter into the fuel system if the DFCM is drained while the system is running. The engine will not operate properly if air enters the system.

2. Locate the DFCM and place an appropriate container under the drain port (see illustration).

3. Rotate the drain counterclockwise until the O-ring is visible. Allow the DFCM to drain for approximately 25 seconds or until clean fuel is observed. Rotate the drain clockwise to tighten it.

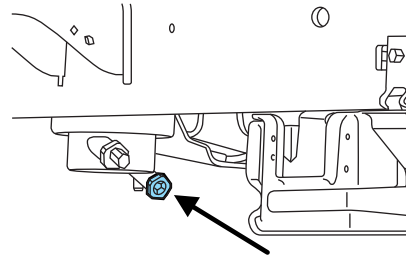

4. Make sure that the drain valve is fully tightened, then remove the container from under the vehicle.

Note: A loose drain valve can allow air to enter the fuel system and cause drivetrain issues. The engine will not operate properly. be sure that the drain valve is fully tightened.

5. Restart the engine. The **WATER IN FUEL DRAIN FILTER** or **WATER IN FUEL DRAIN FILTER SEE MANUAL** message and light should not be illuminated. If they continues to illuminate, have the fuel system checked and repaired.

38

Maintenance and Specifications

LOW FUEL PRESSURE MESSAGE

The engine is equipped with a low fuel pressure detection system. If the message center displays: **LOW FUEL PRESSURE** the following explains why and what to do:

- Cold start or cold operation (below 32°F (0°C): If this message appears during a cold start or during cold operation up to 10 minutes after the initial cold start, monitor the message center. If it disappears and does not re-appear after the engine has fully warmed up, the low fuel pressure message is most likely caused by waxed or gelled fuel.

Do not use alcohol based additives to correct fuel gelling. This may result in damage to the fuel injectors/systems. Use an anti-gel additive as listed in *Maintenance product specifications and capacities* section in this chapter. The customer warranty may be void from using additives that do not meet or exceed Ford specifications.

If the low fuel pressure message persistently appears after re-fueling during the cold start and cold operation conditions defined previously and then disappear when the engine has fully warmed up, consider different fuel sources.

- Low fuel operation: If the message appears when the vehicle is warm and during low fuel tank level operation, i.e. the tank level is at or very near empty, refuel the vehicle and operate the vehicle. If the message reappears after fueling, see below. If the message does not come back, the low fuel pressure condition was due to low fuel levels in the fuel tank.
- Normal operation: If the message appears during normal operation when the vehicle / engine is fully warm, and fuel level is not low, the fuel filters must be changed regardless of the maintenance schedule interval.
- If replacement of the fuel filter does not remedy the low fuel pressure message during normal operation as defined above, take the vehicle to your authorized dealer.

CHANGING THE ENGINE-MOUNTED AND DFCM FUEL FILTERS

Your vehicle is equipped with two fuel filters; one is mounted on top of the driver's side of the engine and the second filter, inside the DFCM, is mounted on the frame rail under the driver-side floorboard near the transmission. Both filters should be replaced at the same time. Regular fuel filter changes are an important part of engine maintenance; failing to keep with the scheduled maintenance could lead to engine performance issues and/or fuel injection system damage. Refer to the *scheduled maintenance information* of this supplement for more information.

Maintenance and Specifications

Refer to *Motorcraft part numbers* later in this chapter for the fuel filter replacement part number. This part number includes filters and seals for both the engine-mounted and frame-mounted filters.

Removal - DFCM filter

The DFCM filter is located in the lower portion of the DFCM housing.

1. Drain the DFCM. See *Fuel filter/water separator* earlier in this chapter.

To install the new DFCM filter, see *Installation – DFCM filter* later in this section.

2. Remove the lower portion of the DFCM housing (filter bowl) by turning it counterclockwise using a 32 mm socket.

Note: Depending on the amount seal swelling, removal of the filter bowl may be noisy and require some effort. Replace the seal prior to reinstalling the filter/bowl to improve assembly.

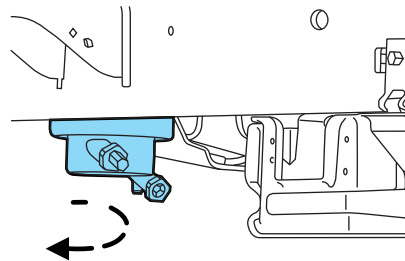

3. Remove and discard the old fuel filter element.

4. Carefully clean the mating surfaces using a lint-free rag.

Installation – DFCM filter

1. Install the new filter into the filter bowl tabs and replace the seal on the DFCM header (top portion of DFCM). Refer to *Motorcraft part numbers* later in this chapter for the fuel filter kit part number.

2. Reinstall the lower portion of the housing by slowly turning it clockwise onto DFCM housing, allowing fuel to soak into the fuel filter element. Tighten the lower housing until it contacts the mechanical stop.

Note: The engine will not run properly if the DFCM fuel filter is not installed in the housing.

The system will need to be purged of air after removal/changing of the filter. See *Purging air from the fuel system after DFCM and engine mounted fuel filter replacement* following.

Maintenance and Specifications

Removal - Engine-mounted fuel filter

The engine-mounted fuel filter is a plastic disposable cartridge. To remove it, do the following:

1. Disconnect both fuel lines by squeezing the connector tabs and pulling the lines straight off.

Note: Although the fuel system is not fully pressurized when the vehicle is off, some residual pressure may remain in the fuel system since it can take some time for the pressure to completely bleed off. Therefore, it is recommended to place a shop rag below the filter connectors to absorb the small amount of fuel that will drain.

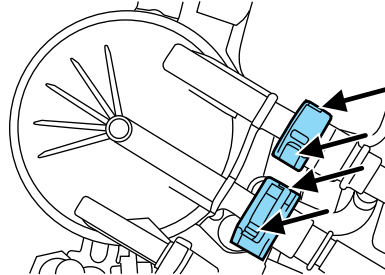

2. Loosen the bracket bolt.

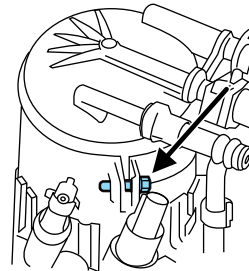

3. Rotate the filter counterclockwise until it unlocks from the bracket.
4. Pull the filter straight out from the bracket and discard the filter.

Installation – Engine-mounted fuel filter

1. Install the new filter into the filter bracket. The filter has two locking tabs: one on the bottom and one on the side approximately 180° from the bracket bolt. Line this tab up with the slot and the bottom will follow. Turn the filter clockwise to lock it in place.

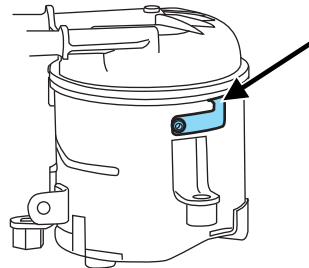

2. Tighten the bracket bolt until the filter is snug in the bracket.

Maintenance and Specifications

3. Reconnect both fuel lines.

Using a fuel which has more than average impurities may require the fuel filter to be replaced more frequently than the service interval specifies.

The system will need to be purged of air after removal/changing of the filter. See *Purging air from the fuel system after DFCM and engine-mounted fuel filter replacement* following.

Purging air from the fuel system after DFCM and engine mounted fuel filter replacement

Turn the ignition key to on for 30 seconds, then turn it to off. Do this a total of six times in a row to purge any trapped air from the fuel system.

After filter service, a no start or rough running engine may indicate that air is entering the system through the filter bowl seal or drain. Make sure the drain is tight.

ENGINE OIL

Checking the engine oil level

Because it is normal to add some oil between oil changes, check your engine oil level each time you stop for fuel. To check the engine oil level consistently and accurately, the following procedure is recommended:

1. Have engine at normal operating temperature (at least into the NORMAL range on the engine coolant temperature gauge).
2. Park the vehicle on a level surface, then turn off the engine and open the hood.
3. Allow at least **20 minutes** after engine shutdown to ensure that the oil contained in the upper parts of the engine has returned to the oil pan.
4. Protecting yourself from engine heat, pull out the dipstick, wipe it clean and reinsert fully.
5. Read oil level on both sides of dipstick and use highest level (reading) for the actual engine oil level.

Maintenance and Specifications

6. it is best to maintain the oil level within the crosshatch area on the dipstick by adding oil as required. The lower hole is the minimum oil level and the upper hole is the maximum oil level. Do not overfill. The distance from the lower hole (oil minimum) to the upper crosshatch area on the dipstick represents 1.0 quart (.95L).

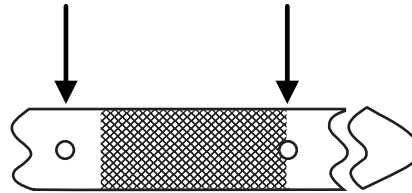

Engine oil specifications

To help achieve acceptable engine performance and durability, it is important that only engine oils of good quality are used in your diesel engine and it is changed at the recommended interval. For normal or severe service, use Motorcraft® oil or an equivalent oil conforming to Ford specifications as listed in the *Maintenance product specifications and capacities* section in this chapter or API service categories CJ-4 or CJ-4/SM. It is important to use these oils because they are compatible with the emission control equipment of your vehicle to meet the more stringent emission standards.

The use of correct oil viscosities for diesel engines is important for satisfactory operation. Determine which oil viscosity best suits the temperature range you expect to encounter for the next service interval from the following SAE viscosity grade chart.

Maintenance and Specifications

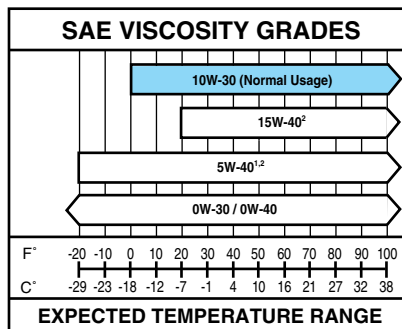

¹For severe duty usage, use SAE 5W-40 API CJ-4.

²For biodiesel (grades B6-B20) usage, use SAE 5W-40 or SAE 15W-40 API CJ-4.

An engine block heater is recommended at temperatures below -10°F (-23°C).

A symbol has been developed by the American Petroleum Institute (API) to help you select the proper engine oil. It will be included on the oil container you purchase. The top section of the symbol shows the oil performance by the API designation. This should match the owner guide recommendation. The center section will show the SAE viscosity grade



performance by the API designation. This should match the owner guide recommendation. The center section will show the SAE viscosity grade

Changing the engine oil and oil filter

Your vehicle is equipped with an Intelligent Oil Life Monitor™ that calculates the proper oil change service interval. When the message center indicates: **OIL CHANGE REQUIRED**, change the engine oil and oil filter. See the *Message center* section of the *Instrument Cluster* chapter for more information.

Refer to *Motorcraft part numbers* later in this chapter for the engine oil filter part number. This filter protects your engine by filtering harmful, abrasive or sludge particles and particles significantly smaller than most available “will-fit” filters.

Maintenance and Specifications

To change the engine oil and oil filter:

1. Unscrew the oil filter and oil pan drain plug and wait for the oil to drain.

Note: The oil pan drain plug only requires 1/4 turn to removal/install. A 3/8 inch socket drive may be used to assist with removal/installation, but be careful not to over-tighten the plug during installation.

2. Replace the filter.

3. Reinstall the oil pan drain plug.

4. Refill the engine with new oil. For the proper capacity, see *Maintenance product specifications and capacities* in this chapter.

5. Reset the Intelligent Oil Life Monitor™. See *Message center* in the *Instrument Cluster* chapter for more information.



WARNING: Do not handle a hot oil filter with bare hands.



WARNING: Continuous contact with used motor oil has caused cancer in laboratory mice. Protect your skin by washing with soap and water.

Engine lubrication for severe service operation

The following conditions define severe operation for which engine operation with SAE 5W-40 API CJ-4 is recommended. Oil and oil filter change intervals will be determined by the Intelligent Oil Life Monitor™ as noted previously.

- frequent or extended idling (over 10 minutes per hour of normal driving)
- low-speed operation/stationary use
- if vehicle is operated in sustained ambient temperatures below -10°F (-23°C) or above 100°F (38°C)
- frequent low-speed operation, consistent heavy traffic less than 25 mph (40 km/h)
- operating in severe dust conditions
- operating the vehicle off road
- towing a trailer over 1,000 miles (1,600 km)
- sustained, high-speed driving at Gross Vehicle Weight Rating (maximum loaded weight for vehicle operation)

Maintenance and Specifications

- use of fuels with sulfur content other than ultra-low sulfur diesel (ULSD)
- use of high-sulfur diesel fuel

ENGINE AND SECONDARY COOLING SYSTEM COOLANT

Checking engine coolant

The concentration (freeze point protection), additive strength (corrosion inhibitor), and level of coolant should be checked at the mileage intervals listed in the *scheduled maintenance information*. The coolant concentration should be maintained at 50/50 coolant and water, which equates to a freeze point of -36°C (-34°F). Coolant concentration testing is possible with a hydrometer or antifreeze tester (such as the Rotunda Battery and Antifreeze Tester, 0014-R1060). The level of coolant should be maintained within the COLD FILL RANGE in the coolant reservoirs. If the level falls below, add coolant per the instructions in the *Adding coolant* section.

Your vehicle was factory-filled with a 50/50 coolant and water concentration. If the concentration of coolant falls below 40% or above 60%, the engine parts could become damaged or not work properly. **A 50/50 mixture of coolant and water provides the following:**

- **freeze protection down to -36°C (-34°F).**
- **boiling protection up to 129°C (265°F).**
- **protection against rust and other forms of corrosion.**
- **an accurate temperature readout from the engine coolant gauge.**

When the engine is cold, check the level of coolant in the reservoirs. See *Identifying components in the engine compartment* for the location of the engine and secondary cooling system reservoirs.

- The coolant should be within the COLD FILL RANGE in the coolant reservoirs.
- Refer to the *scheduled maintenance information* for service interval schedules.
- Be sure to read and understand *Precautions when servicing your vehicle* in your *Owner's Guide*.

If the coolant has not been checked at the recommended interval, the engine or secondary coolant reservoir may become low or empty. If either reservoir is low or empty, add coolant to the reservoir(s). Refer to *Engine and secondary cooling system refill procedure* in this chapter.

46

Maintenance and Specifications

Note: Automotive fluids are not interchangeable; do not use engine coolant or windshield washer fluid outside of its specified function and vehicle location.

Adding coolant

When adding coolant, make sure it is a 50/50 mixture of coolant and distilled water. Add the mixture to the coolant reservoir(s), **when the engine is cool**, until the appropriate fill level is obtained.

If you have to add more than 1.0 quart (1.0 liter) of coolant per month, have your dealer check the cooling system. Your cooling system may have a leak. Operating an engine with a low level of coolant can result in engine overheating and possible engine damage.

Note: If coolant is added to bring the level within the COLD FILL RANGE when the engine is not cold, the system will remain underfilled.



WARNING: Do not add coolant when the engine is hot. Steam and scalding liquids released from a hot cooling system can burn you badly. Also, you can be burned if you spill coolant on hot engine parts.



WARNING: Do not put coolant in the windshield washer fluid container. If sprayed on the windshield, coolant could make it difficult to see through the windshield.

- **Do not mix coolants. Add the coolant type originally equipped in your vehicle.** Refer to *Maintenance product specifications and capacities* in this chapter for the proper coolant type.

Note: Do not use stop leak pellets or cooling system sealants/additives as they can cause damage to the engine cooling and/or heating systems. This damage would not be covered under your vehicle's warranty.

- A large amount of water without engine coolant may be added to the engine cooling system only, in case of emergency, to reach a vehicle service location. Avoid this procedure if delivery to the service location requires heavy engine loads. In this instance, the cooling system(s) must be drained, chemically cleaned with Motorcraft® Engine Cooling System Iron Cleaner, and refilled with a 50/50 mixture of coolant and distilled water as soon as possible. Water alone (without coolant) can cause damage from corrosion, overheating or freezing. **DO NOT** use this method for the secondary cooling system. The secondary cooling system operates close to ambient temperature, and is susceptible to freezing in any subfreezing environment, in the absence of coolant.

Maintenance and Specifications

- **Do not use alcohol, methanol or brine or any engine coolants mixed with alcohol or methanol antifreeze (coolant).** Alcohol and other liquids can cause engine damage from overheating or freezing.
- **Do not mix with recycled coolant unless from a Ford-approved recycling process (see *Use of recycled engine coolant* section).**



WARNING: To reduce the risk of personal injury, make sure the engine is cool before unscrewing the coolant pressure relief cap. The cooling system(s) are under pressure; steam and hot liquid can come out forcefully when the cap is loosened slightly.

Add the proper mixture of coolant and distilled water to the cooling system(s) by following these steps:

1. Before you remove the cap, turn the engine off and let it cool.
2. When the engine is cool, wrap a thick cloth around the cap. Slowly turn cap counterclockwise until pressure begins to release.
3. Step back while the pressure releases.
4. When you are sure that all the pressure has been released, use the cloth to turn it counterclockwise and remove the cap.

Engine and secondary cooling system refill procedure

The following procedure should be used when refilling the engine or secondary cooling systems after it has been drained or become extremely low.

1. Remove the pressure relief cap from the engine or secondary coolant reservoir as previously outlined.
2. Slowly add a 50/50 mixture of coolant and distilled water to the coolant reservoir until the coolant level is within the COLD FILL RANGE as listed on the reservoir.
3. Reinstall the pressure relief cap.
4. Start and run the engine at 2,000 rpm for 2 minutes.
5. Shut engine off, and remove the pressure relief cap as previously outlined.
6. If required, add a 50/50 mixture of coolant and distilled water to the coolant reservoir until the coolant level is within the COLD FILL RANGE as listed on the reservoir.

48

Maintenance and Specifications

7. Engine cooling system: Repeat Step 3 until the coolant level has stabilized (is no longer dropping after each step) AND the upper radiator hose at the radiator is warm to the touch (indicating that the engine thermostat is open and coolant is flowing through the radiator).

Secondary cooling system: Repeat Step 3 until the coolant level has stabilized (is no longer dropping after each step) AND the lower passenger side of the secondary radiator is warm to the touch (indicating secondary thermostat is open and coolant is flowing through the entire system).

8. Reinstall the pressure relief cap. Shut the engine off and let it cool.

9. Check the coolant level in the reservoir before you drive your vehicle the next few times (with the engine cool).

10. If necessary, add a 50/50 mixture of coolant and distilled water to the coolant reservoir until the coolant level is within the COLD FILL RANGE as listed on the reservoir. After any coolant has been added, check the coolant concentration. See *Engine and secondary cooling system coolant* earlier. If the concentration is not 50/50 (protection to $-34^{\circ}\text{F}/-36^{\circ}\text{C}$), drain some coolant and adjust the concentration. It may take several drains and additions to obtain a 50/50 coolant concentration.

Whenever coolant has been added, the coolant level in the coolant reservoir should be checked the next few times you drive the vehicle. If necessary, add enough 50/50 concentration of coolant and distilled water to bring the liquid level to the proper level.

Coolant refill capacity

To find out how much fluid your vehicle's cooling system can hold, refer to *Maintenance product specifications and capacities* in this chapter.

Coolant additives

At specific mileage intervals of 15,000 miles (24,000 km), as listed in the *scheduled maintenance information* chapter, the coolant additive should be checked. The optional message center, if equipped, will also display the message **CHECK COOLANT ADDITIVE** at this time. The purpose of checking is to verify the correct concentration (freeze point protection) and additive strength (corrosion inhibitor) levels of the coolant for maximum engine performance and protection. Three products are available for ensuring the life and health of the coolant: two test kits and a coolant inhibitor additive:

- Rotunda 328-00007 (Matthew's Water CoolCheck) – Evaluates water quality (hardness, chloride, and pH) for 50/50 mixture of coolant and

Maintenance and Specifications

distilled water. Use distilled water. If distilled water is unavailable, water meeting the requirements of Rotunda 328-00007, is sufficient for vehicle use. Using water that fails to meet the requirements can lead to coolant passage scaling and degrade the engine's durability and performance.

- Rotunda 328-00008 (Antifreeze Coolant ELC Contamination Kit) – Evaluates the coolant concentration (freeze point protection) and additive strength (corrosion inhibitor) for overall coolant health. Note that the first step is to verify that the vehicle's coolant concentration is in the window of 40 – 60%. If the concentration falls outside of that window, the evaluation of the corrosion inhibitor strength will not be valid. If the report results in a pass the cooling system does not show excessive contamination. No action is required. If the report results as insufficient, the corrosion inhibitor (additive) strength of the coolant is too low. Add entire contents of one bottle of Motorcraft® Specialty Orange Engine Coolant Revitalizer to the coolant reservoir. The coolant can be recharged with this additive up to two times before the coolant must be changed-out. When exchanging the full coolant volume, the system must be flushed and refilled with distilled water and coolant concentrate (Motorcraft® Specialty Orange Engine Coolant).
- Motorcraft® Specialty Orange Engine Coolant Revitalizer – Additive to boost the corrosion inhibitor level based upon the test results of the Antifreeze Coolant ELC Contamination Kit. The revitalizer may be added two times over the life of the coolant. If additional dosages are required, the cooling system must be flushed and refilled with distilled water and coolant concentrate (Motorcraft® Specialty Orange Coolant).

Refer to *Maintenance product specifications and capacities* in this chapter for the proper coolant and additive specifications.

Coolant change

At specific mileage intervals, as listed in the *scheduled maintenance information*, the coolant should be changed. The optional message center, if equipped, will also display the message **COOLANT CHANGE REQUIRED** at this time.

Refer to *Maintenance product specifications and capacities* in this chapter for the proper coolant.

50

Maintenance and Specifications

AIR FILTER RESTRICTION GAUGE AND AIR FILTER REPLACEMENT

Air filter restriction gauge:

The restriction gauge, located on the upper housing of the air filter assembly, measures the vacuum inside the air filter. The more the air filter is restricted (dirty, clogged), the higher the vacuum reading

Check the air filter restriction gauge whenever the hood is raised to perform general engine maintenance

at least every 7,500 miles (12,000 km). If the vehicle is operated in extremely dusty conditions, check and reset the gauge at least every 500 miles (800 km), or two weeks, whichever comes first.

Change the air filter when the gauge reads near the “change filter” line and the chamber is filled with yellow. Engine performance and fuel economy are adversely affected when the maximum restriction is reached.

Blowing-out the air filter element with compressed air is not recommended as the compressed air may damage the filter paper.

Note: It is not possible to determine the level of filter clogging by visual appearance alone. A filter which appears to be dirty may actually have several thousand miles (kilometers) of life remaining.

Use the underhood air filter restriction gauge to determine when the air filter element needs to be changed.

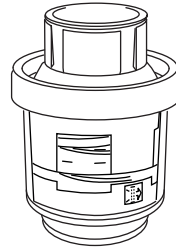

Maintenance and Specifications

After installation of the new filter element, reset the gauge by pressing the reset button on top of the gauge.

Note: Vehicle operation in heavy snowfall or extreme rain conditions may feed excessive amounts of snow/water into the air intake system. This could plug/soak the air filter with snow and may cause the engine to lose power and possibly shut down.

The following actions are recommend after operating the vehicle up to 200 miles (320 km) in heavy snowfall or extreme rain:

- **Snow:** At the earliest opportunity, open the hood and clear all the snow and ice from the air filter housing inlet (do NOT remove the foam filter) and reset the air filter restriction gauge.
- **Extreme rain:** The air filter will dry after about 15–30 minutes at highway speeds. At the earliest opportunity, open the hood and reset the air filter restriction gauge.

Air filter replacement:

When replacing the air filter element, use the Motorcraft® air filter element listed in *Motorcraft part numbers* later in this chapter.



WARNING: To reduce the risk of vehicle damage and/or personal burn injuries do not start your engine with the air filter removed and do not remove it while the engine is running.

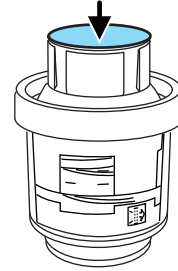

Maintenance and Specifications

Failure to use the correct air filter element may result in severe engine damage.

1. Locate the mass air flow sensor electrical connector on the air inlet tube. This connector will need to be unplugged.

Unlock the locking clip on the connector, then squeeze and pull the connector off of the air inlet tube.

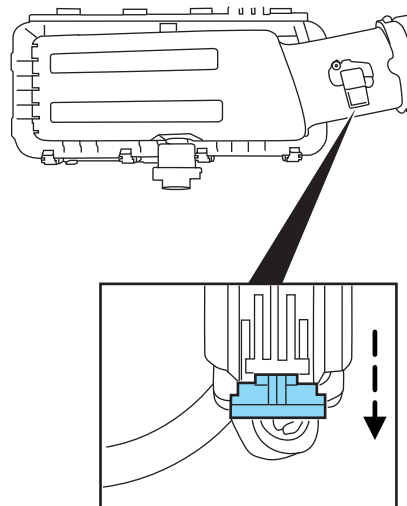

2. Release the four clamps that secure the cover to the air filter housing. Push the air filter cover forward (away from you) and up slightly to release it.

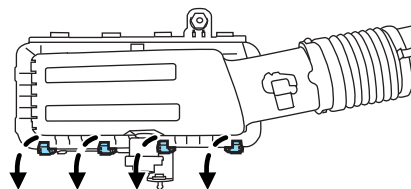

3. Remove the air filter element from the air filter housing.

Maintenance and Specifications

4. Remove and install a new foam filter if needed according to the service interval indicated in the *scheduled maintenance information* in this guide. If the foam filter is not being replaced, be sure the existing foam filter is in place.

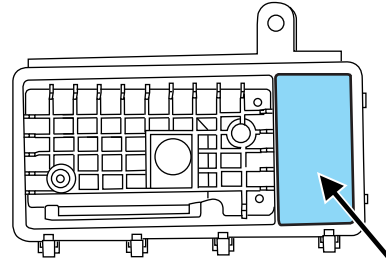

5. Install a new air filter element. be sure that the groove seal on the pleated paper filter traps both sides of the vertical partition of the air box.

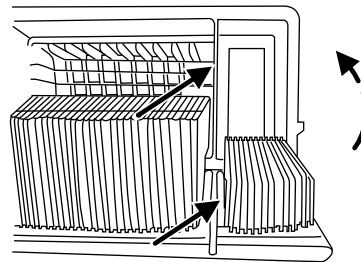

6. Replace the air filter housing cover and secure the clamps. Be careful not to crimp the filter element edges between the air filter housing and cover and ensure that the tabs on the edge are properly aligned into the slots.

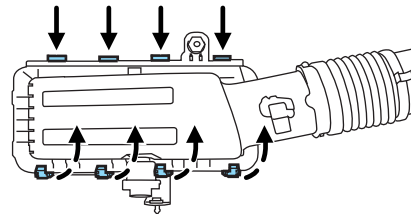

7. Reconnect the mass air flow sensor electrical connector to the inlet tube. Make sure the locking tab on the connector is in the “locked” position.

Maintenance and Specifications

DIESEL EXHAUST SYSTEM: OXIDATION CATALYST/DIESEL PARTICULATE FILTER SYSTEM

Your vehicle is equipped with a diesel particulate filter (DPF). The DPF is an inline filter in the exhaust system which reduces carbon emissions by trapping exhaust particles before they reach the tailpipe. The DPF looks similar to a traditional exhaust catalyst, except larger, and is part of the exhaust system under the vehicle. The DPF is coupled to a diesel oxidation catalyst, that reduces the amount of harmful exhaust emitted from the tailpipe. As soot gathers in the system it begins to restrict the filter. The soot gathered inside the filter needs to be periodically cleaned. The soot can be cleaned in two different ways; passive regeneration and active regeneration. Both methods occur automatically and require no actions from the driver/operator. During either one of these regeneration methods you may notice an increase/change in exhaust noise/tone. At certain times, the message center will display various messages related to the DPF. See *Message center* in the *Instrument Cluster* chapter in the *Owner Guide* for more information.

Passive regeneration

In passive regeneration, the exhaust constituents / temperature are at an appropriate level where some soot can be reduced or oxidized (burned) thus cleaning the filter. This method occurs naturally as a result of normal engine operating conditions (at varying levels due to drive patterns).

Active regeneration

Once the DPF is full of exhaust particles, the engine control module will command the exhaust system to clean the DPF through a process called active regeneration. Active regeneration requires the engine computer to raise the exhaust temperature to eliminate the particles. During cleaning, the particles are converted to harmless gasses, and the DPF will then be clean and ready to continue trapping exhaust particles.

The regeneration process operates more efficiently when the vehicle is safely operated at least 30 mph (48 km/h) with a steady pedal for approximately 20 minutes to complete the process. The frequency and duration of regeneration will fluctuate as both are determined by how you drive your vehicle, outside air temperature, and altitude. For most driving, regeneration frequency will vary from 100 - 500 miles (161 - 805 km) between occurrences and each occurrence will last from 9 - 20 minutes. The duration of regeneration is usually reduced if a constant speed above 30 mph (48 km/h) is maintained.

Maintenance and Specifications

When the engine control module detects that the DPF is nearly full of particulates and that the vehicle is not being operated in a manner to allow effective automatic cleaning, the message center will display **DRIVE TO CLEAN EXHAUST FILTER** guiding the vehicle operator to drive in order to clean the DPF. If the vehicle is operated in a manner to allow effective automatic cleaning, the message center will display **CLEANING EXHAUST FILTER**, which is the normal regeneration process. See *Message center* in the *Instrument Cluster* chapter of the *Owner Guide* for more information.

If the operator is not able to drive in manner that allows effective automatic cleaning (active regeneration) or the operator instead wishes to perform regeneration of the DPF (cleaning) while at idle (stationary), then OCR (operator commanded regeneration) will need to be performed. See *Operator commanded regeneration (OCR)* following.

Note: Do not disregard the **DRIVE TO CLEAN EXHAUST FILTER** maintenance message for extended periods of time. Failure to perform active or operator commanded regeneration (OCR) (if equipped) when instructed may result in a clogged DPF. If your DPF fills beyond what can be safely regenerated, active regeneration and OCR will be disabled. This could cause irreversible damage to the DPF, requiring service and possible replacement that may not be covered by your warranty.

Operator commanded regeneration (OCR) (if equipped)

If your vehicle is operated with significant stationary operation, passive and active regeneration may not sufficiently clean the DPF system. OCR allows you to manually start regeneration of the diesel particulate filter (DPF) at idle (while stationary) to clean the DPF. If you are not sure whether your vehicle is equipped with this feature, contact your authorized dealer.

When to perform OCR

Use the OCR feature when the **DRIVE TO CLEAN EXHAUST FILTER** message appears in the message center and:

- the operator is not able to drive in manner that allows effective automatic cleaning (active regeneration),
- or the operator instead wishes to manually start regeneration (cleaning) of the DPF while the vehicle is idle (stationary).

56

Maintenance and Specifications

OCR precautions and safe exhaust position



WARNING: Failure to comply with the following instructions for operator commanded regeneration (OCR) may result in fire, serious injury, death and/or property damage.

Before you start OCR, observe/do the following:

- Place the vehicle in P (Park) with the parking brake set on stable, level ground.
- The vehicle must not be parked in a structure.
- The vehicle must be away from any obstructions within 10 - 15 feet of vehicle,
- and must be away from materials that can easily combust or melt such as: paper, leaves, petroleum products, fuels, plastics and other dry organic material, such as grass.
- Make sure there is a minimum of 1/8 tank of fuel.
- Make sure all fluids are at proper levels.

Make sure that the louvers (holes) located at the tip of the exhaust are also clear of any obstructions as they are used to introduce fresh air into the tailpipe to cool the exhaust gas as it leaves. See *Exhaust* under the *Cleaning* chapter for more information.

How to start operator commanded regeneration (OCR)



WARNING: Stay clear of exhaust tip during regeneration. You or others can be burned.

Note: OCR will not be allowed to operate if the service engine soon light  is illuminated

Note: During the use of OCR, you may observe a light amount of white smoke. This is normal.

1. Start with the vehicle engine fully warmed.
2. Press the Info button on the steering wheel until the message center reads **EXHAUST FILTER XXX% FULL**.
3. If the DPF needs cleaning and the vehicle is warmed up, a message requesting permission to initiate filter cleaning is displayed **EXH XXX% FULL CLEAN Y/N**. Answering yes to this prompt and then following prompts will initiate OCR. Be sure to understand each prompt. If you are not sure what is being asked by each prompt, contact your authorized dealer.

Maintenance and Specifications

4. Once OCR starts, the engine's rpm will rise to approximately 2,000 - 2,400 rpm and the cooling fan will increase speed; you will hear a change in audible sound due to the fan and engine speed increase.

It is not necessary to open the hood on the engine compartment. Once OCR is complete, the engine rpm and fan will return to normal idling. The exhaust system will remain very hot for several minutes even after regeneration is complete. Do not reposition the vehicle over materials that could burn until the exhaust system has had sufficient time to cool. Depending on the amount of soot collected by the DPF, ambient temperature, and altitude, OCR may last from 10 to 25 minutes.



Note: During stationary PTO operation, OCR will change the engine speed to 2,000 or 2,400 rpm (depending on vehicle application), therefore it is recommended you exit PTO mode before starting OCR. During mobile PTO use, OCR is not necessary; regeneration will function normally.

How to interrupt/cancel OCR

If OCR needs to be cancelled, pressing the brake, accelerator, or shutting off the vehicle will stop OCR. Depending on the amount of time OCR was allowed to operate, soot may not have had sufficient time to be eliminated, but the exhaust system and exhaust gas may still be hot. If the vehicle is shut off during OCR, you will notice turbo flutter. This is a normal consequence caused by shutting off a diesel engine during boosted operation and is considered normal.

Filter service/maintenance

Over time a slight amount of ash will build up in the DPF which is not removed during the regeneration process. The DPF may need to be removed for ash cleaning at approximately 120,000 miles (193,000 km) or greater (actual mileage can vary greatly depending upon engine/vehicle operating conditions) and replaced with a new or remanufactured (ash cleaned) part. The filter may need to be replaced at approximately 250,000 miles (400,000 km) depending upon engine/vehicle operating conditions. In both cases the engine control system will set a service light  to inform you to bring the vehicle to the dealer for service.

If there are any issues with the oxidation catalyst/DPF system a service light  or  will be set by the engine control system to inform you to bring the vehicle into your authorized dealer for service.

Resonator/Tailpipe assembly maintenance

The diesel resonator tail-pipe assembly is a uniquely functioning device that accompanies the Oxidation Catalyst/DPF assembly. The assembly

58

Maintenance and Specifications

serves multiple functions. First it serves as an acoustic device to attenuate exhaust noise. Second it provides an exit path for the exhaust from the vehicle. It also is designed to help control the temperature of the exhaust during DPF regeneration events. The visible holes in each leg of the twin tip and the holes under the shield just inboard of the right rear tire(s) are functional. The holes need to be kept clear of mud/debris or foreign material to maintain proper function of the exhaust system. Clean and remove debris or foreign material if present as needed. Spraying with a hose during regular washing of vehicle should help keep holes clean and clear of debris or foreign material.

Note: Additions of aftermarket devices or modifications to the exhaust system can reduce the effectiveness of the exhaust system as well as cause damage to the exhaust system and/or engine. These actions may also affect the vehicle's warranty. See the *Warranty Guide* for more information.

 **WARNING:** Failure to maintain the functional holes, in the tailpipe section of the exhaust, clean and free of debris or foreign material may result in the holes becoming blocked or plugged. Do not modify or remove the tail-pipe section. Blocked or plugged holes or removal/modification of the system could result in elevated exhaust gas temperatures which may result in vehicle/property damage or personal injury.

 **WARNING:** The normal operating temperature of the exhaust system is very high. Never work around or attempt to repair any part of the exhaust system until it has cooled. Use special care when working around the diesel oxidation catalytic converter and/or the diesel particulate filter (DPF). The diesel oxidation catalytic converter and/or the DPF heats up to a high temperature after only a short period of engine operation and can stay hot even after the engine is turned off. Failure to follow these instructions may result in personal injury.

EMISSION CONTROL SYSTEM(S) LAWS

In the U.S. federal law and certain state laws prohibit removing or rendering inoperative emission control system(s). Similar federal or provincial laws may apply in Canada. Ford recommends against any vehicle modification without determining applicable law.

Maintenance and Specifications



WARNING: Do not remove or alter the original equipment floor covering or insulation between it and the metal floor of the vehicle. The floor covering and insulation protect occupants of the vehicle from the engine and exhaust system heat and noise. On vehicles with no original equipment floor covering insulation, do not carry passengers in a manner that permits prolonged skin contact with the metal floor. Provide adequate insulation. Failure to follow these instructions may result in fire or personal injury.

Tampering with emissions control systems (including related sensors and the diesel exhaust fluid (DEF) injection system) can result in reduced engine power and the illumination of the service engine soon light .

NOISE EMISSIONS WARRANTY, PROHIBITED TAMPERING ACTS AND MAINTENANCE

On January 1, 1978, Federal regulation became effective governing the noise emission on trucks over 10,000 lbs. (4,536 kg) GVWR (Gross Vehicle Weight Rating). The following statements concerning prohibited tampering acts and maintenance, and the noise warranty found in the *Warranty Guide*, are applicable to complete chassis cabs over 10,000 lbs. (4,536 kg) GVWR.

Tampering with noise control system prohibited

Federal law prohibits the following acts or the causing thereof: (1) The removal or rendering inoperative by any person other than for purposes of maintenance, repair or replacement of any device or element of design incorporated into any new vehicle for the purpose of noise control prior to its sale or delivery to the ultimate purchaser or while it is in use, or (2) the use of the vehicle after such device or element of design has been removed or rendered inoperative by any person.

Among those acts which the U.S. Environmental Protection Agency may presume to constitute tampering are the acts listed below:

- Removal of hood blanket, fender apron absorbers, fender apron barriers, underbody noise shields or acoustically absorptive material.
- Tampering or rendering inoperative the engine speed governor, so as to allow engine speed to exceed manufacturer's specifications.

The complexity of the diesel engine makes it so the owner is discouraged from attempting to perform maintenance other than the services described in this supplement.

60

Maintenance and Specifications

If you experience difficult starting, rough idling, excessive exhaust smoke, a decrease in engine performance or excess fuel consumption, perform the following checks:

- a plugged or disconnected air inlet system or engine air filter element.
- water in the fuel filter/water separator.
- a clogged fuel filter.
- contaminated fuel.
- air in the fuel system, due to loose connections.
- an open or pinched sensor hose.
- check engine oil level.
- wrong fuel or oil viscosity for climactic conditions.

If these checks do not help you correct the engine performance problem you are experiencing, consult an authorized dealer.

FUELING



WARNING: Do not use starting fluid such as ether or gasoline in the diesel air intake system. Such fluids can cause immediate explosive damage to the engine and possible personal injury.

If you fuel your vehicle at a truck stop, you may notice that the fuel nozzle may shut off every 5–10 seconds. This is due to the flow rates being designed for larger heavy duty trucks. You may have to fuel at a slower rate (don't depress the nozzle trigger fully).

Do not run your diesel vehicle out of fuel as this will allow air to enter the fuel system which will make restarting difficult. Longer engine cranking time may be required once air is in the fuel system. If air enters the fuel system (either through running the fuel tank(s) empty or during a fuel filter change), the engine will self-purge the trapped air once it starts running. The engine may run roughly and produce white smoke while air is in the fuel system; this is normal and should stop after a short time.

Maintenance and Specifications

MINOR TROUBLESHOOTING GUIDE

Air purge procedure

Turn the key on for 30 seconds, then turn off. Repeat the procedure six times.

If the engine won't crank

Turn on the headlights. If the lights are dim, do not go on at all or when the ignition is turned to START the lights become dim or go out, the battery connections may be loose or corroded, or the battery may be discharged. If there is a clicking or stuttering sound coming from the engine compartment when you turn the key to START, this may also indicate a loose or corroded battery connection.

Check the battery connections at the battery posts, cable connection to the engine grounding point and at the starter connection.

If a discharged battery is suspected, have it checked and corrected.



WARNING: Battery posts, terminals and related accessories contain lead and lead compounds. **Wash hands after handling.**

- The gearshift lever must be in P (Park) or N (Neutral) in order for the starter to operate.
- Try operating the starter switch several times. Should the switch be corroded, this operation may clean the contacts or make the switch temporarily operable until you can reach the dealer.
- If all electrical connections are tight and you need assistance to start, refer to *Jump starting* in the *Roadside Emergencies* chapter of your *Owner's Guide*.

If engine cranks but won't start

Prolonged starter cranking (in excess of 10 seconds) could cause damage to the starter motor.

- Check the fuel gauge. You may be out of fuel. If the gauge shows that there is fuel in the tank, the trouble may be in the electrical system or the fuel system. If equipped with an auxiliary tank, be sure that the tank control switch is set for the tank with fuel and not on an empty tank.
- Leaving the ignition key turned to on for over two minutes without starting may make starting difficult because the glow plugs will cease activation. Reset the system by turning the ignition key to off and then back to on again.

62

Maintenance and Specifications

If the engine runs hot

The following could cause the engine to overheat:

- Lack of coolant.
- Dirty cooling system.
- Plugged radiator fins, A/C condenser and/or oil cooler.
- Malfunctioning fan drive.
- Driving with frozen coolant.
- Sticking thermostat.
- Overloading or pulling heavy trailers during hot weather.
- Grill or radiator air blockage.
- Slipping or missing drive belt.
- Plugged or very dirty air filter.

If fuses burn out

Burned-out or blown fuses usually indicate an electrical short-circuit, although a fuse may occasionally burn out from vibration. Insert a second fuse. If this fuse immediately burns out and you cannot locate the cause, return your vehicle to your dealer for a circuit check.



WARNING: Replacement fuses and circuit breakers must always be the same rating as the original equipment shown. Never replace a fuse or circuit breaker with one of a higher rating. Higher rated fuses or circuit breakers could allow circuit overloading in the event of a circuit malfunction, resulting in severe vehicle damage or personal injury due to fire.

Refer to the *Owner's Guide* for replacement of fuses.

Maintenance and Specifications

Selective catalytic reduction (SCR) system speed limit and Idle-only modes

If the vehicle's speed is limited or in an idle-only mode, the SCR system may be limiting the vehicle's functions due to low or contaminated diesel exhaust fluid (DEF). Check the DEF. See *Selective catalytic reduction (SCR) system* in the *Maintenance and Specifications* chapter for more information.

MOTORCRAFT® PART NUMBERS

Item	Ford Part Number
Engine oil filter	FL-2051
Foam pre-filter	FA-1907
* Air filter	FA-1902
Fuel filter kit (2 included - engine and frame rail mounted)	FD-4615
Battery (2 Required)	BXT-65-750
* Always use the authorized Motorcraft® air filter or an equivalent replacement part. Failure to use the correct air filter may result in severe engine damage.	

Maintenance and Specifications

MAINTENANCE PRODUCT SPECIFICATIONS AND CAPACITIES

Item	Capacity	Ford part name	Ford part number / Ford specification or specification
Engine coolant (primary high-temperature cooling system loop)*	29.4 quarts (27.8L)	Motorcraft® Specialty Orange Engine Coolant with bittering agent (US) / Motorcraft® Specialty Orange Engine Coolant (Canada)	VC-3-B (US) CVC-3-B (Canada) / WSS-M97B44-D
Engine coolant additive	48.0 oz. (1.4L) per addition if required	Motorcraft® Specialty Orange Engine Coolant Revitalizer	VC-12 / —
Engine cooling system cleaner	1 quart (946 mL)	Motorcraft® Coolant System Iron Cleaner	VC-9 / —
Secondary cooling system cleaner	22.0 oz. (651 mL)	Motorcraft® Premium Cooling System Flush	VC-1 / —
Secondary cooling system*	11.7 quarts (11.1L)	Motorcraft® Specialty Orange Engine Coolant with bittering agent (US) / Motorcraft® Specialty Orange Engine Coolant (Canada)	VC-3-B (US) CVC-3-B (Canada) / WSS-M97B44-D

Maintenance and Specifications

Item	Capacity	Ford part name	Ford part number / Ford specification or specification
Engine oil (includes filter change)	13.0 quarts (12.4L)	<ul style="list-style-type: none"> • Motorcraft® Motor Oil 10W30 Super Duty • Motorcraft® Motor Oil 15W40 Super Duty • Motorcraft® Motor Oil 5W40 Super Duty • Motorcraft® Motor Oil 0W30 Super Duty 	<ul style="list-style-type: none"> • XO-10W30-QSD / WSS-M2C171-E • XO-15W40-QSD / WSS-M2C171-E • XO-5W40-5QSD / WSS-M2C171-E • CXO-0W30-LAS12 / WSS-M2C171-D
Diesel Exhaust Fluid (DEF) — Pick-up	5 gallons (18.9L)	Motorcraft® Diesel Exhaust Fluid	PM-27-G / WSS-M99C130-A
Diesel Exhaust Fluid (DEF) — Chassis Cab	6 gallons (22.7L)		
Cetane Booster & Performance Improver	—	Motorcraft® Cetane Booster & Performance Improver	PM-22-A (US) PM-22-B (Canada) / —
Anti-Gel & Performance Improver	—	Motorcraft® Anti-Gel & Performance Improver	PM-23-A (US) PM-23-B (Canada) / —
Fuel tank — Pick up regular cab long box and all short box	26 gallons (98.4L)	—	—

Maintenance and Specifications

Item	Capacity	Ford part name	Ford part number / Ford specification or specification
Fuel tank — Pick Up long box (except regular cab)	37.5 gallons (142.0L)	—	—
Fuel tank — Chassis cab (midship)	28 gallons (106.0L)	—	—
Fuel tank — Chassis cab (aft of axle)	40 gallons (151.4L)	—	—
Fuel tank — Dual tanks	40 gallon (151.4L) and 28 gallon (106.0L)	—	—
Automatic transmission fluid	Refer to <i>Owner's Guide</i>		

* Use only the recommended coolant for topping off and coolant changes. Using any other coolant may result in vehicle damage.

Maintenance and Specifications

ENGINE DRIVEBELT ROUTING

Single Alternator

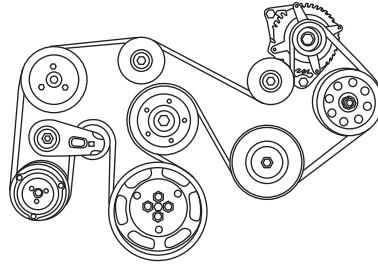

Dual Alternator

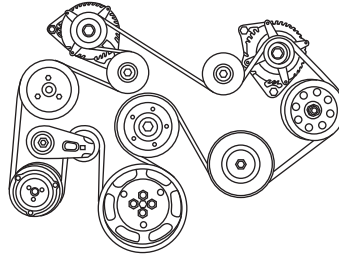

Scheduled Maintenance Guide

GENERAL MAINTENANCE INFORMATION

Why maintain your vehicle?

This guide describes the scheduled maintenance required for your vehicle. Carefully following this schedule helps protect against major repair expenses resulting from neglect or inadequate maintenance and may also help to increase the value of your vehicle when you sell or trade it.

It is your responsibility to see that all scheduled maintenance is performed and that the materials used meet Ford engineering specifications. Failure to perform scheduled maintenance in this guide will invalidate warranty coverage on parts affected by the lack of maintenance. Be sure receipts for completed maintenance are kept with the vehicle and confirmation of the work performed is always recorded in this guide.

Your Ford dealer has factory-trained technicians who can perform the required maintenance using genuine Ford parts. They are committed to meeting your service needs and to assuring your continuing satisfaction.

Protecting your investment

Maintenance is an investment that will pay dividends in the form of improved reliability, durability and resale value. To ensure the proper performance of your vehicle and its emission control systems, it is imperative that scheduled maintenance be completed at the designated intervals.

For your convenience, your vehicle is equipped with a message center which determines the proper oil change service interval. You should perform the engine oil change as indicated by the message center. The message center will display ENGINE OIL CHANGE SOON or OIL CHANGE REQUIRED to indicate when an oil change is needed. The engine oil change service needs to be completed within two weeks or 500 miles (800 km) after the OIL CHANGE REQUIRED message is displayed. Your oil change service interval can be up to one year or 10,000 miles (16,000 km) depending on operating conditions. Reset your Intelligent Oil Life Monitor™ after each engine oil and filter change; refer to the *Instrument Cluster* chapter of the *Owner's Guide*.

If your message center is prematurely reset or becomes inoperative, you should perform the oil change interval at six months, 5,000 miles (8,000 km) or 200 engine hours from your last oil change.

Your vehicle is very sophisticated and built with multiple complex performance systems. Every manufacturer develops these systems using

Scheduled Maintenance Guide

different specifications and performance features. That's why it's important to rely upon your Ford dealership to properly diagnose and repair your vehicle.

Ford Motor Company has recommended maintenance intervals for various parts and component systems based upon engineering testing. Ford Motor Company relies upon this testing to determine the most appropriate mileage for replacement of oils and fluids to protect your vehicle at the lowest overall cost to you and recommends against maintenance schedules that deviate from the scheduled maintenance information.

Ford strongly recommends the use of genuine Ford replacement parts. Parts other than Ford, Motorcraft® or Ford-authorized remanufactured parts that are used for maintenance replacement or for the service of components affecting emission control must be equivalent to genuine Ford Motor Company parts in performance and durability. It is the owner's responsibility to determine the equivalency of such parts. Please consult your *Warranty Guide* for complete warranty information.

Non Ford-approved chemicals or additives are not required for factory recommended maintenance. In fact, Ford Motor Company recommends against the use of such additive products unless specifically recommended by Ford for a particular application.

Oils, fluids and flushing

In many cases, fluid discoloration is a normal operating characteristic of the chemical compound and may not necessarily demonstrate that a fluid needs to be changed. Oils and fluids identified in this guide should be changed at the specified interval or in conjunction with a repair. Flushing is a viable way to change fluid for many vehicle sub-systems during scheduled maintenance and should only be done using the same fluid required to finish the maintenance procedure, or a Ford-approved flushing chemical.

Genuine Ford parts and service

When planning your maintenance services, consider your dealership for all your vehicle's needs.

There are a lot of reasons why your dealership is a great way to help keep your vehicle running great.

Convenience

To make your service visit even more convenient, in many cases, you'll find extended evening hours and Saturday hours. How's that for quality service?

70

Scheduled Maintenance Guide

Factory-trained technicians

Service technicians participate in extensive factory-sponsored training to help them become the experts on the operation of your vehicle. Many participate in Ford-sponsored training to become certified. Ask your dealer about the training and certification their technicians have received.

Genuine Ford and Motorcraft® replacement parts

Dealerships stock Ford and Motorcraft® branded replacement parts. These parts meet or exceed Ford Motor Company's specifications, and we stand behind them. Maintenance parts installed at your dealership carry a nationwide, 12 month/12,000 mile (20,000 km) parts and labor limited warranty. Your dealer can give you details.

Value shopping for your vehicle's maintenance needs

Your dealership recognizes the competitive landscape of maintenance and light repair automotive services. With factory-trained technicians, and one-stop service from routine maintenance like oil changes and tire rotations to repairs like brake service, check out the value your dealers can offer.

Owner checks and services

Certain basic maintenance checks and inspections should be performed by the owner or a service technician at the intervals indicated. Service information and supporting specifications are provided in the *Owner's Guide*.

Any adverse condition should be brought to the attention of your dealer or qualified service technician as soon as possible for the proper service advice. The owner maintenance service checks are generally not covered by warranties so you may be charged for labor, parts or fluids used.

Maximum oil change interval

- Normal schedule: As indicated by the message center (can be up to one year or 10,000 miles [16,000 km])
- Special operating conditions: Consult specific operating condition recommendations

Maximum fuel filter change interval

- Normal schedule: 22,500 miles (36,000 km) or as indicated by the message center (whichever comes first)
- Special operating conditions: 15,000 miles (24,000 km) or 600 engine hours; see appropriate schedule

Scheduled Maintenance Guide

Coolant change interval

- Initial change — 6 years or 105,000 miles (168,000 km) (whichever comes first), or as indicated from the coolant tests for concentration (freeze-point) or additive strength (corrosion inhibitor)
- After initial change — every 3 years or 45,000 miles (72,000 km), or as indicated from the coolant tests for concentration (freeze-point) or additive strength (corrosion inhibitor)
- Use coolant specified in the *Maintenance product specifications and capacities* table in the *Maintenance and Specifications* chapter
- Special operating conditions: See *Special operating conditions* later in this chapter

Check every month

- Engine air filter restriction gauge
- Engine oil level
- Fuel filter/water separator; drain if necessary
- Function of all interior and exterior lights
- Holes/Slots in the tail pipe of the exhaust system to make sure they are clear of debris and functional
- Tires for wear and adjust air pressure (including spare tire)
- Windshield washer fluid level

Check every six months

- All hinges, latches and outside locks; lubricate if necessary
- Battery connections; clean if necessary
- Body and door drain holes; clean if necessary
- Door rubber weatherstrips for wear; lubricate if necessary
- Engine and secondary cooling system concentration (freeze-point protection), additive strength (corrosion inhibitor), coolant level and hoses
- Externally-mounted spare tire for tightness (see *Owner's Guide*)
- Lap/Shoulder belts and seat latches for wear and function
- Parking brake for proper operation
- Power steering fluid level
- Safety warning lamps (brake, ABS, airbag, safety belt) for operation
- Washer spray, wiper operation and clean all wiper blades (replace as necessary)

Retightening lug nuts

- On vehicles with single rear wheels, retighten the lug nuts to the specified torque at 500 miles (800 km) after any wheel disturbance (tire rotation, changing a flat tire, wheel removal, etc)
- On vehicles with dual rear wheels, retighten the wheel lug nuts to the specified torque at 100 miles (160 km), and again at 500 miles (800 km) of new vehicle operation and after any wheel disturbance (tire rotation, changing a flat tire, wheel removal, etc)
- Refer to *Wheel lug nut torque specifications* in your *Owner's Guide* for the proper lug nut torque specification

Scheduled Maintenance Guide

Multi-point inspection

In order to keep your vehicle running right, it is important that you have the systems on your vehicle checked regularly. This can help identify any potential issue before there are any problems. Ford Motor Company suggests the following multi-point inspection to be performed at every scheduled maintenance interval as the way to ensure your vehicle keeps running right.

Multi-point inspection - recommended at every visit

- Battery performance
- Engine air filter
- Exhaust system for leaks, damage, loose parts and foreign materials
- Fluid levels (top-up if necessary): brake, engine coolant reservoir, secondary low-temperature cooling system reservoir, automatic transmission, power steering, window washer
- For oil and fluid leaks
- Holes/Slots in the tail-pipe of the exhaust system to make sure they are clear of debris (the holes/slots are functional)
- Operation of horn, exterior lamps, turn signals and hazard warning lights
- Radiators, coolers and heater and air conditioning hoses
- Shocks and struts and other suspension components for leaks and damage
- Tires for wear and check air pressure, including spare
- Windshield for cracks, chips and pitting
- Windshield washer spray and wiper operation

NORMAL SCHEDULED MAINTENANCE AND LOG

For your convenience, your vehicle is equipped with a message center which calculates the proper oil change service interval. You should perform the engine oil change as indicated by the message center. The message center will display ENGINE OIL CHANGE SOON or OIL CHANGE REQUIRED to indicate when an oil change is needed. The engine oil change service needs to be completed within two weeks or 500 miles (800 km) after the OIL CHANGE REQUIRED message is displayed. Your oil change service interval can be up to one year or 10,000 miles (16,000 km). Reset your Intelligent Oil Life Monitor™ after each engine oil and filter change; refer to the *Instrument Cluster* chapter of the *Owner's Guide*.

If your message center is prematurely reset or becomes inoperative, you should perform the oil change interval at six months, 5,000 miles (8,000 km) or 200 engine hours from your last oil change.

Scheduled Maintenance Guide

Intelligent Oil Life Monitor™

Your diesel engine is equipped with an Intelligent Oil Life Monitor™ that determines the proper engine oil change service interval based on vehicle use. The following table is intended to provide examples of vehicle use and its impact on engine oil change interval; it is provided as a guideline only. Actual engine oil change intervals will depend on several factors and will generally decrease with severity of use.

When to expect the OIL CHANGE REQUIRED message			
Miles (km)	Engine hours	Fuel type	Vehicle use and examples
7500-10000 (12000-16000)	300-400	-ULSD -Biodiesel	Normal
			-No, or moderate, load/towing -Flat to moderately hilly roads -No extended idling
5000-7499 (8000-11999)	200-299	-ULSD -Biodiesel	Severe
			-Moderate to heavy load/towing -Mountainous or off-road conditions -Extended idling -Extended hot or cold operation
2500-4999 (4000-7999)	100-199	-ULSD -Biodiesel -High sulfur diesel fuel*	Extreme
			-Maximum load/towing -Extreme hot or cold operation
ULSD = Ultra low sulfur diesel fuel *Use the appropriate special operating condition for maintenance information when using high sulfur diesel fuels, operating your vehicle off-road or in dusty conditions (such as unpaved roads).			

Scheduled Maintenance Guide

Oil Change Service Interval*	1	2	3	4	5	6	7	8	9	10
Change engine oil and filter	•	•	•	•	•	•	•	•	•	•
Refill diesel exhaust fluid tank	•	•	•	•	•	•	•	•	•	•
Rotate tires, inspect tire wear and measure tread depth; dual rear wheels should only be rotated if unusual wear is observed	•	•	•	•	•	•	•	•	•	•
Inspect air filter restriction gauge, replace filter as necessary	•	•	•	•	•	•	•	•	•	•
Inspect wheels and related components for abnormal noise, wear, looseness or drag	•	•	•	•	•	•	•	•	•	•
Inspect and lubricate steering linkage, ball joints, suspension, tie rod ends, driveshaft, front axle U-joints (4WD vehicles)	•	•	•	•	•	•	•	•	•	•
Perform multi-point inspection (recommended)	•	•	•	•	•	•	•	•	•	•
Inspect automatic transmission fluid level	•	•	•	•	•	•	•	•	•	•
Inspect brake pads, shoes, rotors, drums, brake linings, hoses and parking brake	•	•	•	•	•	•	•	•	•	•
Inspect exhaust system and heat shields	•	•	•	•	•	•	•	•	•	•
*Oil change service intervals should be completed as indicated by the message center										
Reset your Intelligent Oil Life Monitor™ after each engine oil and filter change; refer to the <i>Instrument Cluster</i> chapter of the <i>Owner's Guide</i>										

Scheduled Maintenance Guide

Oil Change Service Interval*	11	12	13	14	15	16	17	18	19	20
Change engine oil and filter	•	•	•	•	•	•	•	•	•	•
Refill diesel exhaust fluid tank	•	•	•	•	•	•	•	•	•	•
Rotate tires, inspect tire wear and measure tread depth; dual rear wheels should only be rotated if unusual wear is observed	•	•	•	•	•	•	•	•	•	•
Inspect air filter restriction gauge, replace filter as necessary	•	•	•	•	•	•	•	•	•	•
Inspect wheels and related components for abnormal noise, wear, looseness or drag	•	•	•	•	•	•	•	•	•	•
Inspect and lubricate steering linkage, ball joints, suspension, tie rod ends, driveshaft, front axle U-joints (4WD vehicles)	•	•	•	•	•	•	•	•	•	•
Perform multi-point inspection (recommended)	•	•	•	•	•	•	•	•	•	•
Inspect automatic transmission fluid level	•	•	•	•	•	•	•	•	•	•
Inspect brake pads, shoes, rotors, drums, brake linings, hoses and parking brake	•	•	•	•	•	•	•	•	•	•
Inspect exhaust system and heat shields	•	•	•	•	•	•	•	•	•	•
*Oil change service intervals should be completed as indicated by the message center										
Reset your Intelligent Oil Life Monitor™ after each engine oil and filter change; refer to the <i>Instrument Cluster</i> chapter of the <i>Owner's Guide</i>										

Scheduled Maintenance Guide

Perform the services noted in the following table at the specified time/mileage (km) period either within 3,000 miles (4,800 km) of the OIL CHANGE REQUIRED message appearing in the message center or when the time/mileage (km) reading indicates service is due.

Example #1: The OIL CHANGE REQUIRED message comes on at 19,751 miles (31,786 km); perform the 22,500 mile (36,000 km) fuel filter replacement.

Example #2: The OIL CHANGE REQUIRED message has **not** come on but the odometer reads 22,500 miles (36,000 km); perform the fuel filter replacement. (i.e., Intelligent Oil Life Monitor™ was reset at 15,000 miles [24,000 km].)

Every 15,000 miles (24,000 km), 600 engine hours or as indicated by the message center	Inspect engine and secondary cooling system concentration (freeze-point protection), additive strength (corrosion inhibitor), coolant level and hoses
Every 22,500 miles (36,000 km) or as indicated by the message center	Replace engine- and frame-mounted fuel filters
Every 30,000 miles (48,000 km)	Replace climate-controlled seat filter (if equipped)
At 45,000 miles (72,000 km)	Replace air inlet foam filter ¹
Every 60,000 miles (96,000 km)	Replace front wheel bearing grease/grease seal if non-sealed bearings are used (2WD vehicles)
At 90,000 miles (144,000 km)	Inspect accessory drive belt(s) ²
At 100,000 miles (160,000 km)	Change rear axle fluid (Dana axles only; refer to <i>Special operating conditions</i>) ³
At 105,000 miles (168,000 km) or 72 months	Change engine coolant and secondary coolant ⁴

Scheduled Maintenance Guide

Every 150,000 miles (240,000 km)	Change automatic transmission fluid and filter on 6-speed TorqShift® transmission
	Change front axle fluid (4WD vehicles)
	Change transfer case fluid (4WD vehicles)
	Replace accessory drive belt(s) if not replaced in the last 100,000 miles (160,000 km)
	Replace front wheel bearings and seals if non-sealed bearings are used (2WD vehicles)
¹ Replace filter again at 97,500 miles (156,000 km) and 150,000 miles (240,000 km)	
² Initial inspection at 90,000 miles (144,000 km), then every 15,000 miles (24,000 km) thereafter until replacement at 150,000 miles (240,000 km)	
³ Initial replacement at 100,000 miles (160,000 km), then again at 150,000 miles (240,000 km)	
⁴ Initial replacement at 105,000 miles (168,000 km) or 72 months or as indicated from coolant tests for concentration (freeze-point) or additive strength (corrosion inhibitor); every 45,000 miles (72,000 km) or 36 months thereafter or as indicated from coolant tests for concentration (freeze-point) or additive strength (corrosion inhibitor)	

Scheduled Maintenance Guide

Maintenance schedule log

<p style="text-align: center;">DEALER VALIDATION:</p> <p style="text-align: center;">P&A CODE:</p> <p>RO#: HOURS:</p> <p>DATE: MILEAGE:</p>	<p style="text-align: center;">DEALER VALIDATION:</p> <p style="text-align: center;">P&A CODE:</p> <p>RO#: HOURS:</p> <p>DATE: MILEAGE:</p>
<p style="text-align: center;">DEALER VALIDATION:</p> <p style="text-align: center;">P&A CODE:</p> <p>RO#: HOURS:</p> <p>DATE: MILEAGE:</p>	<p style="text-align: center;">DEALER VALIDATION:</p> <p style="text-align: center;">P&A CODE:</p> <p>RO#: HOURS:</p> <p>DATE: MILEAGE:</p>
<p style="text-align: center;">DEALER VALIDATION:</p> <p style="text-align: center;">P&A CODE:</p> <p>RO#: HOURS:</p> <p>DATE: MILEAGE:</p>	<p style="text-align: center;">DEALER VALIDATION:</p> <p style="text-align: center;">P&A CODE:</p> <p>RO#: HOURS:</p> <p>DATE: MILEAGE:</p>
<p style="text-align: center;">DEALER VALIDATION:</p> <p style="text-align: center;">P&A CODE:</p> <p>RO#: HOURS:</p> <p>DATE: MILEAGE:</p>	<p style="text-align: center;">DEALER VALIDATION:</p> <p style="text-align: center;">P&A CODE:</p> <p>RO#: HOURS:</p> <p>DATE: MILEAGE:</p>
<p style="text-align: center;">DEALER VALIDATION:</p> <p style="text-align: center;">P&A CODE:</p> <p>RO#: HOURS:</p> <p>DATE: MILEAGE:</p>	<p style="text-align: center;">DEALER VALIDATION:</p> <p style="text-align: center;">P&A CODE:</p> <p>RO#: HOURS:</p> <p>DATE: MILEAGE:</p>

Scheduled Maintenance Guide

<p style="text-align: center;">DEALER VALIDATION:</p> <p style="text-align: center;">P&A CODE:</p> <p>RO#: HOURS:</p> <p>DATE: MILEAGE:</p>	<p style="text-align: center;">DEALER VALIDATION:</p> <p style="text-align: center;">P&A CODE:</p> <p>RO#: HOURS:</p> <p>DATE: MILEAGE:</p>
<p style="text-align: center;">DEALER VALIDATION:</p> <p style="text-align: center;">P&A CODE:</p> <p>RO#: HOURS:</p> <p>DATE: MILEAGE:</p>	<p style="text-align: center;">DEALER VALIDATION:</p> <p style="text-align: center;">P&A CODE:</p> <p>RO#: HOURS:</p> <p>DATE: MILEAGE:</p>
<p style="text-align: center;">DEALER VALIDATION:</p> <p style="text-align: center;">P&A CODE:</p> <p>RO#: HOURS:</p> <p>DATE: MILEAGE:</p>	<p style="text-align: center;">DEALER VALIDATION:</p> <p style="text-align: center;">P&A CODE:</p> <p>RO#: HOURS:</p> <p>DATE: MILEAGE:</p>
<p style="text-align: center;">DEALER VALIDATION:</p> <p style="text-align: center;">P&A CODE:</p> <p>RO#: HOURS:</p> <p>DATE: MILEAGE:</p>	<p style="text-align: center;">DEALER VALIDATION:</p> <p style="text-align: center;">P&A CODE:</p> <p>RO#: HOURS:</p> <p>DATE: MILEAGE:</p>
<p style="text-align: center;">DEALER VALIDATION:</p> <p style="text-align: center;">P&A CODE:</p> <p>RO#: HOURS:</p> <p>DATE: MILEAGE:</p>	<p style="text-align: center;">DEALER VALIDATION:</p> <p style="text-align: center;">P&A CODE:</p> <p>RO#: HOURS:</p> <p>DATE: MILEAGE:</p>

Scheduled Maintenance Guide

<p style="text-align: center;">DEALER VALIDATION:</p> <p style="text-align: center;">P&A CODE:</p> <p>RO#: HOURS:</p> <p>DATE: MILEAGE:</p>	<p style="text-align: center;">DEALER VALIDATION:</p> <p style="text-align: center;">P&A CODE:</p> <p>RO#: HOURS:</p> <p>DATE: MILEAGE:</p>
<p style="text-align: center;">DEALER VALIDATION:</p> <p style="text-align: center;">P&A CODE:</p> <p>RO#: HOURS:</p> <p>DATE: MILEAGE:</p>	<p style="text-align: center;">DEALER VALIDATION:</p> <p style="text-align: center;">P&A CODE:</p> <p>RO#: HOURS:</p> <p>DATE: MILEAGE:</p>
<p style="text-align: center;">DEALER VALIDATION:</p> <p style="text-align: center;">P&A CODE:</p> <p>RO#: HOURS:</p> <p>DATE: MILEAGE:</p>	<p style="text-align: center;">DEALER VALIDATION:</p> <p style="text-align: center;">P&A CODE:</p> <p>RO#: HOURS:</p> <p>DATE: MILEAGE:</p>
<p style="text-align: center;">DEALER VALIDATION:</p> <p style="text-align: center;">P&A CODE:</p> <p>RO#: HOURS:</p> <p>DATE: MILEAGE:</p>	<p style="text-align: center;">DEALER VALIDATION:</p> <p style="text-align: center;">P&A CODE:</p> <p>RO#: HOURS:</p> <p>DATE: MILEAGE:</p>
<p style="text-align: center;">DEALER VALIDATION:</p> <p style="text-align: center;">P&A CODE:</p> <p>RO#: HOURS:</p> <p>DATE: MILEAGE:</p>	<p style="text-align: center;">DEALER VALIDATION:</p> <p style="text-align: center;">P&A CODE:</p> <p>RO#: HOURS:</p> <p>DATE: MILEAGE:</p>

Scheduled Maintenance Guide

SPECIAL OPERATING CONDITIONS

If you operate your vehicle **primarily** in one of the conditions listed below, you will need to have some items serviced more frequently. If you only **occasionally** operate your vehicle under any of these conditions, you don't need to perform the additional maintenance. For specific recommendations, see your dealership service advisor or technician.

Frequent/extended idling (over 10 minutes per hour of normal driving) or frequent low speed operation if vehicle is used for stationary operation

As required	– Change engine oil and filter as indicated by message center and perform services listed in the scheduled maintenance chart
Every 15,000 miles (24,000 km), 6 months, 600 engine hours or as indicated by message center	– Replace engine- and frame-mounted fuel filters
Every 15,000 miles (24,000 km) or 800 engine hours	– Inspect concentration (freeze-point protection) and additive strength (corrosion inhibitor); add engine coolant additive, if required
Every 60,000 miles (96,000 km) or 2,400 engine hours	– Flush and refill engine coolant; do not add engine coolant additive

Perform the services noted in the preceding table at the specified time/mileage (km) period either within 3,000 miles (4,800 km) of the OIL CHANGE REQUIRED message appearing in the message center or when the time/mileage (km) reading indicates service is due.

Example #1: The OIL CHANGE REQUIRED message comes on at 19,751 miles (31,786 km); perform the 22,500 mile (36,000 km) fuel filter replacement.

Example #2: The OIL CHANGE REQUIRED message has **not** come on but the odometer reads 22,500 miles (36,000 km); perform the fuel filter replacement. (i.e., Intelligent Oil Life Monitor™ was reset at 15,000 miles [24,000 km].)

Note: Vehicles operating under these severe service conditions need to have their maintenance requirements adjusted. This needs to be considered when determining vehicle service intervals.

Note: When adding coolant additive, do not exceed the specified maximum of 48 fl. oz. (1.4L). Operating the engine with excessive coolant additive may cause overheating which could lead to severe permanent engine damage.

82

Scheduled Maintenance Guide

Note: After initial coolant flush and fill at 60,000 miles (96,000 km) or 2,400 engine hours, flush and fill every 45,000 miles (72,000 km) or 1,800 engine hours thereafter.

Frequent low speed operation, consistent heavy traffic less than 25 mph (40 km/h) and/or long rush hour traffic

As required	– Change engine oil and filter as indicated by message center and perform services listed in the scheduled maintenance chart
Every 15,000 miles (24,000 km), 6 months, 600 engine hours or as indicated by message center	– Replace engine- and frame-mounted fuel filters
Every 15,000 miles (24,000 km) or 800 engine hours	– Inspect concentration (freeze-point protection) and additive strength (corrosion inhibitor); add engine coolant additive, if required
Every 60,000 miles (96,000 km)	– Change transfer case fluid (4WD vehicles)
Every 60,000 miles (96,000 km) or 2,400 engine hours	– Flush and refill engine coolant; do not add engine coolant additive

Perform the services noted in the preceding table at the specified time/mileage (km) period either within 3,000 miles (4,800 km) of the OIL CHANGE REQUIRED message appearing in the message center or when the time/mileage (km) reading indicates service is due.

Example #1: The OIL CHANGE REQUIRED message comes on at 19,751 miles (31,786 km); perform the 22,500 mile (36,000 km) fuel filter replacement.

Example #2: The OIL CHANGE REQUIRED message has **not** come on but the odometer reads 22,500 miles (36,000 km); perform the fuel filter replacement. (i.e., Intelligent Oil Life Monitor™ was reset at 15,000 miles [24,000 km].)

Note: When adding coolant additive, do not exceed the specified maximum of 48 fl. oz. (1.4L). Operating the engine with excessive coolant additive may cause overheating which could lead to severe permanent engine damage.

Note: After initial coolant flush and fill at 60,000 miles (96,000 km) or 2,400 engine hours, flush and fill every 45,000 miles (72,000 km) or 1,800 engine hours thereafter.

Scheduled Maintenance Guide

Sustained high-speed driving at Gross Vehicle Weight Rating (maximum loaded weight for vehicle operation)

As required	– Change engine oil and filter as indicated by message center and perform services listed in the scheduled maintenance chart
Every 15,000 miles (24,000 km), 6 months, 600 engine hours or as indicated by message center	– Replace engine- and frame-mounted fuel filters
Every 15,000 miles (24,000 km) or 800 engine hours	– Inspect concentration (freeze-point protection) and additive strength (corrosion inhibitor); add engine coolant additive, if required
Every 30,000 miles (48,000 km)	– Replace wheel bearing grease and grease seals if non-sealed bearings are used (2WD vehicles)
Every 50,000 miles (80,000 km)	– Change rear axle fluid (if equipped with a Dana rear axle; some F-350s, all F-450/550s) – Change transfer case fluid (4WD vehicles)
Every 60,000 miles (96,000 km) or 2,400 engine hours	– Flush and refill engine coolant; do not add engine coolant additive

Perform the services noted in the preceding table at the specified time/mileage (km) period either within 3,000 miles (4,800 km) of the OIL CHANGE REQUIRED message appearing in the message center or when the time/mileage (km) reading indicates service is due.

Example #1: The OIL CHANGE REQUIRED message comes on at 19,751 miles (31,786 km); perform the 22,500 mile (36,000 km) fuel filter replacement.

Example #2: The OIL CHANGE REQUIRED message has **not** come on but the odometer reads 22,500 miles (36,000 km); perform the fuel filter replacement. (i.e., Intelligent Oil Life Monitor™ was reset at 15,000 miles [24,000 km].)

Note: When adding coolant additive, do not exceed the specified maximum of 48 fl. oz. (1.4L). Operating the engine with excessive coolant additive may cause overheating which could lead to severe permanent engine damage.

Note: After initial coolant flush and fill at 60,000 miles (96,000 km) or 2,400 engine hours, flush and fill every 45,000 miles (72,000 km) or 1,800 engine hours thereafter.

Scheduled Maintenance Guide

Operating in sustained ambient temperatures below -10°F (-23°C) or above 100°F (38°C)

As required	– Change engine oil and filter as indicated by message center and perform services listed in the scheduled maintenance chart
Every 15,000 miles (24,000 km), 6 months, 600 engine hours or as indicated by message center	– Replace engine- and frame-mounted fuel filters
Every 30,000 miles (48,000 km)	– Replace wheel bearing grease/grease seals if non-sealed bearings are used (2WD vehicles)
Every 60,000 miles (96,000 km)	– Change transfer case fluid (4WD vehicles)

Perform the services noted in the preceding table at the specified time/mileage (km) period either within 3,000 miles (4,800 km) of the OIL CHANGE REQUIRED message appearing in the message center or when the time/mileage (km) reading indicates service is due.

Example #1: The OIL CHANGE REQUIRED message comes on at 19,751 miles (31,786 km); perform the 22,500 mile (36,000 km) fuel filter replacement.

Example #2: The OIL CHANGE REQUIRED message has **not** come on but the odometer reads 22,500 miles (36,000 km); perform the fuel filter replacement. (i.e., Intelligent Oil Life Monitor™ was reset at 15,000 miles [24,000 km].)

Scheduled Maintenance Guide

Towing a trailer or using a camper or car-top carrier

As required	– Change engine oil and filter as indicated by message center and perform services listed in the scheduled maintenance chart
Every 15,000 miles (24,000 km), 6 months, 600 engine hours or as indicated by message center	– Replace engine- and frame-mounted fuel filters
Every 15,000 miles (24,000 km) or 800 engine hours	– Inspect concentration (freeze-point protection) and additive strength (corrosion inhibitor); add engine coolant additive, if required
Every 30,000 miles (48,000 km)	– Replace wheel bearing grease and grease seals if non-sealed bearings are used (2WD vehicles)
Every 60,000 miles (96,000 km)	– Change transfer case fluid (4WD vehicles)
Every 60,000 miles (96,000 km) or 2,400 engine hours	– Flush and refill engine coolant; do not add engine coolant additive

Perform the services noted in the preceding table at the specified time/mileage (km) period either within 3,000 miles (4,800 km) of the OIL CHANGE REQUIRED message appearing in the message center or when the time/mileage (km) reading indicates service is due.

Example #1: The OIL CHANGE REQUIRED message comes on at 19,751 miles (31,786 km); perform the 22,500 mile (36,000 km) fuel filter replacement.

Example #2: The OIL CHANGE REQUIRED message has **not** come on but the odometer reads 22,500 miles (36,000 km); perform the fuel filter replacement. (i.e., Intelligent Oil Life Monitor™ was reset at 15,000 miles [24,000 km].)

Note: When adding coolant additive, do not exceed the specified maximum of 48 fl. oz. (1.4L). Operating the engine with excessive coolant additive may cause overheating which could lead to severe permanent engine damage.

Note: After initial coolant flush and fill at 60,000 miles (96,000 km) or 2,400 engine hours, flush and fill every 45,000 miles (72,000 km) or 1,800 engine hours thereafter.

Scheduled Maintenance Guide

Off-road operation

As required	<ul style="list-style-type: none">– Inspect steering and suspension ball joints and tie rods; lubricate if equipped with grease fittings– Inspect functional holes in each leg of the twin tip and the holes under the shield just inboard of the right rear tire to make sure they are kept clean/clear of debris or foreign materials. Refer to the <i>Cleaning</i> chapter for more information
Every 7,500 miles (12,000 km)	<ul style="list-style-type: none">– Inspect air filter restriction gauge; replace filter as indicated by gauge– Rotate tires, inspect tires for wear and measure tread depth and inspect wheel ends for endplay and noise; dual rear wheels should only be rotated if unusual wear is observed– Inspect brake system pads and rotors
Every 7,500 miles (12,000 km) or 300 engine hours	<ul style="list-style-type: none">– Change engine oil and filter– Inspect and lubricate U-joints
Every 15,000 miles (24,000 km), 6 months, 600 engine hours or as indicated by message center	<ul style="list-style-type: none">– Replace engine- and frame-mounted fuel filters
Every 30,000 miles (48,000 km)	<ul style="list-style-type: none">– Replace wheel bearing grease/grease seals if non-sealed bearings are used (2WD vehicles)
Every 50,000 miles (80,000 km)	<ul style="list-style-type: none">– Change rear axle fluid (if equipped with a Dana rear axle; some F-350s, all F-450/550s)– Change transfer case fluid (4WD vehicles)– Inspect front axle fluid (4WD vehicles)

Reset your Intelligent Oil Life Monitor™ after each engine oil and filter change; refer to the *Instrument Cluster* chapter of the *Owner's Guide*.

Scheduled Maintenance Guide

Operating in dusty conditions (i.e. unpaved or dusty roads)

- | | |
|---|---|
| Every 7,500 miles (12,000 km) | <ul style="list-style-type: none">– Rotate tires, inspect tires for wear and measure tread depth and inspect wheel ends for endplay and noise; dual rear wheels should only be rotated if unusual wear is observed– Inspect steering and suspension ball joints and tie rods; lubricate if equipped with grease fittings– Inspect air filter restriction gauge; replace filter as indicated by gauge– Inspect brake system pads and rotors |
| Every 7,500 miles (12,000 km),
6 months or 300 engine hours | <ul style="list-style-type: none">– Change engine oil and filter– Inspect and lubricate U-joints |
| Every 15,000 miles (24,000 km),
6 months, 600 engine hours or as
indicated by message center | <ul style="list-style-type: none">– Replace engine- and frame-mounted fuel filters |
| Every 30,000 miles (48,000 km) | <ul style="list-style-type: none">– Replace wheel bearing grease/grease seals if non-sealed bearings are used (2WD vehicles) |

Reset your Intelligent Oil Life Monitor™ after each engine oil and filter change; refer to the *Instrument Cluster* chapter of the *Owner's Guide*.

Use of Biodiesel, up to and including 20% Biodiesel (B20)

- | | |
|---|--|
| As required | <ul style="list-style-type: none">– Change engine oil and filter as indicated by message center and perform services listed in the scheduled maintenance chart |
| Every 15,000 miles (24,000 km),
6 months, 600 engine hours or as
indicated by message center | <ul style="list-style-type: none">– Replace engine- and frame-mounted fuel filters |

Scheduled Maintenance Guide

Use of non-Ultra Low Sulfur Diesel (ULSD) fuel - vehicles operated where ULSD fuel isn't required/available

Every 2,500 miles (4,000 km) or 3 months (if using high sulfur fuel with more than 500 ppm sulfur) – Change engine oil and filter

Every 5,000 miles (8,000 km) or 6 months (if using high sulfur fuel with less than 500 ppm sulfur) – Change engine oil and filter

Reset your Intelligent Oil Life Monitor™ after each engine oil and filter change; refer to the *Instrument Cluster* chapter of the *Owner's Guide*.

Scheduled Maintenance Guide

Special operating condition log

<p style="text-align: center;">DEALER VALIDATION:</p> <p style="text-align: center;">P&A CODE:</p> <p>RO#: HOURS:</p> <p>DATE: MILEAGE:</p>	<p style="text-align: center;">DEALER VALIDATION:</p> <p style="text-align: center;">P&A CODE:</p> <p>RO#: HOURS:</p> <p>DATE: MILEAGE:</p>
<p style="text-align: center;">DEALER VALIDATION:</p> <p style="text-align: center;">P&A CODE:</p> <p>RO#: HOURS:</p> <p>DATE: MILEAGE:</p>	<p style="text-align: center;">DEALER VALIDATION:</p> <p style="text-align: center;">P&A CODE:</p> <p>RO#: HOURS:</p> <p>DATE: MILEAGE:</p>
<p style="text-align: center;">DEALER VALIDATION:</p> <p style="text-align: center;">P&A CODE:</p> <p>RO#: HOURS:</p> <p>DATE: MILEAGE:</p>	<p style="text-align: center;">DEALER VALIDATION:</p> <p style="text-align: center;">P&A CODE:</p> <p>RO#: HOURS:</p> <p>DATE: MILEAGE:</p>
<p style="text-align: center;">DEALER VALIDATION:</p> <p style="text-align: center;">P&A CODE:</p> <p>RO#: HOURS:</p> <p>DATE: MILEAGE:</p>	<p style="text-align: center;">DEALER VALIDATION:</p> <p style="text-align: center;">P&A CODE:</p> <p>RO#: HOURS:</p> <p>DATE: MILEAGE:</p>
<p style="text-align: center;">DEALER VALIDATION:</p> <p style="text-align: center;">P&A CODE:</p> <p>RO#: HOURS:</p> <p>DATE: MILEAGE:</p>	<p style="text-align: center;">DEALER VALIDATION:</p> <p style="text-align: center;">P&A CODE:</p> <p>RO#: HOURS:</p> <p>DATE: MILEAGE:</p>

Scheduled Maintenance Guide

<p style="text-align: center;">DEALER VALIDATION:</p> <p style="text-align: center;">P&A CODE:</p> <p>RO#: HOURS:</p> <p>DATE: MILEAGE:</p>	<p style="text-align: center;">DEALER VALIDATION:</p> <p style="text-align: center;">P&A CODE:</p> <p>RO#: HOURS:</p> <p>DATE: MILEAGE:</p>
<p style="text-align: center;">DEALER VALIDATION:</p> <p style="text-align: center;">P&A CODE:</p> <p>RO#: HOURS:</p> <p>DATE: MILEAGE:</p>	<p style="text-align: center;">DEALER VALIDATION:</p> <p style="text-align: center;">P&A CODE:</p> <p>RO#: HOURS:</p> <p>DATE: MILEAGE:</p>
<p style="text-align: center;">DEALER VALIDATION:</p> <p style="text-align: center;">P&A CODE:</p> <p>RO#: HOURS:</p> <p>DATE: MILEAGE:</p>	<p style="text-align: center;">DEALER VALIDATION:</p> <p style="text-align: center;">P&A CODE:</p> <p>RO#: HOURS:</p> <p>DATE: MILEAGE:</p>
<p style="text-align: center;">DEALER VALIDATION:</p> <p style="text-align: center;">P&A CODE:</p> <p>RO#: HOURS:</p> <p>DATE: MILEAGE:</p>	<p style="text-align: center;">DEALER VALIDATION:</p> <p style="text-align: center;">P&A CODE:</p> <p>RO#: HOURS:</p> <p>DATE: MILEAGE:</p>
<p style="text-align: center;">DEALER VALIDATION:</p> <p style="text-align: center;">P&A CODE:</p> <p>RO#: HOURS:</p> <p>DATE: MILEAGE:</p>	<p style="text-align: center;">DEALER VALIDATION:</p> <p style="text-align: center;">P&A CODE:</p> <p>RO#: HOURS:</p> <p>DATE: MILEAGE:</p>

Scheduled Maintenance Guide

EXCEPTIONS

In addition, there are several exceptions to the Normal Schedule. They are listed below:



Normal vehicle axle maintenance

- Rear axles and power take-off (PTO) units containing synthetic fluid and light duty trucks equipped with Ford-design axles are lubricated for life. These fluids are not to be checked or changed unless a leak is suspected, service is required or the axle assembly has been submerged in water. The axle and PTO fluids should be changed anytime the axle and PTO have been submerged in water. Non-synthetic rear axle fluids should be changed every 3,000 miles (4,800 km) or three months, whichever comes first, during extended trailer tow operation above 70°F (21°C) ambient and wide open throttle for extended periods above 45 mph (72 km/h). The 3,000 mile (4,800 km) fluid change interval may be waived if the axle was filled with 75W140 synthetic gear fluid meeting Ford specification WSL-M2C192-A, part number F1TZ-19580-B or equivalent. Add four ounces (118 mL) of additive friction modifier C8AZ-19B546-A (EST-M2C118-A) or equivalent for complete refill of Traction-Lok rear axles. The axle fluid should be changed anytime an axle has been submerged in water.

F-450 and F-550 axle maintenance

- Change rear axle fluid every 100,000 miles (160,000 km) under normal driving conditions on all commercial applications. For trucks operated at or near maximum Gross Vehicle Weights, the rear axle fluid should be changed every 50,000 miles (80,000 km). In addition, this 50,000 mile (80,000 km) schedule should be observed when the vehicles are operated under the Special Operating Conditions, where noted.

Diesel Particulate Filter (DPF)

- The DPF may need to be removed for ash cleaning at approximately 120,000 miles (192,000 km) or greater (actual mileage can vary greatly depending upon engine/vehicle operating conditions) and replaced with a new or remanufactured (ash cleaned) part. The filter may need to be replaced at approximately 250,000 miles (400,000 km) depending upon engine/vehicle operating conditions. In both cases the engine control system will set a service light () to inform you to bring the vehicle to the dealer for service. If there are any issues with the oxidation catalyst/DPF system a service light ( or ) will be set by the engine control system to inform you to bring the vehicle into a dealership for service.

ENGINE COOLANT CHANGE RECORD

Engine coolant

- Initial change — 6 years or 105,000 miles (168,000 km) (whichever comes first), or as indicated from the coolant tests for concentration (freeze-point) or additive strength (corrosion inhibitor)
- After initial change — every 3 years or 45,000 miles (72,000 km), or as indicated from the coolant tests for concentration (freeze-point) or additive strength (corrosion inhibitor)

Scheduled Maintenance Guide

Engine coolant change log

<p style="text-align: center;">DEALER VALIDATION:</p> <p>RO#: P&A CODE: DATE: HOURS: MILEAGE:</p>	<p style="text-align: center;">DEALER VALIDATION:</p> <p>RO#: P&A CODE: DATE: HOURS: MILEAGE:</p>
<p style="text-align: center;">DEALER VALIDATION:</p> <p>RO#: P&A CODE: DATE: HOURS: MILEAGE:</p>	<p style="text-align: center;">DEALER VALIDATION:</p> <p>RO#: P&A CODE: DATE: HOURS: MILEAGE:</p>
<p style="text-align: center;">DEALER VALIDATION:</p> <p>RO#: P&A CODE: DATE: HOURS: MILEAGE:</p>	<p style="text-align: center;">DEALER VALIDATION:</p> <p>RO#: P&A CODE: DATE: HOURS: MILEAGE:</p>
<p style="text-align: center;">DEALER VALIDATION:</p> <p>RO#: P&A CODE: DATE: HOURS: MILEAGE:</p>	<p style="text-align: center;">DEALER VALIDATION:</p> <p>RO#: P&A CODE: DATE: HOURS: MILEAGE:</p>
<p style="text-align: center;">DEALER VALIDATION:</p> <p>RO#: P&A CODE: DATE: HOURS: MILEAGE:</p>	<p style="text-align: center;">DEALER VALIDATION:</p> <p>RO#: P&A CODE: DATE: HOURS: MILEAGE:</p>

Index

A

- Additive
 - coolant65
- Air cleaner filter51, 64
- Air filter restriction gauge51

B

- Battery64
 - auxiliary battery64
 - jumping a disabled battery17
- Break-in period3

C

- Cleaning your vehicle
 - engine compartment18–19
- Coolant5, 65
 - refill capacities65
- Coolant additive65
- Cooler5

D

- Diesel exhaust fluid (DEF)26
- Diesel Particulate Filter (DPF)55–56, 58

E

- Emergencies, roadside
 - jump-starting17
- Emission control system55–56, 58–59
- Engine20
 - cleaning18–19
 - coolant65
 - diesel2–3

94

- refill capacities65
- service points20
- starting after a collision16

Engine fan8

- Engine oil4, 42, 44, 65
 - filter, specifications64
 - refill capacities65
 - specifications43, 65

Exhaust Fluid26

F

Fan, Engine Cooling8

Filter

- fuel39

- Fuel14, 21
 - cap25
 - capacity65
 - dual tank selector switch14
 - filling your vehicle with fuel25
 - filter, specifications39, 64
 - fuel pump shut-off switch16

Fuel pump shut-off switch16

Fuel separator38–39

G

Gas cap (see Fuel cap)25

Gauges7

I

Intelligent Oil Life Monitor44

J

Jump-starting your vehicle17

L

Lights, warning and indicator6

Index

S

Selective Catalytic Reduction (SCR) System	26
Special notice	2
ambulance conversions	2
diesel-powered vehicles	2
Speed control	5
Starting your vehicle	4, 8, 62

jump starting	17
---------------------	----

T

Towing	
trailer towing	15
Transmission	
lubricant specifications	65