

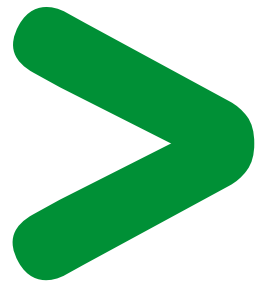

Technical collection

Coordination of LV protection devices

Low voltage
expert guides n° 5



Glossary	2
The requirements of electrical power distribution	3
1.1. Safety and availability of energy	3
1.2. Structure of LV electrical power distribution	4
1.3. Functions and technologies of the protection devices	5
1.3.1. Circuit-breaker functions	5
1.3.2. Level A: the MSB	5
1.3.3. Level B: the subdistribution boards	5
1.3.4. Level C: Final distribution	6
1.4. Standard IEC 60947-2	7
1.4.1 The principles	7
1.4.2. Reminders of standard-related electrical data	7
1.4.3. Circuit-breaker coordination	9
1.5. 1.5. Summarising table	10
The implementation techniques	11
2.1. Limitation	11
2.1.1. Principles	11
2.1.2. Circuit breaker limitation capacity	11
2.1.3. Advantages	12
2.1.4. Limitation curves	13
2.2. Cascading	13
2.2.1. Area of application	13
2.3. Discrimination	15
2.3.1. General information	15
2.3.2. Technical discriminations	15
2.4. The discrimination rules	18
2.4.1. General discrimination rules	18
2.5. Earth leakage protection discrimination	20
2.5.1. Vertical discrimination	20
2.5.2. Horizontal discrimination	21
2.6. Coordination of protection devices installation standards	21
The Schneider Electric choice	24
3.1. For power circuit-breakers	24
3.1.1. The selective pole	24
3.1.2. Technical innovations of new Masterpact for better performances	24
3.2. For moulded case circuit-breakers (MCCB)	28
3.2.1. Trip units	29
3.3. For miniature circuit-breakers MCB	29
3.4. The discrimination rules from 1 to 6300 A	29
3.4.1. General discrimination rules (in distribution)	29
3.4.2. Discrimination rules for Masterpact NT and NW	30
3.4.3. "Natural" discrimination rules between Compact NSX	30
3.4.4 Discrimination enhanced by cascading with Compact NSX	31
3.4.5. Specific applications	32
3.4.6. Summary	33
Implementation of discrimination and cascading	34
4.1. Discrimination tables	34
4.2. Cascading tables	34
4.3. Study of MV/LV discrimination from 1 to 6300 A	35
4.3.1. At the MSB	36
4.3.2. Cascading	36
4.3.3. At the power distribution switchboard	37
4.3.4. At the subdistribution switchboard	37
4.3.5. At the final distribution switchboard	37

Glossary

EDW:	electrodynamic withstand
SCPD:	short circuit protection device
IEC:	International Electrotechnical Commission
CT:	current transformers
CU:	control unit
MSB:	main switchboard
BBT:	busbar trunking
MV:	medium voltage (1 kV to 36 kV)
Isc:	short-circuit current
Isc(D1):	short-circuit current at the point where D1 is installed
Usc:	short-circuit voltage
MCCB:	moulded case circuit-breaker
BC :	breaking capacity
Icu⁽¹⁾:	ultimate breaking capacity
IcuD1⁽¹⁾:	ultimate breaking capacity of D1

(1) The main electrical data of circuit-breakers are defined on page 7.

The requirements of electrical power distribution

The design of LV installations leads to basic protection devices being fitted for three types of faults:

- overloads
- short-circuits
- insulation faults.

1.1. Safety and availability of energy

Safety and availability of energy are the operator's prime requirements.

Coordination of protection devices ensures these needs are met at optimised cost.

Implementation of these protection devices must allow for:

- the statutory aspects, particularly relating to safety of people
- technical and economic requirements.

The chosen switchgear must:

- withstand and eliminate faults at optimised cost with respect to the necessary performance
- limit the effect of a fault to the smallest part possible of the installation in order to ensure continuity of supply.

Achievement of these objectives requires coordination of protection device performance, necessary for:

- **managing safety** and increasing durability of the installation by limiting stresses
- **managing availability** by eliminating the fault by means of the circuit-breaker immediately upstream.

The circuit-breaker coordination means are:

- **cascading**
- **discrimination.**

If the insulation fault is specifically dealt with by earth leakage protection devices, discrimination of the residual current devices (RCDs) must also be guaranteed.

The requirements of electrical power distribution

1.2. Structure of LV electrical power distribution

DB125105

Level A

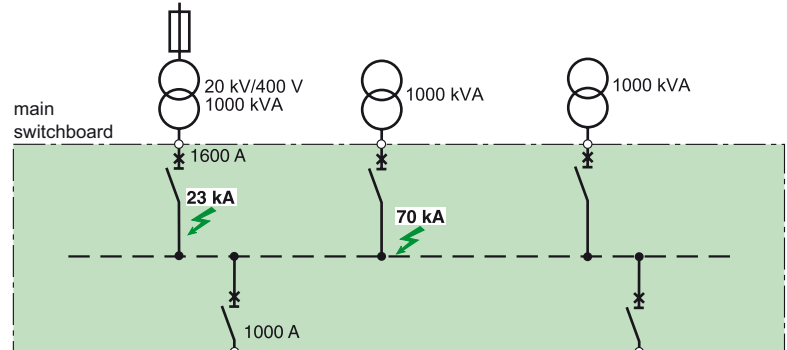

Level B

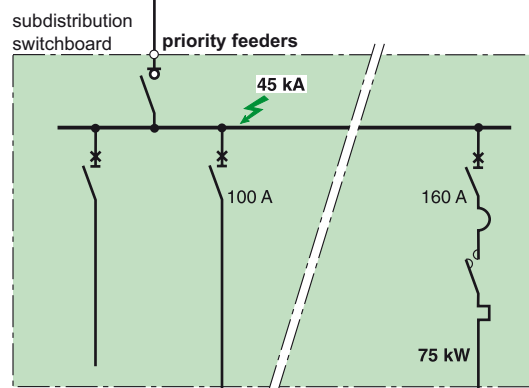
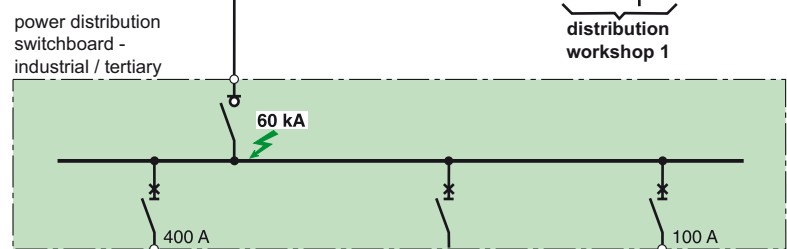

Level C

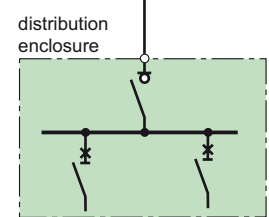
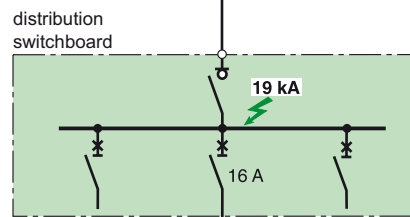

lighting, heating, etc.
building utilities

distribution

Simplified diagram of a standard installation covering most of the cases observed in practice.

The various levels of an LV electrical installation

Each of the three levels of the installation has specific availability and safety needs.

The requirements of electrical power distribution

1.3. Functions and technologies of the protection devices

Protection devices and their coordination must be suited to the specific features of the installation.

- At the MSB, the need for energy availability is greatest.
- At the subdistribution switchboards, limitation of stresses in event of a fault is important.
- At final distribution, user safety is essential.

1.3.1. Circuit-breaker functions

This connection device is able to close and break a circuit regardless of current up to its breaking capacity.

The functions to be performed are:

- close the circuit
- conduct current
- open the circuit and break the current
- guarantee isolation.

The requirements concerning installation, cost optimisation, management of availability and safety generate technological choices concerning the circuit-breaker.

1.3.2. Level A: the MSB

This device is the entrance key to the entire electrical power distribution: availability of energy is essential in this part of the installation.

- Short-circuit currents are great due to:
 - the proximity of the LV sources
 - amply sized busbars for conveying high currents.

This is the area of the power circuit-breakers

These circuit-breakers are designed for high current electrical distribution:

- they are normally installed in the MSBs to protect high current incomers and feeders
- they must remain closed in event of short-circuits so as to let the downstream circuit-breaker eliminate the faults.

Their operation is normally time-delayed.

electrodynamics withstand (EDW) and high thermal withstand characterised by a short time withstand current I_{cw} are essential.

EDW is designed to be as great as possible by an own current compensation effect (see page 24)

Main data of these circuit-breakers:

- of industrial type, meeting standard IEC 60947-2
- with a high breaking capacity I_{cu} from 40 to 150 kV
- with a nominal rating of 1000 to more than 5000 A
- category B:
 - with a high I_{cw} from 40 kA to 100 k - 1 s
 - with a high electrodynamic withstand (EDW)
- with a stored energy operating mechanism allowing source coupling.

Continuity of supply is ensured by total discrimination:

- upstream with the protection fuses of the HV/LV transformer ⁽¹⁾
- downstream with all the feeders (time discrimination).

⁽¹⁾ The value of HV/LV discrimination lies above all in the fact that resumption of operation has fewer constraints in LV (accessibility, padlocking). This offers considerable advantages for continuity of supply.

1.3.3. Level B: the subdistribution boards

These boards belong to the intermediate part of the installation:

- distribution is via conductors (BBT or cables) with optimised sizing
- sources are still relatively close: short-circuit currents can reach 100 kA
- the need for continuity of supply is still very great.

Protection devices must consequently limit stresses and be perfectly coordinated with upstream and downstream LV distribution.

This is the area of the moulded case circuit-breakers.

These circuit-breakers must open and break the current as quickly as possible. The main need is to avoid as far as possible stresses at cable and connection level and even at load level. For this purpose, repulsion at contact level must be encouraged in order to eliminate the fault even before it is made.

The possible diagrams are:

- with a single repulsion loop
- with double repulsion
- with an extractor, a magnetic core pushing or pulling the moving contact.

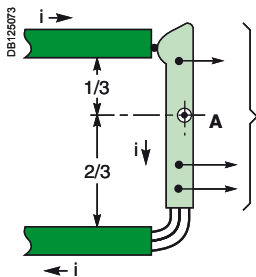

Own current compensation diagram.

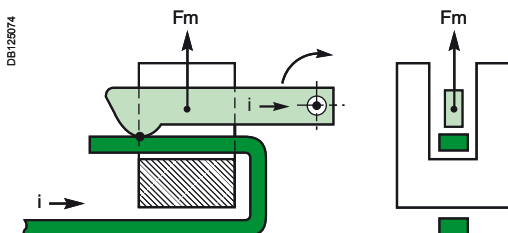

Example of a repulsion diagram.

The requirements of electrical power distribution

The repulsion effects can be enhanced by implementation of magnetic circuits:

- with effects proportional to the current square (U-shaped attracting or expulsion circuit)
- with effects proportional to the current slope (di/dt) and thus particularly effective for high currents (I_{sc}).

Main data of the moulded case circuit-breakers:

- of industrial type, meeting standard IEC 60947-2
- with a high breaking capacity (36 to 150 kA)
- with a nominal rating from 100 A to 1600 A
- category B for high rating circuit-breakers (> 630 A)
- category A for lower rating circuit-breakers (< 630 A)
- with fast closing and opening and with three operating positions (ON/OFF/Tripped).

Continuity of supply is ensured by discrimination:

- partial, possibly, to supply non-priority feeders
- total for downstream distribution requiring high energy availability.

1.3.4. Level C: Final distribution

The protection devices are placed directly upstream of the loads: discrimination with the higher level protection devices must be provided.

A weak short-circuit current (a few kA) characterises this level.

■ This is the area of the miniature circuit-breaker

These circuit-breakers are designed to protect final distribution. The purpose is to limit stresses on cables, connections and loads.

The technologies for the miniature circuit-breakers, mainly used at this installation level, prevent such stresses from occurring.

In miniature circuit-breakers, limitation partly depends on the magnetic actuator.

Once the mechanism has been released, it will strike the moving contact making it move at a high speed very early on. Arc voltage thus develops very quickly at a very early stage. For small rating circuit-breakers, specific pole impedance contributes to limitation.

The miniature circuit-breaker is ideal for domestic use and for the protection of auxiliaries; it is then conform to standard IEC 60898.

On the other hand, if it is designed for industrial use, it must meet standard IEC 60947-2.

Main data of these circuit-breakers:

- a breaking capacity to match needs (i.e. a few kA on average)
- a nominal rating of 1.5 to 125 A according to the loads to be supplied
- normally intended for domestic applications: conform to standard IEC 60898.

The protection devices installed must provide:

- current limitation
- operating convenience
- absolute safety, as these devices are handled by non-specialist users.

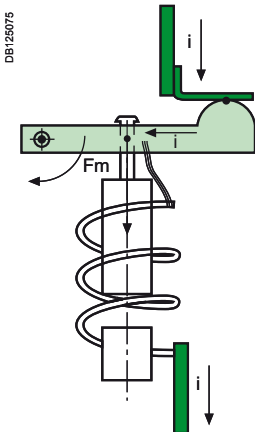

The requirements of electrical power distribution

1.4. Standard IEC 60947-2

Standard IEC 60947.2 specifies the main data of Industrial Circuit-Breakers:

- the utilisation category
- the setting data
- the design measures
- etc

It draws up a series of very complete tests representative of circuit-breaker real operating conditions. In appendix A, it recognises and defines Coordination of Protection Devices – Discrimination and Cascading.

Conformity of a circuit-breaker with standard IEC 60947-2 is a guarantee of quality switchgear.

L'évolution du besoin de sûreté et des technologies a permis un relèvement. Changes in dependability needs and technologies have led to a marked increase in standard requirements for industrial circuit-breakers. Conformity with standard IEC 947-2, renamed IEC 60947-2 in 1997, can be considered as an all-risk insurance for use of circuit-breakers. This standard has been approved by all countries.

1.4.1 The principles

Standard IEC 60947-2 is part of a series of standards defining the specifications for LV electrical switchgear:

- the general rules IEC 60947-1, that group the definitions, specifications and tests common to all LV industrial switchgear
 - the product standards IEC 60947-2 to 7, that deal with specifications and tests specific to the product concerned.
- Standard IEC 60947-2 applies to circuit-breakers and their associated trip units. Circuit-breaker operating data depend on the trip units or relays that control their opening in specific conditions.

This standard defines the main data of industrial circuit-breakers:

- their classification: utilisation category, suitability for isolation, etc
- the electrical setting data
- the information useful for operation
- the design measures
- coordination of protection devices (in appendix A).

The standard also draws up series of conformity tests to be undergone by the circuit-breakers. These tests, which are very complete, are very close to real operating conditions. Conformity of these tests with standard IEC 60947-2 is verified by accredited laboratories.

Table of main data (appendix K IEC 60947-2)

Voltage data	U_e U_i U_{imp}	rated operational voltage rated insulation voltage rated impulse withstand voltage
Current data	I_n I_{th} I_{the} I_{lu}	rated operational current conventional free air thermal current conventional enclosed thermal current rated uninterrupted current
Short-circuit data	I_{cm} I_{cu} I_{cs} I_{cw}	rated short-circuit making capacity rated ultimate short-circuit breaking capacity rated service breaking capacity rated short time withstand current
Trip unit data	I_r 1.05 x I_r 1.30 x I_r I_i I_{sd}	adjustable overload setting current conventional non-tripping current conventional tripping current instantaneous tripping setting current short time tripping setting current

Circuit-breaker category

Standard IEC 60947-2 defines two circuit-breaker categories:

- **category A** circuit-breakers, for which no tripping delay is provided. This is normally the case of moulded case circuit-breakers. These circuit-breakers can provide current discrimination.
- **category B** circuit-breakers, for which, in order to provide time discrimination, tripping can be delayed (up to 1 s) for all short-circuits of value less than the current I_{cw}.

This is normally the case of power or moulded case circuit-breakers with high ratings. For circuit-breakers installed in the MSBs, it is important to have an I_{cw} equal to I_{cu} in order to naturally provide discrimination up to full ultimate breaking capacity I_{cu}.

1.4.2. Reminders of standard-related electrical data

The setting data are given by the tripping curves.

These curves contain some areas limited by the following currents (defined in appendix K of standard IEC 60947-2).



The requirements of electrical power distribution

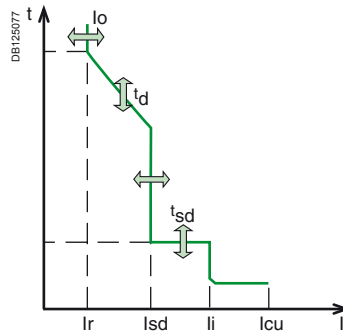

Rated operational current (In)

In (in A rms) = maximum uninterrupted current withstood at a given ambient temperature without abnormal temperature rise.
E.g. 125 A at 40 °C.

Adjustable overload setting current (Ir)

Ir (in A rms) is a function of In. Ir characterises overload protection. For operation in overload, the conventional non-tripping currents Ind and tripping currents Id are:

- Ind = 1.05 Ir
- Id = 1.30 Ir.

Id is given for a conventional tripping time.

For a current greater than Id, tripping by thermal effect will take place according to an inverse time curve. Ir is known as Long Time Protection (LT).

Short time tripping setting current (Isd)

Isd (in kA rms) is a function of Ir. Isd characterises short-circuit protection. The circuit-breaker opens according to the short time tripping curve:

- either with a time delay t_{sd}
- or with constant I²t
- or instantaneously (similar to instantaneous protection).

Isd is known as Short Time Protection or Im.

Instantaneous tripping setting current (Ii)

Ii (in kA) is given as a function of In. It characterises the instantaneous short-circuit protection for all circuit-breaker categories. For high overcurrents (short-circuits) greater than the Ii threshold, the circuit-breaker must immediately break the fault current.

This protection device can be disabled according to the technology and type of circuit-breaker (particularly B category circuit-breakers).

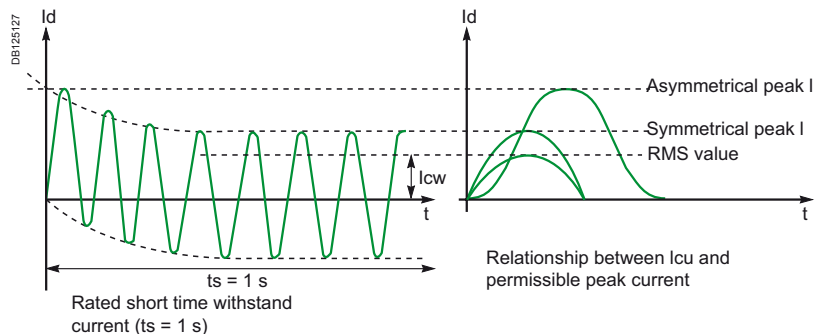

Table for calculation of asymmetrical short-circuits (IEC 60947.2 para. 4.3.5.3.)

Isc: symmetrical assumed short-circuit kA (root mean square value)	asymmetry factor k
4.5 ≤ I ≤ 6	1.5
6 < I ≤ 10	1.7
10 < I ≤ 20	2.0
20 < I ≤ 50	2.1
50 < I	2.2

Rated short-circuit making capacity ⁽¹⁾ (Icm)

Icm (peak kA) is the maximum value of the asymmetrical short-circuit current that the circuit-breaker can make. For a circuit-breaker, the stress to be managed is greatest on closing on a short-circuit.

The requirements of electrical power distribution

■ Rated ultimate breaking capacity ⁽¹⁾ (I_{cu})

I_{cu} (kA rms) is the maximum short-circuit current value that the circuit-breaker can break. It is verified according to a sequence of standardised tests. After this sequence, the circuit-breaker must not be dangerous. This characteristic is defined for a specific voltage rating U_e.

■ Rated service breaking capacity ⁽¹⁾ (I_{cs})

I_{cs} (kA rms) is given by the manufacturer and is expressed as a % of I_{cu}. This performance is very important as it gives the ability of a circuit-breaker to provide totally normal operation once it has broken this short-circuit current three times. The higher I_{cs}, the more effective the circuit-breaker.

■ Rated short time withstand current ⁽¹⁾ (I_{cw})

Defined for B category circuit-breakers.

I_{cw} (kA rms) is the maximum short-circuit current that the circuit-breaker can withstand for a short period of time (0.05 to 1 s) without its properties being affected. This performance is verified during the standardised test sequence.

⁽¹⁾ These data are defined for a specific voltage rating U_e.

1.4.3. Circuit-breaker coordination

The term coordination concerns the behaviour of two devices placed in series in electrical power distribution in the presence of a short-circuit.

Cascading or back-up protection

This consists of installing an upstream circuit-breaker D1 to help a downstream circuit-breaker D2 to break short-circuit currents greater than its ultimate breaking capacity I_{cu}D2. This value is marked I_{cu}D2+D1.

Standard IEC 60947-2 recognises cascading between two circuit-breakers. For critical points, where tripping curves overlap, cascading must be verified by tests.

Discrimination

This consists of providing coordination between the operating characteristics of circuit-breakers placed in series so that should a downstream fault occur, only the circuit-breaker placed immediately upstream of the fault will trip.

Standard IEC 60947-2 defines a current value I_s known as the discrimination limit such that:

- if the fault current is less than this value I_s, only the downstream circuit-breaker D2 trips
- if the fault current is greater than this value I_s, both circuit-breakers D1 and D2 trip.

Just as for cascading, discrimination must be verified by tests for critical points.

Discrimination and cascading can only be guaranteed by the manufacturer who will record his tests in tables.

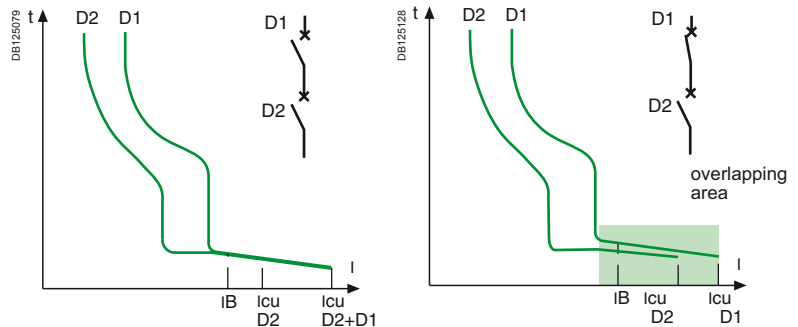



Glossary:

- I_{sc}(D1): Short-circuit current at the point where D1 is installed
- I_{cu}D1: Ultimate breaking capacity of D1.

The requirements of electrical power distribution

1.5. 1.5. Summarising table

	MSB Level A	Subdistribution switchboard Level B	Final distribution switchboard Level C
Switchboard data			
Nominal I	1000 to 6300 A	100 to 1000 A	1 to 100 A
Isc	50 kA to 150 kA	20 kA to 100 kA	3 kA to 10 kA
Thermal withstand Icw / EDW	***	*	*
Continuity of supply	***	***	**
Circuit-breaker type	High current power circuit-breaker or moulded case circuit-breaker	Moulded case circuit-breaker	Miniature circuit-breaker
	 PB104383A40	 PB104383A40	 PB104383A40
Standard IEC 60947-2	■	■	■ (1)
Trip unit			
Thermal magnetic electronic	■	□ (2)	■
Product data			
Standard In	800 to 6300 A	100 to 630 A	1 to 125 A
Icn	50 kA to 150 kA	25 kA to 150 kA	3 kA to 25 kA
Utilisation category	B	A	A
Limiting capacity	* (3)	***	***

■ recommended or compulsory

□ possible

*** important

** normal

* not very important

(1) For domestic use as per IEC 60898 standard.

(2) Possible up to 250 A.

(3) Le Sizing of the switchboard at level A means that this characteristic is not very important for standard applications.

The implementation techniques

2.1. Limitation

Limitation is a technique that allows the circuit-breaker to considerably reduce short-circuit currents.

The advantages of limitation are numerous:

- attenuation of the harmful effects of short-circuits
- electromagnetic
- thermal
- mechanical
- base of the cascading technique.

2.1.1. Principles

The assumed fault current I_{sc} is the short-circuit current I_{sc} that would flow, if there were no limitation, at the point of the installation where the circuit-breaker is placed.

Since the fault current is eliminated in less than one half-period, only the first peak current (asymmetrical peak I) need be considered. This is a function of the installation fault $\cos \varphi$.

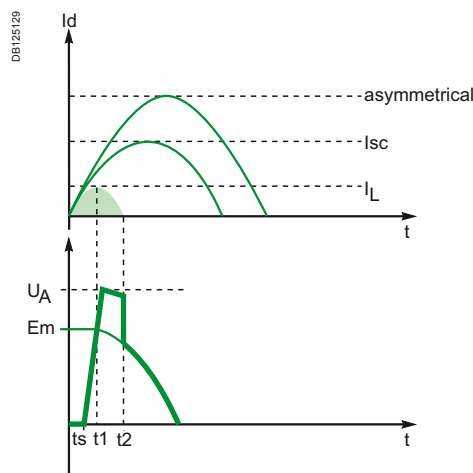

Reduction of this peak I to limited I_L characterises circuit-breaker limitation.

Limitation consists of creating a back-electromotive force opposing the growth of the short-circuit current.

The three decisive criteria guaranteeing the effectiveness of this limitation are:

- intervention time, i.e. the time t_s when the back-electromotive force (bemf) appears
- the rate at which bemf increases
- the value of bemf.

The back-electromotive force is the arc voltage U_a due to the resistance of the arc developing between the contacts on separation. Its speed of development depends on the contact separation speed.

As shown in the figure above, as from the time t_s when the contacts separate, the back less than the assumed fault current flow through when a short-circuit occurs.

2.1.2. Circuit breaker limitation capacity

The circuit breaker limitation capacity defines the way how it reduces the let through current in short-circuit conditions.

The thermal stress of the limited current is the area (shaded) defined by the curve of the square of the limited current $I_{sc}^2(t)$.

If there is no limitation, this stress would be the area, far larger, that would be defined by the curve of the square of the assumed current.

For an assumed short-circuit current I_{sc} , limitation of this current to 10% results in less than 1% of assumed thermal stress.

The cable temperature rise is directly proportional to the thermal stress ⁽¹⁾.

The implementation techniques

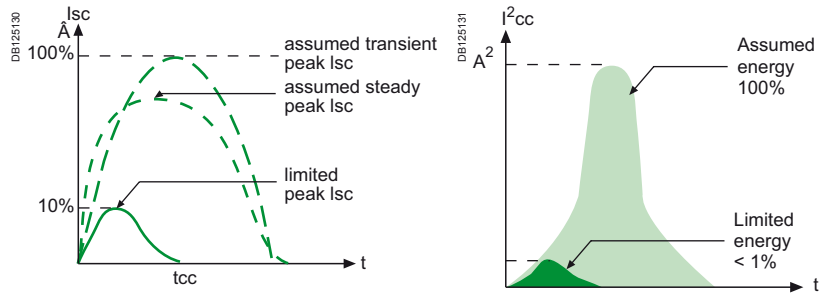

Current and thermal stress limitation.

(1) On a short-circuit, adiabatic temperature rise of conductors occurs (without heat exchange with the outside due to the speed of the energy supply). The increased temperature for a conductor with a cross-section S is:

$$\Delta\theta = \frac{K}{S^2} \int_0^T I^2 dt \text{ where } \int_0^T I^2 dt \text{ is called thermal stress (A}^2\text{s).}$$

2.1.3. Advantages

Application to electrical power distribution

Limitation considerably attenuates the harmful effects of short-circuits on the installation.

Harmful effects of short-circuits	Limitation effects
<ul style="list-style-type: none"> ■ electromagnetic 	Reduction of magnetic field, thus: <ul style="list-style-type: none"> □ less risk of disturbing neighbouring measurement instrument.
<ul style="list-style-type: none"> ■ mechanical 	Peak current limited, thus: <ul style="list-style-type: none"> □ reduced electromagnetic forces □ less risk of deformation or breakage at electrical contact level.
<ul style="list-style-type: none"> ■ thermal 	Limited thermal stress (reduction of amplitude and duration of current flow), thus: <ul style="list-style-type: none"> □ temperature rise of conductors less marked □ increased lifetime of busbar trunking.

Consequently, limitation contributes to the **durability** of electrical installations.

Applications to motors Functions

The following functions must be performed on a motor feeder:

- isolation
- control
- overload protection (specific)
- short-circuit protection
- additional protection.

A motor feeder can be made up of 1, 2, 3 or 4 different items of switchgear. Should a number of devices be associated - most common case - the various functions performed by the switchgear must be coordinated.

Coordination of motor feeder components. Thanks to limitation, the harmful effects of short-circuits on a motor feeder are greatly attenuated. Proper limitation of circuit-breakers ensures easy access to a type 2 coordination as per IEC 60947-4-1, without oversizing of components. This type of coordination guarantees users optimum use of their motor feeders.

Type 1 IEC 60947-4-1	Type 2 IEC 60947-4-1
No risk for the operator. Elements other than contactors and the relay must not be damaged. Isolation must be maintained after an incident..	No damage or malfunctioning is allowed. Isolation must be maintained after an incident and the motor feeder must be able to operate after a short-circuit. The risk of risque de contactor contact welding is accepted if contacts can be easily separated. Before restarting, a quick inspection is sufficient. Reduced maintenance and rapid resumption of operation.
Before restarting, the motor feeder must be repaired.	

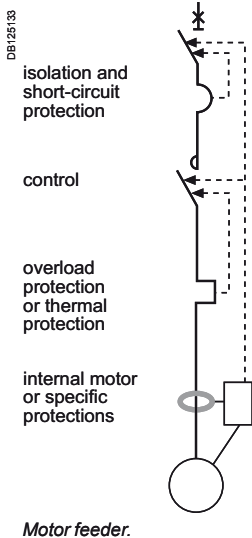

Motor feeder.

The implementation techniques

2.1.4. Limitation curves

A circuit-breaker's limiting capacity is expressed by limitation curves that give:

- **the limited peak current** as a function of the rms current of the assumed short-circuit current.

For example: on a 160 A feeder where the assumed Isc is 90 kA rms, the non-limited peak Isc is 200 kA (asymmetry factor of 2.2) and the limited Isc is 26 kA peak.

- **the limited thermal stress** (in A²s) as a function of the rms current of the assumed short-circuit current.

For example: on the previous feeder, the thermal stress moves from more than 100 10⁶ A²s to 6 10⁶ A²s.

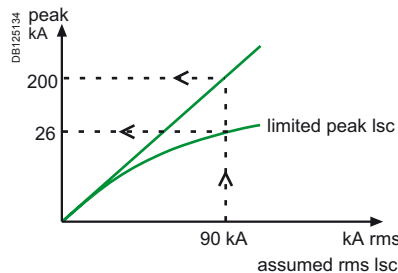

Current limitation curve.

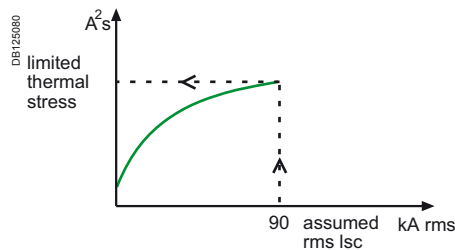

Thermal stress limitation curve.

2.2. Cascading

Cascading is used to:

- **make savings**
- **simplify choice of protection devices, by using circuit-breakers with standard performance.**

Cascading provides circuit-breakers placed downstream of a limiting circuit-breaker with an enhanced breaking capacity. The limiting circuit-breaker helps the circuit-breaker placed downstream by limiting high short-circuit currents. Cascading makes it possible to use a circuit-breaker with a breaking capacity lower than the short-circuit current calculated at its installation point.

2.2.1. Area of application

2.2.1.1. Cascading

- Concerns all devices installed downstream of this circuit-breaker.
- Can be extended to several consecutive devices, even if they are used in different switchboards.

The installation standards (IEC 60364 or local) stipulate that the upstream device must have an ultimate breaking capacity Icu greater than or equal to the assumed short-circuit current at the installation point.

For downstream circuit-breakers, the ultimate breaking capacity Icu to be considered is the ultimate breaking capacity enhanced by coordination.

2.2.1.2. Principles

As soon as the two circuit-breakers trip (as from point IB), an arc voltage UAD1 on separation of the contacts of D1 is added to voltage UAD2 and helps, by additional limitation, circuit-breaker D2 to open. The implementation techniques.

The implementation techniques

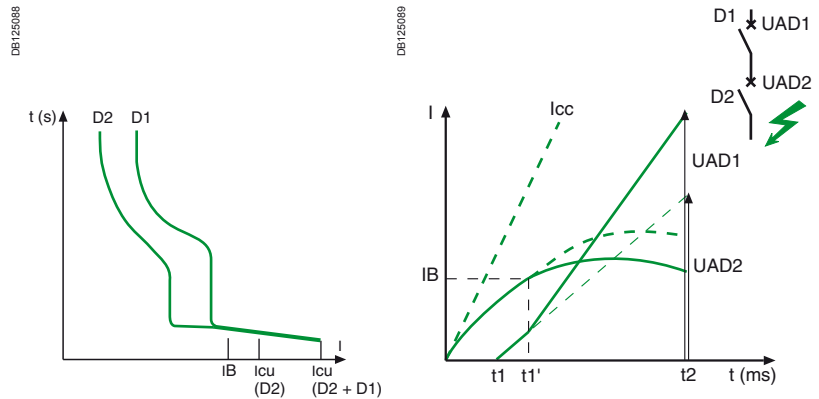

The association D1 + D2 allows an increase in performance of D2 as shown in figure 2:

- limitation curve D2
- enhanced limitation curve of D2 by D1
- Icu D2 enhanced by D1.

In actual fact, in compliance with the recommendations of IEC 60947-2, manufacturers give directly and guarantee Icu enhanced by the association of D1 + D2.

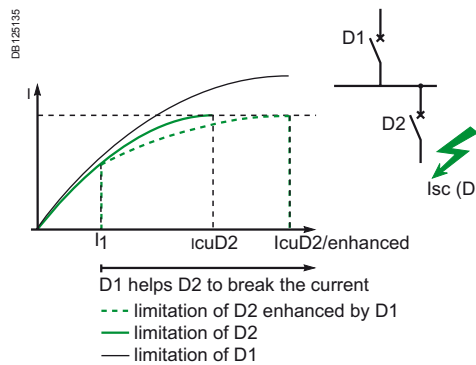

2.2.1.3. Advantages

Cascading allows benefit to be derived from all the advantages of limitation.

Thus, the effects of short-circuit currents are reduced, i.e.:

- electromagnetic effects
- electrodynamic effects
- thermal effects.

Installation of a single limiting circuit-breaker results in considerable simplifications and savings for the entire downstream installation:

- simplification of choice of devices by the cascading tables
- savings on downstream devices. Limitation enables circuit-breakers with standard performance to be used.

The implementation techniques

2.3. Discrimination

Discrimination of protection devices is a key factor in continuity of supply.

Discrimination is:

- partial
- or total,

according to the characteristics of the association of protection devices.

The discrimination techniques implemented are:

- current
- time
- logic.

Discrimination can be optimised by use of limiting downstream circuit-breakers.

2.3.1. General information

2.3.1.1. Principle

Reminder (see paragraph 1.4. "standard IEC 60947-2").

Discrimination consists of providing coordination between the operating characteristics of circuit-breakers placed in series such that should a downstream fault occur, only the circuit-breaker placed immediately upstream of the fault will trip.

A discrimination current I_s is defined such that:

- $I_{\text{fault}} > I_s$: both circuit-breakers tri
- $I_{\text{fault}} < I_s$: only D2 eliminates the fault.

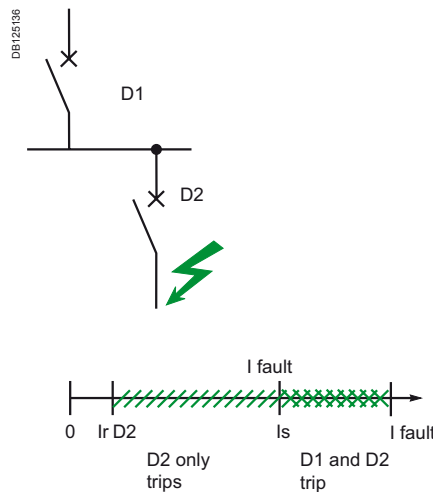

Discrimination quality

The value I_s must be compared with assumed $I_{sc}(D2)$ at point D2 of the installation.

- **Total discrimination:** $I_s > I_{sc}(D2)$; discrimination is qualified as total, i.e. whatever the value of the fault current, D2 only will eliminate it.
- **Partial discrimination:** $I_s < I_{sc}(D2)$; discrimination is qualified as partial, i.e. up to I_s , only D2 eliminates the fault. Beyond I_s , both D1 and D2 open.

Manufacturer's data

In actual fact, manufacturers give discrimination quality intrinsically, i.e.:

- total discrimination, if I_s is equal to $I_{cu}D1$ (the association will never be able to see a fault current greater than this value)
- partial discrimination, limited to I_s . This value I_s can nevertheless be greater than $I_{sc}(D2)$. Seen by the user, discrimination is then total.

Glossary

- $I_{sc}(D1)$: Short-circuit current at the point where D1 is installed
- $I_{cu}D1$: Ultimate breaking capacity of D1.

2.3.2. Technical discriminations

Current discrimination

This technique is directly linked to the staging of the Long Time (LT) tripping curves of two serial-connected circuit-breakers.

The implementation techniques

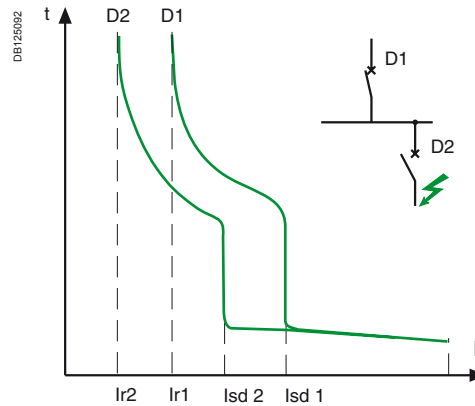

The discrimination limit I_s is:

- $I_s = I_{sd2}$ if the thresholds I_{sd1} and I_{sd2} are too close or merge,
- $I_s = I_{sd1}$ if the thresholds I_{sd1} and I_{sd2} are sufficiently far apart.

As a rule, current discrimination is achieved when:

- $I_{r1} / I_{r2} < 2$,
- $I_{sd1} / I_{sd2} > 2$.

The discrimination limit is:

- $I_s = I_{sd1}$.

Discrimination quality

Discrimination is total if $I_s > I_{sc}(D2)$, i.e. $I_{sd1} > I_{sc}(D2)$.

This normally implies:

- a relatively low level $I_{sc}(D2)$
- a large difference between the ratings of circuit-breakers D1 and D2.

Current discrimination is normally used in final distribution.

Time discrimination

This is the extension of current discrimination and is obtained by staging over time of the tripping curves. This technique consists of giving a time delay of t to the Short Time (ST) tripping of D1.

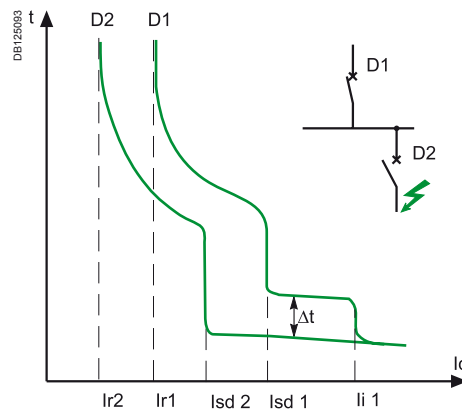

The thresholds (I_{r1} , I_{sd1}) of D1 and (I_{r2} , I_{sd2}) comply with the staging rules of current discrimination.

The discrimination limit I_s of the association is at least equal to I_{i1} , the instantaneous threshold of D1.

The implementation techniques

Discrimination quality

There are two possible applications:

■ on final and/or intermediate feeders

A category circuit-breakers can be used with time-delayed tripping of the upstream circuit-breaker. This allows extension of current discrimination up to the instantaneous threshold I_{i1} of the upstream circuit-breaker: $I_s = I_{i1}$.

If $I_{sc}(D2)$ is not too high - case of a final feeder - total discrimination can be obtained.

■ on the incomers and feeders of the MSB

At this level, as continuity of supply takes priority, the installation characteristics allow use of **B category circuit-breakers** designed for time-delayed tripping. These circuit-breakers have a high thermal withstand ($I_{cw} \geq 50\% I_{cn}$ for $t = 1s$): $I_s = I_{cw1}$.

Even for high $I_{sc}(D2)$, **time discrimination normally provides total discrimination: $I_{cw1} > I_{cc}(D2)$.**

Note: use of B category circuit-breakers means that the installation must withstand high electrodynamic and thermal stresses.

Consequently, these circuit-breakers have a high instantaneous threshold I_i that can be adjusted and disabled in order to protect the busbars if necessary.

Enhancement of current and time discrimination

■ Limiting downstream circuit-breakers.

Use of a limiting downstream circuit-breaker enables the discrimination limit to be pushed back.

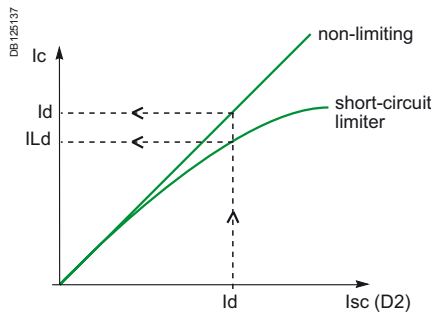

In fact, when referring to the figure, a fault current I_d will be seen by D1:

- equal to I_d for a non-limiting circuit-breaker,
- equal to $I_{Ld} \leq I_d$ for a limiting circuit-breaker.

The limit of current and time discrimination I_s of the association D1 + D2 is thus pushed back to a value that increases when the downstream circuit-breaker is rapid and limiting.

Discrimination quality

Use of a limiting circuit-breaker is extremely effective for achievement of total discrimination when threshold settings (current discrimination) and/or the instantaneous tripping threshold (time discrimination) of the upstream circuit-breaker D1 are too low with respect to the fault current I_d in D2 - $I_{sc}(D2)$.

Logic discrimination or "Zone Selective Interlocking (ZSI)"

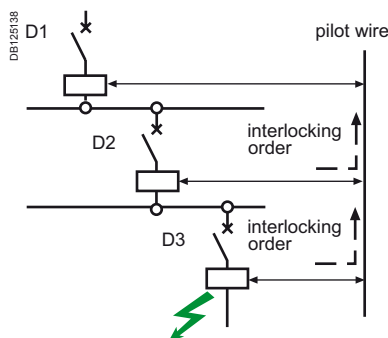

Logic discrimination.

The implementation techniques

This type of discrimination can be achieved with circuit-breakers equipped with specially designed electronic trip units (Compact, Masterpact): only the Short Time Protection (STP) and Ground Fault Protection (GFP) functions of the controlled devices are managed by Logic Discrimination. In particular, the Instantaneous Protection function - inherent protection function - is not concerned.

Settings of controlled circuit-breakers

- Time delay: there are no rules, but staging (if any) of the time delays of time discrimination must be applied ($\Delta tD1 \geq \Delta tD2 \geq \Delta tD3$)
- Thresholds: there are no threshold rules to be applied, but natural staging of the protection device ratings must be complied with ($IcrD1 \geq IcrD2 \geq IcrD3$).

Note: this technique ensures discrimination even with circuit-breakers of similar ratings.

Principles

Activation of the Logic Discrimination function is via transmission of information on the pilot wire:

- ZSI input:
 - low level (no downstream faults): the Protection function is on standby with a reduced time delay ($\leq 0,1$ s)
 - high level (presence of downstream faults): the relevant Protection function moves to the time delay status set on the device.
- ZSI output:
 - low level: the trip unit detects no faults and sends no orders
 - high level: the trip unit detects a fault and sends an order.

Operation

A pilot wire connects in cascading form the protection devices of an installation (see figure showing logic discrimination). When a fault occurs, each circuit-breaker upstream of the fault (detecting a fault) sends an order (high level output) and moves the upstream circuit-breaker to its natural time delay (high level input). The circuit-breaker placed just above the fault does not receive any orders (low level input) and thus trips almost instantaneously.

Discrimination quality

Recommended and extensively used in the USA, this technique enables:

- easy achievement as standard of discrimination on 3 levels or more,
- elimination of important stresses on the installation, relating to time-delayed tripping of the protection device, in event of a fault directly on the upstream busbars.

All the protection devices are thus virtually instantaneous, easy achievement of downstream discrimination with non-controlled circuit-breakers.

2.4. The discrimination rules

2.4.1. General discrimination rules

Overload protection

For any overcurrent value, discrimination is guaranteed on overload if the non-tripping time of the upstream circuit-breaker D1 is greater than the maximum breaking time of circuit-breaker D2.

The condition is fulfilled if the ratio of **Long Time (LT) and Short Time (ST)** settings is greater than **2**.

The discrimination limit I_s is at least equal to the setting threshold of the upstream Short Time (ST) time delay.

The implementation techniques

Short-circuit protection

■ Time discrimination

Tripping of the upstream device D1 is time delayed by Δt .

- The conditions required for current discrimination must be fulfilled.
- The time delay Δt of the upstream device D1 must be sufficient for the downstream device to be able to eliminate the fault.

Time discrimination increases the discrimination limit I_s up to the instantaneous tripping threshold of the upstream circuit-breaker D1.

Discrimination is always total if circuit-breaker D1:

- is of category B,
- has an I_{cw} characteristic equal to its I_{cu} .

Discrimination is total in the other cases if the instantaneous tripping threshold of the upstream circuit-breaker D1 is greater than the assumed I_{sc} in D2.

■ Logic discrimination

Discrimination is always total.

■ General case

There are no general discrimination rules.

- The time/current curves 'clearly' supply a value of I_{sc} (limited or assumed) less than the Short Time tripping of the upstream circuit-breaker; discrimination is then total.

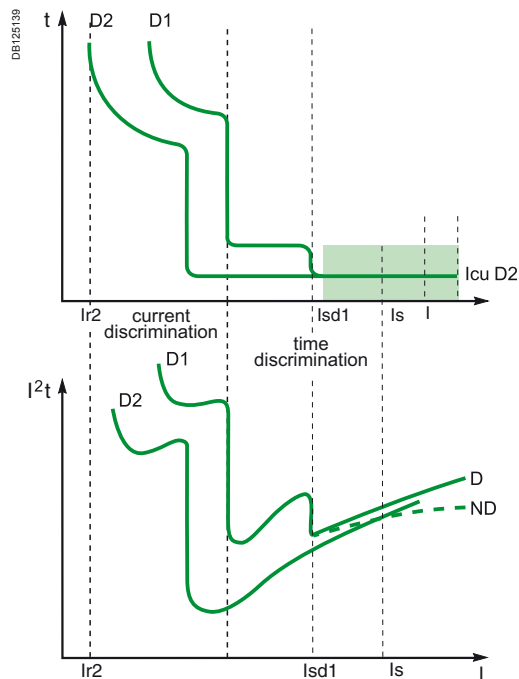

If this is not the case, only tests can indicate discrimination limits of coordination, in particular when circuit-breakers are of the limiting type. The discrimination limit I_s is determined by comparison of curves:

- in tripping energy for the downstream circuit-breaker,
- in non-tripping energy for the upstream circuit-breaker.

The potential intersection point of the curves gives the discrimination limit I_s .

The manufacturers indicate in tables the tested performance of coordination.

The implementation techniques

2.5. Earth leakage protection discrimination

According to the earthing system, discrimination only uses coordination of overcurrent protection devices. When the insulation fault is treated specifically by earth leakage protection devices (e.g. in the TT system), discrimination of the residual current devices (RCDs) with one another must also be guaranteed.

Discrimination of earth leakage protection devices must ensure that, should an insulation fault occur, only the feeder concerned by the fault is de-energised. The aim is to optimise energy availability.

There are two types of earth leakage protection discrimination.

2.5.1. Vertical discrimination

In view of requirements and operating standards, discrimination must simultaneously meet both the time and current conditions.

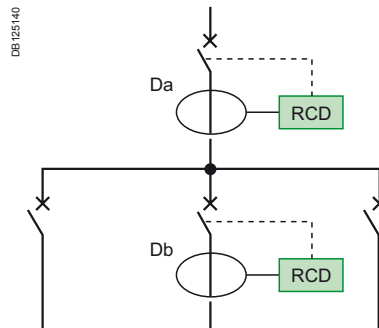

Vertical discrimination.

Current condition:

The RCD must trip between $I\Delta n$ and $I\Delta n/2$, $I\Delta n$ where I_n is the declared operating current. There must therefore exist a minimum ratio of 2 between the sensitivities of the upstream device and the downstream device. In practice, the standardised values indicate a ratio of 3.

Time condition:

The minimum non-tripping time of the upstream device must be greater than the maximum tripping time of the downstream device for all current values.

Note: the tripping time of RCDs must always be less than or equal to the time specified in the installation standards to guarantee protection of people against indirect contacts.

For the domestic area (M9), standards IEC 61008 (residual current circuit-breakers) and IEC 61009 (residual current devices) define operating times.

The values in the table correspond to curves G and S.

Curve G (General) correspond to non-delayed RCDs and S (Selective) to those that are voluntarily delayed.

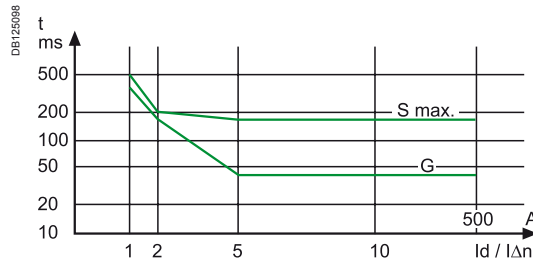

Operating time curves G and S.

The implementation techniques

Standardised values of operating time

Type	In A	I Δ n A	Standardised values of operating time and non-operating time (in seconds) at:				
			I Δ n	2I Δ n	5I Δ n	500 A	
General instantaneous	All valeurs	All valeurs	0.3	0.15	0.04	0.04	Maximum operating time
Selective	> 25	> 0.030	0.5	0.2	0.15	0.15	Maximum operating time
			0.13	0.06	0.05	0.04	Minimum non operating time

2.5.2. Horizontal discrimination

Sometimes known as **circuit selection**, it allows savings at the supply end of the installation of an RCD placed in the cubicle if all its feeders are protected by RCDs. Only the faulty feeder is de-energised, the devices placed on the other feeders do not see the fault.

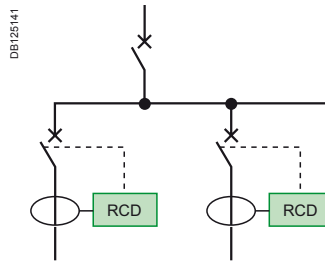

Horizontal discrimination.

2.6. Coordination of protection devices installation standards

Discrimination and cascading can only be guaranteed by the manufacturer who will record his tests in tables.

Installation standard IEC 60364 governs electrical installations of buildings. National standards, based on this IEC standard, recommend good coordination between the protection switchgear. They acknowledge the principles of cascading and discrimination of circuit-breakers based on product standard IEC 60947-2.

Product standards IEC 60947-2

In appendix A, standard IEC 60947-2 recognises and defines coordination between circuit-breakers (see paragraph 1.4 page 9). In particular, it defines the tests to be performed.

■ Discrimination.

This is normally studied on a theoretical level. For critical points where tripping curves overlap, it must be verified by tests. It is guaranteed by the manufacturer who will record the value of I_s (discrimination limit) in tables.

■ Cascading or coordination of the back-up protection device.

The standard indicates the measurements to be taken to verify this coordination.

□ Verification by comparison of characteristics.

In practical cases, this type of verification is sufficient. It must be clearly proved that the I_{cuD2} of the association is compatible with the maximum energy I^2t acceptable by D2.

□ Verification by tests.

Cascading is normally verified by tests for critical points. The tests are performed with an upstream circuit-breaker D1 with a maximum overcurrent setting and a downstream circuit-breaker D2 with a minimum setting. The test results (breaking capacities enhanced by cascading) are in a table and guaranteed by the manufacturer.

Installation standards

National installation standards specify the implementation of these principles as per the earthing system considered, in accordance with standard IEC 60364.

The implementation techniques

Discrimination

Discrimination is defined and established for all earthing systems used and types of fault (overload, short-circuit, insulation fault). However, in event of an insulation fault in the IT system, the advantage of continuity of supply is provided by the actual system that tolerates the 1st fault. This advantage must be maintained by a search and rapid elimination of this fault.

Cascading

On the other hand, cascading rules are given for a TN or TT type earthing system.

Basic rules in TT system:

Cascading rules cannot apply for an IT system due to the double insulation fault. The following rules must be implemented:

- the circuit-breaker must have a breaking capacity that is greater than or equal to the three-phase short-circuit current at the point considered
- in event of a assumed double fault, it is laid down that the double fault short-circuit current will be at most:
 - 15 % of three-phase I_{sc} for a three-phase I_{sc} ≤ 10 000 A
 - 25 % of three-phase I_{sc} for a three-phase I_{sc} > 10 000 A.

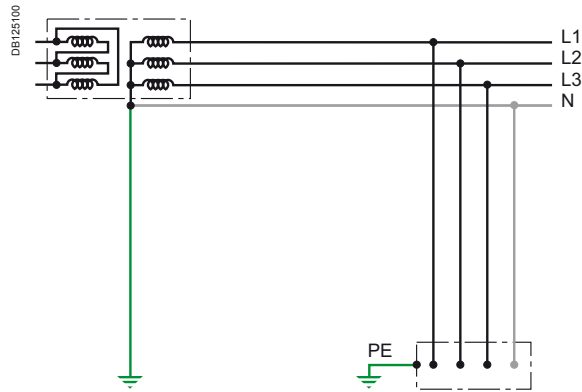

TT system.

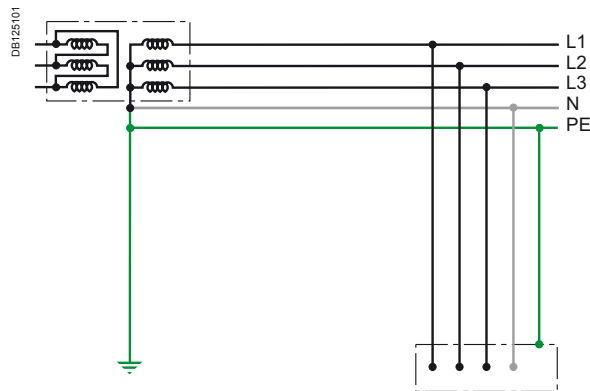

TN system.

The implementation techniques

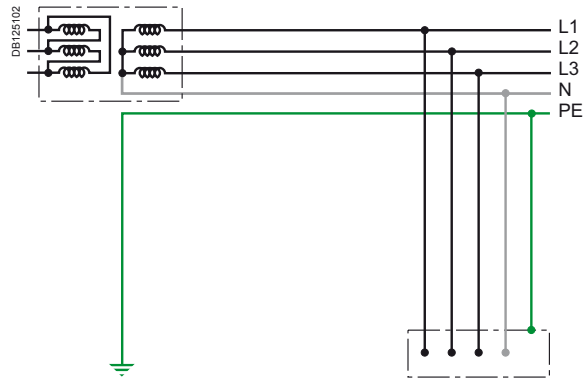

IT system.

Note: standard IEC 60364 defines 3 types of earthing systems. In short:

- **TT:** The neutral point of the LV transformer is earthed.
The equipment frames are connected to a separate earth.
 - **TN:** The neutral point of the LV transformer and the equipment frames are connected to the same earth.
 - **IT:** The neutral point of the LV transformer is unearthed.
The equipment frames are earthed.
- The earthing systems (and associated automatic breaking techniques) have been defined to guarantee protection of people against indirect contacts.

The Schneider Electric choice

The Merlin Gerin and Telemecanique circuit-breaker ranges cover all the requirements of LV electrical power distribution from 0.5 to 6300 A, i.e.:

- the Merlin Gerin 630 to 6300 A Masterpact NT and NW power circuit-breaker ranges
- the range of Compact moulded case circuit-breakers (MCCB):
 - Compact NS from 630 to 3200 A
 - Compact NSX from 100 to 630 A
- the 0.5 to 125 A Multi 9 NG125, C60, DPN miniature circuit-breaker ranges
- the Telemecanique Integral/GV2/GV7 motor protection circuit-breaker ranges.

These products meet product standards IEC 60947-2.

The Merlin Gerin and Telemecanique distribution and motor protection circuit-breaker ranges have been developed coherently. Their coordination has been tested as per IEC 60947-2 and is guaranteed by Schneider Electric. The complete tables giving coordination, cascading and discrimination of circuit-breakers are available.

3.1. For power circuit-breakers

The technologies of Schneider Electric's Masterpact ranges ideally meet the discrimination needs at the supply end of the installation as well as specific limitation requirements relating to certain applications.

3.1.1. The selective pole

3.1.1.1. The selective pole technology

Important discrimination requires enhancement of the switchgear's electrodynamic withstand, using the own current compensation effect.

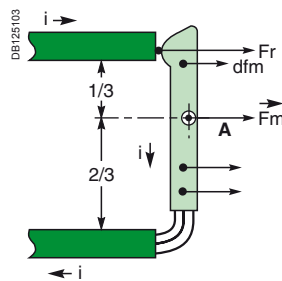

Contact pressure is proportional to I^2 in the loop.

Electromagnetic compensation.

This technology is used in all the Masterpact NT and NW except for performance L1 of the Masterpact NT that uses a limiting pole technology.

The 150 kA/415 V breaking capacity performance in the small volume of the Masterpact NT requires a different pole.

The limiting pole technology

A high limiting capacity is enabled by:

- a fixed pole with current loop and magnetic U
- one axis of the moving pole positioned at its end.

3.1.2. Technical innovations of new Masterpact for better performances

3.1.2.1. Masterpact NT and NW N1 and H1

This performance is ideal on the most common industrial and large tertiary sites ($I_{sc} < 65$ kA). It guarantees total discrimination with the downstream Compact NS circuit-breakers.

For this performance, breaking capacity is equal to thermal withstand $I_{cs} = I_{cw}$.

The Schneider Electric choice

This allows the switchgear to withstand the maximum short-circuit current throughout the short time delay.

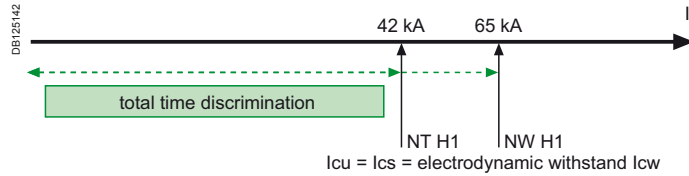

3.1.2.2. Masterpact NW H2

When the short-circuit level at the device installation point is greater than its thermal withstand, its breaking capacity must be greater than its thermal withstand $I_{cs} > I_{cw}$.

An internal protection is now required to prevent the switchgear being damaged. This is an instantaneous tripping device set in the factory to a threshold just below electrodynamic withstand (EDW).

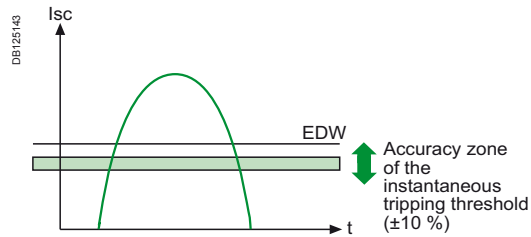

Accuracy zone of the instantaneous tripping threshold ($\pm 10\%$).

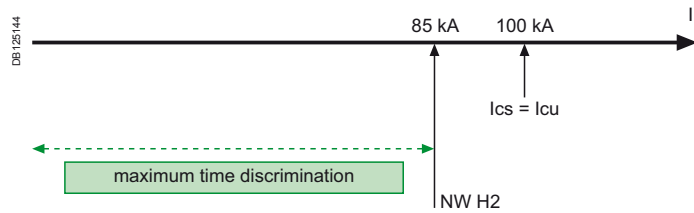

I_{cw} = thermal withstand = self-protection DIN threshold

Limited time discrimination.

Widespread use of air current transformers enables, thanks to more accurate measurement (no saturation) the thermal withstand threshold to be approached, thus markedly enhancing the discrimination level by delaying instantaneous tripping.

For large industrial sites ($I_{sc} < 100$ kA), this performance guarantees total discrimination with the downstream Compact NS.

3.1.2.3. Masterpact NW H3

Just as for the Masterpact H2, the level of performance $I_{cs} > I_{cw}$ also requires calibration of instantaneous tripping.

In order to break an assumed fault current of 150 kA, very early action is required. It is impossible to wait for passage of the first fault current wave as the device's thermal withstand is far lower.

The technology of the electronic measurement channel associated with the mechanical action of the tripping coil does not allow a sufficiently fast reaction. The technology used in Masterpact NW circuit-breakers has been patented.

When a high short-circuit current appears, it creates an electromagnetic force that pushes the pole and moves it apart. The pole movement activates a catch by means of a kinematic chain. The movement of this catch directly releases the pole shaft before intervention of the electronic measurement chain.

The Schneider Electric choice

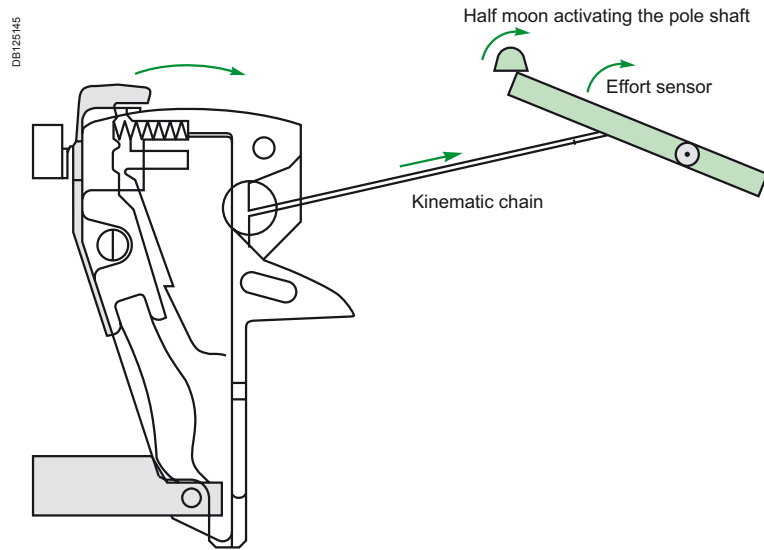

This tripping by mechanical system occurs at the same time as the electronic measurement chain that will confirm circuit-breaker opening and indicate the front face fault.

This system allows:

- a high thermal withstand to be maintained: $I_{cw} = 65 \text{ kA } 1\text{s}$
- beyond I_{cw} , an ultra fast tripping guaranteeing an I_{cu} up to 150 kA.

This performance is ideal for multisource installations with a high short-circuit current ($> 100 \text{ kA}$) on the main busbar and for which continuity of supply is essential.

Discrimination with the downstream Compact NS is total as standard.

3.1.2.4. Masterpact NW and NT L1

The Masterpact NW L1 combines all performances:

- a breaking capacity up to 200 kA/400 V for the UL range
- a thermal withstand of 37 kA/400 V
- an important limiting capacity (NW L1 assumed $I_{sc} = 390 \text{ kA}$ to 380/415 V, limited $I_{sc} = 170 \text{ kA}$).

It therefore uses the technologies described above:

- selective pole like the other switchgear in order to reach a thermal withstand of 30 kA/400 V
- automatic unlatching of the circuit breaker operating mechanism to produce ultra fast tripping.

To obtain a high limiting capacity, the fixed pole has been modified. This modification has been patented.

Limiting capacity depends on the arc voltage created between the fixed pole and the moving pole on opening. It must be established early on and quickly increase to a high value.

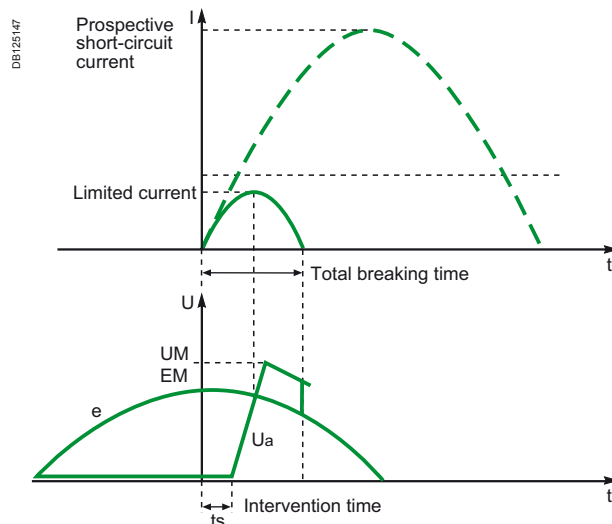

The Schneider Electric choice

For this purpose, repulsion force must be increased and arc projection encouraged in the arc chute.

- Use of a U-shaped current loop to increase the repulsion force.
- Use of a magnetic U around the fixed pole to concentrate field lines and project the arc in the arc chute, early on, quickly and high.

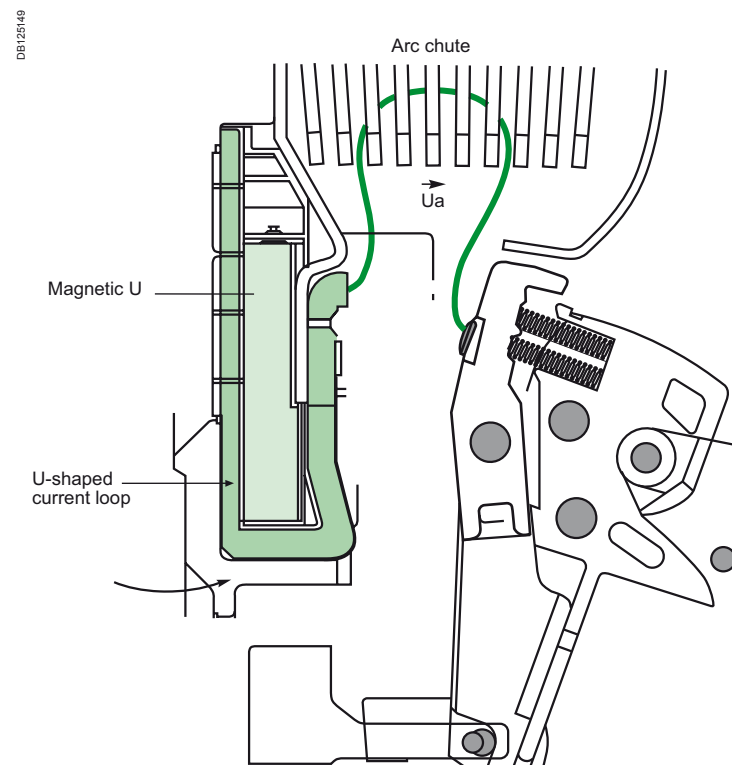
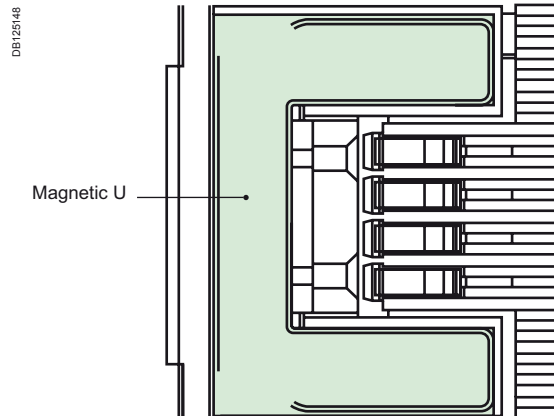

On a high short-circuit, the poles open very slightly and the magnetic U then projects the arc in the arc chutes. The fault current is diverted. The automatic unlatching of the circuit breaker operating mechanism then quickly opens the circuit-breaker.

This performance meets the limitation needs of fault currents while at the same time guaranteeing an unmatched level of discrimination of 37 kA for this circuit-breaker type.

The Masterpact NT L1 uses a limiting pole that guarantees quick opening on a high short-circuit current.

Its limiting capacity is very great for this circuit-breaker type.
NT L1 prospective $I_{sc} = 390$ kA and limited $I_{sc} = 75$ kA.

The Schneider Electric choice

To enhance breaking performance and obtain a high short-circuit current limitation on devices theoretically not very limiting, a trip unit is used, not based on the instantaneous value of the current but on a drift whose peculiarity is not to trip on the first fault current half wave. When a short-circuit current appears, the downstream circuit-breaker opens as soon as the fault current is greater than its tripping threshold and eliminates the fault in less than one half-wave. The upstream Masterpact NT L1 does not trip but its contacts are repulsed, thus limiting stresses on the circuit.

3.2. For moulded case circuit-breakers (MCCB)

The Merlin Gerin and Telemecanique moulded case circuit-breaker (MCCB) ranges are designed to provide users with maximum energy availability. The MCCB:

- give an optimum response to discrimination problems
- are very limiting, even on high short-circuits, in order to drastically reduce stresses on intermediate distribution.

The 100 to 630 A Compact NSX range is mainly used:

- to protect intermediate distribution
- to protect lines supplying large loads.

This range implements an innovating technique: **roto-active breaking**.

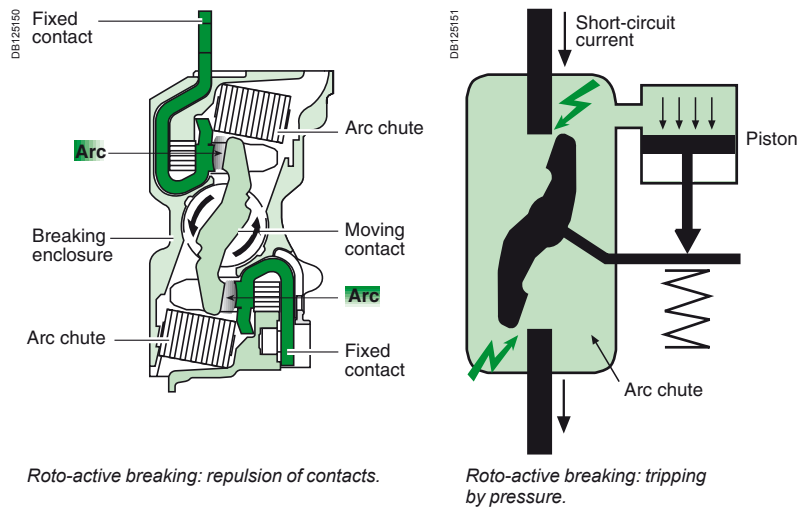

Roto-active breaking: repulsion of contacts.

Roto-active breaking: tripping by pressure.

This high current limiting technique uses a new tripping energy, **pressure**, resulting from **arc energy**.

Its operation is described below.

- Each circuit-breaker pole has an enclosure in which a rotating contact generates, by electromagnetic repulsion, two serial arcs on occurrence of the short-circuit current.
- A piston and spring device uses the pressure from arc energy to cause - beyond a certain threshold (roughly 25 In) - a reflex tripping, roughly 3 ms after contact repulsion.
- Up to this threshold, pressure is not sufficient to cause tripping and arc impedance limits the short-circuit current.
- Beyond this threshold, breaking is very quick (1 ms) and limits still further the short-circuit current.

The enclosure parts are sized to match circuit-breaker size.

Consequently, limitation is greatest when rating is smallest.

This technique provides Compact NSX **with an outstanding limiting capacity** and thus with increased **discrimination** possibilities.

This technique is also very useful for limiting stresses on electrical power distribution.

The Schneider Electric choice

3.2.1. Trip units

The Compact NSX are equipped with a thermal magnetic or electronic type trip unit. Setting of the Long Time (LT) thresholds ensures current discrimination. Short Time (ST) protection has as standard a mini time delay of 5 to 7 ms according to sizes allowing time discrimination for short-circuits of average value beyond the Short Time (ST) tripping threshold of the upstream circuit-breaker D1.

3.3. For miniature circuit-breakers MCB

The Merlin Gerin Multi 9 Miniature circuit-breaker ranges have the necessary performance and characteristics to meet final distribution requirements:

- a nominal rating of 0.5 to 125 A
- a breaking capacity of up to 50 kA as per IEC 60947-2
- tripping curves B, C, D and MA
- simple, safe installation system on DIN rail
- Vigi module can easily be clipped onto the protection devices.

The Multi 9 **circuit-breakers** are designed according to magnetic actuator principles, thus allowing very quick development of arc voltage.

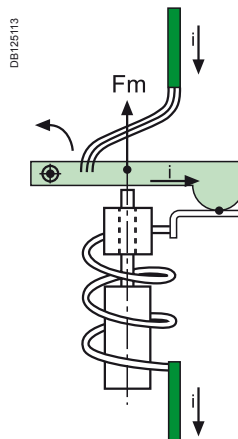

3.4. The discrimination rules from 1 to 6300 A

The **Masterpact N and H circuit-breakers** provide **total discrimination** with **all** the downstream circuit-breakers if the 4 following conditions are met:

- the ratio between Long Time settings of the 2 devices is 1.6
- the ratio between Short Time settings is 1.5
- the intentional time delay settings are compatible
- setting of the instantaneous threshold, if any, must be on OFF.

3.4.1. General discrimination rules (in distribution)

3.4.1.1. Overload protection

- Upstream and downstream circuit-breakers equipped with a thermal magnetic trip unit.

The current discrimination of Merlin Gerin and Telemecanique circuit-breakers is provided if the ratio of the **tripping thresholds**:

- thermal is greater than **1.6**
- **magnetic** is greater than **2**.

- Upstream circuit-breaker equipped with an electronic trip unit and downstream circuit-breaker equipped with a thermal magnetic trip unit.

Current discrimination of the Merlin Gerin and Telemecanique circuit-breakers is provided if the ratio of the **tripping thresholds**:

- **Long Time (LT) and thermal** is greater than **1.6⁽¹⁾ to 2,5**
- **Short Time (ST) and magnetic** is greater than **1.5**.
- upstream and downstream circuit-breakers equipped with an electronic trip unit.

The Schneider Electric choice

Current discrimination of the Merlin Gerin and Telemecanique circuit-breakers is provided if the ratio of the **tripping thresholds**:

- **Long Time (LT)** is greater than **1.2⁽¹⁾ to 1.6**
- **Short Time (ST)** is greater than **1.5**.

(1) Upstream trip unit equipped with a time-delayable LT threshold.

3.4.1.2. Short-circuit protection

■ Time discrimination.

Time discrimination of Merlin Gerin and Telemecanique circuit-breakers is provided as soon as there is a difference of one time delay band between the upstream and the downstream device.

■ Logic discrimination.

Discrimination is always total.

3.4.2. Discrimination rules for Masterpact NT and NW

3.4.2.1. Masterpact NT and NW of the H1 and N1 type

Time discrimination is always total with a Masterpact N1 or H1 upstream ($I_{cw} = I_{cu}$) regardless of the circuit-breaker placed downstream.

3.4.2.2. Masterpact NW of the H2 and H3 type

Time discrimination is provided up to the thermal withstand threshold, i.e.:

- 85 kA for a Masterpact NW H2
- 65 kA for a Masterpact NW H3.

At the MSB:

- discrimination is without doubt not total (figure 1) between an incomer D1 and a feeder D2.

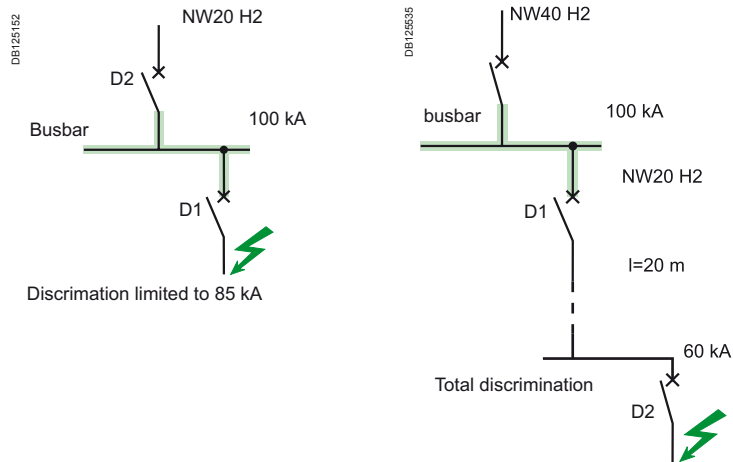

3.4.3. "Natural" discrimination rules between Compact NSX

3.4.3.1. Discrimination between distribution circuit-breakers

With Compact NSX, simple discrimination rules can be drawn up due to the new implementation techniques.

3.4.3.2. Overload protection: current discrimination

As in the general case, current discrimination between Compact NSX is provided if the ratio of the tripping thresholds:

- **Long Time (LT)** is greater than **1.2 to 2.5**
- **Short Time (ST)** is greater than **1.5 to 2**,

according to the types of trip units equipping the devices.

3.4.3.3. Low value short-circuit protection: time discrimination

Tripping of the upstream device D1 is slightly time delayed up to reflex tripping. Consequently, as the downstream circuit-breaker is of a lower rating - current size - it will be far quicker and will break in a time less than the time delay of the upstream circuit-breaker.

This discrimination, of the time type, is applicable up to reflex tripping of the upstream device (roughly $25 I_n$).

The protection between Compact NSX is selective if the ratio between the **physical sizes (ratings)** of the circuit-breakers is greater than **2**.

The Schneider Electric choice

3.4.3.4. High value short-circuit protection: energy discrimination

The breaking technique developed in Compact NSX - outstanding limitation and reflex tripping - allows natural staging of D2 tripping and D1 non-tripping energy curves.

3.4.3.5. Principle

When a very high short-circuit is detected by circuit-breakers D1 and D2, the device contacts open slightly at the same time, thus limiting current.

- The arc energy, high at D2, causes it to trip (T curve of D2).
- The arc energy, limited at D1, is not sufficient for it to trip (NT curve of D1).

As a result, as the downstream circuit-breaker is of a lower rating - current size - it will be more limiting. It will break with a current limitation such that the fault energy is markedly less than the tripping threshold of the upstream circuit-breaker.

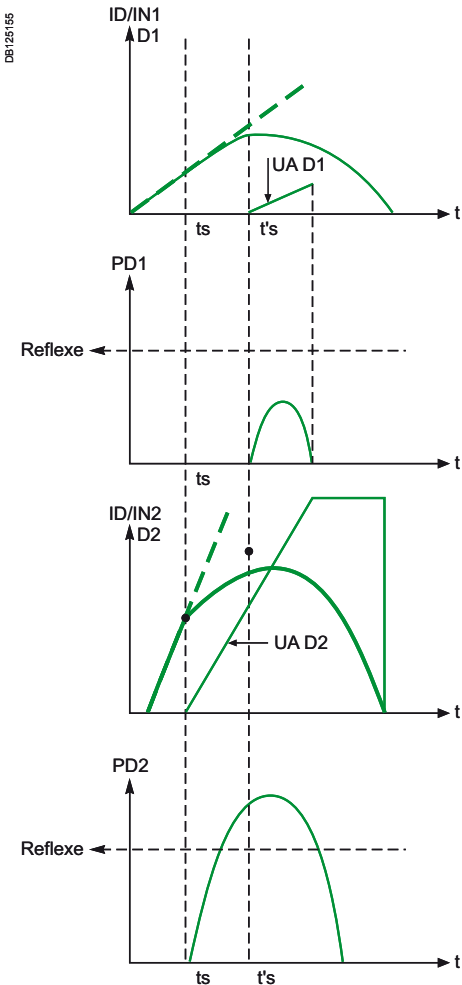

Discrimination enhanced by cascading: principle.

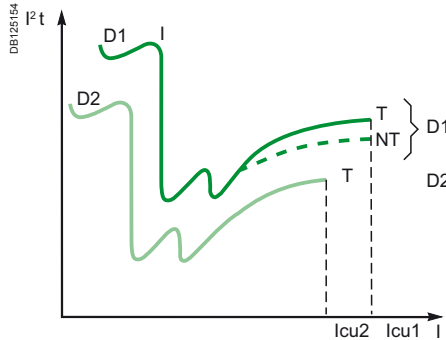
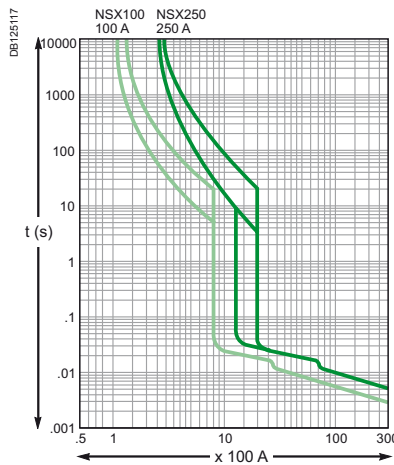

Tripping curves of a Compact NSX100 and 250 and discrimination types.

This technique allows rules for discrimination between devices to be standardised. Protection between Compact NSX is selective if the ratio between **physical sizes (ratings)** of the circuit-breakers is greater than 2.

In the extension of current and time discrimination, this discrimination is known as **"energy discrimination"**.

3.4.4 Discrimination enhanced by cascading with Compact NSX

With traditional circuit-breakers, when cascading is implemented between two devices, discrimination is obtained by tripping of the upstream circuit-breaker D1 to help downstream circuit-breaker D2 to break the current. The discrimination limit has a value I_s at most equal to the breaking capacity I_{cuD2} of the downstream circuit-breaker.

In the case of Compact NSX type circuit-breakers, the breaking technique implemented on high short-circuit currents increases the discrimination limit.

- The Compact NSX downstream D2 sees a very high short-circuit current. Reflex tripping causes it to trip very quickly (< 1 ms) with a very great limitation of the fault current.

The Schneider Electric choice

- The Compact NSX upstream D1 sees a very limited fault current. This current generates repulsion of the contacts/CR curve, resulting in an arc voltage limiting still further the short-circuit current. However arc pressure is not sufficient to cause reflex tripping. Thus the Compact NSX D1 helps the Compact NSX D2 to break the current without tripping. The discrimination limit I_s can exceed the breaking capacity I_{cu2} of the downstream circuit-breaker and reach the breaking capacity enhanced by cascading.

Discrimination then becomes total with an optimised device cost.

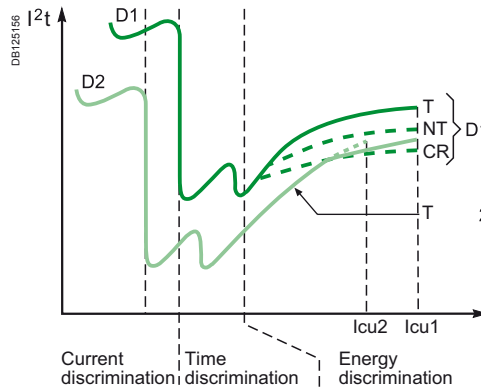

Discrimination enhanced by cascading: curves.

Advantage of total discrimination as standard with Compact NSX

The immediate advantage is making total discrimination with Compact NSX natural as soon as:

- staging of the LT and ST settings is greater than or equal to 1.6
- staging of the nominal device ratings is greater than or equal to 2.5.

The figure above illustrates the three types of discrimination.

3.4.5. Specific applications

3.4.5.1. Comparison with fuses

This rule can be compared with that used for fuse combinations when the ratio of the current ratings must be greater than 1.6.

However, compared with fuse combinations:

- distribution circuit-breaker
- the **enhanced** discrimination tables, depending on test results, often make it possible to come down to comparable ratios
- the possibility of obtaining discrimination and cascading with downstream circuit-breakers (enhanced discrimination)
- motor protection circuit-breaker
- motor protection circuit-breakers are ideally sized for the motor rating, whereas the fuse must be oversized with respect to motor nominal rating.

The combination benefits from all the possibilities offered by the additional integrated functions relating to circuit-breakers. The discrimination ratio is then equivalent.

In this sense, the Compact NSX combine the following:

- qualities of fuses with respect to high short-circuits
- qualities naturally greater for treating overload faults and low value short-circuits, discrimination rules
- advantages relating to functional wealth and the communication potential of circuit-breakers.

3.4.5.2. Discrimination between a distribution circuit-breaker and a protection circuit-breaker

The qualities of the Compact NSX enable them to be used in motor protection.

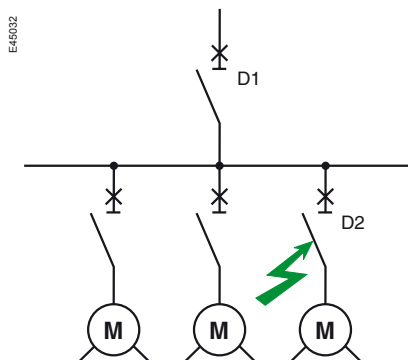

Discrimination of circuit-breakers in motor protection.

3.4.6. Summary

The following table summarises the conditions to be met to obtain total discrimination.

D1	Application	D2	Ratio between nominal device rating	Ratio between upstream and downstream settings	
				Thermal protection	Magnetic protection
TM	Distribution	TM or Multi 9	≥ 2.5	≥ 1.6	≥ 2
		Micrologic	≥ 2.5	≥ 1.6	≥ 1.5
	Motor	MA + separate thermal relay		≥ 3	≥ 2
		motor thermal magnetic		≥ 3	≥ 2
Micrologic	Distribution	TM or Multi 9	≥ 2.5	≥ 1.6	≥ 1.5
		Micrologic	≥ 2.5	≥ 1.2	≥ 1.5
	Motor	MA + separate thermal relay		≥ 3	≥ 1.5
		motor thermal-magnetic		≥ 3	≥ 1.5
		Micrologic		≥ 1.3	≥ 1.5

Implementation of discrimination and cascading

4.1. Discrimination tables

The tables in the "Technical additions" part show the discrimination possibilities of the Merlin Gerin circuit-breakers with one another.

Depending on whether or not there is cascading, the results come from a comparison of characteristics or tests.

4.1.1.1. Conditions of use

Conditions of use are specified: circuit-breakers can be used in distribution or motor protection.

4.1.1.2. Reading the tables

The shaded boxes and boxes containing a "T" correspond to total discrimination between the relevant upstream and downstream circuit-breakers, in the conditions of use specified in the "Technical additions" part.

For the other boxes, discrimination is either partial (indicated discrimination limit) or there is no discrimination (boxes with no value mentioned).

4.1.1.3. Tables of discrimination enhanced by cascading with Compact NSX

With Compact NSX type circuit-breakers, the cascading implemented between two devices increases the discrimination limit.

This can consequently reach the breaking capacity enhanced by cascading and discrimination then becomes total.

This is expressed in "enhanced" discrimination tables with these circuit-breakers presented in the "Technical additions" part.

4.2. Cascading tables

The tables in the "Technical additions" part give, in 220/240 V and 400/415 V phase-to-phase distribution and then in motor protection, the cascading possibilities according to IEC 60947-2 between circuit-breakers:

- Multi 9 with Multi 9

- Compact NS, Compact, Masterpact with Multi 9 and with one another.

For circuit-breakers used in single-phase on a TN system, the 220/240 V table is used.

Note: the cascading tables are given for an earthing system of the TN or TT type. They do not apply to the IT systems.

4.2.1.1. Case of several parallel-connected transformers

In this case, specific tables must be used which give the types of circuit-breaker to be installed on the source feeders and on the main feeders in the case of 2 or 3 parallel-connected transformers.

They are drawn up with the following assumptions:

- short-circuit power of the upstream network of 500 MVA

- coupled transformers are identical (20 kV/410 V) and have a standard short-circuit voltage

- the short-circuit current on the busbar does not allow for link impedances (most unfavourable case)

- **the conditions for parallel-connecting of transformers are met**, i.e. the transformers have:

- the same U_{sc}

- the same ratio

- a ratio of powers ≤ 2 .

Isc is given for information, it may vary according to the U_{sc} as a % given by the transformer manufacturers. The values of the breaking capacities enhanced by cascading are thus given for higher values

Implementation of discrimination and cascading

4.3. Study of MV/LV discrimination from 1 to 6300 A

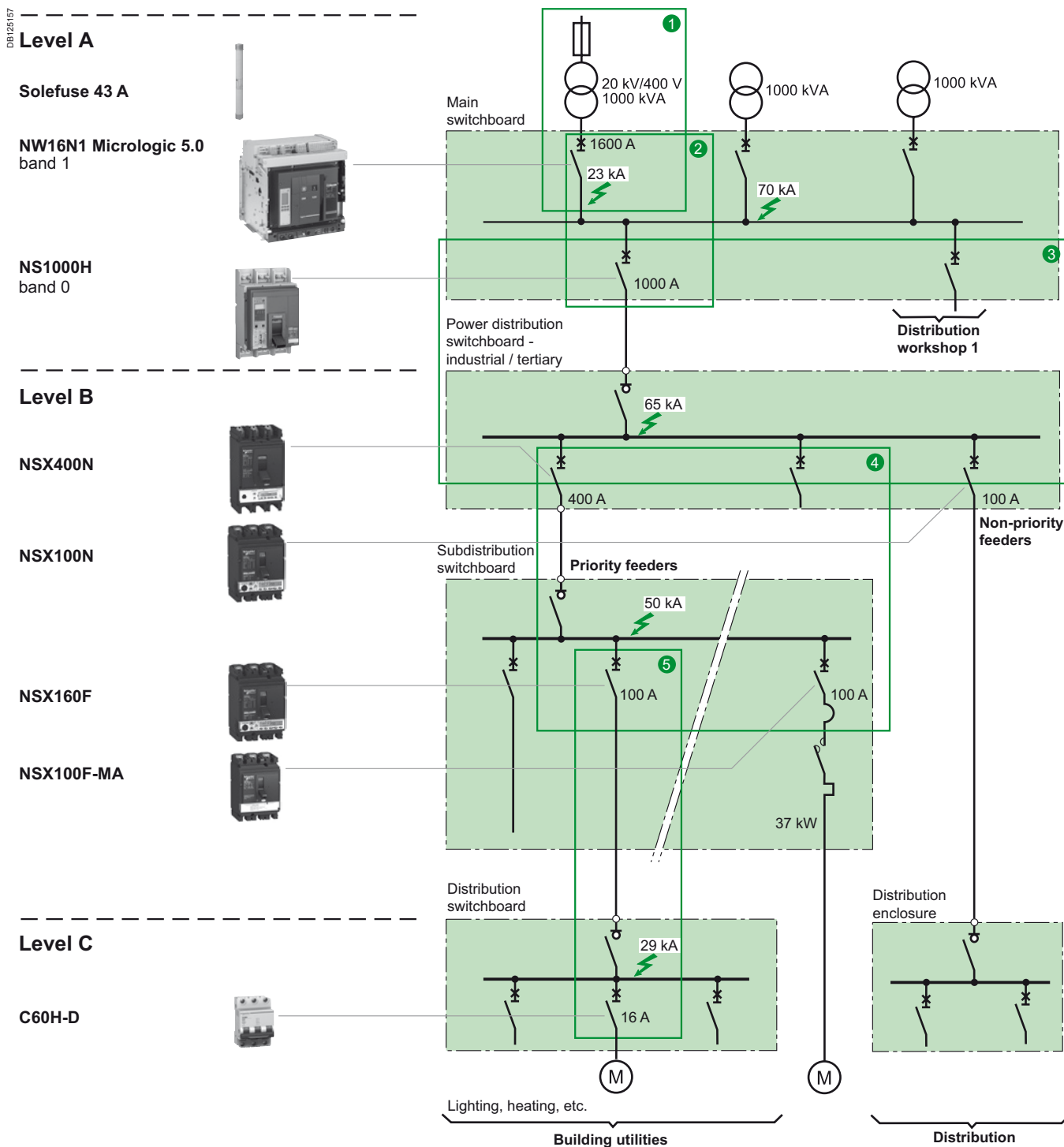

Simplified diagram of a standard installation covering most of the cases observed in practice.

The figure shows the implementation of the coordination of the various protection devices in a HV/LV distribution.

Implementation of discrimination and cascading

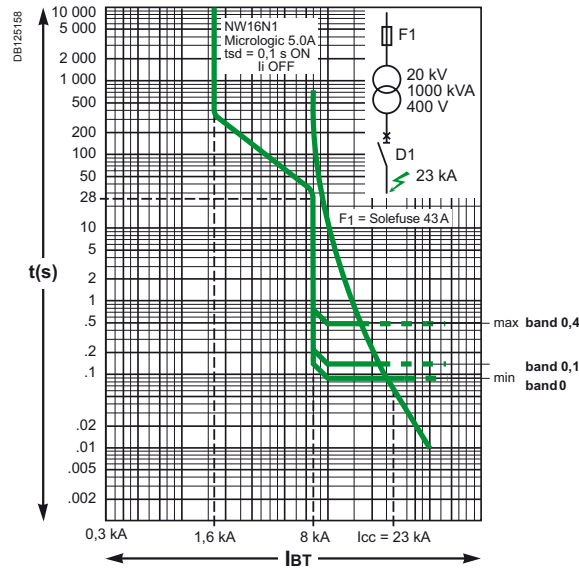

NW16N1/Solefuse discrimination, current brought to the secondary.

4.3.1. At the MSB

4.3.1.1. Discrimination with the HV part ①

The 2 protection devices are in "series". Consequently, the advantages of continuity of supply linked to discrimination between protection devices do not appear interesting. Nevertheless, the main advantage of HV/LV discrimination is that resumption of operation is less restrictive in LV (accessibility, padlocking). Comparison of the tripping curves brought to the secondary of the HV/LV transformer shows that discrimination between the Masterpact NW16 and the SOLEFUSE 43 A fuse is:

- **total**: if the Masterpact has a tripping without intentional time delay,
- **almost total**: if the Masterpact NW has a tripping with intentional time delay at band 0,1 (Micrologic 5.0 A adjustable: time delay from 0.1 ON to 0.4 ON), at worst the discrimination limit is at 20 kA ⁽¹⁾.

⁽¹⁾ The parallel-connection of 3 transformers creates an I_{sc} on the common BB of 70 kA, but each source transformer only sees an I_{sc} of 20 kA.

Note: discrimination is total with an upstream HV circuit-breaker.

4.3.1.2. Discrimination with the downstream LV part ②

According to the rule laid down on page 30, the Masterpact NW16N1 circuit-breaker at band 0.1 is completely selective with all the downstream circuit-breakers:

- if they have an intentional time delay one band lower. In this case, they must not have an intentional time delay (band 0)
- if the ratio of ratings is γ 1.2, see page 32.

Consequently, the Masterpact NW16N1 is totally selective with the downstream NS1000A.

4.3.2. Cascading

There is no cascading between the NW16N1 and NS1000A circuit-breakers Schneider Electric provides a software **Ecodial** to assist with defining circuit-breakers.

This software optimises the choice of circuit-breakers, their coordination and their settings according to the installation type.

Implementation of discrimination and cascading

4.3.3. At the power distribution switchboard ③

The use of the "enhanced discrimination by cascading" technique enables.

- N type (standard) Compact NSX to be installed downstream thanks to cascading between the NS1000H and the NSX400N/NSX100N that enhances the breaking capacity of downstream Compact NSX.
- Total discrimination - i.e. discrimination up to the prospective I_{sc} level - to be reached thanks to the enhanced up to the upstream circuit-breaker breaking capacity discrimination.

At installation level (figure on page 35), the Compact NSX100N supplies non-priority feeders. Consequently, partial discrimination with implementation of an optimised protection solution, could be tolerated. On the other hand, the NSX400N supplies loads requiring a high electrical power availability: total discrimination for the user, is compulsory required for the user. This one is intended as standard using Compact NSX range.

4.3.4. At the subdistribution switchboard ④

Downstream of the NSX400N circuit-breaker, coordination with the NSX160N circuit-breaker is provided the same thanks to enhanced discrimination by cascading:

- with enhancement of breaking capacity of the NSX160N (up to 50 kA)
- enhancement of discrimination (up to the enhanced breaking capacity of NSX160N, i.e. 50 kA).

Discrimination is total.

Note: the discrimination rule between Compact NSX, on page 31, applies to this coordination.

4.3.4.1. Motor protection circuit-breaker

Coordination with upstream distribution

The motor power (45 kW) requires at 400 V a protection by an Compact NSX100F MA circuit-breaker. Coordination performance is identical to that established for distribution protection, i.e.:

- enhancement of breaking capacity of the Compact NSX100F -MA
- with enhancement of discrimination (up to the enhanced breaking capacity of Compact NSX100F -MA, i.e. 50 kA).

Note: protection by fuse in this case would be with an aM whose characteristics are similar to those of a 160 A fuse. The circuit-breaker/circuit-breaker or fuse/fuse discrimination ratio is the same in this case.

Coordination at motor feeder level

The limiting qualities of the Compact NSX100N circuit-breaker results in a type 2 coordination with standard components: Telemecanique contactors and thermal protection relay.

This coordination is guaranteed by Schneider Electric.

Note: protection by fuse results in oversizing of the motor feeder components to obtain a type 2 coordination.

4.3.5. At the final distribution switchboard ⑤

Despite the I_{sc} level, at this point of the installation, coordination performance between the Compact NSX and M9 ranges ensures total discrimination even using a C60H-D or -MA.

Total discrimination of this installation was provided between:

- HV and LV
- on 5 stages of LV distribution.

Notes

Notes

Notes

Schneider Electric Industries SAS

35, rue Joseph Monier
CS 30323
F- 92506 Rueil Malmaison Cedex

RCS Nanterre 954 503 439
Capital social 896 313 776 €
www.schneider-electric.com

As standards, specifications and designs change from time to time, please ask for confirmation of the information given in this publication.



This document has been printed on ecological paper.

Design: Schneider Electric
Photos: Schneider Electric
Printed: