

**Logic analyzers and data meet** in the digital world as designers think more and more in terms of ONEs, ZEROS and logic levels. The analyzer can do what the

analog scope can't: sample and display many inputs at once. It can recognize a preset word or even look back in time. Learn about analyzers. Turn to p. 16.

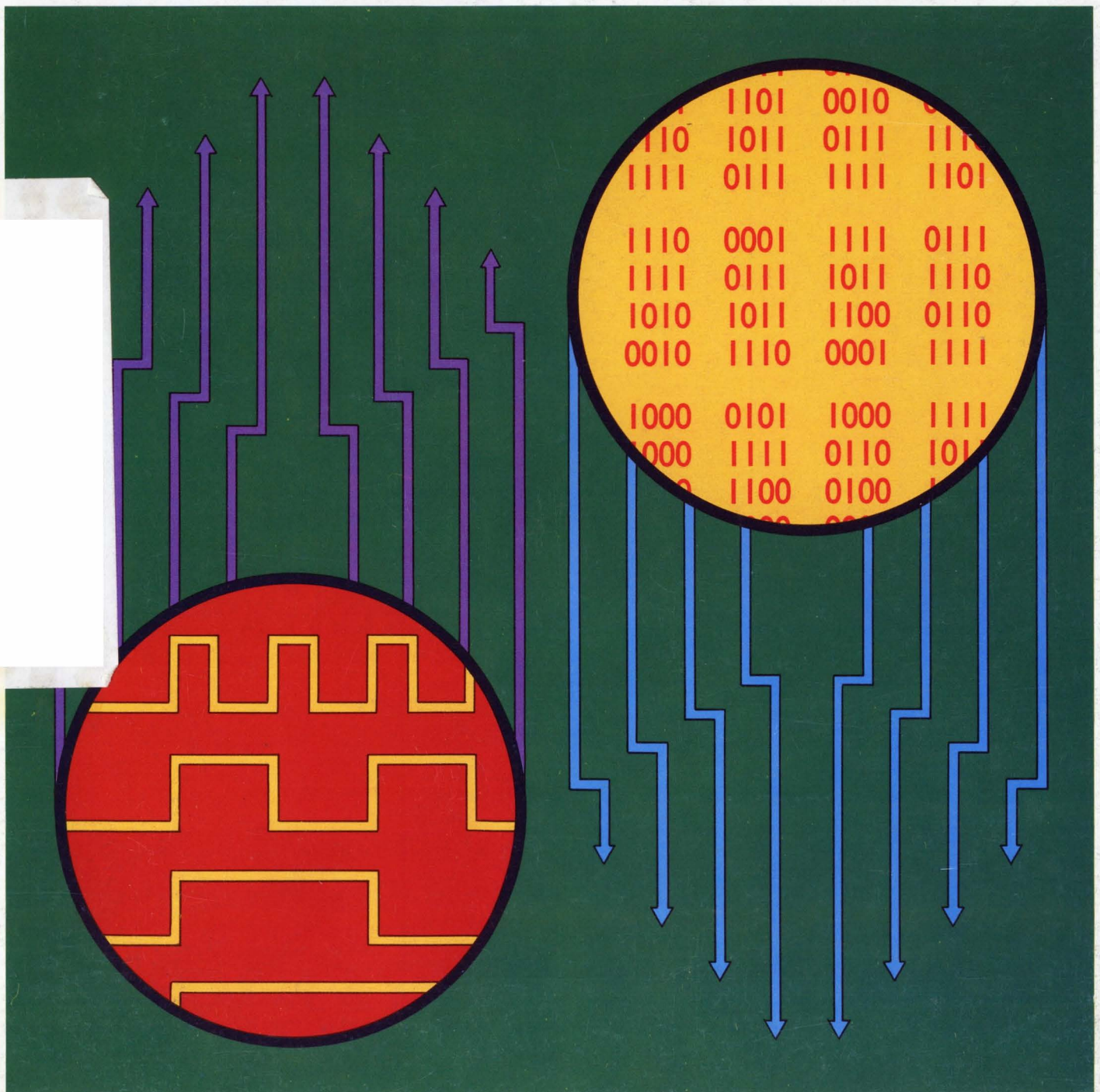



# What Every Designer or Specifier Should Know About RESISTOR NETWORKS!

A wise man once said, "A chain is only as strong as its weakest link".

That phrase says as much for electronic circuitry today . . . as it originally did for the value of the individual quality of man. For example, the failure of a single tiny printed conductor path in a resistor network can cause the failure of an entire circuit . . . or system.

Bourns doesn't want that to happen to one of your circuits. For that reason, we want to share some "inside" information about the design and manufacture of thick-film networks . . . so that you can be a more knowledgeable and more selective specifier.



## 1. Lead Termination Failure

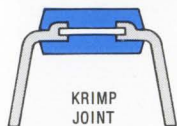

During Bourns initial design program, customer interviews indicated that commonly used "lap joint" and "butt joint" lead termination designs were subject to failure due to weakening of the solder termination during PC board wave soldering operations, and in-circuit heat cycling and vibration. These design-types depend heavily on solder alone for both mechanical and electrical bonding of leads to the substrate.

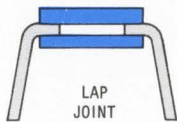

With this in mind, Bourns engineers developed the "Krimp-Joint™" lead frame termination design to protect customers from this hazard.

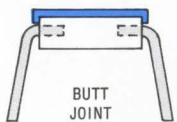

Bourns Krimp-Joint leads are firmly crimped onto the network element, much like a vise grasps a piece of lumber. To "cinch" the electrical connection, a special high temperature, reflow resistant solder is also used.

## 3. The Packaging

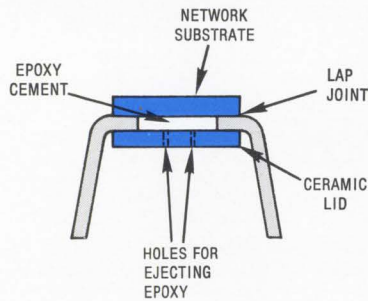

Various types of DIP packaging are utilized of which the molded and "sandwich" types seem most common. One problem that frequently occurs with the sandwich types is delaminating. This happens when air in tiny voids remaining in the epoxy filler (bonds the substrate to the sandwich "lid") expands in hot operating environments to the extent that the package comes apart and fails.

Bourns Krimp-Joint networks are encased in a homogenous **molded** thermoset plastic package, which is highly heat resistant. Both 14- and 16-pin DIP models are machine insertable, and are available in handy cartridge packages.

## 4. Power

Bourns uses a high-copper alloy lead material to **enhance** power dissipation capacity. Other materials — ferrous and brass alloys — do not have comparable performance. Furthermore, there is potential for rust with the ferrous alloy material. The high-copper alloy costs us more . . . but we think your satisfaction is worth it.

## 5. A Good Coat Is Important

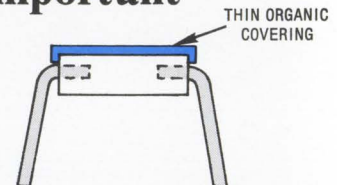

Our little network package must "weather" the homo sapien as well as the electrical environment. Example? Some users report that marking the top of thinly coated networks actually changed internal resistor values. With the tight board spacing found in most equipment cabinets, components occasionally get scraped when boards are inserted and/or removed. Customers report that some thinly protected networks have shorted-out or opened under these conditions. Bourns networks wear a heavy coat of molded plastic to weather the homo sapien climate.

## 2. Krimp-Joint Eliminates "Edge-Arounds"

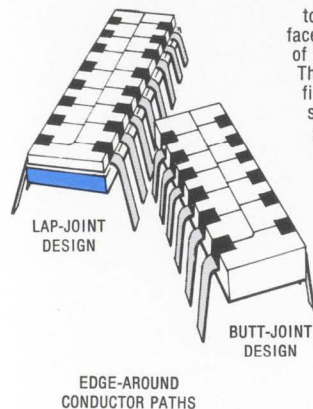

"Edge-around" thick-film printing techniques are required by some designs to electrically connect the network circuit — printed on the horizontal surface of the substrate — to pin leads which are always "buted" to the **edge** of the substrate, or are "lap-jointed" to the opposite side of the substrate. The latter condition exists with lap-joint designs when more complex thick film circuits are executed which require printing on both sides of the substrate (such as resistor/capacitor networks, dual terminators, special application circuits, etc.). Edge-around printing leaves a natural conductor path weakness on the fine edges of the substrate, resulting in the possibility of a very "tenuous" connection. Such connections are subject to failure after exposure to heat cycling, shock, vibration, etc., and can result in an open circuit condition. Sometimes an intermittent condition results, which makes fault diagnosis more difficult.

Since most packages are not tested at full rated power during manufacturing QC, weak edge-arounds sometimes pass final tests . . . and then burn-out (like a fuse), when subjected to full power in an operating circuit.

Bourns Krimp-Joint **mechanically** contacts **both** top and bottom surfaces of the resistor network substrate, resulting in a strong, positive connection between pin lead and both sides of a network circuit. No edge-around paths are required.

## FREE SAMPLES

Try the Bourns "Krimp-Joint" Resistor Network Design. Write to us on your company letterhead telling us

1. current manufacturer's part number you are now using,
2. what resistance values you need . . .

and we will send samples for your evaluation. We'll also include a complete data packet, with a handy **cross-reference guide**.

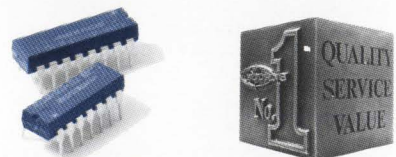



# HP displays.

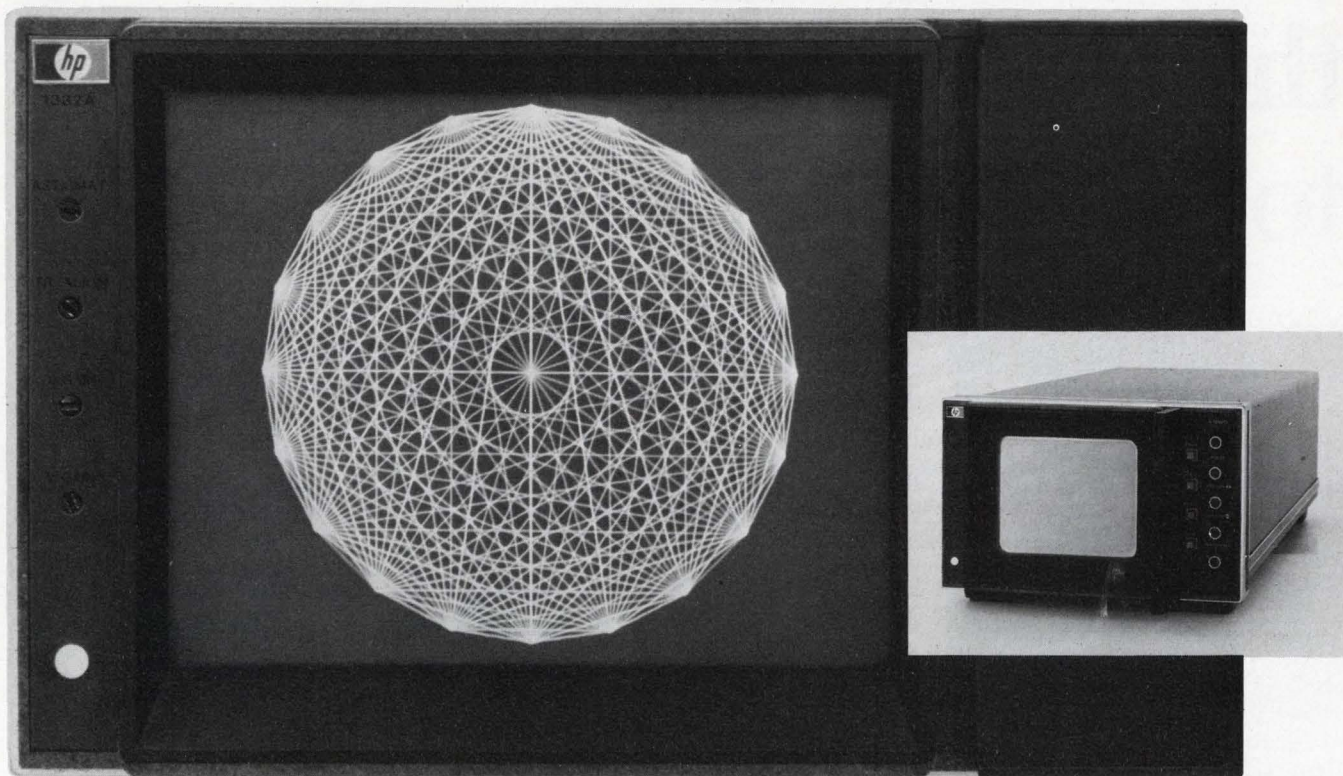

## Because your system deserves a bright, sharp image.

You put a lot into each OEM system: good circuit design, quality components, careful testing. But end users will judge it by what comes out—the information they can get from the display. They expect bright, sharply detailed images. And that's why HP's 1332A and 1335A CRT displays make excellent choices for all types of systems, from spectrum, network, and chemical analyzers, to automatic test systems.

The 1332A and 1335A have very small spot size that focuses uniformly over the complete viewing area regardless of writing speed or intensity level. This eliminates the need to refocus at each intensity setting and assures crisp images, even around the outer edges of the screen. Because these displays reproduce fine image detail with excellent contrast and uniformity, they are particularly suited for applications involving complex graphics, especially those with alphanumeric data.

The 1335A, a variable persistence, storage, and non-storage display, introduces a CRT of a totally new design optimized exclusively for information display. It offers exceptionally good resolution over the entire 8 x 10 div. screen. But the 1335A's versatility is just as impressive as its picture quality. Any operating mode—erase, store, write, conventional, or variable persis-

tence—can be selected with manual front panel controls, remote program inputs, or a combination of both. Manual controls can be inhibited entirely during remote operations. These features make the 1335A a welcome addition to medical and instrumentation systems.

OEMs who need a display with a larger viewing area and a brighter image at faster scan rates have made the 1332A a popular choice. They appreciate its 9.6 x 11.9 cm viewing area, its superior performance, and the ease with which the 1332A, like the 1335A, integrates into a variety of racks, cabinets, or systems. All frequently used controls on both displays have been placed on the front panel for maximum accessibility.

Which display best fits your requirements? Let your local HP field engineer help you decide. Or write for specific details. We'll help you pick a display that makes your system look as good as it actually is.

HEWLETT  PACKARD

Sales and service from 172 offices in 65 countries  
1501 Page Mill Road, Palo Alto, California 94304

INFORMATION RETRIEVAL NUMBER 2



# The 600V Solid State Relay: the true answer to false triggering.

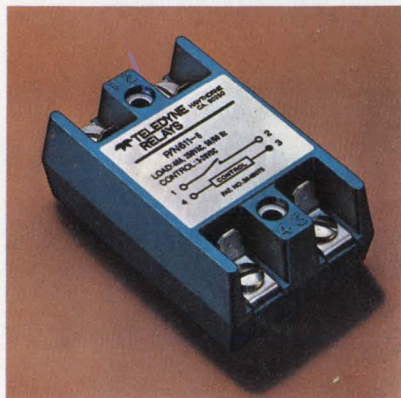

U.L. recognized

We now offer AC solid state relays specifically designed to prevent false triggering by high voltage transients — the Teledyne 611 “H” version. These relays feature a 600-volt peak blocking capability that provides a high margin of transient immunity.

In addition, this feature permits the effective use of external MOV transient suppressors for 240 VRMS

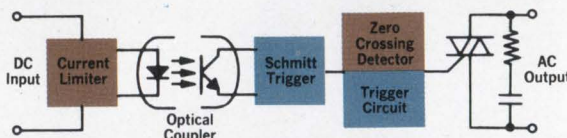

Typical Functional Diagram

line applications. MOV's designed specifically for this use can be ordered direct from Teledyne Relays (Part Number 970-2).

Our full line of Teledyne 611 relays listed below includes ac and dc input ranges, with load ratings of 10, 15, 25 and 40 amps. They feature optical isolation, zero voltage turn-on, and a typical dv/dt rating of 200V/ $\mu$ sec. What's more, we employ a rugged, flame-retardant high-impact package with recessed connections that include both quick-disconnect and screw terminals.

So if it's true transient protection you need, there's a Teledyne 611 ready to do the job —

in machine tool or process controls, computer peripherals, and medical electronics. For full data, technical assistance and fast delivery, contact your local Teledyne Relays people.

INPUT (CONTROL) VOLTAGE	OUTPUT VOLTAGE RATING		OUTPUT CURRENT RATING AND PART NUMBERS			
	CONTINUOUS (RMS)	TRANSIENT (PEAK)	10 AMP	15 AMP	25 AMP	40 AMP
3-28 VDC	140	200	611-7	611-3	611-1	611-5
	250	400	611-8	611-4	611-2	611-6
	250	600	611-8H	611-4H	611-2H	611-6H
90-250 VAC	140	200	611-17	611-13	611-11	611-15
	250	400	611-18	611-14	611-12	611-16
	250	600	611-18H	611-14H	611-12H	611-16H

## TELEDYNE RELAYS

3155 West El Segundo Boulevard, Hawthorne, California 90250  
Telephone (213) 973-4545



---

## NEWS

- 13 **News Scope**
- 16 **Logic analyzers: they're becoming a new force** in digital troubleshooting—An Electronic Design report.
- 26 **Digital shipboard electronics** was featured at the recent boat show in New York.
- 29 **Washington Report**
- 32 **International Technology**

---

## TECHNOLOGY

- 43 **MICROPROCESSOR DESIGN**
- 52 **Specify hybrid components properly.** Know more about their materials and processing, and you'll minimize drift and leakage problems.
- 58 **Improve inductor design accuracy** by analyzing flux density and winding-form effects on the ferrite pot core. You'll also upgrade the coil Q.
- 64 **Use wideband autotransformers** in rf systems. For certain applications, they can outperform transmission-line devices and are simpler to construct.
- 72 **Ideas for Design:**  
Precision instrumentation amplifier built with general-purpose op amps.  
Simple hex VCOs constructed from CMOS inverter and Schmitt trigger.  
Simple transistor circuits speed power-supply testing.

---

## PRODUCTS

- 76 **Data Processing:** Time-sharing desk-top calculator accepts inputs while driving peripherals.
- 78 Packaging & Materials
- 79 Integrated Circuits
- 80 Instrumentation
- 82 Components
- 86 Modules & Subassemblies
- 88 Discrete Semiconductors
- 89 Power Sources
- 90 Microwaves & Lasers

---

## DEPARTMENTS

- 51 **Editorial:** The misunderstanding
- 7 Across the Desk
- 91 New Literature
- 92 Bulletin Board
- 93 Vendors Report
- 95 Advertisers' Index
- 96 Product Index
- 96 Information Retrieval Card

**Cover:** Designed by art director, Bill Kelly.



# AMI 6800: The whole Kit.

## Smart Terminal.

Complete program editing through CRT and keyboard. Also includes Modem communication to remote computers.

## Magnetic Tape.

Cross product software— assembler, loader, simulator.

## AMI 6800 Family.

It's all here: MPU, RAM, ROM, PIA, ACIA, PROM, USRT and Modem. By test, the best.

## Evaluation Board.

Includes everything you need to evaluate parts, program PROMs and, connected with a peripheral, run programs.

## Dual Floppy Disk.

Storage for resident software— assembler, editor, etc.

## Disk Program Storage.

500K bytes for program development and on-line data storage. Cuts out the paper tape!

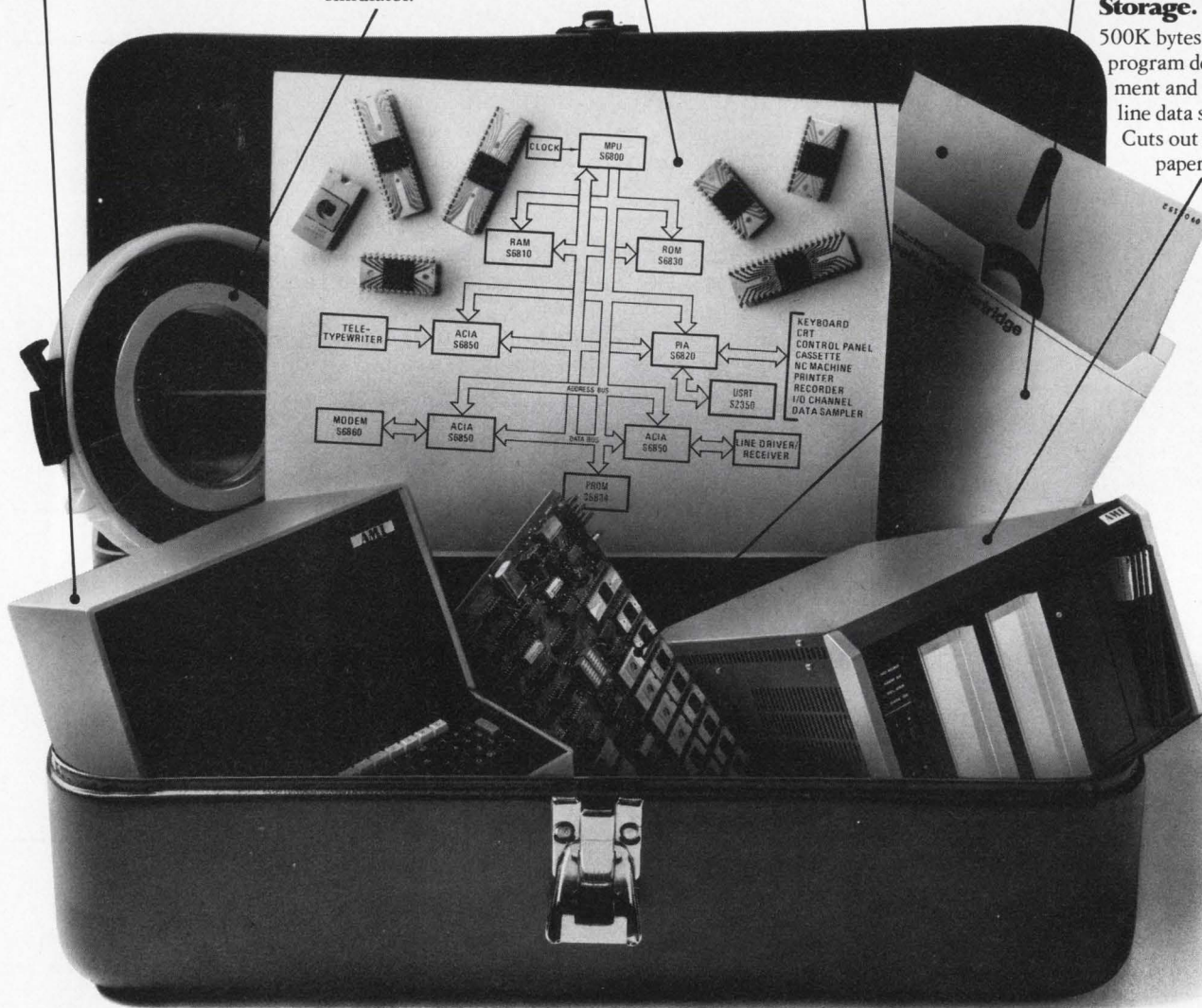

Our AMI 6800 Kit is a big step forward in simplifying your design, evaluation and test programs. For example, our intelligent CRT is simple to operate with either resident or remote software. It really is smart, because it contains an S6800! And it's planned to have an in-circuit emulator added later.

Our dual disk is extremely useful for developing programs, and saves you hours of paper tape shuffling. And our Evaluation Board is loaded with

all the parts you need to get your product on the market on time.

Now for the Caboodle. The dictionary calls it a "package." You'll call it the neatest set of instructions for any kit you've ever bought.

Now why don't you call your nearest AMI sales office or distributor, and ask them for the whole Kit and Caboodle. Or write AMI, 3800 Homestead Road, Santa Clara, CA 95051. What could be easier?

## Here's where you pick up your Kit.

### SALES OFFICES

Manhattan Beach CA • (213) 379-2452  
 San Jose CA • (408) 249-4550  
 Altamonte Springs FL • (305) 830-8889  
 Elk Grove Village IL • (312) 437-6496  
 Norwood MA • (617) 762-0726  
 Livonia MI • (313) 478-9339  
 Minneapolis MN • (612) 559-9004  
 Monsey NY • (914) 352-5333  
 Cleveland OH • (216) 292-6850  
 Ambler PA • (215) 643-0217  
 Richardson TX • (214) 231-5721



# And Caboodle.

## Software Brochure.

A rundown on AMI software products including assembler, loader and simulator.

## AMI 6800 Brochure.

List of goodies. All you want to know about the AMI 6800 family.

## Evaluation Board Application Notes.

The why and wherefore of our Prototyping System, and how to make the most of it!

## NCSS Users Manual.

All the magic necessary to work with National CSS time-sharing network.

## Assembly Language Programming Manual.

Describes the instruction set and how to use the AMI Assembler and Simulator.

## AMI Guide to Standard Products.

All the MOS you might need in addition to microprocessors.

## Hardware Reference Manual.

A detailed description of each component in the system, and how to make them work!



## DISTRIBUTORS

ALTA ELECTRONICS:  
Utah—Salt Lake City (801) 486-7227

ARROW ELECTRONICS:  
Minnesota—Bloomington  
(612) 888-5522

CENTURY ELECTRONICS:  
New Mexico—Albuquerque  
(505) 292-2700  
Utah—Salt Lake City (801) 487-8551

INTERMARK ELECTRONICS:  
Washington—Seattle (206) 767-3160

SCHWEBER ELECTRONICS:  
California—Costa Mesa (714) 924-5594  
and (714) 556-3880  
Connecticut—Danbury (203) 792-3500

Florida—Hollywood (305) 927-0511  
Georgia—Atlanta (404) 449-9170  
Illinois—Elk Grove Village  
(312) 593-2740

Iowa—Cedar Rapids "Lorenz Sales"  
(319) 393-0100  
Maryland—Rockville (301) 881-3300  
Massachusetts—Waltham  
(617) 890-8484

Michigan—Troy (313) 583-9242  
Minnesota—Edina (612) 941-5280  
New Jersey—Somerset  
(201) 469-6008

New York—Rochester (716) 461-4000  
Westbury (516) 334-7474  
Ohio—Beachwood (216) 464-2970

Texas—Austin (512) 837-2890  
Dallas (214) 661-5010  
Houston (713) 784-3600

Canada—Mississauga, Ont.  
(416) 678-9050

SEMICOMP CORP:  
California—Newport Beach  
(714) 971-5253 and  
(714) 833-3070

STERLING ELECTRONICS:  
Arizona—Phoenix (602) 258-4531  
Louisiana—Metairie  
(504) 887-7610

Massachusetts—Watertown  
(617) 926-9720

New Jersey—Perth Amboy  
(201) 442-8000

New Mexico—Albuquerque  
(505) 345-6601

Texas—Dallas (214) 357-9131  
Houston (713) 627-9800

Virginia—Richmond "Meridian"  
(804) 335-6521

R. V. WEATHERFORD CO.:  
Arizona—Phoenix (602) 272-7144  
California—Anaheim (714) 547-0891  
Glendale (213) 849-3451  
Palo Alto (415) 493-5373  
Pomona (714) 623-1261  
San Diego  
(714) 278-7400

Colorado—Englewood  
(303) 761-5432

New Mexico—Albuquerque  
(505) 842-0868

Texas—Dallas (214) 243-1571  
Houston (713) 688-7406

Washington—Seattle  
(206) 243-6340

it's  
standard  
at AMI.  
AMERICAN MICROSYSTEMS, INC.

INFORMATION RETRIEVAL NUMBER 4



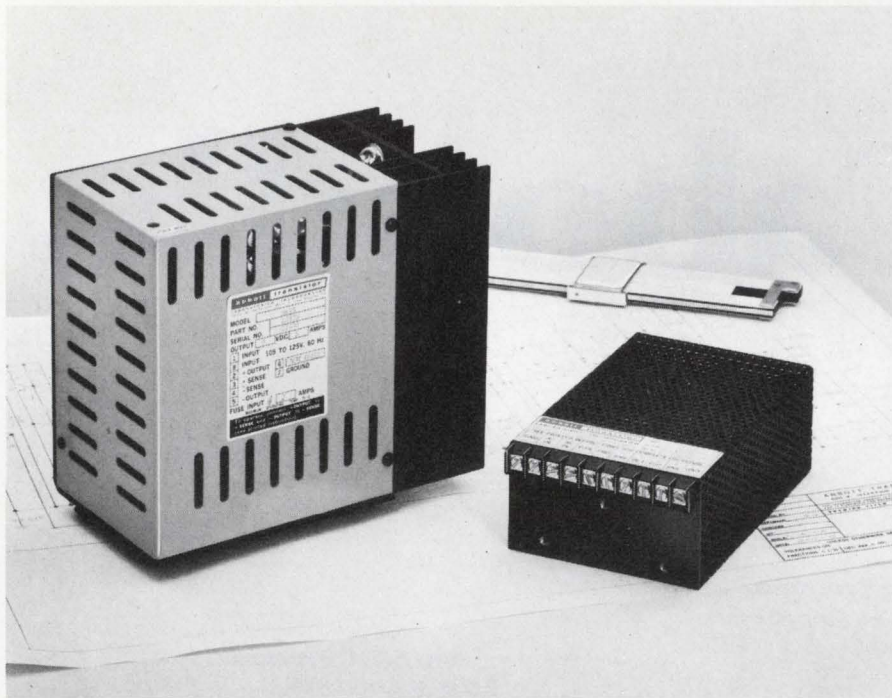

## Reduce Your Power Supply Size and Weight By 70%

A new way has been found to substantially reduce power supply size and weight. Consider the large power supply shown at left in the above photo — it uses an input transformer, into a bridge rectifier, to convert 60 Hz to 5 volts DC at 5 amperes. This unit measures 6½" x 4" x 7½" and weighs 13 pounds. Abbott's new model Z5T10, shown at right, provides the same performance with 70% less weight and volume. It measures only 2¼" x 4" x 6" and weighs just 3 pounds.

This size reduction in the Model Z5T10 is primarily accomplished by eliminating the large input transformer and instead using high voltage, high efficiency, DC to DC conversion circuits. Abbott engineers have been able to control the output ripple to less than 0.02% RMS or 50 millivolts peak-to-peak

maximum. This design approach also allows the unit to operate from 100 to 132 Volts RMS and 47 to 440 Hertz. Close regulation of 0.15% and a typical temperature coefficient of 0.01% per degree Celsius are some of its many outstanding features. This new Model "Z" series is available in output voltages of 2.7 to 31 VDC in 12 days from receipt of order.

Abbott also manufactures 3,000 other models of power supplies with output voltages from 5 to 740 VDC and with output currents from 2 milliamperes to 20 amps. They are all listed with prices in the new Abbott catalog with various inputs:

60  $\text{A}$  to DC  
 400  $\text{A}$  to DC  
 28 VDC to DC  
 28 VDC to 400  $\text{A}$   
 12-28 VDC to 60  $\text{A}$

Please see pages 1037-1056 Volume 1 of your 1975-76 EEM (ELECTRONIC ENGINEERS MASTER Catalog) or pages 612-620 Volume 2 of your 1975-76 GOLD BOOK for complete information on Abbott Modules.

Send for our new 60 page FREE catalog.

**abbott transistor**

**LABORATORIES, INCORPORATED**  
 general offices eastern office

5200 W. Jefferson Blvd./Los Angeles 90016  
 (213) 936-8185 Telex: 69-1398

1224 Anderson Ave./Fort Lee, N.J. 07024  
 (201) 224-6900 Telex: 13-5332

INFORMATION RETRIEVAL NUMBER 5

**Sr. Vice President, Publisher**  
 Peter Coley

### Editors

Editorial Offices  
 50 Essex St.  
 Rochelle Park, NJ 07662  
 (201) 843-0550  
 TWX: 710-990-5071  
 Cable: Haydenpubs Rochellepark

**Editor-in-Chief** George Rostky

### Managing Editors:

Ralph Dobriner  
 Michael Elphick

### Associate Editors:

Dave Bursky  
 Samuel Derman  
 Morris Grossman  
 John F. Mason  
 Stanley Runyon  
 Edward A. Torrero

### Contributing Editors:

Peter N. Budzilovich  
 John Kessler  
 Alberto Socolovsky  
 Nathan Sussman

### Editorial Field Offices

#### East

Jim McDermott, Eastern Editor  
 P.O. Box 272  
 Easthampton, MA 01027  
 (413) 527-3632

#### West

David N. Kaye, Senior Western Editor  
 8939 S. Sepulveda Blvd.  
 Suite 510  
 Los Angeles, CA 90045  
 (213) 641-6544  
 TWX: 1-910-328-7240

### Editorial Production

Marjorie A. Duffy, Production Editor  
 Tom Collins, Copy Editor

### Art

**Art Director**, William Kelly  
 Richard Luce  
 Anthony J. Fischetto

### Production

**Manager**, Dollie S. Viebig  
 Helen De Polo  
 Anne Molfetas

### Circulation

**Manager**, Evan Phoutrides

### Information Retrieval

Peggy Long

### Promotion, Creative Layouts

**Manager**, Albert B. Stempel  
 Maxine Correal  
 Nancy Gordon (Reprints)



# Across the Desk

## Using calculators for timekeeping

I read with interest Mr. Miller's letter regarding using the HP-45 calculator as a stop watch (ED No. 26, December 20, 1975, p. 7). Mr. Miller, however, failed to mention some important features. Since the clock in the HP-45 is not particularly accurate (my HP-45 is about 11.2% slow), a correction factor will be needed to convert the stored information into accurate time measurements.

If the HP-45 is returned to normal operation by pressing the ENTER key as suggested by Mr. Miller, the information in the storage registers will not be in the correct format for direct conversion and application of the correction factor. A better way is to return the calculator to normal operation by pressing the "." key. The calculator now displays the total time information in the correct format for direct conversion to decimal hours whereupon it can be multiplied by the correction factor and then converted back to hours, minutes, and seconds if so desired. Also, all times recorded in the storage registers are in the correct format.

This will save writing down the stored information and re-entering it for correction. After conversion the calculator may be placed back into the clock mode without destroying the total time recorded by simply not clearing the stack and registers, thus a timing function may be continued.

Interestingly the HP-45 only records up to 12:5959 hours whereupon it goes to a reading of 1 hour and continues counting, just like a clock.

*J. Kenneth Guscott*

Aerospace Research Inc.  
130 Lincoln St.  
Boston, MA 02135

## Misplaced Caption Dept.



"How come he's got a calculator and I've got a slide rule?"

Sorry. That's Armand Guillaumin's "Self-Portrait," which hangs in The Louvre, Paris.

## A figure foulup

The following Figures 1 and 2 were inadvertently omitted from Across the Desk item "A 'terrific' Idea, but—" (ED No. 1, Jan. 5, 1976, p. 7).

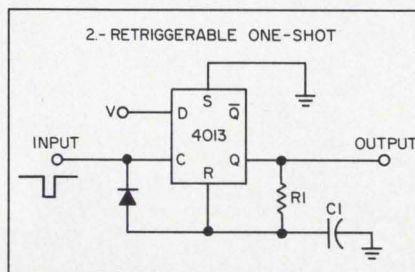
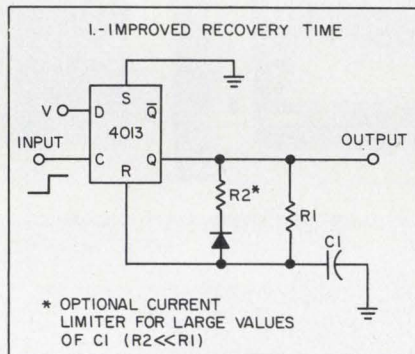

Electronic Design welcomes the opinions of its readers on the issues raised in the magazine's editorial columns. Address letters to Managing Editor, Electronic Design, 50 Essex St. Rochelle Park, N.J. 07662. Try to keep letters under 200 words. Letters must be signed. Names will be withheld on request.

# MATCH

# OR

# MIX!

## LOW COST INFRARED SOURCE/SENSOR PAIR

VERSATILE OPTRON DEVICES ALSO MATCH EQUIVALENT INDUSTRY TYPES!

Now, you can match the high efficiency emission of OPTRON's OP 160 infrared source with the high sensitivity OP 500 sensor or mix either low cost device to pair with equivalent industry types!

The OP 160 LED features a typical output of 1.5 mW at 20 mA in a concentrated beam at a high efficiency emission wavelength of 940 nanometers. The OP 500 N-P-N planar phototransistor has a high spectral sensitivity designed to match that of the OP 160. Typical output of the OP 500 is 10 mA at 20 mW/cm<sup>2</sup> tungsten lamp irradiance.

When operated as a pair, the OP 160/OP 500 provide a typical output of 1.0 mA with an input of 20 mA at a lens-to-lens spacing of 0.25 inch. The identical input at a spacing of 1.0 inch generates an output of 0.5 mA.

Specified individually, the devices are mechanically and optoelectronically matched to replace equivalent industry types as follows:

OPTRON	REPLACES
OP 160	TIL32
OP 500	TIL78

Both the OP 160 LED and OP 500 phototransistor are available from stock in a clear plastic mini-axial package. They are ideally suited for mounting in high density arrays for such applications as shaft encoders, position sensing, key boards, and limit switch replacement.

Detailed technical data on the OP 160 source/OP 500 sensor and other OPTRON optoelectronic products... chips, discrete components, isolators, assemblies, and PC board arrays... is available from your nearest OPTRON sales representative or the factory direct.



**OPTRON, INC.**

1201 Tappan Circle  
Carrollton, Texas 75006, U.S.A.  
214/242-6571 • TELEX-73-0701  
® TWX-910-860-5958



# When you can buy all this for a total of \$701\*

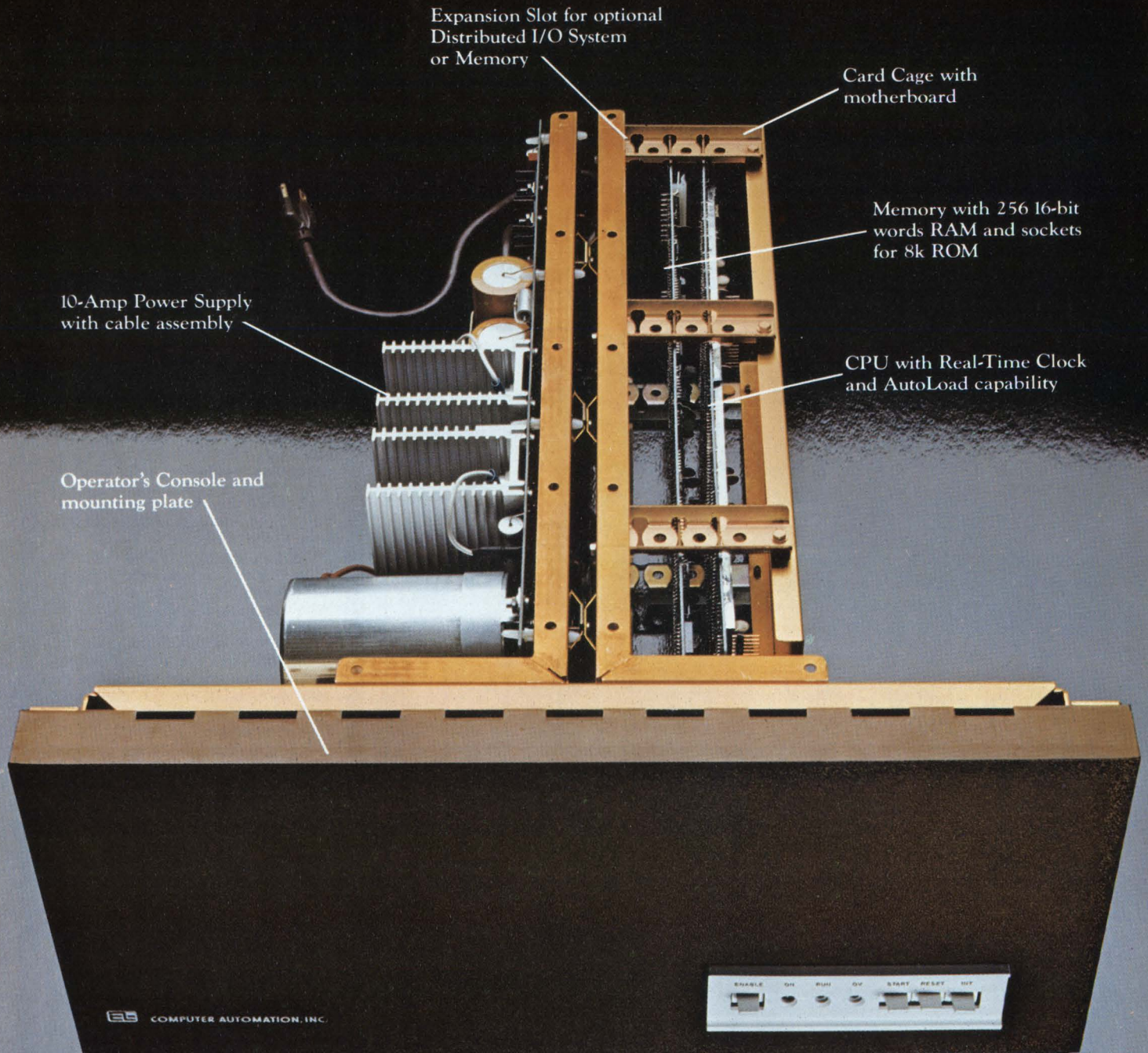

The ALPHA™ LSI-3/05 Millicomputer.  
The lowest priced, 16-bit, full-scale, packaged computer in the world.



# ...building your own just doesn't add up.

Sum and substance. An unbeatable combination even for our competition, so you needn't feel too badly.

Especially when you consider everything we've got going for us.

Specialization, of course. OEM computers — low-cost OEM computers — are our only business. The NAKED MINI® people, remember? And when you do only one thing, you do it better.

Experience, too. Over 10,000 up-and-running, field-proven computers successfully integrated into all kinds of sophisticated OEM products.

Also, some things Henry Ford would have appreciated. Buying in volumes most OEM's can't manage. Building the same way.

Where all that gets you is on the down-hill side of the learning curve... where we get our pay-off and you get the lowest-priced, most reliable computers around.

That explains why we can, but not necessarily why you can't. Here's the rest of the rationale:

## The chip shot: a hit or a myth?

The fallacy of the micro-processor is that a chip set isn't a computer. Even if you got your chip sets free you still couldn't build a computer equivalent to our ALPHA LSI-3/05 for \$701.

Price out the subassemblies shown in the picture and see what we mean. CPU, memory, card cage, power supply and console. All of that design and development time. Amortized over maybe a few hundred systems?

Heart of the ALPHA LSI-3/05 shown at left is this NAKED™ MILLI central processor and memory for \$395\*

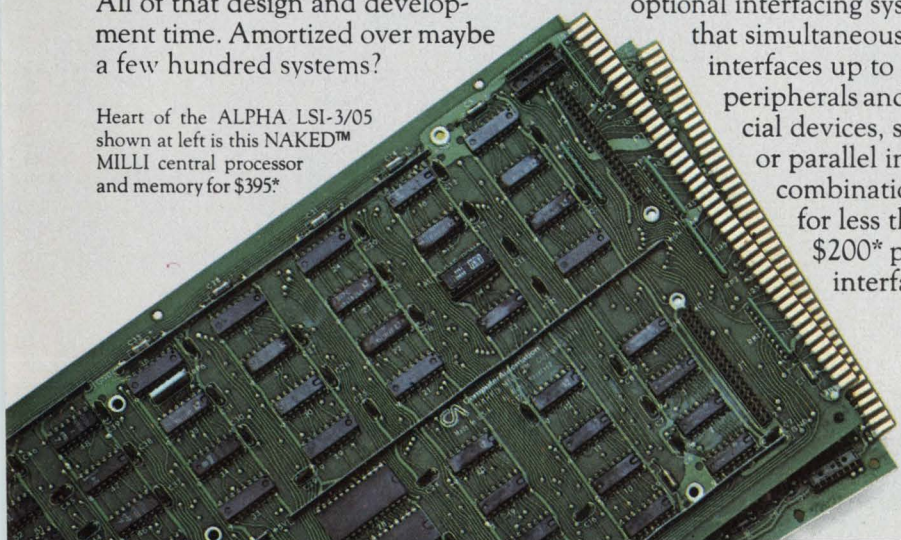

ComputerAutomation will build thousands of ALPHA LSI-3/05 systems.

Then there's the packaging and fabrication. Cable assemblies, too.

Just think about the procurement activity alone. The lead time. Getting our picture?

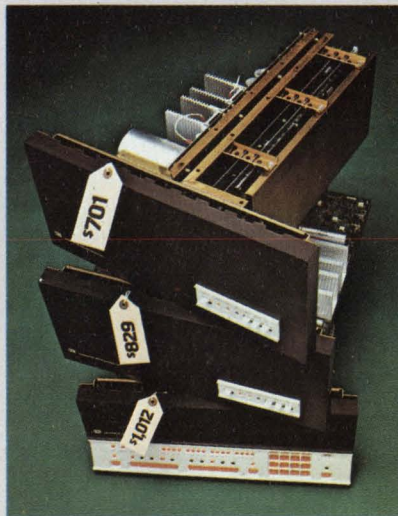

Maxi-Bus compatible ALPHA LSI-3/05 achieves unprecedented cost-effectiveness with ComputerAutomation's new Distributed I/O System.

## Computers vs. computerization

How do you talk to a computer?

Mostly with money, it turns out. Interface money. And mostly a lot of it.

Interfacing a computer to one or two peripheral devices can easily cost as much or more than the computer itself.

Which is why we invented the Distributed I/O System. An optional interfacing system that simultaneously interfaces up to 32 peripherals and special devices, serial or parallel in any combination, for less than \$200\* per interface.

## What you see is not exactly what you get

Here's what else you get when you buy an ALPHA LSI-3/05 millicomputer:

- 95 powerful instructions
  - Individually vectored interrupts
  - Direct Memory Access
  - Memory expansion to 32K
  - Maxi-Bus interchangeability for easy upward expansion to our full line of compatible minicomputers
- Plus full-fledged mini-computer software.

## From the people who brought you the NAKED MINI®

The people with the largest line of compatible computers in the world.

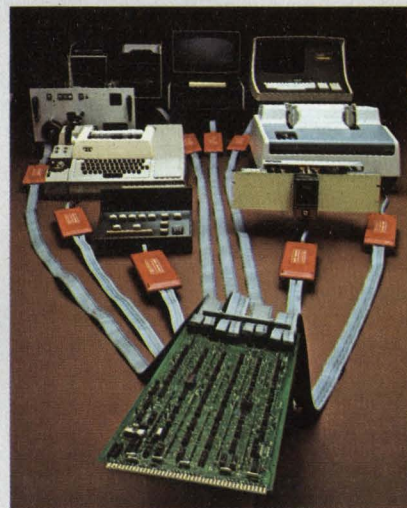

The ALPHA LSI-3/05 is offered in three series featuring a choice of card cages, consoles, memories and power supplies.

The people with the lowest-priced computers in the world.

The people with the first and only Distributed I/O System in the world.

The people who've been simplifying OEM build versus buy decisions for years.

**ComputerAutomation**  
NAKED MINI Division

U.S.A. 18651 Von Karman, Irvine, CA 92715  
(714) 833-8830  
EUROPE Hertford House, Denham Way, Maple Cross, Rickmansworth WD3 2XD, Hertfordshire, England; Telephone: Rickmansworth 71211

\*All prices shown are for lots of 100 (U.S.A. only)  
Patent Pending

FOR FURTHER INFORMATION, CIRCLE #50



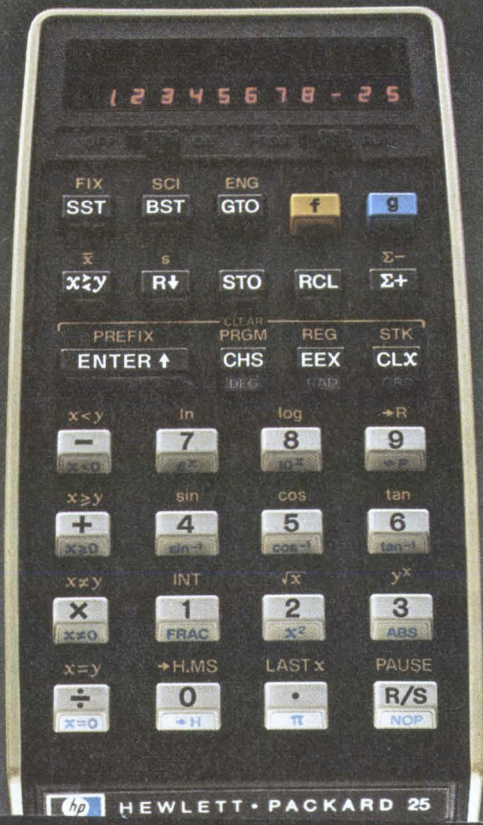



## Is an HP calculator an engineering work of art?

It depends on how you look at it. Stand outside, and you see a collection of parts, a tool — full of utility, but not much more.

Get inside — beyond the keys to the hierarchy of concepts that underlies them, and you sense the harmony of art.

### **Intuitively right ideas.**

You discover that intermediate answers tend to appear automatically, as if on cue. An HP designer saw what could be gained by combining RPN with a 4-register stack.

You discover why the calculator has the number of storage registers it does: the functions demand them. Coherence, too, can be artistic.

You discover that all functions are directly accessible from the keyboard. You don't have to memorize a secret formula to get to a conversion constant.

If your calculator's one of HP's three pocket programmables, you discover that you can add, change or skip program steps at will, that you can branch and conditional test.

If your programmable's an HP-25, you discover that the program memory accommodates multi-keystroke functions as a single instruction. The keycodes of all prefixed functions merge so you have extra capacity, just in case.

(As imaginative as HP designers are, it took them two years and two programmables to come up with this one. Experience counts.)

\*All HP calculators are fully warranted for one year.

### **Behind every calculator, an engineer.**

Another thing that sets HP calculators apart from the welter of machines available today is the support that comes with them.

Say you need help with a problem. Just dial 800-538-7922 (in Calif. 800-662-9862) and ask for an applications engineer. His advice and your call are both free.

You might also check an HP applications book. HP publications provide efficient solutions for hundreds of problems, and they typify a range of software and accessories that's simply unmatched.

Suppose your calculator fails (unlikely given our exhaustive pre-testing procedures). If your HP dealer can't solve the problem, send your instrument to us. We'll repair it within five working days of the time we receive it\*.

(Incidentally, we distribute our calculators through quality dealers, so you can be sure their support meets our standards.)

### **Uncompromising assembly.**

We know how people treat pocket calculators, and we build ours accordingly. That's one reason they've performed on Mt. Everest and in outer space.

It's *the* reason they've survived salt water, snowblowing machines, storm sewers, fires, plane crashes, even a fall from a speeding car.

### **You might discover capabilities "beyond specs."**

Many owners have figured out how to turn an HP-45 into a timer. One has written an 8-step program that does the same sort of thing to his HP-25. An HP-65 owner has created a dandy blackjack program.

### **Engineering work of art? Ask an owner.**

They've experienced the hierarchy of concepts, the precision, the human engineering. They know how it feels to own an engineering work of art, and they're easily persuaded to talk about theirs.

You might also send the coupon for our buyer's guide. It tells all — with considerably less passion, however.

If you'd like a demonstration, call toll-free 800-538-7922 (in Calif. 800-662-9862) for a dealer near you.

**HEWLETT  PACKARD**

Sales and service from 172 offices in 65 countries.  
Dept. 232Q, 19310 Pruneridge Avenue, Cupertino, CA 95014

Hewlett-Packard  
Dept. 232Q, 19310 Pruneridge Avenue  
Cupertino, CA 95014

Please send me your HP pocket calculator magazine and buyer's guide.

Name \_\_\_\_\_

Firm \_\_\_\_\_

Address \_\_\_\_\_

City \_\_\_\_\_

State \_\_\_\_\_ Zip \_\_\_\_\_

616/04



# Here's why REI can rent you what you want when you want it.



Our inventory. It's the biggest in the industry, with over 8,000 items of electronic test equipment in stock and ready to go. And it's getting better all the time, because we add more state-of-the-art equipment every month. This means we can deliver one special instrument... or a dozen... within hours of the time you place your order.

Now, more than ever, renting makes sense... to stretch your equipment budget, to fill temporary needs, and to avoid the long delivery lead times associated with purchasing. And renting from REI makes even more sense... because we're better equipped to fill your needs than any other rental company.

REI is backed by the tremendous resources of the PepsiCo organization, which gives us the financial strength to keep on hand whatever test equipment you may need. And renting from us helps *your* financial strength,

too. Since you pay only for the time you have your instruments, you'll never have to spend your money on idle equipment.

Send for our catalog today for a description of our rental, rental/purchase and leasing plans, and for our low rental prices. Or call the instant inventory center nearest you for immediate assistance.

Rental Electronics, Inc.,  
99 Hartwell Avenue, Lexington, Mass. 02173.  
Please send me your free instrument rental catalog:

Name \_\_\_\_\_ Title \_\_\_\_\_

Company \_\_\_\_\_

Address \_\_\_\_\_

City \_\_\_\_\_ State \_\_\_\_\_ Zip \_\_\_\_\_

Tel. Number \_\_\_\_\_

## Rental Electronics, Inc.

A PEPSICO LEASING COMPANY

Burlington, MA (617) 273-2770 • Gaithersburg, MD (301) 948-0620 • Oakland, NJ (201) 337-3757 • Ft. Lauderdale, FL (305) 771-3500  
Des Plaines, IL (312) 827-6670 • Dallas, TX (214) 661-8082 • Mountain View, CA (415) 968-8845 • Anaheim, CA (714) 879-0561  
Rexdale, Ontario (PLC Leasing Ltd.) (416) 677-7513

INFORMATION RETRIEVAL NUMBER 9



FEBRUARY 2, 1976

## Prompting calculator and \$19.95 watch from TI

A desk-top programmable calculator that can prompt, the first hand-held calculator peripheral—a printer and a \$19.95 digital watch that uses I<sup>2</sup>L logic were highlights of the Texas Instruments exhibit at the Winter Consumer Electronics Show in Chicago.

The SR-60 calculator sells for \$1695 to \$2395, depending upon options. It contains a 20-character alphanumeric LED display, a thermal printer and a magnetic-card reader. The card reader takes 2 × 10-1/2-in. cards. Up to 480 program steps can be stored in the machine. There are 40 data memories. These can be expanded to 1920 program steps and 100 data memories with an optional \$700 module.

Prompting is a conversational function where the SR-60 asks questions using its display.

Using algebraic notation and nine levels of parentheses, the calculator has 46 scientific functions and can be programmed using 78 labels, 10 pending operations, 10 flags, 10 branches, four levels of subroutines and two modes of indirect addressing. Editing of the program is simplified with insert, delete, step, backstep and go-to keys. The calculator can accommodate a variety of peripherals as well.

The PC-100 print cradle (see photo) permits TI's SR-52 hand-held programmable calculator to become a desktop printing calculator.

When the calculator is locked into the cradle, the user is able to print anything shown in the display or print the step-by-step execution of a program. Print and paper advance controls permits the user to handle these functions on the PC-100 as well as on the calculator, and a "trace" key allows monitoring of all functions as they happen.



Texas Instruments SR-52 programmable calculator is converted into a desktop printing unit.

The PC-100 has a thermal printer which prints 5 × 7 dot-matrix characters on a 2.5-in. tape. It prints 20 characters per line and sells for \$295.

A new low in digital watch prices is achieved with the TI-501 and 502 five-function digital watches. They start at \$19.95 and come in polysulfone cases of several different colors. These watches have LED displays and a smart calendar that keeps track of how many days there are in a month.

### Pocket calculator can provide biorhythm data

A unique market for pocket calculators is being tried by Casio, Inc., with its new Biolator machine. The device is advertised to provide the user with information on his physical, emotional and intellectual condition for any time, past, present or future.

This information is based on the theory that an individual's biological condition fluctuates in cycles, beginning the day he is born. One's physical condition follows a 23-day cycle, sensitivity (emotional), a 28-day period, and intellect, a 33-

day interval.

All a user needs to do, according to a spokesman for the Fairfield, NJ, company, is to key in his date of birth, followed by any desired date. The calculator then immediately displays three numbers, which when checked with a chart mounted on the back of the unit, give the three facets of a person's biological state on that date.

The calculator can also be used to compute the number of elapsed days between any two dates in the 20th century, the spokesman added. The Biolator can also perform the usual functions of addition, subtraction, multiplication, and division, all in floating-point decimal. Results appear on an eight-digit green Digitron (gas-discharge) display. The calculator provides an additional feature. When using any of the four arithmetic functions, the second number entered is automatically held in an additional register. This can be a great convenience, a Casio spokesman explained, for repeated calculations where one number is used over and over.

The Biolator operates on two AA batteries or on ac/dc (with optional adaptor) and is marketed in the U.S. at \$29.95.

### Microwave receiver gets better images at 90 GHz

A passive microwave imaging system for airborne use has been developed by the Naval Research Laboratory in Washington, DC, that provides three advantages over existing systems: It provides higher spatial resolution, improved surface-temperature resolution, and it is designed for plug-in radiometers which are changeable during flight.

The improved spatial resolution is achieved by using a higher frequency. The system operates at 90 GHz, while the imager in the meteorological satellite Nimbus 5, for example, operates at 19 GHz and the one in Nimbus 6 at 37 GHz.

By changing antenna-radiometer combinations, alterations can be made in frequency, bandwidth and polarization. Readings are digitized and stored in a computer memory. Later, colors can be as-



signed to the image, according to temperature, thus providing a false-color rendition of the scene with configuration fidelity of "degraded optical quality."

Higher surface-temperature resolution comes from the antennas used: either a horn-fed lens or, in the case of a dual-frequency radiometer that transmits two frequencies simultaneously (21 and 31 GHz), a corrugated horn. The Nimbus satellites are equipped with electronically steered phased-array antennas with limited bandwidth.

NRL's imaging system consists of an oscillating mirror, an antenna-radiometer and a data acquisition unit. Each unit is self-contained and may be operated and controlled separately.

The radiometer output is passed through a low-pass filter, sampled at one-degree intervals along the scan, digitized with 12-bit precision and stored in core memory.

Blocks of digitized radiometer data composed of the most recent 128 scan lines along with the housekeeping, aircraft and radiometer calibration data necessary for processing are recorded periodically on a 9-track magnetic tape. The most recent 100 scan lines are continually displayed in real time on an onboard oscilloscope monitor.

A replay mode exists so that previously recorded 128 line blocks of data may be recalled from the magnetic tape and displayed on the monitor. This can be done during nondata taking lulls during flight or post flight for initial editing of the data.

The new system which has been tested in a C-54 aircraft will be useful, NRL scientists say, for detecting earth resources, oil slicks and ice cover. In military reconnaissance, the unit could conceivably detect troop movements and camouflaged equipment.

An operational system could be carried on aircraft, in balloons, remotely-piloted vehicles and surface ships. Resolution is approximately 50 feet at an altitude of 1500 feet.

## Air Force looks at LCs for cockpit display

The Dick Tracy wristband TV may be a step closer as the result

of a recent Air-Force sponsored development—a two-inch-square liquid crystal display. The display, which is but one-quarter-inch thick, produces a black and white picture when it is fed from a TV camera or a TV receiver video signal.

The liquid-crystal screen is a proprietary design of the reflective type, produced by Hughes Aircraft Co., Culver City, CA, for the Air Force Avionics Laboratory at Wright-Patterson Air Force Base, OH.

Principal advantages of the new screen are its low power requirements—in the order of milliwatts—and its potentially high reliability, according to John Mysing, Air Force project engineer.

The reliability is an inherent characteristic of the device, Mysing points out. It is made up of four one-inch squares, each containing 10,000 picture elements called pixels.

"While you might lose a few pixels in this low-voltage liquid crystal display, it's unlikely that catastrophic failure will occur over the full picture," Mysing says. "On the other hand, when a cathode ray tube burns out the picture vanishes."

The crystal display is of sandwich construction, Mysing notes, with individual MOS picture-element drive circuitry being integrated on a substrate that forms the rear of the device. Additional electronics are required to convert the standard TV scan to one suitable for the liquid crystal unit.

The Air Force is currently considering liquid crystal displays for conventional cockpit displays, head-up displays, displays for portable field communications and test equipment, as well as helmet-mounted displays.

The first device will be delivered to the Air Force for evaluation in February.

## A computer microfilm standard proposed

Standards may soon be set for all microform output generated by Government computers or supplied to Government agencies by service contracts.

The proposed standard was de-

veloped by participants from 12 Federal agencies and now awaits approval by the National Bureau of Standard. The standard contains specifications for roll film and microfiche. The formats provided include both 24:1 and 48:1 reduction ratios.

Within the Federal government, the current major users of computer-output-microfilm are the Social Security Administration and the Dept. of Defense. More than 26,000 readers for microfilm have been installed within the Defense Dept. for logistics applications.

A copy of the proposed standard may be obtained from the NBS office of ADP Standards Management, Washington, DC 20234. Comments are due by Mar. 23, 1976.

## Spectrometer system uses a minicomputer

A minicomputer-controlled gas-chromatograph mass spectrometer is now in use at the Los Angeles, CA, coroner's office to solve problems in toxicology previously considered "almost impossible."

Manufactured by Finnigan Corp., Sunnyvale, CA, the system uses a Naked Mini computer manufactured by Computer Automation, Inc., Irvine, CA, which is coupled to a gas chromatograph mass spectrometer to analyze unknown chemical or biological samples. The analog output of the spectrometer is digitized and stored in the mini's memory.

Through a keyboard control the toxicologist can automatically compare the spectra of known and unknown elements and compounds; the known spectra having been previously stored in memory. The minicomputer then prints out the names of all compounds matching the unknown, and also indicates the degree of match.

"Even the most complex search routine requires only a few minutes of time with the computer," says Edward Thompson, senior toxicologist at the Los Angeles' County coroner's office.

Other applications, according to Thompson, include use in health departments, medical schools and pharmaceutical companies. A number of state agencies are using the system to test race horses for drugs.



# We saw your microprocessor

coming. So we designed an entire family of socket homes for it. Socket cards for card file mounting, and we've even got the card files. Socket boards for LSI mounting in frames, drawers, and racks,

and we've even got the frames, drawers, and racks. Our socket cards, the 3D Series, come with built-in test points, a ceramic monolithic bypass capacitor

at each socket, and solder tab connection to pins on LSI chips. Our socket boards, the 2D Series,

offer a good selection of socket complements, and are compatible with other boards for hybrid installations. We also offer automated wiring service. We're ready for you.



**EECO**

PACKAGING/SWITCHES/READERS

1441 East Chestnut Avenue, Santa Ana, California 92701 Phone 714/835-6000  
Also stocked and serviced in North America by G. S. Marshall, R-A-E, Zentronics.



# Logic analyzers: a new force in digital troubleshooting

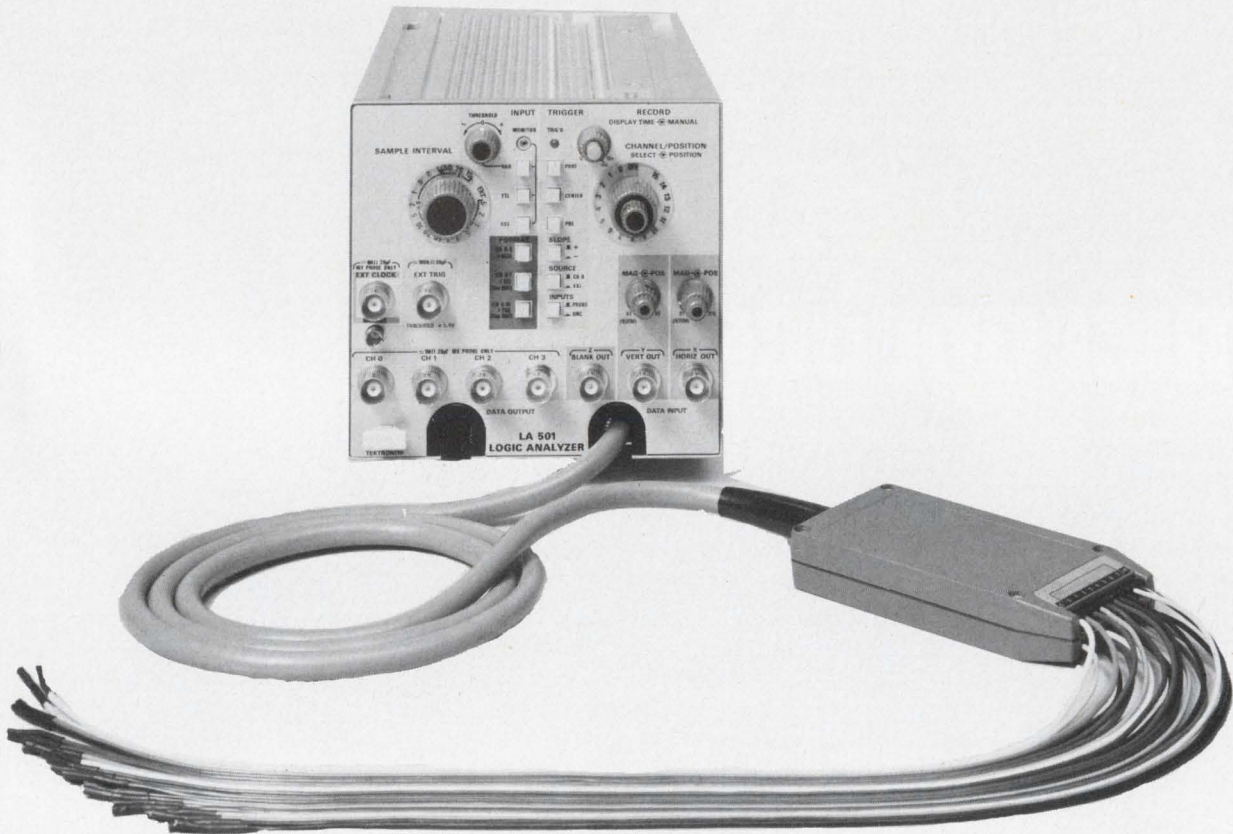

The hottest up-and-coming instrument today is the logic analyzer. There's little doubt that it will become as important in digital troubleshooting as the oscilloscope is now in the analog world.

Even in infancy, the analyzer has already diversified into a surprisingly broad product range, and new developments are being unwrapped almost daily. At least a dozen vendors offer analyzers. More are sure to follow. And with the two largest makers of instruments—Hewlett-Packard and Tektronix—now in the arena, you can bet that the action will gain new momentum.

A number of questions are being raised, however, by the analyzer's

meteoric rise in just a few short years. Included are these: Will it shove the scope aside in digital work and thereby significantly cut into the \$200 million oscilloscope market?

When the shakeout in performance features and vendors occurs, what shape will the surviving equipment take? Will one analyzer dominate or, as is more likely, will various units remain to address different problems in design, development, troubleshooting and field service?

If the history of the oscilloscope offers any lesson, it's that no one instrument can solve all problems.

## The analyzer today

How do analyzers stack up today? Depending on which microscope you use to dissect available

**Reformattable inputs**, with up to 16 channels, mark the Tektronix LA 501 timing-diagram analyzer.

products, you can split analyzers roughly three ways: along dollar lines, intended application and type of display. Considerable overlap occurs within these distinctions—as do arguments for the relative advantages of the various types.

Broadly speaking, you can plunk down about \$600 for a low-speed (under 5 MHz) instrument with no display or you can budget \$14,000 for a top-of-the-line, multi-channel, high-speed (to 200 MHz) unit with integral display. Those analyzers without a display come as either scope plug-ins or as stand-alone packages that deliver signals to a conventional scope.

Whether these extremes really



# The Right DMM Decision Means Five-Function Autoranging for only \$225\*

## Introducing HP's 3476A DMM

The price is a big story in itself. But performance and reliability play a large part too. Take a look at the 3476A:

**Autoranging**—a big plus in a low cost DMM. It lets you concentrate on the point of measurement... minimizes reading errors... and speeds readings too. All readings are made directly in volts, kilohms, or amps—on an LED display. And there's a rangehold button to speed and simplify repetitive measurements.

**Five functions**—all the functions you want and need in a low cost DMM. Simply push the appropriate button to read AC volts, DC volts, AC or DC current, and ohms. There's no worry about polarity or zero... they're both automatic.

**Advanced design**—both circuit and packaging. And both contribute to high reliability. One circuit board contains all the electronics.

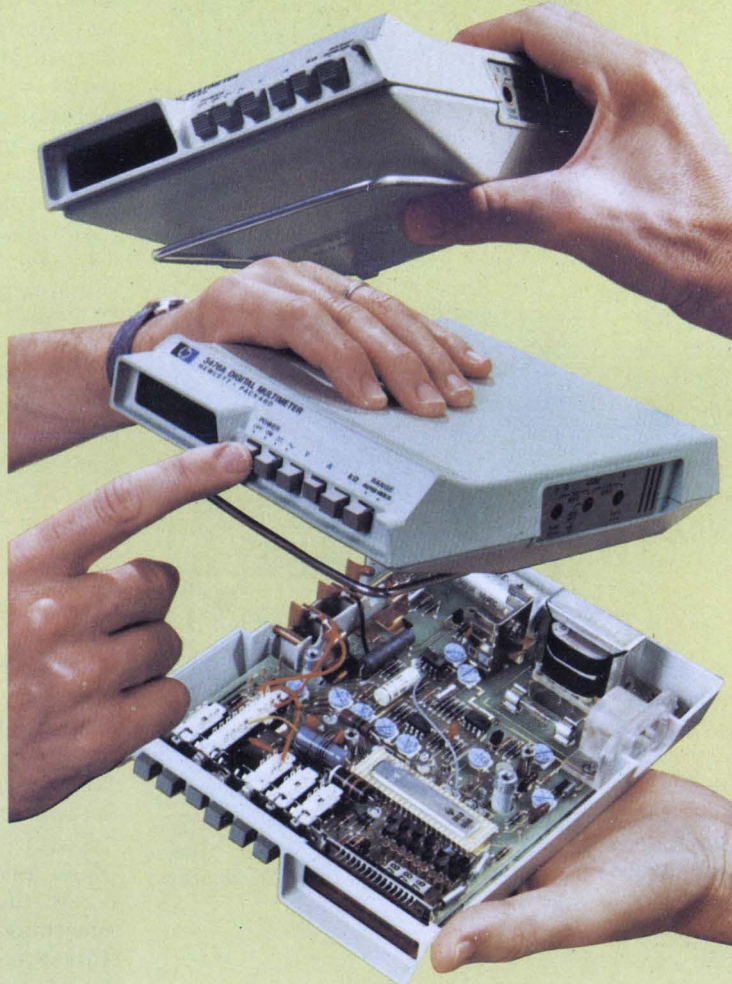

Tantalum nitride on sapphire processing allows replacement of all front end precision resistors by a single chip. That means greater reliability and better temperature stability. Of course it's input protected.

**Convenient size**—just right to hold in your hand... take with you in a brief case... or use on your bench. An optional carrying case and probe kit let you hang the instrument from a strap for "no-hands" operation. The "A" version (\$225\*) operates from the AC line for lab use. And for portable applications, the "B" version (\$275\*) has built-in batteries and recharging circuitry.

The 3476A is backed by HP's service organization... another big plus for a low-cost DMM. With these prices and features, why not put your hands on the 3476A for your 3-1/2 digit measurements? Your local HP field engineer can tell you how.

\*Domestic U.S.A. prices only.

**HP DMM's—  
the right decision**

Actual Size

095/52

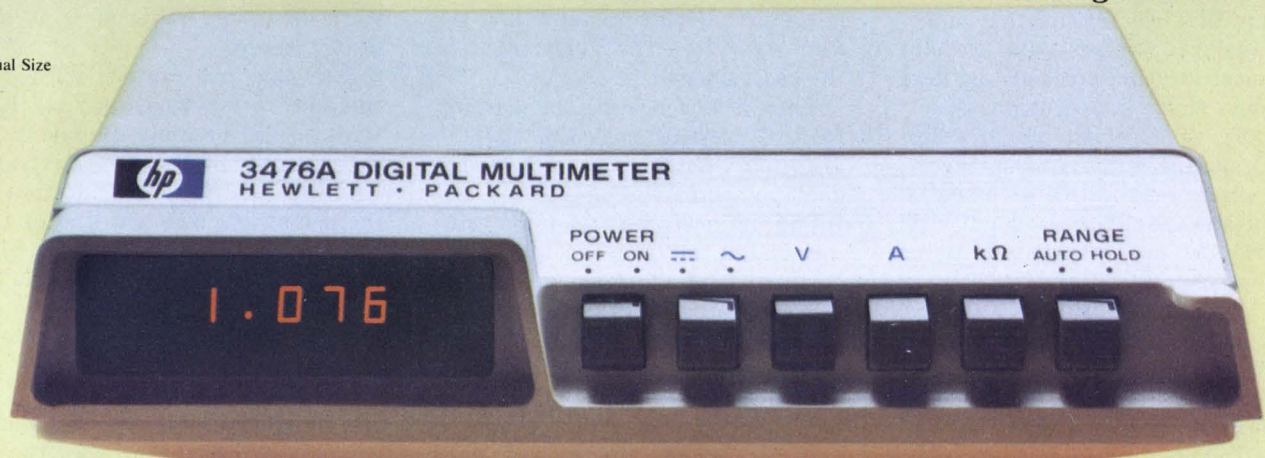

HEWLETT  PACKARD

Sales and service from 172 offices in 65 countries.  
1501 Page Mill Road, Palo Alto, California 94304

INFORMATION RETRIEVAL NUMBER 11



compete is questionable. But in jockeying for recognition and position in a young, unsettled market, vendors are quick to extol the virtues of their own products and point to the limitations of practically all comers. One area frequently mentioned is the type of display.

The timing-diagram display—that is, logic levels vs time—dominates at present, with about 90% of all units offering this format. Only one manufacturer, HP, offers a different display. The company's analyzers show the ONE, ZERO bit pattern, or truth table, of a logic condition or sequence of conditions.

One HP unit, the 1600A, shows ONEs and ZEROs plus what HP calls a map display: an array of up to  $2^{16}$  dots, with each dot representing a 16-bit word. The dots of a logical sequence are connected by lines, and each pattern, or map, thus displayed is uniquely representative of a given digital program or routine.

### What's an analyzer?

Whatever the display, practically all analyzers share a number of features that have become synonymous with the word "analyzer." Included are multiple input lines, or channels, internal storage, the ability to recognize and trigger on a preset digital word, and the ability to look forward or backward in time—that is, to look along a sequence of data events that occur either before or after a reference event.

It is this last feature that makes the analyzer so useful and perhaps the most exciting piece of test gear to come along in recent years.

Some vendors list glitch detectors, special outputs or triggers, plus other capabilities as essential to an analyzer. Others don't. Still others see multichannel units as cumbersome and limited to laboratory use. The latter, of course, offer compact units, with limited features aimed at field-service requirements.

Because the analyzer is still growing up, and will likely continue to change over the next few years, there's no single satisfactory definition of what an analyzer should be. In fact, the word "analyzer" is a misnomer. The

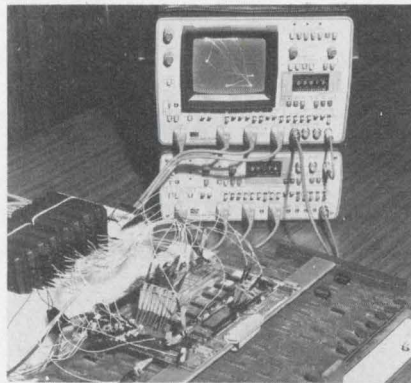

**Mapping logic-circuit performance:** A logic-state analyzer, from Hewlett-Packard, reveals a circuit's characteristic signature pattern.

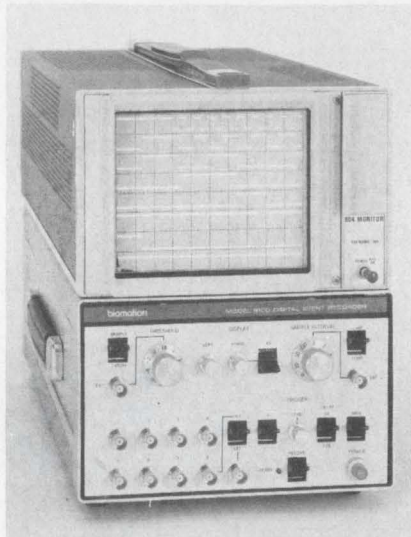

**One of the first analyzers** on the market is still a best seller. The unit is Biomation's 810-D digital logic recorder.

products that now use the name are actually data grabbers, manipulators or displayers, and it's the user who does the analyzing, not the instrument.

Thus a look beyond the common features reveals that most of the analyzers on the market today don't compete head on; each is useful in its own way and can give the design engineer another piece of the troubleshooting puzzle.

The timing-diagram analyzer—as pioneered by E-H Research Laboratories and Biomation and now offered by Tektronix and others—zooms in on one set of problems. The ONEs and ZEROs logic-state analyzer developed by HP takes an entirely different approach.

Basically the difference is this: Because the state analyzer shows words vs events, it examines the

functional behavior of digital systems. By contrast, the timing analyzer displays words vs time (or a pseudo-voltage vs time) and thereby concentrates on such electrical problems as incorrect timing, glitches, ringing, slow rise times and the like.

Some broad implications arise because of the differences in the two approaches. Some people—like Burnell West, the inventor of the E-H Digiscope, and Ken Pine, marketing manager of BP Instruments, Cupertino, CA, maker of the Model 20D Logiscope—see the distinction as the division between a hardware debugger and a software debugger. Others point to more subtle aspects.

### ONEs, ZEROs vs timing diagrams

Roy Tottingham, chief engineer at Biomation, a leading vendor of analyzers, elaborates: "With ONEs and ZEROs, you're synchronized with the clock of the system under test. You don't look for failures or unwanted signals that occur between clock pulses. Most timing-diagram units, however, can run synchronously or, with an internal clock, asynchronously. The internally clocked unit can run a lot faster than the data and can also offer a larger storage capacity than the synchronous machine."

Tottingham concludes: "The ONEs and ZEROs unit thus assumes the hardware is fine and something is wrong with the intelligence. On the other hand, though some people say the timing diagram isn't as handy in the software situation, at least it is still usable there."

One man who agrees with Tottingham, not surprisingly, is Rick Watkins, a product manager for the recently unwrapped Tektronix LA 501 analyzer, an addition to the company's TM 500 line of test instruments. Watkins says: "The timing analyzer, in our view, is the fundamental approach. The state analyzer is an interesting iteration, or subset, of the timing approach. It has glamour and is certainly useful—but less universally useful than a timing analyzer."

But the line between the hardware/software or electrical/functional distinction—while generally accurate—has some fuzzy edges,



# THE WINNING CARDS

for the Electronic Game of Knowledge



**The leading electronic publications  
on the Italian speaking market.**

**Elettronica Oggi** \_\_\_\_\_ for the design engineer, manager  
**Millecanali** \_\_\_\_\_ for the broadcaster, cable operator  
**Selezione Radio TV** \_\_\_\_\_ for the engineer, technician, teacher  
**Sperimentare** \_\_\_\_\_ for the hobbyist, student

**For more information and rate card, write:**

**in Italy**

JCE Publications  
Via Pelizza da Volpedo, 1  
Cinisello B. Milan

**in U.S.A.**

D. Serafini  
J.C.E. Publications  
L.I., N.Y. 11951

ad produced by D. Serafini U.S.A.

INFORMATION RETRIEVAL NUMBER 12



traceable to differences between the various instruments. At least one timing-diagram analyzer doesn't have an internal clock. Another, until recently, couldn't accept externally clocked (synchronized) data.

And such features as glitch catchers, slow-rise-time indicators and dual thresholds vary in performance from unit to unit or aren't available. Finally a large memory—and therefore high resolution—isn't found in all timing-diagram analyzers.

The upshot is that though both the state and timing analyzers can isolate a problem in their own fashion, you may still need an analog scope to pinpoint the exact cause.

Hewlett-Packard's Don Corson, product manager for logic analyzers, sees the need for all three pieces of test gear—the scope and both kinds of analyzers. He says that "it's not unusual for an engineer to look for a fault with state analysis because he can view a large amount of data rapidly and page through fields of program flow.

"Once he finds a mis-set bit," Corson continues, "he might then go to the control lines with a timing analyzer and look for a race condition or something similar. Then he might use a scope to get a microscopic view of the line in question at the point in time where the problem exists. One guy—the engineer—needs all of this capability."

### To catch a glitch

Though glitch catchers are often thought of as a feature exclusive to the timing instrument, Corson notes that if the glitch is wide enough or large enough to mis-set a bit, the state analyzer will show it. The next step with either analyzer, Corson says, is to go to the scope to find the cause.

Items like glitch catchers and multiple thresholds are still in a state of flux. High-speed asynchronous analyzers already sample at a rate that is fast enough to grab many anomalies, so they may not include a separate glitch mode. Other units, though fast, provide a latch mode anyway to catch faster glitches in the 5-to-10-ns range.

At least one unit—the BP In-

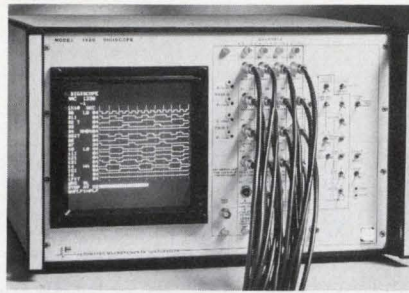

Alphanumeric readout plus a timing diagram are characteristics of the AMC 1320 Digiscope, from E-H Research Laboratories.

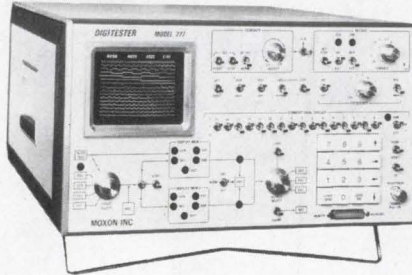

It's not only an analyzer, it's a data generator. With the Moxon 777, you can set up any test pattern.

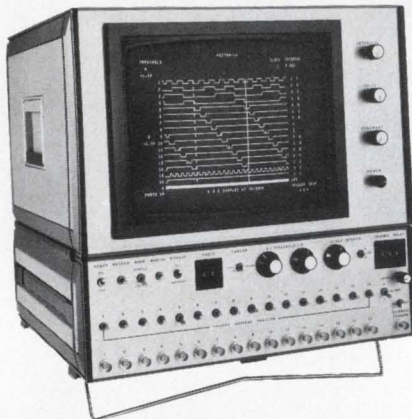

Taking aim at  $\mu$ Ps is the Model 16, from Vector Associates, a 16-channel unit with a microprocessor I/O.

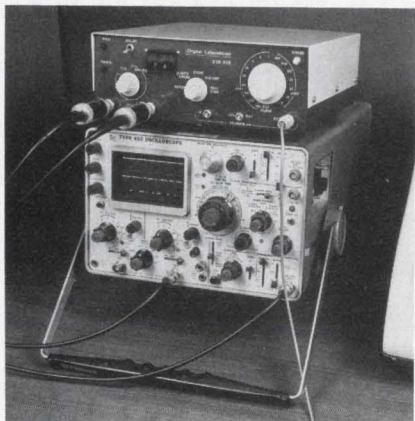

Testing in the field is the forte of the Digital Laboratories DSR 505, a two-channel analyzer.

struments Logiscope—includes a front-panel switch to desensitize the glitch circuit. The idea here is to appeal to those working with relays or other very-low-speed logic (1 kHz), in which slow glitches are of interest.

Another unit—the DL plug-in from Logic Aid, Stamford, CT—is aimed at MOS microprocessors that don't operate above a 2-MHz clock rate.

"The problem here," says James T. Fulton, president of Logic Aid, "is not glitches, but the slow voltage rise following a transition, plus the tendency to hang more elements on the bus than the high-impedance MOS drive circuit can handle."

Therefore, Fulton says, a device that indicates that a circuit failed to reach threshold within the allowed setup time can be very helpful.

The "device" Fulton is referring to is the dual-threshold comparator, used by the DL and two other commercial analyzers: the AMC 1320 Digiscope from E-H Research and the DSR-505, a two-channel, stand-alone unit marketed by Digital Laboratories, Cambridge, MA.

The idea of dual threshold is to display not just the normal high/low logic states but abnormal or ambiguous conditions as well: open circuits, slow-rise signals, low ONES and high ZEROS, ringing and the like.

### Dual threshold vs single

In speaking about dual threshold, and about analyzers in general, E-H's West says: "It's a rather strong assumption to start diagnosis with the supposition that all logic levels are correct and that system timing is also correct. Many malfunctions are caused by inappropriate logic levels, skewed timing and similar problems."

Vendors of single-threshold instruments—and these include Hewlett-Packard, Tektronix, Biomation and probably everyone else—discount the importance of dual threshold. Bernie Floersch, a product support specialist at Tektronix, notes: "You can do the same thing with single threshold by use of the variable threshold adjustment. Just move the threshold level around in the intermediate zone, and you can pick up a signal that went



# NEW

## PRICE/PERFORMANCE BREAKTHROUGH

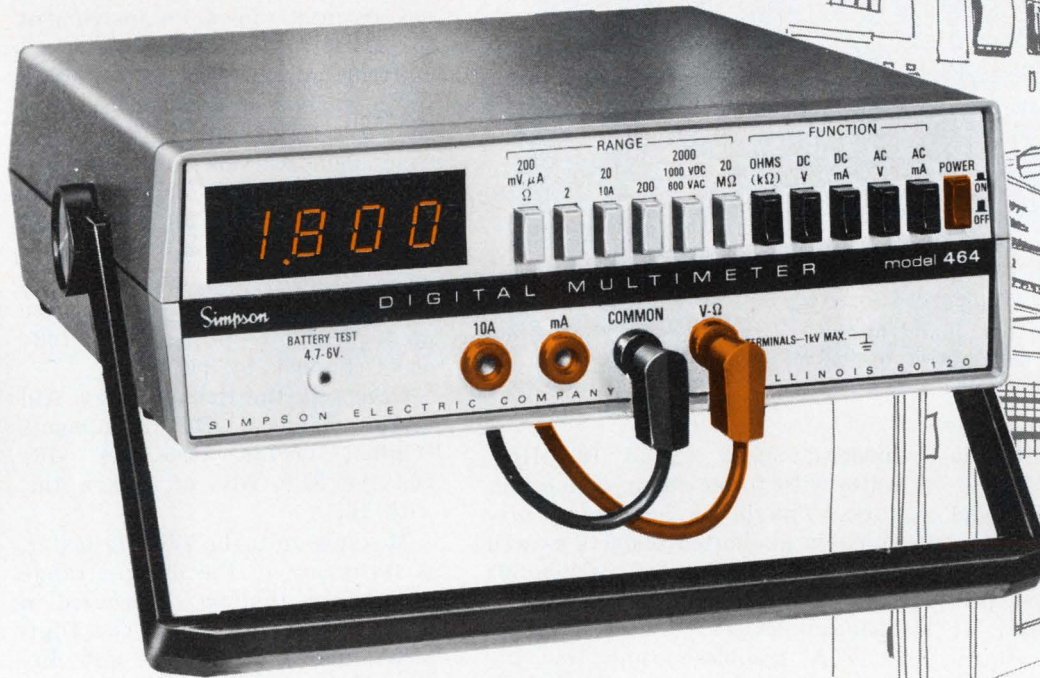

# SIMPSON

## MODEL 464

### Digital Multimeter

**USE IT EVERYWHERE:**  
In Field or Factory  
Production Line Testing,  
Laboratory, R & D, and for  
General Electronic Servicing.

- 3½ Digit, 0.43" LED Readout
- Highly Reliable LSI Circuitry
- Bi-Polar Operation and Automatic Zero
- Full Pushbutton Selection of Ranges and Functions
- 28 Ranges: 6 AC current ranges to 10 amps  
6 DC current ranges to 10 amps  
6 resistance ranges to 20 megohms  
5 AC voltage ranges to 600 volts  
5 DC voltage ranges to 1000 volts

- Choice of Battery/AC Line Combination or AC Line Operation Only
- High Impact Shock-Resistant Case with Tilt-View, Adjustable Handle
- Conforms to Applicable ANSI C39.5 Requirements

**Model 464A** line operation ..... \$210.00  
**Model 464D** line and battery operation .. \$247.00

ORDER FROM YOUR ELECTRONICS DISTRIBUTOR

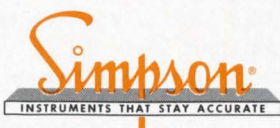

### SIMPSON ELECTRIC COMPANY

853 Dundee Avenue, Elgin, Illinois 60120 • (312) 697-2260

CABLE: SIMELCO • Telex: 72-2416

IN CANADA: Bach-Simpson, Ltd., London, Ontario

IN ENGLAND: Bach-Simpson (U.K.) Ltd., Wadebridge, Cornwall

IN INDIA: Ruttonsha-Simpson Private, Ltd., Vikhroli, Bombay

INFORMATION RETRIEVAL NUMBER 13

KATY INDUSTRIES



INDUSTRIAL  
EQUIPMENT  
GROUP



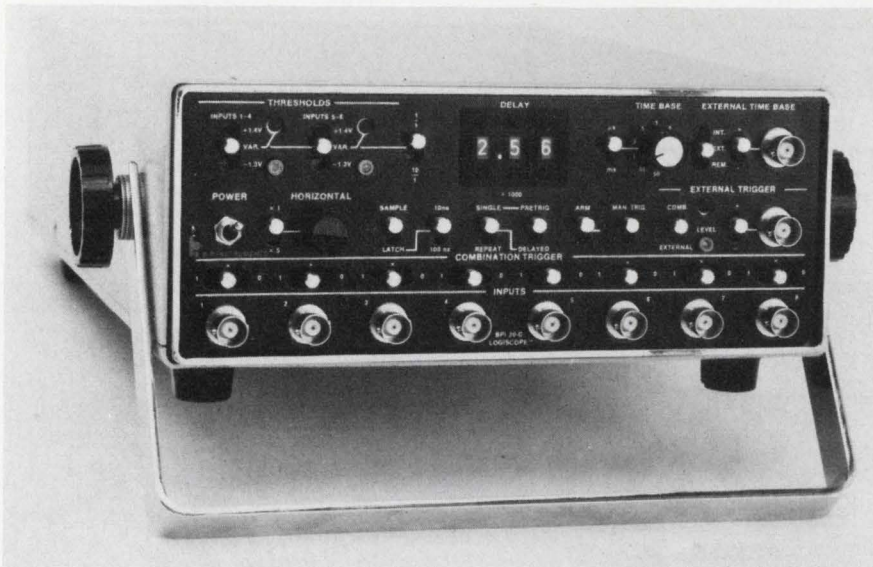

**Glitch detectors**, such as the one found in the BP Instruments 20-D, bring some of the analog scope's capabilities to the analyzer.

through low but didn't get to the high level."

One commercial unit, the Model 80 from Digital Broadcast Systems, Madison, AL, has no settable threshold at all. Though the unit is termed a logic analyzer, it works more like a serializer. It accepts eight logic inputs and delivers two signals to a conventional scope—a multiplexed signal to the vertical input plus a trigger signal. One of the eight inputs is selected by the user as the scope trigger.

The 80 doesn't capture data and therefore can't be used to look forward or backward along a stream. And the unit doesn't recognize, or trigger, on a preset word. But it's still called a logic analyzer, and for \$595, you may not care about those things.

The Digital Laboratories instrument, the DSR-505, isn't labeled an analyzer but a digital signal recorder. Yet it has many of the features expected in an analyzer: adjustable thresholds, storage, historical display of signals prior to triggering and an internal time base. However, the 505 samples only two channels (with 10:1 probes), doesn't recognize words and lacks other analyzer features.

William Kahn, president of Digital Laboratories, offers the 505 as more suitable for field work than multichannel units and, in fact, sees analyzers splitting into two paths: high-speed (50 to 100 MHz), multichannel units and

moderate-speed (2 to 10 MHz) units with fewer channels and features. The latter are aimed presumably at limited budgets as well as the debugging of peripherals and digitally oriented electromechanical devices.

"For troubleshooting in the field," Kahn says, "you don't need more than two channels. Realize that 16 channels are no magic number. Neither is eight. Sometimes you want to look at more than 16 bits—at control signals, for example.

"So two channels form the basis, and you can envision devices that serialize any number of input channels and use just a two-channel display—one channel for the data pattern, the other as a reference marker."

### Number of inputs expands

But though there's nothing magical about the number 8 or 16, there's a compelling reason to be able to examine that many lines simultaneously—as anyone who's worked with microprocessors can tell you. Curiously enough, developments in analyzers appear to have been spurred and paced by progress in microprocessors.

Thus while the original analyzer—Hewlett-Packard's 5000A—accepted just two inputs, and the 1601L plug-in, HP's second-generation unit, took 12, the company's newest analyzers—the 1600A and 1607A—are 16-channel instru-

ments. Working together, the 1600 and 1607 can look at 32-bit words.

Biomation's first entry—the 810-D—started off with eight channels, and the company's newer models—the 100-MHz 8100D and the 200-MHz 8200—accept eight signals at once. And E-H Research, which started with eight channels, has recently upped its instrument to 16.

Practically all the new entries in the analyzer market have settled on eight or 16 inputs, with some expandable to even more. The lineup includes the 100-MHz Tektronix LA 501, which can be reformatted by the user to display four channels by 1024 bits, eight by 512, or 16 by 256. Or the user can slave up to four 501s to get 16 by 1024 or 64 channels by 256 bits.

Others in the lineup: Logic Aid (eight channels), BP Instruments (eight), Vector Associates (16) and the SCR Div. of Moxon Inc. with 16.

Moxon's unit, the 777 Digitester, is testimony to the diverse range of products that have appeared in just a few, short years. The Digitester not only receives and displays data; it's also a data generator. The user can set up his own serial or parallel test pattern and watch the system under test respond as he changes any of the pattern bits. Not surprisingly, the 777 is targeted at  $\mu$ P testing.

Another newcomer aimed at  $\mu$ Ps is the Vector 16 logic recorder/analyzer from Vector Associates, Bellport, NY.

Doug Pope, director of engineering for Vector, explains the rationale behind the Vector 16: "Some  $\mu$ P manufacturers offer a pretty good debugging tool for their own product—for example, the Exorciser, the Inteltec. But until now no one offered a tester that could handle more than one vendor's product—a universal instrument, like the scope, that could be used over a relatively long time, say, three to five years.

"We offer," Pope says, "a 16-bit address register with three trigger sources: internal, external and what we call a  $\mu$ P I/O. With it, you can go into a conversational mode, you can give us op codes rather than press buttons on the front panel. And if you want to go into the  $\mu$ P I/O with your bus lines, you can trigger the 16 at



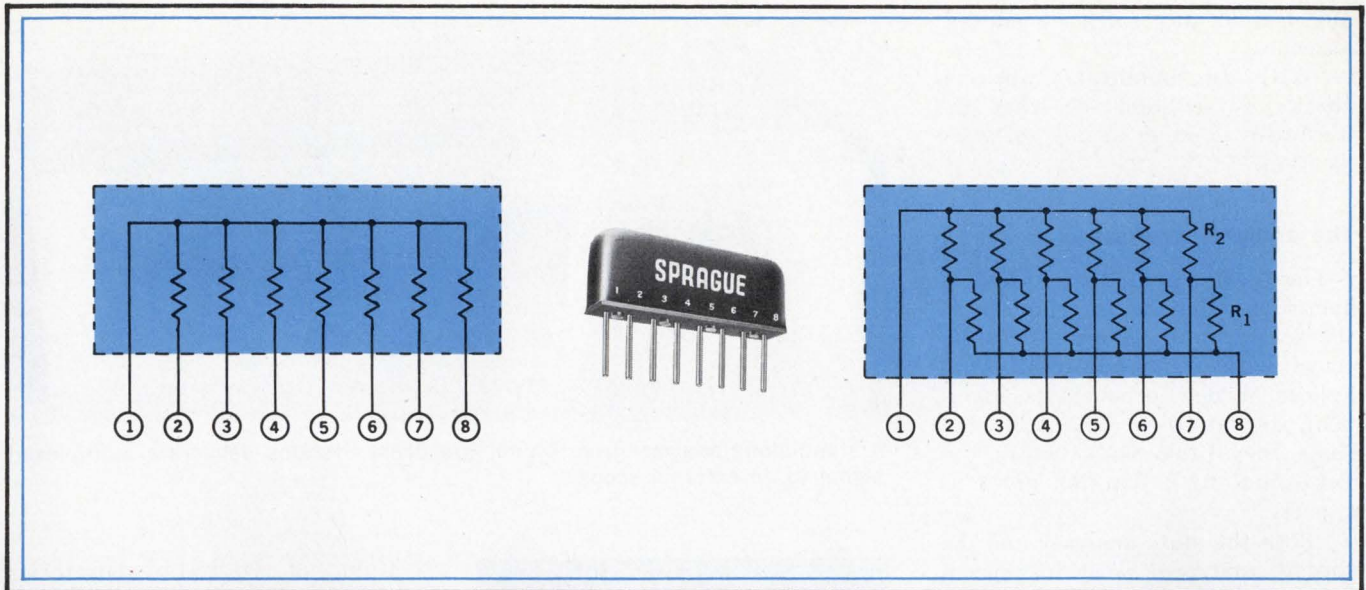

# BOARDABLE AND AFFORDABLE

**Low Cost** and **High Density Configuration** are only two of the features of Sprague Type 216C Metanet® Resistor Networks. Now, you can also enjoy the benefits of improved power dissipation, better temperature coefficient of resistance, and closer standard resistance tolerance.

**Save Board Space.** Single in-line design permits vertical installation, which allows more units to be seated in less space. This mounting style also results in improved high-frequency performance and significant in-place cost reduction.

**Better TCR.** Typical temperature coefficient of resistance is within  $\pm 200\text{ppm}/^\circ\text{C}$ , cutting previous allowable limit almost in half.

**Up-graded Power Dissipation.** Individual terminating, pull-up/pull-down, and interface networks are capable of dissipating 250mW per resistor at 70C, an increase of 100% over previous designs.

**Closer Resistance Tolerance.** Standard resistance tolerance for each resistor is  $\pm 2\%$ , with other tolerances between  $\pm 1\%$  and  $\pm 5\%$  available on special order.

**Proven Product Line.** Sprague has more than fifteen years of experience in the development and manufacture of precision thick-film resistor networks, which include individual terminating, pull-up/pull-down, interface, and dual terminating designs.

*For complete technical data, write for Engineering Bulletin 7041A to:  
Technical Literature Service, Sprague Electric Co.,  
347 Marshall Street, North Adams, Mass. 01247.*

4S2-5124

**THE BROAD-LINE PRODUCER OF ELECTRONIC PARTS**

INFORMATION RETRIEVAL NUMBER 14





any hex or any software address location.

"With 16 umbilicals, you can check any  $\mu$ P and see what the hardware is doing at any software location."

### The analyzer grows up

The Vector and Moxon instruments may be the forerunners of the next crop of analyzers, designed with  $\mu$ P systems in mind. That a host of new products is imminent, you can be sure. Exactly what shape they'll take isn't certain, but Tektronix' Rick Watkins gives us a peek.

"Both the state analyzer and the timing analyzer," Watkins speculates, "are far from the end-all in the evolution of analyzers. With intelligence, you can create characters. You can put the bits into a computer, which doesn't care about ONEs and ZEROs or high/low levels.

"Some folks have already tied the analyzer, as an acquisition system, into a computer. The analyzer is just a front end, a capturer. The computer program is the thing that analyzes."

Both Corson of HP and Tottigham of Biomation reinforce Watkins prediction of smart analyzers. What form will the intelligence take? Listen to Corson:

"We've got to assume that the  $\mu$ P will touch analyzer design, just like it's touched almost every other instrument design. So in the future I think we'll see units that can do more analyzing within themselves. Right now, analyzers aren't—they're presenters."

And Tottigham adds this: "To troubleshoot  $\mu$ P systems, I think we're going to see other equipment—ones that are similar to current logic analyzers but are designed specifically for  $\mu$ P problems. These new testers probably will contain  $\mu$ Ps themselves and a fair amount of software."

Tottigham reflects on what kinds of formats or displays such an analyzer might have:

"Because so many different  $\mu$ Ps exist, the user will have to have some way of telling the test equipment, 'Hey now, I'm working with an 8080 or a 6800.' He'll do that by just calling up another ROM format or program.

"And the user will have more



A stand-alone analyzer from Digital Broadcast Systems delivers a multiplexed signal to an external scope.

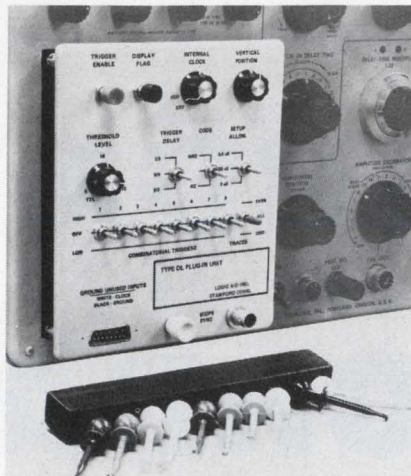

Another form analyzers take is the scope plug-in format. This one is from Logic Aid Inc.

than one display format, not just ONEs and ZEROs or timing diagrams. With complex  $\mu$ Ps, you want to look at higher levels—at least some type of alphanumeric."

Tottigham may see such a unit sooner than he expects. In the works at Logic Aid is an analyzer that will display ONEs and ZEROs for the data words, or the hexadecimal equivalent, but will also show mnemonic codes for the instructions.

Logic Aid's Fulton explains: "The user will set the analyzer's trigger for a given code or data word. The unit will trigger on the first occurrence and store both pre-trigger and post-trigger information. Then the operator will be able to scan through 100 stored words by use of the host oscilloscope's controls. Thus he'll easily verify his processor operation without a teletypewriter or a proprietary  $\mu$ P development system."

Kahn of Digital Laboratories sees two general categories for future analyzers: dedicated and roving. The former will consist of multichannel units plugged directly into, say, a  $\mu$ P system; and the roving will play a field-service role, with perhaps just two or three channels but with more test power per channel.

"Just as two-channel scopes eventually dominated," Kahn says, "so will the two-channel analyzer probably prevail."

Whether Kahn is right remains to be seen. Perhaps a more significant question is this: To what extent will the analyzer take over the analog scope's role in digital work? Both Corson and Watkins—whose companies together share over 90% of the U.S. scope market—feel that some shift will occur.

In Watkin's view, the shift will be in terms of expertise, a way of making measurements, rather than in terms of dollars. And he doesn't see any significant changes for at least five years.

But Corson feels that the market for analyzers is exploding and that "part of the scope dollars has to be divided up among the generic class of logic analyzers—whether it will be an eighth, a quarter, or half, it's too early to tell."

However, Corson also observes that the analyzer market will expand, with all the new vendors coming on board, so that new dollars will be generated as well. And Corson reiterates that the scope certainly still will be needed for a final analysis.

Whatever happens, the logic analyzer is growing up fast and is here to stay. ■■



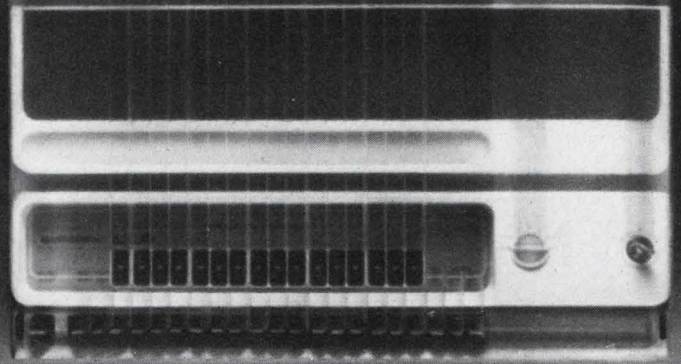
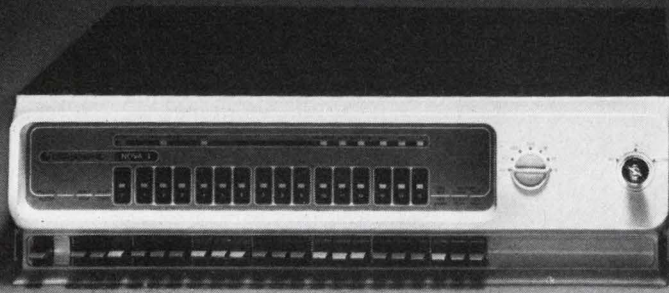

## The biggest thing to ever hit the OEM market, gets even bigger.

The four slot version of the Nova 3 gets pretty big. Up to 32K words of memory. But Nova 3 doesn't stop there. If you want to go further, consider the 12 slot Nova 3.

It can take on up to 128K words of memory. And our optional Memory Management Unit makes efficient use of all that memory, without a lot of systems overhead.

If you're going to need more I/O than the 12 slot Nova 3 can give you, there's an optional 12 slot expansion chassis.

And if one fully expanded Nova 3 still isn't big enough to handle the problem, you can add more Nova 3's and make multiprocessor systems. And they come with standard off-the-shelf software.

Why do we go to the trouble of offering such a wide range of configurations?

So you can meet any number of different systems requirements with the same processor. Without buying a lot of

different spares. Without training your people in a lot of different test and maintenance procedures.

And so you can take your smallest product and make it a lot bigger. Without systems redesign. Without rebuilding your interfaces. Without rewriting your software.

And, no matter how small a Nova 3 you start out with, you get big performance. Nova 3 executes instructions in only 700 nanoseconds. Or more than twice as fast as the computers you're apt to compare it with.

Yet for all its bigness, there is one small feature in the Nova 3. Price. You can get a 64K word MOS memory Nova 3 with Memory Management Unit, Automatic Program Load and Power Fail Protection for just \$16,800\* (Or a smaller Nova 3 for an even smaller price. A 4K MOS system for \$2,600\*.)

Write for the brochure.

You may discover that bigger is better.

\*Single unit price before OEM and quantity discounts get figured in.

## DataGeneral

### Nova 3: The biggest thing to ever hit the OEM market.

•Data General, Dept. N2, Route 9, Southboro, Mass. 01772 (617) 485-9100. Data General (Canada) Ltd., Ontario. Data General Europe, 15 Rue Le Sueur, Paris 75116, France. Data General Australia, Melbourne (03) 82-1361/Sydney (02) 908-1366.



## Digital devices abound at New York boat show

Seafarers are going digital. That was the word at the 66th National Boat Show held last month at the Coliseum in New York City.

Among the shipboard electronic equipment on exhibit, digital depth sounders dominated the scene, but also displayed were digital-speed and distance-measuring devices, a digital compass and uhf telephones using digitally synthesized frequencies.

Wesmar (Western Marine Instruments), Seattle, WA, and Datamarine International, Pocasset, MA, both featured digital depth sounders. The Datamarine device (Capree OB-200D) is said to have a depth-measuring capability of from 2 ft. to 199 ft. to an accuracy of 1 ft. The unit uses integrated circuitry but employs incandescent RCA Numatron tubes for the digital readout.

Datamarine engineer Alan Zemanovic explains that these readout tubes provide good visibility even in bright sunlight, and also allow for intensity dimming for nighttime viewing.

Wesmar's digital depth sounder can accurately measure depths up to 600 ft., and can display this information both in feet and in fathoms, according to Dave White, Wesmar's Marine Systems Division representative.

An additional feature of the Wesmar depth sounder is an alarm that can be set to go off at a preset depth. It provides a safety feature for boats entering shallow water. As an aid to fishermen, the sensitivity control provided can be set to a predetermined threshold such that any fish passing between the hull of the boat and the bottom of the water will be detected and cause the alarm to sound.

Digital, frequency-synthesized radio-telephones were offered by Hy-Gain Electronics, Lincoln, NE, and by Konel Corp., South San Francisco, CA. Konel's Model KR-78 provides 78 channels. The Hy-

Gain unit has a capacity of 55 channels at 25 W.

Wesmar also exhibited a digital compass that uses a saturable core to sense the direction of the earth's magnetic field. According to White, this device uses no moving parts and gives instant readout of direction on 1-inch-high light-emitting diodes that can be read in daylight at distances up to 20 ft. The digital compass also provides a readout of elapsed time in seconds, and can be used as a stopwatch for navigating purposes.

Other devices on exhibit included a digital-direction-finder and an electronic-stopwatch kit, both from Heath Co., Benton Harbor, MI. Also on view was a scanning sonar with CRT display. This Wesmar unit is said to be the first such sonar system available for pleasure and sports craft. The sonar scans a full 360° and plots a radar-like picture on the CRT to indicate submerged objects, including fish, within a range of 50 to 500 ft.

Shipboard sources of electrical power also shared the limelight at the show. SES (Solar Energy Systems) of Newark, DE, exhibited cadmium-sulfide solar-cell panels designed to be mounted on deck or housetop for direct conversion of sunlight to energy.

Each 18 × 18-inch panel generates a peak output of 300 mA at 12 volts. A single solar panel, according to an SES spokesman, is enough to prevent discharge of the shipboard battery. Two would be sufficient to recharge the ship's battery after a weekend of sailing.

Currently available shipboard solar cells are made of silicon and are about twice as efficient (in terms of current output per unit area) as the SES cadmium-sulfide cell, the company spokesman said. However, at a list price of \$99.95 per panel, the SES cadmium-sulfide cell is approximately half the price (per watt of available power) of the silicon cells. ■■

## RAM ROM PROM NOW THERE'S E<sup>2</sup>ROM

FROM THESE  
GENERAL INSTRUMENT  
DISTRIBUTORS

### CALIFORNIA

#### Newport Beach

Semi Comp. .... (714) 833-3070

#### Santa Ana

Intermark ..... (714) 540-1322

#### San Diego

Intermark ..... (714) 279-5200

#### Sunnyvale

Diplomat ..... (408) 734-1900

Intermark ..... (408) 738-1111

### FLORIDA

#### Clearwater

Diplomat ..... (813) 443-4415

### ILLINOIS

#### Elk Grove Village

Diplomat ..... (312) 595-1000

#### Elmhurst

Semiconductor Specialists ..... (312) 279-1000

### INDIANA

#### Fort Wayne

Fort Wayne Electronics ..... (219) 423-3422

#### Indianapolis

Semiconductor Specialists ..... (317) 243-8271

### MARYLAND-WASHINGTON, D.C.

#### Rockville

Pioneer ..... (301) 948-0710

### MASSACHUSETTS

#### Holliston

Diplomat ..... (617) 429-4120

### MICHIGAN

#### Detroit

Semiconductor Specialists ..... (313) 255-0300

#### Farmington

Diplomat ..... (313) 477-3200

### MISSOURI

#### St. Louis

Diplomat ..... (314) 645-8550

Semiconductor Specialists ..... (314) 428-6100

### NEW JERSEY

#### Little Falls

Diplomat ..... (201) 785-1830

### NEW MEXICO

#### Albuquerque

Century Electronics ..... (505) 292-2700

### NEW YORK

#### Woodbury

Diplomat ..... (516) 921-9373

### OHIO

#### Dayton

Diplomat ..... (513) 228-1080

Semiconductor Specialists ..... (513) 278-9455

### OREGON

#### Portland

United Radio Supply ..... (503) 233-7151

### PENNSYLVANIA

#### Pittsburgh

Semiconductor Specialists ..... (412) 781-8120

#### Trevese

Hallmark Electronics ..... (215) 355-7300

### TEXAS

#### Dallas

Semiconductor Specialists ..... (214) 358-5211

### UTAH

#### Salt Lake City

Alta ..... (801) 486-7227

Century Electronics ..... (801) 487-8551

GENERAL INSTRUMENT CORPORATION  
MICROELECTRONICS





# ~~RAM ROM PROM~~

# NOW THERE'S EAROM

FROM GENERAL INSTRUMENT

**THE ELECTRICALLY ALTERABLE NON-VOLATILE MEMORY YOU CAN  
PROGRAM, ERASE, AND REPROGRAM... IN OR OUT OF SYSTEM**

The importance of the EAROM\* to you is that it not only provides the ease of application of a RAM and the non-volatility and density of a ROM, but you can program it, erase it, and reprogram it, electrically, in or out of system. You can't do that with RAM. You can't do that with ROM. You can't do that with PROM. You can only do that with EAROM.

### THE EAROM FAMILY

PART NO.	BITS	ORGANIZATION	ALTERABILITY	UNIT PRICE (100 piece quantity)
ER 2050	512	32 x 16	BY WORD	\$20.00
ER 1105	1024	256 x 4	BY BLOCK	\$20.00
ER 2401	4096	1024 x 4	BY BLOCK	\$25.00

There's a family of EAROMs in stock and available right now from the General Instrument distributors listed on the adjoining page. More EAROMs are on the way. For further information call toll free 800-645-9247 (in N.Y. State: 516-733-3107) or write, General Instrument Corporation, Microelectronics, Dept. E 13, 600 W. John St., Hicksville, N.Y. 11802.

### EAROM VS. RAM, ROM, PROM

	MASK PROGRAMMED ROM	PROM (Fusible Link)	ULTRA-VIOLET ERASABLE PROM	RAM	EAROM
FIELD PROGRAMMABLE	NO	YES	YES	YES	<b>YES</b>
REPROGRAMMABLE	NO	NO	YES	YES	<b>YES</b>
ERASE/WRITE IN-SYSTEM	NO	NO	NO	YES	<b>YES</b>
WORD ALTERABLE	NO	NO	NO	YES	<b>YES**</b>
NON-VOLATILE	YES	YES	YES	NO	<b>YES</b>
AVAILABLE OFF-THE-SHELF	NO	SOMETIMES	SOMETIMES	SOMETIMES	<b>YES</b>

\*Trademark of NCR \*\*ER 2050

**GENERAL INSTRUMENT CORPORATION  
MICROELECTRONICS**



INFORMATION RETRIEVAL NUMBER 16



# four important reasons to specify the KEPCO **PCX** power supply

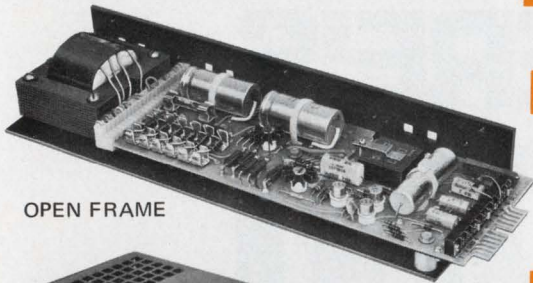

OPEN FRAME

**1 FOR THE OEM**, PCX are available as an open frame module with a massive heat sink that requires no other cold plate for non-derated operation to +71°C.



ENCASED MODULE

**2 FOR THE ACCESSIBLE INSTALLATION**, PCX are available with a perforated metal enclosure. In either the open frame or dust cover configurations, all input-output programming connections can be made via a printed circuit edge connector, or parallel barrier-strip.

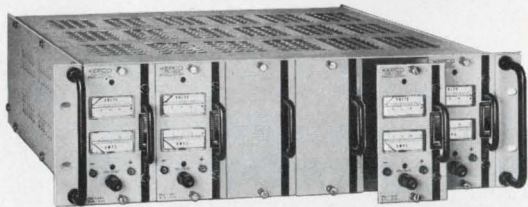

6-IN-A-RACK PLUG-IN

**3 FOR THE SYSTEM DESIGNER**, PCX are available in a convenient plug-in configuration. You can mount six instruments side-by-side in a 5¼" X 19" rack panel, configured either as remotely programmed modules or as metered instruments with 10-turn high resolution voltage controls and full metering.

BENCH INSTRUMENTS



SINGLE

DUAL

**4 FOR THE LAB BENCH EXPERIMENTER**, PCX can be configured as single, dual or triple output power supplies, each with separate, recessed dual-scale voltmeters and ammeters, plus 10-turn voltage controls.



TRIPLE

In any of these configurations, the Kepco PCX is a first-rate **high performance** voltage stabilizer offering better than 0.0005% immunity to source (mains) variations, less than 0.005% output change for a 100% load shift, and a real quiet output whose ripple and noise is under 0.1 mV rms (3 mV p-p measured 20 Hz–10 MHz). They're fully adjustable and programmable 0–7V, 0–15V, 0–21V, 0–40V, 0–72V and 0–100V. 6 models offering approximately 20 watts of honest power with no derating necessary up to +71°C.

**PCX**

is the multi-purpose voltage stabilizer that you can depend upon.

For complete specifications and Applications Notes, write Dept. FC-05

**KEPCO**®

KEPCO, INC. • 131-38 SANFORD AVENUE • FLUSHING, N.Y. 11352 U.S.A.  
(212) 461-7000 • TWX #710-582-2631 • Cable: KEPCOPOWER NEWYORK

INFORMATION RETRIEVAL NUMBER 17



# Washington Report

## **Will a reelection year dampen Congressional zeal?**

Congress came back from vacation with renewed determination to see its own philosophies become law. But so far the new session seems to be a repetition of the previous one—Congress passing bills, the President vetoing most of them and a frustrated Democratic majority unable to muster enough votes to override the vetos.

For the full House and 33 Senators this is reelection year, something that habitually dampens the ardor of reformers. There will be continuing efforts to cut the Defense budget, but that goal won't be as popular this year as last. When in doubt, most Americans lean toward greater defense spending.

Despite Congress' largest Democratic majority in 10 years, neither the batting record of the legislative branch nor the issues it will deal with are likely to change in this 94th session. Major issues will be the economy, energy, foreign policy and cuts in Government spending.

## **EDP trends for the '80s: more 'wands' and mass memories**

The National Bureau of Standards' electronic-data-processing expert doesn't expect computer systems in the 1980s to be radically different from those we use now. If there are innovations they will appear in R&D efforts for defense and space.

Two developments that will find increased application in industry in the 1980s, according to Dr. Ruth M. Davis, director of NBS's Institute for Computer Science and Technology, are automated reading technology, such as "wands" found in point-of-sale systems, and solid-state mass-memory devices, such as bubble memories, cross-tie memories, charge-coupled devices, read-write laser memories and crystal memories.

Changes will be more architectural than technological, Davis says. The conventional semiconductor ICs, magnetic core memories and magnetic storage will continue to dominate computer design.

## **Satellite network to use individual earth stations**

Satellite Business Systems, a partnership between COMSAT General, IBM and Aetna Life and Casualty, has filed applications with the Federal Communications Commission for a digital satellite communications system that will feature small earth stations on the customer's premises.

The system will permit the customer to combine voice, data, and image communications in a single, integrated, private-line, switched network using frequencies in the 12 to 14-GHz bands. Plans call for two satellites in geostationary earth orbit to cover all 48 contiguous states.

The small earth stations, equipped with antennas 16 to 23 feet in diam-



eter, will be designed to operate almost unattended.

SBS has asked the FCC to approve a limited pre-operational program and proposes to lease space-segment facilities from a domestic satellite carrier operating in the 4 to 6-GHz bands.

The new partnership estimates an investment of approximately \$250 million for the system through 1979, when operations would start.

## **Timetable proposal for overhaul of Government agencies**

A popular buzzword these days in Washington is "deregulation," and like motherhood and the flag just about everybody favors it. The word means overhauling such regulatory agencies as the Federal Communications Commission.

Now two senators—Charles H. Percy (R-IL) and Robert C. Byrd (D-WV)—have whipped up a bipartisan bill that would require a phased and timed reorganization instead of the all-or-nothing approach recommended by some others. The bill, which will likely receive serious consideration in the new session, calls for Congress and the Executive Branch to review the entire regulatory structure over a five-year period, and imposes deadlines for both elements of Government to propose and enact specific reforms. If the reforms aren't enacted on time the agencies would automatically be stripped of most of their powers. Deadline for FCC reforms would be 1979.

Here's how the 35 federal agencies, divided into five target groups, would fare: banking and financial reform by 1977; energy and environment, 1978; commerce, communications and transportation, 1979; food, health and safety, 1980; and housing, labor-management relations, equal employment, government procurement and small business by 1981.

**Capital Capsules:** The Defense Dept. has ruled that DOD personnel can attend banquets, luncheons and similar events given by industry associations, such as the Electronic Industries Assoc., only after the association has demonstrated to the Defense Dept. in advance that seating at the function will be arranged in a random manner. Defense personnel won't purposely be seated next to contractor personnel who might exert undue influence on them. . . . The Army has announced its interest in firms that can develop a lightweight airborne radar for detecting missiles. High on the sensor's priority list of specs are low-power and a low false-alarm rate. . . . Responding to news of Mexico's National Airport Plan that calls for new instrumentation for 75 airports, the U.S. Dept. of Commerce is sponsoring an exhibition of such equipment, and plans to present the show in Mexico City from March 29 to April 2. . . . The National Association of Broadcasters has asked the Federal Communications Commission to extend the implementation of the Emergency Broadcast System's new two-tone signaling system for at least six months. The system is to go into effect on April 15, unless the FCC relents. The Association says the broadcasting industry is in a state of confusion and is ill-prepared to adopt the new system on that date. . . . The Tactical Air Command is well on the way to getting a tactical electronic-warfare aircraft. In December Grumman installed and test flew a new radome in the weapons bay of the General Dynamics F-111A, thereby creating the EF-111A. Now Grumman will install approximately three tons of sophisticated electronics gear in the EF-111A, most of it already operational in the EA-6B electronic warfare aircraft Grumman built for the Navy.



# New Tektronix Logic Analyzer Acquires 16 channels

Here's how the new TEKTRONIX LA 501 Logic Analyzer acquires more data than other analyzers in its price range; does it with a higher sampling rate; and provides improved ways of displaying that information.

**Acquires up to 16 data channels simultaneously.** In fact, you can select storage formats of 16 channels x 256 bits, 8 channels x 512 bits, or 4 channels x 1024 bits to best suit your application.

**Stores 4096 data bits on a single pass** for display and study of large blocks of nonrepetitive information.

**Displays data before a trigger** in the pre-trigger mode. Two other modes provide for display of data centered around the trigger or after the trigger.

**Provides timing analysis with 15 ns resolution** in the asynchronous (internal clock) mode. For logic state analysis, the LA 501 accepts external synchronous clocks with rates up to 50 MHz.

**Compares timing between channels easily** using the unique capability of selecting any one of the displayed channels and positioning it vertically.

**Assures detailed views of logic timing** with the unmatched capability of zooming in on any segment of the 4096 bits of data for full screen display. For maximum visual resolution display units with up to 6 1/2" screens are available.

**Offers selection of the data window** to be stored and displayed. This is accomplished by delaying the store trigger with a DD 501 Digital Delay.

With all of this outstanding capability, the LA 501 is priced at only \$3,250 and plugs

into any of four TEKTRONIX TM 500 mainframes priced from \$150. It works with virtually any x-y display.

For a demonstration of how the LA 501 provides solutions to your logic analysis problems, contact your Tektronix Field Engineer. Or for a descriptive brochure, including specifications, write: Tektronix, Inc., P.O. Box 500, Beaverton, Oregon 97077. In Europe, write: Tektronix Limited, P.O. Box 36, St. Peter Port, Guernsey, Channel Islands.

U.S. Sales Prices FOB Beaverton, Oregon



**TEKTRONIX®**

committed to  
technical excellence

FOR TECHNICAL DATA CIRCLE #271  
FOR DEMONSTRATION CIRCLE #272

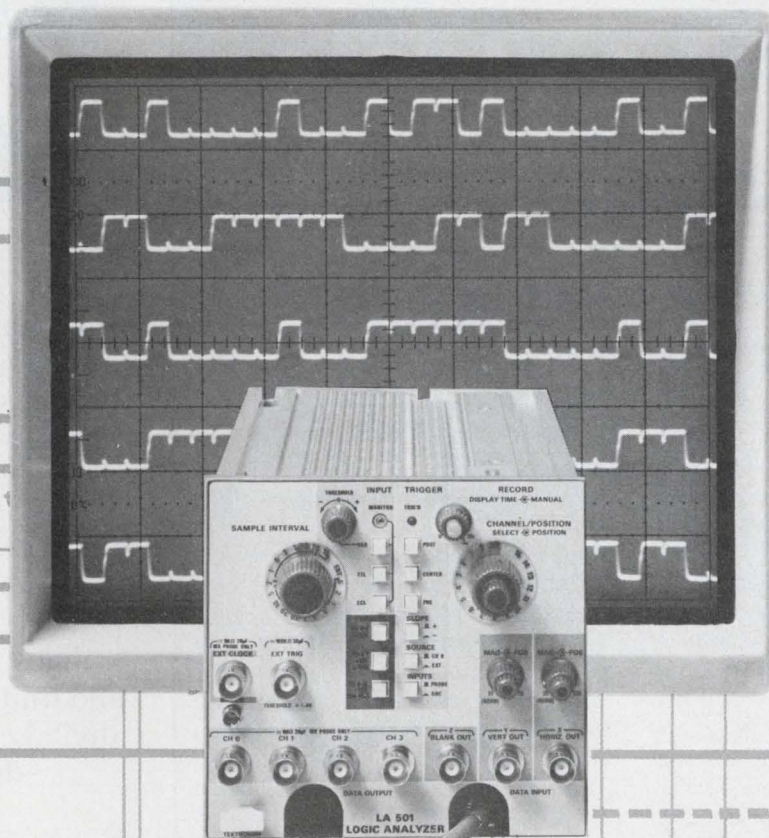

10X Magnified Portion  
of 16 Channel Display



## Pressure-sensitive material has wide resistance range

A new pressure-sensitive conductive silicone manufactured by Lareine Microelectrique of Paris is expected to find broad applications in machine controls and musical instruments. The material—PSCS type 5124—has a resistance of between 0.1  $\Omega$  and 10 M $\Omega$ . The resistance decreases linearly with increasing pressure.

The pressure required for a given resistance depends on the distance between two contact points on the surface of the material—the shorter the distance between the two contact points, the smaller the pressure required to change the resistance from 10 M $\Omega$  to 0.1  $\Omega$ . By selecting the appropriate

distance, the pressure required to achieve 0.1- $\Omega$  resistance can be varied from 60 gm to several kgm.

The distance between the contacts, which are on the same side of the material, may be between 0.1 and 10 mm and the further they are apart, the greater the range of pressure variable resistance available.

The material is available in sheet, die-cut or molded forms and is resistant to oxidizing and corrosive agents. Temperature range is -55 to +100 C. When used as a continuously variable resistance material the maximum applied voltage is 30 V and the maximum current is 100 mA.

## X-band TWTs developed with 40% efficiency

The efficiency of X-band traveling-wave tubes has been increased above 40 percent by means of a two-stage collector coupled with a tapered-helix structure. The development has been done by the Electron Tube Group of Thomson-CSF, Paris.

In single-collector tubes, efficiency can be improved by applying a collector voltage which is much less than the accelerating voltage. Called "collector depression," this technique can give efficiencies up to 35 percent. Taking this technique even further, Thomson-CSF engineers incorporated a two-stage collector in the traveling-wave-tube, collecting electrons at two different potentials—typically 1.6 kV and 0.7 kV.

Efficiencies greater than 40 per-

cent were achieved. By introducing a variable helix pitch, the company was also able to optimize phase characteristics without degrading other characteristics. To keep phase-shifts in the two-stage collector tube acceptably low, a double-tapered helix was devised. In the first constant-pitch section, the helix pitch is selected for maximum small-signal gain. In the first tapered-pitch section, the pitch is adjusted for synchronism between the rf wave and the beam under small-signal conditions. In the final tapered section the pitch is progressively decreased to keep the slow wave on the helix synchronous with the decelerating bunched electron beam. Tubes using this structure have achieved efficiencies of 43 percent.

# Look at the opposite page...

If it doesn't look like this...

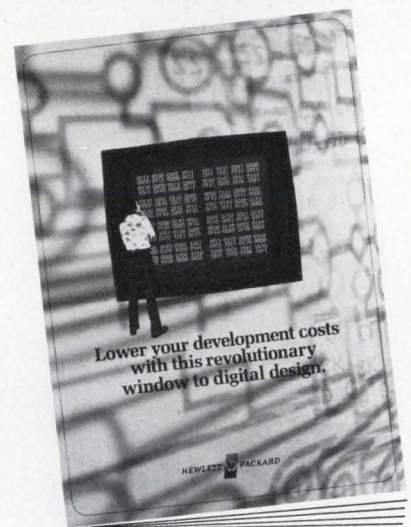

...you're missing eight pages of valuable information about digital design, evaluation, and troubleshooting methods using HP Logic State Analyzers.

Use the reader service number below to get your own free copy. Discover HP's revolutionary window to digital design, and find out how it speeds digital circuit and system development.

086/8

**HEWLETT  PACKARD**

Sales and service from 172 offices in 65 countries.  
1501 Page Mill Road, Palo Alto, CA 94304

INFORMATION RETRIEVAL NUMBER 298



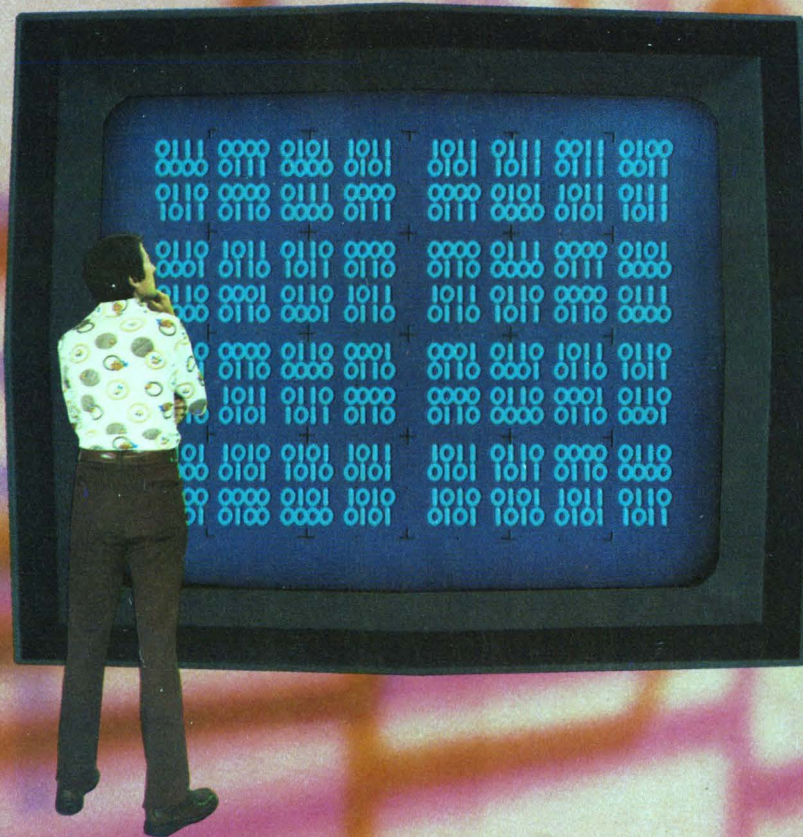

**Lower your development costs  
with this revolutionary  
window to digital design.**

HEWLETT  PACKARD



# If you rely primarily on we think you're

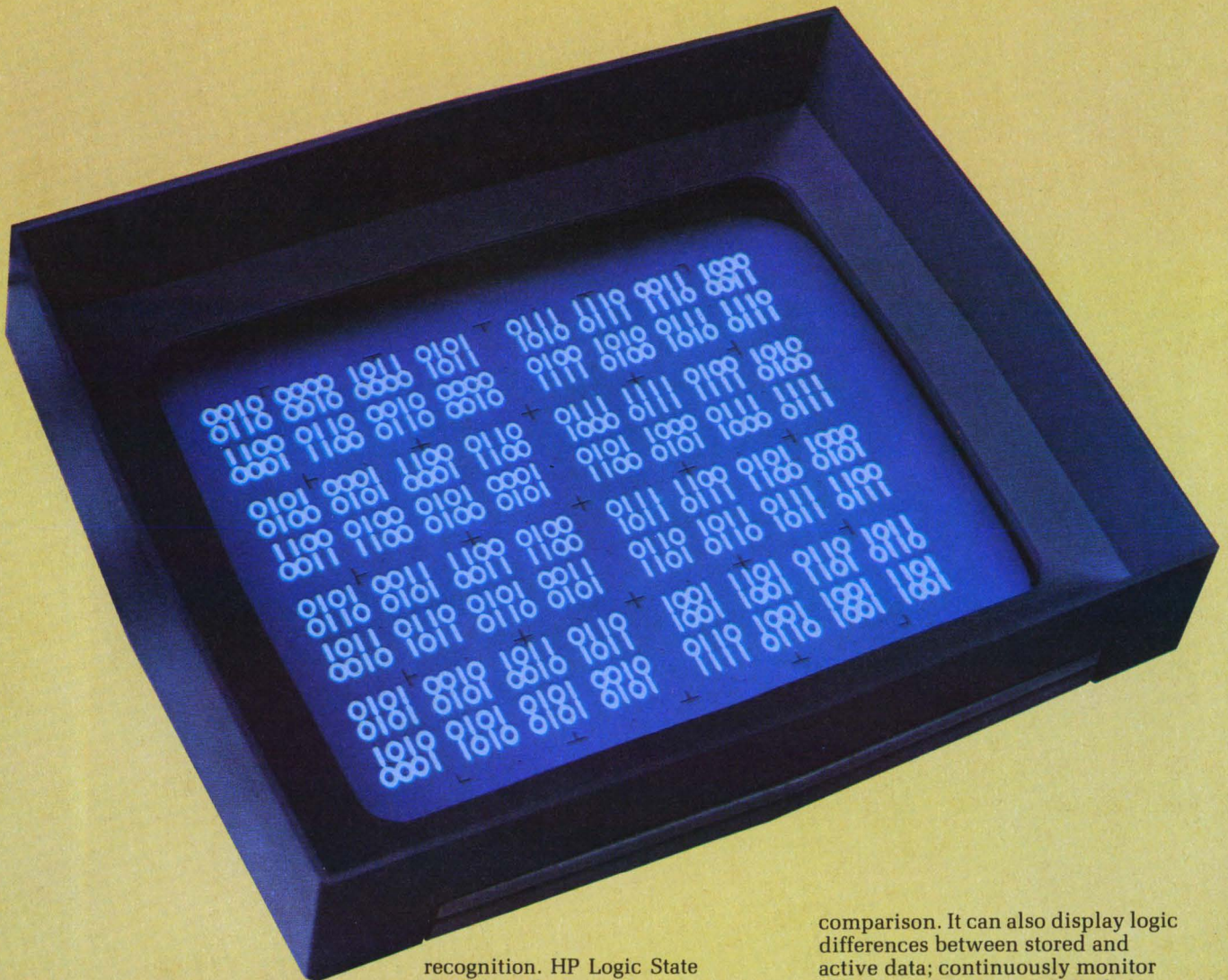

Now we're not advocating that you stop using your scope. You've always needed one and you always will. But if a scope is all you're using, you're probably wasting a lot of time. A couple of years of field experience with logic state analyzers has shown us that about 85% of digital troubleshooting problems can be solved faster with a logic state analyzer than with a scope.

**Think about it.** When you want to observe action on address or data buses, or on control lines, which instruments give you more meaningful data—a scope with four input channels or a logic state analyzer with 12, 16, or 32 channels?

You need a trigger that's related to program steps. Scopes by themselves simply don't have the capability of triggering on pattern

recognition. HP Logic State Analyzers do. Suppose you want to delay the data display to a specific point after the trigger word. The scope's analog time delay system has the inherent problem of display jitter. This is completely eliminated by the stable clock-pulse delay of a logic state analyzer. And when you're viewing data, would you rather mentally convert waveforms to digital words (1's and 0's) or have the instrument do the conversion for you?

Obviously, the scope is the logical choice for electrical measurements such as voltage level, rise time, and timing measurements. But when you're viewing state flow, there's no substitute for a logic state analyzer.

For example, one of HP's Logic State Analyzers can store one table of digital words and display it next to your active word display for

comparison. It can also display logic differences between stored and active data; continuously monitor data flow and automatically halt when the active data does not equal the stored data.

A new technique called mapping gives you an entirely new view of operating logic circuits—over 65,000 data words can be displayed as discrete dots, each representing one input word.

You can easily recognize these dot patterns after some familiarization, thus providing a rapid way to spot system irregularities. And for locating "lost programs," the map provides unequalled speed.

But these aren't just interesting measurement techniques, HP Logic State Analyzers provide more

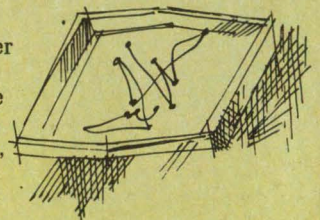



# a scope for digital design. making a mistake.



capability than any other digital troubleshooting instrument can deliver.

The Logic State Analyzer is the only economic alternative when it comes to digital system design.

**Your digital system operates in the data domain.** You know all about time domain and frequency domain measurements, but how do you define data domain measurements? Basically they are measurements of logic state as a function of discrete intervals of time — clock cycles, for example. The emphasis is on word parameters. While the scope gives you an analog display of amplitude vs. time (time-domain dimensions), the logic state analyzer gives you a display of digital words vs. clock cycles.

But what are the other requirements of a data domain instrument? Obviously you need sufficient channels to see what's happening

on address and data buses. With today's systems, that means 16 channels or more. You need data registration — the ability to trigger on a specific bit pattern and the ability to position the display window as

a function of clock cycles (pattern recognition triggering and digital delay). Because you often encounter events that occur only once in a program, you need a method of internal storage. Obviously, you want the ability to look at bit patterns after the trigger point, but you also want to see what happens before that point . . . in other words, you want negative time display; and even the ability to look on both sides of the trigger word at

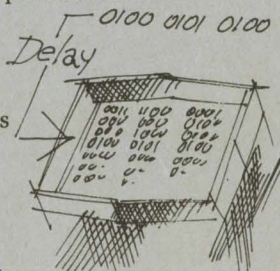
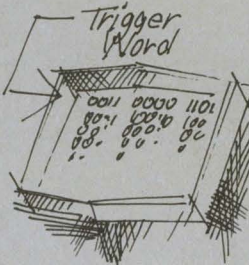

the same time. It's essential that you be able to qualify both the trigger point and the display so you won't trigger on, or display, unwanted data. You'll still need to observe time-domain waveforms on your scope for detailed electrical measurements such as rise times, logic levels, and for locating glitch-generating race conditions. Your data domain instrument should therefore be able to drive a time-domain instrument — providing a trigger upon pattern recognition. Finally, you want data displayed in a functional format (a display of states) to simplify analysis.

From the previous comparison with a scope, you can see that these are the requirements we've used at HP in developing our family of Logic State Analyzers. Obviously, some members of the family have more capability than others, and prices vary accordingly. But the point is, all have been designed specifically to help speed digital design and debugging by giving you a better view of your system's operation. A view in the data domain . . . where your program flow is happening.



# HP's Logic State Analyzers

Software debugging. It's great if you write a program that works right the first time it's implemented in hardware. But you know that it doesn't happen every

time. And when you get into program debugging, it's usually a time consuming task. How can an HP Logic State Analyzer help? By putting a window right on the data and address buses and giving you a real-time view of your program in operation... so you can see the exact word flow while it's happening. What's more, HP Logic State Analyzers let you move the window around at will by triggering on any word you want, or delaying the display a specific number of words beyond the trigger word.

This lets you compare the actual addresses and data on the buses with the program instructions you entered. It becomes much easier to spot an erroneous data word, an erroneous jump in the program, or an unending loop. With the mapping capability of the HP Model 1600A Logic State Analyzer, it's a simple matter to compare an executing program pattern to a known good pattern, or spot unique points in the pattern that indicate problems in an executing program.

The 1600A also gives you the ability to locate any word on the map and trigger on that word so you can pinpoint a potential error source quickly. Then you can zero in by

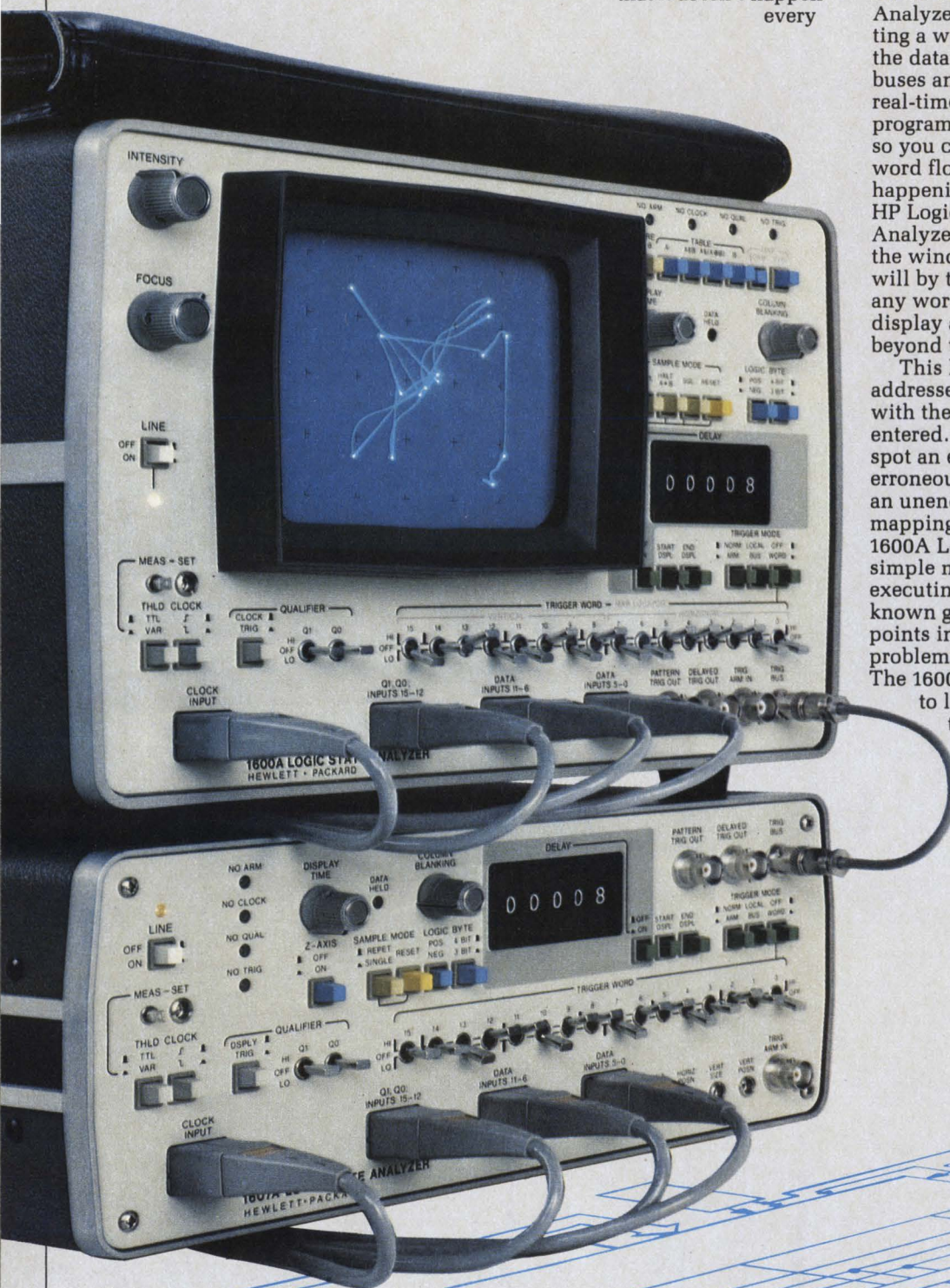
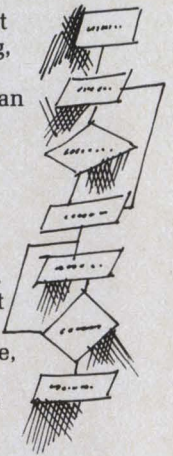



# speed digital design.

using the table display (1's and 0's), and digital delay to examine the program sequence in detail.

Watching your software in action ... it gives you a big edge in problem solving.

## Hardware/software marriage.

In digital design, you often discover incompatibilities between hardware and software—particularly when separate design teams have responsibility for these two aspects of the system.

It's not uncommon for the software to command the hardware to look for a signal (such as a request for interrupt) that apparently never occurs. Failure to get the signal may be a timing problem—the signal may occur too early or too late. The signal may exist at the right time, but at the wrong place—on the wrong data line for example. Or perhaps the signal was omitted altogether in hardware implementation. With microprocessors, the

problem may be due to lack of understanding of CPU peculiarities.

Whatever the case, you could spend an inordinate amount of time looking for the answer with the channel and triggering limitations of time-domain instrumentation.

However, with an HP Logic State Analyzer, you can tie into both the address and data buses at the same time, plus flag or qualifiers (up to 32 channels can be displayed on one screen). You can then run a short test program, trigger on a specific word at the beginning of the program, and view the program implementation leading up to the problem.

With this detailed picture of software in action, it's a simple matter to observe the displayed program sequence and see what's happening to that signal at a specific point in time. Then it's usually easy to spot the problem and apply a software or hardware solution—whichever is more appropriate.

**System interaction.** Additional problems frequently show up when you start transferring information across an I/O port. And your troubleshooting problems are compounded because you have two sources of data to monitor at the same time. They may have independent clocks ... be asynchronous ... but require a common trigger signal.

How do you verify overall system operation? How do you find out if data has been properly transferred from one part of the system to the other? And how do you determine whether or not the instructions have been executed properly?

Suppose, for example, you've designed a microcomputer-controlled test system for production. How do you know that the software is giving proper instructions to the instruments under test? Or that the instruments are inputting data correctly to the microcomputer? Unless you can verify the states in your program flow and look at digital inputs and outputs during the test cycle, your test could be meaningless. But with your microcomputer operating at one clock rate and the monitoring instrumentation at some other rate, how do you observe both and relate microcomputer software to hardware output.

The answer is HP's 1600S Logic State Analyzer. It lets you display two separate tables of data on the same screen—even though clock rates are different or one system is asynchronous. One table can display your micro-

computer software sequence while the other displays the hardware output and input resulting from that software. With program flow displayed alongside the input and output states of the instruments being controlled, there's no doubt about a correct testing sequence ... or about the information being fed back to the microcomputer. Furthermore, if there is a fault, you have adequate information to diagnose problems for correction.

In all of these phases of digital design—from the time you input software right through system checkout—an HP Logic State Analyzer can give you a clear view of program flow and hardware logic states to simplify design and debugging.

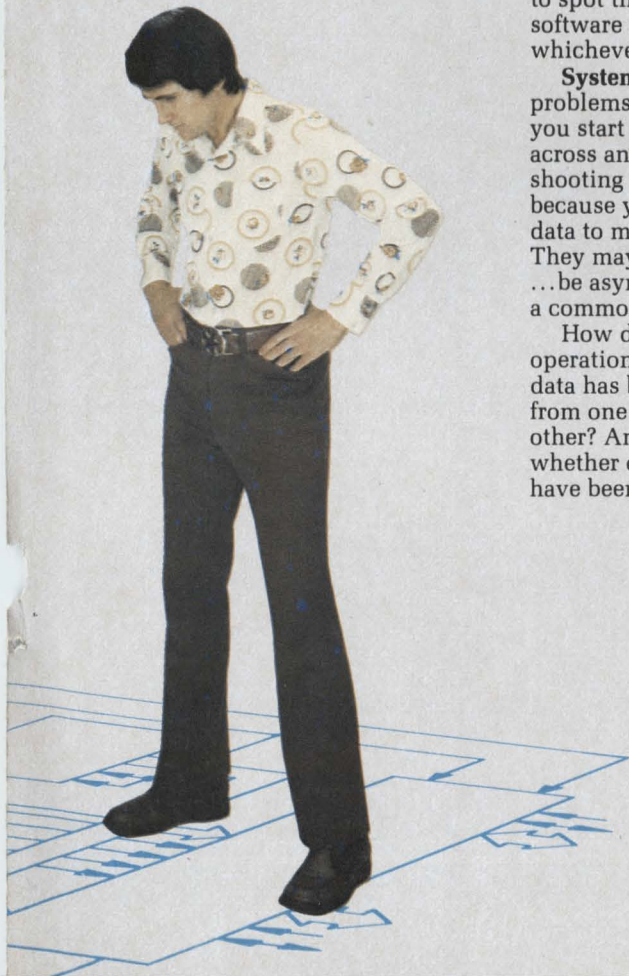
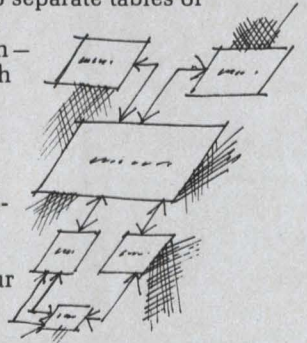
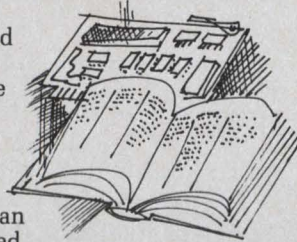



# Pioneers in the data domain are convinced.

Our customers have been using HP Logic State Analyzers since 1973. And we've talked to quite a number of users to find out what designers need in data-domain instrumentation. We've also found out how these data-domain pioneers feel about the HP Logic State Analyzers.

Here's a sampling:

**"With the 1600A analyzer, I can do in an hour what I couldn't do in 3 months otherwise, and that's a fact."**

**"I designed a buffer interface that allows us to make real time tests using a slower tester. With my \$20,000 interface, the \$100,000 tester and your \$4,000 logic analyzer, we can do the job of a \$400,000 real time tester."**

**Don Glancy,**  
*Principal Engineer*

**"We encountered some severe software problems on a real time 4K system where we were at a loss as to how to approach the problem. Because it was a real time system we were unable to stop it to use the standard software debug techniques. By coincidence your salesman called on the same day to demonstrate the 1601 Logic Analyzer. We hooked the analyzer to the system under test and wound up solving the problem that same afternoon. We were so thoroughly convinced of the potential power of the 1601 as it applied to software debug that we ended up buying two of them."**

**"Even though we had limited experience with microprocessor design, there's no question the logic analyzer saved us valuable design time."**

**Ken Fiske,**  
*Senior Design Engineer*



**"When a parity error does occur, our equipment re-reads the data block fifteen times. In order to initiate that search routine, many sequential logic events must occur. Problems occasionally arise in that logic flow and it's been very difficult to analyze using just a scope. The logic analyzer allows us to troubleshoot logic flow in parity error problems about twenty times faster than the scope does. In addition to being faster, it's also easier to interpret the 1's and 0's than it is to interpret waveforms."**

**Don Stewart**  
*Coordinator of  
Service Planning*

You've just read actual testimonials from users who have achieved significant time savings with an HP Logic State Analyzer — savings ranging from a factor of 20 to well over 400 compared to other methods, (Don Glancy's comment, "I can do in an hour what I couldn't do in three months otherwise.") And equipment savings of a factor of 3 or more.

If you or your people spend significant numbers of hours in the development of bus-structured systems such as computers and microprocessor-based systems, consider what those time savings could mean to you:



# Convince yourself.

Over and over again, the reports from the field say: time saving... greater productivity... reduced development time... products into production faster. Whether you're a digital designer or an engineering manager, this message is important to you.

As a circuit designer, you know the importance of sticking to development schedules and budgets. And that always means

solving the problems the fastest way you know how. Take a look and see what kind of savings you might realize with an HP Logic State Analyzer.

If you're an engineering manager, concerned with the productivity of your engineering department, consider how much further your engineering budget could go if your people had HP Logic State Analyzers.

- (A) — Estimated man hours spent in evaluating and debugging hardware and software using conventional techniques.
- ÷ — Your estimated time-saving factor — using a logic state analyzer — based on these testimonials.
- = (B) — Estimated time spent in evaluating and debugging hardware and software with a logic state analyzer.
- (A)–(B)= — Potential time savings during the project.
- × — Your hourly rate including overhead.
- = — Potential direct cost savings.

Make your own analysis of what the time savings can mean in terms of getting products into production faster. The figures you come up with might easily exceed the cost of one of our Logic State Analyzers.

FIRST CLASS  
PERMIT NO. 201,  
PALO ALTO,  
CALIFORNIA

## BUSINESS REPLY MAIL

NO POSTAGE NECESSARY IF MAILED IN THE UNITED STATES

Postage will be paid by:

**Hewlett-Packard Company**  
1820 Embarcadero Road  
Palo Alto, California 94303

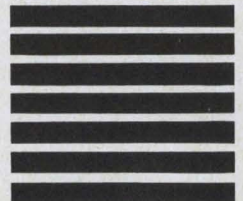



# Join the data domain revolution.



Your choice in data domain instrumentation is growing steadily. It extends from simple 4-bit AND gate trigger probes, to an optional Logic State Switch on HP scopes for selecting either time or data domain, to the 1600S—the system with up to 32 channels plus qualifier inputs, storage, delay, and two modes of display (table or map). There's an instrument or accessory in this family to put you in the data domain and give you a much better view of your digital designs.

## We've just scratched the surface.

There's a lot more to know about the data domain and about HP's family of instruments. And there are several sources for more information.

**Seminars.** HP instructors are now conducting one-day seminars on logic state analyzers and their application, and will continue in 1976.

**Technical Data Sheets.** These publications give you details of operation and instrument specifications on each of the family members.

**Application Notes.** A number of notes cover the use of mapping, using logic state analyzers to troubleshoot mini computer systems, microprocessor systems, etc.

For more technical data, simply mail the attached reply card, indicating the data sheets you want. Or, for even faster action, contact your local HP field engineer and ask him for more details about the instruments or seminars. Give him a call today and join the data domain revolution.

086/4

I'd like more technical information about HP's family of data-domain instruments. Please send data sheets on:

- Logic State Analyzers
- Pattern Trigger Accessories
- Clips and Probes

NAME \_\_\_\_\_

COMPANY \_\_\_\_\_

ADDRESS \_\_\_\_\_

CITY/STATE/ZIP \_\_\_\_\_

HEWLETT  PACKARD

Sales and service from 172 offices in 65 countries.  
1501 Page Mill Road, Palo Alto, California 94304



# Electronic Design

## FREE SUBSCRIPTION APPLICATION

Do you wish to receive (continue to receive) ELECTRONIC DESIGN?

Yes \_\_\_\_\_ Date: \_\_\_\_\_  
 No \_\_\_\_\_ Signature: Does not obligate me or my company

Subscriptions cannot be entered without complete qualifying information.

FOR CHANGE OF ADDRESS . . . .  
 Attach Old Address Label to Insure  
 Uninterrupted Service.

Area Code \_\_\_\_\_ Office Telephone \_\_\_\_\_  
 \_\_\_\_\_ - \_\_\_\_\_ - \_\_\_\_\_

FIRST INITIAL	MIDDLE INITIAL	LAST NAME	TITLE
COMPANY NAME IN FULL			
DIVISION/DEPARTMENT/MAIL STOP			
STREET ADDRESS			
CITY		STATE	ZIP CODE

This questionnaire conforms to the guide lines of the Business Publications Audit of Circulation for eliciting comparable data. The publisher reserves the right to serve only those individuals who qualify for a free subscription. **ELECTRONIC DESIGN is sent free to qualified engineers and engineering managers doing design work, supervising design or setting the standards in the UNITED STATES and WESTERN EUROPE only.**

**1**  Title: (Insert letter)

A President	J Project Engineer
B Vice President	K Senior Engineer
C Vice President of Engineering	L Group Leader
D Technical Director	M Dept. Head
E Chief Engineer	N MTS
F Principal Engineer	O Engineer
G Research Director	P Consultant
H Section Head	R Scientist
	S Physicist

**2**  Your principal job function: (Insert code)

- General and Corporate Management
- Design and Development Engineering (circuits, components, equipment systems)
- Engineering Services (evaluation, quality control, reliability, standards, test)
- Basic Research
- Manufacturing and Production
- Engineering Assistants (draftsman, lab assistant, technician)
- Purchasing and Procurement
- Marketing including Sales
- Other Personnel (explain)

**3**  Plant  Your own work

The primary end product (or service performed) at your plant, and the product (or service) that is your own work. (Insert code in each box even if the same)

A	A Large Computers
B	B Mini-Computers
C	C Computer Peripheral Equipment
D	D Data Processing Systems (Systems Integration)
T	T Office and Business Machines
E	E Test, Measurement and Instrumentation Equipment
F	F Communications Systems and Equipment
H	H Navigation and Guidance Systems and Equipment
J	J Consumer Entertainment Electronic Equipment
G	G Consumer Electronic Appliances
N	N Other Consumer Electronics
K	K Industrial Controls, Systems and Equipment
L	L Components and Sub Assemblies
M	M Materials and Hardware
Q	Q Aircraft, Missiles, Space and Ground Support Equipment
P	P Oceanography and Support Equipment
R	R Medical Electronics
U	U Industrial Companies within the OEM incorporating Electronic Equipment in their end product, not elsewhere classified
V	V Independent Research, Test and Design Laboratory and Consultant. (Only if you are not connected with a manufacturing company.)
X	X Government Agency and Military
2	2 Industrial Companies using and/or incorporating any Electronic products in their manufacturing, research or development activities.
1	1 Commercial Users of Electronic Equipment
3	3 Distributor
4	4 School, University or Library
5	5 Other (explain)

**4**    Your design function: (Insert each letter that applies)

A I do electronic design or development engineering work  
 B I supervise electronic design or development engineering work  
 C I set standards for, or evaluate electronic design components, systems and materials

**5**  Your principal responsibility: (Insert code)

1 Management other than Engineering	3 Engineering
2 Engineering Management	

**6**  Please estimate: (Insert letter)

The number of electronic engineers at this address:  
 (A) 1 (B) 2-5 (C) 6-19 (D) 20-49 (E) 50-99  
 (F) 100-249 (G) 250-499 (H) 500-999 (J) Over 1000

**7**  Please write in box total number (other than self) to be served by this subscription at this address and list individuals below:

Name (Please Print)	Title

**8** Products you specify or authorize purchase of: (Check all codes that apply.)

<input type="checkbox"/>	1 Resistors and Capacitors
<input type="checkbox"/>	2 Connectors
<input type="checkbox"/>	3 Switches and Relays
<input type="checkbox"/>	4 Function Modules: Op Amps, Converters, etc.
<input type="checkbox"/>	5 Potentiometers
<input type="checkbox"/>	6 Test and Measurement Equipment
<input type="checkbox"/>	7 Computers, Medium and Large
<input type="checkbox"/>	8 Electronic Power Supplies
<input type="checkbox"/>	9 ICs and Semiconductors
<input type="checkbox"/>	10 Microwave Devices
<input type="checkbox"/>	11 Minicomputers
<input type="checkbox"/>	12 Computer Peripherals
<input type="checkbox"/>	13 Computer Components
<input type="checkbox"/>	14 Cabinets and Enclosures
<input type="checkbox"/>	15 Panel Meters, Analog or Digital
<input type="checkbox"/>	16 Readout and Display Devices
<input type="checkbox"/>	17 Rotating Components
<input type="checkbox"/>	18 Cooling Products
<input type="checkbox"/>	19 Printed Circuits
<input type="checkbox"/>	20 Calculators
<input type="checkbox"/>	21 Indicators including LEDs
<input type="checkbox"/>	22 Materials, Potting and Stripping
<input type="checkbox"/>	23 Communications Equipment

**9** Do you specify or buy through distributors?  
 YES  NO

**10** Minicomputers at this address:

	Model	Qty.	Model	Qty.
3	Cincinnati Milacron			
C	Computer Automation			
D	Control Data			
E	Data General			
F	Digital Equipment			
I	General Automation			
K	Hewlett Packard			
M	Honeywell			
O	IBM			
N	Interdata			
7	Microdata			
	Modular Computer			
	ROLM			
V	Systems Engineering Labs			
9	Texas Instruments			
x	Varian			
	Other			



# Design refresher on Metal Glaze™ resistors

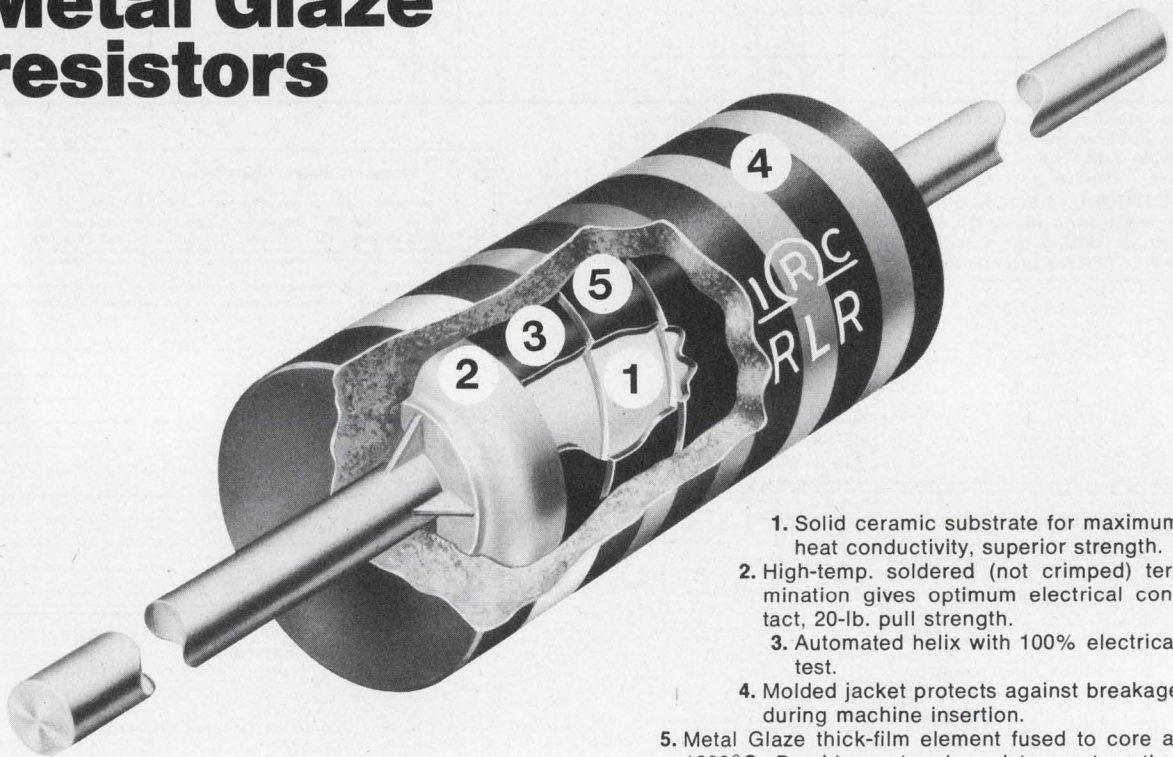

1. Solid ceramic substrate for maximum heat conductivity, superior strength.
2. High-temp. soldered (not crimped) termination gives optimum electrical contact, 20-lb. pull strength.
3. Automated helix with 100% electrical test.
4. Molded jacket protects against breakage during machine insertion.
5. Metal Glaze thick-film element fused to core at 1000°C. Provides a tough resistor system that withstands overloads, environmental extremes.

An all-purpose resistor? Not *quite*. But if you're designing any type of low-power circuitry, it usually pays to look at Metal Glaze.

Mechanically, these resistors are nut tough. Electrically, they offer excellent load life stability. And thermal characteristics are outstanding, giving you lower operating temperatures, greater reliability. In fact, you can often *double-rate* Metal Glaze resistors. So you can use smaller resistors, save board space.

The quality and cost effectiveness of Metal Glaze resistors have been proven *billions* of times over—in all types of electronic equipment, worldwide. Available in ratings  $\leq 5$  watts,  $\geq 1\%$  tolerance, and ranges as low as 1 ohm.

*Complete resistor choice.* TRW offers you a total resistor capability—carbon comp., thin-film, Metal Glaze, wirewound, networks. For complete specs and application data on Metal Glaze, contact your local TRW sales representative (or TRW/IRC's Boone, N.C., plant—(704) 264-8861). Or write TRW/IRC Resistors, an Electronic Components Division of TRW, Inc., 401 N. Broad St., Philadelphia, Pa. 19108.

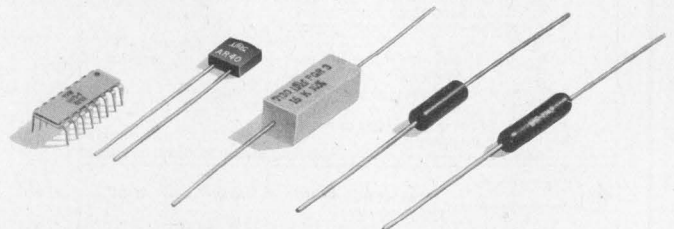

## TRW® IRC RESISTORS

™Metal Glaze is TRW/IRC's trademark for its thick-film resistors.

INFORMATION RETRIEVAL NUMBER 22



# Microprocessor Design

## How useful are benchmark tests for $\mu$ Ps? It depends on whom you ask.

The benchmark test is now being given second thoughts by many engineers, even though it has long been recommended as a valuable tool for comparing the performance of competing microprocessors. As microprocessors see use in an ever-widening variety of applications, engineers are finding the benchmark test doesn't tell the whole story—especially in such areas as required peripheral units, available software, and necessary power supplies.

Opinions on the value of benchmarks vary widely among leaders in the field. "I personally benchmark every project that I'm going to bid on," says Dr. Gary Nelson, vice president of research and development, AH Systems, Chatsworth, CA. But Charles Cech, regional marketing manager at Pro-Log Corp., Monterey, CA, states, "Benchmarks for microprocessors

as applied to the controls business are worthless."

Matt Biewer, vice president of engineering at Pro-Log, takes a more cautious stance. "There are some pitfalls in accepting general benchmarks as an indication of a microprocessor's superiority," he says.

And Jack Grimes, product manager at Tektronix, Beaverton, OR, warns, "the benchmark has to be fairly well matched to the kind of problem complexity you want to solve. There is always some extrapolation from the benchmark."

The reason for this wide range of opinion lies in the variety of architecture and the many applications for present-day microprocessors.

Benchmarks designed for one type of microprocessor architecture may be quite ineffective for another. Nelson cites word size

*(continued on page 44)*

## Memory and peripheral circuits simplify PACE designs

A complete set of memory and peripheral circuits for PACE simplify designs based on the 16-bit single-chip PMOS microprocessor. Offered by National Semiconductor (2900 Semiconductor Dr., Santa Clara, CA 95051. 408-732-5000), the new chips can be used to reduce support and interface package count.

The new circuits consist of "Blue" chips, which directly support the PACE CPU; "Gold" chips, which are specially designed memory devices; and "Green" chips, which provide input/output interfaces to user peripherals or memory.

A pair of Blue chips (two IPC-16A/501s) provide the CPU with system buffering for all 16-bit addresses and data I/O. Another Blue chip (the IPC-16A/502) generates system timing. Gold-chip memories include 256  $\times$  4-bit static RAM (IPC-16A/504), 16-k bit ROM (IPC-16A/505), 4-k bit electrically programmable PROM (IPC-16A/506) and 4-k bit ROM (IPC-16A/507). Interface latch elements—Green chips—consist of eight (ILE/8) or 16 (ILE/16) dual port flip-flops in a single package.

Except for the CPU, the new chips cost \$20 to \$25 in quantities up to 100. The PACE chip costs \$112 in the same quantity.

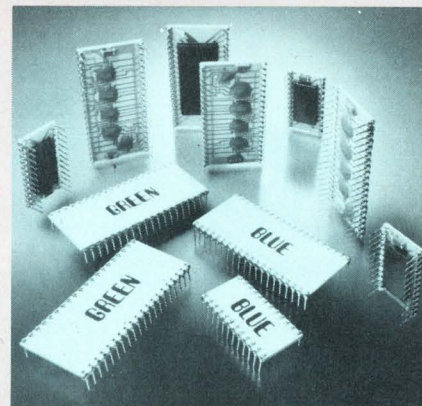

CIRCLE NO. 501



## MICROPROCESSOR DESIGN

(continued from page 43)

as one example. "If you're doing a job that requires 16 bits of precision for the computation, then, of course, that eliminates all the 8-bit processors."

A second consideration is the intended application. Many available benchmarks are oriented toward general data processing and would involve, for example, measurements of the speed of data transfer. But, Biewer points out, when one is discussing logic-processing applications speed is not an important consideration.

"Usually the microprocessor is sitting there idling, waiting for something to happen in the outside-world so it can take action," Cech says.

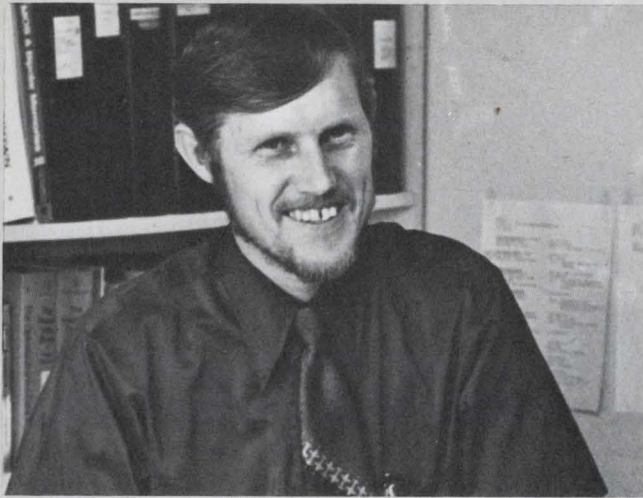

Matt Biewer, Vice President, Pro-Log

A human operator might manually enter data. Or a switch may be closed—an event that requires milliseconds for the bounce to die away.

"A benchmark that merely compares the operating speed of different microprocessors has little relevance to this problem," Cech concludes, "because in data-processing applications things happen a thousand times faster."

A third consideration is that benchmark programs cannot compare such obvious features as the number of different power supplies required (for example, three for Intel's Model 8080 vs one for the Motorola 6800). Other factors are the number of interface chips required, cost, delivery, and second sources.

Benchmarking is valid when the benchmark is fairly well matched to the specific complexity of the problem to be solved. According to Nelson, such matching is possible when the engineer has available a sufficient repertoire of benchmarks, which is one reason AH Systems is currently adding new benchmarks to the five they already have.

"But," Nelson adds, "even a large number of benchmarks will not supply all the answers."

Grimes cites a case where benchmarks do provide an immediate comparison of microprocessor performance—when a benchmark is used for comparing two or more versions of the same microprocessor. In other tests the benchmark must be designed for the specific application at hand.

Nelson describes a rule of thumb he uses in benchmarking microprocessors for real-time applications:

"It's a pretty good chance that the computer

# Now...Mike 3!

**\$149**  
CPU Board

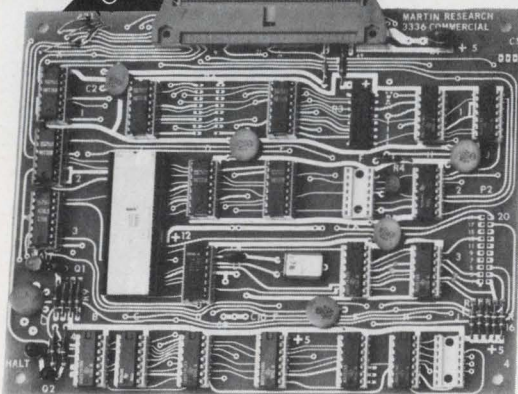

The **MIKE 3** is a good example of the flexibility of the **modular micro** approach. An optimal small system — yet fully expandable. A three-board version, the AT813, includes the Model 471 CPU board (with 8080A); memory board with 8080 Monitor PROM, 512 bytes RAM (expandable to 2K PROM, 1K RAM); console board with keyboard, six LED digits; connectors; and Manual . . . only \$395. (Manual alone, \$35.) Priced at \$149. in quantities of one, with 8080A, the 471 CPU features:

- 3 interrupt levels (8-level priority interrupt board optional)
- Automatic hardware exit from masked interrupt after set interval
- Controls for one DMA channel (8-level prioritized DMA control optional)
- Power bus drivers for system expansion
- 8080, 6800, 8008 I/O address modes



**martin research**

3336 Commercial Ave.  
Northbrook, IL 60062 (312) 498-5060



will do the job if I'm able to do all my computing in approximately 20% of real time, that is, if it takes 0.2 seconds to process all the data that will enter in one second."

There are pitfalls, of course. A "data move" benchmark, designed to move a block of data from point A to point B in memory, will make a microprocessor with two registers look equivalent to one with many.

When performing different operations—as in a decision "tree"—a processor with many registers will prove faster than the processor with fewer registers.

Another common pitfall awaiting the engineer is the possibility of his not breaking down the problem sufficiently to bring out the critical program segments that must be benchmarked. A common occurrence is the benchmarking of an unimportant segment while neglecting a more important one, resulting in test data that are irrelevant.

What are the alternatives to benchmarking? An obvious one is to run the actual program on competing microprocessors. This provides a good comparison but involves a great deal of time and energy.

---

### $\mu$ P-based process controller offers distributed control

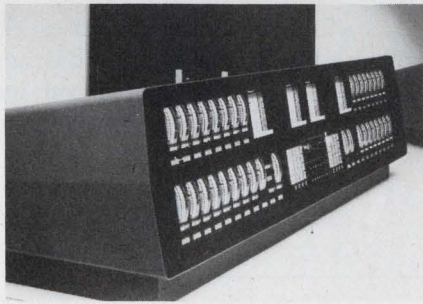

The TDC 2000 Total Distributed Control system made by Honeywell (1100 Virginia Dr., Fort Washington, PA 19034. 215-643-1300) integrates  $\mu$ P-based controllers, stand-alone CRT display stations and a data bus for information transfer. It can be combined with process computer hardware and software packages to provide the flexibility for controlling processes ranging from the most simple to the most advanced.

Dramatic cost savings are possible, claims Honeywell. In field wiring alone, the company estimates that more than \$1 million can be saved. Because the system is

totally digital, diagnostics keep downtime to a minimum. In addition, programs to optimize yields and quality or to minimize energy consumption can be implemented. The basic element of TDC 2000 is a digital controller built with the latest microprocessor technology. The controller can be configured online by pushbuttons to perform any combination of eight control functions from 28 equations. The operator station also uses a microprocessor and makes available all control information on a CRT display. The station may be used as a stand-alone display or as part of a centralized control console. Three operator stations, when grouped together, form an operations center. Through the center, an operator has access to all process variables. Overview, group or detail displays can be called up.

System costs range from \$15,000 for the basic controller to over \$1 million, depending upon requirements and delivery is 2 to 8 months, depending upon system complexity.

CIRCLE NO. 502

---

### Disc-storage system can handle up to 225 Mbytes

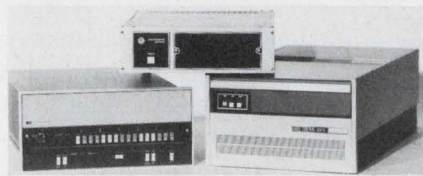

The MSM-10X high density disc-storage system made by Microcomputer Systems Corp. (3068 Kenneth St., Santa Clara, CA 95050. 408-985-1414) can store up to 225 million bytes. It uses a microprogrammed controller that is totally integrated with the host computer's operating system. The disc system can transfer data at a 1.2 Mbyte/s rate and can support up to four disc drives

in its standard configuration. It can be expanded to handle up to 15 drives, for a total capacity per controller of 15 to 4500 Mbytes.

The 12 × 15-in. PC board that holds the controller has automatic self-testing of both

(continued on page 46)



(continued from page 45)

controller and disc; high reliability because of a parts count of only 160 ICs; and a built-in maintenance panel and resident controller diagnostic. The MSM-10X controller interfaces with a number of disc drives, such as those of Ampex, CDC, Calcomp and Caelus, and is aimed at the \$15,000 to \$25,000 market now covered by the 15-to-20-Mbyte disc systems. The controller is also plug-compatible with minis made by Hewlett-Packard, Digital Equipment Corp., Data General, Microdata, and Interdata.

CIRCLE NO. 503

### Development system combines $\mu$ P and terminal in one case

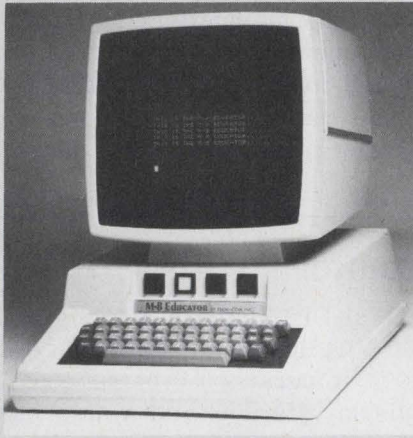

The M-8 Educator development system, designed by Technical Communications Inc. (P.O. Box 306, Olathe, KS 66061. 913-764-0243), provides a CRT communications terminal and  $\mu$ P controller in one unit. The system is built around the Fairchild F-8 microprocessor and includes a 53-key (Hall-Effect) keyboard, 64-character-by-31-line CRT display, 110-baud TTY-compatible serial I/O, 300 or 600-baud TTL serial I/O, composite video output signal for remote CRT and 2-k of RAM, expandable to 32-k.

The  $\mu$ P module has a debug/monitor with user-callable I/O subroutines, two 8-bit TTL compatible output ports and two input ports. At the rear panel, you have access to all F-8 bus and control lines. Some optional

units for the terminal include a firmware resident assembler, cassette tape storage module and PROM programmer. The stock unit costs \$1795 in single-piece lots and can be delivered in six to eight weeks.

CIRCLE NO. 504

### Mask-programmable $\mu$ C chips made for simple control use

Two microcomputer chips, developed for low-cost control applications, have been introduced by Essex International (564 Alpha Dr., Pittsburgh, PA 15238. 412-782-0200). One of the chips, called the Bitsy microcomputer, has 256 words of read-only memory, three working six-digit registers (BCD), a six-digit accumulator and 42 instructions which include BCD arithmetic adjustment and input/output decoding.

The other chip, the SX-200, is a complete p-channel MOS four-bit microcomputer with a 16- $\mu$ s instruction time. On the chip is an 8-k ROM and a 64  $\times$  4-bit RAM. In addition to data storage the SX-200 has 16 individually settable, resettable and testable flag bits that can be used to speed program control options. Outputs of the SX-200 are also mask programmable with an on-chip programmed logic array.

Prices for the microcomputer circuits have not been finalized yet, but are expected to be under \$10 for the Bitsy and slightly higher for the SX-200.

CIRCLE NO. 505

### Legislative body turns to $\mu$ P-based voting machine

A  $\mu$ P-based voting machine has come to the rescue of one legislative body seeking to hold secret ballots, yet retaining the convenience and speed of a conventional roll call. Using National Semiconductor's IMP-16 micro, Com-Tec in Appleton, WI, has built a voting machine for the Wisconsin Assembly that can tally votes in these ways: Each vote can be shown on a large, easily visible display as it is cast in the Assembly chamber, or votes can be shown after all legislators have secretly cast their ballots. In each case, legislators use individual terminals at their desks. The key advantage of secret balloting: Legislators can't be influenced by votes already cast. Com-Tec has similar systems for other legislative bodies priced from \$7000 up to a heady \$100,000, depending on system complexity.



# Let's talk about ending digital display jitters.



**Here's the key.** HP's new 8-bit 1230A Logic Trigger—a handy scope accessory that simplifies data-domain measurements two ways. It gives you an easy way to trigger on digital events. And it gives you a stable display—even with long delays between word recognition and the trigger point.

**Word recognition** simplifies the task of triggering your scope from digital data. Simply connect the eight parallel inputs to the desired points in your circuit and set the level switches to HI, LO, or OFF (don't care). When the operating logic states agree with the selected input levels, the unit indicates word recognition. And, after the preset delay, sends the trigger signal to your scope. It's just that simple.

**Digital delay** is the key to stable traces. Trigger delay is based on clock pulses—not time. So you can window on an event occurring up to 9999 clock pulses from the point of word recognition and obtain a jitter-free trace every time.

To set the delay, you simply tap a pushbutton switch to increment or decrement the delay count a digit at a time. Or hold the switch down to slew to a higher or lower number quickly.

**Sync/Async operation** allows you to be dependent on or independent of clock pulses. A gate input provides a qualifier for word recognition, or, if you need additional parallel inputs, the gate input can be the ninth bit for the word recognizer.

You get the 1230A, a handy carrying case with input cables and probes, scope trigger input cable, and a carrying strap... all for only \$495\*. Optional accessory kit (15268A, \$100\*) includes an external power supply (the 1230A normally operates from your own +5V to +15V logic supply) and a variety of adapters. To get a logic trigger for your scope, and simplify your data domain measurements, just contact your local HP field engineer.

For 4-bit word recognition, ask him about the models 10250A (TTL), 10251A (MOS), and 10252A (ECL) priced at \$95\* each. If you need 16-bit serial or parallel word recognition, he'll tell you about the 1620A priced at \$1,750\*.

\*Domestic U.S.A. prices only.

**HEWLETT  PACKARD**

Sales and service from 172 offices in 65 countries.  
1501 Page Mill Road, Palo Alto, California 94304

INFORMATION RETRIEVAL NUMBER 24



# “We’re switching from EEM to

**“The GOLD BOOK provides more data and our sales offices recommend it.”**

North Atlantic Industries, which invented the Phase-Angle Voltmeter almost two decades ago, joins the growing list of companies moving to the GOLD BOOK.

Sales Manager Peter G. Wittenberg, who is a working group member of DOD’s DEFENSE SCIENCE BOARD TASK FORCE on “Electronic Test Equipment,” reports he has selected the 1976-77 GOLD BOOK for his catalog pages. Among the items he will feature are three new products: Digital Phase-Angle Voltmeter/Ratiometer, Angle-Position Indicator with LSI that provides improved performance and reliability at lower cost, and S/D and D/S conversion modules.

“This past year,” Mr. Wittenberg says, “We’ve received many inquiries here and abroad just from our listing in the GOLD BOOK. And they’re all top-grade inquiries.” Mr. Wittenberg says this prompted him to make a thorough analysis of electronics directories. “As a result,” he says, “We’ll be in the GOLD BOOK as our main directory promotion this year. It’s being used by engineers and engineer managers throughout the United States and overseas.”

## The GOLD BOOK is first in every important editorial comparison!

**First** in number of product headings in the Product Category. GOLD BOOK has 5182. EEM has 335.

**First** in number of pages in the Product Directory. GOLD BOOK has 542. EEM has 225.

**First** in number of pages in the Trade Name Directory. GOLD BOOK has 33. EEM has 24.

**First** in number of pages in the Manufacturers Directory. GOLD BOOK has 397. EEM has 338.

**First** in number of manufacturers listed. GOLD BOOK has 6771. EEM has 3300.

In addition, GOLD BOOKS’s foreign circulation is 13,000. EEM’s is zero.

And on top of all this, GOLD BOOK rates are lower than EEM rates by far.

Source: 1975-76 Editions



**Electronic Design / GOLD BOOK**



# the GOLD BOOK this year”

– says Peter G. Wittenberg  
Sales Manager  
North Atlantic Industries

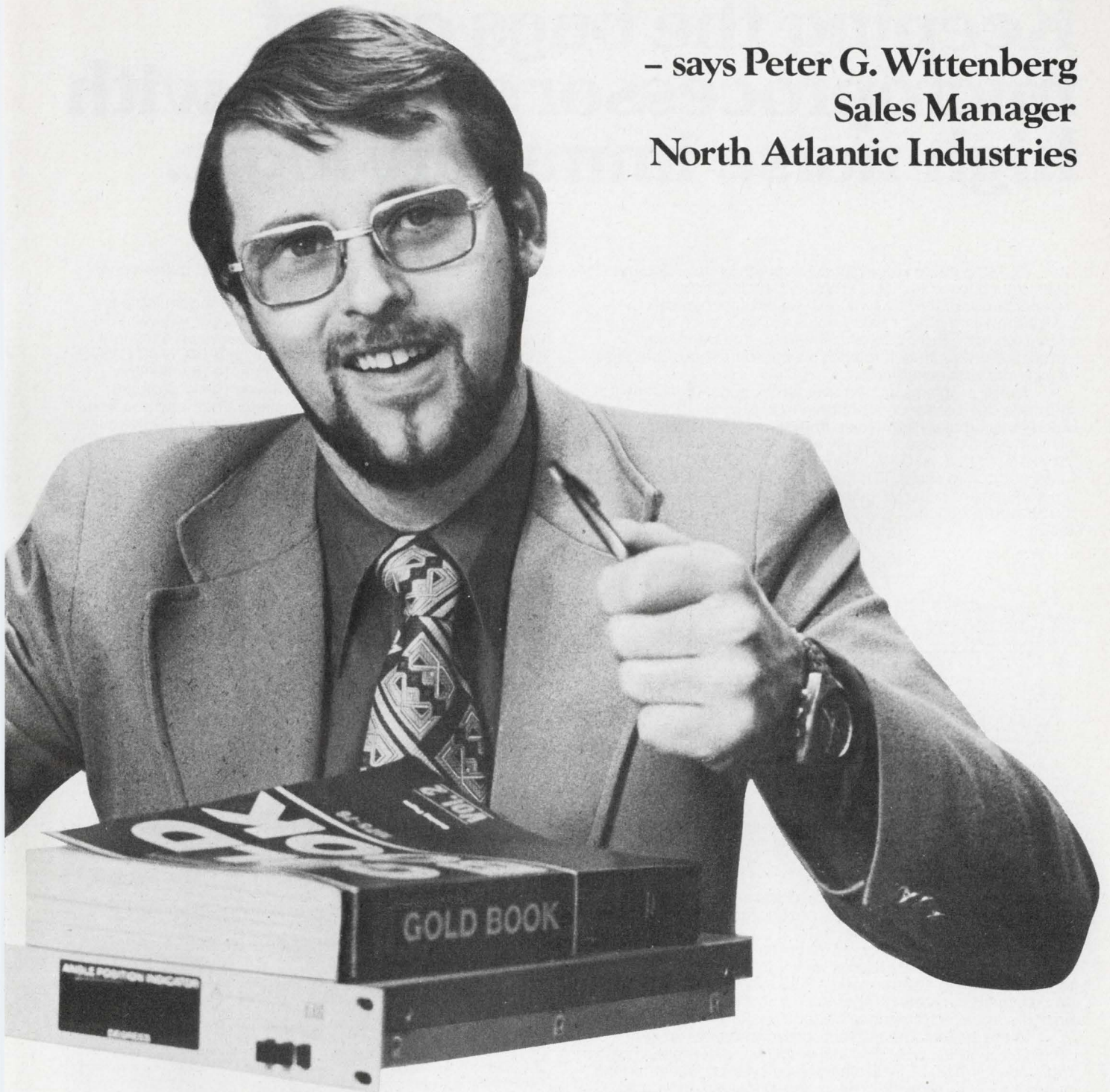

## Join the parade to the GOLD BOOK It can work for you!

• Hayden Publishing Company, Inc. • 50 Essex Street, Rochelle Park, N.J. 07662 • (201) 843-0550



# HiNIL Interface

# Keeping the bugs out of microprocessor systems with high noise immunity logic.

An MOS microprocessor system can be troubled by disastrous bugs unless it is protected against noise transients generated by switches, electromechanical peripherals and other nearby noise sources, such as lamps and machinery. But filters and shielding, the traditional cures, are often difficult to add to a microprocessor because of size and cost constraints.

These problems can be avoided by substituting HiNIL interface devices for conventional I/O logic. HiNIL—Teledyne's bipolar High Noise Immunity Logic—has a guaranteed DC noise immunity about 10 times that of TTL, for example (3.5 vs. 0.4V). Also, HiNIL blocks AC transients large enough to cause TTL malfunctions. Two additional advantages are superior output drive and, in low power systems, protection of CMOS memory and random logic inputs.

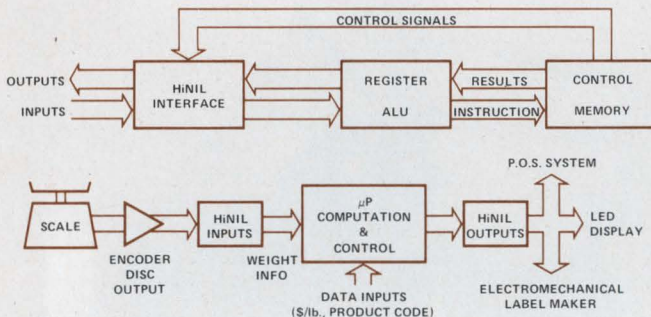

Figure 1. Use of HiNIL interfaces in POS systems with electronic scale. Top diagram shows basic microprocessor configuration.

One manufacturer of microprocessor-controlled electronic scales decided to use the configuration in Figure 1 because he was concerned about the consequences of incorrect weights and prices. The probability of errors resulting from noise transients was high because the scale would be used in a supermarket POS system, where the environment includes refrigerators, fluorescent lamps, meat grinders and electromechanical label makers.

In the system, the microprocessor receives weight codes from an encoder disc in the scale and operates a cash register interface, LED display, and relays of a receipt printer or label maker. The system designers put HiNIL interface logic on the microprocessor board to handle the I/O functions, suppress noise transients picked up along the transmission lines, and drive the peripheral devices. HiNIL output interfaces can drive long lines, relays, displays and lamps without additional components since they sink up to

65 mA and source up to 12 mA. (The new 390 buffer series will sink up to 250 mA.)

Manufacturers of systems requiring random logic are finding that HiNIL and CMOS are an ideal combination. They maximize system noise immunity and assure an excellent system function/power product. HiNIL and 54C/74C CMOS interface directly at  $V_{CC}$  voltages from 10 to 16 volts, the power supply range of HiNIL. Moreover, HiNIL protects CMOS inputs from destruction by static electricity and from harmful DC input levels that can exist before CMOS circuits are powered up.

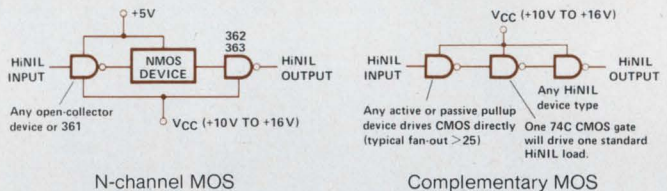

Figure 2. Typical HiNIL/MOS and HiNIL/CMOS interfaces

The rules for using HiNIL with MOS or with CMOS operating at lower voltages are simple. The pullup resistor of an open collector HiNIL device is connected to the desired high logic level voltage (see Figure 2). To use HiNIL with other bipolar logic, just plug in a Teledyne dual or quad interface circuit (see table). HiNIL is also compatible with most analog devices.

### Examples of HiNIL Interface Devices

301 Dual 5-Input Power Gate	65mA relay or lamp driver
302 Quad Power NAND Gate (OC)	
323 Quad NAND Gate (OC)	Input noise protection plus open-collector pullup to other logic levels
332 Hex Inverter (OC)	
334 Strobed Hex Inverter (OC)	
350 8-Bit Multiplexer	Drive longer lines than TTL with 10X noise immunity ( $I_{OH}=12mA$ )
351 Dual 4-Bit Multiplexer	
361 Dual Input Interface	361 directly connects HiNIL to DTL/RTL/TTL
362 Dual Output Interface	362 and 363 connect DTL/RTL/TTL to HiNIL
363 Quad Output Interface	
367 Quad Schmitt Trigger	Suppress 100V/1 $\mu$ s spikes, protect CMOS, decode switches, etc.
368 Quad Schmitt Trigger (OC)	
380 BCD to Decade Decoder	
381 BCD to Decade Decoder (OC)	Provide decode/drive for lamps, LEDs, gas discharge displays, etc.
382 BCD to Decade Decoder	
383 BCD to 7-Segment Decoder	
390 Interface Buffer Series	250mA HiNIL driver series will be available soon.

If you need a simple, inexpensive solution to a difficult noise problem, write or call Teledyne Semiconductor for a copy of application notes and specifications on Teledyne's High Noise Immunity Logic family.

# TELEDYNE SEMICONDUCTOR

1300 Terra Bella Avenue, Mountain View, California 94043 Tel: (415) 968-9241 TWX: 910-379-6494 Telex: 34-8416

ENGLAND: Heathrow House, Cranford, Hounslow, Middlesex, Tel: (44) 01-897-2503 Telex: 851-935008

FRANCE: 90, Avenue Des Champs Elysees, 75008 Paris, Tel: 2563069 Telex: 842-29642

WEST GERMANY: Albert Gebhardtstrasse 32, 7897 Tiengen, Tel: 7741-5066 Telex: 841-792-1462

JAPAN: Nihon Seimei-Akasaka Bldg. (3F), 1-19, Akasaka 8-chome, Minato-ku, Tokyo 107, Tel: 03-405-5738 TWX: 781-2424241

Additional offices in West Germany, Hong Kong and the United States. Representatives and distributors worldwide.



## The misunderstanding

Planning a trip to California, I telephoned a friend and invited her to dinner. "I'd love it," she said, "but I'm going to the opera. I'm seeing *Norma*." "Hey, that's great," I said, sharing her pleasure. "With whom?"

Well, I could almost feel the chill coming over the telephone lines as she paused, then replied, "With a friend." This stunned me for a millisecond, then I realized she was telling me it was none of my business who went to the opera with her. But that wasn't my question. I was asking her who the leading performers were going to be.

Of course, I instantly saw the misunderstanding and we both had a large laugh, albeit an embarrassed one, when I explained that I had not intended to pry.

This situation comes to mind too often. I see, for example, how proud some of us are because of our responsiveness to the wishes of our customers. Many times we drop everything and charge off on a new course when a customer asks for something. But the customer really wanted it only "when it's convenient." A common misunderstanding.

Fortunately, neither of these misunderstandings is particularly serious. But plenty are. A young engineer ditches his design and starts another. Why? The chief engineer was worried about one component and the young engineer thought he disliked the entire design when he said, "Change this." Another misunderstanding.

I wonder how many misunderstandings never get explained. The richness of the English language makes it too easy for us to suggest something we don't mean, unless we choose our words with extreme caution.

I finally did have dinner with my friend in California and we kidded each other about our earlier misunderstanding. But as I think of it now, I wonder if it was very funny.

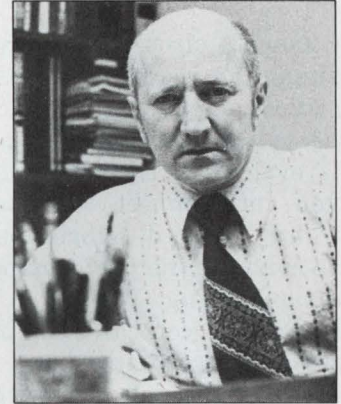

GEORGE ROSTKY  
Editor-in-Chief



## Specify hybrid components properly.

Know more about their materials and processing, and you'll minimize drift and leakage problems.

Once a circuit design has passed the notebook stage, it's ready to be assembled and tested. Resistors, capacitors and active elements are connected on a breadboard, and circuit performance is evaluated. Everything checks out okay. Then you interconnect the same components into a tightly packed hybrid package. But when you re-evaluate the performance, the results are often disappointing. Why?

Because you can't compare the performance of resistors, capacitors and inductors mounted on an open breadboard with assembly in a high-density hybrid package where temperature rise, leakage paths and stray capacitance are unavoidable.

Where a capacitor is called for, the designer can take his choice of multilayer, tantalum, MOS or hybrid (screened). But which is best in terms of capacitance value, stability, breakdown voltage and dissipation factor? For resistors, thin-film and thick-film types are available. But when is one preferable to the other?

If you know the materials and manufacturing processes of the hybrid components, you'll have enough answers to make the right choice.

### Capacitors come in many forms

Capacitors designed for hybrid use come in nearly as many different forms as hybrids themselves. Multilayer ceramic, tantalum, MOS and hybrid capacitors are available from 1 pF to 100  $\mu$ F, and often they are the limiting factors in the ultimate package size and layout. Fig. 1 shows the capacitance ranges and relative volumetric efficiencies of the most commonly used types.<sup>1</sup>

Multilayer ceramic capacitors are by far the most popular capacitor in hybrid use today. Their high volumetric efficiency, low cost and high reliability make them popular for a wide variety of applications, from circuit decoupling to highly

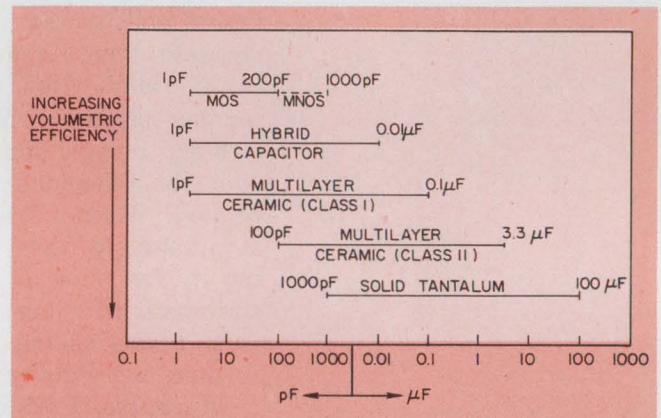

1. Capacitance ranges and volumetric efficiencies available for hybrid subassemblies.

critical timing circuits. The typical construction of a multilayer ceramic capacitor is shown in Fig. 2.

There are two classes of multilayer ceramic capacitors. Class I capacitors offer stable electrical characteristics over temperature changes, with moderate volumetric efficiency. Class II capacitors are highly efficient in volume but have inherently poorer electrical characteristics as temperature varies.

The salient characteristics of Class I capacitors include the following: a capacitance value that varies predictably and linearly with temperature; low dissipation factors; and virtually no sensitivity to aging or applied voltages. Unfortunately, these capacitors also have relatively low dielectric constants, which preclude their use in applications requiring high value and small size. Although Class I dielectrics are available with either a positive or negative temperature coefficient of capacitance, by far the most popular formulation is the material designated NPO (negative-positive-zero).<sup>2</sup> This exhibits a near-zero change in capacitance, with a guaranteed value of  $0 \pm 30$  ppm/ $^{\circ}$ C drift from  $-55$  C to  $+125$  C (Fig. 3).

"High-K" dielectrics are used for Class II capacitors. This type of capacitor achieves its increased volumetric efficiency through a high

Jim Anderson, Engineer, and Joe Santana, Senior Design Engineer, Custom Microcircuits Group, Helipot Div., Beckman Instruments Inc., Fullerton, CA 92634.



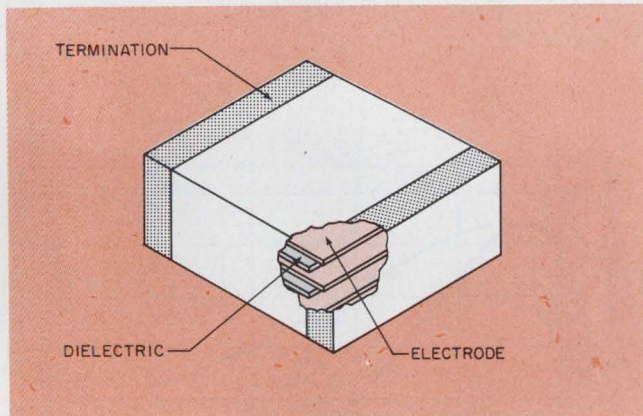

2. Multilayer ceramic capacitors are fabricated by stacking and co-firing thin sheets of metalized green dielectric.

dielectric constant, but it suffers, with respect to its capacitance, dissipation factor (DF) and internal resistance (IR), from increased sensitivity to applied voltage, frequency and aging. As a rule of thumb, the higher the value of the dielectric constant, the greater the change in capacitance value with temperature. However, because of their compactness, Class II capacitors are well suited for a wide range of noncritical capacitor applications, especially in circuits designed to work over a reduced temperature range or the audio frequency spectrum.

Temperature characteristics for Class II capacitors<sup>3</sup> are specified to EIA standards (Fig. 4). For hybrids, the most popular Class II formulations are X7R and Z5U. In some applications a cost savings may be achieved by selection of a guaranteed-minimum-value (GMV) capacitor. As its name implies, this type requires the vendor to guarantee only a minimum capacitance value over the desired operating temperature range.

As shown in Fig. 5, the electrical characteristics for Class II vary widely with temperature, applied voltage, frequency and aging. Therefore the designer must consult the manufacturers' data sheets.

One important factor often overlooked in specifying Class-II type capacitors is aging. Generally aging curves are specified in terms of percent

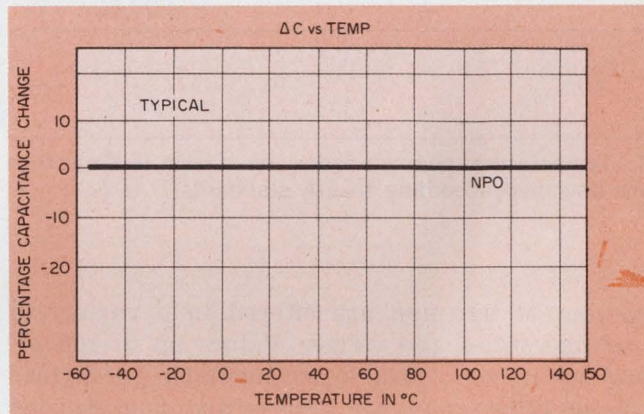

3. Class I NPO dielectric capacitors are available with a guaranteed  $\pm 30$  ppm/ $^{\circ}\text{C}$  drift from  $-55$  C to  $+125$  C.

per decade hour. Problems will arise whenever a capacitor is taken above its curie point. At the curie temperature, Class-II dielectrics undergo a change in internal structure that resets their aging curve. When a Class-II capacitor is raised above its curie temperature, it undergoes an initial increase in capacitance value. After the temperature is dropped below the curie point, the capacitance begins to return to its nominal value and decay rate (for example, 2% the first hour, 2% the next 10 hours, etc.). Since the process temperatures of many hybrid manufacturers may exceed this point, it is important to take it into account in the electrical testing of parts recently processed.

Finally, remember that breakdown voltage has a bearing on over-all chip size. Capacitor vendors usually specify breakdown voltage in 50, 100, and 200-V ranges, while a few offer a 25-V range. Overspecification in this area can result in inefficient use of valuable space on the hybrid assembly.

#### Tantalum capacitors offer high cap/volume

For applications requiring an especially high capacitance-to-volume ratio, solid tantalum capacitors offer an alternative. A relatively new component on the hybrid scene, they are rapidly



Lower temperature limit reference	Upper temperature-limit reference	$\Delta C$ limit reference
+10 Z	+45 2	$\pm 1.0$ A
-30 Y	+65 4	$\pm 1.5$ B
-55 X	+85 5	$\pm 2.2$ C
	+105 6	$\pm 3.3$ D
	+125 7	$\pm 4.7$ E
		$\pm 7.5$ F
		$\pm 10$ P
		$\pm 15$ R
		$\pm 22$ S
		+22-33 T
		+22-56 U
		+22-82 V

Example: Z5U  $\Delta C = 0 \begin{matrix} +22 \\ -56 \end{matrix} \% (25 \text{ C ref})$   
from: +10 to +85 C

**4. Temperature characteristics for Class II dielectrics** are specified according to EIA standards.

coming of age and are offered in a variety of package styles and values. Values up to 100  $\mu\text{F}$  are not uncommon and are available for hybrid use in filter, coupling, bypass and nonprecision timing applications. Tantalums, by nature, are polar, and therefore ac applications require understanding and care.

Although exact process steps vary between manufacturers, most make solid tantalum capacitors by compressing high-purity tantalum powders into a pellet and letting a small wire protrude to form the anode termination. The powder slug is then sintered in a vacuum at high temperature to form a solid, yet porous, structure. Porosity is important, since it accounts for the high cathode-plate area and thus the high volumetric efficiency. A tantalum pentoxide dielectric is formed in the pores as well as on the surface while the slug is dipped in an acid bath. Next, the pellet is dipped in manganese dioxide, which serves as the electrolyte and cathode electrode. Finally, the cathode termination is applied to the end of the slug.

Three electrical parameters are of major concern when you specify tantalum chips: dc leakage current, equivalent series resistance (ESR) and maximum dc working voltage (WVDC).

Due to impurities in the tantalum, as well as surface irregularities within the dielectric, tantalum capacitors exhibit dc leakage currents of 1 to 10  $\mu\text{A}$  at room temperature, depending on the capacitor size and value. In addition leakage is also dependent on temperature and voltage, varying directly with each.

The ESR of solid tantalums is actually a combination of a number of internal resistances due to such parameters as lead, contact and electro-

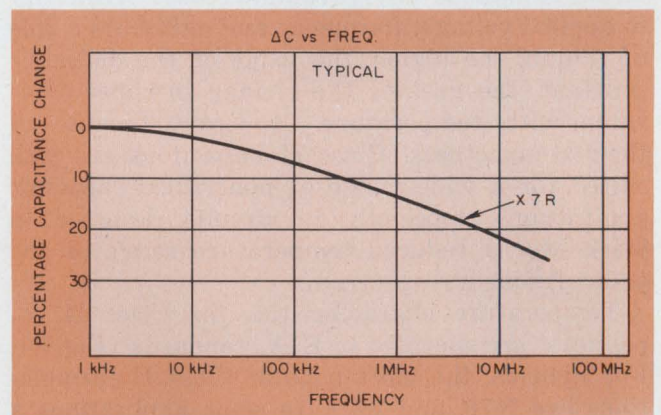
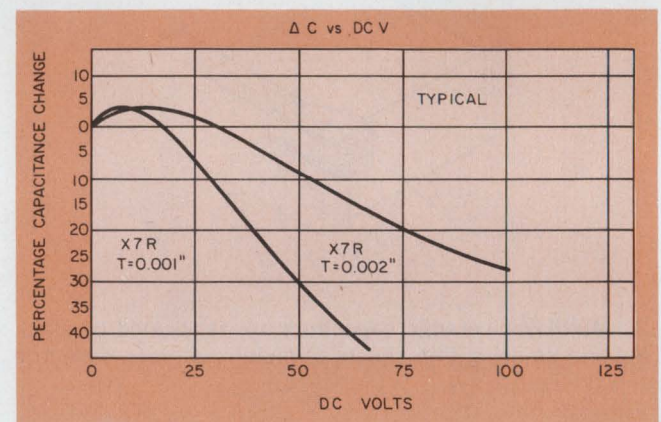
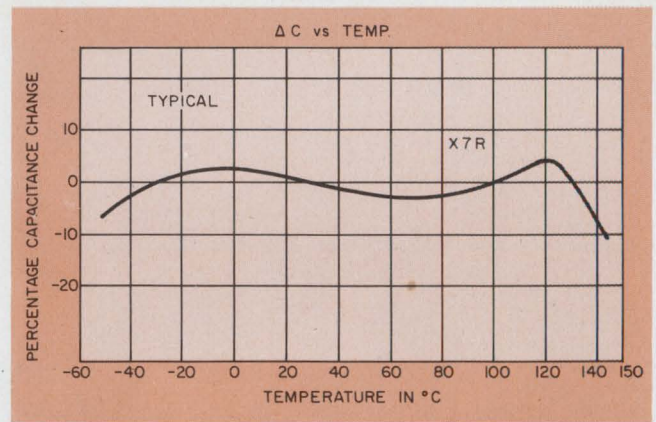

**5. Electrical characteristics for Class II capacitors** vary widely with temperature, offered voltage and frequency.

lyte resistance. Since capacitor losses are frequently expressed in terms of dissipation factor (DF), ESR can be expressed as a function of DF by the equation

$$ESR = \frac{DF \cdot 10^4}{2\pi fC}$$

where C is in microfarads, DF is in percent and the frequency of interest is usually 120 Hz.

WVDC is considered the maximum dc voltage



that may be applied to a capacitor. Because of the thin dielectrics in solid tantalums, the life of the capacitor is directly affected by the magnitude of the applied voltage. The designer must remember that the sum of ac and dc bias must not exceed the WVDC. Another thing: The specified WVDC affects the size of the capacitor just as directly as the capacitance itself, and over-specification can cost valuable real estate.

Be wary when you specify tantalums to a hybrid vendor who is unfamiliar with their uses. Some brands of tantalum chips are especially sensitive to process temperature extremes (such as thermocompression wire bonding), as well as to military temperature cycling requirements. Problems with cracking, flaking and loosening of the anode wire can occur and necessitate costly rework procedures for the hybrid manufacturer, and they may pose reliability problems for the user. Check the hybrid vendor's experience with tantalum chips and under what environmental conditions he has been qualified for his processes.

#### Leakage current low in MOS caps

Although not as widely used, MOS capacitors fulfill many requirements where size is a problem and the required value is relatively small. High capacitance stability with temperature and aging, as well as lower leakage currents, make the MOS capacitor desirable in such applications as filters and precision oscillators. Values range from 1 pF to 200 pF, depending on the exact type, and MOS capacitors generally have a positive temperature coefficient up to about 35 ppm/°C. However, Texas Instruments recently developed a silicon nitride dielectric layer that offers an increased range of capacitances up to 1000 pF on the same sized chip.

MOS chips use semiconductor technology to form a silicon dioxide dielectric between a low-resistivity substrate material and an aluminum metallization. Connection to one electrode is made directly by wire bonding. For the other, the connection is through a back contact or a wire bond to the substrate.

In terms of cost, reliability and handling, the MOS capacitors are more like a MOS transistor than other capacitors. One advantage, however, is that some of these chips offer a binary range of values, all on one chip, which allows the possibility of adjusting the final value with a laser after the hybrid is fabricated.

#### Hybrid capacitors formed by screens

Some hybrid manufacturers have the ability to screen or deposit capacitors in much the same

<input type="checkbox"/> VALUE	<input type="checkbox"/> AC VOLTAGE COEFFICIENT
<input type="checkbox"/> TOLERANCE	<input type="checkbox"/> DC LEAKAGE CURRENT
<input type="checkbox"/> TEMPERATURE COEFFICIENTS	<input type="checkbox"/> FREQUENCY RESPONSE
<input type="checkbox"/> DISSIPATION FACTOR	<input type="checkbox"/> INSULATION RESPONSE
<input type="checkbox"/> DC WORKING VOLTAGE	<input type="checkbox"/> DIELECTRIC ABSORPTION
<input type="checkbox"/> DC VOLTAGE COEFFICIENT	<input type="checkbox"/> AGING

6. Use this capacitor checklist to avoid overlooking critical parameters when you specify hybrid capacitors.

	Thick film	Thin film
Range of values	0.5 $\Omega$ to 100 M $\Omega$	10 $\Omega$ to 10 M $\Omega$
Absolute tolerance	0.1%	0.005%
Absolute temperature coefficient	$\pm 200$ ppm/°C	$\pm 25$ ppm/°C
Matching temperature coefficient	$\pm 50$ ppm/°C	1 ppm/°C
Power dissipation	100 W/in <sup>2</sup>	Alumina 25 W/in <sup>2</sup> Glass 10 W/in <sup>2</sup> Silicon 100 W/in <sup>2</sup>
Noise	-30 dB to +7 dB (Depending on value & trimming method)	< -50 dB
Stability	< 0.5% /year	< 0.1% /year
Voltage coefficient	0.007% /volt	No measurable effect

7. Compare the performance parameters of thick and thin-film resistors in the early decision stages.

way as resistors. The characteristics of these capacitors vary widely with the manufacturer and the technology involved. In general, values are restricted to 10,000 pF for thick-film and under 200 pF for thin-film processes. It is difficult to fabricate thick-film capacitors with tolerances of less than  $\pm 20\%$ ; however, some hybrid manufacturers can tailor capacitors to within 0.5% with negligible degradation in performance. Hybrid capacitors offer the cost-saving advantage of simultaneous fabrication and are principally useful in applications where several low-value capacitors are needed on a single substrate. In some cases where hybrid area is not critical and it is desirable to alter a circuit parameter by varying capacitance, a number of capacitors can be screened in parallel, connected by conductors that may be opened until the desired capacitance value is obtained.

Use the checklist in Fig. 6 when you specify





**NEW  
FROM  
MEPCO/ELECTRA**

**MINIATURE  
CERMET  
TRIMMERS  
49¢ EACH**

(1,000 piece price)

High performance... low profile... low price. That's the story of MEPCO/ELECTRA's new ET 14 series single turn trimmer. It's the smallest size professional trimmer of its type available today. The 1/4" ET 14W has a maximum height of .150" and features a unique slider design and a CRV of 1% max., 0.25% average, regardless of direction of rotation.

Want more information? Call or write MEPCO/ELECTRA, INC., San Diego, CA. 92121 (714) 453-0353.

**Actual Size**



**NEW IDEAS IN ELECTRONICS**



MEPCO/ELECTRA, INC.  
A NORTH AMERICAN PHILIPS COMPANY

your needs; then discuss all parameters with the hybrid vendor.

Thick and thin films are the two basic technologies used to manufacture hybrid resistors. With thick-film technology, resistors and conductors are formed by screening conductive and resistive inks onto a substrate in much the same way that silk-screen printing is done. A blade passing over a screen with the desired pattern forces resistive compositions through the screen and onto the substrate. Subsequent drying and firing operations bond the ink to the substrate.

Thin-film networks are fabricated by vapor-deposition of thin layers of gold, nichrome or similar metals in a vacuum over an entire substrate surface, followed by selective etching to form the desired resistor-conductor pattern. In general, thin-film resistors have smaller size, increased accuracy, better temperature coefficient

- |   |  |
|---|--|
| <input type="checkbox"/> RANGE OF VALUES                  | <input type="checkbox"/> POWER               |
| <input type="checkbox"/> TOLERANCE                        | <input type="checkbox"/> NOISE               |
| <input type="checkbox"/> ABSOLUTE TEMPERATURE COEFFICIENT | <input type="checkbox"/> STABILITY           |
| <input type="checkbox"/> TRACKING TEMPERATURE COEFFICIENT | <input type="checkbox"/> VOLTAGE COEFFICIENT |

8. When specifying hybrid resistors, use this checklist as a reminder of key parameters.

of resistance and lower noise than thick-film types. Thick-films offer increased power dissipation and a wider range of resistor values at lower fabrication cost. Fig. 7 compares typical thick and thin-film resistors.

Entire hybrids may be composed exclusively of thick or thin films; however, it is not uncommon to combine the two. For instance, in a digital-to-analog converter, the increased accuracy and tracking of a thin-film network may be desirable for the binary ladder; however, the thick-film technology offers a low-cost alternative for the remaining comparatively noncritical resistor and conductor runs. Keep in mind, however, that adding thin-film chips to a thick-film layout involves additional process steps, which can affect cost and reliability.

#### How about the substrate?

The type of substrate used can drastically affect hybrid performance. Although alumina is standard for thick films, some vendors offer beryllia for higher power dissipation. Thin-film circuits may be fabricated on a variety of substrates, including silicon, glass, alumina and beryllia. Each type has a distinct advantage in



terms of cost, power dissipation, ease of handling and dielectric constant. For high-speed circuits, the designer should consider the dielectric constant of the substrate itself, since parasitics can play a vital role in determining circuit layout.

What of the cost advantages in functional trimming? Both thick and thin films can be designed for functional tailoring after the hybrid has been manufactured. This allows the accuracy requirements for a number of other components in the circuit to be relaxed. For example, an automatic-gain-control loop may have several resistors that determine the over-all gain of the circuit; these resistors might need a tight tolerance of, say, 0.1% to ensure the desired gain without adjustment. However, if you specify that one or two key resistors be functionally trimmed over a given range, other resistors may require only 1% or 2% tolerance, thus reducing the need for costly precision trimming.

Significant cost savings are possible if the circuit designer takes advantage of a particular hybrid vendor's resistor characteristics. One manufacturer's resistor ink system may offer poor absolute temperature coefficient of resistance (TCR) but extremely tight temperature tracking capabilities between resistors. Similarly another hybrid house may use an ink system with relatively good absolute TCR but poor tracking between resistors. The circuit designer may take advantage of these features to relieve tolerance requirements or even eliminate the need for adding thin-film chips to a thick-film layout.

Use the resistor checklist in Fig. 8 to avoid overlooking important parameters and to provide a common language interface with the hybrid vendor.

### Inductors are still scarce

Inductor is not a word frequently found in the hybrid manufacturer's vocabulary. Inductors are still very difficult to fabricate on a substrate for any but the smallest value at high frequencies. Chip inductors have yet to become a comfortable component for hybrid processes. However, small wound cores can be attached onto substrates. Although they are best left outside the package, where the circuit requires it, chip inductors can be installed at the expense of increased substrate area and package height. ■■

### References:

1. Harper, Charles A., "Handbook of Thick Film Hybrid Microelectronics," McGraw-Hill, New York, 1974.
2. "Monolithic Chip Capacitors", eight-page catalog, Tensor Electronics, Inc., San Diego.
3. "Understanding Chip Capacitors" (Application Note), Johanson/Monolithic Dielectric Div., Burbank, CA.



## NEW FROM MEPCO/ELECTRA

# 3/8" SINGLE TURN CERMET TRIMMERS

With Vernier trimming capability

Trimmers with a totally new design offering low, low pricing with exceptionally low noise performance. And this big plus... vernier trimming. That means trimming with a finer edge than previously available in any single unit of this size. We've built-in space to add two resistors which we can calibrate to your designated value. Then we add our patented sliding action element for superfine trimming within the designated range.

Available in two models. ET 37, general purpose with resistance range of 10Ω to 5MΩ. ET 38 with 15 different resistance values and 9 different standard pin spacing.

Want to know more? Call or write MEPCO/ELECTRA, INC., San Diego, CA. 92121 (714) 453-0353



Verni-Trim



Actual Size



Actual Size

ET 37



Actual Size

ET 38



**NEW IDEAS IN ELECTRONICS**



# Improve inductor design accuracy by analyzing flux density and winding-form effects on the ferrite pot core. You'll also upgrade the coil Q.

Sooner or later, nearly every rf circuit designer has need for a stable, precise inductor for high-frequency LC oscillators and tuned circuits. Then what? Start your coil design with the selection of a ferrite pot core.

You can order pot cores preadjusted to a range of standard induction values with  $\pm 1\%$  tolerance. But, even so, you won't come close to your calculated inductance design value unless you carefully consider the effects of operating flux density and the way the coil is wound.

## Air gap reduces tolerance spread

As shown in Fig. 1, the electrical circuit of a pot-core inductor is completely enclosed in a high-permeability, high-resistivity, low-loss ferrite body. The pot core is completely self-shielding, permitting high-density packaging of nearby external circuitry without fear of stray coupling or interference effects.

The first step to achieve a precise, stable inductor is to narrow the rather wide tolerances on initial permeability of the ferrite material. This is done by introducing an air gap into the magnetic circuit.

While reducing the effective permeability, an air gap also reduces the tolerance spread associated with this parameter. Use of the stabilizing influence of air as part of the magnetic circuit is not new, but the ferrite pot core has been specifically designed with this feature in mind.

To clarify the effect of an air gap in a pot core, Fig. 2 shows the percentage change in effective permeability of ferrite material for a Ferroxcube type 2616 pot core with a specific air gap. As shown in this graph, the  $\pm 25\%$  tolerance on initial permeability is reduced to a more manageable  $-1.8\%$  to  $+1.0\%$  in effective permeability.

Pot cores are preadjusted, by grinding an air gap in the center post, to a range of standard induction factors, or  $A_L$  values. The  $A_L$  value is the inductance in nanohenrys ( $10^{-9}$  H) per the

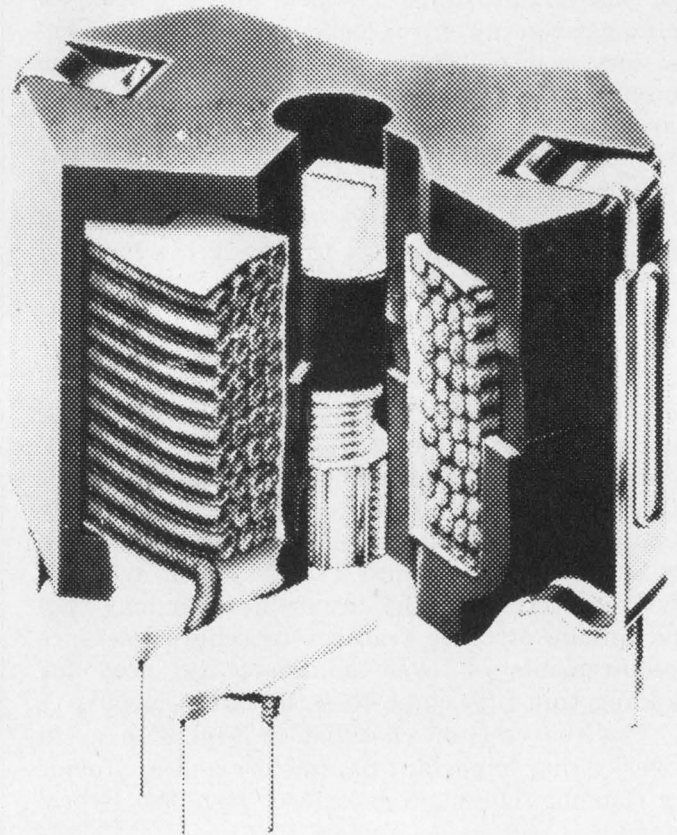

1. A ferrite pot core is completely self-shielding. Thus it eliminates worries about interference with nearby circuit components.

square of turns:

$$A_L = \frac{L}{N^2} \quad (L \text{ in } 10^{-9} \text{ H}) \text{ at low flux densities.}$$

These  $A_L$  values in pot cores now become the basis for calculating the turns for any specific value of inductance. For instance a pot core with an  $A_L$  value of 400 will be considered in the design of an inductor with a value of 1.5 H. The number of turns can be calculated from

$$N = \sqrt{\frac{L}{A_L}} \text{ or } \sqrt{\frac{1,500,000}{0.4}} = 1937 \text{ turns.}$$

A pot core of any size with an  $A_L$  value of 400 and 1937 turns wound on the proper bobbin will yield an inductance of 1.5 H. This relationship between required inductance,  $A_L$  value and number of turns is simple and straightforward. But several factors can influence this inductance

Jan M. van der Poel, Manager, Application Engineering, Ferroxcube Corp., Saugerties, NY 12477.



value: pot-core flux density, and the way the bobbin is wound.

### Flux density critical at low frequencies

The induction factor,  $A_L$ , of a pot core is defined under low flux-density test conditions, typically less than 10 G. If the excitation in an inductor design is well above this low flux-density range, the actual measured inductance will be higher than the calculated inductance.

The inductance increase in a preadjusted 2616 pot core, as a function of the operating flux density, is shown in Fig. 3. Since the operating flux density might result in an increase in the inductance, it is suggested that the operating flux density be calculated in any inductor design. This is particularly required for low-frequency applications, where high excitation levels are surprisingly easy to obtain.

To calculate the operating flux density, use the following formula:

$$B = \frac{E \cdot 10^8}{4.44 f N A_e} \text{ gauss,}$$

where  $E$  = volts, rms,

$f$  = frequency in Hz,

$A_e$  = effective core area,  $\text{cm}^2$ , and

$N$  = number of turns.

The effective areas of pot cores are listed in manufacturers' literature—for example, the Ferroxcube Linear Ferrite Materials and Components Catalog, which is available on request.

### How's the bobbin wound?

Another factor that will influence the actual inductance in a pot core is the way the bobbin is wound. Because of the air gap in the center post, not every turn that can be wound on the bobbin will contribute exactly the same inductance per turn. The flux fringing in the immediate area of the air gap will reduce the flux enclosed by the turns adjacent to the air gap, resulting in a lower-than-average inductance per turn for this part of the winding.

To avoid variations when pot cores are preadjusted to  $A_L$  values, it is necessary that the wound bobbins be used in this operation. It is common to use a fully wound bobbin as the test coil for these pot-core gapping procedures.

This raises an obvious question: How does the measured inductance compare with the calculated inductance if the bobbin is not fully wound? In Fig. 4 the inductance deviation vs the calculated inductance of a 2616 pot core is plotted as a function of the winding height, with the various  $A_L$  values as parameters. From this graph, it is clear that inductance deviations can be obtained that are greater than the tolerances in  $A_L$  value. These deviations are most pronounced, as can be ex-

pected, in pot cores with large air gaps or with low  $A_L$  values. It so happens that these same low  $A_L$  value cores have the tightest tolerances. For instance, a 2616-PA100/3D3 has a  $\pm 1\%$  tolerance on  $A_L$  values, but if this core is used with a bobbin winding that only fills 60% of the total winding height, the actual measured inductance will be 4% lower than the calculated inductance.

Another type of winding dependency is shown in Fig. 5. Here the percent deviation between the measured and calculated inductance is plotted for a single layer of turns. Layers 1 and 2 have less

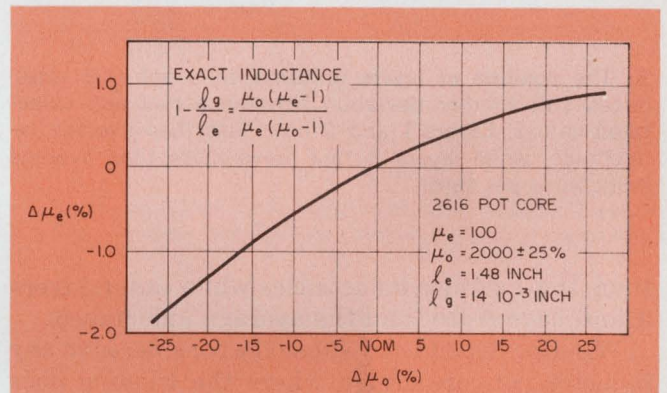

2. An air gap is used in a pot core to reduce the wide tolerance on initial permeability ( $\mu_o$ ). Here a  $\pm 25\%$  initial-permeability tolerance is reduced to  $-1.8\%$  to  $+1\%$  tolerance in effective permeability ( $\mu_e$ ).

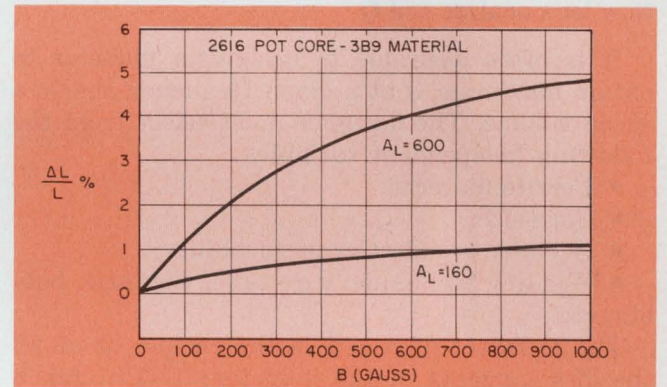

3. An increase in operating flux density will result in an increase in inductance value.

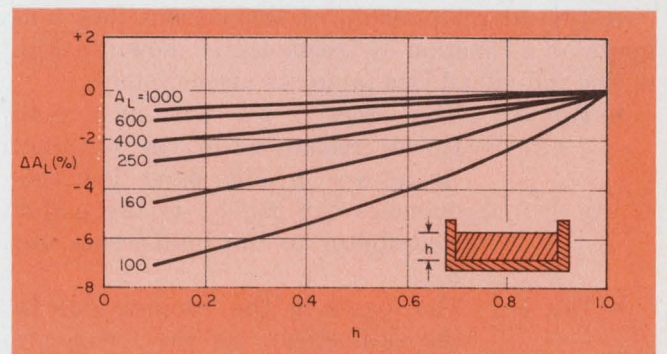

4. If less than the total bobbin height is used, the actual inductance will be lower than the calculated value. The larger the air gap, the greater the deviation.



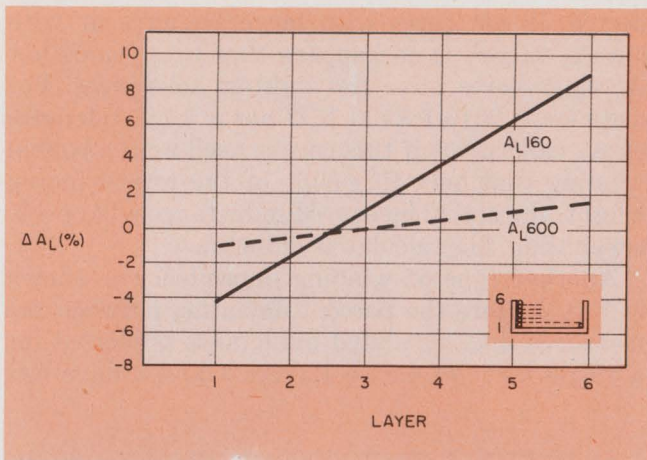

5. The position of layers of turns on a pot core introduces still another deviation between actual and calculated values. Layers 1 and 2 have less than average inductance, while layers 3 to 6 have more than average inductance per turn.

than the average inductance, while outer layers 3 to 6 have more than the average inductance.

Winding dependency should be considered in any inductor pot-core design where the winding does not fill the total winding area. Corrections can be made if you use the same curves as those shown in Fig. 4. These curves are in the Ferroxcube catalog for each pot core size.

#### Now let's analyze coil Q

It is often desirable to design an inductor to obtain maximum Q at a given frequency and in a given volume. The designer must select from the following independent variables:

- Ferrite material.
- Core size.
- $A_L$  value or effective permeability.
- Winding technique, wire type, wire size, bobbin, etc.

The Q factor of a coil is the reciprocal of all the loss tangents in the inductor:  $1/Q = \tan \delta_{\text{total}}$ . To achieve maximum Q, therefore, it is necessary to minimize the total losses in the inductor at the frequency of interest.

A typical relationship of the various loss tangents as a function of frequency is shown in Fig. 6. The individual loss tangents are as follows:

- $\tan \delta_{dc}$ . The losses in the winding due to the dc resistance of the winding. As shown in Fig. 6, at low frequencies the  $\tan \delta_{dc}$  is the major contributor to the total losses  $\tan \delta_{\text{total}}$ .
- $\tan \delta_{se}$ . The losses in the winding due to the skin effect. As the frequency increases, there is a tendency for the alternating current to flow near the surface of the conductor,

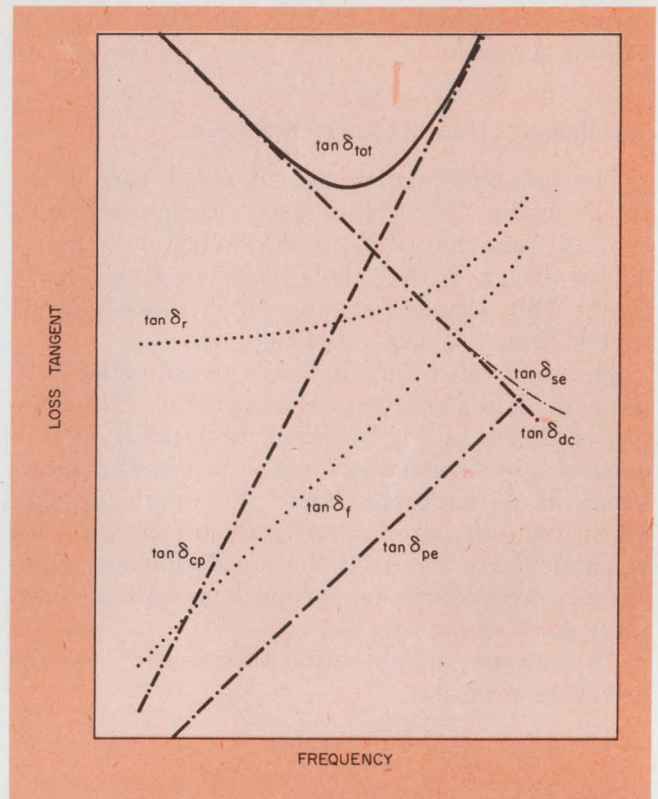

6. Typical variation of contributory loss tangents as a function of frequency. The total loss tangent is the sum of all the contributory loss tangents.

which causes an increase in the dc resistance.

- $\tan \delta_{pe}$ . The losses in the winding due to the proximity effect. These losses are caused when the magnetic field perpendicular to the winding produces eddy currents in each winding opposite to the magnetic field. The losses due to the proximity effect are substantial at higher frequencies, and the use of Litz wire is often necessary to obtain the desired quality factor.
- $\tan \delta_{ep}$ . The losses due to the stray capacitances of the winding. These are caused by two phenomena: (1) from the loss angle of the self-capacitance of the winding, and (2) from circulating currents in the self-capacitance. The winding technique is critical to reduce losses associated with the stray capacitances.
- $\tan \delta_r$ . The residual losses in the core material.
- $\tan \delta_F$ . Eddy-current losses in the core material. The sum of  $\tan \delta_r$  and  $\tan \delta_F$  is usually specified for the various ferrite materials at a given frequency.
- $\tan \delta_h$ . The hysteresis losses in the core



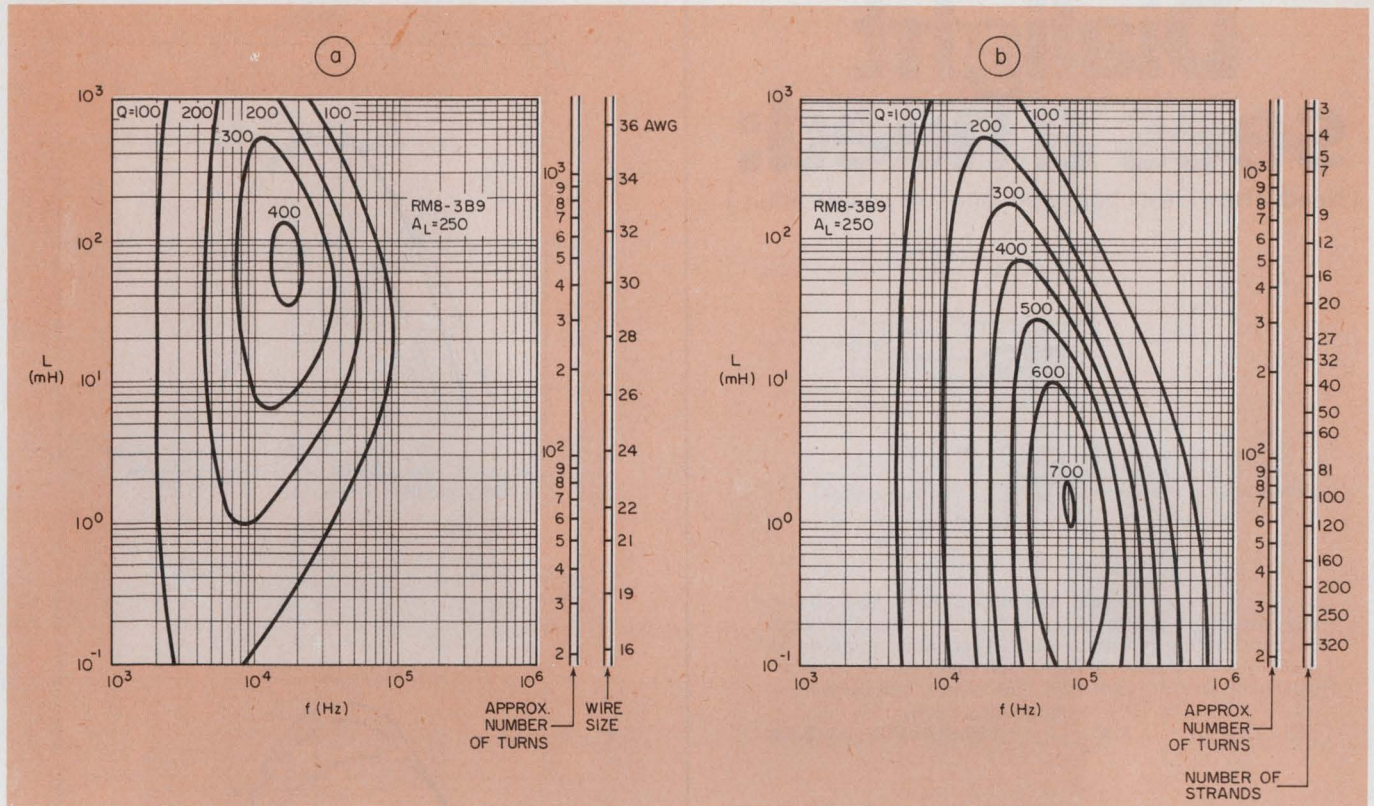

7. Iso-Q curves illustrate the effect of wire size on attainable Q. Typical Q curves obtainable with solid mag-

net wire are shown (a), compared with full windings of Litz wire with varying conductors of 46 AWG (b).

material. For all practical purposes, the operating flux density in high-Q inductor designs is so low that the hysteresis losses are negligible.

The total loss tangent is the sum of all the contributory loss tangents. To ease and aid the inductor designer, it is common for the ferrite core manufacturer to give Q curves for the various core materials, core sizes,  $A_L$  values and windings.

A representation of a set of Iso-Q curves is shown in Fig. 7 (a) and (b). These graphs give typical performance data and will allow an easy selection of inductance, wire size and number of turns. Since the effect of wire size upon attainable Q is significant, these curves have to be given for the various wire sizes and Litz wire combinations.

The advantages of the Iso-Q curves are obvious. For each coil design, performance can be evaluated at a glance, and comparisons between several possible designs can be made quite conveniently. These Iso-Q curves, for a core material suited for frequencies up to approximately 300 kHz, are based upon fully wound bobbins (the normal procedure for all inductor designs for frequencies up to 1 MHz). For frequencies above 1 MHz, a special winding technique can be used to optimize the quality factor.

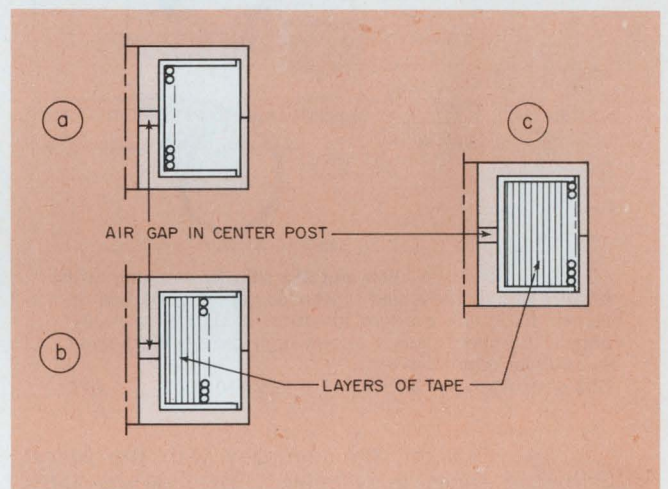

8. Three different winding configurations for a 1408 pot core wound with 15 turns of 12-44 Litz wire.

At high frequencies, the required inductance values are quite low (5-50  $\mu$ H). This, in turn, dictates a relatively low number of turns, with considerably less winding area than is available in the pot core bobbin. Consequently there is a degree of freedom as to how and where to put the winding in the available space.

#### Dependency of Q on winding location

To evaluate the effect of winding location upon the quality factor of the inductor assembly, three



# Dialight sees a need:

(Need: The widest choice for your every application.)

559-0101-001 MOUNTS IN 0.250" HOLE

SNAP-IN MOUNT

558-0101-001 MOUNTS IN 0.156" HOLE

SNAP-IN MOUNT

558 and 559 SERIES Available in red, green or yellow LEDs, with and without integral current limiting resistors. Snap-in mounting requires no additional hardware. Straight terminals suited for wire-wrapping and/or soldering. Low power requirements—15 to 20mA. In 1000-lot quantities each

558-0101-001 . . \$.33.      559-0101-001 . . \$.33.

559-0101-003 MOUNTS IN 0.250" HOLE

SNAP-IN MOUNT

558-0101-003 MOUNTS IN 0.156" HOLE

SNAP-IN MOUNT

558 and 559 SERIES Available with 6" wire leads, these red, green or yellow LEDs are designed for quick positive insertion in 0.031" to 0.062" panels. Compact design allows high density packaging. In 1000-lot quantities each

558-0101-003 . . \$.75.      559-0101-003 . . \$.71.

Dialight, the company with the widest choice in switches, LEDs, indicator lights and readouts, looks for needs . . . your needs . . . and then they develop solutions for your every application. No other company offers you one-stop shopping in all these product areas. And no other company has more experience in the visual display field. Dialight helps you do more with these products than any other company in the business, because we are specialists that have done more with them. Talk to the specialists at Dialight first. You won't have to talk to anyone else. Send for your free new copy of Dialight's current catalog.



## DIALIGHT

Dialight, A North American Philips Company  
203 Harrison Place, Brooklyn, N. Y. 11237  
(212) 497-7600

# See Dialight.

INFORMATION RETRIEVAL NUMBER 30

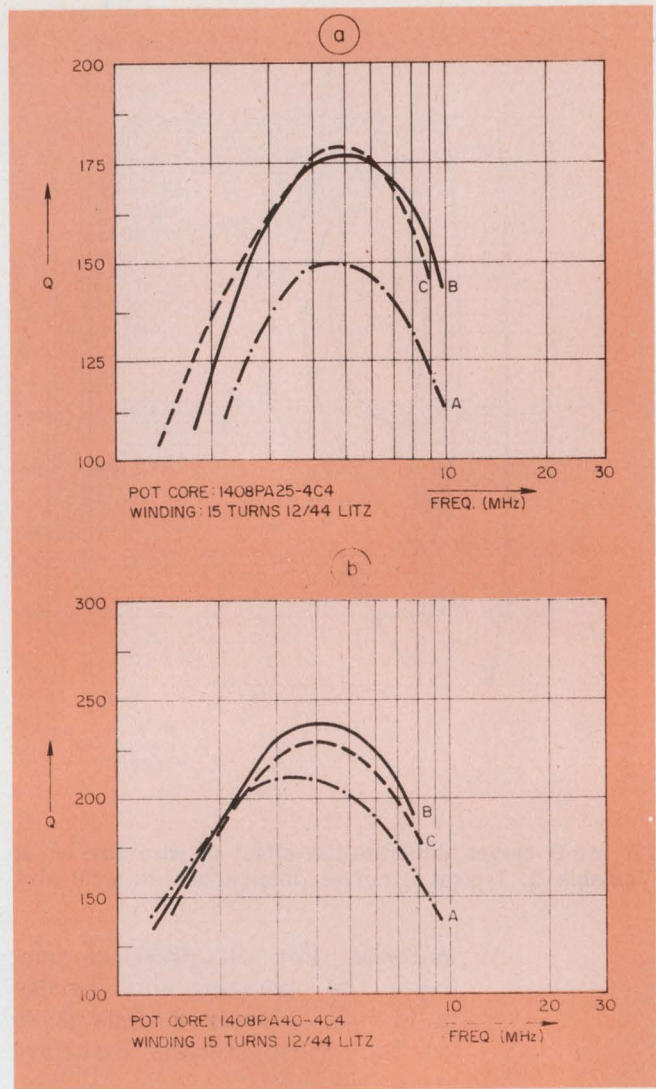

9. Q curves measured on two 1408 pot core sets in 4C4 nickel zinc material with  $A_L$  of 25 (a) and  $A_L$  of 40 (b).

bobbins for a 1408 pot core were wound with 15 turns of 12-44 Litz wire (Fig. 8). One winding (A) is wound directly onto the bobbin, another (B) is wound in the middle of the total winding height, and the third (C) is wound on the outer periphery of the bobbin. Q curves were measured on two 1408 pot core sets in 4C4 nickel-zinc material with  $A_L$  values of 25 and 40 mH/1000 turns. The measured Q curves are shown in Fig. 9 (a) and (b).

As shown in these curves, Q values can be improved by as much as 20% if the winding is moved away from the pot core center post. This approach takes the winding out of the flux fringing field that is generated by the gap in the center post, and it reduces the eddy current losses in the windings adjacent to the air gap. Another benefit is reduction of the capacitive losses in the winding. ■■

#### Reference:

Snelling, E. C., "Soft Ferrites, Properties and Application," Iliffe, 1969.



## RELIABILITY AND PRICE go together in our new Snap-Action Pushbutton Switch



- True over-center snap-action mechanism
- Knurled or hex nut mounting
- Corrosion resistant finishes
- Low operating force

### Low unit cost!

... only \$1.36 single circuit  
\$1.72 two-circuit  
(1,000-piece quantities)

### C160-C170 Series Specifications

Action . . . . . Momentary snap  
Ratings . . . . . 5A, 110VAC or 28VDC, 2.5A, 250VAC  
Life . . . . . 100,000 cycles min.  
Operating force . . . . . 2 lbs (8.89N)  
Terminals . . . . . Solder lug or quick-connect spade terminal

Free sample for qualified requirements  
Write on your letterhead



### CONTROL SWITCH

A CUTLER-HAMMER COMPANY  
1420 DELMAR DRIVE, FOLCROFT, PA. 19032 215/586-7500

LC-1

INFORMATION RETRIEVAL NUMBER 31

## Rose enclosures. New. Beautiful. Quality. Standards.

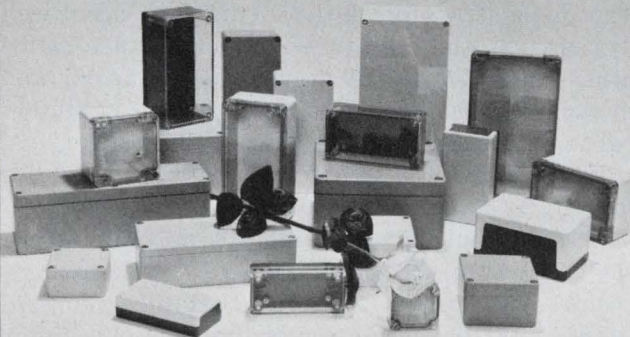

Rose Enclosures, made specifically for electronic use, culminate years of design, engineering and production experience. Extra high quality, precision-finished units provide functional protection, easy access, excellent esthetics. Available materials: Lexan, Aluminum, Polyester and ABS. Clear plastic covers with Lexan and ABS. A competitively-priced stock of Rose Enclosures is maintained in Belding, Mich. for immediate shipment. Contact us at (616) 794-0700.

**STAHLIN**  
BROTHERS, INC.  
Belding, Michigan 48809

INFORMATION RETRIEVAL NUMBER 55

ELECTRONIC DESIGN 3, February 2, 1976

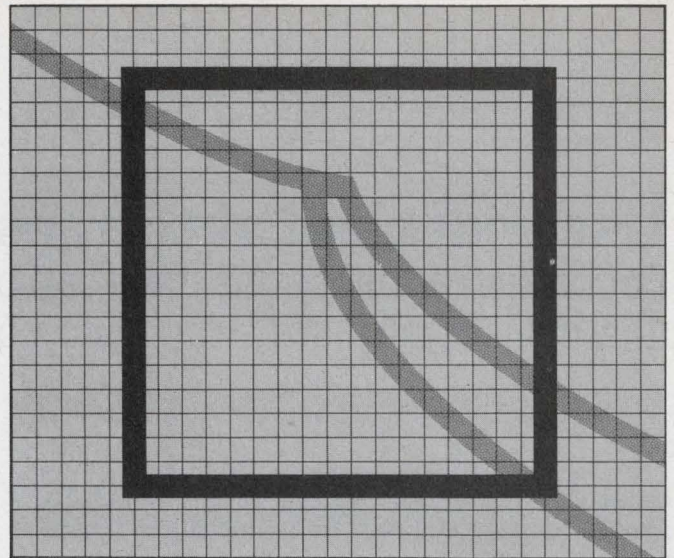

## New From Micro Devices A Unique Slow-Blow Current Limiter.

It's the new MICROTEMP 5P Series MultiProtector. A versatile, yet extremely accurate slow-blow current limiter that lets you design-in protection for a specific current requirement within a precise time and current window.

triggering the exclusive pellet-type opening mechanism.

When properly applied, 5P will not nuisance trip reducing costly and annoying "in warranty" service calls.

No other commercially available slow-blow fuse even comes close to matching the 5P's ability to handle high current surges without being derated.

5P's unique opening mechanism design guarantees life time rating stability and excellent surge absorption. Conventional slow-blow fuses operate through a metallic, current carrying element making them extremely susceptible to surging and derating. Thanks to its patented non-current carrying temperature sensitive opening mechanism, the MICROTEMP® thermal cutoff reacts only when current put through the heater element generates temperatures capable of

### Here's more:

- current values — 600 milliamps to 3.25 amps.
- ambient temperature range—25 to 100° C.
- can be designed to withstand surges up to 100 amps for 30 milliseconds
- operates within 130% of rated current

Recognized under the Component Program of Underwriters' Laboratories, Inc. UL File #E59187.

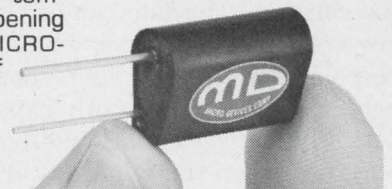

For more information, check the reader service card, or call or write:



## MICRO DEVICES CORP.

1881 Southtown Blvd., Dayton, Ohio 45439  
Ph: (513) 294-0581 Telex: 28-8087

INFORMATION RETRIEVAL NUMBER 32

63



# Use wideband autotransformers in rf systems.

For certain applications, they can outperform transmission-line devices and are simpler to construct.

Need to transform balanced circuits to unbalanced circuits, or vice versa? Does your design require a 4:1, 9:1 or 16:1 impedance transformation? Then use a conventional transmission-line transformer, a popular choice for these applications.

But should your design require balanced-to-unbalanced or unbalanced-to-unbalanced transformation or impedance transformations other than an integer squared, you'll need an autotransformer. The transmission-line transformer just can't do the job. Furthermore some impedance transformations that can be achieved by either type of transformer require multiple cores with the transmission-line transformer and only a single core with the autotransformer.

## What's the difference between types?

The distinguishing feature of the transmission-line transformer<sup>1,2</sup> is that the "winding" is composed of two conductors, with equal and opposite currents flowing in each conductor, as in a balanced transmission line. The net magnetizing ampere-turns in the core is zero. Therefore there is considerable difference in the means by which energy is transformed between the input and output circuits for a transmission-line transformer and an autotransformer.

With the autotransformer, the permeability of the core and the number of turns determine the low-frequency response, while the high-frequency response of these transformers is obtained by very close coupling, both capacitively and magnetically, between the windings. Such coupling is obtained when the windings are twisted together.

The basic autotransformer circuit is shown in Fig. 1. When the transformer is used as an impedance step-down device, the relationship between the load impedance and the impedance seen looking into input terminals is given by

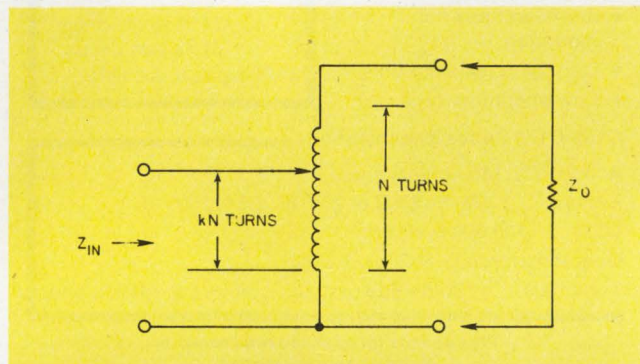

1. In a basic autotransformer used for impedance step-down,  $Z_{in} = k^2 Z_{out}$  where  $k$  is the location of the tap.

$$Z_{in} = k^2 Z_o,$$

where  $Z_o$  is the load or output impedance,  $Z_{in}$  is the impedance seen at the input terminals, and

$k$  is the location of the tap, stated as a fraction of the total number of turns referenced to the common terminal.

When using transmission-line transformers, you must have two identical windings. The tap must be placed at the center, giving a 4-to-1 impedance transformation. This has been well discussed in the literature. But impedance ratios other than 4-to-1 are frequently required, and methods of obtaining both integral and nonintegral impedance ratios are not so well known.

Pitzalis and Couse<sup>3</sup> describe circuits for obtaining 9:1 and 16:1 impedance ratios for unbalanced-to-unbalanced loads. These circuits are shown in Figs. 2a and 2b. The 9:1 transformer requires two cores, while the 16:1 unit requires three cores; in these circuits, there is one bifilar winding on each core.

Because of the requirement for equal and opposite currents in the windings, transmission-line transformers are restricted to impedance ratios of

$$\frac{(2)^2}{1}, \frac{(3)^2}{1}, \frac{(4)^2}{1}, \dots, \frac{(n)^2}{1}$$

where  $n$  is an integer.

In general, the impedance transformations available with this type of circuit are given by

John J. Nagle, Office of System Engineering, National Environment Satellite Service, Dept. of Commerce, Washington, DC 20233. (The work described in this article was done privately by the author.)



Impedance ratio =  $(N_c + 1)^2$ ,  
 where  $N_c$  is the number of cores.

Impedance transformation ratios other than those obtainable from transmission-line transformers are frequently required, and so the autotransformer must be considered.

Krause and Allen<sup>4</sup> have developed an interesting method for extending a 4:1 transformer up to 6:1. After the usual bifilar winding is wound on the core, a third winding is wound over the original winding, as shown in Fig. 3. The length

conductor to carry an equal and opposite current. Care must also be taken to ensure that the core does not become saturated by the unbalanced current flow.

The characteristic of transmission-line transformers cited previously is also evident from Fig. 2; in a true transmission-line transformer, the current flow must be equal and opposite in the two conductors on the core, just as in a transmission line. Many devices labeled transmission-line transformers are not true transmission-line

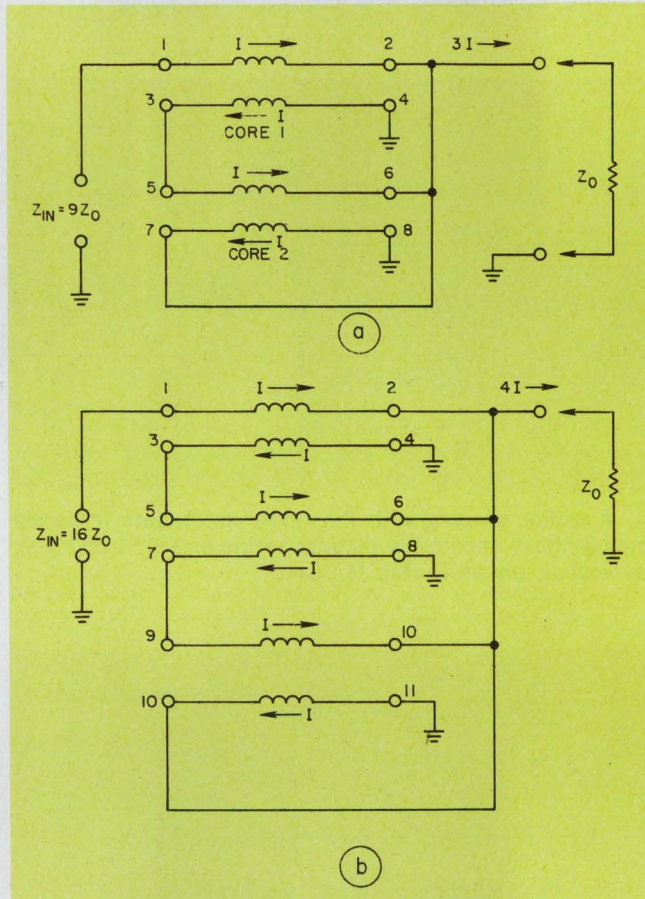

2. Two cores are required in a transmission-line transformer to achieve a 9:1 impedance ratio (a). Three cores are required for a 16:1 ratio (b).

of this winding is given by

$$L_3 = L \left( \sqrt{\frac{R_L}{R_s}} - 2 \right),$$

where  $L_3$  is the length of the third winding,  
 $L$  is the length of the bifilar winding,  
 $R_L$  is the load resistance, and  
 $R_s$  is the source resistance.

If impedance transformations greater than about 6:1 are attempted, bandwidth reductions may take place.

The addition of this third winding changes the transformer from a transmission-line to an autotransformer, since the tertiary winding has no

## Form Factor for various core shapes

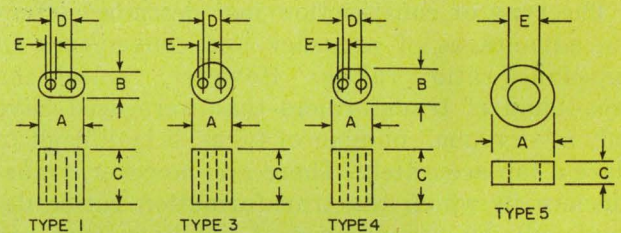

CORE SHAPE	NOMINAL DIMENSIONS					FORM FACTOR
	A	B	C	D	E	
TYPE 1	0.525	0.295	0.407	0.225	0.150	13.0
TYPE 1	0.277	0.160	0.244	0.114	0.071	14.3
TYPE 1	0.136	0.079	0.093	0.057	0.034	14.0
TYPE 3	0.250	—	0.242	0.100	0.050	9.5
TYPE 3	0.250	—	0.471	0.100	0.050	8.8
TYPE 4	0.284	—	0.218	0.104	0.052	8.8
TYPE 3	0.220	—	0.250	0.090	0.035	7.8
TYPE 5	0.380	—	0.190	—	0.197	29.0

NOMINAL DIMENSIONS			FORM FACTOR
A	B	C	
0.138	0.051	0.118	17.3
0.076	0.043	0.150	24.3
0.138	0.051	0.236	14.9
0.138	0.051	0.500	13.7
0.296	0.094	0.297	14.8
0.200	0.062	0.250	15.2
0.200	0.062	0.437	12.3

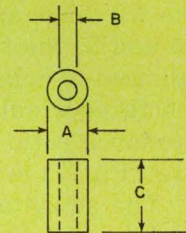

devices, but simply broadband transformers of the autotransformer variety.

With autotransformer techniques, it is possible to obtain transformation ratios of other than 4:1, with the added advantage of requiring only one core. If a trifilar winding is made by tight twisting of three separate conductors together to form a single winding, and the three conductors are connected in series aiding, the circuit of Fig. 4 results. This gives impedance step-up ratios of 1:9/4 and 1:9, depending on which tap is used. This device is of the autotransformer type and not a transmission-line transformer, since the



currents are not equal and opposite through the individual conductors.

Going one step further and using a quadrifilar winding, we obtain impedance step-up ratios of  $1:(4/3)^2$ ,  $1:4$ , and  $1:16$ , as shown in Fig. 5, thereby increasing the flexibility afforded the circuit designer.

It is difficult to say how much further the process can be continued, but the possibilities appear limited by the number of wires it is practical to put on a core. Expect also a decrease in the usable bandwidth as the number of windings increases.

### Finding convenient winding taps

The type of construction just described offers the advantages of accuracy and convenience in impedance-ratio values. However, since the broadband rf transformers that were used have only a very small number of turns, it is difficult to place a tap accurately. There are, however, transformers in which the transformation ratios depend only on the number of windings that are put on a core, so that miscounting a turn or two will not cause an error. The total number of turns can be selected to obtain the required inductance. This arrangement is convenient because the taps are placed at the junction of two windings, which is easily accessible. A further advantage is that the impedance-transformation ratios available are the square of a rational number instead of the square of an integer, as with transmission-line transformers.

In the preceding discussion the unbalanced-to-unbalanced case has been considered. When three or more windings are put on the same core, as in Figs. 6 and 7, the transformer may also be used for balanced-to-balanced impedance transformations. A three-winding core (Fig. 6) will provide an impedance ratio of  $0.111:1$ , and a four-winding core (Fig. 7) will give an impedance ratio of  $0.25:1$ . The advantage of using an even number of windings is that the center tap may be grounded.

It is desirable to be able to determine early in the design stage whether a given impedance transformation can be obtained with an n-filar winding that has taps at the junctions or whether a tapped winding must be used. The following slide-rule algorithm will easily determine this:

Assume it is desired to match an unbalanced  $50\text{-}\Omega$  coaxial cable to a  $72\text{-}\Omega$  load using an auto-transformer. Set 50 on the "A" scale of the slide rule opposite 72 on the "B" scale. Now scan the "C" and "D" scales for two integers that line up; notice that 6 on the "C" scale is immediately opposite 5 on the "D" scale, as shown in Fig. 8. This indicates that a hexfilar winding connected across the  $72\text{-}\Omega$  load, with the  $50\text{-}\Omega$  cable con-

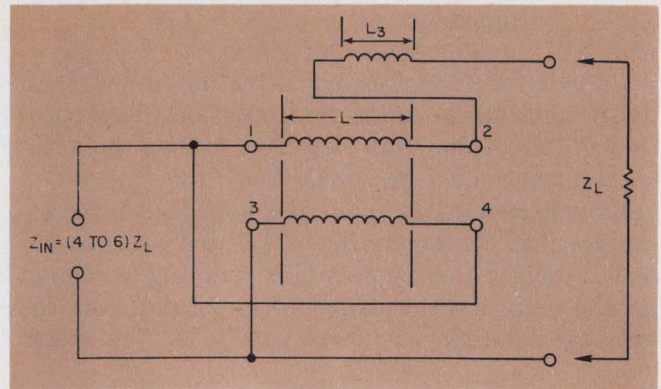

3. To extend a 4:1 impedance ratio to 6:1, a third winding,  $L_3$ , is wound over the original winding,  $L$ .

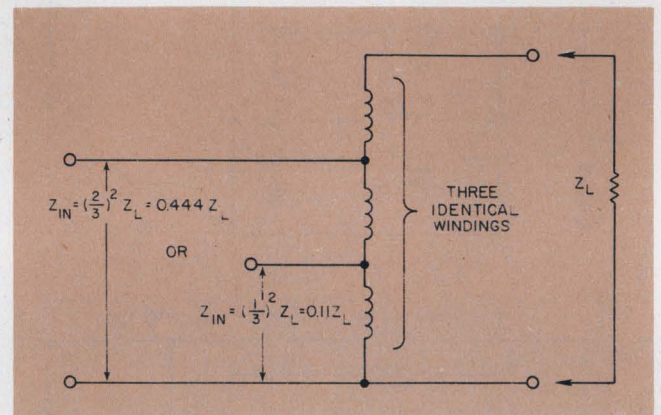

4. A trifilar winding with the three conductors in series aiding offers impedance step-up ratios of  $1:9/4$  and  $1:9$ , depending on which tap is used.

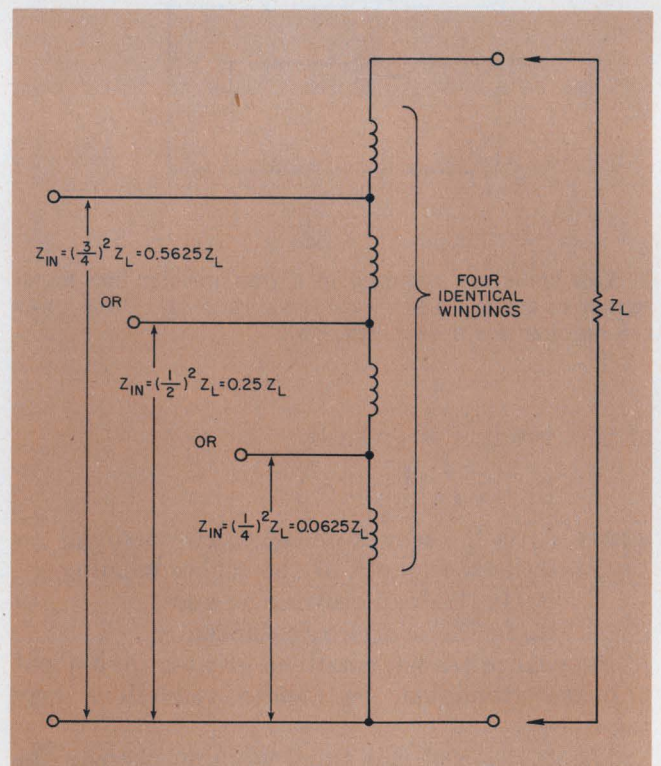

5. A quadrifilar winding can extend impedance ratios to  $1:(4/3)^2$ ,  $1:4$  and  $1:16$ , depending on the tap.



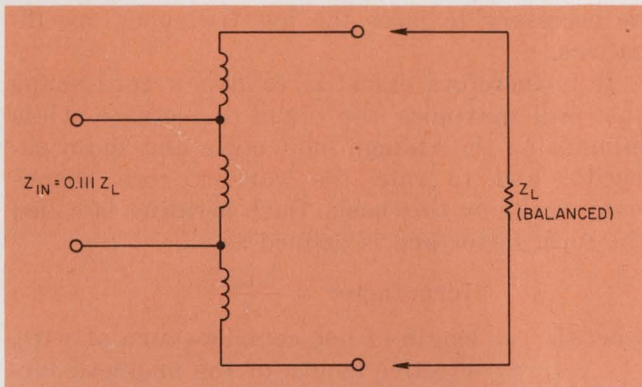

6. A trifilar transformer provides a 0.111-to-1 impedance ratio in a balanced-to-balanced transformation.

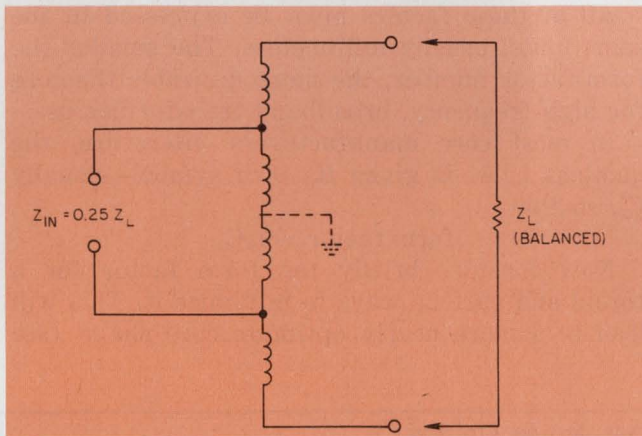

7. A quadrifilar winding offers a 0.25:1 impedance ratio, and the center-tap may be grounded.

nected between the fifth and sixth winding, will be required (Fig. 9). A resistive pad used to obtain the same impedance match would require a loss of 5.7 dB.

The same procedure may be used for balanced lines, except that in scanning the "C" and "D" scales of the slide rule it is necessary to look for integers that are separated by 2, or any other even number. For example, suppose you want to match a 383- $\Omega$  balanced line (AWG 18 wire spaced one-half inch, such as open-wire TV line) to 200  $\Omega$  balanced. (The value 200  $\Omega$  was chosen because it is the impedance obtained in going from 50  $\Omega$  coax through a 4:1 balun.) After set-

ting 200 on the "B" scale opposite 383 on the "A" scale, note that the closest integers separated by 2 are 7 on the "D" scale opposite 5.05 on the "C" scale (Fig. 10).

Because only integral numbers are allowed, an exact match cannot be obtained; it is therefore necessary to move the slide slightly so 5 and 7 are aligned on the "C" and "D" scales. This puts 200 on the "B" scale opposite 390 on the "A" scale and gives a VSWR of  $390/383 = 1.02:1$ , which may or may not be acceptable, depending on the application. At any rate, it is the best that can be done with an n-filar winding. If a better match is required, a tapped winding must be used with the circuit (Fig. 11).

A note of caution in applying this algorithm: Make certain that the proper side of the "A" and "B" scales is used in setting up the impedance ratio. In the first example, both impedances were in the decade between 10 and 100, while in the second example both impedances were between 100 and 1000. In both cases, the same half of the "A" and "B" scales would be used.

If, on the other hand, we were trying to match 75  $\Omega$  to 120  $\Omega$  (both unbalanced), use 75 from the left-hand side of the "A" scale, with 120 from the right-hand side of the "B" scale, and obtain 5.05 over 4 on the "C" and "D" scales. If you mistakenly set 75 on the left-hand "A" scale opposite 120 on the left-hand "B" scale, the results would be 2 over 5 on the "C" and "D" scales—an incorrect result, as shown in Fig. 12.

### Selecting the core shape

One of the important parameters in the design of a successful wideband rf transformer is the shape of the core. Most neophytes in transformer design begin by using toroids, probably because of tradition. Toroids, however, may not be the best choice.

Factors limiting the high-frequency response of a transformer are leakage inductance and winding capacitance,<sup>5,6</sup> and these factors suggest a winding that has as few turns as possible. On the other hand, the low-frequency response is limited by the available shunt inductance, and this suggests that a large number of turns may

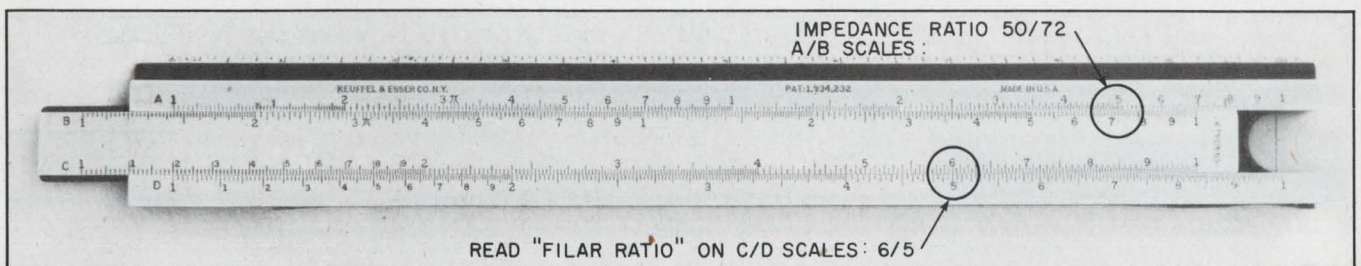

8. Slide-rule algorithm for determining turns ratio for matching 50 to 72  $\Omega$ , unbalanced.



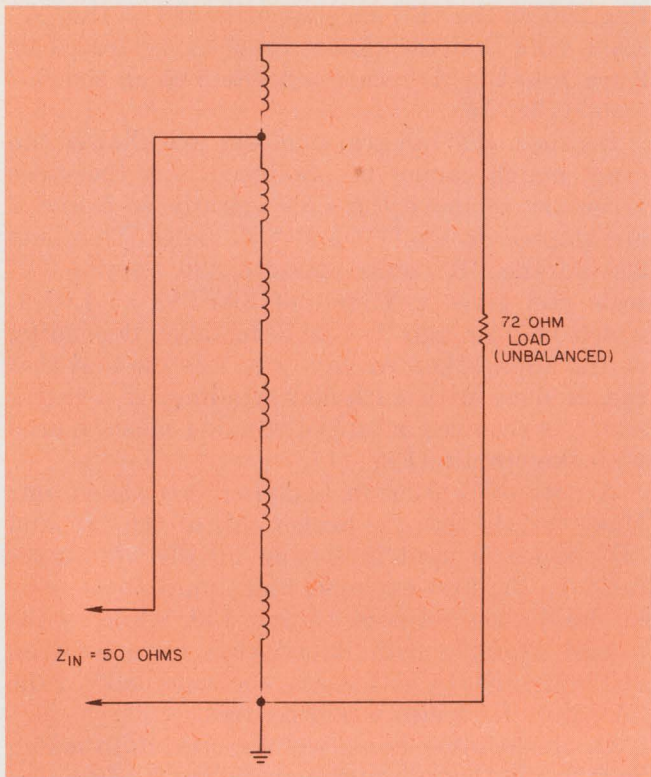

9. A hexafilar winding is used in this example to match a 72-Ω load to a 50-Ω cable.

be necessary to meet the low-frequency specifications.

It is therefore essential to find a core shape that will maximize the shunt inductance while minimizing the leakage inductance and shunt capacity, and to rate the various core shapes numerically on this basis. Such a rating is called the form factor and is defined as

$$\text{form factor} = \frac{l_w l_e}{A_e}$$

where  $l_w$  = length of one complete turn of wire,  
 $l_e$  = effective length of the magnetic circuit,

and

$A_e$  = effective cross sectional area of the core.

All of these factors must be expressed in the same units, usually millimeters. The smaller the form-factor number, the more desirable the core for high-frequency, broadband transformer use.

In most core manufacturers' literature, the quotient  $l_e/A_e$  is given its own symbol—usually  $C_1$ , so that

$$\text{form factor} = l_w C_1.$$

Now consider briefly the form factor for a toroid and various ways to minimize it. This will lead to a more nearly optimum core shape (see

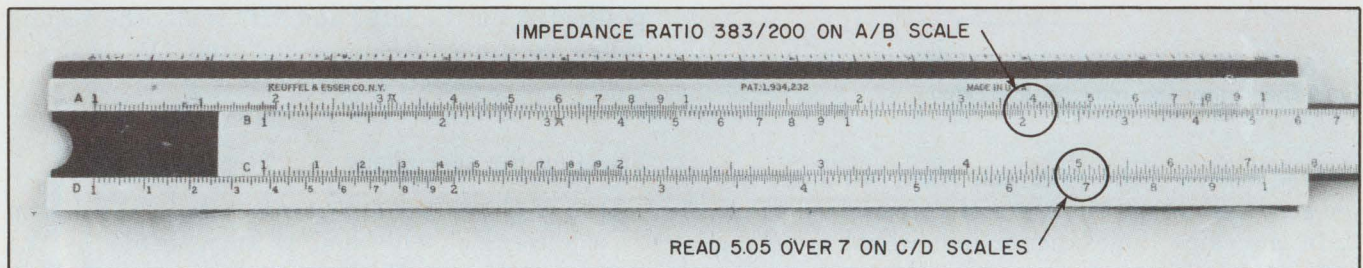

10. Slide-rule algorithm for finding turns ratio to match 200 to 383 Ω, both balanced to ground.

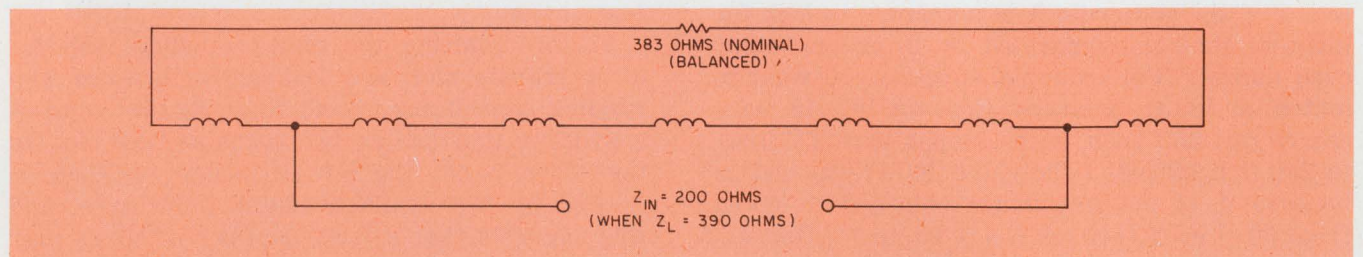

11. A seven-winding autotransformer is needed to match 383 to 200 Ω, both balanced to ground.

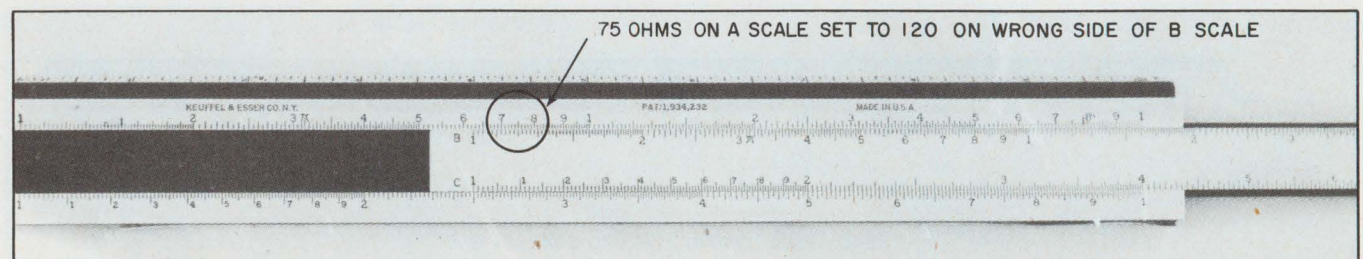

12. An incorrect turns ratio will appear if the wrong half of the A or B is used.



Ref. 6, pg. 265-267).

The length of a single turn of wire,  $l_w$ , for a toroid is given by

$$l_w = d_2 - d_1 + 2h,$$

where  $d_2$  and  $d_1$  are the outer and inner diameters of the core, respectively.

and  $h$  is the axial length (height).

The factor  $C_1$  is given by Snelling<sup>6</sup> as

$$C_1 = \frac{2\pi}{h \log_e \left( \frac{d_2}{d_1} \right)}.$$

The object is to minimize the product  $l_w C_1$ ; this can be done by minimizing either or both factors. You can decrease  $C_1$  by either increasing  $d_2$  or decreasing  $d_1$ . However, when the ratio  $d_2/d_1 \gg 1$ , an increase in  $d_2$  increases  $l_w$  far more than a proportional decrease in  $d_1$ ; thus it is desirable to make  $d_1$  as small as possible. Since only a few turns of wire are used for most broadband rf transformers, the inner diameter can usually be reduced to a very few millimeters in diameter. This results in a toroidal form that is quite different in shape from the usual toroid and is more often referred to as a bead.

There is a practical limit, however, as to how far the form factor can be reduced in this way. Further improvement can be made by placing two toroids, edge to edge (Fig. 13) and threading turns through the two holes. In practice, a single core would be used and it would have the shape shown in Fig. 14; often referred to as a balun core. A disadvantage of this shape is that each turn of the core has to be threaded through two holes, but since the number of turns is small, this is not a serious limitation. The table gives the form factor for various commonly used toroid and balun core sizes. It can be seen that the balun shape has a lower form factor than the toroid.

The design of wideband autotransformers is

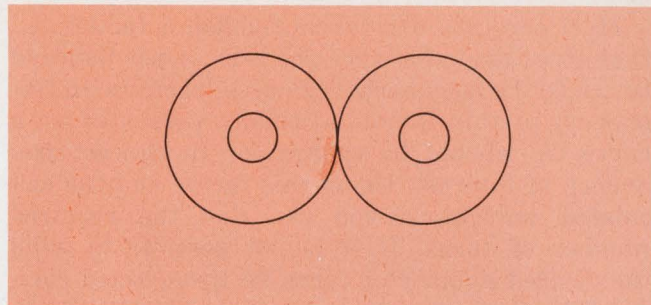

13. Two toroidal cores placed side by side offer a better form factor than a simple toroid.

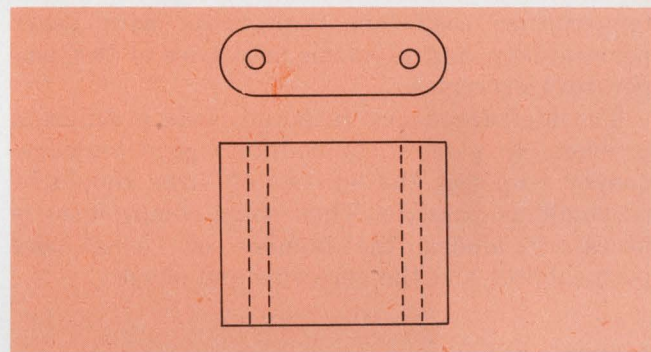

14. A balun core is the form that results when two toroidal coils are placed side by side.

similar to that of transmission-line transformers. For the autotransformer, the desired low-frequency response determines the number of turns and the size of the core. The low-frequency response will be down 3 dB at a frequency,  $f_1$ , when the reactance of the primary is equal to the desired reflected load resistance from the secondary, or when  $2\pi f_1 L_p = k^2 R_L$ . Solving for  $L_p$  gives

$$L_p = \frac{k^2 R_L}{2\pi f_1}.$$

The response will be 1 dB down at  $3f_1$ .

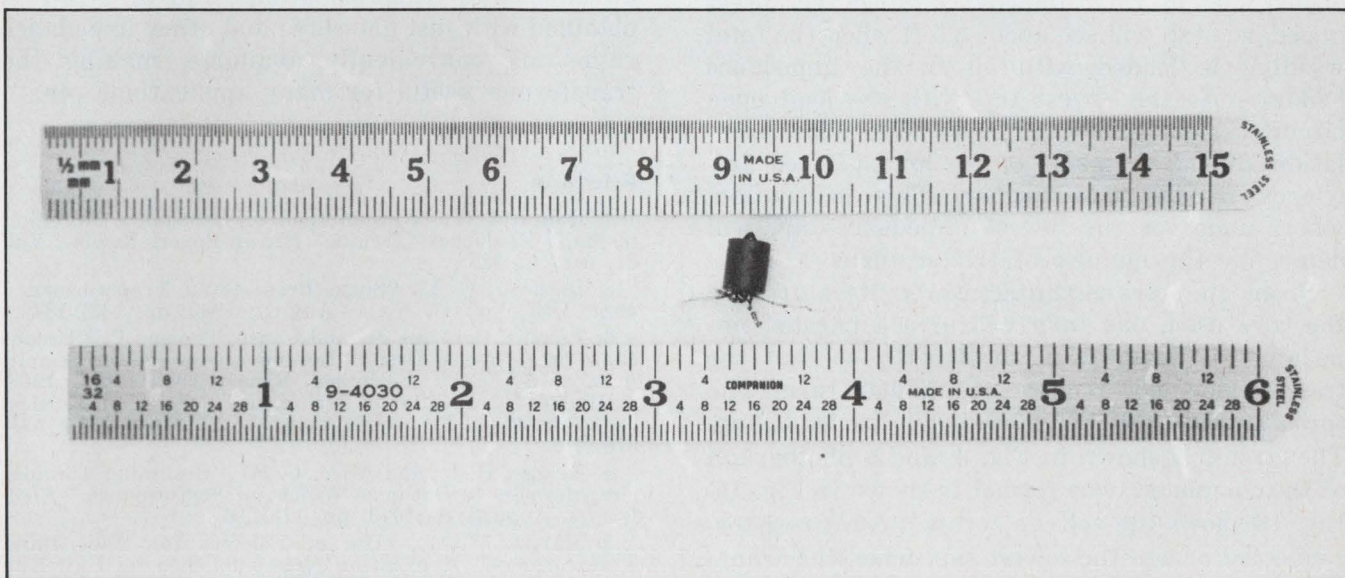

15. The compact 5.5-Ω to 50-Ω transformer uses a trifilar winding, with the strands connected series-aiding.



Most core manufacturers publish a factor,  $A_L$ , that gives the inductance per turn or per hundred turns. In the megahertz region,  $A_L$  varies with frequency, so this factor is usually presented as a curve.  $A_L$  should be chosen for the lowest frequency of interest. Using this factor and the calculated inductance you can find the required number of turns. If it is not possible to wind the desired number of turns on the selected core, use a larger core or a core with a higher permeability. Where wide temperature variations are possible, cores with high permeability should be avoided, as these cores also have a higher temperature coefficient than those with lower permeability, and problems may arise at the temperature extremes.

The high-frequency response poses a different problem. In general, to maintain good high-frequency response, the number of turns should be as small as possible. Thus some compromise is necessary among the number of turns, core permeability and the core size and shape.

### A sample design

Let's say we want to transform approximately  $5.5 \Omega$  to  $50 \Omega$  over a frequency of 2 to 50 MHz. The maximum power level will be 0 dBm.

The impedance transformation ratio is approximately 9, so a trifilar winding is required,  $\sqrt{9} = 3$ . With the relatively low power requirement, a small core is acceptable. A Fair-Rite Products core 2843002802 is selected because it has the smallest form factor. The number of turns to wind on the core is easily determined: To keep the transformer losses low, the minimum impedance seen looking into the lowest tap, with the secondary open-circuited, should be approximately five to 10 times the impedance seen looking into the same terminals with the secondary loaded with its rated impedance. Since the lowest impedance tap will see about  $5.5 \Omega$  when the total winding is loaded with  $50 \Omega$ , the impedance looking into the lowest tap with the load open circuited should be about 25 to  $55 \Omega$ . This calculation should be made at the lowest rated frequency of the transformer. This calculation, when made for the lowest impedance tap, will determine the number of trifilar turns.

From the core manufacturer's literature for the core used, one turn will give a parallel impedance of about  $30 \Omega$  at 2 MHz, so that the transformer will require one trifilar turn. The three strands will be connected in series-aiding. The circuit is shown in Fig. 4, and a photograph of the completed transformer is shown in Fig. 15. Fig. 16 shows the voltage across a  $5.6\text{-}\Omega$  resistor, connected across the lowest tap, when the transformer is driven from a  $50\text{-}\Omega$  generator. The measurements were made with a Hewlett-Pack-

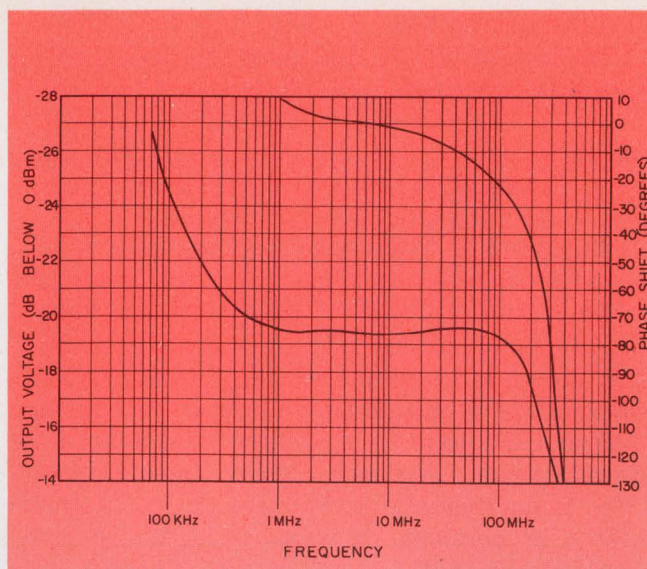

16. Transformer bandwidth is flat from 1 to 100 MHz, with an impedance transformation ratio of 9:1.

ard 8405A vector voltmeter, with the reference channel connected to the transformer input and the slaved channel connected across the load impedance.

The output of the generator was set to 0 dBm into a 10-dB,  $50\text{-}\Omega$  resistive attenuator. The left-hand ordinate in Fig. 16 gives the output voltage in dB below 0 dBm. Since the transformer has a 3:1 voltage step-down ratio, the output voltage would be expected to be  $-19.54$  dB below the input to the 10-dB pad (if the impedance change is disregarded). The right-hand ordinate gives the phase shift of the secondary voltage in degrees.

From Fig. 16, it can be seen that the output is constant within a few tenths of a dB from 1 to 100 MHz. While this bandwidth is not as great as possible with transmission-line transformers, an impedance transformation ratio of 9-to-1 is obtained with just one core; and other impedance ratios are conveniently available, making the transformer useful for many applications. ■■

### References

1. Guanella, G., "New Method of Impedance Matching in Radio Frequency Circuits," *Brown-Boveri Review*, Vol. 21, 1944, p. 327.
2. Ruthroff, C. L., "Some Broad-Band Transformers," *Proc. IRE*, Vol. 47, No. 8, August, 1959, pp. 1337-1342.
3. Pitzalis, Octavius Jr. and Couse, Thomas P., "Broad-band Transformer Design for Transistor Power Amplifiers," USAECOM Technical Report 2989, July, 1968. Available from National Technical Information Service, 5285 Port Royal Rd., Springfield, VA 22151; ask for AD-676-816.
4. Krause, H. L., and Allen, C. W., "Designing Toroidal Transformers to Optimize Wideband Performance," *Electronics*, August, 1973, pp. 113-116.
5. Martin, W. A., "Use of Ferrites for Wide Band Transformers," Application Note published by Fair-Rite Products Corp., Walkill, NY 12589.
6. Snelling, "Soft Ferrites," published by Chemical Rubber Publishing Co., Cleveland.



# The Universal Counter.

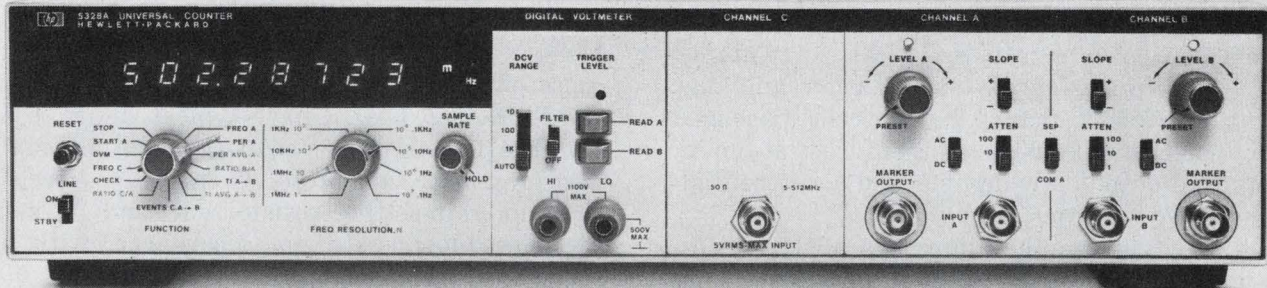

## Everything you're likely to need. The HP 5328A.

Here's a counter so versatile, it can really be called universal. You get high accuracy, operating ease and a low price tag of just \$1300\*. It's modular so you can buy the capability you need. Not more. Not less. Start with the basic 8-digit instrument with 100 MHz frequency range and 100ns single shot T.I. resolution. You also get period, 10 ps time interval averaging, ratio, scaling and totalizing. Then you can add more: 512 MHz with 9 digits and 15 mv sensitivity; time base aging  $< 5 \times 10^{-10}$ /day; and 10 ns single shot time interval with improved averaging. But look what else you get:

### UNIQUE TRIGGER LIGHTS

tell you what's happening. They're on when the input is greater than trigger level and vice versa. And they blink when the input channel is triggering from 0 to 100 MHz. Standard.

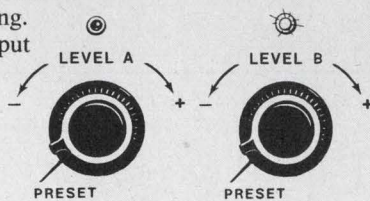

### UNIQUE BUILT-IN DVM gives an instant accurate digital display of trigger levels.

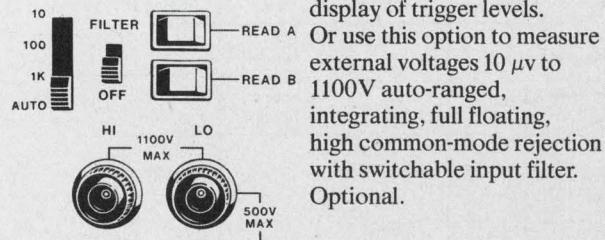

Or use this option to measure external voltages 10  $\mu$ v to 1100V auto-ranged, integrating, full floating, high common-mode rejection with switchable input filter. Optional.

### HIGH SPEED MARKERS show just what your counter is doing with your input waveform.

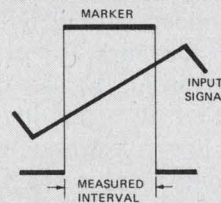

doing with your input waveform. Use the markers on the second channel of your scope to see where the counter is triggering. Really useful thanks to the 5328A's 100 MHz ECL outputs. Standard.

### EASY SYSTEMS INTERFACE with the HP Interface Bus

simplifies integration of the counter into a system. You get this programmability plus standard format data output with a single connector. Optional.



### ARMED MEASUREMENTS solve difficult dynamic measurement problems.

The counter goes to work when your command tells it to. Ideal for burst frequency or sweep generator linearity measurements. Standard.



These are just a few things, of course. There are many more thoughtful engineering innovations that combine to give you everything you're likely to need in a general purpose, medium-priced counter for a long time to come. We talk about them in our 12 page booklet. Write for one or ask your nearby HP field engineer for a copy. We want you to find why we call this universal counter universal.

\*Domestic US Price only.



Sales and service from 172 offices in 65 countries.  
1501 Page Mill Road, Palo Alto, California 94304

INFORMATION RETRIEVAL NUMBER 33



## Precision instrumentation amplifier built with general-purpose op amps

Three general-purpose 741 op amps and two monolithic dual-npn transistors can be combined into a high-precision instrumentation amplifier that outperforms many high-priced, packaged units. The circuit consists of a differential-input/differential-output preamplifier and a differential-to-single-ended output amplifier.

The input preamplifier provides all the necessary gain and boosts the output-amplifier's common-mode rejection ratio. It contains two inter-related feedback loops— $Q_{1A}$ ,  $Q_{2A}$ ,  $A_1$ ,  $R_3$  and  $Q_{1B}$ ,  $Q_{2B}$ ,  $A_2$ ,  $R_4$ —which are cross-coupled by the external gain setting resistor,  $R_G$ . The input stage of the preamplifier is the most critical part of the circuit. Stable collector currents for the dual-npn transistors,  $Q_1$ , are ensured by use of stable thin-film resistors,  $R_1$  and  $R_2$ , the dual-emitter followers,  $Q_2$ , and the low-voltage zener diode,  $Z_1$ , whose negative TC compensates the  $Q_2$  base-emitter voltages.

The amplifier input offset voltage can be set

to less than  $50 \mu\text{V}$  by selection of small series resistors, included in  $R_1$  and  $R_2$ . Drift of the input offset voltage is typically  $0.15 \mu\text{V}/^\circ\text{C}$ , and the PSRR and CMRR have typical values of 120 dB. The two internal feedback loops are stabilized by small capacitors,  $C_1$  and  $C_2$ . Precision thin-film gain-setting resistors,  $R_3$  and  $R_4$ , define the closed-loop gain in accordance with the formula

$$G = [(R_3 + R_4)/R_G] + 1.$$

Other features include an input common-mode voltage range of  $\pm 11 \text{ V}$ ; an input noise voltage of  $0.3 \mu\text{V}$ , peak-to-peak, over the band 0.01 to 1 Hz; an input bias current of 20 nA; a small-signal bandwidth of 200 kHz with  $G = 1$  or 1 kHz with  $G = 1000$ ; and an output slew rate of  $0.5 \text{ V}/\mu\text{s}$ .

*Jiri Dostal, Research Institute for Mathematical Machines, Prague, Czechoslovakia.*

CIRCLE NO. 311

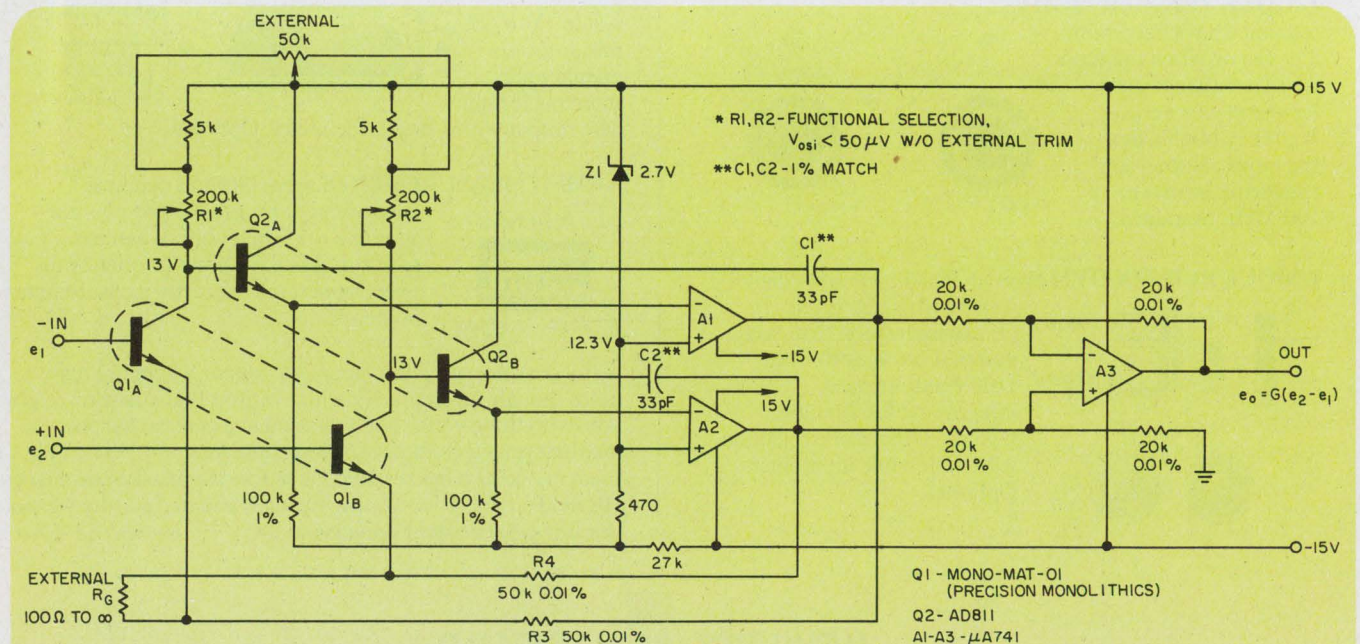

A differential-input, high-precision amplifier, built from general-purpose components, can provide a

gain range of 1 to 1000 by change of resistor  $R$  and can be set to input offset of less than  $50 \mu\text{V}$



**DESIGNERS**  
formulas, curves, diagrams

**RESEARCHERS**  
tables of optical parameters

**BUYERS**  
the world's largest selection of optics from stock

**USERS**  
large variety of optical components

**ENGINEERS**  
design assistance complete specifications

## At last... the complete Optics Guide.

Anyone can design or specify optical systems using the new Melles Griot Optics Guide.

Write stating your area of application and the types of optical components you're now using, and we'll send you this new Guide free of charge. (Regular Price \$8.50).

INDUSTRIAL & SCIENTIFIC OPTICS

# MELLES GRIOT

(formerly Optical Industries)

3006 Enterprise St. S., Costa Mesa, Ca. 92626 (714) 556-8200  
388 Main St., Dept. 2, Danbury, Conn. 06810 (203) 792-2002  
Nieuwe Kade 10 Arnhem, Holland 085-229011

INFORMATION RETRIEVAL NUMBER 34

## Facts.

# The GOULD/Brush 2400 delivers more of them with less fuss, bother and cost than any other oscillograph you can buy.

And it does it on a wide 100mm channel and at a remarkable 30Hz. Available in 2, 3 and 4 channel models with all the Gould exclusives, of course.

For the full Gould 2400 story, write Gould Inc., Instrument Systems Division, 3631 Perkins Avenue, Cleveland, Ohio 44114. Or Gould Allco S.A., 57 rue St. Sauveur, 91160 Ballainvilliers, France.

PHONE FREE (800) 648-4990 FOR BROCHURE.



**GOULD**

INFORMATION RETRIEVAL NUMBER 36

## New! Tipless

### T-1 1/4 & T-1 3/4 lamps

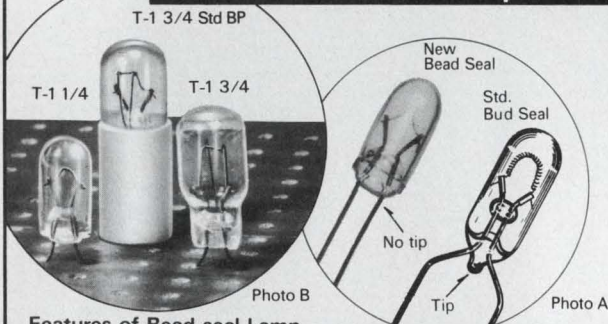

#### Features of Bead-seal Lamp

1. Easy to handle ..... No sharp tips anywhere on the glass bulb help prevent breaking of seal (Photo A).
2. Saves lamp space ..... Maximum overall length shorter than other similar lamps provide a high degree of design freedom.
3. Saves PC board costs... Can be mounted directly to PCB, the same as Bi-Pin lamps (Photo B).
4. Increased reliability..... Stronger seal, Higher vacuum level, Tighter filament mounting.
5. Abundant types ..... Up to 60V lamps in the same size bulb are available, even for T-1 1/4 size.

#### SUBMINIATURE LAMP SPECIALISTS

• Ask informations to:

**WAMCO Technical Sales, Inc.**

705 W. 16th Street, Costa Mesa, California 92627 TEL: (714) 833-9361 TELEX: 678459

**OSHINO ELECTRIC LAMP WORKS, LTD.** TOKYO, JAPAN

INFORMATION RETRIEVAL NUMBER 35

ELECTRONIC DESIGN 3, February 2, 1976

# KNOB KNOW-HOW

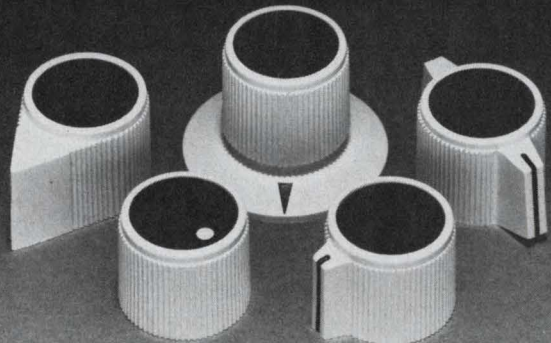

We know how to build quality and attractive styling into our knobs & dials. We've been doing it for more than 30 years.

**ROGAN CORPORATION**

Telephone (312) 498-2300

3455 Woodhead Drive, Northbrook, Illinois 60062

INFORMATION RETRIEVAL NUMBER 37



# Simple hex VCOs constructed from CMOS inverter and Schmitt trigger

A CMOS inverter used as an integrator combines with a CMOS Schmitt trigger used as a comparator to form an inexpensive, low-power, voltage-controlled oscillator that has good linearity. Six voltage-controlled oscillators can be built with only two hex ICs and a few other parts. The oscillator's maximum frequency occurs when the control voltage,  $V_{in}$ , is zero, and the frequency decreases linearly as  $V_{in}$  is made more positive, until the inverter's threshold voltage is reached.

The CMOS inverter integrates the positive difference between its threshold voltage,  $V_{th}$ , and  $V_{in}$ . And the inverter's output ramps up until the positive threshold of the CMOS Schmitt trigger is reached. At this point the Schmitt-trigger output goes low, turning on a general-purpose pnp transistor via resistor  $R_s$  and speed-up capacitor  $C_s$ .

The hysteresis of the Schmitt trigger keeps its output low until its negative threshold is reached. The discharging resistor,  $R_d$ , should be much smaller than the charging resistor,  $R_c$ , to keep

reset time negligible.

The output frequency is given by the equation

$$f_o = \frac{V_{th} - V_{in}}{(V_b - V_a) R_c C}$$

The frequency dependence is given by the derivative of  $f_o$  with respect to  $V_{in}$  as follows:

$$\frac{d(f_o)}{d(V_{in})} = - \frac{1}{(V_b - V_a) R_c C}$$

The minus sign indicates that the output frequency increases as the input control voltage is decreased below the inverter threshold,  $V_{th}$ .

The circuit can operate over a wide  $V_{cc}$  supply range, but both the inverter and Schmitt-trigger thresholds are power-supply dependent; thus the supply-voltage rejection ratio is low.

With the component and voltage values shown in the figure,  $f_o = 5.5$  kHz maximum and  $d(f_o)/d(V_{in}) = 1$  kHz/V.

Gerald Buurma, National Semiconductor Corp.,  
2900 Semiconductor Dr., Santa Clara, CA 95051.

CIRCLE NO. 312

$f_o = 5.5$  kHz (MAX) |  $R_c = 200$  k |  $C = 1000$  pF  
 $\frac{d(f_o)}{d(V_{in})} = -1$  kHz/V |  $R_d = 2$  k |  $C_s = 100$  pF  
 $R_s = 10$  k |  $V_b = 7$  V  
 $V_a = 3$  V  
 $V_{th} \approx 5.5$  V  
 $V_{cc} = 10$  V  
 $V_{gg} = \text{GROUND}$

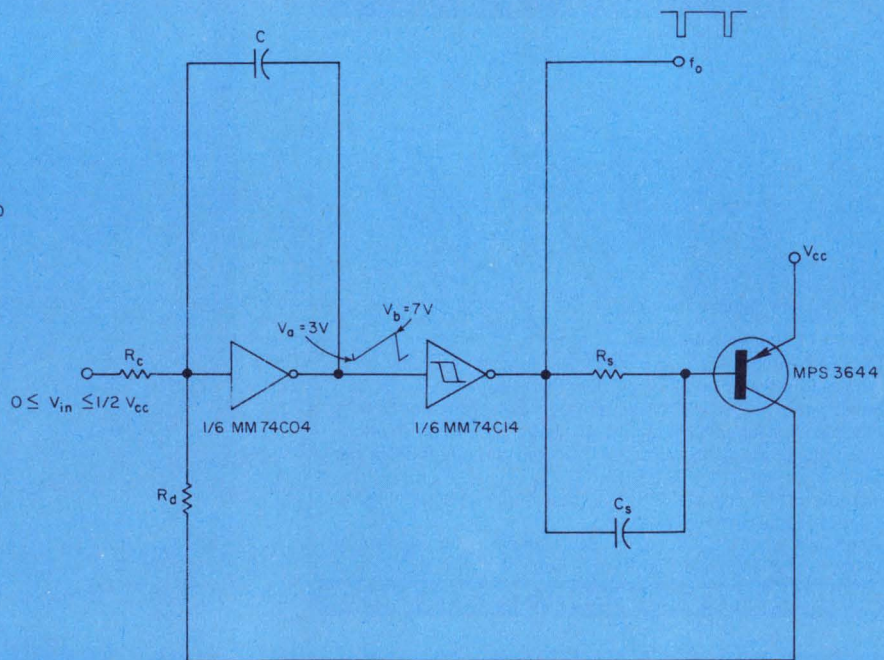

The frequency output of this VCO varies linearly from a 5.5-kHz maximum, when the control voltage

$V_{in} = 0$ , and drops at a rate of 1 kHz/V until  $V_{in}$  reaches  $V_{th}$ .



# Simple transistor circuits speed power-supply testing

Even with the many functions available in ICs, the lowly transistor can still provide savings for test circuits. Here are two useful circuits: a voltage-limit test circuit that can be made with three transistors, and an out-of-limit ripple-sense circuit with only two. And the other parts these circuits need are few, simple and inexpensive. The circuits have saved over 80% of the testing time of production power-supply units and allowed the use of unskilled personnel.

In the voltage-limit circuit (Fig. 1), a LED is illuminated only when the applied voltage rises above a limit set by a 1-k $\Omega$  potentiometer and stays within 0.5 V above this limit, as determined by a diode in the emitter lead of transistor Q<sub>2</sub>.

The values shown are for use with a 5-V supply, and the figures in brackets are for 12 V. Other voltages between 5 and 50 V can be handled by proportionate changes to the bracketed figures.

The ripple-sense circuit (Fig. 2) uses a monostable multivibrator to detect narrow noise or ripple pulses. The circuit's sensitivity is adjusted with a 1-k $\Omega$  potentiometer, which sets the bias on the base of transistor Q<sub>4</sub>. This allows detection of ripple voltages over the range of 10 to 600 mV, peak-to-peak.

The transistors used can be any medium-power silicon transistors with  $V_{cbo} > 55$  V,  $I_{max} > 200$  mA and  $h_{fe} > 40$ . The LEDs are noncritical.

*Bruce Hunter, Banking Systems Engineering, Standard Telephones & Cables Pty. Ltd., 252-280 Botany Rd., Alexandria, Sydney, N.S.W. 2105, Australia.*

CIRCLE No. 313

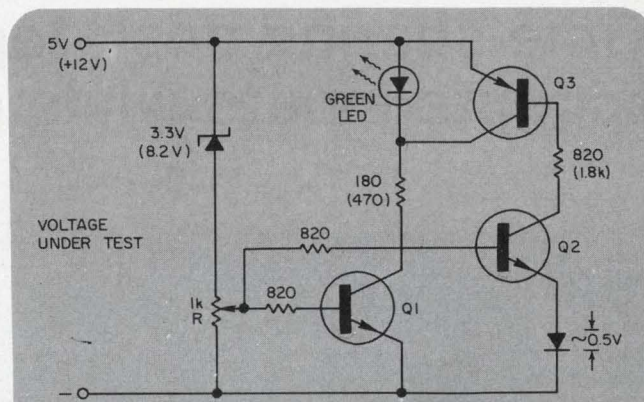

1. A voltage-limit sensing circuit lights a LED when the voltage is within 0.5 V above the limit set by potentiometer R. Values shown in brackets are for 12-V operation.

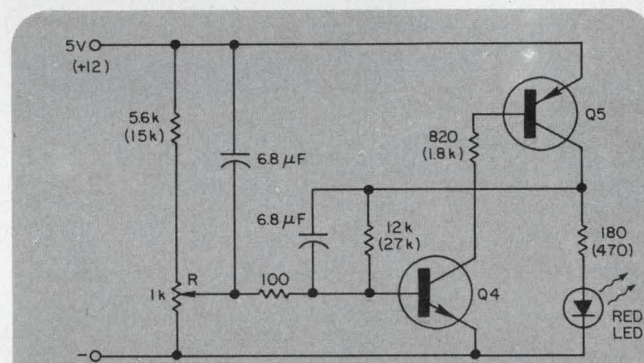

2. Ripple and noise voltages in power supplies can be detected over the range of 10 to 600 mV, peak-to-peak. Sensitivity is adjusted with potentiometer R.

## IFD Winner of September 27, 1975

**Michael L. Roginsky**, Staff Engineer, Engineering Data Systems Dept., Lockheed-Georgia Co., Marietta, GA 30063. His idea "Circuit Turns on Tape Recorder only when Sound Is Detected" has been voted the Most Valuable of Issue Award.

**Vote for the best Idea in this issue** by circling the number for your selection on the Information Retrieval Card at the back of this issue.

**SEND US YOUR IDEAS FOR DESIGN.** You may win a grand total of \$1050 (cash)! Here's how. Submit your IFD describing a new or important circuit or design technique, the clever use of a new component or test equipment, packaging tips, cost-saving ideas to our Ideas for Design editor. Ideas can only be considered for publication if they are submitted exclusively to ELECTRONIC DESIGN. You will receive \$20 for each published idea, \$30 more if it is voted best of issue by our readers. The best-of-issue winners become eligible for the Idea of the Year award of \$1000.



# Time-sharing desk-top calculator accepts inputs while driving peripherals

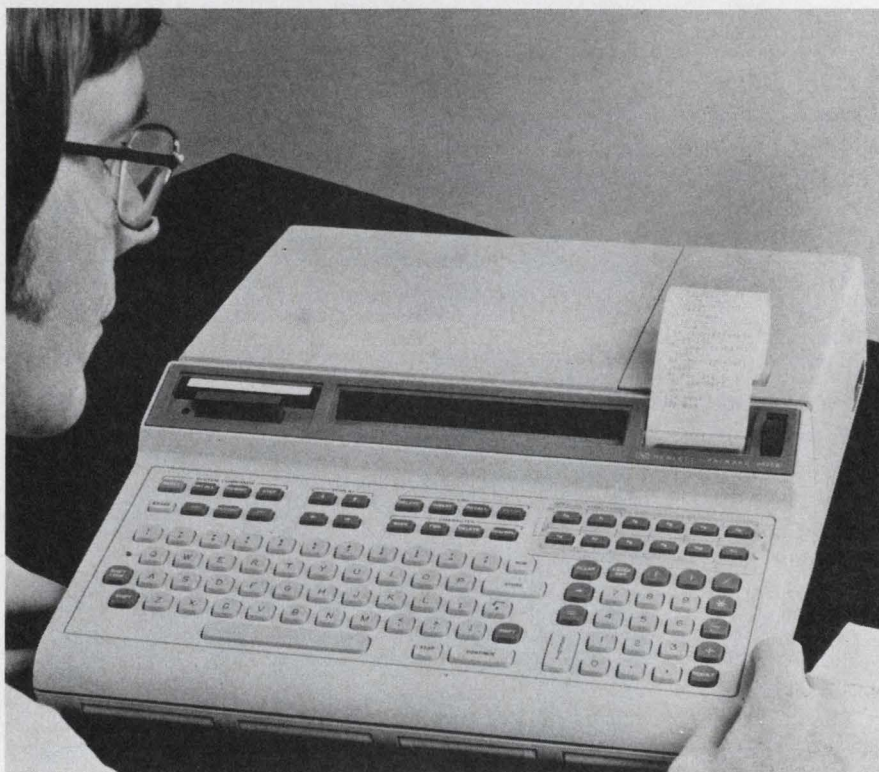

Hewlett-Packard, 1501 Page Mill Rd., Palo Alto, CA 94304. (415) 493-1501. P & A: See text.

Computer-like features, long desired on desk-top calculators, are finally available with the introduction of the Hewlett-Packard 9825A programmable calculator. This machine has on-line time-sharing of its keyboard and controller so that several computing jobs can be done simultaneously.

Data for the 9825A can be entered while the machine is calculating another program, controlling a peripheral or printing out a program. Features of the calculator include: program interrupt, direct memory access with input speeds of up to 400 k, 16-bit words/s and output speeds of up to 200 k, 16-bit words/s, mini-cartridge tape drive for bulk memory storage, multidimensional array handling,

automatic memory record and load, extended internal calculation range of  $\pm 10^{115}$  to  $\pm 10^{-115}$  and provisions for optional plug-in program ROMs.

The 9825A uses the HPL formula-oriented, high-level programming language. HPL handles subroutine nesting and flags, and allows 26 simple variables and 26 multidimensional-array variables that are limited only by the size of the calculator memory.

Editing of lines and characters is accomplished using a 32-character, upper and lower-case alphanumeric display together with a built-in, 16-character thermal printer. The display and printer provide the full ASCII character set.

Error locations in a line are identified by a flashing cursor in the display. Fixed and floating-point formats are set from the typewriter-like keyboard.

The keyboard has 12 special function keys that can handle 24 different operations both for program writing and in peripheral and instrument control. The keys can serve as immediate-execute keys, as call keys for subroutines and as typing aids.

With the time-sharing or "live keyboard" feature, the user can perform simple calculations, examine and change program variables and list programs while the calculator is performing other peripheral or control operations. The interrupt capability apportions these operations on a priority schedule determined by the operator.

The 9825A comes with 8-k bytes of internal read-write memory, which is expandable in 8-k increments to a total of 32-k bytes.

The four optional ROM slots in the front of the machine accept ROMs that can do the following: an extended I/O which is required for interrupts and time-share features; a general I/O; a plotter; string arrays; and advanced programming.

The 9825A's tape cartridge—the same one used in HP's 9815—can hold 250,000 bytes on two tracks (125 k/track) and has a 2750 byte/s transfer rate.

The fast I/O speed, together with the simultaneous interfacing capabilities for 16-bit parallel instruments and for instruments that use the IEEE Standard 488 bus, make the \$5900 programmable calculator from HP suitable as the controller of an instrumentation system. However, the calculator can also serve as a powerful computing tool.

Delivery time for the 9825A is eight weeks.

CIRCLE NO. 301



## Data-acquisition module multiplexes 16 channels

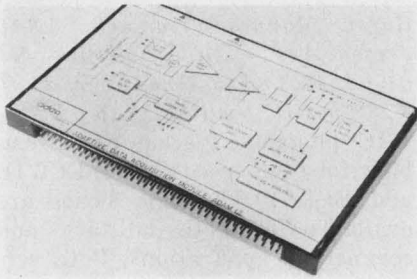

Adac Corp., 29b Cummings Park, Woburn, MA 01801. (617) 935-6668. \$285 (1-9); 45 to 60 days.

The Adam 12 is a 12-bit a/d front-end data-acquisition module for data-logging applications. Its over-all throughput rate is 35 kHz, and its multiplexer inputs can be configured in fully differential, pseudo-differential or single-ended modes. The module is enclosed in a  $3 \times 4.6 \times 0.375$ -in. metal case that provides electrostatic and electromagnetic shielding. Specifications include high-speed sample and hold, 16-channel inputs, input ranges of +5, +10, 0 to 5 and 0 to 10 V, accuracy of  $\pm 0.035\%$  of FSR and three-state outputs for data transfer in bus-oriented systems.

CIRCLE NO. 302

## Impact serial printers operate bidirectionally

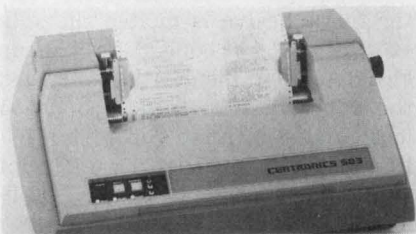

Centronics Data Computer Corp., Hudson, NH 03051. (603) 883-0111. \$4340: 103, \$3565: 503 (unit qty); 45 days.

Two new high-speed, serial, impact printers, Models 103 and 503, can operate at 340 lpm. Bidirectional printing and the ability to seek the fastest path to the next print line eliminate inefficient carriage returns. An optional selection of 6 or 8 lines/in. allows the printing of as many as 88 lines on a standard 11-in. form. Models 103 and 503 offer the same performance and features with the 103 aimed at replacing existing 100 series printers and the 503, the 500 series.

CIRCLE NO. 303

## THE SYSTEM IS MIXED TTL AND ECL. IT WORKS AT 20 MHz. IF IT FAILS ONCE IN EVERY BILLION OPERATIONS SHE HAS TO FIX IT.



By now almost everyone agrees that the conventional oscilloscope isn't the best tool for finding failures in digital systems. The old 'scopes have been superseded by logic analyzers—multichannel devices that observe a set of digital signals, trigger on a particular combination of them, and display a timing diagram or bit array that shows the events before and after the trigger.

A wonderful idea.

But of all the logic analyzers on the market, only the E-H model 1320 Digiscope™ can find the trouble in this high speed word generator. Here's why:

### DUAL-THRESHOLD ACQUISITION

Any failure that occurs so rarely probably isn't a decent logic level. It's probably a glitch, a slow risetime, or a logic race that only occasionally causes trouble. Only the Digiscope can spot all these before or after the trigger.

### MIXED LOGIC CAPABILITY

Most logic analyzers will let you check TTL. Or ECL. Or MOS. The Digiscope lets you check two different logic families at once. You can even observe a set of logic outputs and make a go/nogo test on an analog level. Or select normal or tight tolerances for a threshold pair.

### PLUGIN VERSATILITY

Some logic analyzers plug into 'scopes. Our analyzer has plugins of its own. You get a choice of level selection, combinatorial emphasis, internal or external clocking, and triggering.

An even better idea. And the Digiscope has other virtues:

### 50 MHz DATA ACQUISITION

### HIGH-IMPEDANCE, WIDE-RANGE PROBES

### COMPOSITE VIDEO OUTPUT. For classroom display.

### WATCH MODE FOR SLOW SIGNALS. The traces march politely across the screen.

The best idea yet.

## WITH A DIGISCOPE, SHE CAN FIX IT

**EH** research laboratories, inc.

515 11th Street □ Box 1289, Oakland, California 94604 □ (415) 834-3030 □ TWX 910-366-7258  
In Europe: E-H Research Laboratories (Ned) B.V., Box 1018, Eindhoven, The Netherlands □ Telex 51116  
In Japan: E-H International - Tokyo Branch, 1-5, 3-Chome, Naka-cho, Musashino-shi, Tokyo, Japan □ 0422-54-9261

INFORMATION RETRIEVAL NUMBER 38



## PACKAGING & MATERIALS

### DIP sockets eliminate solder wicking

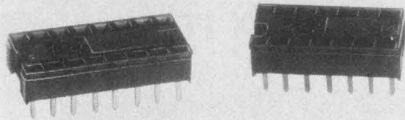

Aries Electronics, P.O. Box 321, Frenchtown, NJ 08825. (201) 996-4096. From \$0.12 to \$0.46; stock.

DIP sockets—only 0.15 in. high—have closed and sealed bottoms to eliminate solder wicking. The sockets are available in both 14 and 16-pin styles. These sockets have bifurcated contacts to assure maximum electrical contact for flat leads (to 0.019 in. square) or round (to 0.02 in. dia.). Other features include a 0.02-in.-high solder standoff and removable cover for pin replacement. Sockets can be used without cover for even a lower profile as an open entry socket. Sockets are stackable end-to-end and side-to-side on a 0.1 in. grid. The contacts are spring tempered phosphor bronze and are plated either with tin or gold over nickel. Solder tail dimensions are 0.13 × 0.025 × 0.006 in. The socket body material is glass-filled thermoplastic.

CIRCLE NO. 304

### Pin inserting machine can set 400 pins/hour

VIP Industries, 246 Knickerbocker Ave., Paterson, NJ 07503. (201) 345-5800. Under \$500; stock.

The "Pin-Serter" is a manually operated, line powered connector pin inserter. It can operate at rates of up to 400 pins per hour. Each pin is inserted uniformly by means of a plunger and anvil mechanism with spring-loaded guide. The unit assures proper electrical contact of all pins in the connector because the depth of pin insertion for both male and female types is precisely controlled. Also, the operator can quickly change adapters, permitting the Pin-Serter's use with virtually all types of pin sizes and styles, even within the same connector. The machine operates from 115 V ac and ordinary shop air (80 to 100 psi).

CIRCLE NO. 305

### Air powered lead cutter needs only 30 psi

Electronic Production Equipment Corp., 6 Kane Industrial Dr., Hudson, MA 01749. (617) 562-9123. From \$60; stock.

The Model 350 micro-pneumatic lead cutter cuts lead wires up to 13 AWG. For IC DIP lead cutting, three leads can be cut at a time. The lead cutter weighs only 4 oz. and operates quietly. It requires only 30 psi air pressure and uses a 0.125 in. diameter red PVC airline. The cutter measures 0.5 × 5.5 × 1.5 in. and is designed to fit comfortably in the operator's hand. Blades have a life of 1 million cycles for copper leads and 0.5 million for steel wire.

CIRCLE NO. 306

### Solder fluxes come in easy to use applicators

Metron Optics, P.O. Box 690, Solana Beach, CA 92075. (214) 755-0894. \$2.65 (5-up); stock.

The RMA 365 is a mildly activated rosin type flux that complies with MIL-F-14256D for use on electronic assemblies. And, type RA 465 rosin flux has characteristics similar to activated core solder (type RA-Federal specification QQ-S-571). Both are available in a squeeze-type applicator that has a long, needle-like tip to provide easy access to hard-to-reach spots.

CIRCLE NO. 307

### Fiber optic cables have low light losses

Valtec Corp., West Boylston, MA 01583. (617) 835-6082. See text.

Low-loss fiber optic communication cables are available in lengths of more than 1 km. The maximum attenuation is 40 dB/km when light with a wavelength of 8000 Å is used. The fiber core is pure fused silica with plastic cladding and the cable sheathing is DuPont Hytrel. Optical cables are produced in a variety of fiber diameters and number of fibers per cable. Connectors are supplied to customer specification. Prices range from \$2/foot for single 0.01-in.-diameter fiber cable to \$12/foot for 37-fiber cable using 0.005-in.-diameter fibers.

CIRCLE NO. 308

### IC ECL boards come in MIL and industrial types

Garry Manufacturing Co., 1010 Jersey Ave., New Brunswick, NJ 08902. (201) 545-2424. From \$1 to \$2.50 per IC position; 4 to 6 wk.

IC pluggable packaging assemblies for high-speed ECL I, ECL II, and ECL 10,000 logic series are available for both military and commercial applications. Both versions use a three-layer low-impedance power distribution system. The commercial design has a laminated third-voltage plane, while the military design is of true multilayer construction, meeting MIL-P-55640. Signal interconnections are completed by standard wrap-ped-wire.

CIRCLE NO. 309

### Water soluble adhesive melts at 125 F

Aremco Products, P.O. Box 429, Ossining, NY 10562. (914) 762-0685. See text; stock.

Crystalbond 555, a water soluble temporary adhesive, can hold substrates and semiconductor materials for dicing, drilling and machining. The adhesive is a thermoplastic monomer, which melts at 125 F and flows at 130 F. It is a very low viscosity (500 cps) adhesive. After the adhesive is melted the substrates can be bonded to backup blocks. When the heat is removed the adhesive sets. Crystalbond 555 is available in lump form for \$15/lb for a 2-lb minimum sample lot and as low as \$8.25/lb for 100-lb lots.

CIRCLE NO. 320

### Aluminum heat sink fits many transistor cases

DAU Ltd., 42 A Main Rd., Burnham Bognor Regis, West Sussex, PO22 OES. \$0.12 to \$0.25 (1000-up); 2 wk.

The Model UK-35 heat sink is designed to accept TO-3, 66, 220, SOT-9 and 32 power transistor cases. The heat sink is made from aluminum and can be either matt etched or black anodized. The units have a thermal rating of 11 C/W and can be supplied with or without punched holes.

CIRCLE NO. 321



## INTEGRATED CIRCUITS

### 1-k CMOS RAM aims for bipolar sockets

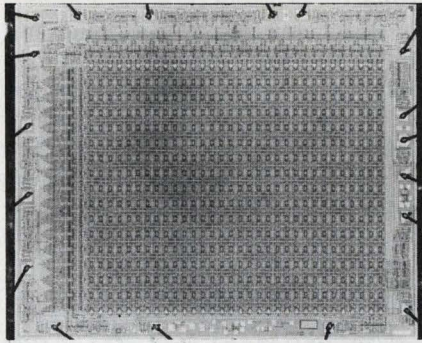

Harris Semiconductor, P.O. Box 883, Melbourne, FL 32901. (305) 727-5407. \$8.95 to \$22.40 (100 up); stock.

A 1024 × 1-bit CMOS static RAM in a 16-pin DIP—the HM-650—features the same pinout as popular 1024-bit bipolar RAMs. An 18-pin version (HM-6518) is also available for designs requiring latched output control or minimum support logic. Both versions require only 50 nW/bit in the standby mode and 15  $\mu$ W/bit during 1-MHz operation. Worst-case access and cycle times are 305 ns and 465 ns, respectively, over the -55-to-125-C temperature range and 5-V  $\pm$ 10% voltage range. Data retention is guaranteed to 3 V.

CIRCLE NO. 322

### 200-MHz divider reduces dissipation

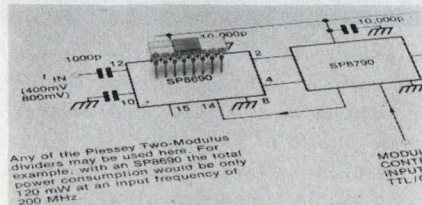

Plessey Semiconductors, 1674 McGaw Ave., Santa Ana, CA 92705. (714) 540-9979. \$14 (100).

The SP8690 programmable divider dissipates only 70 mW (typical) and features pin-compatibility with the 350-mW 95H90 from Fairchild. Two inputs are used to program the SP8690 to divide by 10 or 11 at toggle rates that are typically greater than 200 MHz. Inputs and outputs are ECL-compatible, with outputs available for driving TTL or CMOS circuits.

CIRCLE NO. 323

# 1024 Element Analog Delay 75 DB S/N

RETICON's SAD-1024 Serial Analog Delay is the most recent in our line of analog signal processing devices. It is designed for variable or fixed delay of analog signals including various audio applications (e.g., reverberation, echo and chorus effects in electronic organs and musical instruments, speech compression, voice scrambling, etc.) It is packaged in a 16 lead DIP and is priced at less than 1¢/bit in OEM quantities.

Other units offer up to 12 MHz sampling frequency, independent read-in/read-out, and can be used to perform analog storage, digital filtering, convolution, correlation, real time Fourier transforms and many other functions.

There are over 70 salesmen and 16 distributors to serve you worldwide.

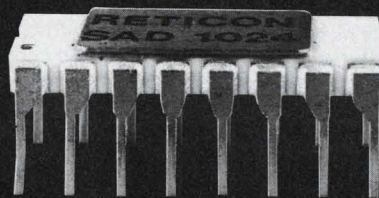

**RETICON**<sup>®</sup>  
910 Benicia Avenue  
Sunnyvale, Ca. 94086  
(408) 738-4266  
TWX: 910-339-9343



# 2 unusual, low-cost DVM's.



## 1. Model 7215.

Most low-cost DVM's don't offer systems capability... let alone the option of buying it now or adding it later. But this autoranging 5½-digit multimeter does. Simply add a plug-in board to the Model 7215, and it becomes a systems DVM. Features:

- complete system programming (optional)
- ACCU-OHM lead compensation
- large in-line/in-plane display
- 16 ranges of DC volts, AC volts and ohms are standard
- guarded input.



## 2. Model 7224.

True RMS is the only accurate way to measure distorted sinewaves, triangles, squarewaves and pulses. Buy true RMS now with your Model 7224, or add it later (a feature no other low-cost DVM offers). This 20,000 count multimeter also features:

- choice of TRUE RMS or AC averaging
- 0.001 ohm resolution
- autoranging
- large in-line/in-plane display
- DC/DC ratio option
- 5 ranges DC volts, 7 ranges ohms standard
- optically isolated BCD output
- FAST and SLOW sample rate.

For details, call your Scientific Devices office or contact Systron-Donner at 10 Systron Drive, Concord, California 94518. Phone (415) 676-5000.



**SYSTRON-DONNER**

## INSTRUMENTATION

### Tiny DMM fits into palm of hand

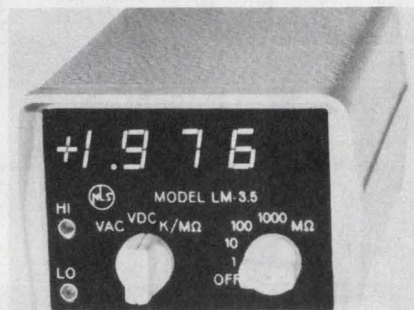

*Non Linear Systems, P.O. Box N, Del Mar, CA 92014. (714) 755-1134. \$147; stock.*

The LM-3.5 is a 3-1/2-digit (three full digits plus 100% over-range) multifunction, multirange meter that fits in the palm of a hand. The 1.9 × 2.7 × 4-in. unit operates with self-contained, rechargeable NiCd batteries for portable operation, or on 115 V ac with a charger (both batteries and charger are standard). Other features are: four ranges of dc and ac V to 1000 V dc or peak ac with 1-mV resolution; five ranges of resistance from 2 kΩ to 20 MΩ fs; ac and dc current in three ranges using shunts supplied; and automatic polarity. Input impedance is 10 MΩ on all voltage ranges.

CIRCLE NO. 328

### In-circuit tester adds functional capability

*Faultfinders, 15 Avis Dr., Latham, NY 12110. (518) 783-7786. \$39,350; 60-90 days.*

The FF101B is a compact, mini-computer-controlled, in-circuit test system. Unlike most test systems, which contact the fingers at the edge connector of a PC-board, the 101B uses a fixture to contact each solder node on the bottom of a printed-wiring assembly. It can thereby test each component, one at a time, using electronic guarding techniques. Because of the minicomputer, a customer can use any programmable functional instrument in his FF101B to build an in-circuit, functional production tester. With a CRT terminal, diagnostic messages and operator instructions may be displayed in plain English statements.

CIRCLE NO. 329

### Generator features phase lock, modulation

*Wavetek, 9045 Balboa Ave., San Diego, CA 92112. (714) 279-2200. \$795.*

Model 186 phase lock generator includes phase control and amplitude and frequency modulation with standard function generator features. The generator can be locked to an external signal or an internal 1-kHz oscillator and the generator phase angle controlled by a calibrated front-panel dial. The generator can be amplitude or frequency modulated by an external signal or the internal 1-kHz oscillator.

CIRCLE NO. 330

### Scope operates as standard or storage unit

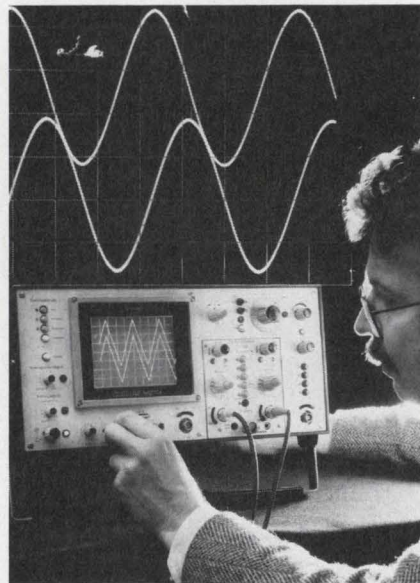

*Siemens AG, Zentralstelle für Information, Joachim Ullman, D-8520 Erlangen 2, Postfach 3240, Federal Republic of Germany.*

Oscillar MO7114 scope features a bistable phosphor that allows standard, real-time or stored operation. Stored writing speed is continuously adjustable to over 200 cm/ms. A built-in auto erase and automatic control, integral cutout provide continuous coverage of disturbances without time limitation. A pushbutton control unit for the different modes of operation has a special interlock that prevents the formation of ion spots on the phosphor storage tube. The unit consists of plug-in modules with PC boards.

CIRCLE NO. 331



## Function generator modulates outputs



Dana/Exact, 455 S.E. 2nd Ave., Hillsboro, OR 97123. (503) 648-6661. \$795; 2 wks.

At \$795, the Model 519 offers a conventional 0.001-Hz-to-11-MHz function generator with trigger, gate, pulse and burst capability; and sine, square, triangle, ramp and pulse output waveforms are combined with a 1-Hz-to-1-MHz modulation generator in one package. The modulation source can sweep the main generator over three decades, or it can AM and FM the main generator from 0 through 100% modulation to suppressed carrier. The carrier can be any of the output waveforms of the main generator. The internal modulating signal can be a sine, square, triangle, ramp or pulse waveform.

CIRCLE NO. 326

## Synthesizer shows low residual FM



Green Electronic & Communication Equipment Ltd., 5-15 Thorold Rd., London N22 4YE England. \$5950 plus freight and duty; stock to 16 wks.

Model 360 synthesized signal generator covers a frequency range of 100 Hz to 100 MHz with six-digit resolution on all seven ranges. Stability is  $3 \times 10^9$ /day. Spectral performance includes less than 40-dB harmonics and less than 20-Hz residual FM. Output level is 1  $\mu$ V to 1 V in 1-dB steps. AM and FM modulation is provided with an internal 100-Hz-to-10-kHz modulation oscillator. All functions are programmable.

CIRCLE NO. 327

# mammoth power miniature price



**1350w** RMS, 4 $\Omega$ . Forever. The M-600 won't blow up, quit or sulk no matter how you hook it up. Put two together for 2700w, 8 $\Omega$ . Also forever.

It's cheap. \$1,695 of the best quality amplifier you can buy. Others in the DC-20KHz range may cost you more, but they won't do more. Write for your free copy of M-600 performance specs.



**CROWN** INTERNATIONAL  
1718 W. MISHAWAKA ROAD ELKHART, INDIANA 46514 219-294-5571

INFORMATION RETRIEVAL NUMBER 43

## PM MAGNETIC SHIELDS

**Immediate Delivery- For Over 90% Of Current Photomultiplier Tube Types**

These high permeability AD-MU magnetic shields are fully hydrogen annealed, ready for use. Already tooled—no tooling cost.

For your special application or specific environment, our Problem Solving Magnetic Shielding Specialists can either modify a stock shield, or custom design a shield to your exact requirement.

18 pages of advanced shielding techniques and components. Also 4-Page Reprint from Electronic Design. Yours for the asking.

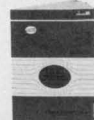

## AD-VANCE MAGNETICS, INC.

226 E. SEVENTH ST., ROCHESTER, IND. 46975  
(219) 223-3158 TWX 810 290 0294

Our 3rd Decade of Magnetic Shielding Leadership



INFORMATION RETRIEVAL NUMBER 44



# POWER SUPPLIES? WHEN YOU THINK POWER SUPPLIES... THINK POWER/MATE

## BECAUSE...

You can't afford to be without this comprehensive catalog that covers more than 34,500 power supplies!



## IT'S FREE...

And it's yours for the asking. SEND FOR YOUR FREE COPY... today.



## POWER/MATE CORP

514 S. River St., Hackensack, N.J. 07601  
Tel. (201) 343-6294 TWX 710-990-5023

World's largest manufacturer of quality power supplies.

INFORMATION RETRIEVAL NUMBER 40

# 19¢\*

ea.

An integrated bridge rectifier in a miniature dual in-line package

# DIB

## DUAL IN-LINE BRIDGE

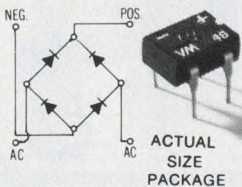

\* 100V; 100,000 qty.

- 4-pin, low-profile DIP
- Leads on standard .10" (2,54 mm) grid
- Compatible with automatic testing, handling and inserting
- 1 Amp at 40°C (I<sub>o</sub>)
- 25V to 1000V (V<sub>RRM</sub>)
- Call Lee Miller 214/272-4551, Ext. 206 for more information.



Design us in... we'll stay there

## VARO SEMICONDUCTOR, INC.

P.O. BOX 676, 1000 N. SHILOH, GARLAND, TEX. 75040 (214) 272-4551 TWX 910-860-5178

INFORMATION RETRIEVAL NUMBER 56

## COMPONENTS

### Metal-film resistors operate at -65 to 235 C

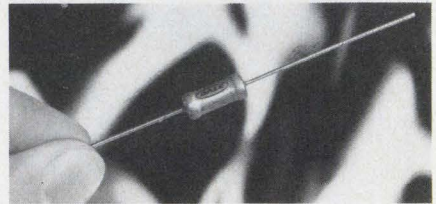

Dale Electronics Inc., Dept. 860, P.O. Box 609, Columbus, NB 68601. (402) 371-0080. Typical: 11¢ (1000 up); 6 to 8 wks.

Type F69, the first in a series of low-cost, flameproof metal-film power resistors, is rated 3 W at 25 C. They operate over a temperature range from -65 to 235 C. In conventional use they may be derated to provide excellent long-term stability. The film resistors are available in a resistance range from 5 Ω to 1 MΩ. Standard tolerances are ±1%, ±2%, ±5%, and ±10%. Standard temperature coefficient is +200 ppm/°C (T-00). Lower tolerances and temperature coefficients are available.

CIRCLE NO. 332

### DIP switches feature detent latching

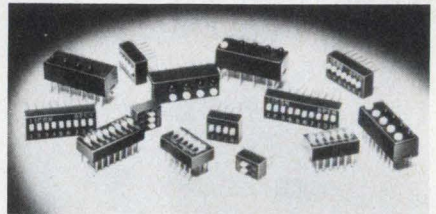

Licon, Div. Illinois Tool Works Inc., 6615 W. Irving Park Rd., Chicago, IL 60634. (312) 282-4040. \$1.37: 2-pole, \$2.18: 10-pole (1000 up); stock, 4 to 6 wks.

Licon's newest entry of programmable DIP switches features a slide detent latching mechanism that prevents accidental actuation and provides a visual indication of open and closed positions. The switches are available in 2-to-10 poles. They present a low profile only 0.280-in. high with terminal spacing of 0.1 × 0.3 in. for easy PC-board insertion. Molded-in terminals, ultrasonically welded base and cover, plus easily removable pop-top covers prevent contamination from entering the switch during installation.

CIRCLE NO. 333



## Snap-in pushbuttons easy to install

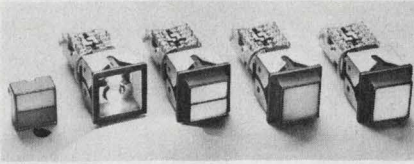

Oak Industries Inc., Crystal Lake, IL 60014. (800) 435-6106. \$2.65; DPDT (250 up); 6 to 8 wks.

A new line of snap-in, two-lamp, lighted pushbutton switches with single and split display, the 300SL Series, complements Oak's existing 300 Series. They offer up to 4PDT switching capacity and 100,000-cycle maximum mechanical life. Momentary or push-push actions are available. Snap-in design reduces installation time. Electrical ratings for silver-plated brass contacts are 0.5 A at 28 V dc or 0.25 A at 110 V ac for 6000 operations; silver-alloy contacts are 1 A at 28 V dc or 0.5 A at 110 V ac for 50,000 operations. Operating force is 7-oz minimum to 28-oz maximum.

CIRCLE NO. 334

## Capacitors withstand high surge currents



Sprague Electric Co., 347 Marshall St., North Adams, MA 01247. (413) 664-4411.

A new series of commutating capacitors, Type 355P and 365P, for use in SCRs and other non-sine-wave voltage applications have a special internal construction to withstand high currents. In addition, self-inductance has been kept to a minimum. Service life is more than 40,000 h at rated conditions with over 90% survival.

CIRCLE NO. 335

## Air capacitors claim ultra-high Qs

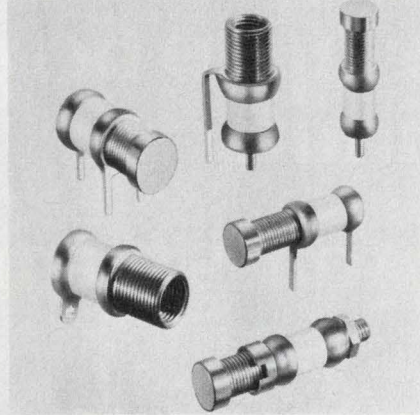

Johanson Manufacturing Corp., 400 Rockaway Valley Rd., Boonton, NJ 07005. (201) 334-2676. \$3.50 (100 up); 2 wks.

Ultra-high Qs, extended capacitance range and fine tuning capabilities are claimed for Johanson's 5750 and 5850 series variable air capacitors. They have approximately zero temperature coefficient and extended frequency range into the C band. Series 5750 has a capacitance range of 0.8 to 10.0 pF with  $Q > 7500$ , is 0.51-in. long and has a diameter of 0.22 in. The 5850 series has a capacitance range of 0.5 to 5.0 pF also with  $Q > 7500$ , is 0.51-in. long and has a 0.15-in. diameter. Both series have a working voltage of 250 V dc.

CIRCLE NO. 336

## Rotary switch claimed to be smallest

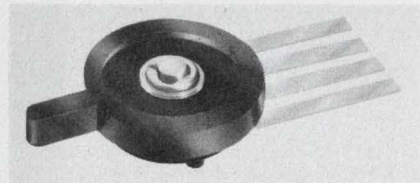

Wilbrecht Electronics, 240 Plato Blvd., St. Paul, MN 55107. (612) 222-2791. 4 to 6 wks.

A microminiature rotary selector switch, Model 2831, requires less than 0.02 in.<sup>3</sup>. The new switch provides two or three-position switching. Its detent action is sharp and crisp and provides the feel of a much larger switch, according to the manufacturer. A tough epoxy housing is available in either black or beige. The unit is easily mounted with one 000-120 fastening screw.

CIRCLE NO. 337

# a little A-300 goes a long way.

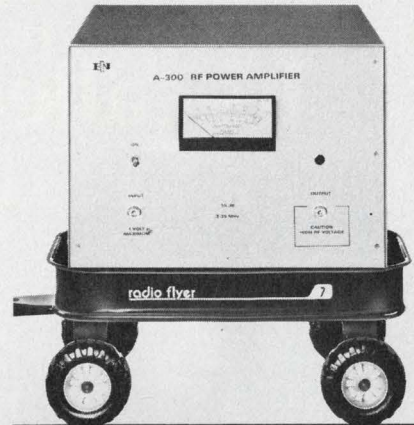

**In high frequency transmission. RF power generation for industrial and research processes. RFI/EMI and general laboratory applications, too.**

The Model A-300 is a totally solid state power amplifier, covering the frequency range of 0.3 to 35MHz with a gain of 55dB. Capable of delivering 300 watts of linear Class A power and up to 500 watts in the CW and pulse mode, the A-300 is the ultimate in reliability.

Although the unit is perfectly matched to a 50 ohm load, it will deliver its full output power to any load (from an open to a short circuit) without oscillation or damage.

Complete with power supply, RF output meter and rack mount, the A-300 weighs a mere 89 pounds and operates from ordinary single phase power.

High power portability goes a long way for \$5350.

For further information or a demonstration, contact ENI, 3000 Winton Road South, Rochester, New York 14623. Call 716-473-6900 or TELEX 97-8283 E N I ROC

**ENI**  
The World's Leader  
in Solid State  
Power Amplifiers

SEE  
Electronic Design's  
**GOLD BOOK**  
FOR COMPLETE  
PURCHASING  
INFORMATION



**“AMP developed a way to  
terminate up to 60 positions  
in one minute.**

**It's called mass termination.”**



CHAMP—the world's first insulation displacing, mass termination connector family—fully intermateable with existing types.





It's the direction industry is taking. And AMP, pioneer of this and many innovations, has already developed connectors to meet your needs.

You can terminate practically all types of cable—woven, laminated, twisted pair, even coaxial ribbon cable—without costly wire preparation. This latest technique is further proof of AMP's leadership in keeping connection costs down, because all can be wired directly into pre-assembled connectors, at production volumes.

Currently we have additional mass terminating ideas in our test labs, and this experience is at your disposal to help with your own ideas.

In coming to AMP you can be assured our field and home-office engineers will support you all the way. On the production line, in quality control, in sampling for prototypes, and by working continually with you to aid future designs. Professional engineers deserve support—at AMP, we have an international reputation for providing it.

For information on Mass Termination call (717) 564-0100, or write AMP Incorporated, Harrisburg, Pa. 17105.

# AMP

INCORPORATED



AMPlimite IDF-20—offers the capability of terminating an industry standard I/O connector to conventional .050" centerline round conductor flexible cable.

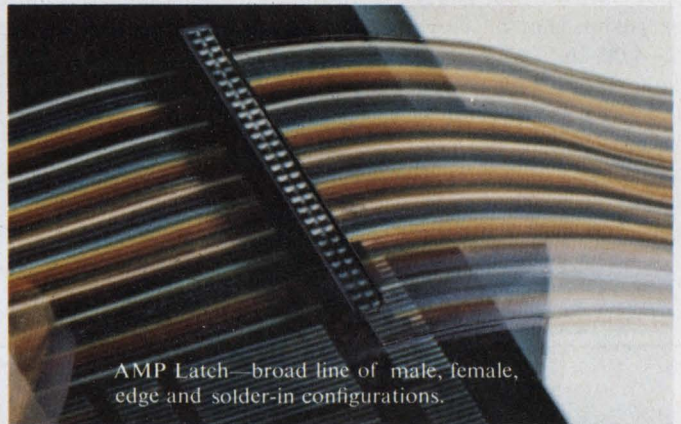

AMP Latch—broad line of male, female, edge and solder-in configurations.

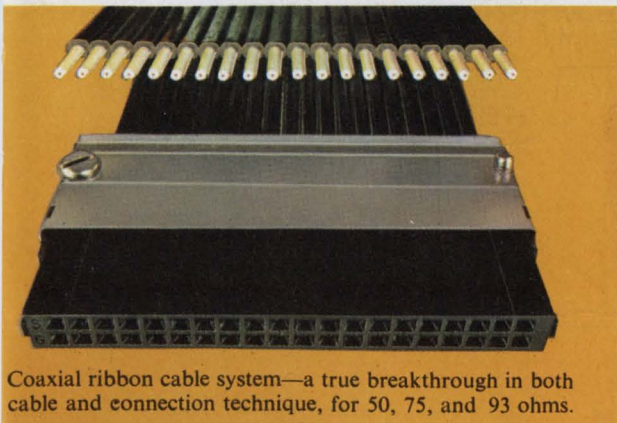

Coaxial ribbon cable system—a true breakthrough in both cable and connection technique, for 50, 75, and 93 ohms.

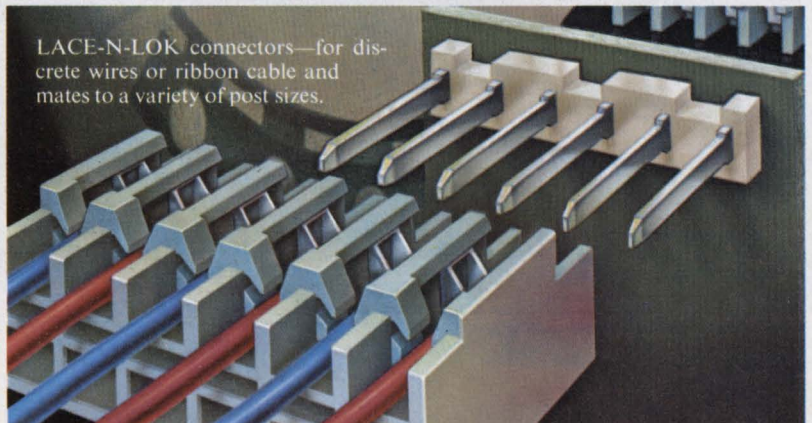

LACE-N-LOK connectors—for discrete wires or ribbon cable and mates to a variety of post sizes.



### Proximity sensor has 30-ft retro range

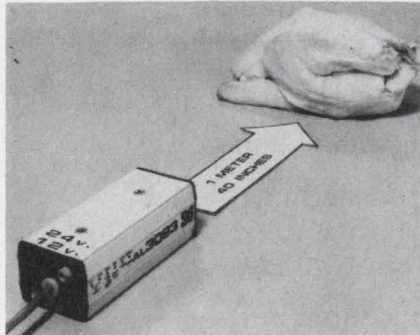

Scientific Technology, 1201 San Antonio Rd., Mountain View, CA 94043. (415) 965-0910. \$134.50; stock.

Model AL3093 is a self-contained detection system. Standard range of the detector, when used as a proximity sensor, is 40 in. (101.6 cm) for a 90% reflectance surface and 24 in. (35.56 cm) for an 18% reflectance surface. When used in the reflex mode with a retro-target the beam make-or-break range is 30 ft (9.144 meters). An adjustable sensitivity control and visible LED alignment and operation indicator is included. The sensors are self-contained and are epoxy sealed in a rugged aluminum extrusion that measures 1.75 x 1.4 x 4.06 in. (4.45 x 3.36 x 10.31 cm). Input power requirement of the AL3093 is 200 mA at 12 V ac or dc. The output is an HTL-compatible logic pulldown from 10 V dc to zero. The output will sink 100 mA and source 1 mA.

CIRCLE NO. 338

### 12-bit a/d converter delivers words in 24 $\mu$ s

Teledyne Philbrick, Allied Dr. at Route 128, Dedham, MA 02026. (617) 329-1600. \$125 (unit qty); stock.

The Model 4129QZ 12-bit a/d converter has a maximum conversion time of 24  $\mu$ s. This converter has a differential linearity of  $\pm 0.5$  LSB max. and a full-scale tempo of  $\pm 30$  ppm/ $^{\circ}$ C max. An optional high impedance input buffer is available.

CIRCLE NO. 339

### Dc integrators measure volumetric flow

Siemens AG, Zentralstelle für Information, D-8520 Erlangen 2, Postfach 3240, West Germany.

A dc integrator, type M72132, is designed for performing accurate flow measurements. It has an overload capacity of 150% relative to the rated current and is available either as a PC board or for mounting in switchboards or consoles. The integrator has a direct reading current output for display. Signal ranges of between 0 to 50 mA (max.) can be assigned to each desired volumetric unit. For range selection, the pulse train and input signal are adapted to the measuring task by an adjustment resistor. The integrator can also be connected to any measuring current circuit since it has an input impedance of only 15  $\Omega$  at 0 to 20 mA. The circuit board version measures 92 x 43 x 135 mm.

CIRCLE NO. 340

### Comparator does low, high or = comparison

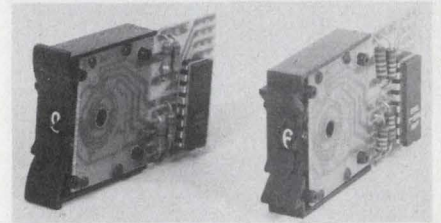

International Microtronics Corp., 4016 E. Tennessee St., Tucson, AZ 85714. (602) 748-7900. From \$8.50; stock to 4 wk.

A BCD comparator thumbwheel switch series is either TTL or CMOS-compatible. The switch can perform high, equal or low comparisons of 4-bit words. The comparators are cascadable and have internal noise protection. The TTL version is the SF/SR-180 and the CMOS, the SF/SR-181.

CIRCLE NO. 341

### Analog multiplier comes trimmed to 0.25%

Burr Brown, International Airport Industrial Park, Tucson, AZ 85734. (602) 294-1431. 100-up prices: \$24 (J), \$34 (K); stock.

The Model 4206 four quadrant analog multiplier is fully laser-trimmed to multiply with accuracies of 0.25% or 0.5% max (J and K models, respectively). These accuracies are guaranteed for combinations of X and Y input voltages from -10 to +10 V. Although the 4206 will achieve specified accuracy with no external trimming, external resistors can improve accuracy to 0.2% or 0.1%. The multipliers are housed in 14-pin DIPs.

CIRCLE NO. 342



**ANALOG**  
GET THE BARE FACTS ON THE A-843 VOLTAGE TO FREQUENCY CONVERTER. STREAKS YOUR SYSTEM AT 0.1MHz IN A STRAIGHT LINE  $\pm 0.01\%$ . NEAT LITTLE  $1 \times 1\frac{1}{2} \times 3$  PACKAGE. RUN OUT AND GET ONE.

**intech** INCORPORATED  
(408) 244-0500  
1220 COLEMAN, SANTA CLARA CA 95050



## Mini data-acquisition system handles 16 lines

Analogic, Audubon Rd., Wakefield, MA 01880. (617) 246-0300. \$180 (100-up); stock.

The MP6812 subminiature data acquisition system cuts the cost of 12-bit, 16-channel data acquisition by more than half to only \$180 (in 100-piece lots). The system can interface directly to the byte-oriented bus structure of microprocessors. It can also accept either 16 single-ended or eight differential analog data channels (48 additional single-ended channels or 24 differential channels can be provided by the MP6848 multiplexer-expander). Three-state output gates make it easy to interface the 6812 with 4, 8, and 12-bit and larger I/O busses. Power consumption is a low 1.5 W and the module's size is only 3 × 4 × 0.375 in.

CIRCLE NO. 343

## Isolation amplifier handles 200 channels

Analog Devices, Rte. 1 Industrial Park, P.O. Box 280, Norwood, MA 02062. (617) 329-4700. \$89 (1 to 9); stock.

The Model 279J isolation amplifier can drive up to 200 channels without interference. It uses an external synchronizing oscillator (Model 280) to avoid modulation interaction. The amplifier can transmit millivolt signals in the presence of up to 7.5 kV of common-mode voltage. The 279J limits input fault currents to 10  $\mu$ A under amplifier failure and ground leakage currents to under 1  $\mu$ A rms when 117 V ac is present between input and output and to the power common. Common-mode rejection with a balanced source at dc is a high 160 dB. There is a 20-pF coupling capacitance between input and output. The FET-input amplifier has a  $\pm$ 3-V signal range, a dc-to-4-kHz frequency response, a 0.2% nonlinearity, a 50-pA differential input current, and only 14  $\mu$ V pk-pk of output noise in a 100-Hz bandwidth. The amplifier can operate from single polarity supplies between 9 and 28 V dc. The Model 279J is specified over 0 to 70 C and is housed in a 3.5 × 2.5 × 1.25 in. module.

CIRCLE NO. 344

**F-16**  
**CUSTOM HYBRIDS**  
 by **CTT**  
 will be aboard!

Circuit Technology, Inc.  
 160 Smith St., Farmingdale, N.Y. 11735  
 (516) 293-8686 • (213) 374-7446

INFORMATION RETRIEVAL NUMBER 46

## In and Out. Analog I/O.

Analog signal processing with minis or microcomputers is now easily done . . . no more fussy analog circuit surprises. At the input our second generation DATA II data acquisition modules are complete with multiplexer, differential amplifier, sample/hold, 12-bit A/D converter, and all control and programming logic . . . plus TRI-STATE outputs for direct connection to computer busses. Interfacing is now fast and low cost with DATA II at only \$375 in 100's.

For computer outputs to CRTs or pen plotters . . . our DT212 Dual D/A Point Plotter does it all. It displays digital information from any computer directly to any Tektronix, H-P, or DEC scope as well as to any analog instrument or control device. This complete point plotting system is only \$245 in 100's and . . . displays graphics and alphanumerics . . . yields more flicker-free data with high speed X, Y, and Z drive . . . provides accurate position placement with dual 12-bit D/A converters . . . and interfaces directly to computer I/O.

Call us at 617/879-3595 for a complete set of applications data.

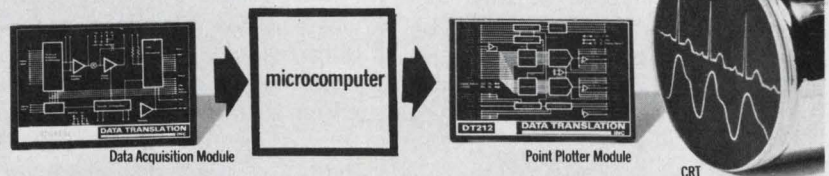

**DATA TRANSLATION**  
INC

. . . the analog I/O company

109 CONCORD STREET, FRAMINGHAM, MA 01701

INFORMATION RETRIEVAL NUMBER 47





## hot stuff

Hot or cold, CHR's family of TEMP-R-TAPE of Kapton provides outstanding endurance. They retain their excellent mechanical and electrical properties over a wide temperature range, -100 to +500F.

Available in thicknesses from .001" to .0045" with a choice of several adhesive systems including two sides.

Find your CHR distributor in the Yellow Pages under "Tapes, Industrial" or in industrial directories. Or write for complete specification kit and sample. The Connecticut Hard Rubber Company, New Haven, Conn. 06509.

# CHR

an ARMCO company

INFORMATION RETRIEVAL NUMBER 48

## DISCRETE SEMICONDUCTORS

### Red, grn & yellow LEDs come in hermetic cases

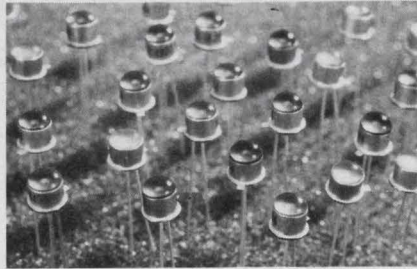

Hewlett-Packard, 1501 Page Mill Rd., Palo Alto, CA 94304. (415) 493-1501. \$5.75 (10-up); stock.

Hermetically sealed LED lamps are now available in red, yellow and green. Models 5082-4520 (yellow) and 5082-4620 (red) have specified luminous intensity of 2.5 millicandelas at 20 mA. The green 5082-4920 is specified at 1.6 millicandelas at 25 mA. All three have a viewing angle of 70° between half-luminous-intensity points. Colored diffused plastic over a glass lens provides high on-to-off contrast. The TO-46 package resists adverse environments.

CIRCLE NO. 345

### 0.27-in. high display includes latch & decoder

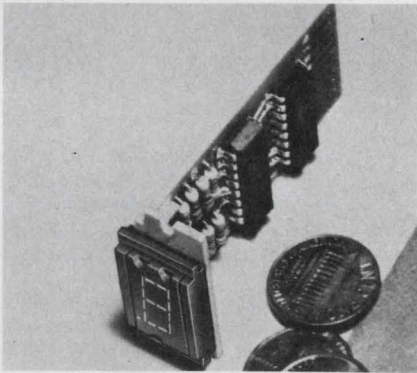

Dialight, 203 Harrison Pl., Brooklyn, NY 11237. (212) 371-8800. \$11.65 (1000-up); stock.

The Model 740-0011 LED display module combines a 0.27-in.-high readout, decoder/driver, 4-bit latch and current-limiting resistors all on a single PC board. Four information lines in an 8421 BCD code are required. Data on the lines are transferred and decoded when the clock is high. Terminals are also provided on the PC board to allow automatic blanking of trailing and/or leading edge zeros.

CIRCLE NO. 346

### Power transistors made for 150-A peak currents

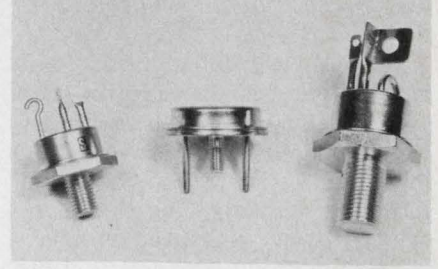

Soliton Devices, Semiconductor Div., 1177 Blue Heron Blvd., Riviera Beach, FL 33404. (305) 848-4311. From \$50 (100 up); 2 wk.

Three series of npn, silicon, power transistors are available with peak current capabilities of 75, 100 and 150 A. The 75-A units are in TO-63 cases and are called the SDT 55405 and 55407 series. Typical specifications include a  $V_{CE(sat)}$  at 50 A of 0.7, an  $h_{FE}$  of 10 to 50 at an  $I_C$  of 50 A, a  $V_{CEO}$  of 150 to 200 V and a  $V_{CBO}$  of 225 to 275 V. The 100-A transistors are in TO-114 (SDT 55905 and 55907) and TO-68 (SDT 55505 and 55507) cases. They have a  $V_{CE(sat)}$  at 75 A of 1.4 V, an  $h_{FE}$  of 10 to 50 at an  $I_C$  of 75 A, a  $V_{CEO}$  of 150 to 200 V and  $V_{CBO}$  of 225 to 275 V. The 150-A devices are also available in TO-114 (SDT 55903 and 55904) and TO-68 (SDT 55503 and 55504) cases. Their  $V_{CE(sat)}$  at 100 A is 0.8 V, the  $h_{FE}$  is 15 to 75 at an  $I_C$  of 100 A, the  $V_{CEO}$  is 100 to 125 V and the  $V_{CBO}$  is 175 to 200 V.

CIRCLE NO. 347

### High power green LED has a 30-mcd luminance

Siemens, 186 Wood Ave. S., Iselin, NJ 08830. (201) 494-1000. Under \$1 (prod. qty.); stock.

The Model LD57C green LED provides a luminous intensity of 30 mcd at an operating current of only 10 mA. In comparison its predecessors produced only 5 mcd at 20 mA. The diode is rated for up to 60 mA forward current and is claimed to be the first LED that not only makes itself visible but can also appreciably illuminate its surroundings. The LED is housed in a clear plastic case that has a diameter of 5.1 mm and is 8.6 mm long.

CIRCLE NO. 348



## POWER SOURCES

### Open-frame supplies boost performance

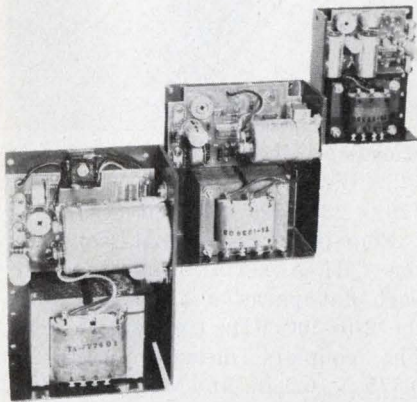

Power/Mate Corp., 514 S. River St., Hackensack, NJ 07601. (201) 343-6294. \$24 to \$86; stock.

Econo/Mate II, a "second generation" of open-frame power supplies, is said to offer 33% more power than any other comparable open-frame available today. The expanded line consists of 45 models in five different case sizes. Output voltages range from 5 to 24 V dc and currents from 0.5 to 15 A. The units operate from either 105 to 125 V ac or 210 to 250 V ac line, 47 to 420 Hz. Input requirements are easily converted; just switch the input connections. An IC chip provides increased reliability, improved regulation and lower ripple. Specs include line regulation of  $\pm 0.05\%$  for a 10% input voltage change and load regulation of  $\pm 0.1\%$  for a zero-to-full-load change. Output ripple is better than 1 mV rms, 3 mV pk-pk, typical. Various protection is offered.

CIRCLE NO. 349

### Inverter offers 400 W yet weighs 13.5 lb

Clifford Industries, Inc., P. O. Box 436, Camarillo, CA 93010. (805) 484-1018. \$79.95.

Vista CXV-4 solid-state power inverter follows the CXV-4, the CXV-1, and the CXV-2, producing, respectively, 40, 100 and 200 W. The CXV-4 produces 400 W of continuous 115-V-ac, 60-Hz power. Peak power is 440 W. CXV-4 weighs 13.5 lb and measures 8 x 6 x 13 in.

CIRCLE NO. 350

### Dc/dc converters offered for op amps, other uses

Teledyne Philbrick, Allied Dr. at Rte. 128, Dedham, MA 02026. (617) 329-1600. \$69, \$79, \$99, respectively.

Three modular dc-to-dc converter power supplies complement the company's line of op amps and data converters. Models 2301 and 2302 convert 5-V logic power to  $\pm 15$  V for op amps and converters. The 2331 provides +5 V and  $\pm 15$  V isolated from the +5-V input and each other. The 2331 provides  $\pm 15$  V and +5 V on any PC board, isolated from logic or other power, without introducing 115 V, 60 Hz to the board. Thus precision analog circuits can be totally isolated from the digital circuits with which they interface.

CIRCLE NO. 351

### Power module converts 400 Hz to 100 W of dc

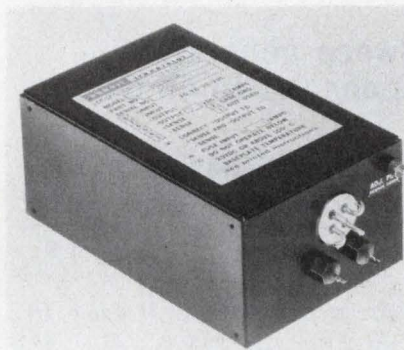

Abbott Transistor Labs, 5200 W. Jefferson Blvd., Los Angeles, CA 90016. (213) 936-8185. \$525; 10 wks.

UN100 series of power modules converts 115-V-ac, 400-Hz input power to 100 W of regulated dc power at voltages ranging from 5 V dc to 50 V dc. The series is said to be one of the few switching regulated power supplies that operates over the full military temperature range of  $-55$  to  $+100$  C. Regulation is to 0.3% over the full input range of 115 V rms  $\pm 10\%$ . Load regulation is 0.5% no load to full load at constant input voltage. PARD (ripple and noise) has been reduced to 25 mV rms, 100 mV pk-pk from 25 to 100 C.

CIRCLE NO. 352

Advertisement

## ELECTRONIC PACKAGING

### Cabinet racks: upright, inclined, big, deep



Bud Radio, Inc., 4605 E. 355 St., Willoughby, O. 44094, (216) 946-3200. Shipped ready for use.

Series 2000 cabinet racks from Bud. Standard uprights, 16 sizes. Clear inside depths, 20 $\frac{1}{2}$ ", 24". Eight extra-deep units have 29 $\frac{1}{4}$ " clear inside depth. Outside heights, 30 $\frac{1}{4}$ " to 88". Mounting rails adjusted horizontally. Six inclined units. Clear inside depths, 20 $\frac{1}{2}$ ", 29 $\frac{1}{4}$ ". Front panel, 20° off vertical. Compare value, shipping economies. For further information phone—

1-800-321-1764, TOLL FREE

IN OHIO, 1-800-362-2265, TOLL FREE

### Custom-made look, yet standard enclosures.



Bud Radio, Inc., 4605 E. 355 St., Willoughby, O. 44094, (216) 946-3200. The sleek TR Series.

Available at your Bud Distributor. Four sizes, plus accessory chassis. Also accepts P.C. boards. Body, .050 aluminum; front panel, .090 aluminum. Top and bottom removed easily for access to dust-free interior. Carrying handle used as tilting bail. Handle/bail, front panel and self-adhesive rubber feet included. Finished in mar-resistant, durable Nextel. Compare delivery, value, shipping economies. For further information, phone —

1-800-321-1764, TOLL FREE

IN OHIO, 1-800-362-2265, TOLL FREE



## ELECTRONIC PACKAGING

## Low silhouette blowers cool electronic equipment

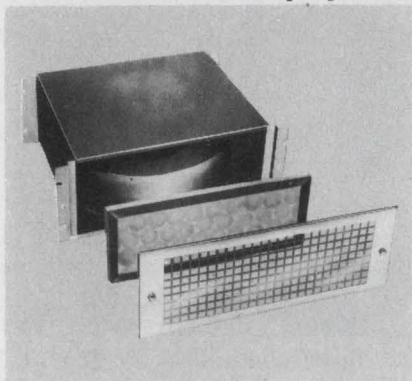

**Bud Radio, Inc., 4605 E. 355 St., Willoughby, O. 44094, (216) 946-3200. Now at your Bud Distributor.**

Six models. Each cools electronic equipment in racks, cabinets, consoles efficiently, economically. Panel heights: 3½", 5¼" and 7" — lowest heights, highest CFM output in the industry. Each has 19" panel width, standard E.I.A. notching for rack mounting. Filters removed through front panel; no tools required. Guaranteed for 20,000 hours. For further information, phone —

1-800-321-1764, TOLL FREE  
IN OHIO, 1-800-362-2265, TOLL FREE

## Handles for enclosures — a complete line

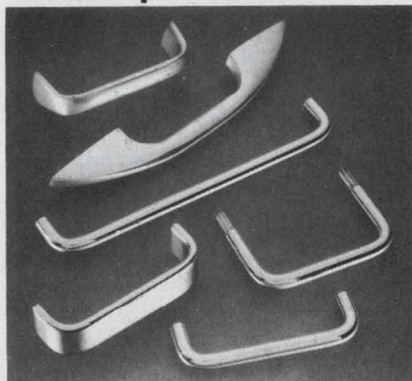

**Bud Radio, Inc., 4605 E. 355 St., Willoughby, O. 44094, (216) 946-3200. 33 different types.**

Handles plus hardware for electronic enclosures are in stock at your Bud Distributor: chrome plated, silver anodized, brushed chrome recessed and satin chrome lever types, chrome plated catch sets. Fasteners included. Designed for all types of applications. Construction equals that of higher priced counterparts. Range of sizes and configurations. Compare. For further information, phone —

1-800-321-1764, TOLL FREE  
IN OHIO, 1-800-362-2265, TOLL FREE

## MICROWAVES &amp; LASERS

## Simulator allows safe laser tests

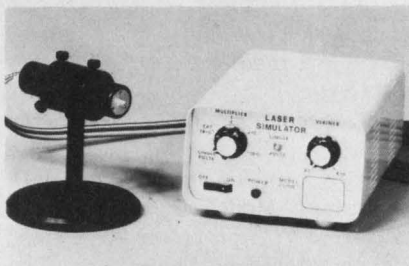

**Power Technology Inc., P.O. Box 4403, Little Rock, AR 72204. (501) 568-1995. \$1200; 6 wks.**

The Laser Simulator, a small self-contained pulsed infrared source, provides a convenient eye-safe signal for laser-system testing and checkout. It can simulate pulse width and pulse rate at the proper wavelength for laser rangefinders and designators. Power output is 20 mW at 20 ns and 1.06  $\mu$ . The unit operates from 115 or 230-V-ac supplies and from 12-to-24-V-dc sources.

CIRCLE NO. 353

## Sweep generator spans 0.1 to 40 GHz

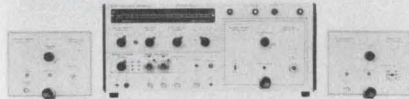

**Wiltron Co., 930 E. Meadow Dr., Palo Alto, CA 94303. (415) 494-6666. \$1475; 4 wks.**

The Model 610D sweep-generator mainframe with solid-state rf plug-ins covers the entire 100-kHz-to-40-GHz frequency range. All special features of the company's previous sweep generators have been maintained. The features include optional crystal markers with 0.01% accuracy, front-panel programming and patented stop-sweep marker. In addition, the new version offers complete compatibility with the HP 8410A and 8410B network analyzer, and it has broadband phase lock and FM capabilities. Further, the 610D not only supplies both positive and negative-polarity retrace blanking, but also both polarities of bandswitch blanking.

CIRCLE NO. 354

## Compact couplers operate up to 500 MHz

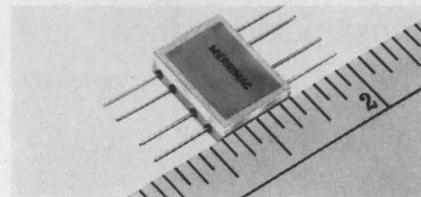

**Merrimac Industries, 41 Fairfield Pl., West Caldwell, NJ 07006. (201) 228-3890. \$45; 30 days.**

Four-port directional couplers, the CRF-A series, come in compact flat packs and operate over the 2-to-500-MHz frequency range. The couplers measure 0.125 × 0.375 × 0.5-in. and weigh only 2.8 grams. Typical specs for the Model CRF-20A-250, which has a 10-to-400-MHz range, are a coupling of 20 ± 1 dB, frequency sensitivity of ± 0.5 dB directivity of 20 dB, VSWR of 1.3:1, insertion loss (above coupling-split loss) of 0.6 dB, and average power of 1 W.

CIRCLE NO. 355

## Low-noise preamps aim for earth terminals

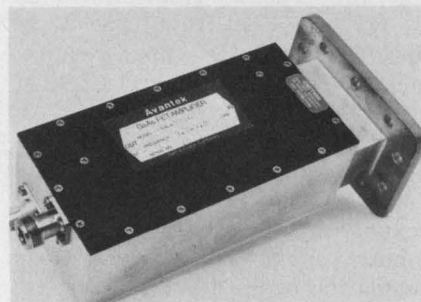

**Avantek, 3175 Bowers Ave., Santa Clara, CA 95051. (408) 249-0700. Under \$2000.**

Low-noise GaAs FET preamplifiers, for use in small satellite stations, operate in the 3.7-to-4.2-GHz down-link band. Called the AW-4220 Series, the new units come with waveguide inputs and coax outputs, and they are completely weatherproofed for unprotected outdoor mounting. Gain ranges from 21 to 56 dB and the standard noise figure is 3.0 dB. Other key specs include ± 0.25-dB gain flatness, +15-dBm linear power output (at 1-dB gain compression), and +25-dBm minimum third-order intercept point. Input power may be any voltage from -15 to -24 V dc and current consumption is 100 to 200 mA.

CIRCLE NO. 356



# New Literature

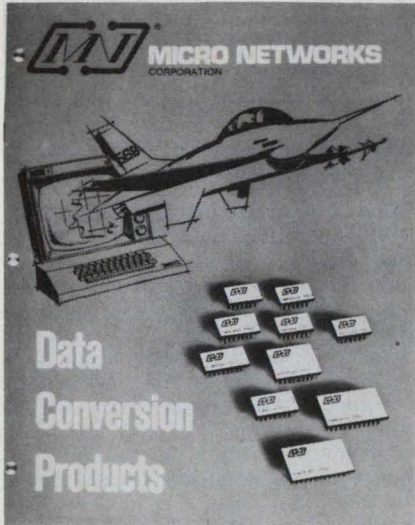

## Data Conversion Products

Electrical and mechanical specifications for over 100 different data conversion products are contained in a 16-page catalog. Micro Networks, Worcester, MA

CIRCLE NO. 357

## Access system

A brochure and booklet describe the HP 2000 access system. Hewlett-Packard, Palo Alto, CA

CIRCLE NO. 358

## Multipoint recorders

Operating data, specifications, outline dimensions and ordering information for standard recorders—including the Brush 816—are given in a four-page catalog. Gould, Instrument Systems Div., Cleveland, OH

CIRCLE NO. 359

## Switches with LEDs

Low-profile switches with light-emitting diode indicators are highlighted in a data sheet. Performance specifications, physical characteristics and LED specifications are charted, and dimensional drawings are included. Oak Switch Div., Crystal Lake, IL

CIRCLE NO. 360

## Semiconductors

A guide to the company's semiconductors furnishes basic specifications and applications data, as well as a cross-reference chart. GC Electronics, Rockford, IL

CIRCLE NO. 361

## Rf and microwave products

Over 156 pages cover the company's rf and microwave products. You can easily locate the products using the alphabetical or numerical indexes. Photos, drawings and tables illustrate the product lines. The Narda Microwave Co., Plainview, NY

CIRCLE NO. 362

## Standards and bridges

A 36-page catalog of impedance standards and precision bridges is divided into four main sections: capacitance standards, resistance standards, inductance standards and precision bridges and accessories. General Radio, Concord, MA

CIRCLE NO. 363

## PC drafting aids

A 120-page catalog features illustrations and complete data on over 15,000 PC drafting aids. An expanded technical section is packed with work and moneysaving tips, techniques and ideas. Bishop Graphics, Chatsworth, CA

CIRCLE NO. 364

## HV power supplies

Ratings and specifications for the 300 "C" series power supplies are covered in a four-page bulletin. Deltron, North Wales, PA

CIRCLE NO. 365

## Specialty gases

A 144-page specialty gases and equipment catalog, dubbed "The Book," features all grades of gaseous chemicals in one place, safety and handling information, convenient symbols noting bulk capabilities and color indices. Contents are in English and metric units and prices are included. Air Products and Chemicals, Allentown, PA

CIRCLE NO. 366



When it's your move check Centralab

## Visual display

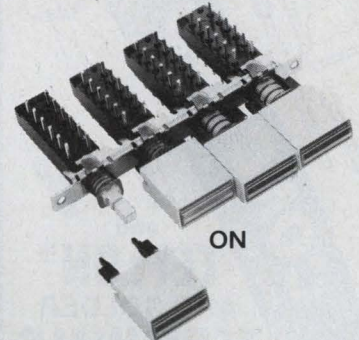

in a non-lighted pushbutton switch

Now you can add visual display to Centralab non-lighted pushbutton switches. Our new status indicator button with a unique fluorescent reflective surface operates with ambient light to indicate switch status when activated. No power is required. There are no lamps to burn out.

Other features include:

- Choice of 6 display colors, 3 lens options and 5 button colors.
- Available with push-push or interlocking action.
- 140° peripheral viewing angle.
- Vertical or horizontal button mounting.

See your Centralab Pushbutton Distributor or send inquiry card for complete specifications.

Isostat Licensed

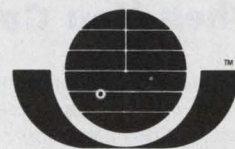

CENTRALAB

Electronics Division  
GLOBE-UNION INC.  
P.O. BOX 858  
FORT DODGE, IOWA 50501



CONNECTORS/  
P.C.

**JACKS &  
PINS**

BERYLLIUM  
COPPER  
CAGES

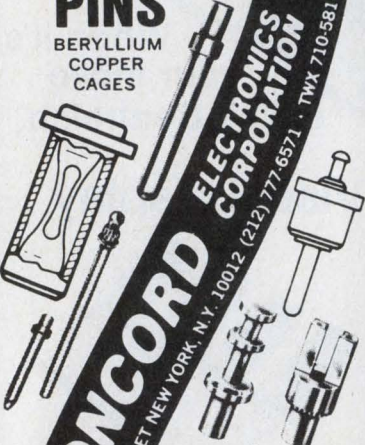

**CONCORD ELECTRONICS CORPORATION**  
37 GREAT JONES STREET NEW YORK, N.Y. 10012 (212) 777-6571 TWX 710-581-4930

and  
**TEFLON\***  
AND SOLDER  
**TERMINALS**

\*DUPONT T.M.

**SEND FOR CATALOG**

INFORMATION RETRIEVAL NUMBER 51

## KEEP

Electronic Design's

## GOLD BOOK HANDY

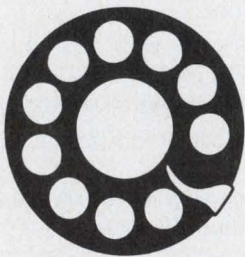

## When You Call

Save time when you contact suppliers. Check their catalog pages first in *Electronic Design's* GOLD BOOK. Maybe the information you need is right at your fingertips.

## Bulletin Board

Custer Research's CADET—computer assisted digital electronic tester—is designed for existing in-house equipment while minimizing training for engineers and operators as the conversational language is as close to English as the state of the art permits.

CIRCLE NO. 367

Microtec has added to its line of microprocessor support products a set of macro-assemblers for the Intel 4004, 4040 and 8080 microprocessors.

CIRCLE NO. 368

STIS (Scientific and Technical Information Services), Fort Lee, NJ, assists engineers, scientists, etc., who are seeking fast answers, not readily available, to practical or theoretical problems. Information retrieval, literature searches, compilation and analysis of data, screening of publications, indexing and abstracting are part of its activities.

CIRCLE NO. 369

Intersil is supplying off-the-shelf delivery on an expanded line of RAMs and PROMs processed to i38510 high-reliability standards.

CIRCLE NO. 370

Optron has introduced a series of high reliability optically coupled isolators with JEDEC registration. The series includes 4N22, 4N23 and 4N24 types.

CIRCLE NO. 371

First Data Corp. has introduced the IN8080, a fast and inexpensive cross-assembler for the Intel 8080 microprocessor.

CIRCLE NO. 372

Data General has introduced the Communications Access Manager (CAM) software package for use with its communications subsystem.

CIRCLE NO. 373

## Electronic Design

ELECTRONIC DESIGN's function is:

- To aid progress in the electronics manufacturing industry by promoting good design.
- To give the electronic design engineer concepts and ideas that make his job easier and more productive.
- To provide a central source of timely electronics information.
- To promote communication among members of the electronics engineering community.

**Want a subscription?** ELECTRONIC DESIGN is sent free to qualified engineers and engineering managers doing design work, supervising design or setting standards in the United States and Western Europe. For a free subscription, use the application form bound in the magazine. If none is included, write to us direct for an application form.

If you do not qualify, you may take out a paid subscription for \$30 a year in the U.S.A., \$40 a year elsewhere. Single copies are \$1.50 each.

**If you change your address,** send us an old mailing label and your new address; there is generally a postcard for this bound in the magazine. You will have to requalify to continue receiving ELECTRONIC DESIGN free.

**The accuracy policy** of ELECTRONIC DESIGN is:

- To make diligent efforts to ensure the accuracy of editorial matter.
- To publish prompt corrections whenever inaccuracies are brought to our attention. Corrections appear in "Across the Desk."
- To encourage our readers as responsible members of our business community to report to us misleading or fraudulent advertising.
- To refuse an advertisement deemed to be misleading or fraudulent.

Microfilm copies are available of complete volumes of ELECTRONIC DESIGN at \$19 per volume, beginning with Volume 1, 1952 through Volume 20. Reprints of individual articles may be obtained for \$3.00 each, prepaid (\$.50 for each additional copy of the same article) no matter how long the article. For further details and to place orders, contact the Customer Services Department, University Microfilms, 300 North Zeeb Road, Ann Arbor, Michigan 48106 telephone (313) 761-4700.

**Want to contact us?** If you have any comments or wish to submit a manuscript or article outline, address your correspondence to:

Editor  
ELECTRONIC DESIGN  
50 Essex Street  
Rochelle Park, N.J. 07662



# Electronic Design

## Advertising Sales Staff

Tom W. Carr, Sales Director

Rochelle Park, NJ 07662

Robert W. Gascoigne

Daniel J. Rowland

50 Essex Street

(201) 843-0550

TWX: 710-9990-5071

## Philadelphia

Thomas P. Barth

50 Essex Street

Rochelle Park, NJ 07662

(201) 843-0550

## Boston 02178

Gene Pritchard

P.O. Box 379

Belmont, MA 02178

## Chicago 60611

Thomas P. Kavooras

Berry Conner, Jr.

200 East Ontario

(312) 337-5088

## Cleveland

Thomas P. Kavooras

(Chicago)

(312) 337-0588

## Los Angeles 90045

Stanley I. Ehrenclou

Burt Underwood

8939 Sepulveda Boulevard

Los Angeles, CA

(213) 641-6544

## Texas/Oklahoma

Burt Underwood

(Los Angeles)

(213) 641-6544

## San Francisco 94040

Robert A. Lukas

3579 Cambridge Lane

Mountain View, CA 94040

(415) 965-2636

## London, Amsterdam, Tokyo, Seoul

Malcolm M. Thiele

Wood Cottage, Shurlock Row

Reading RG 10-QE, England

Phone: Shurlock Row 302 & 619

S.T.D. 073 581

W. J. M. Sanders

Oosterpark 6, De Rijk,

Holland

Phone: 02997-3020

Haruki Hirayama

Electronic Media Service

5th Floor, Lila Bldg.,

4-9-8 Roppongi

Minato-ku, Tokyo, Japan

Phone: 402-4556

Cable: Electronicmedia, Tokyo

Mr. O-kyu Park, President

Dongbo Int'l Corp.—

World Marketing

C.P.O. Box 4010

Seoul, Korea

Tel. 76-3910/3911

Cable: DONGBO SEOUL

Telex: EBKOREA K27286

ABP

BPA

## Vendors Report

Annual and interim reports can provide much more than financial-position information. They often include the first public disclosure of new products, new techniques and new directions of our vendors and customers. Further, they often contain superb analyses of segments of industry that a company serves.

Selected companies with recent reports are listed here with their main electronic products or services. For a copy, circle the indicated number.

**Vitramon.** Inorganic monolithic capacitors.

CIRCLE NO. 374

**Bunker Ramo.** Components, information systems and textiles.

CIRCLE NO. 375

**Fairchild.** Semiconductors, space and defense systems and products, and industrial products.

CIRCLE NO. 376

**Western Union.** Teletypewriter networks, leased systems and related services, telegram message services, money order services and mailgram services.

CIRCLE NO. 377

**EG&G.** Scientific instruments, electronic and mechanical components, environmental and biomedical services, custom services and systems and ERDA support.

CIRCLE NO. 378

**Indian Head.** Containers, metal and automotive products, textiles, utilities and communications products and microfiche records.

CIRCLE NO. 379

**Whittaker Corp.** Metals, chemicals, textiles, marine and recreation crafts, life sciences and technology.

CIRCLE NO. 380

**Basic, Inc.** Refractories, chemicals, power and interface devices for telecommunication systems, power sources, magnetic components, PC cards and electronic assemblies.

CIRCLE NO. 381

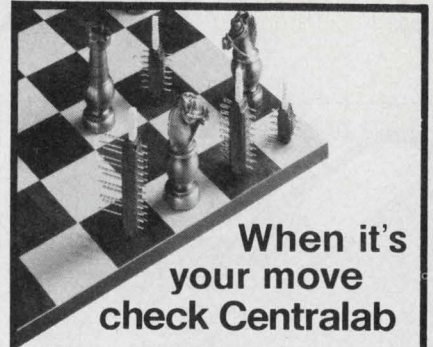

When it's  
your move  
check Centralab

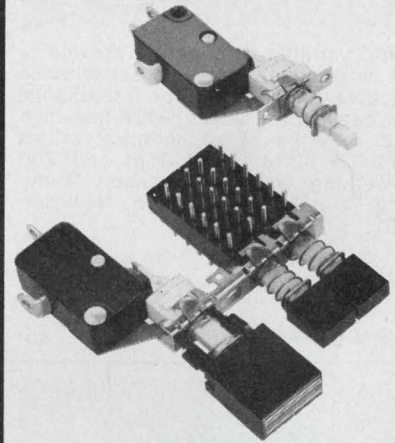

## 5 amp pushbutton switch

You'll meet even the most stringent requirements with this new line switch. It's UL listed for TV-5 rating (120V, 5A, 78A peak in-rush current).

Other features include:

- Furnished as a single station or for left or right mounting on any Centralab pushbutton switch assembly.
- Three circuit options—SPDT, SPST, normally open and SPST, normally closed.
- Button options include lighted, non-lighted or status indicator button (shown above).

See your Centralab Pushbutton Distributor or send inquiry card for complete specifications.

Isostat Licensed



CENTRALAB

Electronics Division

GLOBE-UNION INC.

P.O. BOX 858

FORT DODGE, IOWA 50501



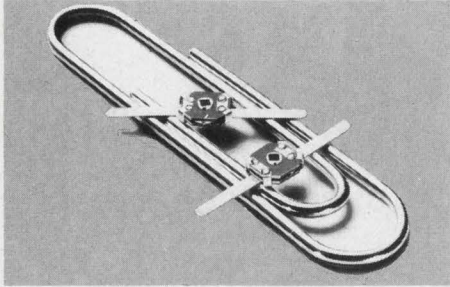

**Thin-Trim variable capacitors** provide a reliable means of adjusting capacitance without abrasive trimming or interchange of fixed capacitors. Series 9401 has high Q's and a range of capacitance values from 0.2-0.6 pf to 3.0-12.0 pf and 250 WVDC working voltage. Johanson Manufacturing Corporation, Boonton, New Jersey (201) 334-2676.

THIN-TRIM CAPACITORS

601



**STURDILITE ELECTRONIC WORK STATIONS** designed to meet exacting requirements for electronic testing, production and assembly. Electrical outlets available in almost any quantity and in convenient locations. Free catalog. Also, free planning service is available. Angle Steel Div., Kewaunee Scientific Equipment Corporation, Plainwell, Mich. 49080 Phone (616) 685-6831

TECHNICAL WORK STATIONS

604

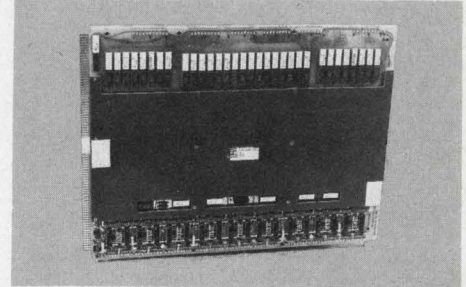

**16K/32K Memory Systems.** Model 696: 16K, 18-bits; to 256K X 9, 128K X 18, 64K X 36. Model 698: 32K, 18 bits; to 512K X 9, 256K X 18, 128K X 36. Cycle 650 nsec, access 250 nsec. Dir. rplcmnts for Micro 3000. Fabri-Tek, Inc., 5901 S. Cnty. Rd. 18, Mpls, MN 55436 (612) 935-8811

MEMORY SYSTEM

607

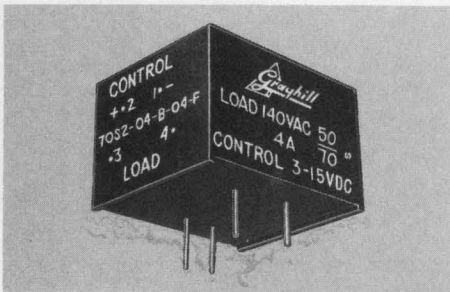

**SPACE-SAVING 4 AMP SOLID STATE RELAY** occupies only 1 cubic inch, is logic compatible, with switching capability from 0.1 to 4 amps, rated @25°C. Optically coupled; zero voltage turn-on. Offers inductive load switching, excellent transient protection. PC mountable. Prototype quantities from stock. Grayhill, Inc., (312) 354-1040.

SOLID STATE RELAY

602

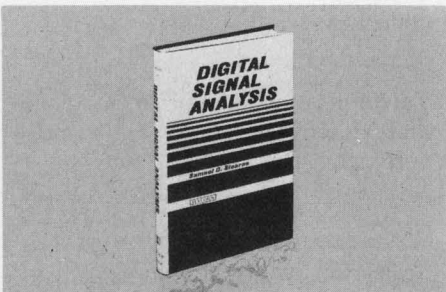

**DIGITAL SIGNAL ANALYSIS**, S. Stearns. Contains the most recent advances, brand-new design material, and a comparison between continuous and digital systems, making it an ideal master reference to today's signal processing techniques and systems. #5828-4, 288 pages, \$18.95. Circle the Info Retrieval Number to order 15-day exam copy. When billed, remit or return book with no obligation. Hayden Book Co., 50 Essex Street, Rochelle Park, N.J. 07662.

DIGITAL SIGNAL ANALYSIS

605

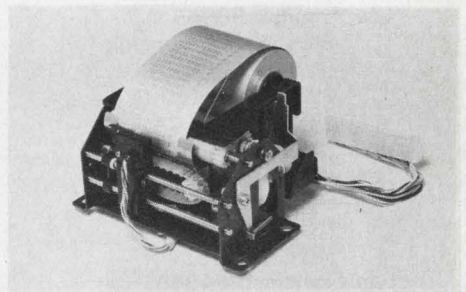

**Hycom has introduced** an improved 16 column Electro Discharge Printer that is faster, more reliable, and costs less than previously available units. (\$69 per unit in 100 quantity.) Designed to enhance the performance of remote terminals, microprocessors, and other low cost terminal applications, the Printer, Model DC-1606B, prints 8 lines per second very quietly, using a 5x7 dot matrix to form alpha-numerics. HYCOM INCORPORATED, 16841 Armstrong Ave., Irvine, Ca. 92714 (714) 557-5252

ELECTRO DISCHARGE PRINTER

608

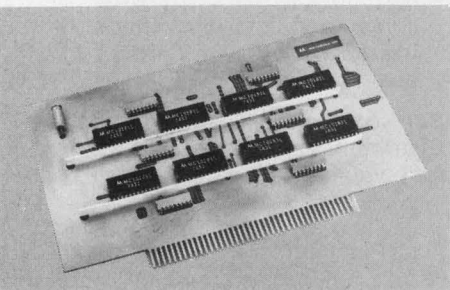

**EASIER ECL VOLTAGE AND GROUND DISTRIBUTION SYSTEMS**—Reduced system noise, high packaging density and less design time for PC boards with ECL circuits are yours with Mini/Bus®, the Rogers way to eliminate the cost of multi-layer boards by off-board voltage and ground distribution. Rogers Corp., Chandler, AZ 85224 (602) 963-4584.

MINI/BUS

603

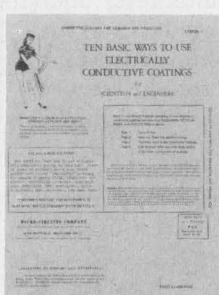

**FREE**  
How to save  
a fortune  
this year  
with painted  
resistors  
and pots.

Save space and money by replacing some resistors (particularly high meg), and wires by painting them on circuit board or on other insulated areas with our resistive inks. Often almost free. Sizes: Fly speck to football field. Solve "impossible" design and research problems. One user saves a yearly fortune painting millions of dot-size, 1000 meg resistors on his tiny circuits. Why not challenge your resistors and pots to beat our system? Data FREE. Micro-Circuits Co., New Buffalo, MI 49117

RESISTIVE INKS

606

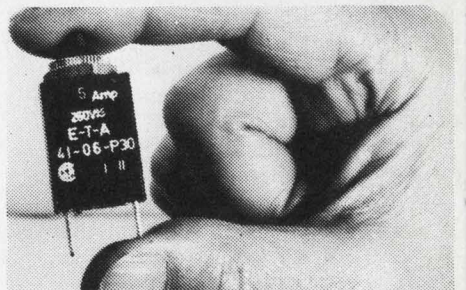

**Overcurrent Protector**, manual reset eliminates fuse replacement. Convenient panel mounting. 19 fractional ratings from 0.1 to 5 amp. Other models up to 400 amp. Trip-free and fool-proof, UL and CSA approved. High quality, low cost \$1.33 ea. in 1000 lots. E-T-A Products Co. of America, 7400 N. Croname Rd., Chicago, Ill. 60648. Tel: (312) 647-8303. Telex: 253780.

CIRCUIT BREAKER

609



## Advertiser's Index

Advertiser	Page
AMP, Incorporated .....	84, 85
Abbott Transistor Laboratories, Inc.....	6
Ad-Vance Magnetics, Inc.....	81
American Microsystems, Inc.....	4, 5
Amphenol Connector Division, Bunker-Ramo .....	Cover III
Angle Steel/Division of Kewaunee Scientific Equipment Co.....	94
Arnold Magnetics Corp. ....	96
Bourns, Inc., Trimpot Products Division .....	Cover II
Bud Radio, Inc.....	89, 90
Centralab, The Electronics Division of Globe-Union, Inc.....	91, 93, 95
Circuit Technology, Inc.....	87
Computer Automation, Inc. ....	8, 9
Concord Electronics Corporation.....	92
Connecticut Hard Rubber Company, The .....	88
Crown International, Inc.....	81
Data General Corporation.....	25
Data Translation, Inc. ....	87
Dialight, A North American Philips Company .....	62
EECO .....	15
E-H Research Laboratories, Inc.....	77
E-T-A Products Co. of America.....	94
Electronic Design .....	12*
Electronic Navigation Industries.....	83
Fabri-Tek, Inc. ....	94
General Instrument Corporation.....	26, 27
Gold Book, The .....	48, 49, 92
Gould Inc., Instrument Systems Division .....	73
Grayhill, Inc. ....	94
Hayden Book Company, Inc.....	94
Hewlett-Packard .....	1, 10, 11, 17, 32 thru 40, 47, 71
Hycom Inc. ....	94
Intech, Incorporated .....	86
JCE Publications .....	19
Johanson Manufacturing Corp.....	94
Johnson Company, E. F.....	95
Kepeco, Inc. ....	28
Magneto, Inc. ....	95
Martin Research .....	44
Melles Griot .....	73
Mepco/Electra, Inc. ....	56, 57
Micro Circuits Co.....	94
Micro Devices Corp. ....	63
Optron, Inc. ....	7
Oshino Electric Lamp Works, Ltd. ....	73
Power/Mate Corp. ....	82
RCA Solid State .....	Cover IV
Rental Electronics, Inc. ....	12
Reticon .....	79
Rogan Corporation .....	73
Rogers Corporation .....	94, 95
Simpson Electric Company .....	21
Sprague Electric Company .....	23
Stahlin Brothers, Inc.....	63
Systron-Donner .....	80
TRW/IRC Resistors, an Electronic Com- ponents Division of TRW, Inc.....	42
Tektronix, Inc. ....	31
Teledyne Relays, A Teledyne Company.....	2
Teledyne Semiconductor .....	50
Varo Semiconductor, Inc.....	82

\*Advertisers in non-U.S. edition

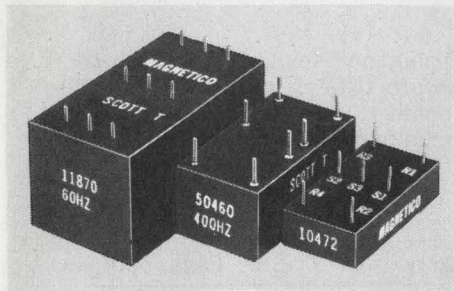

**Scott T Transformer.** 11870: 60HZ, 90v, L-L in. 1.1x2.1x1.1. 50460: 400 HZ, 90v, L-L in. 7/8x1-5/8x11/16. 50642: 400HZ, 11.8v, L-L in. 7/8x5/8-11/16. 10472: 400-HZ, 11.8v, L-L in. 3/4x1-1/2x3/8. All with 6v RMS sine & cosine output. MAGNETICO, INC., 182 Morris Ave., Holtsville, N.Y. 11742 516-654-1166.

TRANSFORMER

610

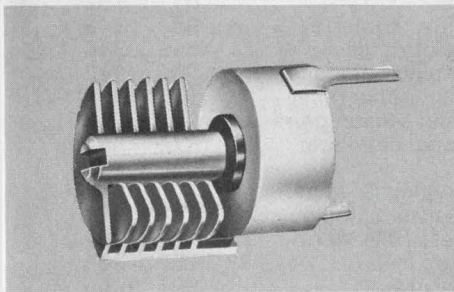

**High performance Type "T" sub-miniature machined-plate capacitors.** Rotors and stators machined from solid brass extrusions provide excellent stability and uniformity. High Q, low temp. coefficient (plus 30 ±ppm/°C). Available in horizontal and vertical tuning for PC and stripline mounts. E. F. Johnson Co., Waseca, MN., (507) 835-5222.

TYPE "T" CAPACITOR

611

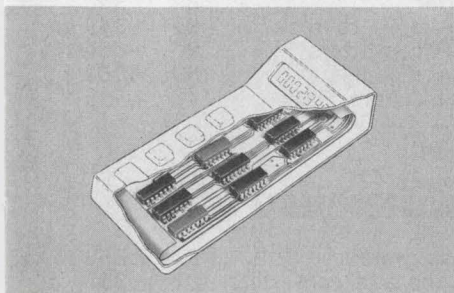

**FLEXIBLE CIRCUITS FOR HANDHELD CALCULATORS** are one example of how your creativity can be given fresh stimulus and flexibility by using flexible circuits from Rogers. Mass-produced at amazingly low cost. Ask for details. Rogers Corporation, Chandler, AZ 85224. Phone (602) 963-4584.

FLEXIBLE CIRCUITS

612

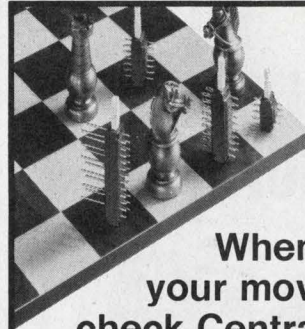

**When it's  
your move  
check Centralab**

**High quality  
pushbutton  
switches at  
a low cost**

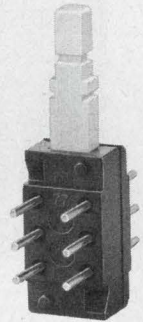

Centralab switches are engineered for quality. Then they're produced on high-speed automated machines to keep your cost down. This means...

**Low Price:** A Centralab 2-pole lighted switch, for example, costs only \$1.36 including lamp, in 1,000 quantities.

**Quality:** Up to 250,000 MTBF in ganged assemblies. Over 500,000 operations on contact systems.

**Plus Options:** Diallyl phthalate housings • gold contacts • epoxy-sealed terminals • 2, 4, 6 and 8 poles • four types of lockouts • and much more for *only pennies more*.

**Newest Additions:** Non-lighted status indicator • low-cost lighted switch • 5 amp line switch.

When you can have quality *and* low price from Centralab, why settle for less? For full information, call your Centralab Pushbutton Distributor or send reader service card, or write...

Isostat Licensed



**CENTRALAB**  
Electronics Division  
GLOBE-UNION INC.  
P.O. BOX 858  
FORT DODGE, IOWA 50501

INFORMATION RETRIEVAL NUMBER 53

95



# BIG POWER SUPPLIES

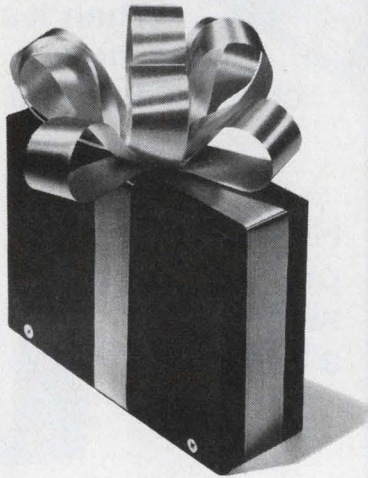

# IN LITTLE PACKAGES

**AC-DC and DC-DC  
miniaturized power converters  
that deliver 3.9 watts  
per cubic inch.**

- AC inputs: 115-220 VAC, 47-500 Hz.
- DC inputs: 12, 28, 48, 115 & 150 VDC.
- 1 to 6 isolated and regulated DC outputs from 4.2 to 300 VDC.
- Line and load regulation to 0.1%.
- Up to 800 watts per output.
- Efficiencies to 85%.
- Design-As-You-Order construction from standard sub-modules . . . over 1200 possible configurations.
- Completed converters provided in tested and encapsulated, conduction cooled packages in just days.

See for yourself how we've packed the power and performance in . . . request our actual size "little black box" punch out kit and catalog today!

Call us collect . . . ask for Jim Dunn.



## ARNOLD MAGNETICS CORPORATION

11520 W. Jefferson Blvd.  
Culver City, Ca. 90230 ● (213) 870-7014

# Product Index

**Information Retrieval Service.** New Products, Evaluation Samples (ES), Design Aids (DA), Application Notes (AN), and New Literature (NL) in this issue are listed here with page and Information Retrieval numbers. Reader requests will be promptly processed by computer and mailed to the manufacturer within three days.

Category	Page	IRN
<b>Components</b>		
capacitor, trimmer	83	336
capacitors	83	335
current limiter	63	32
lamps	73	35
resistor	23	14
resistors	42	22
resistors	82	332
switch, pushbutton	83	334
switch, rotary	83	337
switches	91	50
switches	93	52
switches	95	53
switches, DIP	82	333
trimmers	56	28
trimmers	57	29
trimmers	III	247
<b>Data Processing</b>		
calculator, programmable	76	301
computers	25	15
data-acquisition module	77	302
logic analyzer	31	271
printers, impact	77	303
<b>Discrete Semiconductors</b>		
display, numeric	88	346
LED, high power	88	348
LEDs, hermetic	88	345
Semiconductors (NL)	91	361
source/sensor pairs	7	6
transistors, power	88	347
<b>Instrumentation</b>		
DMM	80	328
DVMs	80	42
Digiscope	77	38
function-generator	81	326
logic analyzer	31	271
multiport recorder (NL)	91	359
PC-board tester	80	329
power amplifier	83	41
power amplifier recorder	80	43
recorder	73	36
rental instruments	12	9
scope	80	331
signal generator	80	330
signal generator	81	327
<b>Integrated Circuits</b>		
analog delay	79	39
CMOS	IV	248
divider	79	323
EAROMs	27	16
RAM, 1-k CMOS	79	322
<b>Microprocessor Design</b>		
circuits, $\mu$ C	46	505
controller, process	45	502
microprocessor kit	5	6
storage system, disc	45	503
support circuitry	43	501
terminal, CRT	46	504

Category	Page	IRN
<b>Microwaves &amp; Lasers</b>		
couplers	90	355
laser simulator	90	353
optics guide	73	34
preamps	90	356
sweep generator	90	354
<b>Modules &amp; Subassemblies</b>		
amplifier, isolation	87	344
comparators, BCD	86	341
converter, a/d	86	339
current limiter	63	32
custom hybrids	87	46
d/a and a/d converters (NL)	91	357
display, numeric	88	346
integrator, dc	86	340
multiplier, analog	86	342
sensor, long range	86	338
source/sensor pairs	7	6
system, data req.	87	343
<b>Packaging &amp; Materials</b>		
adhesive, soluble	78	320
cables, fiber optic	78	308
cutter, lead	78	306
enclosures	82	56
fluxes, solder	78	307
heat sink, transistor	78	321
industrial tapes	88	48
inserter, pin	78	305
jacks and pins	92	51
knobs	73	37
PC drafting aids (NL)	91	364
PM magnetic shield	81	44
panels, ECL	78	309
sockets, DIP	78	304
<b>Power Sources</b>		
dc/dc converters	89	351
HV power supplies (NL)	91	365
inverter	89	350
open-frame source	89	349
power converters	96	54
power modules	89	352
power supply	6	5
<b>new literature</b>		
access system	91	358
d/a and a/d converters	91	357
HV power supplies	91	365
Italian trade mag.	41	21
multiport recorder	91	359
PC drafting aids	91	364
rf and microwave products	91	362
semiconductors	91	361
specialty gases	91	366
standards and bridges	91	363
switches with LEDs	91	360



# Amphenol Scot Pot.<sup>TM</sup> Amphenol trimmers.

Two bargains  
your competitors  
may not know about...

YET.



3810 wirewound

6034 cermet



The word is out — Amphenol offers a big selection of quality precision pots and trimmers. They can replace what you're using now — in form, fit, and function — and save you money in the bargain.

**Our Scot Pot** is as good as (or better than) any other 10-turn wirewound miniature precision pot on the market. It has improved electrical, mechanical, and environmental characteristics. Yet Scot Pots cost as much as 25% less than other equivalent pots.

And that's news that won't stay secret for very long.

**Our 3/4" rectangular trimmers** come in a full range of resistances and in all popular pin spacings. They're sealed to withstand automatic board cleaning. And they're highly stable — no drift. Two series to choose from: 3810 wirewound (available with Vista-Trim for fast, approximate visual settings). And 6034 cermet trimmers. Both series save you plenty. Ask for a quote and see how much you can beat the competition by.

**For off-the-shelf delivery**, call your local Amphenol Industrial Distributor. Your competitors may have already discovered his great service — so should you. Give him a call. Or for more information (and spec sheets on our pots and trimmers) contact: George Boyd, Amphenol Connector Division, Controls Operation, 2801 South 25th Avenue, Broadview, Illinois 60153. Phone: (312) 261-2000.

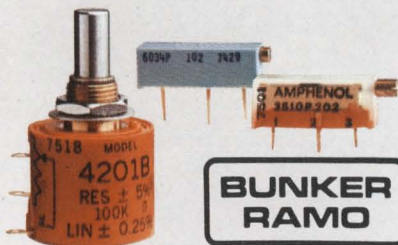

*When you can connect it  
and forget it...that's quality.*

# AMPHENOL



What's new in solid state...

# The last word on reliability. From the first house in CMOS.

Reliability has many aspects. You have to look at it from more than one angle. As the creator of the CMOS technology, RCA has years of experience in measuring and improving the various aspects of CMOS reliability to prove it.

A new 24-page technical paper explores the total RCA reliability test program. It describes how RCA determines and controls the growing reliability of COS/MOS integrated circuits, both plastic and ceramic. It includes RCA developed real-time test procedures and controls. Plus a discussion of circuit and device mechanisms. This information can help designers improve equipment value by increasing reliability without component costs. Where essential, RCA has an Extra Value Program that offers enhanced product.

## New reliability test specs

The paper details how RCA's comprehensive specifications help designers match device to application. Typical RCA specs and test circuits are shown. You'll see how a 4-step testing routine and real-time indication tests assure product quality and long-term reliability.

## Designing for the environment

Curves and data in the paper reveal the effects of environmental extremes on various packaging systems such as plastic, frit seal and the new Gold CHIP. They show accelerated life and thermal cycling tests with high MTTF figures. An important section compares predictable life data of TTL vs. COS/MOS: under the same ambient temperature, COS/MOS would have a better failure rate by a factor exceeding 20.

There's much more in this important document, ST-6418. We want you to have it, free. Contact your local RCA Solid State distributor. Or RCA.

Write: RCA Solid State, Box 3200, Somerville, New Jersey 08876; Ste. Anne de Bellevue 810, Canada; Sunbury-on-Thames, U.K.; Fuji Bldg., Tokyo, Japan.

# RCA

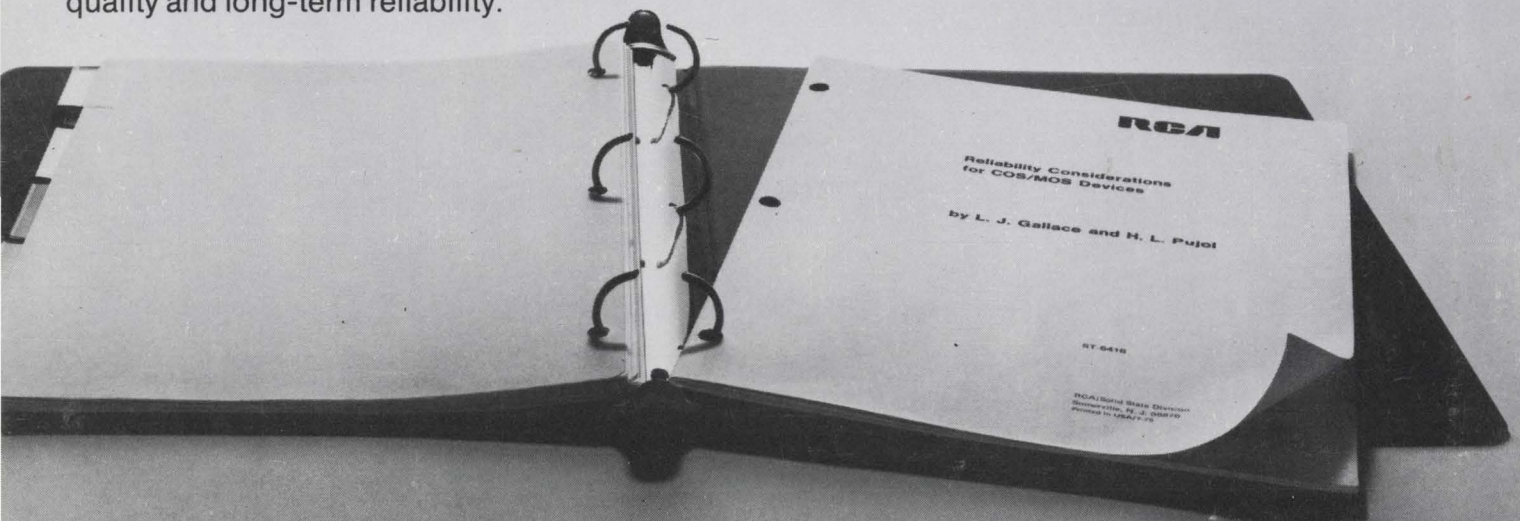

RCA. First house in CMOS.