

**Yealink**

# T40P Skype for Business<sup>®</sup> Edition User Guide



Version 8.60  
Jan.2017

## Copyright

### **Copyright © 2017 YEALINK(XIAMEN) NETWORK TECHNOLOGY CO., LTD**

Copyright © 2017 Yealink(Xiamen) Network Technology CO., LTD. All rights reserved. No parts of this publication may be reproduced or transmitted in any form or by any means, electronic or mechanical, photocopying, recording, or otherwise, for any purpose, without the express written permission of Yealink(Xiamen) Network Technology CO., LTD. Under the law, reproducing includes translating into another language or format.

When this publication is made available on media, Yealink(Xiamen) Network Technology CO., LTD. gives its consent to downloading and printing copies of the content provided in this file only for private use and not for redistribution. No parts of this publication may be subject to alteration, modification or commercial use. Yealink(Xiamen) Network Technology CO., LTD. will not be liable for any damages arising from use of an illegally modified or altered publication.

## Warranty

THE SPECIFICATIONS AND INFORMATION REGARDING THE PRODUCTS IN THIS GUIDE ARE SUBJECT TO CHANGE WITHOUT NOTICE. ALL STATEMENTS, INFORMATION, AND RECOMMENDATIONS IN THIS GUIDE ARE BELIEVED TO BE ACCURATE BUT ARE PRESENTED WITHOUT WARRANTY OF ANY KIND, EXPRESS OR IMPLIED. USERS MUST TAKE FULL RESPONSIBILITY FOR THEIR APPLICATION OF PRODUCTS.

YEALINK(XIAMEN) NETWORK TECHNOLOGY CO., LTD. MAKES NO WARRANTY OF ANY KIND WITH REGARD TO THIS GUIDE, INCLUDING, BUT NOT LIMITED TO, THE IMPLIED WARRANTIES OF MERCHANTABILITY AND FITNESS FOR A PARTICULAR PURPOSE. Yealink(Xiamen) Network Technology CO., LTD. shall not be liable for errors contained herein nor for incidental or consequential damages in connection with the furnishing, performance, or use of this guide.

## Declaration of Conformity



Hereby, Yealink(Xiamen) Network Technology CO., LTD. declares that this phone is in conformity with the essential requirements and other relevant provisions of the CE, FCC.

You can find the CE and FCC information from the label on the back of the Skype for Business phone.

Statements of compliance can be obtained by contacting [support@yealink.com](mailto:support@yealink.com).

## CE Mark Warning

This device is marked with the CE mark in compliance with EC Directives 2014/30/EU and 2014/35/EU.

### **Part 15 FCC Rules**

Any changes or modifications not expressly approved by the party responsible for compliance could void the user's authority to operate the equipment.

This device is compliant with Part 15 of the FCC Rules. Operation is subject to the following two conditions:

1. This device may not cause harmful interference, and

2. This device must accept any interference received, including interference that may cause undesired operation.

## Industry Canada (IC)

This Class [B] digital apparatus complies with Canadian ICES-003 Rules.

## Class B Digital Device or Peripheral

Note: This device is tested and complies with the limits for a Class B digital device, pursuant to Part 15 of the FCC Rules. These limits are designed to provide reasonable protection against harmful interference in a residential installation. This equipment generates, uses, and can radiate radio frequency energy and, if not installed and used in accordance with the instructions, may cause harmful interference to radio communications. However, there is no guarantee that interference will not occur in a particular installation. If this equipment does cause harmful interference to radio or television reception, which can be determined by turning the equipment off and on, the user is encouraged to try to correct the interference by one or more of the following measures:

1. Reorient or relocate the receiving antenna.
2. Increase the separation between the equipment and receiver.
3. Connect the equipment into an outlet on a circuit different from that to which the receiver is connected.
4. Consult the dealer or an experience radio/TV technician for help.

## WEEE Warning



To avoid the potential effects on the environment and human health as a result of the presence of hazardous substances in electrical and electronic equipment, end users of electrical and electronic equipment should understand the meaning of the crossed-out wheeled bin symbol. Do not dispose of WEEE as unsorted municipal waste and have to collect such WEEE separately.

## Customer Feedback

We are striving to improve our documentation quality and we appreciate your feedback. Email your opinions and comments to [DocsFeedback@yealink.com](mailto:DocsFeedback@yealink.com).

## GNU GPL INFORMATION

Yealink T40P firmware contains third-party software under the GNU General Public License (GPL). Yealink uses software under the specific terms of the GPL. Please refer to the GPL for the exact terms and conditions of the license.

The original GPL license, source code of components licensed under GPL and used in Yealink products can be downloaded online:

<http://www.yealink.com/GPLOpenSource.aspx?BaseInfoCateId=293&NewsCateId=293&CateId=293>.

## About This Guide

Yealink T40P phone with Skype for Business firmware enables a new era in unified communications. It is designed to work with Skype for Business Server. Connecting a Yealink T40P Skype for Business phone to Skype for Business Server allows you to place regular and Voice over Internet Protocol (VoIP) calls, answer calls, forward calls, conduct a Skype for Business conference call, and dial from your Skype for Business contacts list through integration with Microsoft's Active Directory.

This guide provides everything you need to quickly use your new phone. First, verify with your system administrator that the network is prepared for configuring your Yealink T40P Skype for Business phone, and your network is correctly configured. Also be sure to read the **Packaging Contents** and **Regulatory Notices** sections in this guide before you set up and use the Yealink T40P Skype for Business phone.

## In This Guide

Topics provided in this guide include:

- [Chapter 1 Overview](#)
- [Chapter 2 Getting Started](#)
- [Chapter 3 Customizing Your Phone](#)
- [Chapter 4 Basic Call Features](#)
- [Chapter 5 Common Area Phone](#)
- [Chapter 6 Better Together over Ethernet](#)
- [Chapter 7 Troubleshooting](#)

## Summary of Changes

This section describes the changes to this guide for each release and guide version.

### Changes for Release 8, Guide Version 8.60

The following sections are new for this edition:

- [Connecting to the Network](#) on page 14
- [Disabling BToE on Your Phone](#) on page 164
- [Exiting BToE on Your Computer](#) on page 165
- [Uninstalling the Yealink BToE Connector](#) on page 165

Major updates have occurred to the following section:

- [Phone Installation](#) on page 12
- [Better Together over Ethernet](#) on page 149

## Changes for Release 8, Guide Version 8.50

The following sections are new for this edition:

- [Remembering Password](#) on page 41
- [Private Line Ring Tones](#) on page 118
- [Hotline](#) on page 74
- [Shared Line Appearance for Skype for Business](#) on page 106
- [Join Calls into a Conference](#) on page 122

Major updates have occurred to the following sections:

- [Signing into Skype for Business](#) on page 15
- [Entering Data and Editing Fields](#) on page v
- [Phone Lock](#) on page 38
- [Local Directory](#) on page 48
- [Call History Management](#) on page 61
- [Emergency Call](#) on page 69
- [Calendar](#) on page 86
- [Joining Skype Conferences from the Calendar](#) on page 92
- [Working with Schedule Reminders](#) on page 91
- [Better Together over Ethernet](#) on page 149
- [Troubleshooting Solutions](#) on page 167

# Table of Contents

<b>About This Guide .....</b>	<b>v</b>
In This Guide .....	v
Summary of Changes .....	v
Changes for Release 8, Guide Version 8.60 .....	v
Changes for Release 8, Guide Version 8.50 .....	vi
<b>Table of Contents .....</b>	<b>vii</b>
<b>Overview .....</b>	<b>1</b>
Hardware Component Instructions .....	1
Icon Instructions .....	3
LED Instructions .....	4
User Interfaces .....	5
Phone User Interface .....	5
Web User Interface .....	6
Documentations .....	8
<b>Getting Started .....</b>	<b>9</b>
Packaging Contents .....	9
Optional Accessories .....	10
Phone Installation .....	12
Attaching the Stand or the Optional Wall Mount Bracket .....	12
Connecting the Handset and Optional Headset .....	13
Connecting the Power .....	13
Connecting to the Network .....	14
Phone Initialization .....	15
Signing into Skype for Business .....	15
User Sign-in .....	15
PIN Authentication .....	17
Web Sign-in .....	18
Signing in via PC .....	21
Signing Out of Skype for Business .....	21
Changing Presence Status .....	22
Always Online .....	23
Account Lock .....	24
Entering Data and Editing Fields .....	25

Phone Status.....	27
Basic Network Settings.....	29
Idle Screen.....	31
<b>Customizing Your Phone.....</b>	<b>33</b>
General Settings.....	33
Contrast.....	33
Language.....	34
Time and Date.....	35
Administrator Password.....	37
Key as Send.....	37
Phone Lock.....	38
Remembering Password.....	41
Audio Settings.....	42
Volume.....	42
Ring Tones.....	43
Contact Management.....	44
Skype for Business Directory.....	44
Local Directory.....	48
Placing Calls to Contacts.....	58
Searching for Contacts.....	59
Call History Management.....	61
Headset Use.....	62
Headset Mode Activation/Deactivation.....	63
Headset Prior.....	63
Dual Headset.....	64
E911.....	65
E911 Location Tip.....	65
Location Notification.....	66
Adding the Location Information.....	68
Viewing the Location Information.....	69
Emergency Call.....	69
Dial-now.....	70
Live Dialpad.....	73
Hotline.....	74
Privacy Mode.....	75
Modifying the Privacy Mode from the Phone.....	75
Modifying the Privacy Mode from the Skype for Business Client.....	76
<b>Basic Call Features.....</b>	<b>79</b>
Placing Calls.....	80
Answering Calls.....	81
Ending Calls.....	83



---

Redialing Numbers.....	83
Auto Answer.....	83
Call Waiting.....	84
Call Mute.....	85
Call Hold/Resume.....	86
Calendar.....	86
Setting up a Skype Conference in Outlook.....	87
Setting up an Appointment in Outlook.....	87
Setting up a Meeting in Outlook.....	88
Setting up an Event in Outlook.....	89
Using the Calendar.....	90
Call Forward.....	96
Static Forwarding.....	96
Dynamic Forwarding.....	104
Response Groups.....	105
Shared Line Appearance for Skype for Business.....	106
Answering SLA Calls.....	106
Placing a SLA Call on Hold.....	107
Resuming Held SLA Calls.....	107
Boss-Admin Feature.....	107
Assigning/Removing Delegates.....	107
Viewing the Bosses/Delegates.....	110
Using the Boss-Admin Feature.....	111
Inbound Private Line.....	117
Private Line Ring Tones.....	118
Call Transfer.....	118
Blind Transfer.....	118
Consultative Transfer.....	119
Group Call Pickup.....	119
Skype for Business Conference.....	120
Initiating a Skype for Business Conference Call.....	120
Viewing the Dial-in Number and Conference ID.....	126
Viewing the Conference Participants.....	127
Managing the Conference Participants.....	127
Call Park.....	133
Voice Mail.....	135
Leaving the Voice Mail.....	135
Managing the Voice Mail.....	135
Multicast Paging.....	139
Sending RTP Stream.....	139
Receiving RTP Stream.....	141
Using Multicast Paging.....	142
Branch Office Resiliency.....	143

<b>Common Area Phone</b> .....	<b>145</b>
Signing into a Common Area Phone .....	145
Using a Common Area Phone .....	145
Switching to a Skype for Business Account.....	146
Signing Out of a Common Area Phone .....	147
<b>Better Together over Ethernet</b> .....	<b>149</b>
Getting Started with Better Together over Ethernet.....	149
Installing the Yealink Better Together over Ethernet Connector .....	149
Enabling Better Together over Ethernet.....	155
Paired Status.....	155
Pairing Your Phone with Your Computer .....	156
Signing in via PC .....	159
Setting Your Phone as Your Primary Audio Device.....	161
Using Better Together over Ethernet.....	162
Placing BToE Calls.....	162
Answering BToE Calls.....	162
Pausing BToE Calls .....	163
Resuming BToE Calls .....	163
Moving Call Audio between Your Phone and Computer: .....	163
Using BToE to Lock and Unlock Your Phone .....	163
Disabling BToE on Your Phone.....	164
Exiting BToE on Your Computer.....	165
Uninstalling the Yealink BToE Connector .....	165
<b>Troubleshooting</b> .....	<b>167</b>
Troubleshooting Solutions.....	167
<b>Regulatory Notices</b> .....	<b>181</b>
Service Agreements .....	181
Limitations of Liability .....	181
Safety Instructions .....	181
<b>Appendix A - Time Zones</b> .....	<b>185</b>
<b>Index</b> .....	<b>187</b>

## Overview

This chapter provides the overview of the T40P Skype for Business phone. Topics include:

- [Hardware Component Instructions](#)
- [Icon Instructions](#)
- [LED Instructions](#)
- [User Interfaces](#)
- [Documentations](#)







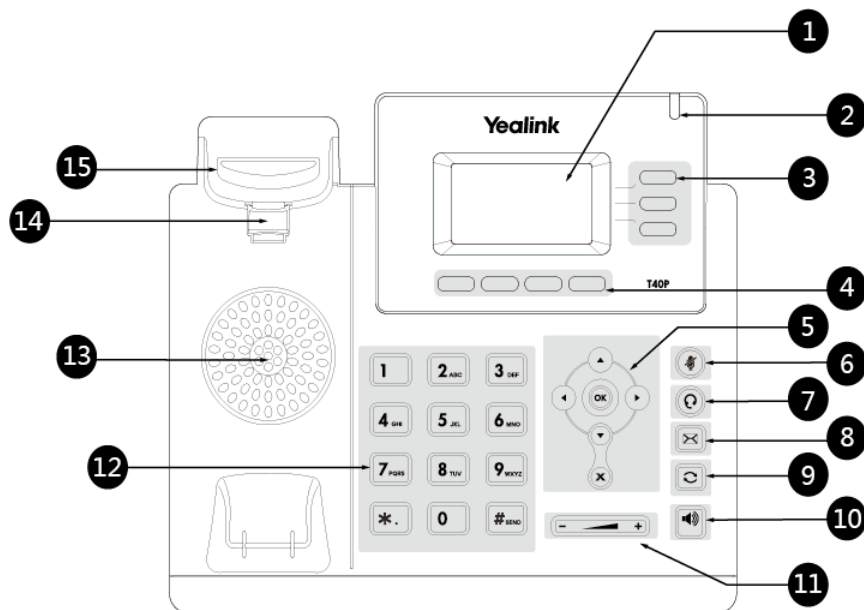



If you require additional information or assistance with your new phone, contact your system administrator.

## Hardware Component Instructions

The main hardware components of the T40P Skype for Business phone are the LCD screen and the keypad.

































Hardware component instructions of the T40P Skype for Business phone are:

	Item	Description
①	LCD Screen	Shows information about calls, messages, soft keys, time, date and other relevant data: <ul style="list-style-type: none"> <li>• Call information—caller ID, call duration</li> <li>• Icons (for example, )</li> <li>• Missed call text or second incoming caller information</li> <li>• Prompt text (for example, "Saving config file!")</li> <li>• Time and date</li> </ul>
②	Power Indicator LED	Indicates phone power and some feature statuses. <ul style="list-style-type: none"> <li>• Receives an incoming call—Fast flashing</li> <li>• Receives a voice mail—Slow flashing</li> </ul>
③	Line Keys	<ul style="list-style-type: none"> <li>• Enable you to select a phone line</li> <li>• Answer incoming calls</li> <li>• Assign boss-admin feature</li> <li>• Assign multicast paging feature</li> </ul>
④	Soft Keys	Label automatically to identity their context-sensitive features.
⑤	   	Scroll through the displayed information.
		Confirms actions or answers an incoming call.
		Cancels actions, rejects incoming calls.
⑥	 (Mute Key)	Toggles the mute feature.
⑦	 (HEADSET Key)	Toggles the headset mode.
⑧	 (MESSAGE Key)	Accesses voice mails.
⑨	 (Redial Key)	Redials a previously dialed number.
⑩	Speakerphone Key	Toggles the hands-free speakerphone mode.
⑪	Volume Key	Adjusts the volume of the handset, headset, speakerphone and ringer.
⑫	Keypad	Provides the digits, letters, and special characters in context-sensitive applications.
⑬	Speaker	Provides hands-free (speakerphone) audio output.
⑭	Hookswitch Tab	Secures the handset in the handset cradle when the Skype for Business phone is mounted vertically. For more information on how to adjust the hookswitch tab, refer to <a href="#">Yealink Wall Mount Quick Installation Guide for SIP-T40 T41 T42 IP Phones</a>
⑮	Hookswitch	<ul style="list-style-type: none"> <li>• Picking up the handset from the handset cradle, the hookswitch bounces and the phone connects to the line.</li> <li>• Laying the handset down on the handset cradle, the phone disconnects from the line.</li> </ul>

## Icon Instructions

Icons appearing on the phone LCD screen are described in the following table:

Icon	Description
	Network is unavailable
	Sign in failed
	Signing in
	Hands-free speakerphone mode
	Handset mode
	Headset mode
	Voice Mail
	Auto Answer
	Call Forward/Forwarded Calls
	Call Hold
	Call Mute
	Ringer volume is 0
	Phone Lock
	Unread voice mail
	Read voice mail
	Received Calls
	Placed Calls
	Missed Calls

Icon	Description
	Optima HD voice
	Local contact
	Conference organizer
	Conference presenter
	Conference attendee
	Conference lock
	Available
	Busy
	Do Not Disturb
	Be Right Back/Off Work/Away
	Off Line
	Unknown

## LED Instructions

### Power Indicator LED

LED Status	Description
Solid red	The phone is initializing.
Fast flashing red (300ms)	The phone is ringing.
Slow flashing red(1s)	The phone receives a voice mail.
Off	The phone is powered off. The phone is idle. The phone is busy. The call is placed on hold or is held. The call is muted.

**The first line key LED (configured as a phone line)**

LED Status	Description
Solid green	The line is seized. The line is in conversation.
Fast flashing green	The line receives an incoming call.
Slow flashing green	The call is placed on hold.
Off	The line is inactive.

**The second line key LED (configured as a Boss/Admin key)**

LED Status	Description
Solid green	The boss or delegate is in conversation.
Solid green	The call is placed on hold.
Fast flashing green	The call is placed on hold by the other party (your boss or delegate).

**Note**

The above introduces the default power indicator LED status. The status of the power indicator LED is configurable via web user interface. For more information, refer to [Yealink\\_Skype\\_for\\_Business\\_HD\\_IP\\_Phones\\_Administrator\\_Guide](#).

## User Interfaces

Two ways to customize configurations of your T40P Skype for Business phone:

- The user interface on the Skype for Business phone
- The user interface in a web browser on your PC

The hardware components keypad and LCD screen constitute the phone user interface, which allows the user to execute all call operation tasks and basic configuration changes directly on the phone. In addition, you can use the web user interface to access all configuration settings. In many cases, either the phone user interface and/or the web user interface interchangeably. However, in some cases, it is only possible to use one or the other interface to operate the phone and change settings.

### Phone User Interface

You can customize your phone by pressing the **Menu** soft key to access the phone user interface. The **Settings->Advanced Settings** option is only accessible to the administrator, and the default administrator password is "admin" (case-sensitive). For more information on customizing your phone with the available options from the phone user interface, refer to [Customizing Your Phone](#) on page 33.

Menus are used to access information and configure the phone.

The figure below shows the phone's menus and submenus.

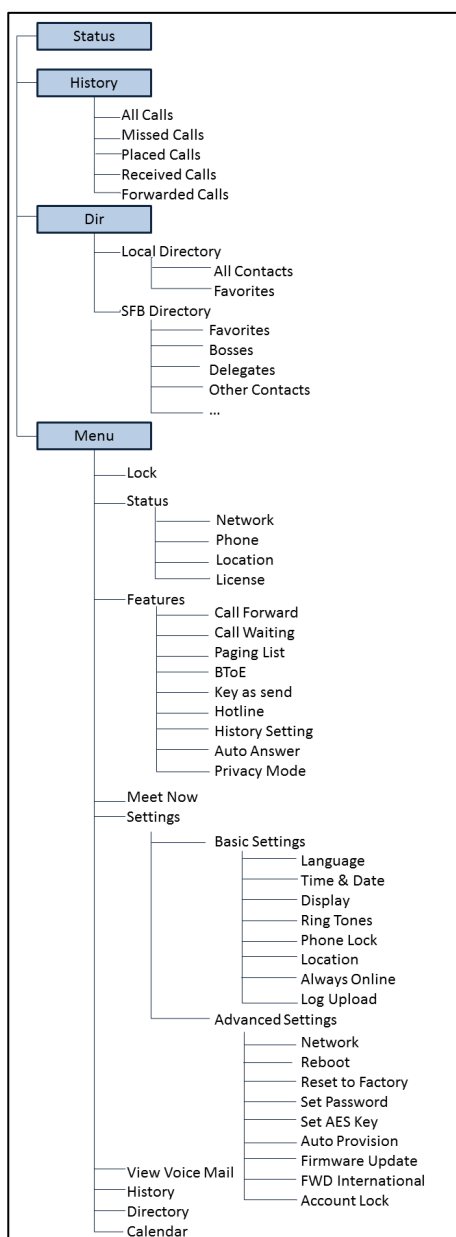

## Web User Interface

In addition to the phone user interface, you can also customize your phone via web user interface. In order to access the web user interface, you need to know the IP address of your new phone. To obtain the IP address, press **OK** on the phone. Enter the IP address (e.g., <http://192.168.0.10> or 192.168.0.10) in the address bar of the web browser on your PC. The default administrator user name and password are both "admin" (case-sensitive).



The main options you can use to customize the Skype for Business phone via phone user interface and/or via web user interface are listed in the following table:

Options	Phone User Interface	Web User Interface
<b>Status</b>		
--IP Address		
--MAC		
--Firmware	√	√
--Network		
--Phone		
--Location		
--License		
<b>Basic Phone Settings</b>		
--Contrast	√	
--Language	√	
--Time & Date	√	√
--Administrator Password	√	
--Key as Send	√	
--Phone Lock	√	
--Account Lock	√	
--Audio Settings		
--Volume	√	×
--Ring Tones	√	√
--Private Line Ring Tones	√	√
--Contact Management		
--Skype for Business Directory	√	×
--Local Directory	√	√
--Call History Management	√	√
--Headset Use		
--Headset Mode	√	×
--Headset Prior	×	
--Dual Headset	×	
--Calendar	√	
--Always Online	√	
--Log Upload	√	√
--E911 Location Tip	√	
--Dial-now	×	
--Live Dialpad	×	
--Hotline	√	
--Privacy Mode	√	×
<b>Basic Call Features</b>		
--Redialing Numbers	√	×
--Auto Answer	√	

Options	Phone User Interface	Web User Interface	
--Call Waiting	√	√	
--Call Mute	√	×	
--Call Hold/Resume	√		
--Call Forward	√		
--Call Transfer	√		
--Multicast Paging	√	√	
--BToE	√		
<b>Skype for Business Account</b>			
-- PIN Authentication		√	
--Extension	√		
--Extension PIN	√		
--User Sign-in			
--Sign in address	√		
--User	√		
--Password	√		
--Web Sign-in	√		
--Sign in via PC	√		×
--Remember Password	×		√

**Note**

The table above lists most of the feature options. Please refer to the relevant sections for more information.

## Documentations

The following table shows documentations available for the T40P Skype for Business phone.

Name	Contents	Where found	Language
Quick Start Guide	Basic call features and phone customizations	In the package/ On the website	English/Chinese
User Guide	Phone/Web user interface settings Basic call features and BToE (Better Together over Ethernet) feature	On the website	English/Chinese

**Note**

You can download the latest documentations online:

<http://support.yealink.com/documentFront/forwardToDocumentDetailPage?documentId=124>.

## Getting Started

This chapter provides basic installation instructions and information for obtaining the best performance with the T40P Skype for Business phone. Topics include:

- [Packaging Contents](#)
- [Phone Installation](#)
- [Phone Initialization](#)
- [Signing into Skype for Business](#)
- [Signing Out of Skype for Business](#)
- [Changing Presence Status](#)
- [Account Lock](#)
- [Entering Data and Editing Fields](#)
- [Phone Status](#)
- [Basic Network Settings](#)
- [Idle Screen](#)

If you require additional information or assistance with your new phone, contact your system administrator.

## Packaging Contents

The following components are included in your T40P Skype for Business phone package:

- **T40P Skype for Business Phone**

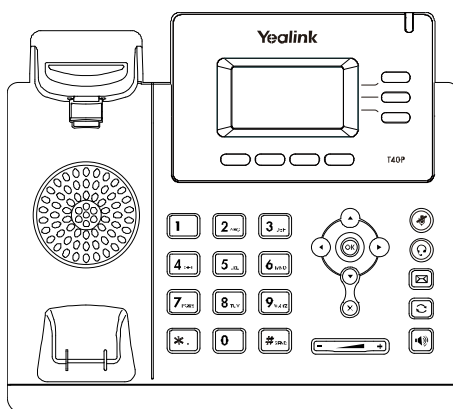

- **Phone Stand**

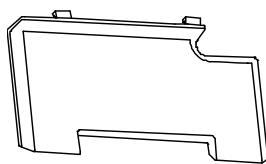

- **Handset & Handset Cord**

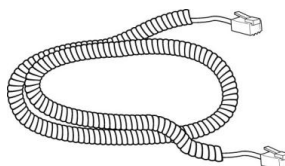
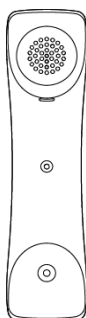

- **Ethernet Cable**

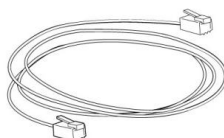

- **Quick Start Guide**



Check the list before installation. If you find anything missing, contact your system administrator.

## Optional Accessories

The following items are optional accessories for your T40P Skype for Business phone. You need to purchase them separately if required.

- **Power Adapter (5.5mm DC plug)**

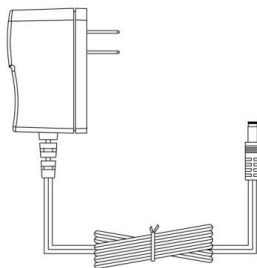

- **Wall Mount Bracket**

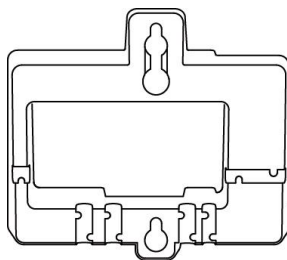

- **Headset**



- **Wireless Headset Adapter EHS36**



**Note**

We recommend that you use the accessories provided or approved by Yealink. The use of unapproved third-party accessories may result in reduced performance.

## Phone Installation

If your phone is already installed, proceed to [Phone Initialization](#) on page 15.

This section introduces how to install the phone:

- 1) Attach the stand or the optional wall mount bracket
- 2) Connect the handset and optional headset
- 3) Connect the power
- 4) Connect to the Network

### Attaching the Stand or the Optional Wall Mount Bracket

#### Desk Mount Method

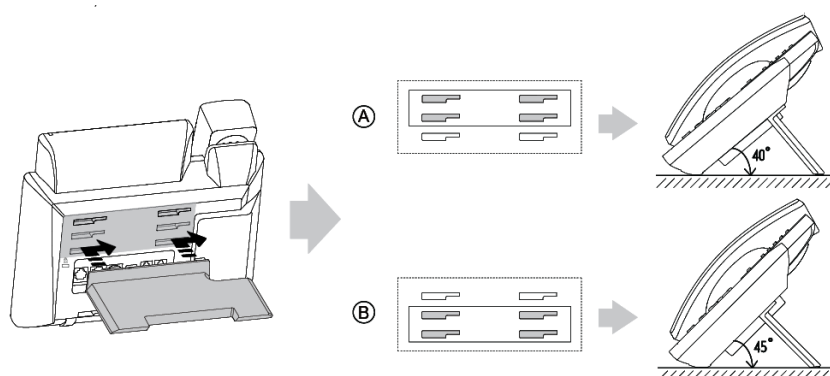

#### Wall Mount Method (Optional)

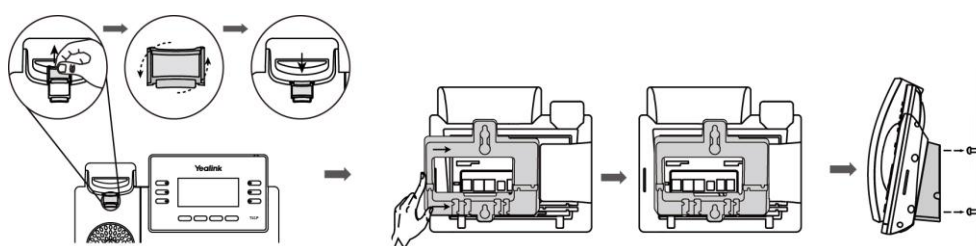

#### Note

The hookswitch tab has a lip which allows the handset to stay on-hook when the Skype for Business phone is mounted vertically.

For more information on how to attach the wall mount bracket, refer to [Yealink Wall Mount Quick Installation Guide for SIP-T40 T41 T42 IP Phones](#)

## Connecting the Handset and Optional Headset

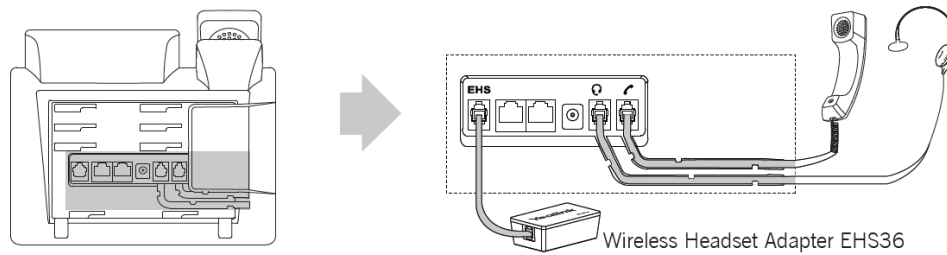

### Note

EHS36 is used for connecting the phone and a compatible wireless headset. For more information on how to use the EHS36, refer to [Yealink EHS36 User Guide](#).

## Connecting the Power

You have two options for power and network connections. Your system administrator will advise you which one to use.

- AC power
- Power over Ethernet (PoE)

### AC Power

#### To connect the AC power:

1. Connect the DC plug on the power adapter to the DC5V port on the phone and connect the other end of the power adapter into an electrical power outlet.

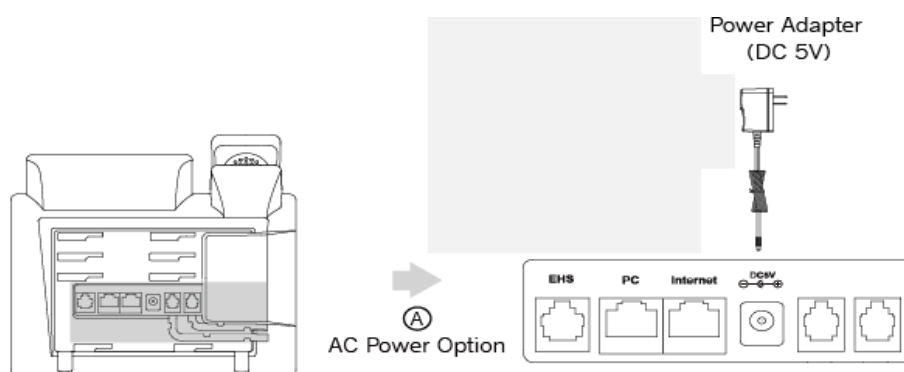

### Note

The Skype for Business phone should be used with Yealink original power adapter (5V/600mA) only. The use of the third-party power adapter may cause the damage to the phone.

## Power over Ethernet

With the included or a regular Ethernet cable, the T40P Skype for Business phone can be powered from a PoE-compliant switch or hub.

### To connect the PoE for the T40P Skype for Business phone:

1. Connect the Ethernet cable between the Internet port on the phone and an available port on the in-line power switch/hub.

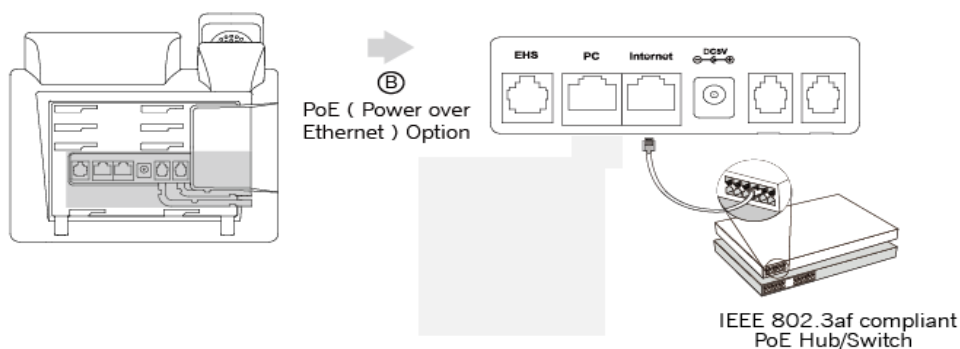

#### Note

If in-line power is provided, you don't need to connect the phone to the power adapter. Make sure the switch/hub is PoE-compliant.

**Important!** Do not remove power from the phone while it is updating firmware and configurations.

## Connecting to the Network

Connect your phone to the network.

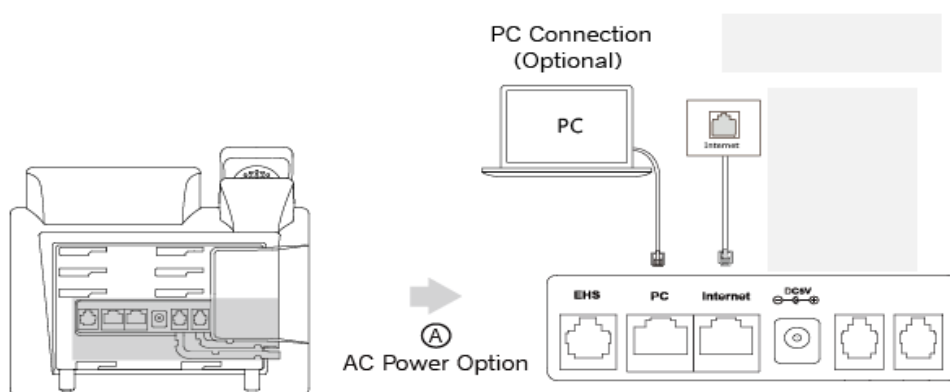

#### Note

The phone can also share the network with another network device such as a PC (personal computer). This is an optional connection. For more information on this function, contact your system administrator.



## Phone Initialization

After your phone is powered on, the system boots up and performs the following steps:

### Automatic Phone Initialization

The phone finishes the initialization by loading the saved configuration. The LCD screen displays "Welcome Initializing Please wait..." during the initialization.

### DHCP (Dynamic Host Configuration Protocol)

The phone attempts to contact a DHCP server in your network to obtain valid IPv4 network settings (e.g., IP address, subnet mask, default gateway address and DNS address) by default.

After the phone finishes the initialization, the sign-in screen appears on the LCD screen.

#### Note

If your network does not use DHCP, proceed to [Basic Network Settings](#) on page 29.

## Signing into Skype for Business

Skype for Business users are authenticated against Microsoft Active Directory Domain Service. The following four sign-in methods are available:

- **User Sign-in:** This method uses the user's credentials (sign-in address, user name, and password) to sign into Skype for Business Server. This sign-in method is applicable to Onprem account and Online account.
- **PIN Authentication:** This method uses the user's phone number (or extension) and personal identification number (PIN) to sign into Skype for Business Server. This sign-in method is only applicable to Onprem account.
- **Web Sign-in:** This method uses the unique website shown on the phone to sign in. This sign-in method is only applicable to Online account.
- **Sign in via PC:** when your phone is paired with your computer using Better Together over Ethernet (BToE), use the Skype for Business client to sign in. This sign-in method is applicable to Onprem account and Online account.

If the Skype for Business Server is configured to forcibly lock the phone. You need to configure an unlock PIN at the initial sign-in. For more information, refer to [Phone Lock](#) on page 38.

#### Note



If the phone reboots after successful login, the login credentials from the previous Sign-In will be cached. User can sign in successfully without reentering the credentials.

## User Sign-in

You can sign into Microsoft Skype for Business on your phone with your login credentials, which includes your address, username, and password. Your system administrator provides you with

your login credentials.

**To sign into Skype for Business Server using User Sign-in method via phone user interface:**

1. Press the **Sign in** soft key.
2. Press  or  to select **User Sign-in**.

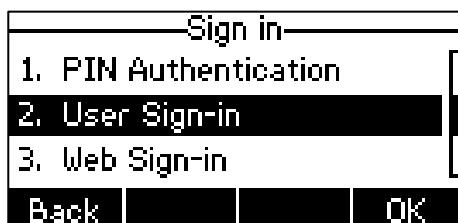

3. Enter your Skype for Business user's sign-in address (e.g., 2216@yealinkuc.com) in the **Sign in address** field.



4. Enter your Skype for Business user name (e.g., 2216@yealinkuc.com) in the **User** field.
5. Enter the sign-in password in the **Password** field.
6. Press the **Sign in** soft key.

**To sign into the Skype for Business Server using User Sign-in method via web user interface:**

1. Click on **Account->Register**.
2. Select **User Sign in** from the pull-down list of **Mode**.
3. Enter your Skype for Business user's sign-in address (e.g., 2216@yealinkuc.com) in the **Login address** field.
4. Enter your Skype for Business user name (e.g., 2216@yealinkuc.com) in the **Register Name** field.

- Enter the sign-in password in the **Password** field.



The screenshot shows the Yealink T40P web interface. The 'Account' tab is selected. The 'Mode' dropdown is set to 'User Sign in'. The 'Login address' field contains '2216@yealinkuc.com', the 'Register Name' field contains '2216@yealinkuc.com', and the 'Password' field is masked with dots. A 'Sign In' button is located at the bottom of the form.

- Click **Sign In** to accept the change.

## PIN Authentication

You can sign into Skype for Business on your phone with your PIN Authentication credentials. Your system administrator provides you with your PIN Authentication credentials.

**To sign into Skype for Business Server using PIN Authentication method via phone user interface:**

- Press the **Sign in** soft key.
- Press  or  to select **PIN Authentication**.

The screenshot shows a 'Sign in' menu on a phone. The menu items are: 1. PIN Authentication, 2. User Sign-in, and 3. Web Sign-in. At the bottom, there are 'Back' and 'OK' soft keys.

- Enter your phone number or extension (e.g., 2216) in the **Extension** field.

The screenshot shows a 'PIN Authentication' screen on a phone. It displays '1. Extension:' followed by a text input field containing '2216'. At the bottom, there are 'Back', '123', 'Delete', and 'Sign in' soft keys.

- Enter your PIN in the **Extension PIN** field.
- Press the **Sign in** soft key.

**To sign into the Skype for Business Server using PIN Authentication method via web user interface:**

- Click on **Account->Register**.

2. Select **Pin Authentication** from the pull-down list of **Mode**.
3. Enter your Skype for Business user's phone number or extension (e.g., 2216) in the **Extension** field.
4. Enter your personal identification number (e.g., user2216) in the **Pin** field.

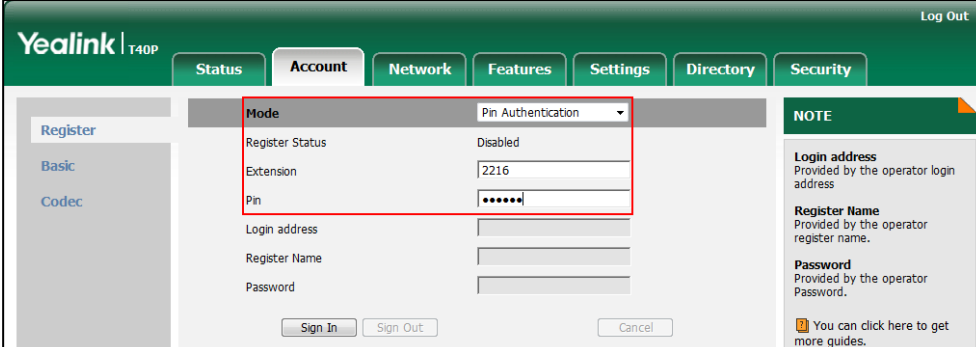

The screenshot shows the Yealink T40P web interface. The top navigation bar includes 'Status', 'Account', 'Network', 'Features', 'Settings', 'Directory', and 'Security'. The 'Account' tab is active. The 'Mode' dropdown is set to 'Pin Authentication'. The 'Extension' field contains '2216' and the 'Pin' field is masked with asterisks. Below these fields are 'Login address', 'Register Name', and 'Password' fields. At the bottom are 'Sign In', 'Sign Out', and 'Cancel' buttons. A 'NOTE' section on the right contains the following text:

**NOTE**

**Login address**  
Provided by the operator login address

**Register Name**  
Provided by the operator register name.

**Password**  
Provided by the operator Password.

 You can click here to get more guides.

5. Click **Sign In** to accept the change.

## Web Sign-in

You can sign into your Skype for Business Online account using the Web Sign-In method, which allows you to sign into the phone with your Skype for Business Online account using a web browser. Your system administrator provides you with your login credentials.

### To configure Web Sign-in method via web user interface:

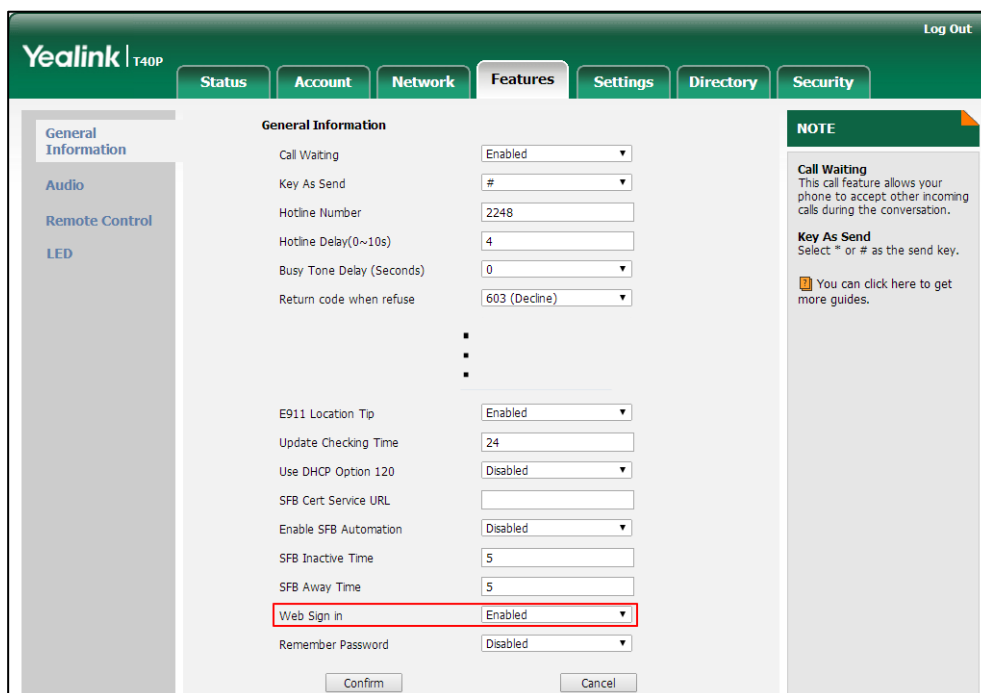

1. Click on **Features->General Information**.
2. Select the desired value from the pull-down list of **Web Sign in**.
  - If it is enabled, you can sign into the Skype for Business Server using Web sign-in method.

- If it is disabled, you cannot sign into the Skype for Business Server using Web sign-in method.



3. Click **Confirm** to accept the change.

**To sign into Skype for Business Server using Web Sign-in method via phone user interface:**

1. Press **Sign in** soft key.
2. Press  or  to select **Web Sign-in**.

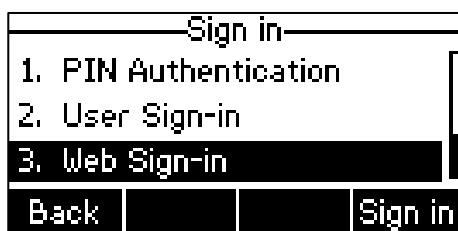

3. Press the **Sign in** soft key.  
The screen will show the pairing code and URL.

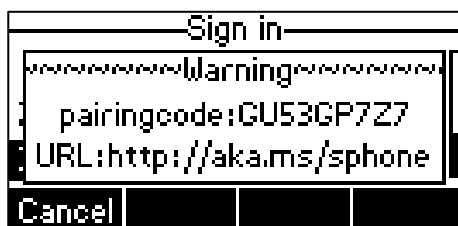

4. Enter the URL (e.g., http://aka.ms/sphone) into your web browser.
5. On the Skype for Business Authentication website, enter your email address (e.g.,

zhangdx@example.com) in the **Email address** field.

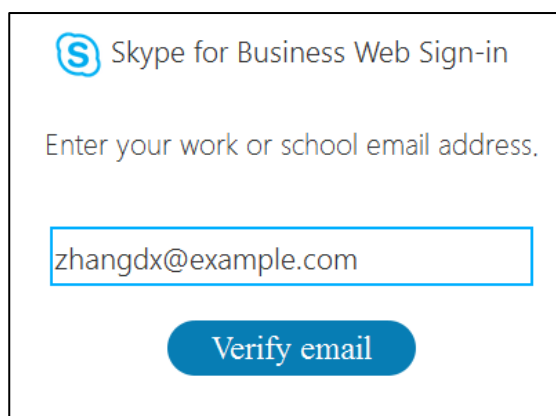

The image shows a web sign-in interface for Skype for Business. At the top left is the Skype logo (a blue 'S' in a circle) followed by the text 'Skype for Business Web Sign-in'. Below this is the instruction 'Enter your work or school email address.' A text input field contains the email address 'zhangdx@example.com'. At the bottom center is a blue button with the text 'Verify email'.

6. Click **Verify email** to check the validity of the email address.  
The sign-in screen will appear if the email address is valid.

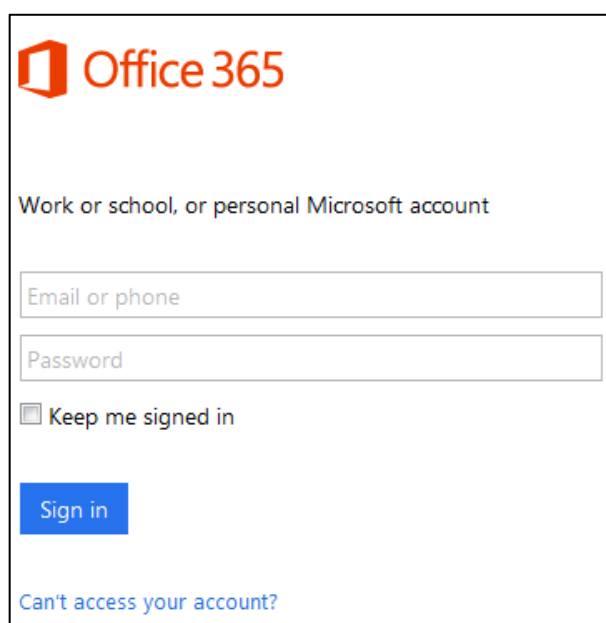

The image shows the Office 365 sign-in screen. At the top left is the Office 365 logo (an orange square with a white 'O') followed by the text 'Office 365'. Below this is the text 'Work or school, or personal Microsoft account'. There are two text input fields: the first is labeled 'Email or phone' and the second is labeled 'Password'. Below the input fields is a checkbox labeled 'Keep me signed in'. At the bottom left is a blue button with the text 'Sign in'. At the bottom center is a blue link that says 'Can't access your account?'.

7. Enter your Online account and password.
8. (Optional) Check the **Keep me signed in** checkbox, so that you don't need to enter a password next time.
9. Click **Sign in**.

10. Enter the pairing code (e.g., GU53GP27) in the **Code** field.

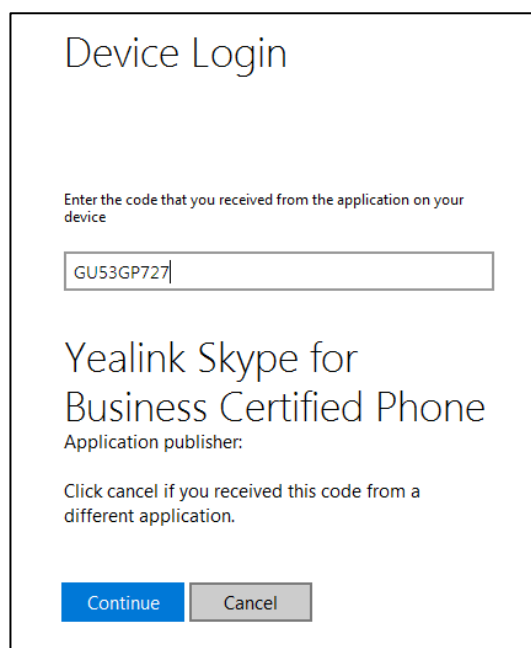

11. Click **Continue**.
12. Click the account to sign in.



A confirmation message is displayed when your phone successfully signs into Skype for Business.

## Signing in via PC

When your phone and your computer are paired using Better Together over Ethernet (BToE), you can sign into your phone using the Skype for Business client on your computer. For more information, refer to [Better Together over Ethernet](#) on page 149.

## Signing Out of Skype for Business

**To sign out of Skype for Business Server:**

1. Press the **Status** soft key.
2. Press  or  to select **Sign Out**.

The phone will sign out of Skype for Business server.

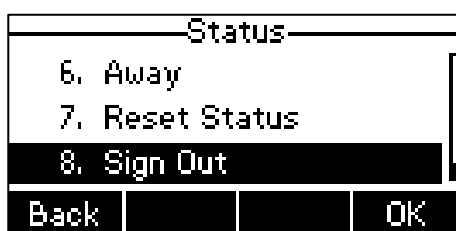

After you sign out of Skype for Business, the account-related features (calling, viewing Skype for Business contacts, calendar, etc.) are not available. However, you can still use other phone features.





Signing out via web user interface at the path: **Account->Register->Sign Out**.

## Changing Presence Status

After signing in successfully, your account and presence status display on the top-left corner of the screen by default.

User's presence information is constantly synchronized with Microsoft Skype for Business Server based on a variety of factors. However, you can change your presence information manually on the phone. For example, when you are busy with urgencies, you can change your status to Do Not Disturb to avoid being disturbed.



The following table lists the status that the contact can change on the phone:

Icon	Status	Description
	Available	The contact is online and available to contact.
	Busy	The contact is available but engaged in another activity. Those activities include: <ul style="list-style-type: none"> <li>• In a call</li> <li>• In a conference</li> </ul>
	Do Not Disturb	If the contact doesn't want to be disturbed and DND is activated, callers will hear a tone indicating that the contact's phone is busy. The incoming call will be forwarded to contact's voice mail directly. The contact can receive calls from the work group only.
	Be Right Back	The contact is engaged in another activity and will return shortly.
	Off Work	The contact is not working and not available to contact.
	Away	The contact is probably not available. This status is displayed for the following reasons: <ul style="list-style-type: none"> <li>• The contact's phone has been idle for more than the idle time period setting—10 minutes by default.</li> <li>• The contact's Microsoft Office Outlook calendar indicates that the contact is out of the office.</li> <li>• The contact is temporarily unavailable. As soon as activity is detected on the contact's phone,</li> </ul>



Icon	Status	Description
		Microsoft Skype for Business Server automatically resets the presence status to Available.



#### To change your presence status:

1. Press the **Status** soft key.
2. Press  or  to highlight the desired status.



3. Press the **OK** soft key to accept the change.  
The presence status will be changed on the phone and be synchronized to the Skype for Business Server.

#### To reset your presence status to the default:

1. Press the **Status** soft key.
2. Press  or  to highlight **Reset Status**.

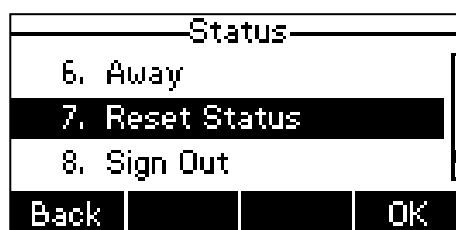



3. Press the **OK** soft key to accept the change.  
Your status is reset to "Available".

## Always Online

Always online feature can maintain current status of the phone until you manually change status. For example, the current status of the phone is available, if the always online feature is enabled, then the phone status will stay available until you manually change it. You can configure this feature via phone user interface or web user interface.

#### To enable the always online via phone user interface:

1. Press **Menu->Settings->Basic Settings->Always Online**.

2. Press  or , or the **Switch** soft key to select **Enabled** from the **Always Online** field.

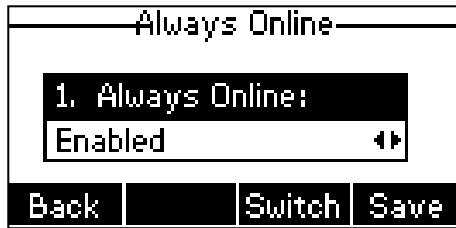

3. Press the **Save** soft key to accept the change or the **Back** soft key to cancel.

Always online is configurable via web user interface at the path **Account->Basic->Always Online**.

**Note**



If your phone status is DND before dialing an emergency number, then the phone status will be changed to available after the emergency call even if always online feature is enabled. For more information on emergency call, refer to [Emergency Call](#) on page 69.

## Account Lock

You can lock your account to prevent your account being signed in or signed out randomly. If account lock feature is enabled, users are prompted for administrator password to sign in or sign out. Note that if you sign into Skype for Business Server using **User Web Sign-in** or **Sign in via PC** method, account lock feature is not applicable.

Account lock feature is disabled by default. You can configure it via phone user interface or web user interface.

**To configure the account lock feature via phone user interface:**

1. Press **Menu->Settings->Advanced Settings** (default password: admin) ->**Account Lock**.
2. Press  or , or the **Switch** soft key to select **Enabled** from the **Account Lock** field.

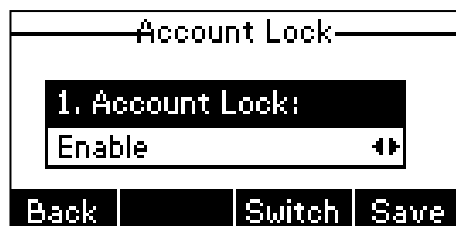

3. Press the **Save** soft key to accept the change or the **Back** soft key to cancel.

Account lock is configurable via web user interface at the path **Account->Basic->Account Lock**.

**To sign out when account lock is enabled via phone user interface:**

1. Press the **Status** soft key.

2. Press  or  to select **Sign Out**.

The screen will be shown as below:



3. Enter the administrator password.
4. Press the **OK** soft key to sign out.

**To sign in when account lock is enabled via phone user interface:**

1. Press the **Sign in** soft key.
2. Select the desired sign-in method.
3. Enter the authentication information in the corresponding field respectively.
4. Press the **Sign in** soft key.

The screen will be shown as below:



5. Enter the administrator password.
6. Press the **OK** soft key.
  - If phone lock feature is enabled, you will enter the unlock PIN settings screen.
  - If phone lock feature is disabled, you will sign in successfully.













For more information on phone lock, refer to [Phone Lock](#) on page 38.

## Entering Data and Editing Fields

You can enter data and edit fields using the phone keypad.

Keypad on the phone can provide different characters when using the **abc**, **ABC** or **123** input mode. You can change the following input modes to enter data and edit fields on your phone. When your phone keypad matches the input mode, you can press the keypad repeatedly to view the character (or number) options and stop to select. When the character (or numbers) you want to enter displays in the field, wait one second, and enter the next character (or number).













The following table lists the input modes and character (or numbers) options for the keypad:

Input Mode Keypad	abc	ABC	123
			1
	abc2äæåàáâãäåç	ABC2ÄÆÅÀÁÂÃÄÅÇ	2
	def3èéêëèð	DEF3ÈÉÊËÈÐ	3
	ghi4íîï	GHI4ÌÍÎ	4
	jkl5£	JKL5£	5
	mno6öøóóôõñ	MNO6ÖØÓÓÔÕÑ	6
	pqrs7ßŠ	PQRS7Š	7
	tuv8ùúûü	TUV8ÙÚÛÜ	8
	wxyz9ýþ	WXYZ9ÝÞ	9
	space	space	0
	*.,?!\\-()@/:_~+&%=< > £ \$¥¤[]{}~^!;§#"	*.,?!\\-()@/:_~+&%=< > £ \$¥¤[]{}~^!;§#"	*.@+\\:
	#	#	#

**To enter or edit data:**

Do one of the following:

If you want to	Then you can
Enter only digits (1), uppercase (A) characters, or lowercase (a) characters.	<p>Press a keypad key one or more times (depending what input mode you're in) to enter the characters that is displayed on the keypad key.</p> <p>You can press the <b>abc</b> soft key one or more times to switch among uppercase (<b>ABC</b> soft key), numeric (<b>123</b> soft key) and lowercase (<b>abc</b> soft key) input modes.</p> <p>For example, if the input mode is <b>ABC</b>:</p> <ul style="list-style-type: none"> <li>- To enter "A", press  once.</li> </ul>

If you want to	Then you can
	<ul style="list-style-type: none"> <li>- To enter "B", press  twice quickly.</li> <li>- To enter "C", press  three times quickly.</li> <li>- To enter "2Ä/ÈÀÀÀÀÇ", press  more than three times quickly.</li> </ul> <p><b>Note:</b> When you are in the uppercase (<b>ABC</b> soft key) or lowercase (<b>abc</b> soft key) input mode,  is not available.</p>
Enter special characters.	<p>Press the keypad key  or , or long press .</p> <p><b>For  Key:</b></p> <ul style="list-style-type: none"> <li>- If it is the uppercase (<b>ABC</b> soft key) or lowercase (<b>abc</b> soft key) input mode, it will provide the space character.</li> <li>- If it is the numeric (<b>123</b> soft key) input mode, it will only provide the digit 0.</li> <li>- Long press  on the pre-dialing screen will provide the special character "+".</li> </ul> <p><b>For  key:</b></p> <ul style="list-style-type: none"> <li>- It only provides the pound character "#".</li> </ul> <p><b>For  key:</b></p> <ul style="list-style-type: none"> <li>- If it is the uppercase (<b>ABC</b> soft key) or lowercase (<b>abc</b> soft key) input mode, it will provide the following special characters:  <code>*.,?!\\-()@/,:;+&amp;!%=&lt;&gt;£\$¥¤□[]{}~^_`¡¢£\$%&amp;'()*+,-./:;&lt;br&gt; </code></li> <li>- If it is the numeric (<b>123</b> soft key) input mode, it will provide the following special characters:  <code>*.@+\\.:&lt;br&gt; </code></li> </ul>
Delete text you entered.	<p>Press  or  to position the cursor to the right of the text you want to delete, and then press the <b>Delete</b> soft key to delete one character at a time.</p>

## Phone Status

You can view the phone status via phone user interface or web user interface.

Available information of phone status includes:



- Network status (e.g., IPv4 status, IP mode, MAC address)
- Phone status (e.g., product name, hardware, firmware, product ID, MAC address and device certificate status)

- Location information (location is set to assist emergency responder)
- License (device license status)

**To view the phone status via phone user interface:**

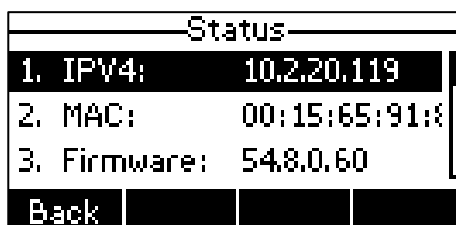
1. Press , or press **Menu->Status**.



2. Press  or  to scroll through the list and view the specific information.

**To view the phone status via web user interface:**

1. Open the web browser on your PC.
2. Enter the IP address in the browser's address bar, and then press the **Enter** key.
3. Enter the user name (admin) and password (admin) in the login page.



4. Click **Confirm** to login.

The phone status is displayed on the first page of the web user interface.

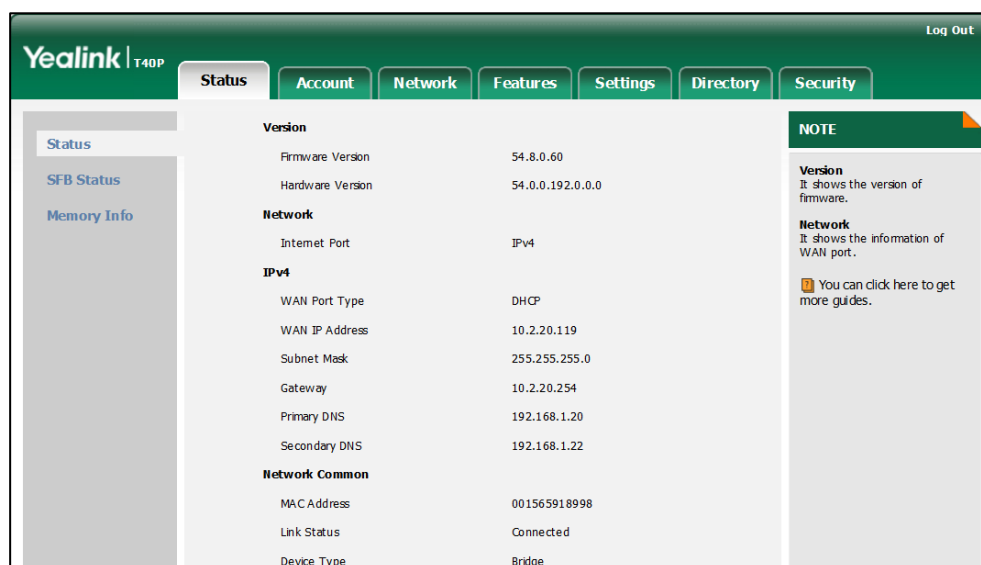

## Basic Network Settings

If your phone cannot contact a DHCP server for any reason, you need to configure network settings manually. The Skype for Business phone supports three IP modes: **IPv4**, **IPv6** and **IPv4&IPv6**.

**To configure the IP mode via phone user interface:**

1. Press **Menu**->**Settings**->**Advanced Settings** (default password: admin)  
->**Network**->**WAN Port**.
2. Press **◀** or **▶** to select **IPv4**, **IPv6** or **IPv4 & IPv6** from the **IP Mode** field.

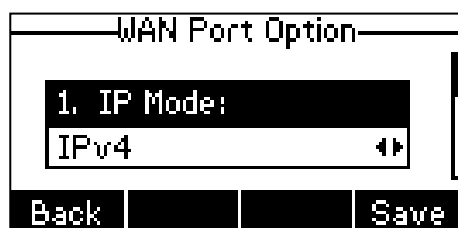

3. Press the **Save** soft key to accept the change or the **Back** soft key to cancel.

You can configure a static IPv4 address for the Skype for Business phone. Before configuring it, make sure that the IP mode is configured as **IPv4** or **IPv4 & IPv6**.

**To configure a static IPv4 address via phone user interface:**

1. Press **Menu**->**Settings**->**Advanced Settings** (default password: admin)  
->**Network**->**WAN Port**.
2. Press **▼** to select **IPv4**, and then press the **Enter** soft key.
3. Press **▼** to select **Static IPv4 Client**, and then press the **Enter** soft key.

4. Enter the desired value in the **IPv4, Subnet Mask, Default Gateway, IPv4 Pri.DNS** and **IPv4 Sec.DNS** field respectively.

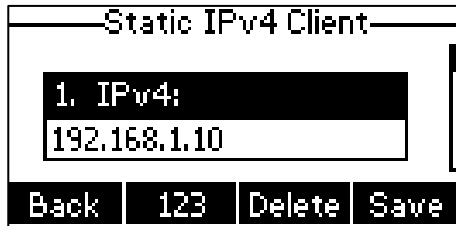

5. Press the **Save** soft key to accept the change or the **Back** soft key to cancel.

You can configure a static IPv6 address for the Skype for Business phone. Before configuring it, make sure that the IP mode is configured as **IPv6** or **IPv4 & IPv6**.

**To configure a static IPv6 address via phone user interface:**

1. Press **Menu->Settings->Advanced Settings** (default password: admin)  
->**Network->WAN Port**.
2. Press **↶** to select **IPv6**, and then press the **Enter** soft key.
3. Press **↷** to select **Static IPv6 Client**, and then press the **Enter** soft key.
4. Enter the desired value in the **IPv6 IP, IPv6 IP Prefix, IPv6 Default Gateway, IPv6 Pri.DNS** and **IPv6 Sec.DNS** field respectively.

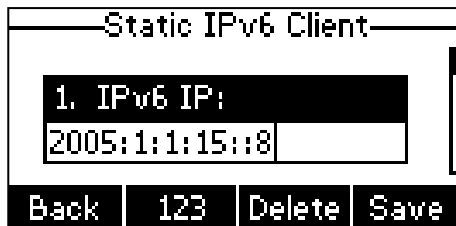

5. Press the **Save** soft key to accept the change or the **Back** soft key to cancel.

**Note**

Wrong network settings may result in inaccessibility of your phone and may also have an impact on your network performance. For more information on these network parameters, contact your system administrator.



## Idle Screen

If the phone is successfully started up, and a Skype for Business user signs into the Skype for Business Server on the phone, the idle screen will be shown as below:



The idle screen displays the label of presence icon, user name, time and date, current account, and four soft keys.



## Customizing Your Phone

---

You can customize your T40P Skype for Business phone by personally configuring certain settings, for example, contrast, time & date, ring tones and E911. You can also manage the contacts and call history.

This chapter provides basic operating instructions for customizing your phone. Topics include:

- [General Settings](#)
- [Audio Settings](#)
- [Contact Management](#)
- [Call History Management](#)
- [Headset Use](#)
- [E911](#)
- [Dial-now](#)
- [Live Dialpad](#)
- [Hotline](#)
- [Privacy Mode](#)



If you require additional information or assistance with your new phone, contact your system administrator.

## General Settings

### Contrast

You can configure the LCD screen contrast to a comfortable level. The intensity of contrast ranges from 1 to 10 and the highest intensity is 10.

**To configure the contrast via phone user interface:**

1. Press **Menu->Settings->Basic Settings->Display->Contrast**.
2. Press  or  , or the **Switch** soft key to increase or decrease the intensity of contrast.

The default contrast level is "6".

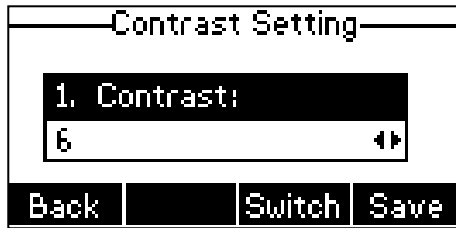



3. Press the **Save** soft key to accept the change or the **Back** soft key to cancel.

Contrast is configurable via web user interface at the path **Settings->Preference->Contrast**.

## Language

The default language of the phone user interface is English. If the language of your web browser is not supported by the phone, the web user interface will use English by default. You can change the language for the phone user interface and the web user interface respectively.

### To change the language for the phone user interface:

1. Press **Menu->Settings->Basic Settings->Language**.
2. Press  or  to select the desired language.



3. Press the **Save** soft key to accept the change.

Text displayed on the phone user interface will change to the selected language.

### To change the language for the web user interface:

1. Click on **Settings->Preference**.
2. Select the desired language from the pull-down list of **Language**.

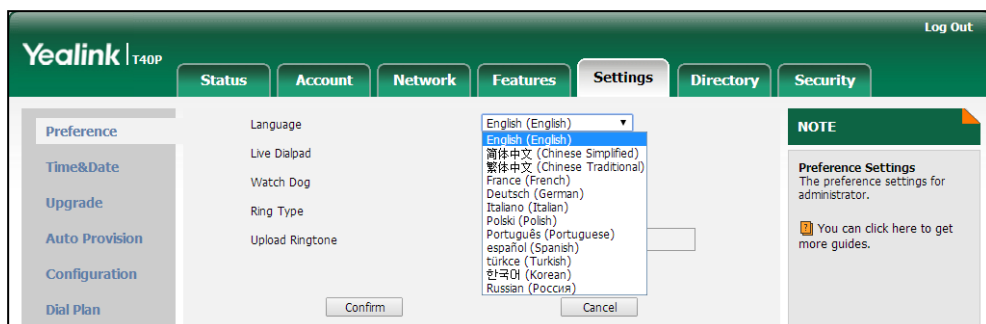



3. Click **Confirm** to accept the change.

Text displayed on the web user interface will change to the selected language.

## Time and Date





The time and date are displayed on the LCD screen when the phone is idle. You can configure the phone to obtain the time and date from the SNTP server automatically, or configure the time and date manually. If the phone cannot obtain the time and date from the Simple Network Time Protocol (SNTP) server, contact your system administrator for more information.

### To configure the SNTP settings via phone user interface:

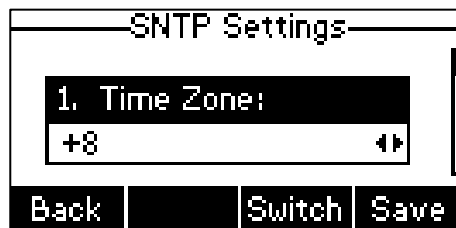
1. Press **Menu**->**Settings**->**Basic Settings**->**Time & Date**->**SNTP Settings**.
2. Press  or , or the **Switch** soft key to select the time zone that applies to your area from the **Time Zone** field.

The default time zone is "+8".



3. Enter the domain names or IP addresses of SNTP servers in the **NTP Server1** and **NTP Server2** field respectively.
4. Press  or , or the **Switch** soft key to select the desired value from the **Daylight Saving** field.
5. Press  or , or the **Switch** soft key to select the desired time zone name from the **Location** field.  
This field appears only if **Daylight Saving** field is selected as **Automatic**.  
The default time zone name is "China(Beijing)".
6. Press the **Save** soft key to accept the change or the **Back** soft key to cancel.

### Note

Please refer to [Appendix A - Time Zones](#) for the list of available time zones on the Skype for Business phone.

### To configure the time and date manually via phone user interface:

1. Press **Menu**->**Settings**->**Basic Settings**->**Time & Date**->**Manual Settings**.
2. Enter the specific date in the **Date(YMD)** field.

3. Enter the specific time in the **Time(HMS)** field.

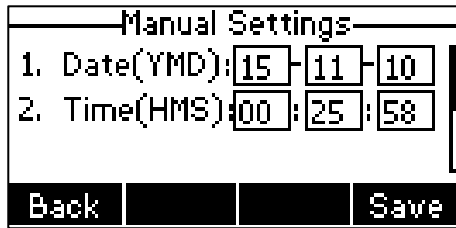

4. Press the **Save** soft key to accept the change.

The time and date displayed on the LCD screen will change accordingly.

**To configure the date and time format via phone user interface:**

1. Press **Menu->Settings->Basic Settings->Time & Date->Time & Date Format**.
2. Press or , or the **Switch** soft key to select the desired time format (**12 Hour** or **24 Hour**) from the **Time Format** field.
3. Press or , or the **Switch** soft key to select the desired date format from the **Date Format** field.

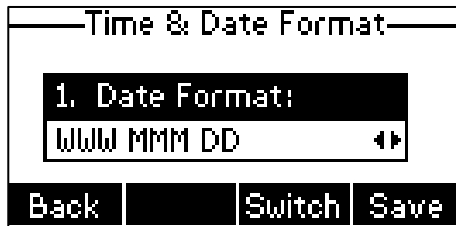

4. Press the **Save** soft key to accept the change or the **Back** soft key to cancel.

There are 7 available date formats. For example, for the date format "WWW DD MMM", "WWW" represents the abbreviation of the week, "DD" represents the two-digit day, and "MMM" represents the first three letters of the month.

The date formats available:

Date Format	Example (2016-8-19)
WWW MMM DD	Fri Aug 19
DD-MMM-YY	19-Aug-16
YYYY-MM-DD	2016-08-19
DD/MM/YYYY	19/08/2016
MM/DD/YY	08/19/16
DD MMM YYYY	19 Aug 2016
WWW DD MMM	Fri 19 Aug

Time and date format is configurable via web user interface at the path **Settings->Time & Date**.

## Administrator Password

The **Advanced Settings** option is only accessible to the administrator. The default administrator password is "admin". For security reasons, you should change the default administrator password as soon as possible.

### To change the administrator password via phone user interface:

1. Press **Menu**->**Settings**->**Advanced Settings** (default password: admin)->**Set Password**.
2. Enter the current password in the **Current PWD** field.

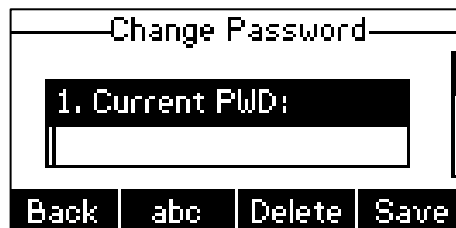

3. Enter the new password in the **New PWD** field.
4. Enter the new password again in the **Confirm PWD** field.
5. Press the **Save** soft key to accept the change or the **Back** soft key to cancel.

Administrator password is configurable via web user interface at the path **Security**->**Password**.

## Key as Send

You can set the "#" key or "\*" key to perform as a send key while dialing.

### To configure key as send via phone user interface:

1. Press **Menu**->**Features**->**Key as send**.
2. Press  $\leftarrow$  or  $\rightarrow$ , or the **Switch** soft key to select # or \* from the **Key as send** field, or select **Disabled** to disable this feature.

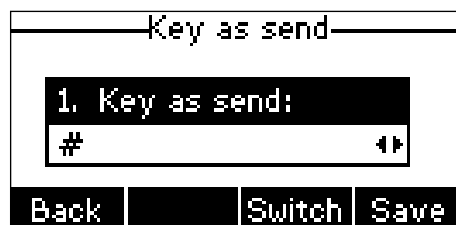

3. Press the **Save** soft key to accept the change or the **Back** soft key to cancel.

Key as send is configurable via web user interface at the path **Features**->**General Information**->**Key as send**.

## Phone Lock

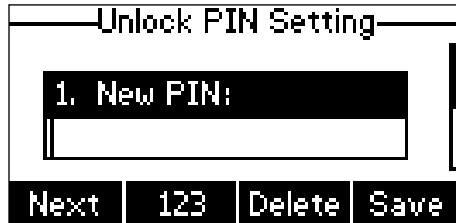

If the Skype for Business Server is configured to forcibly lock the phone, user can use phone lock feature to lock the phone to prevent it from unauthorized use. And the Skype for Business phone will prompt the user to configure an unlock PIN at the initial sign-in.



### To set unlock PIN:

1. Enter the unlock PIN (PIN's length must be from 6 to 15) in the **New PIN** field.
2. Press the **Next** soft key, and then enter the unlock PIN again in the **Confirm PIN** field.
3. Press the **Save** soft key.

When the unlock PIN is configured successfully, you can do one of the following to lock your phone.

- Long press  for two seconds to lock the phone immediately when the phone is idle.
- Press **Menu**->**Lock**.
- Press **Menu**->**Settings**->**Basic Settings**->**Phone Lock**.  
Press  or  to select **Lock the phone**, and then press the **OK** soft key.
- The phone will be locked automatically when it has been inactive for the designated time (in seconds). The time is configurable on the Skype for Business Server only.

When the phone is locked, an icon  appears on the idle screen..

### When the locked phone is making a call:

- You can pick up the handset or press the line key or press the speakerphone key to enter the pre-dialing screen.
- You can press the **Emerg** soft key to select an emergency number.
- When the parameter **DisableHandsetOnLockedMachine** is set to **True** on the Skype for Business Server, the locked phone can only place an emergency call and cannot make other outgoing calls.

When the parameter **DisableHandsetOnLockedMachine** is set to **False** on the Skype for Business Server, the locked phone can place an emergency call and other outgoing call.

By default the locked phone can only place an emergency call and cannot make other outgoing calls.

- You cannot search contacts on the pre-dialing screen.



**When the locked phone is idle:**

Line keys, digit keys, # key, \* key, volume key, headset key and speakerphone key are available and other keys on the phone are locked.

**When the locked phone receives an incoming call:**

You can answer, reject or mute the incoming calls only.



**When the locked phone engages in a call:**

You can place the call on hold, end the call or dial emergency numbers (whether the phone can make other outgoing calls depends on the value of **DisableHandsetOnLockedMachine**) only.

**Note**

Phone status will change to Away after the phone is locked and the phone will revert to previous status when unlocked. For more information, refer to [Changing Presence](#) on page 22.

**To change the phone unlock PIN via phone user interface:**

1. Press **Menu->Settings->Basic Settings->Phone Lock**.
2. Press  or  to select **Change PIN**.

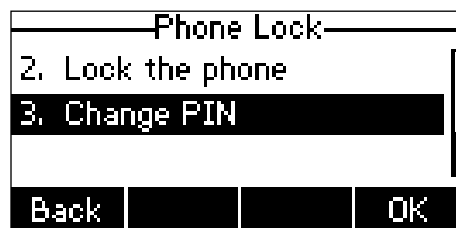

3. Press the **OK** soft key.
4. Enter current PIN in the **Current PIN** field.



5. Enter the new unlock PIN in the **New PIN** field.
6. Enter the new unlock PIN again in the **Confirm PIN** field.
7. Press the **Save** soft key to change the unlock PIN.

Unlock PIN is configurable via web user interface at the path **Settings->Phone Lock**.



**Note**

Rebooting a phone will make you configure the unlock PIN again.

**To unlock the phone via phone user interface:**

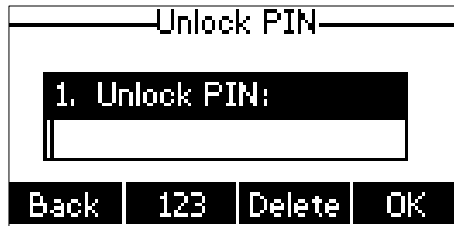
1. Press the **Unlock** soft key or any locked key, the LCD screen will prompt you to enter unlock PIN.





2. Enter the PIN in the **Unlock PIN** field.
3. Press the **OK** soft key or  to unlock the phone.  
The icon  disappears from the idle screen. You can lock the phone again.

**Note**

You can also unlock the phone by administrator password.

**To disable the phone lock feature via web user interface:**

1. Press **Menu->Settings->Basic Settings->Phone Lock**.
2. Press  or , or the **Switch** soft key to select **Disabled** from the **Phone Lock** field.

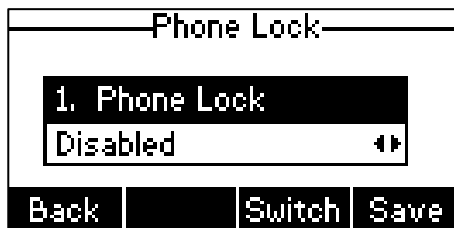

3. Press the **Save** soft key to accept the change.  
The phone user interface prompts "Reboot now?".
4. Press **OK** soft key.  
The phone lock feature will be disabled after a reboot.

Phone lock is configurable via web user interface at the path **Settings->Phone Lock**.

## Remembering Password

You can enable the remember password feature, so that a **Remember Password** option will appear at the phone login screen.

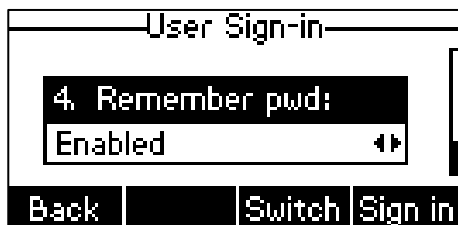

(User Sign-in method)

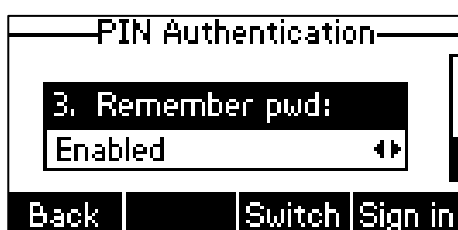

(PIN Authentication method)

Remember password feature is disabled by default, and it is configurable via web user interface only.

**To configure remembering password feature via web user interface:**

1. Click on **Features->General Information**.
2. Select **Enabled** from the pull-down list of **Remember Password**.

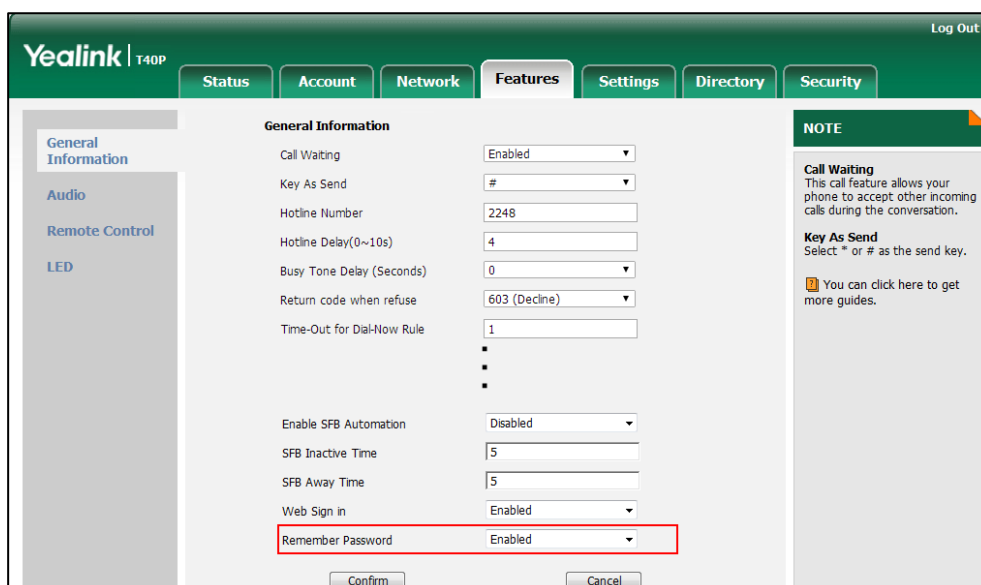

3. Click **Confirm** to accept the change.

A dialog box pops up to prompt you that this configuration will take effect after a reboot.

4. Click **OK** to reboot the phone.

## Audio Settings

### Volume

You can press the Volume key to adjust the ringer volume when the phone is idle or is ringing. You can also press the Volume key to adjust the receiver volume of currently engaged audio device (handset, speakerphone or headset) when the phone is in use.

#### To adjust the volume when the phone is idle:

1. Press  to adjust the ringer volume.



#### Note

If the ringer volume is adjusted to minimum, the  icon will appear on the LCD screen.

#### To adjust the volume when the phone is ringing:

1. Press  to adjust the ringer volume.

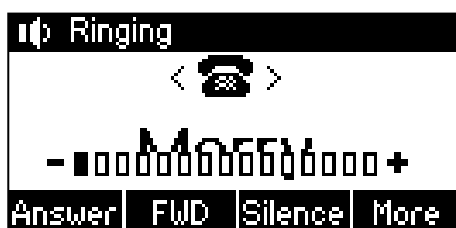

#### To adjust the volume when the phone is during a call:

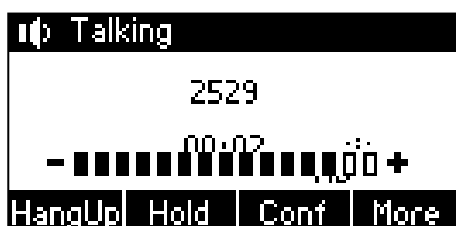

1. Press  to adjust the volume of the currently engaged audio device (handset, speakerphone or headset).



## Ring Tones

Ring tones are used to indicate incoming calls and distinguish your phone from your neighbor's.

**To select a ring tone for the phone via phone user interface:**

1. Press **Menu->Settings->Basic Settings->Ring Tones->Common.**
2. Press  or  to select the desired ring tone.



3. Press the **Save** soft key to accept the change or the **Back** soft key to cancel.

A ring tone for the phone is configurable via web user interface at the path **Settings->Preference->Ring Type.**

**To upload a custom ring tone for the phone via web user interface:**

1. Click on **Settings->Preference.**
2. In the **Upload Ringtone** field, Click **Browse...** to locate a ring tone file (the file format must be .wav) from your local system.

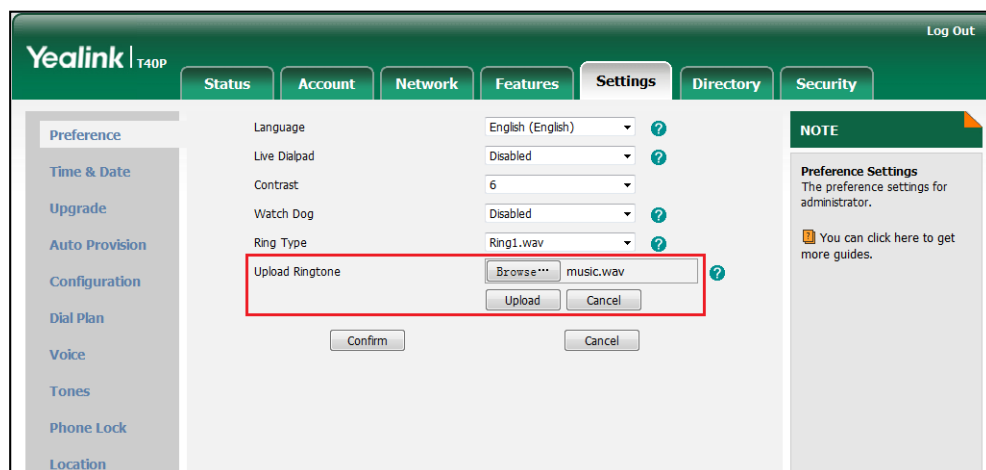

3. Click **Upload** to upload the file.

The custom ring tone appears in the pull-down list of **Ring Type.**

### Note

The priority of ring tone for an incoming call on the phone is as follows: Contact ring tone (refer to [Adding Local Contacts](#))->Phone ring tone.

Both single custom ring tone file and total custom ring tone files must be within 100KB. Uploading custom ring tones for your phone is configurable via web user interface only.

## Contact Management

The phone directory list displays local directory and Skype for Business directory. You can view contact information on the phone.

### Note

Skype for Business Server and Exchange Server are integrated. You can search Outlook contacts on your phone. For more information, refer to [Searching for Contacts](#) on page 59.

## Skype for Business Directory

The Skype for Business directory on your phone displays all Skype for Business contacts of your Microsoft Skype for Business client. You can store up to 50 Skype for Business contacts in your phone's Skype for Business directory. You can view Skype for Business contacts on the phone, but you cannot add, edit or delete Skype for Business contacts on the phone.

## Adding Skype for Business Contacts

### To add contacts via Skype for Business client:

1. Enter a few continuous characters of the contact name or continuous numbers of the contact number in the Search field.

The contacts whose name or phone number matches the characters entered will appear in your contacts list.

2. Right-click the contact, and then click **Add to Contacts List**.

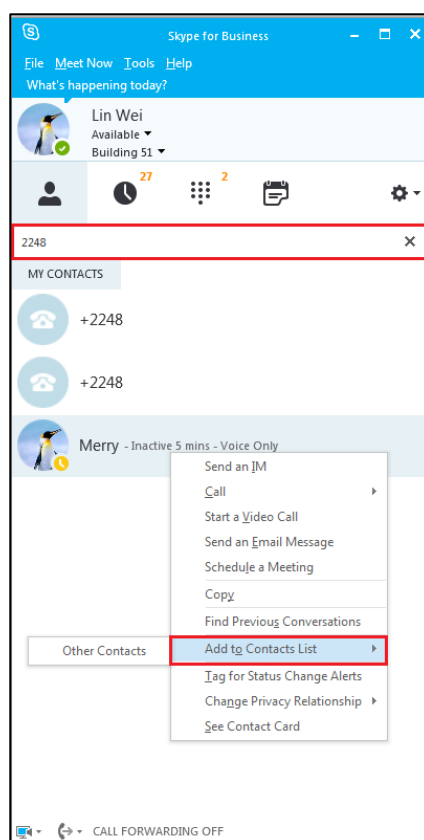

3. Select the desired group.  
The contact is added to the selected group.

## Viewing Skype for Business Contacts

You can view the following information about each contact on the phone:

- The contact's presence icon
- The contact's name
- The detailed information of the contact (e.g., name, mail address)

### Note

For more information on the presence icon, refer to [Icon Instructions](#) on page 3.

**To view the Skype for Business contacts:**

1. Press **Dir**->**SFB Directory**.



2. Press or to select the desired group.
3. Press the **Enter** soft key.

Each contact is displayed with a presence icon.

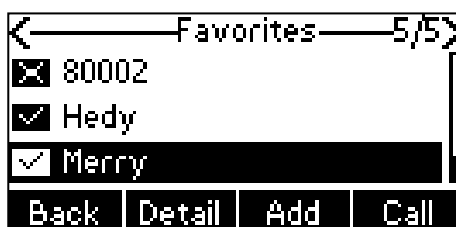

4. Press or to highlight the desired contact.
5. Press the **Detail** soft key to view more information about the contact.
6. Press or to scroll through the information.

The detailed information (e.g., name, status, address and email) of the contact appears on the LCD screen.



## Skype for Business Favorites

You can add your Skype for Business contacts as favorites via your Skype for Business client only. You can view Skype for Business favorites on the phone.

### Adding Skype for Business Favorites

**To add contacts as favorites via Skype for Business client:**

1. Right-click a contact.



2. Click **Add to Favorites**.

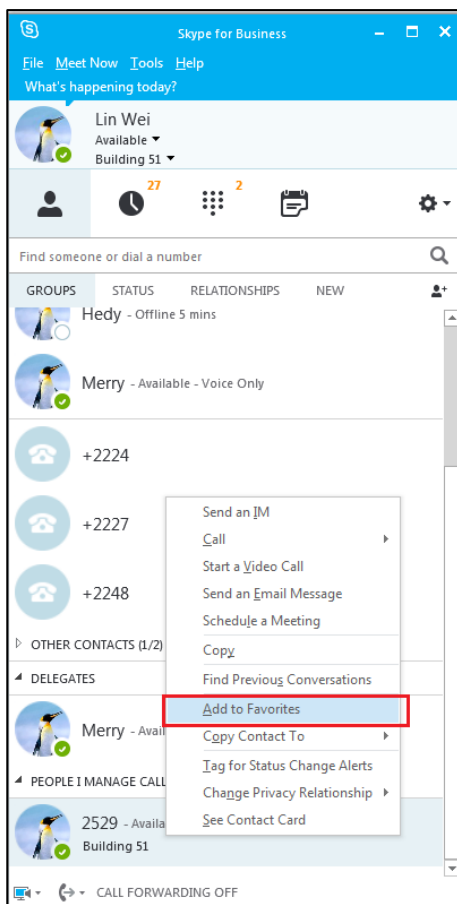

### Viewing Skype for Business Favorites

To view the Skype for Business favorites:

1. Press **Dir**->**SFB Directory**->**Favorites**.

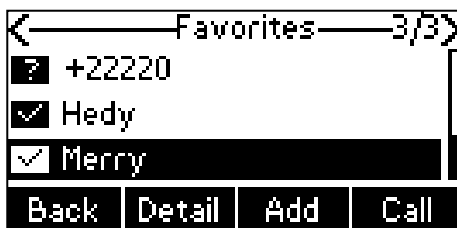

2. Press **▲** or **▼** to highlight the desired contact.
3. Press the **Detail** soft key to view more information about the contact.

The detailed information (e.g., display name, status, address or email) of the contact appears on the screen.

Merry	
Status:	Available
Address:	2248@yealink
Email:	2248@yealink
Back	

## Local Directory

Yealink Skype for Business phones also maintain a local directory. The local directory can store up to 1000 contacts. When adding a contact to the local directory, in addition to name and phone numbers, you can also specify the ring tone and group for the contact. Contacts can be added either one by one or in batch using a local contact file. Yealink Skype for Business phones support both \*.xml and \*.csv format contact files, but only support \*.xml format download for local contact file.

### Adding Local Contacts

You can add contacts to the local directory in the following ways:

- Manually
- From Skype for Business Directory



#### Adding Local Contacts Manually

**To add a contact to the local directory manually:**



1. Press **Dir->Local Directory->All Contacts**.

All Contacts — 1/2	
80001	
80002	
Back	Add
Option	Call

2. Press the **Add** soft key.

- Press  or  to enter name, address, office number, mobile number, other number, title and email in the corresponding fields.



- Press  or , or the **Switch** soft key to select the desired ring tone from the **Ring** field.
- Press the **Save** soft key to accept the change or the **Back** soft key to cancel.

#### Note

If the contact name already exists in the directory, the screen will prompt "Contact name existed!".





Local directory is configurable via web user interface at the path **Directory->Local Directory**.

### Adding Local Contacts from Skype for Business Directory

To add a local contact from Skype for Business directory via phone user interface:



- Press **Dir->SFB Directory**.

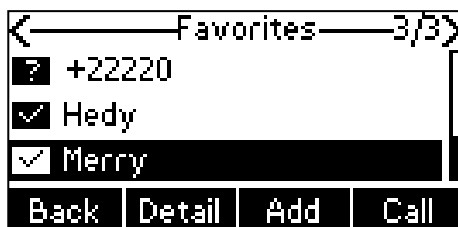

- Press  or  to select the desired group, and then press the **Enter** soft key.
- Press  or  to highlight the desired contact.



- Press the **Add** soft key.

5. Press  or  to edit the contact information.

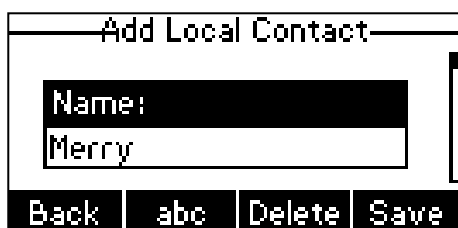

6. Press the **Save** soft key to add the contact to the local directory.  
The Skype for Business contact is successfully saved to the local directory.

## Viewing Local Contacts





You can view the following information about each contact on the phone:

- The contact's name
- The detailed information of the contact (e.g., name, mail address)

**To view the local directory:**

1. Press **Dir->Local Directory**.



2. Press  or  to select the desired group.
3. Press  or  to highlight the desired contact.

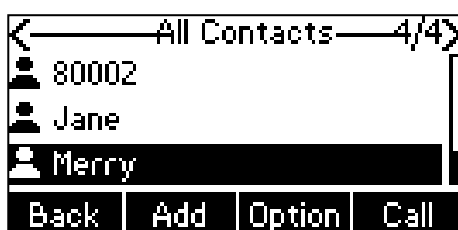

4. Press the **Option** soft key, and then select **Detail** from the prompt list.

The detailed information (e.g., name, address, office number, mobile number, other number, title and email) of the contact appears on the screen.

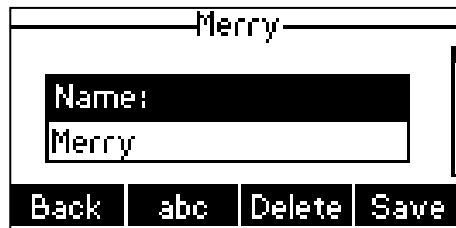

5. Press  $\uparrow$  or  $\downarrow$  to view the detail.

## Editing Local Contacts

**To edit a contact in the local directory:**

1. Press **Dir->Local Directory**.
2. Select the desired group, and then press the **Enter** soft key.
3. Press  $\uparrow$  or  $\downarrow$  to highlight the desired contact.

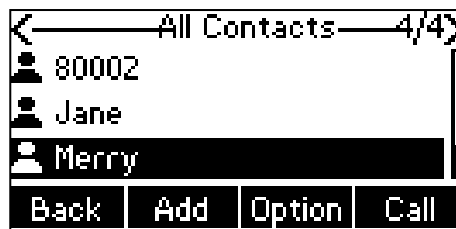

4. Press the **Option** soft key, and then select **Detail** from the prompt list.



5. Press  $\uparrow$  or  $\downarrow$  to highlight the contact information and then edit.

You can edit name, address, office number, mobile number, other number, title and email in the corresponding fields.





6. Press the **Save** soft key to accept change or the **Back** soft key to cancel.

Local directory is configurable via web user interface at the path **Directory->Local Directory**.

## Deleting Local Contacts

**To delete a contact from the local directory:**

1. Press **Dir->Local Directory**.
2. Select the desired group, and then press the **Enter** soft key.
3. Press  or  to highlight the desired contact.
4. Press the **Option** soft key, and then select **Delete** from the prompt list.



The LCD screen prompts "Delete selected item?".

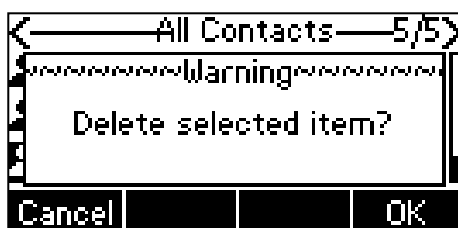

5. Press the **OK** soft key to confirm the deletion or the **Cancel** soft key to cancel.

You can also delete all contacts by pressing the **Option** soft key, and then select **Delete All**.

Deleting a contact or all contacts is configurable via web user interface at the path **Directory->Local Directory**.

## Importing/Exporting Contact Lists

You can manage your phone's local directory via phone user interface or web user interface. But you can only import or export the contact list via web user interface.

**To import an XML contact list file via web user interface:**

1. Click on **Directory->Local Directory**.

- Click **Browse...** to locate a contact list file (the file format must be \*.xml) from your local system.

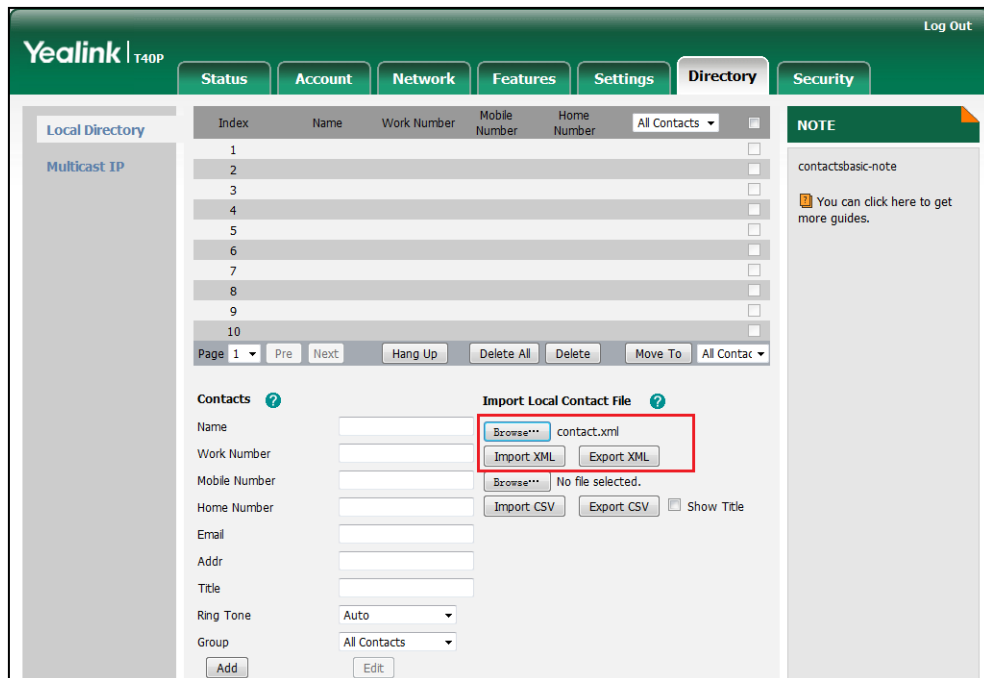

- Click **Import XML** to import the contact list.  
The web user interface prompts "The original contact will be covered, continue?".
- Click **OK** to complete importing the contact list.

**To import a CSV contact list file via web user interface:**

- Click on **Directory**->**Local Directory**.
- Click **Browse...** to locate a contact list file (the file format must be \*.csv) from your local system.
- (Optional) Check the **Show Title** checkbox.

It will prevent importing the title of the contact information which is located in the first line of the CSV file.

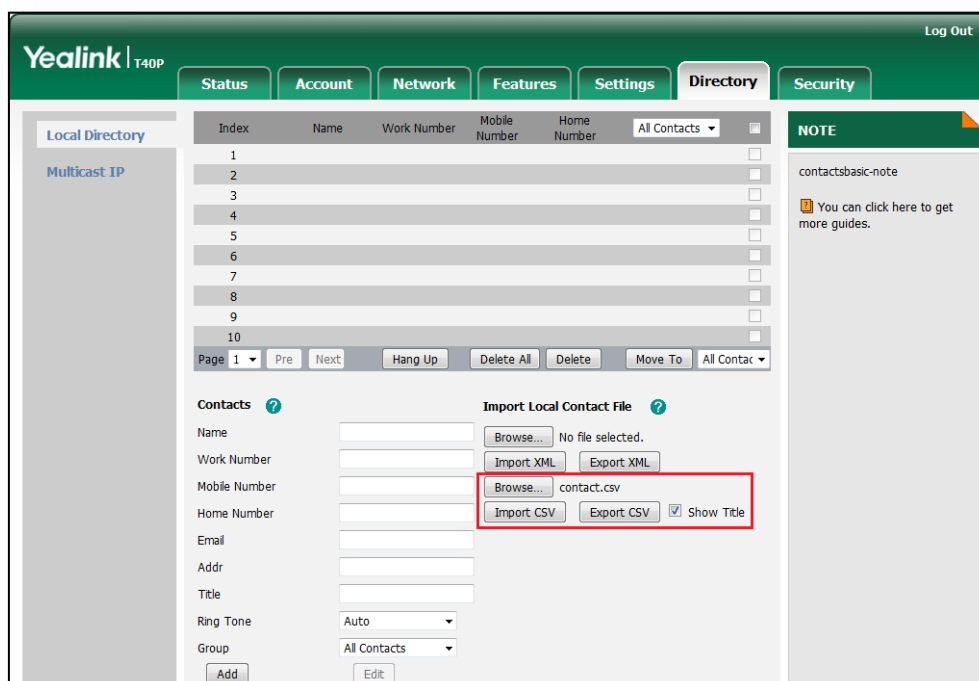

4. Click **Import CSV** to import the contact list.
5. (Optional) Mark the **On** radio box in the **Del Oldcontact** field.  
It will delete all existing contacts while importing the contact list.
6. Select the contact information you want to import into the local directory from the pull-down list of **Index**.  
At least one item should be selected to be imported into the local directory.

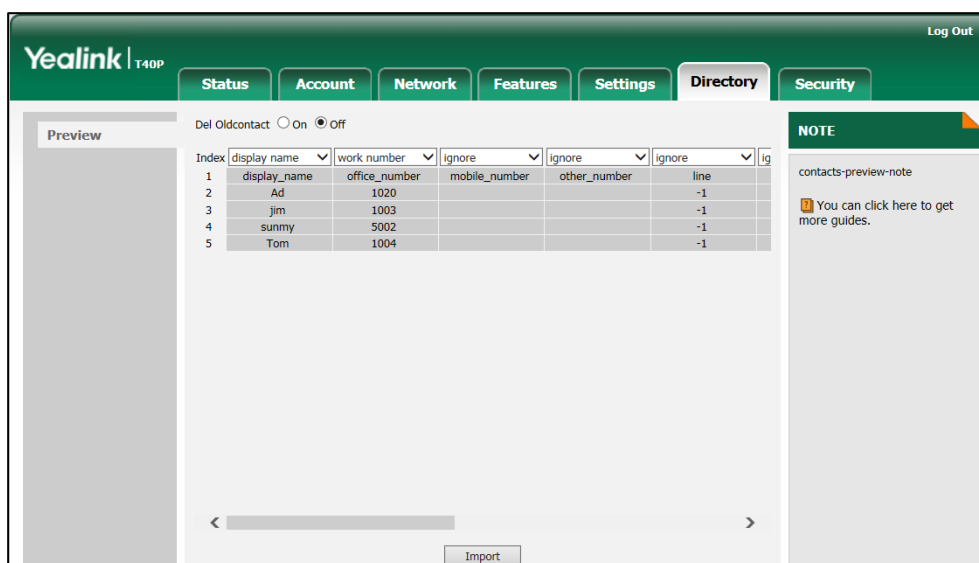

7. Click **Import** to complete importing the contact list.



**To export a contact list via web user interface:**

1. Click on **Directory**->**Local Directory**.
2. Click **Export XML** (or **Export CSV**).
3. Click **Save** to save the contact list to your local system.

## Local Favorites

Favorites are the contacts in your directory that you call most often. You can assign a priority number to a favorite. Local favorites display consecutively according to their priority number, and the contact with the lowest number displays first.

### Adding Local Favorites

You can add the local favorites manually or add local contacts as favorites.

**To add a local favorite via phone user interface:**

1. Press **Dir**->**Local Directory**->**Favorites**.



2. Press the **Add** soft key.
3. Press  $\uparrow$  or  $\downarrow$  to enter the contact name, address, office number, mobile number, other number, title and email in the corresponding fields.



4. Press  $\leftarrow$  or  $\rightarrow$ , or the **Switch** soft key to select the desired ring tone from the **Ring** field.



5. Press  $\leftarrow$  or  $\rightarrow$ , or the **Switch** soft key to select the desired priority number from the

**Priority** field.

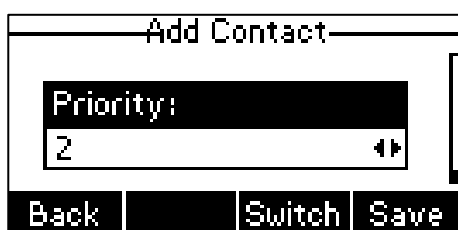

The valid value of priority number ranges from None to 15 and the lowest priority is None. The contact with the lowest priority number displays first.



6. Press the **Save** soft key to accept the change or the **Back** soft key to cancel.

Adding a local favorite is configurable via web user interface at the path **Directory->Local Directory**.

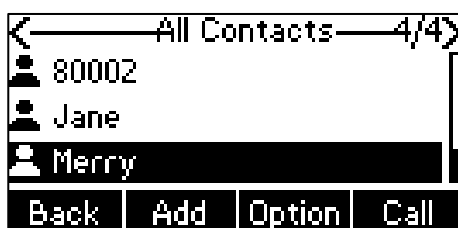

**To add a local contact as the local favorite via phone user interface:**

1. Press **Dir->Local Directory->All Contacts**.
2. Press  or  to highlight the desired contact.





3. Press the **Option** soft key, and then select **Detail** from the prompt list.



4. Press  or , or the **Switch** soft key to select **Favorites** from the **Group** field.



5. Press  or , or the **Switch** soft key to select the desired priority number from the **Priority** field.
6. Press the **Save** soft key to accept the change or the **Back** soft key to cancel.

The local contact is successfully saved to the local favorite.



Adding a local contact as the local favorite is configurable via web user interface at the path **Directory->Local Directory**.

## Viewing Local Favorites

To view the local favorites:

1. Press **Dir->Local Directory->Favorites**.



2. Press  or  to highlight the desired contact.

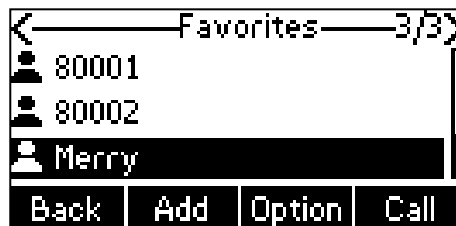

3. Press the **Option** soft key, and then select **Detail** from the prompt list.

The detailed information (e.g., name, address, office number, mobile number, other number, title and email) of the contact appears on the screen.



4. Press  or  to view the detail.

## Reordering Local Favorites

To reorder your local favorites, assign the local favorite a different priority number.

**To reorder your local favorites:**

1. Press **Dir**->**Local Directory**->**Favorites**.

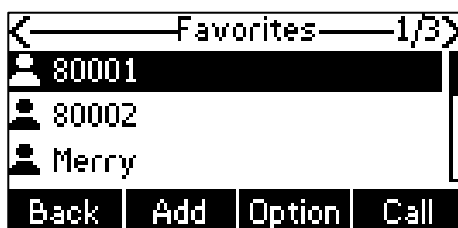

2. Press  $\uparrow$  or  $\downarrow$  to highlight the desired contact.
3. Press the **Option** soft key, and then select **Detail** from the prompt list.
4. Press  $\leftarrow$  or  $\rightarrow$ , or the **Switch** soft key to select the desired priority number from the **Priority** field.



5. Press the **Save** soft key to accept the change or the **Back** soft key to cancel.  
The phone uses the new priority number to order the favorite.

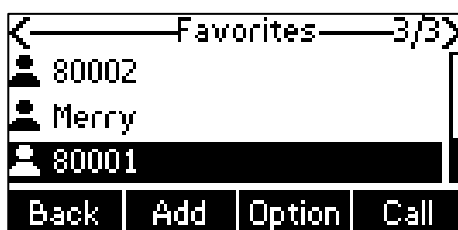





## Placing Calls to Contacts

**To place a call from the directory:**

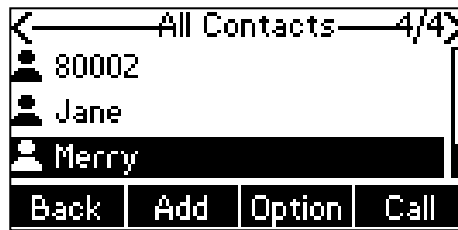
1. Press the **Dir** soft key.
2. Press  $\uparrow$  or  $\downarrow$  to select the desired group, and then press the **Enter** soft key.
3. Press  $\uparrow$  or  $\downarrow$  to highlight the desired contact.
4. Press the **Call** soft key.

- If a contact has only one number, the contact number will be dialed out directly.



- If a contact has multiple numbers, you can press  or  to select the desired number, and then press the **Call** soft key or press .

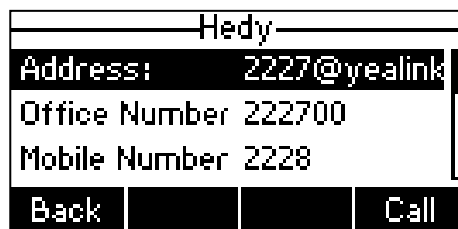

## Searching for Contacts



You can search the contacts on the pre-dialing screen or Skype for Business directory.

- On the pre-dialing screen, you can search for Skype for Business contacts, local contacts and Microsoft Outlook contacts.
- In the Skype for Business directory, you can only search for Skype for Business contacts.

### To search for contacts on the pre-dialing screen:

1. Press the keypad keys to enter the first few continuous characters of the contact name or the contact number.

The phone performs an Intelligent search (e.g., press the digit key 2 to search the letters "2, a, b and c").

The entries whose name or phone number matches the characters entered will appear on the screen. You can press  or  to scroll to the desired contact, and then place a call to the contact.



**To search for contacts in the Skype for Business directory:**

1. Press **Dir->SFB Directory**.



2. Press the **Search** soft key.
3. Enter the first few continuous characters of the contact name or the contact number. (e.g., press the digit key 5 to search the letter "5, j, k and l"). The entries whose name or phone number matches the characters entered will appear on the LCD screen.



You can also configure the Skype for Business phone to search for contacts after the designated time when on the pre-dialing screen.

**To configure dial search delay via web user interface:**

1. Click on **Features->General Information**.
2. Enter the desired value (in seconds) in the **Dial Search Delay** field.

The default value is "1".

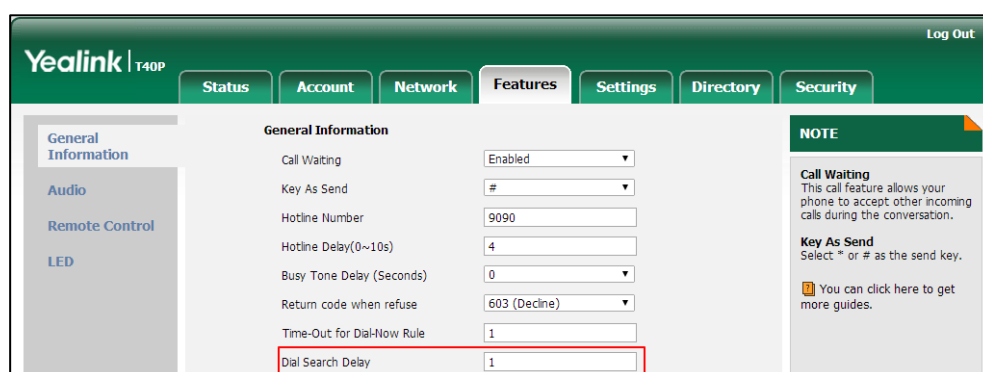

3. Click **Confirm** to accept the change.



**Note** Dial search delay feature is configurable via web user interface only.

## Call History Management

The T40P Skype for Business phone maintains call history lists of Missed Calls, Received Calls, Placed Calls and Forwarded Calls. Call history can store 100 records. You can view the call history, place a call, or delete an entry from the call history list.

History record feature is enabled by default. If you don't want to save the call history, you can disable the feature.

### To disable history record via phone user interface:

1. Press **Menu->Features->History Setting**.
2. Press  or , or the **Switch** soft key to select **Disabled** from the **History Record** field.







3. Press the **Save** soft key to accept the change or the **Back** soft key to cancel.

### To view the call history:

1. Press the **History** soft key.  
The LCD screen displays all call records.



2. Press  or  to switch between **All Calls**, **Missed Calls**, **Placed Calls**, **Received Calls** and **Forwarded Calls** lists.
3. Press  or  to select the desired entry.
4. Press the **Detail** soft key.

The detailed information of the entry appears on the LCD screen.



#### Note

T40P Skype for Business phone doesn't support synchronizing call history from Exchange server.

#### To place a call from the call history list:

1. Press the **History** soft key.
2. Press or to switch between **All Calls**, **Missed Calls**, **Placed Calls**, **Received Calls** and **Forwarded Calls** lists.

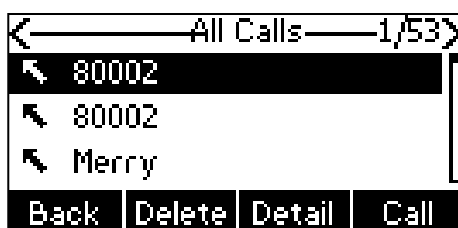

3. Press or to select the desired entry.
4. Press the **Call** soft key.

#### To delete a contact from the call history list:

1. Press the **History** soft key.
2. Press or to switch between **All Calls**, **Missed Calls**, **Placed Calls**, **Received Calls** and **Forwarded Calls** lists.



3. Press or to select the desired entry.
4. Press the **Delete** soft key to delete the entry.

## Headset Use

If you want to use a headset, physically connect your headset and activate the headset mode for use. For more information on physically connecting a headset, refer to [Phone Installation](#) on



page [12](#).

## Headset Mode Activation/Deactivation

### To activate the headset mode:

1. Press  on the phone.

Press the line key or the **Answer** soft key to answer an incoming call. The call will be connected to your headset automatically.

Enter the desired number, and then press the **Call** soft key, the phone will then place a call using the headset automatically. For more information on using the headset to place a call, refer to [Placing Calls](#) on page [80](#).

### To deactivate the headset mode:

1. Press  again on the phone.

The headset mode is deactivated.

## Headset Prior

You can use headset in priority when headset prior feature is enabled. This feature is especially useful for permanent or full-time headset users.

### To enable headset prior via web user interface:

1. Click on **Features->General Information**.

2. Select **Enabled** from the pull-down list of **Headset Prior**.

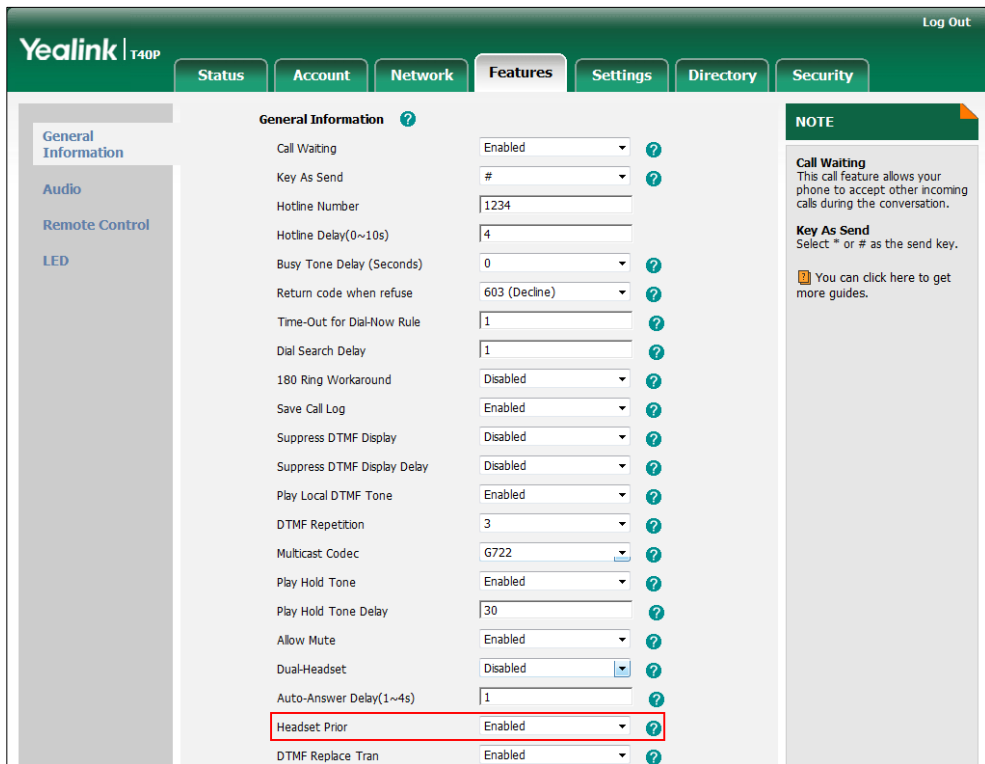

3. Click **Confirm** to accept the change.

**To use headset prior feature, you should activate the headset mode in advance:**

1. Physically connect the headset.
2. Press  to activate the headset mode.

**Note** If headset prior is enabled, the headset mode will not be deactivated until you press the **HEADSET** key again.  
 If headset prior is disabled, the headset mode can be deactivated by pressing the speakerphone key or the **HEADSET** key.  
 Headset prior is configurable via web user interface only.

## Dual Headset

You can use two headsets when enabling dual headset. To use this feature, you must physically connect headsets to the headset jack and handset jack respectively. Once the phone connects to a call, the headset connected to the headset jack will have full-duplex capabilities, while the one connected to the handset jack will only be able to listen.

**To enable dual headset via web user interface:**

1. Click on **Features->General Information**.

2. Select **Enabled** from the pull-down list of **Dual-Headset**.

The screenshot shows the Yealink T40P web user interface. The 'Features' tab is selected, and the 'General Information' section is expanded. The 'Dual-Headset' option is highlighted with a red box and is set to 'Enabled'. Other settings include Call Waiting (Enabled), Key As Send (#), Hotline Number (1234), Hotline Delay (0~10s) (4), Busy Tone Delay (Seconds) (0), Return code when refuse (603 (Decline)), Time-Out for Dial-Now Rule (1), Dial Search Delay (1), 180 Ring Workaround (Disabled), Save Call Log (Enabled), Suppress DTMF Display (Disabled), Suppress DTMF Display Delay (Disabled), Play Local DTMF Tone (Enabled), DTMF Repetition (3), Multicast Codec (G722), Play Hold Tone (Enabled), Play Hold Tone Delay (30), Allow Mute (Enabled), Auto-Answer Delay(1~4s) (1), Headset Prior (Enabled), and DTMF Replace Tran (Enabled). A 'NOTE' section on the right provides information about Call Waiting and Key As Send.

3. Click **Confirm** to accept the change.

**Note** Dual headset is configurable via web user interface only.

## E911

E911 (Enhanced 911) is a location technology that enables the called party to identify the geographical location of the calling party. For example, if a caller makes an emergency call to E911, the feature extracts the caller's information for the police department to immediately identify the caller's location.

### E911 Location Tip

The system administrator configures geographical location for users on the Skype for Business Server. After user signs in, the geographical location is downloaded to the phone. If geographical location is not provisioned by the server, an E911 location tip will appear to prompt the user that the location of the phone is not set.

**To configure E911 location tip via web user interface:**

1. Click on **Features->General Information**.
2. Select desired value from the pull-down list of **E911 Location Tip**.

Depending on your selection:

- If you select **Enabled**:  
When the location is not set, location notification depends on the configuration on the Skype for Business Server.
  - If you select **Disabled**:  
When the location is not set, the LCD screen will not prompt the location notification.
- For more information, refer to [Location Notification](#) on page 66.

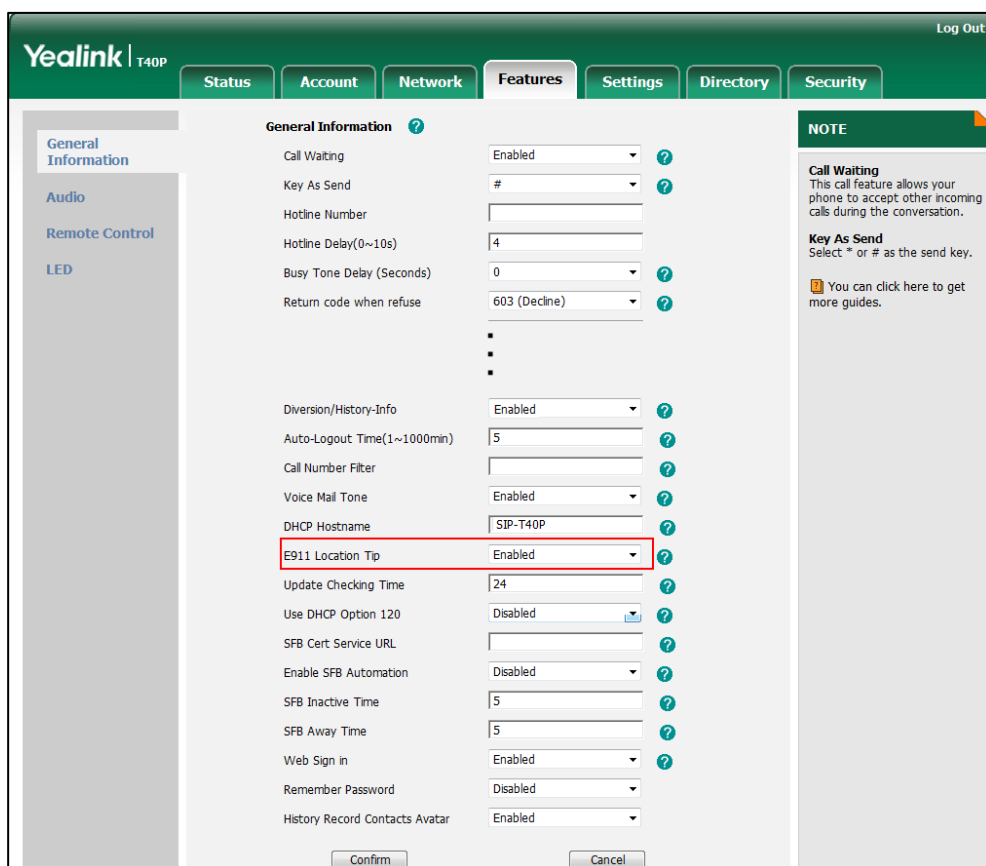

3. Click **Confirm** to accept the change.

**Note**

When the location is set, no matter whether E911 location tip is enabled or disabled, the LCD screen will not prompt the location notification.

E911 location tip feature is configurable via web user interface only.

## Location Notification

When E911 location tip feature is enabled and the location of the phone is not set, the location notification displayed on the phone depends on the configuration on the Skype for Business Server.

- a) When the parameter **Location Required** is set to **Yes** on the Skype for Business Server, the LCD screen is shown as below after login:

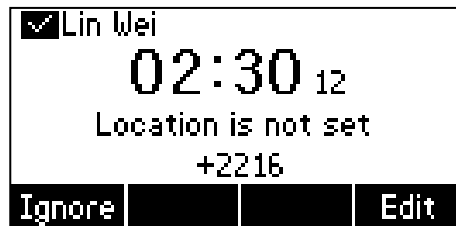

You can do one of the following:

- Press the **Ignore** soft key.  
The phone will return to the idle screen.
- Press the **Edit** soft key.  
The phone will enter the **Location Edit** screen.

- b) When the parameter **Location Required** is set to **Disclaimer** on the Skype for Business Server, the LCD screen is shown as below after login:



You can do one of the following:

- Press the **Ignore** soft key.  
The phone will display the disclaimer configured on the Skype for Business Server.

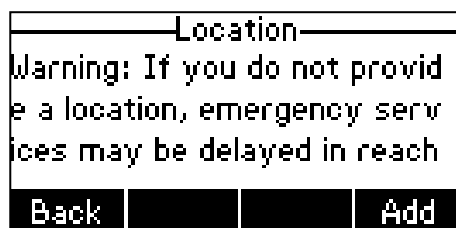

You can press the **Back** soft key to return to the idle screen or press the **Add** soft key to enter the **Location Edit** screen.

- Press the **Edit** soft key.

The phone will enter the **Location Edit** screen.



- c) When the parameter **Location Required** is set to **No** on the Skype for Business Server, the LCD screen is shown as below after login:



## Adding the Location Information

You can add the location information in one of the two ways:

- Reload the location information from the Skype for Business Server.
- Add the location information manually.

## Reloading the Location Information from the Skype for Business Server

The network administrator configures geographical location on the Skype for Business Server for the phone. After the phone signs in or reboots, the geographical location is downloaded automatically. The phone will update the geographical location every 4 hours automatically. If the geographical location configured on the server updates, you can also reload it via phone user interface manually.

**To reload the location information via phone user interface:**

1. Press **Menu->Settings->Basic Settings->Location**.
2. Press the **Reload** soft key to reload the location information from the Skype for Business Server.

Location set on the phone will be covered by location set on the Skype for Business Server.





## Adding the Location Information Manually

If geographical location is not provisioned on the Skype for Business Server, you can add the location information manually via phone user interface.

**To add the location information manually via phone user interface:**

1. Press **Menu->Settings->Basic Settings->Location**.
2. Press the **Add** soft key.



3. Enter the location name in the **Location** field.
4. Enter the address name in the **Address** field.
5. Enter the building name in the **Building** field.
6. Enter the city name in the **City** field.
7. Enter the state name in the **State** field.
8. Enter the postcode in the **Postcode** field.
9. Press  or , or the **Switch** soft key to select your country from the **Country** field.
10. Press the **Save** soft key to accept the change.

Location is configurable via web user interface at the path **Settings->Location**.

### Note

T40P Skype for Business phone has 24 country locations for you to choose. The country names are displayed in alphabetical order.

## Viewing the Location Information

**To view the location information via phone user interface:**

Do one of the following:

- Press **Menu->Settings->Basic Settings->Location**.
- Press ->**More...->Location**.

## Emergency Call



You can dial emergency numbers for assistance whether you set the location or not.

You can dial an Emergency Dial String number or Emergency Dial String Mask number even if the phone is locked. Keypad is available during an emergency call.

**To place an emergency call when the phone is locked:**

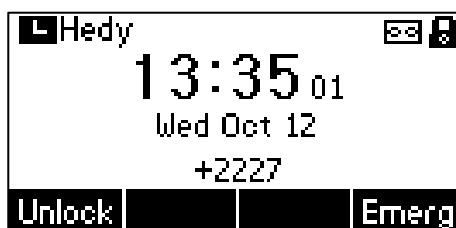
1. Press the **Emerg** soft key.



2. Press  or  to select the desired emergency number.

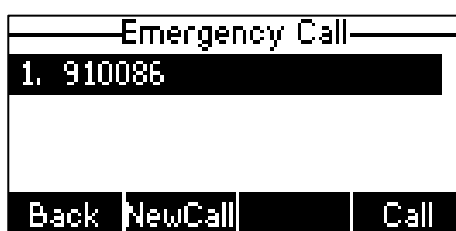

3. Press  or the **Call** soft key.

The LCD screen is shown as below:

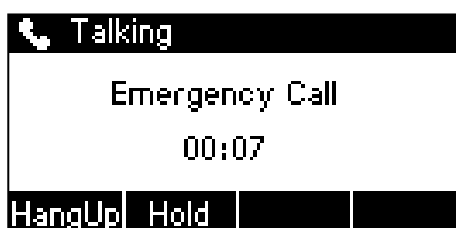

You can cancel or hold the emergency call only.

If call forward feature is configured in advance, the call forward feature will be disabled automatically after calling the emergency number. If the call forward feature is not manually enabled again after the emergency call, it will be enabled automatically after two hours and its settings will also be restored.

If the phone status is DND before dialing an emergency number, then the phone status will change to available after the emergency call. And the phone status will restore to DND status in two hours. Other statuses will not be affected by the emergency call.

**Note**

Emergency Dial String number and Emergency Dial String Mask number are configurable on the Skype for Business Server only. Contact your system administrator for more information.

## Dial-now

You can configure one or more dial-now rules (up to 100) on your phone. When the dialed number matches the dial-now string, the number will be dialed out automatically. For example,



a dial-now rule is configured as "1xxx", any entered four-digit string beginning with 1 will then be dialed out automatically on the phone.

Basic expression syntaxes you need to know:

Syntax	Description
.	The dot "." can be used as a placeholder or multiple placeholders for any character. Example: "12." would match "123", "1234", "12345", "12abc", etc.
x	An "x" can be used as a placeholder for any character. Example: "12x" would match "121", "122", "123", "12a", etc.
-	Numeric ranges are allowed within the brackets: Digit "-" Digit. Example: "[5-7]" would match the number "5", "6" or "7".
[]	The square brackets "[]" can be used as a placeholder for a single character which matches any of a set of characters. Example: "91[5-7]1234" would match "9151234", "9161234", "9171234".
()	The parentheses "()" can be used to group together patterns, for instance, to logically combine two or more patterns. Example: "([1-9])([2-7])3" would match "923", "153", "773", etc.
\$	The "\$" followed by the sequence number of a parenthesis means the characters placed in the parenthesis. The sequence number stands for the corresponding parenthesis. Example: A replace rule configuration, Prefix: "001(xxx)45(xx)", Replace: "9001\$145\$2". When you dial out "0012354599" on your phone, the Skype for Business phone will replace the number with "90012354599". "\$1" means 3 digits in the first parenthesis, that is, "235". "\$2" means 2 digits in the second parenthesis, that is, "99".

**To add a dial-now rule via web user interface:**

1. Click on **Settings->Dial Plan**.

2. Enter the desired value (e.g., 1xxx) in the **Rule** field.

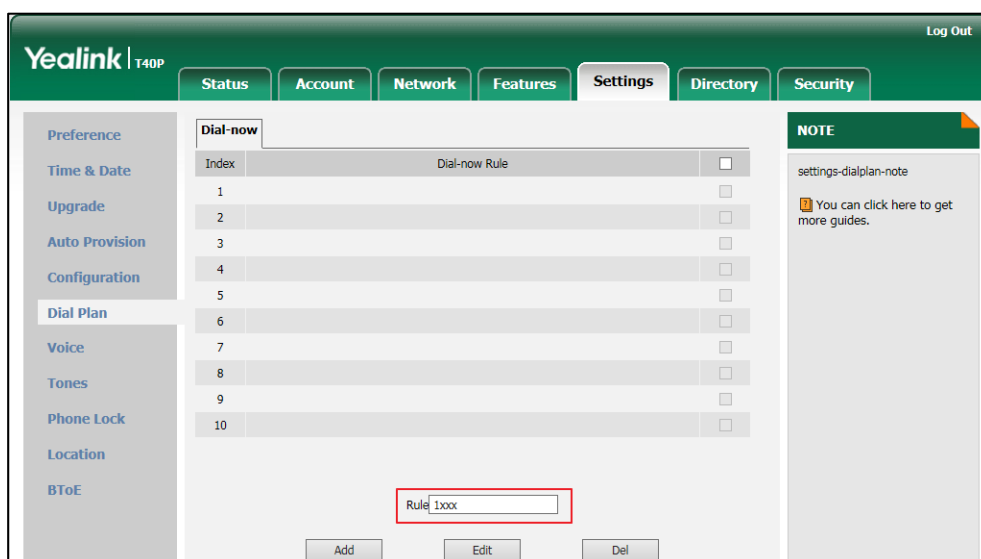

3. Click **Add** to add the dial-now rule.

For example: when you enter the number "1234" using the keypad, the phone will dial out "1234" automatically without pressing any key.

**Note**

Dial-now rule is configurable via web user interface only.

**Delay Time for Dial-Now Rule**

You can configure the delay time for dial-now rules. That is, you can configure your phone to automatically dial out the phone number which matches a dial-now rule, after the designated delay time.

**To configure the delay time for dial-now rule via web user interface:**

1. Click on **Features->General Information**.

- Enter the time between 1 and 14 (seconds) in the **Time-Out for Dial-Now Rule** field.

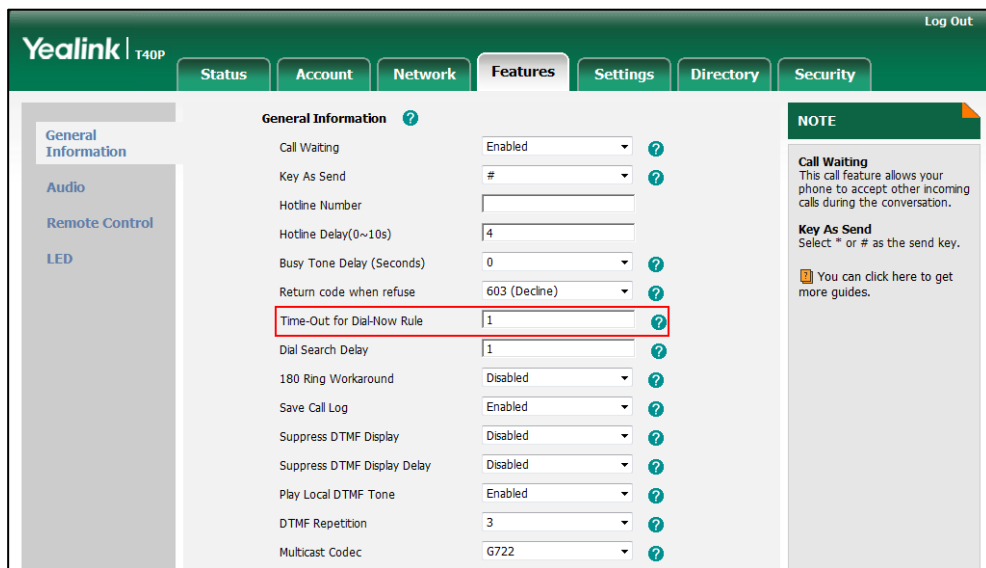

- Click **Confirm** to accept the change.

For example: when you enter the number "1234" using the keypad, the phone will dial out "1234" automatically after 1 second without pressing any key.

#### Note

Delay time for dial-now rule is configurable via web user interface only.

## Live Dialpad

You can enable live dialpad on the T40P Skype for Business phone, which enables the Skype for Business phone to automatically dial out a phone number without pressing the send key. You can also configure a delay, and then the phone will dial out the phone number automatically after the designated period of time. The delay time is configurable on the Skype for Business Server only.

#### To enable live dialpad via web user interface:

- Click on **Settings->Preference**.

2. Select **Enabled** from the pull-down list of **Live Dialpad**.

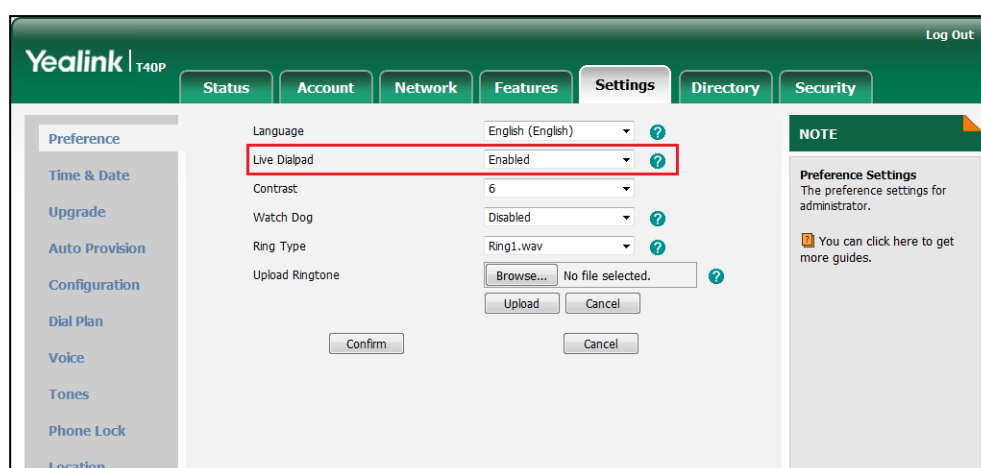

3. Click **Confirm** to accept the change.

**Note** Live dialpad is configurable via web user interface only.

## Hotline

You can dial a hotline number immediately upon lifting the handset, pressing the Speakerphone key or the line key. You can also configure a delay, and then the phone will dial out the hotline number automatically after the designated period of time.

### To configure the hot line number via phone user interface:

1. Press **Menu**->**Features**->**Hotline**.
2. Enter the desired number in the **Hot Number** field.



3. Enter the delay time in the **HotLine Delay** field.  
The valid values range from 0 to 10 (seconds) and the default value is "4".
4. Press the **Save** soft key to accept the change or the **Back** soft key to cancel.

Hotline is configurable via web user interface at the path **Features**->**General Information**.

## Privacy Mode

Privacy mode allows you to restrict your presence information, so that it is visible only to the contacts in your Skype for Business directory.

### Note

Microsoft Active Directory includes all Skype for Business users configured by the system administrator. You can add them as your Skype for Business contacts. For more information on how to add Skype for Business contacts, refer to [Adding Skype for Business Contacts](#) on page 44.

When the privacy mode is disabled on the Skype for Business Server, you can see the following two options available on the phone/Skype for Business client:

- **Everyone Can See My Status Regardless Of System Settings/I want everyone to be able to see my presence regardless of system settings (override default settings):** Everyone in my Microsoft Active Directory Domain can see my presence regardless of system settings.
- **Only Contacts Can See My Status If System Setting/I want the system administrator to decide:** Currently everyone can see my presence but this could be change in the future.

When the privacy mode is enabled on the Skype for Business Server, you can see the following two options available on the phone or Skype for Business client:

- **Everyone can see my status/I want everyone to be able to see my presence:** Everyone in my Microsoft Active Directory Domain can see my presence.
- **Only contacts can see my status/I only want people in Contacts to see my presence:** Only the contacts in my Skype for Business directory can see my presence. My presence is offline to other contacts in Microsoft Active Directory Domain see.

## Modifying the Privacy Mode from the Phone

**To modify the privacy mode from the phone:**

1. Press **Menu->Features->Private Mode**.
2. Do one of the following:
  - a) If the privacy mode is disabled on the Skype for Business Server, the phone LCD screen displays as below:



Select the desired option.

- b) If the privacy mode is enabled on the Skype for Business Server, the phone LCD screen displays as below:



Select the desired option.

3. Press the **Save** soft key to accept the change or the **Back** soft key to cancel.

## Modifying the Privacy Mode from the Skype for Business Client

**To modify the privacy mode from the Skype for Business client:**

1. Open Skype for Business client.
2. Click .
3. In the **Skype for Business-Options** dialog box, click **Status**.
4. Do one of the following:
  - a) If the privacy mode is disabled on the Skype for Business Server:

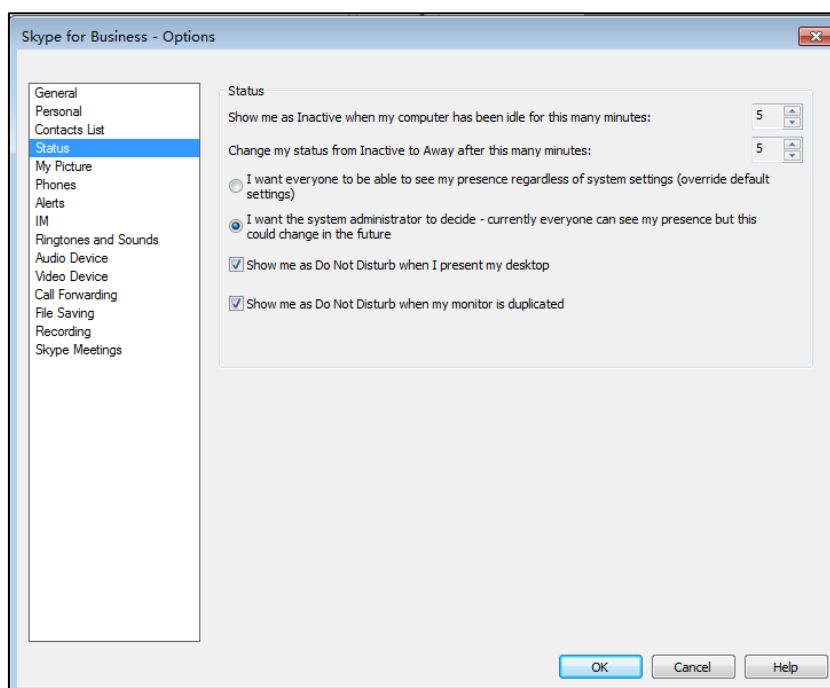

Mark the desired radio box.

b) If the privacy mode is enabled on the Skype for Business Server:

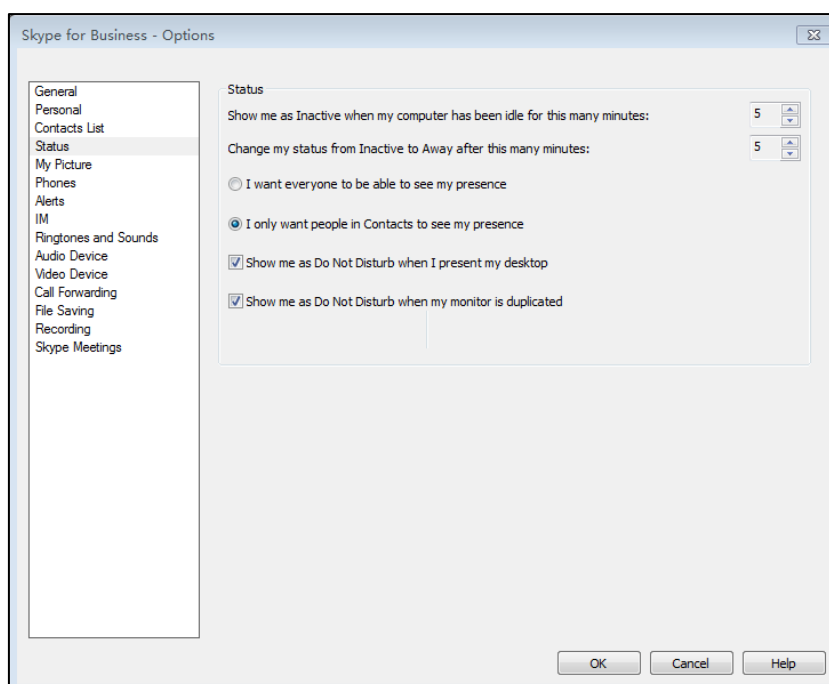

Mark the desired radio box.

5. Click **OK** to accept the change.





## Basic Call Features

---

The T40P Skype for Business phone is designed to be easily used like a regular phone on a public switched telephone network (PSTN). You can place calls, answer calls, transfer a call to someone else, or conduct a Skype for Business conference call. You can also use calendar, response groups or boss-admin Skype for Business feature.

This chapter provides basic operating instructions for the T40P Skype for Business phone. Topics include:

- [Placing Calls](#)
- [Answering Calls](#)
- [Ending Calls](#)
- [Redialing Numbers](#)
- [Auto Answer](#)
- [Call Waiting](#)
- [Call Mute](#)
- [Call Hold/Resume](#)
- [Calendar](#)
- [Call Forward](#)
- [Response Groups](#)
- [Shared Line Appearance for Skype for Business](#)
- [Boss-Admin Feature](#)
- [Inbound Private Line](#)
- [Call Transfer](#)
- [Group Call Pickup](#)
- [Skype for Business Conference](#)
- [Call Park](#)
- [Voice Mail](#)
- [Multicast Paging](#)
- [Branch Office Resiliency](#)

If you require additional information or assistance with your new phone, contact your system administrator.

## Placing Calls

You can place a call in three ways using your T40P Skype for Business phone:

- Using the handset
- Using the speakerphone
- Using the headset

You can also dial the number first, and then choose the way you want to speak to the other party.

You can search for the contacts and then dial from the result list. For more information, refer to [Searching for Contacts](#) on page 59.

During a call, you can alternate between Speakerphone, Headset, and Handset modes by pressing the Speakerphone key, the Headset key, or picking up the handset.

The call duration and the talking mode are visible on the LCD screen. In the figure below, the call to "Hedy" has lasted 3 seconds.

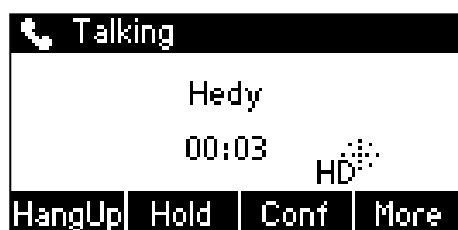



### To place a call:



1. Enter the first few continuous characters of the contact name, phone number or the contact address using the keypad.

You can press the **123** soft key to change the input mode.

The contacts that meet search criteria will appear on the pre-dialing screen.









2. Press  or  to scroll through the result list and highlight the desired contact.

You can press the **Detail** soft key to view the detailed information of the highlighted contact, and then press  or  to select the desired phone number or address.







3. Do one of the following:



- Press , ,  or the **Call** soft key to place a call using the hands-free speakerphone mode.
- Pick up the handset to place a call using the handset mode.
- With the optional headset connected, press  to activate the headset mode, and then press ,  or the **Call** soft key to place a call using the headset mode.

The # key is configured as a send key by default. You can also set the \* key as the send key, or set neither. For more information, refer to [Key as Send](#) on page 37.

### To place multiple calls:

You can have more than one call on your T40P Skype for Business phone. To place a new call during an active call, do the following:

- Press the line key. The active call is placed on hold.  
Enter the desired number using the keypad.  
Press , , or the **Call** soft key.
- Press the **Hold** soft key to place the original call on hold.  
Press the **NewCall** soft key.  
Enter the desired number using the keypad.  
Press , , or the **Call** soft key.

You can press  or  to switch between calls, and then press the **Resume** soft key to retrieve the desired call.

## Answering Calls

When you are not in another call, you can answer a call in three ways:

- Using the handset
- Using the speakerphone

- Using the headset

**Note**

You can ignore incoming calls by pressing the **Reject** soft key or the **Silence** soft key or press the  key. You can also change the presence status to be Do Not Disturb, and then the phone will ignore all incoming calls to your phone. For more information, refer to [Changing Presence Status](#) on page 22.

You can forward incoming calls to someone else by pressing the **FWD** soft key, or to voice mail by pressing the **FWD VM** soft key. For more information, refer to [Call Forward](#) on page 96.

### Answering When Not In Another Call

Call duration and destination will always appear on the LCD screen of the active call.

#### To answer a call using the handset:

1. Pick up the handset.

#### To answer a call using the hands-free speakerphone mode:

Do one of the following:

- Press  .
- With the handset on-hook and headset mode deactivated, press the **Answer** soft key.
- With the handset on-hook and the headset mode deactivated, press the line key (the line key LED flashes green).



#### To answer a call using the headset:

Do one of the following:

- Press  .
- With the headset mode activated, press the **Answer** soft key.
- With the headset mode activated, press the line key (the line key LED flashes green).

### Answering When In Another Call

If you have an active call, and an incoming call arrives on the phone, do one of the following:

- Press the **Answer** soft key.  
The incoming call is answered, and the original call is placed on hold.
- Press  to access the new call.  
Press  or the **Answer** soft key.  
The incoming call is answered, and the original call is placed on hold.



## Ending Calls

### To end a call:

Do one of the following:

- If you are using the handset, press the **HangUp** soft key or hang up the handset.
- If you are using a headset, press the **HangUp** soft key.
- If you are using the speakerphone, press the **HangUp** soft key or .

### Note

When a call is placed on hold, you cannot press  to end it. You should press the **Resume** soft key to resume the call, and then press  to end it.

## Redialing Numbers





### To redial the last dialed number from your phone:

1. Press .  
A call to your last dialed number is attempted.

## Auto Answer

You can use auto answer feature to automatically answer an incoming call.

### To configure auto answer via phone user interface:

1. Press **Menu->Features->Auto Answer**.
2. Press  or  to select **Status** field.
3. Press  or , or the **Switch** soft key to select **Enabled** from the **Status** field.

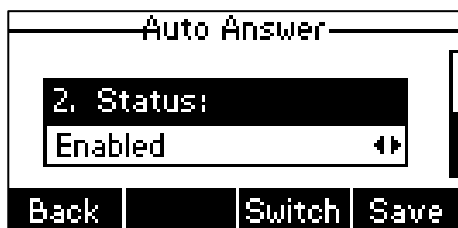

4. Press the **Save** soft key to accept the change or the **Back** soft key to cancel.

The  icon appears on the LCD screen.

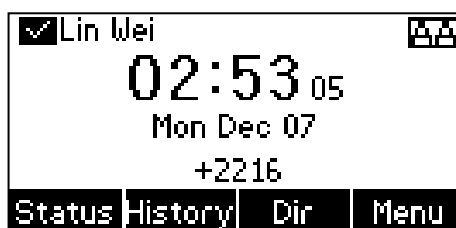

Auto answer is configurable via web user interface at the path **Account->Basic->Auto Answer**.



**Note**

Auto answer is only applicable when there is no other call in progress on the phone.



## Call Waiting

You can enable or disable call waiting on the phone. If call waiting is enabled, you can receive another call while there is an active call on the phone. Otherwise, another incoming call is automatically rejected by the phone with a busy message when there is an active call on the phone. You can also enable or disable the phone to play a warning tone when receiving another call.

**To configure call waiting via phone user interface:**

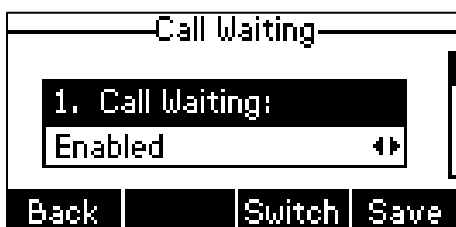
1. Press **Menu->Features->Call Waiting**.
2. Press  or , or the **Switch** soft key to select **Enabled** from the **Call Waiting** field.





3. Press  or , or the **Switch** soft key to select **Enabled** from the **Play Tone** field.
4. Press the **Save** soft key to accept the change or the **Back** soft key to cancel.

**To use the call waiting:**

1. When the phone receives an incoming call during a call.

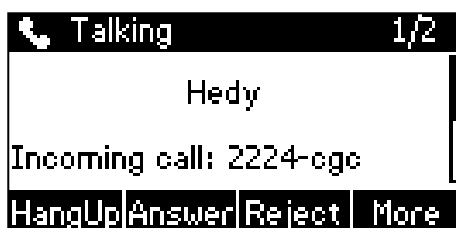
The phone LCD screen displays as below:



2. Press  to see the incoming call.

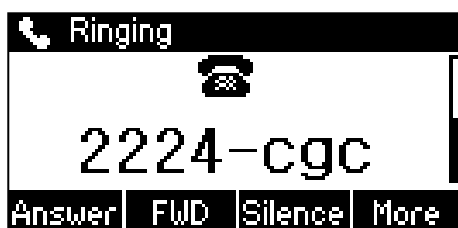

3. Do one of the following:
  - Press the **Answer** soft key to answer the incoming call.  
The original call will be placed on hold.
  - Press the **FWD** soft key to forward the incoming call to another contact.
  - Press the **Silence** soft key to ignore the incoming call.
  - Press **More**->**Reject** to reject the incoming call.
  - Press **More**->**FWD VM** to forward the incoming call to voice mail.

Call waiting is configurable via web user interface at the path **Features->General Information->Call Waiting**.

Call waiting tone is configurable via web user interface at the path **Features->Audio->Call Waiting Tone**.

## Call Mute

You can mute the microphone of the active audio device during an active call so that the other party cannot hear you. Call mute applies to all modes (Handset, Headset and Speakerphone).

### To mute a call:

1. Press  during an active call.  
The LCD screen indicates that the call is now muted.

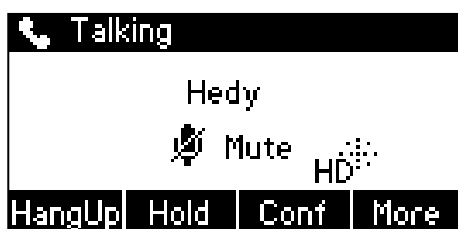

### To un-mute a call:

1. Press  again to un-mute the call.

## Call Hold/Resume

You can place an active call on hold. Only one active call can be in progress at any time. Other calls can be made and received while placing the original call on hold. If **Music on Hold** feature is enabled, the phone will play built-in music when an active call is placed on hold. For more information, contact your system administrator.

### To place a call on hold:

1. Press the **Hold** soft key during a call.

The line key LED flashes green. The LCD screen indicates that the call is on hold.

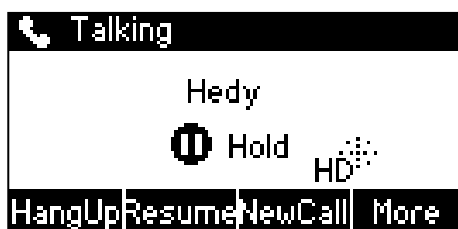

### Note

The phone will beep softly every 30 seconds to remind you that you still have a call on hold.

### To resume a held call:

1. Press the **Resume** soft key.

### Multiple Calls on Hold:

1. Press  $\uparrow$  or  $\downarrow$  to switch between calls, and then press the **Resume** soft key to retrieve the desired call.

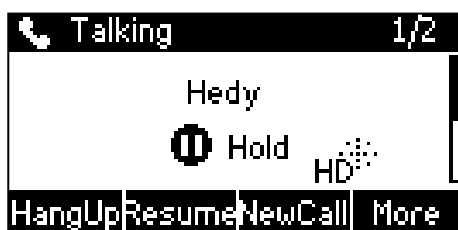

If more than one call is placed on hold, a numbered prompt appears on the LCD screen, for example "1/2", indicating that this is the first call out of second calls.

## Calendar

Yealink Skype for Business phones integrates with the Microsoft Exchange calendar feature. If your phone is configured to connect to the Microsoft Exchange Server, and the Microsoft® Outlook® application is installed at your site, you can view Skype conference, appointment, meeting and event, or join the Skype conference in your Microsoft Outlook application from your phone.



## Setting up a Skype Conference in Outlook

To set up a Skype conference in outlook:

1. Open Outlook and go to your calendar.

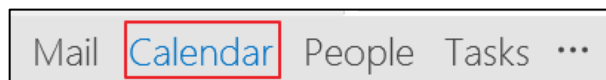

2. Click **HOME**->**New Skype Meeting**.

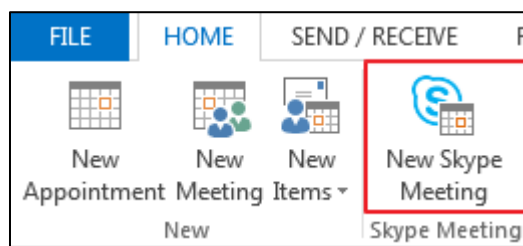

3. In the **To** box, enter the email addresses of your invitees.
4. Enter a subject, location, and then select the start and end time.
5. Enter the content about the Skype conference.
6. Click **Send**.

A Skype conference reminder will display on the phone screen of organizer and invitees 15 minutes before the Skype conference starts.

### Note

If you change the Skype conference content (e.g., location, subject, time) via outlook after you have sent the invitation, the phone will update the Skype conference content.

## Setting up an Appointment in Outlook

To set up an appointment in outlook:

1. Open Outlook and go to your calendar.



2. Click **Home->New Items->More Items->Recurring Appointment**.

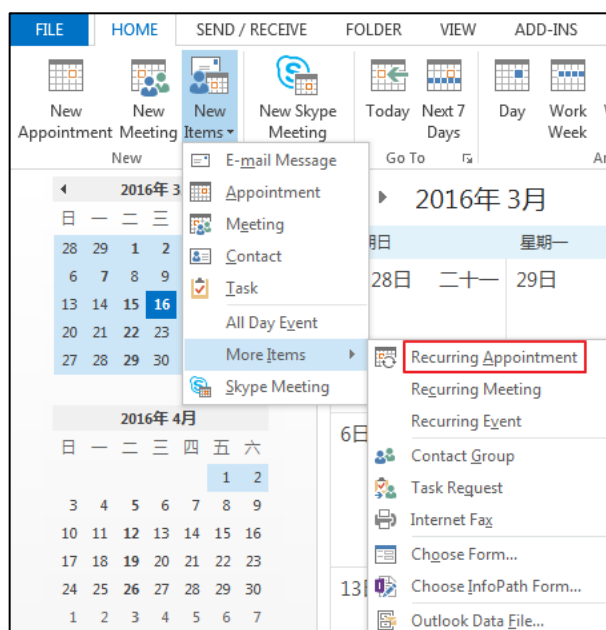

3. Enter the appointment time.
4. Click **OK**.
5. Enter a subject, location and the appointment content.
6. Click **Save & Close**.

An appointment reminder will display on the phone screen 15 minutes before the appointment starts.

## Setting up a Meeting in Outlook

**To set up a meeting in outlook:**

1. Open Outlook and go to your calendar.

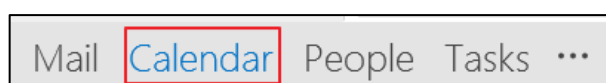

2. Click **Home->New Items->More Items->Recurring Meeting**.

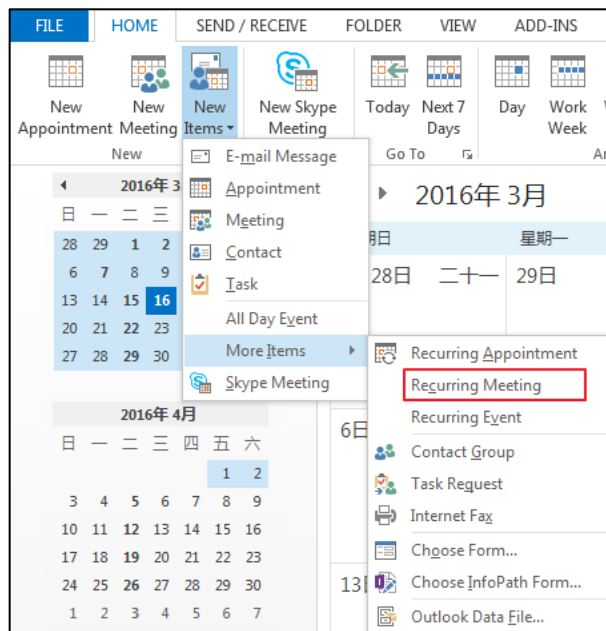

3. Enter the meeting time.
4. Click **OK**.
5. In the **To** box, enter the email addresses of your invitees.
6. Enter a subject, location and the meeting content.
7. Click **Send**.
8. A meeting reminder will display on the phone screen of organizer and invitees 15 minutes before the meeting starts.

## Setting up an Event in Outlook

**To set up an event in outlook:**

1. Open Outlook and go to your calendar.



2. Click **Home->New Items->More Items->Recurring Event**.

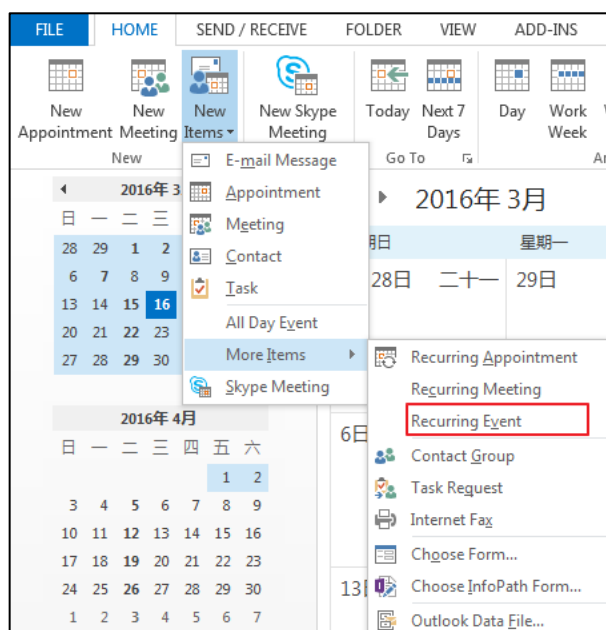

3. Enter the event time.
4. Click **OK**.
5. Enter a subject, location and the event content.
6. Click **Save & Close**.

An event reminder will display on the phone screen 15 minutes before the event starts.

## Using the Calendar

To use the calendar feature on your phone, you must sign into the phone using [User Sign-in](#), [Web Sign-in](#) or [Signing in via PC](#) method. So the phones can display the Microsoft Exchange calendar which gives you quick access to Skype conference, appointment, meeting and event.

## Viewing the Calendar

To view the calendar via phone user interface:

1. Press **Menu**->**Calendar**.

The LCD screen displays the schedules for today. You can view 500 schedules at most on your T40P Skype for Business phone.

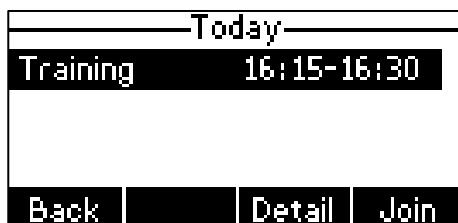

2. Press the **Back** soft key to return to the previous screen.

## Working with Schedule Reminders

If you have a schedule, a reminder pop-up is displayed 15 minutes before it starts. The reminder shows the main information of the schedule, including subject and the rest time.

**If you receive a reminder of an appointment, meeting or event, you can:**

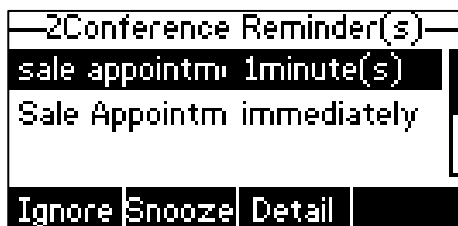

- Press the **Ignore** soft key to permanently remove the reminder from the screen and stop all future reminders for this schedule.
- Press the **Snooze** soft key to temporarily remove the reminder from the screen, until the next schedule reminder. The reminder will appear every 5 minutes and also appear 1 minute before the schedule starts.
- Press the **Detail** soft key to view specific information.

**If you receive a reminder of a Skype conference, you can:**

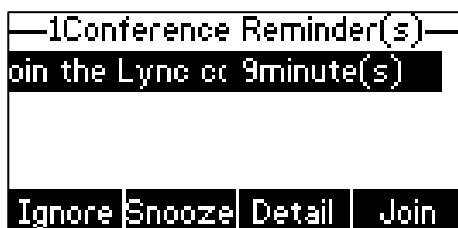

- Press the **Ignore** soft key to permanently remove the reminder from the screen and stop all future reminders for the Skype conference.

- Press the **Snooze** soft key to temporarily remove the reminder from the screen, until the next schedule reminder. The reminder will appear every 5 minutes and also appear 1 minute before the schedule starts.
- Press the **Detail** soft key to view specific information about the Skype conference, including the Skype conference's subject, participants, organizer, start and end time, location and content.
- Press the **Join** soft key to join the Skype conference.

**Note**

When the phone is locked, you can press the **Ignore** or **Snooze** soft key without unlocking the phone. But you need to unlock the phone to view detailed information and join the Skype conference.

If you do not deal with the reminder when rest time ends, the "immediately" will replace the rest time.

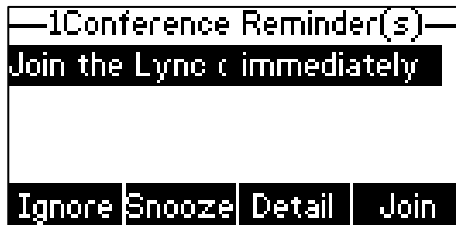

The reminder will show "overdue" when the schedule is overdue.

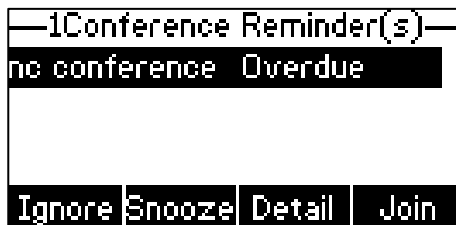



**Note**

You can press (X) on the phone to ignore all reminders.

When receives a Skype conference reminder during a call, you can press the **Join** soft key to join the Skype conference directly. Current call will be held and you can resume it after the Skype conference.

## Joining Skype Conferences from the Calendar

There are three roles in a conference:

- **Organizer** (  ): A user who creates a conference. Organizer can manage the presenters and attendees.
- **Presenter** (  ): The participant who is invited to the conference will be a presenter by default. The presenter can only manage other presenters and attendees.
- **Attendee** (  ): A user who is invited to a conference but who is not authorized to act as

a presenter. The attendee can hold or resume the conference, mute or unmute himself and leave the conference only.

You can join the Skype conferences in following three ways:

- **Joining a Skype conference from a conference reminder** (Once joined, presenter and attendee will be muted automatically, organizer will not be muted).
- **Joining a Skype conference from calendar** (Once joined, presenter and attendee will be muted automatically, organizer will not be muted).
- **Dialing the conference dial-in number to join a Skype conference** (Once joined, presenter, attendee and organizer will not be muted).

#### Note

When the organizer sets up a conference in Outlook and enables **Mute all attendees** feature, all conference participants will be muted automatically once join the Skype conferences in above ways.

## Joining a Skype Conference from a Conference Reminder

**To join a Skype conference from a conference reminder:**

Do one of the following:

- Press the **Join** soft key.

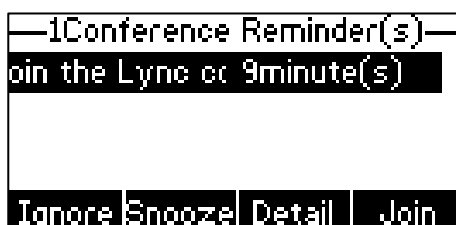

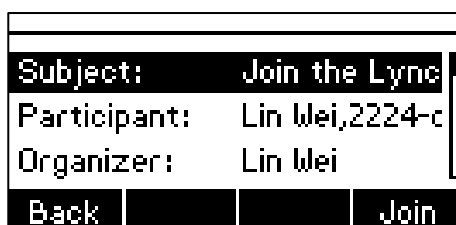

- Press the **Detail** soft key to view detail for a specific Skype conference, and then press the **Join** soft key.



## Joining a Skype Conference from Calendar

**To join a Skype conference from calendar:**

1. Press **Menu->Calendar**.

2. Press  or  to select a desired Skype conference.
3. Do one of the following:
  - Press the **Join** soft key to join the Skype conference.



- Press the **Detail** soft key to view specific information about the Skype conference, and then press the **Join** soft key.

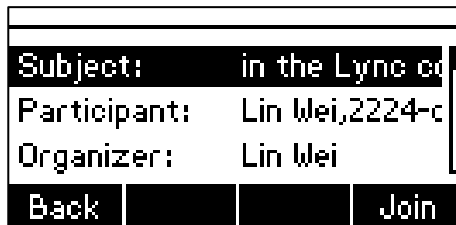

### Joining a Skype Conference by Dialing the Conference Dial-in Number

If you schedule a Skype conference call via Microsoft Outlook Conferencing (Plug-In), dial-in number and Conference ID will be sent to invitees in an email. Invitees can join the Skype conference from phone by dialing dial-in number and Conference ID.

You can also obtain the dial-in number and Conference ID from the phone.

#### To obtain the dial-in number and Conference ID from the phone:

1. Press **Menu->Calendar**.



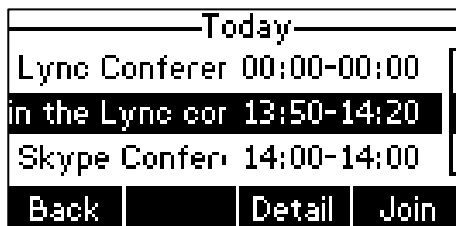

2. Press  or  to select a desired Skype conference.





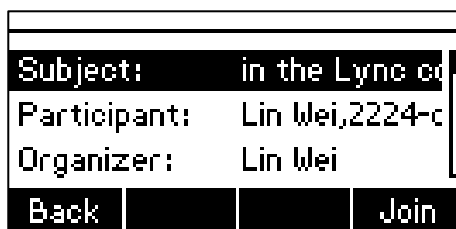

- Press the **Detail** soft key to view detail for specific Skype conference.

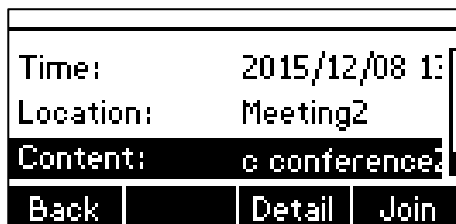

- Press  or  to highlight the content.



- Press the **Detail** soft key.
- Press  or  to view the dial-in number or Conference ID.

You can also view the dial-in number and Conference ID during a conference call. For more information, refer to [Viewing the Dial-in Number and Conference ID](#) on page 126.

**To join a Skype conference by dialing the conference dial-in number:**

- Dial the Skype conference dial-in number (e.g., 15915).



- Enter the Conference ID (e.g., 5493566), and then press  to join the Skype conference.



- More participants can repeat steps 1-2 to join the Skype conference.

For more information on managing the Skype conference participants, refer to [Managing the Conference Participants](#) on page 127.

## Call Forward

You can configure your phone to forward incoming calls to another party or voice mailbox through static forwarding. You can also forward incoming calls manually while your phone is ringing, refer to [Dynamic Forwarding](#).

## Static Forwarding

### Static Forwarding on T40P Skype for Business phone

T40P Skype for Business phone supports the following static forwarding ways:

- **Forward to Voice Mail:** incoming calls are forwarded to voice mailbox.
- **Forward Calls to Number or Contact:** incoming calls are forwarded to the preset number or contact.
- **Simultaneously Ring:** the preset number will ring simultaneously when you receive an incoming call.

#### To enable call forward:

1. Press **Menu**->**Features**->**Call Forward**.
2. Depending on your selection:
  - a) If you select **Forward to Voice Mail**, and then press the **OK** soft key.  
The  icon and the prompting message "Forward to Voice Mail" appear on the idle screen.

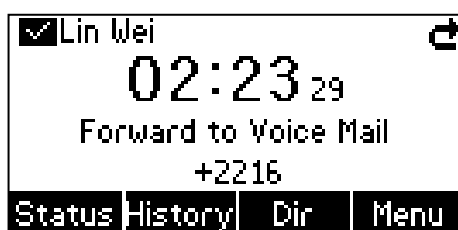

- b) If you select **Forward Calls to Number or Contact**, and then press the **OK** soft key:
  - 1) Enter the desired number in the **Forward to** field.

You can also press the **Dir** soft key to enter the contact list, and then select the desired contact.



- 2) Press the **OK** soft key to accept the change.

The  icon and the prompting message "Call Forwarding On" appear on the idle screen.

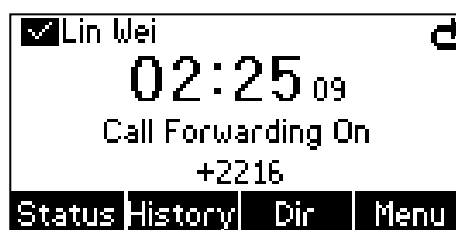

- c) If you select **Simultaneously Ring**, and then press the **OK** soft key:

- 1) Enter the desired number in the **Simultaneously Ring** field.



- 2) Press the **OK** soft key to accept the change.

The  icon and the prompting message "Simultaneous Ring On" appear on the idle screen.



#### To disable call forward:

1. Press **Menu->Features->Call Forward**.

2. Select **Forward Off**.

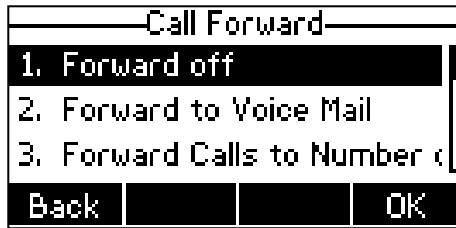

3. Press the **OK** soft key to accept the change.

## Static Forwarding on the Skype for Business client

You can assign static forwarding feature using the Skype for Business client:

- a) **Forward my calls to:**

- **Voice Mail:** incoming calls are forwarded to voice mailbox.
- **New Number or Contact:** incoming calls are forwarded to the preset number or contact.
- **My Delegates:** incoming calls are forwarded to designated delegates.

- b) **Simultaneously ring:**

- **New Number:** the preset number will ring simultaneously when you receive an incoming call.
- **My delegates:** the phones of designated delegates will ring simultaneously when you receive an incoming call.
- **My Team-Call Group:** all members in the designated group will ring simultaneously when you receive an incoming call.

Message displayed on the phone changes according to the forwarding setting on the Skype for Business client.

## Configuring Call Forwarding on Skype for Business Client

**To forward incoming calls immediately without ringing your phone:**

1. In Skype for Business client, click  and then select **Call Forwarding Settings**.

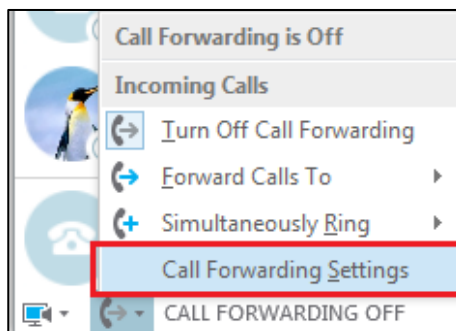

2. Mark the radio box in the **Forward my calls to** field.
3. Select the desired forwarding type from the pull down-list of **Forward my calls to**.  
Depending on your selection:

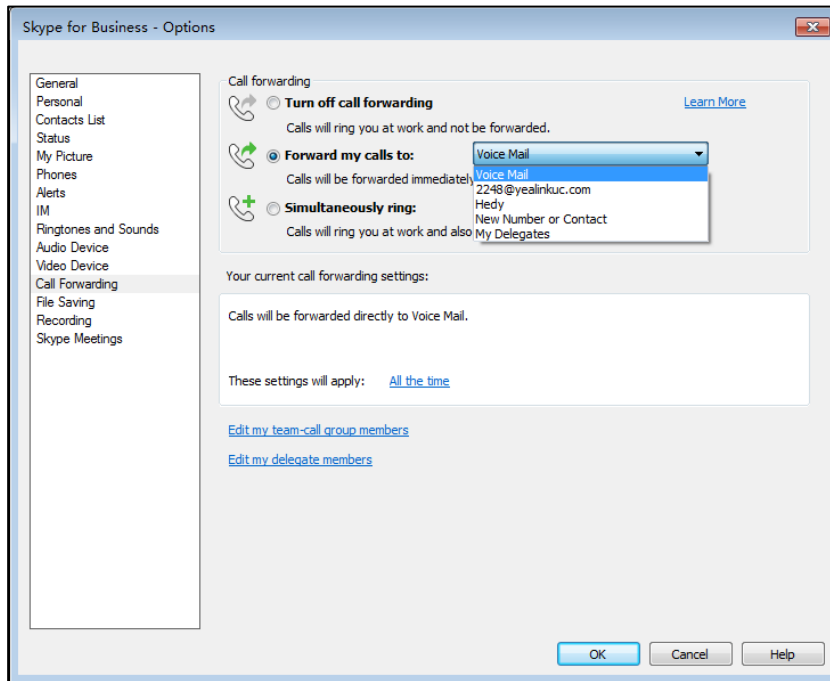

- 1) If you select **Voice Mail**:  
Incoming calls are forwarded directly to the voice mailbox. The LCD screen is shown as below:

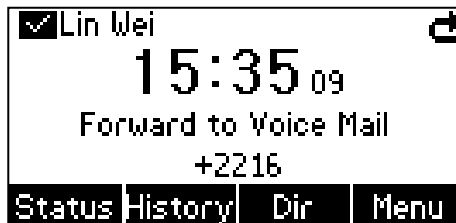

- 2) If you select **New Number or Contact:**  
Select the contact or enter the phone number you want to forward calls to.

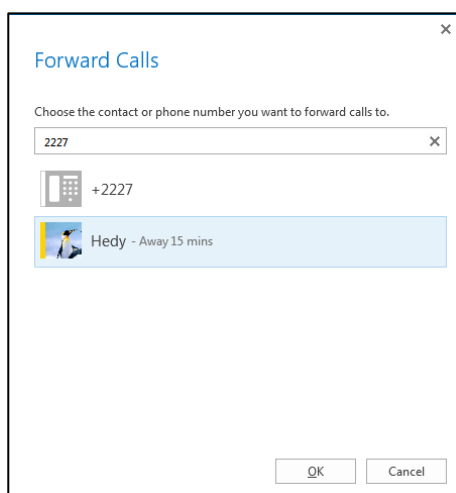

After configuration, incoming calls are forwarded to the preset number or contact.  
The LCD screen is shown as below:



- 3) If you select **My Delegates:**  
Add the delegates you want to forward calls to when you receive an incoming call.  
The phone of the delegates will ring after the time specified by you.

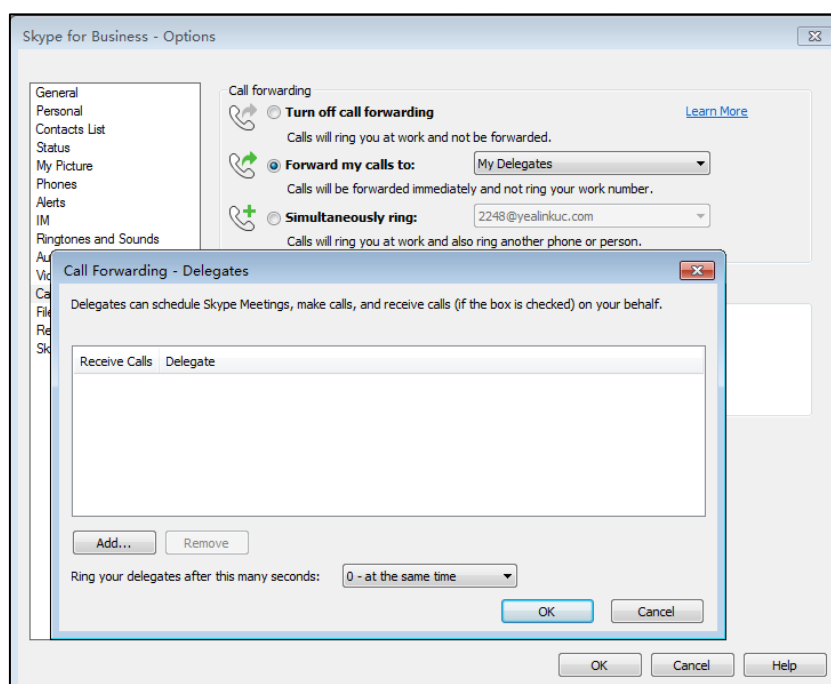

The LCD screen is shown as below:



## Configuring Simultaneously Ring on Skype for Business Client

To configure simultaneously ring:

1. In Skype for Business client, click and then click **Call Forwarding Settings**.
2. Mark the radio box in the **Simultaneously ring** field.
3. Select the desired forwarding type from the pull down-list of **Simultaneously ring**.

Depending on your selection:

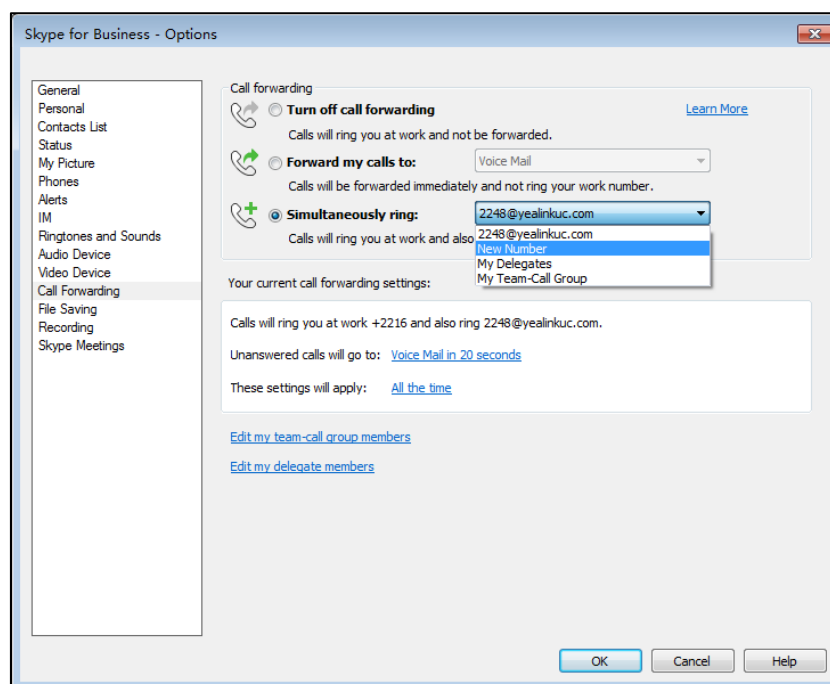

- 1) If you select **New Number**:

Enter the phone number in the pop-up window, and then click **OK** to accept the change.

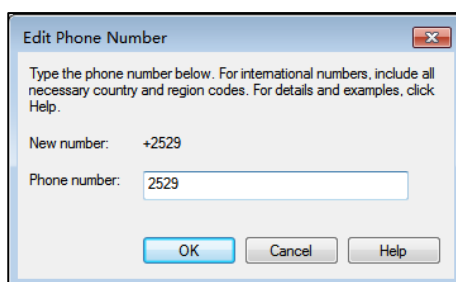

After configuration, the preset number will ring simultaneously when you receive an incoming call.

2) If you select **My Delegates**:

Add the delegates you want to ring simultaneously when you receive an incoming call. The phone of the delegates will ring after the time specified by you.

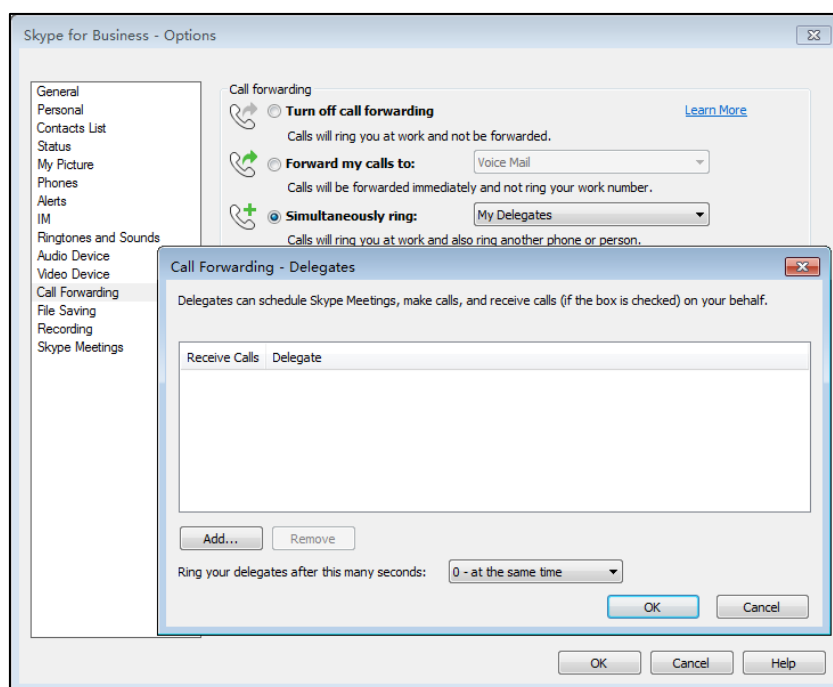

3) If you select **My Team-Call Group**:



Add the contacts in the Team-Call Group. All members in the group will ring simultaneously when you receive an incoming call. The phone of the members in the group will ring after the time specified by you.

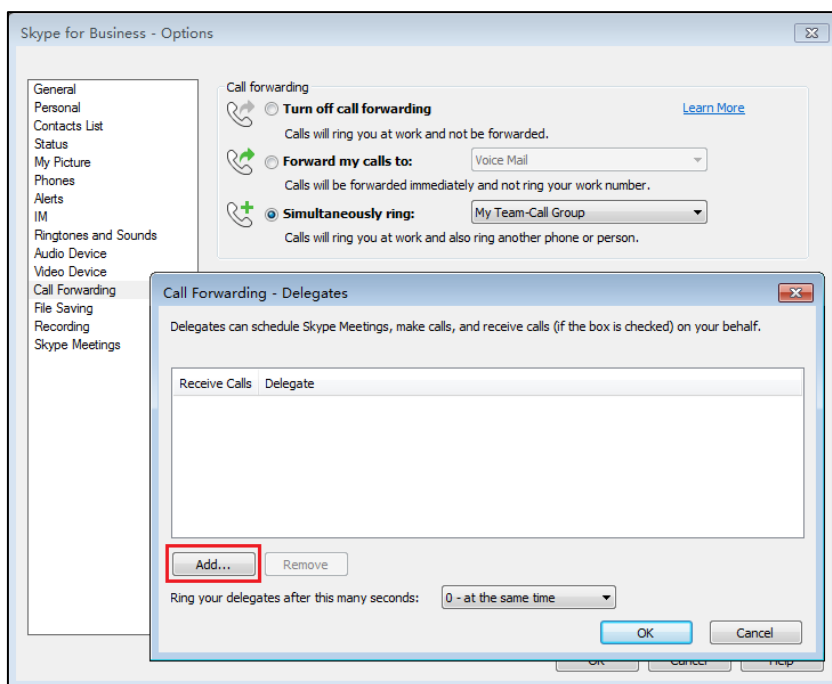

When simultaneously ring feature is enabled, the LCD screen is shown as below:



If one member answers the call, other phones will stop ring.

#### To turn off the call forwarding:

1. In Skype for Business client, click  and then select **Turn Off Call Forwarding**.

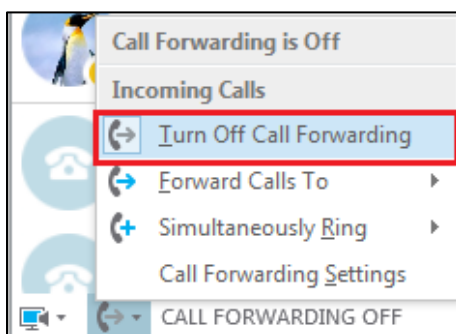

## Dynamic Forwarding

### To forward an incoming call to another party:

1. Press the **FWD** soft key when the phone is ringing.

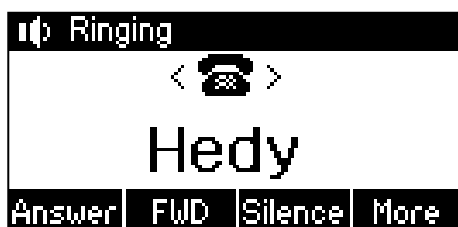

2. Do one of the following:
  - Enter the phone number you want to forward the incoming call to, and then press the **Call** soft key.  
You can also enter the first few continuous characters of the contact name, phone number or the contact address, and then press the navigation keys to scroll through the result list and select the desired contact.
  - Press the **Dir** soft key to select the desired contact from the contact list you want to forward the incoming call to, and then press the **FWD** soft key.

The incoming call is forwarded to the entered number or the selected contact.

### To forward an incoming call to voice mail directly:

1. Press the **More->FWD VM** soft key when the phone is ringing.

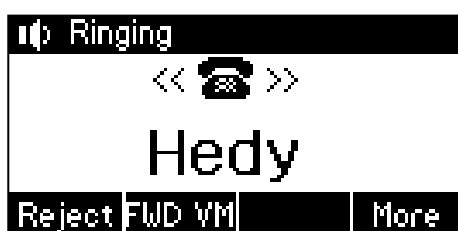

The incoming call will be forwarded to your voice mail directly.

## Forward International

Forward international allows you to forward an incoming call to an international phone number. This feature is enabled by default.

### To disable forward international via phone user interface:

1. Press **Menu->Settings->Advanced Settings** (default password: admin)-> **FWD International**.

- Press ◀ or ▶, or the **Switch** soft key to select **Disabled** from the **FWD International** field.

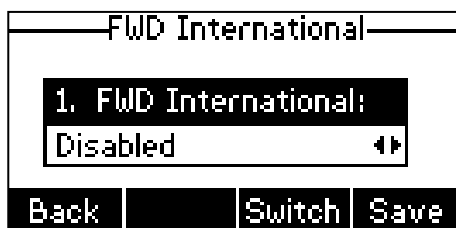

- Press the **Save** soft key.

Forward international is configurable via web user interface at the path **Features->General Information->Fwd International**.

## Response Groups

If you sign into the phone using Onprem account, you can use response groups feature. Current Online environment does not support this feature.

If your organization has groups of people who answer and manage certain types of calls, such as for customer service, an internal help desk, or general telephone support for a department, you can deploy the Response Group application to manage these types of calls. The Response Group application routes and queues incoming calls to designated persons, who are known as agents. You can increase the use of telephone support services and reduce the overhead of running these services by using response groups.

When a caller calls a response group, the call is routed to an agent based on a hunt group or the caller's answers to interactive voice response (IVR) questions.

If no agents are available, the call is held in a queue until an agent is available. While in the queue, the caller hears music until an available agent accepts the call. If the queue is full, or if the call times out while in the queue, the caller might hear a message and then is either disconnected or transferred to a different destination, such as a different phone number or voicemail.

The Response Group application uses standard response group routing methods to route the call to the next available agent. The system administrator can configure the routing methods of response group on the Skype for Business Server.

The routing methods of response group are as follows:

- Longest idle** method: The call is routed to the agent who has the longest idle time.
 

If the agent is unavailable, the call goes into the next agent who has the longest idle time until the call is answered.
- Parallel** method: The call is routed to all idle agents.
 

All idle agents are called at the same time for every incoming call.
- Round robin** method: The call is routed to the agent ordered by agent list circularly.

If the agent is unavailable, the call goes into the next agent t ordered by agents list circularly until the call is answered or the agent list end.

- **Serial** method: The call is routed to the agent ordered by agents list orderly.

If the agent is unavailable, the call goes into the next agent ordered by agents list orderly until the call is answered.

- **Attendant** method: The call is routed to the agents who sign into Skype for Business Server or response group.

All agents are called at the same time for every incoming call, regardless of their current presence.

For example, a response group named “yealink” is configured in advance. When a user named “Hedy” calls the response group, the screen of the agent’s phone is shown as below:

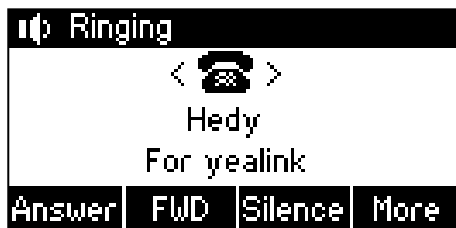

**Note**

Response group should be configured in advance by administrator. Contact your system administrator for more information.

## Shared Line Appearance for Skype for Business

When your phone is registered with the Skype for Business Server, you can use the Shared Line Appearance (SLA) feature to share a single line with other contacts as a member of a group. System administrators assign members to SLA groups. Any SLA group member can place, answer, hold, or resume calls on the line, and all group members can view the call held by the shared line on their phones. Each line supports up to 24 call appearances. Only one call at a time can be active on the shared line appearance. If a call is placed to the shared line with an active call in place, the incoming call is sent to another shared line.

### Answering SLA Calls

Any incoming call to the shared line rings on all group members' phones simultaneously, the call is displayed on all members' screens, and a green LED light flashes on the first line key.

Any group member can respond to an incoming call to the shared line. When a group member answers an incoming call, the second line key's LED indicator on all phones illuminates solid green to indicate the call was answered.

## Placing a SLA Call on Hold

### To place a SLA call on hold:

1. Press the **Hold** soft key to place the call on hold.  
The second line key on other members' phones flash green.

## Resuming Held SLA Calls

Any SLA member can resume a held call on the shared line.

### To resume a call on the shared line:

1. Press the second line key (flashing green) to view the calls that are held by the shared line.
2. Press the **Resume** soft key.

## Boss-Admin Feature

The boss-admin feature, which is also called boss-delegate feature, enables a "boss" phone and delegates' phones to ring simultaneously when a user calls the boss. When one party answers the call, the other phone will stop ringing. A boss can assign delegates and manage calls on the delegate's line.

Delegates can place, answer or hold the call. Delegates can also make a safe transfer to boss's voice mail or call on behalf of the boss's line. The boss can pick up held calls on a delegate's line. What's more, the boss can hold the calls, and the delegate can pick up held calls on the boss's line.

### Boss-Admin Scenario:

For example, the system administrator has configured the phone number 2248 to be the delegate of phone number 2216. For more information on how to assign delegates on the Skype for Business client, refer to [Assigning/Removing Delegate](#) on page 107.

### Note

Boss-admin feature is configurable via the Skype for Business client only.

- **Boss:** Lin Wei (phone number: 2216)
- **Delegate:** Merry (phone number: 2248)
- **Other:** 2224-cgc (phone number: 2224)

## Assigning/Removing Delegates

You can assign delegates to your line using the Skype for Business client. However, you cannot assign yourself as a delegate. As a delegate, you can be assigned to multiple bosses' lines.

**To assign delegates using Skype for Business client:**

1. Open Skype for Business client.
2. Sign into Skype for Business client as the person who wants to assign a delegate.
3. Click the  button, and then click **Call Forwarding Settings**.
4. Mark the radio box in the **Simultaneously ring** field.
5. Select **My Delegates** from the pull-down list of **Simultaneously ring**.

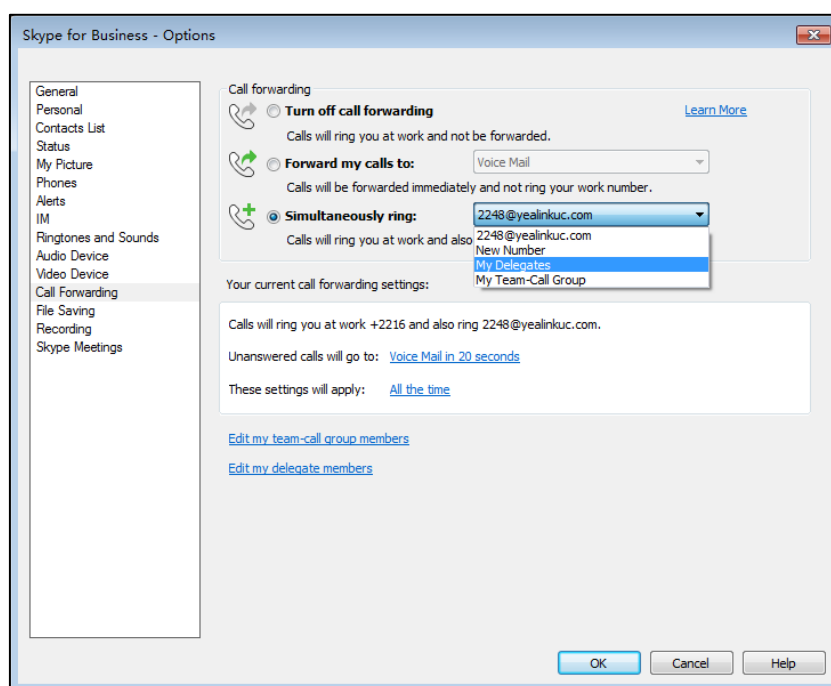

6. In the **Delegates** dialog box, click **Add...**. Each delegate must be a Skype for Business contact.

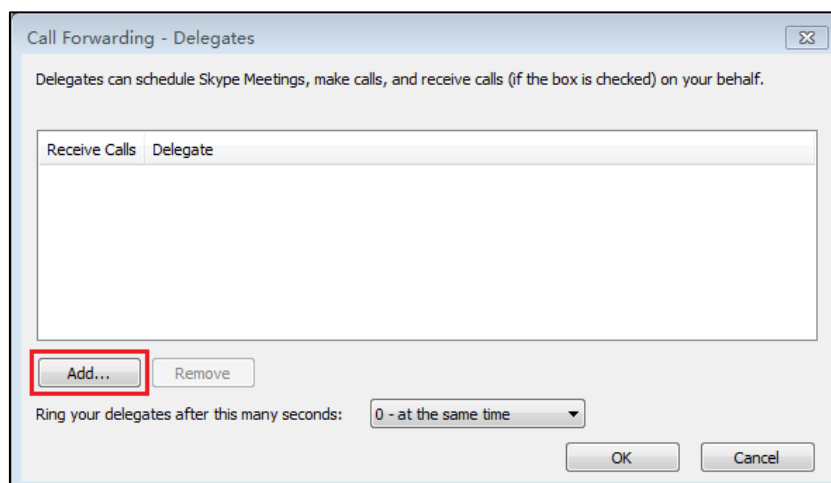

- Select the desired delegates from the **Choose a Delegate** dialog box.

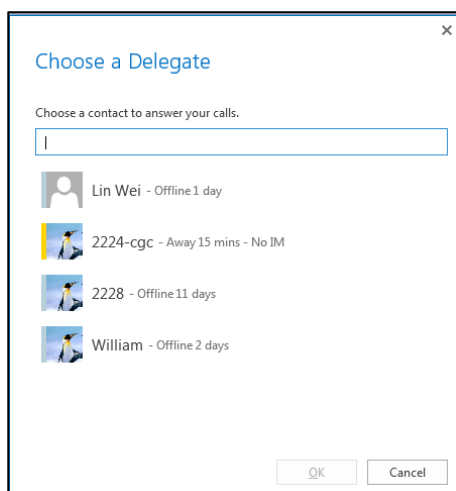

- Click **OK**.
- Click **OK** in the **Delegates** dialog box.
- Click **OK** in the **Options** dialog box.

**To remove a delegate from Skype for Business client:**

- Open Skype for Business client.
- Sign into Skype for Business client as the person who wants to remove a delegate.  
Make sure **My Delegates** option is not selected in either the **Simultaneously ring** or **Forward my calls to** list.
- Click **Edit my delegate members**.

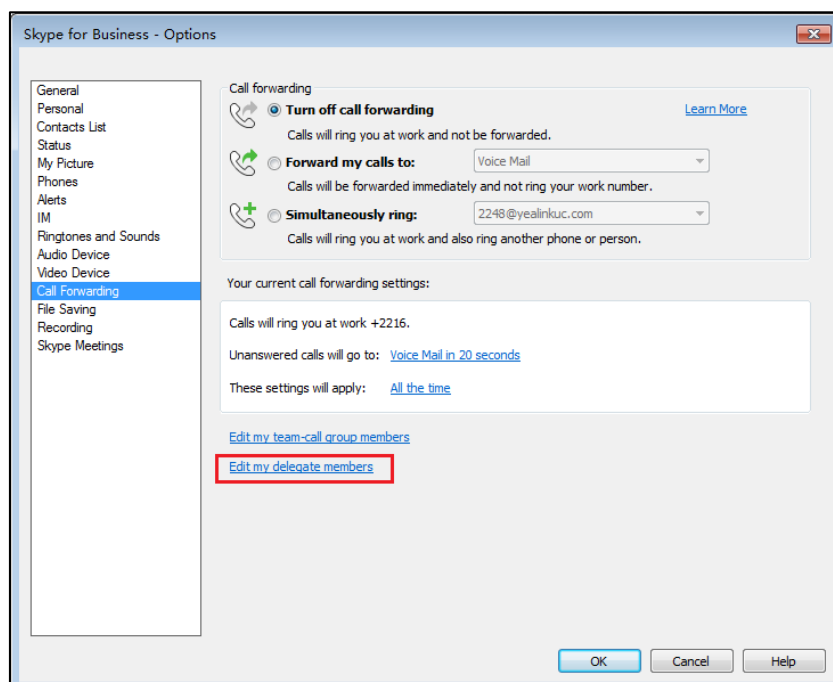

4. Check the checkbox of the delegate you want to remove.

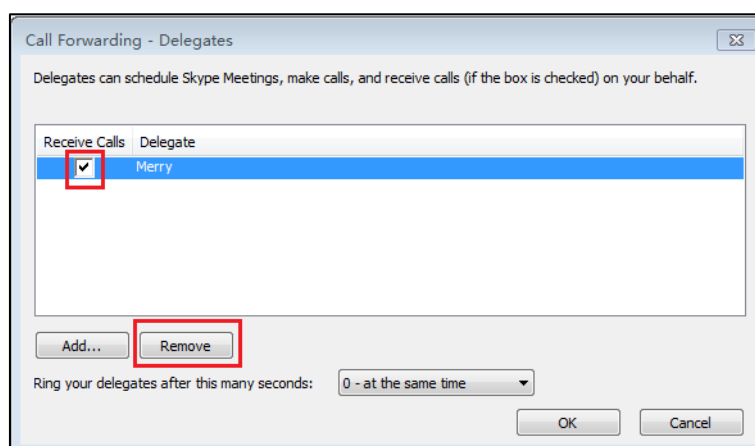



5. Click **Remove**.
6. Click **OK** in the **Delegates** dialog box.
7. Click **OK** in the **Options** dialog box.

## Viewing the Bosses/Delegates

### Viewing the Bosses

Once a user is assigned to be a delegate of the boss on the Skype for Business client, a **Bosses** group will appear on the delegate's phone automatically.

**To view your bosses:**

1. Press **Dir**->**SFB Directory**.
2. Press  or  to select the **Bosses** group.



3. Press the **Enter** soft key.  
Your boss(es) will be displayed.

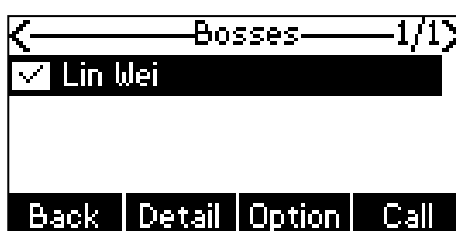





## Viewing the Delegates

Once a boss is assigned delegates on the Skype for Business client, a **Delegates** group will appear on the boss's phone automatically.

**To view your delegates:**

1. Press **Dir**->**SFB Directory**.
2. Press  or  to select the **Delegates** group.



3. Press the **Enter** soft key.  
Your delegate(s) will be displayed.



## Using the Boss-Admin Feature

### Answering Incoming Calls

When a user calls the boss, both boss's and delegate's phones will ring simultaneously.

**To answer an incoming call on a boss's phone:**

1. Press the **Answer** soft key or .

The delegate's phone stops ringing and the LCD screen of the delegate's phone is shown below:



**To answer an incoming call on a delegate's phone:**

1. Press the **Answer** soft key or .

The boss's phone stops ringing and the LCD screen of the boss's phone is shown below:



## Placing the Calls on Hold

**To place a call on hold on a boss's phone:**

1. Press the **Hold** soft key to place the call on hold.

The second line key LED of the delegate's phone flashes green. The Boss/Admin screen appears on the delegate's phone.

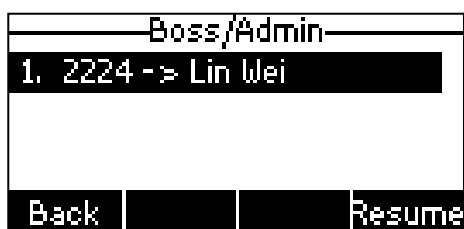

**To place a call on hold on a delegate's phone:**

1. Press the **Hold** soft key to place the call on hold.

The second line key LED of the boss's phone flashes green. The Boss/Admin screen appears on the boss's phone.

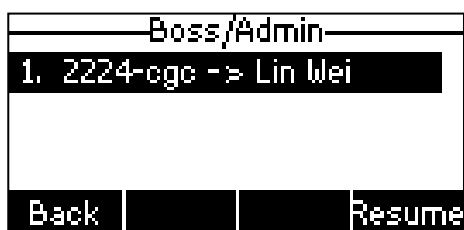

## Resuming the Held Calls

Either boss or delegate can resume the held call. Once one party resumes the call, the other party will drop the call automatically.

**To resume a call held on a boss's phone:**

Do one of the following:

- The boss presses the **Resume** soft key to resume the held call.

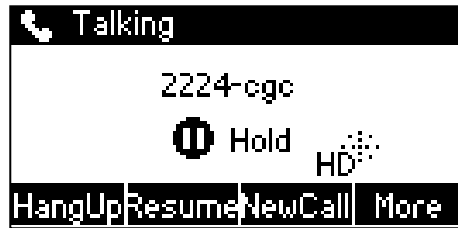

- The delegate presses the second line key to view the calls that are held by the boss.

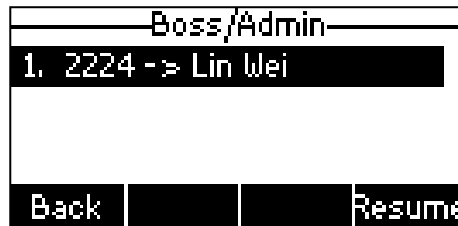

(A call from 2224 to Lin Wei)

Press the **Resume** soft key. The call will be resumed by delegate, and the boss will drop the call automatically.

#### To resume a call held on a delegate's phone:

Do one of the following:

- The delegate presses the **Resume** soft key to resume the held call.

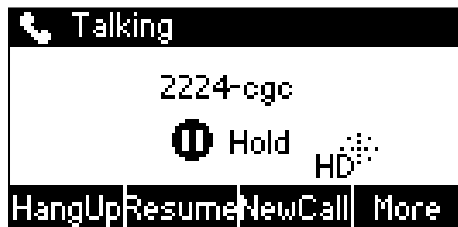

- The boss presses the second line key to view the calls that are held by the delegate.

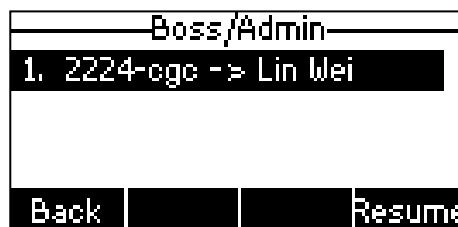

(A call from 2224-cgc to Lin Wei)

Press the **Resume** soft key. The call will be resumed by the boss, and the delegate will drop the call automatically.

## Transferring Calls to Boss Voicemails

If a boss is unavailable to answer calls, delegates can transfer the calls directly to a boss's voicemail. The caller can follow the voice prompt to leave the voice mail.

### To transfer a delegation call to the boss's voicemail:

Do one of the following:

- Before the delegate answers the incoming call:  
Press the **BossVM** soft key to forward the incoming call to boss's voice mail directly.  
The LCD screen of the delegate's phone is shown below:



- After the delegate answers the call:  
Press **More**->**BossVM** to transfer the call to boss's voice mail directly.  
The LCD screen of the delegate's phone is shown below:



## Making a Safe Transfer to Boss

After a delegate answers a delegation call, the delegate can transfer the call to the boss's phone using Safe Transfer, which enables the delegate to transfer the call to the boss's phone and prevent the call from going to the voice mail if the boss does not answer the call.

### To make a safe transfer to a boss's phone:

1. Press **More**->**SafeTr** during a call. The call is placed on hold.  
When the boss answers the call, the call will be transferred to the boss successfully.

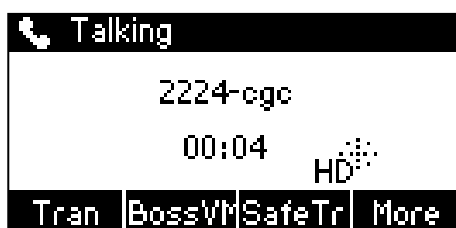

When the boss is not available to answer the transferred call or rejects the transferred call, the delegate's phone displays as "Transfer failed". The delegate can resume the call.

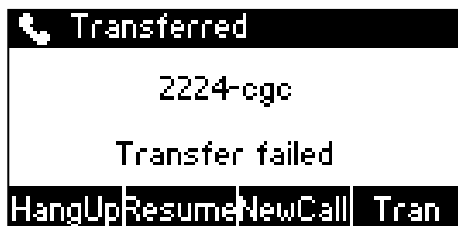

## Calling on Behalf of a Boss

The delegate can make calls on behalf of his assigned boss's lines.

**To place a call on behalf of a boss's line:**

1. Press **Dir**->**SFB Directory**->**Bosses**.
2. Selected the desired boss, and then press the **Option** soft key.
3. Press  $\uparrow$  or  $\downarrow$  to select **On behalf**.

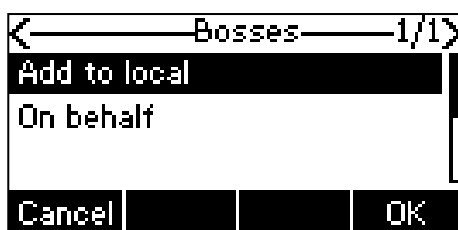

4. Enter the number or press the **Dir** soft key to select the desired contact, and then press  $\text{OK}$ ,  $\text{\#SEND}$  or the **Call** soft key.

The call displays "Calling On behalf of XXX" on the delegate's phone.

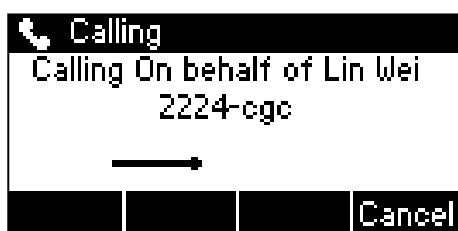

The delegate displays a notification after the third-party answers the phone. As shown below:

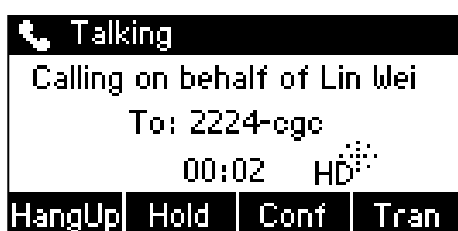

## Joining Conference Calls

The delegate can join an incoming conference call on behalf of a boss's line and add the boss to the conference call.

### To add a boss's line to a conference call:

1. Press the **Answer** soft key to join an incoming conference call.



2. If the conference needs the boss to be present, press the **Invite** soft key to add the boss's line to the conference.

The LCD screen of the delegate's phone is shown below:

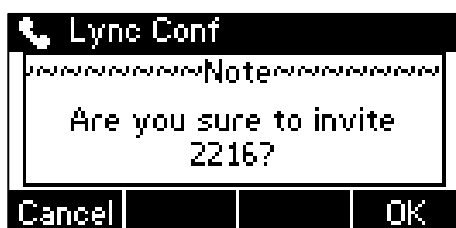

3. Press the **OK** soft key.

The LCD screen of the delegate's phone is shown below:



When the boss joins the conference call, the delegate can choose to continue or leave the conference.



## Inbound Private Line

If you sign into the phone using Onprem account, you can use inbound private line feature. Current Online environment does not support this feature.

The Skype for Business Server enables the system administrator to give users a second, private telephone line in addition to their primary telephone line. Private telephone lines are often assigned to bosses who want an unlisted telephone number at which they can be reached directly.

When the boss receives a private call, the private line will bypass call delegation and only his/her phone rings even though a secretary has been designated as his/her delegate for ring simultaneously feature.

The system administrator can assign a private line to boss in one of the following situations occurs:

- The boss doesn't want to miss important calls denied by his DND status.
- The boss doesn't want the delegate to answer some important or confidential calls for him.
- The boss wishes his friends and families to reach him directly or bypass his delegate.

In many organizations, bosses have administrative secretaries who answer their office phones for them. This is easily accomplished on the Skype for Business Server by using call delegation. As a result, if one people dial the primary line of the boss, the phones of the delegate will ring simultaneously. If the people dial the private line of the boss, only boss's phone rings.

### Characteristics of Private Lines:

- A user can have only one private line.
- A user with a private line has only one voice mailbox.
- Calls to the private telephone line ring through. They do not follow "Do Not Disturb" rules.
- Private lines are inbound only and cannot be used to make outgoing calls.
- None of the following features are available with a private telephone line: delegation, and Response Group application.

For more information on planning for private telephone lines, refer to [Plan for private telephone lines](#).

When receiving a private call, the screen of the phone will prompt "Call for private line":

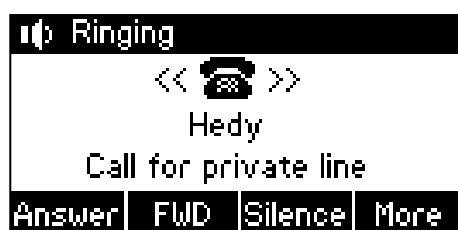

### Note

Private lines can only be configured on the Skype for Business client only. Contact your administrator for more information.



## Private Line Ring Tones

Private line ring tone feature allows the Skype for Business phone to play a specific ring tone when receiving a private call.

**To select a ring tone for the private line via phone user interface:**

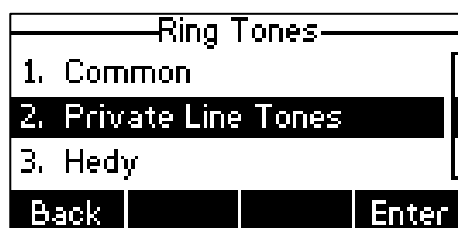
1. Press **Menu->Settings->Basic Settings->Ring Tones->Private Line Tones.**



2. Press  or  to select the desired ring tone.
3. Press the **Save** soft key to accept the change.

A ring tone for the private line is configurable via web user interface at the path **Settings->Preference->Private line ring.**

## Call Transfer

You can transfer a call to another party in one of the two ways:

- **Blind Transfer:** Connect a second party to a third party before the third party answers.
- **Consultative transfer:** Connect a second party to a third party after the third party answers and agrees to take the call from the second party.

## Blind Transfer

**To perform a blind transfer during a call:**

1. Press the **Tran** soft key during a call.
2. Enter the number or press the **Dir** soft key to select the desired contact from the contact list you want to transfer the call to.



You can also enter the first few continuous characters of the contact name, phone number or the contact address, and then press the navigation keys to scroll through the result list and select the desired contact.

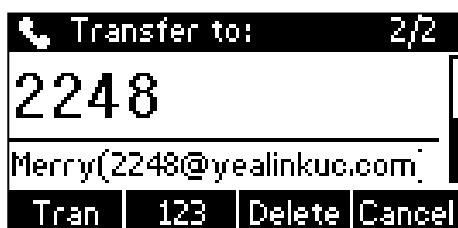

3. Press the **Tran** soft key to complete the transfer.



Then the call is connected to the number to which you are transferring.

## Consultative Transfer

### To perform a consultative transfer:

1. Press the **Tran** soft key during a call.
2. Enter the number or press the **Dir** soft key to select the desired contact from the contact list you want to transfer the call to.

You can also enter the first few continuous characters of the contact name, phone number or the contact address, and then press the navigation keys to scroll through the result list and select the desired contact.

3. Press  or  to dial out.
4. After the party answers the call, press the **Tran** soft key to complete the transfer.

## Group Call Pickup

If you sign into the phone using Onprem account, you can use group call pickup feature. Current Online environment does not support this feature.

Group call pickup is used for picking up incoming calls within a pre-defined group. If the group receives many incoming calls at once, the user will pick up the first incoming call, by dialing the group pickup code. This feature depends on support from a Skype for Business Server.

### Note

Group and group pickup code are configurable on the Skype for Business Server only. Contact your system administrator for more information.

**To use group pickup via phone user interface:**

1. Enter the group pickup code (e.g., #505) on your phone when a phone number in your group receives an incoming call.

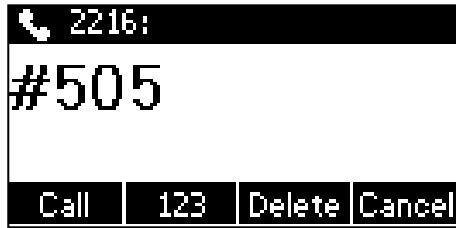

2. Press the **Call** soft key.  
The call is answered on your phone.

## Skype for Business Conference

This chapter provides basic operating instructions for managing Skype for Business conference. You can initiate a Skype for Business conference call on your phone or on the Skype for Business client. You can view the conference participants. And you can also manage the conference participants (e.g., promote or demote conference participants, enable or disable announcements).

## Initiating a Skype for Business Conference Call

You can initiate a Skype for Business conference call on your phone or on the Skype for Business client.



**Note** You can join a Skype conference from the calendar. For more information, refer to [Joining Skype Conferences from the Calendar](#) on page 92.

## Initiating a Skype Conference Call during a Call

### Initiating a Skype Conference Call from the Phone

You can initiate a Skype for Business conference call, add and invite contacts to a conference call from phone.

**To initiate a Skype for Business conference call via phone user interface:**

1. Place a call to the first party.
2. When the first party answers the call, press the **Conf** soft key to invite a new call to the Skype for Business conference.
3. Enter the number of the third party, and then press , , or the **Call** soft key.  
You can also enter the first few continuous characters of the contact name, phone number

or the contact address, and then press the navigation keys to scroll through the result list and select the desired contact.

4. When the third party answers, three parties are now joined in the Skype conference.



5. Press the **Add** soft key to invite a new party.
6. Repeat steps 3-4 to add more parties to the conference.

### Initiating a Skype Conference Call from the Skype for Business Client

You can initiate a Skype conference call on the Skype for Business client.

**To initiate a Skype for Business conference call from the Skype for Business Client:**

1. Place a call to the first party.



2. Click  to enter the number or name of the third party, and then click **OK** to invite a new call to the Skype for Business conference.

You can also enter the first few characters of the contact name or the contact number. Then select the desired contact from the result list, the call will be placed directly.

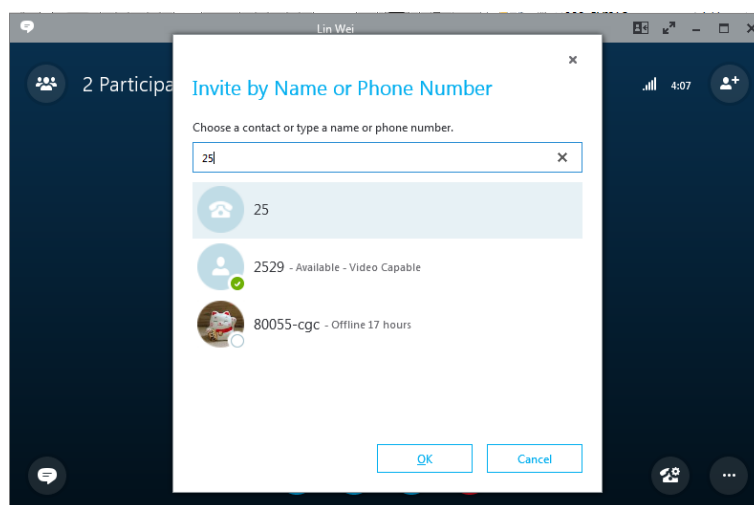

3. When the third party answers, three parties are now joined in the conference.
4. Click  to invite a new party.
5. Repeat steps 2-3 to add more parties to the conference.



## Join Calls into a Conference

### Joining Two Calls into a Conference from the Phone

You can join an active call and a held call into a conference call from the phone.

**To join two calls into a conference call from the phone:**

1. Place a call to the first party.

- When the first party answers the call, press the **Hold** soft key to place the call on hold.

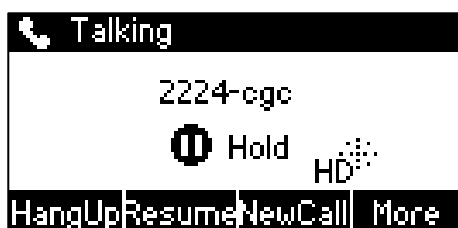

- Press the **NewCall** soft key to place a new call.
- Enter the number of the third party, and then press the **Call** soft key.  
You can also enter the first few characters of the contact name or the contact number. Then select the desired contact from the result list, the call will be placed directly.

- When the third party answers, press the **Conf** soft key.

- Press  to select the contact that is held.

- Press the **Merge** soft key.

The active call and the held call are joined into a conference.







- Press the **Add** soft key, and dial other numbers to invite more parties.

## Joining Two Calls into a Conference from the Skype for Business Client

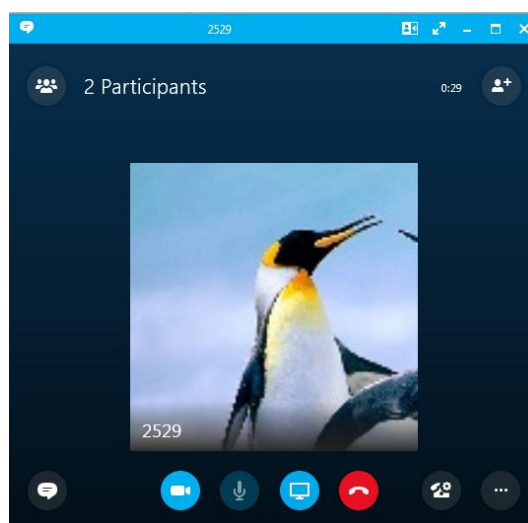
**To initiate a Skype for Business conference call from the Skype for Business Client:**

- Place a call to the first party.



2. Click  ->  to place the call on hold.
3. Enter the first few characters of the contact name or the contact number in the search box.
4. Hover the mouse over the avatar of the contact, and then click .

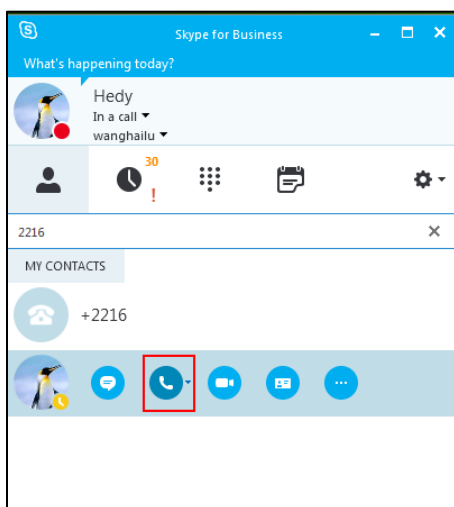

5. When the third party answers, click .
6. Select **Merge This Call Into**, and then click the held call.

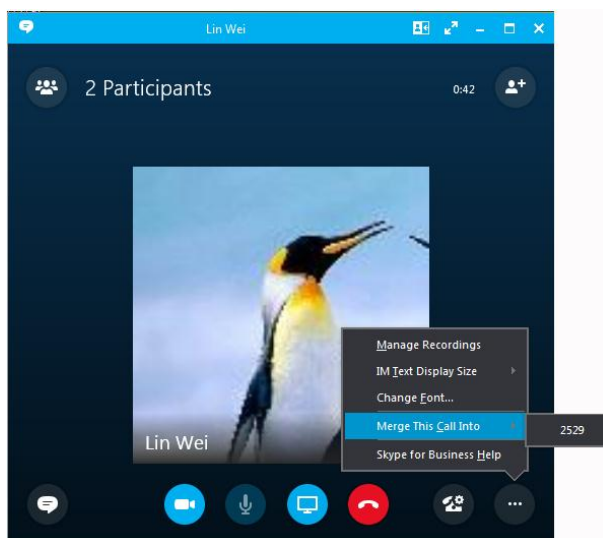

Three parties are now joined in the conference.

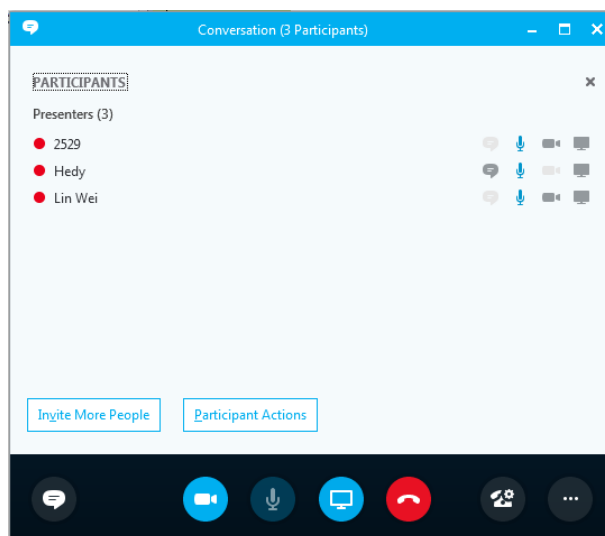

7. Click **Invite More People** to add more parties to the conference.

## Initiating a Skype Conference Call by Meet Now

### Initiating a Skype Conference Call from the Phone

To initiate a Skype for Business conference call by meet now via phone user interface:

1. Press **Menu->Meet Now**.



You will initiate a Skype for Business conference call directly.

2. Press the **Add** soft key.
3. Enter the desired number, and then press the **Call** soft key.  
You can also press the **Dir** soft key or line key to select the desired contact.
4. Repeat steps 2-3 to add more parties to the conference.

## Initiating a Skype Conference Call from the Skype for Business Client

To initiate a Skype for Business conference call by meet now from the Skype for Business client:

1. Click  on the Skype for Business client, and then select **Meet Now**.

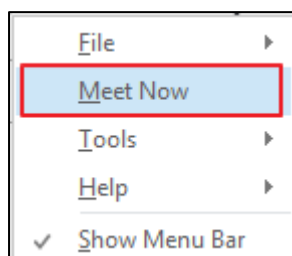

You will initiate a Skype for Business conference call directly.

2. Click  to enter the number or name of the third party, and then click **OK** to invite a new call to the Skype for Business conference.

You can also enter the first few characters of the contact name or the contact number. Then select the desired contact from the result list, the call will be placed directly.

3. Repeat step 2 to add more parties to the conference.

## Viewing the Dial-in Number and Conference ID

You can view the dial-in number and conference ID when you initiate or join a Skype for Business conference.

To view the dial-in number and conference ID via phone user interface:

1. During a Skype for Business conference, press **More->Info** to view the dial-in number and conference ID.

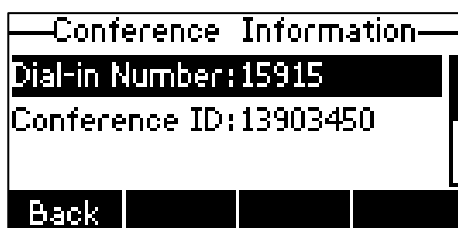

2. Notify other parties of the dial-in number and conference ID. The other parties can use the dial-in number and conference ID to join this Skype for Business conference. If this conference is locked, anyone that tries to join the call will enter the lobby until the organizer or presenters accept(s) the call. For more information, refer to [Locking or Unlocking the Conference](#) on page 130.







## Viewing the Conference Participants

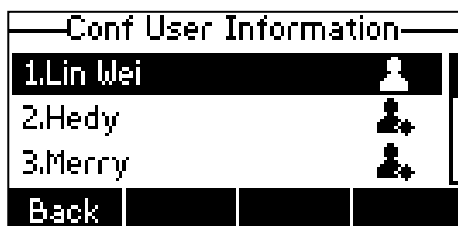

When you initiate or join a conference call, you can view the conference participants.

**To view the conference participants via phone user interface:**

1. Press **More**->**Member** to view the conference participants' information during a conference.



The conference information includes organizer ( , presenter ( ) and attendee ( ). For more information on conference roles, refer to [Joining Skype Conferences from the Calendar](#) on page 92.

2. Press  or  to view the conference participants information.
3. Press the **Back** soft key to return to the previous screen.

## Managing the Conference Participants

When you initiate a Skype for Business conference call, you will be an organizer and other participants are listed as presenters by default.

### Holding or Resuming the Conference Call

All participants can place the conference call on hold.

**To place the conference call on hold:**

1. Press the **Hold** soft key during an active conference call.  
Other participants can hear each other.

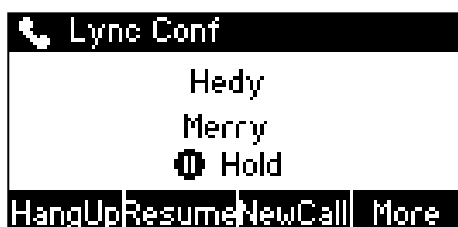

#### Note

The phone will beep softly every 30 seconds to remind you that you still have a call on hold.



**To resume the held conference call:**

1. Press the **Resume** soft key.

## Muting or Unmuting Conference Participants

All participants can mute or unmute themselves. But only the organizer and presenters can mute or unmute other conference participants.

**To mute the conference participants by organizer or presenters:**

1. Press **More->Member**.
2. Press  or  to select the desired participant.

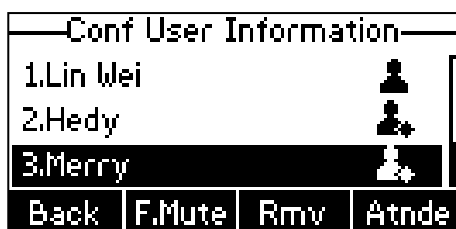

3. Press the **F.Mute** soft key.

The muted participant can hear other participants, but other participants cannot hear the muted participant.

The mute icon  is displayed at the right of the participant who is muted.

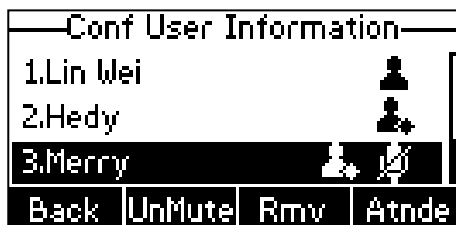



The LCD screen of the muted participant's phone is shown below:



**To unmute the conference participants by organizer or presenters:**

1. Press **More->Member**.

- Press  or  to select the desired muted participant.

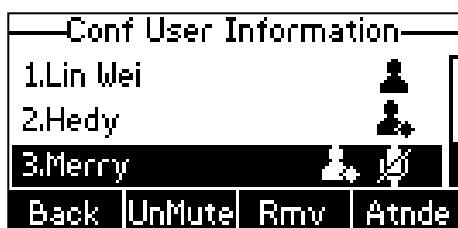

- Press the **UnMute** soft key.

The LCD screen of the muted participant's phone is shown below:





- The muted participants press  to unmute.



## Promoting or Demoting Conference Participants

The organizer and presenters can promote other conference participants from attendees to presenters, or demote conference participants from presenters to attendees. But they cannot demote or promote themselves. The presenters cannot demote or promote the organizer. The attendees cannot promote or demote every participant.

### To demote conference participant:

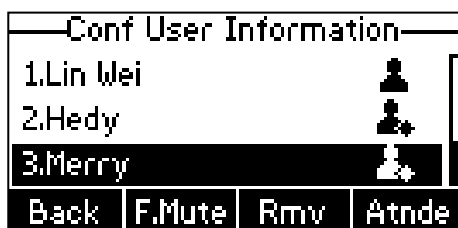

- Press **More**->**Member**.
- Press  or  to select the desired presenter.





- Press the **Atnde** soft key to demote a presenter (  ) to attendee (  ).

### To promote conference participant:

- Press **More**->**Member**.

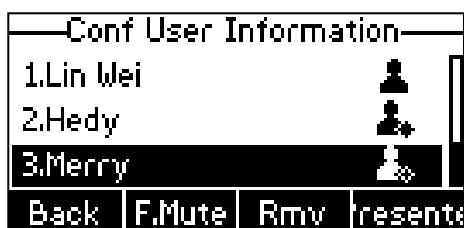
- Press  or  to select the desired attendee.



- Press the **Presenter** soft key to promote an attendee (  ) to presenter (  ).

## Enabling or Disabling the Announcement

Only the organizer and presenters can enable or disable the announcement. When the announcement feature is enabled, the phone will issue a voice message to announce that a participant joins or leaves the conference.

### To disable conference announcements:

- During a conference call, press **More**->**U.Anc** to disable announcement.



### To enable conference announcements:

- During a conference call, press **More**->**E.Anc** to enable announcement.



## Locking or Unlocking the Conference

Only the organizer and presenters can lock or unlock the conference.

The organizer and presenters can lock a conference call to prevent other people from joining the conference call without an organizer's or presenter's approval.

**To lock a conference:**

1. During an active conference, press **More**->**Lock** to lock the conference.



The icon  appears on the LCD screen. Anyone that tries to join the call will enter the lobby until the organizer or presenters accept the call.

**To unlock a conference:**

1. During an active conference, press **More**->**UnLock** to unlock the conference.

The icon  disappears on the LCD screen.

**Joining a Locked Conference Call**

The conference participants can invite you to join a locked conference, you can also join locked conference by dialing dial-in number and Conference ID. For more information, please refer to [Joining a Skype Conference by Dialing the Conference Dial-in Number](#) on page 94.

**The participant invites a new call to a locked conference:**

1. Press the **Add** soft key to invite a new call.



The invitee will enter the lobby until the organizer or presenters accept the call. The LCD screen of the organizer's or presenters' phones are shown below:



**The organizer or presenters admit a new call to join a locked conference:**

When the locked conference receives a call, a number icon (indicating the number of calls waiting in the lobby) will appear on . When the organizer admits or rejects the caller to join the locked conference, the number icon 1 (indicating a call waiting in the lobby) will disappear.

1. Press **More**->**Lobby** to view the caller waiting in the lobby.

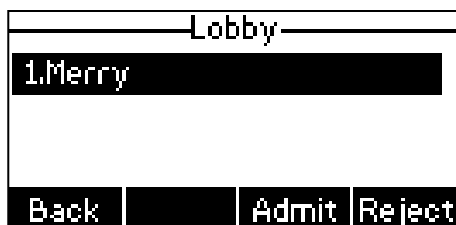

2. Do one of the following:

- Press the **Admit** soft key.

The caller joins the locked conference as a presenter successfully.



- Press the **Reject** soft key.



The caller fails to join the locked conference, and the caller drops the call automatically.



## Removing Conference Participants

All conference participants cannot remove themselves. An organizer can remove presenters and attendees. A presenter can remove other presenters and attendees.

### To remove a conference participant:

1. Press **More**->**Member**.
2. Press  or  to select the desired participant, and then press the **Rmv** soft key to remove the participant from the conference.

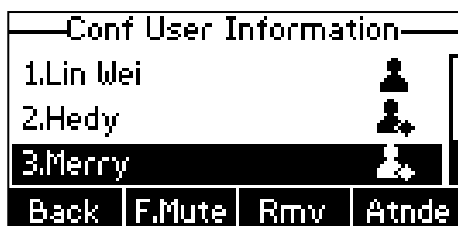

A notification prompts that the participant is removed.

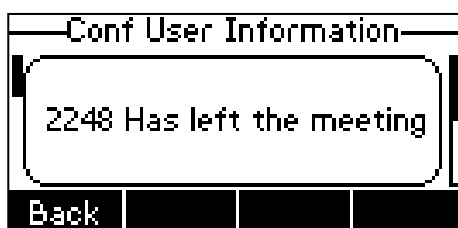

## Leaving the Conference

All participants can leave the conference at any moment.

### To leave the conference:

1. Press the **HangUp** soft key.  
Other participants remain connected.

## Call Park

You can use call park feature to place a call on hold, and then retrieve the call later or from another phone in the system (for example, a phone in another office or conference room). You can park an active call by pressing the **Park** soft key on the phone. If the call is parked successfully, a visible prompt will be displayed on the LCD screen of each party confirming that the call was parked.

Call park is different from call hold. Call hold keeps the held call on the same line, while call park places the call in a call orbit on the Skype for Business Server. Calls placed in the call orbit are given an orbit number and can be retrieved by any Skype for Business-compatible phone with access to the orbit.

**To use call park:**

1. User on phone A is during a call with user on phone B.
2. User on phone A wants to deal with some things or take the call in a conference room for privacy, then presses the **More->Park** soft key on phone A.



The LCD screen of phone A displays the call park orbit number.

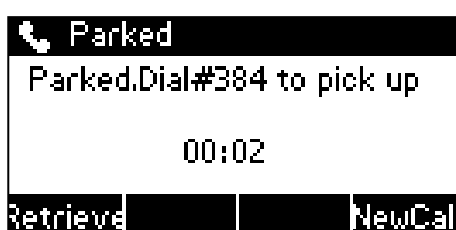

**To retrieve the parked call on phone A:**

After things are processed, user on phone A presses the **Retrieve** soft key to retrieve the parked call directly.

**To retrieve the parked call on phone C:**

User walks to an available conference room where the phone is designated as phone C. The user uses phone C to dial the call park orbit number (appearing on phone A) to retrieve the parked call.

The LCD screen of phone A will prompt that the parked call is retrieved by phone C (user Lin Wei in the following figure).



Two-way voice path is established between phone C and B.

**Note**

If the call is hung up by the other party before parker retrieves the parked call, the prompting message "Call ended before retrieved" will be displayed on the LCD screen of parker.

The parker will receive a ring back if the parked call is not retrieved by anyone after timeout expires. If the parker does not answer or reject the ring back, the call will be terminated and will not get redirected to voice mail.



## Voice Mail

You can leave voice mails for someone else using the T40P Skype for Business phone. You can also listen to voice mails that are stored in a voice mailbox. The voice mailbox can store up to 10 voice mails at most. When receiving a new voice mail, the phone will play a warning tone. The power indicator LED will slow flash red, and the LCD screen will prompt “n New Voice Mail(s)” (“n” indicates the number of unread voice mails, e.g., 6 New Voice Mail(s)) and display an icon .

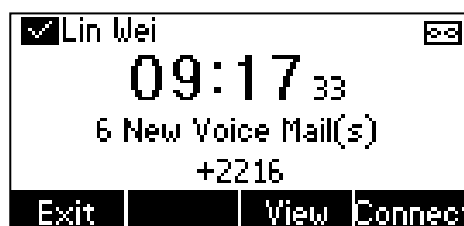

## Leaving the Voice Mail

You can leave a voice mail for someone else when he/she is busy or inconvenient to answer the call. Follow the voice prompt from the system server to leave a voice mail, and then hang up.

## Managing the Voice Mail

### PIN Authentication

When you sign into the phone using [PIN Authentication](#) method, you can follow the voice prompts to listen to voice mails.

**To listen to the voice mail when sign into the phone using PIN Authentication, do the following:**

1. When the LCD screen prompts that the phone receives a new voice mail and the power indicator LED illuminates solid red, press  or the **Connect** soft key.

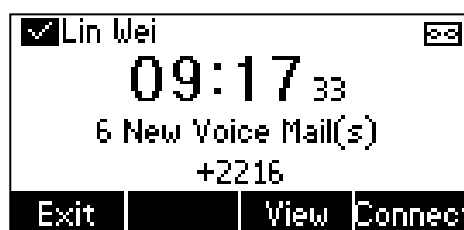

2. Follow the voice prompt to listen to your voice mails.

**To view the voice mail when sign into the phone using PIN Authentication, do the following:**

1. Press **Menu->View Voice Mail**.
2. The LCD screen displays the amount of new and old voice mails.

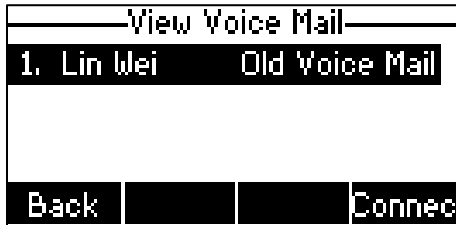

3. Press the **Connect** soft key to listen to voice mails.

### User Sign-in/Web Sign-in/Sign in via PC

When you sign into the phone using [User Sign-in](#), [Web Sign-in](#) or [Signing in via PC](#) method, you can manage the voice mail, includes viewing a list of voice mails, call back to those who left the voice mails list, mark voice mails as read, delete voice mails and follow the voice prompts to listen to voice mails, etc.

### Accessing the Message Center

**To access the message center:**

1. When the phone prompts receiving a new voice mail, do one of the following to enter the Message Center.
  - When the LCD screen prompts that the phone receives a new voice mail and the power indicator LED illuminates solid red, press  or the **Connect** soft key.
  - When the phone is idle, press **Menu->View Voice Mail->Msg** soft key.

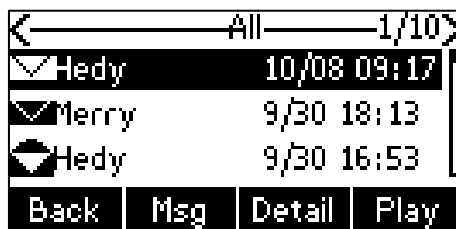

2. Follow the voice prompts to listen to the voice mails.

**Note**

First time you listen to your voice mails, the message center will ask you to configure a voice mail access PIN.



When all new voice mails are retrieved, the flashing power indicator LED will go out and the icon  will disappear.

## Listening to the Voice Mail

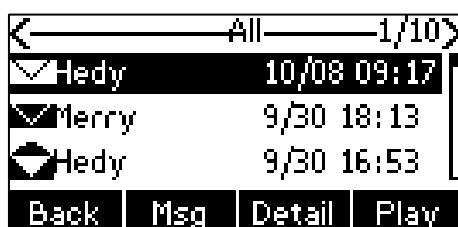

To listen to the voice mail:

1. Press **Menu->View Voice Mail**.

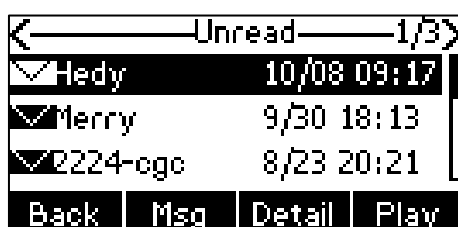

2. Press  or  to switch between unread voice mails and all voice mails.



3. Press  or  to select the desired voice mail.
4. Press the **Play** soft key, the phone will connect to the Exchange server to play the selected voice mail.

### Note



The phone can accept an incoming call while it is connected to Exchange to play a single or all voice mails. The call with the exchange becomes hold when the phone accepts the incoming call.

## Calling a Contact

To call a contact:

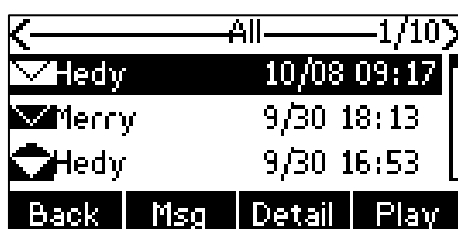
1. Press **Menu->View Voice Mail**.



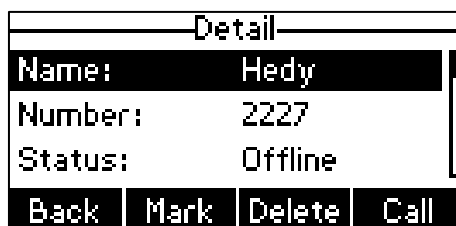

2. Press  or  to select the desired voice mail.

3. Press the **Detail** soft key to view the detail, and then press the **Call** soft key to call the contact.







## Marking the Voice Mail as Read

The following icons indicate the status of the voice mail:

-  Unread voice mail
-  Read voice mail

**To mark the voice mail as read:**

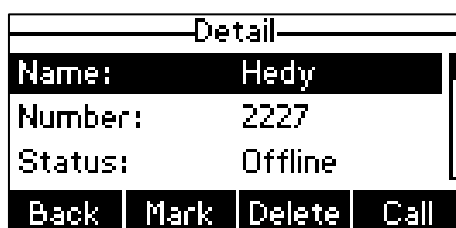

1. Press **Menu**->**View Voice Mail**.
2. Press  or  to select the unread voice mails.
3. Press the **Detail** soft key to view the detail, and then press the **Mark** soft key.

The voice mail icon will change from  to .



## Deleting the Voice Mail

**To delete the voice mail:**

1. Press **Menu**->**View Voice Mail**.
2. Press  or  to select the desired voice mail.
3. Press the **Detail** soft key to view the detail, and then press the **Delete** soft key.

The voice mail you selected will be deleted directly.

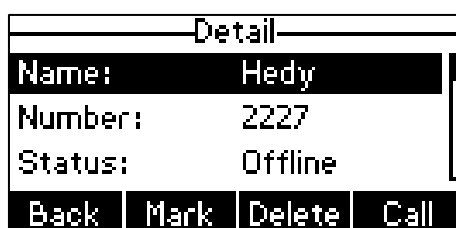



## Multicast Paging

You can use multicast paging to quickly and easily broadcast time sensitive announcements to users who are listening to a specific multicast group. You can configure the paging list on the phone, which allows you to send a Real Time Transport Protocol (RTP) stream to the pre-configured multicast address(es) without involving SIP signaling. You can configure the phone to receive an RTP stream from pre-configured multicast listening address(es) without involving SIP signaling. You can specify up to 10 multicast listening addresses.

## Sending RTP Stream

**To configure paging list via phone user interface:**

1. Press **Menu->Features->Paging List**.
2. Press  or  to select a desired paging group.  
The default tag is Empty if it is not configured before.

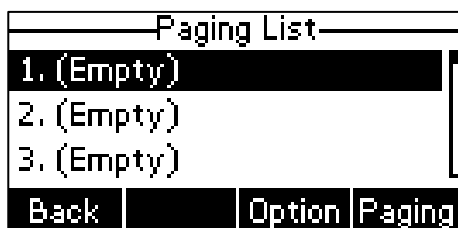

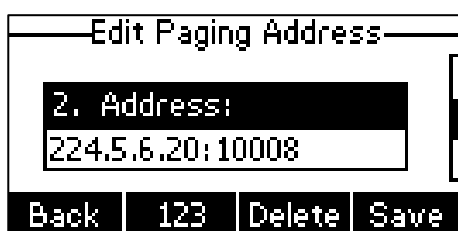

3. Press the **Option** soft key, and then press the **Edit** soft key.
4. Enter the multicast IP address and port number (e.g., 224.5.6.20:10008) in the **Address** field.

The valid multicast IP addresses range from 224.0.0.0 to 239.255.255.255.



5. Enter the group name in the **Label** field.
6. Press the **Save** soft key to accept the change.  
If the paging group is configured successfully, the third line key is assigned as the paging list key automatically. You can press it to enter the paging list.
7. Repeat steps 2 to 6, you can add more paging groups.

**To delete a paging group via phone user interface:**

1. Press the third line key (indicating the paging list key) or press **Menu->Features->Paging List** when the phone is idle.
2. Press  or  to select a desired group.
3. Press the **Option** soft key, and then select **Delete** soft key.  
The LCD screen prompts "Delete selected paging group?".

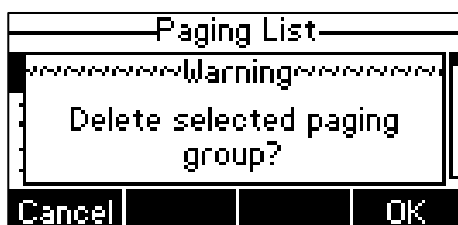

4. Press the **OK** soft key to accept the change or the **Cancel** soft key to cancel.

If you want to delete all paging groups, you can press the **Del All** soft key.

Paging list is configurable via web user interface at the path **Directory->Multicast IP**.

You can also configure the phone to use a codec for sending multicast RTP stream via web user interface.

**To configure a default codec for multicast paging via web user interface:**

1. Click on **Features->General Information**.
2. Select the desired codec from the pull-down list of **Multicast Codec**.

The default codec is G722.

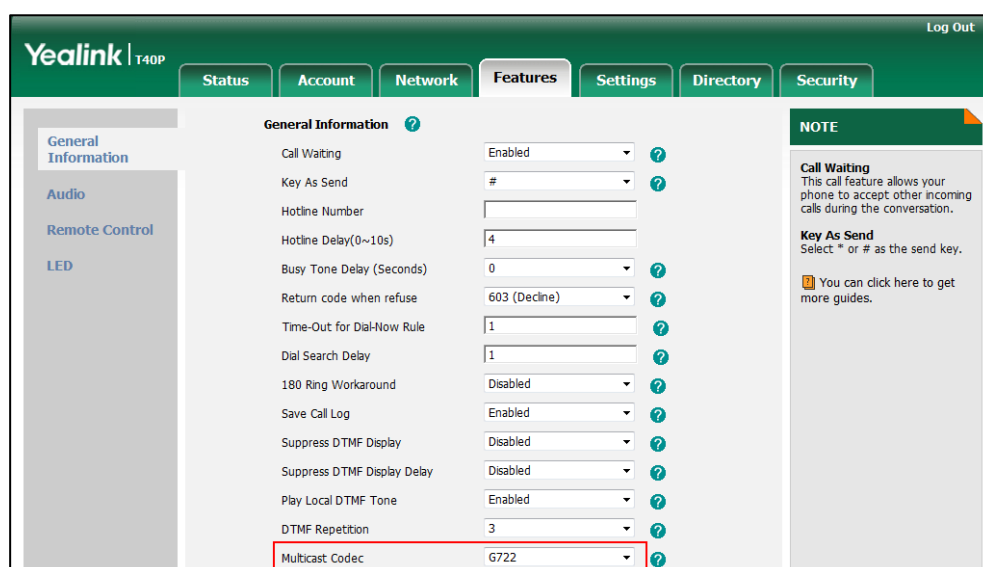

3. Click **Confirm** to accept the change.

**Note** If G722 codec is used for multicast paging, the LCD screen will display the **HD** icon to indicate that it is providing high definition voice.

Default codec for multicast paging is configurable via web user interface only.

## Receiving RTP Stream

You can configure the phone to receive a Real Time Transport Protocol (RTP) stream from the pre-configured multicast address(es) without involving SIP signaling. You can specify up to 10 multicast addresses that the phone listens to on the network.

How the phone handles incoming multicast paging calls depends on Paging Barge and Paging Priority Active parameters configured via web user interface.

### Paging Barge

The Paging Barge parameter defines the priority of the voice call in progress. If the priority of an incoming multicast paging call is lower than that of the active call, it will be ignored automatically. If Disabled is selected from the pull-down list of Paging Barge, the voice call in progress will take precedence over all incoming multicast paging calls. Valid values in the Paging Barge field:

- **1 to 10:** Define the priority of the active call, 1 with the highest priority, 10 with the lowest.
- **Disabled:** The voice call in progress will take precedence over all incoming paging calls.

### Paging Priority Active

The Paging Priority Active parameter decides how the phone handles incoming multicast paging calls when there is already a multicast paging call on the phone. If enabled, the phone will ignore incoming multicast paging calls with lower priorities, otherwise, the phone will answer incoming multicast paging calls automatically and place the previous multicast paging call on hold. If disabled, the phone will automatically ignore all incoming multicast paging calls.

### To configure multicast listening addresses via web user interface:

1. Click on **Directory->Multicast IP**.
2. Select the desired value from the pull-down list of **Paging Barge**.
3. Select the desired value from the pull-down list of **Paging Priority Active**.
4. Enter the multicast IP address(es) and port number (e.g., 224.5.6.20:10008) which the phone listens to for incoming RTP multicast in the **Listening Address** field.
5. Enter the label in the **Label** field.

Label will appear on the LCD screen when receiving the multicast RTP stream.

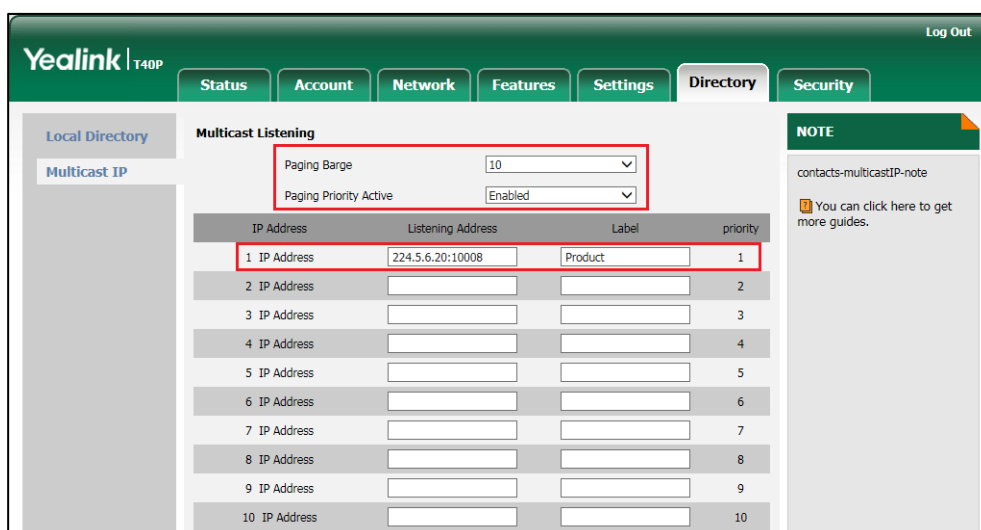

6. Click **Confirm** to accept the change.

**Note** The priorities of listening addresses are predefined: 1 with the highest priority, 10 with the lowest. Multicast listening addresses are configurable via web user interface only.

## Using Multicast Paging

**To send RTP stream via the paging list:**

- Do one of the following to enter the paging list.
  - When the phone is idle, press the third line key (indicating the paging list key) or press **Menu->Features->Paging List**.
  - During a call, press the third line key (indicating the paging list key).
  - During a call, press **Hold->NewCall**, and then press the third line key (indicating the paging list key).
- Press or to select the desired group.

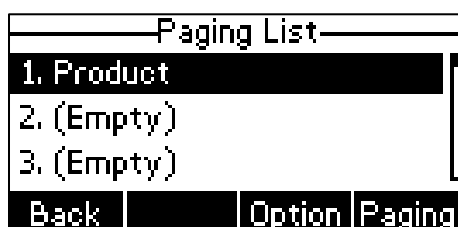

- Press or the **Paging** soft key to send RTP.

Both the sender's and receiver's phones play a warning tone and the receiver automatically answers the multicast RTP session in the speakerphone mode.



The following figure shows a multicast RTP session on the phone:



4. To place the current multicast RTP session on hold, press the **Hold** soft key.  
The sender's phone places the multicast RTP session on hold and receiver's phone releases the session.
5. To resume the held multicast RTP session, press the **Resume** soft key.  
The multicast RTP session is established again.
6. To end the multicast RTP session, press the **HangUp** soft key.

#### Note

Multicast RTP is one way only from the sender to the multicast address(es) (receiver). For outgoing RTP multicasts, all other existing calls on the phone will be placed on hold.

## Branch Office Resiliency

If you sign into the phone using Onprem account, you can use branch office resiliency feature. Current Online environment does not support this feature.

Branch office resiliency is critical for multi-site deployments of Skype for Business where the control servers are located at a central site or data center. It allows branch site users to continue to have Enterprise Voice service and voice mail (if voice mail rerouting settings are configured) when the branch site loses the connection to the central site.

When the WAN connection between the branch site and central site is unavailable, the phone goes into resiliency mode:

- Branch site user on the phone stays signed in with an indication of "Limited service due to outage".
- Call between branch site users is established successfully with 2-way audio.
- Conference between branch site users can be established successfully.
- The call history cannot get modified. (Already downloaded call log entries will not be deleted).
- Calls can be placed from the call history on the phone.
- Contact list is unavailable but you can search for a contact on the phone.
- Presence icon on the phone LCD screen is displayed as **?** (Unknown).
- User is not able to change his presence status manually.
- User is not able to use calendar feature.

- User is not able to receive the voice mail as exchange is unreachable.
- Calls between the branch office phones can be transferred to another branch site user.
- Call forward settings cannot be changed.

When the WAN connection between the branch site and central site becomes available, the phone comes out of resiliency mode automatically. Notification of resiliency is automatically dismissed, and you can use phone features as normal.

**Note**

For more information on branch office resiliency, contact your system administrator.

## Common Area Phone

Common area phones are Skype for Business phones that are not associated with an individual user. Instead of being located in someone's office, common area phones are typically located in building lobbies, cafeterias, employee lounges, conference rooms, and other locations where a large number of people are likely to gather. Unlike other phones on the Skype for Business Server, which are typically maintained by using voice policies and dial plans that are assigned to individual users, common area phones do not have individual users assigned to them.

Your system administrator provides you with login credentials that you can use to sign into a Common Area Phone.

This chapter explains how to use the Common Area Phone. Topics include:

- [Signing into a Common Area Phone](#)
- [Using a Common Area Phone](#)
- [Switching to a Skype for Business Account](#)
- [Signing Out of a Common Area Phone](#)

## Signing into a Common Area Phone

To use the Common Area Phone, you must sign into the phone using [PIN Authentication](#) or [Web Sign-in](#) method.

You need to configure an unlock PIN at the initial sign-in. And it is used to enter the **Advanced Settings**.

If the phone signs into a CAP account, the idle screen will be shown as below:

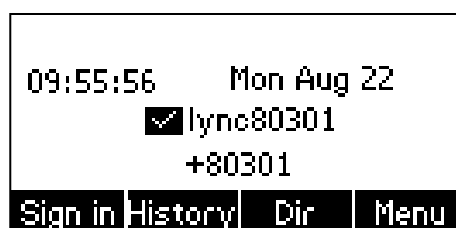

### Note

Your system administrator provides you with login credentials that you can use to sign into a Common Area Phone.

## Using a Common Area Phone

Users should pay attention to the following points when using the Common Area Phone:

- The phone can sign into the last CAP account automatically after the phone recovers from network failure, server failure or being off line. The phone can sign into the last CAP

account automatically after rebooting.

- The phone will not sign into the last CAP account automatically after being reset to factory.

**Available features of the Common Area Phone:**

- The Common Area Phone supports the basic call features, including placing the call, answering the call, placing the call on hold, resuming a held call, muting or unmuting the call and ending the call like a regular phone.
- The Common Area Phone supports switching between a CAP account and a Skype for Business account.
- The Common Area Phone supports the local directory feature.
- The Common Area Phone will switch to away status when screen free time reaches to the set time of the Skype for Business Server.
- If the network administrator enables the advanced feature (e.g., Skype for Business conference, the call park feature, transferring the call) on the Skype for Business Server, you can use these authorized features.

**Unavailable features of the Common Area Phone:**

- The Common Area Phone doesn't have Skype for Business directory.
- The Common Area Phone doesn't have call history feature.
- The Common Area Phone doesn't have phone lock feature, the unlock PIN is used as the administrator password to access the **Advanced Settings**.
- The Common Area Phone doesn't have calendar feature.
- The Common Area Phone doesn't have voice mails feature.
- You can't change your presence manually.
- If the network administrator disables the advanced feature (e.g., Skype for Business conference, the call park feature, transferring the call) on the Skype for Business Server, you can't use these unauthorized features.



## Switching to a Skype for Business Account

If the network administrator enables the sign-in configuration on the Skype for Business Server, users can sign into their own Skype for Business account to use Skype for Business features and their own user profile settings.

**To switch a CAP account to a Skype for Business account:**

1. Press the **Sign in** soft key when the phone is idle.



2. Press  or  to select the desired sign-in method, and then enter your information to sign in a Skype for Business account.

For more information on sign-in, refer to [Signing into Skype for Business](#) on page 15.

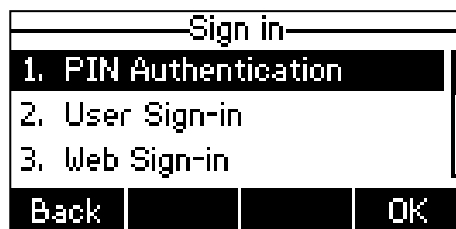

3. Press the **Sign in** soft key.

No matter whether you sign out of the Skype for Business account, the phone will sign into the last CAP account automatically after a period of time. The time is specified on the Skype for Business Server by system administrator.

**Note**

If you switch to another CAP account, your phone will never sign into the last CAP account again.

## Signing Out of a Common Area Phone

System administrator can sign out of the CAP account. Once the CAP account is signed out, the phone will not sign into the last CAP account automatically. User can sign into other CAP account or Skype for Business account.

**To sign out of a Common Area Phone:**

1. Press **Menu->Settings->Advanced Settings** (default password: admin or the unlock PIN) ->**CAP Sign Out**.



2. Press the **Enter** soft key.

The current CAP account will sign out.

---

## Better Together over Ethernet

---

Better Together over Ethernet (BToE) feature on Yealink T40P Skype for Business phones enables you to control call activity from your phones and your computer using your Skype for Business client. You can also use BToE to sign into your phone using your Skype for Business credentials. In order to use BToE, you need to download and install the Yealink BToE Connector application. This chapter explains how to download and install the Yealink BToE Connector application, and how to enable and use BToE feature. Topics include:

- [Getting Started with Better Together over Ethernet](#)
- [Installing the Yealink Better Together over Ethernet Connector](#)
- [Enabling Better Together over Ethernet](#)
- [Using Better Together over Ethernet](#)
- [Disabling BToE on Your Phone](#)
- [Exiting BToE on Your Computer](#)
- [Uninstalling the Yealink BToE Connector](#)

If you require additional information or assistance, contact your system administrator.

## Getting Started with Better Together over Ethernet

To enable and use BToE, you need to ensure the following requirements are available on your PC:

- Skype for Business client
- A registered Skype for Business user (Obtain Skype for Business credentials from your system administrator)
- Running Windows Vista or later
- Administrator privileges are needed to install the Yealink BToE Connector

## Installing the Yealink Better Together over Ethernet Connector

The Yealink BToE Connector enables you to use BToE feature on your Skype for Business client and T40P Skype for Business phone. You need to download, install, and start the Yealink BToE Connector application before enabling BToE and pairing your phone with the Skype for Business client. This section shows you how to download and install the Yealink BToE Connector application on your PC.

Ask the Yealink FAE or reseller for the BToE Connector application, or download it online:

<http://support.yealink.com/documentFront/forwardToDocumentFrontDisplayPage>.

**To install the Yealink BToE Connector on your PC:**

1. Unzip the downloaded file.
2. Double click the installation application **Yealink BToE Connector**.

A User Account Control dialog is displayed as below:

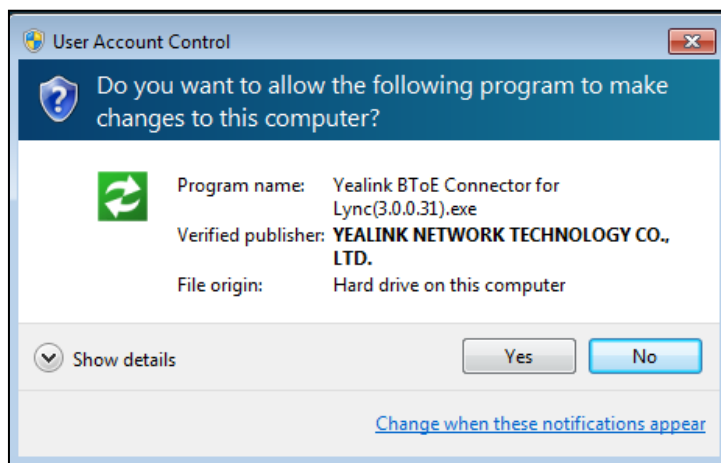

3. Ensure that the dialog lists **YEALINK NETWORK TECHNOLOGY CO., LTD.** as the verified publisher and click **Yes**.

If the YEALINK NETWORK TECHNOLOGY CO., LTD. is not listed as the publisher, click **No** and download the application again from the Yealink website.

The Yealink BToE Connector Setup Wizard is displayed as below:

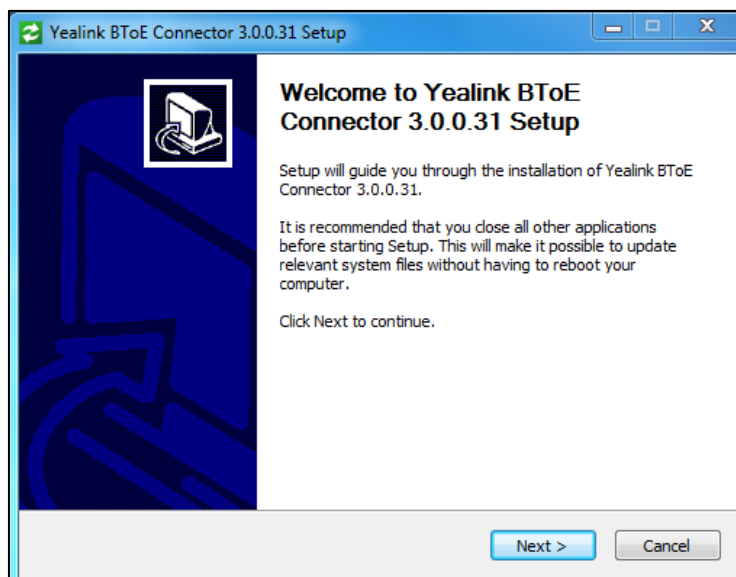

4. Click **Next** to continue.



The License Agreement dialog is displayed as below:

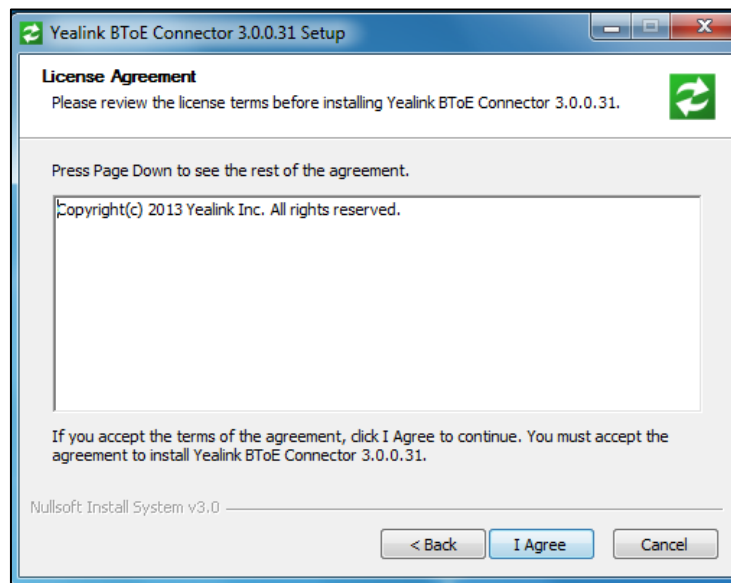

5. Click **I Agree** to accept the agreement.

The Yealink BToE Connector Setup Wizard is displayed as below:

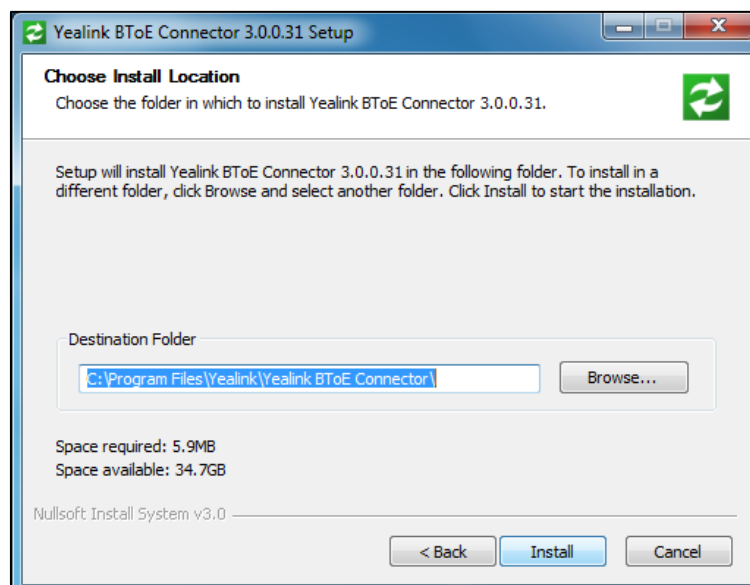

6. Click **Browse...** to select an installation folder and click **Install** to begin the installation.  
By default, the Yealink BToE Connector application is installed in the directory C:\Program Files\Yealink\Yealink BToE Connector\.

A status bar showing the Yealink BToE Connector installation's progress is displayed as below:

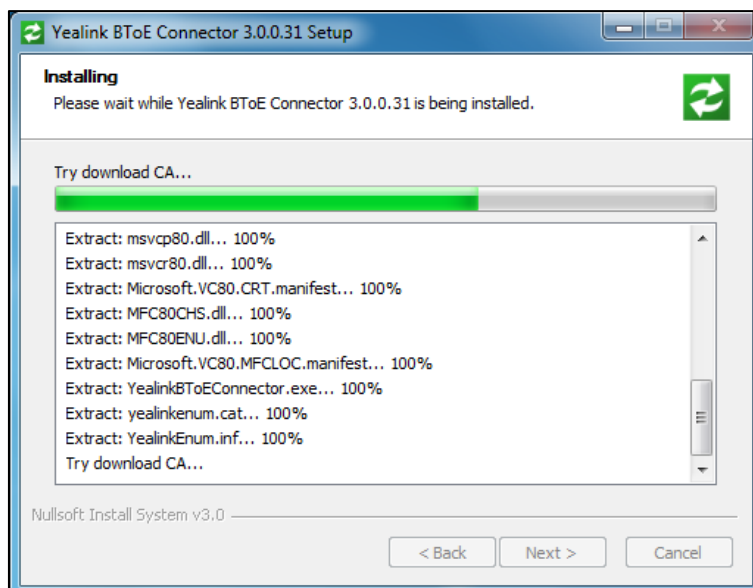

The installation may take several minutes. A Windows Security is displayed as below during installation:

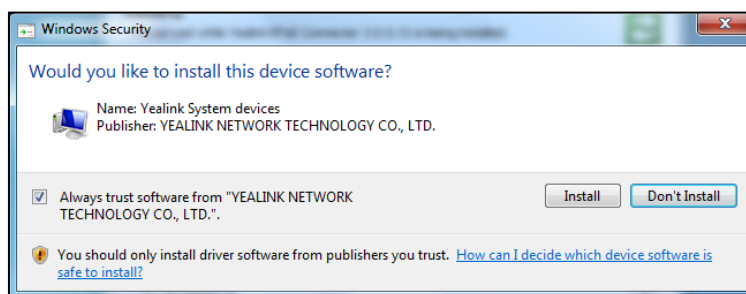

7. Click **Always trust software from "YEALINK NETWORK TECHNOLOGY CO., LTD"**, and then click **Install** to install the driver software.

After the software has completed installing, a dialog is displayed as below:

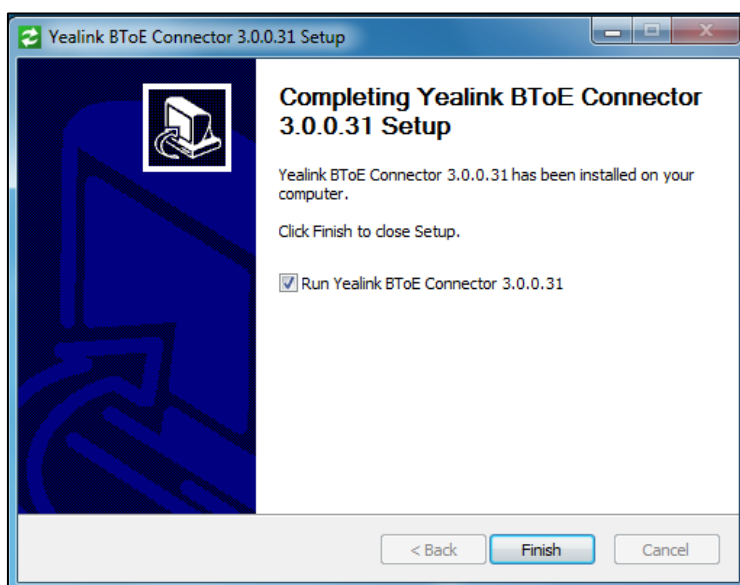

The checkbox of **Run Yealink BToE Connector 3.0.0.31** is checked by default, as shown above. If the checkbox of **Run Yealink BToE Connector 3.0.0.31** is not checked, you need to start the Yealink BToE Connector manually.

**8. Click Finish.**

The Yealink BToE Connector starts on your PC automatically, the following window will appear:



**To set up the Yealink BToE connector:**

Right-click  in the system tray, you can do the following:



- Click **Show/Hide(S)**, the Yealink BToE Connector interface will be shown or hidden.
- Click **Pair & Sign in(G)**, you can pair your phone with your Skype for Business client.
- Click **Sign in via client(L)**, after your phone pairs with Skype for Business client, but your phone and Skype for Business client are signed into with different user accounts, you can use BToE to sign into the Skype for Business client and the connected phone with the same account. For more information, refer to [Signing in via PC](#) on page 159.
- Click **Settings(P)**, you can set up the Yealink BToE Connector, and then click **OK** to save.

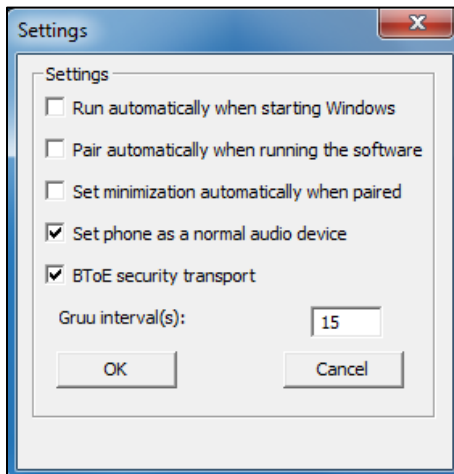

- a) Check the **Run automatically when starting Windows** checkbox, the Yealink BToE Connector software will run automatically when your computer boots up.
- b) Check the **Pair automatically when running the software** checkbox, the Yealink BToE Connector software will attempt to pair with the phone IP address when you start Yealink BToE Connector software.
- c) Check the **Set minimization automatically when paired** checkbox, the Yealink BToE Connector software will be minimized to the system tray after your phone and computer are paired.
- d) Check the **Set phone as a normal audio device** checkbox, your phone will act as the audio output device for your computer after your phone and computer are paired successfully.

- e) Check the **BToE security transport** checkbox, your phone and connected computer will use TLS encryption transmission. If it is unchecked, TCP transmission will be used instead.
- Click **About(A)**, you can view the information of Yealink BToE Connector.
- Click **Exit(E)**, you can close the software.

## Enabling Better Together over Ethernet

You need to pair your phone with your Skype for Business client to enable BToE. This section provides information on how to pair your phone with the Skype for Business client.

### Paired Status

Before you pair your phone with the Skype for Business client, you need to be familiar with the following paired status:

- **Unpaired:** Your phone and your Skype for Business client are not paired.

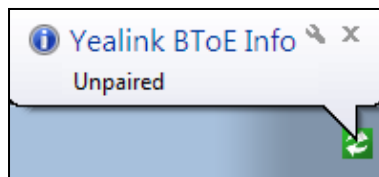

- **Paired (Sign Out):** Your phone and your Skype for Business client are paired but failing to sign in. The reason may be that the user signing on your phone differs from the one signing on the Skype for Business client, or there is no user signing on your phone.

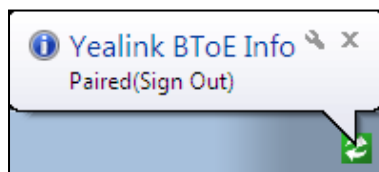

- **Paired (Sign In):** Your phone and your Skype for Business client are paired and sign in successfully. This means the Skype for Business user signing on the phone is the same as the one signing on the Skype for Business client.

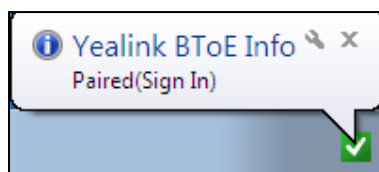

You can view the paired status via phone user interface or PC.

**To view the paired status via phone user interface:**

1. Press **Menu**->**Features**->**BToE**.
2. View the BToE paired status in the **BToE Pairing Status** field.



**To view the paired status on PC:**

1. Double left-click on BToE icon.
2. View the BToE paired status in the **BToE Status** field.

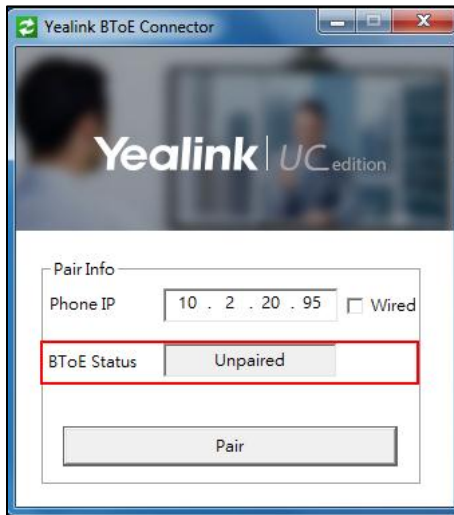

## Pairing Your Phone with Your Computer

There are two BToE Pairing modes on the phone. If **BToE Pairing Mode** is **Auto**, your phone will pair with your computer directly without a pairing code. If **BToE Pairing Mode** is **Manual**, You need to use a pairing code generated by your phone to manually pair your phone with your computer.

**To configure BToE feature via phone user interface:**

1. Press **Menu**-> **Features**->**BToE**.
2. Press ◀ or ▶ , or the **Switch** soft key to select **Enabled** from the **BToE** field.
3. Press ◀ or ▶ , or the **Switch** soft key to select the desired value from the **BToE Pairing Mode** field.

The default value is **Auto**.

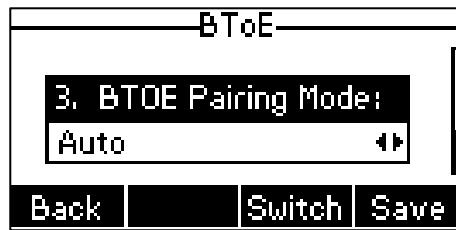

4. Press the **Save** soft key to accept the change or the **Back** soft key to cancel.

Ensure that the Yealink BToE Connector application is running on your PC. To pair your phone with your Skype for Business client, do one of the following on your PC:

- a) **Connect an Ethernet cable from your computer to the PC port on your phone (network of the PC will be provided by the PC port of the phone).**
  1. As the checkbox of **Wired** is checked by default, the IP address of your phone is automatically filled in the **Phone IP** field.
  2. Click **Pair**.



- If **BToE Pairing Mode** is **Auto**, your phone will pair with Skype for Business client directly.

- If **BToE Pairing Mode** is **Manual**, a six-digit pairing code displays. You should enter the six-digit pairing code shown on the phone into the notification on your computer.



(A six-digit pairing code displays on your phone)

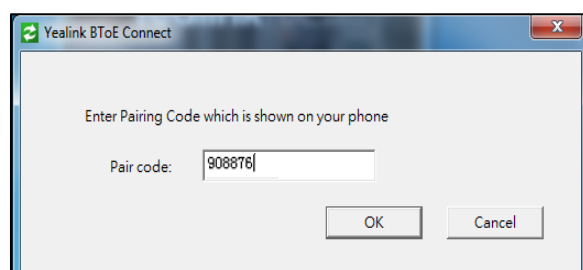

(Enter the pairing code shown on the phone into the notification on your computer)

**b) If your PC is not connected to the PC port on your phone using an Ethernet cable, do the following:**

1. Uncheck the **Wired** checkbox.
2. Enter the IP address of the phone that you want to pair in the **Phone IP** field.
3. Click **Pair**.



- If **BToE Pairing Mode** is **Auto**, your phone will pair with Skype for Business client directly.
- If **BToE Pairing Mode** is **Manual**, a six-digit pairing code displays. You should enter the six-digit pairing code shown on the phone into the notification on



your computer.

**Note** The pairing code is case-sensitive.

BToE is configurable via web user interface at the path: **Settings->BToE**.

## Signing in via PC

After you carry out the above steps, the computer and phone are paired. However if the phone and Skype for Business client are signed into with different user accounts, the BToE is not activated.

To activate the BToE, you can sign into the phone via your computer.

### To sign into the phone via PC:

- a) **If the Skype for Business client is already logged on, but the phone is not signed in:**
  1. A dialog box is displayed on your computer asking for your Skype for Business login credentials.

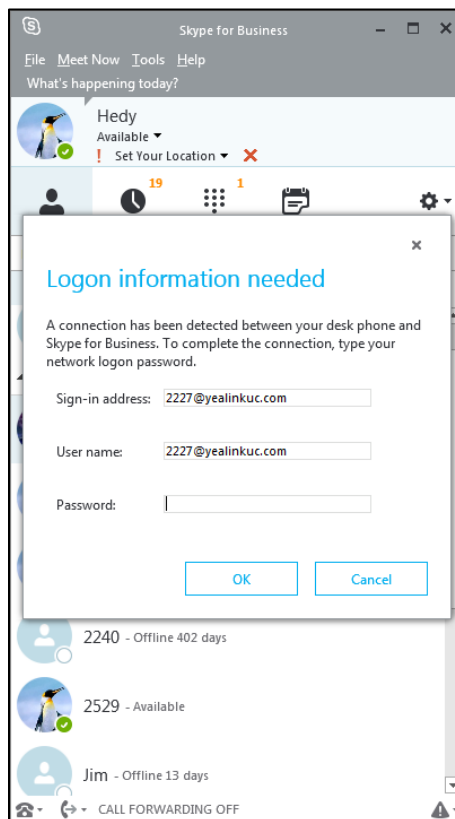

If you click **Cancel**, the dialog box will disappear. You can do one of the following to display the dialog box again:

- On your computer, right-click  on the system tray, and then select **Sign in via client(L)**.

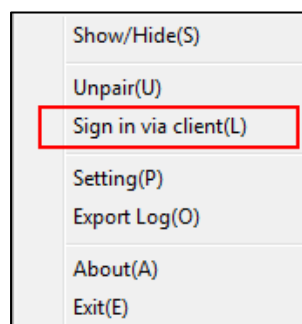

- On your phone, press the **Sign in** soft key to select **Sign in via PC**, and then press the **OK** soft key.



2. Enter your login credentials into the dialog displayed on your computer, click **OK**.
- b) **If the phone and Skype for Business client are signed into with different accounts:**
1. Right-click  on the system tray, and then select **Sign in via client(L)**.

A dialog box is displayed on your computer asking for your Skype for Business login credentials.

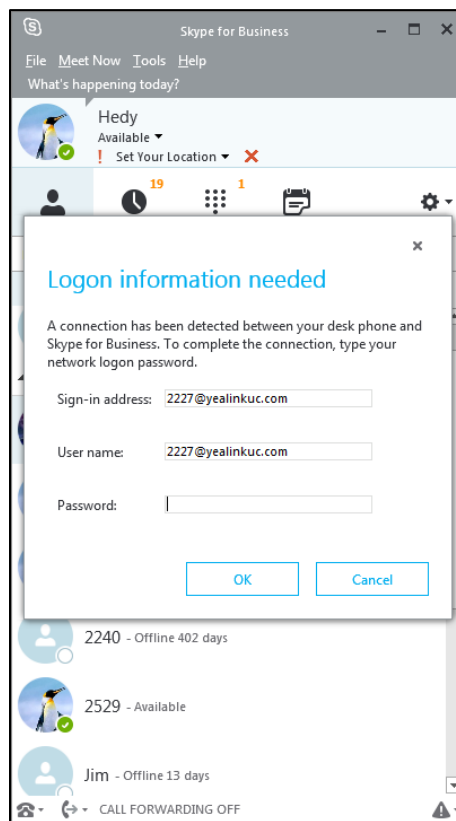

2. Enter your login credentials into the dialog displayed on your computer, click **OK**.

When the same user account is signed into the phone and the Skype for Business client, your computer and phone are paired, and BToE is activated. The paired status changes to **Paired (Sign In)** and the BToE icon changes to .

## Setting Your Phone as Your Primary Audio Device

Before you begin using the BToE feature, you need to ensure that your Skype for Business phone is set as your primary audio device in your Skype for Business client.

### To set your phone as your primary audio device

1. In your Skype for Business client, click the audio device icon.

2. Select your phone as your primary device, as shown next.

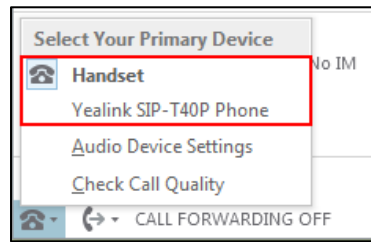

**Note**

If **Yealink SIP-T40P Phone** is not selected as audio device, you will not be able to use BToE feature (for example, calls made on the Skype for Business client will not be displayed on the phone).

## Using Better Together over Ethernet

This section provides information on how to use BToE on your phone and the Skype for Business client.

BToE enables you to call Skype for Business contacts using your Skype for Business client while providing you with quality audio through your phone. After BToE is enabled, you can answer, place, hold and resume calls with your Skype for Business contacts on your phone and the Skype for Business client on your PC simultaneously. What's more, your phone will be locked once paired PC is locked or in sleep mode.

## Placing BToE Calls

**Do one of the following:**

- Select a contact or enter the phone number, and then press the **Call** soft key on your phone.
- Hover the mouse over the avatar of the contact, and then click  in your Skype for Business client.

Your phone and the client are in the calling state.

## Answering BToE Calls

When you receive an incoming call, the incoming call information is displayed on your phone and your Skype for Business client.

**Do one of the following:**



- Press the **Answer** soft key on your phone.
- Click  in your Skype for Business client.

The incoming call is answered both on the phone and the Skype for Business client. The

established call uses the phone as audio device by default.

## Pausing BToE Calls



**Do one of the following:**

- Press the **Hold** soft key on your phone.
- Click  to display the control panel, and then click  in your Skype for Business client.

The call is placed on hold on your phone and your Skype for Business client.

## Resuming BToE Calls



**Do one of the following:**

- Press the **Resume** soft key on your phone.
- Click  to display the control panel, and then click  in your Skype for Business client.

The call is resumed on your phone and your Skype for Business client.

## Moving Call Audio between Your Phone and Computer:

During an active Skype for Business call, you can move the call audio from your phone to your computer or from your computer to your phone. Do the following:

1. Click  to display the control panel, and then click  in your Skype for Business client.
2. Click the desired audio device.
  - Click **PC MIC and Speakers** to move the call audio from your phone to your computer.  
The call on the phone will be released. The Skype for Business client uses the selected audio device to continue the call.
  - Click **Handset** to move the call audio from your computer to your phone.

## Using BToE to Lock and Unlock Your Phone

When your phone is paired with your computer and phone lock is enabled, you can lock and unlock your phone automatically when you lock or unlock your computer.

**To lock you phone:**

**When BToE status is Paired (Sign In), your phone will be locked automatically in following situation:**

- The paired PC gets locked.
- The paired PC enters sleep mode.
- The paired PC starts the screen saver.
- The account status of Skype for Business client changes from active to inactive.
- BToE status changes from **Paired (Sign In)** to **Paired (Sign Out)** or **Unpaired**.

**To unlock you phone:**

If you do not connect an Ethernet cable from your computer to the PC port on your phone, the phone will not be unlocked automatically.

**If you connect an Ethernet cable from your computer to the PC port on your phone and the BToE status is Paired (Sign In), your phone can be unlocked automatically in following situation:**

- The paired PC gets unlocked.
- The paired PC wakes up and is not locked.
- The paired PC stops the screen saver and is not locked.
- The account status of Skype for Business client changes from inactive to active.
- BToE status changes from **Paired (Sign Out)** or **Unpaired** to **Paired (Sign In)** and the paired PC is unlocked, does not in sleep mode, does not start the screen saver and the Skype for Business account is active.

## Disabling BToE on Your Phone

You can disable the BToE feature on your phone and unpair your phone from the computer. When you disable BToE, you can no longer use BToE functions.

**Do one of the following:**

- Disconnect the Ethernet cable from the PC port on your phone.
- Click **Unpair** on the Yealink BToE Connector.
- Press **Menu** -> **Features**-> **BToE** on your phone.

Press ◀ or ▶ , or the **Switch** soft key to select **Disabled** from the **BToE** field.

Press the **Save** soft key to accept the change.

## Exiting BToE on Your Computer

You can exit the Yealink BToE Connector at any time. When you exit the application, you can no longer use the BToE functions on your phone and computer.

### To exit BToE on your computer:

1. Right-click BToE icon (  ) in the system tray and click **Exit(E)**.

## Uninstalling the Yealink BToE Connector

### To uninstall the Yealink BToE connector:

1. Click the **Start** button .
2. Click **All Programs->Yealink BToE Connector->Uninstall**.

A dialog box asking if you're sure you want to uninstall this product is displayed.

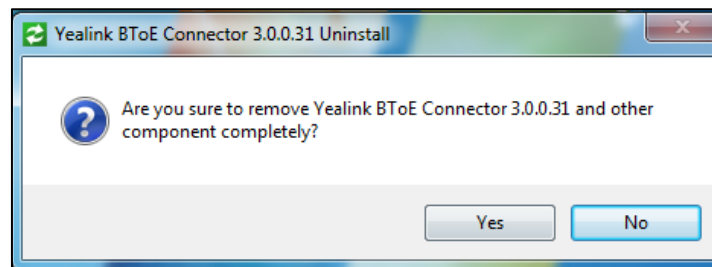

3. Click **Yes** to uninstall the Yealink BToE connector.

A dialog box showing the progress of the application uninstall is displayed.





## Troubleshooting

---

This chapter provides general troubleshooting information to help you solve the problems you might encounter when using your T40P Skype for Business phone.

If you require additional information or assistance with your new phone, contact your system administrator.

## Troubleshooting Solutions

### **Why is the phone LCD screen blank?**

- Ensure that the phone is properly plugged into a functional AC outlet.
- Ensure that the phone is plugged into a socket controlled by a switch that is on.
- If the phone is plugged into a power strip, try plugging it directly into a wall outlet instead.
- If the phone is powered from PoE, ensure you use a PoE-compliant switch or hub.

### **Why does the phone display “Network unavailable”?**

- Ensure that the Ethernet cable is plugged into the Internet port on the phone and the Ethernet cable is not loose.
- Ensure that the switch or hub in your network is operational.
- Contact your system administrator for more information.

### **Why doesn't the phone display time and date correctly?**

Check if you have configured the phone to obtain the time and date from the SNTP server automatically. If the phone fails to connect to the SNTP server, you need to configure the time and date manually.

### **How can I find the basic information of the phone?**

Press the **OK** soft key to check the basic information of the phone when the phone is idle, such as the IP address and firmware version. For more basic information, refer to [Phone Status](#) on page 27.

### **How to obtain the MAC address of a phone when the phone is not powered on?**

Three ways to obtain the MAC address of a phone:

- You can ask your supplier for shipping information sheet which includes MAC addresses according to the corresponding PO (Purchase Order).

- You can find the MAC address on the label of the carton box.
- You can also find the MAC address from the phone's bar code on the back of the phone.

#### **Why can't I sign into the Skype for Business Server on the phone?**

- Check your phone is properly connected to the switch or hub.
- Validate your domain name and sign-in information are correct.
- Ensure that DNS address is properly configured on the phone, or DHCP is configured to provide DNS address as part of DHCP response.

#### **How to check if the application driver of the Yealink BToE Connector is installed on the PC?**

Do one of the following:

- After installation, if the Yealink BToE Connector and the application driver run successfully, the notification area of the system tray will prompt: **Device driver software installed successfully.**

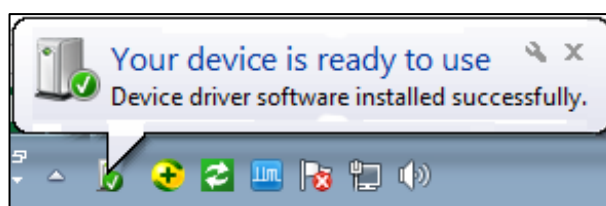

- Do the following steps to check if the application driver is installed (take the Windows 2007 operating system as an example):
  1. Click the **Start** button .
  2. Click **Control Panel**->**Device Manager**.
  3. Double click **System devices**.
  4. Check if the driver **Yealink BToE Enumerator** is displayed.

If Yealink BToE Enumerator is not displayed, reinstall the Yealink BToE Connector application, and ensure that the application driver is installed during the installation process.

#### **How to cancel auto-start for the Yealink BToE connector ?**

1. Right-click  in the system tray.
2. Click **Settings(P)**.

3. Uncheck **Run automatically when starting Windows** to cancel the auto-start feature.  
As shown below:

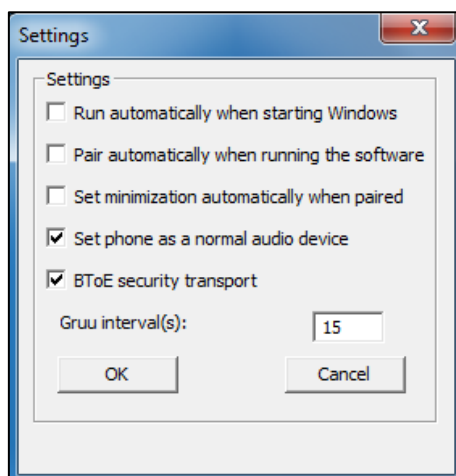

#### Why can't the phone pair with my Skype for Business client?

- Ensure that your Skype for Business client is installed on your PC and a Skype for Business user signs into the Skype for Business Server successfully.
- Ensure that the user signing on the phone is the same as the one signing on the Skype for Business client.
- Re-pair the phone and Skype for Business client manually.
- Ensure that Yealink BToE Connector and application driver are successfully installed on your PC, and both of them start successfully. If the phone still cannot pair with the Skype for Business client, reboot the PC.
- After reboot, if the phone still cannot pair with the Skype for Business client, uninstall the Yealink BToE Connector and application driver, and then reinstall them.
- Ensure that Yealink BToE Connector is an allowed program in your system's firewall on your PC.

#### Why doesn't the phone display the Calendar menu?

- Ensure that your phone has signed in successfully.

#### Why doesn't the Calendar menu display the Skype conference, appointment, meeting or event set up in outlook?

- Ensure that you sign into the phone using [User Sign-in](#), [Web Sign-in](#) or [Signing in via PC](#) method.

#### Why can't I get a dial tone?

- Check for any loose connections and that the phone has been installed properly. For the installation instructions, refer to [Phone Installation](#) on page 12..

- Switch between the Handset, Headset (if present) or Hands-Free Speakerphone to check whether the dial tone is present for one of the audio modes.

If the dial tone exists on another audio mode, connect a different handset or headset to isolate the problem.

#### **Why doesn't the phone ring?**

Check the ringer volume on the phone. To adjust the ringer volume setting, press the Volume key when the phone is on-hook and idle. For more information, refer to [Volume](#) on page 42.

#### **Why can't I receive calls?**

- Check that whether your status is DND mode, if it is, you should reset status. Refer to [Changing Presence Status](#) on page 22.
- Check that whether call forward is disabled on the phone. Refer to [Call Forward](#) on page 96.

#### **Why does my handset not work?**

Check that the handset cord is fully connected to both the handset jack on the phone and handset. Refer to [Phone Installation](#) on page 12.

#### **Why does my headset not work?**

- Check that the headset cord is properly connected to the headset jack on the phone. Refer to [Phone Installation](#) on page 12.
- Check that the headset mode is activated. Refer to [Headset Use](#) on page 62.
- Check that the headset volume is adjusted to an appropriate level. Refer to [Volume](#) on page 42.

#### **Why does the phone play a tone when there is a call on hold? How to disable it?**

When there is a call on hold, the phone will play a hold tone every 30 seconds. Play hold tone is enabled by default. Play hold tone and the interval of playing a hold tone are configurable via web user interface only.

#### **To configure play hold tone and play hold tone delay via web user interface:**

1. Click on **Features->General Information**.
2. Select **Enabled** or **Disabled** from the pull-down list of **Play Hold Tone**.

- Enter the desired time (in seconds) in the **Play Hold Tone Delay** field.

The screenshot shows the Yealink T40P web interface with the 'Features' tab selected. The 'General Information' section is expanded, and the 'Play Hold Tone' and 'Play Hold Tone Delay' fields are highlighted with a red box. The 'Play Hold Tone' is set to 'Enabled' and 'Play Hold Tone Delay' is set to '30'. Other settings include Call Waiting (Enabled), Key As Send (#), Hotline Number, Hotline Delay (0~10s) (4), Busy Tone Delay (Seconds) (0), Return code when refuse (603 (Decline)), Time-Out for Dial-Now Rule (1), Dial Search Delay (1), 180 Ring Workaround (Disabled), Save Call Log (Enabled), Suppress DTMF Display (Disabled), Suppress DTMF Display Delay (Disabled), Play Local DTMF Tone (Enabled), DTMF Repetition (3), Multicast Codec (G722), Allow Mute (Enabled), Dual-Headset (Disabled), Auto-Answer Delay (1~4s) (1), and Headset Prior (Disabled). A 'NOTE' section on the right provides information about Call Waiting and Key As Send.

- Click **Confirm** to accept the change.

#### How to export PCAP trace?

We may need you to provide a PCAP trace to help analyze your problem.

#### To export a PCAP trace via web user interface:

- Click on **Settings->Configuration**.
- Click **Start** to begin recording signal traffic.
- Recreate the error to be documented in the trace.
- Click **Stop** to end recording.
- Click **Export** to open file download window, and then save the file to your local system.

The screenshot shows the Yealink T40P web interface with the 'Settings' tab selected. The 'Configuration' section is expanded, and the 'Pcap Feature' section is highlighted with a red box. The 'Pcap Feature' section has 'Start', 'Stop', and 'Export' buttons. Other settings include 'Export or Import Configuration' (Browse..., No file selected., Import, Export), 'Export Call Log' (Export), 'Export System Log' (Local, Server), and 'Export System Log' (Export). A 'NOTE' section on the right provides information about Configuration.

### How to configure the severity level of the log?

If your Skype for Business phone encounters some problems, commonly the global log files are needed. You can export the global log files to a local system, a syslog server or the Skype for Business Server. You can also specify the severity level of the global log and module log to be reported. The default global log and module log are 3.

Log parameters are described below:

Parameter	Description	Configuration Method
<b>Global Log Level</b>	Configure the severity level of the global logs to be reported to a log file. <b>Default:</b> 3	Web User Interface
<b>Max Log File Size (1-1024KB)</b>	Configure the size of the global log files. <b>Default:</b> 256KB <b>Note:</b> The Skype for Business phone will reboot to make the change take effect.	Web User Interface
<b>Register Log Level</b>	Configure the severity level of the register logs to be reported to a log file. <b>Default:</b> 3	Web User Interface
<b>Subscribe Log Level</b>	Configure the severity level of the subscribe logs to be reported to a log file. <b>Default:</b> 3	Web User Interface
<b>Call Log Level</b>	Configure the severity level of the call logs to be reported to a log file. <b>Default:</b> 3	Web User Interface
<b>Ice Log Level</b>	Configure the severity level of the Ice logs to be reported to a log file. <b>Default:</b> 3	Web User Interface
<b>BToE Log Level</b>	Configure the severity level of the BToE logs to be reported to a log file. <b>Default:</b> 3	Web User Interface
<b>Exchange Log Level</b>	Configure the severity level of the Exchange logs to be reported to a	Web User Interface

Parameter	Description	Configuration Method
	log file. <b>Default: 3</b>	

**Note**

Global Log consists of Module logs. The severity level of the exported Module Log will not be greater than the Global Log Level. For example, if you set Global Log Level to 3 and set ICE log Level to 6, the exported ICE log Level will be 3.

**To configure the level of the log files log via web user interface:**

1. Click on **Settings->Configuration**.
2. Select the desired level from the pull-down list of corresponding log levels.
3. Enter the desired maximum size of global log in the **Max Log File Size(1-1024KB)** field.

4. Click **Confirm** to accept the change.

**How to export global log?****a) Exporting the global Log File to the Skype for Business Server**

You can upload global log file to the Skype for Business Server via phone user interface only.

**To export a global log file to the Skype for Business Server via the phone user interface:**

1. Press **Menu->Settings->Basic Settings->Log Upload**.

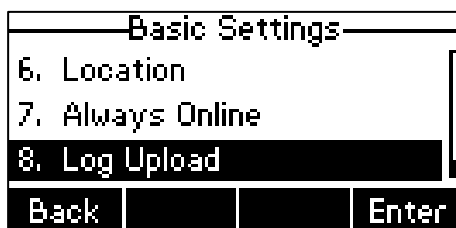

A dialog box pops up to prompt "Log Upload Successfully!".

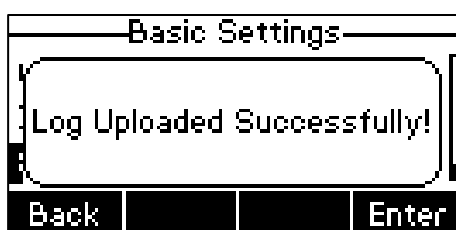

**b) Exporting the global log file to the local system:**

**To export a global log file to the local system via web user interface:**

1. Click on **Settings->Configuration**.
2. Mark the **Local** radio box in the **Export System Log** field.
3. Click **Export** to open file download window, and then save the file to your local system.

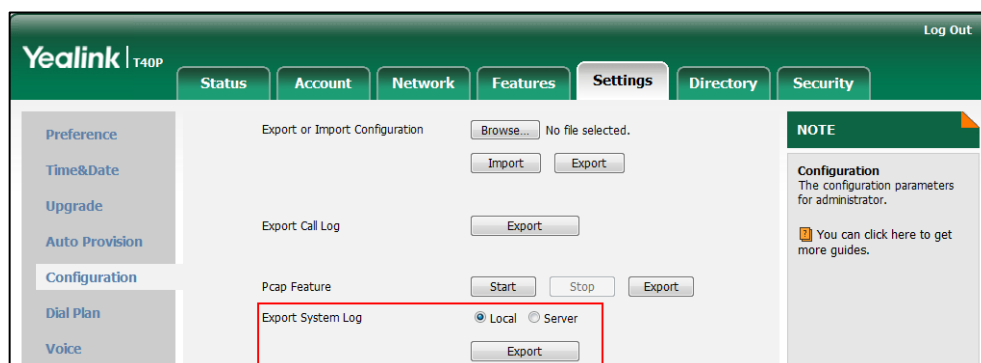

A log file named "MAC address-sys.log" is successfully exported to your local system.

**c) Exporting the global Log File to a Syslog Server**

**To configure the phone to export the global log file to a syslog server via web user interface:**

1. Click on **Settings->Configuration**.
2. Mark the **Server** radio box in the **Export System Log** field.



- Enter the IP address or domain name of the syslog server in the **Server Name** field.  
For example, the IP address of your syslog server is 192.168.1.100.

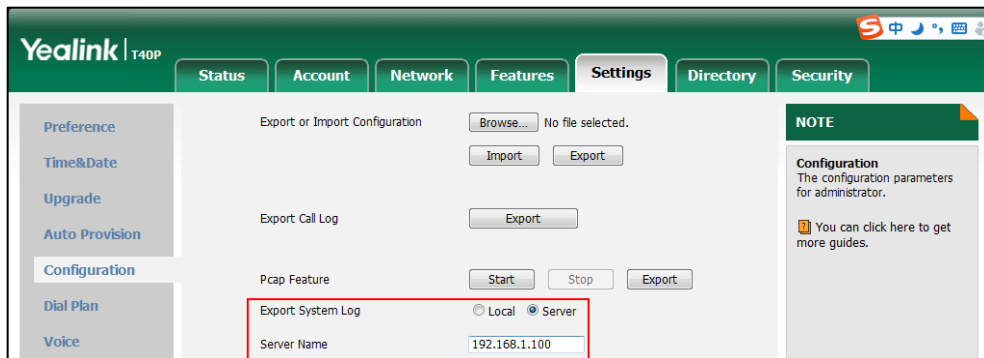

- Click **Confirm** to accept the change.  
A dialog box pops up to prompt "Do you want to restart your machine?". The configuration will take effect after a reboot.
- Click **OK** to reboot the phone.  
The global log **file** will be exported successfully to the desired syslog server (192.168.1.100) after a reboot.

High level may make some sensitive information accessible (e.g., password and dial number), we recommend that you reset the log level to 3 after providing the global log for troubleshooting purpose.

#### To reset severity level of all logs via web user interface:

- Click on **Settings->Configuration**.
- Click **Reset Log Level To Default**.

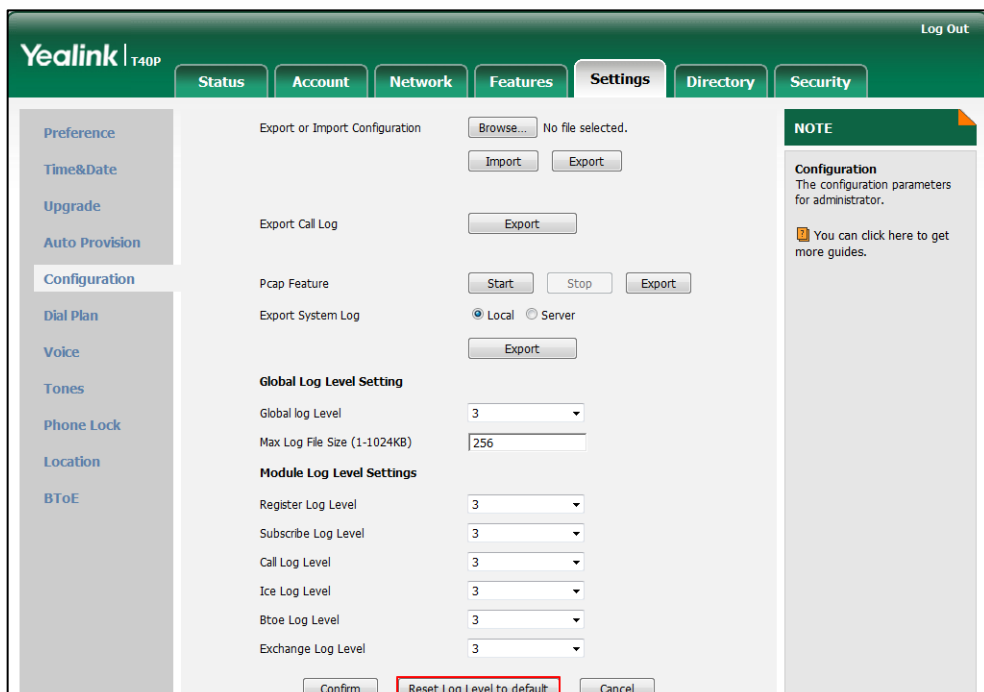

All log level will reset to 3.

### How to export/import phone configurations?

We may need you to provide your phone configurations to help analyze your problem. In some instances, you may need to import configurations to your phone.

#### To export your phone configurations via web user interface:

1. Click on **Settings->Configuration**.
2. Click **Export** to open file download window, and then save the file to your local system.

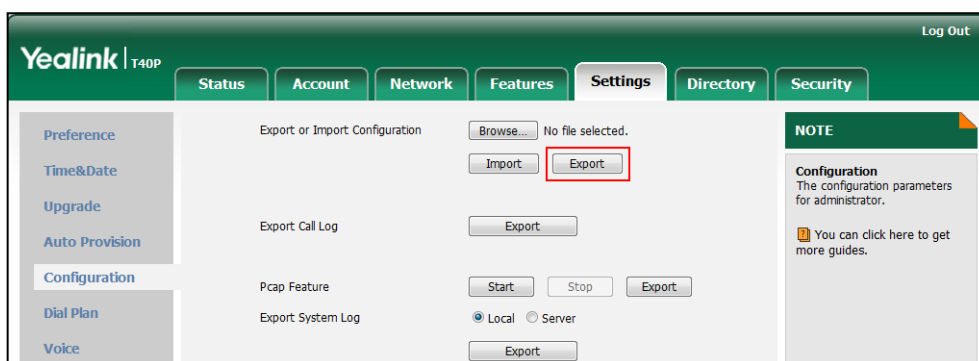

#### To import phone configurations via web user interface:

1. Click on **Settings->Configuration**.
2. Click **Browse...** to locate a configuration file from your local system.
3. Click **Import** to import the configuration file.

**Note** The file format of configuration file must be ".bin".

### How to export call log?

User can access call logs by downloading them to the local system for diagnosis purpose.

#### To export the call log via web user interface:

1. Click on **Settings->Configuration**.
2. Click **Export** to open file download window, and then save the file to your local system.

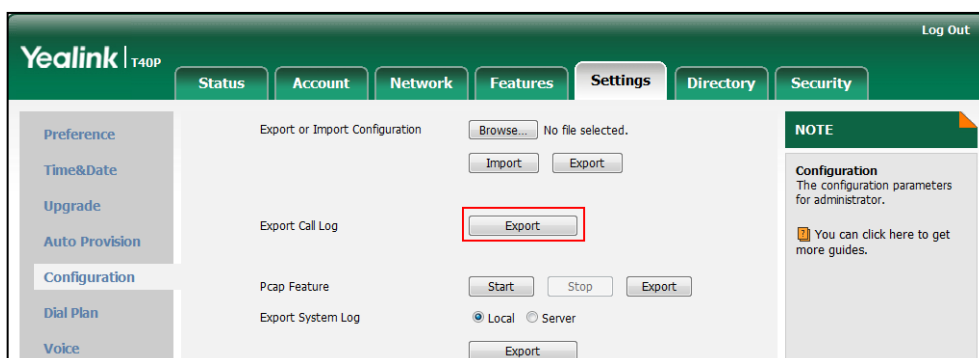

## How to change the user password?

To change the user password via web user interface:

1. Click on **Security**->**Password**.
2. Select **user** from the pull-down list of **User Type**.
3. Enter the new user password in the **New Password** field and **Confirm Password** field.

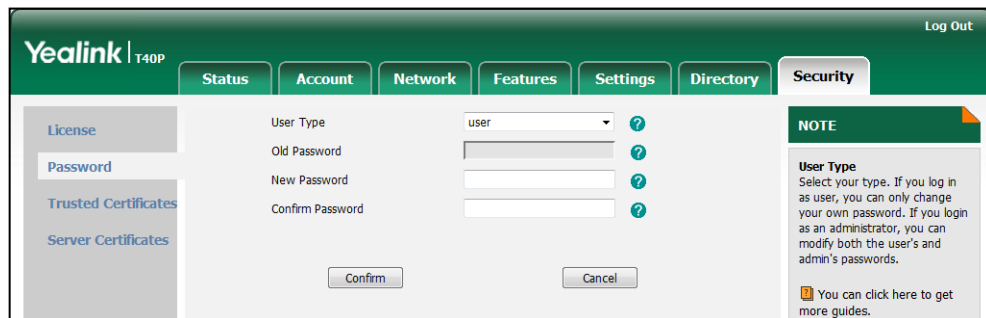

4. Click **Confirm** to accept the change.



### Note

If logging in the web user interface of the phone with the user credential, you need to enter the current user password in the **Old Password** field.

User password is configurable via web user interface only.

## How to reboot the phone?

To reboot the phone via phone user interface:

1. Press **Menu**->**Settings**->**Advanced Settings** (default password: admin).
2. Press  or  to scroll to **Reboot**, and then press the **Enter** soft key.

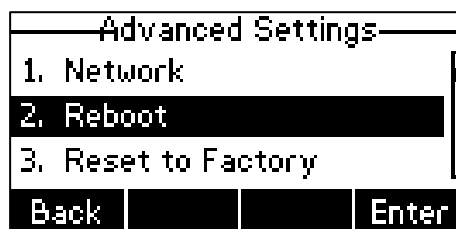

The LCD screen prompts "Reboot the phone?".

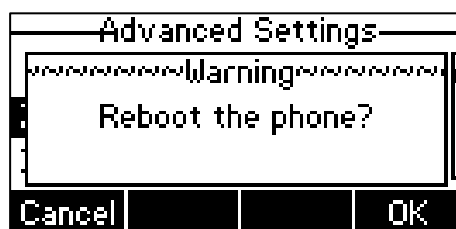

3. Press the **OK** soft key to reboot the phone.

## Note

Any reboot of your phone may take a few minutes.

### How to upgrade firmware?

#### To upgrade firmware via web user interface:

1. Click on **Settings->Upgrade**.
2. Click **Browse...** to locate the firmware from your local system.

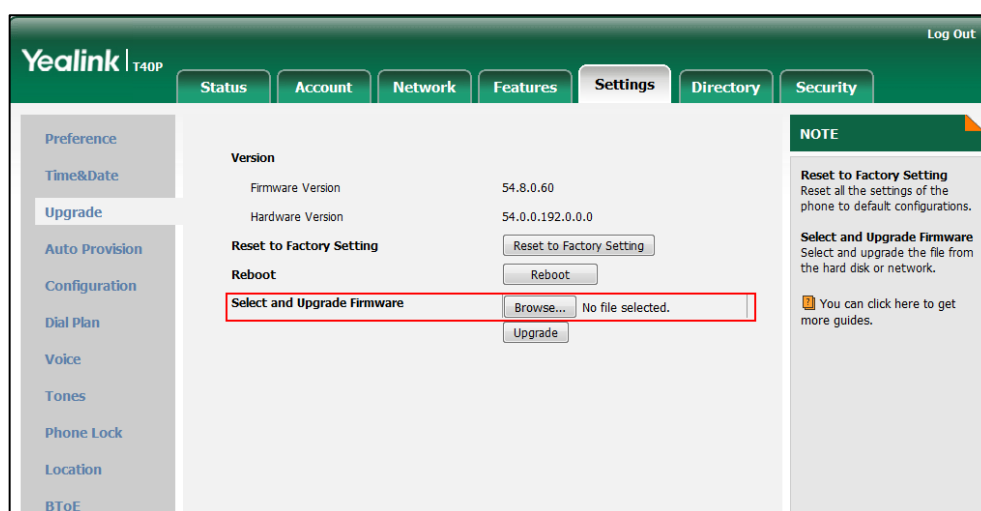

3. Click **Upgrade** to upgrade the firmware.

The browser pops up the dialog box "Firmware of the SIP phone will be updated. It will take 5 minutes to complete. Please don't power off!".

4. Click **OK** to confirm upgrading.

T40P Skype for Business phones can be also upgraded from the Skype for Business Server. For more information on how to upgrade the T40P Skype for Business phone from the Skype for Business Server, refer to [Updating Phone Firmware from Microsoft Skype for Business Server](#).

### How to reset your phone?

Reset the phone when other troubleshooting suggestions do not solve the problem. You need to note that all customized settings will be overwritten after resetting. We recommend you ask your system administrator for advice before resetting the phone.

#### To reset your phone via phone user interface:

1. Press **Menu->Settings->Advanced Settings** (default password: admin).

2. Press  or  to scroll to **Reset to Factory**, and then press the **Enter** soft key.

The LCD screen prompts the following message:

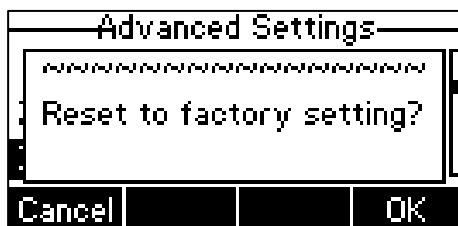

3. Press the **OK** soft key.

The LCD screen prompts "Resetting to factory, Please Wait...".

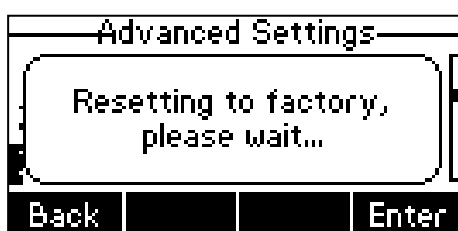

The LCD screen prompts "Welcome Initializing Please wait...".



The phone will be reset to factory successfully after startup.

**Note**

You can also long press the **OK** soft key to reset the phone when the phone is idle.

Reset of the phone may take a few minutes. Do not power off until the phone starts up successfully.

---

## Regulatory Notices

---

### Service Agreements

Contact your Yealink Authorized Reseller for information about service agreements applicable to your product.

### Limitations of Liability

TO THE FULL EXTENT ALLOWED BY LAW, YEALINK EXCLUDES FOR ITSELF AND ITS SUPPLIERS ANY LIABILITY, WHETHER BASED IN CONTRACT OR TORT (INCLUDING NEGLIGENCE), FOR INCIDENTAL, CONSEQUENTIAL, INDIRECT, SPECIAL, OR PUNITIVE DAMAGES OF ANY KIND, OR FOR LOSS OF REVENUE OR PROFITS, LOSS OF BUSINESS, LOSS OF INFORMATION OR DATA, OR OTHER FINANCIAL LOSS ARISING OUT OF OR IN CONNECTION WITH THE SALE, INSTALLATION, MAINTENANCE, USE, PERFORMANCE, FAILURE, OR INTERRUPTION OF ITS PRODUCTS, EVEN IF YEALINK OR ITS AUTHORIZED RESELLER HAS BEEN ADVISED OF THE POSSIBILITY OF SUCH DAMAGES, AND LIMITS ITS LIABILITY TO REPAIR, REPLACEMENT, OR REFUND OF THE PURCHASERICE PAID, AT YEALINK'S OPTION. THIS DISCLAIMER OF LIABILITY FOR DAMAGES WILL NOT BE AFFECTED IF ANY REMEDY PROVIDED HEREIN SHALL FAIL OF ITS ESSENTIAL PURPOSE.

### Safety Instructions

**Save these instructions. Read these safety instructions before use!**

The following basic safety precautions should always be followed to reduce risk of fire, electrical shock, and other personal injury.



#### **General Requirements**

- Before you install and use the device, read the safety instructions carefully and observe the situation during operation.
- During the process of storage, transportation, and operation, please always keep the device dry and clean.
- During the process of storage, transportation, and operation, please avoid collision and crash of the device.
- Please attempt not to dismantle the device by yourself. In case of any discrepancy, please contact the appointed maintenance center for repair.
- Without prior written consent, no organization or individual is permitted to make any change to the structure or the safety design of the device. Yealink is under no circumstance liable to consequences or legal issues caused by such changes.
- Please refer to the relevant laws and statutes while using the device. Legal rights of others should be respected as well.

### **Environmental Requirements**

- Place the device at a well-ventilated place. Do not expose the device under direct sunlight.
- Keep the device dry and free of dusts.
- Place the device on a stable and level platform.
- Please place no heavy objects on the device in case of damage and deformation caused by the heavy load.
- Keep at least 10 cm between the device and the closest object for heat dissipation.
- Do not place the device on or near any inflammable or fire-vulnerable object, such as rubber-made materials.
- Keep the device away from any heat source or bare fire, such as a candle or an electric heater.
- Keep the device away from any household appliance with strong magnetic field or electromagnetic field, such as a microwave oven or a refrigerator.

### **Operating Requirements**

- Do not let a child operate the device without guidance.
- Do not let a child play with the device or any accessory in case of accidental swallowing.
- Please use the accessories provided or authorized by the manufacturer only.
- The power supply of the device shall meet the requirements of the input voltage of the device. Please use the provided surge protection power socket only.
- Before plugging or unplugging any cable, make sure that your hands are completely dry.
- Do not spill liquid of any kind on the product or use the equipment near water, for example, near a bathtub, washbowl, kitchen sink, wet basement or near a swimming pool.
- Do not tread on, pull, or over-bend any cable in case of malfunction of the device.
- During a thunderstorm, stop using the device and disconnect it from the power supply. Unplug the power plug and the Asymmetric Digital Subscriber Line (ADSL) twisted pair (the radio frequency cable) to avoid lightning strike.
- If the device is left unused for a rather long time, disconnect it from the power supply and unplug the power plug.
- When there is smoke emitted from the device, or some abnormal noise or smell, disconnect the device from the power supply, and unplug the power plug immediately. Contact the specified maintenance center for repair.
- Do not insert any object into equipment slots that is not part of the product or auxiliary product.
- Before connecting a cable, connect the grounding cable of the device first. Do not disconnect the grounding cable until you disconnect all other cables.

### **Cleaning Requirements**

- Before cleaning the device, stop using it and disconnect it from the power supply.
- Use a piece of soft, dry and anti-static cloth to clean the device.



Keep the power plug clean and dry. Using a dirty or wet power plug may lead to electric shock or other perils.



## Appendix A - Time Zones

Time Zone	Time Zone Name
-11	Samoa
-10	United States-Hawaii-Aleutian, United States-Alaska-Aleutian
-9:30	French Polynesia
-9	United States-Alaska Time
-8	Canada(Vancouver,Whitehorse), Mexico(Tijuana,Mexicali), United States-Pacific Time
-7	Canada(Edmonton,Calgary), Mexico(Mazatlan,Chihuahua), United States-MST no DST, United States-Mountain Time
-6	Canada-Manitoba(Winnipeg), Chile(Easter Islands), Mexico(Mexico City,Acapulco), United States-Central Time
-5	Bahamas(Nassau), Canada(Montreal,Ottawa,Quebec), Cuba(Havana), United States-Eastern Time
-4:30	Venezuela(Caracas)
-4	Canada(Halifax,Saint John), Chile(Santiago), Paraguay(Asuncion), United Kingdom-Bermuda(Bermuda), United Kingdom(Falkland Islands), Trinidad&Tobago
-3:30	Canada-New Foundland(St.Johns)
-3	Argentina(Buenos Aires), Brazil(DST), Brazil(no DST), Denmark-Greenland(Nuuk)
-2:30	Newfoundland and Labrador
-2	Brazil(no DST)
-1	Portugal(Azores)
0	Denmark-Faroe Islands(Torshavn), GMT, Greenland, Ireland(Dublin), Morocco, Portugal(Lisboa,Porto,Funchal), Spain-Canary Islands(Las Palmas), United Kingdom(London)
+1	Albania(Tirane), Austria(Vienna), Belgium(Brussels), Caicos, Chad, Croatia(Zagreb), Czech Republic(Prague), Denmark(Kopenhagen), France(Paris), Germany(Berlin), Hungary(Budapest), Italy(Rome), Luxembourg(Luxembourg), Macedonia(Skopje), Namibia(Windhoek), Netherlands(Amsterdam), Spain(Madrid)
+2	Estonia(Tallinn), Finland(Helsinki), Gaza Strip(Gaza), Greece(Athens), Israel(Tel Aviv), Jordan(Amman), Latvia(Riga), Lebanon(Beirut), Moldova(Kishinev), Romania(Bucharest), Russia(Kaliningrad), Syria(Damascus), Turkey(Ankara), Ukraine(Kyiv, Odessa)
+3	East Africa Time, Iraq(Baghdad), Russia(Moscow)
+3:30	Iran(Teheran)
+4	Armenia(Yerevan), Azerbaijan(Baku), Georgia(Tbilisi), Abu Dhabi , Kazakhstan(Aktau), Russia(Samara)
+4:30	Afghanistan(Kabul)
+5	Kazakhstan(Aqtobe), Kyrgyzstan(Bishkek), Pakistan(Islamabad), Russia(Chelyabinsk)
+5:30	India(Calcutta)
+5:45	Nepal(Katmandu)
+6	Kazakhstan(Astana, Almaty), Russia(Novosibirsk,Omsk)
+6:30	Myanmar(Naypyitaw)
+7	Russia(Krasnoyarsk), Thailand(Bangkok)
+8	Australia(Perth), China(Beijing), Russia(Irkutsk, Ulan-Ude), Singapore(Singapore)
+8:45	Eucla
+9	Japan(Tokyo), Korea(Seoul), Russia(Yakutsk,Chita)
+9:30	Australia(Adelaide), Australia(Darwin)

<b>Time Zone</b>	<b>Time Zone Name</b>
+10	Australia(Brisbane), Australia(Hobart), Australia(Sydney,Melbourne,Canberra), Russia(Vladivostok)
+10:30	Australia(Lord Howe Islands)
+11	New Caledonia(Noumea), Russia(Srednekolymsk Time)
+11:30	Norfolk Island
+12	New Zealand(Wellington,Auckland), Russia(Kamchatka Time)
+12:45	New Zealand(Chatham Islands)
+13	Tonga(Nukualofa)
+13:30	Chatham Islands
+14	Kiribati

# Index

## A

About This Guide [v](#)  
 Accessing the Message Center [136](#)  
 Account Lock [24](#)  
 Adding Local Contacts from Skype for Business Directory [49](#)  
 Adding Local Contacts Manually [48](#)  
 Adding Local Favorites [55](#)  
 Adding the Location Information [68](#)  
 Adding Skype for Business Favorites [46](#)  
 Administrator Password [37](#)  
 Always Online [23](#)  
 Answering Calls [81](#)  
 Answering SLA Calls [106](#)  
 Appendix A-Time Zone [185](#)  
 Assigning/Removing Delegates [107](#)  
 Attaching the Stand or the Optional Wall Mount Bracket [12](#)  
 Audio Settings [42](#)  
 Auto Answer [83](#)

## B

Basic Network Settings [29](#)  
 Basic Call Features [79](#)  
 Better Together over Ethernet [149](#)  
 Blind Transfer [118](#)  
 Boss-Admin Feature [107](#)  
 Branch Office Resiliency [143](#)

## C

Calendar [86](#)  
 Call Forward [96](#)  
 Call History Management [61](#)  
 Call Hold/Resume [86](#)  
 Call Mute [85](#)  
 Call Park [133](#)  
 Call Transfer [118](#)  
 Call Waiting [84](#)  
 Calling on Behalf of a Boss [115](#)  
 Changing Presence Status [22](#)  
 Common Area Phone [145](#)  
 Connecting the Handset and Optional Headset [13](#)  
 Connecting the Power [13](#)  
 Connecting to the Network [14](#)  
 Contact Management [44](#)  
 Contrast [33](#)  
 Consultative Transfer [119](#)  
 Customizing Your Phone [33](#)

## D

Declaration of Conformity [ii](#)  
 Deleting Local Contacts [52](#)

Deleting the Voice Mail [138](#)  
 Dial-now [70](#)  
 Disabling BToE on Your Phone [164](#)  
 Documentations [8](#)  
 Dual Headset [64](#)  
 Dynamic Forwarding [104](#)

## E

E911 [65](#)  
 E911 Location Tip [65](#)  
 Editing Local Contacts [51](#)  
 Emergency Call [69](#)  
 Enabling Better Together over Ethernet [155](#)  
 Ending Calls [83](#)  
 Enabling or Disabling the Announcement [130](#)  
 Entering Data and Editing Fields [25](#)  
 Exiting BToE on Your Computer [165](#)

## G

General Settings [33](#)  
 Getting Started [9](#)  
 Getting Started with Better Together over Ethernet [149](#)  
 Group Call Pickup [119](#)

## H

Hardware Component Instructions [1](#)  
 Headset Mode Activation/Deactivation [63](#)  
 Headset Prior [63](#)  
 Headset Use [62](#)  
 Holding or Resuming Conference Call [127](#)  
 Hotline [74](#)

## I

Icon Instructions [3](#)  
 Idle Screen [31](#)  
 In This Guide [v](#)  
 Inbound Private Line [117](#)  
 Initiating a Skype Conference Call by Meet Now [125](#)  
 Initiating a Skype for Business Conference Call [120](#)  
 Initiating a Skype for Business Conference Call during a Call [120](#)  
 Installing the Yealink Better Together over Ethernet Connector [149](#)

## J

Joining a Locked Conference Call [131](#)  
 Joining Calls into a Conference [122](#)  
 Joining Conference Calls from the Calendar [92](#)

Joining Skype Conference from the Calendar [93](#)  
 Joining Two Calls into a Conference from the Phone [122](#)  
 Joining Two Calls into a Conference from the Skype for Business Client [123](#)

## K

Key as Send [37](#)

## L

Language [34](#)  
 Leaving the Conference [133](#)  
 Leaving the Voice Mail [135](#)  
 LED Instructions [4](#)  
 Limitation of Liability [181](#)  
 Live Dialpad [73](#)  
 Local Directory [48](#)  
 Local Favorites [55](#)  
 Location Notification [66](#)  
 Locking or Unlocking the Conference [130](#)

## M

Managing the Conference Participants [127](#)  
 Managing the Voice Mail [135](#)  
 Making a Safe Transfer to Boss [114](#)  
 Marking the Voice Mail as Read [138](#)  
 Modifying the Privacy Mode from the Phone [75](#)  
 Modifying the Privacy Mode from the Skype for Business client [76](#)  
 Multicast Paging [139](#)  
 Muting or Unmuting Conference Participants [128](#)

## P

Packaging Contents [9](#)  
 Paired Status [155](#)  
 Pairing your Phone with Your Computer [156](#)  
 Phone Initialization [12](#)  
 Phone Installation [12](#)  
 Phone Lock [38](#)  
 Phone Status [27](#)  
 PIN Authentication [17](#)  
 Placing a SLA Calls on Hold [107](#)  
 Placing Calls [80](#)  
 Placing the Calls on Hold [112](#)  
 Placing Calls to Contacts [58](#)  
 Privacy Line Ring Tones [118](#)  
 Privacy Mode [75](#)  
 Promoting or Demoting Conference Participants [129](#)

## O

Optional Accessories [10](#)  
 Overview [1](#)

## R

Receiving RTP Stream [141](#)

Redialing Numbers [83](#)  
 Regulatory Notices [181](#)  
 Remembering Password [41](#)  
 Removing Conference Participants [133](#)  
 Reordering Local Favorites [57](#)  
 Response Group [105](#)  
 Resuming Held SLA Calls [107](#)  
 Resuming the Held Calls [112](#)  
 Ring Tones [43](#)

## S

Safety Instructions [181](#)  
 Searching for Contacts [59](#)  
 Sending RTP Stream [139](#)  
 Service Agreements [181](#)  
 Setting up a Meeting in Outlook [88](#)  
 Setting up a Skype Conference in Outlook [87](#)  
 Setting up an Appointment in Outlook [87](#)  
 Setting up an Event in Outlook [89](#)  
 Shared Line Appearance for Skype for Business [106](#)  
 Signing into Skype for Business [15](#)  
 Signing into a Common Area Phone [145](#)  
 Signing in via PC [159](#)  
 Signing Out of Skype for Business [21](#)  
 Signing Out of a Common Area Phone [147](#)  
 Skype for Business Conference [120](#)  
 Skype for Business Directory [44](#)  
 Skype for Business Favorites [46](#)  
 Static Forwarding [96](#)  
 Static Forwarding on T40P Skype for Business phone [96](#)  
 Switching to Skype for Business Accounts [146](#)

## T

Table of Contents [vii](#)  
 Time and Date [35](#)  
 Transferring Calls to Boss Voicemails [114](#)  
 Troubleshooting [167](#)  
 Troubleshooting Solution [167](#)

## U

Uninstalling the Yealink BToE Connector [165](#)  
 User Interfaces [5](#)  
 User Sign-in [15](#)  
 User Sign-in/Web Sign-in/Sign in via PC [136](#)  
 Using a Common Area Phone [145](#)  
 Using Better Together over Ethernet [162](#)  
 Using Multicast Paging [142](#)  
 Using the Calendar [90](#)  
 Using the Boss-Admin Feature [111](#)

## V

Viewing Local Contacts [50](#)  
 Viewing Local Favorites [57](#)  
 Viewing the Bosses/Delegates [110](#)  
 Viewing the Bosses [110](#)

Viewing the Dial-in Number and Conference ID  
126  
Viewing the Delegates 111  
Viewing the Calendar 91  
Viewing the Conference Participants 127  
Viewing the Location Information 69  
Viewing Skype for Business Contacts 45  
Viewing Skype for Business Favorites 47  
Voice Mail 135  
Volume 42

## **W**

Web Sign-in 18  
Web User Interface 6  
Working With Schedule Reminders 91