

Nikon

DIGITAL CAMERA

COOLPIX P300

User's Manual

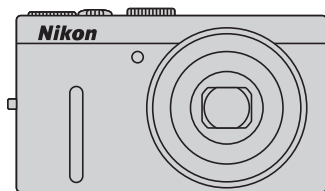

En

Trademark Information

- Microsoft, Windows and Windows Vista are either registered trademarks or trademarks of Microsoft Corporation in the United States and/or other countries.
- Macintosh, Mac OS, and QuickTime are trademarks of Apple Inc., registered in the U.S. and other countries.
- Adobe and Acrobat are registered trademarks of Adobe Systems Inc.
- SDXC, SDHC and SD Logos are trademarks of SD-3C, LLC.
- PictBridge is a trademark.
- HDMI, **HDMI** logo and High-Definition Multimedia Interface are trademarks or registered trademarks of HDMI Licensing LLC.
- All other trade names mentioned in this manual or the other documentation provided with your Nikon product are trademarks or registered trademarks of their respective holders.

AVC Patent Portfolio License

This product is licensed under the AVC Patent Portfolio License for the personal and non-commercial use of a consumer to (i) encode video in compliance with the AVC standard ("AVC video") and/or (ii) decode AVC video that was encoded by a consumer engaged in a personal and non-commercial activity and/or was obtained from a video provider licensed to provide AVC video. No license is granted or shall be implied for any other use. Additional information may be obtained from MPEG LA, L.L.C.

See <http://www.mpegla.com>.

Introduction

First Steps

Basic Photography and Playback: 📷 (Auto) Mode

More on Shooting

More on Playback

Editing Pictures

Movie Recording and Playback

Connecting to Televisions, Computers and Printers

Basic Camera Setup

Caring for the Camera

Technical Notes and Index

For Your Safety

To prevent damage to your Nikon product or injury to yourself or to others, read the following safety precautions in their entirety before using this equipment. Keep these safety instructions where all those who use the product will read them.



This icon marks warnings, information that should be read before using this Nikon product, to prevent possible injury.

WARNINGS

Turn off in the event of malfunction

Should you notice smoke or an unusual smell coming from the camera or Charging AC Adapter, unplug the Charging AC Adapter and remove the battery immediately, taking care to avoid burns. Continued operation could result in injury. After removing or disconnecting the power source, take the equipment to a Nikon-authorized service representative for inspection.

Do not disassemble

Touching the internal parts of the camera or Charging AC Adapter could result in injury. Repairs should be performed only by qualified technicians. Should the camera or Charging AC Adapter break open as the result of a fall or other accident, take the product to a Nikon-authorized service representative for inspection, after unplugging the product and/or removing the battery.

Do not use the camera or Charging AC Adapter in the presence of flammable gas

Do not use electronic equipment in the presence of flammable gas, as this could result in explosion or fire.

Handle the camera strap with care

Never place the strap around the neck of an infant or child.

Keep out of reach of children

Particular care should be taken to prevent infants from putting the battery or other small parts into their mouths.

Observe caution when handling the battery

The battery may leak or explode if improperly handled. Observe the following precautions when handling the battery for use in this product:

- Before replacing the battery, turn the product off. If you are using the Charging AC Adapter/AC adapter, be sure it is unplugged.
 - Use only a Rechargeable Li-ion Battery EN-EL12 (supplied). Charge the battery by inserting it into the camera and connecting the Charging AC Adapter EH-69P (supplied).
 - When inserting the battery, do not attempt to insert it upside down or backwards.
 - Do not short or disassemble the battery or attempt to remove or break the battery insulation or casing.
 - Do not expose the battery to flame or to excessive heat.
 - Do not immerse in or expose to water.
 - Replace the terminal cover when transporting the battery. Do not transport or store with metal objects such as necklaces or hairpins.
 - The battery is prone to leakage when fully discharged. To avoid damage to the product, be sure to remove the battery when no charge remains.
 - Discontinue use immediately should you notice any change in the battery, such as discoloration or deformation.
- If liquid from the damaged battery comes in contact with clothing or skin, rinse immediately with plenty of water.

Observe the following precautions when handling the Charging AC Adapter

- Keep dry. Failure to observe this precaution could result in fire or electric shock.
- Dust on or near the metal parts of the plug should be removed with a dry cloth. Continued use could result in fire.
- Do not handle the plug or go near the Charging AC Adapter during lightning storms. Failure to observe this precaution could result in electric shock.
- Do not damage, modify, forcibly tug or bend the USB cable, place it under heavy objects, or expose it to heat or flames. Should the insulation be damaged and the wires become exposed, take it to a Nikon-authorized service representative for inspection. Failure to observe these precautions could result in fire or electric shock.
- Do not handle the plug or Charging AC Adapter with wet hands. Failure to observe this precaution could result in electric shock.
- Do not use with travel converters or adapters designed to convert from one voltage to another or with DC-to-AC inverters. Failure to observe this precaution could damage the product or cause overheating or fire.

 **Use appropriate cables**

When connecting cables to the input and output jacks, use only the cables provided or sold by Nikon for the purpose, to maintain compliance with product regulations.

 **Handle moving parts with care**

Be careful that your fingers or other objects are not pinched by the lens cover or other moving parts.

 **CD-ROMs**

The CD-ROMs supplied with this device should not be played back on audio CD equipment. Playing CD-ROMs on an audio CD player could cause hearing loss or damage the equipment.

 **Observe caution when using the flash**

Using the flash close to your subject's eyes could cause temporary visual impairment. Particular care should be observed if photographing infants, when the flash should be no less than 1 m (3 ft. 4 in.) from the subject.

 **Do not operate the flash with the flash window touching a person or object**

Failure to observe this precaution could result in burns or fire.

 **Avoid contact with liquid crystal**

Should the monitor break, care should be taken to avoid injury caused by broken glass and to prevent liquid crystal from the monitor touching the skin or entering the eyes or mouth.

 **Turn the power off when using inside an airplane or the hospital**

Turn the power off while inside the airplane during take off or landing. Follow the instructions of the hospital when using while in a hospital. The electromagnetic waves given out by this camera may disrupt the electronic systems of the airplane or the instruments of the hospital.

Notices

Notices for Customers in the U.S.A.

IMPORTANT SAFETY INSTRUCTIONS- SAVE THESE INSTRUCTIONS.

DANGER – TO REDUCE THE RISK OF FIRE OR ELECTRIC SHOCK, CAREFULLY FOLLOW THESE INSTRUCTIONS

For connection to a supply not in the U.S.A., use an attachment plug adapter of the proper configuration for the power outlet if needed.

The power supply unit is intended to be correctly orientated in a vertical or floor mount position.

Federal Communications Commission (FCC) Radio Frequency Interference Statement

This equipment has been tested and found to comply with the limits for a Class B digital device, pursuant to Part 15 of the FCC rules. These limits are designed to provide reasonable protection against harmful interference in a residential installation. This equipment generates, uses, and can radiate radio frequency energy and, if not installed and used in accordance with the instructions, may cause harmful interference to radio communications. However, there is no guarantee that interference will not occur in a particular installation. If this equipment does cause harmful

interference to radio or television reception, which can be determined by turning the equipment off and on, the user is encouraged to try to correct the interference by one or more of the following measures:

- Reorient or relocate the receiving antenna.
- Increase the separation between the equipment and receiver.
- Connect the equipment into an outlet on a circuit different from that to which the receiver is connected.
- Consult the dealer or an experienced radio/television technician for help.



Nikon
COOLPIX P300

CAUTIONS

Modifications

The FCC requires the user to be notified that any changes or modifications made to this device that are not expressly approved by Nikon Corporation may void the user's authority to operate the equipment.

Interface Cables

Use the interface cables sold or provided by Nikon for your equipment. Using other interface cables may exceed the limits of Class B Part 15 of the FCC rules.

Notice for Customers in the State of California

WARNING

Handling the cord on this product will expose you to lead, a chemical known to the State of California to cause birth defects or other reproductive harm.

Wash hands after handling.

Nikon Inc.,
1300 Walt Whitman Road,
Melville, New York 11747-3064
USA
Tel: 631-547-4200

Notice for Customers in Canada

CAUTION

This Class B digital apparatus complies with Canadian ICES-003.

ATTENTION

Cet appareil numérique de la classe B est conforme à la norme NMB-003 du Canada.

Notices for Customers in Europe

CAUTION

RISK OF EXPLOSION IF BATTERY IS REPLACED BY AN INCORRECT TYPE. DISPOSE OF USED BATTERIES ACCORDING TO THE INSTRUCTIONS.

This symbol indicates that this product is to be collected separately.

The following apply only to users in European countries:



- This product is designated for separate collection at an appropriate collection point. Do not dispose of as household waste.
- For more information, contact the retailer or the local authorities in charge of waste management.

This symbol on the battery indicates that the battery is to be collected separately.









The following apply only to users in European countries:

- All batteries, whether marked with this symbol or not, are designated for separate collection at an appropriate collection point. Do not dispose of as household waste.
- For more information, contact the retailer or the local authorities in charge of waste management.

Table of Contents

For Your Safety	ii
WARNINGS	ii
Notices	v
<hr/>	
Introduction	1
About This Manual	1
Information and Precautions	2
Parts of the Camera	4
Camera Body	4
Monitor	6
Basic Operations	9
Command Dial	9
Raising and Lowering the Flash (⚡🔇) (Flash Pop-up) Control	9
Rotary Multi Selector	10
MENU (Menu) Button	11
Switching Between Tabs in the Menu Screen	11
Using Camera Menus	12
Pressing the Shutter-Release Button Halfway/All the Way	13
Attaching the Camera Strap	13
<hr/>	
First Steps	14
Inserting the Battery	14
Removing the Battery	15
Charging the Battery	16
Turning On and Off the Camera	19
Setting the Display Language, Date and Time	20
Inserting the Memory Card	22
Removing the Memory Card	22
<hr/>	
Basic Photography and Playback: 📷 (Auto) Mode	24
Step 1 Turn the Camera On and Select 📷 (Auto) Mode	24
Indicators Displayed in 📷 (Auto) Mode	25
Step 2 Frame a Picture	26
Using the Zoom	27
Step 3 Focus and Shoot	28
Step 4 Viewing and Deleting Pictures	30
Viewing Pictures (Playback Mode)	30
Deleting Unnecessary Images	31
Using the Flash	32
Setting the Flash Mode	33
Taking Pictures with the Self-Timer	35
Taking Pictures of Smiling Faces (Smile Timer)	36
Macro Mode	38
Adjusting Brightness (Exposure Compensation)	39

Table of Contents

More on Shooting	40
Selecting a Shooting Mode (Mode Dial)	40
Selecting Scenes for Shooting (Scene Mode)	41
Shooting in the Scene Selected by the Camera (Scene Auto Selector).....	42
Selecting a Scene Mode to Take Pictures (Features)	44
Taking Pictures with Easy Panorama.....	57
Viewing Pictures Recorded with Easy Panorama.....	59
Taking Pictures with Panorama Assist.....	60
Setting the Exposure for Shooting (P, S, A, M Modes)	62
P, S, A, M Modes	62
P (Programmed Auto) Mode.....	64
S (Shutter-Priority Auto) Mode	65
A (Aperture-Priority Auto) Mode.....	66
M (Manual) Mode.....	67
Adjusting Brightness, Vividness and Hue (P, S, A, M Modes)	69
Operating the Creative Slider.....	69
Shooting Options: Shooting Menu (P, S, A, M Modes)	72
Image Mode (Image Quality/Image Size)	74
White Balance	76
Metering.....	78
Continuous.....	79
ISO Sensitivity.....	81
Exposure Bracketing	82
AF Area Mode	83
Focusing on Moving Subjects for Shooting (Subjec Tracking/Face Priority Tracking).....	87
Autofocus Mode.....	89
Flash Exp. Comp.	89
Functions that Cannot be Applied Simultaneously.....	90
More on Playback	92
Operations in Full-Frame Playback	92
Displaying the Histogram and Shooting Information	93
Viewing Multiple Pictures: Thumbnail Playback	94
Calendar Display.....	95
Taking a Closer Look: Playback Zoom	96
Playback Options: Playback Menu	98
 Print Order: Setting the Pictures and Number of Copies to Print	99
 Slide Show.....	101
 Protect	102
Selecting Pictures	103
 Rotate Image.....	104
 Voice Memo.....	105
 Copy: Copying Between the Internal Memory and Memory Card	107







Editing Pictures	108
Picture Editing Functions	108
Editing Pictures	110
 Quick Retouch: Enhancing Contrast and Saturation	110
 D-Lighting: Enhancing Brightness and Contrast	111
 Skin Softening: Making Skin Appear Smoother	112
 Filter Effects: Digital Filter	114
 Small Picture: Decreasing Image Size	116
 Crop: Creating a Cropped Copy	117
<hr/>	
Movie Recording and Playback	118
Recording Movies	118
Recording Movies in Slow Motion and Fast Motion (HS Movie)	120
Using the Movie Menu	122
Movie Options	123
Autofocus Mode	125
Movie Playback	126
Deleting Unnecessary Movies	126
<hr/>	
Connecting to Televisions, Computers and Printers	127
Connecting to a TV	127
Connecting to a Computer	129
Before Connecting the Camera	129
Transferring Images from a Camera to a Computer	130
Charging While Connecting to a Computer	134
Connecting to a Printer	135
Connecting the Camera and Printer	136
Printing Pictures One at a Time	137
Printing Multiple Pictures	138

Table of Contents

Basic Camera Setup	141
Setup Menu.....	141
Welcome Screen	143
Time Zone and Date.....	144
Monitor Settings.....	147
Print Date	149
Vibration Reduction	150
Motion Detection	151
AF Assist.....	152
Digital Zoom.....	152
Sound Settings.....	153
Auto Off	153
Format Memory/Format Card.....	154
Language.....	155
TV Settings.....	155
Charge by Computer.....	156
Blink Warning	157
Reset All	159
Firmware Version.....	161
Caring for the Camera.....	162
Caring for the Camera	162
Cleaning	164
Storage.....	165
Technical Notes and Index	166
Optional Accessories	166
Approved Memory Cards.....	167
File and Folder Names	168
Error Messages	170
Troubleshooting	175
Specifications	181
Supported Standards	184
Index.....	185

About This Manual

Thank you for your purchase of Nikon COOLPIX P300 digital camera. This manual is written to help you enjoy taking pictures with your Nikon digital camera. Read this manual thoroughly before use, and keep it where all those who use the product will read it.

Symbols and Conventions

To make it easier to find the information you need, the following symbols and conventions are used:



This icon marks cautions, information that should be read before use, to prevent damage to the camera.



This icon marks tips, additional information that may be helpful when using the camera.



This icon marks notes, information that should be read before using the camera.



This icon indicates that more information is available elsewhere in this manual.

Notations

- Secure Digital (SD) memory card, SDHC memory card, and SDXC memory card are referred to as “memory card.”
- The setting at the time of purchase is referred to as the “default setting”.
- The names of menu items displayed in the camera monitor, and the names of buttons or messages displayed on a computer monitor appear in bold.

Screen Samples

In this manual, images are sometimes omitted from monitor display samples so that monitor indicators can be more clearly shown.

Illustrations and Screen Display

Illustrations and text displays shown in this manual may differ from actual display.



Internal Memory and Memory Cards

Pictures taken with this camera can be stored in the camera's internal memory or on removable memory cards. If a memory card is inserted, all new pictures will be stored on the memory card and delete, playback, and format operations will apply only to the pictures on the memory card. The memory card must be removed before the internal memory can be formatted or accessed for picture storage, deletion, or viewing.

Information and Precautions

Life-Long Learning

As part of Nikon's "Life-Long Learning" commitment to ongoing product support and education, continually updated information is available online at the following sites:

- For users in the U.S.A.: <http://www.nikonusa.com/>
- For users in Europe and Africa: <http://www.europe-nikon.com/support/>
- For users in Asia, Oceania, and the Middle East: <http://www.nikon-asia.com/>

Visit these sites to keep up-to-date with the latest product information, tips, answers to frequently asked questions (FAQs), and general advice on digital imaging and photography. Additional information may be available from the Nikon representative in your area. Visit the site below for contact information:

<http://imaging.nikon.com/>

Use Only Nikon Brand Electronic Accessories

Nikon COOLPIX cameras are designed to the highest standards and include complex electronic circuitry. Only Nikon brand electronic accessories (including battery chargers, batteries, Charging AC Adapter and AC adapters) certified by Nikon specifically for use with this Nikon digital camera are engineered and proven to operate within the operational and safety requirements of this electronic circuitry.

THE USE OF NON-NIKON ELECTRONIC ACCESSORIES COULD DAMAGE THE CAMERA AND MAY VOID YOUR NIKON WARRANTY.

The use of third-party rechargeable Li-ion batteries not bearing the Nikon holographic seal could interfere with normal operation of the camera or result in the batteries overheating, igniting, rupturing, or leaking.

For more information about Nikon brand accessories, contact a local authorized Nikon dealer.

Holographic seal: Identifies this device as an authentic Nikon product.



Before Taking Important Pictures

Before taking pictures on important occasions (such as at weddings or before taking the camera on a trip), take a test shot to ensure that the camera is functioning normally. Nikon will not be held liable for damages or lost profits that may result from product malfunction.

About the Manuals

- No part of the manuals included with this product may be reproduced, transmitted, transcribed, stored in a retrieval system, or translated into any language in any form, by any means, without Nikon's prior written permission.
- Nikon reserves the right to change the specifications of the hardware and software described in these manuals at any time and without prior notice.
- Nikon will not be held liable for any damages resulting from the use of this product.
- While every effort was made to ensure that the information in these manuals is accurate and complete, we would appreciate it were you to bring any errors or omissions to the attention of the Nikon representative in your area (address provided separately).

Notice Concerning Prohibition of Copying or Reproduction

Note that simply being in possession of material that was digitally copied or reproduced by means of a scanner, digital camera or other device may be punishable by law.

• Items prohibited by law from being copied or reproduced

Do not copy or reproduce paper money, coins, securities, government bonds or local government bonds, even if such copies or reproductions are stamped "Sample". The copying or reproduction of paper money, coins, or securities which are circulated in a foreign country is prohibited. Unless the prior permission of the government was obtained, the copying or reproduction of unused postage stamps or post cards issued by the government is prohibited.

The copying or reproduction of stamps issued by the government and of certified documents stipulated by law is prohibited.

• Cautions on certain copies and reproductions

The government has issued cautions on copies or reproductions of securities issued by private companies (shares, bills, checks, gift certificates, etc.), commuter passes or coupon tickets, except when a minimum of necessary copies are to be provided for business use by a company. Also, do not copy or reproduce passports issued by the government, licenses issued by public agencies and private groups, ID cards and tickets, such as passes and meal coupons.

• Comply with copyright notices

The copying or reproduction of copyrighted creative works such as books, music, paintings, woodcut prints, maps, drawings, movies and photographs is governed by national and international copyright laws. Do not use this product for the purpose of making illegal copies or to infringe copyright laws.

Disposing of Data Storage Devices

Please note that deleting images or formatting data storage devices such as memory cards or built-in camera memory does not completely erase the original image data. Deleted files can sometimes be recovered from discarded storage devices using commercially available software, potentially resulting in the malicious use of personal image data. Ensuring the privacy of such data is the user's responsibility.

Before discarding a data storage device or transferring ownership to another person, erase all data using commercial deletion software, or format the device and then completely refill it with images containing no private information (for example, pictures of empty sky). Be sure to also replace any pictures selected for the **Select an Image** option in the **Welcome screen** setting (📖143). Care should be taken to avoid injury or damage to property when physically destroying data storage devices.

Parts of the Camera

Camera Body

Introduction

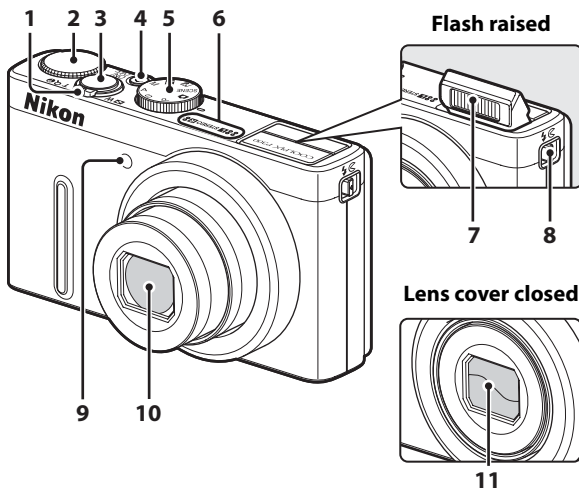

1	Zoom control..... 27
	W : Wide..... 27
	T : Tele..... 27
	: Thumbnail playback..... 94
	: Playback zoom..... 96
	: Help..... 41
2	Command dial 9
3	Shutter-release button..... 13, 28
4	Power switch/power-on lamp... 19, 153
5	Mode dial..... 40

6	Microphone (stereo)..... 105, 118
7	Flash..... 32
8	(flash pop-up) control 33
9	Self-timer lamp..... 35
10	AF-assist illuminator..... 152
10	Lens..... 164, 181
11	Lens cover

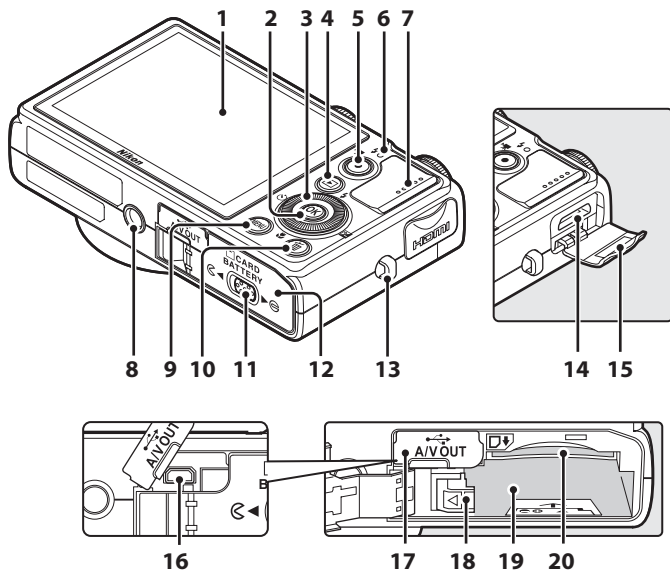

1	Monitor	6, 25
2	OK (apply selection) button	10
3	Rotary multi selector	10
4	▶ (playback) button.....	30
5	● (▶ movie-record) button.....	118
6	Charge lamp	17, 134
	Flash lamp.....	34
7	Speaker	106, 126
8	Tripod socket	
9	MENU button.....	11, 41, 73, 98, 122, 142
10	🗑 (delete) button.....	31, 106, 126

11	Cover latch.....	14, 22
12	Battery-chamber/ memory card slot cover	14, 22
13	Eyelet for camera strap.....	13
14	HDMI Mini Connector.....	127
15	HDMI connector cover.....	127
16	USB/Audio video connector	127, 130, 136
17	Connector cover	127, 130, 136
18	Battery latch.....	14, 15
19	Battery chamber.....	14
20	Memory card slot	22

Monitor

The indicators that appear on the monitor during shooting and playback disappear after a few seconds (147). The displayed information varies according to the camera settings and condition.

Shooting

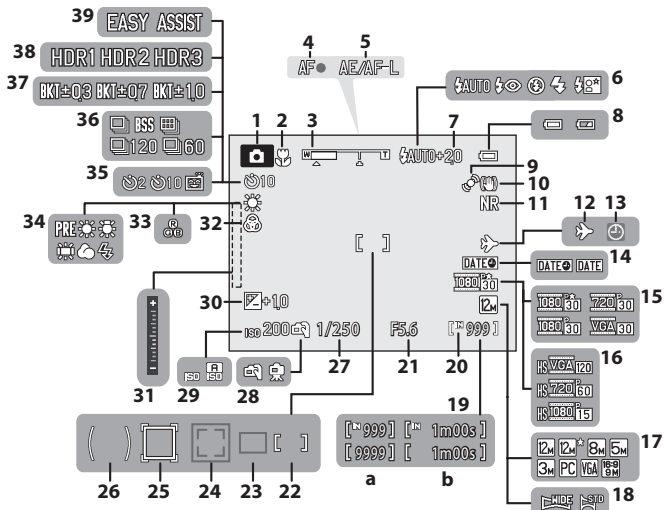

1	Shooting mode*	24, 40, 41, 62	22	Focus area (for manual, center).....	28, 83
2	Macro mode	38	23	Focus area (for auto).....	83
3	Zoom indicator	27	24	Focus area (for face detection, pet detection)	36, 56, 83
4	Focus indicator.....	28	25	Focus area (for subject tracking)	87
5	AE/AF-L indicator.....	61	26	Spot metering area	78
6	Flash mode	32	27	Shutter speed	63
7	Flash exposure compensation	89	28	Hand-held/tripod.....	44, 49
8	Battery level indicator	24	29	ISO sensitivity	34, 81
9	Motion detection icon	151	30	Exposure compensation value.....	39
10	Vibration reduction icon	150	31	Exposure indicator	67
11	Noise reduction burst	47	32	Vividness.....	71
12	Travel destination indicator.....	144	33	Hue.....	71
13	"Date not set" indicator.....	170	34	White balance	76
14	Print date.....	149	35	Self-timer indicator	35
15	Movie options.....	123	35	Smile timer	36
16	HS movie type	124	36	Continuous shooting mode.....	79
17	Image mode	74	37	Exposure bracketing	82
18	Easy panorama	57	38	Backlighting (HDR)	45
19	(a) Number of exposures remaining (still pictures)	24, 75	39	Panorama	55
	(b) Movie length.....	118, 125			
20	Internal memory indicator.....	25			
21	Aperture value.....	63			

* The icons vary with the shooting mode.

Playback

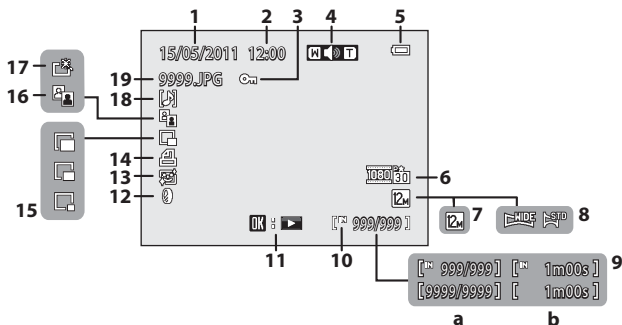

1	Date of recording.....	20	11	Easy panorama playback guide	59
2	Time of recording	20		Movie playback guide	126
3	Protect icon.....	102	12	Filter effects icon.....	114
4	Volume indicator	106, 126	13	Skin softening icon.....	112
5	Battery level indicator	24	14	Print order icon	99
6	Movie types*	123	15	Small picture	116, 117
7	Image mode*	74	16	D-Lighting icon	111
8	Easy panorama indicator.....	59	17	Quick retouch icon.....	110
9	(a) Current frame number/total number of frames.....	30	18	Voice memo indicator	105
	(b) Movie length	126	19	File number and type	168
10	Internal memory indicator	30			

* The icons vary with the settings used for shooting.

Basic Operations

Command Dial

You can rotate the command dial to operate any of the following functions.

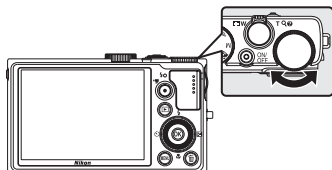

For Shooting

Mode	Description	
Mode dial set to P	Adjust the flexible program	64
Mode dial set to S or M	Adjust shutter speed	65, 67

For Playback

Mode	Description	
Playback zoom	Change the zoom ratio	96

For Menu Screen

Mode	Description	
First level of shooting menu or setup menu is displayed	Change the setting	12, 73, 142

Raising and Lowering the Flash (⚡🔼 (Flash Pop-up) Control)

Slide the ⚡🔼 (flash pop-up) control to raise the flash.

- See "Using the Flash" (32) for more information.

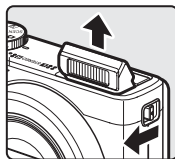

- When not using the flash, lower it by gently pushing it down until it clicks.

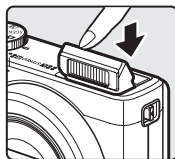



Rotary Multi Selector

Operate by rotating the rotary multi selector, pressing up (▲), down (▼), left (◀) or right (▶) on the rotary multi selector, or pressing the **OK** button.

For Shooting

Rotate to set the aperture value¹/Choose the option above

Display  (Self-timer/Smile timer) menu (35, 36)

Display  (flash mode) menu/Choose the option above (32)

Display creative slider² (69), display the  (exposure compensation) guide (39)

Apply selection

Display  (macro mode) menu (38)/Choose the option below

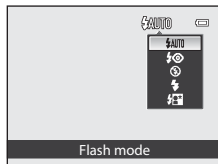

¹ The aperture value can be set in shooting mode **A** or **M** (66, 67).

² Items can be chosen while a menu is displayed.

² Displayed for **P**, **S**, **A** and **M** modes.

For Playback

Choose the previous picture*



Display histogram and shooting information (92, 93)

Choose the next picture*

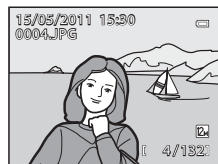

* Previous or subsequent pictures can also be chosen by rotating the rotary multi selector.

For Menu Screen

Choose the option above*

Choose the option on the left/Return display to the previous screen

Choose the option below*



Choose the option on the right/
Display sub-menu or apply selection

Apply selection or display sub-menu

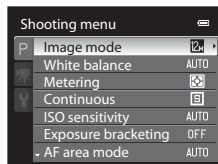

* Items can also be chosen by rotating the rotary multi selector.

MENU (Menu) Button

Press the **MENU** button to display the menu for the selected mode and to select options for the menu items.

- Use the rotary multi selector to navigate the menus (10).

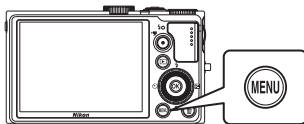

is displayed when there are previous menu options

 is displayed when the menu contains two or more pages

Tab for the menus available in the current shooting mode*/tab for playback mode menu

Tab for movie menu (during shooting mode)

Tab for displaying the setup menu

Displayed when there are following menu options

* The displayed tabs differ according to the chosen shooting mode.

- (auto) mode: Auto menu tab (24)
- (scene): Scene menu tab (41)
- (Night landscape): Night landscape menu tab (44)
- (Backlighting): Backlighting menu tab (45)
- P, S, A, M**: Shooting menu tab (72)

Switching Between Tabs in the Menu Screen

In the menu screen that is displayed when the **MENU** button is pressed, choose the left end tab to switch to the menu of the chosen tab.



Press the rotary multi selector to highlight the tab.

Press the rotary multi selector or to choose another tab, and press either the button or .

The corresponding menu is displayed.

Using Camera Menus

1 Press the **MENU** button.

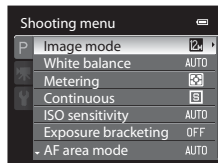

2 Press the rotary multi selector **▲** or **▼** to choose an item, and then press **▶** or the **OK** button.

- Items can also be chosen by rotating the rotary multi selector (10).
- To change tabs, press **◀** (11).

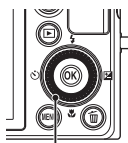

Rotary multi selector

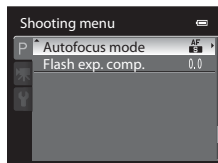

3 Press **▲** or **▼** to choose an item and press the **OK** button.

- The setting is applied.

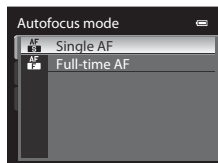

4 When setting is finished, press the **MENU** button.

- The camera exits the menu display.

Command Dial Operations during Menu Display

Rotate the command dial while the first level of the shooting menu or setup menu is displayed (step 2 above) to change the setting for the selected item.

Pressing the Shutter-Release Button Halfway/All the Way

- The camera features a two-stage shutter-release button. To set focus and exposure, press the shutter-release button halfway, stopping when you feel resistance. When the shutter-release button is pressed halfway, focus and exposure (shutter speed and aperture value) are set. Focus and exposure remain locked while the shutter-release button is pressed halfway.
- While the shutter-release button is held in this position, release the shutter and take a picture by pressing the shutter-release button the rest of the way down. Do not use force when pressing the shutter-release button, as this may result in camera shake and blurred images.



Press halfway to lock the focus and exposure.



Press the rest of the way down to shoot.

Attaching the Camera Strap

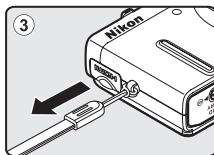
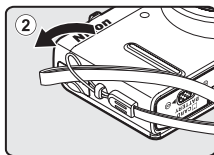
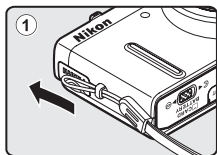

Inserting the Battery

Insert a Rechargeable Li-ion Battery EN-EL12 (supplied) into the camera.

- Charge the battery before first use or when the battery is running low (📖16).

- 1 Slide the cover latch to the ◀ side (①), and open the battery-chamber/memory card slot cover (②).

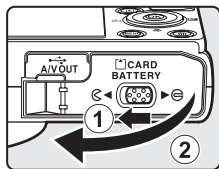

- 2 Insert the battery.

- Use the edge of the battery to push the orange battery latch in the direction shown (①), and fully insert the battery (②).
- When the battery is fully inserted, the battery latch locks it in place.

Battery chamber

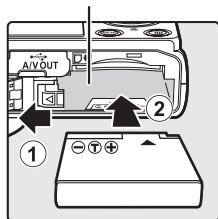

✔ Inserting the Battery Correctly

Inserting the battery upside down or backwards could damage the camera. Be sure to confirm that the battery is in the correct orientation.

- 3 Close the battery-chamber/memory card slot cover (①), and slide the cover latch to the ▶ position (②).

- The camera cannot be turned on if the battery-chamber/memory card slot cover is open. Additionally, the battery inserted into the camera cannot be charged.

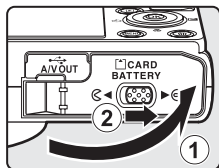

Removing the Battery

Before opening the battery-chamber/memory card slot cover, turn the camera off (📖19) and confirm that the power-on lamp and the monitor are off.

To eject the battery, open the battery-chamber/memory card slot cover and slide the orange battery latch in the direction indicated by the arrow (①), then remove the battery while being careful not to remove the battery at an angle (②).

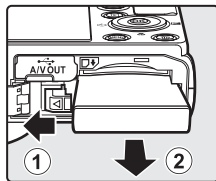

- The camera, battery or memory card may be hot immediately after using the camera. Observe caution when removing the battery or memory card.

✓ Notes on Battery

- Be sure to read and follow the warnings of “For Your Safety” (📖ii) thoroughly before using the battery.
- Be sure to read and follow the warnings for “The Battery” (📖163) thoroughly before using the battery.
- If the battery will not be used for an extended period, recharge it at least once every six months and run it flat before returning it to storage.

Charging the Battery

Charge the supplied Rechargeable Li-ion Battery EN-EL12 inserted into the camera, by connecting the supplied Charging AC Adapter EH-69P to the camera via the supplied USB Cable UC-E6, and then plugging the Charging AC Adapter into an electrical outlet.

1 Prepare the Charging AC Adapter EH-69P.

If a plug adapter* is included, attach the plug adapter to the plug on the Charging AC Adapter. Push the plug adapter firmly until it is securely held in place. Once the two are connected, attempting to forcibly remove the plug adapter could damage the product.

* The shape of the plug adapter varies according to the country or region in which the camera was purchased. The Charging AC Adapter comes with the plug adapter attached in Argentina and Korea.

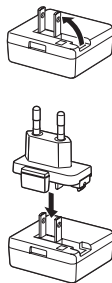

2 Insert the battery into the camera (14).

Do not turn on the camera.

3 Use the supplied USB cable to connect the Charging AC Adapter to the camera.

- Be sure that connectors are properly oriented. Do not attempt to insert connectors at an angle, and do not use force when connecting or disconnecting the USB cable.
- Close the battery-chamber/memory card slot cover.

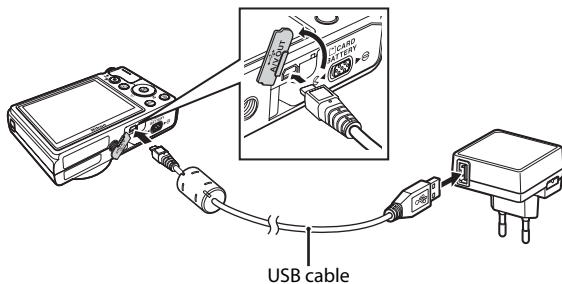

4 Plug the Charging AC Adapter into an electrical outlet.

The charge lamp slowly blinks green to indicate that the battery is charging.

About four hours are required to charge a fully exhausted battery.

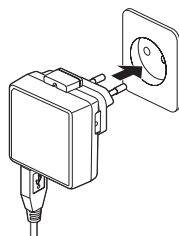

The following chart explains charge lamp status when the camera is plugged into the electrical outlet.

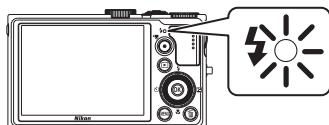

Charge lamp	Description
Blinks slowly (green)	Battery charging.
Off	Battery not charging. When charging is complete, the charge lamp stops blinking green and turns off.
Flickers (green)	<ul style="list-style-type: none"> The ambient temperature is not suited to charging. Charge the battery indoors with an ambient temperature of 5 °C to 35 °C (41 °F to 95 °F). The USB cable or Charging AC Adapter is not properly connected, or there is a problem with the battery. Disconnect the USB cable or unplug the Charging AC Adapter and correctly connect it again, or change the battery.

5 Disconnect the Charging AC Adapter from the electrical outlet and then disconnect the USB cable.

Charging the Battery

Notes on Charging AC Adapter

- The Charging AC Adapter EH-69P is for use only with compatible devices. Do not use with another make or model of device.
- Be sure to read and follow the warnings for the Charging AC Adapter on page iii and the section, “The Battery” (📖 163), before use.
- The EH-69P is compatible with AC 100-240 V, 50/60 Hz electrical outlets. When using in other countries, use a plug adapter (commercially available) as necessary. For more information about plug adapters, consult your travel agency.
- The Charging AC Adapter EH-69P is for charging the battery inserted into the camera. When the camera is connected to an electrical outlet with the Charging AC Adapter, the camera cannot be turned on.
- Do not, under any circumstances, use another make or model of USB-AC adapter other than Charging AC Adapter EH-69P. Failure to observe this precaution could result in overheating or in damage to the camera.

AC Power Source

- If the AC Adapter EH-62F (available separately; 📖166) is used, power is supplied to the camera from an electrical outlet, enabling taking and playing back pictures.
- Do not, under any circumstances, use another make or model of AC adapter other than EH-62F. Failure to observe this precaution could result in overheating or in damage to the camera.

Charging Using Computer or Battery Charger

- Connecting the COOLPIX P300 to a computer also charges the Rechargeable Li-ion Battery EN-EL12 (📖134, 156).
- The EN-EL12 can be charged without using the camera by using the Battery Charger MH-65 (available separately; 📖166).

Turning On and Off the Camera



Press the power switch to turn on the camera.

The power-on lamp (green) lights, and then the monitor is turned on (the power-on lamp turns off when the monitor is turned on).

Press the power switch again to turn off the camera.

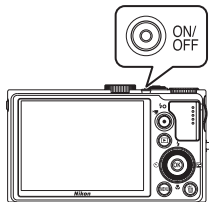



When the power is turned off, the power-on lamp and monitor are also turned off.



- When the camera is off, holding down the  button turns on the camera in playback mode (30).

Standby Mode (Auto Off)

If no operations are performed, the monitor is turned off automatically, the camera enters standby mode and the power-on lamp blinks. The camera turns off when the standby mode continues for about three minutes.

- When the power-on lamp blinks, turn on the monitor again with one of the following operations.
 - Press the power switch, the shutter-release button, the  button or the  button.
 - Rotate the mode dial.
- In shooting or playback mode, the camera will enter standby mode in about one minute (default setting).
- The time that elapses before the camera enters standby mode can be changed from the **Auto off** (153) in the setup menu (141).

Setting the Display Language, Date and Time

Dialogs for language selection and camera clock setting are displayed the first time the camera is turned on.

1 Press the power switch to turn on the camera.

- The power-on lamp lights, and then the monitor is turned on (the power-on lamp turns off when the monitor is turned on).

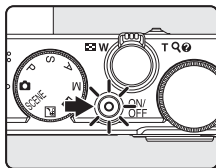

2 Press the rotary multi selector ▲ or ▼ to choose the desired language and press the OK button.

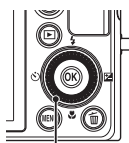

Rotary multi selector

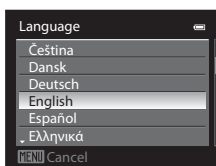

3 Press ▲ or ▼ to choose Yes and press the OK button.

- To cancel setting the time zone and date, select **No**.

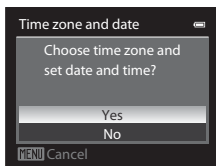

4 Press ◀ or ▶ to select your home time zone (Time zone) (📖146), and press the OK button.

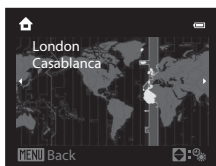

Daylight Saving Time

To set the date and time in a time zone where daylight saving is in effect, turn on the daylight saving setting with ▲ in the time zone selection screen shown in step 4.

- When turned on, the  icon is displayed on the top of the screen.
- To turn off, press ▼.

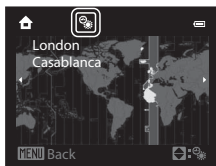

- 5 Press ▲ or ▼ to choose the date display order and press the **OK** button or ►.

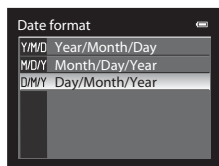

- 6 Press ▲, ◀, ▼ or ► to set date and time, and press the **OK** button.

- To choose an item: Rotate the rotary multi selector, or press ► or ◀ (selected in the following order: **D** (day) → **M** (month) → **Y** (year) → **hour** → **minute**).
- To set the contents: Press ▲ or ▼. Date and time can also be set by rotating the command dial (📖9).
- Finish setting: Choose **minute**, and press the **OK** button or ►.
- After finishing the setting, the lens extends and the shooting screen is displayed.

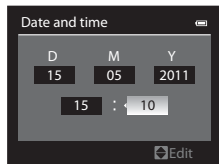

Imprinting the Date and Changing the Date and Time

- To imprint the date on pictures when shooting, first set the date and time, and then set **Print date** (📖149) in the setup menu (📖141).
- To change the date and time of the camera clock, set in **Time zone and date** (📖144) in the setup menu (📖141).

Inserting the Memory Card

The recorded data is stored in the camera's internal memory (approx. 90 MB) or on commercially available Secure Digital (SD) memory cards (📖167).

If a memory card is inserted in the camera, data is automatically stored on the memory card, and data recorded to the memory card can be played back, deleted, or transferred. To use the internal memory, remove the memory card.

- 1 Confirm that the power-on lamp and the monitor are turned off and open the battery-chamber/memory card slot cover.

- Be sure to turn off the camera before opening the cover.

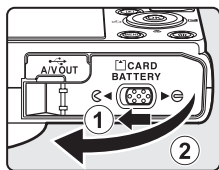

- 2 Insert the memory card.

- Slide the memory card until it clicks into place.

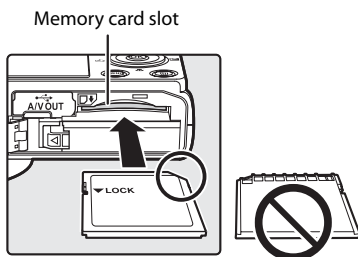

✓ Inserting the Memory Card Correctly

Inserting the memory card upside down or backwards could damage the camera or the memory card. Be sure to confirm that the memory card is in the correct orientation.

- 3 Close the battery-chamber/memory card slot cover.

Removing the Memory Card

Before opening the battery-chamber/memory card slot cover, turn the camera off and confirm that the power-on lamp and the monitor are off.

Press the memory card in lightly with your finger (1) to partially eject it, and then pull it out straight (2).

- The camera, battery or memory card may be hot immediately after using the camera. Observe caution when removing the battery or memory card.

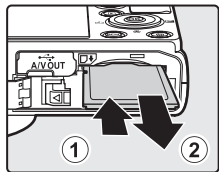

✓ Formatting a Memory Card

If the message on the right is displayed when the camera is turned on, the memory card must be formatted before use. **Note that formatting (📖154) permanently deletes all pictures and other data on the memory card.** Be sure to make copies of any data you wish to keep before formatting the memory card.

To format, use the rotary multi selector to choose **Yes** and press the **OK** button. When the confirmation dialog is displayed, choose **Format** and press the **OK** button to start formatting.

- Do not turn the camera off, or open the battery-chamber/memory card slot cover until formatting is complete.
- The first time you insert a memory card that has been used in another device into this camera, be sure to format it (📖154) with this camera.

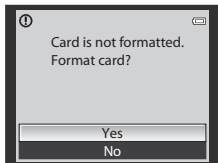

✓ The Write Protect Switch

When the memory card switch is in the "Lock" position, data cannot be written to, or deleted from, the memory card. If you want to record data, delete data or format the memory card, and the switch is in the "Lock" position, slide the switch to its original position to unlock it.

Write protect switch

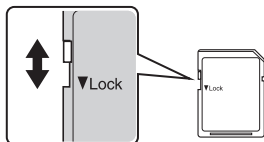

✓ Memory Cards



- Use only Secure Digital memory cards.
- Do not perform the following operations during formatting, while data is being written to or deleted from the memory card, or during data transfer to a computer. Failure to observe this precaution could result in the loss of data or in damage to the memory card:
 - Eject the memory card
 - Remove the battery
 - Turn off the camera
 - Disconnect the AC adapter
- Do not use a computer to format the memory card.
- Do not disassemble or modify.
- Do not drop, bend, or expose to water or strong physical shocks.
- Do not touch the metal terminals with your fingers or metal objects.
- Do not affix labels or stickers to the memory card.
- Do not leave in direct sunlight, closed vehicles or areas exposed to high temperatures.
- Do not expose to humidity, dust, or corrosive gases.



Step 1 Turn the Camera On and Select  (Auto) Mode

This section describes how to take pictures in  (auto) mode, an automatic, “point-and-shoot” mode recommended for first-time users of digital cameras.

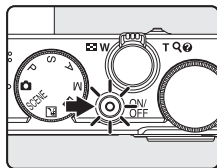
1 Press the power switch to turn on the camera.

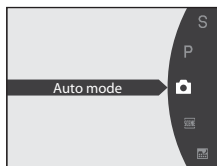
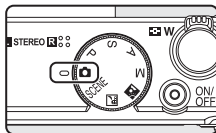
- The lens extends, and the monitor is turned on.

**2 Rotate the mode dial to .****3 Check the battery level and number of exposures remaining.****Battery Level**

Display	Description
	Battery level high.
	Battery level low. Prepare to charge or replace the battery.
 Battery exhausted.	Cannot take pictures. Charge or replace the battery.

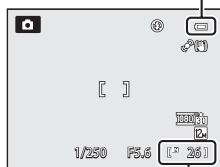
Battery level indicator**Number of exposures remaining****Number of Exposures Remaining**

The number of exposures remaining is displayed.

The number of pictures that can be stored depends on the remaining capacity of the internal memory or memory card and the image mode (74).

Indicators Displayed in (Auto) Mode

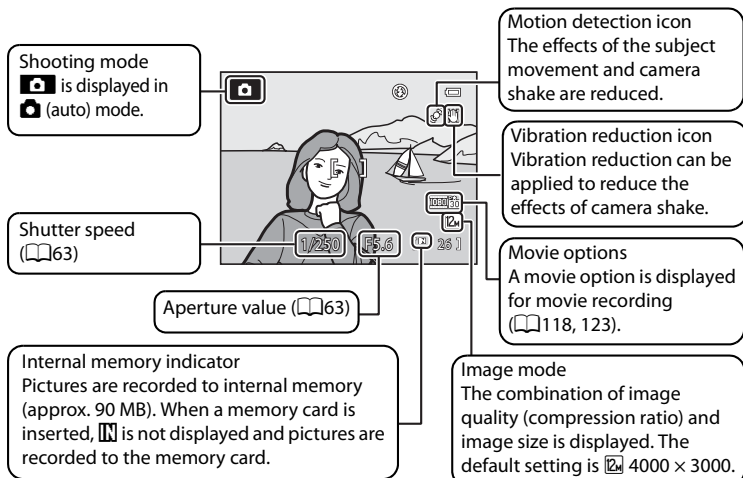

- The indicators and photo info displayed during shooting and playback will turn off after a few seconds (147).
- When the monitor has been turned off in standby mode to save power (the power-on lamp is blinking) (153), press the following buttons to turn it back on.
→ The power switch, the shutter-release button or the  movie-record) button.

Note on the Flash

When the flash is lowered, the flash setting is fixed at off and  appears at the top of the monitor. In situations where a flash is needed, such as in dark locations or when the subject is backlit, be sure to raise the flash (33).

Functions Available in (Auto) Mode

- The flash mode (32) can be adjusted, self-timer (35), macro mode (38) and exposure compensation (39) can be applied.
- Pressing the **MENU** button allows you to specify a combination of image quality (compression ratio) and image size with **Image mode** (74) in the shooting menu.

Vibration Reduction and Motion Detection

- See **Vibration reduction** (150) or **Motion detection** (151) in the setup menu (141) for more information.
- Set **Vibration reduction** to **Off** when using a tripod to stabilize the camera during shooting.

Step 2 Frame a Picture

1 Ready the camera.

- Hold the camera steadily in both hands.
- Keep your fingers, hair, strap and other objects away from the lens, flash, AF-assist illuminator and microphone.
- When using the flash (📖32) to shoot in the “tall” orientation, hold the camera so that the flash is above the lens.

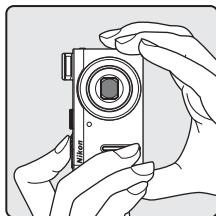
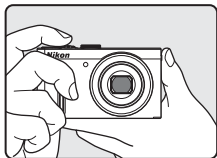

2 Frame a picture.

- Position the main subject near the center of the monitor.

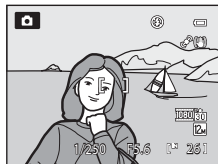

Using the Zoom

Rotate the zoom control to activate the optical zoom. Rotate the zoom control toward **T** to zoom in, increasing the size of the subject. Rotate the zoom control toward **W** to zoom out, increasing the area visible in the frame.

- When the camera is turned on, the zoom is at the maximum wide-angle position.
- A zoom indicator is displayed at the top of the monitor when the zoom control is rotated.

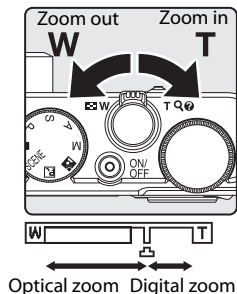

Digital Zoom

When the camera is zoomed in to the maximum optical zoom position, rotating and holding the zoom control at **T** triggers digital zoom. Digital zoom can magnify the subject up to about 2× beyond the maximum magnification of the optical zoom.

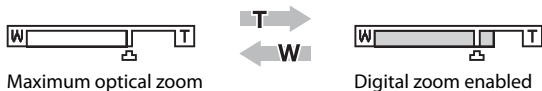

- The camera focuses at the center of the frame and the focus area is not displayed when digital zoom is in effect.

Digital Zoom and Interpolation

Unlike the optical zoom, the digital zoom uses a digital imaging process known as interpolation to magnify images, resulting in slight deterioration of picture quality depending on the image mode (📖74) and digital zoom magnification.

Interpolation is applied at zoom positions beyond 📏 when taking still pictures.

When zoom is increased beyond the 📏 position, interpolation is initiated and the zoom indicator turns yellow to indicate that interpolation is being applied.

The position of 📏 moves to the right as image size decreases, allowing for confirmation of the zoom positions at which shooting without interpolation is possible at the current image mode setting.

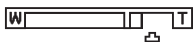

When the image size is small

- Digital zoom can be disabled from the **Digital zoom** option (📖152) in the setup menu (📖141).

Step 3 Focus and Shoot

1 Press the shutter-release button halfway.

- When the shutter-release button is pressed halfway (☞13), the camera sets focus and exposure (shutter speed and aperture value).

The focus and exposure remain locked while the shutter-release button is pressed halfway.

- The camera automatically focuses on the subject in the center focus area. When the subject is in focus, the focus area lights in green.

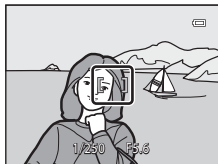

- When the digital zoom is in effect, the camera focuses on the subject at the center of the screen, and the focus area is not displayed. When the subject is in focus, the focus indicator (☞6) lights in green.
- When the shutter-release button is pressed halfway and the focus area or focus indicator blinks red, the camera is unable to focus. Change the composition and press the shutter-release button halfway again.

2 Press the shutter-release button the rest of the way down.

- The shutter is released and the picture is recorded to the memory card or internal memory.



✓ When the Subject Is Close to the Camera

If the camera cannot focus, try shooting with macro mode (☞38) or the **Close-up** scene mode (☞52).

✓ During Recording

While the indicator showing the number of exposures remaining is blinking, images are being recorded. **Do not open the battery-chamber/memory card slot cover.** Cutting the power or removing the memory card in these circumstances could result in loss of data or in damage to the camera or card.

✓ Autofocus

Autofocus may not perform as expected in the following situations. In some rare cases, the subject may not be in focus despite the fact that the active focus area or focus indicator lights in green:

- Subject is very dark
- Objects of sharply differing brightness are included in the scene (e.g. the sun behind the subject makes that subject appear very dark)
- No contrast between the subject and surroundings (e.g. a portrait subject, wearing a white shirt, is standing in front of a white wall)
- Several objects are at different distances from the camera (e.g., an animal inside a cage)
- Subjects that repeat the same pattern (e.g., window blinds, buildings with multiple rows of similarly shaped windows)
- Subject is moving rapidly

In the situations noted above, try pressing the shutter-release button halfway to refocus several times, or focus on another subject and use focus lock.

🔒 Focus Lock

Use focus lock to focus on off-center subjects when Center is selected for AF area mode.

- Be sure that the distance between the camera and the subject does not change.
- When the shutter-release button is pressed halfway, the exposure is locked.



Position the subject at the center of the frame.



Press the shutter-release button halfway.



Confirm that the focus area lights in green.



Continue holding down the shutter-release button halfway and recompose the picture.



Press the shutter-release button the rest of the way down to shoot.













🔦 AF-assist illuminator

In dark places, the AF-assist illuminator (📖152) may light when the shutter-release button is pressed halfway.

Step 4 Viewing and Deleting Pictures

Viewing Pictures (Playback Mode)

Press the  (Playback) button.

- The last picture shot is displayed in full-frame playback mode.
- Rotate the rotary multi selector, or press , ,  or  to view previous or subsequent pictures. Continue holding down , ,  or  to scroll quickly through pictures. Pictures may be briefly displayed at low resolution immediately after switching to the previous or next picture.
- To return to shooting mode, press the  button again or press the shutter-release button or  (movie-record) button.
-  is displayed when pictures stored in the internal memory are displayed. When a memory card is inserted,  is not displayed and pictures stored on the memory card are displayed.

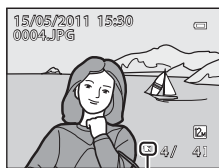
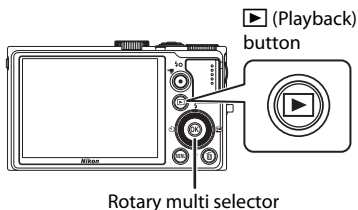

Internal memory indicator



When the Monitor Is Turned Off to Save Power

When the power-on lamp blinks, press the  button to turn on the monitor again (153).

Options Available in Playback Mode

For details, see “More on Playback” (92) or “Editing Pictures” (108).

Displaying Shooting Information

Press the  button in full-frame playback mode to display the histogram and shooting information (93). Press the  button again to return to full-frame playback mode.

Pressing the Button to Turn on the Camera

When the camera is off, holding down the  button turns on the camera in playback mode. The lens does not extend.

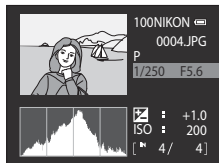

Viewing Pictures

Pictures that were shot using face priority (85) or pet detection (86) are rotated automatically when displayed in full-frame playback mode according to the orientation of the face (except for pictures shot when **Continuous** (79), **Exposure bracketing** (82) or **Face priority tracking** (87) was set).

Deleting Unnecessary Images

- 1 Press the  button to delete the image currently displayed on the monitor.

- To exit without deleting, press the **MENU** button.

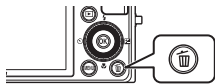

- 2 Use the rotary multi selector to choose the desired deletion method and press the **OK** button.

- **Current image:** Only the current image or voice memo (106) is deleted.
- **Erase selected images:** Multiple images can be selected and deleted. See "Operating the Erase Selected Images Screen" for more information.
- **All images:** All images are deleted.

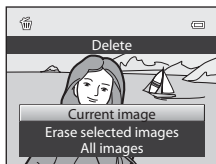

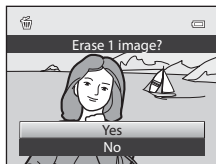

- 3 Choose **Yes** and press the **OK** button.

- Deleted images cannot be recovered.
- To cancel, choose **No** and press the **OK** button.



Operating the Erase Selected Images Screen

- 1 Rotate the rotary multi selector or press **◀** or **▶** to choose an image to be deleted and press **▲** to add  to the image.

- To undo the selection, press **▼** to remove .
- Rotate the zoom control (104) toward **T** (10) to switch back to full-frame playback or **W** (10) to display thumbnails.



- 2 Add  to all desired images and then press the **OK** button to confirm the selection.

- A confirmation dialog is displayed. Follow the instructions displayed on the monitor.

Notes on Deletion

- Deleted images cannot be restored. Transfer important images to a computer before deleting them.
- Protected images cannot be deleted (102).

Deleting the Last Image Captured While in Shooting Mode

In shooting mode, press the  button to delete the last image captured.

Using the Flash

In dark locations or when the subject is backlit, you can shoot pictures with a flash by raising the flash. You can set a flash mode that suits the shooting conditions.

- The flash has a range of about 0.5 to 6.5 m (1 ft. 8 in. to 21 ft.) at the wide-angle zoom position, and about 0.5 to 2.5 m (1 ft. 8 in. to 8 ft. 2 in.) at the telephoto zoom position (when **ISO sensitivity** is set to **Auto**).

Auto

Flash fires automatically when lighting is dim.

Auto with red-eye reduction

Reduces “red-eye” in portraits.

Off

Flash does not fire.











Fill flash

The flash fires when a picture is taken, regardless of how bright the subject is. Use to “fill-in” (illuminate) shadows and backlit subjects.



Slow sync

Auto flash mode is combined with slow shutter speed. Suited to evening and night portraits that include background scenery. Flash illuminates main subject; slow shutter speeds are used to capture background at night or under dim lighting.

Flash Mode Setting

- The default flash mode setting varies with the shooting mode (□40).
 -  (auto) mode:  **Auto**
 - **SCENE** (Scene): Options vary depending on the scenes (□42 to 56).
 -  (Night landscape): fixed at  (Off)
 -  (Backlighting): fixed at  (fill flash) (when **HDR** is Off), fixed at  (Off) (when **HDR** is used) (□45)
 - **P, S, A, M**:  **Auto**
- This feature cannot be used simultaneously with certain features. See “Functions that Cannot be Applied Simultaneously” (□90) for more information.
- In the following situations, the setting for flash mode is stored in the camera’s memory even after the camera is turned off.
 - When shooting mode **P, S, A** or **M** is used
 - When shooting with  (Auto with red-eye reduction) in  (auto) mode

Setting the Flash Mode

- Slide the  (flash pop-up) control.
 - Flash is raised.
 - When the flash is lowered, the flash mode is fixed at  (Off).

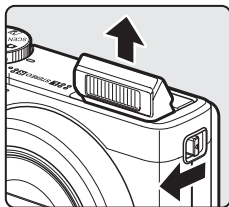



- Press the rotary multi selector  (flash mode).
 - The flash mode menu is displayed.

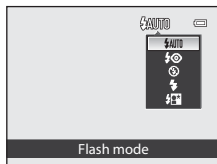

- Use the rotary multi selector to choose the desired mode and press the  button.



- The mode selected for the flash is displayed.
- When  (auto) is applied,  is only displayed for a few seconds, regardless of **Photo info** settings (147).
- If the  button is not pressed within a few seconds, the selection will be canceled.

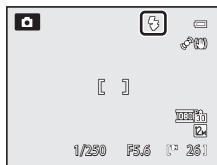

Lowering the Flash

When not using the flash, lower it by gently pushing it down.

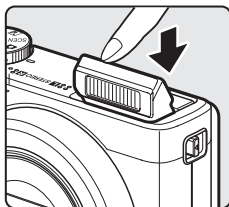

✓ Shooting When Lighting is Dim or When the Flash is Set to ⓧ (Off)

- Use of a tripod is recommended to stabilize the camera during shooting and avoid the effects of camera shake. When the camera is stabilized with a tripod, set **Vibration reduction** (📖 150) to **Off** in the setup menu (📖 141).
- **ISO** may be displayed in the shooting screen. When **ISO** is displayed, the ISO sensitivity has increased automatically.
- When shooting in dark locations, the noise reduction function may operate depending on the shooting conditions. When the noise reduction function operates, it may take more time to save images.

✓ Note on Using the Flash

Reflections from dust particles in the air may appear as bright spots in pictures. To reduce these reflections, set the flash to ⓧ (Off), or shoot pictures with the flash lowered.

✎ Flash Lamp

The flash lamp shows the flash status when the shutter-release button is pressed halfway down.

- On: Flash fires when picture is shot.
- Blinks: Flash is charging. Wait a few seconds and try again.
- Off: Flash does not fire when picture is shot.

When the battery level is low, the monitor is turned off during charging of the flash.

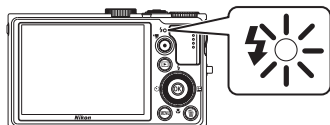

✎ Red-eye Reduction

This camera uses advanced red-eye reduction ("In-Camera Red-Eye Fix").

If the camera detects red eye while saving an image, the affected area will be processed to reduce red-eye before the image is saved.

Note the following when taking pictures:

- The time required to save the picture increases slightly.
- Red-eye reduction may not produce the desired results in some situations.
- In extremely rare instances, areas not subject to red-eye may be affected by advanced red-eye reduction processing. In these cases, choose another mode and try again.

Taking Pictures with the Self-Timer

The self-timer is suitable for taking group pictures and reducing the vibration when the shutter-release button is pressed. Timer durations of two or ten seconds can be selected.



When using the self-timer, use of a tripod is recommended. Set **Vibration reduction** (📖150) in the setup menu (📖141) to **Off** when using a tripod to stabilize the camera.

1 Press the rotary multi selector (self-timer).

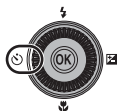
- The self-timer menu is displayed.



2 Use the rotary multi selector to choose **10s** or **2s** and press the button.

- **10s** (ten seconds): suitable for group pictures
- **2s** (two seconds): suitable for preventing camera shake
- When  is selected, the camera uses face detection to detect a human face, and then automatically releases the shutter when a smile is detected (📖36).
- The mode selected for the self-timer is displayed.
- If the  button is not pressed within a few seconds, the selection will be canceled.

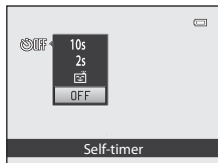

3 Frame the picture and press the shutter-release button halfway.

- The focus and exposure are set.

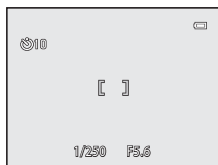

4 Press the shutter-release button the rest of the way down.

- The self-timer starts, and the number of seconds remaining before the shutter is released is displayed. The self-timer lamp blinks while the timer is counting down. About one second before the shutter is released, the lamp stops blinking and remains lit.
- When the shutter is released, the self-timer turns **OFF**.
- To stop the timer before a picture is taken, press the shutter-release button again.

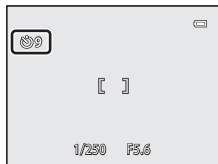

Taking Pictures of Smiling Faces (Smile Timer)

The camera detects smiling faces using face detection and releases the shutter automatically.

This can be used when the shooting mode (📖40) is set to 📷 (auto) mode, the **Portrait** or **Night portrait** scene mode, or **P**, **S**, **A** or **M** mode.

1 Press the rotary multi selector ⏸ (self-timer).

- The self-timer menu is displayed.
- Adjust settings for flash mode, creative slider, exposure compensation, or items in the shooting menu before pressing ⏸.

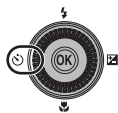

2 Use the rotary multi selector to choose 📷 (Smile timer), and press the OK button.

- If the OK button is not pressed within a few seconds, the selection will be canceled.

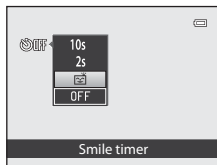

3 Frame the picture.

- Point the camera at the subject.
- When the camera detects a face, the focus area containing the face is displayed with a double border. When the camera focuses on the face, the double border lights in green for a moment, and the focus is locked.
- Up to three faces can be detected. When more than one face is detected, the face closest to the center of the frame is framed by a double border and the others by single borders.

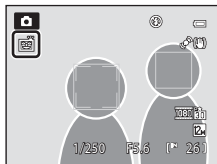

4 The shutter is automatically released.

- When the camera detects a smiling face of the subject framed by the double border, the shutter is released automatically.
- Each time the shutter is released, automatic shooting using face detection and smiling face detection is repeated.

5 Shooting ends.

- To stop automatic shooting of smiling faces, either turn off the camera or return to step 2 and select **OFF**.

Notes on Smile Timer

- The digital zoom is not available.
- Under some shooting conditions, faces and smiling faces may not be detected properly.
- See “Notes on Face Priority” (📖86) for more information.
- This feature cannot be used simultaneously with certain features. See “Functions that Cannot be Applied Simultaneously” (📖90) for more information.

Auto Power Off in Smile Timer Mode

When using the Smile timer, the auto power off function (📖153) is activated and the camera turns off when either of the situations indicated below persists and no other operations are performed.

- The camera does not detect any faces.
- The camera detected a face, but cannot detect a smile.

When the Self-timer Lamp Blinks

When using the Smile timer, the self-timer lamp blinks when the camera detects a face and flickers after the shutter is released.

Releasing the Shutter Manually

The shutter can also be released by pressing the shutter-release button. If no faces are detected, the camera focuses on the subject at the center of the frame.

More Information

See “Autofocus” (📖29) for more information.

Macro Mode

Macro mode is used for taking pictures of objects as close as 3 cm (1.2 in.). Note that the flash may be unable to light the entire subject at distances of less than 50 cm (1 ft. 8 in.).

- 1 Press the rotary multi selector  (macro mode).

- The macro mode menu is displayed.



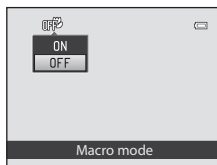

- 2 Use the rotary multi selector to choose **ON** and press the **OK** button.

- The macro mode icon () is displayed.
- If the **OK** button is not pressed within a few seconds, the selection will be canceled.



- 3 Rotate the zoom control to frame the picture.

- The closest distance at which the camera can focus varies depending on the zoom position. When the zoom is at a position where , the zoom indicator light in green (to the left of ) , the camera can focus on subjects as close as 4 cm (1.6 in.) from the lens. At the maximum wide-angle position, the camera can focus on subjects as close as 3 cm (1.2 in.) from the lens.

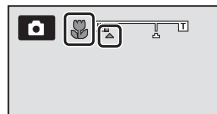

Autofocus

When using **P**, **S**, **A** or **M** mode, if **Autofocus mode** () is set to **Full-time AF**, the camera focuses continuously until the shutter-release button is pressed halfway to lock the focus. Therefore, the sound of lens drive movement can be heard.

In other shooting modes, **Full-time AF** is turned on automatically when macro mode is turned on (except **Pet portrait** scene mode).

Macro Mode Setting

For shooting modes **P**, **S**, **A** and **M**, the changed macro mode setting is stored in the camera's memory even after the camera is turned off.

Adjusting Brightness (Exposure Compensation)

By adjusting exposure compensation when taking pictures, overall image brightness can be adjusted to make images brighter or darker. It can be used in  (Auto) mode or in scene modes.

- To adjust exposure compensation in **P**, **S** and **A** modes, use the creative slider (69).

1 Press the rotary multi selector (exposure compensation).

- The exposure compensation guide and histogram are displayed.





2 Use the rotary multi selector to select a compensation value.

- To make the image brighter, apply positive (+) exposure compensation.
- To make the image darker, apply negative (-) exposure compensation.

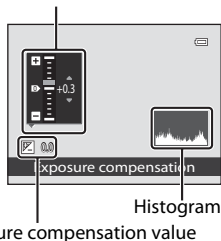
Exposure compensation guide



3 Press the button to set the compensation value.



- If the  button is not pressed within a few seconds, the selection is set and the setting menu disappears.
- When an exposure compensation value other than **0.0** is applied, the value is displayed with the  indicator on the monitor.



4 Press the shutter-release button to take a picture.

- To cancel the exposure compensation setting, return to step 1 and change the value to **0.0**.

Exposure Compensation Value

In shooting mode **M** (Manual) (67) or when the scene mode is **Fireworks show** (54), the exposure compensation cannot be used.

Using the Histogram

A histogram is a graph showing the distribution of tones in the image. Use as a guide when using exposure compensation and shooting without the flash.

- The horizontal axis corresponds to pixel brightness, with dark tones to the left and bright tones to the right. The vertical axis shows the number of pixels.
- Increasing exposure compensation shifts tone distribution to the right, and decreasing it shifts tone distribution to the left.

Selecting a Shooting Mode (Mode Dial)

Rotate the mode dial and align an icon to the mark to select one of the following shooting modes.

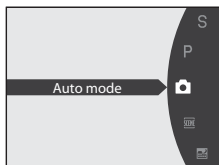
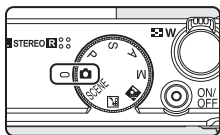

Auto mode (📖24)

An automatic, “point-and-shoot” mode recommended for first-time users of digital cameras.

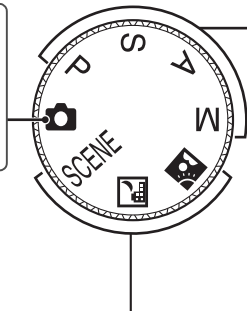

P, S, A, M mode (📖62)

Choose these modes for greater control over shutter speed and aperture value. Brightness, vividness, and hue can be adjusted with the creative slider. Various settings are available in the shooting menu (📖69).

Scene mode (📖41)

Shoot with settings suitable for the scene by choosing one of the scene modes.

SCENE (Scene): Choose the desired scene from 16 different scene types, and the camera's settings are automatically optimized for the selected scene.

In Scene auto selector mode, the camera automatically selects the optimum scene mode for simpler shooting.

Special effects such as Soft or Nostalgic sepia can be added for shooting.

 (Night landscape): Produces night landscape shots with reduced blurring and noise, or capture the atmosphere of a night landscape with a slow shutter speed.

 (Backlighting): The flash fires to prevent the backlit subject from being hidden in shadow, or the HDR function can be used to shoot scenes with high contrast.

Selecting Scenes for Shooting (Scene Mode)

When one of the following scenes is selected using the mode dial or the scene menu, images are captured using settings that are optimized for the selected scene.



Night landscape (📖44)
 Backlighting (📖45)

Rotate the mode dial to or and take pictures.

SCENE (Scene)

Press the **MENU** button to display the scene menu and choose one of the following shooting scenes.

Scene auto selector (default setting) (📖42)	Dusk/dawn (📖51)
Portrait (📖46)	Close-up (📖52)
Landscape (📖47)	Food (📖53)
Sports (📖48)	Museum (📖54)
Night portrait (📖49)	Fireworks show (📖54)
Party/indoor (📖50)	Black and white copy (📖54)
Beach (📖50)	Panorama (📖55)
Snow (📖50)	Pet portrait (📖56)
Sunset (📖51)	Special effects (📖56)

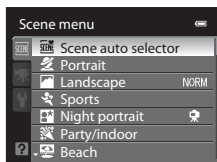
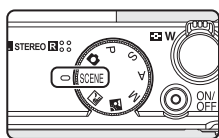







- For scene modes that use the flash, be sure to slide the (flash pop-up) control to raise the flash before shooting.
- Choose a scene type from the scene menu and rotate the zoom control (📖4) toward **T** (?) to view a description (help) of that scene. To return to the original screen, rotate the zoom control toward **T** (?) again.

Image Mode

Press the **MENU** button in the scene menu and adjust **Image mode** (📖74). Changes made to the image mode setting apply to all shooting modes.

Shooting in the Scene Selected by the Camera (Scene Auto Selector)

By simply framing a picture, the camera automatically selects the optimum scene mode from the following for simpler shooting.

- : Auto mode (general shooting)
- : Portrait
- : Landscape
- : Night portrait
- : Night landscape
- : Close-up
- : Backlighting

1 Rotate the mode dial to SCENE.

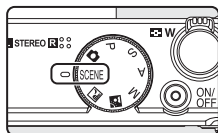

2 Press the MENU button to display the scene menu, choose Scene auto selector with the rotary multi selector and press the button.

- Scene auto selector is enabled.
- When the flash is not raised, the message **The flash is lowered.** is displayed.
- Slide the  (flash pop-up) control to raise the flash.

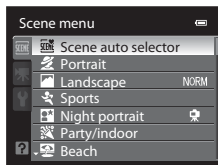

3 Frame the subject and take the picture.

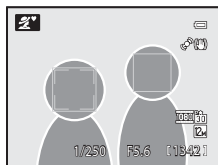

- The shooting mode icon changes.
- Press the shutter-release button halfway to set the focus and exposure. When the subject is in focus, the focus area (active focus area) lights in green.
- Press the shutter-release button the rest of the way down to take the picture.





✔ Notes on Scene Auto Selector

- The digital zoom is not available.
- Depending upon shooting conditions, the camera may not select the desired scene mode. Should this occur, switch to  (Auto) mode (📖24) or choose the desired scene manually (📖44).





📎 Focusing in Scene Auto Selector

- In Scene auto selector, the camera detects and focuses on a face (see “Shooting with Face Priority” (📖85) for more information).
- When the shooting mode icon is  or  (Close-up), in the same way as when the **AF area mode** (📖83) is set to **Auto**, the camera automatically selects one or more of the nine focus areas containing the subject closest to the camera.

📎 Shooting with Night landscape and Night portrait When Using Scene Auto Selector

- If the camera switches to  (Night landscape) when using Scene auto selector, pictures are shot continuously, and the camera combines these pictures to save a single picture.
- If the camera switches to  (Night portrait) when using Scene auto selector, flash mode is fixed at slow sync with red-eye reduction for shooting human subjects (the camera does not shoot continuously).
- In dark surroundings, the use of a tripod is recommended. Set **Vibration reduction** (📖150) to **Off** when using a tripod to stabilize the camera.

📎 Notes on Flash

-  (Auto) (default setting) or  (Off) flash mode settings (📖32) can be applied.
 - When  (Auto) is applied, the camera automatically chooses the optimum flash mode setting for the scene mode it has selected.
 - When  (Off) is set, the flash does not fire even when the flash is raised.
- If you do not want to use the flash, you can shoot while the flash is lowered.

📎 Functions Available in Scene Auto Selector

- Self-timer (📖35) and exposure compensation (📖39) settings can be adjusted.
- Smile timer (📖36) is not available.
- The rotary multi selector  (macro mode) (📖10, 38) is not available.

Selecting a Scene Mode to Take Pictures (Features)

- The mode dial can be used to select scenes when shooting (📖41).
- See “Shooting in the Scene Selected by the Camera (Scene Auto Selector)” (📖42) for more information on Scene auto selector scene mode.
- The ⚡ shown for each scene is the setting for the flash mode when the flash is raised (📖32). ⌚ is the setting for the self-timer (📖35) and Smile timer (📖36), 🌺 is the setting for macro mode (📖38) and ☒ is the setting for exposure compensation (📖39).

Night landscape

Use this mode to capture the ambience of night landscapes. Press the **MENU** button to select **Hand-held** or **Tripod** in **Night landscape**.



- **Hand-held** (default setting): This enables you to shoot with the minimum of camera shake and noise even when holding the camera by hand.
 - The 📷 icon is displayed on the shooting screen.
 - When the shutter-release button is pressed all the way, pictures are shot continuously, and the camera combines these pictures to save a single picture.
 - Once the shutter-release button is pressed all the way, hold the camera steady without moving it until a still picture is displayed. After taking a picture, do not turn the camera off before the monitor switches to the shooting screen.
 - The angle of view (image area) seen in the saved image will be narrower than that seen on the monitor at the time of shooting.
- **Tripod**: Select this mode when the camera is stabilized, such as with a tripod.
 - The 📷 icon is displayed on the shooting screen.
 - **Vibration reduction** (📖150) is automatically set to **Off** regardless of the applied option in the setup menu (📖141).
 - Press the shutter-release button all the way to shoot a single picture at slow shutter speeds.
- The camera focuses on the subject at the center of the frame. When the shutter-release button is pressed halfway, the focus area or focus indicator (📖6) always lights in green.
- AF-assist illuminator (📖152) does not light.

			Off ¹		Off		0.0 ²
---	---	---	------------------	---	-----	---	------------------

1 The self-timer is available.

2 Other settings can be selected.

Backlighting

Use when light is coming from behind the subject, throwing features or details into shadow.

Press the **MENU** button to adjust HDR (high dynamic range) composite settings in **HDR** for the shooting scene.

- When **HDR** is set to **Off** (default setting): The flash fires to prevent the subject from being hidden in shadow.
 - Shoot pictures with the flash raised.
 - Press the shutter-release button all the way to shoot a single picture.



- When **HDR** is set to **Level 1** to **Level 3**: Use when taking pictures with very bright and dark areas in the same frame. **Level 1** is suitable when the contrast is low, and **Level 3** is suitable when the contrast is high.

- The **HDR** icon is displayed on the shooting screen.
- When the shutter-release button is pressed all the way, the camera shoots pictures continuously with a high shutter speed, and saves the following two images.
 - An image without HDR composition
 - HDR composite image (the effects of over-exposure and under-exposure are reduced)
- The second image saved is an HDR composite image. If only one image can be saved, the camera enhances brightness and contrast in dark portions of the image with D-Lighting (📖111) when shooting, and saves a single image.
- Once the shutter-release button is pressed all the way, hold the camera steady without moving it until a still picture is displayed. After taking a picture, it takes some time to save the image. Do not turn the camera off before the monitor switches to the shooting screen.
- The angle of view (image area) seen in the saved image will be narrower than that seen on the monitor at the time of shooting.
- Depending on the scene, dark shadows may appear around a bright subject or the area around a dark subject may appear bright. Set the level low to adjust.



More on Shooting

- The camera focuses on the subject at the center of the frame.



1 When **HDR** is set to **Off**, the flash mode is fixed at  (fill flash).

When **HDR** is set to any setting other than **Off**, the flash mode is fixed at  (off).

2 The self-timer is available.

3 Other settings can be selected.

Selecting Scenes for Shooting (Scene Mode)

SCENE → Portrait

Use this mode for portraits.

- The camera automatically detects and focuses on a face (see “Shooting with Face Priority” (📖85) for more information).
- If the camera detects multiple faces, the camera focuses on the face closest to the camera.
- After the Skin softening feature makes the subject’s skin appear smoother (up to three people), the camera records the image (📖46).
- If no faces are detected, the camera focuses on the subject at the center of the frame.
- The digital zoom is not available.



* Other settings can be selected.

Notes on Skin Softening



- In images taken in the portrait or night portrait scene mode, the camera makes the subject’s skin appear smoother (up to three people), and then records the image (skin softening function). This means that the image recording time is longer than usual.
- Depending on shooting conditions, even if the camera detects a face on the monitor at the time of shooting, effects of the skin softening function may not be visible, and areas other than the face may be processed.
- The extent of skin softening effect that is applied cannot be set.
- Skin softening can also be applied to pictures after they have been taken (📖112).

SCENE → Landscape

Use this mode for vivid landscapes and cityscapes.

Select **Noise reduction burst** or **Single shot** on the screen that is displayed when  **Landscape** scene mode is selected.



- **Noise reduction burst:** This enables you to shoot a sharp landscape with a minimum of noise.
 - The  icon is displayed on the shooting screen.
 - When the shutter-release button is pressed all the way, pictures are shot continuously at high speed, and the camera combines these pictures to save a single picture.
 - Once the shutter-release button is pressed all the way, hold the camera steady without moving it until a still picture is displayed. After taking a picture, do not turn the camera off before the monitor switches to the shooting screen.
 - The angle of view (image area) seen in the saved image will be narrower than that seen on the monitor at the time of shooting.
- **Single shot** (default setting): Records pictures with emphasized outlines and contrast.
 - When the shutter-release button is pressed all the way, one frame is taken.
- The camera focuses on the subject at the center of the frame. When the shutter-release button is pressed halfway, the focus area or focus indicator () always lights in green.
- AF-assist illuminator () does not light.





1 The self-timer is available.

2 Other settings can be selected.

Selecting Scenes for Shooting (Scene Mode)

SCENE → Sports

Use this mode for dynamic action shots that freeze the action in a single shot and record motion in a series of pictures. With continuous shooting, instantaneous movements of moving subjects can be captured clearly.

- The camera focuses on the subject at the center of the frame. The camera continuously adjust the focus until the shutter-release button is pressed halfway to lock the focus.
- While the shutter-release button is pressed all the way, up to seven pictures are shot at a rate of about eight frames per second (fps) (when Image mode is set to  **4000×3000**).
- Focus, exposure, and white balance are fixed at values determined with the first shot in each series.
- The frame rate with continuous shooting may vary, depending upon the image mode, memory card or shooting conditions.
- AF-assist illuminator ( 152) does not light.



			Off		Off		0.0*
---	---	---	-----	---	-----	---	------

* Other settings can be selected.

SCENE →  **Night portrait**

Use this mode for portraits taken at sunset or at night. Flash is used to illuminate the subject while maintaining the mood of the background.

Select **Hand-held** or **Tripod** on the screen that is displayed when  **Night portrait** scene mode is selected.



- **Hand-held:**

- The  icon is displayed on the shooting screen.
- For a scene with a dark background, when the shutter-release button is pressed all the way, pictures are shot continuously. The camera combines these pictures to save a single picture.
- Once the shutter-release button is pressed all the way, hold the camera steady without moving it until a still picture is displayed. After taking a picture, do not turn the camera off before the monitor switches to the shooting screen.
- If the subject moves while the camera is shooting continuously, the image may be distorted, overlapped or blurred.

- **Tripod** (default setting): Select this mode when the camera is stabilized, such as with a tripod.

- The  icon is displayed on the shooting screen.
- **Vibration reduction** (📖150) is automatically set to **Off** regardless of the applied option in the setup menu (📖141).
- Press the shutter-release button all the way to shoot a single picture at slow shutter speeds.

- Shoot pictures with the flash raised.
- The digital zoom is not available.
- The camera automatically detects and focuses on a face (see "Shooting with Face Priority" (📖85) for more information).
 - If the camera detects multiple faces, the camera focuses on the face closest to the camera.
 - After the Skin softening feature makes the subject's skin appear smoother (up to three people), the camera records the image (📖46).
 - If no faces are detected, the camera focuses on the subject at the center of the frame.

	 ¹		Off ²		Off		0.0 ²
---	--	---	------------------	---	-----	---	------------------

1 Fill flash is used with red-eye reduction.

2 Other settings can be selected.

Selecting Scenes for Shooting (Scene Mode)

SCENE → Party/indoor

Suitable for taking pictures in parties. Captures the effects of candlelight and other indoor background lighting.

- The camera focuses on the subject at the center of the frame.
- Hold the camera steadily as pictures are easily affected by camera shake. When shooting under low lighting, use of a tripod is recommended. Set **Vibration reduction** (📖150) to **Off** when using a tripod to stabilize the camera during shooting.



- 1 May switch to slow sync with red-eye reduction flash mode. Other settings can be selected.
- 2 The self-timer is available.
- 3 Other settings can be selected.

SCENE → Beach

Captures the brightness of such subjects as beaches, or sunlit expanses of water.

- The camera focuses on the subject at the center of the frame.



- 1 Other settings can be selected.
- 2 The self-timer is available.

SCENE → Snow

Captures the brightness of such subjects as sunlit snowfields.

- The camera focuses on the subject at the center of the frame.



- 1 Other settings can be selected.
- 2 The self-timer is available.

SCENE → 🌅 **Sunset**

Preserves the deep hues seen in sunsets and sunrises.

- The camera focuses on the subject at the center of the frame.
- When the shutter-release button is pressed halfway, the focus area or focus indicator (📖6) always lights in green.
- AF-assist illuminator (📖152) does not light.



- 1 The self-timer is available.
- 2 Other settings can be selected.

SCENE → 🌆 **Dusk/dawn**

Preserves the colors seen in the weak natural light before sunrise or after sunset.

- The camera focuses on the subject at the center of the frame.
- When the shutter-release button is pressed halfway, the focus area or focus indicator (📖6) always lights in green.
- AF-assist illuminator (📖152) does not light.













- 1 The self-timer is available.
- 2 Other settings can be selected.

: Use of a tripod is recommended in scenes with which is indicated. Set **Vibration reduction** (📖150) to **Off** when using a tripod to stabilize the camera.

Selecting Scenes for Shooting (Scene Mode)

SCENE → Close-up

Photograph flowers, insects and other small objects at close range.

- The macro mode () is enabled and the camera automatically zooms to the closest position to the subject where the camera can shoot.
- The closest distance at which the camera can focus varies depending on the zoom position. When the zoom is at a position where  and the zoom indicator light in green (to the left of ) , the camera can focus on subjects as close as 4 cm (1.6 in.) from the lens. At the maximum wide-angle position, the camera can focus on subjects as close as 3 cm (1.2 in.) from the lens.
- **AF area mode** is set to **Manual** to enable the focus area to be chosen (83). Press the  button, and then rotate the rotary multi selector, or press , ,  or  to move the focus area.
To adjust the following settings, press the  button to temporarily cancel focus area selection, and then adjust each setting.
 - Flash mode or self-timer
 - Exposure compensation
- The camera continuously focuses using autofocus until you press the shutter-release button halfway to lock the focus.
- As pictures are easily affected by camera shake, be sure that **Vibration reduction** (150) is enabled and hold the camera steadily.



	 ¹		Off ²		On		0.0 ³
---	--	---	------------------	---	----	---	------------------





- 1 Other settings can be selected. Note that when shooting with the flash, the flash may be unable to light the entire subject at distances of less than 50 cm (1 ft. 8 in.).
- 2 The self-timer is available.
- 3 Other settings can be selected.

SCENE → Food







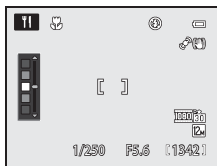

Use this mode when taking pictures of food.

- The macro mode () is enabled and the camera automatically zooms to the closest position to the subject where the camera can shoot.



- The closest distance at which the camera can focus varies depending on the zoom position. When the zoom is at a position where  and the zoom indicator light in green (to the left of ) , the camera can focus on subjects as close as 4 cm (1.6 in.) from the lens. At the maximum wide-angle position, the camera can focus on subjects as close as 3 cm (1.2 in.) from the lens.
- You can adjust hue within a slider display at the left of the monitor. Pressing the rotary multi selector  increases the red hue, and pressing  increases the blue hue. The hue adjustments are stored in the camera's memory even after the camera is turned off.



- AF area mode** is set to **Manual** to enable the focus area to be chosen () . Press the  button, and then rotate the rotary multi selector, or press , ,  or  to move the focus area.
To adjust the following settings, press the  button to temporarily cancel focus area selection, and then adjust each setting.
 - Hue
 - Self-timer
 - Exposure compensation
- The camera focuses continuously until focus is locked by pressing the shutter-release button halfway.
- As pictures are easily affected by camera shake, be sure that **Vibration reduction** () is enabled and hold the camera steadily.

			Off ¹		On		0.0 ²
---	---	---	------------------	---	----	---	------------------

1 The self-timer is available.

2 Other settings can be selected.



Selecting Scenes for Shooting (Scene Mode)

SCENE → Museum

Use indoors where flash photography is prohibited (for example, in museums and art galleries) or in other situations in which you do not want to use the flash.

- The camera focuses on the subject at the center of the frame.
- BSS (Best Shot Selector) ()79) can be used for shooting.



- As pictures are easily affected by camera shake, be sure that **Vibration reduction** ()150) is enabled and hold the camera steadily.
- AF-assist illuminator ()152) does not light.





- 1 The self-timer is available.
- 2 Other settings can be selected.

SCENE → Fireworks show



Slow shutter speeds are used to capture the expanding burst of light from fireworks.

- The camera focuses at infinity. When the shutter-release button is pressed halfway, the focus area or focus indicator ()6) always lights in green. However, because the camera focuses at infinity, it may not be able to focus on nearby objects.
- AF-assist illuminator ()152) does not light.





SCENE → Black and white copy

Provides clear pictures of text or drawings on a white board or in print.

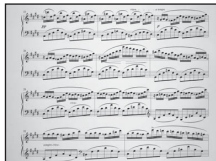
- The camera focuses on the subject at the center of the frame.
- Use the macro mode ()38) with this mode to shoot pictures at close distances.
- Colored text and drawings may not show up well.



- 1 Other settings can be selected.
- 2 The self-timer is available.

: Use of a tripod is recommended in scenes with which  is indicated. Set **Vibration reduction** ()150) to **Off** when using a tripod to stabilize the camera.

SCENE → Panorama



Use this mode for shooting panorama pictures.

Select **Easy panorama** or **Panorama assist** on the screen that is displayed when **Panorama** scene mode is selected.

- **Easy panorama** (default setting): Shoots panorama pictures that can be played back on the camera by moving the camera in the direction you want to create a panorama picture.
 - See "Taking Pictures with Easy Panorama" (p.57).
 - See "Viewing Pictures Recorded with Easy Panorama" (p.59).
- **Panorama assist**: Shoots multiple pictures while confirming the seams. Transfer pictures to a computer and use the supplied **Panorama Maker 5** software (p.133) to join them in a single panorama.
 - See "Taking Pictures with Panorama Assist" (p.60).



- 1 When shooting in **Panorama assist**, other settings can be selected.
- 2 When shooting in **Panorama assist**, the self-timer is available.
- 3 Other settings can be selected.

✔ Note on Printing Panorama Pictures

When printing panorama pictures, a full view may not be printed depending on the printer settings. Additionally, printing may not be available depending on the printer. For more information, see your printer's manual or contact a digital photo lab.

Selecting Scenes for Shooting (Scene Mode)

SCENE → 🐾 Pet portrait

Use this mode for shooting pictures of dogs or cats. The camera detects and focuses on the face of a dog or cat.



- Detected faces are displayed in a double frame indicating the focus area, and when a face is in focus, this double frame lights in green.

Up to five pet faces can be detected simultaneously. If the camera detects multiple faces, the double-frame focus area is displayed around the largest face on the monitor, and single-frame borders are displayed around the other faces.

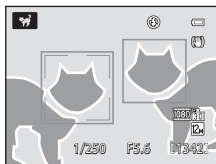

- If a pet's face is not detected, the camera focuses on the subject at the center of the frame.
- The digital zoom is not available.
- AF-assist illuminator (📖152) does not light. Button and shutter sounds (📖153) are disabled.
- In some cases, dogs or cats may not be detected or other animals may be detected, depending on the distance between the camera and the pet, where the pet is facing, how fast it is moving, the brightness, and other shooting conditions.

🔧	📖	🕒	Off	🐾	Off*	📷	0.0*
---	---	---	-----	---	------	---	------

* Other settings can be selected.

SCENE → 🎨 Special effects

You can add special effects for shooting. Press the **MENU** button to select one of the following effects.

- **Soft:** (default setting): Gently blurs the entire picture to create a soft ambience.
- **Nostalgic sepia:** Adds a sepia tone with low contrast to make it look like an old picture.
- **High-contrast monochrome:** Creates a black-and-white photograph with a clear contrast.
- **High key:** Adds a bright tone over the entire picture.
- **Low key:** Adds a dark tone over the entire picture.
- The camera focuses on the subject at the center of the frame.

🔧	📖 ¹	🕒	Off ²	🐾	Off ¹	📷	0.0 ¹
---	----------------	---	------------------	---	------------------	---	------------------

1 Other settings can be selected.

2 The self-timer is available.

Taking Pictures with Easy Panorama

- 1 Rotate the mode dial to **SCENE**.

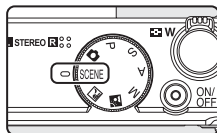

- 2 Press the **MENU** button to display the scene menu screen, choose **▶ Panorama** with the rotary multi selector and press the **OK** button.

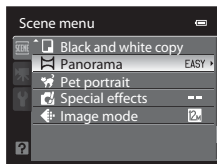

- 3 Choose **EASY Easy panorama** and press the **OK** button.

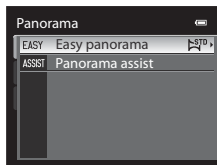

- 4 Select the shooting range from **▶ STD Normal (180°)** or **▶ WIDE Wide (360°)**, and press the **OK** button.

- The image size (W × H) when the camera is held in landscape orientation is as follows.
 - ▶ STD Normal (180°)**: 3200 × 560 when the camera is moved horizontally, 1024 × 3200 when the camera is moved vertically
 - ▶ WIDE Wide (360°)**: 6400 × 560 when the camera is moved horizontally, 1024 × 6400 when the camera is moved vertically
- For the image size when the camera is held in "tall" orientation, the combinations of the moving direction and W × H are the opposites of the above.

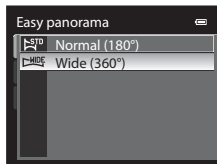

5 Frame the first portion of the panorama scene, and press the shutter-release button halfway to adjust the focus.

- The zoom is fixed at the wide-angle position.
- The framing guide is displayed on the screen.
- The camera focuses on the subject at the center of the frame.
- Exposure compensation (☰39) can be adjusted.
- If the focus or exposure cannot be set for the main subject, try the focus lock (☰29).

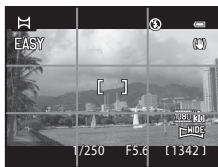

6 Press the shutter-release button all the way, and release it.

- The ▷ icon showing the current panorama direction is displayed.

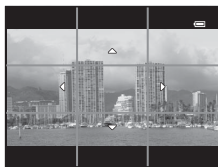

7 Move the camera straight and slowly in one of the four directions to start shooting.

- When the camera detects the panorama direction, the shooting starts.
- The guide showing the current shooting point is displayed.
- When the guide showing the shooting point reaches the end, the shooting ends.



Guide

Example of moving the camera

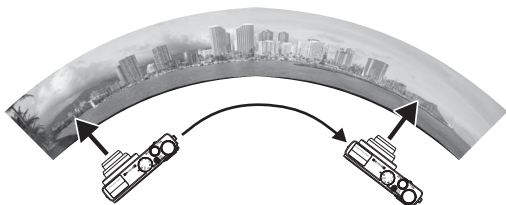

- Hold the camera steadily and move it horizontally or vertically, as in drawing an arc.
- Move the camera from end to end within about 15 seconds when the panorama range is 180°, and within about 30 seconds when it is 360°.

✓ Notes on Easy Panorama Shooting

- The image area seen in the saved image will be narrower than that seen on the monitor at the time of shooting.
- When the camera movement speed is too fast or there is a large amount of camera shake, the shooting ends in an error.
- Panorama pictures are not saved when the shooting stops before reaching half of the panorama range.
- When the shooting reaches more than half of the panorama range but finishes before the end point, the range that is not shot will be recorded as a gray area.

Viewing Pictures Recorded with Easy Panorama

Switch to playback mode (📖30, 92), display the picture recorded with easy panorama in full-frame playback mode and press the **OK** button. The camera displays the short side of the picture filling the entire screen and scrolls the picture automatically.

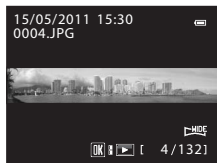

- The picture is scrolled in the direction of the panorama shooting.
- Rotate the rotary multi selector to fast forward or rewind. Playback controls are displayed at the top of the monitor during playback. When you choose a playback control with the rotary multi selector ◀ or ▶ and press the **OK** button, the following operations can be performed.



To	Use	Description	
Rewind	◀	Scroll quickly back while the OK button is pressed.	
Advance	▶	Scroll quickly forward while the OK button is pressed.	
Pause	⏸	The following operations can be performed with the playback controls at the top of the monitor while playback is paused.	
		◀	Rewind while the OK button is pressed.*
		▶	Scroll while the OK button is pressed.*
	▶	Restart the automatic scroll.	
End	■	Return to full-frame playback mode.	

* The pictures can also be scrolled by rotating the rotary multi selector.

✓ Note on Viewing Pictures Recorded with Easy Panorama

Panorama pictures recorded with functions other than easy panorama of the COOLPIX P300 may not be scrolled or zoomed on this camera.

Taking Pictures with Panorama Assist

The camera focuses on the subject at the center of the frame. Using a tripod makes the composition easier. When the camera is stabilized with a tripod, set **Vibration reduction** (📖150) to **Off** in the setup menu (📖141).

- 1 Rotate the mode dial to **SCENE**.

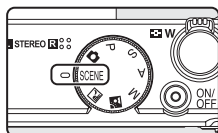

- 2 Press the **MENU** button to display the scene menu screen, choose **📷 Panorama** with the rotary multi selector and press the **OK** button.

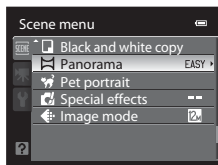

- 3 Choose **ASSIST Panorama assist** and press the **OK** button.

- The **▶** icon is displayed to show the direction in which pictures are joined.

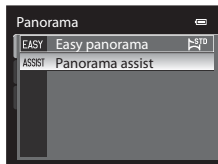

- 4 Use the rotary multi selector to choose the direction and press the **OK** button.

- Select the direction in which pictures are joined in the completed panorama: right (▶), left (◀), up (▲) or down (▼).
- The yellow icon (▶▶) moves to the direction pressed, so press the **OK** button to choose the direction. A white icon (▶) is displayed in the chosen direction.
- Apply flash mode (📖32), self-timer (📖35), macro mode (📖38) and exposure compensation (📖39) settings with this step, if necessary.
- Press the **OK** button again to reselect the direction.

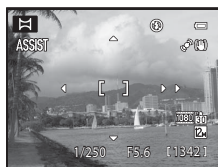

5 Frame the first portion of the panorama scene and take the first picture.

- 1/3 of the image will be displayed as translucent.

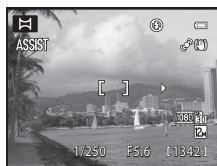

6 Shoot the next picture.

- Match the outline of the next picture so that 1/3 of the frame overlaps the previous picture, and press the shutter-release button.
- Repeat until you have taken the necessary number of pictures to complete the image.



7 Press the **OK** button when shooting is completed.

- The camera returns to step 4.

✓ Notes on Panorama Assist

- Set the flash mode, self-timer, macro mode and exposure compensation before releasing the shutter for the first picture. The settings cannot be changed after shooting the first picture. Pictures cannot be deleted, nor can zoom, or **Image mode** (📖74) be adjusted after shooting the first picture.
- The panorama series is terminated if the auto off function (📖153) triggers the standby mode during shooting. To prevent this, setting a longer time for the auto off function is recommended.

💡 AE/AF-L (exposure lock) Indicator

When using panorama assist mode, all pictures in the panorama have the same exposure, white balance, and focus as the first picture of the panorama.

When the first picture is shot, **AE/AF-L** is displayed to indicate that exposure, white balance, and focus are locked.



💡 Panorama Creation

Transfer pictures to a computer (📖130) and use Panorama Maker 5 (📖133) to join them in a single panorama.

Install Panorama Maker 5 on a computer using the supplied ViewNX 2 CD-ROM.

💡 More Information

See "File and Folder Names" (📖168) for more information.

Setting the Exposure for Shooting (P, S, A, M Modes)

P, S, A, M Modes

By rotating the mode dial, you can shoot pictures in the following four exposure modes: **P** (Programmed auto), **S** (Shutter-priority auto), **A** (Aperture-priority auto), and **M** (Manual).

Not only can you set the shutter speed and aperture value, you can also select a variety of advanced settings, such as changing the ISO sensitivity and white balance with the shooting menu (📖72), or adjusting the brightness (exposure compensation), hue or vividness with the creative slider (📖69).

Mode	Description	Usage
P Programmed auto (📖64)	The camera sets the shutter speed and aperture value automatically for optimal exposure. Flexible program, which changes the combination of shutter speed and aperture value with the same exposure, can be used (📖64).	Recommended for most situations.
S Shutter-priority auto (📖65)	The user chooses the shutter speed; the camera selects the aperture value automatically.	Use to shoot fast moving subjects with a fast shutter speed, or use to emphasize the movements of a moving subject with a slow shutter speed.
A Aperture-priority auto (📖66)	The user chooses the aperture value; the camera selects the shutter speed automatically.	Use to blur the background or bring both the foreground and background into focus.
M Manual (📖67)	The user controls both the shutter speed and aperture value.	Use to control the exposure according to shooting requirements.

Functions Available in P, S, A and M Modes

- The flash mode (📖32) can be changed, and the self-timer (📖35) and macro mode (📖38) settings are available.
- Press the **MENU** button to adjust the shooting menu (📖72) settings.

Shutter Speed and Aperture Value

The same exposure can be achieved with different combinations of shutter speed and aperture value, allowing you to freeze or blur motion and control depth of field. The following figures show how shutter speed and aperture value affect exposure. When the ISO sensitivity setting (81) is changed, the range of shutter speeds and aperture values at which the correct exposure can be obtained also changes.

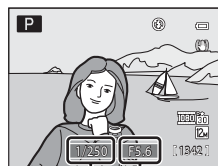

Shutter speed

Aperture value

Shutter Speed



Fast shutter speed
1/1000 s



Slow shutter speed
1/30 s

Aperture Value



Large aperture
(Small f-number)
f/1.8



Small aperture
(Large f-number)
f/8

P (Programmed Auto) Mode

The camera sets the shutter speed and aperture value automatically for optimal exposure.

1 Rotate the mode dial to P.

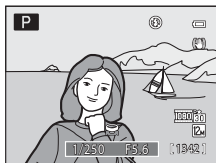

2 Frame the subject and shoot.

- In the default setting, the camera automatically selects one or more of the nine focus areas containing the subject closest to the camera. When the subject is in focus, the focus area (active focus area) lights in green (maximum of nine areas) (□83).

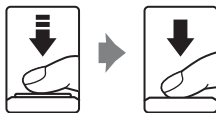

Flexible Program

In mode P (Programmed auto), different combinations of shutter speed and aperture value can be selected without changing the exposure by rotating the command dial (“flexible program”). While flexible program is in effect, a flexible program mark (✳) appears next to the mode indicator (P) in the upper left of the monitor.

- Rotate the command dial to the right for large apertures (small f-numbers) when you want to blur background details, or for fast shutter speeds to capture fast-moving subjects.
- Rotate the command dial to the left for small apertures (large f-numbers) when you want to increase depth of field, or for slow shutter speeds to emphasize the motion of a subject.
- To cancel flexible program, rotate the command dial until the flexible program mark (✳) is no longer displayed. Selecting another shooting mode, or turning off the camera, also cancels flexible program.

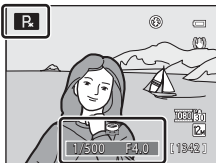
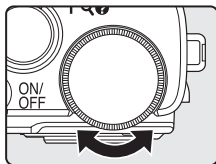

✔ Note on P (Programmed Auto) Shooting

When the subject is too dark or too bright, it may not be possible to obtain the appropriate exposure. In such cases, the shutter speed indicator and aperture value indicator blink when the shutter-release button is pressed halfway. It may be possible to obtain the appropriate exposure by changing settings such as the ISO sensitivity (□81).

🔑 Shutter Speed

- When the aperture value is set to $f/1.8$ (large aperture) or $f/8$, the shutter speed can be set to up to $1/1600$ second.
- The control range of the shutter speed differs depending on the ISO sensitivity setting. Additionally, the range is restricted during continuous shooting (□91).

S (Shutter-Priority Auto) Mode

The user chooses the shutter speed; the camera selects the aperture value automatically.

- 1 Rotate the mode dial to S.

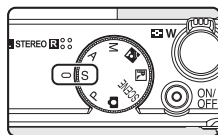

- 2 Rotate the command dial to choose a shutter speed value.

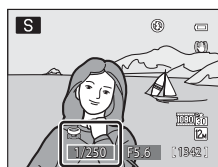

- 3 Focus and shoot.

- In the default setting, the camera automatically selects one or more of the nine focus areas containing the subject closest to the camera. When the subject is in focus, the focus area (active focus area) lights in green (maximum of nine areas) (□83).

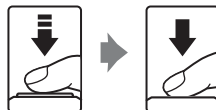

✔ Note on S (Shutter-Priority Auto) Shooting

When the subject is too dark or too bright, it may not be possible to obtain the appropriate exposure with the set shutter speed. In such cases, the shutter speed indicator blinks when the shutter-release button is pressed halfway. Choose another shutter speed and try again.

📎 Shutter Speed

- When the aperture value is set to $f/1.8$ (large aperture), the shutter speed can be set to up to $1/1600$ second.
- The control range of the shutter speed differs depending on the ISO sensitivity setting. Additionally, the range is restricted during continuous shooting (□91).

A (Aperture-Priority Auto) Mode

The user chooses the aperture value; the camera selects the shutter speed automatically.

1 Rotate the mode dial to A.

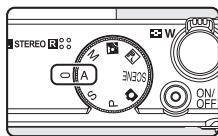

2 Rotate the rotary multi selector to choose the aperture value (f/-number).

- The aperture value can be set in a range of f/1.8 to 8 (wide-angle position) and f/4.9 to 7.8 (telephoto position).

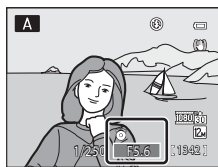

3 Focus and shoot.

- In the default setting, the camera automatically selects one or more of the nine focus areas containing the subject closest to the camera. When the subject is in focus, the focus area (active focus area) lights in green (maximum of nine areas) (83).

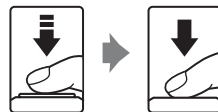

✔ Note on A (Aperture-Priority Auto) Shooting

When the subject is too dark or too bright, it may not be possible to obtain the appropriate exposure with the set aperture value. In such cases, the aperture value indicator blinks when the shutter-release button is pressed halfway. Choose another aperture value and try again.

✎ Shutter Speed

- When the aperture value is set to f/1.8 (large aperture) or f/8, the shutter speed can be set to up to 1/1600 second.
- The control range of the shutter speed differs depending on the ISO sensitivity setting. Additionally, the range is restricted during continuous shooting (91).

👁 Aperture and Zoom

The aperture value (f-number) indicates the lens brightness. Large apertures (expressed by small f-numbers) let more light into the camera, and small apertures (large f-numbers) let less light. When the camera is zoomed in, the lens aperture can be changed within a range of f/1.8 to 4.9. The aperture value increases (becomes darker) when zooming to the telephoto side, and decreases (becomes brighter) when zooming to the wide-angle position.

M (Manual) Mode

The user controls both the shutter speed and aperture value.

- The shutter speed can be set in a range from a maximum speed of 1/2000 to eight seconds.

1 Rotate the mode dial to M.

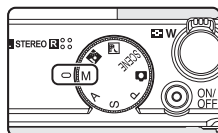

2 Rotate the command dial to choose a shutter speed value.

- When adjusting the aperture value or shutter speed, the degree of deviation from the exposure value measured by the camera is displayed in the exposure indicator.
- The degree of deviation in the exposure indicator is shown in EVs (-2 to +2 EV in increments of 1/3 EV).
The display on the right shows that the picture will be overexposed by 1 EV (+1).

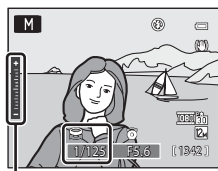

Exposure indicator

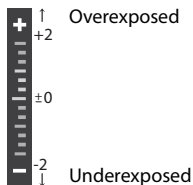

3 Rotate the rotary multi selector to choose an aperture value.

- If necessary, repeat steps 2 to 3 to modify shutter speed and aperture value settings until the desired exposure is achieved.

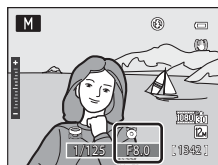

4 Focus and shoot.

- In the default setting, the camera automatically selects one or more of the nine focus areas containing the subject closest to the camera. When the subject is in focus, the focus area (active focus area) lights in green (maximum of nine areas) (📖83).

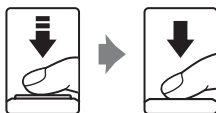

✔ Note on ISO Sensitivity

When **ISO sensitivity** (📖81) is set to **Auto** (default setting) or **Fixed range auto**, ISO sensitivity is fixed at ISO 160.

📌 Shutter Speed

- When the aperture value is set to f/1.8 (large aperture), the shutter speed can be set to up to 1/1600 second.
- The control range of the shutter speed differs depending on the ISO sensitivity setting. Additionally, the range is restricted during continuous shooting (📖91).

Adjusting Brightness, Vividness and Hue (P, S, A, M Modes)

When the rotary multi selector ► (◻) is pressed in the shooting mode **P**, **S**, **A** or **M**, brightness (exposure compensation), vividness and hue can be adjusted with the creative slider.

Brightness (Exp. +/-)

Use to brighten or darken the overall image.

- When the shooting mode is **M** (manual) mode,  brightness (exposure compensation) cannot be used.

Vividness

Use to adjust the vividness of the overall image.

Hue

Use to adjust the hue of the overall image.

Operating the Creative Slider

1 Press the rotary multi selector ► (◻).

- The creative slider is displayed.





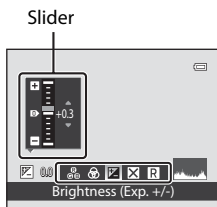

2 Adjust brightness, vividness, or hue.

- The rotary multi selector is used as follows.
 - ▲▼: The slider moves. The effect can be adjusted while confirming the results on the monitor. The effect can also be adjusted by rotating the command dial.
 - ◀▶: Switches among brightness (exposure compensation), vividness and hue. The items can also be switched by rotating the rotary multi selector.
- For more information on each item, see the following.
 - “Adjusting Brightness (Exposure Compensation)” (71)
 - “Adjusting Vividness (Saturation Adjustment)” (71)
 - “Adjusting Hue (White Balance Adjustment)” (71)
- To turn off the effects of the creative slider, press ◀ or ▶ to choose **R** and press the  button.



3 When adjustment is complete, press ◀ or ▶ to choose and press the button.

- If the  button (except when **R** is selected) or the shutter-release button is pressed in step 2, the selected amount of effect is applied. When the effect is applied, the camera returns to the shooting screen.
- If brightness is adjusted,  and the compensation value are displayed.
- If vividness is adjusted,  is displayed.
- If hue is adjusted,  is displayed.

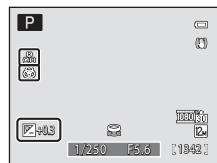
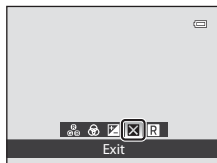

4 Press the shutter-release button to take a picture.

Creative Slider Settings

The settings for brightness (exposure compensation), vividness and hue are saved in the camera's memory even when the camera is turned off.

Adjusting Brightness (Exposure Compensation)

Adjust the overall brightness of the image.

- To make the subject brighter, move the slider toward “+”.
- To make the subject darker, move the slider toward “-”.

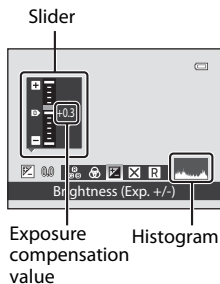

Using the Histogram

- See “Using the Histogram” (📖39) for more information.

Adjusting Vividness (Saturation Adjustment)

Adjust the overall vividness of the image.

- Vividness increases as the slider is moved up.
- Vividness decreases as the slider is moved down.

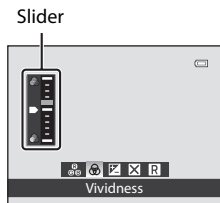

Adjusting Hue (White Balance Adjustment)

Adjust the overall hue of the image.

- The overall image becomes more reddish as the slider is moved up. The overall image becomes more bluish as the slider is moved down.

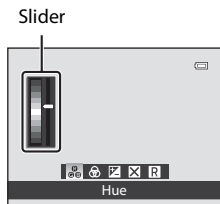

Note on White Balance Adjustment

When hue is adjusted using the creative slider, **White balance** in the shooting menu (📖76) cannot be set.

Shooting Options: Shooting Menu (P, S, A, M Modes)

While shooting in **P**, **S**, **A** and **M**, the shooting menu contains the following options.

Image mode

74

Choose the image mode (combination of image size and compression rate) at which images are saved. This setting can be changed when using any shooting mode.

White balance

76

Match white balance to the light source to produce images with natural-looking colors.

Metering

78

Choose how the camera meters the brightness of the subject.

Continuous

79

Change the settings for continuous shooting and BSS (Best Shot Selector).

ISO sensitivity

81

Set the ISO sensitivity to suit the brightness of the subject.

Exposure bracketing

82

Vary exposure slightly over a burst of pictures.

AF area mode

83

Choose how the focus area is determined.

Autofocus mode

89

Choose how the camera focuses.

Flash exp. comp.

89

Adjust the flash level.

Displaying the Shooting Menu

Choose **P** (Programmed auto), **S** (Shutter-priority auto), **A** (Aperture-priority auto) or **M** (Manual) by rotating the mode dial.

Press the **MENU** button to display the shooting menu.

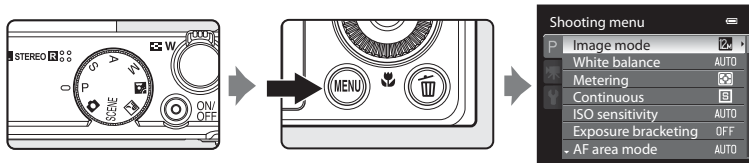

- Use the rotary multi selector to select items and set functions on menus (📖10).
- Press the **MENU** button to exit the shooting menu.

✓ Functions that Cannot be Applied Simultaneously

Some functions cannot be enabled in conjunction with others (📖90).

🔧 Navigating the Camera Menu













Rotate the command dial while the first level of the shooting menu is displayed to change the setting for the selected item.

Image Mode (Image Quality/Image Size)

Set to P, S, A or M → MENU (Shooting menu) → Image mode

Image mode refers to the combination of image size and image quality (compression ratio) at which images are saved. Choose the image mode best suited to the manner in which images will be used and the capacity of the internal memory or memory card.

The higher the image mode setting, the larger the size at which it can be printed, but limiting the number of images that can be saved.

Image mode	Size (pixels)	Description
 4000×3000★	4000×3000	Images are higher quality than  . The compression ratio is approximately 1:4.
 4000×3000 (default setting)	4000×3000	Best choice in most situations. The compression ratio is approximately 1:8.
 3264×2448	3264×2448	
 2592×1944	2592×1944	
 2048×1536	2048×1536	Smaller size than  ,  , or  allows more images to be saved. The compression ratio is approximately 1:8.
 1024×768	1024×768	Suited to display on a computer monitor. The compression ratio is approximately 1:8.
 640×480	640×480	Suited to full-screen display on a television with an aspect ratio of 4:3, or distribution by e-mail. The compression ratio is approximately 1:8.
 3968×2232	3968×2232	Images with an aspect ratio of 16:9 are saved. The compression ratio is approximately 1:8.











The icon for the current setting is displayed on the monitor in shooting and playback modes ( 6 to 8).

Image Mode

- When using shooting modes other than P, S, A or M mode, this setting can be changed by pressing the MENU button.
- The setting is also applied to other shooting modes.
- This feature cannot be used simultaneously with certain features. See “Functions that Cannot be Applied Simultaneously” ( 90) for more information.

Number of Exposures Remaining

The following table lists the approximate number of images that can be saved in the internal memory and on a 4 GB memory card. Note that due to JPEG compression, the number of images that can be saved differs depending on the composition of the image. In addition, this number may vary depending on the make of memory card, even when the memory cards have the same specified capacity.

Image mode	Internal memory (90 MB)	Memory card ¹ (4 GB)	Print size ² (cm/in.)
 4000×3000★	14	620	34 × 25/13 × 10
 4000×3000	26	1,110	34 × 25/13 × 10
 3264×2448	39	1,650	28 × 21/11 × 8
 2592×1944	61	2,560	22 × 16/8.5 × 6.5
 2048×1536	96	4,020	17 × 13/7 × 5
 1024×768	299	12,000	9 × 7/3.5 × 2.5
 640×480	813	30,100	5 × 4/2 × 1.5
 3968×2232	35	1,500	34 × 19/13 × 7.5

¹ If the number of exposures remaining is 10,000 or more, the number of exposures remaining display shows “9999.”

² Print size at an output resolution of 300 dpi.

Print sizes are calculated by dividing the number of pixels by printer resolution (dpi) and multiplying by 2.54 cm (1 in.). However, at the same image size, images printed at higher resolutions will print smaller than the size indicated, and those printed at lower resolutions will print larger than the size indicated.

White Balance

Set to P, S, A or M → MENU (Shooting menu) → White balance

The color of light reflected from an object varies with the color of the light source. The human brain is able to adapt to changes in the color of the light source, with the result that white objects appear white whether seen in the shade, direct sunlight, or under incandescent lighting. Digital cameras can mimic this adjustment of the human eye by processing images according to the color of the light source. This is known as “white balance.” For natural coloration, choose a white balance setting that matches the light source before shooting.

Although the default setting, **Auto**, can be used under most types of lighting, you can apply the white balance setting suited to a particular light source to achieve more accurate results.

Auto (default setting)

The white balance is automatically adjusted to suit the lighting conditions. The best choice in most situations.

Preset manual

Use when shooting under unusual lighting. See “Preset Manual” (📖77) for more information.

Daylight

The white balance is adjusted for direct sunlight.

Incandescent

Use under incandescent lighting.

Fluorescent

Use under most types of fluorescent lighting.

Cloudy

Use when shooting under overcast skies.

Flash

Use with the flash.

When white balance is enabled, the current setting is displayed during shooting (📖6). When **Auto** is selected, an icon for the current setting is not displayed.

Notes on White Balance

- When hue is adjusted using the creative slider (📖71), this feature cannot be set.
- At white balance settings other than **Auto** or **Flash**, set the flash to  (Off) (📖32).
- This feature cannot be used simultaneously with certain features. See “Functions that Cannot be Applied Simultaneously” (📖90) for more information.

Preset Manual

Use when you want to make pictures shot under unusual lighting conditions (such as lamps with reddish light) look as though they were shot in normal light.

Use the procedure below to shoot after measuring the white balance value under the shooting light.

1 Place a white or gray reference object under the lighting that will be used during shooting.

2 Display the shooting menu (73), use the rotary multi selector to choose **PRE Preset manual** in **White balance**, and press the **OK** button.

- The lens extends to the zoom position for measurement.

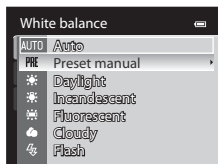

3 Choose **Measure**.

- To apply the most recently measured white balance value, choose **Cancel** and press the **OK** button. The most recently measured white balance value will be set.

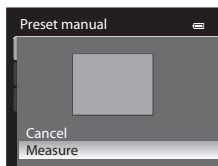

4 Frame a white or gray reference object in the reference object frame.

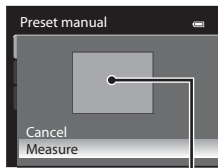

Reference object frame

5 Press the **OK** button to measure the white balance value.

- The shutter is released and the new white balance preset value is set (no picture is recorded).

✓ Note on Preset Manual

The camera cannot measure a white balance value when the flash fires. When shooting with the flash, set **White balance** to **Auto** or **Flash**.

Metering

Set to **P, S, A** or **M** → **MENU** (Shooting menu) → **Metering**

The process of measuring the brightness of the subject to determine the exposure is known as “metering.”

Use this option to choose how the camera meters exposure.



Matrix (default setting)

Uses a wide area of the screen for metering.

This metering mode provides the appropriate exposure for a variety of shooting conditions. Recommended for typical shooting.



Center-weighted

The camera meters the entire frame but assigns greatest weight to the subject at the center of the frame. The classic meter for portraits; it preserves background details while letting lighting conditions at the center of the frame determine exposure. Can be used with focus lock (📖29) to meter off-center subjects.



Notes on Metering

- When the digital zoom is in effect, **Metering** is set to **Center-weighted**. Note that the metered area is not displayed on the monitor.
- This feature cannot be used simultaneously with certain features. See “Functions that Cannot be Applied Simultaneously” (📖90) for more information.



Metering Area

The active metering area is displayed when **Center-weighted** is selected for **Metering** (📖6).

Continuous

Set to **P, S, A** or **M** → **MENU** (Shooting menu) → **Continuous**

Change the settings for continuous shooting and BSS (Best Shot Selector).

Single (default setting)

One picture is shot each time the shutter-release button is pressed.

Continuous

While the shutter-release button is pressed all the way, pictures are taken at a rate of about eight frames per second (fps) (when Image mode is set to  **4000 × 3000**). Shooting ends when the shutter-release button is released, or seven pictures have been taken.

BSS **BSS (Best Shot Selector)**

BSS is recommended for shooting when lighting is dim without the flash, with the camera zoomed in, or in other situations in which camera shake is likely to blur pictures.

The camera continuously takes up to ten pictures while the shutter-release button is pressed all the way. The sharpest picture (picture with the most details) in the series is automatically selected and saved.

Multi-shot 16

Each time the shutter-release button is pressed all the way, the camera shoots 16 pictures at a rate of about 30 frames per second and arranges them in a single picture.

- Image mode is fixed at  (image size: 2560 × 1920 pixels).
- The digital zoom is not available.



120 Continuous H: 120 fps

Each time the shutter-release button is pressed all the way, 60 frames are captured at a speed of about 1/125 s or faster.

- Image mode is fixed at  (image size: 1280 × 960 pixels).

60 Continuous H: 60 fps

Each time the shutter-release button is pressed all the way, 60 frames are captured at a speed of about 1/60 s or faster.

- Image mode is fixed at  (image size: 1280 × 960 pixels).

When continuous shooting is enabled, the current setting is displayed during shooting (6). When **Single** is selected, an icon for the current setting is not displayed.

✔ Notes on Continuous Shooting

- During continuous shooting, the flash is not available. Focus, exposure and white balance are fixed at the values for the first picture in each series.
- The frame rate may become slower depending on the image mode, memory card type or shooting conditions.
- This feature cannot be used simultaneously with certain features. See "Functions that Cannot be Applied Simultaneously" (p.90) for more information.

✔ Note on BSS

BSS is suited for shooting stationary subjects. BSS may not produce the desired results if the subject moves or the composition changes.

✔ Note on Multi-shot 16

Banding or variance in brightness or hue may occur in images that were captured under lighting that flickers at high speeds, such as fluorescent, mercury-vapor, or sodium-vapor lighting.

✔ Notes on Continuous H

- It may take some time to save the images after shooting. The amount of time it takes to finish saving the captured images depends on the number of images, the write speed of the memory card, etc.
- When ISO sensitivity increases, noise may appear in captured images.
- Accurate exposure may not be achieved (images may be over-exposed) in images captured on bright sunny days.
- Banding or variance in brightness or hue may occur in images that were captured under lighting that flickers at high speeds, such as fluorescent, mercury-vapor, or sodium-vapor lighting.

ISO Sensitivity

Set to **P, S, A** or **M** → **MENU** (Shooting menu) → **ISO sensitivity**

When ISO sensitivity is increased, less light is needed when taking pictures. Higher ISO sensitivity allows darker subjects to be captured. Additionally, even with subjects of similar brightness, pictures can be taken at faster shutter speeds, and blurring caused by camera shake and subject movement can be reduced.

- Although higher ISO sensitivity is effective when shooting darker subjects, shooting without the flash, shooting with the camera zoomed in, etc., images may contain noise.

Auto (default setting)

Sensitivity is ISO 160 when there is sufficient lighting; the camera compensates by raising sensitivity to a maximum of ISO 1600 when lighting is dim.

Fixed range auto

Choose the range in which the camera automatically adjusts ISO sensitivity, from **ISO 160-400** (default setting) or **ISO 160-800**. The camera will not raise sensitivity beyond the maximum value in the selected range. Set the maximum value for ISO sensitivity for effective control over the amount of “grain” that appears in images.

160, 200, 400, 800, 1600, 3200

Sensitivity is locked at the specified value.

The icon for the ISO sensitivity setting is displayed on the monitor (📖6).

- When **Auto** is selected, the **ISO** icon is not displayed at ISO 160, but is displayed if the ISO sensitivity automatically increases to more than 160 (📖34).
- When **Fixed range auto** is selected, **ISO** and the maximum ISO sensitivity value are displayed.

✔ Notes on ISO Sensitivity

- In **M** (manual) mode, ISO sensitivity will be fixed at ISO 160 if **Auto** or **Fixed range auto** is selected.
- This feature cannot be used simultaneously with certain features. See “Functions that Cannot be Applied Simultaneously” (📖90) for more information.

Exposure Bracketing

Set to P, S or A → MENU (Shooting menu) → Exposure bracketing

The exposure (brightness) can be changed automatically during continuous shooting. This is effective for shooting when it is difficult to adjust the picture brightness.

±0.3

Camera varies exposure by 0, -0.3, and +0.3 over next three shots. The three shots are taken in sequence when the shutter-release button is pressed all the way.

±0.7

Camera varies exposure by 0, -0.7, and +0.7 over next three shots. The three shots are taken in sequence when the shutter-release button is pressed all the way.

±1.0

Camera varies exposure by 0, -1.0, and +1.0 over next three shots. The three shots are taken in sequence when the shutter-release button is pressed all the way.

Off (default setting)

Exposure bracketing is not performed.

When exposure bracketing is enabled, the current setting is displayed during shooting (📖6). When **Off** is selected, an icon for the current setting is not displayed.

✓ Notes on Exposure Bracketing

- **Exposure bracketing** is not available in **M** (manual) mode.
- When exposure compensation (📖39) and **±0.3**, **±0.7** or **±1.0** in **Exposure bracketing** are set simultaneously, the combined exposure compensation values are applied.
- This feature cannot be used simultaneously with certain features. See “Functions that Cannot be Applied Simultaneously” (📖90) for more information.

AF Area Mode

Set to **P, S, A or M** → **MENU** (Shooting menu) → **AF area mode**

You can set how the camera selects the focus area for autofocus.

Face priority

The camera automatically detects and focuses on a face (see "Shooting with Face Priority" (85) for more information).

If the camera detects multiple faces, the camera focuses on the face closest to the camera.

When non-human subjects are photographed, or a subject with which no face can be detected is framed, AF area mode is set to **Auto**. The camera automatically selects one or more of the nine focus areas containing the subject closest to the camera.

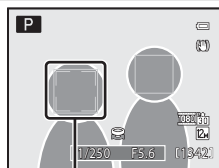

Focus area

More on Shooting

AUTO Auto (default setting)

The camera automatically selects one or more of the nine focus areas containing the subject closest to the camera.

Press the shutter-release button halfway to activate the focus area.

When the shutter-release button is pressed halfway, the focus area selected by the camera is displayed on the monitor (up to nine areas).

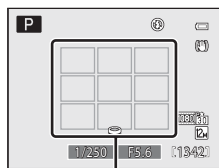

Focus areas

Manual

Choose manually the focus position from 99 areas in the screen. This option is suited to situations in which the intended subject is relatively still and not positioned at the center of the frame.

Rotate the rotary multi selector or press **▲**, **▼**, **◀** or **▶** to move the focus area to where the subject is, and take a picture.

- To adjust the following settings, press the **OK** button to temporarily cancel focus area selection, and then adjust each setting.
 - Flash mode, macro mode or self-timer settings
 - Brightness (exposure compensation), vividness or hue
 To return to the focus-area selection screen, press the **OK** button again.

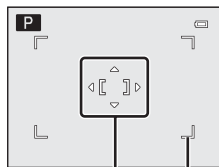

Focus area
Selectable areas

Center

The camera focuses on the subject at the center of the frame.
The focus area is always displayed at the center of the frame.

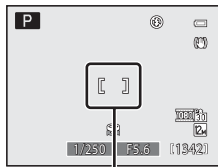

Focus area

Subject tracking

Subject tracking begins once you select a subject to be focused on, and the focus area will move and follow the subject. See "Focusing on Moving Subjects for Shooting (Subject Tracking/Face Priority Tracking)" (87).



Face priority tracking

Once the camera detects a subject's face, that subject is automatically registered as the subject to be tracked, and face priority tracking begins tracking that subject. See "Focusing on Moving Subjects for Shooting (Subject Tracking/Face Priority Tracking)" (87).

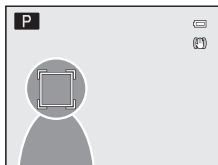

Notes on AF Area Mode

- When the digital zoom is in effect, the camera focuses on the subject in the center focus area regardless of the applied **AF area mode** option.
- In some rare cases of shooting subjects for which autofocus does not perform as expected (829), the subject may not be in focus.
- This feature cannot be used simultaneously with certain features. See "Functions that Cannot be Applied Simultaneously" (890) for more information.

Shooting with Face Priority

The camera automatically detects and focuses on a human face.

The face detection function operates in the following situations.

- When **Face priority** is selected for **AF area mode** (📖83)
 - When **Scene auto selector** (📖42), **Portrait** (📖46) or **Night portrait** (📖49) is selected in scene mode
 - When 📷 (Smile timer) is selected (📖36)
- * See “Focusing on Moving Subjects for Shooting (Subject Tracking/Face Priority Tracking)” (📖87) for more information on face priority tracking.

1 Frame the picture.

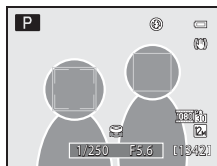

- When the camera detects a face, the focus area containing the face is displayed with a double yellow border.



- When the camera detects more than one face, depending upon the shooting mode, the operation varies as follows.



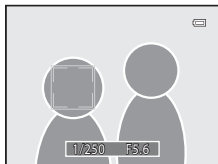

Shooting mode	Faces framed by a double border	Number of faces to be recognized
P, S, A, M modes (Face priority)	The face closest to the camera	Up to 12
Scene auto selector, Portrait or Night portrait scene mode	* The other faces are framed by a single border.	
📷 (Smile timer)	The face closest to the center of the frame	Up to 3
	* The other faces are framed by a single border.	

2 Press the shutter-release button halfway.

- The camera focuses on the face framed by the double border. The double border lights in green and the focus is locked.
- When the camera is unable to focus on a face, the double border blinks. Press the shutter-release button halfway again and focus.
- Press the shutter-release button all the way to shoot.
- When using  (Smile timer), even if the shutter-release button is not pressed, the shutter is released automatically if the camera detects that the face framed by the double border is smiling (36).



Notes on Face Priority

- When **Face priority** is selected for **AF area mode**, the setting automatically switches to **Auto** if no faces are detected when the shutter-release button is pressed halfway.
- If no faces are detected when the shutter-release button is pressed halfway in the **Portrait** or **Night portrait** scene mode, the camera focuses on the subject in the center focus area.
- The camera may not detect faces in the following situations:
 - When faces are partially hidden by sunglasses or other obstructions
 - When faces take up too much or too little of the frame
- If the camera detects more than one face, the face that it focuses on depends on the shooting conditions, such as whether or not the subject is facing the camera.
- In some rare cases of shooting subjects for which autofocus does not perform as expected (29), the subject may not be in focus despite the fact that the double border lights in green. If you cannot focus, change the AF area mode setting to **Manual** or **Center**, or try shooting with focus lock (29) by switching the shooting mode to a mode such as auto mode and refocusing on another subject at the same distance.
- Pictures that were shot using face priority will be rotated automatically when displayed in full-frame or thumbnail playback mode according to the orientation of the face (except for pictures shot while **Continuous** (79), **Exposure bracketing** (82) or **Face priority tracking** (87) was set).

Focusing on Moving Subjects for Shooting (Subject Tracking/Face Priority Tracking)

Choose this mode to shoot moving subjects.

- When **Subject tracking** is selected, it begins once you select a subject to be focused on, and the focus area will move and follow the subject.
- When **Face priority tracking** is selected, once the camera detects a person's face, it automatically registers that face as the subject, and the focus area moves to track the face.

- 1 Display the shooting menu (📖73), use the rotary multi selector to choose **AF area mode**, and press the **OK** button.

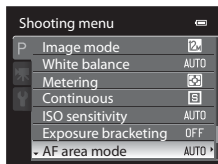

- 2 Choose **Subject tracking** or **Face priority tracking**, and press the **OK** button.
 - A white border is displayed at the center of the frame.

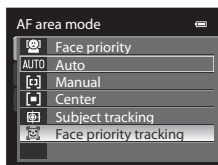

- 3 Select a subject.

- For **Subject tracking**, point the camera at the subject you want to focus on, so that the subject is at the center of the frame, and then press the **OK** button.
 - The subject is registered.
 - When the camera is unable to focus on the subject, the border lights in red. Change the composition and try again.
- For **Face priority tracking**, when the camera detects a face in the frame, that face is automatically registered as the subject.
 - When no faces are detected and the **OK** button is pressed, the subject at the center of the frame is registered.
- Once the subject is registered, it is framed by a yellow focus area display, which moves to track the subject.
- When you want to change subjects, press the **OK** button to cancel the currently selected subject.
- If the camera loses sight of the subject, the focus area display disappears; register the subject again.

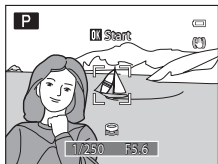

Subject tracking

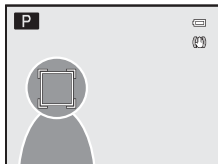

Face priority tracking

4 Press the shutter-release button to take the picture.

- If the camera focuses on the focus area when the shutter-release button is pressed halfway, the focus area display lights in green and the focus is locked.
- If the camera is unable to focus, the focus area display will blink. Press the shutter-release button halfway again to focus.
- If the shutter-release button is pressed halfway while the focus area is not displayed, the camera focuses at the center of the frame.
- Press the shutter-release button the rest of the way down to take the picture.

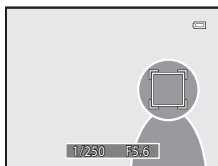

✔ Notes on Subject Tracking

- The digital zoom is not available.
- Set the zoom position, flash mode, creative slider, or menu before registering a subject. If any of these are changed after a subject is registered, the subject will be canceled.
- During certain conditions, such as when the subject is moving quickly, when there is a large amount of camera shake, or when there are multiple subjects that look alike, the camera may not be able to register or track a subject, or the camera may track a different subject. Additionally, the subject may not be tracked properly depending on factors such as the subject's size and brightness.
- In some rare cases of shooting subjects for which autofocus does not perform as expected (📖29), the subject may not be in focus despite the fact that the focus area lights in green. If you cannot focus, change the AF area mode setting to **Manual** or **Center**, or try shooting with focus lock (📖29) by switching the shooting mode to a mode such as auto mode and refocusing on another subject at the same distance.
- This feature cannot be used simultaneously with certain features. See "Functions that Cannot be Applied Simultaneously" (📖90) for more information.

✔ Notes on Face Priority Tracking

- Only one subject can be tracked. If the camera detects multiple faces at the same time, the face closest to the center of the frame is tracked.
- When the frame includes more than one face, the face detected by the camera and registered as the subject to be tracked depends upon a variety of factors, including the direction in which the faces are looking.
- Depending on shooting conditions, such as whether or not the subject is facing the camera, the face may not be detected properly. Additionally, the camera may be unable to detect faces in the following situations:
 - When faces are partially hidden by sunglasses or otherwise obstructed
 - When faces take up too much or too little of the frame

Autofocus Mode

Set to P, S, A or M → MENU (Shooting menu) → Autofocus mode

Choose how the camera focuses.

Single AF (default setting)

The camera focuses only when the shutter-release button is pressed halfway.

Full-time AF

The camera focuses continuously until the shutter-release button is pressed halfway. Use with moving subjects. A sound will be heard while the camera focuses.

- For **Face priority tracking** (📖87), the autofocus mode is set to Full-time AF when the camera starts tracking.

Note on Autofocus Mode

This feature cannot be used simultaneously with certain features. See “Functions that Cannot be Applied Simultaneously” (📖90) for more information.

Autofocus Mode for Movie Recording

Autofocus mode for movie recording can be set with **Autofocus mode** (📖125) in the movie menu (📖122).

Flash Exp. Comp.

Set to P, S, A or M → MENU (Shooting menu) → Flash exp. comp.

Flash compensation is used to adjust the flash output by ± 2.0 EV in increments of $1/3$ EV, changing the brightness of the main subject relative to the background.

-0.3 to -2.0

The flash output is reduced from -0.3 to -2.0 EV, in increments of $1/3$ EV, to prevent unnecessary highlights or reflections.

0.0 (default setting)

The flash output is not adjusted.

+0.3 to +2.0

The flash output is increased from $+0.3$ to $+2.0$ EV, in increments of $1/3$ EV, to make the main subject of the frame appear brighter.

When flash compensation is enabled, the current setting is displayed during shooting (📖6). When **0.0** is selected, an icon for the current setting is not displayed.

Functions that Cannot be Applied Simultaneously

Some settings in the flash mode, the macro mode, the self-timer/smile timer, the creative slider and the shooting menu cannot be used with other functions.

Restricted function	Setting	Description
Flash mode	Continuous (79)	When Continuous, BSS, Multi-shot 16, Continuous H: 120 fps or Continuous H: 60 fps is selected for shooting, the flash is not available.
	Exposure bracketing (82)	The flash is not available.
Self-timer/Smile timer	AF area mode (83)	When Subject tracking or Face priority tracking is selected for shooting, the Self-timer/Smile timer are not available.
Macro mode	AF area mode (83)	When Subject tracking or Face priority tracking is selected for shooting, macro mode is not available.
Image mode	Continuous (79)	<ul style="list-style-type: none"> When Multi-shot 16 is selected for shooting, image mode is fixed at 5 (image size: 2560 × 1920 pixels). When using Continuous H: 120 fps or Continuous H: 60 fps, image mode is fixed at 16 (image size: 1280 × 960 pixels).
White balance	Hue (using the creative slider) (69)	When hue is adjusted using the creative slider, White balance in the shooting menu cannot be set.
Continuous/ Exposure bracketing	Continuous (79)/Exposure bracketing (82)	Continuous and Exposure bracketing are not available simultaneously. Exposure bracketing is reset to Off when Continuous is set to any mode other than Single . The setting for Continuous is reset to Single when Exposure bracketing is set to any mode other than Off .
	Self-timer (35)/ Smile timer (36)	Continuous, BSS, Multi-shot 16, Continuous H: 120 fps, Continuous H: 60 fps or Exposure bracketing and the Self-timer/Smile timer are not available simultaneously.
ISO sensitivity	Continuous (79)	When shooting in Multi-shot 16, Continuous H: 120 fps or Continuous H: 60 fps , ISO sensitivity is set automatically according to the brightness when shooting mode P, S or A is used. The setting for ISO sensitivity is fixed at 160 for shooting mode M .
Autofocus mode	AF area mode (83)	When Face priority is selected for shooting, Autofocus mode is fixed at Single AF .

Restricted function	Setting	Description
Print date	Continuous (📖79)	When Continuous H: 120 fps or Continuous H: 60 fps is selected for shooting, the date cannot be imprinted.
Blink warning	Smile timer (📖36)/ Continuous (📖79)/Exposure bracketing (📖82)	Blink warning does not take effect when using the Smile timer, Continuous is set to a setting other than Single , or exposure bracketing is set.
Digital zoom	Smile timer (📖36)	The digital zoom cannot be used when shooting with the Smile timer.
	AF area mode (📖83)	The digital zoom cannot be used when shooting with Subject tracking or Face priority tracking .
	Continuous (📖79)	The digital zoom cannot be used when Multi-shot 16 is selected for shooting.

Shutter Speed

The control range of the shutter speed differs depending on the ISO sensitivity setting. Additionally, the range is restricted as shown below during continuous shooting.

Setting	Control range	
ISO sensitivity (📖81)	Auto*, Fixed range auto*, ISO 1600	1/2000 to 1 s
	ISO 160*, 200, 400	1/2000 to 4 s
	ISO 800	1/2000 to 2 s
	ISO 3200	1/2000 to 1/2 s
Continuous (📖79)	Continuous, BSS	1/2000 to 1/30 s
	Multi-shot 16	1/4000 to 1/30 s
	Continuous H: 120 fps	1/4000 to 1/125 s
	Continuous H: 60 fps	1/4000 to 1/60 s



* In **M** mode, the slowest shutter speed is eight seconds.

- When the aperture value is set to f/1.8 (large aperture), the shutter speed can be set to up to 1/1600 second (except for **Multi-shot 16**, **Continuous H: 120 fps** and **Continuous H: 60 fps**).
- In **P** or **A** mode, when the aperture value is set to f/8 and the zoom is at the maximum wide-angle position or moved one increment to the telephoto position, the shutter speed can be set to up to 1/1600 second (except for **Multi-shot 16**, **Continuous H: 120 fps** and **Continuous H: 60 fps**).









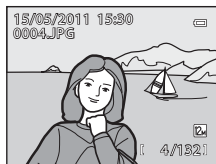













More Information

See "Notes on Digital Zoom" (📖152) for more information.



Operations in Full-Frame Playback

In shooting mode, press the  (playback) button to enter playback mode and play back the images that have been shot (30). The following operations can be performed in full-frame playback mode.



Function	Use	Description	
Choose pictures		Press  ,  ,  or  to choose a picture to display. Press and hold  ,  ,  or  to scroll quickly through pictures. Pictures can also be chosen by rotating the rotary multi selector.	10
Thumbnail display/ Calendar display	W 	Display images by 4, 9, 16 or 72 picture thumbnails. Rotate the zoom control toward W () in the 72-picture thumbnail display to change to the calendar display.	94, 95
Playback zoom	T 	Enlarge the view of the picture currently displayed on the monitor, up to about 10x. Press the  button to return to the full-frame playback mode.	96
Displaying the shooting information		The histogram and shooting information are displayed. Press the  button to return to full-frame playback.	93
Scroll pictures recorded with easy panorama		Display the short side of the current picture filling the entire screen and scroll the picture automatically.	59
Play back movies		Play back the displayed movie.	126
Delete pictures		Select the deletion method and delete the picture(s).	31
Display menu	MENU	Display the playback menu.	98
Switch to shooting mode		Press the  button or the shutter-release button. You can also switch to shooting by pressing the  (movie-record) button.	30
			
			

Changing the Orientation (Vertical and Horizontal Positioning) of Pictures

Change using **Rotate image** (104) in the playback menu (98) after shooting.

Displaying the Histogram and Shooting Information

Press the **OK** button in full-frame playback mode to display the histogram and shooting information (except for movies and easy panorama pictures). Press the **OK** button again to return to full-frame playback mode.

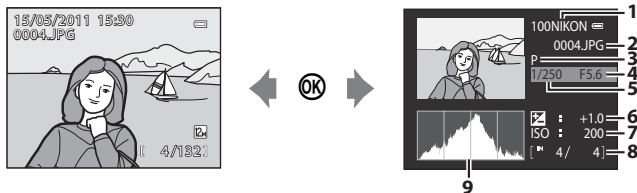

1 Folder name

2 File name

3 Shooting Mode **P, S, A** or **M**¹

4 Aperture value

5 Shutter speed

6 Exposure compensation value

7 ISO sensitivity



8 Current frame number/
total number of frames

9 Histogram²

1 **P** is displayed when the shooting mode is **☑** (auto), **SCENE** (scene), **🌃** (Night landscape) or **📷** (Backlighting).

















2 A histogram is a graph showing the distribution of tones in the image. The horizontal axis corresponds to brightness, with dark tones to the left and bright tones to the right. The vertical axis shows the number of pixels.

Viewing Multiple Pictures: Thumbnail Playback

Rotate the zoom control toward **W** () in full-frame playback mode (, 30, 92) to display pictures as thumbnail images in thumbnail playback mode.



The following operations can be performed in thumbnail playback mode.

To	Use	Description	
Choose pictures		Rotate the rotary multi selector, or press ▲, ▼, ◀ or ▶.	10
Increase the number of thumbnails displayed/Calendar display	W ()	Rotate the zoom control toward the W () direction to increase the number of thumbnails from 4 → 9 → 16 → 72 → Calendar display. In calendar display, the pictures can be selected according to date by moving the cursor ( , 95). Rotate toward the T () direction to return to thumbnail display.	-
Decrease number of picture thumbnails displayed	T ()	Rotate the zoom control toward the T () direction to decrease the number of thumbnails from 72 → 16 → 9 → 4. Rotate toward T () again during 4 thumbnails display to return to full-frame playback.	-
Return to full-frame playback		Press the  button.	30, 92
Delete pictures		Select the deletion method and delete the picture(s).	31
Switch to the shooting screen		Press the  button or the shutter-release button. You can also switch to shooting by pressing the  (● (▶) movie-record) button.	30
			
			

✎ Icons on the Thumbnails

When pictures with **Print order** (📖99) and **Protect** (🔒102) settings are selected, the icons shown on the right appear.

Movies are displayed as film frames (In the 72-picture thumbnail display, 🎞️ is displayed at the top of the monitor when a movie is selected).

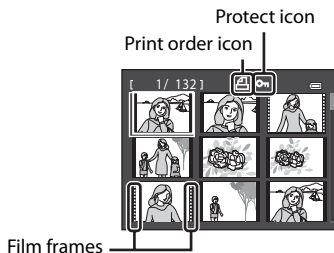



Calendar Display

Rotate the zoom control toward **W** (📐) during playback mode when 72 thumbnails are displayed (📖94) to change to calendar display.

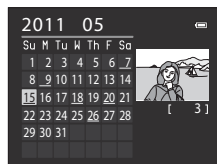
Move the cursor and choose pictures by selecting a date. Dates for which pictures exist are underlined in yellow.



The following operations can be performed in calendar display mode.

To	Use	Description	📖
Select date		Rotate the rotary multi selector, or press ▲, ▼, ◀ or ▶.	10
Return to full-frame playback		Change to full-frame playback for displaying the first picture for that date.	30, 92
Return to picture list display	T (📖)	Rotate the zoom control toward T (📖).	-

✔ Notes on Calendar display

- Pictures taken without the date set are treated as pictures taken on “January 1, 2011.”
- **MENU** and  buttons are disabled while the Calendar is displayed.

Taking a Closer Look: Playback Zoom

Rotate the zoom control toward **T** (Q) in full-frame playback mode (30) to zoom in on the current picture, enlarging and displaying the center of the picture.

- The guide at lower right shows which portion is enlarged.

The following operations can be performed while pictures are zoomed in.



To	Use	Description	
Zoom in	T (Q)	Rotate the zoom control toward T (Q). The zoom increases up to about 10x. Zoom also increases by rotating the command dial to the right.	-
Zoom out	W (Q)	Rotate the zoom control toward W (Q). When the magnification ratio reaches 1x, the display returns to full-frame playback mode. Zoom also decreases by rotating the command dial to the left.	-
Move the display area		Press the rotary multi selector ▲ , ▼ , ◀ or ▶ to move the display area to other areas of the picture(s).	10
Return to full-frame playback		Press the OK button.	30, 92
Delete pictures		Select the deletion method and delete the picture(s).	31
Crop picture	MENU	Press to save the visible portion only as a separate file.	117
Switch to the shooting screen		Press the button or the shutter-release button. You can also switch to shooting by pressing the (movie-record) button.	30

Pictures Taken Using the Face Priority or Pet Detection























When the zoom control is rotated toward **T** (📷) during full-frame playback mode for pictures taken in Face Priority (📖85) or Pet Detection (📖56), the picture is enlarged at the center of the face that was detected during shooting (excluding pictures that were shot using **Continuous** (📖79), **Exposure bracketing** (📖82) or **Face priority tracking** (📖87)).



- If more than one face was detected, the picture is enlarged with the face that was focused on at the center of the monitor. Press the rotary multi selector ▲, ▼, ◀ or ▶ to display other faces that were detected.
- When the zoom control is further rotated toward **T** (📷) or **W** (📐), the zoom ratio changes and becomes a normal playback zoom display.

Playback Options: Playback Menu

The following options are available in playback menu.

	Quick retouch  110
Easily create retouched images in which contrast and saturation have been enhanced.	
	D-Lighting  111
Enhance brightness and contrast in dark portions of pictures.	
	Skin softening  112
Make the subject's skin appear smoother.	
	Filter effects  114
Apply a variety of effects using digital filter.	
	Print order  99
Select pictures to print and the number of copies for each.	
	Slide show  101
View pictures stored in the internal memory or on a memory card in an automatic slide show.	
	Protect  102
Protect selected pictures from accidental deletion.	
	Rotate image  104
Change the orientation of the picture taken.	
	Small picture  116
Create a small copy of the picture taken.	
	Voice memo  105
Add a voice memo to the picture taken.	
	Copy  107
Copy files between the memory card and internal memory.	

Displaying the Playback Menu

Press the  button to enter playback mode ( 30).

Press the **MENU** button to display the playback menu.

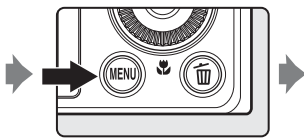
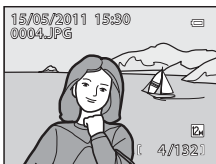





- Use the rotary multi selector to select items and set functions on menus ( 10).
- To exit the playback menu, press the **MENU** button.

Print Order: Setting the Pictures and Number of Copies to Print

Press the  button (Playback mode) → MENU (Playback menu) →  Print order





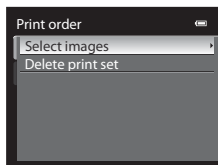

If you choose to use one of the following methods to print pictures that are recorded on a memory card, the pictures to print and the number of copies can be set in advance on the memory card.

- Printing with a DPOF-compatible (184) printer that is equipped with a card slot.
- Ordering the prints from a digital photo lab that has a DPOF service.
- Printing by connecting the camera to a PictBridge-compatible (184) printer (135). (When the memory card is removed from the camera, the print order settings can also be applied to the pictures recorded on the internal memory.)

- 1 Rotate the rotary multi selector to choose **Select images** and press the  button.**



- 2 Choose the pictures (up to a maximum of 99) and number of copies (up to nine per picture).**

- Rotate the rotary multi selector or press  or  to choose the pictures, and press  or  to set the number of copies for each.
- Pictures selected for printing can be recognized by the check mark icon and the numeral indicating the number of copies to be printed. A check mark is not displayed with pictures for which no copies have been specified and these pictures are not printed.
- Rotate the zoom control toward **T** () to switch to full-frame playback, or **W** () to switch to 12 thumbnails display.
- Press the  button when setting is complete.



3 Choose whether or not to also print shooting date and photo information.

- Choose **Date** and press the **OK** button to print the shooting date on all pictures in the print order.
- Choose **Info** and press the **OK** button to print shooting information (shutter speed and aperture value) on all pictures in the print order.
- Choose **Done** and press the **OK** button to complete the print order.

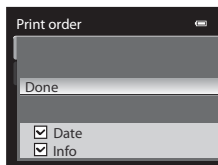

Pictures selected for printing are recognized by the  icon displayed in playback mode.

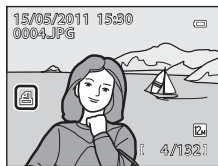

Notes on Printing Shooting Date and Photo Information

When the **Date** and **Info** options are enabled in the print order menu, shooting date and photo information are printed on pictures when a DPOF-compatible ( 184) printer which supports printing of shooting date and photo information is used.

- Photo information cannot be printed when the camera is connected directly to a printer, via the supplied USB cable, for DPOF printing ( 140).
- **Date** and **Info** are reset each time the **Print order** menu is displayed.
- The date printed is that saved when the picture was captured. Changing the camera's date using the **Time zone and date** setting in the setup menu after a picture has been captured has no effect on the date printed on the picture.



Deleting All Print Orders

In step 1 of the print order procedure ( 99), choose **Delete print set** and press the **OK** button to delete the print orders for all pictures.

Print date



The shooting date and time can be printed in pictures at the time of shooting by using **Print date** ( 149) in the setup menu. This information can be printed even from printers that do not support printing of the date and time. Only the date and time of Print date on the pictures are printed, even if **Print order** is enabled with the date selected in the print order screen.

Slide Show

Press the  button (Playback mode) → MENU (Playback menu) →  Slide show



View pictures stored in the internal memory or on a memory card in an automatic slide show.

1 Use the rotary multi selector to choose **Start** and press the button.

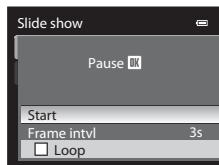
- To change the interval between pictures, choose **Frame intvl**, select the desired interval time, and press the  button before choosing **Start**.
- To repeat the slide show automatically, enable **Loop** and press the  button before choosing **Start**. The check mark () is added to the loop option when enabled.



2 The slide show begins.

- Press the rotary multi selector  to display the next picture, or  to display the previous picture. Press and hold the button to fast forward or rewind.
- To exit partway or pause, press the  button.





3 Choose End or Restart.

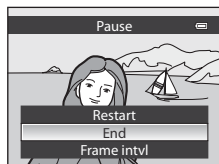

- When exiting or pausing the slide show, the screen shown on the right is displayed. Choose **End** and press the  button to return to the playback menu. Choose **Restart** to play the slide show again.



Notes on Slide Shows

- Only the first frame of movies (126) included in slide shows is displayed.
- Pictures recorded with easy panorama cannot be played back in a slide show.
- Slide shows play for a maximum of about 30 minutes, even when **Loop** is selected (153).

Protect

Press the  button (Playback mode) → MENU (Playback menu) →  Protect

Protect selected pictures from accidental deletion.

In the picture selection screen, choose a picture and set or cancel protection. See “Selecting Pictures” ( 103) for more information.

Note, however, that formatting the camera’s internal memory or the memory card permanently erases the protected files ( 154).

Protected pictures are recognized by the  icon in playback mode ( 8, 95).

Selecting Pictures

The picture selection screen, as shown on the right, is displayed in the following menus.

Only one picture can be selected for some menu items, while for other menu items, multiple pictures can be selected.



Functions for which only one picture can be selected	Functions for which multiple pictures can be selected
<ul style="list-style-type: none"> • Playback menu: Rotate image (📖104) • Setup menu: Select an image in Welcome screen (📖143) 	<ul style="list-style-type: none"> • Playback menu: Select images in Print order (📖99), Protect (📖102), Selected images in Copy (📖107) • Erase selected images in Deleting Unnecessary Images (📖31)

Follow the procedure described below to select pictures.

1 Rotate the rotary multi selector, or press ◀ or ▶ to choose the desired picture.

- Rotate the zoom control toward **T** (📄) to switch to full-frame playback, or **W** (📖) to switch to 12 thumbnails display.
- For functions for which only one picture is selected, proceed to step 3.



2 Press ▲ or ▼ to select or deselect (or to specify the number of copies).

- When a picture is selected, a check mark (☑) is displayed with the picture. Repeat steps 1 and 2 to select additional pictures.



3 Press the Ⓞ button to apply the picture selection.



- With selections such as **Selected images**, the confirmation dialog is displayed. Follow the instructions on the screen.

Rotate Image

Press the  button (Playback mode) → MENU (Playback menu) →  Rotate image

Change the orientation of pictures played back in the camera's monitor after shooting. Still pictures can be rotated 90° clockwise or counterclockwise.

Pictures that were recorded in the "tall" orientation can be rotated up to 180° in either direction.

Select a picture in the picture selection screen ( 103) to display the Rotate image screen. Rotate the rotary multi selector, or press  or  to rotate the picture 90°.

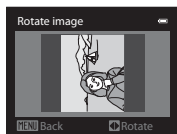

Rotate 90°
counterclockwise

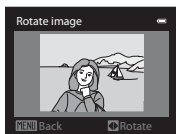

Rotate 90°
clockwise





Press the  button to set the orientation displayed and save the orientation data with the picture.

Voice Memo

Press the  button (Playback mode) → MENU (Playback menu) →  Voice memo

Use the camera's microphone to record voice memos for pictures.

Recording Voice Memos

- 1 Choose the desired picture from full-frame ()30) or thumbnail ()94) playback mode and press the **MENU** button.

- The playback menu is displayed.

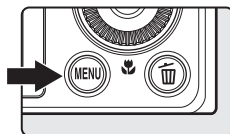

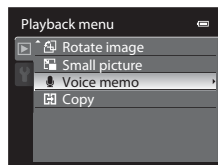

- 2 Use the rotary multi selector to choose  **Voice memo** and press the **OK** button.

- The screen for recording voice memos is displayed.



- 3 Press and hold the **OK** button to record a voice memo.

- Recording ends after about 20 seconds or when the **OK** button is released.
- Do not touch the microphone during recording.
- During recording, **REC** and  blink on the monitor.
- When recording ends, the voice memo playback screen is displayed. Follow the procedure in step 3 of "Playing Voice Memos" ()106) to play the voice memo.
- Press the rotary multi selector  before or after recording a voice memo to return to the playback menu. Press the **MENU** button to exit the playback menu.

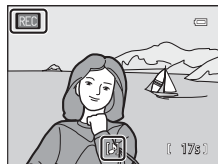
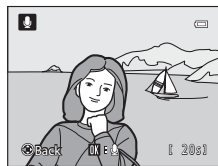



More Information

See "File and Folder Names" ()168) for more information.

Playing Voice Memos

Pictures for which voice memos have been recorded are indicated by  in full-frame playback mode.

- 1 Choose a picture with a voice memo in full-frame playback mode (30) or thumbnail playback mode (94) and press the **MENU** button.

- The playback menu is displayed.

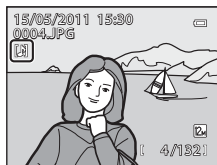

- 2 Use the rotary multi selector to choose  **Voice memo** and press the **OK** button.

- The voice memo playback screen is displayed.

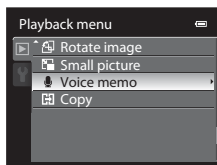







- 3 Press the **OK** button to play the voice memo.

- Press the **OK** button again to stop playback.
- Rotate the zoom control toward **T** or **W** during playback to adjust playback volume.
- Press the rotary multi selector  before or after playing a voice memo to return to the playback menu. Press the **MENU** button to exit the playback menu.



Deleting Voice Memos



Select a picture with a voice memo and press the  button. Rotate the rotary multi selector or press  or  to choose **Current image**, and press the **OK** button (31). When the confirmation dialog is displayed, press the rotary multi selector  or  to choose  and press the **OK** button. Only the voice memo will be deleted.



Notes on Voice Memos





- When a picture with a voice memo attached is deleted, both the picture and its voice memo are deleted.
- Voice memos cannot be recorded for a picture that already has a voice memo attached on it. The current voice memo must be deleted before a new voice memo can be recorded.
- The COOLPIX P300 is not able to record a voice memo for a picture captured with another make or model of digital camera.
- Voice memos cannot be attached to pictures recorded with easy panorama.

Copy: Copying Between the Internal Memory and Memory Card

Press the  button (Playback mode) → MENU (Playback menu) →  Copy

Copy pictures between the internal memory and a memory card.

1 Use the rotary multi selector to choose a destination option to which images are copied and press the  button.

-  → : Copy pictures from the internal memory to the memory card.
-  → : Copy pictures from the memory card to the internal memory.

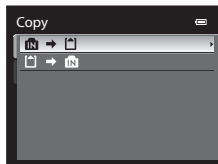

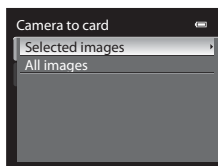

2 Choose a copy option and press the  button.

- **Selected images:** In the picture selection screen (103), choose the pictures for copying.
- **All images:** Copy all pictures.



Notes on Copying Pictures

- JPEG-, MOV- and WAV-format files can be copied. Files recorded in any other format cannot be copied.
- If voice memos (105) are attached to pictures selected for copying, voice memos are copied with the pictures.
- Operation is not guaranteed with pictures recorded with another make or model of camera or that have been modified on a computer.
- When pictures with **Print order** (99) settings are copied, the print order settings are not copied. When pictures with **Protect** (102) settings are copied, the copied pictures are also protected.

Message: “Memory contains no images.”

If there are no pictures stored on the memory card when playback mode is selected, the message, **Memory contains no images.**, is displayed. Press the **MENU** button to display the copy option screen, and copy the pictures stored in the camera’s internal memory to the memory card.

More Information

See “File and Folder Names” (168) for more information.

Picture Editing Functions

Pictures can be easily edited with this camera using the functions below. Edited pictures are stored as separate files (📖168).

Editing function	Application
Quick retouch (📖110)	Easily create a copy with enhanced contrast and richer colors.
D-Lighting (📖111)	Create a copy of the current picture with enhanced brightness and contrast, brightening dark portions of the picture.
Skin softening (📖112)	Make facial skin tones softer.
Filter effects (📖114)	Apply a variety of effects using digital filter. The available effects are Cross screen , Fisheye , Miniature effect and Painting .
Small picture (📖116)	Create a small copy of pictures suitable for uses such as e-mail attachments.
Crop (📖117)	Crop a portion of the image. Use to zoom in on a subject or arrange a composition.

✔ Notes on Picture Editing

- Pictures shot with an **Image mode** (📖74) of 📷 **3968x2232** cannot be edited.
- Pictures recorded with easy panorama cannot be edited.
- When no faces are detected in the picture, skin softening cannot be applied (📖112).
- The COOLPIX P300's editing functions are not available for pictures shot with digital cameras other than the COOLPIX P300.
- If a copy created using the COOLPIX P300 is viewed on a different digital camera, it may not be possible to display the picture properly or transfer it to a computer.
- Editing functions are not available when there is not enough free space in the internal memory or on the memory card.

Restrictions on Picture Editing

The following restrictions apply when editing pictures that were created by editing.

Editing function used	Editing function to add
Quick retouch D-Lighting	Skin softening, Filter effects, Small picture or crop can be used. Quick retouch and D-Lighting cannot be used together.
Skin softening Filter effects	Quick retouch, D-Lighting, Small picture or crop can be used.
Small picture Crop	No additional editing functions can be used.

- Copies created by editing cannot be edited again using the same edit function.
- To use an editing function together with small picture or crop, use the other edit function first, and use small picture or crop as the last edit function performed on that picture.
- Pictures that were taken using skin softening can be edited using skin softening.

Original Pictures and Edited Copies

- Copies created with editing functions are not deleted if the original pictures are deleted. The original pictures are not deleted if copies created with editing functions are deleted.
- Edited copies are stored with the same shooting date and time as the original.
- Even if the pictures that are marked for **Print order** (📖99) or **Protect** (📖102) are used for editing, these settings are not reflected on the edited copies.

Editing Pictures

Quick Retouch: Enhancing Contrast and Saturation

Easily create retouched pictures in which contrast and saturation have been enhanced. Retouched copies are stored as separate files.

- 1 Choose the desired picture from full-frame ()30) or thumbnail ()94) playback mode and press the **MENU** button.

- The playback menu is displayed.

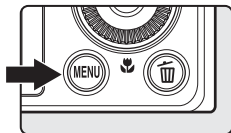

- 2 Use the rotary multi selector to choose  **Quick retouch** and press the **OK** button.

- The original version is displayed on the left and the edited version is displayed on the right.

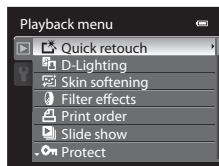

- 3 Press **▲** or **▼** to choose the setting level, and press the **OK** button.

- A retouched copy is created.
- To cancel, press the **MENU** button.

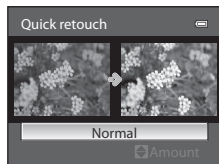

- Quick retouched copies can be recognized by the  icon displayed in playback mode.





More Information

See "File and Folder Names" ()168) for more information.

D-Lighting: Enhancing Brightness and Contrast

Create copies with enhanced brightness and contrast, brightening dark portions of a picture. Enhanced copies are stored as separate files.

- 1 Choose the desired picture from full-frame ()30) or thumbnail ()94) playback mode and press the **MENU** button.

- The playback menu is displayed.

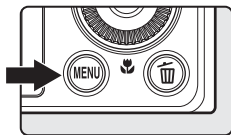

- 2 Use the rotary multi selector to choose  **D-Lighting** and press the **OK** button.

- The original version is displayed on the left and the edited version is displayed on the right.



- 3 Choose **OK** and press the **OK** button.

- A new, edited copy is created.
- To cancel, choose **Cancel** and press the **OK** button.

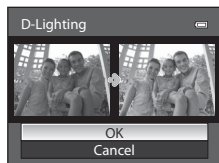

- D-Lighting copies can be recognized by the  icon displayed in playback mode.



More Information

See "File and Folder Names" ()168) for more information.

Skin Softening: Making Skin Appear Smoother

Skin softening can be applied to faces that are detected in pictures already taken, to make skin appear smoother. Pictures edited with this function are stored as separate files.

- 1 Choose the desired picture from full-frame ()30) or thumbnail ()94) playback mode and press the **MENU** button.

- The playback menu is displayed.

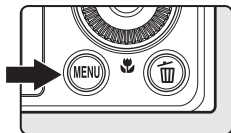

- 2 Use the rotary multi selector to choose  **Skin softening** and press the **OK** button.

- The screen that allows you to set the amount of skin softening is displayed.
- If no faces are detected in the image, a warning is displayed and the screen returns to the playback menu.



- 3 Press **▲** or **▼** to choose the setting level, and press the **OK** button.

- A confirmation screen is displayed, and the image is displayed zoomed in on the face edited by skin softening.
- To cancel, press the **MENU** button.

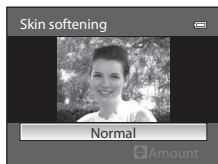

4 Confirm the results.

- Skin tones in up to 12 faces, in the order of that closest to the center of the frame, are softened.
- When multiple faces are edited using skin softening, use the rotary multi selector ◀ and ▶ to switch the face that is displayed.
- To adjust the extent of skin softening, press the **MENU** button and return to step 3.
- To create a copy edited with skin softening, press the **OK** button.
- Copies created by editing with skin softening can be recognized by the  icon displayed in playback mode.

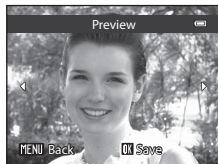

Note on Skin Softening

Depending on conditions such as the direction the subject is facing or the brightness of the face, the face may not be detected properly, or the desired effect may not be achieved.

More Information

See "File and Folder Names" ( 168) for more information.

Filter Effects: Digital Filter

Apply a variety of effects using digital filter. The following effect options are available.

The image created with the filter effect is saved separately from the original picture file.

Option	Description
Cross screen	Produce star-like rays of light that radiate outward from bright objects such as sunlight reflections and city lights. Suitable for night scenes.
Fisheye	Creates images that look like they were shot with a fisheye lens. Suitable for pictures shot in macro mode.
Miniature effect	Creates images that look like close-up photos of a diorama. Suitable for pictures shot while looking down from a high location, with the main subject near the center of the frame.
Painting	Creates images with the ambience of paintings.

- 1 Choose the desired picture from full-frame (📖30) or thumbnail (📖94) playback mode and press the **MENU** button.

- The playback menu is displayed.

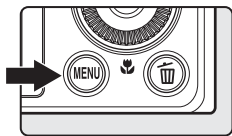

- 2 Use the rotary multi selector to choose **Filter effects** and press the **OK** button.



- 3 Choose the filter effect type and press the **OK** button.

- A confirmation screen is displayed.

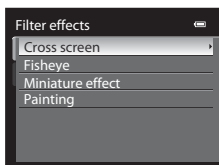

4 Check the effect, choose **Save** and press the **OK** button.

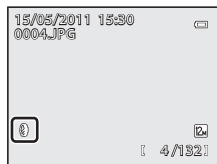
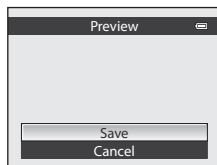

- A new, edited copy is created.
- To cancel, select **Cancel** and press the **OK** button.
- Copies created by editing with filter effect can be recognized by the  icon displayed in playback mode.



More Information

See "File and Folder Names" ( 168) for more information.

Small Picture: Decreasing Image Size

Create a small copy of the picture taken. Suitable for displaying on web pages or sending as e-mail attachments. The available size is  **640×480**,  **320×240** or  **160×120**. Small copies are stored as separate files with a compression ratio of 1:16.

- 1 Choose the desired picture from full-frame () or thumbnail () playback mode and press the **MENU** button.

- The playback menu is displayed.

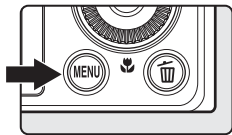

- 2 Use the rotary multi selector to choose  **Small picture** and press the **OK** button.

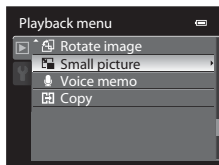

- 3 Choose the desired copy size and press the **OK** button.

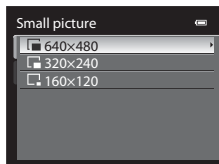

- 4 Choose **Yes** and press the **OK** button.

- A new, smaller copy is created.
- To cancel, choose **No** and press the **OK** button.
- The copy is displayed with a black frame.

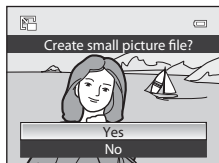

More Information

See "File and Folder Names" () 168) for more information.

✂ Crop: Creating a Cropped Copy

Create a copy containing only the portion visible on the monitor when **MENU** = ✂ is displayed with playback zoom (📖96) enabled. Cropped copies are stored as separate files.

1 Rotate the zoom control toward **T** (📐) in full-frame playback mode (📖30) to zoom in on the picture.

- To crop a picture displayed in "tall" orientation, zoom in on the picture until the black bars displayed on the both sides of the monitor disappear. The cropped picture is displayed in landscape orientation. To crop the picture in its current "tall" orientation, first, use the **Rotate image** option (📖104) to rotate the picture so that it is displayed in landscape orientation. Next, enlarge the picture for cropping, crop the picture, and then rotate the cropped picture back to "tall" orientation.

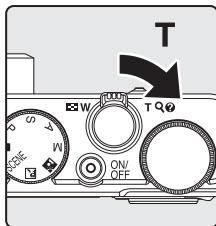

2 Refine copy composition.

- Rotate the zoom control toward **T** (📐) or **W** (📏) to adjust the zoom ratio.
- Press the rotary multi selector ▲, ▼, ◀ or ▶ to scroll the picture so that only the portion to be copied is visible on the monitor.



3 Press the **MENU** button.

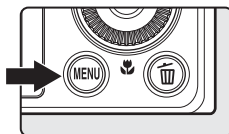

4 Use the rotary multi selector to choose **Yes** and press the **OK** button.

- A cropped copy is created.
- To cancel, choose **No** and press the **OK** button.

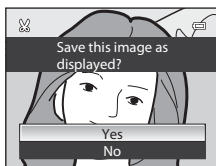

📐 Image Size

As the area to be saved is reduced, the image size (pixels) of the cropped copy is also reduced. When the image size setting for a cropped copy is 320x240 or 160x120, a black frame appears around the picture during playback, and the 📐 or 📏 small picture icon appears on the left side of the monitor.

🔍 More Information

See "File and Folder Names" (📖168) for more information.

Recording Movies

High-definition movies with sound can be recorded.

- The maximum movie length for a single movie is 4 GB or 29 minutes, even when there is sufficient free space on the memory card (📖125).

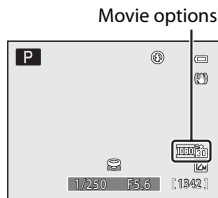

1 Turn on the camera and display the shooting screen.

- Movies can be recorded in any shooting mode (📖40).
- The movie options show the type of movie that will be recorded. The default setting is  **HD 1080p★** (1920×1080) (📖123).

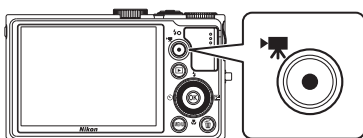

2 Press the movie-record) button to start movie recording.



- The LCD monitor turns off for a moment, and then the movie recording starts.
- Focusing for movie recording
→ See "Autofocus Mode" (📖125).
→ See "Movie Recording of a Subject for Which Autofocus Does Not Perform as Expected" (📖119).
- When recording movies in HD or Full HD, monitor display changes to an aspect ratio of 16:9 with movie recording (the area indicated on the right is recorded).
- When **Movie frame+auto info** is selected for **Photo info** of **Monitor settings** (📖147) in the setup menu, the movie frame can be displayed on the monitor before recording movies.
- When the rotary multi selector  is pressed during movie recording, the exposure is locked. To unlock, press  again.
- The approximate remaining movie length is displayed during recording.
- Recording stops automatically when the maximum movie length has been recorded.



3 Press the movie-record) button to end recording.

Note on Saving Movies



After a movie has been recorded, it is not fully saved to the internal memory or memory card until monitor display returns to the shooting display. **Do not open the battery-chamber/memory card slot cover** before movies have been fully saved. Removing the memory card or the battery while a movie is being saved may result in loss of the movie data or damage to the camera or to the memory card.

✓ Notes on Movie Recording

- When recording a movie onto a memory card, a memory card with an SD speed class of Class 6 or higher is recommended (📖167). If the transfer speed of the card is slow, the movie recording may end unexpectedly.
- When recording movies, the angle of view (i.e., the area visible in the frame) is narrower than that of still pictures.
- Using a digital zoom causes image quality to deteriorate. If you start recording the movie without using digital zoom, and you rotate the zoom control toward **T**, the zoom stops at the maximum optical zoom ratio. Release the zoom control and rotate it again toward **T** to trigger digital zoom. When recording ends, digital zoom turns off.
- The sound of using the zoom control, zoom, autofocus, vibration reduction or aperture control when the brightness changes may be recorded.
- The following phenomena may be seen on the monitor while recording movies. These phenomena are saved in the recorded movies.
 - Banding may occur in images under fluorescent, mercury-vapor, or sodium-vapor lighting.
 - Subjects that move quickly from one side of the frame to the other, such as a moving train or car, may appear skewed.
 - The entire movie image may be skewed when the camera is panned.
 - Lighting or other bright areas may leave residual images when the camera is moved.

✓ Movie Recording of a Subject for Which Autofocus Does Not Perform as Expected



Autofocus may not perform as expected (📖29). Should this occur, try the following:

1. Set to  (Auto) mode, or set **AF area mode** (📖83) to **Center** or **Manual** in **P**, **S**, **A** or **M** mode.
2. Before recording, set **Autofocus mode** (📖125) in the movie menu to  **Single AF** (default setting).
3. Position the focus area on a different subject at the same distance. Press the  (movie-record) button to start the movie recording, and change the composition.

✓ Note on the Camera Temperature

The camera may become warm when recording movies for an extended period of time or when the camera is used in a hot area. This is not a malfunction.

📎 Functions Available in Movie Recording

- The creative slider, exposure compensation or white balance settings are also applied to the movie that is recorded. Hue adjustment in the scene mode (📖41) or special effects (📖56) is also applied to the movie that is recorded. In macro mode, a movie can be recorded closer to the subject. Check the settings before starting to record the movie.
- The self-timer (📖35) can be used. If the self-timer is set and the  (movie-record) button is pressed, the camera starts movie recording after ten or two seconds.
- Flash does not fire.
- Press the **MENU** button before starting to record the movie to display the  (movie) tab and select movie menu settings (📖122).
- Settings cannot be changed during movie recording. Before movie recording, check the settings.

Recording Movies in Slow Motion and Fast Motion (HS Movie)

HS (high speed) movies can be recorded. Movies recorded using HS movie can be played back in slow motion at 1/4 or 1/2 of normal playback speed, or played back in fast motion at a speed two times faster than normal speed.

- 1 Display the movie menu (122), use the rotary multi selector to choose **Movie options**, and then press the **OK** button.

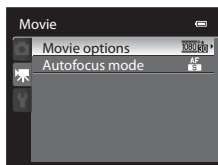

- 2 Change to **VGA** **HS 120 fps (640×480)**, **720p** **HS 60 fps (1280×720)** or **1080p** **HS 15 fps (1920×1080)**, and then press the **OK** button.

- Press the **MENU** button after changing the settings and return to the shooting screen.

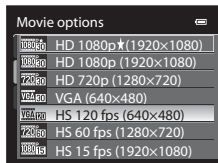

- 3 Press the **REC** (**movie-record**) button to start recording.

- The LCD monitor turns off for a moment, and then the HS movie recording starts.
- The camera focuses at the center of the frame. Focus areas are not displayed during recording.
- When recording movies with **720p** **HS 60 fps (1280×720)** or **1080p** **HS 15 fps (1920×1080)**, monitor display changes to an aspect ratio of 16:9.
- The approximate remaining movie length is displayed during recording.
- Recording stops automatically when the maximum movie length has been recorded.

HS movie options

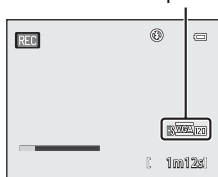

- 4 Press the **REC** (**movie-record**) button to end recording.

✓ Notes on HS Movie

- The sound is not recorded.
- Zoom position, focus, exposure and white balance are locked when the ● (📹 movie-record) button is pressed to start recording.

📹 HS Movie

Recorded movies are played back at about 30 frames per second.

When **Movie options** (📖 123) is set to **VGA₁₂₀ HS 120 fps (640×480)** or **720₆₀ HS 60 fps (1280×720)**, movies that can be played back in slow motion can be recorded. When set to **1080₁₅ HS 15 fps (1920×1080)**, movies that can be played back in fast motion at a speed two times faster than normal speed can be recorded.

When recorded at VGA₁₂₀ HS 120 fps (640×480):

A movie of up to seven minutes and 15 seconds in length is recorded when recording for the purpose of high-speed capture. Movies recorded at high speed can be played back in slow motion at a speed four times slower than normal speed.

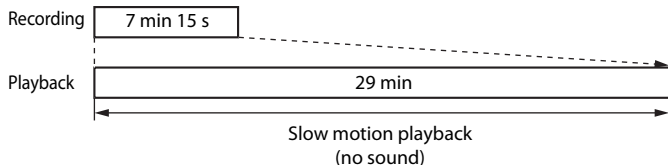

When recorded at 1080₁₅ HS 15 fps (1920×1080):

A movie of up to 29 minutes in length is recorded when recording for the purpose of high-speed playback. Playback is two times faster.

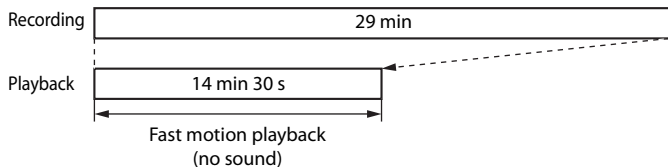

Using the Movie Menu

The options below can be set in the movie menu.

Movie options

123

Select the desired movie option to record.

Autofocus mode

125

Choose how the camera focuses when recording movies.

Displaying the Movie Menu

Press the **MENU** button in the shooting mode to display the menu, use the rotary multi selector to change to the  tab and display the movie menu (11).

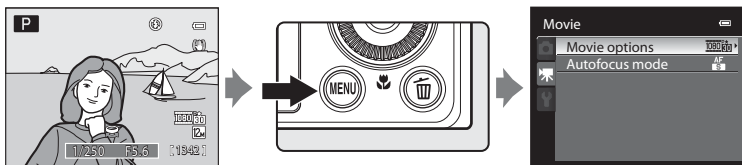

- Use the rotary multi selector to select items and set functions on the menu (10).
- Press the **MENU** button to exit the movie menu.

Movie Options





Display the shooting screen → MENU → 冫 (Movie menu) (122) → Movie options

You can choose the type of movie to shoot.

The camera can record normal speed movies and HS (high speed) movies (120), which can be played back in slow motion or fast motion.



The higher the resolution and bitrate, the higher the picture quality; but the file size also becomes larger.

Normal Speed Movies

Option	Description
 HD 1080p★ (1920×1080) (default setting)	Movies with an aspect ratio of 16:9 are recorded in full high-definition. This option is suited to playback on a wide screen TV that is compatible with full high-definition. <ul style="list-style-type: none"> • Image size: 1920 × 1080 pixels • Movie bitrate: 18.8 Mbps • Frame rate: 30 frames per second
 HD 1080p (1920×1080)	Movies with an aspect ratio of 16:9 are recorded in full high-definition. This option is suited to playback on a wide screen TV that is compatible with full high-definition. <ul style="list-style-type: none"> • Image size: 1920 × 1080 pixels • Movie bitrate: 12.6 Mbps • Frame rate: 30 frames per second
 HD 720p (1280×720)	Movies with an aspect ratio of 16:9 are recorded in high-definition. This option is suited to playback on a wide screen TV. <ul style="list-style-type: none"> • Image size: 1280 × 720 pixels • Movie bitrate: 8.4 Mbps • Frame rate: 30 frames per second
 VGA (640×480)	Movies with an aspect ratio of 4:3 are recorded. <ul style="list-style-type: none"> • Image size: 640 × 480 pixels • Movie bitrate: 2.9 Mbps • Frame rate: 30 frames per second







HS Movies

See “Recording Movies in Slow Motion and Fast Motion (HS Movie)” (📖120) for more information.

Option	Description
 HS 120 fps (640×480)	<p>1/4-speed slow motion movies with an aspect ratio of 4:3 are recorded.</p> <ul style="list-style-type: none"> • Max. movie length: 7 min 15 s (playback time: 29 min) • Image size: 640 × 480 pixels • Movie bitrate: 2.8 Mbps • Frame rate: 120 frames per second • When the shooting mode is set to special effects (📖56), the Soft effect is not applied to the movies. Only hue adjustment in Nostalgic sepia is applied.
 HS 60 fps (1280×720)	<p>1/2-speed slow motion movies with an aspect ratio of 16:9 are recorded.</p> <ul style="list-style-type: none"> • Max. movie length: 14 min 30 s (playback time: 29 min) • Image size: 1280 × 720 pixels • Movie bitrate: 8.3 Mbps • Frame rate: 60 frames per second
 HS 15 fps (1920×1080)	<p>2× speed fast motion movies with an aspect ratio of 16:9 are recorded.</p> <ul style="list-style-type: none"> • Max. movie length: 29 min (playback time: 14 min 30 s) • Image size: 1920 × 1080 pixels • Movie bitrate: 18.6 Mbps • Frame rate: 15 frames per second

- The movie bitrate is the volume of movie data recorded per second. As a variable bitrate (VBR) system has been adopted, the movie recording rate varies automatically according to the subject so that more data is recorded per second for movies containing frequently moving subjects, thus increasing movie file size.

Maximum Movie Length

Option	Internal memory (90 MB)	Memory card (4 GB) ³
 HD 1080p★ (1920×1080) (default setting)	37 s ¹	25 min
 HD 1080p (1920×1080)	57 s	40 min
 HD 720p (1280×720)	1 min 25 s	1 h
 VGA (640×480)	4 min 2 s	3 h
 HS 120 fps (640×480)	1 min 5 s	45 min
 HS 60 fps (1280×720)	42 s ²	30 min
 HS 15 fps (1920×1080)	1 min 17 s	50 min

All figures are approximate. The maximum movie length varies with the make of the memory card and the bitrate of the recorded movie.

- 1 The maximum movie length for a single movie is 25 seconds.
- 2 The maximum movie length for a single movie is 30 seconds.
- 3 The maximum movie length for a single movie is 4 GB or 29 minutes, even when there is sufficient free space on the memory card. The maximum movie length for a single movie is displayed during recording.

More Information



See “File and Folder Names” (📖168) for more information.

Autofocus Mode

Display the shooting screen → MENU →  (Movie menu) (📖122) → Autofocus mode

Choose how the camera focuses during movie recording.

- Focus areas are not displayed during recording.

Option	Description
 Single AF (default setting)	Focus is locked when the  (movie-record) button is pressed to start recording. The camera focuses on the same focus area as when shooting still pictures. Select this option when the distance between the camera and the subject remains fairly consistent.
 Full-time AF	The camera focuses continuously when recording normal speed movies. The camera focuses at the center of the frame. Suitable for shooting when the distance between the camera and subject changes. The operation sound when the camera focuses may be recorded. Setting to Single AF is recommended if the sound is noticeable. <ul style="list-style-type: none"> • In HS movie (📖120), focus is locked at the center of the frame (autofocus does not perform while recording).

Movie Playback

In full-frame playback mode (📖30), movies can be recognized by a movie options icon (📖123). To play a movie, press the **OK** button.

Use the zoom control **T** or **W** during playback to adjust the volume.

Rotate the rotary multi selector to advance or rewind the movie.

Playback controls appear at the top of the monitor. Press the rotary multi selector ◀ or ▶ to choose a playback control, then press the **OK** button to perform the selected operation. The following operations are available.

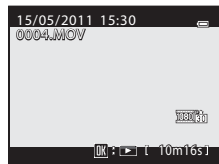

Pausing



During playback Volume indicator

To	Use	Description
Rewind	◀◀	Rewind the movie while the OK button is pressed down.
Advance	▶▶	Advance the movie while the OK button is pressed down.
Pause		The following operations can be performed with the playback controls at the top of the monitor while playback is paused.
		◀◀ Rewind the movie by one frame. Hold down the OK button to rewind continuously.*
		▶▶ Advance the movie by one frame. Hold down the OK button to advance continuously.*
	▶	Resume playback.
End	■	Return to full-frame playback mode.

* The movie can also be advanced or rewound by one frame by rotating the rotary multi selector.

Deleting Unnecessary Movies

Press the **🗑** button when a movie is selected in full-frame playback mode (📖30) or thumbnail playback mode (📖94) to display the confirmation dialog for deletion. See “Deleting Unnecessary Images” (📖31) for more information.

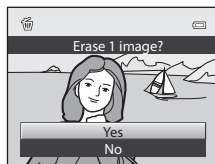

✔ Note on Movie Playback

Movies shot with cameras other than COOLPIX P300 cannot be played back.

Connecting to a TV

Connect the camera to a television to play back pictures on the television. If your television is equipped with an HDMI connector, you can connect it to the camera with a commercially available HDMI cable to enjoy recorded movies in the high-definition quality.

1 Turn off the camera.

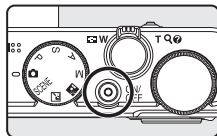

2 Connect the camera to the TV.

When connecting using the supplied audio/video cable

- Connect the yellow plug to the video-in jack on the TV, and the red and white plugs to the audio-in jacks.

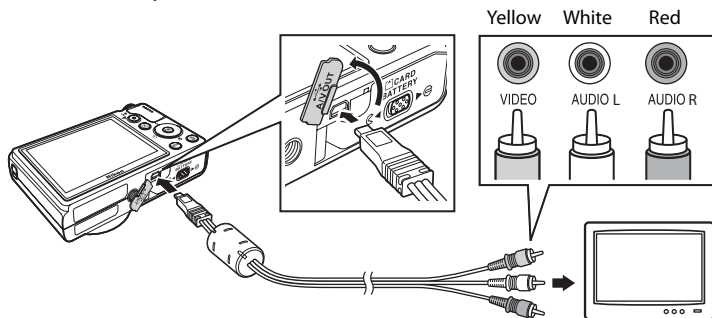

When connecting using a commercially available HDMI cable

- Connect the plug to the HDMI jack on the TV.

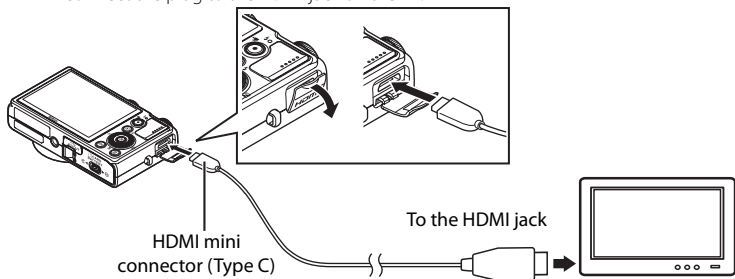

3 Tune the television to the video channel.

- See the documentation provided with your television for details.

4 Hold down the button to turn on the camera.

- The camera enters playback mode, and the recorded pictures are displayed on the television.
- While the camera is connected to the TV, the camera monitor remains off.

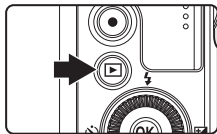

Notes on Connecting an HDMI Cable

- An HDMI cable is not supplied. Use a commercially available HDMI cable to connect the camera to a TV. The output terminal on this camera is a HDMI Mini Connector (Type C). When purchasing an HDMI cable, be sure that the device end of the cable is a HDMI Mini Connector.
- To enjoy playback in high-definition quality when the camera is connected to a television that has an HDMI connector, we recommend shooting still pictures with **Image mode** (📖74) set to **3M 2048x1536** or higher, and recording movies with **Movie options** (📖123) set to **720p HD 720p (1280x720)** or higher.

Notes on Connecting the Audio/Video Cable

- When connecting the cable, be sure that the connector is oriented correctly. Do not force the connector into the camera. When disconnecting the cable, do not pull the connector at an angle.
- Do not connect cables to the camera's HDMI mini connector and USB/audio video connector simultaneously.

When Nothing Appears on the TV

Make sure that **TV settings** (📖155) in the setup menu (📖141) is appropriate for your television.

Using the TV's Remote Control (HDMI Device Control)

The remote control of a TV that conforms to the HDMI-CEC standard can be used to operate the camera during playback.

Instead of the rotary multi selector or zoom control, the remote control can be used for picture selection, playback/pause of movies or easy panorama pictures, and switching between full-frame playback and 4-picture thumbnail display.

- Set **HDMI device control** (📖155) of **TV settings** to **On** (default setting) in the setup menu, and connect the camera to the TV with an HDMI cable.
- Point the remote control at the TV to operate.
- See your TV's manual or other related documentation to check whether your TV supports the HDMI-CEC standard.

Connecting to a Computer

Use the supplied USB cable to connect the camera to a computer and copy (transfer) images to the computer.

Before Connecting the Camera

Install the Software

Use the supplied ViewNX 2 CD and install the following software on the computer. For more information on installing the software, refer to the *Quick Start Guide*.

- ViewNX 2: Use the image transfer feature “Nikon Transfer 2” to save images that were captured with the camera on the computer. Saved images can be viewed and printed. Image and movie editing features are also supported.
- Panorama Maker 5: This software can join a series of images to create a single panorama image.

Compatible Operating Systems

Windows

Windows 7 Home Basic/Home Premium/Professional/Enterprise/Ultimate, Windows Vista Home Basic/Home Premium/Business/Enterprise/Ultimate (Service Pack 2), or Windows XP Home Edition/Professional (Service Pack 3)

Macintosh

Mac OS X (version 10.4.11, 10.5.8, 10.6.5)

For information on the requirements for playing back high-definition movies, refer to “System Requirements” in the ViewNX 2 help information (📖133).

Refer to the Nikon website for the latest information on operating system compatibility.

Note on Computer Connection

Disconnect other USB devices such as commercial USB chargers from the computer. Simultaneous connection of the camera and other USB devices to the computer could result in operation malfunction or excessive supply of power to the camera, causing damage to the camera or memory card. Refer to the documentation supplied with other USB devices for more information.

Connecting to a Computer

✔ Notes on Power Source

- When connecting the camera to a computer, use a battery with a sufficient amount of charge remaining to prevent the camera from turning off unexpectedly.
- When the camera is connected to a computer via the supplied USB cable with **Auto** (default setting) selected for the **Charge by computer** option in the setup menu, the battery inserted into the camera is automatically charged using power supplied by the computer (134, 156).
- If the AC Adapter EH-62F (166) (available separately) is used, COOLPIX P300 can be powered from an electrical outlet. Do not use any other make or model of AC adapter as they may cause the camera to overheat or malfunction.

Transferring Images from a Camera to a Computer

- 1 Start the computer to which ViewNX 2 was installed.
- 2 Be sure that the camera is off.
- 3 Connect the camera to the computer using the supplied USB cable.

Be sure that connectors are properly oriented. Do not attempt to insert connectors at an angle, and do not use force when connecting or disconnecting the USB cable.

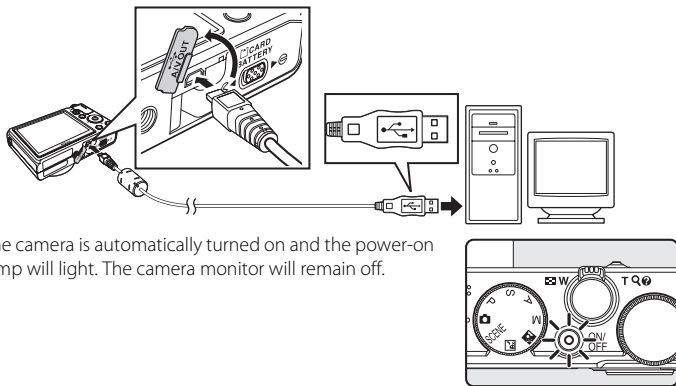

The camera is automatically turned on and the power-on lamp will light. The camera monitor will remain off.

✔ Connecting the USB Cable

The connection may not be recognized if the camera is connected to the computer via a USB hub.

4 Start the ViewNX 2 image transfer feature “Nikon Transfer 2” installed on the computer.

• Windows 7

When the **Devices and Printers ► P300** screen is displayed, click **Change program** under **Import pictures and videos**. Select **Import File using Nikon Transfer 2** in the **Change program** dialog and click **OK**.

Double-click **Import File** on the **Devices and Printers ► P300** screen.

• Windows Vista

When the **AutoPlay** dialog is displayed, click **Import File using Nikon Transfer 2**.

• Windows XP

When the action selection dialog is displayed, select **Nikon Transfer 2 Import File**, and click **OK**.

• Mac OS X

Nikon Transfer 2 will start automatically when the camera is connected to the computer if **Yes** was selected in the **Auto-Launch setting** dialog when ViewNX 2 was first installed.

- See “Starting Nikon Transfer 2 Manually” (📖133) for more information.

- If charge for the battery inserted into the camera is low, the computer may not recognize the camera. If the camera is not recognized, images will not be transferred. When battery charging starts automatically using power supplied by the computer, wait until battery charge has reached a sufficient level to begin transfer.
- If there are a large number of images on the memory card, it may take some time for Nikon Transfer 2 to start.

5 Confirm that the source device is displayed in the transfer options **Source** panel and click **Start Transfer**.

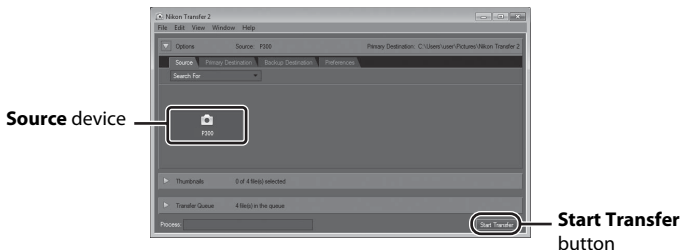

Any images that have not been transferred to the computer will be transferred (default setting of ViewNX 2).

Connecting to a Computer

When transfer is complete, the ViewNX 2 screen is displayed (ViewNX 2 default setting) and transferred images are displayed.

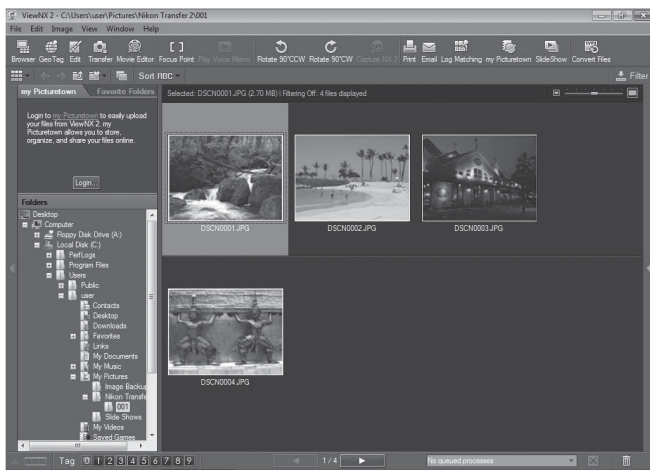

For more information on using ViewNX 2, refer to the ViewNX 2 help information (133).

Disconnecting the Camera

Do not turn off the camera or disconnect the camera from the computer during transfer.

When transfer is complete, turn off the camera and disconnect the USB cable.

The camera turns off automatically if there is no communication with the computer for 30 minutes while the camera is connected via the USB cable.

Charging the Battery

The charge lamp slowly blinks green while the battery inserted into the camera is charging (134).

Transferring Images Using a Computer's Card Slot or a Commercially-available Card Reader

When the memory card is inserted into a computer's card slot or into a commercially-available card reader, the images can be transferred using "Nikon Transfer 2", the image transfer feature of ViewNX 2.

- Make sure that the memory card being used is supported by the card reader or other card reading device.
- To transfer images, insert the memory card into the card reader or card slot and follow the procedure from step 4 (📖131).
- To transfer images saved in the camera's internal memory, the images must first be copied to a memory card using the camera (📖107).

Starting ViewNX 2 Manually

Windows

Choose **Start** menu > **All Programs** > **ViewNX 2** > **ViewNX 2**.

Double-clicking the **ViewNX 2** shortcut icon on the desktop will also start ViewNX 2.

Mac OS X

Open the **Applications** folder, open the **Nikon Software** > **ViewNX 2** folders in that order, and then double-click the **ViewNX 2** icon. Clicking the **ViewNX 2** icon on the Dock will also start ViewNX 2.

Starting Nikon Transfer 2 Manually

To start Nikon Transfer 2, first start ViewNX 2, and then click the **Transfer** icon at the top of the screen or select **Launch Transfer** from the **File** menu.

For More Information on Using ViewNX 2 and Nikon Transfer 2

For more information on ViewNX 2 or Nikon Transfer 2, start ViewNX 2 or Nikon Transfer 2 and select **ViewNX 2 Help** from the **Help** menu.

Panorama Creation with Panorama Maker 5

- Use a series of images captured with **Panorama assist** in the **Panorama** scene mode (📖60) to create a single panorama photo with Panorama Maker 5.
- Panorama Maker 5 can be installed on a computer using the supplied ViewNX 2 CD.
- After installation is complete, follow the procedure described below to start Panorama Maker 5.

Windows

Choose **Start** menu>**All Programs**>**ArcSoft Panorama Maker 5**>**Panorama Maker 5**.

Mac OS X

Open **Applications** and double-click the **Panorama Maker 5** icon.

- For more information on using Panorama Maker 5, refer to the on-screen instructions and help information contained in Panorama Maker 5.

Image File Names and Folder Names

See "File and Folder Names" (📖168) for more information.

Charging While Connecting to a Computer

When the **Charge by computer** option (📖156) in the camera's setup menu is set to **Auto** (default setting), if the camera is connected to a computer using the USB cable, the battery inserted into the camera can be automatically charged depending on the ability of the computer to supply power.

See "Before Connecting the Camera" (📖129) and "Transferring Images from a Camera to a Computer" (📖130) for more information on connecting the camera to a computer.

Charge Lamp

The following chart explains charge lamp status when the camera is connected to a computer.

Charge lamp	Description
Blinks slowly (green)	Battery charging.
Off	Battery not charging. If the charge lamp changes from slow blinking (green) to off while the power-on lamp is lit, charging is complete.
Flickers (green)	<ul style="list-style-type: none"> The ambient temperature is not suited to charging. Charge the battery indoors with an ambient temperature of 5 °C to 35 °C (41 °F to 95 °F). A USB cable is not correctly connected or the battery is faulty. Reconnect the USB cable correctly or replace the battery. Computer is in sleep mode and does not supply power. Reboot the computer. The battery cannot be charged as computer's specifications or settings does not support power supply to the camera.

✓ Notes on Charging with Connection to a Computer

- The battery cannot be charged, nor can data be transferred, when the camera is connected to a computer before the camera's display language and date and time have been set (📖20). If the camera's clock battery (📖145) has been exhausted, the date and time must be reset before the battery can be charged or images can be transferred with connection to a computer. In this case, use the Charging AC Adapter EH-69P (📖16) to charge the battery and then set the camera's date and time.
- If the camera is turned off, charging will also stop.
- If a computer enters sleep mode while charging, charging will stop and the camera may be turned off.
- When disconnecting the camera from a computer, turn the camera off and then disconnect the USB cable.
- It may take longer to charge the battery with connection to a computer than with charging using the Charging AC Adapter EH-69P. Charging time increases when images are transferred while the battery is charging.
- When the camera is connected to a computer, an application installed on the computer, such as Nikon Transfer 2, may start. If the camera was connected to the computer for the sole purpose of charging the battery, exit the application.
- The camera turns off automatically if there is no communication with the computer for 30 minutes after the battery has finished charging.
- Depending upon computer specifications, settings, and power supply and allocation, it may be impossible to charge the battery inserted into the camera via computer connection.

Connecting to a Printer

Users of PictBridge-compatible (📖184) printers can connect the camera directly to the printer and print pictures without using a computer. Follow the procedures below to print pictures.

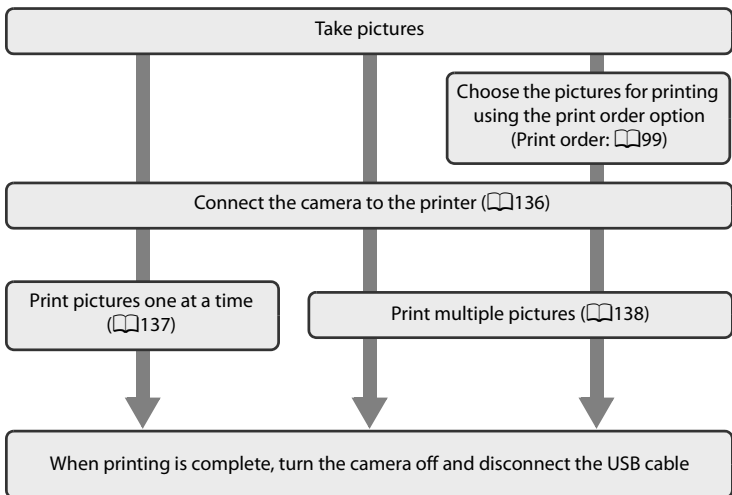

✓ Notes on Power Source

- When connecting the camera to a printer, use a fully charged battery to prevent the camera from turning off unexpectedly.
- If the AC Adapter EH-62F (available separately) (📖166) is used, COOLPIX P300 can be powered from an electrical outlet. Do not use any other make or model of AC adapters as they may cause the camera to heat up or malfunction.

🔍 Printing Pictures

In addition to printing pictures transferred to a computer and printing pictures with a direct camera-to-printer connection, the following options are also available for printing pictures recorded on the memory card:

- Insert a memory card into a DPOF-compatible printer's card slot.
- Take a memory card to a digital photo lab.

For printing using these methods, you can specify the pictures and the number of prints each using the **Print order** (📖99) option in the playback menu.

Connecting the Camera and Printer

- 1 Turn off the camera.

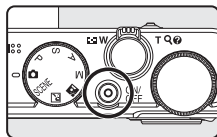

- 2 Turn on the printer.

- Check the printer settings.

- 3 Connect the camera to the printer using the supplied USB cable.

- Be sure that connectors are properly oriented. Do not attempt to insert connectors at an angle, and do not use force when connecting or disconnecting the USB cable.

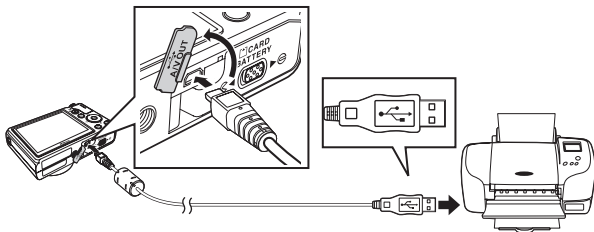

- 4 The camera is automatically turned on.

- When connected correctly, the **PictBridge** startup screen (①) is displayed in the camera monitor. Then the **Print selection** screen (②) is displayed.

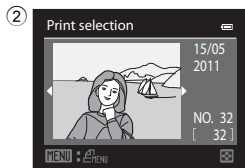
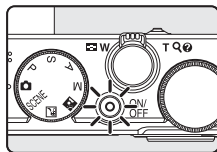

✔ If the PictBridge Startup Screen Is Not Displayed

Turn the camera off and disconnect the USB cable. Set the **Charge by computer** option (📖156) in the camera's setup menu to **Off** and reconnect the cable.

Printing Pictures One at a Time

After connecting the camera to the printer correctly (136), print pictures by following the procedure below.

1 Use the rotary multi selector to choose the picture to be printed and press the **OK** button.

- Rotate the zoom control to **W** (12) to display 12 thumbnails, or to **T** (Q) to switch back to full-frame playback.

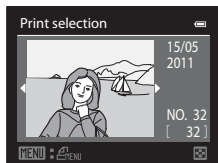

2 Choose **Copies** and press the **OK** button.

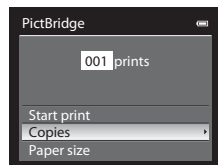

3 Choose the number of copies (up to nine) and press the **OK** button.



4 Choose **Paper size** and press the **OK** button.

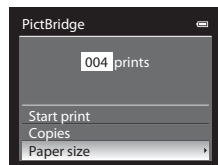

5 Choose the desired paper size and press the **OK** button.

- To specify the paper size using the printer settings, choose **Default** in the paper size menu.

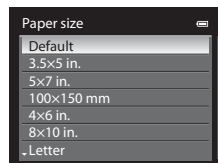

6 Choose **Start print** and press the **OK** button.

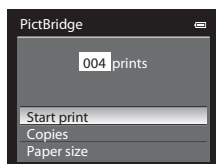

7 Printing starts.

- The monitor display returns to that shown in step 1 when printing is complete.
- To cancel before all copies have been printed, press the **OK** button.

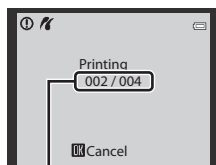

Current print/total number of prints

Printing Multiple Pictures

After connecting the camera to the printer correctly (📖136), print pictures by following the procedure below.

1 When the **Print selection** screen is displayed, press the **MENU** button.

- The **Print menu** is displayed.

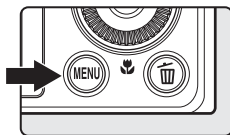

2 Use the rotary multi selector to choose **Paper size** and press the **OK** button.

- To exit the print menu, press the **MENU** button.

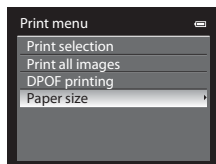

3 Choose the desired paper size and press the **OK** button.

- To specify the paper size using the printer settings, choose **Default** in the paper size menu.

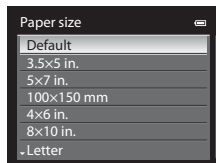

- 4** Choose **Print selection**, **Print all images** or **DPOF printing** and press the **OK** button.

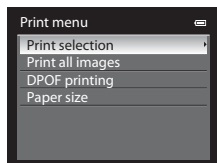

Print selection

Choose the pictures (up to a maximum of 99) and number of copies (up to nine per picture).

- Rotate the rotary multi selector, or press ◀ or ▶ to choose the pictures, and press ▲ or ▼ to set the number of copies for each.
- Pictures selected for printing can be recognized by the check mark icon and the numeral indicating the number of copies to be printed. A check mark is not displayed with pictures for which no copies have been specified and these pictures are not printed.
- Rotate the zoom control to **T** (Q) to switch to full-frame playback, or **W** (📐) to switch to 12 thumbnails display.
- Press the **OK** button when setting is complete.
- When the menu shown on the right is displayed, choose **Start print** and press the **OK** button to start printing.
- Choose **Cancel** and press the **OK** button to return to the print menu.

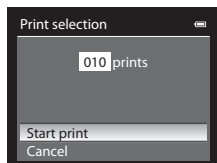

Print all images

All pictures stored in the internal memory or on the memory card are printed one per each.

- When the menu shown on the right is displayed, choose **Start print** and press the **OK** button to start printing.
- Choose **Cancel** and press the **OK** button to return to the print menu.

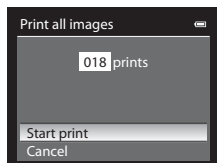

DPOF printing

Pictures for which a print order was created in the **Print order** option (📄99) can be printed.

- When the menu shown on the right is displayed, choose **Start print** and press the **OK** button to start printing.
- Choose **Cancel** and press the **OK** button to return to the print menu.
- To view the current print order, choose **View images** and press the **OK** button. To print pictures, press the **OK** button again.

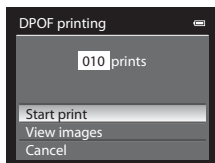

5 Printing starts.

- The monitor display returns to that shown in step 2 when printing is complete.
- To cancel before all copies have been printed, press the **OK** button.

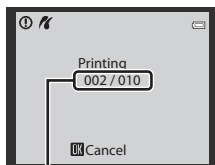

Current print/total number of prints

Paper Size

The camera supports the following paper sizes: **Default** (the default paper size for the current printer), **3.5×5 in.**, **5×7 in.**, **100×150 mm**, **4×6 in.**, **8×10 in.**, **Letter**, **A3**, and **A4**. Only sizes supported by the current printer are displayed.

Setup Menu

The setup menu contains the following options.

Welcome screen	143
Choose whether or not to display the Welcome screen on the monitor when the camera is turned on.	
Time zone and date	144
Set camera clock and choose home and destination time zones.	
Monitor settings	147
Adjust photo information display and monitor brightness settings.	
Print date	149
Imprint date and time of recording on pictures.	
Vibration reduction	150
Set the vibration reduction for taking still pictures and movies.	
Motion detection	151
Enable motion detection to reduce the effects of camera shake and subject movement when shooting still pictures.	
AF assist	152
Enable or disable AF-assist illuminator.	
Digital zoom	152
Enable or disable the digital zoom.	
Sound settings	153
Adjust sound settings.	
Auto off	153
Set the time before the camera enters standby mode to save power.	
Format memory/Format card	154
Format the internal memory or memory card.	
Language	155
Choose the language used for the camera monitor display.	
TV settings	155
Adjust the settings for connecting to a TV.	
Charge by computer	156
Choose whether or not to charge the camera battery when connecting to a computer via the USB cable.	
Blink warning	157
Choose whether or not to detect blinking eyes when shooting pictures using face priority.	
Reset all	159
Restore camera settings to default values.	
Firmware version	161
Display the camera firmware version.	

Displaying the Setup Menu

Choose the **Y** (Setup) tab in the menu screen.

- 1 Press the **MENU** button to display the menu screen.

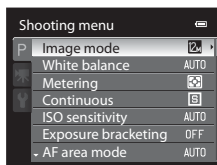
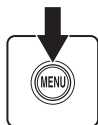

- 2 Press **◀** on the rotary multi selector.

- The tabs can now be selected.
- See “Rotary Multi Selector” (📖10).

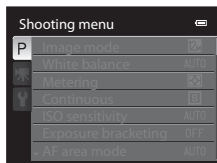

- 3 Press **▲** or **▼** to select the **Y** tab.

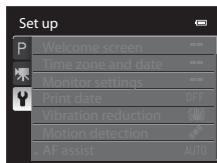

- 4 Press **▶** or the **OK** button.

- The setup menu items can now be selected.
- Use the rotary multi selector to select items and set functions on menus (📖10).
- To exit the setup menu, press the **MENU** button or press **◀** and switch to another tab.

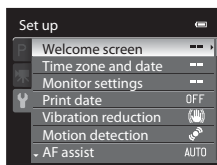

Navigating the Camera Menu

Rotate the command dial while the first level of the setup menu is displayed to change the setting for the selected item.

Welcome Screen

Press the **MENU** button →  (Setup menu) (📖142) → Welcome screen

Choose whether or not to display the Welcome screen on the monitor when the camera is turned on.

None (default setting)

Displays the shooting or playback screen without displaying the Welcome screen.

COOLPIX

Displays the Welcome screen before displaying the shooting or playback screen.

Select an image

Select a picture that you have shot to display as the Welcome screen. Display the picture selection screen, choose a picture (📖103), and press the  button to register it.

- Because the selected picture is stored in the camera, the picture appears in the Welcome screen even if the original picture is deleted.
- Pictures shot with **Image mode** (📖74) of  **3968x2232** cannot be selected.
- Pictures recorded with easy panorama cannot be selected.
- Pictures reduced to 320x240 or smaller using Small picture editing (📖116) or cropping (📖117) cannot be selected.

Time Zone and Date

Press the **MENU** button → **Y** (Setup menu) (📖142) → Time zone and date

Set the camera's internal clock.

Date and time

Set the camera clock to the current date and time.

Use the rotary multi selector to set the date and time in the date screen.

- Choose an item: Rotate the rotary multi selector, or press **▶** or **◀** (selected in the following order: **D** (day) → **M** (month) → **Y** (year) → **hour** → **minute**).
- Set the contents: Press **▲** or **▼**. Date and time can also be set by rotating the command dial (📖9).
- Finish setting: Choose **minute** and press the **OK** button or **▶**.

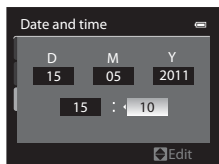

Date format

Choose the order in which the day, month, and year are displayed (**Year/Month/Day**, **Month/Day/Year** or **Day/Month/Year**).

Time zone

🏠 Home time zone can be specified and daylight saving can be enabled or disabled. When ➔ travel destination is registered, the time difference (📖146) from the 🏠 home time zone is automatically calculated and the local date and time are recorded. Useful when traveling.

Setting the Travel Destination Time Zone

1 Use the rotary multi selector to choose **Time zone** and press the **OK** button.

- The **Time zone** screen is displayed.

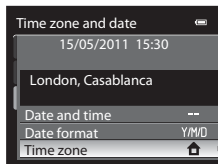

2 Choose ➔ **Travel destination** and press the **OK** button.

- The date and time displayed on the monitor change according to the region currently selected.

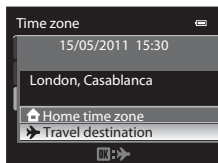

3 Press ►.

- The time zone selection screen is displayed.

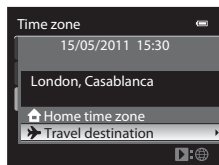

4 Press ◀ or ▶ to choose the travel destination (Time zone).

- The time difference between home and the travel destination is displayed.
- When using the camera in an area where daylight saving time is in effect, turn on the daylight saving setting with ▲. When set to on, the ☀ icon is displayed and the clock advances by one hour. To turn off, press ▼.
- Press the OK button to register the travel destination time zone.
- While the travel destination time zone is selected, the 📷 icon is displayed on the monitor when the camera is in shooting mode.

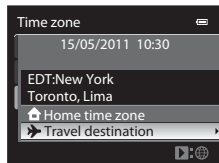
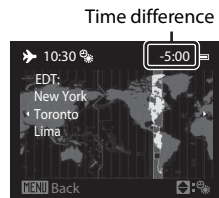

✓ The Clock Battery

The camera's internal clock uses a different battery from the camera's battery. The clock battery charges when the main battery is installed or the AC adapter is connected, and provides several days of clock battery power after about ten hours of charging.

📎 Home time zone

- To switch to the home time zone, choose 🏠 **Home time zone** in step 2 and press the OK button.
- To change the home time zone, choose 🏠 **Home time zone** in step 2 and perform the same procedure as for ► **Travel destination** to set the home time zone.

📎 Daylight Saving Time

When daylight saving time starts or ends, turn on or off the daylight saving time option from the time zone selection screen displayed in step 4.

📷 Imprinting the Date on Pictures while Shooting

After setting the date and time, set the **Print date** setting in the setup menu (📖149). Once **Print date** is set, the shooting date and time can be imprinted on the pictures.

**Time Zones**

The camera supports the time zones listed below.

For time differences not listed below, set the camera clock using **Date and time**.

UTC +/-	Location	UTC +/-	Location
-11	Midway, Samoa	+1	Madrid, Paris, Berlin
-10	Hawaii, Tahiti	+2	Athens, Helsinki, Ankara
-9	Alaska, Anchorage	+3	Moscow, Nairobi, Riyadh, Kuwait, Manama
-8	PST (PDT): Los Angeles, Seattle, Vancouver	+4	Abu Dhabi, Dubai
-7	MST (MDT): Denver, Phoenix	+5	Islamabad, Karachi
-6	CST (CDT): Chicago, Houston, Mexico City	+5.5	New Delhi
-5	EST (EDT): New York, Toronto, Lima	+6	Colombo, Dhaka
-4.5	Caracas	+7	Bangkok, Jakarta
-4	Manaus	+8	Beijing, Hong Kong, Singapore
-3	Buenos Aires, Sao Paulo	+9	Tokyo, Seoul
-2	Fernando de Noronha	+10	Sydney, Guam
-1	Azores	+11	New Caledonia
±0	London, Casablanca	+12	Auckland, Fiji

Monitor Settings

Press the **MENU** button → **Y** (Setup menu) (📖142) → Monitor settings

Change the settings for the options below.

Photo info



Choose information displayed on the monitor during shooting and playback mode (📖148).

Brightness

Choose from five settings to select the monitor brightness. The default setting is **3**.

Photo info

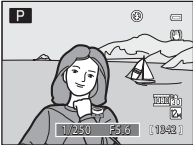
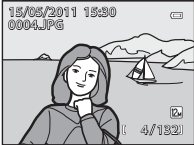
Select whether or not the photo information is displayed on the monitor.
See "Monitor" (📖 6) for information on indicators displayed on the monitor.

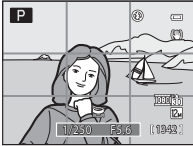
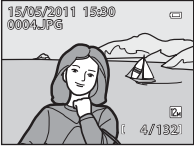
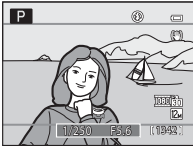
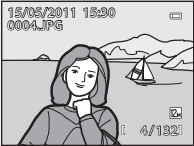
	Shooting mode	Playback mode
Show info		
Auto info (default setting)	The same information as in Show info is displayed. If no operations are performed after a few seconds, the display will be the same as Hide info . The information is displayed again when an operation is performed.	
Hide info		
Framing grid+auto info	 In addition to information shown with Auto info above, a framing grid is displayed to help frame pictures. It is not displayed while recording movies.	 The same information as in Auto info is displayed.
Movie frame+auto info	 In addition to information shown with Auto info above, the movie frame is displayed before recording movies.	 The same information as in Auto info is displayed.

Print Date

Press the **MENU** button →  (Setup menu) (📖142) → **Print date**

The shooting date and time can be imprinted on pictures at the time of shooting. This information can be printed even from printers that do not support printing of the date and time (📖100).



DATE Date

The date is imprinted on pictures.

DATE Date and time

The date and time are imprinted on pictures.

OFF Off (default setting)

The date and time are not imprinted on pictures.

When print date is enabled, the current setting is displayed during shooting (📖6). When **Off** is selected, an icon for the current setting is not displayed.

Notes on Print Date

- Imprinted dates cannot be deleted from the image, nor can dates be imprinted after the picture has been taken.
- Dates cannot be imprinted in the following situations.
 - When **Panorama** is selected for scene mode
 - When **Continuous H: 120 fps** or **Continuous H: 60 fps** is selected for **Continuous** (📖79)
 - During movie recording
- Dates imprinted with an **Image mode** (📖74) setting of **VGA 640×480** may be difficult to read. Set the image mode to **PC 1024×768** or higher.
- The date is recorded using the format selected in the setup menu's **Time zone and date** option (📖20, 144).

Print date and Print order

When printing from DPOF-compatible printers that support the printing of shooting date and photo information, the date and information can be printed without imprinting this information on them using settings in the **Print order** option (📖99).

Vibration Reduction

Press the **MENU** button →  (Setup menu) (📖142) → **Vibration reduction**

Set the vibration reduction function for taking still pictures and movies. Use to correct blur, which is caused by the slight hand movements known as camera shake that commonly occur when shooting at the telephoto zoom position or at slow shutter speeds.

When the camera is stabilized for shooting with a tripod, set vibration reduction to **Off**.

On (default setting)

Compensates for camera shake. The camera automatically detects the panning direction and only corrects for vibration caused by camera shake.

When the camera is panned horizontally, for example, vibration reduction only reduces vertical shake. If the camera is panned vertically, vibration reduction only compensates for horizontal shake.

OFF **Off**

Vibration reduction is disabled.

When vibration reduction is enabled, the current setting is displayed during shooting (📖6, 25). When **Off** is selected, an icon for the current setting is not displayed.

Notes on Vibration Reduction

- After the power is turned on or the camera enters shooting mode from playback mode, wait until the display stabilizes before shooting.
- Due to the characteristics of the vibration reduction function, images displayed on the monitor immediately after shooting may appear blurry.
- Vibration reduction may be unable to completely eliminate the effects of camera shake in some situations.

Motion Detection



Press the **MENU** button →  (Setup menu) (📖142) → Motion detection

Enable motion detection to reduce the effects of subject movement and camera shake when shooting still pictures.



Auto (default setting)

When the camera detects the movement of the subject or camera shake, the ISO sensitivity is raised and the shutter speed is increased to reduce their effects. However, motion detection does not function in the following situations.

- When the fill flash fires
- In the following scene modes:  (Night landscape), , **Landscape, Sports, Night portrait, Fireworks show, Pet portrait** and **Easy panorama** in **Panorama**
- When shooting mode is **P, S, A** or **M**

OFF Off

Motion detection is not applied.

When motion detection is enabled, the current setting is displayed during shooting (📖6).

The motion detection icon lights in green when the camera detects any vibration and increases the shutter speed. When **Off** is selected, an icon for the current setting is not displayed.

Notes on Motion Detection

- Motion detection may be unable to completely reduce effects of camera shake and subject movement in some situations.
- Motion detection may not function if the subject exhibits significant movement or is too dark.
- The pictures taken may become grainy.

AF Assist

Press the **MENU** button → **Y** (Setup menu) (📖142) → AF assist

Enable or disable the AF-assist illuminator that assists the autofocus when the lighting is dim.

Auto (default setting)

AF-assist illuminator turns on automatically when the subject is dimly lit. The illuminator has a range of about 4.0 m (13 ft.) at the maximum wide-angle position and about 1.5 m (4 ft. 11 in.) at the maximum telephoto position. However, for some focus areas and scene modes, AF-assist illuminator does not turn on even if **Auto** is set.

Off

Disable the function. The camera may be unable to focus if lighting is dim.

Digital Zoom

Press the **MENU** button → **Y** (Setup menu) (📖142) → Digital zoom

Enable or disable the digital zoom.

On (default setting)

When the camera is zoomed in to the maximum optical zoom position, rotating and holding the zoom control at **T** (📖) triggers the digital zoom (📖27).

Off

The digital zoom is not activated.

👍 Notes on Digital Zoom

- When digital zoom is in effect, the camera focuses at the center of the frame.
- Digital zoom cannot be used in the following situations.
 - When Smile timer (📖36) is set
 - When **Scene auto selector**, **Portrait**, **Night portrait**, **Easy panorama** in **Panorama** or **Pet portrait** is selected in scene mode (📖41)
 - When **Multi-shot 16** is selected for the **Continuous** (📖79) setting
 - When **Subject tracking** or **Face priority tracking** is selected for **AF area mode** (📖83)
- When the digital zoom is in effect, **Metering** is set to **Center-weighted**.

Sound Settings

Press the **MENU** button → **Y** (Setup menu) (📖142) → Sound settings

Adjust the following sound settings.

Button sound

Turn the beep and start-up sounds **On** (default setting) or **Off**. The beep sounds once when the settings are completed successfully, twice when the camera focuses on the subject, and three times when an error is detected.

Shutter sound

Choose whether to set the shutter sound to **On** (default setting) or **Off**.

✔ Notes on Sound Settings

- In **Pet portrait** scene mode, even when **On** is set, the button sound and shutter sound are disabled.
- Even when **On** is set, the shutter sound is disabled during continuous shooting or movie recording.

Auto Off

Press the **MENU** button → **Y** (Setup menu) (📖142) → Auto off

If no operations are performed for a certain period while the camera is on, the monitor is turned off to save power and the camera enters standby mode (📖19). This option sets the amount of time allowed to elapse before the camera enters standby mode.

Choose from **30 s**, **1 min** (default setting), **5 min** and **30 min**.

✍ When the Monitor Is Turned Off to Save Power



- The power-on lamp blinks in standby mode.
- The camera turns off when the standby mode continues for about three minutes.
- When the power-on lamp blinks, turn on the monitor again with one of the following operations.
 - Press the power switch, shutter-release button, the **▶** button or the **●** (🎬 movie-record) button.
 - Rotate the mode dial.

✔ Auto Off Setting

In the following situations, the time taken for the camera to enter standby mode is fixed.

- When menus are displayed: three minutes (when auto off is set to **30 s** or **1 min**)
- During slideshow playback: maximum of 30 minutes
- When the AC adapter EH-62F is connected: 30 minutes

Format Memory/Format Card

Press the MENU button →  (Setup menu) (142) → Format memory/Format card

Format the internal memory or a memory card.

Formatting permanently deletes all data in the internal memory or memory card. The deleted data cannot be recovered. Be sure to transfer important pictures to a computer before formatting.

Formatting Internal Memory

To format the internal memory, remove the memory card from the camera. The **Format memory** option is displayed in the setup menu.

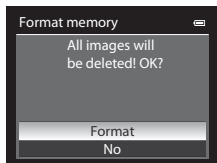

Formatting Memory Card

When the memory card is inserted in the camera, the **Format card** option is displayed in the setup menu.

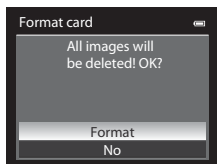

Formatting Internal Memory and Memory card

- Do not turn off the camera or open the battery-chamber/memory card slot cover during formatting.
- The first time you insert a memory card that has been used in another device into this camera, be sure to format it with this camera.

Language

Press the **MENU** button → **Y** (Setup menu) (📖142) → Language

Choose one of 26 languages for displaying the camera menus and messages.

Čeština	Czech	Magyar	Hungarian	Türkçe	Turkish
Dansk	Danish	Nederlands	Dutch	Українська	Ukrainian
Deutsch	German	Norsk	Norwegian	عربي	Arabic
English	(default setting)	Polski	Polish	简体中文	Simplified Chinese
Español	Spanish	Português	Portuguese	繁體中文	Traditional Chinese
Ελληνικά	Greek	Русский	Russian	日本語	Japanese
Français	French	Română	Romanian	한글	Korean
Indonesia	Indonesian	Suomi	Finnish	ภาษาไทย	Thai
Italiano	Italian	Svenska	Swedish		

TV Settings

Press the **MENU** button → **Y** (Setup menu) (📖142) → TV settings

Adjust the settings for connecting to a TV.

Video mode

Choose from **NTSC** and **PAL**.

HDMI

Choose a picture resolution for HDMI output from **Auto** (default setting), **480p**, **720p**, or **1080i**. When **Auto** is set, the output resolution that is best suited to the connected high-definition TV is selected automatically from **480p**, **720p** or **1080i**.

HDMI device control

Choose whether or not the camera receives signals from a TV when a TV that conforms to the HDMI-CEC standard is connected with an HDMI cable. When set to **On** (default setting), the television remote control can be used to operate the camera during playback.

See "Using the TV's Remote Control (HDMI Device Control)" (📖 128) for more information.



HDMI and HDMI-CEC

"HDMI" is an abbreviation of High-Definition Multimedia Interface, which is one type of multimedia interface. "HDMI-CEC" is an abbreviation of HDMI-Consumer Electronics Control, which enables operations to be linked between compatible devices.

Charge by Computer

Press the MENU button →  (Setup menu) (142) → Charge by computer

Choose whether or not the battery inserted into the camera is charged when the camera is connected to a computer via the USB cable (134).

Auto (default setting)

When the camera is connected to a computer that is running, the battery inserted into the camera is automatically charged using power supplied by the computer.

Off

The battery inserted into the camera is not charged when the camera is connected to a computer.

Notes on Connecting the Camera to a Printer

- The battery cannot be charged with connection to a printer, even if the printer complies with the PictBridge standard.
- When **Auto** is selected for **Charge by computer**, it may be impossible to print images with direct connection of the camera to some printers. If the PictBridge startup screen is not displayed on the monitor after the camera is connected to a printer and turned on, turn the camera off and disconnect the USB cable. Set **Charge by computer** to **Off** and reconnect the camera to the printer.

Blink Warning

Press the **MENU** button → **Y** (Setup menu) (📖142) → **Blink warning**

Choose whether or not blinking eyes are detected when using face priority (📖85) in the following shooting modes.

- In the following scene modes: **Scene auto selector** (📖42), **Portrait** (📖46) and **Tripod** in **Night portrait** (📖49)
- Shooting modes **P**, **S**, **A** and **M** (when **Face priority** (📖83) is selected for **AF area mode**)

On

When the camera detects that a human subject may have closed the eyes immediately after recognizing the face and shooting the subject, the **Did someone blink?** screen appears on the monitor.

The face of the human subject that may have closed his/her eyes is framed by a yellow border. You can check the picture taken and determine if you need to take the picture again.

See "Operating the Did someone blink? Screen" (📖158) for more information.

Off (default setting)

Blink warning does not take effect.

✔ Note on Blink Warning

When a setting other than **Single** is set for **Continuous** (📖79), when **Exposure bracketing** (📖82) is set or when Smile timer is set (📖36), blink warning does not take effect.

Operating the Did someone blink? Screen

The following operations can be performed when the **Did someone blink?** screen is displayed.

If no operations are performed for a few seconds, the screen automatically returns to the shooting screen.



To	Use	Description
Zoom in to the face for which blinking was detected	T (Q)	Rotate the zoom control toward T (Q).
Return to full-frame playback	W (checkered flag)	Rotate the zoom control toward W (checkered flag).
Select the face to be displayed		When the camera detects one or more human subjects with closed eyes, press ◀ or ▶ during playback zoom to display other faces.
Delete the picture taken		Press the button.
Return to shooting screen		Press the button or the shutter-release button.

Reset All

Press the MENU button → Y (Setup menu) (📖142) → Reset all

When **Reset** is selected, the camera settings are restored to the default values.

Pop-up Menu

Option	Default value
Flash mode (📖32)	Auto
Self-timer (📖35)/Smile timer (📖36)	OFF
Macro mode (📖38)	OFF
Creative slider adjustment (📖69)	Off
Exposure compensation (📖39)	0.0

Shooting in the Scene Mode

Option	Default value
Scene menu (📖41)	Scene auto selector
Landscape (📖47)	Single shot
Night portrait (📖49)	Tripod
Hue adjustment in Food mode (📖53)	Center
Panorama (📖55)	Normal (180°) of Easy panorama
Special effects (📖56)	Soft

Night Landscape Menu

Option	Default value
Night landscape (📖44)	Hand-held

Backlighting Menu

Option	Default value
HDR (📖45)	Off

Shooting Menu

Option	Default value
Image mode (📖74)	2. 4000×3000
White balance (📖76)	Auto
Metering (📖78)	Matrix
Continuous (📖79)	Single
ISO sensitivity (📖81)	Auto
Exposure bracketing (📖82)	Off
AF area mode (📖83)	Auto
Autofocus mode (📖89)	Single AF
Flash exp. comp. (📖89)	0.0

Movie Menu

Option	Default value
Movie options (📖123)	HD 1080p★ (1920×1080)
Autofocus mode (📖125)	Single AF

Setup Menu

Option	Default value
Welcome screen (📖143)	None
Photo info (📖147)	Auto info
Brightness (📖147)	3
Print date (📖149)	Off
Vibration reduction (📖150)	On
Motion detection (📖151)	Auto
AF assist (📖152)	Auto
Digital zoom (📖152)	On
Button sound (📖153)	On
Shutter sound (📖153)	On
Auto off (📖153)	1 min
HDMI (📖155)	Auto
HDMI device control (📖155)	On
Charge by computer (📖156)	Auto
Blink warning (📖157)	Off

Others

Option	Default value
Paper size (📖137, 138)	Default
Frame intvl for Slide show (📖101)	3 s

- Choosing **Reset all** also clears the current file number (📖168) in the memory. After resetting, numbering continues from the lowest number available in the internal memory or the memory card. To reset file numbering to "0001", delete all images saved in the internal memory or on the memory card (📖31) before selecting **Reset all**.
- The following settings remain unaffected even if **Reset all** is performed.
Shooting menu: Preset manual data for **White balance** (📖77)
Setup menu: **Time zone and date** (📖144), **Language** (📖155) and **Video mode** (📖155) in **TV settings**

Firmware Version

Press the MENU button → Y (Setup menu) (📖142) → Firmware version

Displays the current camera firmware version.

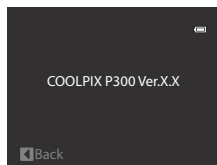

Caring for the Camera

To ensure continued enjoyment of this Nikon product, observe the following precautions when using or storing the device.

Keep dry

The device will be damaged if immersed in water or subjected to high humidity.

Do not drop

The product may malfunction if subjected to strong shock or vibration.

Handle the lens and all moving parts with care

Do not apply force to the lens, lens cover, monitor, memory card slot or battery chamber. These parts are easily damaged. Applying force to the lens cover could result in camera malfunction or damage to the lens. Should the monitor break, care should be taken to avoid injury caused by broken glass and to prevent the liquid crystal from the display touching the skin or entering the eyes or mouth.

Do not point the lens at strong light sources for extended periods

Avoid pointing the lens at the sun or other strong light sources for extended periods when using or storing the camera. Intense light may cause deterioration of the image sensor, producing a white blur effect in photographs.

Keep away from strong magnetic fields

Do not use or store this device in the vicinity of equipment that generates strong electromagnetic radiation or magnetic fields. Strong static charges or the magnetic fields produced by equipment such as radio transmitters could interfere with the monitor, damage data stored on the memory card, or affect the product's internal circuitry.

Avoid sudden changes in temperature

Sudden changes in temperature, such as when entering or leaving a heated building on a cold day, can cause condensation to form inside the device. To prevent condensation, place the device in a carrying case or a plastic bag before exposing it to sudden changes in temperature.

Turn the product off before removing or disconnecting the power source

Do not remove the battery while the product is on, or while images are being recorded or deleted. Forcibly cutting power in these circumstances could result in loss of data or in damage to product memory or internal circuitry.

 **The Battery**

- Check the battery level when taking the camera out, and charge the battery if necessary. Do not continue charging once the battery is fully charged, as this will result in reduced battery performance. If possible, carry a fully-charged spare battery when taking pictures on important occasions.
- Do not use the battery at ambient temperatures below 0 °C (32 °F) or above 40 °C (104 °F). Failure to observe this precaution could damage the battery or impair its performance.
- Charge the battery in an indoor environment that is between 5 and 35 °C (41 to 95 °F).
- When charging the battery by connecting the COOLPIX P300 to the Charging AC Adapter EH-69P or to a computer, the chargeable capacity may decrease when the battery temperature is between 45 to 60 °C (113 to 140 °F). The battery will not charge if its temperature is below 0 °C (32 °F) or above 60 °C (140 °F).
- If an exhausted battery is used at a low temperature, the camera may not turn on. Be sure that the battery is fully charged and spare batteries are prepared before heading outside to take pictures in cold weather. Keep spare batteries in a warm place and exchange as necessary. Once warmed, a cold battery that could not be used temporarily due to lowered performance may recover some of its charge.
- Should the battery terminals become dirty, the camera may not turn on due to poor contact. Wipe the terminals off with a clean, dry cloth before use.
- Recharge it at least once every six months and run it flat before returning it to storage. Attach the included terminal cover to the battery and store it in a cool location with an ambient temperature of 15 to 25 °C (59 to 77 °F). Do not store the battery in hot or extremely cold locations.
- While the battery is in storage, charge it at least once every six months and then use the camera to run it flat again before storing it in a cool location.
- Always remove the battery from the camera or battery charger when it is not being used. Left installed, minute amounts of current flow even when unused, and the battery may become excessively drained and no longer function.
- A marked drop in the time a fully-charged battery retains its charge, when used at room temperature, indicates that the battery needs to be replaced. Purchase a new battery.
- Replace the battery when it no longer holds a charge. Used batteries are a valuable resource. Please recycle used batteries in accordance with local regulations.

Cleaning

Lens	Avoid touching glass parts with your fingers. Remove dust or lint with a blower (typically a small device with a rubber bulb attached to one end that is pumped to produce a stream of air out the other end). To remove fingerprints or other stains that cannot be removed with a blower, wipe the lens with a soft cloth, using a spiral motion that starts at the center of the lens and working toward the edges. If this fails, clean the lens using a cloth lightly dampened with commercial lens cleaner.
Monitor	Remove dust or lint with a blower. To remove fingerprints and other stains, clean the monitor with a soft, dry cloth, being careful not to apply pressure.
Body	Use a blower to remove dust, dirt or sand, then wipe gently with a soft, dry cloth. After using the camera at the beach or seaside, wipe off any sand or salt with a dry cloth lightly dampened with fresh water, then dry thoroughly. Note that foreign matter inside the camera could cause damage not covered by the warranty.

Do not use alcohol, thinner, or other volatile chemicals.

Storage

Turn the camera off when not in use. Check that the power-on lamp is off before putting the camera away. Remove the battery if the camera will not be used for an extended period. Do not store the camera with naphtha or camphor moth balls, or in any of the following locations:

- Next to equipment that produces strong electromagnetic fields, such as televisions or radios
- Exposed to temperatures below -10 °C (14 °F) or above 50 °C (122 °F)
- Poorly ventilated or subject to humidities of over 60%

To prevent mold or mildew, take the camera out of storage at least once a month. Turn the camera on and release the shutter a few times before putting the camera away again.



Notes on the Monitor

- The monitor may contain a few pixels that are always lit or that do not light. This is a characteristic common to all TFT LCD displays, and does not indicate a malfunction. Images recorded using the product will not be affected.
- Images on the monitor may be difficult to see under bright lighting.
- The monitor is lit by an LED backlight. Should the monitor begin to dim or flicker, contact your Nikon-authorized service representative.

Optional Accessories

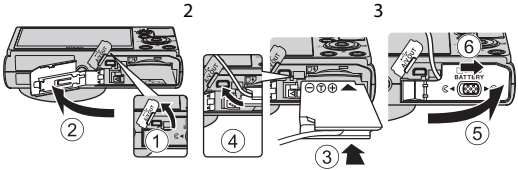
Rechargeable battery	Rechargeable Li-ion Battery EN-EL12 ¹
Charging AC adapter	Charging AC Adapter EH-69P ^{1,2}
Battery charger	Battery Charger MH-65 ²
AC adapter	<p>AC Adapter EH-62F (connect as shown)</p>  <p>Be sure that the power connector cord has been properly aligned in power connector and battery chamber grooves before closing the battery-chamber/memory card slot cover. If part of the cord runs out of the grooves, the cover or cord may be damaged when the cover is closed.</p>
USB cable	USB Cable UC-E6 ¹
Audio/video cable	Audio Video Cable EG-CP16 ¹

- Supplied with the camera at the time of purchase (→ page 3 of the *Quick Start Guide*).
- When using in other countries, use a commercially available plug adapter as necessary. For more information about plug adapters, consult your travel agency.

Approved Memory Cards

The following Secure Digital (SD) memory cards have been tested and approved for use in this camera.

- When recording a movie onto a memory card, a memory card with an SD speed class of Class 6 or higher is recommended. If the transfer speed of the card is slow, the movie recording may end unexpectedly.

	SD memory cards	SDHC memory cards ²	SDXC memory cards ³
SanDisk	2 GB ¹	4 GB, 8 GB, 16 GB, 32 GB	64 GB
TOSHIBA	2 GB ¹	4 GB, 8 GB, 16 GB, 32 GB	64 GB
Panasonic	2 GB ¹	4 GB, 8 GB, 12 GB, 16 GB, 24 GB, 32 GB	48 GB, 64 GB
Lexar	2 GB ¹	4 GB, 8 GB, 16 GB, 32 GB	-

- Before using a card reader or similar device, check that the device supports 2 GB cards.
- SDHC-compliant. Before using a card reader or similar device, check that the device supports SDHC.
- SDXC-compliant. Before using a card reader or similar device, check that the device supports SDXC.



- Contact the manufacturer for details on the above cards.

File and Folder Names

Pictures, movies and voice memos are assigned file names as follows.

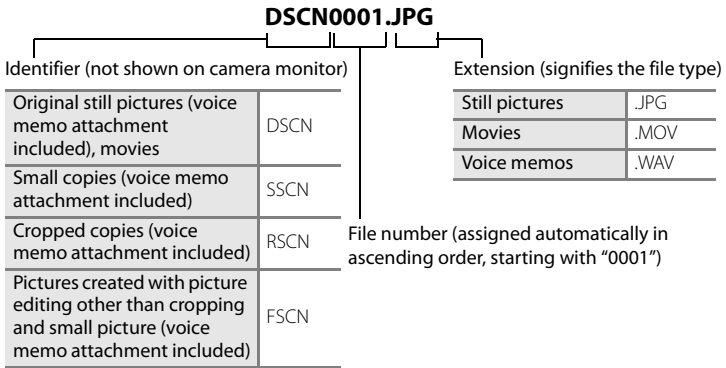













- A folder for storing files is automatically created using the following naming convention: "Folder number + NIKON" (e.g., "100NIKON"). If there are 200 files in a folder, a new folder is created. (For example, the folder name following "100NIKON" becomes "101NIKON.") A new folder is also created when the file numbers in a folder reach 9999. The next file number is set automatically to "0001."
- Voice memo file names have the same identifier and file number as the picture to which the voice memo is attached.
- In Panorama assist (📖55), a folder is created for each shooting session using the following naming convention: "Folder number + P_XXX" (e.g., "101P_001"). Pictures are saved in sequence in file numbers starting from 0001.

- When image files or voice files are copied between the internal memory and a memory card (📖107), the file naming conventions are as follows:
 - Files copied using **Selected images** are copied to the current folder (or to the folder used for subsequent pictures), where they are assigned file numbers in ascending order following the largest file number in memory.
 - Files copied using **All images**, along with their folder, are copied together. Folder numbers are assigned in ascending order, following the largest folder number on the destination medium. File names are not changed.
- If the current folder is numbered 999 and contains 200 files, or a file is numbered 9999, no further pictures can be captured until the internal memory or memory card is formatted (📖154), or a new memory card is inserted.











Error Messages

The following table lists the error messages and other warnings displayed on the monitor, as well as the solutions for dealing with them.

Display	Description	Solution	
 (blinks)	Clock not set.	Set date and time.	144
 Battery exhausted.	Battery exhausted.	Charge or replace the battery.	14, 16
 Battery temperature high	Battery temperature is high.	Turn off camera, and allow battery to cool down before resuming use. Five seconds after this message appears, the monitor is turned off, and the power-on lamp flickers. After the lamp blinks for three minutes, the camera turns off automatically, but you can also press the power switch to turn it off manually.	19
 The camera will turn off to prevent overheating.	Inside of the camera has become hot. The camera turns off automatically.	Leave the camera off until the inside of the camera has cooled and then turn it on again.	–
 (blinks red)	Camera cannot focus.	<ul style="list-style-type: none"> • Refocus. • Use focus lock. 	28, 29 29
 Please wait for the camera to finish recording.	Camera cannot perform other operations until recording is complete.	Wait until message clears from display automatically when recording is complete.	–
 Memory card is write protected.	Write-protect switch is in "lock" position.	Slide the write-protect switch to "write" position.	23
 This card cannot be used.	Error accessing memory card.	<ul style="list-style-type: none"> • Use an approved card. • Check that connectors are clean. • Confirm that memory card is correctly inserted. 	167
 This card cannot be read.			23 22







Display	Description	Solution	
<p>i Card is not formatted. Format card? Yes No</p>	Memory card has not been formatted for use in this camera.	All data stored on the memory card is deleted when formatted. If there is any data on the card that you want to keep, select No , and backup the data to a computer before formatting the memory card. To format the memory card, select Yes and press the  button.	23
<p>i Out of memory.</p>	Memory card is full.	<ul style="list-style-type: none"> • Change image mode. • Delete pictures and movies. • Replace memory card. • Remove memory card and use internal memory. 	74 31, 126 22 22
<p>i Image cannot be saved.</p>	Error occurred while recording picture.	Format the internal memory or memory card.	154
	Camera has run out of file numbers.	Replace the memory card, or format the internal memory/memory card.	22, 154, 169
	Picture cannot be used for Welcome screen.	<p>The following pictures cannot be used.</p> <ul style="list-style-type: none"> • Pictures shot with Image mode of  3968x2232 • Pictures created with small picture or crop function that are 320x240 or smaller • Pictures recorded with easy panorama. 	74 116, 117 57
	There is insufficient space to save a copy.	Delete pictures from destination.	31
<p>i Unable to create panorama.</p> <p>i Unable to create panorama. Pan the camera in one direction only.</p> <p>i Unable to create panorama. Pan the camera more slowly.</p>	Cannot perform easy panorama shooting.	<p>Easy panorama shooting may not be available in the following situations.</p> <ul style="list-style-type: none"> • When shooting has not finished after a certain period of time • When the camera movement speed is too fast • When the camera is not straight relative to the panorama direction 	57

Error Messages

Display	Description	Solution	
 Sound file cannot be saved.	A voice memo cannot be attached to this file.	<ul style="list-style-type: none"> Voice memos cannot be attached to movies. Select an image captured with this camera. 	- 105
 Image cannot be modified.	Cannot edit selected picture.	<ul style="list-style-type: none"> Confirm the conditions that are required for editing. Movies cannot be edited. 	108 -
 Cannot record movie.	Time out error while recording movie.	Choose memory card with faster write speed.	167
 Memory contains no images.	No pictures in the internal memory or memory card.	<ul style="list-style-type: none"> Remove the memory card from the camera to play back images saved in the camera's internal memory. To copy files from internal memory to memory card, press the MENU button to display the copy screen, then copy the files from internal memory to memory card. 	22 107
 File contains no image data.	File not created with COOLPIX P300.	File cannot be viewed on this camera. View file using the computer or any other device which was used to create or edit this file.	-
 This file cannot be played back.			
 All images are hidden.	The picture cannot be played back in a slide show.	-	101
 This image cannot be deleted.	Picture is protected.	Disable protection.	102
 Travel destination is in the current time zone.	Destination in same time zone as home.	-	146
 Mode dial is not in the proper position.	Mode dial is between two modes.	Rotate the mode dial to select the desired mode.	40

Display	Description	Solution	
 Raise the flash.	The flash is lowered when the scene mode is  (Backlighting) and HDR is Off or Night portrait .	Slide the  (flash pop-up) control to raise the flash.	33, 45, 49
 The flash is lowered.	The flash is not raised during the Scene auto selector mode.	Slide the  (flash pop-up) control to raise the flash. The camera can still shoot normally with the flash lowered if you do not wish to use it.	33, 42
Lens error 	Lens is not operating properly.	Turn camera off and then on again. If error persists, contact retailer or Nikon-authorized service representative.	19
 Communications error	Error occurred during communication with printer.	Turn off camera and reconnect USB cable.	136
System error 	Error has occurred in camera's internal circuitry.	Turn off camera, remove and reinsert battery, and turn on camera. If the error persists, contact retailer or Nikon-authorized service representative.	19
 Printer error: check printer status.	Printer error	Check printer. After solving the problem, select Resume and press the  button to resume printing.*	-
 Printer error: check paper	Specified size of paper is not loaded.	Load the specified paper, select Resume and press the  button to resume printing.*	-
 Printer error: paper jam	Paper has jammed in the printer.	Remove the jammed paper, select Resume and press the  button to resume printing.*	-
 Printer error: out of paper	No paper is loaded in the printer.	Load the specified paper, select Resume and press the  button to resume printing.*	-

Error Messages



Display	Description	Solution	
 Printer error: check ink	Ink error	Check ink, select Resume and press the  button to resume printing.*	-
 Printer error: out of ink	Ink cartridge is empty.	Replace ink cartridge, select Resume and press the  button to resume printing.*	-
 Printer error: file corrupt	An error caused by the image file has occurred.	Select Cancel and press the  button to cancel printing.	-

* See the documentation provided with your printer for further guidance and information.

Troubleshooting

If the camera fails to function as expected, check the list of common problems below before consulting your retailer or Nikon-authorized service representative. Refer to the page numbers in the right-most column for more information.

Display, Settings and Power Supply





Problem	Cause/Solution	
The battery inserted in the camera cannot be charged.	<ul style="list-style-type: none"> • Confirm all connections. • Close the battery-chamber/memory card slot cover. 	16 14
The battery cannot be charged by connecting the camera to a computer.	<ul style="list-style-type: none"> • Off is selected for Charge by computer in the setup menu. • When charging by connecting the camera to a computer, battery charging stops when the camera is turned off. • When charging by connecting the camera to a computer, battery charging stops when the computer is suspended (sleeping), and the camera may turn off. • Depending upon computer specifications, settings, and status, charging the battery inserted in the camera may not be possible via computer connection. 	156 134 134 –
Camera cannot be turned on.	<ul style="list-style-type: none"> • Battery is exhausted. • The camera cannot be turned on while connected to an electrical outlet via the Charging AC Adapter. • Camera cannot be turned on if the battery-chamber/memory card slot cover is open. 	24 16 14
Camera turns off without warning.	<ul style="list-style-type: none"> • Battery is exhausted. • Camera has turned off automatically to save power. • The camera turns off if the Charging AC Adapter is connected while the camera is on. • The camera turns off if the USB cable connecting it to a computer or printer is disconnected. Reconnect the USB cable. • Inside of the camera has become hot. Leave the camera off until the inside of the camera has cooled, and then try turning it on again. • The camera and battery may not perform properly if they are cold. 	24 153 16 130, 132, 136 – 163
Monitor is blank.	<ul style="list-style-type: none"> • Camera is off. • Battery is exhausted. • Standby mode for saving power: Press the power switch, shutter-release button or the  button, or rotate the mode dial. • When flash lamp blinks, wait until flash has charged. • Camera and computer are connected via USB cable. • Camera and TV are connected via A/V cable or HDMI cable. 	19 24 19, 30 34 129 127





Problem	Cause/Solution	
Monitor is hard to read.	<ul style="list-style-type: none"> Adjust monitor brightness. Monitor is dirty. Clean monitor. 	147 162
Date and time of recording are not correct.	<ul style="list-style-type: none"> If the camera clock has not been set ("Date not set" indicator blinks during shooting), still pictures have a time stamp of "00/00/0000 00:00"; and movies are dated "01/01/2011 00:00." Set the correct date and time using Time zone and date in the setup menu. The camera clock is not as accurate as a normal clock, such as watches. Check camera clock regularly against more accurate timepieces and reset as required. 	20, 144 144
No information displayed in monitor.	Hide info is selected for Photo info of Monitor settings in the setup menu.	147
Print date not available.	Time zone and date has not been set.	20, 144
Date not appearing on pictures even when Print date is enabled.	<ul style="list-style-type: none"> A shooting mode that does not support Print date is selected. The date cannot be imprinted onto a movie. 	149 -
Camera settings reset.	Clock battery is exhausted; all settings were restored to their default values.	145
Monitor is turned off, and the power-on lamp flickers.	Battery temperature is high. Turn off camera, and allow battery to cool down before resuming use. After the lamp blinks for three minutes, the camera turns off automatically, but you can also press the power switch to turn it off manually.	19
Camera temperature rises.	When functions such as movie recording are used for a long time, or when the camera is used in a location with a high ambient temperature, the camera temperature may rise. This is not a malfunction.	119







Electronically Controlled Cameras

In extremely rare instances, unusual characters may appear on the monitor and the camera may stop functioning. In most cases, this phenomenon is caused by a strong external static charge. Turn the camera off, remove and replace the battery, then turn the camera on again. Note that disconnecting the power source as described above may result in the loss of any data not recorded on the internal memory or memory card at the time the problem occurred. Data already recorded is not affected. In the event of continued malfunction, contact your retailer or Nikon-authorized service representative.

Shooting



Problem	Cause/Solution	
Cannot set to shooting mode	Disconnect the HDMI cable or USB cable.	127, 130, 136
No picture taken when shutter-release button is pressed.	• When camera is in playback mode, press the  or shutter-release button.	30
	• When menus are displayed, press the MENU button.	11
	• Battery is exhausted.	24
	• When the scene mode is  (Backlighting) and HDR is Off or Night portrait , raise the flash.	33, 45, 49
	• When flash lamp blinks, flash is charging.	34
Camera cannot focus.	• Subject is too close to the camera. Try shooting with macro mode, or Scene auto selector or Close-up scene mode.	38, 42, 52
	• The intended subject is one with which autofocus does not perform well.	29
	• Set AF assist in the setup menu to Auto .	152
	• Subject not in focus area when shutter-release button pressed halfway.	28, 83
	• Turn camera off and then on again.	19
Colored bands appear on the shooting screen.	Colored bands (interference patterns, moiré) may appear on subjects that repeat the same pattern (e.g., window blinds). This is not a malfunction. These phenomena are not saved in the recorded pictures or movies. However, they may be saved on the pictures or movies that are recorded with Continuous H: 120 fps or HS 120 fps (640x480) .	–
Pictures are blurred.	• Use flash.	32
	• Use vibration reduction or motion detection.	150, 151
	• Use BSS (Best Shot Selector).	79
	• Use a tripod to stabilize the camera (use with the self-timer for better results).	35
Bright specks appear in pictures shot using flash.	Flash is reflecting off particles in air. Set the flash to  (Off).	32
Flash does not fire.	• Flash is set to  (Off).	32
	• A scene mode that cannot turn on flash is selected.	41
	• Another function that is set now is restricting the flash.	90

Problem	Cause/Solution	
Digital zoom is not available.	<ul style="list-style-type: none"> • Off is selected for Digital zoom in the setup menu. • The digital zoom cannot be used in the following situations. <ul style="list-style-type: none"> - When Smile timer is set - When the scene mode is Scene auto selector, Portrait, Night portrait, Easy panorama in Panorama or Pet portrait - When Multi-shot 16 is set for Continuous in the shooting menu - When Subject tracking or Face priority tracking is selected for AF area mode 	152 36 42, 46, 49, 55, 56 79 84
Image mode not available.	Another function that is set now is restricting Image mode .	90
No sound when shutter is released.	<ul style="list-style-type: none"> • Off is selected for Shutter sound under Sound settings in the setup menu. • When Continuous or Exposure bracketing is set in the shooting menu. • Sports, Museum or Pet portrait is selected in scene mode. • When the camera is recording a movie. • Do not block the speaker. 	153 79, 82 48, 54, 56 118 5
AF-assist illuminator does not light.	Off is selected for AF assist in the setup menu. Even when Auto is set, AF-assist illuminator may not light depending on the focus area position or scene mode.	152
Pictures appear smeared.	Lens is dirty. Clean lens.	162
Colors are unnatural.	White balance or hue does not match light source.	69, 76
Randomly spaced bright pixels ("noise") appear in image.	As the subject is dark, shutter speed is too slow or ISO sensitivity is too high. <ul style="list-style-type: none"> • Use flash. • Specify a lower ISO sensitivity setting. 	32 81
Pictures are too dark (underexposed).	<ul style="list-style-type: none"> • Flash is set to  (Off). • Flash window is blocked. • Subject is beyond flash range. • Adjust exposure compensation. • Raise the ISO sensitivity. • Subject is backlit. Raise the flash, and set the scene mode to  (Backlighting) or set the flash mode to  (fill flash). 	32 26 32 39 81 32, 45
Pictures are too bright (overexposed).	Adjust exposure compensation.	39

Problem	Cause/Solution	
Unexpected results occurred when flash is set to auto with red-eye reduction.	In very rare cases, when  (Auto with red-eye reduction) or the red-eye reduction fill flash or slow-sync fill flash in the Night portrait scene mode is used for flash photography, areas other than red eyes may be corrected. Set a flash mode other than  (Auto with red-eye reduction), select a scene mode other than Night portrait , and resume shooting.	32, 49
Skin softening results are not as expected.	• Skin softening may not produce the desired results depending on shooting conditions.	36
	• For pictures with four or more faces, try using Skin softening in the playback menu.	112
Saving images takes time.	It may take more time to save images in the following situations.	
	• When the noise reduction function is in operation	–
	• When flash is set to  (Auto with red-eye reduction)	32
	• When taking pictures in the following scene modes.	
	- Hand-held in  (Night landscape)	44
	- HDR set to other than Off in  (Backlighting)	45
- Noise reduction burst in Landscape	47	
- Hand-held in Night portrait	49	
- Easy panorama in Panorama	55	
• When Continuous H: 120 fps or Continuous H: 60 fps is selected for Continuous in the shooting menu	79	
Cannot set or use Continuous or Exposure bracketing.	Another function that is set now is restricting the Continuous setting or Exposure bracketing.	90

Playback

Problem	Cause/Solution	
File cannot be played back.	<ul style="list-style-type: none"> • File was overwritten or renamed by computer or another make or model of camera. • Movies recorded with cameras other than COOLPIX P300 cannot be played back. 	118
Cannot zoom in on picture.	• Playback zoom cannot be used with movies, small pictures, or cropped copies of size 320 x 240 pixels or smaller.	–
	• Playback zoom may not be available for pictures taken with cameras other than COOLPIX P300.	–

Problem	Cause/Solution	
Cannot record or play back voice memo.	<ul style="list-style-type: none"> • Voice memos cannot be attached to movies or pictures recorded with easy panorama. • Voice memos cannot be attached to pictures shot by cameras other than COOLPIX P300, and voice memos recorded by other cameras cannot be played back on this camera. 	57, 126 105
Pictures cannot be edited.	<ul style="list-style-type: none"> • Movies cannot be edited. • Editing is not available for pictures shot when the Image mode was set to  3968x2232. • Pictures recorded with easy panorama cannot be edited. • Confirm the conditions that are required for editing. • Pictures taken with cameras other than COOLPIX P300 cannot be edited. 	– 74 – 108 –
Pictures not displayed on television.	<ul style="list-style-type: none"> • Video mode or HDMI is not correctly set in the TV settings setup menu. • Cables are connected to both the HDMI mini connector and USB/audio video connector. • Memory card contains no pictures. Replace memory card. Remove memory card to play back pictures from internal memory. 	155 127 22
Nikon Transfer 2 does not start when camera is connected to a computer.	<ul style="list-style-type: none"> • Camera is off. • Battery is exhausted. • USB cable is not correctly connected. • Camera is not recognized by the computer. • Confirm that the operating system used is compatible with the camera. • Computer is not set to launch Nikon Transfer 2 automatically. For more information on Nikon Transfer 2, refer to help information contained in ViewNX 2. 	19 24 130 – 129 133
The PictBridge startup screen is not displayed when the camera is connected to a printer.	With some PictBridge-compatible printers, the PictBridge startup screen may not be displayed and it may be impossible to print images when Auto is selected for Charge by computer . Set Charge by computer to Off and reconnect the camera to the printer.	156
Pictures to be printed are not displayed.	<ul style="list-style-type: none"> • Memory card contains no pictures. Replace memory card. • Remove memory card to print pictures from internal memory. 	22 22
Cannot select paper size with camera.	<p>Paper size cannot be selected from the camera in the following situations, even for PictBridge compatible printers. Use the printer to select paper size.</p> <ul style="list-style-type: none"> • The paper size selected using the camera is not compatible with the printer. • A printer that automatically sets the paper size is being used. 	137, 138 –

Specifications

Nikon COOLPIX P300 Digital Camera

Type	Compact digital camera
Effective pixels	12.2 million
Image sensor	1/2.3-in. type CMOS; approx. 12.75 million total pixels
Lens	4.2x optical zoom, NIKKOR lens
Focal length	4.3-17.9mm (angle of view equivalent to that of 24-100 mm lens in 35mm [135] format)
f/-number	f/1.8-4.9
Construction	7 elements in 6 groups
Digital zoom	Up to 2x (angle of view equivalent to that of approx. 200 mm lens in 35mm [135] format)
Vibration reduction	Lens shift
Autofocus (AF)	Contrast-detect AF
Focus range (from lens)	<ul style="list-style-type: none">• Approx. 30 cm (1 ft.) to ∞ (wide-angle position), approx. 60 cm (2 ft.) to ∞ (telephoto position)• Macro close-up mode: Approx. 3 cm (1.2 in.) to ∞ (wide-angle position)
Focus-area selection	Face priority, auto (9-area automatic selection), center, manual with 99 focus areas, subject tracking, face priority tracking
Monitor	7.5 cm (3-in.), approx. 921k-dot, wide viewing angle TFT LCD monitor with anti-reflection coating and 5-level brightness adjustment
Frame coverage (shooting mode)	Approx. 100% horizontal and 100% vertical (compared to actual picture)
Frame coverage (playback mode)	Approx. 100% horizontal and 100% vertical (compared to actual picture)
Storage	
Media	<ul style="list-style-type: none">• Internal memory (approx. 90 MB)• SD/SDHC/SDXC memory card
File system	DCF, Exif 2.3, and DPOF compliant
File formats	Still pictures: JPEG Sound file (voice memo): WAV Movies: MOV (Video: H.264/MPEG-4 AVC, Audio: AAC stereo)
Image size (pixels)	<ul style="list-style-type: none">• 12M (High) 4000x3000★• 12M 4000x3000• 8M 3264x2448• 5M 2592x1944• 3M 2048x1536• PC 1024x768• VGA 640x480• 16:9 3968x2232

Specifications

ISO sensitivity (Standard output sensitivity)	<ul style="list-style-type: none"> • ISO 160, 200, 400, 800, 1600, 3200 • Auto (auto gain from ISO 160 to 1600) • Fixed range auto (ISO 160 to 400, 160 to 800)
Exposure	
Metering	224-segment matrix, center-weighted
Exposure control	Programmed auto exposure with flexible program, shutter priority auto, aperture-priority auto, manual, exposure bracketing, motion detection, exposure compensation (-2.0 to +2.0 EV in steps of 1/3 EV)
Shutter	Mechanical and CMOS electronic shutter
Speed	Auto mode, scene mode <ul style="list-style-type: none"> • 1/2000¹ to 1 s • 1/2000¹ to 2 s (Tripod in Night landscape scene mode) • 4 s (Fireworks show scene mode) P, S, A or M mode <ul style="list-style-type: none"> • 1/2000² to 8 s (when ISO sensitivity is set to 160 in M mode: including when set to Auto or Fixed range auto) • 1/2000^{1,2} to 4 s (when ISO sensitivity is fixed at 160, 200 or 400 in P, S or A mode, and when ISO sensitivity is fixed at 200 or 400 in M mode) • 1/2000^{1,2} to 2 s (when ISO sensitivity is fixed at 800) • 1/2000^{1,2} to 1 s (when ISO sensitivity is fixed at 1600, and when set to Auto or Fixed range auto in P, S or A mode) • 1/2000^{1,2} to 1/2 s (when ISO sensitivity is fixed at 3200) • 1/4000 to 1/60 s (Continuous H) <p>¹ In auto mode, scene mode, P or A mode, when the aperture value is f/8 and the zoom is at the maximum wide-angle position or moved one increment to the telephoto position, the fastest shutter speed is 1/1600 s</p> <p>² When the aperture value is f/1.8, the fastest shutter speed is 1/1600 s</p>
Aperture	Electronically-controlled 6-blade iris diaphragm
Range	14 steps of 1/3 EV
Self-timer	Can be selected from 10 and 2 seconds duration
Built-in flash	
Range (approx.) (ISO sensitivity: Auto)	[W]: 0.5 to 6.5 m (1 ft. 8 in. to 21 ft.) [T]: 0.5 to 2.5 m (1 ft. 8 in. to 8 ft. 2 in.)
Flash control	TTL auto flash with monitor preflashes
Interface	Hi-Speed USB
Data transfer protocol	MTP, PTP
Video output	Can be selected from NTSC and PAL
HDMI output	Can be selected from Auto, 480p, 720p, and 1080i
I/O terminal	Audio/video output; digital I/O (USB); HDMI mini connector (HDMI output)

Supported languages	Arabic, Chinese (Simplified and Traditional), Czech, Danish, Dutch, English, Finnish, French, German, Greek, Hungarian, Indonesian, Italian, Japanese, Korean, Norwegian, Polish, Portuguese, Romanian, Russian, Spanish, Swedish, Thai, Turkish, Ukrainian
Power sources	<ul style="list-style-type: none"> • One Rechargeable Li-ion Battery EN-EL12 (supplied) • AC Adapter EH-62F (available separately)
Charging time	Approx. 4 hours (when using Charging AC Adapter EH-69P and when no charge remains)
Battery life (EN-EL12)	Still pictures*: Approx. 240 shots Movies: Approx. 1 h 5 min (HD 1080p★ (1920 × 1080))
Tripod socket	1/4 (ISO 1222)
Dimensions (W × H × D)	Approx. 103.0 × 58.3 × 32.0 mm (4.1 × 2.3 × 1.3 in.) (excluding projections)
Weight	Approx. 189 g (6.7 oz) (including battery and memory card)
Operating environment	
Temperature	0 °C to 40 °C (32 °F to 104 °F)
Humidity	85% and below (no condensation)

- Unless otherwise stated, all figures are for a camera with a fully-charged Rechargeable Li-ion Battery EN-EL12 operated at an ambient temperature of 25 °C (77 °F).

* Based on Camera and Imaging Products Association (CIPA) standards for measuring the life of camera batteries. Measured at 23 (±2) °C (73 (±4) °F); zoom adjusted with each shot, flash fired with every other shot, Image mode set to **4000×3000**. Battery life may vary depending on shooting interval and length of time menus and images are displayed.

Rechargeable Li-ion Battery EN-EL12

Type	Rechargeable lithium-ion battery
Rated capacity	DC 3.7 V, 1050 mAh
Operating temperature	0 °C to 40 °C (32 °F to 104 °F)
Dimensions (W × H × D)	Approx. 32 × 43.8 × 7.9 mm (1.3 × 1.7 × 0.3 in.)
Weight	Approx. 22.5 g (0.8 oz) (excluding terminal cover)

Charging AC Adapter EH-69P

Rated input	AC 100 to 240 V, 50/60 Hz, 0.068 to 0.042 A
Rated output	DC 5.0 V, 550 mA
Operating temperature	0 °C to 40 °C (32 °F to 104 °F)
Dimensions (W × H × D)	Approx. 55 × 22 × 54 mm (2.2 × 0.9 × 2.2 in.) (excluding plug adapter) For Argentina: Approx. 55 × 59 × 63 mm (2.2 × 2.4 × 2.5 in.)
Weight	Approx. 55 g (2.0 oz) (excluding plug adapter) For Argentina: Approx. 80 g (2.9 oz)

✔ Specifications

- Nikon will not be held liable for any errors this manual may contain.
- The appearance of this product and its specifications are subject to change without notice.

Supported Standards

- **DCF:** Design Rule for Camera File System is a standard widely used in the digital camera industry to ensure compatibility among different makes of camera.
- **DPOF:** Digital Print Order Format is an industry-wide standard that allows pictures to be printed at a digital photo lab or with a household printer from print orders stored on the memory card.
- **Exif version 2.3:** This camera supports Exif (Exchangeable Image File Format for Digital Still Cameras) version 2.3, a standard that allows information stored with photographs to be used for optimal color reproduction when images are output from Exif-compliant printers.
- **PictBridge:** A standard developed cooperatively by the digital camera and printer industries, allowing photographs to be output directly to a printer without connecting the camera to a computer.

Symbols

61

A Aperture-priority auto mode 62, 66

(apply selection) button 10

Auto mode 24

Backlighting mode 45

Delete button 31, 106, 126

Exposure compensation 39, 69

Flash mode 32

Flash pop-up control 33

Macro mode 38

M Manual mode 62, 67

MENU Menu button 11

(movie-record) button 118

Night landscape mode 44

Playback button 30

Playback mode 30

Playback zoom 96

P Programmed auto mode 62, 64

SCENE Scene mode 41

Self-timer 35

S Shutter-priority auto mode 62, 65

T Tele 27

Thumbnail display 94

W Wide 27

.JPG 168

.MOV 168

.WAV 168

A

AC adapter 166

AF area mode 83

AF assist 4, 152

Aperture value 63

Aperture-priority auto mode 66

Audio/video cable 127

Audio/video-in jack 127

Auto 32

Auto mode 24

Auto off 153

Autofocus 38, 89, 125

Autofocus mode 89, 125

AV cable 127, 166

B

Backlighting 45

Battery 14, 16, 166

Battery charger 18, 166

Battery level indicator 24

Battery-chamber/memory card slot cover 14, 22

Beach 50

Best shot selector 79

Black and white copy 54

Blink warning 157

Brightness 69, 71

BSS 79

Button sound 153

C

Calendar display 95

Charge by computer 156

Charge lamp 134

Charger 166

Charging AC Adapter 16, 166

Close-up 52

Command dial 9

Computer 129

Continuous 79

Creative slider 69

Crop 117

D

Date and time 20, 144

Daylight saving time 20, 145

Delete 31, 106, 126

Digital zoom 27, 152

D-Lighting 111

DPOF printing 140

DSCN 168

Dusk/dawn 51

E

Easy panorama 55, 57

Exposure 63

Exposure bracketing 82

Exposure compensation 39, 69



Exposure mode 62

Extension 168

F

Face priority 83

Face priority tracking 84, 87

File name 168
 Fill flash 32
 Filter effects 114
 Fireworks show  54
 Firmware version 161
 Flash 32
 Flash exposure compensation 89
 Flash lamp 34
 Flash mode 32
 Focus 13, 28, 83, 89, 125
 Focus area 28, 83
 Focus lock 29
 Folder name 168
 Food  53
 Format 23, 154
 Format the internal memory 154
 Format the memory card 23, 154
 FSCN 168
 Full-frame playback 30, 92
 Functions that cannot be applied simultaneously 90

H

HDMI 127, 155
 HDMI device control 155
 HDMI mini connector 127
 Histogram 39, 71, 93
 HS movie 120, 124
 Hue 69, 71

I

Identifier 168
 Image copy 107
 Image mode 74
 Internal memory 22
 Internal memory indicator 25
 ISO sensitivity 81

L



Landscape  47
 Language 155
 Lens 164, 181
 Li-ion rechargeable battery 16, 166
 Lithium-ion type battery 14, 16, 166

M

Macro mode 38

Manual mode 67
 Memory capacity 24
 Memory card 22, 167
 Memory card slot 22
 Metering 78
 Microphone 105, 118
 Mode dial 40
 Monitor 6, 8, 164
 Monitor brightness 147
 Monitor settings 147
 Motion detection 151
 Movie length 125
 Movie menu 122
 Movie options 123
 Movie playback 126
 Movie recording 118
 Multi-shot 16 79
 Museum  54





N

Night landscape  44
 Night portrait  49
 Nikon Transfer 2 129
 Number of exposures remaining 24, 75

O

Off 32
 Optical zoom 27
 Optional accessories 166

P

Panorama assist 55, 60
 Panorama  55
 Paper size 137, 138
 Party/indoor  50
 Pet portrait  56
 Photo info 147
 PictBridge 135, 184
 Picture editing 108
 Playback 30, 92, 94, 95, 96, 106, 126
 Playback menu 98
 Playback zoom 96
 Portrait  46
 Power 19, 20, 24
 Power switch/power-on lamp 19
 Preset manual 77
 Print 135, 137, 138

Print date 21, 100, 149
 Print order 99
 Printer 135
 Programmed auto mode 64
 Protect 102





Q

Quick retouch 110

R

Rechargeable battery 166
 Recording slow motion movies 120
 Red-eye reduction 32
 Reset all 159
 Rotary multi selector 10
 Rotate image 104
 RSCN 168

S

Scene auto selector  42
 Scene mode 41
 Selecting pictures 103
 Self-timer 35
 Self-timer lamp 35
 Setup menu 141
 Shooting 24, 40
 Shooting information 30, 93
 Shooting menu 72
 Shooting with Face Priority 85
 Shutter sound 153
 Shutter speed 63
 Shutter-priority auto mode 65
 Shutter-release button 4, 28
 Single 79
 Skin softening 46, 49, 112
 Slide show 101
 Slow sync 32
 Small picture 116
 Smile timer 36
 Snow  50
 Sound settings 153
 Special effects 56
 Sports  48
 SSCN 168
 Strap 13
 Subject tracking 84, 87
 Sunset  51

Switching between tabs 11

T

Tele 27
 Television 127
 Thumbnail playback 94
 Time difference 146
 Time zone 146
 Time zone and date 20, 144
 TV settings 155

U

USB cable 130, 136, 166
 USB/Audio video connector 127, 130, 136

V

Vibration reduction 150
 Video output 155
 ViewNX 2 129, 133
 Vividness 69, 71
 Voice memo 105
 Volume 126

W

Welcome screen 143
 White balance 76
 Wide 27

Z

Zoom 27
 Zoom control 27

Nikon

No reproduction in any form of this manual, in whole or in part (except for brief quotation in critical articles or reviews), may be made without written authorization from NIKON CORPORATION.



NIKON CORPORATION

© 2011 Nikon Corporation

FX1A03(11)
6MM04611-03