

**HYUNDAI**

**VOICE RECOGNITION TIPS** (if equipped)

**BLUETOOTH®**

**Command**      **Example**

Dial <Phone #> — “Dial 7-1-4-9-6-5-3-0-0-0”

Call <Name> — “Call John Smith”

**Improving how you store your contacts can optimize your Bluetooth® Voice Recognition performance:**

- Use full names instead of short or single-syllable names (“John or Dad”)
- Avoid using special characters/emojis or abbreviations (“Dr.”) when saving contacts

**NAVIGATION**

**Command**      **Example**

Find Address — “1-2-3-4-5 1st Street, <House #, Street, City, State>”

Find <POI Name> — “Find McDonald’s”

Located on Rearview Mirror

**LOCAL SEARCH**

**Command**      **Example**

Find <POI Name> — “Find Lowe’s® near me”

<POI Name> — “Starbucks®”

WINDSHIELD WIPER / WASHER - page 10

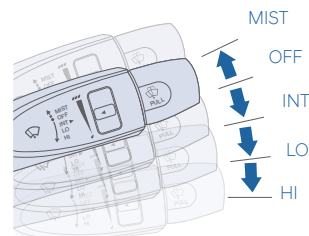

- To activate wipers, move the speed control switch down to one of the three positions (INT, LO, HI)
- To adjust “INT” speed, move the speed control switch.
- To spray the washer fluid, pull the lever towards you
- Push the lever up for a single wiper pass

UNLOCKING VEHICLE - page 01

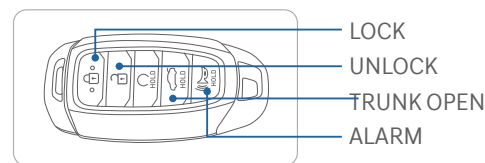

BLUE LINK

- Assist with creating MyHyundai.com account
- Assist with Blue Link enrollment
- Encourage customer to download the MyHyundai with Blue Link app

INTRODUCTION AND LOCATION OF THE SERVICE DEPARTMENT

SET FIRST SERVICE APPOINTMENT

REVIEW FACTORY RECOMMENDED MAINTENANCE SCHEDULE

WAS THE CONDITION OF YOUR VEHICLE (AT DELIVERY) TO YOUR SATISFACTION?

Sales Consultant      Date      Sales Manager      Date

Customer      Date

Email

**MAINTENANCE**

Scheduled Maintenance	2.0L	1.4T/1.6T
Engine Oil and Filter*	Replace 7,500 or 12 mos.	Replace 6,000 or 12 mos.
Fuel Additive*	Add 7,500 or 12 mos.	Add 6,000 or 12 mos.
Tire Rotation	Perform 7,500	Perform 6,000
Air Cleaner Filter	Inspect 7,500 Replace 30,000	Inspect 6,000 Replace 24,000
Vacuum Hose	Inspect 7,500	Inspect 6,000
Climate Control Air Filter (for Evaporator and Blower Unit)	Replace 12 mos	Replace 12 mos
Air Conditioning Refrigerant	Inspect 7,500	Inspect 6,000
Brake Hoses & Lines	Inspect 7,500	Inspect 6,000
Drive Shafts & Boots	Inspect 7,500	Inspect 6,000
Exhaust Pipe & Muffler	Inspect 7,500	Inspect 6,000
Disc Brake Pads, Calipers	Inspect 7,500	Inspect 6,000
Rear Brake Drum / Linings	Inspect 7,500	Inspect 6,000
Steering Gear Box, Linkage & Boots / Lower Arm Ball Joint, Upper Arm Ball Joint	Inspect 7,500	Inspect 6,000
Suspension Mounting Bolts	Inspect 7,500	Inspect 6,000
Brake / Clutch Fluid	Inspect 15,000	Inspect 12,000
Crankcase Ventilation Hose	Inspect 15,000	Inspect 12,000
Fuel Filter	Inspect 15,000	Inspect 12,000
Fuel Lines, Fuel Hoses and Connections	Inspect 30,000	Inspect 24,000
Fuel Tank Air Filter	Inspect 15,000	Inspect 12,000
Parking Brake	Inspect 15,000	Inspect 12,000
Vapor Hose, Fuel Tank & Fuel Filler Cap	Inspect 15,000	Inspect 12,000
Spark Plugs	Replace 97,500	Replace 42,000
Drive Belt (Alt, A / C)	1st Inspect 60,000 or 72 mos. Add'l Inspect 15,000 or 24 mos.	1st Inspect 60,000 or 72 mos. Add'l Inspect 12,000 or 24 mos.
Coolant	1st Replace 120,000 or 120 mos. Add'l Replace 30,000 or 24 mos.	1st Replace 120,000 or 120 mos. Add'l Replace 30,000 or 24 mos.
Dual Clutch Transmission	-	Inspect 24,000
Intelligent Variable Transmission Fluid	No check, No service required	-
Intercooler, In / Out Hose, Air Intake Hose (1.4T/1.6T)	-	Inspect 6,000

\*Check the engine oil regularly between recommended oil change. Hyundai recommends Quaker State oil.  
 \*1 If TOP TIER Detergent Gasoline is not available, one bottle of additive is recommended. Additives are available from your authorized Hyundai dealer along with information on how to use them. Do not mix other additives.  
 \*See Owner's Manual for details.

Looking for more detailed information? This Quick Reference Guide does not replace your vehicle's Owner's Manual. If you require additional information or are unsure of a specific issue, we recommend that you always refer to the vehicle's Owner's Manual or contact your authorized Hyundai dealer. The information contained in this Quick Reference Guide is correct at the time of printing; however, specifications and equipment can change without notice. No warranty or guarantee is being extended in this Quick Reference Guide, and Hyundai reserves the right to change product specifications and equipment at any time without incurring obligations. Some vehicles are shown with optional equipment.

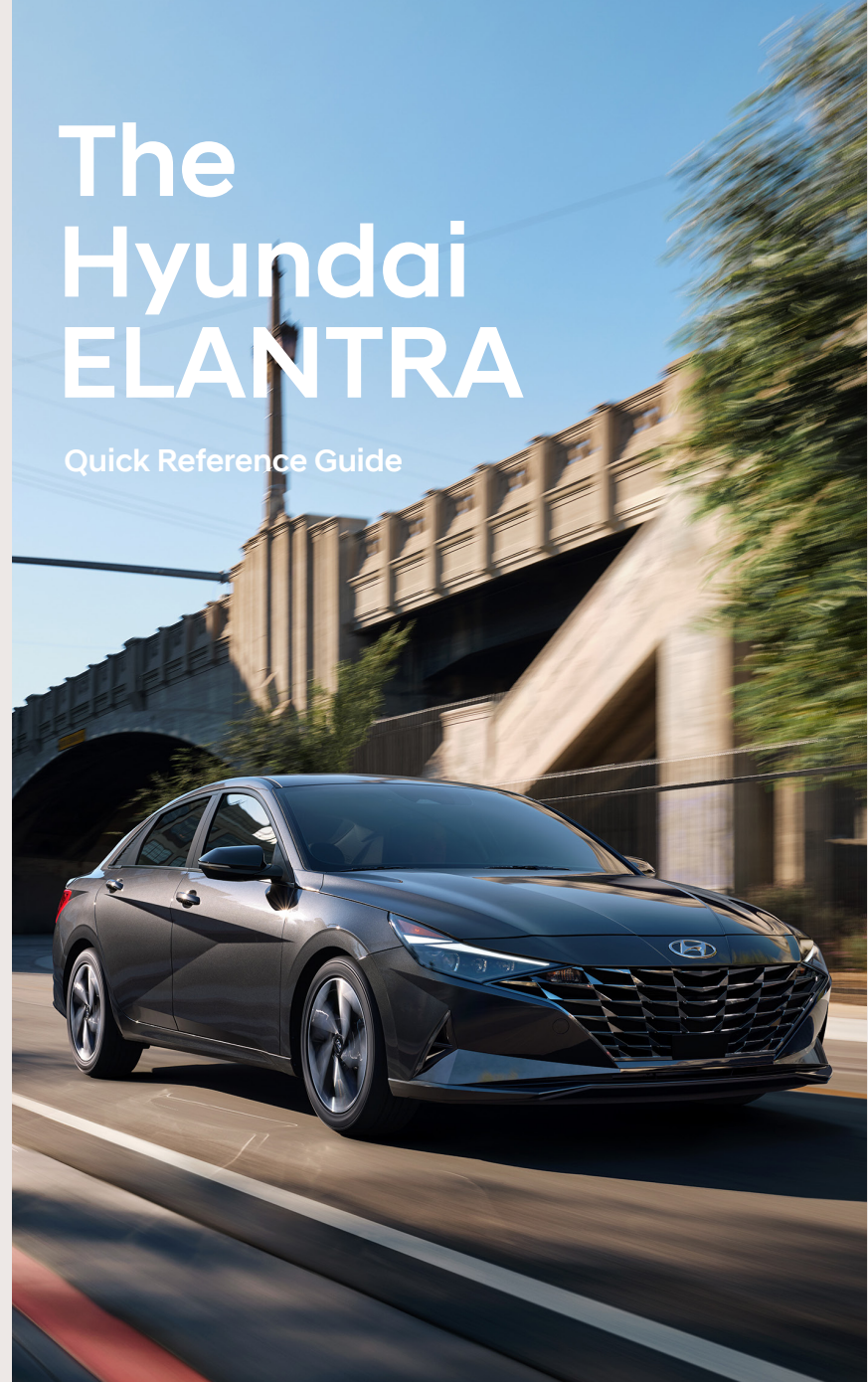

# The Hyundai ELANTRA

Quick Reference Guide

Roadside Assistance: 1-800-243-7766  
 Consumer Affairs: 1-800-633-5151  
 Sirius XM® Radio: 1-800-967-2346  
 Blue Link: 1-855-2BLUELINK (1-855-225-8354)



## **HYUNDAI VEHICLE OWNER PRIVACY POLICY**

Your Hyundai vehicle may be equipped with technologies and services that use information collected, generated, recorded or stored by the vehicle. Hyundai has created a Vehicle Owner Privacy Policy to explain how these technologies and services collect, use, and share this information.

You may read our Vehicle Owner Privacy Policy on the Hyundaiusa.com website at <https://www.hyundaiusa.com/owner-privacy-policy.aspx>. If you would like to receive a hard copy of our Vehicle Owner Privacy Policy, please contact our Customer Connect Center at:

Hyundai Motor America  
Hyundai Customer Connect Center  
P.O. Box 20850  
Fountain Valley, CA 92728-0850  
800-633-5151 [consumeraffairs@hmausa.com](mailto:consumeraffairs@hmausa.com)

Hyundai's Customer Connect Center representatives are available Monday through Friday, between the hours of 5:00 AM and 7:00 PM PST and Saturday and Sunday between 6:30 AM and 3:00 PM PST (English). For Customer Connect Center assistance in Spanish or Korean, representatives are available Monday through Friday between 6:30 AM and 3:00 PM PST.

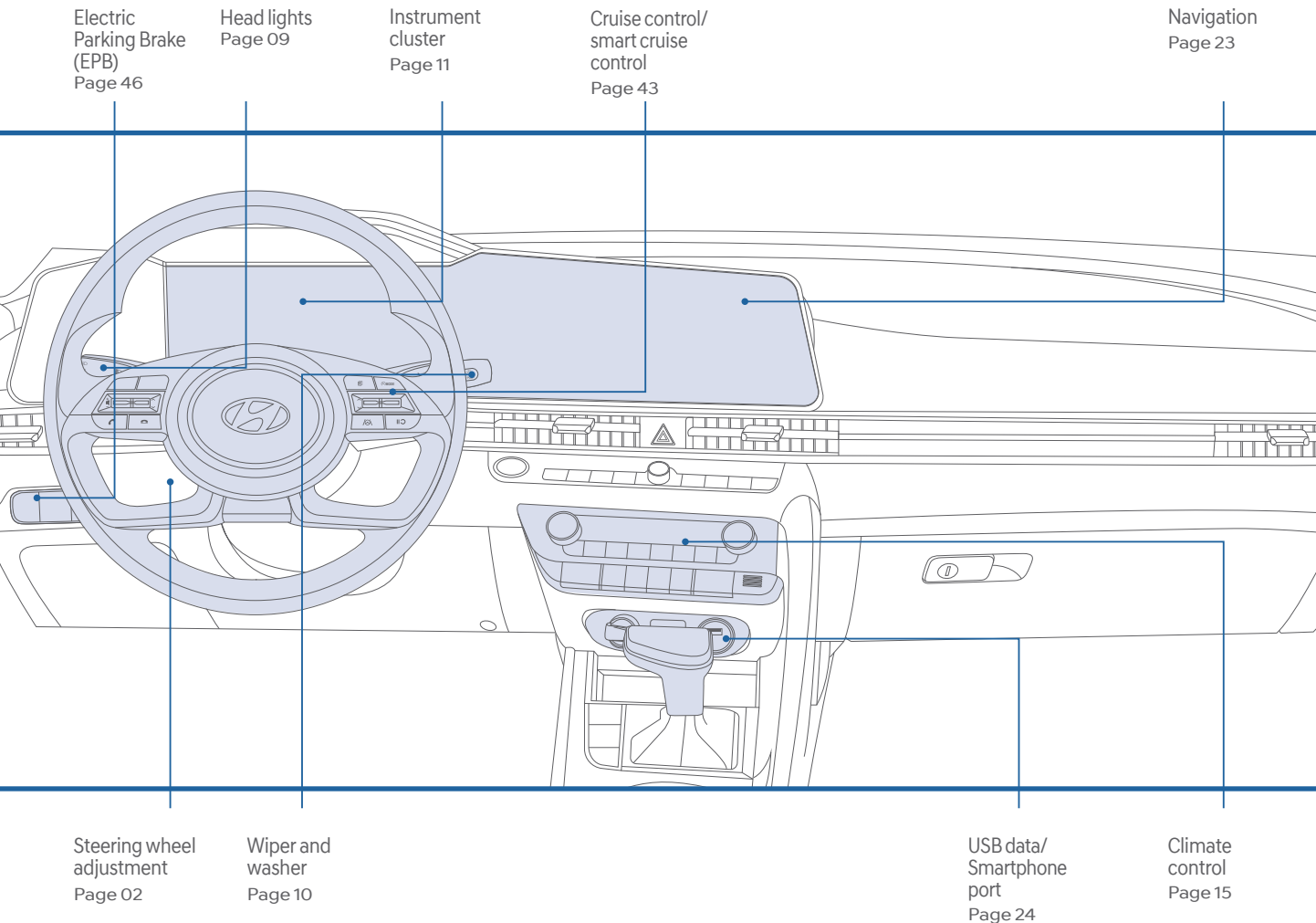

## FEATURES AND CONTROLS

Climate control	15
Driver's main controls	02
Fuel filler door	06
Headlights	09
Instrument cluster	11
Instrument panel illumination	14
Interior lights	08
LCD display control	13
LCD display modes	13
Sunroof	07
Remote & Smart key	01
Seat-Front seat adjustment	03
Seat-Headrest adjustment	04
Seat-Seat belt adjustment	04
Seat-Seat warmer	04
Steering wheel adjustment	02
Trunk-Smart trunk	06
Trunk-Trunk opening	05
Warnings and indicators	14
Wipers and washer	10

## INFOTAINMENT

Android Auto™	27
Android Auto™ wireless	29
Apple CarPlay™	31
Apple CarPlay™ wireless	35
Audio mode	21
Bluetooth operational tips	20
Bluetooth phone operation	19
Bluetooth phone pairing	19
FM radio	22
Homelink wireless control system	25
Navigation	23
Steering wheel audio control	22
USB data/Smartphone port	24
Wireless cellular phone charging system	24

## DRIVING

Auto Hold	46
Blind-Spot Collision-Avoidance Assist(BCA)	38
Cruise control / Smart cruise control	43
Digital key pairing	47
Drive mode	41
Electric Parking Brake (EPB)	46
Forward Collision-Avoidance Assist (FCA)	38
Highway Driving Assist (HDA)	44
Idle Stop and Go (ISG)	40
Intelligent variable transmission (IVT)	45
Lane Following Assist (LFA)	37
Lane Keeping Assist System (LKAS)	37
Leading vehicle departure alert	44
Near field communication (NFC)	48
Rear Cross-traffic Collision-Avoidance Assist (ROCA)	45
Rear Occupant Alert (ROA)	39
Tire Pressure Monitoring System (TPMS)	42

\* Some vehicles may not be equipped with all the listed features.





### WARNING!

To reduce the risk of serious injury to yourself and others, read and understand the important SAFETY INFORMATION in your Owner's Manual.

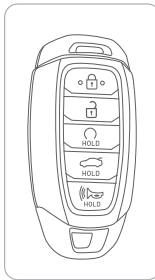
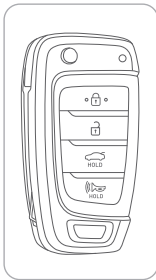
Use this Quick Reference Guide to learn about the features that will enhance your enjoyment of your Hyundai. More detailed information about these features are available in your Owner's Manual.

## REMOTE & SMART KEY



-  Lock
-  Unlock
-  Engine remote start button
-  Trunk Unlock
-  Panic

**NOTE:** To start the vehicle remotely, press and hold the remote start button for over 2 seconds within 4 seconds after locking the doors.

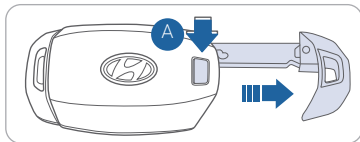

**Removing the mechanical key**  
Slide and hold the release button **A** to remove the mechanical key.

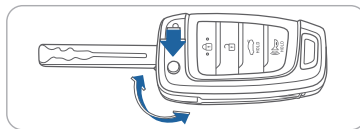

**NOTE:** User selectable option:  
Please see section 5 from Owner's Manual for more details.  
To unfold the mechanical key, press the release button on the remote.

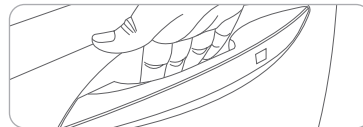
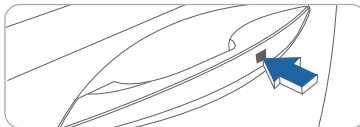

### Driver's door Lock / Unlock

- **Touch :** One time - Unlock driver door  
Two Times - Unlock all door
- **To Lock :** Press the touch sensor on the outside of the handle to lock.
- **To Disable/Enable 2 Press Unlock Function :** Vehicle must be in P(park) and OFF. Press and hold both door lock and door unlock button simultaneously on the key fob until the warning hazard lights blink.

### \* CAUTION

- If you locked the door with the touch sensor on the door handle, the doors cannot be unlocked with the sensor within 3 seconds.
- If you unlocked the door with the touch sensor on the door handle, the doors cannot be locked with the sensor within 2 seconds.

## STEERING WHEEL ADJUSTMENTS

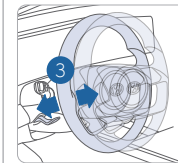
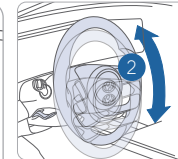
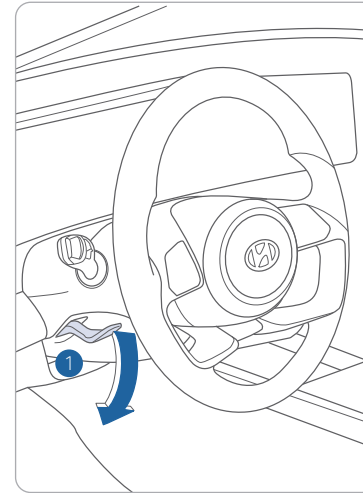

**NOTE:** Do not adjust while driving.

1. Pull the lever **1** down.
2. Set the angle **2** and distance **3**.
3. Pull the lever **1** up to lock position.

## DRIVER'S MAIN CONTROLS

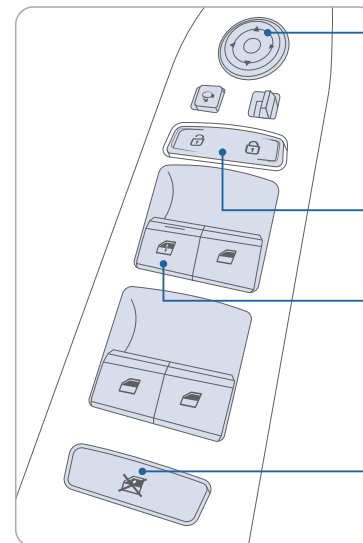

**Outside Rearview Mirror**  
Move the lever towards L (left) or R (right) on the switch. Then adjust the mirror by using the mirror adjustment control switch.

**Door Lock**  
Locks/unlocks all doors.

**Window Auto down/up (if equipped)**  
Press past detent to fully open/close window.

**Power window lock button**  
Disables the power window switches on the rear passenger doors.

## FRONT SEAT ADJUSTMENT (Manual)



Forward and Backward ①



Seat Height ②

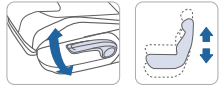

- Push down on the lever several times to lower the seat cushion.
- Pull up on the lever several times to raise it.

Seatback Angle ③



## FRONT SEAT ADJUSTMENT (Power, for the Driver's Seat)

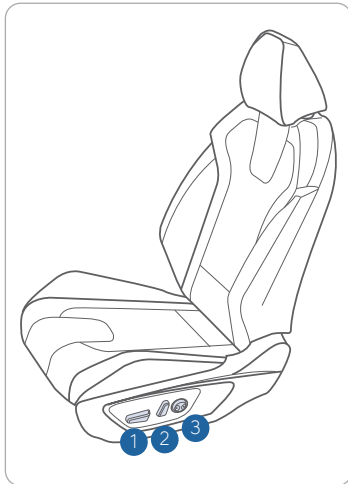

Forward and Backward ①

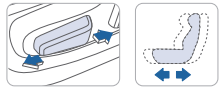

Seat Height

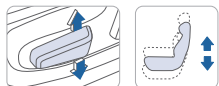
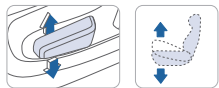

Seatback Angle ②



Lumbar Support (driver's seat only) ③

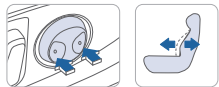

## HEADREST ADJUSTMENT

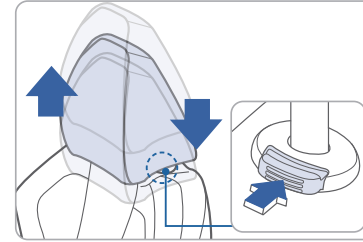

To Raise Headrest:  
Pull headrest up.

To Lower Headrest:  
Press lock button while pressing down on headrest.

## SEAT BELT ADJUSTMENT (Front seat)

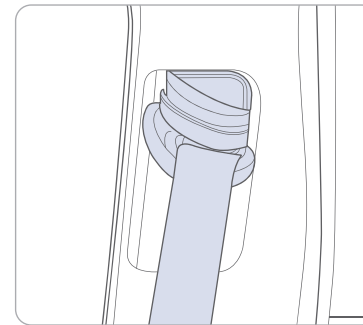

Pull up to raise.

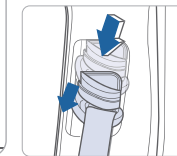
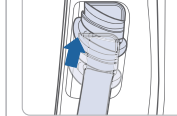

Press button and push down to lower.

## SEAT WARMER

Seat Warmer

Press the button **A** to increase heat

OFF → LOW (☰) → MED (☷) → HIGH (☳)

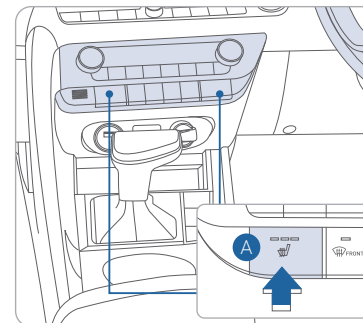

## TRUNK OPENING

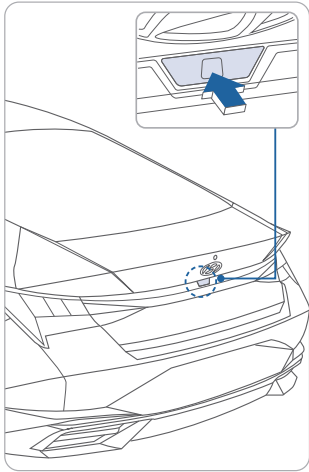

### Opening the trunk

The trunk can be opened using the key FOB or Smart Key, by pressing the trunk release button under the emblem, or by pulling the trunk release lever inside the vehicle.

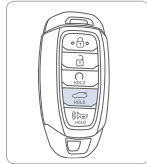

### Key FOB / Smart Key

Press and hold the trunk unlock button on the remote key FOB or Smart Key for about 1.5 seconds



### Trunk Release Lever

From inside the vehicle, pull the trunk release lever located inside the vehicle.

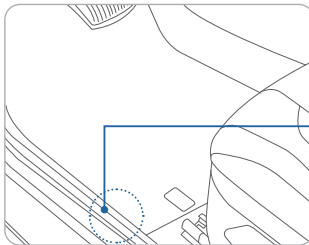

## SMART TRUNK

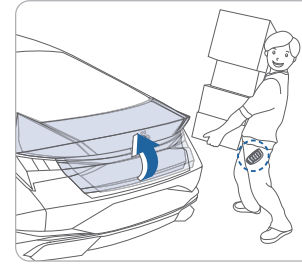

### Smart Trunk

Trunk will slightly open automatically when detecting smart key within range near the trunk for more than 3 seconds.

### To enable Smart Trunk function:

Vehicle must be in P (Park) to adjust settings in the User Setting mode.

1. Select "Door/Trunk" in the User Settings in the instrument cluster.
2. Check "Smart Trunk".

**NOTE:** Function is active after 15 seconds when all doors are closed and locked and key is not detected. The vehicle will also provide an audible and visual alarm while activating. For more details, refer to Owner's Manual.

## FUEL FILLER DOOR

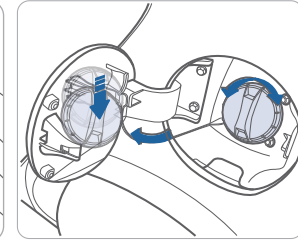
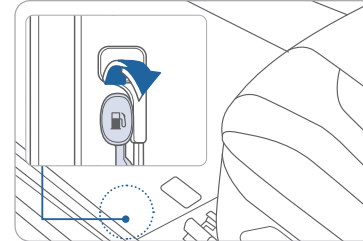

### To open fuel filler door :

The fuel filler door must be opened from inside the vehicle by pulling up the fuel filler door opener.

1. Turn the engine off.
2. Pull up the fuel filler door opener.

## SUNROOF

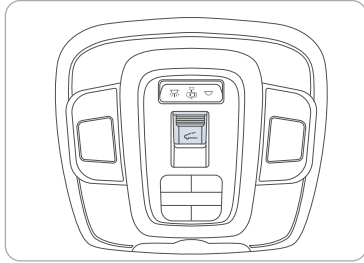

### Sunshade

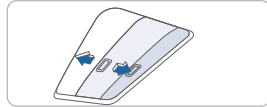

The sunshade will open automatically with the sunroof when the glass panel moves. If you want it closed, move the sunshade manually.

### Sliding the sunroof



Pull the sunroof control lever backward to open the sunroof. (This operation will also open the Sunshade, if it is not in the open position.)  
Push the sunroof control lever forward to close the sunroof.

### Tilting the sunroof

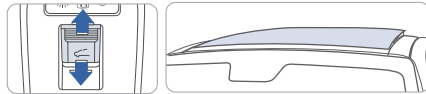

Push the sunroof control lever upward to open the sunroof to the tilt position. (This operation will also open the Sunshade, if it is not in the open position.)  
Push again the sunroof control lever upward to close the sunroof from the tilt position.

## INTERIOR LIGHTS

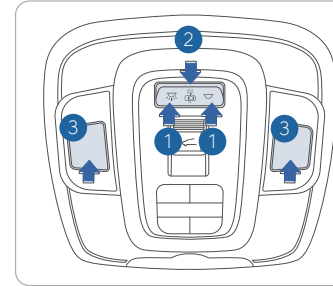

### Master Switch ①

Push the switch to turn the map lamp ③ and room lamp ④ on or off.

When the Master Switch ① is pushed, the other switches ③, ④ do not operate.

### Door Mode Switch ( ) ②

When the Door Mode Switch ② is pushed, map lamp ③ and room lamp ④ turn on if any door is opened and will turn off after all doors are closed.

### Room Lamp (Rear)

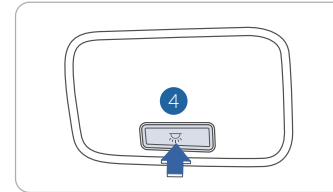

### Map Lamp (Lens Switch) ③

Press the lens to turn on and off for each side of map lamp.

### Room Lamp Switch ( ) ④

Press the switch to turn on and off the room lamp.

When this switch is pushed, master switch can't control room lamp

## HEADLIGHTS

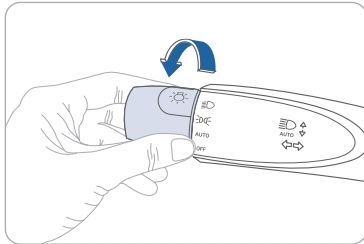

- ▶ | Headlight
- ▶ | Parking light
- ▶ | **AUTO** Auto light
- ▶ | **OFF** OFF

### Headlight Delay

Headlights may stay on for 15 seconds after exiting and locking vehicle. Press remote lock button twice to turn headlights off.

### Turn signals and lane change signals

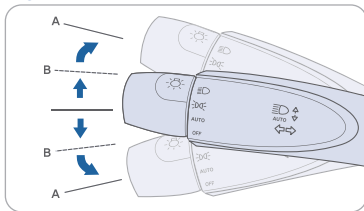

### Flashing headlights

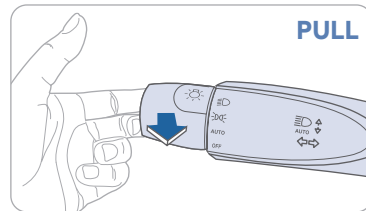

### High beam

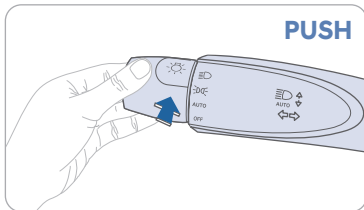

### High Beam Assist

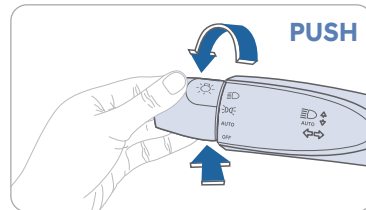

### NOTE:

To turn off high beam, pull the lever towards you.

### High Beam Assist

1. Select AUTO position on lever.
2. Turn on the high beam by pushing the lever away from you. High Beam Assist Indicator will illuminate
3. High Beam Assist system will turn on when vehicle speed is above 25 mph.
4. To turn off high beam assist, push the lever forward.

## WIPERS AND WASHER

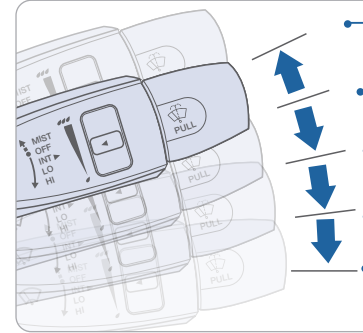

- **MIST** - Single wipe
- **OFF**
- **INT** - Intermittent wipe
- **LO** - Low wiper speed
- **HI** - High wiper speed

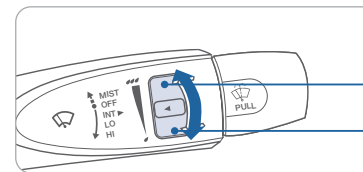

### Intermittent Wipe Time Adjustment

Move the control switch.

Fastest wiper speed

Slowest wiper speed

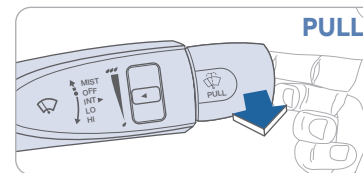

### Windshield Washer

Pull the lever gently toward you to spray washer fluid on the windshield and to run the wipers 1-3 cycles.



## INSTRUMENT CLUSTER

### Type A

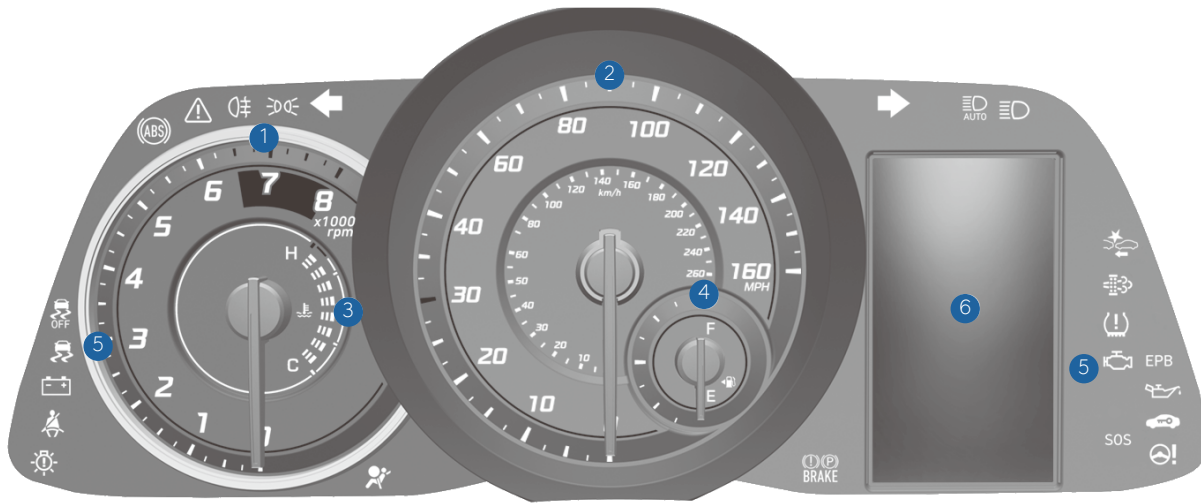

### Type B (LCD display)

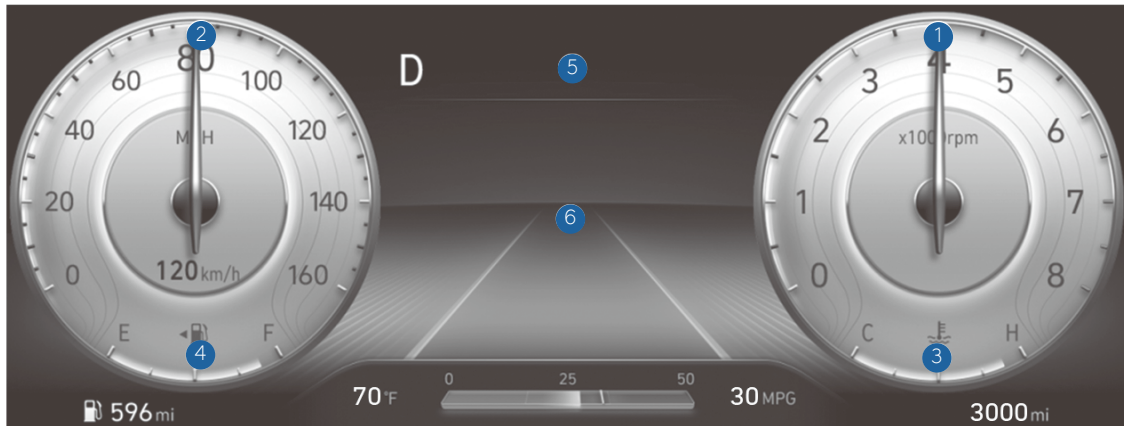

- ① Tachometer
- ② Speedometer
- ③ Engine Coolant Temperature Gauge
- ④ Fuel Gauge
- ⑤ Warning and Indicator Lights
- ⑥ LCD Display (including trip computer)

## LCD DISPLAY MODES

Modes	Symbol	Explanation
Trip Computer		This mode displays driving information like the tripmeter, fuel economy, and so on.
Turn By Turn (TBT) (if equipped)		This mode displays the state of the navigation.
Assist		- Smart Cruise Control (SCC) - Lane Keeping Assist (LKA) - Lane Following Assist (LFA) - Driver Attention Warning (DAW) - Tire pressure
Drive Assist (if equipped)		This mode displays the state of: - Smart Cruise Control system - Lane Keeping Assist - Lane Following Assist - Driver Attention Warning - Tire pressure
User Settings		Displays service interval and warning messages. Changes settings.
Warning		Displays service interval and warning messages.

## LCD DISPLAY CONTROL

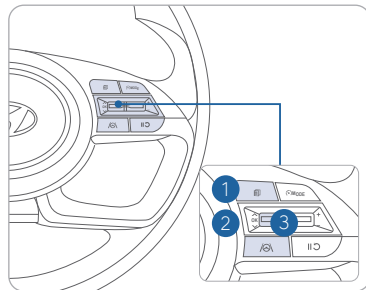

- 1 : MODE button for changing modes
- 2 : MOVE switch for changing items
- 3 : SELECT/RESET button for setting or resetting the selected item

## WARNINGS AND INDICATORS

Air bag warning light	Seat belt warning light	Parking brake & Brake fluid warning light
Anti-lock Brake System (ABS) warning light	Electronic Brake Force Distribution (EBD) system warning light	
Electric Power Steering (EPS) warning light	Malfunction Indicator Lamp (MIL)	Charging system warning light
Engine coolant temperature warning light	Engine oil pressure warning light	Low fuel level warning light
Low tire pressure warning indicator/TPMS malfunction lamp	Electric Parking Brake (EPB) warning light	Master warning light
Electronic Stability Control (ESC) indicator	Electronic Stability Control (ESC) OFF indicator	Immobilizer indicator
Turn signal indicator	Low beam indicator	High beam indicator
Light ON indicator	Smart high beam indicator	CRUISE Cruise indicator
AUTO HOLD indicator	SPORT mode indicator	Lane Keep Assist Indicator
Forward Collision-Avoidance Assist	Icy Road Warning Light	Headlamp Warning Light
Lane Follow Assist		

## INSTRUMENT PANEL ILLUMINATION

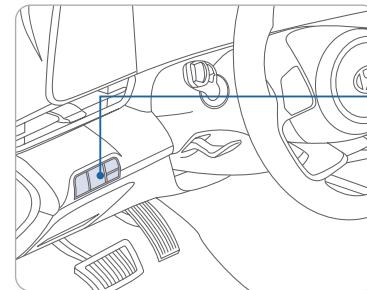

Press - or + to adjust instrument cluster illumination brightness.

## MANUAL CLIMATE CONTROL

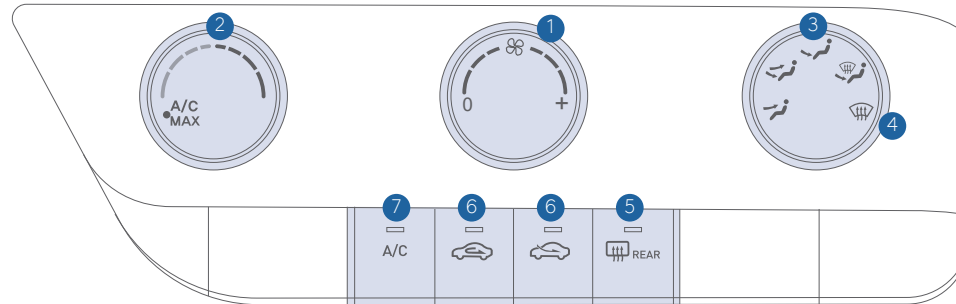

- 1 Fan Speed Control Knob
- 2 Temperature control knob
- 3 Mode selection knob
- 4 Front windshield defroster position
- 5 Rear Window Defroster Button
- 6 Air intake control button
- 7 A/C (Air conditioning) button

### Defogging / Defrosting



1. Select the Front Windshield Defrost Mode.



3. Set the fan speed to the medium speed.



2. Select the warmest temperature.

### NOTE:

To reduce the tendency of the glass fogging and also to improve visibility, keep the interior surface of the windshield clean by wiping it with a clean cloth and glass cleaner. In addition, select air intake control to the outside (fresh) air position whenever possible while operating the vehicle.

### Air intake control



Recirculated air position



Outside (fresh) air position

### Mode selection



Changes the direction of the air flow as following:

- Face-Level
- Bi-Level
- Floor-Level
- Floor & Defrost-Level
- Defrost-Level

### Rear Window Defroster

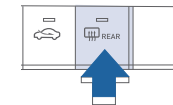

Press to activate/deactivate the rear defroster.

### MAX A/C mode

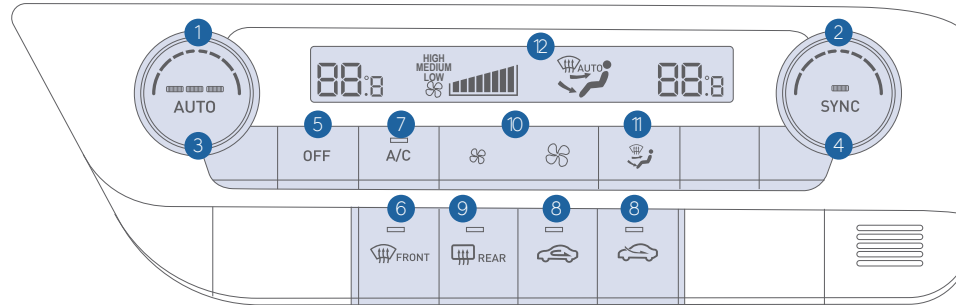

MAX A/C Mode automatically engages Recirculated air position and air conditioning. Return to normal A/C mode after the vehicle interior has cooled sufficiently.

## AUTOMATIC CLIMATE CONTROL



- 1 Driver's temperature control knob
- 2 Passenger's temperature control knob
- 3 AUTO (automatic control) button
- 4 SYNC button
- 5 OFF button
- 6 Front windshield defroster button
- 7 Air conditioning button
- 8 Air intake control button
- 9 Rear window defroster button
- 10 Fan speed control button
- 11 Mode selection button
- 12 Climate control information screen

### Air intake control

-  Recirculated air position (LED ON)
-  Outside (fresh) air position (LED OFF)

### Automatic heating / Air conditioning



### Mode selection



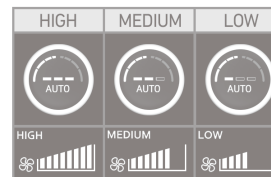

### Auto fan speed control



1. The fan speed is controlled automatically in 3 available settings.
2. Pressing the AUTO button will activate the AUTO function and change the AUTO fan speed setting
3. Settings: HIGH → MEDIUM → LOW
4. If the temperature is set to either 'HI' or 'LO', the fan speed setting will be 'HIGH'.

\* For detailed precautions and instructions, see the Owner's Manual.

### Defogging / Defrosting

1. Press the defrost button.  

2. Select warmest temperature.  

3. Set the fan speed to the highest speed.  

### NOTE:

To reduce tendency of the glass fogging and also to improve visibility, keep the interior surface of the windshield clean by wiping it with a clean cloth and glass cleaner. In addition, select air intake control to the outside (fresh) air position whenever possible while operating the vehicle.

### System off

- Pressing the OFF button will place the system in the OFF mode.
- Climate control fan will turn off.
  - Outside (fresh) air position will be selected.
  - Vented air will be at last set temperature.

## BLUETOOTH PHONE PAIRING

Pairing tutorials, phone compatibility and operational tips can be found through the Smart QR code using the QR reader application on your Smartphone.



## BLUETOOTH PHONE OPERATION

Phone setup (pairing phone)

1. Turn Bluetooth® on from your mobile phone. : All Menus > Setup > Device Connections > Bluetooth > Bluetooth Connections > Add New.

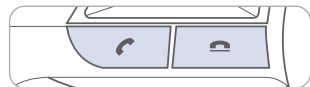

2. Select the car name shown on your mobile phone to pair.
3. Enter the passkey or accept the authorization popup on your phone. (The default passkey is 0000.)



4. Bluetooth is connected.

**NOTE:** Vehicle must be parked to complete pairing process.

## BLUETOOTH® OPERATIONAL TIPS

In the following situations you or the other party may have difficulty hearing each other:

1. Keep the Bluetooth® volume to a low level. High level volume may result in distortion and echo.
2. When driving on a rough road, high speeds and/or with the window open.
3. When the air conditioning vents are facing the microphone and/or when the air conditioning fan is at the max speed.

Steering wheel bluetooth® control

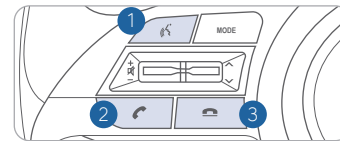

- 1 TALK Activates voice recognition.
- 2 CALL Places and transfers calls.
- 3 END Ends calls or cancels functions.

**To Answer a Call:** • Press button on the steering wheel.

**To Reject a Call:** • Press button on the steering wheel.

**To Adjust Ring Volume:** • Use the VOLUME buttons on the steering wheel.

**To Transfer a Call to the Phone**

**(Private call on handset – do not use while driving):**

- Press and hold button on the steering wheel until the audio system transfers a call to the phone.

**To Finish a Call:** • Press button on the steering wheel.

Making a call using voice recognition:

The menu tree identifies available voice recognition Bluetooth® functions.

**Calling by Name:**

1. Press button.
2. Say the following command:
  - “Call <John Smith>”: Connects the call to John.
  - “Call <John Smith> on <on Mobile/at Work/at Home>”: Connects the call to John’s Mobile, Home, or Work phone number.

**Dialing by Number:**

1. Press button.
2. Say “Dial Number”.
3. Say desired phone number.

For complete list of commands, refer to your Owner’s Manual.

**Note:** Vehicles without Navigation require a compatible Apple or Android phone connected to the USB port to use the Voice recognition button on the steering wheel.

- If connected via Bluetooth you cannot place a call using VR, you can only accept and end a call.

## AUDIO MODE

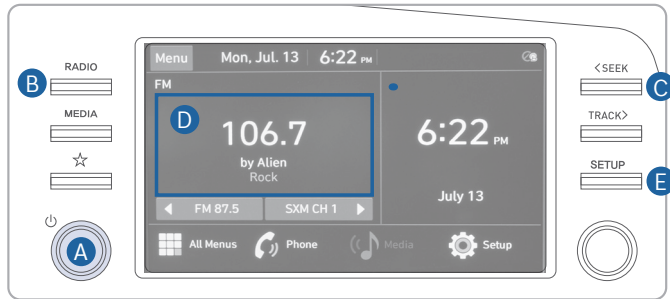

Press POWER button **A** to turn radio on.

### • TUNING/LISTENING TO CHANNELS

1. Press the RADIO button **B**.
2. Press the search backward button SEEK **C** or the search forward button TRACK to desired channel.

**NOTE:** A clear view of the southern sky is recommended to ensure SXM® radio reception.

### • SETTING PRESET MEMORY BUTTONS (FM/AM/SXM®)

Press and hold any preset button **D** until an audible beep is heard to store current channel.

### • ADJUSTING THE SOUND CONTROL

1. Press SETUP button **E**.
2. Select Sound button on screen.
3. Touch on-screen arrows to adjust desired setting.



### NOTE:

1. Users can set the volume level of each source (FM, AM, SXM, USB, BT and etc.) individually by adjusting the “A” knob.
2. When the volume of a source is adjusted to the desired level, it will be automatically saved at that setting. Thus, when the user changes source and reverts back, the volume will be set at the last desired level.

## FM RADIO



### RADIO NOISE CONTROL MODE

1. Press the **A** Menu button
  2. Press the **B** FM Radio Noise Control button
  3. Select Radio Noise Control Mode **1**, **2**, **3** as your preference.
- ※ Default : **2** Minimum Noise Reduction

## STEERING WHEEL AUDIO CONTROL

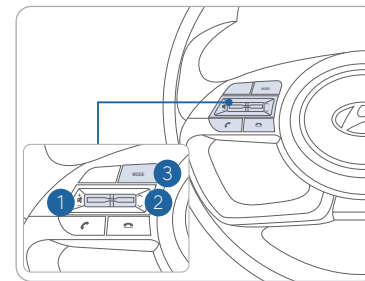

- 1 VOLUME**  
Raises or lowers speaker volume.
- 2 SEEK/PRESET**  
Change station.
- 3 MODE**  
Change the audio source.

## NAVIGATION

### Basic features on the map screen

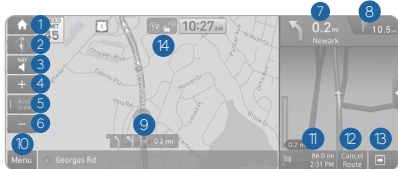

- 1 Displays the Home screen.
- 2 Used to change the map display mode.
- 3 You can adjust the volume of navigation or GPS warning sound.
- 4 Zoom in the map
- 5 The scale of the map automatically changes.
- 6 Zoom out the map
- 7 Guides the point to change the driving direction.

- 8 Guides the next point to change the driving direction.
- 9 Displays the lanes in different colors.
- 10 Displays quick menu items that can be used during a guidance.
- 11 Displays the remaining distance to the destination and the estimated time of arrival. For more details, touch the information item.
- 12 Pause route button to temporarily pause route guidance.
- NOTE:** Press and hold button to CANCEL route guidance.
- 13 Displays or hides the detailed guidance.
- 14 Displays system information on the map.

### Destination search screen

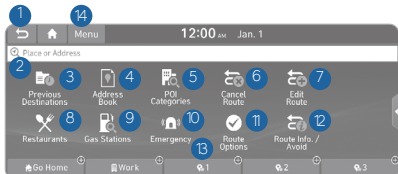

Press **[NAV]** button in the navigation head unit, and finds a destination by using the **[Destination]** menu.

- 1 Returns to the previous step.
- 2 Search for a location by entering various types of keywords such as place name and address.
- 3 Select any of previous destinations to set as a destination.
- 4 Register the location or use the address book for setting a destination.
- 5 Search for POIs by category to set as a destination.
- 6 You can cancel guidance to the destination.
- 7 You can edit the current route so that you can travel via waypoints on the way to the destination.
- 8 You can easily search for restaurants.
- 9 You can set a destination after searching for gas stations.
- 10 You can easily search for emergency services.
- 11 You can change the route search criteria to resume routing.
- 12 You can see the entire route information to the destination.
- 13 You can register your home, office, or other frequently visited place as a favorite for ease of search.
- 14 The list of menu items appears.

## WIRELESS CELLULAR PHONE CHARGING SYSTEM

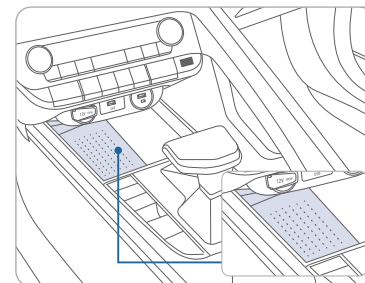

There is a wireless cellular phone charging system inside the front console. The system will operate when all doors are closed, and the ignition switch is in the ACC/ON position. The wireless charging pad is equipped with a cooling fan to help prevent overheating while charging.

### NOTE:

The wireless cellular phone charging system supports only the Qi-enabled cellular phones (☑).

### NOTE:

Do not place any metallic items such as coins, keys on the charger. Avoid putting credit cards, etc. on the charger as they might get damaged by the magnetic field.

## USB DATA/SMARTPHONE PORT

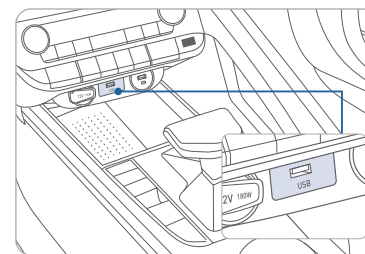

The USB data port can be used to connect an external audio device and listen to it through the audio system in your vehicle.

The USB data port can also be used to access Android Auto or Apple Car Play with your compatible phone.

## HOMELINK WIRELESS CONTROL SYSTEM

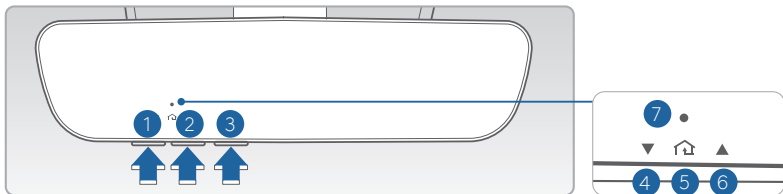

1. Press and release ①, ② or ③ button.
  - If the indicator ⑦ is turned ON in Orange, go to Step 3 (programming mode)
  - If the indicator ⑦ is continuously turned ON or flashes in Green rapidly several times, go to Step 2 (erasing mode)
2. Press and hold the button you wish to program for approximately 15- 25 seconds until the LED flashes in Orange for several times.
3. Hold the Garage Door Opener Original Transmitter near the HomeLink Mirror.
4. Press the Original Transmitter button until the indicator ⑦ is turned continuously ON or flashes in Green for approximately 10 seconds and it indicates the programing is completed.

**NOTE:** If the indicator ⑦ flashes in Green continuously, but if the garage door opener does not operate, please continue to follow Rolling Code Programming steps below.

### Two Way Communication

Some new garage door openers come equipped with a two-way communication feature. If your garage door opener has this feature, please also continue to follow the Rolling Code Programming steps below. For more information and programming tips on two-way communication please visit [www.homelink.com/compatible/two-waycommunication](http://www.homelink.com/compatible/two-waycommunication) or call (800)-355-3515.

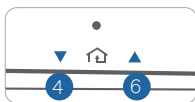

Indicator ④ & ⑥:  
 Flashes in orange → “Closing” & “Opening”  
 Solid Green → “Closed” & “Opened”

**NOTE:** If your garage door opener has Two-Way Communication functionality, it is possible for HomeLink to stop functioning the garage door shortly after initial programming, if the Two-Way Communication Programming wasn't properly completed. If you experience this, completing the “Programming a New HomeLink Button” and “Two-Way Communication Programming” will restore door operation.

### Rolling Code Programming

- You may need a ladder to access your garage door opener.
  - You may need help from a second person.
  - Be prepared some of the steps are time sensitive.
1. Firmly press and release the “Learn”, Smart”, or “ Program” button of garage door opener on the ceiling while the indicator ⑦ flashes in Green. Once the button is pressed, you have approximately 30 seconds to initiate the next step.

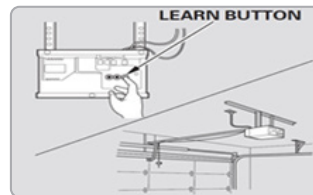

2. Return to the vehicle and firmly press the HomeLink button, hold for two seconds and release the button up to three times. Do not press the HomeLink button rapidly. At this point programming is complete and your device should operate.

For more detailed information, please refer to your Owner's manual or visit [www.homelink.com](http://www.homelink.com) or call (800) 355-3515





## ANDROID AUTO™

### REQUIREMENTS:

- USB cable
- OS Android™ 5.0 or higher
- Compatible Android Phone
- Data and wireless plan for applicable features

### BEFORE YOU BEGIN:

- Android Auto features may operate differently than on your phone.
- Message and data charges may apply when using Android Auto.
- Android Auto relies on the performance of your phone. If you experience performance issues:
  - Close all apps and then restart them
  - Disconnect and then reconnect your phone
- Using the USB cable that was provided with your phone is recommended.
- When Android Auto is active, your in-vehicle voice recognition system is disabled and you will be using talk to Google™ to make your requests.

### ANDROID AUTO SUPPORT



<https://support.google.com/androidauto/>

## PHONE SETUP

Turn on Bluetooth® on your phone and connect the micro USB cable to your phone and the USB port on the vehicle.

Phone will prompt you to download the Android Auto app and update other needed apps (e.g. Google Maps™, Google Play Music™, Google Now™).

**NOTE:** Vehicle must be parked.

- Location mode setting should be set to High accuracy.
- Car and phone setup should be completed in one sitting. If phone setup needs to be resumed, recommend to Force Stop the Android Auto app on the Phone then reopen the app and accept the Disclaimer notifications.

## CAR SETUP

1. Press the SETUP button on the radio.
2. Touch the “Device Connections” icon on screen.
3. Select Android Auto
4. Select Enable Android Auto
5. Connect your Android phone to the vehicle USB port. Agree to the notification and disclaimers on your phone then the “Android Auto” icon will appear confirming the setup.

For more detailed information on how to operate Android Auto, please refer to your display audio or navigation manual.

For additional Android Auto support, please refer to the Android Auto Support Website

<https://support.google.com/androidauto/>

Android Auto, Google Play, Android, and other marks are trademarks of Google Inc.

## ANDROID AUTO™ WIRELESS (IF EQUIPPED)

### REQUIREMENTS:

- Compatible Android Phone that supports Android Auto Wireless
- Data and wireless plan for applicable features
- Bluetooth & Wifi must be enabled

### BEFORE YOU BEGIN:

- Android Auto can be set up and utilized with both the Wi-Fi and USB Chord

## PHONE SETUP

- Turn on Bluetooth and Wifi on your phone
- Download Android Auto App, and update other needed apps (e.g. Google Maps, Google Play Music, Google Now)

## CAR SETUP



### Activate Wireless Connectivity

On the Home Screen, select the following:  
All Menu > Setup > Wi-Fi > **Use Wi-fi Connection**

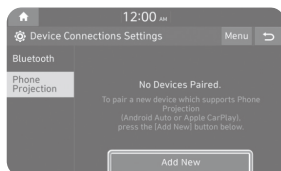

### Pairing Smartphone With Phone Projection

On the Home Screen, select the following:  
All Menu > Setup > Device Connections > Phone Projection > **Add New**

## ON YOUR SMARTPHONE

- Activate Bluetooth and Wifi
- Search for your vehicle on Bluetooth device list
- Select your Vehicle
- Confirm Bluetooth passkeys match the touch screen display
- Read and accept prompts from the touch screen display

### NOTE:

If the smartphone has been added to the system's Bluetooth device list, first delete the smartphone from the Bluetooth list, and add it to the phone projection list. Smartphone will also be registered to Bluetooth after registering to Phone Projection.

### Connect to Android Auto

On the Home Screen, select the following:  
All Menu > Android Auto

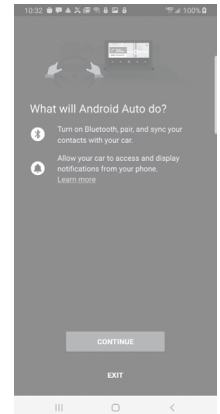

## APPLE CARPLAY™

### REQUIREMENTS

- Apple Lightning® cable (Apple-certified cable)
- Latest iOS
- iPhone® 5 or above
- Data and wireless plan for applicable features

### BEFORE YOU BEGIN

- Apple® CarPlay features may operate differently than on your phone.
- Message and data charges may apply when using Apple CarPlay.
- Apple CarPlay relies on the performance of your phone. If you experience performance issues:
  - Close all apps and then restart them
  - Disconnect and then reconnect your phone
- Using the Apple Lightning cable that was provided with your phone is recommended.
- When Apple CarPlay is active, your voice recognition system is disabled and you will be using Siri® to make your requests.

### PHONE SETUP

On your phone, go to Settings > General > CarPlay to allow CarPlay access.

On your phone, go to Settings > Siri and ensure Siri is turned ON.

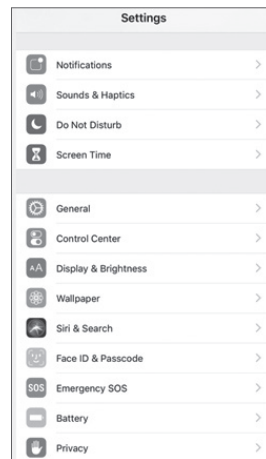

### CAR SETUP

1. Press the SETUP button.
2. Touch the “Device Connections” icon on the screen.
3. Touch Apple CarPlay.
4. Touch Enable Apple CarPlay.
5. Connect your Apple iPhone to the vehicle USB port then touch ‘OK’ when the pop-up message appears. The Apple CarPlay icon will now appear on the vehicle Home screen confirming the setup.

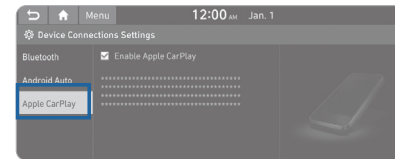

Apple CarPlay, Apple, and other marks are trademarks of Apple Inc.

## CarPlay Home Screen

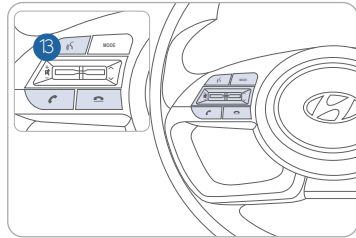
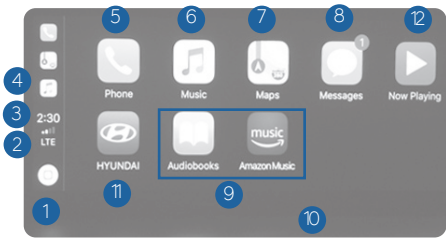

- |                         |                                  |
|-------------------------|----------------------------------|
| 1 HOME ICON             | 7 APPLE MAPS                     |
| 2 WIRELESS CONNECTIVITY | 8 MESSAGES                       |
| 3 CELLULAR SIGNAL       | 9 3RD PARTY APPS                 |
| 4 PHONE TIME            | 10 SCREEN PAGE INDICATOR         |
| 5 PHONE                 | 11 EXIT TO HYUNDAI               |
| 6 APPLE MUSIC™          | 12 CURRENT CARPLAY AUDIO PLAYING |
|                         | 13 VOICE RECOGNITION TIPS        |

## SIRI

Apple CarPlay uses Siri to perform many actions like sending messages, placing calls, and looking up/setting POI/Destinations. A Siri session can be initiated on any screen by:

1. Touch and holding the HOME icon 1 on the CarPlay screen or
2. Press the steering wheel VOICE RECOGNITION 13 button.

Note: Ensure Siri feature is set to ON in your phone (Go to Settings > General > Siri).

3. Say any of the following commands;
  - “Text <John Smith> ‘Call you later’” to send a text message.
  - “Read text messages” to read available text message.
  - “Call <John Smith>” to make a phone call.
  - “Find <POI/Destination>” to locate a POI/Destination.

## PHONE

Touch the PHONE 5 icon to access the Phone screen. Siri will automatically ask ‘Who would you like to call’ when the PHONE 5 icon is selected.

**NOTE:** Phone call sound quality is dependent on the wired connection. Using the Lightning cable that came with the phone is recommended.

## APPLE MUSIC

Touch the APPLE MUSIC 6 icon to access the Apple Music screen.

## APPLE MAPS

Touch the APPLE MAPS 7 icon to access the Apple Map screen.

## MESSAGES

Touch the MESSAGES 8 icon to access the Message screen. Siri will automatically ask ‘To hear unread messages or create a new one’ when the MESSAGE icon is selected.

## 3rd PARTY APPS

Supported CarPlay apps that are downloaded on your phone will appear on the CarPlay screen. Touch the apps icons to access those supported apps.

**NOTE:** A list of the supported CarPlay supported apps can be found at <http://www.apple.com/ios/carplay/>

Ensure phone has latest version of the 3rd Party Apps.

## APPLE CARPLAY™ WIRELESS (IF EQUIPPED)

### REQUIREMENTS:

- Latest iOS
- Compatible iOS Phone that supports Wireless Carplay
- Data and Wireless plan for applicable features

### BEFORE YOU BEGIN:

- Carplay is only available via Wi-Fi Phone Projection

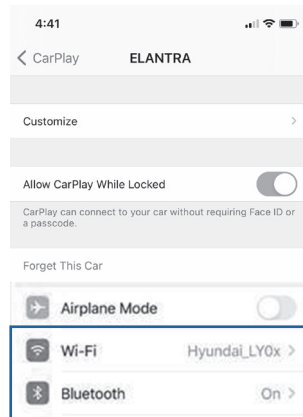

### PHONE SETUP

1. On your phone, go to Settings > General > Carplay to allow Carplay access.
2. On your phone, go to Settings > Siri and ensure Siri is turned ON.
3. On your phone, go to Settings > Wi-Fi and ensure Wi-Fi is turned ON.
4. On your phone, go to Settings > Bluetooth and ensure Bluetooth is turned.

### CAR SETUP



#### Activate Wireless Connectivity

On the Home Screen, select the following:

All Menu > Setup > Wi-Fi > **Use Wi-fi Connection**

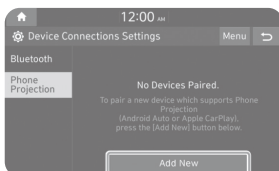

#### Pairing Smartphone With Phone Projection

On the Home Screen, select the following:

All Menu > Setup > Device Connections > Phone Projection > **Add New**

### ON YOUR SMARTPHONE

- Activate Bluetooth and Wifi
- Search for your vehicle on Bluetooth device list
- Select your Vehicle
- Confirm Bluetooth passkeys match the touch screen display
- Read and accept prompts from the touch screen display

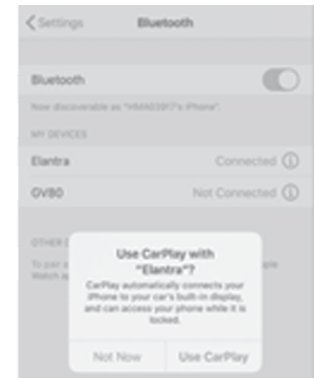

### NOTE:

If the smartphone has been added to the system's Bluetooth device list, first delete the smartphone from the Bluetooth list, and add it to the phone projection list. Smartphone will also be registered to Bluetooth after registering to Phone Projection.

#### Connect to CarPlay

On the Home Screen, select the following:

All Menu > CarPlay

## LANE KEEPING ASSIST SYSTEM (LKAS)

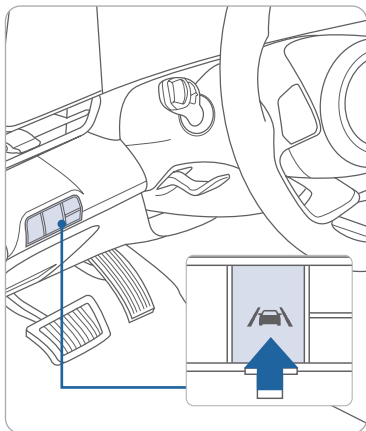

When the Lane Keeping Assist System detects the vehicle straying from its lane, it alerts the driver with a visual and audible warning, while applying a counter-steering torque to help prevent the vehicle from departing from its lane.

- To turn LKAS on, press the LKAS switch.
- To turn LKAS off, press the switch again.
- LKAS settings may be adjusted in the Vehicle Settings menu under Driver Assistance > Lane Safety

**NOTE:** LKAS Settings can be adjusted in the User Settings page of the instrument cluster under Driving Assist.

For LKAS to operate, vehicle speed must be at least approximately 40 mph to enable the LKA system. The indicator in the cluster display will illuminate green when all the conditions have been met. Refer to the Owner's Manual for more detailed information.

## LANE FOLLOWING ASSIST (LFA)

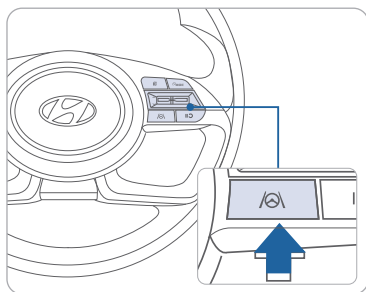

The Lane Following Assist (LFA) system detects lane markers on the road using a multi-function camera mounted on the front windshield. The system helps to assist the driver steering to help keep the vehicle centered in the lane.

To enable the LFA system while driving, press the Lane Driving Assist ON/OFF button on the steering wheel.

### Operating conditions

When the system is activated, the indicator (Ⓢ) on the cluster will illuminate. The color of the indicator will change depending on the condition of LFA system.

- Green: Steering assist mode is ON
- White: Steering assist mode is OFF

## FORWARD COLLISION-AVOIDANCE ASSIST (FCA)

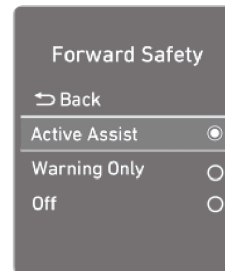

The Forward Collision Avoidance (FCA) system is designed to detect and monitor the vehicle ahead and warn the driver if a collision is imminent. This feature also allows pedestrian detection.

To operate the system, select the Forward Safety Active Assist sub menu in the LCD cluster display under User Settings.

Setup > Vehicle Settings > Driver Assistance > Forward Safety

Please refer to your Owner's Manual for further information.

## BLIND-SPOT COLLISION-AVOIDANCE ASSIST (BCA)

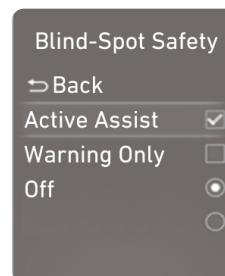

The Blind-Spot Collision-Avoidance Assist (BCA) system may apply braking power, when an approaching vehicle is detected within a certain distance next to or behind your vehicle. The instrument cluster will inform the driver of activation. If vehicle speed exceeds 40 mph the system will activate. Press the switch again to deactivate the system.



- A** **Blind spot collision warning (BCW)**  
Warning range is dependent on your vehicle speed. Example, if your vehicle speed is 20 mph greater than other vehicles, the warning is not active.

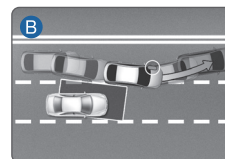

- B** **Blind spot collision avoidance (BCA)**  
When changing lanes, the system detects the front lane through the camera installed on the windshield and detects the side/rear areas through radar sensors.

## REAR OCCUPANT ALERT (ROA)

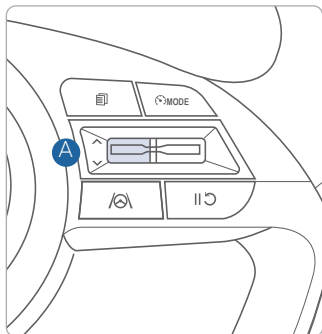

### Check rear seats



**NOTE:** The overhead sensor is located above the rear passenger seats.

The Rear Occupant Alert system helps prevent exiting the vehicle with the rear passengers left in the vehicle.

#### 1st Alert

When you open the front door after opening and closing the rear door and the engine is off, a “check rear seats” warning message appears.

#### 2nd Alert

When any movement in the vehicle is detected after the driver’s door is closed and all doors are locked, the horn will activate for 25 seconds. To stop this alert, unlock the door with the remote key or smart key.

**NOTE:** After the first alert, press the OK **A** button on the steering wheel to deactivate the second alert. If the system continues to detect movement, the horn activates up to 8 times. The system detects movement in the vehicle for 24 hours after the doors are locked.

#### Activate/Deactivate

Select the following items on the instrument cluster in order:

1. Select User Settings on the cluster LCD display
2. Select Convenience
3. Select Rear Occupant Alert

## IDLE STOP AND GO (ISG) (if equipped)

The ISG system will automatically shut off the engine when the vehicle is at a standstill (i.e. red stop light, stop sign, and traffic jam) to increase vehicle’s fuel economy and reduce exhaust gas emissions. The auto stop indicator will illuminate in green on the instrument cluster when activated. To restart the engine in auto stop mode, release the brake pedal (and depress the accelerator pedal when Auto Hold is activated). The auto stop indicator goes OFF on the instrument cluster once the engine is restarted.

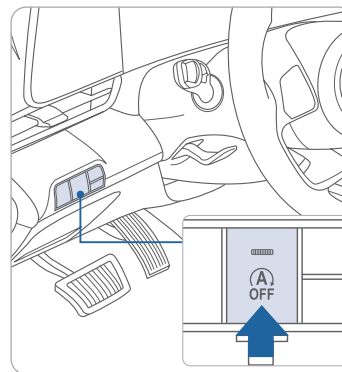

#### Prerequisite for activation:

- The driver’s seatbelt is fastened.
- The driver’s door and the hood are closed.
- The brake pressure is adequate.
- The battery is sufficiently charged.
- The outside temperature is between 14°F and 95°F (-10°C and 35°C).
- Engine is warmed up.
- The incline is gradual.
- Steering wheel is turned less than 180 degrees.
- Shift lever is in DRIVE or NEUTRAL.

**NOTE:** The engine will not shut off if the prerequisites are not satisfied. In that case, the Auto Stop indicator will illuminate in yellow on the instrument cluster.

#### To deactivate

Press the ISG OFF button, indicator illuminates.

#### To activate

Press the ISG OFF button, indicator turns OFF.

## DRIVE MODE

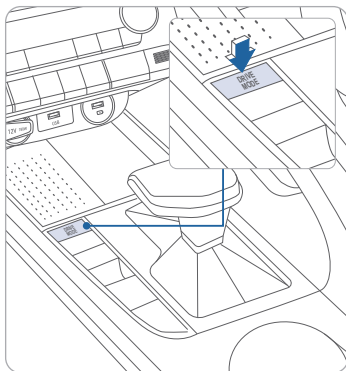

The mode changes, as below, whenever the DRIVE MODE selection switch is toggled up and down. An indicator will illuminate on the instrument cluster when the vehicle is in sport mode or smart mode. When the vehicle is in normal mode, it is not displayed on the instrument cluster.

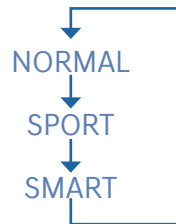

### NORMAL mode:

In normal mode, the engine and transmission control logic work together to provide regular daily driving performance with fuel efficiency.

### SPORT mode:

Sport mode manages the driving dynamics by automatically adjusting the steering effort, and the engine and transmission control logic for enhanced driving performance. When sport mode is activated, the engine RPM will be a little higher than normal.

### SMART mode:

Smart mode selects the proper driving mode between normal and sport by judging the driver's driving habits.

**NOTE:** Whenever the engine is restarted, the drive mode will revert back to the default normal mode

## TIRE PRESSURE MONITORING SYSTEM (TPMS)

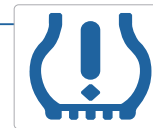

Low Tire Pressure Indicator / TPMS Malfunction Indicator



Low Tire Pressure / Tire Pressure Monitor / TPMS Malfunction Display (shown on the cluster LCD display)

### LOW TIRE PRESSURE INDICATOR

Illuminates if one or more of your tires are significantly under-inflated.

### TPMS MALFUNCTION INDICATOR

Blinks for approximately one minute, then remains illuminated when there is a malfunction with the TPMS. Inspect all tires and adjust the tire pressure to specification. If the lamp remains illuminated, it is recommended that the vehicle be checked by an authorized HYUNDAI dealer.

### LOW TIRE PRESSURE / TIRE PRESSURE MONITOR / TPMS MALFUNCTION DISPLAY(LCD DISPLAY)

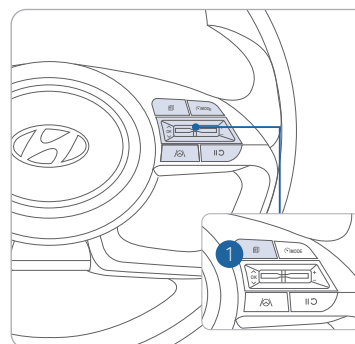

Select the Assist mode **A** by pressing the MODE **1** button on the steering wheel to display tire pressure.

Tire pressures will display after driving a short distance. If a tire pressure drops lower than predetermined specification, the Low Tire Pressure Indicator **!** will illuminate and the cluster **!** display will indicate which tire requires air.

**NOTE:** Environmental factors can affect the tire pressure. The two main environmental factors are ambient air temperature and elevation. Colder ambient air will reduce tire pressure, while hotter ambient air will increase tire pressure. High elevation may also increase tire pressure.



## CRUISE CONTROL/SMART CRUISE CONTROL

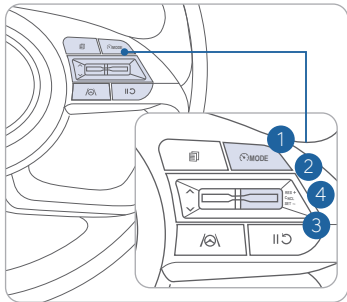

The Cruise Control system allows you to program the vehicle to maintain a constant speed without holding the accelerator pedal.

- 1 To turn On/Off cruise control.
- 2 Toggle switch UP to Resume or Increase the cruise control speed.
- 3 Toggle switch DOWN to Set or Decrease the cruise control speed.
- 4 To Pause the Cruise Control

### Setting Vehicle Distance (Smart Cruise Control only)

This system assist you in setting the distance from the vehicle ahead and will maintain the selected distance without you depressing the accelerator or the brake pedal.

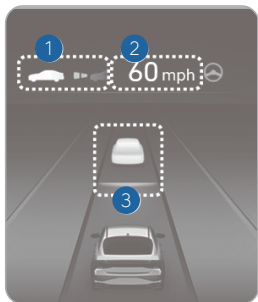
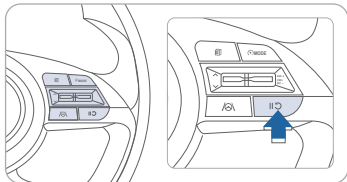

Press the button to set and maintain the vehicle-to-vehicle distance without pressing the accelerator or brake pedal.

The vehicle-to-vehicle distance 1 will automatically activate when you set the cruise speed 2.

Each time the button is pressed, the vehicle-to-vehicle distance changes as follows:



### Setting Cruise Control

1. Press the "CRUISE" button 1 to turn on Cruise Control. The icon will illuminate in the instrument cluster.
2. Toggle "--SET" switch (3) DOWN to set cruising speed.

### Adjusting the vehicle speed

1. Toggle "+RES" switch 2 UP to increase cruising speed.
2. Toggle "--SET" switch 3 DOWN to decrease cruising speed.

**NOTE:** Quick toggle up/down will change speed by 1 mph. Holding switch up/down will change speed by 5 mph.

### To Cancel Cruise Control

Press the "CRUISE" button 1 or depress the brake pedal.

Please refer to your Owner's Manual for more information.

## LEADING VEHICLE DEPARTURE ALERT

The Leading Vehicle Departure Alert system alerts the driver of the departure of the vehicle in front when the vehicle is stopped and the Smart Cruise Control (SCC) is in activation.

### To activate

Select the following items on the instrument cluster in order:

1. Select User Settings on the cluster LCD display.
2. Select Driver Assistance
3. Select Driver Attention Warning
4. Select Leading Vehicle Departure Alert

The system stops operation when the setting is deactivated. However, if the engine is turned off then on again, the system maintains in the previous state.

## HIGHWAY DRIVING ASSIST (HDA) (if equipped)



The Highway Driving Assist (HDA) system helps keep the vehicle between lanes, maintain a distance with the vehicle ahead, and automatically adjusts the vehicle speed to the speed limit while driving on the highway.

With the Engine Start/Stop button in the ON or START position, the Highway Driving Assist can be activated from the Settings menu in the infotainment system screen by selecting the following:

'Setup → Vehicle Settings → Driver Assistance → Highway Driving Assist' Deselect the setting to turn off the system.

**NOTE:** If the engine is turned off then on again, the system maintains the last setting.

### Operating Conditions:

- Driving on the highway main line.
- Smart Cruise Control is operating.
  - If the Smart Cruise Control is in the READY state the Highway Driving Assist will be in the READY state. The indicator on the cluster will illuminate white.
- Vehicle speed is under 95 mph (153 km/h).

If all the mentioned conditions are satisfied, the system is ENABLED and the indicator on the cluster will illuminate green.

## INTELLIGENT VARIABLE TRANSMISSION (IVT)

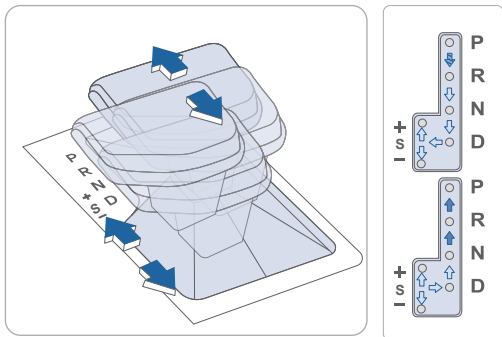

(➡): Press the shift button, then move the shift lever.

(⚡): Depress the brake pedal, press the shift button, and then move the shift lever.

(↔): Move the shift lever.

### Manual shift mode

Move the shift lever from D (Drive) into the manual gate to select. Move the shift lever forward (+) to up shift or rearward (-) to downshift.

## REAR CROSS-TRAFFIC COLLISION-AVOIDANCE ASSIST (RCCA)

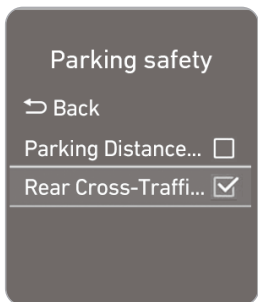

The RCCA system uses radar sensors to monitor approaching vehicles to the left and right while your vehicle is in reverse. If the risk of collision is detected while the RCCW is generated, brake is controlled. The instrument cluster will inform the driver of the brake control. If the rear view monitor system is in activation, a message will also appear on the audio or AVN screen.

### Activate/Deactivate

Select the following items on the instrument cluster in order:

1. Select User Settings
2. Select Driver Assistance
3. Select Parking Safety
4. Select Rear Cross Traffic Safety

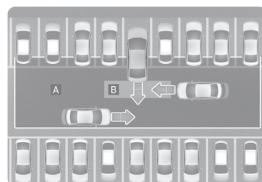

## ELECTRIC PARKING BRAKE (EPB)

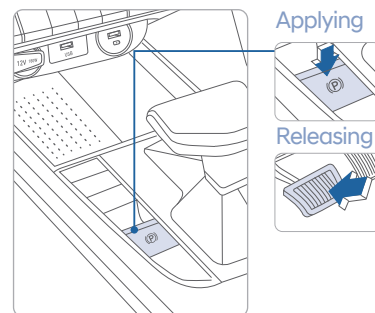

**Applying**  
Stop the vehicle then push the EPB button.

**Releasing**  
Press the EPB button while depressing the brake pedal.

The EPB will automatically be applied when:

- Engine off while Auto Hold is enabled, parked on a slope, or with the engine off in park but the vehicle still moves a bit.

To release the automatic EPB:

- With engine running, depress the brake pedal and shift into R(Reverse) or D(Drive) and then depress accelerator pedal.

**NOTE:** Please see the owner's manual for additional details

## AUTO HOLD

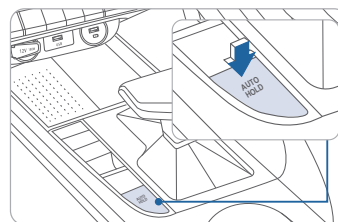

The Auto Hold feature assists in steep hill areas. It holds the brake until the accelerator pedal is pressed.

**WHITE  
AUTO  
HOLD**

1. Press the AUTO HOLD switch.

**GREEN  
AUTO  
HOLD**

2. Stop the vehicle by pressing the brake pedal. The brakes will remain engaged even if the brake pedal is released.

**WHITE  
AUTO  
HOLD**

3. The brakes will release when the accelerator pedal is pressed with transmission in D, R or manual mode.

To cancel the AUTO HOLD operation, press the AUTO HOLD switch again.

## DIGITAL KEY PAIRING (if equipped)

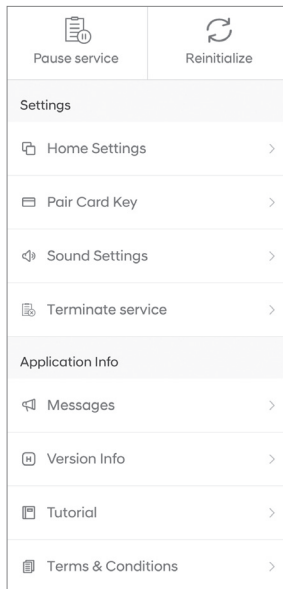
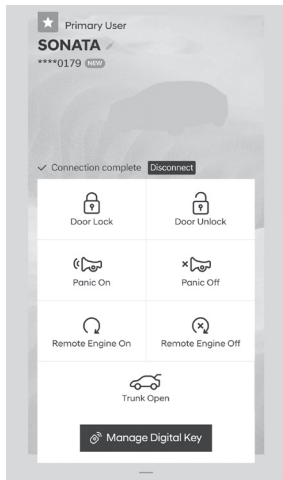

Hyundai Digital Key allows drivers to start the engine of their car using a smartphone app and Near-Field Communication (NFC). Hyundai Digital Key provides many of the same functions as your physical key. To pair your smartphone, complete the following steps:

1. Login to the Hyundai Digital Key Application using your MyHyundai username and password
2. Start the vehicle with the proximity key
3. Pair the phone to the vehicle as follows:
  - Navigation Vehicles: Settings → Vehicle → Digital Key → Smartphone Key → Save
  - Display Audio: Instrument Cluster User Settings Mode → Digital Key → Smartphone Key → Save
4. Open the Hyundai Digital Key Application on the primary user's smartphone. Select the + Icon on the main screen of the smartphone app.
5. Place the smartphone on the Wireless Phone Charger in the vehicle and the process will begin automatically
6. Once the screen in the vehicle says saved, your Digital Key is ready to use.

**NOTE:** This application is only available for Android users.

If the NFC card is lost or stolen, please contact your local Hyundai dealer for replacement.

## NEAR FIELD COMMUNICATION (NFC)



### Pair Card Key authentication

- Authenticate using NFC
- Authenticate using BLE

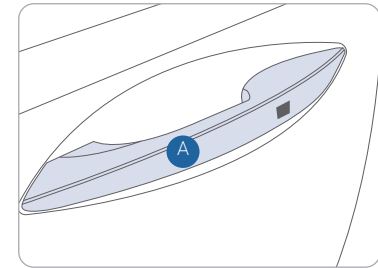

To lock/unlock your vehicle using the NFC key card, hold the key card up to the center of the door handle **A**.

If you try to lock your vehicle with the NFC card under the following conditions, it will not work:

- The Smart Key is in the vehicle.
- The POWER button is in ACC or ON position.
- Any of the doors, hood and trunk are open.

**NOTE:** If you overlap and use the key card with other NFC-enabled cards such as a transportation card or credit card, it will not work.

\*For security reasons, the vehicle can only have one NFC key card paired to it at one time. Any time that a new Key card is paired to the car it will disable the previously paired Key Card .

Blank memo area consisting of 20 horizontal lines for notes.

**ELANTRA CUSTOMER DELIVERY CHECK LIST**

HYUNDAI OWNER	DEALERSHIP NAME
SALES CONSULTANT	DATE
VIN	PREVIOUS VEHICLE

**BEFORE DELIVERY**

- SET TIRE PRESURE LF\_\_ RF\_\_ RR\_\_ LR\_\_
- VERIFY VEHICLE IS CLEAN, IN GOOD CONDITION, FREE OF CHIPS AND SCRATCHES · CLEAN WINDSHIELD AND BACK WINDOW
- ENSURE FLOORMATS ARE SNAPPED INTO PLACE

**WALK THE CUSTOMER THROUGH EACH OF THE FOLLOWING KEY DELIVERY FEATURES**

- REVIEW QUICK REFERENCE GUIDE
- PAIR CUSTOMER'S PHONE TO THE BLUETOOTH SYSTEM (if equipped) - page 19
- OPERATION OF THE NAVIGATION SYSTEM (if equipped) - page 23
- REVIEW AND TEAR OFF VOICE COMMAND / QUICK TIP CARD
- OPERATION OF THE AUDIO SYSTEM
- HOW TO DEFROST - page 15
  - ① Press the front defrost button.
  - ② Set to warmest temperature setting.
  - ③ Set to highest fan speed.
- TIRE PRESSURE MONITORING SYSTEM (TPMS) - page 42



LOW TIRE PRESSURE INDICATOR /  
TPMS MALFUNCTION INDICATOR

**NOTE:** Tire pressure may vary in colder temperatures causing the low tire pressure indicator  to illuminate. Inflate tires according to the Tire Pressure Label located on the driver's side door pillar.

**CONNECTING YOUR PHONE**
**On the radio:**

1. Push the **SETUP** button.
2. Select **Bluetooth**.
3. Select **Bluetooth Connection**.
4. Select **Add New**.

**In your phone's Bluetooth settings:**

5. Select the <Vehicle Name> on your phone.
6. Enter the passkey from the radio or accept the authorization pop-up on your phone.

**SWITCHING BETWEEN PAIRED PHONES**
**Using Voice Command:**  
*"Change Bluetooth device"*
**On the radio:**

1. Push the **SETUP** button.
2. Select **Bluetooth**.
3. Select **Bluetooth Connection**.
4. Select **Connect** next to the desired phone.

For more information, visit  
[HyundaiBluetooth.com](http://HyundaiBluetooth.com)