

For Stamping & Forming

NEW **PSA** the Start in a new Sensor Era



SENSOREN

DigitalSensors
AnalogueSensors
Piezo, sound, eddy current
Accessories





1 Sensors



2 Controls



3 Systems



More than 30 years of unidor, more than 30 years of stamping and forming technology for which we have not only successfully installed thousands of systems around the world, but also decisively shaped the technology. We have pioneered much of what is today state of the art.

The future of stamping and forming is changing at a great pace: more complex, faster, more precise and everything fully documented, right down to the highest number of strokes. Innovative product demands made by your customers and the permanent costs pressure force you to go to **the limits of what is possible** with your products and tools and that day after day.

This is why it is becoming increasingly important to comprehensively visualize the stamping and forming process so that each of the working steps can be exactly controlled and optimized. Only those who have an **exact understanding of what is happening** will be able to meet the customer demands for a perfect production and quality product and gain a technological advantage which secures orders in the long-term.

unidor supplies products, a great number of ideas and a large number of services for this purpose. We manufacture facilities from special sensors to practical monitoring devices and comfortable universal measuring systems which enable you to fully control your **stamping & forming** down to the smallest detail.

Our products guarantee that you will have a secure command of the production process even when working at the limits of your technical possibilities, in addition to you always achieving **excellent results**.

We cannot do everything but we are professionals and your reliable partner when it comes to stamping & forming. An enthusiastic problem-solver for optimized production processes in a perfect quality.

more information: www.unidor.de

- 1 We supply a large selection of stamping & forming sensors in various shapes. These form the basis for an exact visualization, optimization, measuring, controlling and logging.
- 2 Controls are the classic and most inexpensive introduction to the professional visualization and monitoring of diverse stamping and forming processes. The controls are exactly adapted to certain tasks.
- 3 Systems are universal devices which are prepared for the carrying out of numerous tasks and which flexibly and accurately meet both your current and your future requirements by means of a simple parameterization.



Sensors in the tool and on the machine record everything which is important for the production, quality and repair.

They generate digital or analogue signals from the force, pressure, sound, temperature, path, oscillations and vibrations. In order to meet all requirements, we supply you with a comprehensive sensor program which is exactly tailored to stamping & forming.

the Themes

the tool for perfect stamping & forming	4
the tool and its sensors	5
Sensors and everything that goes with them	6
Sensors the general overview	7
New: PSA the start in a new sensor era	8
Sensors the product range	10
1 Digital sensors	11
2 Analogue sensors	15
Installation boxes	20
we are there for you creative and dynamic	22

All of our sensors are conform with the latest safety criteria and the valid VDE regulations

	GS tested safety
	CE standard
	Observe the laser warning



The typical design of a stamping and forming tool is based on the interplay between various plates. Each plate is hereby responsible for a certain function and task.

Suitable sensors on and in the tool or on the machine provide important production process information which our **multiCONTROL** and **compactPRESS** control systems then automatically visualize, measure, monitor and log.

Knowing what is exactly happening is the basis for increased production, improved quality, a minimum of standstill time and controlled maintenance.

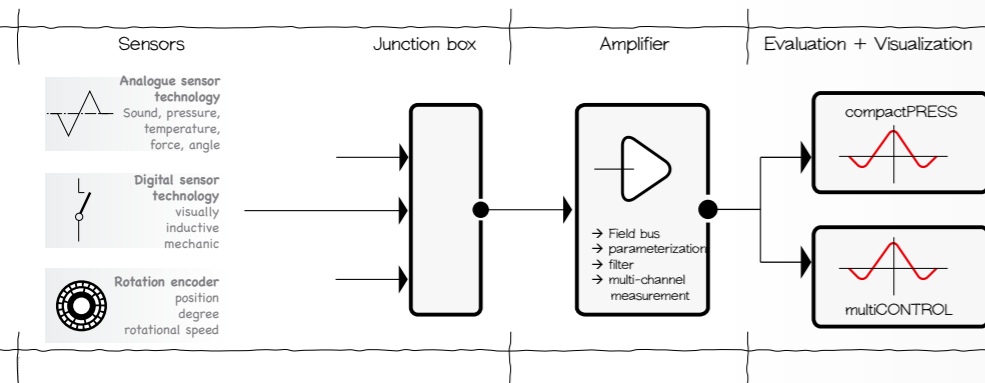
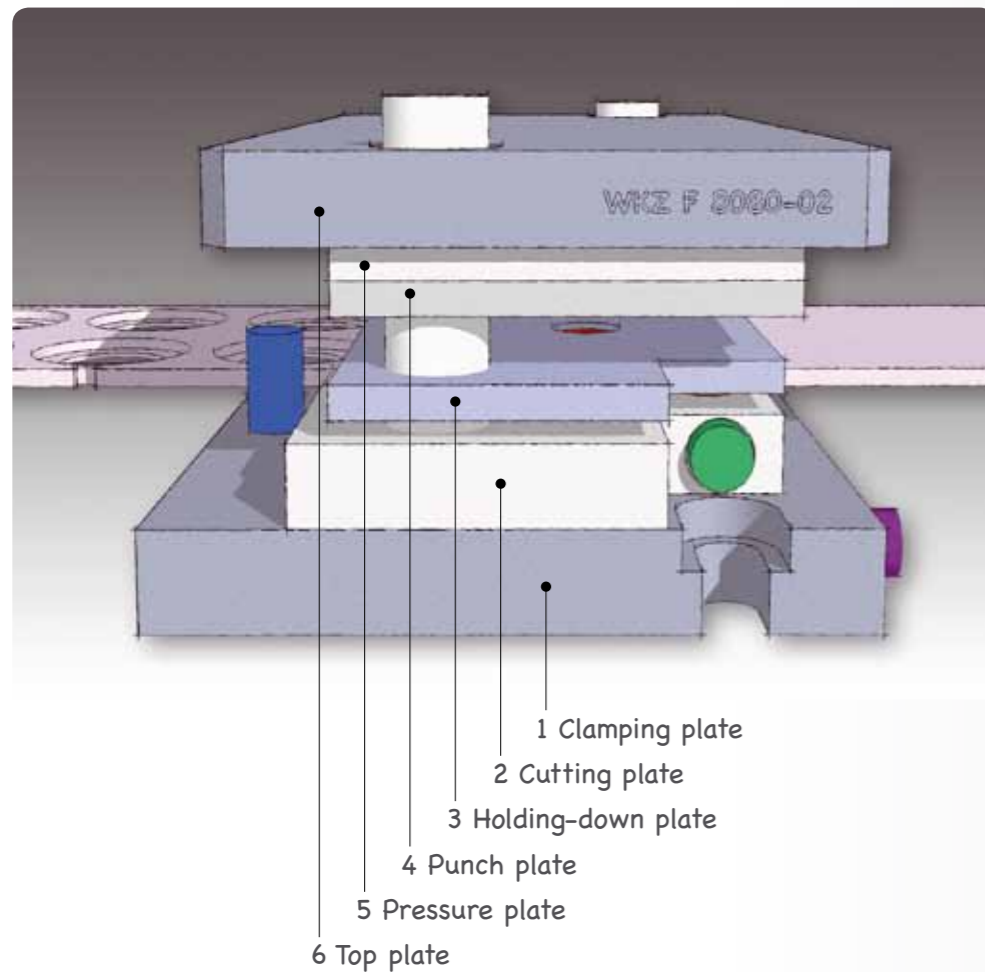

As different as the tasks of the sensors are, the different their positions in the tool are. The following examples provide a vivid orientation as to how and which sensors with which tasks are to be positioned.

PSA sensors in the tool pressure plate show the force curve of the stamp which is positioned underneath it. Any changes to a normal curve signalize a stamp problem: wear or breakage. This enables the various stamps in a tool to be monitored in a very differentiated and detailed manner.

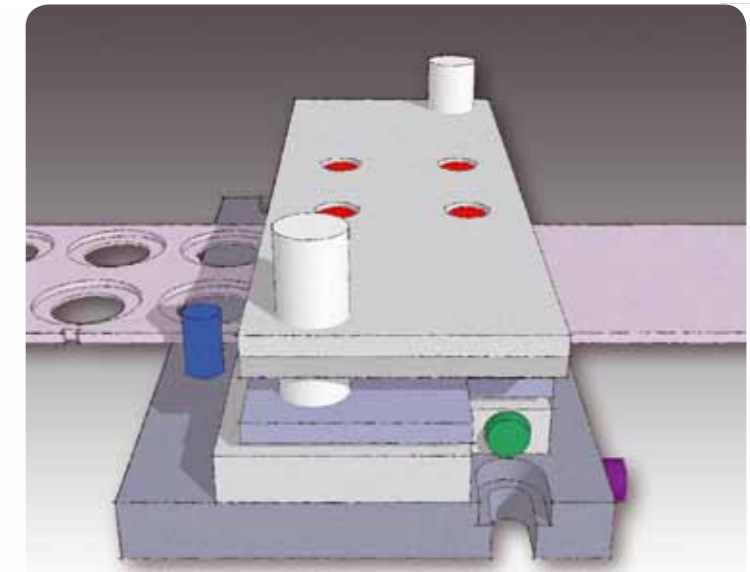

PSA sensors in the tool holding-down plate supply a significant force-sound-signal curve for each forming process. Changes to this curve signalize the slightest forming errors.

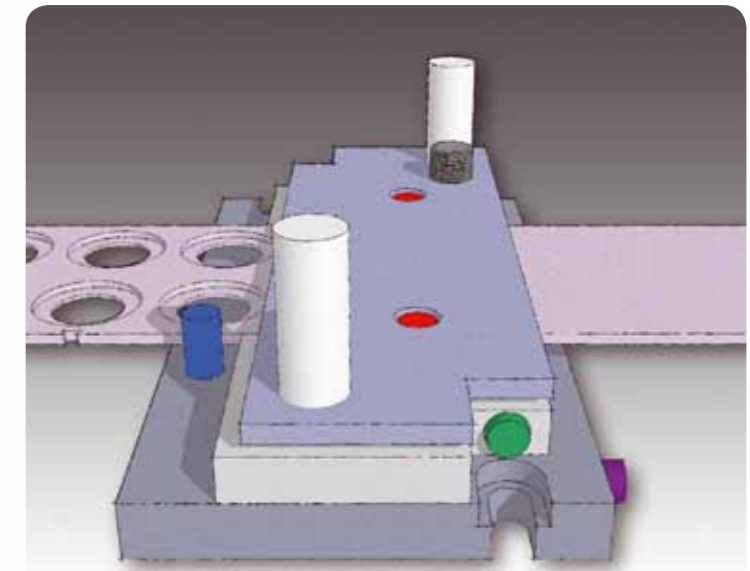

Advance sensors (blue) serve the precise advance measuring and advance positioning.

Eddy current sensors (yellow) monitor and measure the dimensional accuracy of parts. These are also ideal for the monitoring of double sheets or slugs.

Force sensors (green) for the precise measuring and monitoring of force curves such as the pressure force.

memodübel plugs (purple) are the ideal data and information archive for everything which is important in connection with the tool. Always available immediately and nothing is lost. *You will find more information in our memodübel brochure.*

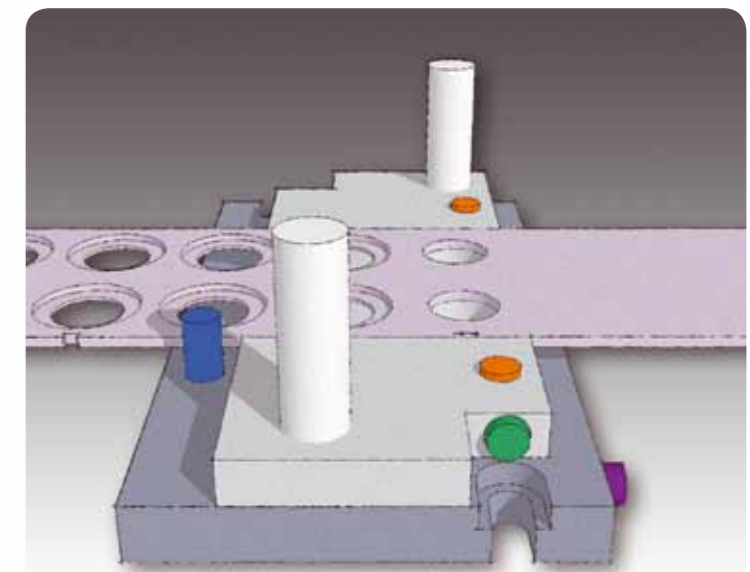

Each sensor needs a connection with the control systems. We are able to supply you with a comprehensive range of cables, connectors, terminals and junction boxes which all match our sensors and systems.

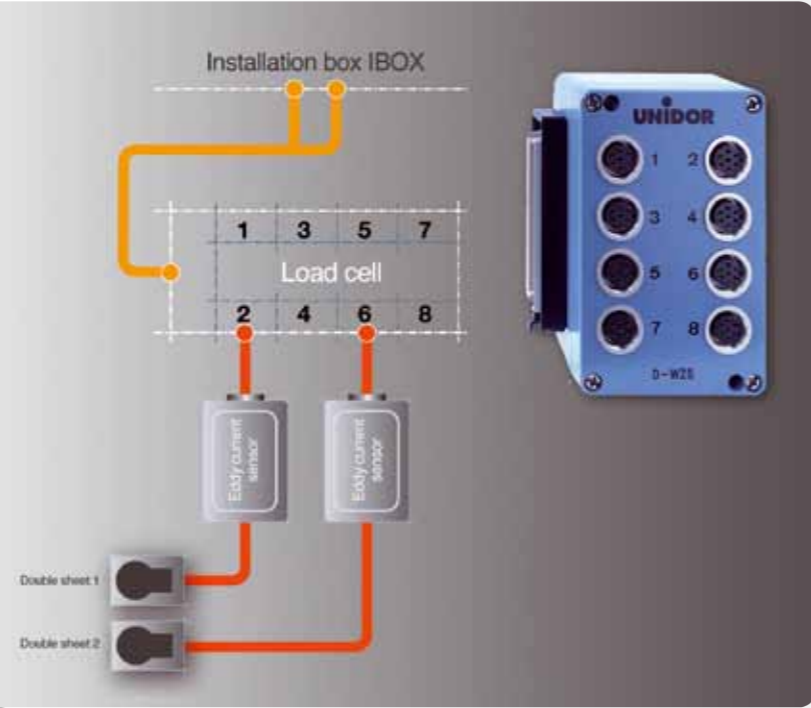

Strokes are the measure of all things when stamping & forming. All of the process sequences of a stamp or press stroke move within 360 degrees of angle.

We supply a number of absolute angular encoders in various resolutions and mechanical designs for the measuring of the angle within a stroke. All rotary encoders have an SSI interface.

	Digital Sensors						Analogue Sensors					
	Single beam	Multiple beam	Reflex, fibreglass	Inductive	Wire probes	Colour detection	Single beam	Multiple beam	Eddy current	Force	Sound	PSA
Ejection control		😊	😊	😊								
Recognition of objects or parts	😊	😊	😊	😊	😊	😊						😊
Metrology	😊	😊					😊	😊	😊			
Measuring of parts: height, width, depth	😊						😊	😊				
Measuring of parts: density	😊						😊	😊	😊			
Measuring of parts: angle									😊			
Counting parts	😊		😊	😊	😊		😊	😊	😊			
Detecting edges	😊		😊	😊	😊		😊	😊	😊			
Measuring the feed							😊	😊				
Controlling the feed	😊		😊	😊	😊							
Force and pressure curve										😊		😊
Acoustic emission (sound)											😊	😊
Structure-borne sound											😊	😊
Stamp monitoring and diagnosis									😊	😊	😊	😊
Distortion monitoring												😊
Distortion defects												😊
Slugs									😊			😊
Double plate detection	😊			😊					😊			😊
Clock pulse measuring									😊			
Strip end monitoring	😊		😊	😊	😊							
Position control	😊	😊	😊	😊	😊	😊	😊					
Feed control	😊	😊	😊	😊	😊		😊					
Colour recognition						😊						
Coloured edges recognition						😊						
Coloured structures						😊						
Vibration											😊	😊
Oscillation											😊	😊
Crack detection								😊	😊	😊	😊	😊
Stamping strip position							😊					
Contactless detection of metals				😊								
Rivet detection				😊								

😊 optimally suitable, 😊 suitable



1

The PSA technology revolutionises sensor technology when stamping & forming, in addition to it generating a series of measured values which had not been feasible in the past. This now enables processes and procedures to be rendered visible which could not be visualized or controlled in the past. This opens up completely new perspectives when it comes to controlling marginal stamping and forming processes. The result defines itself in more stroke and greater quality.

The minimal size of the piezo sensors enables an optimal place to be found for them on a tool, and even more so in it.

By the way: the extremely inexpensive piezo disks are very quickly mounted: remove the protective adhesive foil and fix it in place permanently by briefly pressing the disc against a suitable place.

The low-cost multiCONTROL or our high-end compactPRESS are especially suitable for the visualization, analyzing, controlling, evaluating and logging of the complex piezo signals.

2

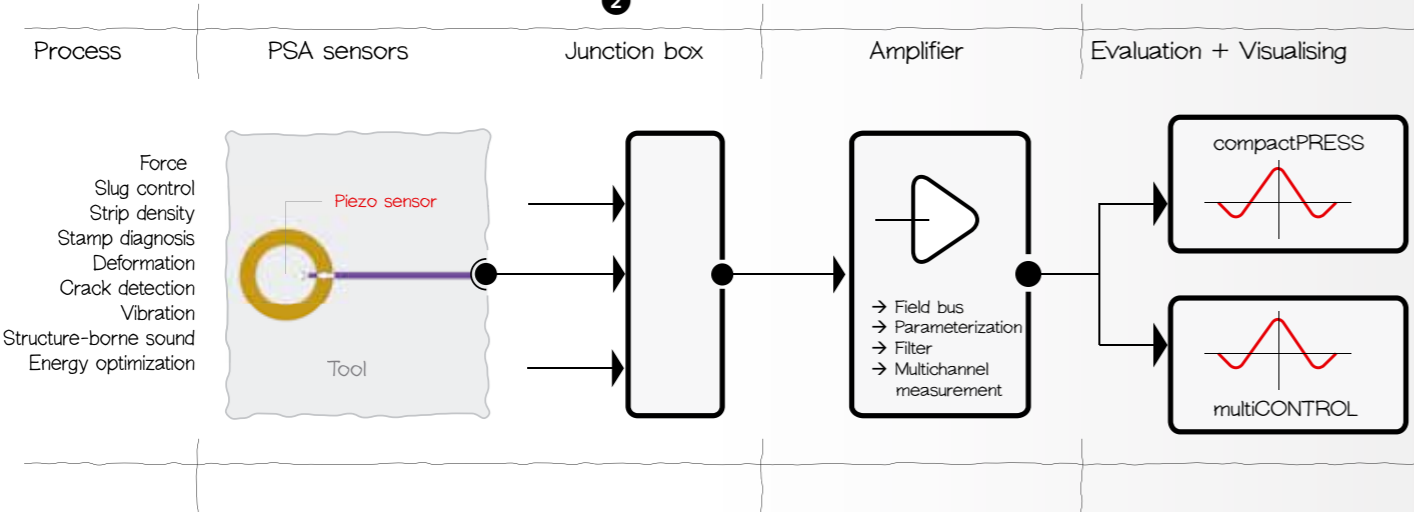

- 1 We preferably supply the piezo sensors as discs or plugs
- 2 From the tool to the visualization, a basic PSA application
- 3 PSA diagram showing a correct forming with a top and bottom envelope cover

Two examples serve to show the practical applications using PSA sensors:

1

PSA sensors in the tool pressure plate monitor the stamp.

Stamp wear or breakage are repeatedly the cause of considerable quality defects and can even be responsible for expensive tool damages. A precautionary stamp monitoring saves money and ensures a lower number of standstills.

A PSA sensor above each stamp or stamp nest generates a pressure signal which is repeated with each stroke. Deviations from a learned standard curve signalize that changes have been made to the stamp and demands the taking of corresponding corrective measures.

The finer the piezo raster is in the pressure plate, the more accurate is the possibility of selecting difficult stamps.

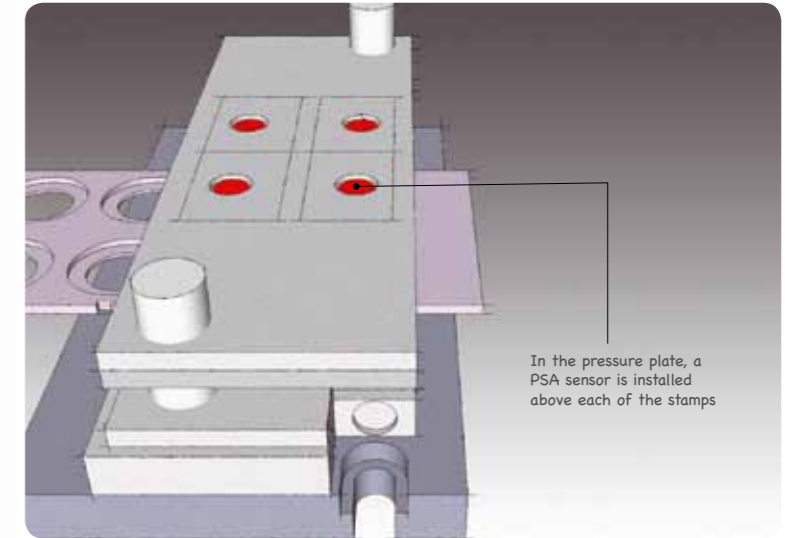

In the pressure plate, a PSA sensor is installed above each of the stamps

2

PSA sensors in the tool holding-down plate are able to precisely and certainly detect forming errors of up to 0.01mm.

Slugs, double plates, burrs and material residues result in forming errors and in turn, in production defects or even damage being caused to the tool.

One or more PSA sensors in the holding-down plate generate a specific PSA signal curve per stroke. Deviations from a learned standard curve signalise the smallest changes within the forming process, indications of specific part-forming errors or residues in the tool.

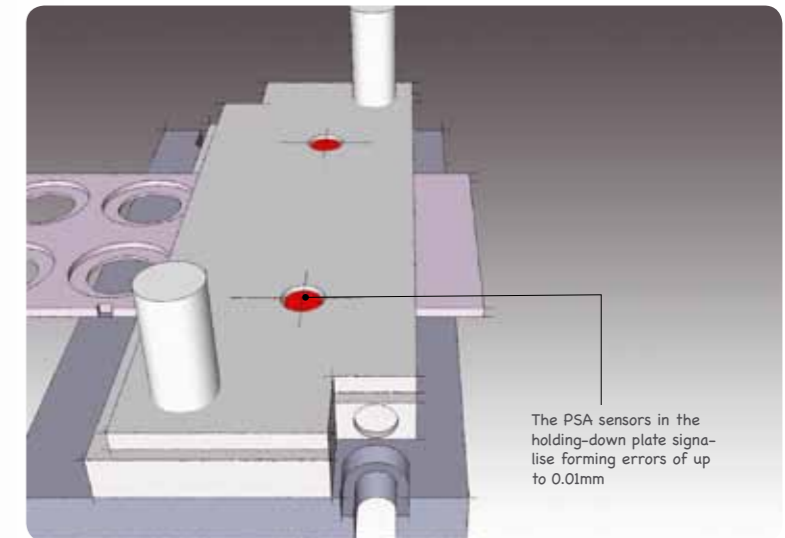

The PSA sensors in the holding-down plate signalise forming errors of up to 0.01mm

DigitalSensors

Digital signals, fixed or pluggable cable, fast, robust and oil resistant, adjustable sensitivity, operating voltage 10...30 VDC

AnalogueSensors

Analogue signals in various resolutions with fixed and variable diaphragms, operating voltage 10...30 VDC

InductiveSensors

Universal position transmitter, flush or non-flush mountable, for all metals

TouchSensors

Extremely fast switching accuracy, switched against ground, no electronics, wide temperature range

SpecialSensors

We also supply exactly the right sensors for specific measuring tasks:

Piezo

for force measurements at the machines and the tool, temperature stable, robust and high level of interference immunity

Colour detection

for recording materials and markings

Eddy current

very fast, ultra-accurate, contactless sensors with an extreme linearity, max. 2mm, flat design

Sound

simplest assembly, detection of sound waves with the simplest mounting, detection of sound waves in the tool

Accessories

In order for the sensors to be used, we supply everything which is required for a trouble-free installation: junction boxes, angular encoders, preformed cables and terminals.

→ DigitalSensors ←



4 single beam
fork, rod form, reflex

6 multiple beam
fork, frame, ring

→ AnalogueSensors ←



8 fork

9 rod form

9 split

→ InductiveSensors ←



10 rod form

10 frame

→ TouchSensors ←



10 wire probe

→ SpecialSensors ←



11 piezo

12 colour detection

12 eddy current

12 sound

→ Installation box ←



13 tool box

13 load cell

13 I/O box

→ optical, single beam, fork ←

Description	Type	Dimension	Application
Infrared	GD	GD 5x8 bis GD 40x20	Control: Position, Advance, Double sheet
Constant light			
Blast air connection			
Integrated amplifier			
Switching status indicator			
Infrared	GLE	GLE 10x15 to GLE 30x50	Control: Position, Advance, Parts
Constant light			
Pluggable connection			
Integrated amplifier			
Switching status indicator			
Infrared	FG	FG 5x16 to FG 40x40	Control: Position, Advance, Parts
Constant light			
Integrated amplifier			
Switching status indicator			
Infrared, visible light	GLS	GLS 5x10 (vis) to GLS 30x30 (vis)	Control: Position, Advance, Parts
Alternating light			
External amplifier			
Switching status indicator			

Image

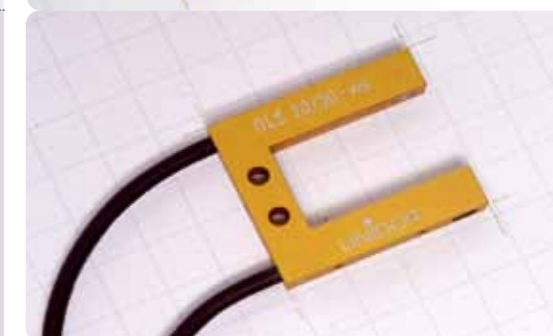
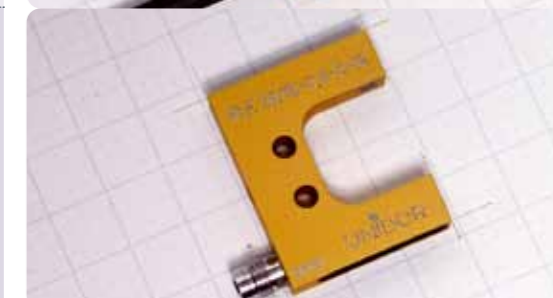
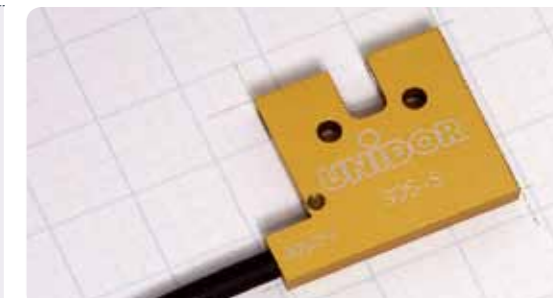

→ optical, single beam, split, rod form ←

Application	Dimension	Type	Description
Position control for clearances of max. 20 m	M 8x1	LAS3 	Laser
			Integrated amplifier Pluggable connection
Edge-position control	SL 4 SL 8 SL M 10x1	SL	Infrared
			Signal status indicator External alternating light amplifier
Edge-position control also for liquid media	LS 05 (8x8x30)	LS	Infrared
			Signal status indicator External alternating light amplifier

→ optical, single beam, reflex ←

Application	Dimension	Type	Description
Position and ejection control with adjustable range	GM 1/250 to GM 3/1500	GM	Infrared
			Glass fibre optics External amplifier



→ optical, multiple beam, reflex ←

Description	Type	Dimension	Application
Infrared	LAGM	LAG M20 X LAG M40 X	Ejection control Counting parts
Alternating light			
External amplifier			
Switching status indicator			
Infrared	LAG	LAG 60x60 to LAG 100x100	Ejection control Counting parts
Alternating light			
Internal amplifier			
Switching status indicator			
Output: dynamic and quasi-static			

→ optical, multiple beam, split ←

Description	Type	Dimension	Application
Infrared	LAV	LAV 60 to LAV 300	Ejection control with variable clearance
Alternating light			
Internal amplifier			
Switching status indicator			
Output: dynamic and quasi-static			

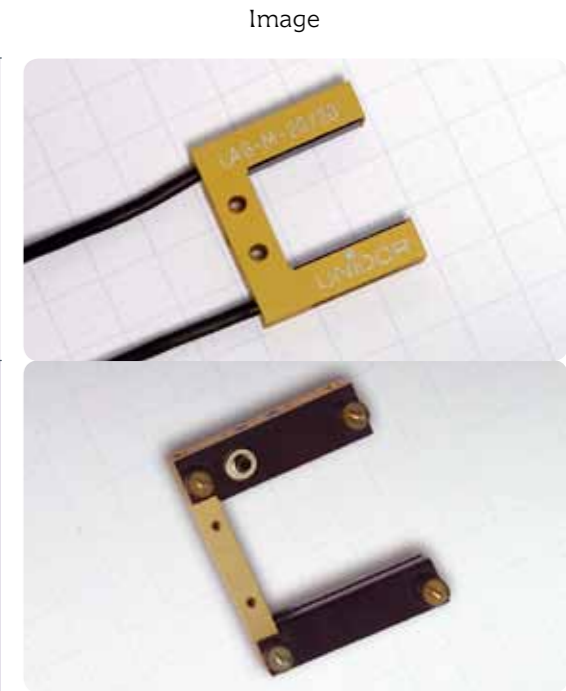

→ optical, multiple beam, split ←

Image

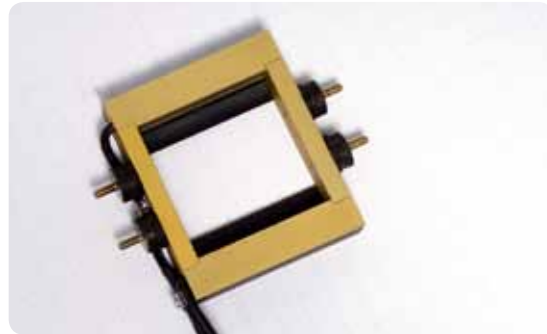

Application	Dimension	Type	Description
Ejection control	FPE 60x60 FPE 80x80 FPE 100x100	FPE	Infrared
			Alternating light
			External amplifier
			Switching status indicator
			Dynamic output can be adjusted

→ optical, multiple beam, ring ←

Image



Application	Dimension	Type	Description
Ejection control	RS 29 RS 37	RS	Infrared
			Constant light
			Internal amplifier

1 DigitalSensors: colour detection

→ optical, colour detection ←

Image



Application	Dimension	Type	Description
Measuring and detecting colours, coloured edges and colour structures	COLO 2 COLO 3 COLO 4	COLO	White light LED
			can be parameterized via interface
			max. 100 colours (12 Bit)
			teachable

→ Rod form ←

Image



Description	Type	Dimension	Application
flush/non-flush mountable	ZT	ZT 398 (M4) to ZT 410 (M18)	Position control
various switching distances			
from M4 to M18			

→ Frame ←

Image

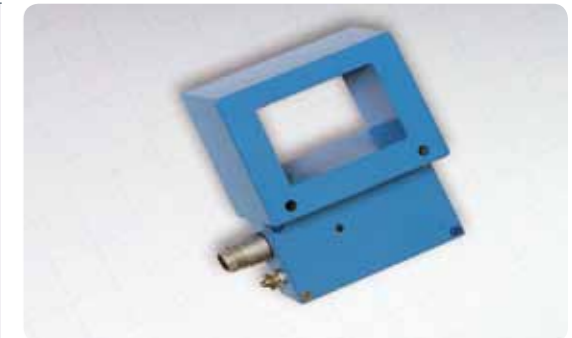

Description	Type	Dimension	Typ. application
for a robust use	IPH	IPH 60 x 80 to IPH 245 x 290	Ejection or passage control
Adjustable sensitivity			
External/internal amplifier			
Various sizes			

1 DigitalSensors: wire probes

→ wire probe ←

Image



Description	Type	Dimension	Typ. application
Diverse sizes	GM	GM 04 GM 05 GM 08 GM 10x1	Position and parts control
Easy tool installation			
Diverse elasticities			
Switched against ground			

→ optical, rod form ←



Application	Dimension	Type	Description
Measuring with a wide range	ALAS 08 ALAS 10	ALAS 	Laser
			External amplifier
			Pluggable connection
			Interface to PC
			Diaphragms 0.2 ... 30mm
Contact and differential measuring	ABM LS 08	ABM	Infrared
			Signal status indicator
			External amplifier
			Various diaphragms

→ optical, split ←

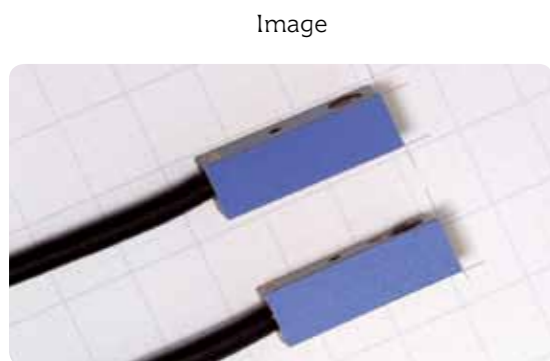

Typ. application	Dimension	Type	Description
Measuring with a wide range	ALAS 12/90 ALAS 24/90	ALAS 	Laser
			External amplifier
			Pluggable connection
			Interface to PC
			Diaphragms 0.2 ... 30mm

→ optical, fork ←

Description	Type	Dimension	Application
Visible light	AGL	AGL 5x10 to AGL 40x40	General measuring application
Constant light			
External electronics			
External amplifier			
Infrared			
External electronics	GABM	GABM 20/30	Measuring parts
left/right version			
Laser			
External amplifier	ALASF 	ALAS F 08 ALAS F 10 ALAS F 12	General measuring application
Pluggable connection			
Interface to PC			
Diaphragms 0.2 ... 30mm			
Infrared			
Alternating light	LAGM	LAG M 20 X LAG M 40 X	General measuring application
External amplifier			
Switching status indicator			

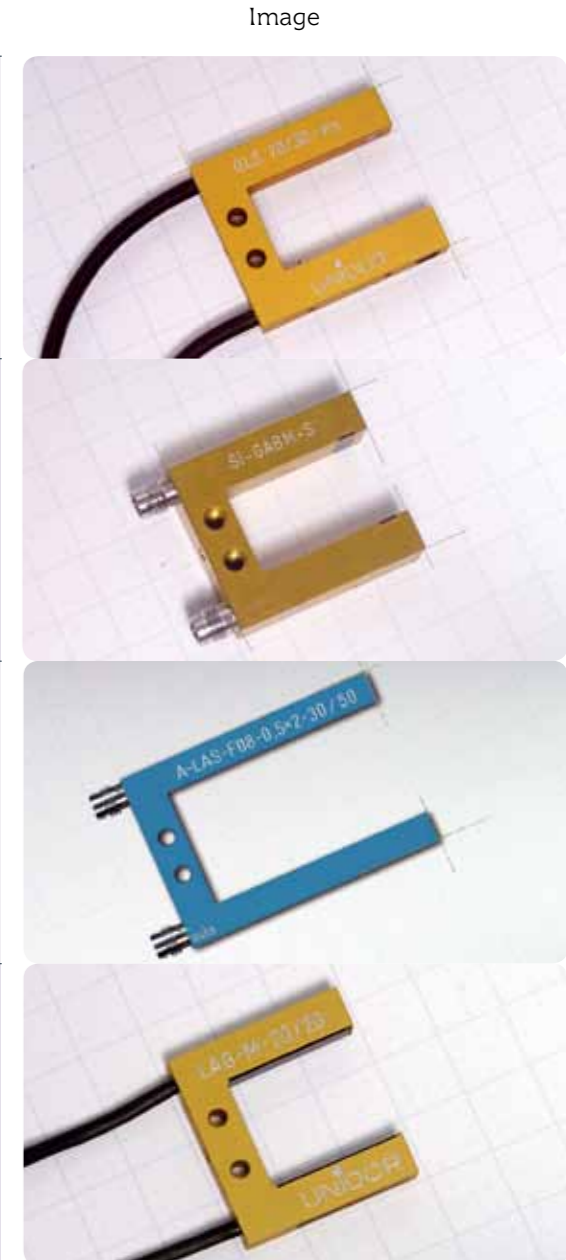

→ Piezo ←

Image

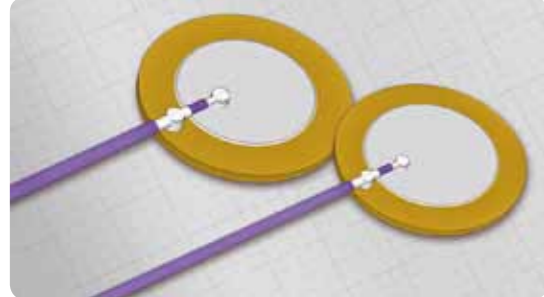

Application	Dimension	Type	Description
Measuring force curves at the machine	JZT 127	JZT	High linearity can be connected to pressure or tension Robust sensor
Measuring force curves in the tool	QMD 8	QMD	High resolution Rod form Easiest mounting Robust sensor
Measuring of dynamic and quasi-static forces of < N ... 1200 kN	QMS 9001 to QMS 9091	QMS	High sensitivity Ring form Various sizes
Dynamic measuring of sound, pressure, force, vibration, etc. in the tool and at machines	NEW PSA 10 to PSA 30	PSA	High sensitivity Disc form Various sizes Adhesive mounting low cost

→ Eddy current ←

Description	Type	Dimension	Application
Eddy current	WSD	WSD 70 WSD 150 WSD 500	Slug detection, double plate and distance measuring
External amplifier			
Highest measuring accuracy			
Measuring time in µs			
Maximum measuring range 2mm			

Image

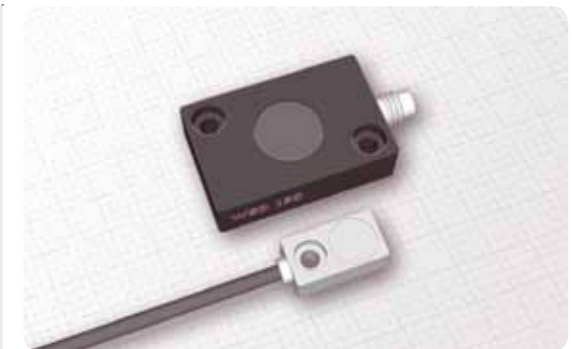

2 AnalogueSensors: sound

→ Sound ←

Description	Type	Dimension	Application
Robust housing	KSS	UNI KSS	Measuring of high-frequency ultrasound signals at the machine and the tool
Easy mounting			
External transducer			
Logarithmic or linear measuring			
Robust housing	VIB	UNI VIB	Measuring of low-frequency ultrasound signals at the machine and the tool
Easy mounting			
External transducer			
Logarithmic or linear measuring			

Image



It is normally the case that a different number of sensors are mounted on the machine and in the tool. Junction boxes have proven to be the best when it comes to an easy and fast electrical installation. These are the robust interface between the sensory technology and the evaluation systems.

We normally make a differentiation between the sensors, on the basis of their task and function.

Tool box

For the connection of up to 8 digital sensors (signal transmitters), PNP or NPN switching.

→ Tool box ←



→ active load cell ←



Load cell

For connecting up to 8 analogue sensors (signal transmitters) with an integrated 8-fold analogue measuring amplifier.

→ active/passive I/O box ←



I/O box

For the I/O periphery with signal status LEDs. We supply these boxes in a pre-configured state.





Successful components and systems from practitioners for the practitioner are only possible if we exactly know your needs and your requirements. You should therefore not only look upon our sales representatives as being committed salespeople, but also passionate technology partners with a great amount of understanding of your special requirements.

Enthusiastic employees, specialist with lots of know how and own initiative are what characterize the professional nature of our work, from the development to the production and quality assurance, not to forget the service. Our top priority is the quality and fast availability. This has validity for everything from electronic components to the complete device:

Quality Inside: for Mechanics & Electronics

Quality Outside: for Support & Service

This is why we subject all of our systems to a 48h endurance test under worst-case conditions. We perform tests pursuant to the national and international standards ISO, GS, IEC, just to name a few

Our products not only excel with a maximum in economic viability and reliability, but also with our comprehensive complete service: *you will benefit from everything from advice to customer support, from the hotline to the service, from the manual to training.*

We are always there when you need us: dynamic, creative and enormously efficient and that with the entire experience of a successful company.

- ① We look forward to receiving your telephone call
- ② Selling our passion
- ③ Presentations and workshops
- ④ Quality and safety are at the top of our list

more information: www.unidor.de

Sales Centre South

Marcus Pleßnitzer

Tel +49 (0) 7231/3152 62
 Fax +49 (0) 7231/3152 48
 Mobil +49 (0) 172/925 5866
marcus.plessnitzer@trsystems.de
 unidor TR systems GmbH
 D-75179 Pforzheim

Sales Centre North-West

Reinhard Wulf

Tel +49 (0) 2371/15956 14
 Fax +49 (0) 2371/15956 29
 Mobil +49 (0) 172/599 4092
reinhard.wulf@trsystems.de
 unidor TR systems GmbH
 Sales Centre North-West
 D-58638 Iserlohn

Sales Centre North-West

Susanne Nowak

Tel +49 (0) 2371/15956 0
 Fax +49 (0) 2371/15956 29
susanne.nowak@trsystems.de
 unidor TR systems GmbH
 Sales Centre North-West
 D-58638 Iserlohn

Sales Centre East

Dr. Dietrich Thoss

Tel +49 (0) 3661/6711 04
 Fax +49 (0) 3661/6711 05
 Mobil +49 (0) 172/924 2376
dietrich.thoss@tr-gruppe.de
 TR-Electronic TB East
 D-07973 Greiz

Technology & Marketing

Roland Bott

Tel +49 (0) 7231/3152 24
 Fax +49 (0) 7231/3152 48
 Mobil +49 (0) 171/604 5250
roland.bott@trsystems.de
 unidor TR systems GmbH
 D-75179 Pforzheim

Export

André Schuster

ExportManagement
 Tel +49 (0) 7231/3152 19
 Fax +49 (0) 7231/3152 99
 mobil +49 (0) 171/51414 52
andre.schuster@trsystems.de
 unidor TR systems GmbH
 D-75179 Pforzheim

AUSTRIA

TR-Electronic GmbH
 Tragösserstraße 117
 A-8600 Bruck/Mur
 Tel.: +43 (0)3862-550 06 0
 Fax: +43 (0)3862-55006 33
info@tr-electronic.at

BRAZIL

C + Technologia
 Avenida Pedroso de Morais
 433-13º andar
 CEP-05419-000 São Paulo - SP
 Tel.: +55 (011) 3815 6554
 Fax: +55 (011) 3815 4947
info@ctecnologia.com.br

CHINA

TR-Electronic GmbH
 Shanghai Rep.
 Office Rm102, #74
 Phoenix City
 3536 Nong Yin Du Road
 201108 Shanghai
 Tel.: +86 21 5443 5113
 Fax: +86 21 5831 4829
tr-electronic@online.sh.cn

CZECH REPUBLIC/SLOVAKIA

Del a. s.
 Strojirenská 38
 CZ- 59101 Zdar Nad Sázavou
 Tel.: +420566 642 257
 Fax: +420566 621 657
del@del.cz

FRANCE

unidor TR systems France
 Boite Postale 60075
 F-67152 Erstein
 Tel.: +33 388 59 83 01
 Fax: +33 388 59 83 53
antz.lucien@wanadoo.fr

DENMARK

TR-Electronic Danmark ApS
 Hustedgardvej 22
 DK-8722 Hedensted
 Tel.: +45 (0)75890603
 Fax: +45 (0)75890636
cbj@tr-electronic.dk

GREAT BRITAIN

Bruderer UK LTD.
 Cradock Road
 GB-Luton. Beds LU4 0SF
 Tel.: +44 (0)1582 560 300
 Fax: +44 (0)1582 570 611
mail@bruderer.co.uk

ITALY

Telestar S.r.l.
 Via C. Colombo 13
 I-22069 Rovellasca (Co)
 Tel.: +39 02 96 74 02 68
 Fax: +39 02 96 74 02 73
telestar@telestar-automation.it

MALAYSIA/THAILAND

Monkol Engineering
 Block 204 Hougang Str.21
 Singapore 530204
 Tel.: +65 648 13678
 Fax: +65 648 13679
mongkol@singnet.com.sg

NETHERLANDS/BELGIUM

F. Hoffmann B. V.
 Gildenweg 25-35
 NL-3334 KC Zwijndrecht
 Tel.: +31 (0)78 610 23 88
 Fax: +31 (0)78 6 10 32 55
info@hoffmann-machines.nl

SPAIN/PORTUGAL

Intertronic Internacional, S.L.
 Azagador de la Torre, 67
 E-46006 Valencia
 Tel.: +34 (96) 3 75 80 50
 Fax: +34 (96) 3 75 10 22
info@intertronic.es

SINGAPORE

Globaltec Pte. Ltd
 50, Bukit Batok Street 23
 #06-27 Midview Building
 Singapore 659578
 Tel.: +65 626 79188
 Fax: +65 626 78011
globaltec@pacific.net.sg

SWITZERLAND

TR-Electronic SA
 14, Ch. Pré-Fleuri
 CH-1228 Plan-les-Ouates/Genève
 Tel.: +41 (0)22-7 94 21 50
 Fax: +41 (0)22-7 94 21 71
info@trelectronic.ch

SWEDEN

TR-Electronic Sweden AB
 Djursholmsvägen 50A
 Box 3038
 S-183 03 Täby
 Tel.: +46 (08) 756 72 20
 Fax: +46 (08) 756 76 80
mailbox@trelectronic.se

POLAND

Stoltronic-Polska Sp.z.o.o
 ul. Poniatowskiego 238C
 PL- 93-231 Lodz
 Tel.: +48 42 649 12 15
 Fax: +48 42 649 11 08
stoltronic@stoltronic.pl

USA

TR-ELECTRONIC
 P.O. Box 4448
 USA-Troy, MI 48099
 Tel.: +1 248 244-2280
 Fax: +1 248 244-2283
trencoder@trelectronic.com

always the best for Production and Quality

1

SENSORS

... optimal for all tools and machines in connection with stamping & forming

2

multiCONTROL

... ideal for a quick start in measuring and controlling technology on and in the tool

3

compactPRESS

... the high-speed visualizing, measuring and controlling system with the "everyone can" touch operation

4

powerPRESS

... steering, visualizing, controlling: all in one go. The complete automation for both machine and tool

5

smartOilspraying

... for an extremely economical oil dosing with the highest homogenous oil application