

Alber Cellcorder™ CRT-400

User's Guide



Vertiv Corporation
1050 Dearborn Drive
Columbus, OH 43085
Tel: (954) 377-7101 Fax: (954) 377-7042
www.vertivco.com
590-2099-501A/SL-29414/4200-070

The information contained in this document is subject to change without notice and may not be suitable for all applications. While every precaution has been taken to ensure the accuracy and completeness of this document, Vertiv assumes no responsibility and disclaims all liability for damages resulting from use of this information or for any errors or omissions. Refer to other local practices or building codes as applicable for the correct methods, tools, and materials to be used in performing procedures not specifically described in this document.

The products covered by this instruction manual are manufactured and/or sold by Vertiv. This document is the property of Vertiv and contains confidential and proprietary information owned by Vertiv. Any copying, use or disclosure of it without the written permission of Vertiv is strictly prohibited.

Notice to Users

Vertiv Corporation reserves the right to make changes to this document without notice to any user or reseller of this product. Vertiv Corporation also reserves the right to substitute or terminate distribution of this document, with no obligation to notify any person or party of such substitutions or terminations.

Vertiv Customer Service

Vertiv Customer Service is available Monday to Friday, 8:00AM to 4:30PM Eastern Time.

Telephone: (954) 377-7101
Fax: (954) 377-7042
Email: alber-service@vertivco.com
Website: www.vertivco.com

Corporate Office Address:
Vertiv Corporation
1050 Dearborn Drive
Columbus, OH 43085 USA



EUROPEAN UNION CUSTOMER NOTICE: Disposal of Old Appliances*

This product uses components that are dangerous for the environment, such as electronic cards and other electronic components. Any component that is removed must be taken to specialized collection and disposal centers. If this unit must be dismantled, this must be done by a specialized center for collection and disposal of electric and electronics appliances or other dangerous substances. This product has been supplied from an environmentally aware manufacturer that complies with the Waste Electrical and Electronic Equipment (WEEE) Directive 2002/96/EC. The "crossed-out wheeled bin" symbol to the left is placed on this product to encourage you to recycle wherever possible.

Please be environmentally responsible and recycle this product through your recycling facility at its end of life. Do not dispose of this product as unsorted municipal waste. Follow local municipal waste ordinances for proper disposal provisions to reduce the environmental impact of waste electrical and electronic equipment (WEEE) Directive 2012/19/EU.

For information regarding the scrapping of this equipment, go to www.eu.emersonnetworkpower.com ("Products" or "Contact us" sections) or call Emerson's worldwide technical support at: **00 80011554499 (Toll free number)** or **+39 0298250222 (Toll number based in Italy)**

**This notice only applies to 50Hz units placed on the European Union market.*

Table of Contents

1.	Safety Information	1-1
1.1.	General.....	1-1
1.2.	Document Symbols	1-1
1.3.	Safety Symbols	1-2
1.4.	Product Safety Practices	1-2
2.	Preventive Maintenance.....	2-1
2.1.	Visual Inspection	2-1
2.2.	Cleaning System Components	2-1
2.3.	Internal Component Replacement.....	2-1
2.4.	Shipping, Storage, Normal Use Protection	2-1
3.	Product Overview	3-1
3.1.	BAS Software.....	3-1
3.2.	Cellcorder Serial Number	3-1
3.3.	Features	3-1
3.4.	Cellcorder CRT-400	3-5
3.5.	Panel Controls and Indicators	3-8
3.6.	Specifications	3-15
4.	Before Using The CRT-400	4-1
4.1.	Highly Recommended Reading	4-1
4.2.	Charging the Cellcorder Battery.....	4-1
4.3.	Test Lead Connection Practices	4-3
4.4.	Understanding the USB Port and Flash Hard Drive	4-3
4.5.	Understanding <i>Bluetooth</i> [®]	4-6
5.	Getting Ready to Test Batteries with the CRT-400	5-1
5.1.	Power	5-1
5.2.	Basic Main Menu Functions.....	5-1
5.3.	Navigation	5-3
5.4.	The Baseline Resistance Data File on USB	5-3
5.5.	Insert the USB Device Into the CRT.....	5-3
5.6.	How to Edit Items within the Site Template	5-4
5.7.	Deselecting a Site	5-8
5.8.	Next Steps, Battery Selection.....	5-8
6.	Taking Float Voltage Readings First	6-1

6.1.	F4/Done Voltage Testing.....	6-2
6.2.	Stored In Memory Explained	6-2
6.3.	Resume Testing Explained	6-3
7.	Setting Up To Take Resistance Readings	7-1
7.1.	Check/Set Amp Hours	7-3
7.2.	Set Intercell Connections	7-3
8.	Taking Resistance Readings	8-1
8.1.	Resistance Readings.....	8-1
9.	Connecting Resistance Test Leads	9-1
9.1.	Connection for Single Intercell Connectors	9-1
9.2.	Connection for Dual Post Cells – Example One.....	9-2
9.3.	Connection for Dual Post Cells – Example Two	9-3
9.4.	Connections for Triple Post Cells	9-4
9.5.	Performing a Resistance Test.....	9-5
9.6.	Moving Probes from Cell to Cell	9-6
9.7.	When No Float Voltages Exist	9-7
10.	Understanding Voltage Skewing Effect.....	10-1
11.	Using the CRT-400 as a Digital Voltmeter	11-1
12.	The Hydrometer and the Data Logger	12-1
12.1.	Setting Up the CRT for Hydrometer Usage	12-2
12.2.	Taking Readings with the Hydrometer	12-4
12.3.	Transferring Hydrometer Data to Computer	12-6
13.	Setting Up the CRT	13-1
13.1.	Selecting a Battery	13-2
13.2.	Reading USB.....	13-2
13.3.	Selecting a Manufacturer.....	13-2
13.4.	Selecting a Model.....	13-2
13.5.	Setting Thresholds.....	13-3
13.6.	Setting Thresholds without a Site File.....	13-4
13.7.	Clearing Memory.....	13-6
13.8.	Displaying Additional Functions.....	13-8
13.9.	Sound Adjustment	13-9
13.10.	Frequency.....	13-9
13.11.	Adjusting Date and Time.....	13-10
13.12.	Reserved.....	13-10

13.13.	Setting Up Bluetooth Wireless Communication	13-10
14.	Setting Up and Editing a Site Template	14-1
15.	Working with Files.....	15-1
15.1.	Saving Readings and Files to the USB Flash Hard Drive	15-1
15.2.	File Types Located on the USB Flash Hard Drive.....	15-2
15.3.	Appending to an Existing File	15-9
15.4.	Storing Data for Multiple Strings	15-11
15.5.	Deleting a File from the USB Flash Hard Drive.....	15-11
15.6.	Sending Readings Via IR	15-12
15.7.	Sending Readings Via <i>Bluetooth</i> Wireless.....	15-15
16.	Viewing Results	16-1
16.1.	Viewing Status.....	16-1
16.2.	Viewing the Overall Voltage Data	16-1
17.	Using Diagnostics	17-1
17.1.	Testing Keypad	17-1
17.2.	A/D Linearity	17-3
18.	Utilizing CRT-400 Service Menu	18-1
18.1.	Entering the Password	18-1
18.2.	Changing the Password.....	18-3
18.3.	Error Codes.....	18-4
18.4.	Battery Maintenance Schedule.....	18-4
18.5.	Upgrading Firmware	18-5
19.	Application Note CC-001	19-1
20.	Application Note CC-002-A.....	20-1
21.	Cellcorder Connection Options.....	21-1
22.	Cellcorder Jaw Options	22-1
23.	Index.....	23-1

List of Figures

Figure 1 - Serial Number Location and Label	3-2
Figure 2 - Cellcorder Right Panel Connector/Infrared	3-2
Figure 3 - Cellcorder Left Panel Connector/Test Lead and USB	3-3
Figure 4 - CRT Front Panel Diagram Left.....	3-8
Figure 5 - CRT Front Panel Diagram Right.....	3-9
Figure 6 - Top Panel LED Indicators.....	3-10
Figure 7 - Keypad	3-10
Figure 8 - Trans-reflective LCD Display	3-12
Figure 9 - Top Panel Controls, F1, F2, F3, and F4.....	3-12
Figure 10 - Back Panel/Telco/Reset Switch/Power	3-14
Figure 11 - Green LED Charge Indicator	4-1
Figure 12 - USB Device.....	4-4
Figure 13 - My Computer/Eject.....	4-4
Figure 14 - Safely Remove Hardware Window.....	4-5
Figure 15 - Confirmation To Stop Hardware Device	4-5
Figure 16 - CRT-400 Main Menu on LCD with F1, F2, F3 and F4 buttons	5-1
Figure 17 - CRT-400 F1, F2, F3 and F4 buttons	5-2
Figure 18 - CRT-400 Power and Arrow buttons	5-3
Figure 19 - CRT-400 with USB Flash Hard Drive	5-4
Figure 20 - CRT-400 Keypad Buttons.....	5-5
Figure 21 - CRT-400 Load Data Functions	5-5
Figure 22 - Deselecting a Site.....	5-8
Figure 23 - CRT Set up.....	5-9
Figure 24 - CRT Test Mode.....	5-9
Figure 25 - Connect Voltage Test Leads	6-1
Figure 26 - CRT - Test Mode	6-1
Figure 27 - Placement of Probes on Cells.....	6-2
Figure 28 - Resistance Test Lead Assembly Clamps.....	7-1
Figure 29 - Insert Resistance Test Leads Left Side CRT.....	7-1
Figure 30 - CRT-Test Mode/F1	7-2
Figure 31 - Quad Testing	7-4
Figure 32 - CRT-Test Mode/F1	8-1
Figure 33 - Single Intercell Connectors	9-1
Figure 34 - Connections For Dual Post Cells – Example One	9-2
Figure 35 - Connections for Dual Post Cells – Example Two.....	9-3
Figure 36 - Connections For Trip Post Cells – One.....	9-4
Figure 37 - Connections for Trip Post Cells – Two.....	9-4
Figure 38 - Connections for Trip Post Cells – Three.....	9-5
Figure 39 - CRT-Test Mode/F1	11-1
Figure 40 - Hydrometer, Data Logger, PC, CRT, USB Interaction.....	12-1
Figure 41 - CRT-CRT Setup/F4.....	12-2
Figure 42 - CRT-Thresholds F4/F2.....	12-2
Figure 43 - CRT-Main Menu/Load Data/F3	12-4
Figure 44 - Data Logger.....	12-6

Figure 45 - CRT–Main Menu with F Buttons for CRT Setup/F4	13-1
Figure 46 - CRT– Setup/Bat. Select–F4/	13-2
Figure 47 - CRT– Setup/Thresholds or F4/F2	13-3
Figure 48 - CRT Setup/Clear Memory or F4/F3	13-7
Figure 49 - CRT Setup/Display Functions.....	13-8
Figure 50 - CRT Sound Adjustment	13-9
Figure 51 - CRT AC Line Frequency 50/60 Hz	13-9
Figure 52 - CRT Time and Date	13-10
Figure 53 - CRT Load Data Main Menu	14-1
Figure 54 - CRT Load Data Main Menu	14-4
Figure 55 - CRT Clear/F3/Deselect a Site	14-5
Figure 56 - CRT Main Menu on LCD/Load Data	14-6
Figure 57 - CRT Main Menu on LCD/Load Data	14-7
Figure 58 - CRT Main Menu on LCD/Load Data	14-8
Figure 59 - CRT Main Menu on LCD/LOAD DATA.....	14-12
Figure 60 - www.vertivco.com/Baseline Resistance Data.....	15-4
Figure 61 - Snapshot Baseline Resistance Data.....	15-4
Figure 62 - File Download Window	15-5
Figure 63 - Saving BLF File	15-5
Figure 64 - My Computer ICON	15-6
Figure 65 - My Computer/Eject.....	15-6
Figure 66 - Safely Remove Hardware Window.....	15-7
Figure 67 - Confirmation to Stop Hardware Device.....	15-7
Figure 68 - Safe to Remove Hardware Device	15-7
Figure 69 - CRT Main Menu on LCD/Load Data	15-8
Figure 70 - CRT Main Menu on LCD/Load Data	15-11
Figure 71 - BAS Software Program Select Cellcorder	15-13
Figure 72 - BAS/CRT Interface Window	15-14
Figure 73 - BAS/Battery Data Capture Open or Create New File.....	15-14
Figure 74 - BAS/Cellcorder Battery Data Capture	15-14
Figure 75 - BAS/CRT Interface Data Transfer Completed	15-15
Figure 76 - BAS Software Program Select Cellcorder	15-16
Figure 77 - BAS/CRT Interface Window	15-16
Figure 78 - BAS/Battery Data Capture Open or Create New File.....	15-17
Figure 79 - BAS/Cellcorder Battery Data Capture	15-17
Figure 80 - BAS/CRT Interface Data Transfer Completed	15-18
Figure 81 - View Results/F2–Faults/F3.....	16-2
Figure 82 - Communications Settings Com Port BAS Software.....	18-7
Figure 83 - BAS Software Program Select Cellcorder	18-7
Figure 84 - BAS/CRT Interface.....	18-8
Figure 85 - BAS/CRT Interface Window	18-9
Figure 86 - Valve Regulated and Vented Cells	19-1
Figure 87 - Classical Cell Model	19-2
Figure 88 - Internal Resistance Model.....	19-3
Figure 89 - Capacity and Internal Resistance Ratio.....	19-4
Figure 90 - Typical Discharge Curve of a 100% Capacity Cell	19-4

Figure 91 - Typical Discharge Curve with Metallic Resistance Problem	19-5
Figure 92 - Typical Discharge Curve with a Cell with an Electrochemical Resistance Problem	19-6
Figure 93 - Normalized Internal Resistance Vs. Temperature	19-7
Figure 94 - Measuring Internal Resistance	19-8
Figure 95 - Single Interconnections	20-2
Figure 96 - Contacting Tips to Posts (Fig. 2A and Fig. 2B).....	20-2
Figure 97 - (Figure 3A and 3B) Connections for Dual Posts.	20-3
Figure 98 - (Figure 4) Connections for Triple Posts.....	20-4
Figure 99 - (Fig 5) Connections for Triple Posts.....	20-4
Figure 100 - CRT-400 Cellcorder Connection Options	21-1
Figure 101 - CRT-400 Cellcorder Jaw Options	22-1

List of Tables

Table 1 - Back Panel/Telco/Reset Switch/Power 3-16
Table 2 - Function Buttons 5-1
Table 3 - CRT-400 Keypad Buttons 5-7
Table 4 - Editing a Site Template 14-3
Table 5 - Battery Maintenance Schedule 18-4

1. Safety Information

1.1. General



The protective features of this product may be compromised if it is used in a manner not specified in this guide and/or related operation or installation instructions. This manual describes general installation of the device. If the device has features or accessories not described in this manual, contact Vertiv.

The following general safety precautions must be observed during all phases of operation, service, and repair of this product. Failure to comply with these precautions or with specific warnings elsewhere in this manual violates safety standards of design, manufacture, and intended use of the product. Vertiv assumes no liability for the customer's failure to comply with these requirements.

 Note	<ul style="list-style-type: none">• Use safety equipment when working in and around the batteries.• Never exceed equipment voltage, power ratings or capabilities.• Use of this product in a manner not specified could compromise the designed in safety if this product.
---	--

1.2. Document Symbols

The symbols below appear in this manual or are affixed to the Vertiv device. It is important to review these symbols and to understand the type of instructional information they convey.

 WARNING	<p>Highlights areas related to user safety.</p> <p>Calls attention to a procedure, practice, or condition which, if not correctly followed, could result in personal injury. Do not proceed beyond a WARNING symbol until the indicated conditions are fully understood and met. Always observe safety information when installing, setting up or operating this product.</p>
 CAUTION	<p>Highlights areas related to product or data safety.</p> <p>Calls attention to an operating procedure or condition which, if not correctly followed, could result in damage to the product or permanent loss of data. Do not proceed beyond a CAUTION symbol until the indicated conditions are fully understood and met.</p>
 Note	<p>The Note symbol calls attention to important information.</p> <p>Describes additional information to help the user.</p>

1.3. Safety Symbols

The following symbols may appear on the system or individual equipment.



CAUTION. Risk of danger.

1.4. Product Safety Practices

The following describe safety practices particular to the installation or operation of the product.

Equipment Service

If you have questions, contact Vertiv and request assistance. Except as explained in this manual, do not attempt to service Vertiv equipment.

Any adjustment, maintenance or repair of this product must be performed by qualified personnel. Contact a Vertiv customer service engineer and request assistance. Only qualified and trained personnel may perform the operations described in this manual. All safety information must be read, understood, and strictly adhered to before installing, powering up or using the equipment.

Equipment Access

Operating personnel must not remove equipment covers, shields, and or panels. Component repair and/or replacement and internal adjustments must be made only by qualified service personnel.

Operating Damaged Equipment

Do not operate damaged equipment. Equipment that appears damaged or defective must be made inoperative and secured against unintended operation until repaired by qualified service personnel. Whenever it is possible that the safety protection features built into this product have been impaired, either through physical damage, excessive moisture or any other reason, remove power and do not use the product until safe operation can be verified by qualified service personnel. If necessary, contact Vertiv to ensure the safety features are maintained.

Servicing and Adjusting



CAUTION: Do not service or adjust alone. While in the battery circuit, do not attempt internal service or adjustment of this equipment unless another person, capable of calling for or rendering first aid and resuscitation, is present.

Safety Information

Substituting Parts or Modifying Equipment



CAUTION: Do not substitute parts or modify equipment. Due to the possibility of introducing additional hazards, do not substitute parts or perform any unauthorized modification to the product. If necessary, contact Vertiv to ensure the safety features are maintained.

Ventilation

Never block equipment ventilation ports or openings. The equipment must have adequate ventilation to prevent overheating. Ensure equipment is operated within specified temperature and humidity ranges.

2. Preventive Maintenance

2.1. Visual Inspection

Visually inspect device components for damaged or frayed power cables, or damaged component panels, controls, and connectors. When damage is detected, remove the equipment from service until the damage is repaired.

2.2. Cleaning System Components

Clean device components using a soft cloth, slightly moistened with water. Do not use commercial or industrial cleaners that may attack the computer display and housing. Never expose components to water, high humidity, or dampness.



WARNING: Before cleaning equipment, ensure the device is shut off.

2.3. Internal Component Replacement

The device has no user replaceable components. Since high voltage is on this device, only knowledgeable users should remove the covers. Failure to comply with this restriction could pose a safety hazard and/or void the product warranty.

2.4. Shipping, Storage, Normal Use Protection

Protect the device from physical impact during normal use or storage, and when necessary, provide protection during shipment between test sites.

3. Product Overview

The Cellcorder™ CRT-400 Cell Resistance Tester is specially designed to strictly comply with IEEE standards for testing batteries. When a battery is tested, the measurements are affected by several factors.

- Online tests are subject to ripple (AC noise) from the charger or inverters.
- Batteries have a natural capacitance that will influence the accuracy of the readings.
- The size of the test current directly relates to the accuracy of the measurement.

With Vertiv's patented technology, the Cellcorder's DC resistance test is not influenced by these factors.

The Cellcorder reads single cells and multicell modules, and displays and records cell float voltage, internal cell resistance, and intercell connection resistance. A compatible hydrometer can transfer specific gravity and temperature. The self-contained CRT-400 Cellcorder is comprised of a microprocessor, load resistor, display, and rechargeable battery. Voltmeter probes and a three clip resistance set are provided; optional test leads are available from Vertiv. The CRT-400 functions well even in high noise environments, without the need to disconnect the battery from service. A 60 amp DC load (on 2V cells) is used to calculate internal cell resistance and intercell resistance. Circuitry rejects the 50Hz/60Hz ripple and associated harmonics often troublesome to AC-based impedance and conductance meters.

This well-proven and patented DC resistance test completely eliminates the guess work when trying to find the weakest link.

The New Cellcorder CRT-400 at a glance is lightweight, rugged and durable. The Cellcorder comes complete with a durable carrying case, voltage probes, resistance leads, USB flash drive, AC charger, data trending and analysis software, and a user manual. Everything required to get started in one case from Vertiv!

3.1. BAS Software

The Battery Analysis Software helps you identify bad cells, generate descriptive reports and archive data. Measurements are stored and presented to allow trending. This makes it possible to detect early performance degradation in individual battery cells.

3.2. Cellcorder Serial Number

The Cellcorder's serial number is located on the label on the back of the Cellcorder, toward the top of the Cellcorder.

3.3. Features

The CRT-400 Cellcorder battery cell voltage and resistance tester features:

- a USB port for USB data storage devices and ease of data transfer from the field
- graphical reflective LCD display
- audible feedback when enabled
- infrared IR communication

Product Overview

- optional short range Radio Frequency RF communication via *Bluetooth*® allowing data transfer to a *Bluetooth* compatible computer, and/or testing instructions via headset

The self-contained CRT-400 Cellcorder is comprised of a microprocessor, internal resistance test module, display, and rechargeable battery.

Voltmeter probes part number 1100-222 and a three clip resistance set, part number 1100-221 are provided; optional test leads and accessories are available from Vertiv. Contact Vertiv at 954-377-7101.

Serial Number Location

The label contains the model number, input information, serial number and the upcoming calibration date.

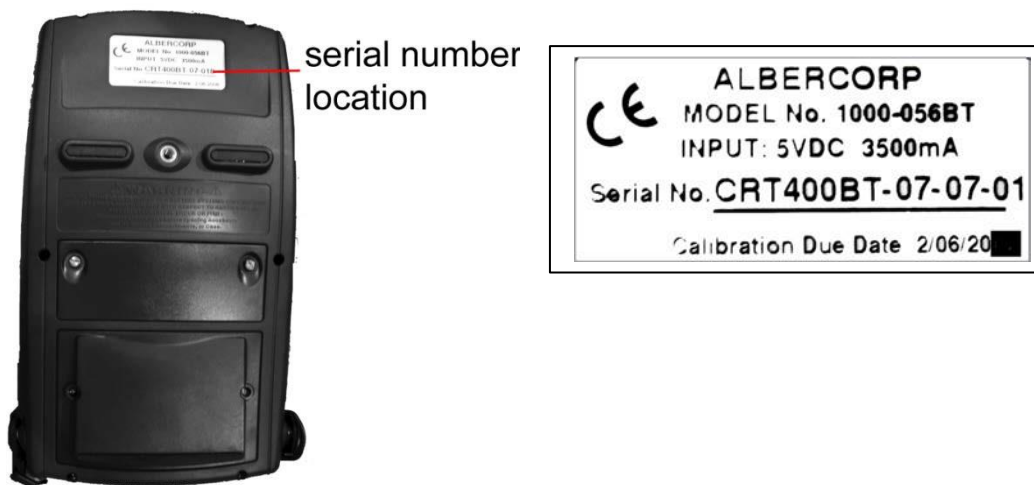

Figure 1 - Serial Number Location and Label

Infrared Port

The Cellcorder comes with an infrared IR port which is located on the right panel, this port is used for communicating with a computer, printer or data logger via IR light signal.

Note: When using the IrDA interface port with a CRT printer, the printer must be set up in “IRDA Physical layer” mode to communicate with an Vertiv CRT-400.



Figure 2 - Cellcorder Right Panel Connector/Infrared

Product Overview

Other Features Include

Ventilation

A temperature controlled cooling fan is installed.



Figure 3 - Cellcorder Left Panel Connector/Test Lead and USB

Test Lead

Easy port for molded test cables and optimized battery clamps.

USB connection

Universal Serial Bus USB port for portable USB flash drive/data storage devices. May insert/remove with power on or off, the **USB Memory** amber LED lights up when the drive is accessed.

Important Note!: The Portable USB flash drive should not be connected to the CRT-400 when the power cord is plugged into the CRT-400.

Measurement Capabilities

The CRT-400 functions well even in high noise environments, without the need to disconnect the battery from service. An approximate 60 Amp DC load on 2V cells are used to calculate internal cell resistance and intercell resistance. Circuitry rejects the 50Hz/60Hz ripple and associated harmonics often troublesome to AC-based impedance and conductance meters.

Readings

The Cellcorder reads single cells and multicell modules, and displays and records:

- cell float voltage
- internal cell resistance
- intercell connection resistance

A compatible hydrometer can transfer specific gravity and temperature data via the IR port. Data can be transferred to a PC and merged with previously stored readings using the serial cable supplied with the hydrometer or by using the USB data storage device.

Auto Ranging

The CRT-400 automatically selects the correct voltage range, load resistor, and test time.

Float Voltage

The CRT-400 measures the voltage applied during full float operation. The voltage range covers all cells or modules up to 20 volts. Accuracy of readings is to four full digits.

Product Overview

Internal Cell Resistance

Using a patented process, the CRT-400 applies a momentary load and calculates internal cell resistance by determining instantaneous voltage drop and load current. Cells floating on-line or off-line can be measured. This method helps find weak, potentially failing cells when comparing internal cell resistance of all like cells in the string.

Intercell Resistance

The CRT-400 measures the resistance between two electrically connected cell terminals. The measurement consists of connector resistance and contact resistance at the points of connection to the cell terminals.

Data Analysis, Storage and Transfer

A large amount of data can be stored within the CRT-400 and obtained by IR, or USB device. The IR port transfers readings to a computer for analysis and report generation or the user may insert a portable USB device/flash hard drive for data capture and retrieval. The CRT-400 creates two files each time the data is stored to the USB flash hard drive. These two files each have three letter extensions, .CSV and .CDF. The .CSV file is used by Microsoft® Excel to display data in spreadsheet format. The .CDF file is used by the Battery Analysis Program/BAS software, or CRT Previewer program when test data is saved to the USB device.

The BAS program analyzes data, displays results in graph or tabulated formats, and prints reports. It also exports report files in ASCII, Excel or .CSV, comma-delimited format so other programs can generate customized reports. Refer to the Battery Analysis System User's Guide.

Radio Frequency RF Headset Communication

The CRT-400 is capable of communicating via radio frequency using *Bluetooth*. This optional feature allows the user to receive verbal testing instructions or test status via a *Bluetooth* headset instead of having to read the instructions on the CRT-400 display.



Reset Switch

Note: The Mechanical Reset Switch is under the battery compartment on the rear panel next to the input for the charger module. The Telco connection option is not widely used and is disconnected.

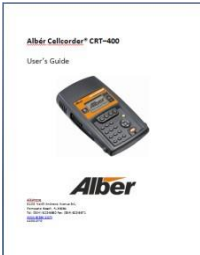

3.4. Cellcorder CRT-400

Part Number	Part	Description
KIT-1000-056/ KIT-1000-056BT* *Bluetooth model		Cellcorder battery tester.
5V@4A Desktop power supply/ charger module for Cellcorder KIT- 4000-034		Power supply charges Cellcorder
Resistance test lead assembly clips 1100-221		Resistance Test Lead Assembly Clamps Test cell and intercell resistance values.
Shoulder strap 3800-029		Shoulder Strap allows for easy CRT portability.
USB 2GB flash drive 2030-005		A plug and play data storage device that is fully compatible with USB. The USB flash drive contains all the CRT-400 User Guides
Voltage lead assembly 1100-222		Voltage sense lead connector.

Product Overview

Part Number	Part	Description
CRT carrying case 3800-028		A convenient carrying case for Cellcorder and its accessories.
Battery Analysis System BAS and Previewer software and User's Guides 2027-014 4200-002 BAS 4200-040 Preview		Software downloads, updates and User's Guides can be downloaded from the Website at: www.vertivco.com
2 Wire Cord W/ IEC-320 Plug 6003-015 = US, 6003-016 = Euro, 6003-017 = UK		Power for the charger module part number KIT-4000-034, to charge the CRT's battery.
Spike Probes 1101 Series		The Cellcorder Spike Probes are for use with hard-to-access battery terminal posts. Using these probes, it is possible to measure the internal resistance of a cell or module and take float voltage readings. Check www.vertivco.com for the latest models.
Printer 2025-132L Thermal Printer Paper 2025-126		Printer with IrDA interface Note: When using the IrDA interface port with a CRT printer, the printer must be set up in "IrDA Physical layer" mode to communicate with an Vertiv CRT-400.

Product Overview

Part Number	Part	Description
<p>Bluetooth® Headset 2025-036</p>		<p>Hands-free communication while testing.</p>
<p>DMA 35n Portable Density/Specific Gravity/ Concentration Meter, Hydrometer Kit 2900-032</p>		<p>The hydrometer measures the amount of sulfuric acid in the electrolyte to determine if the battery needs charging. A data logger module is included in the Hydrometer Kit</p> <p>Note: A data logger module is included in the DMA35n Kit. The RS232 cable is for use with data transfer to a pc. The data logger's IR port can be used to obtain information from the hydrometer. Then, this data can be transferred to the CRT via IR.</p>
<p>PC/Computer</p>		<p>To be used in conjunction with BAS software to analyze test data.</p>

3.5. Panel Controls and Indicators

This section illustrates the CRT's controls, indicators, and connectors.

Note: Prior to powering up your CRT-400, be sure to charge the lithium ion rechargeable battery. When the Battery Charge LED is off, it indicates a fully charged battery.

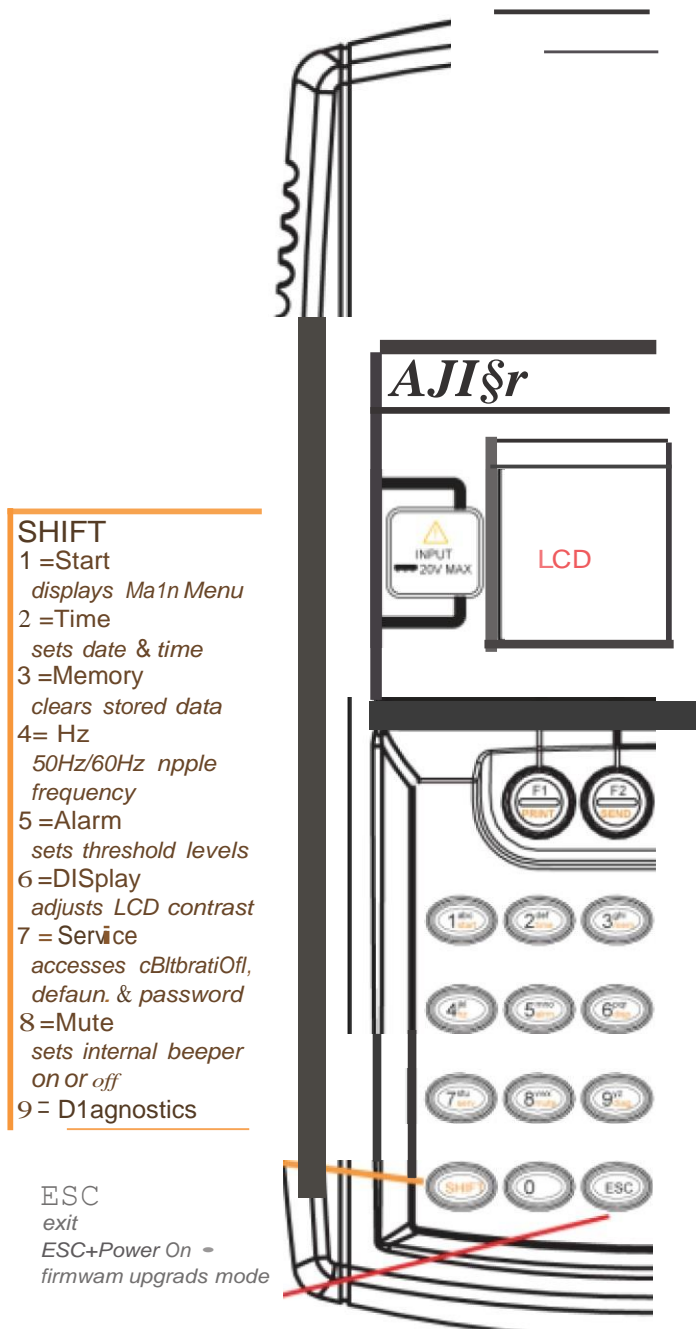

Figure 4- CRT Front Panel Diagram Left

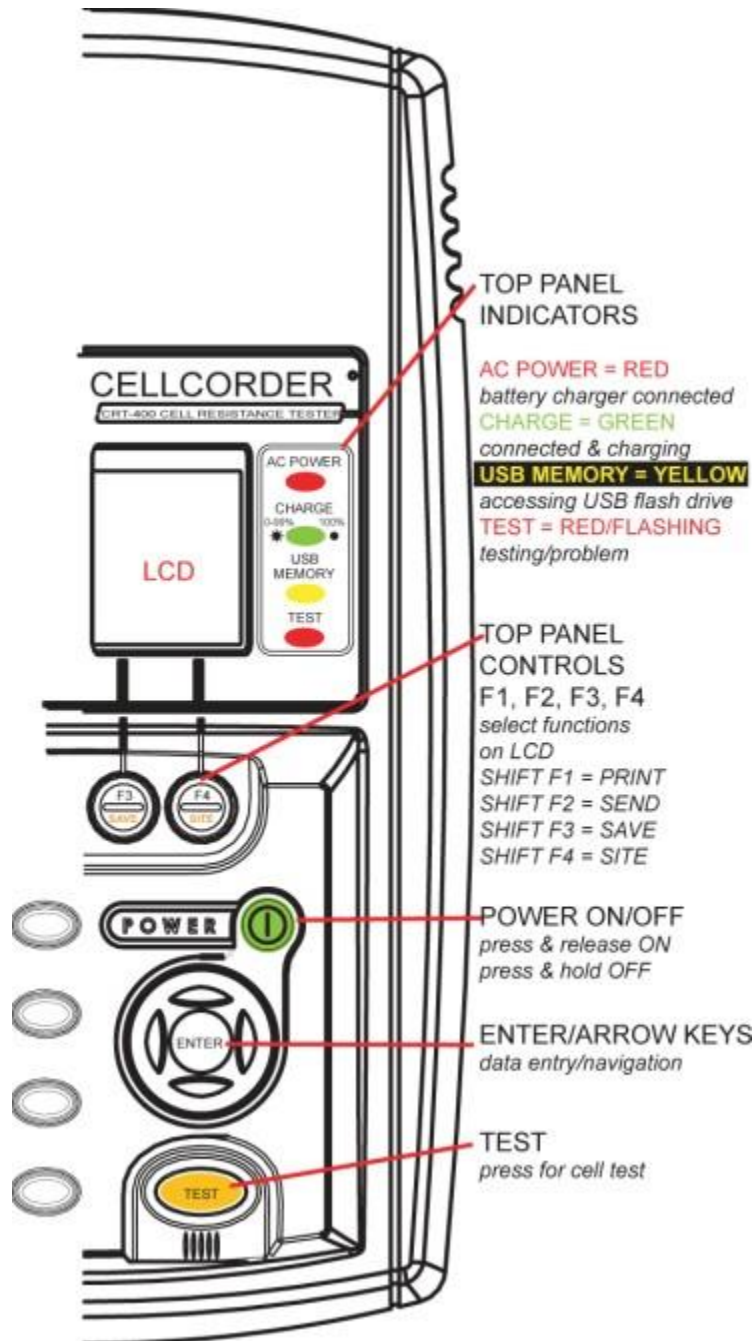

Figure 5 - CRT Front Panel Diagram Right

Top Panel Indicators

AC Power LED - indicator is illuminated red when connected to AC power.

Battery Charge LED - indicator is illuminated green when charger/power supply is connected and charging is in process. When the LED is off, it indicates a fully charged battery.

Product Overview

USB LED - indicator is illuminated yellow when the USB flash drive is engaged.

Important Note!: The Portable USB flash drive should not be connected to the CRT-400 when the power cord is plugged into the CRT-400.

Test LED - indicator is illuminated red when testing is in progress. The LED Flashes to indicate a problem with the resistance test.

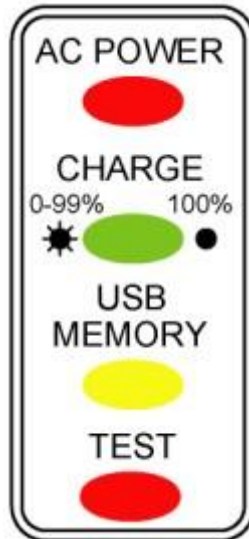

Figure 6 - Top Panel LED Indicators

Top Panel Controls Keypad - a combination keypad for alphanumeric data entry and shift key for quick function keys. Press **Shift**, release **Shift**, then press another key from **0** to **9** to select orange text on any key.

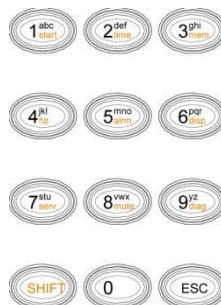
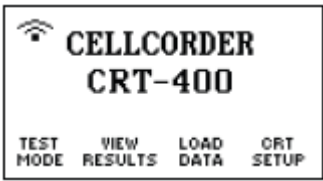

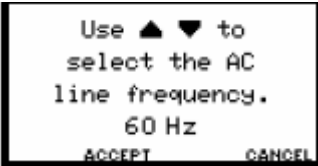
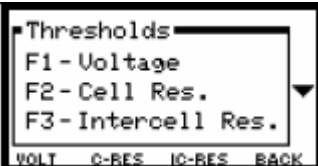
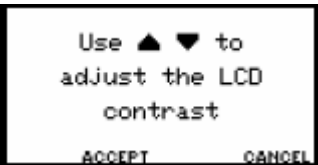





Figure 7 - Keypad

Product Overview

The keypad offers alphanumeric data entry and the following options.

Button	Display	Description
To start, press Shift then 1	Main start LCD window	Displays the main menu. 
To set date and time, press Shift then 2	Data and Time LCD window	Sets the date format and time. 
To clear or save stored data, press Shift then 3	Mem/memory LCD window	Clears stored data and saves readings to USB. 
To select AC line frequency, press Shift then 4	Hz/frequency LCD window	Selects line frequency; 0/60Hz. 
To set threshold levels for alarms, press Shift then 5	Alrm/alarms LCD window	Sets alarms threshold levels. 
To adjust LCD contrast display, press Shift then 6	disp/display LCD window	Adjusts LCD contrast display. 
To access calibration, default and password settings, press Shift then 7	Serv/service LCD window	Accesses calibration and password settings. 

Product Overview

Button	Display	Description
To mute beeper, press Shift then 8	Mute LCD window	Sets the internal beeper to either on or off. 
To access diagnostics, press Shift then 9 .	Diag/diagnostics LCD window	Accesses diagnostics, menu. 

Trans-reflective LCD

The high contrast, 128 x 64 pixel backlit graphical display shows menus, warnings, and test results. The display makes it easy to navigate through the menus. On power up the LCD window displays the Albér logo, the firmware version, and the main menu.

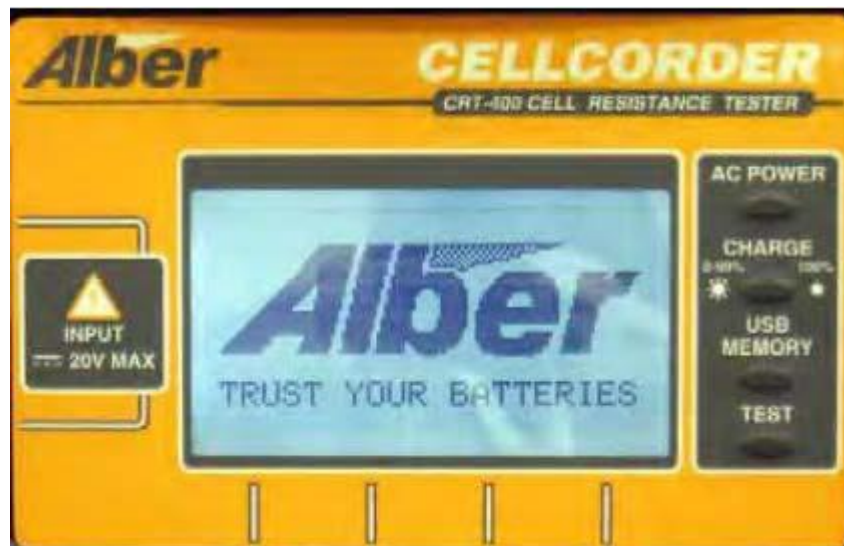

Figure 8 - Trans-reflective LCD Display

F1, F2, F3, and F4 Buttons

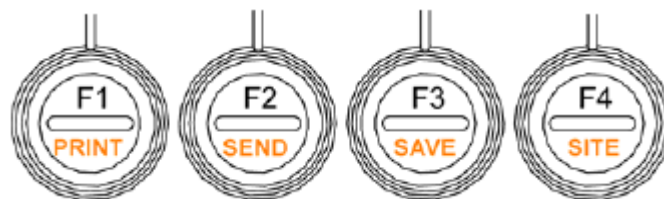

Figure 9 - Top Panel Controls, F1, F2, F3, and F4

Product Overview

The **F1**, **F2**, **F3** and **F4** buttons select the functions that display on the LCD Display directly above. These buttons also have the following options.

Note: Press **Shift** on the keypad, then release SHIFT, then press **F1**, **F2**, **F3** and **F4** to select the orange text on any key.

Button	Function	Description
SHIFT F1	Print	Sends data to the printer via IR/ <i>Bluetooth</i> .
SHIFT F2	Send	Sends data to the computer via IR/ <i>Bluetooth</i> .
SHIFT F3	Save	Saves data to the USB flash hard drive.
SHIFT F4	Site	Displays the site selected.

F1/F2 Yes/No - When possible, F1 is used for Yes and F2 is used for No.

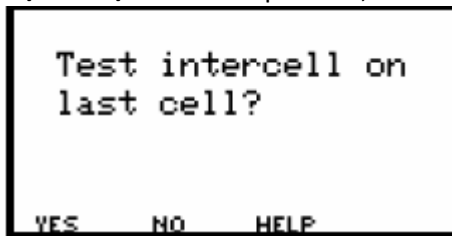

F3/F4 Back/ Cancel - When possible, F3 is used for Back and F4 is used for Cancel.



Power - Press and release **Power** to power on the CRT. Press and hold **Power** to power off. The CRT-400 is powered by a lithium ion rechargeable battery.



Enter/Arrows functions - **Enter** plus **arrow** keys. Press **Enter** after typing data, such as password. Press Up, Down, Left or Right arrows to navigate LCD windows.

Test - The **Test** key initiates the test sequence. Press and hold for approximately ½ second to initiate cell testing.

ESC/Escape - press the **ESC** key to exit certain LCD windows. Hold and press **Power + ESC** to start in firmware upgrade mode.

Product Overview

Press **Test** and **Enter** key simultaneously to reset the CRT. If the keys on the CRT lock-up, pressing these buttons simultaneously will reset the unit.

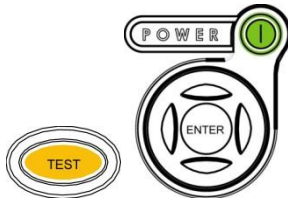

Bottom Panel Connectors/Accessory Compartment

TELCO - A modular RJ-11 jack for communicating with a remote computer via telephone not supported at this time.

AC Power - A 5VDC input jack for connecting the CRT battery charger module.

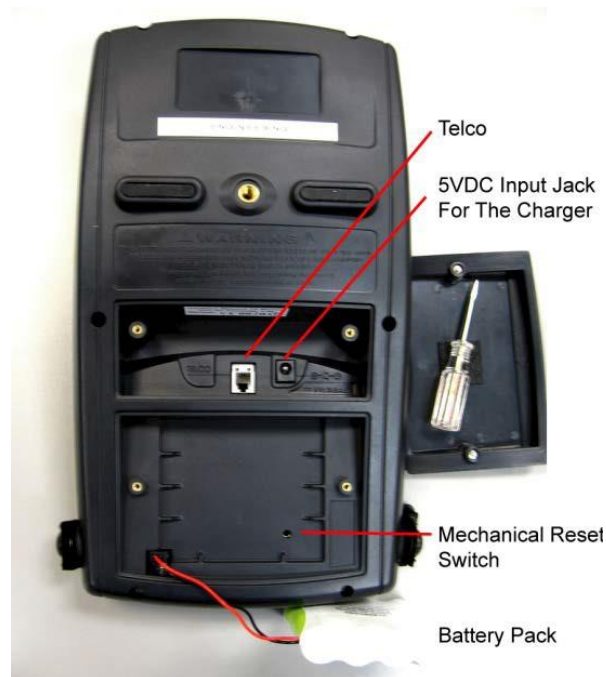

Figure 10 - Back Panel/Telco/Reset Switch/Power

Help LCD windows and Menu Selections

The CRT-400 has easy-to-use LCD windows, offering Help pages that provide details about options on the LCD window. Descriptions of Menu items on the LCD display are in the sections of the manual where Menu items appear. In addition, use F1 to F4 function buttons. To speed up the selection process, function locations are standardized.

Product Overview

3.6. Specifications

Physical

- Dimensions - 12"Height x 7"Width x 3"Diameter or metric 305mm Height x 178mm Width x 76mm Diameter
- Weight - 3.4 pounds or metric 1.5Kg
- Keypad - Rubber keys with polyurethane coating

Display

- Type LCD - STN Reflective
- Viewing Area - 2.619" x 1.309"
- Resolution - Graphics LCD 128 x 64
- Viewing Angle - 40°
- Backlight White LED

Memory

- **Type** - USB flash hard drive
- **Size** - 256MB
- **Storage Capability** - 71 strings of 256 cells per megabyte MB of size. (256MB USB flash drive can store up to 18176 strings.)
- **Data Retention** - 10 years

Communication

- **Infrared** - Fully IrDA compliant for PC interface. Physical IrDA compliant for printer interface.
- **Bluetooth** - PC Interface for data transfer Earpiece interface for voice test status

Battery

- **Type** - 4 cell, 8800mAh lithium ion
- **Voltage** - 3.7V nominal
- **Charge Time** - 8 hours

AC Adaptor - The Power Supply is part number KIT-4000-034 w/6003-015/16/17

- **Input Voltage** - 90 to 264VAC
- **Output Voltage** - 5VDC
- **Output Current** - 4.0A
- **Frequency** - 47 to 63Hz

Environmental Temperature Range

Operating - 32° to 104°F, 0° to 40°C

Storage - -20° to 140°F, -29° to 60°C. For extended periods: <77°F /<25°C

Humidity - Range 0% to 80%RH (non-condensing) at 0°C to 31°C, 0% to 50%RH (non-condensing) at 32°C to 40°C.

Insulation Category - II

Pollution Degree - 2

Altitude - 0 to 2000 meters above sea level

Accuracy

Product Overview

Input	Test Current	Resistance Resolution $\pm 0.1\%$ of reading	Voltage Resolution $\pm 0.1\%$ of reading	Intercell Range/ Resolution $\pm 1\%$ of reading
2V	50A	$\pm 5\mu\Omega$	$\pm 1\text{mV}$	$2\text{m}\Omega \pm 2\mu\Omega$
4V to 6V	25A to 35A	$\pm 25\mu\Omega$	$\pm 3\text{mV}$	$3.3\text{m}\Omega \pm 5\mu\Omega$
8V to 12V	30A to 35A	$\pm 75\mu\Omega$	$\pm 6\text{mV}$	$5\text{m}\Omega \pm 10\mu\Omega$
16V	5A	$\pm 400\mu\Omega$	$\pm 10\text{mV}$	$20\text{m}\Omega \pm 20\mu\Omega$

Table 1 - Back Panel/Telco/Reset Switch/Power

Note: Specifications are subject to change without notice.

Voltage and Current Protection

An internal circuit helps protect the Cellcorder if inadvertently placed across a high voltage. Circuitry senses the input voltage across the current carrying leads and, if the input voltage exceeds 20 volts, a beep sounds and the test current relays are disabled.



WARNING: It is potentially hazardous to exceed the rated voltage of the Cellcorder, 20 volts.

4. Before Using The CRT-400

4.1. Highly Recommended Reading

Please read the following sections of this manual as well as the other manuals mentioned in this list:

- The Safety, Legal Warranty and user sections of this manual
- Battery Analysis System User's Guide, 4200-002
- USB Flash Drive manufacturer's instructions
- If a Hydrometer is used, its instructions as well as the Data Logger Module instructions for data transfer from the Hydrometer.
- For *Bluetooth* option: *Bluetooth* compatible computer manual, to send CRT-400 test data to the computer via the RF option. *Bluetooth* compatible headset manufacturer's instructions.

Please refer to the following if more information is needed.

IEEE 450-2002 -IEEE Recommended Practice for Maintenance, Testing, and Replacement of Vented Lead-Acid Batteries for Stationary Applications.

IEEE 1188-2005 - IEEE Recommended Practice for Maintenance, Testing, and Replacement of Valve-Regulated Lead- Acid (VRLA) Batteries for Stationary Applications.

4.2. Charging the Cellcorder Battery

Prior to testing, charge the CRT-400 using the charger module until the green Charge LED goes out. This illuminated green Charge LED indicates the battery level only when the charger is connected. Charging may take several hours.

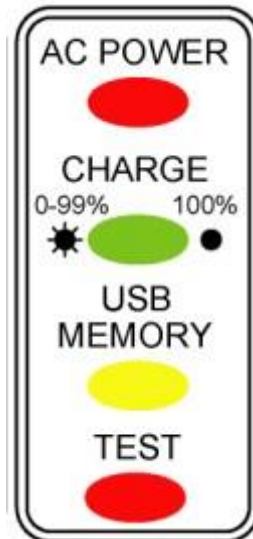

Figure 11 - Green LED Charge Indicator

Note: A discharged battery does not affect data readings in temporary storage.

Before Using The CRT-400

Before Charging, Disconnect Any Test Leads

Before charging the battery, disconnect any test leads. Open the accessory compartment cover by loosening the two slotted screws. Connect the charger to the power connector inside the accessory compartment located on the back of the CRT, then plug in the charger. When charging is complete, the green LED will turn off.

Charge Complete

When the battery is fully charged, the green LED goes off upon charging completion, unplug the charger from the power source and then unplug it from the CRT-400. Replace the accessory compartment cover before beginning test.

Note: The life of the battery depends on how well it is charged. Please refrain from leaving the CRT in extreme cold or hot temperatures. Subjecting the CRT to extreme temperature conditions will shorten the life of the battery.



CAUTION: Never store the CRT-400 in a discharged condition. If you use a unit needing recharge, it will shut down without warning.

Low Battery

When the battery is low, warnings indicate remaining test time. At full discharge, the unit turns off. You can access data in temporary storage after recharging.

Note: The CRT-400 shuts down if inactive for ten minutes to prolong battery life.



WARNING: If the battery wears down during testing, do not use the charger for power when testing cells.



WARNING: Injury to personnel or damage to equipment could result.

CRT-400 low battery warning messages:

- Low Battery Detected

```
WARNING!  
Low battery detected.  
Power will shut down  
automatically in 5  
minutes.  
  
CONTINUE
```

- One Hour Remaining



4.3. Test Lead Connection Practices

This section summarizes good test lead connection practices to help ensure the accuracy of readings. For actual test lead connection, refer to “Connecting Resistance Test Leads” section. Always be consistent in how test leads are connected once testing has started on a battery. Changing the technique of how leads are actually connected to the measurement point, can result in different reading results. Being consistent is very important when measuring large high amp hour batteries where the internal resistance is very low and any change in the lead connections can alter the reading results. If the post is accessible underneath the strap, then alternate types of jaws that are available for the test leads. These jaws are constructed so that they extend their reach underneath the strap for direct connection to the battery post.

Note: For detailed information refer to “Cellcorder Jaw Options” section.

On some batteries (typically VRLA), the posts are inaccessible because they are covered by the intercell connector. For valve regulated batteries, where only the intercell and the mounting bolt are accessible, connect the current lead to the bolt head and the voltage sensing lead to the intercell.

Measuring from bolt head to bolt head is not a true measure of the connection between the post and intercell bar; in most cases, the reading will be high because of the high resistance of the bolt itself. Refer to “Application Note CC-002-A beginning”, for connection diagrams. Most battery terminal posts have a layer of lead peroxide, lead sulfate, copper sulfate, lead hydrate, copper oxide or dirt mixed with No-Ox grease.

All are high in resistance, so make sure the test leads have good connection to the metal surfaces.

Where possible, always try and connect the test lead connections directly to the post while not making any connection to the intercell or hardware.



WARNING: Do not attempt to read internal resistance of an open cell/module while the battery is on-line. An open cell can be determined by the unusually high voltage across it and the lower nominal voltage across all other cells/modules.

4.4. Understanding the USB Port and Flash Hard Drive

Data can be stored on a USB flash hard drive via the USB port. Use the USB flash hard drive to transfer test data recorded by the CRT to a computer for analysis, transfer firmware upgrades from computer to CRT, backup and restore calibration constants, and store site setup.

Before Using The CRT-400

Computer System Requirements for USB

Windows XP, 2000 Available USB port (USB 2.0 recommended)

Important Note!: The Portable USB flash drive should not be connected to the CRT-400 when the power cord is plugged into the CRT-400.

Accessing Stored Data on the USB Device From PC

Insert the USB flash hard drive into the computer's USB port on the PC.
Use Windows Explorer to access the USB flash hard drive and stored data.



Figure 12 - USB Device

Recommended Removal (From PC) Practice

1. When using Windows, we recommend the following steps to remove the USB device from the PC. Double-click the **My Computer** icon on the Windows desktop. Right click on **Removable Disk** drive, in this case (E) and select **Eject** from the menu. Or double-click the **safely remove device** icon, that is located in the toolbar.

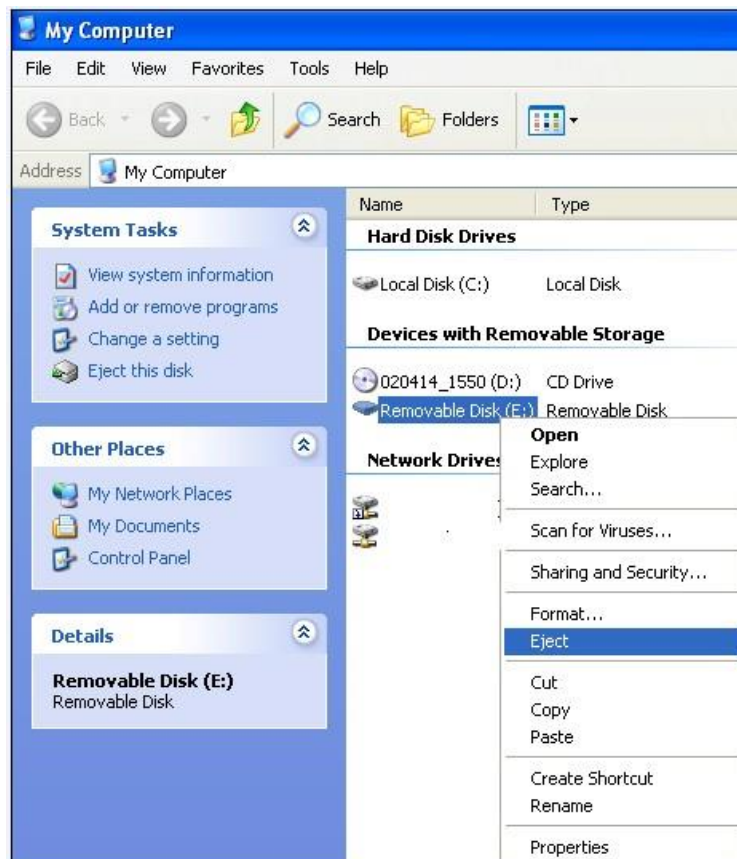

Figure 13 - My Computer/Eject

Before Using The CRT-400

2. The **Safely Remove Hardware** window displays. Highlight the **USB Mass Storage Device** and click **Stop**.



Figure 14 - Safely Remove Hardware Window

3. A confirmation window displays. Scroll down with the mouse and select the device to be removed and click **OK**.



Figure 15 - Confirmation To Stop Hardware Device

4. Wait until the message, **Safe to Remove Hardware** appears, then remove the USB flash hard drive.



CAUTION: Make sure the light on the USB is off before removing the USB device from the PC. Failure to follow the Safe Hardware Removal steps could result in lost data.

Using the USB Device with the CRT

Insert the USB flash hard drive into the CRT's USB port to read or write data.

Important Note! The Portable USB flash drive should not be connected to the CRT-400 when the power cord is plugged into the CRT-400.

Recommended Removal (from CRT) Practice



CAUTION: You may insert or remove the flash hard drive from the CRT-400 with POWER On or Off, but do not remove the USB flash hard drive when the Cellcorder USB Memory LED is lit as the LED indicates the USB memory is engaged.

4.5. Understanding *Bluetooth*[®]

Bluetooth wireless technology is a short-range communications technology intended to replace the cables connecting portable and/or fixed devices while maintaining high levels of security. When a *Bluetooth* device comes within range of another, an electronic conversation takes place to determine if they have data to share or if one device needs to control the other. This electronic conversation/connection happens automatically when the *Bluetooth* device is on and the two devices have been paired or in contact before.

5. Getting Ready to Test Batteries with the CRT-400

5.1. Power

To turn on the CRT-400, press the green **Power** button. To turn off, press and hold the green **Power** button until the message, Release power button appears on the LCD. The main menu window appears.

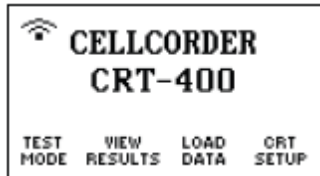

5.2. Basic Main Menu Functions

The main menu options are Test Mode/F1, View Results/F2, Load Data/F3, and CRT Setup/F4. Press the **F1**, **F2**, **F3** and **F4** buttons below these main menu options to select a function.

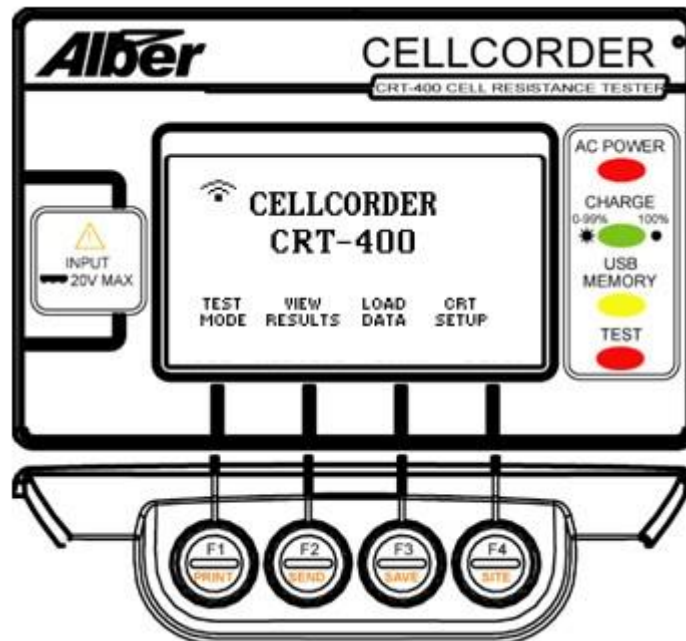

Figure 16 - CRT-400 Main Menu on LCD with F1, F2, F3 and F4 buttons

Button	Function	Description
F1	Print	Test Mode
F2	Send	View Results
F3	Save	Load data
F4	Site	CRT setup

Table 2 - Function Buttons

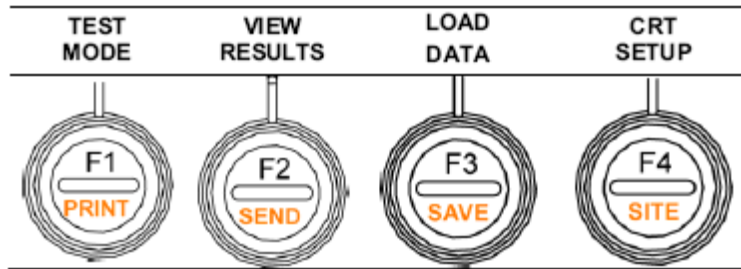

Figure 17 - CRT-400 F1, F2, F3 and F4 buttons

Test Mode/F1

Displays menus to measure voltage, determine resistance or add Specific Gravity SG and temperature readings.



Note: Specific Gravity/Temperature are imported from a separate instrument.

View Results/F2

Summarizes the Overall Voltage OV, cell voltage, cell resistance, and intercell resistance readings as averages, min/max lists, or threshold violations. This will help to determine if retesting is needed.

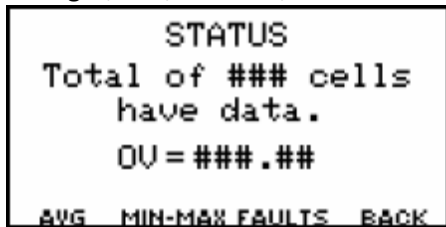

Load Data/F3

Accesses Site Setup/F1 and Cell Data/F2 .CDF files.

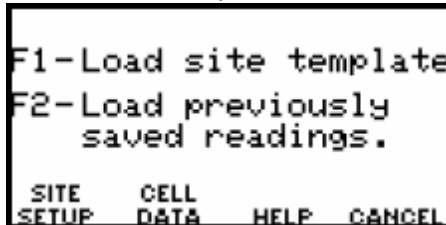

CRT Setup/F4

Displays menus for voltage, resistance, and SG/Temperature threshold limits, memory, LCD settings, sound, ripple frequency, date/time, and RF communication.



5.3. Navigation

To scroll through LCD windows or lists, use the arrow keys.



Figure 18 - CRT-400 Power and Arrow buttons

To go back a LCD window, exit a function, or return to the main menu, press **Back/F3**, **Cancel/F4** or **ESC**

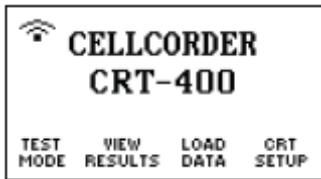

5.4. The Baseline Resistance Data File on USB

The BLF file has been placed on the USB flash hard drive for your convenience for first time users. This file contains Baseline Resistance Data for various well known batteries to help first time users get started. More information on the BLF file will be found in the “How To Work With Files” section. If you are an advanced user, please review the “How To Work With Files” section and proceed with testing.

5.5. Insert the USB Device Into the CRT

Turn on the CRT-400 by pressing the green **Power** button to view the main menu.

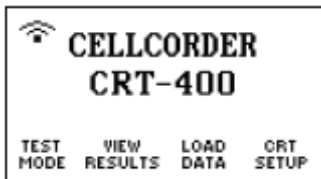

Insert the USB flash hard drive into the CRT’s USB port.

Important Note!: The Portable USB flash drive should not be connected to the CRT-400 when the power cord is plugged into the CRT-400.



Figure 19 - CRT-400 with USB Flash Hard Drive

5.6. How to Edit Items within the Site Template

This section is placed here to make it easy for beginners and first time users. Most alphanumeric keypad key types four characters: a number and three letters. The blank space character is on the 9 key.

Note: The cursor advances two seconds after pressing an alphanumeric key, or you may use the Right Arrow. For example to type a name, press a key then wait or press the Right Arrow. Location, battery, and string names have a limited number of characters, and other parameters have minimum/maximum values.

When Temperature and Specific Gravity summary thresholds are exceeded, the Cellcorder beeps twice, displays reverse video, and prints out in the Thresholds section.

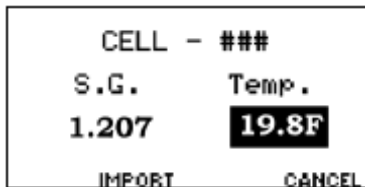

Press 9 on the keypad to type spaces in location, battery, string or model names.

Getting Ready to Test Batteries with the CRT-400

To delete characters, highlight the character and press **F1/Delete Char**.

Note: You cannot use the space key with file names.

Using the keypad, type the location name at the blinking cursor.

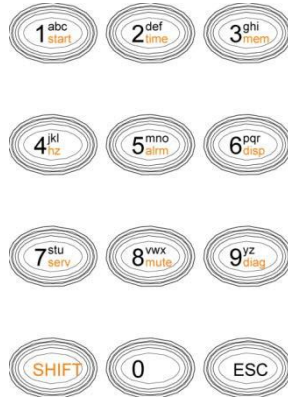

Figure 20 - CRT-400 Keypad Buttons

Press **F3/Load Data** Functions

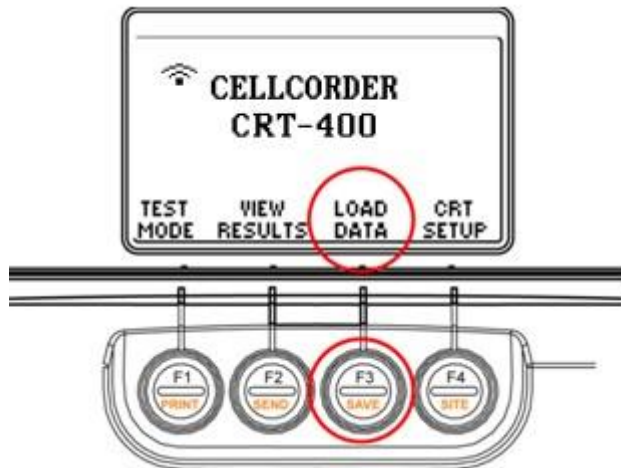

Figure 21 - CRT-400 Load Data Functions

Getting Ready to Test Batteries with the CRT-400

At the main menu, select **Load Data/F3** to obtain this LCD window:

```
F1-Load site template
F2-Load previously
   saved readings.

SITE  CELL
SETUP DATA  HELP  CANCEL
```

Note: Using arrows allow access to the specifics of the site, such as LOCation, BATtery, etc.

Press **F1/SITE SETUP** To load the site template

```
F1-Load site template
F2-Load previously
   saved readings.

SITE  CELL
SETUP DATA  HELP  CANCEL
```

When the USB flash hard drive has no sites stored, then the New Site LCD window appears.

```
▲ | New Site
LOC |
BAT |
STG |
MOD |
S#  |
▼ |
CHANGE SAVE CANCEL
```

Highlight LOCation

To begin, make sure **LOC** is highlighted by using the arrow keys.

```
(Location Name)
.
DELETE
CHAR  SAVE CANCEL
```

Type the location name.

Press F1/Change

Press **Save/F2**. Site ### of ### appears. The first set of ### is the new site number created. The second set of ### is the number of sites on the USB flash hard drive or sites entered. For this first case, the message should read, "Site 001 of 001."

```
▲ | Site ### of ###
|  |
|  |
|  |
▼ |
SELECT SAVE CANCEL
```

Highlight Battery

Press the down arrow key to highlight the next information item, **BAT**.

- Press **F1/Change**
- Press **Save/F2**
- Highlight **STG For String Name**

Getting Ready to Test Batteries with the CRT-400

Press the down arrow to highlight the next information item, STG.

- Press F1/Change
- Press Save/F2

The following table lists all editable items and the keys to use arrows and the alphanumeric keypad.

Note: Location, battery and string name are what is the minimum entry needed to begin testing.

Item	Description	Edit Text Using
LOC	Location name. 39 characters max.	Left and right arrows and keypad
BAT	Battery name. 18 characters max.	Left and right arrows and keypad
STG	String name. 15 characters max.	Left and right arrows and keypad
MOD	Model number of battery. 39 characters max.	Left and right arrows and keypad
S#	Total number of strings. Defaults to 01	Left, right, up, and down arrows
C#	Total number of cells. Defaults to 24	Left, right, up, and down arrows
DAT	Battery installation date.	Left, right, up, and down arrows
OPT	Options. Sets the ripple filter (AC line) Frequency. Defaults to 60 Hz	Up and down arrows
HV,	LV High/low cell voltage. Sets limits.*	Up and down arrows
HR,	High/low internal cell resistance. Sets limits.*	Up and down arrows
LR	High/low internal cell resistance. Sets limits.*	Up and down arrows
HI1	High intercell resistance 1, 2, 3, 4. Sets limits.*	Left, right, up, and down arrows
HI2	High intercell resistance 1, 2, 3, 4. Sets limits.*	Left, right, up, and down arrows
HI3	High intercell resistance 1, 2, 3, 4. Sets limits.*	Left, right, up, and down arrows
HI4	High intercell resistance 1, 2, 3, 4. Sets limits.*	Left, right, up, and down arrows
HT	High/low cell temperature. Sets limits.*	Left, right, up, and down arrows
LT	High/low cell temperature. Sets limits.*	Left, right, up, and down arrows
HSG	High/low specific gravity. Sets limits.*	Left, right, up, and down arrows
LSG	Sets Amp hours for load test and TST intercell type. F2 and F3 keys	F2 and F3 buttons
TST	Sets Amp hours for load test and intercell type.	F2 and F3 buttons
VLT	Sets the high and low cell voltage range.	F2 and F3 buttons

Table 3 - CRT-400 Keypad Buttons

*During testing, two beeps and reverse video indicate limits are exceeded. max = maximum.

Note: A site template is not required for testing, but is useful for managing many sites.

When a site is selected before testing, both the readings and site information will be saved in a *.CDF file. Confirm Site selection by pressing **Shift/F4 Site**.

5.7. Deselecting a Site

Press **Shift/F4 Site** then **Shift F3 Save**.

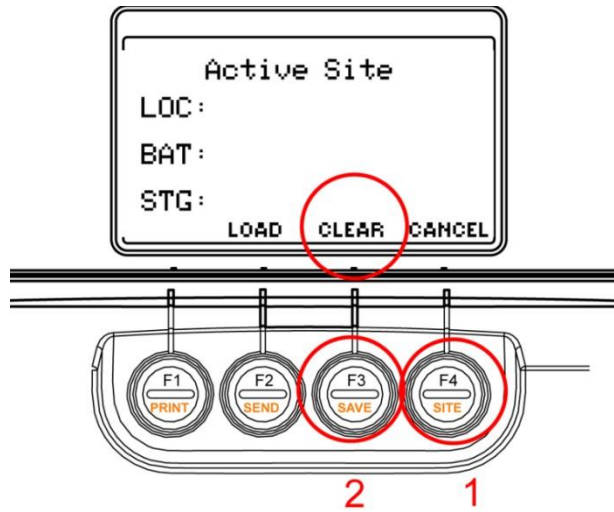

Figure 22 - Deselecting a Site

When a site is selected and you want to take readings with no site selected, press **Clear/F3** to clear. Confirm the change. To Unlink A File And To Clear Thresholds refer to the “Unlink a file and to Clear Thresholds” section. To select a different site, press **Load/F2**, and use the arrow keys to find the desired site and then **Select/F1**.

Note: To determine at any time what site is selected, press **F4 Site**.



WARNING: Do not test any cells when the Cellcorder AC Power indicator is lit. Injury to personnel or damage to equipment could result.

5.8. Next Steps, Battery Selection

CRT Setup/F4

Now, select CRT Setup by pressing **F4**.

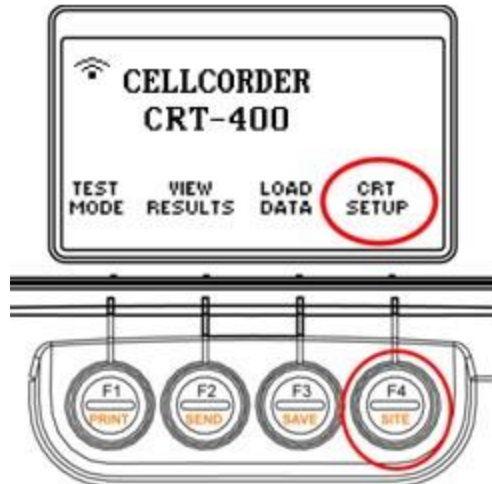

Figure 23 - CRT Set up

CRT Setup/F4

Press **F1/Battery Select**

Press **F1** to access the Baseline Resistance Data File containing battery models that automatically set certain threshold parameters.

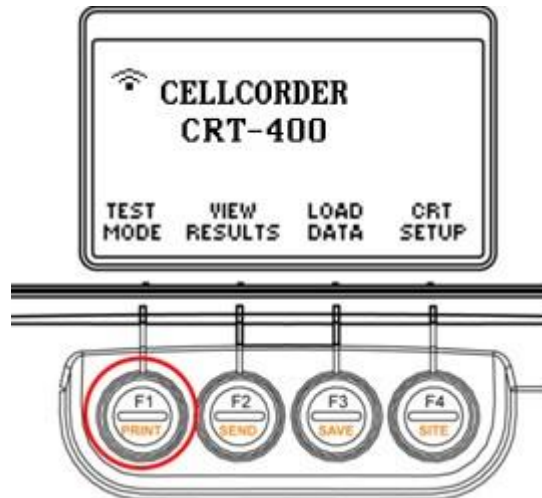

Figure 24 - CRT Test Mode

Reading USB

Note: The USB flash hard drive must be inserted to accomplish this Battery Select function. The BattList.blf file has been placed on the USB device at the factory to aid first time users.

For consistency in data capture, always use the same USB flash hard drive.

Wait for the USB device to be read to populate the Manufacturers and Models lists.

Getting Ready to Test Batteries with the CRT-400

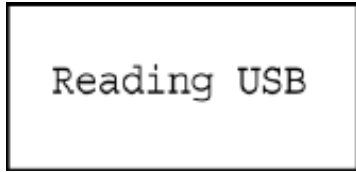

Selecting a Manufacturer

To select a manufacturer, press **F2/Accept**.



Selecting a Model

Select a battery model and press **F2/Accept**.

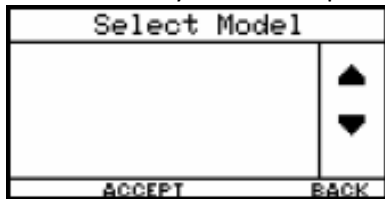

WARNING: Do not test any cells when the Cellcorder AC Power indicator is lit. Injury to personnel or damage to equipment could result.

6. Taking Float Voltage Readings First



WARNING: Do not test any cells when the CRT AC Power indicator is lit. Injury to personnel or damage to equipment could result. The maximum voltage the CRT can read is 20V. Do not attempt to read Overall Volts OV. The CRT calculates OV based on cell voltage readings.

Note: Vertiv highly recommends that you take cell voltage measurements first to eliminate possible voltage skewing effects, then move on to cell/connection resistance.

To take float voltage readings, connect the voltage test leads to the Cellcorder as shown in the figure below.



Figure 25 - Connect Voltage Test Leads

Make sure the CRT is powered on. You have already set up a new site template to begin your first test.

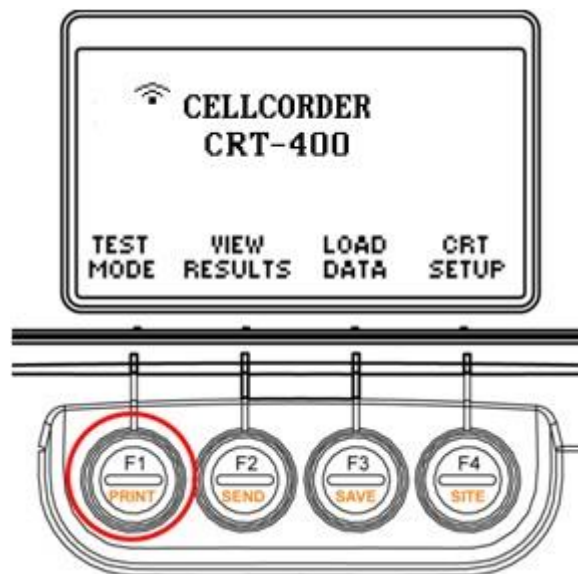
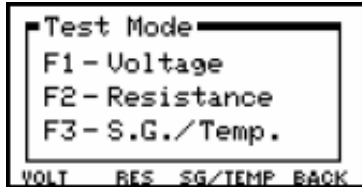

Figure 26 - CRT - Test Mode

CRT-Test Mode/F1

Taking Float Voltage Readings First

- Press **F1/Test Mode**
- Press **F1 - Voltage**



The LCD displays the CELL ### and Volts and either Resume Testing or Stored in Memory.

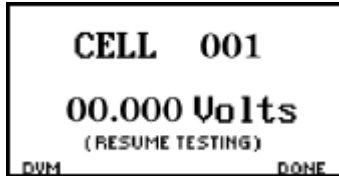

Note: The CRT ignores polarity in Voltage mode only, so that you may connect the leads either way.

When the probes/test leads contact a cell, the CRT displays the voltage and beeps to indicate the reading is stored in temporary storage.

When the probes/test leads are lifted off the cell, the CRT steps to the next cell. Continue taking readings by placing the probes/test leads on each cell. Probes are being used in the figure below.

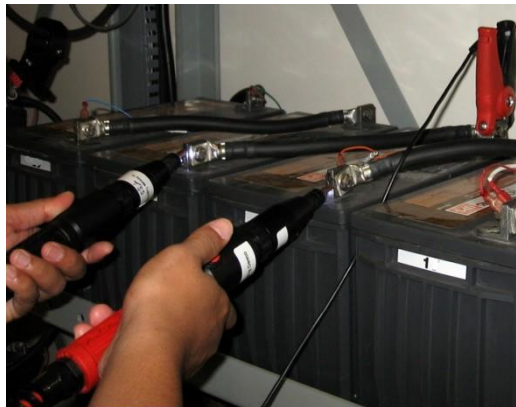

Figure 27 - Placement of Probes on Cells

6.1. F4/Done Voltage Testing

When testing is completed, remove the leads from the last cell under test and press **Done/F4**.

Note: When the *Bluetooth* headset is worn, verbal instructions that the cell has been tested and is now “Stored in Memory,” indicates to move the probes to the next cell. Best practice for accurate results is to place the probes on each cell precisely as placed on the first cell, until finished with the last cell.

6.2. Stored In Memory Explained

Stored in Memory indicates the cell number was previously read. During testing, you may review or retest previously read cells.

Taking Float Voltage Readings First

Note: To display another cell number and/or retest a cell, type the number then press **Enter**, or use the arrows.

To test again, press **Retest/F3**, place the probes onto the cell, and wait for the beep. Lift the leads; the next cell number appears. If the next cell number was also previously read, you can either retest or change the number using the arrows or keypad.

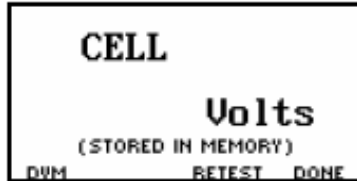

6.3. Resume Testing Explained

Resume Testing means no reading exists for the cell number. Place the voltage probes onto the cell. The Cellcorder reads the voltage and beeps. Move the leads to the next cell; the LCD displays the next cell.

7. Setting Up To Take Resistance Readings



WARNING: Do not test any cells when the Cellcorder AC Power indicator is lit. Injury to personnel or damage to equipment could result.

Prior to performing the resistance test, the CRT must be setup to match the type of battery to be tested. Since you have setup your first site template, some batteries require non-standard test leads or jaw options, please refer to “Cellcorder Jaw Options” section to obtain optimal results, use the appropriate jaws/leads for the batteries to be tested.



Figure 28 - Resistance Test Lead Assembly Clamps



Figure 29 - Insert Resistance Test Leads Left Side CRT

Select the 3 clip resistance test leads pn 1100-221 and insert into the CRT, left side.

Note: The standard jaws or test lead set may not provide the best connection to some cell posts. If you encounter poor post connection, contact Vertiv for a current list at 954-377-7101 or visit the website at www.vertivco.com.

Once the leads are connected, make sure the CRT is charged and powered on.

Setting Up To Take Resistance Readings

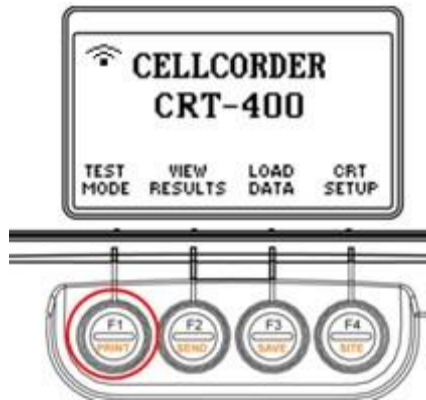
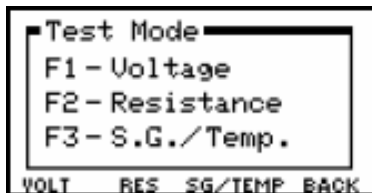

Figure 30 - CRT-Test Mode/F1

You have already set up a new site template to begin your first resistance test.

- Press **F1/Test Mode**



WARNING: Do not attempt to read internal resistance of an open cell/module while the battery is on-line. An open cell can be determined by the unusually high voltage across it and the lower (nominal) voltage across all other cells/modules.

Press **F2/Resistance**, the **Beginning Resistance test** LCD window appears.

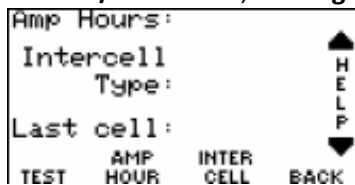

Press **F1/Test** the **Select Normal Cell Voltage** LCD window appears. Use the arrows to select the desired voltage of the cells to be tested.

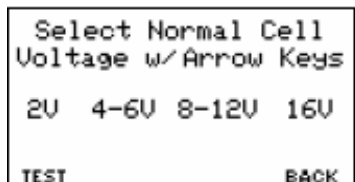

Note: You can choose to go back to the previous LCD window by selecting **F4/Back**.

Press **F1/Test**

Setting Up To Take Resistance Readings

Based on cell voltage, the CRT determines the correct range, connects a fixed resistance across the cell and intercell under test, and briefly applies 60 Amps on 2V cells. Test current changes from 5 to 60 Amps depending upon cell/module voltage; 16V to 1V.

During load condition, the unit reads cell voltage, current, and intercell voltage drop and calculates internal cell and intercell resistances. At completion, the internal cell resistance (Rc) and the intercell resistance (Ric) are displayed.

7.1. Check/Set Amp Hours

Check the battery and select whether Amp Hours needs to be smaller or larger than 1000 AH (default)/ <1000AH or >1000 AH. Make sure the CRT is charged and powered on. Make sure the resistance test leads are connected to the CRT, but not to the cell under test.

Press **AMP Hour/F2** to Toggle < or > **1000 AH**

This sets the length of time the Cellcorder applies a load.

7.2. Set Intercell Connections

To select how many Intercell Connections IC per cell will be read, one to four.

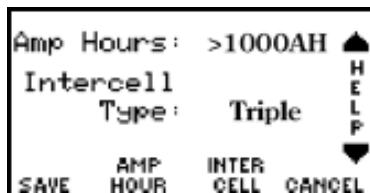

Press **F3/Intercell**

- Single
- Dual
- Triple
- Quad
- Combined
- Computed

Note: The arrow keys may also be used to display Single, Dual, Triple, Quad, Combined or Computed information.

Single Testing

If you are testing batteries with two (2) terminals and they are connected in series. Please refer to Single Intercell Connectors figure on the following pages.

Dual Testing

If you are testing batteries with four (4) terminals and they are connected in series. Please refer to Connections for Dual Post Cells - Example One figure and Connections For Dual Post Cells – Example Two figure on the following pages.

Setting Up To Take Resistance Readings

Triple Testing

If you are testing batteries with six (6) terminals and they are connected in series or if three (3) positive terminals are connected together and the three (3) negatives are connected together. Please refer to Connections for Trip Post Cell – One figure, Connections for Trip Post Cell - Two figure and Connections for Trip Post Cell – Three figure on the following pages.

Quad Testing

If you are testing batteries when each negative of (3) negative terminals are connected to each positive of the (3) positive terminals of the next battery.

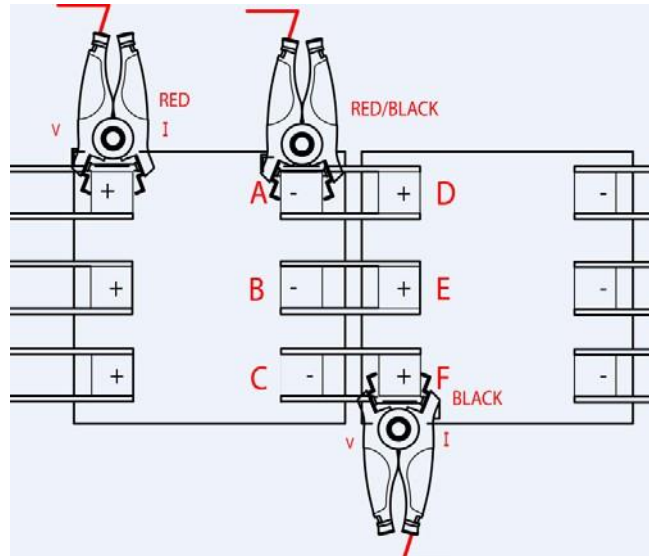

Figure 31 - Quad Testing

Combined Testing

Combined testing is done in one step using only two leads and does not require the use of the third intercell lead. Connect the positive lead to the positive post of the cell being tested. Connect the negative lead to the positive post of the next cell. The reading combines the cell resistance/ R_c plus the intercell resistance/ R_{ic} . Using Combined, no $\mu\Omega$ values are displayed for R_{ic1} to R_{ic4} . Combined is faster than computed, but does not separately indicate cell and intercell resistance values, whereas computed does. This mode of testing can be used on the last cell of a series.

Computed Testing

Computed testing requires two steps using two leads. First, attach the leads to the positive and negative terminals of a jar connected to a second jar via an intercell connection, then perform the resistance test. Then, move the negative lead to the positive terminal (with the intercell connection) of the second jar and perform the resistance test. The CRT-400 subtracts the lower R_c and displays two resistance readings: the cell R_c and the computed intercell R_{ic} . Use Computed to determine if a problem is in the cell or in the intercell connection. This mode of testing can be used on the last cell of a series.

8. Taking Resistance Readings

8.1. Resistance Readings

When taking a resistance reading, it is possible that the CRT is still on after you have completed the previous set up section.

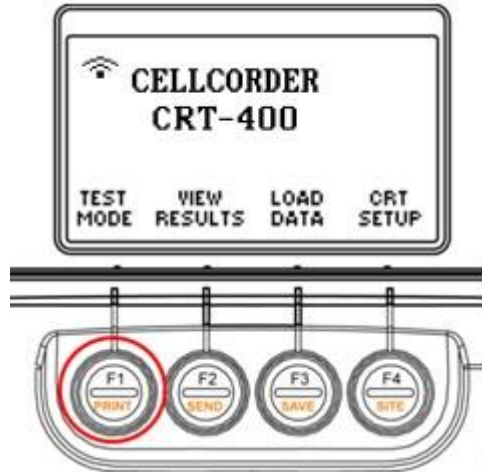
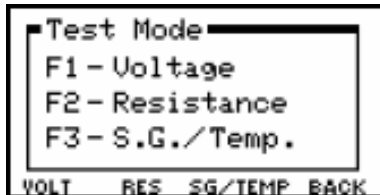

Figure 32 - CRT-Test Mode/F1

Turn on the CRT and select **Test Mode/F1**. The Test Mode menu displays.



Press **F2/Resistance**

Note: You have already set up Amp Hours, Intercell Type and Battery Voltage.

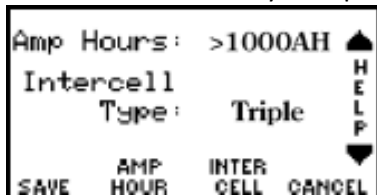

The CRT-400 is ready for testing.

Note: Help is always available via the arrow keys.

Taking float voltage readings before resistance readings, rather than concurrently, to avoid any voltage skewing effect. Please refer to "Understanding the Voltage Skewing Effect" section.

Press **F1/Test** to begin testing. Or press the **Orange Test** button on the keypad.

9. Connecting Resistance Test Leads

When Ready to Test is flashing, depending on what type of intercell measurement is selected, connect the three clip resistance test leads to the cell and intercell under test. If using spike probes, refer to the manual that accompanied the spike probes.

9.1. Connection for Single Intercell Connectors

Connect the probes as follows:

1. Red clip goes to the positive post of the cell being tested.
2. Red/Black clip goes to the negative post of the cell being tested.
3. Black clip goes to the positive post of the next cell.

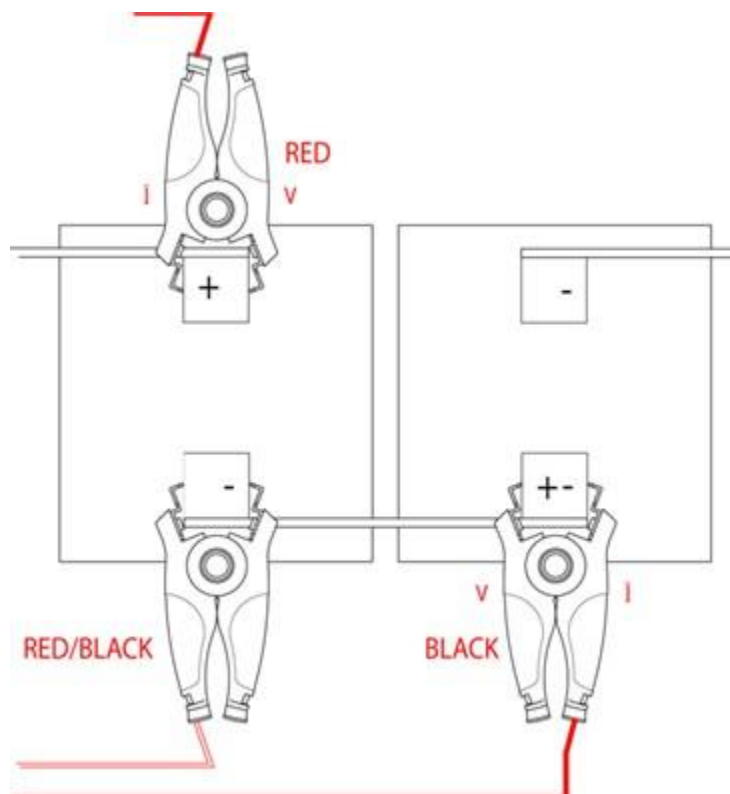

Figure 33 - Single Intercell Connectors

9.2. Connection for Dual Post Cells – Example One

There are many types of dual intercell connection schemes. Here are two examples that are commonly used. No matter what type, being consistent in how the leads are attached is the most important aspect of testing and taking readings.

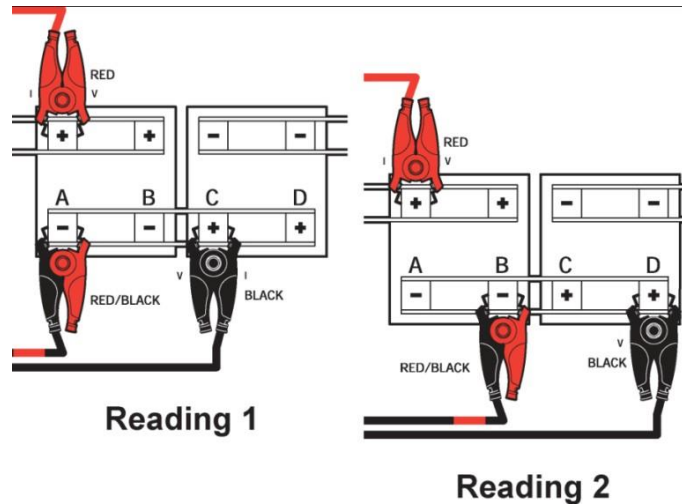

Figure 34 - Connections For Dual Post Cells – Example One

Take Two Readings

Two readings are required and the CRT will prompt the user to move the leads after each reading.

- The first reading occurs upon the initial press of the **Orange Test** button and measure terminal posts A to C.
- When prompted to move the leads, the second time the **Orange Test** button is pushed, the measurement will be from terminal posts B to D.

9.3. Connection for Dual Post Cells – Example Two

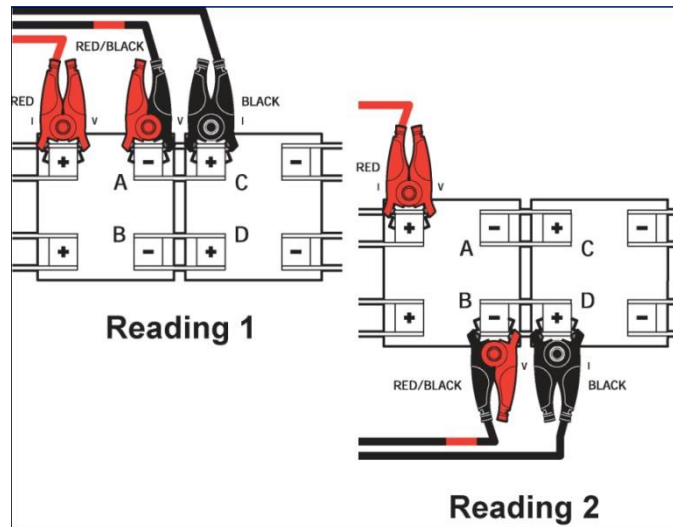

Figure 35 - Connections for Dual Post Cells – Example Two

Take Two Readings

Two readings are required, and the CRT will prompt the user to move the leads after each reading.

- The first reading will occur upon the initial press of the **Orange Test** button and will measure terminal posts A to C.
- When prompted to move the leads, the second time the **Orange Test** button is pushed, the measurement will be from terminal posts B to D.

9.4. Connections for Triple Post Cells

Take Three Readings

- Reading with the intercell leads connected from terminal posts A to D.

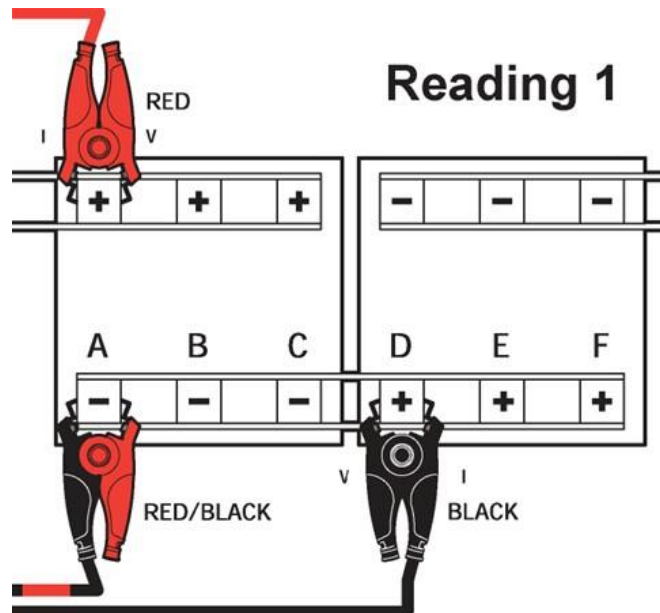

Figure 36 - Connections For Trip Post Cells – One

Readings with the intercell leads connected from terminal posts B to E.

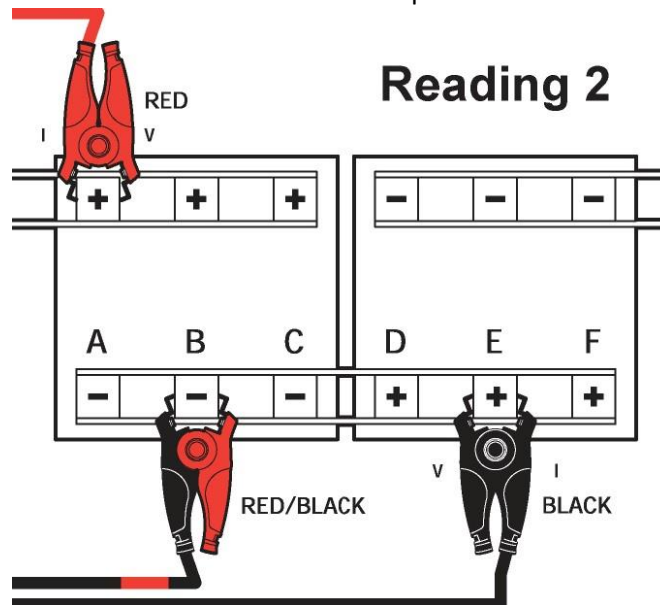

Figure 37 - Connections for Trip Post Cells – Two

Readings with the intercell leads connected from terminal posts C to F.

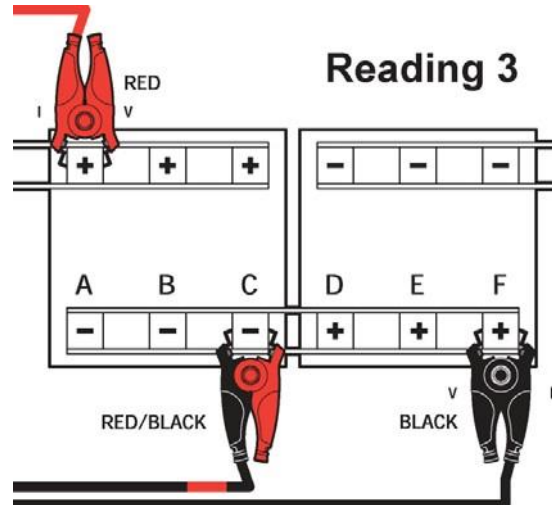

Figure 38 - Connections for Trip Post Cells – Three

9.5. Performing a Resistance Test

Since float voltage readings exist, the Resistance LCD window flashes **Ready to Test**. Press the **Orange Test** button.

The Resistance LCD window displays Vc(act) or Vc(mem). Vc(act) shows the actual cell voltage being read. Vc(mem) means the cell voltage was read earlier and is in memory.

S#:C#-##:### Uo()	
##.### Uo	Ric1)----- $\mu\Omega$
Rc	Ric2)----- $\mu\Omega$
##### $\mu\Omega$	Ric3)----- $\mu\Omega$
	Ric4)----- $\mu\Omega$
Ready to test	DONE

Note: The figure above shows the window for multiple strings. If only one string is present then the S# will not display; Cell# only will display.

While testing is in progress, the LCD will display the **Test Progress** LCD window.

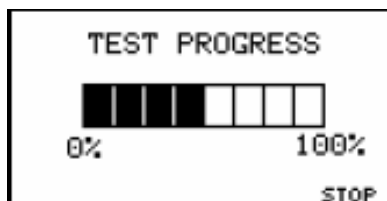

9.6. Moving Probes from Cell to Cell

After the cell or Ric1 intercell resistance appears, move the probes to the next cell or intercell and press the **Orange Test** button. The cell or intercell number advances when the leads are moved.

If the cell requires two or more intercell Ric resistance readings, move the black/red and black leads to the next Ric connection, then press the **Orange Test** button for each Ric measurement.

The first Ric reading displays when **Test** is initially pressed; the next one displays after the leads are moved and **Test** is pressed again. In this case, the cell number does not increment until the last intercell is read.

Note: If you are using a *Bluetooth* headset, the instructions will dictate when you can move to the next cell. You can step to the next cell number using the up arrow, but then you may have unread cell or intercell numbers. Use arrows primarily to review readings upon test completion.

If you press the **Orange Test** button before moving the probes to the next cell, then a **WARNING** message, "Reading exists. Overwrite?" appears.

To read the same cell/intercells, select YES/F1. Select NO/F2 to move to the next cell.

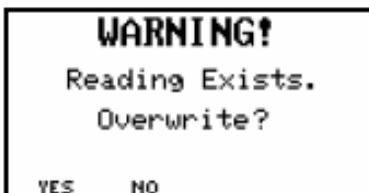

Note: If you press the **Orange Test** button too soon, 'Initializing' appears while internal components cool down. Testing may halt if components get too hot.

Continue Measuring All Cells until Testing Is Complete

Remove the leads from the cell under test and press **DONE/F4**. You may save the readings from the next LCD window.

To Stop a Resistance Test

Press Stop/F4, the stop LCD window appears.

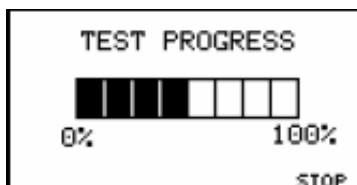

9.7. When No Float Voltages Exist

When no float voltage readings exist, a message appears; select **Yes/F1** to switch to Voltage mode, insert the voltage leads, and select the cell number to read voltage. Resume resistance testing when finished.

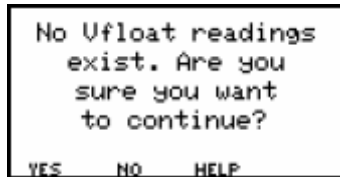

```
No Ufloat readings
exist. Are you
sure you want
to continue?
YES  NO  HELP
```

If **No/F2**, is selected the Cellcorder concurrently reads voltage and resistance for each cell.

Note: Allowing the CRT to do this will result in an error in the voltage recorded. Refer to section for a better understanding.

10. Understanding Voltage Skewing Effect

The Cellcorder has the ability to read and record voltages at the same time resistance readings are taken. However, when doing so, a small error in the actual float voltage, results. This derivation manifests into a skewing effect of the voltage readings. As the resistance test starts, the beginning of the skewing affect will be seen as a gradual increase in voltage as the end of the string is approached. This is caused by the constant voltage charger wanting to maintain a fixed overall voltage and will increase the voltage of untested cells to make up the difference. The string each cell is lightly loaded causing the connection of overall voltage to occur on the cells further down the string that have not been tested.

To avoid voltage skewing be sure to take all voltage readings before you take resistance readings.

11. Using the CRT-400 as a Digital Voltmeter

Note: These readings cannot be saved and the unit does not beep once the voltage of a cell is checked.

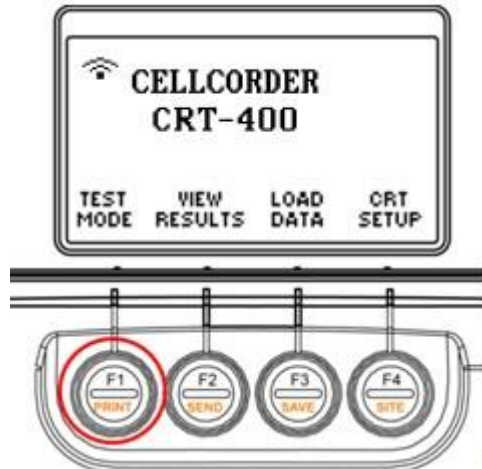
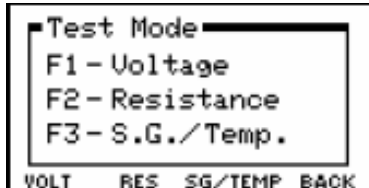
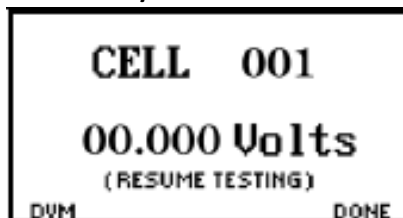

Figure 39 - CRT-Test Mode/F1

Make sure the CRT is powered on and the voltage test leads are connected. To use the Cellcorder as a digital DC voltmeter, select **Test Mode/F1**. Select **F1- Voltage/Volt** to obtain the voltage LCD window.



Select **DVM/F1**. The LCD window displays voltage readings as they are taken.



WARNING: Do not measure any voltage higher than 20VDC.

To leave the voltmeter mode and return to a previous LCD window, press **Cancel**.

12. The Hydrometer and the Data Logger

The optional hydrometer reads Specific Gravity SG and Temperature. The data storage logger that holds data for up to eight strings A to H, 256 readings for each string, is a separate module that mounts on the hydrometer. You may transfer Specific Gravity and temperature readings from the data storage logger in three ways:

1. To cellcorder via IR
2. To computer via IR
3. To computer via RS-232

The hydrometer data module's IR port interfaces with the Hydrometer first and then either the Cellcorder or computer; the RS-232 port transfers data from the data logger directly to the computer.

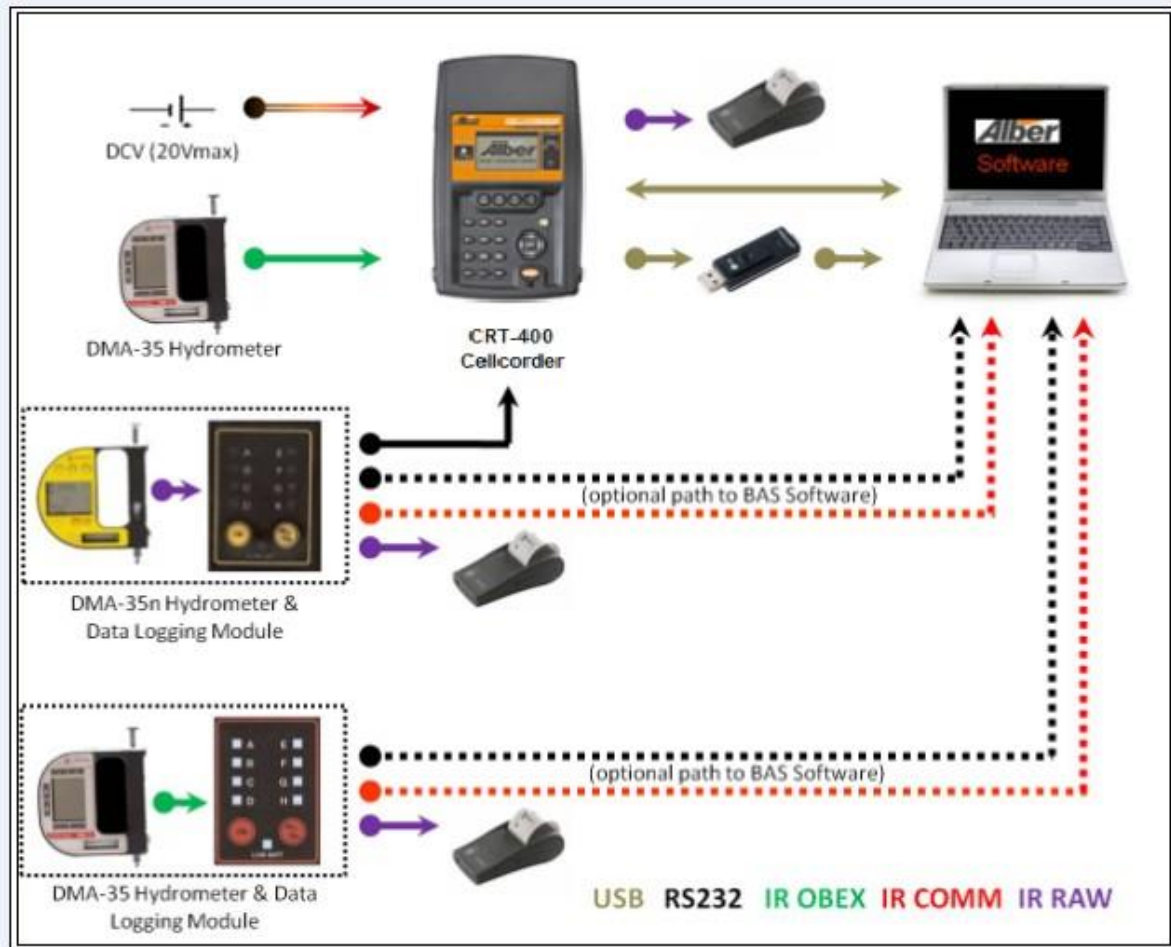

Figure 40 - Hydrometer, Data Logger, PC, CRT, USB Interaction

Note: When using RS-232, refer to the Battery Analysis System User's Guide. If both the Cellcorder and hydrometer have data for the same parameters, it's important to know which data is to be captured first as data captured last overwrites data captured first. e.g. if you capture Specific Gravity and temperature data from the Cellcorder and then the hydrometer, the hydrometer data will overwrite the already captured Cellcorder's data.

12.1. Setting Up the CRT for Hydrometer Usage

To Setup the CRT for Hydrometer Usage

Press **F4/CRT Setup** or select CRT Setup by pressing **F4**. Before transferring specific gravity and temperature data to the CRT – the CRT must know the specific temperature units that the hydrometer is set to, either Fahrenheit °F or Celsius °C. By default the Cellcorder is set to Fahrenheit °F.

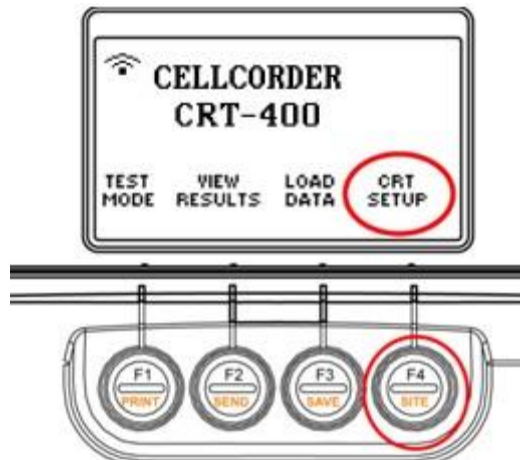

Figure 41 - CRT–CRT Setup/F4

Press **F2/Thresholds** to check for Fahrenheit °F or Celsius °C on the CRT, press **F2** for Thresholds.

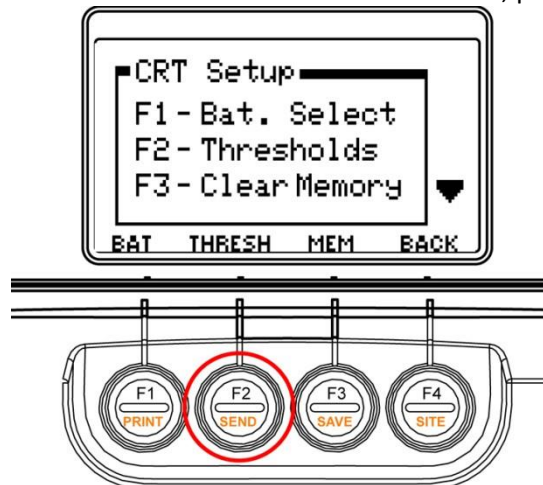

Figure 42 - CRT–Thresholds F4/F2

Note: Press **Shift/ 5** to access Thresholds. Press the down arrow to access **F2/Temperature**.



The Hydrometer and the Data Logger

Note: Both the CRT and Hydrometer must be set to Fahrenheit °F or both the CRT and Hydrometer must be set to Celsius °C.

Press **F2/TEMP**

Change to Fahrenheit °F or Celsius °C by depressing **F3-C/F**. The temperature will need to be entered for the High Threshold by using the arrow keys. Then press **F2/Accept**.

```
Temperature
Threshold High
  90.0 F
ACCEPT  C/F  CANCEL
```

Threshold Temperatures

The temperature will need to be entered for the Low Threshold by using the arrow keys. Then press **F2/Accept**.

```
Temperature
Threshold Low
  32.0 F
ACCEPT  C/F  CANCEL
```

Specific Gravity Thresholds High

Press **F1/Specific Gravity**. The specific gravity threshold will need to be entered for High by using the arrow keys. Then press **F2/Accept**.

```
Specific Gravity
Threshold High
  #.###
ACCEPT          CANCEL
```

Specific Gravity Thresholds Low

Press **F1/Specific Gravity**. The specific gravity threshold will need to be entered for Low by using the arrow keys. Then press **F2/Accept**.

```
Specific Gravity
Threshold Low
  #.###
ACCEPT          CANCEL
```

Once the highs and lows are entered, press **F4/Back**.

The up arrow key can access the other thresholds if necessary.

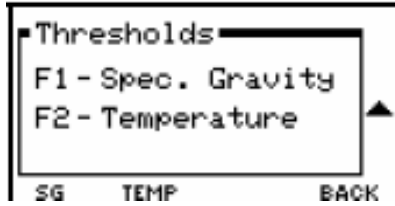

Or press **F4/Back** may be selected again to go back to the main menu.

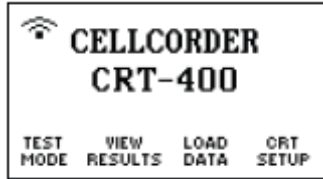

12.2. Taking Readings with the Hydrometer

Once both the CRT and Hydrometer settings are 'synchronized' use the hydrometer as instructed in its manual.

To Transfer Hydrometer Data to CRT Via IR

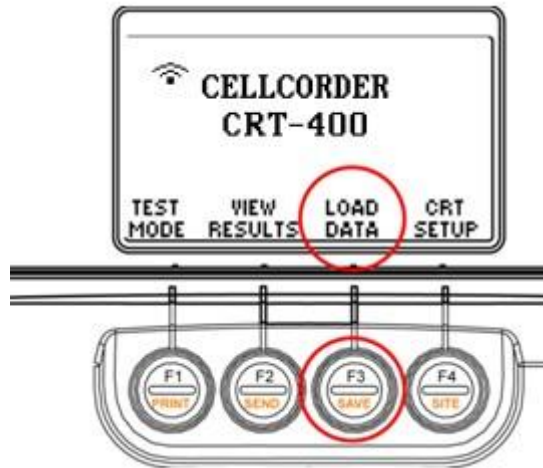

Figure 43 - CRT–Main Menu/Load Data/F3

Note: The USB flash hard drive must be inserted to accomplish this **Load Data** function. The data logger must be attached to the hydrometer.

1. Press **F3/Load Data**.
2. Press **F2/Cell Data**
3. Select **Cell Data** by pressing **F2**.

The Hydrometer and the Data Logger

```
F1-Load site template
F2-Load previously
  saved readings.

SITE   CELL
SETUP  DATA  HELP  CANCEL
```

Cell Data/F2

Highlight a .CDF file name by using the arrow keys and press **Select/F1**.

```
Select File

12345.cdf
extra.cdf
sample.cdf

SELECT DELETE BACK CANCEL
```

A warning displays if data exists in the CRT's memory. Press **F3** to **Continue** or **F1** to **Cancel**.

```
WARNING!

Existing Data
will be erased

CANCEL      CONTINUE
```

If **F3** is pressed to **Continue**, the CRT reads the USB and loads the cell information. The main menu appears once the file has been selected or if **Cancel/F1** is pressed.

Now, select **Test Mode/F1**.

```
CELLCORDER
CRT-400

TEST   VIEW   LOAD   CRT
MODE  RESULTS DATA SETUP
```

Select **SG/Temperature/F3**, then press **Import/F2**.

```
CELL - ###

S.G.   Temp.
#.###  ##.#

IMPORT  CANCEL
```

Use The Hydrometer's Data Logger to Transfer Data to your Previewer

1. Turn the data logger on.
2. On the data logger, press **SEL** to select the channel (string) A through H from which data will be transferred to your previewer. The module LEDs indicate memory status as follows:
 - **Fast** - If the LED next to A through H is flashing fast, that channel has data and is selected.
 - **Steady** - If the LED is on, that channel has data but is not selected.

The Hydrometer and the Data Logger

- **Slow** - If the LED is flashing slowly, the channel is selected but has no data.



Figure 44 - Data Logger

The CRT-400 calls the data logger a “Hydrometer Memory Module” in the LCD window.

```
On hydrometer
memory module,
select string (A-H)
and align IR ports.
CONTINUE      BACK
```

Align the data logger’s IR port with the IR port on the right side of the Cellcorder.

On the Cellcorder, press **Continue/F2**. The Cellcorder displays Receiving Data, and the data logger’s LED remains lit. When all readings have been loaded, the data module LEDs resume flashing, and the Cellcorder displays the SG/Temp for Cell 001.

```
CELL - ###
S.G.    Temp.
#.###   ##.#
IMPORT  CANCEL
```

To save the file with the SG/Temp data, press **Shift Save** type the file name, then press **Save/F3**.

Note: The data logger/memory module powers off after about one minute of inactivity.

To delete data on a data logger’s channel, select the channel and press **Del** until the flashing LED goes out. Refer to the data module and hydrometer manuals for additional instructions.

12.3. Transferring Hydrometer Data to Computer

Use the CRT–400 Previewer or BAS program to transfer Specific Gravity/temperature from the hydrometer’s data logger to the computer via IR or RS–232 serial cable. To transfer data, refer to the CRT–400 Previewer User's Guide or the Battery Analysis System User's Guide.

13. Setting Up the CRT

Once you select CRT Setup by depressing F4, the setup options display in the figure below.

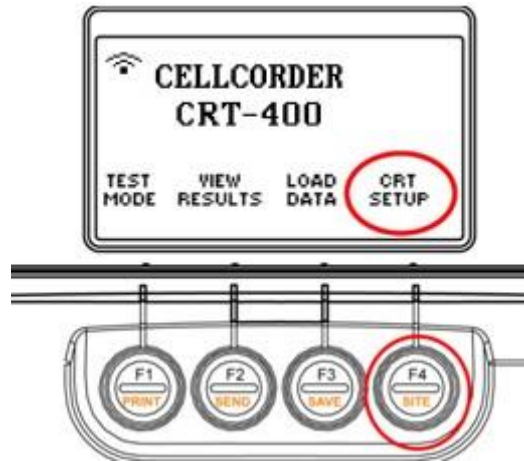

Figure 45 - CRT–Main Menu with F Buttons for CRT Setup/F4

CRT Setup/F4:



- F1–Bat. Select/
- F2–Thresholds/
- F3–Clear Memory



- F1–Display/
- F2–Sounds/
- F3–Frequency

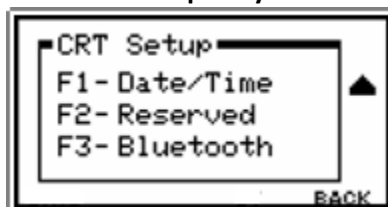

- F1–Date/Time/
- F2–Reserved/
- F3–Bluetooth

13.1. Selecting a Battery

This section accesses the USB flash hard drive to open a file called Battlist.blf, a baseline resistance data file that contains a list of common battery information. If the file is not loaded on the USB device, then it will need to be placed on the USB device to help select battery data information.

Press **F1** to access the Baseline Resistance Data File containing battery models that automatically set certain threshold parameters.

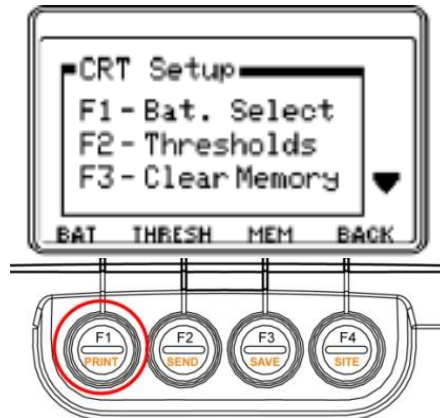
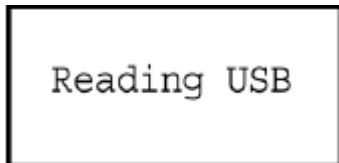

Figure 46 - CRT- Setup/Bat. Select-F4/

Note: The USB flash hard drive must be inserted to accomplish this Battery Select function.

13.2. Reading USB

Wait for the USB device to be read to populate the Manufacturers and Models lists.



13.3. Selecting a Manufacturer

To select a manufacturer, press **F2/ACCEPT**.



13.4. Selecting a Model

Select a battery model and press **F2/Accept**.

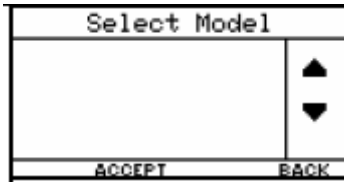

13.5. Setting Thresholds

To set thresholds press **F2**.

Note: **Shift/5** also accesses Thresholds.

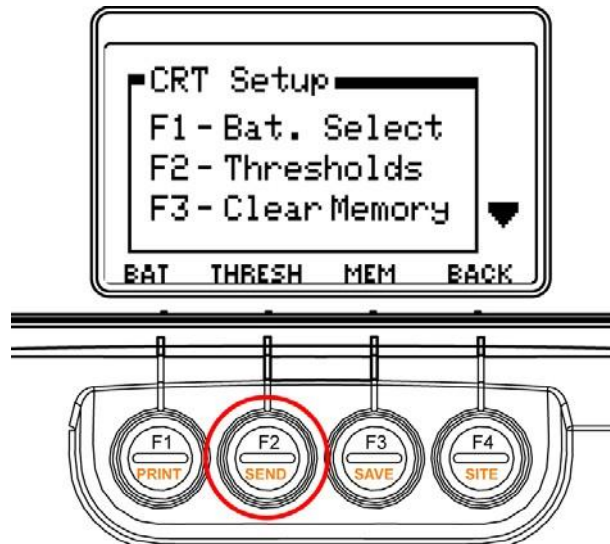

Figure 47 - CRT- Setup/Thresholds or F4/F2

Voltage and resistance thresholds can be set or changed outside of site setup. The Cellcorder indicates an out of tolerance reading by beeping twice and displaying the reading in reverse video.

Site Is Not Selected

If a site is not selected, you can set up thresholds using **CRT Setup/Thresholds F4/F2**. The settings remain in Cellcorder temporary storage until changed, cleared to default (zero) values or a site is selected.

Site Is Selected

If a site is selected, you can change the thresholds using **CRT SETUP/Thresholds F4/F2**, but the changes affect only the Cellcorder and not the site file. The settings remain in temporary storage until changed, cleared to default or another site is selected.

Default Thresholds

If a site is selected, you can quit the site settings and return to default thresholds for voltage, resistance, temperature, and Specific Gravity without affecting the site file.

To Clear Site Setup and Thresholds

To have no site associated with a file that has been linked, and to clear threshold settings, use the Clear button on the Active Site LCD window.

13.6. Setting Thresholds without a Site File

Select **CRT Setup F4** then **ThresholdsF2**, then choose Voltage, Cell Resistance, Intercell Resistance, Specific Gravity or Temperature.

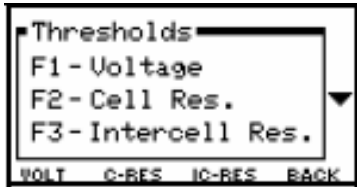

**F1–Voltage F2–
Cell Res. F3–
Intercell Res.**



**F1–Spec. Gravity
F2–Temperature**

A series of LCD windows appears for parameters that may be set. Press the Arrows to change values. Press **F2/Accept** to accept the value displayed.

F1–Voltage High



F1–Voltage Low



Setting Up the CRT

F2-Cell Resistance High

```
Cell Resistance
Threshold High

      μΩ

ACCEPT      CANCEL
```

F2-Cell Resistance Low

```
Cell Resistance
Threshold Low

      μΩ

ACCEPT      CANCEL
```

F3-Intercell Resistance Threshold High

```
Intercell Resistance
Threshold High

Rio 1 of 4  ####μΩ

ACCEPT      CANCEL
```

F1-Specific Gravity Threshold High F1-

```
Specific Gravity
Threshold High

#.###

ACCEPT      CANCEL
```

Specific Gravity Threshold Low F2-

```
Specific Gravity
Threshold Low

#.###

ACCEPT      CANCEL
```

Temperature Threshold High

```
Temperature
Threshold High

##.#

ACCEPT  C/F  CANCEL
```

F2-Temperature Threshold Low

Setting Up the CRT



Temperature/Fahrenheit or Celsius

On the Temperature LCD windows, before setting the high/low temperatures, select °Celsius or °Fahrenheit by selecting **C/F–F3**.

Disabling A Threshold

Setting any threshold value to zero (or 32°F / 0°C for temperature) disables the threshold. Use the arrows to enter threshold values. You cannot use the keypad to type numeric values. The following list shows the ranges for each programmable threshold limits.

Voltage Threshold

- High 00.000V to 19.999V
- Low 00.000V to 19.999V

Cell Resistance Threshold

- High 00000μΩ •to 64999μΩ
- Low 00000μΩ •to 64999μΩ

Intercell Resistance Threshold

- (Ric 1 of 4) High 00000μΩ •to 24999μΩ
- (Ric 2 of 4) High 00000μΩ •to 24999μΩ
- (Ric 3 of 4) High 00000μΩ •to 24999μΩ
- (Ric 4 of 4) High 00000μΩ •to 24999μΩ

Specific Gravity Threshold

- High 0.000 to 9.999
- Low 0.000 to 9.999

Temperature Threshold

- High 32.0°F (0°C) to 99.9°F (37.7°C)
- Low 32.0°F (0°C) to 99.9°F (37.7°C)

Note: **Shift** and an **Orange Button** opens the function in **Orange** text on the button. Press **Shift**, release **Shift**, then press an **Orange Button** to select an **Orange** text on a key.

13.7. Clearing Memory

To clear memory on the CRT-400, press **F3**.



CAUTION: After clearing CRT-400 temporary storage, data cannot be recovered unless it had been previously saved to the USB flash hard drive.

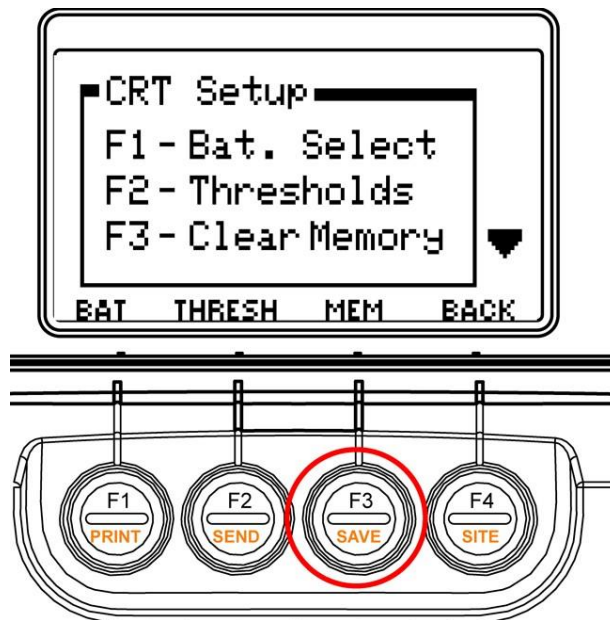
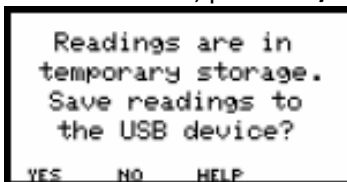

Figure 48 - CRT Setup/Clear Memory or F4/F3

Note: Also access Clear Memory. If you want to take readings on another battery, save the previous readings to the USB flash drive before clearing them from temporary storage.

This function is used to save to the USB flash drive and/or clear temporary storage. At power up and power down, if data is in temporary storage, messages to save and clear also appear.

To save the data, press **Yes/F1** and refer to Saving to the USB flash drive.



If you are certain you want to delete/erase the readings, press **Yes/F1** To keep readings, press **No/F2**.

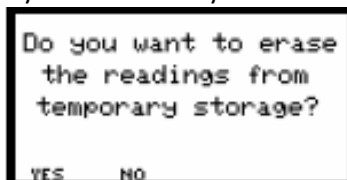

Confirm your decision, **Yes/F1** to keep readings, press **No/F2** to discard readings.

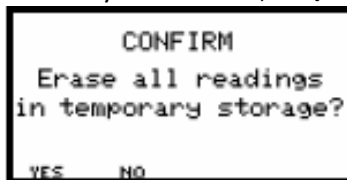

Setting Up the CRT

Note: Data will not clear until after you save it.

Important: Powering off does not remove readings from temporary storage. To prolong battery life, the CRT-400 shuts down if inactive for ten minutes. At power up or power down, a message may appear: Readings are in temporary storage. Save readings to the USB device?

To save cell readings to the USB flash drive, insert the drive and press **Yes/F1**. Whether you press **Yes** or **No**, data remains in Cellcorder temporary storage. To clear data from memory when the message, Do you want to erase the readings from temporary storage? appears, press **Yes/F1**; all readings in temporary storage will be deleted.

Note: To keep cell data, it must be saved before clearing temporary storage. Cleared data is lost but can be retrieved from the USB flash drive. If you back up USB flash drive data to a computer, you can use the BAS program to analyze cell readings.

13.8. Displaying Additional Functions

When in CRT Setup, use the down arrow to access the next set of functions, F1–Display, F2–Sound and F3– Frequency. Select F1 to adjust the CRT’s LCD display.

Note: Shift then 6 accesses the Display functions.

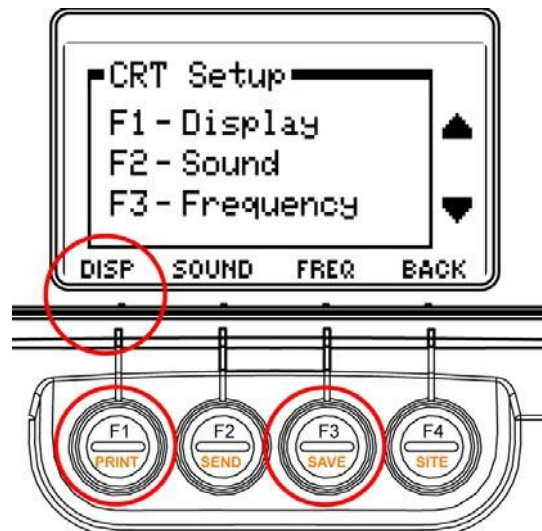
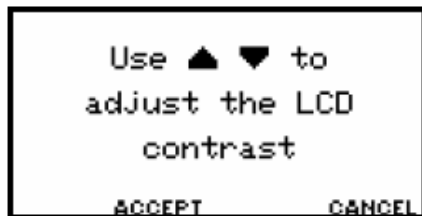

Figure 49 - CRT Setup/Display Functions

Adjust LCD Contrast



13.9. Sound Adjustment

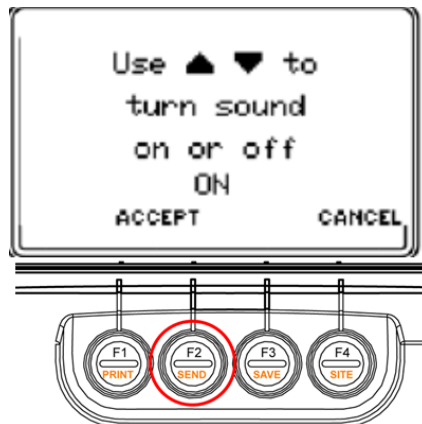

Figure 50 - CRT Sound Adjustment

Use Sound to turn the Cellcorder beeper off or on.

1. To adjust the sound, press **F2** then **Accept**.
2. Use the up and down arrows to select off or on, and then press **Accept**.

Note: **Shift** then **8** will also access sound.

13.10. Frequency

Use Frequency to have the Cellcorder A/D circuitry filter out the AC line frequency noise. Use the up and down arrows to select 50Hz or 60Hz, then press **Accept**.

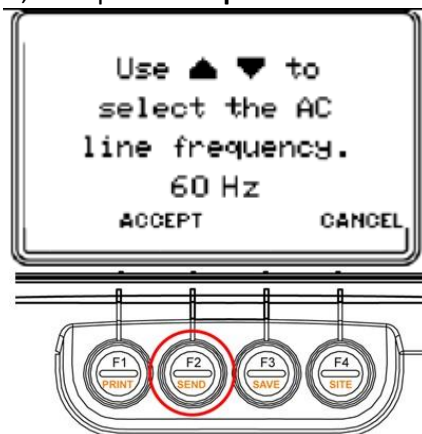

Figure 51 - CRT AC Line Frequency 50/60 Hz

Note: **Shift** then **4** will also access AC Line Frequency.

13.11. Adjusting Date and Time

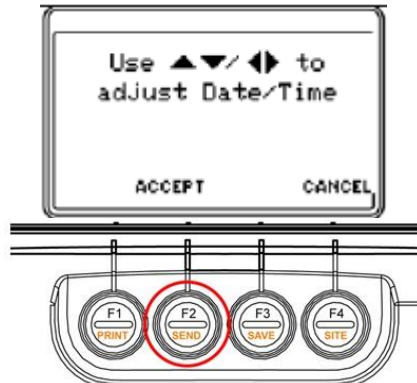

Figure 52 - CRT Time and Date

Use Date to set the date, time, and date format. Use the up, down, left and right arrows to set the date and time, then press **F2/Accept**.

To select date format (MM:DD:YY or other), press the corresponding F key.

Note: Shift then 2 will also access Date/Time.

13.12. Reserved

Reserved **F2** is for future use.

13.13. Setting Up Bluetooth Wireless Communication

On power up, if the *Bluetooth* wireless option is installed then the wireless symbol appears on the main menu. The first LCD window shows the wireless disconnected and the second LCD window shows the wireless connected.

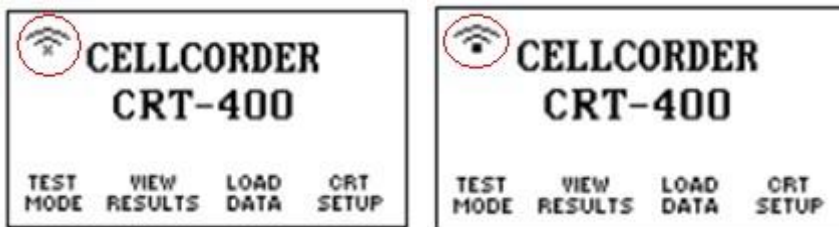

Choose a New *Bluetooth* Device

Power up the CRT-400, press **CRT Setup/F4** on the main menu and use the arrow key to scroll down, press the down arrow twice, and press **F3-Bluetooth**.



The message “Checking for *Bluetooth* Option” is displayed. Please Wait appears.

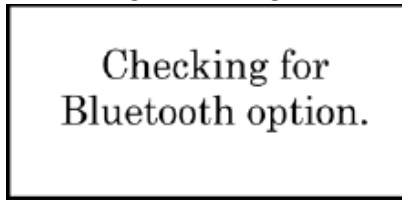

Checking for
Bluetooth option.

Initially, the message “No devices paired.” indicates no *Bluetooth* device is stored in memory.

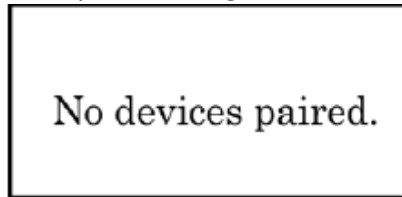

No devices paired.

Select **New/F1**. Then **F1-Headset**.

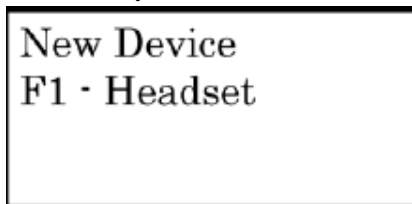

New Device
F1 - Headset

Note: Use the corresponding F key to select the desired device type.

The message Configuring *Bluetooth* appears.



Configuring
Bluetooth

The next message on the LCD window prompts you to **Turn on the device and place it in discovery mode**. Place the *Bluetooth* device in discovery mode according to the devices manufacturer’s directions. Select **Continue/F2**.

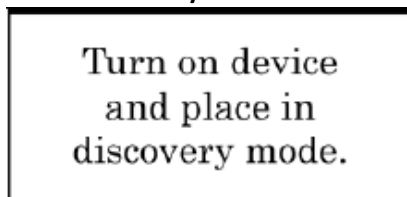

Turn on device
and place in
discovery mode.

When searching devices is complete, the Cellcorder lists all discovered devices.

Setting Up the CRT



The device Address and Name will display. Use the arrow keys to scroll to the desired device and press **Select/F1** to connect to it.

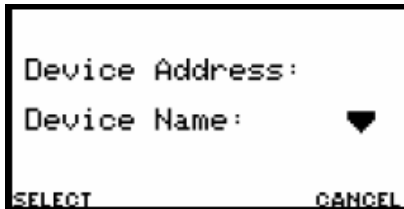

The LCD display flashes Connecting...

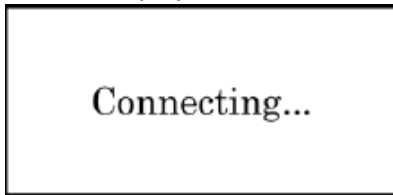

Turn the wireless device on. Select Connect/F2.

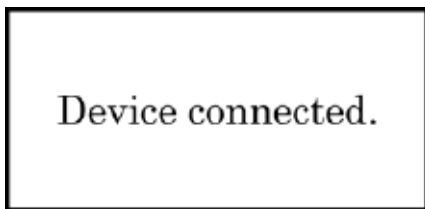

The connection is confirmed by the devices connection message. The LCD displays the wireless connected symbol on the main menu.

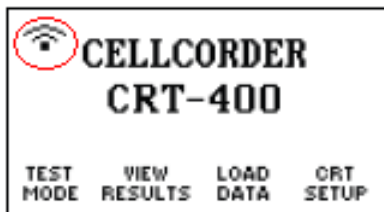

Reconnect *Bluetooth* Device That Fails To Connect

The message Failed to Connect indicates that the last device or previously connected device could not be accessed.

Setting Up the CRT

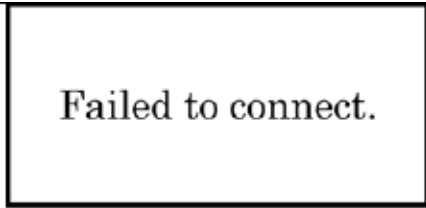

To connect, choose **CRT Setup F4**, use the down arrow to scroll to **F3–Bluetooth** and press **F3**.

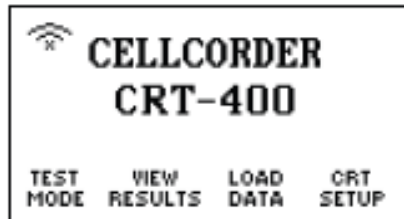

The message Checking for *Bluetooth* option appears.

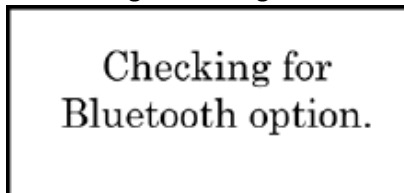

The last connected *Bluetooth* device will display. Decide if a new connection to a different device is needed or the established connection is desired.



Connecting to a Previously Established *Bluetooth* Device

To connect, choose **CRT Setup/F4**, use the down arrow to scroll to **F3– Bluetooth** and press **F3**.

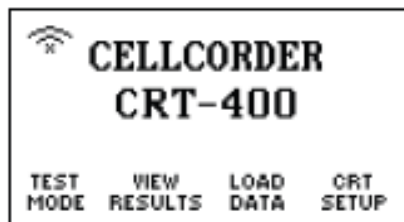

The message "Checking for *Bluetooth* option" appears.

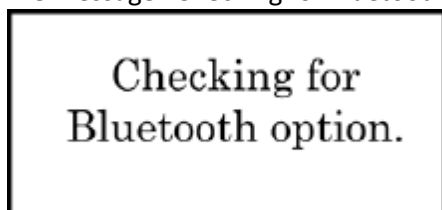

Setting Up the CRT

The last connected *Bluetooth* device will display.



Turn the wireless device on. Select **Connect/F2**.

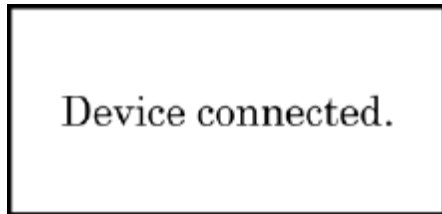

The connection is confirmed by the devices connection message. The LCD displays the wireless connected symbol on the main menu.

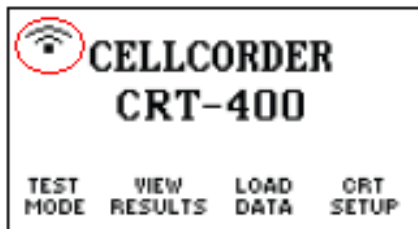

Deleting a *Bluetooth* Device That Is Not Connected

Choose **CRT Setup F4**, use the down arrow to scroll to **F3– Bluetooth** and press **F3**.

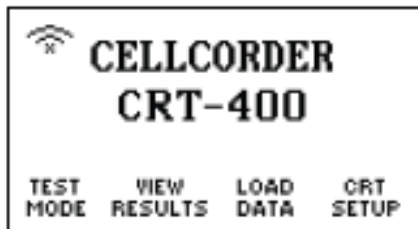

Note: In this example, the wireless symbol with an “x” indicates no device is connected.

The message **Checking for Bluetooth option** appears.

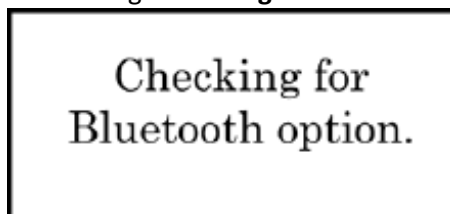

Setting Up the CRT

The last connected *Bluetooth* device(s) will display.



Select **DELETE/F3** and a warning message appears: "WARNING! Are you sure you want to delete *Bluetooth* device?"



To delete, select **Delete/ F1**. The message No device paired appears. Select **New** if you would like to setup a new *Bluetooth* device, or press **Cancel** to go out of the *Bluetooth* setup function.

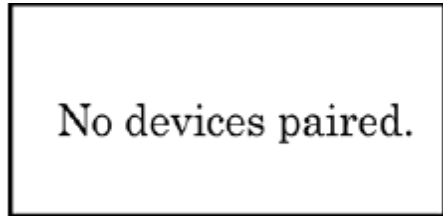

Deleting a *Bluetooth* Device That Is Connected

Choose **CRT Setup F4**, use the down arrow to scroll to **F3–Bluetooth** and press **F3**.

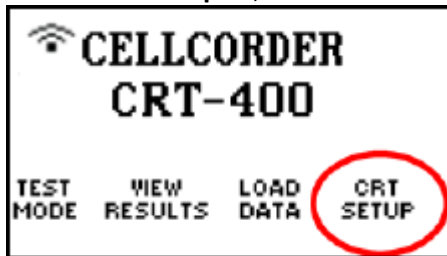

Note: In this example, the wireless symbol with a shaded square indicates the CRT is connected to a *Bluetooth* device.

The CRT displays this message. Choose **Disconnect F1**.

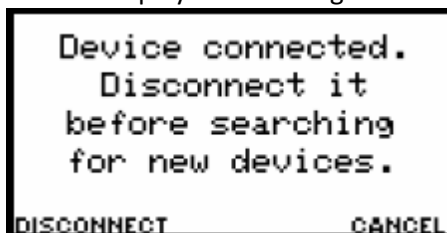

Setting Up the CRT

The main menu will display and the square will be an x underneath the symbol.

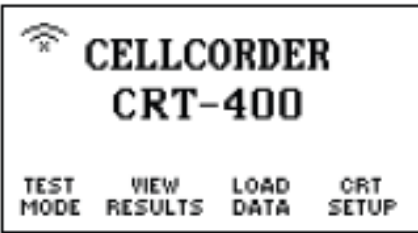

The device can now be deleted by following the instructions in “Deleting a *Bluetooth* device that is not connected”.

Selecting a Different *Bluetooth* Device

If a device name appears and you want a different device, press **New** and follow the instructions in “Discover and/or Choose A New *Bluetooth* Device” in this guide.



CAUTION: Do not use the CRT-400 menu to connect to a *Bluetooth* equipped computer for data transfer. Use the BAS program for connection.

14. Setting Up and Editing a Site Template

Sites let you record details for locations remotely and use the same information for future testing. This section describes site LCD windows and setting up, linking, editing, and deleting sites.

Note: To display the main menu from any LCD window, press and release **Shift**, then press **1**.

To create a new site, press **Load Data/F3**:

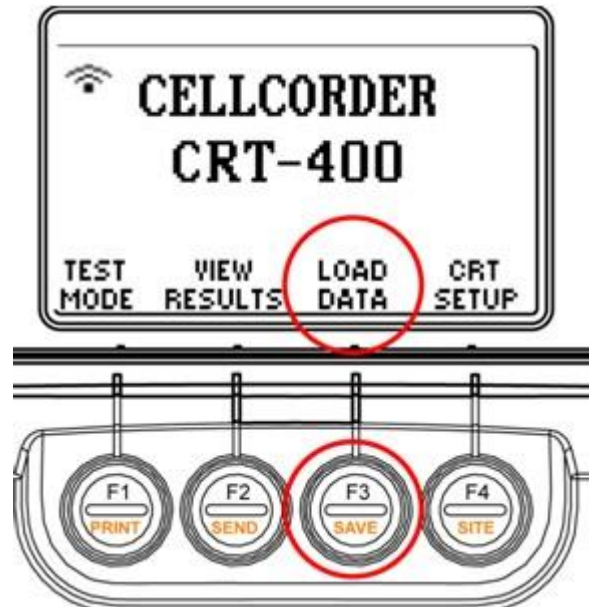
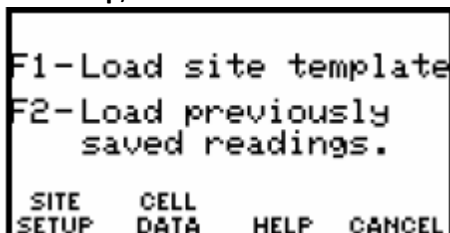

Figure 53 - CRT Load Data Main Menu

Note: The USB flash hard drive must be inserted to accomplish this Load Data function.

Before reading voltage or resistance, select a site for best practice. A site setup is not required for testing, but is useful for managing many sites. If a site is selected before testing, both the readings and site setup will be saved in the .CDF file.

To select a site template, at the main menu, select **Load Data/F3** to obtain this LCD window and select **Site Setup/F1**.



Press the right and left arrows to step to a site so that it is highlighted within the list, then press **Select/F1**.

Note: The keypad may also be used to enter site information.

Setting Up and Editing a Site Template

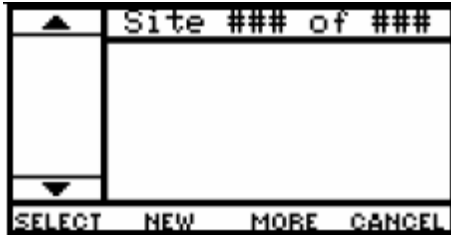

If the USB flash hard drive has no sites stored, then the New Site LCD window appears. If sites exist, press **New** to display New Site.



To begin site setup for a new site location, make sure LOC is highlighted by using the arrow keys. Press **Change/F1**.



Using the keypad, type the location name at the blinking cursor and press **Save/F2**. To correct a mistyped entry, use the arrow keys to highlight the character and retype or press **F1/Delete Char**.

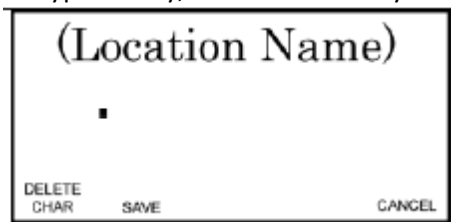

Press the arrow to highlight the next information item, BAT, press **Change/F1**, type, then **Save/F2**. Complete all items in the list. The following table lists all editable items and the keys to use arrows and the alphanumeric keypad.

Note: Location, battery and string name are what is the minimum entry needed to begin testing.

Setting Up and Editing a Site Template

Item	Description	Edit Text Using
LOC	Location name. 39 characters max.	Left and right arrows and keypad
BAT	Battery name. 18 characters max.	Left and right arrows and keypad
STG	String name. 15 characters max.	Left and right arrows and keypad
MOD	Model number of battery. 39 characters max.	Left and right arrows and keypad
S#	Total number of strings. Defaults to 01	Left, right, up, and down arrows
C#	Total number of cells. Defaults to 24	Left, right, up, and down arrows
DAT	Battery installation date.	Left, right, up, and down arrows
OPT	Options. Sets the ripple filter (AC line) Frequency. Defaults to 60 Hz	Up and down arrows
HV,	LV High/low cell voltage. Sets limits.*	Up and down arrows
HR,	High/low internal cell resistance. Sets limits.*	Up and down arrows
LR	High/low internal cell resistance. Sets limits.*	Up and down arrows
HI1	High intercell resistance 1, 2, 3, 4. Sets limits.*	Left, right, up, and down arrows
HI2	High intercell resistance 1, 2, 3, 4. Sets limits.*	Left, right, up, and down arrows
HI3	High intercell resistance 1, 2, 3, 4. Sets limits.*	Left, right, up, and down arrows
HI4	High intercell resistance 1, 2, 3, 4. Sets limits.*	Left, right, up, and down arrows
HT	High/low cell temperature. Sets limits.*	Left, right, up, and down arrows
LT	High/low cell temperature. Sets limits.*	Left, right, up, and down arrows
HSG	High/low specific gravity. Sets limits.*	Left, right, up, and down arrows
LSG	Sets Amp hours for load test and TST intercell type. F2 and F3 keys	F2 and F3 buttons
TST	Sets Amp hours for load test and intercell type.	F2 and F3 buttons
VLT	Sets the high and low cell voltage range.	F2 and F3 buttons

Table 4 - Editing a Site Template

*During testing, two beeps and reverse video indicate limits are exceeded. max = maximum.

Note: The blank space character is on the 9 key. The cursor advances two seconds after pressing an alphanumeric key, or you may use the Right Arrow. To type a name, for example, press a key then wait or press the Right Arrow.

Some items use Accept instead of Save.

After assigning all values, press **Save/F2** on the New Site LCD window. Site NNN of ### appears. NNN is this site number; ### is the number of sites on the USB flash hard drive.

To Select/Work With A Site Template

To select a site template, at the main menu, select **Load Data/F3**.

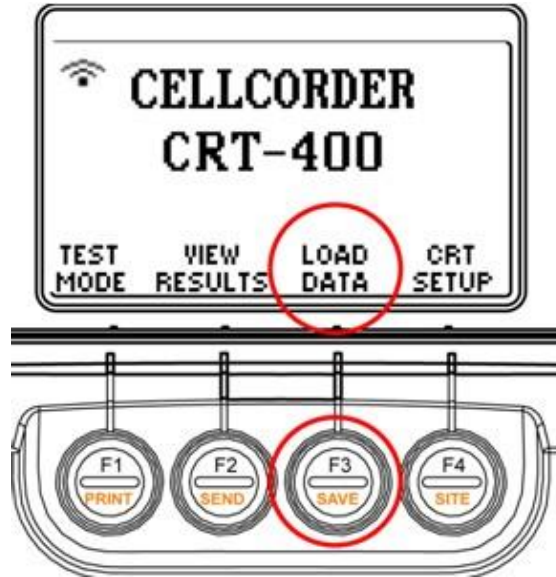

Figure 54 - CRT Load Data Main Menu

Site templates are useful because a field representative can set up a new location in the field when a pc and BAS software are not available. A site template can be set up before any testing is done with all the right thresholds etc. and can be used over and over again to set up additional sites that may need exactly the same information or similar information.

The site can be edited at any time after the testing but this preparation saves time and helps keep data readings consistent.

Note: The USB flash hard drive must be inserted to accomplish this **Load Data** function.

This LCD window displays, now press **F1/Site Setup** to load a site template.

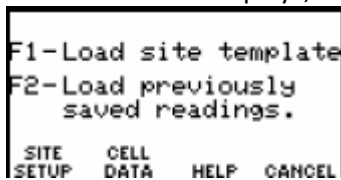

Press the right and left arrows to step to a site.

To select a site, press **Select/F1**. To go back a LCD window, exit a function, or return to the main menu, press **Cancel/F4**

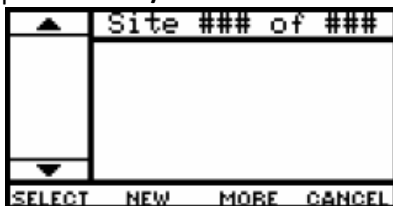

Note: You may also press **Shift** then **1**.

Setting Up and Editing a Site Template

When sites have been stored previously, then Site 001 of ### appears, where ### is the number of sites on the USB flash hard drive. Available options are **Select/F1**, **New/F2**, **More/F3**, and **Cancel/F4**.

Pressing **More/F3** displays a new LCD window with options **Change/F1**, **Delete/F2**, and **Back/F4**.



To Deselect a Selected Site

Press **Shift** then press **Site/F4**. Press **Clear/F3** to clear so that you may take readings with no site selected.

You are prompted to confirm your decision.

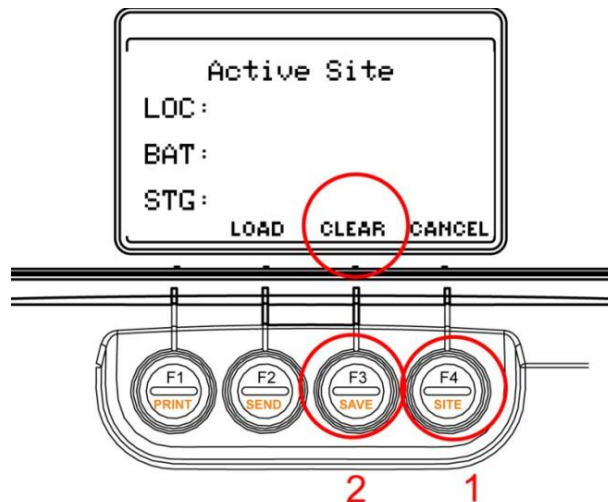

Figure 55 - CRT Clear/F3/Deselect a Site

Note: To determine at any time what site is selected, press **Shift/F4 Site**.

To Select A Different Site

Press **Load/F2**, use the arrow keys to find the desired site and then press **Select/F1**.

To Access Any Site LCD window

Insert a USB flash drive into the Cellcorder, then select **Load Data/F3** at the main menu and then press **Select/F1**.

If the USB flash drive has no sites, the New Site LCD window appears with **Change/F1**, **Save/F2**, and **Cancel/F3** options.

You can assign values to the items in the left column. Descriptions appear when an item is highlighted.

Setting Up and Editing a Site Template



To Edit an Existing Site

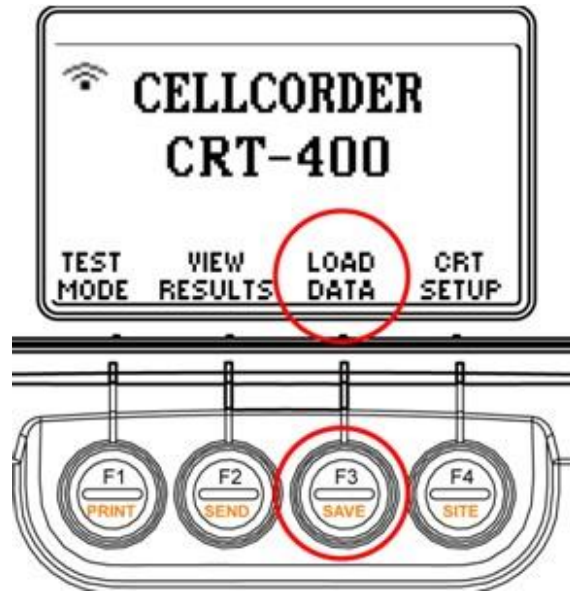
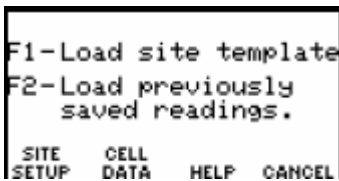

Figure 56 - CRT Main Menu on LCD/Load Data

To edit a site, at the main menu, select **Load Data/F3** to obtain this LCD window. Press **F1/Site Setup**.



Note: The USB flash hard drive must be inserted to accomplish this Load Data function.

Press the Right/Left Arrows to step to choose a site. In this case we chose Boca Raton. Press **More/F3**.

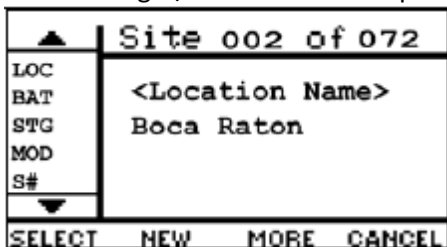

Setting Up and Editing a Site Template

Using the keypad or arrows, choose the item within the site that needs to be edited, Battery, String etc. Press **F1/Change**. Type the new data and press **Save/Accept/F2**.

To edit another item, repeat the process. When editing is done, you may select the site by pressing **Back/F4** then **Select/F1**.

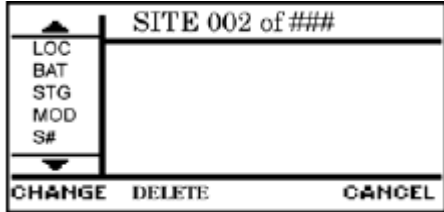

Note: Editing is not dependent on whether a .CDF data file is or is not associated with the site to be edited.

To Set Up a Site Before Test

For best results set up a site before reading voltage or resistance, a site setup is not required for testing, but is useful for managing many sites. If a site is selected before/after testing, both the readings and site setup will be saved in the .CDF file.

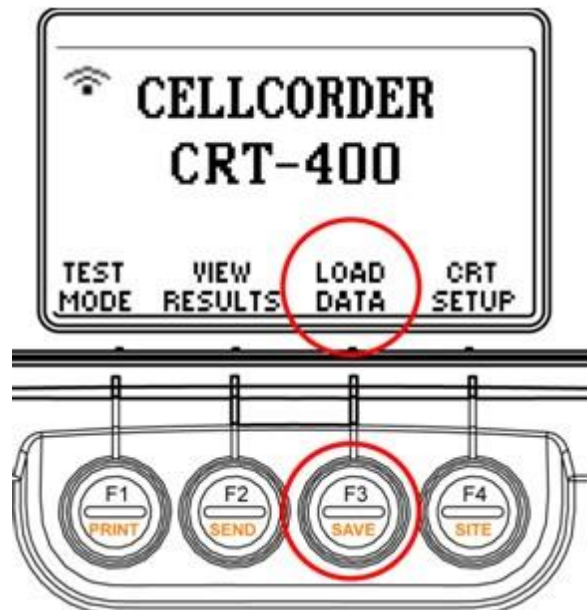
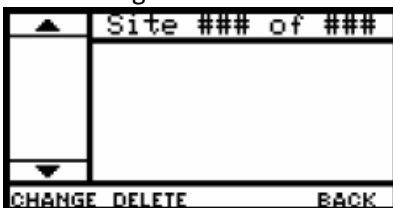

Figure 57 - CRT Main Menu on LCD/Load Data

Note: The USB flash hard drive must be inserted to accomplish this Load Data function.

Press the right and left arrows to step to a site, then press **Select/F1**.



Setting Up and Editing a Site Template

To Link a File to a Site after Test

Note: The USB flash hard drive must be inserted to accomplish this Load Data function. If the readings are only in the CRT's temporary storage, first save them to the USB flash hard drive.

Linking a .CDF file or an existing set of readings that are in the CRT's memory to a site embeds Site Setup information. When transferring data to the computer, this lets the BAS program set up a new .ADF battery file with predefined information e.g. location, site name, string name, location etc. if one does not exist.

If cell readings were taken with no site selected, or saved to a .CDF file not associated with a site, you can link the file to a defined site or create a new site, then link the file.

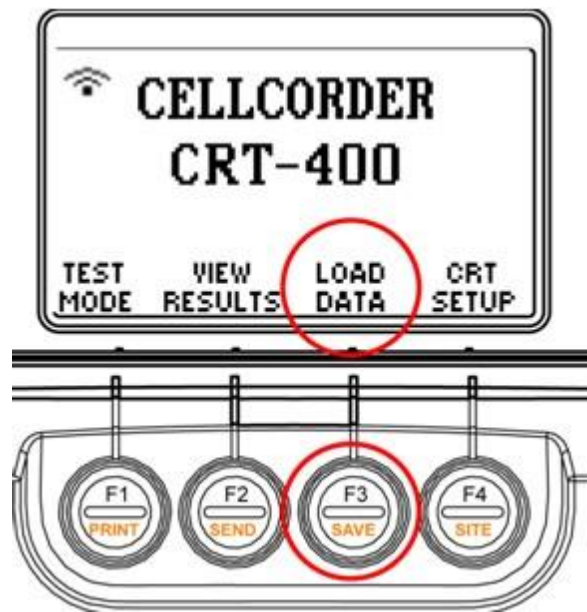

Figure 58 - CRT Main Menu on LCD/Load Data

To link a file to a site, at the main menu, select **Load Data/F3** to obtain this LCD window and then press **F2/Cell Data**.

```
F1-Load site template
F2-Load previously
  saved readings.
SITE  CELL
SETUP DATA  HELP  CANCEL
```

To open the data file you want to link to a site, select **Load Data/F3**, then **Cell Data/F2**. Use the arrow keys to move through the list to highlight the desired .CDF file, then press **Select/F1**.

Setting Up and Editing a Site Template



After the data loads into memory, the main menu appears.

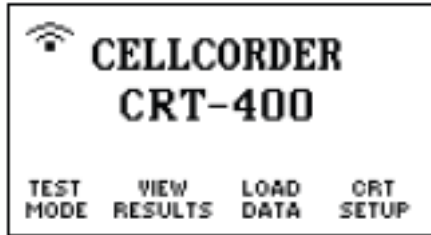

To confirm that the file is not already linked to a site, press **Shift/F4 Site**.

The Active Site LCD window should be empty of data and nothing should display in location, battery or string names. To return to the main menu, press **Cancel/F4**.



Note: If Active Site displays names, you can link the .CDF file to a different site by loading the new site and saving the file.

To select the site you want linked to the .CDF data file, select **Load Data/F3**, then **Site Setup/F1**, press the right, left arrows to step to the desired site, then press **Select/F1**. After the data loads into memory, the main menu appears.

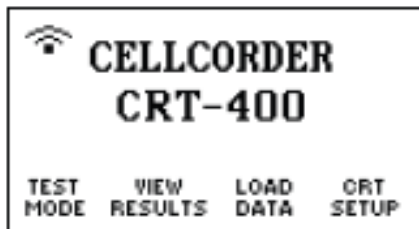

Note: You may also press **Load/F2** from the Active Site LCD window, then select a site. To save the linked data file to the USB flash hard drive, press and release **Shift** and then press **F3/Save**.

Setting Up and Editing a Site Template

Using the keypad, type the file name at the blinking cursor and press **Save/F2**. To correct a mistyped entry, use the arrow keys to move to where the typo is located and type in the correct letter. Press **F2/Save**.



If the file name already exists then a warning window will appear: **WARNING!** Existing Data will be erased.

To cancel, press **F1**. To continue, press **F3** and a message will flash: Writing to USB. Notice the USB Memory LED will light up Yellow.



Note: The blank space character is on the 9 key. The cursor advances two seconds after pressing an alphanumeric key, or you may use the right arrow. To type a name, for example, press a key then wait or press the right arrow.

After the file is saved, you may confirm the site/file correlation by pressing **Shift/F4 Site**.

Now, the Active Site LCD window should display information in the location, battery and string name fields as it has just been entered.

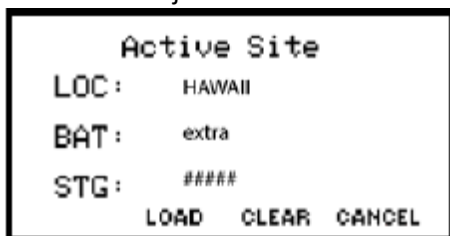

If Active Site displays the correct site information, then press **Cancel/F4** to go back to the main menu.

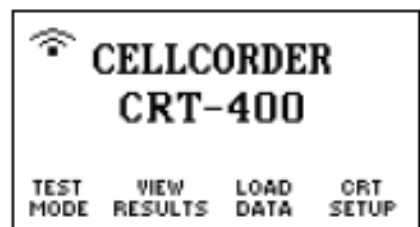

Setting Up and Editing a Site Template

To select a different site, press **Load/F2** from the Active Site LCD window to begin again.

```
Active Site
LOC:  HAWAII
BAT:  extra
STG:  ####
LOAD  CLEAR  CANCEL
```

Note: To determine at any time what site is selected, press **Shift/F4 Site**.

To Unlink a File and To Clear Thresholds

If you want to have no site associated with a file that has been linked, press **Shift/F4 Site** to display the Active Site LCD window with location, battery, and string names of the site currently selected.

```
Active Site
LOC:  HAWAII
BAT:  extra
STG:  ####
LOAD  CLEAR  CANCEL
```

To unlink, press **Clear/F3** on the Active Site LCD window to return setup to default. The Confirm window unlinks the data file from the site. Select **Yes/F1**.

```
CONFIRM
Restore site setup
data to default?
YES  NO  HELP
```

Select **Continue/F2**. The Site setup data is restored to default

```
Site setup data
restored to default.
CONTINUE
```

Select **Yes/F1** to clear all threshold settings to default.

```
Do you want to
clear all threshold
settings to default?
YES  NO
```

Setting Up and Editing a Site Template

To accept the changes on the Active Site LCD window, press **Cancel/F4**. Press **Shift/F3 Save** to save the file.



To Delete a Site

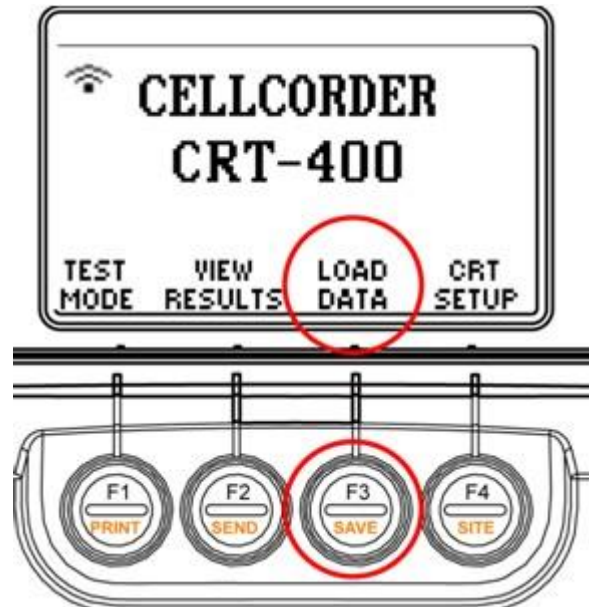
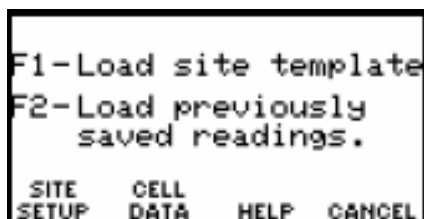

Figure 59 - CRT Main Menu on LCD/LOAD DATA

To delete a site, at the main menu, select **Load Data/F3** to obtain this LCD window and select **F1**.



Note: The USB flash hard drive must be inserted to accomplish this Load Data function.

Press the right and left arrows to step to a site, then press **Delete/F2**.

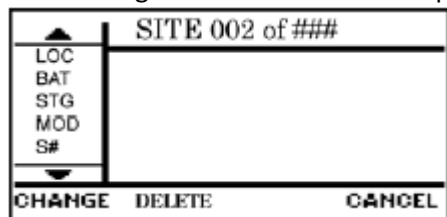

Setting Up and Editing a Site Template

The Delete Site At confirm LCD window appears



At the confirm LCD window, press **Yes/F1**.

The site is now deleted.

If the deleted site was the currently selected site, press **Shift/F4** to display the Active Site LCD window to load or clear.



Press **Load/F2** and select a new site or press **Clear/F3** to have no site selected.

Note: When a site is deleted, the last site shifts to fill the deleted site. For example, if site 003 of 006 is deleted, site 006 becomes 003 of 005. You may use the BAS program or CRT-400 Previewer to sort the sites on location, battery or string name.

15. Working with Files

15.1. Saving Readings and Files to the USB Flash Hard Drive

Insert the USB flash hard drive into the CRT and turn on.

To save readings, press **Shift** then **F3**.

Enter File Name, type a name, up to eight characters, no spaces. Or press **Select Names/F3** to select an existing file name.

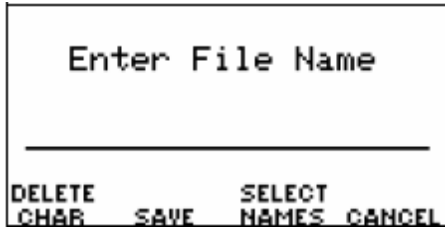

Press **Select/F2**. To save to the USB flash hard drive, press **Save/F2**.



Press **F3/Continue**.

Press **F1/Cancel** when you wish to cancel saving the readings to the file chosen.



If the file exists, another warning will alert you and ask to confirm saving the file name typed or chosen.

For Yes press **F1**, for No press **F2**.



Note: Readings in temporary storage can also be sent to a computer via IR. A space cannot be inserted in a file name.

Saving readings to the USB flash hard drive does not delete them from the CRT's temporary storage. After saving cell readings to the USB flash hard drive, you may clear the CRT's temporary storage and take readings on another battery.

You may also use Microsoft Explorer to transfer files from the USB device to a computer.

15.2. File Types Located on the USB Flash Hard Drive

There are many file types used with the Cellcorder and BAS program, this section describes the most common.

.CCF Configuration File

The CLC400.CCF configuration file holds setup data for all sites on a USB flash hard drive and is accessed when reading or saving site setup information.

.CCF Configuration File

The .CCF configuration file holds setup data for all sites on a USB flash hard drive and is accessed when reading or saving site setup information. Site setup defines site names, thresholds, and other parameters. During testing, the Cellcorder uses site settings for voltage and resistance thresholds. A site setup is not required for testing, but is useful for managing many sites. This is especially also useful for managing multiple sites. This file is created by the Battery Analysis System (BAS) program for importing into a CRT-400. The .CCF can also be created on the CRT-400 unit.

Creating and using a .CCF file for Loading Battery Readings from CRT-400 to BAS

To Load readings from the CRT-400 to the BAS:

1. Insert the USB device into your computer where BAS is installed. From the main menu of the BAS application click, **File** then **Configuration Editor**. In the Configuration File Editor window enter the site information and click **Save**. The site information will be saved to your USB device.
2. Remove the USB device from the computer and insert it into the CRT-400 and press **F3** to load data. Then press **F1** to load site template.
3. Use the arrow keys to navigate to the new site template and press **F1** to select the site.
4. Press **F1** and the main menu appears for you to take your battery readings for your site.
5. After the readings are taken, insert the USB device into the CRT-400 and save the readings to your USB device.
6. Remove the USB device from the CRT-400 to transport the readings to the BAS software to store and view your readings.

.UPG File/Firmware Upgrade File

The .UPG file contains CRT-400 firmware updates. The CRT-400 stores firmware and updates in Flash memory, and cell data, thresholds, and calibration in EEPROM. Both types of memory retain data with the power off. Site setup and readings are stored in EEPROM and then stored to the removable USB flash hard drive when **Save** is selected.

.CDF File Cell Data File

The cell readings are in .CDF data files. These files are created by the CRT-400 for saving readings to the USB device. It is the transport file that gets data from the CRT-400 to the computer. This file contains one set or multiple sets (if in multi-string mode) of readings for a complete string of batteries. The Battery Analysis System (BAS) program imports this file into an ADF file.

.ADF File Accumulated Data File

The .CDF Data File can be imported by the BAS program into an **.ADF** accumulated data file, or viewed separately using the CRT-400 Previewer program. The ADF file contains sets of readings that were imported from CDF files. One ADF file can contain many CDF files from the same string. This gives the BAS program the ability to trend over many sets (different dates) of data. Create one ADF file for each string or one battery with parallel strings. Every time readings are taken for that string, import the data in the CDF file into the ADF file.

.CSV File Comma Separated Value File

When the CRT-400 creates a **.CDF** file, it also creates a **.CSV** file with the same name. Microsoft Excel uses **.CSV** files to display data in spreadsheet format. If the **.CDF** file is overwritten, the **.CSV** file will be overwritten.

Note: At **Load Data/F3-Cell Data/F2**, the Cellcorder LCD window displays only **.CDF** cell data files. Other file formats are handled automatically.



CAUTION: Use only one USB flash hard drive. If more than one device is used, it is possible that setup, file then site information may not be exactly the same on both USB flash hard drives and results will be affected.

.BLF Baseline Resistance File

This BLF battery list file for the Cellcorder BAS program has baseline data searchable by manufacturer and model number. If you already have battery baseline data, you can download then save the file to the USB, so existing baseline data is not overwritten.

Acquire File from the Web site – Save to USB Device

Go to www.vertivco.com and select **Baseline Resistance Data** or go to <http://www.vertivco.com/BaselineRef.htm>.



TRUST YOUR BATTERIES™

Technology and Solutions for Battery Testing



- WHAT'S NEW?
- HOME
- ABOUT US
- PRODUCTS
- SERVICES
- SEMINARS
- SALES REPS
- TECH LIBRARY
- DOWNLOADS
- TRAINING
- DEMO
- CONTACT

New York Times Features Photo with Alber BDS-40

The New York Times newspaper highlights New Jersey's increase in data center construction and battery backups having backups of their own.

[View the Times photo](#) of the Alber BDS-40 units installed.

Alber Battery Monitoring and Training

Alber offers a full line of stationary battery monitors and test equipment, battery diagnostic systems, capacity test systems, resistance testers, hydrometers, and load banks, plus seminars on battery maintenance and testing.

Call us at (954) 623-6660 or (800) 851-4632.

LINKS

+BATTCON
STAY ENERGIZED
Orlando, FL
May 16 to 18, 2011

TRAINING SEMINARS

ALBER EVENTS

WARRANTY REGISTRATION

EMPLOYMENT OPPORTUNITIES

BASELINE RESISTANCE DATA

MAILING LIST

Figure 60 - www.vertivco.com/Baseline Resistance Data

1. Review the page to look at the information provided.

Internal Resistance Baseline Values		
Manufacturer	Cell Model	Average Resistance (micro-ohms)
Alcad		
Alcad	H22P	2331
Alcad	SD-5	1412
Alcad	SD-13	533
Alcad	XHP 28	1186
Alcad	XHP 36	775
Alcad	XHP 90	507
Americad		
Americad	HED-30	1841
C&D		
C&D	3DCU-5	2987
C&D	4LC-YC11	236
C&D	GC12V75A	6046
C&D	KRC-15	253
C&D	LS12-100	3666
C&D	MCT4000	100
C&D	TEL12-90	4237

Figure 61 - Snapshot Baseline Resistance Data

Working with Files

2. Or the file may be downloaded by selecting the letters **BLF** from the downloading a BLF file paragraph on the same page.
3. Once you have clicked on **BLF**, the File Download window displays, select **Save** to save the file.

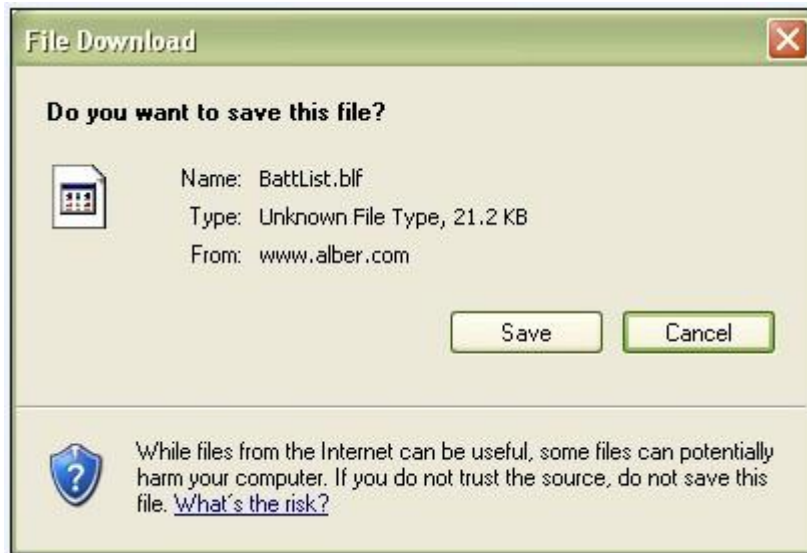

Figure 62 - File Download Window

4. Insert the USB flash hard drive into the CRT's USB port and save the file to the USB flash hard drive.

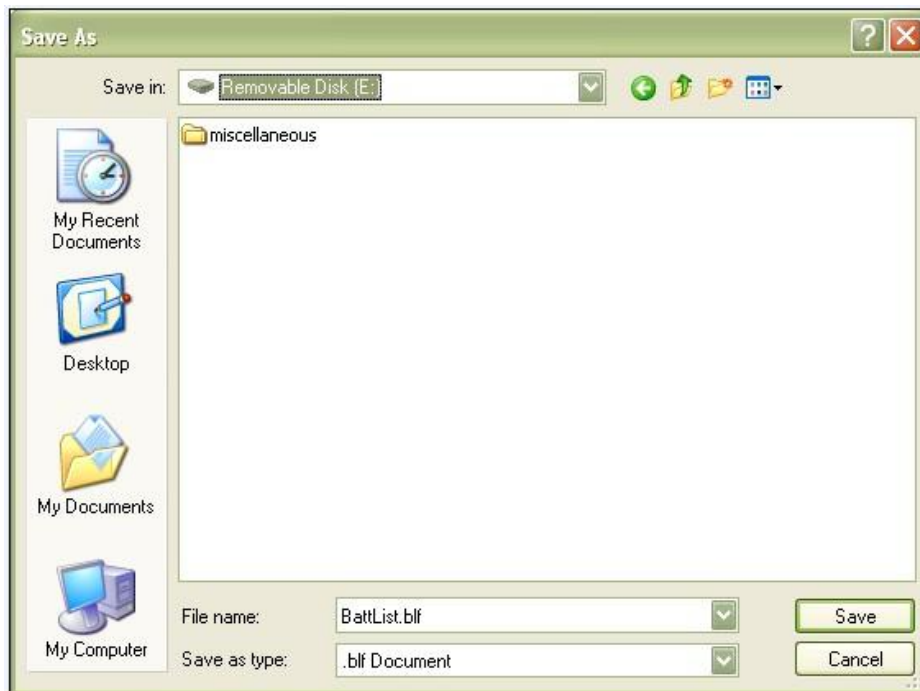

Figure 63 - Saving BLF File

Working with Files

5. Remove the USB device from the computer as follows, double-click the **My Computer** icon on the Windows desktop.



Figure 64 - My Computer ICON

6. Right click the **Removable Disk** drive, in this case (E) and select **Eject** from the menu. Or double-click the safely remove device icon, that is located in the toolbar.

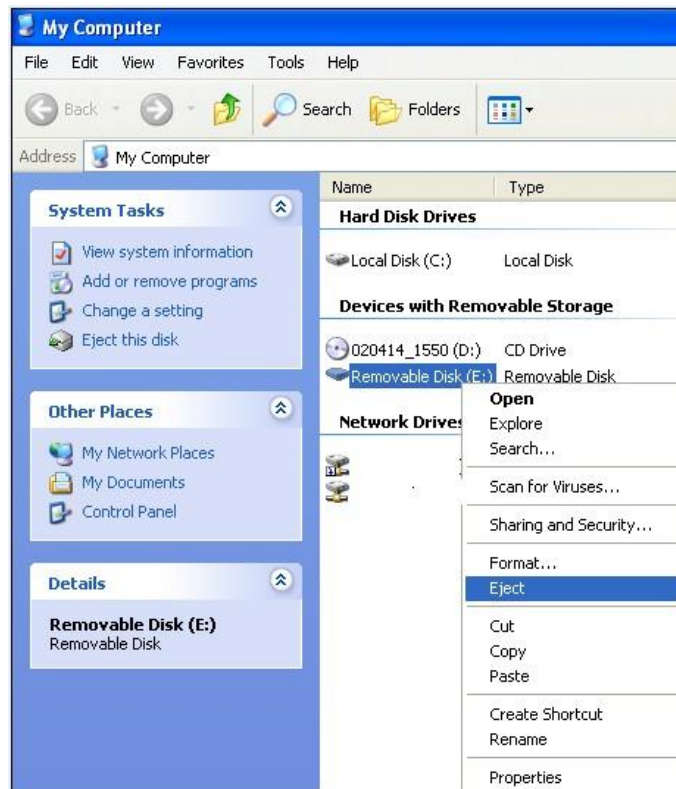

Figure 65 - My Computer/Eject

7. The Safely Remove Hardware window displays. It is best to highlight the device and click **Stop**.



Figure 66 - Safely Remove Hardware Window

8. A confirmation window displays. Scroll down with the mouse and select the device to be removed and click **OK**.



Figure 67 - Confirmation to Stop Hardware Device

9. Once the message **Safe To Remove Hardware** appears, then remove the USB flash hard drive.



Figure 68 - Safe to Remove Hardware Device



CAUTION: Make sure the light on the USB is off before removing the USB device from the PC. Failure to follow the Safe Hardware Removal steps could result in lost data.

14.2 To Load an Existing File

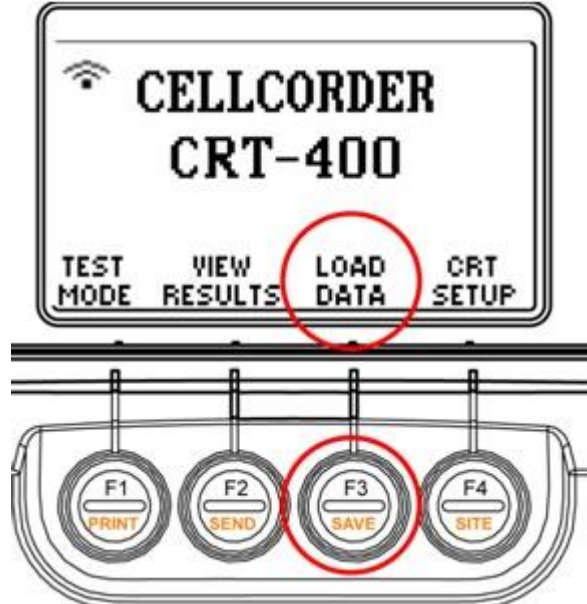
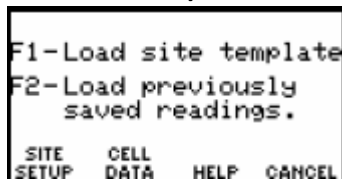

Figure 69 - CRT Main Menu on LCD/Load Data

Select Cell Data/F2.



Note: The USB flash hard drive must be inserted to accomplish this Load Data function.

Highlight a **.CDF** data file from the USB flash hard drive by using the arrow keys. Now, press **Select/F1**.



The main menu appears once the file is selected.

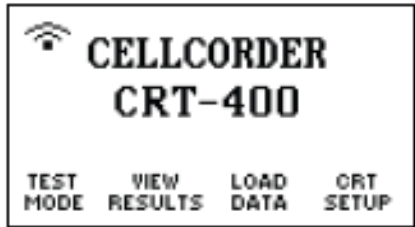

15.3. Appending to an Existing File

New readings can be appended to an already existing data file.

Once the file is loaded, press **F1/Test Mode** and select either test:

- F1-Voltage/Volt
- F2-Resistance/Res
- F3-S.G./Temp./SG/Temp

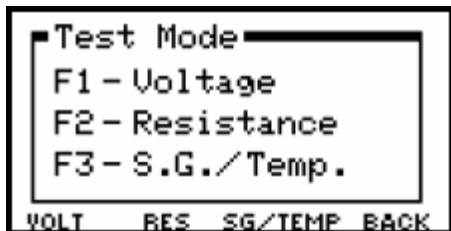

Press F1-Voltage/Volt

If available, data for Cell 001 appears. When you press **F1** for Voltage/Volt and the test is done and confirmed by selecting **F4/Done**, then you will be asked to confirm saving the information to the USB flash hard drive: **F1/Yes** or **F2/No**. When the test is done, select **F4/Done**.

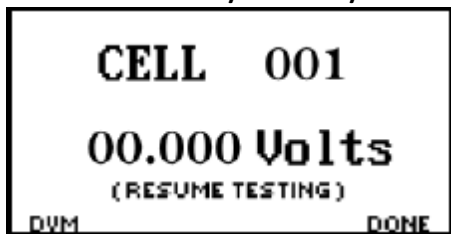

Now, enter File Name by typing it into the space provided or press **F3/Select Names** to choose the filename that you want the information to be included in.



Working with Files



Press **F2–Resistance/RES** or

Confirm battery voltage, amp hours and intercell connections.

Note: To display a cell number, type a number and press **Enter** or use the arrows. Resume testing on cells with no data (not yet tested) or press Retest to test cells previously tested. To go back to **Test Mode** after selecting **F2– Resistance/RES** you must choose **F4/Back**.

Press **F1/Test Mode** and press **F2–Resistance/RES**. Perform test and select **F4/Done** when test is completed.

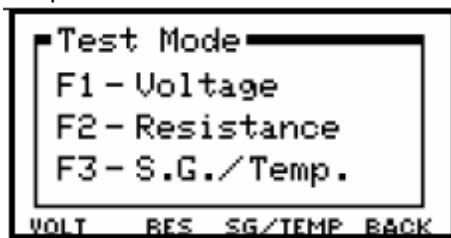

Enter File Name by typing it into the space provided or press **F3/Select Names** to choose the filename that you want the information to be included in.



Specific Gravity and Temperature

Since Specific Gravity and Temperature readings come from the optional hydrometer, refer to “The Hydrometer and the Data Logger” for instructions on how to measure with a hydrometer and to make sure the most current readings are transferred to the USB device.

15.4. Storing Data for Multiple Strings

To read and store data for a new battery, first save the previous battery data to the USB flash drive by pressing **Shift/ F3**.

Now enter the file name and then clear the data from CRT's temporary storage by pressing **F1**.

The CRT asks for confirmation, press **F1** for Yes.

15.5. Deleting a File from the USB Flash Hard Drive

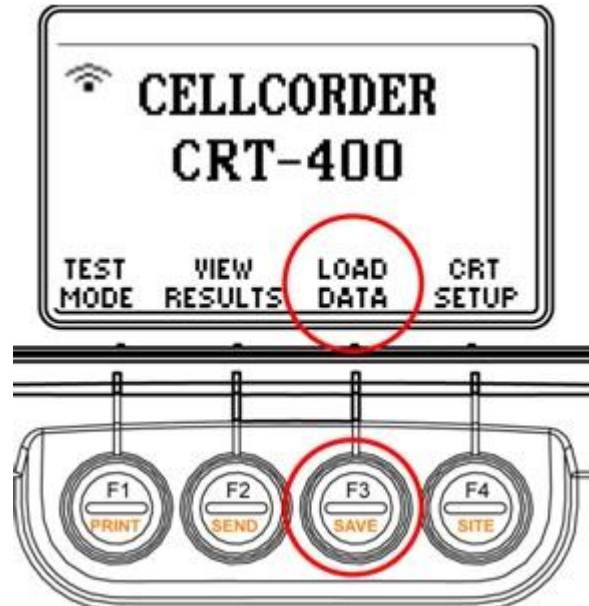
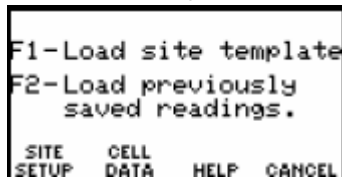

Figure 70 - CRT Main Menu on LCD/Load Data

Note: The USB flash hard drive must be inserted to accomplish this **Load Data/F3** function.

Select **Cell Data/F2**.



Highlight a **.CDF** data file from the USB flash hard drive by using the arrow keys.

Now, press **Delete/F2**.



At the confirm LCD window, press **Yes/F1**.

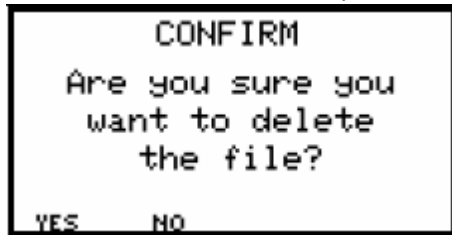

When **Data File Deleted** appears, press **Continue/F3**.



The main menu will appear once the file has been deleted.

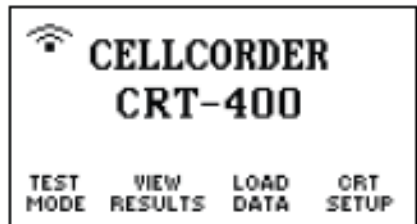

15.6. Sending Readings Via IR

Data can also be sent via IR or *Bluetooth* using the BAS or Previewer programs. Refer to the Battery Analysis System (BAS) User's Guide or CRT-400 Previewer User's Guide for more about creating and importing into an .ADF file.

Note: The fastest way of transferring readings from Cellcorder temporary storage to a computer is with the USB flash hard drive.

To Send Readings from the CRT-400 to a computer follow these steps:

1. Start the BAS program, then click the **Cellcorder Interface** button.
2. On the next box, select **CRT** and click **OK**.

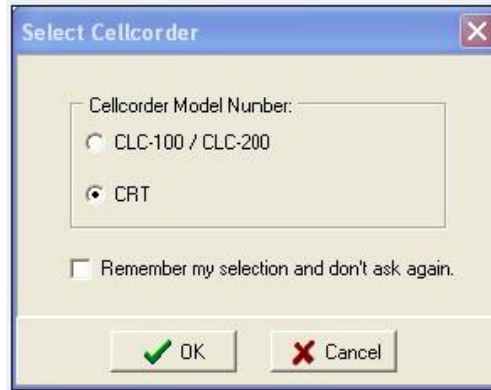
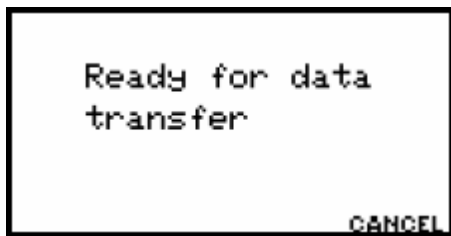

Figure 71 - BAS Software Program Select Cellcorder

3. Power on the CRT. Press and release Shift then press F2. At the next LCD window, press **F1** for IR or **F2** for *Bluetooth*. Or press **F4** to Cancel.
Wait for the message, "Ready for data transfer" to display.



4. On the BAS LCD window, Instructions for CRT, click **Continue**.
5. Align the computer and CRT-400 IR ports.
6. On the CRT Interface window, click **Include Configuration** within the Battery Data area, to include site configuration data.
7. This is not mandatory if accurate configuration data already exists.
8. Then, click **Capture**.

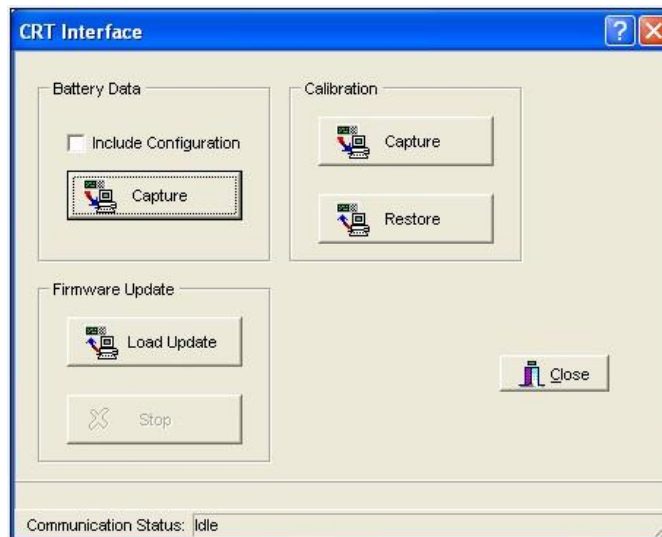

Figure 72 - BAS/CRT Interface Window

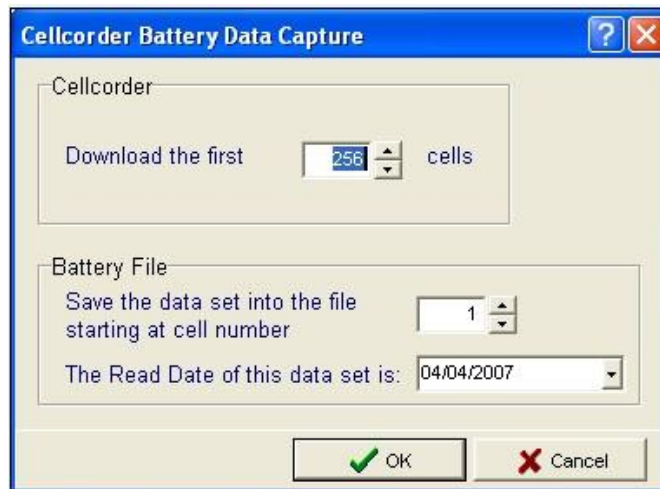

Figure 73 - BAS/Battery Data Capture Open or Create New File

Note: If an .ADF file is not open, select or create one.

On the Cellcorder Battery Data Capture window, select:

1. Number of cells to download
2. Starting cell number
3. Read date and click **OK**.

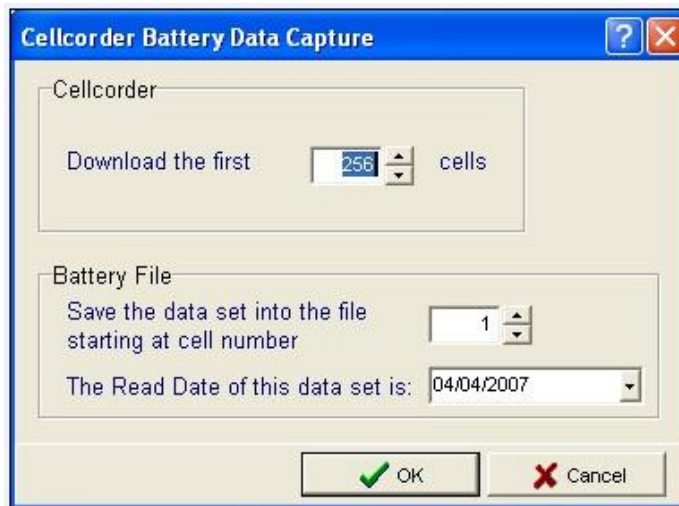
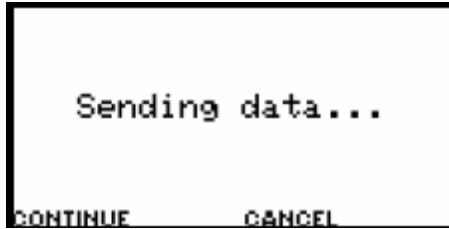

Figure 74 - BAS/Cellcorder Battery Data Capture

The Cellcorder displays Sending data...



When done, the CRT Interface window displays Data transfer completed.

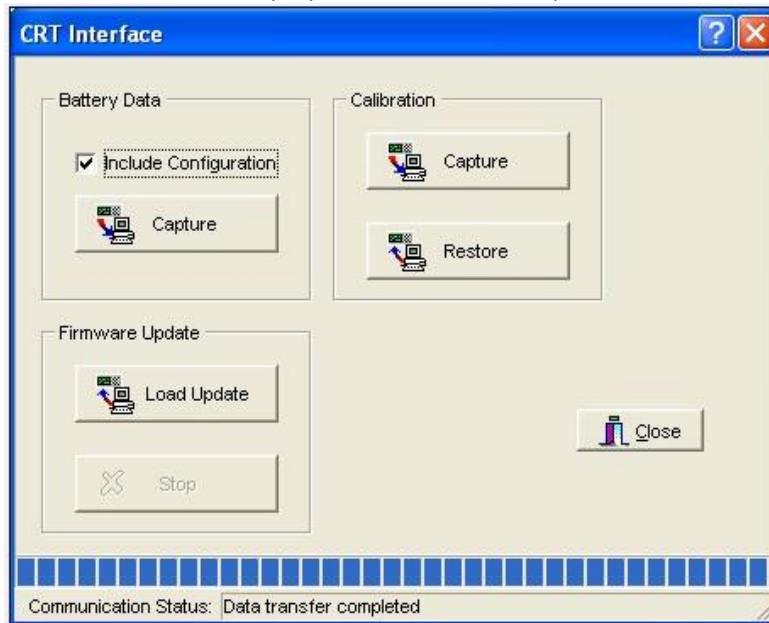

Figure 75 - BAS/CRT Interface Data Transfer Completed

4. Click **Close**.

Once, finished, select **F3/Cancel** twice to go back to the main menu on the CRT.

In the BAS software's main menu, select **File** then **Save**, type the file name in the box provided, and click **Save** to store the **.ADF** file under **Programs/Alber/Alber Battery Analysis/Cellcorder ADF Files**.

15.7. Sending Readings Via Bluetooth Wireless

Note: Discovering, pairing, and setting up the COM Port for *Bluetooth* devices on the PC and within the BAS software needs to be done first. If the PC displays the *Bluetooth* PIN Code Request box, type the *Bluetooth* PIN code 0000 and click **OK**.

1. Start the BAS program, then click the  **Start the Cellcorder Interface** button. The **Select Cellcorder** window appears. Select **CRT** and click **OK**.

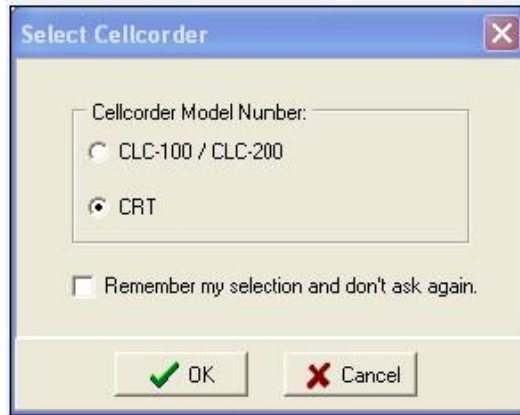
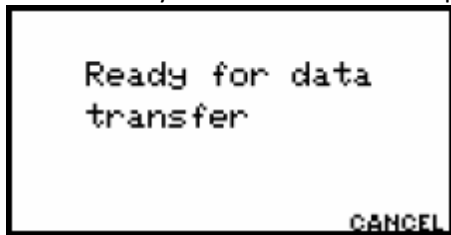

Figure 76 - BAS Software Program Select Cellcorder

2. Power on the CRT-400. Press **Shift** then press **F2**. Press **F2/Bluetooth**. Wait for the message, Ready for data transfer to display.



3. On the **BAS Instructions for CRT** window, click **Continue**. On the **CRT Interface** window, click **Include Configuration** within the Battery Data area, to include site configuration data. Then, click **Capture**.

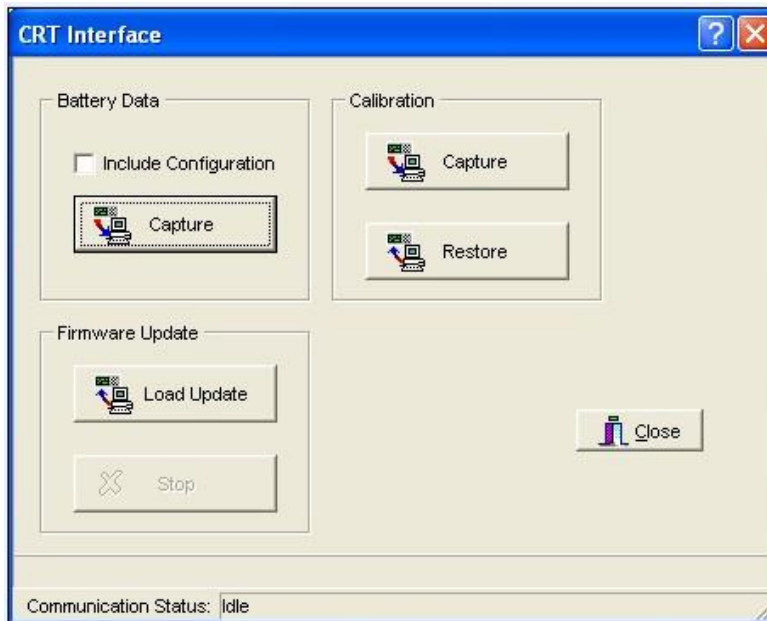

Figure 77 - BAS/CRT Interface Window

Note: If an .ADF file is not open, select or create one.



Figure 78 - BAS/Battery Data Capture Open or Create New File

4. On the Cellcorder Battery Data Capture window, select the following:
 - number of cells to download
 - starting cell number
 - read date
5. Then click **OK**.

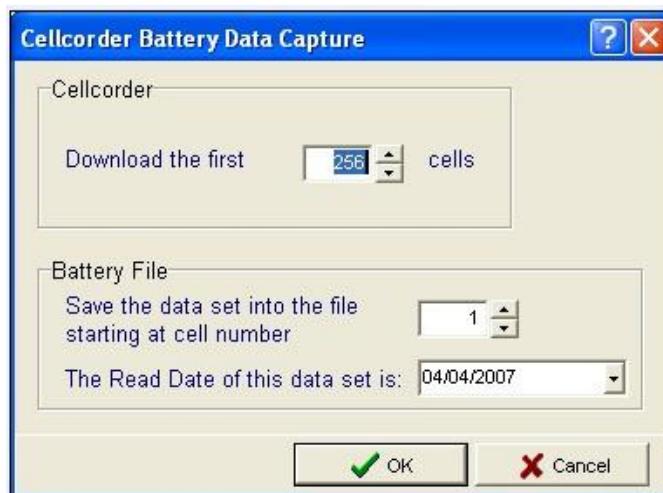
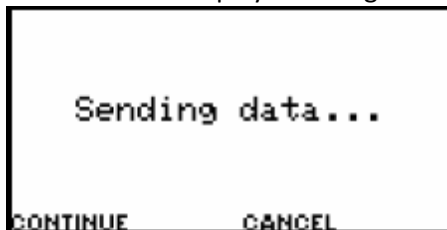

Figure 79 - BAS/Cellcorder Battery Data Capture

The Cellcorder displays Sending data...



6. When done, the BAS CRT-400 Interface window displays Data transfer completed. Click **Close**. Once, the transfer is complete, select **F4/Cancel** twice to go back to the main menu on the CRT.

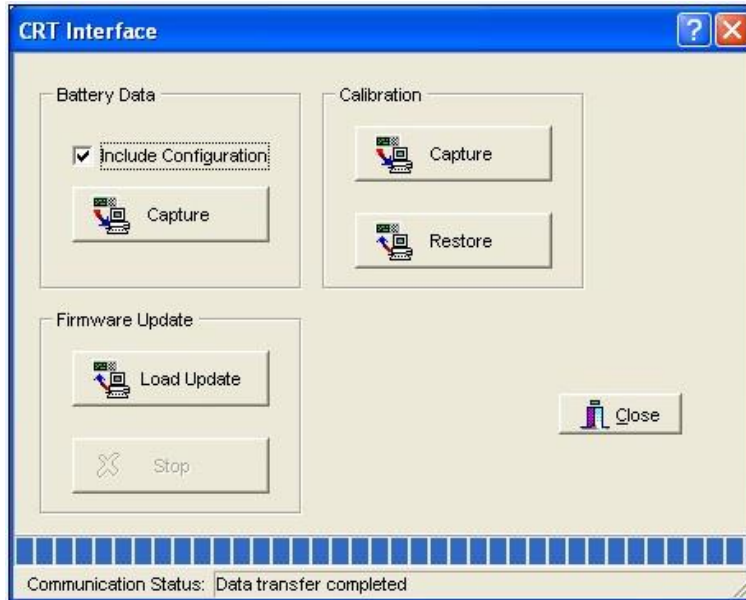

Figure 80 - BAS/CRT Interface Data Transfer Completed

7. In the BAS software's main menu, select **File** then **Save**, type the file name in the box provided.
8. Click **Save** to store the .ADF file under **Programs/Alber/Alber Battery Analysis/Cellcorder ADF Files**.

You may print test results using the optional thermal printer that interfaces to the Cellcorder via IR, or you may transfer data to a computer and send to any printer on your system. A complete test printout contains the following:

Site Information:

- Location shows the location name
- Battery shows the battery name
- String shows the string name
- Model # shows the battery model number
- Total V shows the strings Overall Voltage OV
- # cells shows the number of cells in the string
- Installed shows the battery Installation date
- Read shows the date that the Cellcorder readings were taken

Summary and Thresholds

A summary of average, minimum, and maximum values:

- VOLT shows the cell voltage
- RES shows the cell resistance
- SG shows the specific gravity
- Temp shows the temperature
- Int R1, 2, 3, 4 shows the Intercell resistance of 1, 2, 3 and 4

Working with Files

Cell Data Listed For Each Cell

- VOLT shows the cell voltage
- RES shows the cell resistance
- Int R1 shows the Intercell resistance R1
- Int R2 shows the intercell resistance R2
- Int R3 shows the intercell resistance R3
- Int R4 shows the intercell resistance R4
- Specific Gravity shows the specific gravity
- Temp shows the temperature

Set the thermal printer power switch to ON. If the Status LED is on, connect the printer charger. A flashing Status LED means high temperature or paper out. Refer to the printer manual for more information.



CAUTION: Charge the printer's battery with the printer's power off. The printer cannot operate from the charger. Minimum charge time is one hour. Do not leave the charger connected; this will shorten battery life. To begin to print to the thermal printer, press **Shift** then **F1**.

On the **Select Headers** LCD window, select items for the report: site information, statistics, faults, and thresholds. Press **Next/F2**, Select Data you want included, then press **Next/F2**,

Note: Use the arrows to highlight an item, then press **Enter** to select or unselect it.

Select Headers

```
Select Header(s):
 Site    Stats
 Faults  Thresholds
NEXT  HELP  CANCEL
```

Select Data

```
Select Data:
 Voltage   IoR1
 Resistance  IoR2
 S/G       IoR3
 Temp.     IoR4
NEXT  BACK  CANCEL
```

Place PC/Printer

```
Place a PC with an
IRDA port within
1 meter of the IR
port.
CONTINUE  CANCEL
```

Align the Cellcorder and printer IR ports, and press **Continue/F1**. The printer Status LED flashes while data is being received.

16. Viewing Results

16.1. Viewing Status

When data is in Cellcorder temporary storage, the Status LCD windows display the total number of cells with data, overall voltage (OV), averages, min– max values, and threshold violations (faults).

View Results/F2– Status

```
STATUS
Total of ### cells
have data.
OV = ###.##
AVG MIN-MAX FAULTS BACK
```

View Results/F2–Average Status/F1

```
STATUS - Average
Vc(U) = -----
Rc( $\mu\Omega$ ) = -----
Ric1( $\mu\Omega$ ) = -----
MORE CANCEL BACK
```

View Results/F2–Min Max Status/F2

```
STATUS - Min Cell
S.G. = ----- ---
Temp.(#) = ----- ---
MORE CANCEL BACK
```

Note: To go back a LCD window, exit a function, or return to the main menu, press **Back/F4**, **Cancel/F3** or press **ESC**.

16.2. Viewing the Overall Voltage Data

View Results/F2–Status to see where OV is located on the LCD.

```
STATUS
Total of ### cells
have data.
OV = ###.##
AVG MIN-MAX FAULTS BACK
```

The Cellcorder adds the cell voltages in a string and calculates overall voltage OV. Press **View Results/F2** to display the number of cells that contain data and the calculated OV of those cells. You may also view OV using the BAS program and print OV in reports.

Note: The OV value cannot be typed in.

Average Avg

View Results/F2–Average Status/F1 as an example.

Viewing Results

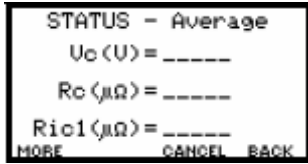

Press **Avg/F1** to display the average cell voltage V_c , cell resistance R_c , and intercell resistance R_{ic} .

Press **More/F1** to display more average R_{ic} , specific gravity SG, and temperature values.

Min-Max

View **Results/F2–Min Max Status/F2** for reference.



Press **Min–Max/F2** to display minimum and maximum values for V_c , R_c and R_{ic} , and the associated cell numbers.

Faults

To display values that exceed thresholds, press **Faults/F3**.

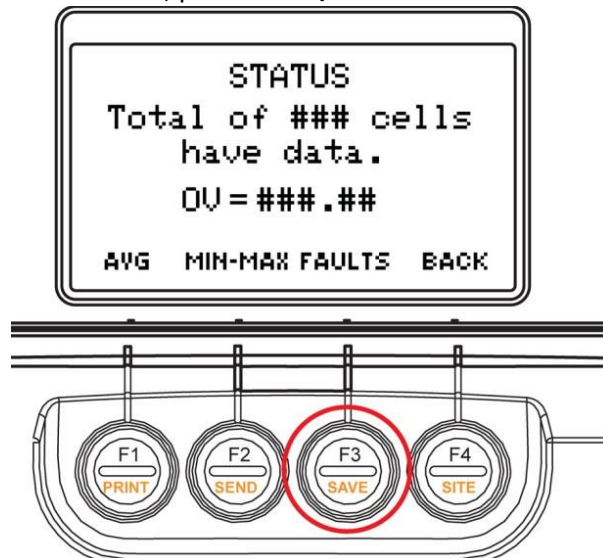

Figure 81 - View Results/F2–Faults/F3

Then the item for which you want faults displayed:

- F1/Volts/
- F2/RC/intercell resistance
- F3/More

Select Parameters–Volt–RC–More

Viewing Results

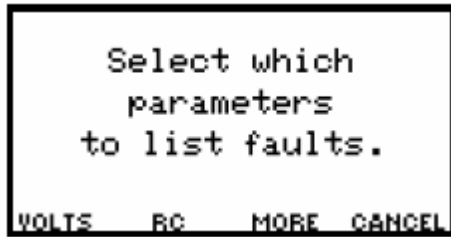

- F1/S/G
- F2/Temperature
- F3/RIC/intercell resistance

Select Fault Parameters–S/G–TEMP–RIC

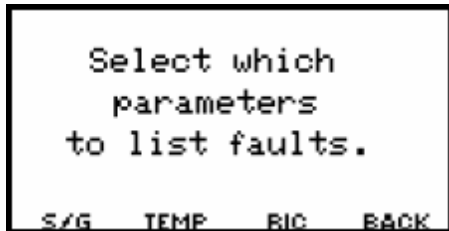

Voltage/resistance fault LCD windows indicate cell number and fault type: Voltage, Internal or Intercell. The reading at fault is highlighted. To retest a voltage or resistance reading that violates thresholds, press **Retest/F3**.

VOLT Faults

CELL - ###	Uc()
##.### Uc	Ric1)----- $\mu\Omega$
	Ric2)----- $\mu\Omega$
Rc	Ric3)----- $\mu\Omega$
##### $\mu\Omega$	Ric4)----- $\mu\Omega$
NEXT	PREV RETEST CANCEL

Specific Gravity/temperature LCD windows show cell number, with the problem **Specific Gravity/Temp value** highlighted.

Cell Specific Gravity Temp

CELL - ###

S.G. Temp.

##.### **##.#**

NEXT PREV CANCEL

To display more faults, press **F1/Next** or **F2/Prev** Previous.

17. Using Diagnostics

Warning and error messages indicate operation and connection status. On power up, the Cellcorder displays up loadable flash memory and boot memory versions. If errors occur during use, messages appear. If the Cellcorder malfunctions, Diagnostics may help determine the cause.

To display Diagnostics, press **Shift** release then press **9**. To view more menu items, press the arrow keys.



Note: To go back a LCD window, exit a function, or return to the main menu, press **Back/F3**, **Cancel/F3** or **ESC**.

17.1. Testing Keypad

To test keypad functionality, press **1** on the keypad. Press any key except the green Power button and the LCD window indicates the key Is pressed.

Note: Do not press ESC twice or you will exit. If you press **Shift**, press **Shift** again before continuing with other keys.

Display

To cause the LCD window to display a series of letters and numbers to make sure the display is functioning properly, select **2**. Display by pressing **2**. To escape press **ESC**

IR Port

This test requires a PC or printer with IR interface. To test the IR communication port with a computer or printer, select **3**.

Note: When using the IrDA interface port with a CRT printer, the printer must be set up in “IRDA Physical layer” mode to communicate with an Vertiv CRT-400.

IR Port by pressing **3**, then select PC Interface or Printer Interface.

Follow the LCD window instructions.

Safety Relay



WARNING: Disconnect the CRT-400 Cellcorder test leads from any equipment before initiating this Safety Relay diagnostic. If the diagnostic is enabled while the CRT-400 is connected to a voltage source, the unit can be damaged.

Select **4**. Safety Relay by pressing **4** to test the internal relay that protects Cellcorder circuitry. The relay clicks while this diagnostic is active.

Using Diagnostics

USB Flash Hard Drive

Press **Shift** release, then press **9**.

Press **1** to check if the USB port is working properly.

USB Port Good



To check the version, press **F1/VER**. If the message, USB port failed appears then try another USB flash hard drive.

If this message occurs with the second/third alternate USB device, then call 954-377-7101 and ask for CRT assistance.

USB port failed



CAUTION: Do not remove the USB flash drive when the Cellcorder USB Memory LED is lit.

To test the input/output I/O to the USB flash hard drive, use the down arrow to view the next diagnostics options and select **1**. USB flash hard drive by pressing **1**. When testing is successful, the LCD window displays USB port good!

Load Module

This test requires test leads and the voltage source to test all conditions. If the leads are not connected, only the 1 to 2 volt range operates.



WARNING: This diagnostic draws up to approximately 60 Amps from the voltage/current source. The AC Power indicator must not be lit while test leads are connected.

Select Load Module by pressing **2** to test the circuitry that applies a load current to the battery under test. To exit, press **F3/Cancel**.

Select Load



On the **Select Load** menu, select the voltage range by choosing the corresponding number on the keypad, then connect the resistance load leads to the voltage source.

17.2. A/D Linearity

Important: Use Only When Instructed By Vertiv Technical Support

To display readings from analog to a digital converter, select **A/D Linearity** by pressing **3**.

Select Channel



Voltage Channel

Voltage Channel/press **1** and the LCD window displays the actual value of the test current. To exit, press **F3/Cancel**.

Test I Channel

Test I Channel/press **2** and the LCD window displays the actual value of the test current. To exit, press **F3/Cancel**.

ICr Channel

ICr Channel/press **3** and the LCD window displays the voltage connected to the black clip and the red/black sense clip on the resistance three lead set. This input is for the voltage reading across the intercell connector under a test condition. Input voltage must not exceed 130mV.

To exit, press **F3/Cancel**.

A/D Reference

A/D Reference/press **4** and the LCD window displays the internal reference for the analog to digital converter. The raw count A/D value should be approximately 10000. Press to go back to the previous window. Then to exit, press **F3/CANCEL**.

Protection Circuit

To test the circuitry that protects the Cellcorder against overload conditions, select **4. Protection Ckt/Circuit** by pressing **4** and the LCD window displays 2 choices:

Using Diagnostics

Protection Circuit

- 1 Over Voltage
- 2 Reverse Polarity.

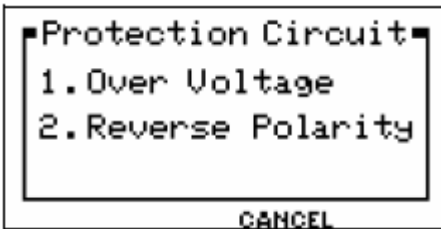

Both choices necessitate lead connection and further directions on the LCD window.

Modem (If Installed)

Use the down arrow to view the next diagnostics options. Reset modem by pressing **1.**)

Buzzer

Tests the buzzer by selecting **2.** The CRT provides an audible feedback for keystrokes and alarm conditions. To continue diagnostics, select **Continue/F1.**

Fan

Test the Cellcorder's fan by selecting **3.** To stop the fan diagnostic and continue on, select **Continue/F1.**

Temperature Sensors

Temp. Sensors/press **4** and the LCD displays temperatures of the CRT-400 circuit board; Load Temperature and regulator Ambient Temperature. When the load temperature rises due to continual testing, the fan turns on. If the load temperature goes too high, testing circuitry is disabled and a warning appears.

Load And Ambient Temperature

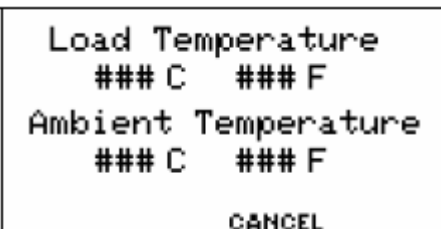

To do further diagnostic tests select **Cancel/F3.**

18. Utilizing CRT-400 Service Menu

The password protected Service Menu has the Calibration, Factory Defaults, and Change Password options. The Service menu is not used during normal use. To display the Service Menu, press **Shift** release then press **Shift**. The password LCD window appears.

Note: To go back a LCD window, exit a function, or return to the main menu, press **Back/F3**, **Cancel/F3** or **ESC**.

18.1. Entering the Password

The factory set default password is **1234**. If the password is unknown, contact Vertiv for a password based on the randomly generated four numbers following Service code.

Password and Service Code

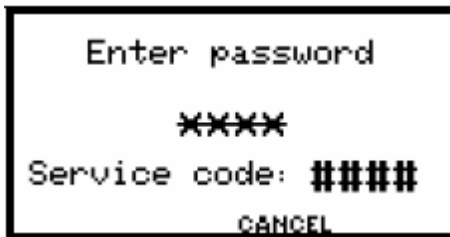

Service Menu to Calibrate the CRT-400

After you type the password, press **Enter** to display the Service Menu:

1. Calibration
2. Factory Defaults
3. Chg. Password



If calibration is necessary, please contact Vertiv at 954-377-7101 for service.

To Record the Flash Code

The current for the 8V to 12V Load (I3) test depends on the Cellcorder flash code. Power up the CRT-400 and, after the initial LCD window, note the flash code, which either has no asterisk (*), such as 05.0200, or has an asterisk, such as 05.0200,*. Make sure to note the presence or absence of an asterisk on the Calibration Form as well.

Utilizing CRT-400 Service Menu

Flash Version Factory Defaults

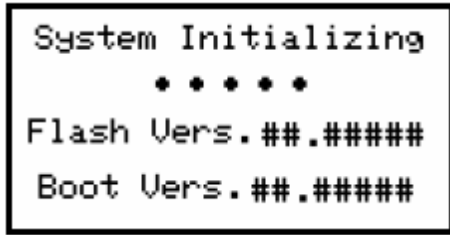

Resetting to factory defaults resets the calibration constants, sets the password to **1234**, resets threshold settings, resets the values of any site in temporary memory, and restores display settings.



WARNING: The Cellcorder loses calibration when reset to factory default and must be recalibrated.

Unplug any test leads from the Cellcorder before initiating a firmware reset.

To display the password protected Service Menu and Calibration Menus, press **Shift** release, then press **7**.

Type in the password and press **Enter**. The default password is **1234**.

Password And Service Code

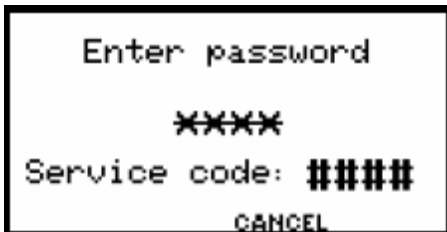

At the **Service** Menu, select **2** for the Factory Defaults

Service Menu



At the **Memory Initialize** message prompt to restore to default settings, press **Yes/F2**. To go back to the main menu select **Cancel/F3**.

Factory Defaults

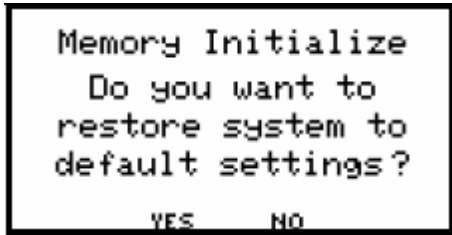

18.2. Changing the Password

You may change the password to any four digit number. To display the password protected Service Menu and Calibration Menus, press **Shift** release, then press **7**. Type in the password and press **Enter**. Use the default password **1234**.

Password and Service Code

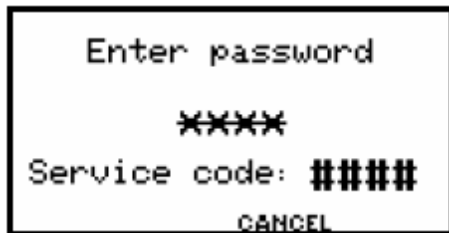

At the **Service** menu, select **3** to change the Password.



Note: Do not press Enter.

At **Enter New Password**, type the new, four digit password. Use the arrow key if the cursor does not advance. Type the new password again in the Confirm New Password area, then press **F2/Accept**.



If New Password and Confirm Password agree then the Service Menu appears.



18.3. Error Codes

USB flash hard drive error messages display text such as USB drive is not installed Press **ESC** to continue or out of memory, or numeric error codes. Determine if the problem is the USB flash hard drive. Remove the troublesome flash drive and, if available, insert another device. If the Cellcorder reads the USB flash drive, then the problem exists in the first USB flash drive.

Attempt to read the defective USB flash drive using the USB drive on the computer. If neither the Cellcorder nor the computer can read the USB flash drive, then the drive is defective or data on the USB is corrupted.

If the computer reads the data successfully, copy the data to another USB flash drive and see if the Cellcorder can read it. If not, remove the USB flash drive from the Cellcorder.

Power down and restart the Cellcorder. Insert the USB flash drive and attempt to read it. If the error message still appears, the problem may be in the Cellcorder. Contact the factory for assistance.

18.4. Battery Maintenance Schedule

The CRT-400 Cellcorder can easily take periodic maintenance readings. An effective maintenance program that meets the recommendations of most battery manufacturers calls for the following measurements:

	Vented Batteries		
Parameter	Quarterly	Semi-Annually	Annually
Cell Voltage	X	-	X
Internal Cell Resistance	-	-	X
Intercell Resistance	X 10%	-	X
Specific Gravity	X 10%	-	X

	VRLA Batteries		
Parameter	Quarterly	Semi-Annually	Annually
Cell Voltage	-	X	X
Internal Cell Resistance	X	-	X
Intercell Resistance	-	-	X
Specific Gravity	-	-	-

Table 5 - Battery Maintenance Schedule

Note: VRLA or sealed cells must be tested more often because of their shorter life expectancy and lower reliability.

Use Cellcorder resistance measurements in conjunction with baseline data on the batteries being maintained. Obtain cell resistance baseline data from the battery manufacturer or Vertiv, or acquire it with a capacity test.

Take Cellcorder readings according to the Maintenance Schedule table; the resistance readings dictate which battery string should be subjected to capacity testing. If one or more cells exhibit cell resistance 30% to 40% higher than the average or baseline value, then capacity test those cells using a single cell tester, such as the Vertiv SCT. If most cells are above the normal expected readings, then capacity test the entire string.

18.5. Upgrading Firmware

Upgrade CRT-400 Cellcorder firmware using the USB flash drive or the IR ports on the computer and CRT-400. Upgrades are on the Web: www.vertivco.com.

Note: Upgrading using the USB flash hard drive is much faster than via IR.



WARNING: Do not continue until you have the .UPG upgrade file ready. You will be clearing the current firmware.

To Upgrade Firmware Using the USB Device

Download the .UPG file from the Vertiv Web site www.vertivco.com or an Vertiv CD to Program Files/Alber/Alber Battery Analysis, then use Windows Explorer to copy the file to the USB flash hard drive. With Cellcorder power off, insert the USB flash hard drive into the Cellcorder. Hold **ESC** and press the **Power** button to start in firmware upgrade mode.

The CRT-400 is ready to clear Flash memory for the new program, press **Continue/F2**.

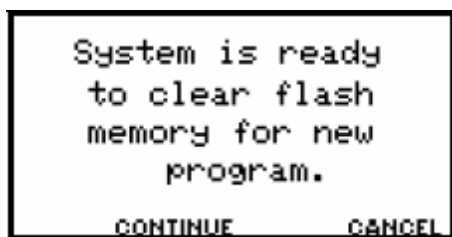

The CRT-400 is ready for an upgrade, select file transfer method, press **USB/F2**.

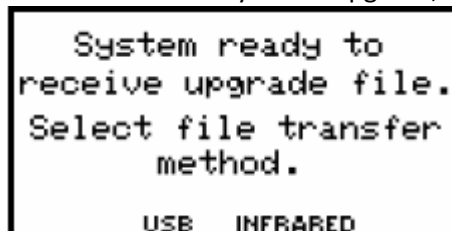

The CRT LCD lets you know that it is being prepared for the Memory Upgrade.

```
Preparing Memory
for upgrade.
```

File transfer in progress appears and the frame number counts down.

```
File transfer
in progress.
Frame:####
CANCEL
```

When the upgrade is successful. System is running Version nn.nnnnn appears, press **Continue/F3**.

```
Upgrade Successful
System is running
Version ##.####
CONTINUE
```

To Upgrade Firmware Using the IR Port W/BAS and PC

Download the .UPG file from the Vertiv Web site, www.vertivco.com or an Vertiv CD to Program Files/Alber/Alber Battery Analysis, then use Windows Explorer to copy the file to the USB flash hard drive.

With Cellcorder powered off, insert the USB flash hard drive into the Cellcorder. Hold ESC and press **Power** to start in firmware upgrade mode. At the message System is ready to clear Flash memory for new program, press **Continue/F2**.

```
System is ready
to clear flash
memory for new
program.
CONTINUE CANCEL
```

At System ready to receive upgrade file. Select file transfer method, press **Infrared/F3**.

The CRT LCD lets you know that it is being prepared for the Memory Upgrade. File transfer in progress appears.

```
File transfer
in progress.
Frame:####
CANCEL
```

Utilizing CRT-400 Service Menu

Note: The Frame: ##### does not count down at this time.

Start the BAS program. Check or choose the COM port that enables the IR interface. Select  from the BAS software toolbar.

To change the port click on the down arrow to select a highlight and select a port, then click **OK**.



Figure 82 - Communications Settings Com Port BAS Software

Then click the Start the Cellcorder Interface button. Select **CRT** and click **OK**.

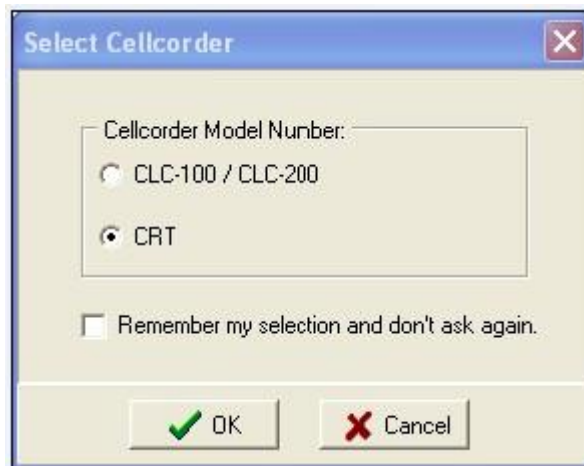
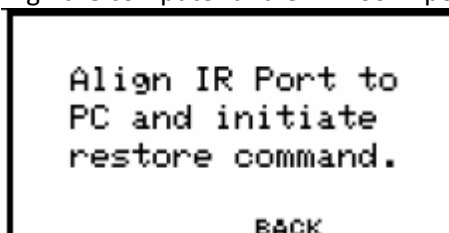

Figure 83 - BAS Software Program Select Cellcorder

On the BAS Instructions for CRT LCD window, click **Continue**.

Align the computer and CRT-400 IR ports.



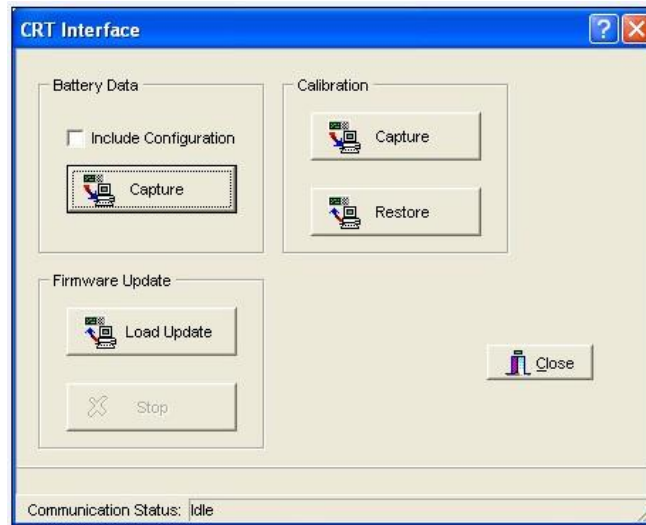

Figure 84 - BAS/CRT Interface

On the BAS CRT Interface window, click **Load Update** under Firmware Update.

Select the **.UPG file**, then click **Open**. File transfer in progress begins to count down on the CRT.



Note: The Frame: #### counts down at this time.

When the upgrade is successful and the system is running Version nn.nnnnn appears, press **Continue/F3**.

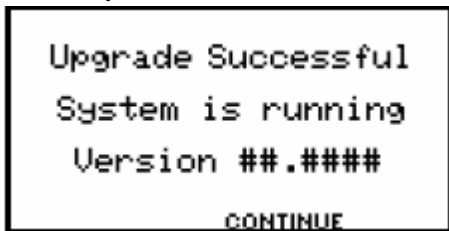

Click **Close**.

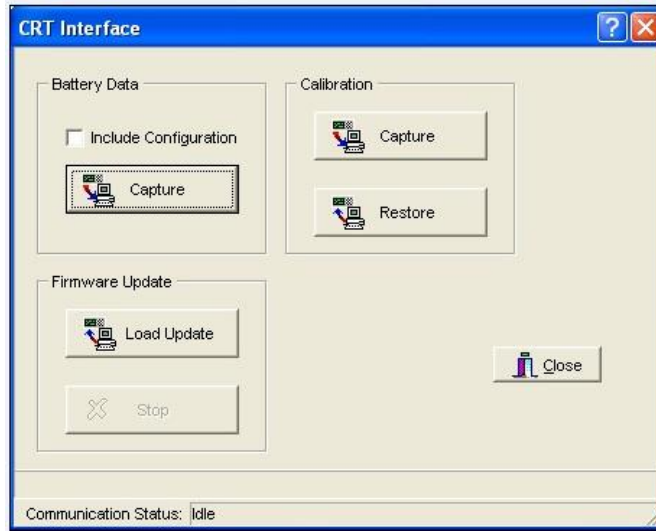

Figure 85 - BAS/CRT Interface Window

19. Application Note CC-001

The Internal Resistance and Cellcorder document is available on Vertiv's Web site at:
<http://www.vertivco.com/>

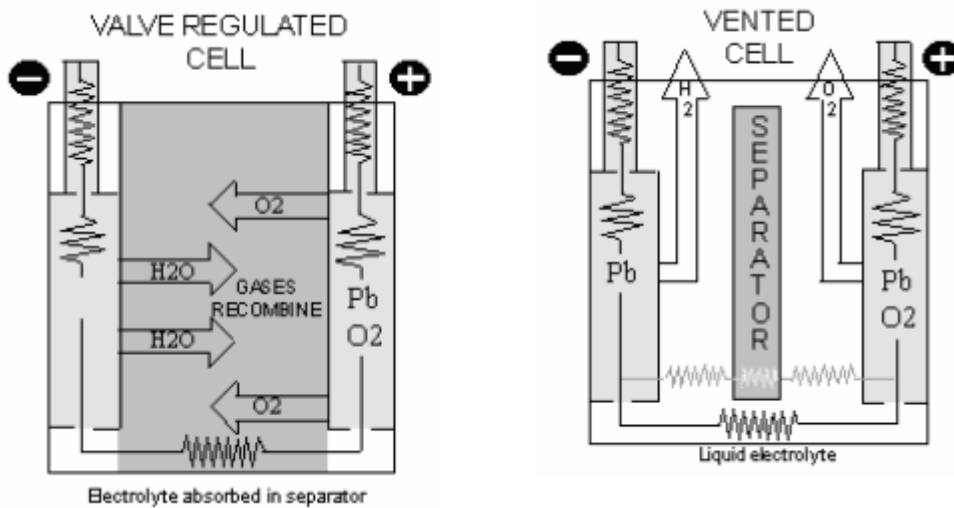

Figure 86 - Valve Regulated and Vented Cells

Introduction

With the changeover from “vented” cells to “sealed,” VRLA cells, and the proliferation of UPS systems, an even greater impetus has been placed in finding economical and reliable ways to establish the state of a battery’s capacity and its conduction path. In this Application Note, the primary focus will be on a new, relatively low cost aid in determining a battery’s health by virtue of its cells’ internal resistances together with float voltages and intercell connection resistances. All three of these variables are rapidly measured and conveniently recorded by the Vertiv Cellcorder, the storage battery multimeter.

The Search

The search for new approach to capacity and conduction path testing has been ongoing. Traditionally, a battery’s capacity to store energy has been specified by its manufacturers as its ability to supply a constant amount of current, or power, to the load for a defined time period to a final voltage. The real test of the battery’s actual capacity as opposed to its rated capacity frequently involves hours of manpower and load and data acquisition equipment.

Unfortunately, a new approach has yet to gain industry-wide acceptance. The consensus of battery experts is still that load testing under controlled conditions is the only method with certainty of establishing a battery’s actual capacity. This is reflected in several national standards; the latest of which was issued in 1995.

However, after many years of experience, studies and experiments, a wealth of information about battery behavior and measurements has been produced and some light has been shed on new tools that will help assess a battery’s condition.

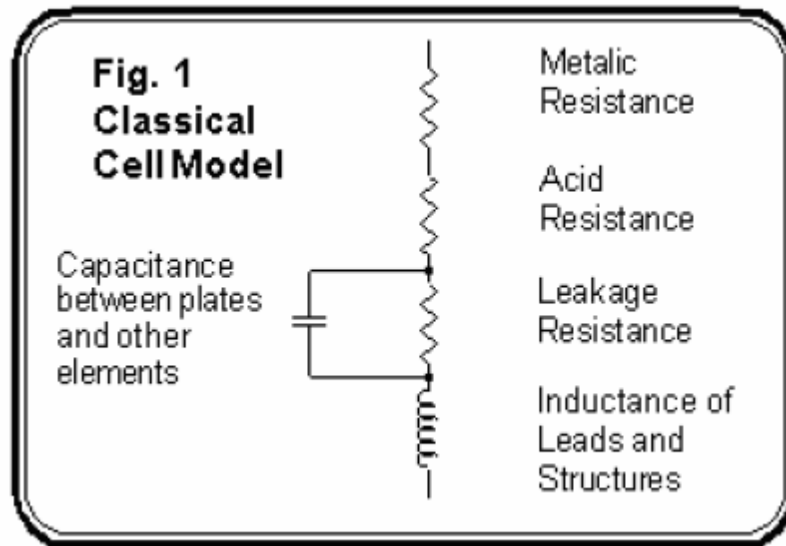

Figure 87 - Classical Cell Model

As early as 1959, the equivalent circuits of cells and typical circuit values were published. These circuit models of a battery's cell, are critical to understanding how its condition relates to cell internal parameters, conduction paths and capacity.

The Basics: Resistance, Inductance and Capacitance

The models' circuit elements are resistance, capacitance and inductance. Researchers have investigated battery parameters from DC through several thousand hertz and have made measurements in all units. They tried to relate those to cell capacity, often with mixed or conflicting results.

In almost all typical battery applications, the inductance has no practical impact on battery performance because of its small magnitude (from 0.05 to 0.2 micro henries.) On the other hand, the actual capacitance of cells is surprisingly large, as much as 1.7 Farads per 100 Amp-Hours. This cell characteristic is put to good use by charger manufacturers. They depend on it to filter their charger output.

However, little evidence has evolved that ties capacitance with the actual capacity of a cell. It's worth noting that one researcher felt capacitive reactance "obscures" the predominant indicator of cell capacity, electrochemical resistance. More so, as the test frequency is increased. Impedance and admittance measurements include both capacitance and inductance in their readings.

The Nature Of Internal Resistance

At Vertiv, we have centered our efforts on cell internal resistance. A refined cell model has been developed which subdivides the internal resistances of a cell, into its metallic and electrochemical components. These resistances do not change with test frequency. Indeed, researchers have concluded that a zero frequency, DC, or extremely low frequencies, yield the best results when studying capacity relationships.

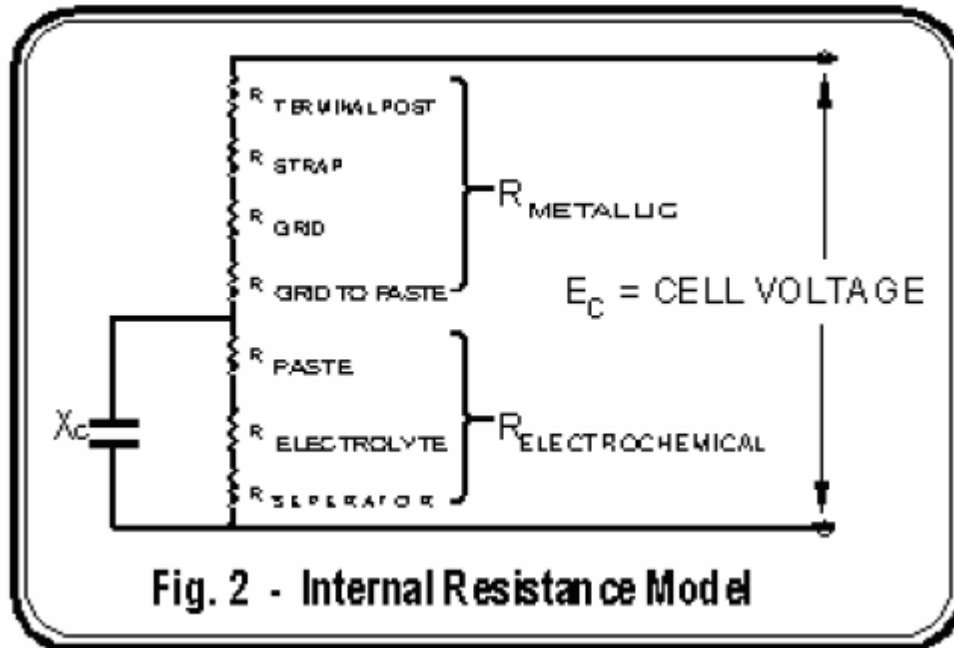

Figure 88 - Internal Resistance Model

Another group focusing on internal resistance is prestigious Nippon Telephone and Telegraph. Their research and field personnel have shown that a major result of the lead acid battery deterioration mechanism is an increased internal resistance. A 500 microsecond duration pulse technique is used to measure cell internal resistance. Test results lead them to conclude that battery deterioration (capacity) can be estimated within $\pm 10\%$ by internal resistance measure.

Note that Capacity vs. Normalized R internal curve, is somewhat curved. Some feel the relationship between most cell internal parameters and capacity is not a simple straight line as has been described in recent times but rather a more complex curvi-linear function.

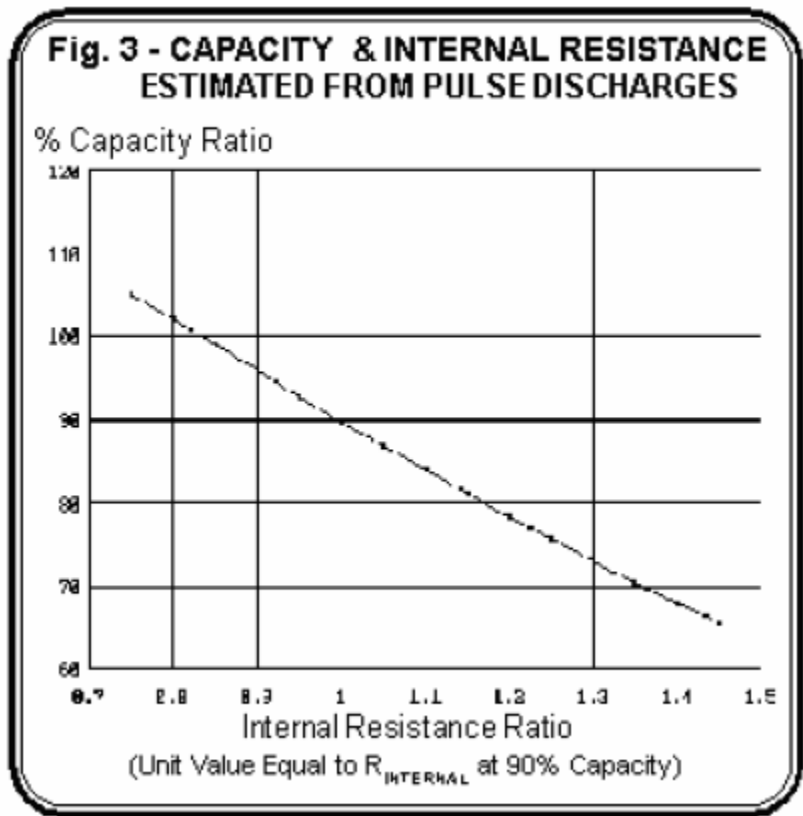

Figure 89 - Capacity and Internal Resistance Ratio

Part of this belief that a straight line cannot describe a capacity relationship is rooted in the differences exhibited during battery discharges from cells with metallic vs. electrochemical resistance problems. The typical discharge curve of a cell at 100% capacity.

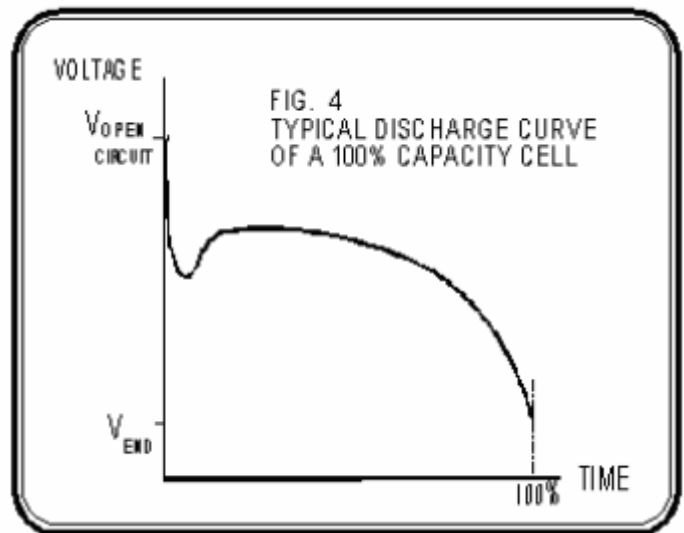

Figure 90 - Typical Discharge Curve of a 100% Capacity Cell

A battery's capacity is adversely affected by an increased internal resistance. Obviously, the power is dissipated internally, $I^2 \times R_{INTERNAL}$, and is not available where it is really needed... at the load. Thus, actual capacity is diminished. However, during discharge this reduction in capacity appears differently depending upon whether the resistance change is primarily metallic or electrochemical in nature.

Metallic Resistance

This portion of the internal conduction path troubles most battery test experts. It is here that deterioration of a cell can occur most rapidly and then will often go undetected between the yearly integrity tests or, even less frequently, the capacity tests. The tear down of failed batteries with abnormal internal resistances has proven that the terminal posts and the internal straps and grids are most often the victims of corrosion, poor welds or "burns." Where found, contact surfaces of a copper insert can corrode or loosen from its surrounding lead post. The Cellcorder easily detects these types of problems.

The illustration clearly shows the loss of capacity due to a high internal metallic resistance. The available voltage at the battery's terminals is reduced from the start of the discharge and continues to the end.

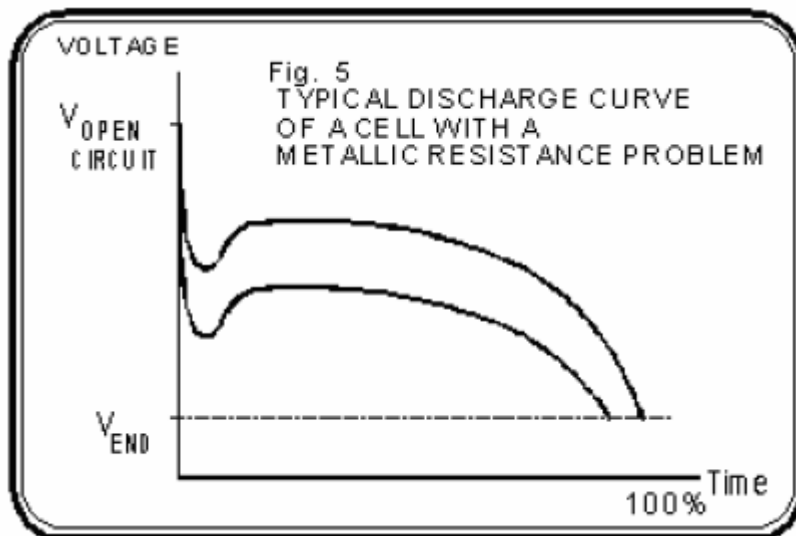

Figure 91 - Typical Discharge Curve with Metallic Resistance Problem

Electrochemical Resistance

Cell paste, electrolyte and separators form the electrochemical part of cell internal resistance. Long-term increases in RELECTROCHEMICAL can be caused by loss of active material or paste due to aging. Short-term changes also occur naturally during parts of the charge or discharge processes when the specific gravity is altered; or when the contents of the separators varies and/or the chemical composition of the surfaces change. Separator compression, clogging or shorts, and conditions like sulfation are frequently causes of abnormal, increased electrochemical resistance; however, accelerated electrolyte dry out appears to be public enemy #1 when it comes to VRLA failures.

The next figure reveals how a battery with an electrochemical resistance problem behaves. Its reduced capacity does not become apparent until much further into the discharge, like "running out of fuel." On the other hand, the metallic resistance problem can be viewed as pinching the fuel line! In either case, the worse the resistance, the greater the shortfall between the cell's rated and actual capacity.

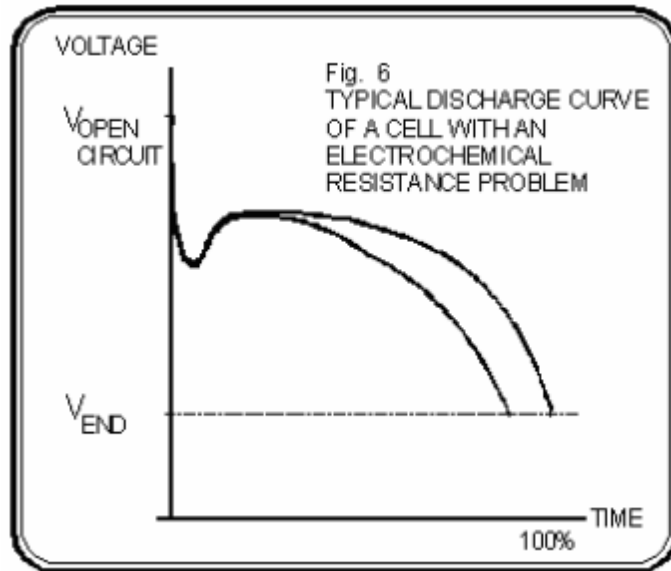

Figure 92 - Typical Discharge Curve with a Cell with an Electrochemical Resistance Problem

Battery Aging and Internal Resistance

Internal resistance provides a clue to aging. The aging process of a battery's cells is based upon the rates at which their materials and construction deteriorate under design conditions. For example, the life of nearly all stationary cells is specified at 77°F, under particular float charge conditions and discharges of stipulated depth and frequency. Very slow corrosion of conduction paths, the loosening of active materials from plates, grid deformation and, in the case of VRLA cells, dry out of electrolyte are all natural processes that push a cell to its end life. This aging process is marked by increasing cell internal resistance and decreasing capacity. It is generally agreed that below 80% actual capacity, the cell's deterioration will accelerate rapidly and replacement is recommended.

The internal resistance increases slowly but, toward the end of a cell's life, it accelerates greatly. Its end-life value is normally about 25% or so above its initial value, but can be as high as 50%.

Temperature and Internal Resistance

Being aware of the effect of temperature on internal resistance is important. The next figure shows a typical AGM VRLA cell, it clearly shows rapid internal resistance and impedance increases below temperatures of about 45°F.

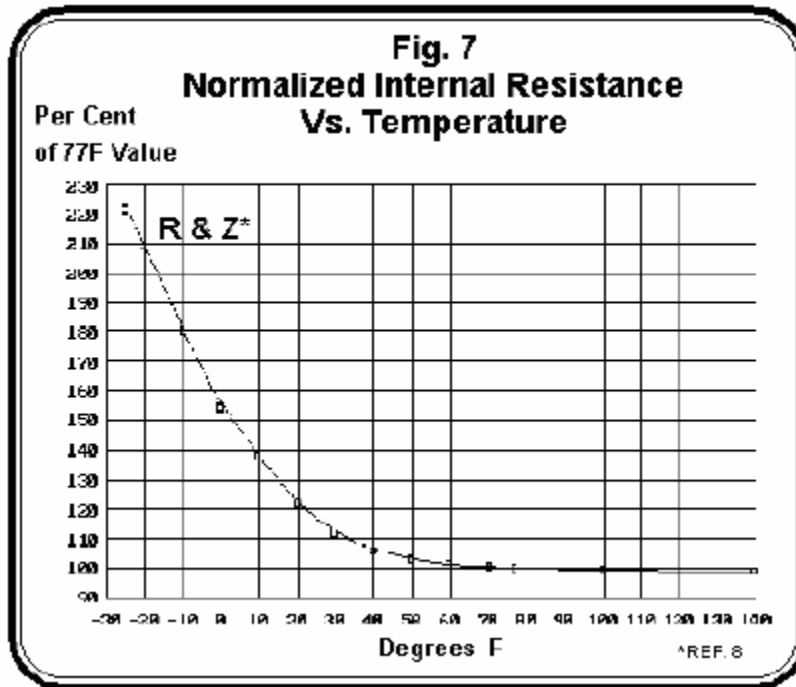

Figure 93 - Normalized Internal Resistance Vs. Temperature

In temperate climates, VRLA cells in unconditioned temperature environments may show considerable internal resistance variation between quarterly measurements. Recording of the ambient temperatures at the time of measurement will save you further testing and false alarms. Similarly, cells chilled by air conditioning exhibit higher readings than their sheltered neighbors. If possible, try to re-direct the air flow.

The Cellcorder

The Cellcorder is invaluable in determining what a battery or cell's internal resistance is and in helping to identify abnormal conditions and normal aging. While a battery or cell is on-line, it accurately and repetitively measures the internal resistance using DC techniques. The AC filtering currents, stray 60 hertz fields, noise and normal float currents have virtually no effect on its readings.

The authors can't help but wonder what earlier researchers could have accomplished if they had access to microprocessor and solid state technology. The microprocessor of the Cellcorder permits it to not only control measurements, but to also precisely time the readings and performs calculations. To boot, it can tell whether a reading is valid and then records the results. The battery manufacturers have customarily determined the internal resistance of cells using simple Ohms Law. They usually measure the voltage differences and current during a battery discharge. The Cellcorder does the same thing, but very quickly and accurately. Figure 8 reveals what happens when a battery is subjected to a load. The instantaneous voltage drop when the load is applied, or the instantaneous voltage recovery when the load is removed, is due to the internal resistance. The Cellcorder reads the current and the cell voltage just prior to removal of the load and then measures the recovered cell's voltage.

The resultant resistance is simply $R_{Internal}$.

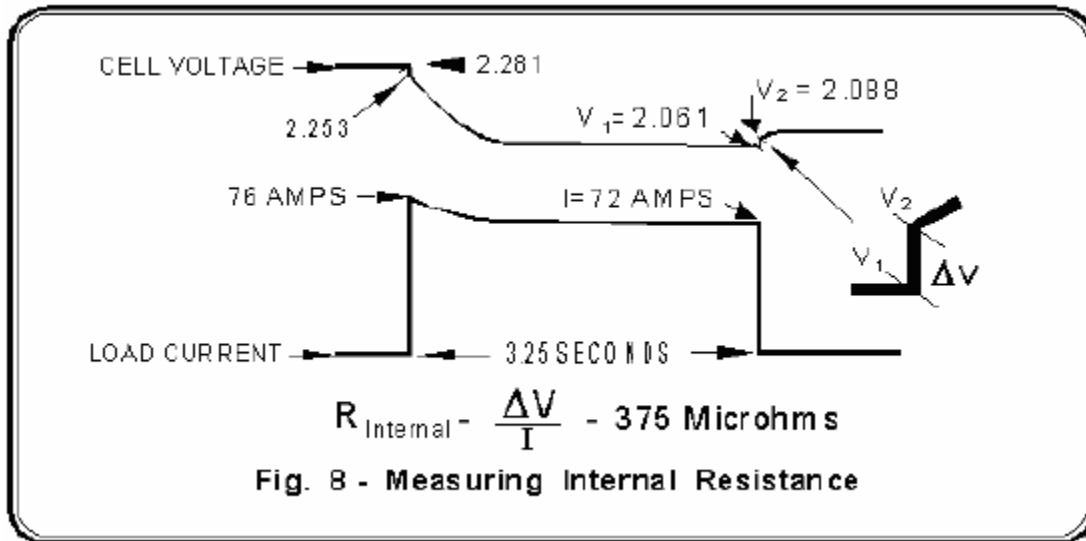

Figure 94 - Measuring Internal Resistance

The Momentary Test Discharge

This is a feature worth your time to understand. It is, in part, what distinguishes the Cellcorder from most instruments presently on the market and will help provide readings in which you can be confident. For rated cell capacities of less than 1000 Amp-hours, the discharge is short, only three to four seconds, in the order of 20 to 75 amps. For larger capacities, the duration is close to 10 seconds.

To prove a point about safety and the effects of short-term high currents, we performed the following experiment. We imagined an internal conductor corroded down to the size of a dot.

We found that passing the Cellcorder's test current through a skinny wire (27 inches of #20 gauge wire) caused no damage nor barely heated it. Try it! The reason is that very little energy is involved. It amounts to only a maximum of 5 watts per 1000 microhms and lasts only seconds.

In an actual test, within milliseconds of starting, the Cellcorder senses the current level. If there is a very high internal resistance, the current will be low and the discharge will be instantaneously terminated. Thus, a cell with an exceptionally corroded internal conductor will not be further damaged. After tens of thousands of cell tests, there have been no reports indicating that the Cellcorder's test discharge has caused a cell to open circuit.

Interestingly, many battery specialists feel disappointed that their most severely corroded cells have not opened. They would rather have them open during a supervised test than during an actual emergency when no one is around!

Vertiv Research

Carefully conducted Vertiv experiments have revealed other important properties of cell internal resistance. One is the relationship between metallic resistance and electrochemical resistance. Many would expect that as the energy stored in a fully charged cell diminishes, the internal resistance of the cell would increase both proportionately and significantly. This belief is widely held because of how the lead acid cell electrochemistry is envisioned.

Measured amounts of energy were methodically removed and each time the internal resistance was read. It was found that the internal resistance rose no more than 3% after removal of 32% of the cell's energy. Upon continued discharge, the internal resistance increased rapidly in a non-linear fashion.

Since it is extremely unlikely that the cells' metallic resistance could have changed while the cells were discharged, it can be concluded that:

- changes noted in total internal resistance were due exclusively to electrochemical resistance change
- electrochemical resistance change is a small part of total internal resistance as the stored energy drops from 100% to substantially lower levels of charge

In the real testing world, this is good news. It means that a battery can be reliably tested by the Cellcorder at float, open circuit voltage and even partially discharged.

The "Baseline" and when Best to Get it

The fantasy of a "battery literate" person is that complete capacity and internal resistance test data, from day zero, is available for analysis. He seeks to determine the typical internal resistance of cells at 100% and 80% as well as the trend from 100% through 80% capacity.

The fantasy begins with the battery's installation. An acceptance capacity test is conducted and the cells' internal resistances measured. The results should be fairly uniform and he would safeguard this data. He knows it serves as the ideal baseline, or "reference" per IEEE/ANSI P-1188, for future internal resistance tests. He will then be able to make cut and dry decisions about maintenance or cell replacement.

Unfortunately, it's a fantasy in most environments because, in the rush and tumult of getting a facility on-line, establishing a baseline usually has low priority. As a result, we are then left to getting data in the best ways possible.

The second best time to obtain a set of data is shortly after capacities have been determined on the same model cells of the same age. Lastly, try obtaining data on the same model cells of any age. Over time, data to the end-life or 80% capacity level will be accumulated.

Caution

Internal resistance data taken *without* the benefit of correlated known capacities is often referred to as "as-found comparative values." This as-found data could be used to set a baseline, but be *very cautious*. It is not unusual to find an entire string of cells of uniform internal resistances, and normal appearance on float, but with *failing capacities*. In this situation, we highly recommend at least a crude service/load test be performed to lend some credence to the internal resistance measurements.

The Course Of Action

If you do not have end-life or 80% baselines developed from significant samples of the same cells, age, etc., you should use the following rough rules-of-thumb based upon Cellcorder user reports and in-house experience.

If the internal resistance is: 20%–50% above the 100% baseline, then the cell be load tested.... the sooner the better if it's towards the high end; at 50% or above the baseline, the cell be replaced.

Surprisingly, the IEEE/ANSI VRLA P-1188 proposed standard is more liberal in this matter. It recommends that from 25% to about 43%, the cell's manufacturer be contacted. Above 43%, a load test be done ASAP. Actually, the standard is expressed in the reciprocal of internal resistance, conductance (mhos.)

Data Anomalies

Another part of the battery literates' fantasy is also likely to be shattered: that all the data gathered for the baseline, or test readings taken afterward, would fall reasonably close to any trend line. That is, higher capacity cells will have uniformly lower internal resistances and lower capacity cells will have proportionately higher internal resistances. Even cells fresh off of a tightly controlled production line fail to completely conform with this expected behavior.

In the course of your own testing, you will find tested, high capacity cells with an unusually high internal resistance. Similarly, there will be cells with the low internal resistance characteristic of a good cell that would fail a capacity test. Unfortunately, the current state of the art does not permit impedance, conductance, admittance or resistance testing to definitively identify the cells with anomalies—without the assistance of a load test.

If you are fortunate to have large amounts of both capacity and corresponding internal resistance data, developing a baseline should be no problem. When a program is just starting, or there are few cells of a particular model, some educated “guess-timating” helps in sorting out data. If you need baseline data try calling us or the cell's manufacturer.

Internal Resistance Test Frequency

The whole purpose of the internal resistance check is to determine whether a cell has deteriorated and if so, how much and how fast. Logically, checks are done periodically. At least quarterly, check cells that have exhibited signs of abnormality either from inspection or an earlier capacity, integrity or internal resistance test.

Since neither specific gravity nor visual checks can be done on sealed cells, you would want to do much more frequent testing than on vented cells. For that reason, it's no surprise the P-1188 VRLA proposed Standard recommends internal measurements be taken quarterly. On the other hand, the standard for vented batteries, 4501, doesn't specify this type of check. However, it does call for annual connection resistance readings and you would want to take the internal resistances at the same time.

That's the nicest part of the Cellcorder...its “multimeter” functions measure and record both the internal and connection resistances at the same time! It saves you time and you don't even move the test leads for single post cells. For detailed information, request Cellcorder Application Note CC002, Intercell Resistance Measurement Procedures which covers single and multiple-post cells measurements.

Managing the Cellcorder's Data Files

As a testing program progresses, the number of computer data files will increase rapidly... as many as four yearly per battery string if the P-1188 guidelines are followed. To quickly identify these type files and manage them with minimum errors through DOS or through Windows File Manager, a file naming system can be important. Try to include in the filenames' eight characters as many descriptors as possible to reflect the data's date, location and battery. Thus, filename 941WPB1A.DAT would describe the first test data, in 1994, for location WPB's battery 1, string A.

Application Note CC-001

Whether you use numbers or characters, the important thing is to make the filename as recognizable as possible while avoiding duplicate filenames. This helps immensely in finding files and to avoid overwriting, deleting or copying wrong files, especially when using operating systems before version MSDOS 6.

Safeguarding the Cellcorder

By far, the most common cause of damage to the Cellcorder is from grossly excessive input voltages, particularly when taking UPS cell readings.

AWARENESS is the most important factor in avoiding these kind of problems. Before any testing begins, take five minutes to survey the battery bank to make sure that:

- cells are not miss numbered
- the intertier cable routing is unmistakable
- the main battery terminals and other span able high voltage points are identified and temporarily covered

Also, before making a measurement that includes a cable routed through a tray to another tier, use a voltmeter to identify the other end. Make sure no potentially damaging voltage is present.

- POWER-UP the Cellcorder before connecting it to a battery. This activates additional protective circuitry.
- CLEAN-UP is also important especially in preserving the jaws and clips
- of the test leads. Wipe off all grease and then apply an acid neutralizing solution.

References

1. ANSI/IEEE 450-1995, "IEEE Recommended Practice for Maintenance, Testing and Replacement of Vented Lead-Acid Batteries for Stationary Batteries," ANSI, New York, NY 1995
2. ANSI/IEEE PAR #1188, "IEEE Recommended Practice for Maintenance, Testing and Replacement of Valve Regulated Lead-Acid Batteries for Stationary Batteries," ANSI, New York, NY 1994
3. E. Willihnganz and P. Rohner, "Battery Impedance: Farads, Milliohms, Microhenries," AIEE, 1959
4. S. DeBardelaben, "Determining the End of Battery Life," Intelec '86, Toronto, Canada
5. S. Misra, T. Noveske, L. Holden, S. Mraz, "Use of AC Impedance/Conductance and DC Resistance for Determining the Reliability of VRLA Battery Systems", Intelec '93, Paris, France
6. Y. Konya, T. Takeda, K. Takano, M. Kohno, Et. Al., "A Deterioration Estimating System for 200 AH Sealed Lead-Acid Batteries", Intelec '94, Vancouver, B.C.
7. K. Peters, "Ten Years Experience of VRLA Batteries in Telecommunications Service," May 1994, 8th Battery Conference and Exhibition, Solihull, UK
8. Johnson Controls, "Impedance and Conductance Testing," Application Note Form 41-7271, Aug. 1994, Milwaukee, WI and Vertiv in-house data.
9. G. Alber, "Are Internal Cell Parameter Measurements a Substitute or Supplement to Capacity Testing?" Sep. 1994, NE Utilities Battery Conference, Albany, N.Y.

20. Application Note CC-002-A

Internal Resistance Measurement Procedures Introduction

Intercell resistance problems account for a great many battery system failures. In UPS or other high current applications, the failures can lead to explosions and fires that are not only costly but also represent safety hazards.

Most battery manufacturers, unfortunately, do not supply baseline resistance values, so presently users must establish their own values. The recommended procedures for establishing base lines are:

New systems... read all the resistance values after installation and calculate the average value.

Older systems... disassemble 10 sets of intercell connections; burnish, neutralize and clean them; reapply corrosion inhibiting compound, reconnect, retorque, and then calculate the average of the new readings. Intercell resistance measurements should be taken once a year of all cells (IEEE-450-1995 and forthcoming IEEE VRLA maintenance recommendations). Any connection that is 20% or greater than the baseline or installation value requires corrective action. The importance of these measurements is illustrated by the new VRLA standard that recommends quarterly sampling 25% of the intercell connection resistances. If an upward trend is detected, all connection resistances should be measured to aid in determining the cause and corrective actions.

How to Take Readings

When taking intercell connection resistance readings, it is important that: the test leads are connected properly. Measurements should include the post to intercell connector resistance. Always check your connections and connect *only* to posts, *not* nuts, bolts or straps. (This is the main area where connection problems occur) The test probe tips make a good connection, piercing any grease, lead oxide or crud coating the posts or straps. This is the leading cause of error messages after pressing the test button. Often jiggling the probe will lower the readings significantly and save you the heartache of unnecessarily reworking a connection.

Single Interconnections

The following figure shows how the Vertiv Cellcorder should ideally be connected to obtain the proper measurement. Note that, ideally, the reading includes both the intercell connector resistance and the post to intercell connection resistance.

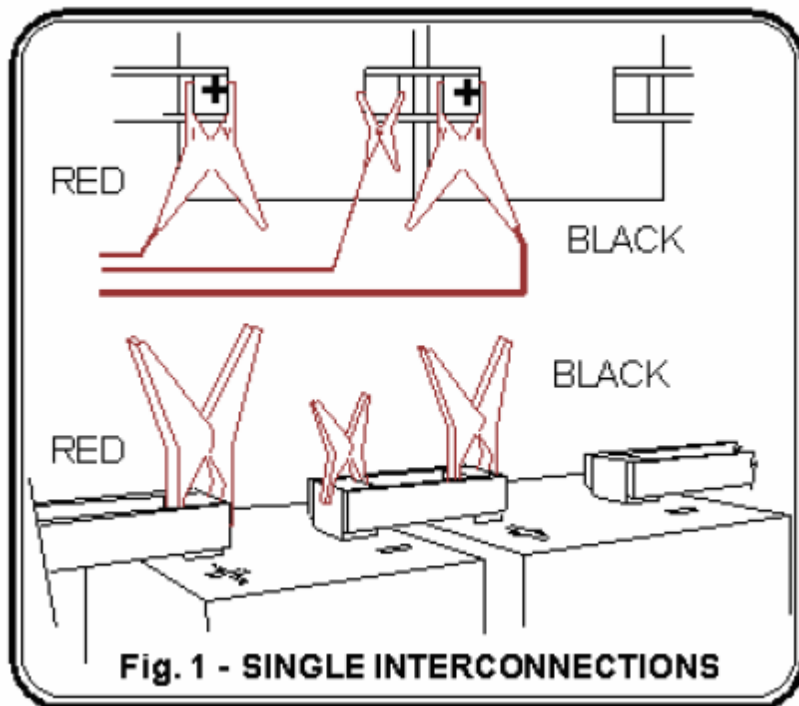

Figure 95 - Single Interconnections

The next figure (Fig 2A) below shows the connection for VRLA cells, such as the ABSOLYTE II batteries, where the terminal post is accessible. Figure (Fig 2B) below shows the connection for VRLA cells where the terminal post is not accessible. In this type of cell, the intercell to post connection resistance is included in the internal cell resistance measurement.

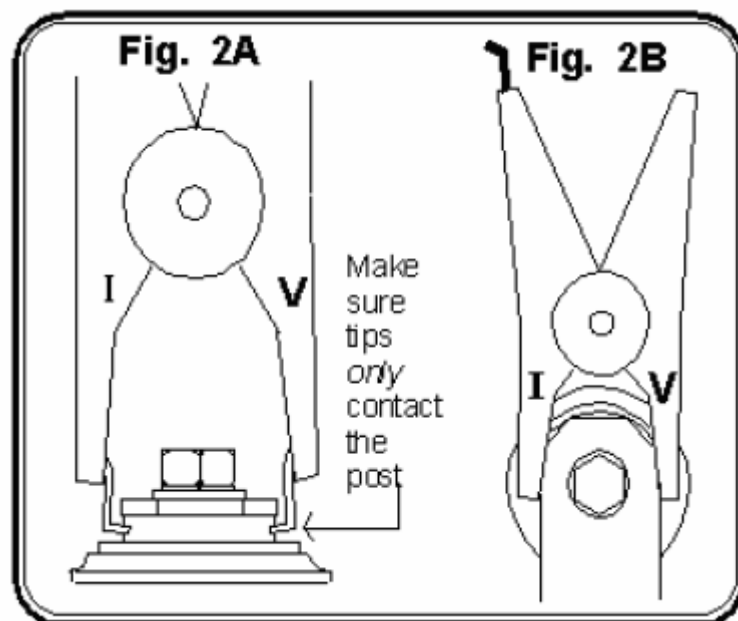

Figure 96 - Contacting Tips to Posts (Fig. 2A and Fig. 2B)

Note: Do not connect to the stainless steel bolt heads to make this measurement.

Dual Interconnections

Figures (3A) and (3B) below, show the typical intercell connections for dual post cells. This type of interconnection requires that two readings be taken.

The first one shown should be with the intercell leads connected from Terminal Post A to Terminal Post C. Take the second reading with the intercell leads connected from Terminal Post B to Terminal Post D. The positive (a red clip) Cellcorder lead should remain connected (as shown) to the same terminal post for both measurements.

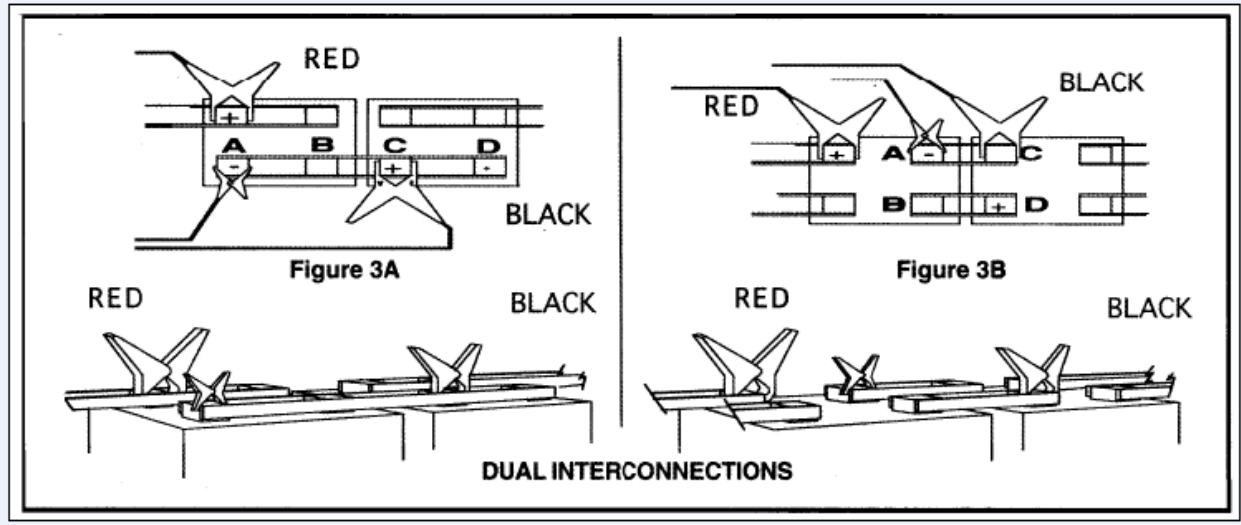

Figure 97 - (Figure 3A and 3B) Connections for Dual Posts.

Triple Interconnections

Figures (4) and (5) show the typical intercell connections for triple post cells. For cells arranged as in (Fig. 4), three readings are made. The first one, shown, should be with the intercell leads connected from Terminal Post A to Terminal Post D. Take the second reading with the intercell leads connected from Terminal Post B to Post E. The third reading is with the intercell leads connected from Terminal Post C to Post F.

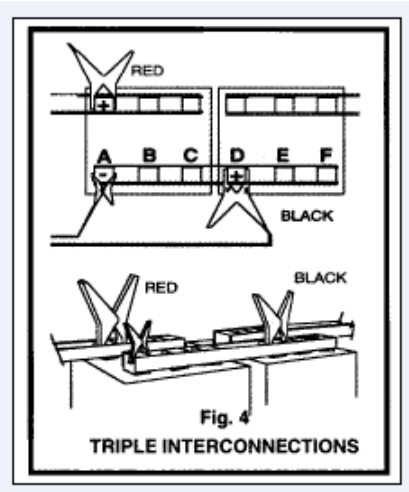

Figure 98 - (Figure 4) Connections for Triple Posts.

For VRLA cells or flooded cells configured as shown in the figure below, four readings are made, forming two “X’s.” Terminal Posts A to E then B to D, and B to F then C to E.

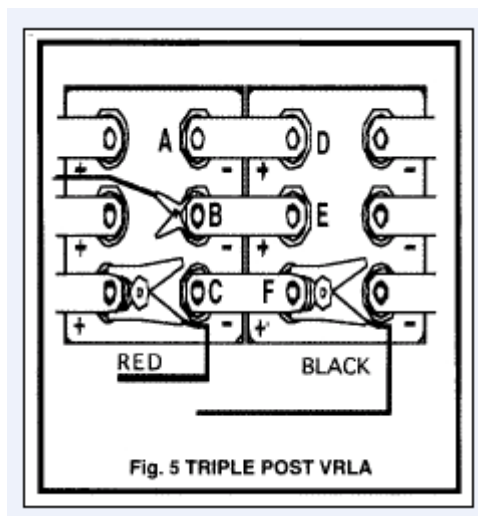

Figure 99 - (Fig 5) Connections for Triple Posts.

In all triple post strap measurements, the positive (a red clip) Cellcorder lead should remain connected (as shown) to the same terminal post for all readings.

21. Cellcorder Connection Options

For further information on which Cellcorder leads are best suited to your individual requirements, contact your local VERTIV representative or VERTIV directly at: www.vertivco.com Phone (954) 377-7101 Fax (954) 377-7042.

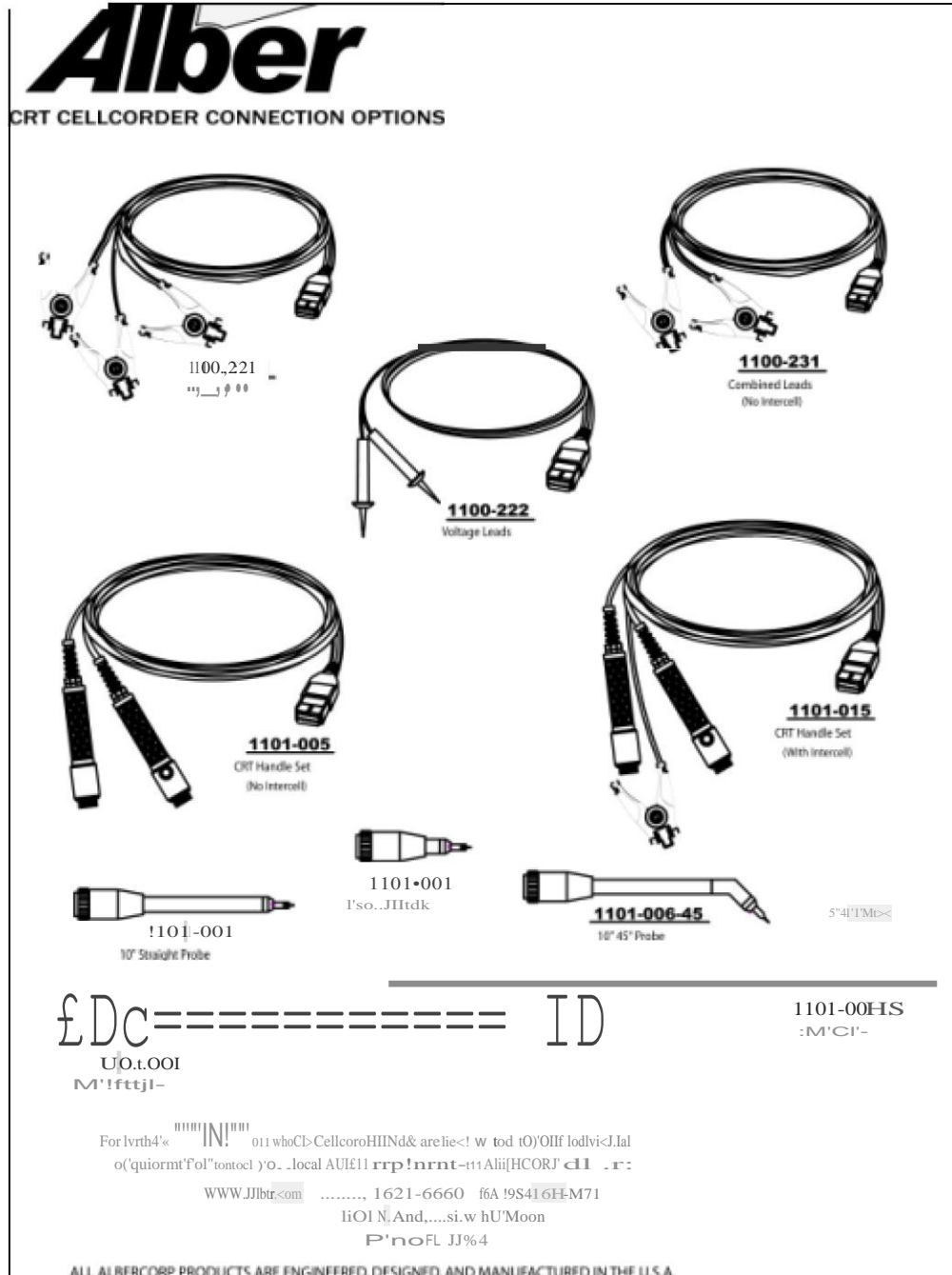

Figure 100- CRT-400 Cellcorder Connection Options

23. Index

- .ADF File 15-3
- .BLF Baseline Resistance File 15-3
- .CSV File Comma Separated Value File 15-3
- A/D Linearity 17-3
- AC Power 3-14
- AC Power LED 3-9
- Auto Ranging 3-3
- BAS Software 3-1
- Baseline Resistance Data 15-4
- Baseline Resistance Data File on USB 5-3
- Battery Aging and Internal Resistance 19-6
- Battery Charge LED 3-9
- Battery Maintenance Schedule 18-4
- Bluetooth* option 4-1
- Bottom Panel Connectors/Accessory
 - Compartment 3-14
- Buzzer 17-4
- Cellcorder
 - features 3-1
- Cellcorder Serial Number 3-1
- Changing the Password 18-3
- Charge Complete 4-2
- Charging
 - Cellcorder Battery 4-1
- Classical Cell Model 19-2
- Clearing Memory 13-6
- Combined Testing 7-4
- Computed Testing 7-4
- Connecting
 - Resistance Test Leads 9-1
- Connection
 - Dual Post Cells 9-2
 - Single Intercell 9-1
- Connection Options 21-1
- Connections
 - Triple Post Cells 9-4
- CRT Clear 14-5
- CRT Load Data Main Menu 14-4
- CRT Setup 5-2, 5-9, 13-1
- CRT-400
 - Display 3-15
 - Physical 3-15
- CRT-400
 - Memory 3-15
- CRT-400
 - Communication 3-15
- CRT-400
 - Battery 3-15
- CRT-400
 - Main Menu Functions 5-1
- Damaged Equipment 1-2
- Data Analysis, Storage and Transfer 3-4
- Data Anomalies 19-10
- Data Logger 12-1
- Data Logger to Transfer Data 12-5
- Deleting a *Bluetooth* Device 13-14
- Deselect a Site 14-5
- Deselecting a Site 5-8
- Diagnostics 17-1
- Digital Voltmeter 11-1
- Displaying Additional Functions 13-8
- Document Symbols 1-1
- Dual Interconnections 20-3
- Dual Testing 7-3
- Editing a Site Template 14-1
- Electrochemical Resistance 19-5
- Entering the Password 18-1
- Equipment
 - Service 1-2
- Error Codes 18-4
- F1, F2, F3, and F4 Buttons 3-12
- Fan 17-4
- Flash Code 18-1
- Float Voltage 3-3
- Frequency 13-9
- Help LCD windows and Menu Selections 3-14
- Hydrometer 12-1
- Hydrometer Usage 12-2
- ICr Channel 17-3
- Infrared Port 3-2
- Intercell Resistance 3-4
- Intercell Resistance Threshold 13-6
- Internal Cell Resistance 3-4
- Internal Components 2-1
- Internal Resistance 19-10
- Jaw Options 22-1
- Keypad Buttons 5-7
- Load Data 5-2, 5-5

Index

- Load Module 17-2
- Measurement Capabilities 3-3
- Metallic Resistance 19-5
- Modem (If Installed) 17-4
- Momentary Test Discharge 19-8
- Moving Probes 9-6
- Nature Of Internal Resistance 19-2
- Navigation 5-3
- Normal Use Protection 2-1
- Panel Controls and Indicators 3-8
- Part Numbers 3-5
- Password 18-1
- Password Change 18-3
- Preventive Maintenance 2-1
- Product Safety Practices 1-2
- Protection Circuit 17-3
- Quad Testing 7-4
- Radio Frequency RF Headset Communication 3-4
- Reading USB 5-9, 13-2
- Readings 3-3
- Recommended Reading 4-1
- Reset Switch 3-4
- Resistance Measurement Procedures 20-1
- Resistance Readings 7-1, 8-1
- Resume Testing 6-3
- Safeguarding 19-11
- Safely Remove Hardware 4-5
- Safety Information 1-1
- Safety Relay 17-1
- Safety Symbols 1-2
- Selecting a Battery 13-2
- Selecting a Manufacturer 13-2
- Selecting a Model 13-2
- Sending Readings Via IR 15-12
- Serial Number Location 3-2
- Service Menu 18-1
- Servicing and Adjusting 1-2
- Set Amp Hours 7-3
- Set Intercell Connections 7-3
- Setting Date and Time 13-10
- Setting Thresholds 13-3
- Shipping 2-1
- Single Interconnections 20-1
- Single Testing 7-3
- Sound Adjustment 13-9
- Specific Gravity Threshold 13-6
- Specific Gravity Thresholds 12-3
- Stop a Resistance Test 9-6
- Storage 2-1
- Stored In Memory 6-2
- Substituting Parts or Modifying Equipment 1-3
- System Overview 3-1
- TELCO 3-14
- Temperature and Internal Resistance 19-6
- Temperature Sensors 17-4
- Test Lead 3-3
- Test Lead Connection 4-3
- Test LED 3-10
- Test Mode 5-2
- Threshold Temperatures 12-3
- Top Panel Controls Keypad 3-10
- Top Panel Indicators 3-9
- Transferring
 - Hydrometer Data to Computer 12-6
- Trans-reflective LCD 3-12
- Triple Interconnections 20-3
- Triple Testing 7-4
- Uninterruptible Power Supply 1-3
- Upgrade Firmware Using the USB Device 18-5
- Upgrading Firmware 18-5
- UPS 1-3
- USB connection 3-3
- USB Device 4-4
- USB LED 3-10
- USB Port and Flash Hard Drive 4-4
- Using the Hydrometer 12-4
- Valve Regulated 19-1
- Vented Cells 19-1
- View Results 5-2
- Viewing Status 16-1
- Voltage and Current Protection 3-16
- Voltage Skewing Effect 10-1
- Voltage Test Leads 6-1
- Voltage Testing 6-2