

***MESA/BOOGIE***



**SOLO 50<sup>™</sup> / RECT-O-VERB 50<sup>™</sup>**

---

**Series 2**

***Owner's Manual***

## *Hello from the Tone Farm*

*...You, smart player and all around intuitive human, have put your trust in us to be your amplifier company. This is something we do not take lightly. By purchasing and choosing this unit to be a part of your musical voice, you have become part of the MESA family...WELCOME! Our goal is to never let you down. Your reward is that you are now the owner of a great amp, bred of fine all tube amp heritage...benefiting from the many pioneering and patented MESA circuits that led to the refinement of your new instrument. Feel confident, as we do, this amp will inspire many hours of musical satisfaction and lasting enjoyment. It was built with you in mind, by players who know the value of a fine musical instrument and the commitment it takes to make great music. The same commitment to quality, value and support we make to you...our new friend.*

# SOLO 50™ / RECT-O-VERB 50™ Series 2

## TABLE OF CONTENTS

Precautions	
OVERVIEW	1/2
INSTANT GRATIFICATION (2 DEMONSTRATION SETTINGS)	2
CHANNEL / MODE SELECT	
CHANNEL 1: CLEAN & PUSHED	3
CHANNEL 2: RAW, VINTAGE & MODERN	3/4
<b>CONTROLS</b>	
GAIN	4/5
TREBLE	5
MIDDLE	5/6
BASS	6
PRESENCE	6
REVERB ( <i>Rect-o-Verb Combo &amp; Heads only</i> )	6
MASTER	7
OUTPUT CONTROL	7
SOLO CONTROL	8
<b>TOGGLE SWITCHES</b>	
STANDBY	8
POWER	8
<b>REAR PANEL CONTROLS, SWITCHES &amp; JACKS</b>	
SLAVE OUT	9
SPEAKERS	9
BIAS SELECT	9/10
FX LOOP: Send & Return	10
EXTERNAL SWITCHING	10
CHANNEL SELECT TOGGLE	11
FUSE	11
AC RECEPTACLE	11
FACTORY SAMPLE SETTINGS	12/13
PERSONAL SETTINGS SHEET	14/15
TUBE DESCRIPTION & TASK CHARTS	16
SPEAKER IMPEDANCE & POSSIBLE HOOK-UP SCHEMES: Amplifiers to Speaker Cabinets	17/22
DIAGNOSING POWER TUBE FAILURES & MAINTENANCE	23
DIAGNOSING PRE-AMP TUBE PROBLEMS	24
BIAS ADJUSTMENT: <i>A feature article by Randall Smith</i>	25/27
TRIODES, PENTODES & IRISHMEN: <i>A feature article by Randall Smith</i>	28/30
PART SHEET	31

# PRECAUTIONS & WARNINGS

*Your MESA/Boogie Amplifier is a professional instrument. Please treat it with respect and operate it properly.*

## USE COMMON SENSE AND ALWAYS OBSERVE THESE PRECAUTIONS:

**WARNING:** EU: permission from the Supply Authority is needed before connection.

**WARNING:** Vacuum tube amplifiers generate heat. To insure proper ventilation always make certain there is at least four inches (100mm) of space behind the rear of the amplifier cabinet. Keep away from curtains or any flammable objects.

**WARNING:** Do not block any ventilation openings on the rear or top of the amplifier. Do not impede ventilation by placing objects on top of the amplifier which extend past the rear edge of its cabinet.

**WARNING:** Do not expose the amplifier to rain, moisture, dripping or splashing water. Do not place objects filled with liquids on or nearby the amplifier.

**WARNING:** Always make certain proper load is connected before operating the amplifier. Failure to do so could pose a shock hazard and may result in damage to the amplifier.

Do not expose amplifier to direct sunlight or extremely high temperatures.

Always insure that amplifier is properly grounded. Always unplug AC power cord before changing fuse or any tubes. When replacing fuse, use only same type and rating.

Avoid direct contact with heated tubes. Keep amplifier away from children.

Be sure to connect to an AC power supply that meets the power supply specifications listed on the rear of the unit. Remove the power plug from the AC mains socket if the unit is to be stored for an extended period of time. If there is any danger of lightning occurring nearby, remove the power plug from the wall socket in advance.

To avoid damaging your speakers and other playback equipment, turn off the power of all related equipment before making the connections.

Do not use excessive force in handling control buttons, switches and controls. Do not use solvents such as benzene or paint thinner to clean the unit. Wipe off the exterior with soft cloth.

**YOUR AMPLIFIER IS LOUD! EXPOSURE TO HIGH SOUND VOLUMES MAY CAUSE PERMANENT HEARING DAMAGE !**

**No user serviceable parts inside. Refer service to qualified personnel. Always unplug AC power before removing chassis.**

**EXPORT MODELS: Always insure that unit is wired for proper voltage. Make certain grounding conforms with local standards.**

**READ AND FOLLOW INSTRUCTIONS OF PROPER USAGE.**

# SOLO 50™ / RECT-O-VERB 50™ Series 2

## Operating Instructions

### OVERVIEW:

Congratulations on your choice of the *SINGLE RECTIFIER 50 Series 2* amplifier. You have purchased a handbuilt instrument of the finest quality and craftsmanship. A unique blend of yesteryears' black magic power section design combined with our race-shop approach to finely tuned, high gain pre-amp circuitry leaves the *RECT-O 50 Series 2* standing alone...instantly a classic destined for vintage status. With two channels housing five definitive and distinctly different Modes, a complete array of amazing guitar sounds can be obtained quickly and easily.

Looking to the Rear Panel assures that all your interfacing needs are covered. A Parallel Effects Loop with a MIX Control provides tone insurance for even those questionable effects. To use the *SINGLE RECTIFIER 50* in larger rack systems, or to interface to other power sections, the SLAVE jack and is a welcome feature. Two speaker jack combinations have been provided - two 4 Ohm and one 8 Ohm - to ensure the proper impedance match to many types of speaker enclosures. The other features will prove to be quite valuable to you and further along in this manual they are covered extensively.

### FRONT PANEL HEAD VERSION: SOLO 50 HEAD SERIES 2

### Instant Gratification Demo Settings

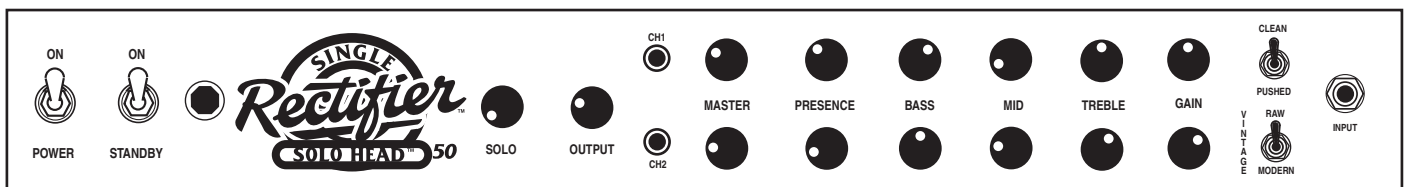

### REAR PANEL HEAD VERSION: SOLO 50 HEAD SERIES 2

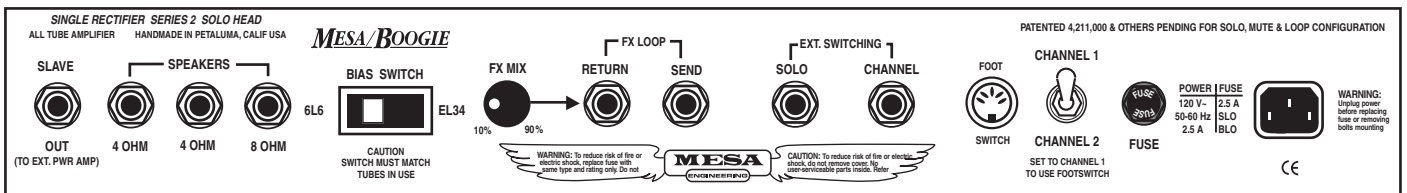

### FRONT PANEL COMBO VERSION: RECT-O-VERB 50 SERIES 2

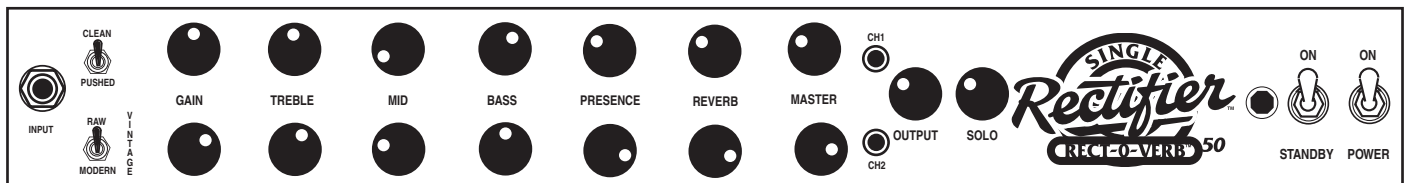

### REAR PANEL COMBO VERSION: RECT-O-VERB 50 SERIES 2

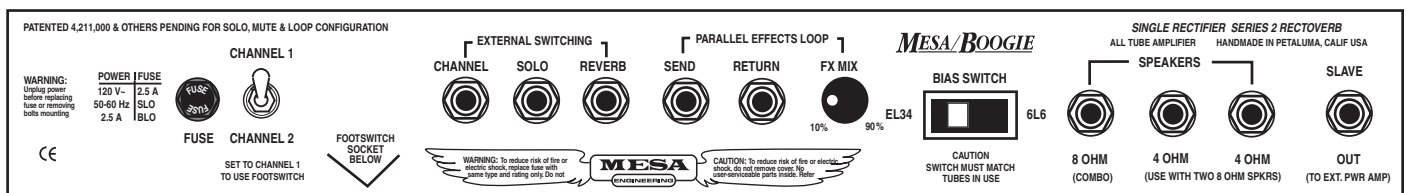

# FRONT PANEL:

First familiarize yourself with the layout of the Front Panel. Next, remove the footswitch from the transport pouch located inside the cabinet ( combo ) and connect it to the proper jack. **RECT-O-VERB Series 2** amplifiers use a DIN jack located on the underside of the chassis's outer edge. Labeling which reads FOOTSWITCH SOCKET BELOW should help you locate the jack. **SOLO 50 HEAD Series 2** amplifiers have their DIN Jack located on the Rear Panel proper. (See illustration at the bottom of this page). If the footswitch is not available, you may select the two channels via the manual Channel Select toggle switch located on the Rear Panel.

**POWER UP:** First remove the protective covers from the tubes (plastic webbing) before connecting the A.C. cord to a power receptacle. Connect your favorite guitar to the instrument INPUT jack. Flip the POWER switch to the ON position while leaving the STANDBY switch set to STANDBY. (It is always a good idea to practice this start up procedure as at least 30 seconds of warm-up time lessens the shock on cold power tubes, thus prolonging their life substantially.) Next, using the example below as a guide, set the controls as illustrated and flip the STANDBY switch to the ON position to listen to the two distinctly different channels using either the footswitch or the Channel Select toggle switch as mentioned in the paragraph above.

Before discussing each control, let's audition a couple of possible ways the two channels might be configured for footswitchable sounds. The first example leans towards a more traditional format with a clean rhythm dialed up on CHANNEL 1 ( Green ) and a moderate gain, vintage style solo sound dialed up on CHANNEL 2 ( Red ).

This second example leans in a more aggressive direction with CHANNEL 1 switched to PUSHED for a crunchy high gain rhythm sound and CHANNEL 2 switched to MODERN for a blistering lead voice.

**NOTE: CAUTION - REDUCE THE OUTPUT LEVEL CONTROL BEFORE PLAYING THESE SOUNDS AS THE ADDED GAIN INCREASES VOLUME LEVELS.**

Now that you've heard the **RECT-O 50's** two channels, let's move on to understanding the controls and their interactive roles in achieving the sounds that *you* want to hear.

## INSTANT GRATIFICATION: Demo Setting #1

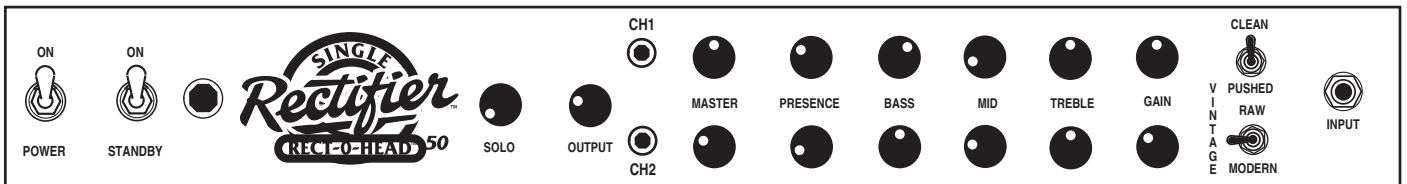

## INSTANT GRATIFICATION: Demo Setting #2

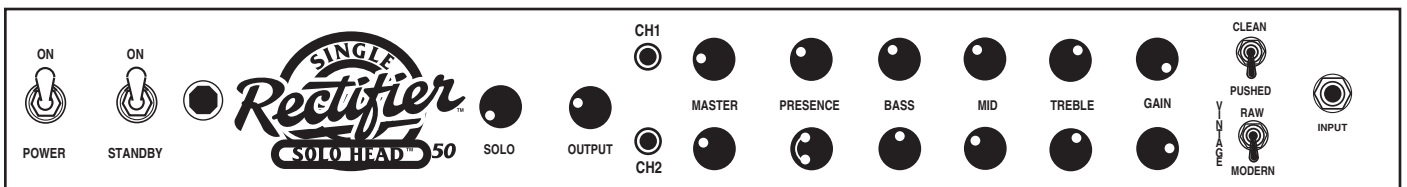

RECT-O-VERB COMBO Series 2

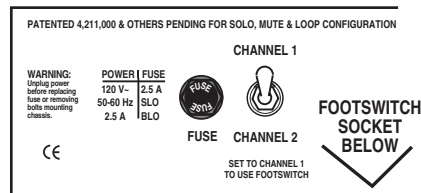

SOLO 50 HEAD Series 2

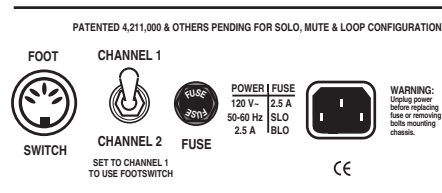

## CHANNEL / MODE SELECT:

Each channel of your amplifier contains different modes of operation that may be selected depending on your application. In this way you may decide to use the channels for their most obvious sounds or with the flick of a switch - invert the channels for the opposite sound style. The voicing of the modes is accomplished by rerouting and reconfiguring the circuit in both pre-amp and power sections of the amplifier. Here are the choices;

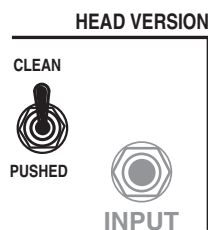

### CHANNEL 1

**CLEAN :** This is the lowest gain circuit of the *RECT-OS*' five modes and is optimized for producing balanced pristine clean sounds. For the best understanding of how to achieve a great sound in this mode, please refer back to the GAIN Control section of this manual. However, a great place to start is 12:30 or so on the GAIN Control with more sparkle available below this and more warmth apparent above...from there adjust according to your guitars individual response.

Because of its more traditional architecture this mode also works extremely well for vintage style drive sounds. By turning the gain all the way up, a beautiful old school solo sound is possible...especially with neck single coil pick-ups. The TREBLE and MIDDLE Controls can also add gain and sustain to this sound ( reduce Presence to blend highs ), but you will probably want to run the BASS Control below 10:30 to avoid flubbiness and preserve a focused attack.

**PUSHED:** This mode is a radical departure from the sweet shimmering blend of the CLEAN modes low gain character. Huge increases in gain early on in the first stages of the pre-amp produce one of the biggest differences between modes in the entire amplifier and transforms what you thought to be a tame and gentle clean channel into a raging crunch machine. This incredible amount of gain also creates one of the most expressive solo modes in your *RECT-O*. Because there are less stages of gain for the signal to travel through and the tone control network is tuned for the brighter nature of clean sounds, this mode responds quicker to your pick attack and has a more urgent, snappy feel. Don't overlook this mode for some of the *RECT-OS*' coolest overdrive solo sounds.

**NOTE:** When using PUSHED with the GAIN Control maxed (5:30), do not run the TREBLE Control above (2:30). Settings above (2:30) can create possible oscillation in certain preamp tubes in the V-1 position. This can be avoided altogether by setting the TREBLE Control sensibly when the GAIN Control is maxed. Use the PRESENCE Control for additional brightness.

### CHANNEL 2 / Modes

**RAW:** This new *RECT-O* mode has the lowest gain of the three in the high gain lead channel. Its' less saturated nature greatly enhances the already versatile bevy of sounds the lead channel offers. The range of gain available covers an extremely wide spectrum and it can be set to double as a formidable alternate clean mode, a low gain purring blues sound and beyond, all the way up to a grinding crunch or searing solo sound.

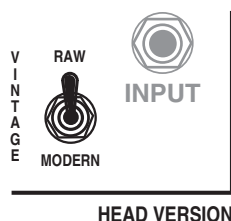

The TREBLE can be set relatively high (2:00) to add a little more gain and shred when using **RAW** for certain crunch rhythm sounds. Don't overlook the amazing low and medium gain soloing potential **RAW** offers, as its more gradual GAIN response produces a wide range of voice like single note sounds that are somewhat more dynamic due to less saturation.

**VINTAGE:** This high gain mode is the famous liquid *RECT-O* voice and it can be found in its original state here in CHANNEL 2. Its lush harmonic content and fat creamy feel has found its way onto so many recordings, it is now a staple for anyone headed to the studio for an album project. Combining this super juicy, expressive preamp with the *RECT-OS*' magic 50 watt power section creates colors in gain that most players find truly addictive. Single note solo work is effortless as the strings become easy to play with **VINTAGE** modes musical and natural tube compression. Spend time learning the lower regions of the **VINTAGE** mode as the overlap between RAW and **VINTAGE** is a place where many beautiful sounds lie. These two modes are similar enough when **VINTAGE** is set in its lower range and RAW is set in its medium to higher range and yet each possesses a character that is unique and identifiable. You will likely find your new trademark lead sound lurking somewhere in this sea of liquid gain.



## CHANNEL / MODE SELECT: (Continued)

### MODERN:

Aggressive. This is the word that best describes the menacing power of the *RECT-OS*' most rebellious of all modes. A take no prisoners, crushing assault of top end cut and lightning fast response creates a sound of unparalleled aggression that has set a new standard for hard core sounds. The added tightness of the low end response combined with the radically more present top end keeps the MODERN mode tracking accurately even at extreme gain settings.

## CONTROLS:

### GAIN:

This control adjusts the predominant gain stage in each channels' circuit with the function and taper being optimized for each individual channel. Remember that your *RECT-O 50* is really two separate multi-mode amplifiers built onto one chassis, so though each channel looks identical, the **GAIN** Control for each channel comes in a different place and adjusts a different point in that channels circuit.

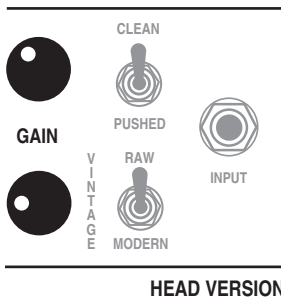

In most guitar amplifiers, and especially in all-tube circuits, the **GAIN** Control is the most powerful control in the preamp. It shapes the overall style and character of the sound and is responsible for whether the sound is clean, overdriven or anywhere in between. In your *RECT-O 50*, the **GAIN** Control is even more powerful. It not only determines the amount of drive, but also acts as an integral part of the tone control string as well.

To simplify the **GAIN** Controls' role in shaping the overall tone of the sound we will look at it in two ways - 1; alone and 2; in conjunction with the tone controls.

### 1) By itself the **GAIN** Control has basically three tonal regions -

**Low ( 7:00 - 11:00 )** provides the cleanest, least saturated sounds and in this region the sound will be brighter and contain more upper harmonics lending a three dimensional character to the sound.

**Middle ( 11:15 - 2:00 )** enhances the saturation and replaces some of the upper harmonics with a richer, warmer quality and a fuller bottom end response. Not yet fully saturated, this region is the easiest place to get a great sound in all three channels. This region contains many of the *RECT-OS*' best sounds...especially for soloing due to the crucial blend of an expressive attack combined with ample sustain.

**High ( 2:15 - 5:00 )** saturates the signal and enhances low and low mid frequencies. While this region provides the maximum saturation and therefor sustain, it also compresses and softens the attack characteristics. For this reason we suggest using this higher region of the **GAIN** Control sparingly and only when maximum sustain is needed.

**NOTE:** Due to the *RECT-OS*' extreme gain potential, the highest regions of the **GAIN** Control may possibly push the pre-amp tubes past what they can handle, producing microphonic squealing. While we screen and test the tubes your amplifier was shipped with and the tubes in your amp passed our rigorous test, we can't predict how the tubes will respond over time exposed to extreme gain settings. Your tubes are warranted for a period of 6 months under normal use, but you can save yourself the present and future inconvenience of having to deal with annoying microphonic tube problems by simply using a little common sense...**Don't turn the Gain all the way up!**

If you must for a specific part or at very low volumes, back down the **TREBLE** and **PRESENCE** Controls. Your *RECT-O 50* was designed to provide amazing gain and tone at less than extreme settings removing the need for you to crank everything all the way up. If you are not able to achieve the sound you want at sensible settings on any or all of the controls, your problem may lie elsewhere in the signal chain, i.e. pick-ups, cabinetry, processing etc. Keep in mind you can always call on one of our product specialist Monday through Thursday and seek some advice should you find yourself struggling to get the sound you want.



## CONTROLS: (Continued)

**2.) GAIN - In conjunction with the Tone Controls** - Basically, a simple rule applies...as the Gain is increased the Tone control string has less and less effect on the signal until at 5:00 the signal is so saturated that you are *getting mostly Gain and very little Tone*. Again, this is the reason we suggest using the **GAIN** Control in its middle region. Here the Tone control string is very active and provides maximum shaping power - allowing you to dial virtually any sound you desire.

**TREBLE:** As in most tube guitar amplifiers, the **TREBLE** Control ( in both channels of your *RECT-O 50* ) is the most powerful of the rotary controls and is next in line only to the **GAIN** Control as a shaping tool. Because it is first in the signal path of the tone controls - and from here the Middle and Bass receive their signal - it is by far the dominant tone control. For this reason the setting of the **TREBLE** Control is very important for equal representation of the three frequency regions to appear at their respective controls. Like most of the controls on your *RECT-O 50*, there is an optimum region of the **TREBLE** Control where ample top end is mixed in and yet enough signal is still passed on to the **MIDDLE** and **BASS** Controls.



Between 11:00 and 1:30 is where you'll find the sweet spot . There are definitely great sounds above and below this middle region, but the balance between the **TREBLE** Control and the other two tone controls is compromised.



The one place you may want to throw caution to the wind and set the **TREBLE** Control above this median zone presents itself in Channel 1 of your new *RECT-O 50*. In both modes ( Clean & Pushed ), the **TREBLE** Control can be used to dump extra gain into the mix. This is especially effective in the **PUSHED** mode for crunch sounds. When doing so use the **PRESENCE** Control to roll off some of the more than ample top end

for a more compressed feel and fatter voice. As you might surmise, the **BASS** Controls' effectiveness will be reduced, so you may have to run a much higher setting than you are used to seeing to achieve a balance. This said, keep in mind that the **TREBLE** Control in Channel 1 Pushed should not be set much above 2:30 to avoid unwanted microphonic tube problems.

**MID:** The **MID** Control is responsible for the blend of midrange frequencies in the mix and though its effect is not as dramatic as that of the **TREBLE** Control, it plays an integral part in achieving any sound in your *RECT-O 50*. It is capable of changing the feel dramatically as it blends in a group of frequencies that tend to soften or stiffen the way a sound feels to play.



Most players tend to lean in the direction of lower **MIDDLE** Control settings ( 7:00 - 11:00 ) where a scoop in this region produces *girth* ( by letting the Bass become a little more dominant ) and a lack of punch lends a more compressed, *even* feel to the strings and therefore less apparent resistance to the pick. As the **MIDDLE** Control is increased, ( 11:30 - 1:30 ) the sound is rounded-out and filled-in with a focused mid attack appearing rather quickly. As you would guess, the feel starts to change - becoming more resistant. Above this region the **MIDDLE** Control could be used to compensate for either weaker pick-ups or for times when a specific deficiency is produced by either an extremely high setting of other tone controls, or a physical anomaly in the room. While these **MIDDLE** Control settings ( 2:00 - 5:00 ) can introduce added gain and create enhanced focus, the trade-off will be a stiffer, more forward, less compressed feel.

HEAD VERSION

**Channel 1 utilizes a different MIDDLE Control than that of the Channel 2** with a custom-designed taper and value. In its low range ( below 12:00 ) it functions as a normal midrange control with a taper suited to blending fine increments of these frequencies. Most players lean toward a fairly radical scoop ( 7:00 - 10:30 ) for clean playing, preferring to let Treble and Bass remain dominant, thus producing the signature sparkle and breath essential for a pristine clean sound.

## CONTROLS: (Continued)

As Channel 1's **MIDDLE** Control is swept past 1:00, it quickly starts to add gain in these midrange frequencies adding cut and punch. As the top end of the control is reached, ( 3:00 - 5:00 ) it becomes an additional *gain control* capable of taking both **CLEAN** and **PUSHED** modes to extremes. Experiment with this cranked region in conjunction with conservative settings of the other tone controls to balance both sound and feel. While this added flexibility may make Channel 1's **MIDDLE** Control a little more tricky to learn at first, it will become quite valuable as you start to realize the power of this super versatile channel.

**BASS:** Last, but not least in the string of tone controls we come to the **BASS**. This control works similarly in both channels in that it determines the amount of low frequencies present in a sound. However, the actual frequencies and *style of lows* it mixes in changes from channel to channel. Like the **MIDDLE** Control, it falls in line signal-wise *after* the **TREBLE** Control and the same scheme applies.

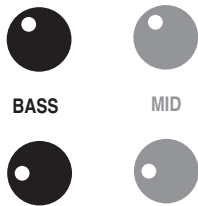

HEAD VERSION

When the **TREBLE** Control is set high, the effectiveness of the **BASS** and **MIDDLE** Controls is reduced. If the **TREBLE** Control is set low these two controls become dominant.

For the most balanced sound and a balance of power between the three rotary tone controls, try to use the **TREBLE** Control in its middle ranges. This scenario produces nearly equal representation of all the frequencies on the tone controls and provides a great neutral starting point for further tweaking.

**PRESENCE:** The **PRESENCE** Control is a high frequency attenuator that is placed at the end of each channels pre-amp stage and affects frequencies higher than those of the **TREBLE** Control. It acts independently of the other rotary tone controls and is crucial in voicing the Channel. It is a powerful global tone control. Lower **PRESENCE** Control settings darken and, in fact compress the signal which works well to fatten single note solo sounds, giving them girth and focus. Some of the best lead sounds in your **RECT-O** will find the **PRESENCE** Control in its lower regions, where a balanced, vocal response is achieved.

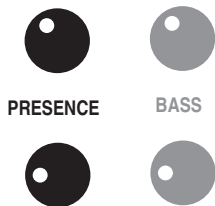

HEAD VERSION

Higher settings unleash the mighty roar of your **RECT-O** and this can be great for sparkling clean sounds in Channel 1 and more aggressive crunch rhythm sounds in the high gain modes. Be sure to taunt the beast that lurks in Channel 2 **MODERN** as the **PRESENCE** is truly amazing in this most agro mode.

**REVERB: RECT-O-VERB / COMBO & HEAD** These self explanatory controls deliver the rich natural reverb sound. Although the circuit is the same for both Channel 1 & Channel 2, the amount of **REVERB** available is not. In Channel 2 there is slightly less **REVERB** available overall because of this channels' very nature.

The reason behind this is two fold: 1.) that it is easier to prevent the massive amount of Gain and signal strength present in either of Channel 2's high gain modes from causing unwanted **REVERB** oscillations.

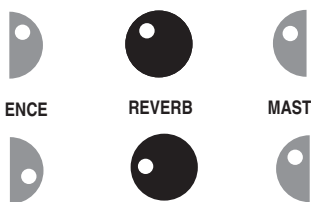

2.) This channels aggressive nature lends itself more to musical styles where high settings of **REVERB** are simply not traditional. Don't worry...there is still plenty of **REVERB** for drenched solo work in both the **RAW** & **MODERN** Mode in Channel 2. Simply run the **REVERB** Control a little higher than that of Channel 1.

## CONTROLS: *(Continued)*

### MASTER:

This control is the master feed from the end of the pre-amp to the driver stage and the Effects Loop. As you can see each Channel is fitted with its own **MASTER** Control, enabling the two channels relative volumes to be matched regardless of their extremely different sound styles and gain signatures. The **MASTER** Control makes possible a wide range of sounds through its ability to use very low **Gain** sounds at high volumes and conversely, high **Gain** sounds at low volumes and everywhere between.



Again, we suggest using the **MASTER** Control in its *sensible* ranges ( 9:00 - 2:00 ). Here, the channels will be easier to match with each other and the Effects Loop will see more reasonable signal levels.



**NOTE:** Because the **MASTER** Control creates the send to the Effects Loop, extreme settings will cause a large signal to be sent to the Loop for that Channel. Not only may this cause possible overloading of the processors Input stage, but will make balancing the two channels' Effect Send level difficult.

### OUTPUT:

This control determines the overall output volume level of the amplifier. After the GAIN Controls have been set for the desired sound style and the two channels levels have been balanced with the channel MASTER Controls, the **OUTPUT** Control allows you to change the playing level by adjusting a single control. The **OUTPUT** Control is also wired as the Effects Loop Return Level Control. Should you ever use your **RECT-O 50** amplifier as a power amp alone by inserting a signal into the RETURN jack, the **OUTPUT** Control will serve as the master level control.

HEAD VERSION



**NOTE:** When using the EFFECTS RETURN as an input - to use the **RECT-O** amplifier as a power amp - the SOLO Control can be used to attain a footswitchable boost if the Footswitch is connected. It is wired in parallel to the **OUTPUT** Control and therefore also controls the volume of the power section.

**NOTE:** The Effects Loop RETURN jack can serve as a power amp input so that you may use the **RECT-O 50** amplifier as a power amp for either stereo reproduction or to incorporate additional pre-amps. Here are a few things to remember that will help you when interfacing to the **RECT-O** for use as a power amp only;

- 1.) Connect "Dummy" plug or loose cable to SEND jack. ( This prevents any possible loading that could result in diminished RETURN sensitivity.)
- 2.) The OUTPUT Level will be the only active control on the Front Panel (the PRESENCE Control of Channel 1 will be active only when that channel is engaged - see #3 )
- 3.) The SOLO Control may be used to footswitch to a pre-determined amount of boost when the footswitch is connected.
- 4.) Channel 2's MODERN mode - as part of its voicing - utilizes substantially less negative feedback in the power stage creating a scenario of greatly increased power sensitivity. This internal revoicing produces amazing results in the lead sounds and requires a sophisticated network of elements to switch to prevent the increased power sensitivity from blowing you out of the room as Channel 2's RAW & MODERN modes are toggled between.

Therefor, we recommend selecting Channel 1 when you wish to use the **RECT-O** as a power amp. The more conventional power sensitivity of this channel will be the most compatible with external sources. Also, using Channel 1 in a power-only application means that the PRESENCE Control will be active which allows you to tailor the power voicing to your specific tastes. If you do need the extra sensitivity that Channel 2's MODERN mode produces for a source that is unusually weak, it is there if you need it. The PRESENCE Control will not have any effect on the sound as it switches with the mode change to an earlier stage in the pre-amp.

- 5.) The EFFECTS MIX Control must be set to 90%.

## CONTROLS: *(Continued)*

**SOLO:** This control can only be activated if the correct Footswitch is connected to the Footswitch DIN jack. **SOLO** is an additional final output level control wired in parallel with the OUTPUT Control. It is capable of a setting above that of the OUTPUT Control and can not be set below. The amount of apparent boost also depends on that of the OUTPUT Control - in that if the amplifier is at either the extreme low or extreme high levels of the OUTPUT, its effectiveness is minimized. It has been optimized for live performance volume levels.

HEAD VERSION



SOLO



OUTPUT

If the power section is either not a part of the sound (super quiet), or producing all its rated wattage (super loud), there is very little signal for the **SOLO** control to work with. By using the Footswitch and selecting **SOLO**, a pre-settable boost in overall levels is possible on the fly...giving you some control over your levels when it's time to step out. Engineers may give you a bit of a frown the first time you use it...but isn't it time you heard yourself. It might even prevent them from punishing you with the dreaded monitor or sidefill version of your tone.

**STANDBY:** Perfect for set breaks... this toggle switch also serves an even more important purpose. In the Standby position the tubes are at idle so that during power up they may warm up before being put to use. Before Power is switched on make sure the **STANDBY** switch is in the Standby position.

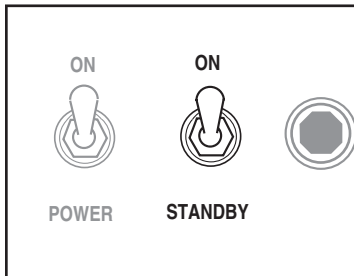

HEAD VERSION

Wait at least 30 seconds and then flip the **STANDBY** switch to the ON position. This prevents tube problems and increases their toneful life substantially.

**POWER:** This switch delivers the A.C. power to the **RECT-O 50**. Make sure the unit is grounded (all three terminals of the A.C. power cord must be connected whenever possible to avoid injury to the user as well as to the unit) and that the proper voltage is present.

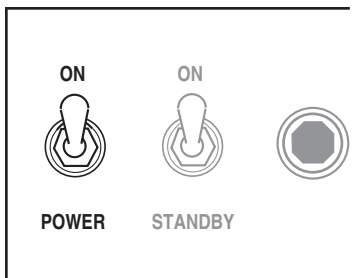

HEAD VERSION

Follow the cold start procedure described in the ON/ STANDBY section above when powering up your new **RECT-O 50**.

# REAR PANEL:

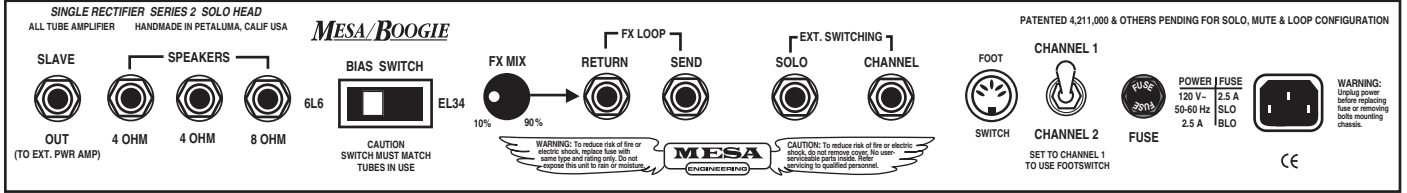

REAR VIEW - HEAD VERSION

**SLAVE OUT:** This 1/4" jack provides a signal derived from the speaker jack. Perfect for using the **RECT-O 50** as a master pre-amp, or additional power amps may be connected for more power when needed. Some players use this to derive an FX Send Signal and go to other amps for their wet sound.

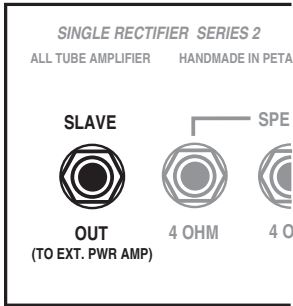

**NOTE:** Once a signal is taken from the **SLAVE**, it can not be inserted back into the FX Loop Return jack or a feedback loop will occur. Much like holding a microphone into the PA system's cabinets...a loud high pitched squeal will occur.

**SPEAKERS:** Sensitivity to speaker mismatching in regards to ohmage differences is low, hence no damage to the amplifier will occur. However, very low ohmage loads will cause the power tubes to wear faster. The **RECT-O 50** (combo only) is equipped with a Celestion Custom 90 single 12 inch - 8 Ohm speaker, but as you can see, other speaker configurations may be used.

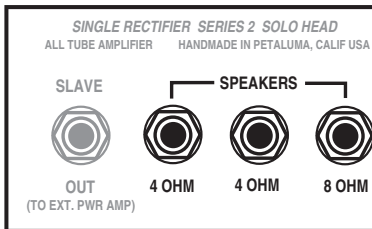

HEAD VERSION

When using two 8 Ohm speakers, connect each of them to the 4 Ohm speaker jacks that are provided, this will equal a 4 Ohm load which is the proper impedance required when using this particular speaker configuration.

**BIAS SELECT:** Your **RECT-O 50** amplifier was designed with versatility in mind. So to add to the already awesome array of on board features...we felt it essential that these new **RECT-O 50 Series 2** amplifiers be able to adapt their power output section to use the other classic pentode power tubes, the British style EL 34. These tubes are largely responsible for the signature sound of many immediately identifiable and wonderful sounding amps created in Great Britain and used on some of the best recordings to date.

**MESA/BOOGIE**

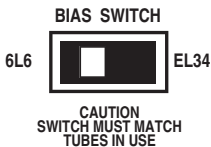

The nature of their sound is usually brighter in the extremely high frequencies...some players find this almost thin at first. However, aficionados of the EL34 sound know that nothing has the lushness of harmonics or spread like a power amp using EL34's. In truth EL34's do focus in on a region of upper harmonics that 6L6's reproduce, but not really enhance, in the same way the EL34's do.

This characteristic is sometimes preferred for sounds that range from a soft clip that would be used for

## REAR PANEL: (Continued)

### BIAS SELECT: (Continued)

chording or soloing, to an all out high gain crunch or lead sound. Players that use mostly these types of sounds may prefer the EL34 clip to the 6L6's that come standard in the new **RECT-O 50** amplifiers. If you need a variety of sounds and rely on a clean chording sound much of the time, you will likely prefer the stock compliment of 6L6's that both of these two versions are fitted with. We feel the 6L6 is a more balanced sounding tube that produces plenty of harmonic lushness, while at the same time delivering the rich lows that are crucial to both a warm clean sound and huge, tight high gain crunch sound.

**We recommend the 6L6 for reliability:** In our many tests and continued use of the currently available EL34 type power tubes on the market today, we regret to say that they do not appear to be as rugged in construction as the available 6L6. This is another reason why your new **RECT-O 50** amplifier was shipped with 6L6 power tubes. If you plan to use the EL34's we suggest that you keep a full set of tubes and extra fuses with you during all performances in the event of a tube failure occurring when using the currently available EL34's.

**Make sure that the BIAS Switch is set correctly to match the tube type that you are using. Failure to do this will result in tube failure that could possibly burn resistors in the Bias supply. Although this is a fairly simple repair for an authorized technician, it is easily avoidable.**

**ALWAYS CHECK THE BIAS SWITCH setting if you experiment with alternate tube types and you will enjoy uninterrupted performances from your amplifier.**

### EFFECTS LOOP: SEND, RETURN & MIX

These two 1/4" jacks are the patch point for external signal processing effects. The **EFFECTS LOOP** in the **RECT-O 50** is wired in parallel with the unaffected or dry signal which enables you to preserve the integrity of the all tube tone and feel that the **RECT-O 50** is capable of delivering. To use the **EFFECTS LOOP** for your processors, simply connect the Effects Loop **SEND** jack to your first effects' Input jack. Connect your last effects Output jack to the Effects Loop **RETURN** jack.

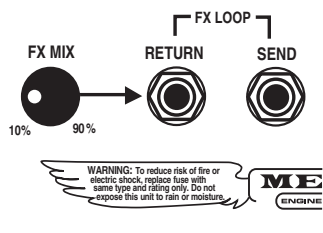

Use the rotary **MIX** Control to blend in the desired amount of the processed signal with the original dry signal. The least degradation of signal is usually found by setting the processor's mix at 100% and the **EFFECTS LOOP MIX** Control at the lower end of the control. In this manner the least amount of your pure tone will be processed and you will be dialing in a "very small amount" of a "very wet" signal to be mixed with the original. This method seems to produce the best results for tone and signal to noise ratio. The **EFFECTS LOOP** interrupts the signal between the pre-amp and power section. Therefore, the **RETURN** jack can double as a power amp input jack. You will also want to run the **MIX** Control at 90% to use the **EFFECTS LOOP** as a Power In patch point. Connect your last effects' Output jack to the Effects **RETURN** jack. We suggest that when using the **RECT-O 50's** power section only, that you have the amp switched to Channel 1's CLEAN mode or Channel 2's MODERN mode. This assures a more neutral power sensitivity thus making the **RECT-O 50** more friendly to use as a power amp. See PRESENCE Control section of this manual for more information.

### EXTERNAL SWITCHING:

These jacks allow ( usually MIDI-programmed ) operation of your amplifier's functions from an external switching source. The switching is accomplished by connecting ( "shorting" ) the jack's "Tip" to its "Ring" ( or ground.)

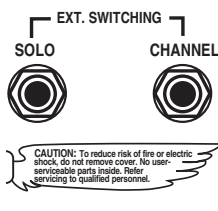



# REAR PANEL: (Continued)

**CHANNEL SELECT:** This switch simply allows you to switch between the two channels (CHANNEL 1 and CHANNEL 2) without using the Channel Select Footswitch or, when one is not available.

To use the footswitch however, the Channel Select switch must be in the (up) position.

CHANNEL 1



CHANNEL 2

SET TO CHANNEL 1  
TO USE FOOTSWITCH

**FUSE:** This is the A.C.'s (Alternating Current) main fuse and provides protection from outside A.C. fluctuations as well as power tube failure damage. Should the **FUSE** blow, replace it with the same rating in a Slo-Blo type package. The domestic U.S. version requires a 2.5 amp Slo-Blo fuse. A power tube short or failure is often the cause of a blown fuse...Follow the cold start procedure mentioned in the ON/STANDBY switch section and watch the power tubes as you flip the STANDBY switch to the ON position.

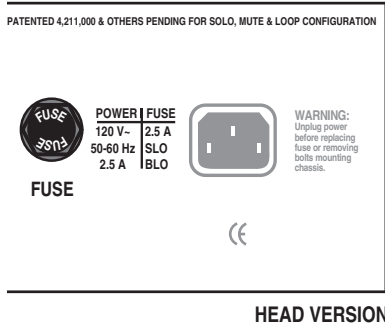

If a power tube is going bad or is arcing you will see it! Flip the STANDBY switch to Standby immediately and replace the faulty power tube and the fuse if necessary. If you see nothing abnormal as you lift the STANDBY switch it is possible that a power tube shorted temporarily and blew the **FUSE**. If this is the case it may work again normally. To be extra safe, you might want to replace just the adjacent tube or all power tubes in the "shotgun" troubleshooting tradition and save the replaced set as spares. Spare fuses are a must for the fabled cord bag along with your spare tubes. Always carry both for they could be worth their weight in gold someday.

**A.C. RECEPTACLE:** The total power consumption for the *RECT-O 50* is 2.5Amps @ 120 Volts. Thus, a 15 Amp circuit (which is what most house circuitry is wired with) is adequate. Make sure the Euro style A.C. power cord is firmly seated in the power receptacle before powering up the unit. Always connect the A.C. cord to a 3 terminal grounded socket. If none are available, connect the A.C. power cord to a ground lift adaptor and then connect to a 2 terminal outlet. This may also be necessary from time to time for noise problems.

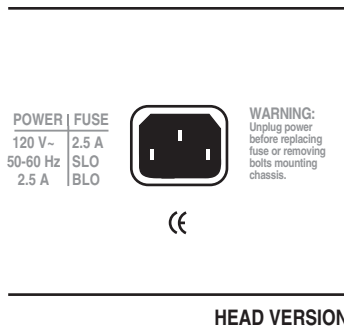

This style of power cord will make tear-downs and cable routing a lot easier and save you time as well. If you should ever need a replacement, just call and we'll be happy to send you another one for a nominal charge or visit your nearest *MESA/Boogie* Pro Center.



# FACTORY SAMPLE SETTINGS

## HEAD VERSION SHOWN

### SAMPLE 1 *Sparkling Clean*

SOLO: 100%    OUTPUT: 100%    CH1: 100%    CH2: 100%

MASTER: 0%    PRESENCE: 0%    BASS: 0%    MID: 0%    TREBLE: 0%    GAIN: 0%

CLEAN (selected)    PUSHED    RAW (selected)    MODERN    INPUT: RAW

### SAMPLE 2 *Pushed Bluesy Rhythm / Solo: Both Channels*

SOLO: 100%    OUTPUT: 100%    CH1: 100%    CH2: 100%

MASTER: 100%    PRESENCE: 100%    BASS: 100%    MID: 100%    TREBLE: 75%    GAIN: 100%

CLEAN (selected)    PUSHED    RAW (selected)    MODERN    INPUT: RAW

### SAMPLE 3 *Blues Lead: Both Channels*

SOLO: 100%    OUTPUT: 100%    CH1: 100%    CH2: 100%

MASTER: 100%    PRESENCE: 100%    BASS: 100%    MID: 100%    TREBLE: 100%    GAIN: 100%

CLEAN (selected)    PUSHED    RAW (selected)    MODERN    INPUT: RAW

### SAMPLE 4 *High Gain Lead / Crunch: Both Channels*

SOLO: 100%    OUTPUT: 100%    CH1: 100%    CH2: 100%

MASTER: 100%    PRESENCE: 100%    BASS: 100%    MID: 100%    TREBLE: 100%    GAIN: 100%

CLEAN (selected)    PUSHED    RAW (selected)    MODERN    INPUT: RAW

# FACTORY SAMPLE SETTINGS

## COMBO VERSION SHOWN

### SAMPLE 1 *Sparkling Clean*

INPUT	CLEAN	GAIN	TREBLE	MID	BASS	PRESENCE	MASTER	CH1	CH2	OUTPUT
	PUSHED									

### SAMPLE 2 *Pushed Bluesy Rhythm / Solo: Both Channels*

INPUT	CLEAN	GAIN	TREBLE	MID	BASS	PRESENCE	MASTER	CH1	CH2	OUTPUT
	PUSHED									

### SAMPLE 3 *Blues Lead: Both Channels*

INPUT	CLEAN	GAIN	TREBLE	MID	BASS	PRESENCE	MASTER	CH1	CH2	OUTPUT
	PUSHED									

### SAMPLE 4 *High Gain Lead / Crunch: Both Channels*

INPUT	CLEAN	GAIN	TREBLE	MID	BASS	PRESENCE	MASTER	CH1	CH2	OUTPUT
	PUSHED									

# PERSONAL SETTINGS PAGE

## HEAD VERSION SHOWN

### SOUND 1

		<small>CH1</small> 							<small>CLEAN</small> 	<small>V I N T A G E</small>	<small>PUSHED</small> 	
<small>SOLO</small>	<small>OUTPUT</small>	<small>CH2</small> 	<small>MASTER</small>	<small>PRESENCE</small>	<small>BASS</small>	<small>MID</small>	<small>TREBLE</small>	<small>GAIN</small>	<small>RAW</small> 			
									<small>MODERN</small> 			

### SOUND 2

		<small>CH1</small> 							<small>CLEAN</small> 	<small>V I N T A G E</small>	<small>PUSHED</small> 	
<small>SOLO</small>	<small>OUTPUT</small>	<small>CH2</small> 	<small>MASTER</small>	<small>PRESENCE</small>	<small>BASS</small>	<small>MID</small>	<small>TREBLE</small>	<small>GAIN</small>	<small>RAW</small> 			
									<small>MODERN</small> 			

### SOUND 3

		<small>CH1</small> 							<small>CLEAN</small> 	<small>V I N T A G E</small>	<small>PUSHED</small> 	
<small>SOLO</small>	<small>OUTPUT</small>	<small>CH2</small> 	<small>MASTER</small>	<small>PRESENCE</small>	<small>BASS</small>	<small>MID</small>	<small>TREBLE</small>	<small>GAIN</small>	<small>RAW</small> 			
									<small>MODERN</small> 			





### SOUND 4

		<small>CH1</small> 							<small>CLEAN</small> 	<small>V I N T A G E</small>	<small>PUSHED</small> 	
<small>SOLO</small>	<small>OUTPUT</small>	<small>CH2</small> 	<small>MASTER</small>	<small>PRESENCE</small>	<small>BASS</small>	<small>MID</small>	<small>TREBLE</small>	<small>GAIN</small>	<small>RAW</small> 			
									<small>MODERN</small> 			





# PERSONAL SETTINGS PAGE

## COMBO VERSION SHOWN





### SOUND 1

 INPUT	CLEAN 	<input type="radio"/>	<input type="radio"/>	<input type="radio"/>	<input type="radio"/>	<input type="radio"/>	<input type="radio"/>	<input type="radio"/>	CH1  CH2 	<input type="radio"/> OUTPUT	<input type="radio"/> SOLO
	PUSHED RAW  MODERN VINTAGE	GAIN	TREBLE	MID	BASS	PRESENCE	MASTER				





### SOUND 2

 INPUT	CLEAN 	<input type="radio"/>	<input type="radio"/>	<input type="radio"/>	<input type="radio"/>	<input type="radio"/>	<input type="radio"/>	<input type="radio"/>	CH1  CH2 	<input type="radio"/> OUTPUT	<input type="radio"/> SOLO
	PUSHED RAW  MODERN VINTAGE	GAIN	TREBLE	MID	BASS	PRESENCE	MASTER				

### SOUND 3

 INPUT	CLEAN 	<input type="radio"/>	<input type="radio"/>	<input type="radio"/>	<input type="radio"/>	<input type="radio"/>	<input type="radio"/>	<input type="radio"/>	CH1  CH2 	<input type="radio"/> OUTPUT	<input type="radio"/> SOLO
	PUSHED RAW  MODERN VINTAGE	GAIN	TREBLE	MID	BASS	PRESENCE	MASTER				

### SOUND 4

 INPUT	CLEAN 	<input type="radio"/>	<input type="radio"/>	<input type="radio"/>	<input type="radio"/>	<input type="radio"/>	<input type="radio"/>	<input type="radio"/>	CH1  CH2 	<input type="radio"/> OUTPUT	<input type="radio"/> SOLO
	PUSHED RAW  MODERN VINTAGE	GAIN	TREBLE	MID	BASS	PRESENCE	MASTER				

# RECT-O-VERB / SOLO 50 TUBE TASK CHART

NOTE: POWER TUBES ARE HOT ! BEFORE CHANGING TUBES TURN POWER SWITCH TO OFF AND LET COOL OR USE A RAG FOR PROTECTION.

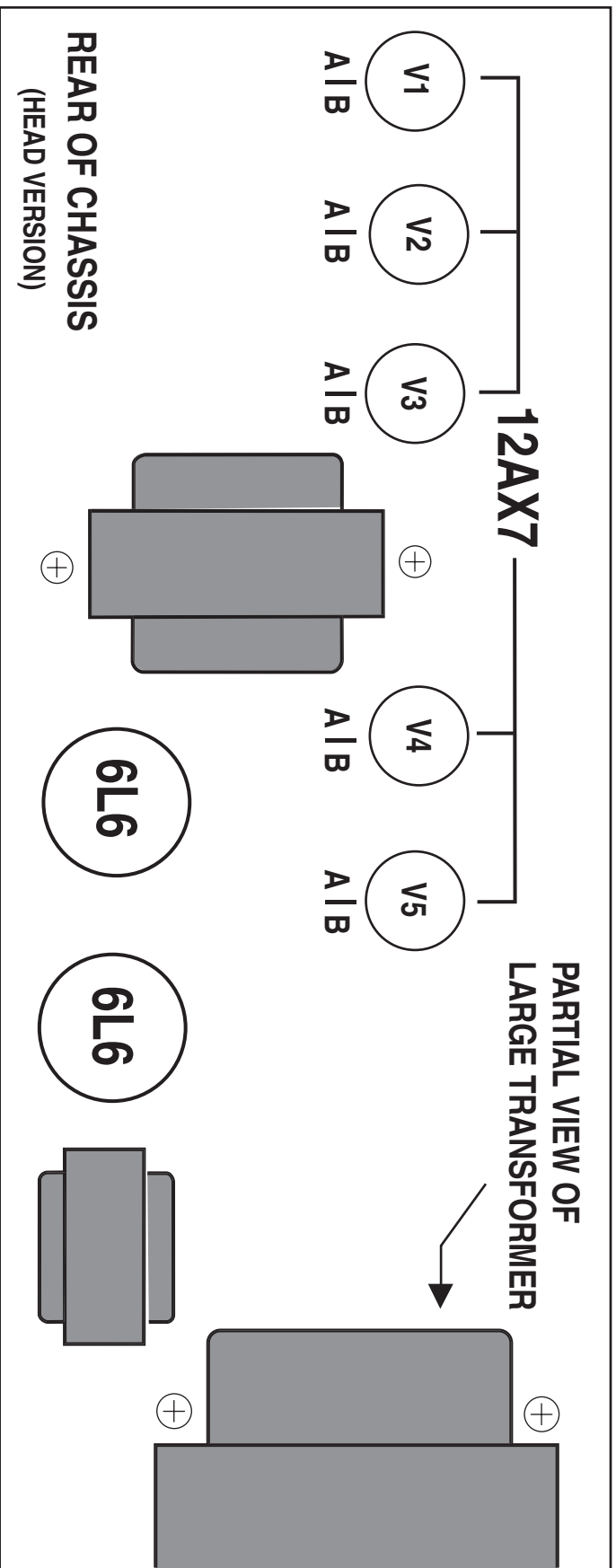

## Description of Tube Functions

- V1A= Input Stage
- V1B= 2nd Stage (Rhythm & Lead)
- V2A=3rdStage Rhythm
- V2B= 3rd Stage Lead
- V3A= 4th Stage Lead
- V3B= 5th Stage Lead
- V4A= FX Send
- V4B=FX Return
- V5=A > Phase Inverter
- V5=B

## SPEAKER IMPEDANCE MATCHING & HOOK-UP GUIDE:

**IMPEDANCE:** Wiring up speakers to provide the most effective load and making sure that all of them are in phase will help in creating the best sound possible. This is not too difficult, as long as you understand a few things about loading and how to connect your speakers to provide an optimal resistive load.

*MESA/Boogie* amplifiers can handle 4 and 8 ohms effectively. Never run below 4 ohms in a tube amplifier unless you are absolutely certain that the system can handle it properly; this can cause damage to the Output transformer. A few amplifiers can handle 2 ohms effectively without damaging them ( for example the *MESA'S Bass 400+* ). You can always have a higher resistance ( 16 ohms, for example ) without damaging results, but too low of a resistance will likely cause problems.

**MIS-MATCHING:** When running a higher resistance ( for example: 8 ohm output into 16 ohm cabinet ), a slightly different feel and response will be eminent. A slight mismatch can provide a darker smoother tone with a little less output and attack. This response is a result of the amplifier running a bit cooler. Sometimes when using more than one cabinet a mismatch will be the only option.

**WHAT IS MY CABINETS IMPEDANCE:** If you have only a single speaker, you just match that single speakers impedance to the amplifier, and you are done. In many cases, you will have a number of speakers, and then you must calculate the "load" that the amplifier will need to support. There are generally three ways to wire multiple speakers together. They are as follows:

**SERIES:** When you wire ( hook-up ) speakers in Series, the speakers resistance ( as measured in ohms ) is additive - i.e. putting two 8 ohm speakers in Series results in a 16 ohm load.

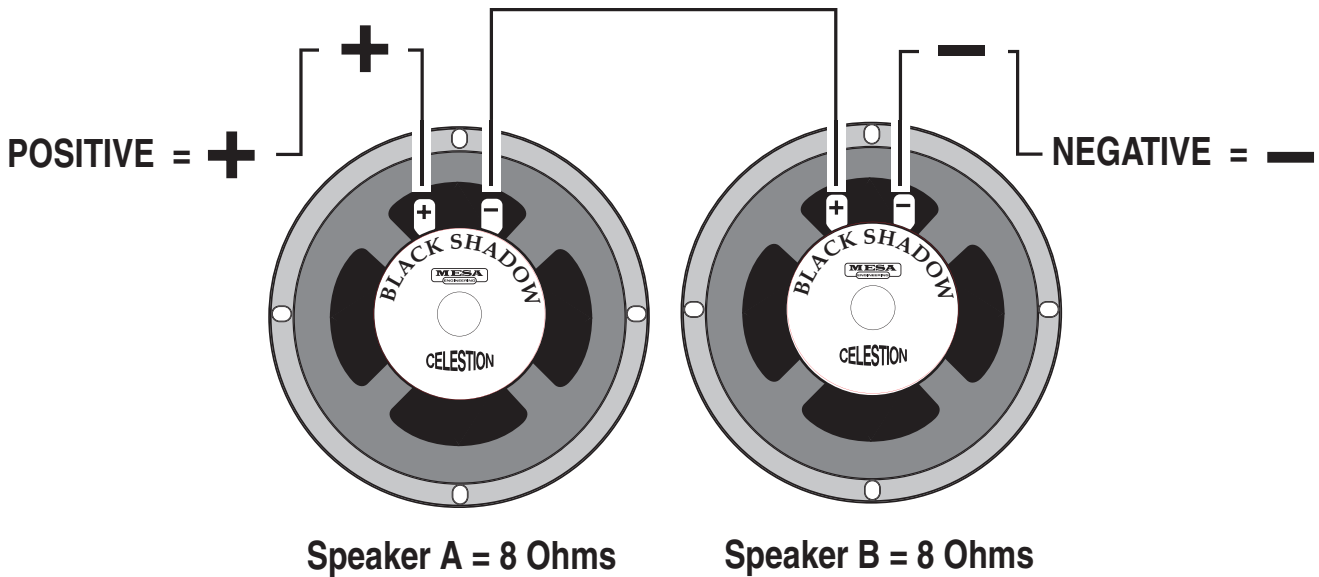

**SERIES:** Connect the Negative side of Speaker A to the Positive side of Speaker B

## SPEAKER IMPEDANCE MATCHING & HOOK-UP GUIDE: (Continued)

**PARALLEL:** When wiring in parallel, the resistance of the speakers decreases. Two 8 ohm speakers wired in (hooked-up) Parallel results in a 4 ohm load. It's easy to calculate the effect of a resistive load when all the speakers are all the same resistance. It is really not suggested to wire different resistive load values in Parallel ( 8 and 4, 16 and 8 etc. ) The formula for figuring the total impedance in Parallel is the multiplication of the two loads divided by the sum of the two loads - i.e. putting two 8 ohm speakers in Parallel results in a 4 ohm load. Connect the Positive side of Speaker A to the Positive side of Speaker B - Connect the Negative side of Speaker A to the Negative side of Speaker B.

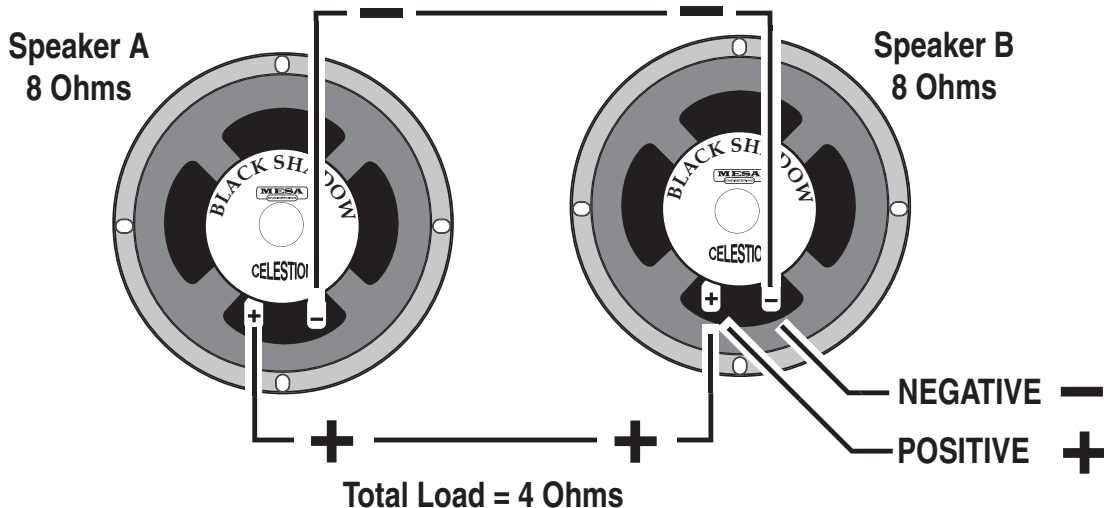

**COMBINATION OF SERIES & PARALLEL:** This is really just two sets of Series wired speakers connected in Parallel. This is how you maintain a consistent load with multiple speakers. The importance of this is more evident when you have more than one cabinet to connect to your amplifier. This is when you need to figure out the loads and how to wire them up without applying too low of a resistance on the amplifier.

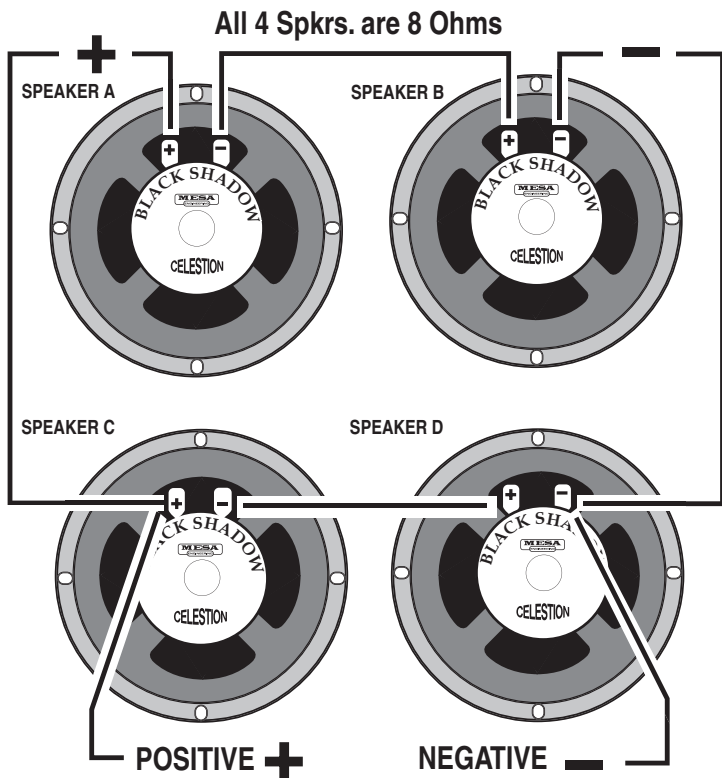

Simply connect the Positive side of Speaker A to the Positive side of Speaker C.

Connect the Negative side of Speaker A to the Positive side of Speaker B. Next, connect the Negative side of Speaker C to the Positive side of Speaker D.

And lastly, connect the Negative side of Speaker B to the Negative side of Speaker D.

4 Eight ( 8 ) Ohm speakers wired in Series Parallel = a Total Load of 8 Ohms.



# WIRING SCHEMES...Amplifier to Speaker Cabinets

1

2

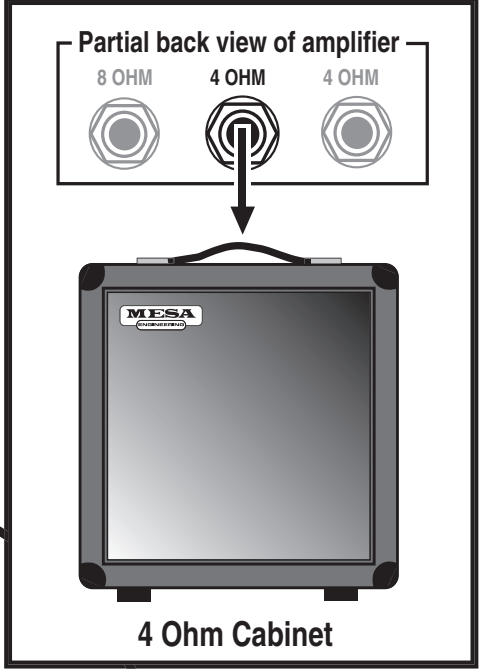
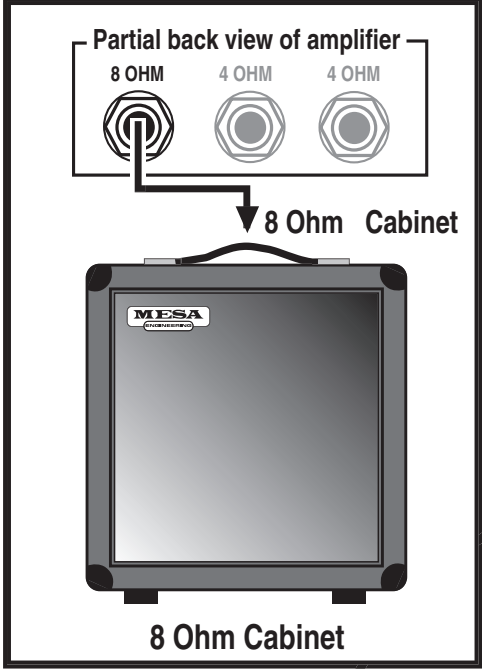

3

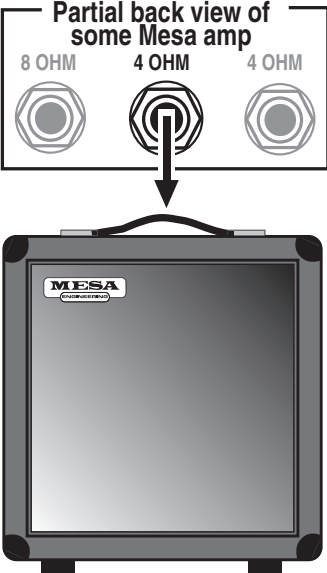

4

5

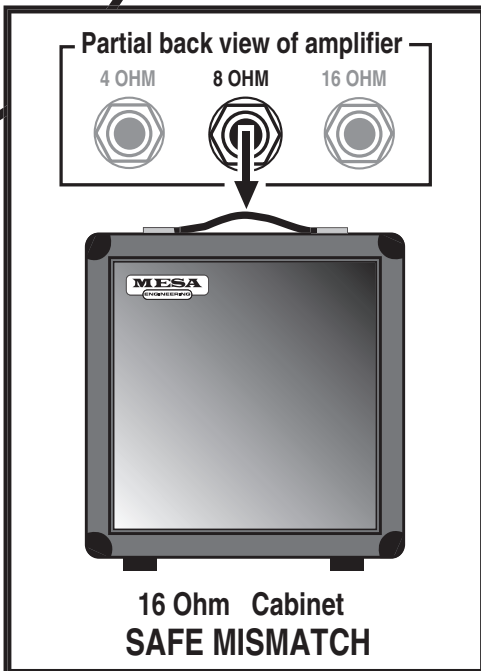
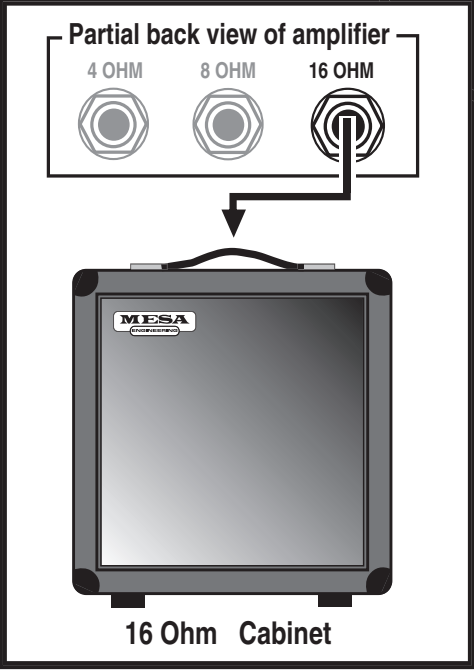

# WIRING SCHEMES...Amplifier to Speaker Cabinets

6

7

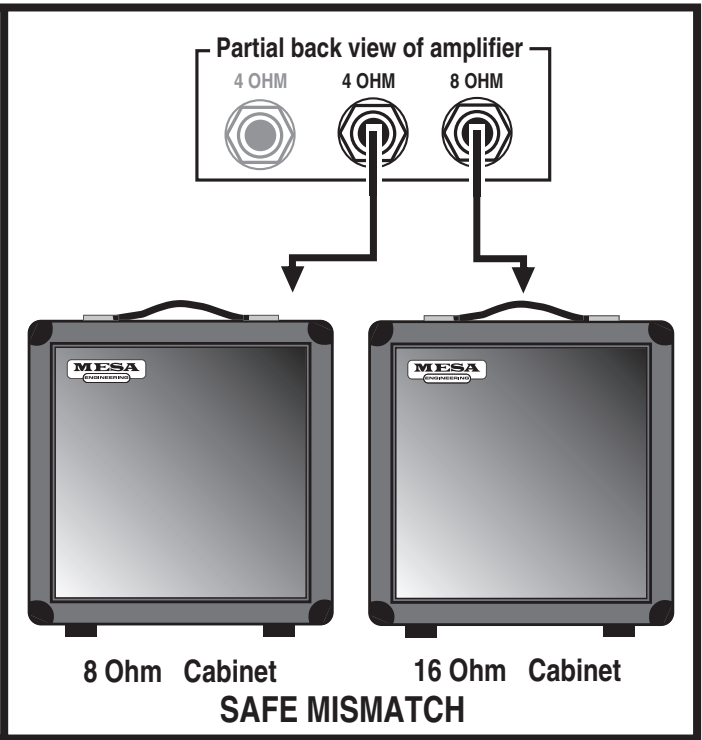
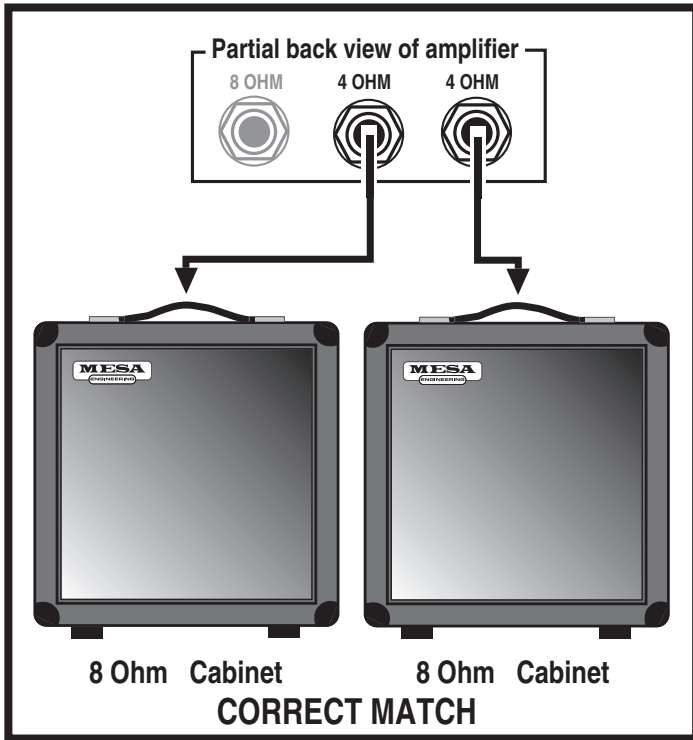

8

9

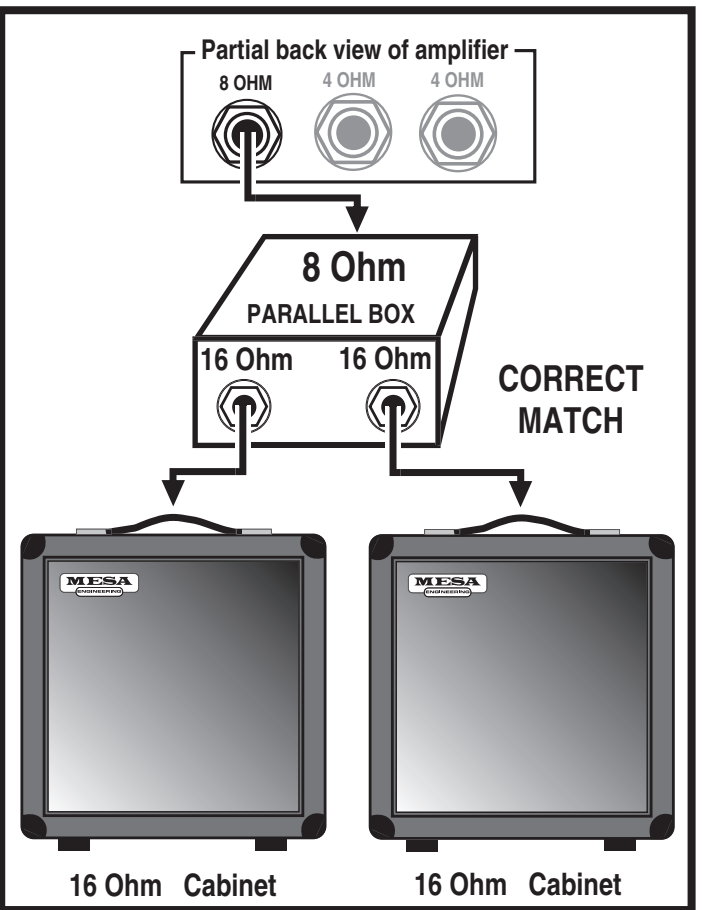
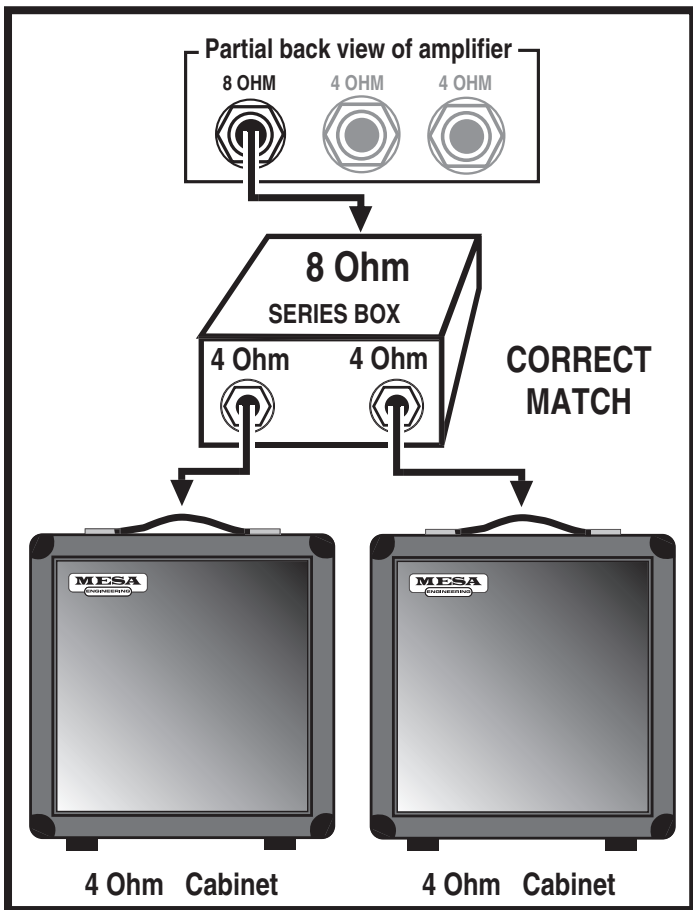

# WIRING SCHEMES...Amplifier to Speaker Cabinets

10

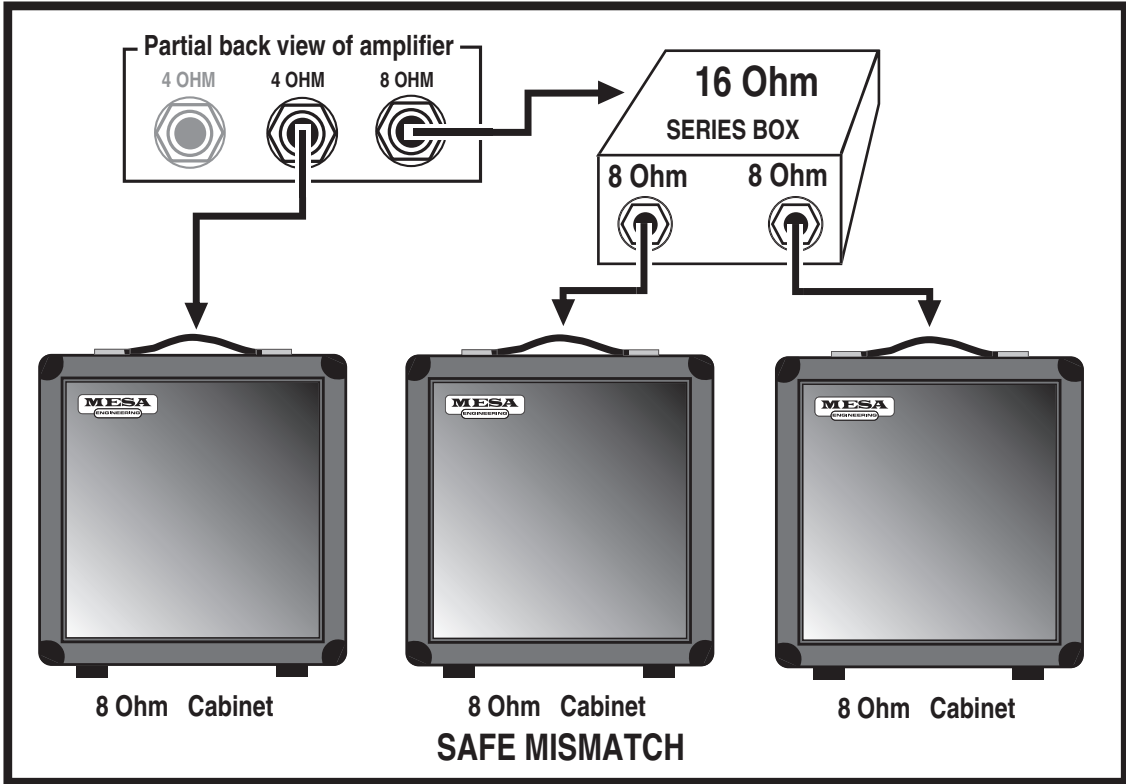

11

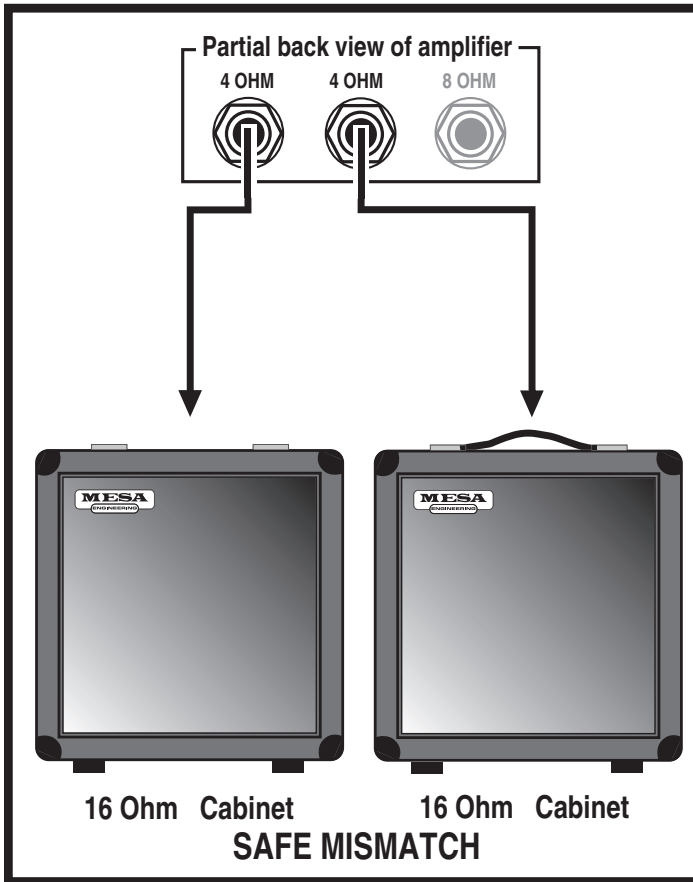

12

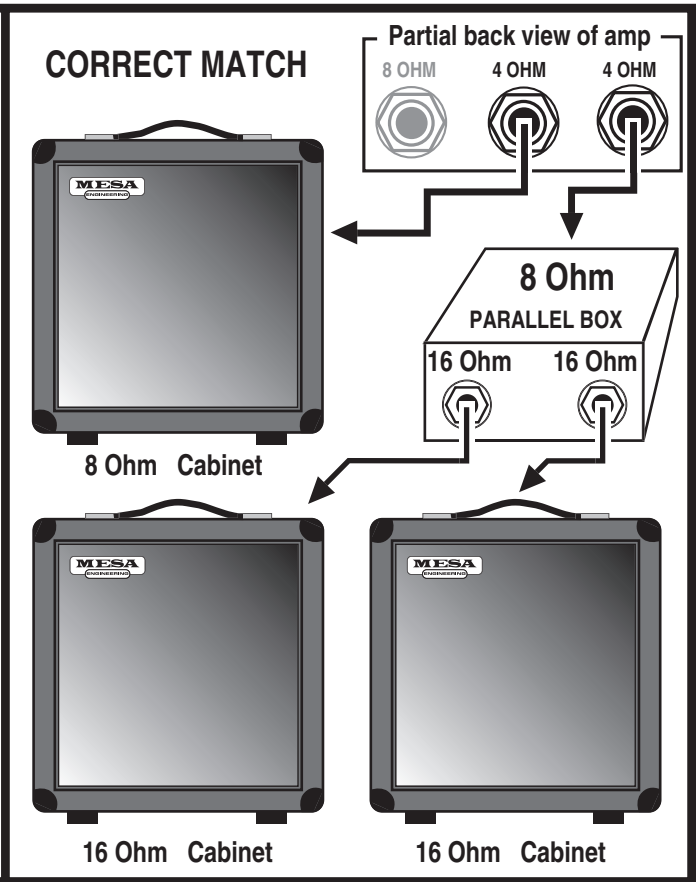

# WIRING SCHEMES...Amplifier to Speaker Cabinets

13

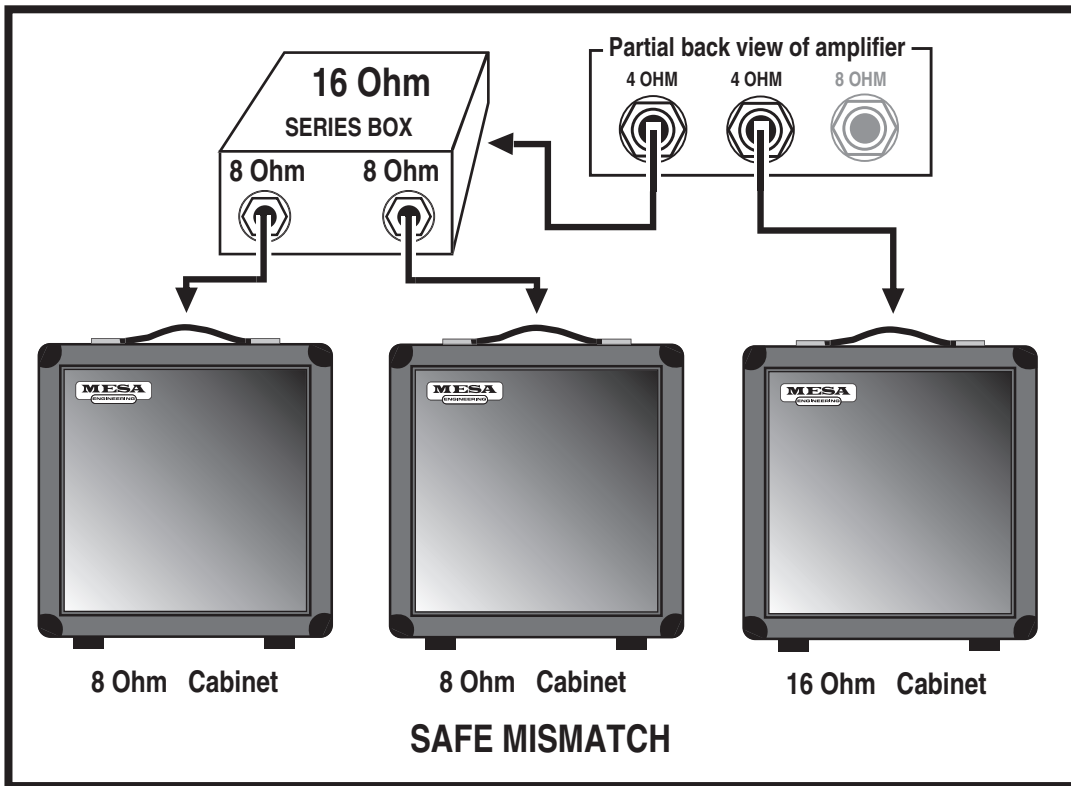

14

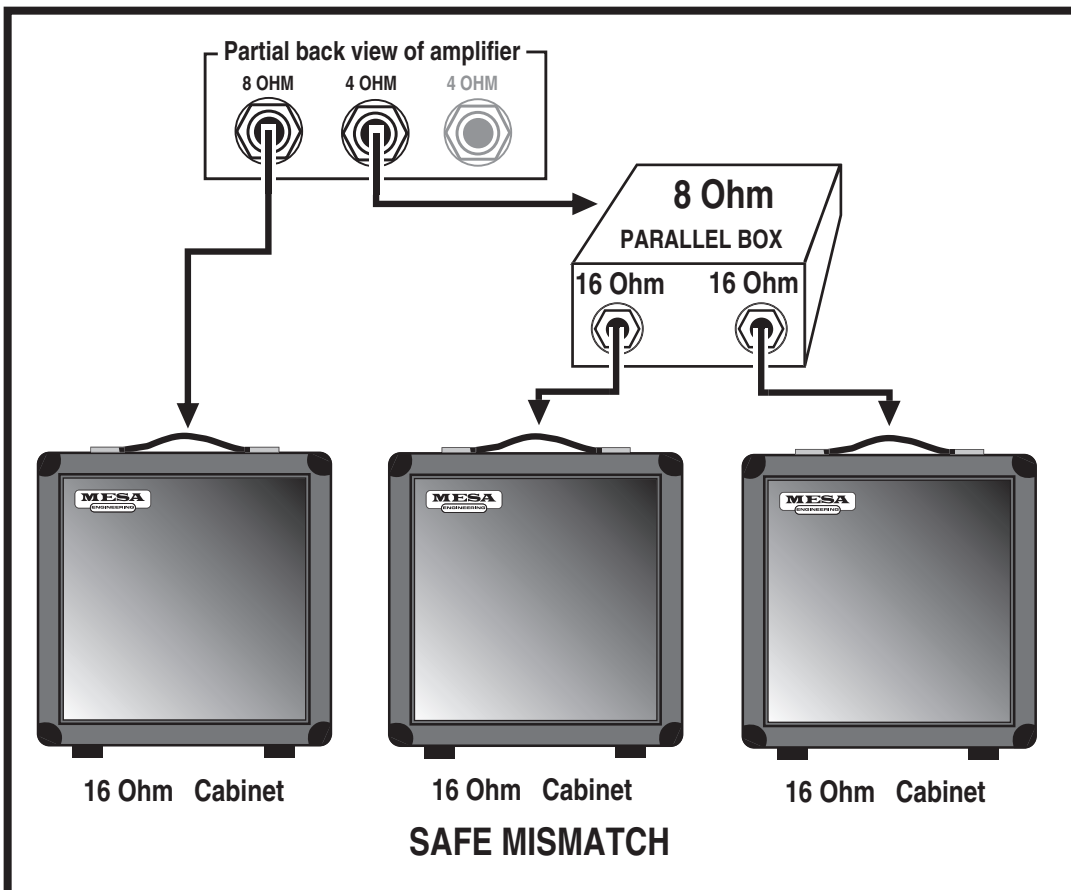

**TUBE NOISE & MICROPHONICS:** You may occasionally experience some form of tube noise or microphonics. Certainly no cause for alarm, this quirky behavior comes with the territory and the Tone. Much like changing a light bulb, you don't need a technician to cure these types of minor user serviceable annoyances and in fact, you'll be amazed at how easy it is to cure tube problems...by simply swapping out a pre-amp or power tube!

First may we suggest that you set the amplifier up on something so that you can get to the tubes comfortably without having to bend down. It also helps to have adequate lighting as you will need to see the tube sockets clearly to swap tubes. **Use caution and common sense when touching the tubes after the amplifier has been on as they may be extremely hot!** If they are hot and you don't want to wait for them to cool off, try grasping them with a rag and also note that the glass down around the bulbous silvery tip is considerably less hot which makes it easier to handle. Gently rock the tube back and forth as you pull it away from its socket.

**DIAGNOSING POWER TUBE FAILURE:** There are two main types of tube faults: shorts and noise. Both large and small tubes may fall prey to either of these problems but diagnosis and remedy is usually simple.

If a fuse blows, the problem is most likely a shorted power tube and shorts can either be mild or severe. In a mildly shorted tube the electron flow has overcome the control grid and excess current flows to the plate. You will usually hear the amp become distorted and begin to hum slightly. If this occurs, quickly look at the power tubes as you switch the amp to STANDBY and try to identify one as glowing red hot. It is likely that two of a pair will be glowing since the "shorted" tube will pull down the bias for its adjacent mates, but one tube may be glowing hotter — and that one is the culprit. The other two are often fine — unless they've been glowing bright red for several minutes.

Because there is no physical short inside the tube (just electrons rioting out of control) merely switching to STANDBY for a few moments then back to ON will usually cure the problem...at least temporarily. Watch the tubes carefully now. Should the problem recur, the intermittent tube will visibly start to over heat before the others and thus it can be identified. It should be replaced with one from the same color batch, shown on its label. Call us and we will send one out to you.

The severe short is not nearly so benign. In the worst cases, a major arcing short occurs between the plate and the cathode with visible lightning inside the glass and a major noise through the speaker. If this is seen to happen, IMMEDIATELY turn the amp to STANDBY. By this time the fuse probably will have blown. Such a short is usually caused by a physical breakdown inside the tube including contaminate coming loose or physical contact (or near contact) between the elements. Replace it and the fuse with the proper slo-blo type and power up the amp using the power up procedure as we described earlier in this manual.

**TUBE NOISE:** Often caused by contamination within in a tube, the culprit can usually be identified, and by lightly tapping on the glass, you will probably hear the noise change. Hearing some noise through the speakers while tapping on the 12AX7's is normal however. And the one nearer the INPUT will always sound louder because its output is being further amplified by the second 12AX7.

The power tubes should be all but quiet when they are tapped. If crackling or hissing changes with the tapping, you have probably found the problem. To confirm a noisy power tube, merely put the *Road King* on Standby, remove it from its socket and turn it back on. It will cause no damage to run the *Road King* briefly with one power tube missing. You may notice a slight background hum, however, as the push-pull becomes unbalanced. Whenever you are trying to diagnose a suspect tube, keep your other hand on the POWER and STANDBY switches ready to shut them off instantly in the unlikely case you provoke a major short.

If you think you've located a problem tube but aren't sure, we recommend substituting the suspect with a new one just to be sure of your diagnoses. You will be doing yourself and us a big favor by just following the simple guidelines previously mentioned regarding tube replacement. You'll probably be successful with much less effort than is required to disconnect everything and haul the unit to a technician who will basically perform the same simple tests. If the tubes are still within their six-month warranty period, we will happily send you a replacement. Just note the color designation on the tube label so that we can send you the appropriate match.

**DIAGNOSING PRE-AMP TUBE PROBLEMS:**

Because your amplifier is an all tube design, it is quite possible that you will at some point experience minor pre-amp tube noise. Rest assured - this is no cause for alarm and you can take care of the problem yourself in a matter of minutes by simply swapping tubes.

Let us begin by saying; It is a "very good" idea to keep at least a couple of spare pre-amp tubes on hand at all times to insure uninterrupted performance. These minor pre-amp tube problems can take many forms but can generally be described in two categories: Noise and Microphonics. Noise can be in the form of crackling, sputtering, white noise/hiss and/or hum. Microphonic problems usually appear in the form of a ringing or high pitched squealing that gets worse as the gain or volume is increased thus are more noticeable in the higher gain "HI" modes. Microphonic problems are easily identified because the problem is still present even with the instruments' volume off or unplugged altogether - unlike pick-up feedback which ceases as the instrument is turned down. Microphonic noise is caused by mechanical vibration and shock: think of banging a microphone around and you'll understand where the word came from.

The best way to approach a pre-amp tube problem is to see if it occurs only in one specific mode or channel. This should lead you to the tube needing replacement. Then all that remains is to swap the suspect tube for a known good performer. If you cannot narrow down the trouble to a specific mode or channel, the problem may be the small tube that drives the power tubes which is operational in all modes and channels. Though rare, a problem with the driver tube would show up in all aspects of performance - so if you can't narrow the problem down to being mode or channel specific, you may want to try replacing the driver tube. Driver problems generally show themselves in the form of crackling or hum in all modes of performance and/or weak overall output from the amplifier. Occasionally an anemic driver tube will cause the amplifier to sound flat and lifeless, but this is somewhat uncommon, as worn power tubes are a more likely suspect for this type of problem.

Sometimes making the diagnosis is more trouble than it's worth and it's faster and easier to merely replace the small pre-amp tubes ONE AT A TIME with a replacement known to be good. But MAKE SURE you keep returning the tubes to their original socket until you hit the one that cures the problem. You'll notice that tubes located nearer to the INPUT jack always sound noisier...but this is because they are at the start of the chain and their noise gets amplified over and over by the tubes that follow. The tube that goes into this "input socket" (usually labeled V1) needs to be the least noisy of the bunch. The tube that goes at the end of the preamp chain - just ahead of the power tubes - can be quite noisy without causing any problem at all. The tubes in your amp have already been located in the most appropriate sockets and this is why you should NEVER pull them all out at once and ALWAYS swap them one at a time. ALWAYS return a perfectly good tube to its original socket. Also it's a good idea to put the amp on STANDBY when swapping tubes to reduce the heat build up in the tubes themselves and to prevent explosive noises (which can still occur even if you are pulling the tubes away from their sockets gently) from coming through the speaker.

Remember, take your time, be patient and chances are real good that you can fix your amp yourself by finding and replacing the bad tube. It kills us to see someone who has shipped their amp back to us...and all it needed was a simple tube replacement! If you must send back your amp, remove the chassis from the cabinet by unscrewing the four mounting bolts on the bottom top. The chassis then slides back like a drawer and comes out from the back. Remove the big power tubes and mark them according to their location from left to right 1, 2 etc. They need to be wrapped separately with plenty of wadded up newspaper around them and put in a smaller box within the larger carton. Remove the Rectifier tubes and wrap them also. You can leave the preamp tubes in or remove them and wrap them separately being sure to label their location. (See Tube Task Chart.)

To wrap the chassis, use plenty of tightly wadded up newspaper so there is at least six inches of "crush space" between the chassis and the cardboard box. Bubble wrap also works well, but please DON'T use styrene peanuts - they will shift during transit and get lodged inside your electronics as well as allowing your amp to end up at the bottom of the box unprotected and possibly damaged.

Pre-amp tubes don't normally wear out as a rule. Therefore, it is not a good idea to change them just for the sake of changing them. If there isn't a problem - don't fix it. If there is no result from your substitutions, it may be possible that you have more than one problematic tube. Though rare, this does happen and though it makes the troubleshooting process a little more intimidating, it is still possible to cure the problem yourself.

**NOTE:** *It is normal to hear a slight metallic ringing sound when tapping on the preamp tubes. As long as the tube does not break into oscillation or start crackling or any other form of bizarre noise, it is considered normal and functional.*

**BIAS ADJUSTMENT:** *(Part of a continuing series)*

An Article written by Randall Smith that we thought you might find interesting.

Here's a question we often hear:

"Why doesn't *Mesa* put bias adjustments in their amplifiers?"

Well, there's a short answer and a long answer to this question.

The short answer is that during my 12 years of repairing Fenders, one of the most frequent problems I saw was bias controls that were either set wrong or that had wandered out of adjustment due to vibration. As any honest tech will tell you, there's lot's of easy money to be made by sprinkling "holy water" on amplifiers ... uh, what I meant to say is "Your amp needed biasing." See what I mean? What customer is going to argue with that?

It only takes a moment and a volt meter: The Fender diagram shows how: "Adjust this trim pot for - 52 volts." That's it. Nothing more.

Now don't be fooled into thinking that tubes "draw" more or less bias, they don't. The way a bias supply is connected to a tube is akin to a dead end road, it just trails off to nowhere without really completing a circuit. It's a static voltage and regardless of what tube is in the socket — or even if the tubes aren't plugged in at all, it doesn't change the bias voltage a bit.

So the end of the short answer is this: Since a bias supply needs to put out the right voltage and never vary, I wanted to build amplifiers that were individually hard wired to the correct values and NEVER needed adjustment. And for 25 years, that's how *MESA/Boogies* have been built.

Time to change tubes? Just plug our tubes into any one of our amps and you're DONE. No tech needed. NO bills and no BS about biasing. And most important: The bias is RIGHT because it can't change!

Now, you want the long answer? Here's more information on how our hard-wired bias avoids trouble. Please read on.

But first, let's make an important distinction. Our business is designing and building high performance amplifiers. And for this we need tubes whose variance is within a narrow range. Our warehouse is full of rejects ...oh, they work — they just don't perform within our tolerance range. We have a very sophisticated computer - based tube testing system (nicknamed "Robotube") that matches and measures tubes over seven important parameters. It can even predict which tubes are likely to have a shortened lifetime — even though they work perfectly during the test.

Because our business is building quality amps, we can afford to reject a lot of wayward tubes. The guys you hear complaining because *Boogies* don't have bias adjusters are primarily in the business of selling tubes - not amps. They don't want to throw away 30 percent of their inventory, so they promote the idea that tubes outside our parameters can be used to "customize" amplifiers and they criticize us because our amps can't be adjusted to accommodate their out-of-*MESA* tolerance tubes.

Now you might be thinking, "But I thought you just said that tubes don't "draw" bias, therefore they don't effect the bias supply and thus it doesn't need to be adjustable." When you set the bias (whether it's by selecting the right resistors, as we do, or adjusting a trimmer — which is quicker) what you are doing is establishing the correct amount of idle CURRENT that flows through the power tubes. But you can't adjust the current directly, you can only change it by adjusting the amount of bias VOLTAGE that goes onto the tubes'

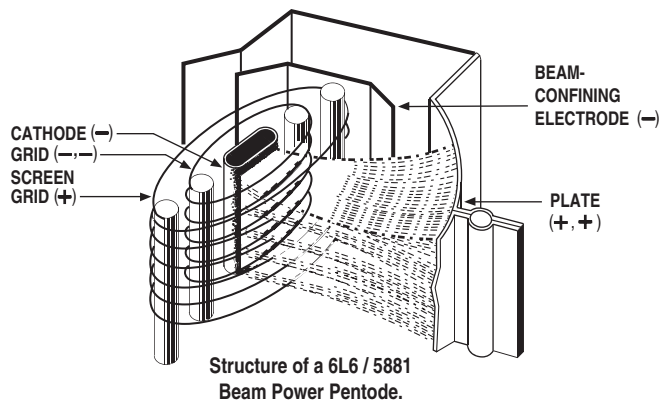



**BIAS ADJUSTMENT:** *(Continued)* control grids. Voltage and current are NOT the same. Current is the AMOUNT of electricity, the “quantity” — and is measured in amperes. Voltage is the degree of electric charge — like the “pressure” to use the old water analogy. Let me illustrate how different voltage and current are:

When you scrape your feet across a carpeted floor in dry, wintery conditions, your body can become charged with 50,000 to 100,000 volts of static electricity. And when you reach for the door knob, a spark jumps and you feel it! The voltage is super high but the current (measured in micro-amps) is tiny - otherwise you would die from electrocution.

Contrast this with your car battery, which puts out a mere 12 volts. You can lay your hands right across the terminals and not feel a thing. Yet the amount of current available can run to several hundred amperes .. enough to turn over a cold engine and get it started.

So current and voltage are two totally separate electrical parameters — though when you multiply them together, you get POWER, which is measured in watts.

When you set the bias of an amplifier, you are adjusting the static VOLTAGE at the control grid of the tube in order to produce a desired amount of idle CURRENT flowing to the tube’s plate. A small change in grid voltage, produces a large change in the amount of current flowing — and that’s basically how a tube works. Say that again because it’s super important: A small change in voltage at the grid causes a large change in current flowing to the plate. See, that’s the essence of amplification: A small change causing a large change. And here it’s a small voltage change causing a large current change.

The bias conditions are what determines how much current flows through the big power tubes when you’re not playing. And what drives your speakers is fluctuations in that current flow when you ARE playing. If the amount of current increases and decreases 440 times per second, then you’ll hear an A note. If the fluctuations in current flow are large and still at 440 per second, you’ll hear an A that is LOUD!

But for purposes of biasing, it’s the amount of “plate current” flowing with no signal applied that’s important. Unfortunately current is hard to measure because the circuit must be interrupted — as in “cut the wire” — and the meter spliced “in series” with the broken circuit. But measuring VOLTAGE is easy. It is not necessary to interrupt the circuit because a voltage reading can be taken in PARALLEL with the circuit intact.

Thus, as a matter of convenience, most bias settings are given in volts at the grid ... even though current through the plate is the important factor. In fact plate current is so inconvenient (and dangerous) to measure that Fender doesn’t even state what the correct value should be. They only give the grid voltage that will produce that current. (That’s the minus 52.) But that only happens if the tubes being used are “in spec.”

As long as the tubes ARE “in spec”, the right bias voltage will always give the correct plate “CURRENT” — but then there’s no need for the bias voltage to be adjustable!

If the tubes are NOT in spec, then the only proper way to re-set the bias is to cut the circuit and measure the current while adjusting the bias ... but no manufacturer I know even STATES the desired current value! Be that as it may, when the original bias voltage is altered far enough, it will compensate for the tube’s abnormal performance and the correct amount of idle current flow may then be restored. Clearly this is something most repair techs should not attempt.

Some newer amps have LED indicators connected to the circuit which will turn on when the right threshold of current flow has been reached. This is an improvement, and almost worthy if you’re willing to except resistors and lights added into your amplifier’s audio path — which we aren’t.

The other “advantage” of this system is that it allows some amp manufacturers to avoid matching their power tubes. The thinking is that adjusting the bias to each tube separately eradicates the inherent differences between the tubes by insuring that the same current flows through each one.

**BIAS ADJUSTMENT:** *(Continued)* Again, this has some merit .. but it's still not as good as using tubes that are matched in the first place because compensating for the mis-match causes the push-pull circuit itself to become unbalanced. Two wrongs don't really make a right.

Some of the other recommended biasing, "methods" — such as -".. tubes running red hot, increase the bias .. sounds harsh and runs too cool, turn it down ..." are guesswork at best. Luckily, one of the great things about tube amps is that they can usually stand some abuse without causing any real harm ... at least not immediately. But don't these alterations imply that you are second-guessing the amp designer and that there's a better set of operating conditions that the designer missed but the tube sellers have discovered?

Now some players may like the sound of their amp altered by tubes with extreme characteristics and with the bias set to help compensate. But often it is the mere novelty of change that they're really responding to and when the amp goes back to the proper original way, we've seen them be far happier still!

Because every part in every one of our designs has been meticulously evaluated, compared and stressed over — no matter how seemingly insignificant it might be. And with every design we look for a "sweet spot" where all the parameters — including the bias — come together to give the best sonic performance, consistently and reliably. Every part and voltage is important — yet no one complains that these other parameters aren't available for tinkering.

Consider our patented *Simul-Class* circuitry where there are two different bias voltages used for separate pairs of power tubes ... and changing one voltage also changes the other. Great care goes into getting this just right and we think we'd be asking for trouble to have it adjustable for the world to play with ... unless you like paying to have your amp messed up. Sorry, I meant to say, "Uh, ... your amp needed biasing."

If that doesn't appeal to you, then merely plug a matched set of *MESA* tubes into one of our amps and you're ready for tone. Guaranteed. You'd be amazed at the number of service calls we field every day that lead to a diagnosis of out-of-tolerance, non-spec tube problems. To think these would be prevented by including a bias adjustment is something of an insult to you and us. If you put the wrong size tires on your car, do you think changing the pressure will make them right?

Please, don't think this is a blanket indictment of the other guys selling tubes — it isn't. And their tubes aren't all bad either. It just doesn't make sense to pay more of your hard earned cash for tubes that were probably made in the same Russian or Chinese factory and which have the possibility of being outside the performance window we select for your amp. And it pains us to hear the hype and mystique built up around biasing when twenty-five years of evidence affirms our decision to make bias circuits that "never need adjustment". How much money and trouble that has saved *MESA/Boogie* players you couldn't estimate.

Our rigorously tested and hand selected tubes are available at your nearest *MESA/Boogie* Pro Center or from us directly. Nobody offers better price, quality or warranty than we do ... so why swerve?

Next time we'll talk about our part in developing the great Sylvania STR 415 type 6L6 and how we're on the verge of seeing something fairly close reappear on the market. Remember, we still have some of these super rugged mondo-bottles available for older amps — *Boogies* only please! Until then, Relax, Breathe and Nourish your soul!

Cheers!

*MESA/Boogie Ltd.*

## ON TRIODES, PENTODES & IRISHMEN:

With apologies to Friends and Relatives from the Emerald Isle - who will make their appearance soon enough - the humor which follows is dedicated to the memories of Spec McAuliff and Fae (Rafael) McNally, two of the True Greats.

As their numerical references suggest, the terms Diode, Triode and Pentode indicate the number of elements within the vacuum tube i.e. two, three or five. All tubes also require a filament or heater which is not included in the count. Its purpose is to excite electrons from the cathode coating by raising the temperature such that they are able to boil out of the electron-rich coating material and form a cloud of free electrons in the vacuum space surrounding the cathode.

Although the term filament and heater are often used interchangeably, there are specific differences: A filament is a directly heated cathode where cathode coating is applied directly to the heating element. Examples are 5U4 twin diode rectifier and 300B triode amplifier tubes. A heater, on the other hand, is a heating element which is separate from the cathode and is usually inserted within the tubular cathode sleeve. Examples are 12AX7 twin triode amplifier and 6V6 or EL84 beam power pentode tubes. In all cases this fundamental aspect of each tube's construction is clearly visible, especially when the heating element is glowing red hot.

The cathode, then, would be considered the first numbered element because it is the source of the electrons. The word itself is from the Greek literally meaning completely down, which implies a sense of central origin - like the center of the earth where Tone begins. It might be said that an ecstatic audiophile experiences a positive catharsis, his soul being purified when his system transports him to Audio Nirvana. The only trouble with taking this positive imagery too far is that the cathode is, unfortunately, negative... at least electrically speaking. However this is easily remembered since virtually all musicians and audiophiles have also experienced the more common negative catharsis when they emerge from the emotional rebirth kicking and screaming in rage and frustration.

Once heated, the intrinsically negative electrons are energetic little fellows of almost no mass. Thus they may be accelerated almost instantaneously and will travel through a vacuum a nearly the speed of light. Being of like, negative charge, they tend to repel one another and thus within the electron cloud surrounding the cathode, there is much jostling and elbowing as each one tries to maintain his distance from all the others... unless there is a strong and universal attraction from an outside influence.

Visualize, if you will, a group of sub-atomic Irishmen milling about and in a repellent, negative state of mind. All are scowling and none wants to have anything to do with the other. Now introduce a strong attraction say, a public bar, and you can easily picture an orderly, if rapid movement of the lot in a single direction. This is what happens when a positively charged element called the anode or plate is introduced into the vacuum.

The plate is the large metal element most prominently visible through the glass of an electron tube. It is the outermost element of a tube's structure and it surrounds all the others. The cathode is at the center radiating electrons outwards. As higher and higher positive voltage is applied to the plate, the attraction for the electrons surrounding the cathode is increased and with nothing standing in the way, full uninhibited flow to the plate occurs... sort of like removing the doors and offering free drinks to the crowd of surly Irishmen milling around outside. As electrons flow to the plate, the space charge will continually be replenished by further 'boiling' of the hot, electron-rich cathode as you can easily imagine other Irishmen impatiently taking up the places of those who've gone inside - until the entire village is deserted.

Now, where do they come from and how do they emerge? Well, a grand and elegant lady once showed me how to revive flat champagne: She dropped a raisin into the glass. There was a dramatic and immediate increase in effervescence with the introduction of a cathoding surface. Thousands of tiny bubbles suddenly appeared - and continued to flow from the raisin. Of course the bubbles were made up of gas dissolved in the beverage, but the analogy makes it easy to visualize the loosely bound electrons dissolved in the rich cathode coating as they effervesce from its heated surface.

But back to the electron flow. If the electrons are strongly attracted to a positively charged plate, then it follows that they are strongly repelled by a negatively charged plate and they are. Thus, if an alternating current - such as comes from a transformer - is applied to the plate, electrons will flow only during the times when the plate is positively charged. During periods of negative plate charge, electron flow is stopped and the space charge of electrons remains compressed in the area around the cathode.

**ON TRIODES, PENTODES & IRISHMEN: (Continued)**

Thus a diode tube - one with a cathode and an anode - is mostly used to rectify alternating current into direct current by passing it without restriction, but in one direction only. This also explains why closing time is strictly enforced at Irish pubs: During normal operation, the traffic flow is similarly unimpeded and uni-directional toward the bar and this process rectifies the work-day negativity. It goes without saying that no one leaves as long as the atmosphere around the bar remains positively charged.

**TRIODES:**

This section is a continuing technical treatise on the workings of Irish Pubs but to make it easier for the layman to understand, it is explained in terms of vacuum tube technology. Enter the original bar - free beer and no doors. Well, it turns out that some control over the flow can be a necessary and useful advantage. This led to the invention of those swinging louvered saloon doors which are open at the top and bottom. They are patterned after the control grid of the vacuum tube, which is a loosely wound coil of thin wire located between the cathode and the plate.

In a Triode the plate is always positively charged with high voltage D.C. and even though the grid is blocking the path, those negative electrons can still FEEL the strong attraction - just as the Irishmen can see in through the louvers of the bar doors. They know what pleasures lie beyond, but to get there requires overcoming the negative influences controlling the access. This negative influence is typically called a Bias. In electronic terms that means the grid is supplied with a voltage which is slightly MORE NEGATIVE than the already negative electrons. The more negative the Bias, the more it tends to neutralize the attraction of the plate and repel the electrons back toward the cathode.

The Irish can be similarly charged with Bias, but unless you are Irish yourself, this type of Biasing may be more difficult to understand. The effect is similar though: The more negative the Bias, the more it impedes forward progress. Generally speaking though, the electronic Bias of the grid is easiest to overcome, and for two main reasons: First, the Bias is set - like the bar doors - to allow some passage. Second, the grid is mostly NOT THERE, like the louvered doors which are mostly open spaces. Unlike the plate which is solid, the grid is like a coiled bed spring. It can create a repelling field but mostly it's empty space in between widely separated windings of wire. It's very easy to control the electrons as they pass through the grid's force field: Changing the grid voltage only slightly will have an enormous effect on how much current flows through... and that's what AMPLIFICATION is: a small change in voltage at the grid causing a large change in current flowing to the plate.

The purpose of the louvered bar doors is similar to that of the grid, namely, to give momentary pause while still revealing the promise within. Hesitation mostly gives way to temptation, but there are those few stalwart Irishmen who think twice and decide to come back later. Most just pause slightly then go on through. That is the purpose of the bar doors: to prevent everyone from crowding in all at once - and as the door is made less of a barrier, wider spaces between the louvers, more of the bar's attractive influence is felt outside thus amplifying the customer flow and increasing the crowd at the bar.

**PENTODES:**

Occasionally though, bar doors - even the louvered type - were found to be too effective, and too many customers turned away. Something further was needed to increase the attraction of the bar and overcome the resistance created by the door. Thus the cocktail waitress was invented.

Once again the idea was inspired by the vacuum tube. It had been discovered in some tubes, often large power types, that the distance to the plate was too great to attract enough electrons past the negative influence of the control grid. So another grid coil of fine wire was inserted between the first grid and the plate. This was called the screen grid and carrying a highly positive charge, it functioned as a "bait" for the plate.

In a properly designed power tube such as an EL84 or a 6V6, the windings of the screen grid are precisely aligned to fall in the shadow of the control grid. This way the electrons responding to the pull of the screen grid are lined up in sheets as they pass between windings of the inner control grid... only to find that they have been fooled! Once past the control grid and drawn toward the screen grid, they discover...there's almost nothing there. The path they're on has them aligned to zing straight through the spaces BETWEEN screen grid windings. So rather than a close and personal encounter, they just fly on past - and once they're out that far, there's no stopping them. The influence of the plate takes over and - being solid metal and of the highest positive attraction - it is at this final destination that the electrons congregate.

**PENTODES:** *(Continued)*

Thus the proper cocktail waitress - visible through the louvers - is scantily clad so as to be all the more effective at reinforcing the attractive influence of her bar and by being located in between the door and the bar, she serves as bait to lure customers past the door's negative influence. Once through the door however, it is the rare Irishman who actually comes in personal contact with the cocktail waitress as, for all intents and purposes, she - like the screen grid - turns out to be a vanishing illusion. Yet, having come this far, the solid influence of the bar itself now takes over and attracts the customers to congregate, having happily reached their destination.

If you're still following this and haven't lost track of the count, you'll know we're still one element short of the five needed to make a Pentode. This last part is a pair of beam-confining shields which being negatively charged, serve to direct the flow right toward the plate. This is much the way a short entrance hall to the bar prevents wandering accidentally into the Men's room on the way.

Once at the bar though, the circuit is complete and the process of soul-nourishing works its ritual magic. Biases having been overcome, illusory nightingales having vanished, the spirits truly soar and the once surly Irishmen now are filled with warmth, wit and kindred friendship, enjoying the music and glowing nicely with their heaters on.

With appreciative thanks to the inhabitants of the Land of the Leprechaun, we have now concluded our little diversion into the mechanics of proper bar lay-out.

A feature article by Randall Smith  
Designer / President

**FRONT VIEW HEAD VERSION:**

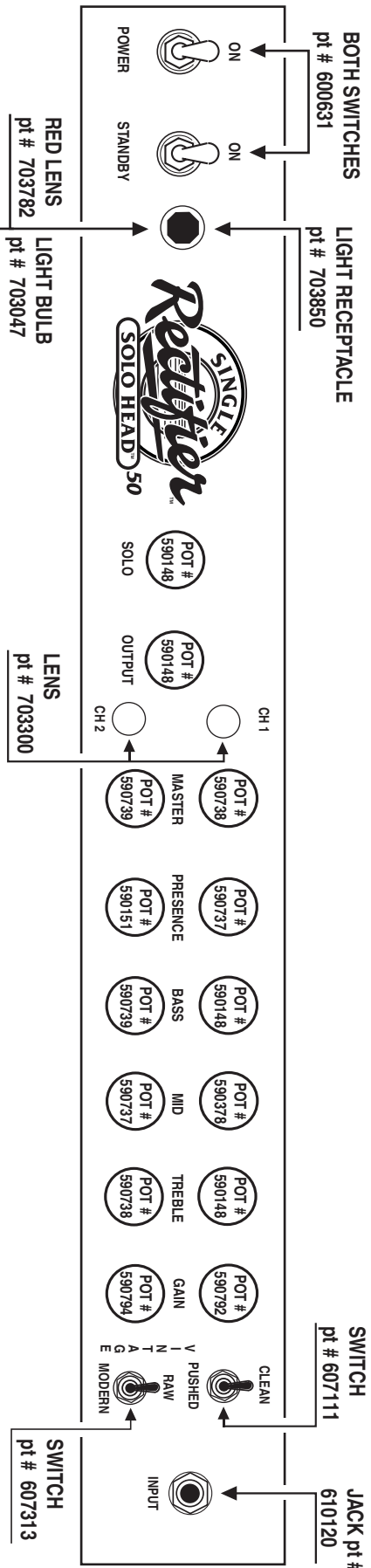

**NOTE: CHASSIS PARTS AND THEIR RESPECTIVE NUMBERS ARE THE SAME FOR BOTH THE HEAD & COMBO VERSIONS OF THE RECTO 50 SERIES 2 AMPLIFIERS**

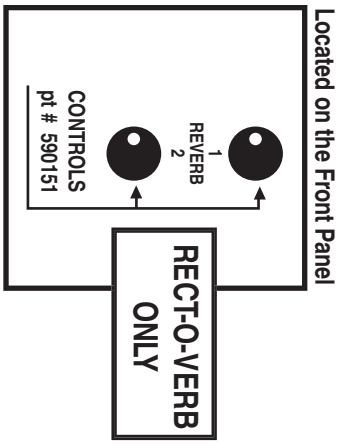

**REAR PANEL HEAD VERSION:**

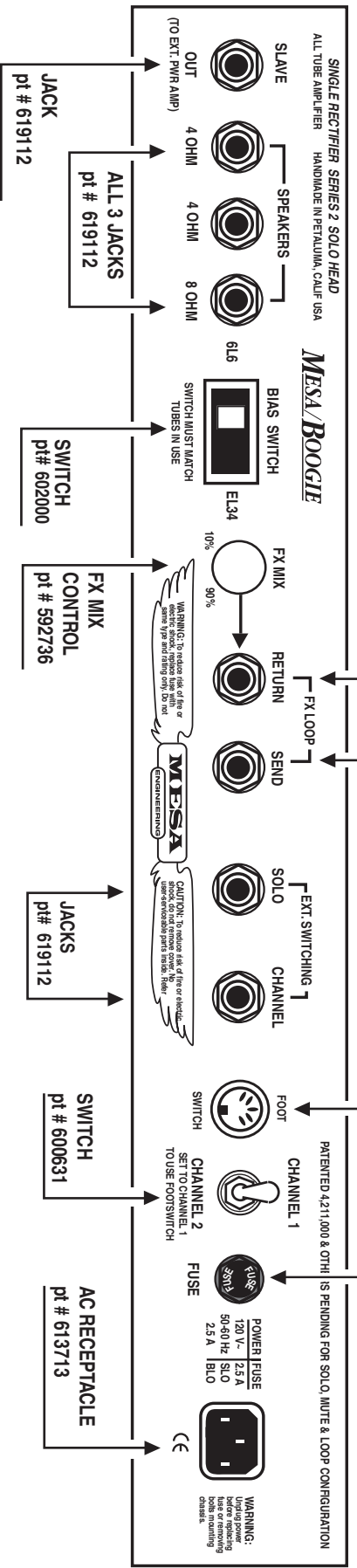





# ***MESA/BOOGIE***<sup>®</sup>

*The Spirit of Art in Technology*<sup>™</sup>

*Thank you for trusting MESA/Boogie to be your amplifier company.  
We wish you many years of toneful enjoyment from this handbuilt all  
tube instrument.*

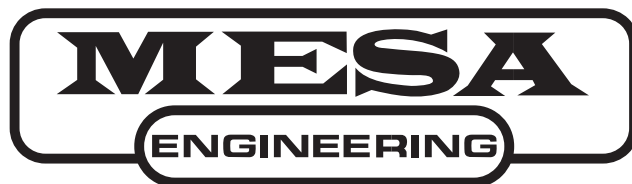

*The Spirit of Art in Technology*



*1317 Ross Street Petaluma, CA 94954  
USA*

*Phone: (707) 778-6565 Fax: (707) 765-1503*