



HP Retail Integrated Barcode Scanner

User Guide

© 2013, 2018 HP Development Company, L.P.

Microsoft and Windows are either trademarks or registered trademarks of Microsoft Corporation in the United States and/or other countries.

The information contained herein is subject to change without notice. The only warranties for HP products and services are set forth in the express warranty statements accompanying such products and services. Nothing herein should be construed as constituting an additional warranty. HP shall not be liable for technical or editorial errors or omissions contained herein.

Second Edition: June 2018

First Edition: June 2013

Document Part Number: 736672-002

About This Guide

This guide provides information on setting up and using the HP Retail Integrated Barcode Scanner.

 **WARNING!** Text set off in this manner indicates that failure to follow directions could result in bodily harm or loss of life.

 **CAUTION:** Text set off in this manner indicates that failure to follow directions could result in damage to equipment or loss of information.

 **NOTE:** Text set off in this manner provides important supplemental information.

Table of contents

1 Quick Setup	1
OPOS Driver	1
Carriage Return	1
Tab	3
Volume	4
2 Product Features	6
HP Retail Integrated Barcode Scanner	6
3 Safety and Maintenance	7
Ergonomic Recommendations	7
4 Setting Up and Using the Scanner	8
Using the Scanner	8
Configuring the Interface	9
USB-COM	9
Keyboard Interface	9
Scancode Tables	9
Country Mode	10
5 Programming the Scanner	11
Using Programming Bar Codes	11
Configure Other Settings	11
Resetting Standard Product Defaults	11
Reading Parameters	12
Aiming System	12
Good Read Green Spot Duration	12
Operating Modes	13
Appendix A Troubleshooting	14
Solving Common Problems	14
Online Technical Support	14
Preparing to Call Technical Support	14

Appendix B Technical Specifications	16
LED and Beeper Indications	19
Error Codes	20
Appendix C Product Labeling	21
Aiming System	21

1 Quick Setup

Use the bar codes in this chapter to perform quick setup procedures for common tasks. Scan the following bar code to set the scanner back to the factory defaults.

Figure 1-1 Set All Defaults



NOTE: Scanning the “Set All Defaults” bar code does not change the interface type.

Scan the following bar code (USB HID Keyboard Emulation) in order to put the HP Retail Integrated Barcode Scanner into the default mode of the scanner.

Figure 1-2 USB HID Keyboard Emulation



When the scanner is changed between HID and USB-COM mode, allow the Windows operating system a little time to reload the native drivers for the scanner.

OPOS Driver

The HP Retail Integrated Barcode Scanner by default is shipped in the human interface device (HID) keyboard emulation mode. In order to use the barcode scanner with OLE for Retail POS (OPOS) drivers the scanner must be put into USB COM (OPOS) mode.

For your convenience the bar code to put the HP Retail Integrated Barcode Scanner into USB COM (OPOS) mode or into HID keyboard emulation are located in this document. Refer to the *HP Retail Integrated Barcode Scanner Programming Reference Guide* for complete list of barcodes. The document can be found on the HP Point of Sale System Software and Documentation CD that comes with the scanner or the softpaq that is located on the HP support web site.

Scan the following bar code (USB COM OPOS) in order to put the HP Retail Integrated Barcode Scanner into the mode to be used with the OPOS drivers.

Figure 1-3 USB COM (OPOS)



Carriage Return

Scan the following bar code to set the scanner back to the factory defaults.

Figure 1-4 Set All Defaults



NOTE: Scanning the “Set All Defaults” bar code does not change the interface type.

If a carriage return is required after each scanned bar code, scan the following bar codes in order:

Figure 1-5 Enter Programming Mode



Figure 1-6 Set Global Suffix



Figure 1-7 0



Figure 1-8 D



Figure 1-9 Exit Global Suffix Mode



Figure 1-10 Exit Programming Mode



Tab

Scan the following bar code to set the scanner back to the factory defaults.

Figure 1-11 Set All Defaults



 **NOTE:** Scanning the “Set All Defaults” bar code does not change the interface type.

If a tab is required after each scanned bar code, scan the following bar codes in order:

Figure 1-12 Enter Programming Mode



Figure 1-13 Set Global Suffix



Figure 1-14 0



Figure 1-15 9



Figure 1-16 Exit Global Suffix Mode



Figure 1-17 Exit Programming Mode



Volume

Scan the following bar code to set the scanner back to the factory defaults.

Figure 1-18 Set All Defaults



Scan the following barcode to set the volume of the good read beep on the HP Retail Integrated Barcode Scanner:

Figure 1-19 Enter Programming Mode



Scan one of the four barcodes to set the volume to the desired setting:

Figure 1-20 Off



Figure 1-21 Low



Figure 1-22 Medium



Figure 1-23 High



Scan the following barcode to exit the programming mode.

Figure 1-24 Exit Programming Mode



2 Product Features

HP Retail Integrated Barcode Scanner

With rich feature sets, the HP Retail Integrated Barcode Scanner represents the premium level of data collection equipment for general purpose point of sale applications. The HP scanner has enhanced optics with improved motion tolerance, allowing codes placed on fast-moving objects to be easily and quickly captured, creating the ideal scanner for tasks requiring high throughput like those found in retail environments. The scanner includes the following features:

- **Omni-Directional Operation:** To read a symbol or capture an image, simply present to the scanner and the object sense, read, and decode automatically take place. The HP Retail Integrated Barcode Scanner is a powerful omni-directional scanner, so the orientation of the symbol is not important.
- **Intuitive Aiming System:** The “Green Spot” for good-read feedback helps to improve productivity in noisy environments or in situations where silence is required. While using the scanner with its multi-orientation capabilities, the aiming pattern can work as an aiming system to aid in positioning the bar code for quick and intuitive reading.
- **1D and 2D Symbol Decoding:** Reliably decodes all standard 1D (linear) and 2D bar codes, including:
 - GS1 DataBar™ linear codes
 - Postal Codes (China Post)
 - Stacked Codes (such as GS1 DataBar Expanded Stacked, GS1 DataBar Stacked, GS1 DataBar, Stacked Omnidirectional)

The data stream — acquired from decoding a symbol — is rapidly sent to the host. The scanner is immediately available to read another symbol.

- **Imaging:** The scanner can also function as a camera by capturing entire images or image portions of labels, signatures, and other items.
- **Mobile Phone Scanning:** The scanner is designed with enhanced motion tolerance and technology to optimize contrast levels. These features allow quick reading of barcodes off of mobile phones and PDAs.
- **Flexible Orientation:** When mounted in application, the scanner's orientation feature allows for flexible 2-axis positioning, permitting each user to optimize for their set up and scanning.

3 Safety and Maintenance

Ergonomic Recommendations

⚠ WARNING! In order to avoid or minimize the potential risk of ergonomic injury follow the recommendations below. Consult with your local Health & Safety Manager to ensure that you are adhering to your company's safety programs to prevent employee injury.

- Reduce or eliminate repetitive motion
- Maintain a natural position
- Reduce or eliminate excessive force
- Keep objects that are used frequently within easy reach
- Perform tasks at correct heights
- Reduce or eliminate vibration
- Reduce or eliminate direct pressure
- Provide adjustable workstations
- Provide adequate clearance
- Provide a suitable working environment
- Improve work procedures

⚠ CAUTION: The chemicals contained in Hecicide bacterial cleaners that are used in the retail market to reduce the risk and spread of bacterial disease from contaminated scanner surfaces may affect plastic structural properties and result in permanent failure of plastics under pressure.

4 Setting Up and Using the Scanner

Follow the steps below to connect and get the scanner up and communicating with its host.

1. Attach the HP Retail Integrated Barcode Scanner to the host device.
2. Configure the Interface, if necessary (refer to [Configuring the Interface on page 9](#)).
3. Configure the scanner as described in [Programming the Scanner on page 11](#) (optional, depends on settings needed).

Using the Scanner

The scanner functions by capturing the barcode (object) image and decoding the codes. The bar code scanner is set by default for Automatic Object Sense Read Mode that activates the aiming system on object motion. The aiming system indicates the field of view as an indication of where the bar code or object should be located for decoding.

Figure 4-1 Aiming System



Figure 4-2 Relative Size and Location of Aiming System Pattern

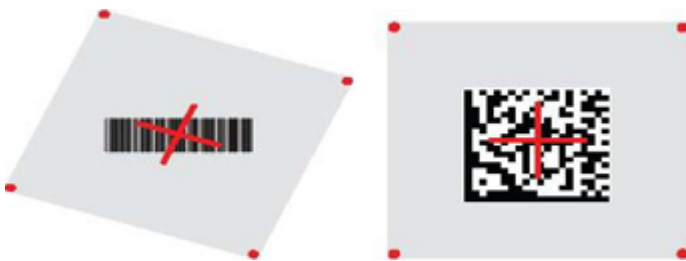

A red illumination lights up the label. The field of view indicated by the aiming system will be smaller when the scanner is closer to the bar code and larger when it is farther from the code. Symbologies with smaller bars or elements (mil size) should be read closer to the unit. Symbologies with larger bars or elements (mil size) should be read farther from the unit.

If the aiming system is centered and the entire bar code is within the aiming field, you will get a good read. Successful reading is signaled by an audible tone plus a good-read green spot indication.

Refer to the *HP Retail Integrated Barcode Scanner Programming Reference Guide (PRG)* for more information about this feature and other programmable settings.

Configuring the Interface

The scanner supports USB as the host interface. Upon completing the physical connection between the scanner and its host, select the desired Interface option (USB HID KBD is default) by scanning the appropriate bar code to select your system's interface type.

If you want to customize additional settings and features associated with the USB interface, proceed to the corresponding chapter in the HP Retail Integrated Barcode Scanner PRG.

 **NOTE:** Unlike some other programming features and options, USB type selections require that you scan only one programming bar code label. DO NOT scan an ENTER/EXIT barcode prior to scanning an interface selection bar code.

USB-COM

USB Com to simulate RS-232 standard interface

Figure 4-3 Select USB-COM-STD



 **NOTE:** Install the correct USB Com driver from the CD included with your product.

Keyboard Interface

Select options for USB Keyboard Interfaces.

USB Keyboard with alternate key encoding

Figure 4-4 Select USB Alternate Keyboard



USB Keyboard with standard key encoding

Figure 4-5 Select USB Keyboard



Scancode Tables

See the *HP Retail Integrated Barcode Scanner Programming Reference Guide (PRG)* for information about control character emulation which applies to keyboard interfaces.

Country Mode

This feature specifies the country/language supported by the keyboard. The following languages are supported:

U.S. English	Norwegian	Korean
UK English	Spanish	Russian
Belgian	Swedish	Hebrew
Danish	Traditional Chinese	Arabic
French	Thai	Greek
French Canadian	Portuguese (EU)	Hungarian
German	Brazilian Portuguese	Slovakian
Italian	Japanese	

See the *HP Retail Integrated Barcode Scanner Programming Reference Guide (PRG)* for information and programming bar codes for this feature.

5 Programming the Scanner

The scanner is factory-configured with a set of standard default features. After scanning the interface bar code from the Interfaces section (if necessary), select other options and customize the scanner through use of the programming bar codes available in the *HP Retail Integrated Barcode Scanner Programming Reference Guide* (PRG). Check the corresponding features section for your interface, and also the Data Editing and Symbologies chapters of the PRG.

Using Programming Bar Codes

This guide contains bar codes that allow you to reconfigure the scanner. Some programming bar code labels, like the "Standard Product Default Settings" in this chapter, require only the scan of that single label to enact the change.

Other bar codes require the scanner to be placed in Programming Mode prior to scanning them. Scan an ENTER/EXIT bar code once to enter Programming Mode; scan the desired parameter settings; scan the ENTER/EXIT bar code again to accept your changes, which exits Programming Mode and returns the scanner to normal operation.

Configure Other Settings

Additional programming bar codes are available in the PRG to allow for customizing programming features. If your installation requires different programming than the standard factory default settings, refer to the PRG.

Resetting Standard Product Defaults

Reference the PRG for a listing of standard factory settings. If you aren't sure what programming options are in the scanner, or you've changed some options and want the factory settings restored, scan the **Standard Product Default Settings** bar code below to copy the factory configuration for the currently active interface to the current configuration.

 **NOTE:** Factory defaults are based on the interface type. Configure the scanner for the correct interface before scanning this label.

Figure 5-1 Standard Product Default Settings



Reading Parameters

The scanner default is Automatic Object Sense Reading mode. Simply present the bar code label in front of the scanner and center the aiming pattern and illumination system to capture and decode the image. See [Using the Scanner on page 8](#) for more information.

The aiming system will briefly switch off after the acquisition time, and if no code is decoded will switch on again before the next acquisition. While movement and the object are being sensed, illumination will remain on until the symbol is decoded.

As you read code symbols, adjust the distance at which you are holding the object to optimize reading performance.

Aiming System

A number of options for customizing control of the Aiming System are available. See the *HP Retail Integrated Barcode Scanner Programming Reference Guide (PRG)* for more information and programming bar codes.

Good Read Green Spot Duration

Successful reading can be signaled by a good read green spot indication.

Use the bar codes that follow to specify the duration of the good read pointer beam after a good read.

Figure 5-2 ENTER/EXIT PROGRAMMING MODE



Figure 5-3 Disabled



Figure 5-4 Short (300 ms)



Figure 5-5 Medium (500 ms)



Figure 5-6 Long (800 ms)



Operating Modes

The reader can operate in two scanning (read) modes, plus the illumination can be programmed for several different operations states (off = default, dim, or on) while the read phase is not active. See the *HP Retail Integrated Barcode Scanner Programming Reference Guide* for more information and options.

Automatic: Scanning is continually on.

Automatic (Object Sense): Scanning is turned on automatically when an item is placed in the reader's field of view (default).

A Troubleshooting

Solving Common Problems

The following table lists possible problems and recommended solutions.

Problem	Solution
Scanner does not power up.	Ensure that the POS computer is powered on. Ensure that the scan module is properly connected to the USB port of the terminal monitor. If the scan module is attached to a standalone monitor, ensure the monitor USB cable is properly connected to the host. Reposition the scan module to a different USB port. If still not working, swap out with a different or new scan module.
Top light on scanner is flashing.	Reader may be indicating that the scanner is currently disabled. <ol style="list-style-type: none">1. Enable through host command.2. Connect with Configuration Utility and change interface.
Scanner does not read barcodes (scanner emits a target cross hair but there is no green dot or single beep when reading a barcode).	Try scanning a different product barcode. Clean the front window on the scanner if it is dirty. Check the front window on the scanner. If it is heavily damaged, replace the scanner. Determine the symbology type and ensure the symbology is enabled.
Scanner emits a target cross, emits a green dot, and emits a single beep when reading a barcode but does not transmit data to the host.	Reset the Interface option: USB Com or USB Keyboard Wedge <ul style="list-style-type: none">• If interface = USB Com, open a comport emulator and determine in Device Manager the correct comport number.• If interface = USB Keyboard Wedge, open a generic text editor such as Notepad, Microsoft Word or Command prompt.

Online Technical Support

For the online access to technical support information, self-solve tools, online assistance, community forums or IT experts, broad multi-vendor knowledge base, monitoring and diagnostic tools, go to <http://www.hp.com/support>.

Preparing to Call Technical Support

If you can not solve a problem using the troubleshooting tips in this section, you may need to call technical support. Have the following information available when you call:

- If the product is connected to an HP POS computer, provide the serial number of the POS computer
- Purchase date on invoice
- The spares part number located on the product

- Condition under which the problem occurred
- Error messages received
- Hardware configuration
- Hardware and software you are using

B Technical Specifications

The following table contains physical and performance characteristics, user environment and regulatory information.

Item	Description
Physical Characteristics	
Color	Black
Dimensions (Scan Head)	Height 2.10"/53.4mm Length 3.07"/78.0mm Width 2.5"/63.5mm
Weight	Approximately 6.1 ounces / 172 grams
Positional Adjustments	10,000 cycles
Electrical Characteristics	
Voltage & Current	Idle/Standby (typical) = 98ma @ 5.0VDC Operating ¹ (typical) = 160ma @ 5VDC Operating ² (max) = 215ma @ 5VDC Operating ³ (peak) = 335ma @ 5VDC Input Voltage (USB Vbus) = 4.5 - 5.5VDC
Performance Characteristics	
Light Source (illumination)	LEDs Red (625nm typ)
Roll (Tilt)	± 180° Tolerance from normal
Pitch Tolerance	± 40°
Skew (Yaw)	± 40°
Minimum Element Width	4 mil (1D Linear and HD) 5 mil (PDF-417) 7 mil (DataMatrix)
Print Contrast Minimum	25% minimum reflectance
¹ while actively scanning ² during good read of label (max = 100ms capture) ³ during good read of label (max peak = 250µS capture)	
Depth of Field (Typical)¹	
Symbology	SR: (typical)
Code 39	5mil: 1.8" - 7.0" (4.7 - 17.7cm) 10mil: 0.7" - 13.1" (1.7 - 33.2cm)

Depth of Field (Typical)¹	
Symbology	SR: (typical)
	20mil: 0.4" - 19.4" (1.1 - 49.2cm)
EAN	13mil: 1.0" - 16.5" (2.5 - 41.9cm)
	7.5mil: 1.1" - 10.8" (2.8 - 27.3cm)
PDF-417	6.6mil: 1.3" - 6.0" (3.3 - 15.4cm)
	10mil: 0.9" - 9.4" (2.2 - 23.9cm)
	15mil: 1.0" - 14.0" (2.5 - 35.6cm)
DataMatrix	10mil: 1.1" - 6.7" (2.7 - 17.1cm)
	15mil: 0.5" - 9.7" (1.2 - 24.6cm)
QR Code	10mil: 1.4" - 6.3" (3.5 - 16.0cm)
	15mil: 0.2" - 24.3" (0.5 - 24.6cm)

¹ 13 mils DOF based on EAN. All other 1D codes are Code 39. All labels grade A, typical environmental light, 20°C, label inclination 10°.

Decode Capability		
1D Bar Codes		
• UPC/EAN/JAN (A, E, 13, 8)	• Code 128 ISBT	• ABC Codabar
• UPC/EAN/JAN (including P2 /P5)	• LaPoste A/R 39	• Code 93
• UPC/EAN/JAN (including; ISBN / Bookland & ISSN)	• Interleaved 2 of 5	• MSI
• UPC/EAN Coupons	• Standard 2 of 5	• Plessey
• Code 39 (including full ASCII)	• Interleaved 2 of 5 CIP (HR)	• Follet 2 of 5
• EAN 128 (GS1-128)	• Industrial 2 of 5	• GS1 DataBar Omnidirectional
• Code39 CIP (French Pharmaceutical)	• Datalogic 2 of 5 (China Post Code/ Chinese 2 of 5)	• GS1 DataBar Limited
• Code 32 (Italian Pharmacode 39)	• IATA 2 of 5 Air cargo code	• GS1 DataBar Expanded
• Code 128	• Code 11	• GS1 DataBar Truncated
	• Codabar	• GS1 DATABAR Expanded Coupon

2D / Stacked Codes		
The scanner is capable of decoding the following symbologies using multiple frames (i.e. Multi-Frame Decoding):		
• Aztec	• QR Codes (QR, Micro QR and Multiple QR Codes)	• Royal Mail Code (RM45CC)
• QR Code	• Sweden Post	• Intelligent Mail Barcode (IMB)
• Datamatrix	• Portugal Post	• PDF
• Inverse Datamatrix	• Australian Post	• Micro PDF417
• Datamatrix is configurable for the following parameters:	• Japanese Post	• GS1 Composites
– Normal or Inverted	• KIX Post	• GS1 DataBar Stacked Omnidirectional

2D / Stacked Codes

The scanner is capable of decoding the following symbologies using multiple frames (i.e. Multi-Frame Decoding):

- Square or Rectangular Style
- Data length (1 - 3600 characters)
- Maxicode
- Planet Code
- Postnet
- GS1 DataBar Expanded Stacked
- Chinese Sensible Code

Interfaces Supported	USB Com Std., USB Keyboard, USB (see Configuring the Interface on page 9 for a listing of available interface options)
----------------------	--

User Environment

Operating Temperature	50° to 104° F (10 to 40° C)
Storage Temperature	-22° to 149° F (-30° to 65° C)
Humidity	Operating 20% to 85% Non-operating 5% to 90% relative humidity, non-condensing at ambient
Drop Specifications	Scanner withstands 18 drops from 0.3 meters (12 inches) to concrete
Ambient Light Immunity	Up to 100,000 Lux
Contaminants Spray/rain Dust/particulates	IEC 529-IP32
ESD Level	16 KV

Regulatory

Laser Safety	IEC Class 2
Wavelength	650 nm
Beam Divergence	±8°
Pulse duration	Continuous wave
Max power output	1mW Avg

LED and Beeper Indications

The scanner's beeper sounds and its LED illuminates to indicate various functions or errors on the scanner. An optional "Green Spot" also performs useful functions. The following tables list these indications. One exception to the behaviors listed in the tables is that the scanner's functions are programmable, and so may or may not be turned on. For example, certain indications such as the power-up beep can be disabled using programming bar code labels.

Indicator	Description	LED	Beeper
Power-up Beep	The scanner is in the process of powering-up.	N/A	Scanner beeps four times at highest frequency and volume upon power-up.
Good Read Beep	A label has been successfully scanned by the scanner.	LED behavior for this indication is configurable via the feature "Good Read: When to Indicate" (see the PRG for information).	The scanner will beep once at current frequency, volume, mono/bitonal setting and duration upon a successful label scan.
ROM Failure	There is an error in the scanner's software/ programming.	Flashes	Scanner sounds one error beep at highest volume.
Limited Scanning Label Read	Indicates that a host connection is not established.	N/A	Scanner 'chirps' six times at the highest frequency and current volume.
Scanner Active Mode	The scanner is active and ready to scan.	The Illumination LED is lit steadily ¹	N/A
Scanner Disabled	The scanner has been disabled by the host.	The LED blinks continuously	N/A
Green Spot ¹ flashes momentarily	Upon successful read of a label, the software shall turn the green spot on for the time specified by the configured value.	N/A	N/A
Image Capture	Capturing an Image	Upon image capture light blinks once and will blink multiple during larger image transfers	N/A

¹ Except when in sleep mode or when a Good Read LED Duration other than 00 is selected

Programming Mode - The following indications ONLY occur when the scanner is in Programming Mode.

INDICATION	DESCRIPTION	LED	BEEPER
Label Programming Mode Entry	A valid programming label has been scanned.	LED blinks continuously	Scanner sounds four low frequency beeps.
Label Programming Mode Rejection of Label	A label has been rejected.	N/A	Scanner sounds three times at lowest frequency and current volume.
Scanner Configurator Mode	Scanner is in support mode ready for configuration change.	The Indicator LED is lit steady	N/A
Label Programming Mode Acceptance of Partial Label	In cases where multiple labels must be scanned to program one feature, this indication	N/A	Scanner sounds one short beep at highest frequency and current volume.

INDICATION	DESCRIPTION	LED	BEEPER
	acknowledges each portion as it is successfully scanned.		
Label Programming Mode Acceptance of Programming	Configuration option(s) have been successfully programmed via labels and the scanner has exited Programming Mode.	N/A	Scanner sounds one high frequency beep and 4 low frequency beeps followed by reset beeps.
Label Programming Mode Cancel Item Entry	Cancel label has been scanned.	N/A	Scanner sounds two times at low frequency and current volume.

Error Codes

Upon startup, if the scanner sounds a long tone, this means the scanner has not passed its automatic Selftest and has entered FRU (Field Replaceable Unit) isolation mode. If the scanner is reset, the sequence will be repeated.



NOTE: To reset the scanner, insert a straightened paper clip into the reset hole and push firmly.

The following table describes the LED flashes/beep codes associated with an error found.

Number of LED Flashes/Beeps	Error	Corrective Action
1	Configuration	Contact Help desk for assistance
2	Interface PCB	Contact Help desk for assistance
6	Digital PCB	Contact Help desk for assistance
11	Imager	Contact Help desk for assistance

C Product Labeling

The sample label shown is for illustrative purposes only. Please view the label on your product for actual details, as they may vary.

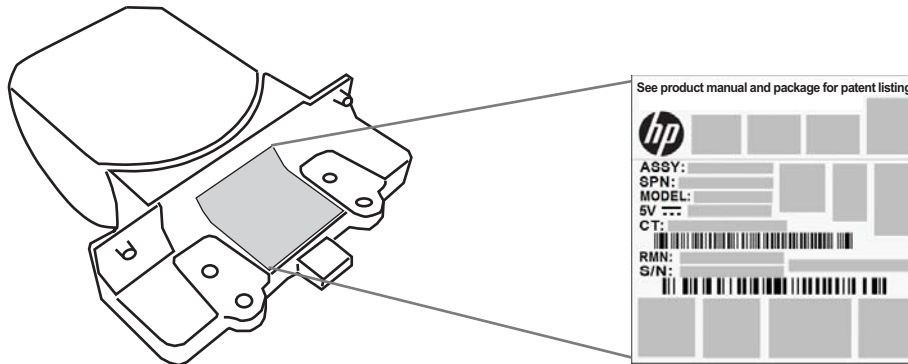

Aiming System

The Integrated Scanner's aiming system meets the Class 2 requirements for laser safety. The laser information is located on the aimer label as illustrated below.

