



TEREX®

**Compact Track Loader
Operation and Maintenance Manual**

Version: EN

Edition: 2011-09

Part Number: 2047-013

Valid From Serial No: DTH 00682 (70)

TTH 00101 (70)

DTI 01310 (80)

TTI 01294 (80)

Original Instructions

PT-70/80



The operator must read and understand all the instructions in this manual before operating the machine.

	Page
Introduction	2
Safety	5
Technical Data.....	33
Machine Description / Controls.....	39
Operation	47
Transportation	57
Maintenance	63
California Proposition 65	84
Service Log	85

1 INTRODUCTION

1.1 Product Identification (PIN)

The machine PIN is located on the identification plate, on the front surface of the operator enclosure.

Please state the model of the machine and PIN when making inquiries in regards to parts, service, or warranty.

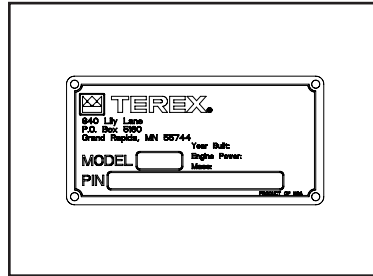

1.2 Introduction

Thank you for purchasing a Terex Compact Track Loader. We are confident that the machine you have chosen will provide excellent performance and efficient operation.

The information contained in this manual is intended to provide the operator with all necessary information for the proper use of the machine.

It is imperative that this manual be provided to the end user at the time of purchase, prior to operation and kept with the machine at all times. If lost or damaged, contact your dealer immediately to obtain a replacement prior to resuming operation.

It is very important that the operator read and understand the information in this manual prior to operating the machine or performing maintenance or service.

During operation, it is very important that the operator obey the instructions in this manual to ensure safe and efficient operation.

Should you need clarification or further explanation of the topics in this manual, please contact your dealer immediately for assistance.

Information describing special equipment or attachments and their operation are not included in this manual.

1.3 Safety Alert Symbol



The safety alert symbol is used to alert you to potential personal injury hazards. Obey all safety messages that follow this symbol to avoid possible injury or death.

1.4 Intended Use

The machine with standard dirt bucket is intended to be used solely for work consistent with its design. Such work involves loosening, collecting, transporting, and distributing soil, rock, or similar materials as well as loading these materials onto trucks, conveyors, or other methods of transport.

After installation of additionally approved special working attachments, the equipment can be used for corresponding applications.

The operator must follow the enclosed operating instructions for any externally supplied components or attachments.

Any use varying from that described here or any lack of adherence to the operating instructions, maintenance procedures, or replacement intervals described in this manual shall be regarded as unintended or improper use. The supplier cannot be held responsible for any damage resulting from improper use. This risk is borne solely by the user.

Note: Mulching type brush cutting attachments commonly used on this type of machine may become unbalanced due to worn, damaged, or missing “teeth”, causing vibration. If the attachment is operated in this condition, it can cause metal fatigue and / or cracking in both the host machine and the attachment itself. Vibration can also cause hydraulic component failure (ex: relief valves).

Mulching type brush cutters also generate more dust and flying debris than other attachments. The increased particles can plug coolers, radiators, and air cleaners much faster causing overheating or even engine failure if left unattended. The debris can also be introduced into many high temperature areas and can become a fire hazard. Debris should be cleaned frequently from these areas.

Although these mulching type heads work extremely well on Terex machines with high flow hydraulics, educate yourself on the increased maintenance and operating costs before using this type of attachment.

1.5 Copyright

This manual is intended for use by personnel responsible for operation, maintenance, repair, and supervision activities involving the machine described within.

This manual is copyrighted. It shall not, either in whole or in part, be reproduced, transmitted, or used for the purpose of competition without our prior written consent.

1.6 Warranty

Your Terex PT-70/80 is warranted under the Terex Compact Track Loader and Utility Vehicle Standard Limited New Product Warranty (“Warranty”). A copy of the Warranty certificate is included with this manual and is also available from your Authorized Terex Distributor.

	Page
2.1 Safety Alert System	7
2.2 Symbols	8
2.3 Graphical Symbols	10
2.4 Safety Signs (ANSI)	14
2.4.1 Safety Signs (ISO).....	16
2.5 General Notes	18
2.6 Personal Protection Equipment.....	19
2.7 Hazard Zone.....	19
2.8 Operation	20
2.9 Stability.....	21
2.10 Transport of Persons.....	21
2.11 Fire Prevention	22
2.12 Crush / Burn Avoidance.....	23
2.13 Placing Into Operation	24
2.14 Starting the Machine	24
2.15 Jobsite Safety	25
2.16 Parking the Machine	26
2.17 Towing / Retrieving.....	26
2.18 Transporting	27
2.19 Maintenance	28
2.20 Battery	30
2.21 Hydraulic Lines / Hoses.....	31

2.1 Safety Alert System



Safety Alert Symbol

This symbol means: **Attention! Be alert! Your safety is involved!**

The safety alert symbol is used to alert you to potential personal injury hazards. Obey all safety messages that follow this symbol to avoid possible injury or death.

This symbol is used as an attention-getting device throughout this manual as well as on decals and labels fixed to the machinery to assist in potential hazard recognition and prevention.

NOTICE indicates a property damage message.

Hazard Classification (applies only to ANSI safety signs)

The following signal words used with the safety alert symbol indicate a specific level of severity of the potential hazard. Signal words used without the safety alert symbol relate to property damage and protection only. Warnings in this publication and on the product labels are identified by these symbols.



DANGER indicates a hazardous situation which, if not avoided, will result in death or serious injury.













WARNING indicates a hazardous situation which, if not avoided, could result in death or serious injury.





CAUTION, used with the safety alert symbol, indicates a hazardous situation which, if not avoided, could result in minor or moderate injury.

2 SAFETY









2.2 Symbols











Symbol	Description
	Engine Pre-heat
	Battery
	Engine Speed: Fast Transmission Range: High
	Engine Speed: Slow Transmission Range: Low
	Windshield Wiper
	Beacon Light
	Oil Pressure
	Engine Coolant Temperature
	Hydraulic Oil Temperature
	Air Conditioning

Symbol	Description
 A symbol representing work lights, consisting of a semi-circle on the right and three horizontal lines of varying lengths extending to the left, resembling a light beam.	Work Lights
 A symbol representing a fan, showing a central hub with four curved blades radiating outwards.	Fan
 A symbol representing bucket positioning, showing a right-angled triangle with a horizontal line extending from the right vertex and a vertical line extending from the top vertex.	Bucket Positioning





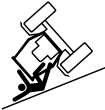



2 SAFETY



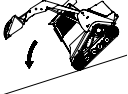

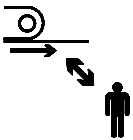

2.3 Graphical Symbols

Hazard Pictorial	Avoidance Pictorial	Description
		<p>Hazard: Skin/Oil Injection</p> <p>Avoidance:</p> <ul style="list-style-type: none">• Relieve internal pressure before disconnecting any line or fitting.• Keep away from leaks or pin-holes.• Use cardboard to check for leaks. <p>Fluid injected into skin must be surgically removed within a few hours by a doctor familiar with this type of injury or gangrene will result.</p>
		<p>Hazard: Corrosive</p> <p>Avoidance: Read and understand the operator's manual.</p>
		<p>Hazard: Entanglement</p> <p>Avoidance: Stop machine and remove key before servicing.</p>
		<p>Hazard: Burn/Scald</p> <p>Avoidance: Allow to cool before opening.</p>

Hazard Pictorial	Avoidance Pictorial	Description
		<p>Hazard: Explosion/Burn</p> <p>Avoidance:</p> <ul style="list-style-type: none"> • Keep all flames/sparks away! • No Smoking! • Read and understand all manuals.
		<p>Hazard: Fall</p> <p>Avoidance: Use the provided access system when entering or exiting the machine.</p>
		<p>Hazard: Fall</p> <p>Avoidance: No Riders.</p>
		<p>Hazard: Burn</p> <p>Avoidance: Do not touch hot surfaces.</p>
		<p>Hazard: Crush</p> <p>Avoidance: Fasten seat belt.</p>

2 SAFETY

Hazard Pictorial	Avoidance Pictorial	Description
		<p>Hazard: Entanglement</p> <p>Avoidance: Stop machine and remove key before servicing.</p>
		<p>Hazard: Rollover / Ejection</p> <p>Avoidance: Carry loads low, keep heaviest end of machine uphill at all times while operating on inclines.</p>
		<p>Hazard: Fall</p> <p>Avoidance: Do not use the bucket or attachment as a work platform.</p>
		<p>Hazard: Crush</p> <p>Avoidance: Stay clear of moving machine.</p>
		<p>Hazard: Crush</p> <p>Avoidance: Keep clear of lift arms and attachments.</p>

Hazard Pictorial	Avoidance Pictorial	Description
		<p>Hazard: Crush</p> <p>Avoidance: Install lift arm brace before servicing.</p>
		<p>Hazard: The safety alert symbol is used to alert you to potential personal injury hazards. Obey all safety messages that follow this symbol to avoid possible injury or death.</p> <p>Avoidance: Read and understand the operator's manual.</p>
		<p>Hazard: Fire</p> <p>Avoidance: Read and understand the operator's manual.</p>

2 SAFETY

2.4 Safety Signs (ANSI)

The safety signs are located in/on the machine as indicated. (Descriptions of the symbols are provided in section 2.3)

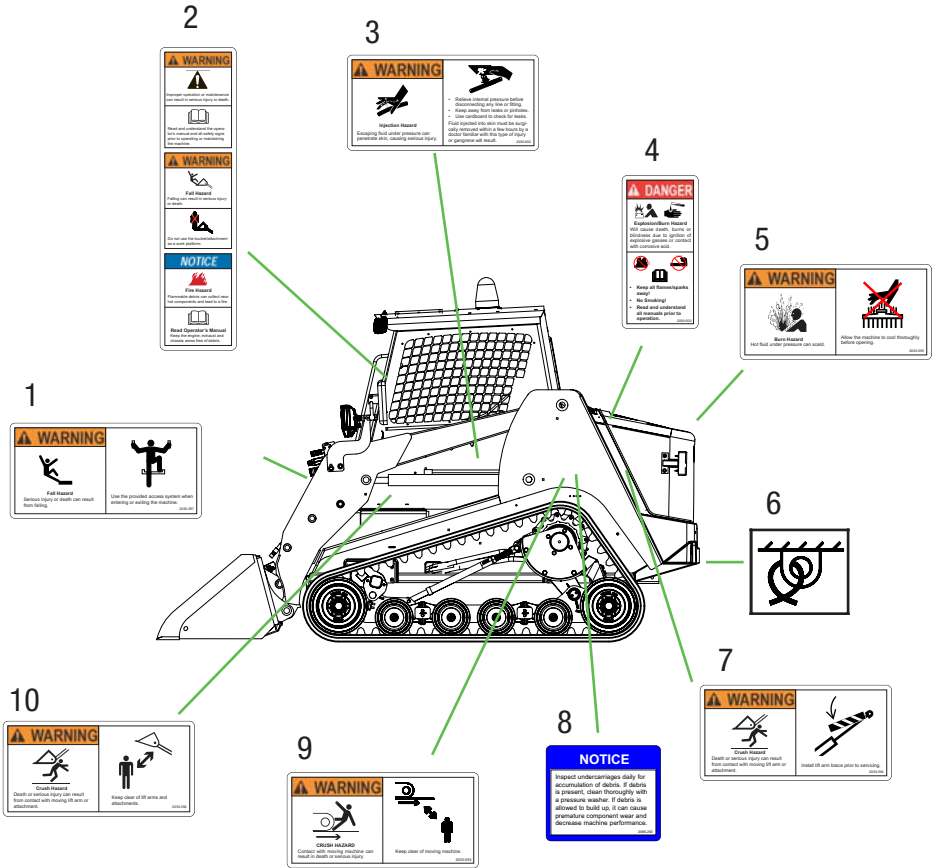

Key

1. Fall hazard
2. Read manual / fire hazard / fall hazard (inside cab)
3. Skin (oil) injection hazard
4. Explosion / burn hazard (read operator's manual) (engine area)
5. Burn hazard (engine area)
6. Tie down location
7. Crush hazard (lift arm brace)
8. Clean undercarriages notice
9. Crush (run over) hazard
10. Crush hazard (lift arms)

Note:

If any of the safety signs shown in this section are missing or damaged, contact your dealer to obtain a replacement.

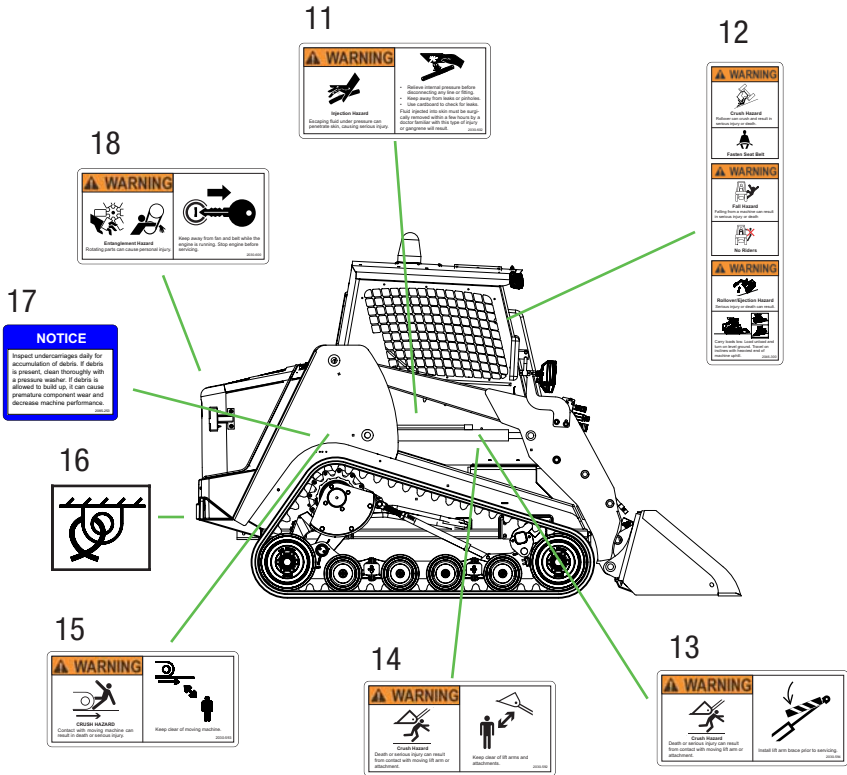

Key (continued)

11. Skin (oil) injection hazard
12. Crush hazard / fall hazard / rollover/ejection hazard (inside cab)
13. Crush hazard (lift arm brace)
14. Crush hazard (lift arms)
15. Crush (run over) hazard
16. Tie down location
17. Clean undercarriages notice
18. Belt/fan entanglement hazard (engine area)

2 SAFETY

2.4.1 Safety Signs (ISO)

The safety signs are located in/on the machine as indicated. (Descriptions of the symbols are provided in section 2.3)

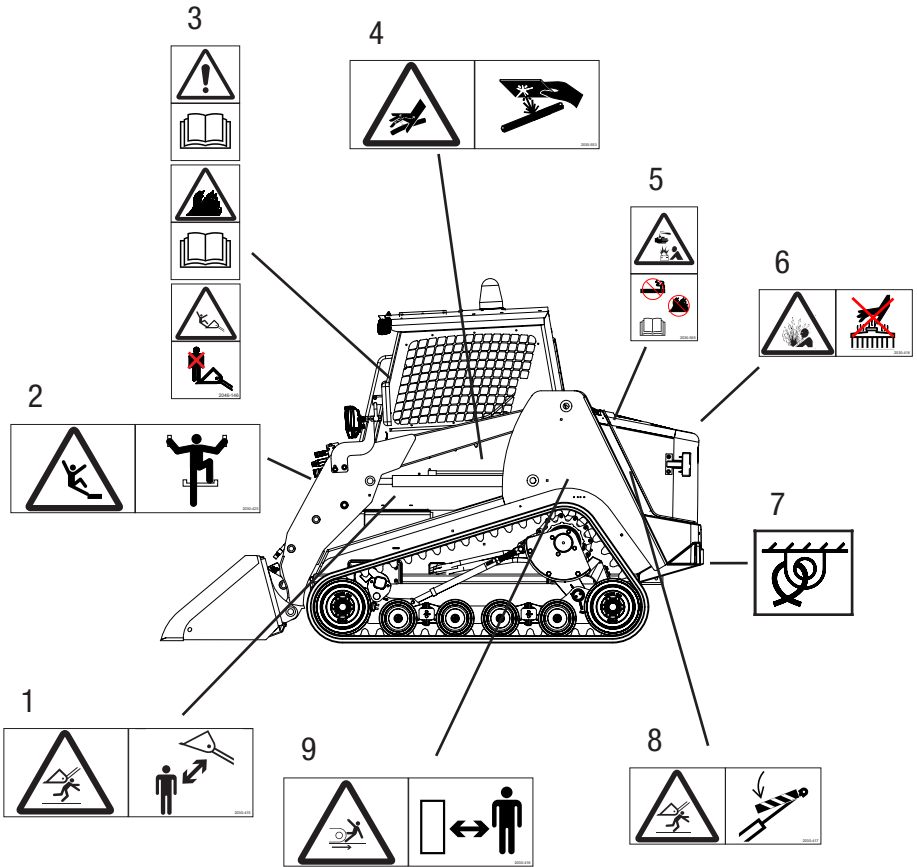

Key

1. Crush hazard (lift arms)
2. Fall hazard
3. Read manual / Fire hazard / Fall hazard (inside cab)
4. Skin (oil) injection hazard
5. Explosion / burn hazard (read operator's manual) (engine area)
6. Burn hazard (engine area)
7. Tie down location
8. Crush hazard (lift arm brace)
9. Crush hazard (run over)

Note:

If any of the safety signs shown in this section are missing or damaged, contact your dealer to obtain a replacement.

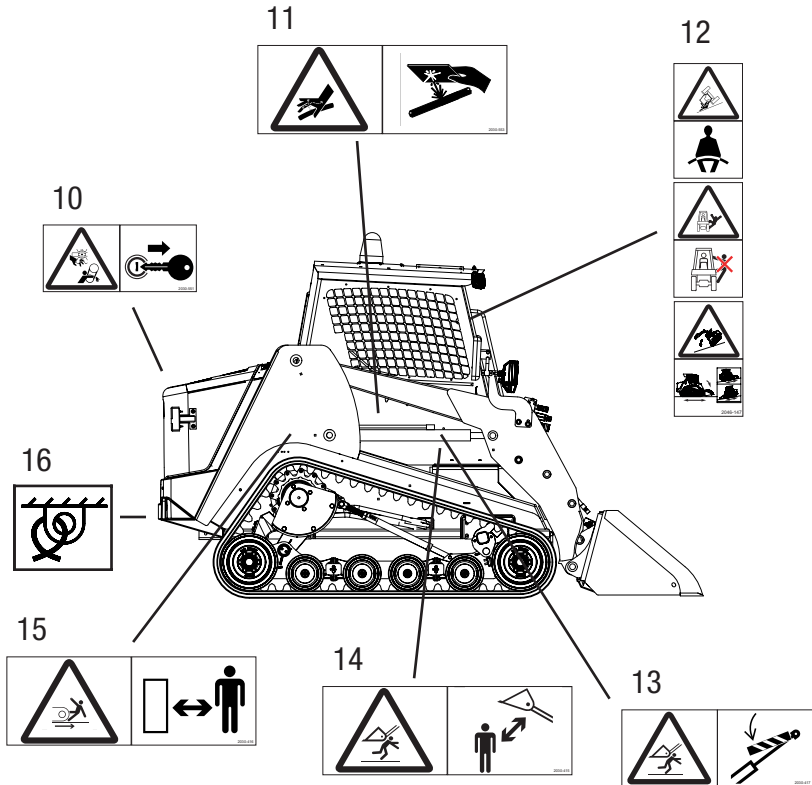

Key (continued)

- 10. Belt/fan entanglement hazard (engine area)
- 11. Skin (oil) injection hazard
- 12. Crush hazard / fall hazard / rollover hazards (inside cab)
- 13. Crush hazard (lift arm brace)
- 14. Crush hazard (lift arms)
- 15. Crush hazard (run over)
- 16. Tie down location

2 SAFETY



2.5 General Safety Notes

- Read and understand all safety signs and operator's manuals prior to operation.
- If safety signs are obstructed by dirt or debris, clean them using mild soap and water prior to operation.
- If safety signs are damaged or illegible, replace them immediately, prior to operation.
- Never jump off of the machine. Instead use the hand holds and step designed for entering and exiting the machine. Face the machine and use three points of contact to ensure your safety.
- Do not use any method of operation, inspection, or maintenance that may impair safety.
- This machine is only to be used when properly equipped for the task to be performed and when properly inspected and maintained to ensure safe operation.
- The manufacturer's instructions regarding operation, inspection, maintenance, repair and transportation **must** be followed.
- Never place the machine into operation without having first performed a thorough walk-around inspection and making any necessary repairs or adjustments.
- Safety devices on the machine shall not be deactivated or removed.
- Do not make any changes, additions or conversions to the machine that could have a negative effect on safety without the manufacturer's approval.

2.6 Personal Protection Equipment

The machine is designed to accommodate and protect an operator during operation from foreseeable injury **when used as intended and when equipped properly for the task(s) being performed**. Operators should not wear rings, scarves, open jackets, and should ensure that all clothing is tightly secured. Long hair should be restrained. Personal Protective Equipment (PPE) must be worn in the absence of an enclosed cab. In this case PPE would include, but not be limited to, safety glasses. The use of some attachments may require additional PPE, such as hearing protection, hardhat, gloves, and steel-toed shoes. In some applications high visibility/reflective jackets are required.

Personal protection equipment is also recommended when performing maintenance or service on a machine. Always wear appropriate protective equipment for working conditions when working on or around the machine. Loose clothing should not be worn and long hair should be restrained. Wear hard hats, protective face/eyewear, safety shoes and any other equipment necessary to ensure your safety and the safety of others around you as you work.

2.7 Hazard Zone

The hazard zone encompasses the area around the machine in which persons may be injured by movements of the machine during operation, its attachments, or by falling loads.

Do not position yourself or allow anyone else within this hazard zone during machine operation. Keep a safe distance to ensure your safety while the machine is in operation.

If someone enters the hazard zone, the operator must stop all work and give a warning signal to the person who may be in danger to leave the hazard zone. Work should not resume until all persons have vacated the hazard zone.

To minimize the possibility of a crushing hazard, a sufficient safety distance (min. 1.6 ft (0.5 m)) must be kept from solid objects, e. g. buildings, slopes, scaffolding, other machines, etc. If that distance cannot be kept, fence off the area between solid construction elements and the working range of the machine.

If conditions are such that the machine operator's view of the driving and working zone is restricted, he must be guided or the driving and working zone must be secured by means of a solid barricade.

2 SAFETY



2.8 Operation

Earth moving machines are only to be operated and serviced by individuals who

- are physically and mentally able to operate and / or service the machine in a safe manner.
- have been instructed in the proper operation or maintenance of the machine and have demonstrated competence in these areas.
- can be trusted to perform their assigned duties in a safe and reliable manner.
- are of the legal minimum age for performing such duties.

It is the responsibility of the operator to

- inspect the machine prior to operation and perform any necessary checks, adjustments or repairs to ensure safe operation.
- read and understand the instructions in this manual prior to operation and to follow them during operation.
- familiarize him/herself with the local worksite conditions and immediately remedy any fault that may compromise safety.
- use the machine in accordance with the appropriate local job site organization system to ensure safe coordination with other machines, vehicles, and people on the job site.

Investigate any work site prior to operation to determine whether any special hazards exist. Take necessary measures to eliminate or reduce any hazard.

Do not operate the machine in unsafe conditions including, but not limited to: near overhead electric lines, in enclosed areas without proper ventilation, in contaminated areas without necessary safety equipment and personnel.

2.9 Stability

The machine must always be operated with caution in order to maximize machine stability and guard against the possibility of a rollover.

- Travel only at speeds appropriate for the local conditions.
- Do not exceed the operating capacity of the machine.
- Exercise extreme caution while operating on inclines.
- Avoid operation on steep inclines.
- Do not make sudden changes in direction, move slowly, and always carry loads low to maximize machine stability.
- Always keep the heaviest end of the machine facing uphill when travelling on an incline.
- When operating on any surface other than firm and level ground, use extra caution. Decrease work speeds, limit load size and make any other necessary adjustments to maximize your safety and that of others in the work area.

2.10 Transporting Persons

- The machine must not be used to transport persons.

2 SAFETY



2.11 Fire Prevention

Compact Track loaders have components that operate at high temperatures. It is important to observe all inspection, operation and maintenance guidelines to minimize the possibility of fire.

- Turn the engine off when refueling.
- When refueling or charging the battery, do not smoke or allow open flame near the machine.
- Always start the engine according to the procedure in the operating instructions.
- Inspect and clean the radiator/oil cooler, engine compartment, exhaust system and other areas where there may be hot or rotating parts **daily**. In some work environments, flammable debris including but not limited to: leaves, straw, wood particles (dust), and similar items can accumulate in these areas and can lead to fire.
- Check the electrical system regularly. Have any faults such as loose connections, burnt fuses, glow lamps and damaged wiring repaired by professional personnel immediately.
- Regularly check all lines, hoses and threaded couplings for leaks and damage. Repair leaks immediately and replace any defective parts. Oil leaks can easily lead to a fire. **NEVER use bare hands to check for hydraulic leaks!** Pressurized fluid (oil) can penetrate skin and cause gangrene. If injection occurs, seek medical attention immediately!
- Do not use any starting aids containing ether to start diesel engines with pre-heat systems! Use of starting aids of this nature can cause an EXPLOSION!
- Familiarize yourself with the location of any fire extinguishers in/on the machine and how to use them as well as local options for reporting and fighting fires should one occur.

2.12 Crush and Burn Avoidance

- Do not work under the lift arms unless they are resting safely on the ground or supported by the lift arm brace.
- Do not use any restraining devices such as cables or chains that are damaged or do not have sufficient carrying capacity. Always wear safety gloves when working with wire cables.
- Never align holes with your fingers when working on the machine. Instead use a suitable mandrel.
- Keep yourself and all objects that could be drawn into the fan at a safe distance while the engine is running. The fan may deflect these objects away or destroy them and would likely be damaged by the objects.
- The entire cooling system is hot and under pressure when it is at or near operating temperature. Avoid touching parts that carry coolant to avoid the possibility of burns.
- Allow the machine to cool thoroughly prior to touching or removing the cooling system cap. Once cool, loosen the cover slowly to bleed off any excess pressure.
- The engine and hydraulic oil are hot when at or near operating temperature. Avoid skin contact with hot oil or parts carrying oil.
- Wear safety goggles and protective gloves when you are working with the battery. Keep sparks and open flames away from the work area.
- Before performing any work in the engine compartment, make sure the locking mechanism is engaged on the hood support strut so that the engine cover cannot close unintentionally.
- Exhaust components are hot when at or near operating temperature. Allow the machine to cool thoroughly prior to touching or performing service work on exhaust components to avoid the possibility of burns.

2 SAFETY



2.13 Placing into Operation

- Every time before placing the machine into operation, perform a thorough walk-around inspection of the machine.
- Check the machine for loose pins, cracks, tears, wear, leaks and deliberate damage.
- Never place a damaged machine into operation.
- Make any necessary repairs immediately, prior to resuming operation.
- Close and lock all hoods and covers, then inspect to make sure all warning signs are in place and legible.
- Make sure all windows and mirrors are clean. Secure door and windows against unintentional movements.
- Make certain no one is working on or under the machine and warn any persons standing nearby that the machine will be placed into operation.
- Prior to placing the machine into operation, adjust the driver's seat, mirrors, and ventilation system settings (if equipped) so you can work in comfort and safety.



2.14 Starting the Machine

- Before starting, check all indicator lamps and instruments to make certain they are working properly.
- Start the engine in the manner described in the operating instructions.
- Only allow the engine to run in enclosed rooms if there is adequate ventilation. If necessary, open doors and windows to ensure a proper supply of fresh air.
- Bring the engine and hydraulic oil up to operating temperature. Low oil temperatures can cause the control system to respond sluggishly.
- Move the machine carefully to open ground and then check the functionality of the lift arm and drive controls as well as the signal and lighting equipment.

2.15 Jobsite Safety

- Before beginning work, become acquainted with any special features or requirements of the work site. These may include, for example, obstructions in the work area, the carrying capacity of the ground and requirements to close the work site off from public traffic.
- Always maintain an adequate safety distance to overhanging features, edges, embankments and unsafe surfaces.
- Be especially cautious if visibility is poor, light conditions are low or soil conditions vary.
- Become acquainted with the location of supply lines at the work site and be especially careful when working close to them. Consult appropriate local authorities for necessary information regarding any such lines prior to commencing work.
- Keep the machine at an adequate distance from overhead electrical lines. When working in the vicinity of overhead electrical lines, do not come close to the lines with the machine. **Injury or death may result!** If possible, have the current turned off or line re-routed prior to beginning work.
- In the event electrical current jumps from a line to the machine, follow these rules:
 - do not perform any movements with the machine
 - do not leave the cab
 - warn persons outside not to approach or touch the machine
 - have the current turned off immediately
- Always turn on the appropriate lighting when visibility is poor or light conditions are low.
- Do not allow any passengers in or on the machine.
- Stay seated with the safety belt fastened while working.
- Report any operating faults immediately. Make sure any necessary repairs are performed prior to resuming operation.
- Never leave the machine unattended with the engine running.

2 SAFETY



2.16 Parking the Machine

- If possible, turn the machine off only on an even and solid surface.
- Lower the lift arms to the frame stop and rest the bucket on the ground.
- Turn off the engine as described in the operating instructions.
- Close the machine doors and windows (if equipped), remove the key to secure the machine against unauthorized use.



2.17 Towing/Retrieving the Machine

- Always observe the correct procedure as described in the operating instructions.
- The machine should be towed only in exceptional cases, for example to bring the machine away from an endangered place for repair.
- Check all trailing and drawing devices for their safety when pulling or towing.
- Towing equipment such as ropes, rods, etc., must be of the correct capacity and must use at least two of the d-rings on the front or rear of the machine on the chassis.
- Pull the rope taut slowly and carefully. A sudden jerk can cause a sagging rope or cable to tear or snap.

2.18 Transporting the Machine

- Use only suitable transport and lifting equipment with sufficient carrying capacity.
- Load the machine on firm and level ground.
- Before driving onto the ramps, clean them and the machine tracks of any materials that may cause slippage (snow, ice, water, mud, sludge, oil, etc.).
- Properly align the machine with the loading ramp.
- Have a guide give the machine operator any necessary signs to maximize safety during loading.
- Move carefully onto the ramps and transport vehicle.
- Before you leave the machine, relieve all residual pressure by making sure all operating levers and switches are in their neutral positions. Remove the ignition key.
- Secure the door, windows and hood on the machine.
- Secure the machine and any other items against slipping with chains, ropes of the proper capacity.
- Before departure, investigate the route to be taken, especially in regard to limits for width, height and weight.
- Pay close attention when driving under electrical lines, bridges, or through tunnels.
- Use the same caution when unloading as for loading. Remove all cables/chains. Start the engine as described in the operating instructions. Carefully drive down the ramp from the transport vehicle using a guide if necessary to direct movement.
- When lifting attachments or components, use caution. Attach straps or chains securely and in such a way that they evenly distribute the weight of the item to be lifted, ensuring a balanced load. Stay clear of expected travel path.

2 SAFETY



2.19 Maintenance

- Do not perform any maintenance work or repair task that you do not understand thoroughly.
- Park the machine on firm and level ground in a well lit and well ventilated area suitable for performing service or maintenance work.
- Disconnect the battery and remove the ignition key from the ignition before beginning work on a machine. Place a **Do Not Operate** tag across the opening of the cab to alert any operator that maintenance is in progress.
- Do not work on or under any machine that is supported only by a hydraulic jack or hoist. Always use mechanical supports to ensure that the machine will not fall.
- Make sure the work area around the machine is safe and make yourself aware of any hazardous conditions that may exist. If the engine needs to be started inside an enclosure, make sure that the engine's exhaust is properly vented.
- Be sure all protective devices including guards and shields are properly installed and functioning correctly before beginning any service task. If a guard or shield must be removed to perform the maintenance work, use extra caution.
- Always use the appropriate tools for the work to be performed. Tools should be in good condition and you should understand how to use them properly before performing any task.
- When replacing parts or fasteners, use parts of equivalent quality, grade and/or size. Use original Terex components to ensure the proper form, fit, and function of replacement parts.
- When performing maintenance work, always wear appropriate safety clothing for the task to be performed. Some examples might include: safety shoes, safety goggles and safety gloves.
- Relieve hydraulic system pressure by relaxing all hydraulic actuators prior to attempting any hydraulic maintenance or repair.

- When performing service that requires the lift arms to be in the raised position, always utilize the lift arm brace.
- If safety equipment needs to be dismantled to fit equipment or perform maintenance or repairs, it must be reattached and tested immediately after the maintenance and repair jobs are completed.
- Clean the machine prior to beginning work. Clean especially the connections and screw couplings of oil, fuel and upkeep materials at the beginning of the maintenance/repair job.
- Do not use flammable liquids to clean the machine.
- Perform tasks on the machine that involve welding or grinding only if approved by Terex. Clean the machine and the work area of dust and any combustible materials before welding or grinding to avoid fire or explosion.
- Before cleaning the machine with water or steam jets (high pressure cleaner) or other cleaning agents, cover or seal over all openings in which water, steam or cleaning agents should not penetrate for safety and/or functional reasons. Electrical motors, switch panels and plug connections are especially subject to damage. Before cleaning, inspect all fuel, engine oil and hydraulic oil lines for leaks, loose connections, rubbed spots and damage. Repair or replace any damaged components immediately.
- When working with oils, greases and other chemical substances, observe all safety requirements that apply to the product in question.
- Ensure that fuels, lubricants and coolants as well as replaced parts are disposed of in an environmentally proper manner.
- Proceed carefully when working with hot lubricants, coolants and fuels (danger of burns and scalding).

2 SAFETY

- Do not attempt to lift heavy parts. Use work aids with sufficient carrying capacity designed for that purpose. Fasten and secure individual parts and large assemblies carefully on lifting equipment to minimize the possibility of objects falling. Use only suitable lifting equipment with no technical defects. Do not work under suspended loads.
- Use only climbing aids and work platforms that meet safety requirements for assembly tasks above body height. Do not use machine parts as climbing aids if they were not designed for that purpose.
- If working at significant height, use a safety harness of the proper style and capacity to prevent falls. Keep all grips, steps, platforms, ladders, etc. free of dirt, snow and ice.



2.20 Battery (corrosive)

- Use caution, wear face shield, safety gloves, and any other appropriate safety equipment when working near or with the battery. The battery contains acid and should be handled with care.
- **DO NOT** smoke or allow open flame or sparks near the battery. Explosion could result.
- When disconnecting the battery, disconnect the **negative** terminal **first**.
- When connecting the battery, connect the **negative** terminal **last**.

2.21 Hydraulic Hoses/Lines

- Repairs to hydraulic hoses and hydraulic hose lines are forbidden! These repairs must be performed by trained personnel.
- All hoses, hose lines and screw connections must be checked regularly, at least once a year, for leaks and externally visible damage! Replace any damaged parts immediately! Oil spraying out can cause injuries and burns.
- Even if they are stored properly and subject to proper loads, hoses and hose lines are subject to natural aging. Their service life is therefore limited.

Improper storage, mechanical damage and impermissible load are the most frequent causes of failure.

The usage period of a hose line should not exceed 6 years, including a storage time of no more than 2 years (note manufacturer's date on the hoses).

Use in the limit zone of permissible load may reduce the duration of the usage period (for example high temperatures, multi-shift operation).

- Hoses and hose lines must be replaced if any of the following criteria are encountered during inspections:
 - damage to the outer hose up to the insert (for example worn spots, cuts and tears)
 - embrittlement of the outer layer (formation of cracks in the hose material)
 - deformation when under pressure, without pressure or when bending which differ from the original shape of the hose or hose line, for example separation of layers, formation of bubbles or leaks
 - failure to observe requirements of installation
 - damage or deformation to the hose fitting that reduces the stability of the fitting or the hose/fitting connection
 - hose coming loose from the fitting
 - corrosion of the fitting that reduces functionality and stability
 - exceeding storage times and usage periods
- When replacing hoses and hose lines, use only original spare parts. Install hoses and hose lines properly. Do not confuse connections.

	Page
3.1 General Structure	35
3.2 Views	36
3.3 Engine.....	36
3.4 Electrical System.....	36
3.5 Undercarriage	36
3.6 Transmission	37
3.7 Auxiliary Hydraulics	37
3.8 Ground Pressure	37
3.9 Operating Specifications.....	37
3.10 Service / Refill Capacities.....	37
3.11 Fluid Specifications	38
3.12 Dimensions and Weights	38

3.1 General Structure

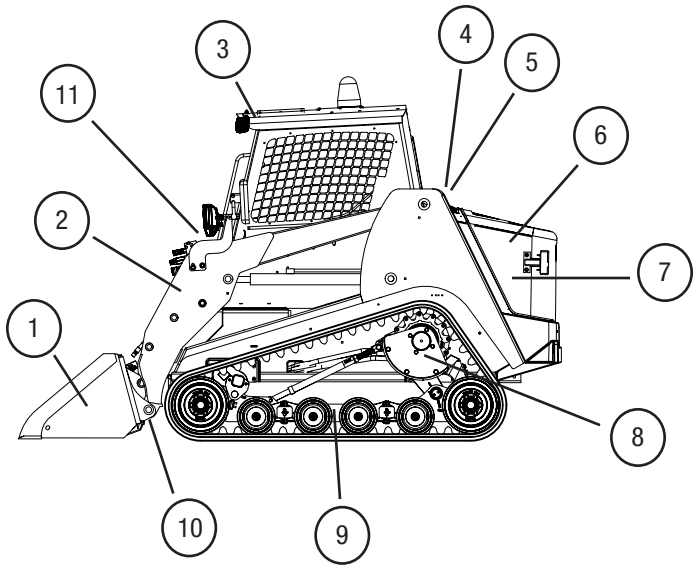

Key

1. Bucket
2. Lift Arm
3. Operator Enclosure (R.O.P.S./F.O.P.S. approved)
4. Hydraulic Oil (fill location)
5. Diesel Fuel (fill location)
6. Hood (engine cover)
7. Engine
8. Drive Motor and Sprocket
9. Undercarriage
10. Quick Attach
11. Product PIN Plate (on front of operator enclosure)

3 TECHNICAL DATA

3.2 Views

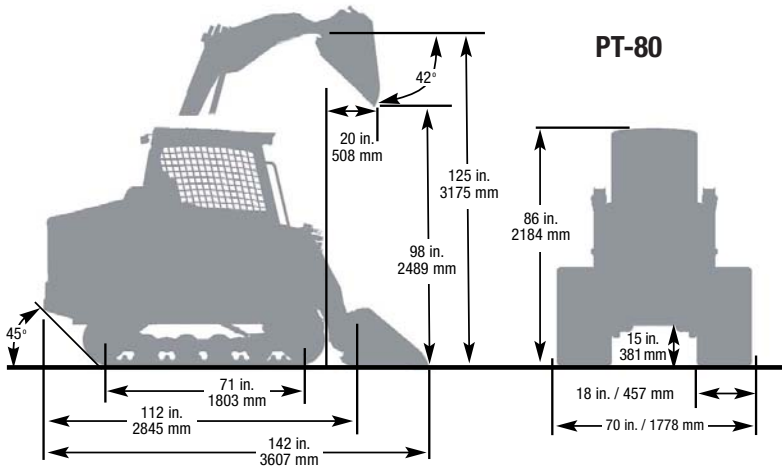

3.3 Engine

PT-70

PT-80

Make	Perkins	Perkins
Type	804D-33T	804D-33T
Design	4 cyl. in line (turbo)	4 cyl. in line (turbo)
Displacement	201.4 in. ³ (3.3L)	201.4 in. ³ (3.3L)
Power @ 2600 RPM	71 hp (53 kW)	83.1 hp (60 kW)
Admissible inclines	25° all directions (engine)	25° all directions (engine)
Cooling	Water-antifreeze blend	Water-antifreeze blend

3.4 Electrical System

PT-70

PT-80

Operating Voltage	12 V	12 V
Battery @ 32° F (0° C)	12V 950 CCA	12V 950 CCA
Alternator	12V 90A	12V 90A
Starter	12V	12V
Starting Aid	Glow Plugs, w/pre-heat	Glow Plugs, w/pre-heat
Lighting System	Cab mounted work lights	Cab mounted work lights

3.5 Undercarriage

PT-70

PT-80

Type	Suspended, rubber track	Suspended, rubber track
Max. Speed (Low/High)	7 mph (11.3 kph)	6/11 mph (9.7/17.7 kph)
Power Transmission	variable disp.	variable disp.
Track length, on ground	71 in. (180.3 cm)	71 in. (180.3 cm)

3 TECHNICAL DATA

3.6 Transmission

PT-70

PT-80

	PT-70	PT-80
Make	Rexroth	Rexroth
Type	A22VG	A22VG
Design	Axial piston	Axial piston
Displacement	2.75 in. ³ (45 cc) / rev.	2.35 in. ³ (38.5 cc) / rev.
Relief Pressure	5500 psi (37,920 kPa)	5500 psi (37,920 kPa)

3.7 Auxiliary Hydraulics

PT-70

PT-80

	PT-70	PT-80
Make	Rexroth	Rexroth
Type	A10VO	A10VO
Design	Axial Piston	Axial Piston
Displacement	2.75 in. ³ (45 cc) /rev.	2.75 in. ³ (45 cc) /rev.
Relief pressure	3000 psi (20,684 kPa)	3000 psi (20,684 kPa)
Low Flow @2600 RPM	0-20 gpm (0-75.7 lpm)	0-20 gpm (0-75.7 lpm)
High Flow @2600 RPM	30 gpm (113.6 lpm)	30 gpm (113.6 lpm)

3.8 Ground pressure

PT-70

PT-80

	PT-70	PT-80
At operating weight	3.7 psi (25.5 kPa)	3.5 psi (24.1 kPa)
At shipping weight	3.43 psi (23.6 kPa)	3.15 psi (21.7 kPa)



3.9 Operating Specs.

PT-70

PT-80

	PT-70	PT-80
Tipping load	5500 lb (2495 kg)	6200 lb (2812 kg)
Operating capacity 50%	2750 lb(1247 kg)	3100 lb(1406 kg)
Operating capacity 35%	1925 lb (873 kg)	2170 lb (984 kg)

Note: The Maximum Gross Vehicle Weight of the PT-70 is not to exceed 11,500 lb (5216 kg.) / PT-80 12,500 (5670 kg.). This excludes an operator, but does include accessories, attachments and material being carried.

3.10 Refill Capacities (approx.) PT-70

PT-80

	PT-70	PT-80
Fuel tank	18 gal (68 l)	18 gal (68 l)
Hydraulic tank	20.9 gal (79 l)	20.9 gal (79 l)
Engine coolant	3.2 gal (12 l)	3.2 gal (12 l)
Engine oil including filter	2.25 gal (8.52 l)	2.25 gal (8.52 l)

3 TECHNICAL DATA

3.11 Fluid Specifications (applies to both machines)

Specifications	Designation	Specification/standard
Fuel	Diesel Fuel	EN590 or ASTM D975 1-D / 2-D
Engine Oil	Engine Oil	SAE 10W-30 (API CH-4)
Engine Coolant	Coolant	Antifreeze/Water w/SCA additive
Hydraulic Oil	Hydraulic Oil	Mobil DTE 10 Excel Series 46
Lubricating Points	MP Grease	Multi-purpose lithium grease

Alternative Temperature Recommendations

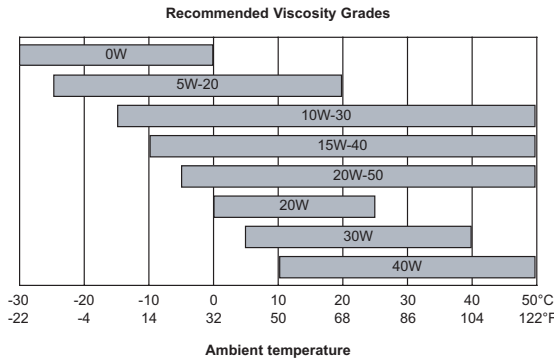

3.12 Dimensions and Weights **PT-70**

PT-80

Length w/o bucket	112 in. (2845 mm)	112 in. (2845 mm)
Length w/bucket	141 in (3581 mm)	142 in. (3607 mm)
Width	66 in. (1676 mm)	72 in. (1778 mm)
Height (to top of cab)	86 in. (2184 mm)	86 in. (2184 mm)
Ground Clearance	15 in. (381 mm)	15 in. (381 mm)
Weight (operating)	7890 lb (3579 kg)	8972 lb (4070 kg)
Weight (ship / no bucket)	7315 lb (3318 kg)	8060 lb(3656 kg)

4 MACHINE DESCRIPTION / CONTROLS

	Page
4.1 Display Elements.....	41
4.2 Controls	42
4.3 Throttle	43
4.4 Operator Seat	43
4.5 Two Speed	43
4.6 Auxiliary Hydraulics.....	44
4.7 Bucket Positioning.....	45
4.8 Electric Attachment Control	45
4.9 Emergency Exit.....	46

4.1 Display Elements

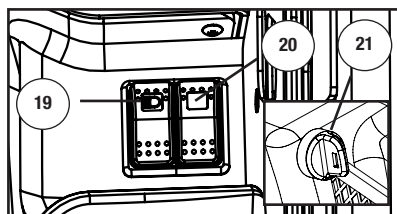
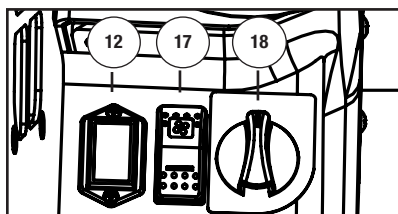
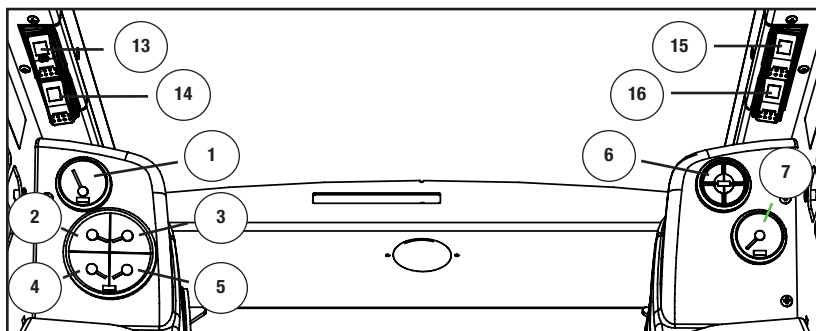

Learn the location and function of these items prior to operation.

Instruments:

1. Engine Temperature Gauge
2. Oil Pressure Gauge
3. Fuel Gauge
4. Hydraulic Oil Temp. Gauge
5. Voltmeter
6. 4 in one light
7. Tachometer
8. High Range Indicator
9. Glow Plug Operation Indicator
10. Low Range Indicator
11. Parking Brake Indicator
12. Hour Meter

Switches:

13. Parking Brake Switch
14. Hyd. Quick Attach Switch
15. High Flow Aux. Switch
16. Low Flow Aux. Switch
17. Heater Fan (optional)
18. Heater Temp. Control (optional)
19. Work Light Switch
20. Bucket Positioning (optional)
21. Ignition Switch

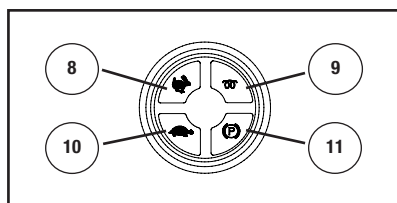

Note: The glow plug operation light should illuminate only when the ignition switch is turned to the pre-heat position.

NOTICE

Should the engine or hydraulic temperature gauges read excessive temperatures, or should the oil pressure gauge indicate low oil pressure during normal operation, shut the machine down immediately (in a safe location). Diagnose the problem and make needed repairs before resuming operation.

4 MACHINE DESCRIPTION / CONTROLS

4.2 Controls

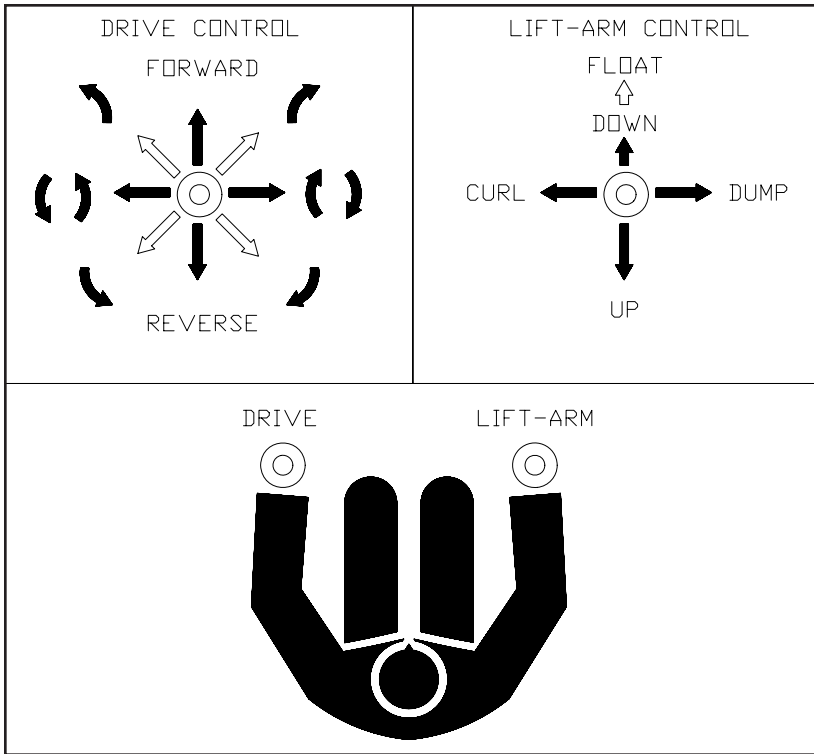

The PT-70/80 has two hydraulic pilot joystick controls. The joysticks are used to control machine speed and direction as well as lift arm and bucket functions.

4.2.1 Lift Arm Control

The lift arm joystick is used to control the lift arms, bucket, and to engage the float function. The illustration above shows the relationship between joystick movement and resulting lift arm action.

Note: To activate the float function, move the joystick fully forward in a quick motion. The joystick will then be held in detent by the magnet attached to the joystick base. Pull back quickly to disengage the float function.

4.2.2 Drive Control

The drive joystick controls the direction and speed of the machine. The illustration above shows the relationship between joystick movement and resulting machine motion.

4.3 Throttle

The throttle (foot pedal) is located beneath the operator's right foot when seated in the machine. The throttle controls engine rpm.

- Press the front of the pedal down to increase engine RPM.
- Press the rear of the pedal down to decrease engine RPM.
- Select a lower rpm for work that requires delicate operation of the machine.
- Select a higher rpm for faster travel speed or when more power or flow is required for a task.

4.4 Operator Seat

Seat Adjustment

The PT-70/80 machines are available with a suspension style seat adjustable for both operator weight (spring preload) and operator height variation in fore and aft directions.

To adjust for weight:

Twist the knob clockwise for heavier operator or counter-clockwise for lighter operator.

To adjust for height:

Pull outward on the height adjustment lever, slide the seat forward or rearward as needed, then release the lever to set.

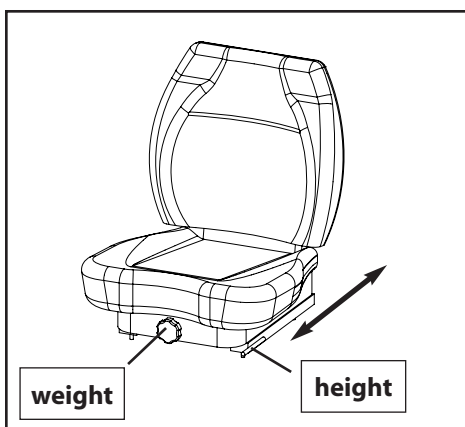

4.5 Two Speed

The PT-80 is equipped with a two-speed drive system. Low range is best suited to performing strenuous work or operating attachments. High range is intended mainly for transporting.

To shift between high and low ranges, push the button on the front of the right joystick. When shifting between ranges, slow the machine to ensure a smooth transition. The high range indicator (item 8, section 4.1) illuminates to confirm high range operation.

Note: If the machine is turned off, the seat belt is removed, or the operator exits the seat, the machine automatically returns to low range.

4 MACHINE DESCRIPTION / CONTROLS

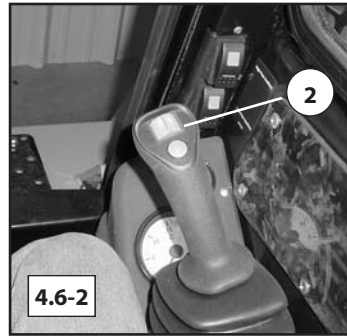
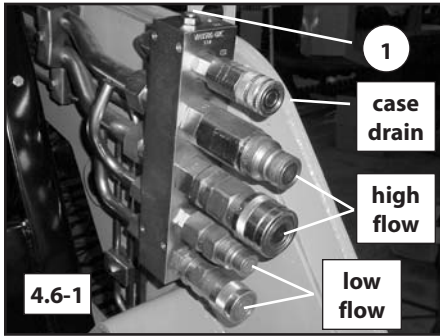

4.6 Auxiliary Hydraulics

The PT-70/80 models come equipped with an auxiliary hydraulic system designed to power approved hydraulic attachments.

To operate, connect the attachment to the appropriate quick couplers (fig. 4.6-1).

To connect couplers:

1. Clean couplers thoroughly (both ends).
2. Release residual pressure in the system by pressing item 1 (fig. 4.6-1).
3. Push the male and female coupler ends together, then turn coupler collar 1/4 turn to lock.

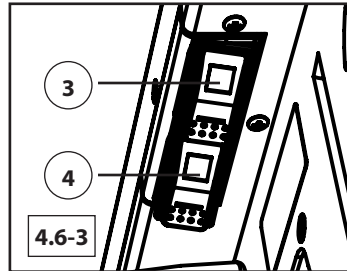

The auxiliary hydraulics can be engaged intermittently or continuously depending on the requirements of the attachment being utilized.

To engage the low flow auxiliary circuit intermittently, roll the switch on the top of the right joystick (item 2) to the right or left of center to control flow volume and direction (fig. 4.6-2).

To engage the high or low flow auxiliary circuit continuously, activate the switch for the desired circuit on the dash panel, labeled 3 or 4 in figure 4.6-3.

Note: Moving any of the auxiliary switches from one position to the other has the effect of reversing flow through the circuit.

Note: The continuous flow switches must be in the neutral position in order to start the engine.

Note: The continuous flow auxiliary switches have an orange locking device that must be disengaged before the switch will activate.

4 MACHINE DESCRIPTION / CONTROLS

4.7 Bucket Positioning (optional)

The PT-70/80 machines can be equipped with feature commonly referred to as “bucket positioning”. The bucket positioning system does not automatically level your attachment. Instead, it will maintain the current angle of the quick attach (relative to level) throughout the upward cycle of the lift arms.

The bucket positioning feature can be turned on or off with the switch located on the side console (item 20, section 4.1).

Note: During the upward cycle, the bucket positioning function can be overridden by operating the tilt or curl functions of the joystick.

Note: The bucket positioning feature works on the upward cycle only. The operator must position the attachment manually on the downward cycle.

4.8 Electric Attachment Control

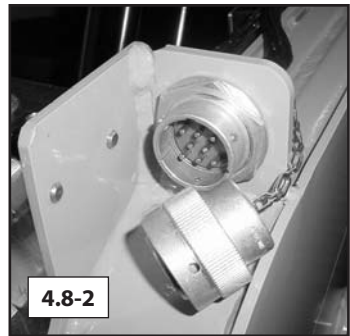
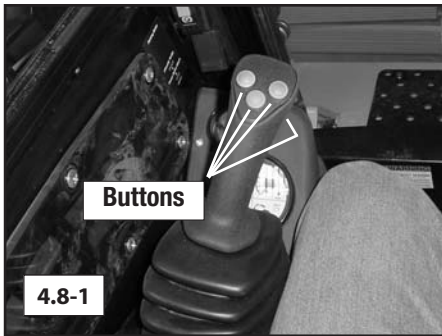

Attachments for the PT-70/80 are controlled by pressing various buttons on the joysticks or switches in the cab. Most attachments are controlled hydraulically, but some require both hydraulic and electrical inputs. The 4 buttons on the left joystick (4.8-1) send electrical current to the receptacle on the lift arms (4.8-2). Approved attachments that require electrical inputs have a matching receptacle.

Note: The electrical receptacle is not necessarily compatible with other brands. Use only approved attachments for proper function.

4 MACHINE DESCRIPTION / CONTROLS

4.9 Emergency Exit

Familiarize yourself with the emergency exit and associated features located in the cab enclosure prior to operation. These features allow an operator to escape from the cab in an emergency.



Operator Escape (Rear Window Exit):

Firmly grasp the triangular tag attached to the window molding on the rear window. Pull on the tag forcefully to remove the window molding, then push or kick the window out to escape (fig. 4.9-1).

	Page
5.1 General Information.....	49
5.2 Pre-Operation Safety Checklist.....	49
5.3 Starting Procedure	50
5.4 Surface Preservation.....	51
5.5 Filling the Bucket	51
5.6 Grading.....	52
5.7 Leveling	52
5.8 Loading.....	53
5.9 Fastening Attachments.....	53
5.10 Unfastening Attachments.....	54
5.11 Power Quick Attach	54
5.12 Operation on Inclines	55
5.13 Shut-Down Procedure	55
5.14 Lift Arm Brace	56

5.1 General Information

Operating a Terex Compact Track Loader is intended to be as safe and simple as possible. This section expands on the machine controls portion of the manual and also covers safe operation procedures to follow while operating.

5.2 Pre-Operation Safety Checklist

Before operating the machine, perform a pre-operation safety check. Inspect the machine for any items that may affect safe operation.

Check to make sure:

1. Engine compartment, chassis and coolers are clean and free of debris.
2. Windows and lights are clean and unobstructed.
3. Tracks are in good condition and are properly tensioned.
4. Fluids are filled to proper levels.
5. Accessory belts are in good condition and properly tensioned.
6. Hydraulic hoses and fittings are in good condition. (no visible signs of wear)



Never use bare hands to check for leaks! Pressurized oil can penetrate skin and cause gangrene. Seek medical attention immediately from a physician familiar with this type of injury!

7. Battery cables are in good condition and properly fastened.
8. Joysticks, auxiliary hydraulic switch are in neutral position. Power quick attach switch (if present) must be in the locked position.
9. The R.O.P.S./F.O.P.S. approved operator enclosure is not damaged or distorted structurally in any way.
10. The seat belt and lap bar restraint (if equipped) are in good working order.
11. All safety signs are in place and legible on the machine.
12. All control devices are present, appear to be in good condition, and are not damaged in any way.
13. The rear/side view mirrors are adjusted for proper viewing.
14. The safety circuit is functioning properly by performing the following:
 - A. Start the engine according to section 5.3.
 - B. Raise the lap bar, then attempt to curl the bucket.
 - C. Lower the lap bar.
 - D. Raise yourself off of the seat to remove pressure from the operator presence safety switch located in the seat, then attempt to curl the bucket.

If the bucket moves during either of these tests, the safety circuit is not functioning properly. It must be repaired prior to operation.

15. You have read and understood the information in this manual in its entirety.

5 OPERATION

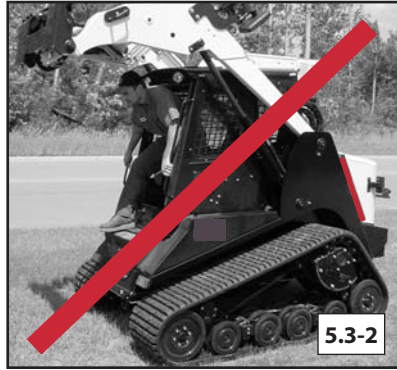

5.3 Starting Procedure

Before starting the engine, perform the pre-operation safety checklist. Once complete, you may proceed by following this procedure:

1. Enter machine with lift arms all the way down. Maintain three points of contact with the machine (fig. 5.3-1).
2. Sit down into the operator's seat and fasten the seat belt.
3. Starting with the throttle in the SLOW (turtle icon) position, push the throttle 1/3 of the way open (toward the rabbit icon).
4. Turn the ignition key to the left for 6 seconds to "pre-heat" the engine. While pre-heating, the glow plug operation light will illuminate.
5. Turn the ignition key to the right to start the engine.
6. Let the engine run at low idle for 2 to 3 minutes to warm it.
7. Set the throttle to desired rpm for operation.

Note: The parking brake is automatically engaged when the engine is turned off, the operator is not in the operator seat or the seat belt is unfastened.



Entering or exiting the vehicle under raised lift arms could result in injury or death. Never allow anyone beneath raised, unsecured lift arms (fig. 5.3-2).

5.4 Surface Preservation

Terex Compact Track Loaders are designed to produce minimal ground disturbance while operating on finished surfaces like turf, however, care should be taken while operating on these surfaces to prevent blemishes from occurring.

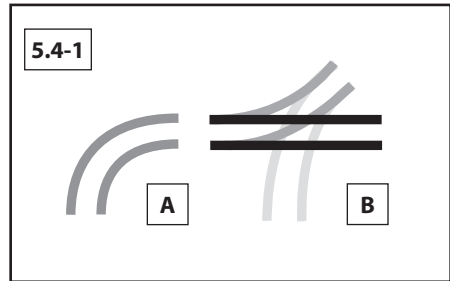

Turning poses the greatest risk of surface disturbance during operation. Moving in a straight line across turf will cause little or no disturbance, whereas tight cornering will most likely cause blemishes.

While working on turf, make gradual turns. (see item A) If space is limited, turn gradually by moving back and forth until facing the desired direction. (see item B)

5.5 Filling The Bucket

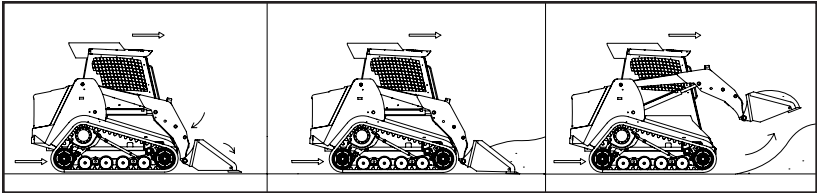

Steps: (see illustration)

1. Lower the lift arms until they rest on the frame.
2. Tilt the bucket slowly forward until the cutting edge engages the ground.
3. Drive the machine forward until the bucket is full of material.
4. Curl the bucket and raise the lift arms simultaneously to break the load free from the pile.
5. Maneuver the machine clear of the pile and then lower the lift arms, keeping the bucket curled upward, to approximately 10-12 in. (25-30 cm) above the ground for transporting.

5 OPERATION

5.6 Grading

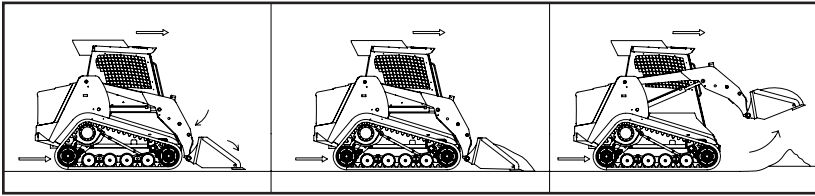

Steps: (see illustration)

1. Lower the lift arms until they rest on the frame.
2. Tilt the bucket slowly forward until the cutting edge engages the ground.
3. Drive the machine forward making slight bucket angle adjustments to vary cut depth as necessary.
4. When full, curl the bucket and raise the lift arms simultaneously. Once clear, lower them to approximately 10-12 in. (25-30 cm) above the ground for transporting.

NOTICE

Do not push or pull dirt as done in digging, grading, or leveling operations with the bucket tilted fully forward into the “Dump” position. This will stress the bucket cylinders and may damage them.

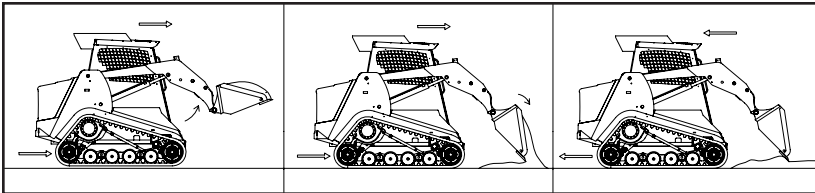

5.7 Leveling

Steps: (see illustration)

1. Moving forward, raise the lift arms as you tilt the bucket slowly forward to evenly spread the material out over the ground.
2. Once the load is released, tilt the bucket forward to an angle 45° or less to the ground.
3. Lower the lift arms until the cutting edge rests on the ground.
4. Engage the float function and back the machine over the material varying bucket angle slightly as necessary to maintain grade.

5.8 Loading

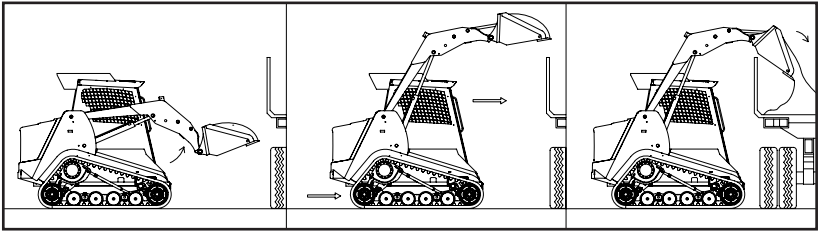

Steps: (see illustration)

1. Engage the bucket positioning function (if equipped), then raise the lift arms upward until the bottom of the bucket clears the side of the truck bed or trailer.
2. Once clear, drive the machine forward until the pivot point of the bucket clears the bed side.
3. Tilt the bucket forward until all of the material has been released into the bed.

Note: It may be necessary to quickly tilt and curl the bucket while releasing material into the truck bed to evenly distribute the material within the bed.

5.9 Fastening Attachments (see also section 5.11)

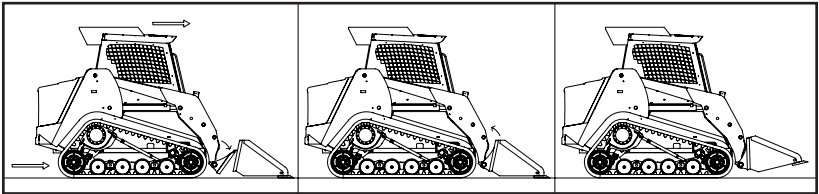

1. Make sure the locking levers on the quick attach mechanism are in their respective unlocked positions. (fig. 5.10-1)
2. Drive the machine to the attachment and hook the top edge of the quick attach under the upper lip of the attachment.
3. Curl the quick attach slowly upward by moving the lift arm control joystick to the left until the attachment is properly mated with the quick attach mechanism. (Curl enough to lift the attachment off of the ground.)
4. Once the attachment is properly mated, move the two locking levers inward and downward to lock the attachment in place.

Note: When fastening an attachment, always visually verify that the attachment is locked in place prior to operation. (fig. 5.10-2, 5.10-3)

5 OPERATION

5.10 Unfastening Attachments (see also section 5.11)

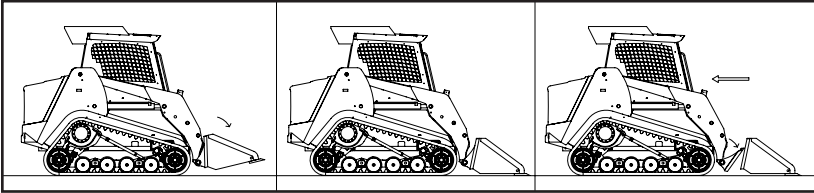

1. Lower the lift arms so that the attachment is just barely off of the ground.
2. Pull the locking levers on the quick attach mechanism upwards and toward the outside of the machine to unlock the attachment.
3. Lay the attachment gently onto the ground by moving the lift arm control joystick slowly to the right.
4. Once the attachment is in contact with the ground, move the lift arm control joystick gently to the right until the quick-attach is clear of the attachment.
5. Back the machine away from the attachment.

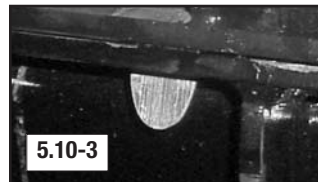
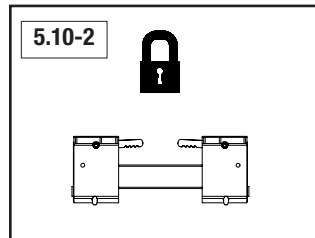
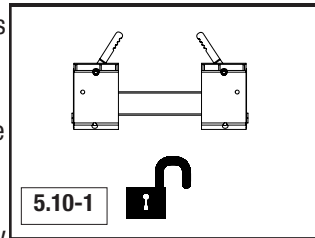

5.11 Power Quick Attach (optional)

Some machines may be equipped with a hydraulic (power) quick attach. The procedure is the same for fastening and unfastening attachments as described in sections 5.9 and 5.10 with one exception. The locking and unlocking of the mechanism is performed by pressing a switch instead of moving levers on the unit itself.

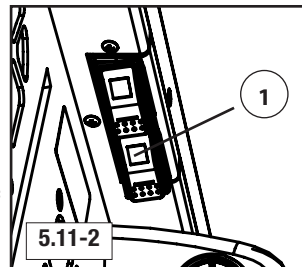

To lock the quick attach:

- Press the switch (item 1) into the lock position.

To unlock the quick attach:

- Press the switch (item 1) into the unlock position

5.12 Operation on Inclines

By design, Compact Track Loaders are very stable on inclines. Machine weight is distributed evenly throughout the chassis and the suspended undercarriage track system provides excellent traction and floatation on nearly all surfaces.



Even with these capabilities, extreme caution should always be exercised while operating the machine on an incline. Avoid operation on steep inclines. Do not make sudden changes in direction, move slowly, and always carry loads low to maximize machine stability.

5.13 Shut Down Procedure

1. Stop, lower and disconnect any work attachments that may be coupled to the quick attach.
2. Park the machine in a safe location (on firm and level ground) where it is protected from the elements and vandals.
3. Lower the lift arms until they rest on the frame stops.
4. Reduce engine RPM to a low idle.
5. Turn the ignition key to the off position to stop the engine.
6. Remove the safety belt and raise the lap bar (if equipped).
7. Open the door (if equipped) and exit the machine using 3 points of contact as described in the starting procedure in this section.

5 OPERATION

5.14 Lift Arm Brace

When the lift arms must be left in the raised position, the lift arm brace must be engaged.

To install:

1. Lower the lift arms, remove any attachments and park the machine on firm and level ground.
2. Have an assistant withdraw the retaining pins from the lift arm brace on the tower and remove the brace.
3. Raise the lift arms to the upper limit to allow for brace installation.

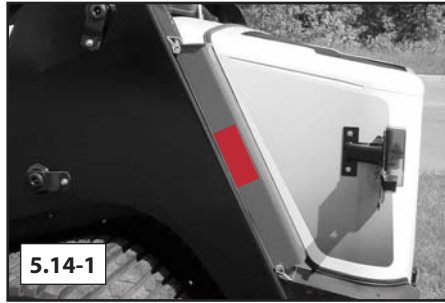

4. Have the assistant place the lift arm brace onto the top side of the cylinder ram and install the retaining pins to secure it there.
5. Slowly lower the lift arms until they come to rest on the brace.

To remove:

1. Raise the lift arms until they are clear of the brace.
2. Have an assistant withdraw the retaining pins and remove the brace from the cylinder.
3. Lower the lift arms to the lower stop.
4. Position the lift arm brace over the tower brackets as found and install the retaining pins to secure it there.



Do not go beneath unsecured lift arms. Always install the lift arm brace prior to going beneath the lift arms while raised.

	Page
6.1 Transporting.....	59
6.2 Towing / Retrieving	59
6.3 Loading / Unloading Procedure	60
6.4 Lifting Procedure	61

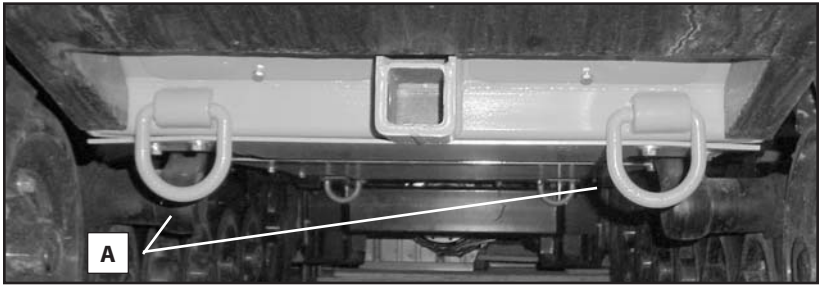

6.1 Transporting

At times, you will most likely need to transport the machine to distant locations with a transport vehicle. To do this safely, there are some precautions that must be observed.

When transporting:

1. Always make sure the transport vehicle (trailer or truck) being used to haul the machine is capable of bearing the weight and size of the machine over the distance and terrain that will be covered.
2. Secure the machine to the transport vehicle bed, facing the direction of travel, with heavy chains rated for use with a machine of this nature (size and weight).
3. Attach the chains to the machine at four points (D-rings), one on each corner of the chassis and secure to suitable locations on the transport vehicle (Items A, see photo). Tighten as needed to eliminate possible load shift during transport.

Note: Close and latch doors and windows, secure any loose items prior to transporting.

6.2 Towing/Retrieving

In the event that the PT-70/80 needs to be towed or retrieved, it will not roll freely. You must drag it to safety. Use only chains that are rated for pulling a machine of this size and weight. Attach these chains to **at least two of the D-rings** in the front or rear of the machine. If possible, drag the machine onto a trailer, then secure and transport.

6 TRANSPORTATION

6.3 Transport Loading / Unloading procedure

1. Load the machine only on firm and level ground.
2. Before driving onto the ramps, clean them and the machine tracks of any materials that may cause slippage (snow, ice, water, mud, sludge, oil, etc.).
3. Properly align the machine with the loading ramp.
4. Have a guide give the machine operator any necessary signs to maximize safety during loading.
5. Move carefully onto the ramps and transport vehicle.
6. Have a guide instruct you as to where and when to stop and park the machine. Lower the lift arms and turn off the engine.
7. Before securing the machine, relieve all residual pressure by making sure the operating levers and the auxiliary hydraulic switch are in their neutral positions. Remove the ignition key.
8. Secure the door, windows and hood on the machine.
9. Secure the machine and any other items to the transport vehicle with chains or ropes of the proper capacity.
10. Before departure, investigate the route to be taken, especially in regard to limits for width, height and weight.
11. Pay close attention when driving under electrical lines, bridges, or through tunnels.



Electrocution hazard exists if electrical lines are contacted! Stay clear of electrical lines!

12. To unload, reverse steps 1-9 of this procedure. Use the same caution when unloading as for loading. Remove all cables or chains. Start the engine as described in the operating instructions. Carefully drive down the ramp from the transport vehicle using a guide if necessary to direct movement.

6.4 Lifting Procedure

Lifting the machine should only be done from beneath the machine with a jack of the proper capacity.

To safely lift your machine:

1. Remove any attachments that may be fastened to the machine and raise the lift arms.
2. Install the lift arm brace as instructed in section 5.14.
3. Once the lift arms are secured, carefully exit the machine.
4. Roll or slide your jack under the front of the machine and center the lifting pad **beneath the center of the front torsion axle**.

NOTICE

Note: When using a jack to lift the machine, place the jack beneath the torsion axles only. Lifting at any other point will cause machine damage.

5. Once in place, jack/lift the machine upward making sure it remains stable until it has reached sufficient height to install suitable mechanical supports beneath the machine.
6. Slide the mechanical supports into place making sure they are positioned beneath the torsion axles or structural tubing along the bottom of the chassis only and spaced in such a manner that the machine will be stable when its weight rests solely on the supports.
7. Once the supports are in place, slowly lower the machine onto them and then remove the jack.

 When lifting attachments or components, use caution. Attach straps or chains securely and in such a way that they evenly distribute the weight of the item to be lifted, ensuring a balanced load. Stay clear of expected travel path.

Repeat steps 4-7 at the rear of the machine should both ends of the machine need to be off of the ground for service.

Lift the machine straight up in a slow and careful manner (under the torsion axles only). Lower it this same way making sure all persons in the area are clear of the machine and its expected path.

	Page
7.1 General	65
7.2 Care and Cleaning.....	65
7.3 Maintenance Intervals	66
7.4 Lubrication Points.....	67
7.5 Engine Oil Check.....	68
7.6 Engine Oil Change.....	69
7.7 Hydraulic Oil Change	70
7.8 Hydraulic Filter Change	71
7.9 Accessory Belt.....	71
7.10 Water Separator	72
7.11 Fuel Filter Change	72
7.12 General Undercarriage	73
7.13 Track Tension Check.....	73
7.14 Track Tension Adjustment.....	74
7.15 Drive Sprocket Rollers.....	75
7.16 Air Cleaner Removal / Inspection	76
7.17 Air Cleaner Cleaning	77
7.18 Radiator Oil Cooler Cleaning.....	78
7.19 Engine Coolant Change	78
7.20 Chassis Cleaning.....	79
7.21 Electrical System.....	80
7.22 Storage	81
7.23 Cab Tilt.....	83

7.1 General

The operating condition and life expectancy of a machine is largely influenced by care and maintenance. For this reason, it is in every machine owner's interest to perform the specified maintenance work and comply with the service intervals.

This chapter describes periodic maintenance, inspection and lubricating tasks. The maintenance interval charts list all work to be performed on the machine at regular intervals.

The supplemental engine operation and maintenance manual provided with every machine contains information specific to the proper operation, inspection and maintenance of the engine and its internal components. This manual must be read, understood and followed in order to properly maintain the engine and comply with warranty requirements.

The operator must have sufficient knowledge to inspect and maintain the machine. The operator should follow the procedures in this manual and take any necessary precautions to ensure his/her safety. Wear appropriate personal protection equipment for all tasks.

7.2 Care and cleaning

Cleaning the machine

- Do not use aggressive detergents to clean the machine. We recommend using commercially available cleaning agents for passenger cars.
- Linings (insulating materials, etc.) should not be exposed directly to water, steam or high-pressure jets.
- When cleaning with water or steam jets, take care not to direct the jet into exhaust and air filter openings.
- When cleaning the engine with water or steam jet, do not expose sensitive engine parts, such as generator, wiring, oil pressure switches, etc. directly to the jet.
- Pay particular attention to the radiator / oil cooler, engine compartment, and chassis area when cleaning. Remove any visible debris from these areas prior to cleaning.
- After wet cleaning lubricate the machine as specified in section 7.4 prior to operation.
- Inspect the machine after cleaning for the presence and condition of safety signs. If any are missing or damaged, contact your dealer immediately to obtain a replacement.

7 MAINTENANCE

7.3 Maintenance Intervals

7.3-1 Daily Maintenance Tasks

Daily		Page
1	Check hydraulic oil level (figure 7.7-3, p-70)	70
2	Check engine oil level	68
3	Check fuel level (gauge on instrument panel)	41
4	Check fan belt tension / condition	71
5	Check track tension / condition	73
6	Check for proper control operation	42
7	Check for proper switch and lighting operation	41
8	Check / clean air cleaner elements	76
9	General visual check for cracks, damage, completeness	24,49
10	Check for leaks in hoses, tubes, valves, pumps, cylinders, etc.	22,31,49
11	Drain water separator	72
12	Lubricate all grease points	67
13	Inspect / clean the radiator/cooler and engine compartment	78-79

7.3-2 50-1000 hour Tasks

Every 50 operating hours		Page
1	Inspect drive sprocket rollers (replace as needed)	75
Every 250 operating hours		Page
1	Replace engine oil & filter	69
2	Replace hydraulic filter(s)	71
Every 500 operating hours		Page
1	Replace fuel filter element	72
Every 1000 operating hours		Page
1	Replace hydraulic oil	70
2	Replace engine coolant (use SCA additive, see engine manual)	78

7.4 Lubrication Points

The illustration below shows the location of grease points found on the left side of the machine. Identical points also exist on the opposite side of the machine. Lubricate all points daily, prior to operation.

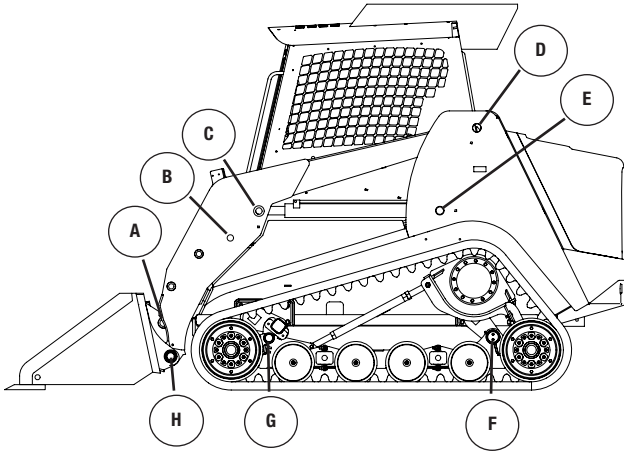

- A. Lower Bucket Cylinder Pivot
- B. Upper Bucket Cylinder Pivot
- C. Front Lift Cylinder Pivot
- D. Lift Arm Pivot
- E. Rear Lift Cylinder Pivot
- F. Rear Axle Pivot (2)
- G. Front Axle Pivot (2)
- H. Lower Bucket Pivot

7 MAINTENANCE

7.5 Engine Oil Check

1. Shut the machine down according to the procedure in section 5.13.
2. Open the hood to gain access to the engine compartment.
3. Locate and remove the engine oil dipstick (1) from its tube. (fig. 7.5-1)

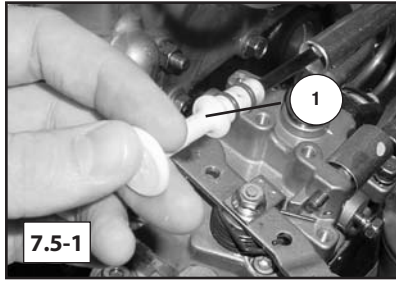

4. Wipe the dipstick with a clean shop cloth and reinsert it into the tube until it comes to rest in its seated position.
5. Remove the dipstick once again and inspect the end for oil on the level indicator.

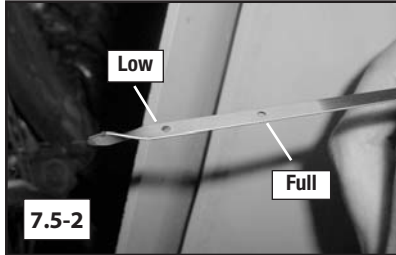

6. Oil should be present on the dipstick up to, but not over the upper (full) level indicator notch. If the level is correct, reinstall the dipstick and then close and latch the hood to complete the procedure. (fig. 7.5-2)
7. If the level is low, add the proper grade and viscosity engine oil and re-check as necessary until the proper level has been achieved. Then reinstall the dipstick and filler cap and close and latch the hood to complete the procedure.

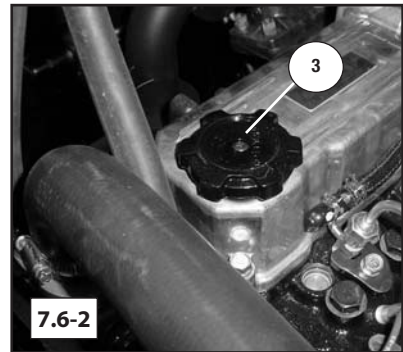
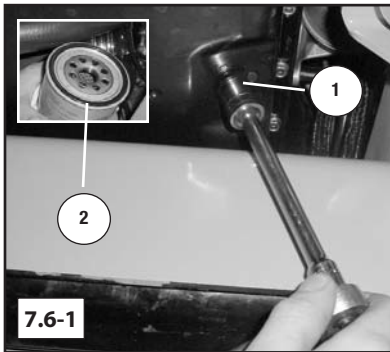

7.6 Engine Oil Change

Regular oil changes are necessary to maintain a strong running engine. Terex recommends a normal oil change interval of 250 hours or every six months. Allow the machine to cool prior to service. Wear safety glasses, safety gloves and any other items necessary to ensure your safety while performing maintenance or service.

To change engine oil:

1. Shut the machine down according to the procedure in section 5.13 and allow the machine to cool prior to performing this procedure.
2. Remove the belly pan beneath the engine to access the drain.
3. Remove the oil drain plug (item 1, fig. 7.6-1) from the pan.
4. Drain the oil into a suitable catch container.
5. Remove engine oil filter. Upon removal, make sure the filter gasket (item 2, fig. 7.6-1) is still present on the filter. If not, remove it from the filter port on the engine prior to installing the new filter to prevent leaks.
6. Apply fresh oil to the new filter gasket surface and install the new filter.
7. Tighten the new oil filter to specifications on filter label or box.
8. Refill the engine to capacity at the location labeled 3 above with oil as specified in the chapter 3, Technical Data.
9. Reinstall the belly pan as found upon removal, and dispose of the used oil and filter according to local mandates.



Oil and machine components can be HOT! Allow the machine to cool thoroughly prior to performing maintenance or service to avoid the possibility of burns.

7 MAINTENANCE

7.7 Hydraulic Oil Change

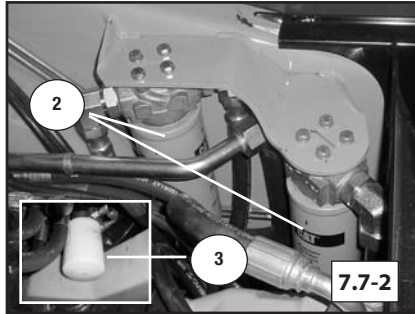
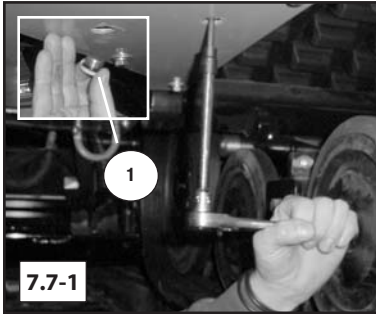

The hydraulic oil should be changed every 1000 service hours. Before beginning the procedure, make sure the machine is in a clean working environment. Take any necessary measures to prevent dirt or debris from entering the hydraulic system.

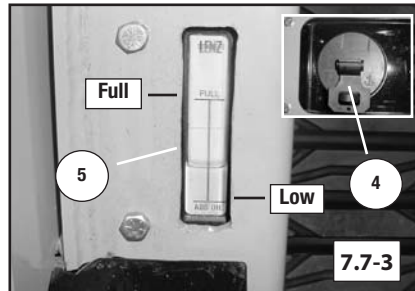

To change hydraulic oil and filter:

1. Shut the machine down according to the procedure in section 5.13.
2. Allow the machine to cool, then release any residual pressure in the hydraulic system by following the procedure in section 4.6 of this manual.
3. Locate and remove the hydraulic fluid drain plug (item 1) through the drain hole in the belly pan. (fig. 7.7-1)
4. Drain the used oil into a suitable catch container.
5. Dispose of the oil according to local mandates.
6. Reinstall the drain plug and tighten.
7. Refill the hydraulic reservoir (item 4) with Mobil DTE 10 Excel Series 46 Hydraulic Oil, or equivalent. (fig. 7.7-3)

Note: Observe the hydraulic oil level sight gauge (item 5) located on the back of the hydraulic reservoir to ensure that the level is correct (fig. 7.7-3). Once oil is visible, fill slowly to avoid overfilling.

8. Once full, start the engine according to the proper starting procedure and operate all hydraulic circuits to work any trapped air out of the system. Then, check the oil level. If low, add oil as necessary until full.

7.8 Hydraulic Filter Change

The hydraulic filter should be changed every 250 hours. Hydrostatic components require extremely clean oil in order to have a long service life. Use caution when changing the hydraulic filter. Before beginning the procedure, make sure the machine is in a clean working environment. Take any necessary measures to prevent dirt or debris from entering the hydraulic system.

To change the hydraulic filter:

1. Shut the machine down according to the procedure in section 5.13.
2. Allow the machine to cool, then release any residual pressure in the hydraulic system by following the procedure in section 4.6 of this manual.
3. Raise the cab according to the procedure in this section.
4. Locate the hydraulic filters (item 2), as shown in fig. 7.7-2).
5. Clean around the filters, then thread the filters off and replace them. Dispose of the used filter according to local mandates.
6. Reverse step 3 to complete the procedure.

Note: The machine is also equipped with a filter in the auxiliary circuit case drain line. It protects the main hydraulic system in the event of catastrophic failure in an attachment. This filter is designed to last the life of the machine unless an attachment equipped with a case drain has a drive motor failure during use. (item 3 fig. 7.7-2)

Note: Should a hydraulic hose or fitting need to be removed for maintenance or service, always inspect it for damage prior to re-installation. If none is found it may be reused; if damaged, replace.

7.9 Accessory Belt

The engine uses a belt to drive accessories like the alternator, water pump, and cooling fan. Belts stretch and wear during their service life. The accessory belt on the PT-70/80 should be visually inspected daily for tension, condition, and presence prior to operation

To check drive belt:

1. Shut the machine down according to the procedure in section 5.13, allow the machine to cool thoroughly.
2. Raise the hood at the rear of the machine to access the belt.
3. Visually inspect the belt to make sure it is present, tight on the pulleys and and in good condition.

7 MAINTENANCE

7.10 Water Separator

The water separator (item 1) removes water from the fuel supply as the engine runs. (fig. 7.10-1) It is located on the right side of the radiator shroud. Drain the water separator daily to maintain proper function.

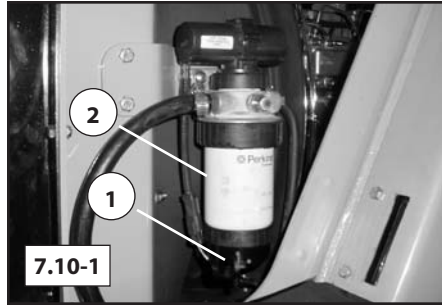

To drain the water separator:

1. Shut the machine down according to the procedure in section 5.13, then open the hood at the rear of the machine to access the water separator.
2. Loosen the twist valve on the bottom of the separator.
3. Retighten the valve once all of the water has been drained from the catch bowl and close the hood to complete the procedure.

7.11 Fuel Filter Change

The fuel filter should be changed every 500 service hours, or as needed. A plugged fuel filter can cause loss of engine power, rough running, or no start.

To change the filter:

1. Shut the machine down according to the procedure in section 5.13, then open the hood at the rear of the machine to access the fuel filter.
2. Clean the outside of the filter (item 2) thoroughly (fig. 7.10-1).
3. Twist the black plastic rings CCW when viewed from the bottom to separate the fuel filter from the water separator and filter head.
4. Reverse step 3 to reinstall the assembly (with new filter) into the machine.

7.12 General Undercarriage Information

The undercarriage assemblies typically operate in harsh working conditions. They work in mud, gravel, debris and various other abrasive materials during operation. Terex recommends a daily inspection of the undercarriage assemblies and cleaning if necessary.

Materials that are particularly sticky or abrasive like clay, mud, or gravel should be cleaned from the undercarriages often to minimize component wear. A pressure washer works well for cleaning materials from the undercarriages. At times when a pressure washer is not available, use a bar, shovel or similar device to carefully remove foreign materials.

When cleaning, pay particular attention to the drive motors/sprockets and the front and rear wheels where debris is likely to accumulate. If working in scrap or debris, inspect the undercarriages more often and remove foreign objects that may wrap around or lodge themselves between components causing premature wear and damage.

Operation on sand, turf, or other finished surfaces may require less frequent cleaning, but daily inspection is still advised.

7.13 Track Tension Check

Proper track tension is important for optimum performance and maximum track life. Operating with tracks that are too loose can cause them to misfeed, possibly causing damage. During the first 50 hours of operation, the tracks will "break-in", and may require adjustment.

To check for proper track adjustment:

1. Drive the machine forward 5 ft (1.5 m) to remove slack from the lower and rear portions of the track. Stop the engine and remove the key from the ignition.
2. Lay a straight edge along the top of the track, across the sprocket and the front idler wheel (fig. 7.13-1).
3. Using a rope or wire, put 90 lb (41 kg) of down force on the track at the mid point between the sprocket and idler.
4. Using a ruler or tape, measure the distance between the straight edge and track (fig. 7.13-2). The track should not deflect more than .75 in. (2.5 cm) between the top of the track and the straight edge.
5. If the track does deflect more than .75 in. (2.5 cm), tighten the track until within specification. .

7 MAINTENANCE

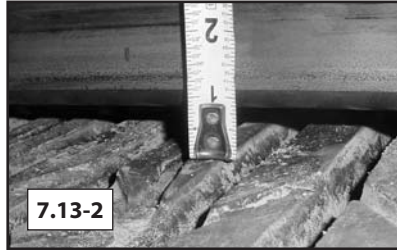
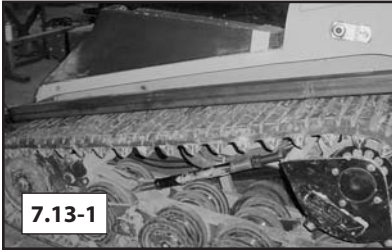

7.14 Track Tension Adjust

1. Shut the machine down according to the procedure in section 5.13, then locate the jam nut on track tension device and clean the threads thoroughly before proceeding. (fig. 7.14-1).
2. Using a wrench, loosen the jam nut (item 1) on the track tension device. (fig. 7.14-1)
3. Once the jam nut is loose, turn the tensioner until the track tension is within specification (figure 7.14-2).
4. Turn the tensioner the opposite direction to loosen the track.
5. Once proper tension is achieved, retighten the jam nut on the tensioner.

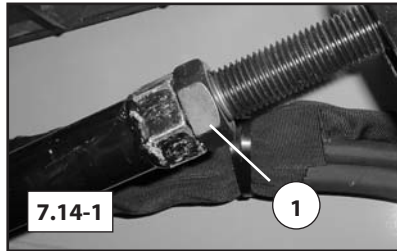

Note: If the track tensioner is stiff, it may be helpful to apply a penetrating lubricant onto the threads prior to adjusting tension.

7.15 Drive Sprocket Rollers

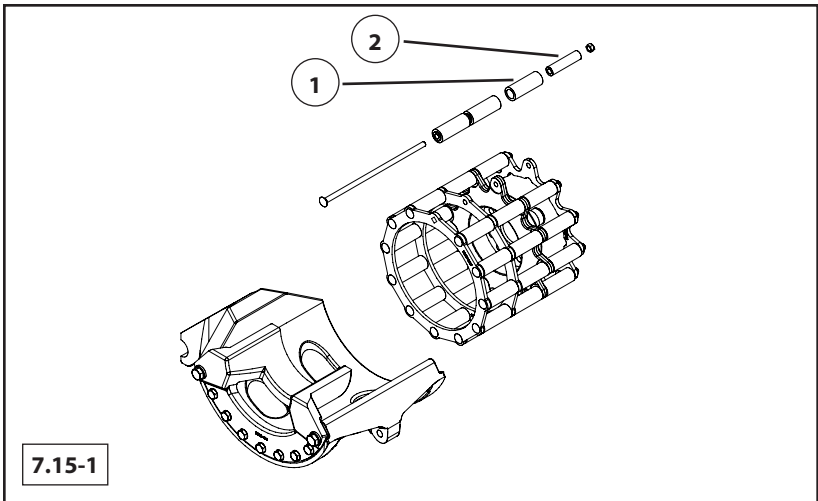

Compact Track Loaders use rollers on each drive tooth of the drive sprockets. These rollers help minimize friction between lugs on the track and the sprocket. Sprocket rollers should be treated as wear items that are inspected regularly and replaced as needed.

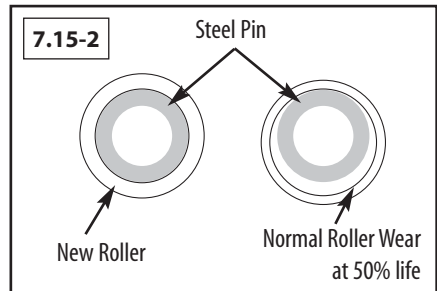

The rollers (1) rotate on steel pins (2), limiting wear to the inside of the rollers. As they wear, the rollers become thinner, but will continue to function and perform as long as they are rotating.

Visually inspect rollers every 50 hours and replace any that show signs of cracking or wear-through.

Drive sprocket removal and roller / pin replacement should be performed by your local Terex dealer.

7 MAINTENANCE

7.16 Air Cleaner Removal / Inspection

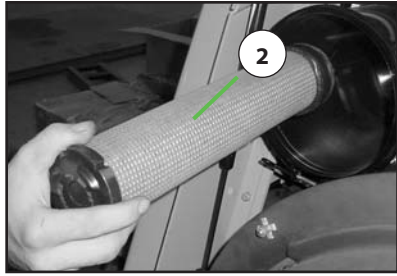
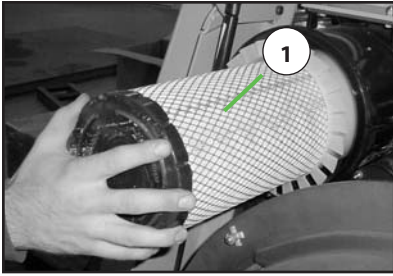

The air cleaner is one of the most important maintenance items on the machine. Regular inspection and replacement is necessary to ensure proper performance and to prolong engine life. **Inspect the air cleaner elements daily.** If damaged or heavily soiled, clean or replace the elements.

1. Shut the machine down according to the procedure in section 5.13, then open the hood to access the air cleaner. Twist the tension screw on the air cleaner housing counter-clockwise until the band is loose enough to remove the cover, then remove the cover.
2. Remove the primary element (1). The primary element can be cleaned and reused up to five times, but should be changed at least once a year.
3. Remove the secondary element (2). The secondary element is not serviceable or washable. The secondary element should be replaced after every three cleanings of the primary element.

7.17 Air Cleaner Cleaning procedure

1. Remove loose dirt from the element with compressed air or water hose.
 - Compressed air: 100 psi (690 kPa) max. 1/8 in. (.32 cm) diameter nozzle at least 2 in. (5 cm) away from the filter element.
 - Water: 40 psi (276 kPa) max. without nozzle.
2. Soak the filter element in a non sudsing detergent solution for at least 15 minutes moving it gently through the solution to further clean the element. (Never soak for more than 24 hours.)
3. Rinse the filter thoroughly with a gentle stream of water to remove all dirt and remaining detergent.
4. **Allow the filter to dry completely** before reinstalling it into the machine.

NOTICE

Do not use any heat source other than warm air at less than 160°F (71° C) to dry the filter.

NOTICE

During the engine warranty period, do not clean the filter elements. Instead, replace the filter elements when soiled or damaged to comply with engine warranty requirements.

7 MAINTENANCE

7.18 Radiator / Oil Cooler Cleaning Procedure

The radiator and oil cooler must be clean to ensure proper operation. Engine and hydraulic system overheating, damage and even failure can result if the radiator/oil cooler is not kept clean. A pressure washer or compressed air nozzle work well to blow debris clear of the fins in the oil cooler and radiator.

To clean radiator / oil cooler:

1. Shut the machine down according to the procedure in section 5.13 and allow the machine to cool prior to performing this cleaning procedure.
2. Thoroughly clean radiator/oil cooler with a pressure washer or compressed air. Wear any appropriate safety clothing. Direct spray forward through the cooler as shown. (fig. 7.18-1 & 2)



Note: If hydraulic oil or engine coolant temperature lights illuminate during operation, clean coolers more often.

NOTICE

Make sure water nozzle is at least 12 in. (30.5 cm), for air 8 in. (20.3 cm) from the cooler and that the spray is directed straight through the cooler or the cooling fins may be damaged (bent over) which will decrease cooling performance.



In dusty applications check and clean the coolers and chassis often to avoid overheating and prevent fires.

7.19 Engine Coolant Change Procedure

1. Shut the machine down according to the procedure in section 5.13, then remove the right rear belly pan (1) and raise the hood.
2. Attach a section of hose to the radiator drain outlet, then open the valve (2) and drain the old coolant into a suitable catch container. Dispose according to local mandates. (fig. 7.19-2)
3. Close the drain valve, then add coolant (with SCA additive, see engine manual) into the radiator through the fill neck until full.
4. Warm the engine to operating temperature, then turn the engine off, remove the key and allow the machine to cool.
5. Check the coolant level, and top off (repeat steps 4 and 5 until all air has been purged and the level is full when cold).

⚠ Coolant and machine components can be HOT! Allow the machine to cool thoroughly prior to performing maintenance or service to avoid the possibility of burns.

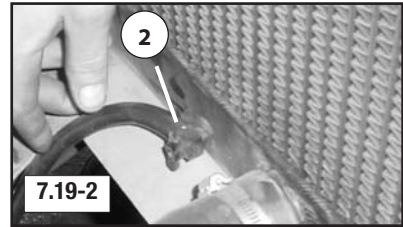
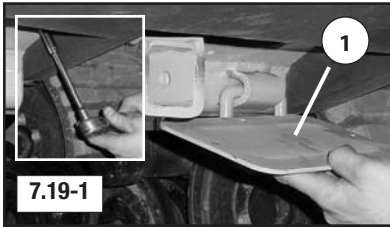

7.20 Chassis Cleaning Procedure

Periodic cleaning of the chassis area beneath the cab and engine compartment is also necessary to maintain safe operation. Clean as necessary. (fig. 7.20-1)

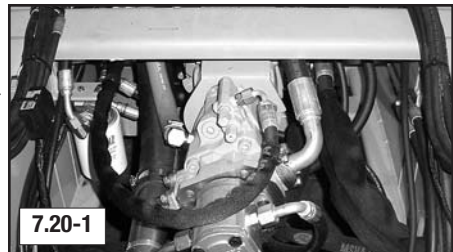

To clean the chassis/engine:

1. Shut the machine down according to the procedure in section 5.13, then remove the belly pans on the underside of the machine.
2. Raise the hood at the rear of the machine.
3. Tilt the cab as described in section 7.23.
4. Pressure wash any debris from the engine compartment and chassis area out through the lower opening.
5. Re-install the belly pans and close the hood to complete the cleaning procedure.

⚠ If any safety signs are found to be damaged or missing after cleaning, contact your dealer for a replacement immediately. They can be re-applied according to the location illustration in section 2.4 of this manual.

⚠ When using pressurized air or water for cleaning purposes, always wear appropriate personal protection equipment to ensure your safety.

7 MAINTENANCE

7.21 Electrical System

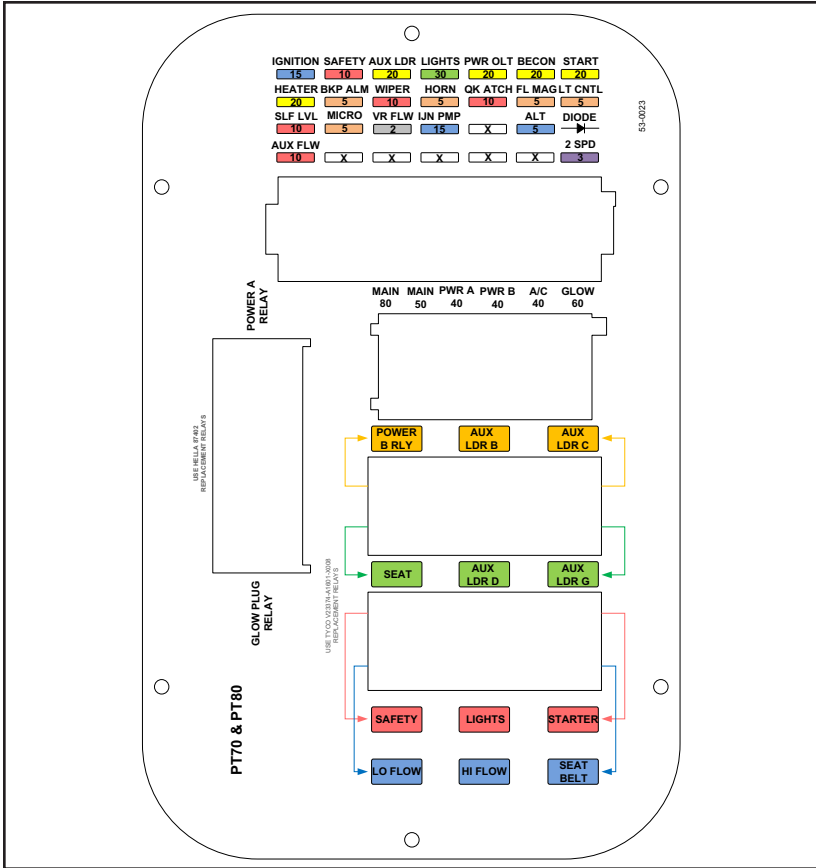

The electrical systems in PT machines are equipped with fuses that help to protect the electrical components from damage. They are found in the fuse panel enclosure which is located behind the panel cover in the right side console beneath the gauges.

In the event of an electrical malfunction, check the fuse panel. Remove the fuse related to the component that is not working properly and inspect it. If it appears damaged in any way, replace it.

7.22 Storage

It may be necessary to store your Terex Compact Track Loader for an extended period of time.

Perform the following tasks to prepare the machine for storage.

7.22.1 Storage Preparation

- Thoroughly clean the machine (inside and out) including the engine compartment and underbody. Open hood, remove belly pans and pressure wash to remove all buildup and debris.
- Allow machine to dry thoroughly, then reinstall belly pans, close hood. Touch up any paint blemishes to prevent rust.
- Lubricate all chassis, loader and undercarriage points as indicated on the chart in this chapter. Wipe away any excess grease.
- Replace any worn or damaged components.
- Add fuel stabilizer to near empty fuel tank, then fill to evenly distribute stabilizer throughout fuel.

Note: Run the engine for 5 minutes to circulate stabilized fuel throughout fuel system.

- Park the machine in a dry place that provides protection from the elements.
- Drain and refill the cooling system with 50/50 pre-mixed antifreeze/water.
- Replace engine oil and filter. (ch. 7)
- Replace hydraulic oil and filters (ch. 7)
- Jack the machine and rest the chassis on suitable mechanical supports to remove weight from the torsion axles and suspend the tracks off of the ground.
- Apply protective lubricant (grease) to all exposed cylinder rods.
- Replace air cleaner elements and a/c filter element (if equipped).
- Return all controls to neutral position.
- Cover the exhaust outlet to shield it from the elements and foreign objects.
- Disconnect and remove the battery from the machine. Adjust the electrolyte level if needed and charge before storing. Store in a warm dry place. **Do not allow battery to freeze.** Charge periodically during storage as necessary.
- Label or tag the machine to indicate storage condition.



Battery contents are flammable and corrosive. Contact with skin can cause burns! Do not smoke or allow open flame near the battery to avoid explosion! Wear appropriate PPE.

7 MAINTENANCE

7.22.2 Removal From Storage

Perform the following tasks to remove the Terex Compact Track Loader from storage and return to operating condition.

Return to Operating Condition:

- Remove protective lubricant from cylinder rods.
- Lubricate all chassis, loader and undercarriage points.
- Safely remove mechanical supports and lower machine to the ground.
- Install fully charged battery.
- Remove exhaust outlet cover.
- Perform pre-operation safety checklist in chapter 5 of this manual.
- Perform starting procedure (chapter 5)
- Let engine run while observing engine monitoring systems (gauges/lights). Look for anything out of the ordinary. Should the optional engine temp. gauge read excessive temperatures (**or** warning light illuminate) or should the oil pressure or hydraulic oil temp. lights illuminate, shut the machine down immediately. Diagnose and make needed repairs before resuming operation.

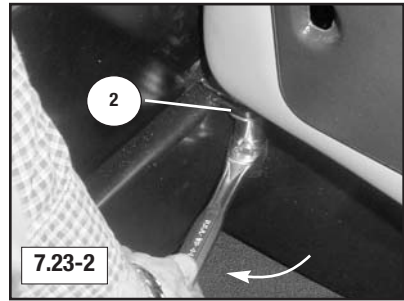
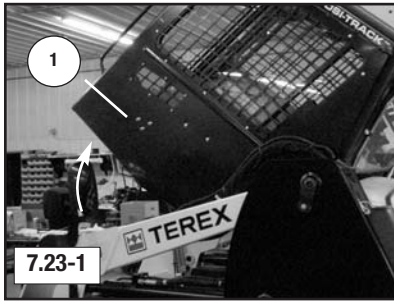

7.23 Cab Tilt Procedure

The ROPS/FOPS approved cab (1) tilts up to allow easy access to components while performing maintenance or service. It is equipped with a gas spring assist and a brace mechanism to hold it in place while tilted.

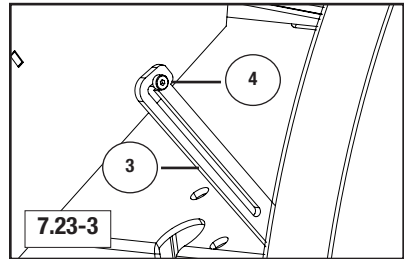

To tilt the cab:

1. Remove any attachments that may be fastened to the machine.
2. (Optional) Raise the lift arms and secure them with the lift arm brace.
3. Remove the two bolts (2) that fasten the cab to the footwell. They are located inside the cab, one in each of the lower front corners.
4. Once the bolts have been removed, tilt the cab slowly upwards. The cab brace (3) should fall onto the shoulder bolt (4) locking the cab in its upright position.

The cab is now secure.

To lower the cab:

1. Raise the cab brace so that the locking channel is clear of the shoulder bolt.
2. Hold the brace upwards and lower the cab until the locking channel is clear of the shoulder bolt then release the brace.
3. The cab is now free to be lowered into operating position.
4. Lower the cab completely and then fasten it to the footwell with the two bolts removed previously.

CALIFORNIA PROPOSITION 65

California (U.S.A.) state law stipulates that manufacturers of machines operated within its borders must provide a clear warning to customers regarding exposure to substances commonly associated with the machine that are recognized by the state as harmful. Terex/ASV complies with this requirement by providing the following information.

CALIFORNIA Proposition 65

Warning: This product contains lead and lead compounds, diesel engine exhaust, and used engine oil, chemicals known to the state of California to cause cancer.

CALIFORNIA Proposition 65

Warning: This product contains lead, a chemical known to the state of California to cause birth defects or other reproductive harm.

SERVICE LOG

<u>Hours</u>	<u>Service Performed</u>	<u>Notes</u>

