

Eccellenza™ touch



Operation Manual



Carefully read this instruction manual before proceeding with the installation and operation of this equipment. Keep this manual in a safe place for future reference.

Disclaimer:

Although the utmost care was taken putting together this publication, VKI Technologies accepts no liability for inaccuracies or omissions to this publication. VKI Technologies is not responsible for misinterpretation of any information contained in this publication. VKI Technologies is not responsible for injuries or damages resulting from incorrect or improper use of this equipment, unauthorized modifications to the equipment, the use of non-original replacement components in the equipment, or improper installation of the equipment.

Copyright:

VKI Technologies © 2018

The information and contents of this publication are property of VKI Technologies. No part of this publication can be reproduced, reused, modified or published in any format without the written permission of VKI Technologies.

VKI Technologies reserves the right to change the specifications to the equipment, and to modify the information contained in this publication at any time and without prior notification to the purchaser of this equipment. All rights are reserved.

To view and download other equipment documentation, visit the "Documentation" section of our web site at the following URL: <http://www.vkitech.com/documentation.html>

Contact Information:

VKI Technologies

3200 2e rue,
St-Hubert, Québec,
Canada, J3Y 8Y7

Phone

Local: 450-676-0504
Customer Service: 1-800-567-2951
Technical Support: 1-888-854-0207
Fax: 1-800-567-7776

Web Site

www.vkitech.com

Email

Customer Service: customer.service@vkitech.com
Technical Support: tech.support@vkitech.com

Table of Contents

Section 1 - Safety Information & Equipment Specifications	5
<i>Safety Symbols</i>	5
<i>Important Safeguards and Precautions</i>	6
<i>Specifications</i>	8
<i>Capacities</i>	8
<i>Equipment Dimensions</i>	8
<i>Installation Dimensions</i>	8
Section 2 - Setting up the Equipment.....	9
<i>Unpacking</i>	9
<i>Counter Seal</i>	10
<i>Equipment Overview - Exterior</i>	11
<i>Equipment Overview - Interior</i>	11
<i>Installation Precautions</i>	12
<i>Water Connection</i>	12
<i>Water Filter</i>	13
<i>Starting the Equipment</i>	13
<i>The Touch Screen</i>	14
Selecting and Dispensing a Beverage.....	14
<i>Filling the Coffee Bean Dispensers</i>	15
Adjusting the Coffee Dispenser Divider.....	16
<i>Filling the Powder Dispensers</i>	17
<i>Checking Water Temperature</i>	18
<i>Initial Adjustments</i>	18
Change PINs for the Operator and Administrator.....	18
Setting the Date and Time.....	18
Water Levels.....	18
Gram Throws.....	18
Beverages.....	18
Notifications.....	18
<i>Clearing Error and Reminder Messages</i>	19
<i>System Status Report Screen</i>	21
Section 3 - Configuring the Equipment.....	23
<i>Accessing the Configuration System</i>	23
<i>Programming Menu Structure</i>	25
Menu Drop-List Overview.....	25
Sub-Menu Tabs.....	26
Exiting the Setup.....	26
<i>Dashboard</i>	27
Counters.....	27
Beverages Tab.....	29
Ingredients Tab.....	32
Emailing Data or Saving it to a USB Flash Drive.....	32
<i>System Status</i>	33
Current Status.....	33
Fault Codes.....	34
Logs.....	35
System Info.....	35
Event Deactivation.....	36
<i>General Settings</i>	38
Installation.....	38
Waste Management (Waste Chute).....	38
Regional.....	38
Language.....	38
Units of Measure.....	39
Date and Time.....	40

<i>Power Settings</i>	42
Auto Dim Delay	42
Energy Saving	43
<i>Vending (Coin Acceptor & Cashless)</i>	47
General Tab	47
Beverages Tab	48
Setting the Base Price.....	49
Adjusting the Price for Exceptions.....	51
Pricing Hot Water	52
Devices Tab	53
<i>Network</i>	54
WIFI	54
SMTP	57
Notifications	58
<i>Setup</i>	61
Beverages	61
Cup Size and Strength.....	61
Default Beverage	62
Disabling Beverages	63
Ingredients	64
Recipes	67
Setting Coffees	67
Gourmet Mode	72
Setting Specialty Beverages.....	72
Disabling “Press & Hold” Hot Water.....	74
Restore Defaults	75
Configuring for Decaf.....	76
Water	77
Brewing	82
Water Temperature.....	82
Calibration	83
<i>Security</i>	84
Administrator	85
Operator.....	87
<i>Maintenance</i>	89
Operations Menu	89
Powder Rinse.....	89
Brewer Rinse.....	89
Wiper Home Position	90
Remove Filter	90
Calibrate Powder Level	90
Manual Activation	91
Coffee System.....	91
Powder System.....	94
Water System	95
Miscellaneous Components	96
Section 4 - Care and Maintenance	97
<i>Daily Care</i>	97
<i>Every 1-2 Weeks</i>	97
<i>Every 10,000 Cycles or 12 Months</i>	97
<i>Every 3 Years</i>	98
<i>Miscellaneous</i>	98
Section 5 - Error and Reminder Messages	99
<i>Main Screen</i>	99
<i>System Status Screen</i>	100
Section 6 - Updating Firmware	105
Section 7 - Product Warranty Information	107

SECTION 1

Safety Information & Equipment Specifications

Your safety is extremely important to us. To avoid personal injury or damage to the equipment and its surrounding areas, it is **imperative** that you read and understand the safety information outlined in this section before proceeding with the installation and operation of this equipment.

Safety Symbols

The following symbols are used throughout this publication:



Indicates an electrical shock hazard.



Indicates a potential safety risk, or a risk of damage to equipment and/or its surroundings.



Indicates important information that must be understood before proceeding.



Indicates an important note or useful tip.

Important Safeguards and Precautions



- This equipment is designed for indoor use **ONLY** and must **never** be installed outdoors.
- The installation of this equipment **must** comply with **all** municipal, state/provincial, and federal electrical and plumbing codes.
- Installation and servicing of this equipment must **only be performed by qualified personnel**. Do not attempt to install or service this equipment if you are not qualified as it may result in personal injury. There are no user-serviceable parts inside the equipment.
- Do not use an electrical extension cord or power bar.
- This equipment must be installed in a location with an ambient temperature between 5°C-35°C (40°F-95°F).
- The main water supply pressure must be between a minimum of 20psi and a maximum of 100psi.
- This equipment must be positioned so that the wall plug and the main power switch are both easily accessible.
- Do not connect this equipment to a voltage supply other than the voltage indicated on the serial number decal.
- Do not immerse this equipment, or any part of this equipment, in liquid.
- Do not install the equipment in an area where water spray is present.
- This equipment must be installed securely on a level surface. If it does not appear to be a stable location, select another installation location.
- Leave a **minimum of 2" (5cm)** of space all around this equipment for proper ventilation.
- Keep hands clear of the dispensing area at the front of this equipment. Liquids being dispensed are extremely hot and can cause severe burns.
- **Never** disconnect this equipment from the wall outlet by pulling on the service cord, and never use this equipment if the service cord is damaged.
- If the service cord is damaged, **it must be replaced with a new service cord** that is available from your distributor or the manufacturer of this equipment.
- **Never** circumvent the safety features incorporated into the equipment. They are there for your protection and **should never be disabled or bypassed under any circumstances**.
- **Always** switch the power off and disconnect the service cord when cleaning the interior of this equipment. Components inside this equipment can cause electrical shock resulting in personal injury.

- Use caution when servicing the water tank or any of its components - the water in the tank and the tank components may be extremely hot and can cause severe burns.
- Use caution when working inside this equipment as there may be sharp edges on some components that can cause cuts.
- To prevent electrical shock, remove all jewelry (rings, watches, etc.) when servicing this equipment.
- **Use only original equipment manufacturer replacement parts.** Unapproved replacement parts can result in personal injury, fire and/or further damage to the equipment.
- **Do not** allow children to access this equipment. They are not aware of the potential dangers that exist.
- **Never** use ammonia-based cleaners on the surfaces of this equipment as they will become discolored and/or damaged permanently. Use mild cleaning products, such as dish soap.
- **Do not** lean on, push or shake the equipment as there is a risk that it can tip or fall, or cause water to overflow and contact electrical components creating a shock hazard.
- **Do not** operate the equipment with the rear panel removed.



Unauthorized modifications made to this equipment can result in serious personal injury and/or damage to the equipment and its surroundings (including a risk of fire), and voids all warranties and safety certifications/listings.

Specifications

Voltage Rating	120 Volts AC @ 60hz (120 Volt Model)
Heater Wattage	1300 Watts
Weight	76 lbs (34.5 kg)
Cup Sizes	8-oz, 10-oz, 12-oz
Temperature Control	Electronic Probe
Heating Time	20 minutes after install
Brew Temperature	198°F (92°C)
Heater Protection	Yes
Overflow Protection	Yes
Circuit Protection	Yes
Certifications & Listings	  

Capacities

Coffee Hopper 1	1000 grams (2.25 lbs) with partition at center <u>or</u> 1350 grams (3 lbs) with partition at right side
Coffee Hopper 2	1000 grams (2.25 lbs) with partition at center <u>or</u> 650 grams (1.5 lbs) with partition at right side
Powder Hopper 1	1000 grams (2.25 lbs)
Powder Hopper 2	1000 grams (2.25 lbs)
Powder Hopper 3	1000 grams (2.25 lbs)
Water Tank	3.8 litres (1 gallon)
Waste Bin	Approximately 25 cups (10-oz)

Equipment Dimensions

Height:	28.0" (71 cm)
Width:	20.0" (56 cm)
Depth:	20.25" (51 cm)

Installation Dimensions

Height:	34.5" (88 cm)
Width:	24.0" (61 cm)
Depth:	22.5" (57 cm)



Any references made in this manual to coffee blends, powder products and beverages are for example purposes only. The actual products used in the equipment may differ from the examples used in this manual.



Please disregard any references to the Carafe feature and settings in the Eccellenza Touch programming, as the "Carafe" option is not currently available.

SECTION 2

Setting up the Equipment

Unpacking



Prior to signing for the delivery, check the shipping carton for damage. Indicate any damage on the delivery slip and have the delivery driver sign to acknowledge the damage. Damages during shipping must be claimed with the carrier, and not with VKI Technologies.

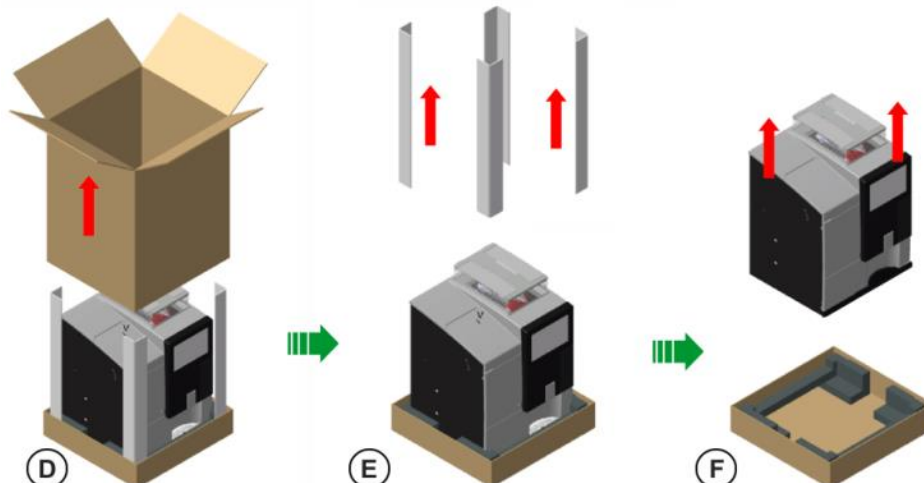
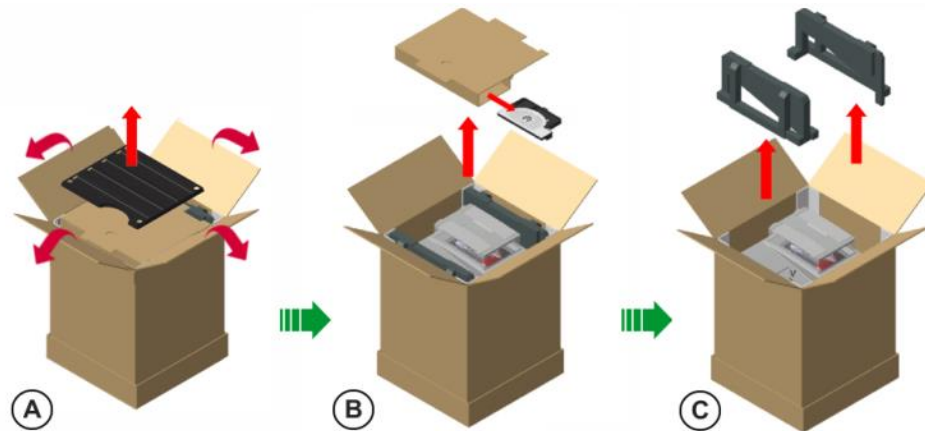

1. Cut the straps on the outside of the box, open the flaps on the top of the box and remove the floor liner (A).
2. Lift the top carton and remove the cup stand assembly that is stored in it (B).
3. Remove the two foam supports (C).
4. Lift the box over the machine (D) and remove the four corner supports (E).

5. Ensure that **all four levelers** are installed underneath the machine.
6. With the help of a colleague, lift the coffee maker off the base of the packaging (F) and place it onto a workbench or cabinet. **Do not attempt to lift the machine by yourself.**



DO NOT lift the coffee maker by placing your hand underneath the front door. It is not designed to support the weight of the machine, and serious personal injury and/or damage to the unit may occur.

7. Remove the blue shipping tape ① and protective film ② from the outside of the machine.

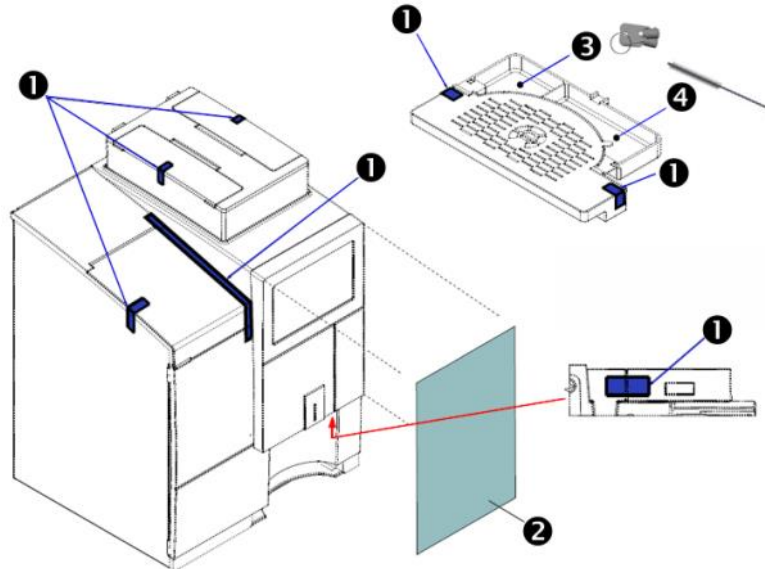

8. Remove the keys from the cup stand ③ and the small tubing brush ④, and then install the cup stand assembly onto the front door.



Keep all packaging material in case the equipment must be transported or shipped. When transporting the unit for installation, leave it on the base of the packaging to reduce the risk of damage to the levelers.

Counter Seal

In order to comply with **NSF Certification** requirements, the Eccellenza Touch **must be** installed on top of the provided counter seal.



Equipment Overview - Exterior

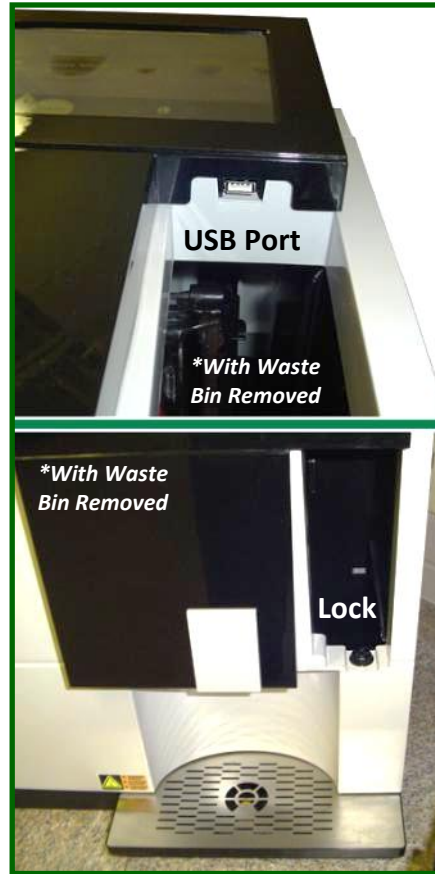
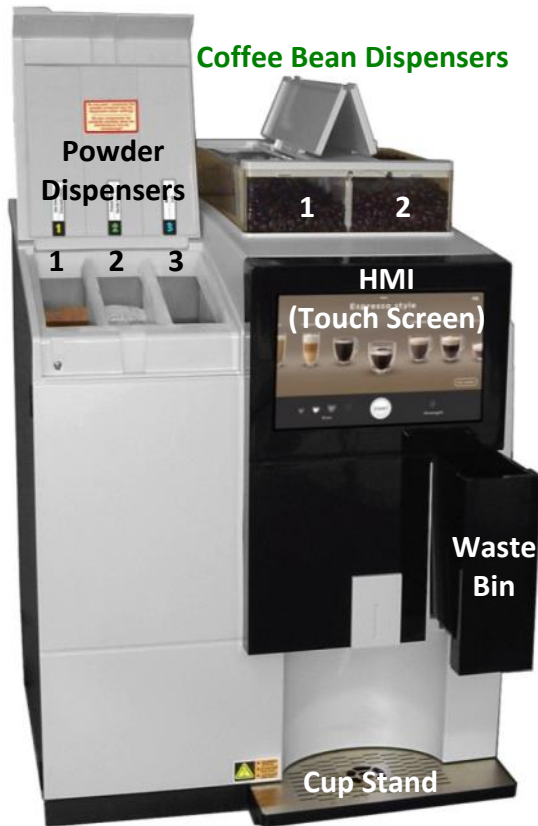

Equipment Overview - Interior

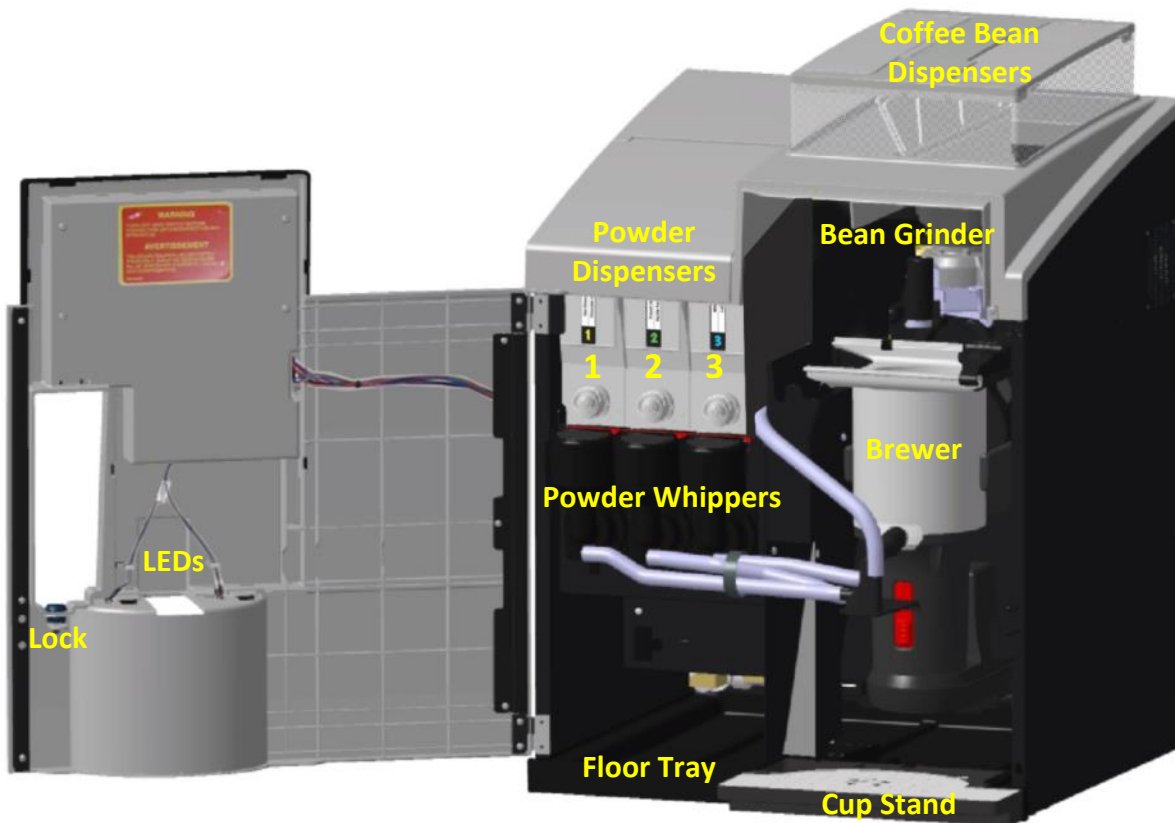

Installation Precautions



This equipment is designed for indoor use only and must never be installed outdoors.



Installation of this equipment must comply with all local, state/provincial and federal codes and regulations. It is the sole responsibility of the installer to research and to comply with these codes and regulations.



This equipment must be installed on a dedicated 15 amp outlet. Do not install other equipment on the same outlet/circuit.



Ensure that the equipment is level and stable. This is done by adjusting the levelers (legs) at the bottom of the machine. Also, do not block any of the equipment's ventilation ports.



Avoid using extension cords and power bars when connecting this equipment to a power source. If the use of an extension cord or power bar cannot be avoided and must be used (this is not recommended by VKI Technologies), they must be of the heavy duty type with a minimum rating of 15 Amps.



Leave room at the rear of the equipment for the plumbing fitting and water hose, as well as for adequate ventilation.

Leave ample room above the equipment to open and fill the product hoppers.

Water Connection



Installation of this equipment must comply with all local, state/provincial and federal codes and regulations. It is the sole responsibility of the installer to research and to comply with these codes and regulations.



Accessibility to shut-off valve(s) must be provided and explained to customer in the event water supply to brewing equipment must be shut off.



For multi-unit locations whereby the main water conduit is supplying water to more than one unit (including water coolers), a separate in-line shut off valve must be installed onto each individual equipment unit.

Water Filter

We recommend the use of a high quality water filter which eliminates most odors present in water, and reduces the amount of particles entering the water tank.

When installing a water filter, you must refer to the water filter manufacturer's installation instructions.



When the filter is installed or replaced, make sure to write the installation date in the provided area on the filter cartridge. Always follow the manufacturer's recommendations for filter replacement intervals.

Starting the Equipment

The main power switch for the Eccellenza Touch is located at the rear of the machine, on the right side.

To switch the power ON, toggle the power switch to the "I" position.



The Eccellenza Touch now goes through a quick initialization process, after which, it is ready to be used.

The Touch Screen

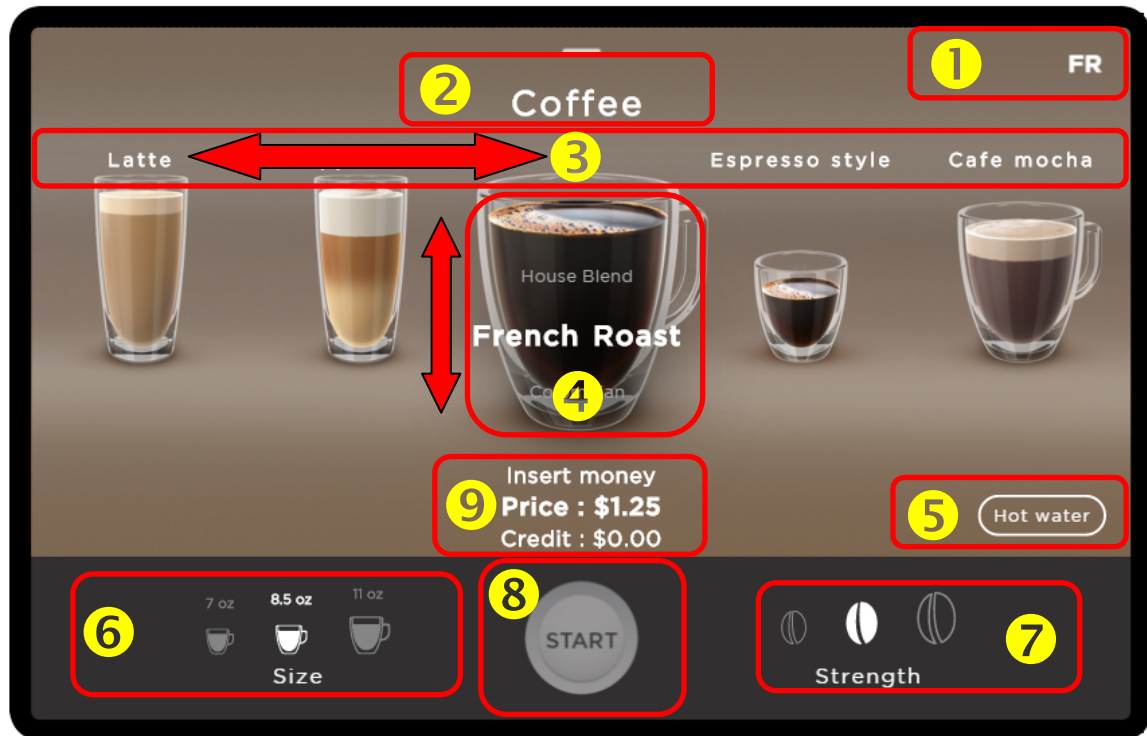

①	Language Selection (secondary) - can be set for French or Spanish
②	Shows currently selected product (in this case, Coffee)
③	Available beverage list - swipe left or right to change selection
④	Shows available product types and what is currently selected (in this case, House Blend) - swipe up or down to change selection.
⑤	Hot Water option
⑥	Cup size selection area - also displays the cup size value, if enabled
⑦	Strength selection area
⑧	Start button - begins beverage preparation cycle
⑨	Vending Price and Credit information (if applicable)

Selecting and Dispensing a Beverage

1. Place your cup or mug on the cup stand at the bottom of the door.
2. Swipe to the left or to the right on the screen to select the type of beverage desired.
3. Select the options or specific ingredients desired for the beverage type that was initially selected.
4. Chose the cup size and the strength (if applicable) for the beverage that you selected.
5. Press the **'Start'** button to begin the brewing or dispensing cycle.
6. Remove your cup or mug and enjoy your delicious beverage!

Filling the Coffee Bean Dispensers



The Eccellenza Touch comes pre-configured as follows:

Coffee 1 - French Roast (bolder blend), Coffee 2 - Colombian

Should you prefer a different configuration, you can reconfigure the coffee dispensers and blend names in the 'Setup' menu ([see page 64](#)).



Do **NOT** pack the coffee beans into the dispensers!



1. To fill the **Coffee 1** dispenser, lift the left side lid towards the right, fill the dispenser with the desired coffee beans, and then close the lid. **We recommend you use the bolder of the two coffee blends in the Coffee 1 dispenser.**
2. To fill the **Coffee 2** dispenser, lift the right side lid towards the left, fill the dispenser with the desired coffee beans, and then close the lid.



If the dispensers are completely empty, you need to make a few vends until the dispensers are properly primed. During this time, you may notice dispenser-related errors on the screen - these errors will clear automatically once the dispenser is primed.



Any ingredient references made in this manual are for example purposes only. The actual products used in the equipment may differ from the examples used in this manual.

Adjusting the Coffee Dispenser Divider

The coffee dispenser in the Eccellenza Touch can be reconfigured to increase the bean capacity for Coffee 1 by **approximately 35%** (note, however, that doing so decreases the bean capacity for Coffee 2). This is accomplished by changing the position of the center divider inside the coffee bean dispenser.

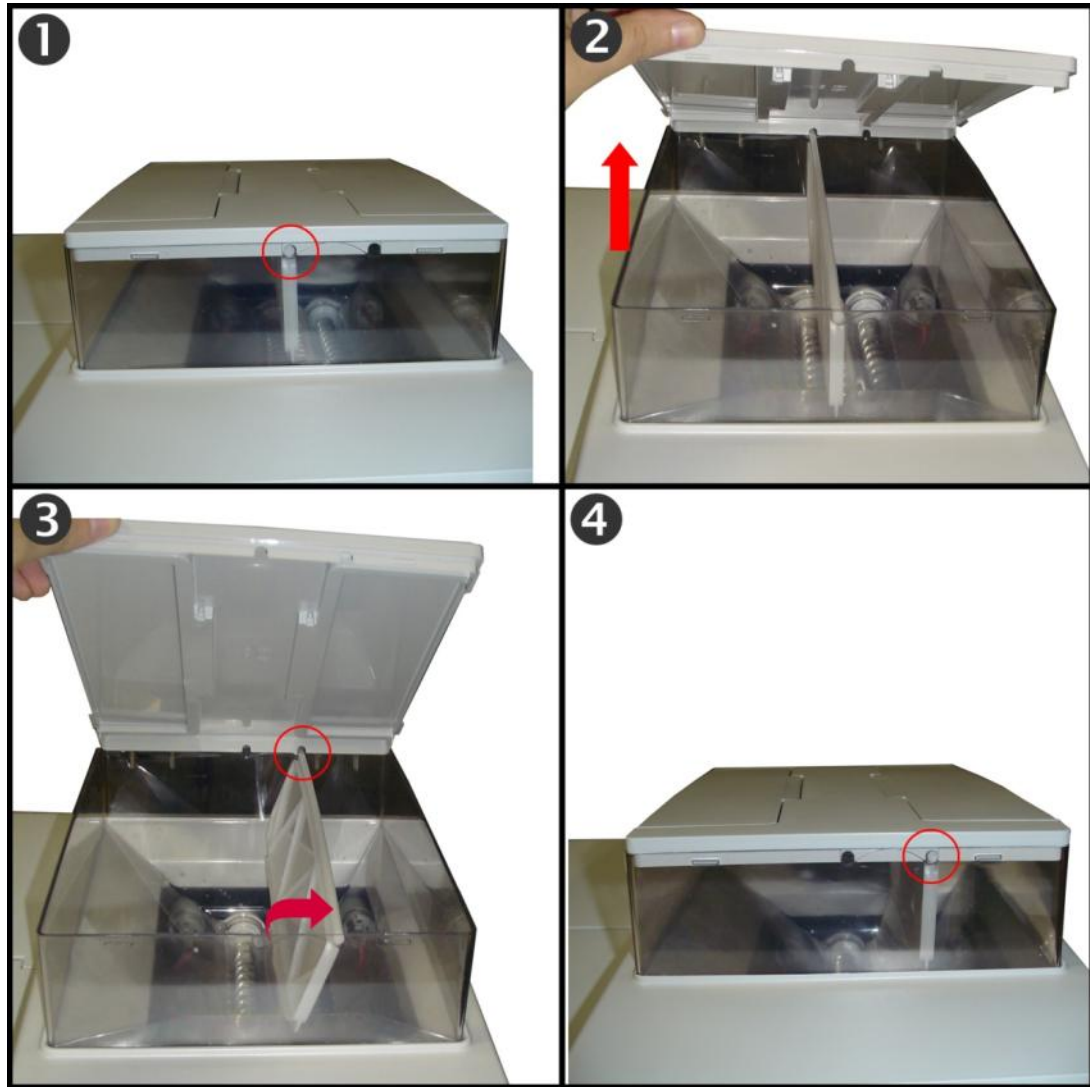

To reconfigure the coffee bean dispensers:

1. By default, the coffee bean dispenser is configured with the divider in the center.
2. Lift the complete coffee lid assembly until the divider disengages from the rear of the lid.
3. Slide the divider towards the right side, making certain it engages with the rear of the lid.
4. Close the lid assembly locking the divider in its new position.

Filling the Powder Dispensers



The Eccellenza Touch comes pre-configured as follows:

Powder 1 - Hot Chocolate

Powder 2 - French Vanilla

*Powder 3 - Milk**



Do NOT pack the powder into the dispensers!

***Do NOT use coffee whitener instead of milk as it may create blockages in the whipper system!**



- To fill the powder dispensers, lift the main powder lid, remove the individual lid and fill the respective dispenser with the desired powder product. Once filled, **re-install the individual lid back onto the dispenser** and proceed to the next dispenser, if required.



If the dispensers are completely empty, you'll need to make a few vends until the dispensers are properly primed. During this time, you may notice dispenser-related errors on the screen - these errors will clear automatically once the dispenser is primed.



Any ingredient references made in this manual are for example purposes only. The actual products used in the equipment may differ from the examples used in this manual.

Checking Water Temperature

To check the current water temperature in the hot water tank, remove and re-install the waste bin. The machine will display the water temperature in the lower center of the screen during re-initialization.

Initial Adjustments

Change PINs for the Operator and Administrator

To prevent unauthorized access to the Eccellenza Touch programming, we highly recommend that you change the default PIN (Personal Identification Numbers) for both the Operator and Administrator.

Both PIN numbers can be changed in the '**Security**' menu ([see page 84](#)).

Setting the Date and Time

Enter the set up of the machine and set the correct date and time. This is necessary when using the beverage counters, setting the Energy Savings features, tracking data that the equipment has collected and when reports are sent to the operator of the equipment.

The date and time settings are found in the '**General Settings**' menu ([see page 38](#)).

Water Levels

The Eccellenza Touch is factory preset to **only** dispense 8-oz, 10-oz, and 12-oz cups sizes. The water levels can be fine-tuned in the 'Setup' menu ([see page 61](#)).

Gram Throws

You will also need to calibrate the gram throws for the coffee blends and powder types you will be using in the equipment. Calibration ensures that the equipment delivers the best tasting beverage possible.

Product settings are adjusted in the '**Setup**' menu ([see page 61](#)).

Beverages

The Eccellenza Touch is preset with all of the beverages and beverage options (such as cup sizes and strengths) enabled.

Beverage options are set in the '**Setup**' menu ([see page 61](#)).

Notifications

The Eccellenza Touch can be configured to provide notifications about usage and consumption, counters, faults and messages, etc.

To configure the '**Notifications**' feature, go to the '**Network**' menu ([see page 54](#)).

Clearing Error and Reminder Messages

Should an error or reminder message be triggered, the error or message is displayed at the lower left of the screen. In the example below, the message reads "Powder #2 low level". However, in our example, there are three messages present, as indicated by the number "3" in the upper right corner of the message box. Messages are stacked in the order in which they occur.

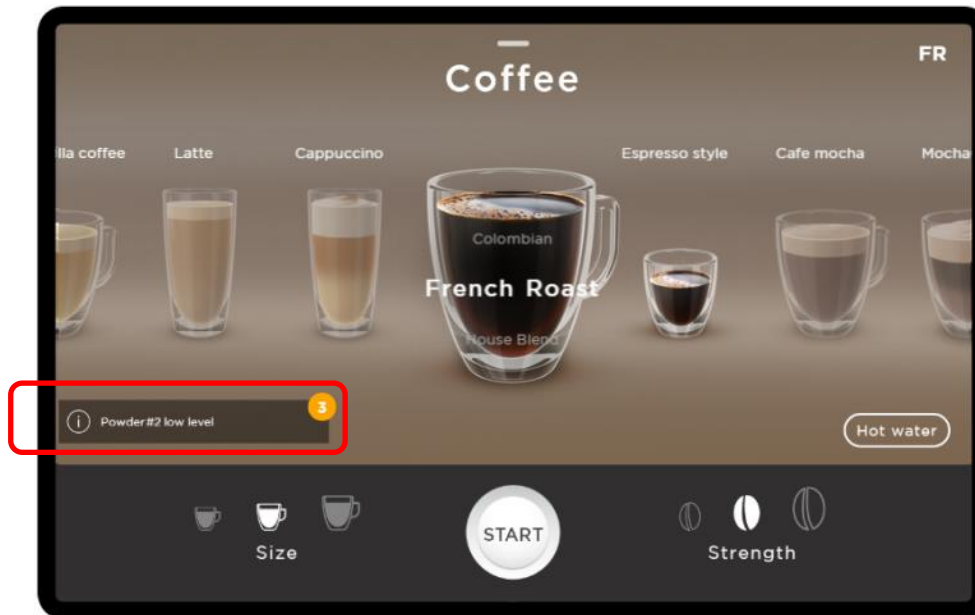

Tap the message box to view more details about the message and the steps required to rectify the issue.

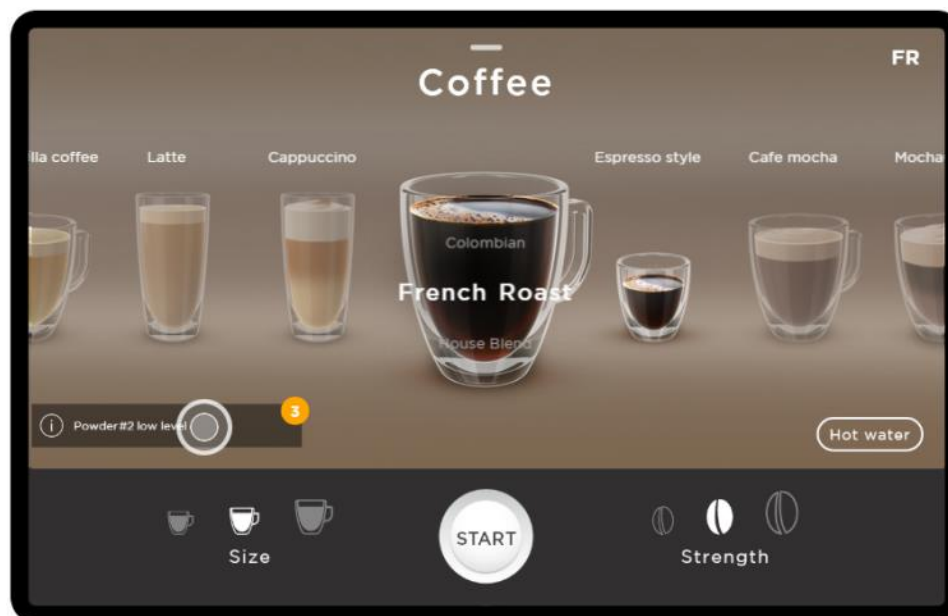

The following symbol is used to identify a "touch" location on the machine's touch screen.

In this case, the 'Powder 2' dispenser is running low and must be refilled. Open the powder dispenser lid and refill the dispenser.

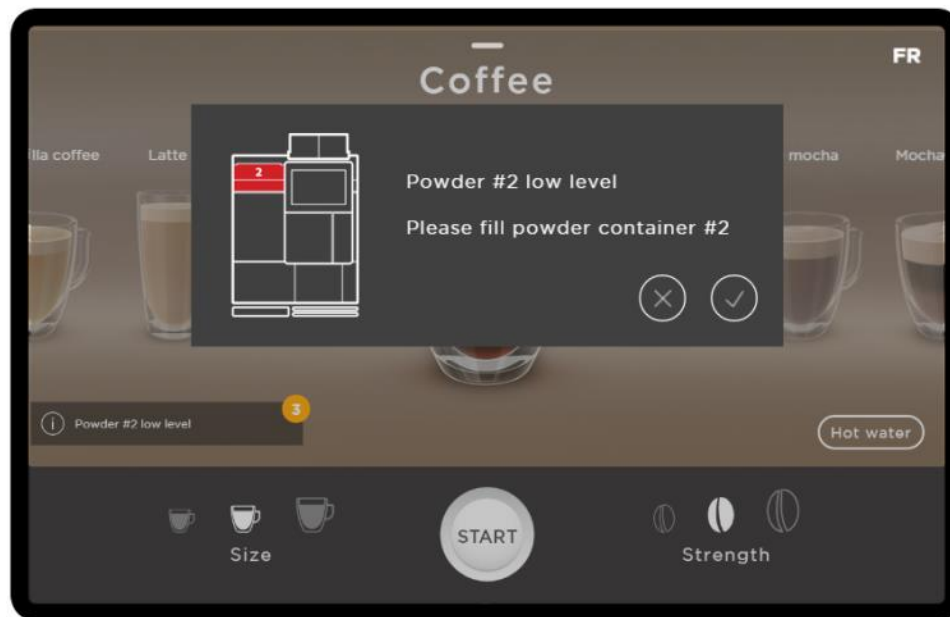

Once done, tap the checkmark to clear this message. If you cannot immediately refill the dispenser, tap the 'X' to close this window without clearing the message.



In a case where multiple messages are present, after clearing the first message, any subsequent messages are displayed (one at a time) until they are all cleared.



If a "Call for Service" error is displayed, you need to go to the "System Status" menu to get more details about the error.

System Status Report Screen

The System Status Report screen provides a quick snapshot of the equipment's serial number and other important information. If contacting VKI for technical assistance, you may be asked to send a photo of the **System Status Report** screen as it may prove useful during equipment troubleshooting.

To access the System Status Report screen:

1. Touch the small line at the top center of the screen, and swipe downwards.

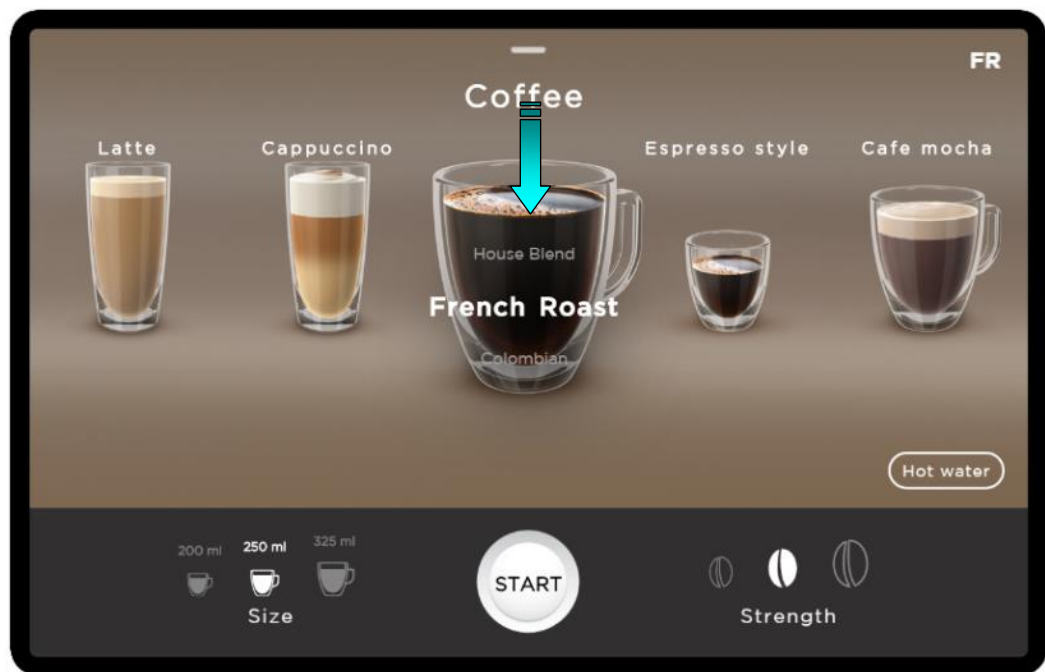

2. A screen with a numeric keypad opens. At the top of the screen, tap on the **System Status Report** option.

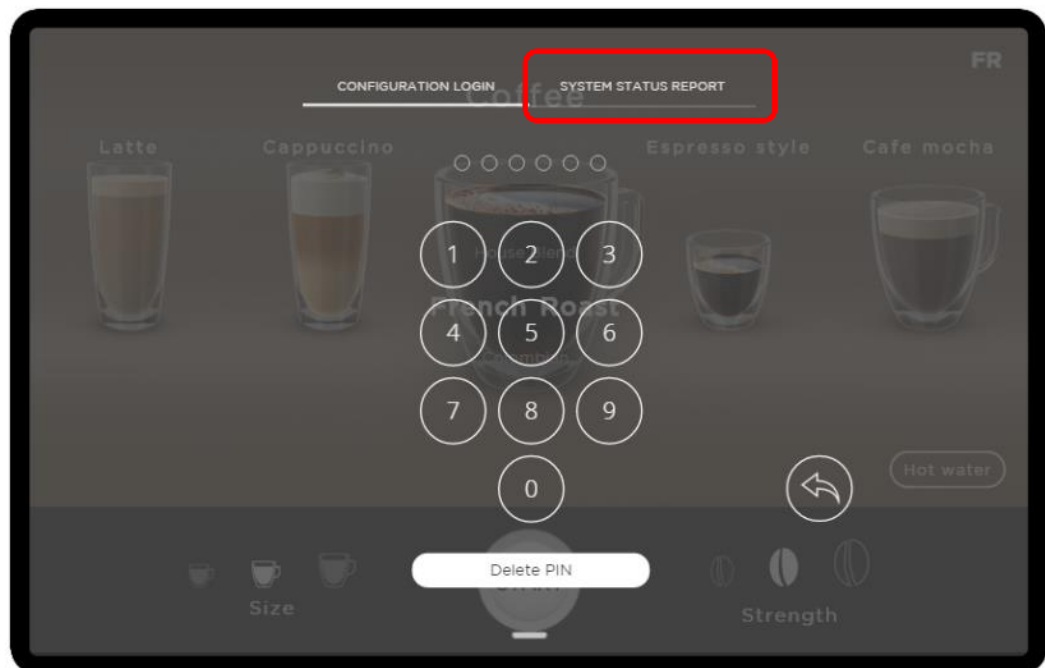

3. The System Status Report screen opens to provide a quick snapshot of the machine's most important information. This includes:
 - the serial number and other unique identifiers
 - current temperature
 - some maintenance information
 - active errors and logs
 - software, firmware and OS information
 - product counters
 - resource usage

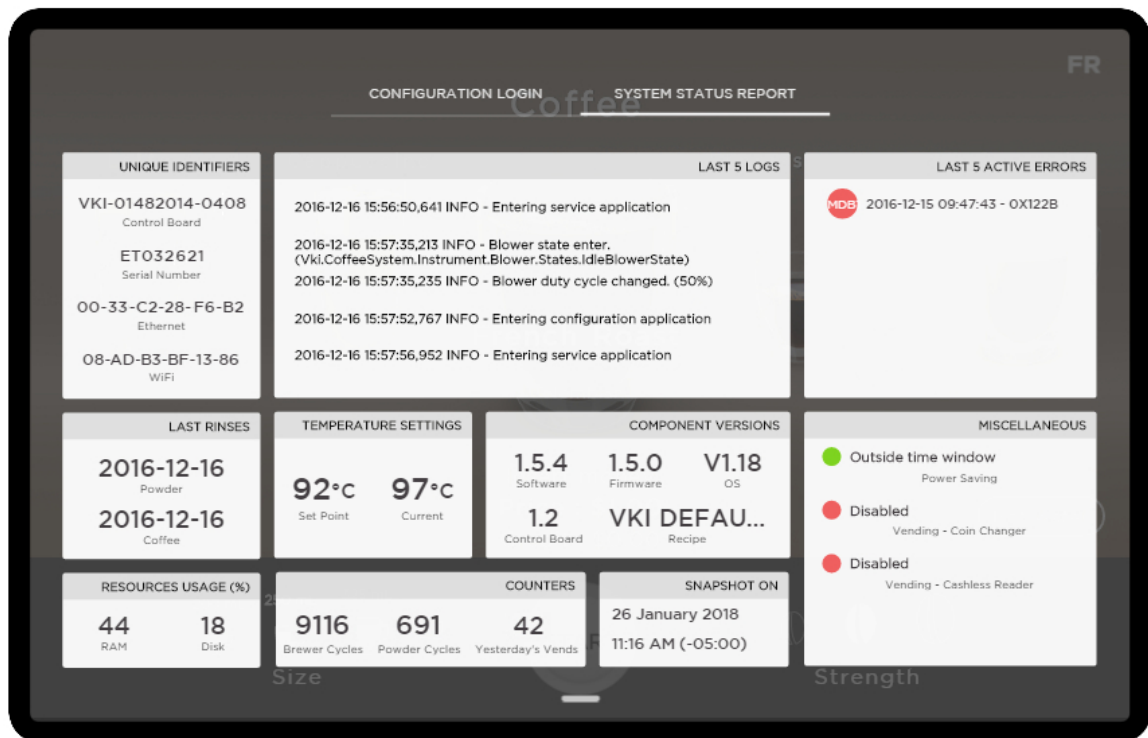

As previously stated, you may be asked to send a photo of the System Status Report screen to VKI Technical Support as it may prove useful during equipment troubleshooting.

SECTION 3

Configuring the Equipment



The following symbol is used to identify a "touch" location on the machine's touch screen.

Accessing the Configuration System

To access the equipment Configuration System:

1. Touch the small line at the top center of the screen, and swipe downwards.



2. A numeric keypad opens and you are required to enter your personal identification number (PIN).

The default PIN for the **Operator** is '345678'. The default PIN for the **Administrator** is '234567'. See the '**Security**' section ([page 84](#)) for more information.

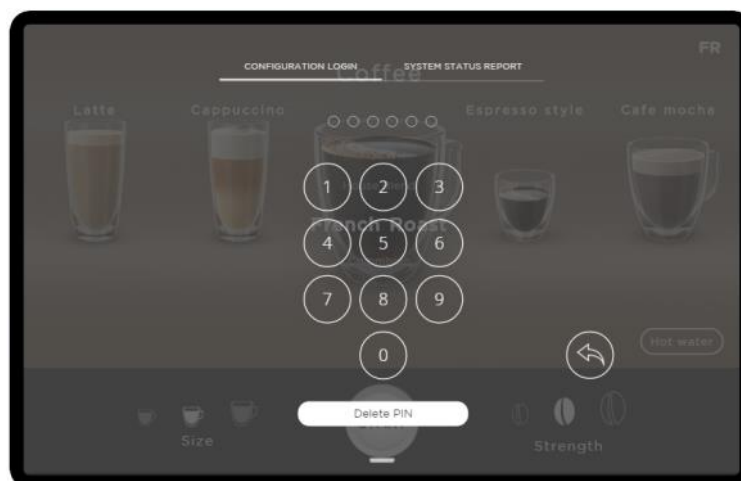

- If the correct PIN is entered, the 'System Status' screen shown below opens. If an incorrect PIN is entered, it remains on the keypad screen.

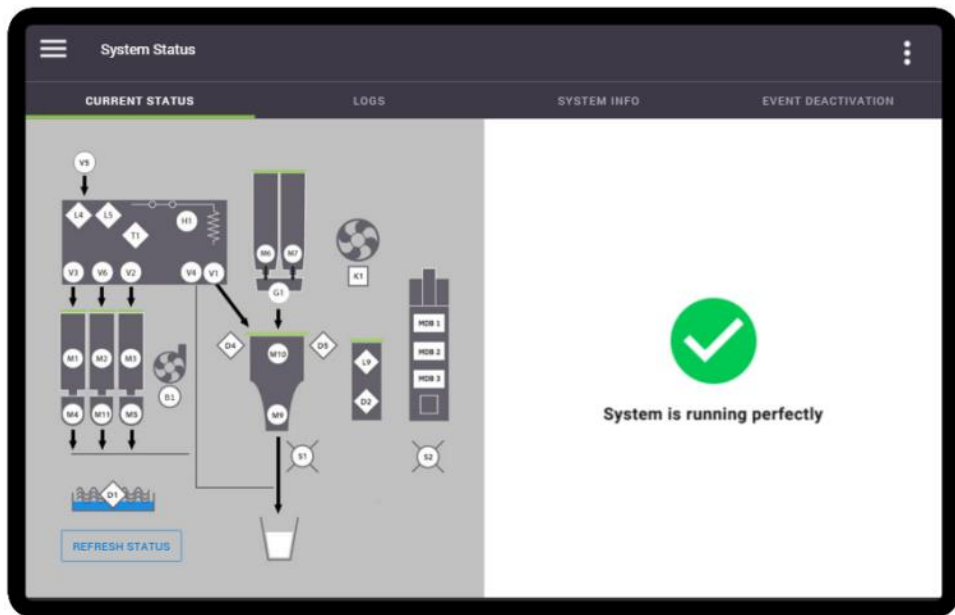

If logging in as an Operator, all menus will be visible as you have full rights/access to the programming mode. If logging in as an Administrator, your rights/accesses may be limited and some menus may not be accessible.



Your PIN must remain confidential, therefore you should never disclose your PIN to anyone.

Programming Menu Structure

The Setup menu drop-list can be viewed at any time by touching the triple-bar icon on the upper left side of the screen. When the drop-list is open, simply touch the required setting on the list to open the corresponding configuration menu.

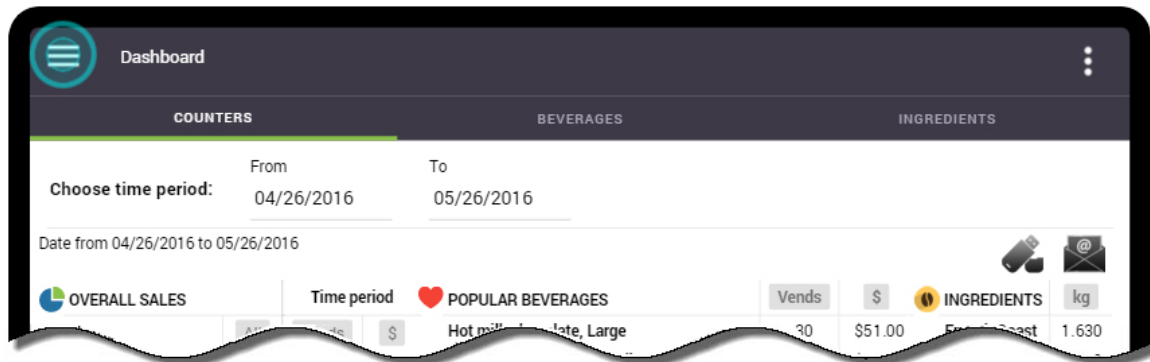

Menu Drop-List Overview

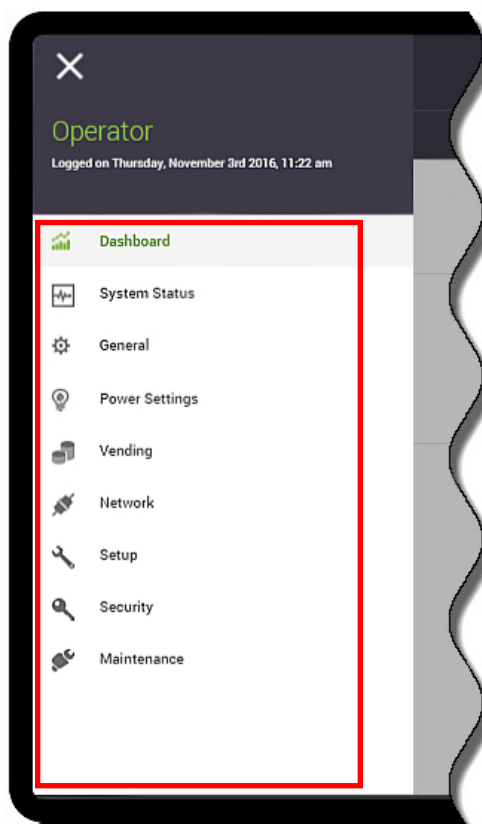

Dashboard - displays statistics on consumption, counters, and sales.

System Status - displays the status of the machine (including current faults) and provides logs of previous faults.

General Settings - set language, units and date/time, set speaker volume and screen brightness.

Power Settings - set energy saving features.

Vending / Pricing - enable vending and set pricing

Personalization - currently unavailable.

Network - configure network connections and email notifications.

Setup - enable and rename products and beverages, set recipes and timings, set temperature, fine-tune water settings, and product calibrations.

Security - assign/change PIN numbers, and grant or remove access to individual sections of the machine programming.

Maintenance - perform maintenance and test each component individually for functionality.



All of the menus and tabs in this section will only be visible to anyone that logs in as an **Operator**. If you log in as an Administrator, you may **not** have access to all of these menus and tabs. See the "Security" section ([page 84](#)) for more information.

Sub-Menu Tabs

Some of the settings in the drop-down list also contain sub-menus. If you want to view a sub-menu, select (tap) one of the sub-menu tabs at the top of the screen.

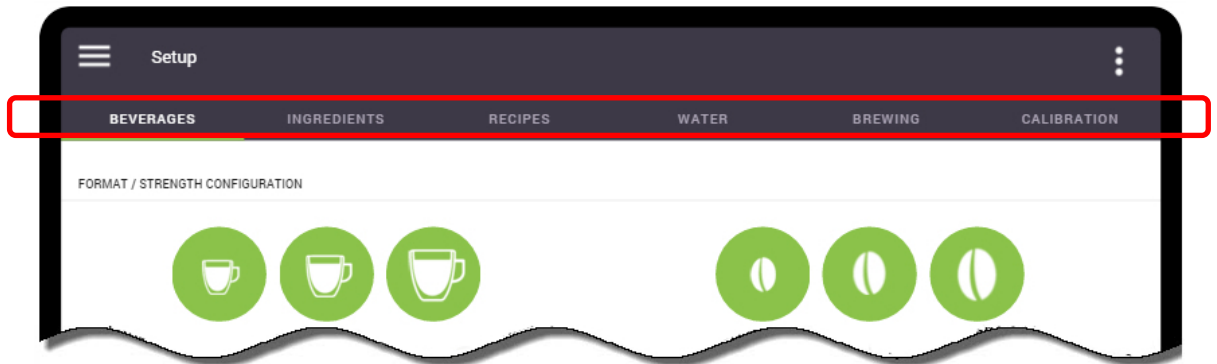

If multiple tabs are available, the currently active tab is identified by a green line directly beneath the sub-menu name, which also appears white instead of gray.

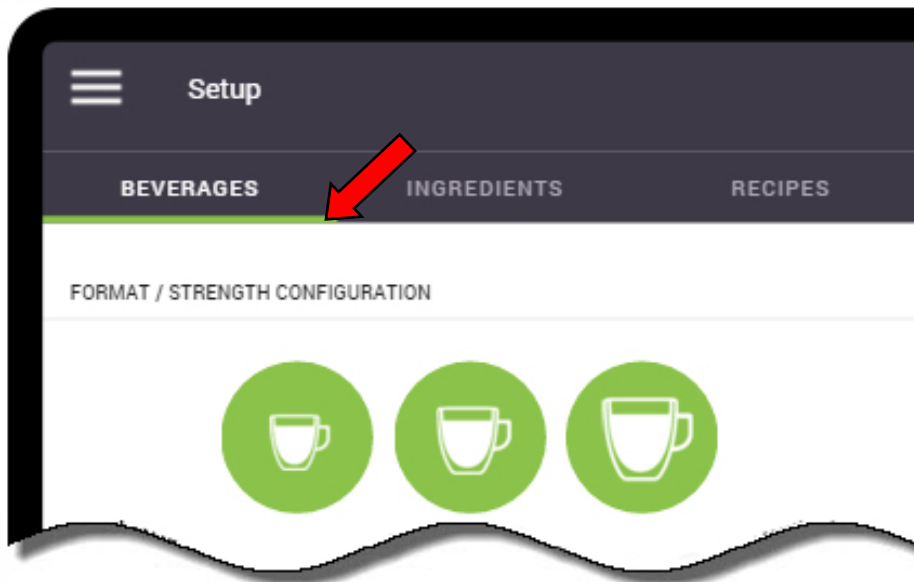

Exiting the Setup

To exit the Setup at any time, touch the three dots on the top right corner. This opens the "Log Off" tab that closes the Setup.

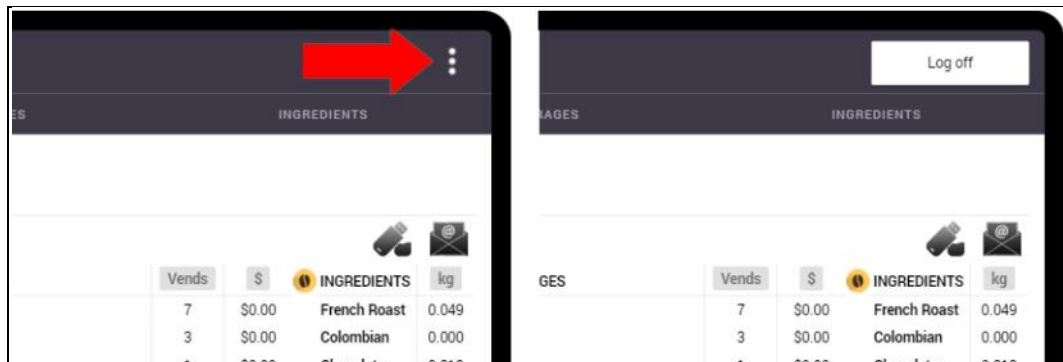

Dashboard

The Eccellenza Touch '**Dashboard**' displays statistics on counters, consumption, and sales (vending).

Counters

The 'Counters' tab displays a view of the internal counters in the machine. The counters provide a snapshot of the machine's consumption and sales. **Please note that these counters are displayed based on the time period chosen and are non-resettable.**

The screenshot shows the 'Dashboard' interface with the 'COUNTERS' tab selected. The time period is set from 04/26/2016 to 05/26/2016. The dashboard displays the following data:

OVERALL SALES			Time period		POPULAR BEVERAGES		Vends	\$
	All	Vends	\$					
Total	190	19	\$24.60	Hot milk chocolate, Large		30	\$51.00	
Specialty beverages	75	7	\$9.75	Coffee French Roast, Medium		45	\$42.55	
Powder Only	40	5	\$7.60	Hot chocolate, Large		20	\$25.00	
Coffee Only	75	7	\$7.25	Mochaccino French Roast, Large		15	\$21.55	
				French vanilla coffee Colombian, Large		15	\$19.55	

INGREDIENTS		kg
French Roast	1.630	
Colombian	0.530	
Chocolate	2.490	
Vanilla	0.540	
Milk	1.040	

MAINTENANCE	
Remaining Powder Vends Before Powder Rinse	63 Date of Last Powder Rinse 05/20/2016
Remaining Coffee Vends Before Brewer Rinse	486 Date of Last Brewer Rinse 05/20/2016

CASHBOX	
Credits - Time period	\$202.55
Credits - Current	\$41.50
Credits - Last Reset	\$119.55
Last reset date	05/26/2016

- ❶ **Time Period:** allows you to select the time period for which to display the counters or statistics.
- ❷ **Overall Sales:** displays the overall beverage sales (in cups) for the selected time period. Also displays sales information for 'Popular Beverages'.
- ❸ **Save or Email Information:** allows you to save the information to a USB flash drive, or to send it by email (in Microsoft Excel format).
- ❹ **Ingredients:** displays the overall product sales (by weight) for the selected time period.
- ❺ **Maintenance:** displays how many '**coffee**' or '**powder**' vends remain before an automated brewer rinse or powder rinse request is activated.
- ❻ **Cashbox:** displays the 'Cashbox' information (if applicable) for the selected time period.

To specify the time period for which you want to view the data:

1. Tap on the "From" field and enter the desired month, date and year and tap "Done".

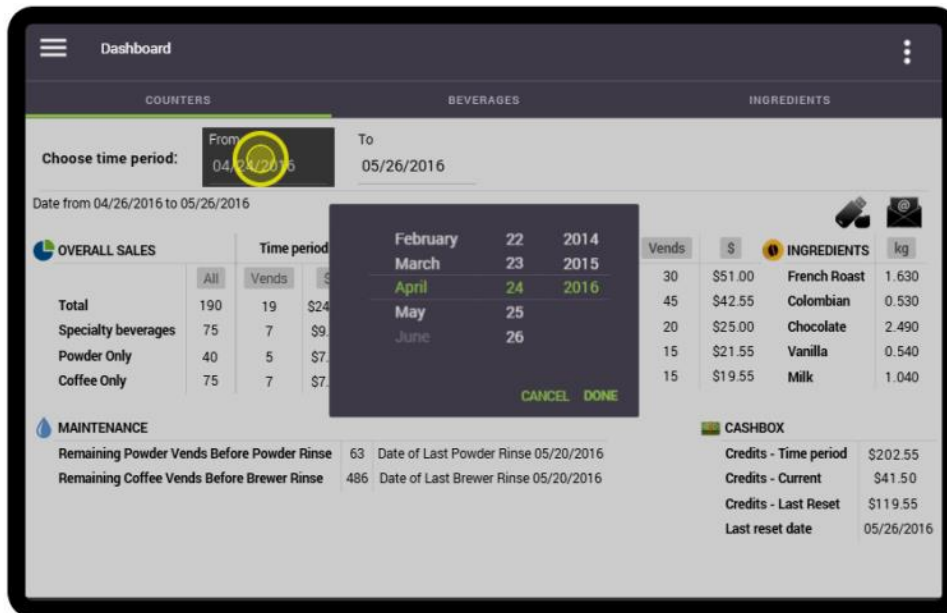

2. Tap on the "To" field and enter the desired month, date and year and tap "Done".

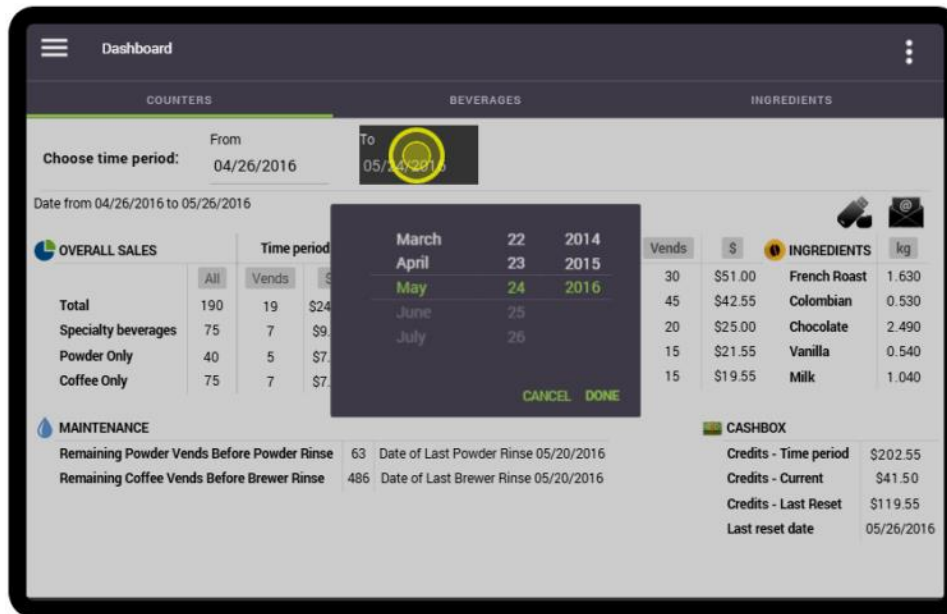

- The screen now displays the statistics for the time period selected.

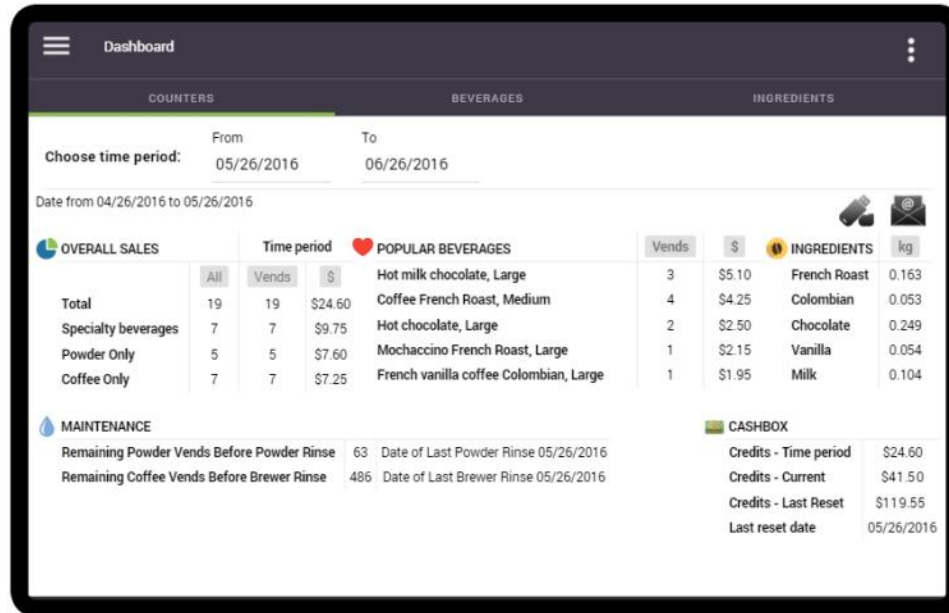

Beverages Tab

The 'Beverages' tab allows you to select and view the consumption (by cups) for a specific time period for each of the individual beverages the equipment dispenses. To specify the time period:

- Tap on the "From" field and enter the desired month, date and year and tap "Done".

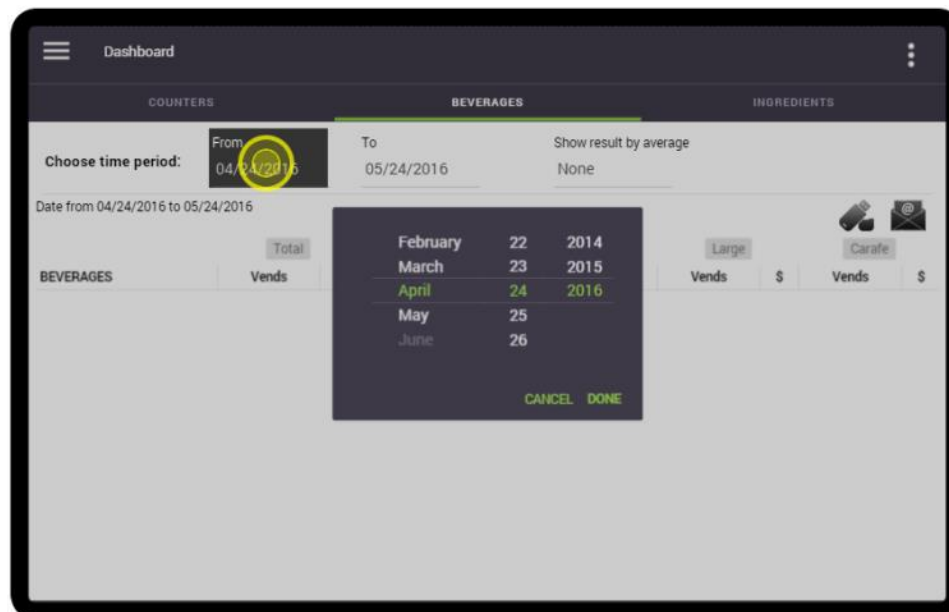

- Tap on the "To" field and enter the desired month, date and year and tap "Done".

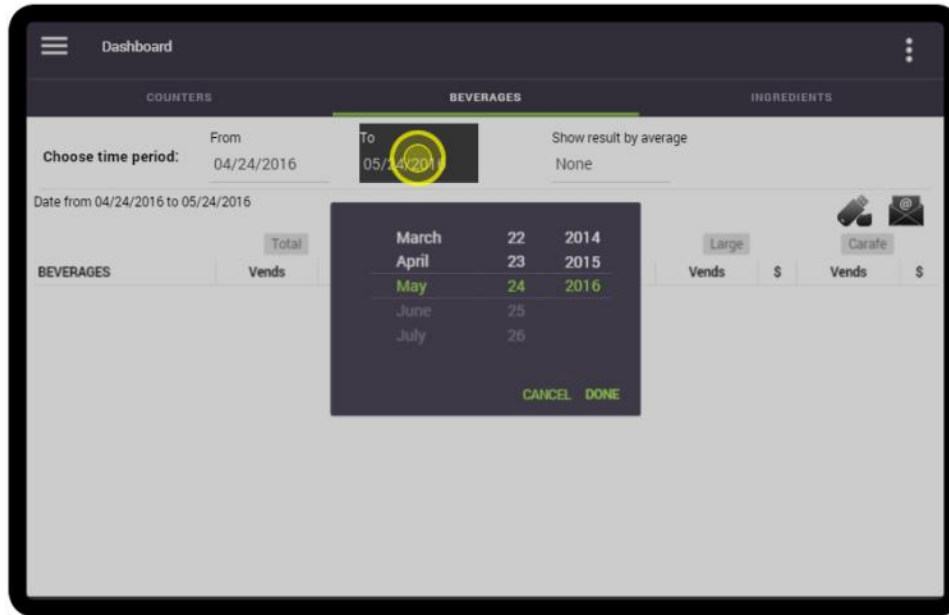

- The number of cups brewed and the amount of money collected (if applicable) are displayed for the time period that was selected.

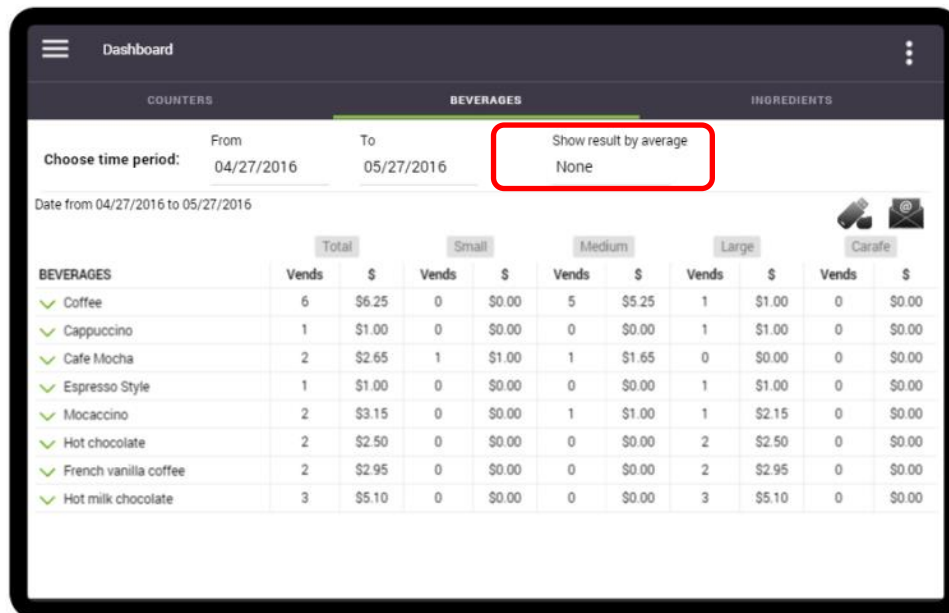

If you would prefer to view the results as a Daily, Weekly or Monthly average, you can change the parameter in the 'Show result by average' field.

- Tap on the green "down" arrow beside any of the beverages shown to expand the selections for a more thorough breakdown of the data shown.

For example, the "Coffee" field shows 6 cups. Tapping on the green "down" arrow beside 'Coffee' shows you that of the 6 cups brewed, 4 were French Roast, 1 was Colombian and 1 was House Blend. This procedure can be performed on any of the beverages listed.

BEVERAGES	Total		Small		Medium		Large		Carafe		
	Vends	\$	Vends	\$	Vends	\$	Vends	\$	Vends	\$	
☑ Coffee	6	\$6.25	0	\$0.00	5	\$5.25	1	\$1.00	0	\$0.00	
French Roast	Regular	4	\$4.25	0	\$0.00	4	\$4.25	0	\$0.00	0	\$0.00
Colombian	Regular	1	\$1.00	0	\$0.00	0	\$0.00	1	\$1.00	0	\$0.00
House Blend	Regular	1	\$1.00	0	\$0.00	1	\$1.00	0	\$0.00	0	\$0.00
☑ Cappuccino		1	\$1.00	0	\$0.00	0	\$0.00	1	\$1.00	0	\$0.00
☑ Cafe Mocha		2	\$2.65	1	\$1.00	1	\$1.65	0	\$0.00	0	\$0.00
☑ Espresso Style		1	\$1.00	0	\$0.00	0	\$0.00	1	\$1.00	0	\$0.00
☑ Mocaccino		2	\$3.15	0	\$0.00	1	\$1.00	1	\$2.15	0	\$0.00
☑ Hot chocolate		2	\$2.50	0	\$0.00	0	\$0.00	2	\$2.50	0	\$0.00
☑ French vanilla coffee		2	\$2.95	0	\$0.00	0	\$0.00	2	\$2.95	0	\$0.00
☑ Hot milk chocolate		3	\$5.10	0	\$0.00	0	\$0.00	3	\$5.10	0	\$0.00

Here is an example with the 'French vanilla coffee' selection expanded.

BEVERAGES	Total		Small		Medium		Large		Carafe		
	Vends	\$	Vends	\$	Vends	\$	Vends	\$	Vends	\$	
☑ Coffee		6	\$6.25	0	\$0.00	5	\$5.25	1	\$1.00	0	\$0.00
☑ Cappuccino		1	\$1.00	0	\$0.00	0	\$0.00	1	\$1.00	0	\$0.00
☑ Cafe Mocha		2	\$2.65	1	\$1.00	1	\$1.65	0	\$0.00	0	\$0.00
☑ Espresso Style		1	\$1.00	0	\$0.00	0	\$0.00	1	\$1.00	0	\$0.00
☑ Mocaccino		2	\$3.15	0	\$0.00	1	\$1.00	1	\$2.15	0	\$0.00
☑ Hot chocolate		2	\$2.50	0	\$0.00	0	\$0.00	2	\$2.50	0	\$0.00
☑ French vanilla coffee		2	\$2.95	0	\$0.00	0	\$0.00	2	\$2.95	0	\$0.00
House Blend	Strong	1	\$1.00	0	\$0.00	0	\$0.00	1	\$1.00	0	\$0.00
Colombian	Strong	1	\$1.95	0	\$0.00	0	\$0.00	1	\$1.95	0	\$0.00
☑ Hot milk chocolate		3	\$5.10	0	\$0.00	0	\$0.00	3	\$5.10	0	\$0.00

Ingredients Tab

The 'Ingredients' tab displays the consumption (in weight) for each of the ingredients used (as well as the volume of water used) to prepare the beverages the equipment dispenses.

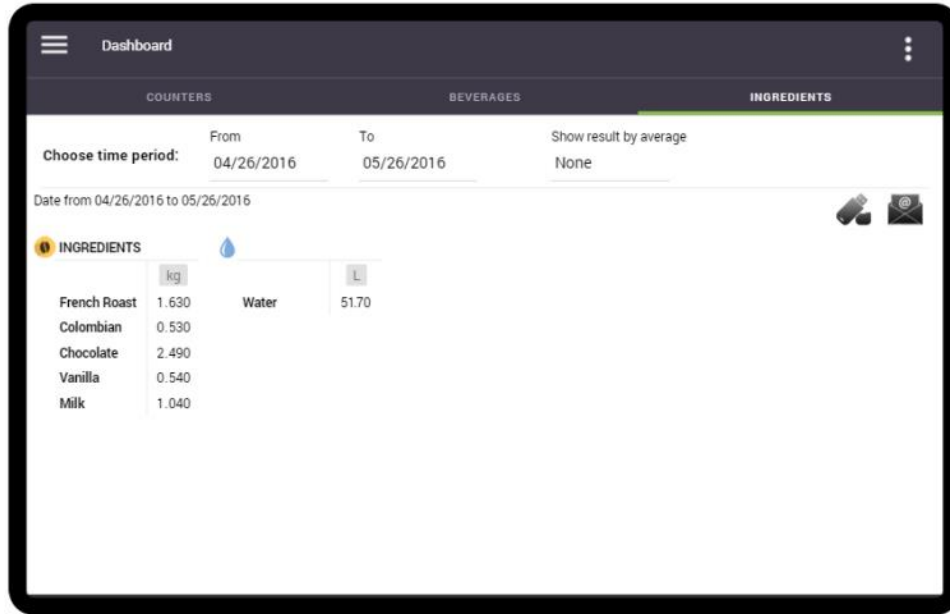

Emailing Data or Saving it to a USB Flash Drive

All of the data available in the Eccellenza Touch's Dashboard can either be saved to a USB flash drive, or sent to an email address as an attachment (if an email address has been set in the "Network" menu). Whether saved to a USB drive or sent by email, the attachment is in Microsoft Excel format.

To save the data to a USB drive, tap on the USB drive icon on the left. To send it by email, tap on the email icon (envelope) on the right, and follow the prompts on the screen.

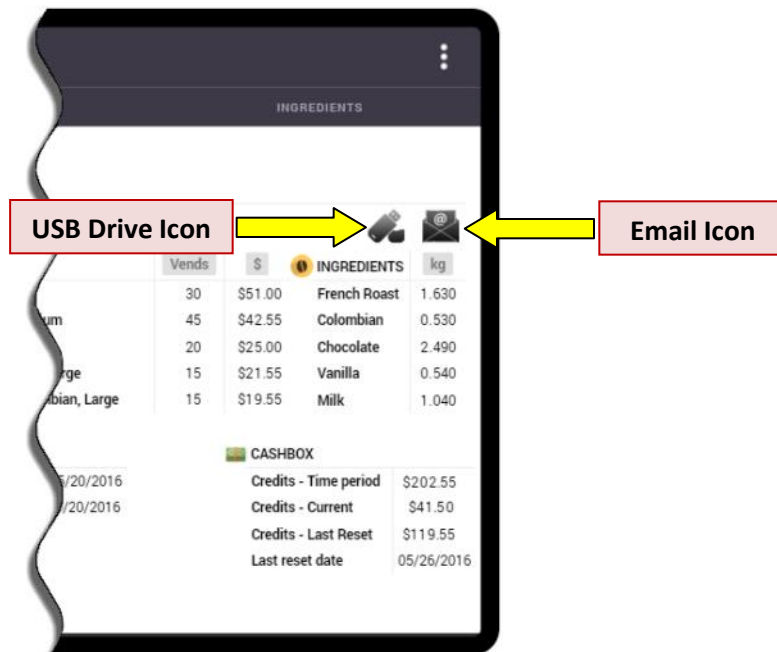

System Status

The 'System Status' screen displays the status of the machine (including current faults) and provides logs of previous faults. The equipment system info (such as serial number, firmware version, IP address, etc.) and maintenance functions are also found here.

Current Status

The machine's current operating status is displayed with an easy-to-read graphic. If the system is functioning properly (with no faults detected), a green checkmark is displayed (see image below).

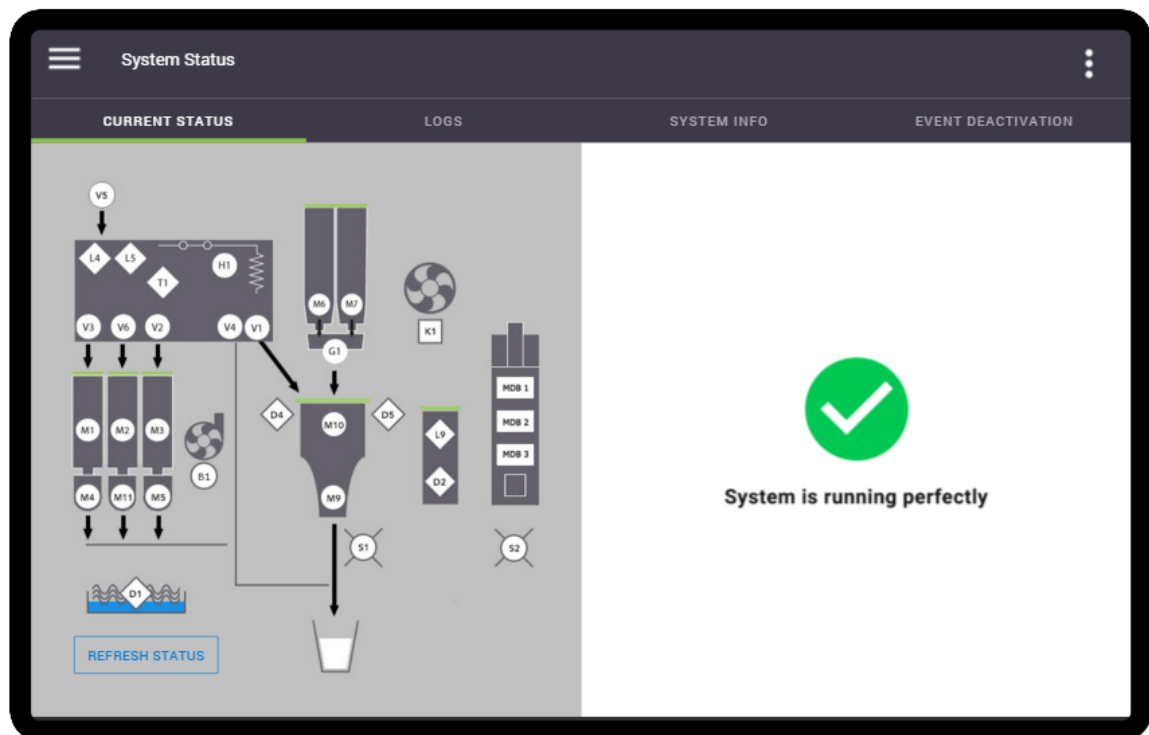

Fault Codes

Should a fault be present, it is identified in the "Current Status" tab, under the "System Status" menu, using one of the codes from the list below. The right section of the screen shows the component code (and pending component codes) and a brief description of the fault.

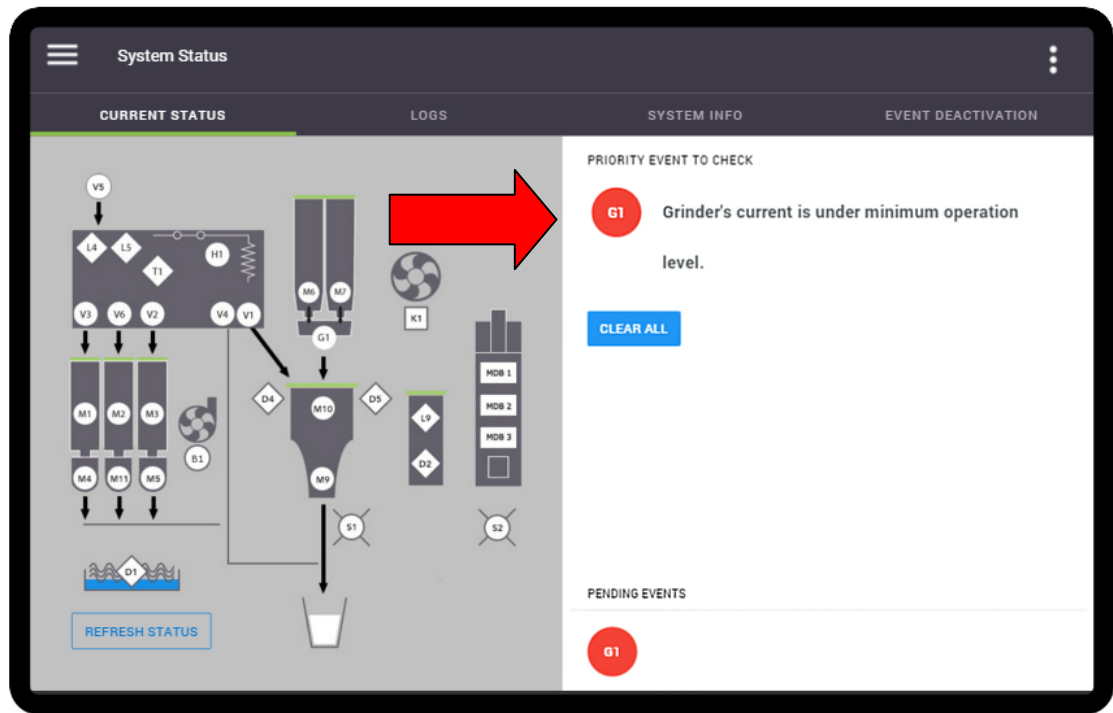

CODE	COMPONENT
B1	Blower (Powders)
D1	Tank Overflow Detection
D2	Waste Bin Presence Detection
D4	Wiper Switch - Left
D5	Wiper Switch - Right
G1	Grinder
H1	Heating Element
K1	Exhaust Fan
L4	Normal Water Level Detection
L5	Safety Water Level Detection
L9	Waste Bin Level Detection
M1	Powder 1 Motor
M2	Powder 2 Motor
M3	Powder 3 Motor
M4	Powder 1 Whipper Motor

CODE	COMPONENT
M5	Powder 3 Whipper Motor
M6	Coffee 1 Motor
M7	Coffee 2 Motor
M9	Brewer Motor
M10	Brewer Wiper Motor
M11	Powder 2 Whipper Motor
S1	Cup Lighting
S2	Esthetic Lighting
T1	Temperature Probe
V1	Outlet Valve - Coffee
V2	Outlet Valve - Powder 3
V3	Outlet Valve - Powder 1
V4	Outlet Valve - Hot Water
V5	Inlet Valve
V6	Outlet Valve - Powder 2

In the example above, a fault has been detected with "G1", which is the grinder. After correcting the error, tap the "Clear All" button. The screen then displays a green checkmark with the "System is running perfectly" message beneath it. In some cases, the error may re-appear when the machine is placed back in normal operation, at which point a more thorough troubleshooting is required.



Fault codes must be manually cleared (in this menu) after the fault has been corrected, otherwise the error message will continue to appear on the main screen.

Logs

The 'Logs' tab shows the fault history of the equipment in list form (from newest to oldest). Codes marked in Red identify that servicing was required. Yellow-marked codes warn of potential faults. Codes in green identify that the fault was corrected, and when it was corrected.

CODE	DATE	DESCRIPTION
Z99	16 days ago	All errors cleared
M9	16 days ago	BrewerTimeout
MB01	20 days ago	CoinChangerMaxNonResponseTimeout
MD01	20 days ago	CoinChangerCashboxReset
MD01	20 days ago	CoinChangerCashboxReset
MB01	20 days ago	CoinChangerMaxNonResponseTimeout
MB01	20 days ago	CoinChangerMaxNonResponseTimeout
MB01	20 days ago	CoinChangerMaxNonResponseTimeout
MB01	20 days ago	CoinChangerMaxNonResponseTimeout

System Info

Information about the equipment, such as serial number, firmware versions, network and MAC address, vending devices, etc., can be found in this menu.

HMI	CONTROL BOARD	MACHINE	VENDING DEVICES *
FRONT-END 1.5.4.0 CONFIGURATION SYSTEM 1.5.4.0 BACK-END 1.5.4.0 OPERATING SYSTEM V1.18 SERIAL NUMBER N/A RECIPES VKI DEFAULT REV. T_B 23/01/2018 10:42:40 ORIGINAL	FIRMWARE 1.5.0 HARDWARE 1.2 SERIAL NUMBER VKI-01020814-0928	MACHINE NAME Eccellenza Touch SERIAL NUMBER ET032621 IP ADDRESS WIFI: 10.107.162.125 ETH: NOT CONNECTED MAC ADDRESS WIFI: 08-A5-4E-66-1B-F5 ETH: 00-05-2C-8C-AB-81	COIN CHANGER UNKNOWN MODEL UNKNOWN CASHLESS PAYMENT UNKNOWN MODEL UNKNOWN

**NOTE: The "Vending Devices" option is only visible when "Vending" is set to 'ON'.*



The "Machine Name" field can be edited. To do so, simply tap on the machine name and the keyboard appears, allowing you to rename the machine.

Event Deactivation

The Event Deactivation tab allows you to deactivate any of the error messages that can potentially appear should the system detect a fault.



Deactivating error messages allows the equipment to continue to operate with a defective component, as a fault notification is not displayed. This, in turn, may cause further damage to the equipment and/or its surroundings.

To deactivate a particular error message:

1. Select the required component from the list of components. The table below identifies the component code.
 - a. Once a component is selected, the list of related error messages for this component is displayed under the "Event Name" heading.

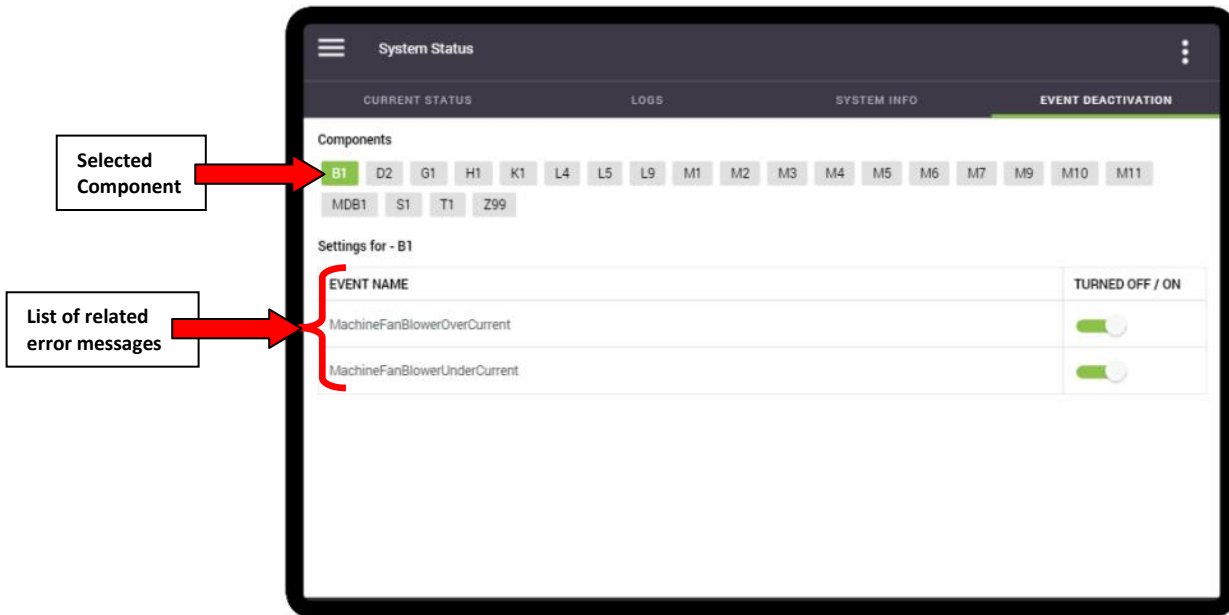

CODE	COMPONENT	CODE	COMPONENT
B1	Blower (Powders)	M4	Powder 1 Whipper Motor
D1	Tank Overflow Detection	M5	Powder 3 Whipper Motor
D2	Waste Bin Presence Detection	M6	Coffee 1 Motor
G1	Grinder	M7	Coffee 2 Motor
H1	Heating Element	M9	Brewer Motor
K1	Exhaust Fan	M10	Brewer Wiper Motor
L4	Normal Water Level Detection	M11	Powder 2 Whipper Motor
L5	Safety Water Level Detection	S1	Cup Lighting
MDB1	Vending Devices	T1	Temperature Probe
M1	Powder 1 Motor	Z99	Various Components
M2	Powder 2 Motor		
M3	Powder 3 Motor		

- Under the "**Turned Off / On**" heading at the right, turn off the error to be deactivated using the slider (green slider = ON, gray slider = OFF).

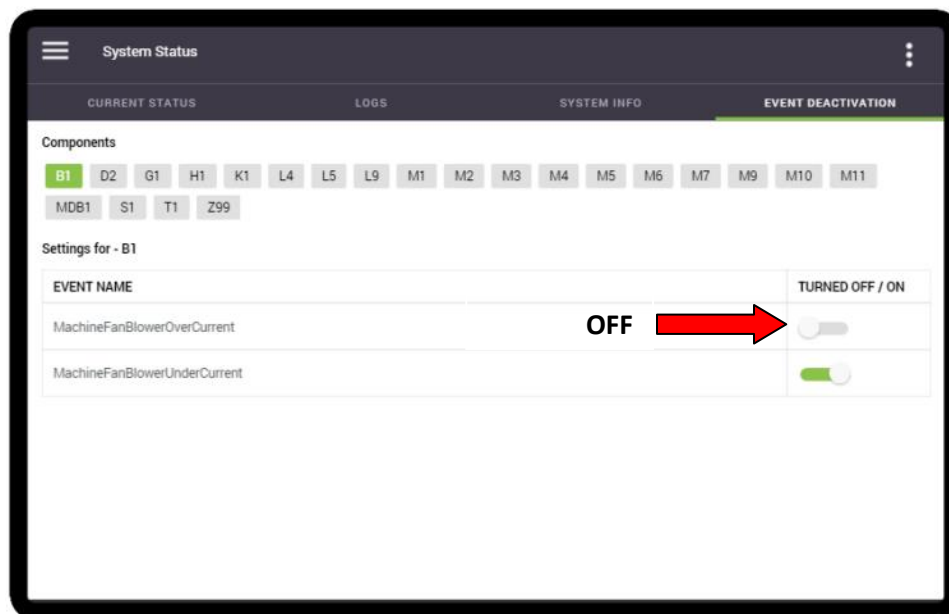
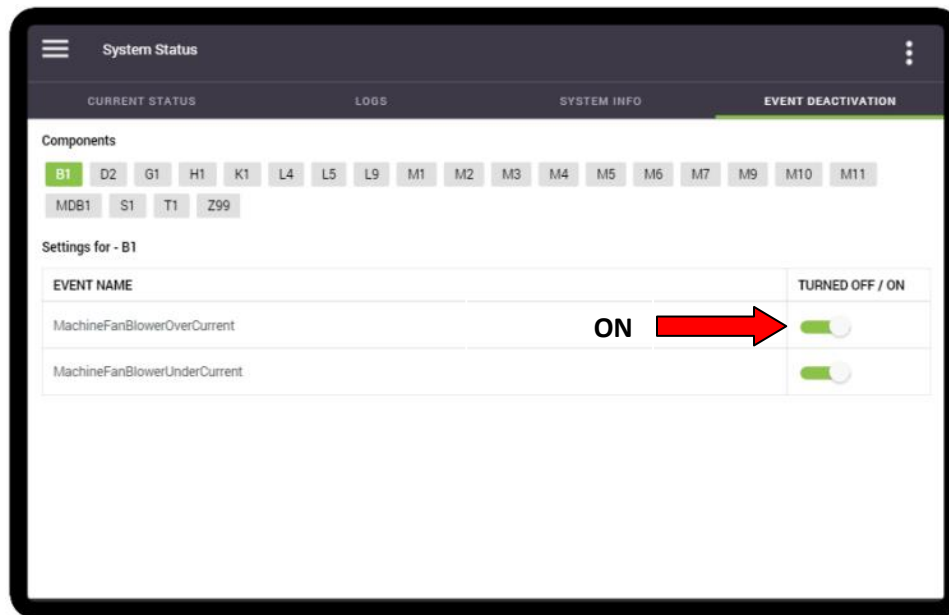

- Repeat the procedure for any other components, if necessary.

General Settings

The '**General**' screen is where you can configure the waste chute system, the primary and secondary interface languages to be used, units of measure (Metric or U.S. Standard) and the date and time, as well as the display and sound settings. You can also change the frequency at which the brewer and powder rinse cycles are triggered in the "Task Schedule" tab.

Installation

Waste Management (Waste Chute)

If the machine will be equipped with the optional waste chute kit, you'll need to come to this tab and enable the '**Use Waste Chute**' option. Doing so will make the wiper move from right to left, guiding the spent coffee grounds into the waste chute instead of the waste bin.



Regional

Language

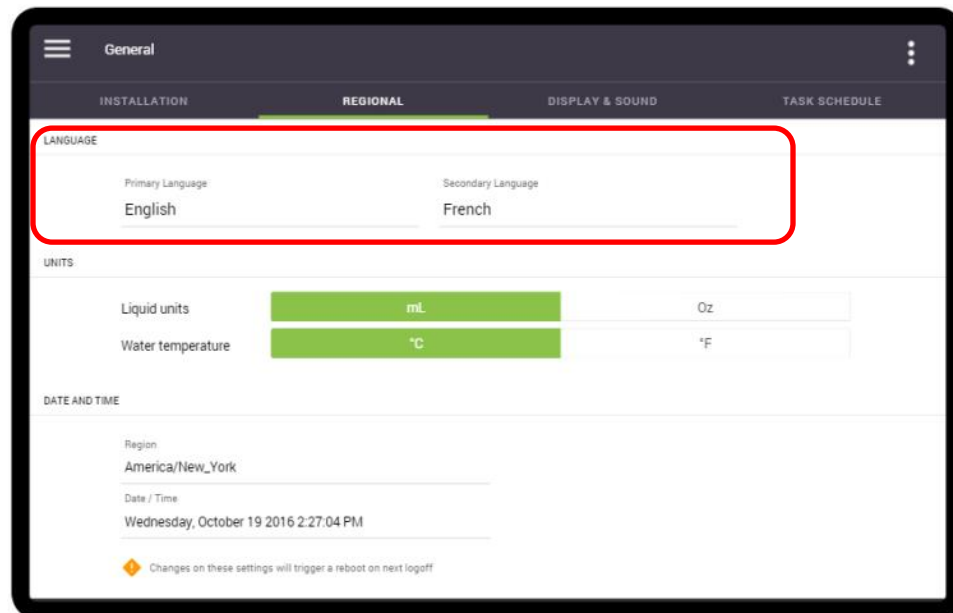

The Eccellenza Touch comes pre-loaded with three different languages (English, French and Spanish), however **only two can be active at one time**. In this tab, you can define the Primary Language, which will be the default, and the Secondary Language, which will be selectable by the user.

To change the language settings, select either the Primary or Secondary setting, choose the required language from the list, and select '**Done**'. Note that you can also select '**None**' as the secondary language (see example below) should you want only one language available.

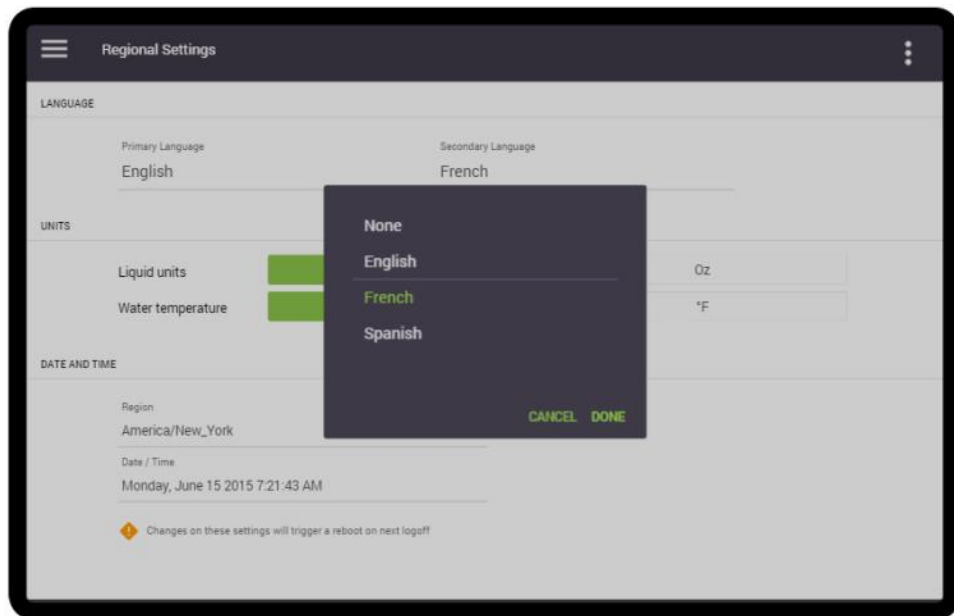

Units of Measure

The units of measure displayed by the Eccellenza Touch can be set in this tab. Liquid units can be set to either milliliters (ml) or ounces (oz), and the temperature can be set to either °C or °F.

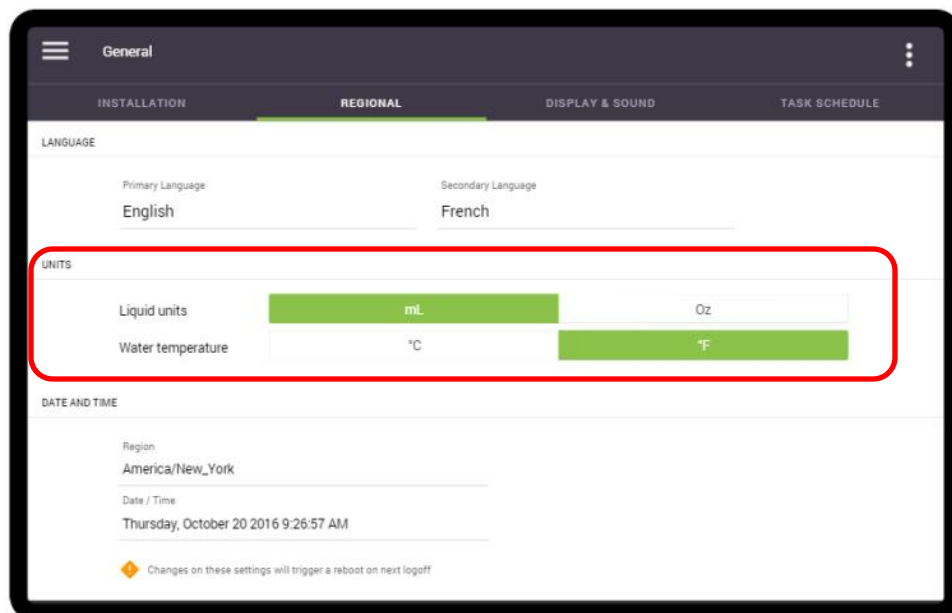

To simplify weight settings for coffees and powders, the Eccellenza Touch only displays the units as grams when they are being set.

Date and Time

To adjust the date, time and time zone setting, first, set the **'Region'** (Time Zone) in which you are located, and then select the **'Date and Time'** feature to open the scroll list.

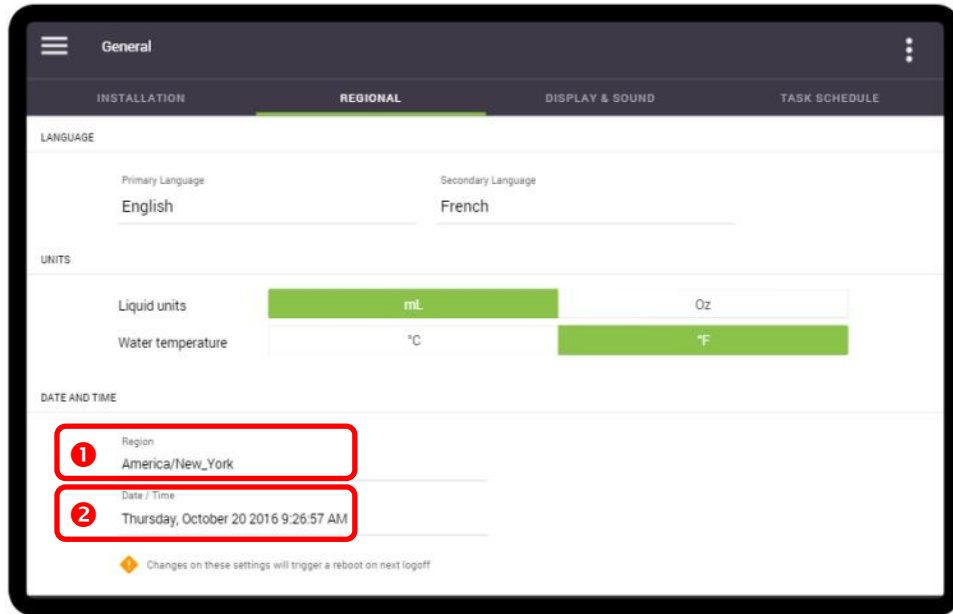

Adjust each of the **'Date & Time'** fields by scrolling up or down to the required setting. Once all are set, press **'Done'** to save the new settings. The table in the image identifies what each of the fields of the scroll list represents.

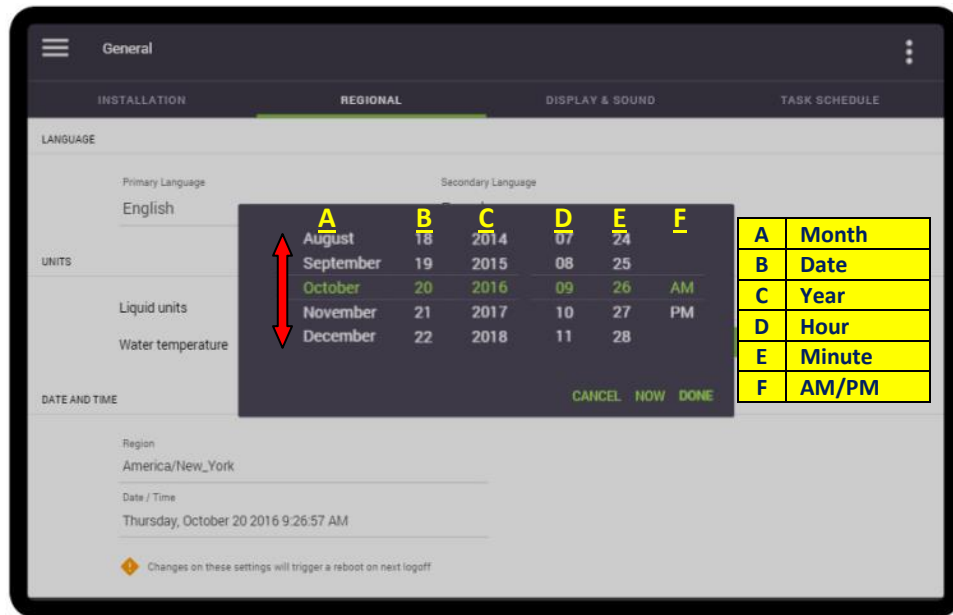

 Once the month, date and year are selected, the day of the week will be calculated and set automatically.

Display and Sound

This screen is used to set the volume level (available **only** when speakers are used) and the brightness of the screen.

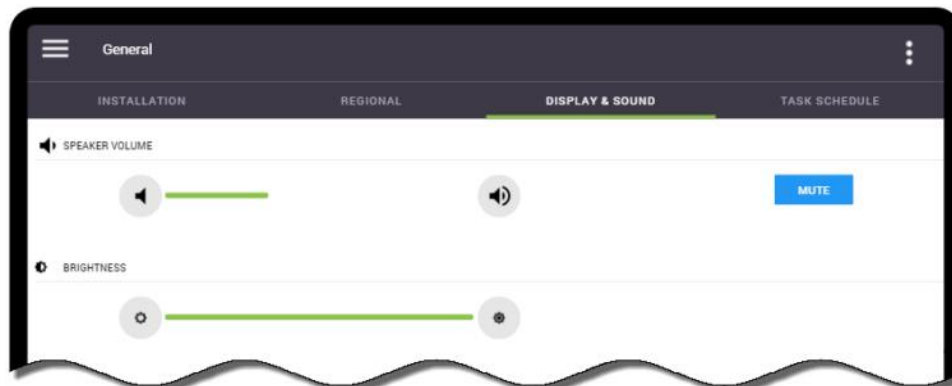

Task Schedule

This screen is used to set the frequency at which the notifications for **mandatory** Brewer Rinse and Powder Rinse cycles are triggered. By default, the Brewer Rinse is set to 500 cups, and the Powder Rinse is set to 75 cups.

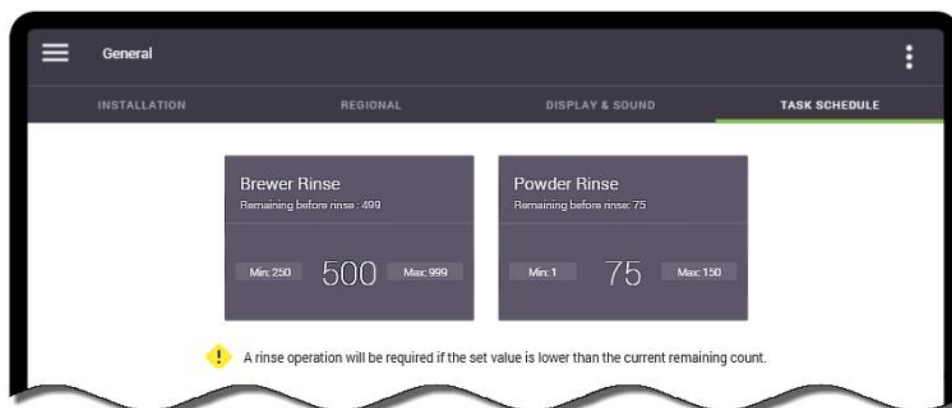

To change the frequency, tap on the desired option and input the new setting. Once you are finished, tap the **'Done'** button to save your new setting.

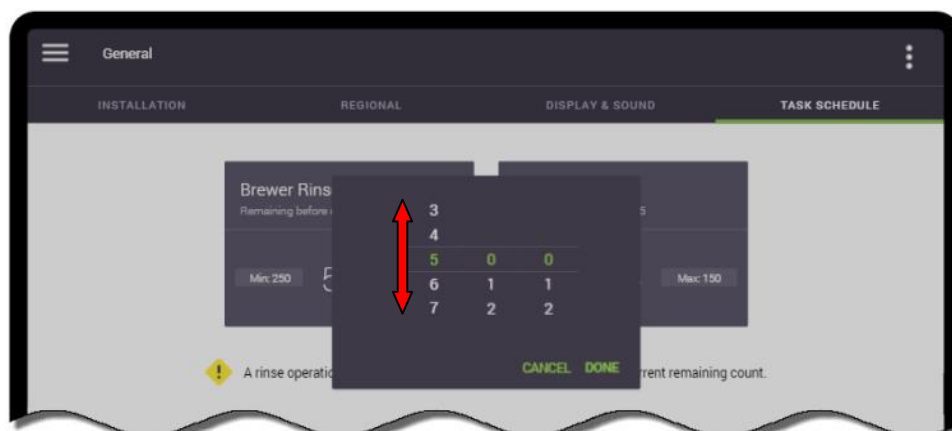

Power Settings

The '**Power Settings**' screen is used to set the energy saving options available in the Eccellenza Touch.

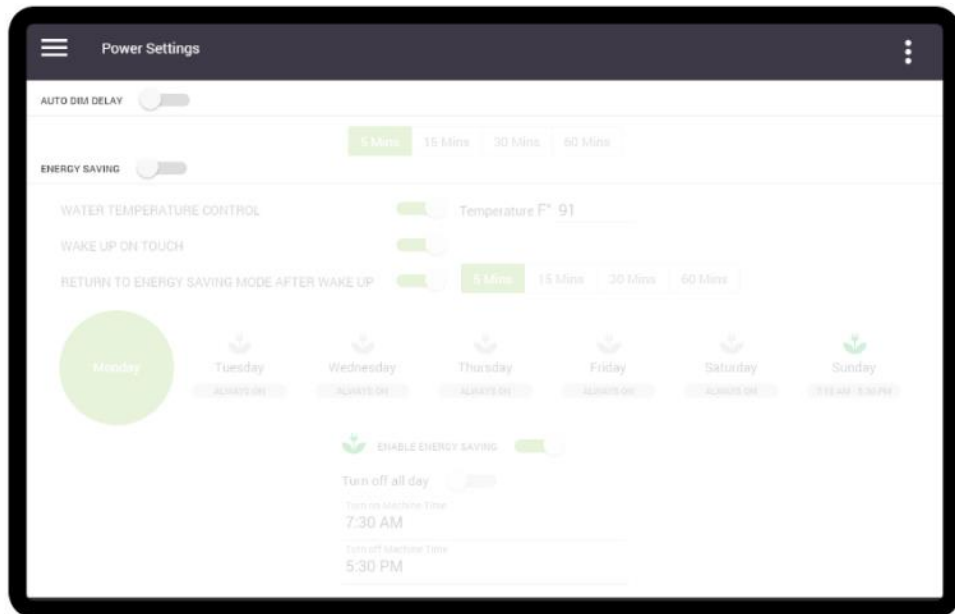

Auto Dim Delay

If the 'Auto-Dim Delay' feature is activated, the screen will dim slightly after the preset amount of time to reduce energy consumption.

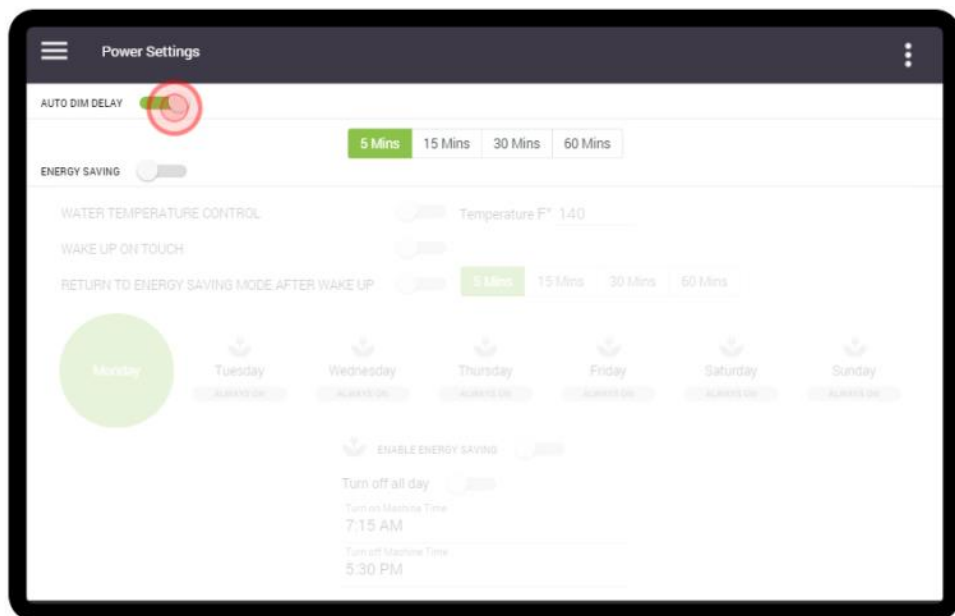

Energy Saving

To conserve energy, the Eccellenza Touch can be set to go into an 'Energy Saving' mode during preset periods of time. While in Energy Saving mode, only the machine screen functions to advise users that the machine is in Energy Saving mode. All other components are disabled, including the heating element.

1. Tap the '**Energy Saving**' slider to activate the Energy Saving mode.

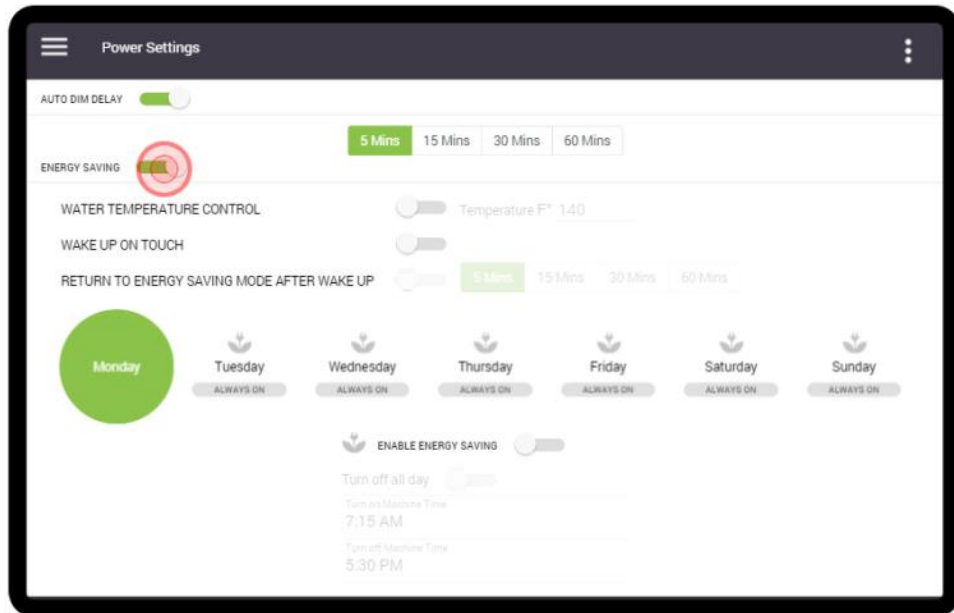

- a) **Water Temperature Control** - if enabled, the temperature at which the water in the tank is maintained while the machine is in 'Energy Saving' mode can be set here.
- b) **Wake Up on Touch** - the machine exits 'Energy Saving' mode when the screen is touched only if this option is activated.
- c) **Return to Energy Saving Mode After Wake Up** - if activated and set, it tells the machine when to go back into 'Energy Saving' mode after a wake up.

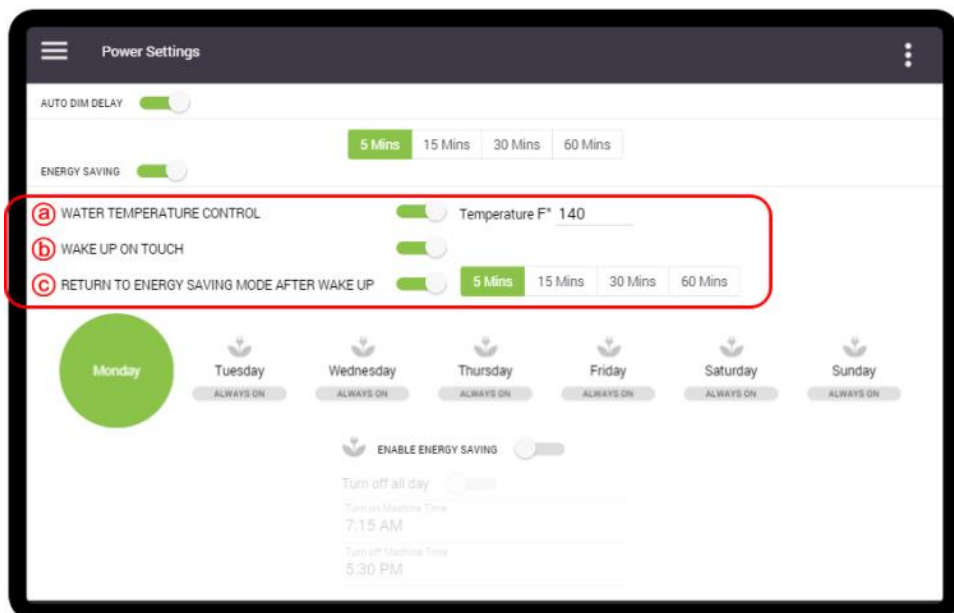

- Select the 'Day' for which you want to enable the Energy Saving mode (in this example, Monday is selected).

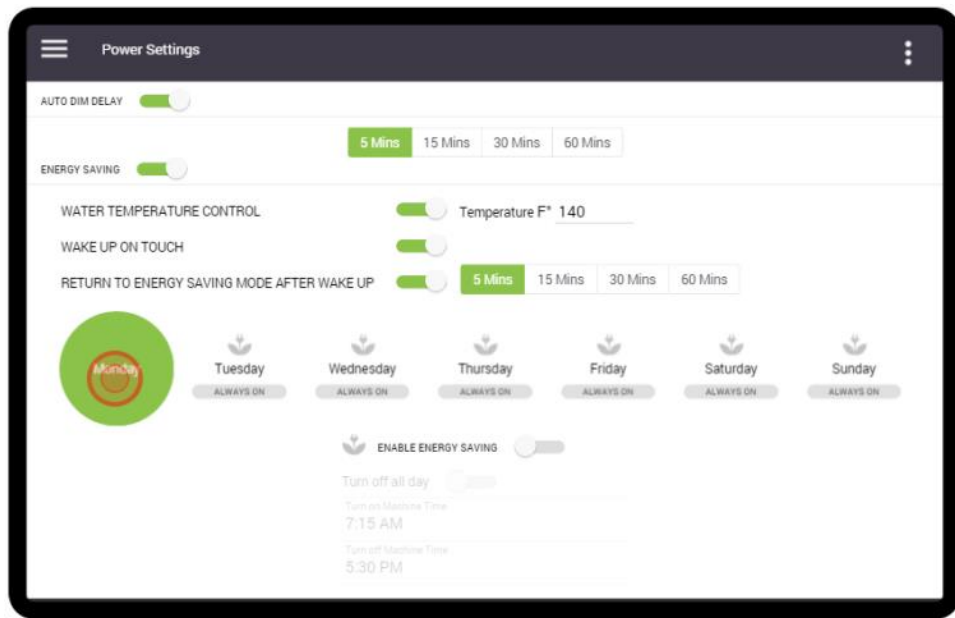

If using the Energy Saving mode, it must be activated and set individually for each day of the week.

- Tap the 'Enable Energy Saving' slider to enable the Energy Saving mode.

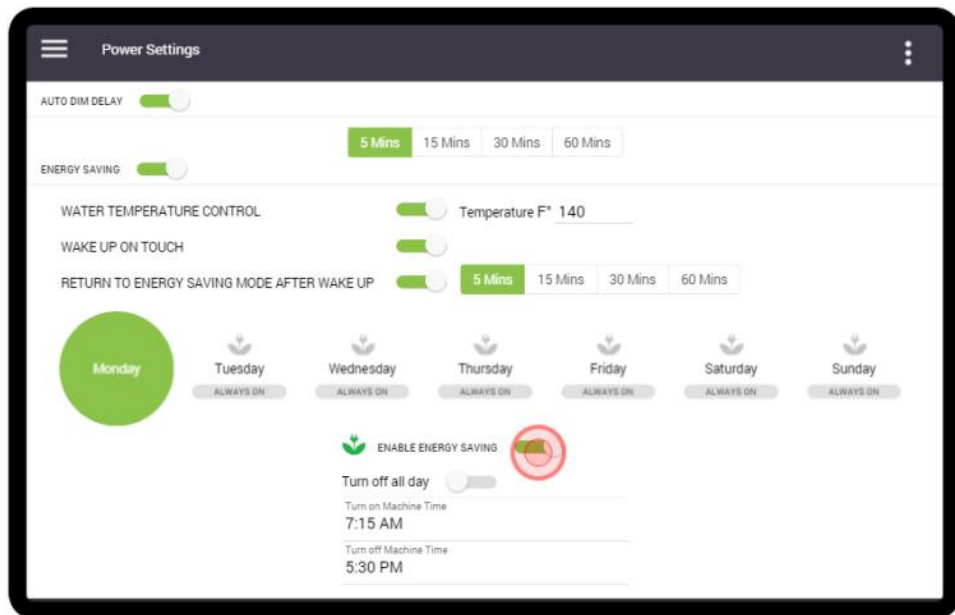

- To set the time that the machine turns ON (for Mondays in this example), tap on the 'Turn on machine time' setting.

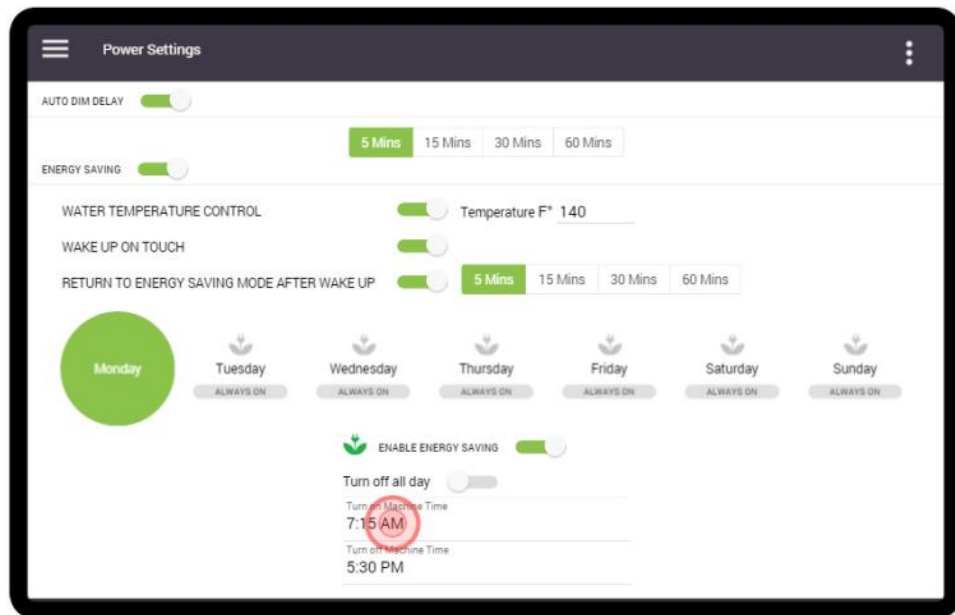

- Adjust each of the fields by scrolling up or down to the required setting. Once all are set, press 'Done' to save the time setting. The table in the image identifies what each of the fields of the scroll list represents.

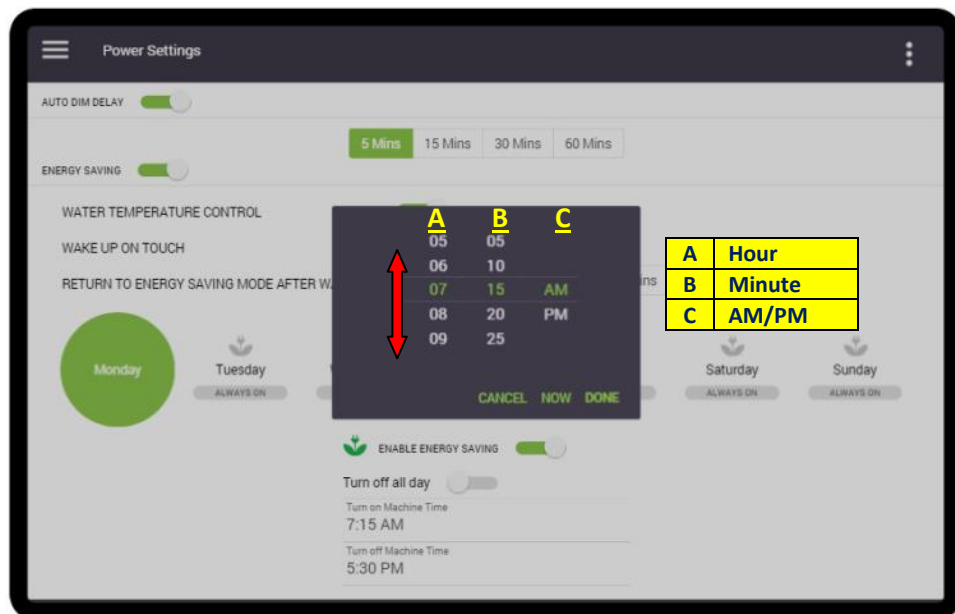

- Repeat this procedure for setting time that the machine turns OFF by tapping on the 'Turn off machine time' setting, and adjusting the time.

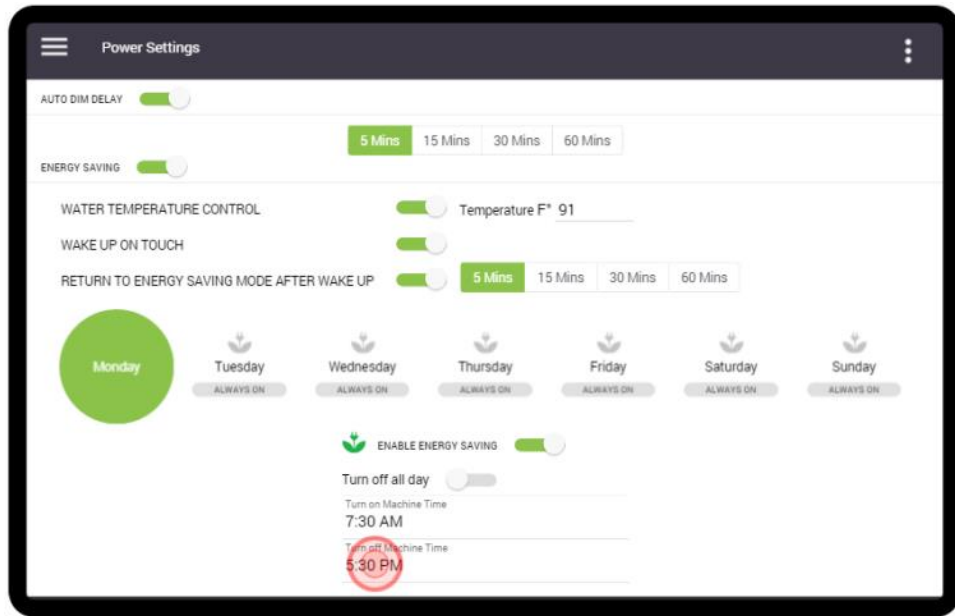

- Now that Monday is set, repeat the complete procedure to set the Energy Saving for every other day of the week.
- Should you need to set the machine to be in Energy Saving mode for the full day (on Sunday, for example), select the day and then enable the 'Turn off all day' option.

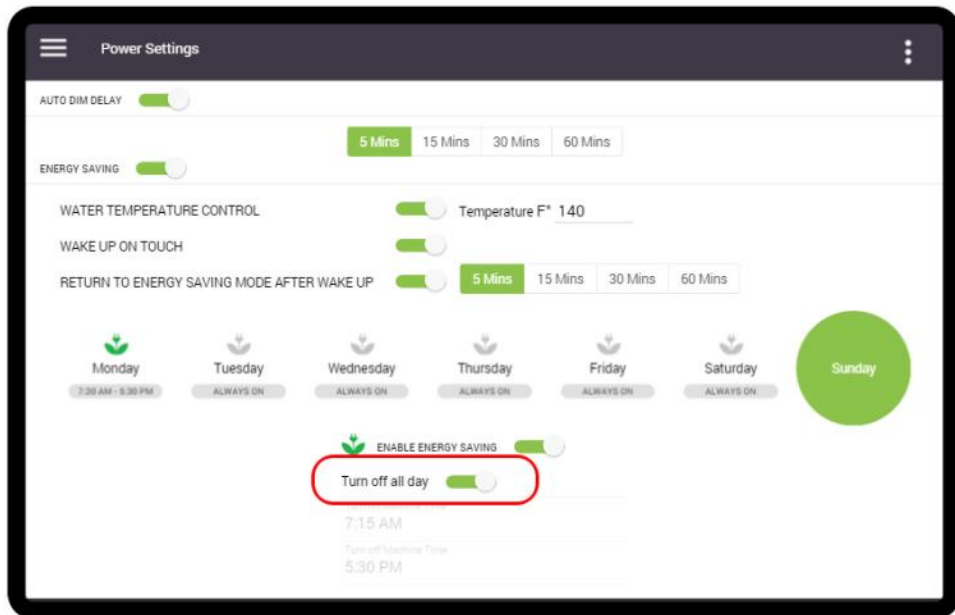

Vending (Coin Acceptor & Cashless)



The Eccellenza Touch is currently only compatible with a Coin Changer unit or a Cashless option (card reader). **Consult the manufacturer documentation for configuring these devices.**

General Tab

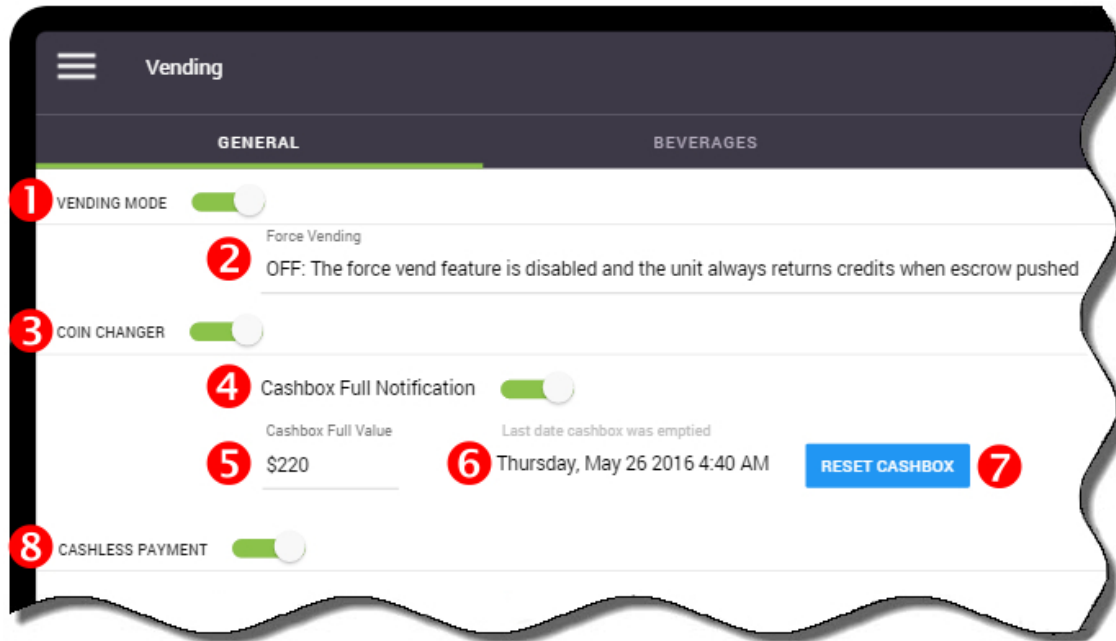

The **Vending Mode** slider **1** enables or disables the vending functions - vending is enabled when the slider is green.

You can also enable the '**Force Vending**' option **2**, which when enabled, prevents people from using the Eccellenza Touch as a 'change maker'. This is usually done by inserting a \$1 or \$2 coin and then pressing the coin return button to have the machine dispense change in quarters. There are three possible configurations for this option:

- **OFF** - the force vend feature is disabled and the unit will function normally.
- **SMART** - the coin return feature of the changer is disabled when a \$1 or \$2 coin is inserted.
- **ON** - the coin return feature of the changer is completely disabled.

The vending devices are also enabled and disabled in this menu. The **Coin Changer** **3** and/or **Cashless (card reader)** **8** options and can be enabled in this menu.

The Cashbox options are configured in this menu. These include:

- **Cashbox Full Notification** **4** - a "Call for Service" message appears on the screen advising that the cashbox is full and requires emptying.
- The '**Cashbox Full Value**' **5** can be set here. This is the value used to determine when the Cashbox Full notification appears. By default, it is set to \$220. Tap on the value to change it, if required.
- The last date the cashbox was emptied (reset) can be verified here **6**.
- Tapping this button **7** resets the cashbox total counter.

Beverages Tab

The main page displayed in this tab shows a list of all of the available beverages and the pricing set for each. To change the price of a beverage, tap the "Edit Pricing" button and the screen will change to the pricing menu.

Recipe	Small			Medium			Large			Carafe		
	French Roast	Colombian	House Blend	French Roast	Colombian	House Blend	French Roast	Colombian	House Blend	French Roast	Colombian	House Blend
Coffee	\$1.00	\$1.00	\$1.00	\$1.00	\$1.00	\$1.00	\$1.00	\$1.00	\$1.00	\$1.00	\$1.00	\$1.00
Espresso	\$1.00	\$1.00	\$1.00	\$1.00	\$1.00	\$1.00	\$1.00	\$1.00	\$1.00	\$1.00	\$1.00	\$1.00
Cappuccino	\$1.00	\$1.00	\$1.00	\$1.00	\$1.00	\$1.00	\$1.00	\$1.00	\$1.00	\$1.00	\$1.00	\$1.00
Latte	\$1.00	\$1.00	\$1.00	\$1.00	\$1.00	\$1.00	\$1.00	\$1.00	\$1.00	\$1.00	\$1.00	\$1.00
Mocaccino	\$1.00	\$1.00	\$1.00	\$1.00	\$1.00	\$1.00	\$1.00	\$1.00	\$1.00	\$1.00	\$1.00	\$1.00
Mocha Coffee	\$1.00	\$1.00	\$1.00	\$1.00	\$1.00	\$1.00	\$1.00	\$1.00	\$1.00	\$1.00	\$1.00	\$1.00
Vanilla Coffee	\$1.00	\$1.00	\$1.00	\$1.00	\$1.00	\$1.00	\$1.00	\$1.00	\$1.00	\$1.00	\$1.00	\$1.00
Hot Chocolate		\$1.00			\$1.00			\$1.00			\$1.00	
Hot Milk Chocolate		\$1.00			\$1.00			\$1.00			\$1.00	
Vanilla		\$1.00			\$1.00			\$1.00			\$1.00	



Base Price Section

Beverage Type: Coffee

Price: \$1.00

Size: Small

Coffee Type: French Roast

Base price = \$1.00

Exceptions

Coffee: \$1.00

Espresso: \$1.00

The pricing menu screen consists of 2 sections:

Base Price Section (Left Side): This section is where the beverage type, cup size and coffee type is selected and priced.

Exceptions (Right Side): This section allows you to create an exception and price a specific ingredient higher or lower than the base price.

Setting the Base Price

Beverage Type Selections

- Coffee
- Specialty
- Powders

Size Selections

- Small
- Medium
- Large

Coffee Type Selections

- French Roast
- Colombian
- House Blend

1. Select the "**Beverage Type**" using the left/right arrows.
2. Set the "**Beverage Type**" price using the '+' or '-' buttons. The default price setting is \$1 for all selections. The base price of the product selected is shown in the "**Base Price**" box.



Please note that the options displayed may vary depending on the beverage type selected, but the method of pricing remains the same.

3. Select the **cup size** using the left/right arrows.
4. Increase the **cup size** price using '+' or '-' buttons. The price displayed here is added to the beverage type pricing. The **total** price of the product and cup size selected is shown in the "**Base Price**" box.

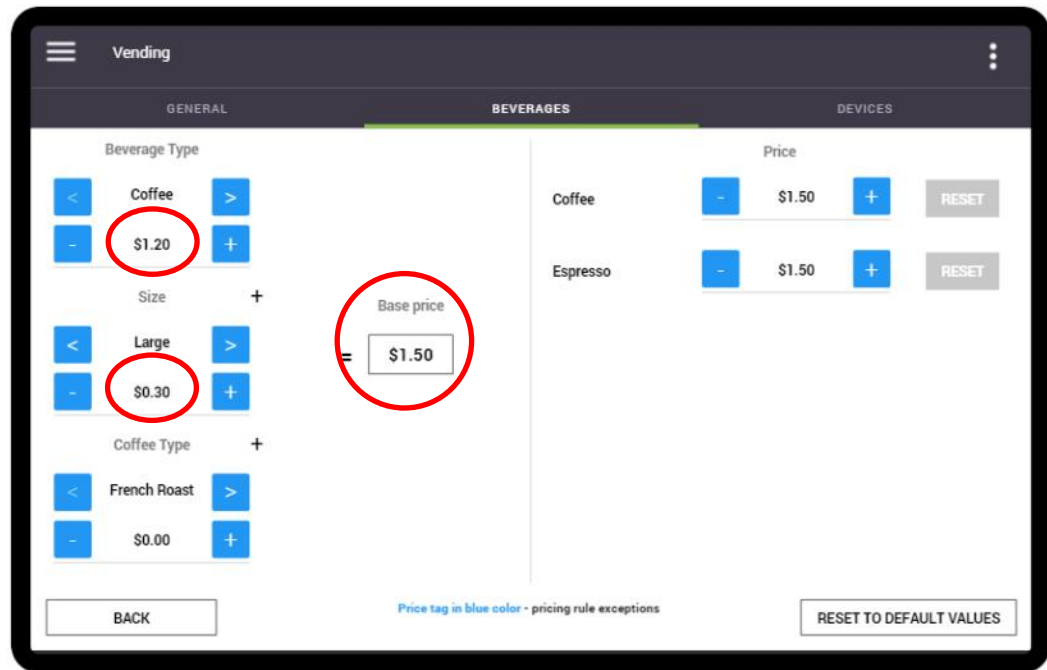

5. Should you want to set a different price for a specific coffee, select the "**Coffee Type**" using the left/right arrows.
6. Increase the "**Coffee Type**" price using '+' or '-' buttons. The price displayed here is added to the beverage type and cup size pricing. The **total** price of the product, cup size and coffee type selected is shown in the "**Base Price**" box.

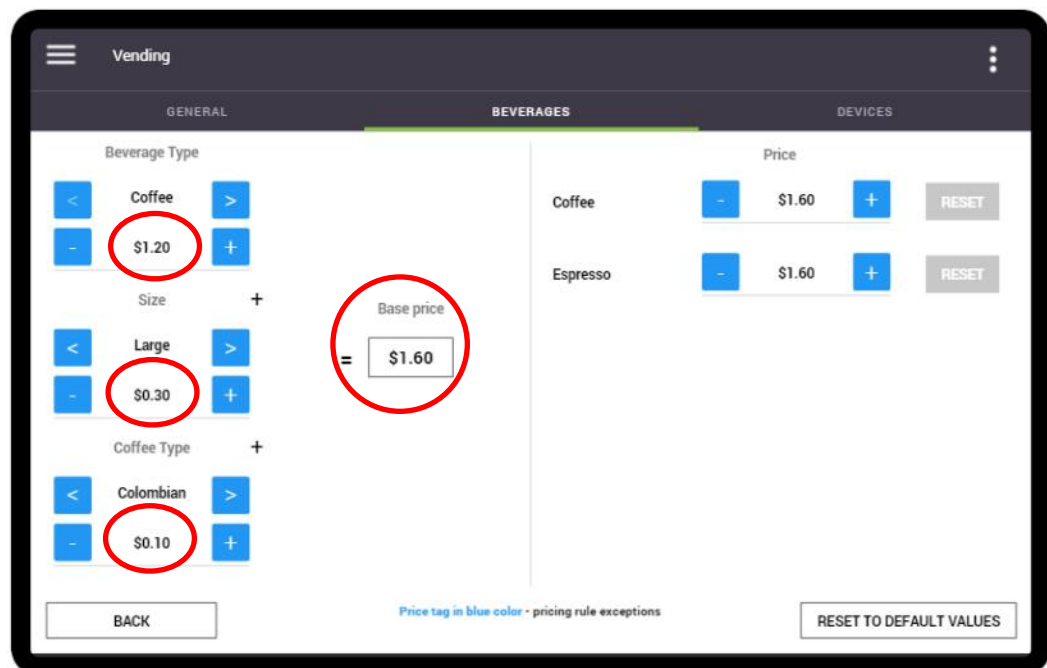

Adjusting the Price for Exceptions

This section allows you to create an exception and price a specific ingredient higher or lower than the base price. The images below show the available "Exception" pricing options, based on the type of beverage that is selected in the left section.



Using the "Coffee" selection as an example, if you want to make a pricing exception for the 'Espresso' and sell it for 15 cents more than the regular coffee, you can increase **only the Espresso price** by using '+' button beside it. Note that pricing exceptions are identified in blue.

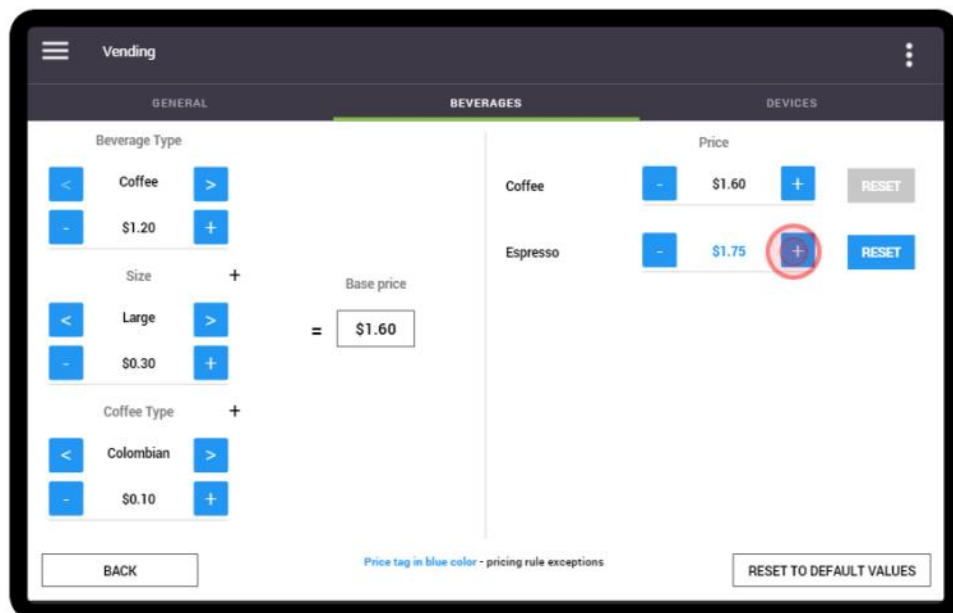

If you go back to the main screen of the Beverages tab, you can see the pricing changes that were made. The prices in blue indicate pricing exceptions.

The screenshot shows the 'Vending' app interface with the 'BEVERAGES' tab selected. The table below represents the data shown in the app:

Recipe	Small			Medium			Large			Carafe		
	French Roast	Colombian	House Blend	French Roast	Colombian	House Blend	French Roast	Colombian	House Blend	French Roast	Colombian	House Blend
Coffee	\$1.00	\$1.00	\$1.00	\$1.00	\$1.00	\$1.00	\$1.60	\$1.60	\$1.60	\$1.00	\$1.00	\$1.00
Espresso	\$1.00	\$1.00	\$1.00	\$1.00	\$1.00	\$1.00	\$1.60	\$1.75	\$1.60	\$1.00	\$1.00	\$1.00
Cappuccino	\$1.00	\$1.00	\$1.00	\$1.00	\$1.00	\$1.00	\$1.00	\$1.00	\$1.00	\$1.00	\$1.00	\$1.00
Latte	\$1.00	\$1.00	\$1.00	\$1.00	\$1.00	\$1.00	\$1.00	\$1.00	\$1.00	\$1.00	\$1.00	\$1.00
Mocaccino	\$1.00	\$1.00	\$1.00	\$1.00	\$1.00	\$1.00	\$1.00	\$1.00	\$1.00	\$1.00	\$1.00	\$1.00
Mocha Coffee	\$1.00	\$1.00	\$1.00	\$1.00	\$1.00	\$1.00	\$1.00	\$1.00	\$1.00	\$1.00	\$1.00	\$1.00
Vanilla Coffee	\$1.00	\$1.00	\$1.00	\$1.00	\$1.00	\$1.00	\$1.00	\$1.00	\$1.00	\$1.00	\$1.00	\$1.00
Hot Chocolate		\$1.00			\$1.00			\$1.00			\$1.00	
Hot Milk Chocolate		\$1.00			\$1.00			\$1.00			\$1.00	
Vanilla		\$1.00			\$1.00			\$1.00			\$1.00	

At the bottom of the screen, there are three elements: an 'EDIT PRICING' button, a text note 'Price tag in blue color - pricing rule exceptions', and a 'RESET TO DEFAULT VALUES' button.

To change the pricing for other beverages that are listed, tap the "Edit Pricing" option. To reset the "Exception" pricing (in blue) to its default value, tap the "Reset to Default Values" option.

Pricing Hot Water

If you would like to add a price for "Hot Water", you'll need to disable the "Press&Hold" setting for Hot Water. This is done in the "Recipes" tab of the Setup menu ([page 74](#)).

Devices Tab

This tab provides detailed information about the vending devices connected to the Eccellenza Touch (if this information is available on the device).

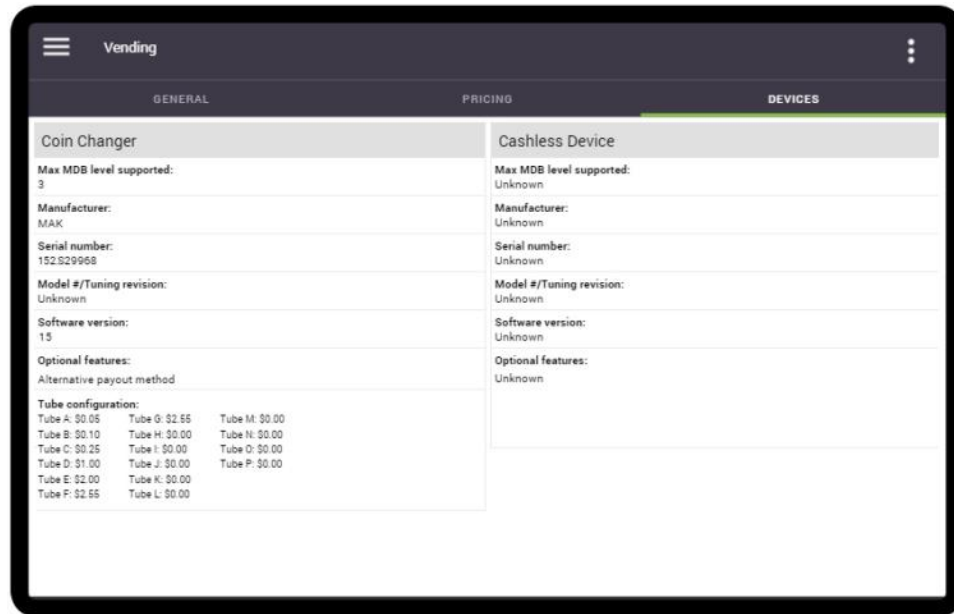

The type of information displayed is shown in the image below. This information is useful when troubleshooting the vending devices with the manufacturer of these devices.

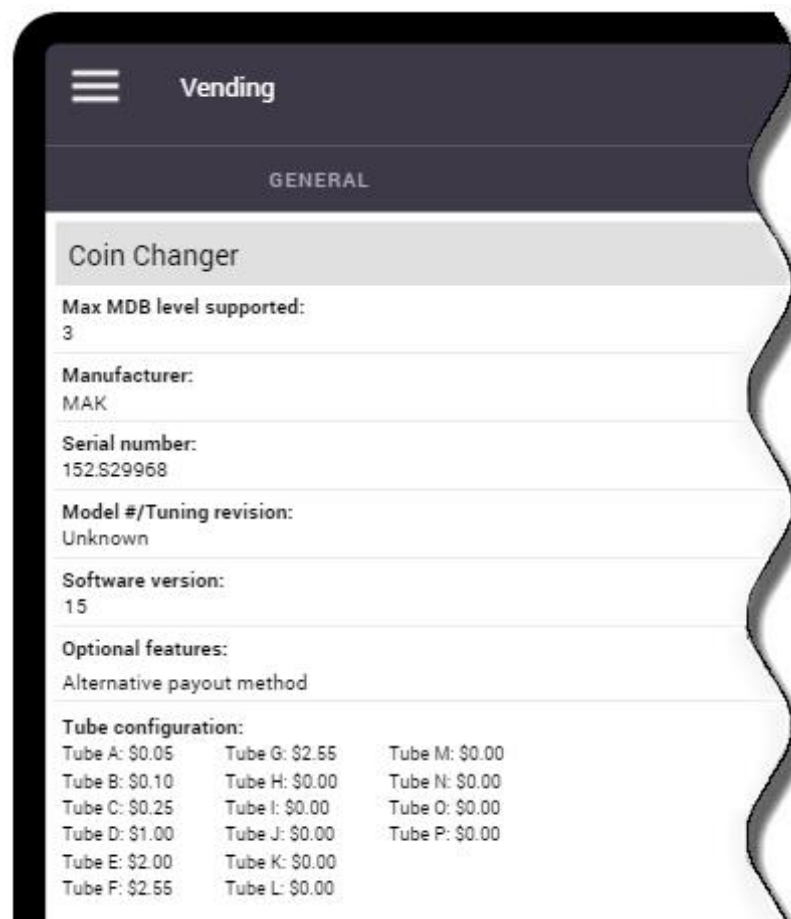

Network

The Network screen is used to configure the network connection and SMTP settings, as well as notification settings that allow the Eccellenza Touch to send email notifications concerning consumption, sales and faults/messages.

WiFi

Should you want to establish remote communication with the Eccellenza Touch, you'll first need to enable the WiFi feature by tapping on the '**WiFi Connexion**' slider.

1. Once WiFi is enabled, the Eccellenza Touch begins scanning for any wireless networks in its vicinity.

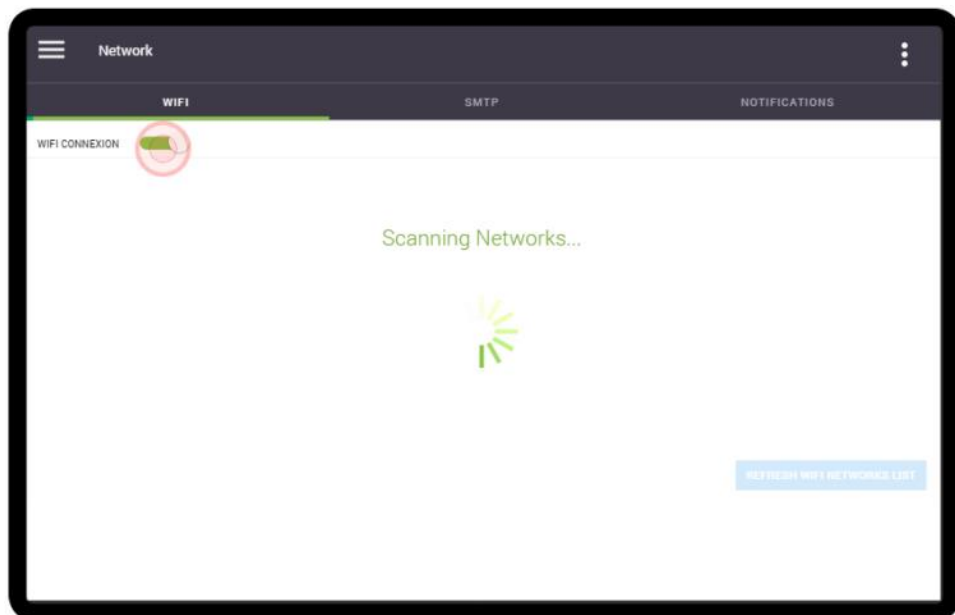

2. When scanning is complete, all of the detected networks are listed on the screen.

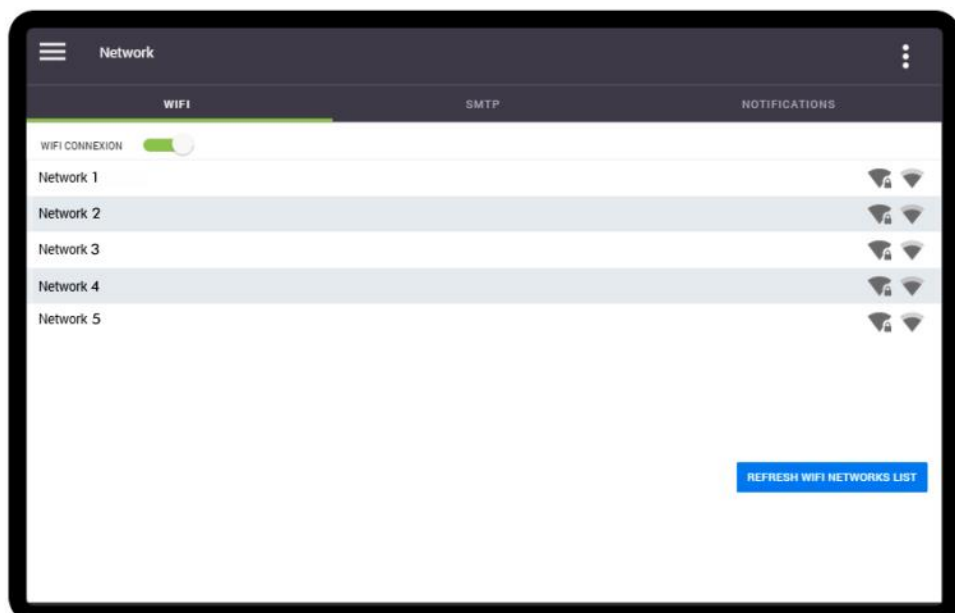



You will be required to work with the customer's IT administrator to obtain their WiFi login credentials (Network Name/SSID and Network Password), as well as any required network permissions. Without these credentials, it is not possible to connect to a network to use the machine's WiFi capabilities.

- Select the network to which you want the Eccellenza Touch to connect, and then tap on the 'Connect' button.

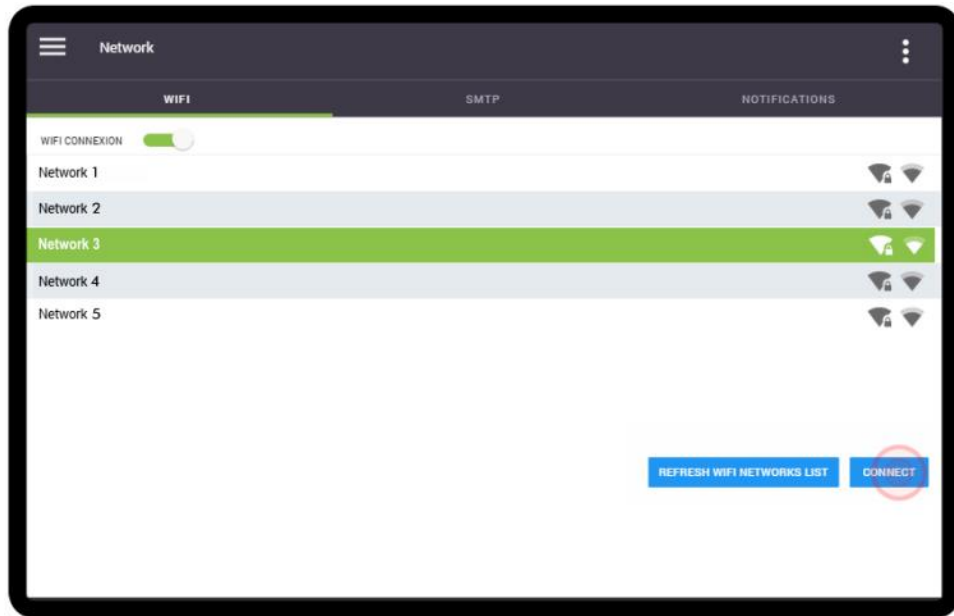

- The keyboard appears and you must now type in the required password to connect to the selected network. Once done, tap the 'Accept Change' button.

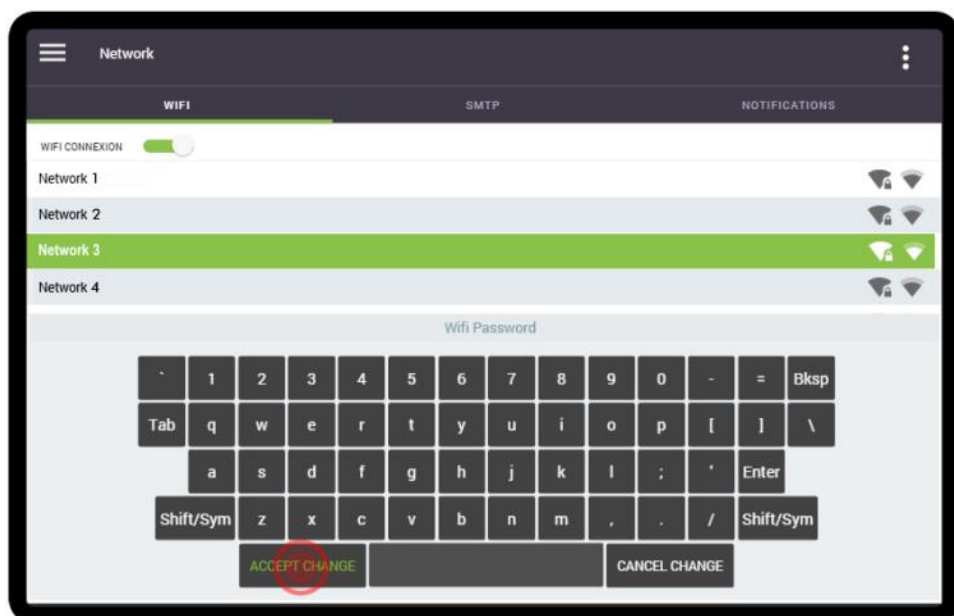

- The Eccellenza Touch now communicates with the network server and if the correct credentials were used, network access is granted.

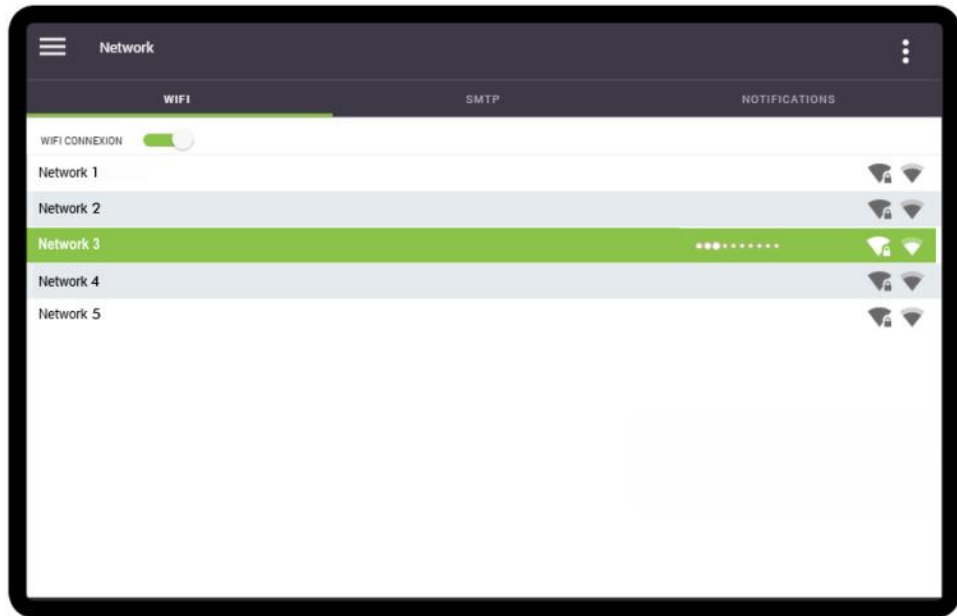

- Once connected to the network, a green indicator appears to the right of the network name/SSID.

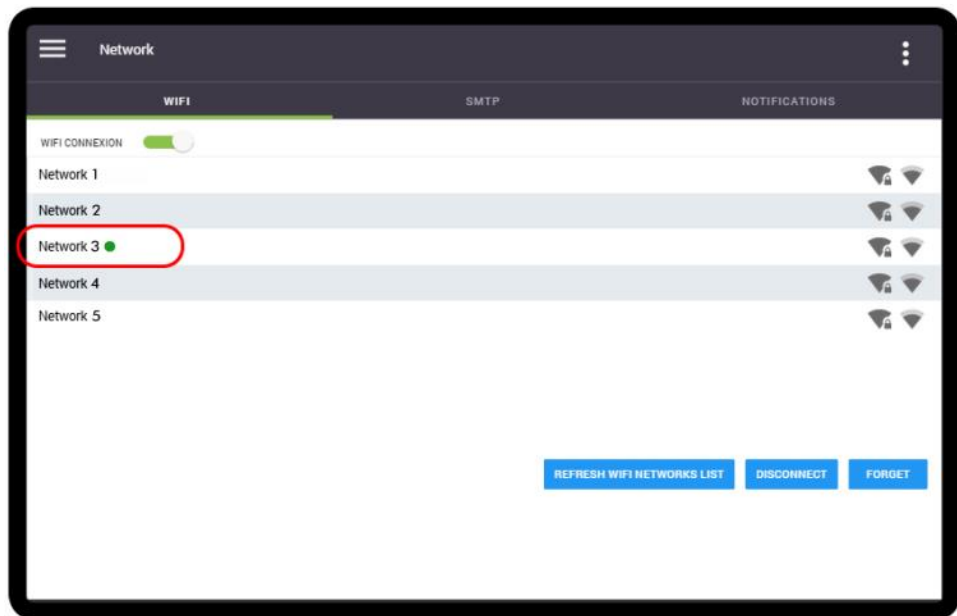

SMTP



To use the SMTP capabilities of the Eccellenza Touch, you need to have **both** a network connection **and** a dedicated SMTP server. Contact your company's IT Department for more information about setting up an SMTP server.

Only after obtaining network access, the Eccellenza Touch can then be configured to upload notifications concerning consumption, sales and faults/messages directly to your SMTP server.

1. Tap on the '**Requires Authentication**' slider to activate the SMTP feature.

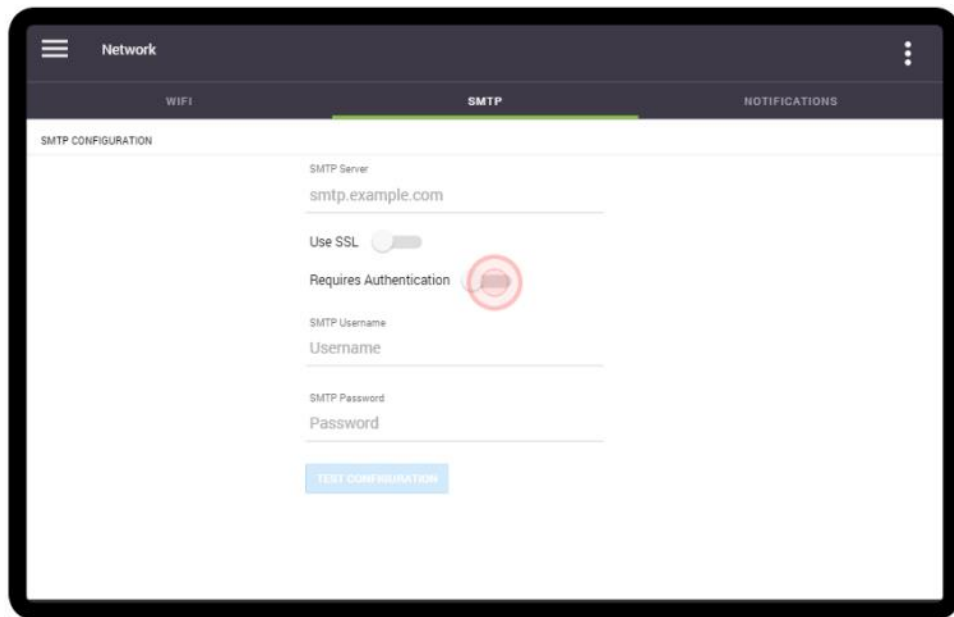

2. Enter the required information in the SMTP Server field, as well as your SMTP username and password.

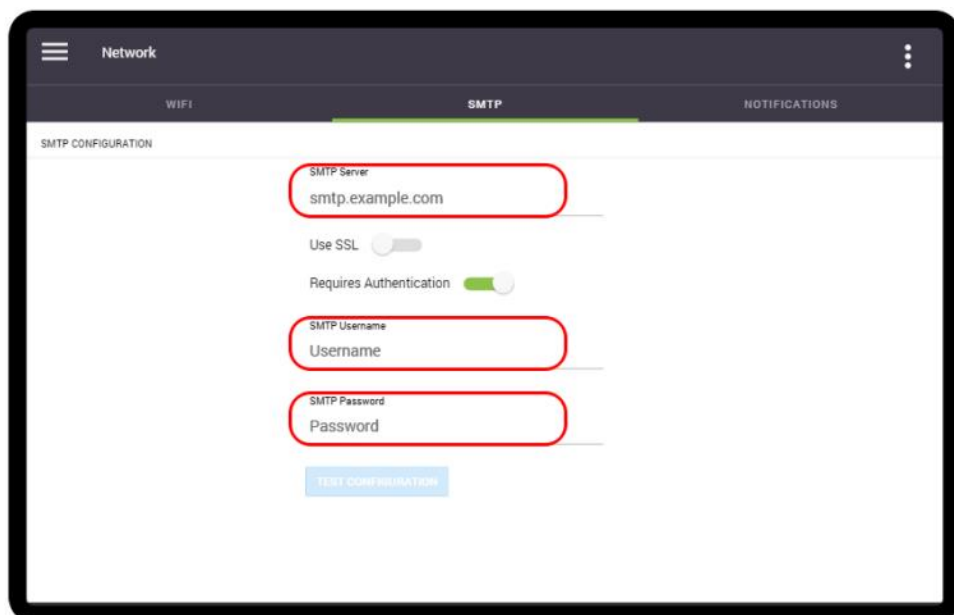

3. Tap the **'Test Configuration'** button to validate that your configuration is functioning properly.

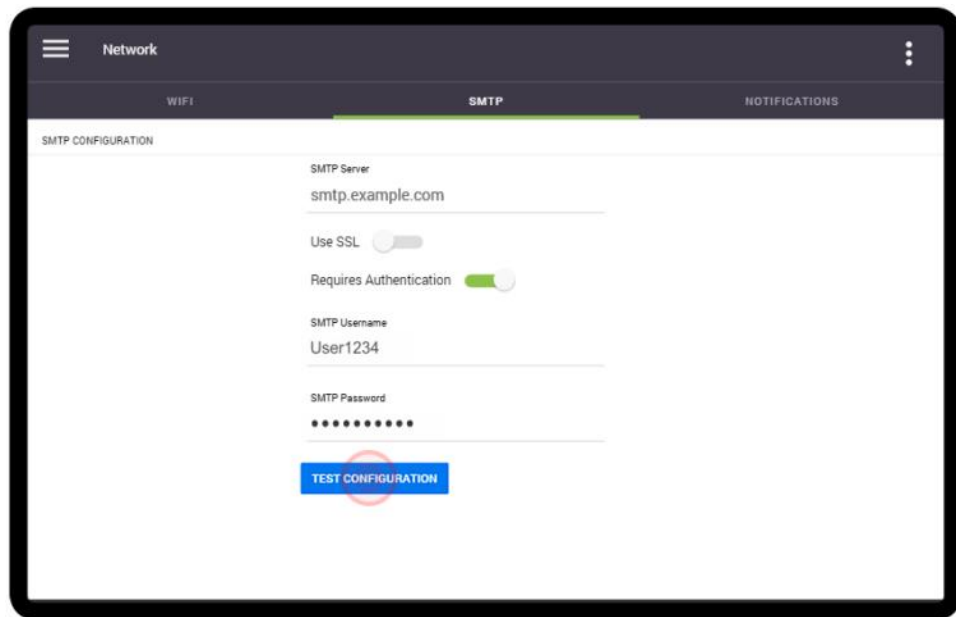

Notifications

The **'Notifications'** screen is used to configure the Eccellenza Touch to send notifications concerning ingredient consumption, beverage sales, counters and faults/messages directly into your email's Inbox. Fault and message notifications are sent immediately after they occur so that they can be addressed as soon as possible to minimize downtime. Consumption, sales and counter notifications can be set to be sent on a daily (**at midnight**), weekly or monthly basis.



An SMTP server must first be configured to be able to use the 'Notifications' feature ([see page 57](#)).

1. Tap on the **'Email Notifications'** slider to activate this feature.

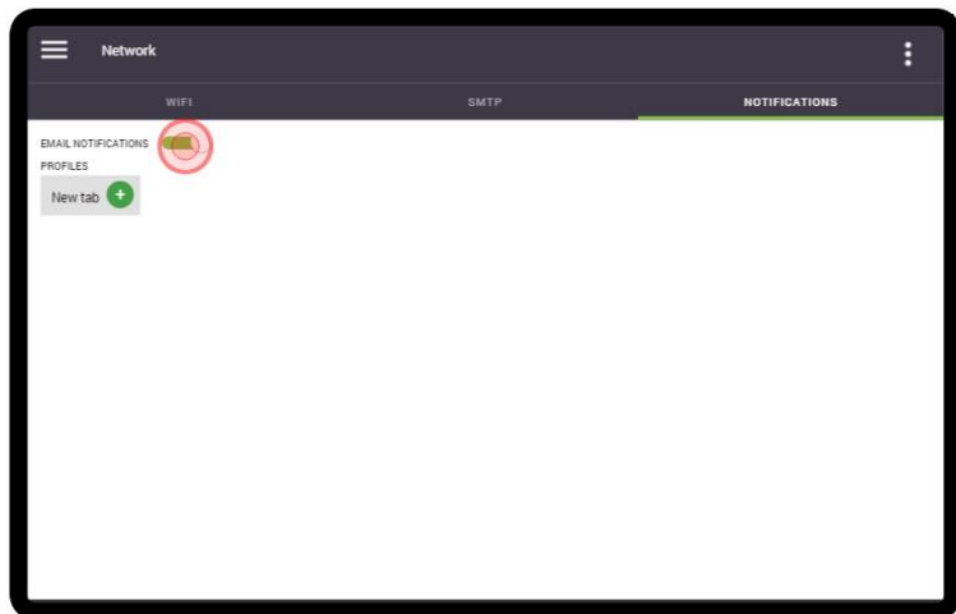

2. Tap on the **'New Tab'** setting to create an email profile for the notifications.



3. Tap on the **'Enter Email Address'** field to bring up the keyboard.

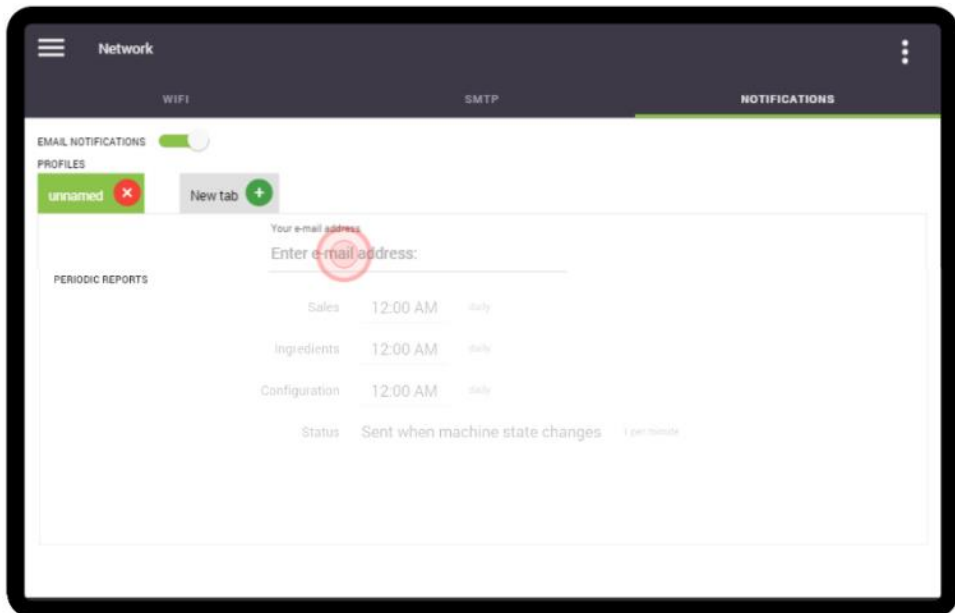

4. Type the email address to which the notifications will be sent, and press **'Accept Change'**.

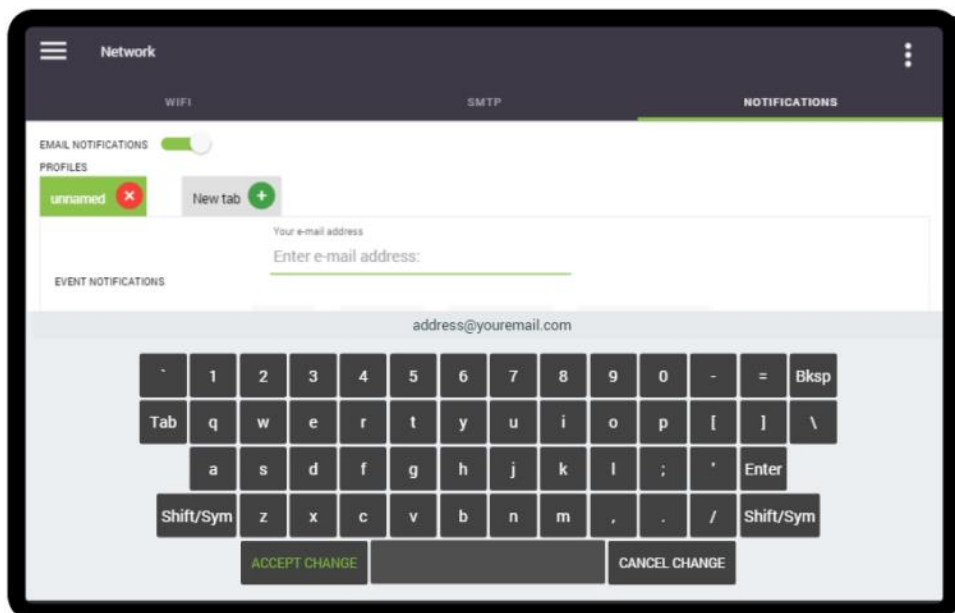

- Set the time at which each type of notification is to be sent by tapping the respective time field and adjusting it accordingly.

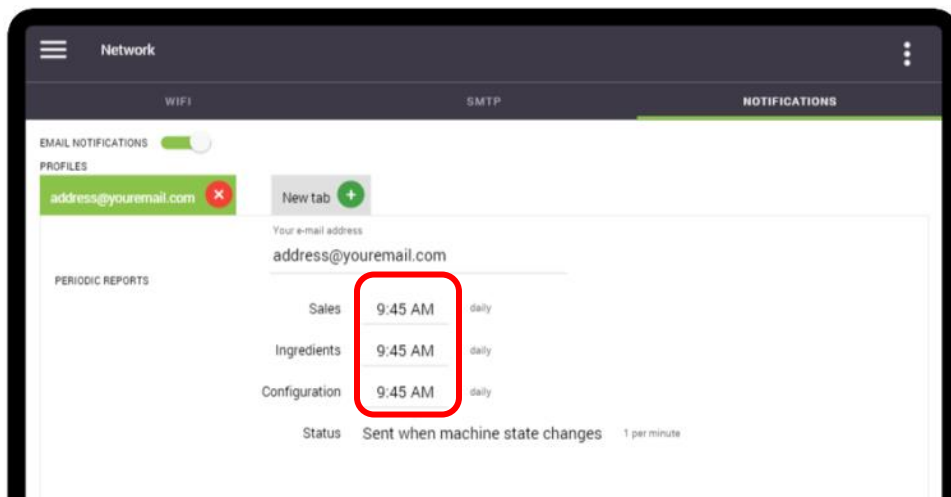
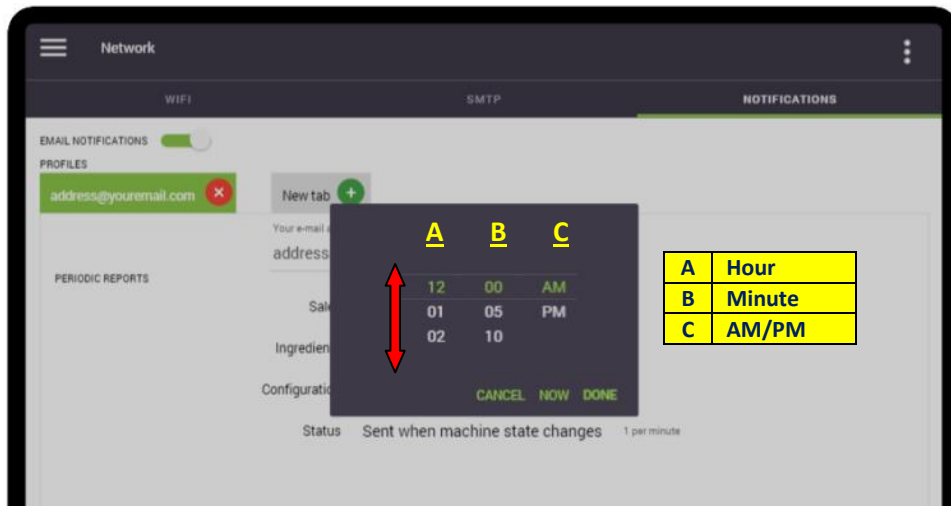
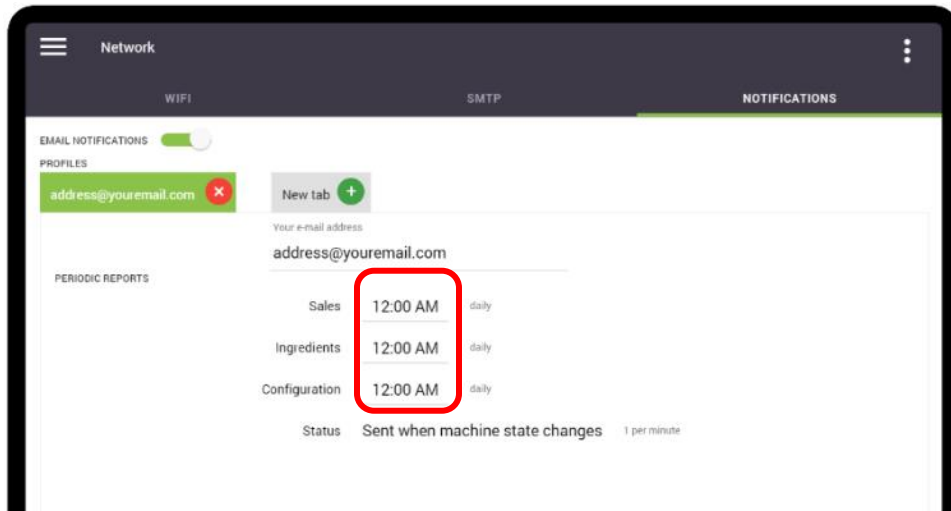

Setup

The Setup screen is used to configure and rename products and beverages, set recipes and timings, set temperature, and perform product calibrations.

Beverages

Cup Size and Strength

The Beverages tab allows you to set the availability of cups sizes and coffee strengths **1**, and allows you to enable the feature that shows the cup size value (in ounces or milliliters) **2** on the main screen. In the example below, all three cups sizes and strengths are enabled (green).

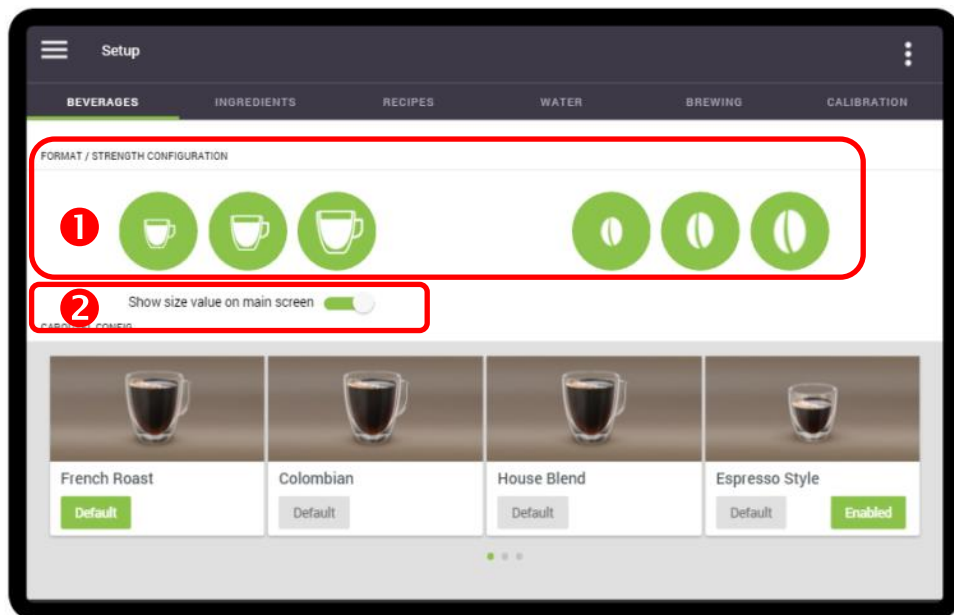

If, for example, you want to offer only a medium cup size and only medium strength, simply tap on the small and large cups, and then on the mild and strong strengths to disable them.

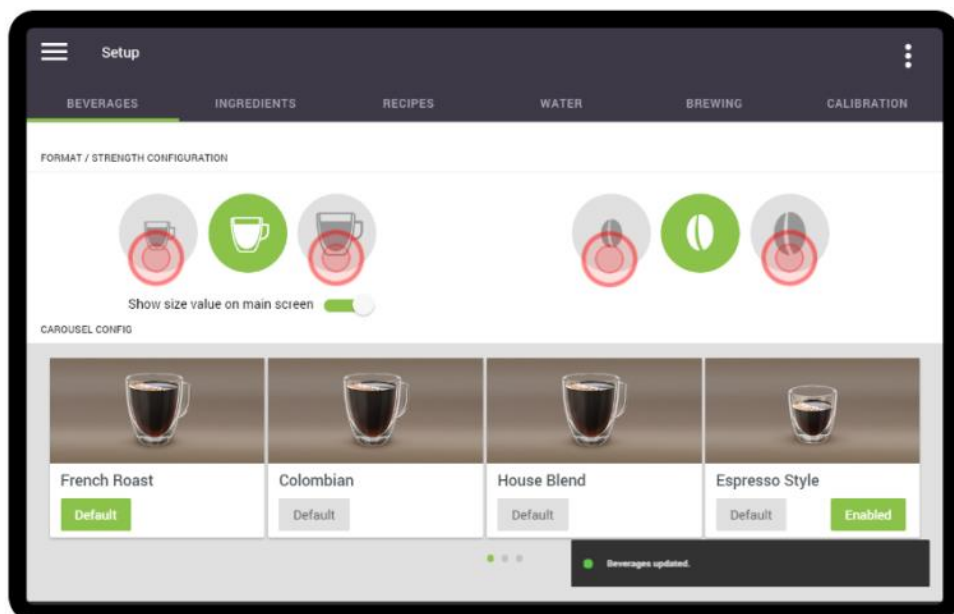

Default Beverage

The default beverage is the beverage to which the Eccellenza Touch automatically reverts when it is powered on, or after it has dispensed a beverage. In other words, it is the machine's pre-set starting point.

In the example below, the French Roast has been set as the default beverage - the 'Default' label beneath the beverage name is green. You can view all of the other beverages by swiping to the left or to the right. Simply tap on the 'Default' option beneath the beverage name to change that particular beverage to the default beverage.

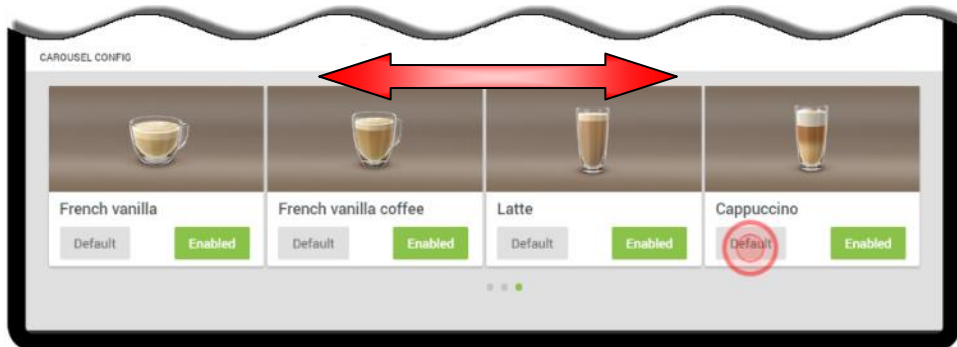
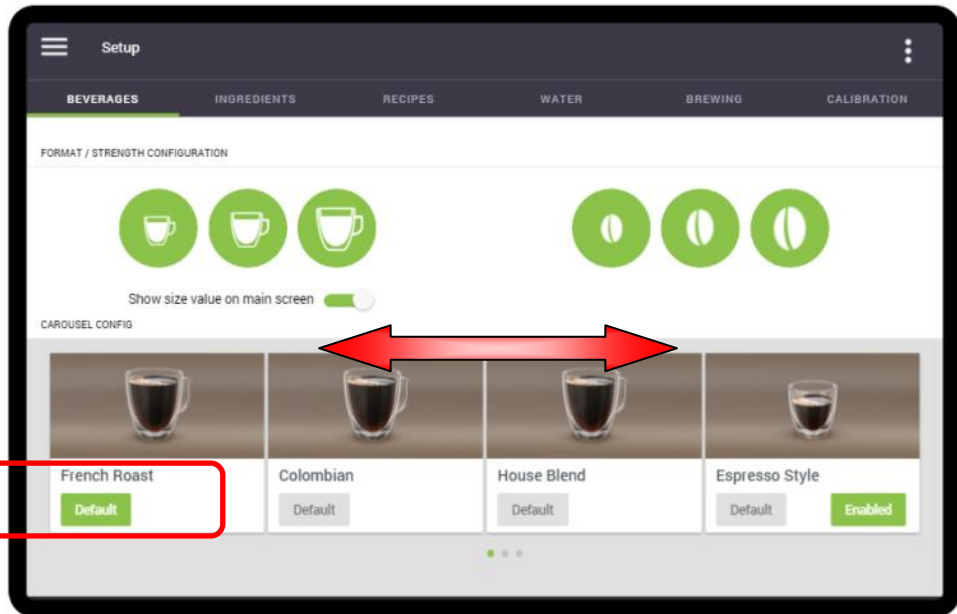

In the example below, the Cappuccino beverage has now been set as the default beverage. Note that **only one beverage can be set as the default beverage**.



Disabling Beverages

While in the **'Ingredients'** tab, you can also disable one or multiple specialty beverages, if required. Please note that it is not possible to disable any of the three base coffee beverages.

In the example below, the **Mochaccino** beverage will be disabled. Swipe through the list of beverages until the Mochaccino beverage is shown. By default, all of the beverages are enabled in the Eccellenza Touch, as indicated by the **green 'Enabled' button**. To disable a beverage option, simply tap of the green **'Enabled'** button.

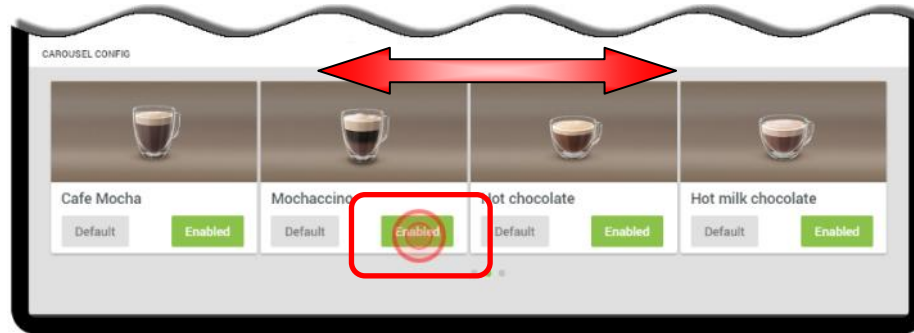

The **'Enabled'** button is now grayed out, indicating that the beverage is disabled. To re-enable the beverage, simply touch the grayed out **'Enabled'** button and it will change to green, indicating that the beverage is once again enabled.

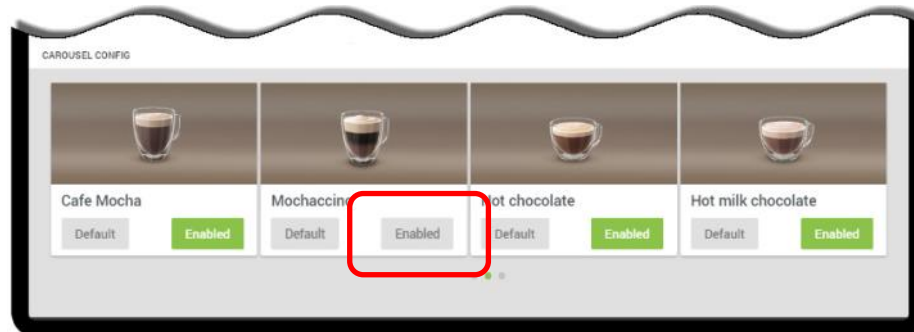

The disabled product will no longer be offered on the main screen.

Ingredients

Should you need to change the name of any of the coffee ingredients, it can be easily done in 'Ingredients' tab. When this tab is selected, a list of the coffee and powder names is displayed. Please note that for now, only the coffee names can be changed, if required.



The powder names cannot be changed. Changing the powder names in this menu will not change the powder names on the main screen.

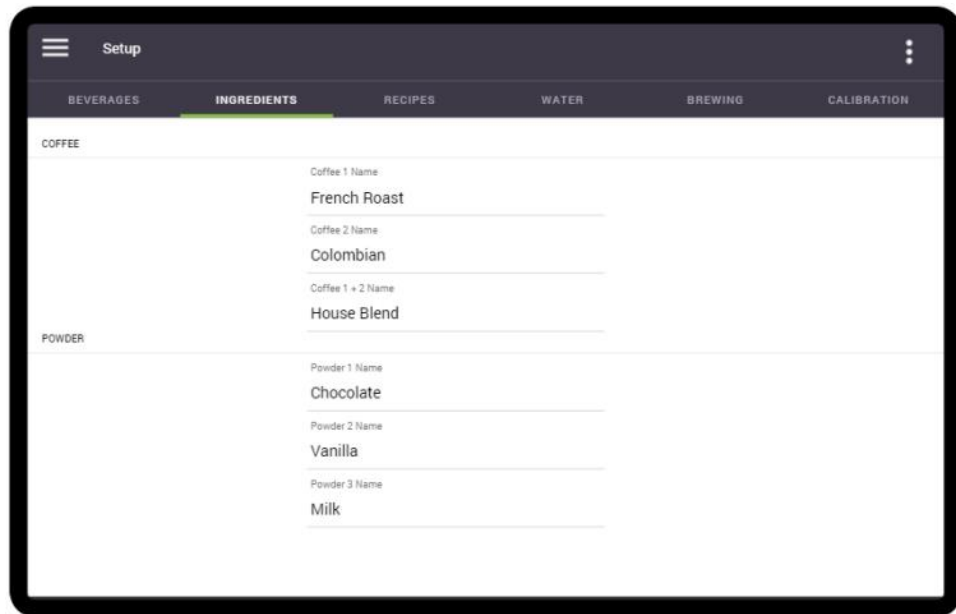

1. If, for example, you will be using a Mocha Java coffee blend instead of Colombian, you'll need to modify the '**Coffee 2 Name**' on the list. Tap 'Colombian' on the screen (the current blend name for Coffee 2) to bring up the keyboard.

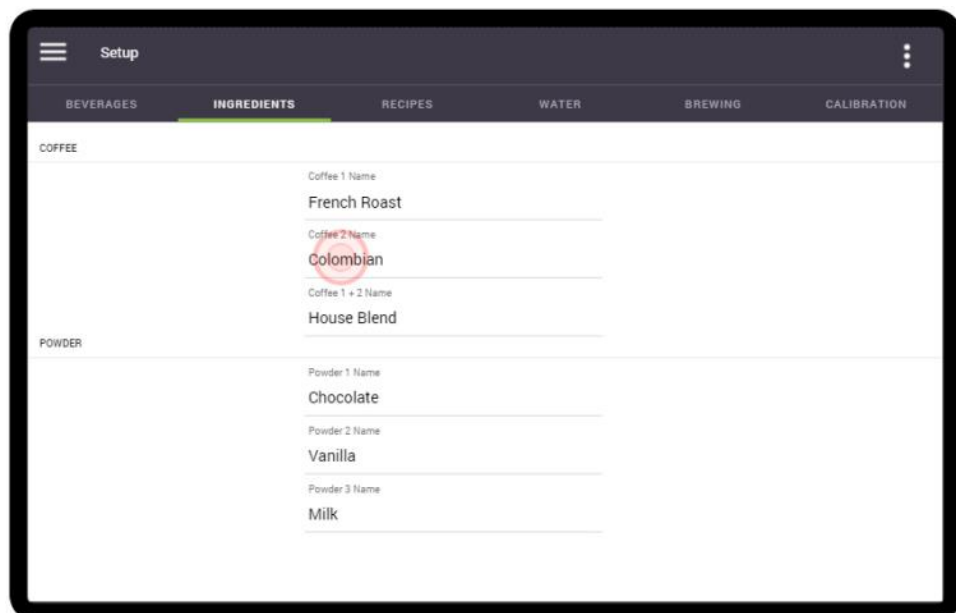

2. With the cursor at the end of the Colombian text, press the **'backspace'** button until all of the text is deleted.

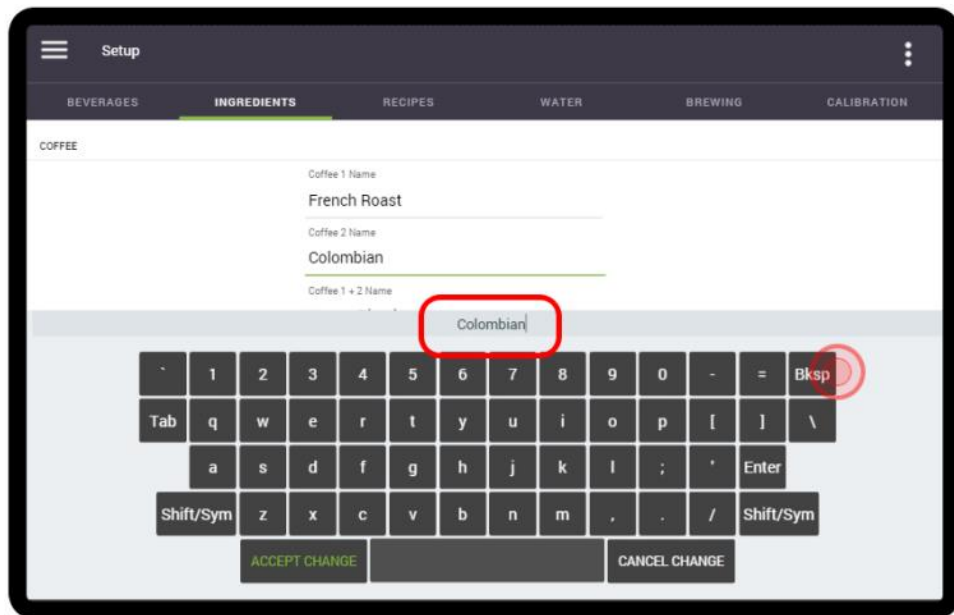

3. When the text is deleted, **'Coffee 2 Name'** is displayed in this field instead of an actual blend name. Using the keyboard, type in the new name for Coffee 2 - which in this case changes to **'Mocha Java'**.

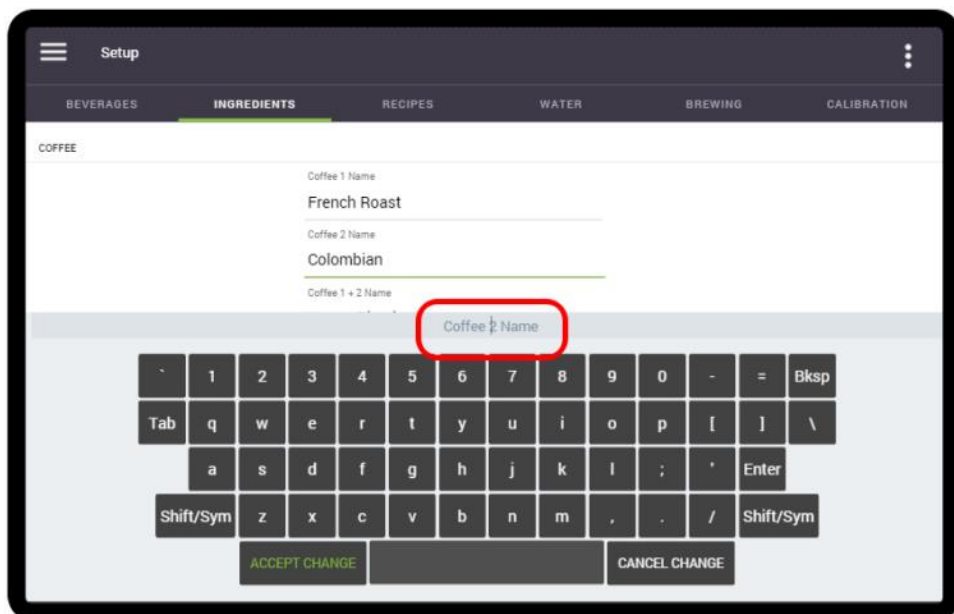

4. Tap the 'Accept Change' button to save your changes.

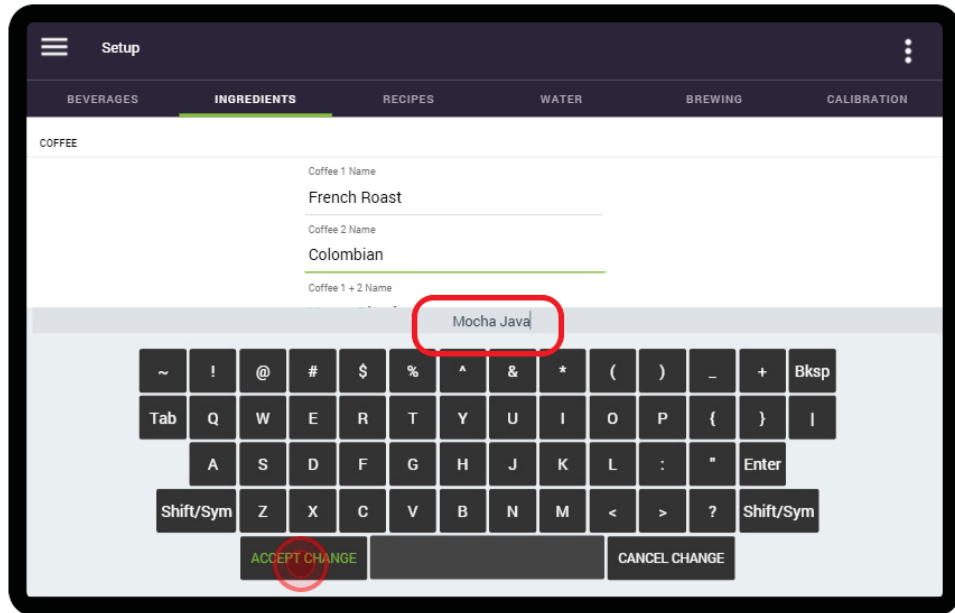

5. Coffee 2 has now been renamed from Colombian to Mocha Java on the list of ingredients.

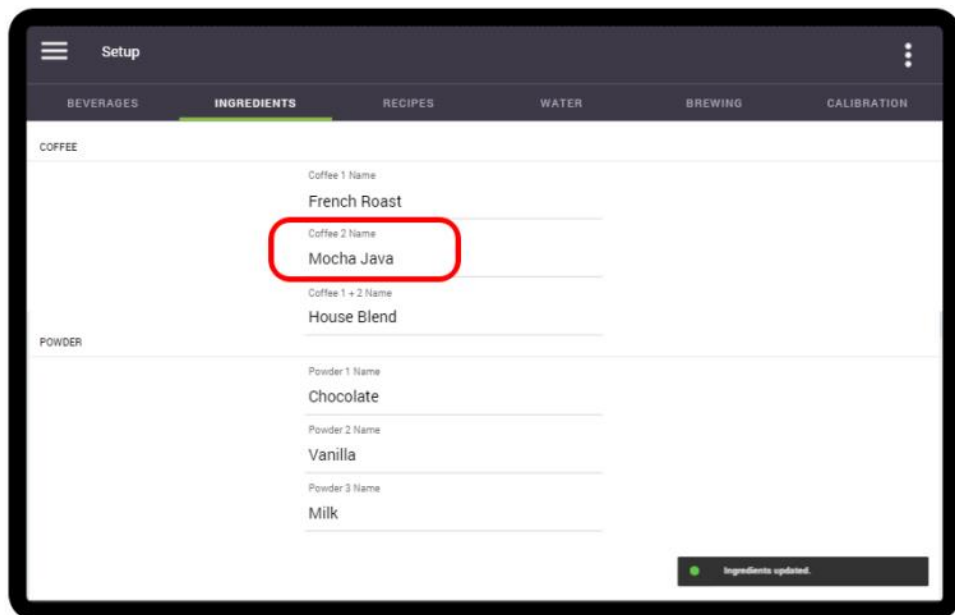

6. 'Mocha Java' is now displayed everywhere 'Colombian' was previously displayed.

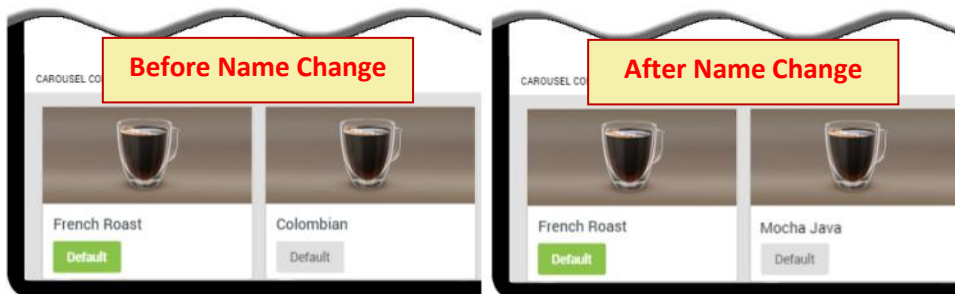

Recipes

The product settings for every available beverage can be adjusted in the '**Recipes**' tab of the setup.



Please disregard any references to the Carafe feature and settings as the "Carafe" option is not currently available.

Setting Coffees

1. Tap on the '**Selected Beverage**' location beside Line 1.

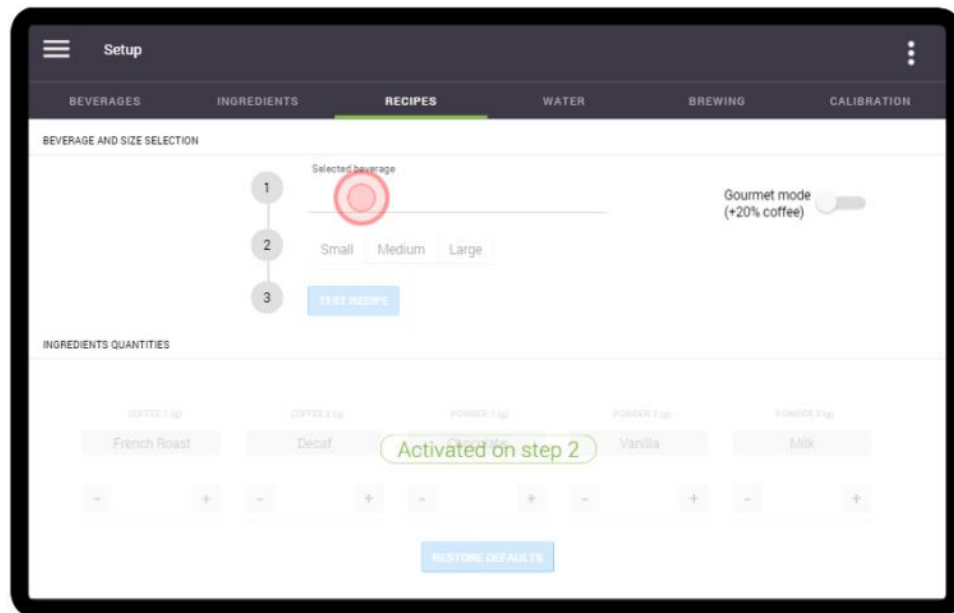

2. A scroll list of all the available beverages appears.

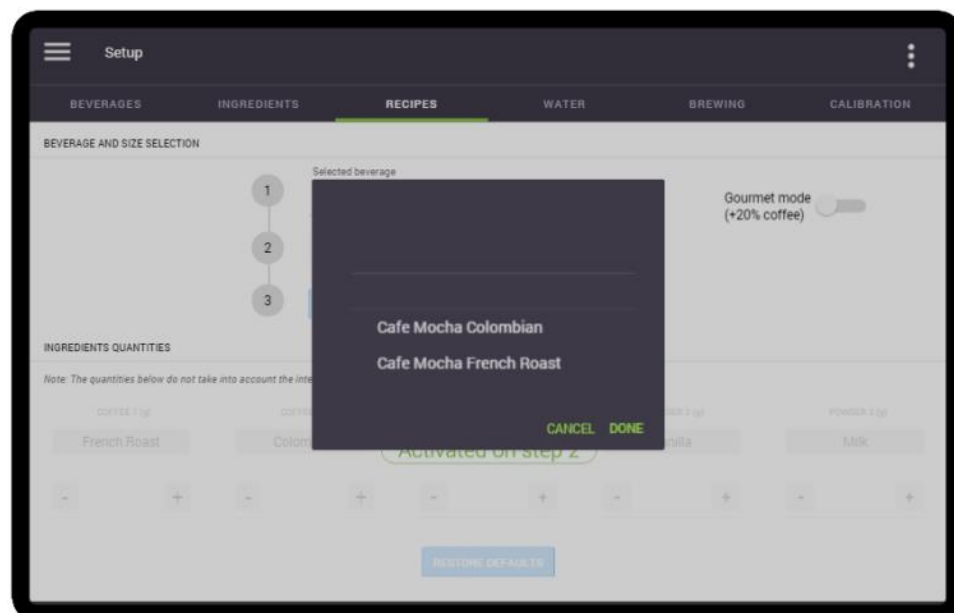

- Swipe up or down to scroll through the list of beverages and then select the one that requires adjusting by tapping 'Done'. In this example, 'Coffee French Roast' is selected.

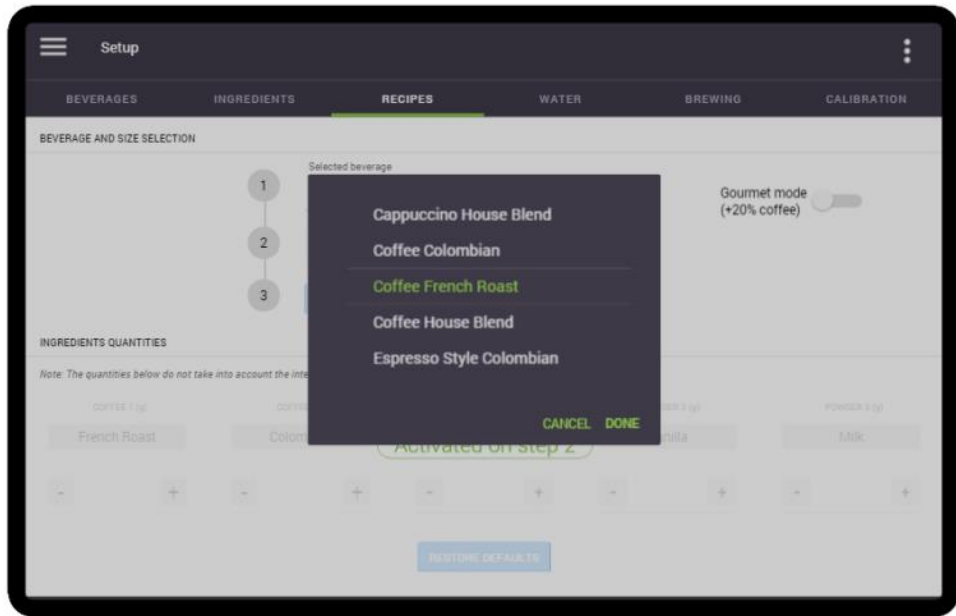

- On Line 2, select the cup size that needs to be adjusted. In this example, the 'Medium' cup size is selected.

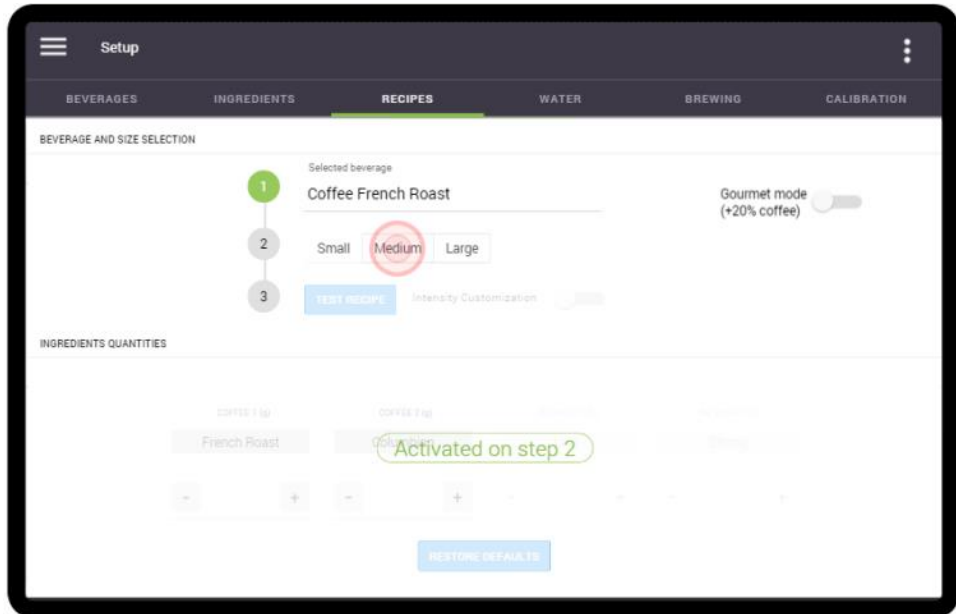

Notice that the French Roast setting is now active (not grayed out) in the '**Ingredients Quantities**' section of the screen. This indicates that this setting can now be adjusted. Also note the '**Intensity Customization**' setting on Line 3. This is used to adjust the '**Mild**' and '**Strong**' strength coffee settings. Tap on the slider to activate it.

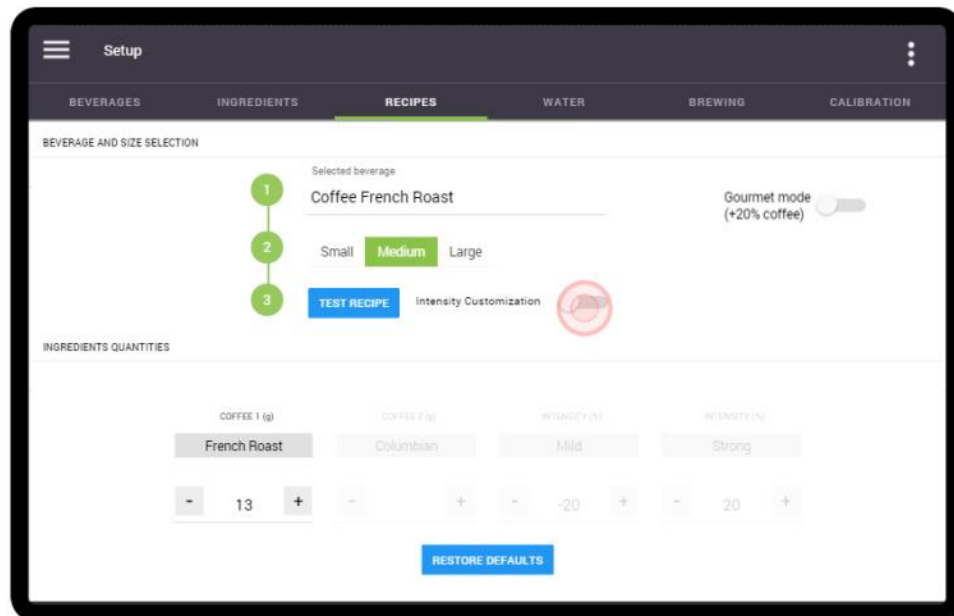

- The '**Mild**' and '**Strong**' settings are now also active (not grayed out) in the '**Ingredients Quantities**' section of the screen.

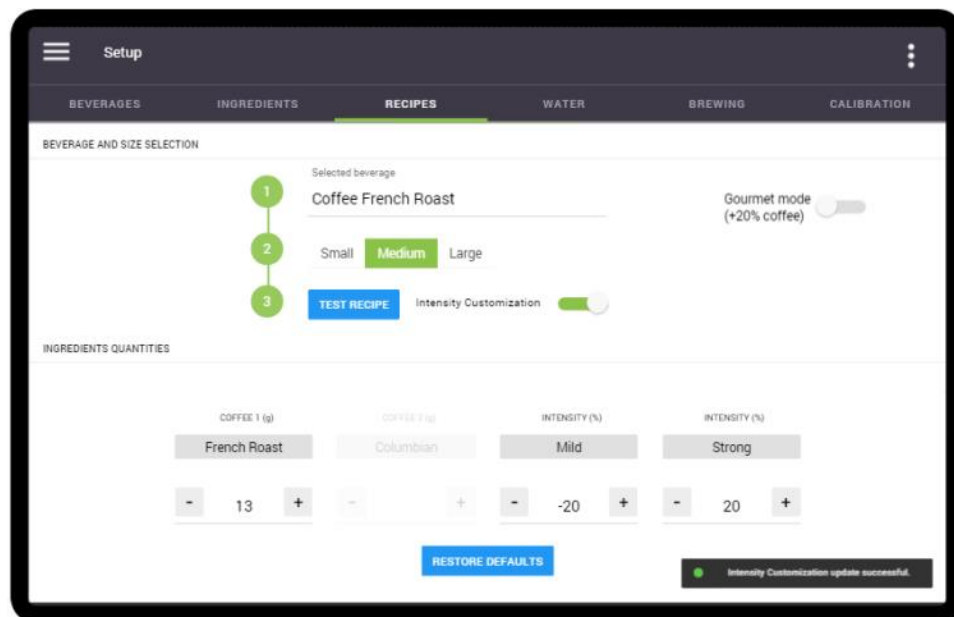

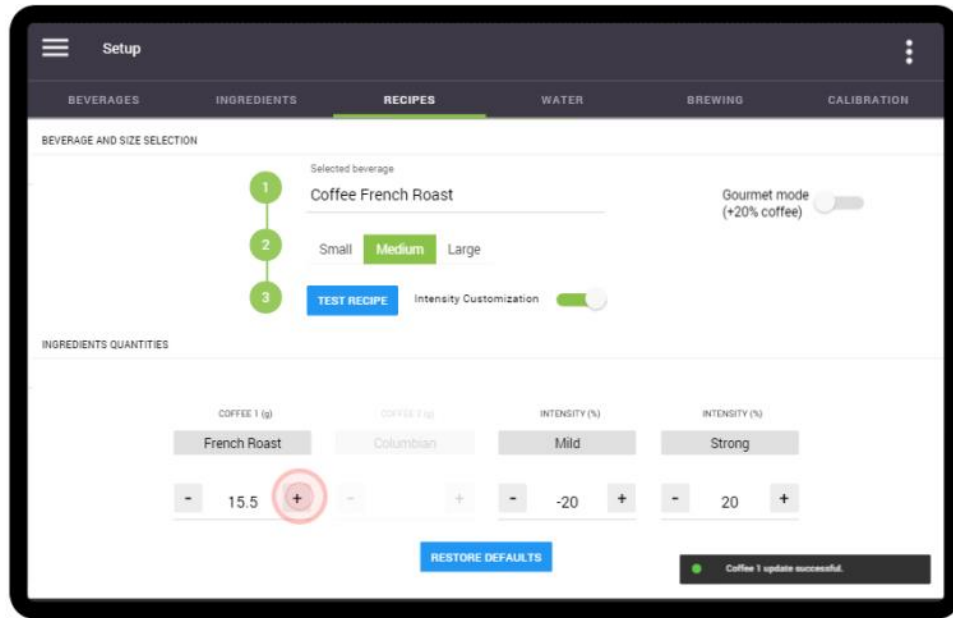

Coffee settings are measured in grams, whereas the 'Intensity' settings are measured as a percentage of the coffee setting - 'Mild' is a percentage decrease, whereas 'Strong' is a percentage increase.

- In our example, we will increase the French Roast coffee setting for a medium cup size to 15.5 grams.

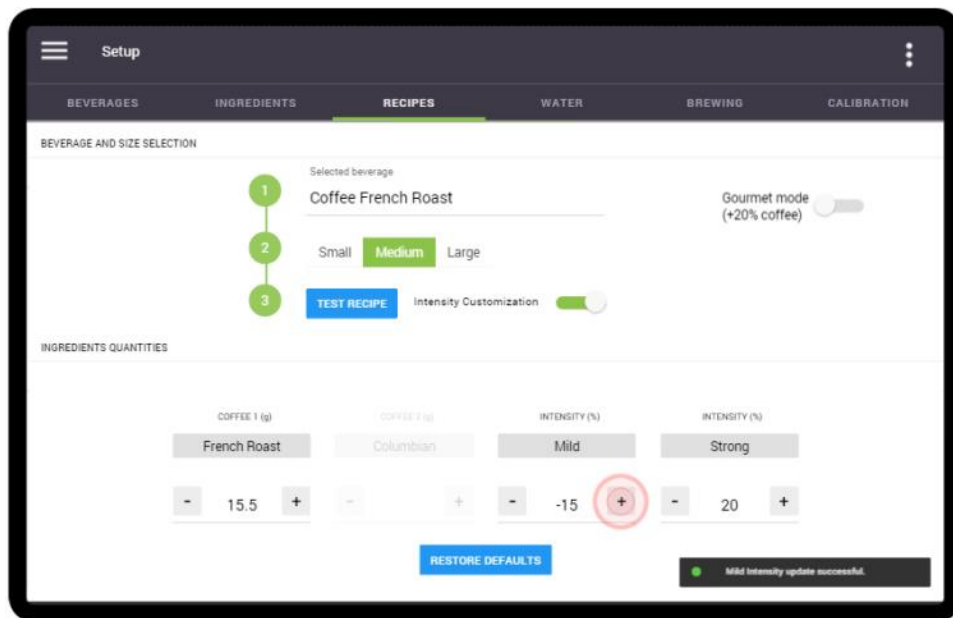

- We also want to adjust the 'Mild' strength setting so that it is -15% milder, than the actual French Roast setting of **15.5 grams**, instead of -20% milder by increasing (+) the 'Mild' setting. The 'Strong' setting percentage can also be increased or decreased.



 Mild strength settings are shown as a negative (-) number as the actual coffee setting is decreased by the percentage shown.

8. To brew a test beverage using the new settings, place a cup on the cup stand and tap on the blue **'Test Recipe'** button on line 3. The Eccellenza Touch will now dispense the beverage so that you or your customer can perform a taste test. If further adjustments are required, make the changes and test the beverage again until you get the desired results.

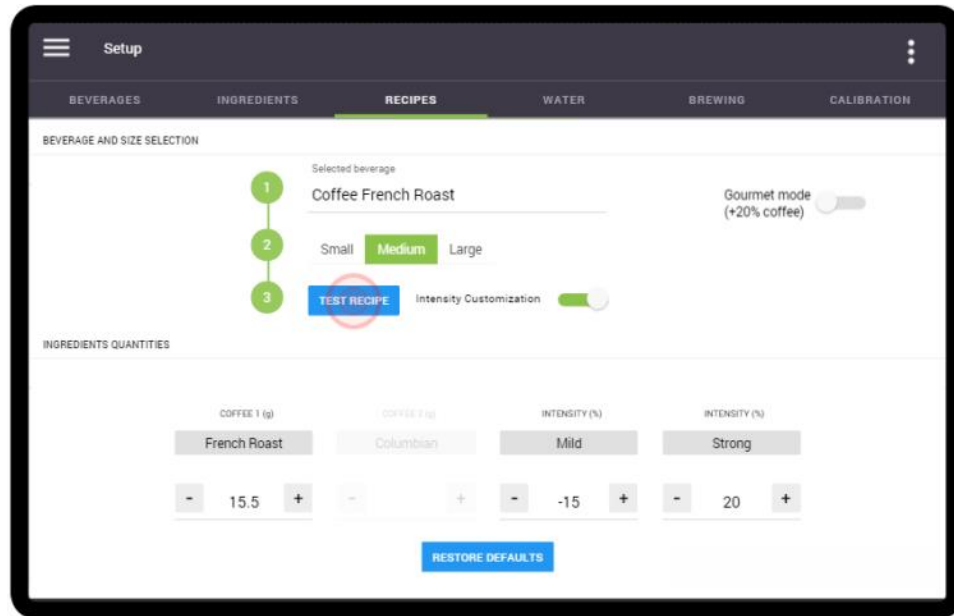

Gourmet Mode

When enabled, the “Gourmet mode” option adds **20% more coffee** (up to a limit of 11 grams of coffee per ounce of water) into all coffee-based beverage recipes, giving these beverages an even richer coffee taste.

To enable/disable this mode, tap the “Gourmet Mode” slider.

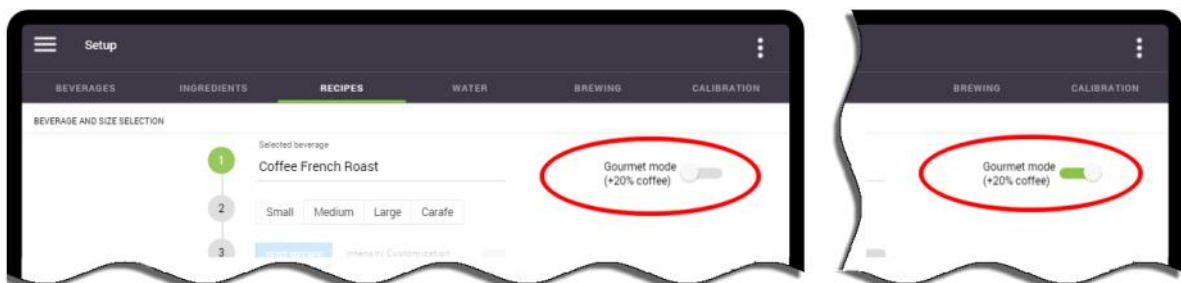

Setting Specialty Beverages

1. Tap on the 'Selected Beverage' location beside Line 1.

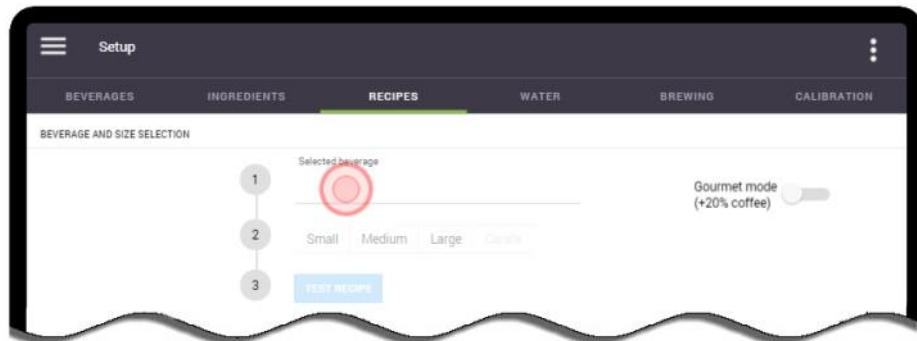

2. A scroll list of all the available beverages appears.

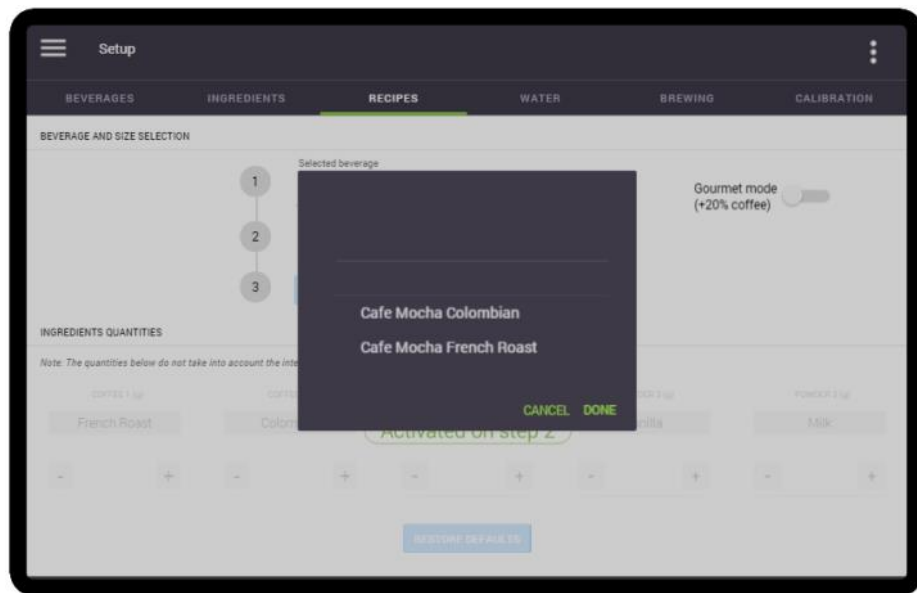

3. Swipe up or down to scroll through the list of beverages, select the one that requires adjusting and then by tap 'Done'. In this example, 'Mochaccino French Roast' is selected.

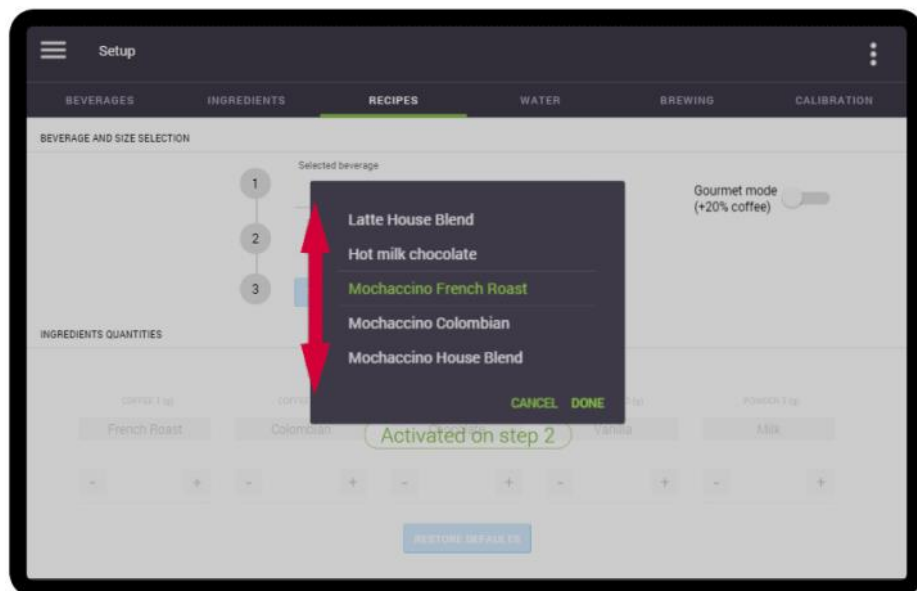

- On Line 2, select the cup size that needs to be adjusted. In this example, the 'Small' cup size is selected.

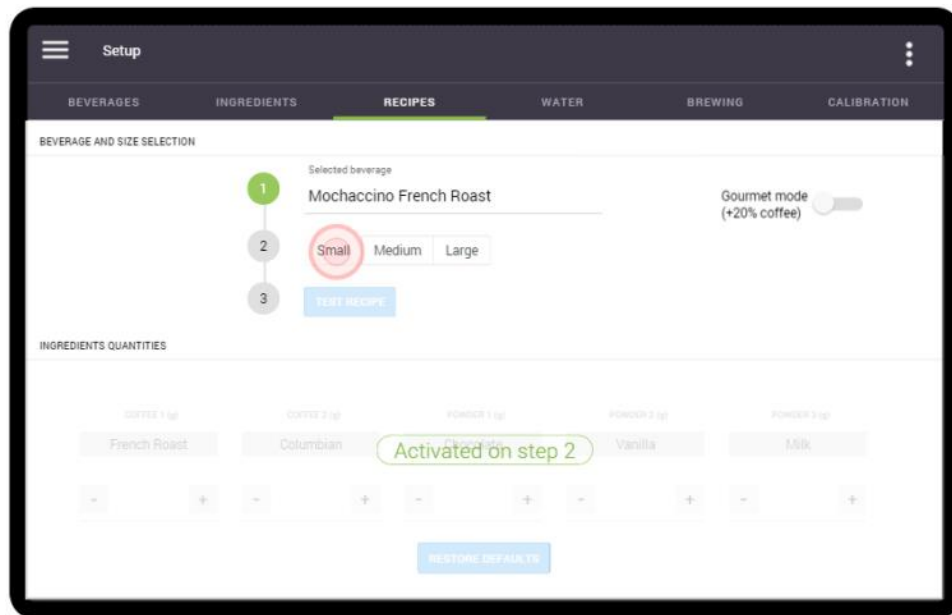

- Notice that all of the ingredients required to make a Mochaccino French Roast are now active (not grayed out) in the 'Ingredients Quantities' section of the screen. This indicates that each of these ingredients can now be individually adjusted.

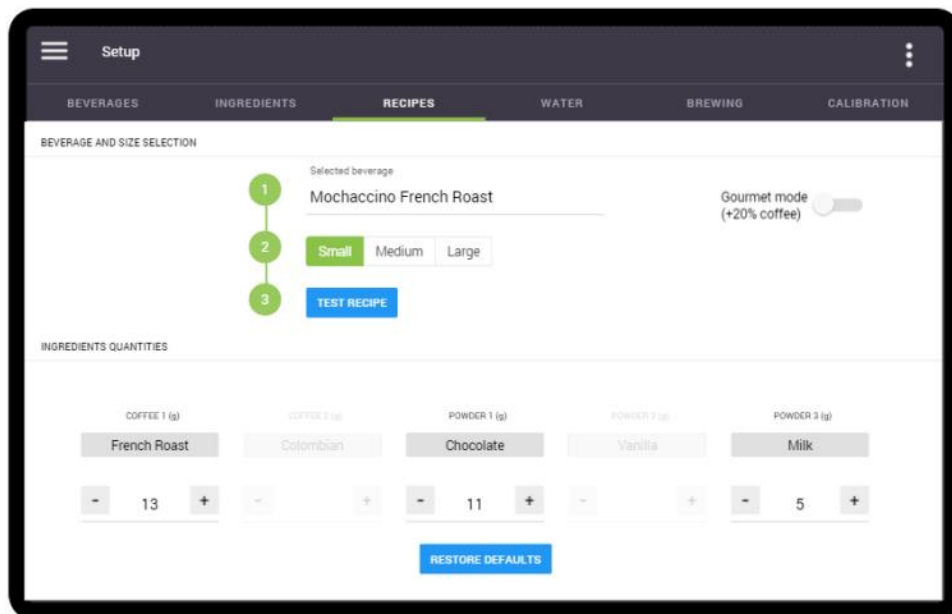

- In our example, we will slightly increase the French Roast coffee to 15 grams, but we will decrease the chocolate to 10 grams, while leaving the milk untouched.

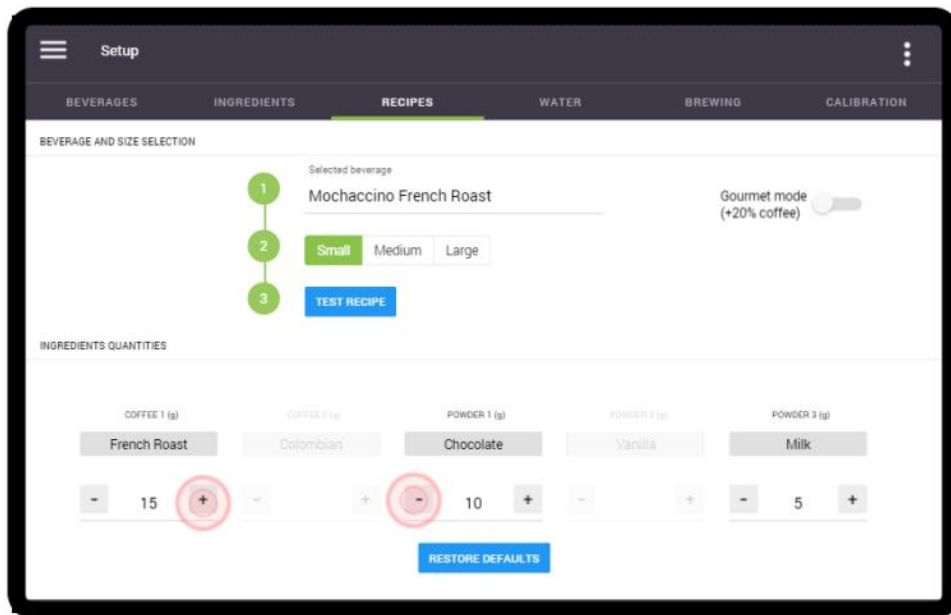

- To brew a test beverage using the new settings, place a cup on the cup stand and tap on the blue 'Test Recipe' button on line 3. The Eccellenza Touch will now dispense a Mochaccino French Roast that you or your customer can taste test. If further adjustments are required, make the changes and the test the beverage again until you get the required results.

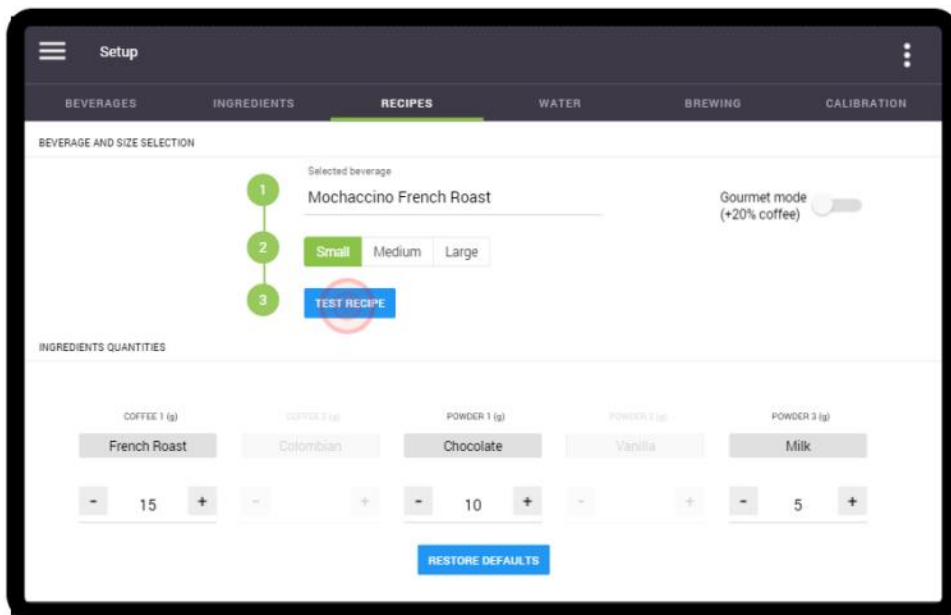

Disabling “Press & Hold” Hot Water

If you would like to dispense hot water by the cup and/or to add a price for “Hot Water”, you’ll need to disable the “Press & Hold” setting. Select “Hot Water” as the beverage in Line 1, then set the “Press & Hold” slider to the Off position.

Restore Defaults

Should you need to restore the default settings of a certain beverage, select that beverage in the 'Recipes' tab, as well as a cup size, and then tap the 'Restore Defaults' button.

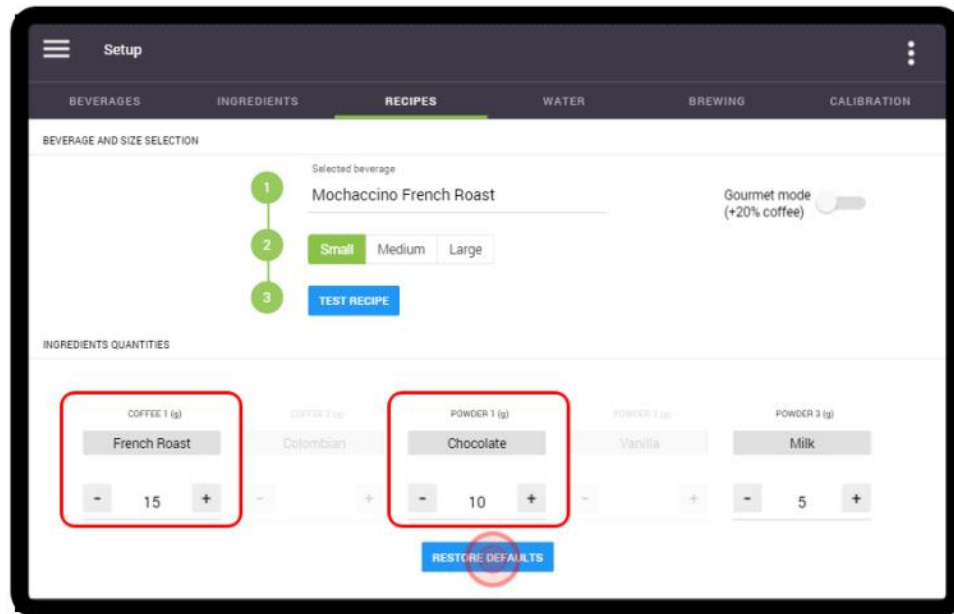

The Factory Settings for only that particular selection will be restored.

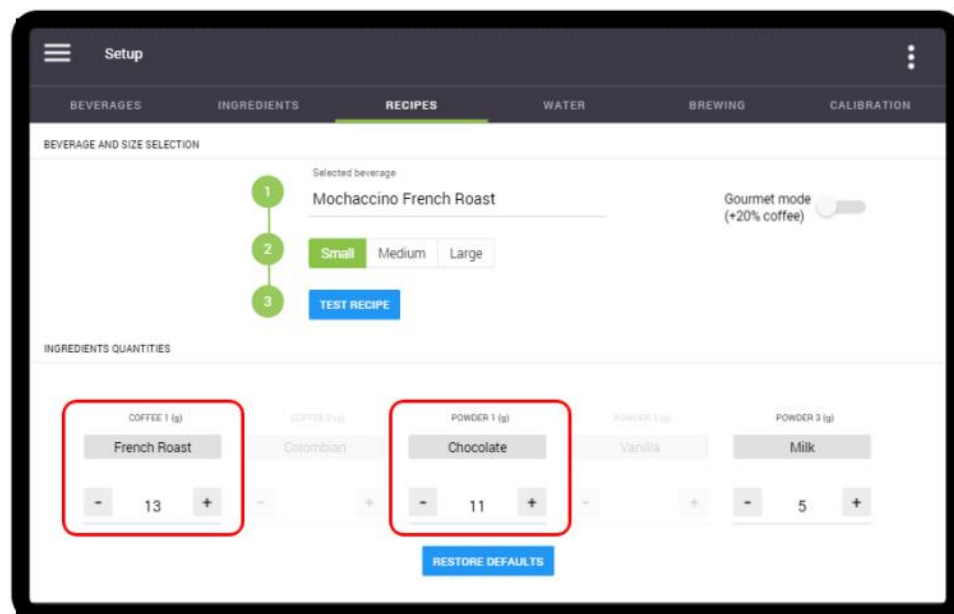

When the factory settings are restored for a selection, any changes that were made to your previous settings will be overwritten.

Configuring for Decaf

Configuring the Eccellenza Touch to deliver a decaffeinated coffee, as well as decaffeinated specialty beverages, can be done quickly and easily by simply renaming one of the two coffee blend names.

In the example below, Coffee 2 is renamed to '**Decaf**' (see [page 64](#) for the complete renaming procedure). It is also recommended to rename the 'House Blend' beverage to 50/50 or half-caf, for example, as a typical House Blend does not contain decaf.

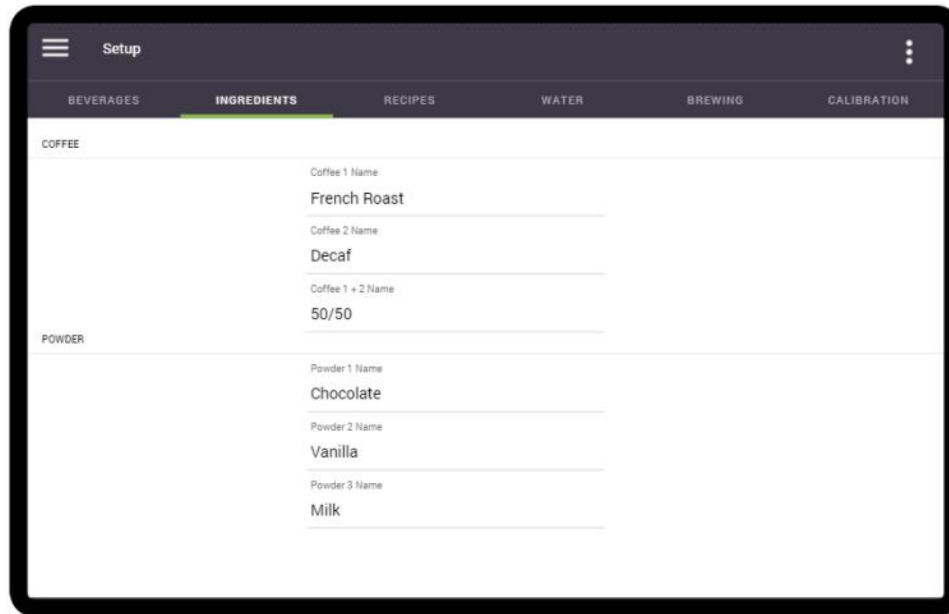

When you access the '**Recipes**' menu to make adjustments, the beverage names indicate the type of coffee being used to make them. In this example (after renaming 'Colombian' to 'Decaf'), it is very easy to identify which beverages use regular coffee, and which use decaf or 50/50.

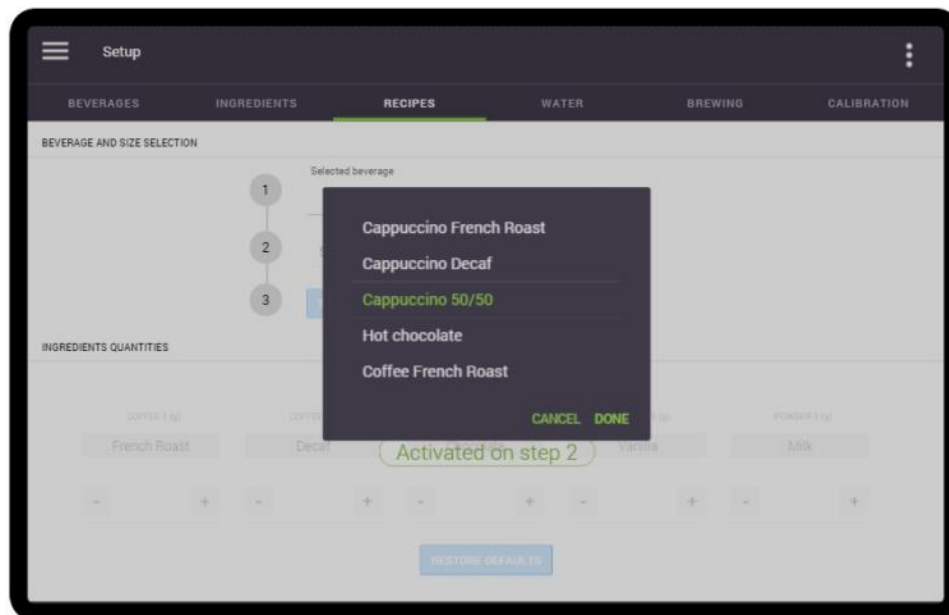

Water

The water settings for every available beverage can be adjusted in the '**Water**' tab of the setup.



The Eccellenza Touch is factory preset to only dispense 8-oz, 10-oz, and 12-oz cups sizes. These settings can be fine-tuned in this menu.

1. After selecting the '**Water**' tab, the following options appear - Coffees, Specialty Coffees, and Powder Beverages.

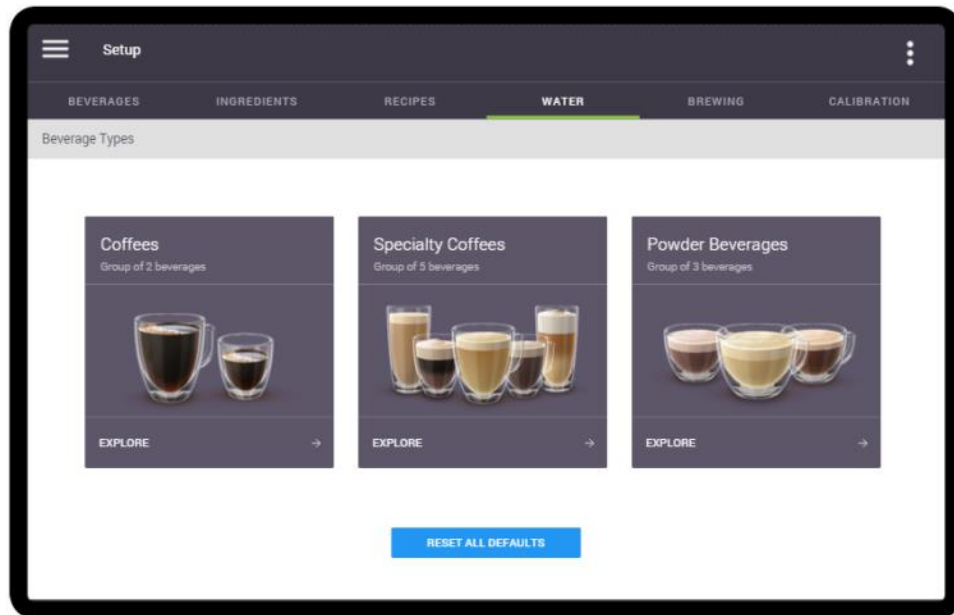

2. Select the type of beverage for which you want to adjust the water. In this example, '**Specialty Coffees**' is selected.

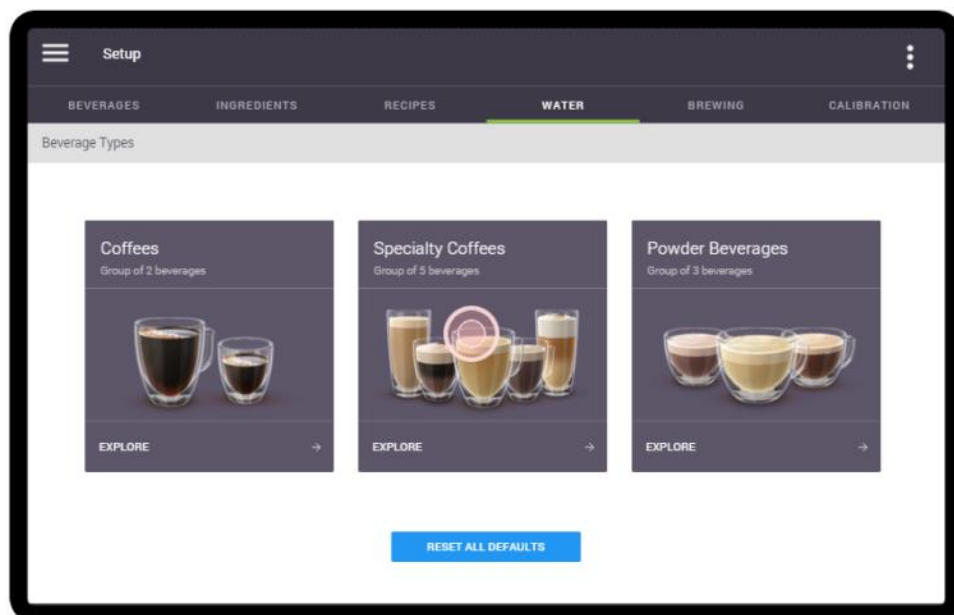

- Select the specific beverage for which you want to adjust the water. In this example, 'Mochaccino' is selected.

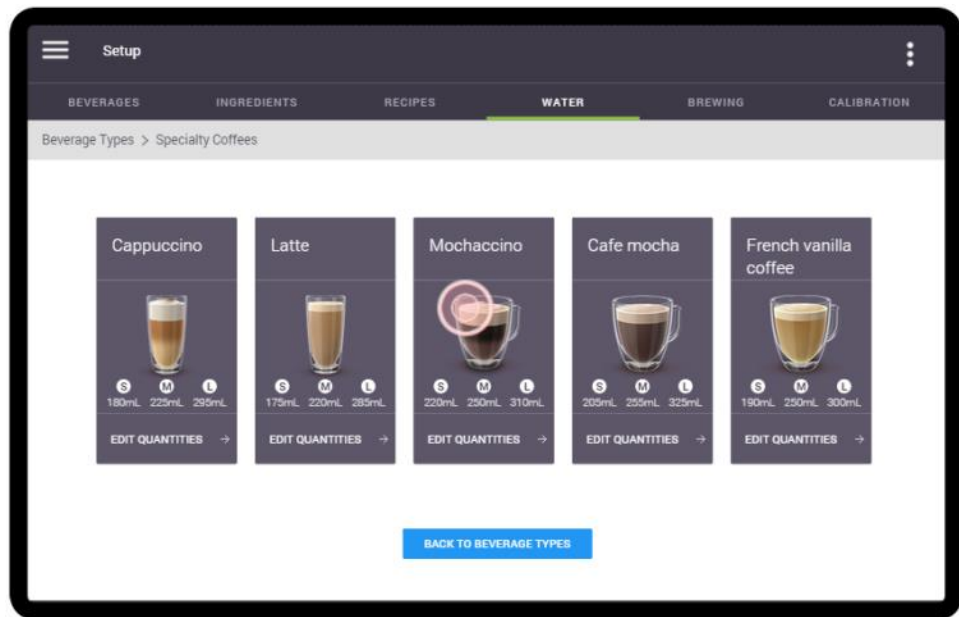

- All three cup sizes are now displayed. To increase or decrease the quantity of water for a specific cup size, press the '-' or '+' buttons in the corresponding box.

In this example, the 'Medium' cup size will be increased to 265ml. Press the '+' button in the 'Medium' box until 265 is displayed.

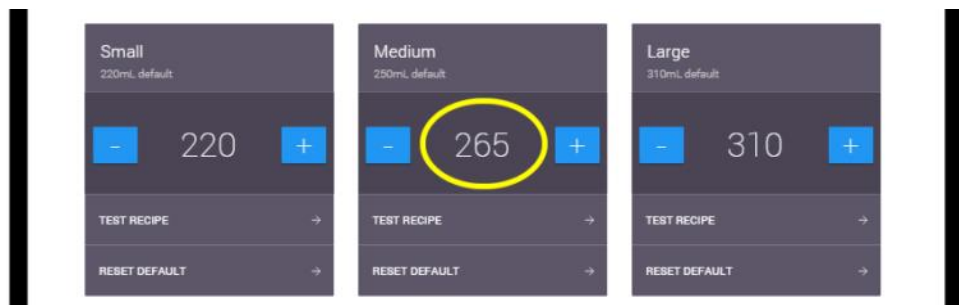
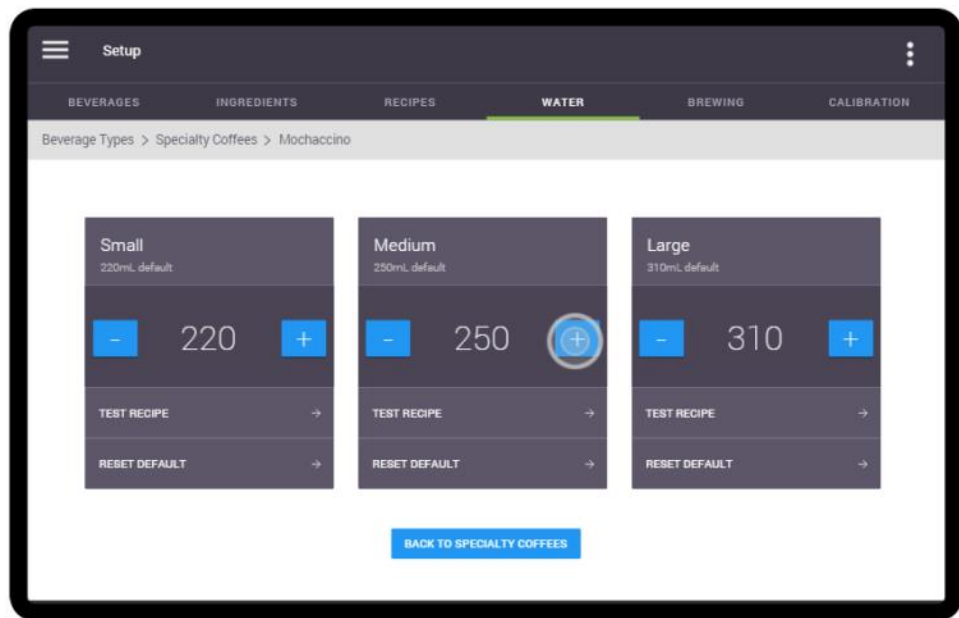

- Place a cup on the cup stand and tap on the **'Test Recipe'** button to make a test vend with the new water settings. Make any adjustments, if necessary.

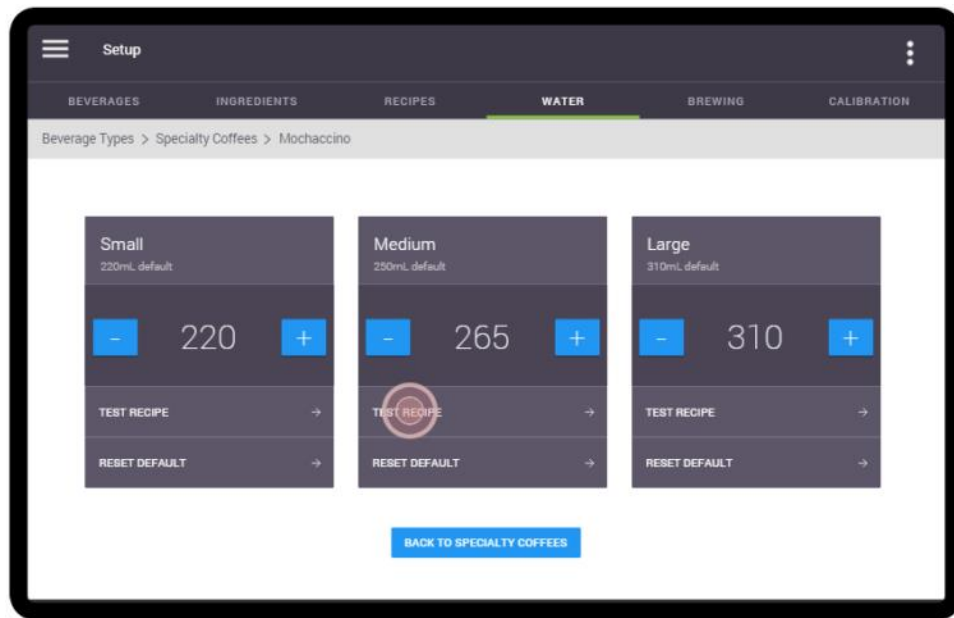

- To reset a specific setting back to its default, press the **'Reset Default'** setting for the corresponding cup size. *Note that the original default setting is beneath each cup size.*

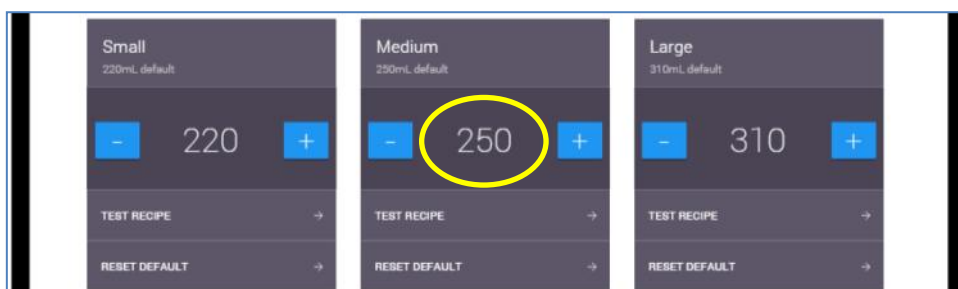
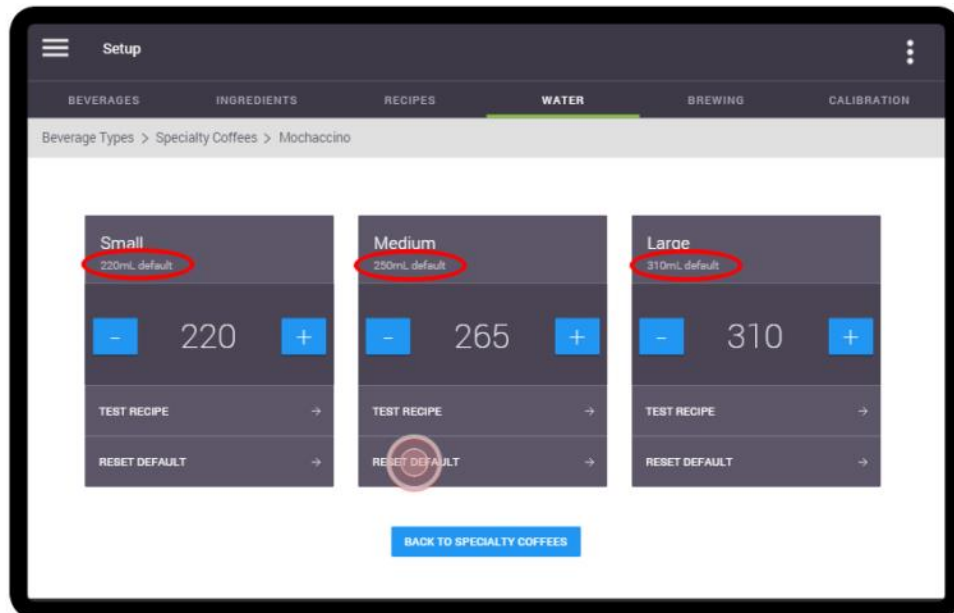

- To return to the 'Specialty Coffees' screen, tap the **'Back to Specialty Coffees'** button.

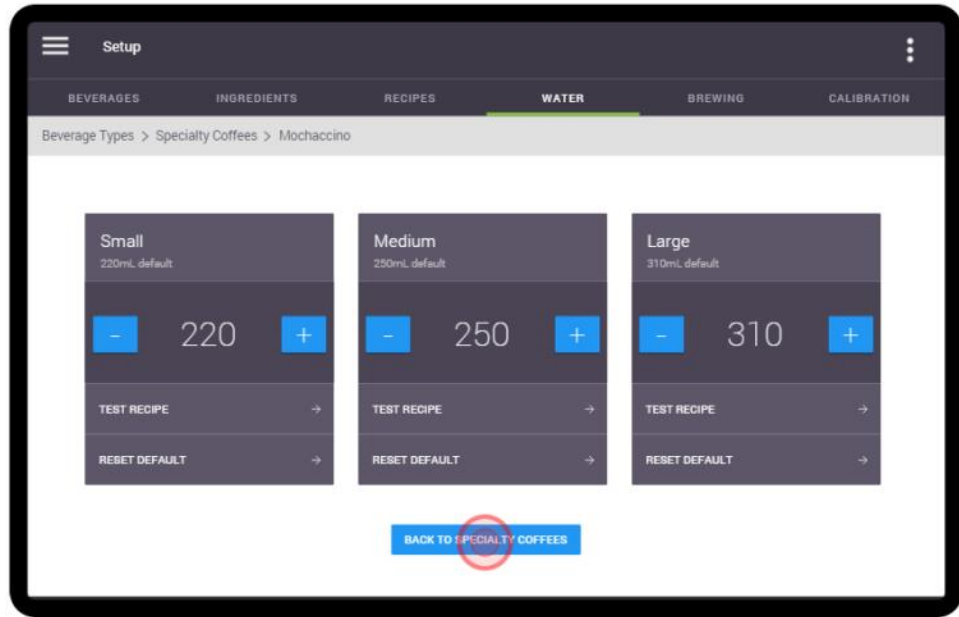

- From this screen, either select another specialty beverage to adjust, or tap the **'Back to Beverage Types'** button to return to the main screen.

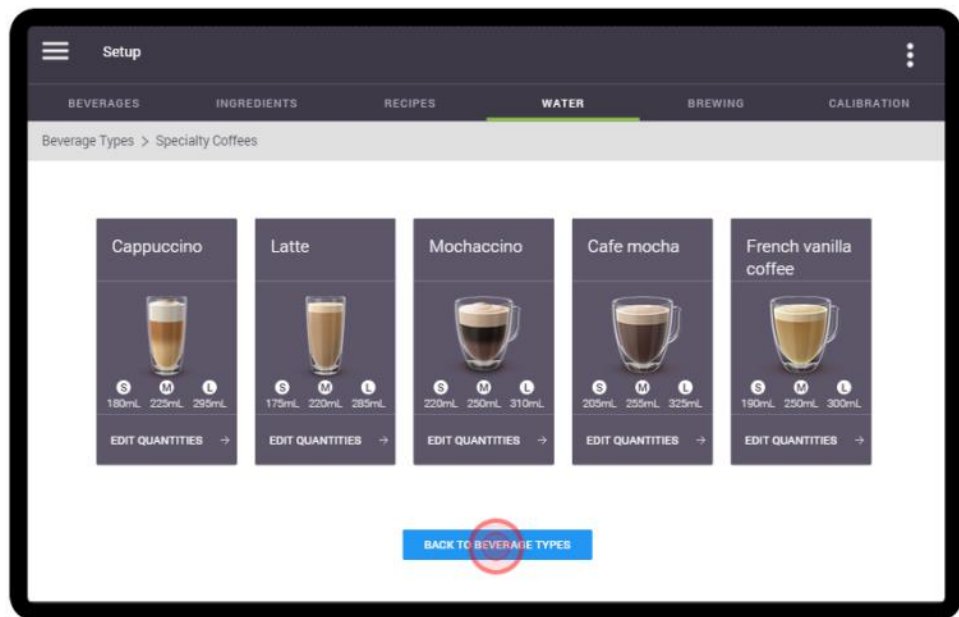

9. Select another beverage and repeat the water adjustment process, if required.

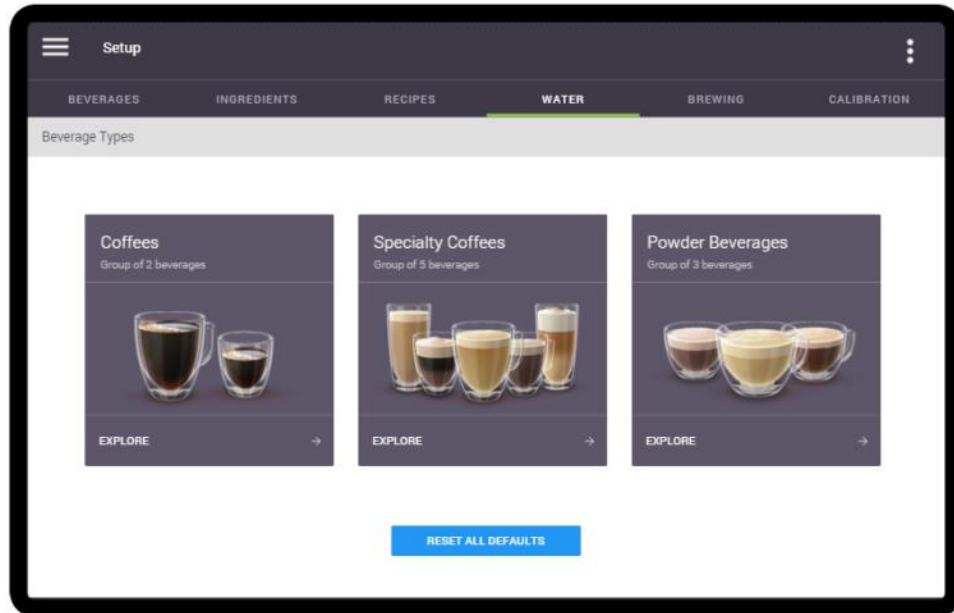

10. The following screen appears if 'Coffees' is selected.

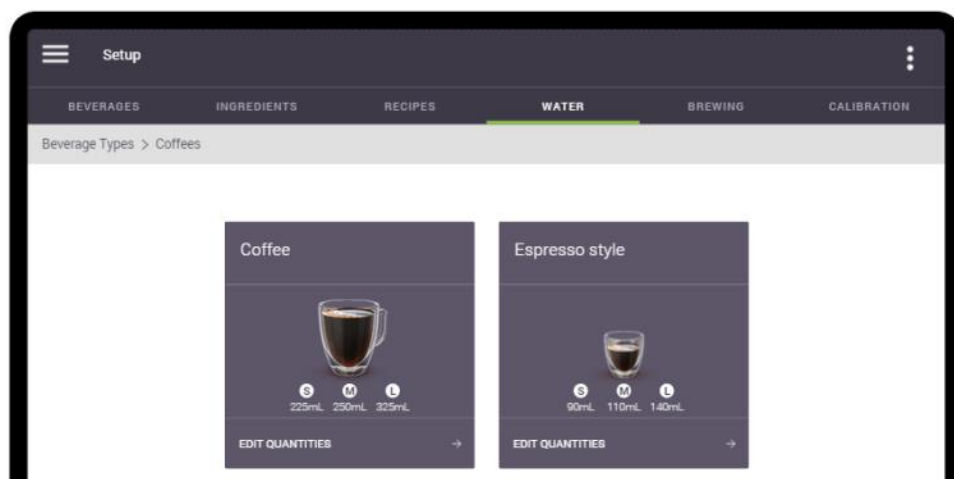

11. The following screen appears if 'Powder Beverages' is selected.

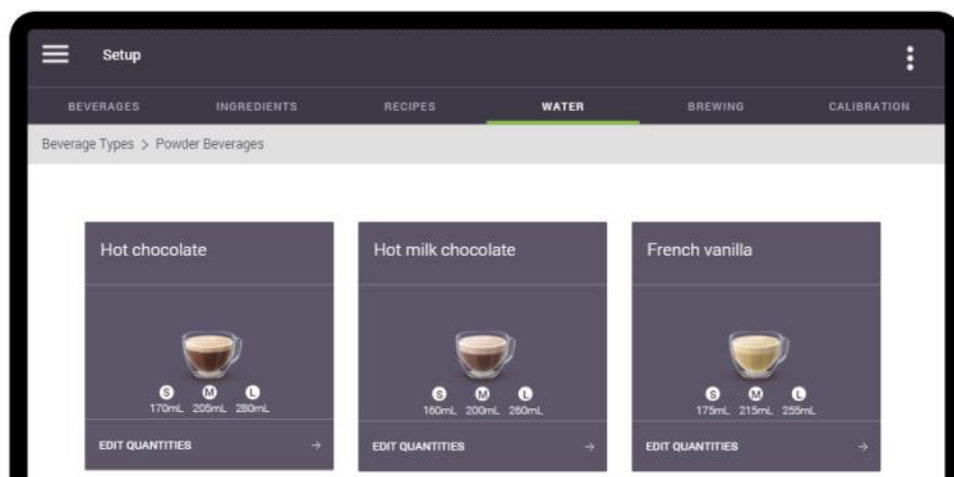

- Should you need to reset **all of the water settings back to their default settings at the same time**, you can do so from the main 'Water' screen simply by tapping on the 'Reset all Defaults' button.

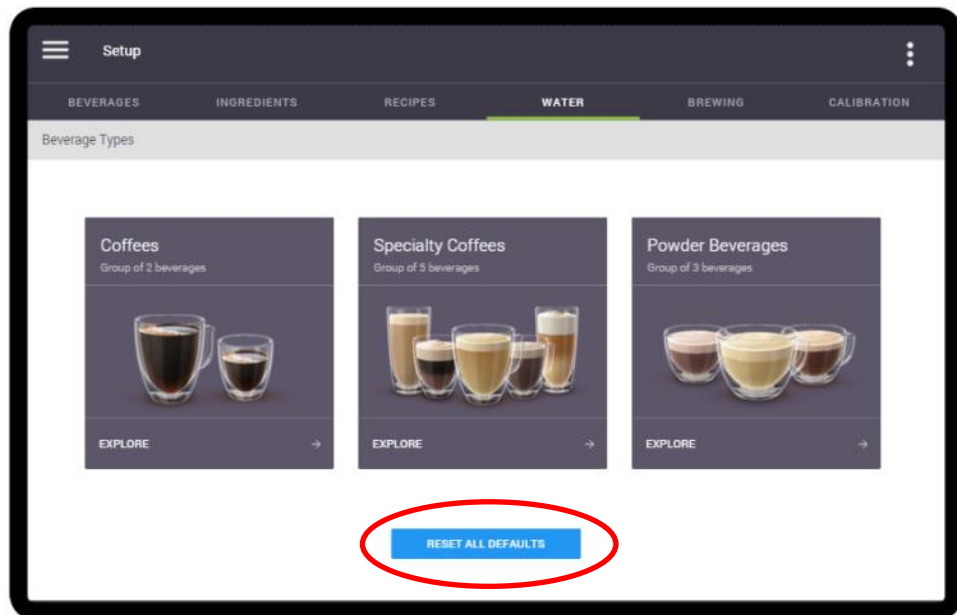

Brewing

All water temperature related settings are set in this tab.

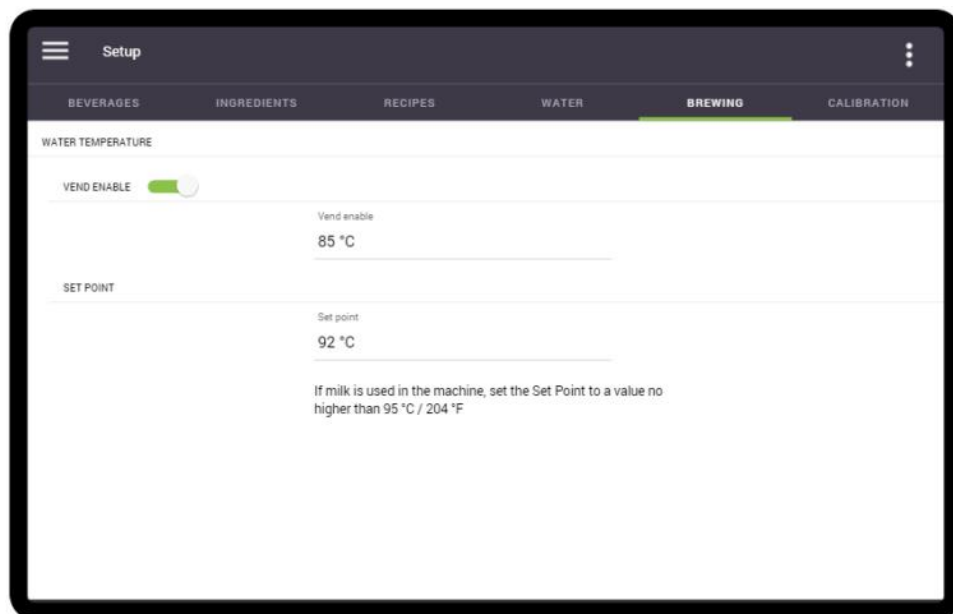

Water Temperature

Vend Enable

By activating and setting the 'Vend Enable' feature, you are setting the minimum temperature at which the machine will brew a beverage. Should the temperature drop below this setting, you will not be able to brew a beverage and the screen will display a 'Tank is Heating' message.

Set Point

The '**Set Point**' is the temperature at which the heating system maintains the water in the tank. To change the '**Set Point**', tap on the temperature setting and use the scroll list to change the setting and press '**Done**' to save it.

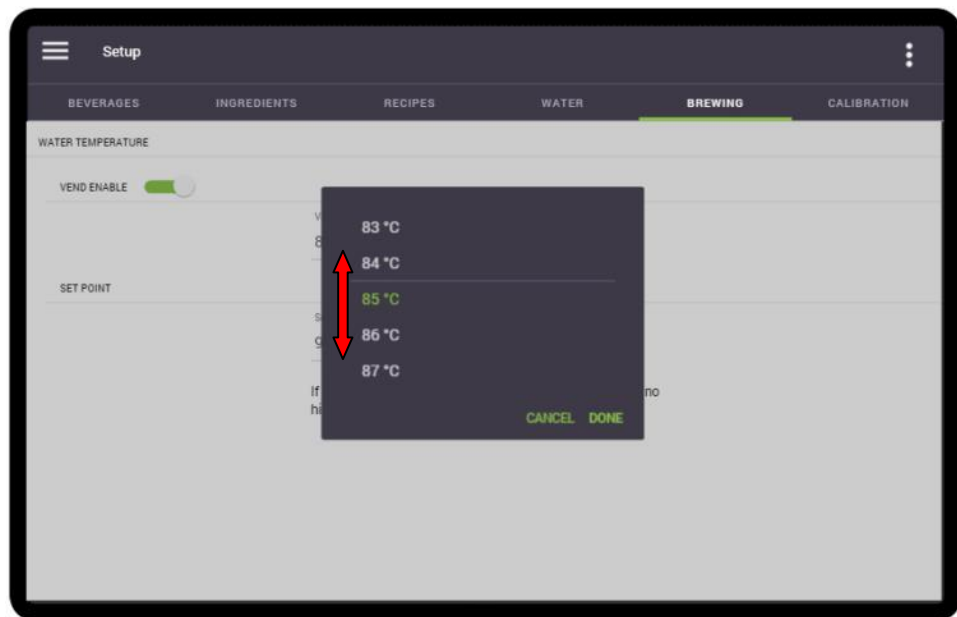

Calibration

The '**Calibration**' options (for calibrating product motors and outlet valves) are currently unavailable for the Eccellenza Touch. These features will be activated in a future firmware release.

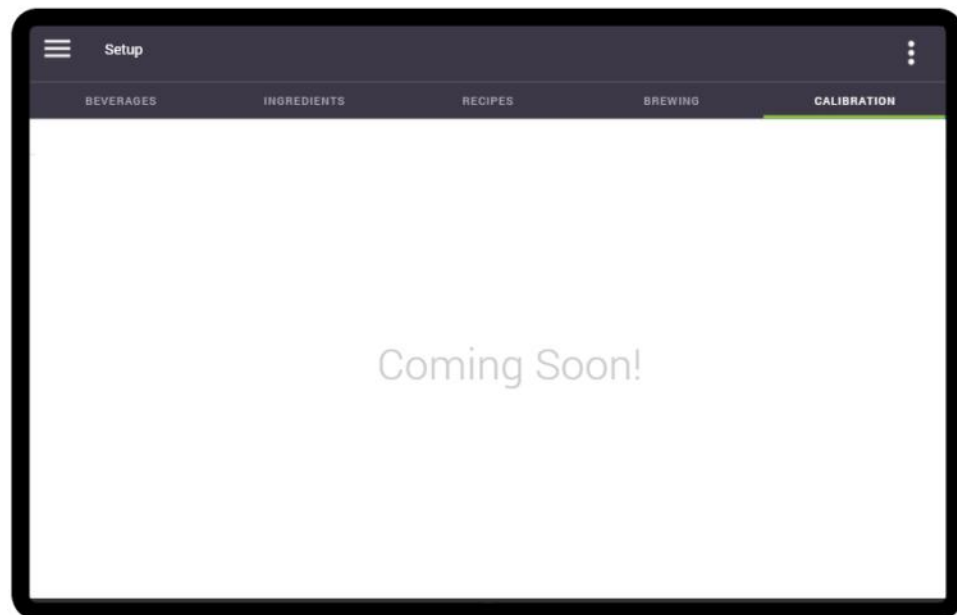

Security

The Security screen is used to assign or change PIN numbers, and grant/remove access to individual sections of the machine programming.

There are two tabs on this screen - Administrator and Operator. The **Operator** is generally the owner of the equipment, and the **Administrator** is the person responsible for the equipment at the account. The Operator has complete access to the programming menus and sets the rights for the Administrator, who has limited access.

In the example below, you'll notice that the Administrator has only two accessible menus, while the Operator has access to all of the menus. **It is the Operator who decides what access is granted to the Administrator**, and in this case, the Administrator only has access to the Dashboard and General menus.

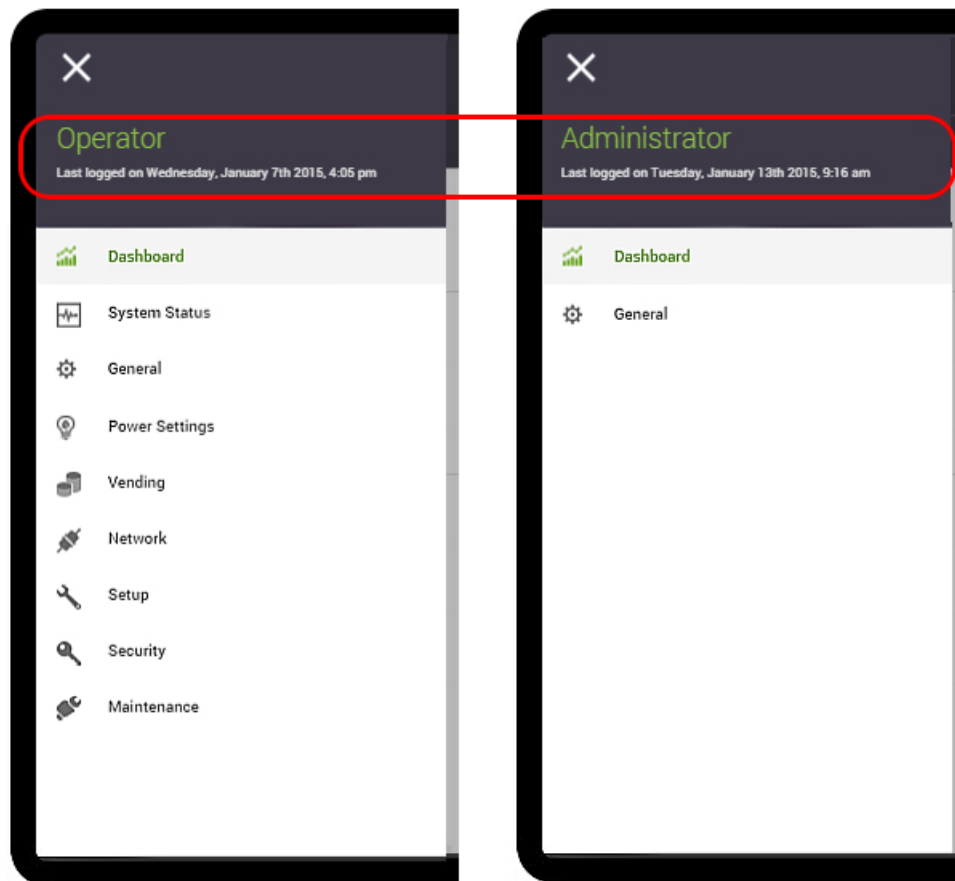

The information in the Operator section applies only to someone logged in as an Operator. If logged in as an Administrator, the Operator tab is not accessible to you.

Administrator

The Administrator can set or change their own PIN number in this tab.



The default pin for the Administrator is '234567'. We recommend that you change this pin on the machine's initial set-up. ***Store the new PIN information somewhere where it can easily be found (in your customer's file, for example)!***

1. Tap on 'New Pin' (or change PIN, if changing it) to open the numeric keypad.

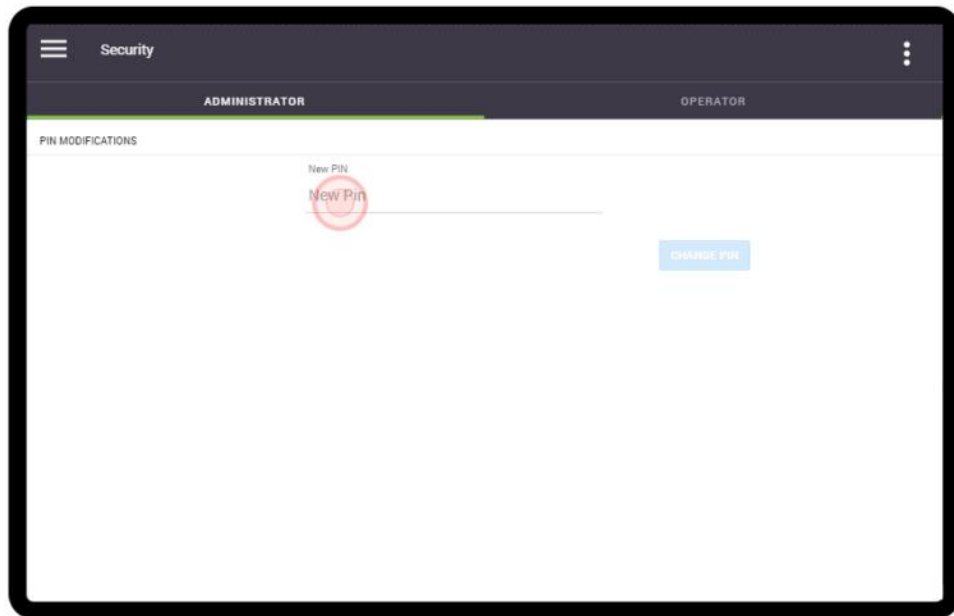

2. Using the keypad, enter a 4-6 digit PIN and tap on 'Accept Change!'.

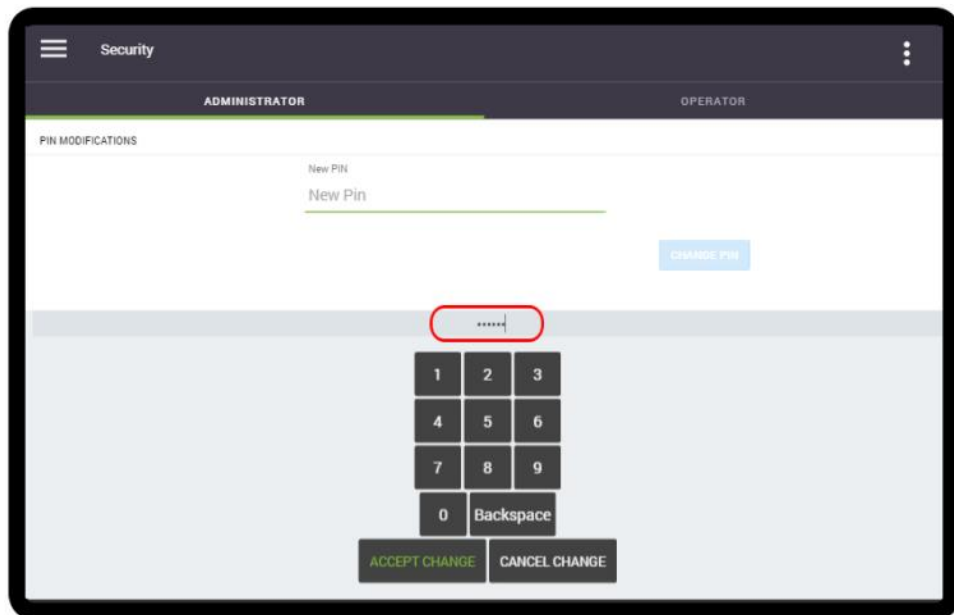

3. Tap on '**Confirm PIN**', and re-enter the same PIN on the keypad, and then tap on '**Accept Change**'.

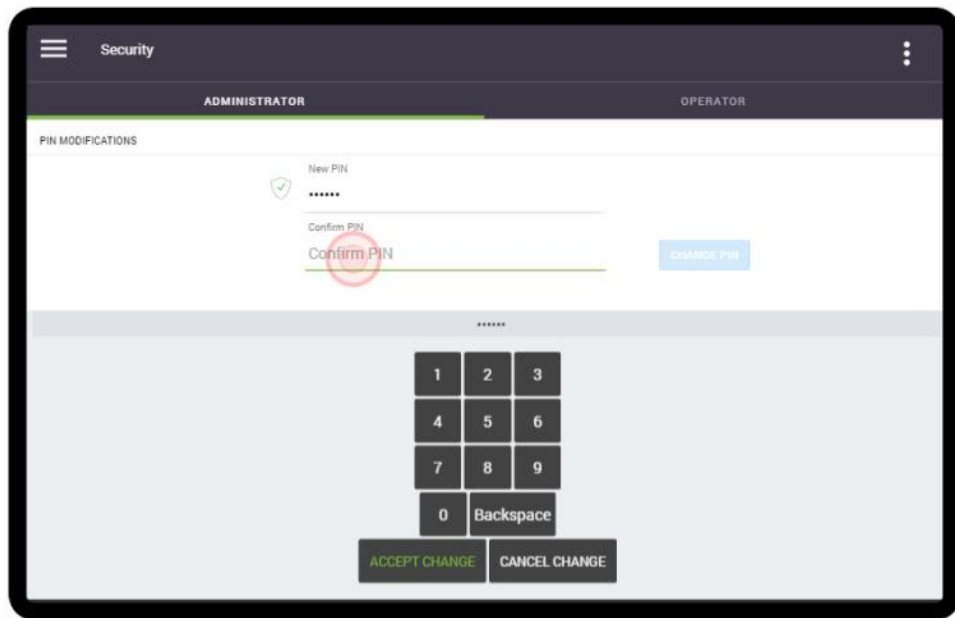

4. If the PINs matches, you will see a checkmark beside both entries to inform you that the new PIN has been accepted.

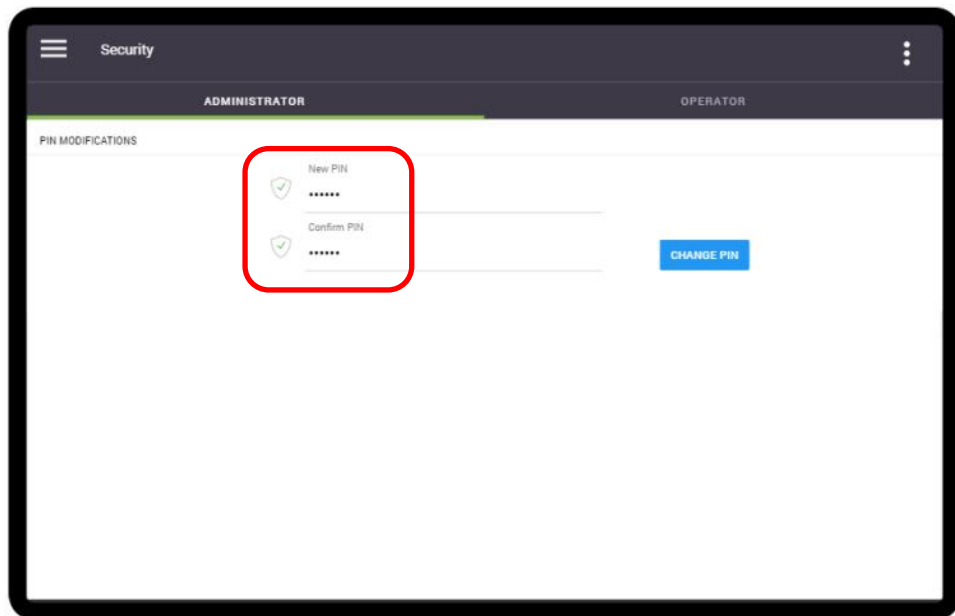

After entering their PIN on the main screen, the Administrator will have access to the menus for which the Operator gave them the necessary permissions. In most cases, this access will be limited and some options will not be available.

Operator

The Operator can set or change their own PIN number in this tab, and can grant the necessary privileges (rights and access) to the Administrator.



The default pin for the Operator is '345678'. We recommend that you change this pin on the machine's initial set-up. **Store the new PIN information somewhere where it can easily be found (in your customer's file, for example)!**

1. Tap on 'Current Pin' to open the numeric keypad.

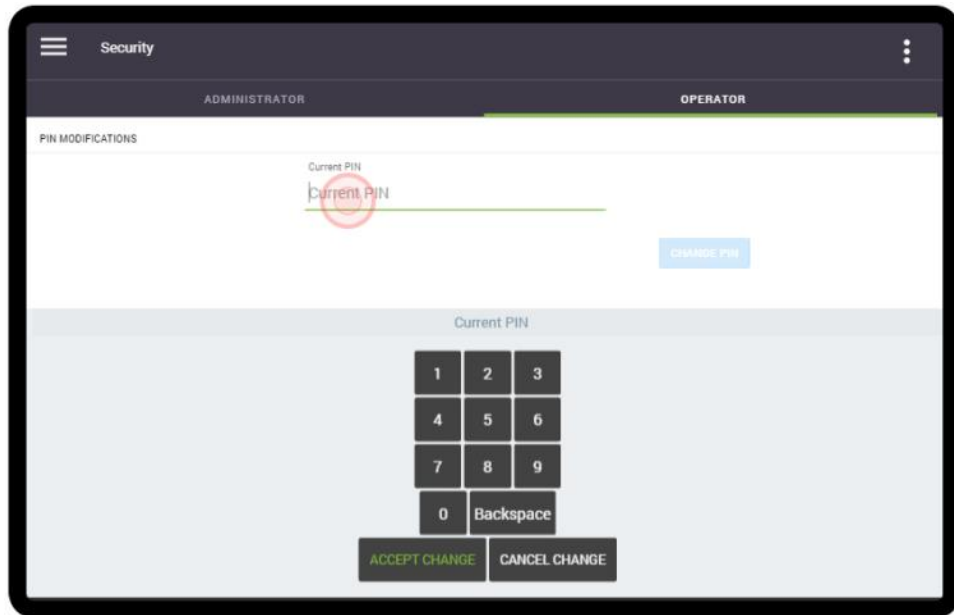

2. Using the keypad, enter your 4-6 digit PIN and then tap on 'Accept Change'.

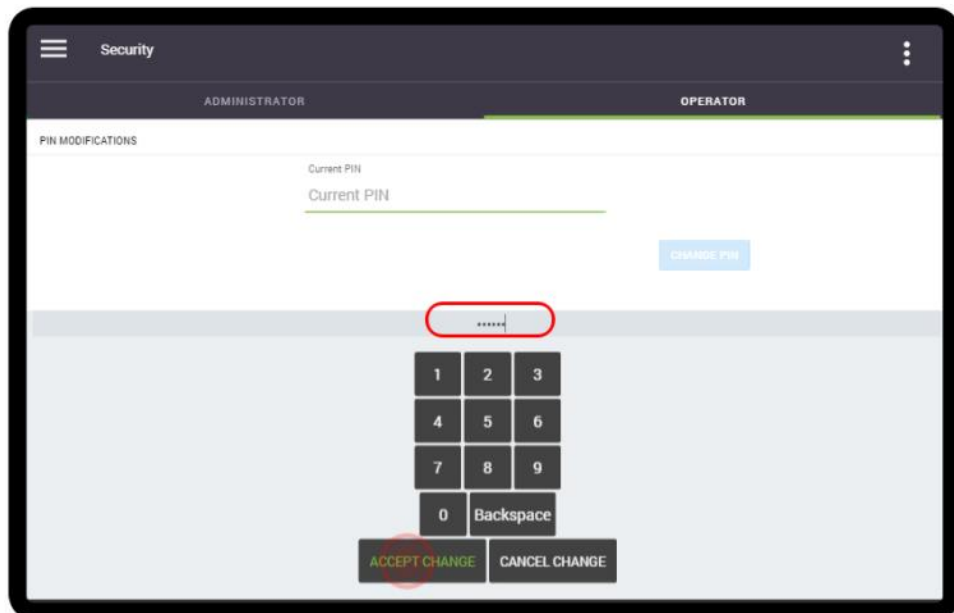

3. A checkmark appears beside the PIN if it was entered correctly. If you need to change the Operator PIN, tap 'New PIN', and follow the prompts.

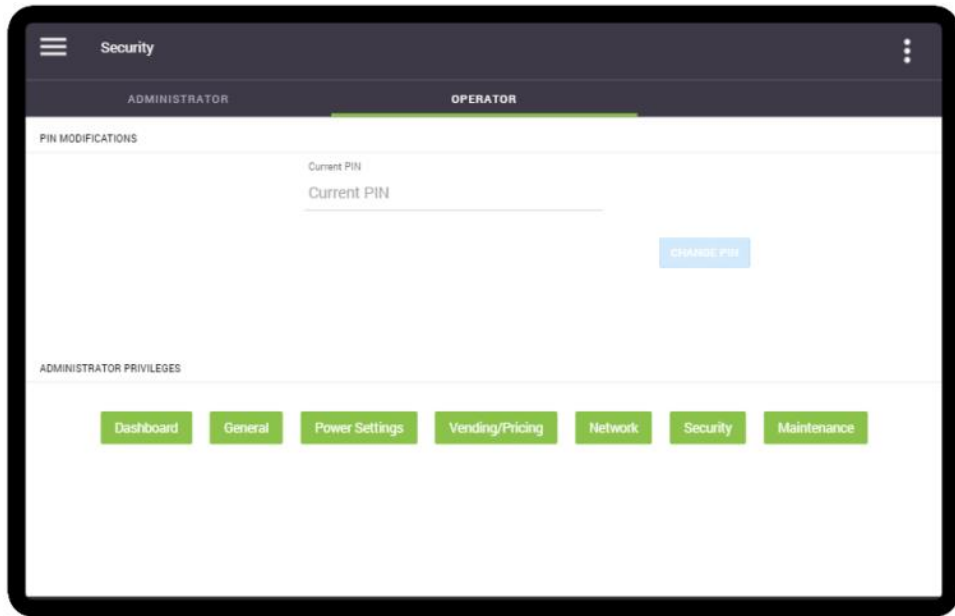

In the screenshot above, in the '**Administrator Privileges**' section you'll notice that almost all of the options are green. These are the current options available to the Administrator.

4. To change these options, tap on the options that you want to make available to the Administrator (they will change color to green). To remove the availability of any options, tap them so that they are grayed out.

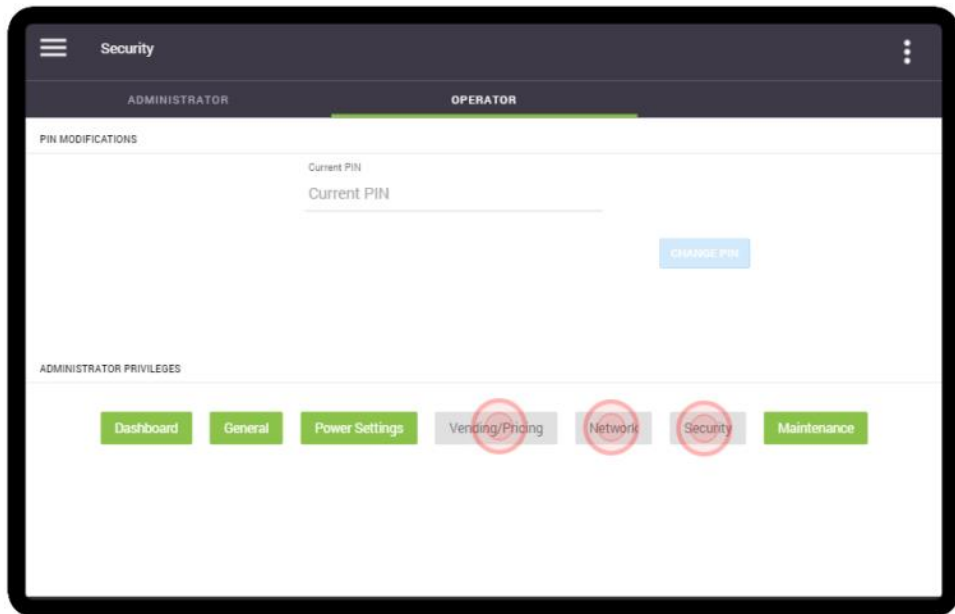

In the screenshot above, in the '**Administrator Privileges**' section you'll now notice that the '**Dashboard**', '**General**', '**Power Settings**' and '**Maintenance**' options are green. These are the updated options available to the Administrator. The grayed-out options will not be visible to the Administrator.

Maintenance

Operations Menu

This tab provides access to maintenance-related options.

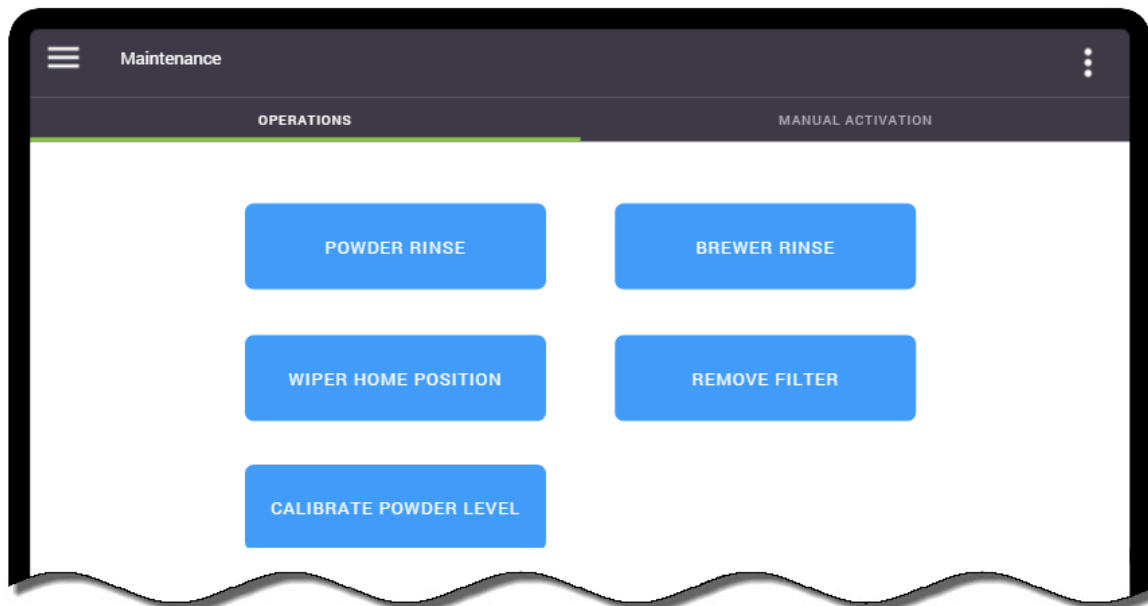

Powder Rinse

The Eccellenza Touch runs an automatic powder rinse cycle request every 75 cups. This cycle cleans all three of the powder whipper systems by sending hot water through each of the whipper units, while at the same time activating each of the whipper motors.

To manually run a powder rinse cycle, tap the '**Powder Rinse**' option while in the '**Maintenance**' tab.

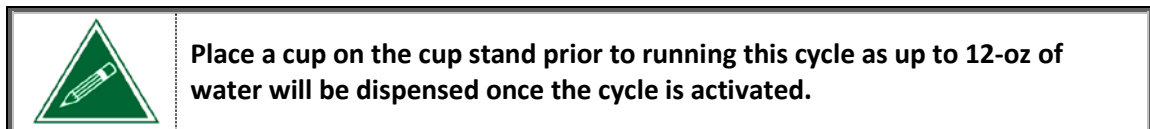

Brewer Rinse

The Eccellenza Touch runs an automatic brewer rinse cycle request every 500 cups. The brewer rinse cycle dispenses water into the brewer as the piston repeatedly rises and lowers, creating agitation above and below the screen. This cycle is fully automated and does not require the use of any cleaning agents.

To manually run a brewer rinse cycle, tap the '**Brewer Rinse**' option while in the '**Maintenance**' tab.

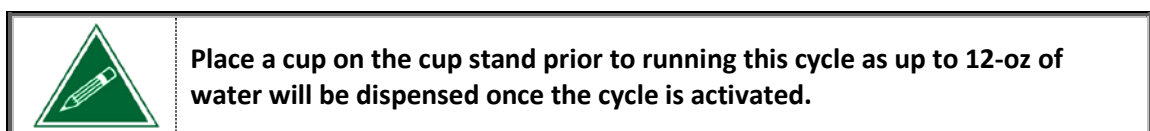

Wiper Home Position

This option reinitializes the brewer wiper to its home position (same procedure that occurs when the waste bin is removed and re-inserted).

Remove Filter

This option causes the brewer piston to cycle all the way to the bottom of the cylinder, which will "pop" (unclip) the filter screen from the piston. The piston then moves to the top of the cylinder so that the filter screen can be easily retrieved.

Calibrate Powder Level

This option automatically calibrates the powder motors and dispensers. Note that the machine comes pre-calibrated from the factory, therefore running this cycle is not necessary. Should you replace one of the powder motors or one of the powder dispensers, we recommend that you execute this calibration cycle.





This cycle must be executed with empty powder dispenser(s). Do not run this cycle if there is product in the powder dispenser(s) as the calibration will not be accurate and the whipper bowls will fill with powder.

After the cycle is finished, it takes several vends for the dispenser(s) to properly complete their calibration. The machine can be used normally throughout this brief period.

Manual Activation

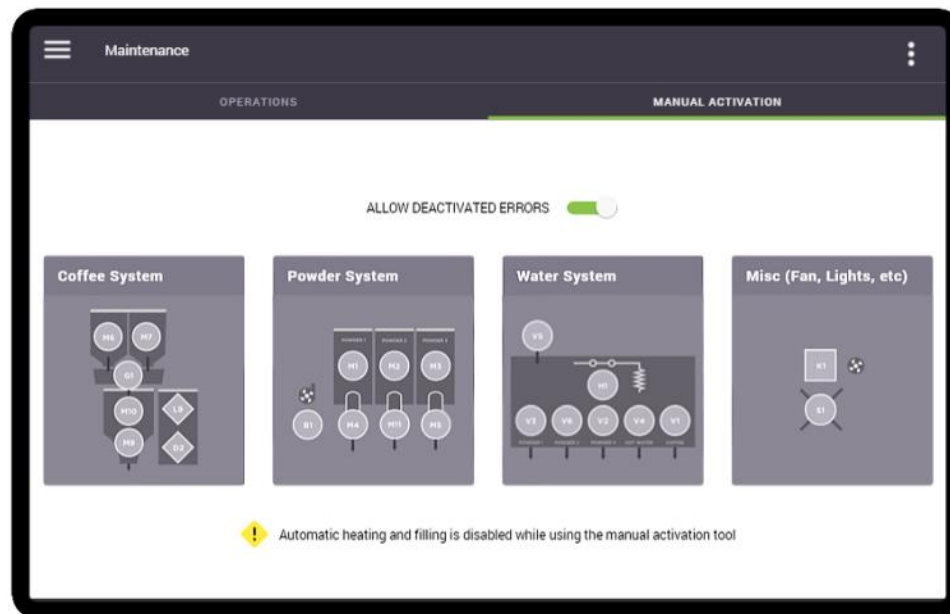
The Manual Activation screen allows you to test individual components to ensure they are functioning properly. The main screen outlines all of the systems within the Eccellenza Touch. Once the main system is selected, any of the components within this system can then be selected.





When testing components in this menu, note that only one component will activate at any given time. This is extremely important to remember when testing coffee or powder dispenser motors, as well as outlet valves.

Coffee System

In the following example, the component to be tested is the **bean grinder**. First, select the main system, which in this case is the “Coffee System”.

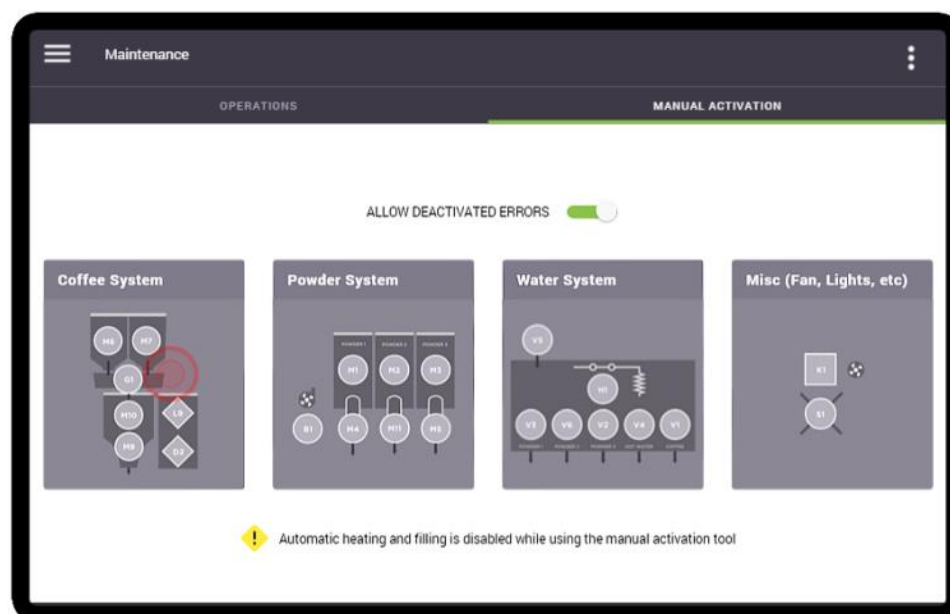

A new screen now appears showing all of the components that are part of the Coffee System. Each component is identified by a unique component code.

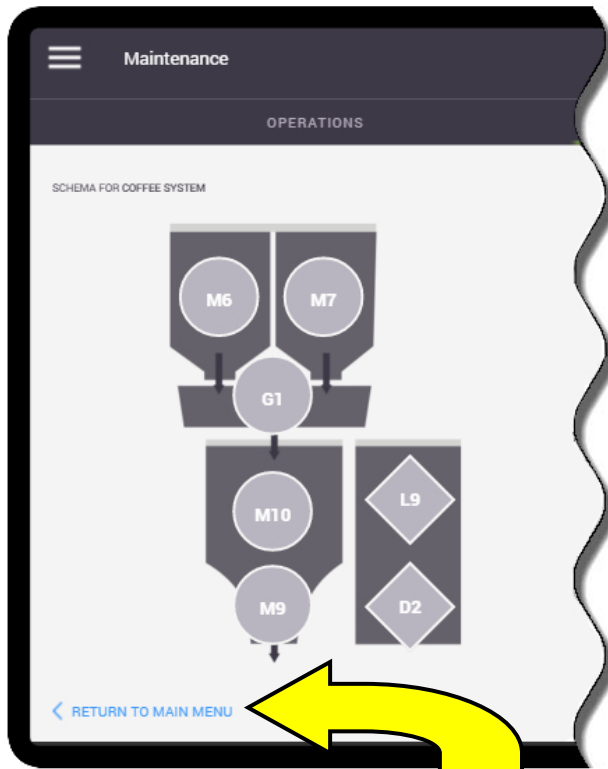

CODE	COMPONENT
D2	Waste Bin Presence Detection
G1	Grinder
L9	Waste Bin Full Sensor
M6	Coffee 1 Motor
M7	Coffee 2 Motor
M9	Brewer Motor
M10	Brewer Wiper Motor

 You can select the “Return to Main Menu” option at the lower left of the screen at any time to return to the main Engineering menu.

Select the component to be tested by tapping on it on the screen (in this example, the component is the grinder – G1).

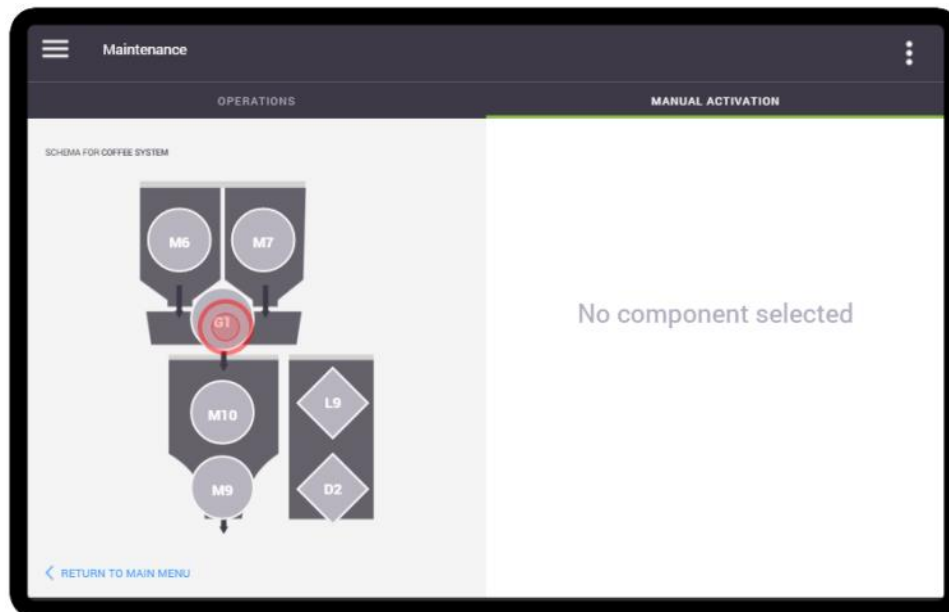

The testing options now appear on the right section of the screen. In this example, the only option available is to activate the grinder for 3 seconds.

Tap the “Activate” button and the grinder (**only**) will energize for 3 seconds.

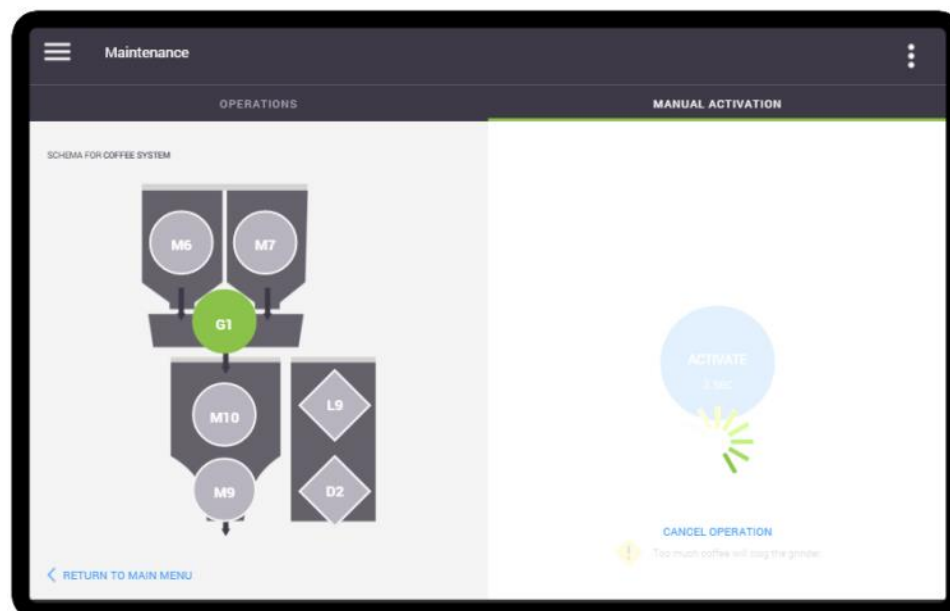
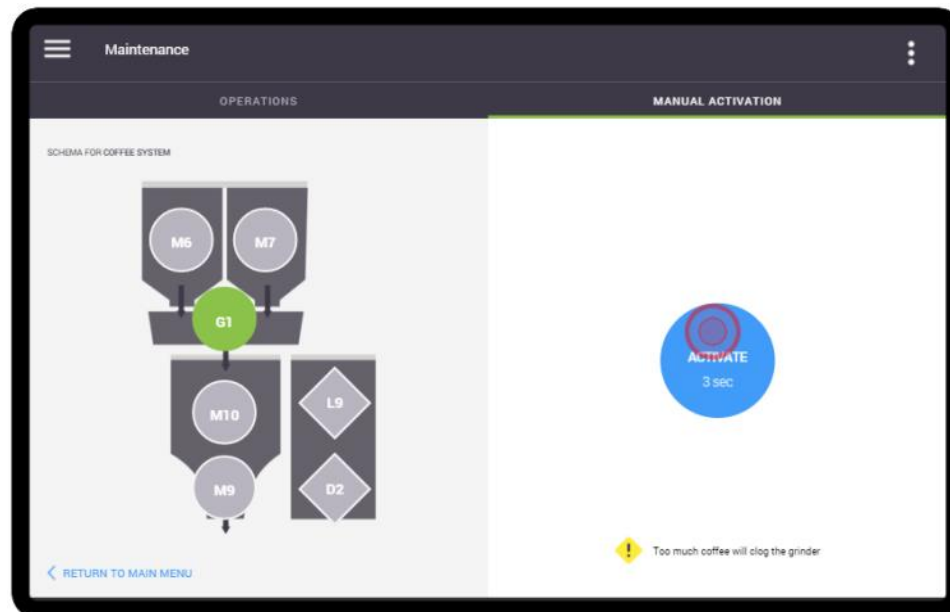

It is extremely important to note that when testing the coffee motors (M6 or M7), **ONLY** the coffee motor will activate. Coffee beans will be dispensed into the grinder but the grinder, or any other component, will **NOT** activate.



When testing the Waste Bin Presence (D2) or Waste Bin Full (L9) sensors, a voltage level and the bin's status (present or absent) are displayed on the screen.

Powder System

If the Powder System is selected from the main Engineering screen, the following component options appear for testing:

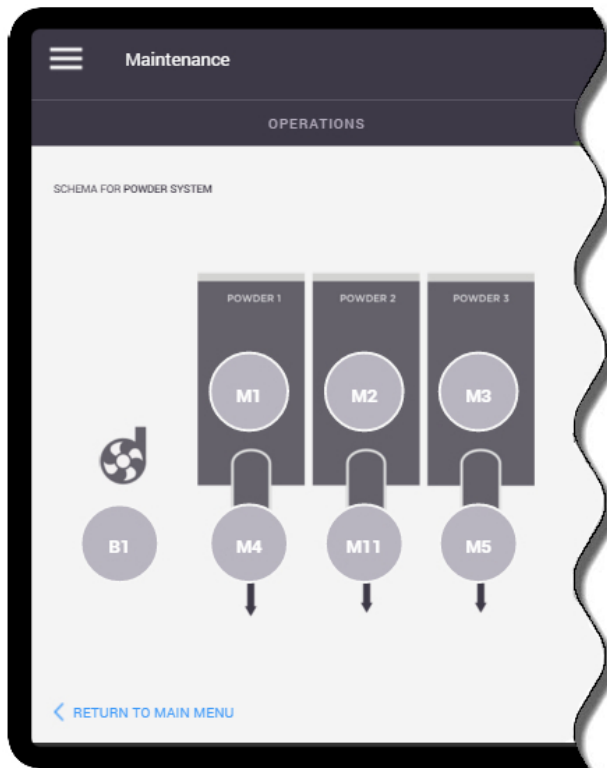

CODE	COMPONENT
B1	Blower (Powders)
M1	Powder 1 Motor
M2	Powder 2 Motor
M3	Powder 3 Motor
M4	Powder 1 Whipper Motor
M5	Powder 3 Whipper Motor
M11	Powder 2 Whipper Motor



It is extremely important to note that when testing the powder motors (M1, M2 or M3), **ONLY** the powder motor will activate. Powder will be dispensed into the whipper but the whipper motor and powder valve, will **NOT** activate.

Water System

If the Water System is selected from the main Engineering screen, the following component options appear for testing:

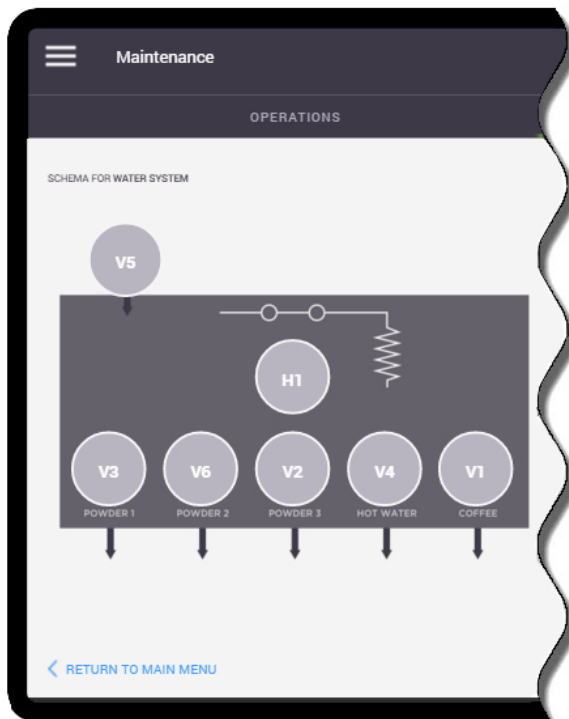

CODE	COMPONENT
H1	Heating Element
V1	Coffee Valve
V2	Powder 3 Valve
V3	Powder 1 Valve
V4	Hot Water Valve
V5	Inlet Valve
V6	Powder 2 Valve

CAUTION: Extremely hot water will be dispensed when testing any of the outlet valves! Please note that the coffee valve (V1) will dispense water directly into the brewer, but the brewer will not activate.

When testing the heating element (H1), if the element is working correctly, the screen will display an amperage draw between 11 and 12 amps. If it displays "0" amps, there is no power going through the heating element.

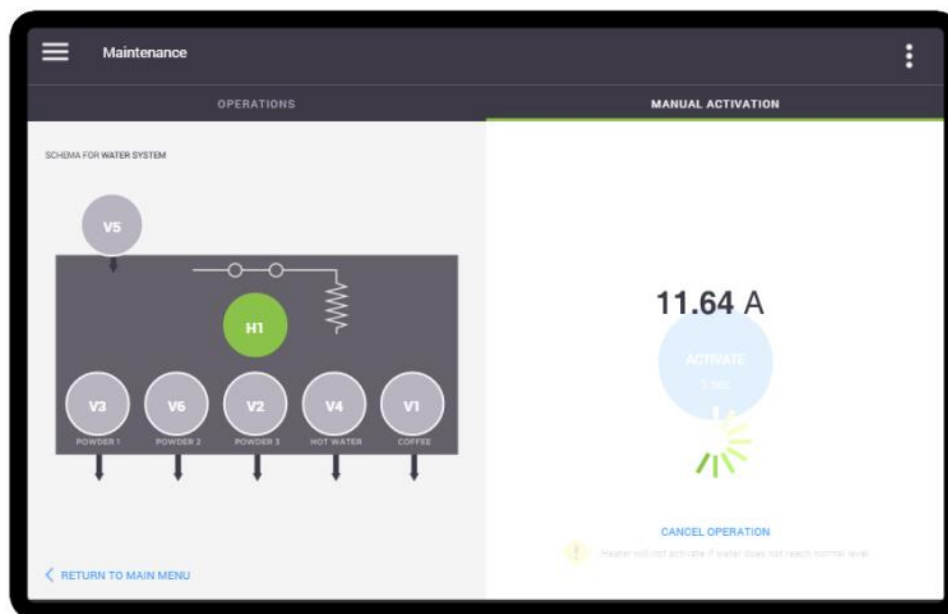

Miscellaneous Components

If Miscellaneous is selected from the main Engineering screen, the following component options appear for testing:

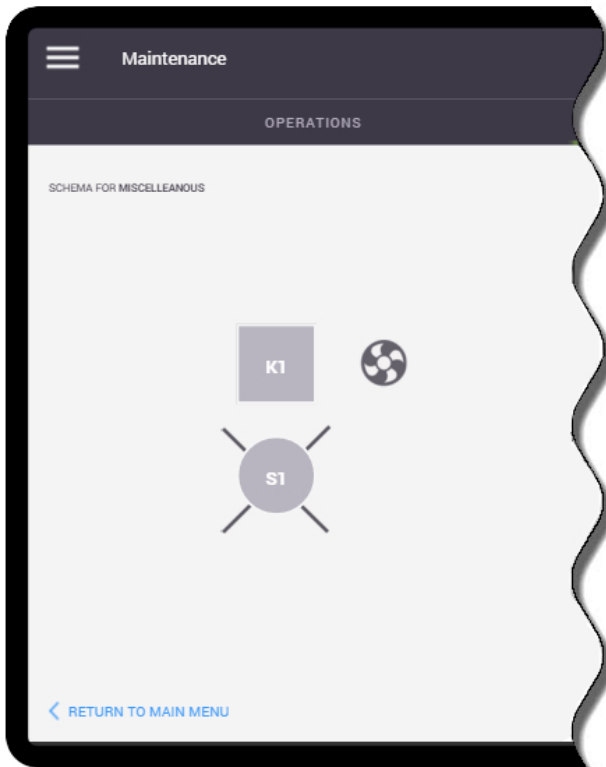

CODE	COMPONENT
K1	Exhaust Fan
S1	Cup Lighting

SECTION 4

Care and Maintenance

To keep the Eccellenza Touch running efficiently and at peak performance, the following maintenance procedures must be performed at their specified intervals. It is recommended that equipment maintenance be scheduled at a time that would be the least disruptive to your customers. Whenever possible, replace the components requiring maintenance with new or refurbished ones, and then refurbish the older components at your shop.



Failure to perform the required care and maintenance will result in poor beverage quality and will lead to equipment malfunctions. It may also void any remaining warranty on the equipment and its components.

Daily Care

- ▶ **Empty the Cup Stand** – empty the contents of the cup stand and rinse the stand and grill under clean running water.
- ▶ **Empty the Waste Bin** – empty the contents of the waste bin.
- ▶ **Refill the Coffee Dispensers and Powder Dispensers** – top off the coffee and powder dispensers. **Do not pack the products into the dispensers!**
- ▶ **Wipe Exterior and Countertop** – using a clean towel, wipe any coffee grounds and spills from the exterior of the machine and the countertop.

Every 1-2 Weeks

- ▶ **Clean the whipper components** - for detailed information about disassembling and cleaning the whipper components, consult the Eccellenza Touch Service Manual (VKI Publication #100309-001).
- ▶ **Inspect Water Hoses and Tubing** - inspect all plumbing connections, water hoses, tubing, clamps, fittings and water related components (valves, water tank, etc.) for signs of wear or damage. Replace them, if required.

Every 10,000 Cycles or 12 Months

- ▶ **Clean the brewer components** with warm water and dish soap. For detailed information about disassembling the brewer, consult the Eccellenza Touch Service Manual (VKI Publication #100309-001).
- ▶ **Clean the whipper hoses** - remove all three whipper outlet hoses and thoroughly clean the exterior and the interior of each of the hoses. A plastic bristled brush (VKI P/N - 202477-001) must be used to clean the interior of the hoses.



- ▶ **Replace Brewer Seals and Gaskets** - there are several seals and gaskets located throughout the brewer assembly that need to be replaced every 12 months or 10,000 cycles. The brewer '**Yearly Maintenance Kit**' (p/n - 202341-001) contains everything required.

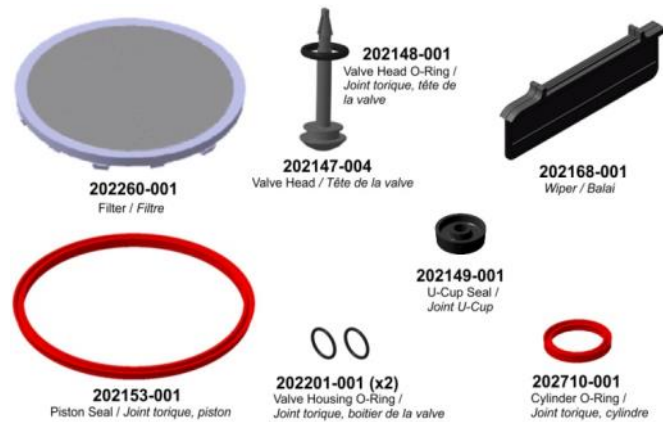

Contents of Yearly Maintenance Kit (202341-001)

- ▶ **Replace whipper seals** - replace the rubber seals on all three whipper bases.
- ▶ **Inspect Electrical Wiring and Components** - inspect all of the equipment wiring, terminals, connectors and electrical components (valves, motors, relays, element, etc.) for signs of wear, damage or overheating at connection points. Replace them, if required.

Every 3 Years

- ▶ **Replace the following:** heater element, thermal cut-off switch, external relays, all seals and gaskets and o-rings.
- ▶ **Refurbish the Brewer** - the brewer must be disassembled and all worn components must be replaced. The brewer '**3 Year Maintenance Kit**' (p/n - 202341-002) contains everything required.

Miscellaneous

- ▶ Run the **Brewer Rinse and/or Powder Rinse Cycles** when prompted by the machine (a message appears on the touch screen).
- ▶ **Verify Water Tank Components** - dependant on the local water conditions, inspect, clean or replace components, as required.
- ▶ **Clean the Side Exhaust Fan** - over time, dust will accumulate on the exhaust fan on the right side wall and it must be cleaned to maintain the fan's performance.
- ▶ **Cleaning the Coffee Dispenser** - empty, remove, and clean the coffee dispenser with warm water and dish soap. Thoroughly dry the dispenser before re-installing it. For detailed information about removing the coffee dispenser, consult the *Eccellenza Touch Service Manual* (VKI Publication #100309-001).
- ▶ **Cleaning the Powder Dispensers** - empty, remove, and clean the powder dispensers with warm water and dish soap. Thoroughly dry the dispensers before re-installing them. For detailed information about removing the powder dispensers, consult the *Eccellenza Touch Service Manual* (VKI Publication #100309-001).
- ▶ **Inspect the grinder** – to prevent the grinder from jamming, re-adjust the grinder heads if the coffee grounds are too fine, and keep the grinder chute clean.



Failure to perform the required care and maintenance will result in poor beverage quality and will lead to equipment malfunctions. It may also void any remaining warranty on the equipment and its components.

SECTION 5

Error and Reminder Messages

Main Screen

Message Displayed	Condition	Action(s) Required
Backend Services Unreachable. Trying to reconnect...	The connection was lost.	Will reconnect automatically. If not, reboot the machine.
<ul style="list-style-type: none"> • System Starting • Waiting for initialization • System initialization • System update • Warming up • Machine warming up • System Ready • Brewing in progress • Water filling • Brewer reinitialization 	These are all regular operation messages.	These messages will clear themselves automatically.
Power Saving Mode	The machine is currently in Power Saving mode.	The machine will exit Power Saving mode at its preset wake time.
Powder #1 (#2, #3) low level. Fill powder container #1 (#2, #3)	The powder level for the indentified container (#1, #2 or #3) is low.	Refill the powder container(s). Note: <i>the message may continue to appear for a few vends after refilling - this is normal and it will clear.</i>
Empty waste bin and cup stand	The waste bin is full.	Empty the contents of both the waste bin and the cup stand.
Automatic brewer (or powder system) rinse. Insert an empty container under spout and press <Start>.	The automatic rinse cycle for the brewer or for the powder system has been triggered.	Place an empty, leak proof container under the pour spouts area, and then press <Start> to begin the rinse cycle.
Overflow detected. Remove and empty cup stand and floor tray.	An overflow has been detected.	Remove the cup stand and floor tray and empty their contents.
Verify water connection and feed	The water tank is taking too long to fill.	Check the main water source, as well as the hoses going to the machine inlet valve for leaks or blockages.
Please reinsert waste bin	The waste bin is not installed.	Install the waste bin. If message persists, check the waste bin sensor. *If message persists, clean the proximity sensor and the brewer wiper.
Water Safety Level. Water level has reached the level safety probes.	The water tank has overfilled.	Drain some water from the tank. If this persists, clean the level probes.
Interrupted vend. Insert an empty container under spout and press Start.	The vend was interrupted and the cycle did not finish.	Place a cup under the pour spouts and press the <Start> button. Any liquid still in the system will drain into the cup. NOTE: If Step 2 of 2 cannot be activated, go to "System Status" menu and clear any errors that are present.
Call for Service (in VENDING MODE)	The Cashbox is full.	Empty the cashbox and reset the cashbox counter.

System Status Screen

Code	Message Displayed	Condition	Action(s) Required
--	Electronic Board Communication Lost Please Call for Service or Press Acknowledge to Retry	Communication between the control board and HMI is lost.	1 - Press "Acknowledge" to reset 2 - Reboot the machine. 3 - If message persists, check the HMI, Control Board and wiring.
B1	Blower & Fan current is over safety level	Blower & Fan current is above the recommended safety level. Fan may be drawing too much power.	1 - Check the wiring and connections for the powder system blower. 2 - Clean any accumulation from the blower. 3 - If message persists, replace the powder system blower.
	Blower & Fan current is under minimum operation level	Blower & Fan current is below the minimum operating level. Fan may not be drawing enough power.	1 - Check wiring and connections for the powder system blower. 2 - If message persists, replace the powder system blower.
D2	LED in Waste Bin detector has a fault	The IR LED of the waste bin sensor voltage is over the configured maximum operation level.	1 - Clear the message. 2 - Reboot the machine. 3 - If message persists, replace the waste bin presence sensor.
G1	Coffee Grinder Over Current Standby	The grinder current was over the stand by operation level.	1 - Clear the message. 2 - Reboot the machine.
	Grinder Fuse Fault	Grinder fuse is in fault.	1 - Check the fuse on the control board.
	Grinder Sensor Error	Grinder Current Sensor is out of range.	1 - Clear the message. 2 - Reboot the machine.
	Grinder's current is close to critical level	Grinder current is close to maximum operating level. Grinder may be drawing too much power.	1 - Check to see if the grinder is jammed (possibly a foreign object in the grinder heads). 2 - Check the condition of the grinder belt. 3 - Reboot the machine. 4 - If message persists, replace the grinder.
	Grinder's current is close to minimum operation level	Grinder current is close to minimum operating level. Grinder may not be drawing enough power.	1 - Reboot the machine. 2 - If message persists, replace the grinder.
	Grinder's current is over safety level	Grinder current has exceeded the maximum operating level.	1 - Check to see if the grinder is jammed (possibly a foreign object in the grinder heads). 2 - Check the condition of the grinder belt. 3 - Reboot the machine. 4 - If message persists, replace the grinder.
	Grinder's current is under minimum operation level	Grinder current is below the minimum operating level.	1 - Check the condition of the grinder belt. 2 - Check the wiring and connections to the grinder. 3 - The grinder may need to be replaced.

Code	Message Displayed	Condition	Action(s) Required
H1	Heater's current is close to critical level	Heater current is close to maximum operating level. Heater may be drawing too much power.	1 - Inspect wiring and connections to the heater relay and heater element. 2 - Heater element may be drawing too much power. If message persists, replace the heater element.
	Heater's current is close to minimum operation level	Heater current is close to minimum operating level. Heater may not be drawing enough power.	1 - Reboot the machine. 2 - If message persists, replace the heater element.
	Heater's current is over safety level	Heater current has exceeded the maximum operating level.	1 - Inspect wiring and connections to the heater relay and heater element. 2 - Heater element may need to be replaced. 3 - Heater relay may need to be replaced.
	Heater's current is under minimum operation level	Heater current is below the minimum operating level.	1 - Check wiring and connections to the heater relay. 2 - Check wiring and connections to the heater element. 3 - Replace heater element.
	Water Tank Default Critical Min Temp	Water temperature went below the configured minimum critical temperature (Default 0 C).	1 - Clear the message. 2 - Reboot the machine.
	Water Tank Default Fill Heating Time	Inlet valve and heater were both activated for a period of time longer than the configured timeout.	1 - Clear the message. 2 - Reboot the machine.
	Water Tank Heating Timeout	Reaching the water set point (Default 95°C) took longer than the maximum configured heating timeout (Default: 30 min.)	1 - Clear the message. 2 - Reboot the machine. 3 - If message persists, replace the heater element.
	Water Tank Heating Probe Error	Heater bad connection count has exceeded the configured limit.	1 - Clear the message. 2 - Reboot the machine.
	Water temperature is over the maximum level	Water temperature has exceeded configured temperature setting.	1- Heater relay may need to be replaced. 2 - Control board may need to be replaced.
K1	Fan is not present or has abnormal operation	Fan is not present or operating abnormally.	1 - Check fan wiring and connection to the control board. 2 - Clean any accumulation from fan. 3 - If message persists, replace the exhaust fan. 4 - If message persists, replace the control board.
L4	Water Tank Level Error	Safety level probe is detected while the normal level probe is not.	1 - Check wiring and connections to the level probes. 2 - Clean level probes.
L5	The water level is reaching the safety level probes	The water tank has overfilled and the water level is reaching the safety level probe.	1 - If this occurs during initial heating, it may be due to water expansion. Empty some water from tank. 2 - The machine may have been moved causing tank to overfill. Empty some water from tank. 3 - Level probes require cleaning.
MDB1	Cash Box Full	The cash box in the changer housing is full.	1 - Empty the cash box. 2 - Reset the Cash Box counter.
	Coin Changer...(various messages)	Miscellaneous Coin Changer-related issues.	Consult the coin changer manufacturer's documentation.

Code	Message Displayed	Condition	Action(s) Required
M1, M2, M3	Powder Dispensers current is close to critical level	Powder Dispenser current is close to maximum operating level. Powder motor may be drawing too much power.	<ol style="list-style-type: none"> 1 - The powder product in the dispenser may be packed or compressed. Empty the dispenser. 2 - The dispenser may be jammed. 3 - The dispenser motor may be seized. Try to unseize the motor. 4 - If message persists, replace the powder dispenser motor.
	Powder Dispensers current is close to minimum operation level	Powder Dispenser current is close to minimum operating level. Powder motor may not be drawing enough power.	<ol style="list-style-type: none"> 1 - Check the wiring and connections to the powder dispenser motor. 2 - The powder dispenser may not be engaged properly with the powder dispenser motor. 3 - The powder dispenser motor coupling may need to be replaced. 4 - If message persists, replace the powder dispenser motor.
	Powder Dispensers current is over safety level	Powder Dispenser current has exceeded the maximum operating level.	<ol style="list-style-type: none"> 1 - The powder in the dispenser may be packed or compressed. Empty the powder dispenser. 2 - Powder dispenser may be jammed. 3 - The powder dispenser motor may be seized. Try to free the motor. 4 - If message persists, replace the powder dispenser motor.
	Powder Dispensers current is under minimum operation level	Powder Dispenser current is below the minimum operating level.	<ol style="list-style-type: none"> 1 - Check the wiring and connections to the powder dispenser motor. 2 - If message persists, replace the powder dispenser motor.
M4, M5, M11	Whippers current is close to critical level	Powder Whipper current is close to maximum operating level.	<ol style="list-style-type: none"> 1 - If message persists, replace the faulty whipper motor.
	Whippers current is close to minimum operation level	Powder Whipper current is close to minimum operating level.	<ol style="list-style-type: none"> 1 - If message persists, replace the faulty whipper motor.
	Whippers current is over safety level	Powder Whipper current has exceeded the maximum operating level.	<ol style="list-style-type: none"> 1 - If message persists, replace the faulty whipper motor.
	Whippers current is under minimum operation level	Powder Whipper current is below the minimum operating level.	<ol style="list-style-type: none"> 1 - Check the wiring and connections to the whipper motor. 2 - If message persists, replace the faulty whipper motor.
M6, M7	Coffee Dispensers current is close to critical level	Coffee Dispenser current is close to maximum operating level.	<ol style="list-style-type: none"> 1 - The dispenser may be jammed. 2 - The coffee dispenser motor may be seized. 3 - If message persists, replace the coffee dispenser motor.
	Coffee Dispensers current is close to minimum operation level	Coffee Dispenser current is close to minimum operating level.	<ol style="list-style-type: none"> 1 - Check the wiring and connections to the dispenser motor. 2 - The coffee dispenser may not be engaged with the dispenser motor. 3 - The coffee dispenser motor coupling may need to be replaced. 4 - If message persists, replace the coffee dispenser motor.
	Coffee Dispensers current is over safety level	Coffee dispenser motor current has exceeded the maximum operating level.	<ol style="list-style-type: none"> 1 - Check to see if the coffee dispenser motor is jammed. 2 - Reboot the machine. 3 - If message persists, replace the coffee dispenser motor.

Code	Message Displayed	Condition	Action(s) Required
M6, M7	Coffee Dispensers current is under minimum operation level	Coffee dispenser motor current is below the minimum operating level.	<ol style="list-style-type: none"> 1 - Check wiring and connections to the coffee dispenser motor. 2 - The coffee dispenser may not be engaged with the dispenser motor. 3 - The coffee dispenser motor coupling may need to be replaced. 4 - If message persists, replace the coffee dispenser motor.
M9	Brewer current is over safety level	Brewer current has exceeded the maximum operating level.	<ol style="list-style-type: none"> 1 - The brewer may be seized/jammed. 2 - The brewer motor may need to be replaced.
	Brewer current is under minimum operation level	Brewer current is below the minimum operating level.	<ol style="list-style-type: none"> 1 - Check the wiring and connections to the brewer motor. 2 - The brewer motor may need to be replaced.
	Brewer Inversion	<p>Brewer is going in the wrong direction.</p> <p><i>or</i></p> <p>Wiper is going in the wrong direction (detected by the activation of the wrong switch).</p>	<ol style="list-style-type: none"> 1 - Check the wiring and connections to the brewer motor. 2 - Check wiring and connections to the wiper motor switches. 3 - One, or both, of the wiper motor switches needs to be replaced.
	Brewer Not Counting	The brewer quadrature encoder is not returning any count.	<ol style="list-style-type: none"> 1 - Clear the message. 2 - Reboot the machine. 3 - If message persists, replace the brewer motor.
	Brewer Not Initialized	A brewer sequence was started while the brewer was not initialized.	<ol style="list-style-type: none"> 1 - Reboot the machine to initialize the brewer.
	Brewer Over Current Standby	The brewer current was over the configured stand by operation level.	<ol style="list-style-type: none"> 1 - Clear the message. 2 - Reboot the machine.
	Brewer Safety Fault	The IC of the brewer driver is in fault.	<ol style="list-style-type: none"> 1 - Clear the message. 2 - Reboot the machine. 3 - If message persists, replace the brewer motor.
	Brewer Timeout	Brewer motion is timed out: brewer is moving too slow, and unable to reach required position in the allotted period of time.	<ol style="list-style-type: none"> 1 - Check the wiring and connections to the brewer motor. 2 - The brewer motor may need to be replaced.
	Brewer Unexpected Item Received	A brewer sequence step was received while a wiper sequence was already in progress.	<ol style="list-style-type: none"> 1 - Clear the message. 2 - Reboot the machine. 3 - If message persists, replace the brewer motor.
M10	Wiper current is over safety level	The wiper motor current was over the configured maximum operation level.	<ol style="list-style-type: none"> 1 - The wiper may be jammed or binding. 2 - The wiper motor may need to be replaced.
	Wiper current is under minimum operation level	The wiper motor current was under the configured minimum operation level.	<ol style="list-style-type: none"> 1 - The wiper may be missing or improperly installed. 2 - Check wiper motor connections. 3 - The motor may need to be replaced.
	Wiper Inversion	The wiper limit switches are inverted.	<ol style="list-style-type: none"> 1 - Reverse the wiring connections to the wiper switches.
	Wiper Not Initialized	A wiper sequence was started while the wiper was not initialized (homed).	<ol style="list-style-type: none"> 1 - Clear the message. 2 - Reboot the machine. 3 - If message persists, check wiper motor switches and connections. 4 - If message persists, a wiper motor switch needs to be replaced.
	Wiper Over Current Standby	The wiper current was over the configured stand by operation level.	<ol style="list-style-type: none"> 1 - Clear the message. 2 - Reboot the machine.

Code	Message Displayed	Condition	Action(s) Required
M10	Wiper Safety Fault	The IC of the wiper driver is in fault mode.	1 - Reboot the machine. 2 - If message persists, the control board may need to be replaced.
	Wiper Timeout	Wiper motion is timed out: brewer is moving too slow (or stopped), unable to reach required position in the allotted period of time.	1 - The wiper may be jammed/binding. 2 - Check wiper motor connections. 3 - The wiper motor may need to be replaced.
	Wiper Unexpected Item Received	A wiper sequence step was received while a wiper was already in progress.	1 - Clear the message. 2 - Reboot the machine.
S1, S2	Machine No Cup Light 1 Short / Machine No Cup Light 2 Short	Cup Light LED #1 or #2 is shorted.	1 - Replace LED/harness.
	Impossible temperature (greater than over heat or below 0)	Invalid temperature being reported.	1 - Inaccurate temperature reading - replace the temperature probe.
T1	Impossible temperature (greater than over heat or below 0)	Invalid temperature being reported.	1 - Inaccurate temperature reading - replace the temperature probe.
	Water Tank Temperature Probe Short	Temperature probe is shorted	1 - Check the wiring and connection to the temperature probe. 2 - Replace the temperature probe.
	Water Tank Temperature Probe Not Present	Temp probe is open.	1 - Check the wiring and connection to the temperature probe. 2 - Replace the temperature probe.
	Water temperature is not rising	Water temperature is not increasing while in heating mode.	1 - Check wiring and connections to heater relay, heater element and control board. 2 - Heater relay may need to be replaced. 3 - Element may need to be replaced. 4 - Control board may need to be replaced.
V1-V6	Valves & Relay current is under minimum operation level	Valves & Relay current is below the minimum operating level.	1 - Clear the message. 2 - Check wiring and connections to inlet and outlet valves. 3 - If message persists, the inlet valve or one of the outlet valves may need to be replaced.
	Valves & Relay current is over safety level.	Valves & Relay current has exceeded the maximum operating level.	1 - Clear the message. 2 - If message persists, the inlet valve or one of the outlet valves may need to be replaced.
Z99	Coffee Dispensers Over Current StandBy	The coffee dispensers current sum was over the configured stand by operation level.	1 - Clear the message. 2 - Reboot the machine.
	Machine Fan Blower Over Current StandBy	The fan or blower current sum was over the configured stand by operation level	1 - Clear the message. 2 - Reboot the machine.
	Powder Dispensers Over Current StandBy	The powder dispensers current sum was over the configured stand by operation level.	1 - Clear the message. 2 - Reboot the machine.
	Powder Whippers Over Current StandBy	Powder whippers current sum was over the configured stand by operation level	1 - Clear the message. 2 - Reboot the machine.
	Water Tank Coil Valves Over Current StandBy	Valve(s) current has exceeded the configured stand by operation level.	1 - Clears automatically. If not, reboot the machine.
	Water Tank Detectors Power Failure	Fault signal triggered due to a failure of the level probes and overflow detector power supply.	1 - Clear the message. 2 - Reboot the machine. 3 - If message persists, replace the control board.
	Water Tank Heater Over Current StandBy	Heater current has exceeded the configured stand by operation level.	1 - Clears automatically. If not, reboot the machine.

SECTION 6

Updating Firmware



Never attempt to install an older version of software than the version currently installed in your equipment as it is not backwards compatible! This may result in a failure of the HMI (touch screen) and void its warranty.

Firmware updates may be released periodically for the Eccellenza Touch. These updates may consist of fixes, new options and features, customizations, etc. This section guides you through the simple process of updating your equipment to the latest firmware.



After replacing the control board, the firmware must be loaded when the machine is first powered up. Do not power up the machine until the USB Flash drive with the proper firmware is connected to the machine.

1. Load the latest firmware files onto an **empty** USB flash drive (minimum **8GB**).
2. Remove the waste bin.
3. Remove the plug from the USB connector and insert your USB flash drive into it. ***Make sure to push the USB flash drive into the USB connector as far as it can go.***



4. Reboot the machine using the main power switch (switch the power off for 5 seconds and then on again).

- The updating process is automated and requires no user input. The screen reverts to command-style prompts that provide progress information on the update.

```

Small partition setup script, version 2017-03-27.
No INAND flash directory found. That's OK, no flashing will be done.

Eccellenza Touch Software Update, script version 14.
Starting at 2017-08-01 17:56:41 UTC, logging in /mnt/usb/InstallLogs/log_2017-08-01_17-56-41.txt.

=====
**** DO NOT REMOVE THE USB KEY UNTIL PROMPTED. This could render the machine inoperable. ****
=====

Cannot find the application version on the HWI. Allowing update...
The new OS (v1.10) is already installed on the HWI. Skipping OS installation.
=====
Updating application from '0' to '1.4.2.0'...
=====

UKI Coffee System: install Coffee Application without OS
-----

Install/Update product from /mnt/usb to /mnt/tftp2... (this should take about a minute)
= Unpack rc.local
= Unpack coffee-system-backend
= Unpack resources-backend
= Unpack coffee-system-frontend
= Unpack resources-frontend
= Unpack Firmware
= Unpack FactorySettings
= Copy DefaultBeverages folder
= Unpack rc.local
= Unpack local-bck
Product installed.

-----

Finishing update...
Installation took 0m21s.
Update success, please disconnect the USB key and the machine should restart automatically.
If the machine doesn't restart within 10 seconds of removing the USB key, please turn it OFF and then ON.

Please remove the USB key to reboot properly.
-
    
```

- Once the update is complete (it may take up to 30 minutes), you are prompted to remove the USB flash drive to reboot the machine.

Remove the flash drive and the Eccellenza Touch will reboot itself twice. While it is rebooting, re-install the plug onto the USB connector and re-install the waste bin.



If the screen remains black with a “log-in” prompt, allow the machine sit undisturbed for 15 minutes or so as the upgrade may still be in progress in the background.

- It is possible that an error may be displayed on the screen after the reboot. If this is the case, simply clear the error.



If the update process was interrupted prior to completion, you must connect the USB flash drive to a computer, and delete the “Backup” folder that was created, otherwise further updates will not be possible with this flash drive.



Updating the Eccellenza Touch firmware will not overwrite or change any existing settings or customizations you may have made in the programming. These settings will be maintained.

SECTION 7

Product Warranty Information

(Updated - 2018)

Important note: The serial number of the machine must be reported at the time a warranty claim is submitted on a machine or any of the components contained therein. Any removal of or tampering with the serial number or date code of a component will void warranty.

1 - General

VKI provides a one (1) year parts warranty on equipment produced at its factory. This coverage is limited to defects in material and workmanship under normal use and service for a period of one (1) year commencing from the date of purchase, unless otherwise stated herein. This warranty applies only to the original owner of the equipment.

VKI's sole responsibility under this warranty shall be, at VKI's option, to repair, replace or credit the defective part. VKI shall only be responsible for its own costs or materials and its own labor in connection with warranty claims. VKI reserves the right in the performance of this warranty, in the event of shortages of materials, to substitute other materials of similar or better suitability.

This warranty covers original products at time of purchase only. VKI assumes no responsibility for substitute replacement parts installed on VKI equipment that have not been purchased from VKI or installed and use in accordance with VKI's instructions.

All warranty service must have prior authorization from VKI by contacting VKI Customer Service. No equipment or parts will be treated or returned if they are not accompanied by a completed Return Authorization (RA) Form, or whose information is inaccurate (e.g. - wrong serial number). The Return Authorization number must appear on shipping labels and cartons.

2 - Service parts and accessories

VKI provides a one (1) year parts warranty on all service parts and accessories produced at its factory or by a sub-contractor or distributed by the company. This coverage is limited to defects in material and workmanship under normal use and service, for a period of one (1) year commencing from the date of purchase, unless otherwise stated herein.

3 - Brewer assembly

VKI provides a one (1) year parts warranty on the Eccellenza Touch brewer - factory installed in new equipment or purchased separately. This coverage is limited to defects in material and workmanship under normal use and service, commencing from the date of purchase, unless otherwise stated herein.

VKI provides a three (3) month parts warranty on brewers repaired, reconditioned or upgraded but no longer covered under warranty. On brewers with warranty coverage remaining, the balance of warranty coverage or three (3) month limited warranty may be applied, whichever period is longer.

Please note that non-compliance with preventive maintenance could result in damage to the brewer and brewer-related components, and may void the warranty.

4 - Electronic board assemblies

VKI provides a one (1) year warranty on all electronic boards used in the Eccellenza Touch.

This coverage is limited to defects in material and workmanship under normal use and service, commencing from the date of shipment from VKI's factory, unless otherwise stated herein.

VKI provides a three (3) month warranty on all reconditioned, repaired or upgraded electronic boards, factory installed in rebuilt equipment or purchased/serviced separately, commencing from the date of shipment, unless otherwise stated herein.

Note: An administrative charge of \$50.00 will be invoiced for any board returned with no fault found (NFF).

Any tampering with these electronic assemblies is strictly prohibited and will void the warranty. Warranty on software is limited to the correction of software code.

5 - Freight charges

VKI will absorb all **standard** freight charges on merchandise returned under warranty. Merchandise must be returned in accordance with VKI's Return Procedure. The customer will absorb freight charges on all merchandise returned for repair that is no longer covered under warranty. The customer will absorb freight charges on all merchandise returned to VKI for restocking.

6 - Exclusions and conditions

Warranty shall become void on all machines, accessories, kits or service parts having been subject to misuse, alteration, neglect or as a result of poor installation, poor maintenance or damage due to electrical fluctuations as the result of extreme conditions, fire and flooding.

Warranty does not include wear parts such as valve seats, gaskets or o-rings which are required during normal upkeep of product on an annual basis.

Subsequent to an internal inspection of all parts deemed defective under normal use, VKI reserves the right to credit, replace or repair these parts.

Serial numbers and/or date stamp codes will be used to determine and validate the applicable warranty coverage period on all machines, accessories, kits and service parts.

Warranty does not apply on parts subject to factory recall and/or upgrade programs. Terms and conditions are applied according to the published program announcement.

Changes or improvements to our products may be made at any time by VKI, but VKI shall be under no obligation to incorporate same in or substitute the same for any products previously purchased by any customer.

Warranty is void on Products damaged in transit from customer to VKI due to improper packaging. Wherever possible, coffee systems, and/or accessories should be shipped in their original shipping carton or in packaging that will prevent damaged in transit and should also be shipped on a pallet.

VKI will endeavor to provide parts and service for a period of seven (7) years from the date of termination of production of the equipment. During this period, VKI's ability to provide parts and service will be governed by the availability of components and technology from its suppliers.

This warranty is in lieu of and excludes all other warranties, guarantees or representations, expressed or implied. VKI reserves the right to change this policy without prior notice.

For more information, please contact VKI Customer Service:

Phone: 1-800-567-2951

Email: customer.service@vkiteh.com