

Electronics®

Eliminating ground-loop errors: page 58

Fast, precise a-d converters: page 69

Air isolation for IC diode arrays: page 75

April 29, 1968

\$1.00

A McGraw-Hill Publication

Below: In-flight checkout is made automatic, page 81

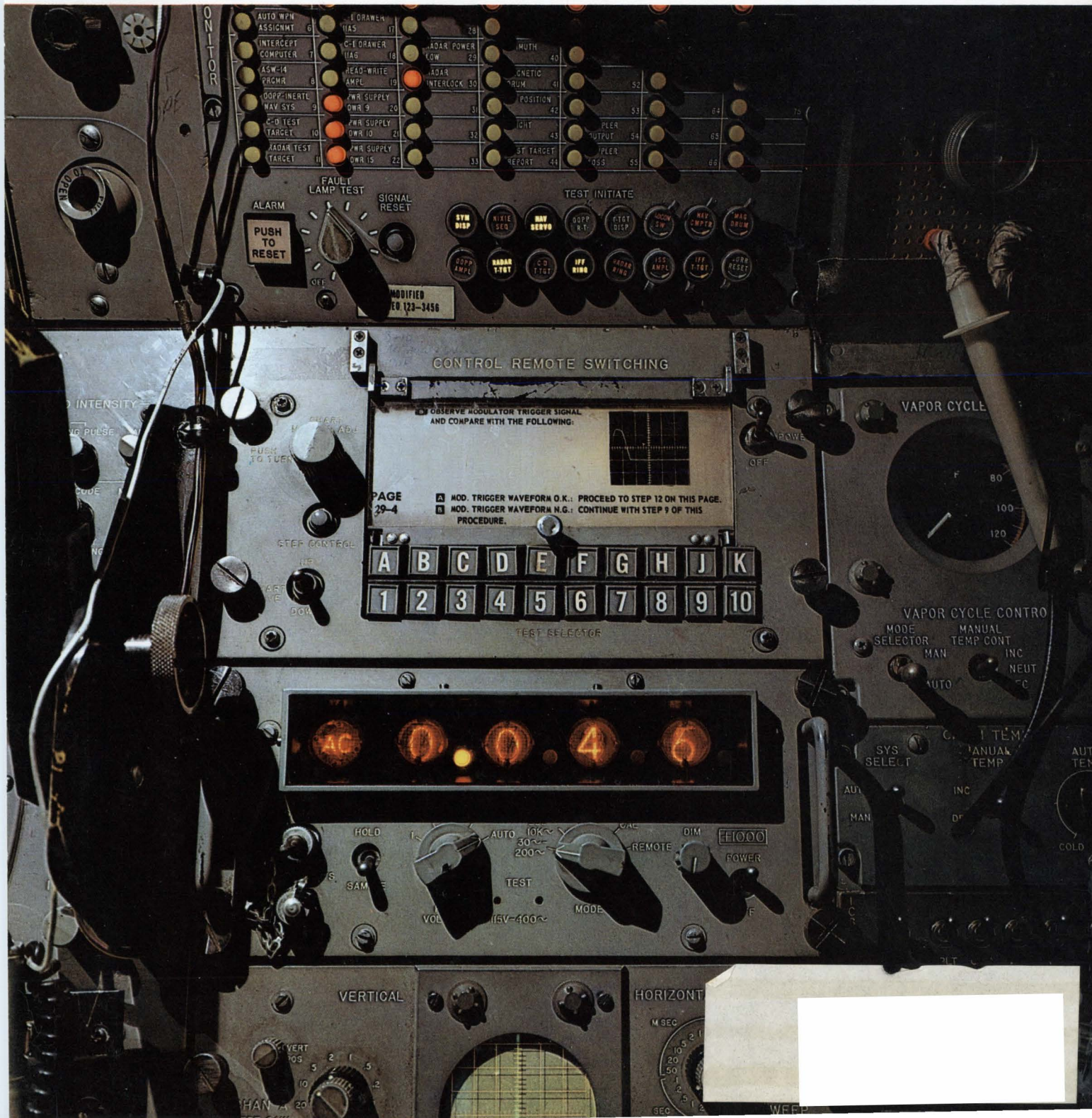



NEW "MS"™ LINE OF TOROIDAL INDUCTORS



- **ULTRAMINIATURE**
(Less than 1/4" high)
- **HIGH Q**
- **PRECISION ADJUSTED WITH EXCELLENT TEMPERATURE CHARACTERISTICS**

DESIGNED & SUCCESSFULLY TESTED TO COMPLETE MIL-T-27B ENVIRONMENTAL REQUIREMENTS

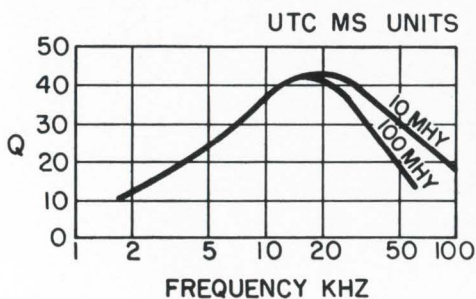

Stock Type No.	Ind. Mhy (0 DC)	ma DC Max.*	DCR Ω Max.
MS-1	1	60	1.4
MS-5	5	28	7
MS-10	10	20	11
MS-25	25	13	38
MS-50	50	9	75
MS-100	100	6	132

*The maDC shown is for approximately 5% drop in inductance.

The new "MS" toroidal high Q coils provide unique packaging flexibility: only .23" high x .35" diameter (conforms to TO-5 base and terminal dimensions) with solderable and weldable leads which make them ideal for hybrid Flat Pack and IC applications. These units have excellent Q in the 10 kHz to 50 kHz range and are designed for usage from 1 kHz to 100 kHz (see curve).

They are precision adjusted $\pm 2\%$ at 0.1V RMS at 1 kHz. Inductance variation is less than 2% from -55° to $+105^\circ$ C. MIL type TF5RX20ZZ.

Stock items shown are available for immediate delivery. Special values will be designed to your requirements.

Write for brochure
for complete data

UNITED® TRANSFORMER CO. TRW®
DIVISION OF TRW INC. • 150 VARICK STREET, NEW YORK, N. Y. 10013

What would you call this new Microwave instrument?



Our project engineer calls it a "microwave multimeter."
Our marketing people call it a "universal microwave test set."
Our catalog calls it the HP 8410A Network Analyzer.
You'll call it the answer to your measurement problems. Here's why—

First, "it" measures all these microwave parameters: gain/attenuation and phase shift, i.e., complete transmission coefficients; magnitude and angle of reflection coefficient with polar or Smith Chart plots of impedance/admittance. With "it," you can characterize active and passive components or systems at single or swept frequencies.

Second, "it" features all these advantages: broad frequency coverage from 110 MHz to 12.4 GHz; more than 60 dB dynamic range with less than ten milliwatts drive signal; swept frequency operation over octave bands with automatic tuning; high accuracy and resolution; unparalleled ease of operation.

"It" is actually a modular system: a signal-processing main-frame with choice of two readout plug-ins; a wideband RF

converter unit; a full-range transmission test unit; and two reflection test units for 0.11 to 12.4 GHz coverage.

Whatever you measure with "it," you can do the job more accurately, more completely, in less time, with less work and fewer pieces of equipment at lower cost than ever before. "It" is a designer's dream.

The modules for transmission measurements, 0.11 to 12.4 GHz, cost \$6450. Add the capability for polar and Smith Chart displays of reflection characteristics, 0.11 to 12.4 GHz, for \$3985.

Ask your HP field engineer how the 8410A "microwave multimeter, universal test set, network analyzer" can answer your problems. Or write Hewlett-Packard, Palo Alto, Calif. 94304; Europe: 54 Route des Acacias, Geneva.

HEWLETT  PACKARD

MICROWAVE NETWORK ANALYZERS

**Walco Electric bought
downtime insurance
by switching to
Westinghouse semiconductors.**

**With service expert
attached.**

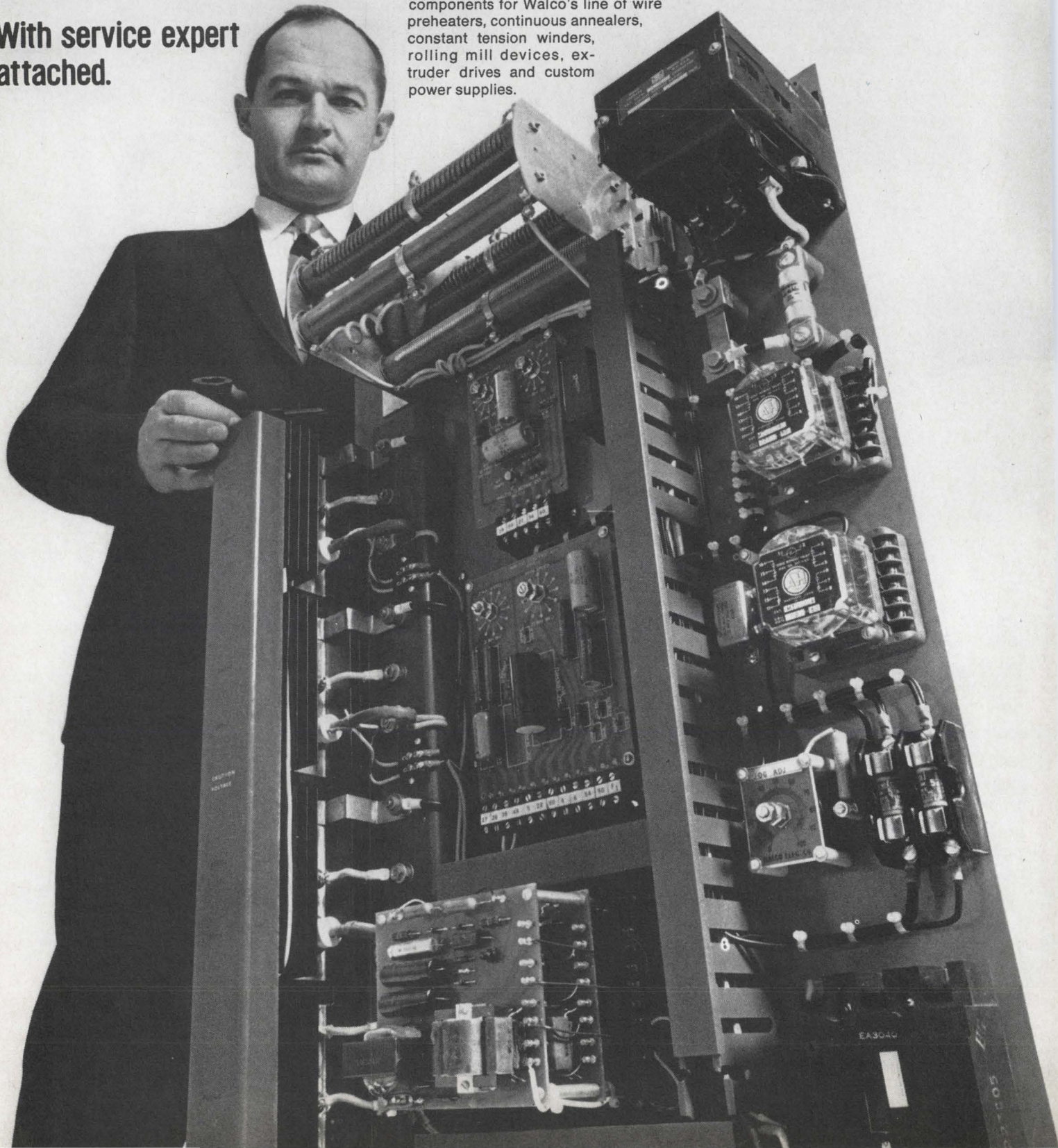

Walco Electric, Providence, R. I., made a startling improvement in the downtime savings they could promise customers. They switched to Westinghouse rectifiers and thyristors for increased reliability.

The application service expert who recommended this improvement was a Westinghouse Area Manager. As an applications specialist, his job is to help solve your toughest circuit problems—find ways to upgrade your product's performance, get around cost corners.

For instance, the Area Manager working with Walco's Chief Engineer helped eliminate costly downtime problems—by selecting the most reliable solid state components for Walco's line of wire preheaters, continuous annealers, constant tension winders, rolling mill devices, extruder drives and custom power supplies.

Switch to Westinghouse for this brand of service and semiconductor dependability. Big user or not, you'll get the same intensive action from a Westinghouse Area Manager. Call your local Westinghouse Sales Office or write Westinghouse, Semiconductor Division, Youngwood, Pa. 15697.

SC-2112

You can be sure... if it's
Westinghouse



News Features

Probing the News

- 93 Signal gains for electronic music
101 Second-source IC's on firm footing

Electronics Review

- 37 **Industrial electronics:** Impatt diodes in police radars
38 **Computers:** New GE computer man; Competition from MOS
39 **Consumer electronics:** Mini-microwave ovens
39 **Advanced technology:** New vidicon; Long-distance holography
40 **Medical electronics:** Preventing "crib death"
41 **Government:** FAA buying policy
44 **Avionics:** CAT detector
46 **Space electronics:** Luneberg lens
48 **For the Record**

Electronics Abroad

- 145 **Japan:** Sony's color tv tube has three cathodes; Nippon Electric readies high-gain IC i-f amplifier
147 **West Germany:** More automation for Germany's railroads; Everything's fine at the Hanover Fair
148 **Great Britain:** Instrument spots defects in steel tubing

New Products

- 109 **IC's poaching on op amp preserves**
115 **Components review**
115 Semiflexible cable turns the corner
119 **Instruments review**
119 Oscillator serves many functions
120 Place on panels sought for meters
123 **Microwave review**
123 Tiny tee in attenuator increases range
127 **Subassemblies review**
127 Three-wire design speeds up memory
131 **Semiconductors review**
131 FET reaches into gigahertz range
132 Optics aid pulse amplifier

Technical Articles

I. Design

- Design theory** 58 **Protecting data from the ground up**
Differential data amplifiers eliminate error voltages created by circulating ground currents
Robert I. Demrow, Analog Devices Inc.

- Circuit design** 64 **Designer's casebook**
▪ FET's resistance change trips heater control
▪ SCR helps video signal gate a-c power line
▪ P-i-n diodes turn on microwave bands faster

- Industrial electronics** 69 **Triple play speeds a-d conversion**
Three-ramp integration scheme makes conversions 85 times faster than dual-ramp circuits
H. Bent Aasnaes and Thomas J. Harrison
International Business Machines Corp.

II. Application

- Integrated electronics** 75 **Isolation problems get an airing**
New air-isolation technique for integrated circuits is set for large-scale production
Hal Clausen and Roger B. Rusert
Fairchild Semiconductor Corp.

- Avionics** 81 **Testing on the wing**
Automatic airborne checkout systems are needed to monitor performance of new aircraft in flight
Alfred Rosenblatt
Avionics and space editor

Departments

- | | | | |
|----|------------------------|-----|------------------------|
| 4 | Readers Comment | 51 | Washington Newsletter |
| 8 | People | 134 | New Books |
| 14 | Meetings | 136 | Technical Abstracts |
| 23 | Editorial Comment | 138 | New Literature |
| 25 | Electronics Newsletter | 143 | Newsletter from Abroad |

Electronics

Editor-in-Chief: Donald Christiansen

Associate managing editors

Technical: Stephen E. Scrupski

News: Robert Henkel

Copy: Sally Powell

Senior associate editors

Joseph Mittleman, Harry R. Karp

Department editors

Avionics & Space: Alfred Rosenblatt

Computers: Wallace B. Riley

Communications: William Buccì

Consumer electronics: John D. Drummond

Design theory: Joseph Mittleman

Industrial electronics: Harry R. Karp

Instrumentation: Carl Moskowitz

Military electronics: Richard Gundlach

Solid state: Mark B. Leeds

Regional bureaus

Domestic

Boston: James Brinton, manager

Los Angeles: Lawrence Curran, manager; Burton Bell

New York: Howard Wolff, manager

San Francisco: Walter Barney, manager; Peter Vogel

Washington: Robert Skole, manager; Paul Dickson

Foreign

Bonn: John Gosch

London: Michael Payne

Tokyo: Charles Cohen

Copy editors

James Chang, Frederick Corey, Larry Miller

Graphic design

Art director: Saul Sussman

Assistant art directors: Ann Mella, Valerie Betz

Production editor: Arthur C. Miller

Editorial secretaries: Claire Benell, Lynn Emery, Kay Fontana, Patricia Gardner, Lorraine Longo, Barbara Razulis, Frances Vacca

McGraw-Hill News Service

Director: Arthur L. Moore; Atlanta: Fran Ridgway; Chicago: Bruce Cross;

Cleveland: Arthur Zimmerman; Dallas: Marvin Reid;

Detroit: James Wargo; Houston: Robert E. Lee; Los Angeles: Michael Murphy

Pittsburgh: Louis Gomolak

San Francisco: William F. Arnold

Seattle: Ray Bloomberg; Washington: Charles Gardner, Daniel B. Moskowitz,

Herbert W. Cheshire, Seth Payne, Warren Burkett, William Small, William D. Hickman

McGraw-Hill World News Service

Bonn: Robert Dorang; Brussels: George Williamson; Hong Kong: Wes Perry;

London: John Shinn; Mexico City: Gerald Parkinson; Milan: Ronald Taggiasco, Jack Star;

Moscow: Howard Rausch; Paris: Robert E. Farrell, Peter Kilborn;

Rio de Janeiro: Leslie Warren; Tokyo: Marvin Petal

Reprints: Susan Nugent

Circulation: Milton Drake

Publisher: Gordon Jones

Electronics: April 29, 1968, Vol. 41, No. 9

Published every other Monday by McGraw-Hill, Inc. Founder: James H. McGraw 1860-1948.

Printed at 99 North Broadway, Albany, N.Y. 12207; second class postage paid at Albany, N.Y.

Executive, editorial, circulation and advertising addresses: McGraw-Hill Building, 330 W. 42nd Street New York, N.Y. 10036. Telephone (212) 971-3333. Teletype TWX N.Y. 710-581-4235. Cable address: MCGRAWHILL N.Y.

Subscriptions solicited only from those professionally engaged in electronics technology. Subscription rates: qualified subscribers in the United States and possessions and Canada, \$8.00 one year, \$12.00 two years, \$16.00 three years; all other countries \$25.00 one year. Non-qualified subscribers in the U.S. and possessions and Canada, \$25.00 one year; all other countries \$50.00. Air freight service to Japan \$50.00 one year. Single copies: United States and possessions and Canada, \$1.00; all other countries, \$1.75.

Officers of McGraw-Hill Publications: Joseph H. Allen, President; Bayard E. Sawyer, Executive Vice-President; J. Elton Tuohig, Senior Vice-President-Operations; Vice Presidents: John R. Callahan, Editorial, John M. Holden, Marketing; Paul F. Cowie, Circulation; Angelo R. Venezie, Production; Jerome D. Luntz, Planning & Development; Robert M. Wilhelmy, Controller.

Officers of the Corporation: Shelton Fisher, President and Chief Executive Officer; John L. McGraw, Chairman; L. K. Goodrich, Executive Vice President; Daniel F. Crowley, Donald C. McGraw, Jr., R.E. Slaughter, Senior Vice Presidents; John J. Cooke, Vice President and Secretary; Gordon W. McKinley, Vice President and Treasurer.

Title © registered in U.S. Patent Office; © Copyright 1968 by McGraw-Hill, Inc. All rights reserved. The contents of this publication may not be reproduced either in whole or in part without the consent of copyright owner.

Subscribers: The publisher, upon written request to our New York office from any subscriber, agrees to refund that part of the subscription price applying to copies not yet mailed. Please send change of address notices or complaints to Fulfillment Manager; subscription orders to Circulation Manager, Electronics at address below. Change of address notices should provide old as well as new address, including postal zip code number. If possible, attach address label from recent issue. Allow one month for change to become effective.

Postmaster: Please send form 3579 to Fulfillment Manager, Electronics, P.O. Box 430, Hightstown, New Jersey 08520

Readers Comment

Hardening isn't easy

To the Editor:

In our article "Skipping the hard part of radiation" [March 4, p. 122] it was intended that the information we presented be restricted initially to the task of selecting the most likely candidates for electronic components that would eventually be used in designing a hardened circuit. Although the technique described can be applied to predictions of circuit behavior, such predictions should by no means be considered as other than preliminary.

We make this point because we do not wish engineers to be misled into believing that we have set down the only requisite for hardening electronics in nuclear radiations.

Joseph T. Finnell
Fred W. Karpowich

Avco Corp.
Wilmington, Mass.

Receiver reinvented

To the Editor:

It looks as though my f-m receiver, using the wide band principle and a counter discriminator ["Mobile f-m broadcast receiver design," May, 1954, p. 130], is being reinvented. However, I hold U.S. Patent 3,018,371 on it.

During the 14 years since the article, my f-m receiver has reappeared, both here and abroad, in a number of guises and in papers that add nothing to my original work. For example, an article by Richard Sanguini [Electronics, May 16, 1966] corresponds to figure 5 of my article.

The most recent reinvention was described in February of this year in a paper delivered by L.L. Kossakowski of ITT Europe at the International Solid State Circuits Conference in Philadelphia. It is no more than what I indicated in figure 6 of my article.

The title I suggested, over a decade ago, was "A new f-m receiver free from multipath distortion." I still believe that title describes my work more accurately

New Bridge Design For Safe, Accurate, Easy Measurement of 'Lytic Capacitors

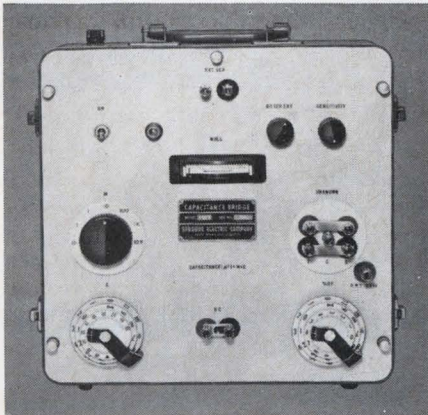

The Sprague Model 1W7 Capacitance Bridge introduces new, improved technical refinements as well as restyling for added attractiveness and ease of operation. Built by capacitor engineers for capacitor users, it incorporates the best features of bridges used for many years in Sprague laboratories and production facilities.

Precision Measurements over Entire Range from 0 to 120,000 μ F

The capacitance range of the 1W7 Bridge can be extended to 1.2F with an external standard capacitor. The internal generator is a line-driven frequency converter, and detection is obtained from an internal tuned transistor amplifier/null detector, whose sensitivity increases as the balance point is approached. It has provision for 2-terminal, 3-terminal, and 4-terminal capacitance measurements, which are essential for accurate measurement . . . $\pm(1 + D)\%$ + 10pF . . . of medium, low, and high capacitance values, respectively.

No Damage to Capacitors

The model 1W7 Capacitance Bridge will not cause degradation or failure in electrolytic or low-voltage ceramic capacitors during test, as is the case in many conventional bridges and test circuits. The 120 Hz a-c voltage, applied to capacitors under test from a built-in source, never exceeds 0.5 volt! It is usually unnecessary to apply d-c polarizing voltage to electrolytic capacitors because of this safe, low voltage.

Complete Specifications Available

For complete technical data on this precision instrument, write for Engineering Bulletin 90,011 to Technical Literature Service, Sprague Electric Co., 35 Marshall St., North Adams, Mass. 01247.

480-8116

Circle 510 on reader service card

New from Sprague!

**5 Times the Resistance of
a Conventional Metal-Film Resistor
of Equal Size!**

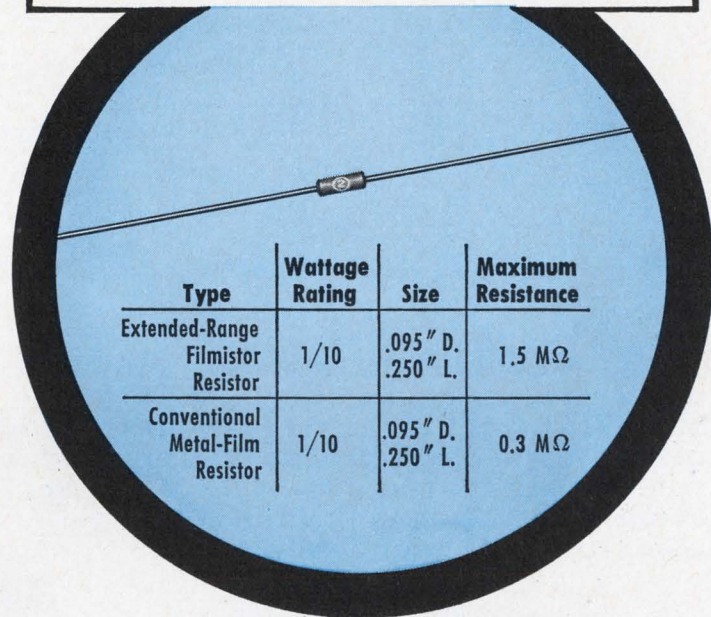

EXTENDED-RANGE FILMISTOR[®] METAL-FILM RESISTORS

**Substantial saving of space in all wattage ratings—
1/20, 1/10, 1/8, 1/4, 1/2, and 1 watt—with
absolutely NO SACRIFICE IN STABILITY!**

Extended-Range Filmistor Resistors now offer, in addition to accuracy . . . stability . . . reliability . . . resistance values in size reductions which were previously unobtainable. Size and weight advantages of Filmistor Resistors now make them ideal for applications in high-impedance circuits, field-effect transistor circuits, etc. Many designs which previously had to settle for the higher temperature coefficients of carbon-film resistors in order to obtain required resistance values can now utilize the low and controlled temperature coefficients of Filmistor Metal-Film Resistors.

Other key features are $\pm 1\%$ standard resistance tolerance, low inherent noise level, negligible voltage coefficient of resistance, and tough molded case for protection against mechanical damage and humidity.

For complete technical data, write for Engineering Bulletin 7025D to Technical Literature Service, Sprague Electric Co., 35 Marshall Street, North Adams, Massachusetts 01247.

SPRAGUE COMPONENTS

RESISTORS
CAPACITORS
TRANSISTORS
INTEGRATED CIRCUITS
THIN-FILM MICROCIRCUITS
INTERFERENCE FILTERS

48R-8139

PACKAGED COMPONENT ASSEMBLIES
FUNCTIONAL DIGITAL CIRCUITS
MAGNETIC COMPONENTS
PULSE TRANSFORMERS
CERAMIC-BASE PRINTED NETWORKS
PULSE-FORMING NETWORKS



[®]'Sprague' and '®' are registered trademarks of the Sprague Electric Co.

Circle 511 on reader service card

5

LF

MF

HF

VHF

UHF

SHF

First counters to operate automatically across the VHF gap.

Until now you couldn't make simple, automatic frequency measurements from 100 to 300 MHz without a special VHF plug-in. The extra plug-in was clumsy in the lab. And when switching plug-ins was impossible—as in automatic console systems—the VHF gap was unavoidable. Now two self-contained Systron-Donner counters span the VHF gap, operating automatically from DC to the microwave region.



Non-stop DC to 12.4 GHz. The VHF gap is filled by a built-in prescaler in this new Thin Line counter. The instrument operates just like a simple frequency counter across the board from DC to 12.4 GHz. You merely connect the signal and read the final answer on the display. Built with IC's to take only 1-3/4" of rack space and operable by remote control, it is the ideal instrument for automatic systems.



Non-stop DC to 3 GHz. New ACTO® plug-in with built-in prescaler carries this counter across the VHF gap to 3 GHz with fully-automatic operation. The new broadband plug-in can be replaced by others to raise the frequency range to 40 GHz, to measure very noisy signals, to measure FM and pulsed RF, to read time interval, etc. This is the best available wide-range laboratory counter—the root of a system that can accomplish nearly everything possible with counter instrumentation.

**...two more reasons
to check with
Systron-Donner
before you buy.**



Send for Catalog.

Circle 6 on reader service card

SYSTRON  DONNER

888 Galindo Street, Concord, California 94520.

than the title under which the article appeared.

Kerim Onder, M.A.
Fellow, IEE
Senior member, IEEE
New York City

The price isn't right

To the Editor:

The news item [March 4, p. 26] concerning a Post Office Department bid invitation for a new facer-canceler to replace Pitney-Bowes units now in use incorrectly quoted the unit price as \$24,000.

The last order for 107 machines was negotiated at \$16,500 each, delivered and installed.

F.S. Wardwell

Pitney-Bowes Inc.
Stamford
Conn.

▪ Electronics erred.

Revvng up

To the Editor:

In the article, "Motor gives reverse twist to the Intelsat 3 antenna," [April 1, p. 71] the authors say that they have conducted a survey of different motors for this task and have concluded "brushless d-c motors have a higher reliability, but they would need a complex, low-efficiency analog driving circuit to achieve the required beam pointing accuracy."

This seems to indicate that their survey was not complete. This quote would apply to an electronically commutated motor, but not to a scheme which uses inductive elements for the commutation. At Philco-Ford SRS division a despin drive has been developed which uses a brushless d-c motor. This unit is lighter, consumes less power, and the electronic control

unit is much less complex than the digital drive described in the article. Furthermore, the brushless d-c motor does not have the starting anomalies associated with a synchronous motor driven in a stepping mode.

Stephen H. Marx

Supervisor, Equipment Design
Philco-Ford Corp.
Palo Alto
Calif.

The authors reply:

We were aware, in our survey, of Philco's work on its d-c motor. However, we felt the stepper motor we selected satisfied our requirements better.

The d-c motor always operates at the peak point on the torque-speed curve. Any load change is then reflected as a speed change which the motor loop must correct for. In Sylvania's digital system, speed remains constant with load change but the antenna steps in phase to correct for the load disturbance.

Power consumption could be less for the d-c motor than for the stepper. But circuit drift with the d-c design becomes more of a problem. And while the Philco motor does not have the same starting anomalies as the stepper, it has another set of design considerations. It must operate first in a speed control mode, then switch over to a position mode. The complexity of the controlling circuitry could be comparable to Sylvania's starting circuitry.

Francis E. Donnelly Jr.

Reynold P. Graunas

John D. Killian

Sylvania Electric Systems
Waltham
Mass.

Application For

FET SWITCHES

PROBLEM: Use one flat pack to switch two ± 10 V signals . . . and drive with 5 V logic.

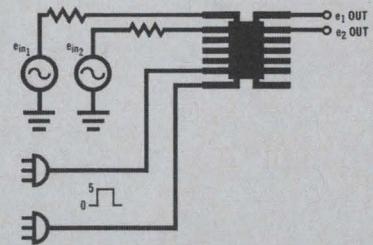

REQUIRED: Two switching channels completely contained in one package . . . Delay less than $1 \mu\text{S}$. . . Inverting logic (logic low — switch OFF) . . . -55°C to $+125^\circ\text{C}$ operation.

GIVEN

- $e_{in} \pm 10$ V.
- DTL logic — output swing is 5 V.
- Available power supplies: +5 V, +10 V, -20 V.

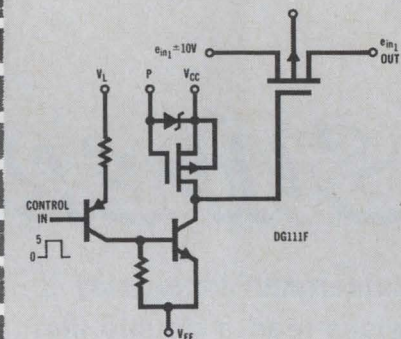

SOLUTION: Siliconix DG111F - Both channels complete in one package, MOS FET switch and bipolar driver . . . no other parts needed. Connect DTL output to driver input, ground "R", V_{CC} to +10, P and V_{EE} to -20, apply e_{in} to source and drain is output.

Tight packaging your hang up? Contact us for applications assistance or write for our free FET Switch and Driver Data Packet.



Siliconix incorporated

1140 W. Evelyn Ave. • Sunnyvale, CA 94086
Phone (408) 245-1000 • TWX: 910-339-9216

SUBSCRIPTION SERVICE

Please include an Electronics Magazine address label to insure prompt service whenever you write us about your subscription.

Mail to: Fulfillment Manager
Electronics
P.O. Box 430
Hightstown, N.J. 08520

To subscribe mail this form with your payment and check new subscription renew my present subscription

Subscription rates: qualified subscribers in the U.S.: 1 year \$8; two years, \$12; three years, \$16. Non-qualified: 1 year \$25. Subscription rates for foreign countries available on request.

CHANGE OF ADDRESS

ATTACH LABEL HERE If you are moving, please let us know five weeks before changing your address. Place magazine address label here, print your new address below.

name _____

address _____

city _____

state _____

zip code _____

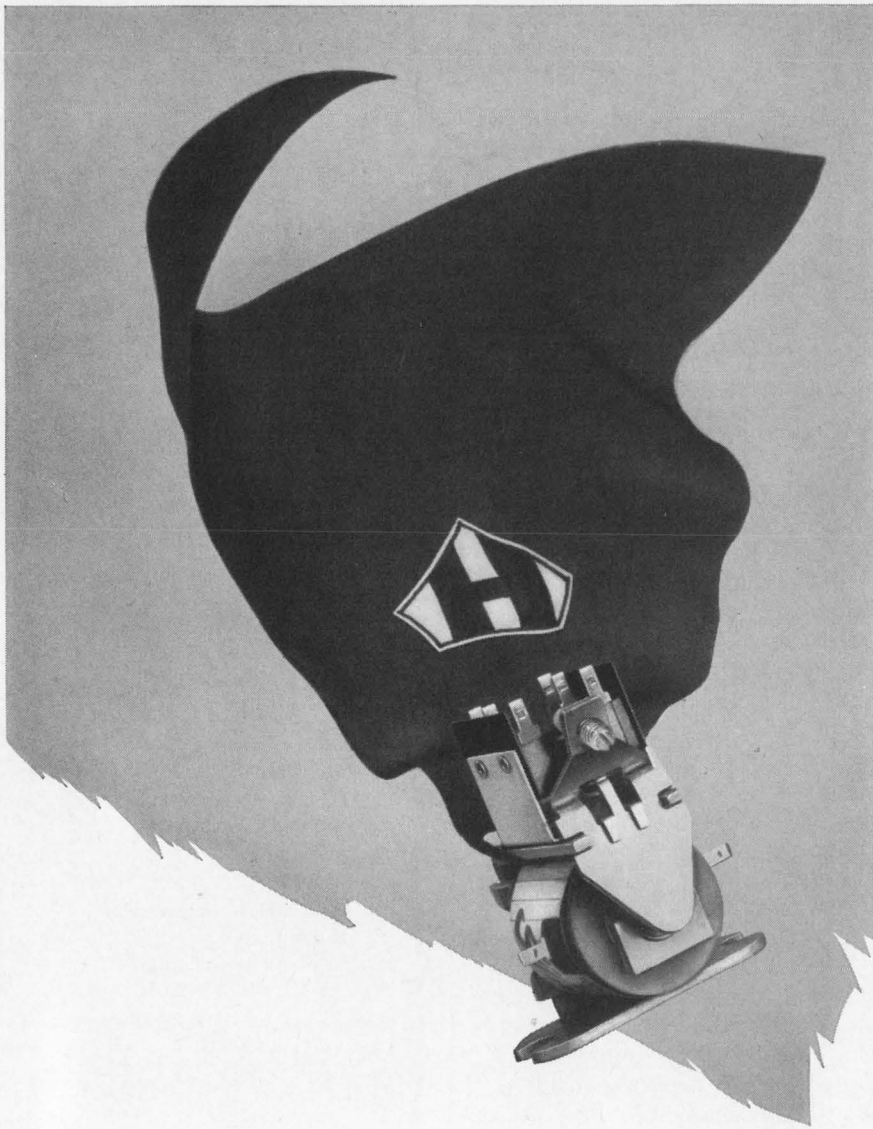

SUPER RELAY!

Heinemann time-delay relays lead a double life.

Most time-delay relays give you a pause for your money. And that's it. Our hydraulic-magnetic time-delay relays go a good bit further. They can double as their own load relays.

This is possible because the relays have continuous-duty coils. They can remain energized indefinitely after actuation. If you can get by with a contact capacity of up to 5 amps (125vac, resistive) you can have a simpler, less expensive product to put on the market.

There are some other advantages worth noting. Non-thermal actuation, for one. It avoids the problem of heat-loading effect

when you have frequent recycling. It also minimizes ambient temperature complications. Recycling time is shorter, too; it can be as brief as 15% of the specified delay period.

We offer a diversity of models, ranging from open frame to hermetically sealed, for AC or DC operation. Switching can be either SPDT or DPDT. Delays: 0.25 to 120 seconds.

Our Bulletin 5006 will give you full data. Drop us a line and we'll put a copy in the mail. Heinemann Electric Company, 2600 Brunswick Pike, Trenton, N.J. 08602.



HEINEMANN

4018

People

Until a few years ago, ships were designed piecemeal; space for the electronics equipment was near the bottom of a long list of priorities. The Navy is changing that; projects under consideration now undergo the same kind of systems approach as space projects.



Roderick

It's hardly surprising, then, that Litton Industries Inc. turned to a man with spacecraft experience when it needed a new president for its Advanced Marine Technology division. It chose Robert L. Roderick, 43, who has been manager of Hughes Aircraft Co.'s Surveyor project.

The division that Roderick heads works closely with another Litton division, Ingalls Shipbuilding, which is constructing a new yard in Mississippi. "Our function," explains Roderick, "is to get marine contracts, perform the systems engineering, and then turn the design over to Ingalls."

Whole package. Roderick has his hands full with new business. Litton won the contract-definition phase for the Navy's fast-deployment logistics ship, only to see the program cut from the fiscal 1968 defense budget. The fiscal 1969 request, however, contains \$186 million for four of the ships.

Litton was also one of three winners in the contract-definition phase for the Navy's landing helicopter assault ship, and it's competing for a development and production contract. And the Advanced Marine Technology division will submit by April 30 its bid for the contract-definition phase for the Navy's new destroyer, designated dx.

Roderick, noting the broad transfer of his systems management experience from Surveyor to his new job, says, "This is valuable, especially in the dx competition, because of its high electronics content. There are 250 tons of electronic hardware in the dx."

The list includes sonars, air-defense missiles, tracking and search

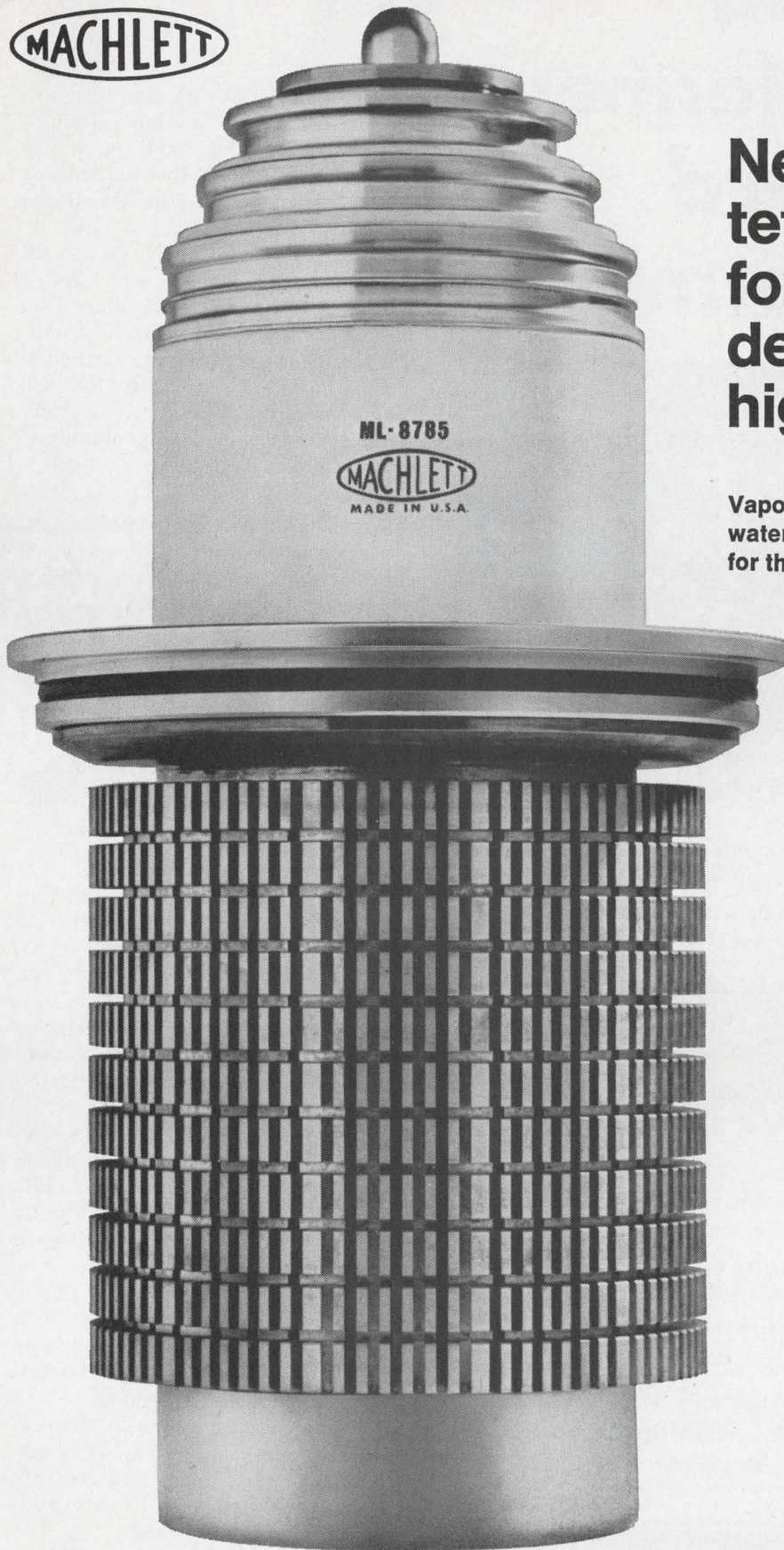

New Machlett tetrode... for single tube design at high power levels

Vapor-cooled ML-8785 (or ML-8786, water-cooled) is particularly suitable for these applications:

High Power Communications

Class C Telegraphy...to
350 kW

Linear RF Power Amplification

Class AB—Suppressed Carrier Service
to 260 kW PEP

Pulse Modulation or Amplification

40 kv	DC Plate Voltage
50 kv	Peak Plate Voltage
500 a	Pulse Cathode Current
1000 μ s	Pulse Duration
.01	Duty
Pulse Power to 15 Mw	

Write today for details on these versatile "single-tube-design" tetrodes. The Machlett Laboratories, Inc., 1063 Hope Street, Stamford, Conn. 06907.



THE MACHLETT LABORATORIES, INC.

A SUBSIDIARY OF RAYTHEON COMPANY

Your custom pulse transformer is a standard DST* transformer

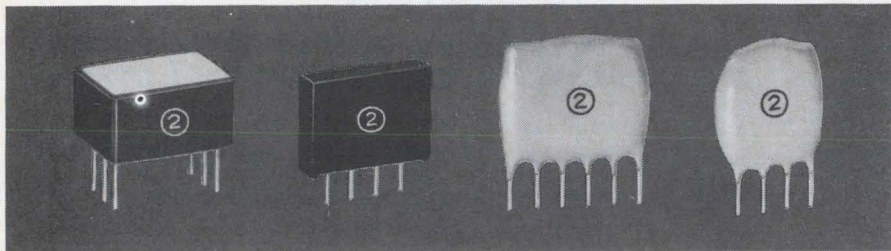

Some of the case styles in which Sprague DST Pulse Transformers are available. Note the in-line leads.

You can select the transformer design you need from the new Sprague DST Family, a fully-characterized series of Designer Specified Transformers which Sprague Electric has pioneered. It's easy. Start with the two basic parameters dictated by your circuit requirements: primary (magnetizing) inductance and volt-second capacity.

New Sprague engineering data gives basic information from which all nominal sine wave parameters are derived. This data allows you to specify the one transformer from thousands of possibilities which will optimize performance in your application.

Design Style A minimizes magnetizing inductance change as a function of temperature. Typically it's $< \pm 10\%$ change from 0 to 60 C; $< \pm 30\%$ from -55 to $+85$ C.

Design Style B and C give you broad bandpass characteristics, and still keep magnetizing inductance change $< \pm 15\%$ from 0 to 60 C.

Design Style D is *fast*. Associated leakage inductance and coupling capacitance are kept at a minimum. This style is just what you need for interstage and coupling devices in computer drive circuits.

The Sprague DST Series packs a lot of transformer into minimum volume packages — epoxy dipped for minimum cost, or pre-molded. The 100 mil in-line lead spacing is compatible with integrated circuit mounting dimensions on printed wiring boards.

To solve your pulse transformer design, start now. Write for Engineering Bulletin 40,350 to the Technical Literature Service, Sprague Electric Company, 35 Marshall St., North Adams, Mass. 01247.

*Trademark

SPRAGUE COMPONENTS

PULSE TRANSFORMERS
CAPACITORS
TRANSISTORS
RESISTORS
THIN-FILM MICROCIRCUITS
INTEGRATED CIRCUITS

INTERFERENCE FILTERS
PACKAGED COMPONENT ASSEMBLIES
FUNCTIONAL DIGITAL CIRCUITS
MAGNETIC COMPONENTS
CERAMIC-BASE PRINTED NETWORKS
PULSE-FORMING NETWORKS



Sprague® and "®" are registered trademarks of the Sprague Electric Co.

455C-8122

People

radars, and antisubmarine missiles. "These are all developed items," Roderick explains, "and our job is to pull them all together in the most effective way. We will design the command-and-control system."

Roderick says the Navy is sold on the systems approach, "and I think someone from the aerospace industry is likely to come up with a more imaginative approach than a marine designer, because the idea of going about it as a whole package—engineering and economics—is so new to the marine business."

Motorola thinks its European semiconductor operations have grown up enough to get along without direct supervision by the parent company. "We're ready to cut the cord," says C. Lester Hogan, vice president and general manager of the Semiconductor Products division.



Scalise

Hogan is turning over direction of all European production and marketing to George M. Scalise, 33, who'll work out of Geneva at first. Backing this move to give European operations more autonomy will be a 60,000-square-foot plant in Toulouse, France, to be dedicated May 1.

Start-up in June. Scalise says the plant will start assembling silicon transistors and integrated circuits in June. He expects full production—from diffusion to final testing—in 12 to 18 months.

"Our customers will be mainly in the computer and consumer business, and we'll be making the same kind of packages made in Phoenix, including plastics," he says.

Toulouse was chosen as the production site because the University of Toulouse is there and the city is the third largest in France, so it offers a good labor pool.

Scalise, who'll report to Hogan, has held several posts associated with IC production since joining Motorola in 1962. He was manager of manufacturing support operations in Phoenix.



For the short haul, why tie up capital in test instruments?

It Makes More Sense to Rent What You Need from Electro Rents.

Say you've got a "one shot" test or a peak load problem. We can supply whatever test equipment you need — in calibration, ready to plug in — and deliver inside of 24 hours.

No red tape, no maintenance problems, no project hold-ups, no capital expense. No wonder engineers all over the country cite Electro Rents as their one reliable source for the electronic test equipment they need *now* but not for keeps.

Make sense to you? Make a note to call, write or wire for our brochure.

LOS ANGELES (Main Office and Laboratories)
4131 Vanowen Place, Burbank, Calif. 91504 • Phone: (213) 843-3131
Other locations in San Francisco, San Diego, Phoenix and Dallas.

Electro Rents

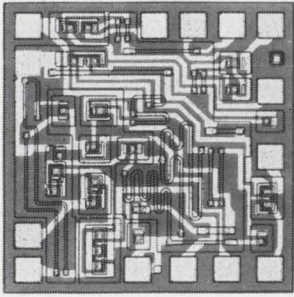

**One name
keeps cropping up
as a source for
integrated circuits—
regardless of the
type you are ordering.**

**Your
purchasing agent
can tell you who.**

MOTOROLA SEMICONDUCTOR PRODUCTS INC.

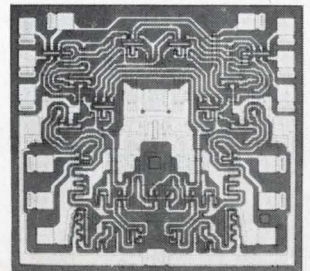

PROTOTYPES

We'll ship them immediately—toroids and oscillators* right out of stock—at far below competitive prices.

At Allen Electronics Division, we manufacture these, and other components, in quantity for the world's finest electronic organs. So we constantly maintain a complete stock of high quality frequency sources, and over 150 sizes of toroids. We'll send you the few you need to start your idea; the many you'll need to produce it.

All Allen components are made under the most rigid quality controls, including thorough inspection and testing, at one of the most modern and efficient plants in the country.

Send for complete information on the "Prototypes". Then, when you have an application that requires quality components immediately, at no-penalty prices, you'll know where to get them. Pronto.

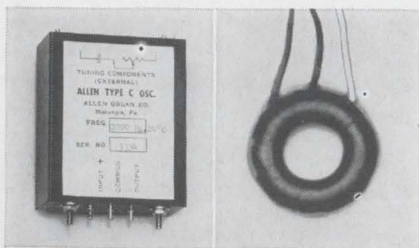

Type C Oscillator
Range: 15 Hz to
10 kHz

Use: Designed for applications having moderate requirements for stability in respect to temperature and frequency drift.

Toroids
Over 150 sizes available from stock include Permalloy, Ferrite and Powdered iron types. Some no-center-tap. Inductance tolerance $\pm 2\%$.

*Allow several extra days for packaging.

ALLEN electronics division

Allen ORGAN COMPANY Dept. E 468
Macungie, Pa. 18062

Meetings

Quantum talks will focus on theory

There'll be a shift in emphasis at this year's International Quantum Electronics Conference in Miami, May 14 to 17. Attention will focus more on the theoretical areas, such as nonlinear optics, although there will still be a number of papers on lasers. The change stems from the establishment, last year, of a Conference on Laser Applications and Engineering.

In one session, two research teams working independently will report on methods for calculating with reasonable accuracy nonlinearities in crystals. Their work should aid in the search for materials that interact better with light. One of the papers, by Sudhanshu S. Jha and Nicolaas Bloembergen, both of Harvard University's engineering and applied physics department, will discuss quantitative results from the standpoint of Miller's indexes of crystallography. The other paper, by J. Ducuing and C. Flytzanis of the Institute d'Optique in Orsay, France, will deal with the magnitude of different nonlinearities, presenting experimental data for both har-

monic generation and frequency mixing.

Light tuning. Five engineers from the Bell Telephone Laboratories, R. G. Smith, Joseph E. Geusic, Hyman J. Levinstein, Shobha Singh, and Le Grand Van Uitert, will contribute a paper on their work with continuously pumped optical parametric oscillators, work that makes it possible to tune coherent light through the visible spectrum down through the infrared [Electronics, April 15, p. 52].

Another paper on lasers covers work by F. E. Goodwin and T. A. Nussmeier, engineers from Hughes Aircraft Co. Their report will describe the development of a carbon dioxide laser system that beams a tv signal 18 miles [Electronics, April 15, p. 54].

Ali Javan, a physics professor at the Massachusetts Institute of Technology, will discuss phase-locking lasers to lower frequency sources to stabilize absolute frequency measurements in the far infrared.

For more information write R.W. Terhune, Ford Motor Co. Research Laboratories, Dearborn, Mich. 48121

Calendar

Symposium and Equipment Show, American Vacuum Society; Grand Hotel, Anaheim, Calif., **May 1-3.**

Human Factors in Electronics Symposium, IEEE; Marriott Twin Bridges Motor Hotel, Washington, **May 6-7.**

Aerospace Electronics Conference, IEEE; Sheraton-Dayton Hotel, Dayton, Ohio, **May 6-8.**

National Conference on Aerospace Meteorology, American Institute of Aeronautics and Astronautics; New Orleans, **May 6-9.**

Technical Conference and Exhibit, American Society for Quality Control; Sheraton Hotel, Philadelphia, **May 6-8.**

Appliance Technical Conference, IEEE; Columbus-Plaza Sheraton Hotel, Columbus, Ohio, **May 7-8.**

Industry and Communications Power System and Air Conditioning Joint Technical Conference, IEEE; St. Louis Gateway Hotel, St. Louis, Mo., **May 7-10.**

International Technical Communications Conference, Society of Technical Writers and Publishers; International Hotel, International Airport, Los Angeles, **May 8-11.**

Electronic Components Conference, IEEE and Electronic Industries Association; Marriott Twin Bridges Motor Hotel, Washington, **May 8-10.**

Electronic Components Technical Conference, IEEE; Everglades Hotel, Marriott Twin Bridges Motor Hotel, Washington, **May 8-10.**

International Quantum Electronics Conference, IEEE and American Institute of Physics; Everglades Hotel, Miami, Fla., **May 14-17.**

Pattern Recognition: the Retina and the Machine; University of Manitoba, Winnipeg, Canada, **May 15-17.**

(Continued on p. 16)

The CONNECTOR Thing

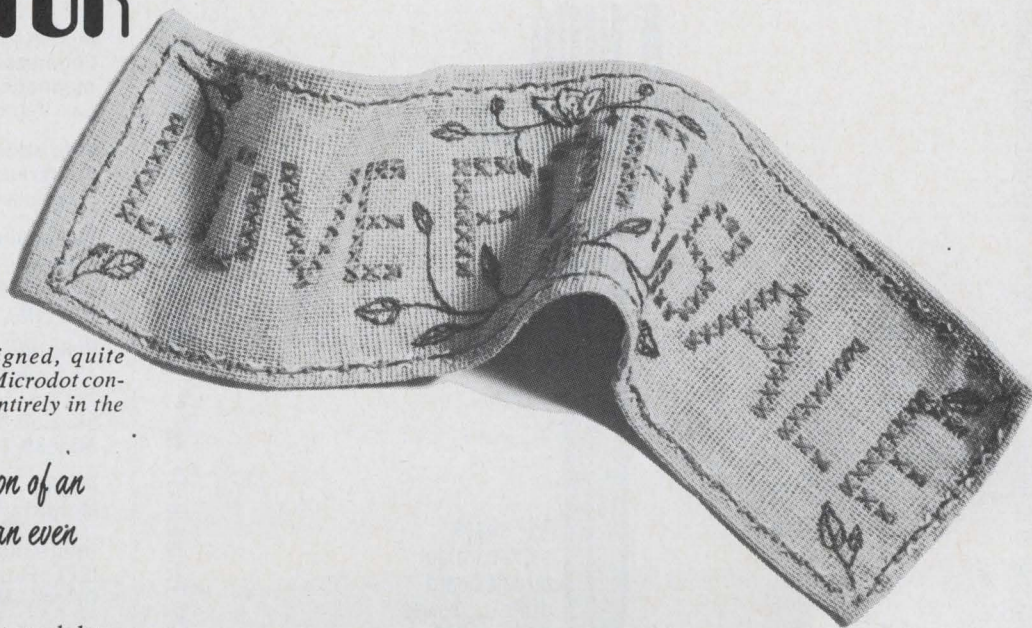

A periodical periodical designed, quite frankly, to further the sales of Microdot connectors and cables. Published entirely in the interests of profit.

Announcing the interruption of an important commercial for an even importanter one.

Our cage door was rattled last week by a harassed engineer type who was sprouting cables and connectors and holding a large sampler that was sloppily stitched with

LOVE FOR SALE

We quoted him section 404.5 of the penal code just to be on the safe side, and invited him in.

He said he was from the cable assembly department. And we said whose? And he said Microdot's. And we said Hmmm. And he said there's a lot of people that don't think of Microdot as a cable assembly house and he'd like to do something about it like write an ad.

So we said fine, what would it be about and he brought out a fat stack of papers and said here, and we said forget it, but if you could tell it to us like it is in about twenty seconds we'd tape it. So he did. And we were so impressed, we thought we'd play it back to you. It's darned interesting. Ready? (And remember, he's not a professional and he talks fast, but we think the points came across.)

TAKE ONE — LOVE FOR SALE — SIDE ONE

"Not enough people have thought of Microdot as being in the cable assembly business. But we are, because we make cables and connectors. We're also very experienced in cable assemblies.

"And we'll assemble all sorts of funny combinations. Our cables, somebody else's connectors. Some of our connectors with someone else's. Mix and match!"

We turned off the recorder. "You mean we'll assemble competitive stuff?"

"Sure."

"Does the Pres know?"

"Sure."

"Okay?"

TAKE TWO — LOVE FOR SALE — SIDE ONE

"Where was I. Oh, I was saying

MICRODOT IS IN THE CABLE ASSEMBLY BUSINESS AND AT CUT RATE PRICES.

The idea is we can assemble cables for a lot less than people who try to do it themselves because we know what we're doing.

There are no set-up charges. And we'll even make up one assembly. And we can really save people a lot of money if they use our connectors.

"Another thing, people not only save money, but they can be sure their assemblies will be right. We figure why should they take a chance on their learning curve and build, say thirty assemblies, and have ten maybe turn out not so hot? Our way you order thirty, you get thirty that work!"

"You're running out of time."

"Okay. Real quick. Hey out there. Why buy connectors one place, cable another, and assembly in a third? The cost in

paper work alone would drive your comptroller grayish. With us it's one P.O. One big savings. We've cut costs on cable assemblies not the performance just the cost. How's that?"

END OF TAPE

"Okay," we said, "but you didn't explain the Love for Sale bit. It was a sneaky way to get us interested in your pitch."

"Oh, it truly is love for sale. We love our work."

A guy with dedicated humor that crumbly can't be all bad. We told him we'd see what we could do about spreading the word. So, to test if anyone is interested in low cost cable assemblies, we're running this microminiaturized RFQ. The whole idea seems to be worthy. If you agree, write in. We'll respond immediately.



MICRODOT INC.

MICROMIN RFQ FOR FAST FAST ACTION.

To Microdot Inc., 220 Pasadena Ave., So. Pasadena, Calif. 91030

Dear Pricers:

Please accept this abbreviated form as a gauntlet flung at you as a challenge, challenging your low, low assembly price claim.

Job to quote on, attached.

We have something in mind. You should get in touch.

Name _____

Company _____

Title _____ Phone _____

Address _____

City _____

State _____ Zip _____



We have impedance measuring down to a SYSTEM

Automatic impedance-measuring systems are here! Start with a GR automatic capacitance bridge or an automatic impedance comparator and you're on your way to making measurements in half a second or less at 0.1% accuracy or better.

- Add a scanner to connect components automatically.
 - Add a printer to give you a permanent record of output data.
 - Add a recorder to plot curves for you.
 - Add a component handler to feed and to sort components automatically.
 - Add an on-line computer to perform calculations, to direct the measurement process, or even to type a report.
- Scan, measure, compare, sort, compute, record — systems perform these functions faster, more accurately, and more economically. Choose from standard system components, or let us custom-design a system for you.

For complete information, write General Radio Company, W. Concord, Massachusetts 01781; telephone (617) 369-4400. In Europe, write Postfach 124, CH8034 Zurich 34, Switzerland.

GENERAL RADIO

Circle 17 on reader service card



The Kokomoans' power

Thanks to our Delco distributors. They stand ready to deliver power fast. From 32 offices all over the country, with one near you. Each distributor is hand-picked for his organization, experience and ability to provide quality service. So he can give you what you need in power semiconductors: silicon or germanium power transistors; silicon power rectifiers and diodes. Anything in the Delco line. If you're still in the design stage, he's got up-to-date specs, prices and applications information. And sample quantities* when you need them. Just give him a call. He'll show you why the Kokomoans are in power.

**From 1 to 4,999 pieces.*



MARK OF EXCELLENCE

DELCO RADIO
DIVISION OF GENERAL MOTORS
KOKOMO, INDIANA

Kokomoans' Regional Headquarters

Union, New Jersey* 07083 Box 1018 Chestnut Station (201) 687-3770	Syracuse, New York 13203 1054 James Street (315) 472-2668	Detroit, Michigan 48202 57 Harper Avenue (313) 873-6560
Chicago, Illinois* 60656 5151 N. Harlem Avenue (312) 775-5411	Santa Monica, Calif.* 90401 726 Santa Monica Blvd. (213) 870-8807	Kokomo, Ind. 46901 700 E. Firmin (317) 459-2175 Home Office

*Office includes field lab and resident engineer for application assistance.

is everywhere.

IN THE EAST

BALTIMORE, MD. 21201
Radio Electric Service Co.
5 North Howard Street
(301)-539-3835

BINGHAMTON, N.Y. 13902
Federal Electronics, Inc.
P. O. Box 1208
(607)-748-8211

CLIFTON, N.J. 07015
Eastern Radio Corporation
312 Clifton Avenue
(201)-471-6600

NEWTON, MASS. 02195
The Greene Shaw Co., Inc.
341-347 Watertown St.
(617)-969-8900

NEW YORK, NEW YORK 10036
Harvey Radio Co., Inc.
2 West 45th St.
(212)-582-2590

PHILADELPHIA, PENN. 19123
Almo Industrial Electronics, Inc.
412 North 6th Street
(215)-922-5918

PITTSBURGH, PENN. 15206
Radio Parts Company, Inc.
6401 Penn Ave.
(412)-361-4600

WOODBURY, L.I., N.Y. 11797
Harvey Radio Company, Inc.
60 Crossways Park West
(516)-921-8700

IN THE SOUTH

BIRMINGHAM, ALA. 35233
Forbes Distributing Company, Inc.
1416 Fourth Ave., South
(205)-251-4104

MIAMI, FLORIDA 33142
Mountain Electronics
Division of Mountain National Co.
3730 Northwest 36th St.
(305)-634-4556

RICHMOND, VA. 23220
Meridian Electronics, Inc.
1001 West Broad Street
(703)-353-6648

WEST PALM BEACH, FLA. 33402
Mountain Electronics
Division of Mountain National Co.
1000 N. Dixie Highway
(305)-833-5701

IN THE MIDWEST

CINCINNATI, OHIO 45237
United Radio, Inc.
7713 Reinhold Drive
(513)-761-4030

CLEVELAND, OHIO 44125
The W. M. Pattison Supply Co.
Industrial Electronics Division
4550 Willow Parkway
(216)-441-3000

INDIANAPOLIS, IND. 46225
Graham Electronics Supply, Inc.
122 South Senate Avenue
(317)-634-8486

KALAMAZOO, MICH. 49005
Electronic Supply Corp.
P. O. Box 831
(616)-381-4626

KANSAS CITY, MO. 64111
Walters Radio Supply, Inc.
3635 Main Street
(816)-531-7015

MINNEAPOLIS, MINNESOTA 55401
Stark Electronics Supply Co.
112 3rd Ave., North
(612)-332-1325

SKOKIE, ILL. 60076
Merquip Electronics, Inc.
7701 N. Austin Ave.
(312)-282-5400

ST. LOUIS, MO. 63144
Electronic Components for Industry Co.
2605 South Hanley Road
(314)-647-5505

IN THE WEST

ALBUQUERQUE, N. M. 87103
Sterling Electronics, Inc.
1712 Lomas Blvd., N. E.
(505)-247-2486

DALLAS, TEXAS 75201
Adleta Electronics Company
1907 McKinney Ave.
(214)-742-8257

DENVER, COLO. 80219
L. B. Walker Radio Company
300 Bryant Street
(303)-935-2406

HOUSTON, TEXAS 77001
Harrison Equipment Co., Inc.
1422 San Jacinto Street
(713)-224-9131

LOS ANGELES, CAL. 90015
Radio Products Sales, Inc.
1501 South Hill Street
(213)-748-1271

LOS ANGELES, CAL. 90022
Kierulff Electronics, Inc.
2585 Commerce Way
(213)-685-5511

OKLAHOMA CITY, OKLAHOMA 73102
Radio, Inc.
903 North Hudson
(405)-235-1551

PALO ALTO, CAL. 94303
Kierulff Electronics, Inc.
3969 East Bayshore Road
(415)-968-6292

PHOENIX, ARIZ. 85005
Sterling Electronics, Inc.
1930 North 22nd Ave.
(602)-258-4531

SAN DIEGO, CAL. 92101
Milo of California, Inc.
2060 India Street, Box 2710
(714)-232-8951

SEATTLE, WASH. 98108
Kierulff Electronics, Inc.
5940 6th Ave., South
(206)-763-1550

TACOMA, WASH. 98402
C & G Electronics Company
2502 Jefferson Ave.
(206)-272-3181

TULSA, OKLAHOMA 74119
Radio, Inc.
1000 South Main Street
(918)-587-9124

IN CANADA

SCARBOROUGH, ONTARIO
Lake Engineering Co., Ltd.
123 Manville Rd.
(416)-751-5980





Announce the Completion of an INTERNATIONAL TECHNOLOGICAL AND COMMERCIAL SURVEY ON INTEGRATED CIRCUITS (Microelectronics)

Purpose of the Survey

This survey is intended to provide expert advice on a number of important decisions facing managements, which are more difficult to make than the judgements required about five years ago on changing from electronic tubes to transistors. The latter only involved replacing one active component by another, whereas the use of microelectronics, of whatever type, means replacing entire elementary circuits with "circuit blocks".

At this critical stage of development, reliable up-to-date information and assessments are required, on a whole series of questions, for the right technical and commercial decisions to be made by the managements, chief engineers and circuit designers of the large number of industries involved, including: Computers, Calculators, Telecommunications, Electrical Power Control, Scientific and Industrial Measuring and Testing Instruments, Industrial Controls, Remote Signals and Control, Television, Radio, Dictating Machines, Signal Equipment, Nuclear Measurement and Controls, etc.

Proposal

International Technical Surveys, Inc. (I.T.S.), Geneva, an independent international organization specializing in carrying out multi-client surveys on advanced techniques, has organized this study for their clients. Past surveys, at early stages in their development, have dealt with (a) Fuel Cells, (b) Thermo-electricity, (c) Magnetohydrodynamic Power Conversion, (d) Thermionic Power Conversion, (e) Semiconductors, etc...

Terms and Conditions

As with previous surveys, the final report will be available only to subscribers. It will not be published, and obtainable only by clients agreeing to the conditions contained in the acceptance form.

Scope of the Survey

The scope of the survey, carried out by a team of international experts, will provide up-to-date information, assessments and guidance on the following questions:

- | | |
|---|--|
| 1) Microelectronics or integrated electronics? | 11e) Connectors. |
| 2) Why integrated electronics? | 11f) Displays. |
| 3) Linear vs digital circuits; is there a place for both? | 12) The applications of integrated electronics. |
| 4) Hybrids vs monolithics; advantages and drawbacks. | 12a) Counting, pulsing and memory circuits. |
| 4a) Thick-film circuits. | 12b) Logic. |
| 4b) Thin-film circuits. | 12c) Linear circuits. |
| 4c) Components for thin- and thick-film circuits. | 13) Integrated electronics in computers. |
| 4d) Monolithics. | 14) Integrated electronics and power circuits. |
| 5) Digital integrated circuits: RTL, DTL, E2CL or TTL? | 15) Integrated electronics in communications and tele-
metry. |
| 6) Design and manufacturing problems using inte-
grated electronics. | 16) Integrated electronics and consumer products. |
| 7) Is "make or buy" the real alternative? | 17) Integrated electronics in industrial control. |
| 8) Large-scale integration: when, what and by whom? | 18) Other applications of integrated electronics. |
| 9) The economics of integrated electronics. | 19) The testing of integrated electronics. |
| 10) The reliability of integrated electronics. | 20) Price developments of integrated electronics. |
| 11) The impact of integrated electronics on discrete
components markets. | 20a) Examples of integrated circuits. |
| 11a) Discrete semiconductors. | 20b) The price/cost confusion. |
| 11b) Resistors and capacitors. | 20c) What quantity discounts to expect? |
| 11c) Potentiometers, switches, selectors. | 21) Market data and forecasts. |
| 11d) Relays. | 22) The top world suppliers of integrated electronics. |
| | 23) Conclusions and recommendations. |

INTERNATIONAL TECHNOLOGICAL AND COMMERCIAL SURVEY ON INTEGRATED CIRCUITS (Microelectronics)

For acceptance or more information, please fill in coupon, clip and mail without delay.

It is understood that:

- a) the final report is of a private nature for use within subscribers' own organization or associated companies,
- b) the final report will not be disseminated publicly,
- c) the final report will be made available by I.T.S. only to subscribers accepting the above conditions.

- We agree to subscribe to the above survey for a total fee of US \$400.— (or equivalent in local currency) payable on delivery of the final report.
- We wish to receive more information on the survey. (cross the that applies).



INTERNATIONAL TECHNICAL SURVEYS INC.

Tel. 253373 - Cables: Itsintech Telex: 22643 (Delval) 8, rue de la Madeleine Geneva (Switzerland)

NAME: _____ DATE: _____
 COMPANY: _____ SIGNED: _____
 ADDRESS: _____

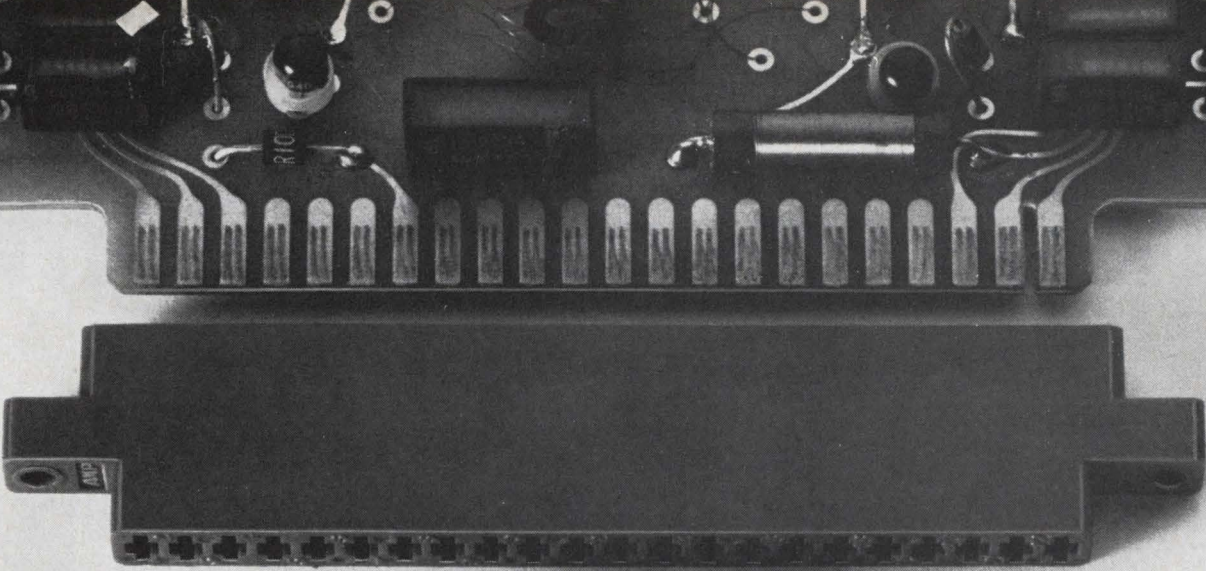

Look what AMP just did to edge connector costs:

Newly designed contacts and housings. Plus automation. Lowest per-line cost we've ever offered on an edge connector.

We modified the proven fork design by adding large contoured contact surfaces. We molded housings of UL-approved polysulfone with eggcrating; set cavities on .156" centers, allowing for .100" density if desired. Provided crimp snap-in contacts. And designed connectors with from 3 to 33 positions.

Then we tooled up our AMPOMATOR[★] machine to give you 5,000 automatically terminated leads each hour. And updated our AMP-O-LECTRIC[★] machine to provide 3,000 ready-to-use fork contacts an hour. And with either machine, you get AMP's precision controlled crimping and simplified worry-free operation. Plus cost savings.

For details on the Modified Fork edge connector, write AMP Incorporated, Harrisburg, Pa. 17105.

[★]Trademark of AMP Incorporated

One of a full line of printed circuit connectors available from AMP . . . Worldwide.

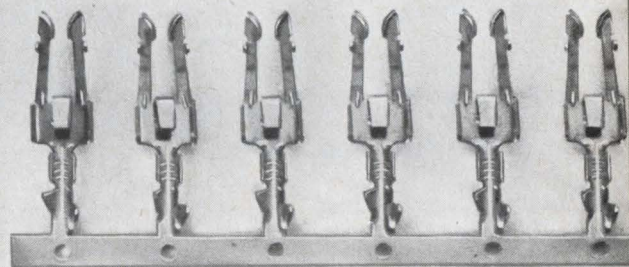
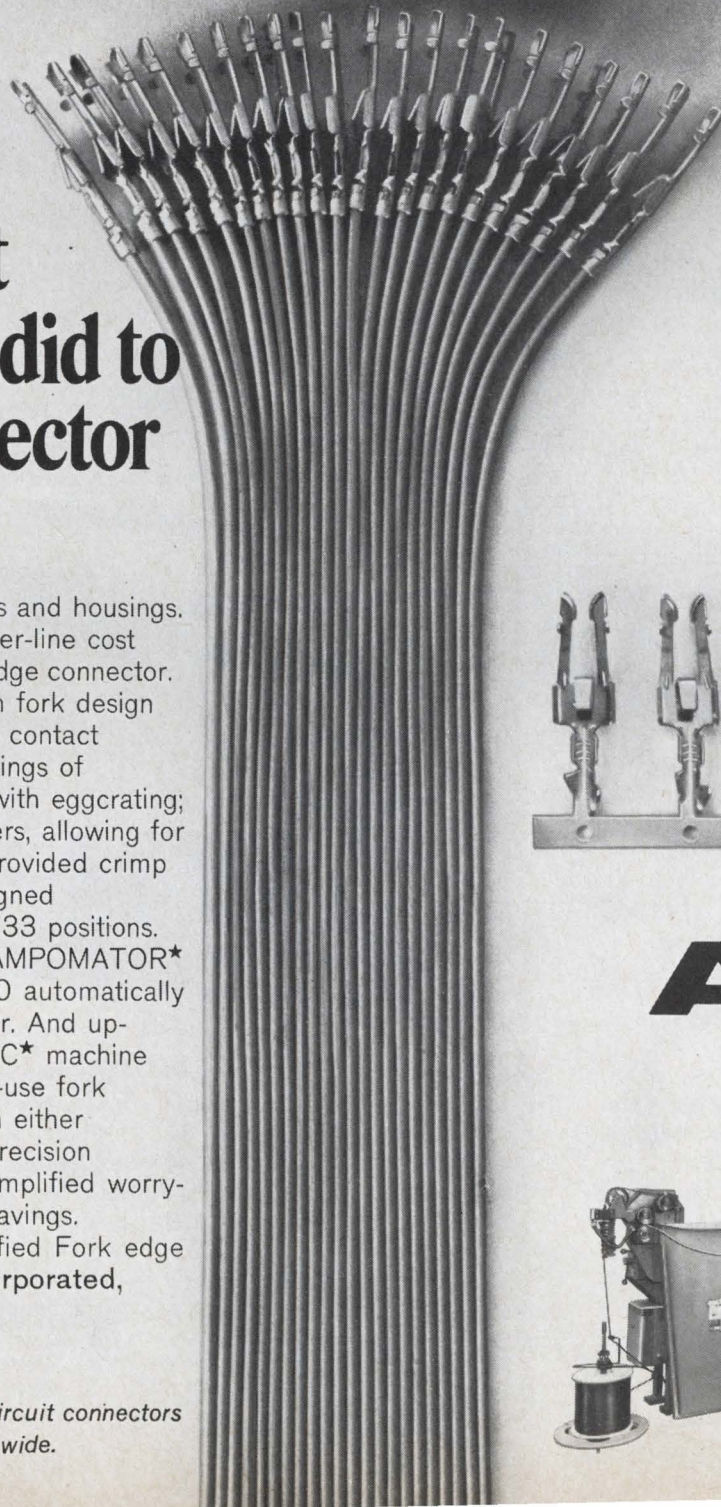

AMP

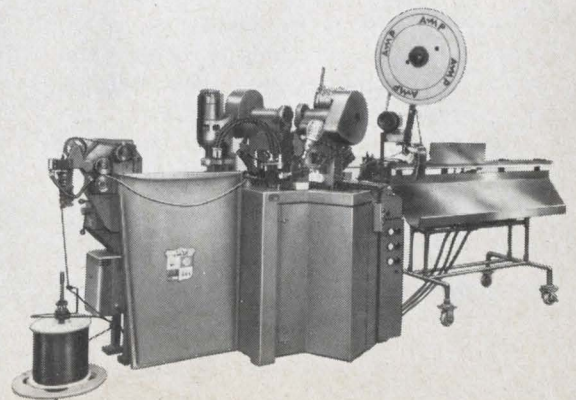

These are impulse items

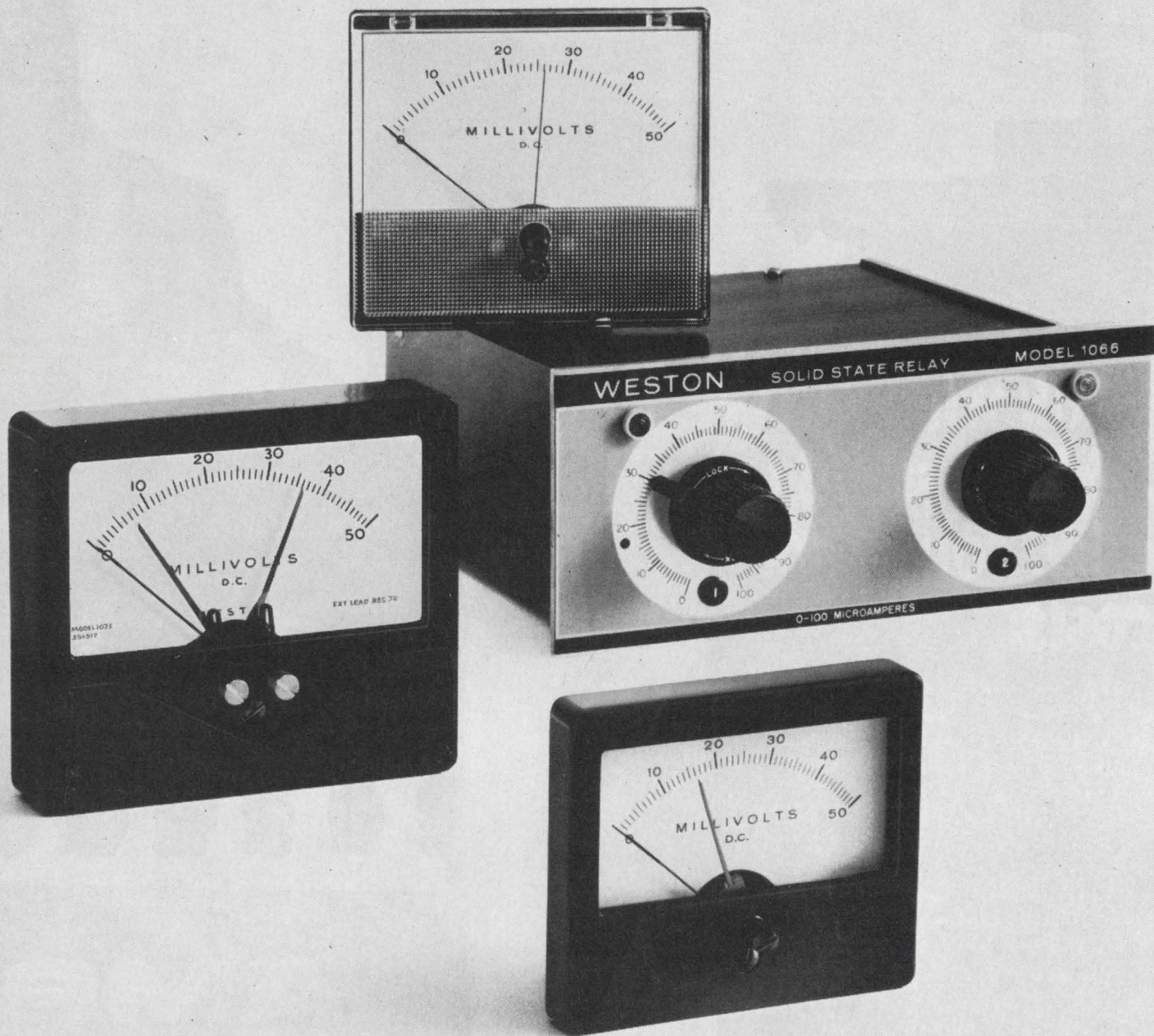

Any impulse from half a microamp activates our relays. No other meter relay manufacturer offers this full scale sensitivity. And Weston can provide the type of closure best suited to your application—sensitive (non-locking), LCCA, magnetic contact, non-physical contact, or all solid-state. Photo sensing and solid-state switching are com-

bined in the Model 1075, for example, with wide scale DC ranges from 10μ to 500 volts. Or, you can switch a five amp AC load entirely by photoelectric means with our 1930/1940 Series relays. Model 1066, the ultimate in solid-state design, provides two independently adjustable set points, switching capacity of one amp at 117 volts AC,

selectivity to 1μ , and an optional input monitor. For the full story on industry's broadest selection of adjustable relays, write for Catalog 02-110. WESTON INSTRUMENTS DIVISION, Weston Instruments, Inc., Newark, N.J. 07114, a Schlumberger company.

WESTON[®]

Editorial comment

McNamara's parting shot is almost on target

War is hell but, happily, wars do come to an end. In contrast, the Defense Department's battle with its countless suppliers goes on forever.

The electronics industry opened a new front recently with its criticism of the department's procurement procedures [March 4, p. 23]. Not only is that conflict continuing, it may have been exacerbated by Robert S. McNamara's parting shot—a memo to his staff in which he expressed his satisfaction with DoD procurement policies. True, he had misgivings about the way they were being applied, and urged his staff, in a number of specific recommendations, to assure that “fair and equitable practices cover the buyer-seller relationship.”

But McNamara issued his memorandum almost at the moment he was leaving his post as Secretary of Defense and the electronics industry's suspicion that he waited too long may be justified.

Because of growing dissatisfaction by contractors, McNamara had assigned Thomas Morris, assistant secretary of defense, to sound out the views of executives at major defense companies on DoD practices and policies. Moreover, the defense agency had been keeping its ear to the ground for feedback from discontented suppliers. McNamara's memorandum, while defending his policies, notes the criticisms and seeks to answer them.

Morris reported nearly universal support for the procurement reforms (such as extensive use of incentive and fixed-price contracts and the use of weighted guidelines in profit negotiations), made during McNamara's administration. But he noted growing concern by contractors that the reforms, improperly applied, might cause them to assume “undue financial risk and cost penalties.”

Replying to the charge of improper cost sharing, McNamara said he wanted to be sure that research and development performed for DoD at its direction is not subsidized by industry.

A frequent complaint of contractors concerns the careless dissemination of proprietary technical information among competitive bidders during the contract-definition stage. On that score, McNamara insisted that the department must ensure the in-

tegrity of its procedures “to preclude the transfer of one contractor's competitive advantage to another, thus reducing the eventual competition to a price basis only.” Otherwise, he said, it will penalize the most efficient contractors and discourage their continued interest in doing business with the Government.

Other companies complained that sometimes work will be requested but contracts aren't written to cover it. McNamara called for a halt to the practice, and recommended that when inadequate contractual arrangements result in an increase or decrease in the contractor's cost, the Defense Department must provide “equitable adjustments in a timely manner.”

Contractors have been particularly vocal when they have been required to accept firm, fixed-price contracts in areas where many development and production uncertainties exist. Calling for good judgment in the choice of contracts, McNamara said the emphasis on the higher-risk-type contracts should not be construed as a mandate for their use in inappropriate situations.

Often when contractors propose value engineering changes, they are mulled over for months at a time. Some are never acted upon, but others are made as normal engineering changes and the contractor does not benefit as he would if they were handled as value engineering changes. McNamara said those practices must cease, since they tend to deny the Government the benefit of good cost saving ideas.

The weighted guidelines are favored by many contractors, but criticism arises when the guidelines are manipulated to support a preconceived rate of profit. McNamara agrees that the guidelines are intended to “offer profit opportunity to conform with the degree of risk the contractor is called upon to assume.”

The use of competitive and fixed-price contracts and the high degree of capital investment was designed by the defense agency to reduce the degree of contract supervision needed. But it doesn't always work that way. In some cases more government personnel are involved in administering contracts than during the era of cost-plus-fixed-fee contracting.

We applaud the ex-Secretary's admonitions that Pentagon personnel exercise careful judgment in applying existing policies. We hope that Secretary Clark Clifford will continue where McNamara left off. Without implementation, McNamara's memo will be no more than an admission that there is much room for improvement in the Defense Department's relationship with its suppliers.



Our Mexican string quartet.

Even in this automated world, stringing memory planes is still a hand operation. That's why Indiana General went to Mexico.

Here, at Ferromagnetica, a long tradition of handcrafted quality goes into every plane we make. The inherent skill and a pride of workmanship of our large staff assures reliability.

Mexico means another kind of reliability, too. Close to the United States, travel is unhindered.

It has a firm economy and stable government. Neither long distances or social upheavals are likely to interfere with delivery.

And backing up Ferromagnetica is our Memory Products operation in Keasbey, N.J.—the people who first developed memory cores. This combination offers you the greatest selection in cores, planes, and stacks in a full range of materials and sizes for all applications.

We'd like to tell you more about our memory products. What they are, how they work, and why they are the best. Write G. P. Perkins, Manager of Sales, for the complete story on IGC memory products. Indiana General Corporation, Electronics Division/Memory Products, Keasbey, New Jersey. Don't fiddle around.



INDIANA GENERAL

Making Magnetics Work

Electronics Newsletter

April 29, 1968

Autonetics tickets Phillips for LSI job

The new assistant to the president at Autonetics—and undoubtedly the man who will run the firm's large-scale integration facility when it swings into production later this year—is Alvin Phillips, often referred to as the father of Sylvania Semiconductor's SUHL line of transistor-transistor-logic IC's. Phillips joined Autonetics April 22 as S.F. Eyestone's assistant after serving as general manager of Sylvania's integrated-circuit operation.

Autonetics, a division of North American Rockwell, has often used the post of president's assistant to familiarize new executives with the company before assigning them more descriptive titles and more specific jobs. C.F. O'Donnell, Autonetics' senior vice president for research and engineering, says Phillips has a solid background in engineering, production, and marketing—the kind of experience needed to convert the firm's engineer-dominated MOS microelectronics laboratory into a profitable production operation.

Relabeling IC chips saves face abroad

A big part of the growing business in unpackaged integrated-circuit chips [Electronics, April 15, p. 47] is the sale of IC's to British and Continental semiconductor makers for relabeling. These companies, lagging behind American technology in this field and pressed with demands for IC's from their customers, are quietly buying diced circuits and whole wafers, packaging them, and putting on their own labels. And U. S. suppliers are going along with the face-saving subterfuge.

Insiders guess that this relabeling business accounts for as much as 20% of the \$15 million market for unpackaged chips. And they expect this ratio to grow as U. S. firms develop more advanced transistor-transistor-logic and linear circuits. Some smaller U. S. makers, especially those that are second sources, are also buying unpackaged chips for relabeling.

Litton computer to use wafers

In what may be a major step toward LSI computer design, Litton Industries' Guidance and Control Systems division is developing a model of a navigation computer that would employ unpackaged 1½-inch-diameter semiconductor wafers containing 70,000 MOS transistors each.

A block-oriented computer, the unit will be a parallel multiprocessor; each wafer will contain up to 36 arithmetic units and a central processor. Although the computer is still in the early design stage, Alden Stevenson, the division's vice president, says the wafers may have contact pads around their perimeters to which bonds could be attached. Epoxy may be used to encapsulate entire trays of wafers. The memory will also consist of MOS wafers.

Litton is developing the computer under a contract from the Avionics Laboratory at Wright-Patterson Air Force Base.

Beam-lead bipolars ordered for Mark 2

Autonetics is buying beam-lead integrated circuits for the Air Force F-111A's Mark 2 avionics system. The firm has ordered \$285,000 of diode-transistor and transistor-transistor IC's, plus some beam-lead discrete transistors, from Raytheon's semiconductor operation in Mountain View, Calif. This is believed to be the first major production order outside the

Electronics Newsletter

Bell System for beam-lead devices. The devices will be furnished in chip form to Autonetics and will replace other bipolar IC's Raytheon has been supplying for the program. The devices will probably go into hybrid circuits.

Fairchild won't be TTL second source

Despite the lure of a quick buck, Fairchild Semiconductor still declines to become an alternate supplier of transistor-transistor-logic digital IC's. **Fairchild apparently decided that it can make money with its TTL design and that its major production problems will be cleared up by year's end.**

Economic pressure has been building up in the company—after a year of belt-tightening—to copy Texas Instruments' 54/74 and Sylvania's SUHL series. But Fairchild claims that becoming a second source would ruin its image as an innovator. It has made a few SUHL and 54/74 chips on one or two occasions, though.

A Fairchild marketing spokesman conceded the risk in refusing to follow TI and Sylvania, **but said the TTL battle will be resolved not with the IC's available but with medium-scale and large-scale IC's.**

LTV gets contract to study solid state switching in planes

The Air Force and Navy are moving closer to a solid state system for handling all signal and power switching in aircraft. LTV Aerospace, which since 1960 has been investigating the feasibility of substituting semiconductor switching systems for present electromechanical techniques, has received an Air Force contract to design, fabricate, and evaluate a complete system for the A-7 attack plane. The firm earlier worked out a systems concept and developed hardware specifications under a Navy grant.

In the solid state approach, signal—or control—switching is kept separate from power switching to minimize the number of operations at the power level. **Information flows directly from source to the control logic, and power flows from its source—or electric bus—through a single device directly to the load.** This setup thus requires fewer and thinner wires than does an electromechanical arrangement, and permits the design of a system from three basic types of modules: signal sources, control logic, and power controllers.

LTV believes the solid state system will be five times as reliable as conventional switching. Weight of the distribution system could be 30% less, the firm adds, and the modular packaging could ease maintenance by as much as 40%.

Honeywell will sell rival's transducers

Instrumentation firms usually shy away from intercompany marketing arrangements. But on June 1, **Statham Instruments and the Test Instrument division of Honeywell will break tradition with an agreement under which Honeywell will market a line of industrial transducers designed and built by Statham.**

The pact will open an immediate market for Honeywell's test equipment, which can be used with Statham sensors to measure such things as pressure, load, weight, displacement, and acceleration.

More than a dozen transducers and related gear are covered by the agreement, including Statham's newest device—a transducing cell that can be made to measure a variety of parameters simply by changing sensor heads.

whatever direction
your design takes...

Allen-Bradley thick film networks will put you out front in...

Packaging—Advanced manufacturing capability covers virtually every type and every configuration of resistive and/or capacitive networks—single or dual in-line, as well as flat-packs, with or without hermetic sealing.

Characteristics—Exclusive and patented formulations enable A-B to provide resistance values from 1 ohm to 5.0 megohm. Ratings to 20 watts/in² at 85°C. Capacitance values from 10 pfd to 0.5 mfd with voltage ratings to 50 volts. Applications include precision tuned circuits.

Performance—Standard resistance tolerance $\pm 10\%$. For critical circuitry, tolerances to $\pm 0.1\%$ can be furnished—with resistances and TC's matched. Temperature coefficient less than 250 ppm in all cases. Special units to 100 ppm or less. Load life stability of 1% in 10,000 hours can be achieved.

Reliability—Allen-Bradley has precise control over all raw materials and manufactures all basic components—glasses, organic materials, and substrates. Special machines—designed and built by A-B—assure uniform product quality—at a competitive price.

Timing—Allen-Bradley has unique in-plant ceramic facilities. Prototype networks—with or without holes—can be prepared to meet your specific needs. Quickly. Economically.

For more details, write Henry G. Rosenkranz, Allen-Bradley Co., 1315 S. First St., Milwaukee, Wis. 53204. In Canada: Allen-Bradley Canada Ltd. Export Office: 630 Third Ave., New York, N. Y., U.S.A. 10017.

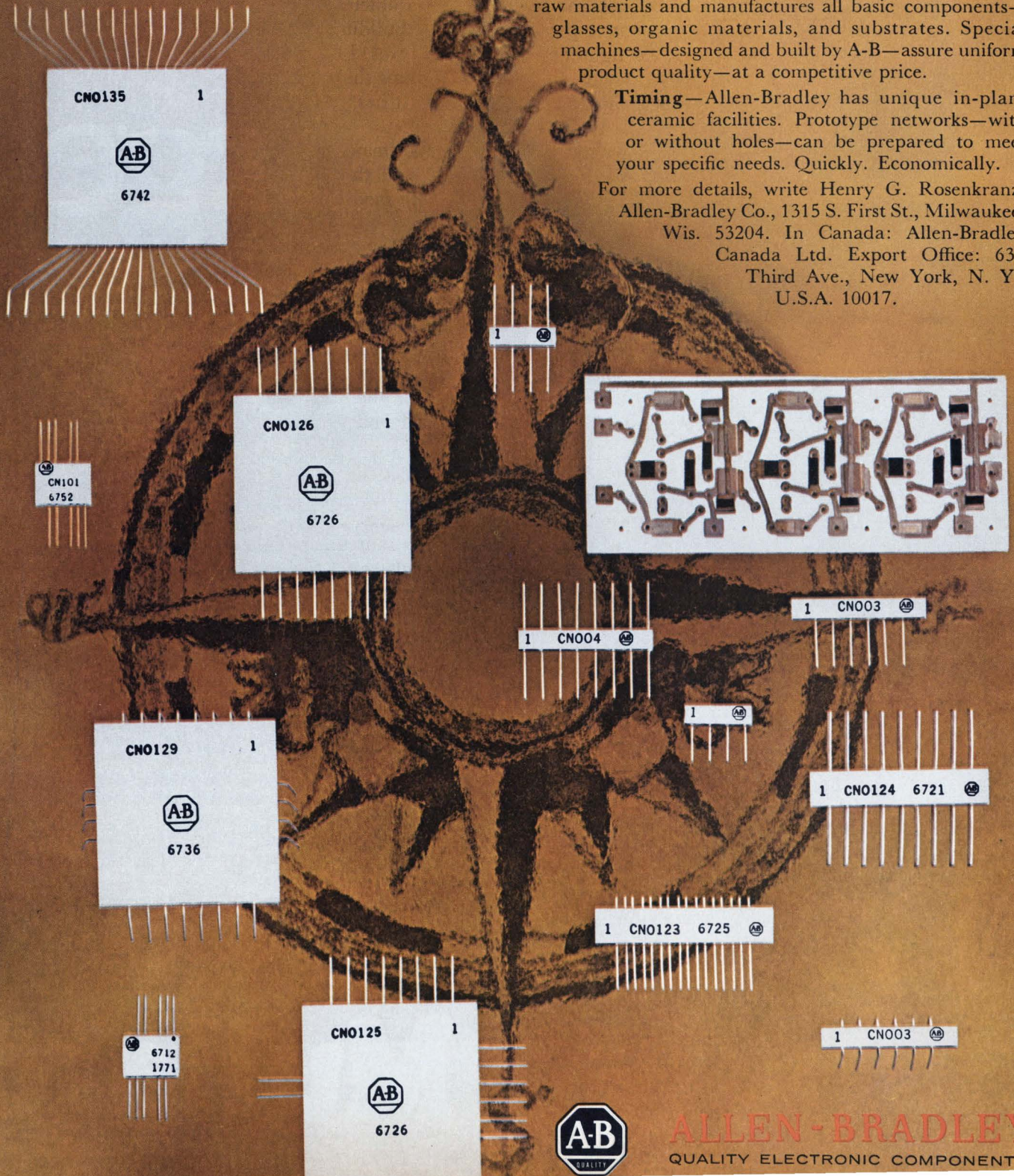

ALLEN-BRADLEY
QUALITY ELECTRONIC COMPONENTS

75W zener withstands 4.4kW surges for 100µs...

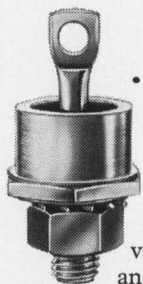

...part of a range extending
from 0.4 to 75W, 3.3 to
75V with 5% tolerance

Mullard zeners give you over 120 different voltage/power ratings in the ranges 0.4 to 75W and 3.3 to 75V. They exhibit sharp knee characteristics, low dynamic resistance and low leakage currents.

Mullard range of zeners

	Voltage Range	Power Rating	Encapsulation
*BZY91	7.5 to 75V	75W	DO-5
*BZY93	7.5 to 75V	20W	DO-4
OAZ222-3	5.6 and 6.2V	10W	DO-4
BZY96	4.7 to 10V	1.5W	DO-1
BZY95	10 to 75V	1.5W	DO-1
BZY88	3.3 to 30V	0.4W	DO-7
BZX61	33 to 75V	0.4W	DO-7

*Available with either normal or reverse polarities.

The BZY91 series is capable of withstanding peak surges of 4.4kW for 100µs.

Every designer should have a copy of the Mullard Quick Reference Guide giving information on Silicon Voltage Regulator (zener) and Reference Diodes. Also ask to be put on the mailing list of the Mullard Bulletin—a regular publication which gives details of new components and applications . . . the result of extensive research and development programs in the Mullard laboratories in England.

Write today for information on Mullard zeners and for the name of your local Distributor.

Mullard Limited, Mullard House, Torrington Place, London WC1 England.

U.S.A. enquiries to Mullard Inc., 100 Finn Court, Farmingdale, Long Island, New York. 11735 U.S.A. Telephone: (516) 694-8989 Telex: 961455.

Mullard LIMITED

ALLEN-BRADLEY
Metal-Grid resistor networks
combine a new measure of

precision, stability and performance in a sealed, compact package



Precision Metal-Grid resistor network shown
approximately 1½ times actual size

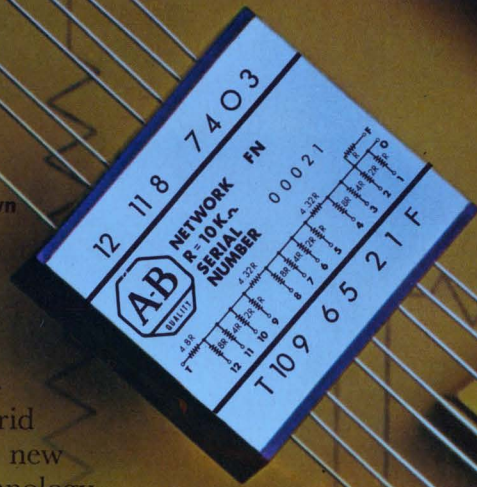

The advanced capabilities—developed from years of manufacturing Allen-Bradley Metal-Grid resistors—are now applied to a new line of resistor networks. This technology enables the production of complex resistive networks on a single substrate.

Allen-Bradley's exclusive simultaneous deposition method is used to obtain the best resistance tolerance and temperature coefficient matching. The reliability of interconnections on the common resistance plane is incomparable. Uniformity and quality are inherent in A-B networks. To illustrate, 2 PPM temperature tracking is normal.

A-B Metal-Grid networks offer a wide range of values—with individual resistances as low as 25 ohms and as high as 2.0 megohms. Both the inductance and capacitance are low, permitting efficient operation at high frequencies.

A-B engineers will be pleased to cooperate in developing networks for your specific need. For additional details, please write to Henry G. Rosenkranz, Allen-Bradley Co., 1315 S. First Street, Milwaukee, Wisconsin 53204. In Canada: Allen-Bradley Canada Ltd. Export Office: 630 Third Avenue, New York, N. Y., U.S.A. 10017.

BRIEF SPECIFICATIONS

Resistor Networks

- Tolerances:** $\pm 1.0\%$ to $\pm 0.01\%$
- Resistance Matching:** to 0.005%
- Temperature Range:** -65°C to $+175^{\circ}\text{C}$
- Temp. Coef.:** to ± 5 ppm/ $^{\circ}\text{C}$
- Load Life** (Full load for 1000 hr @ 125°C): 0.2% maximum change

Ladder Networks

- Full Scale Accuracy:** 10 bits or less, better than $\pm \frac{1}{4}$ least significant bit. More than 10 bits, better than $\pm \frac{1}{2}$ least significant bit.
- Frequency Response:** Less than 100 nanosecond rise time or settling time
- Temp. Coef.:** Less than 10 ppm/ $^{\circ}\text{C}$
- Temperature Range:** -65°C to $+175^{\circ}\text{C}$

ALLEN-BRADLEY
QUALITY ELECTRONIC COMPONENTS

SANGAMO'S 4700 Recorder / Reproducer Excels All Others In Tapeability



You be the judge:

The 4700 challenges any other IRIG laboratory system to offer 1/4, 1/2, 1, and 2-inch tape widths as a standard feature. Provides tape movements with low static and dynamic skew, under low tension, low flutter, low mass drive, with exclusive vacuum guiding and cleaning—all at eight speeds from 120 to 15/16 ips. Eliminates an entire tape transport for those reel-to-reel/loop dubbing applications by employing a set of dual IRIG heads—another tapeability feature of the 4700.

DATA ACQUISITION ADVANTAGES

Analog and digital data formats are easily accepted by off-shelf IRIG channel electronics with improved stability, drift, and linearity characteristics. Choose any combination of Direct, FM, PDM, constant bandwidth FM, serial PCM and parallel PCM solid state electronics for all eight transport speeds. For data requiring isolation from long lines, choose FM modulators with differential inputs for both bi-polar or unipolar operation to 80 KHz.

SUPERB RELIABILITY

Excellent MTBF and MTR figures have resulted in an exceedingly

small spare parts kit and no extra charge for Sangamo's one-year warranty on parts and service. The long life expectancy of the 4700 offers the user the best price/useage ratio.

TO BE MORE PRECISE, SPECIFY THE 4700

Can we arrange a demonstration? Contact one of our application engineers, Information Systems Division, Department E-4. TWX: 910-242-0533. Phone: 217-544-6411.

*The innovators
in tape
instrumentation*

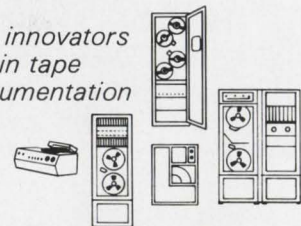

SANGAMO
Information Systems
Springfield, Illinois

**THIS IS THE WIDEST SELECTION of
MINIATURIZED CERAMIC CAPACITORS
IN THE INDUSTRY!**

New
RED CAPS

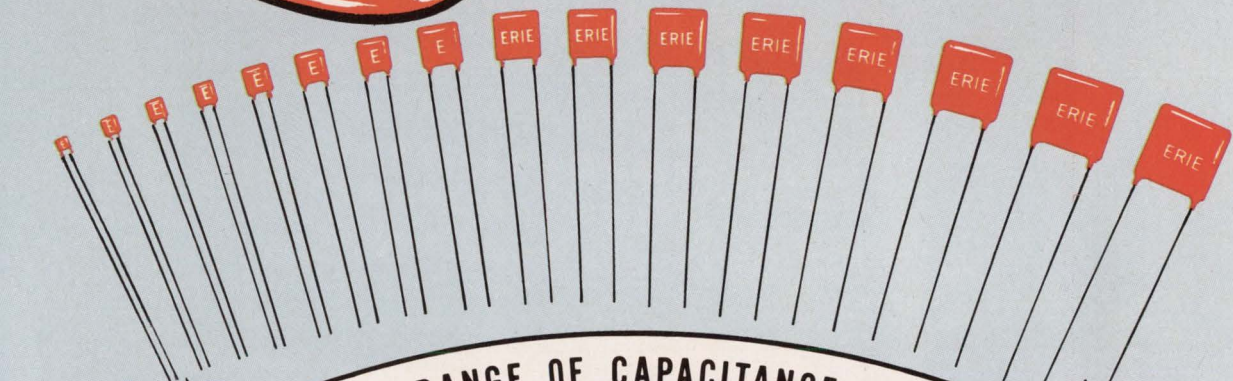

BROAD RANGE OF CAPACITANCE VALUES

1.0 pF.

AVAILABLE IN EVERY
STANDARD TEMPERATURE COEFFICIENT
...and in SEVEN DIFFERENT HI-K® Formulations

4.7 uF.

- *Red Caps meet or exceed all applicable requirements of MIL-C-20 and MIL-C-11015 per MIL-STD-202*

RED CAPS feature *JET-SEAL* **ENCAPSULANT**
ERIE'S EXCLUSIVE NEW

- Erie's new *Jet-Seal* excels in mechanical and electrical ruggedness
- Provides excellent moisture protection • Maintains electrical and mechanical stability at temperatures from -55°C through 150°C • *Jet Seal's* bright color and gloss finish will be outstanding in even the most sophisticated equipment.

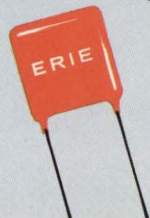

WRITE FOR SAMPLES on your company letterhead
ERIE TECHNOLOGICAL PRODUCTS, INC.
State College, Pennsylvania
Attention: Applications Engineering



Erie, Pennsylvania

DataMate 8

DIGITAL COMPUTER

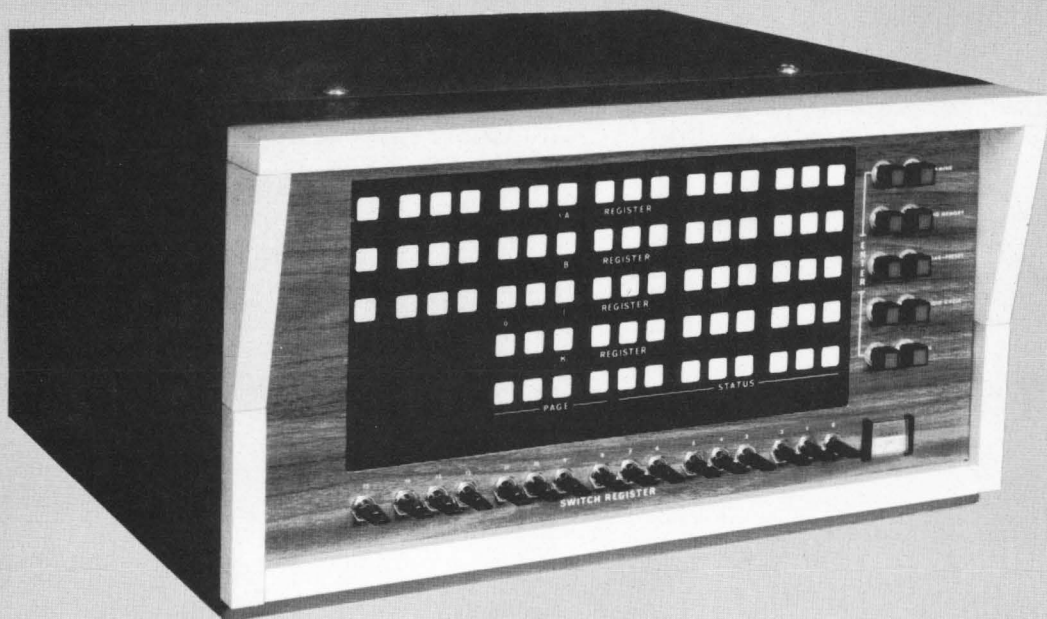

FEATURING:

FOURTH GENERATION MSI CONSTRUCTION
OVER 80 COMMANDS
16 BIT WORD LENGTH
TWO GENERAL PURPOSE ACCUMULATORS
4K BYTE ORIENTED EXPANDABLE MEMORY
DIRECTLY ADDRESSABLE TO 64K
2.5 μ S MEMORY CYCLE TIME
PRIORITY INTERRUPT
EXTENSIVE INTERFACE CAPABILITIES
OCCUPIES ONLY 8- $\frac{3}{4}$ INCHES RACK SPACE
\$13,900, COMPLETE WITH TELETYPE

See us at booth X3, SJCC

CONTACT:

DATAMATE DIVISION
GAMCO INDUSTRIES, INC.
P.O. BOX 310
BIG SPRING, TEXAS 79720
(915) 267-8766

**Versatile
curve tracer.
FET/SCR capability:
\$1575.**

Fairchild's Model 6200B can test a greater variety of devices than any curve tracer in its price range. It operates FETs, MOS-FETs, bipolars, unijunctions, diodes, tunnel diodes and SCRs. It provides 1000V for high voltage measurement and 5 amps for high current tests. Base drive can be as low as 100nA for high-gain devices and up to 35V for FETs. The 6200B is compact, lightweight and rack-mountable. We also have a programmable version for high-volume production applications: the 6200B/P. It does a lot more. And costs a little more. We'll gladly tell you about one or both. Ask for our data sheets.

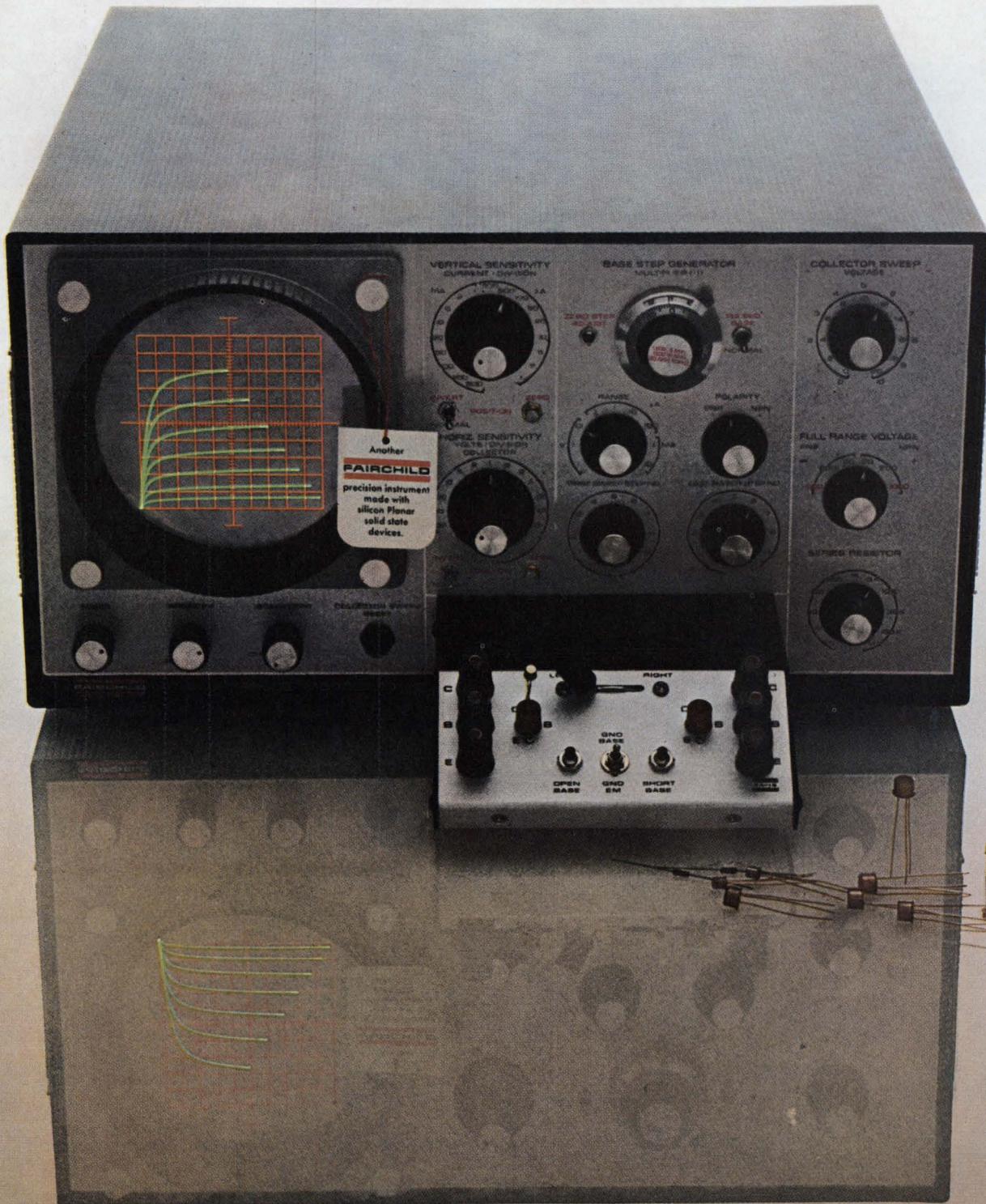

NEW EG&G PICOAMMETERS

A full line of low-level current measurement instruments

All EG&G Picoammeters include features others only talk about. Like the unique combination of precise accuracy and rapid, accurate calibration capability without resorting to calibration charts or resistor measurement. And, the all solid-state design, including a low level MOS FET input stage. What's more . . . you'll find an

EG&G Picoammeter to meet *your* needs and *your* budget. That's because EG&G offers the most complete line of low level current measurement instruments available. From high precision units or automatic ranging units, both complete with digital readout, to general purpose, manually-operated bench top models.

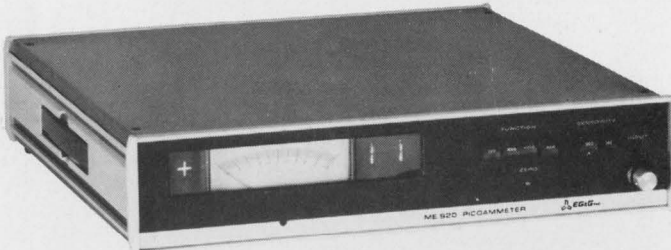
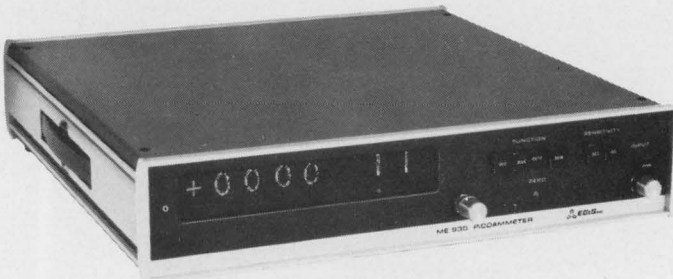

HERE ARE THE SPECIFICS ON FOUR OF THE MOST POPULAR EG&G PICOAMMETERS.

Model ME-1035, Precision Picoammeter — for Standards or Calibration labs. Current measuring range of 10^{-5} amps to 10^{-12} amps with 10^{-15} amps resolution. All solid state design with MOS FET input, temperature controlled feedback resistors for added stability, pushbutton range control, adjustable summing point voltage and current offset monitor, pushbutton controls for rapid internal calibration requiring no external standards or sources. Digital readout. Price: \$3,945.00

Model ME-930, Digital Picoammeter — for general lab work and automatic digital systems. Current measuring range of 10^{-11} amps through 10^{-2} amps full scale in 10 decade steps. A full digital picoammeter with automatic range changing capability and automatic polarity selection. All solid-state design with MOS FET input, remote function control and optional printer drive, digital readout of level and range. Price: \$3,575.00

Model ME-920, Automatic Range Changing Picoammeter — for general laboratory use and production line testing. Current measuring range of 10^{-11} amps through 10^{-2} amps in 10 decade steps. An automatic ranging picoammeter with remote function capabilities. All solid-state design, with MOS FET input and automatic polarity indication. Price: \$2,435.00

Model ME-705, General Purpose Picoammeter — for general laboratory use. Current measuring range of 3×10^{-13} amps through 10^{-2} amps in 22 steps (11 decades with X3 meter multiplier). A general purpose, manually operated bench-top picoammeter. All solid-state design, with MOS FET input stage. Price: \$560.00

For more complete details on the more complete line of EG&G Picoammeters, contact your local EG&G Products Division representative. Or, write EG&G Inc., Laboratory Products Division, P.O. Box 755, Goleta, California 93017.



BUY A THYRISTOR . . . GET A TRIGGER FREE!

Prototype your 1969

power control designs with a 'T&T' Kit!

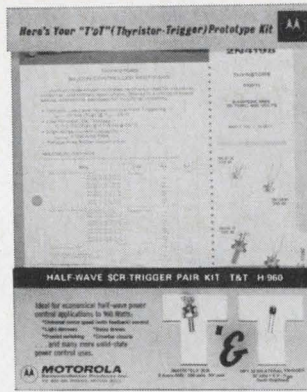

960 W Half-Wave Kit



960 W Full-Wave Kit

If you're looking ahead to getting higher performance and more economy out of next year's power control designs than you realized from this year's circuits (and what designer isn't!) . . . you'll want one or both of these "T & T" — Thyristor and Trigger — prototype kits designed to introduce you to both application advantages — now!

Each kit is priced at the regular, 1-99 price for the thyristor alone — you get the 28 V, plastic trigger free together with performance data and circuits, ready for use right on your "new design" workbench!

Elf* SCR's, long a popular, industry-standard for medium-powered, 50 to 600 V, commercial/industrial designs, furnish minimum power loss — low, 1.3-volt V_F @ 5 A, 25°C; immunity from false triggering due to noise with a realistic, 10 mA (typ) gate firing level;

100 A current surge protection and mounting versatility with 6 different hermetic cases.

Motorola's 960 W TRIAC takes the place of two conventional, back-to-back SCR's and has symmetrical gating and holding characteristics in all modes. In addition, 100 A peak surge capability, 50 to 400-volt V_{BOM} and built-in transient overvoltage protection make it a natural choice for a variety of cost-lowering, circuit-simplifying applications.

Both kits include one of the new, silicon Annular† plastic bilateral triggers offering symmetrical switching, low switching current, and higher-energy pulses-to-gate.

Prototype extra workpower into your continuous control circuits . . . fill in and mail the coupon today!

H-960 Half-Wave Kit

Ideal for prototyping universal motor speed control circuits with feedback control, crowbar, voltage regulators, battery charging, etc., circuits, the T & T H-960 kit consists of:

- 2N4170, 8 A, 200 V stud Elf SCR
- MPT28, 28 V, Bilateral Trigger
- Complete Technical Specifications
- "New Design" Circuits and "SCR Power Control Fundamentals"

PRICE \$2.10

F-960 Full-Wave Kit

The "power vs. price" design struggle in light dimmers, static contactors, capacitive motor starting and a host of other demanding AC applications can be won with the versatile, T & T F-960 kit of:

- MAC2-4, 8 A, 200 V stud TRIAC
- MPT28, 28 V, Bilateral Trigger
- Complete Technical Specifications
- "New Design" Circuits and "SCR Power Control Fundamentals"

PRICE \$3.45

Send me the following number of each special-offer Motorola T & T Kits:

- T & T H-960 Kits @ \$2.10 each for the SCR and Free Trigger
- T & T F-960 Kits @ \$3.45 each for the TRIAC and Free Trigger

Name _____ Title _____

Company _____ Div/Dept _____

Address _____

City _____ State _____ Zip _____

(Please enclose check for appropriate amount payable to Motorola Inc. Send to Box 955, Phoenix, Arizona 85001. Offer expires June 1, 1968.)

*Trademark Motorola Inc.

†Annular semiconductors are patented by Motorola.

-where the priceless ingredient is care!



MOTOROLA
Semiconductors

Noisy Signal?

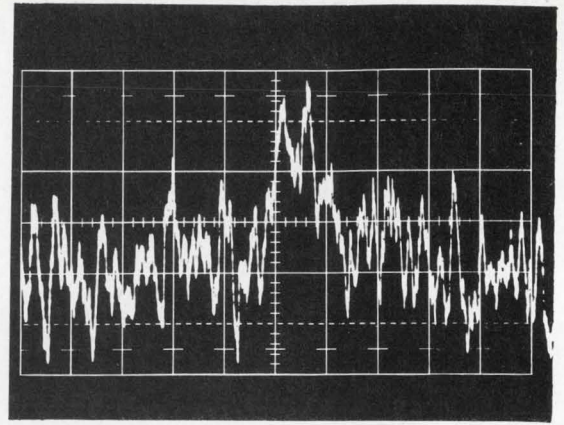

Extract it with a PAR Waveform Eductor™

The PAR Waveform Eductor is a signal averager used to extract repetitive signals from noise. For complete information or to arrange a demonstration of this instrument, which is priced at only \$4,200, write Princeton Applied Research Corporation, P.O. Box 565, Princeton, New Jersey 08540, or call (609) 924-6835.

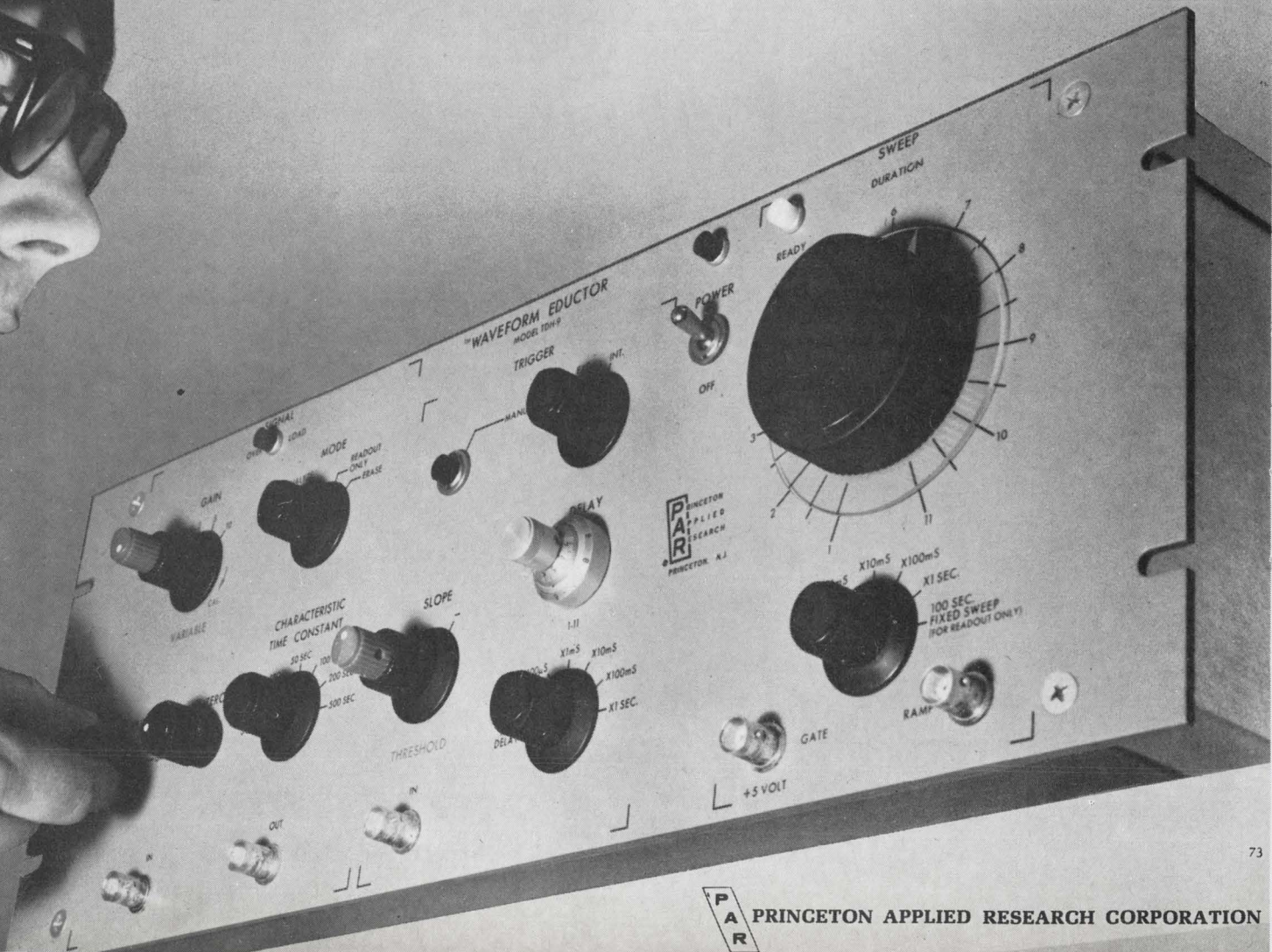
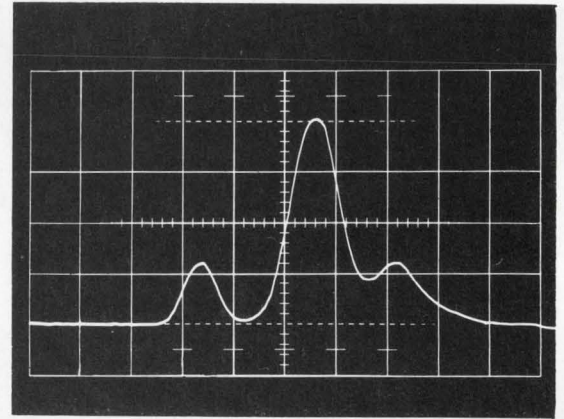

Electronics Review

Volume 41

Number 9

Industrial electronics

Impatt impact

Impatt diodes, until now used exclusively in military hardware, may soon make themselves felt in the civilian market, and the price of this progress may turn out to be a traffic fine for speeding. The Bomac division of Varian Associates has developed a microwave radar "trap" using impatt diodes in place of an oscillator tube.

The first model of the system has just been delivered to the Muni Quip Corp., a subsidiary of the Duncan Parking Meter Corp., Elkridge Grove Village, Ind.

According to Muni Quip's chief engineer, Floyd Harwood, the new radar works at least as well as systems with klystrons. The Bomac system also promises to produce less spurious output, making the radar more accurate.

More expensive. The Bomac modifications were simple. Beginning with one of Muni Quip's standard radars, the engineers cut the power supply voltage by about two-thirds to get the 83 volts d-c required by the impatt. They also changed the power-supply regulation slightly and added a current control.

The modified unit has an output of 67 milliwatts at 10.5 gigahertz. In Bomac's parking lot, the engineers found that the system worked like a charm up to the maximum speeds tested, about 45 miles per hour.

However, other factors, such as life expectancy of the impatts, are still under study; tests will continue through this year at Muni Quip.

Also, the typical impatt costs more than \$100 unmounted but the klystron tube is only about \$90. The mount needed for the diode may easily raise the price of the

combination to more than \$200.

Muni Quip's executive vice president, William R. Shiry, estimates that adding an impatt would also mean adding a grand total of about \$400 to the list price of the firm's standard unit, which costs \$1,440. And thus he feels he'll have to wait for the price of impatts to fall before the device can get out of the lab—or the parking lot.

However, Shiry may not have long to wait. John Heiber, Bomac's director of microwave marketing, thinks that the impatt could soon be competitive with tubes. "Prices are high now because orders are for only a few units at a time. If we received an order for 1,000 oscillators, (diodes and oscillators), our price would drop below \$100." He also points out that a power supply designed for the impatt—not a readjusted one as used in the experimental unit—could be cheaper than those now needed for klystrons.

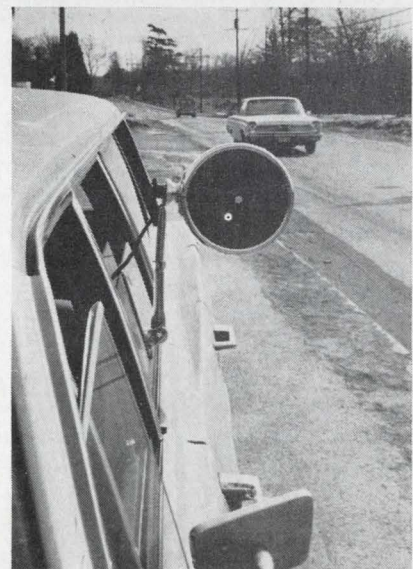

Pull over. Varian's Bomac division has developed an impatt diode as the microwave power source for police radar traps. Solid state device shrinks system into two packages—meter and controls, on the left, and antenna, right. But its price—still a few hundred dollars more than conventional gear—is keeping it out of the market. One design is being tested by the Mini Quip Corp.

Computers

Deficit mending

It's no secret that the General Electric Co. hasn't exactly been piling up profits from its computer business. In fact, industry rumors have it that GE's losses on its computer operation have run into the many millions of dollars, despite cut-backs in activities both here and abroad. A change may be at hand. The company this month named John W. Haanstra general manager of its Information Systems Equipment division, Phoenix, Ariz., the



Big job. John W. Haanstra takes over GE's computer operations in Phoenix in a move evidently aimed at stemming the company's losses there.

unit that produces commercial computers.

Haanstra, known in the computer industry as an executive more interested in profits than technical breakthroughs, joined GE last summer after spending most of his professional career at International Business Machines Corp.

Great debate. Haanstra made a name for himself at IBM, where he is remembered as the man who almost single-handedly blocked the development of the System 360 series. He believed, at the time, that the advent of the 360 line would threaten the position of the General Products division, the operation he headed and the source then of some two-thirds of IBM's revenue.

Haanstra's first post at GE was as a consultant to J. Stanford Smith, who himself had only recently been brought in to revamp the faltering computer division. Last January, Haanstra was promoted to general manager of the Advanced Development and Resources Planning division, another unit of the company in Smith's charge. This appointment, quite interesting in its own right, becomes even more significant if changes are to be made in the computer division.

Now Haanstra is taking over the manufacturing and marketing side of the computer business from Louis E. Wengert, who becomes manager of GE's Constant Speed Drives division, the motors and motor-controls section of the company.

Remembering the MOS

A maxim in the electronics industry is, "You have to run hard to stand still." Memory Technology Inc., of Waltham, Mass., which has been doing well with its braided read-only memories [Electronics, Jan. 8, p. 52,] is beginning to learn first-hand how true this is. In planning a new product based on the technology, a universal bidirectional code converter, MTI has suddenly encountered competition from an unexpected quarter—semiconductor memories.

"When we first went into business a couple of years ago," says John J. Marino, president of MTI, "we had to sell prospective customers on the idea of using read-only memories. Now that these are a generally accepted idea, we can concentrate more on the advantages of braided memories over other kinds of read-only memories, such as speed and flexibility." But manufacturers of metal oxide semiconductor (MOS) memories have recently been making some rather broad claims about MOS, so that MTI has had to delay introducing its new converter until it can be sure what the MOS people are up to. No MOS memories have yet been delivered, says Marino.

Whirling disks. The only off-the-

shelf converter now available, other than specially designed units, is a mechanical contrivance made by the Invac Corp., another Waltham company. Invac's device uses light bulbs, photo-sensors, and whirling disks driven by a motor. Marino says MTI's braid assembly could be sold for half the cost of Invac's device. He concedes that a 2,000-bit MOS read-only memory equivalent in performance to his braided memory could sell for a competitive price; and MOS has a definite size and weight advantage. However, the MOS memories are subject to a large masking cost that makes them quite expensive in small quantities.

The converter that MTI is working on is basically two braid memories connected end to end, so that one drives the other. The two braids encompass sets of core pairs instead of single cores.

The present breadboard model can convert between two eight-bit codes—any two, in either direction. It contains 32 U-shaped cores in two sets of eight pairs, and a single braid of 256 wires. Each wire in the braid threads a particular combination of eight core pairs, and a different combination of the other eight pairs, passing through one of a pair for a binary 1 and the other for a 0. The two combinations represent the two coded forms of a single character.

Bit position. A flip-flop register holds an eight-bit character that comes in on eight lines in parallel. The complementary outputs of each flip-flop drive selection coils on the two cores corresponding to that bit position. Because of the pattern of wires in the braid, these coils generate voltage pulses on every wire but one. The pulses reverse-bias the diodes connected to the braids; the one diode left unbiased admits a current pulse to its wire. This wire also threads a unique combination of core pairs in the other set; sense windings in that set pick up the corresponding code, which is amplified and presented to eight parallel output lines.

Changing braid. The converter is called universal because it can

work between any two codes, simply by changing the braid. It can also work with three or more codes at once, with a longer braid and a set of core pairs for each code—as in a communications system that uses binary-coded decimal, Hollerith (punched card), and Baudot (teletypewriter) codes. The converter is also bidirectional, because the selection windings on the input side and the sense windings on the output side are identical. Current drivers and sense amplifiers are both connected to each winding, and biased on or off depending on the direction of conversion.

Consumer electronics

Microwave mini-oven

The American housewife is apparently happy cooking with electric heat or gas. The handful of companies that produce microwave ovens have been most successful in

selling to restaurants and institutional kitchens. And all the major airlines use microwave ovens in their airborne kitchens.

But the Raytheon Co.'s Amana Refrigeration subsidiary is trying to change all that. It's introduced a small (23-by-17-by-15 inch) counter-top oven, called the Radarange, that operates from a standard 115-volt, 60-hertz power line and sells for \$475.

The only other consumer microwave ovens available in the U.S. are part of large stoves and sell for more than \$800.

Amana says the Radarange can bake a potato in four minutes, a hamburger in one minute, and a five-pound roast—well done—in 37½ minutes. Although the microwave mini-oven is new to the U.S., foreign electronics firms have been in the market for some time [Electronics, Sept. 4, 1967, p. 207] with such low-cost appliances for the consumer market.

Raytheon isn't alone in believing that microwaves will soon catch on in the U.S. Last month RCA said it set up a division to sell microwave tubes to oven makers.

Advanced technology

Bright idea

Television cameramen covering news and sports events have to guard against suddenly aiming their cameras at high-intensity lights without first "peaking" the tubes to accommodate the brightness. If they don't, the tubes are saturated and permanently damaged.

However, developmental work initiated at Bell Telephone Laboratories before 1967, and now in progress at both Bell Labs and Texas Instruments Inc., promises aid for the cameramen.

Bell developed a technique that replaces photo-conductive coatings (usually antimony trisulfide) in standard tv camera vidicon tubes with a silicon diode array. The array can handle sudden brightness without suffering fatigue. What's more, the array is said to provide higher sensitivity than the conventional coatings, without any loss of resolution.

Bell began the work for its Picturephone system, which is now being tested and involves the visible part of the light spectrum (0.4 to 0.7 microns). Last June, TI got permission from Bell to do similar work in the near-infrared region (0.9 to 1.1 microns) for classified military applications.

Standard tubes. A 540-by-540 array of 291,600 photo diodes on a thin silicon slice was made by Bell in its early work. Texas Instruments has since made similar sizes and, more recently, has developed a 600-by-780 format that measures 0.48 by 0.64 inch.

TI switched from the visible to the near i-r range by tailoring the diode spacing and thickness. Its present format has a center section 0.001 inch thick. A standard vidicon tube equipped with the TI array can be tuned across the spectrum from 0.3 to 1.2 microns.

To modify a standard vidicon tube, the silicon diode array is mechanically fitted into the front end just behind the front glass. Light passes through the glass and



What's cooking. Table-top microwave oven developed by Raytheon's Amana division will sell for \$475. It plugs into ordinary house current. Most other U.S. designed microwave ovens are large or were designed for institutional kitchens.

penetrates the silicon. The array is then scanned by an electron beam the same way the conventional tube is scanned.

"We get the sensitivity needed with silicon because it peaks at around 0.9 microns," reports Ward Paxton, manager of the advanced i-r systems components branch at TI. "The array is of low enough capacitance that it has few image smear characteristics."

Longer life. Using silicon instead of the glass plate may also extend the life of the modified tube; hydrocarbons and gases in the glass eventually poison the cathode. Frank Skaggs, an engineer on TI's project, says, "Most tv people now replace their tubes after 500 hours because the tubes begin to lag from fatigue. We think the array-equipped tube will have at least a 5,000-hour lifetime."

TI has used the arrays primarily in standard vidicon tubes, because these are the type used in military systems the firm is working on. Commercial-tv people often use orthicon tubes because of certain vidicon-tube limitations. Paxton believes, however, that array-equipped vidicon tubes could satisfy many commercial needs because these tubes span a wide range of the spectrum.

TI has produced several developmental systems for its military work, and Skaggs believes the silicon diode array technique will eventually break into the market for commercial camera tubes. For one thing, he points out, the array system has better red-light sensitivity than present tubes.

Seen from afar

Long-distance photography is only as good as the medium through which the picture is snapped. And obviously, the greater the distance the greater the distortion caused by the atmosphere. But a research team from Stanford University reported to the Air Force this month that holograms may be able to produce clear pictures despite atmospheric distortion.

Using a 1-joule ruby laser

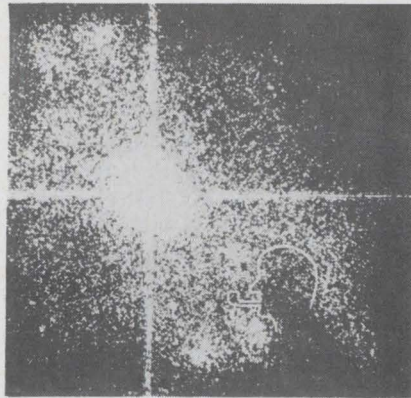

Far-out photo. Hologram taken from eight miles away. Note outline of man smoking pipe at lower right corner.

mounted on a 48-inch telescope, the researchers were able to photograph a man standing more than eight miles away at nighttime. Pictures were taken on a desert range near Holloman Air Force Base, New Mexico, under conditions of significant atmospheric distortion, the researchers said.

With further increases in laser power and film sensitivity, the technique promises the transmission of clear hologram pictures between the earth and satellites orbiting 100 miles or more away. Atmospheric distortion would be less a problem in this case than it is between points on earth.

Glassy-eyed. The Holloman experiment was the first practical demonstration of a laboratory test performed at Stanford more than a year ago. In that test, shower glass was used as the distorting medium.

A hologram is the product of the interference pattern created by the phase difference between reference beam and image beam. Since the effect of the wave distortion is the same for both, any distortion is, in effect, canceled out.

Another advantage of holography over conventional photography, notes Prof. Joseph Goodman of Stanford's applied electronics laboratory, is that it detects the image first before forming it, thus allowing for fine adjustments.

Several outstanding problems remain to be solved before effective long-distance transmission can be achieved, Goodman concedes. Signal-to-noise ratio must be boosted to at least 10, preferably to 100, by

extending the dynamic range of the film.

Researchers must also find out how much more laser power it would take to ensure a strong signal at the receiver. The Stanford laser has 50 megawatts of power, producing 1-joule for 30 seconds. Goodman thinks a Q switched 20-joule ruby laser would be needed to produce a clear picture of a moving target at very long distances.

Different rig. Another advance might be to substitute foil-lined parabolas and a television camera for the telescope and film. Computer processing of the images would also sharpen results.

In the Holloman experiment, the telescope received the reflected laser light and focused it through a reflecting mirror and lens to the film. The man eight miles off stood in front of a flat, light-reflecting surface. Mounted a few centimeters above him was a retro-reflector—a triangular-shaped reflecting mirror—for the laser.

Although the picture was crude, the Stanford team considers it a significant step in an area of great promise. Further development will have to be conducted by the Air Force's Avionics Laboratory, though, Goodman comments, because "it's reached the stage where the university isn't the one to continue the research."

Medical electronics

Night watch

One of the most agonizing mysteries in medicine is the "crib death syndrome," which in the U.S. alone annually takes the lives of 10,000 to 20,000 infants in their sleep for no apparent reason. Various theories have been advanced, and while many have been ruled out, a few are now gaining attention.

One such theory, now being pursued by a research team composed of an engineer, a pathologist, and a surgeon at the Atlantic Research

TRW
announces

**50 W at
500 MHz**



ACTUAL SIZE

28 Volts...5dB Gain...60% Efficiency!

TRW announces a major breakthrough in communication transistor technology with the introduction of this high efficiency, high gain 50 watt/500 MHz device.

In high power military aircraft transmitters, a single 2N5178 will do the job formerly requiring vacuum tubes or multiple-transistor circuits. The 2N5178 is also

well suited for use in radar pulse circuits.

This state-of-the-art device employs a patented cellular construction in a grounded emitter strip-line package comparable in size to the TO-37. A 25-watt version, type 2N5177, is also available.

For evaluation quantities and complete technical details, con-

tact any TRW distributor or TRW Semiconductors, 14520 Aviation Blvd., Lawndale, Calif. 90260. Phone: 679-4561, TWX: 910-325-6206. *TRW Semiconductors Inc. is a subsidiary of TRW INC.*

TRW[®]

division of the Susquehanna Corp., will soon be tested with microelectronic equipment.

The team believes the crucial element in the phenomenon to be the vagus nerve—the nerve that triggers the heart when it begins to falter. It believes that when an infant goes to sleep, heartbeat and pulse drop sharply, and that this slowing down of the heart continues as sleep deepens. If the process isn't interrupted, the re-



Guardian. Pulse of sleeping infant is monitored to prevent "crib death." Band fits on infant's arm.

searchers contend, the child can literally sleep to death.

Close calls. A hiccup or cough or other cause of arousal in sleep produces a "vagal storm" that speeds the heartbeat and pulse. Says a member of the team: "If the theory is correct, a large number of infants in their first months have 'near misses' every night they sleep."

The first step in testing the theory will be to monitor the pulse of a sleeping infant. In conjunction with the Case Institute of

Western Reserve University, the team has fashioned a breadboard "wristwatch" that uses a piezoelectric chip as a sensor and contains a simple transmitter made of discrete semiconductors that will transmit a wideband f-m signal. The monitoring system is now being tested on adults at Atlantic Research.

Remedy. Should the theory be correct, says Jack Spurlock, the team's engineer, the monitor could be used to trigger a remedial "control overtake," such as a vibrator, to stimulate the child's vagus.

In the early fall, the researchers hope to have a much smaller prototype monitor built with integrated circuits. Transmitter, battery, and sensor will be embedded in a thin nylon bracelet a child could wear without discomfort. The signal, at a frequency of 230 megahertz and a bandwidth of 35 kilohertz, would be received by a small broadband receiver in the home. From the home, it would be forwarded over landline to a central computer for analysis. According to Spurlock, the team's hypothesis will be proven or disproven in the next two years.

The project, which has been sponsored in-house by Atlantic Research, was recently granted funds by the Northern Virginia Heart Association.

Government

Grounding the middlemen

Although many electronics contractors maintain that the Federal Aviation Administration isn't the easiest Government agency to work with, many still are attracted by the business. But now, as a result of investigations by the General Accounting Office, much of that allure will fade.

The FAA has sometimes purchased test equipment only as part of a basic air traffic control or navigation system—even if the equipment was standard—but this is going to stop completely.

The FAA will now buy standard test equipment directly, instead of using the prime contractor as a middleman. However, when test equipment isn't standard, the FAA will allow the prime contractor to supply it.

In the purchase of the semiautomated terminal air traffic control system Tracon-C, for example, the contractors will supply the test equipment as part of the turnkey package supplied to each airport. Bids on Tracon-C are due May 28, but the FAA still has no definite idea of how many terminals its \$14.5 million will cover [Electronics, Feb. 19, p. 155].

Double fares. The GAO found that in eight of the 20 cases investigated the FAA purchased off-the-shelf, standard test equipment through prime contractors rather than directly from the manufacturers. This meant, of course, that the FAA was paying for two companies' profits and for more overhead and handling. The GAO studied two contracts closely.

In one, the purchase price of the test equipment was \$178,050. The prime contractor added \$57,264, which included \$25,205 in profit and 20,426 in general and administrative costs. The rest was for packing, shipping, engineering aids, and "materials variance."

In the second contract, the test equipment itself cost \$240,995. The prime contractor charged an additional \$62,790, of which \$27,617 was profit, \$15,905 was for material overhead, and \$19,268 was for general and administrative costs.

Round trips. The GAO study disclosed that the FAA paid to have some test equipment shipped about 6,000 miles—from a manufacturer in Oregon to the prime contractor's plant near Boston, then back to the installation site situated near Los Angeles.

The GAO found a number of other cross-country treks for test equipment. So obvious was the waste of money that the GAO reported: "We made no effort to calculate the amount of additional transportation costs incurred by the FAA."

In addition, the GAO discovered that test equipment was being inspected and calibrated twice: once

4 ways to view displays with the Tektronix Type 564

split-screen storage oscilloscope

The Tektronix Type 564 is virtually two instruments in one. It offers all the advantages of a storage oscilloscope plus those of a conventional oscilloscope.

Split-Screen Displays

An unique split-screen display area enables you to simultaneously use either half of the screen for storage and the other half for conventional displays, or use the entire area for stored or conventional displays.

Independent control of both halves of the screen permits you to take full advantage of the storage facilities. For example, you can use half the screen to store a reference waveform, the other half to display waveforms for comparison. You can erase or retain either half of the display area as you choose.

Bistable Storage Advantages

With bistable storage oscilloscopes, such as the Type 564 and Type 549, the contrast ratio and brightness of stored displays are constant and independent of the viewing time, writing and sweep speeds, or signal repetition rates. This also simplifies waveform photography. Once initial camera settings are made for photographs of one stored display, no further adjustments are needed for photographs of subsequent stored displays.

Storage time is up to one hour, and erase time is less than 250 milliseconds. An illuminated 8 cm by 10 cm graticule facilitates measurements and aids in taking photographs with well-defined graticule lines. Adding to the operating ease is a trace position locator that indicates, in a nonstore area, the vertical position of the next trace or traces.

Tektronix bistable storage cathode ray tubes are not inherently susceptible to burn-damage and require only the ordinary precautions taken in operating conventional oscilloscopes.

Plug-In Unit Adaptability

The Type 564 accepts Tektronix 2 and 3-series plug-in units for both vertical and horizontal deflection. Display capabilities of these units include single and multi-trace with normal and delayed sweep; single and multiple X-Y; low-level differential; dual-trace sampling; spectrum analysis, and many other general and special purpose measurements.

- Type 564, without plug-in units \$ 925
- Rack-Mount RM564 \$1025
Similar electrical characteristics to Type 564. 7" high.
- Type 3A6 Dual-Trace Amplifier Unit \$ 525
DC to 10 MHz from 10 mV/div to 10 V/div. 5 display modes.
Internal signal delay line.
- Type 3B4 Time Base Unit \$ 425
Sweep speeds from 0.2 μ s/div to 5 s/div. Single sweep. Up to X50 direct-reading magnifier extends fastest sweep to 50 ns/div.

U.S. Sales Prices FOB Beaverton, Oregon

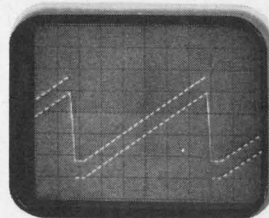

Entire screen can be used for a stored display.

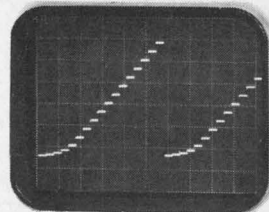

Entire screen can be used for a nonstored display.

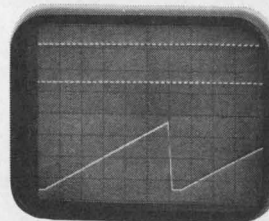

Each half of split-screen can be used independently for stored displays.

Either half of the split-screen can be used for a stored display, the other half for a nonstored display. (Shown below).

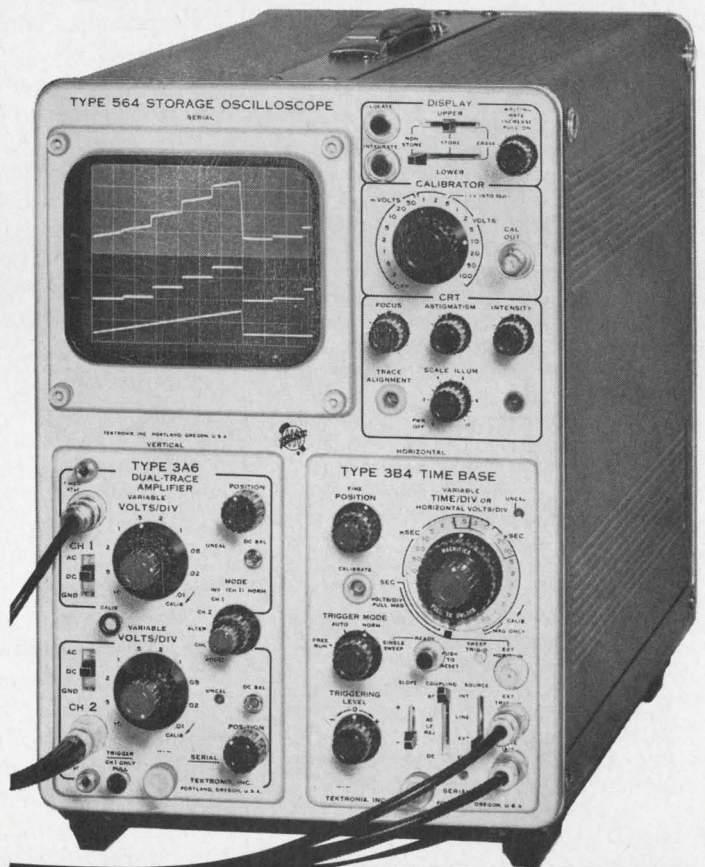

Tektronix, Inc.



For a demonstration, contact your nearby Tektronix field engineer or write: Tektronix, Inc., P. O. Box 500, Beaverton, Oregon 97005.



"Bulldog" Marshall spends another disappointing day with Super-Mercury.

Marshall? He's the crankiest of the Twelve Cranks on Pleasant Avenue. One of the extra-picky grumps at Trygon Power Supplies who feels good all over only when he can pick something off our production line and shriek, "Hey! This is no % #&ç@# good!"

So far, he's had problems with our Super-Mercury series. Because there haven't been any problems.

The Super-Mercury is a brand new competitively priced series, the new generation of the industry-accepted, field-proven Trygon Mercury Series: fully programmable wide-range power supplies, power and value packed, offering precision Constant Voltage/Constant Current operation. Precision performance (with up to 2000 watts output), in ranges up to 160 volts and up to 100 amps. .005% regulation and 0.015% stability are standard (.005% stability optional) as is MIL Spec, RFI-free performance. Total ripple and noise less than 1mv rms and 10MV P-P (to 10MHz). Master-slave tracking, auto-load share paralleling and remote sensing and programming are also standard with Trygon's patented tracking overvoltage protection available.

Marshall and his friends check the dozens of Super-Mercury features that make this series a Super-buy for you. Now it's your turn to check on them. Order a Super-Mercury as a starter.

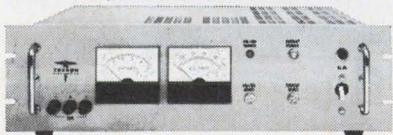

Trygon Power Supplies

111 Pleasant Avenue, Roosevelt, L.I., N.Y. 11575
Trygon GmbH 8 München 60, Haidelweg 20, Germany

Electronics Review

on receipt by the prime contractor and again on receipt by the FAA at the installation site. Both were based on the manufacturer's manual. Of course, the prime contractor was charging the Federal Aviation Administration for its inspection and calibration services.

The GAO, an investigating arm of Congress, didn't identify the companies involved, in line with its policies of soft-peddling reports [Electronics, Dec. 25, 1967, p. 107]. The FAA conceded that the charges were substantially correct.

Avionics

CAT by the tail

Much has been said in avionics circles about "belling the CAT," but clear-air turbulence remains the same menace to aircraft it was when the pun was considered funny. Of the many research efforts aimed at finding a means of alerting pilots to the presence of turbulence, however, one has finally resulted in a marketable system.

The Autonetics division of the North American Rockwell Corp. is taking the "experimental" tag off its air-turbulence detector and offering it to the airlines as a commercial product. Armed with statistics compiled in 372 hours of operation during 76 flights—30 in an Air Force C-135 and 46 in an Pan American World Airways Boeing 707 on regular passenger runs [Electronics, Nov. 27, 1967, p. 52]—Autonetics representatives have been presenting the case for the system to officials of American, Eastern, TWA, Pan Am, and United Air Lines.

The latest version of the detector—configuration number five—has three major parts: an infrared radiometer sensor, a data processor, and an indicator panel. The system operates in the far infrared range at the lower edge of the carbon-dioxide absorption band—between 14 and 16 microns.

Time to prepare. In the most recent Pan Am tests, conducted last December and January, the system

operated for 157 hours and detected 14 areas of turbulence. It missed one and triggered five false alarms. Warning time averaged three to four minutes before the turbulence was encountered.

The latest version should be ready in about nine months, according to Edward Flint, manager of the program at Autonetics. It will incorporate a number of improvements over earlier models, which were prone to triggering false alarms. Flint notes, however, that the airlines are willing to live with some false alarms if they can be certain that no critical turbulence goes undetected.

The i-r sensor beam is fixed to detect disturbances out to 50 miles ahead of the plane within a 2° vertical and 10° horizontal field of view. The fourth version of the system, the one used in the most recent Pan Am tests, was the first to employ a fixed beam.

Another refinement, first used in the third version of the detector, helps minimize false alarms triggered by the minor turbulence that results from momentary changes in the aircraft's attitude. This problem is licked by using a vertical gyro cutoff signal to turn off the infrared CAT sensor when the aircraft pitches down 1° or up 3.5° or rolls 4.5°.

Temperature change. During the Air Force flights, Autonetics engineers found that the presence of turbulence was signaled by a change in carbon-dioxide temperature, a change in carbon-dioxide density, and a change in ice-crystal concentration. The CO₂ absorption band was selected for the system on the basis of studies conducted by Autonetics that were started some eight years ago.

The system weighs under 50 pounds and requires less than 100 watts; both levels, Flint says, are lower than would be required by a radar detector. Besides CAT, incidentally, the detector can pick up turbulence caused by thunderstorms.

No price tag has yet been put on the system. It's designed for any aircraft that cruises between 25,000 and 41,000 feet, and Flint says it looks technically feasible, with a

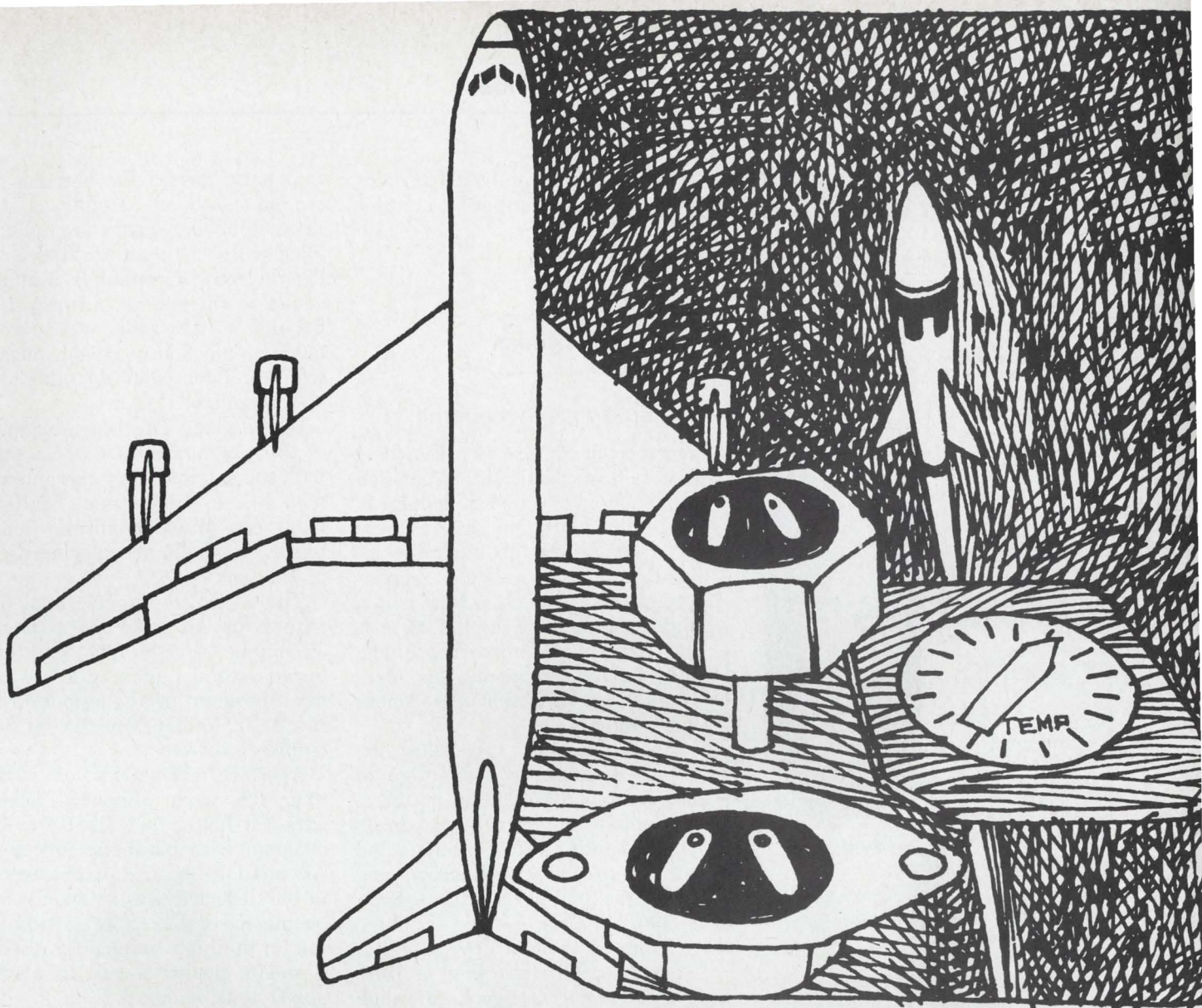

protect

Protect your critical functional systems against damage from temperature changes—whether in aircraft, missiles, space vehicles, military ordnance, aerospace ground equipment or industrial equipment. It's a snap, with United Control's inherently simple, snap-acting, bimetallic disc thermal switches. Refined and perfected to put maximum emphasis on precision, reliability and flexibility of application. For more information, call or write United Control.



UNITED CONTROL

Circle 45 on reader service card

A SUBSIDIARY OF SUNDSTRAND CORPORATION
REDMOND, WASHINGTON 98052 • PHONE (206) 885-0711

To put it in writing...

look first to BRUSH®

No matter what your direct writing recording requirements, look first to Brush for the optimum answer. There's the famous Mark 200 series of modular systems plus a complete line of portable and general purpose recorders:

Mark 200—8 Channel Recorder

New generation Series 1707 system combines all solid state electronics with modular construction for tailoring to specific requirements. Choice of channel widths and input preamplifiers. Range of chart speeds 0.05 to 200 mm/sec. Patented pressurized-ink writing system.



Mark 220 Portable Recorder

High performance two analog channel unit weighs only 25 pounds, writes in any position. Has the Mark 200 writing system. Chart speeds from 1 to 125 mm/sec. One millivolt sensitivity. Portable.

Mark 250 Strip Chart Recorder

Fastest, most versatile 5" strip chart recorder anywhere. Contactless servo. Detachable chart magazine. Has the Mark 200 writing system. Chart speeds from 0.2 sec/div. to 5 min/div., sprocketed drive. Portable.

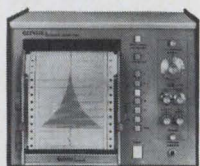

Mark 280 Dual 80mm Recorder

Feedback penmotor unit has two "double width" analog channels. Has the Mark 200 writing system. Chart speeds from .05 to 200 mm/sec. Portable.



Brush Lightbeam Oscillographs

Choice of three high performance models with up to 25 channels, frequency response to above 5000 Hz, variety of chart speeds .002 ips to 120 ips. Writing speeds to 60,000 ips.



To put it in writing, write for complete catalog. Clevite Corporation, Brush Instruments Division, 37th and Perkins, Cleveland, Ohio 44114.

CLEVITE BRUSH

Electronics Review

range extension to about 150 miles, for supersonic transports.

Space electronics

Fiddling with Symphonie

A paper on the use of a Luneberg lens in a mechanically despun satellite antenna drew an indulgent, and even faintly amused, response at an American Institute of Aeronautics and Astronautics conference in San Francisco this month. But Henning W. Scheel, a 26-year-old German electronic consultant, may have been aiming his ideas beyond his predominantly American audience.

Scheel and his associates are trying to influence the design of the Symphonie satellite, a three-axis-stabilized craft being developed jointly by Germany and France to provide television and telephone relays [Electronics, Sept. 4, 1967, p. 207].

Plans are to launch two satellites—one by 1971, the other in 1972. They're being designed to weigh less than 374 pounds, to permit launching by the ELDO-PAS vehicle. The two countries are putting up about \$56 million for the project; requests for proposals went out in January.

Scheel says flatly that three-axis stabilization will cost twice as much as spin stabilization and be less reliable. He and a colleague, K. Rudzinski, convinced the influential German newspaper, Frankfurter Allgemeine Zeitung, to devote nearly a full page last month to their discussion of "unnecessary risks in the Symphonie project" and to Scheel's alternative.

Rudzinski said that no satellite with three-axis stabilization that weighed less than 660 pounds had yet been built. He said the three U.S. satellites with three-axis stabilization all required nearly as much money for one satellite as the Symphonie sponsors are prepared to spend for two.

Scheel made his case for the

Luneberg lens as the antenna for a spin-stabilized satellite at the AIAA. Luneberg lenses are spheres filled with a nonuniform dielectric; the dielectric constant is 2 at the center of the sphere but only 1 at the rim, so that radio waves emitted from any source on the surface will be collimated on the other side of the sphere.

Despunning. The big advantage of this antenna is that it can spin with the satellite; only the antenna feed has to be despun. Multiple feeds can provide multiple pencil beams to illuminate specific areas of the earth.

The German Experimental Institute for Air and Space Travel Technique, near Munich, built and tested several Luneberg lenses under a program partly supported by the West German Ministry for Scientific Research.

Aperture efficiencies of better than 0.8 were obtained, Scheel says—far better than the 0.5 or 0.6 common with parabolic reflectors. Attenuation because of absorption in the dielectric was so small as to be unmeasurable; Scheel attributes this to the high frequencies used—4 and 6 gigahertz—and to a new polystyrene material.

The big argument against lens antennas, and the one that led many U.S. engineers who heard Scheel's paper to discount it, is that their weight increases with the cube of their diameter.

Also, to obtain narrow beams, large apertures are required. An 18-inch diameter Luneberg lens of pure polystyrene foam that produces a 10-degree beam at 4 GHz weighs 35 pounds—"too much for certain space applications," Scheel admits. But, he says, lenses of the same diameter that weigh only 7 to 9 pounds are available—though the artificial dielectric used causes an absorption loss that cuts gain by about 1.5 decibels. "And it seems possible to fabricate lenses of only 2 to 3 pounds," Scheel predicts.

But Scheel's biggest weapon against weight is to increase the frequency, thus reducing wavelength and increasing the aperture-wavelength ratio.

Whether the Luneberg lens ar-

27 seconds from now you'll know whose JAN 1N3611 you want to use . . . and why

This is an actual section of a conventional plastic JAN 1N3611 rectifier

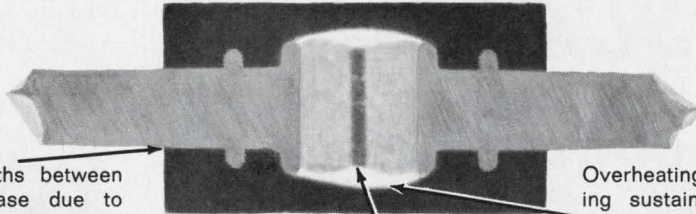

Possible moisture paths between leads and plastic case due to unequal thermal coefficients of expansion and shrinkage of plastic from leads during cure.

Overheating of silicone rubber during sustained power overload often results in long-term leakage degradation.

Relative porosity of plastic allows penetration of moisture over extended period, creating possible electrical degradation.

Usually not controlled avalanche. Conventional passivation by oxides, varnish, or silicone rubber (as shown) allows possibility of surface leakage degradation.

This is an actual section of a Unitrode glass 2 amp JAN 1N3611 rectifier

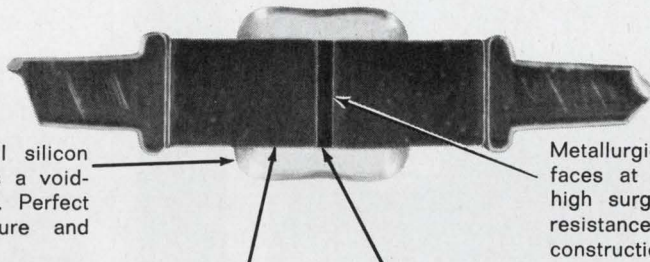

Hard glass fused to all silicon and pin surfaces creates a voidless monolithic structure. Perfect seal against all moisture and contaminants.

Metallurgical bond of pins to die-faces at 1000°C allows extremely high surge capability, low thermal resistance. Virtually indestructible construction.

Temperature coefficient of glass and pins is matched to silicon. No degradation under severe thermal stress of high transients or repeated temperature shock — even from -195°C to +300°C.

Controlled avalanche and permanently stable surface leakage characteristics. Hyperclean silicon surface fused only in hard glass. No oxides, silicones, or varnish are used.

And by the way . . .

Glass doesn't always cost more than plastic. Not when you get the economies of making 250 thousand at a time. So don't be shocked at how low our prices are. And . . . you can buy a 100 thousand right off the shelf.

For fast action, call Dave Greene COLLECT at (617) 926-0404.



Our catalog sheet is loaded with charts, graphs, and all kinds of detailed specs you'll want to have, so circle the reply card number now.

ACTUAL SIZE



Part #	PIV	Rating
JAN1N3611	200V	2A
JAN1N3612	400	2
JAN1N3613	600	2
JAN1N3614	800	2

580 Pleasant St., Watertown, Mass. 02172, (617) 926-0404

UNITRODE

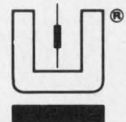

RMC DISCAPS

*the complete
Ceramic Disc
line*

Over the years Radio Materials Company has maintained its leadership in the production of ceramic disc capacitors. A complete line offering outstanding quality has been the key to continuing growth.

STANDARD

Type C, B, BA, JF, JL and JE

SUBMINIATURE

Type SM, BT, TA and Magnacaps

GREENCAPS

Type CG, JG, and BG

SPECIAL

U.L. Listed Discaps, T.C. High Voltage, High K High Voltage and Dual Section By-Pass

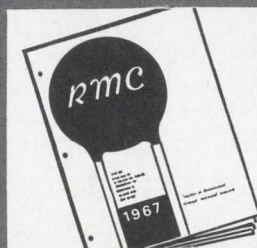

*Send for
Your
Catalog Today!*

Write on your letterhead for a copy of the RMC catalog that lists the complete line of RMC DISCAPS.

DISCAP
CERAMIC
CAPACITORS



RADIO MATERIALS COMPANY

A DIVISION OF P. R. MALLORY & CO., INC.
GENERAL OFFICE: 4242 W. Bryn Mawr Ave., Chicago 46, Ill.
Two RMC Plants Devoted Exclusively to Ceramic Capacitors
FACTORIES AT CHICAGO, ILL. AND ATTICA, IND.

gument can convince the West German government—in the face of present plans and the existing technology for mechanically despun parabolic antennas—is problematical. Scheel still expects the devices to play a role in satellite communications. At least one U.S. representative at the AIAA meeting saw some future for the lens as a cheap ground antenna in a direct broadcast television system.

For the record

Millimeter tv. A point-to-point system capable of carrying 12 or more television channels at millimeter-range frequencies could save the CATV industry a lot of money by eliminating the need for underground cables. But even such advanced research houses as Bell Labs haven't been able to find an answer to the signal attenuation caused by heavy rain.

Now, however, the Chromalloy American Corp. and the Laser Link Corp. claim they have a system that not only can transmit up to 20 tv programs at one time over a 42-gigahertz carrier, but can guarantee excellent reception even in rain.

The secret of their scheme is being kept just that, a secret. Based on a proprietary modulation technique—the “quasi-laser” is what representatives of the two companies call it—the system is to be tested in the New York City area.

Happy landings. The Boeing Co. has purchased a military radar system that measures a plane's descent speed and landing velocity and plans to install it in its 737 civilian transport. The system, developed by the Ryan Aeronautical Co., is now being used in the F-4 Phantom jet fighter, the CH-46 helicopter, and the C-130 Hercules.

Scuttlebutt. In the wake of the Pueblo's seizure by North Korea, the Defense Department is studying the reliability of self-destruct mechanisms for electronic espionage gear.

Official weigh-in.

The first in a series of bouts as "the mighty mite," but as yet unheralded, M. "Tex" Aemco takes on all challengers to determine the championship relay and timer supplier of the world. Surprisingly, Las Vegas odds-makers have rated the match a tossup. Said one of them, "Little Tex packs all the punches of the big boy, so from here on the outcome looks like it will go to the man who can think fast and move quickly."

US vs THEM



TEX

Thinks fast and moves quickly. Can match his opponent punch for punch. Lightning-like delivery. Scores best before tough judges. Great crowd pleaser because of his manner of charging in head first and not stopping until the battle is won. Clean fighter. Doesn't pull any punches.



YES 155 YES
5 and 10 Ampere 3 Pole Industrial Relay



YES 156 YES
Miniature 4 Pole 3 Ampere Industrial Relay

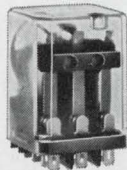

YES 157 YES
10 Ampere 3 Pole Industrial Relay

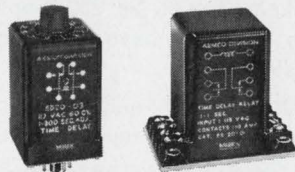

YES 615 YES
Adjustable and Fixed Industrial Time Delays



POTTY BUTTERFELL

Has a lot of size going for him. Has done well in past. He's a nice guy.

MIDTEX 
INCORPORATED

AEMCO DIVISION

10 STATE STREET
MANKATO, MINNESOTA 56001

PROGRAMMERS/TIME DELAY RELAYS/MINIATURE COAXIAL RELAYS/INDUSTRIAL RELAYS/MERCURY-WETTED CONTACT RELAYS

MICROWAVE IC PROGRESS REPORT #1

Sperry PACT program carries avalanche transit time oscillator past 5,000 hours of life testing

Sperry's PACT (Progress in Advanced Component Technology) Program now offers more than 5000 hours of life test data on an X band Avalanche Transit Time Oscillator. With a test history dating from July 6, 1967, the device has not yet shown a measurable change in characteristics.

A direct result of PACT, Sperry's intensified effort to accelerate the development of microwave integrated circuits, the ATTO is believed to be the smallest device of this type available anywhere for the direct conversion of DC to a microwave signal. Its outline dimensions are identical with that of a DO-5 diode package.

In developing the device, PACT engineers attacked the following requirements:

- Relatively high power output in microwave IC size packages.
- Electronic tunability over 5 to 50% bandwidths.
- Frequency modulation capability without excessive spurious amplitude modulation.
- Minimum AM and FM noise characteristics.

Success of the project depended largely on Sperry's in-house capability for development and production

of avalanche diodes. This capability met the challenge, and ATTO's are now produced entirely within Sperry's Clearwater, Fla., facility.

As soon as PACT had demonstrated its ability to deliver the diodes required, the other technical problems came under staff scrutiny. One of the first developments was an "upside-down" diode mounting technique which puts the heat dissipating region of the silicon mesa chip as close as possible to the heat sink. Resulting reduction of thermal resistance between junction and heat sink enabled

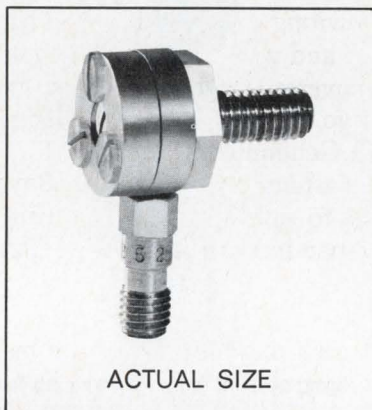

PACT engineers to handle current densities as high as 850 amps/cm². Power outputs have reached 380 mW CW.

Both frequency and phase locking techniques have been demonstrated.

Tuning requirements were met by utilizing mechanical, varactor or YIG techniques. Magnetic tuning across a 40% bandwidth is a reasonable expectation, and Sperry's experience in stalo design has permitted FM noise reduction by a factor of 30.

In summary, PACT has now demonstrated the feasibility of ATTO power output from 20 to 350 mW at specified frequencies between 5 and 10 GHz; inputs would vary from 80 to 110 VDC at 30 - 50 mA. These forerunners of true microwave IC's will deliver conversion efficiency as high as 5%, and

SPURIOUS AMPLITUDE MODULATION

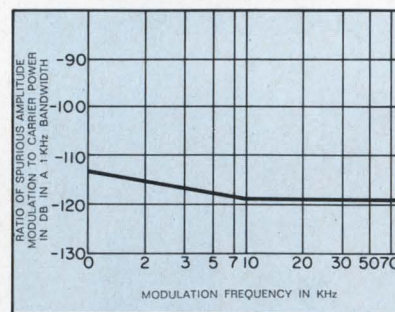

frequency stability of 4.5 ppm/°C between -10 and +50/°C.

In its ATTO effort, the PACT program has already proved its ability to provide direct DC to microwave conversion for the most demanding of custom specifications. Chances are that the technology required for your application is already in existence. And, PACT's achievements in ATTO development foreshadow a quickening pace in the refinement of microwave integrated circuits.

To learn more about an ATTO for your application or the coming impact of PACT, contact your Cain & Co. representative or write Sperry Microwave Electronics Division, Sperry Rand Corporation, Clearwater, Florida.

*For faster microwave progress,
make a PACT with people
who know microwaves.*

SPERRY
MICROWAVE ELECTRONICS DIVISION
CLEARWATER, FLORIDA

Washington Newsletter

April 29, 1968

Telecommunications panel unlikely to ask for new Cabinet post

Prospects for a Federal Department of Communications are fading. The President's telecommunications task force now leans toward recommending that an agency similar to NASA be formed to cover the field of communications, but not at the Cabinet level.

James D. O'Connell, director of telecommunications management and vice chairman of the task force, has been instrumental in swaying the panel away from the department idea. He's also against turning over the regulatory duties of the Federal Communications Commission to any new agency, and is just as firmly opposed to lumping communications with transportation under one Cabinet-rank department.

Boyd in slow burn on fast-train delay

Transportation Secretary Boyd is ready to blow the whistle on contractors who have failed to get the high-speed rail service between New York and Washington into operation. The trains were supposed to roll last fall but have been delayed at least twice.

After the Budd Co. recalled 31 of the cars because of problems with control gear and stray voltages, Boyd appointed a task force to find out what was wrong and how to speed the project. The task force will report by May 17 and will probably recommend appointment of one prime contractor to oversee the entire project and coordinate efforts between Budd and the two firms building the electrical and control systems, Westinghouse and General Electric.

Some Washington sources say Boyd is so fed up with the delay that he's ready to publicly suggest hiring Japanese consultants to lead the project. Japan has had high-speed trains operating for several years.

More R&D cash for Post Office

Don't expect Congress to start the ball rolling toward changing the Post Office Department into a nonprofit Government corporation—something the President's Post Office Commission is expected to recommend in its report this week. But Congress is expected to pay more attention to the commission's urging that greater emphasis be given research and development to provide more efficient mail handling.

Likely to come out of this: another increase next year in the postal R&D budget, which grew from \$16 million in fiscal 1968 to \$23 million in fiscal 1969.

New missile studies point to a bonanza

Study contracts just awarded for an improved tactical all-weather, air-to-ground missile system—called AGM-X3—presage hardware orders that may total more than \$500 million over the next few years. The \$650,000 project-definition contracts have been issued to Hughes, Martin, and Boeing.

The new missile will supplement the Maverick, which uses television guidance and is limited to clear-weather daylight operation. The guidance system for the AGM-X3 hasn't yet been selected, but one prospect is a passive millimeter-wave radar. The Air Force is also asking the study contractors to investigate a combination optical-radar system using inertial guidance for midcourse corrections.

Washington Newsletter

Airlines may alone fund Comsat craft

The nation's airlines are considering the possibility of going ahead with Comsat on the aeronautical services satellite without waiting for Federal assistance. This line of thought, expressed by officials of the Air Transport Association, reflects worries that the oft-delayed project will be further postponed by a lack of Government funds [Electronics, March 4, p. 62], and has been spurred by recent Comsat statements that the company's charges or satellite services would come to "less than \$100" per flight. This is about three times what the airlines now pay for communications on transatlantic runs, but they seem to feel that such added benefits as data relay might justify the higher price. The carriers still aren't happy, however, about Comsat's long-standing proposal that they pay a lump sum in advance.

One possible hitch in the approach being mulled is legal: Comsat's charter may not cover the independent operation of such a system.

A report on a national aeronautical satellite plan being worked out by the FAA, other Government agencies, and industry is due in two months.

Radiation roundup: Senate to hear calls for a tough bill . . .

It's beginning to look as if the radiation bill the Senate will pass will be sufficiently different from the recently passed House version to force a compromise.

Some key provisions of the tough Administration measure excluded from the House bill will be strongly urged by several witnesses at the Senate Commerce Committee's hearings on radiation. At the sessions—due to start May 6—consumer champion Ralph Nader, among others, is expected to demand that the Senate bill provide for Federal inspection of plants making radiation-emitting products and for the recall of faulty equipment—items dropped by the House [Electronics, April 1, p. 46]. And union representatives will probably push for inclusion of the Administration's call for constant monitoring of workshops where radiation-emitting goods are made.

. . . as workers balk at radar overhaul

All the talk about the potential dangers of radiation-emitting equipment is having its effect in other places. Concern over possible hazards may delay the FAA's plans to overhaul its radar antennas in a dozen locations.

The FAA says there's no danger, but its technicians are refusing to work on antennas at Benson, N.C., while temporary radar equipment is in full operation 88 feet away. In past overhauls, the FAA turned off the airport radar and closed down the field, but at Benson—and other fields due for renovation—it's bringing in portable radars to keep the airports open during the overhaul period. The National Association of Government Workers has asked the National Center for Radiological Health to investigate.

F-m radio bill gets little House backing

Washington observers say Rep. Alvin E. O'Konski (R., Wis.) won't get to first base with a bill requiring that all radios imported or sold interstate be capable of receiving both a-m and f-m broadcasts. The bill has been referred to the Interstate and Foreign Commerce Committee, but chances are good that no hearings will be held this year. The House is not enthusiastic about the measure simply because f-m radios are selling well—their share of the home-radio market rose to 37% last year from 30% in 1966. And of the car radios sold in 1967, 10% were f-m, compared with 6.8% the year before. In all, about 15 million f-m receivers were sold last year.



Sorensen's new QRS 40-.75 delivers 1½ times the watts per dollar of most competitive power supplies... with no stinting on performance.

New Sorensen QRS:

- Voltage Regulation/Current Regulation (with automatic crossover).
- Voltage Regulation: $\pm 0.01\%$ or $\pm 1\text{mV}$ for maximum line and load changes combined.
- Voltage Ripple: $400 \mu\text{V}$ r.m.s. (6 mV peak-peak to 25 MHz)!
- Output Voltage Resolution: 0.01% of maximum output voltage.
- Remote Programming.
- Remote Sensing.
- Ambient Temperature: -20 to $+71^\circ\text{C}$

Model Number	Output Voltage Range	Output Current Range @ Ambient			Size (inches)			Price
		@ 40°C	@ 55°C	@ 71°C	h	w	d	
QRS 15-2	0-15Vdc	0-2.20A	0-2.00A	0-1.20A	3½	8	13	\$145.
QRS 20-4	0-20	0-4.40	0-4.00	0-2.40	5¼	8	13¼	\$255.
QRS 30-1	0-30	0-1.10	0-1.00	0-0.60	3½	8	13	\$145.
QRS 40-.75	0-40	0-0.83	0-0.75	0-0.45	3½	8	13	\$145.
QRS 40-2	0-40	0-2.20	0-2.00	0-1.20	5¼	8	13¼	\$255.
QRS 60-.5	0-60	0-0.55	0-0.50	0-0.30	3½	8	13	\$155.
QRS 60-1.5	0-60	0-1.65	0-1.50	0-0.90	5¼	8	13¼	\$265.

Contact your local Sorensen representative or: Raytheon Company, Sorensen Operation, Richards Ave., Norwalk, Conn. 06856. TWX 710-468-2940.



for more data on this versatile instrument . . . **Call Sorensen: 203-838-6571**



**Complex-function
integrated circuits
give you a new look
in system package count
... system costs, too!
(MECL II MAKES IT POSSIBLE!)**

- where the priceless ingredient is care!



30% SYSTEM COST REDUCTIONS POSSIBLE!

Since we don't know your exact system requirements, we can't predict precisely how much MECL II can reduce your costs. But, our engineers figure that 30% is a *conservative* estimate for most systems! Why? There are three reasons: First, there's the recent reduction in piece-part prices — as much as 65% on some types. Then, we've now introduced several new complex-function types (and, more on the way) to further reduce "can-count." And, of course, there's the complementary output feature of all MECL circuits — to provide superior design flexibility as well as reduced package-count.

It's a great combination!

Further, even the new complex-function circuits are lower in price than other comparable types. For example, the cost-per-gate-element of the MC1030/MC1031 is less than 33 cents! Yet, these Quad 2-Input Exclusive OR and NOR gates will replace up to 12 standard gates and make it possible for you to build a 25 ns, 16-Bit Parity Checker, as shown

COMPLEMENTARY OUTPUTS REDUCE PACKAGE COUNT The six-input OR/NOR gates in the MECL II series are extremely useful in generating multiple wired-OR logic functions since six independent outputs are provided, as shown. In addition to lowering system costs by reducing package count, this unique feature reduces delay time and design headaches; plus, it provides almost unlimited flexibility of logic design.

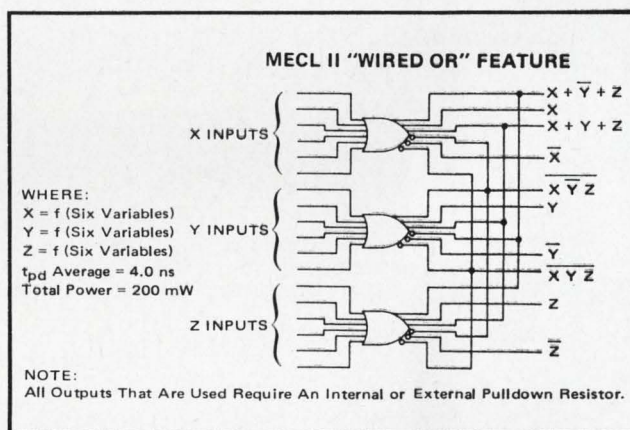
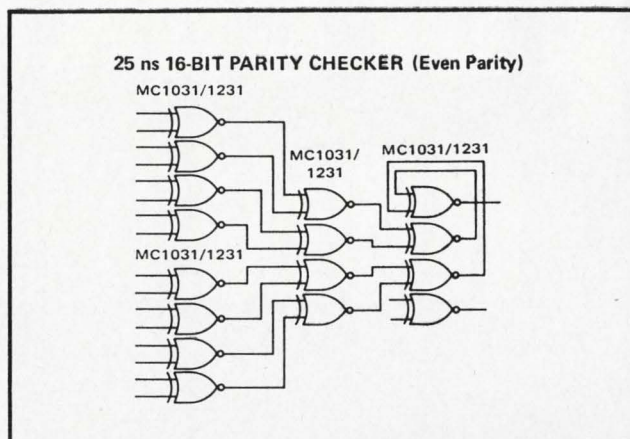

NOW - UP TO 65% LOWER PRICES ON SOME MECL II TYPES!

TYPE NO.	FUNCTION	PRICE 1000-UP	TYPE NO.	FUNCTION	PRICE 1000-UP
MC1001P	Single 6-Input Gate	\$1.25	MC1017P	Translator (Sat. Logic to MECL)	\$2.75
MC1002P	Single 6-Input Gate	1.25	MC1018P	Translator (MECL to Sat. Logic)	2.75
MC1003P	Single 6-Input Gate	1.25	MC1019P	Full Adder	3.50
MC1004P	Dual 4-Input Gate	1.30	MC1020P	Quad Line Receiver	1.25
MC1005P	Dual 4-Input Gate	1.30	MC1021P	Full Subtractor	3.50
MC1006P	Dual 4-Input Gate	1.30	MC1022P	Type D Flip-Flop	3.70
MC1007P	Triple 3-Input Gate	1.35	MC1023P	Dual 4-Input Clock Driver (2ns t _{pd})	5.80
MC1008P	Triple 3-Input Gate	1.35	MC1024P	Dual 2-Input Expandable Gate	1.35
MC1009P	Triple 3-Input Gate	1.35	MC1025P	Dual 4- and 5-Input Expander	1.30
MC1010P	Quad 2-Input Gate	1.40	MC1027P	120 MHz AC Coupled J-K FlipFlop	5.80
MC1011P	Quad 2-Input Gate	1.40	MC1029P	Data Distributor	2.60
MC1012P	Quad 2-Input Gate	1.40	MC1030P	Quad 2-Input Exclusive OR Gate	3.95
MC1013P	85 MHz AC Coupled J-K Flip-Flop	2.40	MC1031P	Quad 2-Input Exclusive NOR Gate	3.95
MC1014P	Dual R-S Flip-Flop (Pos. Clock)	2.60	MC1033P	Dual R-S Flip-Flop (Neg. Clock)	2.60
MC1015P	Dual R-S Flip-Flop (Neg. Clock)	2.60			
MC1016P	Dual R-S Flip-Flop (Single Rail)	2.60			
OTHER COMPLEX FUNCTIONS TO BE ANNOUNCED SOON:			16-Bit Coincident Memory	Transmission Line Driver	
			100 MHz Decade Counter	Dual Schmitt Trigger	
			180 MHz Type "D" Flip-Flop		

New MECL Data Brochure provides "how-to-use" information plus complete specifications, for the World's Fastest, Most Advanced I/C Logic Line . . . 80-pages of pertinent applications information, complete data for 58 MECL II devices (30 circuits) and a general information section that includes a full explanation of the emitter coupled logic design approach. It's yours for the asking! Simply write on your company letterhead to: P.O. Box 955, Phoenix, Arizona 85001.

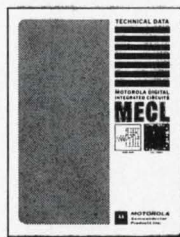

Most MECL II circuits also available in ceramic flat pack (TO-86) for -55° to +125°C operation.

MOTOROLA Semiconductor Products Inc.

4 breakthroughs: new NIXIE® tube

1

size

.530" dia. x 1.5" for IC compatibility — largest numeral height provides best readability.

2

anode strobing

new design permits all like-numerals to be driven in parallel for time sharing operation with improved brightness.

3

pin spacer

simplifies both PC board layout and tube insertion.

4

price

in quantities of 1,000 — only **\$395** each.

This new tube, type B-5750, has been engineered to achieve all these outstanding breakthroughs in a single design. The new slim-line tube not only has two internal decimal points but also has an "in-line" lead arrangement which is compatible with dual in-line IC's. In addition, the numeral aspect ratio has been designed to provide the optimum in readability and viewing distance.

The movable pin spacer — standoff, which is used to align the tube pins for ease of PC layout and insertion, is part of the tube assembly. The anode strobing/time sharing operation permits substantial reduction in driver costs for many multi-digit display applications. For more information on these and other features contact your nearest Burroughs representative or sales engineer, or write: *Burroughs Corporation, Electronic Components Division, P.O. Box 1226, Department N6, Plainfield, New Jersey 07061 TEL: (201) 757-5000.*



ACTUAL SIZE

Burroughs

Technical Articles

**Eliminating
ground-loop errors**
page 58

Ground-loop current plagues both the designer and user of electronic equipment. Separate grounding of electronic gear in a common system can cause hum in hi-fi systems or, more importantly, errors in data-measuring systems. A method that eliminates the problem uses two operational amplifiers connected as a differential circuit.

**Speedier a-d converter
adds integrating ramp**
page 69

One way to waste the valuable time of a computer is to feed it an analog input through a slow a-d converter. Today's process-control and data-acquisition systems demand speeds up to 20,000 conversions per second with a resolution of 14 bits. A new development, the triple-ramp-integrating converter, not only does the job as well as the successive approximation technique, but does so at lower cost.

**New isolation
boosts performance
of diode arrays**
page 75

The advantages of discrete diode arrays (high forward conductance) along with the advantages of monolithic arrays (economy and uniformity) can be achieved using a new air-isolation process. The technique, an outgrowth of the "mesa" proposals of a few years ago, may be applied in the future to other types of integrated circuits.

**Automatic checkout
rides co-pilot**
page 81

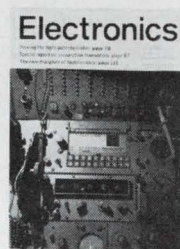

Avionics companies have been tackling the problem of getting cumbersome checkout equipment, now housed in huge ground vans that have to be brought up to the flight line, down to a size that will let it ride aboard the plane. Their aim is to give the pilot a constant reading of the performance of the many systems that today's military craft must carry, automatically detecting faults occurring while the plane is aloft. A survey of some of the approaches taken by avionics engineers indicates that on-board automatic checkout equipment may one day be as routine as a fuel gauge. The in-flight performance monitor designed by the Grumman Aircraft Engineering Corp. for the Navy's E-2A Hawkeye airborne early warning system is shown on the cover.

Coming **Testing integrated circuits**

With the rising complexity of integrated electronic devices comes an increasing challenge in testing them. Manufacturers and users alike have developed ingenious methods to guarantee high performance and reliability in IC's.

Protecting data from the ground up

Error voltages that are created by circulating currents between pieces of separately grounded electronic equipment can be eliminated by using a differential data amplifier

By Robert I. Demrow

Analog Devices Inc., Cambridge, Mass.

Common ground may be the goal of diplomatic machinery, but it's the bane of data-measuring gear. Ground-loop currents running between pieces of equipment that are grounded at separate points to a common ground introduce voltages that can throw off the measurements.

There are ways to counter ground potential errors—the most practical and inexpensive of which is to use two operational amplifiers connected in a differential configuration as the data amplifier—but all the answers raise some questions of their own.

The ground-loop problem, of course, isn't limited to measuring devices. In an ordinary hi-fi installation, as on page 60, where signal source and power amplifier each has its own power supply, a 60-hertz leakage current flowing between the primary and secondary of the two transformers will be converted into a 60-hz noise at the power amplifier's input.

Dust and atmospheric humidity reduce the leakage resistance between primary and secondary transformer windings to a few megohms, and poor primary-to-secondary shielding places a substantial leakage capacitance in parallel with the leakage

resistance. For example, 100 picofarads of leakage capacitance puts roughly 30 megohms reactance at 60 hz in parallel with the leakage resistance. These leakage paths set up currents that circulate between the amplifiers, developing spurious hum voltages that are applied with the signal to the output amplifier.

The leakage currents flow in parallel through the common ground and the signal lines connecting the amplifiers. Both paths have finite resistances, R_g and R_s , though they may be as low as a fraction of an ohm. In practice, plug-and-socket connections introduce appreciable resistance, especially if they're oxide-coated or loose.

The leakage resistance and reactance of the two transformers are lumped together as a leakage impedance, Z_L , connected in series with the source, V_L . If each transformer has a leakage resistance and reactance of 5 megohms, the two series-connected leakage impedances will total somewhat less than 10 megohms. Since transformer leakage is by far the largest impedance in the ground-current path, the ground currents will be roughly equal to V_L/Z_L . With a 115-volt source and a 10-megohm load, for instance, the ground-loop current would be a nominal 11 microamperes split between the parallel paths provided by R_g and the series-connected resistances, R_o , R_s , and R_{IN} .

Hum at the speaker

Because the amplifier's input resistance, R_{IN} , is very high compared with the ground-conductor's resistance, R_g , most of this 11- μ a ground-loop current flows through R_g . Hum voltage developed across R_g in this case would be $11 \times R_g$.

The author



Robert I. Demrow, a staff engineer at Analog Devices, has the job of finding new applications for operational amplifiers, evaluating the devices' performance, and checking out problems. He received his MSEE from Northeastern University in 1958, and has worked for GE, the Foxboro Co., and Honeywell.

If the ground path, including plug-and-socket connections, has a resistance of 1 ohm, the hum voltage, V_{BC} , across R_g will be 11 microvolts. This voltage is then applied to the series network of R_o , R_s , and R_{IN} , but because amplifier-input resistance is usually several orders of magnitude greater than R_o and R_s , almost the whole of the hum is developed across R_{IN} .

But if hum is a nuisance in a hi-fi system, the effects of ground-loop currents can be a disaster in a data-measuring system. The key specifications for a data amplifier include high common-mode and differential-input impedance, a high common-mode rejection ratio, good d-c stability, and in many cases, wide bandwidth, fast slewing, and fast settling time.

Data amplifiers are widely used to measure low-level signals developed by strain gages, thermo-

couples, biological probes, and other sensitive transducers. The transducer is often located at a remote test site, while the amplifier is housed in an instrumentation center. For example, signals developed by strain gages strung along a bridge structure would most probably be fed back to a data center at one end of the bridge. Similarly, thermocouple-temperature signals produced during tests on rocket engines would usually be fed to recorders and computers located in a well-protected blockhouse.

Separate sites for transducer and instrumentation mean separate grounds, and this creates a ground-loop problem.

Since the requirements for measuring millivolt signals developed by remote transducers aren't available in any one off-the-shelf op amp, the data amplifier must be designed from scratch. Key per-

Defining some op-amp properties

Parameter	Invert- ing	Non- invert- ing	Differential	Differential ⁴	Differen- tial ⁴	Differential ^{3,4}
Signal Gain	R_f/R_i	$1 + R_1/R_2$	R_2/R_1	$1 + N$	$-R_3/R_2$	$\frac{R_3}{R_4} \left[1 + \frac{2R_1}{R_2} \right]$
Differential Input Resistance	NA	NA	$2R_1$	$R_{IN} [1+A]$	$R_1 + R_2$	$1 + \frac{R_2 A}{2R_1 + R_2}$
Common Mode Input Resistance	R_i	$R_{IN} [1+A\beta]$ Paralled by R_{CM}	$\frac{1}{2} \left[R_1 + \frac{R_2 R_{CM}}{R_2 + R_{CM}} \right]$	$\frac{R_{CM}}{2}$	$\frac{R_1 R_2}{R_1 + R_2}$	$\frac{R_{CM}}{2}$
Voltage Drift Referred to Input	$e_{os} \left[1 + \frac{R_i}{R_f} \right]$	e_{os}	$e_{os} \left[1 + \frac{R_1}{R_2} \right]$	$2e_{os}$	$4e_{os} \left[1 + \frac{R_2}{4R_3} \right]$	$e_{os} \left[2 + \frac{1 + \text{GAIN B}}{\text{GAIN A}} \right]$
	$i_b R_i$	$i_b R_{source}$	$i_d R_1$	$i_b R_s$	$i_b [R_1 + R_2]$	$i_b R_s + \frac{i_d R_4}{\text{GAIN A}}$
CMRR Due to Resistance Deviations, K	NA	NA	$\frac{1 + G_{CL}}{4K}$	$G_{CL}/4K$	$1/4K$	$\frac{\text{GAIN A} (1 + \text{GAIN B})}{4K}$
CMRR Due to Amplifier's Gain Inequality	NA	$A/(A_2 - A_1)$ As listed in data sheet	$A/(A_2 - A_1)$	$\frac{A}{2(A_2 - A_1)}$	NA	$\frac{A}{2(A_2 - A_1)}$ in parallel with $\frac{A}{A_2 - A_1}$ (GAIN A)
Combined Error, e_{cm}/V_{cm} $\left(\text{CMRR} = \frac{1}{e_{cm}/V_{cm}} \right)$	NA	$(A_2 - A_1)/A$	$\frac{4K}{1 + G_{CL}} + \frac{A_2 - A_1}{A}$	$\frac{4K}{G_{CL}} + \frac{2(A_2 - A_1)}{A}$	$4K$	$\frac{2(A_2 - A_1)}{A} + \frac{(A_2 - A_1)}{\text{GAIN A} + A} + \frac{4K}{\text{GAIN A} (1 + \text{GAIN B})}$

NOTES 1. e_{os} is the amplifier offset voltage drift due to temperature i.e., $\left(\frac{\Delta e}{\Delta T} \right) \Delta T$.

2. i_b and i_d is the amplifier bias current drift and the bias difference current drift due to temperature i.e., $\left(\frac{\Delta i}{\Delta T} \right) \Delta T$.

3. Calculations shown for $R_1 = R_2$

4. These amplifier parameters are assumed equal in magnitude but not necessarily of the same sign.

Around the loop. Transformer leakage sets up ground current I_g , which circulates between the two amplifiers via path ABCD (top). Ground-loop current flows through signal and ground lines connecting the two amplifiers (lower left), and creates hum voltage, V_h , at power amplifier's input terminals (lower right).

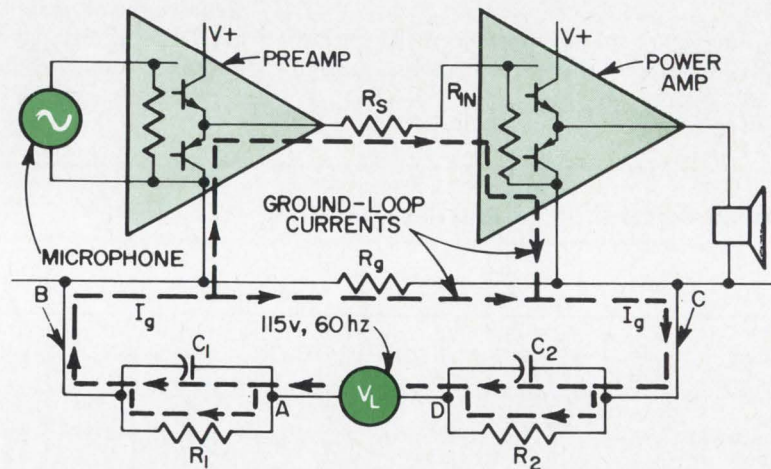
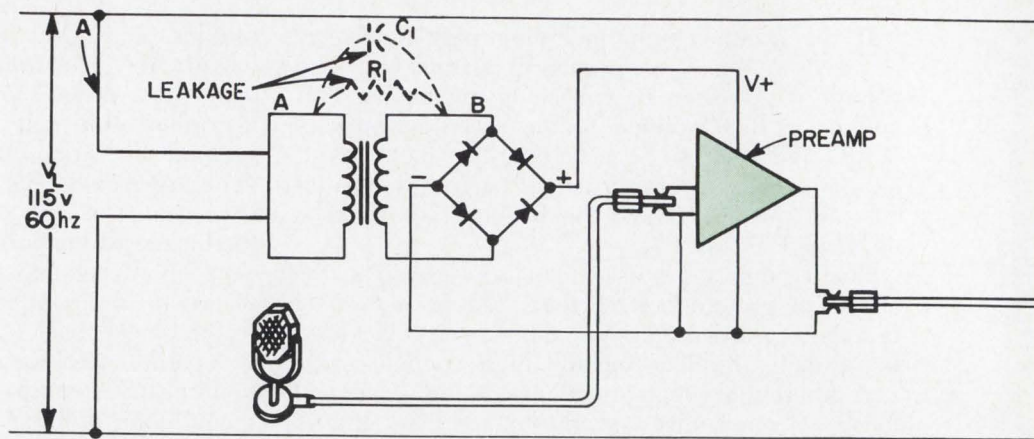

formance parameters have to be built in at a cost perhaps double that of a premium op amp.

Test-bed

In the data-measuring system on page 62, signals generated by a thermocouple placed in the stream of exhaust gases from a rocket engine undergoing test are fed over shielded cables to recording and data-processing equipment sheltered some 200 feet away. The difference in potential between the system's two ground points ends up as an error voltage applied to the amplifier along with its true input signals, a difficulty analogous to the hi-fi hum.

In extreme instances, ground potential difference at this test station could be as much as 5 volts; more typically, though, differences of 1 mv upwards are almost always present.

Typical sources of ground potential here include electrochemical effects, rectifier effects caused by soil crystals contacting buried metals and ores, thermoelectric effects created by temperature gradients in buried metals and soil elements, plus capacitive, inductive, and resistive coupling from power lines and charged clouds.

All these voltages can be lumped together into a single ground source, V_g , in series with the sum, Z_g , of all the ground impedances between rocket

and blockhouse. As in the hi-fi case, it turns out that a substantial portion of this ground voltage is developed across the data amplifier's two input terminals.

Impedance levels are different, however. Whereas it would be rare to find the earth's resistance exceeding about 1 ohm, it isn't unusual for 200 feet of connecting cable to introduce 20 ohms or more of resistance. Consequently, practically all the 10-mv ground voltage is applied across points A and B in the diagram, and in turn across the amplifier's input terminals.

The thermocouple transducer acts as a low resistance, designated $2R_T$, split between the two separate current paths joining A and B. The thermocouple itself is represented for simplicity by resistance R_T in each ground-loop path.

Some remedies

Before discussing the use of an op-amp differential circuit to eliminate ground potential errors, it's perhaps worthwhile to outline alternative approaches sometimes adopted. Some are aimed at interrupting the continuity of the ground loop while preserving the path for transducer signals. Increasing the ground impedance value Z_g would be a step in this direction.

Another tactic—an expensive one—is to reduce the

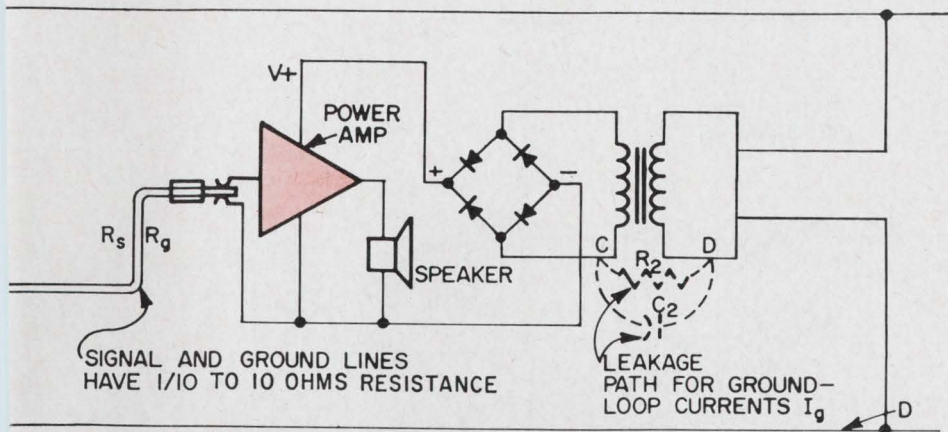

One common method of interrupting ground-loop currents is to interpose an open circuit between signal source and amplifier, arranging for the open circuit to transmit signals while blocking ground-loop currents. This seemingly impossible job is handled by a transformer between the thermocouple and final amplifier, shown on page 63. A modulator-demodulator arrangement, the transformer responds only to signal voltage V_s and presents an open circuit to the ground voltage, V_g .

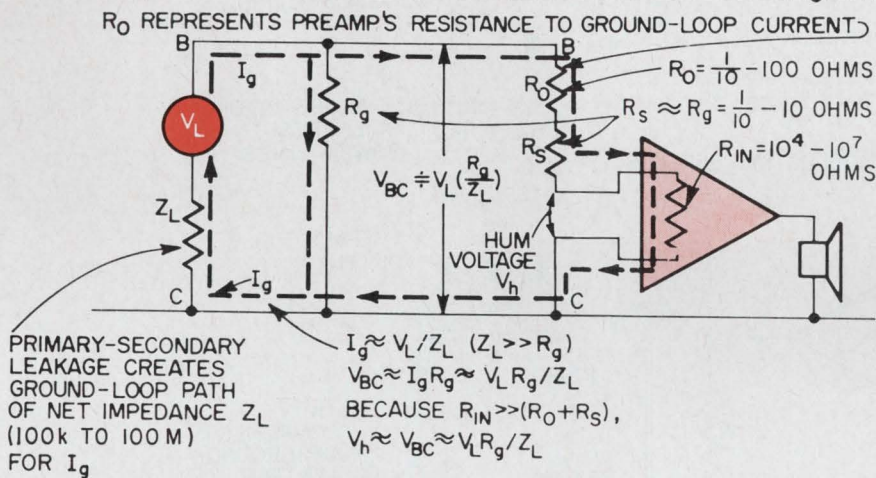

resistance of ground conductor R_g so as to short-circuit the ground potentials, V_{AB} .

Yet another approach would break the ground-current path by operating the amplifier from an isolated power supply or by insulating the thermocouple from ground.

These methods are more easily described than implemented. For one thing, the amplifier is frequently used to feed signals into recorders, analog-to-digital converters, displays, and other data-handling devices, all of them likely to be separately grounded. In these cases, the ground loop is completed through the amplifier to ground via the additional piece of equipment, nullifying efforts to run the amplifier from an isolated supply.

For good thermal response, it's often necessary to weld the thermocouple to the structure monitored. And even if this extreme measure weren't required, the ionized gas issuing from the rocket motor would certainly provide a low-resistance path from thermocouple to ground.

In any event, the instrumentation engineer is usually presented with a pair of wires carrying signal- and ground-loop noise, and has no chance to make large-scale modifications in the over-all system. He must instead find ways within the limits of his instrumentation package to reject ground currents and the resulting error voltages.

closed-loop gain setting—which is certainly not the case in the differential-circuit scheme.

Disadvantages include limited bandwidth, which can only be a fraction of the modulation frequency, and output errors created by intermodulation between the chopper and the signal. Another drawback is that error-reducing feedback cannot cover both modulator and demodulator without restoring a path for ground currents.

The switched-capacitor technique is an alternative way to break the ground-loop circuit. Similar in principal to the modulator-demodulator method, it tends to yield similar advantages and disadvantages, along with the added problem of poor frequency response.

Balancing act

The most widely applied method of minimizing ground-loop errors aims not to attenuate the current, but to apply identical fractions of ground-loop voltage to the inverting and noninverting terminals of a differential amplifier. The ground voltage is thus seen as a common-mode voltage when the transducer signal is applied differentially to the amplifier's input terminals, and if the amplifier has high common-mode rejection, it will ignore the spurious voltage and respond only to the valid input.

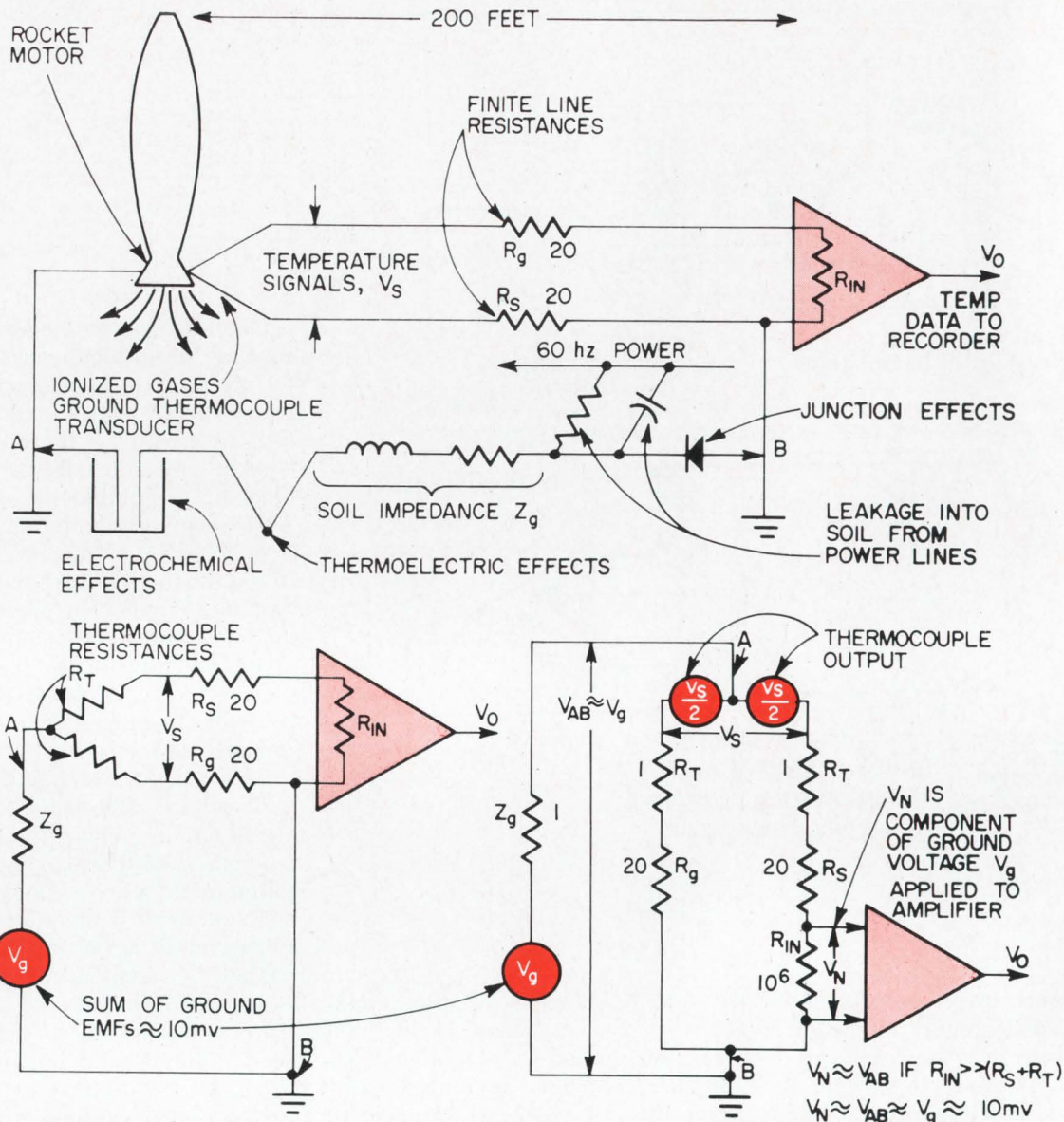

Vicious cycle. Separation of signal source and data amplifier can lead to considerable voltage difference between ground connections at each location (above). Ground voltage, reaching 5 volts in extreme instances, is represented as V_g in series with ground impedance Z_g (lower left). Ground-loop current set up by V_g develops error voltage V_N at amplifier's input terminals (lower right).

The ground-loop currents shown on page 64 flow through parallel paths APB and AQB, adding to voltages V_1 and V_2 at the amplifier's input terminals. If the signal source were removed, these voltages would be created solely by the ground-loop currents. Accordingly, it's possible—for d-c errors at least—to adjust the balance resistor, R_B , so as to make V_1 exactly equal to V_2 . The equal voltages become a common-mode input for the amplifier, which ideally develops no output for identical voltages applied to its inverting and noninverting input terminals.

Commercial amplifiers are available with common-mode rejection ratios of 10^6 or more; these can reduce every volt of common-mode input to a microvolt of equivalent common-mode error, making over-all accuracies of 100 ppm feasible.

This setup handles only d-c common-mode errors, but the principles of balancing a-c inputs are similar.

So far, the op-amp differential circuit has been described only as an economical way to overcome ground-loop problems in high-accuracy data-measurement applications. However, it should be noted that the differential arrangement can be used for data measurements in which the transducer's signal is differential rather than single-ended.

Strain-gage elements, for example, are usually connected in Wheatstone-bridge arrangements, and develop push-pull output signals perched on relatively high levels of common-mode voltage. Even when the strain-gage elements are isolated from ground by as much as leakage capacitance permits, the amplifier must invariably be a differential one

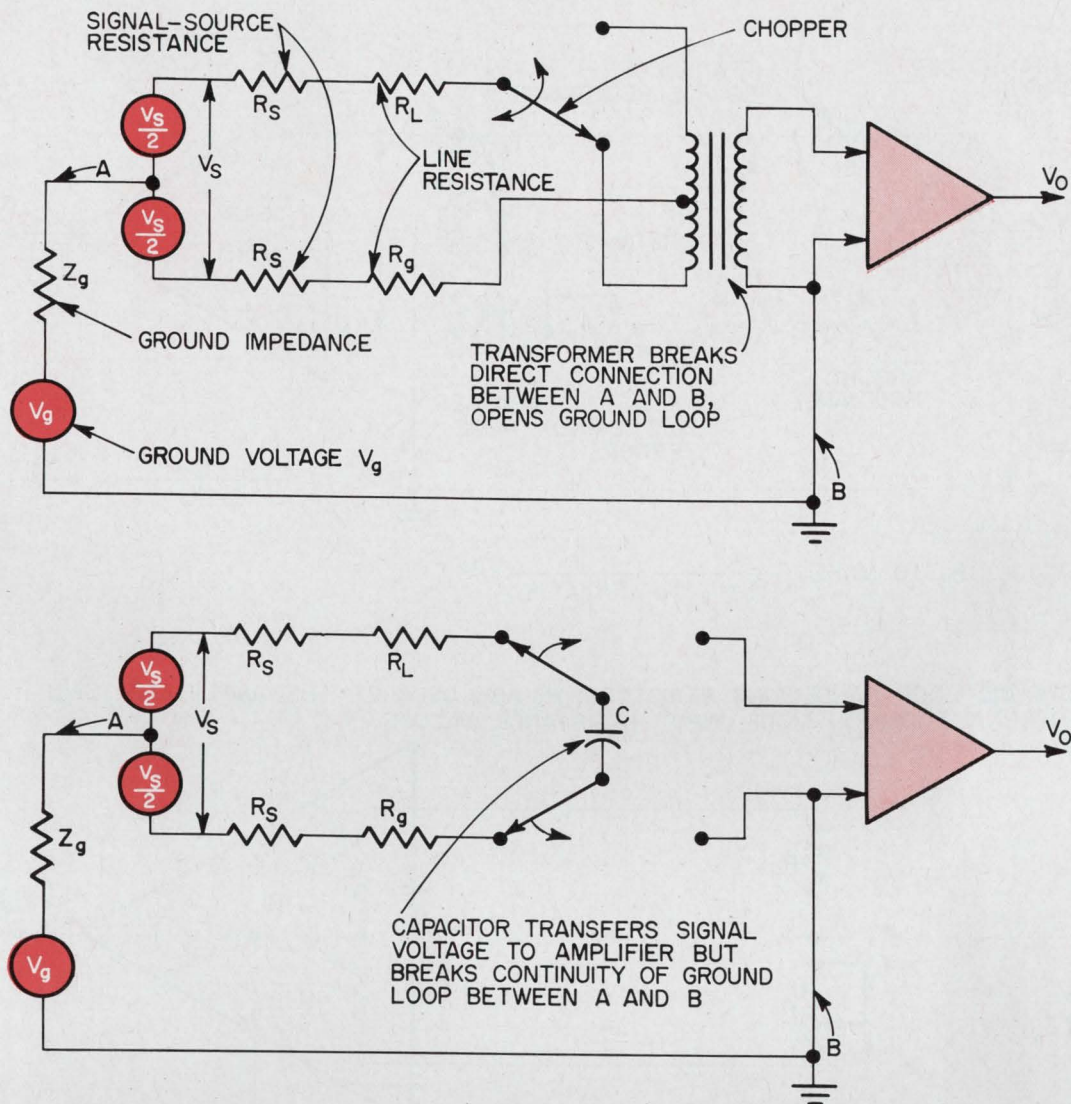

Blocking grounders. Magnetic coupling between transformer's primary and secondary breaks direct connection for ground-loop currents and transmits signal as equivalent a-c voltage (above). Alternative technique breaks direct ground-loop continuity with a switched capacitor that alternately charges to signal voltage V_s and then passes this voltage to the amplifier.

to extract millivolt signals from several volts of common-mode carrier. Biomedical measuring instruments, too, invariably require differential amplifiers to extract information from high levels of 60-hz pickup.

Picking a pair

Having established that a circuit that has to measure millivolt signals in the presence of several volts of common-mode or ground-loop noise must have low drift, high CMRR, high input impedance, fast response, and variable gain, the next step is to see how conventional operational amplifier circuits fulfill these basic requirements.

The need for impedance levels of 1,000 megohms or more rules out a differential amplifier based on an inverting circuit whose input impedance is equal

to the circuit's input resistance; a noninverting circuit can provide adequate input impedance when used as a differential amplifier.

D-c stability depends on the drift of the two op amps selected for the differential circuit. Chopper-stabilized op amps are out of the running because they require special power supplies to offset their single-endedness. But some conventional operational amplifiers have the necessary d-c stability, along with good response and input impedance.

The closed-loop gain and gain linearity that an amplifier can provide depends upon the amount of open-loop gain available for use as negative feedback.

The relationship between closed-loop gain stability, $\% \Delta G_{cl}/G_{cl}$, and open-loop gain variation, $\% \Delta A/A$, is $\Delta \% G_{cl}/G_{cl} = \% \Delta A/A \times 1/(1 + A\beta)$

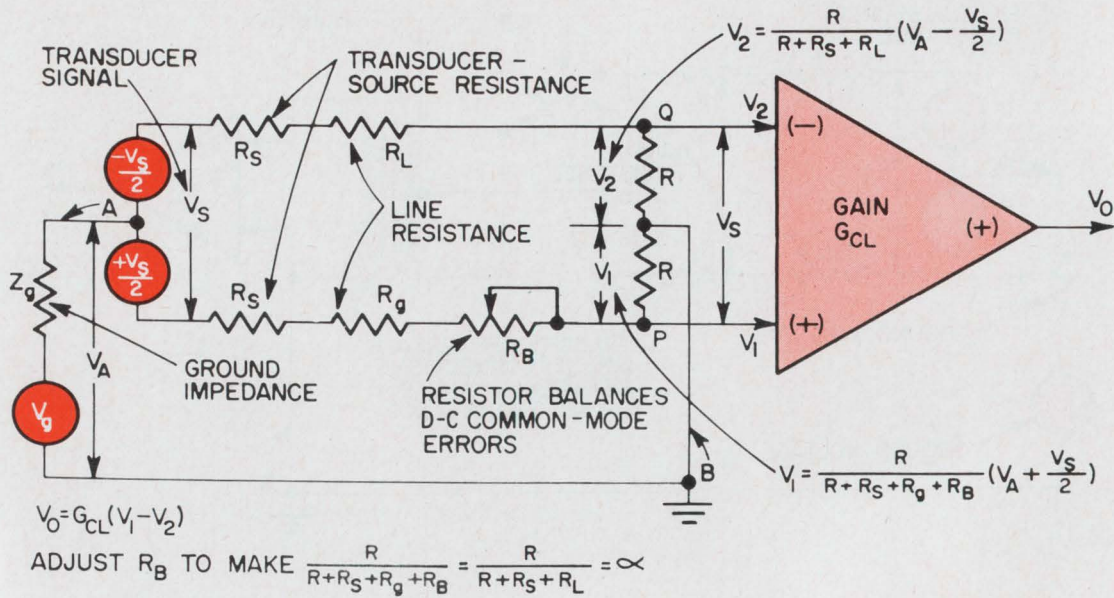

GROUND-LOOP CANCELLING RESISTORS, R, ARE USUALLY THE AMPLIFIER'S OWN INTERNAL COMMON-MODE INPUT RESISTANCE VALUES, R_{CM}

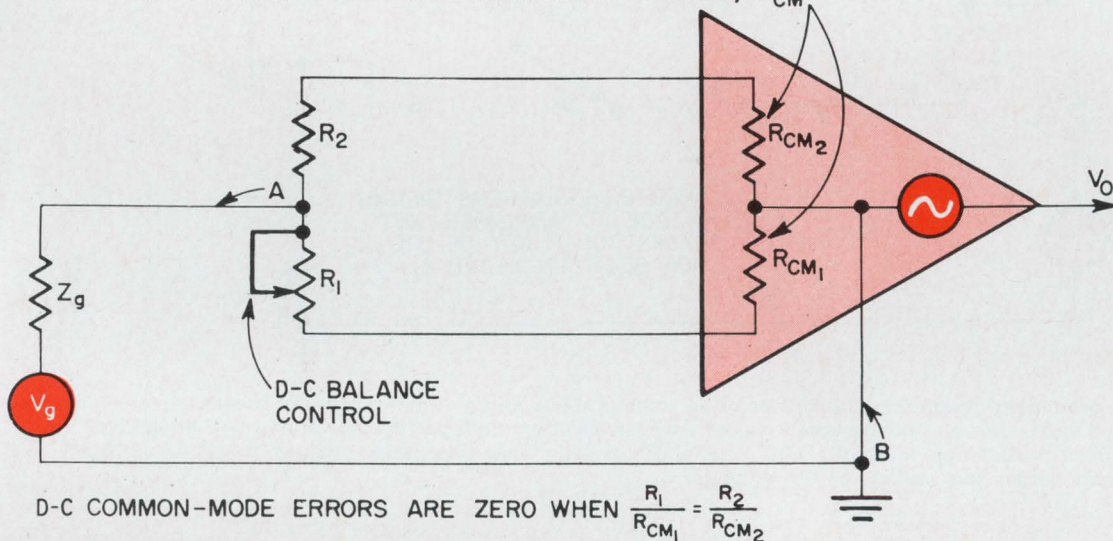

Identical twins. Ground-loop errors can be reduced by converting ground-loop voltage into common-mode input voltage. Equal parts of V_{Σ} are applied to inverting and non-inverting terminals and their effect is scaled down in proportion to amplifier's CMRR (above). In practical circuit, high-value balancing resistors, R, are replaced by amplifier's common-mode input resistances, R_{CM} . Although this setup handles only d-c balancing, the same principles are applicable to a-c ground-loop and common-mode errors.

where β is the fraction of open-loop gain used as feedback. Because $1/\beta$ is very nearly the same as closed-loop gain G_{cl} , and $A\beta \gg 1$, the equation simplifies to

$$\% \Delta G_{cl}/G_{cl} \approx \% \Delta A/A \times G_{cl}/A$$

If the data amplifier must provide 2,000 volts/volt gain for d-c signal scaling, and specifications call for 0.5% gain linearity, the stability equation can be manipulated to give the nominal value of open-loop d-c gain A in terms of the amplifier's expected open-loop gain variation, $\% \Delta A/A$.

For example, if open-loop gain varies by 25%

due to loading, aging, or the effects of temperature—that is $100\% \Delta A/A = 25\%$ —then $0.05\% \approx 25\% \times 2,000/A$. So the minimum open-loop gain under these conditions is $25 \times 2,000 \div 0.05 = 10^6$, or 120 db—a bit beyond the range of op amps with the required stability.

Chopper-stabilized amplifiers could handle it, but, as noted earlier, they need elaborate power-supply arrangements when used in high-impedance differential circuitry. Thus, high closed-loop gain, input impedance, and common-mode rejection with low drift make off-the-shelf op amps impractical for this kind of differential circuitry.

Designer's casebook

Designer's casebook is a regular feature in Electronics. Readers are invited to submit novel circuit ideas, packaging schemes, or other unusual solutions to design problems. Descriptions should be short. We'll pay \$50 for each item published.

FET's resistance change trips heater control

By Emanuel Elad

University of California, Berkeley

Transconductance in a field effect transistor is a parameter that can accurately establish the high-temperature cutoff in a heat chamber. As the temperature in the chamber rises, transconductance drops, causing a bistable circuit composed of the FET and a bipolar transistor to switch. In switching, the bistable circuit opens the line between the chamber's heating elements and the supply. By adjusting a potentiometer between the FET and the bipolar, the cutoff point is determined for any temperature between 35°C and 65°C.

Closing the reset switch allows a negative voltage to appear on the other side of R_6 at the base of Q_2 . This strongly biases Q_2 off, establishing a 1-milliampere current flow through R_3 , R_1 , and R_2 . The potential drop across R_3 causes an 11-volt d-c

level on Q_2 's collector, which is used to control the heater's supply line.

Voltage division by R_1 and R_2 results in -0.6 volts at the gate of Q_1 . Drain-to-source resistance in the FET is low at this gate voltage, and consequently high current—in the milliampere range—flows through Q_1 and the drain resistor R_8 . Only microamperes flow through R_4 and R_5 —the two resistors paralleling the FET—making for a negligible voltage drop across R_5 . The high negative voltage that is therefore present at the base of Q_2 keeps it off despite the opening of the reset switch.

As the ambient temperature increases, drain-to-source resistance in Q_1 increases, thus deflecting current flow out of Q_1 into R_4 and R_5 . The voltage drop across R_5 increases until a level is reached—dependent on the setting of R_4 —where the base of Q_2 becomes positive with respect to its emitter. Enough current flows through the limiting resistor R_7 to bias Q_2 into saturation, and the increase in Q_2 's beta resulting from the rising temperature makes it easier to switch that transistor on. This places the collector of Q_2 close to ground potential, thus removing the heater control voltage.

Resistors R_1 and R_2 now divide the -12 -volt sup-

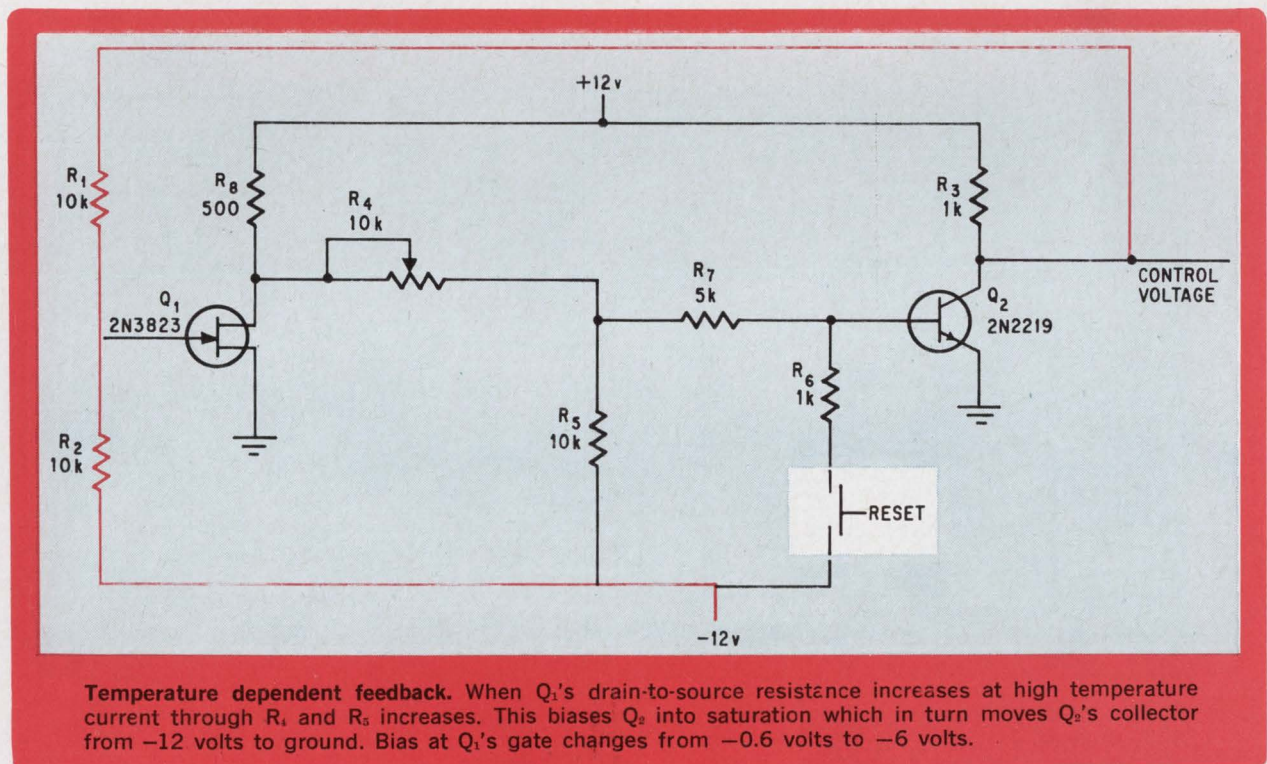

Temperature dependent feedback. When Q_1 's drain-to-source resistance increases at high temperature current through R_1 and R_5 increases. This biases Q_2 into saturation which in turn moves Q_2 's collector from -12 volts to ground. Bias at Q_1 's gate changes from -0.6 volts to -6 volts.

ply. The gate voltage is therefore -6 volts—which is above the FET's pinch off—and current flow in Q_2 is mere microamperes.

After the ambient temperature falls below the circuit trip point, the reset switch must again be closed.

The circuit can be made to trip at low temperatures by placing the reset switch between the gate of Q_1 and resistors R_2 . It's preferable for reasons of accuracy, however, to use a p-channel FET and a pnp transistor in that application.

SCR helps video signal gate a-c power line

By Wayne Simister

University of Utah, Salt Lake City

Television receivers scattered throughout a closed-circuit system can be turned on by video signals from a camera. These signals—usually only 30 microamperes—are able to switch on the 117-volt line because the SCR circuit they gate helps in the switching.

When no signal is present at the gate of SCR_1 re-

sistor R_2 maintains the gate and cathode of the SCR at the same potential. Resistor R_3 at the gate cathode of SCR_2 does the same thing. Consequently the a-c line between the receiver and the 117-volt supply is open.

When a detected video signal reaches R_2 , SCR_1 is gated into conduction. When the positive part of the a-c voltage appears it is passed through SCR_1 . Power is delivered to the receiver's d-c supply and capacitor C_1 charges through to D_1 and the current-limiting resistor R_5 , the positive cycle's peak voltage. After the positive cycle returns to zero, C_1 's discharge through R_4 and R_3 gates SCR_2 into conduction. Although SCR_2 's gate voltage isn't present during all of the negative cycle, it stays on until the peak voltage is reached. Anode current in the interval between the peak and zero points keeps the SCR on.

As long as the detected signal is present at the gate of SCR_1 , each succeeding cycle will be coupled into the receiver's supply. The values of R_1 and R_2 must be selected with care, since a low R_1 and high R_2 will make the SCR's gate sensitive to line transients. Conversely, a high R_1 and low R_2 weaken the gate signal so much that it doesn't work.

The 7-watt bulb connected across the line absorbs any inductive kicks that might occur in the receiver's filter network. A spike, resonating between capacitor C_1 and internal inductance, prevents SCR_2 's from turning off. If the circuit is used to control an electric motor instead of a tv receiver, the incandescent bulb must be larger to absorb the inductive phase shifting.

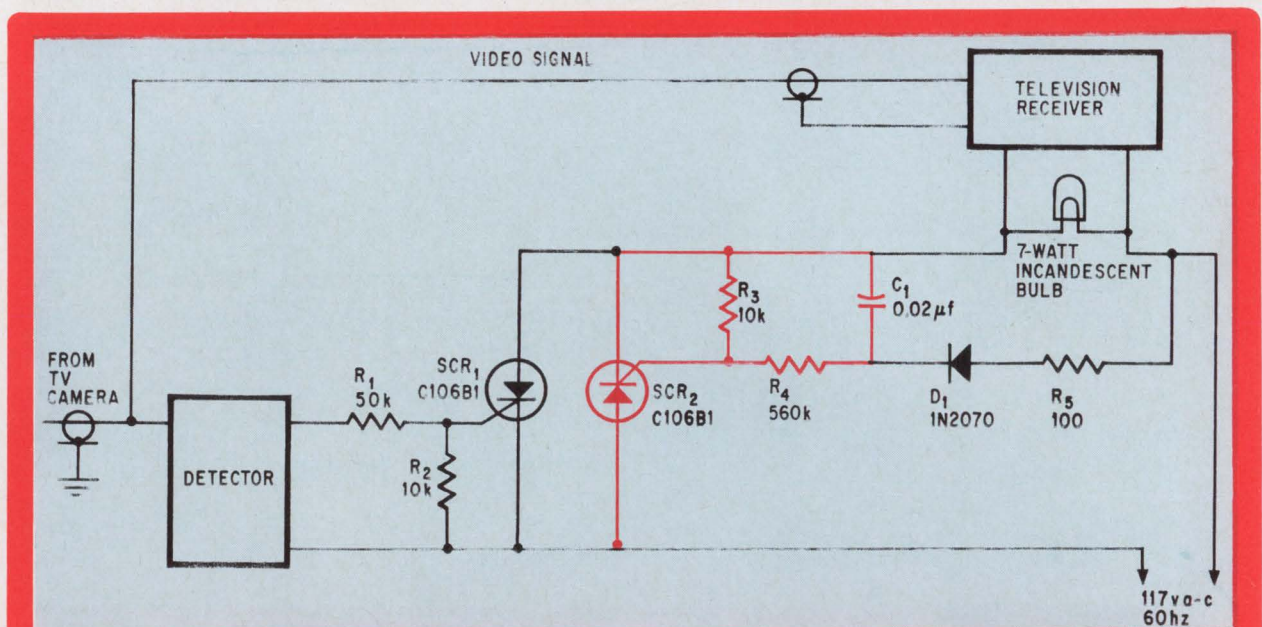

Domino theory. A small signal gates SCR_1 into conduction during the a-c's positive swing; SCR_2 is gated on during the negative swing. Capacitor C_1 charges to the line voltage when SCR_1 is conducting, as it discharges through R_4 SCR_2 is gated on.

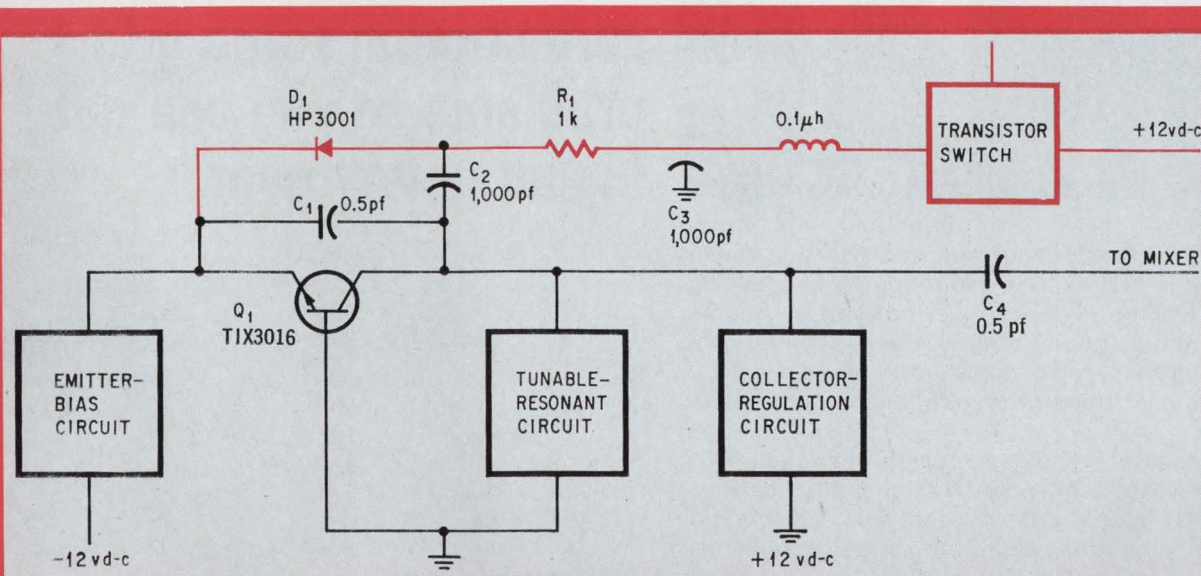

Waiting for the gun. A transistor with a forward-biased p-i-n diode across its collector-emitter junction acts as a d-c amplifier. Opening the switch lets the diode return to its natural high resistance, causing oscillations to begin.

P-i-n diodes turn on microwave bands faster

By August Barone

Airborne Instruments Laboratory, Deer Park, N.Y.

Discrete frequency bands—necessary in wide-spectrum communication equipment—are generated by several tunable oscillators in a receiver. These oscillators must turn on immediately so the operator won't lose time in sweeping the bands in search of a signal. If the junctions in the oscillators' transistors are kept at 50°C, full oscillations begin 50 milliseconds after the turn-on signal appears. Collector current maintains this high junction temperature, and a p-i-n diode in each oscillator is used for switching in and out of a-c operation. Conventional systems stop oscillations by removing the d-c bias from the transistors. Unfortunately this lengthens the turn on time of the oscillator because the junctions start their temperature rise from a low temperature. The obvious drawback in the conventional system is the long waiting times necessary while switching through the different bands in the receiver. These waiting times are long enough to cause the operator to miss distress signals.

P-i-n diodes are nonrectifying semiconductors used extensively as switches in microwave circuits. Unbiased, the diode has naturally high resistance and low capacitance because of the intrinsic region, where carrier lifetime is long. When forward-biased

by a d-c voltage, the intrinsic region has a high conductivity.

A p-i-n diode connected across the collector-emitter junction of a transistor offers a high impedance while a band-command trigger holds the line open between it and the +12-volt d-c supply. Consequently, regenerative feedback can be coupled through C_1 from the oscillator's collector circuit into the emitter's tank circuit. Oscillations occur and are coupled out through C_4 until a command signal opens the d-c line.

When this line is opened, current through D_1 reduces its resistance to about 10 ohms. Any a-c voltage that might appear in the collector circuit won't have the type of phase relationship that causes oscillations, because the low resistance lets the current flow back to the emitter circuit. When the operator turns on an oscillator by closing the d-c line, the oscillations begin in 50 milliseconds and the frequency is within 4% of nominal value.

Short lead lengths are necessary on all the components of this circuit, especially the bypass capacitor C_3 . At microwave frequencies the added inductance resonates with the bypass capacitor. The p-i-n diode must also be carefully located and have a minimum lead length, since any inductance resonates with the isolating capacitor C_2 . Instead of using C_1 as the feedback capacitor the circuit designer may wish to make use of the p-i-n diode's capacitance. Circuit operation is not changed if this method is used. The capacitance in the diode which is low when no d-c current is flowing is shorted out when the p-i-n diode is forward biased by the closed command switch.

EIMAC

zeroed in on some grid problems so you can get higher power gain.

Want up to 20 times power gain in a cathode driven circuit? Try one of the tubes in our complete zero-bias power triode line. While you're solving problems, throw out the bias power supply. Forget some of the associated circuitry. And don't worry about destroying the tubes if you lose grid voltage. They don't need any.

These triodes are designed for use as Class B or C amplifiers in audio or radio-frequency applications. We've got zero-bias triodes ranging from 400 watts to 10,000 watts—the most complete range of zero-bias triodes available.

Contact your nearest distributor or the Varian Field Office for further information. Offices are located in 16 major cities. Ask Information for Varian Electron Tube and Device Group.

	TYPICAL OPERATION					
	CLASS B RF LINEAR POWER AMPLIFIER, GROUNDED GRID					
	GLASS			CERAMIC		
	3-400Z	3-500Z	3-1000Z	3CX1000A7	3CX3000A7	3CX10000A7
Plate Voltage, Vdc	3000	3000	3500	2500	5000	7000
Max Signal Plate Current, A	0.333	0.333	0.75	0.800	1.56	5.0
Drive Power, W	32	35	85	60	215	1540
Output Power, W	655	644	1770	1170	5500	24,200
Filament Voltage, V	5.0	5.0	5.	5.0	7.5	7.5
Filament Current, A	14.5	14.5	21.5 23.0	28/33	51	94/104

EIMAC
Division of Varian
San Carlos, California 94070



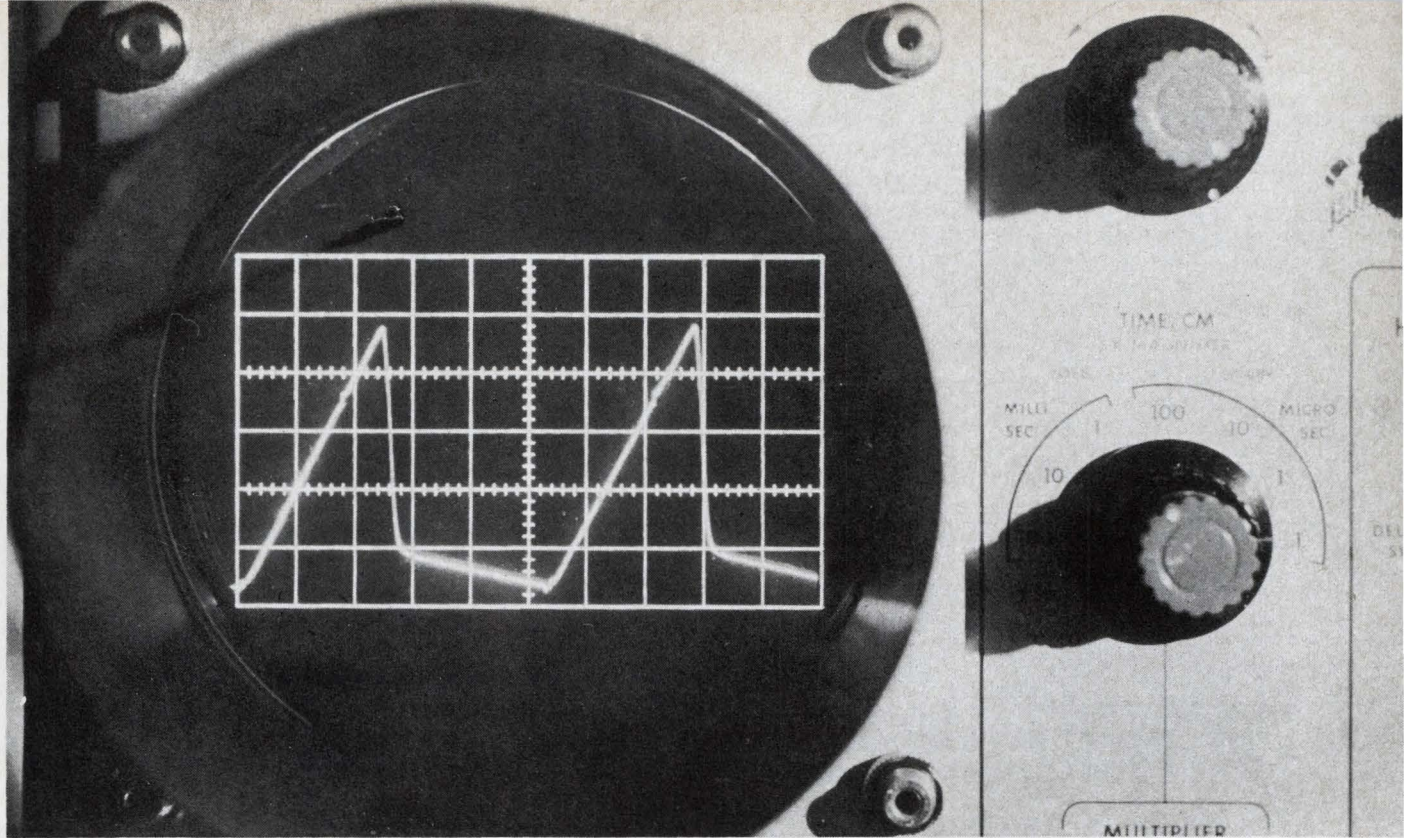

Industrial electronics

Triple play speeds a-d conversion

Designed for high-performance applications, triple-ramp converter does the job 85 times faster than dual-integrating-ramp circuits

By H. Bent Aasnaes and Thomas J. Harrison

Systems Development Division, International Business Machines Corp., San Jose, Calif.

The high performance demanded of today's process-control and data-acquisition systems require analog-to-digital converters capable of speeds up to 20,000 conversions per second and a resolution of 14 bits. A new technique, triple-integrating-ramp conversion, not only does the job as well as the successive-approximation technique, but does so at a lower cost.

Unlike the successive-approximation converter, the triple-ramp circuit doesn't require expensive component precision. Instead, it operates on the voltage-to-time principle of the relatively inexpen-

sive dual-ramp converter. This principle involves the conversion of an input voltage to a time interval, which is easily measured with digital methods. But the third ramp makes the big difference—putting the new converter in the same high-performance class as the successive-approximation circuit.

An experimental triple-ramp converter is now undergoing tests at the International Business Machines Corp.'s San Jose, Calif., facilities.

The new circuit achieves its high speed by converting the integrated measured analog voltage—the first ramp—during two subsequent ramps, one

coarse and one fine. The coarse ramp rapidly converts most of the input voltage by using less-than-full resolution. During the fine ramp, the remaining voltage is converted for full resolution. Total conversion time is about 1/80th that when converting the full value at full resolution.

Even though the voltage level at which the converter switches from the coarse to the fine step may not be precisely known, any error is included in the third, or fine, ramp, where it is resolved and added to the converted value obtained during the second, or coarse, step.

Building blocks

In single- and dual-ramp converters, the input-signal amplitude is changed to a time interval as an intermediate step in obtaining a digital value. And during this interval, pulses are counted—with the total pulse count corresponding to the unknown voltage.

The single-ramp circuit compares the analog input signal, V_{in} , with a ramp voltage, $V_t(t)$, which is produced by a function generator. Because the slope of the ramp is constant, the time interval between $V_r = 0$ and $V_r = V_{in}$ is proportional to V_{in} .

Single-ramp converters have long been used in low-cost, low-performance industrial applications. Accuracy in this type of converter primarily depends on the linearity of the ramp generator, and the stability of both the clock frequency and the comparator threshold voltage. Moreover, the circuit is sensitive to any noise on the input signal during the instant of comparison of V_r and V_{in} , and its conversion time is directly proportional to the value of the input voltage.

In an n -bit binary converter with a clock frequency, f_c , in pulses per second, the maximum number of pulses is 2^n , so the conversion rate is limited to $f_c/2^n$ conversions a second. Therefore, a 12-bit converter using a 10-megahertz clock can only provide about 2,500 conversions a second. These factors generally limit the single-ramp converter to applications requiring fewer than 12 bits and to speeds from 5,000 to 10,000 conversions a second.

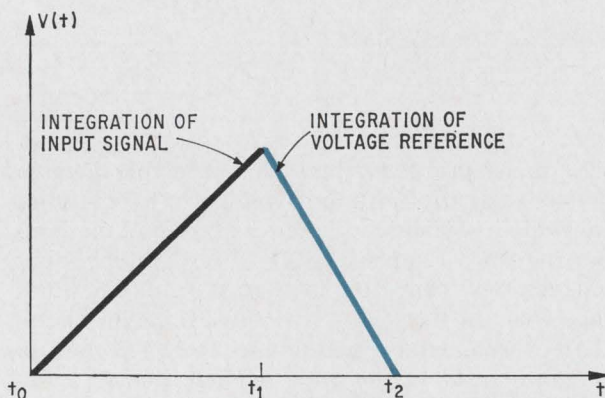

Only two. In dual-ramp converter, the unknown input signal is integrated for a fixed time, t_0 to t_1 . Then, integration of reference voltage yields a time interval, t_1 to t_2 , which is proportional to input signal.

The double-integration or dual-ramp technique doesn't depend on a highly stable ramp and clock for conversion accuracy. The input signal to the dual-ramp converter is first integrated for a fixed time interval, set by counting a number of clock pulses. The integrator voltage at the end of this interval is proportional to the input signal averaged over the integration time. A reference voltage of polarity opposite to the input signal is then integrated for the time it takes to reduce the integrator voltage to its initial value. A binary number proportional to the average-signal value is obtained by counting clock pulses during this second integration period.

This up-down integration makes the dual-ramp converter inherently more accurate than the single-ramp converter and results in an over-all conversion linearity superior to that of the integrator. Since the digital number is independent of the integrator's time constant, precision resistors and capacitors with low temperature coefficients aren't required. Moreover, with the same clock measuring both the first and second integration intervals, a precision clock is unnecessary. Noise error is minimized because the input signal is integrated, and the actual analog-to-digital conversion occurs during the second integration period—after the input signal has been disconnected from the converter.

However, for all the dual-ramp converter's advantages, there is a price to be paid in speed. A total of 2^{n+1} clock pulses is normally required for an n -bit full-scale conversion. With a 10-Mhz clock and a 14-bit resolution, which is feasible using inexpensive components, a rate of only about 300 conversions per second can be obtained.

Although this 14-bit conversion rate is adequate for some instrumentation systems, many process-control and data-acquisition installations require higher rates. The successive-approximation a-d converter commonly used for such applications is capable of 14-bit resolution at 20,000 conversions a second. This type of converter, however, is sensitive to noise, and is expensive—primarily because its design doesn't lend itself to integrated circuits.

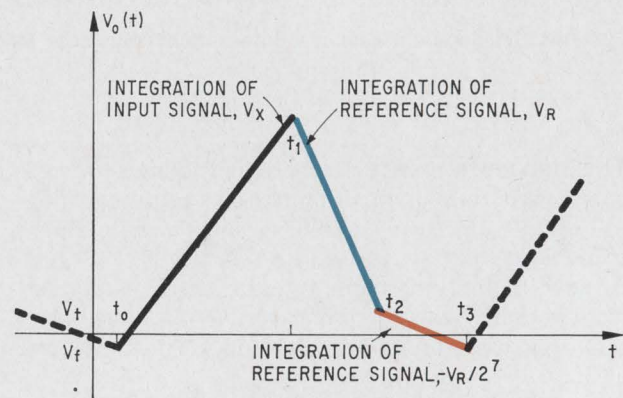

Added step. Output of triple-ramp analog-to-digital converter is integrated twice. Then a third ramp, from t_2 to t_3 , provides vernier action for high-speed, high-resolution conversions.

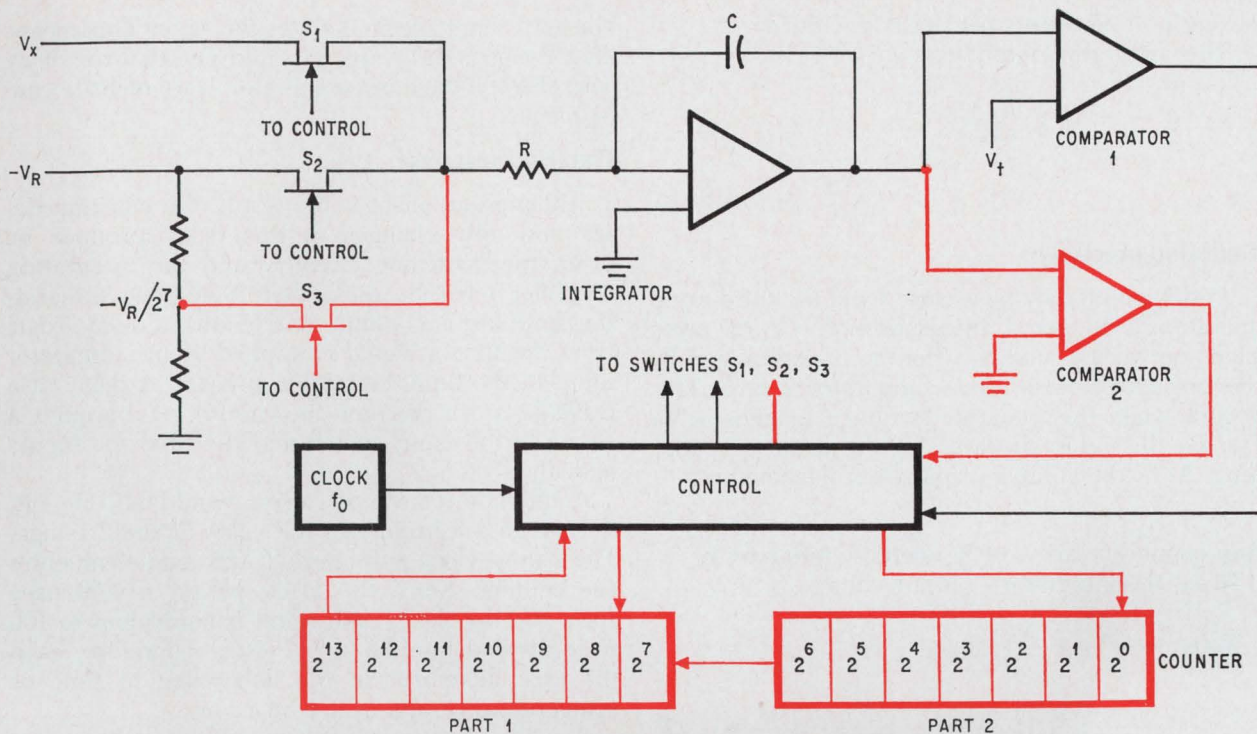

Precise split. Like a dual-ramp integrator, but with one more comparator and switch and a two-part counter, the triple-ramp converter provides fast 14-bit conversion.

A triple-ramp converter with the same 14-bit resolution contains a two-part binary counter, two comparators, an analog integrator, control logic and three switches, and a pulse clock. The circuit differs from the dual type in that the dual's second ramp is broken into the two ramps—coarse and fine. The converter's three main analog signals are the input voltage, V_x , a reference voltage, $-V_R$, and another reference $-V_R/2^7$. The control logic determines which signal becomes the integrator's input.

Converting by parts

When the integrator output reaches a predetermined threshold, V_t , comparator 1 changes state. Although the value of V_t isn't critical, it must be at least slightly greater than the absolute value of $V_R/2^7$. In a similar manner, comparator 2 responds when the integrator output reaches ground. The counter, divided into two parts having seven bits each, is connected so that overflow pulses from part 2 (2^0 to 2^6) proceed into part 1 (2^7 to 2^{13}). Sequencing the converter's internal operations is the control circuit.

The conversion cycle consists of three time-based operations: integration of V_x for a fixed time interval, integration of $-V_R$ until the first clock pulse after the integrator output reaches the threshold, and integration of $-V_R/2^7$ until the first clock pulse after the integrator output causes comparator 2 to change state. During the first two integrations, clock pulses accumulate in part 1 of the counter and, during the third, pulses accumulate in part 2.

A conversion cycle starts at time t_0 . The initial integrator output voltage is:

$$V_o(t_0) = -V_f \quad (1)$$

where $-V_f$ is an offset voltage resulting from minor time delays in the circuits. Each part of the counter is at zero. The control logic closes S_1 and opens S_2 and S_3 , thereby connecting analog input voltage V_x to the integrator. Then V_x is integrated for the fixed time interval

$$(t_1 = t_0) - \frac{2^7}{f_c} \quad (2)$$

determined by the time it takes for part 1 of the counter to count 2^7 clock pulses. The last pulse resets part 1 to zero. The integrator output voltage at this time is

$$V_o(t_1) = V_f + \frac{V_{x \text{ avg}}}{RC} (t_1 - t_0) \quad (3)$$

where the integrator is assumed to be ideal and $V_{x \text{ avg}}$ is the average value of the input voltage over the time of integration.

Immediately, the second-ramp operation starts. Reference $-V_R$ is connected to the integrator by closing S_2 and opening S_1 ; S_3 remains open. This reference voltage is equal in magnitude to the maximum allowable V_x but opposite in polarity. Integration proceeds until t_2 , the time of the first clock pulse after comparator 1, changes state. The comparator changes state when the integral of $-V_R$ equals V_t . Then, comparator 1 changes state. During the integration of $-V_R$, only part 1 of the counter is running. It receives clock pulses at the 2^7 stage. At t_2 , the number in the counter is

$$N_1 = 2^7 f_c (t_2 - t_1) \quad (4)$$

Since each clock pulse enters the counter at the

seventh bit, 2^7 counts per pulse are added.

The integrator output voltage at t_2 is

$$V_o(t_2) = -V_f + \frac{V_{x \text{ avg}}}{RC} (t_1 - t_0) - \frac{V_R}{RC} (t_2 - t_1) \quad (5)$$

Counting precisely

At this point, only S_3 is closed and the third-ramp operation is triggered. Integration of $-V_R/2^7$ takes place between t_2 and t_3 , where t_3 is determined by the first clock pulse after comparator 2 fires. This occurs when the integrated voltage reaches $-V_f$. During this interval, part 2 of the counter is running. At t_3 , the number of pulses in the counter is

$$N_2 = f_c(t_3 - t_2) \quad (6)$$

Any counts in excess of 2^7 overflow into part 1.

At t_3 , the integrator's output voltage is

$$V_o(t_3) = -V_f + \frac{V_{x \text{ avg}}}{RC} (t_1 - t_0) - \frac{V_R}{RC} (t_2 - t_1) - \frac{V_R}{2^7 RC} (t_3 - t_2) \quad (7)$$

Because of the integrator offset and the time delay through comparator 2, this voltage isn't zero. However, as long as the converter runs continuously, $V_o(t_3)$ equals the initial voltage $-V_f$. Equation 7 is then reduced to

$$V_{x \text{ avg}}(t_1 - t_0) = V_R(t_2 - t_1) + \frac{V_R}{2^7} (t_3 - t_2) \quad (8)$$

which, combined with equations 2, 4, and 6, yields

$$V_{x \text{ avg}} = V_R \frac{N_1 + N_2}{2^{14}} = V_R \frac{N}{2^{14}} \quad (9)$$

Thus, the number N in the counter at the end of conversion is the 14-bit representation of the average input voltage over the interval t_0 to t_1 .

Faster by far

The triple-ramp converter, like the dual-ramp type, doesn't require the resistor, the capacitor, and the clock to be precise or highly stable. Both types minimize noise-induced errors by averaging the input signal, but the new converter is much faster.

Since 2^7 pulses have to be counted in each of the three integration periods for a full-scale signal, V_x , the maximum conversion time for a 14-bit triple-ramp converter is $(3 \times 2^7)/f_c$ —about 85 times faster than a 14-bit dual ramp's $2^{15}/f_c$. With a 10-Mhz clock, the triple-ramp unit operates at about 26,000 conversions a second, compared with 300 for the dual-ramp device. In general, the triple-ramp converter is faster than the dual-ramp type by a factor of $3/2(2^n/2^2)$.

Conversion accuracy isn't affected by the value of V_t . Since $-V_R/2^7$ is switched into the integrator at t_2 , an increase in V_t may result in one less pulse being applied to part 1 of the counter. But this pulse is equal to 128 pulses applied to part 2, so

the final count accommodates the error. This means that V_t need not be highly stable, and that the delay and offset voltage of comparator 1 are of little consequence.

Delaying response

Although an offset is the result of a constant delay and only changes in this delay produce an error, the switching circuitry and the integrating amplifier must be quite fast. Since the integrating amplifier has a finite bandwidth, a delay exists from the time a signal is applied at the integrator input to the time the output appears. A delay also exists between the time the control logic applies a signal to the input switch and the time the inputs actually switch.

A tolerable conversion error would be one bit, that is, an uncertainty in the value at the 2^0 stage. During one clock pulse period, 128 counts can enter the counter. Since the clock period is 100 nsec for a 10-Mhz clock, each count is equivalent to 100 nsec divided by 128, or 0.7 nsec. Therefore, each 0.7 nsec increment in the delay due to time or temperature results in a 1-bit error.

Long on options

The triple-ramp method is by no means limited to a 14-bit converter. Changes in the counter's word length and in the reference voltage-divider resistors make it possible to trade speed for resolution. At a given clock frequency, speed is doubled for each two-bit decrease in resolution. A 12-bit converter, for example, operates in excess of 50,000 conversions a second with a 10-Mhz clock frequency.

An offset voltage added to the integrator input enables signals of both polarities to be converted. This shifts the sum of the inputs to the positive range. Since an extra bit is required in the counter, conversion speed is reduced. The most significant bit in the counter is the sign bit; if zero is written as 1000 . . . 0, negative signals are represented in a 2^2 's complement code.

The authors



H. Bent Aasnaes, a senior associate engineer at IBM's Systems Development division, specializes in the development of analog circuits for process-control computers.



Thomas J. Harrison, with IBM since 1958, is manager of analog technology for process control at the systems division's laboratory in San Jose, Calif.

Compare our Ribbon* Connector with the one you're using now

40 TIMES THE LIFE Amphenol's exclusive "Ribbon" contact connector gives you 20,000 insertional/withdrawal cycles compared to only 500 for pin and socket designs. It's engineered for 25 years' service in mated condition, too.

Amphenol Micro-Ribbon Connectors alone have recorded some five trillion terminations without failure.

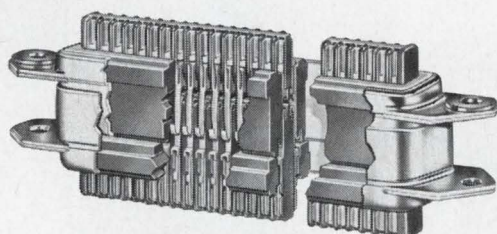

Amphenol Micro-Ribbon Connector

GREATER CONTINUITY Flat, broad "Ribbon" contacts maintain continuity over a much larger area than pin and socket contacts. Double-flexing members give constant contact pressure.

"Ribbon" contacts eliminate misalignment and bent contacts experienced with pin and socket connectors. And, they mate with half the forces.

Unlike pin and socket contacts, the "Ribbon" contacts are self-cleaning and

self-wiping. They dislodge all foreign matter during insertion for greater contact continuity.

LOWER COST Amphenol Blue Ribbon and Micro-Ribbon Connectors cost less than most standard pin and socket contact connectors.

51 CONFIGURATIONS Choose from 28 standard size Blue Ribbon and 23 miniature Micro-Ribbon connectors. Rack and panel, cable-to-chassis, cable-to-cable, right-angle shell, barrier or pin polarization are available.

Applications include telephony, communications, data processing, entertainment, instrumentation, industrial control, avionics, transportation . . . anyplace where current doesn't exceed five amps per contact.

OFF-THE-SHELF DELIVERY Sixty-six Amphenol Industrial Distributors stock "Ribbon" connectors in all major cities. Twenty-two Amphenol Sales Offices are at your immediate service. You'll find them in our catalog or in EEM, ELECTRONIC BUYERS GUIDE, ELECTRONIC SOURCE PROCUREMENT, and THOMAS REGISTER.

*Blue Ribbon® and Micro-Ribbon® trademarks Amphenol Corporation

The first pair's on us.

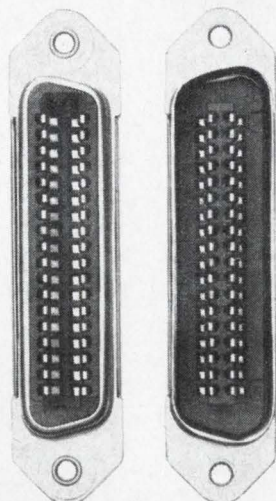

We'll send you the first pair free. Simply fill out and mail the coupon or circle the reader service card number below. We'll take it from there.

NAME _____

TITLE _____

COMPANY _____

CITY _____ STATE _____ ZIP CODE _____

Send to: Amphenol Industrial Division, 1830 South 54th Avenue, Chicago, Illinois 60650.



AMPHENOL

This little relay can make you a living legend.

The new RF3 vacuum relay is 2¼ inches long...that's small for something which can take peak voltages up to 12,000 volts with no strain.

It carries 25 amps rms at 2.5 MHz quite easily. It interrupts 20,000 watts of power like nothing (7 Kv or 3a max). That means it can be used in any operation involving power or rf currents...in either communications or industrial applications.

The RF3 is only one ounce heavier than our RF1 vacuum relay, which at ¾ ounce controls more power for more applications than any other relay in the world. This makes the RF3 an extremely economical item for handling almost 20 times more power with only a limited increase in space requirement.

Details: 7.5 peak kv at 16 MHz operating voltage; 17 amps rms at 16 MHz continuous current; contact resistance of less than .012 ohms; life of 10⁶; less than 10 milliseconds operate time; and SPDT latching contact arrangement...soon to be supplemented by non-latching Form C configuration.

All of this should give you a lot of ideas as to how the RF3 vacuum relay can make you a legend in your own time.

For more detailed information write to ITT Jennings, a Division of International Telephone and Telegraph Corporation, 970 McLaughlin Avenue, San Jose, California 95108.

JENNINGS **ITT**

Isolation problems get an airing

Planar air technique gives more reliability and design freedom than the solid method, and is being used for diode arrays

By Hal Clausen and Roger B. Rusert

Fairchild Semiconductor Corp., Mountain View, Calif.

Isolating the elements of an integrated circuit so they'll behave like discrete components has long been one of the most stubborn problems in designing and manufacturing ic's. In the most widely used dielectric isolation technique, a thermal oxide layer envelops the element islands and a polycrystalline substrate provides support. Now, however, another technique—planar air isolation—has been developed to the point where it's being commercially used in diode arrays [Electronics, April 15, p. 25]. This air isolation "challenger" has several advantages over the solid method:

- Two layers of protection instead of one, giving greater reliability.
- Compatibility with standard processing techniques, which may lead to higher yields.
- Greater freedom of design, because of the shorter lead paths, easier access, and fewer wire-crossover restrictions.
- Higher forward conductance in the diode array, because of shorter lead paths.
- Easier manufacture, because isolation is ac-

complished after element fabrication and the surface is flat, without the bumps encountered when the solid method is used.

Many other methods have been tried over the past decade, but none worked out well enough to be put in high-volume commercial production. Some of them, such as beam-lead, have been produced for in-house use. The others have been relegated to even lesser roles, in a few custom "ultra-performance" ic's or as laboratory curiosities or subjects of conference papers.

Planar's parents

Like the solid method, planar air isolation is making its commercial debut in the form of diode arrays. It's an offshoot of the 1964-66 proposals for mesa and handle-wafer isolation [Electronics, March 20, 1967, p. 91].

In the mesa method, transistor elements and interconnections were formed in the conventional way. A substrate was then joined to the wafer surface by a glass wafer. Excess material was removed and the elements were isolated by selective etching.

In the handle-wafer scheme, standard active elements were protected by thermal-oxide layers. Mesas containing the devices were then etched out. A glass-coated silicon handle-wafer was then fused to the mesas, and the wafer was isolated by lapping the material. Glass was formed around exposed mesas by backfilling, and then the handle-wafer was etched away.

Both processes were basically compatible with standard production techniques but required too fine a control and were relatively costly. Prototype runs suffered from low yields of usable ic's and inconsistencies from unit to unit. Still, both the mesa and handle-wafer techniques showed enough promise to merit additional research, and it was this further work that led to planar air isolation.

What was needed at first was a marriage of the mesa and handle-wafer techniques. This yielded

The authors



Hal Clausen is senior marketing engineer in specialty products at Fairchild. He has a B.S. in education from the University of Illinois and nearly 12 years of experience in semiconductor work.



Roger B. Rusert received a B.A. in physics from Carleton College in 1964 and an M.A. in physics from the University of California at Berkeley in 1966. He's a research engineer at Fairchild and a specialist in isolation.

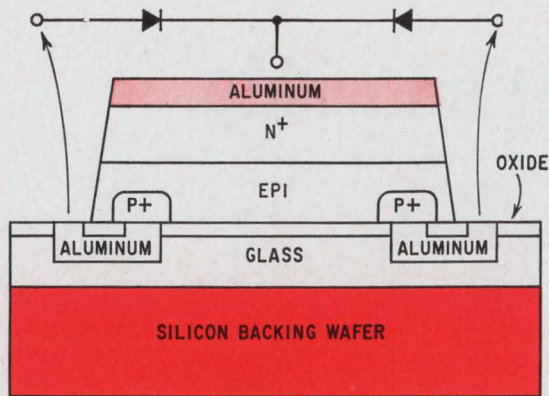

COMMON CATHODE

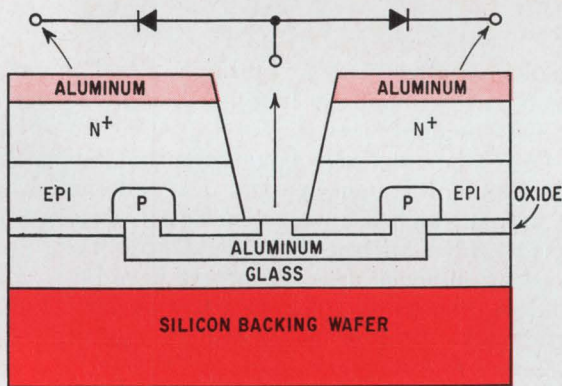

COMMON ANODE

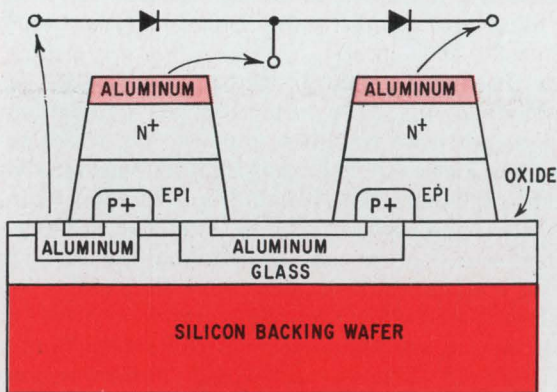

ANODE / CATHODE

Interconnections. Air isolation applied to three diode arrangements. In these simplified array segments, the only change from one interconnection scheme to another is that of the mask; the order and arrangement of each "layer" remains the same. This advantage has been put to use in the fabrication of commercial 16-diode and dual 8-diode arrays.

better contacts with the elements; contacts could be made directly to the n+ region, through the "back door." Long paths weren't necessary.

Second, the original mesa idea called for a critical thinning step, done by etching. This was imprecise, often leaving unwanted silicon areas. The problem was solved by switching to a lapping technique—again done from the back.

Third, the glass material used left a lot to be desired. It didn't sufficiently resist acids, its thermal coefficient of expansion differed from that of silicon, and its melting point wasn't very much below the alloy temperature of the silicon and aluminum parts. Engineers finally developed a glass material that was sodium-free and had the right melting point resistance and thermal coefficient. The glass is sedimented by a centrifuge technique using a specially constructed wafer press that maintains a constant temperature during fusion, thus preventing irregularities in the glass layer.

Designers saw that bonding directly to the pads would require removal of the unwanted oxide during the contact cut step. They previously had removed oxide after the isolation step, but this increased mask and diffusion requirements.

Finally, production became possible when ic makers became more adept at maintaining close tolerances.

Why be discrete?

The electrical performance of planar air-isolated devices is as good as that of discrete arrays. Air isolation seems to have achieved discrete characteristics that were beyond the reach of pn-junction isolated ic's: high breakdown voltage, reduced parasitic effects, and uniform parameters from element to element, among others.

The new technique provides double protection for all junctions: oxide passivation and encapsulation in glass. Compared with other forms of isolation, it requires fewer assembly operations, die attachments, and bonds. It accommodates volume production methods through batch processing. And, because it requires no special masks or expensive materials, and little in the way of new production equipment, planar air-isolated ic's will be sold at regular prices.

Illustrations of the step-by-step manufacturing cycle appear on page 78; the entire technique is straight-forward and easy to visualize.

How it's made

After the elements have been diffused, a phosphorus-doped n+ region is diffused as a bordering ring around the p+ element areas. This is to prevent channel-type inversions, which cause excessive leakages and shorts. The step, commonly called the phosphorous channel cutoff diffusion, is often applied in solid-isolation processing, and occasionally in low-leakage discrete devices as well [Electronics, April 1, p. 59].

A contact cut is then made. Next, a thick alumi-

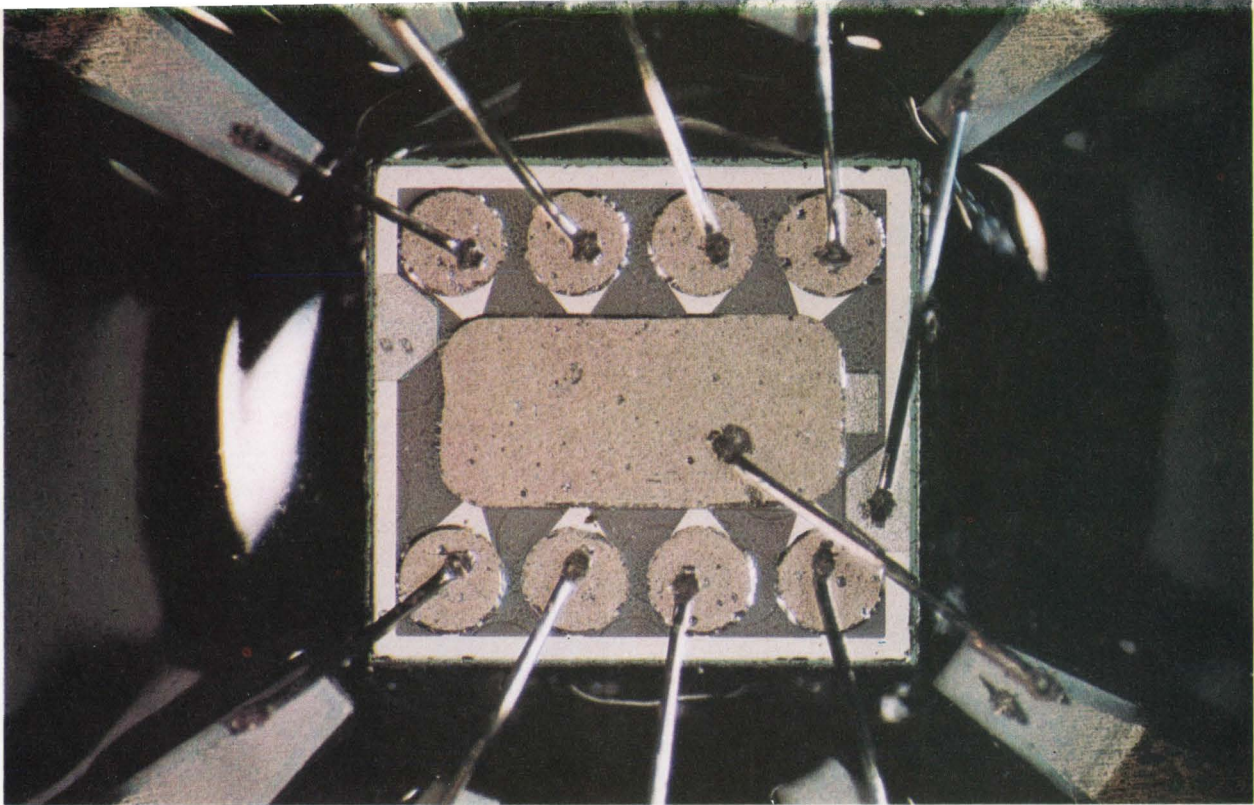

Sixteen diodes. Ceramic flat-pack mounted array fabricated with air-isolation. Large moat in center is common-cathode contact; eight circular moats are anode-to-cathode junction point contacts; trapezoidal area is common-anode contact. The cement-like gray portion around the contacts is the oxide.

num layer is evaporated and etched to form interconnections. A finely divided glass, five microns thick, is then sedimented from a suspension, over the aluminum and onto the front of the wafer. A support wafer—six mils thick—is placed over the glass layer and against the device wafer. The glass is fused under heat and pressure to join the wafers permanently.

The back of the device wafer is then lapped and etched, until its thickness reaches 20 microns. Next, an aluminum film is evaporated on the back, minimizing diode resistance drop at the die's extremities. Then an isolation mask, aligned with the patterns on the front of the wafer, is placed over the

aluminum. The aluminum is etched, and then the silicon parts are etched down to the thermal oxide layer. At this point, the IC consists of mesa-like substructures, each surrounded by moats of insulating air.

Padding exposed

Because oxide cuts have been made beneath the aluminum contact pads and the silicon has already been etched, the aluminum pads are exposed. Bonds can now be made to the back of the aluminum, which itself is firmly attached to the fused glass. Thick aluminum lead conductors are then attached. Since these may be attached on both

Arrays: Hybrid vs. monolithic

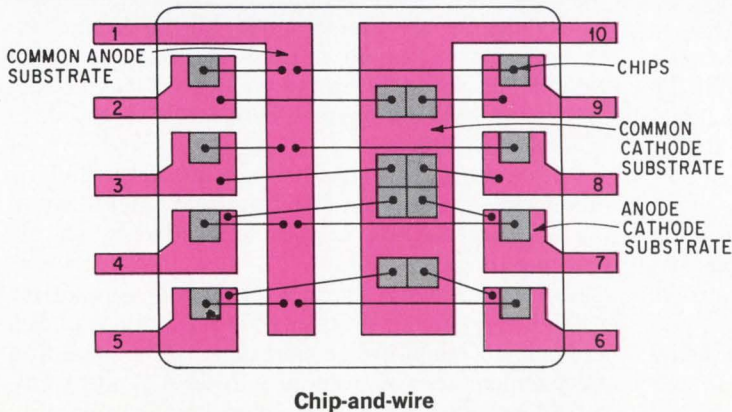

Contrasting diode arrays. Hybrid technique (above) involves many chips, more bonds, and has wire-crossover restrictions. Planar scheme uses only one chip, has fewer bonds, and easier pin arrangement.

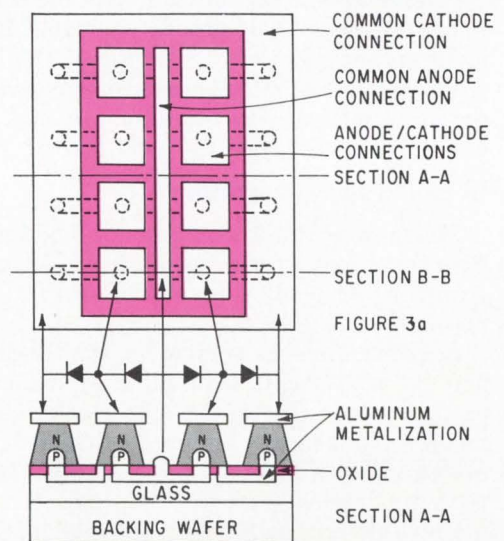

Air-isolated

Planar air

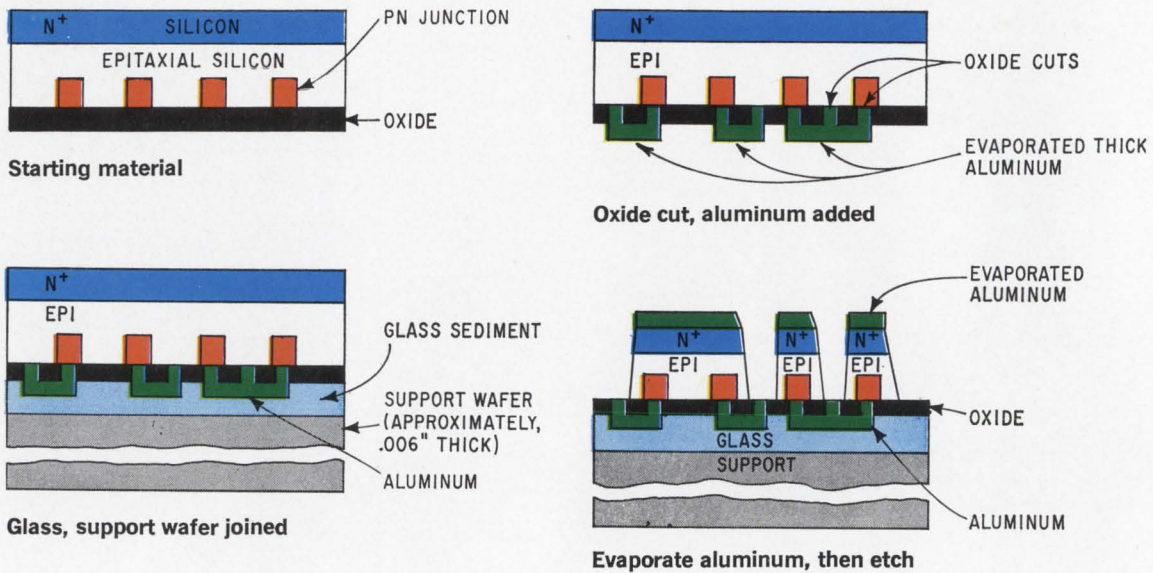

Isolation. Step-by-step processing of a planar-air-isolated diode array. In final form, mesa-like active elements are surrounded by air moats.

sides of the die, resistance drops are relatively low and complex interconnection schemes are easily accommodated.

Bumpy path

Solid isolation has a number of drawbacks. It provides only normal oxide protection; there is no supplementary glass coating. And because solid isolation is done before the circuit's elements are diffused and metalized, it requires a nonconventional processing cycle.

One must contend with the "bumps" on the dielectrically isolated wafer surface. The oxide layer arrangement doesn't always permit easy access for the lead paths. As a result of the occasional long lead paths—particularly evident in large matrices—forward conductances of the elements are relatively poor. The processing cycle itself is so involved (for example, the thinning step) that only one semiconductor manufacturer has mastered the method sufficiently to enjoy broad commercial success [Electronics, Jan. 22, p. 44 and April 1, p. 25].

Chipping away at hybrids

The new method also provides better isolation than the chip-and-wire technique of hybrid IC construction, which is a popular way to make arrays in small packages.

A typical hybrid version of the 16-diode array and its air-isolated monolithic equivalent appear on page 77. In the former, two electrically isolated metalized substrates are used, each with two chips of eight diodes mounted on it. One substrate has a p-on-n common cathode die, and the other an n-on-p common anode die. These chips have been fabricated in blocks of eight junctions to facilitate

handling and to increase the net yield. Even if four of the junctions are rejects, four usable junctions remain. Note that lead-wire crossover problems might arise if the good junctions aren't on the same die plane.

In any event, four separate die attachments and 28 lead bonds are required for each array. But if planar air isolation is used for the same type of 16-diode array, only one die attachment and 20 bonds are needed. One chip, instead of two, is required. Double protection—glass encapsulation as well as the oxide passivation—is provided. There aren't any wire-crossover problems. And, of course, there are the other general advantages cited earlier.

In the typical diode array the interconnection scheme determines the arrangement, but with air isolation only two junctions are required in each case. Thus, for a common anode, all the anodes are connected to a common point, and for common cathode, all cathodes are so connected. For anode-cathode arrays, anodes are connected to cathodes in a series string.

These alternative schemes are accomplished by merely changing the isolation and metalization masks. Larger arrays may be fabricated by simply building more junctions.

As for packaging, the new process is compatible with all three major practices—TO-5 can, flat-packs, and plastic dual-in-line packages. The bonding arrangement uses aluminum wire that is ultrasonically bonded to the chip, yielding greater reliability and strength than standard gold-ball bonding.

Planar air isolation has been incorporated—in prototype quantities—in linear IC's and in ultrafast digital circuits. Volume production of these monolithics is expected later this year.



Introducing Honeywell Series 32

**Computer systems with the golden touch...
that work for pennies**

First member of the Honeywell Series 32 family of 32-bit real-time I/C computer systems, the H632, is 850 nanoseconds fast. A high-performance system for real-time scientific and control applications, like: ground support/checkout, trainers/simulators, hybrid computation, message switching/data retrieval, and general purpose scientific.

It not only costs less per instruction than any other medium-scale machine, but has an advanced concept of modular system integration and design that makes it shine in multiprocessor/multiprogrammable configurations. Of course, its software package is extensive, and a complete line of peripherals and

subsystems is ready to meet almost any requirement.

The H632 can grow with you . . . from a minimum 8K memory with one central processor and one input/output processor to a maximum system of 131,072 words of memory, four central processors, and four input/output processors. I/C construction throughout adds to system reliability (we're I/C people from way back).

Because the H632 does so many things so well for so little, we call it "the computer with the golden touch . . . that works for pennies." Want to learn more about the H632? Write for our new summary brochure. Honeywell, Computer Control Division, Old Connecticut Path, Framingham, Massachusetts 01701.

Honeywell

 **COMPUTER CONTROL
DIVISION**



Compliments of a friend — a complete multimeter at less than \$3000

We think you'll agree that it's pretty friendly of Cimron to put out such a flexible instrument for so little. But it's typical of the philosophy that has always guided Cimron — **customer concern**. You need the most sophisticated instruments to do your work under a variety of changing conditions. And the Model 6653 gives you a great sendoff for both systems applications and laboratory or production testing. You get 5-digit readout including overrange, with an accuracy of $\pm 0.01\%$ f.s. $+0.01\%$

of reading for six months or longer. You'll save on calibration costs. Sample rates up to 300 per second; automatic polarity and automatic ranging; AC, ohms, millivolts. And look! You also get auto ranging through six millivolt and DC ranges. It's especially hard to beat all those Cimron customer concern features like remote control and printout, maintainable plug-in pc boards, and accessible calibration and test points. Write Cimron®, Dept. B-109, 1152 Morena, San Diego, Calif. 92110.



LEAR SIEGLER, INC.

CIMRON DIVISION





Big job. Close to 1,000 points will be monitored in flight aboard the Air Force's C-5A, giant cargo and troop transport built by Lockheed-Georgia that is the world's largest airplane.

Avionics

Testing on the wing

Automatic airborne systems for monitoring avionics performance in flight are a must for today's—and tomorrow's—fast, complex military aircraft

By Alfred Rosenblatt

Avionics and space editor

A military pilot used to have a relatively easy time keeping track of his plane's electronic instruments. There weren't many to worry about, first of all, and each piece of avionics equipment performed an essentially independent function. Checking his instruments, the pilot could decide whether the displayed readings for altitude, velocity, and bearing were reasonable, and he used this data to perform such operational tasks as navigation and bomb delivery.

Not so today. Present—and planned—military aircraft are so fast and complex that the pilot is out of touch with the workings of his avionics and, in a sense, with the outside world. With the speeds and altitudes at which missions are currently flown, sightings from the cockpit may be of small value. And the sophistication of modern avionics has made

for an interdependence among the instruments. For example, navigation is now performed by a doppler radar, an inertial platform, and a computer, with the operation of each piece of equipment depending on information supplied by the others. And while this gear is bringing the plane in on its target, related avionics systems are aiming and firing off weapons and keeping tabs by radar on the enemy's response.

A strike mission may involve more than 150 different modes of operation, and all functions—and combinations of functions—must be handled precisely if the sortie is to succeed. Ground maintenance can't ensure this degree of reliability, nor can pilot or crew. Hence the need for continuous, automatic in-flight checkout of avionics equipment. The

aim of a considerable effort now is the development of systems that cannot only spot faulty operation, but can diagnose and isolate it, and can switch the operation to an alternate mode. Such systems would be able to predict failures, too, and would alert the pilot of the status of his avionics.

Setting the sights

All new military aircraft feature some degree of automatic, computer-controlled monitoring; the newer the plane, the more self-test and maintenance equipment it will carry, and the more previously ground-based checkout gear will be built into its avionics. But the sort of systems envisioned by engineers now won't be flying until the mid-1970's.

functioning at full capacity, and, finally, it will display the monitored data to the pilot or another crew member.

There are, of course, problems—some very basic ones. The most obvious is the question of how all this complex monitoring circuitry is to be engineered into a plane. Another difficulty is that most of the avionics systems now being developed employ subsystems already designed. Engineers must thus build new self-checking systems around existing test points and cannot apply an integrated approach to monitoring.

Completely integrated monitoring setups will certainly be possible in the future, though, and the problem of space is largely being solved by ad-



For openers. First extensive in-flight performance monitoring in an operational aircraft was developed by Grumman for the five-place E-2A Hawkeye used for early warning, command, and control.

“What we're after is dynamic monitoring of the craft's total avionics system,” says Greg Foster of Autonetics' Strike Avionics division.

The features of such a monitoring system are listed in a paper to be presented at next week's National Aerospace Electronics Conference in Dayton, Ohio, by Helgi Heinzmann, a senior design engineer at the General Dynamics Corp.'s Convair division. First, says Heinzmann, it will be able to perform all preflight, in-flight, and postflight testing, producing a no-go signal when it discovers a faulty subsystem. Second, it will trace the fault down to the level of line-replaceable units (LRU's). It will further record all this data to aid in maintenance and to provide a basis for failure predictions, and will be able itself to recognize gradual performance degradation. It will, as noted earlier, be capable of switching operations from a degraded mode to one

vances in electronics miniaturization. A more fundamental question concerns the over-all approach to in-flight checkout.

There are currently two schools of thought about the role of the central computer in a monitoring system. Paul Tracy, a program engineer at the General Electric Co.'s airborne early-warning radar department, puts it this way: “Should each piece of equipment evaluate itself, or should the evaluation be made at a central computer site?” In the first case, the go/no-go decision would be made on the spot and the computer would receive only a status report.

“In-flight monitoring at this point is not a well-shaped program,” concedes L.M. Puckett, an associate technical director for avionics systems at the Naval Air Systems Command. “However, we're quite conscious of its necessity and are incorporat-

ing various degrees of performance monitoring and failure warning into all Naval avionics projects. Quite a bit more development in philosophy is needed before an over-all point of view can be imposed on all systems.

"Depending on the aircraft," Puckett continues, "part of the monitoring is being done on a systems basis, part on an equipment basis. Some projects have already used a central computer for diagnostic routines—creating a stimulus to the equipment and evaluating the response to determine operational status.

"We're trying in most cases to integrate the performance-monitoring capability that's there, and also to get these concepts into new equipment early in the design process," he says.

Several paths

Enough new systems have already been designed to give an indication of where things are headed. As could be guessed, they've been heading in several different directions since the first extensive in-flight monitoring arrangement became operational three years ago aboard the Navy's E-2A Hawkeye airborne early warning, command, and control craft, a plane developed by the Grumman Aircraft Engineering Corp.

One basic approach is represented by the Mark II avionics now being integrated for the FB-111 and F-111D fighter-bomber by Autonetics, a division of the North American Rockwell Corp. The Mark II system uses the central computer not to compare preset limits with performance data but simply to program tests; the testing and evaluation are done right in the avionics boxes.

Another approach is taken in the Malfunction Detection, Analysis, and Recording (Madar) subsystem developed by the Lockheed-Georgia Co. and now being produced by the Lockheed Electronics Corp. for the Air Force's huge C-5A transport. Madar ties almost 1,000 test points dispersed throughout the airplane into a central fault-monitoring and diagnosis system that digests raw analog signals sensed in the individual black boxes, quantizes this data, and compares it with the limits and references stored in a central computer. The computer indicates on a console any malfunctions in the aircraft's subsystems and directs the flight engineer to the source of the trouble, right down to a line-replaceable module.

Other aircraft

Besides the Mark II and Madar projects, various kinds of self-testing and checkout arrangements are being integrated into such helicopters as the Lockheed-California Co.'s AH-56 Cheyenne, and the IHAAS and ILAAS craft. Built-in test equipment is also a feature of the A-New avionics going into Lockheed's P-3C patrol plane. A Univac general-purpose computer derived from the Model 1230 will perform the tests on the P-3C, and a high-speed printer, a cathode-ray tube, and an audio system will provide warnings of any malfunctions.

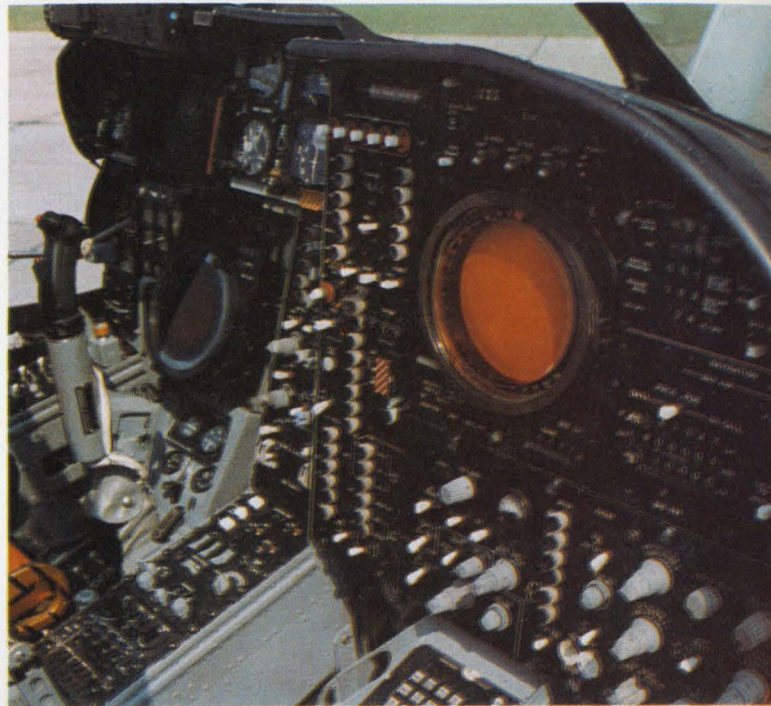

Dual role. Displays in the cockpit of the A-6A are now also used for in-flight checkout of the avionics' operation.

Systems integrators are now introducing self-check capabilities into aircraft originally designed without them, such as Grumman's A-6A Intruder. And the International Business Machines Corp. is studying the possibility of adding what the company calls Automatic System Self-Test (ASST) to the A-7D/E Corsair. IBM is integrating the A-7's avionics, as well as supplying the on-board digital computer.

Several companies, among them Autonetics, GE, and the Boeing Co., apparently sense a retrofit market in the making here. They're working to develop standard interfacing modules with which in-flight



Intruder. The avionics' systems integrator for the A-6A added computer-aided checkout features after each subsystem had been designed.

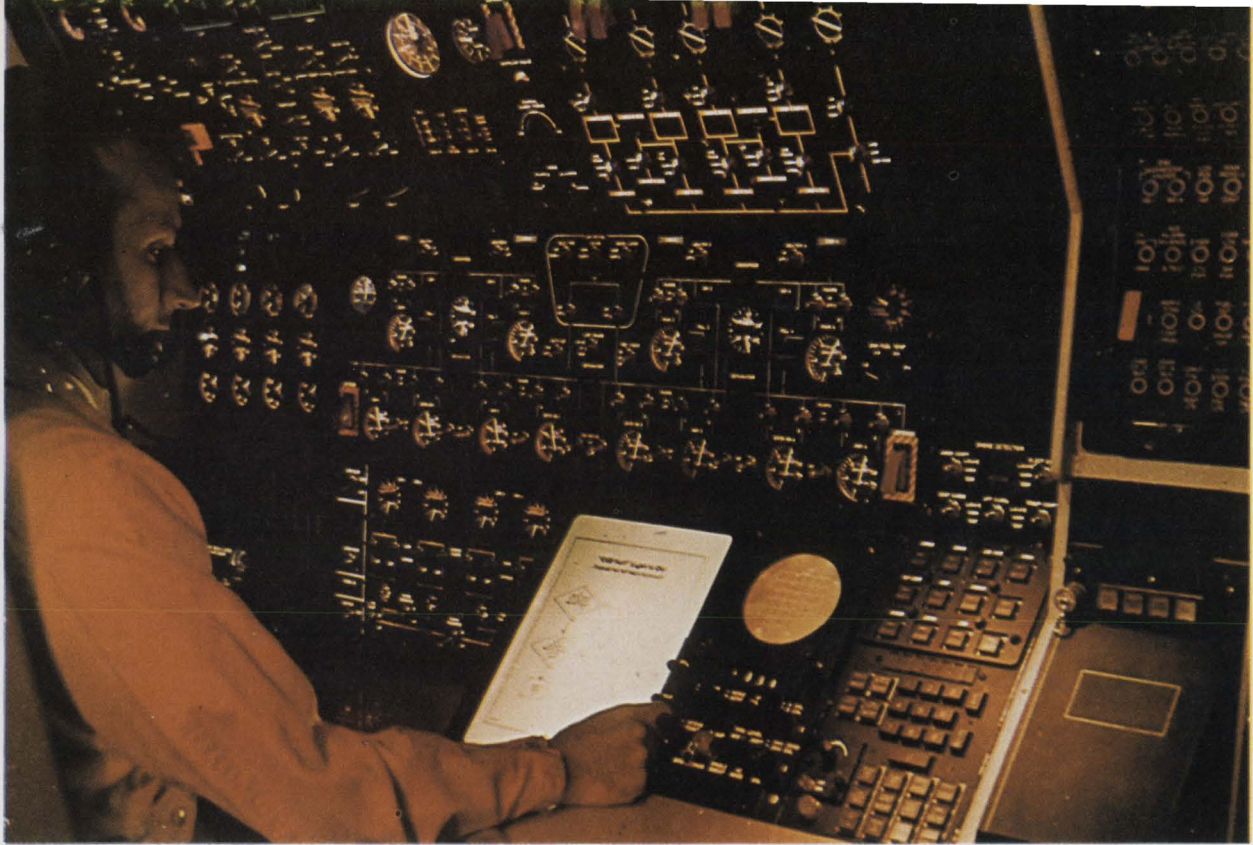

Diagnosing console. Subsystem malfunctions displayed on the console of the C-5A's Madar system can be isolated with the help of a random-access film store and oscilloscope.

monitoring features could be easily added to a plane's avionics.

Shape of the future

The Mark II avionics system contains many of the features projected by Heinzmann for the total system of the 1970's. Among these are automatic switching from a degraded mode to an alternate by computer, and the production—on paper tape—of permanent fault data to aid in maintenance.

Harvey I. Hylton, the computer design engineer in the F-111 project office at Wright-Patterson Air Force Base, Dayton, Ohio, notes that the Mark II

system was designed specifically to reduce ground maintenance work and speed the F-111's turn-around time between missions.

Test circuitry is built into all the LRU's in the avionics, Hylton says, so that each unit undergoes end-to-end internal self-testing. Any malfunction is signaled to the central computer, which addresses each LRU over a serial digital channel. The computer then flashes a light on a specially designed status board to alert the pilot to the problem. The status board, as well as the maintenance-data recorder, was built by the Kearfott group of General Precision Systems Inc.

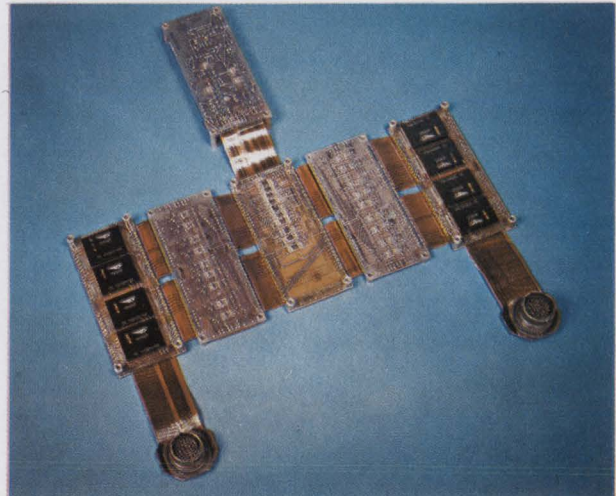
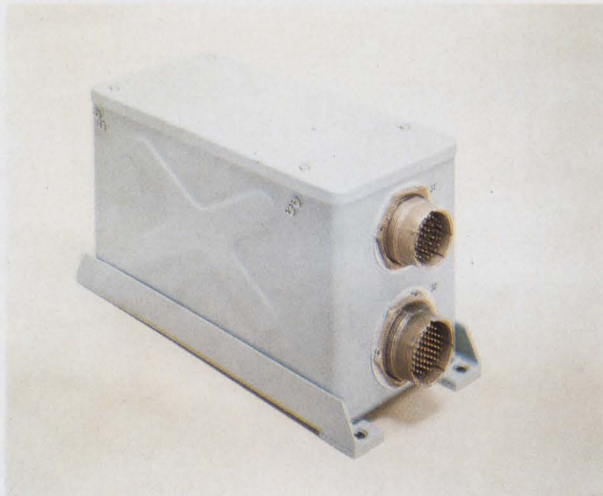

Information gatherer. Remote acquisition unit in Madar senses test-point signals. A one-piece multilayer cable is used to interconnect its circuitry. Signal conditioning circuitry—the black packages—takes up a large amount of space, may be left out of unit being considered for advanced Madar design.

Signals from the avionics equipment go to a box that combines the functions of multiplexing and analog-to-digital conversion. Most of the information is already in digital form, Hylton explains, but synchro-type equipment does produce analog data.

All self-testing and limit-comparison is done in the LRU's themselves. The digital computer merely scans the signals from the units to determine whether there has been a malfunction, and to decide, if necessary, to which alternate mode to switch the operation.

This monitoring of LRU status requires no more than 5% of the on-board computer's memory capacity, Hylton points out.

With one exception, failure thresholds in the subsystems are set by hard wire in the factory. The exception: the limit conditions for the multiplexer-converter's self-test, which are set in digital registers within the converter by a code word from the computer.

Comparing the capabilities of the Mark II avionics with those of the Mark I in the F-111A's now flying out of Thailand is like comparing a Cadillac with a Model T. Although the Mark I system includes built-in-place test equipment, there's no central computer directing the monitoring nor is there any recording of fault information. Lighted lamps on subsystem control panels indicate malfunctions but ground personnel must isolate the faults. However, a malfunction in the terrain-following radar, the first such system operational in a tactical fighter, is displayed on the aircraft's caution panel.

Checking out a giant

Lockheed's Madar is designed for automatic or manual step-by-step, troubleshooting by an operator while the plane—the C-5A—is in flight. Indicator lights linked to the 10 major subsystems aboard the huge craft are displayed on one side of a three-part console.

When a malfunction occurs, step-by-step maintenance procedures, such as would be found in a maintenance manual, are selected from a 10,000-frame random-access film store and are projected on the other side of the console.

Also included in these frames are pictures of the waveforms that should be found at the various test points. Based on the information in the frame, the operator can call for a live waveform from any of the manual test points in the system and display it on a two-channel oscilloscope that is also part of the console. Following the directions given him by the film store, and using the waveforms presented on the scope as a guide, the operator can quickly trace the fault to a specific LRU. He can then decide how to remedy the problem or how to operate around it.

Madar operates through 32 remote signal-acquisition units installed throughout the plane. Twenty are scanned automatically and 12 are tied into a manual on-demand system controlled by the operator as he checks the equipment. Each acquisition unit scans 30 test points, multiplexes the analog sig-

nals—ranging from d-c to 400 hertz and up to 200 volts peak-to-peak—and feeds them, in a standard ± 5 volts peak-to-peak range, to a central multiplex adapter. This adapter then multiplexes the incoming signals through a common analog-to-digital converter to a digital computer.

Each remote acquisition unit weighs about $3\frac{1}{2}$ pounds, dissipates 3.75 watts, and measures $4\frac{1}{2}$ by 9 by 5 inches. A flat multilayer cable developed by Lockheed and manufactured by Sanders Associates Inc. eliminates the need for connectors in the package; the unit's elements, mostly silicon monolithic integrated circuits, are flow soldered to the cable.

Metal oxide semiconductor field effect transistors are used in the multiplexing unit, principally because a junction FET would remain closed if power failed, thereby interconnecting all the test points.

All 600 automatically monitored test points are scanned at a 10-kilohertz rate. A Nortronics 1060A computer is used solely to store limits and fault data and to control the scanning system. The central multiplexing unit controls a magnetic recorder for storing changed or out-of-limits data, a crash data recorder, and a paper-tape printer that presents the flight engineer with a numerically coded statement of what's gone wrong.

Within limits

The Lockheed engineers had to work, in some cases, with existing subsystems in designing their in-flight monitoring systems, observes Joseph Barrett, Madar program manager. In the communications subsystem, for example, the LRU's were already designed and Lockheed had to go with those test points that were available. However, the multi-mode radar was specially developed for the C-5A, and Lockheed could specify, in this case, where it wanted the test points.

A next-generation version of Madar has already been proposed for a NASA space mission, Barrett says. In this system, each remote acquisition unit will have its own a-d converter. The central multiplexer will scan waveforms at such a high rate that there'll be no need for the oscilloscope display; the amplitudes will be stored and processed in the digital computer memory.

Lockheed is investigating hard-wire storage of limits data in a fast ferrite-core memory. The company also wants to reduce the size of the signal-acquisition units and place them closer to the LRU's. To achieve this, engineers are working with low-power MOS devices and thick-film interconnections between hybrid and monolithic circuits. The goal, according to Leonard Merel, chief design engineer for Madar, is to put an eight-channel signal-acquisition unit—with its own a-d converter—into a 2-inch cube.

Upgrading

Grumman is planning to redesign its in-flight monitoring system for the next version of the Hawkeye. In the E-2A monitor shown on the cover, up to 77 alarm channels feed directly in from built-in-place

test equipment circuits at various points in the avionics to energize indicator lights at the top of the console. Using a cross-bar switch, the operator can select live waveforms from the appropriate test points for oscilloscope display; voltage values at other points can be read out on a digital voltmeter. Then, following the instructions in a manual of fault-diagnoses routines, the operator can isolate the fault and choose alternate modes of operation.

There's no computer in the E-2A monitoring setup, but all the test gear in the advanced Hawkeye will be linked to a stored-program digital processor.

"The new system will have a flexible machine with a large core-memory capacity," says Julius Cohen, Grumman's E-2 program manager. "We've learned from experience with the E-2A what additional points should be monitored. Diagnostic procedures will be able to trace faults to even lower levels than the LRU's."

Monitoring limits will be set in the computer, says Cohen. Grumman is trying to decide now whether to build a-d conversion circuitry into each subsystem or use a separate signal-conditioning unit. Also under consideration is a multiplexing system to cut down on the wiring.

The primary alarm readout being studied for the advanced system is an alphanumeric message displayed on cathode-ray tubes at each of the three crew stations in the Hawkeye. There will also be a panel of lights similar to the one in the E-2A but much smaller, a test oscilloscope, and a digital voltohmmeter at the radar operator's console. The light panel will indicate malfunctions in the central computer and the equipment-cooling system—faults that could prevent an alphanumeric message from being displayed.

Each crewman will be able to call for alphanumeric readouts of system status and to initiate tests. Only the radar operator, however, will be able to examine a waveform from a specific test point or get a reading on the digital volt-ohmmeter.

In the case of its A-6A, Grumman has added a self-monitoring capability to an avionics system originally designed without it—"and without adding equipment," according to Grumman's George A. Walz. "We used equipment supplied to us by the subcontractors," he says.

The company inserted diagnostic routines into the drum memory already on board the aircraft, and hooked the whole system into display equipment already on hand. "Data such as airspeed and pressure altitude coming in from the air data computer can be presented on digital readouts already in the cockpit," says Walz.

Fundamental split

All discussions of automatic in-flight checkout come back to the basic question of whether evaluation should be done by a central computer.

In the technique exemplified by the Mark II avionics, both test and evaluation circuitry is designed right into each piece of equipment. A self-contained monitor in a radar, for example, circulates its own

test signals through the subsystem, and such parameters as time, amplitude, and pulse width are compared to references set up within the subsystem. Operational capability is assessed on the spot by calculating, say, signal-to-noise ratio, subclutter visibility, and detection sensitivity.

When questioned by the central computer, the built-in circuitry simply reports its own evaluation of its operational status. The computer, of course, is programmed to take action in the case of a malfunction—warning the pilot and initiating a diagnostic procedure.

In much of the Madar system, the test-stimulation hardware is built into the equipment to be monitored, but the evaluation capability is not. Evaluation is the function of the computer, which periodically addresses all of the test points in the system. The tolerable limits for the parameters checked at these points is stored in the computer, and from these it determines when performance is falling below standards. It also isolates the faults and keeps track of trends in equipment operation. The degree to which a computer could actually forecast failures is, according to GE's Tracy, "limited only by the imagination of those designing the data-evaluation system and the programing."

Process control

Autonetic's Foster predicts that the computer in the systems of mid-1970's will set the tolerances and limits for the test points throughout the avionics. But the Air Force's Hylton contends that "we don't know if there's really a need for such set-point control to be done by the computer. It would be just like a process-control computer setting limit points on the basis of what's going on inside the process. For in-flight monitoring, it's quite possible that setting the limit points by hard-wire—tailoring a resistor network, for instance—may be adequate."

Hylton maintains that "there isn't a need to change limit points so rapidly," and warns that "you might need more complex circuitry in the LRU. You'd need holding registers for storing the limits. The great advantage, of course, would be the flexibility; you could tighten or loosen set-point tolerances based directly on operational experience."

Other systems problems complicate the basic question. Tracy points out that the operating speeds and complexity of radar systems have reached the point where it would be just about impossible for an external computer to assess a radar's performance. Analog-to-digital conversion of signals to measure amplitudes, timing, and pulse width would require fantastic bit rates, he says, "especially with the 100-to-200-nanosecond resolution required in the coherent radars we're designing."

The answer, Tracy states, "is a happy mix of both techniques, even within the same piece of equipment. Radar test signals have to be circulated anyway during interpulse periods to tweak up the system. Better to use these signals for self-monitoring instead of converting them to digital form and transmitting them to a computer."

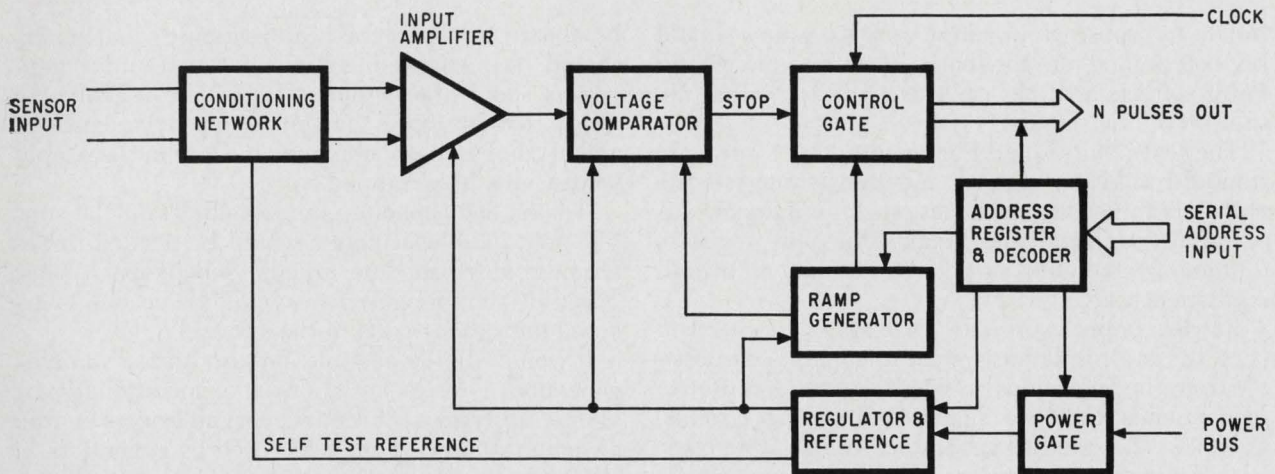

Conversion. Circuit proposed by RCA would sense the levels of analog signals at remote test points and send digital data to a central computer.

As Tracy sees it, "The computer would monitor the results of these self-tests and at the same time make detailed assessments of the performance of less complex subsystems based on limits stored in its memory."

Challenge and burden

The job of implementing the complex new monitoring systems is falling increasingly on the integrating contractor. Eventually, says Convair's Heinzmann, he will specify all airborne monitoring requirements, much as he now specifies weight and power.

Autonetics' Foster agrees. "A subcontractor in future won't just be told to supply a radar that contains a monitor," he says. "He will be told to supply a radar that performs specific and exacting self-tests."

But the management techniques needed for the procurement of these systems have yet to be developed. Engineers connected with the Air Force's Airborne Warning and Control System (Awacs), for example, are frankly concerned about the gigantic procurement task that faces them. One estimates that as many as 10,000 test points will be monitored in this system, more than 10 times the number in the C-5A. It's clear that the systems managers in charge of the monitoring will have to get busy very early in the design phase.

This kind of designing from the ground up is fine for future avionics, but the military may also be interested in retrofit systems. The Air Force is reported to be considering retrofitting the C-141 and B-52H, and several companies are developing circuitry to do the job.

Autonetics has something called Focas, for Fast Operational Checkout Avionics Systems, a group of sensors that will interface between test points in the subsystems and a central monitoring unit. Silicon-on-sapphire and mos circuitry will be used in the signal-conditioning section. Autonetics hopes to add Focas sensors to the avionics carried aboard

such tactical aircraft as the F-4 and the F-105.

The company's aim is to eliminate the need for ground-support equipment on the flight line. Because Focas monitors down to the LRU level, a faulty black box can be replaced on the flight line; maintenance crews won't have to tear down the whole system.

Data from Focas' sensors is sent through a signal-conversion network to a central computer or several separate processors, where it is evaluated on a go/no-go basis. Norman Gortz, one of the system's developers, says the test sensors can monitor any signal at the interface between the connector and the LRU—"a-c, d-c, synchro, low-level noise, whatever is desired."

A recording device, perhaps located in the aircraft's bomb bay, stores data on the condition of the various avionic subsystems for later analysis. If a monitored LRU malfunctions and the problem is of concern to the pilot, a light flashes on his control panel. Focas has a self-testing capability to determine if it, rather than the avionics gear, is inoperative, Gortz notes.

In addition to its avionics-monitoring ability, the unit can be applied to such other aircraft systems, as hydraulics, fire control, and the engine. Once monitoring is begun, it continues throughout the mission.

GE, too, is developing a family of general-purpose sensors. "We're trying for a whole shopping list of basic sensing modules," says Tracy. "These will be in chip and thick-film form, with go/no-go limits tailored, for example, by hitting taps on a voltage divider network before the unit is attached to a monitor point. A half-dozen modules could meet the majority of testing requirements, and 1 cubic inch per module is the design goal."

In another paper to be presented at the NAECON meeting next week, Donald Bowie, a research engineer at Boeing, will discuss another development effort in this field. Bowie stresses the need for great care in selecting the additional test points required to give a fault-detecting system the capability to

isolate the cause of a malfunction. Locations should be determined on the basis of failure-mode and failure-effects analyses carried out in the initial design phase, he says.

The test points should be conditioned to provide standard indicator signals, and Bowie suggests the use of high-density packages, such as flatpack differential amplifiers and single-chip shift registers to minimize the effect of this conditioning on overall equipment size.

Bowie's paper especially emphasizes the need to keep the fault-isolation system as separate as possible from the operational systems. To this end, Bowie recommends that the signal-conditioning circuits, as well as the stimulus generators for initiating tests, be contained within the LRU. With internal conditioning, the operational signals don't enter the monitoring system; access is only to the conditioned test points.

Describing the Boeing project, Bowie says both test and operational signals would be fed into what the company calls a RAU—for remote access unit. Located adjacent to the LRU, the RAU converts the signals to digital form and time-multiplexes them on common transmission lines to a digital computer. A multiplex control and computer buffer provide power, timing control, and synchronization for the unit, Bowie explains. Test points would be both sequentially and randomly accessible.

Boeing has actually built a RAU-type unit using MOS FET components. Bowie predicts that the application of large-scale integration techniques can bring the size of the RAU down to 1 cubic inch, and estimates that the unit will consume about 1 watt of power.

Bowie observes that removal of the remote access unit wouldn't alter the operating characteristics of the LRU; the line-replaceable unit could thus be used in avionics systems without integrated self-testing.

Way out

The Aerospace Systems division of RCA is considering the development of standard signal-sensing packages for on-board monitoring and maintenance during long-term space missions in the 1970's.

For a projected orbiting laboratory that would carry 10 or 11 people for five years, RCA is studying what it calls an Adaptive Dynamic Analysis and Maintenance (Adam) system. Adam would check all the spacecraft's critical parameters against limits stored in a central computer, according to Richard R. Schellenbach, senior staff scientist at the Aerospace Systems division. "Spares would be carried on board or ferried up from earth," he adds.

"We estimate there'll be roughly 5,000 points monitoring the health of the craft and taking data from experiments," Schellenbach says. "Another 3,000 points will be needed to isolate a fault to an LRU. To make our design problems easier, we're looking at a mix of sensing modules that will handle analog, digital, and discrete parameters."

Thus far, Schellenbach has studied the power-supply and communications subsystems that might

be aboard the spacecraft to determine what points should be monitored and what test-stimulus generators should be employed to isolate a fault. He found that by using the test points by themselves and in combinations, not every module in the supply would have to be tapped.

"Of the 360 separate circuit modules in the supply, only 250 sensor points would be needed to determine which module failed," Schellenbach says. "Only 10 stimulus generators would be needed to exercise the various parts of the system."

It would also be possible, he says, to use stimulus generators already built into the operational part of the subsystem. "Frequency synthesizers in the communications set could be used as generators in other parts of the equipment, and reference voltages could be used in making limit checks."

Studies by Schellenbach have shown that d-c and a-c analog voltage monitoring would account for roughly 90% of the instrumentation. A standard analog module, on page 87, would be addressable by the central digital computer, and monitored amplitudes would be fed digitally back to the computer. The goal, again, is a 1-cubic-inch module, Schellenbach indicates.

Monitored new world

If monitoring subsystems in a craft orbiting a group of scientists around the earth for five years sounds pretty far out, consider the closing statement in Heinzmann's paper on future systems:

"Automatic integral checkout will be part of all future vehicles. Even the automobile will have its share. A future designer may well specify LRUs with one of several standard checkout features. But the technique will not stop with the LRU: why should the SSR pilots' physiological parameters not be monitored? And why should a comprehensive checkout system merely display and record a fault?"

"Automatic repair action, initially perhaps limited to substituting good components and manipulating variables, is certainly within the grasp of our technology. A faltering propulsion plant may be restored to satisfactory operational condition by fast, automatic manipulation of the fuel and ignition systems. If the engine must fail, the future automatic checkout system will at least select the optimum degraded mode operation. Much work lies ahead, but the results cannot fail to be interesting and rewarding."

In the next issue

Developing a system to monitor the performance of modern avionics in flight is especially complex when the process and equipment are to be integrated throughout the aircraft. In the next issue, F.H. Hardie and G.E. Simaitis of the International Business Machine Corp.'s electronics systems center in Owego, N.Y., describe how they've tackled the job with the Automatic System Self-Test (ASST) design.

The great divider.

What else could we call our new DM 7520? Especially after we found out that it's the only unit on the market that can divide by *any* number without having to use an additional electronics network.

It's programmable, so you can easily vary the digital input code to determine the exact number you want to divide by. And, using multiple packages of the 7520, you can divide by any number you want.

It's an MSI monolithic TTL circuit which performs brilliantly in frequency synthesis up to 10 MHz. The package is dual in-line, with the military version DM 7520 priced at \$25.00 each and the commercial version DM 8520 priced at \$12.50 each for 100 to 999.

For more information, including where to get our great divider *now*, call or write: National Semiconductor Corporation, 2975 San Ysidro Way, Santa Clara, Calif. 95051. Phone (408) 245-4320.

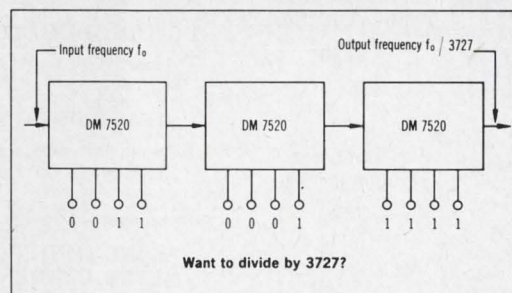

National Semiconductor



NEW

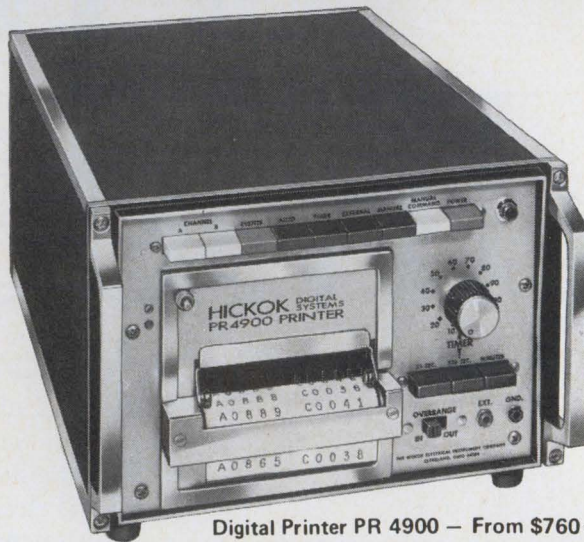

NEW

Main Frame DMS 3200A — \$375
(or DMS 3200P Main Frame with printer output — \$450)
Shown with DC Voltmeter Plug-in

Digital Printer PR 4900 — From \$760

The HICKOK DMS 3200 Digital Measuring System is a precision electronic measuring device which displays readings in digital form instead of the relatively inaccurate and difficult-to-read moving-pointer meter display. A companion PR 4900 Digital Printer allows the displayed readings of the DMS 3200 System to be printed in permanent form for storage and future reference.

Because the DMS 3200 System consists of a main frame which will accept a number of "plug-in" units, it can be used to measure a variety of electrical parameters. The main frame provides display of the reading; the plug-in determines the application.

Depending on the plug-in selected, the instrument can be a:

DIGITAL DC VOLTMETER

Range: 00.1 mv to 999. volts
Accuracy: $\pm 0.1\%$ of reading ± 1 digit

DIGITAL EVENT COUNTER

Counting Rate: 0 to 1,000,000 counts/second

DIGITAL 1 MHz COUNTER

Frequency Measurements: 00.1 Hz to 999. kHz
Period Measurements: 00.1 ms to 999. seconds
Accuracy: $\pm 0.0005\%$ of reading ± 1 digit

DIGITAL OHMMETER

Range: .001 ohm (1 milliohm) to 999. megohms
Accuracy: $\pm 0.1\%$ of reading ± 1 digit

DIGITAL CAPACITY METER

Range: 001. picofarad to 9.99 millifarads (9,990 microfarads)
Accuracy: $\pm 0.1\%$ of reading ± 1 digit

Other plug-ins to be announced:

AC VOLTMETER, HF COUNTER, TIME INTERVAL METER, CURRENT METER

Through overrange capabilities of many of the plug-ins, the three-digit display actually provides resolution capability equivalent to that of 4-, 5-, 6- and 7-digit displays in many cases.

The DMS 3200 System is designed for rugged industrial and laboratory applications. Solid-state construction and conservative design ratings insure long, trouble-free life. By utilizing a design which has the optimum combination of accuracy capability and number of digit display, the DMS 3200 meets the general purpose measurement needs of industry for reliable digital measurement equipment in the \$500 price range.



DC Voltmeter Plug-in DP 100
\$175

Event Counter Plug-in DP 140
\$90

1 MHz Counter Plug-in DP 150A
\$230

Ohmmeter Plug-in DP 170
\$275

Capacity Meter Plug-in DP 200
\$275

Prices and Specifications subject to change without notice

The odd couple.

DM7830 LINE DRIVER



This unique new combo works together like no other. No nonsense. No added circuitry. And no shopping around. They're together now at our distributors. And, even though it seems a shame, we'll also sell them separately.

Our DM7830 dual line driver works on a single 5-volt power supply. It's DTL/TTL compatible, performs logic on inputs, drives a 5000 pF capacitance load and delivers a 5-volt differential output signal. Short-circuit protection is built-in, and diodes, on all outputs, clamp positive and negative common mode transients. The price is \$16.00 for 100-999, or you can get our DM8830 commercial version at \$8.00.

DM7820 LINE RECEIVER

Our DTL/TTL compatible DM7820 is a dual line receiver that operates from a single 5-volt power supply yet rejects common mode input signals up to ± 15 volts. Response time can be controlled with an external capacitor to eliminate noise spikes, and each channel can be strobed independently. Termination resistors for the twisted pair are included on the chip. The DM7820 has a differential threshold voltage of zero, but you can get another version of it, the DM7821, that has a threshold of 1.5 volts. 100-999 price for the DM7820 is \$24.00, and the commercial DM8820 is \$10.00.

For more technical data...write to National Semiconductor, 2975 San Ysidro Way, Santa Clara, California 95051. (408) 245-4320.

National Semiconductor

Why waste time on bypass/filter capacitors?

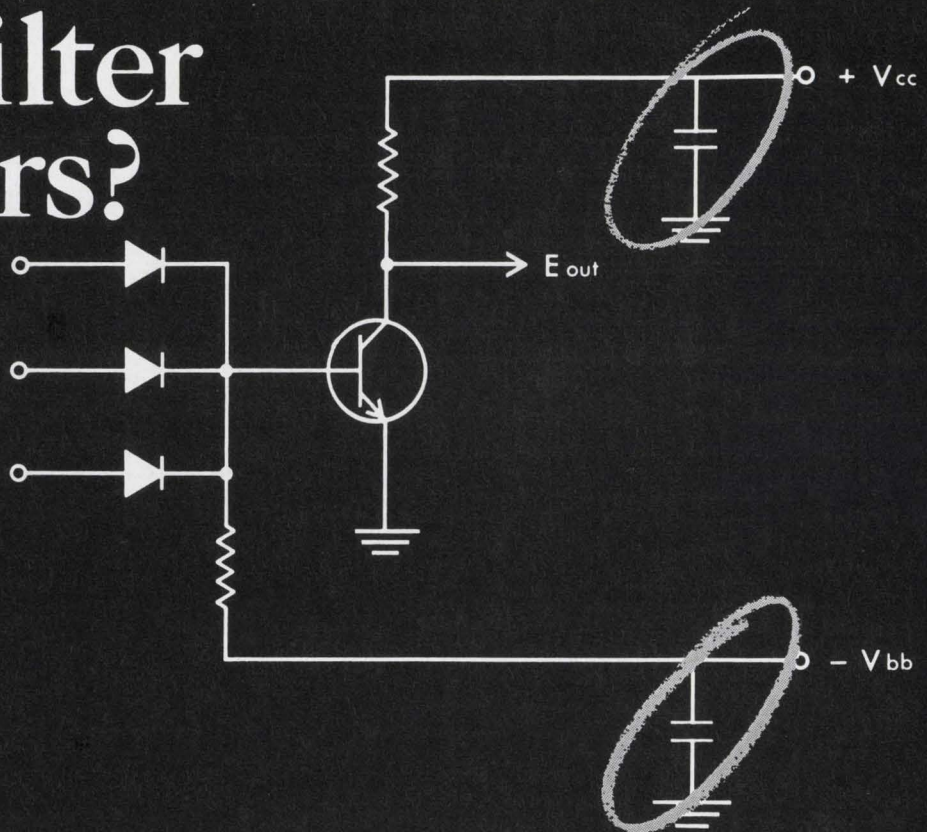

Specify CORNING® Glass-K Capacitors, and move on.

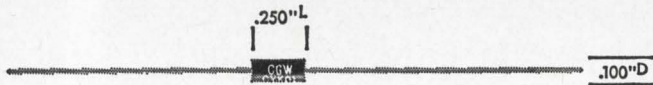

There's only one real concern with a bypass/filter capacitor. If it goes, your circuit will probably follow. Specify the guaranteed reliability of CORNING Glass-K Capacitors and forget it.

You can forget it for the same reason we can guarantee it:

1. Large capacitance in minimum case size, 1000 to 51,000 μf in $.250'' \times .100''$ or 12,000 to 100,000 μf in $.250'' \times .140''$.
2. Low power factor and low DC leakage.
3. Adaptability to cordwood, printed circuit, and point-to-point packaging and automatic insertion.
4. Tight end-of-life design with guaranteed stability.

Get this confidence at a competitive price, and inside two weeks for standard items. Get complete data by writing to: Corning Glass Works, Electronic Products Division, Corning, New York 14830.

CORNING
ELECTRONICS

Circle 92 on reader service card

Probing the News

The arts

Signal gains for electronic music

The one-time ugly duckling of the arts shows signs of becoming a swan of sorts as serious composers work with random-sound effects, computers, and synthesizers

By Peter J. Schuyten and Stephen W. Fields

Assistant editors

Electronic music is reaching the point where little Johnnie, instead of enduring a weekly piano lesson, may soon be learning to switch his signal sources and vary voltages on a synthesizer.

Right now, the bleeps, blaps,

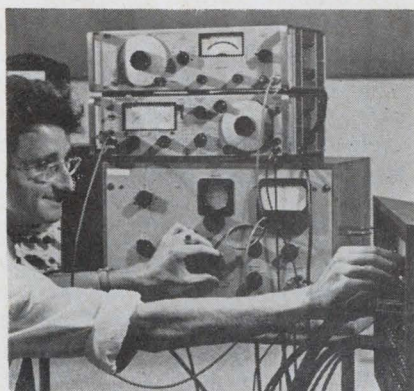

Composer Douglas Leedy adjusts

screeches, and oogahs produced by sine-wave generators, frequency synthesizers, and even computers are forcibly arresting the attentions of skeptical purists from the world of serious music.

Reprise. Less than a decade ago, electronic music was largely the province of a few establishment outcasts splicing tape and working with crude reproduction equipment. Their efforts were generally treated with indifference or scorn. But in recent years the medium has gathered momentum; it is now heard in concert halls, on records, at World's Fairs, and in television

commercials. And a sizable number of respected institutions in the U.S. and overseas have made substantial investments in electronic equipment.

Today, a composer dissatisfied with conventional musical instruments and techniques can turn to electronics. His only problem is deciding whether to use computers,



frequency generator to get tone that

synthesizers, or a mixed bag of electronic gadgetry that can produce only random sound.

Body and soul

Random sound, one of three principal forms in the world of electronic music, is variously produced. Alvin Lucier, a composer who directs Brandeis University's Electronic Music Laboratory in Waltham, Mass., has devised one of the more exotic methods. He attaches electroencephalogram elec-

trodes to his head and blinks his eyelids rapidly to produce brain waves that are converted into sound.

In another vein, Max Neuhaus, a freelance percussionist and composer of electronic music from New York City, has invented what he calls the Max-Feed, an "instrument" that produces random sounds somewhat easier on the ear than the output of Lucier's system. The Max-Feed houses a transistor



is mixed to form a complete measure.

radio, an amplifier, and a microphone in a transparent plastic box. The microphone picks up an audio signal from the radio and feeds it into the amplifier, which sends the signal back into the radio. The output—a function of the original broadcast signal—is chance music, a highly random sound that Neuhaus says, "expands our perception of the world around us. Put 100

IEC makes miniature electrolytic capacitors BETTER

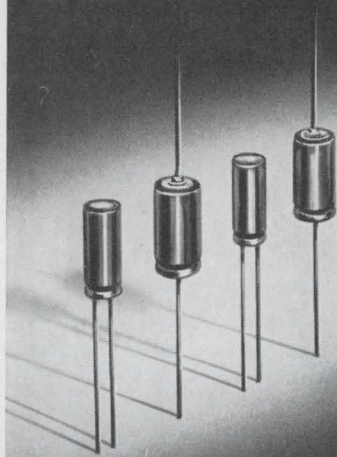

... and look at these features:

- Small size
- Aluminum can construction
- Welded lead connections
- Extremely low leakage current
- Meets stringent life and storage test requirements
- Available temperature range: -25°C to $+85^{\circ}\text{C}$

... and look at these prices*:

- 5 mfd 15V @ 5¢
(-25°C to $+70^{\circ}\text{C}$)
IEC Part No. PCW 5A15
(dimensions: $3/16'' \times .433''$)
- 10 mfd 15V @ 6¢
(-10°C to $+85^{\circ}\text{C}$)
IEC Part No. TAZ 10B15
(dimensions: $1/4'' \times .472''$)

Send for general information and specifications on IEC's miniature electrolytic and miniature polyester capacitors for solid state equipment.



INTERNATIONAL ELECTRONICS CORP.
Melville, Long Island, New York

ELECTRON TUBES • SEMICONDUCTORS • COMPONENTS

*In production quantities

For love — and money

Although electronic music is still largely a noncommercial proposition, some composers are using their talents to good account in the business world.

For example, Morton Subotnick, a free-lance composer, recalls when he would do electronic music for one-minute commercials and settle for only \$50 a spot. "I've wised up now," he says. "If I need a \$5,000 four-track tape recorder, I work very hard for a couple of weeks turning out only a few 60-second spots. And I have it." Subotnick's credits include the theme music for the Columbia Broadcasting System's program *The 21st Century*, and background music for the Western Electric and Vote toothpaste broadcast ads.

And Ferretti-Lay Inc., an MIT spinoff that set up shop a year ago, is bent on selling visual and aural presentations for radio and television broadcasts as well as backgrounds for dance and drama productions. Equipment is still being installed at the firm's Newton, Mass., facility, but the company hopes to start looking for outlets soon.

Max-Feeds in a room and they create a symphony."

Organization men. But other composers feel that there is more to electronic music than pure chance. J. W. Beauchamp, a member of the engineering faculty at the University of Illinois and a composer of electronic music, says: "Music is more interesting if it is built around a logical framework. Although music should be full of surprise and variety, it's still the organization of the sounds that counts."

Ercolino Ferretti, co-founder of Ferretti-Lay Inc., Newton, Mass., a spinoff from the Massachusetts Institute of Technology that produces electronic music for profit, bristles at the idea of randomness for its own sake: "There are two sides to human behavior, randomness and redundancy. Unless randomness is used within highly limited bounds, it is pretty useless. If I have a handful of marbles and I throw them down 100 times, you might find one pattern that is pleasing, but what about the other 99? I can't prove that random music is a point of no return, but until something tells me different, random sound will continue to be just one of the parameters of my music."

State-of-the-art muse. Also at odds with the random-sound school are computer composers. Using highly complex equipment, they must laboriously program five sound parameters for every note: timbre (the quality of tone distinguishing instruments or voices), attack (initiation of performance, especially with respect to the degree of unanimity with which a

phrase is begun by several instruments), pitch (a musical tone determined by the frequency of vibration of the sound waves that strike the ear), decay (decrease in quantity, volume, or force of sound), and rhythm (regularity or flow of movement). To hear what he has created, the composer must connect a digital-to-analog converter with frequency and envelope generators, as well as modulators, to his computer outlet.

While such music can be controlled to the nth degree, most would-be composers find that trying to justify computer time for such applications at today's prices is a tough proposition.

Calculated disks

However, things are looking up for the computer composer. Several years ago the Bell Telephone Laboratories developed two programs—Music IV and V—that a composer can use in working up his own piece. Written in Fortran, the Bell programs are based on a pulse-code-modulation sampling scheme. Comparable software is in various stages of dress and undress at other computing centers around the U.S., including the University of California at Santa Barbara and the University of Illinois in Champaign-Urbana.

Overseas, too. Sweden's government-owned Radio Stockholm is now debugging a \$500,000 electronic music studio that Jon Appleton, head of Dartmouth College's recently opened Griffith Electronic Music Studio, says "is a good 10 years ahead of its time."

Among other things, the Swedish

facility features a special-purpose computer designed solely for music composition. The machine has a selective memory and analog converter that automatically stores on tape what is being composed, making playbacks a simple matter. A composer can also store the completed portions of his work on magnetic tape when he's through for the day, leaving the entire memory free for other composers to work with.

Another indication that computer-composed music is starting to come into its own is that the International Federation for Information Processing is holding a competition for such works. The three top entries will be played at the IFIP Congress in Edinburgh, Scotland, this August.

Medleys

Synthesizers are the third route being taken by composers of electronic music. Such machines are a series of modules controlled by fixed or varying voltages. The modules combine frequency or tone generators, electronic switches or sequencers, modulators, band-pass filters, and amplifiers to produce an audio signal that's piped into a speaker system.

The audio signals originate with a set of voltage-controlled oscillators whose input is a signal from a keyboard or other voltage divider network.

The output is a single frequency tone, or range of frequencies, if the oscillator is being swept. The output is fed to an amplifier, a switch, a modulator, a mixer, or combination of such devices. Since the switches are controlled by a voltage signal, the rhythm they set can either be varied or held constant.

The output from the switches is then combined with other signals and further shaped and processed by the modulators. The shaping sets both the attack and decay time of the sounds.

Hark. After a final mixing of the various signals from still other modulators, mixers, and oscillators, the end product—music—finally reaches a waiting world through speakers.

In theory at least, a synthesizer can create almost any imaginable sound, including those of standard musical instruments. "But it's pointless to duplicate the sound of a conventional symphony orchestra on one," says Gerald Strang, chairman of the music department at California State College in Long Beach and himself a composer of electronic music. "The real value of electronic music lies in the creation of new forms that can't be reproduced any other way."

White elephant. During the early 1950's RCA built one of the first synthesizers. Strictly a commercial proposition, the Mark II was designed to save the company's Vic-

LOW PROFILE... RUGGED CONSTRUCTION

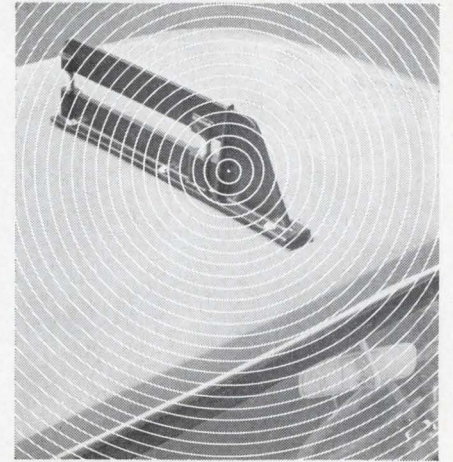

THAT'S EXCALIBER™

A rust and damage resistant cast aluminum antenna whose low-silhouette configuration was originally developed for railroad use is now available in two factory-stocked models to meet the broader needs of public utilities and transit systems, on and off-the-road construction equipment, forest services and other governmental agencies. Combining ruggedness with high performance, the Sinclair EXCALIBER utilizes a large base contact surface to increase efficiency in vehicle roof top applications.

An important feature of the low cost, solid construction design is its ability to cut maintenance and replacement expense resulting from damage by vandalism, automatic washers and general service abuse. EXCALIBER models are offered for frequency ranges of 157-164 MHz and 450-470 MHz, with other ranges available on request. Both standard units are rated at 50 ohms impedance, with power ratings of 200 watts and 300 watts, respectively.

SINCLAIR RADIO LABORATORIES

FREE LITERATURE

TO: SINCLAIR RADIO LABORATORIES, INC.
676 Ensminger Rd., P.O. Box 23
Tonawanda, New York 14150

Name: _____

Title: _____

Company: _____

Address: _____

City: _____

State: _____ Zip: _____

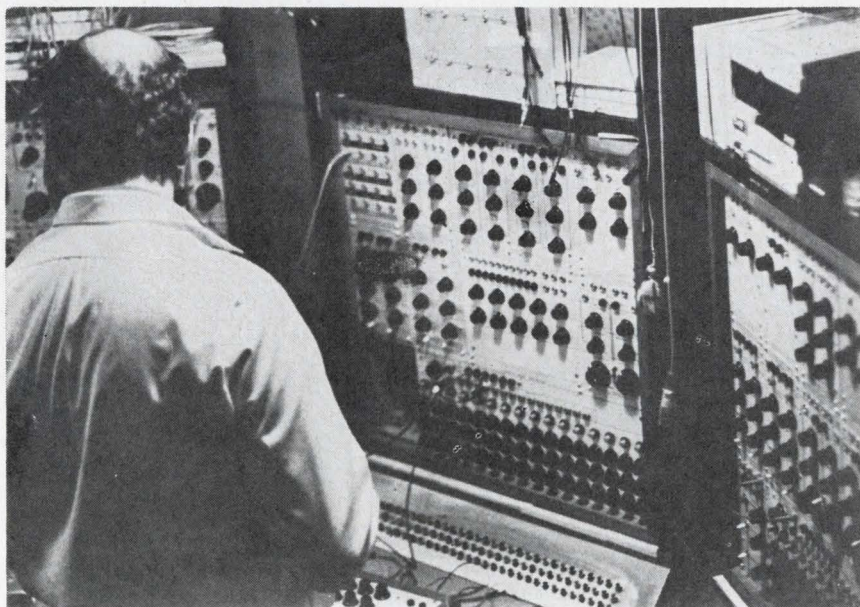

Face the music. Morton Subotnick, a free-lance composer, works with a Buchla synthesizer at New York University's electronic music center.

The Material of Unlimited Uses...

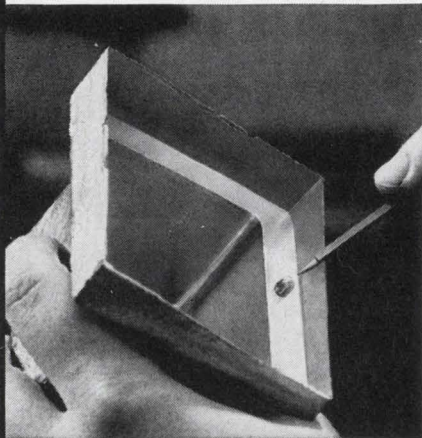

INSTANT DIP-A-MOLD

In seconds, you can make perfect molds, like this one, for potting any encapsulation, and make them economically, with low-melting CERRO® Alloys. Just dip the master in molten alloy. A thin coating of alloy clings to the pattern. Withdraw the pattern, and you have a perfect high fidelity mold. When the encapsulating plastic cures, simply remove the CERRO Alloy. Use it over and over again, almost without limit.

This particular alloy—CERROTRU®—does not shrink, slips easily from the pattern without parting or contaminating compounds or coatings. Because of its low melting point, it is safe and easy to handle.

You can reproduce such unusual details as positioning lugs for transformer cases, as shown above, without the use of cores, inserts or secondary operations.

Instant molding is just one of the many uses for CERRO Alloys. To find out more, contact Cerro Copper & Brass Co., Cerro Alloy Dept., Stamford, Conn. 06907... R. S. Darnell (203) 327-0550.

CERRO®

Technology's offbeat offspring

Music isn't the only lively art to be touched by electronics. Technology's impact is now being felt in the visual media and even in literature.

A number of research institutions, including Bell Labs and the Lincoln Lab, are experimenting with computerized animation, using light pens, on-line color oscilloscopes and plotters, digital and analog generators of lines and symbols, and other peripheral gear. An off-line movie camera is usually used to record the computer's output, but Bell Labs has been able to put output directly onto microfilm in real time with a Stromberg-Carlson 4060 processor and a cathode-ray-tube display. And holography, still in the early stages of development, seems to have exciting possibilities.

Goodbye to the stone age. In the plastic arts, electronics has provided the means for a new medium of expression, kinetic sculpture. Using servomotors, stepping relays, silicon-controlled rectifiers, amplifiers, light-sensitive semiconductors, sequence timers, and flip-flop circuits, sculptors are now creating vibrant and sometimes explosive forms.

In literature, the attempts to produce computer-written poetry are rarely taken seriously, but computers may be of great value in critical studies of meter and rhyme.

tor division the time and trouble of hiring musicians and songwriters. The machine was supposed to turn out new material as well as provide background music for pop standards. Eventually, however, the idea came a cropper to the tune of about \$100,000. "The sound was too tinny and the rhythms too precise for the human ear. Frankly, it just wasn't pleasant to listen to for very long," says James Seawright,

technical advisor to the Columbia-Princeton Electronic Music Laboratories, where RCA sent the Mark II on "permanent loan."

With early synthesizers, editing was one of the most important steps in producing a finished piece of music. Equipment was only able to produce one sound at a time. Once the desired sound was made, it was put on tape and the synthesizer was reprogrammed for the next



Two for the role. Ercolino Ferretti and Michael Lay, former MIT professors, have set up a company to produce electronic music on a commercial basis.

Stop worrying about your IC digital system and let Raytheon Computer ask one question. How do you want it?

Ask for a MINIVERTER™, not just a converter. Start with a 16-channel multiplexer, sample-and-hold amplifier and 10 or 12-bit binary or 13-bit BCD A/D converter—wired, tested and mounted on a connector block you can hold in your hand or install in your own drawer. Or order it in a 40-module drawer with indicator lights, panel controls and other options, or in a 120-module case with even more options (like up to 256 channels), only, or just a sample-and-hold or multiplexer.

Analog and Digital IC Modules. There's a complete range of analog and digital functions. To make systems design and assembly easy, mounting hardware and accessories have analog and digital power and ground distribution built in. You can even send us your wire list and we'll send you an automatically wire-wrapped and assembled system within weeks—faster and cheaper than you can do it yourself. All modules and instruments are compatible with our \$15,000 703 IC Systems Computer.

We've done most of the work, so for the first time digital systems engineering can be fun. Call or write today and ask for Data File C-152. Raytheon Computer, 2700 South Fairview St., Santa Ana, Calif. 92704
Phone (714) 546-7160.



**Raytheon
Computer...
the company that
gives you a
break.**

The original lacing tape
is still the best . . .

. . . and saves money too!

That's
GUDELACE® 18

You ought to try
a sample . . .

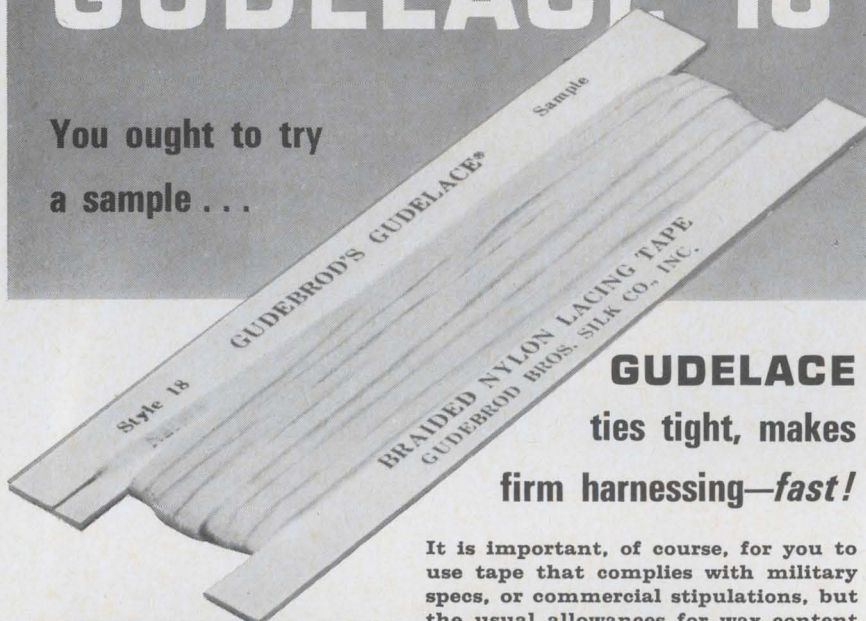

GUDELACE
ties tight, makes
firm harnessing—*fast!*

It is important, of course, for you to use tape that complies with military specs, or commercial stipulations, but the usual allowances for wax content in such specs give no consideration to the best lacing conditions. Gudebrod GUDELACE is made within the specs—BUT, it's made too, for easy handling, tight knotting, firm harnessing. THAT'S WHERE IT SAVES MONEY, in the harnessing operation. GUDELACE, the original harness lacing tape, is manufactured under strict control. Every yard is impregnated exactly the same, exactly right. You can count on that—and on getting better harnessing—fast—with minimum rejects. Why not send for a sample, test it any way you want. Let your harness crew try it. You'll be glad you did! (Remember, the Gudebrod Lacing Tape line includes tape for nearly every special situation—ask for The Product Data Book.)

NOW—GUDEBROD HAS
TWO AIDS TO FASTER—
BETTER HARNESSING



**CABLE-LACER®
& GUDE-SNIPS®**

The production tested Cable-Lacer is now reduced in price—only \$9.95. Holds bobbin of tapes—makes tight knots. The palm held GUDE-SNIPS provide convenient tape cutting—using either right- or left-hand, \$3.75.

GUDEBROD
Electronics Division

GUDEBROD BROS. SILK CO., INC.
Founded 1870
12 SOUTH TWELFTH STREET
PHILADELPHIA, PA. 19107

. . . the new synthesizers
are on-line machines . . .

output. The process continued until all of the sounds were taped. Then the editing began. Each sound had to be put in its proper place. Sounds that were to be used more than once, were duplicated and mixed in later. Such work was more a scissors-and-tape proposition than an electronic process.

Noteworthy. But modern synthesizers can be programed to produce a complete composition. And whereas the RCA machine produces only one note at a time, the new devices are on-line. The real-time feature allows the composer to hear what he is composing immediately and eliminates the need for heavy tape editing.

Another attractive feature of the new machines is their portability. The R.A. Moog Co. in Trumansburg, N.Y., is now selling a device that can be carried around by pop music groups to augment the sound of their electric guitars and rhythm sections [Electronics, March 4, p. 41].

In Moog equipment, most of the interconnections between modules are made internally. In its simplest version, the device sells for around \$1,500. Robert A. Moog, founder and president of the company, says: "The time will soon be upon us when people will start buying them for the home instead of an electric

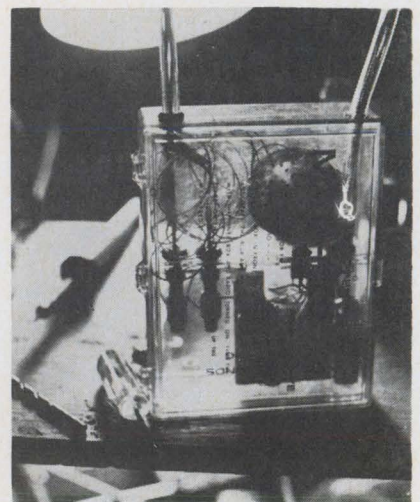

Off the shelf. The Max-Feed produces random sound, one form of electronic music. Set's output is obtained from transistor radio and feedback network.

organ or a piano.”

Playing jacks. The only other commercial synthesizer is made by Buchla Associates of Berkeley, Calif. The basic model—15 modules and a keyboard—sells for \$2,400. In the Buchla unit all the modules are independent; interconnections are made by plugging patch cords into input and output jacks on the front panels. Operating the Buchla thus requires a thorough knowledge of the many knobs and input-output jacks on the panels. Once mastered, though, the equipment is able to produce a greater range of sound dynamics than the Moog.

There is a drawback to the synthesizer—it has no memory. Although this can be partially compensated for by the addition of a tape recorder, such an arrangement is cumbersome for both composers and performers.

Hookup. “One solution to the synthesizer’s memory problem would be to connect it to a small general-purpose computer,” says Richard Friedman, a systems programmer at New York University’s Courant Institute Computing Center. “This would satisfy everyone. Not only would it lower composing costs considerably, but it would give the random composer as much freedom as he wants.” Friedman, who is also a composer, thinks machines like the PDP-8S are suitable.

Douglas Leedy, faculty composer and assistant professor of music at the University of California at Los Angeles, feels that improvised concerts represent the real future of the medium. A musician who has played the French horn with several leading symphonies, Leedy is interested in the entire range of electronic music. His philosophy: “We live in a throwaway society. People aren’t interested in preserving conventional art forms any more, but are trying to create new artistic experiences for today. Electronic music has taken what was once a very distant art form out of the hands of the elite and placed it within the reach of almost everyone.”

Contributions to this report were made by Bill Bell in Los Angeles, Robin Carlson in Boston, Peter Vogel in San Francisco, and Bruce Cross in Chicago.

If you're concerned with
Transistor Pads and Clips—
Heat Sinks and Adapters . . .

JERMYN

ACCESSORIES

are worth
a closer
look . . .



Precision made in Kent,
England by JERMYN Industries, these
important items of circuit hardware
are manufactured with traditional
English craftsmanship. They are stocked
and sold exclusively in the U.S. by
GUDEBROD. Ask for our new Catalog
GJ100 which describes the full line—
or tell us about your custom needs.

GUDEBROD

Electronics Division

Gudebrod Bros. Silk Co., Inc.
Founded 1870
12 South Twelfth Street
Philadelphia, Pa. 19107

Utilogic II

Read all about it!

Free Handbook!



Signetics' new Utilogic II is the most flexible, reliable, economical line in the business. The entire series now comes in dual in-line silicone packages, which gives you convenience and ease of handling, in addition to the performance proven by over 10 million Utilogic elements in the field. Utilogic II also provides dual J-K binaries and triple and quadruple gates. The system is now simpler, faster, more flexible and requires fewer packages. On top of all that, Utilogic II is priced at RTL levels. Get the facts, plus our new Utilogic II handbook. It tells you everything you need to know about the specifications, usage rules and application for using Utilogic II. Write Signetics, 811 E. Arques Ave., Sunnyvale, Calif. 94086.

**SIGNETICS
INTEGRATED
CIRCUITS** 
A SUBSIDIARY OF CORNING GLASS WORKS

SIGNETICS SALES OFFICES: Fort Lee, New Jersey (201) 947-9870; Syracuse, New York (315) 469-1072; Richardson, Texas (214) 231-6344; Beverly Hills, California (213) 272-9421; Garden Grove, California (714) 636-4260; Wakefield, Massachusetts (617) 245-8200; Silver Springs, Maryland (301) 946-6030; Collingswood, New Jersey (609) 858-2864; Clearwater, Florida (813) 726-3734; Rolling Meadows, Illinois (312) 259-8300; Sunnyvale, California (408) 738-2710.

DISTRIBUTORS: Compar at all locations listed below. Semiconductor Specialists, Inc. (312) 279-1000; Terminal Hudson Electronics (212) 243-5200; Wesco Electronics (213) 684-0880; Wesco Electronics (405) 968-3475; Hammond Electronics (305) 241-6601; Avnet Electronics Corp. of Massachusetts (617) 272-3060; Pioneer Standard Electronics Inc. (301) 427-3300; Kieruluff Electronics (206) RO 3-5510; G. S. Marshall (213) 684-1530; Milgray Delaware Valley (215) 228-2000; Universal Electronics Inc. (713) 781-0421.

DOMESTIC REPRESENTATIVES: Jack Pyle Company (415) 349-1266; Ozark Electronic Marketing, Inc. (314) 423-7200. A Compar Corporation at the following locations: Alabama (205) 539-8476; Arizona (602) 947-4336; California (213) 245-1172; California (415) 697-6244; Colorado (303) 781-0912; Connecticut (203) 288-9276; Florida (305) 855-3964; Illinois (312) 692-4125; Maryland (301) 484-5400; Massachusetts (617) 969-7140; Michigan (313) 357-5369; Minnesota (612) 922-7011; Missouri (314) 542-3399; New Jersey (609) 429-1526; New Mexico (505) 265-1020; New York (518) 436-8536; New York (607) 723-8743; New York (516) 921-9393; North Carolina (919) 724-0750; Ohio (216) 333-4120; Ohio (513) 878-2631; Texas (214) EM 3-1526; Texas (713) 667-3420; Washington (206) 763-1711.

INTERNATIONAL SALES: France, Germany, Italy, Belgium, Holland, Luxemburg, Spain—Sovcor Electronique, 11, Chemin de Ronde, Le Vesinet, (S.-&O.) France. United Kingdom, Ireland, Sweden, Denmark, Norway, Switzerland, Austria, Portugal—Electrosil Ltd., Lakeside Estate, Colnbrook-Bypass Slough, Buckinghamshire, Great Britain. Australia—Corning, 1202 Plaza Building, Australia Square, Sydney, N.S.W. 27-4318. Canada—Corning Glass Works of Canada, Ltd., Leaside Plant, Ontario, Canada (416) 421-1500. Israel—Optronix, P.O. Box 195, Ramat-Gan, Israel 724-437. Japan—ASAHI Glass Co., Ltd., Corning Products Sales Dept. No. 2, 3-Chome Marunouchi, Chiyoda-ku, Tokyo, Japan.

Second-source IC's on firm footing

Since device users generally insist on alternate suppliers for volume buys, semiconductor houses make a virtue of necessity and duplicate best sellers

Imitation, once considered the sincerest form of flattery, is becoming almost as important as innovation in the field of integrated circuitry. Most IC customers prefer to have second sources, and semiconductor houses—for a variety of reasons—are generally anxious to oblige.

However, "generally" is the operative word in this context; even the industry's big three—Motorola Inc.'s Semiconductor Products division, the Semiconductor division of the Fairchild Camera & Instrument Corp., and Texas Instrument Incorporated—differ in their attitudes toward second sourcing. Motorola embraces the concept wholeheartedly; Fairchild professes, except in rare cases, to be disinterested; and TI occupies a middle ground.

Insurance policies. Realistic pricing and delivery protection are the big factors in customers' insistence upon second and even third sources for IC's. "Strikes, fires, dyspeptic engineers, or acts of God at suppliers can wreak havoc with production schedules," says Larry Steele, director of procurement at the Military Communications division of the International Telephone & Telegraph Corp. "Besides, the Government likes dual sourcing; it's the American way."

"With multiple sources of supply, prices are lower," says Winston R. Willmert, manager of purchasing at Honeywell Inc.'s Electronic Data Processing division. "I'd rather have at least two parties fighting for my business. With a sole source, you might get better device performance, but never more realistic price or delivery." His colleague, Robert R. Leonard, group director of circuits and hardware, points out: "During development of our 4200 and 8200 computer lines, we were paying through the nose for an IC supplied by a single source. When we began purchasing in volume from a number of suppliers,

the circuit's cost dropped by a factor of three or so."

Fat copycats

Profits motivate IC houses to produce competitors' devices. "Second-sourcing gives our salesmen more to work with and affords us a marketing edge," says Thomas J. Connors, vice president and director of marketing at Motorola's semi-

was developed in-house, Motorola entered all of these markets as an alternate source.

Connors warns, however, that there are three prerequisites for a supplier's becoming a second source. First, there must be a sizable market; second, the company must be able to compete in high-volume, low-cost situations. And third, entry must be carefully

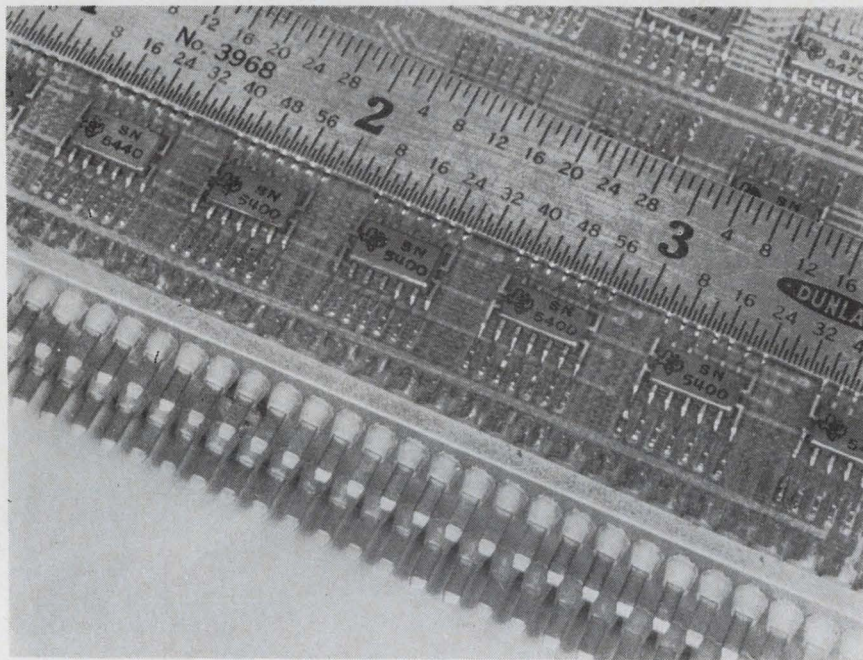

Choice item. Best-selling IC's like those in this digital assembly from TI are widely copied by other semiconductor houses.

conductor unit. "We don't worry about the not-invented-here aspects. And since we don't have the time, money, or facilities to innovate everything, we'll try to duplicate any assembly that's created a market."

At the moment, the company offers just about every commercially available digital assembly, including resistor-transistor logic, diode-transistor logic, and three different versions of transistor-transistor logic. With the exception of its emitter-coupled logic series that

timed. "If you get in too early, you'll watch your investment go down the tubes for a while," he says.

Nudging. Connors notes customers often urge his division to become an alternate source for a new IC family. "If the big suppliers haven't made a device, their customers beat on them to become second sources. And the smaller the sole-source supplier is, the harder the customers lean on the leaders to get into the business and provide

... customers call the shots on duplication of characteristics ...

a back-up delivery capability.”

Strategem. The Semiconductor division of Sylvania Electric Products Inc. furnishes an interesting example that IC makers are also mindful of such considerations. “There was a time when we feared that TI would push its 54/74 series by lining up a second source and signing up some potential customers for our SUHL (Sylvania Universal High-Level Logic),” says Harry M. Luhrs, IC marketing manager. “Transitron was not as good a second source as we would have liked. Buyers tended to think of them as a specialty or quick-reaction house rather than a volume producer. We wanted Motorola and hoped, too, for Signetics. So we went out and lined up accounts and got them looking for second sources. We then offered limited engineering advice, some masks, and a selection of chips to Motorola. They went for it. Soon after, the dam broke and Westinghouse, Philco-Ford, and Raytheon as well as Transitron also came into the fold. Our SUHL was on firm ground.”

There’s still no hard-and-fast corporate policy on second-sourcing at Sylvania. “We’ll do it if it seems

profitable, but we prefer to innovate. In this industry if you don’t, you are continually playing ‘catch up,’” says Luhrs.

Sylvania second sourced Fairchild’s 930 DTL line for a time, but dropped it after the field became overcrowded and profits harder to come by. Interestingly enough, the company is now turning out TI’s 54/74 assemblies for the International Business Machines Corp. “With a single, big customer, we have only one set of specs, deadlines, and qualification procedures to meet,” says Luhrs. “And since we don’t push our second-sourcing, we avoid confusion.”

Reluctant dragon

Texas Instruments also prefers to be an originator but is always ready to go after targets of opportunity. Ed O’Neill, IC marketing manager, estimates that about one-third of the company’s IC business is in second-source items. Most of this volume is in DTL lines. In TTL and other complex circuits, TI does almost no second-sourcing; its assemblies are, however, extensively copied. One reason for this may be that the geometry and configura-

tions developed for TTL represent a feeder technology for medium-scale-integration and large-scale-integration assemblies as well as flip-flop circuits and gate work. As a result, TTL has caught the attention of engineers throughout the electronics field.

O’Neill cautions that there are no guarantees in second-sourcing. “Even the best are bound to flop occasionally,” he says. “A house depending entirely on second-sourcing will be hit harder by a miss than one with balance—the more established a line is, the lower will be prices and profits.”

Customers usually call the shots on ensuring duplication of characteristics by maintaining elaborate testing facilities, O’Neill says. He doesn’t consider this a real problem for a company with resources, but admits the difficulties are considerably more complex with IC’s than discrete components.

Consuming interest

Users of IC’s agree—albeit warily—that most second-source assemblies stack up pretty well against those from originators. “There’s a fairly close match on characteristics and packaging,” says Richard Stewart, manager of the advanced technology department in the Data Systems division of the Hughes Aircraft Co. “However, we still have to guard against ‘specmanship’ by the marketing departments of second sources. At times, they push assemblies that aren’t compatible with our requirements. We look closely at our originals and decide what criteria our alternate suppliers will have to meet.”

Similarly at the General Dynamics Corp.’s Pomona division, there is a policy that all systems be so designed that at least two IC sources can be used. In cases where there is no time or money to run proofing tests, the company will struggle along with its prime supplier. “We’ve found variations occur even on licensed devices, so we run proof tests on all suppliers,” says Robert Martin, group engineer. “How the device performs in a system is the key to its acceptability.”

Field trials. The Autonetics division of the North American Rockwell Corp. uses second sources for IC’s because of Government and in-

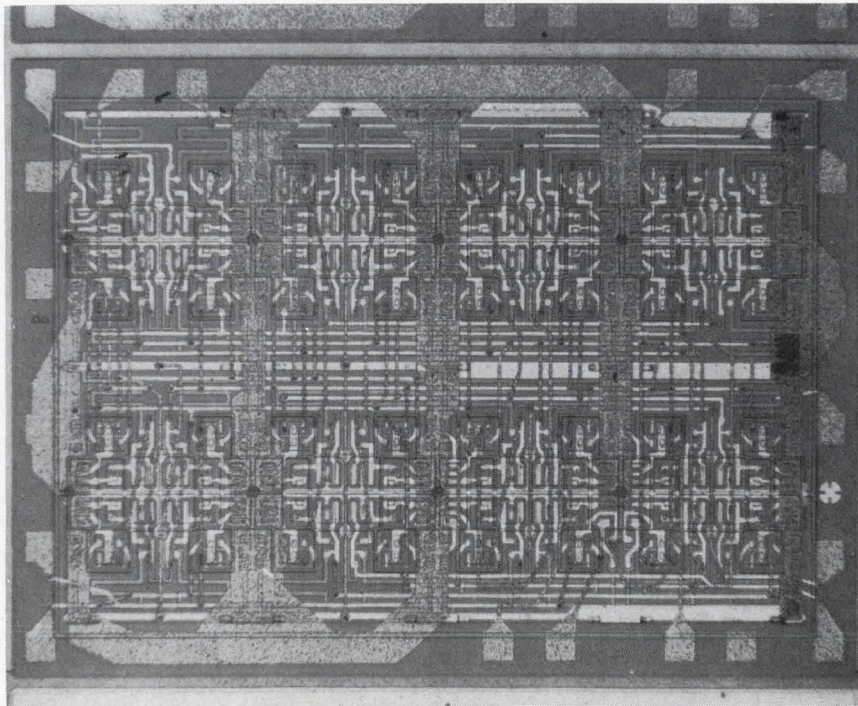

Tough act to follow. Fairchild hopes to discourage would-be imitators by developing more complex devices; this 32-gate LSI unit is an example.

house requirements that back-ups be available. "There are no particularly divergent patterns in the performance of IC's from originators and second sources," says Arthur Lowell, assistant director of Autonetics' Research and Engineering division. "Most of our suppliers work both sides of the street, and we make a pretty thorough facilities evaluation check on all of them. This is important in the case of small specialty houses when a large volume of devices is required."

Although most IC users make a virtue of the necessity of riding herd on their suppliers, some doubt the efficacy. "There's always some difference between a prime and second-source product," says William R. Rodrigues de Miranda, senior reliability engineer at the communication and data processing operation of the Raytheon Co.'s Equipment division. "To get complete matches, we would have to define all measurable parameters which might affect operating characteristics. They aren't exactly common knowledge, though. Manufacturers are still trying to relate parameters—and not just those you find on a spec sheet—to actual performance."

An equally tolerant approach is taken by James Mintern, senior components engineer, at Raytheon's Space and Information Systems division. "The need for second sourcing depends on one's primary sources and on the nature of the product," he says. "Second sources are always preferred on standard IC's, but often individual situations make this impossible or even undesirable. Highly individualized specifications or ultrahigh reliability call for so much emphasis on information exchange between user and vendor that second-sourcing becomes an encumbrance—even more so when the user must try to protect the secrets of individual vendors while getting equal performance from them. In such cases, you give one man all the business. Make sure he knows it, and usually, he'll come through for you."

"In the case of an S-band power amplifier for the lunar module portion of Apollo, I insisted on a single source," says Mintern. "We needed reliability and quality. And this

was an instance where there was no justification for price shopping."

Trouble. Most users have at least one horror story to tell about using a sole source. The experience of LTV Electrosystems Inc., a subsidiary of Ling-Temco-Vought Inc., is typical. "We used a metal oxide semiconductor IC as a 50-bit shift register in a recent piece of equipment," says C. F. Turrentine, director of materials at the company's Garland division. "Only one supplier produced it and we felt we had to go with him. But we ended up getting into all kinds of trouble. The source ran into delivery problems and we had to stop our production lines on a number of occasions. We scoured the industry for an alternate supplier, and while some came close to meeting our requirements, we would have had to invest extra money on design to work with them. We finally had to stick with the sole source and help overcome the difficulties."

Stranger than fiction. In the main, however, semiconductor houses are convinced that their IC customers need and want second sources of supply. And a marketing aide at one IC maker even admits to having printed one of his own company's data sheets on the letterhead of a rival concern just to give a potential buyer the impression that there were two suppliers. The ruse worked. Subsequently his company bought the second which then began to turn out the circuits.

Above the strife

Some IC concerns, notably Fairchild, disparage second-sourcing. Says Jerry Sanders, the Semiconductor division's marketing manager: "If everyone second-sources, we'll cannibalize our industry. All we'll do is drive the cost per gate down and down. I'd like to see the dollars wasted in solder, printed circuit boards, overhead, and the like put into 'vertical integration' to guard against pricing ourselves out of business. Otherwise, we'll give more and more for less and less until we eventually fly up our own tails."

Refusing to second-source is the company's way of protecting its own contributed value. Fairchild wants to integrate more and more of the system onto the chip, maintaining its contribution and keeping prices

TUNG-SOL® FLAT PACKS

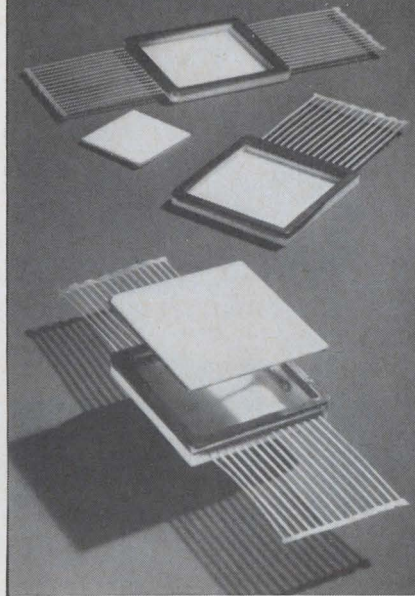

High mechanical strength, excellent thermal dissipation and precise dimensional accuracy provide microcircuit packaging that assures maximum performance and utmost reliability with widest latitude of design freedom.

TYPICAL CONFIGURATIONS

Available in closed and "see-through" types.



WRITE FOR "MICROCIRCUIT PACKAGES"



This brochure is eight pages of detailed information about Tung-Sol Flat Packs. No charge.

TUNG-SOL DIVISION

Wagner Electric Corporation
One Summer Avenue, Newark, N. J. 07104

© REG. T. M. WAGNER ELECTRIC CORPORATION

EDGEWISE PANEL METERS

...we've got your number

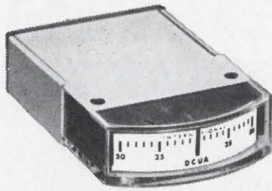

1122 flat, stackable, self-shielding; 1.24" scale in less than a square inch of panel.

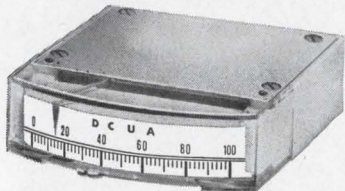

1136 scale length (2") of a 3½" conventional meter in a stackable, 2.6" wide edgewise. Easy to read, too: bi-level scale, optional internal illumination.

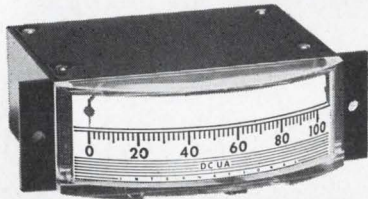

1145 2.7" scale, bi-level, for easy reading. A completely shielded, 3½" stackable meter, ideal where you need a bigger readout.

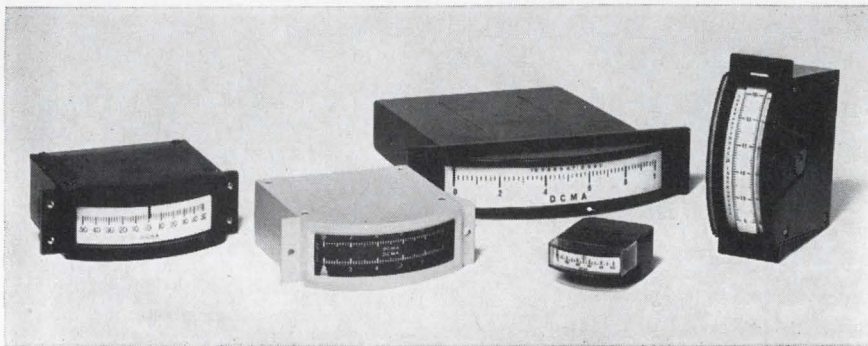

1147, 2520, 2150, 1120, 2500 military models, dual-scale meters, 5" scales, economy versions, meters with interchangeable scales, specials to order.

The move is on to edgewise. Equipment designers everywhere are realizing that edgewise meters give as much as three times the scale readout as conventional meters in the same panel space.

We're the leaders in edgewise meters, have been since we pioneered the concept years ago. Now we offer industry's broadest line of up-to-date, space-saving edgewise models. Our new edgewise catalog, Bulletin 391, has all the details. Write for a copy.



international instruments inc.

8703 Marsh Hill Road • Orange, Connecticut 06477

at a high level.

Fairchild, of course, is an innovator and still a leader in the IC field. But not every concern can afford to be so aloof. Raytheon's Semiconductor division, which got a late start in the business, furnishes a case in point. "We've been second-sourcing since our inception," says Paul Sullivan, IC marketing manager. "It's a good business, per se, but we've also gained the know-how to turn out products of our own design."

Back door. Similarly, ITT Semiconductors' IC output is 100% in second-source items. Robert F. Graham, the division's director of marketing, considers such a role a natural for latecomers with resources. "The phenomenal growth of IC's, together with the industry's poor record on deliveries, makes for excellent opportunities," he says. "Technical talent can be found anywhere; manufacturing and marketing skills have now become the keys to success."

The company has done well hitching rides. It caught the crest of the DTL wave and is now setting its sights on TTL and MSI assemblies.

In another vein, Intersil Inc., a small specialty IC house formed last year by Jean A. Hoerni, inventor of the planar process, is embarking on its corporate life with a refreshing *chutzpah*. It intends to reverse the field's normal procedures and convince one or all of the big three to make its volume proprietary circuits as they are developed. As for second-sourcing, Ward Gebhardt, the company's director of marketing, says: "Our role will be to contribute to the store of new products. But we have no hang-ups about second-sourcing, and if it helps our customers, we'll do it."

Second class. One of the reasons for the smaller houses' obvious reluctance to build reputations in second-source operations is the fear that making good could ultimately do harm. "Second-source houses will not attract the engineering talent they need to put them into the innovation markets," says William Berg, marketing manager at the Signetics Corp., a subsidiary of the Corning Glass Works. However, Signetics recognizes customers' need for alternate

3442

Is it true that you can generate 50 watts of electricity non-stop, twenty-four hours a day for five years? Without refueling or maintenance?

Yes. What do you have in mind?

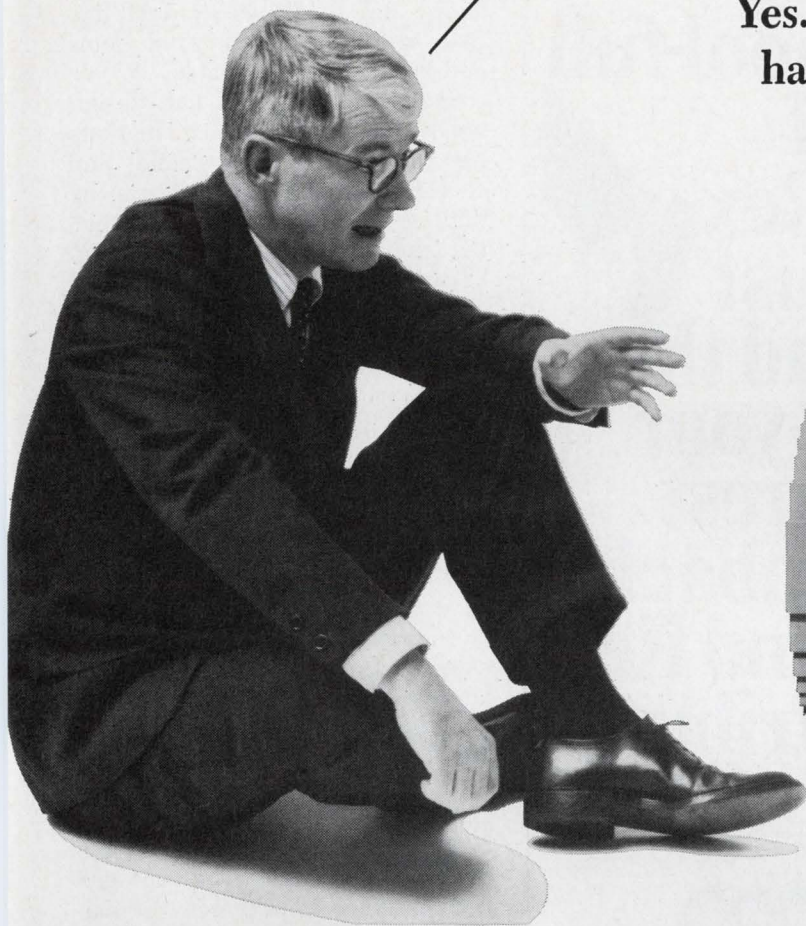

Man: Who are you? Are there any more like you back home?

Generator: I'm the largest of the Martin Marietta family of nuclear generators. I've smaller 25-watt and 3-watt relatives. We're rugged, dependable and available. We're not laboratory curiosities. You can put us to work right now.

Man: What do you do?

Generator: We can fill your low-power requirements in any remote location where it's too expensive—or downright impossible—to use a conventional power source. With my 50 watts, for example, I'll give you more than 2-million watt hours. And I'll guarantee my output for five years on a single feeding.

Man: You're pretty sure of yourself.

Generator: Why not? There's nothing to go wrong. Just give me my fuel capsule when you put me to work, and then forget me for five years. I've no moving parts, so I can't wear out. And I need

absolutely no maintenance.

Man: Suppose I need more power.

Generator: Well, you could buy two or more of us. We work fine in tandem. But better yet, my 50 watts of power can be stored on a cyclical basis, so that my system output can be stepped up to several hundred watts.

Man: How about working conditions?

Generator: As rugged as you like. Put me to work anywhere—on an icy mountain peak, in a steaming jungle, or hundreds of fathoms under the sea. I'm not affected by heat, cold, dust, gasses, or anything else you can think of.

Man: Prove it.

Generator: Right now, one of my brothers is powering an oceanographic measuring station on Fairway Rock in the middle of the frozen Bering Strait. A cousin has been powering a navigational homing device 15,000 feet down in the Atlantic for two years. One of my sisters married a buoy and has gone

to sea off Puerto Rico. (She talks to satellites, ships and planes.) A cousin is stationed on a floating weather platform in the Gulf of Mexico. Other cousins power a wellhead-control system for subsea oilwells.

Man: What else can you do?

Generator: We can power aircraft and ship navigation beacons, microwave repeater stations, radio transmitters, and many types of remote monitoring and control systems. In underdeveloped regions of the world, especially, we nuclear generators can prove very useful far from conventional power sources. If you need dependable power in far-out places, why not go nuclear?

We're versatile, so just tell us what you have in mind. Write our manager, John Morrison, Box 1100L3 Nuclear Division, Martin Marietta Corporation, Baltimore, Maryland 21203.

MARTIN MARIETTA

Circle 105 on reader service card

Now,
the next time
you need
just a spool-full
or so of
Brand Rex
you can just
run around the
corner to your
nearest
**Birnbach
Brand Rex***
distributor



(he's got a warehouse full.)

If you hadn't heard of a B/BR distributor before, that's because there wasn't one before. Now there is. Nearby. And it means you can buy the full range of Brand-Rex electronic products, in a full range of quantities. If you don't know just where to find your local B/BR man, drop us a line. We'll corner him for you.

Birnbach Brand-Rex, 435 Hudson Street, New York, 10014 Phone: 212-255-6600



Circle 106 on reader service card

Our little black book has over 100,000 phone numbers.

You never had a black book like it. Over 1,500 pages. And those phone numbers! More than 100,000 telling you who to call/where to go, for the over 4,000 different product categories listed and advertised in the yellow pages of the Electronics Buyers' Guide.

It's the industry's one-stop shopping center that lets you find the products and services you need quickly.

You can depend on EBG.

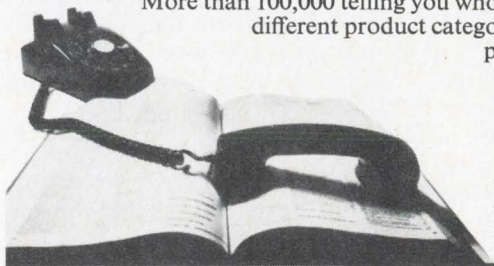

Electronics Buyers' Guide

A McGraw-Hill Market Directed Publication
330 West 42nd Street, New York, N.Y. 10036

suppliers, and has an exchange agreement with the Sprague Electric Co. "They use the same masks," says Berg. "And for all practical purposes, Sprague and Signetics IC's are interchangeable."

And the National Semiconductor Corp., also espouses the second-source concept with enthusiasm. In the IC business only a year, National has a surprisingly well-balanced and profitable product line that includes both original items and best-selling alternates. "We've concentrated most of our design talent on up-for-grabs markets like the linear and MOS fields and chosen to second-source TTL in the digital area," says Don Valentine, the company's marketing manager. "This way the money comes in fast, and we can apply the profits to other areas with good potential."

Teledyne Inc.'s Amelco Semiconductor division is also working both sides of the IC street. About 25% of IC dollar volume is attributable to second-source items. But Amelco also makes its own 809 op amp and 58 different logic devices.

Isolated case. In a few instances, IC makers can come up with devices that defy imitation. In this category are the dielectrically isolated assemblies built by the Microelectronics division of Radiation Inc. High-cost markets, where low to medium volume is required, are the company's prime targets. But being in a class by one's self has drawbacks as well as advantages. Says William Weir, director of marketing: "We have a problem finding second sources for our more complex IC's. The Government and original-equipment manufacturers want back-ups. But if you're making a device that others can't duplicate profitably, the customer has to pay for it." Weir concedes that the widespread availability of technical talent will eventually intensify competitive pressures. "But right now, our process know-how separates us from the rest of the pack, and we have no intention of peddling it away for the few dollars it might bring in," he says.

Contributions to this report were made by Walt Barney, Peter Vogel, and Bill Arnold in San Francisco; Lawrence Curran and Bill Bell in Los Angeles; James Brinton in Boston; Marvin Reid in Dallas; and Mark Leeds, Howard Wolff, and Peter Schuyten in New York. It was compiled by Eric Aiken.



Psssst!

Monsieur. Good book. Unexpurgated version.

Tells how rotary stepping switches can improve performance of products that count, control, monitor, select, indicate, or time.

Tells all. Shows all. Plenty pictures. Diagrams, too.

It's free. Fill out coupon below and send in. Too hot for mail. Your AE representative will deliver in plain brown wrapper right to your desk. No obligation.

V. E. James, Director, Relay Control Equipment Sales
Automatic Electric Company, Northlake, Illinois 60164

I would like to read the complete and unabridged version of "HOW TO USE ROTARY STEPPING SWITCHES," now in paperback. I understand an AE representative will deliver my free copy in a plain brown wrapper.

Name _____

Title _____

Company _____

Address _____

City _____ State _____ Zip _____

AUTOMATIC ELECTRIC

SUBSIDIARY OF GENERAL TELEPHONE & ELECTRONICS

GLASS-TO-METAL SEALS

by
AIRPAX

Exacting customer specifications are met by the quality, glass insulated terminals manufactured by Airpax.

A wide variety of terminal designs are producible and glass can be color coded for identification. (We like blue, one reason is that blue is supposed to be difficult.)

Leads can be kovar, or sleeved solid copper, or tubular. A large choice of standardized pins and lugs permits quick delivery to your specific needs. A 90 page catalog giving technical details is yours for the asking.

AIRPAX ELECTRONICS

CAMBRIDGE DIVISION, CAMBRIDGE, MARYLAND 21613

Phone 301-228-4600

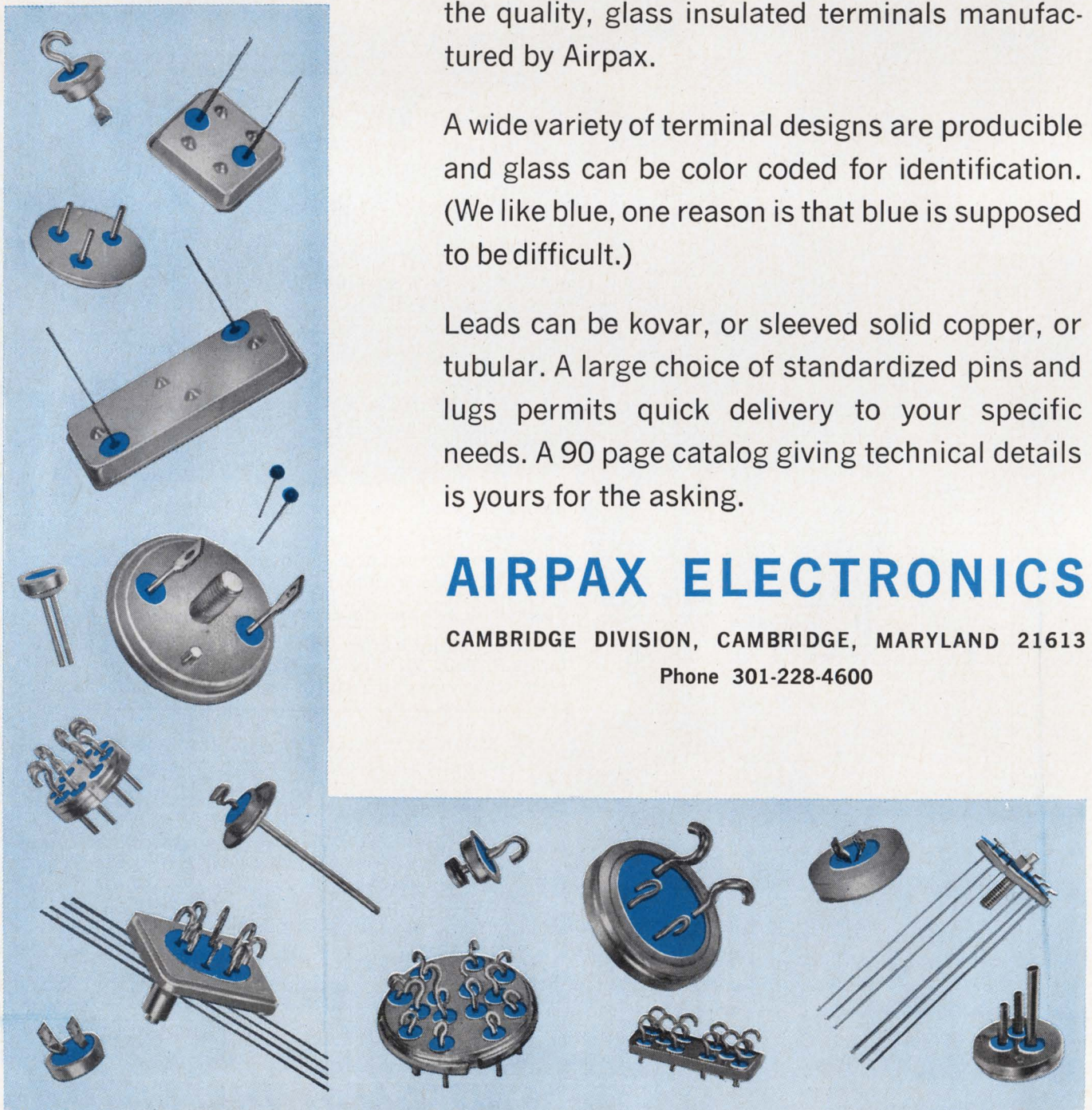

New Products

Components

IC's poaching on op amp preserves

But assemblies with discrete components are still thriving in applications where design specifications are demanding

Don't count out the discrete operational amplifier! It may be losing some ground to the monolithic integrated-circuit device, but assemblies with discrete components are still making their way.

"Op amp applications are certainly expanding, and so far ic's are having an impact in medium-high-frequency, low-power, and low-voltage areas," says Jim Balderson, linear ic product manager at Texas Instruments Incorporated, Dallas. "But when specifications get tight, ic's can't compete. This is where the smaller producers of op amps will have to take refuge. They'll have plenty of room for growth, but will find the range of their market is smaller."

Versatility is at the root of op amps' growing popularity. They can do just about any kind of computing job—addition, subtraction, integration, differentiation, sign and scale changes, calculation of fractional and higher-order powers—and can control, compare, process, regulate, and detect both linear and nonlinear signals.

Open road

Although precise data isn't available, op amps appear to be climbing into the very-big business category. Dale Dukes, manager of management information and services at the Burr-Brown Research Corp., Tucson, Ariz., pegs the 1968 market at \$90 million, about \$20 million ahead of last year's. Jerry Metzger, product manager at the Fairchild

Camera & Instrument Corp.'s Controls division, estimates monolithic units' share at \$30 million—up 20% from 1967's record. And by the early 1970's says Dukes, ic op amps may be ringing up sales of over \$100 million a year.

Might have been. "I can't help but wonder what would happen if the ic had been a few years late. We'd probably have a \$100 million market on our hands," says Ray Stata, marketing vice president at Analog Devices Inc., Cambridge, Mass., a firm with 40 or so conventional op amps in its catalog. "The advent of ic's poured cold water on our dreams, but the fire's not out yet."

"Op amps with discrete components and hybrid arrangements with ic's will be around for a long time," says David Ludwig, director of engineering at Philbrick/Nexus Inc., Dedham, Mass., a division of Teledyne Inc. "It's always possible to reach much higher levels of technical performance with a unit you can adjust. So, for the best common-mode rejection, highest input impedance (without having to resort to Darlington inputs), lowest offset current, highest input voltage, maximum frequencies, and the like, users will continue to specify units with discrete components."

Analog Devices' Stata isn't ready to throw in the towel. "Companies

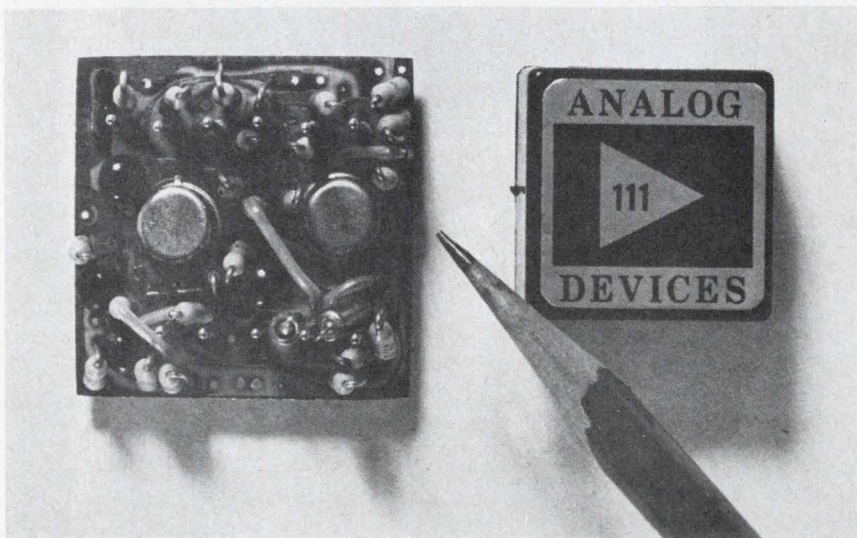

Shrinking. Op amp with discrete components at the right is Analog Device's cheapest model at \$13. Company saves both space and money in modules like the 420A multiplier at left by using an IC op amp. This assembly sells for \$165.

... op amp companies will never be plowed under by the IC houses ...

like ours will never be plowed under by the IC houses," he says. "We'll always be one step ahead, applying our best units and improving on them. At the very least, we'll supply the design engineering needed to use circuits in the most elegant way." As evidence, Stata cites the company's model 420A amplifier, which has two $\mu\text{A-726}$ monolithic dual-transistor pairs on a temperature-controlled substrate.

Where it's at

Integrated circuits, however, are continuing to make significant inroads at the low end of the line—devices selling for \$10 to \$18 each. "There are a number of unsophisticated assemblies at this level that will be displaced in the next year or so," says David Taskett, marketing manager at Zeltex Inc., Concord, Calif., a firm that offers 60 different versions of op amps. Fairchild, for example, dropped its low-cost ADO-47 op amp because it couldn't compete with IC's. Similarly, all of the company's chopper-stabilized devices have been discontinued. But Fairchild is readying a hybrid assembly to take their place. Called

the ADO-70B, the unit has an IC input stage.

Arresting gear. "The 709-type monolithic units have cut into the growth of our AD5 and SQ5 op amps that sell for under \$10," says Daniel Sheingold, a staff consultant at Philbrick/Nexus. "However, unit sales continue to climb by as much as 10% because of follow-on orders." Fairchild's Metzger also notes the impact of repeat business.

With IC's chipping away at the low end of the line, Philbrick/Nexus is turning to larger, more complex op amps like its recently introduced model 1003, which has a field effect transistor input. "This device has only a few picoamps leakage and a temperature coefficient of 1 microvolt per degree Centigrade, and it has no IC's," says Ludwig. "We haven't abandoned the IC and are looking at unpackaged chips and discrete components on ceramic substrates. This would give us some of the size advantages of integration. But we'll do this only if we don't have to add too many components to get the IC's operating parameters up to snuff."

Examples of Philbrick/Nexus'

more complex units are the Meter Mates introduced at last month's IEEE show in New York. Presently, there are two versions—a high-impedance input device and a unit that converts a zero-center meter into a null-center meter that reads logarithmically on either side of center. The first a-c Meter Mate is expected to be available next month; it will yield root-mean-square, peak-to-peak, or full-wave rectified average voltage from an audio-frequency input. Both linear and log readouts will be offered.

Burr-Brown's Dukes says discrete op amps tend to offer more design flexibility than IC's and thinks that design fundamentals still favor discrete components where performance is critical. "But in standard production-line op amps where costs and size count most, IC's are superior," he states.

Magic number. Fairchild's Metzger agrees with the proviso that 100,000-unit runs are a minimum requirement to make the monolithic-unit production economically feasible. Analog Devices goes so far as to steer customers to IC's when they seem appropriate. "If a purchaser's application permits loose specs and he's ordering in volume, we point him toward IC's. We're casting our bread upon the waters against the time he'll need tighter parameters," says Stata.

Long haul

Over the long run, technology will force change in the character of op-amp outlets. Future assemblies will be largely modular amalgamations of IC's and discrete components. Moreover, products will increasingly be specified in terms of their function within a system rather than as an operational or differential amplifier with given characteristics.

Stata says Analog Devices plans to take advantage of the best the IC houses have to offer, and then, by outboarding components and building larger modules, to improve on their offerings. "As far as the market is concerned," he says, "the winning companies now are making the correct guesses as to which modules to work on now. Active filters are obviously a good bet as are the multipliers and chopper-stabilized amps."

But the inbred nature of the op-

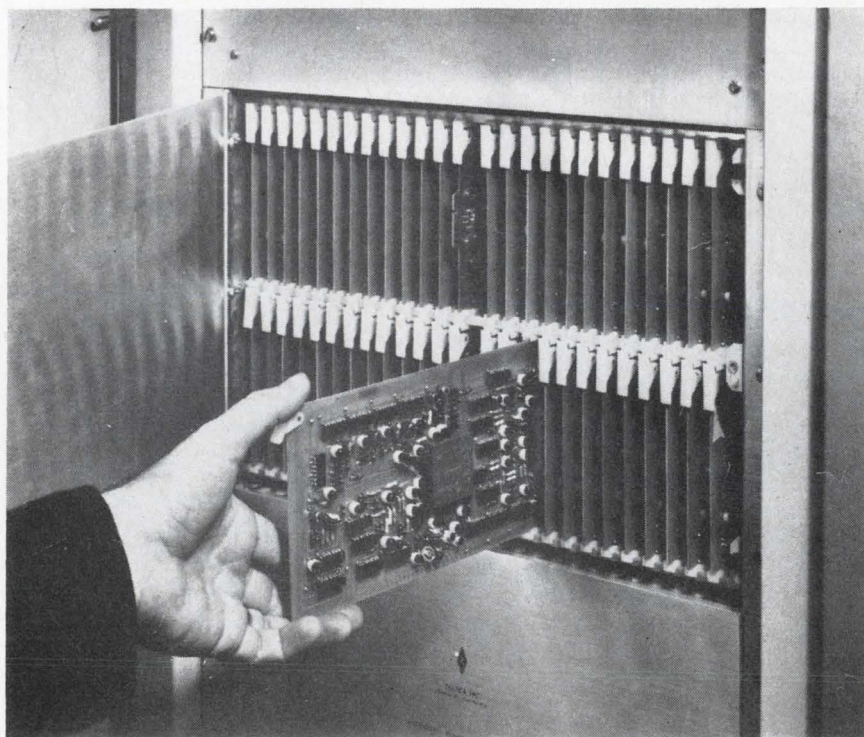

Hedged bet. Zeltex, an op amp maker, is diversifying its product base by adding wares like this element for hybrid/analog function generator.



Over 80% of current magnetic shield designs originated at MSD. Some were pretty simple . . . and some were pretty complicated. Each was so successful that they have made MSD the world recognized standard in magnetic shield design and fabricating.

Whether your specific shield problem requires a complicated

or simple solution, MSD's vast design, engineering and fabricating experience is available to you.

Write for EMC Engineering and Procurement Catalog.

**AT
MSD,
THE
UNUSUAL
IS A WAY
OF LIFE**

MAGNETIC SHIELD DIVISION

Originators of permanently effective non-shock sensitive shielding alloys

West Coast Stocking Reps

Tech Rep Distributor Co.
10606 W. Pico Blvd.
Los Angeles, Calif. 90064
213, 836-6806 213, 871-0055

Frauman Associates
P.O. Box 969
Menlo Park, Calif. 94026
415, 322-8461

Perfection Mica Company • 1322 N. Elston Avenue, Chicago, Illinois 60622 • Phone: 312, EV 4-2122 • TWX 910 221-0105

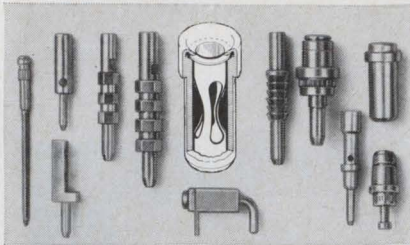

ACTUAL SIZE

Cambion Cage Jacks fight connector fatigue

Can more than 40,000 insertion/extraction cycles be wrong?

These are all the "ins" and "outs" CAMBION cage jacks must endure to meet CAMBION standards for connector reliability for both printed circuits and conventional circuits.

It's the cage that does it. Unique compound curvature design keeps full pressure contact with over 60% of the plug circumference (most competitive jacks can't do half that). Metallurgical engineering ensures integrity even after repeated high temperature soldering. Delivery is off the shelf.

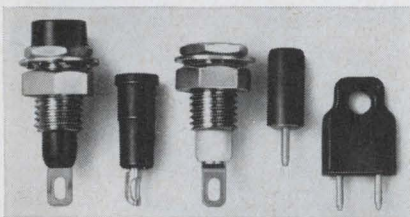

ACTUAL SIZE

CAMBION plugs are just as easy to obtain. There's at least one for every CAMBION jack, in 6 basic pin diameter sizes: .016"; .020"; .030"; .040"; .062" and .080". Regular, insulated, printed circuit, MIL-type 4-point crimp, combinations plug/jack and piggy-back patch cords answer a wide range of needs.

Over 93 basic types with hundreds of varieties . . . all standard, all available. The increasing number of CAMBION plug and jack configurations means you have more of a complete selection to choose from for edge-mounted connectors, patchcords, patch panels, patch strip assemblies . . . and for applications including printed, standard and stacked circuits, socket boards and wire connections. For every connector part, there's a perfect CAMBION mate . . . we guarantee it.

For complete data on reliable CAMBION circuit interconnections, write Cambridge Thermionic Corporation, 447 Concord Avenue, Cambridge, Massachusetts 02138. Phone: (617) 491-5400. In Los Angeles, 8703 La Tijera Blvd. Phone: (213) 776-0472.

©Reg., U.S. Pat. Off.

CAMBION
CAMBRIDGE THERMIONIC CORPORATION

Standardize on CAMBION . . .
21,541 Guaranteed Electronic components

3/4 SIZE

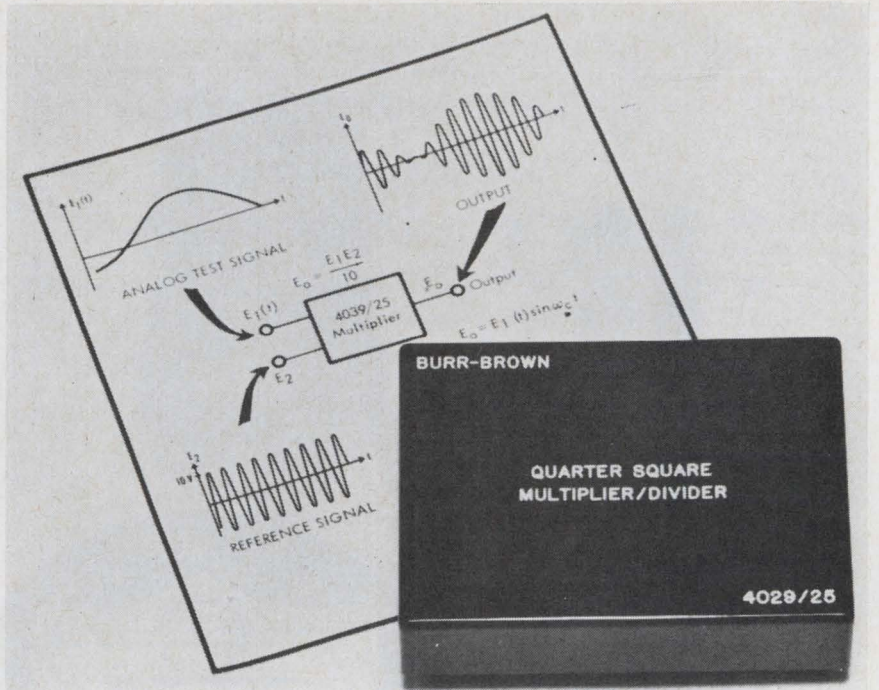
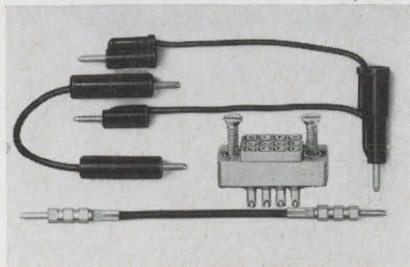

It figures. This quarter square multiplier introduced by Burr-Brown has a rated output of ± 10 volts at 5 milliamps; unit cost is \$195.

amp business is a danger, says Stata. Companies are looking over their shoulders and second-guessing like mad. "If Burr-Brown brings out a gadget, or if we do for that matter, it sets off ripples throughout our industry," he says.

Repeat performance. "Market planning is tough right now; it's very hard to get opinion on samples because customers haven't been exposed to the sort of devices we look forward to selling," says Stata. "It's almost like the situation in the 1950's when General Electric tried to estimate the (now profitable) market for the unijunction transistor and found none since nobody knew what the company was talking about. They didn't have applications data either, and we face almost the same situation now."

Some companies are now making data amplifiers with rack mounts and selling them for \$500 to \$600. Stata believes his company should be able to do the same thing in a miniature package for about \$225. Analog Devices model 601, which includes a $\mu\text{A-726}$ temperature-controlled transistor pair, represents a step in this direction.

"We recommend the 601 for use as a bridge amp, a thermocouple amp, or high-impedance differential amp among other applications," says Stata. "The 601 has a common mode or rejection of about 120 deci-

bel over a band of d-c to 60 hertz, and a bandwidth of 30 kilohertz. The 601's potential looks good to us, and there will be 602 along in the middle of this year to broaden our coverage here."

Burr-Brown is concentrating on specific functions rather than universal modules, says Dukes. "We're interested in the market for specialized versions of general-purpose, building-block devices."

"Our high-cost, high-performance op amps get a large part of our engineering effort. Complexity is rising along with price in this area," says Philbrick/Nexus' Ludwig. "Our list of customers shouldn't change much; we'll just be selling them a larger part of the system."

And with the advent of Meter Mates, it is only natural for the company to expand into instrumentation. "We'll be looking for holes in the instrumentation field left untouched by the Hewlett-Packards and the General Radios, but which present real customer needs," says Ludwig. The company has already introduced two 5000-series measurement devices, essentially specialized Meter-Mate modules with panel meters and controls.

Contributions for this report were made by Peter Vogel in San Francisco, Bill Bell in Los Angeles, Marvin Reid in Dallas, and James Brinton in Boston. It was compiled in New York by Eric Aiken.

Integrated circuit package sealing application centers opened by GTI

GTI has opened two new application centers to assist engineers in developing reliable procedures for hermetically sealing packages for integrated circuits, thin and thick film packages. These centers are located in Costa Mesa, California and Providence, Rhode Island.

As leading suppliers of both integrated circuit packages and sealing equipment, GTI is uniquely qualified to provide expert counsel in this field.

To utilize this service, engineers are invited to submit samples of their flat packs, and information on the model of DIX sealer they are using or are contemplating using. GTI will develop a complete sealing cycle profile such as this of the recommended procedure:

COMPANY	ABC CORPORATION		DATE 3/28/68				
PRODUCT	¼" x ¼" ABC CLAD LID Au-Sn						
	No. 1	No. 2	No. 3	No. 4	No. 5	No. 6	No. 7
	On-Off	Preheat	Purge	Vacuum	Pressure	Heat	On-Off
	0-92	0-0	4-25	26-30	31-84	33-70	88-90
TIMER	1	2	3	4	5		
POWERSTAT	14						
	Size			Material			
ELECTRODE	¼" x ¼" IR-PT Ceramic Wafer						
HEAT SINK	¼ x ¼		PRESSURE		3½ lbs.		
SEALER MODEL NO.	FP-VP-103						
ATMOSPHERE	Purge 15 PSI N ₂ , PRESS 10 PSI He						
PREHEAT	0						
Typical profile for ¼" x ¼" flat pack sealing cycle on DIX FP-VP-103 Sealer.							

Flat-Pack Sealers from Dix are offered in both production and laboratory models. All feature perimeter heating that rapidly and efficiently creates a hermetic seal while keeping the device temperature at a safe, lower level.

Production models are available with three, five and ten package stations. The laboratory and pilot production model is a single head unit with great versatility.

GTI also offers extensive technical assistance in setting up equipment, training your personnel and developing sealing profiles for maximum quality and yield.

Just fill in the coupon to see how GTI can help you maximize your flat pack production. Send at least ten packages, lids, and braze preforms and complete sealing specifications.

To: GTI Integrated Circuit Package Sealing Application Center

Dear Sirs:

Please develop a sealing profile for the enclosed flat packs.

We are currently using, considering these sealers:

- DIX FP-VP-10 five station sealer; DIX FP-VP-210 ten station sealer;
 DIX FP-VP-103 three station sealer; DIX FP-VP-1 single station sealer.

Please send information on DIX sealers.

Name: _____

Position: _____

Company: _____

Address: _____

City _____ State _____ Zip _____

EAST

GTI Providence Division

100 Niantic Avenue
Providence, Rhode Island 02907
Attn: John Springob

WEST

GTI DIX Division

1399 Logan Avenue
Costa Mesa, California 92627
Attn: Major St. John

GTI CORPORATION

Fastest way to start a savings account

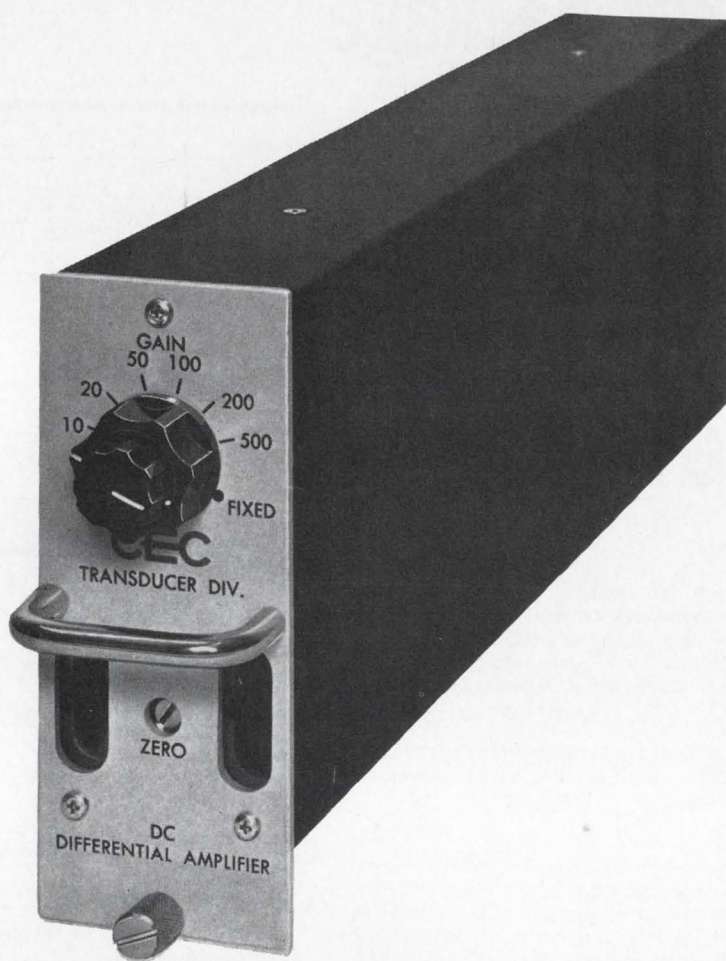

The data this unimpressive-looking little instrument can save you defies computation.

Because—CEC's new 1-366 Differential Amplifier has an **overload recovery time of less than 1 microsecond**. No DC amplifier known to us, or our customers, is able to match this achievement.

As a result, the solid-state, wideband 1-366 is proving invaluable in all signal conditioning applications where critical information must be recorded immediately upon cessation of the initial pulse. A current use is that of securing data 1 microsecond after shock waves, such as those encountered in mechanical and explosive shock testing.

Other significant advantages:

- *Frequency response*— ± 1 db, DC to 1 MHz.
- *Common mode rejection at 1 MHz*—greater than 20 db, regardless of gain.

- *Input range*—up to ± 5 volts peak.
- *Output*— ± 5 volts at ± 50 ma minimum.

For complete information about this advanced new transducer amplifier, call your nearest CEC Field Office. Or write Consolidated Electroynamics, Pasadena, California 91109. A subsidiary of Bell & Howell. Ask for Bulletin 1366-X4.

CEC/TRANSDUCER PRODUCTS

 **BELL & HOWELL**

New Components Review

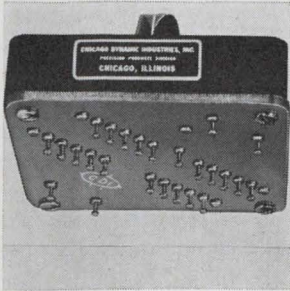

Adjustable-stop, single p-c wafer rotary switch type RS275 has a switching matrix of 20 inputs and 5 outputs. It meets applicable portions of MIL-S-3786. Applications include computers, check-out equipment, test equipment, and programing. Price is approximately \$130; delivery, 30 days. Chicago Dynamic Industries Inc., 1725 Diversey Blvd., Chicago 60614. [341]

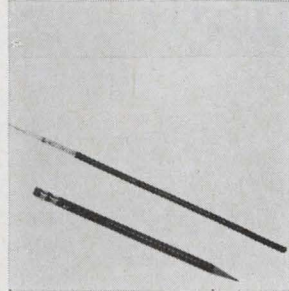

Miniature coaxial cable, with a 0.150-in.-diameter shield, has an inductance of only 0.061 μ h per ft measured at 100 khz. The center conductor has an o-d of 0.059 in. and dielectric is solid polyethylene. Cable's attenuation is 18 db per 100 ft at 400 Mhz, and operating temperature range is -55° to $+85^{\circ}$ C. Times Wire and Cable, 385 Hall Ave., Wallingford, Conn. 06492. [342]

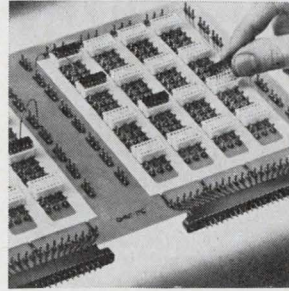

IC breadboard panels in the Omny-Pac series feature advanced laminar bus bar-capacitor design and 16 or 32 dual in-line IC sockets. Each socket is designed for easily inserting 14-pin IC's. The MBB-1000 (16-circuit panel) measures $6\frac{1}{2} \times 8\frac{1}{2}$ in., and the 32-circuit panel MBB-2000 is $13 \times 8\frac{1}{2}$ in. Methode Mfg. Corp., 1700 Hicks Rd., Rolling Meadows, Ill. 60008. [343]

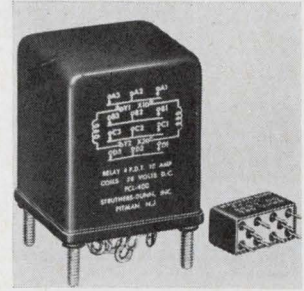

Military grade aerospace relays models FCL-400 and FCL-1 save energy by using power just to transfer the contacts, not to hold them. The 10-amp FCL-400 operates on as little as 35 mw-sec; the 2-amp, half crystal can size FCL-1, on 2 mw-sec. Once transferred, contacts remain in the last operated position with zero power drain. Struthers-Dunn Inc., Pitman, N.J. 08071. [344]

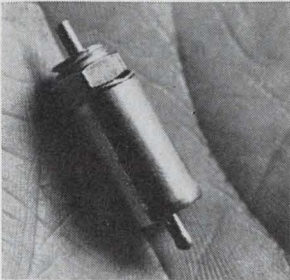

R-f filter type 550 is suitable for use in communications equipment, aircraft instruments, etc., which may be interfered with or damaged by high power radio energy. It gives average attenuation of 75 db of r-f energy in a range from 1 Mhz to 20,000 Mhz. It comes in 1 amp, 0.45 amp or 0.3 amp ratings. Elliott-Automation Ltd., Airport Works, Rochester, Kent, England. [345]

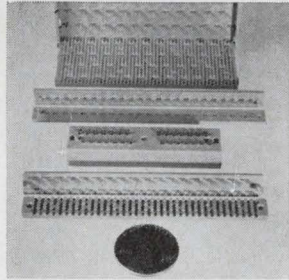

Solderless gas-tight connectors are for connecting flat cable or individual conductors to wire wrap or solder posts and to various types of p-c board contact systems. The contacts make up to 63 connections simultaneously, and can handle wire sizes from No. 30 Awg to No. 22 Awg stranded. 3M Company, 3M Center, St. Paul, Minn. 55101. [346]

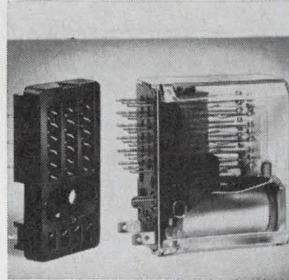

Miniature relay series AZ430, with a 6 Form C contact arrangement, is designed for multipole switching applications. It is available with low-level bifurcated, 2 amp or 5 amp silver alloy, heavy duty contacts. Coil voltages range from 6 v to 115 v d-c. Over-all size is $47/64 \times 1\frac{13}{32} \times 1\frac{3}{16}$ in. American Zettler Inc., 697 Randolph Ave., Costa Mesa, Calif. 92626. [347]

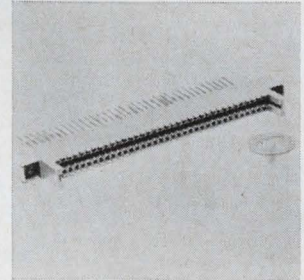

Card-edge connectors series 6309 are designed for high packaging density (mounting on 0.300-in. centers) in programed wire wrap applications. They are suited for mounting on chassis, p-c boards and metal plate assemblies. They incorporate contacts spaced on 0.100-in. square grid, and accommodate 1/16-in. p-c cards. Elco Corp., Willow Grove, Pa. 19090. [348]

New components

Semiflexible cable turns the corner

Right-angle connector has vswr under 1.15; precision casting of outer shell reduces bend radius to 1 inch

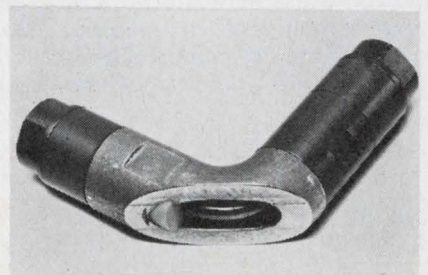

Bending brings out the worst in semiflexible cable. The inner conductor and the solid aluminum outer conductor crease and the inner conductor goes off-center. Reflections appear in the line and the voltage standing-wave ratio goes up.

Engineers at the Times Wire and Cable division of the International Silver Co. found that the vswr rose when the radius of the bend was less than 10 times the diameter of the cable. They developed special tooling, and were able to get the bend radius down to four times the

Match up. The connector can join two semiflexible cables, or a semiflexible to a standard cable.

diameter of the cable.

But much of Times' semiflexible cable was going into aircraft systems and bending the cable still took up too much room. So the com-

For Those Who Think Small

\$128 ————— ○ Low Cost

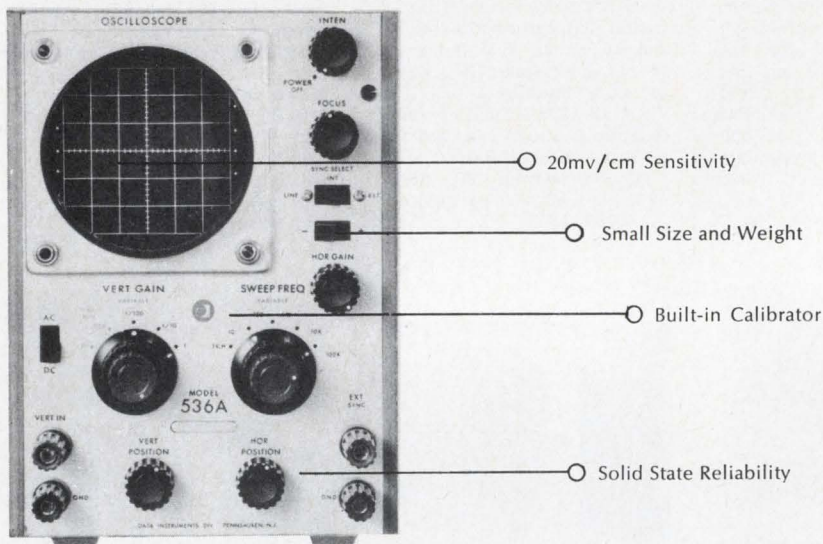

Here's Data Instruments 536A—proof that you can reduce the size of a scope without reducing its performance. The 536A is small. So small, in fact, that four of them take up little more than a square foot of panel space. This makes it desirable for field, production line, classroom and systems applications where panel and shelf space are critical. But there's more to it than that. The 536A matches their performance requirements in a way usually reserved for larger and more expensive instruments. The flat-faced 3" CRT, with a viewing area of 4 x 6 cm and a finely focused trace, provides it with excellent legibility; the 1.5 MHz bandwidth makes the 536A adaptable to a wide range of applications. And its unusual sensitivity—better than 20mv/cm—makes possible precise measurements of regularly recurring waveforms over its entire bandwidth.

Moreover, it has the features to back up its performance. All amplifiers are solid state, multistage, DC coupled and fully compensated. The attenuator has a variable trimmer, and a built-in calibrator stabilizes time and voltage. In addition, there is a full year's warranty and complete field and factory service.

The specifications:

VERTICAL AMPLIFIER				
BANDWIDTH DC-1 MHz	SENSITIVITY/CM 20mv	ATTENUATOR 3 pos + var.	ACCURACY ±.5 db	IMPEDANCE 1MΩ + 22pf
SWEEP/CM	HORIZONTAL AMP	CRT	PHYSICAL	
10μs-10ms (4 ranges)	2Hz-500KHz 300 mv/cm	3"	5½" x 7½" x 12" 11 lbs.	

But why not see it in action? We'll gladly arrange a demonstration in your plant. You'll find that everything about the 536A is designed for those who think small. Everything except the Price. That is for those who think microminiature.

Data Instruments Division • 7300 Crescent Blvd. • Pennsauken, N. J. 08110

. . . air used
as the dielectric . . .

pany developed a right-angle connector with a 1-inch bend radius and a maximum vswr of 1.15—about the same as that of the cable.

Into the turn. Ralph Kragle, manager of connector operations at Times, says the bend is made as a smooth coaxial transition by precisely casting the connector's outer shell. Bends have normally been made by drilling, in a solid casing, two holes that meet at a 90° angle. So when the inner conductor was inserted, it was bent sharply. The inner conductor of the Times' connector is a solid piece of beryllium copper that bends smoothly in the casing, and the dielectric is air. Short sections of low-loss dielectric are at each end for compensation. Kragle says the key part of the connector is the Teflon bead that supports the conductor. "The bend is very smooth, and the bead is almost reflectionless."

The cutoff frequency depends on cable diameter. Connectors are available for diameters from ¼ to ⅞ inches. For the largest diameter, the cutoff is 4 gigahertz, and for ½-in cable, the connector's vswr stays under 1.15 up to 12 Ghz. Insertion loss is low; for a ¾-in connector, it's 0.2 decibels.

Highly eligible. The unit can mate with semiflexible cable at both ends, or it can be fitted to mate with type N, type C, or the General Radio Co.'s type GRL-874 connector.

The unit was first used on Lockheed Aircraft Corp.'s C-5A cargo plane, and has been sold to Pan American World Airways, Inc.

The company says the connector will be useful wherever high isolation and low loss aluminum-sheathed semiflexible cable is needed. Principle applications are now in aircraft, missile, and submarine systems. Times expects the use of semiflexible cable to increase in commercial communication systems, like cable tv.

Prices are \$50 to \$100 for small quantities. Connectors for 50-ohm systems are available within a month, and units with other impedances can be designed.

Times Wire and Cable Div., 358 Hall Ave., Wallingford, Conn. 06493 [349]

can't get away for evening classes?



here's a practical way to avoid technical obsolescence

Are irregular hours, travel and family obligations keeping you from attending classes—even though you worry about becoming technically obsolescent? Check into the Special Programs in Electronics for Engineers developed by CREI, the Home Study Division of the McGraw-Hill Book Company.

These are not simply courses, but comprehensive programs in advanced electronics offering major electives in such fields as:

Communications Engineering, Aeronautical and Navigational, Television Engineering, Automatic Control Engineering, Missile and Spacecraft Guidance, Radar and Sonar Engineering, Nuclear Instrumentation and Control, Computers.

Industry-recognized CREI Programs make it possible for you to catch up on new developments in electronics through study in your own home, at your own pace,

your own schedule. Free book gives complete information and details of technical material covered. For your copy, mail coupon below or write: CREI, Home Study Division, McGraw-Hill Book Company, Dept. 1818G, 3224 Sixteenth St., N.W., Washington, D.C. 20010.

Founded 1927



Accredited Member of the National Home Study Council



CREI, Home Study Division, McGraw-Hill Book Company
Dept. 1818G, 3224 Sixteenth St., N.W.
Washington, D.C. 20010

Send me free brochure describing CREI Programs in Electronics for Engineers.

NAME _____ AGE _____

ADDRESS _____

CITY _____ STATE _____ ZIP CODE _____

COMPANY _____

TITLE _____

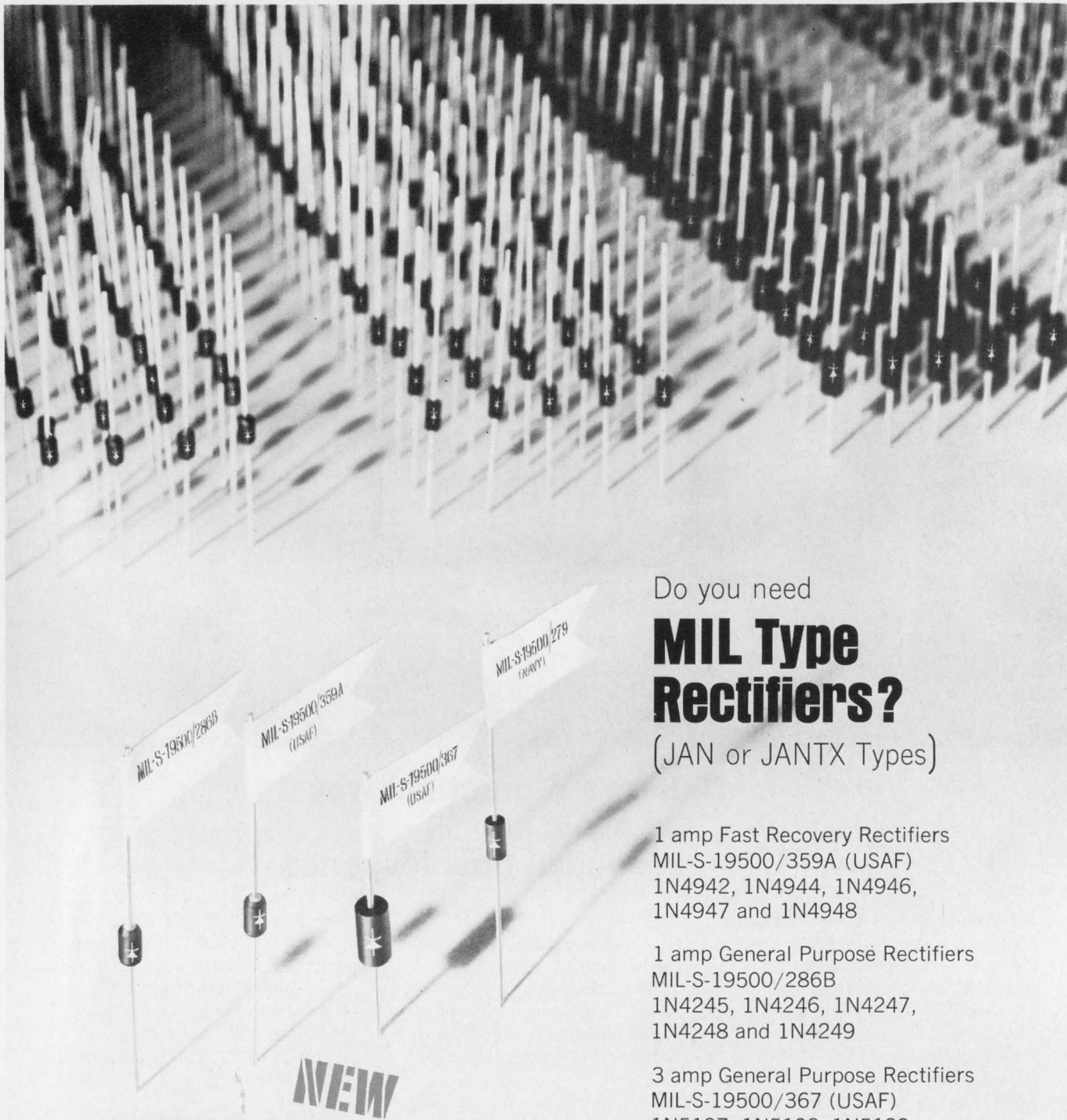

Do you need

MIL Type Rectifiers?

(JAN or JANTX Types)

1 amp Fast Recovery Rectifiers
 MIL-S-19500/359A (USAF)
 1N4942, 1N4944, 1N4946,
 1N4947 and 1N4948

1 amp General Purpose Rectifiers
 MIL-S-19500/286B
 1N4245, 1N4246, 1N4247,
 1N4248 and 1N4249

3 amp General Purpose Rectifiers
 MIL-S-19500/367 (USAF)
 1N5197, 1N5198, 1N5199,
 1N5200 and 1N5201

High Voltage Sub-miniature Rectifiers
 MIL-S-19500/279 (NAVY)
 1N3644, 1N3645, 1N3646
 and 1N3647

Semtech has extensive environmental and power burn-in facilities available to process your military and high reliability requirements.

Contact your local representative for immediate delivery —

San Francisco — 941 E. Charleston, Suite 10, Palo Alto, California 94303
 (415) 328-8025
Chicago — 140 N. La Grange Road, La Grange, Illinois 60525
 (312) 352-3227 / TWX: 910-683-1896
Dallas — 402 Irving Bank Tower, Irving, Texas 75060 / (214) 253-7644
New York — 116-55 Queens Blvd., Forest Hills, New York 11375
 (212) 263-3115 / TWX: 710-582-2959
European Sales — Bournes A. G., Alpenstrasse 1, Zug, Switzerland
 (042) 4 82 72/73



SEMTECH™
 CORPORATION

652 Mitchell Road, Newbury Park, California 91320
 (805) 498-2111, (213) 628-5392 / TWX: 910-336-1264

New Instruments Review

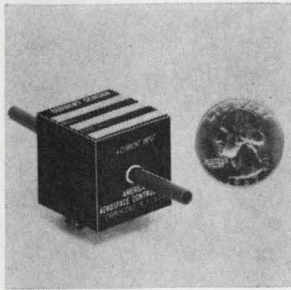

Current sensors 2006H utilize magnetoresistors to detect current in ranges from 0 to 25 amps to 0 to 300 amps a-c or d-c. Output from the sensor is suitable for remote transmission in automatic checkout equipment. Price is \$298.50 each in lots of 1 to 9 and delivery is 2 to 4 weeks. American Aerospace Controls Inc., 129 Verdi St., Farmingdale, N.Y. [361]

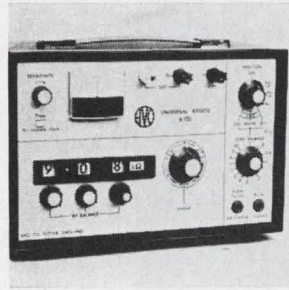

Digital readout, universal measuring bridge type 8-150 is for both laboratory and production use. The 24 ranges of measurement include inductance 0.15 μ h to 120 henrys, capacitance 0.2 pf to 1,200 μ f, resistance 0.002 ohm to 12 megohms, with an over-all accuracy of 1%. A 1-khz oscillator is included. Whittaker Corp., Gencom Div., 80 Express St., Plainview, N.Y. 11803. [362]

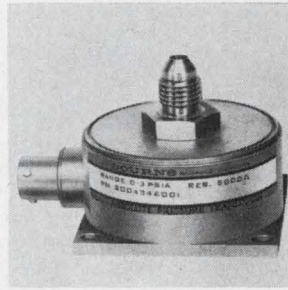

Pressure transducer model 434/534 covers pressure ranges from 1 psi to 5 psi with high accuracy during 35 g vibration. The 434 covers absolute pressure ranges, while the 534 covers various differential and gage pressure ranges. Power rating is 1 w at 165°F. Insulation resistance is 50 megohms at 200 v d-c. Bourns Inc., 6135 Magnolia Ave., Riverside, Calif. 92506. [363]

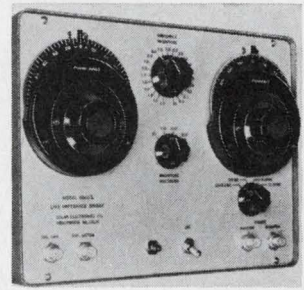

Line impedance bridge 6363-2 is for measuring r-f impedance and phase angle without direct connection to power line. Two current transformer probes couple to unknown impedance providing measurement magnitudes from 0.3 to 1,000 ohms and phase angles $\pm 180^\circ$ from 15 khz to 30 Mhz. Price is \$1,365. Solar Electronics Co., 901 N. Highland Ave., Hollywood, Calif. 90038. [364]

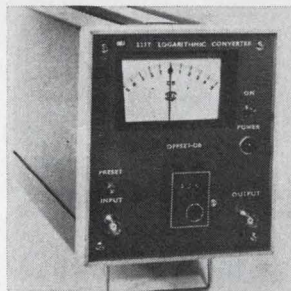

Logarithmic converter model 2277 provides accurate db measurements of complex waveforms or d-c voltages. Features include 120-db dynamic range, bipolar input, and d-c to 200 khz frequency response. Applications include oscilloscope preamp, logarithmic null voltmeter, and production comparison voltmeter. Optical Electronics Inc., Box 11-140, Tucson, Ariz. 85706. [365]

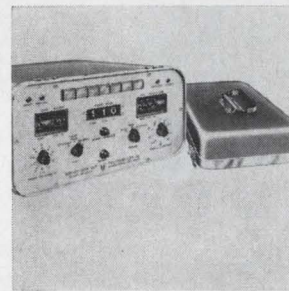

Automatic circuit test set model AP-502 is a completely portable unit (weighing less than 40 lbs) that will make up to 1,200 continuity or insulation tests per minute. The automatic sequencing and simple controls permit operation by unskilled personnel. Price is \$4,950; delivery 45 days after receipt of order. Teleproducts Inc., 351 New Albany Rd., Moorestown, N.J. 08057. [366]

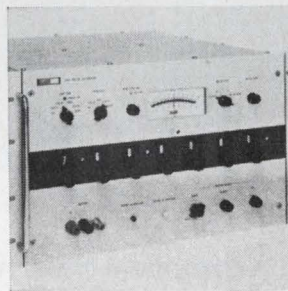

Meter calibrator 760A reads percentage error directly of any a-c/d-c, ampere, or voltmeter on its own front panel meter. D-c accuracy is $\pm 0.1\%$ from 0.001 to 1,000 v. Current range is 1 μ a to 10 amps with $\pm 0.25\%$ accuracy. Resistance is 0 to 10 megohms, accurate to $\pm 0.1\%$. A-c accuracy is $\pm 0.25\%$, 0.001 to 1,000 v. John Flukey Mfg. Co., Box 7428, Seattle, Wash. [367]

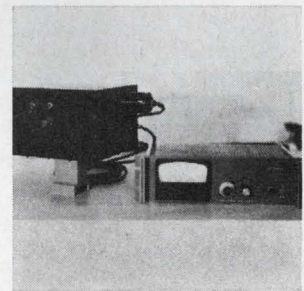

Absolute reflectance transmittance photometer model 209 is for narrow band measurements between 1,650 Angstroms and 2.4 microns. It is a double-beam a-c null balance photometer to be coupled to a monochromator or narrow-band interference filters. The double-beam system permits rapid scanning. Kaye Scientific Corp., 39 Manhattan St., Stamford, Conn. 06902. [368]

New instruments

Oscillator serves many functions

Nyquist plotting, spectrum analysis, and digging a signal out of noise are just a few applications

A programmable filter oscillator has bobbed up Down Under and the maker, AIM Electronics Ltd. of Melbourne, Australia, claims it's the only one of its kind available. The oscillator is the newest addition to AIM's modular instrumentation system.

The unit, PFO 166, has a variety of operating modes, including filter accept, filter reject, and oscillate. Variation of the applied programming voltage between 1 and 5 volts alters the oscillator output frequency by up to 400:1 within an available frequency range of 15 to 50 kilohertz.

When used as an oscillator or accept filter, it also gives a quadrature output (an identical frequency 90° out of phase). The quadrature signal in a feedback loop means the equipment will phase-lock a lock-in amplifier or a tracking filter. It also permits the unit to be used for automatic Nyquist plotting.

In spectrum analysis, the unit can be either a conventional oscillator or a filter. Two PFO 166 units can be used to inspect the electrical characteristics of circuits or equipment: one as an oscillator with programmable frequency driving the input of the circuit under test, and

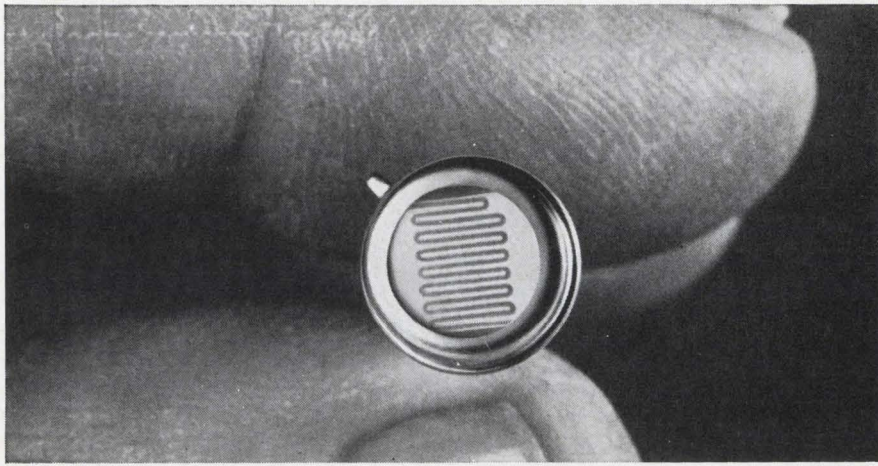

Clairex Type 7H cells offer faster decay time... .0006 sec. at 100 ft-C

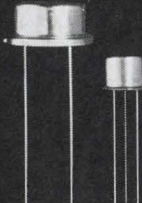

In addition to fast decay time, Clairex Type 7H photocells also provide 240 ohms @ 100 ft-c and CdS stability. They are available in TO-18 and TO-5 cases and in 6 resistance ranges.

Clairex may already have a "standard" answer to your "special" photocell problem.



1239 BROADWAY
NEW YORK, 10001

Circle 154 on reader service card

WIDEBAND RECEIVER



The **977 VHF Receiver** monitors the spectrum from 30 to 300 MHz . . . AM, FM, CW, pulse signals . . . IF bandwidths: 60 kHz, 300 kHz, 3 MHz . . . Dual-gate MOS FETs in all gain-controlled stages . . . Wide dynamic range . . . Call or write for specifications.



SUBSIDIARY OF WATKINS JOHNSON
WJ

COMMUNICATION ELECTRONICS
6006 Executive Blvd., Rockville, Md. 20852 • 301/881-3300 • TWX 710-824-9603

one as a filter at the output to assist examination of the resulting frequency spectrum. A third PFO may be used as a reject filter to reject the dominant harmonic of the input signal and reduce its distortion to less than 0.1%. The resulting signal may be displayed on a meter, oscilloscope, or an x-y recorder. For display purposes, a ramp waveform must be used as a time base and as the programing voltage.

In the presence of noise, the PFO 166 can also be applied in signal recovery where an amplifier is required to lock to an unknown frequency and phase. The technique requires a local phase-locked reference generator, consisting of a phase-sensitive detector and the voltage programable filter. The PFO generates a reference signal and adjusts its frequency automatically to the incoming frequency. A phase-sensitive detector referred to the quadrature output provides an error voltage that is applied to the PFO to maintain the phase-lock.

In Nyquist plotting, the unit is used to generate a variable frequency sweeping through the full 400:1 range. The in-phase quadrature outputs are connected to two phase-sensitive detectors, and these resolve the signal from the system under test into two components. These can then be automatically displayed on an x-y recorder or oscilloscope.

Other possible applications are as a tracking filter and as a programable comb filter where several units are used in combination.

AIM Electronics Ltd., Melbourne, Australia [369]

New instruments

Place on panels sought for meters

French-made digital unit
displays voltage, current
and resistance readings

Not content with manufacturing Europe's lowest-priced digital multimeter, France's Schneider Radio

Television has now come up with the Continent's lowest-priced digital panel meter. Called the VT-100, the meter displays digits from 0000 to 1999 and is priced in the neighborhood of \$175. U.S.-made panel meters cost about \$295.

Schneider is aiming the new instrument at the original-equipment market. "We wanted to develop as inexpensive a meter as possible so that equipment makers wouldn't have to raise their prices," says Martin Birnbaum, head of the company's Professional Electronics division.

The company has yet to set a price for the meter in the U.S. and still hasn't decided on a distributor. Honeywell Inc. distributes Schnei-

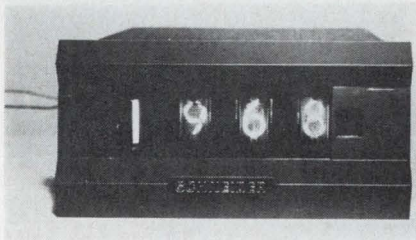

Gallic display. The VT-100 panel meter reads out to 1999.

der's multimeter, called the Digi-test, in this nation. Priced at \$300 in Europe, the Digttest sells for \$525 in the U.S.

Several ranges. The VT-100 measures voltage, current, and resistance; it reads out d-c voltage over three ranges, d-c current over five ranges, a-c voltage over three ranges, a-c current over three ranges, and resistance over five ranges. The instrument's input impedance is 1 megohm, and its measuring cadence is one per second. Resolution is 1 millivolt.

Part of VT-100's circuitry is made up of diode-transistor-logic integrated circuits, with the rest discrete solid state components. Birnbaum says the whole unit could have been made with IC's, but this would have meant a higher production cost.

The unit measures 5.8 by 2.9 by 7.8 inches, and features automatic zeroing. It was exhibited for the first time at the annual Paris Components show last month.

Schneider Radio Television, 12 rue Louis Bertrand, Ivry, France [370]

Why settle for Mylar® when you can get Metallized Polycarbonate Film Capacitors at the same low price?



C280: flat

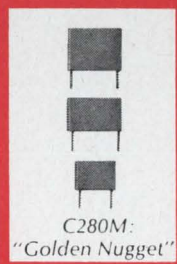

C280M:
"Golden Nugget"

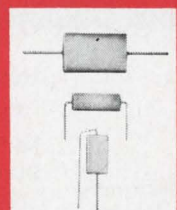

C281: molded

We don't know of a single application, professional or entertainment, where metallized polycarbonate film capacitors cannot replace metallized Mylar®... without changes in production setup... and do a better job, all around.

The advantages offered by Amperex metallized polycarbonate film capacitors over metallized Mylar® include: stability, lower leakage, no voltage derating to 125°C and negligible capacitance change over the operating temperature range.

Volume production efficiencies have sharply reduced the price of Amperex metallized polycarbonate capacitors so that they are now competitive with metallized Mylar®.

In the rectangular "Golden Nugget" style, Amperex C280M series capacitors offer values from 0.01 to 6.8 μf , mount rigidly on printed circuit boards and are especially easy to identify with their high-visibility embossed markings. The C281 molded axial-lead types in values to 6.8 μf are ideal for consumer and professional applications.

For detailed data and samples of Amperex fixed film capacitors or Amperex variable capacitors (with ceramic or film dielectrics), write: Amperex Electronic Corporation, Component Div., Hauppauge, L.I., N.Y. 11787.

Amperex®

TOMORROW'S THINKING IN TODAY'S PRODUCTS

®: A DuPont trademark.



Quick response on Ram Air Turbine Systems.

Garrett now has 30 types of RATS (Ram Air Turbine Systems) to choose from, and more standard designs are on the way. That's how we can promise quick response.

But what if we don't have a model that meets your exact needs? No problem—we can design and build one that does, and we'll do it quickly.

Take a look at our lineup:

Electrical RATS—power outputs from 500 watts to 40 KW.

Mechanical RATS—ratings up to 60 shaft hp at speeds from 600 to 60,000 rpm.

Hydraulic RATS—reliable power at pressures and flow rates compatible with current hydraulic designs.

Combination RATS—versatile performance with any combination of electrical, mechanical, or hydraulic outputs.

We supply more than 90% of all Ram Air Turbines for externally-stored systems—applications that provide military aircraft with a mission flexibility unsurpassed by any other type of secondary power system.

Like to hear more about our RAT capabilities? Drop a line to AiResearch Manufacturing Division, 9851 Sepulveda Blvd., Los Angeles, California 90009.



AiResearch
Ram Air Turbine Systems

New Microwave Review

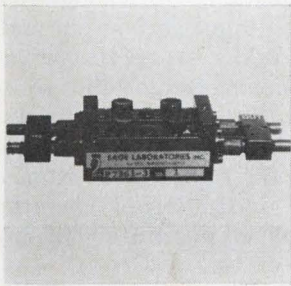

Custom-engineered zero return-loss diplexer is basically a narrow-band bandpass filter, but it terminates out-of-band signals into an internal load rather than reflecting them back to the input. Over the 2.97-3.13 Ghz passband, insertion loss is less than 0.9 db. At 2 and 4 Ghz, insertion loss is greater than 40 db. Sage Laboratories Inc., 3 Huron Drive, Natick, Mass. 01760. [401]

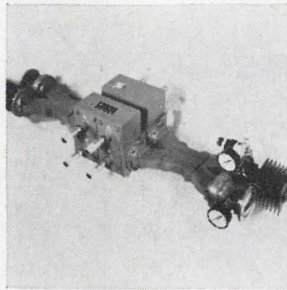

C-band tunable filter model 51-923-1 comes in a waveguide assembly consisting of cylindrical cavity resonators, power dividers, and high power loads. It is designed to eliminate the rfi problem in an operational weather radar system. Tuning range is 5.45 to 5.65 Ghz, bandwidth 20 Mhz, power handling 400 kw peak, and vswr 1.5:1 max. AAI Corp., Cockeysville, Md. 21030. [402]

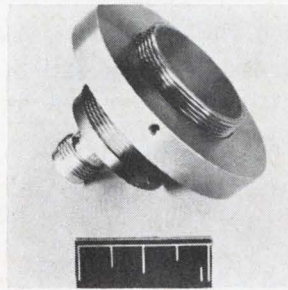

C-band beacon antenna DMAQ-200-1 will survive heat pulses to 3,000°F and will operate for 5 minutes in a 1,000°F environment. It weighs 5 oz, is 1.5 in. long and has a 1.13 in. diameter. Frequency range is 5.4 to 5.8 Ghz, vswr less than 1.5:1 and power handling capability 1 kw peak, 10 w average. Dorne and Margolin Inc., Veterans Memorial Highway, Bohemia, N.Y. [403]

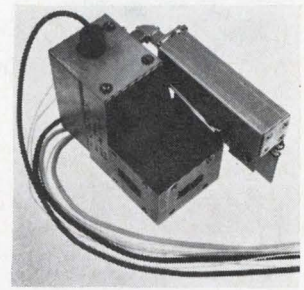

X-band preamplifier model APX-2, designed for radar applications, is a fixed-tuned parametric amplifier providing a 50-Mhz bandwidth anywhere in the 8.5 to 12 Ghz range. Noise figure is 3.5 db max with 16 db of gain. The unit handles up to 200 mw c-w input without damage. It measures 4 x 5 x 6 in. Melabs, 3300 Hillview Ave., Stanford Industrial Park, Palo Alto, Calif. 94304. [404]

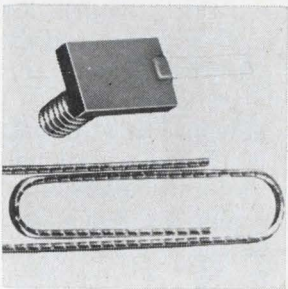

A line of 20-w stripline terminations features a metal-film element deposited on a beryllium oxide substrate. Model 125-20W-T is for insertion in 3/8-in. stripline. Vswr rating is 1.1 or better below 1 Ghz and 1.25 or better below 4 Ghz. Dimensions are 0.250 x 0.375 x 0.065 in. Price is \$35; delivery, 2 to 3 weeks. EMC Technology Inc., 1133 Arch St., Philadelphia, Pa. [405]

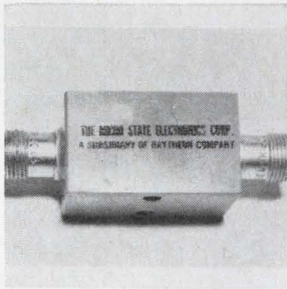

High power limiter operates over the frequency range of 2 to 8 Ghz. The device can limit peak r-f input powers up to 500 w and average power up to 5 w. Maximum r-f power output is 100 mw. Low power insertion loss is 1.25 db maximum and input vswr is 1.75 to 1. The unit comes with OSM or TNC connectors. Micro State Electronics, 152 Floral Ave., Murray Hill, N.J. [406]

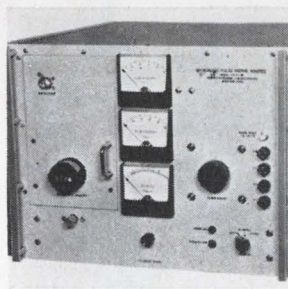

Microwave pulse signal source 03-54-00 provides up to 40 kw peak power output and tuning range of 700 to 850 Mhz. The instrument offers stable frequency, variable pulse width, repetition rate and power output as well as external and internal pulse synchronization which permits separate use of modulator. Applied Microwave Laboratory Inc., Andover St., Andover, Mass. [407]

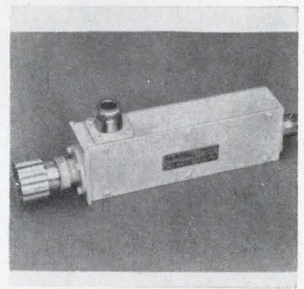

Directional couplers covering 200 Mhz to 12.4 Ghz provide high accuracy coaxial measurement. They are suited for broad-band swept reflectometer set-ups or constant vswr monitoring systems. Minimum directivity for the 5 couplers that cover the band ranges from greater than 40 db at the low end to more than 30 db at the high end. Emerson Electric Co., Calabasas, Calif. [408]

New microwave

Tiny tee in attenuator increases range

Voltage-controlled unit, with ferrite hybrid junction, has phase shift under 5°, operates from 50 to 2,000 Mhz

"It seemed as though Lady Luck were on our side. Every time we thought our designs were going to be stymied, along came the hardware that could do the job." That's how Allen Podell, director of development at the A-R Anzac Electronics Co., described how Anzac

engineers came up with a voltage-controlled attenuator (vca) that offers high performance from 50 to 2,000 megahertz.

Anzac's first attempt to make a vca was hindered by isolation and phase-shift problems. Company engineers built a device but it was

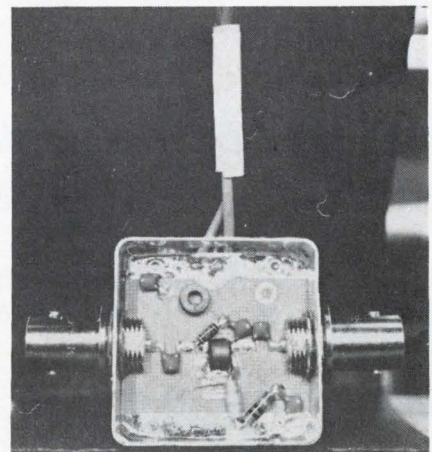

Down to 20 db. Since the ferrite magic tee (in center of attenuator) is small, phase shift is low.

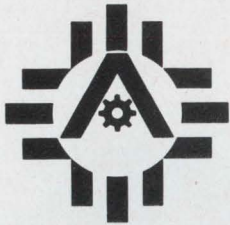

We're not the nation's best-kept secret any more!
Albuquerque . . . Sunshine. No crowds. No smog.
You can golf and ski on the same winter day.
Two universities, outstanding recreation outdoors.
Symphony, opera, much more, in unique New Mexico
Contact: Albuquerque Industrial Development Service
400-Z Elm N.E., Albuquerque, New Mexico 87103



Circle 124 on reader service card

Our little black book has over 100,000 phone numbers.

You never had a black book like it. Over 1,500 pages. And those phone numbers!
More than 100,000 telling you who to call/where to go, for the over 4,000
different product categories listed and advertised in the yellow
pages of the Electronics Buyers' Guide.

It's the industry's one-stop shopping
center that lets you find the products
and services you need quickly.
You can depend on EBG.

Electronics Buyers' Guide

A McGraw-Hill Market Directed Publication,
330 West 42nd Street, New York, N.Y. 10036

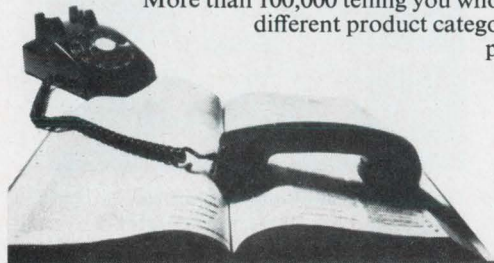

flat only up to 8 decibels.

It's magic. Podell thought of using a magic tee—a four-port junction—in the attenuator because of its high isolation. He wanted two ports for the input and output and, across the other two ports, he intended to connect adjustable resistors. But when he analyzed the system, he found that for a low voltage standing-wave ratio, the resistance at one port must increase when the other resistance decreases. He saw no way to do that.

Then, along came the p-i-n diode, a device whose resistance goes up with increasing d-c current. Podell put two p-i-n's in series across the two ports, and, by biasing one diode, he could control the attenuation and, at the same time, keep the vswr down.

But the dynamic range was still low because of large phase shifts. Then, along came ferrite magic tees, five-millimeters thick. Podell, by putting one in the vca, reduced the attenuator's electrical length, cutting phase shift to under 5°.

Anzac's attenuator has a dynamic range of 0 to 20 db, and a maximum vswr under 1.2. Insertion loss is 1.0 db for low frequencies, and 1.5 db at higher values. For a given control voltage, the plot of attenuation versus frequency is a line with a slope of 0.000025 db per Mhz.

On the level. Anzac expects its vca to replace mechanical attenuators, popular because of their flat attenuation over broad frequency bands. "We're close to them in performance now," says Podell. He claims there is no other vca that can match its performance under 1 gigahertz.

Anzac hopes to sell to the military and to makers of sweep generators. One use suggested by Podell is matching the outputs of a pair of antennas tracking the same object.

The vca could also be used to regulate the output of a sweep generator.

If more than 20-db attenuation is required, the vca's can be cascaded. The devices are normally controlled by a current source, 5.8 milliamps for 0 db to -0.58 milliamps for 20 db attenuation.

The cost is about \$200 and delivery time is four weeks.

A-R Anzac Electronics Co., 121 Water St., Norwalk, Conn. 06854 [409]

NEW EFFICIENCY FOR ULTRASONIC TRANSDUCERS

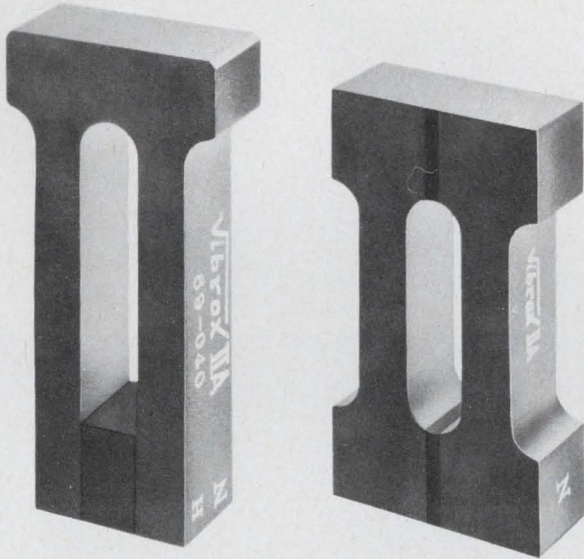

π type

NA type

Now, adding new efficiency to ultrasonic propagation, **Tokin** introduces VIBROX—unique ferrite magnetostrictive vibrators. VIBROX has minimum eddy current loss and a far greater electro-mechanical transduction efficiency than conventional vibrators. A wide range of application embraces ultrasonic cleaning and degreasing; metal, textile, and chemical processing; and echo-sounding and navigation devices such as depth-sounder, fish-finders, etc.

Tokin VIBROX is supplied in two shape-types with nominal frequencies ranging from 15 to 100Kc. Termed NA and π respectively, both make use of associated permanent magnets to totally eliminate the need for DC bias—despite the fact that VIBROX is magnetostrictive.

For further information and brochures, write to:

Tokin

Tohoku Metal Industries, Ltd.

7-4, GINZA-HIGASHI, CHUO-KU, TOKYO, JAPAN
Telephone: Tokyo (542) 6171 Cable Address: TOHOKUMETAL TOKYO

Main Products: Permanent Magnets (Cast, Ferrite), Tape Wound Cores, Bobbin Cores, Magnetic Laminations, Fe-Co Alloys, Sendust Cores, Ferrite Cores, Memory Cores, Memory Matrices, Pulse Transformers

Circle 155 on reader service card

What price performance in a quality filter?

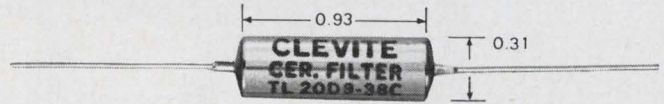

less than \$15
with Clevite's compact
ceramic ladder filter.*

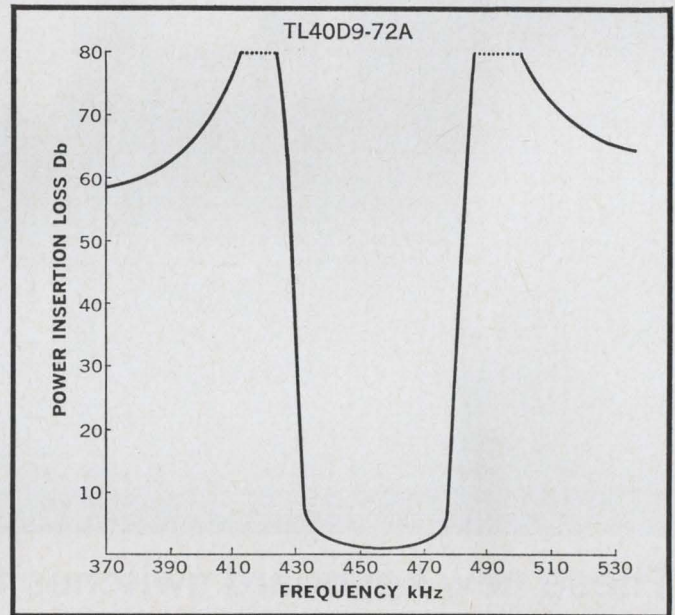

Here's the smallest (less than 0.07 cu. in.), most rugged fixed-tuned filter on the market today!

Clevite's 9-disc miniature filter is packaged in a hermetically-sealed cylinder, exceeds all military environmental specifications, is ideal for transistorized i-f amplifier circuitry in AM and FM sets plus many other applications that call for a fixed-tuned filter. Stop band rejection: 50 db. Center frequency tolerance: ± 3 kHz. Stability: within $\pm 0.2\%$ for 5 years; within 0.2% from -40°C to $+85^{\circ}\text{C}$. Impedance (in and out) 2000 ohms for B/W less than 12 kHz; 1000 ohms for broader bandwidths.

Following models standard at 455 kHz (A) or 500 kHz (C) (custom models on special order):

Model Number	B/W	
	min. @ 6db	max. @ 60 db
TL10D9-20 (A or C)	10 kHz	20 kHz
TL16D9-32 (A or C)	16 kHz	32 kHz
TL20D9-38 (A or C)	20 kHz	38 kHz
TL30D9-57 (A or C)	30 kHz	57 kHz
TL40D9-72 (A or C)	40 kHz	72 kHz

*PRICES: 1—\$25 ea; 25—\$20 ea; 100—\$17.50 ea; 500—\$15 ea; 1000—\$13.75 ea; 2500—\$12 ea.

(Prices subject to change without notice)

Send order or request for Bulletin 94021 to: Clevite Corporation Piezoelectric Div., 232 Forbes Rd., Bedford, Ohio 44014, U.S.A. Or: Brush Clevite Company, Limited, Southampton, England.

CLEVITE

Circle 125 on reader service card

125

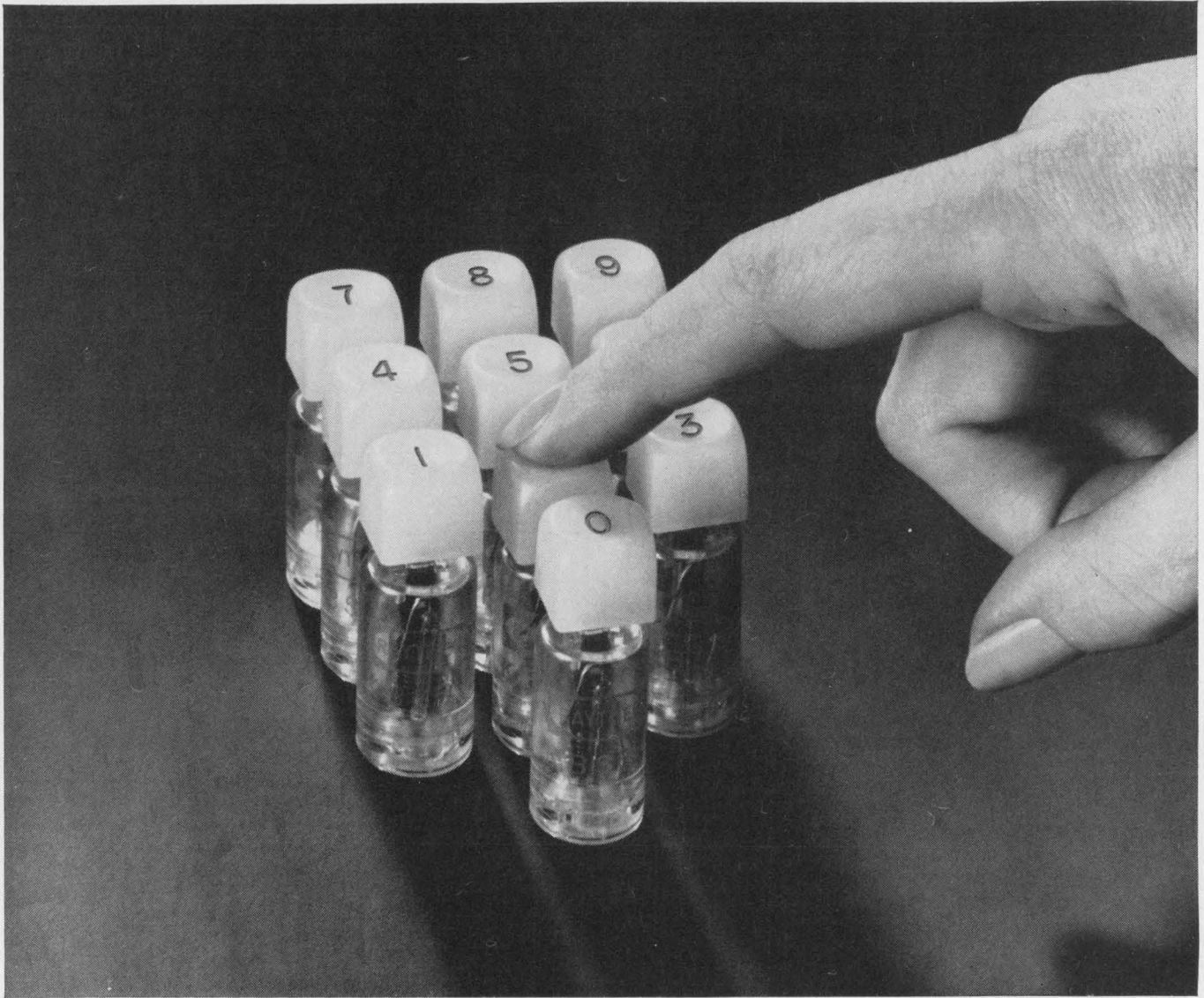

These new keyboard switches feature unusually precise action and low-cost mounting. See for yourself—write for samples.

These elegantly styled key switches are especially suitable for computers, learning and business machines, and other advanced control equipment.

Designed by Raytheon, they have a featherlight touch that is precise and reliable. Just a 3-oz. touch activates the switch. Because of the unique design, this action can be repeated more than 10 million times. Yet the switches cost as little as 60¢ in production quantities.

Raytheon key switches are available in a wide range of standard- and custom-cap shapes, sizes, colors,

and alphanumeric. The characters can be illuminated by backlighting. All switches are made of high-quality materials: stain-resistant caps; polycarbonate body parts; stainless steel springs; beryllium and stainless steel contacts. They are available in single- and double-level wipe-action types, and in dry-reed, hermetically sealed single- and double-level types.

Write for samples. For free samples, write on your letterhead describing your application to: *Raytheon Company, Industrial Components Operation, Dept. 2351-EL, Quincy, Massachusetts 02169.*

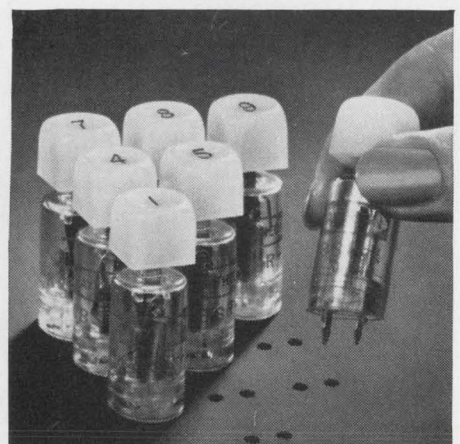

Simple, low-cost mounting. Raytheon switches plug into .125" PC board. Contact pins snap in, firmly lock switch in place for soldering. This permits you to use flow soldering techniques—cut keyboard assembly time and costs.



New Subassemblies Review

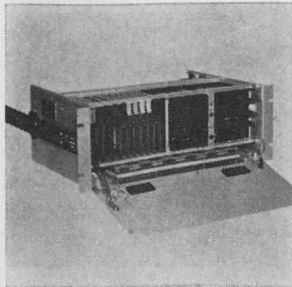

Read-only transformer memory systems series LBS have bit capacity ranging from 32,768 to 262,144 bits. The nondestructive read-only cycle time is 300 nsec. Access time is 250 nsec. The system provides a parallel read-out of up to 128 bits. Operating temperature range is 0° to +50°C. Memory Technology Inc., 223 Crescent St., Waltham, Mass. 02145. [381]

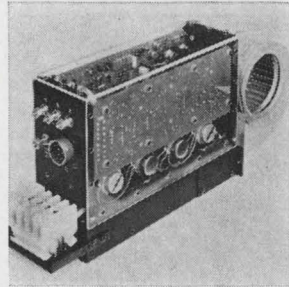

D-c servo amplifier model A505 can provide a 70-amp peak pulse output at 40 v d-c for fast acceleration and deceleration of high-response d-c motors. It has an integrally mounted cooling and provide for adequate cooling and increased steady state rating. Voltage gain is 50. Power supply can be 28 or 40 v d-c. Westamp Inc., 1542-15th St., Santa Monica, Calif. [382]

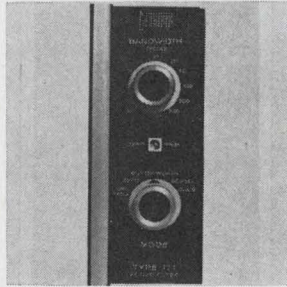

Active low-pass filter type 171 is designed to reduce noise, restrict bandwidth, and provide data correlation. Cut-off frequencies from 2 to 2,000 hz with Butterworth, Bessel, or gaussian characteristics are available by switch selection. Input impedance is greater than 100 megohms. Price is \$590. Neff Instrument Corp., 1088 E. Hamilton Rd., Duarte, Calif. 91010. [383]

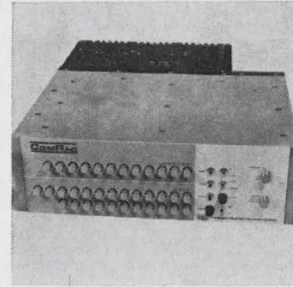

Core memory systems in the Com Rac series will be available in several models. Model 100 exhibits a cycle time of 1 μ sec, an access time of 0.45 μ sec, and is available in capacities up to 4,096 words by 24 bits or 8,192 by 12 bits. The memory is packaged in plug-in assemblies 7 $\frac{1}{4}$ x 9 $\frac{1}{4}$ in. Information Control Corp., 1320 E. Franklin Ave., El Segundo, Calif. 90245. [384]

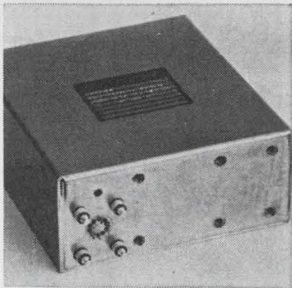

A-c/d-c power modules series RA-80 are adjustable from zero to max. output and externally programmable in several modes. They come with outputs of 0-10 v to 0-160 v d-c, power to 1,000 v. Regulation and ripple characteristics are good, and efficiency up to 80%. Units operate at base temperatures to 80°C. Technipower Inc., Benrus Center, Ridgefield, Conn. 06877. [385]

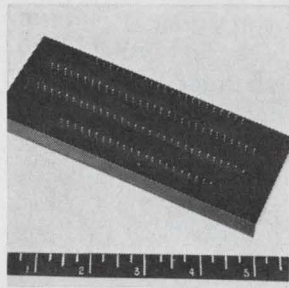

High-reliability 100-tap delay line model BF-14-419 is especially designed for memory systems. It features a maximum rise time of 30 nsec, for a delay of 1,000 nsec, with distortion at the taps held to less than 5%. The unit is available from stock at an impedance of 93 ohms. Custom-engineered units are also available. Bel Fuse Inc., 198 Van Vorst St., Jersey City, N.J. [386]

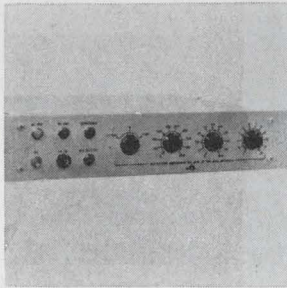

Power supply model 5002-10 delivers up to 2,012 v d-c and up to 10 ma. Highly regulated, its output varies only 0.0025% or 2 mv for a 100% load change or 10% line change. The unit can operate at either positive or negative polarity with a temperature coefficient less than 50 ppm/°C and stability of 0.005%/hr. Raytheon Co., Richards Ave., S. Norwalk, Conn. 06856. [387]

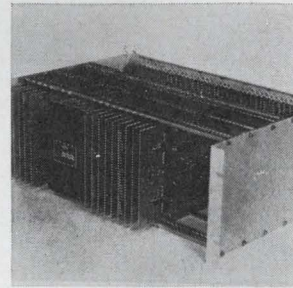

Integrated circuit memory system model CE-150 is available in capacities of 4096, 8192 and 16,384 words with word lengths variable in 4-bit increments from 8 to 36 bits. The random access unit has a full cycle time of 1.5 μ sec and an access time of 750 nsec. It has application in small computers. Lockheed Electronics Co., 6201 E. Randolph St., Los Angeles 90022. [388]

New subassemblies

Three-wire design speeds up memory

Smaller cores and combined sense-inhibit line permit nanosecond access with conventional 3-D organization

A large ferrite-core memory that has the cost advantages of three-dimensional design but attains unusually high speeds by using smaller cores will be shown this week at the Spring Joint Computer Conference in Atlantic City, N.J. The memory is the Ampex Corp.'s

new model 3DM-750 unit, which has a 750-nanosecond cycle time and a 300-nsec data access time. These speeds—perhaps double those of the usual large 3-D memory—are made possible with cores only 18 mils in diameter threaded with three wires.



Three wires for speed. New 3-D memory fits in 19-inch rack.

now...a dozen tools for dozens of jobs in a hip pocket set!



No. 99PS-50

Really compact, this new nutdriver/screwdriver set features 12 interchangeable blades and an amber plastic (UL) handle. All are contained in a slim, trim, see-thru plastic case which easily fits hip pocket. Broad, flat base permits case to be used as a bench stand. Ideal for assembly and service work.

7 NUTDRIVERS:

3/16", 7/32", 1/4",
9/32", 5/16", 11/32",
3/8" hex openings.

2 SLOTTED SCREWDRIVERS:

3/16" and 9/32" tips.

2 PHILLIPS SCREWDRIVERS:

#1 and #2 sizes.

EXTENSION BLADE:

Adds 4" reach to
driving blades.

HANDLE:

Shockproof, breakproof. Exclusive, positive
locking device holds blades firmly for turn-
ing, permits easy removal.

WRITE FOR
CATALOG 162



XCELITE, INC., 130 Bank St., Orchard Park, N.Y. 14127
In Canada contact Charles W. Pointon, Ltd.

Conventional 3-D memories use 22-mil cores and four wires—for x-select, y-select, sense, and inhibit functions. Most high-speed ferrite-core memories—such as Ampex' last major development, the model RM [Electronics, Nov. 13, 1967, p. 201]—are 2-D or 2½-D. But these cost more than the 3-D because they require more electronic drive and sense circuits in proportion to the amount of information they can store.

The basic 2-D memory has two orthogonal sets of wires, one set containing a wire for each word and the other a wire for each bit in a word. At each intersection of the two sets, a word wire and a bit wire pass through the hole in a toroidal ferrite core. A third set, the sense wires, is parallel to the bit wires.

To read data from a 2-D memory, a current strong enough to switch to 0 all the cores that it threads flows along a single word wire. Cores that switch from 1 to 0 generate voltage pulses in the sense wires. To store data, a current, half the magnitude of the read current, passes through the word wire in the reverse direction, and another half current passes along those bit wires threading cores that are to store 1's. The two currents combine to set the proper cores to 1 where only the half-current flows, the cores don't switch.

The conventional 3-D memory is a series of stacked planes, each containing one bit of each word in the memory. In each plane two orthogonal sets of wires permit any core in the plane to be addressed; the corresponding wires in all planes are connected in series to select all the bits of a word. In each plane a sense wire detects the change in magnetization of any core, and an inhibit wire opposes the current in one of the two select wires to store a 0.

To read data from a 3-D memory, a half-current passes along one wire in each of the two orthogonal sets, in such a direction as to switch to 0 all cores that the two wires thread. Cores that switch generate voltage pulses in the sense wires; where only the half-current flows, the cores remain unswitched. To write data, a half-current runs through each of the two wires in the opposite direction,

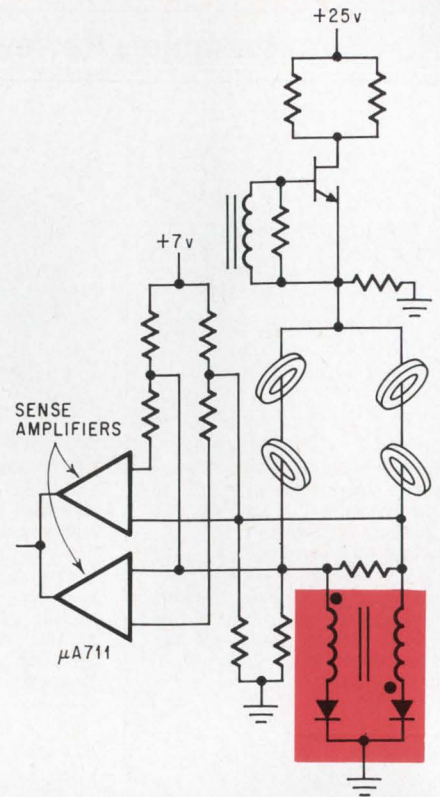

switching cores to 1 except where the inhibit current opposes them.

Because the larger cores take longer to switch, and because the longer wires are accompanied by more parasitic effects that tend to reduce speed, the speed of the 3-D has generally been thought to be limited. Getting four wires through 22-mil cores is difficult; nobody has seriously considered trying it on a production basis with smaller cores. But Ampex engineers sidestepped both difficulties by designing a 3-D memory with only three wires through each core, combining the sense and inhibit functions on a single winding.

The key to the design is what the designers call an antibalun transformer. This is a transformer with a 1:1 turns ratio, whose two coils are connected with opposite polarities to the two sides of the inhibit line, as shown above. These two sides, as in conventional 3-D memories, pass in parallel through adjacent rows of cores, exchanging positions at the center of the row; this arrangement minimizes the noise picked up while data is being read out. If the resistance of both sides of the winding is exactly equal, the same amount of current flows through both coils of the transformer. If

for some reason the current through one side tends to increase, the transformer generates a back voltage on that side to hold back the current and an opposite voltage on the other side to increase the smaller current—thus tending to keep the two currents equal. Because the currents in the two coils tend to remain equal and in the same direction, the connection is called an antibalun.

Because the two coils have opposite polarities, the two currents see a low common-mode impedance in the antibalun and build up quickly when the transistor switch at the top of the diagram turns on. When it turns off, if the currents haven't been equal, a correcting flux has built up in the transformer, creating circulating currents in the sense-inhibit line. Because the resistance of the line plus the transformer coils is only a few ohms, the ratio L/R in the winding is high and the time constant is long—so that these circulating currents could continue for many microseconds. To increase R and reduce the time constant, two diodes at the bottom of the antibalun pass normal inhibit current with hardly any resistance but increase the resistance to circulating currents to several megohms.

With the circulating current thus quickly decaying and the transistor switch turned off, the inhibit line is effectively floated electrically at the end of the inhibit cycle. The differential voltage generated during a sense cycle sees a very high impedance in the antibalun, providing a maximum input to the sense amplifier.

The basic module in the new memory contains 16,384 words of 40 bits each and is packaged in a unit that occupies $5\frac{1}{4}$ inches vertically in a standard rack 19 inches wide. Smaller memories are available in the same package. Any word count that is a multiple of 4,096 is available, and the word length can be anything from four to 40 bits. Up to eight of the $5\frac{1}{4}$ -inch modules can be stacked, building a memory as large as 65,536 words of 80 bits each—more than 5 million bits. The price range is \$12,000 to \$250,000, including the drive and sense circuits.

Ampex Corp., 401 Broadway, Redwood City, Calif. 94063 [389]

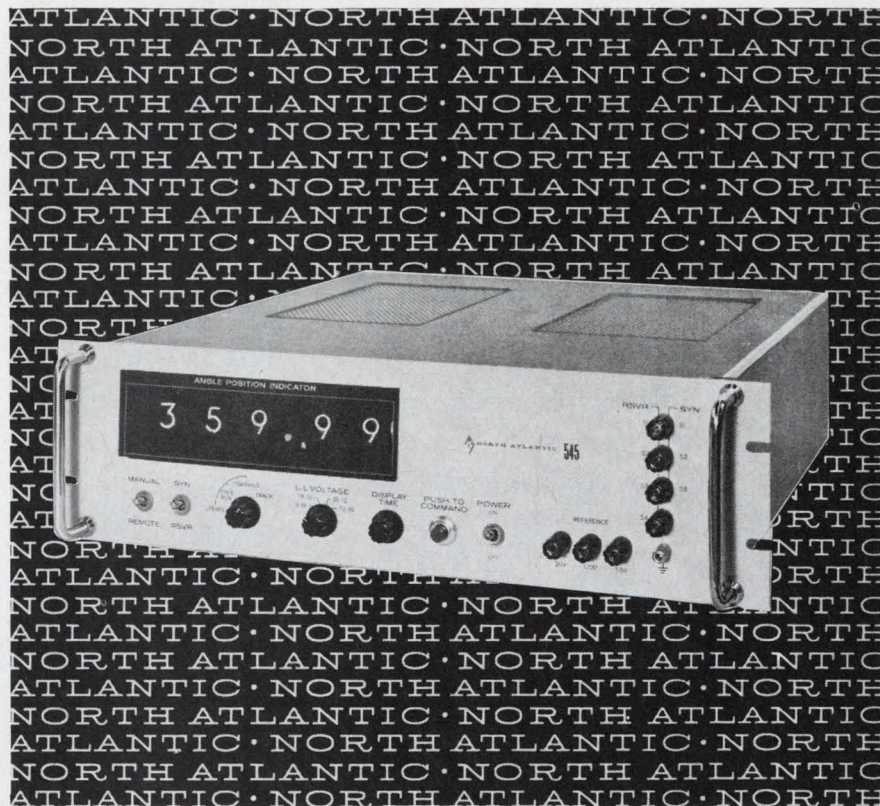

resolver/synchro to digital conversion

~~20,000°~~... **.01° accuracy**
~~20,000°~~ **/sec. tracking**

North Atlantic now brings you a new generation of solid-state analog-to-digital converters for resolver and synchro data. They offer major advances in high-speed precision tracking as required in modern antenna readout, ground support, simulation, and measurement systems.

For example, the Model 545 provides conversion of both resolver and synchro data at rates to ~~2000°~~ **20,000°**/second, and accommodates 11.8v to 90v 400Hz line-line signals. For multiplexed applications, acquisition time is less than 50ms. Digital output data is visually displayed and simultaneously available on rear connectors. All modes are programmable as well as manually controlled. Optional features include .001° resolution with 10 arc second accuracy, data frequencies from 60Hz to 4.8KHz, data freeze command for digital readout at a critical instant, and programmed mode where difference angle computation is required.

Your North Atlantic representative (see EEM) has complete specifications and application information. He'll be glad to show you how these converters can answer critical interface problems in your system.



NORTH ATLANTIC industries, inc.
TERMINAL DRIVE, PLAINVIEW, NEW YORK 11803 • 516-681-8600

Trusonic found a better sound at Durez

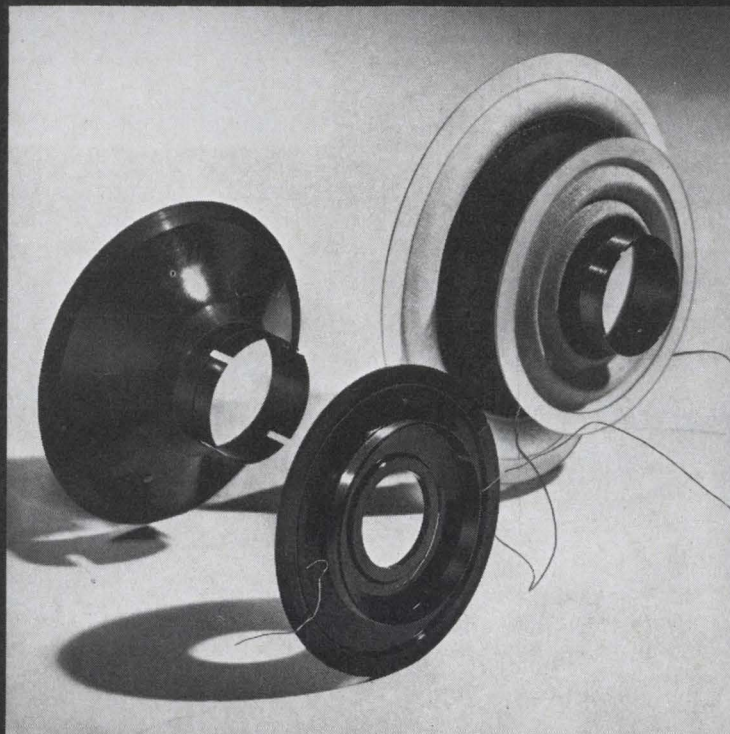

Trusonic builds its new, sophisticated sound systems around speaker cones precision-molded from Durez® phenolics.

Trusonic has found that our phenolics, molded into cones with perimeters as thin as .0065", gave a truer energy transmission than any other material. The added resistance of our phenolics to moisture, shock, and distortion lets Trusonic guarantee its sound systems for 10 years with complete confidence.

Would a tough wafer-thin material with excellent electrical properties improve an idea of yours? Challenge us with your design. Ask your molder for details, or write Durez Division, 9004 Walck Road, North Tonawanda, N.Y. 14120.

 **hooker**
DUREZ DIVISION

New Semiconductors Review

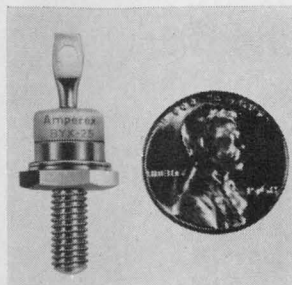

Silicon rectifier diodes series BYX are for heavy industrial use. The BYX25 controlled-avalanche units are used from 600 to 1,000 v at 20 amps average current. The 600-v units have avalanche breakdown ratings from 750 v to 1,880 v. For 1,000-v diodes, minimum avalanche breakdown rating is 1,250 v; maximum, 1,880 v. Ampere Electronic Corp., Slatersville, R.I. 02876. [436]

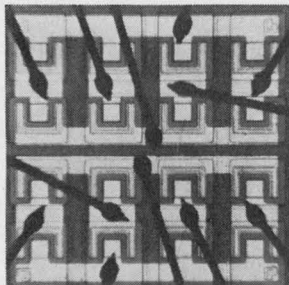

Single-chip diode array RDA-10 is for core driver applications. It shrugs off surge currents to 1,000 ma with a steady state forward current of 200 ma. The device features working inverse voltage of 30 v, and provides max. reverse recovery time of 20 nsec, even at extreme switching conditions. Rated power dissipation is 400 mw. Radiation Inc., Melbourne, Fla. 32901. [437]

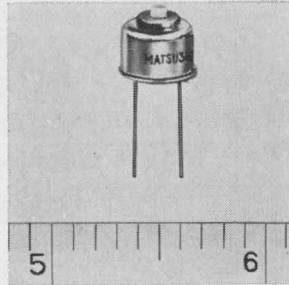

Pressure-sensitive diodes employ impurities that are highly sensitive to semiconductor stress effects. Variation of resistance is 10^3 . Sensitivity increases in proportion to the impurity concentration (atoms per cm^3). Operating temperature range is -30° to $+60^\circ\text{C}$. Rated working voltage is 20 v d-c max. Matsushita Electric Corp. of America, 200 Park Ave., N.Y. 10017. [438]

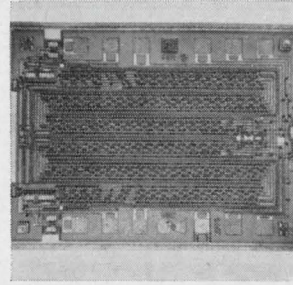

Dual 50-bit dynamic serial shift register MEM 3100 is constructed on a single monolithic chip utilizing 656 MTOS P-channel enhancement mode transistors. It utilizes 4-phase operation and requires only two external clocks. Features include low power dissipation, high noise immunity, and input data selection. General Instrument Corp., 600 W. John St., Hicksville, N.Y. 11802. [439]

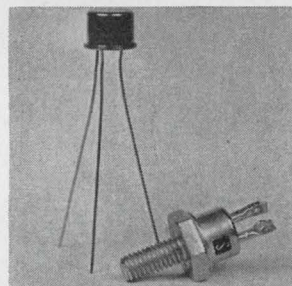

Pnp silicon power transistors in TO-111 cases (SDT3301-4) and TO-5 cases (SDT3321-4) have breakdown voltages of -40 , -60 , -80 and -100 v respectively. Minimum gain is 10 at collector current of 5 amps, and gain range is 40-120 at collector current of 2 amps. Gain-bandwidth product is 40 Mhz min. Solitron Devices Inc., 1177 Blue Heron Blvd., Riviera Beach, Fla. 33404. [440]

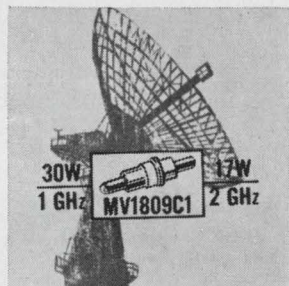

Silicon, step-recovery power varactor diodes provide 17 w of output power at 2 GHz ($P_{in} = 30$ w). Type MV1809C offers a minimum doubling efficiency of 52% at 20 w input power, and the MV1809C1 guarantees a 58% minimum efficiency at 25 w in. Both units are available in the standard cartridge package. Motorola Semiconductor Products Inc., Box 955, Phoenix, Ariz. 85001. [441]

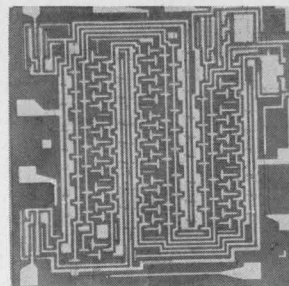

Static shift register 3300 is a serial access, 25-bit MOS IC. It operates on 1.5 mw per bit at 250 khz and has 25 flip-flops arranged serially in 16-, 8-, and 1-bit strings. There are over 200 components in the 70 by 75 mil chip. In a temperature range of -55° to $+85^\circ\text{C}$, price is \$27 each in lots of 1-24. Fairchild Semiconductor, 313 Fairchild Dr., Mtn. View, Calif., 94040. [442]



X-band and Ka-band Schottky barrier detector diodes D5754, D5691, and D5733 feature high burnout resistance (typically 5 to 10 w peak pulse power). Small junction areas permit tangential signal sensitivities in excess of -50 dbm at X-band and up to -45 dbm at 40 Ghz. Prices (1 to 9) range from \$12 to \$50. Sylvania Electric Products Inc., 730 Third Ave., N.Y. 10017 [443]

New semiconductors

FET reaches for the high ground

Higher operating frequency and reduction of static-charge problems are the principal features of a new transistor

A specialist in field effect transistors has decided to respecify the devices so an engineer knows what he is dealing with. At the same time, Siliconix Inc. has developed a FET that reaches the gigahertz range.

Designed for low-noise ampli-

fiers, oscillators, and mixers, the 2N5397 has a minimum gain of 15 decibels and a maximum noise of 3.5 db at 450 megahertz. Its competitors, one of which Siliconix second-sources, are rated at 10 db gain and 4 db noise and 13 and 4 db, respectively, both at 400 Mhz.

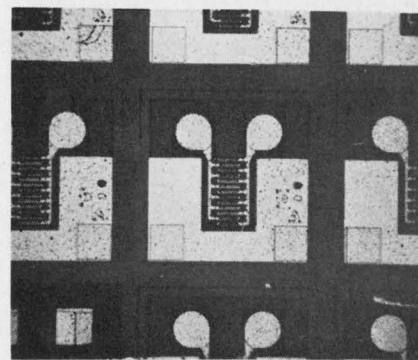

Math counts. Change in geometry resulted in a higher operating frequency for FET.

Replace Costly AC/DC Circuits!

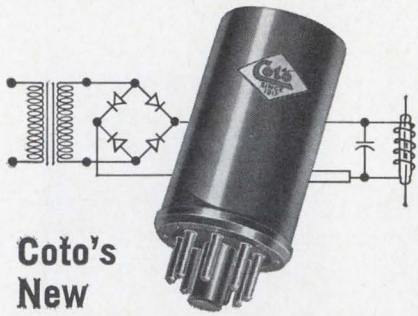

Coto's
New

A.C. Reed Relay

Designed to Operate on
Standard 60 Hz input

Contacts: Forms A, B, C with single or multiple poles.

Ratings: To 3 amperes or up to 5000 volts D.C.

Inputs: 50-400 Hz voltages available.

Physical: Available in steel or plastic octal base housings for plug-in mounting.

Write for complete specifications. For special requirements, give complete details for quotation.

Coto-Coil COMPANY, INC.
61 Pavilion Ave.
Providence, R. I. 02905
Phone (401) 941-3355

Circle 156 on reader service card

2 MODERN BUILDINGS FOR OFFICES, LIGHT INDUSTRY NEAR CAPE KENNEDY, FLORIDA

Prime 2-story bldgs. on Merritt Island, ideal for space-oriented firms. 4,653 sq. ft. Mila Office Bldg. available in 423 sq. ft. units. 56,400 sq. ft. Corps of Engineers Bldg. for industry and office use. 25,000 sq. ft. each floor. Minimum leasable area, 6,000 sq. ft. Alter to suit. Attractive rentals.

ESCO
Eastern Shopping Centers, Inc.

P.O. Box 3095G, Orlando, Fla. 32802

The FET's improved performance is partly due to changes in geometry that the designer, J.B. Compton, senior engineer, considers proprietary.

Customer's man. According to Compton, "We tried to spec the device the way the customer will use it." Minimum transconductance is 5,500 micromhos measured at a drain current of 10 milliamps. Competitors claim 4,500 micromhos at zero bias.

"Transconductance specified at zero bias will not necessarily yield a usable transconductance at that value in a practical circuit," Compton says. He cites a competing device that would probably yield a transconductance of 3,400 micromhos at an operating current of 5 milliamps, even though it's rated at 4,500. He says the 2N5397 reaches 6,500 micromhos at zero bias.

"This kind of specification tells the circuit designer more," Compton asserts. Typical circuits would be in two-way radios, military telemetry systems and low-noise microwave amplifiers.

By the chip. The cutoff frequency of the 2N5397 is not higher than other FET's, but it's limited to 900 Mhz by its package, a TO-72 can header, Compton says. The device has a maximum usable frequency of 1.5 gigahertz in chip form. Siliconix also plans to sell chips individually for higher-frequency hybrid applications.

Being a junction FET, the 2N5397 is less subject to the handling problems of metal-oxide semiconductor high-frequency FET's. Mos FET's are commonly subject to static-discharge problems around the gates, causing them to burn out.

Climbing up. With a chip peaking at 1.5 Ghz., higher ranges must be near. Compton thinks there's a good chance of 3 Ghz in 18 months. Improvements in photomasking techniques should raise cutoff frequencies even higher, without any fundamental breakthroughs, Compton believes. However, he does see a materials limitation for silicon FET's at about 10 Ghz.

Prices are \$5.70 in lots of 100 or \$8.50 apiece for the 2N5397 and \$4 and \$6 respectively for the 2N5398 industrial version.

Siliconix Inc., 1140 W. Evelyn Ave., Sunnyvale, Calif. 94068 [444]

New semiconductors

Optics aid pulse amplifier

Photo diode and light sensor form input stage for IC amplifier

A new semiconductor technology using optical coupling to obtain complete electrical isolation within a standard integrated circuit package has led to the development of an optoelectronic pulse amplifier by Texas Instruments.

Designated the SNX1304, the device is being offered for engineering evaluation and consists of an IC feedback amplifier with an input from a light-sensitive diode in the silicon chip. Fixed to the surface of the chip is a gallium-arsenide pn-junction light emitter. This is placed on top of the diode.

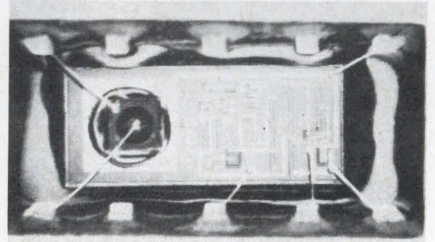

Applications include transmission of a-c or d-c signals across computer-subsystem interfaces where circulating currents prevent interconnection of ground leads, and where rejection of common-mode noise at the end of a long data-transmission line is required. The high input-to-output isolation (± 100 volts) of the optical coupling allows the device to function as a broad-band pulse transformer with response extending from d-c to 100 kilohertz.

The device has a forward input threshold current of 4 milliamps and a forward input voltage rating of 1.2 volts. Its off voltage is 5 and its on voltage is 0.2 volt. Rise and fall times are 250 and 350 nanoseconds respectively, and it comes in a standard 10-lead TO-89 flat pack.

Texas Instruments Inc., Dallas, Texas [445]

CLASSIFIED ADVERTISING

SEARCHLIGHT SECTION

BUSINESS OPPORTUNITIES
USED OR SURPLUS EQUIPMENT

**GET IT from GOODHEART!
0.01% SORENSEN Line Voltage Regulator**

#1001 regul. against load changes 0-1 kva & line changes 95-130 v. 1 ph 55/65 cy; adj. output 110-120 v, holds to 0.01%. Distortion max. 3%. Response 0.1 sec. Regularly \$570.00. From us, OK

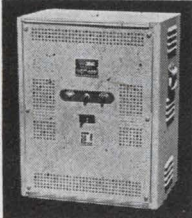

grtd, only \$275.00
#500S is same, 0.5 kva, 0.1% . . . \$89.50
#1000S is same, 1 kva, 0.1% . . . \$99.50
#2000S is same, 2 kva, 0.1% . . . \$179.50
Sup. Electric #IE-5102 is same spec, electronic regul., but 2 1/2 kva, 0.1% . . . \$199.50

Sup. Elect. IE-20060: Same specs as above but MIL-spec built, all potted xfmrs, etc. Behind rack panel 21" h, 14 1/2" dp, no cabinet. Regular \$960. BRAND NEW, export boxed, 330# fob Utica, N.Y. . . . \$279.50 (Cabinet for above \$30 fob Utica.)

Sorensen R5010 all-solid-state, zener reference, 0-5 kva, 90% efficient. Regular \$792. With cabinet \$450.00

Sup. Elect. IE-5105: Same specs as Sorensen "S" series, 0-5 kva, regularly \$655.00. Only . . . \$349.50

Sorensen 10,000S: Same specs as all above, but 0-10 kva. Regular \$1272. With spares, 670# fob San Diego \$695.00

ALL ABOVE are 1 ph 95-130 v. Two below are 1 ph 190-250 v in, adjust. 220-240 v out, 0-5 kva. Same specs, choose Sorensen 5000-2S or Sup. IE-5205P \$450.00

(Picture is #5000-2S.)

Above are electronic. Following are electromech. A servo system senses output, turns a Variac or Powerstat, corrects to 1% very fast. Life tested 99 years. 47-63 cy OK. AND NO DISTORTION!

Gen. Radio #1570AL: 0-6 kva, regular \$530. From us only \$199.50

Sup. Elect. EM-4106 in upright metered cabinet, 0-6 kva \$199.50

Sup. Elect. EM-4119 in metered cabinet, 1 ph, 0-15 kva \$295.00

Sup. Elect. EM-4228 0-27.5 kva 1 ph. \$495.00

Above are all 95-130 v; 190-260 v follows:

Sup. Elect. EM-4228, 1 ph, 0-27 1/2 kva, regular \$750. New \$495.00

EMT 6220Y (transistorized) 3 ph 20 kva, \$1200 value, only \$450.00

SP-600 RECEIVERS WANTED! Phone person-to-person George Lichterman 213-272-5707 and make a deal! Phone collect if you prefer.

DO NOT ASK FOR CATALOG! ASK FOR SPECIFIC ITEMS OR KINDS OF ITEMS YOU NEED!

R. E. GOODHEART CO. INC.

Box 1220-E, Beverly Hills, Calif. 90213

Phones: Area 213, office 272-5707, messages 275-5342

CIRCLE 968 ON READER SERVICE CARD

free catalog
POTTING APPLICATORS
MANUAL AND DISPOSABLE
6cc 12cc 30cc
FOR POTTING, ENCAPSULATING, AND SEALING OF MINIATURE COMPONENTS
PHILIP FISHMAN COMPANY
7 CAMERON ST., WELLESLEY 81, MASSACHUSETTS

CIRCLE 969 ON READER SERVICE CARD



*Somebody—
Somewhere,*

needs your idle equipment!
Reach that buyer quickly and economically thru the

“SEARCHLIGHT SECTION”

*The meeting place of Used
Equipment Buyers and Sellers*

Today's brand new ocean opens your brand of engineering career opportunity.

Newport News, world's largest and most advanced shipbuilding company—involved with all today's revolutionary marine developments—has immediate career openings in all these engineering fields:

- Mechanical Engineers
- Electrical Engineers
- Marine Engineers
- Industrial Engineers
- Naval Architects
- Nuclear Engineers
- Civil Engineers
- Metallurgical Engineers
- Data Programmers
- Systems Analysts
- Chemists
- Laboratory Analysts

With an order backlog now over \$500,000,000, we're bidding for creative engineers who like challenges and personal responsibility. Write our employment manager, John J. Gaughan. You'll get fast action.



Newport News

SHIPBUILDING AND DRY DOCK COMPANY, NEWPORT NEWS, VIRGINIA

An Equal Opportunity Employer

CIRCLE 966 ON READER SERVICE CARD

Opportunities

ENGINEERS

**CAREER IN DEVELOPMENT, DESIGN, AND MAINTENANCE
ENGINEERING IN NAVAL AND MARINE AVIATION**

If you are a graduate in Aeronautical, Electrical, Electronics, Mechanical, Industrial or Chemical Engineering, or a Metallurgist—If you want to serve your Nation in a well-paid professional post with all the fringe benefits (ample retirement pay, paid holidays and vacations, sick leave, health and hospitalization insurance)—If you like outdoor living in a moderate climate, with unsurpassed ocean beaches, boating, swimming, hunting, fishing at your doorstep—If you like your U. S. History spread out around you—

**THE NAVAL AIR REWORK FACILITY MARINE CORPS AIR STATION
CHERRY POINT, NORTH CAROLINA NEEDS YOU NOW
IN A RESPONSIBLE CAREER CIVIL SERVICE POSITION**

— Starting Salaries —

GS-5	degree required	\$ 7239
GS-7	degree plus 1 year experience	8759
GS-9	degree plus 2 years experience	9668
GS-11	degree plus 3 years experience	10945

MS or PhD Degree Holders Earn More Proportionately

Send Application Form 57 (Available at Most Post Offices) To:

Miss A. E. Williams, Employment Superintendent
Industrial Relations Department

U. S. Marine Corps. Air Station

Cherry Point, North Carolina 28533

Where Equal Opportunities for Employment are Guaranteed

CIRCLE 967 ON READER SERVICE CARD

New Books

Solid Statements

Fundamental of Silicon Integrated Device Technology, Volume II—Bipolar and Unipolar Transistors
R.M. Burger and R.P. Donovan
Prentice-Hall Inc.
480 pp., \$15

The two pillars of integrated-circuit technology, bipolar and unipolar (junction and surface) transistors, are discussed from the simple models of their d-c operation through their more complex relationships. The authors include second-order effects, such as drift currents and small parasitics.

Sections on bipolars include carrier and current theory, capacitance, parasitics, small-signal and large-signal behavior, structures, and topological design. The authors compare the ic and discrete versions and provide data on metalization, multiple structures, diodes, and complete ic design.

The discussion of junction and

surface elements includes static and dynamic characteristics, noise, temperature effects, stability, and design. Among applications covered are linear and logic circuits, radiation effects, and ic construction.

The material can be grasped easily by those who haven't read Volume I of this series, which covers oxidation, diffusion, and epitaxy and is geared to processing rather than final design.

The book has two minor drawbacks: the minimal treatment of passive elements and the overabundance of tutorial presentation.

Fielder's choice

FET Applications Handbook
Jerome Eimbinder
Tab Books
288 pp., \$12.95

To this compilation of articles on field effect transistors which originally appeared in the *EEE* magazine,

Jerome Eimbinder—the managing editor of that publication—has added a number of papers presented at applications clinics and seminars sponsored by his magazine.

Through this technique, a variety of topics is covered by more than 20 experts. The reader gets a fairly thorough discussion of FET theory, substantial design information, and numerous examples of FET application. But, despite its considerable merits, this anthology does not fulfill the promise of its title nor can it be used as a single source of information on FET applications.

The anthology approach is self-defeating. With each of the contributors expressing his special point of view and using his own terminology, there is the inevitable loss of a unifying perspective and continuity. This is particularly evident when the reader comes upon different symbols for identical terms or repetition of material he has already read in a slightly different form earlier in the book.

The editor has organized his ma-

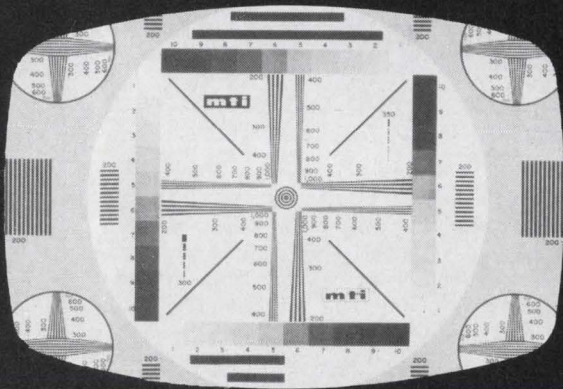

Video: MTI Test Pattern

Audio: This is a storyboard. A storyboard is, fundamentally, a blueprint for TV production. Thus, this is the MTI story about producing the finest closed circuit television equipment made. It is our *only* business so we concentrate on making the best in the business.

The MTI products, like the MTI test pattern have become the standards which all camera manufacturers attempt to attain. Comparison is the key. The products exhibited in our storyboards are the best. Compare them with any other product—even above our price range—see for yourself. All inquirers will receive a free copy of our 1000 line test pattern.

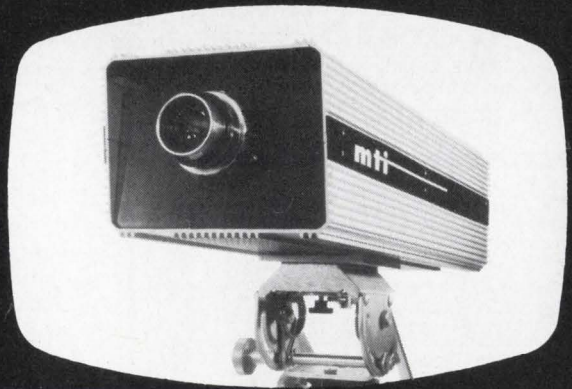

Video: Orth III

Audio: Image Orthicon/Image Isocon Separate Head Camera — for low light levels and applications where Vidicon and Plumbicon lag is intolerable.

A favorite for astronomers, broadcasters, radiologists, oceanographers, aircraft and helicopter applications, pressure and vacuum chamber applications • A proven product—continually updated but with years of active service to prove its reliability • 800 plus lines horizontal resolution standard • Your choice of tubes • Self contained or separate sync • Integrating modes available • Available 525, 875, 945, 1023 and other horizontal scanning rates • Available 50—60—400 cycle operations • Light weight—less than 25 lbs. • Long list of satisfied users • The standard all other manufacturers try to reach • Specify the best—The Orth III—Compare quality and price!

terial so that basic FET characteristics and simple applications are presented first. This permits the reader to make his way through to the more complex sections without too much difficulty.

Included in this survey of field-effect technology are discussions of a-c and d-c amplifiers, attenuators, r-f amplifiers, limiters and choppers. Also covered are complementary FET's, FET biasing, oscillators, FET noise, and preamplifiers as well as switches, serial arrays, commutation, photo-FET's and electrometers.

The magnificent seven

The Art of Computer Programing
Volume I: Fundamental Algorithms
Donald E. Knuth
Addison-Wesley Publishing Co.
634 pp., \$19.50

Computer programing is an art that has grown from the cameo to the heroic. Donald E. Knuth decided in 1962 to bring together most of the writings on computers. He envisioned a book of 12 chapters.

But before long he knew he

would need a seven-volume work. "Fundamental Algorithms" is the first of the projected seven.

Knuth packs into the first 120 pages all the mathematical derivations of computers, allowing an engineer who knows them to skip that section. But then he presents his feeling that there are "intriguing connections" between computers and the abstract mathematics that is his forte.

To back up that idea, he discusses computers and their ties to algorithms, mathematical induction, sums and products, permutations and factorials, binomial coefficients, and harmonic and fibonacci numbers.

Knuth has created an imaginary computer he calls "MIX," and a machine language to go with it. He applies MIX programs to his discussions of permutations and programing techniques such as subroutines, co-routines, interpretive routines, and input and output.

Other subjects covered, for which Knuth has prepared exam-

ples and graded practice exercises, are allocation, lists, trees, and multilinked structures. A working understanding of calculus and advanced algebra is necessary to appreciate this work, which might best serve as a graduate-level text.

Stephen Strell

Recently published

Introduction to Calculus, Donald Greenspan, Harper & Row, 439 pp., \$9.95

Treats derivatives, integrals, differential equations and other fundamentals of calculus; also develops theory, techniques, and applications relating to discrete functions, difference quotients, finite sums, and nonlinear difference equations.

Applied Mathematics for Electronics, J.H. Westlake and G.E. Noden, Prentice-Hall Inc., 608 pp., \$12.25

Covers the important middle ground between basic mathematics and the sophisticated topics associated with modern electronics—such as computers, filters and amplifiers. As each new principle is introduced, its application is discussed and illustrative examples are presented.

Electrochemistry, C.W. Davies, Philosophical Library Inc., 234 pp., \$20.00

Gives an up-to-date and concise account of the principles of electrochemistry. Is suitable for novices and for the industrial scientist who is looking for guidance in this field. Covers electrolytes, ionization, surfaces, cells, and kinetics.

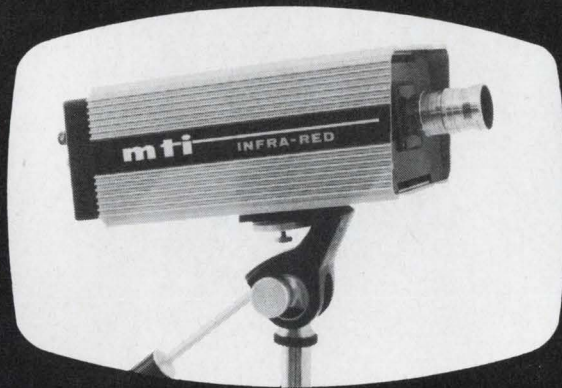

Video: VC 41 IR

Audio: Infra-red sensitive — self contained full EIA RS170 Vidicon camera for those applications requiring pictures with *no* visible light.

Very sensitive — will operate in visible light spectrum also • High resolution • Completely self-contained including EIA RS170 sync generator • Designed as an infra-red camera • Fully regulated • Premium construction • Infra-red sources available as companion item • Designed for completely unattended operation •

Specify the best — the VC 41 IR — Compare quality and price!

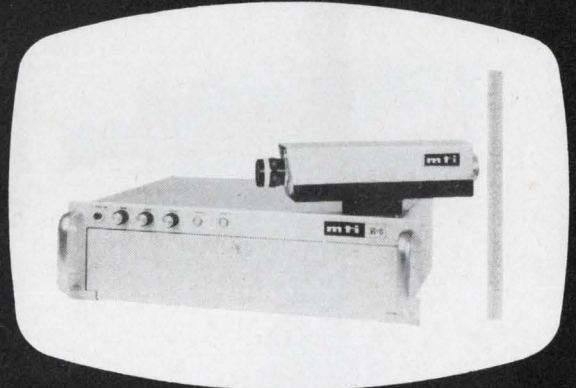

Video: VC 20

Audio: Separate head Vidicon camera for quality television instrumentation requirements.

Small size: 2 3/4" x 2 3/4" x 9 3/4" or 2 3/4" x 2 3/4" x 8" • Lightweight—less than 3 pounds • Camera control unit - 5" rack panel adaptable to power two cameras simultaneously • 800 plus lines horizontal resolution — 600 line corners • Available 525, 875, 945, 1023 scan rates • **Exclusive** — Quantum Light Sensor automatically adjusts sensitivity and pedestal over a 20,000 to 1 light change — compensates automatically for flares or bright spots in scene • Connecting cable super flexible — less than 1/2" diameter • Completely automatic — turn on and forget it — period •

Specify the best — the VC-20 — Compare quality and price!

Technical Abstracts

By wire

Field distribution of plated wire memory elements and its effect on memory characteristics
Judea Pearl
Electronic Memories Inc.
Hawthorne, Calif.

In a plated wire memory, the way the magnetic field is distributed on the surface seriously affects several important factors: adjacent bit interactions, drive currents, and sense signal amplitudes. An analysis shows that there is a characteristic length associated with the applied field and the magnetic properties of the wire that defines the shortest length in which the magnetization can be localized.

For a wire of diameter, d , and film thickness, t , and with a hard-axis susceptibility, x , the length is equal to the square root of the product of d , t , and x . In a typical plated wire, the characteristic length varies between 0.020 and 0.025 inch,

which corresponds to a maximum bit density of 40 to 50 bits per inch.

With these results, universal curves also can be plotted that give the required word current for the geometries chosen.

Presented at the 1968 Intermag Conference, Washington, April 3-5.

Pcm for privacy

Transmission performance of telephone networks containing pcm links
D.L. Richards
Post Office Research Station, London

Military men and others worried about eavesdropping can relax a little. A new pulse-code modulation coder-decoder designed to fit inside a telephone set can be used to digitize and scramble voice signals before they get on a line, making it difficult to tap in. The new device also permits large offices to economize on wiring by carrying all internal calls on wide-band digital circuits.

One such coder-decoder, using integrated digital-logic circuits in 40 flat packages and analog thin-film circuits, takes up only four cubic inches. Its power dissipation is less than 500 mw.

Analog-to-digital conversion begins when a narrow pulse opens a sampling gate, whose pulse amplitude output then excites a damped tuned circuit. The result is a decaying wave with an initial amplitude proportional to the sampled analog voltage. A Schmitt trigger generates an output pulse for each peak until the wave's amplitude falls below a set threshold. Thus, the number of pulses for each sample is a measure of its compressed amplitude. A standard binary counter then keeps track of the number of pulses, and a shift register converts the parallel output from the counter to the pcm train.

The decoder generates a fixed-amplitude pulse with a width that's proportional to the incoming line pulses. The same sort of counting techniques used in the coder determine the pulse length. Next, the

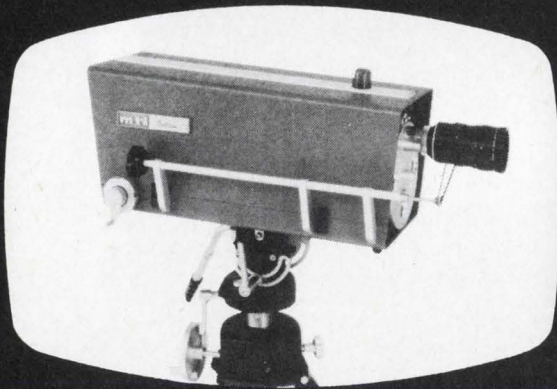

Video: VC 6

Audio: Viewfinder Vidicon camera for education and low budget broadcast stations. 800 lines at 0.3 foot candles target illumination • 8" viewfinder • Rear control lens turret or zoom lens • 3 channel audio built in • Standard 8280 cable • Lightweight. . . easy carrying handles standard. Rack mount CCU takes only 3½" space • Splash proof construction — that sudden rain shower will not bother the VC-6 • Premium Vidicon included •

Specify the best — the VC 6 — Compare quality and price!

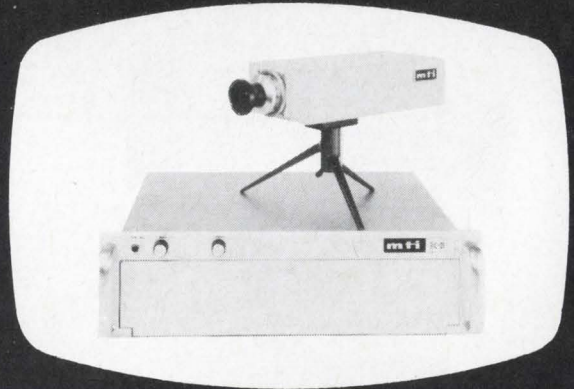

Video: PC 21

Audio: Separate head Plumbicon camera with exceptional resolution and gray scale — for those applications requiring a Plumbicon camera of instrumentation grade with an unusually fine signal/noise ratio. Very small size and weight • Camera control unit — 5" Rack Panel • 800 plus lines center resolution — 600 line corners • Available with separate or self-contained sync • Available 525, 875, 945, 1023 and other scanning rates • Connecting cable super flexible — less than ½" diameter • Light weight — less than 4 lbs • Rock stable — turn it on and forget it •

Specify the best — the PC 21 — Compare quality and price!

pulse is applied to an RC network that charges twice as fast as it discharges. The network's voltage is sampled for a fixed time that equals or exceeds the pulse width, producing the expanded decoder output, which is proportional to the original coder input.

Advantages of the pcm coder-decoder include a minimum amount of analog circuitry, the acceptance of positive and negative signals without the need for inversion or rectification, and a threshold level high enough to minimize drift.

Presented at the Colloquium on Pulse-Code Modulation, London, March 4.

Telltale heat

Infrared analysis of second-breakdown modes in power transistors

A.S. Dostoomian
Raytheon Co.
Wayland, Mass.
M.F. Nowakowski
NASA
Huntsville, Ala.

Testing a transistor for second breakdown without destroying or degrading the device has long been

a problem. Now a system that senses the imminence of second breakdown through thermal tests with a fast-scan infrared microscope eliminates this problem; the destructive effect of second breakdown is never reached. Thus, there is no permanent damage to the device.

The transistor is energized by a pulse that is synchronized with the microscope's scan cycle. This pulse can be delayed to allow the detector's instantaneous field of view to be phased to the infrared flash caused by second breakdown, at whatever point it might take place. As the transistor is scanned, the system's display shows a pulse, whose amplitude depends on the intensity of the hot spot, and a thermal map of the area scanned.

A complete raster scan of 150 transistors was taken at the second-breakdown current level, at half that current, and at two-thirds that current. For almost all lower current levels, the location of the initial hot spot occurred at the same point as the heat peak observed

during second breakdown. At the full second breakdown current level, about 30 transistors showed hot spots; second breakdown in these transistors occurred at a lower current level than the other transistors. Transistors that showed hot spots when scanned at current levels less than the rated maximum tended to go into second breakdown at lower current levels than units that exhibited no hot spots.

When testing for second breakdown in the forward- and reverse-bias directions, about half of the transistors showed hot spots occurring at the same point. The probable reasons for hot spots differing are the presence of more than one anomaly, and the temperature increase during testing.

After infrared testing, a number of transistors were again subjected to second breakdown. In the units that failed, melted areas occurred at the points where the initial heating was observed with the infrared microscope.

Presented at IEEE International Convention, New York City, March 18-21.



Video: VC 8

Audio: Separate head Vidicon camera for film chains and critical instrumentation applications.

A favorite for many years. Specified often by NASA and other critical buyers • 800 lines resolution / 0.3 foot candles • Standard 8280 cable • Premium Vidicon included • Rack mount CCU takes only 3½" space • Fully regulated • Designed for completely unattended operation • Premium construction • Outstanding signal/noise ratio •

Specify the best — the VC 8 — Compare quality and price!



Video: VC 11

Audio: Low cost instrumentation grade Vidicon camera — for those applications requiring high sensitivity with high resolution pictures at a budget price. Completely solid state with exception of Vidicon • Make excellent pictures in near darkness • Stable interlace — no interaction between sweeps • Resolution in excess of 600 lines horizontal • Scratch resistant case • Rugged splash resistant case • Easy to operate — learn in 5 minutes • Stable — set it and forget it •

Specify the best — the VC 11 — Compare quality and price!

New Literature

Single channel terminal. Lenkurt Electric Co., 1105 County Road, San Carlos, Calif. 94070. A flysheet describes the 46A single channel terminal that furnishes a voice channel with choice of in-band or out-of-band signaling. Circle 446 on reader service card.

Videotape recorder. Ampex Corp., 401 Broadway, Redwood City, Calif. 94063. Bulletin V158 contains features, specifications and a description of the VR-1200A high-band color and monochrome videotape recorder for broadcast and sophisticated closed circuit tv use. [447]

Reed relay. Solid State Electronics Corp., 15321 Rayen St., Sepulveda, Calif. 91343, has issued a bulletin on the model 7001 Microreed relay, a single-pole double-throw unit designed to be driven by transistors. [448]

Miniature terminals. Robinson Nugent Inc., 802 E. Eighth St., New Albany, Ind. 47150. A six-page catalog illustrates 94 different miniature and sub-miniature terminal styles. [449]

Antenna system. Andrew Corp., 10500 W. 153rd St., Orland Park, Ill. 60462. Bulletin 266 covers a 350-450 Mhz

remote controlled receiving antenna system. [450]

Microwave equipment. Microwave Systems Co., 6915 Lakewood Place, Denver, Colo., 80215, offers a product line catalog describing large passive repeaters, guyed and self-supporting towers, and microwave accessories. [451]

Shielding materials. Russell Industries Inc., 96 Station Plaza, Lynbrook, N.Y. 11563. Catalog No. 70 covers the full spectrum of shielding materials for electromagnetic and radio-frequency interference problems. [452]

Heterodyne mixer-oscillator. Weinschel Engineering, Gaithersburg, Md. 20760, has published an illustrated catalog sheet on the model HO-1 heterodyne mixer-oscillator. [453]

Elapsed time indicator. ENM Co., 5306 W. Lawrence Ave., Chicago 60630, has issued a catalog sheet describing the series T5B economy model elapsed time indicator. [454]

Wirewound resistors. Kelvin, 5919 Noble Ave., Van Nuys, Calif. 91401. Bulletin HR400-20-4 outlines the

specifications and test procedures set up by the company to approach the maximum in reliability goals for precision wirewound resistors. [455]

Electronic tachometers. Airpax Electronics, P.O. Box 8488, Fort Lauderdale, Fla. 33310. Bulletin F-11 describes the Tach-Pak, an electronic tachometer that converts rpm, speed or frequency into an output current or voltage linearly proportional to the input signal usually generated by the motion of a rotating component. [456]

Xenon flashtubes. Torr Laboratories Inc., 2228 Cotner Ave., Los Angeles 90064. A four-page brochure describes the Torrlite series of xenon flashtubes. [457]

Power amplifier. Beckman Instruments Inc., 2500 Harbor Blvd., Fullerton, Calif. 92634. Data sheet 68266 covers the unity voltage gain model 821 power amplifier, a unit that can increase power output of IC operational amplifiers as much as 40 times. [458]

Incremental shaft encoders. Disc Instruments Inc., 2701 S. Halladay St., Santa Ana, Calif. 92705. The use of Rota-switch shaft encoders for automatically

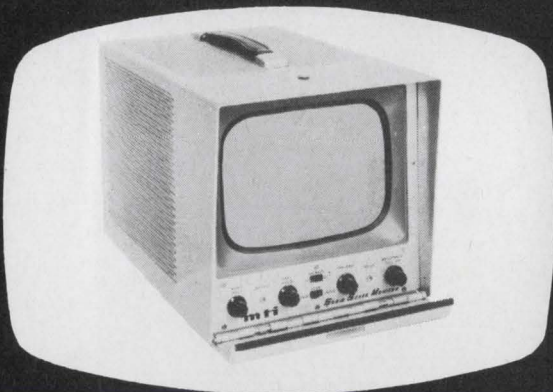

Video: VM 218

Audio: Fully solid state monitor — for quality broadcast and instrumentation applications. Completely solid state — including high voltage rectifier. Regulated low voltage • Regulated high voltage • Bright screen up to 100 footlamberts • 9" rectangular bonded face kinescope • Front panel switch permits viewing of raster corners and sides. High impedance video output — 2.2 megohms in parallel with 15pF or terminated into 75 ohms, switch selectable. High video impedance permits parallel operation of more monitors • Linearity — within 1% of picture height • Choice of models •

Specify the best — the VM 218 — Compare quality and price.



Video: VC 41

Audio: Self contained EIA RS170 Vidicon camera for those applications requiring extremely stable — very sensitive high resolution displays. Completely self contained — including EIA RS170 sync generator • 800 lines/0.3 foot candles • Premium Vidicon included • Fully regulated • Premium construction • Outstanding signal/noise ratio • Designed for completely unattended operation •

Specify the best — the VC 41 — Compare quality and price!



One Gift Works Many Wonders
THE UNITED WAY

Another PITRAN Application:

DEBUG FLUIDIC SYSTEMS FAST

PITRAN™
 PRESSURE SENSITIVE
 TRANSISTORS

The unique combination of fast mechanical response, low volumetric displacement, and high sensitivity make the PITRAN a valuable device around fluidic logic systems. PITRANS at critical function points cause little or no circuit disturbance — allowing transient responses to be accurately displayed and cutting by hours the time required to trace malfunctions to their source.



ACTUAL SIZE

PITRAN FEATURES:

Fast Response
 Rise times of 30 μ seconds can be followed faithfully.

Low Volumetric Displacement
 $\Delta V \sim 10^{-8}$ in³ for 2 volts output.

High Sensitivity
 7" H₂O produces 2 volt linear (1%) output.

STOLAB

STOW LABORATORIES, INC.

157 BARTON ROAD, STOW, MASS. 01775 (617) 562-9347

Circle 157 on reader service card

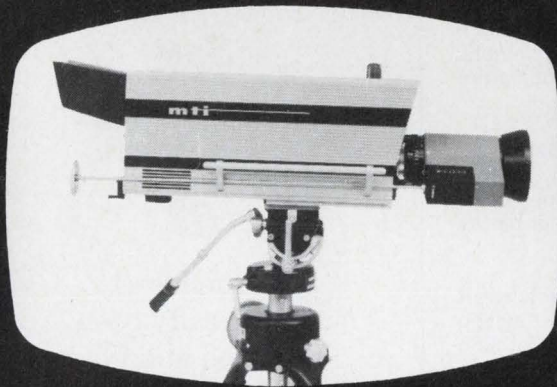

Video: Orth IX

Audio: Low cost Image Orthicon viewfinder camera — for remote or studio program origination.

The lightest weight I.O. viewfinder camera with the ruggedness needed for remote broadcasting operation. Less than 40 lbs (not including lens) • Exceptionally easy to operate • Resolution — in excess of 800 lines horizontal • Self contained or external sync • Sensitive — 800 line resolution with 0.0002 foot candle photo cathode illumination • 5" viewfinder • Rugged extruded aluminum case — anodized finish for durability • Must be seen to be appreciated •

Specify the best — The Orth IX — Compare quality and price!



Video: President of MTI, Frederick J. "Jack" Beste

Audio: I could tell you all about the MTI quality in three or four more pages of print. But we believe in proof. All you have to do is call us in for a side by side demonstration with any equipment on the market today — even those at prices above MTI. Another point — since we make the most complete line of equipment in the world our sales engineers can recommend a camera and/or system to meet your needs. So don't just buy a camera — buy the right camera for your needs — buy the right system for your needs.

Be sure — compare MTI — then buy the best!

mti MARYLAND TELECOMMUNICATIONS, INC.
 Division of KMS Industries, Inc.

York & Video Roads, Cockeysville, Maryland 301 - 666-2727
 World's largest manufacturer of low light level television cameras.

Circle 139 on reader service card

New Literature

controlling the positions of industrial work-tables is described in Bulletin 454. [459]

Chemical etching equipment. Western Technology Inc., 220 W. Central Ave., Santa Ana, Calif. 92707. An eight-page brochure describes a complete line of precision laboratory and production chemical etching products. [460]

Power supply. Analog Devices Inc., 221 Fifth St., Cambridge, Mass. 02142. A one-page data sheet describes a low-cost, p-c mounting power supply for operational amplifiers. [461]

IC telemetry receiver. Defense Electronics Inc., Rockville, Md. 20854, offers a bulletin containing engineering features, performance specifications, functional block diagram and outline data on an IC telemetry receiver for ground-based, special airborne, mobile and portable applications. [462]

Audio connectors. Switchcraft Inc., 5555 N. Elston Ave., Chicago 60630. Catalog C502a provides the engineer and designer with an up-to-the-minute guide to the latest in audio connectors. [463]

Tone transmitter and receiver. Quindar Electronics Inc., 60 Fadem Rd., Springfield, N.J. 07081. Bulletins 1007 and 1008 cover the QT/QR-50 tone transmitter and receiver. [464]

Tuning fork oscillator. Solid State Electronics Corp., 15321 Rayen St., Sepulveda, Calif. 91343. Model TF-120 silicon transistorized tuning fork oscillator is illustrated and described in a single-sheet bulletin. [465]

Spark gaps. ITT Electron Tube Division, Box 100, Easton, Pa. 18042, has available a brochure describing its line of two-electrode spark gaps, which protect circuit components from damage by overvoltages. [466]

Test equipment. Beckman Instruments Inc., 89 Commerce Rd., Cedar Grove, N.J. 07009. Insulation test equipment, electronic test and measuring instruments, high-voltage power supplies, and automatic component testers are comprehensively covered in 40-page Catalog 31. [467]

Wave filters. ADC Products, 6405 Cambridge St., Minneapolis 55426. A 14-page catalog contains a general approach to wave-filter design and a discussion of the problems encountered in writing wave-filter specifications. [468]

Pressure switch. Control Products Inc., East Hanover, N.J. 07936, has issued a bulletin illustrating and describing the P-6000 pressure switch. [469]

Rectangular connectors. ITT Cannon Electric, 3208 Humboldt St., Los Angeles 90031. Catalog 2D-D covers a line of double density "D" rectangular connectors. [470]

Rfi components. Filtron Co., 131-15 Fowler Ave., Flushing, N.Y. 11355. A complete line of filters and components for suppressing radio frequency interference is presented in 24-page Catalog P-68. [471]

Ferrite material. Krystinel Corp., Fox Island Road, Port Chester, N.Y. 10573, has available a specification sheet on the K-940 advanced, high permeability ferrite material that permits the miniaturization of magnetic components. [472]

Time-delay relays. Plessey Airborne Corp., 1414 Chestnut Ave., Hillside, N.J. 07205. The "UltDelay Economini" time delay relays are described in two-page illustrated bulletin PS-19. [473]

Power supplies. Raytheon Co., Sorensen Operation, Richards Ave., Norwalk, Conn. 06856, has issued short-form catalog 68A covering its d-c power supplies and a-c line regulators. [474]

Strip-chart recorders. Foxboro Co., Foxboro, Mass. 02035. Bulletin C-14 describes the ERB series of electronic strip chart recorders. [475]

Resin dispenser. Hardman Inc., 600 Cortlandt St., Belleville, N.J. 07109. A catalog sheet describes the Triplematic 700 resin dispenser for microminiature shots. [476]

Terminal blocks. Thomas & Betts Co., 36 Butler St., Elizabeth, N.J. 07207. Eight-page, illustrated bulletin 500.2 describes a new line of terminal blocks and their accessories. [477]

Electronic components. Switchcraft Inc., 5555 N. Elston Ave., Chicago 60630. A 25-page booklet covers such major product categories as jacks, plugs, switches, connectors, indicating devices and audio accessories. [478]

Subsystems. Reeves Instrument Division Dynamics Corp. of America, Garden City, N.Y. 11530, offers a 24-page brochure detailing subsystems in such areas as telemetry, digital ranging, airborne radar, tactical radar, satellite and spacecraft tracking radars, analog computers and aerospace ground equipment. [479]

Coil bobbins. Gries Reproducer Co., 400 Beechwood Ave., New Rochelle, N.Y. 10802, has published a pocket-size booklet covering the advantages and design features of its precision molded thermoplastic coil bobbins. [480]

The Best IC Op-Amp Yet...

To Find-Out
How
Motorola's New
MC1539/MC1439
I/C Op Amps
Offer Six
Performance
Improvements...

See

The following
2-Page insert

Or

If the insert
has already been
removed and filed
by one of your associates...

Circle this Reader
Service Number

324



MOTOROLA
Semiconductor Products Inc.

- where the priceless ingredient is *care!*

The Best IC Op-Amp Yet

$20 \text{ V}_{p-p} @ 20 \text{ kHz (min)}$
 $A_{VOL} = 50,000 \text{ (min)}$
 $V_{io} = 3 \text{ mV (max)}$
 $I_{io} = 60 \text{ nA (max)}$

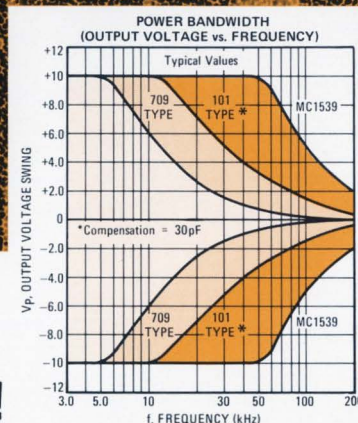

New MC1539 Offers Six Performance Improvements!

Our engineers say the MC1539 integrated circuit operational amplifier is "the finest I/C Op Amp available today. Period." The six advantages below and the specs on the next page offer strong supporting proof:

1. Input Offset Voltage — 2.0 mV lower than comparable circuits ... requires less input bias compensation.
2. Input Offset Current — almost an order of magnitude lower ... making it ideal for high input impedance circuitry.
3. Output Short-Circuit Protection and Input Over-Voltage Protection — built-in to provide "accident-proof" operation

and transient suppression.

4. Guaranteed minimum gain over full temperature range — twice that of previous types ... for higher performance — with stability.
5. Power Bandwidth — typically an order of magnitude better (See Inset).
6. Slew Rate — typically 34 V/ μ sec at $A_v = 100$... twice as

high — for extremely fast comparator applications.

Best of all, the MC1539 (and, a low-temperature range version, MC1439) are 100-up priced at a low \$12.00 and \$7.50, respectively, in the 8-pin (TO-99) metal package. And, the pin configuration is the same as the 709 and 101.

TURN PAGE 



MOTOROLA
Semiconductor Products Inc.

— where the priceless ingredient is care!

Here's Detailed Data For The MC1539/Op Amp Compare The Specs For All Three*

... proof that it's "The Best I/C Op Amp Yet!"

1. 2.



MONOLITHIC OPERATIONAL AMPLIFIER

... designed for use as a summing amplifier, integrator, or amplifier with operating characteristics as a function of the external feedback components.

- Low Input Offset Voltage — 3.0 mV max
- Low Input Offset Current — 60 nA max
- Large Power-Bandwidth — 20 V_{p-p} Output Swing at 20 kHz min
- Output Short-Circuit Protection
- Input Over-Voltage Protection
- Class AB Output for Excellent Linearity
- Slew Rate — 34 V/μs typ

Characteristic	Symbol	Rating	Unit
Power Supply Voltage	V ⁺	-18	V _{dc}
Differential Input Signal	V _{in}	-18	V _{dc}
Common-Mode Input Swing	CMV _{in}	-17	V _{dc}
Load Current	I _L	15	mA
Output Short-Circuit Duration	t _{sc}	Continuous	
Power Dissipation (Package Limitation)	P _D	480	mW
Derate above T _A = 25°C		4.4	mW/°C
Operating Temperature Range	T _A	-55 to +125	°C
Storage Temperature Range	T _{stg}	-65 to +150	°C

MC1539G

OPERATIONAL AMPLIFIER
INTEGRATED CIRCUIT

MONOLITHIC SILICON EPITAXIAL PASSIVATED

MARCH 1968—DS 9094



TO-99 CASE 96

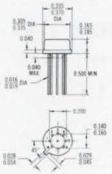

LINEAR INTEGRATED CIRCUIT

CIRCUIT SCHEMATICS

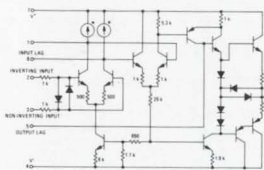

*Patent pending.

EQUIVALENT CIRCUIT

*Compare the specs for all three

CHARACTERISTIC	Symbol	MC1709	101 Type	MC1539	Unit
Open Loop Voltage Gain (V _{out} = 10V, I _A = -55°C to +125°C)	A _{vol}	25,000	25,000	50,000	V/V min
Output Impedance (f = 20 Hz)	Z _{out}	150	—③	4 k	Ω typ
Input Impedance (f = 20 Hz)	Z _{in}	150	300	150	kΩ min
Output Voltage Swing (R _L = 10 kΩ) (R _L = 2.0 kΩ)	V _{out}	±12 ±10	±12 ±10	±12 ±10	V _{peak} min
Power Bandwidth (A _v = 1, R _L = 1.0 kΩ) (f _{HD} = 5%, V _o = 20 V _{p-p})	P _{bw}	—③	—③	20	kHz min
Input Common Mode Voltage Swing	CMV _{in}	±8	±12	±11	V _{peak} min
Common Mode Rejection Ratio	CM _{rr}	70	70	80	dB min
Input Bias Current (I _b = I ₁ + I ₂ , T _A = +25°C) (I _b = I ₁ - I ₂ , T _A = -55°C)	I _b	500 1500	500 1500	500 700	nA max
Input Offset Current (I _{os} = I ₁ - I ₂) (I _{os} = I ₁ + I ₂ , T _A = -55°C) (I _{os} = I ₁ - I ₂ , T _A = +125°C)	I _{os}	200 500 200	200 500 200	60 75 75	nA max
Input Offset Voltage (T _A = 25°C) (T _A = -55°C, +125°C)	V _{io}	5.0 6.0	5.0 6.0	3.0 4.0	mV max
Step Response Gain = 100 Gain = 10 Gain = 1	t _r t _{pd} dV _{out} /dt t _r t _{pd} dV _{out} /dt t _r t _{pd} dV _{out} /dt	800 380 12.0 600 340 1.7 2200 1300 0.25	—③ —③ —③ —③ —③ —③ —③ —③ —③	700 100 34.0 600 80 6.2 400 80 4.2	ns typ ns typ V/μs typ ns typ ns typ V/μs typ ns typ ns typ V/μs typ
Equivalent Input Noise Voltage (Open Loop) (R _s = 10 kΩ, Noise Bandwidth = 1.0 Hz, f = 1.0 kHz)	e _n	90	—③	30	nV (Hz) ^{1/2} typ
Average Temperature Coefficient of Input Offset Voltage (R _s = 50k, T _A = -55°C to +125°C) (R _s = 10 kΩ, T _A = -55°C to +125°C)	TC _{Vio}	3.0 6.0	3.0 6.0	3.0 5.0	μV/° typ
DC Power Dissipation (Power Supply = ±15V, V _{out} = 0)	P _D	165	—③	150	mW max
Positive Supply Sensitivity (V ₋ constant)	S ₊	150	—③	150	μV/V max
Negative Supply Sensitivity (V ₊ constant)	S ₋	150	—③	150	max μV/V

① R_L = 1.0 kΩ ② Not shown as such on data sheet. ③ dV_{out}/dt = Slew Rate.

TYPICAL OUTPUT CHARACTERISTICS

(V⁺ = +15 Vdc, V⁻ = -15 Vdc, T_A = 25°C)

FIGURE NO.	CURVE NO.	VOLTAGE GAIN	TEST CONDITIONS (FIGURE 1)						
			R ₁ (kΩ)	R ₂ (kΩ)	R ₃ (kΩ)	R ₄ (kΩ)	R ₅ (kΩ)	C ₁ (pF)	
2	1	1.0	10 k	10 k	5.0 k	390	10 k	2200	
	2	1.0	10 k	10 k	5.0 k	390	10 k	2200	
3	1	A _{vol}	0	∞	0	∞	0	∞	0
	2	1000	1000	1.0 M	1000	0	∞	0	10
	3	100	1000	100 k	1000	10 k	∞	∞	2200
	4	10	1000	10 k	1000	1.0 k	∞	∞	2200
	5	1.0	10 k	10 k	5.0 k	390	10 k	2200	7200
4	1	A _{vol}	0	∞	0	∞	0	∞	0
	2	A _{vol}	0	∞	0	10 k	∞	∞	2200
	3	A _{vol}	0	∞	0	390	∞	∞	2200

*To improve performance, development is in process to include resistor R₅ = 10 kΩ on the device chip. Available after September 1968.

FIGURE 1 - TEST CIRCUIT

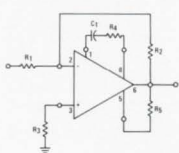

FIGURE 2 - POWER BANDWIDTH (LARGE SIGNAL SWING versus FREQUENCY)

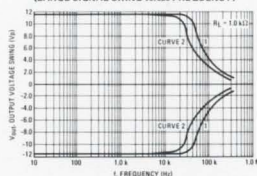

FIGURE 3 - VOLTAGE GAIN versus FREQUENCY

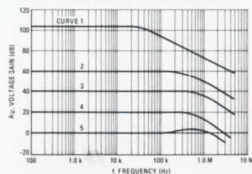
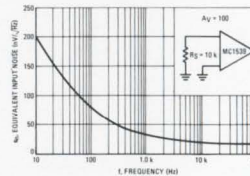
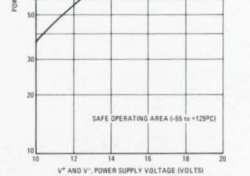
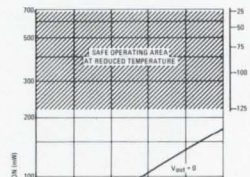
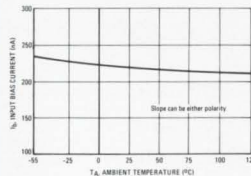
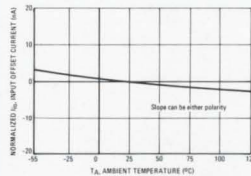
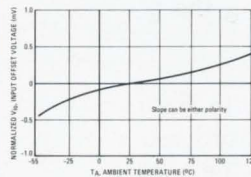
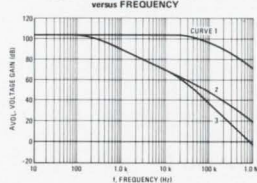

FIGURE 4 - OPEN LOOP VOLTAGE GAIN versus FREQUENCY



3. 4.

For further information write:

MOTOROLA Semiconductor Products Inc.

P. O. Box 955, • Phoenix, Arizona 85001



Newsletter from Abroad

April 29, 1968

Europe ponders place in space

West European space officials face a round of harsh decisions now that Britain has decided to call it quits on two key international programs—the Europa rocket and the proposed European television-relay satellite.

The British move puts the fate of Europa, a joint effort by the seven countries in the European Launcher Development Organization (ELDO), up to France and West Germany. They need the rocket for their Symphonie communications satellite and most likely will find a way to keep the program going after Britain drops out in 1971.

There's scant chance, though, that France and Germany can convince other ELDO governments to help them pick up Britain's share of the tab—a hefty 27%. So far, about \$400 million has been allocated for the project. Italy was losing interest in ELDO even before Britain adopted its new stance toward prestige space projects. Nor can Symphonie's promoters expect any substantial help from Belgium and the Netherlands; both have tight space budgets.

ELDO's sister space body, the 13-nation European Space Research Organization (ESRO), has its own woes, even though Britain will boost her contribution to ESRO's work slightly over the next three years. ESRO, set up to handle scientific programs, has been switching its emphasis to communications satellites. Britain's decision not to support a tv-relay satellite is a setback for ESRO, which seemed likely to be named project manager.

Europe's space ministers will meet in Bonn this July and may attempt a salvage effort then. The eventual result could be a single program combining the projects that survive.

Australia uneasy over F-111 order

A row is in the offing in Australia over the two dozen F-111C fighter-bombers ordered from the U.S. Defense officials in Canberra have let out that the cost of the 24 swingwing aircraft will likely come to \$270 million, some \$79 million more than the government's original estimate. What's more, the opposition Labor Party has been raising a fuss over the decision to buy the planes every time a U.S. F-111 has been lost.

Defense Minister Allen Fairhall will air the government's stand on the F-111C order in late April or early May. Because of the spiraling costs for the initial 24 planes, the government almost surely will drop its plan to buy an additional six F-111's fitted out with special electronic reconnaissance gear.

Japan clearing up patent picture

Japan's electronics industry is moving fast to straighten out its patent position regarding color television and integrated circuits.

Insiders say eight of the country's dozen color-set makers have asked the government to approve a deal that would license them to use the basic color-tv patents held by the Hazeltine Corp. The royalties, on an if-used basis: 15 cents a set. Japanese manufacturers held off making a deal until it became apparent that the need for licenses wouldn't be eliminated by the legal fight between Hazeltine and the Zenith Corp.

The end is almost in sight, too, for Japan's IC patent problems. Five major producers have signed up for licenses from Texas Instruments. Still to be signed, though, is Nippon Electric. Since it holds the Japanese

Newsletter from Abroad

rights to Fairchild Semiconductor's planar-process patent, which is complementary to TI's basic IC patent, Nippon Electric wants a special deal with TI. The U.S. company plans to go into IC production in Japan through a joint venture with the Sony Corp. and **presumably will come to terms with Nippon Electric in the next month or two.**

Contacts point way to new transducer

Researchers at the Fuji Electric Co. have come up with an oscillating semiconductor transducer they think may turn out a winner. **Its output frequency varies with either applied voltage, light, or temperature.** The frequency ranges from several hundred hertz to several megahertz. But with an added external capacitor of about 100 microfarads, the value drops to well below 1 hertz.

Fuji calls the device a point-contact transducer. **It has two rectifying point contacts on a silicon chip having a high-resistivity n-type layer atop a low-resistivity p + layer.**

Relaxation oscillation starts when the voltage applied between the contacts rises above a threshold level—around 3 volts. But the oscillation stops when the voltage goes too high. Shining light onto the n-layer changes the values at which oscillations start and stop.

Touch phone lets caller see number

Italian semiconductor maker SGS-Fairchild has readied still another integrated-circuit device for the telephone market. This time it's a keyboard telephone set that **displays the number punched into it, something current touch phones can't do.** Earlier, the company developed a cut-out that prevents unauthorized long-distance calls.

In the latest SGS unit, the number punched into the keyboard is stored in a memory until the call is completed. Meanwhile, the number glows on a display of 16 cold-cathode tubes.

SGS expects to price its touch-phone unit between \$100 and \$130. This makes it a candidate for small switchboards, where it could catch wrong numbers in long-distance calls. **The prototype, built around 25 IC packages, can be adapted for electronic switching simply by changing one capacitor.**

U.S. may duck Paris Air Show

To the dismay of the aerospace industry, it appears that there'll be no U.S. Government participation in next year's Paris Air Show.

The Defense Department apparently intends to stick with its decision not to go, and other **Government agencies will probably follow suit.** This means that manufacturers will have to arrange their own exhibitions without the traditional help of the Commerce Department and without space in a U.S. pavilion. **The upshot: many small companies will be forced to skip the show.**

Bonn seeks F-104 warning system

West Germany's defense ministry has called on the Nortronics division of the Northrop Corp. to design an integrated status-reporting system for the Lockheed F-104G Starfighter, the Luftwaffe's standard fighter-bomber. The ministry says it **may install the gear in all of its more than 600 F-104G's after evaluation tests early next year.** The voice-based system would be similar to the one used in U.S. Air Force B-58 bombers for several years.

Japan

Three-shot gun

The Sony Corp. has decided to drop the Chromatron tube from the new 7-inch color tv set it will start shipping to the U.S. this June and use instead a tube right out of the laboratory. But Sony engineers insist that if they had followed the lead of other color-set makers and used a shadow-mask tube instead of working with the Chromatron, they would never have come up with their new baby—the Trinitron.

Despite production-line difficulties with a 19-inch Chromatron it used in a set made for the Japanese market, Sony originally planned to incorporate the tube in its 7-inch model because the Chromatron's brightness and convergence characteristics are superior to those of the conventional shadow-mask tube [Electronics, June 26, 1967, p. 208].

Tradeoffs. Among the production problems is the fact that the one-gun Chromatron requires hard-to-make color-switching grids with alternate wires insulated, a high-power switching input for the grids, and switching at the electronic gun's input. With this complicated arrangement, the one-gun model offered the advantage of

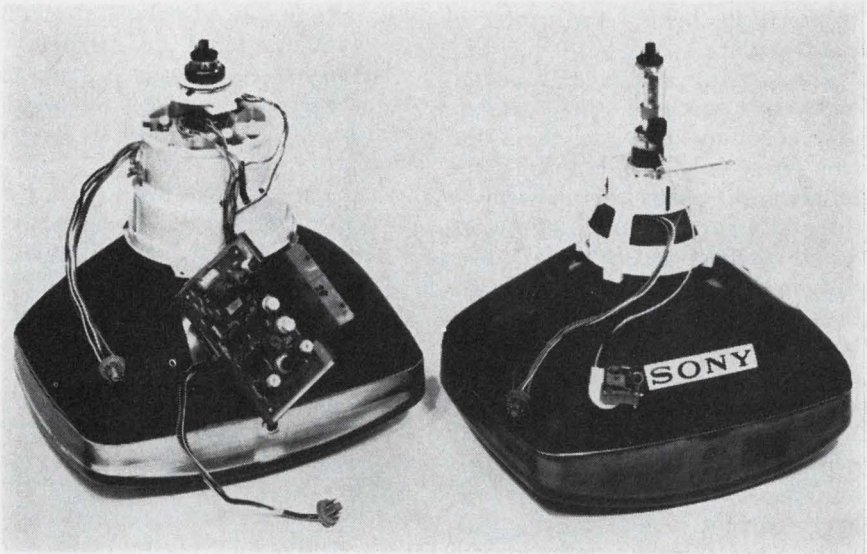

Yoke-less. With the Trinitron gun, Sony's tube needs no convergence yoke and panel. Flyback, shown resting on tube, does the job.

automatic beam convergence.

To simplify the color-switching setup, Sony went to a three-gun version. But despite the inclusion of a dynamic convergence generator and yoke, plus 12 convergence adjustment controls, this Chromatron suffered from the same kind of misconvergence that plagues shadow-mask tubes.

So, combining the advantages of the first two models, Sony came up with the Chromagnetron, a one-gun tube that employs the simplified color-selection grid of the three-

gun version. The problem here was that the Chromagnetron only works well in a line-sequential system and requires switching at about 3.58 megahertz. It uses two color-switching yokes—one to separate the beam so that it appears to originate at different sources, and the other to cause the beam to re-converge on the faceplate.

Trio. Instead of making one cathode do the work of three, Sony engineers decided to add two more, placing them where the other two beams in the Chromagnetron appear to come from. In this way, the Trinitron evolved.

The Trinitron gun doesn't need a convergence yoke. It has five grids and produces three separate beams from the three cathodes. The cathode assemblies are aligned behind three holes in the number one grid. Directly in front of this grid is another, also with three holes. Grids three, four, and five are tubular structures that surround the three beams. And at the muzzle of the gun is an electrostatic convergence arrangement consisting of four flat, vertical plates. The two inner and two outer plates are elec-

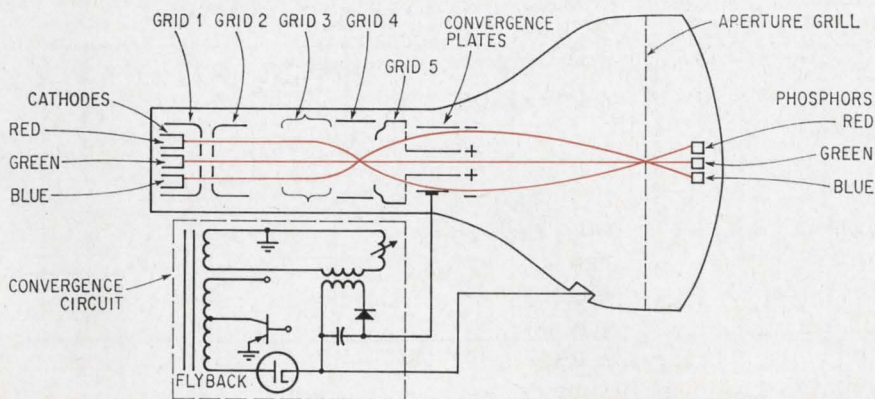

Color-full. The three beams are bent and shaped by five grids. Deflection plates, controlled by the flyback circuit, cause the beams to converge.

trically tied together, with the center pair being slightly positive—about 100 volts—with respect to the outer pair.

The three beams leave the gun in a single horizontal plane after the deflection plates have caused them to converge behind the center of the faceplate.

Sony points to several advantages this one-gun, three-cathode scheme offers. For one, the Trinitron uses only about a third the number of parts required by a three-gun arrangement. For another, electron density is far lower than in conventional tubes because the Trinitron grids' diameter is large and the beams are focused at the point where they cross—at the center of grid number four.

The neck of Sony's tube has a diameter of only 29 millimeters, but the company says the total beam current is 50% greater than that provided by the three guns of a shadow-mask tube, which has a 36-mm neck. Sony stresses that the 50% added current is not a maximum but rather an arbitrary limit at which the tube will maintain a better focus and brightness than the three-gun delta arrangement of the shadow-mask.

Well-shaped. The increased brightness results from the use of a slat-like structure called an aperture grill. This device, an array of vertical slots in front of vertical phosphor strips on the face of the tube, is formed into a cylindrical shape before the slats are etched. The faceplate is therefore also cylindrical. Because of this geometry, heating from wasted power merely causes the aperture grill frame to expand slightly in a vertical direction; there's no relative motion between the grill and the phosphor strips on the faceplate in a direction that would upset registration.

Sony notes that beam width is usually so narrow that only the color trio beneath one slot is excited at any given time. The shadow-mask tube's beam normally excites dots three holes away—vertically and horizontally—from its center, blurring the picture to a degree.

Big gainer

Until now, Japanese tv-set makers looking to design high-gain, integrated-circuit i-f sound amplifiers into their receivers have had to use U.S.-made IC's because domestic units produced only 50 decibels of voltage gain at 4.5 megahertz. The Nippon Electric Co. has moved to fill this gap, though, with a circuit having a gain of 72 db at that frequency.

The company has already started to distribute samples to prospective customers. In production quantities, the circuits will be available in either a silicone plastic dual in-line package or a 12-lead TO-5 can. The IC is expected to sell for between \$1 and \$1.10 in large quantities, compared with the \$1.20 large-order price for a comparable RCA device.

Nippon Electric's circuit is basically similar in content to the one pioneered by RCA; it has three high-frequency differential-amplifier stages, a ratio discriminator, and a Darlington audio amplifier. But there is some difference in design.

Zener. The Japanese firm claims that its circuit is the first of its type to incorporate a zener diode in the regulated power supply. The zener, it says, makes for more consistent operation over a wide range of power-supply voltages—about 7 to 12 volts—and eliminates the need for the string of forward-biased diodes that perform the same function in the RCA design. The zener, which is diffused into the transistor emitter isolation area,

has a voltage almost the same as the transistor emitter reverse breakdown level—about 6 volts.

The IC is designed for Japanese and American television sets, which have a carrier frequency of 4.5 Mhz, and European sets, which have a 5.5-Mhz carrier.

Nippon Electric says distortion of the ratio detector—mostly third harmonic—runs under 1%, against about 1.8% in the RCA device.

A current sink in the common-emitter lead of the differential-amplifier stages is used to improve limiting characteristics.

Bias push. Silicon diodes with threshold voltages of 0.6 to 0.7 volt are used in a ratio detector. At this level, a voltage input of more than 10 volts would be needed for undistorted detection. To improve the characteristics of low-signal inputs, the drop across diodes D₁ and D₂ is used to push a forward bias of about 16 microamperes through the ratio-detector diodes, which are both forward biased.

A portion of the ratio-detector bias is fed into the Darlington audio stage. No radio-frequency bypass capacitors are provided, but distributed capacitance of the resistors and the low impedance of the forward-biased diodes provides sufficient bypass action.

About 2 milliamperes can be tapped from the voltage regulator circuit for use in other circuits. However, one must be careful and not connect a large electrolytic capacitor to these terminals because the high inrush current could produce enough heat to evaporate the aluminum wiring in the IC.

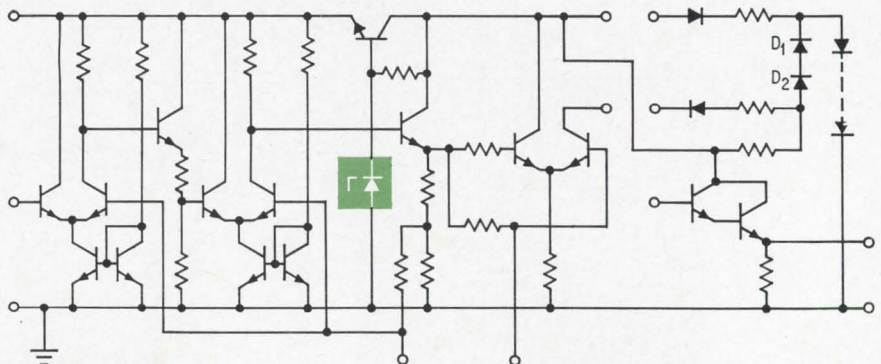

Regulated. Zener diode, shown in color, provides regulated voltage for i-f circuit and also supplies 2 milliamps to external circuits.

West Germany

Training aid

Germany's federal railroad system seems to be going all out for electronics when it comes to streamlining operations and traffic control. The past year saw the start of large-scale trials in computer-aided train routing, freight handling, and train breakup and make-up at several facilities including Seelze and Kassel-Bettenhausen in northern Germany [Electronics, Sept. 4, 1967, p. 206]. At Frankfurt's main freight terminal, work is in progress on re-equipping a train classification yard where track switches and car braking are electronically controlled.

The \$4-million system, expected to be completed by mid-1969, will be capable of handling up to 5,000 cars a day on 51 makeup tracks. Already, 18 makeup tracks, complete with switching and braking gear, have been put under electronic control.

The yard will be controlled by Siemens AG digital equipment in the main control tower. The electronic gear, most of it already in place, costs about \$350,000.

Train gang. The old facility required 15 control towers for yard operations, but the new one will have only two, and 24 people will do the work of 80.

At the terminal, information on individual freight cars—final destination, identification number, and other data—is radioed by a dispatcher to a nearby freight office. Each car is assigned a number that corresponds to the makeup and destination track into which it must be switched. The information is then coded and sent by teletypewriter to the main control tower.

At the tower, another teletypewriter prints out the incoming data and simultaneously produces a tape, which is put into a tape reader. The reader output programs the electronic control equipment.

The first step in making up new trains at the Frankfurt facility is determining a car's weight and

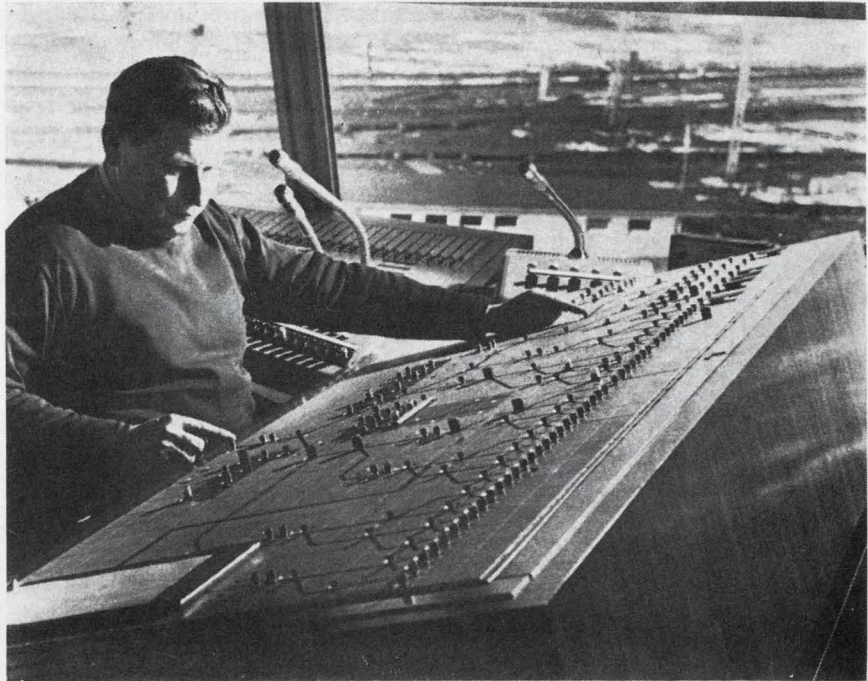

Fast brake. Operator at control panel of automated railway yard monitors movement of freight cars while controlling switches and braking apparatus.

speed as it comes from a ramp toward the automatic braking facility.

Car weight is determined by a bridge circuit arrangement in which a piece of track forms one branch of the circuit. As the car wheels move over that part of the track the branch resistance changes, unbalancing the bridge. The circuit output is then a measure of the car's weight. The amplified output is processed and evaluated in the control equipment, which then determines how hard the brakes are applied.

Car speed is measured by a radar set installed between the rails just ahead of the braking apparatus. Radar pulses reflected from the car's undercarriage are sent to the control equipment for processing and evaluation. The output acts to release the brakes when the car has been slowed to its proper roll-out speed.

On their way to the makeup tracks, cars pass over as many as five track switches. Equipment in the tower controls the position of the track switches in accordance with the program derived from the punched tape.

Magnetic rail contacts are used to count the number of car axles that pass over each track switch. If part of a car is still over the switch, the electronic control equipment is prevented from putting out a track-switching signal.

When the Frankfurt and Seelze facilities are connected, perhaps next year, the computer in the north will be linked by teletypewriter to one at Frankfurt.

Fair weather

The mood of this year's Hanover Industrial Fair, which opened April 27, leaves no doubt that West Germany's electronics industry is riding high once again. It contrasts sharply with the gloom that surrounded the 1967 fair, held at a time when the country's industry was going through one of its worst slumps in postwar history. The industry's sales last year fell an estimated 3% to 4% from the 1966 level.

"This year, though, it looks as if we'll see production expand at a rate of 7% or more," says an executive of a leading German compo-

nents manufacturer. Pump-priming efforts by the Kiesinger government are paying off, with gains being registered across the board.

Last year, the government directed about half of the \$625 million it added to the budget to the post office and the federal railroad system, the country's two biggest users of telecommunications gear.

Another boost to the electronics industry is promised by Bonn's efforts to shift its military hardware purchases away from foreign suppliers, a policy expressed recently by West Germany's defense minister, Gerhard Schroeder.

Renaissance. But by far the biggest gains this year reflect a revival in the consumer electronics market. "Confidence again prevails in the entertainment electronics industry," says Guenther Huecking, head of the radio and television section of the electrotechnical industry's trade association. Huecking predicts that 1.9 million black-and-white sets will be sold this year, against 1.56 million in 1967.

However, sharp production cutbacks during the 1967 slump have resulted in low inventories, and some producers are afraid they won't be able to meet the renewed demand for monochrome receivers.

Even with this demand for black-and-white sets, sales of color sets are expected to continue climbing. Huecking predicts that from 250,000 to 300,000 color receivers will be produced this year for both domestic and foreign markets. A big boost will come later this year when each of the country's two major networks expands color programming from the present four to five hours a week to between eight and 10. At the end of 1967 there were about 100,000 color sets in West German households.

IC gains. Although sales of integrated circuits to makers of consumer products are off to a healthy start, they account for less than 20% of the total West German IC market. However, marketing specialists at Hanover are forecasting a rise in over-all IC sales to about \$20 million a year by 1975 from the present \$1.5 million.

By far the biggest user of IC's

in consumer products is Grundig Werke GmbH, whose share of West Germany's black-and-white TV market is around 20%—the largest single slice. Grundig says it uses more than 1,000 IC's a day.

The circuit it's talking about is the TAA 350 produced by Valvo GmbH, a subsidiary of Philips Gloeilampenfabrieken of the Netherlands. It's made up of four differential amplifiers and incorporates 21 transistors and 24 resistors on a 18-millimeter-square chip housed in a TO-74 can. The circuit, used in the sound i-f stage of the TV receivers, has an 80-decibel amplification and operates at 12 Mhz.

Great Britain

Down the tubes

Producers of precision metal tubing usually have to rely on the subjective judgment of a young lady with a microscope to determine the quality of steel tubing samples. She's the one who compares with graded charts the number, size, and coloring of microscopic nonmetallic particles, known as inclusions, and classifies the sample accordingly.

Now, however, researchers at Tube Investments Ltd., Birmingham, one of Europe's leading producers of precision tubing, have developed an instrument that automatically reads a polished metal surface.

Their machine, called an inclusion counter, classifies the nonmetallic particles and gives a digital readout of the number of each and the part of the total taken up by each type of inclusion. The operator need only set up the instrument to distinguish among sulphides, oxides, and holes in the surface of a given batch of samples.

Illuminated samples. Four prototypes of the counter have been built, and 12 preproduction units are being made under license by Hilger and Watts Ltd. of London.

A sample of polished metal tubing is passed over a scanning pinhole. The sample is illuminated

through the pinhole at a constant level, producing an illuminated area one micron in diameter; smaller inclusions don't affect quality. The light reflected by the metal is focused onto a photomultiplier.

Bright pure metal returns nearly all the light and stimulates a strong signal from the photomultiplier; the grayish sulphides return less light and stimulate a weaker signal; and oxides, darker still, stimulate an even smaller response. The signals are turned into pulses inversely proportional to the amplitudes by adjustable discriminators, which then divide up the amplitude range into a bright metal part, a sulphide part, and an oxide part, with the oxide producing the widest pulse and the bright metal the narrowest.

The three signal-level discriminators are conventional Schmitt trigger circuits fed via emitter-follower buffer stages from the sliders of potentiometers, which are used to set the minimum response levels. Logic gating is used to separate the discriminator outputs and in this way distinguish among metal, sulphides, and oxides. The logic gates then route the discriminator output to the appropriate counting mechanisms.

Slits vs. holes. The inclusion counter provides the operator with four simultaneous digital readouts, incrementing continuously during the duration of the scan: the total number of oxide inclusions, the proportion of oxide, the total number of sulphide inclusions, and the proportion of sulphide.

The fraction measurements are obtained by counting the pulses from a 45-kilohertz pulse generator during the duration of the discriminator outputs. Average inclusion size must be worked out manually.

To overcome this, the research laboratories at Tube Investments are now working toward substituting narrow slits for the pinholes. In this case, as the slit passes sideways across the inclusions, the photomultiplier's output is in proportion to the length of the inclusion relative to the length of the slit. By using a series of slits of different lengths, it will be possible to classify the inclusions by size.

Acopian will ship this power supply in only 3 DAYS

and any of the other 61,999 too.

Next time you need power supplies in a hurry, contact Acopian and request a copy of our latest catalog. It lists 62,000 different AC to DC plug-in power supplies, any of which will be shipped to you in **just three days!** Choose the exact DC output you need. Singles or duals. Regulated or unregulated. Whether you need one power supply or several, your order will be shipped in just three days! That's our promise. For particulars, contact your local Acopian rep, call us at (215) 258-5441, or write to Acopian Corp., Easton, Penna. 18042.



Acopian SINGLE OUTPUT SOLID STATE REGULATED POWER SUPPLIES Ambient temperature rating 0 to 55 C.

Nominal Output Voltage	Adjustment - Volts	Output Current Amps	REGULATION		Style or BMS	Price	Model	Size	Nominal Output Voltage	Adjustment - Volts	Output Current Amps	REGULATION		Style or BMS	Price	Model	Size
			Load - % Line - %	% RMS								Load - % Line - %	% RMS				
34	1	100	.5	.5	5	\$ 60	34A10	A	55	1	250	.5	.5	5	\$ 65	34B10	A
34	1	100	.05	.05	1	65	34B10	A	55	1	100	.05	.05	1	70	34B20	A
34	1	200	.05	.05	1	70	34B20	A	55	1	200	.05	.05	1	75	34D30	A
34	1	300	.05	.05	1	75	34D30	A	55	1	300	.05	.05	1	85	34D50	A
34	1	500	.1	.05	1	85	34D50	A	55	1	500	.1	.05	1	95	34D60	A
34	1	600	.1	.05	1	95	34D60	A	55	1	600	.1	.05	1	105	34D80	A
34	1	800	.15	.05	1	105	34D80	A	55	1	800	.15	.05	1	175	34B150	U
34	1	1.5	.3	.05	1	175	34B150	U	60	1	250	.5	.5	5	60	35A10	A
35	1	100	.5	.5	5	60	35A10	A	60	1	100	.05	.05	1	65	35B10	A
35	1	100	.05	.05	1	65	35B10	A	60	1	200	.05	.05	1	70	35B20	A
35	1	200	.05	.05	1	70	35B20	A	60	1	300	.05	.05	1	75	35D30	A
35	1	300	.05	.05	1	75	35D30	A	60	1	500	.1	.05	1	85	35D50	A
35	1	500	.1	.05	1	85	35D50	A	60	1	600	.1	.05	1	95	35D60	A
35	1	600	.1	.05	1	95	35D60	A	60	1	800	.15	.05	1	105	35D80	A
35	1	800	.15	.05	1	105	35D80	A	60	1	100	.5	.5	5	60	36A10	A
36	1	100	.5	.5	5	60	36A10	A	60	1	100	.05	.05	1	65	36B10	A
36	1	100	.05	.05	1	65	36B10	A	60	1	200	.05	.05	1	70	36B20	A
36	1	200	.05	.05	1	70	36B20	A	60	1	300	.05	.05	1	75	36D30	A
36	1	300	.05	.05	1	75	36D30	A	60	1	500	.1	.05	1	85	36D50	A
36	1	500	.1	.05	1	85	36D50	A	60	1	600	.1	.05	1	95	36D60	A
36	1	600	.1	.05	1	95	36D60	A	60	1	800	.15	.05	1	105	36D80	A
36	1	800	.15	.05	1	105	36D80	A	60	1	100	.5	.5	5	60	37F10	A
36	1	100	.5	.5	5	60	37F10	A	60	1	100	.05	.05	1	65	37D10	A
36	1	100	.05	.05	1	65	37D10	A	60	1	200	.05	.05	1	70	37D20	A
36	1	200	.05	.05	1	70	37D20	A	60	1	300	.05	.05	1	75	37D30	A
36	1	300	.05	.05	1	75	37D30	A	60	1	400	.1	.05	1	85	37D50	A
36	1	400	.1	.05	1	85	37D50	A	60	1	500	.1	.05	1	95	37D60	A
36	1	500	.1	.05	1	95	37D60	A	60	1	600	.1	.05	1	105	37D80	A
36	1	600	.1	.05	1	105	37D80	A	60	1	100	.5	.5	5	60	38F10	A
36	1	100	.5	.5	5	60	38F10	A	60	1	100	.05	.05	1	65	38D10	A
36	1	100	.05	.05	1	65	38D10	A	60	1	200	.05	.05	1	70	38D20	A
36	1	200	.05	.05	1	70	38D20	A	60	1	300	.05	.05	1	75	38D30	A
36	1	300	.05	.05	1	75	38D30	A	60	1	400	.1	.05	1	85	38D50	A
36	1	400	.1	.05	1	85	38D50	A	60	1	500	.1	.05	1	95	38D60	A
36	1	500	.1	.05	1	95	38D60	A	60	1	600	.1	.05	1	105	38D75	A
36	1	600	.1	.05	1	105	38D75	A	60	1	100	.5	.5	5	60	39F10	A
36	1	100	.5	.5	5	60	39F10	A	60	1	100	.05	.05	1	65	39D10	A
36	1	100	.05	.05	1	65	39D10	A	60	1	200	.05	.05	1	70	39D20	A
36	1	200	.05	.05	1	70	39D20	A	60	1	300	.05	.05	1	75	39D30	A
36	1	300	.05	.05	1	75	39D30	A	60	1	400	.1	.05	1	85	39D50	A
36	1	400	.1	.05	1	85	39D50	A	60	1	500	.1	.05	1	95	39D60	A
36	1	500	.1	.05	1	95	39D60	A	60	1	600	.1	.05	1	105	39D70	A
36	1	600	.1	.05	1	105	39D70	A	60	1	100	.5	.5	5	60	40F10	A
36	1	100	.5	.5	5	60	40F10	A	60	1	100	.05	.05	1	65	40D10	A
36	1	100	.05	.05	1	65	40D10	A	60	1	200	.05	.05	1	70	40D20	A
36	1	200	.05	.05	1	70	40D20	A	60	1	300	.05	.05	1	75	40D30	A
36	1	300	.05	.05	1	75	40D30	A	60	1	400	.1	.05	1	85	40D40	A
36	1	400	.1	.05	1	85	40D40	A	60	1	500	.1	.05	1	95	40D60	A
36	1	500	.1	.05	1	95	40D60	A	60	1	100	.5	.5	5	60	41F10	A
36	1	100	.5	.5	5	60	41F10	A	60	1	100	.05	.05	1	65	41D10	A
36	1	100	.05	.05	1	65	41D10	A	60	1	200	.05	.05	1	70	41D20	A
36	1	200	.05	.05	1	70	41D20	A	60	1	300	.05	.05	1	75	41D40	A
36	1	300	.05	.05	1	75	41D40	A	60	1	400	.1	.05	1	85	42F10	A
36	1	400	.1	.05	1	85	42F10	A	60	1	100	.5	.5	5	60	42D10	A
36	1	500	.1	.05	1	95	42D10	A	60	1	100	.05	.05	1	65	42D20	A
36	1	600	.15	.05	1	115	42D20	A	60	1	200	.05	.05	1	70	42D40	A
36	1	100	.5	.5	5	60	42F10	A	60	1	300	.05	.05	1	75	42D60	A
36	1	100	.05	.05	1	65	42D10	A	60	1	400	.1	.05	1	85	43F10	A
36	1	200	.05	.05	1	70	43F10	A	60	1	100	.5	.5	5	60	43D10	A
36	1	300	.05	.05	1	75	43D10	A	60	1	100	.05	.05	1	65	43D20	A
36	1	400	.1	.05	1	85	43D20	A	60	1	200	.05	.05	1	70	43D40	A
36	1	500	.1	.05	1	95	43D40	A	60	1	300	.05	.05	1	75	44F10	A
36	1	600	.15	.05	1	115	44F10	A	60	1	100	.5	.5	5	60	44D10	A
36	1	100	.5	.5	5	60	44F10	A	60	1	100	.05	.05	1	65	44D20	A
36	1	100	.05	.05	1	65	44D10	A	60	1	200	.05	.05	1	70	44D20	A
36	1	200	.05	.05	1	70	44D20	A	60	1	300	.05	.05	1	75	44D40	A
36	1	300	.05	.05	1	75	44D40	A	60	1	400	.1	.05	1	85	44F10	A
36	1	400	.1	.05	1	85	44F10	A	60	1	100	.5	.5	5	60	44D10	A
36	1	500	.1	.05	1	95	44D10	A	60	1	100	.05	.05	1	65	44D20	A
36	1	600	.15	.05	1	115	44D20	A	60	1	200	.05	.05	1	70	44D40	A

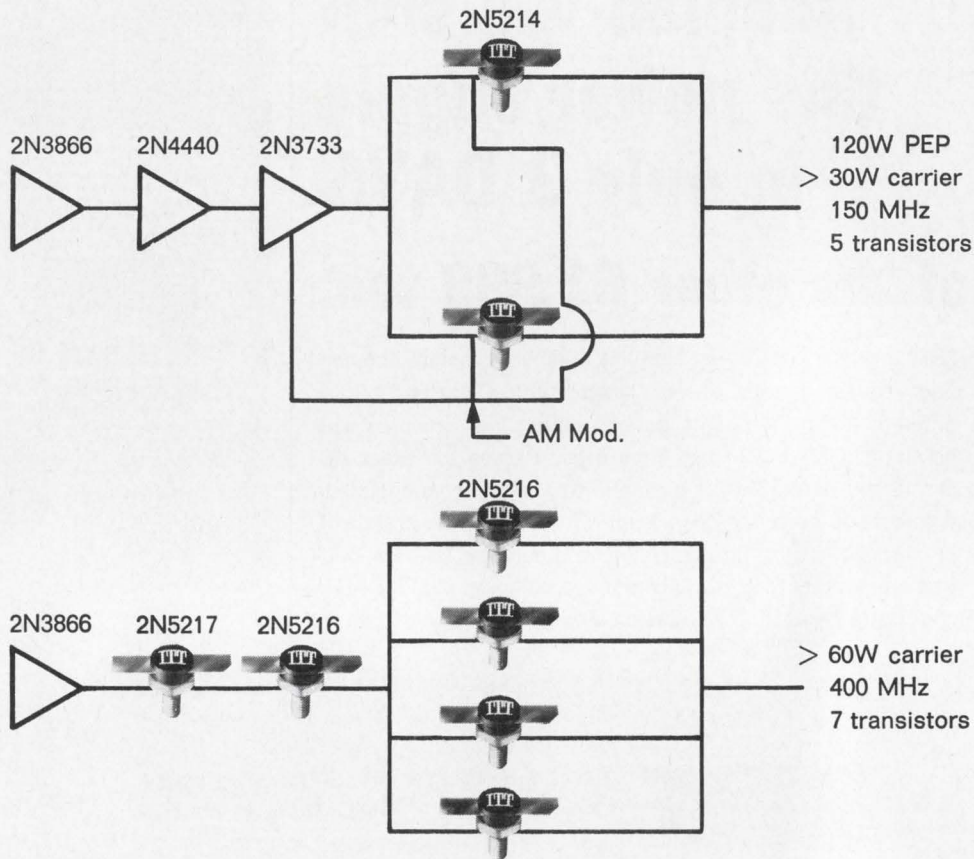

Only ITT delivers so much broadband RF power with so few transistors

Another reason to buy from "The Predictables"

Is your goal circuit simplification through higher power? Would you like to increase reliability and cut cost by reducing the total number of components in your equipment? Then ITT's strip line RF power transistors are for you.

Two application examples are

shown above, but the possibilities are almost endless. Here's why:

Strip line packaging gives you lower inductance, higher power output, broader bandwidth and greatly improved stability. The high BV_{CEO} ratings of the 2N5214 and 2N5216 give you better up modulation capabilities and reduce the danger of damage from transients. Resistor stabilization provides increased safe operating area and built-in bias stability

for class A and AB amplifiers.

Want more information? Write for a free copy of "VHF/UHF Transistor Power Amplifier Design". Want immediate delivery of strip line transistors? Contact any ITT distributor or your ITT factory representative. ITT Semiconductors is a Division of International Telephone and Telegraph Corporation, 3301 Electronics Way, West Palm Beach, Florida.

semiconductors **ITT**

FACTORIES IN FLORIDA • CALIFORNIA • MASSACHUSETTS • ENGLAND • FRANCE • GERMANY • PORTUGAL • AUSTRALIA



Something new under the sun!
Bissett-Berman E-CELL® Timers

UNDETECTABLE E-CELL* TIMER WON'T TICK, HUM OR RADIATE

Problem: Arm or safe an ordnance device using self-destruct or self-sterilize methods with precision components that emit no sounds or electromagnetic energy. Solution: Use an E-CELL timing component in an all solid-state circuit (see schematic) and your timer will have no moving parts, mechanical functions, or energy radiation. When the pre-set interval has elapsed (it could be anywhere from seconds to months), the E-CELL will deliver an output signal in the 1-volt range. Your complete timer will occupy less than one-half cubic inch of space, will consume only microwatts of power, will work in hostile environments, and will work every time!

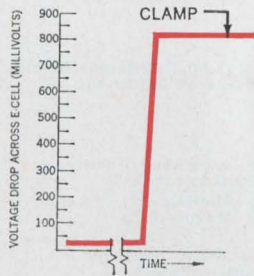
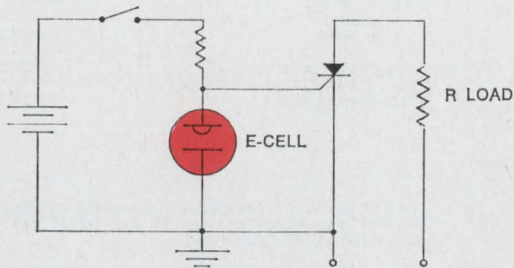

Actual size

* E-CELL timers are used in many of today's advanced ordnance weapon systems. E-CELL timers are also ideally suited for scuttling sonobuoy transmission, in addition to many industrial control applications. Patents applied for.

Environmental Tolerance

E-CELL devices have been tested and approved by users for severe shock and vibration tolerance, and are designed to meet or exceed the following requirements:

Altitude: MIL-STD-202C, Method 105C Test Condition B.

Ordnance: MIL-STD-303A, 304, 306, 314, 358, 828, etc.

Airborne: MIL-E-5400, MIL-E-5272, Procedures I, II, VIB, etc. and air drop, hi-shock service.

Marine: Requirements for air-dropped sonobuoy use.

For technical information and application notes, contact: Component Division, The Bissett-Berman Corporation, 3860 Centinela Avenue, Los Angeles, California 90066; Phone (213) 390-3585.

**BISSETT
BERMAN**

Advertising Sales Staff

Frank E. LeBeau [212] 971-6464
Advertising Sales Manager

Wallis Clarke [212] 971-2187
Assistant to sales manager

Donald J. Austermann [212] 971-3139
Promotion Manager

Warren H. Gardner [215] LO 8-6161
Eastern Advertising Sales Manager

Atlanta, Ga. 30309: Michael H. Miller, 1375 Peachtree St., N.E.
[404] 892-2868

Boston, Mass. 02116: William S. Hodgkinson
McGraw-Hill Building, Copley Square
[617] CO 2-1160

Cleveland, Ohio 44113: William J. Boyle, 55 Public Square, [216] SU 1-7000

New York, N.Y. 10036
500 Fifth Avenue
Donald R. Furth [212] 971-3615
James R. Pierce [212] 971-3616
John A. Garland [212] 971-3617

Philadelphia, Pa. 19103:
Jeffrey M. Preston
Warren H. Gardner,
6 Penn Center Plaza,
[215] LO 8-6161

Pittsburgh, Pa. 15222: Warren H. Gardner,
4 Gateway Center, [412] 391-1314

Rochester, N.Y. 14534: William J. Boyle,
9 Greylock Ridge, Pittsford, N.Y.
[716] 586-5040

J. Bradley MacKimm [312] MO 4-5800
Midwest Advertising Sales Manager

Chicago, Ill. 60611: Robert M. Denmead,
J. Bradley MacKimm, Ralph Hanning,
645 North Michigan Avenue,
[312] MO 4-5800

Dallas, Texas 75201: Richard P. Poole, 1800 Republic National Bank Tower,
[214] RI 7-9721

Houston, Texas 77002: Kenneth George,
2270 Humble Bldg., [713] CA 4-8381

Detroit, Michigan 48226: Ralph Hanning
856 Penobscot Building
[313] 962-1793

Minneapolis, Minn. 55402: J. Bradley
MacKimm, 1104 Northstar Center
[612] 332-7425

St. Louis, Mo. 63105: Robert M. Denmead
The Clayton Tower, 7751 Carondelet Ave.
[314] PA 5-7285

James T. Hauptli [415] DO 2-4600
Western Advertising Sales Manager

Denver, Colo. 80202: Joseph C. Page, David
M. Watson, Tower Bldg., 1700 Broadway
[303] 255-5484

Los Angeles, Calif. 90017: Ian C. Hill,
John G. Zisch, 1125 W. 6th St.,
[213] HU 2-5450

Portland, Ore. 97204: James T. Hauptli,
218 Mohawk Building, 222 S.W. Morrison
Street, Phone [503] 223-5118

San Francisco, Calif. 94111:
James T. Hauptli, 255 California Street,
[415] DO 2-4600

Pierre Braude Tel: 225 85 88

European Director
88-90 Avenue Des Champs-Elysees, Paris 8

Brian Bowes Tel. Hyde Park 1451

United Kingdom and Scandinavia
34 Dover Street,
London W1

Milan: Robert Saidel

1 via Baracchini Phone: 86-90-656

Frankfurt/Main: Hans Haller

Elsa-Brandstroem Str. 2

Phone: 72 01 81

Geneva: 1, rue du Temple Phone: 31 95 60

Tokyo: George E. Olcott, 1, Kotohiracho

Shiba, Minato-Ku [502] 0656

Osaka: Ryoji Kobayashi 163, Umegae-cho

Kita-ku [362] 8771

Business Department

Wallace C. Carmichael, Manager

[212] 971-3191

Stephen R. Weiss, Production Manager

[212] 971-2044

Thomas M. Egan,

Assistant Production Manager [212] 971-3140

Dorothy Carmesin, Contracts and Billings

[212] 971-2908

Frances Vallone, Reader Service Manager

[212] 971-2865

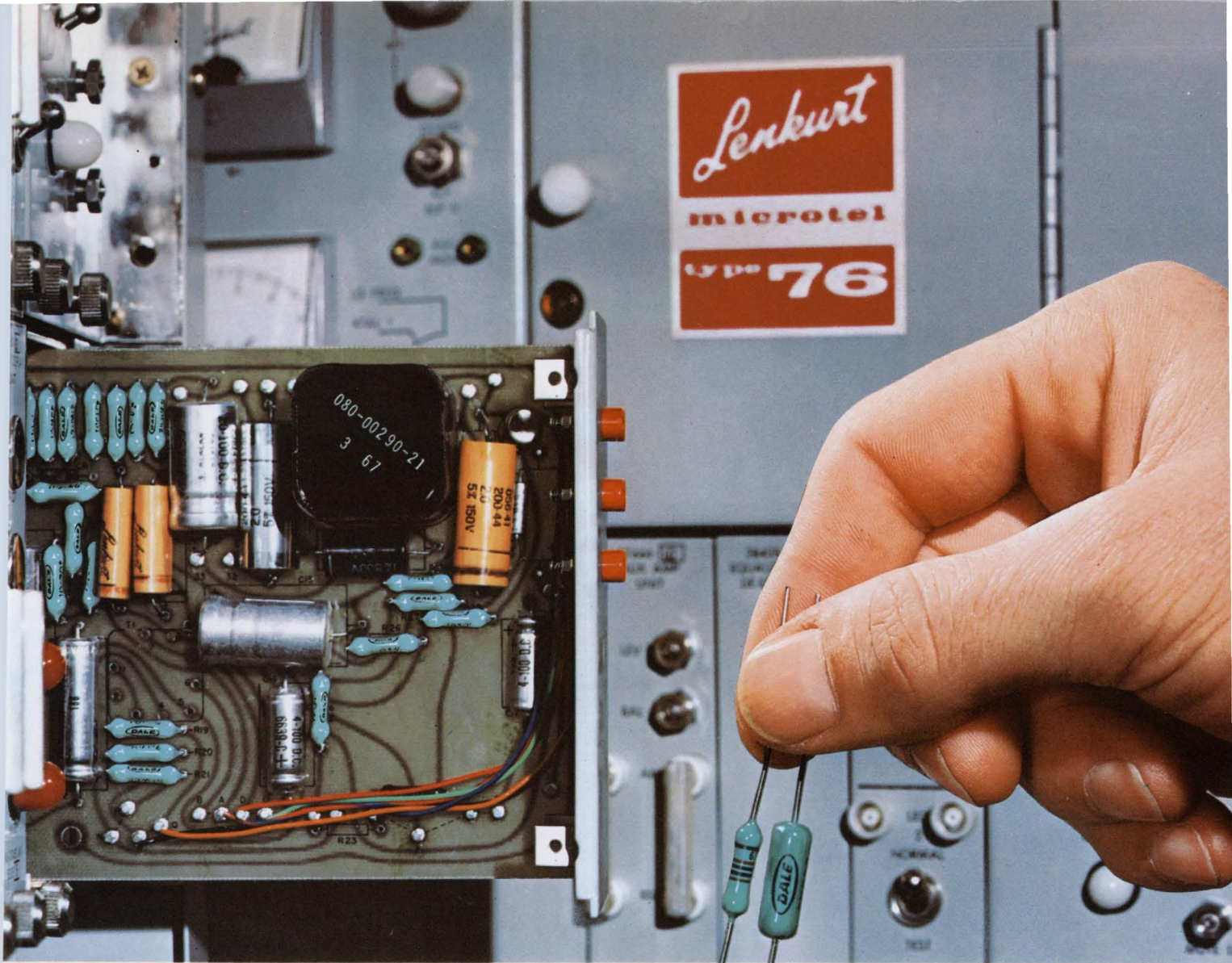

20 years of stability

...a job for DALE Metal Film Resistors

Twenty years – the design life of Lenkurt's versatile "76" Microwave Systems – puts stringent demands on a resistor. To meet them, Lenkurt uses Dale MFF Metal Film Resistors to maintain bias stability in critical amplification circuits. Their evaluation: "Good performance."

Here's how Dale multiplies the advantages of metal film for your application: **Broader design choice** – From subminiature 1/20 watt through 12 watts of housed power plus microresistive package and networks to your specification. **Proven failure rate** – See data at right. **Faster delivery** – Expanded production facilities let you call the shots on shipment of both MF and MFF types.

Call Dale today...402-564-3131 or circle 181 for complete Resistor Catalog A

GENERAL SPECIFICATIONS TYPE MF* MIL-R-10509F				
DALE TYPE	MIL. TYPE	125° C RATING (Char. C & E)	70° C RATING (Char D)	RESISTANCE RANGE (Ohms)
MF50	RN-50	1/20 w	1/10 w	30.1 to 80.6K
MF-1/10	RN-55	1/10 w	1/8 w	30.1 to 301K
MF-1/8	RN-60	1/8 w	1/4 w	10 to 1 MΩ
MF-1/4	RN-65	1/4 w	1/2 w	10 to 1 MΩ
MFS-1/2	RN-70	1/2 w	3/4 w	10 to 1.5 MΩ
MF-1	RN-75	1 w	–	25 to 2.6 MΩ
MF-2	RN-80	–	2 w†	100 to 10 MΩ

*Also available in conformal coated (MFF) and housed chassis mount (D) styles with power to 12 watts. †Char. B.

Tolerance: ±1%, ±.5%, ±.25%, ±.10% standard. Characteristics D, C, or E apply depending on T.C. required.

Proven Failure Rate: .004% per 1,000 hrs. (60% confidence at 50% power, 70° C ambient). Based on 16,320,000 hrs. of load life testing without a failure (100% rated power, 70° C, failure defined as ΔR > 1%).

Gard Testing is available to meet Established Reliability requirements at significant time/cost savings over typical 100 hr. burn in. Write for Test Report #19590.



for optimum value in metal film resistors

DALE ELECTRONICS, INC., 1300 28th Ave. Columbus, Nebraska 68601
In Canada: Dale Electronics, Canada, Ltd.



RCA announces

Medium-Power DTL CD2300 Line

at economy prices

45 types / 3 package styles / 2 Temperature Ranges
Gates / Expanders / High Fanout Gates
Clocked Flip-Flops / Hex Inverters
2K Ω and 6K Ω Output Pull-Up Options

- For Your Military Applications:
CD2300 Series—15 circuits in RCA's Unique Ceramic Flat Package.
CD2300D Series—15 circuits in RCA's Unique Ceramic Dual In-Line Package.
- For Industrial and Commercial Applications:
CD2300E Series—15 circuits in RCA's Dual In-Line Silicone Package.
- Compatible with RCA CD2200 and 2200D Low-Power DTL Series.

exact replacements for 830 and 930 series DTL

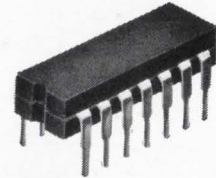
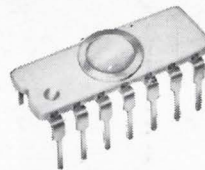
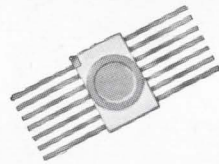

Circuit and Pull-up Option	-55°C to +125°C Operation				0°C to +75°C Operation	
	14-Lead Ceramic Flat Pack	Price (1000 Units)	14-Lead Ceramic Dual In-Line Package	Price (1000 Units)	14-Lead Dual In-Line Silicone Package	Price (1000 Units)
NAND Gates						
Dual-4 Expandable (6K Ω)	CD2300/930	\$2.50	CD2300D/930	\$2.50	CD2300E/830	\$1.05
Dual-4 Expandable (2K Ω)	CD2301/961	\$2.50	CD2301D/961	\$2.50	CD2301E/861	\$1.05
Dual-4 High Fanout, Expandable (transistor output pull-up)	CD2306/932	\$2.75	CD2306D/932	\$2.75	CD2306E/832	\$1.15
Dual-4 High Fanout Expandable (no output pull-up)	CD2307/944	\$2.75	CD2307D/944	\$2.75	CD2307E/844	\$1.15
Triple-3 Input (6K Ω)	CD2308/962	\$2.75	CD2308D/962	\$2.75	CD2308E/862	\$1.15
Triple-3 Input (2K Ω)	CD2309/963	\$2.75	CD2309D/963	\$2.75	CD2309E/863	\$1.15
Quadruple-2 Input (6K Ω)	CD2302/946	\$2.75	CD2302D/946	\$2.75	CD2302E/846	\$1.15
Quadruple-2 Input (2K Ω)	CD2303/949	\$2.75	CD2303D/949	\$2.75	CD2303E/849	\$1.15
Hex Inverters						
Diode Input (6K Ω)	CD2310/936	\$2.90	CD2310D/936	\$2.90	CD2310E/836	\$1.45
Diode Input (2K Ω)	CD2311/937	\$2.90	CD2311D/937	\$2.90	CD2311E/837	\$1.45
Expandable Input (6K Ω)	CD2312	\$2.90	CD2312D	\$2.90	CD2312E	\$1.45
Expandable Input (2K Ω)	CD2313	\$2.90	CD2313D	\$2.90	CD2313E	\$1.45
Flip-Flops						
Clocked RS with JK Capability (6K Ω)	CD2304/945	\$3.00	CD2304D/945	\$3.00	CD2304E/845	\$1.90
Clocked RS with JK Capability (2K Ω)	CD2305/948	\$3.00	CD2305D/948	\$3.00	CD2305E/848	\$1.90
Input Expander						
Dual 4-Diode	CD2314/933	\$2.25	CD2314D/933	\$2.25	CD2314E/833	\$.90

Ask your RCA Representative for details. See your RCA Distributor for his price and delivery. For technical information, write Commercial Engineering, Section ICN 4-5, RCA Electronic Components, Harrison, N.J. 07029.

RCA
Integrated
Circuits