

Intel® NUC Products

NUC8i3BE/NUC8i5BE/NUC8i7BE

Technical Product Specification

Regulatory Models: NUC8BEK (Short Kit/Mini PC)

NUC8BEH (Tall Kit/Mini PC)

NUC8BEB (Board)

July 2018

Order Number: K15389-001

Intel NUC Products NUC8i3BE, NUC8i5BE and NUC8i7BE may contain design defects or errors known as errata that may cause the product to deviate from published specifications. Current characterized errata, if any, are documented in Intel NUC Products NUC8i3BE/NUC8i5BE/NUC8i7BE Specification Update.

Revision History

Revision	Revision History	Date
001	First release of Intel NUC Products NUC8i3BE/NUC8i5BE/NUC8i7BE Technical Product Specification	April 2018
002	First production release of the Intel NUC Products NUC8i3BE/NUC8i5BE/NUC8i7BE Technical Product Specification	July 2018

Disclaimer

This product specification applies to only the standard Intel NUC Board, Kit or System with BIOS identifier BECFL357.86A.

INFORMATION IN THIS DOCUMENT IS PROVIDED IN CONNECTION WITH INTEL® PRODUCTS. NO LICENSE, EXPRESS OR IMPLIED, BY ESTOPPEL OR OTHERWISE, TO ANY INTELLECTUAL PROPERTY RIGHTS IS GRANTED BY THIS DOCUMENT. EXCEPT AS PROVIDED IN INTEL'S TERMS AND CONDITIONS OF SALE FOR SUCH PRODUCTS, INTEL ASSUMES NO LIABILITY WHATSOEVER, AND INTEL DISCLAIMS ANY EXPRESS OR IMPLIED WARRANTY, RELATING TO SALE AND/OR USE OF INTEL PRODUCTS INCLUDING LIABILITY OR WARRANTIES RELATING TO FITNESS FOR A PARTICULAR PURPOSE, MERCHANTABILITY, OR INFRINGEMENT OF ANY PATENT, COPYRIGHT OR OTHER INTELLECTUAL PROPERTY RIGHT. UNLESS OTHERWISE AGREED IN WRITING BY INTEL, THE INTEL PRODUCTS ARE NOT DESIGNED NOR INTENDED FOR ANY APPLICATION IN WHICH THE FAILURE OF THE INTEL PRODUCT COULD CREATE A SITUATION WHERE PERSONAL INJURY OR DEATH MAY OCCUR.

All Intel NUC Boards are evaluated as Information Technology Equipment (I.T.E.) for use in personal computers (PC) for installation in homes, offices, schools, computer rooms, and similar locations. The suitability of this product for other PC or embedded non-PC applications or other environments, such as medical, industrial, alarm systems, test equipment, etc. may not be supported without further evaluation by Intel.

Intel Corporation may have patents or pending patent applications, trademarks, copyrights, or other intellectual property rights that relate to the presented subject matter. The furnishing of documents and other materials and information does not provide any license, express or implied, by estoppel or otherwise, to any such patents, trademarks, copyrights, or other intellectual property rights.

Intel may make changes to specifications and product descriptions at any time, without notice.

Designers must not rely on the absence or characteristics of any features or instructions marked "reserved" or "undefined." Intel reserves these for future definition and shall have no responsibility whatsoever for conflicts or incompatibilities arising from future changes to them.

Intel processor numbers are not a measure of performance. Processor numbers differentiate features within each processor family, not across different processor families: Go to: [Learn About Intel® Processor Numbers](#)

Intel NUC may contain design defects or errors known as errata, which may cause the product to deviate from published specifications. Current characterized errata are available on request.

Contact your local Intel sales office or your distributor to obtain the latest specifications before placing your product order.

Intel, the Intel logo, Intel NUC and Intel Core are trademarks of Intel Corporation in the U.S. and/or other countries.

* Other names and brands may be claimed as the property of others.

Copyright © 2018 Intel Corporation. All rights reserved.

Note: For this Technical Product Specification, the use of **Intel NUC Products NUC8i3BE/NUC8i5BE/NUC8i7BE** refers to **Intel NUC Kit NUC8i3BEH, Intel NUC Kit NUC8i5BEH, Intel NUC Kit NUC8i7BEH, Intel NUC Kit NUC8i3BEK, Intel NUC Kit NUC8i5BEK, Intel NUC Mini PC NUC8i3BEKx, Intel NUC Mini PC NUC8i5BEKx, Intel NUC Mini PC NUC8i3BEHx, Intel NUC Mini PC NUC8i5BEHx, Intel NUC Mini PC NUC8i7BEHx, and Intel NUC Boards NUC8i3BEB, NUC8i5BEB and NUC8i7BEB.**

Board Identification Information

Basic Intel® NUC Board NUC8i3BEB Identification Information

AA Revision	BIOS Revision	Notes
J72693-303	BECFL357.86A.0038	1,2

Notes:

1. The AA number is found on a small label on the SO-DIMM sockets.
2. The Intel® Core™ i3-8109U processor is used on this AA revision consisting of the following component:

Device	Stepping	S-Spec Numbers
Intel Core i3-8109U	D0	SRCKC

Basic Intel® NUC Board NUC8i5BEB Identification Information

AA Revision	BIOS Revision	Notes
J72692-303	BECFL357.86A.0038	1,2

Notes:

1. The AA number is found on a small label on the SO-DIMM sockets.
2. The Intel® Core™ i5-8259U processor is used on this AA revision consisting of the following component:

Device	Stepping	S-Spec Numbers
Intel Core i5-8259U	D0	SRCKB

Basic Intel® NUC Board NUC8i7BEB Identification Information

AA Revision	BIOS Revision	Notes
J72688-303	BECFL357.86A.0038	1,2

Notes:

1. The AA number is found on a small label on the SO-DIMM sockets.
2. The Intel® Core™ i7-8559U processor is used on this AA revision consisting of the following component:

Device	Stepping	S-Spec Numbers
Intel Core i7-8559U	D0	SRCK5

Product Identification Information

Intel® NUC Products NUC8i{x}BE{y}{z}¹ Identification Information

Product Name	Intel® NUC Board	Differentiating Features
NUC8i3BEK	NUC8i3BEB J72693-303	Kit with power adapter
NUC8i3BEH		HDD-capable kit with power adapter
NUC8i3BEHXF		HDD kit with power adapter, 16GB Intel® Optane™ Module, 1TB HDD, 4GB DDR4-2400 SDRAM ^[2] , Microsoft Windows 10 Home, "Intel® NUC 8 Home, a Mini PC with Windows 10"
NUC8i5BEK	NUC8i5BEB J72692-303	Kit with power adapter
NUC8i5BEH		HDD-capable kit with power adapter
NUC8i5BEHXF		HDD kit with power adapter, 16GB Intel® Optane™ Module, 1TB HDD, 4GB DDR4-2400 SDRAM ^[2] , Microsoft Windows 10 Home, "Intel® NUC 8 Home, a Mini PC with Windows 10"
NUC8i7BEH	NUC8i7BEB J72688-303	HDD-capable kit with power adapter
NUC8i7BEHGX		32GB Intel® Optane™ Module, 2TB HDD, 8GB DDR4-2400 SDRAM ^[2] , Microsoft* Windows* 10 Home, "Intel® NUC 8 Enthusiast, a Mini PC with Windows 10"

Notes:

1. Where {x} = 3|5|7; {y} = "K" for "slim kit", "H" for "tall kit"; and {z} = "XF" | "XG" for "Intel Optane system"
2. The maximum supported memory speed of the Intel NUC Board NUC8i{x}BEB is 2400 MHz.

Specification Changes or Clarifications

The table below indicates the Specification Changes or Specification Clarifications that apply to the Intel NUC Products NUC8i3BE, NUC8i5BE and NUC8i7BE.

Specification Changes or Clarifications

Date	Type of Change	Description of Changes or Clarifications

Errata

Current characterized errata, if any, are documented in a separate Specification Update. See <http://www.intel.com/content/www/us/en/nuc/overview.html> for the latest documentation.

Preface

This Technical Product Specification (TPS) specifies the board layout, components, connectors, power and environmental requirements, and the BIOS for Intel® NUC Board NUC8i3BEB, Intel® NUC Board NUC8i5BEB and Intel® NUC Board NUC8i7BEB.

Intended Audience

The TPS is intended to provide detailed, technical information about Intel® NUC Board NUC8i3BEB, Intel® NUC Board NUC8i5BEB and Intel® NUC Board NUC8i7BEB and its components to the vendors, system integrators, and other engineers and technicians who need this level of information. It is specifically *not* intended for general audiences.

What This Document Contains

Chapter	Description
1	A description of the features and hardware used on Intel NUC Board NUC8i3BEB, Intel NUC Board NUC8i5BEB and Intel NUC Board NUC8i7BEB
2	A map of the resources of the Intel NUC Board
3	The features supported by the BIOS Setup program
4	A description of the BIOS error messages, beep codes, and POST codes
5	A description of the Intel NUC kit NUC8i3BE[x], Intel NUC kit NUC8i5BE[x] and Intel NUC kit NUC8i7BEH features

Typographical Conventions

This section contains information about the conventions used in this specification. Not all of these symbols and abbreviations appear in all specifications of this type.

Notes, Cautions, and Warnings



NOTE

Notes call attention to important information.



CAUTION

Cautions are included to help you avoid damaging hardware or losing data.

Other Common Notation

#	Used after a signal name to identify an active-low signal (such as USBP0#)
GB	Gigabyte (1,073,741,824 bytes)
GBps	Gigabytes per second
Gbps	Gigabits per second
KB	Kilobyte (1024 bytes)
Kb	Kilobit (1024 bits)
kbps	1000 bits per second
MB	Megabyte (1,048,576 bytes)
MBps	Megabytes per second
Mb	Megabit (1,048,576 bits)
Mbps	Megabits per second
TDP	Thermal Design Power
Xxh	An address or data value ending with a lowercase h indicates a hexadecimal value.
x.x V	Volts. Voltages are DC unless otherwise specified.
*	This symbol is used to indicate third-party brands and names that are the property of their respective owners.

Contents

Revision History	ii
Disclaimer	ii
Note: For this Technical Product Specification, the use of Intel NUC Products NUC8i3BE/NUC8i5BE/NUC8i7BE refers to Intel NUC Kit NUC8i3BEH, Intel NUC Kit NUC8i5BEH, Intel NUC Kit NUC8i7BEH, Intel NUC Kit NUC8i3BEK, Intel NUC Kit NUC8i5BEK, Intel NUC Mini PC NUC8i3BEKx, Intel NUC Mini PC NUC8i5BEKx, Intel NUC Mini PC NUC8i3BEHx, Intel NUC Mini PC NUC8i5BEHx, Intel NUC Mini PC NUC8i7BEHx, and Intel NUC Boards NUC8i3BEB, NUC8i5BEB and NUC8i7BEB.	iii
Board Identification Information.....	iii
Product Identification Information.....	iv
Errata.....	iv
Preface	v
Intended Audience.....	v
What This Document Contains	v
Typographical Conventions	v
Contents	vii
1 Product Description	1
1.1 Overview	1
1.1.1 Feature Summary	1
1.1.2 Board Layout (Top)	3
1.1.3 Board Layout (Bottom).....	4
1.1.4 Block Diagram	6
1.2 Online Support.....	7
1.3 Processor	8
1.4 System Memory	8
1.5 Processor Graphics Subsystem.....	11
1.5.1 Integrated Graphics	11
1.6 USB.....	14
1.7 SATA Interface.....	14
1.7.1 AHCI Mode.....	15
1.7.2 Intel® Rapid Storage Technology / SATA RAID	15
1.7.3 Intel® Next Generation Storage Acceleration.....	15
1.8 Thunderbolt 3.....	16
1.9 Real-Time Clock Subsystem.....	16
1.10 Audio Subsystem	16
1.10.1 Audio Subsystem Software	17
1.11 LAN Subsystem.....	17

1.11.1	Intel® I219V Gigabit Ethernet Controller	17
1.11.2	LAN Subsystem Software	18
1.11.3	RJ-45 LAN Connector with Integrated LEDs	18
1.11.4	Wireless Network Module	19
1.12	Hardware Management Subsystem	19
1.12.1	Hardware Monitoring	19
1.12.2	Fan Monitoring	19
1.12.3	Thermal Solution	19
1.13	Power Management	20
1.13.1	ACPI	21
1.13.2	Hardware Support	23
1.13.3	Microsoft Modern Standby Support	26
1.14	Intel Platform Security Technologies	26
1.14.1	Intel® Virtualization Technology	26
1.14.2	Intel® Platform Trust Technology	27
2	Technical Reference	28
2.1	Memory Resources	28
2.1.1	Addressable Memory	28
2.2	Connectors and Headers	28
2.2.1	Front Panel Connectors	29
2.2.2	Back Panel Connectors	29
2.2.3	Headers and Connectors (Top)	30
2.2.4	Connectors and Headers (Bottom)	31
2.3	BIOS Security Jumper	41
2.4	Mechanical Considerations	43
2.4.1	Form Factor	43
2.5	Electrical Considerations	44
2.5.1	Power Supply Considerations	44
2.5.2	Fan Header Current Capability	44
2.6	Thermal Considerations	45
2.7	Reliability	50
2.8	Environmental	50
3	Overview of BIOS Features	51
3.1	Introduction	51
3.2	BIOS Flash Memory Organization	51
3.3	System Management BIOS (SMBIOS)	51
3.4	Legacy USB Support	52
3.5	BIOS Updates	52
3.5.1	Language Support	53
3.6	BIOS Recovery	53
3.7	Boot Options	54
3.7.1	Network Boot	54

3.7.2	Booting Without Attached Devices (Headless).....	54
3.7.3	Changing the Default Boot Device during POST	54
3.7.4	Power Button Menu.....	55
3.8	Hard Disk Drive Password Security Feature.....	56
3.9	BIOS Security Features	57
4	Error Messages and Blink Codes	58
4.1	Front-panel Power LED Blink Codes.....	58
4.2	BIOS Error Messages.....	58
5	Intel NUC Kit Features	59
5.1	Chassis Front Panel Features.....	59
5.3	Chassis Rear Panel Features.....	61

Figures

Figure 1. Major Board Components (Top)	3
Figure 2. Major Board Components (Bottom)	4
Figure 3. Block Diagram.....	6
Figure 4. Memory Channel and SO-DIMM Configuration.....	10
Figure 5. 4-Pin 3.5 mm (1/8 inch) Audio Jack Pin Out	17
Figure 6. LAN Connector LED Locations.....	18
Figure 7. Thermal Solution and Fan Header.....	20
Figure 8. Location of the Standby Power LED	25
Figure 9. Front Panel Connectors.....	29
Figure 10. Back Panel Connectors	29
Figure 11. Headers and Connectors (Top).....	30
Figure 12. Connectors and Headers (Bottom)	31
Figure 13. Connection Diagram for Front Panel Header (2.0 mm Pitch)	37
Figure 14. Connection Diagram for the Internal USB 2.0 Single-Port Header (1.25 mm Pitch)	39
Figure 15. Location of the CIR Sensor	39
Figure 16. Location of the BIOS Security Jumper	41
Figure 17. Board Dimensions	43
Figure 18. Board Height Dimensions	44
Figure 19. Localized High Temperature Zones	46
Figure 20. Installation Area of Thermal Pad for Intel NUC Kit NUC8i3BEK/NUC8i5BEK	47
Figure 21. Installation area of Thermal Pad for Intel NUC Kit NUC8i3BEH/NUC8i5BEH/NUC8i7BEH	48
Figure 22. Intel NUC Kit NUC8i3BEH/NUC8i5BEH/NUC8i7BEH Features – Front.....	59
Figure 23. Intel NUC Kit NUC8i3BEK/NUC8i5BEK Features – Front	60
Figure 24. Intel NUC Kit NUC8i3BEH/NUC8i5BEH/NUC8i7BEH Features – Rear	61
Figure 25. Intel NUC Kit NUC8i3BEK/NUC8i5BEK Features – Rear	62

Tables

Table 1. Feature Summary	1
Table 2. Components Shown in Figure 1	3
Table 3. Components Shown in Figure 2	5
Table 4. Supported Memory Configurations.....	9
Table 5. Unsupported Memory Configurations.....	9
Table 6. DisplayPort Multi-Streaming Resolutions.....	12
Table 7. Multiple Display Configuration Maximum Resolutions	13
Table 8. Audio Formats Supported by the HDMI and USB Type C Interfaces.....	13
Table 9. LAN Connector LED States.....	18
Table 10. Effects of Pressing the Power Switch.....	21
Table 11. Power States and Targeted System Power.....	22
Table 12. Wake-up Devices and Events	23
Table 13. Headers and Connectors Shown in Figure 11	30
Table 14. Connectors and Headers Shown in Figure 12	32

Table 15. SATA Power Connector (1.25 mm pitch).....	33
Table 16. Single-Port Internal USB 2.0 Header (1.25 mm pitch).....	33
Table 17. M.2 2280 Module (key type M) Connector.....	33
Table 18. Digital Microphone (DMICS) Array Connector (1.25 mm Pitch).....	34
Table 19. RGB LED Connector (1.25 mm Pitch).....	35
Table 20. CEC Header (1.25 mm pitch).....	35
Table 21. USB Type C Connector.....	36
Table 22. Front Panel Header (2.0 mm Pitch).....	36
Table 23. States for a One-Color Power LED.....	37
Table 24. States for a Dual-Color Power LED.....	37
Table 25. SDXC Card Reader Connector.....	38
Table 26. HDMI CEC expected behavior.....	40
Table 27. RGB LED Options.....	40
Table 28. Fan Header Current Capability.....	44
Table 29. Thermal Considerations for Components.....	49
Table 30. Tcontrol Values for Components.....	49
Table 31. Environmental Specifications.....	50
Table 32. Acceptable Drives/Media Types for BIOS Recovery.....	53
Table 33. Boot Device Menu Options.....	54
Table 34. Master Key and User Hard Drive Password Functions.....	56
Table 35. Supervisor and User Password Functions.....	57
Table 36. Front-panel Power LED Blink Codes.....	58
Table 37. Components Shown in Figure 22.....	59
Table 38. Components Shown in Figure 23.....	60
Table 39. Components Shown in Figure 24.....	61
Table 40. Components Shown in Figure 25.....	62

1 Product Description

1.1 Overview

1.1.1 Feature Summary

Table 1 summarizes the major features of Intel® NUC Board NUC8i3BEB, Intel® NUC Board NUC8i5BEB and Intel® NUC Board NUC8i7BEB.

Table 1. Feature Summary

Form Factor	4.0 inches by 4.0 inches (101.60 millimeters by 101.60 millimeters)
Processor (one of 3 models)	<ul style="list-style-type: none"> • A soldered-down 8th generation Intel® Core™ i3-8109U dual-core processor with a maximum 28 W TDP, 3.0 GHz base, 3.6 GHz Turbo, 4 threads <ul style="list-style-type: none"> — Intel® Iris™ Plus Graphics 655 — Integrated memory controller — Integrated PCH • A soldered-down 8th generation Intel® Core™ i5-8259U quad-core processor with a maximum 28 W TDP, 2.3 GHz base, 3.8 GHz Turbo, 8 threads <ul style="list-style-type: none"> — Intel® Iris™ Plus Graphics 655 — Integrated memory controller — Integrated PCHA • A soldered-down 8th generation Intel® Core™ i7-8559U quad-core processor with a maximum 28 W TDP, 2.7 GHz base, 4.5 GHz Turbo, 8 threads <ul style="list-style-type: none"> — Intel® Iris™ Plus Graphics 655 — Integrated memory controller — Integrated PCH
Memory	<ul style="list-style-type: none"> • Two 260-pin 1.2 V DDR4 SDRAM Small Outline Dual Inline Memory Module (SO-DIMM) sockets • Support for DDR4 2400 MHz SO-DIMMs • Support for 4 Gb and 8 Gb memory technology • Support for up to 32 GB of system memory with two SO-DIMMs using 8 Gb memory technology • Support for non-ECC memory • Support for 1.2 V low voltage JEDEC memory only <p>Note: 2 Gb memory technology (SDRAM Density) is not compatible</p>
Graphics	<ul style="list-style-type: none"> • Integrated graphics support for processors with Intel® Graphics Technology: <ul style="list-style-type: none"> — One High Definition Multimedia Interface* (HDMI*) back panel connector — One DisplayPort signal via USB Type C back panel connector
Audio	<ul style="list-style-type: none"> • Intel® High Definition (Intel® HD) Audio via the HDMI v2.0 and USB Type C interfaces through the processor • Realtek HD Audio via a stereo microphone/headphone 3.5 mm jack on the front panel • Digital microphone array (DMICS) connector (internal)
Storage	<ul style="list-style-type: none"> • SATA ports: <ul style="list-style-type: none"> — One SATA 6.0 Gbps port (black) for 2.5" storage device • One SATA 6.0 Gbps port is reserved for an M.2 storage module supporting M.2 2242 and M.2 2280 (key type M and B+M) modules <p>Note: Supports key type M and B+M (PCI Express* x1/x2/x4 and SATA)</p>

continued

Table 1. Feature Summary (continued)

Peripheral Interfaces	<ul style="list-style-type: none">• One USB 3.1 (Gen 2/10 Gbps) port implemented via the external back panel Type C connector• USB 3.1 (Gen 2/10 Gbps) Type A ports:<ul style="list-style-type: none">• Two ports are implemented with external front panel connectors (one blue and one orange charging capable)• Two ports are implemented with external back panel connectors (blue)• USB 2.0 ports:<ul style="list-style-type: none">• Two ports via two single-port internal 1x4 1.25 mm pitch headers (white)• One port is reserved for the NGFF 1216 Wireless module Bluetooth capability• Consumer Infrared (CIR)
Expansion Capabilities	<ul style="list-style-type: none">• One M.2 connector supporting M.2 2242 and M.2 2280 (key type M and B+M) modules• One Micro SDXC slot• One Thunderbolt™ 3 via back panel USB Type C connector
BIOS	<ul style="list-style-type: none">• Intel® BIOS resident in the Serial Peripheral Interface (SPI) Flash device• Support for Advanced Configuration and Power Interface (ACPI), Plug and Play, System Management BIOS (SMBIOS), and Modern Standby
Instantly Available PC Technology	<ul style="list-style-type: none">• Suspend to RAM support• Wake on PCI Express, LAN, front panel, CIR, and USB ports
LAN	Gigabit (10/100/1000 Mbps) LAN subsystem using the Intel® I219V Gigabit Ethernet Controller
Hardware Monitor Subsystem	Hardware monitoring subsystem, based on an ITE Tech. IT8987E-VG embedded controller, including: <ul style="list-style-type: none">• Voltage sense to detect out of range power supply voltages• Thermal sense to detect out of range thermal values• One processor fan header• Fan sense input used to monitor fan activity• Fan speed control
Wireless	Intel® Dual Band Wireless-AC 9560 <ul style="list-style-type: none">• 802.11ac, Dual Band, 2x2 Wi-Fi + Bluetooth 5• Maximum Transfer speed up to 1.73 Gbps• Supports Intel® Smart Connect Technology• Next Generation Form Factor (NGFF) 12x16 soldered-down package

1.1.2 Board Layout (Top)

Figure 1 shows the location of the major components on the top-side of Intel NUC Board NUC8i3BEB, Intel NUC Board NUC8i5BEB and Intel NUC Board NUC8i7BEB.

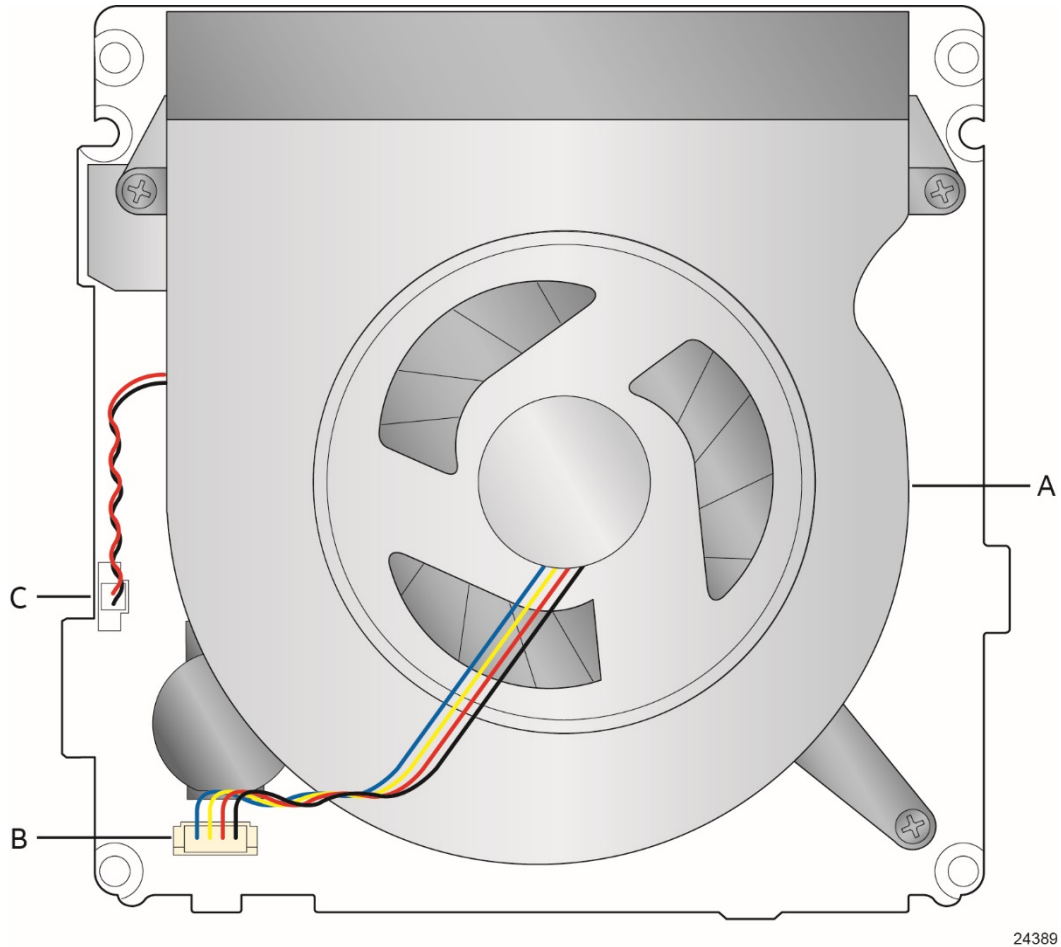

24389

Figure 1. Major Board Components (Top)

Table 2 lists the components identified in Figure 1.

Table 2. Components Shown in Figure 1

Item from Figure 1	Description
A	Thermal solution
B	Processor fan header
C	Battery connector

1.1.3 Board Layout (Bottom)

Figure 2 shows the location of the major components on the bottom-side of Intel NUC Board NUC8i3BEB, Intel NUC Board NUC8i5BEB and Intel NUC Board NUC8i7BEB.

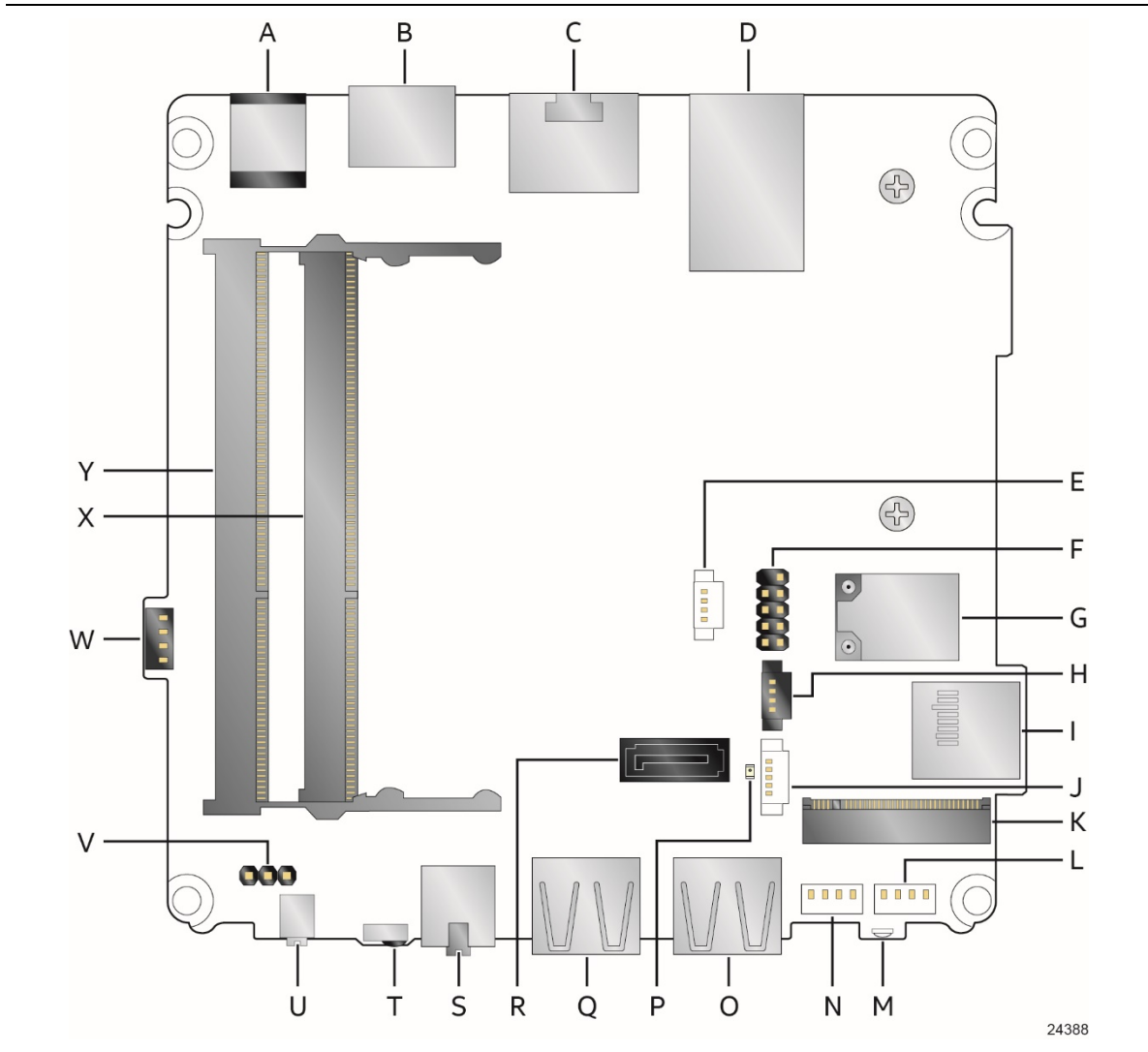

Figure 2. Major Board Components (Bottom)

Table 3. Components Shown in Figure 2

Item from Figure 2	Description
A	DC Input Jack
B	HDMI connector
C	LAN connector
D	USB 3.1 ports (blue)
E	Digital Microphones (DMICs) header
F	Front Panel header
G	Intel Dual Band Wireless AC + Bluetooth 9560 module
H	RGB (HDD) LED header
I	Micro SDXC slot
J	SATA power connector (1.25 mm pitch)
K	M.2 connector (key type M and B+M) for 2242 and 2280 modules
L	Front panel single-port USB 2.0 header (1.25 mm pitch)
M	HDD Activity LED
N	Front panel single-port USB 2.0 header (1.25 mm pitch)
O	Front panel USB 3.1 connector (blue)
P	Standby LED
Q	Front panel USB 3.1 connector (orange, charging)
R	SATA 6.0 Gbps connector
S	Front panel stereo microphone/headphone jack
T	Consumer Infrared (CIR) sensor
U	Front panel power button
V	BIOS security header & jumper
W	Consumer electronics control (CEC) header
X	DDR4 SO-DIMM1 socket
Y	DDR4 SO-DIMM2 socket

1.1.4 Block Diagram

Figure 3 is a block diagram of the major functional areas of the board.

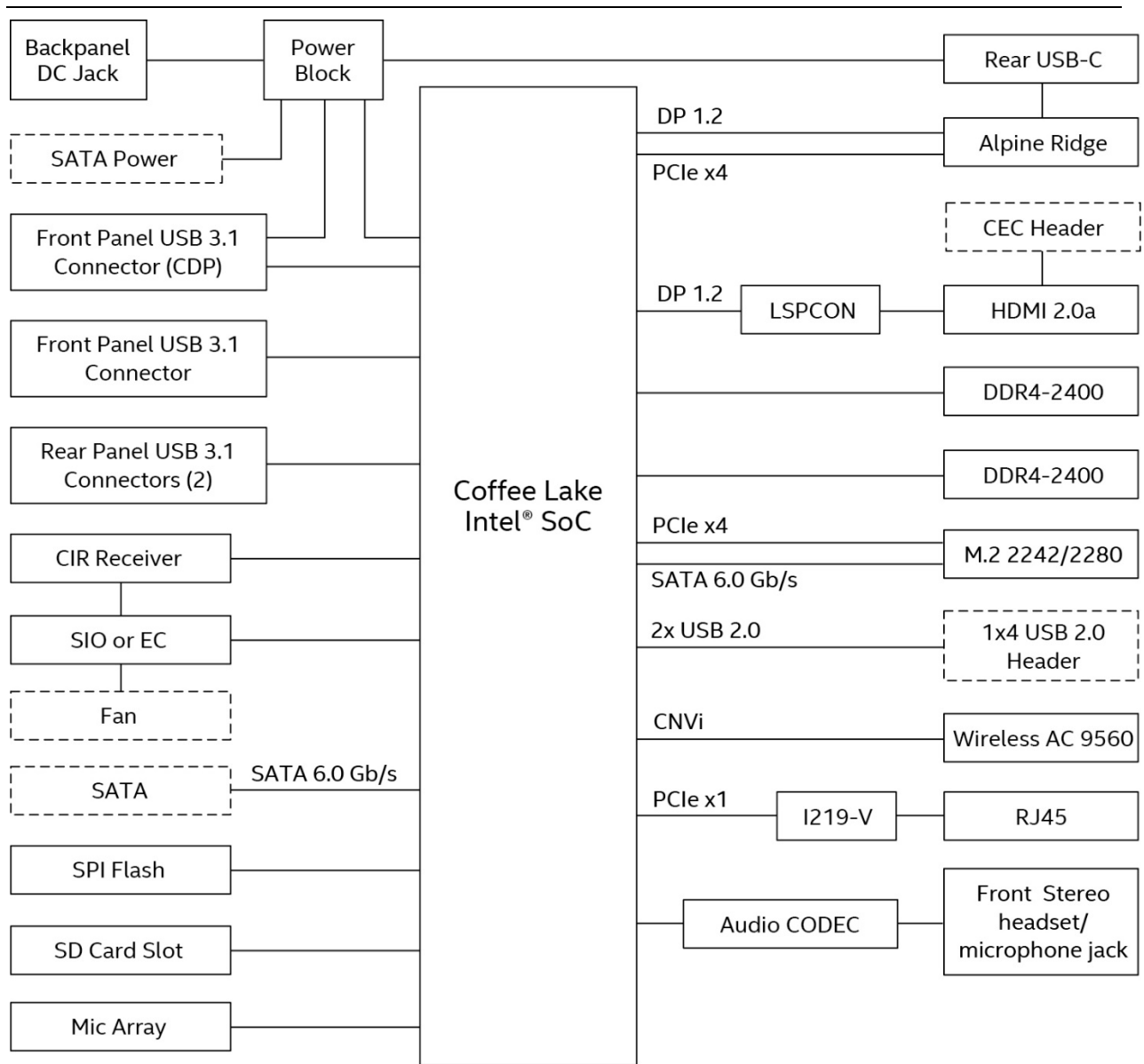

24390

Figure 3. Block Diagram

1.2 Online Support

To find information about...

Intel NUC Board NUC8i3BEB, Intel NUC Board NUC8i5BEB, and Intel NUC Board NUC8i7BEB

Intel NUC Support

Available configurations for Intel NUC Board NUC8i3BEB, Intel NUC Board NUC8i5BEB and Intel NUC Board NUC8i7BEB

Product support page NUC8i3BEK

Product support page NUC8i3BEH

Product support page NUC8i5BEK

Product support page NUC8i5BEH

Product support page NUC8i7BEH

BIOS and driver updates

BIOS and driver updates for NUC8i3BEK

BIOS and driver updates for NUC8i3BEH

BIOS and driver updates for NUC8i5BEK

BIOS and driver updates for NUC8i5BEH

BIOS and driver updates for NUC8i7BEH

Tested memory

Compatible peripherals and components

Integration information

Processor datasheet

Regulatory documentation

Visit this Intel web site:

<http://www.intel.com/NUC>

<http://www.intel.com/NUCSupport>

<http://ark.intel.com>

<https://www.intel.com/content/www/us/en/support/boards-and-kits/intel-nuc-kits/intel-nuc-kit-nuc8i3bek.html>

<http://www.intel.com/content/www/us/en/support/boards-and-kits/intel-nuc-kits/intel-nuc-kit-nuc8i3beh.html>

<https://www.intel.com/content/www/us/en/support/boards-and-kits/intel-nuc-boards/intel-nuc-board-nuc8i5bek.html>

<http://www.intel.com/content/www/us/en/support/boards-and-kits/intel-nuc-kits/intel-nuc-kit-nuc8i5beh.html>

<http://www.intel.com/content/www/us/en/support/boards-and-kits/intel-nuc-kits/intel-nuc-kit-nuc8i7beh.html>

<http://downloadcenter.intel.com>

<https://downloadcenter.intel.com/product/126149>

<https://downloadcenter.intel.com/product/126150>

<https://downloadcenter.intel.com/product/126147>

<https://downloadcenter.intel.com/product/126148>

<https://downloadcenter.intel.com/product/126140>

<http://www.intel.com/content/www/us/en/support/boards-and-kits/000027798.html>

<https://www.intel.com/content/www/us/en/support/articles/00027966.html>

<http://www.intel.com/NUCSupport>

<http://ark.intel.com>

<https://www.intel.com/content/www/us/en/support/articles/00028043.html>

1.3 Processor

One of the following:

A soldered-down 8th generation Intel® Core™ i3-8109U dual-core processor with up to a maximum 28 W TDP (if thermal margin is available).

- 3.0 GHz base frequency, 3.6 GHz turbo frequency, 4 threads
- Intel® Iris™ Plus Graphics 655
- Integrated memory controller
- Integrated PCH

A soldered-down 8th generation Intel® Core™ i5-8259U quad-core processor with up to a maximum 28 W TDP (if thermal margin is available).

- 2.3 GHz base frequency, 3.8 GHz turbo frequency, 8 threads
- Intel® Iris™ Plus Graphics 655
- Integrated memory controller
- Integrated PCH

A soldered-down 8th generation Intel® Core™ i7-8559U quad-core processor with up to a maximum 28 W TDP (if thermal margin is available).

- 2.7 GHz base frequency, 4.5 GHz turbo frequency, 8 threads
- Intel® Iris™ Plus Graphics 655
- Integrated memory controller
- Integrated PCH



NOTE

There are specific requirements for providing power to the processor. Refer to Section 2.5.1 on page 44 for information on power supply requirements.

1.4 System Memory

The board has two 260-pin SO-DIMM sockets and supports the following memory features:

- 1.2 V DDR4 SDRAM SO-DIMMs with gold plated contacts
- Two independent memory channels with interleaved mode support
- Unbuffered, single-sided or double-sided SO-DIMMs
- 32 GB maximum total system memory (with 8 Gb memory technology). Refer to Section 2.1.1 on page 28 for information on the total amount of addressable memory.
- Minimum recommended total system memory: 2048 MB
- Non-ECC SO-DIMMs
- Serial Presence Detect
- DDR4 2400 MHz SDRAM SO-DIMMs
- Supports 4 Gb and 8Gb memory technology (SDRAM density)

**NOTE**

To be fully compliant with all applicable DDR SDRAM memory specifications, the board should be populated with SO-DIMMs that support the Serial Presence Detect (SPD) data structure. This allows the BIOS to read the SPD data and program the chipset to accurately configure memory settings for optimum performance. If non-SPD memory is installed, the BIOS will attempt to correctly configure the memory settings, but performance and reliability may be impacted or the SO-DIMMs may not function under the determined frequency.

**NOTE**

Intel NUC Boards NUC8i3BEB, NUC8i5BEB and NUC8i7BEB support only 4 Gb and 8 Gb memory technologies (also referred to as “SDRAM density”). Table 4 lists the supported SO-DIMM configurations. Table 5 lists the SO-DIMM configurations that are **not** supported.

Table 4. Supported Memory Configurations

SO-DIMM Capacity	Configuration ^(Note)	SDRAM Density	SDRAM Organization Front-side/Back-side	Number of SDRAM Devices
2048 MB	SS	4 Gbit	512 M x4/empty	4
4096 MB	DS	4 Gbit	512 M x4/512 M x4	8
4096 MB	SS	8 Gbit	1024 M x4/empty	4
8192 MB	DS	4 Gbit	512 M x8/512 M x8	16
8192 MB	DS	8 Gbit	1024 M x4/1024 M x4	8
16384 MB	DS	8 Gbit	1024 M X8/1024 M x8	16

Note: “DS” refers to double-sided memory modules and “SS” refers to single-sided memory modules.

Table 5. Unsupported Memory Configurations

SO-DIMM Capacity	Configuration ^(Note)	SDRAM Density	SDRAM Organization Front-side/Back-side	Number of SDRAM Devices
1024 MB	SS	1 Gbit	128 M x8/empty	8
2048 MB	DS	1 Gbit	128 M x8/128 M x8	16
2048 MB	SS	2 Gbit	256 M x8/empty	8
4096 MB	DS	2 Gbit	256 M x8/256 M x8	16

Note: “DS” refers to double-sided memory modules and “SS” refers to single-sided memory modules.

For information about...**Refer to:**

Tested Memory

<http://www.intel.com/content/www/us/en/support/boards-and-kits/000027798.html>

Figure 4 illustrates the memory channel and SO-DIMM configuration.

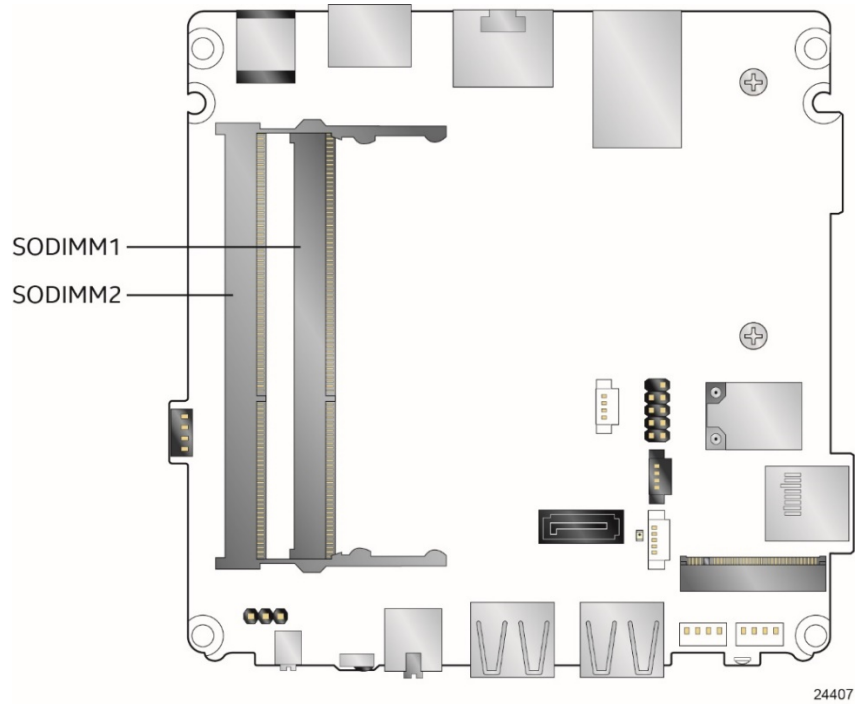

Figure 4. Memory Channel and SO-DIMM Configuration

1.5 Processor Graphics Subsystem

The Intel NUC Boards NUC8i3BEB, NUC8i5BEB and NUC8i7BEB support graphics through Intel Iris™ Plus Graphics 655.

1.5.1 Integrated Graphics

The board supports integrated graphics via the processor.

1.5.1.1 Intel® High Definition (Intel® HD) Graphics

The Intel Iris™ Plus graphics controller features the following:

- API support
 - Direct3D* 2015, Direct3D 11.2, Direct3D 11.1, Direct3D 9, Direct3D 10, Direct2D
 - OpenGL* 4.5 support
 - OpenCL* 2.1 , OpenCL 2.0, OpenCL 1.2 support
- Next Generation Intel® Clear Video Technology HD support is a collection of video playback and enhancement features that improve the end user's viewing experience
- Encode/transcode HD content
- Playback of high definition content including Blu-ray* disc
- Superior image quality with sharper, more colorful images
- DirectX* Video Acceleration (DXVA2) support for accelerating video processing
- Full AVC/VC1/MPEG2/HEVC/VP8/VP9/JPEG hardware-accelerated video decode
- Full AVC/MPEG2/HEVC/VP8/JPEG hardware-accelerated video encode
- Intel HD Graphics with Advanced Hardware Video Transcoding (Intel® Quick Sync Video)



NOTES

Intel Quick Sync Video is enabled by an appropriate software application.

HDMI 2.0a is enabled by LSPCON (DP 1.2 to HDMI 2.0a protocol converter); Stereo 3D (S3D) technology is not supported.

HDMI 2.0a supports High Dynamic Range (HDR) and 10-bit sampling. HDR requires use of appropriate software and display hardware.

1.5.1.2 Video Memory Allocation

Intel® Dynamic Video Memory Technology (DVMT) is a method for dynamically allocating system memory for use as graphics memory to balance 2D/3D graphics and system performance. If your computer is configured to use DVMT, graphics memory is allocated based on system requirements and application demands (up to the configured maximum amount). When memory is no longer needed by an application, the dynamically allocated portion of memory is returned to the operating system for other uses.

1.5.1.3 High Definition Multimedia Interface* (HDMI*)

HDMI is supported through a MegaChips MCDP2800-BCT DisplayPort 1.2a to HDMI 2.0 Level Shifter/Protocol Converter (LSPCON). The HDMI port supports standard, enhanced, or high definition video, plus multi-channel digital audio on a single cable. The port is compatible with all ATSC and DVB HDTV standards and supports eight full range channels at 24-bit/192 kHz audio of lossless audio formats. The maximum supported resolution is 4096 x 2160 @ 60 Hz, 24bpp. The HDMI port is compliant with the HDMI 2.0a specification.

For information about

HDMI technology

Refer to

<http://www.hdmi.org>

1.5.1.4 DisplayPort* via USB Type-C

DisplayPort is a digital communication interface that utilizes differential signaling to achieve a high bandwidth bus interface designed to support connections between PCs and monitors, projectors, and TV displays. DisplayPort is suitable for display connections between consumer electronics devices such as high definition optical disc players, set top boxes, and TV displays. The maximum supported resolution is 4096 x 2304 @ 60 Hz, 24bpp. DisplayPort via USB Type C connector is compliant with the DisplayPort 1.2 specification.

DisplayPort output supports Multi-Stream Transport (MST) which allows for multiple independent video streams (daisy-chain connection with multiple monitors) over a single DisplayPort. This will require the use of displays that support DisplayPort 1.2 and allow for this feature.

For information about

DisplayPort technology

Refer to

<http://www.displayport.org>

1.5.1.4.1 DisplayPort 1.2 Multi-Stream Transport Daisy-Chaining

Table 6 lists the maximum resolutions available when using DisplayPort 1.2 Multi-Stream Transport.

Table 6. DisplayPort Multi-Streaming Resolutions

DisplayPort Usage Models	Monitor 1	Monitor 2	Monitor 3
3 Monitors	1920 x 1200 @ 60 Hz	1920 x 1080 @ 60 Hz	1920 x 1080 @ 60 Hz
2 Monitors	2560 x 1600 @ 60 Hz	2560 x 1600 @ 60 Hz	
3 Monitors (with DisplayPort 1.2 hub)	1920 x 1080 @ 60 Hz	1920 x 1080 @ 60 Hz	1920 x 1080 @ 60 Hz

1.5.1.5 Multiple DisplayPort and HDMI Configurations

Multiple DisplayPort and HDMI configurations feature the following:

- Single HDMI 2.0a with 4K @ 60 Hz support
- Single DisplayPort 1.2 with 4K @ 60 Hz support via USB Type C connector
- Two independent displays with 4K @ 60 Hz support
 - HDMI and DisplayPort via USB Type C
- Three independent displays with 4K support
 - One HDMI 4096 x 2160 @ 60 Hz
 - Two DisplayPort 4096 x 2304 @ 30 Hz via USB Type C using DisplayPort Multi-Stream Transport capability

Table 7. Multiple Display Configuration Maximum Resolutions

Single Display HDMI	Single Display DisplayPort via USB Type C	Dual Display USB Type C and HDMI	Triple Display USB Type C and HDMI
4096 x 2160 @ 60 Hz	4096 x 2304 @ 60 Hz	4096 x 2304 @ 60 Hz (USB Type C/DP) 4096 x 2160 @ 60 Hz (HDMI)	4096 x 2304 @ 30 Hz (USB Type C/DP MST) 4096 x 2304 @ 30 Hz (USB Type C/DP MST) 4096 x 2160 @ 60 Hz (HDMI)

Note: Higher resolutions may be achievable but only at lower refresh rates

For information about

Multiple display maximum resolutions

Refer to

<https://www-ssl.intel.com/content/www/us/en/processors/core/CoreTechnicalResources.html>
(Generic link)

1.5.1.6 High-bandwidth Digital Content Protection (HDCP)

HDCP is the technology for protecting high definition content against unauthorized copy or interception between a source (computer, digital set top boxes, etc.) and the sink (panels, monitor, and TVs). The processor supports HDCP 2.2 for 4k Premium content protection over wired displays (USB Type C and HDMI).

1.5.1.7 Integrated Audio Provided by the HDMI and USB Type C Interfaces

The HDMI and USB Type C interfaces from the processor support audio. The processor supports two High Definition audio streams on two digital ports simultaneously (the DMA controllers are in PCH). The integrated audio processing (DSP) is performed by the PCH.

Table 8 shows the specific audio technologies supported by the processor.

Table 8. Audio Formats Supported by the HDMI and USB Type C Interfaces

Audio Formats	HDMI	USB Type C
AC3 – Dolby* Digital	Yes	Yes
Dolby Digital Plus	Yes	Yes
DTS-HD*	Yes	Yes

LPCM, 192kHz/24 bit, 8 channel	Yes	Yes
Dolby True HD, DTS-HD Master Audio* (Lossless Blu-ray Disc Audio Format)	Yes	Yes

1.6 USB

The USB port arrangement is as follows:

- USB 3.1 Gen 2 (10 Gbps) Type C port implemented via the external back panel Type C connector (maximum current is 3A)
- USB 3.1 Gen 2 (10 Gbps) Type A ports (maximum current is 900 mA for each blue port, 1.5 A for the orange charging port):
 - Two ports are implemented with external front panel connectors (one blue and one orange charging capable)
 - Two ports are implemented with external back panel connectors (blue)
- USB 2.0 ports (maximum current is 500 mA for each port of the white header (1 A total):
 - Two ports via two single-port internal 1x4 1.25 mm pitch headers (white)
 - One port is reserved for the M.2 2230 Wireless module

All the USB ports are high-speed, full-speed, and low-speed capable.



NOTE

Computer systems that have an unshielded cable attached to a USB port may not meet FCC Class B requirements, even if no device is attached to the cable. Use a shielded cable that meets the requirements for full-speed devices.

For information about	Refer to
The location of the USB connectors on the back panel	Figure 9, page 29
The location of the front panel USB headers	Figure 2, page 4

1.7 SATA Interface

The board provides the following SATA interfaces:

- SATA ports:
 - One SATA 6.0 Gbps port for 2.5" storage device
- One SATA 6.0 Gbps port is reserved for an M.2 storage module supporting M.2 2242 and M.2 2280 (key type M and B+M) modules

The PCH provides independent SATA ports with a theoretical maximum transfer rate of 6 Gbps. A point-to-point interface is used for host to device connections.

1.7.1 AHCI Mode

The board supports AHCI storage mode.



NOTE

In order to use AHCI mode, AHCI must be enabled in the BIOS. Microsoft Windows* 10 includes the necessary AHCI drivers without the need to install separate AHCI drivers during the operating system installation process; however, it is always good practice to update the AHCI drivers to the latest available by Intel.*

1.7.2 Intel® Rapid Storage Technology / SATA RAID

The PCH supports Intel® Rapid Storage Technology, providing both AHCI and integrated RAID functionality. The RAID capability provides high-performance RAID 0 and 1 functionality on all SATA ports. Other RAID features include hot spare support and SMART alerting. Software components include an Option ROM for pre-boot configuration and boot functionality, a Microsoft Windows compatible driver, and a user interface for configuration and management of the RAID capability of the PCH.



NOTE

Intel Rapid Storage Technology / SATA RAID is only supported if an M.2 SATA SSD module is used with the onboard SATA interface. RAID is not available when using M.2 PCIe SSD module and onboard SATA interface.

1.7.3 Intel® Next Generation Storage Acceleration

Intel® Next Generation Storage Acceleration with Intel® Optane™ Technology is a disk caching solution that can provide improved computer system performance with improved power savings. It allows configuration of a computer system with the advantage of having HDDs for maximum storage capacity and with Intel® Optane™ Technology for improved system performance.

For information about	Refer to
Intel® Optane™ Technology	http://www.intel.com/content/www/us/en/architecture-and-technology/non-volatile-memory.html



NOTE

In order to use supported RAID and Intel Next Generation Storage Acceleration with Intel® Optane™ Technology features, you must first enable RAID in the BIOS.

1.8 Thunderbolt 3

The boards support Thunderbolt™ 3 with up to 40 Gbps of data throughput, one 4k (60Hz) monitor output, USB3.1 (Gen 2) connection and charging capabilities up to 5V at 3A via the back panel USB Type C connector. Item A in Figure 11 shows the location of the rear panel USB Type C port.

For information about	Refer to
Compatible Thunderbolt™ 3 devices	https://www.intel.com/content/www/us/en/support/articles/000027966.html
Thunderbolt™ 3 information	http://www.intel.com/Thunderbolt

1.9 Real-Time Clock Subsystem

A coin-cell battery (CR2032) powers the real-time clock and CMOS memory. When the computer is not plugged into a wall socket, the battery has an estimated life of three years. When the computer is plugged in, the standby current from the power supply extends the life of the battery. The clock is accurate to ± 13 minutes/year at 25 °C with 3.3 VSB applied via the power supply 5 V STBY rail.



NOTE

If the battery and AC power fail, date and time values will be reset and the user will be notified during the POST.

When the voltage drops below a certain level, the BIOS Setup program settings stored in CMOS RAM (for example, the date and time) might not be accurate. Replace the battery with an equivalent one. Figure 1 on page 3 shows the location of the battery.



CAUTION

Risk of explosion if the battery is replaced with an incorrect type. Batteries should be recycled where possible. Disposal of used batteries must be in accordance with local environmental regulations.

1.10 Audio Subsystem

The audio subsystem supports the following features:

- Digital microphone array (DMICS) connectors (internal)
- Analog line-out/Analog Headphone/Analog Microphone (front panel jack)
- Support for 44.1 kHz/48 kHz/96 kHz/192 kHz sample rates on all analog inputs
- Front Panel Audio Jack Support (see Figure 5 for 3.5 mm audio jack pin out):
 - Speakers only (Stereo)
 - Headphones only (Stereo)
 - Microphone only (mono)
 - Combo Headphone (Stereo)/Microphone (mono)

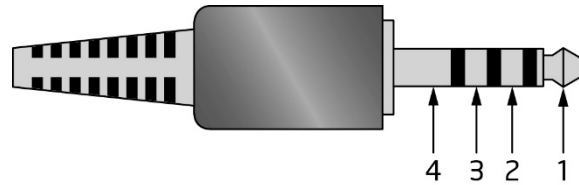

Pin Number	Pin Name	Description
1	Tip	Left Audio Out
2	Ring	Right Audio Out
3	Ring	Common/Ground
4	Sleeve	Audio In/MIC

Figure 5. 4-Pin 3.5 mm (1/8 inch) Audio Jack Pin Out



NOTE

The analog circuit of the front panel audio connector is designed to power headphones or amplified speakers only. Poor audio quality occurs if passive (nonamplified) speakers are connected to this output.

1.10.1 Audio Subsystem Software

Audio software and drivers are available from Intel's web site.

For information about

Obtaining Audio software and drivers

Refer to

<http://downloadcenter.intel.com>

1.11 LAN Subsystem

The LAN subsystem consists of the following:

- Intel I219V Gigabit Ethernet Controller (10/100/1000 Mbps)
- RJ-45 LAN connector with integrated status LEDs

Additional features of the LAN subsystem include:

- CSMA/CD protocol engine
- LAN connect interface between the Processor and the LAN controller
- Power management capabilities
 - ACPI technology support
 - LAN wake capabilities
- LAN subsystem software

1.11.1 Intel® I219V Gigabit Ethernet Controller

The Intel I219V Gigabit Ethernet Controller supports the following features:

- Compliant with the 1 Gbps Ethernet 802.3, 802.3u, 802.3z, 802.3ab specifications
- Multi-speed operation: 10/100/1000 Mbps
- Full-duplex operation at 10/100/1000 Mbps; Half-duplex operation at 10/100 Mbps

- Flow control support compliant with the 802.3X specification as well as the specific operation of asymmetrical flow control defined by 802.3z
- VLAN support compliant with the 802.3q specification
- Supports Jumbo Frames (up to 9 kB)
 - IEEE 1588 supports (Precision Time Protocol)
- MAC address filters: perfect match unicast filters, multicast hash filtering, broadcast filter, and promiscuous mode
- Preboot eXecution Environment (PXE): support in both Legacy and UEFI modes. Requires a preconfigured PXE server infrastructure.

1.11.2 LAN Subsystem Software

LAN software and drivers are available from Intel's web site.

For information about	Refer to
Obtaining LAN software and drivers	http://downloadcenter.intel.com

1.11.3 RJ-45 LAN Connector with Integrated LEDs

Two LEDs are built into the RJ-45 LAN connector (shown in Figure 6).

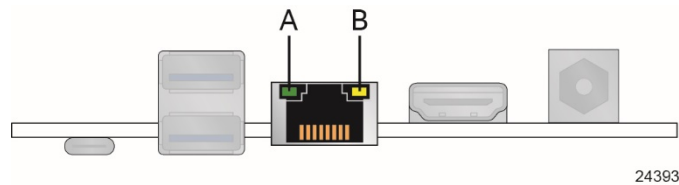

Item	Description
A	Link LED (Green)
B	Data Rate LED (Green/Yellow)

Figure 6. LAN Connector LED Locations

Table 9 describes the LED states when the board is powered up and the LAN subsystem is operating.

Table 9. LAN Connector LED States

LED	LED Color	LED State	Condition
Link	Green	Off	LAN link is not established.
		On	LAN link is established.
		Blinking	LAN activity is occurring.
Data Rate	Green/Yellow	Off	10 Mbps data rate is selected.
		Green	100 Mbps data rate is selected.
		Yellow	1000 Mbps data rate is selected.

1.11.4 Wireless Network Module

The Intel Dual Band Wireless-AC 9560 module provides hi-speed wireless connectivity with the following capabilities:

- Compliant with IEEE 802.11a/b/g/n/ac, 802.11d, 802.11e, 802.11h, 802.11i, 802.11w, 802.11r, 802.11k specifications
- Wi-Fi CERTIFIED* a/b/g/n/ac with wave 2 features, WMM*, WMM-PS*, WPA*, WPA2*, WPS2*
- Maximum bandwidth of 1.73 Gbps
- Dual Mode Bluetooth® 5
- Downlink MU-MIMO
- 2x2: two Transmit and two Receive streams
- 160 MHz channels (2.4 GHz, 5 GHz)
- Seamless roaming between access points
- OS certified with Microsoft Windows* 10; limited feature support for Linux*
- Wi-Fi Direct* encryption and authentication (Microsoft Windows only): WPA2-PSK, AES-CCMP
- Wi-Fi Miracast* as Source, Protected Management Frames
- Security Features
 - Authentication: WPA* and WPA2*, 802.1X (EAP-TLS, TTLS, PEAP, EAP-SIM, EAP-AKA)
 - Authentication protocols: PAP, CHAP, TLS, MS-CHAP*, MS-CHAPv2
 - Encryption: 64-bit and 128-bit WEP, TKIP, 128-bit AES-CCMP

For information about	Refer to
Obtaining WLAN software and drivers	http://downloadcenter.intel.com
Full Specifications	http://intel.com/wireless

1.12 Hardware Management Subsystem

The board has several hardware management features, including thermal and voltage monitoring.

1.12.1 Hardware Monitoring

The hardware monitoring and fan control subsystem is based on an ITE Tech. IT8987E-VG embedded controller, which supports the following:

- Processor and system ambient temperature monitoring
- Chassis fan speed monitoring
- Voltage monitoring of CPU IO Vcc (+Vccio), Memory Vcc (V_SM), CPU IN Vcc (+Vccp)
- SMBus interface

1.12.2 Fan Monitoring

Fan monitoring can be implemented using third-party software.

1.12.3 Thermal Solution

Figure 7 shows the location of the thermal solution and processor fan header.

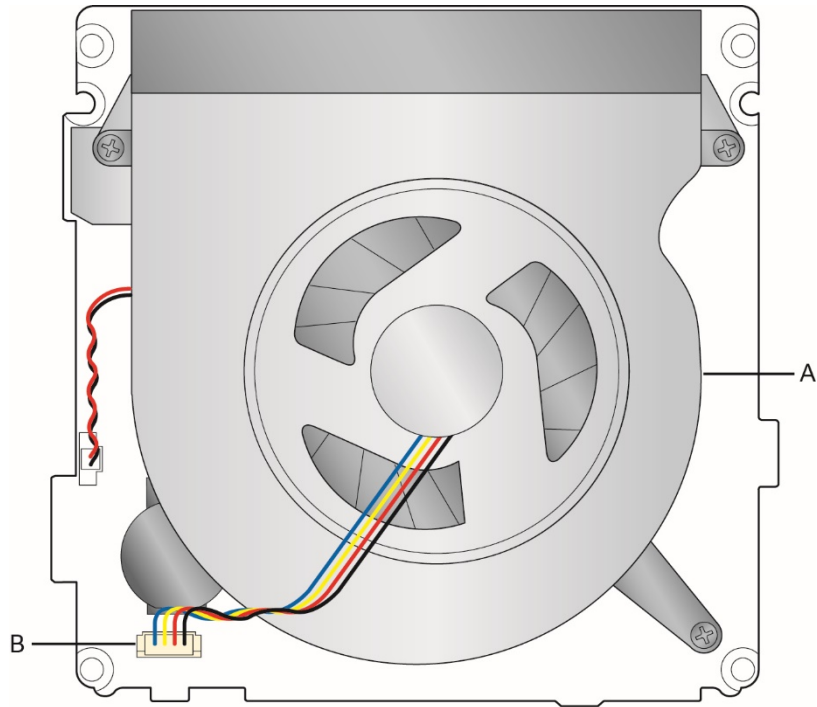

24395

Item	Description
A	Thermal solution
B	Processor fan header

Figure 7. Thermal Solution and Fan Header

1.13 Power Management

Power management is implemented at several levels, including:

- Software support through Advanced Configuration and Power Interface (ACPI)
- Hardware support:
 - Power Input
 - Instantly Available PC technology
 - LAN wake capabilities
 - Wake from USB
 - WAKE# signal wake-up support
 - Wake from S5
 - Wake from CIR
 - +5 V Standby Power Indicator LED
- Microsoft* Modern Standby* (ACPI Low Power S0 Idle) support

1.13.1 ACPI

ACPI gives the operating system direct control over the power management and Plug and Play functions of a computer. The use of ACPI with this board requires an operating system that provides full ACPI support. ACPI features include:

- Plug and Play (including bus and device enumeration)
- Power management control of individual devices, add-in boards (some add-in boards may require an ACPI-aware driver), video displays, and hard disk drives
- Methods for achieving less than 15-watt system operation in the power-on/standby sleeping state
- A Soft-off feature that enables the operating system to power-off the computer
- Support for multiple wake-up events (see Table 12 on page 23)
- Support for a front panel power and sleep mode switch

Table 10 lists the system states based on how long the power switch is pressed, depending on how ACPI is configured with an ACPI-aware operating system.

Table 10. Effects of Pressing the Power Switch

If the system is in this state...	...and the power switch is pressed for	...the system enters this state
Off (ACPI G2/G5 – Soft off)	Less than four seconds	Power-on (ACPI G0 – working state)
On (ACPI G0 – working state)	Less than four seconds	Soft-off/Standby (ACPI G1 – sleeping state) ^{Note}
On (ACPI G0 – working state)	More than six seconds	Fail safe power-off (ACPI G2/G5 – Soft off)
Sleep (ACPI G1 – sleeping state)	Less than four seconds	Wake-up (ACPI G0 – working state)
Sleep (ACPI G1 – sleeping state)	More than six seconds	Power-off (ACPI G2/G5 – Soft off)

Note: Depending on power management settings in the operating system.

1.13.1.1 System States and Power States

Under ACPI, the operating system directs all system and device power state transitions. The operating system puts devices in and out of low-power states based on user preferences and knowledge of how devices are being used by applications. Devices that are not being used can be turned off. The operating system uses information from applications and user settings to put the system as a whole into a low-power state.

Table 11 lists the power states supported by the board along with the associated system power targets. See the ACPI specification for a complete description of the various system and power states.

Table 11. Power States and Targeted System Power

Global States	Sleeping States	Processor States	Device States	Targeted System Power ^(Note 1)
G0 – working state	S0 – working	C0 – working	D0 – working state.	Full power > 30 W
G1 – sleeping state	S3 – Suspend to RAM. Context saved to RAM.	No power	D3 – no power except for wake-up logic.	Power < 5 W ^(Note 2)
G1 – sleeping state	S4 – Suspend to disk. Context saved to disk.	No power	D3 – no power except for wake-up logic.	Power < 5 W ^(Note 2)
G2/S5	S5 – Soft off. Context not saved. Cold boot is required.	No power	D3 – no power except for wake-up logic.	Power < 5 W ^(Note 2)
G3 – mechanical off AC power is disconnected from the computer.	No power to the system.	No power	D3 – no power for wake-up logic, except when provided by battery or external source.	No power to the system. Service can be performed safely.

Notes:

1. Total system power is dependent on the system configuration, including add-in boards and peripherals powered by the system chassis' power supply.
2. Dependent on the standby power consumption of wake-up devices used in the system.

1.13.1.2 Wake-up Devices and Events

Table 12 lists the devices or specific events that can wake the computer from specific states.

Table 12. Wake-up Devices and Events

Devices/events that wake up the system...	...from this sleep state	Comments
Power switch	S3, S4, S5 ¹	
RTC alarm	S3, S4, S5 ¹	Monitor to remain in sleep state
LAN	S3, S4, S5 ^{1,3}	"S5 WOL after G3" must be supported; monitor to remain in sleep state
USB	S3, S4, S5 ^{1,2,3}	Wake S4, S5 controlled by BIOS option (not after G3)
WAKE#	S3, S4 ¹	Via WAKE; monitor to remain in sleep state
Consumer IR	S3, S4, S5 ^{1,3}	Will not wake when in Deep S4/S5 sleep state
Bluetooth	N/A	Wake from Bluetooth is not supported

Notes:

1. S4 implies operating system support only.
2. Will not wake from Deep S4/S5. USB S4/S5 Power is controlled by BIOS. USB S5 wake is controlled by BIOS. USB S4 wake is controlled by OS driver, not just BIOS option.
3. Windows 10 Fast startup will block wake from LAN, USB, and CIR from S5.



NOTE

The use of these wake-up events from an ACPI state requires an operating system that provides full ACPI support. In addition, software, drivers, and peripherals must fully support ACPI wake events.

1.13.2 Hardware Support

The boards provide several power management hardware features, including:

- Wake from Power Button signal
- Instantly Available PC technology
- LAN wake capabilities
- Wake from USB (not after G3)
- WAKE# signal wake-up support
- Wake from S5
- Wake from CIR
- +5 V Standby Power Indicator LED



NOTE

The use of Wake from USB from an ACPI state requires an operating system that provides full ACPI support.

1.13.2.1 Power Input

When resuming from an AC power failure, the computer returns to the power state it was in before power was interrupted (on or off). The computer's response can be set using the Last Power State feature in the BIOS Setup program's Boot menu.

1.13.2.2 Instantly Available PC Technology

Instantly Available PC technology enables the board to enter the ACPI S3 (Suspend-to-RAM) sleep-state. While in the S3 sleep-state, the computer will appear to be off (the power supply is only supplying Standby power, and the front panel LED will be amber or secondary color if dual colored, or off if single colored.) When signaled by a wake-up device or event, the system quickly returns to its last known wake state. Table 12 on page 23 lists the devices and events that can wake the computer from the S3 state.

The use of Instantly Available PC technology requires operating system support and drivers for any installed M.2 add-in card.

1.13.2.3 LAN Wake Capabilities

LAN wake capabilities enable remote wake-up of the computer through a network. The LAN subsystem monitors network traffic at the Media Independent Interface. Upon detecting a Magic Packet* frame, the LAN subsystem asserts a wake-up signal that powers up the computer.

1.13.2.4 Wake from USB

USB bus activity wakes the computer from an ACPI S3 state (not after G3).



NOTE

Wake from USB requires the use of a USB peripheral that supports Wake from USB.

1.13.2.5 WAKE# Signal Wake-up Support

When the WAKE# signal on the PCI Express bus is asserted, the computer wakes from an ACPI S3 or S4 state.

1.13.2.6 Wake from S5

When the RTC Date and Time is set in the BIOS, the computer will automatically wake from an ACPI S5 state.

1.13.2.7 Wake from Consumer IR

CIR activity wakes the computer from an ACPI S3, S4, or S5 state.

1.13.2.8 +5 V Standby Power Indicator LED

The standby power indicator LED shows that power is still present even when the computer appears to be off. Figure 8 shows the location of the standby power LED.

**CAUTION**

If AC power has been switched off and the standby power indicator is still lit, disconnect the power cord before installing or removing any devices connected to the board. Failure to do so could damage the board and any attached devices.

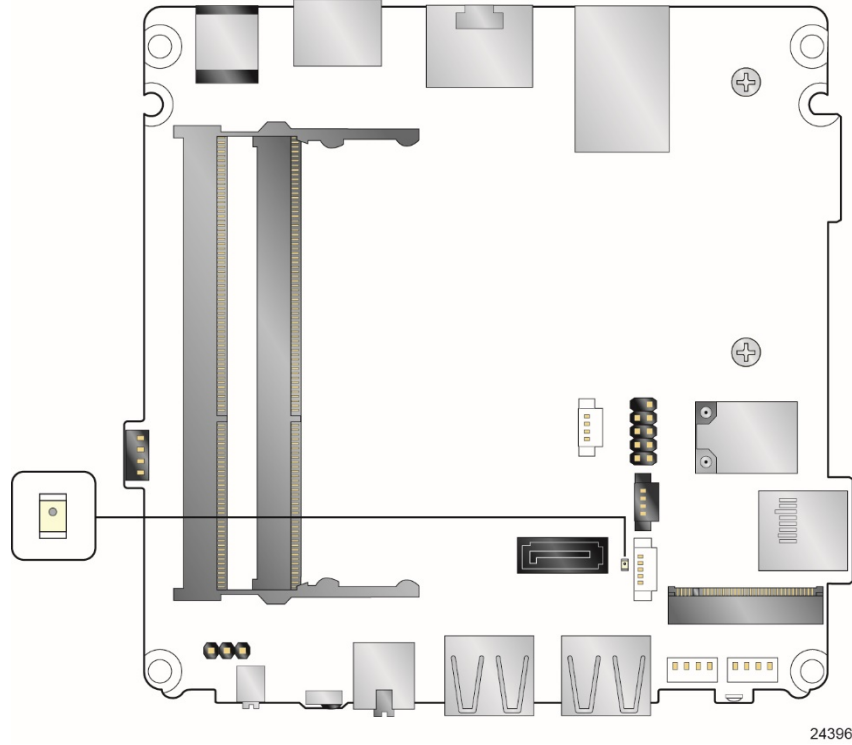

Figure 8. Location of the Standby Power LED

1.13.3 Microsoft Modern Standby Support

Intel NUC Products NUC8i3BE/NUC8i5BE/NUC8i7BE support Windows* 10 Modern Standby, Microsoft's implementation of ACPI low power S0 idle. This allows the system to reduce power consumption and only wake when necessary, as for system maintenance tasks or user intervention. Modern Standby is required for Wake-on-Voice capability.



NOTES

You cannot switch between ACPI S3 and Modern Standby. Standby power model switching is only supported with a complete operating system reinstallation. Switching from one standby power model to another will prevent the proper functioning of sleep states.

Updating BIOS or resetting BIOS to defaults will preserve the current standby power model.

For information about	Refer to
Microsoft Modern Standby	https://docs.microsoft.com/en-us/windows-hardware/design/device-experiences/modern-standby
Intel ACPI Low Power S0 Idle	http://www.uefi.org/sites/default/files/resources/Intel_ACPI_Low_Power_S0_Idle.pdf

1.14 Intel Platform Security Technologies

Intel platform security technologies provides tools and resources to help the user protect their information by creating a safer computing environment.



NOTE

Software with security capability is required to take advantage of Intel platform security technologies.

1.14.1 Intel® Virtualization Technology

Intel Virtualization Technology (Intel® VT) is a hardware-assisted technology that, when combined with software-based virtualization solutions, provides maximum system utilization by consolidating multiple environments into a single server or client.



NOTE

A processor with Intel VT does not guarantee that virtualization will work on your system. Intel VT requires a computer system with a chipset, BIOS, enabling software and/or operating system, device drivers, and applications designed for this feature.

For information about	Refer to
Intel Virtualization Technology	http://www.intel.com/technology/virtualization/technology.htm

1.14.2 Intel® Platform Trust Technology

Intel® Platform Trust Technology (Intel® PTT) is a platform functionality for credential storage and key management. Intel® PTT supports Microsoft* BitLocker* Drive Encryption for hard drive encryption and supports all Microsoft requirements for firmware Trusted Platform Module (fTPM) 2.0 for client computers.



NOTE

Support for fTPM version 2.0 requires a UEFI-enabled operating system, such as Microsoft Windows* 10.*



CAUTION

BIOS recovery using the BIOS security jumper clears Intel® Platform Trust Technology (Intel® PTT) keys. These keys will not be restored after the BIOS recovery. Disable HDD encryption like BitLocker and other uses of data encryption and authentication before using BIOS recovery.

For information about	Refer to
-----------------------	----------

Intel Platform Trust Technology	http://www.intel.com/content/dam/www/public/us/en/documents/white-papers/enterprise-security-platform-trust-technology-white-paper.pdf
---------------------------------	---

2 Technical Reference

2.1 Memory Resources

2.1.1 Addressable Memory

The board utilizes a maximum of 32 GB of addressable system memory. Typically the address space that is allocated for PCI Conventional bus add-in cards, PCI Express configuration space, BIOS (SPI Flash device), and chipset overhead resides above the top of DRAM (total system memory). On a system that has 32 GB of system memory installed, it is not possible to use all of the installed memory due to system address space being allocated for other system critical functions. These functions include the following:

- BIOS/SPI Flash device (64 Mb)
- Local APIC (19 MB)
- Direct Media Interface (40 MB)
- PCI Express configuration space (256 MB)
- PCH base address registers PCI Express ports (up to 256 MB)
- Memory-mapped I/O that is dynamically allocated for M.2 add-in cards (256 MB)
- Integrated graphics shared memory (up to 512 MB; 64 MB by default)

The board provides the capability to reclaim the physical memory overlapped by the memory mapped I/O logical address space. The board remaps physical memory from the top of usable DRAM boundary to the 4 GB boundary to an equivalent sized logical address range located just above the 4 GB boundary. All installed system memory can be used when there is no overlap of system addresses.

2.2 Connectors and Headers



CAUTION

Only the following connectors and headers have overcurrent protection: back panel and front panel USB.

The other internal connectors and headers are not overcurrent protected and should connect only to devices inside the computer's chassis, such as fans and internal peripherals. Do not use these connectors or headers to power devices external to the computer's chassis. A fault in the load presented by the external devices could cause damage to the computer, the power cable, and the external devices themselves.

Furthermore, improper connection of USB header single wire connectors may eventually overload the overcurrent protection and cause damage to the board.

This section describes the board's connectors and headers. The connectors and headers can be divided into these groups:

- Front panel I/O connectors
- Back panel I/O connectors

2.2.1 Front Panel Connectors

Figure 9 shows the location of the front panel connectors for the board.

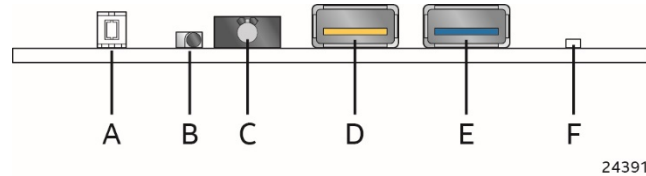

Item	Description
A	Front panel power button
B	CIR
C	Front panel Stereo microphone/headphone jack
D	USB 3.1 (Gen 2) ports (orange charging capable)
E	USB 3.1 (Gen 2) (blue)
F	HDD LED

Figure 9. Front Panel Connectors

2.2.2 Back Panel Connectors

Figure 10 shows the location of the back panel connectors for the board.

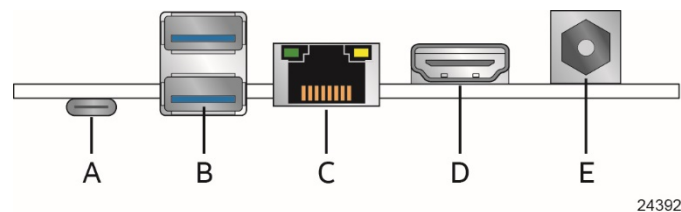

Item	Description
A	USB Type C (Thunderbolt) connector
B	USB 3.1 (Gen 2) ports (blue)
C	LAN
D	HDMI 2.0a connector
E	12-19 V DC power input jack

Figure 10. Back Panel Connectors

2.2.3 Headers and Connectors (Top)

Figure 11 shows the location of the headers and connectors on the top-side of the board.

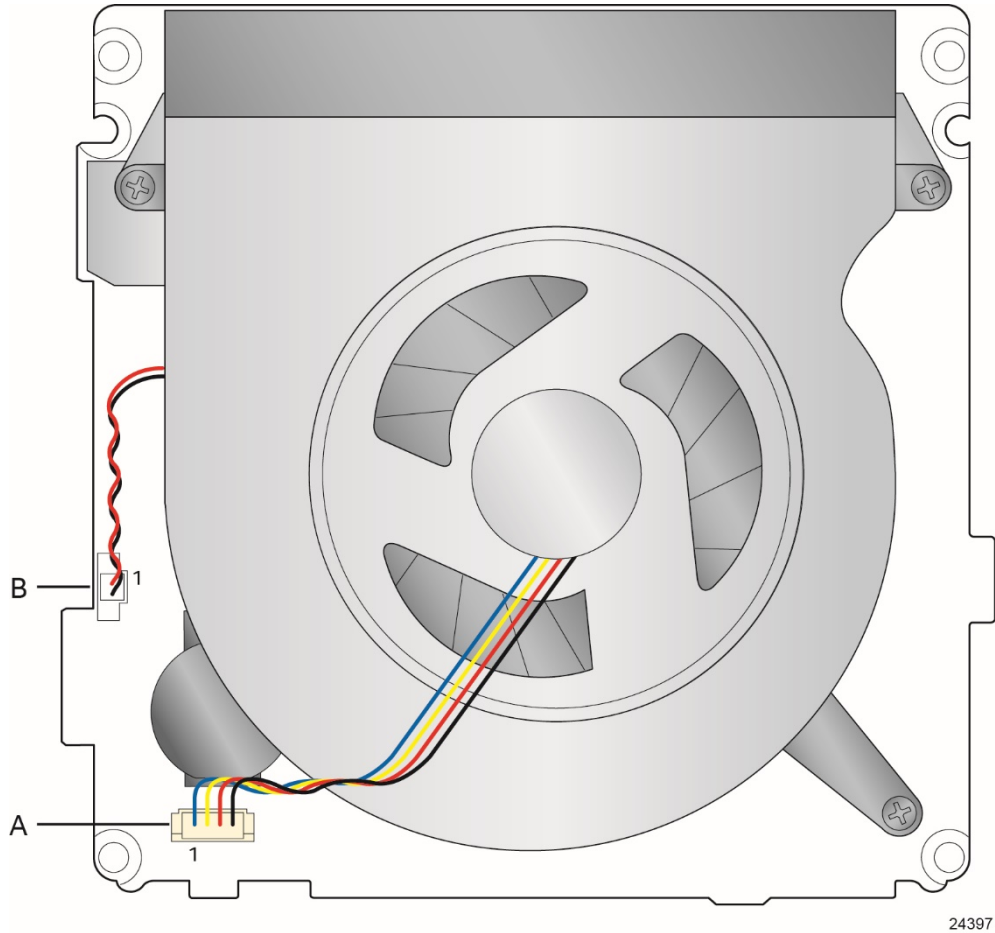

24397

Figure 11. Headers and Connectors (Top)

Table 13 lists the headers and connectors identified in Figure 11.

Table 13. Headers and Connectors Shown in Figure 11

Item from Figure 11	Description
A	Processor fan header
B	Battery and header

2.2.4 Connectors and Headers (Bottom)

Figure 12 shows the locations of the connectors and headers on the bottom-side of the board.

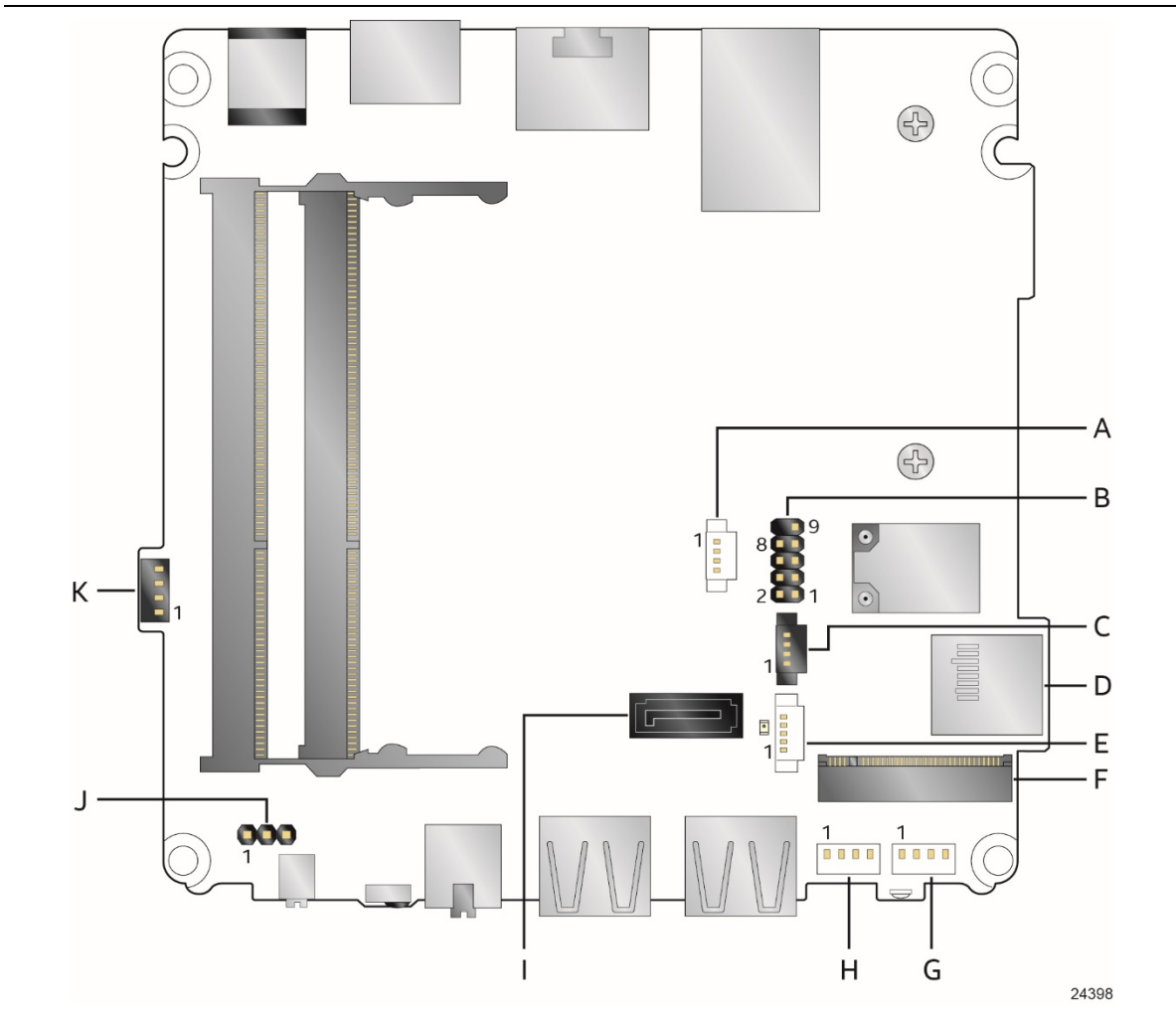

Figure 12. Connectors and Headers (Bottom)

Table 14 lists the connectors and headers identified in Figure 12.

Table 14. Connectors and Headers Shown in Figure 12

Item from Figure 12	Description
A	Digital microphone array connector
B	Front panel header
C	RGB LED connector
D	Micro SDXC slot
E	SATA power connector (1.25 mm pitch)
F	M.2 connector (key type M and B+M) for 2242 and 2280 modules
G	Front panel single-port USB 2.0 header (1.25 mm pitch)
H	Front panel single-port USB 2.0 header (1.25 mm pitch)
I	SATA 6.0 Gbps connector
J	BIOS security jumper
K	Consumer electronics control (CEC) header

2.2.4.1 Signal Tables for the Connectors and Headers

Table 15. SATA Power Connector (1.25 mm pitch)

Pin	Signal Name
1	+5 V
2	+5 V
3	+3.3 V
4	GND
5	GND



NOTE

Connector is Molex* part number 53398-0571, 1.25 mm pitch PicoBlade* header, surface mount, vertical, lead-free, 5 circuits.

Table 16. Single-Port Internal USB 2.0 Header (1.25 mm pitch)

Pin	Signal Name	Pin	Signal Name
1	+5 V DC	2	D-
3	D+	4	Ground

See section 2.2.4.7 for more information on USB 2.0 headers.



NOTE

Connector is Molex part number 53398-0471, 1.25 mm pitch PicoBlade header, surface mount, vertical, lead-free, 4 circuits.

Table 17. M.2 2280 Module (key type M) Connector

Pin	Signal Name	Pin	Signal Name
74	3.3V	75	GND
72	3.3V	73	GND
70	3.3V	71	GND
68	SUSCLK(32kHz) (O)(0/3.3V)	69	PEDET (NC-PCIe/GND-SATA)
66	Connector Key	67	N/C
64	Connector Key	65	Connector Key
62	Connector Key	63	Connector Key
60	Connector Key	61	Connector Key
58	N/C	59	Connector Key
56	N/C	57	GND

continued

Table 17. M.2 2280 Module (key type M) Connector (continued)

Pin	Signal Name	Pin	Signal Name
54	PEWAKE# (I/O)(0/3.3V) or N/C	55	REFCLKP
52	CLKREQ# (I/O)(0/3.3V) or N/C	53	REFCLKN
50	PERST# (O)(0/3.3V) or N/C	51	GND
48	N/C	49	PETp0/SATA-A+
46	N/C	47	PETn0/SATA-A-
44	N/C	45	GND
42	N/C	43	PERp0/SATA-B-
40	N/C	41	PERn0/SATA-B+
38	DEVSLP (O)	39	GND
36	N/C	37	PETp1
34	N/C	35	PETn1
32	N/C	33	GND
30	N/C	31	PERp1
28	N/C	29	PERn1
26	N/C	27	GND
24	N/C	25	PETp2
22	N/C	23	PETn2
20	N/C	21	GND
18	3.3V	19	PERp2
16	3.3V	17	PERn2
14	3.3V	15	GND
12	3.3V	13	PETp3
10	DAS/DSS# (I/O)/LED1# (I)(0/3.3V)	11	PETn3
8	N/C	9	GND
6	N/C	7	PERp3
4	3.3V	5	PERn3
2	3.3V	3	GND
		1	GND

See section 2.2.4.2 for more information on the M.2 connector.

Table 18. Digital Microphone (DMICS) Array Connector (1.25 mm Pitch)

Pin	Signal Name
1	Ground
2	+3.3 V DC (+3V3_DMIC)
3	Clock (DMIC_CLK)
4	Data (DMIC_DAT)

See section 2.2.4.11 for more information on the DMIC Array connector.

**NOTE**

Connector is Aces part number 50273-0047C-002, 1.25 mm pitch header, surface mount, vertical, lead-free, 4 circuits.

Table 19. RGB LED Connector (1.25 mm Pitch)

Pin	Signal Name
1	+5VSB
2	Red HDD LED
3	Green HDD LED
4	Blue HDD LED

See section 2.2.4.10 for more information on the RGB LED connector.

**NOTE**

Connector is Aces part number 50273-0047C-002, 1.25 mm pitch header, surface mount, vertical, lead-free, 4 circuits.

Table 20. CEC Header (1.25 mm pitch)

Pin	Signal Name
1	5VSTBY
2	GND
3	PWR_SWITCH#
4	HDMI_CEC

See section 2.2.4.9 for more information on the CEC header.

**NOTE**

Connector is Aces part number 50273-0047C-002, 1.25 mm pitch header, surface mount, vertical, lead-free, 4 circuits.

2.2.4.2 Add-in Card Connectors

The board supports M.2 2242 and 2280 (key type M) modules.

- Supports M.2 SSD SATA drives
 - Maximum bandwidth is approximately 540 MBps
- Supports M.2 SSD Gen 3 PCIe AHCI and NVMe drives (PCIe x1, x2, and x4)
 - Using PCIe x4 M.2 SSD maximum bandwidth is approximately 4000 MBps

2.2.4.3 USB Type C connector

The board has several features that are supported via the USB Type C connector.

- Supports USB 3.1 Gen 2.0
 - Maximum bandwidth is approximately 10 Gbps
- Supports Display port 1.2
 - Maximum bandwidth is approximately 17.28 Gbps
- Supports Thunderbolt 3 PCIe x4 connection
 - Maximum bandwidth is approximately 40 Gbps

Table 21. USB Type C Connector

Pin	Signal Name	Description	Pin	Signal Name	Description
A12	GND2	Ground	B1	GND3	Ground
A11	RX_P2	High speed receive 2 +	B2	TX_P2	High speed transmit 2 +
A10	RX_N2	High speed receive 2 –	B3	TX_N2	High speed transmit 2 –
A9	VBUS2	USB bus power	B4	VBUS3	USB bus power
A8	SBU1	Sideband use 1	B5	CC2	Channel config 2
A7	DN1	USB 2.0 data 1 –	B6	DP2	USB 2.0 data 2 +
A6	DP1	USB 2.0 data 1 +	B7	DN2	USB 2.0 data 2 –
A5	CC1	Channel config 1	B8	SBU2	Sideband use 2
A4	VBUS1	USB bus power	B9	VBUS4	USB bus power
A3	TX_N1	High speed transmit 1 +	B10	RX_N1	High speed receive 1 –
A2	TX_P1	High speed transmit 1 –	B11	RX_P1	High speed receive 1 +
A1	GND1	Ground	B12	GND4	Ground

2.2.4.4 Front Panel Header (2.0 mm Pitch)

This section describes the functions of the front panel header. Table 22 lists the signal names of the front panel header. Figure 13 is a connection diagram for the front panel header.

Table 22. Front Panel Header (2.0 mm Pitch)

Pin	Signal Name	Description	Pin	Signal Name	Description
1	HDD_POWER_LED	Pull-up resistor (750 Ω) to +5V	2	POWER_LED_MAIN	[Out] Front panel LED (main color)

3	HDD_LED#	[Out] Hard disk activity LED	4	POWER_LED_ALT	[Out] Front panel LED (alt color)
5	GROUND	Ground	6	POWER_SWITCH#	[In] Power switch
7	RESET_SWITCH#	[In] Reset switch	8	GROUND	Ground
9	+5V_DC	Power	10	Key	No pin

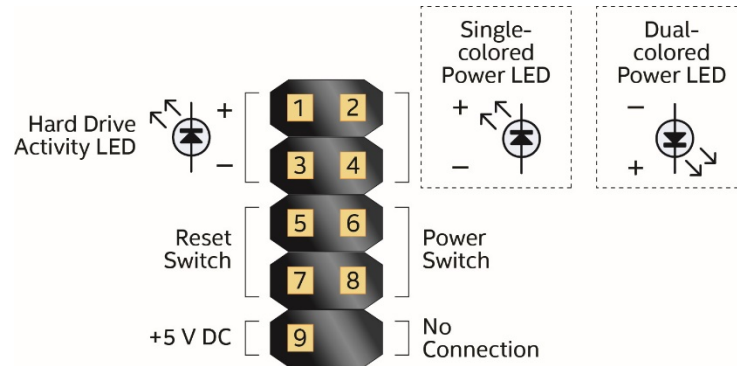

24273

Figure 13. Connection Diagram for Front Panel Header (2.0 mm Pitch)

2.2.4.4.1 Hard Drive Activity LED Pins

Pins 1 and 3 can be connected to an LED to provide a visual indicator that data is being read from or written to a hard drive. Proper LED function requires a SATA hard drive or optical drive connected to an onboard SATA connector.

2.2.4.4.2 Reset Switch Pins

Pins 5 and 7 can be connected to a momentary single pole, single throw (SPST) type switch that is normally open. When the switch is closed, the board resets and runs the POST.

2.2.4.4.3 Power/Sleep LED Pins

Pins 2 and 4 can be connected to a one- or two-color LED. Table 23 and Table 24 show the possible LED states.

Table 23. States for a One-Color Power LED

LED State	Description
Off	Power off
Blinking	Standby
Steady	Normal operation

Table 24. States for a Dual-Color Power LED

LED State	Description
Off	Power off
Secondary color blinking (amber)	Standby

Primary color steady (Blue)	Normal operation
-----------------------------	------------------



NOTE

The LED behavior shown in Table 23 is default – other patterns may be set via BIOS setup.

2.2.4.4.4 Power Switch Pins

Pins 6 and 8 can be connected to a front panel momentary-contact power switch. The switch must pull the SW_ON# pin to ground for at least 50 ms to signal the power supply to switch on or off. (The time requirement is due to internal debounce circuitry on the board.) At least two seconds must pass before the power supply will recognize another on/off signal.

2.2.4.5 Micro SDXC Card Reader

The board has a micro Secure Digital (Micro SD) card reader that supports the Secure Digital eXtended Capacity (SDXC) format, 3.01 specification.

Table 25. SDXC Card Reader Connector

Pin	Signal Name	Descriptive Name
1	CD	Card Detection
2	DATA1	Serial Data 1
3	DATA0	Serial Data 0
4	GND	Ground
5	CLK	Serial Clock
6	VDD	Power (3.3 V)
7	CMD	Command
8	DATA3	Serial Data 3
9	DATA2	Serial Data 2

2.2.4.6 Power Supply Connector

The board has the following power supply connector:

- **External Power Supply** – the board can be powered through a 12-19 V DC connector on the back panel. The back panel DC connector is compatible with a 5.5 mm/OD (outer diameter) and 2.5 mm/ID (inner diameter) plug, where the inner contact is +12-19 ($\pm 10\%$) V DC and the shell is GND. The maximum current rating is 10 A.



NOTE

External power voltage, 12-19 V DC, is dependent on the type of power adapter used.

2.2.4.6.1 Power Sensing Circuit

The board has a power sensing circuit that:

- Manages CPU power usage to maintain system power consumption below 90 W.
- Designed for use with 90 W AC-DC adapters.



NOTE

It is recommended that you disable this feature (via BIOS option) when using an AC-DC adapter greater than 90 W.

2.2.4.7 Internal USB 2.0 Single-Port Header (1.25 mm Pitch)

Figure 14 is a connection diagram for the internal USB header.



NOTE

- The +5 V DC power on the USB header is fused.
- Use only an internal USB connector that conforms to the USB 2.0 specification for high-speed USB devices.

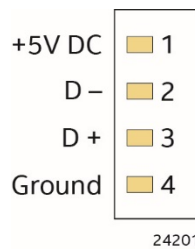

Figure 14. Connection Diagram for the Internal USB 2.0 Single-Port Header (1.25 mm Pitch)

2.2.4.8 Consumer Infrared (CIR) Sensor

The Consumer Infrared (CIR) sensor on the front panel provides features that are designed to comply with Microsoft Consumer Infrared usage models (RC-6).

The CIR feature is made up of the receiving sensor. The receiving sensor consists of a filtered translated infrared input compliant with Microsoft CIR specifications.

Customers are required to provide their own media center compatible remote or smart phone application for use with the Intel NUC. Figure 15 shows the location of the CIR sensor.

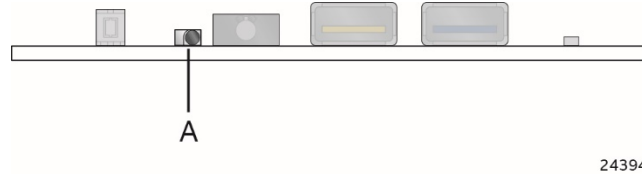

Item	Description
A	CIR Sensor

Figure 15. Location of the CIR Sensor

2.2.4.9 Consumer Electronics Control (CEC) Header

The board contains two mutually-exclusive methods for controlling HDMI CEC devices:

- External CEC adaptor connected via CEC connector (item K in Figure 12; pinout in Table 20)
- Onboard CEC control from the embedded controller via HDMI cable and BIOS setup. Expected behavior is provided in Table 26 below.

Table 26. HDMI CEC expected behavior

Activity	Current Status		Action	Expected Behavior
	PC ^{1,2}	TV ³		
Wake On TV	Off	Off	TV on	PC on
Standby by TV	On	On	TV Standby	PC sleep or power off ⁴
Auto Turn Off TV (S0 -> S5)	On	On	PC Shutdown	TV standby ³
Auto Turn On TV (S5 -> S0)	Off	Off	PC On	TV on ³
Auto Turn Off TV (S0 -> S3)	On	On	PC Sleep	TV standby ³
Auto Turn On TV (S3 -> S0)	Off	Off	PC On	TV on ³

Notes:

1. *HDMI CEC Control* enabled in BIOS Setup and in TV setup, if necessary. Please consult your TV's documentation.
2. *Fast Boot* and *Deep S4/S5* disabled in BIOS Setup.
3. Results seen with Panasonic LED TV VIERA TH-40A400W. Other TVs may have different results due to variable implementations of CEC features.
4. PC power off behavior dependent upon power button setting in operating system.
5. If using external CEC adaptor, onboard CEC control must be disabled in BIOS Setup.



NOTE

CEC Connector is Aces part number 50273-0047C-002, 1.25 mm pitch header, surface mount, vertical, lead-free, 4 circuits.

For information about

HDMI CEC technology

Refer to

<http://www.hdmi.org/pdf/whitepaper/DesigningCECintoYourNextHDMIProduct.pdf>

2.2.4.10 RGB LED

The board supports an RGB LED which is connected through Item C shown in Figure 12. The RGB LED is configurable within the BIOS under the *Power* tab within *Advanced* settings. Table 22 lists the signal names of the RGB LED connector. Table 27 lists the available settings for the RGB LED within BIOS.

Table 27. RGB LED Options

BIOS Option	Possible Configurations
RGB LED Color	Yellow, cyan, magenta, blue, red, green and white.
RGB LED Brightness	0%, 50% 100%
RGB LED Activity Indicator	None, Power indicator, HDD Activity or Software defined

2.2.4.11 Digital Microphone Array

The digital microphone array consists of dual front facing digital microphones located on either side of the front panel to minimize acoustic interference. The digital microphone array is intended to be used with a digital assistant like Microsoft's Cortana*. Item A in Figure 12 shows the location of the digital microphone array connector. Table 18 lists the signal names of the DMIC connector. See Chapter 5 for the physical location of the DMIC array on the Intel NUC Kit NUC8i[x]BEK and Intel NUC Kit NUC8i[x]BEH chassis.

2.3 BIOS Security Jumper



CAUTION

Do not move a jumper with the power on. Always turn off the power and unplug the power cord from the computer before changing a jumper setting. Otherwise, the board could be damaged.

Figure 16 shows the location of the BIOS Security Jumper. The 3-pin jumper determines the BIOS Security program's mode.

Table 20 describes the jumper settings for the three modes: normal, lockdown, and configuration.

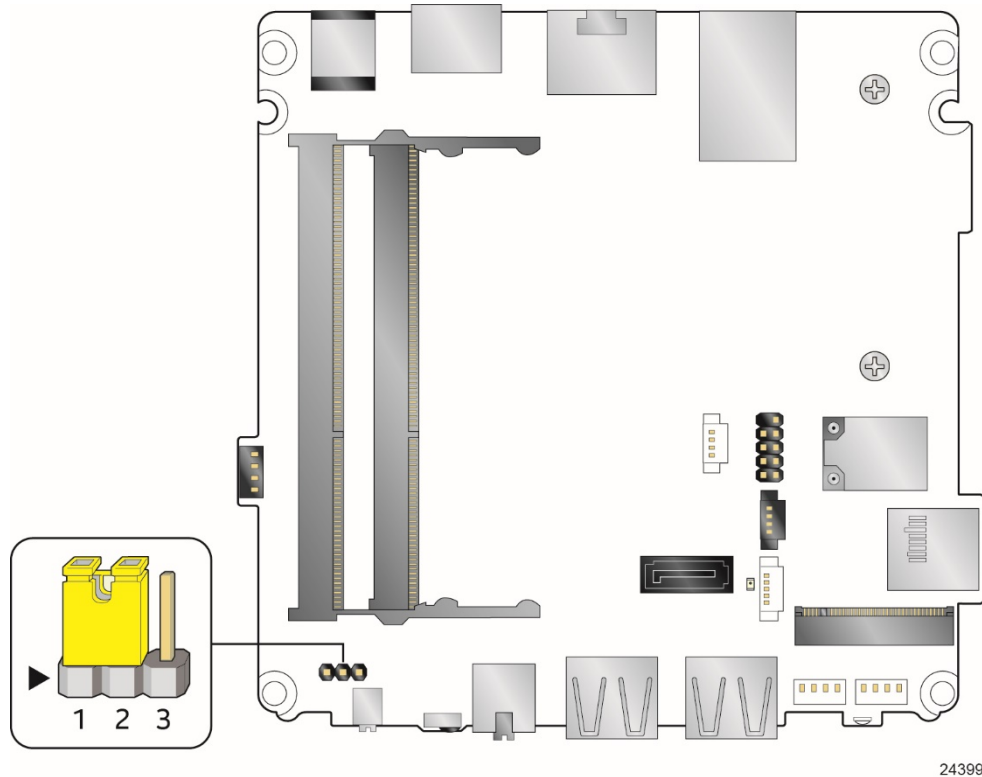

24399

Figure 16. Location of the BIOS Security Jumper

Table 20 lists the settings for the jumper.

Table 20. BIOS Security Jumper Settings

Function/Mode	Jumper Setting	Configuration
Normal	1-2	The BIOS uses current configuration information and passwords for booting.
Lockdown	2-3	<p>The BIOS uses current configuration information and passwords for booting, except:</p> <ul style="list-style-type: none"> • All POST Hotkeys are suppressed (prompts are not displayed and keys are not accepted. For example, F2 for Setup, F10 for the Boot Menu). • Power Button Menu is not available (see Section 3.7.4 Power Button Menu). <p>BIOS updates are not available except for automatic Recovery due to flash corruption.</p>
Configuration	None	<p>BIOS Recovery Update process if a matching *.bio file is found. Recovery Update can be cancelled by pressing the Esc key.</p> <p>If the Recovery Update was cancelled or a matching *.bio file was not found, a Config Menu will be displayed. The Config Menu consists of the following options:</p> <ul style="list-style-type: none"> [1] Suppress this menu until the BIOS Security Jumper is replaced. [2] Clear BIOS User and Supervisor Passwords. [3] Clear Trusted Platform Module Warning: Data encrypted with the TPM will no longer be accessible if the TPM is cleared [4] Disable Privacy MSR Bit (Clear MSR C80[0] to 0) [5] Enable Privacy MSR Bit (Set MSR C80[0] to 1) [F2] Intel® Visual BIOS [F4] BIOS Recovery

2.4 Mechanical Considerations

2.4.1 Form Factor

The board is designed to fit into a custom chassis. Figure 17 illustrates the mechanical form factor for the board. Dimensions are given in inches [millimeters].

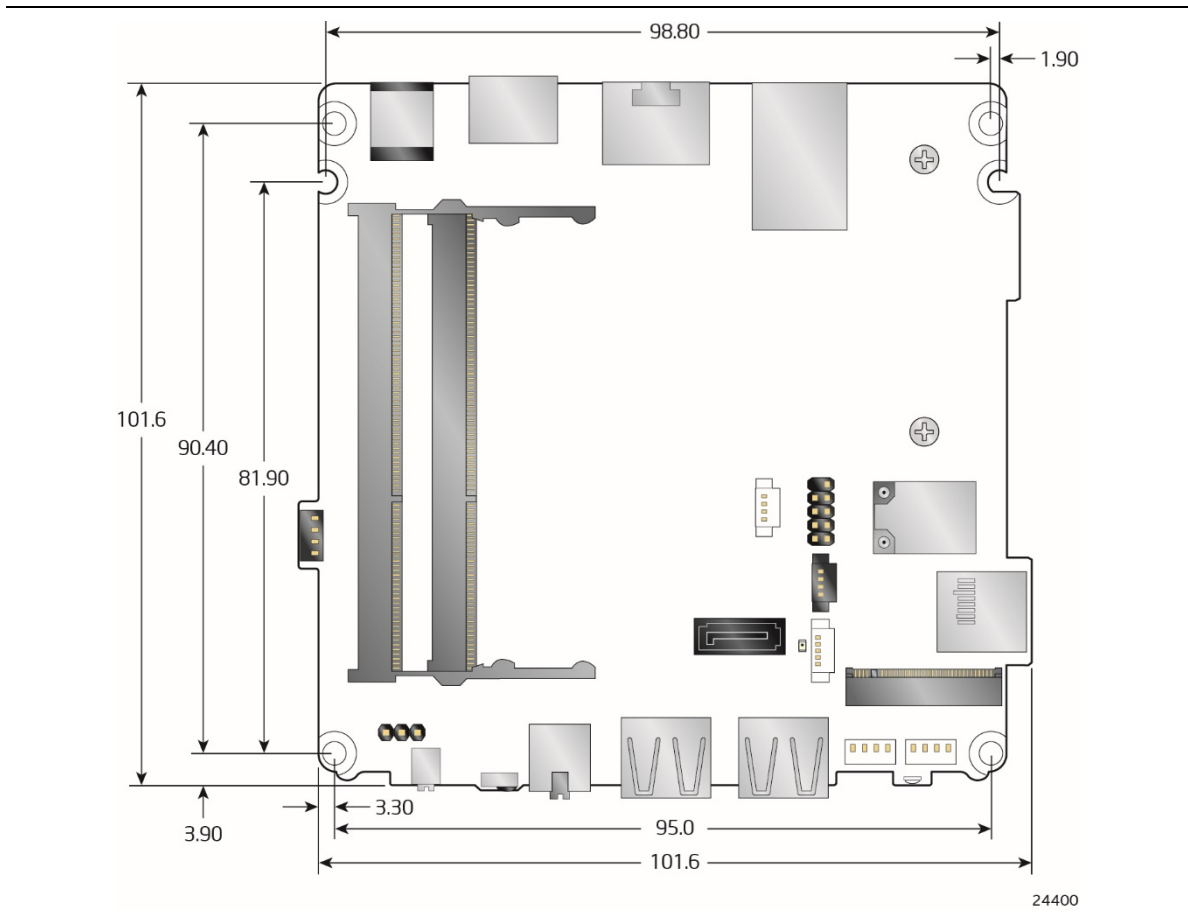

Figure 17. Board Dimensions

Figure 18 shows the height dimensions of the board.

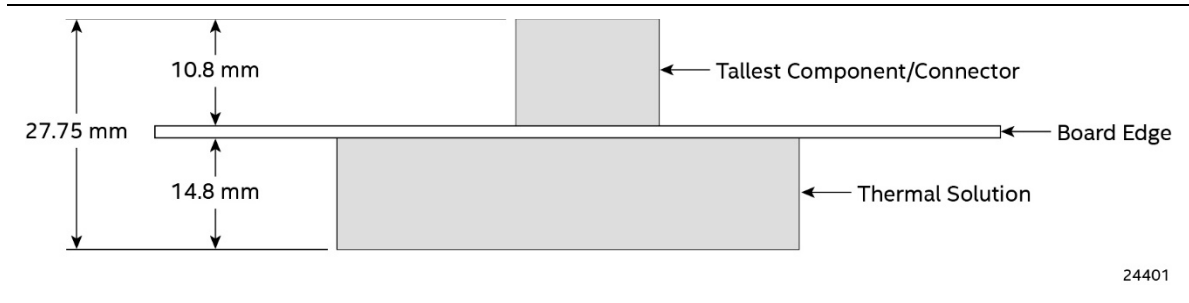

Figure 18. Board Height Dimensions

2.5 Electrical Considerations

2.5.1 Power Supply Considerations

System power requirements will depend on actual system configurations chosen by the integrator, as well as end user expansion preferences. It is the system integrator's responsibility to ensure an appropriate power budget for the system configuration is properly assessed based on the system-level components chosen.

2.5.2 Fan Header Current Capability

Table 28 lists the current capability of the fan header.

Table 28. Fan Header Current Capability

Fan Header	Maximum Available Current
Processor fan	0.5 A

2.6 Thermal Considerations



CAUTION

A chassis with a maximum temperature of 50 °C at the processor fan inlet is recommended. If the internal ambient temperature exceeds 50 °C, further thermal testing is required to ensure components do not exceed their maximum case temperature.



CAUTION

Failure to ensure appropriate airflow may result in reduced performance of both the processor and/or voltage regulator or, in some instances, damage to the board.

All responsibility for determining the adequacy of any thermal or system design remains solely with the system integrator. Intel makes no warranties or representations that merely following the instructions presented in this document will result in a system with adequate thermal performance.



CAUTION

Ensure that the ambient temperature does not exceed the board's maximum operating temperature. Failure to do so could cause components to exceed their maximum case temperature and malfunction. For information about the maximum operating temperature, see the environmental specifications in Section 2.8.



CAUTION

Ensure that proper airflow is maintained in the processor voltage regulator circuit. Failure to do so may result in shorter than expected product lifetime.

Figure 19 shows the locations of the localized high temperature zones.

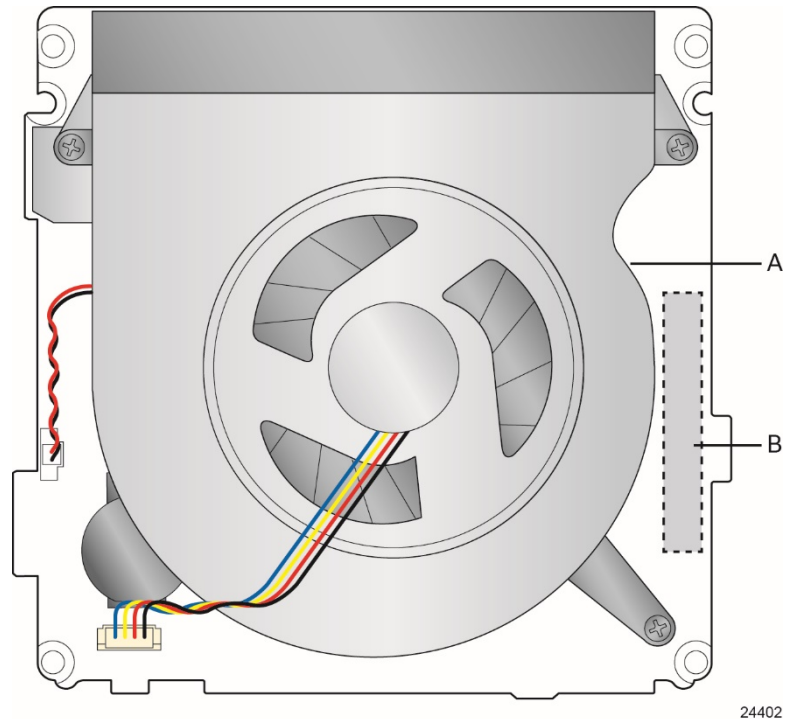

Item	Description
A	Thermal solution
B	Processor voltage regulator area

Figure 19. Localized High Temperature Zones

A thermal pad has been installed for the bottom of the chassis to improve the thermal performance when using M.2 devices that operate at higher temperatures. If the thermal pad ever needs to be replaced, Figure 20 shows the installation area of the thermal pad for Intel NUC Kit NUC8i3BEK and Intel NUC Kit NUC8i5BEK.

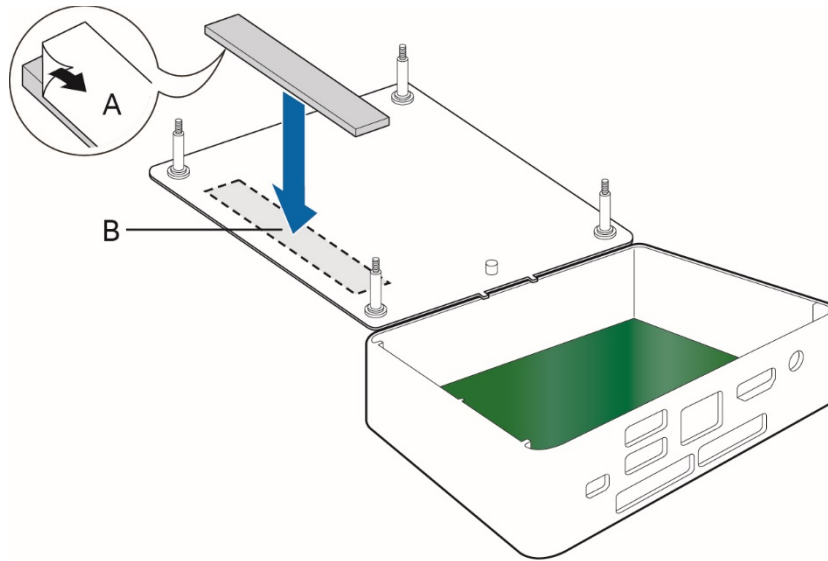

24292

Item	Description
A	Thermal Pad
B	Thermal Pad Installation Area

Figure 20. Installation Area of Thermal Pad for Intel NUC Kit NUC8i3BEK/NUC8i5BEK

Figure 21 shows the installation area of the thermal pad for Intel NUC Kit NUC8i3BEH, Intel NUC Kit NUC8i5BEH and Intel NUC Kit NUC8i7BEH.

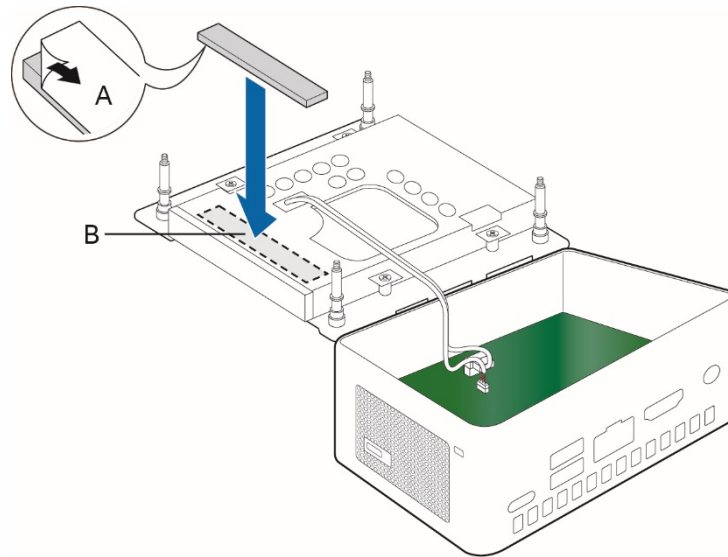

24408

Item	Description
A	Thermal Pad
B	Thermal Pad Installation Area

Figure 21. Installation area of Thermal Pad for Intel NUC Kit NUC8i3BEH/NUC8i5BEH/NUC8i7BEH

Table 29 provides maximum case temperatures for the components that are sensitive to thermal changes. The operating temperature, current load, or operating frequency could affect case temperatures. Maximum case temperatures are important when considering proper airflow to cool the board.

Table 29. Thermal Considerations for Components

Component	Maximum Case Temperature
Processor	For processor case temperature, see processor datasheets and processor specification updates

To ensure functionality and reliability, the component is specified for proper operation when Case Temperature is maintained at or below the maximum temperature listed in Table 30. This is a requirement for sustained power dissipation equal to Thermal Design Power (TDP is specified as the maximum sustainable power to be dissipated by the components). When the component is dissipating less than TDP, the case temperature should be below the Maximum Case Temperature. The surface temperature at the geometric center of the component corresponds to Case Temperature.

It is important to note that the temperature measurement in the system BIOS is a value reported by embedded thermal sensors in the components and does not directly correspond to the Maximum Case Temperature. The upper operating limit when monitoring this thermal sensor is Tcontrol.

Table 30. Tcontrol Values for Components

Component	Tcontrol
Processor	For processor case temperature, see processor datasheets and processor specification updates

For information about	Refer to
Processor datasheets and specification updates	Section 1.2, page 7

2.7 Reliability

The Mean Time between Failures (MTBF) predictions are calculated using component and subassembly random failure rates. The calculation is based on the Telcordia SR-332 Issue 2, Method I, Case 3, 55 °C ambient. The MTBF prediction is used to estimate repair rates and spare parts requirements. The MTBF for Intel NUC8i3BEB board is 62,994 hours. The MTBF for Intel NUC8i5BEB board is 63,369 hours. The MTBF for Intel NUC8i7BEB board is 64,998 hours.

2.8 Environmental

Table 31 lists the environmental specifications for the board.

Table 31. Environmental Specifications

Parameter	Specification	
Temperature		
Non-Operating	-40 °C to +60 °C	
Operating	0 °C to +50 °C The operating temperature of the board may be determined by measuring the air temperature from the junction of the heatsink fins and fan, next to the attachment screw, in a closed chassis, while the system is in operation.	
Shock		
Unpackaged	50 g trapezoidal waveform	
	Velocity change of 170 inches/s ²	
Packaged	Free fall package drop machine set to the height determined by the weight of the package.	
	Product Weight (pounds)	Free Fall (inches)
	<20	36
	21-40	30
	41-80	24
	81-100	18
Vibration		
Unpackaged	5 Hz to 20 Hz: 0.01 g ² Hz sloping up to 0.02 g ² Hz	
	20 Hz to 500 Hz: 0.02 g ² Hz (flat)	
Packaged	5 Hz to 40 Hz: 0.015 g ² Hz (flat)	
	40 Hz to 500 Hz: 0.015 g ² Hz sloping down to 0.00015 g ² Hz	
Acoustic		
Cool Setting	4.5 BA (~35dBA)	
100% duty (@3400 RPM)	5.7BA (~47dBA)	

Note: Before attempting to operate this board, the overall temperature of the board must be above the minimum operating temperature specified. It is recommended that the board temperature be at least room temperature before attempting to power on the board. The operating and non-operating environment must avoid condensing humidity.

3 Overview of BIOS Features

3.1 Introduction

The board uses Intel Visual BIOS that is stored in the Serial Peripheral Interface Flash Memory (SPI Flash) and can be updated using a disk-based program. The SPI Flash contains the Visual BIOS Setup program, POST, the PCI auto-configuration utility, embedded controller (EC) firmware, LAN EEPROM information, and Plug and Play support.

The BIOS displays a message during POST identifying the type of BIOS and a revision code. The production BIOSes are identified as BECFL357.86A.

The Visual BIOS Setup program can be used to view and change the BIOS settings for the computer. The BIOS Setup program is accessed by pressing the <F2> key after the Power-On Self-Test (POST) memory test begins and before the operating system boot begins.

3.2 BIOS Flash Memory Organization

The Serial Peripheral Interface Flash Memory (SPI Flash) includes a 64 Mb flash memory device.

3.3 System Management BIOS (SMBIOS)

SMBIOS is a Desktop Management Interface (DMI) compliant method for managing computers in a managed network.

The main component of SMBIOS is the Management Information Format (MIF) database, which contains information about the computing system and its components. Using SMBIOS, a system administrator can obtain the system types, capabilities, operational status, and installation dates for system components. The MIF database defines the data and provides the method for accessing this information. The BIOS enables applications such as third-party management software to use SMBIOS. The BIOS stores and reports the following SMBIOS information:

- BIOS data, such as the BIOS revision level
- Fixed-system data, such as peripherals, serial numbers, and asset tags
- Resource data, such as memory size, cache size, and processor speed
- Dynamic data, such as event detection and error logging

Non-Plug and Play operating systems require an additional interface for obtaining the SMBIOS information. The BIOS supports an SMBIOS table interface for such operating systems. Using this support, an SMBIOS service-level application running on a non-Plug and Play operating system can obtain the SMBIOS information. Additional board information can be found in the BIOS under the Additional Information header under the Main BIOS page.

3.4 Legacy USB Support

Legacy USB support enables USB devices to be used even when the operating system's USB drivers are not yet available. Legacy USB support is used to access the BIOS Setup program, and to install an operating system that supports USB. By default, Legacy USB support is set to Enabled.

Legacy USB support operates as follows:

1. When you first apply power to the computer, legacy support is disabled.
2. POST begins.
3. Legacy USB support is enabled by the BIOS allowing you to use a USB keyboard to enter and configure the BIOS Setup program and the maintenance menu.
4. POST completes.
5. The operating system loads. While the operating system is loading, USB keyboards and mice are recognized and may be used to configure the operating system. (Keyboards and mice are not recognized during this period if Legacy USB support was set to Disabled in the BIOS Setup program.)
6. After the operating system loads the USB drivers, all legacy and non-legacy USB devices are recognized by the operating system, and Legacy USB support from the BIOS is no longer used.

3.5 BIOS Updates

The BIOS can be updated using one of the following methods:

- Intel Express BIOS Update Utility, which enables automated updating while in the Windows environment. Using this utility, the BIOS can be updated from a file on a hard disk or a USB drive (a flash drive or a USB hard drive).
- Intel Flash Memory Update Utility, which requires booting from DOS. Using this utility, the BIOS can be updated from a file on a hard disk or a USB drive (a flash drive or a USB hard drive).
- Pressing <F7> key during POST allows a user to select where the BIOS .bio file is located and perform the update from that location/device. Similar to performing a BIOS Recovery without removing the BIOS configuration jumper.
- Intel® Visual BIOS has an option to update the BIOS from a valid .bio file located on a hard disk or USB drive. Enter Intel Visual BIOS by pressing <F2> during POST.
- Using Front Panel power button menu option

The update BIOS will be verified that it matches the target system to prevent accidentally installing an incompatible BIOS.



NOTE

Review the instructions distributed with the upgrade utility before attempting a BIOS update.

For information about

BIOS update utilities

Refer to

<http://www.intel.com/content/www/us/en/support/boards-and-kits/000005636.html>

3.5.1 Language Support

The BIOS Setup program and help messages are supported in US English. Check the Intel web site for support.

3.6 BIOS Recovery

It is unlikely that anything will interrupt a BIOS update; however, if an interruption occurs, the BIOS could be damaged. Table 32 lists the drives and media types that can and cannot be used for BIOS recovery. The BIOS recovery media does not need to be made bootable.

Table 32. Acceptable Drives/Media Types for BIOS Recovery

Media Type ^(Note)	Can be used for BIOS recovery?
Hard disk drive (connected to SATA or USB)	Yes
CD/DVD drive (connected to SATA or USB)	No
USB flash drive	Yes
USB diskette drive (with a 1.4 MB diskette)	No (BIOS update file is bigger than 1.4 MB size limit)



NOTE

Supported file systems for BIOS recovery:

- *NTFS (sparse, compressed, or encrypted files are not supported)*
- *FAT32*
- *FAT16*
- *FAT12*

For information about	Refer to
BIOS recovery	http://www.intel.com/support/motherboards/desktop/sb/cs-034524.htm

3.7 Boot Options

In the BIOS Setup program, the user can choose to boot from a hard drive, optical drive, removable drive, or the network. The default setting is for the optical drive to be the first boot device, the hard drive second, removable drive third, and the network fourth.



NOTE

Optical drives are not supported by the onboard SATA connectors. Optical drives are supported only via the USB interfaces. If the optical drive is not bootable, it will be ignored during the POST process.

3.7.1 Network Boot

The network can be selected as a boot device. This selection allows booting from the onboard LAN.

Pressing the <F12> key during POST automatically forces booting from the LAN. To use this key during POST, the User Access Level in the BIOS Setup program's Security menu must be set to "Full."



NOTE

When no bootable disk or USB device is found, the system will default to network boot.

3.7.2 Booting Without Attached Devices (Headless)

For use in embedded applications, the BIOS has been designed so that after passing the POST, the operating system loader is invoked even if the following devices are not present:

- Video monitor
- Keyboard
- Mouse

3.7.3 Changing the Default Boot Device during POST

Pressing the <F10> key during POST causes a boot device menu to be displayed. This menu displays the list of available boot devices. Table 33 lists the boot device menu options.

Table 33. Boot Device Menu Options

Boot Device Menu Function Keys	Description
<↑> or <↓>	Selects a default boot device
<Enter>	Exits the menu, and boots from the selected device
<Esc>	Exits the menu and boots according to the boot priority defined through BIOS setup

3.7.4 Power Button Menu

As an alternative to normal POST Hotkeys, the user can use the power button to access a menu. The Power Button Menu is accessible via the following sequence:

1. System is in S4/S5 (soft off); will not work if system is in G3 (after “no power” state)
2. User pushes the power button and holds it down for 3 seconds
3. The front panel power button LED will change from Blue to Amber then the user can release the power button.
4. User releases the power button before the 4-second shutdown override can occur.

If this path is taken, the BIOS will use default settings, ignoring settings in VPD where possible.

The BIOS will display the following prompt and wait for a keystroke:

[ESC] Normal Boot
[F2] Intel Visual BIOS
[F3] Disable Fast Boot[†]
[F4] BIOS Recovery
[F7] Update BIOS
[F10] Enter Boot Menu
[F12] Network Boot

[†] **[F3] Disable Fast Boot** is only displayed if at least one Fast Boot optimization is enabled.

If an unrecognized key is hit, then the BIOS will wait for another keystroke. If one of the listed hotkeys is hit, the BIOS will follow the indicated boot path. Password requirements must still be honored.

If Disable Fast Boot is selected, the BIOS will disable all Fast Boot optimizations and reset the system.

3.8 Hard Disk Drive Password Security Feature

The Hard Disk Drive Password Security feature blocks read and write accesses to the hard disk drive until the correct password is given. Hard Disk Drive Passwords are set in BIOS SETUP and are prompted for during BIOS POST. For convenient support of S3 resume, the system BIOS will automatically unlock drives on resume from S3. Valid password characters are A-Z, a-z, and 0-9. Passwords may be up to 19 characters in length.

The User hard disk drive password, when installed, will be required upon each power-cycle until the Master Key or User hard disk drive password is submitted.

The Master Key hard disk drive password, when installed, will not lock the drive. The Master Key hard disk drive password exists as an unlock override in the event that the User hard disk drive password is forgotten. Only the installation of the User hard disk drive password will cause a hard disk to be locked upon a system power-cycle.

Table 34 shows the effects of setting the Hard Disk Drive Passwords.

Table 34. Master Key and User Hard Drive Password Functions

Password Set	Password During Boot
Neither	None
Master only	None
User only	User only
Master and User Set	Master or User

During every POST, if a User hard disk drive password is set, POST execution will pause with the following prompt to force the user to enter the Master Key or User hard disk drive password:

Enter Hard Disk Drive Password:

Upon successful entry of the Master Key or User hard disk drive password, the system will continue with normal POST.

If the hard disk drive password is not correctly entered, the system will go back to the above prompt. The user will have three attempts to correctly enter the hard disk drive password. After the third unsuccessful hard disk drive password attempt, the system will halt with the message:

Hard Disk Drive Password Entry Error

A manual power cycle will be required to resume system operation.



NOTE

As implemented on Intel NUC Board NUC8i3BEB, Intel NUC Board NUC8i5BEB and Intel NUC Board NUC8i7BEB, Hard Disk Drive Password Security is only supported on either SATA port 0 (M.2) or SATA Port 1 (onboard SATA connector). The passwords are stored on the hard disk drive so if the drive is relocated to another computer that does not support Hard Disk Drive Password Security feature, the drive will not be accessible.

Currently, there is no industry standard for implementing Hard Disk Drive Password Security on AHCI or NVME drives. Hard drive encryption can still be implemented and does not require Hard Disk Drive Password Security.

3.9 BIOS Security Features

The BIOS includes security features that restrict access to the BIOS Setup program and who can boot the computer. A supervisor password and a user password can be set for the BIOS Setup program and for booting the computer, with the following restrictions:

- The supervisor password gives unrestricted access to view and change all the Setup options in the BIOS Setup program. This is the supervisor mode.
- The user password gives restricted access to view and change Setup options in the BIOS Setup program. This is the user mode.
- If only the supervisor password is set, pressing the <Enter> key at the password prompt of the BIOS Setup program allows the user restricted access to Setup.
- If both the supervisor and user passwords are set, users can enter either the supervisor password or the user password to access Setup. Users have access to Setup respective to which password is entered.
- Setting the user password restricts who can boot the computer. The password prompt will be displayed before the computer is booted. If only the supervisor password is set, the computer boots without asking for a password. If both passwords are set, the user can enter either password to boot the computer.
- For enhanced security, use different passwords for the supervisor and user passwords.
- Valid password characters are A-Z, a-z, and 0-9. Passwords may be up to 20 characters in length.
- To clear a set password, enter a blank password after entering the existing password.

Table 35 shows the effects of setting the supervisor password and user password. This table is for reference only and is not displayed on the screen.

Table 35. Supervisor and User Password Functions

Password Set	Supervisor Mode	User Mode	Setup Options	Password to Enter Setup	Password During Boot
Neither	Can change all options (Note)	Can change all options (Note)	None	None	None
Supervisor only	Can change all options	Can change a limited number of options	Supervisor Password	Supervisor	None
User only	N/A	Can change all options	Enter Password Clear User Password	User	User
Supervisor and user set	Can change all options	Can change a limited number of options	Supervisor Password Enter Password	Supervisor or user	Supervisor or user

Note: If no password is set, any user can change all Setup options.

4 Error Messages and Blink Codes

4.1 Front-panel Power LED Blink Codes

Whenever a recoverable error occurs during POST, the BIOS causes the board's front panel power LED to blink an error message describing the problem (see Table 36).

Table 36. Front-panel Power LED Blink Codes

Type	Pattern	Note
Power-on	Solid on primary color. Indicates S0 state.	Default to On; can be disabled via BIOS Setup
S3 Standby	Blink alternate color .25 seconds on, .25 seconds off, indefinitely. Indicates S3 state.	Default behavior; can be changed via BIOS Setup
Intel Ready Mode	Blink primary color, 1 second on, 1 second off, indefinitely.	
BIOS update in progress	Off when the update begins, then primary color on for 0.5 seconds, then off for 0.5 seconds. The pattern repeats until the BIOS update is complete.	
Memory error	On-off (1.0 second each) three times, then 2.5-second pause (off), entire pattern repeats (blinks and pause) until the system is powered off.	
Thermal trip warning	Blink primary color .25 seconds on, .25 seconds off, .25 seconds on, .25 seconds off. This will result in a total of 16 blinks (blink for 8 seconds).	

4.2 BIOS Error Messages

Table 30 lists the error messages and provides a brief description of each.

Table 30. BIOS Error Messages

Error Message	Explanation
CMOS Battery Low	The battery may be losing power. Replace the battery soon.
CMOS Checksum Bad	The CMOS checksum is incorrect. CMOS memory may have been corrupted. Run Setup to reset values.
Memory Size Decreased	Memory size has decreased since the last boot. If no memory was removed, then memory may be bad.
A bootable device has not been detected	System did not find a device to boot.

5 Intel NUC Kit Features

5.1 Chassis Front Panel Features

See the Product Identification Information section on page iv to identify Intel NUC Boards and their respective kit or system. Figure 22 and Figure 23 shows the location of the features located on or near the front of the chassis.

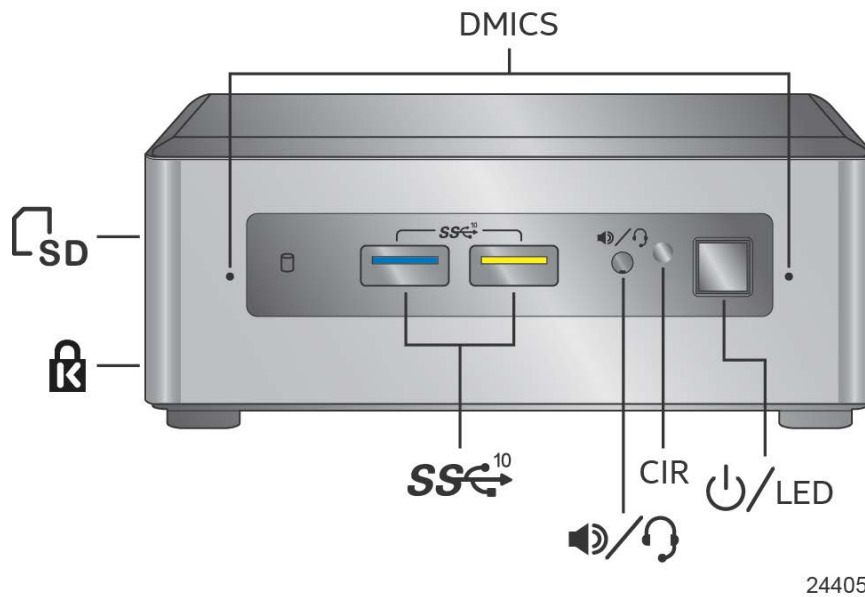



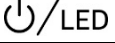



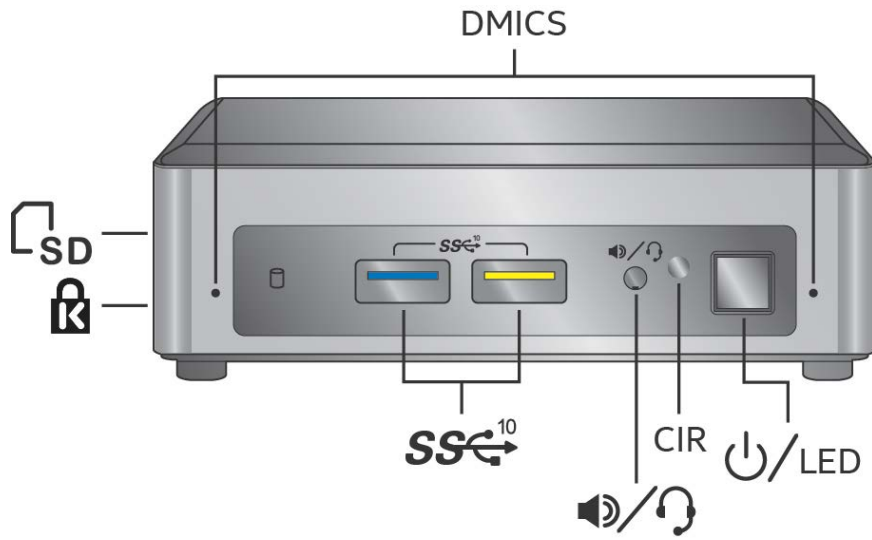

Figure 22. Intel NUC Kit NUC8i3BEH/NUC8i5BEH/NUC8i7BEH Features – Front

Table 37 lists the components identified in Figure 22.

Table 37. Components Shown in Figure 22

Item from Figure 22	Description
	Kensington* Anti-Theft Key Lock Hole
	Micro SDXC Card Reader
	Digital Microphone Array
	Power Switch and Power LED
	Consumer Infrared Sensor
	Speaker/Headset Jack
	USB 3.1 Type A Connectors







24403

Figure 23. Intel NUC Kit NUC8i3BEK/NUC8i5BEK Features – Front

Table 38 lists the components identified in Figure 23.

Table 38. Components Shown in Figure 23

Item from Figure 23	Description
	Kensington* Anti-Theft Key Lock Hole
	Micro SDXC Card Reader
DMICS	Digital Microphone Array
	Power Switch and Power LED
CIR	Consumer Infrared Sensor
	Speaker/Headset Jack
	USB 3.1 Type A Connectors

5.3 Chassis Rear Panel Features

Figure 24 shows the location of the features located on the rear of the chassis.

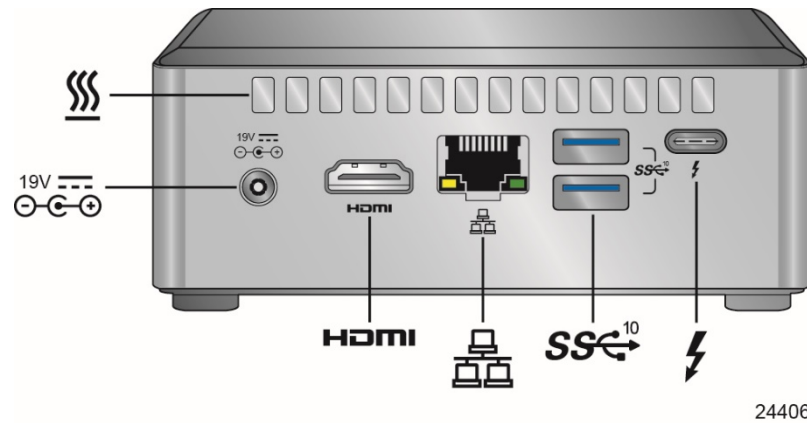

24406

Figure 24. Intel NUC Kit NUC8i3BEH/NUC8i5BEH/NUC8i7BEH Features – Rear

Table 39 lists the components identified in Figure 24.

Table 39. Components Shown in Figure 24







Item from Figure 24	Description
 19V	19V DC Power Inlet
	Cooling Vents
	Thunderbolt™ 3 via USB Type C connector
	USB 3.1 Type A connectors
	Ethernet Port
	High Definition Multimedia Interface Connector

Figure 25 shows the location of the features located on the rear of the chassis.







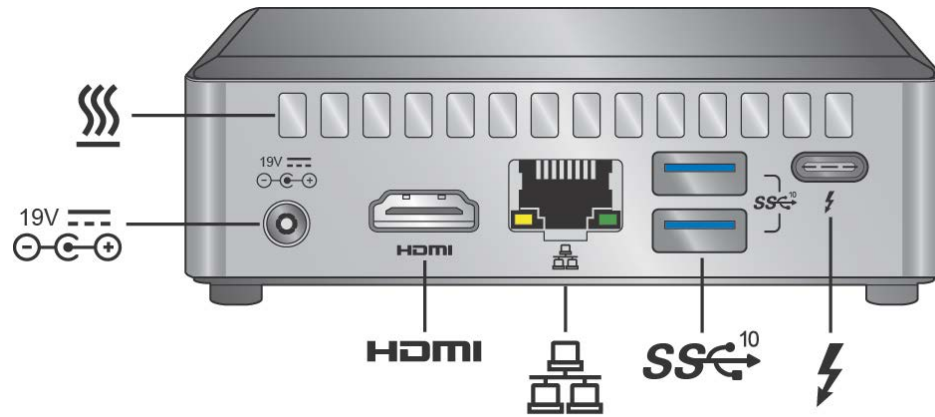

24404

Figure 25. Intel NUC Kit NUC8i3BEK/NUC8i5BEK Features – Rear

Table 39 lists the components identified in Figure 25.

Table 40. Components Shown in Figure 25

Item from Figure 25	Description
	Cooling Vents
	Thunderbolt™ 3 via USB Type C connector
	USB 3.1 Type A Connectors
	Ethernet Port
	High Definition Multimedia Interface Connector
	19V DC Power Inlet