



Milk Steamer

Instruction Manual & Guarantee

Dualit®

Since 1945

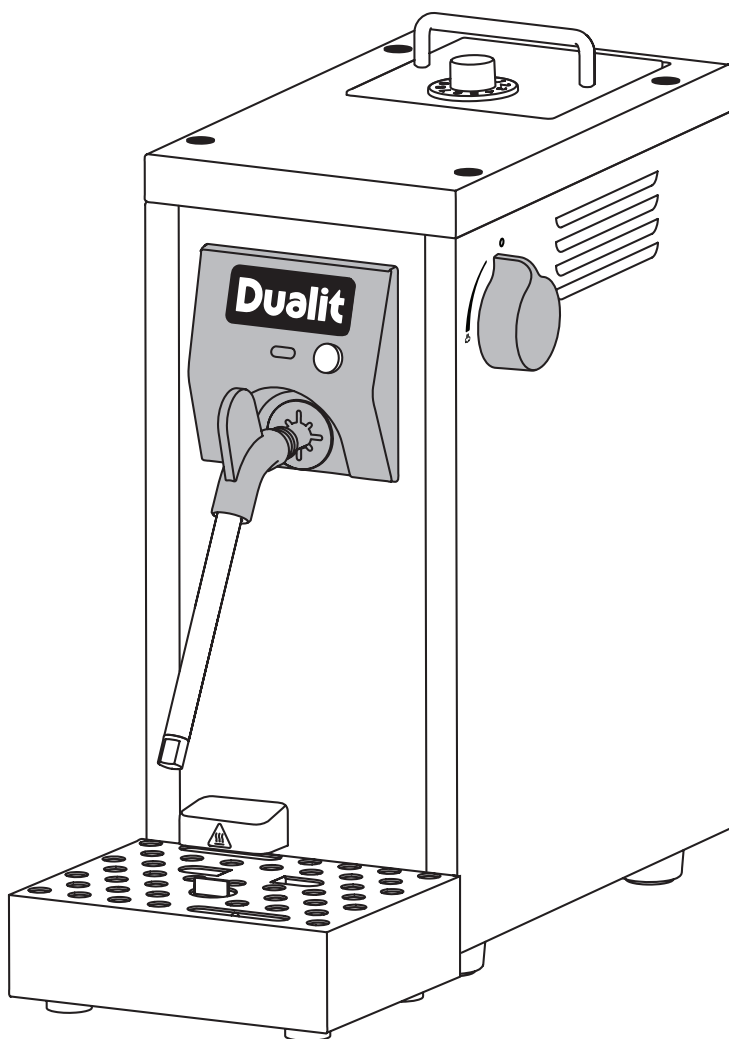

STEAM AND FROTH YOUR WAY TO PERFECT MILK

No more delayed hot drink orders or waiting to use the steam wand on the coffee machine; our Cino™ milk steamer will change the way your coffee service is run. Our easy to use, compact, freestanding milk steamer is perfect for making cappuccinos, babyminos, lattes, mochas and hot chocolates.

Creating perfectly steamed and frothed milk, effortlessly and quickly, you will get through hot drinks orders in no time. The Cino's simple, sleek, stainless steel design means it will also be a great addition to your kitchen if you enjoy enjoy coffee shop style coffee at home.



Unpack the box with care, keeping all the packaging materials until you are satisfied everything is present and in working order. Once satisfied remove any tags from the appliance body and recycle the packaging appropriately. Do not remove tags from the cord. You may wish to keep the box to store your appliance.

All illustrations are for representation only; your model may vary from illustrations shown.

CONTENTS

Safety precautions _____	04
Know your Dualit Cino™ _____	06
Set-Up _____	07
Water Filter Replacement _____	08
Before First Use _____	08
Indicator Light _____	09
Warming Milk Using Steam _____	10
Frothing Milk _____	11
Cleaning After Each Use _____	12
Cleaning & Descaling _____	13
Troubleshooting _____	16
Tip & Recipes _____	18
Guarantee _____	20



IMPORTANT SAFETY PRECAUTIONS



READ ALL THE INSTRUCTIONS

BEFORE USING THE DUALIT CINO™. KEEP THESE INSTRUCTIONS FOR FUTURE REFERENCE.

- THIS IS AN ATTENDED APPLIANCE. Do not leave unattended during use, unplug after each use (risk of fire if an unattended appliance is left operating).
- This appliance must not be used by children younger than 8 years old and persons with very extensive and complex disabilities. Children aged 8-14 years and persons with reduced physical, sensory or mental capabilities or lack of experience and knowledge shall not use this appliance, unless they are supervised and have been given instruction concerning the use of the appliance in a safe way and understand the hazards involved. Children shall not play with the appliance. Cleaning and user maintenance shall not be made by children unless they are older than 8 and supervised. Keep the appliance and its cord out of reach of children less than 8 years old.

Electrical safety

- Ensure that the voltage of the appliance corresponds to that of the mains supply.
- **WARNING:** This appliance must be earthed.
- Unplug the appliance from the mains before cleaning or maintaining.
- Do not operate any appliance with a damaged lead or plug, or after the appliance malfunctions or has been damaged, cracked or dropped in any manner.
- If the supply cord is damaged, it must be replaced by Dualit Ltd, its service agent or similarly qualified persons in order to avoid a hazard.
- We recommend that the milk steamer is plugged into a socket that has no other

appliance connected to it. Failure to do this may cause an overload, trip a circuit breaker or blow a fuse. Preferably the socket outlet should be protected by a Residual Current Device (RCD).

- The power supply cable should not be allowed to come into contact with hot surfaces.
- This appliance conforms to directive 2014/30/EU CEE regarding electromagnetic compatibility.
- Dualit does not recommend using extension cables as they may cause damage or accidents.

General safety

- Do not use the appliance for anything other than its intended use in order to avoid potential injury.
- Heating element surface is subject to residual heat after use.
- This unit is suitable for use in the household and for similar applications, for example in worker's kitchens in shops and offices, in agricultural farms, in hotels, motels and other bed and breakfasts, guest houses and institutions.
- Do not touch the metal parts, or its housing when the appliance is in use, as this may cause burns or scalding.
- Do not lift the appliance up using the Steam Wand. Only hold the appliance body. Unplug and allow to cool prior to moving.
- Do not place the appliance on a polished wood surface or any porous surface, it could damage the surface.
- Do not place on a tray or surface that may collect liquid.
- Do not operate on an uneven surface.
- Do not place the appliance over or close to sources of heat such as electric rings, hot ovens or open flames.
- Do not use the appliance without water as this may cause damage to the pump/boiler.

- Do not leave the appliance in a room with a temperature below 0°C, as any water remaining in the appliance could freeze and cause damage.
- Do not place hands in direct contact with the metal parts of the Steam Wand.
- Do not place hands directly under the steam as this may cause burns or scalding.
- Before refilling the Water Tank, unplug the appliance from the mains.
- Do not overfill the Water Tank.
- Do not use sparkling water (with carbon dioxide).
- Never fill the Water Tank with anything other than water.
- Your machine is fitted with a pressure release valve that dispenses into the Drip Tray.
- Only use the appliance with the Drip Tray correctly located, against the front of the machine.
-  **Warning :** Drip Tray and Drip Tray Cover may be hot due to expelled water or steam, allow drip tray to cool before handling.
- Ensure Water Filter Holder is removed before descaling solution is placed in the water tank. Risk of contamination or injury. See descale page 13.
- Do not immerse the appliance in water or other liquids.
- Turn the appliance and main power off when not in use.
- Condensation may appear on the work surface, under the machine. This is normal.

INSTRUCTIONS ON ENVIRONMENT PROTECTION



Do not dispose this product in the usual household garbage at the end of its life cycle. Please hand it over to a collection point for the recycling of electrical and electronic appliances.

The symbol on the product, the instruction of use or the packaging will inform you about the methods of disposal. The materials are recyclable as mentioned on its marking. By recycling, material recycling or other forms of re-utilization of old appliances you are making an important contribution to protect our environment. Please enquire at the community administration for the authorised disposal location.

SAVE THESE INSTRUCTIONS

BEFORE FIRST USE

- Read this instruction manual before you start using the Dualit Cino™. It gives you important safety information and will ensure you get the most out of your Dualit product.
- Keep this manual and your proof of purchase in a safe place.
- Don't forget to register your product at www.dualit.com/register
- 1. The Dualit Cino™ must be flushed through with steam before first use. **CAUTION:** Ensure that the Drip Tray is located against the front surface of the machine.
- 2. Ensure there is water in the Water Tank. Turn the machine on and wait till machine is up to temperature. Place the Milk Jug on the Drip Tray under the Steam Wand. Ensure the Steam Wand is directed into the Milk Jug.
- 3. Open the Steam Valve for 1 minute, steam will dispense from the Steam Wand. This will rinse the internals ready for first use.
- NOTE: The control knob may be harder to turn when the machine is new. This will loosen with use.
- NOTE: For cleaning, please refer to the section "Cleaning after each use" and "Cleaning & Descaling".
- These instructions are also available at www.dualit.com/cino.

KNOW YOUR DUALIT CINO™

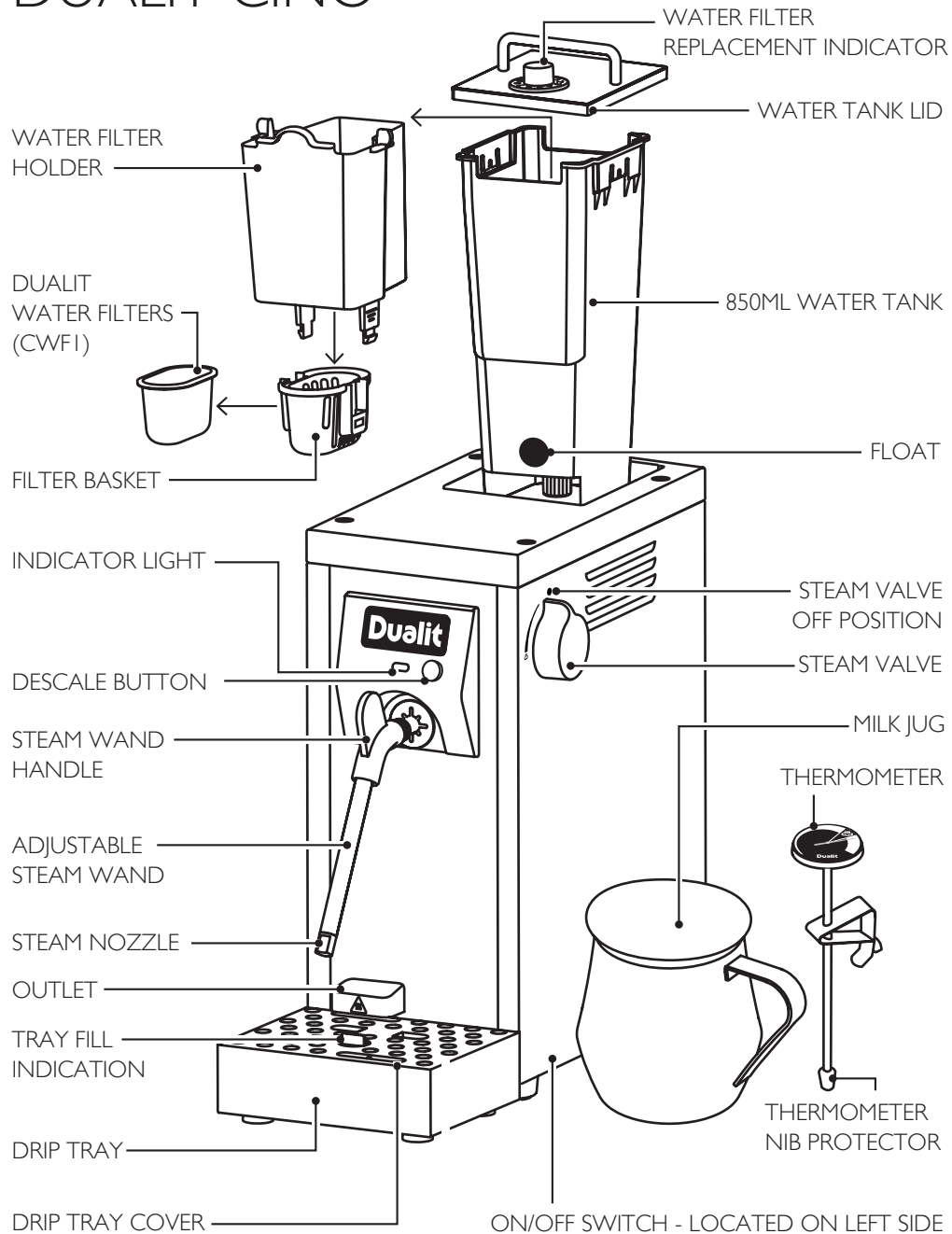

SET-UP

Your Dualit Cino™ is supplied with three Dualit Water Filters (CWF1). Store Dualit Water Filters in a cool, dry place. Only open wrapper just before use. Keep away from children. Remove all packaging from the machine. Ensure there is no debris in the Water Tank or cavity that the Water Tank sits in.

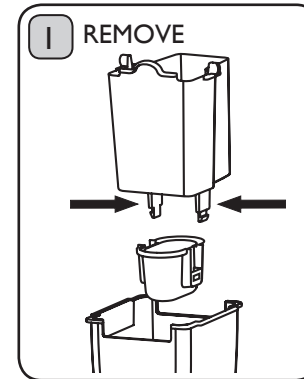

Remove Water Tank Lid. Remove the Water Filter Holder from the Water Tank. Remove the Filter Basket by pinching both tabs on the Water Filter Holder and pull the Filter Basket off.



Wash the Water Tank, Water Filter Holder and Filter Basket before first use with warm, soapy water. Rinse well.

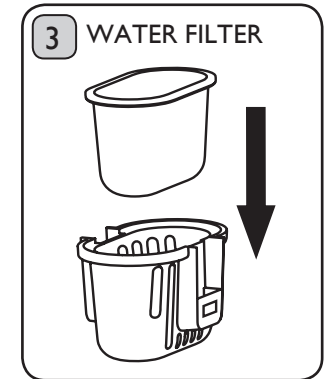

Place one Dualit Water Filter into the Filter Basket, ensuring the rounded end is placed in first. The flat end should sit within the Filter Basket when correctly located.

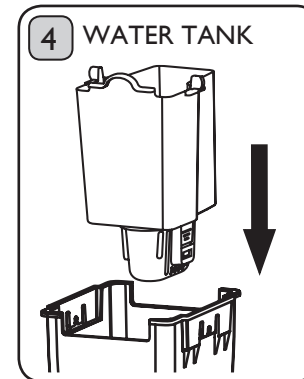

Click the Filter Basket onto the Water Filter Holder, and then place it back into the Water Tank.

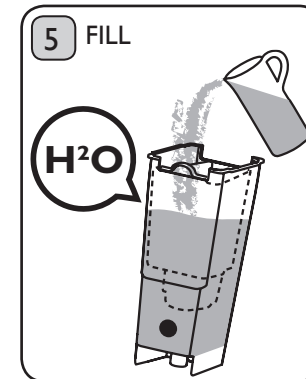

Fill the Water Tank with fresh water until the Dualit Water Filter is submerged. Maximum fill level is the top of the Water Filter Holder. Do not overfill.

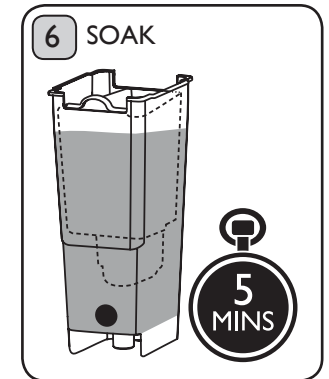

Soak for 5 minutes to activate the Dualit Water Filter. Discard the water. The Dualit Water Filter only needs to be activated before first use. From then on, you can fill Water Tank as normal.

To purchase more Dualit Water Filters visit our website on www.dualit.com/waterfilters or Contact Dualit on 01293 652500.

WATER FILTER REPLACEMENT

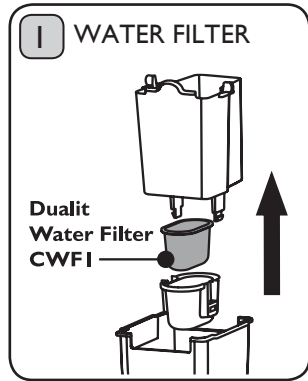

Remove the Water Filter Holder and disassemble. Place 1x Water Filter inside the Filter Basket. Click the Filter Basket back onto the Water Filter Holder and locate in Water Tank.

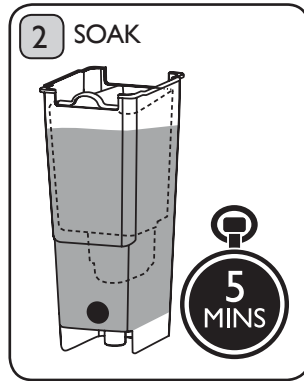

Soak for 5 minutes to activate the Water Filter. Discard the water. The water only needs to be activated before first use. From then on, you can fill the Water Tank as normal.

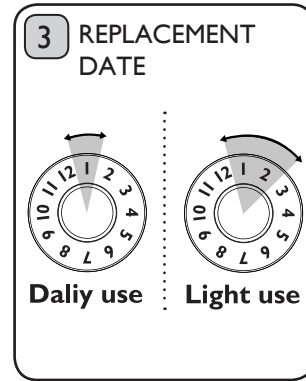

Once Water Filter has been replaced, turn the Water Filter Replacement Indicator to the required month.
Daily use: Replace Water Filter every month.
Light use: Replace Water Filter every two months.

BEFORE FIRST USE

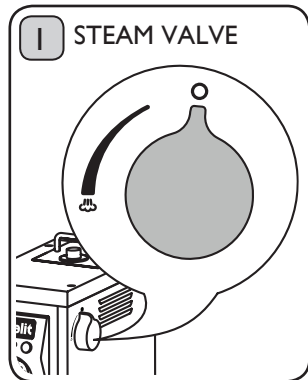

CAUTION: Ensure the Drip Tray is located against the front of the machine. Ensure the Steam Valve is in the closed position. **Warning - Risk of Scalding-** Keep hands away from the Outlet at all times.

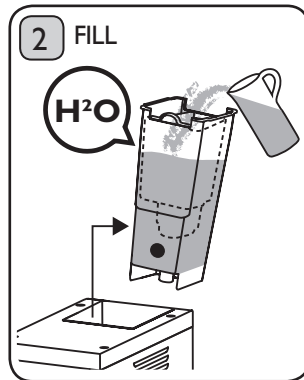

Remove the Water Tank and pour fresh water into the Water Filter Holder. The water will flow through the Filter. Top up as the level drops. Maximum fill level is the top of the Water Filter Holder. Do not overfill.

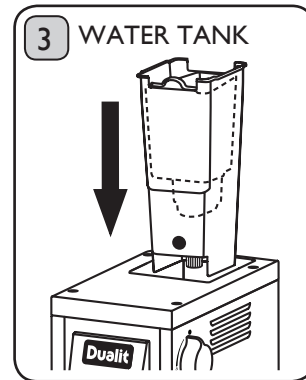

Place the Water Tank into the machine, pressing down firmly. Ensure the Float is facing towards the front. The Water Tank Lid will sit flush with the top surface when the Water Tank is fitted correctly.

BEFORE FIRST USE

- CONTINUED

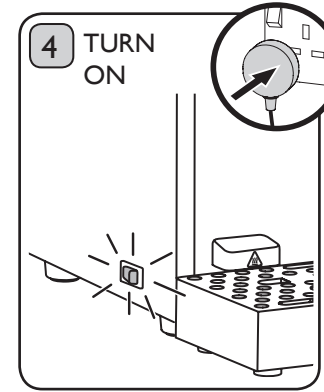

Plug the machine in and turn on. The ON/OFF switch will illuminate Red.

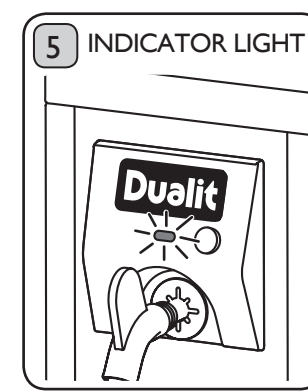

The Indicator Light will flash Green whilst warming and stop flashing when ready to use. If it's Amber or Red, see Quick Reference Guide on page 09. **Note:** The machine may whistle whilst pre-heating. This is normal operation.

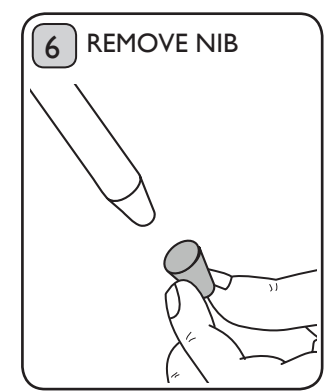

Remove the Thermometer Nib Protector from the Thermometer. Clip the Thermometer onto the side of the Milk Jug.

INDICATOR LIGHT: QUICK REFERENCE GUIDE:

To help understand each Indicator Light status, see the table below.

INDICATOR LIGHT	MEANINGS
Red and Amber (Flashing)	Re-fill Water Tank.
Green (Flashing/ Solid)	Machine is warming up to operating temperature. Once Green illumination is solid, the machine is ready to use.
Amber (Flashing/ Solid)	Descale Required.
Red (Flashing/Solid)	Machine in Lock Mode. Carry out mandatory Descale.
Red (Quick Flash)	In Descale Mode.

WARMING MILK USING STEAM

The machine and Milk Jug are capable of steaming between **100 and 600ml** of milk at any one time.

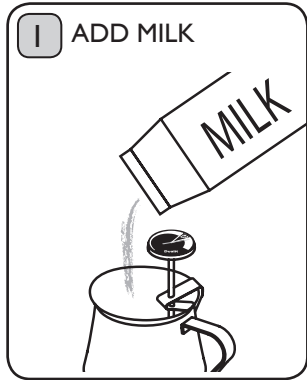

Determine how much milk is required and pour into the Milk Jug. We recommend using a chilled Milk Jug and fresh semi-skimmed milk straight from the fridge, for best results.



Hold the Milk Jug by the handle, at a slight angle. Lower the Steam Wand under the surface of the milk. Hold jug still, and keep the Steam Wand Nozzle close to the bottom.

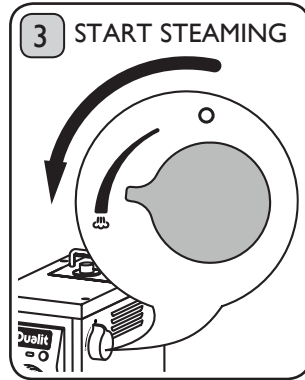

Slowly open the Steam Valve to halfway. Pump will start and steam will flow from the Steam Wand Nozzle. To speed up the process, gradually open the Steam Valve, take care not to splash

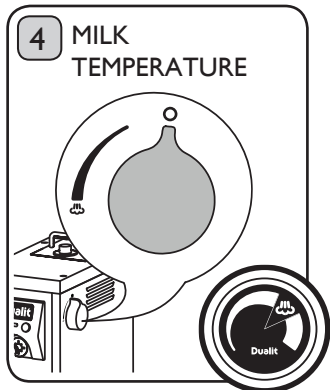

Warning: Never lift the Steam Wand Nozzle out of the milk whilst Steam Valve is open. The Steam symbol on the Thermometer indicates recommended milk temperature. When desired milk temperature is reached, close the Steam Valve

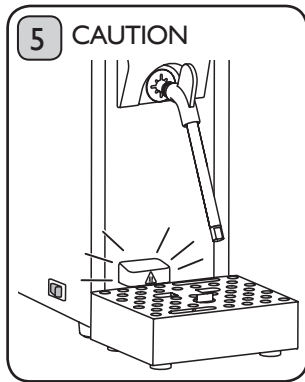

CAUTION: HOT / RISK OF SCALDING. Keep hands away from the Outlet at all times. Some steam and water will expel into the Drip Tray from the Outlet when the Steam Valve has just been closed. This is normal operation.

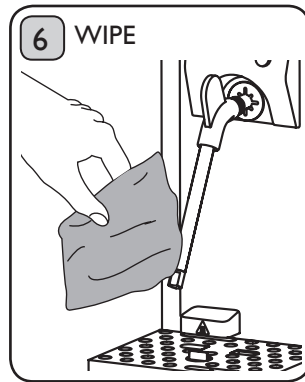

After each frothing, open the Steam Valve to clean. Immediately wipe the Steam Wand with a damp cloth. **Warning: Steam Wand will be hot.** Turn the machine off using the ON/OFF switch and unplug.

FROTHING MILK

The machine and Milk Jug are capable of frothing between **100 and 300ml** of milk at any one time. Approximately 100ml for Cappuccino and 150ml for Latte per large cup / mug. It is recommended to use a chilled Milk Jug and fresh Semi-Skimmed milk straight from the fridge for best results. **Note: Skimmed and Full Fat can also be used.**

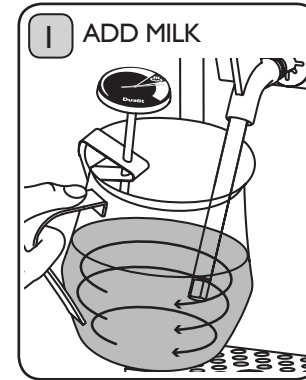

Add milk to the jug. Holding the Jug by the handle, and at a slight angle, place the tip of the Steam Wand Nozzle 1-2 cm below the surface. The wand should be close to the edge of the jug, not in the centre.

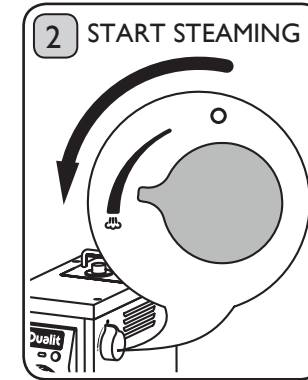

Slowly open the Valve. The steam will flow from the Nozzle and start to rotate the milk like a whirlpool. To speed up the process, gradually open Steam Valve. Take care not to splash the milk.

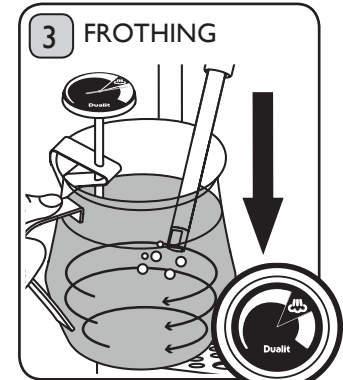

As the thermometer dial starts to rise, lower the Jug to bring the Nozzle to the surface of the milk. This will start to introduce air and develop the froth. Large bubbles indicate nozzle is raised too high.

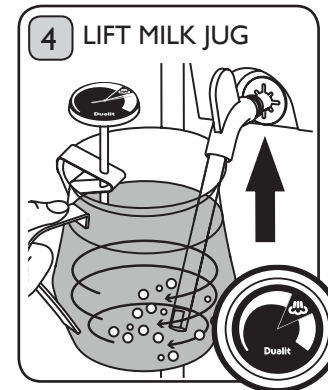

Once there is sufficient milk textured, raise the jug and continue until the Steam symbol is reached on the Thermometer Dial. **Caution - Close the Steam Valve before removing Steam Wand from jug.**

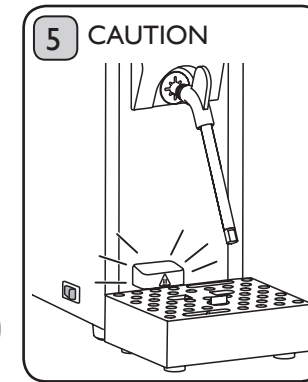

CAUTION: HOT / RISK OF SCALDING. Keep hands away from the Outlet. Steam/Water will expel from Outlet when Steam Valve has been closed. This is normal operation. **Caution - Steam wand will be hot.**

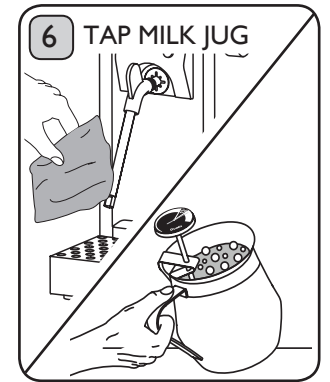

Immediately after frothing, open the Valve and wipe wand to clean. Gently tap Milk Jug against the worktop to collapse any large bubbles. Swirling will mix the milk with the froth. Pour immediately. Turn machine off and unplug.

CLEANING AFTER EACH USE

It is important to clean the **DUALIT CINO™** after each use. Make sure the machine is switched off, unplugged and allowed to cool.

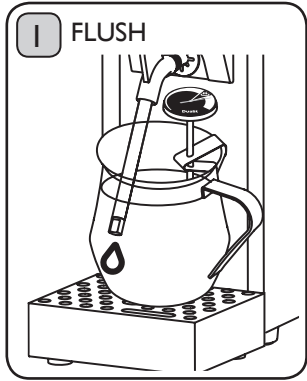

1 FLUSH
Flush the Steam Wand by dispensing steam to remove any milk residue from inside the Steam Wand after each use.

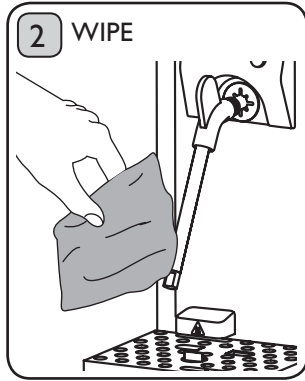

2 WIPE
Thoroughly wipe the Steam Wand to clean off any milk residue with a damp cloth. **CAUTION: Steam Wand will be hot.**

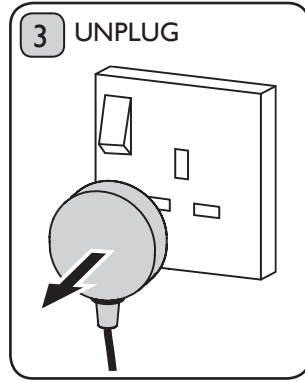

3 UNPLUG
Unplug the machine, and allow to cool.

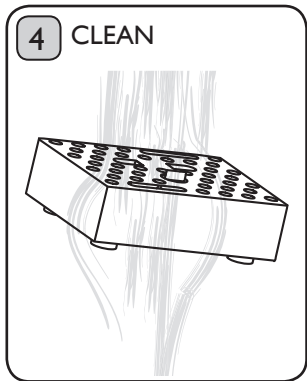

4 CLEAN
CAUTION: Allow Drip Tray to cool down before emptying. Clean Drip Tray with warm soapy water using a non-abrasive pad and dry. Wipe up any Descaler overspill.

CLEANING & DESCALING

The machine has a Descal Counter. The machine will advise you when a descale is required based on the number of uses.

If the Indicator Light is **Amber**, machine needs to be descaled immediately.

If the Indicator Light is **Red**, machine has entered Lock Mode, to prevent use until a descale is performed.

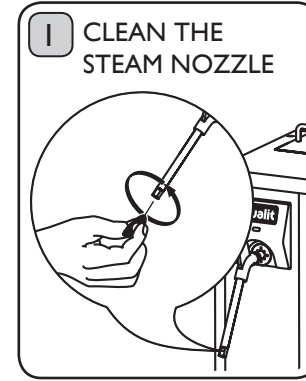

1 CLEAN THE STEAM NOZZLE
Unscrew the Steam Nozzle anti-clockwise and use a pin to remove dried milk. If too tight to unscrew, use an 8mm spanner. Screw Steam Nozzle back onto the steam wand, ensuring it is tight.

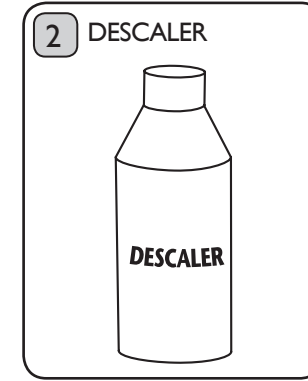

2 DESCALER
Purchase Descal Solution which is suitable for Coffee Machines. Ensure the Steam Valve is closed and ensure the Drip Tray is located against the front of the machine.

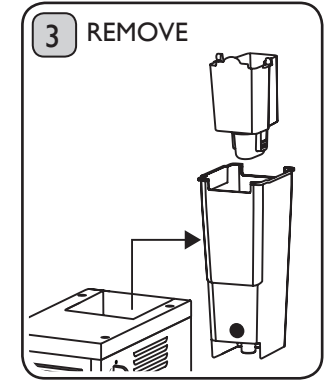

3 REMOVE
CAUTION: Remove Water Tank from machine then remove Water Filter Holder from Water Tank. Do not allow Descal Solution to come in contact with Dualit Water Filter. Risk of injury or contamination!

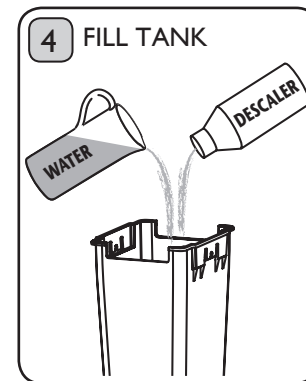

4 FILL TANK
Fill the Water Tank with 1 litre of Descal Solution. **Follow instructions and safety precautions on the Descaler packaging.** If using granular descaler, ensure it is fully dissolved before switching the machine on.



5 PLACE CONTAINER
Place Water Tank back into machine. Place a container with a capacity of more than 2 litres on top of the Drip Tray, located under the Steam Wand. Ensure Drip Tray is located against the front surface of the machine.

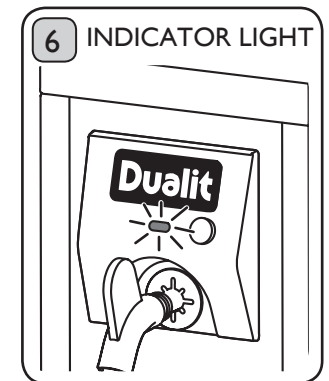

6 INDICATOR LIGHT
Depending on the machine's status the Indicator Light will be flashing Green, Amber or Red whilst warming up. Once machine is warmed up the Indicator Light will stop flashing and remain on.

CLEANING & DESCALING

- CONTINUED

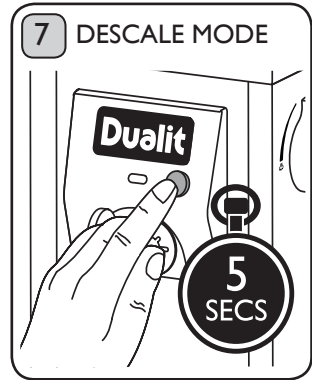

To enter the Descale Mode; Press and hold the Descale Button for **5 seconds**. Once released the Indicator Light will quickly flash red to indicate machine is in Descale Mode.



Open Steam Valve; steam will dispense initially, followed by Descaling solution. Dispense all solution. Indicator Light will flash Red and Amber when Water Tank is empty.

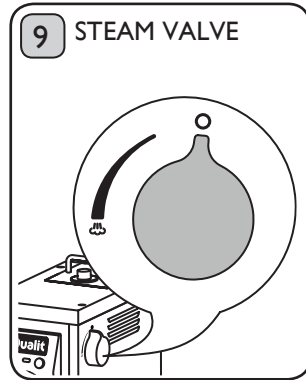

Close Steam Valve, discard Descale solution, following the Descaler instructions. Leave for 10 minutes to allow time for the solution to take effect. Do not switch off the machine.

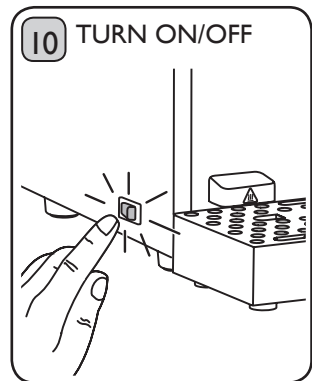

If the machine is accidentally switched off whilst in Descale Mode, switch back on, the machine will automatically enter back in Descale Mode. Continue process.

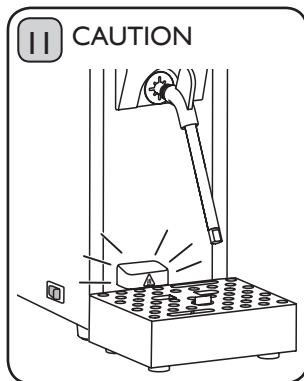

CAUTION: RISK OF SCALDING. Keep hands away from the Outlet at all times. Steam/Water will expel from Outlet when Steam Valve has been closed. This is normal operation. 14

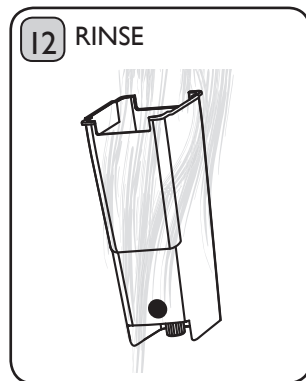

Remove Water Tank and rinse with fresh water. Fill Water Tank with fresh water and place back in the Machine.

CLEANING & DESCALING

- CONTINUED



IMPORTANT: Do not use Descale mode for any other functionality. It will cause damage to pump as it is not designed to regularly run continuously.

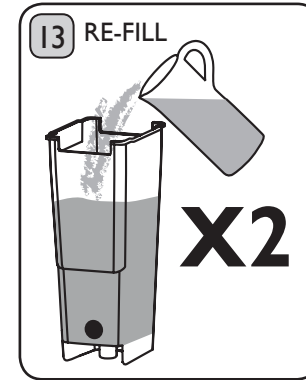

Open Steam Valve and allow all the water in the Water Tank to dispense into the container. Re-fill Water Tank with fresh water and repeat. This will remove any traces of the descale solution within the machine's internals.

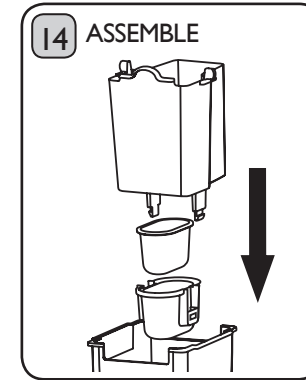

Close Steam Valve. **CAUTION: Keep hands away from the Outlet.** Remove the Water Tank and re-insert the Water Filter Holder and Dualit Water Filter.

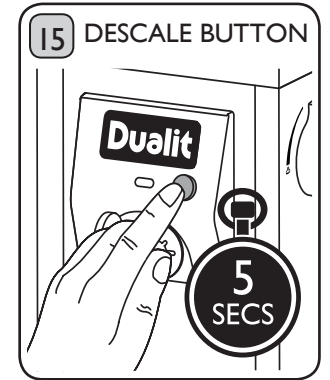

Press and hold the Descale button for **5 seconds** to exit. Indicator Light will flash Green whilst warming up. Indicator Light will stop flashing and remain on when ready.

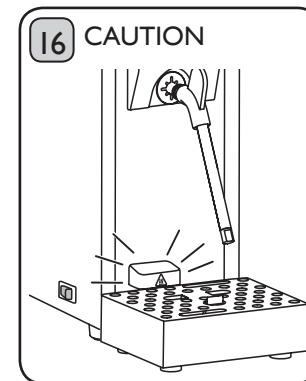

CAUTION: RISK OF SCALDING. Keep hands away from the Outlet at all times. Steam/Water will expel from Outlet when Steam Valve has been closed. This is normal operation.

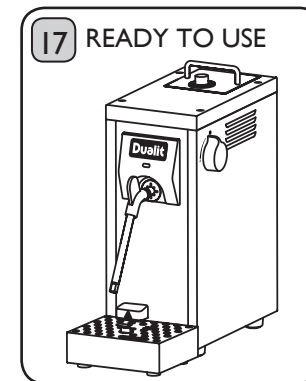

Machine has been successfully descaled and is ready to use again.

TIP: Regular descaling can ensure maximum steam efficiency and help prolong the life of the machine. Dualit recommend weekly descaling.

TROUBLESHOOTING



POSSIBLE CAUSE(S)	SOLUTION(S)
MY MACHINE IS MAKING A LOUD WHISTLING NOISE WHILST PRE-HEATING	
1. The machine is pumping water through the system at high pressure.	1. This is normal operation.
AFTER FROTHING MILK, MY MILK IS NOT FOAMY	
1. Your milk is not cold or fresh enough.	1. It is easier to make froth using fresh, cold semi-skimmed milk.
2. The Steam Wand is blocked with milk residue.	2. Clean Steam Wand and Nozzle and descale machine (see page 12-15). If you are unable to unblock your Steam Wand then contact Dualit on 01293 652500 for advice or spare parts.
3. My milk is burning.	3. Reduce steam flow, rotate Steam Valve clockwise between the steam and off position (see page 10-11) or steam for a shorter period.
NO STEAM OR REDUCED STEAM IS FLOWING FROM THE STEAM WAND	
1. Steam wand is blocked with milk residue.	1. Clean steam wand and nozzle and descale machine (see page 12-15). If you are unable to unblock your steam wand then contact Dualit on 01293 652500 for advice or spare parts.
2. The machine has been turned on with the steam valve left open.	2. Close the steam valve and open again to steam.
3. The machine has not been descaled in the recommended time. The Indicator Light has illuminated RED . The machine has entered Lock Mode.	3. Complete Descal procedure. (See Page 12-15)
UNSURE WHAT THE INDICATOR LIGHT COLOUR MEANS	
RED and AMBER illumination: (Flashing):	1.1 Low water level Indicator. Add a minimum of 500ml to the Water Filter Holder.
	1.2. The Water Tank is not correctly seated into position. Press firmly on the Water Tank to locate. The Water Tank will sit flush with the top surface of the machine when the Water Tank is fitted correctly.
GREEN illumination: (Flashing / Solid):	Machine is warming up to operating temperature. Once Green illumination is solid, the machine is ready to use.
AMBER illumination: (Flashing / Solid):	Descal required and machine is warming up to operating temperature. Recommended to carry out descale procedure soon otherwise the machine will shortly enter Lock Mode. (See Page 12-15)

RED illumination: (Flashing / Solid):	Lock Mode. Complete Descal procedure. (See Page 12-15)
RED illumination: (Quick flash):	Machine is in Descal Mode, to exit, press the Descal Button for 5 seconds.
DRIP TRAY FILLING TOO QUICKLY	
Each time the Steam Valve is closed, Steam and Water is purged through the machine and expels from out of the Outlet. This is to increase the machines life.	This is normal operation.
STEAM SPEED IS TOO HIGH	
Steam Valve is fully open.	Turn the Steam Valve clockwise to reduce the flow.
I HAVE RUN OUT OF DUALIT WATER FILTERS	
To purchase more Dualit Water Filters visit our website on www.dualit.com/waterfilters or Contact Dualit on 01293 652500.	
MY MACHINE IS NOT WORKING – THE LIGHTS ARE OFF AND THE MACHINE CEASES TO OPERATE.	
Machine not plugged in	Ensure the machine's plug is connected to the socket, and socket switch turned on.
Fuse may have failed.	Check and replace fuse. Contact the Dualit customer helpline on 01293 652500.

TIPS

GENERAL TIPS

- To avoid hot milk spillages when steaming, never fill the jug more than half way as the milk volume will double when you froth.
- Use the thermometer to ensure the milk has steamed/frothed to the optimum temperature.
- Operate the steam once you have finished making coffees to remove any remaining milk residue from inside the steam wand.
- Wipe the steam wand after each use.

WHAT IS STEAMING?

- Heating the milk using steam.
- For best results hold the jug still.
- Great for making lattes, mochas and hot chocolate, as dense froth is not required.

WHAT IS FROTHING?

- Combining the milk with air by slowly lowering the jug.
- Keep the jug slightly at an angle with the steaming wand, just under the surface of the milk.

WHAT IS TEXTURING?

- Combining the steamed and frothed milk to create a creamy glossy texture.
- Perfect for making cappuccinos, Babycinos and flavoured cinos.

RECIPES

All coffees start with an espresso, we recommend Dualit NX® capsules as a base; add milk to create different types of drinks. If using ground or instant coffee please make espresso to taste.

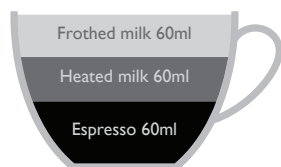

CAPPUCCINO

1. Make espresso for the cappuccino.
2. Steam, froth and texture the milk by following steps 1-6 (pg 10-11).
3. Pour a third of the hot textured milk then spoon a third of the foamed milk over the espresso.
4. Sprinkle with cinnamon or powdered cocoa to finish (optional).

LATTE

1. Make espresso for the latte.
2. Steam the milk by following steps 1-6 (pg 10-11).
3. Pour steamed milk over the espresso, adding a little froth at the end.
4. Tip: Add flavoured syrups to enhance the flavor of the coffee (optional).

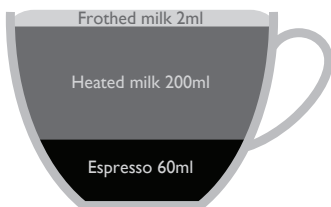

RECIPES

MOCHA



1. Add 3 teaspoons of cocoa powder with a little water and stir into a paste.
2. Make and add the espresso to the cocoa powder paste.
3. Steam the milk by following steps 1-6 (pg 11).
4. Pour steamed milk over the cocoa espresso mix, adding a little froth at the end.
5. Finish off with whipped cream and dust with cocoa powder (optional).

HOT CHOCOLATE

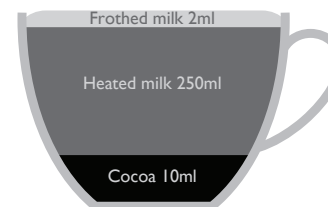

1. Add 3 teaspoons of cocoa powder with a little water and stir into a paste.
2. Steam the milk by following steps 1-6 (pg 10-11).
3. Pour steamed milk over the cocoa mix, adding a little froth at the end.
4. Finish off with whipped cream and dust with cocoa powder (optional).

FLAT WHITE



1. Less milk more coffee.
2. Make a double espresso for the flat white.
3. Steam the milk by following steps 1-6 (pg 10).
4. Pour steamed milk over the espresso and serve.

BABYCINO



1. Cappuccino without the coffee.
2. Steam, froth and texture the milk by following steps 1-6 (pg 10-11).
3. Pour straight into a cup, top with cocoa powder and serve with marshmallows.
4. Add sugar to taste or flavoured syrups to add a new dimension to the Babycino (optional).



watch the video at
[DUALIT.COM/CINO](https://dualit.com/cino)

GUARANTEE

This appliance is of excellent quality and construction. However, if any defects in materials or workmanship do appear during the relevant guarantee period, we will, at our discretion, either repair or replace the defective parts, free of charge, subject to the terms and conditions of our Guarantee shown below.

This Guarantee covers both parts and labour. Carriage is not included.

Your Guarantee period is as follows:

- 1 year

This Guarantee provides benefits which are additional to, and do not affect, your statutory rights. This Guarantee does not cover the cost of returning the product to the dealer from whom it was purchased or to ourselves. This Guarantee applies only to products sold and located in mainland Great Britain. It does not cover liability in respect of or replacement of plugs, cables or fuses and also does not cover defects due to:

- Failure to use or maintain product in accordance with Dualit's instructions which includes rinsing and wiping after every frothing cycle and descaling. See pages 12-15.
- The product being connected to an unsuitable electricity supply.
- Accidental damage to or abuse or misuse of the product including failure to use the product for its normal intended purposes.
- The product modified, except by Dualit or approved agent.
- Dismantling of or interference with the product.
- Theft or attempted theft of the product.

Before returning any product under this Guarantee, please check that:

- You have followed the product instructions

correctly.

- Your mains electricity supply is functional.
- **The defect is not due to a blown fuse.**

If you wish to claim under this guarantee you should:

- Send the product, postage or carriage paid, to the dealer from whom it was purchased or to Dualit direct.
- Ensure that the product is clean and packed carefully (preferably in its original carton).
- Enclose details of your name, address and telephone number and when and where the product was purchased, together with proof of purchase (e.g. a till receipt).
- Give exact details of the nature of the defect.

This Guarantee does not cover any other claims whatsoever, including, without limitation, any liability for incidental, indirect or consequential damage, nor does it cover any claims for conversion or modification or for the costs of repair carried out by any third party without the prior consent of Dualit. If replacement parts are fitted to the product this will not extend the period of the Guarantee.

For further advice contact the Dualit customer helpline on +44 (0)1293 652 500 (09:00 to 17:00 Monday to Friday).

Alternatively, email Dualit at info@dualit.com or visit www.dualit.com

DON'T FORGET TO REGISTER YOUR PRODUCT

Take a minute to register your product with us to receive these outstanding benefits:

1 Fast and efficient customer service and access to manuals and product information should you require assistance with your purchase

2 Access to a library of mouth-watering recipes and regular articles from leading chefs, food critics and industry experts

3 Be the first to hear about exciting new Dualit products

Register ✓
my appliance

Dualit recommends safety first: please register your product so that we can contact you in the unlikely event that a safety notification is issued.

WWW.DUALIT.COM/REGISTER

OR BY POST



Dualit[®]

NESPRESSO[®]
COMPATIBLE*

COMPOSTABLE#
CAPSULES

REVOLUTIONISING CAPSULES ONE ESPRESSO AT A TIME

Sustainability is the vital ingredient in Dualit coffee. Discover quality and great tasting coffee with the benefit of compostable capsules.

Order your coffee at:
www.dualit.com/capsules



* Suitable for drop through machines only. Excluding professional machines and 'built in' models
Nespresso trademark is owned by Société des Produits Nestlé S.A.
Industrial composting by authorised collection schemes

Dualit Limited County Oak Way Crawley West Sussex RH11 7ST
Telephone: +44(0)1293 652 500 Facsimile: +44(0)1293 652 555
Email: info@dualit.com Web: www.dualit.com



GB-C