



THE MEASURABLE DIFFERENCE

# H25-IR PRO

INFRARED REFRIGERANT GAS LEAK DETECTOR

Configuration • Operation • Troubleshooting

User Manual 3015-5678  
Revision 6, May 2020



Product Leadership • Training • Service • Reliability

## WARRANTY

Bacharach, Inc. warrants to Buyer that at the time of delivery this Product will be free from defects in material and manufacture and will conform substantially to Bacharach Inc.'s applicable specifications. Bacharach's liability and Buyer's remedy under this warranty are limited to the repair or replacement, at Bacharach's option, of this Product or parts thereof returned to Seller at the factory of manufacture and shown to Bacharach Inc.'s reasonable satisfaction to have been defective; provided that written notice of the defect shall have been given by Buyer to Bacharach Inc. within two (2) years after the date of delivery of this Product by Bacharach, Inc.

Bacharach, Inc. warrants to Buyer that it will convey good title to this Product. Bacharach's liability and Buyer's remedy under this warranty of title are limited to the removal of any title defects or, at the election of Bacharach, to the replacement of this Product or parts thereof that are defective in title.

The warranty set forth in paragraph 1 does not apply to parts the operating instructions designate as having a limited shelf-life or as being expended in normal use (e.g., filters).

THE FOREGOING WARRANTIES ARE EXCLUSIVE AND ARE GIVEN AND ACCEPTED IN LIEU OF:

- (I) ANY AND ALL OTHER WARRANTIES, EXPRESS OR IMPLIED, INCLUDING WITHOUT LIMITATION THE IMPLIED WARRANTIES OF MERCHANTABILITY AND FITNESS FOR A PARTICULAR PURPOSE: AND
- (II) ANY OBLIGATION, LIABILITY, RIGHT, CLAIM OR REMEDY IN CONTRACT OR TORT, WHETHER OR NOT ARISING FROM BACHARACH'S NEGLIGENCE, ACTUAL OR IMPLIED.

The remedies of the Buyer shall be limited to those provided herein to the exclusion of any and all other remedies including, without limitation incidental or consequential damages. No agreement varying or extending the foregoing warranties, remedies or this limitation will be binding upon Bacharach, Inc. unless in writing, signed by a duly authorized officer of Bacharach.

**Register your warranty by visiting [www.mybacharach.com](http://www.mybacharach.com).**

## NOTICE

Product improvements and enhancements are continuous, therefore the specifications and information contained in this document may change without notice. Bacharach, Inc. shall not be liable for errors contained herein or for incidental or consequential damages in connection with the furnishing, performance, or use of this material. No part of this document may be photocopied, reproduced, or translated to another language without the prior written consent of Bacharach, Inc.

Revision 6 of this manual corresponds to firmware version 1.20 or newer.

Patent 6,590,690. Other patents pending.

Copyright © 2005–2020, Bacharach, Inc.  
All rights reserved.

BACHARACH® is a registered trademark of Bacharach, Inc. All other trademarks, trade names, service marks and logos referenced herein belong to their respective owners.

Table of Contents

**CHAPTER 1: INTRODUCTION ..... 1**

1.1. Product Overview ..... 1

1.2. Conventions Used in This Manual..... 1

1.3. Safety Precautions ..... 2

1.4. Features and Capabilities ..... 3

1.5. Functional Overview ..... 3

    1.5.1. Key System Components ..... 3

    1.5.2. Operation Modes: Search vs. Measure..... 4

    1.5.3. Operational Functions/Features ..... 5

    1.5.4. Advanced Leak Quantification (ALQ™) Technology ..... 6

    1.5.5. Using a Reference Leak Source ..... 6

1.6. Specifications..... 9

**CHAPTER 2: HARDWARE OVERVIEW ..... 11**

2.1. Unpacking..... 11

2.2. External Components..... 11

    2.2.1. Front Panel ..... 11

    2.2.2. Back Panel..... 12

2.3. Probes and Hoses ..... 12

    2.3.1. Standard Probe with Flexible Tubing..... 12

    2.3.2. Standard Probe with LED and Push Button..... 13

    2.3.3. Smart Probe ..... 14

    2.3.4. Connecting the Flexible Probe Tube..... 15

2.4. Power Cord..... 16

2.5. Internal Components ..... 17

    2.5.1.   NDIR Sensor ..... 17

**CHAPTER 3: MENU SYSTEM OVERVIEW ..... 18**

3.1. Menu Architecture..... 18

3.2. Menu Navigation ..... 20

    3.2.1. Overview..... 20

    3.2.2. Front Panel Buttons..... 22

    3.2.3. Changing Values of Menu Items ..... 22

    3.2.4. Configuration-Dependent Menu Items ..... 23

    3.2.5. Special Key Combinations..... 24

3.3. Version Screen (at Power Up)..... 24

3.4. Setup Summary Screen (Warm-up) ..... 25

3.5. Search Mode Screen ..... 25

3.6. Measure Mode Screen..... 26

3.7. Basic Setup Screen ..... 26

3.8. Advanced Setup Screen..... 27

3.9. Diagnostics Screen ..... 28

**CHAPTER 4: WIRING..... 30**

4.1. Introduction..... 30

4.2. Relay Connections..... 30

4.3. 4-20mA Current Loop Connection ..... 31

4.4. RS-232 Communications Connection..... 32

4.5. Standard Versus Smart Probe Wiring..... 32

<b>CHAPTER 5: OPERATION</b> .....	<b>34</b>
5.1. Introduction .....	34
5.2. Turning on the H25-IR PRO .....	36
5.3. Search Mode Screen.....	36
5.3.1. Overview .....	36
5.3.2. Display Styles (Graphic vs. Numeric).....	36
5.3.3. Mode Button .....	37
5.3.4. Volume Button .....	38
5.3.5. Range Button.....	38
5.3.6. Setup (and Right Arrow) Button .....	39
5.3.7. Zero (ENT) Button .....	41
5.3.8. Information (i) Button .....	41
5.4. Measure Mode Screen.....	42
5.4.1. Overview .....	42
5.4.2. Log (Esc) Button.....	43
5.5. Basic Setup Screen.....	45
5.5.1. Gas Type.....	46
5.5.2. Unit Display .....	48
5.5.3. Alarm Setpoint.....	49
5.5.4. Display Style .....	51
5.6. Advanced Setup Screen .....	53
5.6.1. User Setups 1-4.....	54
5.6.2. Relay Settings Screen .....	61
5.6.3. Measurement Log.....	63
5.6.4. Date/Time Set.....	65
5.6.5. Log Limit .....	66
5.6.6. Loop Factor.....	68
5.6.7. Serial Data .....	70
5.6.8. Probe Button (Optional).....	71
5.7. Diagnostics Screen.....	74
5.7.1. Current Faults Screen.....	77
5.7.2. Sensor Data Screen .....	79
5.8. Adjustment to a Known External Leak Source .....	81
5.9. Custom Gas Type Configuration.....	83
5.10. Factory Gas Type Configuration .....	84
<b>CHAPTER 6: MAINTENANCE</b> .....	<b>88</b>
6.1. Fuse Replacement .....	88
6.2. Probe Tip Filter Replacement.....	89
6.3. Probe "O" Ring Replacement .....	90
6.4. External Filter Replacement.....	90
6.5. NDIR Sensor Replacement .....	92
6.6. NDIR Sensor Adjustment.....	95
6.7. Spare Parts and Accessories.....	95
6.8. Firmware Upgrade Procedure.....	96
<b>CHAPTER 7: TROUBLESHOOTING</b> .....	<b>100</b>
7.1. Diagnostics.....	100
7.2. Service Centers.....	100
7.3. System Faults .....	101
<b>APPENDIX A: GLOSSARY OF TERMS</b> .....	<b>102</b>
<b>APPENDIX B: ACRONYMS AND ABBREVIATIONS</b> .....	<b>104</b>

**APPENDIX C: SUPPORTED GAS TYPES..... 106**

C.1. Basic Gas Types..... 106

C.2. Factory Gas Types..... 108

**APPENDIX D: DECLARATION OF CONFORMITY.....ERROR! BOOKMARK NOT DEFINED.**

**INDEX ..... 111**





List of Figures

Figure 1-1. Toggling Between Search and Measure Modes..... 4

Figure 1-2. H25-IR PRO’s ALQ™ Technology ..... 7

Figure 1-3. Adjusting the H25-IR Pro to a Recognized Leak Standard ..... 8

Figure 2-1. Front Panel Components of the H25-IR PRO ..... 11

Figure 2-2. Back Panel Components of the H25-IR PRO ..... 12

Figure 2-3. Components of the Standard Probe with Flexible Tubing..... 12

Figure 2-4. Components of the Standard Probe with LED and Push Button..... 13

Figure 2-5. Components of the Smart Probe ..... 14

Figure 2-6. H25-IR PRO Smart Probe Key Lock Feature ..... 15

Figure 2-7. Connecting the Probe to the H25-IR PRO..... 16

Figure 2-8. Connecting the Power Cord to the H25-IR PRO ..... 16

Figure 2-9. NDIR Optical Sensor ..... 17

Figure 3-1. The Menu Interface (Display and Buttons): A Key User Interface with a Menu-Driven Architecture ..... 18

Figure 3-2. Arrows Indicating Additional Menus, Menu Items, and Parameter Editing Options ..... 20

Figure 3-3. Menu Architecture Summary ..... 21

Figure 3-4. Front Panel Components with Sample Display..... 21

Figure 3-5. Examples of Value Types ..... 23

Figure 3-6. PROBE BUTTON Menu Item Based on Probe Style Ordered..... 23

Figure 3-7. Version Screen at Power Up ..... 24

Figure 3-8. Setup Summary Screen Showing 60-Second Initialization Countdown..... 25

Figure 3-9. Sample Search Mode Screens (Showing Graphic and Numeric Display Styles) ..... 25

Figure 3-10. Sample Measure Mode Screen ..... 26

Figure 3-11. Basic Setup Screen ..... 26

Figure 3-12. Advanced Setup Screen..... 27

Figure 3-13. Diagnostics Screen ..... 28

Figure 4-1. Sample Relay Wiring ..... 30

Figure 4-2. 4-20mA Loop Connector Used..... 31

Figure 4-3. Front Panel Printed Circuit Board Containing Probe Connectors J2 and J7..... 33

Figure 5-1. Sample Search Mode Screens (Showing Graphic and Numeric Display Styles) ..... 36

Figure 5-2. Toggling Between Search Mode and Measure Mode (Example 1) ..... 37

Figure 5-3. Toggling Between Search Mode and Measure Mode (Example 2) ..... 37

Figure 5-4. Sample 2X, 3X, and 4X Range Displays in the Graphic SEARCH MODE Screen ..... 39

Figure 5-5. Sample Search and Measure Screens Before Zeroing..... 41

Figure 5-6. Sample Search and Measure Screens Shortly After Zeroing..... 41

Figure 5-7. Sample Measure Mode Screen..... 42

Figure 5-8. Graphical Representation of the Measurement Log..... 43

Figure 5-9. Samples of Graphic and Numeric Display Styles..... 51

Figure 5-10. Options of the Advanced Setup Screen..... 54

Figure 5-11. Weighing Your Application Needs: When to Use User Setup 0 (Default) vs. User Setups 1-4..... 55

Figure 5-12. Sample Search Screen (with User Setup Active) Showing User Name “FREEZER 1” ..... 57

Figure 5-13. Advanced Setup Screen Without (Left) and With (Right) a Detected Smart Probe ..... 72

Figure 5-14. Locked Message for Subsequent Attempts at External Adjustment..... 83

Figure 6-1. Location of Fuse Holder..... 89

Figure 6-2. Probe Filter and “O” Ring Locations..... 90

Figure 6-3. Back Panel of the H25-IR Pro Showing Proper Orientation of the External Filter ..... 91

Figure 6-4. Removing the Top Cover ..... 92

Figure 6-5. NDIR Sensor Showing Three Cable Ties Removed ..... 93







List of Tables

Table 1-1. H25-IR PRO Functions and Features..... 5

Table 1-2. Specifications..... 9

Table 2-1. H25-IR PRO Standard Probe Components..... 13

Table 2-2. H25-IR PRO Standard Probe Components..... 13

Table 2-3. H25-IR PRO Smart Probe Components..... 15

Table 2-4. Connecting the Flexible Probe Tube..... 15

Table 3-1. Key Components of the Menu Structure..... 19

Table 3-1. Front Panel Buttons..... 22

Table 3-2. Common Key Combinations..... 24

Table 4-1. RS-232 Communications Settings..... 32

Table 4-2. Procedure to Change Factory-Set Probe Configuration..... 33

Table 5-1. Function Reference ..... 35

Table 5-2. Turning on the H25-IR PRO..... 36

Table 5-3. Changing the Volume Setting ..... 38

Table 5-4. Accessing the Main Menu Screens Using the Setup Button ..... 40

Table 5-5. Logging Data ..... 44

Table 5-6. Accessing the BASIC SETUP Screen..... 45

Table 5-7. Setting the Gas Type from the List of Standard Gases ..... 46

Table 5-8. Gas Type Menus and Selection ..... 47

Table 5-9. Display Units Available in the H25-IR PRO ..... 48

Table 5-10. Leak Rate Conversion Chart..... 48

Table 5-11. Changing the Unit Display Setting..... 49

Table 5-12. Changing the Alarm Setpoint ..... 50

Table 5-13. Changing the Display Style..... 52

Table 5-14. Accessing the ADVANCED SETUP Screen ..... 53

Table 5-15. Accessing the USER SETUP Screens 1-4 ..... 55

Table 5-16. Changing a User Setup Name..... 56

Table 5-17. Changing a User Setup Gas Type..... 57

Table 5-18. Changing a User Setup Alarm Setpoint..... 58

Table 5-19. Changing a User Setup Feedback Mode ..... 60

Table 5-20. Accessing the RELAY SETTING Screen..... 61

Table 5-21. Relay Setting Options ..... 63

Table 5-22. Accessing the Measurement Log ..... 64

Table 5-23. Setting the Date and Time ..... 65

Table 5-24. Setting the Log Limit..... 66

Table 5-25. Default Loop Factor Mapping Example (0.016 mA = 1 PPM) ..... 68

Table 5-26. Changing the Loop Factor ..... 68

Table 5-27. Serial Data Options..... 70

Table 5-28. Changing the Serial Data Setting..... 70

Table 5-29. Assign Probe Button Options ..... 71

Table 5-30. Changing the Probe Button Setting..... 73

Table 5-31. Accessing the Diagnostics Screen (Method #1)..... 74

Table 5-32. Accessing the DIAGNOSTICS Screen (Method #2)..... 75

Table 5-33. Accessing the Current Faults Screen ..... 77

Table 5-34. Fault Codes ..... 78

Table 5-35. Accessing the Sensor Data Screen..... 79

Table 5-36. Sensor Data Parameters and Sample Values ..... 80

Table 5-37. Adjusting the H25-IR PRO to a Known External Leak Source ..... 81

Table 5-38. Configuring the H25-IR PRO to use a Factory Gas Type..... 84

Table 6-1. Items Required for Fuse Replacement ..... 88

Table 6-2. Fuse Replacement Procedure ..... 88

Table 6-3. Items Required for Probe Tip Filter Replacement..... 89

---

Table 6-4. Probe Tip Filter Replacement Procedure .....	89
Table 6-5. Items Required for “O” Ring Replacement.....	90
Table 6-6. Probe “O” Ring Replacement Procedure.....	90
Table 6-7. Items Required for External Filter Replacement.....	90
Table 6-8. External Filter Replacement Procedure .....	90
Table 6-9. Items Required for NDIR Sensor Replacement.....	92
Table 6-10. Replacement NDIR Sensor Kit.....	92
Table 6-11. NDIR Sensor Replacement Procedure.....	92
Table 6-12. Spare Parts and Accessories .....	95
Table 6-13. Items Required for Upgrading Firmware.....	96
Table 6-14. Firmware Upgrade Procedure .....	96
Table 7-1. Common Concerns.....	100
Table 7-2. Fault Codes.....	101
Table A-1. Glossary of Terms .....	102
Table B-1. Acronyms and Abbreviations .....	104
Table C-1. Basic (Primary) Gas Types .....	106
Table C-2. Factory (Secondary) Gas Types.....	109



## CHAPTER 1: INTRODUCTION

IN THIS SECTION	
• Product Overview .....	1
• Conventions Used in This Manual.....	1
• Safety Precautions .....	2
• Features and Capabilities .....	3
• Functional Overview .....	3
• Specifications.....	9

### 1.1. Product Overview


The H25-IR PRO is the next generation of industrial-grade refrigerant leak detector and gas analyzer for the detection of CFCs, HCFCs, HFCs and halogen gas compounds including R600a. This instrument can be used to locate and then quantify gas leaks, as well as log and totalize a group of leaks in a system. Building on the success of the H25-IR, the H25-IR PRO adds new groundbreaking capabilities that ensure accurate and reliable operation.

The H25-IR PRO from Bacharach continues the tradition of rugged industrial gas detection and analysis that the H25-IR established. New ALQ™ technology raises the bar for gas detection instruments, and has real benefits to the end user. The new menu system in the H25-IR PRO simplifies setup and operation. Recognized and valued for its digital numeric leak rate display (versus other solutions featuring only light bars), the Bacharach H25-IR PRO continues to offer the features requested by industry.

If you have a working knowledge of your leak detector, you will find this manual useful as a reference tool. If you are new to the use of leak detectors, this document is educational in the principles of gas detection and the proper operation of this device.

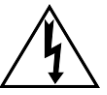
### 1.2. Conventions Used in This Manual

The following symbols and statements may be used within this manual.

- 
- 


**WARNING:** This symbol and/or the use of the word **WARNING** indicates a potential hazard associated with the use of this equipment. Failure to correctly perform or adhere to the procedure, practice, or condition could result in death or serious injury.

---

  - 


**WARNING:** This symbol and/or the use of the word **WARNING** indicates a potential hazard from **electrical shock**. Failure to correctly perform or adhere to the procedure, practice, or condition could result in death or serious injury from electrical shock.

---

  - 

**CAUTION:** This symbol and/or the use of the word **CAUTION** indicates a potential hazard associated with the use of this equipment. Failure to correctly perform or adhere to the procedure, practice, or condition could result in minor or moderate injury. This may also be used to alert readers of unsafe practices.

---

  - 

**IMPORTANT:** This symbol and the use of the word **IMPORTANT** calls attention to components that are sensitive to the effects of electro-static discharge (ESD). Equipment damage will likely occur if proper ESD mitigation procedures are not followed.



**IMPORTANT:** The use of the word **IMPORTANT** in this manual calls attention to a procedure, practice, condition, or the like, which if not correctly performed or adhered to, could result in incorrect performance of or damage to the equipment and may void the warranty.



**NOTE:** The use of the word **NOTE** in this manual provides emphasis of a feature, operation, etc. Notes are also useful to address potential service calls/issues.

### 1.3. Safety Precautions

To assure operator safety and the proper use of the leak detector, please read this manual. It provides important information on the configuration, operation, and maintenance of the leak detector.



**WARNING:** This instrument has not been designed to be intrinsically safe for use in areas classified as hazardous locations. For your safety, **DO NOT** use it in hazardous (classified) locations.



**WARNING:** This is NOT a safety device. Some gases which this instrument can detect may be combustible/flammable. When properly configured, this instrument is designed to alarm at concentrations that are lower than the explosive limit of the gas. As such, it is the buyer's responsibility to initiate an immediate planned response to any gas leaks as soon as they are detected. This equipment should NEVER be used to measure or sample gases at or above their respective lower explosive limits.



**WARNING:** The leak detector must be operated with a connection to a protective ground. Failure to do poses a potential shock hazard and is also a violation of electrical safety standards applicable to this type of equipment.



**WARNING:** Do not operate this equipment in the presence of flammable liquids, vapors, or aerosols. Operation of any electrical instrument in such an environment constitutes a safety hazard.



**WARNING:** It is imperative that the exhaust port on this instrument be properly vented as described in this manual. Failure to do so may constitute a safety hazard.



**WARNING:** Extreme care should be exercised when accessing the interior of the leak detector. Only qualified electrical maintenance personnel should make connections and perform adjustments. Always remove AC power before opening the leak detector's enclosure.



**WARNING:** The protection provided by the leak detector may be impaired if the leak detector is used in a manner not specified by Bacharach, Inc. Modifications to this leak detector, not expressly approved, will void the warranty.



**WARNING:** Do not continue to use this equipment if there are any symptoms of malfunction or failure. In the case of such occurrence, de-energize the power supply and contact a qualified repair technician or the nearest Bacharach Service Center.



**WARNING:** This device uses type "F" fuses rated at 1.0 A, 250 VAC. Replace ONLY with Bacharach-approved fuses (see Spare Parts and Accessories on page 95 for the part number).



**IMPORTANT:** Operating this device above the altitude limit of 6,562 ft (2,000 m) will affect the expected results and specifications.



**IMPORTANT:** The leak detector uses a universal power supply that is capable of accepting inputs of 100 to 240 VAC, 50/60 Hz. The leak detector's power consumption is 16 Watts. It is highly recommended that the leak detector be connected directly to the AC power source, preferably on its own circuit with UPS or surge protection.



**NOTE:** Use ONLY the provided connectors for electrical and communications wiring. Drilling into the box will void the warranty.



**NOTE:** To clean the outside of the case use a dry cloth. To avoid shock hazard and/or equipment damage, DO NOT use soap and water.

## 1.4. Features and Capabilities

Below are some of the key the features and capabilities of the H25-IR PRO.

- Automatic calculation of gas concentration regardless of flow rate (not effected by dilution effects that would normally cause reading inaccuracy)
- No periodic calibration required
- Available in various gas models to detect and measure:
  - Halogen Refrigerants - SF6
  - R600a and R290 - CO<sub>2</sub>
- Infrared detector
- Provision for external adjustment, including adjustment to other refrigerant types
- User-selectable leak rate measurement in:
  - oz/yr - mL/s × 10<sup>-5</sup>
  - g/yr - PaM3/s × 10<sup>-5</sup>
  - ppm
- Easy to read LED backlit display
- Excellent background gas rejection (3 times improved versus H25-IR)
- 4–20 mA current loop output
- Relay outputs for external equipment control
- On-screen menu system for system setup, diagnostics, and data logging
- Probe and hose assemblies available in two lengths:
  - 6 foot (1.8 m) - 12 foot (3.7 m)
- 8 inch (200 mm) flexible probe tube
- Various probe styles to meet your needs:
  - Standard
  - Standard with push button
  - Smart Probe

## 1.5. Functional Overview

### 1.5.1. Key System Components

The front panel of the H25-IR PRO contains 7 membrane push buttons, probe connector, and a 128x64 dot LCD (Liquid Crystal Display) that provides a bright, high-contrast display for easy viewing. The instrument is housed in an all-metal case with adjustable handle. A hand-held probe is used to draw in a gas sample from the area under inspection. The probe is available in various styles and lengths.

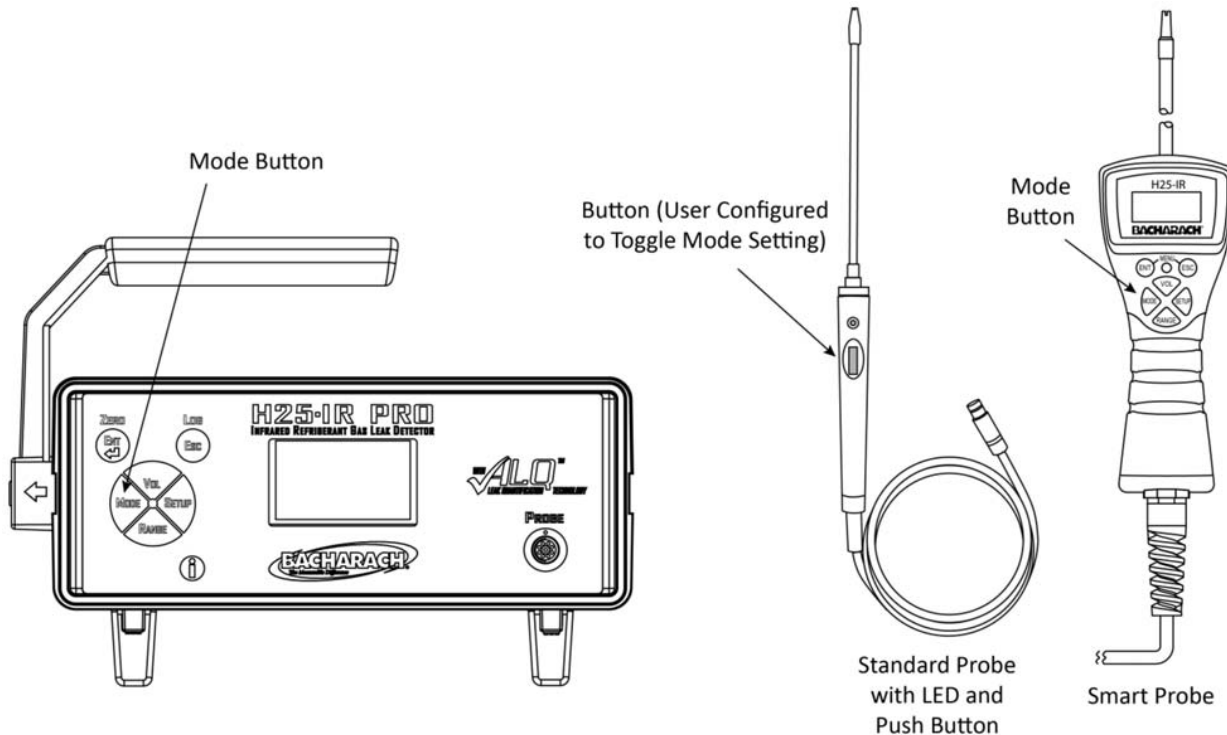
### 1.5.2. Operation Modes: Search vs. Measure

The instrument has two modes of operation: **Search** and **Measure**.

- *Search mode* is used to locate the source of a leak.
- *Measure mode* is used to quantify the size of the leak.



**NOTE:** To toggle between search mode and measure mode, use the MODE button on the front panel. This feature is also available from the probe itself. The push button on the *standard probe with push button* can be programmed to toggle between modes. The *smart probe* has a MODE button that functions the same as the front panel MODE button.



**Figure 1-1. Toggling Between Search and Measure Modes**



**NOTE:** The function of the button on the standard probe with push button is defined by the user. It can be programmed to zero the instrument or to toggle the instrument between search mode and measure mode.

In *search mode*, the location of a leak is pinpointed by means of visual and audio indicators positioned on both the instrument and probe (probe indication, when equipped). As the probe tip approaches the leak point:

- The length of a bar graph on the front panel display becomes longer (or the digital reading increases).
- The frequency of an audible tone increases (depends on Feedback Mode setting, described later).
- The probe with LED (when equipped) also indicates a system response with an LED blinking faster as the response increases.



**NOTE:** The user may easily set an alarm setpoint, which automatically scales the instrument's response. This feature is useful in avoiding small nuisance leaks when searching for larger ones.

In the *measure mode*, the probe tip is held over the leak point until the displayed value of the leak rate stabilizes. Leak rates can be displayed in units of:

- oz/yr (ounces per year)
- g/yr (grams per year)
- mL/s-5 (milliliters per second × 10<sup>-5</sup>)
- Pa·m<sup>3</sup>/s-5 (Pascal meters cubed per second × 10<sup>-5</sup>)
- ppm (parts per million)

The measure mode can also be used to display the concentration of gas contained in a confined space with the instrument set up in its ppm mode after first zeroing on fresh air. Measure mode automatically changes the display from a bar graph to a digital reading.

The leak rate is measured by first capturing all the gas leaking from the component under test. Then, by accurately measuring the flow rate of the sampling stream and the gas concentration within that stream, the leak rate can be calculated using the equation listed below. The instrument then converts this data into the desired leak rate units of measure and displays the leak rate on the instrument’s front panel.

**Leak Rate = Mass Flow Rate × Gas Concentration**

where:      Leak Rate                      = Rate of gas leak from component under test  
                  Mass Flow Rate                = Sample mass flow rate  
                  Gas Concentration                = Concentration of gas in the sample (ppm)

**1.5.3. Operational Functions/Features**

**Table 1-1. H25-IR PRO Functions and Features**

Feature	Description
Data Logging	A leak measurement can be logged in memory with a time/date stamp. Up to 50 leaks can be logged. This feature is useful in testing an installation that has a maximum permissible leak rate. Logged data can be recalled for viewing on the display. Works in Measure Mode only.
Setup Presets	There are four user-defined setups that allow the operator to quickly switch between frequently used combinations of Gas Type, Range, Feedback Mode, Setpoint, and other custom capabilities.
Diagnostics	Extensive diagnostics keep track of several system parameters. When an error is detected, the ⓘ symbol along with a brief error message is shown at the top of the display, and an audible beep is heard every 2 seconds. Pressing the ⓘ button on the instrument keypad takes the user to additional information, making diagnosis simple and easy. Text descriptions of all current error conditions can be displayed from the instrument’s Diagnostics menu.
Relay Outputs	Four SPDT relays provide control over a variety of external equipment (e.g., horns, bells, strobe lights) that can be automatically triggered when their associated relays are energized by any one of several different operating conditions.
Current Loop Output	A 4–20 mA current loop output can be used for the connection of external monitoring equipment (e.g., chart recorder). An RS-232 serial port can output leak rate data as ASCII text at 10 times per second.

### 1.5.4. Advanced Leak Quantification (ALQ™) Technology

ALQ™ technology eliminates the need to periodically adjust the instrument to a calibrated reference leak source. The result is an instrument that maintains its accuracy in real time, even under changing conditions. ALQ™ technology:

- eliminates down time for periodic adjustments or instrument checks
- extends the working life of the probe tip filters
- makes the instrument impervious to problems that normally could cause inaccurate results.

For example, small leaks that normally could dilute the sample and cause the measured concentration to change have no effect on the H25-IR PRO. The H25-IR PRO comes standard with ALQ™ technology.

ALQ™ technology eliminates the need to periodically adjust the instrument, so the H25-IR PRO contains no internal leak reference. For users who require a “bump test” to verify normal operation, any compatible gas source or reference leak source can be used. For users who are required to validate instruments against a known reference leak source (due to company quality policies or practices, for example), an easy-to-use adjustment option is available to set a leak rate multiplier for the selected target gas (see Adjustment to a Known External Leak Source on page 81). An optional NIST-traceable, calibrated leak reference is available from Bacharach that may be used for bump testing and/or validation.

### 1.5.5. Using a Reference Leak Source

An optional Bacharach leak reference may be purchased and established as a reference standard, and used to adjust the H25-IR PRO's indicated reading. It features a calibrated output (NIST traceable certification provided) and may be refilled as needed. The optional Bacharach leak reference is available with most industry-standard refrigerants. Special calibrations on other refrigerants are available at extra cost. Contact Bacharach for additional information.

Reference leaks provide reliable output when used correctly. However, even the best reference leaks are typically only accurate to within  $\pm 15\%$  (absolute) of the indicated reading. For example, if the indicated leak rate is 5 g/yr, the actual leak rate could be anywhere from 5.75 g/yr to 4.25 g/yr. For leak references that do not include a pressure gauge, the tolerance can be even larger, as the indicated leak rate (usually on the certificate of calibration) is only true at *one* reference temperature. The same  $\pm 15\%$  output tolerance combined with varying temperatures means these devices have to be used very carefully for meaningful results. Refer to the example shown in Figure 1-2 on page 7.

The H25-IR PRO responds to within  $\pm 5\%$  of reading (absolute) at reference conditions and maintains this across the specified operating temperature range (see Figure 1-2 on page 7). Users who need to adjust the H25-IR PRO to their recognized leak standard may do so within a  $\pm 25\%$  (absolute) tolerance band, to allow for the temperature-affected output tolerance that is present in reference leaks. Refer to Figure 1-3 on page 8. The user simply applies his leak reference, and uses the H25-IR PRO keypad to adjust the indicated measurement to match the leak reference value. After the adjustment is applied, the H25-IR PRO will use its built-in calculations to provide relative leak rates, while ensuring conformance to the required standard.



**NOTE:** The factory default reference conditions for the H25-IR PRO refrigerant model are: R134a gas, 100 PPM, and 20 °C.



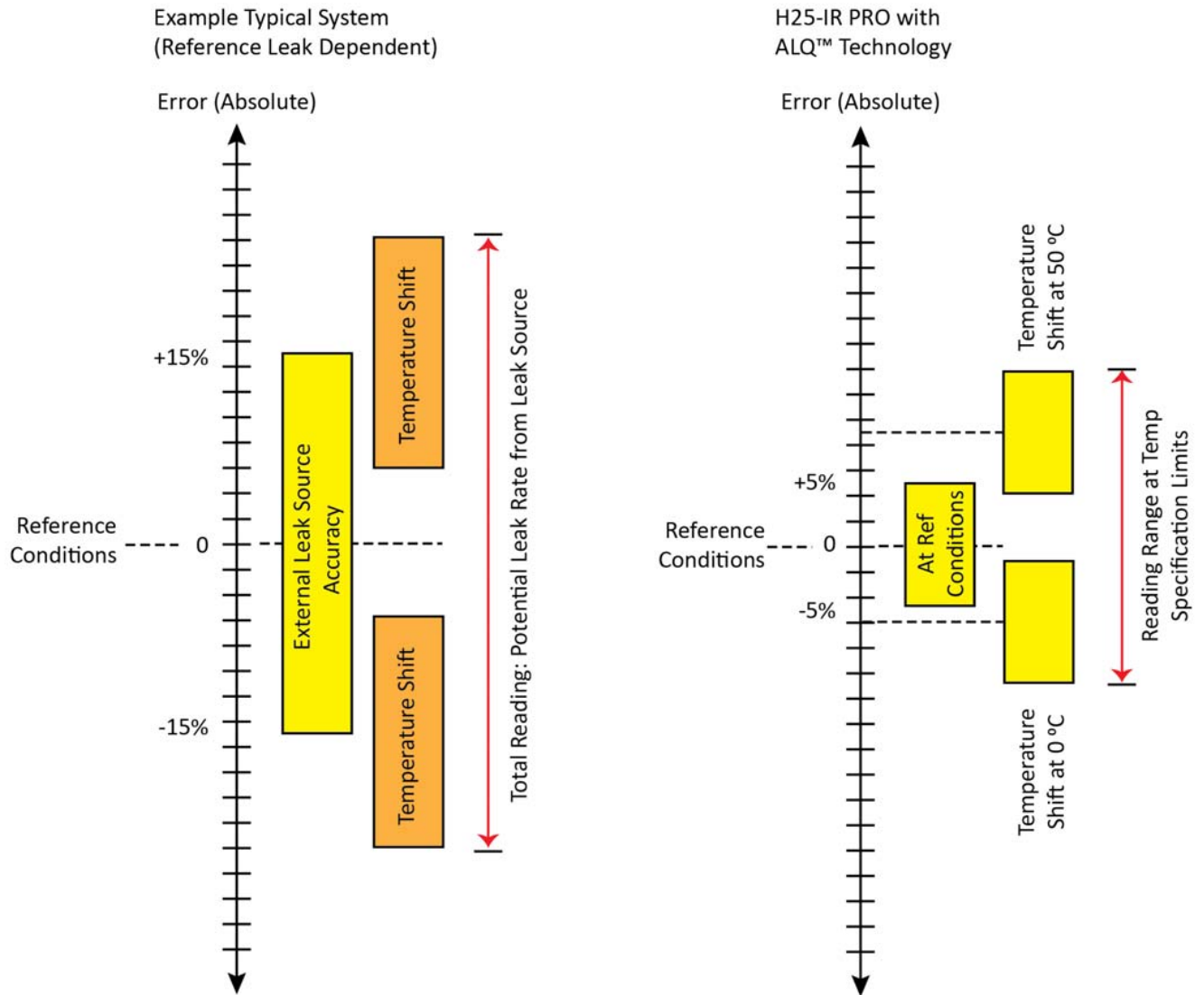


Figure 1-2. H25-IR PRO's ALQ™ Technology

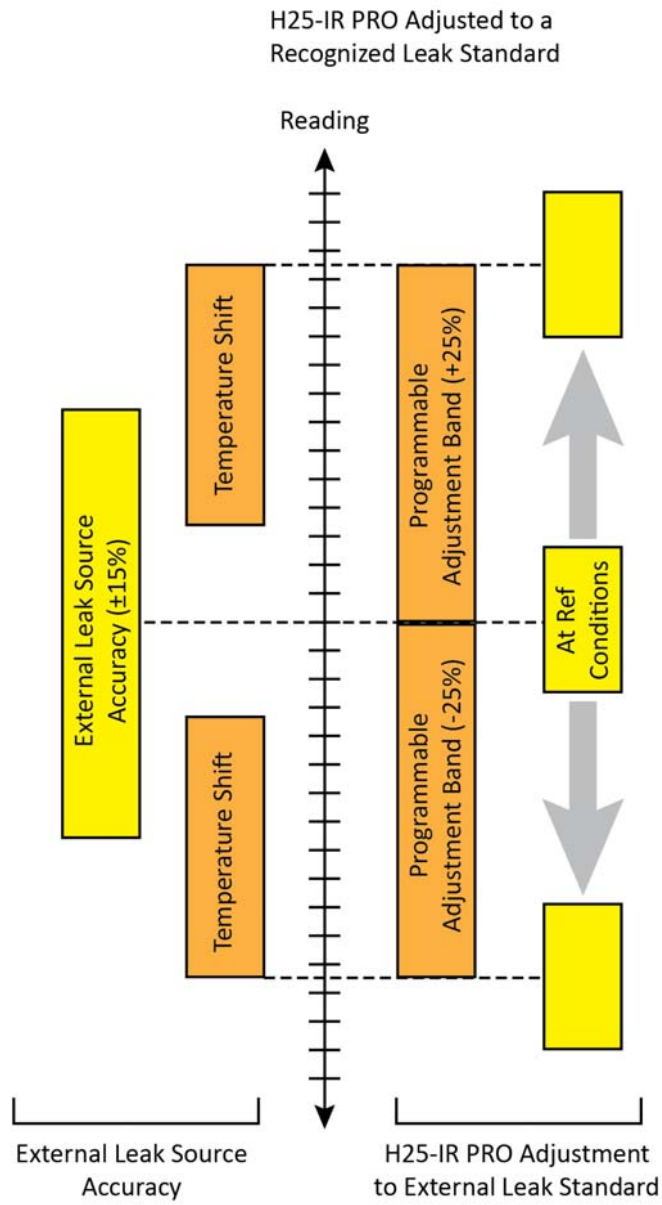


Figure 1-3. Adjusting the H25-IR Pro to a Recognized Leak Standard

## 1.6. Specifications

Table 1-2. Specifications

Category	Description
Gases Detected (GAS TYPE)	R12, R21, R22, R23, R113, R114, R123, R134a, R236fa, R245fa, R401A, R 420A, R402B, R404A, R407A R407C, R408A, R409A, R410A, R422D, R426A, R427A, R448A, R449A, R452A, R452B, R500, R503, R507, R508B, R513A, R514A, HFP, FA188, H1234YF, R32, H1301, N1230, H1211, H2402, R124, R125, R227, R422a, R438a, R502, FC72, R407F, H1234ZE, N4710, N7100, N7200, N7300, N7600. <ul style="list-style-type: none"> <li>• Basic gas types</li> <li>• Halogen NDIR (non-dispersive infrared) sensor</li> <li>• Listed in the product Gas Type menu unless overridden by selecting a Factory Gas Option</li> <li>• Presented in the standard menu (see Table 5-7 on page 46).</li> <li>• When equipped with the halogen NDIR sensor this list includes the most popular refrigerant gases; a “CUSTOM” refrigerant option is also shown.</li> </ul>
	CUSTOM <ul style="list-style-type: none"> <li>• Halogen NDIR (non-dispersive infrared) sensor</li> <li>• The user adjusts the instrument response to a known concentration via the “external reference” feature (refer to Adjustment to a Known External Leak Source on page 81).</li> <li>• Presented in the standard menu (see Table 5-7 on page 46).</li> </ul>
	<ul style="list-style-type: none"> <li>• R600a, R290, CO2_A, SF6</li> <li>• A dedicated NDIR (non-dispersive infrared) sensor is required</li> <li>• If so equipped, the instrument is dedicated to detect the gas shown in the GAS TYPE menu; no other gases will be listed.</li> <li>• Refer to Factory Gas Type Configuration on page 84 to set one of the gases listed above</li> </ul>
Detection Method	Non-Dispersive Infrared (NDIR)
Warm-Up Time	1 minute to begin use in Search Mode; 6 minutes for best accuracy in Measure Mode.
Measurement Units	oz/yr, g/yr, mL/s, PaM <sup>3</sup> /s, ppm
Measurement Range	0.03 to 5.00 oz/yr 0.85 to 142 g/yr 0.08 x 10 <sup>-5</sup> to 100 x 10 <sup>-5</sup> mL/s 0.08 x 10 <sup>-5</sup> to 100 x 10 <sup>-5</sup> PaM <sup>3</sup> /s 0 to 999 ppm (or 0.0 to 99.9 with one decimal place)
Measurement Adjustment	Possible with a customer-supplied leak source of a known gas type and leak rate
Operating Modes	Search: Detects presence and location of gas leaks Measure: Calculates and displays leak rate
Response Time	Less than 1 second, typical (dependent on probe-hose length)
Sensitivity	0.03 oz/yr (0.9 g/yr) for all HFC refrigerants. For other gases, consult Bacharach.
Resolution	0.1 leak units
PPM Accuracy	±1 PPM ±10% of reading (or ±1% if recalibrated using a known concentration of refrigerant gas)
Temperature Drift	±0.3% of reading per °C
Relays	Four SPDT relays rated 2 A at 250 VAC (inductive) 5 A at 250 VAC (resistive) Programmable to energize under various operating conditions

Category	Description
Speaker	Audible indication of leak level
Dimensions	4.00 in x 10.75 in x 15.50 in (101.6 mm x 273.1 mm x 393.7 mm)
Weight	18 lb (8.2 kg)
Temperature	Operating: 32° to 122° F (0° to 50° C) Storage: -4° to 122° F (-20° to 50° C)
Ambient Humidity	5 to 90% RH, non-condensing
AC Power	100 to 240 VAC, 50/60 Hz
Power Consumption	16 Watts



## CHAPTER 2: HARDWARE OVERVIEW

IN THIS SECTION	
• Unpacking.....	11
• Front Panel.....	11
• Back Panel.....	12
• Probes and Hoses.....	12
• Power Cord.....	16
• Internal Components.....	17

### 2.1. Unpacking

Your H25-IR PRO Refrigerant Gas Leak Detector and all accessories were carefully inspected at the factory before shipment, and packed to be highly resistant to damage while in transport.

When you receive the instrument, please unpack it promptly and make a visual inspection to make sure that no damage has occurred during shipment and that all ordered items have been received. Your order should consist of:

- H25-IR PRO Instrument
- Probe and Hose Assembly (as ordered) with 8 inch Flexible Probe Tube
- AC Power Cord (as ordered)
- Instruction Manual

If damage was found, immediately file a claim with the carrier. If an item is missing, please contact Bacharach’s Service Department for assistance.

### 2.2. External Components

#### 2.2.1. Front Panel

Front panel components are shown in Figure 2-1.

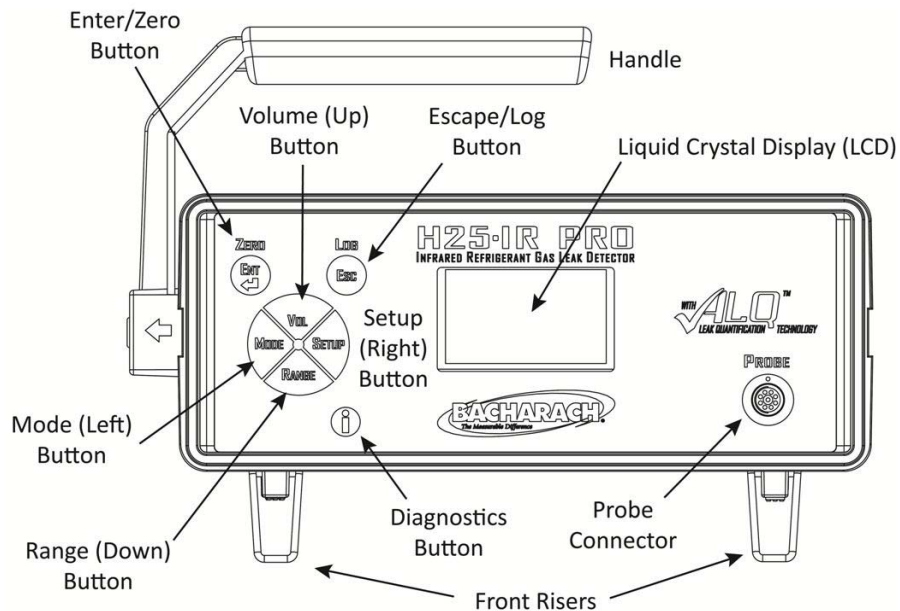


Figure 2-1. Front Panel Components of the H25-IR PRO

## 2.2.2. Back Panel

Back panel components are shown in Figure 2-2.

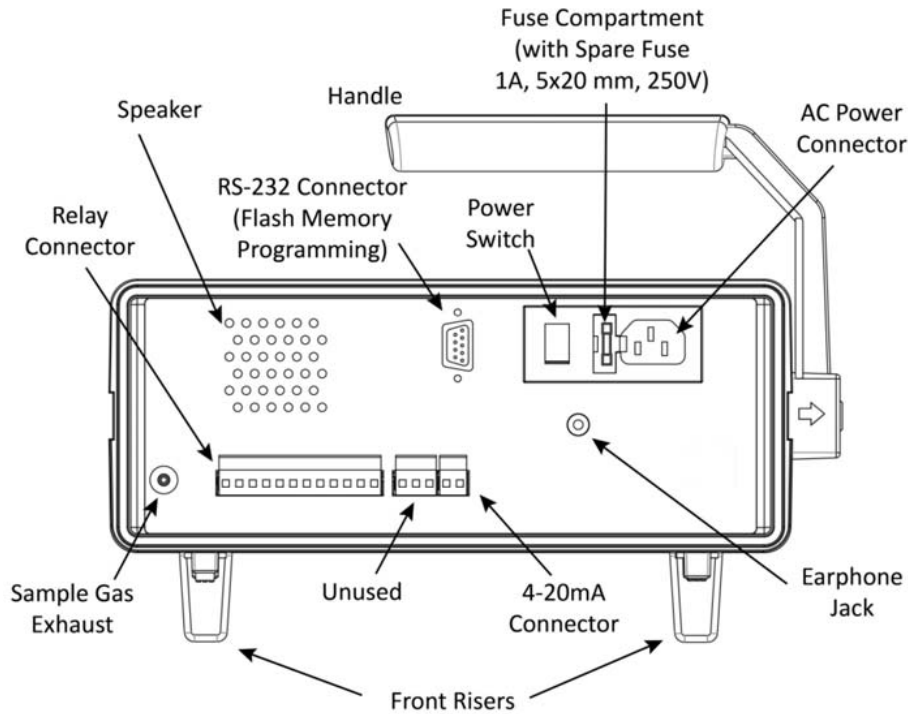


Figure 2-2. Back Panel Components of the H25-IR PRO

## 2.3. Probes and Hoses



**IMPORTANT:** The H25-IR PRO is factory configured to use the probe with which it is purchased. This factory configuration includes internal wiring connections. If you plan to use a different probe than the type that was shipped with your H25-IR PRO, you must move an internal cable to a different connector. For additional information, refer to Standard Versus Smart Probe Wiring on page 32.

### 2.3.1. Standard Probe with Flexible Tubing

The standard probe is available in a 6-foot hose model and a 12-foot hose model. Components of the standard probe are shown in Figure 2-3 and described in Table 2-1.

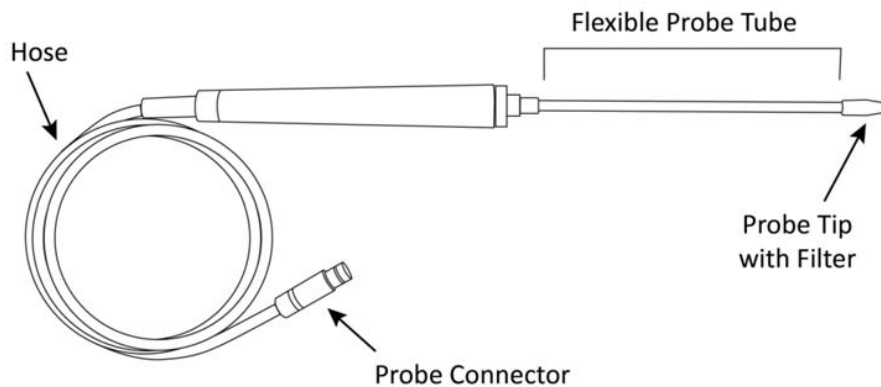


Figure 2-3. Components of the Standard Probe with Flexible Tubing



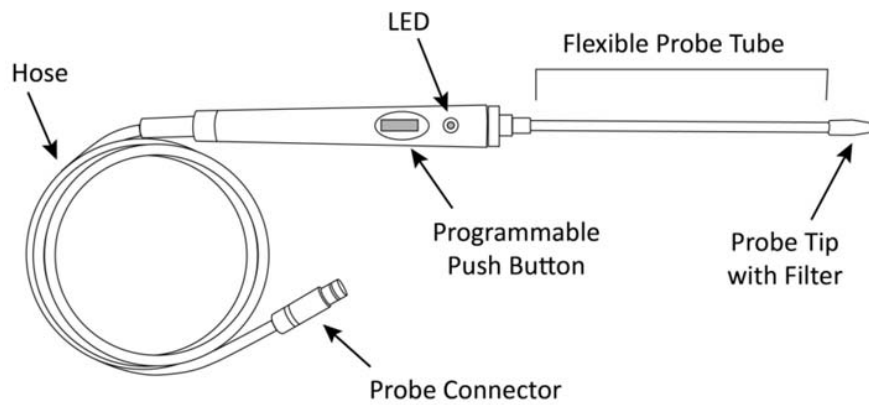
**NOTE:** When ordered *with* the instrument, the probe type is configured at the factory. If a standard probe is to be used as a Smart Probe replacement, additional internal changes are required.

**Table 2-1. H25-IR PRO Standard Probe Components**

Component	Function/Notes
Probe Tube	<ul style="list-style-type: none"> <li>• Flexible</li> <li>• Length: 8 in (203 mm)</li> </ul>
Probe Tip	<ul style="list-style-type: none"> <li>• Contains filter</li> </ul>
Probe Connector	<ul style="list-style-type: none"> <li>• Align with red dot on instrument’s front panel PROBE receptacle</li> </ul>
Hose	<ul style="list-style-type: none"> <li>• Available in 6-foot (1.8 m) length and 12-foot (3.7 m) length</li> </ul>

**2.3.2. Standard Probe with LED and Push Button**

The standard probe with LED and push button has an LED indicator and a programmable button (to either zero the instrument or switch between search mode and measurement mode). The standard probe with LED and push button is available in a 6-foot hose model and a 12-foot hose model. Components are shown in Figure 2-3 and described in Table 2-1.



**Figure 2-4. Components of the Standard Probe with LED and Push Button**

**Table 2-2. H25-IR PRO Standard Probe Components**

Component	Function/Notes
Probe Tube	<ul style="list-style-type: none"> <li>• Flexible</li> <li>• Length: 8 in (203 mm)</li> </ul>
Probe Tip	<ul style="list-style-type: none"> <li>• Contains filter</li> </ul>
Push Button	<ul style="list-style-type: none"> <li>• Can be programmed to either zero the instrument, or switch between the search and measure mode of operation</li> </ul>
LED	<ul style="list-style-type: none"> <li>• Flash rate increases as the detected gas level increases, or lights steady when a user selected leak rate is detected</li> </ul>
Probe Connector	<ul style="list-style-type: none"> <li>• Align with red dot on instrument’s front panel PROBE receptacle</li> </ul>
Hose	<ul style="list-style-type: none"> <li>• Available in 6-foot (1.8 m) length and 12-foot (3.7 m) length</li> </ul>



**NOTE:** The function of the button on the standard probe is defined by the user. It can be programmed to zero the instrument or to toggle the instrument between search mode and measure mode.



**NOTE:** When ordered *with* the instrument, the probe type is configured at the factory. If a standard probe with push button and LED is to be used as a Smart Probe replacement, additional internal changes are required.

### 2.3.3. Smart Probe

The smart probe has an LCD display screen and control panel buttons similar in look and function to those on the front panel. The smart probe is available in a 6-foot hose model and a 12-foot hose model. Components of the standard probe are shown in Figure 2-5 and described in Table 2-3.

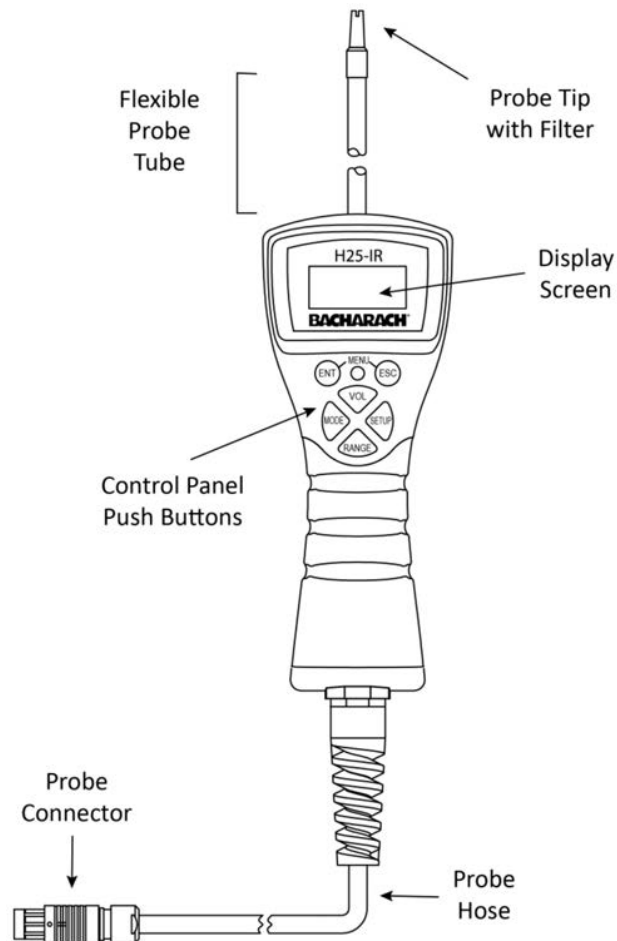


Figure 2-5. Components of the Smart Probe



Table 2-3. H25-IR PRO Smart Probe Components

Component	Function/Notes
Probe Tube	<ul style="list-style-type: none"> <li>• Flexible</li> <li>• Length: 8 in (203 mm)</li> </ul>
Probe Tip	<ul style="list-style-type: none"> <li>• Contains filter</li> </ul>
Control Panel Push Buttons	<ul style="list-style-type: none"> <li>• Same functions as front panel buttons on instrument</li> <li>• MODE and SETUP buttons can be used to lock/unlock the keypad (see Figure 2-6)</li> </ul>
Display Screen	<ul style="list-style-type: none"> <li>• Same function as front panel display on instrument</li> </ul>
Probe Connector	<ul style="list-style-type: none"> <li>• Align with red dot on the PROBE receptacle of the instrument’s front panel.</li> </ul>
Hose	<ul style="list-style-type: none"> <li>• Available in 6-foot (1.8 m) length and 12-foot (3.7 m) length</li> </ul>



**NOTE:** The keypad on the smart probe can be locked to prevent accidental key presses (for example, when working in tight spaces). Press the MODE and SETUP buttons simultaneously to toggle this feature. Refer to Figure 2-6.

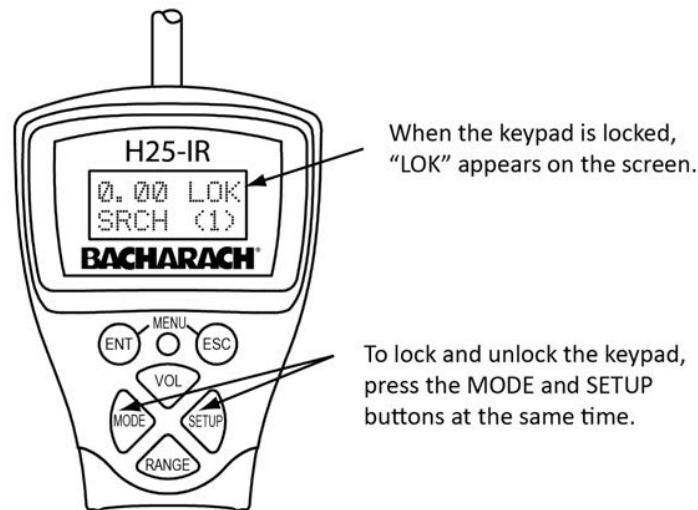


Figure 2-6. H25-IR PRO Smart Probe Key Lock Feature

### 2.3.4. Connecting the Flexible Probe Tube

Table 2-4. Connecting the Flexible Probe Tube

Step	Description
1	Screw the flexible probe tube onto the probe assembly.
2	Plug the probe connector into the front panel PROBE receptacle by aligning the red dots on both the connector and receptacle.

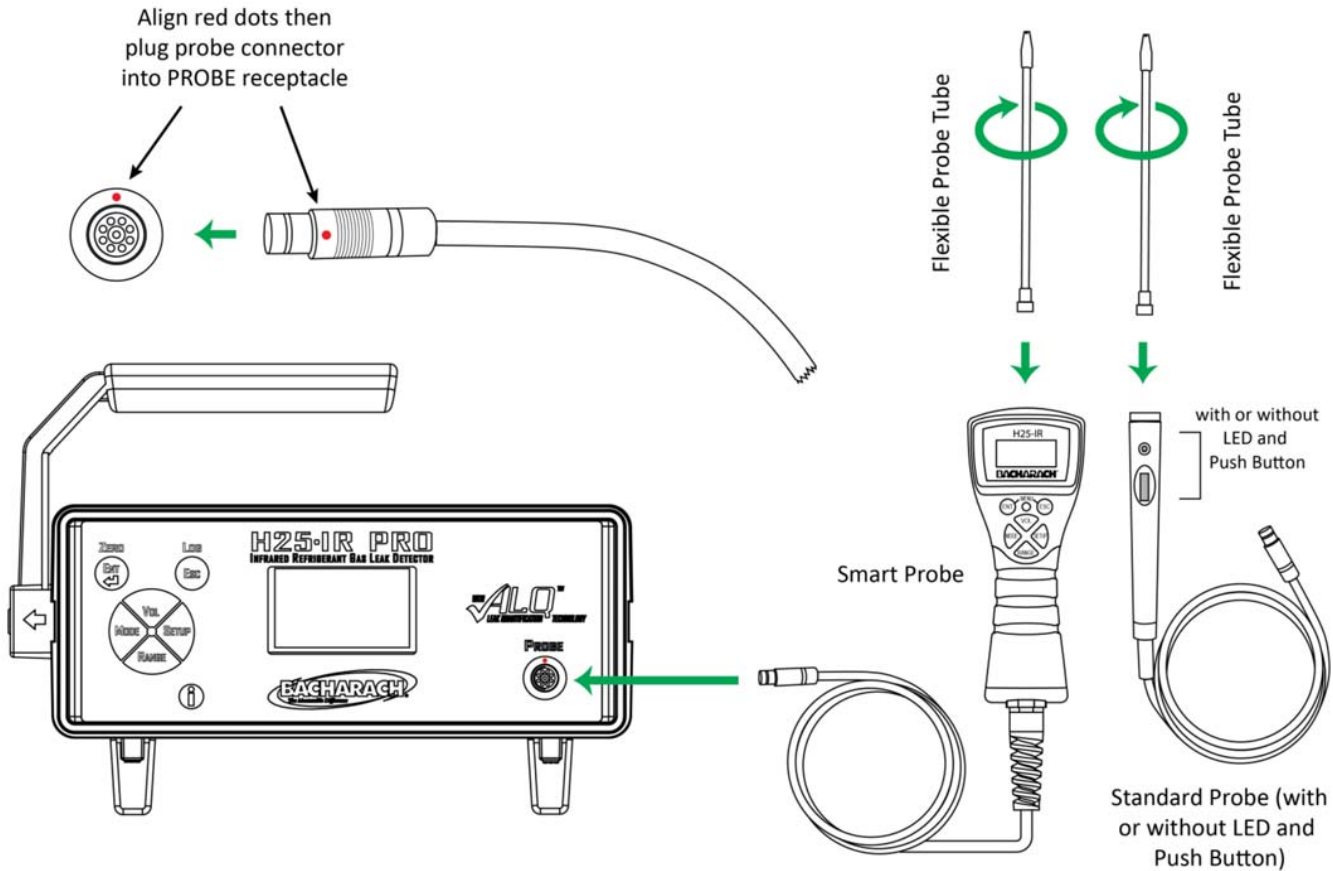


Figure 2-7. Connecting the Probe to the H25-IR PRO

## 2.4. Power Cord



**NOTE:** The H25-IR PRO is supplied with a 6 foot grounded AC power cord. Make sure that a compatible AC power receptacle (socket) is available nearby.

The H25-IR PRO uses a universal AC power supply that accepts inputs of 100 to 240 VAC, 50/60 Hz. Power consumption is approximately 16 Watts (maximum).

Before connecting the AC power cord, first make sure the instrument's power switch is OFF. Next, connect the power cord to the instrument's rear panel AC power receptacle, and then plug the power cord into a nearby AC power receptacle.

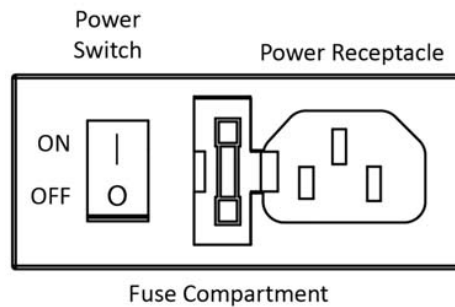


Figure 2-8. Connecting the Power Cord to the H25-IR PRO

## 2.5. Internal Components

### 2.5.1. NDIR Sensor

The NDIR sensor is an internal component that sends infrared light through the sampled gas. The amount of infrared light that passes through the gas (vs. the amount that is absorbed *by* the gas) provides a complex electrical signature that is used to quantify the target gas. This component is an 11.5" long cylinder that can be removed and installed in the field, should it ever need to be replaced. For information on replacing the NDIR sensor yourself, refer to Chapter 6: Maintenance (page 88) for more information. Alternatively, you can send your H25-IR PRO to the factory or service center to have the NDIR sensor replaced.



Figure 2-9. NDIR Optical Sensor



## CHAPTER 3: MENU SYSTEM OVERVIEW

### IN THIS SECTION

- Menu Architecture ..... 18
- Menu Navigation..... 20
- Version Screen (at Power Up) ..... 24
- Setup Summary Screen (Warm-up)..... 25
- Search Mode Screen..... 25
- Measure Mode Screen..... 26
- Basic Setup Screen..... 26
- Advanced Setup Screen ..... 27
- Diagnostics Screen..... 28

### 3.1. Menu Architecture

The H25-IR PRO is used to locate and quantify gas leaks. Interfaces provide external information, configuration, operation, evaluation results, and even diagnostic information, among other things. Interfaces (i.e., the “borders” between the outside world and the H25-IR PRO) are those key boundaries where the information is *exchanged*. The main interfaces of the H25-IR PRO are:

- Speaker (used to audibly notify the operator of analysis information)
- The gas probe (used by the operator to draw gas into the detector for analysis)
- Front panel LCD and buttons (used to exchange configuration, operation, evaluation, and diagnostic information).
- Relay outputs (used as switches to control electrical devices based on input gas and programmable conditions)
- 4-20mA output (used to drive a graphical chart recorder or similar device)
- RS-232 communications port (PC interface to receive live flow rate data).

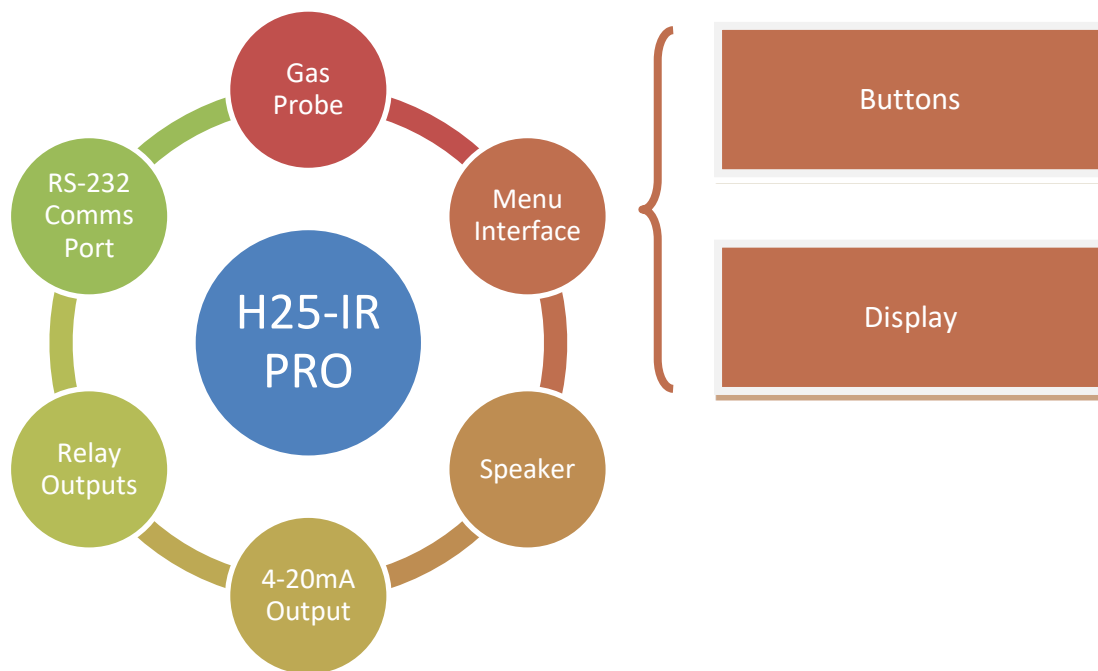


Figure 3-1. The Menu Interface (Display and Buttons): A Key User Interface with a Menu-Driven Architecture

Though all of these “interfaces” may be used during the operation of the H25-IR PRO, the front panel LCD and buttons provide an easy-to-use interface consisting of a robust suite of configuration, customization, operation, evaluation, and diagnostic functions. These features are grouped logically and functionally in a *menu architecture*.

An operator selects items from SETUP, ADVANCED SETUP, and DIAGNOSTICS menus. Each category contains related items from which you may choose using the Arrow keys (the active field is highlighted). Some of these “choices” provide feedback about the sampled gas or the status of the H25-IR PRO, while some set important parameters that define how you would like the H25-IR PRO to operate. Regardless, it is important to become familiar with the menu architecture of the H25-IR so that you can easily locate options, properly configure them, and take advantage of the customizable features.

Table 3-1 shows key components of the H25-IR PRO’s menu structure.

**Table 3-1. Key Components of the Menu Structure**

Menu Component	Function/Notes
Firmware Version Screen	<ul style="list-style-type: none"> <li>• Displays firmware version for approximately 5 seconds after power up.</li> <li>• Afterwards, the Setup Summary screen is displayed automatically for 60 seconds (warm-up).</li> </ul>
Setup Summary Screen	<ul style="list-style-type: none"> <li>• Automatically displayed after the Firmware Version screen.</li> <li>• Can also be accessed from the Search Mode or Measure Mode screen using the ENT+ESC button combination.</li> <li>• Provides a 60-second initialization countdown.</li> <li>• Displays key configuration settings (Gas Type, Unit Display, Alarm Setpoint, etc.)</li> <li>• Automatically changes to Search/Measure mode screen after countdown reaches zero.</li> </ul>
Search/Measure Mode	<ul style="list-style-type: none"> <li>• Main monitoring screens</li> <li>• Two default displays for each operation mode: Search Screen and Measure Screen</li> <li>• Search screen for finding leaks, and Measure screen for quantifying the leak</li> <li>• Toggle between displays using the MODE button</li> <li>• Can return to this screen from any menu by pressing the ESC button one or more times</li> <li>• Timeouts cause this screen to be displayed automatically after a predefined inactivity period</li> <li>• Press the VOL button to access the volume control screen</li> <li>• Press the RANGE button to toggle the display among three display ranges</li> <li>• The menus are accessible from this screen by using the SETUP button</li> </ul>
Basic Setup Menu	<ul style="list-style-type: none"> <li>• Contains basic setup parameters needed to configure the H25-IR PRO for basic operation</li> <li>• Accessed from the Search/Measure screen using the SETUP button</li> <li>• Use the Up and Down Arrow buttons to select menu items. Use the ENT button to edit.</li> <li>• Press the ESC button to return to the Search/Measure Mode screen</li> </ul>
Advanced Setup Menu	<ul style="list-style-type: none"> <li>• Contains configuration parameters needed to configure the more advanced functions of the H25-IR PRO</li> <li>• Accessed from the Basic Setup Menu screen using the Right Arrow (SETUP) button (a second time from the Search/Measure screen) (must be at the top of the menu)</li> <li>• Use the Up and Down Arrow buttons to select menu items. Use the ENT button to edit.</li> <li>• Press the ESC button to return to the Search/Measure Mode screen</li> </ul>
Diagnostics Menu	<ul style="list-style-type: none"> <li>• Contains troubleshooting and diagnostic information about the H25-IR PRO</li> <li>• Accessed from the Advanced Setup Menu screen using the Right Arrow (SETUP) button (a third time from the Search/Measure screen)</li> <li>• Accessed directly from the Search/Measure screen using the Info (i) button</li> <li>• Use the Up and Down Arrow buttons to select menu items. Use the ENT button to edit.</li> <li>• Press the ESC button to return to the Search/Measure Mode screen</li> </ul>

## 3.2. Menu Navigation

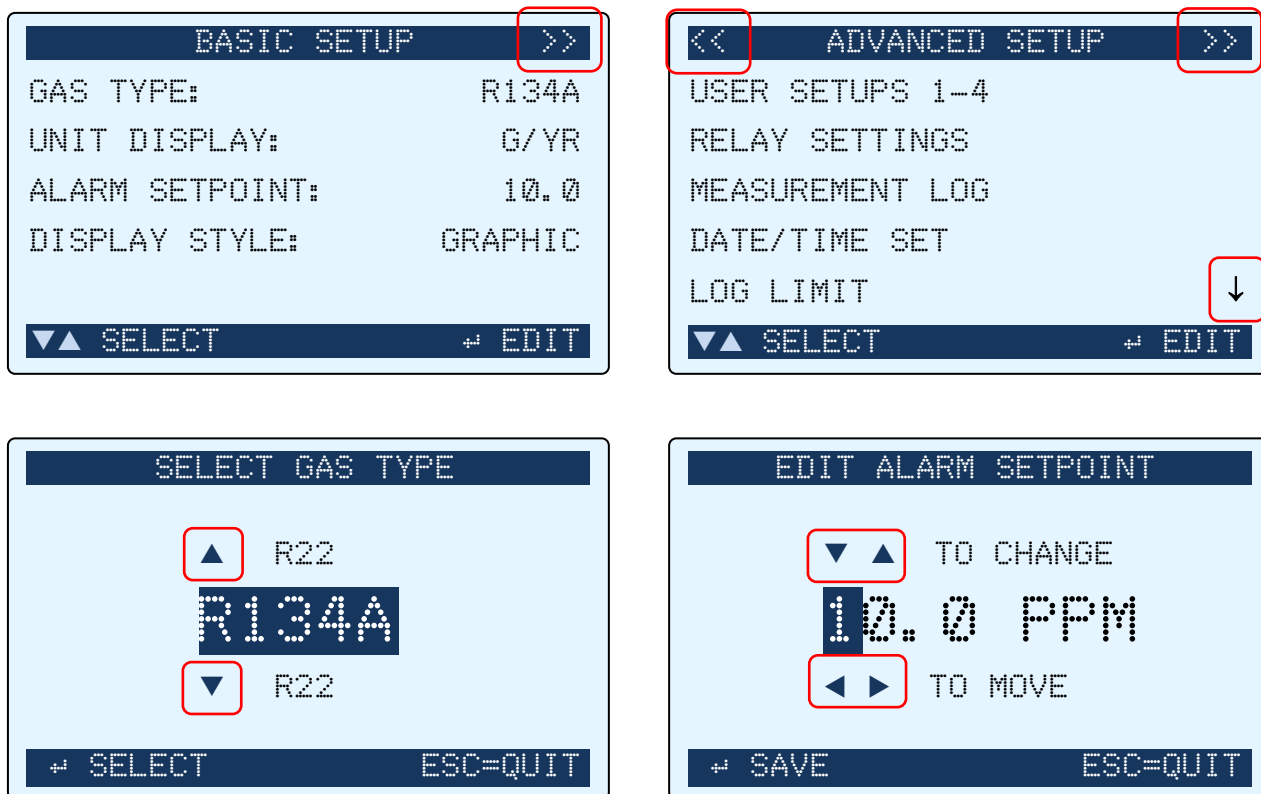
### 3.2.1. Overview

Navigating the H25-IR PRO menus is intuitive. Furthermore, it is likely that operators will spend only a proportionally small amount of time configuring the unit versus a greater amount of time at the search and measure screens (locating leaks and quantifying them once they are found). Nevertheless, understanding how to navigate all of the menus promotes efficient operation and the best use of your time.

Consider the following general rules for menu navigation.

- The SEARCH MODE or MEASURE MODE screen is typically your home screen
- The VOL, MODE, and RANGE buttons are typically used from that screen during normal operation
- The SETUP button is typically used to access the menu system (starting with the BASIC SETUP menu)
- The BASIC SETUP menu contains all of the options that are required to setup and operate the instrument
- From the BASIC SETUP menu, the VOL, RANGE, MODE, and SETUP buttons are used primarily as UP, DOWN, LEFT, and RIGHT navigation controls (respectively)
- The ESC key is used to cancel an operation or “back out” of a menu
- The ENT key (↵) is used to confirm the selection of a menu or value

In addition to these general rules, be sure to watch for clues such as arrows on the LCD display. Arrows are used to indicate additional menus, additional menu items, and/or parameter editing options. Examples are shown below in Figure 3-2.



**Figure 3-2. Arrows Indicating Additional Menus, Menu Items, and Parameter Editing Options**

Press the SETUP button to access the main menu system. The menu system (see Figure 3-3) enables the operator to perform such functions as setting up the instrument, viewing logged readings, configuring the four user-defined setups, and viewing the instrument’s diagnostic readings. The buttons on the instrument’s front panel (see Figure 3-4) and Smart Probe are mapped the same and can be used inter-changeably, with exception of the **ⓘ** button.

After pressing SETUP, select a menu item by first using the Up and Down Arrow buttons to highlight the desired item, and then pressing ENT to select that item and display its data screen. After an item has been selected, use the Left, Right, Up, and Down Arrow buttons to highlight or change data within a screen. Pressing the ENT button saves the new data, while pressing the ESC button aborts the operation and displays the previous screen.

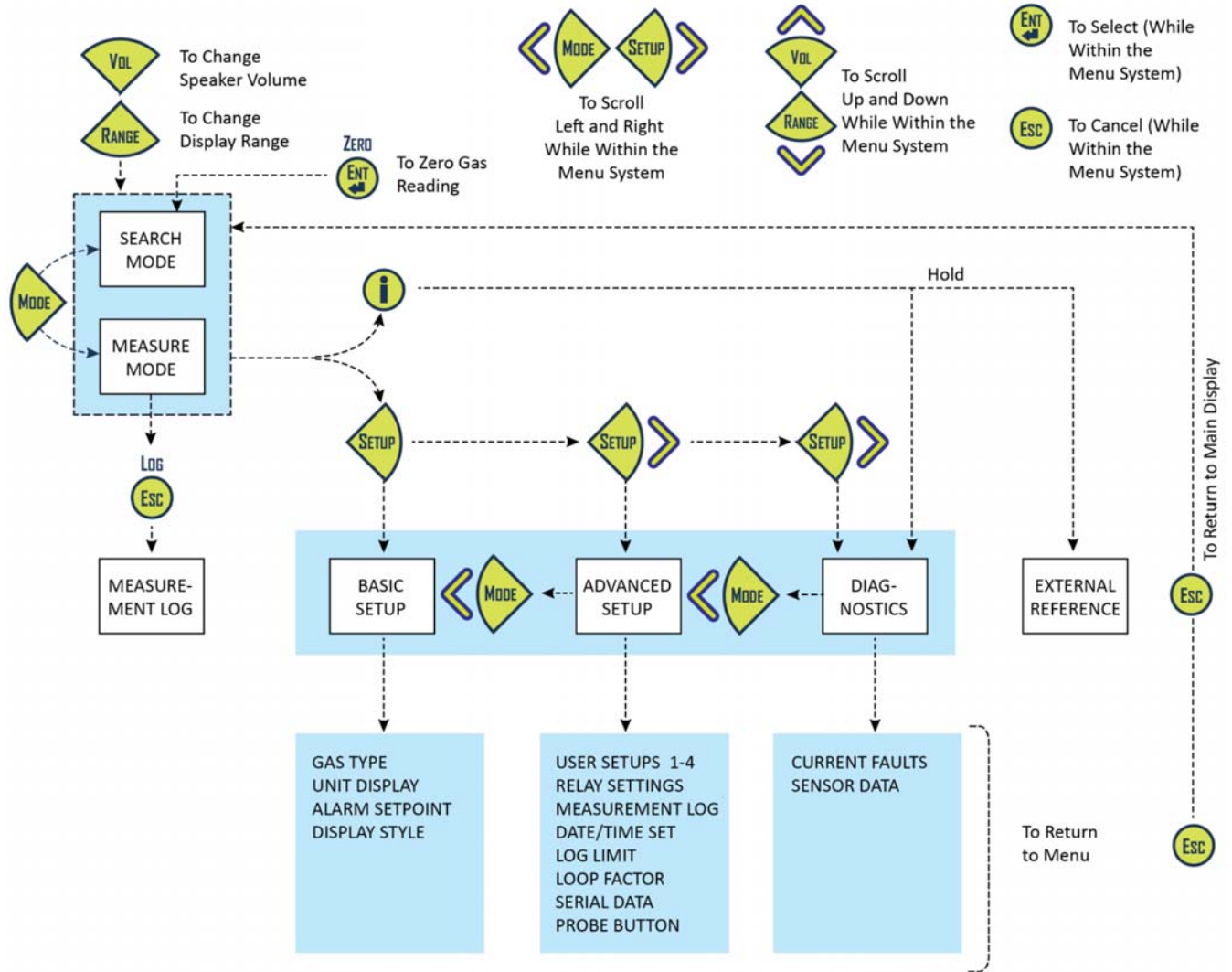










Figure 3-3. Menu Architecture Summary



Figure 3-4. Front Panel Components with Sample Display

### 3.2.2. Front Panel Buttons

Table 3-1. Front Panel Buttons

Button	Function
	<ul style="list-style-type: none"> <li>Selects a highlighted menu item</li> <li>Saves a selection or manually entered data (e.g. date and time)</li> <li>Zeros the gas reading (in the Measure and Search screens)</li> </ul>
	<ul style="list-style-type: none"> <li>Displays a previously viewed menu or data screen</li> <li>Cancels a data entry function; retains old data; and displays previous screen</li> <li>Logs the currently displayed gas measurement in memory when in the Measure mode, where it can later be reviewed using the Main menu's MEASUREMENT LOG function</li> </ul>
	<ul style="list-style-type: none"> <li>Directly accesses the Diagnostics menu.</li> <li>Used to enable instrument adjustment to an external leak reference (when pressed and held—refer to Adjustment to a Known External Leak Source on page 81).</li> </ul>
	<ul style="list-style-type: none"> <li>Displays the Volume Adjustment screen (then Up Arrow button slowly raises volume, Down Arrow button slowly lowers volume)</li> </ul>
	<ul style="list-style-type: none"> <li>Accesses the instrument's setup menus</li> </ul>
	<ul style="list-style-type: none"> <li>Toggles the operating mode between Search and Measure</li> </ul>
	<ul style="list-style-type: none"> <li>Adjusts the bar graph range (2X, 3X, 4X), the resulting display, and instrument response</li> </ul>
	
<p><b>NOTE:</b> These four buttons also serve as up, down, left, and right <i>navigation</i> and <i>value adjustment</i> buttons based on menu context. The front panel shows corresponding arrows next to each button's alternate function.</p>	
<ul style="list-style-type: none"> <li>Menu selection and value adjustment arrow buttons:           <ul style="list-style-type: none"> <li><b>VOL</b> <u>Up button:</u> Moves selected (highlighted) menu item up through screen, or increments an alphanumerical value when entering data.</li> <li><b>RANGE</b> <u>Down button:</u> Moves selected (highlighted) menu item down through screen, or decrements an alphanumerical value when entering data.</li> <li><b>MODE</b> <u>Left button:</u> Moves cursor left across screen.</li> <li><b>SETUP</b> <u>Right button:</u> Moves cursor right across screen.</li> </ul> </li> </ul>	



**NOTE:** Button images are used extensively in Chapter 5. When the MODE, VOL, SETUP, and RANGE buttons are used as “arrow” buttons (to explain navigation and value adjustment procedures), each button’s corresponding arrow is shown *with* the button image to illustrate more clearly its function in that particular context.

### 3.2.3. Changing Values of Menu Items

Use the arrow buttons to change the values of menu items. After being selected for editing, menu items generally take one of two forms:

- Scrolling list
- Scrolling numeric value.



In a scrolling list, simply use the Up and Down Arrow buttons to select the desired item from the list. In the SELECT GAS TYPE example below, use the Up and Down Arrow buttons to select the desired GAS TYPE. The current selection is highlighted and displayed larger.

In a scrolling numeric value, use the Up and Down Arrow buttons to increase and decrease (respectively) the desired value from the highlighted position. For numeric values, the Left and Right Arrow buttons move the highlighted numeral to provide a larger increment/decrement base. For example, in the EDIT ALARM SETPOINT example below, the highlighted numeral is in the “units” or “ones” position, so the Up and Down Arrow buttons increment the PPM value by 1. To increment or decrement the value in larger steps, use the Left Arrow button to position the active (highlighted) digit one place to the left (the “tens” position). Now, the Up and Down Arrow buttons adjust the PPM value by increments (or decrements) of 10 (versus increments of 1).

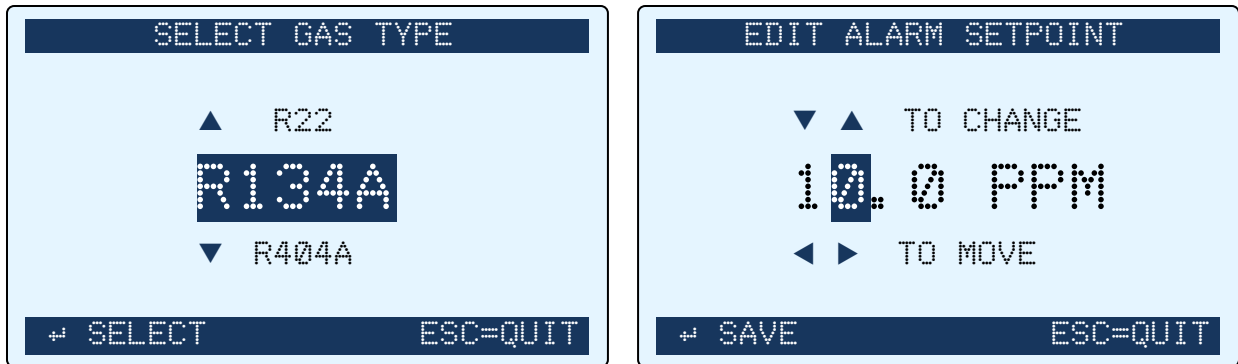


Figure 3-5. Examples of Value Types

Regardless of value type, once the desired value has been achieved, use the ENT (↵) button to save the new value. To ignore the changes you have made to this item and to return it to its previous value, simply press the ESC button.



**NOTE:** A timeout monitors front panel keys for regular activity. After approximately 60 seconds of no key presses, the H25-IR PRO returns to the main display (either the SEARCH MODE or MEASURE MODE screen—whichever was last active).

### 3.2.4. Configuration-Dependent Menu Items

Not all menu items may be available on your H25-IR PRO. The device displays certain menu options based on your particular hardware. In particular, the choice of probe type that is ordered (standard or Smart probe) determines whether or not the PROBE BUTTON option is shown in the ADVANCED SETUP menu. Refer to Figure 3-6 below. For detailed information on the function of the PROBE BUTTON menu item, refer to Section 5.6.8: Probe Button on page 71 and Figure 5-13 on page 72.

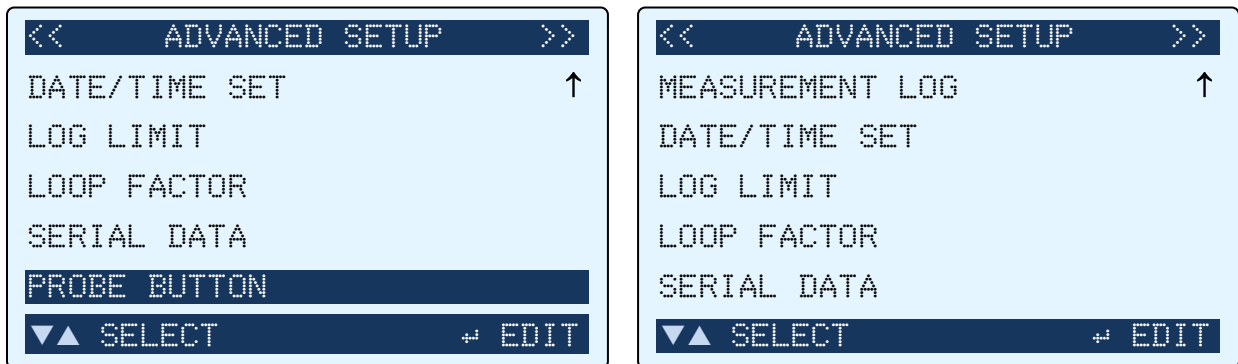

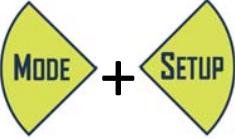



Figure 3-6. PROBE BUTTON Menu Item Based on Probe Style Ordered

### 3.2.5. Special Key Combinations

Buttons on the front panel have unique associated functions as explained earlier. Additional functions are available through the use of key combinations. Such functions are enabled by simultaneously pressing two or more of the front panel buttons. A summary is shown in Table 3-2.

**Table 3-2. Common Key Combinations**

Key Combination	Description
	User Setup Selection (1-4)
	Locks the Smart Probe keys (from Smart Probe) Also used to clear the measurement log (from Measurement Log) Also used to Lock/Unlock access to External Reference menu
	Show Setup Summary screen (from Startup)

### 3.3. Version Screen (at Power Up)



**WARNING:** Explosion Hazard. Do not operate this instrument in the presence of flammable liquids, vapors or aerosols. Operation of this instrument in such an environment constitutes a safety hazard.

After the H25-IR PRO is turned on, the FIRMWARE VERSION screen is displayed for approximately 15 seconds. Afterwards, the SETUP SUMMARY screen is automatically displayed. A sample FIRMWARE VERSION screen is shown in Figure 3-7



**Figure 3-7. Version Screen at Power Up**



**NOTE:** If your H25-IR PRO has the Smart Probe option, its LCD will also show a version number after startup. Note that the version shown on the Smart Probe is the version of the Smart Probe firmware, while the version displayed on the main LCD (Figure 3-7) refers to the firmware version of the H25-IR PRO unit.

### 3.4. Setup Summary Screen (Warm-up)

The SETUP SUMMARY screen is displayed automatically after the FIRMWARE VERSION screen. This screen displays key setup information (shown in Figure 3-8) and a 60-second initialization countdown. After the 60-second countdown, the H25-IR PRO displays the SEARCH MODE screen and is ready for operation.

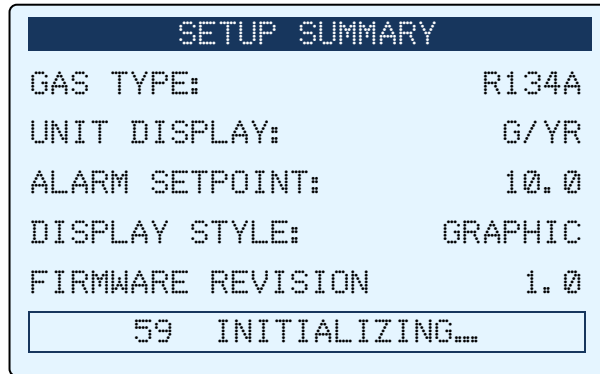


Figure 3-8. Setup Summary Screen Showing 60-Second Initialization Countdown

### 3.5. Search Mode Screen

After the SETUP SUMMARY screen and the 60-second initialization, the H25-IR PRO automatically displays the SEARCH MODE screen. Search mode is used to locate the source of a refrigerant leak.

The SEARCH MODE screen contains the following key elements:

- Gas reading in bar graph or numerical format based on the selected display style (see Figure 3-9)
- Gas type shown in the banner line of the SEARCH MODE screen
- Mode shown in the footer line of the SEARCH MODE screen
- Active USER SETUP name 1, 2, 3, 4, or "-----" if none selected
- Programmed alarm setpoint



**NOTE:** Unless otherwise changed (via the MODE button), the Search Mode screen is the default display of the H25-IR PRO. That is, inactivity timeouts will automatically return the display to the SEARCH MODE screen, as will successive presses of the ESC button.



**NOTE:** Unlike the SEARCH MODE screen which offers two display styles (graphic and numeric), the MEASURE MODE screen only appears in numeric display style.

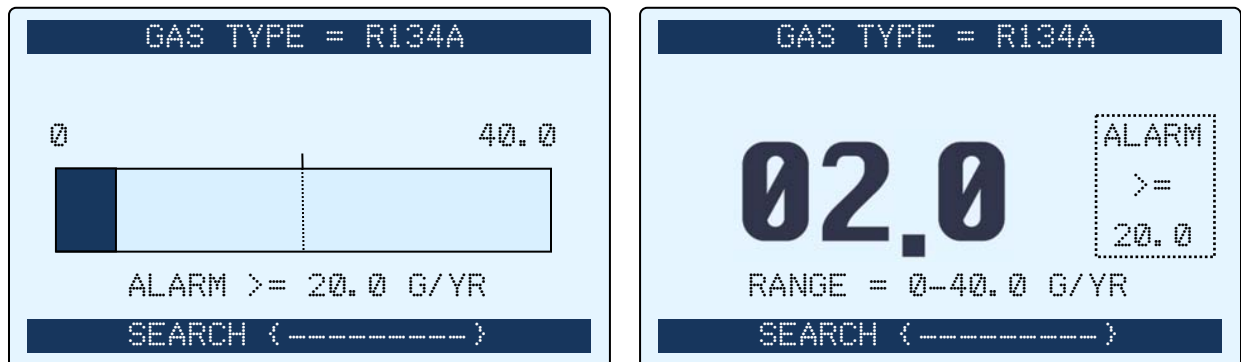


Figure 3-9. Sample Search Mode Screens (Showing Graphic and Numeric Display Styles)

### 3.6. Measure Mode Screen

After locating a gas leak using the SEARCH MODE screen, switch to the MEASURE MODE screen to measure the extent of that leak. Use the MODE button to toggle between the MEASURE MODE screen and the SEARCH MODE screen.



**NOTE:** Unlike the Search Mode screen which offers two display styles (graphic and numeric), the Measure Mode screen only appears in numeric display style.

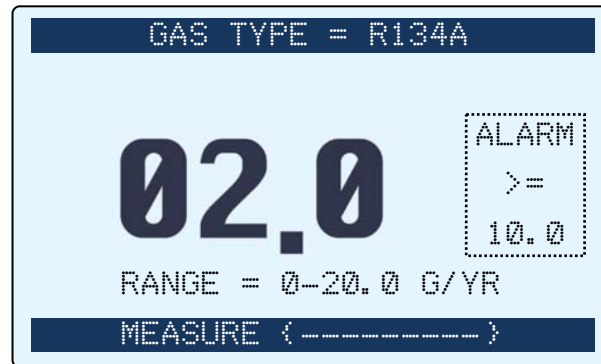


Figure 3-10. Sample Measure Mode Screen

The MEASURE MODE screen contains the following key elements:

- Gas reading in numerical format
- Gas type shown in the banner line of the SEARCH MODE screen
- Mode shown in the footer line of the MEASURE MODE screen
- Active USER SETUP name 1, 2, 3, 4, or “-----” if none selected
- Programmed alarm setpoint
- Range display shown below the gas reading.



**NOTE:** Use the MODE button to toggle between the SEARCH MODE screen and the MEASURE MODE screen.

### 3.7. Basic Setup Screen

The Basic Setup screen contains configuration settings that you define before searching for or measuring a gas leak. To access the Basic Setup screen from the Search Mode screen or Measure Mode screen, press the SETUP button.

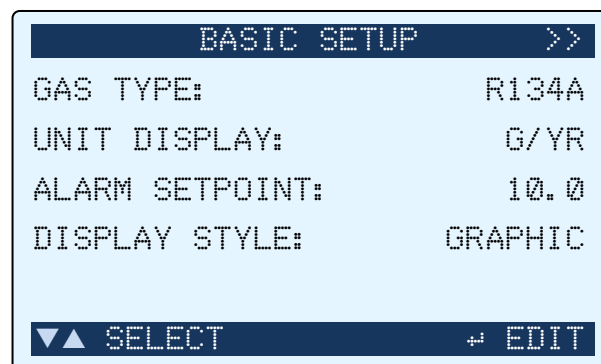


Figure 3-11. Basic Setup Screen

The BASIC SETUP screen contains the following key elements:

- Menu identifier located in the banner line (BASIC SETUP in this example)
- Right arrows in the banner line indicate another menu to the right (use the right arrow key to access)
- GAS TYPE menu item (selects the type of refrigerant gas you are checking)
- UNIT DISPLAY menu item (selects your preference for gas leak rate from a list of standard units)
- ALARM SETPOINT menu item (used to define the gas leak rate setpoint above which an alarm sounds)
- DISPLAY STYLE menu item (selects your preference of graphic or numeric display for the SEARCH MODE screen)
- Command options in the footer line (in this case, the keys to press to select and edit menu items)

To select an item from the BASIC SETUP, scroll through the menu using the Up and Down Arrow buttons until the desired menu item is highlighted and then press the ENT button to select the item for possible editing.



**NOTE:** The right arrows in the header of the BASIC SETUP screen indicate the existence of an additional “tabbed” menu to the right (and the key to press in order to access it).

### 3.8. Advanced Setup Screen

The Advanced Setup screen contains configuration options that allow you to take advantage of some of the more complex or infrequently-used features of the H25-IR PRO. To access the Advanced Setup screen from the Search Mode screen or Measure Mode screen, press the SETUP button once to reach the Basic Setup menu, then press the SETUP button a second time (as the Right Arrow button).

The Advanced Setup screen contains more menu items than will fit on the front panel display, so small up and down arrows on the far right side of the menu items indicate additional menu items. Use the Up and Down Arrow buttons on the front panel to scroll through the list of menu items. All of the menu items from the Advanced Setup screen are shown in the two images of Figure 3-12. Note the arrows indicating additional menu items in the scrollable list.

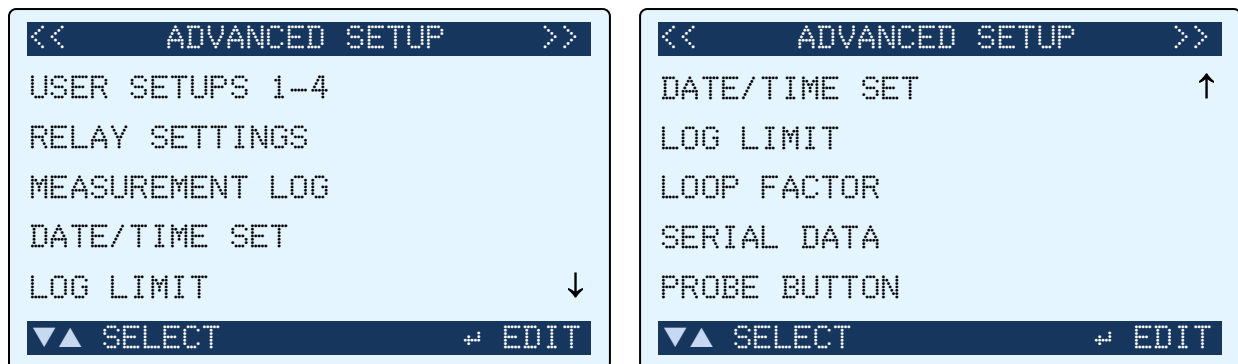


Figure 3-12. Advanced Setup Screen

The Advanced Setup screen contains the following options.

- User Setups 1-4 (optional user-based pre-sets)
- Relay Settings (conditional controls for the four output relays)
- Measurement Log
- Date/Time Set
- Log Limit (an upper limit logged leak rate value, above which one or more output relays can be activated)
- Loop Factor (current loop scaling for the 4-20mA output)
- Serial Data (None, Text Packet, or Text Only option for RS-232 communications)
- Probe Button (Only present if Smart Probe is not auto-detected. Selects function of button on standard probe.)
- Menu identifier located in the banner line (Advanced Setup in this example)
- Right arrows in the banner line indicate another menu to the right (use the Right Arrow button to access)
- Left arrows in the banner line indicate another menu to the left (use the Left Arrow button to access)
- Command options in the footer line (in this case, the keys to press to select and edit menu items)



**NOTE:** The right arrows in the header of the Advanced Setup screen indicate the existence of an additional “tabbed” menu to the right (and the key to press in order to access it). Similarly, the left arrows show how to return to the Basic Setup screen.



**NOTE:** The function of the probe button located on the standard probe can be set through the Probe Button setting of the Advanced Setup menu. The Probe Button setting (see Figure 5-10 above) is only present (at the bottom of the Advanced Setup menu) if a Smart Probe is *not* automatically detected. Refer to section 5.6.8: Probe Button (on page 71) for more information.

### 3.9. Diagnostics Screen

The Diagnostics screen contains advanced system details used for identifying faults, troubleshooting, and maintenance. To access the Diagnostics screen from the Search Mode screen or Measure Mode screen:

- Press the SETUP button once to reach the Basic Setup menu, then press the SETUP button two more times (as the Right Arrow button), or
- Press the Info (ⓘ) button.

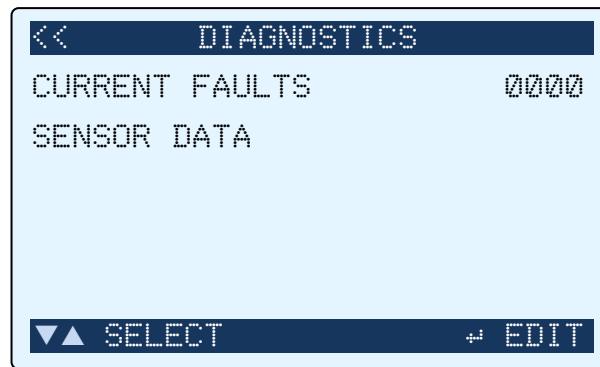


Figure 3-13. Diagnostics Screen

The Diagnostics screen contains the following options:

- Current Faults menu (lists currently active fault codes) with 4-digit fault code summary)
- Sensor Data menu (parameters for the NDIR sensor, used for troubleshooting and maintenance)
- Menu identifier located in the banner line (DIAGNOSTICS in this example)
- Left arrows in the banner line that indicate one or more additional menus (use the left arrow key to access)
- Command options in the footer line (in this case, the keys to press to select and edit menu items)



**NOTE:** Pressing the ENT button when the Current Faults menu item is selected interrogates the faults and provides you with fault details.





## CHAPTER 4: WIRING

### IN THIS SECTION

- Introduction ..... 30
- Relay Connections ..... 30
- 4-20mA Current Loop Connection ..... 31
- RS-232 Communications Connection ..... 32
- Standard Versus Smart Probe Wiring ..... 32

### 4.1. Introduction

This section contains information on wiring the following ports to optional hardware devices:

- Relays to control external alarm devices such as horns and strobes
- 4-20mA current output to control an external device such as a chart recorder
- RS-232 communications port to export leak data to a computer.



**NOTE:** The external connections and optional hardware devices discussed in this section are NOT required for the operation of the H25-IR PRO. You may skip any sections that do not apply to your particular configuration of the H25-IR PRO.

### 4.2. Relay Connections

The H25-IR PRO includes four single pole double throw (SPDT) relay contacts. These relay contacts can be used to control external alarm devices such as:

- Horns
- Bells
- Strobe lights.

The external alarm devices can be connected to these relays and activated when their associated relay is energized. Each relay contact has a 2 A rating at 250 VAC (inductive) and 5 A at 250 VAC (resistive).

Locate the external relay connector on the rear of the unit. Secure the leads from the external device and its power source to the external relay connector as shown in the example diagram below. This diagram shows a typical alarm device being connected to Relay 1. Repeat this procedure, as necessary, for the remaining relays.

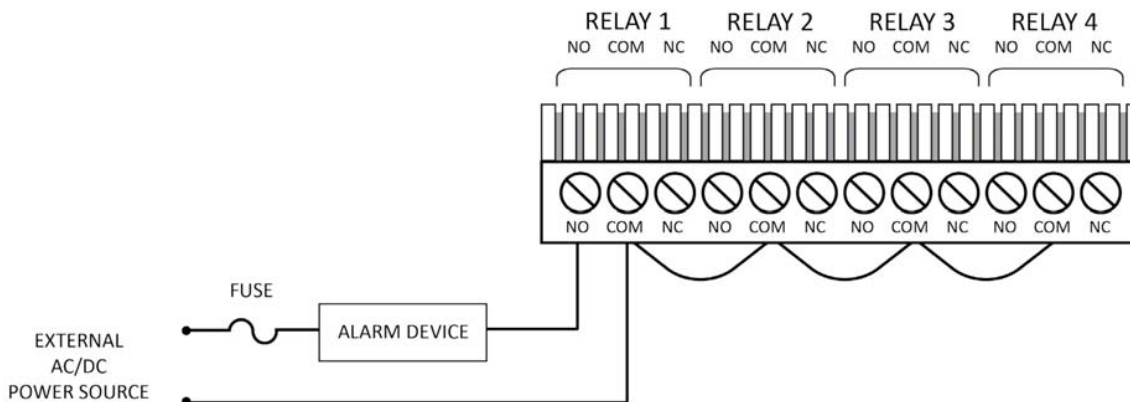


Figure 4-1. Sample Relay Wiring



- Each relay may be connected as normally open (NO) or normally closed (NC).
- The relay contacts are rated 2 A at 250 VAC (inductive) and 5 A at 250 VAC (resistive).
- Power for the external alarm devices is supplied from an external power source.
- Jumper the “neutral” line of an external power source to the “common” terminals on the relay connector.
- Connect one end of the alarm device to the appropriate terminal of the desired relay (NO or NC).
- The other end of the alarm device is connected to the other leg of the external power source. For protection, install an in-line fuse of the appropriate size and design for the external alarm device being used.



**NOTE:** Be sure to configure the relays in the ADVANCED SETUP menu. Refer to Relay Settings on page 61.



**NOTE:** Ensure the circuit load does not exceed the relay ratings.

### 4.3. 4-20mA Current Loop Connection

An external 4–20 mA monitoring device (e.g., chart recorder) can be connected to the H25-IR PRO using a shielded-twisted-pair cable. Locate the 4–20 mA connector on the rear of the unit, and then remove the resistor or shorting wire from its terminals.

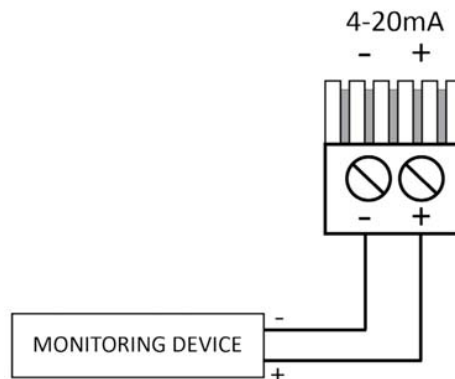


**IMPORTANT:** The monitoring device must be isolated from ground (i.e., a *floating* ground). For non-isolated equipment, a loop-isolator must be between the H25-IR PRO and the monitoring device. Bacharach recommends DataForth model DSCL21 at [www.dataforth.com](http://www.dataforth.com).



**NOTE:** A shorting wire must be connected to the 4–20 mA connector if no external monitoring device is used. Failure to install this resistor will cause a “Loop Open Error” to occur.

Secure the wire leads from the external monitoring device to the connector as shown in the diagram below, making sure that the polarity at this connector matches the wiring at the monitoring device.



**Figure 4-2. 4-20mA Loop Connector Used**



**CAUTION:** Never apply power to the 4–20 mA Loop Connector from an external power supply. In addition, connect only a load resistor or a *floating* measurement device.



**NOTE:** Wiring to the monitoring device should consist of 24 AWG, twisted pair up to 2000 feet in length.

The default current-to-ppm factor is set to 0.016 mA = 1 ppm, providing a measurement range of 0 ppm (4 mA) to 1,000 ppm (20 mA). Note that the current-to-ppm factor can be changed using the instrument's Loop Factor function. Refer to Loop Factor on page 68.



**NOTE:** Be sure to configure/verify the Loop Factor setting (see Loop Factor on page 68).

#### 4.4. RS-232 Communications Connection

Leak rate data can be output as ASCII text via the 9-pin RS-232 connector on the back panel of the H25-IR PRO. Using a standard RS-232 cable, connect the H25-IR PRO to a computer. To export ASCII formatted live data to a computer, you need:

- Serial communications software package (e.g., HyperTerminal™)
- Personal computer with an available COM port and running Windows® 95/98/2000/NT/XP/Vista/7 or later
- 9-pin-female to 9-pin-male serial cable (for example, P/N 104-4027)



**NOTE:** Be sure to configure your H25-IR PRO to send the ASCII data in the appropriate format (text packet or text only). Also, be sure that the communications settings on your computer match those listed below.

Table 4-1. RS-232 Communications Settings

Setting	Value
Baud Rate	19200
Parity	None
Stop Bit(s)	1
Flow Control	None



**NOTE:** USB-to-Serial adapters *may* work, but are unsupported.

#### 4.5. Standard Versus Smart Probe Wiring


When the H25-IR PRO is shipped from the factory, it has been configured to use the probe & hose assembly that was supplied with the instrument.

If a different probe style is used, then the ribbon cable from the front panel PROBE connector must be reconnected to either J2 or J7 of the LCD printed circuit board, located behind the front panel, as follows.



**WARNING:** SHOCK HAZARD. When performing this procedure, turn OFF the instrument and disconnect its AC power cord.

Table 4-2. Procedure to Change Factory-Set Probe Configuration

Step	Description
1	Remove power cord from back panel.
2	Remove both the front and rear bezels by first disengaging the plastic tabs on the right and left sides of the bezel, and then pulling the bezel straight out.
3	Remove the top two screws that secure the front panel, and the top two screws that secure the rear panel.
4	Find the seam at the side of the enclosure nearest the top. Using your fingers gently pry up on one side of the enclosure lid. The lid will disengage and swing upward, leaving the opposite side of the lid engaged. With the lid freely moving in the opposite side, gently lift up the front and rear edges of the lid to fully disengage it. Set it to one side and continue with the replacement.
5	<p>Connect the ribbon cable from the front panel PROBE connector to either J2 or J7 according to the probe to be connected:</p> <ul style="list-style-type: none"> <li>• J7 – Standard probe with LED and push button (and Standard probe with flex tubing)</li> <li>• J2 – Smart probe</li> </ul> <hr/> <p> <b>IMPORTANT:</b> Note the orientation of Pin 1 on both the ribbon cable and connectors J2 and J7. The red stripe on the ribbon cable denotes pin 1.</p> <hr/>
6	Reassemble the case, then connect the power cord.

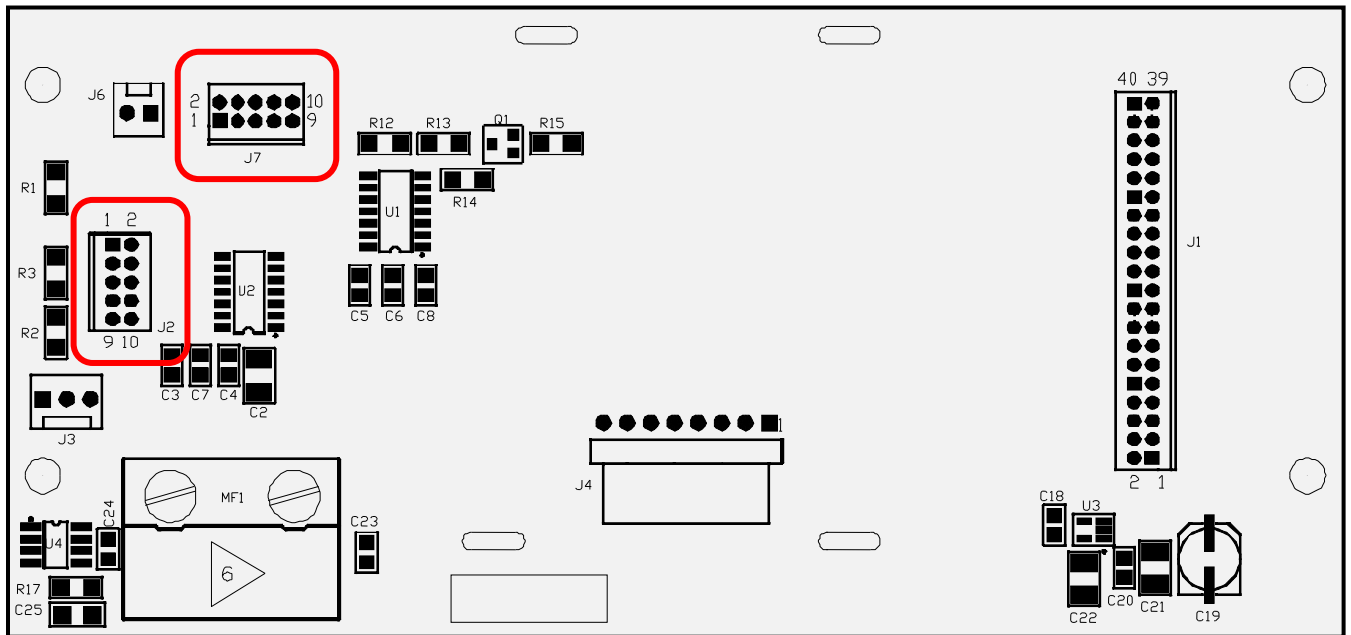


Figure 4-3. Front Panel Printed Circuit Board Containing Probe Connectors J2 and J7



## CHAPTER 5: OPERATION

### IN THIS SECTION

• Introduction .....	34
• Turning on the H25-IR PRO .....	36
• Function Reference .....	35
• Search Mode Screen.....	36
• Measure Mode Screen.....	42
• Basic Setup Screen.....	45
• Advanced Setup Screen .....	53
• Diagnostics Screen.....	74
• Adjustment to a Known External Leak Source .....	81
• Custom Gas Type Configuration.....	83
• Factory Gas Type Configuration .....	84

### 5.1. Introduction

This section describes the operation of the H25-IR PRO. The instructions in this section assume the following:

- You read and understood the previous sections.
- You assembled and connected your gas probe.
- You connected the power cord to an appropriate power supply receptacle.
- You wired optional external devices to the relays, current output, and/or RS-232 computer connector as desired.

For basic applications, your H25-IR PRO is ready to use after you turn it on. If your application takes advantage of one or more of the optional features, you should review the settings to ensure that any customizations you desire are properly configured. Note that some features require both hardware configuration (e.g., wiring from relay outputs to external notification devices) and firmware configuration (e.g., setup of menu parameters).

Table 5-1 on page 35 shows common application options and where to look for configuration information.



**WARNING:** Explosion Hazard. Do not operate this instrument in the presence of flammable liquids, vapors or aerosols. Operation of this instrument in such an environment constitutes a safety hazard.



**NOTE:** Button images are used extensively in this chapter. When the MODE, VOLUME, SETUP, and RANGE buttons are used as “arrow” buttons (to explain navigation and value adjustment procedures), each button’s corresponding arrow is shown *with* the button image to illustrate more clearly its function in that particular context.

Table 5-1. Function Reference

Category	Function/Application	Refer to...
Gas Type	Search for and measure a specific refrigerant gas	Search Mode Screen..... 36 Gas Type..... 46
	Search for the same 2, 3, or 4 gases without repeatedly re-configuring the gas type and alarm settings	User Setups 1-4 ..... 54
	Configure the H25-IR PRO to support one of the "custom" gases	Gas Type..... 46 Custom Gas Type Configuration ..... 83
Basic Configuration	Use a different unit for leak rates (for example, PPM, versus g/yr)	Unit Display ..... 48
	Use a leak rate unit not shown in the Unit Display menu	Leak Rate Conversion Chart ..... 48
	Configure the H25-IR PRO to sound an alarm when the leak rate exceeds a certain value	Alarm Setpoint ..... 49 Changing the Volume Setting ..... 38 Unit Display ..... 48
	Zero the sensor	Zero (ENT) Button..... 41
	Synchronize the leak rate readings to an external leak standard	Using a Reference Leak Source..... 6 Adjustment to a Known External Leak Source .. 81
Personal Preferences	Show a bar graph or numerical display for leak rates	Display Style ..... 51
	Lock the Smart Probe's keys to avoid accidental presses when working in confined spaces	H25-IR PRO Smart Probe Components ..... 15 H25-IR PRO Smart Probe Key Lock Feature..... 15
	Recognize alerts in noisy environments (headphones, volume control, external alerts)	Changing the Volume Setting ..... 38 Back Panel Components of the H25-IR PRO ..... 12 Wiring ..... 30 Relay Settings ..... 61
Reporting and Notifications	Beep only when gas level is above alarm setpoint or change beep pitch based on gas concentration	Changing a User Setup Feedback Mode ..... 60 Alarm Setpoint ..... 49
	Operate external alarms, lights, warning devices based on programmable conditions	Wiring ..... 30 Relay Settings ..... 61
	Scale the 4-20mA output to the input sample range	4-20mA Current Loop Connection..... 31 Loop Factor ..... 68
	Log leak data manually to the H25-IR PRO	Measurement Log..... 63 Setting the Date and Time ..... 65 Log (Esc) Button..... 43 Logging Data..... 44
	Log leak data to a PC for later use	Setting the Date and Time ..... 65 Serial Data Options..... 70

## 5.2. Turning on the H25-IR PRO

Table 5-2. Turning on the H25-IR PRO

Step	Description
1	Ensure appropriate wiring has been completed and probe is connected (see Hardware Overview on page 11 and Wiring on page 30).
2	Flip power switch (see Figure 2-2 on page 12) to the "ON" (   ) position and wait for the Search Mode screen to appear.

## 5.3. Search Mode Screen

### 5.3.1. Overview

After the SETUP SUMMARY screen and the 60-second initialization, the H25-IR PRO automatically displays the SEARCH MODE screen. Search mode is used to locate the source of a refrigerant leak.

The SEARCH MODE screen contains the following key elements:

- Gas reading in bar graph or numerical format based on the selected display style (see Display Style on page 51)
- Gas type shown in the banner line of the SEARCH MODE screen (see Gas Type on page 46)
- Mode shown in the footer line of the SEARCH MODE screen (also see Measure Mode Screen on page 42)
- Active USER SETUP name 1, 2, 3, 4, or "-----" if none selected (see User Setups 1-4 on page 54)
- Programmed alarm setpoint (see Alarm Setpoint on page 49)
- Graphic or numeric range display based on the display style (see Display Styles (Graphic vs. Numeric) on page 36).



**NOTE:** Unless otherwise changed (via the MODE button), the Search Mode screen is the default display of the H25-IR PRO. That is, inactivity timeouts will automatically return the display to the Search Mode screen, as will successive presses of the ESC button.

### 5.3.2. Display Styles (Graphic vs. Numeric)

Based on your desired preference, you can choose between two display styles (see Figure 5-1) for the Search Mode screen:

- Graphic display style (left)
- Numeric display style (right).

The display style is a user preference that is selected in the DISPLAY STYLE option (Display Style on page 51) of the Basic Setup menu.

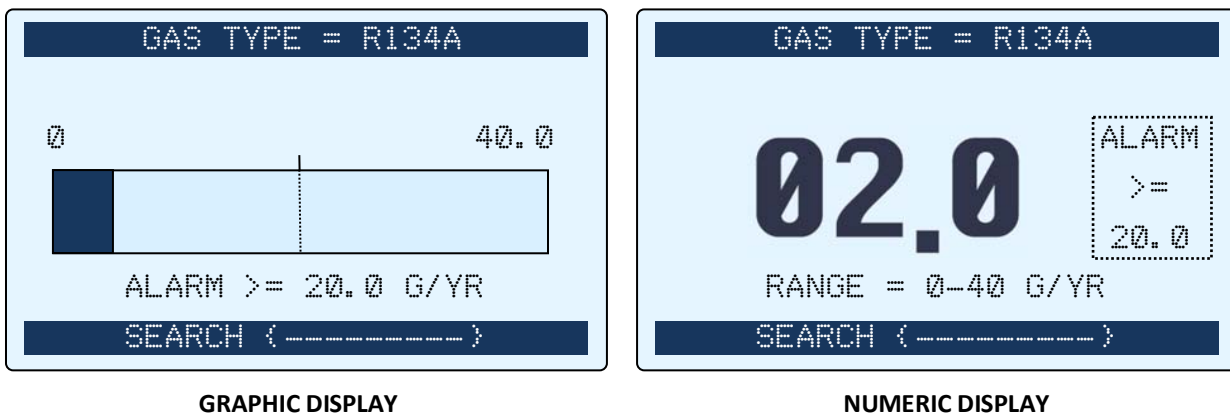


Figure 5-1. Sample Search Mode Screens (Showing Graphic and Numeric Display Styles)

### 5.3.3. Mode Button

During search mode operation, it may be desirable (after *locating* the source of the refrigerant gas leak) to *quantify* or *measure* the extent of that leak. This is accomplished by switching the H25-IR PRO from the Search Mode screen to the Measure Mode screen using the MODE button.



**NOTE:** The MODE button toggles the H25-IR PRO between search mode (locating the leak source) and measure mode (quantifying the leak). The Search Mode screen and Measure Mode screen are displayed, respectively.

In Figure 5-2, notice the differences between the Search Mode screen and the Measure Mode screen. The H25-IR PRO in Figure 5-2 is configured for graphic display style. The H25-IR PRO in Figure 5-3 is configured for numeric display style. Refer to Display Style on page 51 for additional information.

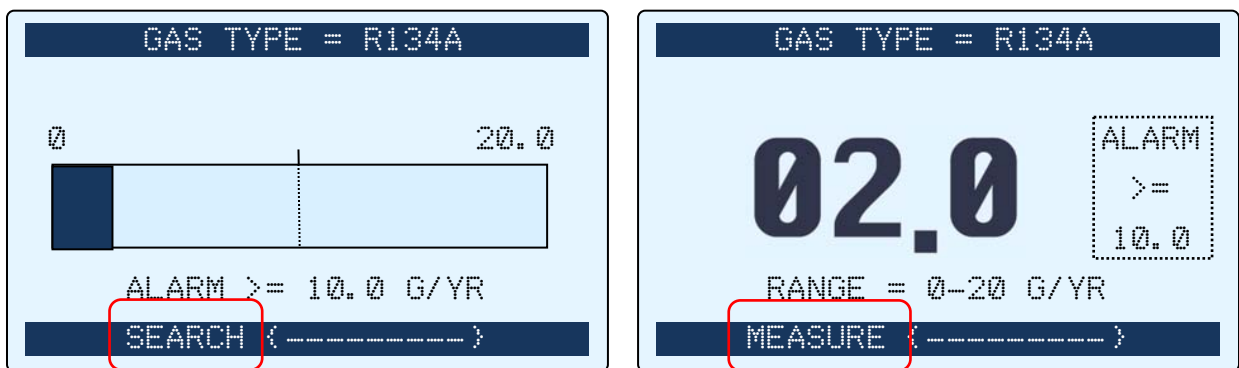


Figure 5-2. Toggling Between Search Mode and Measure Mode (Example 1)

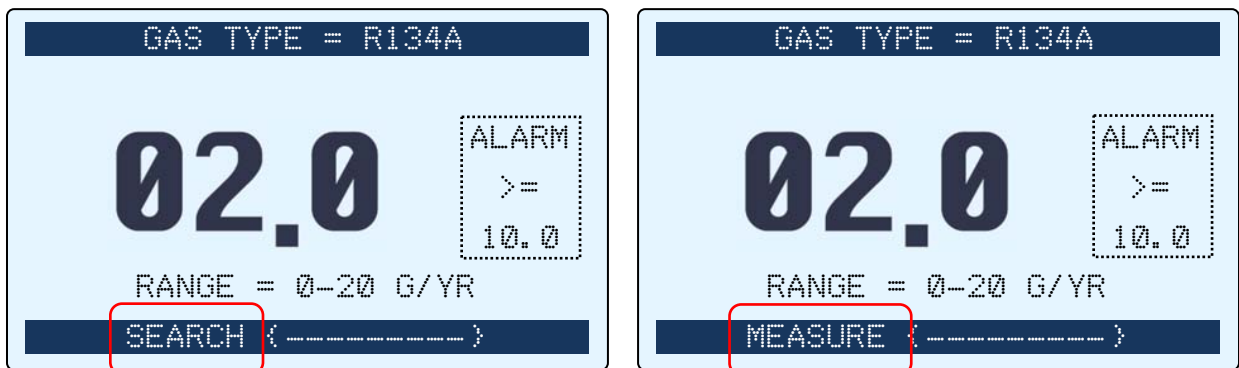


Figure 5-3. Toggling Between Search Mode and Measure Mode (Example 2)



**NOTE:** Regardless of the display style that is selected (graphic display or numeric display), numeric display is always used exclusively in measure mode.

### 5.3.4. Volume Button

The H25-IR PRO can be configured to produce audible tones under the following conditions:

- When the quantity of a sampled gas exceeds a programmed setpoint limit (a steady, constant-frequency tone)
- When the detected gas level increases (an audible tone whose frequency increases as the detected level of gas increases).



The audible tones emanate from either the speaker (at the back of the H25-IR PRO unit) or from headphones (or an amplified speaker) connected to the headphones jack on the back panel of the unit.

The VOL button is used to access the Adjust Speaker Volume screen. From there, the volume of the audible tones can be increased or decreased (using the Up Arrow and Down Arrow buttons). Adjust the speaker (and earphones) volume as follows.



**NOTE:** An earphone plugged into the instrument’s earphone jack automatically disconnects the speaker and allows the operator to listen to the unit’s audible tone in high-noise environments. If additional volume is required, connect an amplified speaker to the earphone jack.

Table 5-3. Changing the Volume Setting

Step	Button	Description	Sample Screen
1		Press the VOL button to display the Speaker Volume screen.	
2	   	Press the Up Arrow button to increase volume. Press the Down Arrow button to decrease volume. A visual indication of the volume level is provided by a bar graph at the bottom of the Data Display screen.	
3		Press ENT to save the new volume level.	

### 5.3.5. Range Button

In addition to display style, another option is the ability to change the range for gas readings. This is accomplished using the RANGE button on the front panel and is useful during search mode to better monitor larger swings in detected gas. The range feature is best illustrated using the graphic display style of the Search Mode screen. Note that it contains a hash mark delineating the alarm setpoint (refer to the graphic display style in Figure 5-1).



By default, the display range maximum is set to twice the alarm setpoint (e.g., 40.0 g/yr for a 20.0 g/yr alarm setpoint). The RANGE button toggles between 2x (the default), 3x, and 4x (that is, two times, three times, and four times the alarm setpoint setting), and then returns to the default 2x range. These examples, shown as 3 successive presses of the RANGE button, are illustrated in Figure 5-4.



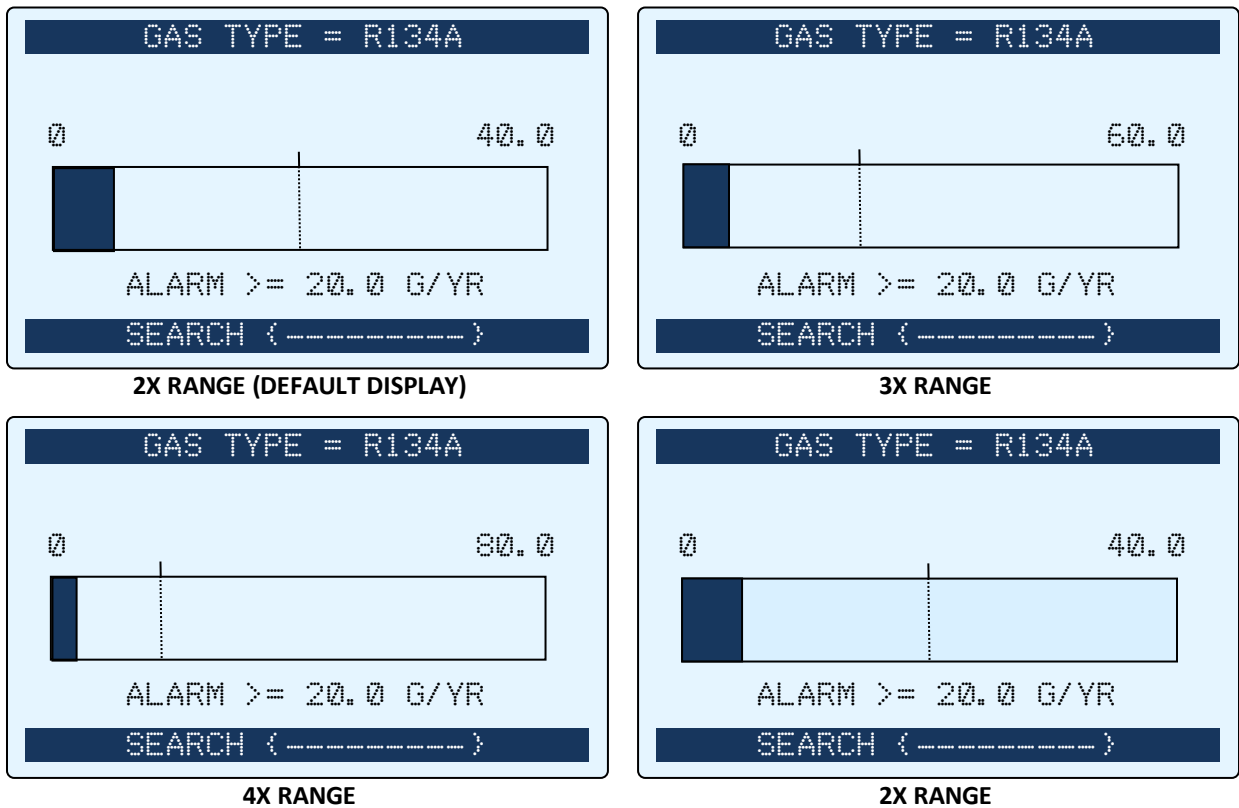


Figure 5-4. Sample 2X, 3X, and 4X Range Displays in the Graphic SEARCH MODE Screen



**NOTE:** When using the graphic display style, the maximum range value is shown above the right-most limit of the bar graph. When using the numeric display style, the maximum range value is shown in text format below the gas reading. Refer to Figure 5-1.

To provide the ability to scale up the range from the default of 2 times (2X) the alarm SETPOINT, the user may press the RANGE button. Doing this will cycle through the following scaling:

- First press = 3X scaling
- Second press = 4X scaling
- Third press = return to 2X scaling

The scaling repeats in this loop. This feature operates for both data presentation methods (Graphic and Numeric) and for both Search and Measure modes. The range values displayed on the screen change accordingly to show the scale. The placement of the vertical line delineating the alarm setpoint is moved to the left to show the change in scale.

### 5.3.6. Setup (and Right Arrow) Button

The SETUP button is used to access and scroll forward through the three main menu screens from the Search Mode or Measure Mode screen:

- BASIC SETUP screen (see Basic Setup Screen on page 45)
- ADVANCED SETUP screen (see Advanced Setup Screen on page 53)
- DIAGNOSTICS screen (see Diagnostics Screen on page 74)

Refer to these individual screens later in this section for more information.





**NOTE:** From any point in the menu structure, press the ESC button until you return to the SEARCH MODE screen or the MEASURE MODE screen.

**Table 5-4. Accessing the Main Menu Screens Using the Setup Button**

Step	Button	Description	Sample Screen(s)
1		Press the SETUP button once to access the Basic Setup screen.	
2		Press the SETUP button (Right Arrow button) again to access the Advanced Setup screen.	
3		Press the SETUP button (Right Arrow button) again to access the Diagnostics screen.	



**NOTE:** Consider using the Information (i) button as a shortcut to the Diagnostics screen. Refer to the Information (i) Button section on page 41 for additional information.

### 5.3.7. Zero (ENT) Button

The ZERO button manually resets the current gas level to zero. It is also used as the ENT button when changing configuration values within the menus.



**NOTE:** Automatic zeroing occurs at startup during initialization. It is therefore recommended to perform startup of the H25-IR PRO in a refrigerant-free clean-air environment.



**NOTE:** In Search Mode, the H25-IR PRO performs an auto zero process to remove the effects of background refrigerant in the air. Measure Mode does *not* automatically zero.

Figure 5-5 and Figure 5-6 show a sample Search screen and Measure screen both before and shortly after the ZERO button is pressed.

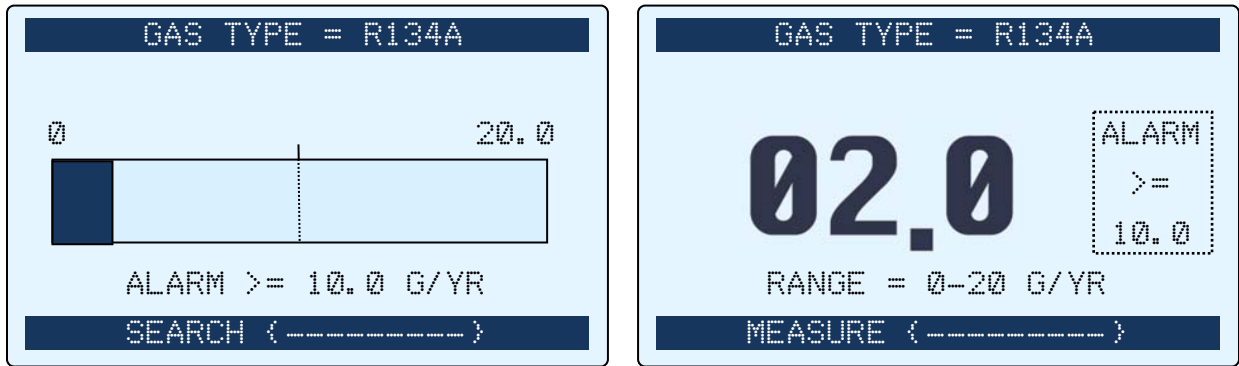


Figure 5-5. Sample Search and Measure Screens Before Zeroing

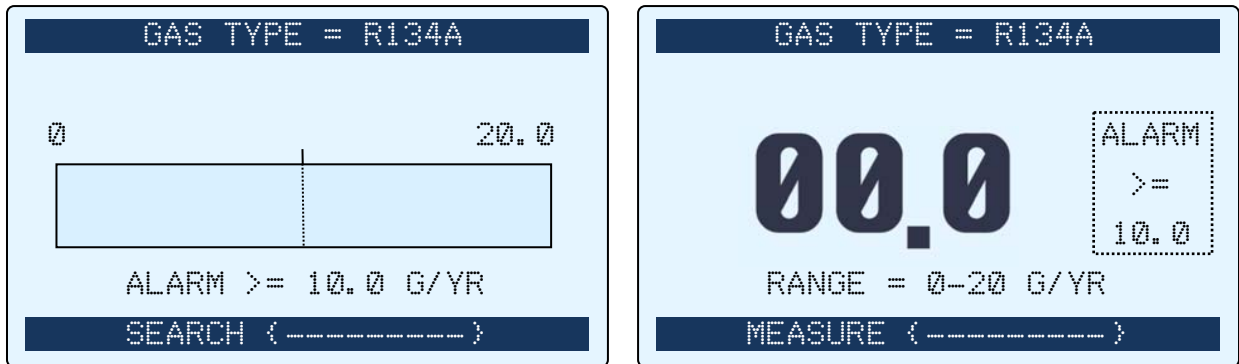


Figure 5-6. Sample Search and Measure Screens Shortly After Zeroing

### 5.3.8. Information (i) Button

The Information (i) button provides a shortcut to the DIAGNOSTICS screen. For more information on the Diagnostics screen, refer to the Diagnostics Screen section on page 74. Faults and other diagnostics are displayed in the header portion of the main screen. The i symbol is shown along with any fault condition to prompt the user to use the i keypad button.



**NOTE:** The Information button is also used to setup a leak reference. For more information, refer to the sections on Adjustment to a Known External Leak Source (on page 81) and Using a Reference Leak Source (on page 6).

## 5.4. Measure Mode Screen

### 5.4.1. Overview

After locating a gas leak using the SEARCH MODE screen, switch to the MEASURE MODE screen to measure the extent of that leak. Use the MODE button to toggle between the MEASURE MODE screen and the SEARCH MODE screen.



**NOTE:** Unlike the SEARCH MODE screen which offers two display styles (graphic and numeric), the MEASURE MODE screen only appears in numeric display style.

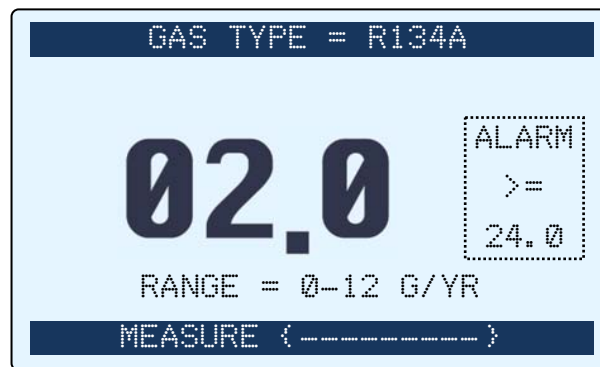


Figure 5-7. Sample Measure Mode Screen

The MEASUREMENT MODE screen contains the following key elements:

- Gas reading in numerical format
- Gas type shown in the banner line of the SEARCH MODE screen (see Gas Type on page 46)
- Mode shown in the footer line of the MEASURE MODE screen (also see Search Mode Screen on page 36)
- Active USER SETUP name 1, 2, 3, 4, or "-----" if none selected (see User Setups 1-4 on page 54)
- Programmed alarm setpoint (see Alarm Setpoint on page 49)
- Range display shown below the gas reading (refer to RANGE button description in the Search Mode Screen section on page 36).



**NOTE:** Use the MODE button to toggle between the Search Mode screen and the Measure Mode screen.



**NOTE:** With the exception of the LOG button (discussed in the next section), most of the front panel buttons on the H25-IR PRO behave similarly in the Measure Mode screen as they do in the Search Mode screen. For additional information on the ENT (ZERO), Information (ⓘ), VOL, SETUP, RANGE, and MODE buttons, refer to the corresponding subsections in the Search Mode Screen section starting on page 36.



**NOTE:** In Search Mode, the H25-IR PRO performs an auto zero process to remove the effects of background refrigerant in the air. Measure Mode does *not* automatically zero.

### 5.4.2. Log (Esc) Button

While in Measure Mode, the LOG (ESC) button adds the current non-zero gas measurement to the next data storage location of the measurement log. The measurement log contains 50 data locations in which leak rate data may be stored. Refer to Figure 5-8 and Table 5-5 on page 44.



**NOTE:** The H25-IR PRO must be in Measure Mode and must be sampling a non-zero leak rate in order to log leak rate data to the measurement log.

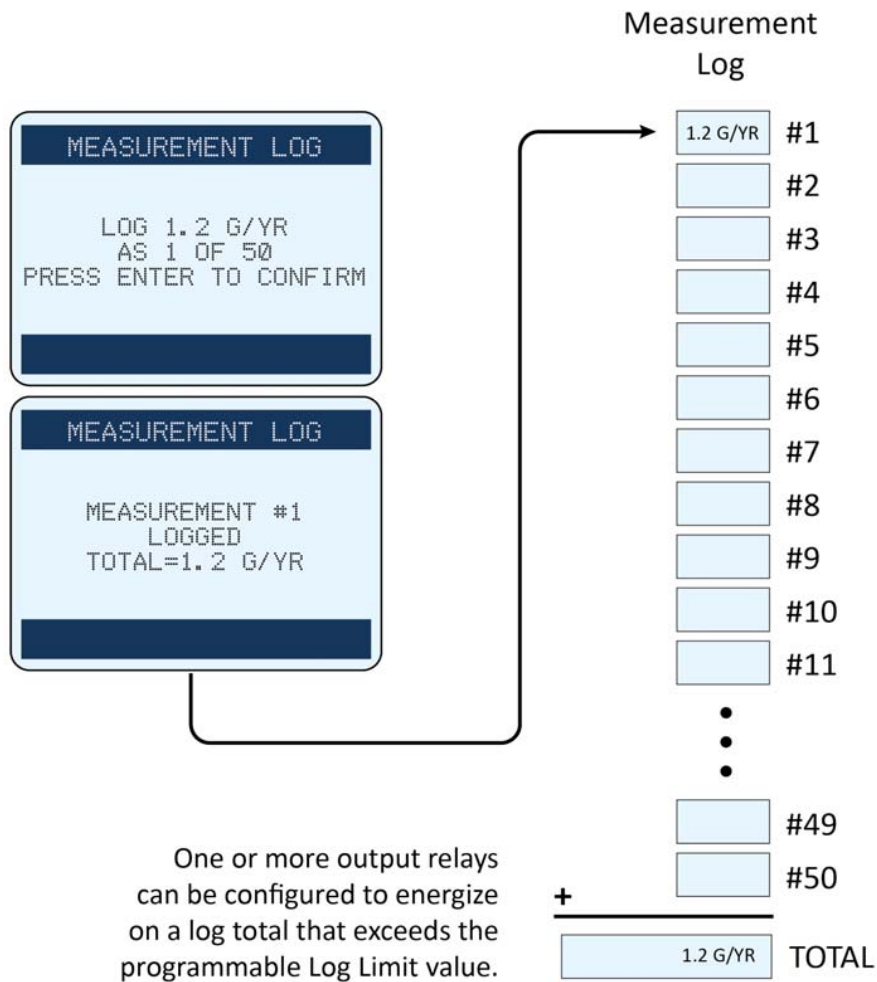

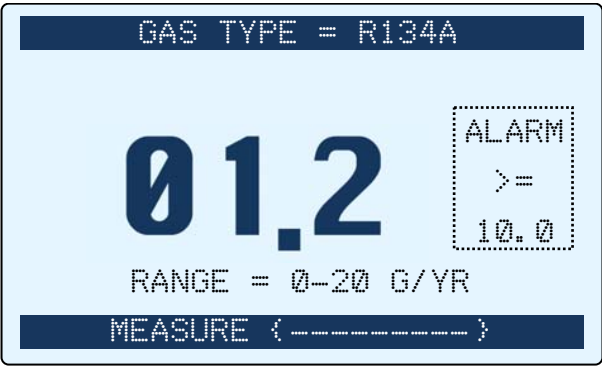

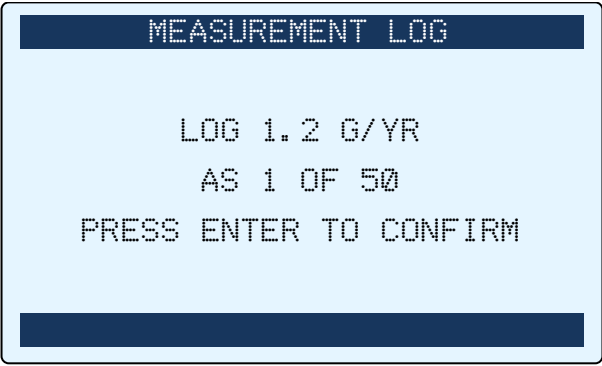

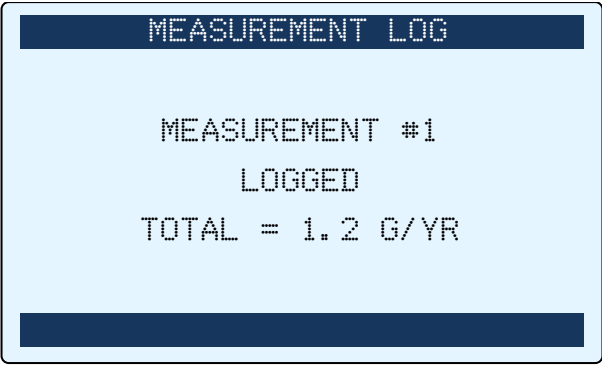


Figure 5-8. Graphical Representation of the Measurement Log



**NOTE:** Use the Log Limit setting in conjunction with the programmable relay control settings to configure your H25-IR PRO for totalizer applications. For example, consider a repetitive compressor test function at an air conditioner manufacturer for inspecting up to 50 solder joints on each production unit for gas leaks. Consider a corporate or environmental restriction that limits *each unit* to a leak rate of not more than 20 grams/yr. The H25-IR PRO can be configured to measure all 50 points, quantify each leak rate, calculate the total of all 50 leak rates, and activate an alert device (light, buzzer, alarm) via one or more of the output relays based on a programmable Log Limit value. The measurement log can then be reset and the test repeated for the next device.

Table 5-5. Logging Data


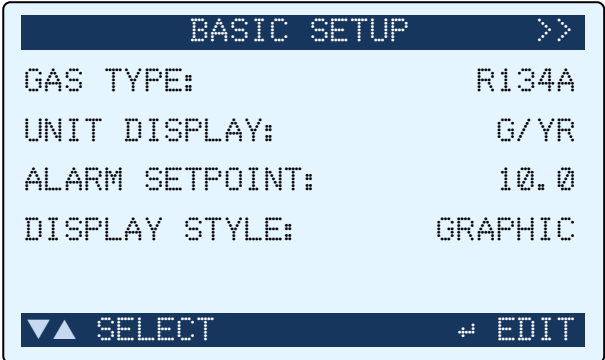

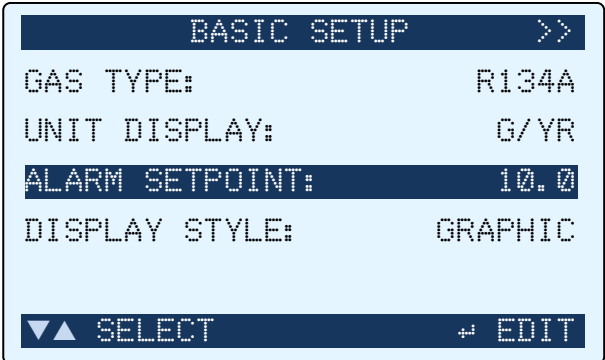

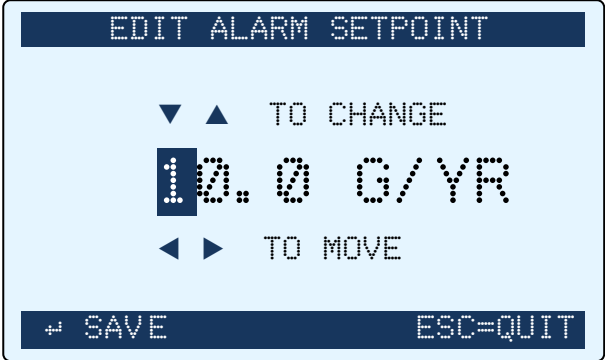
Step	Button	Description	Sample Screen(s)
1		Ensure that the H25-IR PRO is in Measure Mode. Use the MODE button if needed.	
2		Press the LOG button to capture the current (non-zero) leak rate. You are prompted to press the ENT button to confirm that you want to store this value in the measurement log.  Do nothing (i.e., wait for the inactivity timeout to occur) or press the ESC button to return to the main Measure screen.	
3		To log the leak rate value, press the ENT button when confirmation is requested. An acknowledgement screen is displayed for approximately 5 seconds, followed by the main Measure screen.	



**NOTE:** With the exception of the LOG button (discussed in the next section), most of the front panel buttons on the H25-IR PRO behave similarly in the Measure Mode screen as they do in the SEARCH MODE screen. For additional information on the ENT (ZERO), Information (Ⓢ), VOL, SETUP, RANGE, and MODE buttons, refer to the corresponding subsections in the Search Mode Screen section starting on page 36.

### 5.5. Basic Setup Screen

Table 5-6. Accessing the BASIC SETUP Screen

Step	Button	Description	Sample Screen(s)
1		From the main Search screen or Measure screen, press the SETUP button once to access the Basic Setup screen.	
2		Press the Up Arrow (VOL) and Down Arrow (RANGE) buttons to highlight the desired menu item.	
3		Press ENT to select that item for editing.	

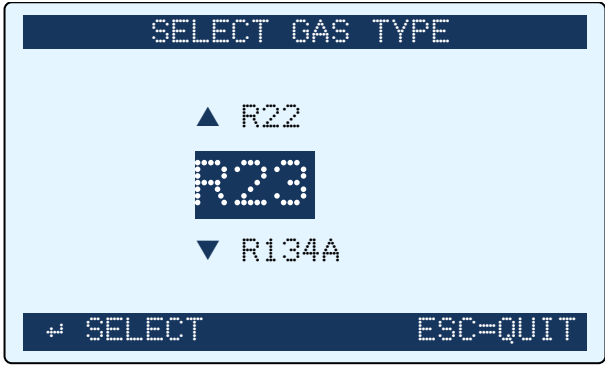

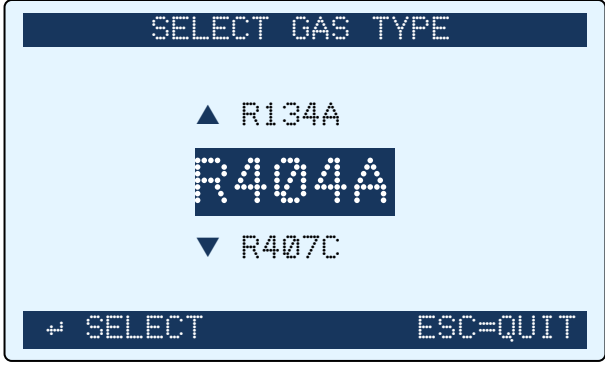

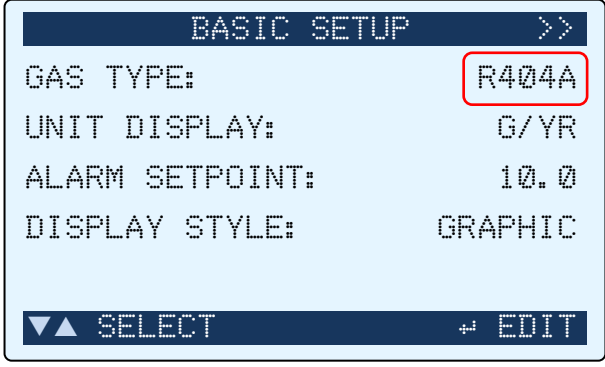

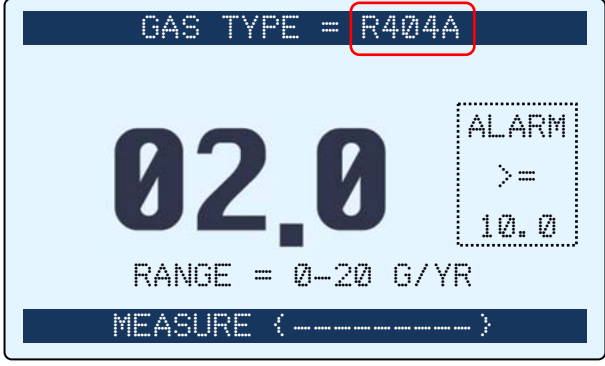


**NOTE:** For detailed instructions on editing menu items in the BASIC SETUP screen, refer to the sections that follow.

### 5.5.1. Gas Type

Gas Type sets the gas to be detected by the H25-IR PRO.

**Table 5-7. Setting the Gas Type from the List of Standard Gases**

Step	Button	Description	Sample Screen(s)
1	See Table 5-6 on page 45	Follow the steps in Table 5-6 on page 45 to access the Gas Type menu option and to display the Select Gas Type screen. The active selection is twice the size of the previous and next items (shown above and below the active selection).	
2		Press the Up Arrow and Down Arrow buttons to scroll through the list of gases. Pressing and holding each button scrolls through the list as well.	
3		Press the ENT button to configure the H25-IR PRO for the selected gas. Pressing ENT returns the user to the previous screen with the selected value in place. Pressing the ESC button aborts the change and maintain the previous gas type.	
4		Press the ESC button to return to the main Measure Mode screen and verify that the Gas Type you selected is now shown in the header.	





**NOTE:** After changing the gas type, the screen heading on the main Measure screen or Search Screen is changed to reflect the name of the newly selected menu option.



**NOTE:** Configuration values are retained (even after power is cycled) in non-volatile memory.



**NOTE:** Configuration settings under the Basic Setup menu can be thought of as “User Setup 0” and remain active unless one of the four User Setups has been selected. See User Setups 1-4 on page 54 for more information.



**NOTE:** If “Custom” is selected, the user is expected to use the External Reference feature to adjust the instrument to his needs. For “Custom” gas configurations, the upper and lower external reference adjustment bounds must be set by the user. Also, the user is responsible for verifying instrument response if “custom” is used.

Table 5-8. Gas Type Menus and Selection

Menu Option	Location, Description	Gases Included
GAS TYPE	<p>Primary List Presented in the standard menu (see Table 5-7 on page 46).</p> <p>When equipped with the halogen NDIR sensor this list includes the most popular refrigerant gases; a “CUSTOM” refrigerant option is also shown.</p>	<p>Halogen NDIR R12, R21, R22, R23, R113, R114, R123, R134a, R236fa, R245fa, R401A, R402A, R402B, R404A, R407A R407C, R408A, R409A, R410A, R422D, R426A, R427A, R448A, R449A, R452A, R452B, R500, R503, R507, R508B, R513A, R514A, HFP, FA188, H1234YF, R32, H1301, N1230, H1211, H2402, R124, R125, R227, R422a, R438a, R502, FC72, R407F, H1234ZE, N4710, N7100, N7200, N7300, N7600</p> <p>CUSTOM: The user adjusts the instrument response to a known concentration via the “external reference” feature. Refer to Adjustment to a Known External Leak Source on page 81.</p>
GAS TYPE	<p>Secondary “Factory” List Presented only in the Factory Menu.</p> <p>When equipped with the halogen NDIR sensor the instrument may be set to one of the gases in this extended gas list. The selected gas becomes the only gas listed in the standard Gas Type menu; no other gases will be listed.</p>	<p>R290, R600a, CO2_A, SF6</p> <p>NOTE: A dedicated NDIR Sensor is required; if so equipped, the instrument is dedicated to detect the gas shown in the GAS TYPE menu; no other gases will be listed.</p> <p>Refer to Factory Gas Type Configuration on page 84 to set one of the gases listed above.</p>

### 5.5.2. Unit Display

The unit display function sets the engineering units used in leak flow rate (and other related) calculations. Available display units are listed in Table 5-9.

**Table 5-9. Display Units Available in the H25-IR PRO**

Units	Description
oz/yr	ounces per year
g/yr	grams per year
mL/sec-5	milliliters per second x 10 <sup>-5</sup>
Pa-M/sec-5	Pascal meters cubed per second x 10 <sup>-5</sup>
PPM	parts per million



**NOTE:** If your application uses different units than those provided in Table 5-9, use Table 5-10 to convert your units to one of the available H25-IR PRO units.

**Table 5-10. Leak Rate Conversion Chart**

From/To	cfm <sup>3</sup> /s	Pa M <sup>3</sup> /s	Pa L/s	mbar L/s	Torr L/s	Kg Mole/s	Molecules of Air/s	Air oz/yr	Air mg/s
cfm <sup>3</sup> /s	1	0.10	101.33	1.01	0.76	4.46x10 <sup>-8</sup>	2.69x10 <sup>-19</sup>	1.44x10 <sup>3</sup>	1.29
Pa M <sup>3</sup> /s	9.87	1	100x10 <sup>3</sup>	10.00	7.50	4.40x10 <sup>-7</sup>	2.65x10 <sup>20</sup>	1.42x10 <sup>4</sup>	12.75
Pa L/s	9.87x10 <sup>-3</sup>	100x10 <sup>-3</sup>	1	.001	7.50x10 <sup>-3</sup>	4.40x10 <sup>-10</sup>	2.65x10 <sup>17</sup>	14.19	1.28x10 <sup>-2</sup>
mbar L/s	0.99	0.10	100.00	1	0.75	4.40x10 <sup>-8</sup>	2.65x10 <sup>-19</sup>	1.42x10 <sup>3</sup>	1.28
Torr L/s	1.32	0.13	133.32	1.33	1	5.87x10 <sup>-8</sup>	3.54x10 <sup>19</sup>	1.89x10 <sup>3</sup>	1.70
kg Mole/s	2.24x10 <sup>7</sup>	2.27x10 <sup>8</sup>	2.27x10 <sup>9</sup>	2.27x10 <sup>7</sup>	1.70x10 <sup>7</sup>	1	6.02x10 <sup>26</sup>	3.22x10 <sup>10</sup>	2.90x10 <sup>7</sup>
Molecules of air/s	3.72x10 <sup>20</sup>	3.77x10 <sup>-21</sup>	3.77x10 <sup>-18</sup>	3.77x10 <sup>-20</sup>	2.83x10 <sup>-20</sup>	1.66x10 <sup>-27</sup>	1	5.35x10 <sup>-17</sup>	4.81x10 <sup>-20</sup>
Air oz/yr	6.96x10 <sup>-4</sup>	7.05x10 <sup>-5</sup>	7.05x10 <sup>-2</sup>	7.05x10 <sup>-4</sup>	5.29x10 <sup>-4</sup>	3.10x10 <sup>-11</sup>	1.87x10 <sup>16</sup>	1	8.99x10 <sup>-4</sup>
Air mg/s	0.77	7.84x10 <sup>-2</sup>	78.41	0.78	0.59	3.45x10 <sup>-8</sup>	2.08x10 <sup>19</sup>	1.11x10 <sup>3</sup>	1

Table 5-11. Changing the Unit Display Setting

Step	Button	Description	Sample Screen(s)
1	See Table 5-6 on page 45	Follow the steps in Table 5-6 on page 45 to access the Display Units menu option and to display the Select Display Units screen. The active selection is twice the size of the previous and next items (shown above and below the active selection).	
2		Press the Up Arrow and Down Arrow buttons to scroll through the list of display units. Pressing and holding each button scrolls through the list as well.	
3		Press the ENTER button to configure the H25-IR PRO for the selected unit display. Pressing ENT returns the user to the previous screen with the selected value in place. Pressing the ESC button aborts the change and maintain the previous unit display.	

### 5.5.3. Alarm Setpoint

The Alarm Setpoint defines a gas leak setpoint value above which the alarm sounds. Below this value there is no alarm. Setting it to 0 means that the instrument alarms on any gas detected.

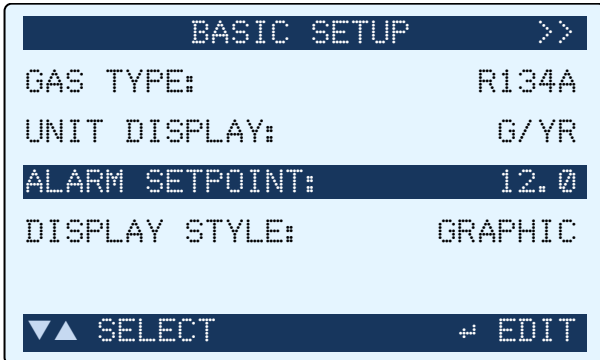


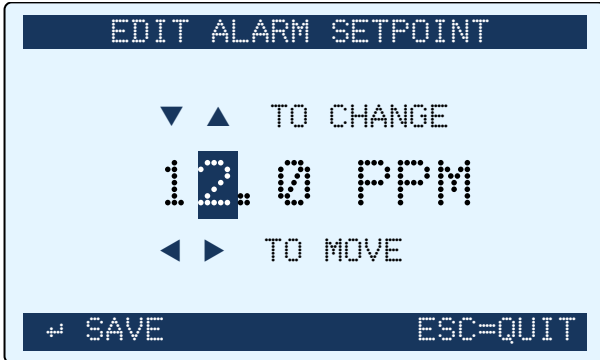


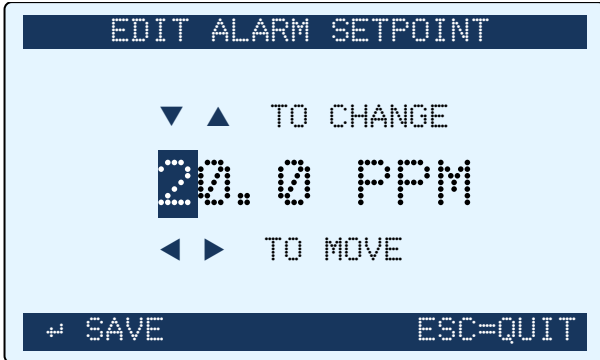

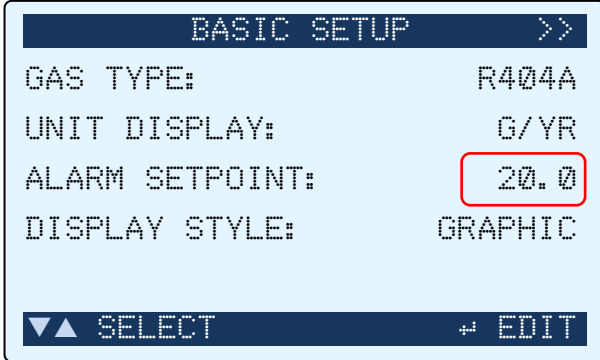


**NOTE:** The default detection range is calculated as 2X the ALARM setpoint. This is done to standardize the GRAPHIC display mode.



**NOTE:** The audio output scales to the detected gas concentration when the alarm setpoint is set to 0 in the Basic Setup menu. Otherwise, its sound level is either ON or OFF (at the volume setting that was defined by the user), using the alarm setpoint as the trigger for activation. Similarly, if User Setup 1-4 is used, the alarm can be set to “continuous” or “setpoint”.

Table 5-12. Changing the Alarm Setpoint

Step	Button	Description	Sample Screen(s)
1	See Table 5-6 on page 45	Follow the steps in Table 5-6 on page 45 to access the Alarm Setpoint menu option and to display the Edit Alarm Setpoint screen.	
2	 	<p>Press the Up Arrow and Down Arrow buttons to increase/ decrease (respectively) the highlighted position of the value.</p> <p>Pressing and holding each button increments (or decrements) the value of the selected position.</p> <p>Values rollover to (or from) the adjacent next highest significant digit(s).</p>	
3	 	<p>Press the Left Arrow and Right Arrow buttons to change position of the selected digit in the setpoint. The selected digit is the one that is highlighted.</p>	
4		<p>Press the ENT button to configure the H25-IR PRO to use the defined setpoint.</p> <p>Pressing the ENT button returns the user to the previous screen with the selected value in place.</p> <p>Pressing the ESC button aborts the change and maintain the previous setpoint.</p>	



**NOTE:** Alarm messages are shown in the header of the main Search/Monitor screen. If 0 is entered for the Alarm Setpoint, no alarm message will be shown.



**NOTE:** If you set the alarm setpoint to a non-zero value, the alarm “beep” sounds only when the gas sample exceeds the alarm setpoint. If you set the alarm setpoint to zero, the alarm will sound for *any* detected gas, and will increase in frequency based on the concentration of the gas.

#### 5.5.4. Display Style

The Display Style setting defines the format of the main Search screen. Options are Graphic and Numeric. You choose your preference from the Select Display Style screen.

- Graphic
  - Bar graph and basic setup information
  - The Alarm Setpoint setting is used to establish the bar graph’s mid-point and scaling
  - Default setting
- Numeric
  - Large digital numeric display of the real-time gas concentration and basic setup information



**NOTE:** Display Style only affects the *Search* mode display. Measure mode *always* shows a numeric display.



**NOTE:** The dark area shown in the bar graph is a real time display of the detected gas. The bar fills to the right as the gas level increases. When the alarm setpoint is reached or exceeded the speaker sounds.

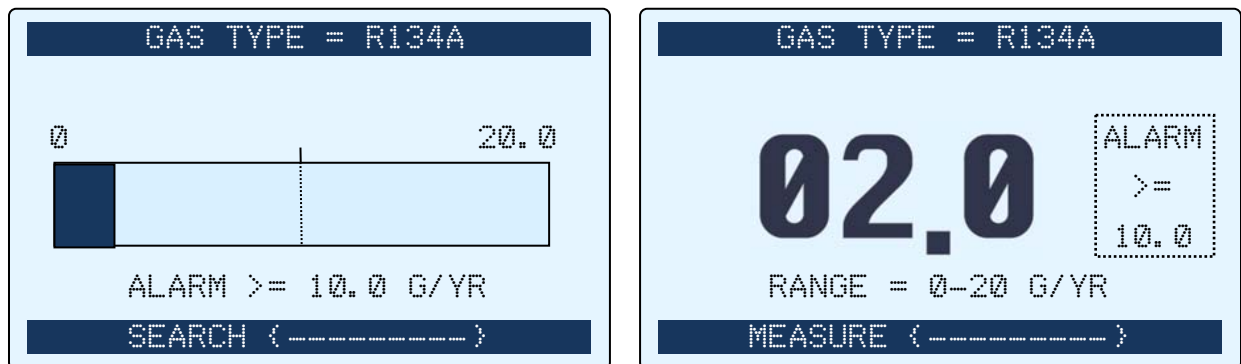



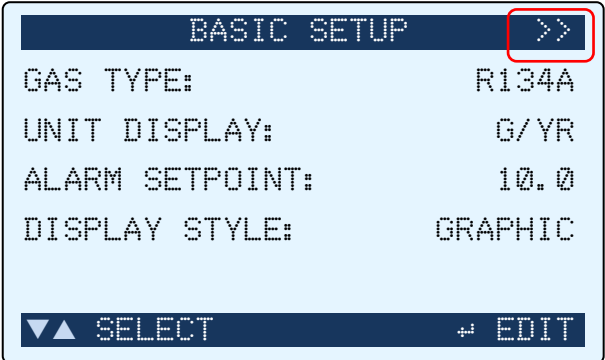

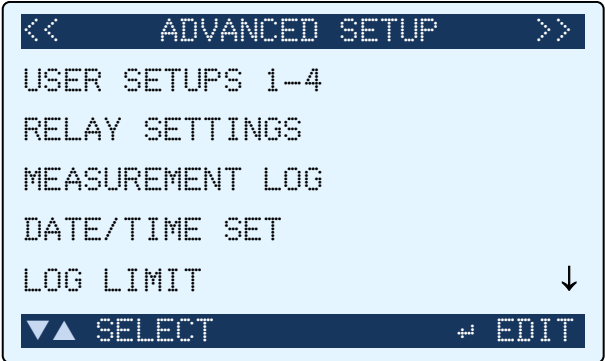

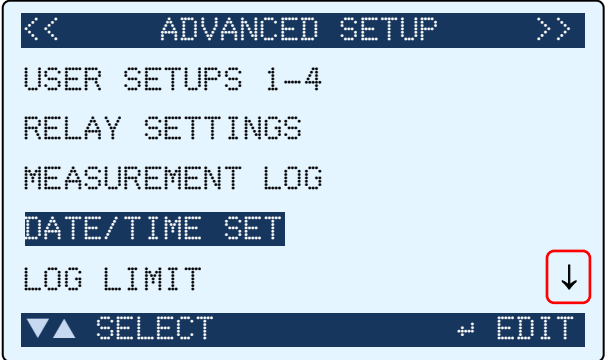

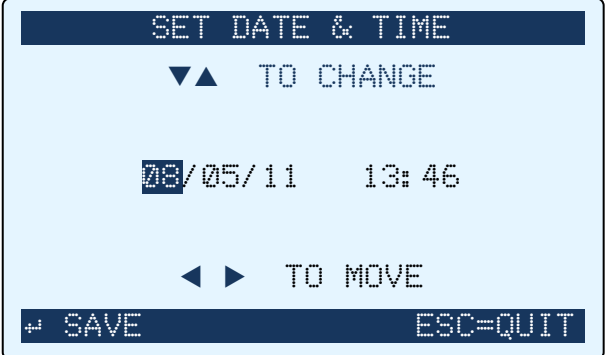
Figure 5-9. Samples of Graphic and Numeric Display Styles

Table 5-13. Changing the Display Style

Step	Button	Description	Sample Screen(s)
1	See Table 5-6 on page 45	Follow the steps in Table 5-6 on page 45 to access the Alarm Setpoint menu option and to display the Edit Alarm Setpoint screen.	
2		Press the Up Arrow and Down Arrow buttons to select the desired Display Style.	
4		Press the ENT button to configure the H25-IR PRO to use the selected Display Style. Pressing ENT returns the user to the previous screen with the selected Display Style in place. Pressing the ESC button aborts the change and maintain the previous Display Style.	

## 5.6. Advanced Setup Screen

Table 5-14. Accessing the ADVANCED SETUP Screen

Step	Button	Description	Sample Screen(s)
1		From the main Search screen or Measure screen, press the SETUP button once to access the Basic Setup screen.	
2		Press the Setup (Right Arrow) button again to access the Advanced Setup screen.	
3		Press the Up Arrow (VOL) and Down Arrow (RANGE) buttons to highlight the desired menu item. Note the small arrow to the right of the menu indicating that additional menu items are available. Use the Down Arrow button to access these menu items.	
4		Press the ENT button to select that item for editing. Note that time is given in 24-hour military format.	



**NOTE:** For detailed instructions on editing menu items in the ADVANCED SETUP screen, refer to the sections that follow.

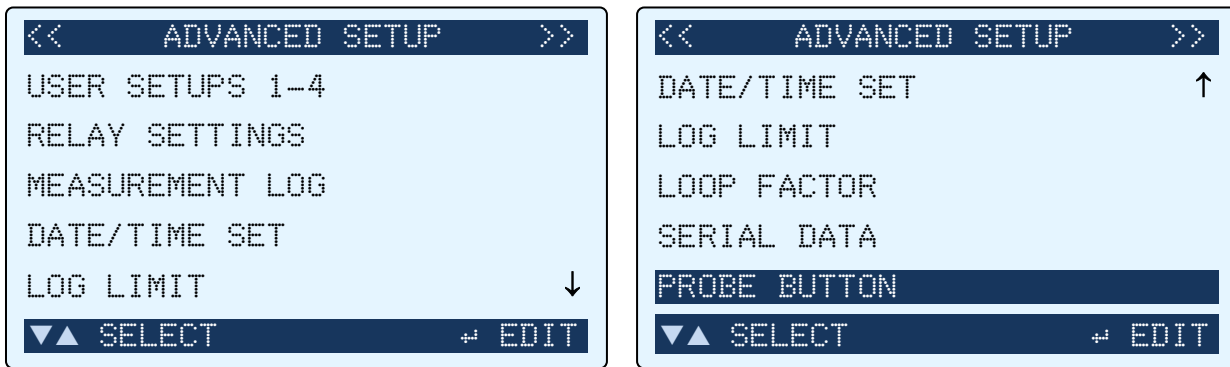


Figure 5-10. Options of the Advanced Setup Screen



**NOTE:** The function of the probe button located on the standard probe can be set through the Probe Button setting of the Advanced Setup menu. The Probe Button setting (see Figure 5-10 above) is only present (at the bottom of the Advanced Setup menu) if a Smart Probe is *not* automatically detected. Refer to section 5.6.8: Probe Button (on page 71) for more information.



**NOTE:** For detailed instructions on editing menu items in the ADVANCED SETUP screen, refer to the sections that follow.

### 5.6.1. User Setups 1-4

User Setups provide a method of customizing up to four distinct configurations of your H25-IR PRO. You can define up to four configurations once and then switch between them much quicker than re-configuring those settings. User Setups are most useful if you change gas types, alarm setpoints, and/or feedback modes frequently.



**NOTE:** Gas Type, Alarm Setpoint, and Feedback Mode settings for User Setups 1-4 are defined in the User Setup 1-4 menus. User Setup 0 (the default user) is defined through settings in the Basic Setup screen.



**NOTE:** If you change settings on the H25-IR PRO every time it is used, and those settings may vary greatly from one application to the next, then the User Setups feature may not offer any significant time savings. Likewise, if your application is always the same (i.e., same gas type, same alarm setpoint, same preference for display style) then the User Setups feature may not offer any significant time savings.

However, if your applications have you searching for and measuring the same 2, 3, or 4 gas types, or have you using the same 2, 3, or 4 alarm setpoints, then setting these once and switching between them very quickly could be useful. In such cases, the User Setups feature may be very convenient and save you time.

**IMPORTANT:** Use the ENT+SETUP button combination to activate one of the pre-defined User Setups (1-4).

Change either the Gas Type or Alarm Setpoint value of the User Setup 0 menu items (from the Basic Setup menu) to cancel the User Setup (1-4) and to begin using User Setup 0 again. In this case, the initial values of Gas Type and Alarm Setpoint will be from the last active User Setup (1-4), over-writing the original User Setup 0 (Basic Setup) values. There is no provision for storing or recalling User Setup 0 values.



To avoid potential confusion, use the diagram in Figure 5-11 to determine whether your applications are best served using *either* User Setup 0 *or* User Setup (1-4). Bacharach recommends using either User Setup 0 (Basic Setup) or User Setup (1-4), but not both. Using, or switching between User Setup 0 *and* User Setup (1-4) may cause confusion, since the Basic Setup Gas Type and Alarm Setpoint are over-written whenever a User Setup (1-4) is activated.



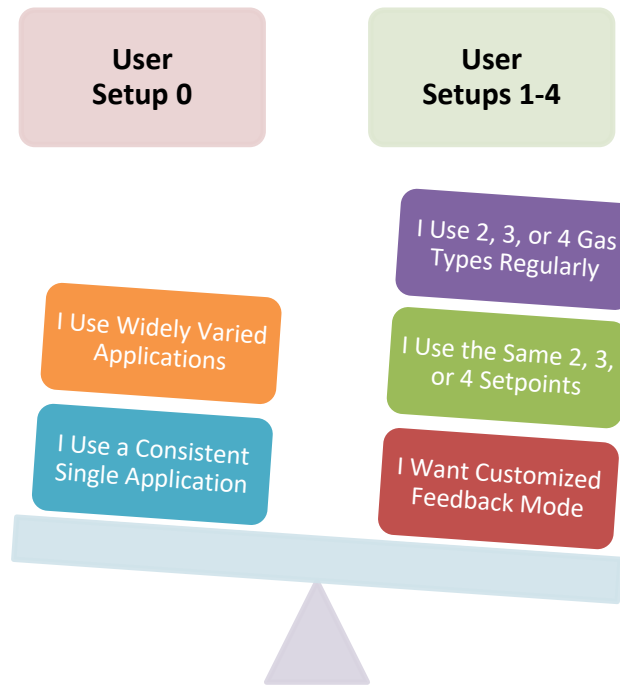




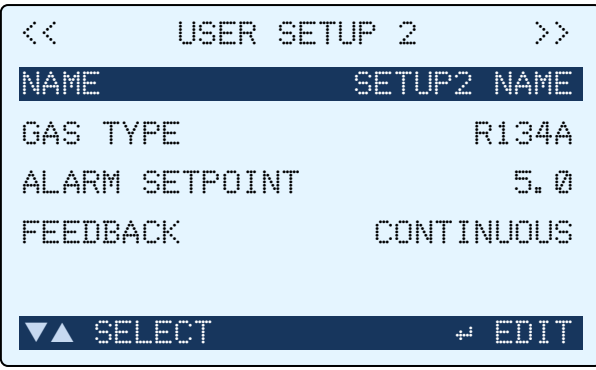

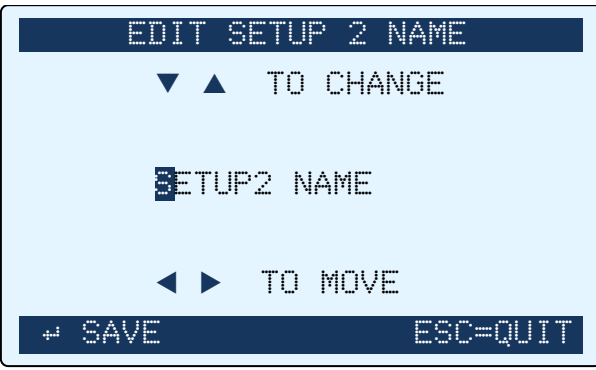




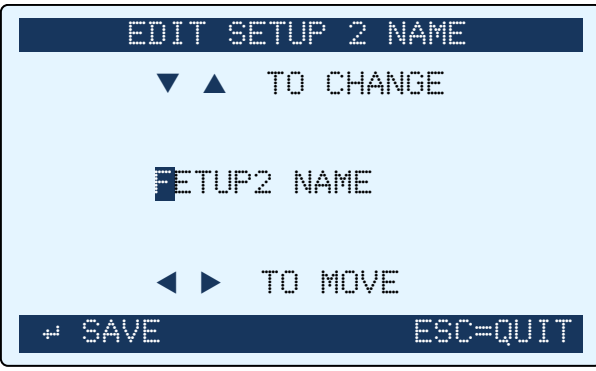




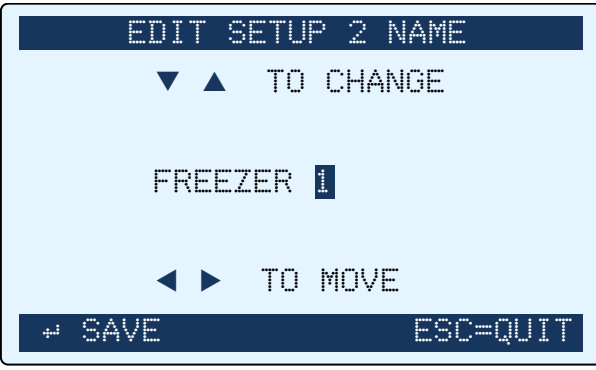



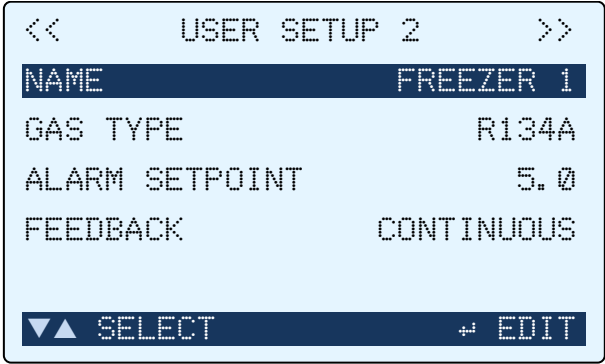
Figure 5-11. Weighing Your Application Needs: When to Use User Setup 0 (Default) vs. User Setups 1-4

Table 5-15. Accessing the USER SETUP Screens 1-4

Step	Button	Description	Sample Screen(s)
1	See Table 5-14 on page 53.	Follow the steps in Table 5-14 on page 53 to access the User Setups 1-4 menu option and to display the User Setup 1 screen.	
2		Press the Left Arrow and Right Arrow buttons to access User Setup Screens 1 through 4.	

Table 5-16. Changing a User Setup Name

Step	Button	Description	Sample Screen(s)
1	   	When the desired User Setup screen is displayed (see Table 5-15 on page 55), use the Up and Down Arrow buttons to select the NAME setting.	
2		Press ENT to select that item for editing.	
3	   	Press the Up Arrow and Down Arrow buttons to increase/decrease (respectively) the highlighted letter.  Press and hold the button to scroll quickly through the letters.	
4	   	Press the Left Arrow and Right Arrow buttons to change position of the selected character. The selected character is the one that is highlighted.  Repeat these last 2 steps for each position in the Setup Name.	

Step	Button	Description	Sample Screen(s)
5		Press the ENT button to save the defined User Name and return to the previous User Setup screen.	



**NOTE:** When a custom setup is active, the name of the setup appears at the bottom of the screen next to the SEARCH / MEASURE indication.

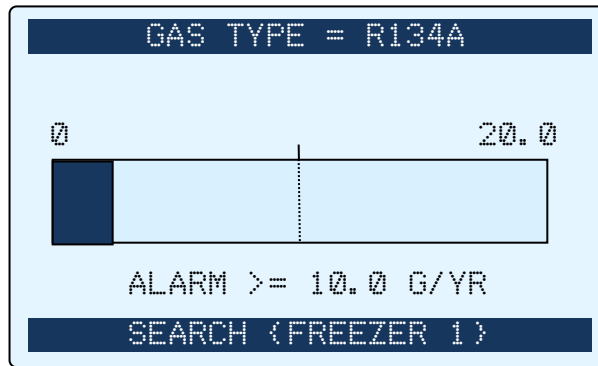


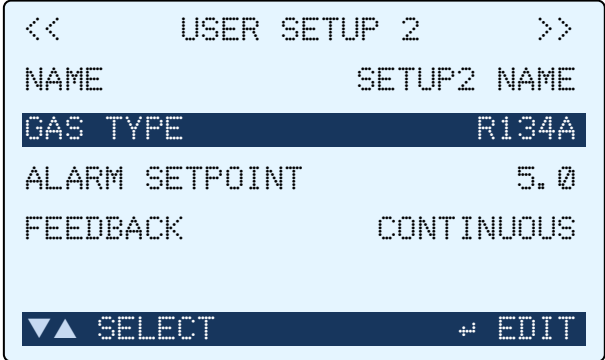


Figure 5-12. Sample Search Screen (with User Setup Active) Showing User Name “FREEZER 1”



**NOTE:** For information on Factory Gas Type configurations, refer to Factory Gas Type Configuration on page 84.

Table 5-17. Changing a User Setup Gas Type

Step	Button	Description	Sample Screen(s)
1	 	When the desired User Setup screen is displayed (see Table 5-15 on page 55), use the Up and Down Arrow buttons to select the GAS TYPE setting.	


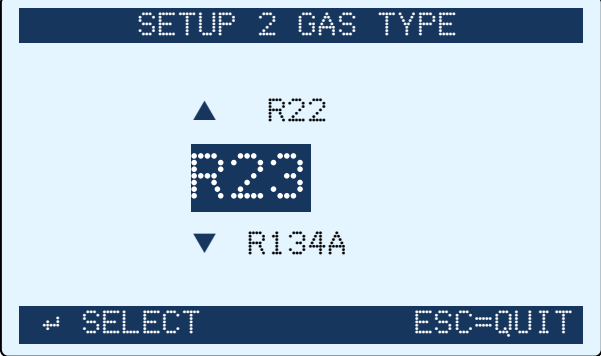




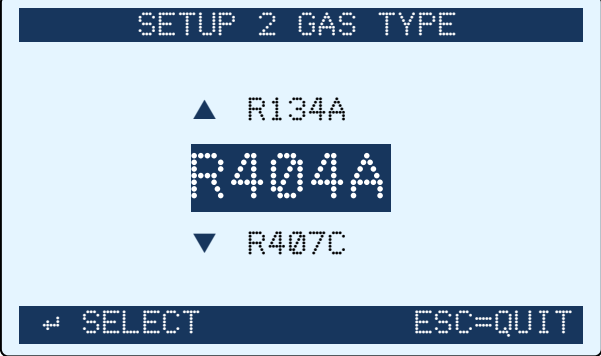

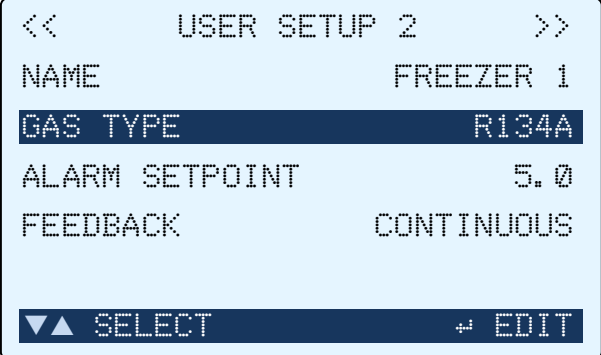




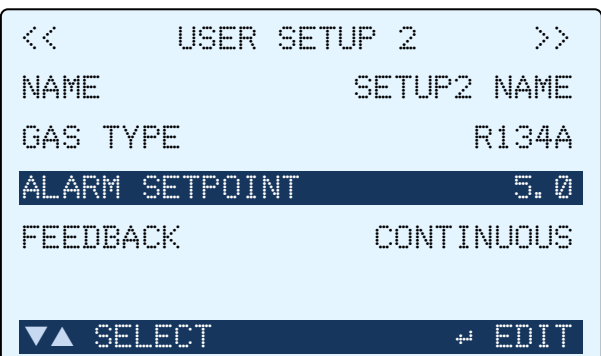
Step	Button	Description	Sample Screen(s)
2		Press <b>ENT</b> to select that item for editing. Note that the unit of measure follows the Basic Setup selection. It is not possible to set different units of measure for each User Setup.	
3	   	Press the Up Arrow and Down Arrow buttons to select the desired Gas Type from the Basic Gas list. Press and hold the button to scroll quickly through the list.	
4		Press the ENT button to save the defined Gas Type and return to the previous User Setup screen.	

Table 5-18. Changing a User Setup Alarm Setpoint

Step	Button	Description	Sample Screen(s)
1	   	When the desired User Setup screen is displayed (see Table 5-15 on page 55), use the Up and Down Arrow buttons to select the ALARM SETPOINT setting.	





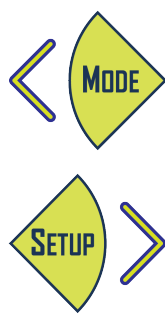


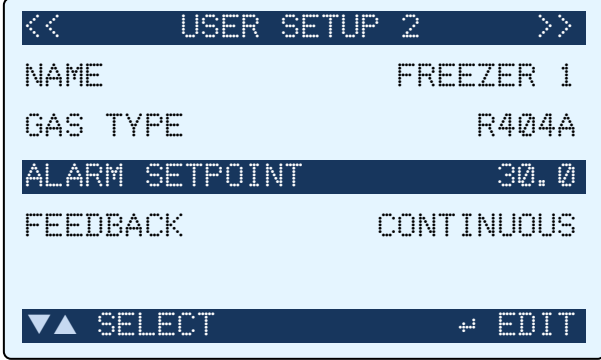




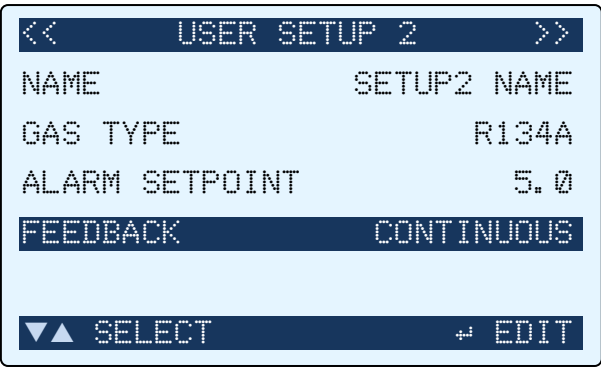

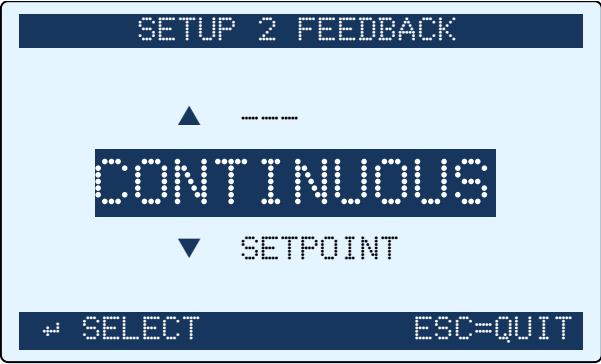




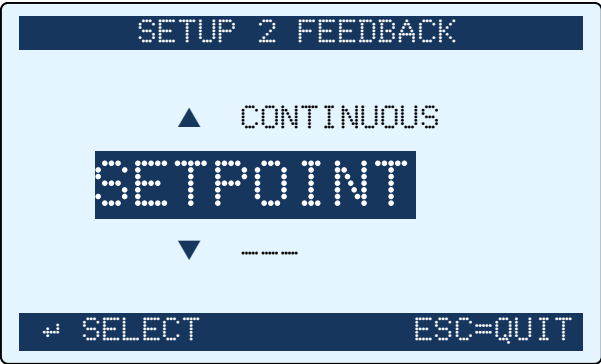

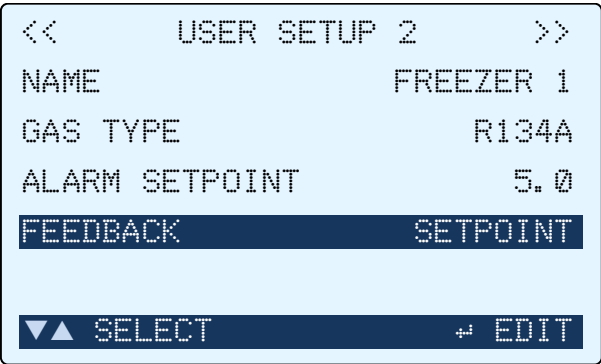
Step	Button	Description	Sample Screen(s)
2		Press <b>ENT</b> to select that item for editing.	
3		Press the Up Arrow and Down Arrow buttons to select the desired Gas Type from the list.  Press and hold the button to scroll quickly through the list.	
4		Press the Left Arrow and Right Arrow buttons (if desired) to change position of the selected digit. The selected digit is the one that is highlighted.  Repeat these last 2 steps until the desired setpoint is reached.	
5		Press the ENT button to save the defined Gas Type and return to the previous User Setup screen.	

Table 5-19. Changing a User Setup Feedback Mode

Step	Button	Description	Sample Screen(s)
1	   	When the desired User Setup screen is displayed (see Table 5-15 on page 55), use the Up and Down Arrow buttons to select the FEEDBACK setting.	
2		Press the ENT button to select that item for editing.	
3	   	Press the Up Arrow and Down Arrow buttons to select the desired Feedback mode from the list.	
4		Press the ENT button to save the defined Feedback type and return to the previous User Setup screen.	



**NOTE:** When Feedback is set to SETPOINT, the audio alarm only occurs when the sampled gas level is at or above the defined Alarm Setpoint value. When set to CONTINUOUS, the audio alarm will sound for any non-zero gas sample. In CONTINUOUS mode, the pitch of the audio alarm will increase and decrease based on the leak rate of the sampled gas.



**NOTE:** To return to the Advanced Setup, press the ESC button.



**NOTE:** From the main Search or Measure screen, use the ENT + SETUP button combination to activate one of the pre-defined User Setups (1-4).



**NOTE:** When a custom setup is active, the name of the setup appears at the bottom of the screen next to the SEARCH / MEASURE indication.

### 5.6.2. Relay Settings Screen







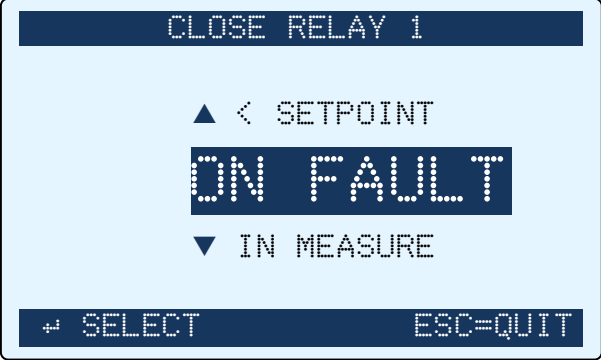

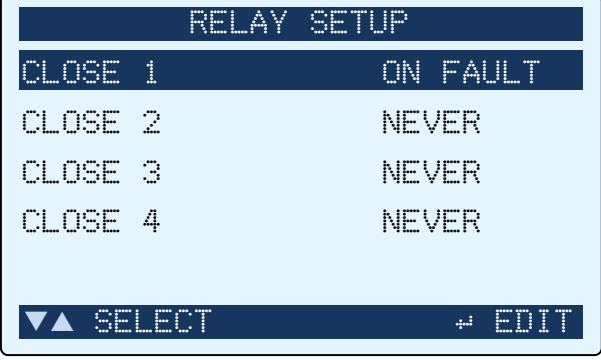
The relay settings screen defines how each of the H25-IR Pro’s four relays function—specifically, when (if) they energize.



**NOTE:** Be sure to read the Relay Connections section in Chapter 4, and properly wire your relay connection(s) for the desired results.

Table 5-20. Accessing the RELAY SETTING Screen

Step	Button	Description	Sample Screen(s)
1	See Table 5-14 on page 53.	Follow the steps in Table 5-14 on page 53 to access the Relay Settings option.	
2	   	Press the Up Arrow and Down Arrow buttons to select the desired relay (1-4).	

Step	Button	Description	Sample Screen(s)
3		Press the ENT button to select that relay for editing (the Close Relay #1-4 screen).	
4	   	Press the Up Arrow and Down Arrow buttons to scroll through the list of functions that define <i>when</i> the relay should be energized (closed).  Refer to Table 5-21 on page 63 for relay setting options and descriptions.	
5		Press the ENT button to select that condition.	



**NOTE:** Repeat the previous steps for each relay you want to activate.



**NOTE:** To return to the Advanced Setup menu, press the ESC button.



Table 5-21. Relay Setting Options

Options	When to Close the Associated Relay's Contact
NEVER	Never
>= SETPOINT	If current reading is greater than or equal to the corresponding ALARM SETPOINT value
< SETPOINT	If current reading is less than the corresponding ALARM SETPOINT value
ON FAULT	If a fault occurs (see Fault Codes on page 78)
IN MEASURE	When the H25-IR PRO is in measure mode
AT LOG LIMIT	If the current reading reaches or exceeds the programmed LOG LIMIT value
SETUP 1 ON	User Setup #1 is active
SETUP 2 ON	User Setup #2 is active
SETUP 3 ON	User Setup #3 is active
SETUP 4 ON	User Setup #4 is active
IF TESTING	The relay is closed if the instrument is operating normally (Search or Measure modes). The relay opens if the menu system is accessed or the instrument experiences a fault.

### 5.6.3. Measurement Log

The Measurement Log is a 50-element array that contains up to 50 log points that you choose. Each log point contains:

- Log point number (e.g., 1 of 50, 2 of 50, etc.)
- Date and time stamp when the log point was collected
- Measured sample rate at that date and time
- The total of all log data samples (used for totalization applications).

The user can scroll through the available data by using the Up Arrow and Down Arrow buttons. For additional information on logging data, refer to Figure 5-8 on page 43 and Table 5-5 on page 44.



**NOTE:** Logging is only possible when the H25-IR PRO is in Measure mode.

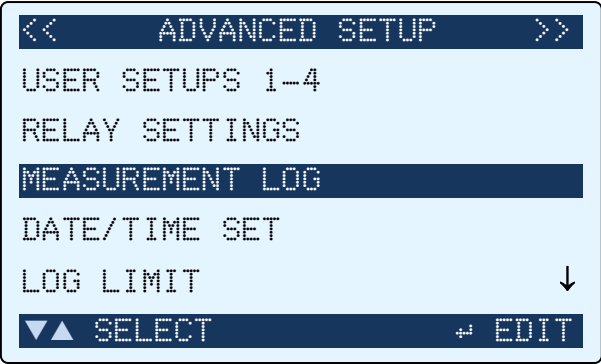

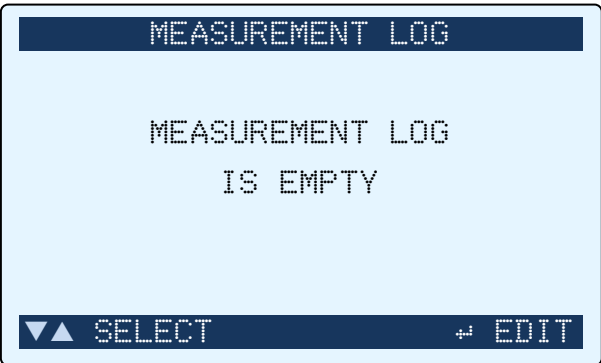

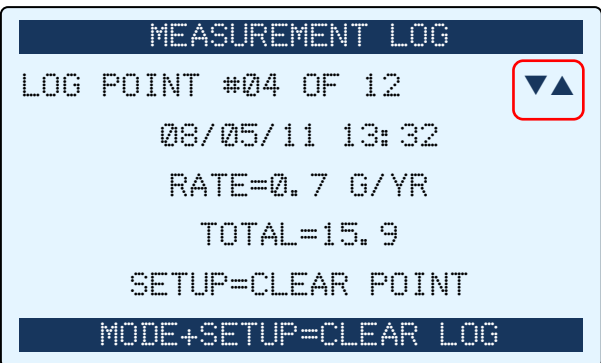


**NOTE:** Use the SETUP button to clear individual log points.



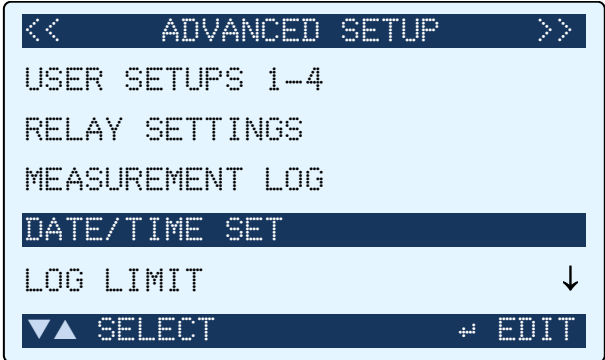

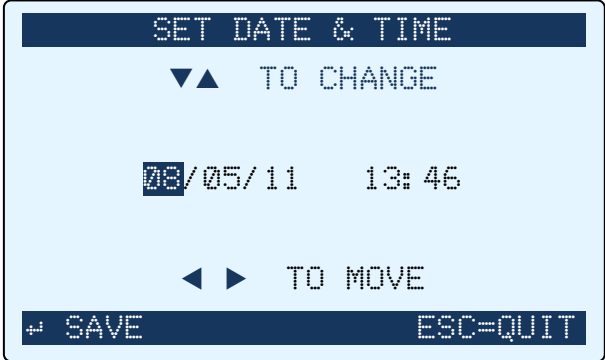

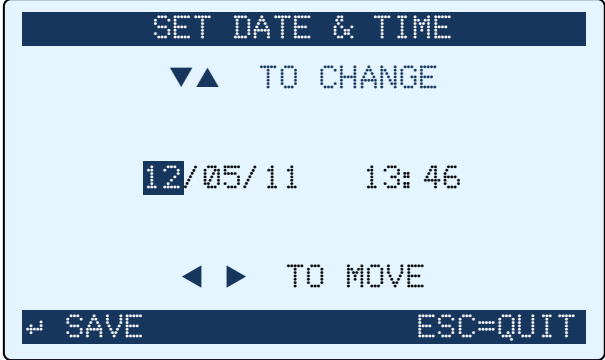
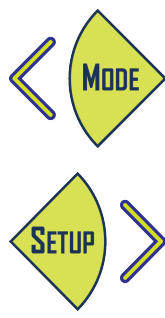
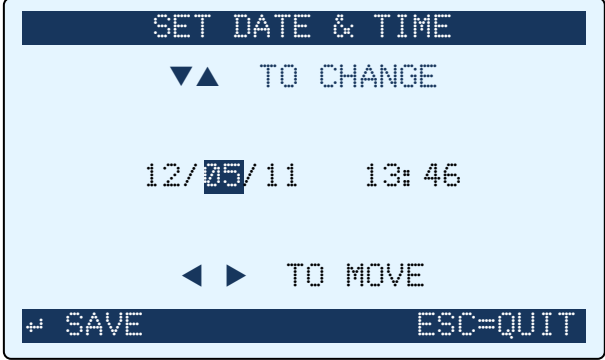
**NOTE:** Use the MODE+SETUP button combination to clear the entire Measurement Log.


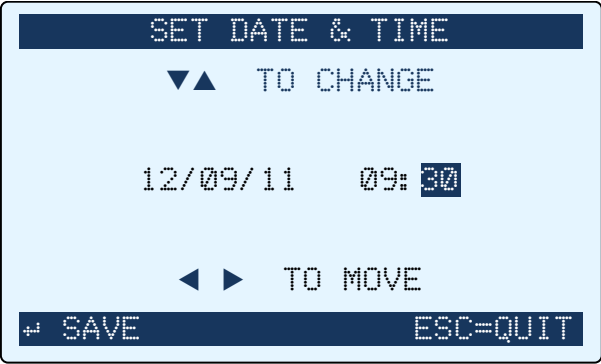
Table 5-22. Accessing the Measurement Log

Step	Button	Description	Sample Screen(s)
1	See Table 5-14 on page 53.	Follow the steps in Table 5-14 on page 53 to highlight the Measurement Log option.	 <p>                 &lt;&lt; ADVANCED SETUP &gt;&gt;                  USER SETUPS 1-4                  RELAY SETTINGS  <b>MEASUREMENT LOG</b>                  DATE/TIME SET                  LOG LIMIT ↓                  ▼▲ SELECT      ↵ EDIT             </p>
2		Press ENT to view the measurement Log. If no log data is present, the message "MEASUREMENT LOG IS EMPTY" is displayed.	 <p>                 MEASUREMENT LOG                  MEASUREMENT LOG                  IS EMPTY                  ▼▲ SELECT      ↵ EDIT             </p>
3		If the measurement Log <i>does</i> contain entries, press the Up Arrow and Down Arrow buttons to scroll through the Log Points.	 <p>                 MEASUREMENT LOG                  LOG POINT #04 OF 12                  08/05/11 13:32                  RATE=0.7 G/YR                  TOTAL=15.9                  SETUP=CLEAR POINT                  MODE+SETUP=CLEAR LOG             </p>

5.6.4. Date/Time Set

Table 5-23. Setting the Date and Time

Step	Button	Description	Sample Screen(s)
1	See Table 5-14 on page 53.	Follow the steps in Table 5-14 on page 53 to highlight the Date/Time Set option.	 <p>                 &lt;&lt; ADVANCED SETUP &gt;&gt;                  USER SETUPS 1-4                  RELAY SETTINGS                  MEASUREMENT LOG  <b>DATE/TIME SET</b>                  LOG LIMIT ↓                  ▼▲ SELECT      # EDIT             </p>
2		Press ENT to view the Set Date & Time screen. Note that dates are given in mm/dd/yy format.	 <p>                 SET DATE &amp; TIME                  ▼▲ TO CHANGE                    08/05/11    13:46                    ◀ ▶ TO MOVE                  # SAVE                      ESC=QUIT             </p>
3		Press the Up Arrow and Down Arrow buttons to change the value of the selected element (in this case, the month field).  Press and hold the button to scroll quickly through the list.	 <p>                 SET DATE &amp; TIME                  ▼▲ TO CHANGE                    12/05/11    13:46                    ◀ ▶ TO MOVE                  # SAVE                      ESC=QUIT             </p>
4		Press the Left Arrow and Right Arrow buttons to select a different element of the date and time. The selected element is the one that is highlighted.  Repeat these last 2 steps until the desired date and time are properly set.	 <p>                 SET DATE &amp; TIME                  ▼▲ TO CHANGE                    12/05/11    13:46                    ◀ ▶ TO MOVE                  # SAVE                      ESC=QUIT             </p>

Step	Button	Description	Sample Screen(s)
5		Press the ENT button to save the new date and time and return to the previous User Setup screen.	



**NOTE:** The Date and Time are used in the Log Point data of the Measurement Log.

### 5.6.5. Log Limit

The Log Limit value is used in totalization applications and in conjunction with the relay outputs. Every time a measurement is logged, its value is accumulated (until the Measurement Log is reset). Relay outputs can be energized if this accumulated value ever exceeds a programmed log limit. The Log Limit is that setpoint.

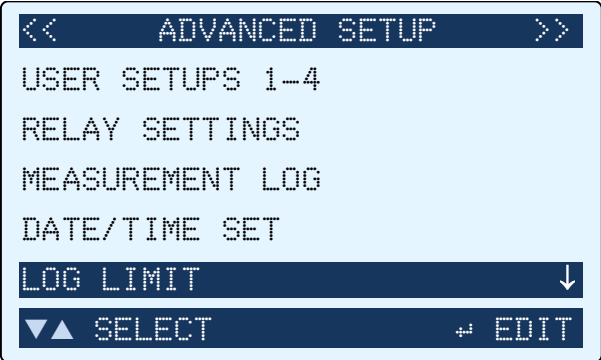



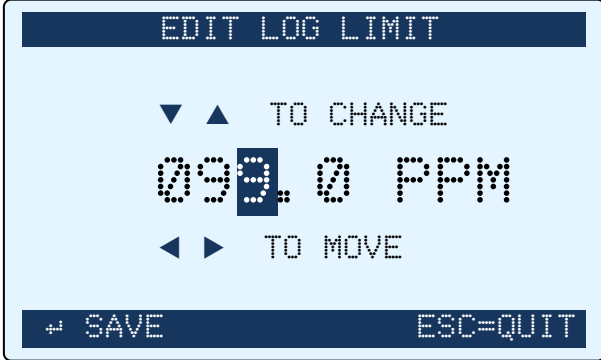

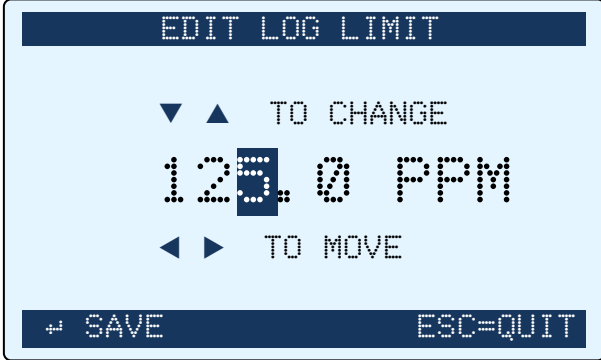
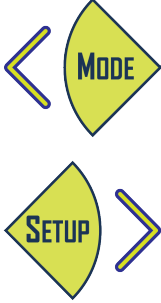
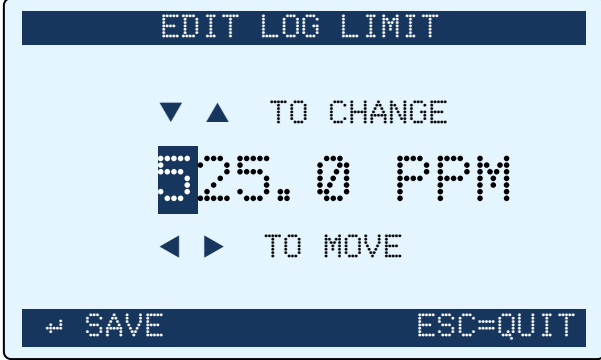

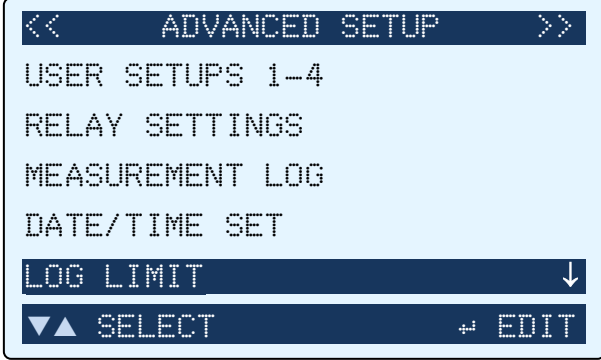
**NOTE:** For additional information on logging data and totalization applications, refer to Figure 5-8 on page 43 and Table 5-5 on page 44.



**NOTE:** For relay configuration information, refer to the AT LOG LIMIT option in Table 5-21 (on page 63).

Table 5-24. Setting the Log Limit

Step	Button	Description	Sample Screen(s)
1	See Table 5-14 on page 53.	Follow the steps in Table 5-14 on page 53 to highlight the Log Limit option.	

Step	Button	Description	Sample Screen(s)
2		<p>Press ENT to view the Edit Log Limit screen.</p> <p>Note that the unit of measure is set in the Basic Setup menu, and is not independently configurable.</p>	
3		<p>Press the Up Arrow and Down Arrow buttons to change the value of the selected digit (note that increasing the value will increment the next significant digit).</p> <p>Press and hold the button to scroll quickly through the list.</p>	
4		<p>Press the Left Arrow and Right Arrow buttons to select a different digit to change. The selected element is the one that is highlighted.</p> <p>Repeat these last 2 steps until the desired date and time are properly set.</p>	
5		<p>Press the ENT button to save the defined Log Limit and return to the previous User Setup screen.</p>	

### 5.6.6. Loop Factor



**NOTE:** The Loop Factor setting configures the 4-20mA current output for the sample range. By default, the standard 4-20mA output is mapped linearly to the input reading range (for example, with “ppm” set as the unit of measure, and a range of 0 ppm to 1000 ppm, each of the 1000 ppm steps corresponds to the default 0.016 mA). This can be adjusted to your particular application using the Loop Factor setting and the following equation.


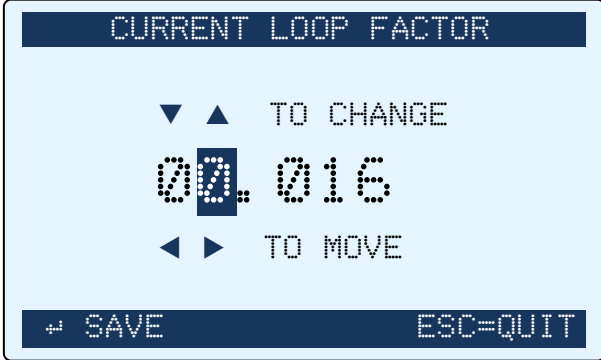

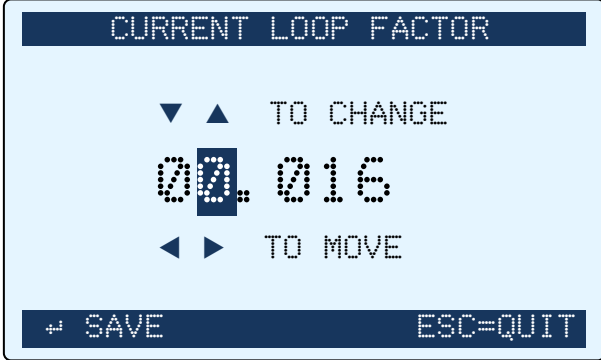
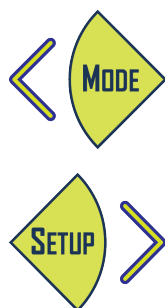
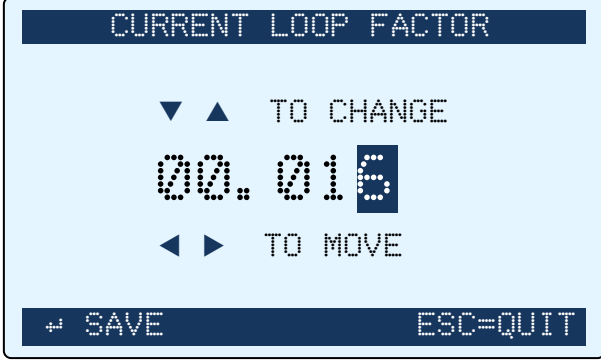

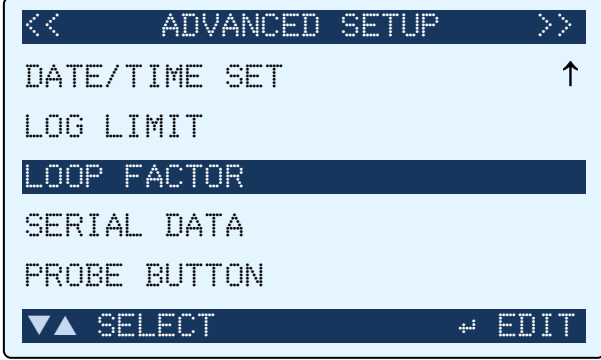
$$\text{Loop Output in mA} = (\text{Loop Factor} \times \text{PPM}) + 4\text{mA}$$

**Table 5-25. Default Loop Factor Mapping Example (0.016 mA = 1 PPM)**

Output	PPM (Default)	Output	PPM (Default)
4 mA DC	0 PPM	13 mA DC	563 PPM
5 mA DC	63 PPM	14 mA DC	625 PPM
6 mA DC	125 PPM	15 mA DC	688 PPM
7 mA DC	188 PPM	16 mA DC	750 PPM
8 mA DC	250 PPM	17 mA DC	813 PPM
9 mA DC	313 PPM	18 mA DC	875 PPM
10 mA DC	375 PPM	19 mA DC	937 PPM
11 mA DC	438 PPM	20 mA DC	1000 PPM
12 mA DC	500 PPM		

**Table 5-26. Changing the Loop Factor**

Step	Button	Description	Sample Screen(s)
1	See Table 5-14 on page 53.	Follow the steps in Table 5-14 on page 53 to highlight the Loop Factor option.	<pre> &lt;&lt;  ADVANCED SETUP  &gt;&gt; DATE/TIME SET           ↑ LOG LIMIT LOOP FACTOR SERIAL DATA PROBE BUTTON ▼▲ SELECT                ↵ EDIT                     </pre>

Step	Button	Description	Sample Screen(s)
2		<p>Press ENT to view the Current Loop Factor screen. The default is set to 0.016.</p>	
3		<p>Press the Up Arrow and Down Arrow buttons to change the value of the selected digit (note that increasing the value will increment the next significant digit). Press and hold the button to scroll quickly through the list.</p>	
4		<p>Press the Left Arrow and Right Arrow buttons to select a different digit to change. The selected digit is the one that is highlighted. Repeat these last 2 steps until the desired Current Loop Factor is set.</p>	
5		<p>Press the ENT button to save the Current Loop Factor and return to the previous User Setup screen.</p>	

### 5.6.7. Serial Data

The Serial Data option provides an automated, high-speed data logging tool. When enabled, the H25-IR PRO sends leak rate data (in ASCII text format) to the RS-232 port 10 times per second. The Serial Data option defines the format of the text data:

- Text packet
- Plain serial text.

These options are summarized below.

**Table 5-27. Serial Data Options**

Serial Data Setting	Description
None	<ul style="list-style-type: none"> <li>• No data is sent to the RS-232 port.</li> </ul>
Text Packet	<ul style="list-style-type: none"> <li>• A 16-character ASCII string is output approximately 10 times per second.</li> <li>• The string is formatted as follows:                      &lt;STX&gt; XX.X,-p.pp&lt;ETX&gt;cc                      where XX.X is the leak rate as displayed on the front panel                      -p.pp is the internal pressure drop in PSI                      cc is a two-byte checksum.</li> </ul>
Text Only	<ul style="list-style-type: none"> <li>• A 10-character ASCII string is output approximately 10 times per second.</li> <li>• The string is formatted as follows:                      XX.X,-p.pp &lt;CR&gt;&lt;LF&gt;                      where XX.X is the leak rate as displayed on the front panel                      -p.pp is the internal pressure drop in PSI                      CR &amp; LF stand for carriage return and line feed</li> <li>• This option is convenient for capture to file using HyperTerminal or similar software.</li> </ul>


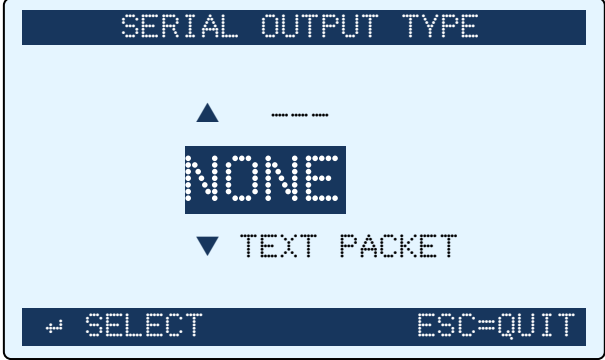

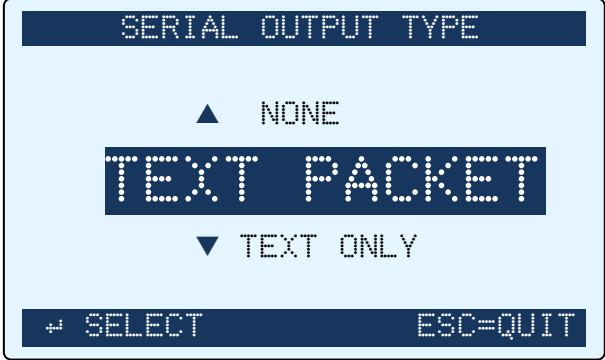


**NOTE:** Be sure to read the RS-232 Communications Connection section in Chapter 4 (page 32), properly connect a computer, and configure data capture utility software. See RS-232 Communications Settings on page 32.

**Table 5-28. Changing the Serial Data Setting**

Step	Button	Description	Sample Screen(s)
1	See Table 5-14 on page 53.	Follow the steps in Table 5-14 on page 53 to access the Serial Data option.	<pre> &lt;&lt;  ADVANCED SETUP  &gt;&gt; DATE/TIME SET          ↑ LOG LIMIT LOOP FACTOR SERIAL DATA PROBE BUTTON ▼▲  SELECT           ↵  EDIT                     </pre>



Step	Button	Description	Sample Screen(s)
4		Press the Up Arrow and Down Arrow buttons to scroll through the Serial Output Type options.	
5		Press the ENT button to select that output type.	

### 5.6.8. Probe Button (Optional)

The H25-IR PRO supports three types of probes:

- Standard Probe with Flex Tubing
- Standard Probe with LED and Push Button
- Smart Probe.

The Smart Probe contains buttons that function the same as the buttons on the front panel. The standard probe (with LED and push button) contains a single programmable button. The Probe Button option defines the function of that single button.



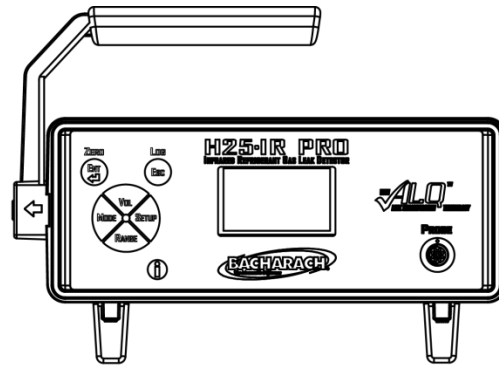
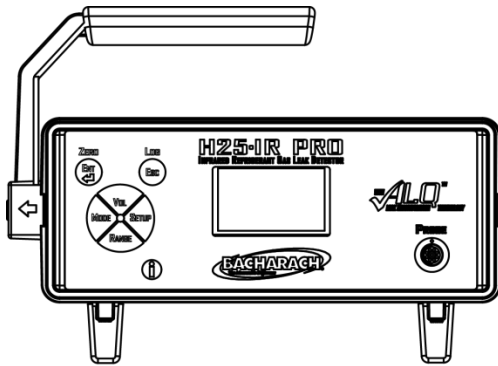
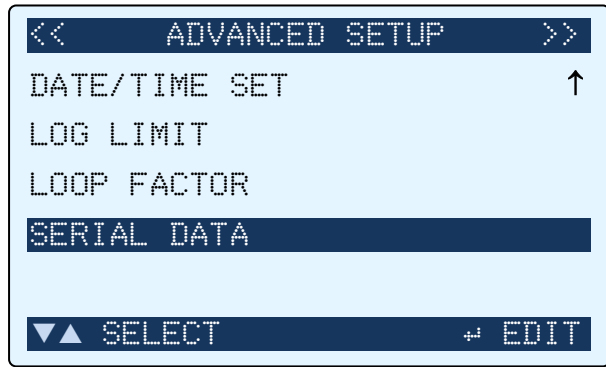
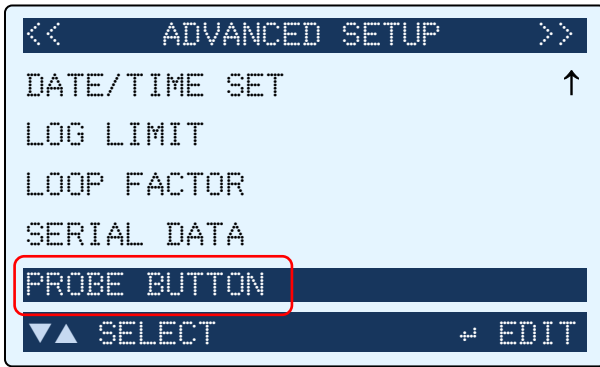
**NOTE:** The buttons on the instrument’s front panel and the Smart Probe are mapped the same and can be used inter-changeably.



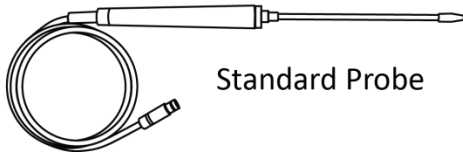
**NOTE:** The function of the probe button can be set through the Probe Button setting of the Advanced Setup menu. The Probe Button setting (see Figure 5-10 above) is only present (at the bottom of the Advanced Setup menu) if a Smart Probe is *not* automatically detected. See Figure 5-13 below.

Table 5-29. Assign Probe Button Options

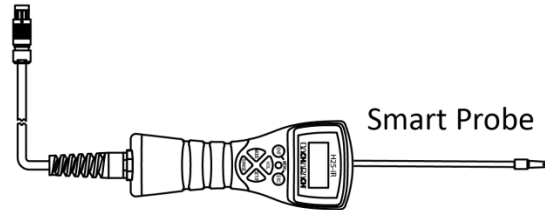
Options	Function of Button on Standard Probe
DISABLED	Button is disabled
MODE KEY	Button toggles mode function between Search and Measurement modes
ENTER KEY	Button has the same function as the ENTER (↵) key on the front panel



Standard Probe with LED and Push Button



Standard Probe



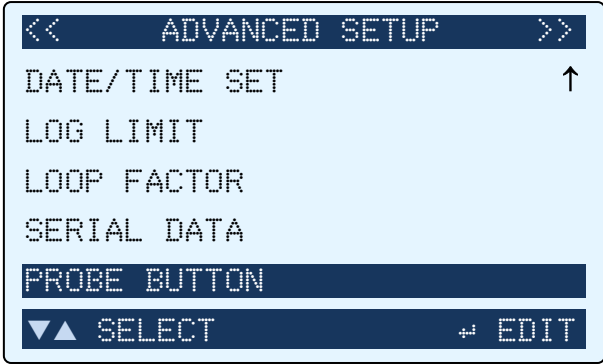

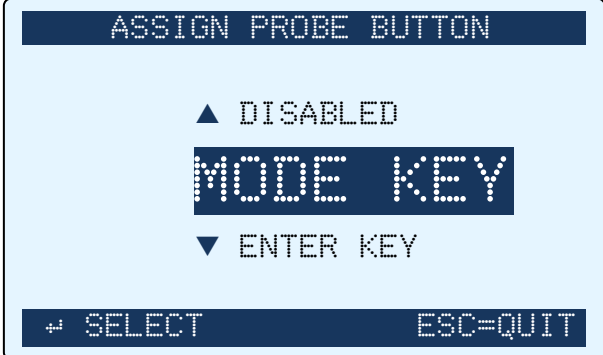

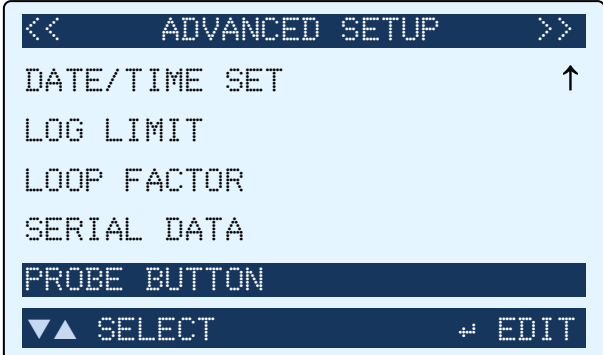
Smart Probe

Figure 5-13. Advanced Setup Screen Without (Left) and With (Right) a Detected Smart Probe




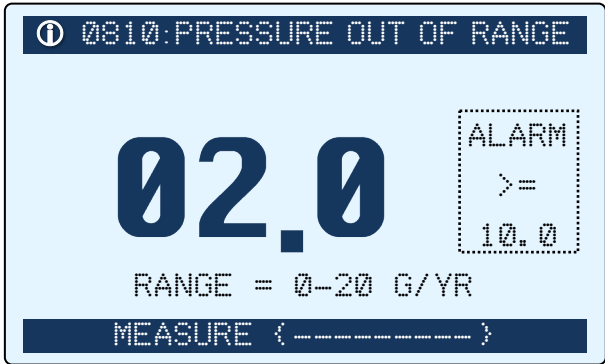

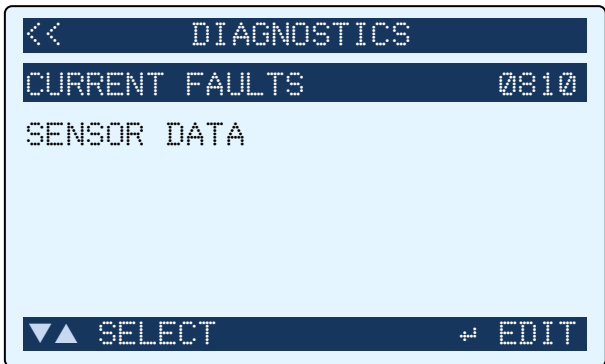

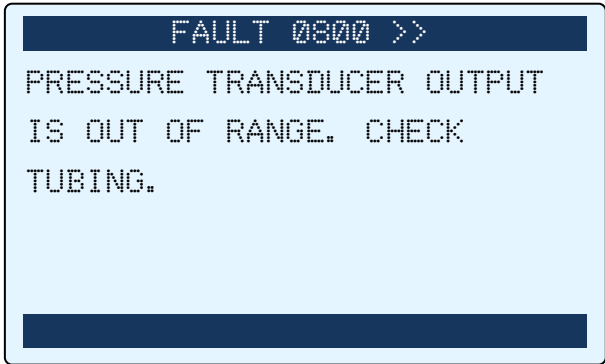

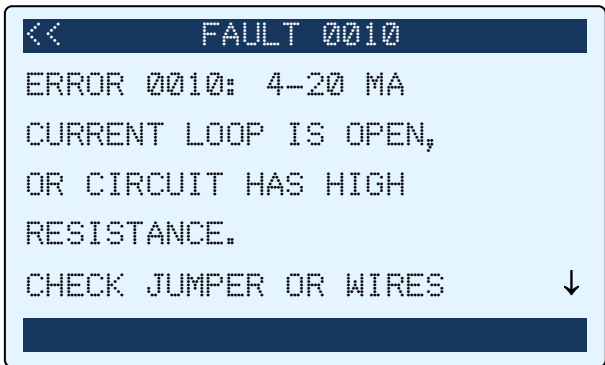
**IMPORTANT:** The H25-IR PRO is factory configured to use the probe with which it is purchased. This factory configuration includes internal wiring connections. If you plan to use a different probe than was shipped with your H25-IR PRO, you must move an internal cable to a different connector. For additional information, refer to Standard Versus Smart Probe Wiring on page 32.


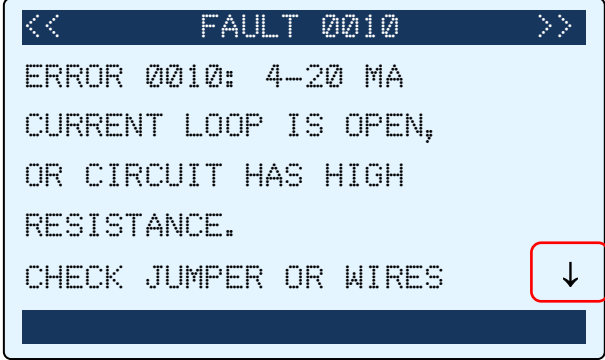
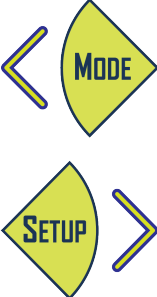
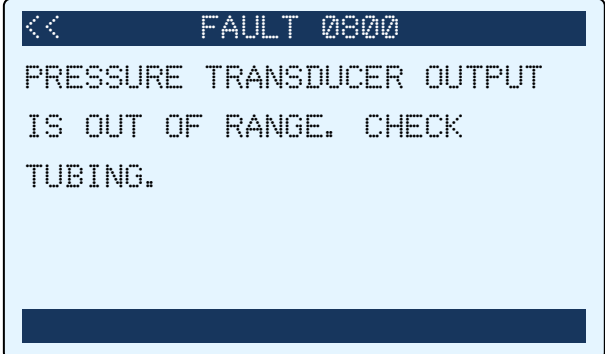
Table 5-30. Changing the Probe Button Setting

Step	Button	Description	Sample Screen(s)
1	See Table 5-14 on page 53.	Follow the steps in Table 5-14 on page 53 to access the Probe Button option.	 <p>                 &lt;&lt; ADVANCED SETUP &gt;&gt;                  DATE/TIME SET ↑                  LOG LIMIT                  LOOP FACTOR                  SERIAL DATA                  PROBE BUTTON                  ▼▲ SELECT      ↵ EDIT             </p>
2		Press the Up Arrow and Down Arrow buttons to scroll through the Probe Button options.	 <p>                 ASSIGN PROBE BUTTON                  ▲ DISABLED                  MODE KEY                  ▼ ENTER KEY                  ↵ SELECT      ESC=QUIT             </p>
3		Press ENT to select desired probe function and return to the Advanced Setup menu.	 <p>                 &lt;&lt; ADVANCED SETUP &gt;&gt;                  DATE/TIME SET ↑                  LOG LIMIT                  LOOP FACTOR                  SERIAL DATA                  PROBE BUTTON                  ▼▲ SELECT      ↵ EDIT             </p>

## 5.7. Diagnostics Screen

Table 5-31. Accessing the Diagnostics Screen (Method #1)


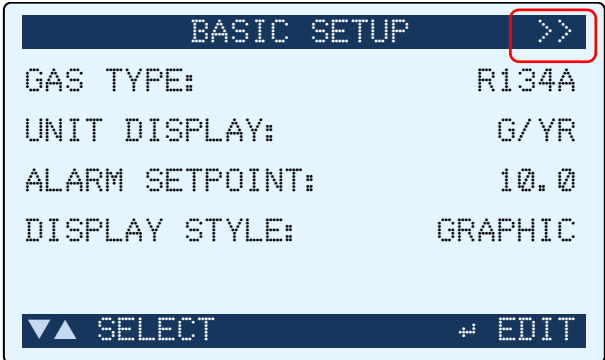
Step	Button	Description	Sample Screen(s)
1		<p>Access the main Search or Measure screen by pressing the ESC button.</p> <p>Check the header for a fault notification.</p> <p>Note that multiple faults may exist, but only the first is displayed.</p>	
2		<p>Press the Info (i) button when the ⓘ icon appears in the header of the main Search or Measure screen. The Current Faults option of the Diagnostics menu is highlighted.</p>	
3		<p>Press the ENT button to select the Current Faults option and display the first fault.</p>	
4		<p>Press the Right Arrow button to view the next fault (if one exists).</p>	


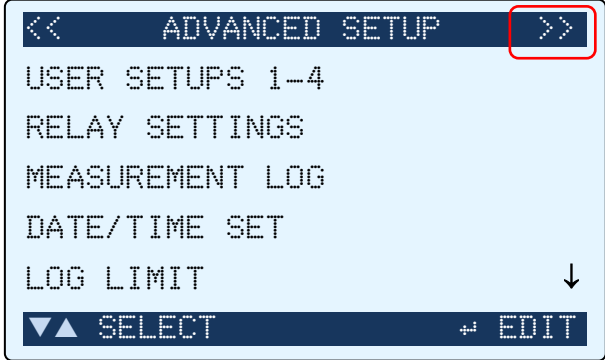

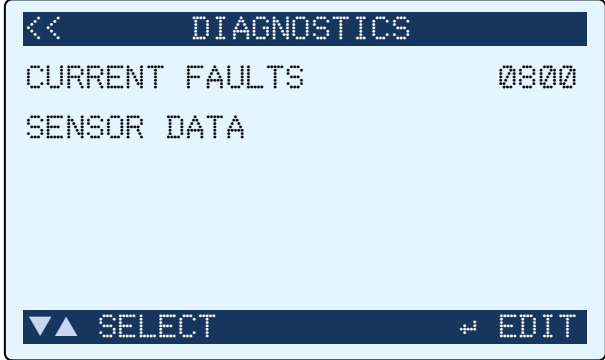

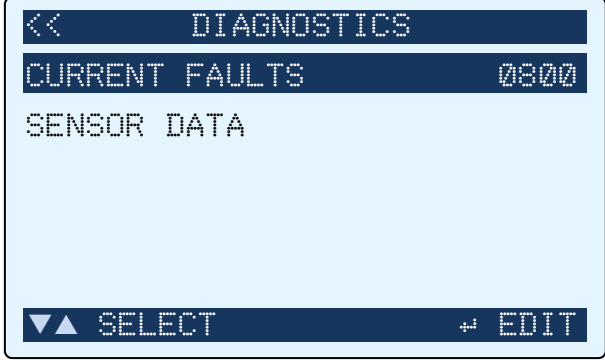

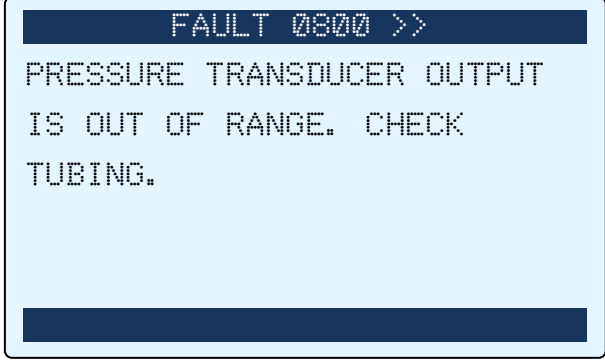
Step	Button	Description	Sample Screen(s)
5		Press the Up Arrow and Down Arrow buttons to scroll through the fault text if it is too long to fit on one screen.	
5		<p>Press the Right Arrow button to view the next fault (if one exists).</p> <p>Use the Left Arrow button to return to the previous fault.</p>	



**NOTE:** If no fault exists, pressing the Info (ⓘ) button displays the Diagnostics screen.

Table 5-32. Accessing the DIAGNOSTICS Screen (Method #2)

Step	Button	Description	Sample Screen(s)
1		From the main SEARCH screen or MEASURE screen, press the SETUP button once to access the BASIC SETUP screen.	

Step	Button	Description	Sample Screen(s)
2		Press the Setup (Right Arrow) button again to access the Advanced Setup screen.	
3		Press the Setup (Right Arrow) button again to access the Diagnostics screen.	
4		Press the Up Arrow (VOL) and Down Arrow (RANGE) buttons to highlight the desired menu item.	
5		Press the ENT button to view that item.	



**NOTE:** For detailed instructions on menu items in the DIAGNOSTICS screen, refer to the sections that follow.



**NOTE:** A fault code of 0000 indicates that there are no current faults.

**5.7.1. Current Faults Screen**

**Table 5-33. Accessing the Current Faults Screen**

Step	Button	Description	Sample Screen
1	See Table 5-32 on page 75.	Follow the steps in Table 5-32 on page 75 to access the Current Faults.	
2		Press the ENT button to view details of the current faults.	
3	 	Press the Right Arrow button to view the next fault (if one exists). Use the Left Arrow button to return to the previous fault.	



**NOTE:** The Info (ⓘ) button can also be used to access the Diagnostics Menu and the CURRENT FAULTS screen.



**NOTE:** The Info symbol (ⓘ) may also be displayed at the banner line on the display when a maintenance condition warranting the users attention occurs.



**NOTE:** The 4-digit fault code is an additive code that can represent multiple fault conditions. The first detected fault is shown on the Search/Measure screen. The Diagnostics screen shows the fault “total”.

Table 5-34. Fault Codes

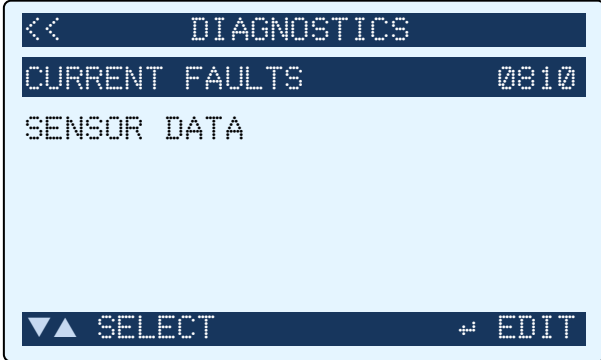

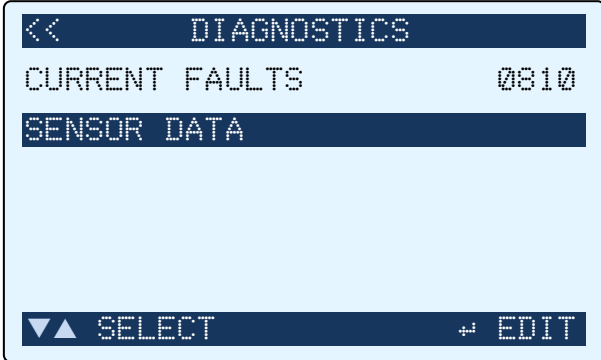

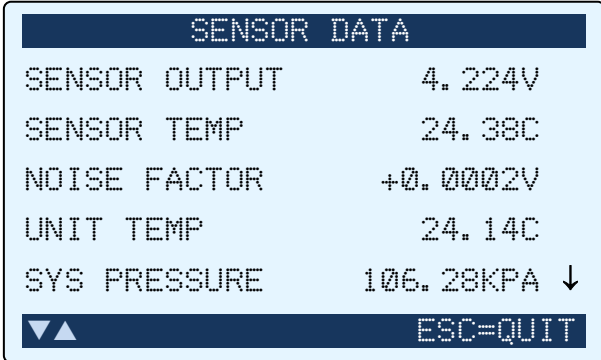

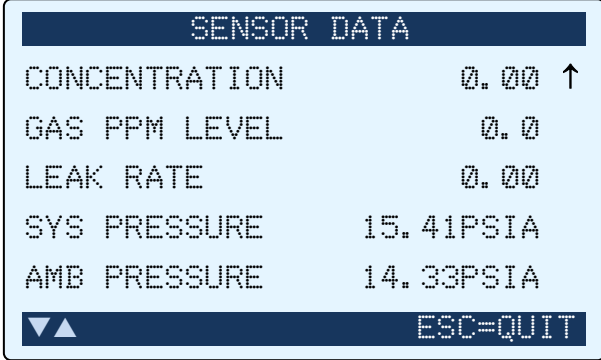
Fault Code	Fault	Message	Cause(s)	Possible Solution(s) or Next Step(s)
0002	Box temp error	UNIT TEMPERATURE IS HIGH: MOVE UNIT AWAY FROM SOURCES OF HEAT	Temp >55	<ul style="list-style-type: none"> <li>Move unit away from sources of heat.</li> </ul>
0004	PSIA sensor error	PRESSURE SENSOR OUTPUT IS OUT OF RANGE EXHAUST OR INLET MAY BE BLOCKED	Pressure <10.0 psia or Pressure >16.7 psia	<ul style="list-style-type: none"> <li>Replace filter (refer to Probe Tip Filter Replacement on page 89 and External Filter Replacement on page 90).</li> <li>Ensure exhaust port is not clogged.</li> </ul>
0008	Mass flow error	MF SENSOR VOLTAGE IS OUT OF RANGE CONTACT FACTORY FOR SERVICE	Sensor out < -0.1V or Sensor out >3.0V	<ul style="list-style-type: none"> <li>Contact factory for service.</li> </ul>
0010	Loop open	4-20MA CURRENT LOOP IS OPEN OR CIRCUIT HAS HIGH RESISTANCE. CHECK JUMPER OR WIRES ON REAR OF UNIT	Loop is "open"	<ul style="list-style-type: none"> <li>Ensure that the wire jumper is in place on 4-20mA output connector.</li> </ul>
0200	DigiPot range error	DIGIPOT RANGE ERROR ADJUST DIGIPOT PER MANUAL TO INCREASE DIGIPOT COUNT	DigiPot range < min value for gas type selected	<ul style="list-style-type: none"> <li>Adjust DigiPot (refer to IR Sensor Adjustment on page 95).</li> </ul>
0400	A/D failure	A/D FAILURE CONSULT BACHARACH SUPPORT AT WWW.MYBACHARACH.COM	No response from A/D converter	<ul style="list-style-type: none"> <li>Contact factory for service.</li> </ul>
0800	Search flow fault	LOW AIR FLOW. CHECK TIP FILTER AND REPLACE, CHECK HOSES FOR BLOCKAGE	In search mode: Flow <550 sccm or Flow >1650 sccm	<ul style="list-style-type: none"> <li>Replace filter (refer to Probe Tip Filter Replacement on page 89 and External Filter Replacement on page 90).</li> <li>Ensure exhaust port is not clogged.</li> </ul>
1000	Measure flow fault	LOW AIR FLOW. CHECK TIP FILTER AND REPLACE, CHECK HOSES FOR BLOCKAGE	In measure mode: Flow <300 sccm or Flow >550 sccm	<ul style="list-style-type: none"> <li>Replace filter (refer to Probe Tip Filter Replacement on page 89 and External Filter Replacement on page 90).</li> <li>Ensure exhaust port is not clogged.</li> </ul>
4000	Zero volt error	SENSOR OUTPUT VOLTAGE IS OUT OF RANGE ADJUST TO 4.2V IN FACTORY MENU	Sensor out <3.9V or Sensor out >4.5V	<ul style="list-style-type: none"> <li>Adjust DigiPot (refer to IR Sensor Adjustment on page 95).</li> </ul>
8000	A/D clipping error	SENSOR OUTPUT IS TOO HIGH, ADJUST TO 4.2V, IN FACTORY MENU SELECT DIGIPOT	Sensor out >4.55V	<ul style="list-style-type: none"> <li>Adjust DigiPot (refer to IR Sensor Adjustment on page 95).</li> </ul>



### 5.7.2. Sensor Data Screen

The sensor data screen is used in troubleshooting the instrument.

**Table 5-35. Accessing the Sensor Data Screen**

Step	Button	Description	Sample Screen(s)
1	See Table 5-32 on page 75.	Follow the steps in Table 5-32 on page 75 to access the Diagnostics screen and the Current Faults option.	 <p>                 &lt;&lt; DIAGNOSTICS                  CURRENT FAULTS 0810                  SENSOR DATA                  ▼▲ SELECT → EDIT             </p>
2		Press the Down Arrow (RANGE) button to highlight the Sensor Data option.	 <p>                 &lt;&lt; DIAGNOSTICS                  CURRENT FAULTS 0810                  SENSOR DATA                  ▼▲ SELECT → EDIT             </p>
3		With the Sensor Data option highlighted, press the ENT button to view Sensor Data details.	 <p>                 SENSOR DATA                  SENSOR OUTPUT 4.224V                  SENSOR TEMP 24.38C                  NOISE FACTOR +0.0002V                  UNIT TEMP 24.14C                  SYS PRESSURE 106.28KPA ↓                  ▼▲ ESC=QUIT             </p>
4		Press the Up Arrow and Down Arrow buttons to scroll through the sensor data.	 <p>                 SENSOR DATA                  CONCENTRATION 0.00 ↑                  GAS PPM LEVEL 0.0                  LEAK RATE 0.00                  SYS PRESSURE 15.41PSIA                  AMB PRESSURE 14.33PSIA                  ▼▲ ESC=QUIT             </p>


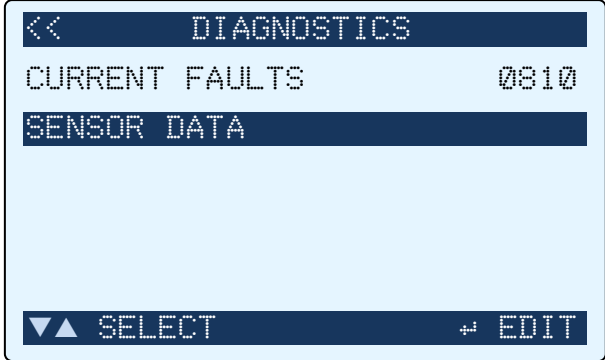
Step	Button	Description	Sample Screen(s)
5		Press the ESC button to return to the Diagnostics screen.	

Table 5-36. Sensor Data Parameters and Sample Values

NEW H25-IR PRO On Screen Name	Sample Value	
SENSOR OUTPUT	4.224V	
SENSOR TEMP	24.38C	
NOISE FACTOR	+0.0002V	
UNIT TEMP	24.14C	
SYS PRESSURE	106.28Kpa	← See below
AMB PRESSURE	98.81Kpa	← See below
MASS FLOW	804SCCM	
ABSORBANCE	0.0000	
CONCENTRATION	0.00	
GAS PPM LEVEL	0.0	
LEAK RATE	0.00	
SYS PRESSURE	15.41PSIA	Represents English (Imperial) unit version of Metric equivalent above.
AMB PRESSURE	14.33PSIA	Represents English (Imperial) unit version of Metric equivalent above.


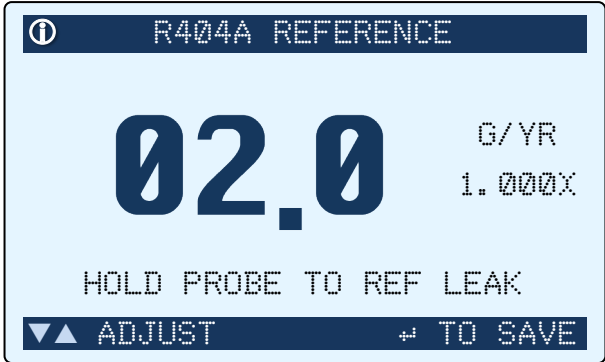




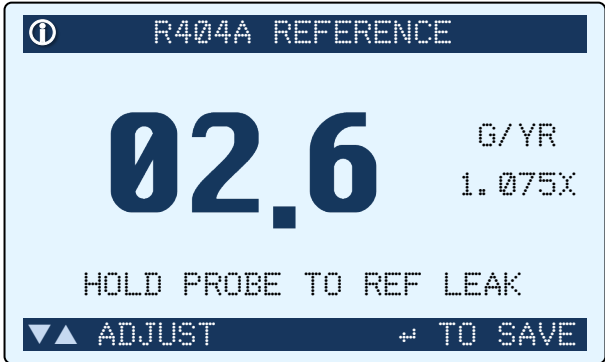
## 5.8. Adjustment to a Known External Leak Source



**NOTE:** Before adjusting the H25-IR PRO to a known external leak source, refer to Using a Reference Leak Source on page 6.


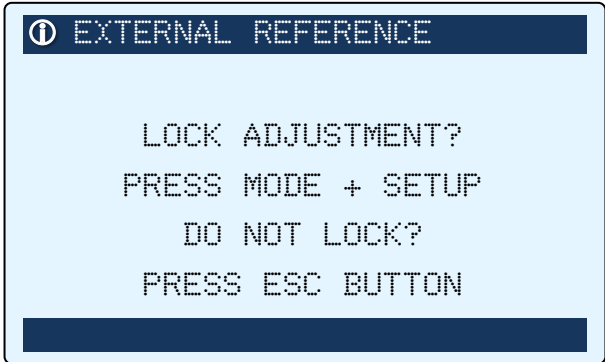

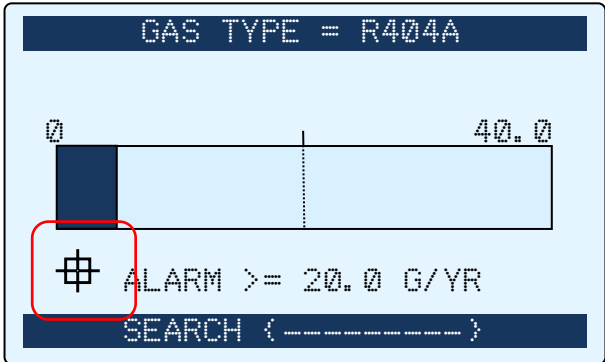
Table 5-37. Adjusting the H25-IR PRO to a Known External Leak Source



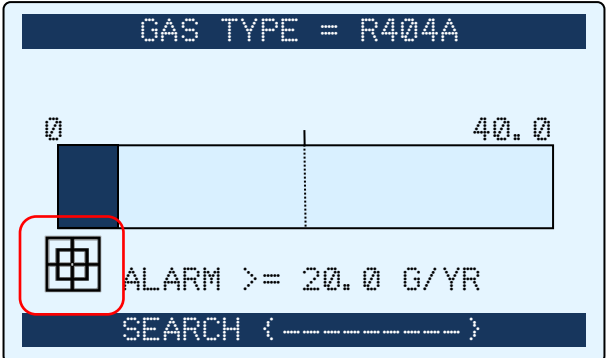
Step	Button	Description	Sample Screen(s)
1		Press and hold the Info (i) button for approximately 5 seconds. Note that a "Clear Adjustment?" prompt is presented if this adjustment was done before and the internal setting does not equal 1.	
2		Press the ENT button to continue. This displays the Reference Gas Type screen.	
3		Use the Up and Down Arrow buttons to highlight the desired reference gas type.	

Step	Button	Description	Sample Screen(s)
4		<p>Press <b>ENT</b> to select the desired reference gas type. This displays the reference screen.</p> <p>At this point, hold the probe to the reference leak source.</p> <p>The timeout for this screen is 5 minutes.</p>	
5	   	<p>Press the Up Arrow and Down Arrow buttons until the displayed (sampled) leak rate matches the leak rate of your external leak source certificate.</p> <p>As the leak rate changes, so does the adjustment coefficient (1.075x in this case).</p>	



**IMPORTANT:** While using this feature, the user is responsible for ascertaining the temperature of the leak source and compensating for the temperature-induced change to the leak reference output.

Step	Button	Description	Sample Screen(s)
6		<p>Press the ENT button when the display rate and leak source rate match.</p> <p>You are then prompted to Lock the Adjustment.</p>	
7		<p>Press the ESC button to exit without locking.</p> <p>Note the crosshair icon that appears on the main screen indicating that an unlocked adjustment is in place.</p>	

Step	Button	Description	Sample Screen(s)
	 +  	<p>Simultaneously press the MODE button and the SETUP button to lock the adjustment. This prevents inadvertent adjustment and tampering.</p> <p>Note the icon that appears on the main screen indicating that a locked adjustment is in place.</p>	

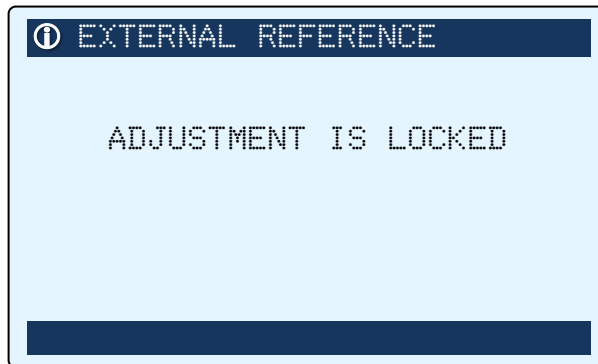


Figure 5-14. Locked Message for Subsequent Attempts at External Adjustment



**NOTE:** When an adjustment is in place and locked, an “ADJUSTMENT IS LOCKED” message will be displayed the next time the operator enters the External Adjustment option by holding the ⓘ button. The user at this screen must unlock the adjustment by pressing MODE + SETUP for 3 seconds to unlock the adjustment. The operator has 1 minute to do this before the screen times out. Pressing ESC will cancel the adjustment routine and return to normal operation.

If the operator correctly unlocks the adjustment, he is presented the normal EXTERNAL REFERENCE start screen, followed by the gas selection screen. If the adjustment wasn’t locked to begin with, this same screen would be presented directly. The user may clear the applied adjustment. Any icons set on the main screens are cleared. Alternatively, the user may continue and set the adjustment to 1.00 to clear the setting.

### 5.9. Custom Gas Type Configuration

For a custom gas type, select CUSTOM from the Basic Gas List (refer to Gas Type Menus and Selection on page 47), and configure the gas using the same procedure used to adjust the H25-IR PRO to a known external leak source that contains the custom gas. Refer to the previous section (Adjustment to a Known External Leak Source) on page 81.



**IMPORTANT:** The customer and/or user is responsible for verifying the response of the H25-IR PRO if the custom gas type option is used.

## 5.10. Factory Gas Type Configuration

Gases listed as “factory gas types” are used less frequently than the more common basic gas types listed in Gas Type Menus and Selection on page 47. Though used less frequently, the large list of supported factory gas types *are* available as H25-IR PRO configuration options, but in a special Factory menu (versus the standard Gas Type menu) to minimize the sheer volume of options in the Gas Type menu.



**NOTE:** The Factory menu has restricted access and is not visible during normal operations. The procedure below details how qualified operators may access the Factory menu. To return the Factory menu to restricted access status, simply cycle the power to the H25-IR PRO.

If you have chosen to use one of these factory gas types (refer to Gas Type Menus and Selection on page 47), the gas type shown in the Gas Type menu will reflect the your gas choice from the Factory menu. Four NDIR sensors are used to support the listed factory gas types. These four NDIR sensors support the following factory gas types:

- R600A and R290.
- CO<sub>2</sub>.
- SF<sub>6</sub>.



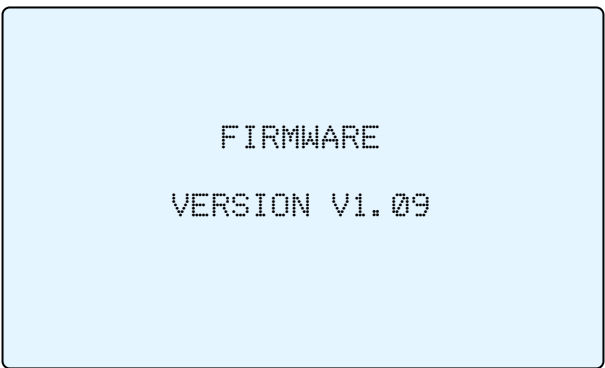


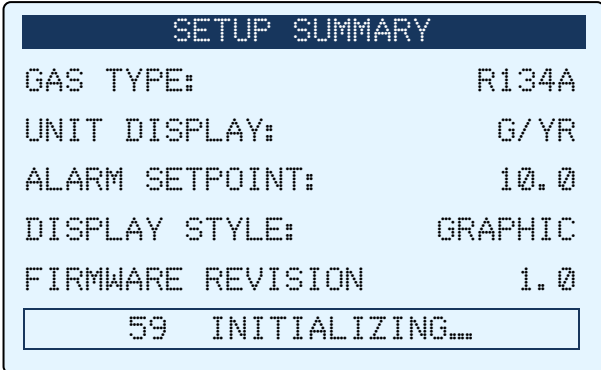
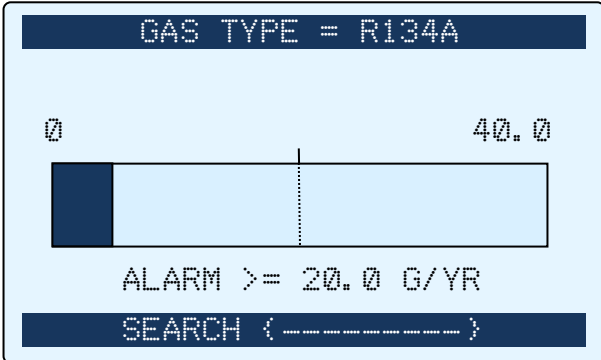

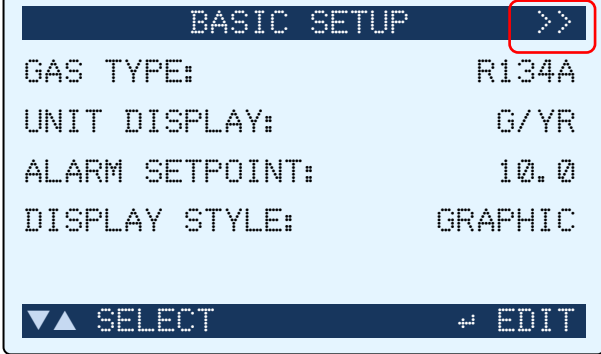

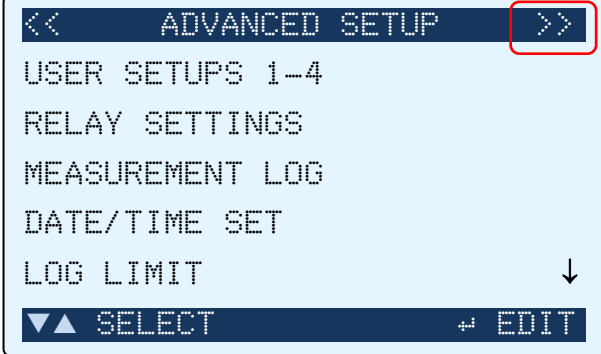
**IMPORTANT:** Configuring the H25-IR PRO for a sample factory gas type requires (a) an appropriate NDIR sensor installed in the instrument, and (b) gas type configuration in the Factory menu. Be sure you ordered an H25-IR PRO with an appropriate NDIR sensor for the corresponding gas you wish to detect.


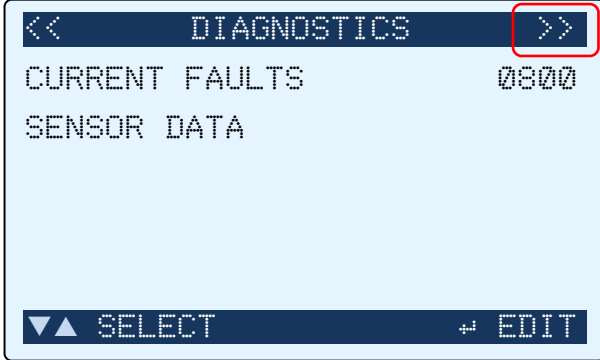

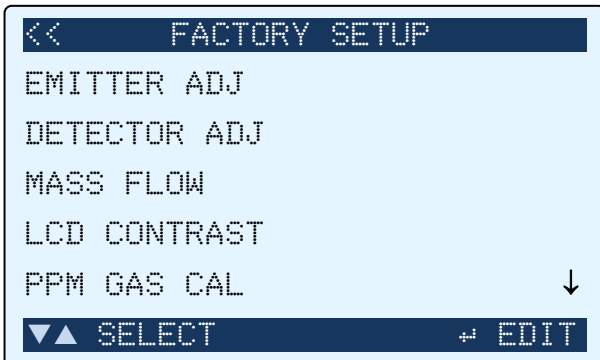

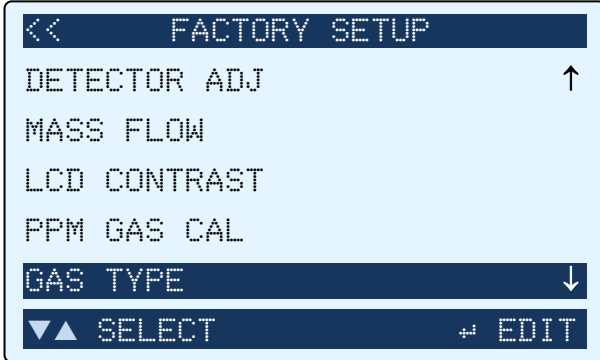

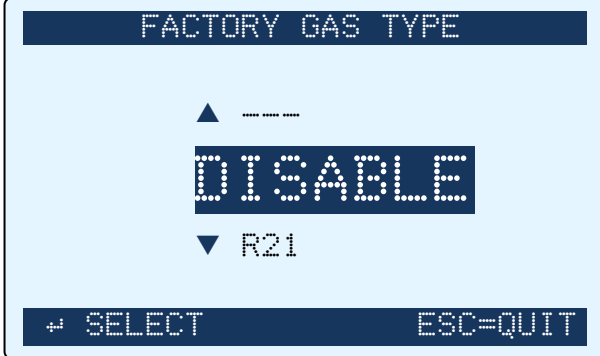


**IMPORTANT:** Though setting your factory gas type is very straightforward, it *does* involve accessing the Factory menu. Arbitrarily changing settings in the Factory menu or deviating from the procedure listed below may produce non-standard operation, cause system failures, and void your factory warranty. Use caution when making changes to the Factory menu.





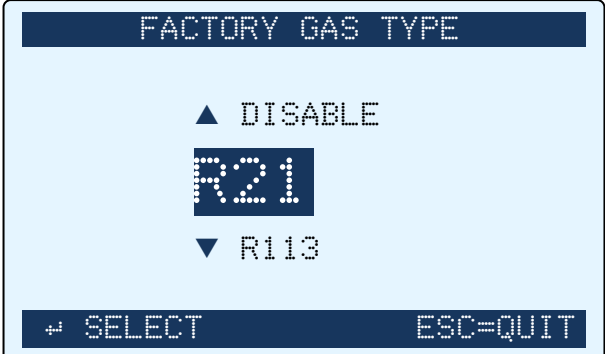

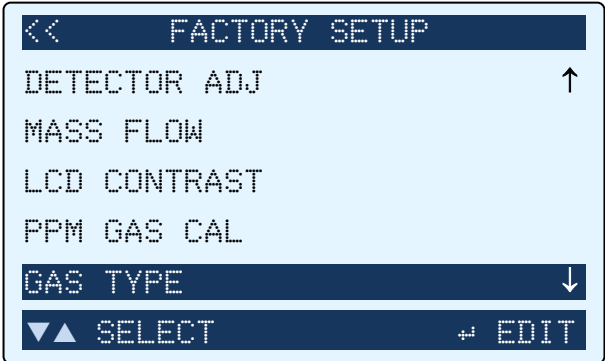


Table 5-38. Configuring the H25-IR PRO to use a Factory Gas Type

Step	Button	Description	Sample Screen(s)
1	 + 	<p>Enable the factory menu. With the instrument OFF, press and hold the ENT button while turning ON the instrument.</p> <p>You will hear a long beep, then the Firmware Version screen is displayed for approximately 15 seconds.</p>	

Step	Button	Description	Sample Screen(s)
2	n/a	The Setup Summary screen is displayed automatically after the Firmware Version screen. This screen displays key setup information and a 60-second initialization countdown.	
3	n/a	After the 60-second countdown, the H25-IR PRO automatically displays the SEARCH MODE screen and is ready for operation with the Factory menu enabled.	
4		From the main Search screen or Measure screen, press the SETUP button once to access the Basic Setup screen. (Notice the right arrows in the header, indicating an additional menu.)	
5		Press the SETUP (Right Arrow) button again to access the Advanced Setup screen. (Notice the right arrows in the header, indicating an additional menu.)	

Step	Button	Description	Sample Screen(s)
6		<p>Press the SETUP (Right Arrow) button again to access the Diagnostics screen. (Notice the right arrows in the header, indicating an additional menu.)</p>	
7		<p>Press the SETUP (Right Arrow) button again to access the Factory Setup screen.</p>	
8		<p>Press the RANGE (Down Arrow) button six (6) times to highlight the Factory Gas Type option.</p>	
9		<p>Press the ENT button to select the Gas Type option and to display the Factory Gas Type screen.</p>	



Step	Button	Description	Sample Screen(s)
10	   	<p>Press the Up Arrow and Down Arrow buttons to scroll through the list of factory gases.</p> <p>Pressing and holding each button scrolls through the list as well.</p>	
11		<p>Press the ENT button to configure the H25-IR PRO for the selected gas.</p> <p>Pressing the ESC button returns the user to the previous screen with the selected factory gas type in place.</p> <p>Pressing the ESC button while in the GAS TYPE menu aborts the change and maintain the previous factory gas type.</p>	
12	 → 	<p>Cycle power. This returns the factory menu to restricted access.</p>	



**NOTE:** The Factory Gas Type menu includes a “DISABLED” option. When this is selected, the primary gas list is used in the Gas Type option of the Basic Setup menu. This is the default condition for the halogen NDIR sensor equipped product.



## CHAPTER 6: MAINTENANCE

### IN THIS SECTION

- Fuse Replacement ..... 88
- Probe Tip Filter Replacement..... 89
- Probe “O” Ring Replacement..... 90
- External Filter Replacement..... 90
- IR Sensor Replacement ..... 92
- IR Sensor Adjustment ..... 95
- Spare Parts and Accessories..... 95
- Firmware Upgrade Procedure..... 96

### 6.1. Fuse Replacement

Table 6-1. Items Required for Fuse Replacement

Item	Description
1	Small flat-blade screwdriver
2	Fuse



**NOTE:** A spare fuse is located in the fuse holder.

Table 6-2. Fuse Replacement Procedure

Step	Description
1	Remove power cord from back panel.
2	Locate fuse compartment.
3	Using a small, flat-blade screwdriver, carefully pry out the fuse holder from the fuse compartment.
4	Inspect the fuse for damage or check its continuity. Remove and discard blown fuse.
5	Use screwdriver to carefully slide out back-up fuse from storage compartment.
6	Move back-up fuse into fuse holder.
7	Replace fuse compartment (flush with back panel to ensure seated properly).
8	Replace power cord.
9	Supply power and turn on the unit to verify operation.
10	Replace the spare fuse as soon as possible with the same type and rating. Refer to Spare Parts and Accessories on page 95 for the part number.

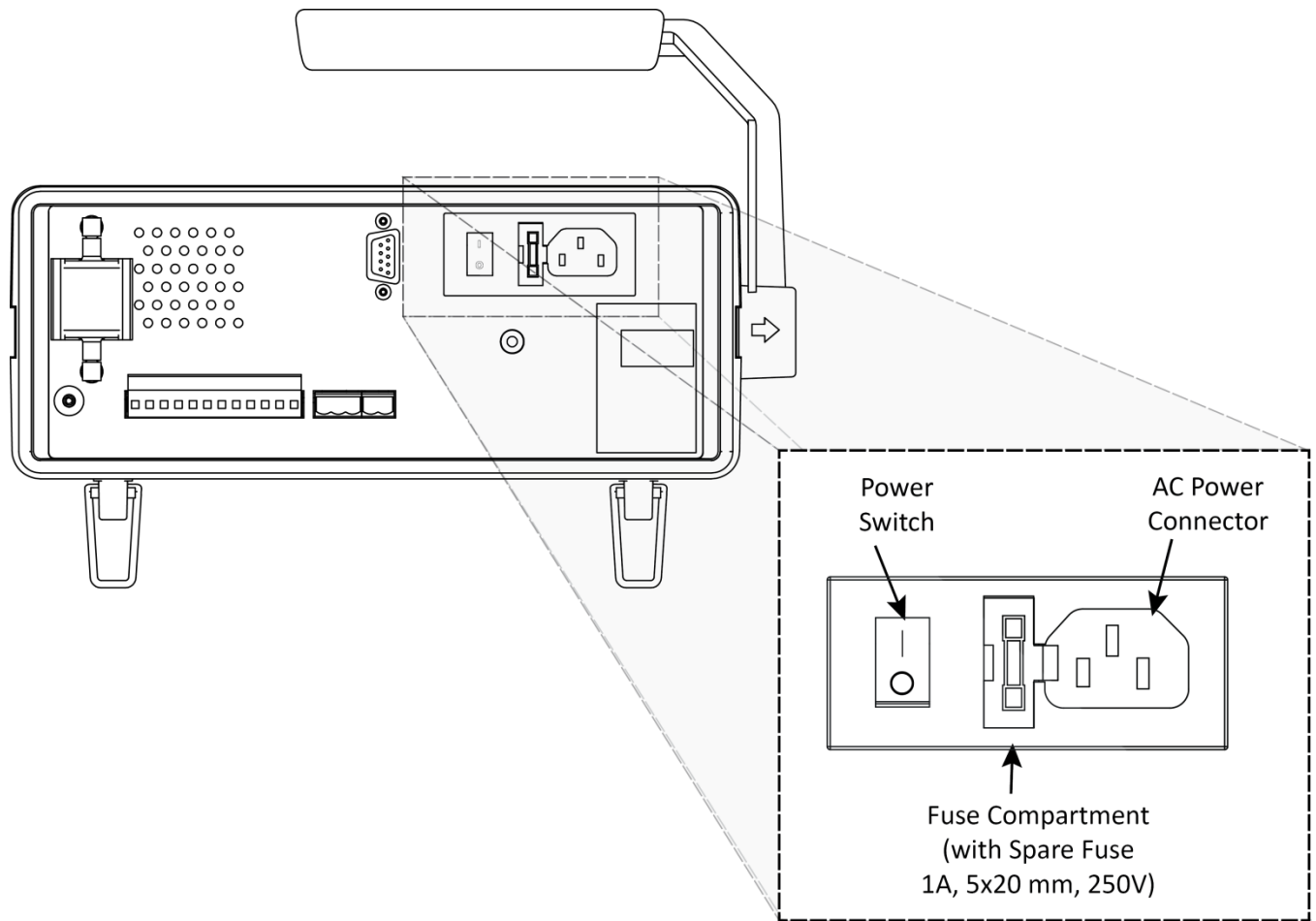


Figure 6-1. Location of Fuse Holder

## 6.2. Probe Tip Filter Replacement

Table 6-3. Items Required for Probe Tip Filter Replacement

Item	Description
1	Probe Tip Filter (diameter: 0.287 in. [7.2 mm]) (Available in bags of 50 from Bacharach. Refer to Probe Tip Filter Replacement on page 89)
2	Pin or tweezers

Table 6-4. Probe Tip Filter Replacement Procedure

Step	Description
1	Unscrew metal tip from flexible probe.
2	Remove filter from inside metal tip using pin or tweezers.
3	Insert new filter into probe tip.
4	Inspect "O" ring. Replace "O" ring if defective. (See Probe "O" Ring Replacement on page 90 for information.)
5	Replace metal tip onto flexible probe.

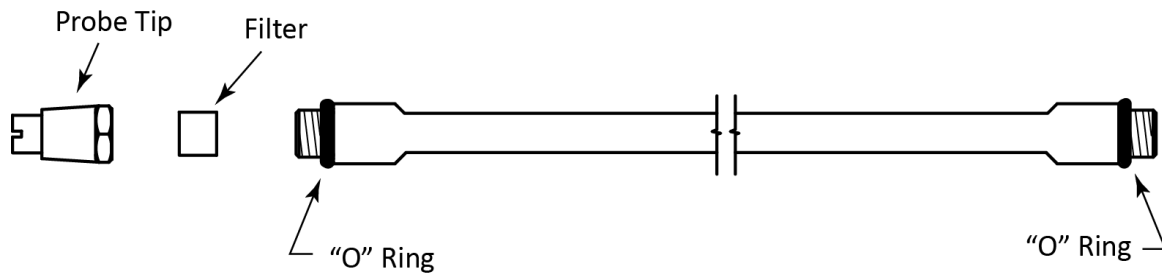


Figure 6-2. Probe Filter and “O” Ring Locations

### 6.3. Probe “O” Ring Replacement

Table 6-5. Items Required for “O” Ring Replacement

Item	Description
1	Probe Tube “O” Rings (2)

Table 6-6. Probe “O” Ring Replacement Procedure

Step	Description
1	Unscrew metal tip from flexible probe.
2	Inspect “O” ring and, if defective, remove and replace with new “O” ring.
3	Replace metal tip.
4	Unscrew flexible probe from probe housing.
5	Inspect “O” ring and, if defective, remove and replace with new “O” ring.
6	Re-attach flexible probe to probe housing.

### 6.4. External Filter Replacement

Table 6-7. Items Required for External Filter Replacement

Item	Description
1	Replacement filter

Table 6-8. External Filter Replacement Procedure

Step	Description
1	Turn off power.
2	Grasp the filter housing and rotate the top back and down, twisting the filter out of the mounting clip. Use caution as the clip has high force. Do not pull the filter away further than 2” (50 mm) from the back of the instrument. If the tubing becomes taut, move the filter closer to the instrument.
3	With the filter free of the clip, disconnect the top tubing from the fitting.
4	Noting its orientation, install the new filter for proper flow of sample gas (the internal white filter membrane is at the bottom of the filter assembly).

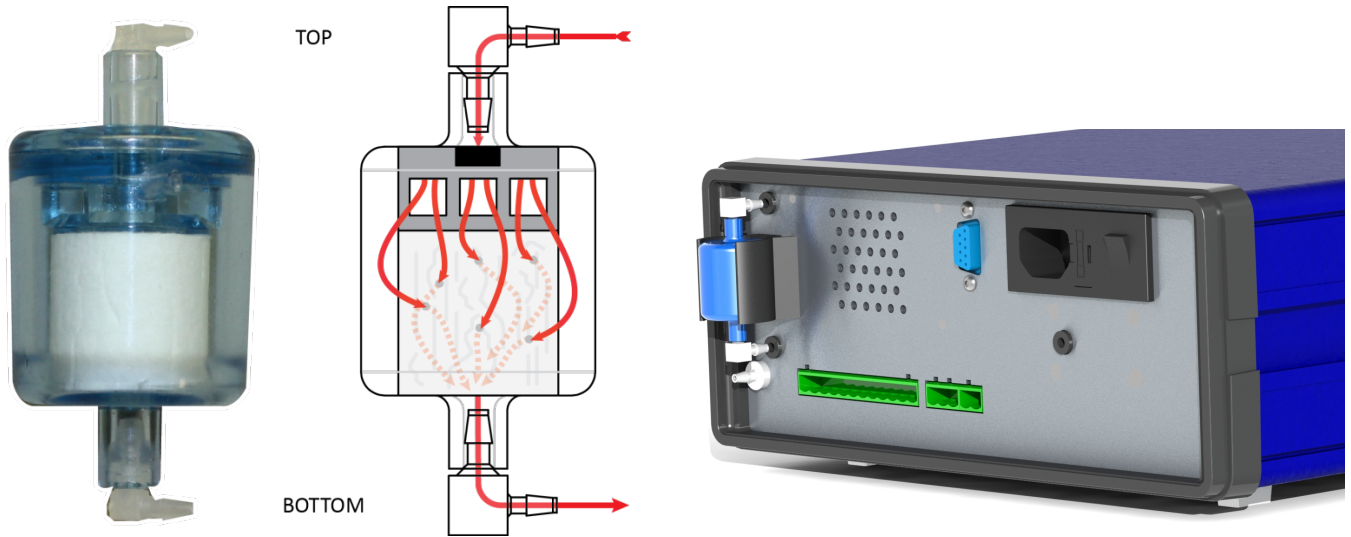


Figure 6-3. Back Panel of the H25-IR Pro Showing Proper Orientation of the External Filter

Step	Description
5	Repeat for the lower tubing.
6	Dispose of the used filter.
7	Install the filter in the opposite manner to removal. Start with the filter at an angle, with the lower part pressed into the clip.
8	Guide the tubing through the rear plate as needed to ensure the tubing isn't kinked.
9	Rotate the filter inward and upward into the clip. As the top of the filter enters the clip it will be strongly pulled in.
10	Double check the tubing, ensuring it is fully seated on the elbow fittings and is not kinked or pinched.

## 6.5. NDIR Sensor Replacement

These instructions describe how to replace the NDIR sensor in the H25-IR PRO Infrared Gas Leak Detector. It is assumed that the user is familiar with the operation and menu system of the H25-IR PRO.

**Table 6-9. Items Required for NDIR Sensor Replacement**

Item	Description
1	Replacement NDIR Sensor Kit which contains NDIR Sensor and 3 cable ties (see table below)
2	Medium Phillips head screwdriver
3	Wire cutter (for removing cable ties)
4	Two sets of needle nose pliers (or equivalent) to release and re-install the tubing clamp


**Table 6-10. Replacement NDIR Sensor Kit**

Model	Sensor Kit	Reference Sensor P/N	Nominal Emitter Power
CFC, HCFC, HFC, and Halogen gases	3015-4501	3015-5086	325 mW
R600, R290	3015-4502	3015-5089	540 mW
SF6	3015-4561	3015-5087	450 mW
CO <sub>2</sub>	3015-4562	3015-5090	450 mW










**NOTE:** Only replacement sensor *kits* are available for sale, *not* individual sensors. As such, the reference sensor part numbers in the previous table are for identification purposes only. For example, to order a replacement kit for your sensor which is labeled model number 3015-5086, place order for kit number 3015-4501.

**Table 6-11. NDIR Sensor Replacement Procedure**


Step	Description
1	Remove both the front and rear bezels by first disengaging the plastic tabs on the right and left sides of the bezel, and then pulling the bezel straight out.
2	Remove the top two screws that secure the front panel, and the top two screws that secure the rear panel.
3	Find the seam at the side of the enclosure nearest the top. Using your fingers gently pry up on one side of the enclosure lid. The lid will disengage and swing upward, leaving the opposite side of the lid engaged. With the lid freely moving in the opposite side, gently lift up the front and rear edges of the lid to fully disengage it. Set it to one side and continue with the replacement.
	
4	Cut off the three cable ties that secure the NDIR sensor to the chassis, and remove the sensor from the

**Figure 6-4. Removing the Top Cover**

Step	Description
	<p>instrument.</p>  <p style="text-align: center;"><b>Figure 6-5. NDIR Sensor Showing Three Cable Ties Removed</b></p>
5	<p>Carefully remove tubing and electrical connectors from old NDIR sensor.</p> <hr/> <p> <b>NOTE:</b> The connection at the back of the NDIR sensor includes a reusable tubing clamp. The clamp is opened by gently prying the ratcheting jaws away from each other (side to side).</p> <hr/> <p> <b>IMPORTANT:</b> Note the position of the cable ties around the NDIR sensor. The rear cable tie secures the NDIR sensor and the tubing. The cable tie passes over a tubing connector to prevent the tubing from being restricted. It is important that the replacement cable tie reproduce the condition at assembly. The middle cable tie is used to route the tubing and is also not fully tight. All three cable ties are not to be fully tightened – <b>DO NOT compress the foam insulation excessively.</b></p>
6	<p>Place new NDIR sensor inside chassis, positioning its 10-pin electrical connector toward the rear of the instrument. Rotate the sensor so that its gas inlet and outlet fittings and its electrical connectors are positioned as shown in Figure 6-6.</p>
7	<p>Remove protective caps from the gas inlet and outlet fittings of the new NDIR sensor.</p>
8	<p>Connect the 12-conductor ribbon cable from IR SOURCE connector J5 on main board to IR SENSOR EMITTER connector (front of instrument).</p>
9	<p>Connect the 10-conductor ribbon cable from DET connector J6 on main board to IR SENSOR DETECTOR connector (rear of instrument).</p>

Step	Description
10	Using the three supplied cable ties, secure the NDIR sensor to the chassis by threading the front and rear cable tie through its cable-tie mount; around the foam insulation that surrounds the NDIR sensor. Place the third cable tie near the middle of the NDIR Sensor, securing the tubing as before. Cut off the cable-tie excess.
11	Connect tubing from pump to the NDIR sensor gas inlet fitting, and connect the NDIR sensor gas outlet fitting to the tubing disconnected earlier. Re-install the tubing clamp by squeezing the jaws closed with pliers.
12	<p>IR emitter adjustment.</p> <hr/>  <p><b>WARNING:</b> SHOCK HAZARD. When performing the following step, be careful not to come in contact with AC voltages when working inside the instrument with the cover off and AC voltage applied.</p> <hr/>
13	Reconnect the AC power cord, and then turn the instrument ON while holding down the front panel ENT button to enable the Factory menu.
14	Wait until the instrument warms up and the User Display screen appears before proceeding (60 seconds).
15	Press the SETUP button to access the Basic menu, then press it again 3 more times to enter the Factory menu.
16	<p>Select the emitter adjustment option using the front navigation keys and press ENT. Make the adjustment by using the VOL and RANGE buttons to change the power setting to the Nominal Emitter Power value presented in the table at the beginning of these instructions (<math>\pm 10</math> mW). Press ENT to save the adjustment and return to the Factory menu.</p> <hr/>  <p><b>IMPORTANT:</b> The instrument will automatically adjust the NDIR Sensor detector at power up based on the IR Emitter setting. It is possible that the IR Emitter setting is too large or too small, which will prevent the automatic adjustment from succeeding. If a <i>0200 DigiPot Range</i> fault is reported by the instrument, reduce the IR Emitter power setting by 25 mW. If a <i>4000 Zero Volts</i> fault is reported, increase the IR Emitter power setting by 25 mW. Repeat if needed to lower or raise the IR Emitter power another 25 mW if required. It is more typical to lower the value than to raise it.</p> <hr/>
17	<p>IR detector adjustment. After adjusting the IR Emitter, select the Detector adjustment in the Factory menu and press ENT.</p> <hr/>  <p><b>IMPORTANT:</b> When performing the following step, the instrument <b>must</b> be sampling fresh air (zero gas) when adjusting the detector value.</p> <hr/>
18	<p>Use the Up and Down Arrow buttons to adjust the value until the reading is <math>4.20 \pm 0.05</math> volts (count range of 130-240). Press ENT to save the new value.</p> <hr/>  <p><b>IMPORTANT:</b> If the adjustment does not reach 4.20 volts then return to step 16 to lower the IR Emitter setting as noted; next, repeat the Detector adjustment. An IR DIGIPOT setting of up to 450 mW is acceptable. If higher power is required, it may indicate a contaminated bench. In this case, contact Bacharach Technical Support for guidance.</p> <hr/>
19	Press ESC two times to return to the User Display screen. Confirm that no faults are indicated (top of display).



Step	Description
20	Turn OFF instrument and remove the AC power cord. <hr/>  <b>NOTE:</b> Turning off the instrument returns the Factory menu to restricted access.
21	Once the unit is reassembled, reconnect the AC power cord and turn it back on. Allow it to complete the warm up (60 seconds) and confirm no faults are displayed. This completes replacing the NDIR Sensor.

## 6.6. NDIR Sensor Adjustment

It may become necessary to adjust the emitter and detector components of the NDIR sensor without actually replacing the NDIR sensor. Such instances may present themselves as clipping faults (fault code 8000), DigiPot range errors (fault code 0200), and other faults. If you suspect a sensor adjustment may be in order, or if you are directed to adjust your NDIR sensor's DigiPot settings by a Bacharach service representative, then use the *IR Emitter Adjustment* and *IR Detector Adjustment* components of the NDIR Sensor Replacement procedure found in the previous section.



**NOTE:** "DigiPot" is a shortened version of *digital potentiometer*. The H25-IR PRO uses DigiPots to simplify certain configuration processes by integrating the manual tweaking process of an internal potentiometer into the user interface. If, for example, minor adjustments need to be made to the NDIR sensor power settings, the operator can use the front panel buttons and display panel to make the adjustments (versus opening the case, attaching a voltmeter to test points on the printed circuit board, and tweaking a potentiometer with a small screwdriver).

## 6.7. Spare Parts and Accessories

Table 6-12. Spare Parts and Accessories

Part Number	Description
3015-5668	O-Ring Kit, H25IR-Pro
3015-5818	External Filter Kit, H25IR-Pro (Includes 5 coalescing filters)
3015-5135	Probe Tip Filters (Qty 50)
3015-5099	Replacement Probe Tip
3015-5137	Replacement 8" Flexible Probe Gooseneck Assembly
3015-4670	Bezel, Case
4998-8986	Power Cord, USA (Type B)
0304-3462	Power Cord, India (Type D)
3015-5638	Power Cord (China)
0204-0020	Battery, Clock Backup
0604-2611	Fuse, 1A, Slow Blow (each)
See Table 6-10 on page 92	IR Sensors

## 6.8. Firmware Upgrade Procedure

As updates to the instrument's firmware become available, the instrument can be upgraded by using the procedure below.



**NOTE:** The firmware upgrade procedure is sometimes referred to as *flashing memory*.



**Table 6-13. Items Required for Upgrading Firmware**

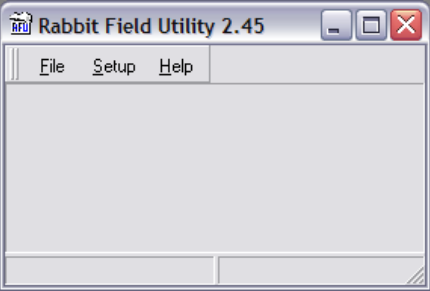
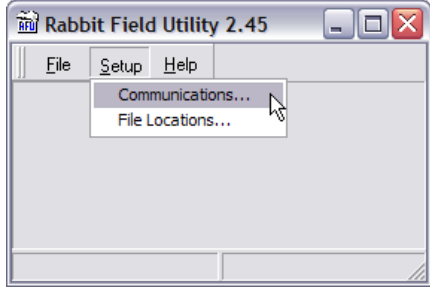

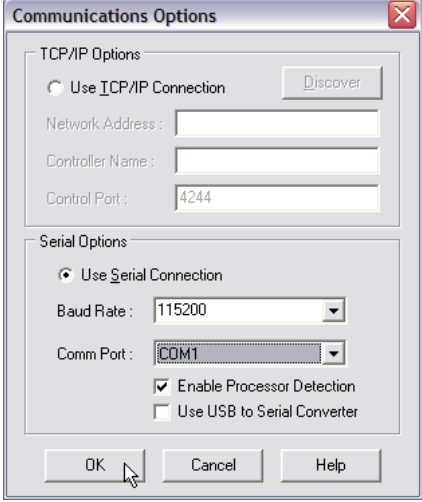
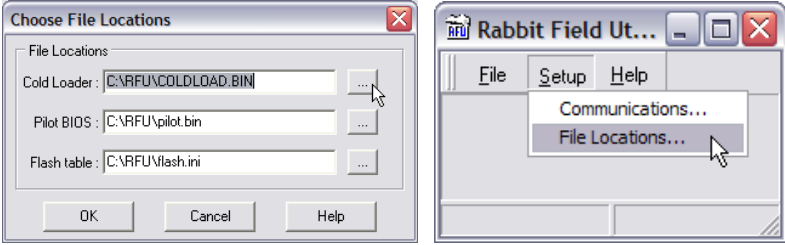
Item	Description
1	9-pin-Female to 9-pin-Male Serial Cable (P/N 104-4027)
2	Flash Utility Software and Latest Firmware Image File (downloaded from Website <a href="http://www.mybacharach.com/downloads.htm">http://www.mybacharach.com/downloads.htm</a> )
3	Personal computer running Windows® 95/98/2000/NT/XP/Vista/7
4	An open COM port on the computer

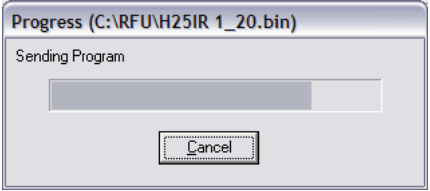
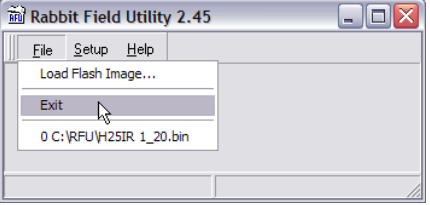


**NOTE:** USB-to-Serial adapters *may* work, but are unsupported.

**Table 6-14. Firmware Upgrade Procedure**

Step	Description
1	Connect one end of a "9-pin female to 9-pin male" serial cable to the instrument's RS-232 connector located at the back of the instrument.
2	Connect the other end of the cable to an open COM port connector on the computer (it may be necessary to use a 9-pin to 25-pin adapter to make the computer connection).   <b>NOTE:</b> COM1 is the default port used by the Flash Memory Program. If COM1 is already in use by another device, then connect the instrument to the next available COM port. The software will need to be reconfigured as described in Step 8 to use this port.
3	Press and hold the <b>ⓘ</b> button on the front keypad and Turn ON the instrument. After the unit beeps quickly several times release the <b>ⓘ</b> button. Pressing the ENT key will place the instrument in firmware upgrade mode.   <b>NOTE:</b> The following steps assume that the operator is familiar with the Windows Operating System, and is knowledgeable in creating folders, copying files, and navigating the file system using Windows Explorer. If necessary, refer to the Windows help files for information on performing these operations.
4	Create a folder on the computer's hard drive named "C:\RFU" (Rabbit Field Utility).
5	Copy the flash utility software and the latest firmware image file ( <i>xxx.bin</i> – where "xxx" is the name and version number of the file) into the folder created in Step 4.

Step	Description	
6	From the C:\RFU folder, run the flash memory program by double clicking the file <i>rfu.exe</i> .	
7	Select <i>Setup &gt; Communications</i> .	
8	<p>Under “Serial Options”, select <i>Use Serial Connection</i>. Then set the Baud Rate to <i>115200</i>, and select <i>Enable Processor Detection</i>.</p> <hr/> <p> <b>NOTE:</b> COM1 is the default COM port. If necessary, change the COM port to match the port that the instrument was connected to in Step 1.</p> <hr/> <p>Click the OK button.</p>	
9	Select <i>Setup &gt; File Locations</i> and verify that the coldload.bin, pilot.bin, and flash.ini files are all located in the C:\RFU folder.	
10	Click <i>OK</i> if these files are in the correct folder. If necessary, use the browse buttons in the Choose File Locations dialog box to locate each of these files.	
11	Drag and drop the firmware file onto the program window. A plus sign (+) indicates the file is ready to copy. Release the mouse and drop the firmware file onto the program window.	

Step	Description	
12	A progress-dialog box will appear during the flashing process, and will disappear when the flashing process is complete.	
13	When flashing is complete: <ul data-bbox="212 478 529 573" style="list-style-type: none"><li>• Exit the flash program</li><li>• Turn OFF the instrument</li><li>• Remove the serial cable.</li></ul>	
14	The new firmware will be active the next time the instrument is turned on. This can be confirmed by checking the firmware revision listed on the startup splash screen.	





## CHAPTER 7: TROUBLESHOOTING

**IN THIS SECTION**

- Diagnostics..... 100
- Service Centers..... 100
- System Faults ..... 101

### 7.1. Diagnostics

Table 7-1. Common Concerns

Issue	Possible Solutions
Instrument won't turn on	<ul style="list-style-type: none"> <li>• Check/ensure source power is active</li> <li>• Check power cord connections are secure</li> <li>• Check fuse</li> </ul>
Gas probe won't fit in front panel connector	<ul style="list-style-type: none"> <li>• Probe connector is keyed. Align red dots on probe connector and front panel connector.</li> </ul>
Can't control H25-IR PRO from the Smart Probe keys	<ul style="list-style-type: none"> <li>• Be sure Smart Probe is fully plugged in to the H25-IR PRO</li> <li>• Be sure the H25-IR PRO is configured for Smart Probe use (i.e., you should NOT see the "Probe Button" function in the Setup menu</li> <li>• Be sure the Smart Probe keys have not been inadvertently locked</li> <li>• Verify internal cable connections (see Standard Versus Smart Probe Wiring on page 32)</li> </ul>
Unable to Log Data to The Measurement Log	<ul style="list-style-type: none"> <li>• Be sure the H25-IR PRO is in MEASURE mode (not SEARCH mode).</li> <li>• Be sure the leak rate of the sampled gas is non-zero.</li> </ul>

### 7.2. Service Centers

Service and replacement parts can be obtained by contacting one of the following Bacharach Service Centers.

**United States**

Bacharach, Inc.  
 621 Hunt Valley Circle  
 New Kensington, PA 15068, United States  
 Phone: 724-334-5051  
 Fax: 724-334-5723  
 Email: help@mybacharach.com

**Canada**

Bacharach of Canada, Inc.  
 10 West Pearce Street, Unit 4  
 Richmond Hill, Ontario L4B 1B6, Canada  
 Phone: 905-470-8985  
 Fax: 905-470-8963  
 E-mail: Support@bachcan.ca

## 7.3. System Faults

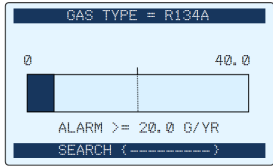
Table 7-2. Fault Codes

Fault Code	Fault	Message	Cause(s)	Possible Solution(s) or Next Step(s)
0002	Box temp error	UNIT TEMPERATURE IS HIGH: MOVE UNIT AWAY FROM SOURCES OF HEAT	Temp >55	<ul style="list-style-type: none"> <li>Move unit away from sources of heat.</li> </ul>
0004	PSIA sensor error	PRESSURE SENSOR OUTPUT IS OUT OF RANGE EXHAUST OR INLET MAY BE BLOCKED	Pressure <10.0 psia or Pressure >16.7 psia	<ul style="list-style-type: none"> <li>Replace filter (refer to Probe Tip Filter Replacement on page 89 and External Filter Replacement on page 90).</li> <li>Ensure exhaust port is not clogged.</li> </ul>
0008	Mass flow error	MF SENSOR VOLTAGE IS OUT OF RANGE CONTACT FACTORY FOR SERVICE	Sensor out < -0.1V or Sensor out >3.0V	<ul style="list-style-type: none"> <li>Contact factory for service.</li> </ul>
0010	Loop open	4-20MA CURRENT LOOP IS OPEN OR CIRCUIT HAS HIGH RESISTANCE. CHECK JUMPER OR WIRES ON REAR OF UNIT	Loop is "open"	<ul style="list-style-type: none"> <li>Ensure that the wire jumper is in place on 4-20mA output connector.</li> </ul>
0200	DigiPot range error	DIGIPOT RANGE ERROR ADJUST DIGIPOT PER MANUAL TO INCREASE DIGIPOT COUNT	DigiPot range < min value for gas type selected	<ul style="list-style-type: none"> <li>Adjust DigiPot (refer to IR Sensor Adjustment on page 95).</li> </ul>
0400	A/D failure	A/D FAILURE CONSULT FACTORY FOR ASSISTANCE	No response from A/D converter	<ul style="list-style-type: none"> <li>Contact factory for service.</li> </ul>
0800	Search flow fault	LOW AIR FLOW. CHECK TIP FILTER AND REPLACE, CHECK HOSES FOR BLOCKAGE	In search mode: Flow <550 sccm or Flow >1650 sccm	<ul style="list-style-type: none"> <li>Replace filter (refer to Probe Tip Filter Replacement on page 89 and External Filter Replacement on page 90).</li> <li>Ensure exhaust port is not clogged.</li> </ul>
1000	Measure flow fault	LOW AIR FLOW. CHECK TIP FILTER AND REPLACE, CHECK HOSES FOR BLOCKAGE	In measure mode: Flow <300 sccm or Flow >550 sccm	<ul style="list-style-type: none"> <li>Replace filter (refer to Probe Tip Filter Replacement on page 89 and External Filter Replacement on page 90).</li> <li>Ensure exhaust port is not clogged.</li> </ul>
4000	Zero volt error	SENSOR OUTPUT VOLTAGE IS OUT OF RANGE ADJUST TO 4.2V IN FACTORY MENU	Sensor out <3.9V or Sensor out >4.5V	<ul style="list-style-type: none"> <li>Adjust DigiPot (refer to IR Sensor Adjustment on page 95).</li> </ul>
8000	A/D clipping error	SENSOR OUTPUT IS TOO HIGH, ADJUST TO 4.2V, IN FACTORY MENU SELECT DIGIPOT	Sensor out >4.55V	<ul style="list-style-type: none"> <li>Adjust DigiPot (refer to IR Sensor Adjustment on page 95).</li> </ul>

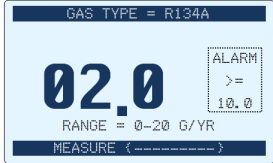


## APPENDIX A: GLOSSARY OF TERMS

Table A-1. Glossary of Terms

Term	Description
alarm setpoint	A value of a measured quantity above which an alarm will occur. The H25-IR PRO has a programmable alarm setpoint for the default user (User Setup 0) and for each of the four custom users (User Setup 1-4). The alarm setpoint is a function of the measured gas reading. You set the alarm setpoint for User Setup 0 from the Basic Setup Menu (see Alarm Setpoint on page 49). Alarm Setpoints for User Setups 1-4 are set from the Advanced Setup Menu (see Advanced Setup Screen on page 53 and Changing a User Setup Alarm Setpoint on page 58). When the alarm setpoint is exceeded, the audible alarm will sound. In addition, output relays may be programmed to energize if the alarm setpoint is exceeded (refer to Relay Connections on page 30 and Table 5-21 on page 63).
ALQ™	ALQ™ (Advanced Leak Quantification) is a technology that eliminates the need to periodically adjust the instrument to a calibrated reference leak source. The result is an instrument that maintains its accuracy in real time, even under changing conditions. See Advanced Leak Quantification (ALQ™) Technology on page 6 for more information.
bar graph	See <i>graphic display</i> .
bump test	A bump test is a quick functional (not quantitative) test of the operation of a gas detector. It is also used to test the internal and external alarm capabilities of the system. Compared to a more complex <i>quantitative</i> test requiring a reference gas of precisely known quantity and certified quality, a bump test may be accomplished with sample gas ampoules, or using everyday items having similar molecular structure (therefore, recognized by the instrument's sensor). For example, depending on the type of gas sensor in your H25-IR PRO, you may be able to perform a simple bump test using an uncapped permanent marker, typing correction fluid, a can of aerosol spray used for dusting delicate computer components, or even a disposable lighter (by just releasing the gas—not lighting it).
fault	A fault is an error. The H25-IR PRO can identify various faults and provide the operator with feedback regarding the fault type and possible correction options. Refer to Fault Codes on page 78 and page 101 for more information.
graphic display	Graphic display (or <i>bar graph</i> mode) is one of two display styles from which the operator may choose for displaying the search mode screen. (The other display style is numeric mode.) This user preference is set from the Display Style option in the Basic Setup menu (see Display Styles (Graphic vs. Numeric) on page 36, Basic Setup Screen on page 45, and Display Style on page 51). 
IR emitter	The IR (infrared) emitter is a component of the NDIR sensor. The emitter generates a focused infrared beam through the gas sample and toward the detector. See <i>NDIR sensor</i> for more information.
IR detector	The IR (infrared) detector is a component of the NDIR sensor. The detector identifies how much light (from the emitter) is getting through the tube (i.e., the amount of light NOT being absorbed by the sample gas located in the tube). This is used to ultimately determine the leak rate. See <i>NDIR sensor</i> for more information.
loop factor	Loop factor is a coefficient used for scaling the 4-20mA output to the input reading range (of the sampled gas). Refer to Loop Factor on page 68 for additional information.
measure mode	Measure mode is one of two main operating modes of the H25-IR PRO. It is used to quantify a leak rate and is typically use <i>after</i> using search mode to locate a leak.



Term	Description
NDIR sensor	<p>An NDIR sensor is a device that detects the presence of gas by measuring the amount of infrared light that is absorbed by a sample. The NDIR sensor is a cylindrical tube containing an emitter at one end and a highly sensitive detector at the other. The emitter generates a focused infrared beam through the gas sample and toward the detector. The light that is not absorbed by the gas drawn into the chamber strikes the detector. Comparing the amount of light emitted versus what was detected gives a differential that is then matched against the gas type setting and other values to determine the quantity and leak rate of the gas.</p>
numeric display	<p>Numeric display is one of two display styles from which the operator may choose for displaying the search mode screen. (The other display style is graphic display mode.) This user preference is set from the Display Style option in the Basic Setup menu (see Display Styles (Graphic vs. Numeric) on page 36, Basic Setup Screen on page 45, and Display Style on page 51). Note that the numeric display is also used exclusively in measure mode.</p> 
log limit	<p>The log limit is used in totalizer applications with the measurement log. It is an alarm setpoint based on the accumulated sum of logged data point values. Refer to <i>totalizer</i> for more information.</p>
measurement log	<p>The measurement log is a 50-element array into which the operator may store (or <i>log</i>) gas readings. Gas values and time/date stamps are stored sequentially when the operator chooses to log the data point. Menu options permit the clearing of individual data points or the entire measurement log.</p>
search mode	<p>Search mode is one of two main operating modes of the H25-IR PRO. It is used to locate a leak and is typically use <i>before</i> using measure mode.</p>
totalizer	<p>Totalizer is a unique gas detection/alarm application in which the leak rate of <i>multiple</i> sample points are logged and then summed. This summed leak rate is compared to a user-programmable setpoint (the Log Limit option of the Advanced Setup menu). If the summed leak rate exceeds the Log Limit setpoint, external alerts can be generated using the configurable relay outputs (e.g., horns, warning lights, etc.).</p>
unit display	<p>Unit display is a programmable option in the H25-IR PRO that defines the engineering units to be used by the instrument. The H25-IR PRO is used to locate and quantify refrigerant gas leak rates, so available engineering units include oz/yr, g/yr, mL/sec-5, Pa-M/sec-5, and PPM. Available display units are listed in Table 5-9 on page 48.</p>



## APPENDIX B: ACRONYMS AND ABBREVIATIONS

Table B-1. Acronyms and Abbreviations

Acronym	Meaning
'	feet
"	Inches
°	degrees
↵	enter
A	Amperes, Amps
A/D	analog/digital
AC	Alternating current
ALQ™	Advanced Leak Quantification
ASCII	American Standard Code for Information Interchange
AWG	American Wire Gauge
C	Centigrade
ccm	cubic centimeters (also see cm <sup>3</sup> )
CFC	chlorofluorocarbon
cm	centimeter
cm <sup>3</sup>	cubic centimeters (also see ccm)
COM	common (a relay terminal), communications (COM port)
CR	carriage return
DC	Direct current
dd	day
DigiPot	digital potentiometer
ENT	enter
ESC	escape
ESD	electrostatic discharge
F	Fahrenheit
ft	feet
g	gram
HCFC	hydrochlorofluorocarbon
HFC	hydrofluorocarbon
Hz	Hertz
i	information
in	inch
IR	infrared

Acronym	Meaning
lb	pound
LCD	liquid crystal display
LED	light emitting diode
LEL	lower explosive limit
LF	line feed
LOK	locked
m	meter
mA	milliamp, milliampere
mL	milliliter
mm	millimeter, month
NC	normally closed
NDIR	Non-dispersive Infrared
NIST	National Institute of Standards and Technology
NO	normally open
oz	ounce
P/N	part number
Pa	Pascal
PC	personal computer
ppm	parts per million
psia	pounds per square inch – absolute (including atmospheric pressure)
rev	revision
RS-232	recommended standard 232
SCCM	standard cubic centimeters per minute
SPDT	single pole double throw
SRCH	search
UL	Underwriters Laboratories
USB	universal serial bus
V	Volts
VAC	Volts alternating current
VDC	Volts direct current
vol	volume
yr, yy	year



## APPENDIX C: SUPPORTED GAS TYPES

### IN THIS SECTION

- Basic Gas Types ..... 106
- Factory Gas Types..... 108

### C.1. Basic Gas Types



**NOTE:** Basic gas types are those listed in the H25-IR PRO's GAS TYPE menu item, when equipped with the halogen NDIR sensor, unless overridden by selecting a factory gas option.

Table C-1. Basic (Primary) Gas Types

Gas Abbr		Formula	Gas Name/Description
R12		CCl <sub>2</sub> F <sub>2</sub>	Dichlorodifluoromethane
R21		CHCl <sub>2</sub>	Dichlorofluoromethane
R22		CHClF <sub>2</sub>	Chlorodifluoromethane
R23		CHF <sub>3</sub>	Trifluoromethane
R113		C <sub>2</sub> F <sub>3</sub> Cl <sub>3</sub>	1,1,2-Trichlorotrifluoroethane
R114		C <sub>2</sub> F <sub>4</sub> Cl <sub>2</sub>	1,2-Dichlorotetrafluoroethane
R123		C <sub>2</sub> HF <sub>3</sub> Cl <sub>2</sub>	2,2-Dichloro-1,1,1-trifluoroethane
R134A		C <sub>2</sub> H <sub>2</sub> F <sub>4</sub>	1,1,1,2-Tetrafluoroethane
R236fa		C <sub>3</sub> H <sub>2</sub> F <sub>6</sub>	1,1,1,3,3,3-Hexafluoropropane
R245fa		C <sub>3</sub> H <sub>3</sub> F <sub>5</sub>	1,1,1,3,3-Pentafluoropropane
R401A	R-22 ..... (53%) R-152a ..... (13%) R-124 ..... (34%)	Mix	See information on individual gases.
R402A	R-125..... (60%) R-290 ..... (2%) R-22 ..... (38%)	Mix	See information on individual gases.
R402b	R-125..... (38%) R-290 ..... (2%) R-22 ..... (60%)	Mix	See information on individual gases.
R404A	R-125..... (44%) R-143a ..... (52%) R-134a ..... (4%)	C <sub>2</sub> HF <sub>5</sub> C <sub>2</sub> H <sub>3</sub> F <sub>3</sub> O C <sub>2</sub> H <sub>2</sub> F <sub>4</sub>	Pentafluoroethane 2,2,2-Trifluoroethyl methyl ether 1,1,1,2-Tetrafluoroethane
R407A	R-32 ..... (20%) R-125..... (40%) R-134a..... (40%)	Mix	See information on individual gases.
R407C	R-32 ..... (23%) R-125 ..... (25%) R-134a ..... (52%)	CH <sub>2</sub> F <sub>2</sub> C <sub>2</sub> HF <sub>5</sub> C <sub>2</sub> H <sub>2</sub> F <sub>4</sub>	Difluoromethane Pentafluoroethane 1,1,1,2-Tetrafluoroethane
R408A	R-125..... (7%) R-143a..... (46%) R-22 ..... (47%)	Mix	See information on individual gases.

Gas Abbr		Formula	Gas Name/Description
R409A	R-22.....(60%) R-124.....(25%) R-142b.....(15%)	Mix	See information on individual gases.
R410A	R-32.....(50%) R-125.....(50%)	CH <sub>2</sub> F <sub>2</sub> C <sub>2</sub> HF <sub>5</sub>	Difluoromethane Pentafluoroethane
R422d	R-125.....(65.1%) R-134a... (31.5%) R-600a.....(3.4%)	Mix	See information on individual gases.
R424a	R-125.....(50.5%) R-134a... (47.0%) R-600a.....(0.9%) R-600.....(1.0%) R-601a.....(0.6%)	Mix	See information on individual gases.
R426a	R-125.....(5.1%) R-134a... (93.0%) R-600.....(1.3%) R-601a.....(0.6%)	Mix	See information on individual gases.
R427a	R-32.....(15%) R-125.....(25%) R-143a.....(10%) R-134a.....(50%)	Mix	See information on individual gases.
R448A	R-32.....(26%) R-125.....(26%) R-134a.....(21%) R-1234yf... (20%)	Mix	See information on individual gases.
R449A	R-32.....(24.3%) R-125.....(24.7%) R-134a... (25.7%) R-1234yf (25.3%)	Mix	See information on individual gases.
R452A	R-32.....(11%) R-125.....(59%) R-1234yf... (30%)	Mix	See information on individual gases.
R452B	R-32.....(67%) R-125.....(7%) R-1234yf... (26%)	Mix	See information on individual gases.
R500	R-12.....(73.8%) R-152a... (26.2%)	Mix	See information on individual gases.
R503	R-23.....(40.1%) R-13.....(59.9%)	Mix	See information on individual gases.
R507	R-125.....(50%) R-143a.....(50%)	Mix	See information on individual gases.
R508B	R-23.....(46%) R-116.....(54%)	Mix	See information on individual gases.

Gas Abbr		Formula	Gas Name/Description
R513A	R-134a..... (44%) R-1234yf... (56%)	Mix	See information on individual gases.
R514A	HFO1336mzz(Z) ..... (74.7%) R-1130(E) ..... (25.3%)	Mix	See information on individual gases.
H1234YF		C <sub>3</sub> H <sub>2</sub> F <sub>4</sub>	2,3,3,3-Tetrafluoropropene
R32		CH <sub>2</sub> F <sub>2</sub>	Difluoromethane
H1301		CBrF <sub>3</sub>	Bromotrifluoromethane
N1230		C <sub>6</sub> F <sub>12</sub> O	Novec™ 1230
H1211		CF <sub>2</sub> ClBr	Bromochlorodifluoromethane
H2402		C <sub>2</sub> Br <sub>2</sub> F <sub>4</sub>	Dibromotetrafluoroethane
R124		C <sub>2</sub> HF <sub>4</sub> Cl	2-Chloro-1,1,1,2-tetrafluoroethane
R125		C <sub>2</sub> HF <sub>5</sub>	Pentafluoroethane
R227		C <sub>3</sub> HF <sub>7</sub>	Heptafluoropropane (F3C-CHF-CF3 )
R422a	R-125..... (85.1%) R-134a... (11.5%) R-600a..... (3.4%)	Mix	See information on individual gases
R438a	n/a	n/a	ISCEON® MO99™
R502	R-22 ..... (48.8%) R-115..... (51.2%)	Mix	See information on individual gases
FC72		C <sub>6</sub> F <sub>14</sub>	Tetradecafluorohexane
R407F	CH <sub>2</sub> F <sub>2</sub> ..... (30%) C <sub>2</sub> HF <sub>5</sub> ..... (30%) C <sub>2</sub> H <sub>2</sub> F <sub>4</sub> ..... (40%)	Mix	Blend of HFC32,HFC125, and HFC134a
HFP		C <sub>3</sub> F <sub>6</sub>	Hexafluoropropylene
FA188		n/a	n/a
H1234ZE		C <sub>3</sub> H <sub>2</sub> F <sub>4</sub>	1,3,3,3-Tetrafluoropropene
N4710		SF <sub>6</sub>	Novec™ 4710 insulating gas
N7100		C <sub>4</sub> F <sub>9</sub> OCH <sub>3</sub>	Novec™ 7100 engineered fluid
N7200		C <sub>4</sub> F <sub>9</sub> OC <sub>2</sub> H <sub>5</sub>	Novec™ 7200 engineered fluid
N7300		n/a	Novec™ 7300 engineered fluid
N7600		n/a	Novec™ 7600 engineered fluid
CUSTOM		Various	Custom gas type allows the user to adjust the instrument to a known concentration via the "external reference" feature.

## C.2. Factory Gas Types



**NOTE:** With factory gas types, the selected gas becomes the only gas listed in the user GAS TYPE menu.

Table C-2. Factory (Secondary) Gas Types

Gas Abbr	Formula	Gas Name/Description
R600a**	C <sub>4</sub> H <sub>10</sub>	Isobutane or methylpropane
R290**	C <sub>3</sub> H <sub>8</sub>	Propane
CO2_A**	CO <sub>2</sub>	Carbon dioxide
SF6**	F <sub>6</sub> S	Sulfur hexafluoride

\*\* Requires a different NDIR sensor inside the instrument.







INDEX

To facilitate quick access to desired reference material, index locator page numbers are coded based on the nature of how the target material is displayed. Index reference page numbers that are given in standard face fonts refer to generic text references. Italic locator page numbers refer to reference material found within tables. Bold locator page numbers refer to pages containing references within illustrations. See the examples below.

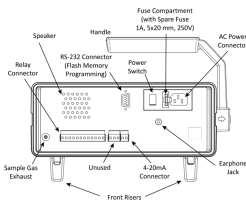
4-20mA output ..... **8, 22**  
 absorption ..... **3, 4**  
 specifications ..... **35**

**Bold:** Referenced pages show related illustrations.  
**Standard:** Referenced pages contain related text.  
*Italic:* Referenced pages contain tables with related topics.

**bold**.....**1, 2, 3**

**standard**.....**1, 2, 3**

**italic**.....**1, 2, 3**



2.1. Principles of Infrared Gas Detection

This instrument utilizes the principle of *infrared absorption* to measure the absolute concentration of a particular gas that is contained in the sample.

7.1. Specifications

Category	Description
	R12, R21, R33A, R40A, R401C, R410A, R423A1P, R42
	CUSTOM
	R600a, R90 (CO, S <sub>2</sub> )
Gases Detected (GAS TYPE)	R12, R21, R113, R114, R123, R124, R125, R127, R230A, R405A, R421A, R422A, R427a, R427b, R427c, R427d, R427e, R427f, R427g, R427h, R427i, R427j, R427k, R427l, R427m, R427n, R427o, R427p, R427q, R427r, R427s, R427t, R427u, R427v, R427w, R427x, R427y, R427z, R428, R429, R430, R431, R432, R433, R434, R435, R436, R437, R438, R439, R440, R441, R442, R443, R444, R445, R446, R447, R448, R449, R450, R451, R452, R453, R454, R455, R456, R457, R458, R459, R460, R461, R462, R463, R464, R465, R466, R467, R468, R469, R470, R471, R472, R473, R474, R475, R476, R477, R478, R479, R480, R481, R482, R483, R484, R485, R486, R487, R488, R489, R490, R491, R492, R493, R494, R495, R496, R497, R498, R499, R500, R501, R502, R503, R504, R505, R506, R507, R508, R509, R510, R511, R512, R513, R514, R515, R516, R517, R518, R519, R520, R521, R522, R523, R524, R525, R526, R527, R528, R529, R530, R531, R532, R533, R534, R535, R536, R537, R538, R539, R540, R541, R542, R543, R544, R545, R546, R547, R548, R549, R550, R551, R552, R553, R554, R555, R556, R557, R558, R559, R560, R561, R562, R563, R564, R565, R566, R567, R568, R569, R570, R571, R572, R573, R574, R575, R576, R577, R578, R579, R580, R581, R582, R583, R584, R585, R586, R587, R588, R589, R590, R591, R592, R593, R594, R595, R596, R597, R598, R599, R600, R601, R602, R603, R604, R605, R606, R607, R608, R609, R610, R611, R612, R613, R614, R615, R616, R617, R618, R619, R620, R621, R622, R623, R624, R625, R626, R627, R628, R629, R630, R631, R632, R633, R634, R635, R636, R637, R638, R639, R640, R641, R642, R643, R644, R645, R646, R647, R648, R649, R650, R651, R652, R653, R654, R655, R656, R657, R658, R659, R660, R661, R662, R663, R664, R665, R666, R667, R668, R669, R670, R671, R672, R673, R674, R675, R676, R677, R678, R679, R680, R681, R682, R683, R684, R685, R686, R687, R688, R689, R690, R691, R692, R693, R694, R695, R696, R697, R698, R699, R700, R701, R702, R703, R704, R705, R706, R707, R708, R709, R710, R711, R712, R713, R714, R715, R716, R717, R718, R719, R720, R721, R722, R723, R724, R725, R726, R727, R728, R729, R730, R731, R732, R733, R734, R735, R736, R737, R738, R739, R740, R741, R742, R743, R744, R745, R746, R747, R748, R749, R750, R751, R752, R753, R754, R755, R756, R757, R758, R759, R760, R761, R762, R763, R764, R765, R766, R767, R768, R769, R770, R771, R772, R773, R774, R775, R776, R777, R778, R779, R780, R781, R782, R783, R784, R785, R786, R787, R788, R789, R790, R791, R792, R793, R794, R795, R796, R797, R798, R799, R800, R801, R802, R803, R804, R805, R806, R807, R808, R809, R810, R811, R812, R813, R814, R815, R816, R817, R818, R819, R820, R821, R822, R823, R824, R825, R826, R827, R828, R829, R830, R831, R832, R833, R834, R835, R836, R837, R838, R839, R840, R841, R842, R843, R844, R845, R846, R847, R848, R849, R850, R851, R852, R853, R854, R855, R856, R857, R858, R859, R860, R861, R862, R863, R864, R865, R866, R867, R868, R869, R870, R871, R872, R873, R874, R875, R876, R877, R878, R879, R880, R881, R882, R883, R884, R885, R886, R887, R888, R889, R890, R891, R892, R893, R894, R895, R896, R897, R898, R899, R900, R901, R902, R903, R904, R905, R906, R907, R908, R909, R910, R911, R912, R913, R914, R915, R916, R917, R918, R919, R920, R921, R922, R923, R924, R925, R926, R927, R928, R929, R930, R931, R932, R933, R934, R935, R936, R937, R938, R939, R940, R941, R942, R943, R944, R945, R946, R947, R948, R949, R950, R951, R952, R953, R954, R955, R956, R957, R958, R959, R960, R961, R962, R963, R964, R965, R966, R967, R968, R969, R970, R971, R972, R973, R974, R975, R976, R977, R978, R979, R980, R981, R982, R983, R984, R985, R986, R987, R988, R989, R990, R991, R992, R993, R994, R995, R996, R997, R998, R999, R1000
Detection Method	Non-Dispersive Infrared (NDIR)

**Illustrations**

**Text**

**Tables**

**Symbols**

ⓘ button ..... **5, 11, 20, 23, 29, 41, 42, 43, 45, 75, 76, 78, 82, 97**

**Numbers**

12-foot hose ..... **12, 13, 14, 15**  
 24 AWG, twisted pair ..... **32**  
 24-hour military format ..... **54**  
 4–20 mA loop  
     connector ..... **12, 32**  
     CURRENT LOOP IS OPEN ..... **79, 102**  
     output ..... **12, 19, 28, 31, 36, 69, 79, 102, 104**  
 4-digit fault code summary ..... **29, 78**  
 6 foot grounded AC power cord ..... **16**  
 6-foot hose ..... **12, 13, 14, 15**  
 9-pin to 25-pin adapter ..... **97**

**A**

A/D FAILURE ..... **79, 102**  
 abbreviations ..... **105**  
 ABSORBANCE ..... **81**  
 AC power ..... **3, 10, 11**  
     connection ..... **12**  
     cord ..... **16, 33, 95, 96**  
     removing prior to service ..... **2**  
     source ..... **3**  
     supply ..... **16**  
 accuracy ..... **6, 10, 103**  
 acronyms ..... **105**  
 adjustable handle ..... **3**

adjusting the volume setting ..... **39**  
 adjustment coefficient ..... **83**  
 ADJUSTMENT IS LOCKED ..... **84**  
 Advanced Leak Quantification (ALQ™) .1, **6, 7, 8, 103, 105**  
 Advanced Setup menu ... **20, 24, 28, 29, 32, 40, 41, 54, 55, 63, 72, 74, 77, 86, 104, 103**  
 alarm setpoint **4, 23, 26, 27, 36, 37, 39, 40, 43, 50, 52, 55, 103**  
 ALARM setpoint ..... **50, 59, 64**  
 ALQ™ technology ..... **1, 6, 7, 8, 103, 105**  
 altitude limit ..... **3**  
 AMB PRESSURE ..... **81**  
 ambient humidity ..... **10**  
 architecture summary ..... **22**  
 arrow buttons ..... **20, 21, 22, 23, 24, 28, 29, 39, 47, 50, 51, 53, 56, 57, 58, 59, 60, 61, 62, 63, 64, 65, 66, 68, 70, 72, 74, 76, 80, 82, 83, 86, 87, 88, 95**  
 arrows on the LCD ..... **21**  
 ASCII data ..... **33**  
 ASCII text ..... **5, 33, 71**  
 audible tone(s) ..... **5, 39**  
     frequency ..... **4**  
 avoiding small nuisance leaks ..... **4**

**B**

Bacharach Service Centers ..... **2, 101**  
 back panel ..... **33, 34, 39, 89, 91**  
 background gas rejection ..... **3**  
 background refrigerant ..... **42**  
 banner line ..... **26, 27, 28, 29, 37, 43, 78**  
 bar graph ..... **4, 5, 26, 36, 37, 39, 40, 52, 103**

basic gas types .....9, 84, 108  
 Basic Setup menu .....20, 21, 27, 28, 29, 37, 40, **41**,  
 46, 48, 50, **54**, 55, 68, 86, 88, 103, 104  
 Baud Rate ..... 33, 98  
 bezels .....34, 91, 93  
 Box temp error ..... 79  
 bump test..... 6, 103  
 buttons..... **11, 13, 14, 19, 22**

**C**

cable ties .....93, 94, 95  
 calibrated output ..... 6  
 calibration ..... 3, 6  
 capabilities ..... 3  
 CFCs .....1, 93, 105  
 changing conditions..... 6, 103  
 changing the values of menu items ..... 23  
 changing the volume setting ..... 39  
 chart recorder..... 5, 19, 31, 32  
 CHECK HOSES FOR BLOCKAGE ..... 79, 102  
 CHECK JUMPER OR WIRES ON REAR OF UNIT ..... 79, 102  
 CHECK TIP FILTER AND REPLACE ..... 79, 102  
 circuit board ..... **34**  
 CIRCUIT HAS HIGH RESISTANCE ..... 79, 102  
 clean-air environment ..... 42  
 cleaning ..... 3  
 clearing applied adjustments ..... 84  
 CO<sub>2</sub> .....3, 9, 48, 85, 93, 110  
 coalescing filter, external..... 17, 91, **92**, 96  
 COM port..... 19, 31, 33, 97, 98, 105  
 COM1 ..... 97, 98  
 combustible gases ..... 2  
 Command options in the footer ..... 28, 29  
 communications port..... 19, 31, 33, 97, 98, 105  
 communications settings ..... 33  
 communications software..... 33  
 computer..... 31, 33, 35, 71, 97, 103, 106  
 connection..... 97  
 concentration ..... 5, 6, 9, 10, 48, 52, 81, 108  
 ppm ..... 5  
 configuration settings ..... 20, 27  
 configuration-dependent menu items..... 24  
 connecting an amplified speaker ..... 39  
 connectors..... 2, **12, 13, 15, 16**, 31, 32, 33, 34, 35,  
 73, 79, 94, 95, 97, 101, 102  
 continuity ..... 89  
 control panel ..... 15  
 conventions used in this manual ..... 1  
 copying files..... 97  
 creating folders..... 97  
 crosshair icon..... 83  
 CSA 61010-1 ..... 112  
 current faults..... 29, 75, 78, 80  
 Current Faults menu ..... 29, 78  
 Current Loop Factor screen..... **70**

current loop  
 output ..... 3, 5  
 scaling ..... 28  
 custom gas types .....9, 36, 48, 84, 108  
 cycling power ..... 85, 88

**D**

damage ..... 1, 2, 3, 11, 89  
 data logging..... 3, 5, 71  
 date and time..... 67  
 stamp ..... 64  
 setting ..... 28  
 declaration of conformity ..... 112  
 dedicated NDIR sensor.....9, 48  
 detection method..... 9  
 detector ..... 2, 3, 19, 95, 96, 103, 104  
 adjustment ..... 95  
 value ..... 95  
 diagnostics ..... 3, 5, 19, 20, 29, 40, 42, 76, 77, 101  
 button ..... 11  
 screen ... 5, 20, 23, 29, 41, 42, 75, 76, 77, 78, 80, 81, 87  
 DIGIPOT RANGE ERROR ..... 79, 96, 102  
 digital potentiometer (DigiPot) ..... 96, 105  
 digital reading ..... 4, 5  
 dilution effects of sample ..... 3, 6  
 dimensions ..... 10  
 display. 1, 3, 4, 5, **11, 14, 15, 19, 21, 22, 23, 24, 26, 27, 28**,  
 36, 37, 38, 39, 40, 43, 47, 49, 50, 51, 52, 53, 55, 56, 75,  
 78, 83, 87, 96, 103, 104, 106  
 toggling ..... 20  
 options ..... 26, 37, 43, 52, 53, 103, 104  
 Down Arrow button.....**11, 20, 22, 23, 24, 28, 39, 46**,  
 47, 50, 51, 53, 54, 57, 58, 59, 60, 61, 62, 63, 64, 65, 66,  
 68, 70, 72, 74, **76, 77, 80, 82, 83, 87, 88, 95**

**E**

earphone jack..... **12**  
 editing Log Limit ..... **68**  
 editing menu items..... 28, 29  
 Electromagnetic Compatibility ..... 112  
 emitter ..... 95, 96, 103, 104  
 adjustment ..... 95  
 EN 50270:2006 ..... 112  
 EN 55011:2009 /A1:2010 ..... 112  
 EN 61010-1 ..... 112  
 enclosure ..... 2, **92, 93**  
 ENT button ... **11, 20, 22, 23, 29, 42, 45, 47, 51, 53, 58, 59**,  
 60, 61, 63, 67, 68, 70, 72, **75, 77, 78, 80, 82, 83, 85, 87**,  
 88, 95  
 ENT+ESC button combination ..... 20  
 equations  
 leak rate ..... 5  
 loop factor ..... 69  
 error(s)..... 5, 79, 102, 103  
 audible beep..... 5

conditions .....5  
 message .....5  
 ESC button ..... **11**, 20, 21, 22, **23**, 24, 26, 37, 41, 44, 45, 47,  
 50, 51, 53, 62, 63, **75**, 81, 83, 84, 88, 96, 105  
 EXHAUST OR INLET MAY BE BLOCKED..... 79, 102  
 exhaust port..... 2, **12**  
 explosion hazard ..... 25, 35  
 explosive atmosphere warning .....2  
 explosive limit .....2  
 extended gas list .....9, 48  
 external adjustment .....3  
 external alarm device(s) ..... 5, 31, 32  
 external filter .....17, 91, **92**, 96  
 external leak source/reference. **7**, 8, 9, 48, 82, 83, 84, 108

**F**

FA188 ..... 9, 48, 110  
 factory default reference conditions.....6  
 factory gas type(s)/option ..... 9, 85, 87, 88, 108  
 Factory menu .....9, 48, 85, 86, 88, 95, 96  
 Factory Setup screen .....87  
 fault code(s)..... 29, 42, 78, 79, 96, 102  
 FC72 ..... 9, 48, 110  
 features ..... 1, 3, 6, 20, 28, 35  
 feedback mode .....4, 5, 55, 61  
 FEEDBACK setting.....61  
 filter..... 3, 6, **12**, 13, **14**, 15, 17, 79, 90, 91, 92, 102, 103  
 firmware .....3, 20, 25, 35, 97, 98, 99  
     upgrading.....97  
     Image File.....97  
     version .....3, 20, 25, 26  
         screen ..... 20, 85, 86  
 flammable gases ..... 2, 25, 35  
 flammable liquids.....2  
 Flash Memory Program .....97  
 Flash Utility Software .....97  
 flashing process.....99  
 flexible probe tube..... 3, **13**, **14**, 15, **16**  
 floating ground .....32  
 flow chart.....**22**  
 Flow Control .....33  
 flow rate ..... 3, 5, 19, 49, 103, 104  
 foam insulation .....94, 95  
 foreign matter.....103  
 front panel....3, 4, 5, **11**, 13, 14, 15, **16**, 20, 21, **22**, 23, 24,  
 25, 28, 33, 34, 39, 43, 45, 71, 72, 91, 93, 95, 96, 101  
     circuit board.....**34**  
 front risers ..... **11**, **12**  
 fuse(s)..... 2, **12**, **16**, 32, 89, 90, 96, 101  
     compartment ..... 12, 16, 89  
     holder .....89

**G**

gas analyzer .....1  
 gas concentration.....5

calculation of ..... 3, 36, 50, 52  
 gas exhaust..... **12**  
 gas leaks ..... 1, 9, 19, 44  
 GAS PPM LEVEL..... 81  
 gas probe..... **19**  
 gas type. 5, 9, 20, 24, **26**, 28, 36, 47, 48, 55,**58**, 59, 60, 82,  
 84, 85, 87, 88, 108  
     menu ..... 9, 28, 47, 48, 85, 88, 108  
 Glossary of Terms ..... 103  
 grams per year ..... 5, 49  
 graphic display style..... **37**, 43  
 grounded AC power cord ..... 16

**H**

H1211 .....9, 48, 110  
 H1234YF .....9, 48, 108  
 H1234ZE .....9, 48, 107-108  
 H1301 .....9, 48, 110  
 H2402 .....9, 48, 110  
 halogen ..... 1, 9, 48, 85, 88, 108  
     gas compounds ..... 1  
     NDIR sensor .....9  
 handle ..... **11**, **12**, **16**  
 hardware overview ..... 11  
 hazard ..... 35  
 hazardous locations ..... 2  
 HCFCs .....1, 93, 105  
 header ..... 28, 29, 42, 47, 51, 75, 86, 87  
 HFCs ..... 1, 9, 93, 105  
 HFP.....9, 48, 110  
 high-noise environments ..... 39  
 home screen ..... 21  
 hose ..... 11, **12**, 13, **14**, 15  
     lengths..... 9, 13  
 housing..... 3  
 HyperTerminal™..... 33

**I**

IEC 61010-1 ..... 112  
 INCREASE DIGIPOT COUNT..... 79, 102  
 Info (i) button ..... 5, **11**, 20, **23**, 29, 41, **42**, 43,  
 45, **75**, 76, 78, 82, 97  
 initialization ..... 20, 26, 37, 42, 86  
     countdown .....20, 26, 86  
 in-line filter ..... **103**  
 interfaces..... 19  
 internal cable .....12, 73, 101  
 internal components..... 17, **18**  
 internal leak reference .....6  
 introduction..... 1  
 IR detector adjustment .....95  
 IR Emitter ..... 95, 96  
     adjustment ..... 95  
 IR SENSOR DETECTOR connector..... 95  
 IR SENSOR EMITTER connector..... 95

<b>J</b>	
J2 .....	33, 34
J5 .....	95
J7 .....	33, 34
<b>K</b>	
keypad	
lock/unlock feature.....	15
locking and unlocking.....	15
<b>L</b>	
LCD.....	3, 11, 14, 19, 20, 21, 22, 23, 25, 33, 106
leak detector .....	1, 2, 3
proper use .....	2
leak point .....	4, 5
leak rate .....	1, 3, 5, 6, 9, 13, 28, 36, 44, 45, 61, 71, 81, 83, 101, 104
conversion chart .....	49
equation .....	5
g/yr.....	3, 5, 6, 9, 36, 39, 49, 104
measurement .....	3
mL/s-5 .....	5, 9
multiplier .....	6
oz/yr.....	3, 5, 9, 49, 104
Pa·m <sup>3</sup> /s-5.....	5
PaM <sup>3</sup> /s-5.....	9
ppm.....	3, 5, 9, 33, 69, 106
stabilizing.....	5
units .....	5
leak reference(s).....	6, 23, 42, 83
NIST-traceable .....	6
LED.....	3, 4, 13, 14, 34, 72, 106
backlit display .....	3
indicator .....	13
Left Arrow button .....	11, 24, 28, 76, 78
live flow rate data.....	19
lock/unlock feature.....	15
locking adjustments.....	83, 84
locking and unlocking the probe's keypad .....	15
LOG button.....	11, 23, 43, 44, 45
Log Limit.....	28, 44, 64, 67, 68, 104
Log point number .....	64
logged data point values .....	104
logging data.....	64, 67
loop factor.....	28, 33, 69, 70
equation .....	69
Loop is "open" .....	32, 79, 102
Loop Open Error .....	32, 79, 102
LOW AIR FLOW .....	79, 102
lower explosive limit (LEL).....	2
<b>M</b>	
main board .....	95
maintenance.....	2, 29, 78, 89
malfunction .....	2
MASS FLOW .....	81
error.....	79
rate .....	5
Measure flow fault .....	79
measure mode ...	4, 5, 9, 13, 14, 19, 20, 21, 23, 27, 28, 29, 38, 40, 42, 43, 44, 45, 46, 47, 48, 52, 54, 62, 64, 75, 78, 79, 86, 102, 104
overview.....	43
measurement adjustment .....	9
measurement log .....	23, 25, 28, 44, 64, 65, 67, 101
measurement mode .....	13
measurement range .....	9
measurement units .....	9
memory .....	5, 23, 48, 97, 98
menu architecture summary.....	22
menu flow chart .....	22
menu identifier.....	28, 29
menu interface.....	19
menu system.....	1, 3, 19, 21, 93
metal lid.....	34
MF SENSOR VOLTAGE IS OUT OF RANGE.....	79
military format .....	54
milliliters per second .....	5, 49
mL/sec-5 .....	104
mm/dd/yy format.....	66
MODE button .	4, 11, 15, 20, 21, 23, 24, 26, 27, 28, 35, 37, 38, 40, 41, 43, 45, 64, 72, 84, 86
toggling .....	38
modifications.....	2
monitor mode .....	104
monitoring device.....	32
<b>N</b>	
N1230 .....	9, 48, 110
N7100 .....	9, 48, 107-108
N7200 .....	9, 48, 107-108
N7300 .....	9, 48, 107-108
N7600 .....	9, 48, 107-108
navigating menus .....	21
navigation controls.....	21
NDIR optical sensor .....	18
NDIR sensor.....	9, 17, 29, 48, 85, 88, 94, 95, 96, 103, 104, 108, 110
operation.....	17
replacement.....	93
kit.....	93
NIST traceable certification.....	6
No response from A/D converter .....	79, 102
NOISE FACTOR.....	81
Non-Dispersive Infrared (NDIR).....	9
numeric display style .....	26, 27, 37, 38, 40, 43
numerical format.....	26, 27, 37, 43
<b>O</b>	
operating modes .....	4, 9, 23

operation.. 1, 2, 4, 6, 13, 19, 20, 21, 22, 26, 31, 35, 38, 84, 85, 86, 89, 93, 103  
 optimal .....103  
 optional hardware devices .....31  
 O-ring ..... 90, 91  
 ounces per year.....5, 49  
 OUT OF RANGE .....79  
 output connectors.....12  
 output tolerance .....6  
 overview ..... 11, 37  
     functional.....3  
     measure mode .....43  
     menu navigation .....21  
     menu system.....19

**P**

Pa-M/sec-5..... 5, 49, 104  
 parity .....33  
 parts per million (PPM)..... 5, 49, 106  
 Pascal meters cubed per second..... 5, 49, 104  
 PC interface .....19  
 gas leaks .....2  
 polarity .....32  
 power  
     connection .....12  
     consumption ..... 10, 16  
     cord ..... 16, 34, 35, 89, 91, 96, 101  
     receptacle .....16  
     source ..... 17, 31, 32  
     supply  
         de-energizing on malfunction .....2  
         universal.....3  
     switch ..... 12, 16  
 PPM accuracy.....10  
 pressure gauge.....6  
 PRESSURE SENSOR OUTPUT IS OUT OF RANGE .....79  
 probe(s) .... 3, 4, 6, 9, 12, 13, 14, 15, 19, 24, 29, 33, 34, 35, 37, 55, 72, 73, 74, 83, 90, 91, 101  
     assemblies .....3  
     button.....24, 28, 29, 55, 72, 74, 101  
     components .....13  
     connector.....3, 11, 12, 13, 14, 15, 101  
     connecting .....16  
     hose .....14  
     lengths .....3  
     locking and unlocking the keypad .....15  
     locking keypad .....15  
     screen .....14  
     selecting button function.....28  
     styles.....3  
     tip .....5, 12, 13, 14, 15, 90, 96  
     tube ..... 11, 12, 13, 14, 15, 16, 91  
         using different..... 12, 13  
         with push button and LED ..... 3, 4, 14  
 product overview .....1

programmable button..... 13, 72  
 protective caps ..... 94  
 protective ground ..... 2  
 PSIA sensor error ..... 79  
 pump..... 95  
 push button(s) ..... 3, 4, 13, 14, 15, 34, 72

**Q**

quality policies .....6

**R**

R113 ..... 9, 48, 85, 108  
 R114 ..... 9, 48, 85, 108  
 R12 ..... 9, 48, 108  
 R123 ..... 9, 48, 109  
 R124 ..... 9, 48, 109  
 R125 ..... 9, 48, 109  
 R134a ..... 6, 9, 48  
 R134A ..... 108  
 R21 ..... 9, 48, 85, 108  
 R22 ..... 9, 48, 108  
 R227 ..... 9, 48, 109  
 R23 ..... 9, 48, 85, 108  
 R236fa ..... 9, 48, 109  
 R245fa ..... 9, 48, 109  
 R290 ..... 3, 9, 48, 85, 93, 110  
 R32 ..... 9, 48, 108  
 R401A ..... 9, 48, 109  
 R402A ..... 9, 48, 109  
 R402b ..... 9, 48, 109  
 R404A ..... 9, 48, 108  
 R407A ..... 9, 48, 109  
 R407C ..... 9, 48, 108  
 R407F ..... 9, 48, 108  
 R408A ..... 9, 48, 109  
 R409A ..... 9, 48, 109  
 R410A ..... 9, 48, 108  
 R422a ..... 9, 48, 109  
 R422d ..... 9, 48, 109  
 R424a ..... 9, 48, 109  
 R426a ..... 9, 48, 109  
 R427a ..... 9, 48, 110  
 R438a ..... 9, 48, 110  
 R500 ..... 9, 48, 110  
 R502 ..... 9, 48, 110  
 R503 ..... 9, 48, 110  
 R507 ..... 9, 48, 110  
 R508B ..... 9, 48, 110  
 R600 ..... 85, 93  
 R600a ..... 1, 3, 9, 48, 110  
 Radio Disturbance Characteristics ..... 112  
 RANGE button.....11, 20, 21, 23, 35, 39, 40, 43, 45, 46, 54, 77, 80, 87, 95, 102  
 receptacle..... 13, 15, 16, 35  
 red dot..... 13, 15, 16, 101

- reference conditions..... 6, **7**, **8**  
reference leak source..... 6, **83**, **103**  
reference standard ..... 6  
reference temperature ..... 6  
refrigerant 1, 3, 6, 9, **10**, 26, 28, 36, 37, 38, 42, 43, **48**, **104**  
  most popular ..... 9  
relays..... **5**, **10**, 28, 31, 32, 35, 44, 62, **103**  
  activating..... **63**  
  activating using log limit..... 28  
  connectors..... **12**  
  contacts..... 31, 32  
  outputs..... 3, 10, 19, 31, 67  
  programming..... **64**  
  settings..... 28, 62  
  wiring ..... 31  
removing the top cover..... **93**  
repair..... 2  
replacement parts ..... 101  
resistor ..... 32  
resolution ..... 9  
response time..... 9  
restricted access ..... 85, 88, 96  
retaining old data ..... 23  
rfu.exe..... 98  
ribbon cable..... 33, 34, 95  
Right Arrow button .. **11**, 20, 24, 28, 29, 40, **41**, 51, 54, 56,  
  57, 60, 66, 68, 70, **75**, **76**, 77, 78, 86, 87  
RS-232 ..... **5**, 19, 28, 31, 33, 35, 71, 97, 106  
  communications settings..... 33  
  connector ..... 12
- S**
- safety ..... 2  
  hazard ..... 35  
  precautions..... 2, 25  
  standard ..... 112  
sample gas exhaust..... **12**  
sampled gas..... 17, 20, 39, 61, **101**, **104**  
sampling stream ..... 5  
scaling ..... 40, 52, **104**  
  response..... 4  
screen time out..... 84  
screws ..... 91, 93  
scrolling quickly ..... 57, 59, 60, 66, 68, 70  
Search flow fault..... 79  
search mode..... 4, 9, 13, 14, 19, 20, 21, 23,  
  26-29, 36, **37**, 38-40, 42, 43, 46, 48, 51, 52, 54, **58**, 62,  
  72, 75, 78, 79, 86, **102-104**  
Select Display Style screen ..... 52  
sensitivity ..... 9  
sensor..... **18**  
Sensor Data menu ..... 29, 81  
SENSOR OUTPUT..... 79, 81, 102  
  IS TOO HIGH..... 79, 102  
  VOLTAGE IS OUT OF RANGE ..... 79
- SENSOR TEMP ..... 81  
serial cable ..... 33, 97, 99  
serial communications software ..... 33  
Serial Data..... 28, 71  
Serial Output Type options ..... 72  
serial port..... 5  
  data..... 28, 71  
  transfer rate ..... 5  
setpoint..... 20, 51, 52, 53, 55, 59, 61  
  alarm..... 50  
  switching between..... 5  
setting date and time..... 28, 66  
SETUP button **11**, 15, 20, 21, 22, **23**, 25, 26, 27, 28, 29, 35,  
  37, 40, **41**, 43, 45, 46, 54, 55, 62, 64, 76, 84, 86, 87, 95  
SETUP menu..... 20, 23, 46, 55, 101  
setup presets..... 5  
Setup Summary screen ..... 19, 20, 25, 26, 86  
SF6 ..... 3, 9, 48, 85, 93, 110  
shock hazard ..... 2, 3, 33, 95  
small leaks..... 6  
Smart Probe ..... 3, 4, 13, 14, **16**, 21, 25, 28, 33, 36, 55,  
  72, 101  
  automatically detected ..... 29  
  buttons..... 72  
  components ..... 15  
  locking keypad..... **15**  
spare fuse..... 89  
spare parts and accessories ..... 96  
speaker ..... 10, **12**, 19, 39, 52  
  disconnecting ..... 39  
specifications..... 3, 9  
splash screen..... 99  
standard menu ..... 9, 48  
standard probe with flex tubing..... 12, 72  
standard probe with LED and push button ..... 13, **16**, 72  
startup..... 25, 42, 99  
Stop Bit(s)..... 33  
storage compartment..... 89  
supported gas types ..... 108  
surge protection..... 3  
switch..... **12**  
SYS PRESSURE..... 81  
system faults ..... 102  
system setup..... 3
- T**
- temperature..... 10  
  temperature drift..... 7, 8, 10  
temperature-induced change to the leak reference ..... 83  
text only..... 28, 33, 71  
text packet ..... 28, 33, 71  
time out ..... 84  
toggling between search and measure mode ..... 4  
tolerance..... 6  
top cover..... 17, 91, 93

removed .....18  
 totalization applications ..... 1, **44**, 64, 67, 104  
 totalizing gas leaks ..... 1, **44**  
 trigger for activation .....50  
 troubleshooting ..... 20, 29, 80, 101  
 tubing ..... 17, 34, 92, 94, 95  
     clamp ..... 93, 95  
 turning ON the instrument ..... 37, 85, 97  
 tweezers .....90

**U**

UL 61010-1:2001 .....112  
 Unit Display ..... 20, **26**, 36, 49, 50  
 unit of measure ..... 59, 68, 69  
 UNIT TEMP .....81  
 UNIT TEMPERATURE IS HIGH ..... 79, 102  
 units for leak rates .....5  
 universal AC power supply .....16  
 unlocked adjustment .....83  
 unlocking keypad .....**15**  
 unlocking the adjustment .....84  
 unpacking .....11  
 Up Arrow button .....**11**, 20, 23, 39, 46, 47, 50, 51, 53,  
     54, 57, 59, 60, 61, 62, 63, 64, 65, 66, 68, 70, 72, 74, **76**,  
     77, 80, 83, 88  
 upgrading firmware .....97  
 UPS .....3  
 USB-to-Serial adapters .....33  
 User Setup 0 ..... 5, 21, 48, 55, **56**, 103  
 User Setup screen ..... 57, 58, 59, 60, 61, 67, 68, 70  
 User Setups 1-4 ..... 5, 21, 28, 55, **56**, 103

user-defined setups ..... 5, 21, 28, 48, 55, **56**, 103  
 using a different probe .....12, 13, 73  
 using a reference leak source ..... 6

**V**

VOL button ..... **11**, 20, 21, **23**, **39**, 43, 45, 46, 54, 77, 95  
 Volume Adjustment screen ..... 23  
 volume control ..... 20, 36, 39, 50

**W**

warm-up mode .....9, 20, 96  
 warranty .....3, 2, 3, 85  
     voiding ..... 2, 3  
 web site ..... 3, 79, 97, 102  
 weight .....10  
 Windows® ..... 33, 97  
     Explorer .....97  
 wire leads .....32  
 wiring ..... 3, 12, 31, 32, 35, 37, 73  
     4–20 mA Loop Connector .....**32**  
 working life of the probe, extending ..... 6

**Z**

ZERO button .....**11**, **23**, **42**  
 zero gas .....95  
 zeroing ..... 4, 5, 13, 14, 42, 43, 44, 45, 52, 61, 101  
     automatic ..... 42  
     countdown ..... 20  
     gas reading ..... 23  
     on fresh air ..... 5  
     sensor ..... 36





Headquarters:  
621 Hunt Valley Circle, New Kensington, PA 15068  
Website: [www.mybacharach.com](http://www.mybacharach.com) • E-mail: [help@mybacharach.com](mailto:help@mybacharach.com)